

OCTOBER 1949

35 CENTS

ANC



POPULAR MECHANICS

MAGAZINE

WRITTEN SO YOU CAN UNDERSTAND IT

REG'D. TRADE MARK, GREAT BRITAIN, No. 410428

ICE SCOOT—Build It for Winter Fun
--Page 190



**NOW... LIGHT
WHEN YOU NEED IT!**

**Ray-O-Vac LEAK PROOF batteries
stay fresh for years!**

(because they're sealed in steel!)



© 1949 BY RAY-O-VAC COMPANY, MADISON, WIS. RAY-O-VAC, CANADA LTD., WINNIPEG, MAN.

See how much more you get

in these truly modern batteries. Each Ray-O-Vac Leak Proof starts with a powerful, well made battery. Then . . .

1. Steel bottom is added.
2. And a steel top.
3. Next — Multi-ply insulation. Many layers of protection against corrosion.
4. Last — a steel jacket. This completes an air-tight seal, to stop corrosion and keep the battery fresh and powerful. Only Ray-O-Vac builds batteries with all four of these safeguards.

GUARANTEE on every Ray-O-Vac Leak Proof: "If your flashlight is damaged by corrosion, leakage or swelling of this battery, send it to us with the batteries and we will give you **FREE** a new, comparable flashlight with batteries."

Ask for Ray-O-Vac Leak Proofs

Buy Spares... they stay fresh



WHITE SIDEWALL TIRES, CHROME WHEEL COVERS, REAR BUMPER GUARDS AND REAR FENDER SCUFF GUARDS OPTIONAL AT EXTRA COST

The car that likes
to be compared

NEW **PLYMOUTH**

Yes, it likes to be compared for COMFORT, too!



Ride with a new glide! The new Plymouth cradles all passengers between the wheels. It has airplane-type shock absorbers; a lower center of gravity; and a new diagonal mounting of rear shock absorbers that reduces sidesway.



Sit straight up—then compare! The new Plymouth gives you generous head and shoulder room where you need it. Chair-height seats are wider, deeper from front to back.



Breathe clean fresh air the year 'round. An optional under-the-hood system provides the comfort of ventilation in summer, both heat and defrosting in winter.



Bolster heavier-than-average people with individual cushioning! These extra seat springs front and back can be inserted to meet family requirements for cushion firmness.

COMPARE!	
of 22 quality features found in most high-priced cars	
Low-priced PLYMOUTH has	21
Low-priced car "A" has	13
Low-priced car "B" has	4

Check—Plymouth value against other cars. Not only for comfort, but for performance, for safety, for all features! Drive Plymouth. Compare it on the road. And see the new Quality Chart at your dealer's; a condensed version at left.

PLYMOUTH Division of CHRYSLER CORPORATION, Detroit 31, Michigan



Материал подготовлен авторским отделом

**"That hammer?
You're kidding!"**



It's a fact, Bill. I've been using this same hammer for 29 years. It helped to build the house you were born in.

Well, I don't know how you do it. I hardly ever *use* a hammer, and yet I've broken two of them in the last year or so.

That so? What kind of hammers were they? What brand, I mean.

Gosh, I don't know. Guess they didn't *have* any brand names. But they were good bargains.

That's where the trouble is, Bill. Look . . . see the name on this hammer? Whenever you see that brand name, you

know it's a good hammer. Stick to the well-known, advertised brands when you buy tools, and in the long run you'll save a lot of money.

That makes sense, Fred. I'll remember it.

And do your buying at the hardware store, where they don't try to sell you anything but quality tools. That way you'll always get your money's worth.

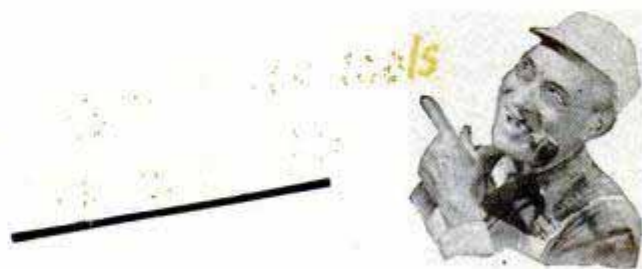

POPULAR MECHANICS

Popular Mechanics Magazine

Registered in U. S. Patent Office and Canada

H. H. WINDSOR, Founder

H. H. WINDSOR, JR., Editor and Publisher



this month's cover

BRUCE BOMBERGER'S cover painting of the iceboat "Scoot" is his proof that a Californian (native of San Francisco) knows a thing or two about iceboating. Although Bomberger does some work in Chicago he has yet to live through a rugged Illinois winter. The frigid scene he has painted on the cover was imagined by the artist in his Chicago studio on a sultry summer day when he began work on the picture. He used photographs and scale drawings to make his preliminary sketches of the iceboat. Bill Harless, the racing champ who designed and built the original boat, was satisfied that Bomberger's Scoot was cutting across the canvas in the proper manner before the final go-ahead was given on the cover. Men on the staff, including Wayne Leckey and Clyde Lamme who worked on layout and text, have become iceboat enthusiasts. Warning: if you read the how-to-build-it article on page 190, you, too, may be buying planking

Published monthly by Popular Mechanics Company, 200 E. Ontario St., Chicago 11, Ill. H. H. Windsor, Jr., president; William Harrison Petridge, vice president; D. F. Windsor, vice president and secretary-treasurer; Clover L. Perkins, advertising manager; Alan M. Deyoe, circulation manager. Single copy in the United States and Canada, 35 cents; subscription rates in United States and possessions, Canada, Philippines and countries of the Pan-American Postal Union, 1 year, \$3.50; 2 years, \$6.00; 3 years \$8.00. To all other countries add \$1.00 a year over United States prices for overseas postage. If you plan to move, notify us at least 30 days in advance so you will not miss an issue. Give both old and new addresses. Entered as Second Class Matter, September 15, 1903, at the Post Office at Chicago, Illinois, under Act of March 3, 1879. Entered as Second Class Matter at Post Office Dept., Canada. Copyright 1949 by Popular Mechanics Company. Copyright under International Copyright Union. Copyright in France. All rights reserved under Pan-American Copyright Union. Printed in the United States of America.

Volume 92 OCTOBER 1949 Number 4

Managing Editor.....Roderick M. Grant
 Assistant Managing Editor.....Wayne Whittaker
 Shop Notes and Crafts Editor.....James R. Ward
 Radio-Television, Electronics Editor.....Frank L. Brittin
 Associate Editor, Aviation.....Aubrey O. Cookman, Jr.
 Associate Editor.....Clifford B. Hicks
 Art Director.....Frank Beatty

Assistant Editors

Donald R. Brooks Dorothy E. Hoffmann Arthur R. Railton

Assistant Editors, Shop Notes and Crafts

W.Clyde Lamme Wayne C. Leckey Frank N. Stephany A.E. Youngquist

Eastern Editor.....Richard F. Dempewolf
 Empire State Bldg., Room 2906, New York 1, N. Y.

Western Editor.....Thomas E. Stimson, Jr.
 3872 Franklin Ave., Los Angeles 27, Calif.

Representative in Great Britain.....Douglas W. Wedderspoon
 London, England

IN THIS ISSUE

Million-Dollar Baby of the Atom Age	89
Alice Poses in Wonderland	96
Big Game "At Home" to Visitors	100
Color Magic From Black and White	104
They Pilot Sky-Piercing Rockets	114
The Ship That Rides on Air	120
Deep-Sea Diver—4500 Feet Down	136
Bowling's Mr. Big	141
Reading, Writing and Aviation	152
Artist With Wire	158
Weather a la Carte	167
Seal It With Rubber	174

For the Craftsman

Musical Novelties	182
Your Iceboat "Scoot"—Part I	190
Dining-Room Furniture—Part II	202
Better Performance From Heating Systems	210
From Camera to Enlarger	216
Portable Ski Tow	225
Arc Welding for Beginners—Part I	230
Radio-Television, Electronics	237
Clinic for Homemakers	248

Other items, and manufacturers of available products described, are listed on pages 10, 14 and 24

Get and for only \$14
and BUILD THIS HOUSE

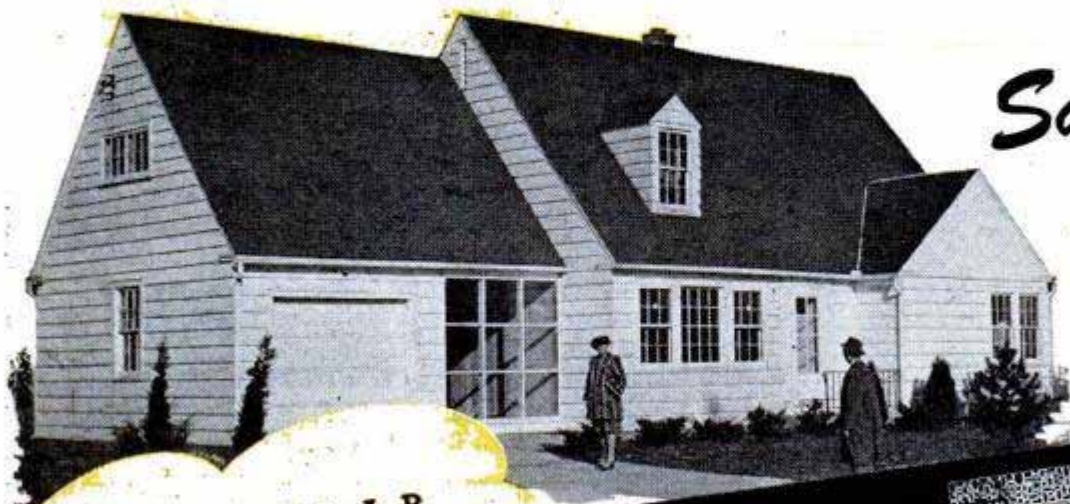

Save

POPULAR
MECHANICS

Actual Photograph of House Built
by 23 Year Old Veteran



If you can use common tools you can build this house yourself, in any of its five exterior designs, following the Popular Mechanics Build-It-Yourself Book and plans and save thousands of dollars. Even if you have the work done by a contractor or an ordinary carpenter, this amazing book and plans will give you a tremendous saving.

SPACE FOR LIVING AND FAMILY GROWTH

This beautiful, modern home, with breezeway and garage, as pictured above, was built from these same plans and instructions by Jacques Brownson, a 23-year-old veteran in Aurora, Illinois. It is 1½ stories with basement, recreation room, living room, kitchen, dining nook, two bedrooms, bath, plenty of closets and space for 2 additional bedrooms on the second floor. An inspection of floor plans, shown in reduced size, indicates an unusually large amount of good, usable living space that can easily be increased to meet the needs of a growing family. The house itself is 35'-9"x28'-11"; breezeway 20'-10"x8"; garage 20'-10"x12'.

DESIGNED BY POPULAR MECHANICS AND FAMOUS ARCHITECTS

The big, basic idea behind the design of the Build-It-Yourself House is ease of construction (so a man could do the job himself with very little assistance) and the most living space and the most useful space, at the least

cost, considering attractiveness and suitability for any neighborhood and most income groups. It is a home anyone can enjoy and be proud to own.

Read the Book—Study the Plans—Start Building When You Can

"Your Home and How to Build it Yourself," contains 100 pages, size 8½x11 inches. Three-fifths of the book consists of photographs and drawings. Several sections are printed in extra colors and a full-color insert shows just how your own house will look in actual colors. Every detail of the house and its construction is discussed in minute details that will guide you in every step. Plans consist of ten working-size blueprints, giving floor plans, elevations, notes on construction, framing, lumber list, millwork list, specifications, plumbing and wiring diagrams. Every measurement is marked, every detail made as clear as A.B.C.

FOR EXTRA SAVING ORDER BOOK AND PLANS TOGETHER

With the Build-It-Yourself Book as a guide and the remarkably complete plans to follow, any handy man who can use simple tools can build this remarkable house and enjoy every minute of the work while saving thousands of dollars.



Set of ten full-size working blueprints — easy to read and easy to follow. Every construction detail included. See reduced combination price below.

Your Home — How to Build It Yourself

Plastic bound. 8½ x 11 inches. 100 pages—60 in colors. Complete instructions for building "Build-It-Yourself House." Valuable also to every home builder no matter what house is built. Can easily save you hundreds of dollars—much time, trouble and worry, too.

- Your Home and How to Build It Yourself \$ 3.00
- Complete set of plans 12.50
- Book and Plans ordered together 14.00
- Duplicate sets of plans 5.00

POPULAR MECHANICS PRESS, 200 East Ontario Street, Chicago 11, Illinois

**CRAFTSMEN
RECOGNIZE
QUALITY**

by these fine features in

TINNER'S SNIPS

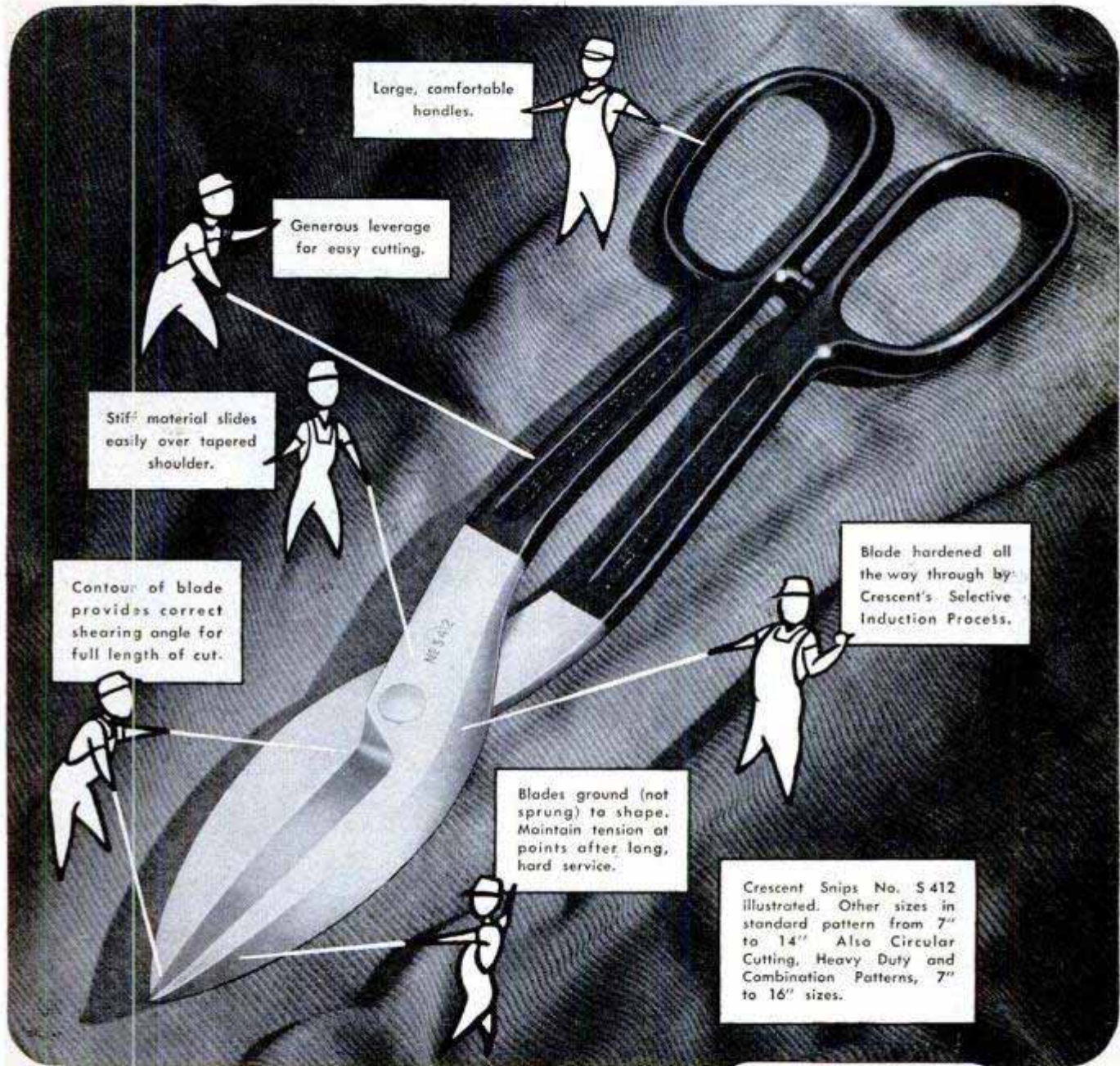

Large, comfortable handles.

Generous leverage for easy cutting.

Stiff material slides easily over tapered shoulder.

Contour of blade provides correct shearing angle for full length of cut.

Blades ground (not sprung) to shape. Maintain tension at points after long, hard service.

Blade hardened all the way through by Crescent's Selective Induction Process.

Crescent Snips No. 5412 illustrated. Other sizes in standard pattern from 7" to 14" Also Circular Cutting, Heavy Duty and Combination Patterns, 7" to 16" sizes.

**EVERYBODY
RECOGNIZES
QUALITY**

by this Trade-mark

CRESCENT TOOLS



*Sign of the Artisan
Symbol of Excellence*

"Crescent" is our trade-mark, registered in the United States and abroad, for wrenches and other tools. Sold by leading distributors and retailers everywhere and made only by **CRESCENT TOOL COMPANY, JAMESTOWN, NEW YORK**



EXTRA!

a different name for your old friends!

PROTO TOOLS

—formerly—

PLOMB TOOLS



Here is the biggest news in the tool industry today. The leading hand service tools are now named PROTO tools—formerly Plomb tools. All PROTO tools are of the very finest quality. That's why they have been the favorites of professionals since 1907. Remember the name — PROTO tools— formerly Plomb tools, when you want the best. Buy the ones you need from your dealer today.

Write for catalog to

PLOMB TOOL COMPANY
2255M Santa Fe Ave., Los Angeles 54, Calif.

4985



in this corner.....

THE EDITORS



Gar Wood

All the time Gar Wood was racing his Miss Americas to international fame (he holds the coveted Harmsworth Trophy and has defended and won it nine times since 1920) it seems he was dreaming of building a prototype for an ocean liner that will not roll or pitch. He is shown below on this craft, the Venturi, which is featured in story, pictures and diagrams beginning on page 120. This story broke right on the deadline for our October issue and getting

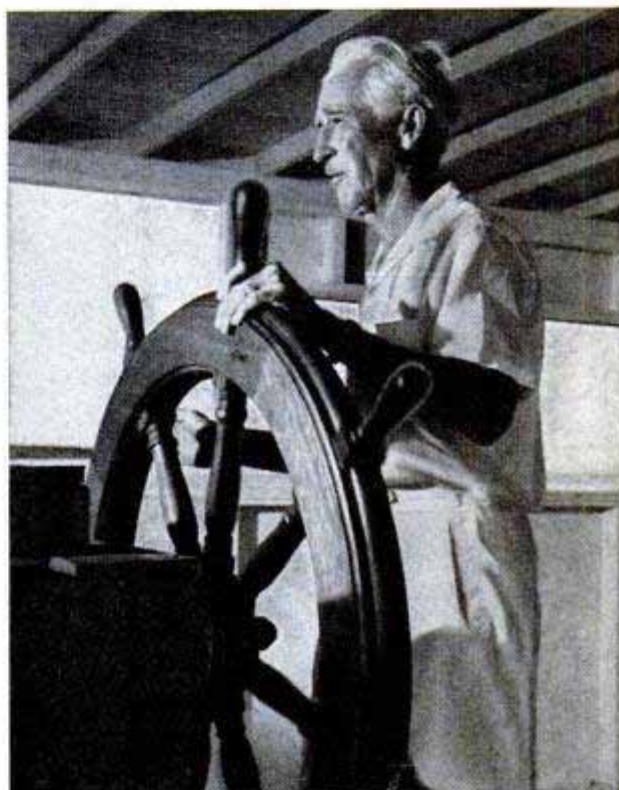

it into the magazine necessitated a speed play that even Gar Wood would applaud. We wired our eastern editor, Richard Dempewolff, in New York, to grab a plane for Miami, Fla., to get the story and pictures from Mr. Wood who was at his home on Fisher's Island near Miami Beach. Dempewolff left New York on a Tuesday morning and 24 hours later the complete story and pictures were in our Chicago office with much credit due to the fine cooperation of Eastern Air Lines. Many of the diagrams and photos in the layout, particularly those of Mr. Wood and the hull models, are exclusive. The photographs on page 122 clearly show the basic Venturi principle which assures a smooth ride.

(Continued to page 8)

Why be a BOOKKEEPER?

... When Accountancy
offers more Money
and Success...

If you are a bookkeeper, you are right on the threshold of a profession that pays far above average—where there's real opportunity to get ahead and move up fast.

Why not step UP from bookkeeping—be an accountant—make real money!

You can learn Accountancy by the interesting LaSalle Problem Method—in your convenient spare time, at home, without losing a day from your work. You learn by *doing* . . . you study Accounting principles and solve Accounting problems under the clear guidance of experienced C.P.A.'s. You cover Accountancy from the basic principles right up through Accounting Systems and Income Tax Procedure—to advanced training for the C.P.A. degree if you so desire. And as you go along step-by-step, you master the principles of auditing, business law, statistical control, cost accounting, organization, management, finance, etc.

You go as fast or as slowly as you choose. And you may start "cashing in" on your new ability long before you complete the training—as thousands of others have proved. Many advance quickly to better positions, even before they are half way through. And that is only the *beginning* of a growing and continuing success for the rest of your business life.

Why remain "just a bookkeeper" when Accountancy holds so much for you? Our free 48-page booklet, "ACCOUNTANCY, THE PROFESSION THAT PAYS," tells you what you must know to be an Accountant, and how you can prepare in your

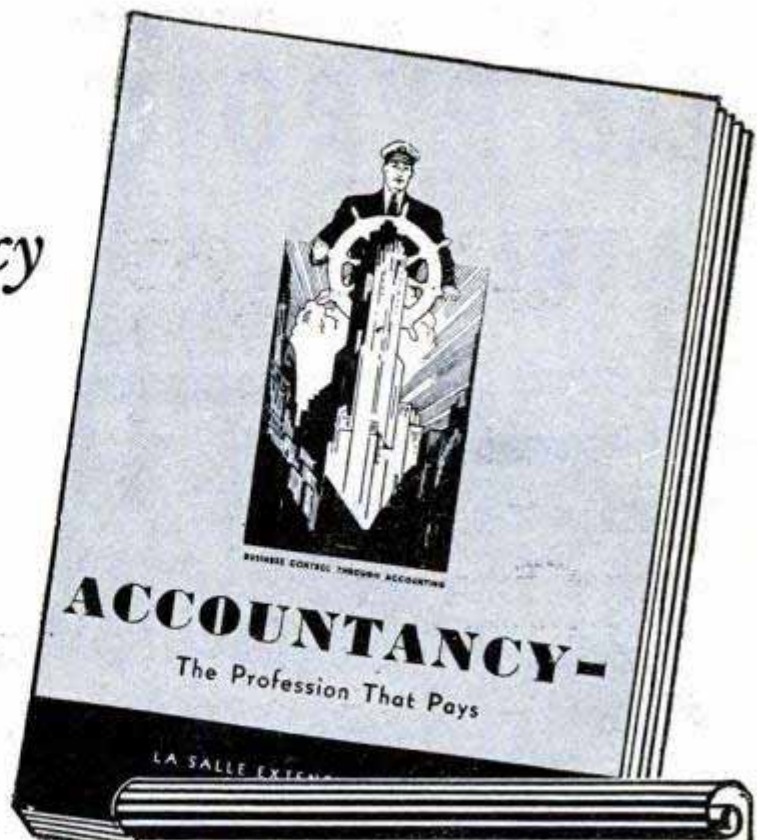

LASALLE Extension University

A Correspondence Institution

Dept. 1064-HR • 417 S. Dearborn • Chicago 5, Ill.

Send me your free 48-page booklet, "Accountancy, the Profession That Pays,"—plus "Ten Years' Promotion in One"—a book which has helped many men.

Higher Accountancy

Other LaSalle opportunities:

- | | |
|--|--|
| <input type="checkbox"/> C.P.A. Coaching | <input type="checkbox"/> Traffic Management |
| <input type="checkbox"/> Bookkeeping | <input type="checkbox"/> Foremanship |
| <input type="checkbox"/> Law: LL.B. Degree | <input type="checkbox"/> Industrial Management |
| <input type="checkbox"/> Business Management | <input type="checkbox"/> Stenotypy (Machine Shorthand) |
| <input type="checkbox"/> Salesmanship | |

Name..... Age.....

Address

City, Zone, State.....

LASALLE EXTENSION UNIVERSITY

A Correspondence Institution

Dept. 1064-HR 417 S. Dearborn St.
Chicago 5, Illinois

leisure time, at moderate cost and on easy terms.

Send the coupon today and we'll include "Ten Years' Promotion in One"—a book which has helped many men. Get all the facts and judge for yourself. There is no obligation. You are already started in this field . . . find out how you can rapidly go to the top! Mail coupon NOW!

HAS YOUR CAR HAD PYROIL LATELY?

PYROIL prevents sludge and carbon formation

PYROIL improves lubrication

PYROIL clings to metal parts

PYROIL keeps motors clean

PYROIL eliminates dry starts

Pyroil gives your car much added protection at little cost. When you stop for gas or oil, just say "add Pyroil"—add miles to your car.

Pyroil for Aircraft Engines

Use Aircraft Pyroil B for lubricating oil, Aircraft Pyroil A for gasoline.

Ideal Christmas Gift

Surprise him with a practical gift that will be enjoyed for months—a twin quart Christmas wrapped package of Pyroil—one quart for the gasoline—one quart for the lubricating oil. Included in each package (without extra cost) are two useful auto accessories—a windshield scraper and a rubber key case—extra gifts he will appreciate.



2 extra gifts
at no extra cost

SPECIAL GET ACQUAINTED OFFER

This unusual gift—2 quarts of Pyroil and 2 extra gift items only \$3.25 postage prepaid anywhere in the U. S. You not only give a gift—but improved car motor performance that will thrill him. Mail your order today. It's a great way to remember all your friends who drive. Send remittance with order to save C.O.D. charges—we will have a local dealer fill your order or we will fill direct.

PYROIL COMPANY

96 Pyroil Building

La Crosse

Wisconsin

(Continued from page 6)

World's Deepest Diver

Man's quest into the mysteries of Nature carried Dr. Otis Barton 4500 feet beneath the sea to set a new diving record. At 4100 feet the lights in his benthoscope went out and he courageously gave the signal to drop 400 feet farther just to "see what I can without lights." Doctor Barton is shown below (foreground) as he shook hands with Dr. Maurice Nelles, an associate, immediately after he had emerged from the benthoscope on completion of the dive off Santa Cruz Island, Calif. The story of the deep-sea explorer's thrilling dive into a strange world of luminous creatures begins on page 136. He still hopes to reach 6000 feet.



* * *

Plastic Engine Runs

Haydn D. Smith, a reader in Orpington, England, sent in this picture of a horizontal steam engine he built of transparent plastic. Most of the engine was cut from solid plastic with a bandsaw and the cylinder was bored and polished in a lathe, as was the bore of the piston-type valve. The engine runs on compressed air. The base plate is 4 by 10 inches and the flywheel is 4 inches in diameter.

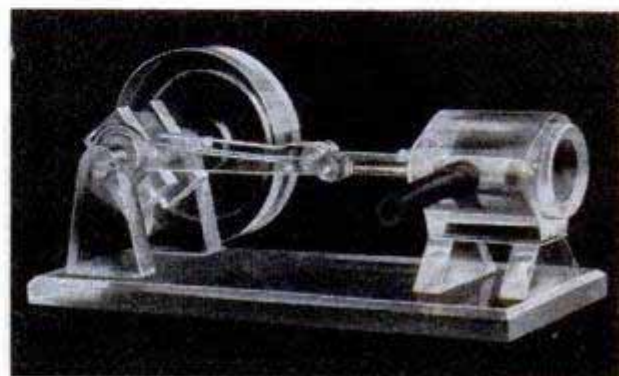

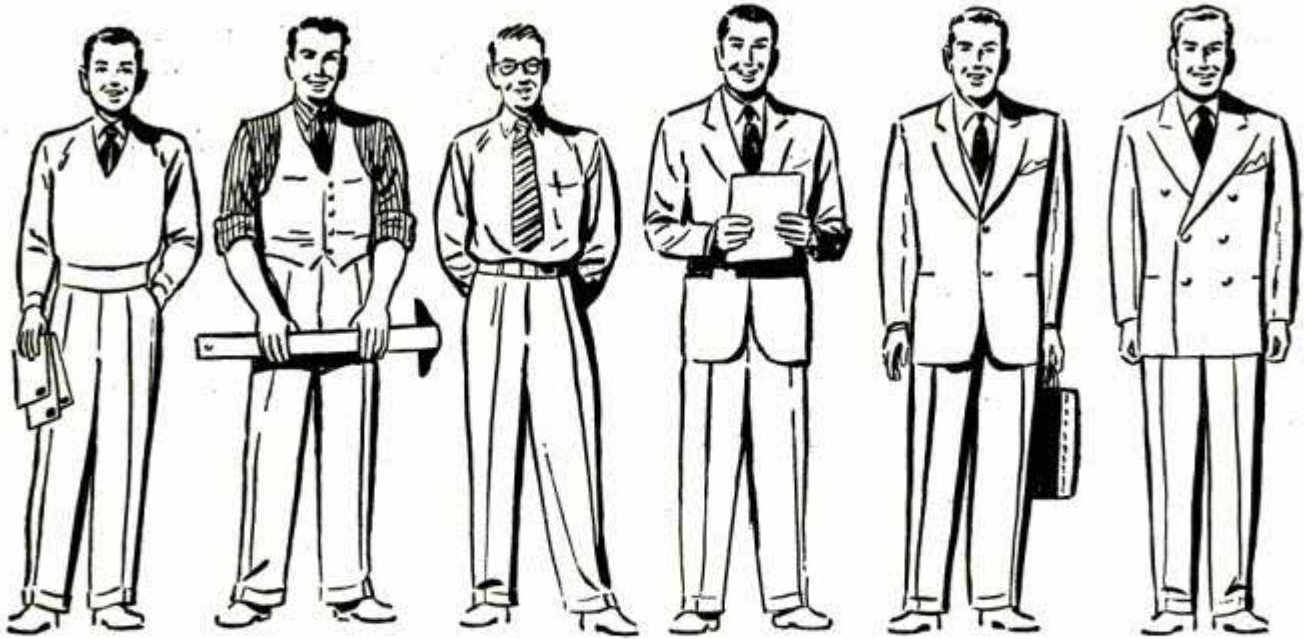

*How do you
rank in your
new outfit?*

You've been in civvies for some time now. How are you doing? Are you moving ahead as fast as you want? Or have you struck a snag? You may have found that there are things you have to know — training you have to have — before you can move up.

You can get that training — without leaving your job — from I.C.S. When you study with I.C.S. you study at home in your spare time — with the world's largest educational institution.

I.C.S. training has put others at the top. How about you? If you want to matter in your new outfit, start by filling in the coupon and mailing it, *today!*

INTERNATIONAL CORRESPONDENCE SCHOOLS

APPROVED
under the
G.I. BILL

BOX 5661-K, SCRANTON 9, PENNA.

Without cost or obligation, please send me full particulars about the course BEFORE which I have marked X:

- | | | | |
|--|--|---|---|
| <p>Business and Academic Courses</p> <ul style="list-style-type: none"> <input type="checkbox"/> Accounting <input type="checkbox"/> App. Psychology <input type="checkbox"/> Business Administration <input type="checkbox"/> Bus. Correspondence <input type="checkbox"/> Certified Public Accounting <input type="checkbox"/> Commercial <input type="checkbox"/> Commercial Art <input type="checkbox"/> Cost Accounting <input type="checkbox"/> Federal Tax <input type="checkbox"/> First Year College <input type="checkbox"/> Foremanship <input type="checkbox"/> Good English <input type="checkbox"/> Higher Mathematics <input type="checkbox"/> Industrial Supervision <input type="checkbox"/> Motor Traffic <input type="checkbox"/> Retailing <input type="checkbox"/> Salesmanship <input type="checkbox"/> Sign Lettering <input type="checkbox"/> Spanish <input type="checkbox"/> Air Conditioning and Plumbing Courses <input type="checkbox"/> Air Conditioning <input type="checkbox"/> Heating <input type="checkbox"/> Refrigeration | <p>Chemical Courses</p> <ul style="list-style-type: none"> <input type="checkbox"/> Chemical Engineering <input type="checkbox"/> Chemistry, Analytical <input type="checkbox"/> Chemistry, Industrial <input type="checkbox"/> Chemistry, Mfg. Iron & Steel <input type="checkbox"/> Petroleum Refining <input type="checkbox"/> Pulp and Paper Making <input type="checkbox"/> Civil Engineering, Architectural and Mining Courses <input type="checkbox"/> Architecture <input type="checkbox"/> Building Estimating <input type="checkbox"/> Civil Engineering <input type="checkbox"/> Contracting and Building <input type="checkbox"/> Highway Engineering <input type="checkbox"/> Lumber Dealer <input type="checkbox"/> Reading Structural Blueprints <input type="checkbox"/> Sanitary Engineering <input type="checkbox"/> Structural Drafting <input type="checkbox"/> Structural Engineering <input type="checkbox"/> Surveying and Mapping <input type="checkbox"/> Communications Courses <input type="checkbox"/> Electronics <input type="checkbox"/> Prac. FM and Television <input type="checkbox"/> Prac. Telephony <input type="checkbox"/> Radio, General <input type="checkbox"/> Telegraph Engineering | <p>Electrical Courses</p> <ul style="list-style-type: none"> <input type="checkbox"/> Electrical Drafting <input type="checkbox"/> Electrical Engineering <input type="checkbox"/> Electric Light and Power <input type="checkbox"/> Lighting Technician <input type="checkbox"/> Practical Electrician <input type="checkbox"/> Power House Electric <input type="checkbox"/> Ship Electrician <input type="checkbox"/> Internal Combustion Engines Courses <input type="checkbox"/> Auto Technician <input type="checkbox"/> Diesel-Electric <input type="checkbox"/> Diesel Engines <input type="checkbox"/> Mechanical Courses <input type="checkbox"/> Aeronautical Engineer's, Jr. <input type="checkbox"/> Aircraft Drafting <input type="checkbox"/> Forging <input type="checkbox"/> Heat Treatment of Metals <input type="checkbox"/> Industrial Engineering <input type="checkbox"/> Industrial Instrumentation <input type="checkbox"/> Industrial Metallurgy <input type="checkbox"/> Machine Shop <input type="checkbox"/> Machine Shop Inspection <input type="checkbox"/> Mechanical Drafting <input type="checkbox"/> Mechanical Engineering | <p><input type="checkbox"/> Mold-Loft Work</p> <p><input type="checkbox"/> Patternmaking—Wood, Metal</p> <p><input type="checkbox"/> Reading Shop Blueprints</p> <p><input type="checkbox"/> Sheet-Metal Drafting</p> <p><input type="checkbox"/> Sheet-Metal Worker</p> <p><input type="checkbox"/> Ship Drafting</p> <p><input type="checkbox"/> Ship Fitting</p> <p><input type="checkbox"/> Tool Designing</p> <p><input type="checkbox"/> Toolmaking</p> <p><input type="checkbox"/> Welding Engineering</p> <p><input type="checkbox"/> Welding—Gas and Electric</p> <p>Railroad Courses</p> <ul style="list-style-type: none"> <input type="checkbox"/> Air Brake <input type="checkbox"/> Diesel Locomotive <input type="checkbox"/> Locomotive Engineer <input type="checkbox"/> Locomotive Fireman <input type="checkbox"/> Locomotive Machinist <input type="checkbox"/> Railroad Section Foreman <input type="checkbox"/> Steam and Diesel Loco. Eng. <input type="checkbox"/> Stationary Engineering Courses <input type="checkbox"/> Boilermaking <input type="checkbox"/> Combust. Engrg. <input type="checkbox"/> Marine Engineering <input type="checkbox"/> Power Plant Engr. <input type="checkbox"/> Steam Engineer <input type="checkbox"/> Textile Courses <input type="checkbox"/> Cotton Manufacturing <input type="checkbox"/> Rayon Weaving <input type="checkbox"/> Woolen Manufacturing |
|--|--|---|---|

Name _____ Age _____ Home Address _____

City _____ State _____ Working Hours _____ A.M. to _____ P.M.

Present Position _____ Employed by _____

Length of Service _____
In World War II _____

Enrollment under G.I. Bill approved for World War II Veterans. Special tuition rates to members of the Armed Forces.
Canadian residents send coupon to International Correspondence Schools Canadian, Ltd., Montreal, Canada.

4 Keys to SUCCESS IN AVIATION

Through **Embry-Riddle** Training

1 AIRCRAFT & ENGINE MECHANICS

We have hundreds of urgent requests for A. & E. Mechanics -- key men in Aviation -- from airlines, oil companies, fixed base operators, etc.; both U. S. and Overseas. Training in a C. A. A. approved school is the quickest way to get ahead. Embry-Riddle students learn fast with modern equipment... working on live aircraft in airline-size hangars.



2 ENGINEERING

Embry-Riddle's Design Engineering and Maintenance course offers you eligibility for A. & E. certification plus necessary basic engineering knowledge required to fill positions such as Maintenance Foreman or Field Service, Project or Sales Engineer. If your aim is high, take this course.



A.&E. COMBINED WITH COMMERCIAL

Pilot Mechanics who can test fly the ships they repair... executive pilots able to service their own aircraft -- airmen with dual ability are needed by aviation companies and operators. Embry-Riddle combination training offers you the most in your aviation career.



3 COMMERCIAL PILOTS

Flying holds a real future for Embry-Riddle trained pilots. A quarter-century of experience with 30,000 students... the best instructors, up-to-date aircraft, superb year-round flying weather... qualifications unexcelled anywhere. Instrument and instructor's ratings are also available.



Aviation needs you now! Never has there been such opportunity for you in Aviation. Start your career now at Embry-Riddle -- living facilities directly on the Airport. Write today for full information and proof of job opportunities.

AUTHORIZED G. I. TRAINING

Dean of Enrollments - Dept. 99
Embry-Riddle School of Aviation
Miami 30, Florida

Please Print

NAME _____

ADDRESS _____

City _____

State _____ Age _____

I am interested in...

- A.&E. Mechanic
 Commercial Pilot
 Engineering
 A.&E. Combined with Commercial Pilot
 Flying Mechanic
 Drafting & Design

Check One Veteran Non-Veteran

TRAIN IN MIAMI--AIR CAPITAL OF THE WORLD

WHERE-TO-BUY-IT INDEX

Source of supply appears after items commercially available

AUTOMOTIVE

Arm locks wheels for repairs (John Bean-Division, Food Machinery & Chemical Corp., Lansing 4, Mich.)	95
High-pressure machine cleans inside engines (Youngstown Welding and Engineering Co., Youngstown, Ohio)	95
Spray-on car wax (Plasti-Kote, Inc., 425 Lakeside N.W., Cleveland 13, Ohio)	95
Mechanic's stethoscope (Star Development Co., 1713 Hildreth St., South Bend 15, Ind.)	95
Auto-wheel balancer (Zagar Tool, Inc., 23680 Lakeland Blvd., Cleveland 23, Ohio)	103
Hydra-matic drive featured on '50 Nash (Nash Division, Nash-Kelvinator Corp., Kenosha, Wis.)	113
Tiny French car (Andre Vaucelle, Manager, S.T.R.O.J. Co., Poitiers, France)	125
Water jet sprayer washes cars (Phillips Pump & Tank Co., 500 Brotherton, Cincinnati 9, Ohio)	125
Cars by the pound--latest price idea	129
Safety car-door handle (Imperial Handle Co., 1695 McDonald Ave., Brooklyn 30, N. Y.)	146
Dolly and jack team up to change truck tires (The Cleveland Pneumatic Tool Co., 3781 E. 77th St., Cleveland 5, Ohio)	178
Front wheel grease seals (Douglass Products Co., 4129 43rd St., Sacramento, Calif.)	179
Spark plug produces 'halo' spark (American Eagle Spark Plug Co., 627 Barlum Tower, Detroit 26, Mich.)	270

AVIATION

Amphibious helicopter has wheels and floats (Sikorsky Aircraft Division, United Aircraft Corp., Bridgeport 1, Conn.)	113
Portable airport in bomber gear	134
Automatic pilot for light planes weighs only 20 pounds	135
Slow-speed plane lands and takes off from tennis court	139
'Round-the-clock fighter	180

BOATS

Fiberglass assault boat (Owens-Corning Fiberglass Corp., Toledo 1, Ohio)	103
Self-powered aquaplane (Hansen Inc., Bryn Mawr, Pa.)	109
Two-section boat is its own trailer	112
Air-filled rollers help beach boat (The Airoller Co., 21 Whitfield St., Guilford, Conn.)	128
Boys in houseboat cruise 'ole Miss'	150
'Automoboot'	157
Rubber lifeboat inflates itself (B. F. Goodrich Co., Akron, Ohio)	180

CYCLES

Folding motor bike for "in between" transportation (Argyle Mfg. Co., 600 Coal St., Colchester, Ill.)	99
Sealed-beam lamp triples bike light (General Electric Co., Lamp Dept., Nola Park, Cleveland 12, Ohio)	99
Extra rear wheels make bicycles safe (Convertabike Co., 2863 N. Clark St., Chicago 14)	99
Cycle for three	147
Cycling signs advertise movies	151

FARM

Reel-up irrigation system	94
Twin fruit-picking "baskets"	111
Roller punches holes in ground to prevent erosion by rainfall	173

HOUSE AND HOME

Light switch glows when off (Sears, Roebuck & Co., W. Arthington & S. Homan, Chicago)	125
Clothesline lock won't slip (Instant-Tite Corp., 4901 Calumet Ave., Hammond, Ind.)	130
Venetian blind raised and lowered like a window (The Cordless Blind Co., 5605 Herman Ave., Cleveland 2, Ohio)	130
Sewing table for portable sewing machine (The Warner Shops, 1512 Jarvis Ave., Chicago 26)	130
Fountain nozzle turns faucet into bubbler (Handy Ann Products, 104 N. First St., Minneapolis 1, Minn.)	130
Candle gripper (F. H. Smith Mfg. Co., 3029 Carroll Ave., Chicago 12)	130
Aluminum trays for home freezing (Reynolds Metals Co., 19 E. 47th St., New York City 17)	131
Plastic serving tongs (Amos Molded Plastics, Edinburg, Ind.)	131
Disappearing clotheslines roll up and out of sight (Bocaroy Mfg. Corp., 2227 Rush St., El Monte, Calif.)	131
Revolving brush scrubs and polishes floors (Beal Speed Polisher, Inc., 4707 S.E. 17th Ave., Portland 2, Ore.)	131
Vegetable reamer (Esnar Products Co., Box 84, San Francisco, Calif.)	132
Automatic water heater fits in kitchen (Wessix Electric Heater Co., 390 First St., San Francisco 5, Calif.)	132
Picnic basket keeps food either hot or cold (Plastic Sheet Fabrication, Inc., 885 Ave. of the Americas, New York City)	132
Hoop for knitting requires no skill or needles (Creative Crafts Corp., 46 E. 11th St., New York City 3)	132
Towel holder (A. J. Ganz Co., 112 N. Hayworth St., Hollywood 36, Calif.)	132
Armchair crib (Unique Furniture & Fixture Co., Albuquerque, N. Mex.)	133
Can puncher (Otto J. Schreiber, 1947 Flushing Ave., Queens, N. Y.)	133
Suitcase crib folds for traveling (Fashion Advertising Co., 461 8th Ave., New York City 1)	133

(Continued to page 14)

WHAT Every AUTO MECHANIC Wants to Know

A motor vehicle is a machine of many parts, each part designed and constructed for its own special function.

All good mechanics, like good doctors, should know the working theory and operation of each part and understand what causes trouble and how to remedy it.

LET AUDELS AUTO GUIDE SOLVE YOUR PROBLEMS

Every auto mechanic, helper, serviceman and operator can use AUDELS AUTO GUIDE. The information it gives saves time, money and worry. Highly endorsed by all users. It presents the whole subject of auto mechanics from A to Z in plain language and simple terms.

This Big Practical Book gives full information with working diagrams covering the principles, construction, ignition, service and repair of modern cars, trucks and buses.

A complete Guide of 1800 pages, with over 1500 illustrations showing inside views of the working parts, with instructions for service jobs. Diesel engines, Fluid and Hydra-matic drives fully explained.

IT PAYS TO KNOW HOW TO

How to fit pistons—How to locate engine knocks—How to fit connecting rod bearings—How to service main bearings—How to recondition valves—How to time valves—How to adjust fan belts—How to adjust carburetors & chokes—How to rebuild a clutch—How to service automatic transmissions—How to service brakes—How to adjust steering gear—How to cope with ignition troubles—How to service distributors—How to time ignition—How to "tune up" an engine.

INFORMATION IN A HANDY FORM

73 INTERESTING CHAPTERS—Read this partial list of subjects on which practical information is fully given for quick reference under the headings as shown below. Ready Reference Index.

All Parts of an Automobile—Automotive Physics—The Gas Engine—Gas Engine Principles—Multi-Cylinder Engines—Horse Power—Automobile Engines—Stationary Parts—Moving Parts—Pistons—Piston Rings—Connecting Rods—Crank Shafts—Valves—Valve Gear—Cams and Cam Action—Valve Timing—Cooling Systems—Fuel Feed Systems—Dual Fuel Feed—Mixture—Carburetors—Carburetor Service—Automatic Choke—Super-Chargers—Transmissions—Special Transmissions—Fluid and Hydra-matic Drives—Clutches—Universals and Propeller Shafts

A Ready Reference

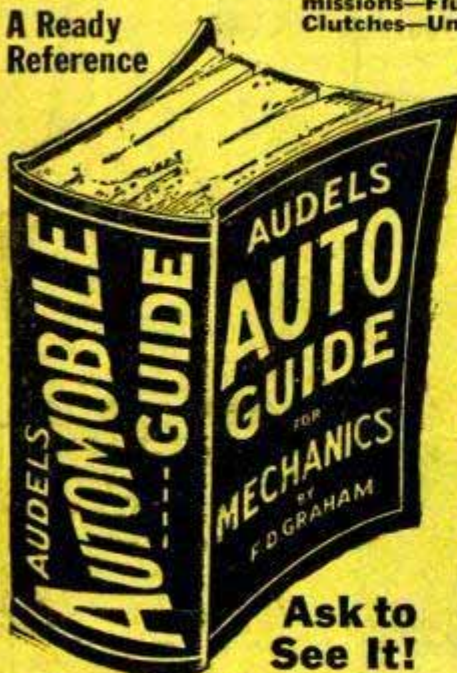

—The Differential—Rear Axles—Rear and Front Suspension—Running Gear—Brakes—Wheel Alignment—Knee Action—Steering Gear—Tires—Lubricants and Lubrication—Automotive Electricity—Ignition Systems—Magneto Ignition—Spark Plugs—Ignition Coils—Distributors—Automatic Spark Control—Ignition Timing—Generators—Starters—Generator and Starter Testing—Lighting Systems—Storage Batteries—Charging and Testing—Diesel Engines and Trouble Shooting.

7 DAYS' FREE TRIAL
TO GET THIS ASSISTANCE FOR YOURSELF SIMPLY FILL IN AND MAIL COUPON TODAY.

\$4 COMPLETE PAY \$1A ONLY 1 MO.



Sent on 7 Days Approval

Step up your own skill with the facts and figures of your trade. Audels Mechanics Guides contain Practical Inside Trade Information in a handy form. Fully Illustrated and Easy to Understand. Highly Endorsed. Check the book you want for 7 DAYS FREE EXAMINATION. Send No Money. Nothing to pay postman.

CUT HERE MAIL ORDER

AUDEL, Publishers, 49 W. 23 St., NEW YORK 10, N. Y.

Please send me postpaid for FREE EXAMINATION books marked 00 below. If I decide to keep them I agree to mail \$1 in 7 Days on each book or set ordered and further mail \$1 monthly on each book or set until I have paid price, otherwise I will return them.

- AUTO GUIDE**, 1800 Pages . . . \$4
- DIESEL ENGINE MANUAL, 400 Pages . . . 2
- WELDERS GUIDE, 400 Pages . . . 1
- MACHINISTS Handy Book, 1600 Pages . . . 4
- POWER PLANT ENGINEERS Guide, 1500 Pages. . . 4
- ENGINEERS & FIREMANS EXAMS, 528 Pgs. . . 1
- PUMPS, Hydraulics & Air Compressors, 1658 Pgs. . . 4
- MARINE ENGINEERS Handy Book, 1280 Pages. . . 4
- ENGINEERS & Mechanics Guides (8 Book Set). . . 12
- Answers on Practical ENGINEERING, 254 Pages . . . 1
- ELECTRIC WIRING DIAGRAMS, 210 Pages . . . 1
- ELECTRICIANS EXAMINATIONS, 250 Pages. . . 1
- ELECTRICAL DICTIONARY, 9000 Terms . . . 2
- ELECTRIC MOTOR GUIDE, 1000 Pages . . . 4
- HANDY BOOK OF ELECTRICITY, 1440 Pages . . . 4
- ELECTRICAL POWER CALCULATIONS, 425 Pgs. . . 2
- RADIOMANS GUIDE, 914 Pages . . . 4
- ELECTRONIC DEVICES, 216 Pages . . . 2
- ELECTRIC LIBRARY, 7000 Pages (12 Book Set). . . 18
- Vols. I, II, III, IV, V, VI, VII, VIII, IX, X, XI, XII \$1.50 Ea.
- OIL BURNER GUIDE, 384 Pages . . . 1
- HOUSE HEATING GUIDE, 1000 Pages . . . 4
- CARPENTERS & Builders Guides (4 Book Set). . . 6
- PLUMBERS & Steamfitters Guides (4 Book Set). . . 6
- MASONS & Builders Guides (4 Book Set). . . 6
- BLUE PRINT READING, 416 Pages . . . 2
- PAINTERS & DECORATORS MANUAL, 450 Pgs. . . 2
- GARDENERS & GROWERS Guides (4 Book Set). . . 6
- REFRIGERATION & Air Conditioning, 1280 Pgs. . . 4
- SHEET METAL WORKERS Handy Book, 388 Pgs. . . 1
- SHEET METAL PATTERN LAYOUTS, 1100 Pgs. . . 4
- AIRCRAFT WORKER, 240 Pages . . . 1
- MECHANICAL DRAWING GUIDE, 160 Pages. . . 1
- MECHANICAL DRAWING & DESIGN, 480 Pgs. . . 2
- MATHEMATICS & CALCULATIONS, 700 Pgs.. . . 2
- MECHANICAL Dictionary, 968 Pages . . . 4
- MILLWRIGHTS & Mechanics Guide, 1200 Pgs. . . 4

Name _____
Address _____
Occupation _____
Employed by _____

AUDEL, Publishers, 49 W. 23 St., New York 10, N. Y.



Makes \$10 a week

Has Radio Television Servicing Store



Spare Time Service Pays Well



Calls N.R.I. His "Stepping Stone"

BE A SUCCESS IN RADIO-

RADIO- Learn by Practicing

You Build Equipment Like This With Kits I Send

I give you PRACTICAL EXPERIENCE with many Valuable Kits I send that "bring to life" my illustrated texts. In my Servicing Course, you build a modern Radio, Set Tester, AM Signal Generator, etc. In my Communications Course, you assemble a low-power Broadcasting Transmitter, Wavemeter, Electronic Multitester, etc. Some equipment from both the courses is shown on this page. All of the equipment that you build is yours to keep.

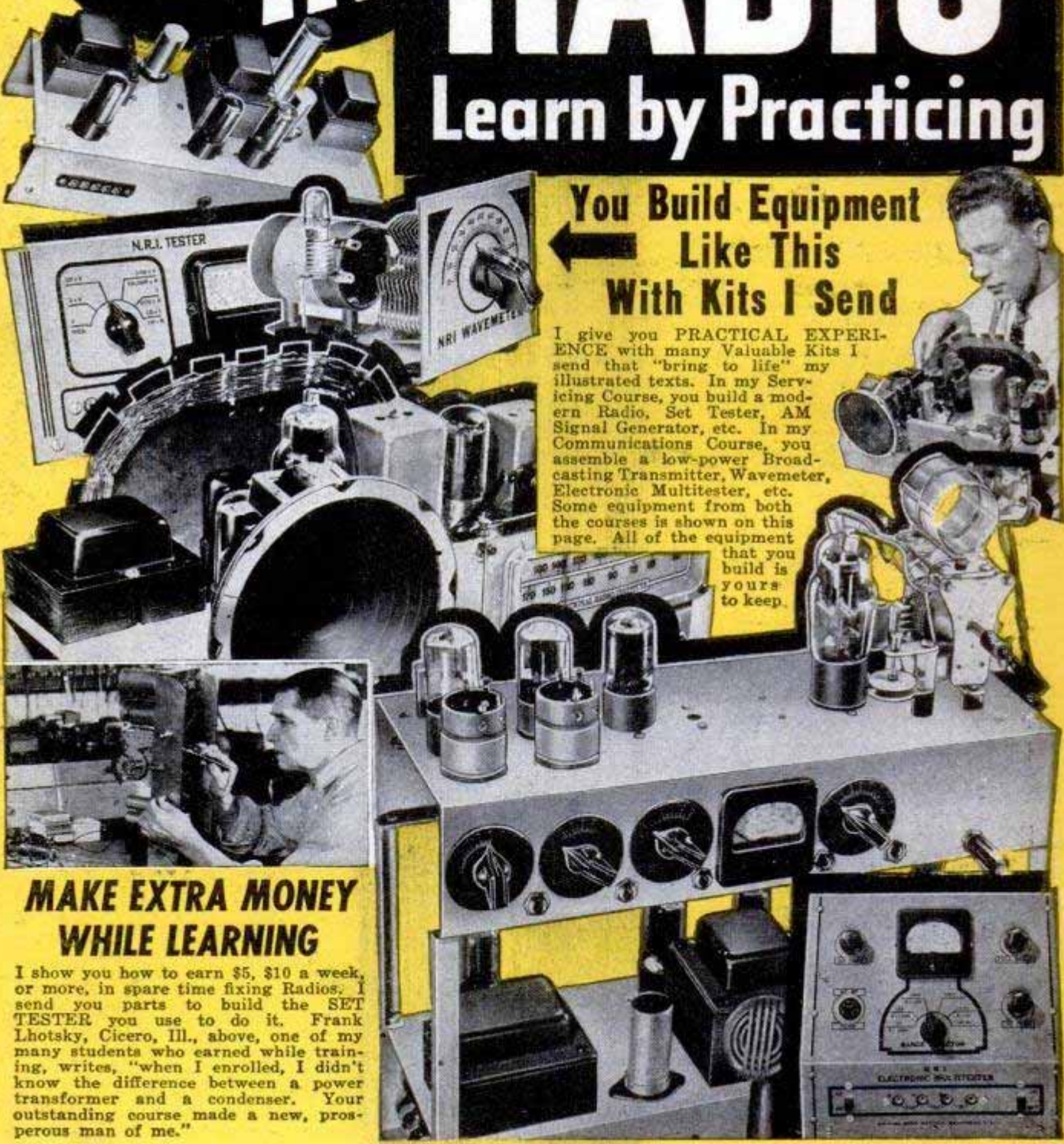

MAKE EXTRA MONEY WHILE LEARNING

I show you how to earn \$5, \$10 a week, or more, in spare time fixing Radios. I send you parts to build the SET TESTER you use to do it. Frank Lhotsky, Cicero, Ill., above, one of my many students who earned while training, writes, "when I enrolled, I didn't know the difference between a power transformer and a condenser. Your outstanding course made a new, prosperous man of me."



Sees Profit In Radio-Television

"I am operating a Radio Sales and Service business. With FM (Frequency Modulation) and Television in the offing, we have a very profitable future."—Albert Patrick, Tampa, Fla.



Radio Mechanic For Air Line

"N.R.I. helped qualify me for position as Radio Mechanic with United Airlines. Have my Radiotelephone 2nd Class License."—L. M. Hauger, San Bruno, California.



Gets First Job Through N.R.I.

"My first job was operator with KDLE, obtained for me by your Graduate Service Dept. Am now Chief Engineer Police Radio Station WQOX."—T. S. Norton, Hamilton, Ohio.

I TRAINED THESE MEN



TELEVISION

at Home in Spare Time

Get a Good Job--Have a Bright Future in America's Fast Growing Industry

Do you want a good pay job in the fast growing RADIO-TELEVISION Industry? Or do you want your own money-making Radio-Television Shop? Here is your opportunity. I've trained hundreds of men to be successful Technicians. **MEN WITH NO PREVIOUS EXPERIENCE.** My tested and proved train-at-home method makes learning easy. You learn Radio-Television principles from my illustrated lessons. You get practical experience building, testing and experimenting with **MANY KITS OF PARTS** I send. All equipment I send is yours to keep.

MAKE EXTRA MONEY IN SPARE TIME

The day you enroll, I start sending you **SPECIAL BOOKLETS** that show you how to make \$5, \$10 a week or more **EXTRA MONEY** fixing neighbors' Radios in spare time while learning. From here, it's a short step to your own shop or a good pay Radio-



HAVE A BUSINESS OF YOUR OWN

Let me show you how to have a good, steady income from your own Radio-Television shop. Many N.R.I.-trained men each year start without capital, like Robert Dohmen, New Prague, Minn., above. He writes, "Am now tied in with two television outfits."

VETERANS

Get This Training Without Cost Under G. I. Bill

Television servicing job. Or be a licensed Television Operator or Technician.

TELEVISION OFFERS BRIGHT FUTURE

In 1945, there were 943 Radio Stations. Today, about 2700 are on the air! **RESULT—THOUSANDS OF QUALIFIED MEN STEPPED INTO GOOD JOBS.** Another example—only 19 Television stations were on the air in 1947. Today, more than fifty. Within a few months, 150, say the experts—and 1000 within three years. Then add developments in FM (Frequency Modulation), Two Way Radio, Police, Marine, Aviation, Microwave Relay Radio. Think what this means! New jobs, more jobs for qualified men. The man who prepares **NOW** can reap rich rewards in this changing, developing, fast growing field!

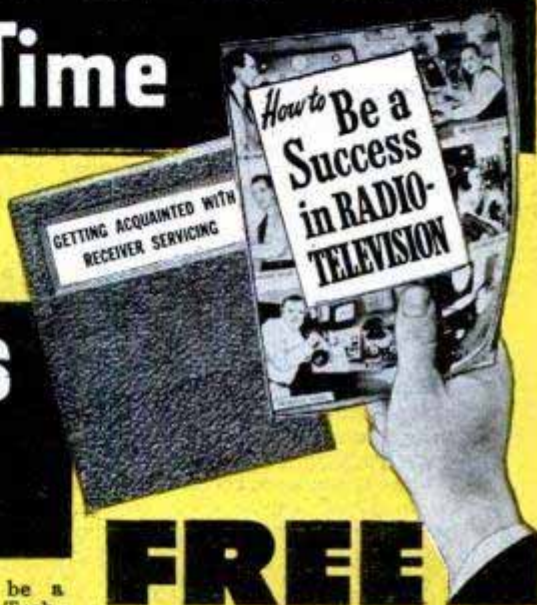

FREE ACTUAL LESSON AND 64 PAGE BOOK

Act now! Send for my **FREE DOUBLE OFFER.** Coupon entitles you to actual lesson, "GETTING ACQUAINTED WITH RECEIVER SERVICING." It shows how many pictures and diagrams are used to make learning at home easier, practical. You also get my 64-page book, "HOW TO BE A SUCCESS IN RADIO-TELEVISION." It tells more about YOUR opportunities . . . details of my Course . . . what my graduates are doing and earning . . . how quickly you can be on your way to good pay, success, a bright future. Send coupon in envelope or paste on penny postal. **J. E. SMITH, Pres., Dept. 9KP, National Radio Institute, Pioneer Home Study Radio School, Washington 9, D. C.**

MAIL THIS NOW

Good For 2 Books FREE

MR. J. E. SMITH, President, Dept. 9KP National Radio Institute, Washington 9, D. C.

Mail me Sample Lesson and 64-page book on winning success in Radio-Television—both **FREE.** (No salesman will call. Please write plainly.)

NAME.....AGE.....
 ADDRESS.....
 CITY.....ZONE.....STATE.....
 Check if Veteran. Approved Under G. I. Bill.

Lots of DIESEL

IN THE PACIFIC NORTHWEST



Yes, DIESEL is BIG business in Oregon, Washington, and adjoining states where industries and populations are growing so incredibly fast.

DIESEL IS THE KING OF POWER . . . on our railroads, highways, waterways and in our industries.

MEN WHO ARE equipped with the thorough training they get at the **ADCOX SCHOOL**, are prepared for a splendid future in the great Northwest. A fine place to live and enjoy life.



L. L. ADCOX, President

I PRODUCE DIESEL MEN IN 3 SHORT MONTHS

NEWEST FACILITIES AND EQUIPMENT, Advanced Instruction Methods by highly paid, Expert Instructors, combined with my 40 YEARS of trade school experience, enable me to turn out **REAL DIESEL ENGINE TROUBLE SHOOTERS**. When you receive your Adcox Diploma you are ready to begin your career in Diesel.

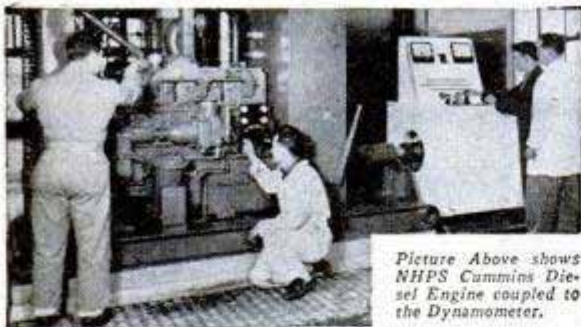

Picture Above shows NHPS Cummins Diesel Engine coupled to the Dynamometer.

YOU LEARN ENGINE CONSTRUCTION FROM THE GROUND UP. Special laboratory for Injection, Fuel Pumps, Nozzles and Governors. Trouble Shooting under full Dynamometer Load (as shown in picture).

This kind of training puts ADCOX out in front!

CLASSES LIMITED — Latest type equipment (no obsolete engines), Skilled Instructors — combine to insure best possible training. You learn Diesel **RIGHT**, and you learn it **FAST** . . . in this Nationally Famous School!

DIESEL SCHOOL CATALOG FREE APPROVED FOR VETERANS

L. L. ADCOX, President
ADCOX SCHOOL
237 N. E. Broadway, Portland 12, Oregon
Without obligation, please send me your **FREE** Catalog No. PM.

Name.....

Address.....

Town.....

State.....



(Continued from page 10)

Pancake griddle has built-in thermometer (Layne Mfg. Co., 2035 Milan Ave., South Pasadena, Calif.).....	133
Indoor fireplace grill (Bellkool Co., Appleton, Wis.).....	133
Robot "nurse" sings to baby.....	147
Safety electric outlet won't shock probing children (Harvey Hubbell, Inc., Bridgeport, Conn.).....	178

INDUSTRY

Fluorine in air hazard to livestock.....	111
Old Swedish mines converted into bombproof oil depots.....	146
Metal coated with powder.....	146
Hydraulic loader (Stratton Equipment Co., Cleveland, Ohio).....	146
Process borrowed from mining cuts cost of canned peas.....	147
1000-foot-long window.....	150
Tram-rail crane rotates and tilts load as it moves along track (The Cleveland Crane & Engineering Co., Wickliffe, Ohio).....	162
"Mushroom" roof supports itself.....	163
Aluminum-plastic cloth.....	166
Chemicals from stumps.....	179
Coffee roasted by infrared rays (Infra Roast Inc., 84 State St., Boston, Mass.).....	272
Electronic towel (Electronic Towel Corp., 57 William St., New York City 5).....	272

OUTDOOR RECREATION

Follow the ducks by trailer.....	148
Easy-aiming rifle has hinged grip (O. F. Mossberg & Sons, Inc., 131 St. John St., Box 1302, New Haven 5, Conn.).....	157
Outboards distribute fish poison.....	162
Snap-on trolling lure (Meridian Manufacturing Co., 5805 Marilyn Ave., Culver City, Calif.).....	178

TOOLS

Hand cutter drills holes in glass (Smith Tool Co., 191 Bay Ave., Glen Ridge, N. J.).....	134
Hand-drill adapter cuts mortises (Bertram Mfg. Co., Dept. A, 3121 Main St., Kansas City, Mo.).....	135
Small bench press has one-ton punch (Denison Engineering Co., 1160 Dublin Road, Columbus 16, Ohio).....	135
Door-straightening set (Holcraft Corp., 250 N. Vinedo Ave., Pasadena 8, Calif.).....	151
Tiny plane has extra handle (Speed Corp., 512 N.E. 73rd Ave., Portland, Ore.).....	179

MISCELLANEOUS

Hornet detectives aid atom research.....	24
Radar in three dimensions.....	110
Growth hormone produces giant rats.....	112
Typewriter feeder (American Business Systems, 1229 Belmont Ave., Philadelphia 4, Pa.).....	112
Sighting—in the "big S".....	126
Self-help hospital room.....	128
Horseshoe-shaped iceberg.....	129
Bomb experts use television "eyes" for dangerous work.....	139
Lumberjacks go to "sea".....	140
Shelf-size loran.....	146
Bird in gilded cage—trailer carries ostrich.....	150
Tripod for telescope is auto window (Tinsley Laboratories, 601 Tinsley Bldg., Berkeley, Calif.).....	151
Setting type with a camera.....	164
Rate controller speeds reading (Three Dimension Co., 4555 Addison St., Chicago).....	166
Midget greenhouses made of glass protect tomato plants.....	166
Electronic squirter breaks dog of barking habit.....	173
Sensitive emulsion will photograph ultraviolet rays of sun from rockets.....	173
Holder for handbags (Morris Mann & Reilly, Inc., 200 W. Monroe St., Chicago 6).....	173
No-dip paintbrush (No-Dip Brush Co., Inc., 141 E. 75th St., New York City 21).....	179
Injection for leaky dams.....	264

Craftsman and Shop Notes Index

AUTOMOTIVE

Tire chains carried in oilcan.....	188
Milk carton provides road flare for changing flat tire.....	208
Pin-type hinges for swinging garage doors prevent sag and permit lifting to clear ice.....	223
Giant C-bracket on hoist speeds installing truck engine.....	229
Oilcan for priming carburetors has special safety features.....	229
Fumes piped from valve cover.....	229
Keeping spark-plug contacts clean.....	229
Roller sand tracks for off-highway driving rescue car mired in muddy or soft ground.....	235
Individual spark-plug cleaner chips away carbon deposits.....	236
Spare tape kept under car hood.....	236

FARM

Sturdy wheel bench for farm shop made from old wagon tires.....	224
Wooden wheels on farm wagon adapted for rubber tires.....	228
Concrete splash block under pump keeps well platform dry.....	228
Baiting coyote traps.....	228
Green feed in poultry yard protected with hardware cloth.....	228
Water system for brooder house has barrel reservoir.....	236
Cleats nailed to fence posts provide convenient stiles.....	236
Weed killer applied with brush.....	236

(Continued to page 24)

IMPORTANT NOTICE—It is the intention of this magazine to provide its readers with information regarding the latest developments in the mechanical arts. We take no responsibility as to whether the disclosures contained in our articles are covered by patents and advise readers to investigate this subject before making, using, or selling any of the products, machines, or processes described in order to avoid possible liability for patent infringements.



INVENTORS



Learn how to protect your invention. The U. S. Patent Laws provide that any new and useful art, machine, article of manufacture, or composition of matter, or any new and useful improvement thereof, may be patented if the act of invention is involved. Therefore, every inventor with a valuable invention should take advantage of the Patent Laws and proceed for patent protection in order to safeguard his rights.

A patent gives the inventor the exclusive right to prevent others from making, using, or selling the invention claimed in the patent for a period of seventeen years.

The Patent Laws were enacted for the benefit of the inventor to give him protection for the features of his invention which are patentable. These features must be properly and concisely set forth and claimed in a formal application for patent, in order to comply with the requirements of the Patent Laws. For that reason, unless the inventor is familiar with patent matters, he should engage a competent registered patent attorney or agent to represent him. We are registered to practice before the U. S. Patent Office and are prepared to serve you in the handling of your patent matters.

A specially prepared booklet entitled "Patent Guide for the Inventor", containing detailed information with respect to patent protection and procedure, together with a "Record of Invention" form will be promptly forwarded to you without obligation upon request.

CLARENCE A. O'BRIEN & HARVEY JACOBSON

Registered Patent Attorneys

91-K DISTRICT NATIONAL BUILDING • WASHINGTON 5, D. C.

Patents
Trademarks
Copyrights

CLARENCE A. O'BRIEN & HARVEY JACOBSON
 Registered Patent Attorneys
 91-K District National Bldg., Washington 5, D. C.
 Please send me copy of "Patent Guide for the Inventor" and also
 "Record of Invention" form. This request does not obligate me.

Name _____

Address _____

City _____ State _____

(Please write or print plainly.)

YOU Need My **PRACTICAL** Training to Make Money in

TELEVISION- RADIO and ELECTRONICS!



I'll Send You
8 BIG KITS of
Radio Parts and Equipment



Each of the hundreds of Radio parts and other items I send my students is theirs "for keeps." You may use this equipment in your Radio and Television service work and save many dollars by not having to buy expensive "ready-made" test equipment.



of
New Orleans, La. tells us he makes \$5 to \$10 in spare time repairing radios. He is now also working with a Television set.



of
Coloma, Mich. reports that my training has made it possible for him to repair large numbers of Radio and Television sets.

I have trained hundreds of men to become technicians—and I'm ready to do the same for you. Whether your goal is a fine paying job in one of Radio's many branches—or a successful Radio and Television business of your own—you need the kind of training I offer! My training is practical and down to earth. **YOU NEED NO PREVIOUS EXPERIENCE.** I start you with basic fundamentals and give you plenty of practical shop-bench training with many kits of parts I send you. This is the training that sticks with you and makes money for you on the job!

FOR SPARE

Soon after you start training I send you my famous **BUSINESS BUILDERS** that show you how to make money in spare time doing interesting Radio jobs. I send you 8 big kits of Radio parts and equipment and help you build step-by-step a powerful 6-tube superhet radio, a 16-range test meter, plus other mighty useful equipment for Radio and Television servicing. You will perform over 175 fascinating experiments while training. You will learn about Television—so that you will be qualified to step into this fast growing, profitable field. I also send you many valuable service manuals, diagrams, and my book telling exactly how to set up your own Television and Radio shop. Clip and mail the coupon below for my two big **FREE** Radio books. I employ no salesmen—and nobody will call on you



A profitable Radio and Television Service Shop may be started with little capital. I will show you how to get started. At left is pictured one of my graduates, Mr. Merrit C. Sperry, Fairmont, Minn. in his own shop.

You couldn't pick a better time to get into Radio-Television and Electronics. New Television stations are going off the air to serve every major city—hundreds of new AM and FM Radio broadcasting stations are also on the air. All this creates new and bigger opportunities for the trained man who knows Radio-Television and Electronics

**THIS
TRAINING
AVAILABLE TO
YOU UNDER
THE G.I. BILL**

SPRAYBERRY ACADEMY of RADIO, Dept. 10-B
111 North Canal Street,
Chicago 6, Illinois

Please rush my **FREE** copies of "How To Make Money In Radio-Television and Electronics" and "How To Read Radio Diagrams and Symbols."

Name.....Age.....

Address.....

City.....State.....

() Check here if you are a Veteran

**My Training
Includes...
Television,
FM (Frequency
Modulation),
Public
Address
and High
Frequency
Applications**



Just mail coupon for a **FREE** sample Sprayberry Lesson and my big **FREE** book, "How To Make Money In Radio-Television and Electronics." Learn why my really *practical* training is best of all for you. Discover what's ahead for you in Radio-Television and Electronics. **No obligation. Don't delay!** Mail the coupon now—and count on me for fast action.

SPRAYBERRY ACADEMY OF RADIO
111 N. CANAL, DEPT. 10-B, CHICAGO 6, ILL.

INVENTORS

Patent laws encourage the development of inventions.

We recommend that an inventor employ a registered Patent Attorney or agent, if the inventor is not familiar with patent matters. This is because the value of a patent depends largely upon the skillful preparation of the specification and claims in the patent application.

The firm of McMorrow, Berman and Davidson is registered to practice before the United States Patent Office. Additionally it engages patent attorneys able to readily understand inventors' disclosures, to advise concerning patentability, and to prepare appropriate specifications and claims.

If an inventor believes he has an invention, a search of the most pertinent prior U. S. patents should be made and a report obtained relative to its patentability. Where such report indicates that the invention appears patentable, in order to secure protection, diligence should be exercised in making application for a patent.

Send for a copy of Patent Booklet entitled "How To Protect Your Invention." This booklet contains information on patent protection and procedure. You will also receive an "Invention Record" blank. This will be promptly forwarded to you upon request—no obligation.

McMORROW, BERMAN & DAVIDSON

Registered Patent Attorneys

PATENTS • TRADE MARKS • COPYRIGHTS

1355 VICTOR BUILDING, WASHINGTON 1, D. C.

McMORROW, BERMAN & DAVIDSON

Registered Patent Attorneys

1355 Victor Building, Washington 1, D. C.

Send me your Patent Booklet, "How To Protect Your Invention", and also "Invention Record" form at once. I understand this request does not obligate me.

Name.....

Address.....

City.....

(WRITE OR PRINT NAME CLEARLY)

And to think they used to call me SKINNY!

Give Me 15 Minutes a Day and I'll Give You a NEW BODY

PEOPLE used to laugh at my skinny 97 lb. body. I was ashamed to strip for sports or for a swim. Girls made fun of me behind my back. THEN I discovered my muscle-building system—"Dynamic Tension." It turned me into such a complete specimen of MANHOOD that today I hold the title "THE WORLD'S MOST PERFECTLY DEVELOPED MAN."

That's how I traded in my "bag of bones" for a barrel of muscle! And I felt so much on top of the world in my big new, husky body that I decided to devote my life to helping other fellows change themselves into "perfectly developed men."

What's My Secret?

When you look in the mirror and see a healthy, husky, strapping fellow smiling back at you—then you'll be astonished at how short a time it takes "Dynamic Tension" to GET RESULTS! "Dynamic Tension" is the easy, NATURAL method you can practice in the privacy of your own room—JUST 15 MINUTES EACH DAY—while your scrawny shoulder muscles begin to swell . . . those spindly arms and legs of yours bulge . . . and your whole body starts to feel "alive," full of zip and go!

Thousands are becoming marvelous physical specimens—my way. I give you no gadgets or contraptions to fool with. With "Dynamic Tension" you simply utilize the dormant muscle power in your own body—watch it increase and multiply into real, solid LIVE MUSCLE.

FREE BOOK

Mail coupon right now for my illustrated book, "Everlasting Health and Strength." Tells all about my "Dynamic Tension" method. Shows actual photos of men I've made into Atlas Champions. It's a valuable book—and it's FREE. Mail coupon to me personally. CHARLES ATLAS, Dept. 8Y, 115 East 23rd St., New York 10, N. Y.



CHARLES ATLAS, DEPT. 8Y,
115 East 23rd Street, New York 10, N. Y.

I want the proof that "Dynamic Tension" will help make a new man of me—give me a healthy, husky body and big muscle development. Send me your free book, "Everlasting Health and Strength."

Name _____ Age _____
(Please print or write plainly)
Address _____
City _____ State _____

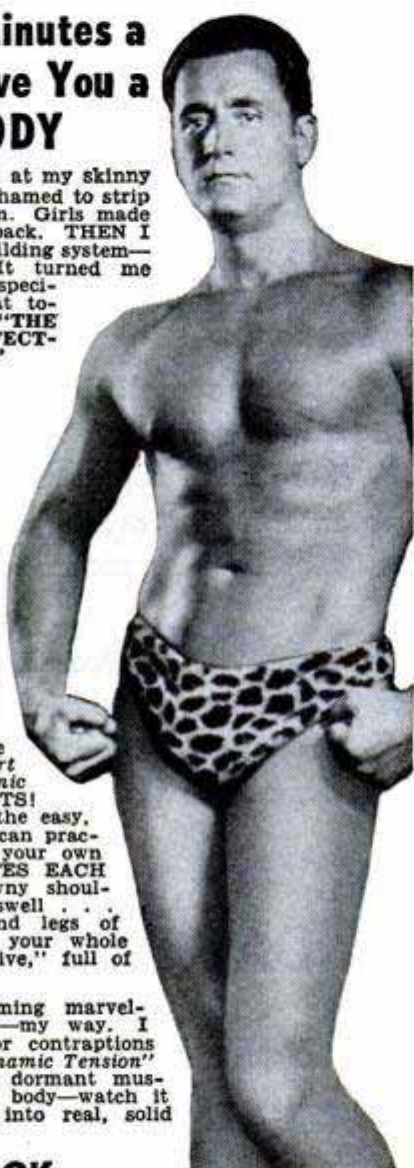

Command Bigger Money! STUDY LAW

STUDY AT HOME for BUSINESS SUCCESS and LARGER PERSONAL EARNINGS. 40 years expert instruction — over 114,000 students enrolled. LL.B. Degree awarded. All text material furnished. Easy payment plan. Send now for FREE BOOK—"Law and Executive Guidance." It explains the course — how you may enroll and the many ways you can profit from Law Study. Write TODAY to: (G.I. Approved)

AMERICAN EXTENSION SCHOOL OF LAW
Dept. 19-PM, 646 N. Michigan Ave., Chicago 11, Ill.

SUCCEED IN THE POULTRY BUSINESS!

Poultry is providing many trained men and women with a good, comfortable living, either part or full time. For 28 years our Home Study Course has been helping thousands obtain training and "know how" that means extra income from the start. Don't delay — Write today for prospectus describing courses, methods, service, opportunities.

NATIONAL POULTRY INSTITUTE
DEPT. 50 ADAMS CENTER, N. Y.

THERE'S MONEY IN CARTOONS!

RAYE BURNS will teach you HOW to CREATE ORIGINAL CARTOONS at home that you may SELL! Course contains 26 lessons and over 600 illustrations. All for Only... **\$2.85**
Send name and address for free details.
RAYE BURNS SCHOOL, Dept. M, Box 3583, Cleveland, Ohio

HYDROPONICS

24 Page FREE Illustrated Book

Grow out-of-season vegetables, rare flowers or house plants by hydroponics WITHOUT SOIL. Start a fascinating hobby or profitable business in your home. No experience needed for top results. Small space gets BIG RETURNS. Easy, clean, pleasant way to grow any plant indoors or out every day in the year. Fast growth, increased yields, unlimited PROFIT OPPORTUNITIES. Send postcard today for free illustrated book showing how others from every state are succeeding in this wide open field.

CHARLES C GILBERT & CO., 824 W. IVY STREET, SAN DIEGO 1, CALIF.

BE A NOTARY PUBLIC

Old legal-supply house, 22 cities, helps you get appointment by governor if you qualify, equips you fully. Pay after appointment (2 payments \$12.50 each). Respected public office. You certify legal papers, use official seal made with your name, collect your fees. Easy. Inquire—
STATIONERS EXCHANGE BOERNE 40, TEXAS

Say You Saw It in Popular Mechanics

Photography for



PLEASURE or PROFIT

Learn at home. Spare time. Practical basic training. Long-established school. Many have earned while learning. Send coupon below for free booklet, "Opportunities in Modern Photography" and full particulars.

AMERICAN SCHOOL OF PHOTOGRAPHY
1315 Michigan Avenue Dept. 1357 Chicago 5, Illinois
Send booklet, "Opportunities in Modern Photography," full particulars and requirements. No salesman will call.
Name _____ Age _____
Address _____
City _____ Zone _____ State _____

are you suffering from

HIDDEN TALENTS?



Locked in your mind may be the germ of a valuable idea . . . an undeveloped aptitude . . . a hidden talent. And the key that can help unlock those capabilities of yours is *training*—sound, practical, down-to-earth training!

Helping men and women bring out the best that's in them has been the job of I. C. S. for more than 57 years. In every field of industry, you'll find leaders whose skills were developed through study with I. C. S.

They are the ones who sensed a latent ability within themselves—and *who proceeded to do something about it*. While others (equally gifted, perhaps) plodded along in routine jobs, they mastered I. C. S. courses . . . qualified themselves for rich rewards.

You can develop your hidden talents the same way they did. Start *today* and be ready for tomorrow's opportunities. Here's the coupon to mail:

INTERNATIONAL CORRESPONDENCE SCHOOLS

APPROVED
under the
G. I. BILL

BOX 5662-K, SCRANTON 9, PENNA.

Without cost or obligation, please send me full particulars about the course BEFORE which I have marked X:

- | | | | |
|---|--|---|---|
| <p>Air Conditioning and Plumbing Courses</p> <ul style="list-style-type: none"> <input type="checkbox"/> Air Conditioning <input type="checkbox"/> Heating <input type="checkbox"/> Refrigeration <p>Chemical Courses</p> <ul style="list-style-type: none"> <input type="checkbox"/> Chemical Engineering <input type="checkbox"/> Chemistry, Analytical <input type="checkbox"/> Chemistry, Industrial <input type="checkbox"/> Chemistry, Mfg. Iron & Steel <input type="checkbox"/> Petroleum Refining <input type="checkbox"/> Pulp and Paper Making <p>Civil Engineering, Architectural and Mining Courses</p> <ul style="list-style-type: none"> <input type="checkbox"/> Architecture <input type="checkbox"/> Architectural Drafting <input type="checkbox"/> Bridge and Building Foreman <input type="checkbox"/> Building Estimating <input type="checkbox"/> Civil Engineering <input type="checkbox"/> Coal Mining <input type="checkbox"/> Contracting and Building <input type="checkbox"/> Highway Engineering <input type="checkbox"/> Lumber Dealer <input type="checkbox"/> Reading Structural Blueprints <input type="checkbox"/> Sanitary Engineering <input type="checkbox"/> Structural Drafting | <ul style="list-style-type: none"> <input type="checkbox"/> Plumbing <input type="checkbox"/> Steam Fitting <p>Communications Courses</p> <ul style="list-style-type: none"> <input type="checkbox"/> Electronics <input type="checkbox"/> Practical Telephony <input type="checkbox"/> Radio, General <input type="checkbox"/> Radio Servicing <input type="checkbox"/> Telegraph Engineering <p>Electrical Courses</p> <ul style="list-style-type: none"> <input type="checkbox"/> Electrical Drafting <input type="checkbox"/> Electrical Engineering <input type="checkbox"/> Electric Light and Power <input type="checkbox"/> Lighting Technician <input type="checkbox"/> Practical Electrician <p>Internal Combustion Engines Courses</p> <ul style="list-style-type: none"> <input type="checkbox"/> Auto Technician <input type="checkbox"/> Diesel-Electric <input type="checkbox"/> Diesel Engines <p>Mechanical Courses</p> <ul style="list-style-type: none"> <input type="checkbox"/> Aeronautical Engineer's, Jr. <input type="checkbox"/> Aircraft Drafting <input type="checkbox"/> Forging <input type="checkbox"/> Heat Treatment of Metals <input type="checkbox"/> Industrial Engineering <input type="checkbox"/> Industrial Instrumentation | <ul style="list-style-type: none"> <input type="checkbox"/> Mech. Drafting <input type="checkbox"/> Mold-Loft Work <input type="checkbox"/> Patternmaking—Wood, Metal <input type="checkbox"/> Reading Shop Blueprints <input type="checkbox"/> Sheet-Metal Drafting <input type="checkbox"/> Sheet-Metal Worker <input type="checkbox"/> Ship Drafting <input type="checkbox"/> Tool Designing <input type="checkbox"/> Welding Engineering <input type="checkbox"/> Welding—Gas and Electric <p>Railroad Courses</p> <ul style="list-style-type: none"> <input type="checkbox"/> Air Brake <input type="checkbox"/> Diesel Locomotive <input type="checkbox"/> Locomotive Engineer <input type="checkbox"/> Locomotive Fireman <input type="checkbox"/> Locomotive Machinist <input type="checkbox"/> Railroad Section Foreman <input type="checkbox"/> Steam-Diesel Loco. Eng. <p>Stationary Eng'r's Courses</p> <ul style="list-style-type: none"> <input type="checkbox"/> Boilermaking <input type="checkbox"/> Combustion Engineering <input type="checkbox"/> Engine Running <input type="checkbox"/> Marine Engineering <input type="checkbox"/> Power Plant Eng'r'g | <p>Textile Courses</p> <ul style="list-style-type: none"> <input type="checkbox"/> Cotton Manufacturing <input type="checkbox"/> Loom Fixing <input type="checkbox"/> Textile Designing <input type="checkbox"/> Woolen Manufacturing <p>Business and Academic Courses</p> <ul style="list-style-type: none"> <input type="checkbox"/> Accounting <input type="checkbox"/> App. Psychology <input type="checkbox"/> Business Administration <input type="checkbox"/> Bus. Correspondence <input type="checkbox"/> Certified Public Accounting <input type="checkbox"/> Commercial <input type="checkbox"/> Cost Accounting <input type="checkbox"/> Federal Tax <input type="checkbox"/> Foremanship <input type="checkbox"/> Good English <input type="checkbox"/> Higher Mathematics <input type="checkbox"/> Industrial Supervision <input type="checkbox"/> Motor Traffic <input type="checkbox"/> Retailing <input type="checkbox"/> Salesmanship <input type="checkbox"/> Sign Lettering <input type="checkbox"/> Spanish <input type="checkbox"/> Traffic Management |
|---|--|---|---|

Name _____ Age _____ Home Address _____

City _____ State _____ Working Hours _____ A.M. to _____ P.M.

Present Position _____ Employed by _____

Length of Service in World War II _____ Enrollment under G.I. Bill approved for World War II Veterans. Special tuition rates to members of the Armed Forces. Canadian residents send coupon to International Correspondence Schools Canadian, Ltd., Montreal, Canada.

INVENTORS

A patent is a valuable right. On the basis of a provision in the Constitution of the United States, Congress has established a system under which inventors may secure the exclusive right to prevent the unauthorized use, manufacture and sale of their inventions for periods of seventeen years. The inventor secures this protection for his invention by obtaining a patent.

This firm is registered to practice before the U. S. Patent Office and is available to assist inventors in the preparation and prosecution of their cases. Detailed information and the steps to take to obtain patent protection will be furnished upon request.

Form below for mailing convenience

VICTOR J. EVANS & Co. *Merlin M. Evans*
REGISTERED PATENT ATTORNEY

430-L MERLIN BUILDING, WASHINGTON 6, D.C.

• • • • •

VICTOR J. EVANS & CO.

430-L Merlin Building, Washington 6, D.C.

Please send me without obligation a copy of your booklet "Patent Protection For Inventors" together with your convenient "Evidence of Invention" form.

Name.....

Address.....

City and State.....

• • • • •

PATENTS TRADEMARKS COPYRIGHTS

BE AN AUTO MACHINIST



Draw Top Pay • No Job Worries
Earn more money in auto mechanics—Specialize! New FREE booklet tells how to prepare for good jobs with high pay and job security. Our modern equipment and practical instructions make it easy to learn—get experience in **ENGINE REBUILDING or GENERAL AUTO MECHANICS** Job Placement Service FREE

Practical Shop Training
Learn to operate the very latest shop machinery. Friendly instructors take a real interest in preparing you for a good job.

VETERANS
American is a G.I. approved school.

WRITE TODAY FOR FREE BOOKLET

AMERICAN TRADE SCHOOL
2411 McGee Kansas City, Mo.



LEARN WATCH REPAIRING



AT HOME. By our modern and original system of instruction you can learn every part of the **WATCH REPAIRING TRADE AT HOME.** Prepare yourself for a well-paying position or start in business after completing our course of instruction. Good watch repairers are in demand and generally earn very good salaries. For particulars apply to the **Wisconsin School of Watch Repairing** 759 North Milwaukee St., Milwaukee 2, Wis.

CARPENTRY BRICKLAYING

APPROVED FOR VETERAN TRAINING • FREE CATALOG

PENNSYLVANIA INSTITUTE SCHOOL OF TRADES
30th & MARKET STS. PHILA. 4, PENNA.

BOYS-IT'S FREE!

This exciting book "THE WONDERS OF CHEMISTRY" Shows how to amaze your friends with chemical magic, describes many fascinating home experiments, tells of fun, thrills, adventure and big future opportunities for boys who know chemistry. Send today!

THE PORTER CHEMICAL COMPANY
23 Prospect Avenue Hagerstown, Md.



MAKE MONEY IN LANDSCAPING

Thorough training by Internationally known Landscape Architect to start your own business, improve your home or advance in this well paid field. Many Opportunities. Approved for Veterans. Send for FREE BOOK.

NATIONAL LANDSCAPE INSTITUTE
Dept. P-10, 310 So. Robertson Los Angeles 36, Calif.



TURN SPARE TIME INTO PROFIT

with our RUB-ER-SPRA. Make Genuine Rubber Molds that cost ONLY A FEW CENTS EACH and then cast thousands of FAST SELLING NOVELTIES. Make Money Fast . . . Send 25c for catalog.

KEN-DOR STUDIO, 949 George St., Dept. P-10, Lake Geneva, Wisc.

SAY YOU SAW IT IN POPULAR MECHANICS

make **MONEY CASTING AT HOME**

Make your own rubber molds quickly, cheaply with X.L. RUBBER. Cast thousands of perfect figurines, book ends, plaques, ornaments, ash trays, etc. **GREAT PROFITS!**

Write for NEW Catalog.
X.L. Rubber, Pts. \$2.00; Qts. \$3.50; Gallons \$8.95; Models and enough rubber for 3 molds \$1.30 postpaid.

PLASTIC ARTS STUDIO • Route 5 • Dept. 2 • Muncie Ind.



Prepare in our
Big Training
Shops for these

GREAT OPPORTUNITY FIELDS!

ELECTRICITY OR **RADIO TELEVISION**



This big fire-proof building is occupied entirely by Coyne.

FIVE BIG FLOORS PACKED WITH MASSIVE EQUIPMENT

Thousands of men and young men have come to our big training shops where we have floor upon floor packed with massive equipment to train with, to prepare for good jobs and real futures in the opportunity fields of Electricity and Radio-Television. For many years, these fields have offered great opportunities to trained men. With new developments, including Electronics and Television, they will continue to grow and offer even greater opportunities. Why be satisfied with a "no future" job? Many "one operation" jobs that exist today will not last. Prepare for a good job with a real future for steady pay and advancement by training NOW in the great training shops of COYNE in Chicago.

NOT "HOME-STUDY" COURSES

Our famous Radio-Television Practical-Technical method gives you practical experience on a massive outlay of equipment. Not by correspondence, but actual shop work plus necessary technical training. You are trained right here in the great Coyne shops that have been training men and young men for over 50 years.

ELECTRICITY RADIO-TELEVISION

INCLUDING INDUSTRIAL ELECTRONICS

Big future in Power Plant Work, Motors, Armature Winding, Home and Factory Wiring, Appliances, Refrigeration, Maintenance, Illumination, etc. Electricians are in demand everywhere—lifetime job service to Coyne graduates. Send for BIG FREE BOOK.

A great field now, even greater growth ahead. Here at COYNE you're trained for Construction, Testing, Trouble-Shooting on Radio, Public Address, Sound Units. Training includes FM, Television Servicing, etc. Many Coyne trained men in good jobs or own well paying Radio-Television businesses of their own.

ELECTRIC REFRIGERATION

This valuable training now included with either course means added opportunities.

G. I. APPROVED

NON-VETERANS who are short of cash can finance most of their tuition and pay in easy monthly payments after graduation. Many earn while learning.

B. W. COOKE, President

COYNE ELECTRICAL AND RADIO SCHOOL

500 So. Paulina St., Dept. 79-72H, Chicago 12, ILL.

LARGEST, OLDEST, BEST EQUIPPED SCHOOL OF ITS KIND IN THE U.S.

Mail Coupon for Big FREE Book!

Whether you prefer Electricity, or Radio-Television, train on actual equipment at Coyne. We have a big, fully illustrated book on each course, and we'll send you the one you want, or both if you want to consider both fields, without obligation. Mail coupon—TODAY.

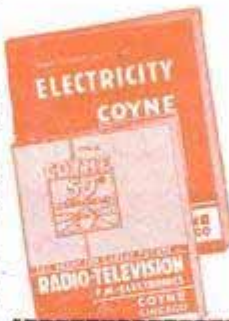

B. W. Cooke, President
COYNE ELECTRICAL AND RADIO SCHOOL,
500 S. Paulina St., Dept. 79-72H, Chicago 12, Ill.

Send me the book, checked below and details of your training offer. This does not obligate me and no salesman will call.

ELECTRICITY RADIO-TELEVISION

NAME.....

ADDRESS.....

CITY..... STATE.....

C. T. I. Students wrote this ad!



"I'm glad I enrolled with C.T.I. because the instructors sure know their stuff. They're always willing to answer any questions that we students have in mind. You learn fast when a good instructor tells you how to handle an assignment, and then stands by as you do it yourself."—Orlin R. Kling, Ind.



"Learning a trade at C.T.I. is a pleasant experience. My fellow students are swell fellows. We all work together and help each other out. I find that you learn a lot faster when the surroundings are congenial. You make friends fast at C.T.I."—B. H. Glendenning, Ind.



"One of the best things about C.T.I. is the personal interest that the school takes in a student. It gives you plenty of confidence when you know a big institution like C.T.I. is always willing to give you a helping hand."—E. J. Good, Okla.



"Take it from me—I'm certainly getting my money's worth from C.T.I. We don't have any time to loaf in school because every minute is taken up with intensive training. When I receive my diploma in a few weeks, I feel sure I can tackle any job."—George E. Brewer, Ind.

"THANKS TO C. T. I. TRAINING, I NOW OWN MY OWN SHOP!"...

Yes, students and graduates have plenty to say about the efficiency of C.T.I. training! Let them suggest *in their own words* how you, too, can prepare for a successful future by learning a well-paid trade through C.T.I.—at home in spare time or at the Chicago residential school:

"I recently went into business for myself. I wish to thank you for C.T.I. training, for it has provided a great future for me." . . . "I now operate a very successful business. Have a \$12,000 building and \$4,000 worth of stock and equipment." . . . "I cannot thank you enough for the training I have received. I have made good progress, and have had three raises in pay within eight months" . . . "Please accept the thanks of an average man who now feels that he has taken a big step on the road to becoming more educated and independent." . . . "As you can see, I am now on my own. It came sooner than I anticipated, and with the training I've received from C.T.I., I'm sure I'll go places, but fast!"

Why don't *you* train for advancement through C.T.I.? Choose your future from opportunities listed in coupon below. Then write or mail coupon for valuable, FREE information. *Act today!*



"When I enrolled with C.T.I., I had absolutely no previous experience or training. I knew I had a lot to learn, and at first I was skeptical that I could really learn a trade in a few months. Now I know differently. C.T.I. training is so intensive that a fellow just can't help learning a trade if he applies himself."—Joseph Kilner, Mich.



"The thing that impressed me most about C.T.I. is that the training is just as good as the booklets and other literature claim it is—even better. As far as I'm concerned, C.T.I. is the best trade school in the world. I just don't see how my schooling could be improved."—Ivan A. Reed, Ind.

C. T. I. TRAINING IS G. I. APPROVED

All C.T.I. courses, both residential and home study, are fully approved by the Veterans' Administration—which means that eligible veterans will have their tuition paid by the government. Remember, there's a time limit on when training must begin, so act now!

NON-VETERANS—We'd like to tell you about our Easy-Payment Finance Plan and Pay-After-Graduation Plan. Write for information.



R. C. Anderson
President

FILL OUT - CUT OUT - MAIL TODAY

Mr. R. C. Anderson, President
COMMERCIAL TRADES INSTITUTE, Dept. E2-10
1400 W. Greenleaf, Chicago 26, Ill.

Send free illustrated Brochures and other information about the field I have checked below:

- | | | |
|---|--|--------------------------------------|
| <input type="checkbox"/> Automotive Mechanics | <input type="checkbox"/> Veteran | <input type="checkbox"/> Non-Veteran |
| <input type="checkbox"/> Body & Fender Rebuilding | <input type="checkbox"/> Electricity & Electronics | |
| <input type="checkbox"/> Diesel Mechanics | <input type="checkbox"/> Radio & Television | |
| <input type="checkbox"/> Refrigeration & Air Conditioning | <input type="checkbox"/> Building Construction | |
| | <input type="checkbox"/> Mechanical Drafting | |

Name _____ Age _____

Address _____

City _____ State _____

C.T.I. OFFERS TRAINING IN ALL THESE GREAT FIELDS—WRITE FOR INFORMATION TODAY

COMMERCIAL TRADES INSTITUTE, Dept. E2-10
1400 Greenleaf, Chicago 26



WHICH OF THESE *Opportunities* INTERESTS *You* MOST?

Accounting
Air Conditioning
Architecture & Building
Automotive Engineering
Aviation—Practical
Aviation Drafting & Design
Better Foremanship
Bookkeeping
Business Management

Contracting
Diesel Engineering
Drafting & Design
Electrical Engineering
Electricity—Practical
Electronics, Industrial
High School Courses
Machine Shop Operations
Mechanical Engineering

Plastics Engineering
Plumbing—Practical
Private Secretary
Radio Operating & Servicing
Railway Training
Refrigeration
Sheet Metal Pattern Drafting
Shop Management
Tool Making

THINK! LOOK FORWARD!

Business is making big, new plans

Men and Women are preparing for the future

WHAT ARE YOU DOING ABOUT YOUR TOMORROWS?

● *Today*, choose the job you want—and prepare for it. Or if you are already engaged in the work you like best, start training *now* for quicker promotion. Acquire the knowledge that will help you to get ahead faster, make more money and have greater security.

Invest part of your spare time in more rapid progress. Start training now, in spare time in your own home. Be ready to grasp your opportunity and step out ahead of those who lack the ability you have attained.

American School, founded in 1897 as an educational institution *not for profit*, can help you to reach your goal just as it has helped others during the past fifty-two years. Give serious thought to the list above. Pick one or more subjects that interest you. Then check the coupon at right, add your name and address and mail it at once. The school will send you details on its training plan and outline of study prepared by specialists. There is no charge, no obligation, so send the coupon immediately.

PRACTICAL, EFFECTIVE HOME - STUDY TRAINING SINCE 1897

Take This First Easy Step

CHECK, CLIP AND MAIL COUPON NOW

AMERICAN SCHOOL, Dept. G745, Drexel at 58th, Chicago 37, Ill.
Without obligation, Please send FREE and postpaid, bulletin and details of the Subject checked.

- | | | |
|--|---|--|
| <input type="checkbox"/> PLASTICS ENG'R | <input type="checkbox"/> Accounting | <input type="checkbox"/> Drafting and Design for Men and Women |
| <input type="checkbox"/> Refrigeration | <input type="checkbox"/> Electrical Engr. | <input type="checkbox"/> Radio |
| <input type="checkbox"/> Architecture and Building | <input type="checkbox"/> Electricity-Pract. | <input type="checkbox"/> High School |
| <input type="checkbox"/> Contracting | <input type="checkbox"/> Electronics, Industr. | <input type="checkbox"/> Air Conditioning |
| <input type="checkbox"/> Practical Plumbing | <input type="checkbox"/> Bookkeeping | <input type="checkbox"/> Mechanical Eng. |
| <input type="checkbox"/> Automotive Engineering | <input type="checkbox"/> Private Secretary | <input type="checkbox"/> Shop Management |
| <input type="checkbox"/> Aviation Drafting | <input type="checkbox"/> Diesel Engineering | <input type="checkbox"/> Tool Making |
| <input type="checkbox"/> Aviation | <input type="checkbox"/> Sheet Metal Pattern Drafting | <input type="checkbox"/> Better Foremanship |
| <input type="checkbox"/> Business Mgmt | | <input type="checkbox"/> Machine Shop Operations |
| <input type="checkbox"/> Railway Training | | |

Name..... Occupation.....
Address..... Age.....
City..... State.....

AMERICAN SCHOOL

Dept. G745, Drexel at 58th Street, Chicago 37

FREE!!

HOW TO MAKE BIG MONEY

AT HOME
FULL OR
SPARE
TIME



WITH
METALIZED
BABY SHOES

A NEW BIG PROFIT
FIELD NOW OPEN TO YOU

Metalize Baby Shoes and other precious keepsakes with Genuine Metal, in beautiful 2-tone BRONZE, SILVER and GOLD and popular PEARL and GLASS Finishes. Even simple dime-store objects, lowly leaves of trees and hundreds of other items become objects of beauty like magic when covered with jewel-like metal.

IF YOU WANT
BIG MONEY

Instead of small weekly pay checks, if you want to add to the family income in your spare time, then you owe it to yourself and family to get the FREE FACTS about this exciting, profitable business.

IF YOU WANT TO
BE YOUR OWN BOSS

and are tired of working for others THIS is what you've been looking for. A chance to be independent and build a secure future without risking your present job.

MILLIONS OF NEW
PROSPECTS YEARLY

Yes, the market is HUGE and growing BIGGER each year. No seasonal slumps — a steady year 'round income. This is ideal for a man and wife who want to work together. Right at Home for extra income or a profitable Full Time Business. Quickly learned in a matter of days and without previous experience of any kind. A few cents can bring back many dollars to YOU. Delay may be costly. Write now! NO RISK OR OBLIGATION ON YOUR PART.

ACT NOW AND
CASH IN ON HUGE
XMAS DEMAND!

KIKTAVI COMPANY, Dept. PM-10
2111 W. Manchester, Los Angeles 47
Okay, send me FREE FACTS on How to Make
BIG MONEY At Home.

NAME _____
ADDRESS _____
CITY _____ ZONE _____ STATE _____

TIRED OF
WORKING
FOR OTHERS ?

NEED MORE
MONEY ?

START YOUR
OWN BUSINESS
ON A
SHOESTRING

\$5 PER HOUR

NO EXPERIENCE
NECESSARY

PAY DAY
EVERY DAY

START EARNING
AT ONCE

FOR
FREE FACTS

on the opportunity
of a lifetime

MAIL COUPON
TODAY!

(Continued from page 14)

HOUSE AND HOME

House numbers are readily visible when jigsawed in novel wooden gate	185
Keeping long tapers straight in hot weather	186
Holder sharpens paring knives	186
Hint for saving steps and electricity	186
Pipetern cleaner protects spectacles	186
Saving matched buttons	186
Paper-plate cover for mixer bowl	186
Hiding place for small valuables	186
Skirt marker improvised from yardstick	186
Keep fire extinguisher handy	188
Thermostat mounted temporarily to determine best location	188
Syrup pitcher dispenses salt	198
Dressing table for baby	209

NOVELTIES

Copper float provides candy dish	198
Walnut picture frame	199
Safe jack-o'-lantern for Halloween	200
Six-in-one puzzle	201

PHOTOGRAPHY

Clamps hold camera back rigid for color-separation work	220
Receptacle box has switch to control photoflood lamps	220
Darkroom thermometer indicates solution temperatures	220
Borderless prints made quickly with improvised easel	220
Flash-extension plug jacks taken from radio tube	220

TOOLS

Horizontal disk sander mounted on workbench provides handy tool for forming small work	185
Self-gripping support blocks hold door for planing	188
Tape aids starting screws	188
Thin board held under work insures smooth end cutting	198
Inexpensive power-tool stands from sewing-machine legs	215
Ball-bearing center rest	221
Improved protractor formed by combining folding rule with inch scale	223
U-shaped rod prevents nicks when sharpening cordwood saw	224
Ratchet-grip stud wrench does not mar surface	224
Graduated carpenter's gauge of sheet metal speeds laying out mortises	235

MISCELLANEOUS

Screen-door catch holds papers	185
Gun cabinet	189
Football tee made from plunger	198
Water pressure read at hydrant by gauge mounted on cap	198
Bobby pin secures lapel button	200
Leave house key in mailbox	200
Steel wool prevents shifting when clamping glued joints	200
Nail polish cements watch crystal	200
Labels printed on glass jars with china-marking pencil	200
Pocket sewing kit improvised from dental-floss container	208
Bookmark indicates exact line	208
Ever-ready glue brush	208
Cardboard relieves sore feet	208
Coins taped inside match book are mailed safely	215
Lettering truck doors speeded with paper pounce pattern	222
Acetone aids drying glassware	224
Renewing stripped brass fittings	224
Corners cut from cardboard box align paper when stapling	228

Radio-Television, Electronics

Sub-miniature-tube receivers (Privat-Ear, Electronics Systems Corp., 112 W. 18th St., Kansas City, Mo.; Micro Pocket Radio, Micro-Electronic Products Inc., Peru, Ind.)	237
Two-tube "Mini-Pal" portable has built-in loop antenna	238
Turntable for TV receiver	240

Hornet Detectives Aid Atom Research

Hornets—the ordinary kind with the stingers—promise to become detectives investigating the leakage of radioactive materials from atomic-energy laboratories. It has been known for years that hornets accumulate the element barium in their bodies. Barium also is one of the elements formed in the radioactive breakdown of uranium. Now scientists are proposing that hornets be encouraged to live in the neighborhood of atomic laboratories and to seek food among plants exposed to possible radioactive leaks. Periodically some of them will be killed and analyzed. If their bodies contain too much barium, it will be a sure sign there's a radioactive leak in the laboratory that must be stopped.

SENSATIONAL

New Training Offer!

NOW you build and keep a top quality

TELEVISION

RECEIVER

to help you prepare for a real job in

TELEVISION

RADIO-ELECTRONICS



Choice of 10, 12 or 16 INCH TELEVISION PICTURE TUBE

Now you can get this amazingly practical aid for learning Television at home, to help you get started toward **FASCINATING WORK... GOOD MONEY... a THRILLING FUTURE** — in a real job, or your own sales and service business. • When you complete our regular home training—described below—you can build and keep a top quality commercial-type Television Receiver. Standardized chassis is adaptable for a 10, 12 or 16 inch direct view tube that gives big, bright, sharp, steady pictures. This is an optional training advantage — designed to provide the utmost in practical "learn-by-doing" home training in Television. Mail coupon for complete details. See why you owe it to your "Television Future" to enroll for DeForest's Training, Inc.

Mail Coupon NOW for FREE Information!

See how D.T.I.'s amazingly effective methods help start you toward a **GOOD JOB** or your **OWN BUSINESS** in one of America's most promising fields — including Television, F. M. Radio, Aviation, Train, and Taxi Radio, Broadcast Radio, Industrial Electronics. Get modern lessons... plus 16 shipments of Radio-Electronic parts. Work over 300 experiments and projects — including building of (1) commercial-type **OSCILLOSCOPE** for practical T-V circuit training, (2) double-range **R-F SIGNAL GENERATOR**, (3) jewel-bearing **MULTIMETER**, (4) quality 6-tube **SUPERHET RADIO**. Then build and keep that big new Television Receiver. Here's **EVERYTHING YOU NEED** for real laboratory-type training... **AT HOME!**

YOU ALSO BUILD AND KEEP THIS PROFESSIONAL TYPE EQUIPMENT!



Modern Chicago Laboratories

★ If you prefer, you can get ALL your preparation in our new, Chicago training laboratories... one of the finest of its kind. Ample instructors... modern equipment. Write for details!

Employment Service

★ When you complete your training, our effective Employment Service helps you get started toward a real future in Television — Radio — Electronics.



You also use **HOME MOVIES!** a D. T. I. Exclusive!

D. T. I. alone includes the modern, visual training aid... **MOVIES**... to help you learn faster, easier at home. See electrons on the march and other fascinating "hidden action" — a remarkable home training advantage that speeds your progress.

MAIL THIS COUPON TODAY!

DeFOREST'S TRAINING, INC.
2533 North Ashland Avenue, Dept. PM-F10
Chicago 14, Illinois

Without obligation, give me complete facts showing how I may make my start in Television-Radio-Electronics.

Name _____ Age _____
Street _____ Apt. _____
City _____ Zone _____ State _____

De FOREST'S TRAINING, INC.

CHICAGO 14, ILLINOIS
A DE VRY Institution



IS THERE *Life* ON OTHER PLANETS?

Strange Cosmic Forces

HAVE YOU EVER, in the stillness of night, gazed at the heavens overhead? If so, you may have wondered if there are living things—perhaps human beings—moving about on the numerous worlds in the vast reaches of space. Do you know that the entire universe is *alive*, vibrant with an intelligence and an energy that can be harnessed by man on earth?

What is more important, is that this Cosmic mind-force is also *within you*. You can use it to become more positive, vibrant, and exuberant with ideas—to achieve greater things in life.

Write for **FREE** Book

The Rosicrucians (NOT a religious organization) have for centuries investigated and preserved the unusual facts about the mysteries of life and of the universe. These truths they make available to sincere seekers *everywhere*, without discrimination. They offer you a **FREE** book, *The Mastery of Life*, which tells how you can learn to remake your life by converting hopes into realities. For your free copy, write *today* to:

Scribe L.X.C.

The **ROSICRUCIANS (AMORC)**
San Jose, California

Now YOU-TOO-Can Be a "WHIZ" on ANY AUTO REPAIR JOB!

Free 7-DAY OFFER!



"MoToR's Manual paid for itself on the first two jobs and saved me valuable time by eliminating 'guess work.'"
— WILSON J. SCHROEP, Akron, Ohio



"Fixed motor another mechanic had worked on half a day. With your Manual I did it in 30 minutes."
— CURTIS AUBERRY, Murfreesboro, Tenn.



"I have done jobs with this Manual that I would not have attempted without it."
— C. L. V. A. N. E. R. STROM, Hazel Park, Mich.

HERE'S the book YOU need to "whiz through" any repair job on any car built from 1935 thru 1949—including those "ornery" extra-hard jobs that give other mechanics such a headache.

THOUSANDS of men like the three above are letting MoToR's brand-new **AUTO REPAIR MANUAL** help them "lick" even the toughest repair problems—in LESS TIME, with LESS work and MORE profits!

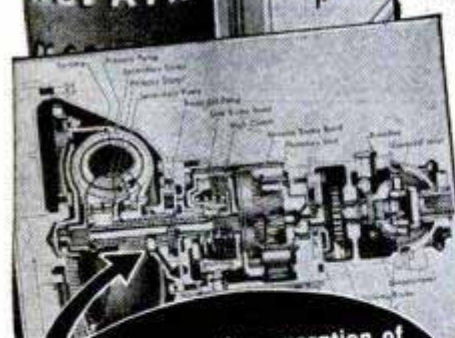

ABOVE: Showing operation of Buick Dyna-Flow—and, BELOW: How to adjust Ford Clutch. Every moving part is covered in simple words and BIG, CLEAR Pictures.

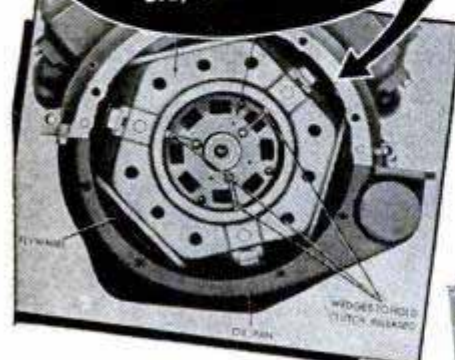

- COVERS ANY CAR BUILT SINCE 1935!**
- Auburn
 - Austin
 - Buick
 - Cadillac
 - Chevrolet
 - Chrysler
 - Cord
 - Crosley
 - De Soto
 - Dodge
 - Ford
 - Fraser
 - Graham
 - Hudson
 - Hupmobile
 - Kaiser
 - Lafayette
 - La Salle
 - Lincoln
 - Mercury
 - Oldsmobile
 - Nash
 - Packard
 - Pierce
 - Arrow
 - Plymouth
 - Pontiac
 - Reo
 - Studebaker
 - Terraplane
 - Willys

Complete "How-To-Do-It"

Now let these 200,000 factory-correct instructions and facts, 2100 "how-to-do-it" pictures, 200 "quick-check" charts and tables, go to work for YOU! With them you can repair anything from carburetor to rear end, Ford or Cadillac, shaly '35 model to shining '49—quickly, easily, right!

Just look up make, model, job in quick index; then let official step-by-step instructions, "boiled down" from 150 auto manufacturers' factory shop manuals, show you how! Thick binding, 8½ x 11 inches, 795 big pages.

SEND NO MONEY

Find out for yourself how this book can pay for itself first few days you use it. Try it FREE 7 days! Just mail coupon. Pay postman nothing. Put Manual to actual test. Then if not entirely satisfied with it, return book in 7 days, pay nothing. Mail coupon today! MoToR Book Dept., Desk 110, 250 West 55th Street, New York 19, N. Y.



Same FREE Offer on MoToR's TRUCK MANUAL

Covers EVERY job on EVERY truck made from 1936 thru 1948! 1400 pictures, 952 pages, 300,000 facts. All types Gasoline Engines, Truck Diesels, Hesselmanns, Fuel Systems, Governors, Lubrication, Ignition, Starters, Clutches, Axles, Brakes, etc., etc.

ALSO covers many buses, tractors, contractor and road building equipment, stationary power machinery. Check box in coupon.

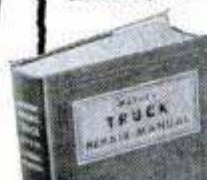

MAIL COUPON NOW FOR 7-DAY FREE TRIAL

MoToR BOOK DEPT.
Desk 110, 250 W. 55th St., New York 19, N. Y.

Rush to me at once (check box opposite book you want):

MoToR's New **AUTO REPAIR MANUAL**. If O.K., I will remit \$1 in 7 days (plus 35c delivery charges), \$2 monthly for 2 months and a final payment of 95c one month after that. Otherwise I will return the book postpaid in 7 days. (Foreign price, remit \$8 cash with order.)

MoToR's **TRUCK REPAIR MANUAL**. (Described at left.) If O.K., I will remit \$2 in 7 days, and \$2 monthly for 3 months, plus 35c delivery charges with final payment. Otherwise I will return book postpaid in 7 days. (Foreign price, remit \$10 cash with order.)

Print Name..... Age.....

Print Address

City..... State.....

Check box and save 35c delivery charge by enclosing WITH coupon entire payment of \$5.95 for Auto Repair Manual (or \$8 for Truck Repair Manual). Same 7-day return-refund privilege applies.



Published by MoToR, The Leading Automotive Business Magazine

FREE
ALLIED'S
NEW 1950
RADIO
CATALOG!



SEND FOR THIS
 196-PAGE BOOK

Save on Everything in Radio



**Get Radio's Leading
 Buying Guide!**

Get everything you need from the world's largest radio supply house—and save money on every purchase! ALLIED's new 196-page 1950 Buying Guide offers widest selections of top quality equipment—ready for speedy, dependable shipment at lowest prices. Have the advantages of expert, friendly service, and guaranteed satisfaction on every purchase. To get more for your radio dollar, send today for your FREE 1950 ALLIED Catalog, the preferred Buying Guide to everything in radio and electronics.



- BUILDERS' KITS
- TELEVISION SETS
- HI-FIDELITY SOUND
- AMATEUR GEAR
- THOUSANDS OF PARTS
- TUBES, TOOLS, TESTERS
- BOOKS & DIAGRAMS

Everything for
 Servicemen, Engineers,
 Experimenters, Builders,
 Soundmen, Amateurs

ALLIED RADIO

ALLIED RADIO CORP.
 833 W. Jackson Blvd., Dept. 5-K-9
 Chicago 7, Illinois

Rush FREE 196-Page Catalog

Name.....

Address.....

City.....Zone.....State.....



**What Makes
 an Executive Worth
 \$25,000 a Year?**

EXECUTIVES earn top salaries because they hold the key to profits in any business. They make the plans, policies, decisions vital to success. Executive know-how is the pay-off.

Today's great need is for individuals who understand the complexities of modern business, who can organize, control, coordinate its various functions. To meet this need, Funk & Wagnalls announces its exciting new Reading Course in Executive Technique, prepared by 45 high executives.

FREE BOOKLET ON EXECUTIVE TECHNIQUE outlines essentials. Mailed without obligation; no representative will call. Write to:

FUNK & WAGNALLS, Dept. PM10
 153 East 24th St., New York 10, N. Y.

Be an INVESTIGATOR

JAMES S. BOLAN, FORMER POLICE COMMISSIONER OF NEW YORK CITY offers MEN & WOMEN an attractive opportunity to prepare for a future in *Investigation & Criminology* by comprehensive Home Study Course. Free placement service assists graduates to obtain jobs. APPROVED UNDER G. I. BILL OF RIGHTS. Write for Free Booklet PM.

THE BOLAN ACADEMY, INC.
 EMPIRE STATE BLDG., NEW YORK 1, N. Y.

ELECTRICIANS' SCHOOL

HOUSE AND COMMERCIAL WIRING • MOTOR REPAIR
 AND REWINDING • ELECTRIC REFRIGERATION

Approved for Veterans Training

PENNSYLVANIA INSTITUTE SCHOOL OF ELECTRICITY
 42nd and SPRUCE STS. PHILADELPHIA 4, PENNA.

Become a Doctor of PSYCHOLOGY

Win the degree of Ps.D. Teach the secret of contentment, happiness. Solve mental worries. Experience the revelation of truth. Chartered college. Individual help. Write for FREE book. COLLEGE OF UNIVERSAL TRUTH, 5153-B North Clark St., Chicago.

TRAIN TO BE A TOP-NOTCH

DENTAL TECHNICIAN



Day & Evening Courses

FOR A BRIGHTER FUTURE

Study at a modern, well-equipped school under skilled, professional teachers. Approved for Veterans.

KERPEL SCHOOL OF DENTAL TECHNOLOGY—309 S. BROAD ST. PHILADELPHIA 7, PA. — KI 5-6760

Get
Into

RADIO, TELEVISION and ELECTRONICS

Master ALL Phases

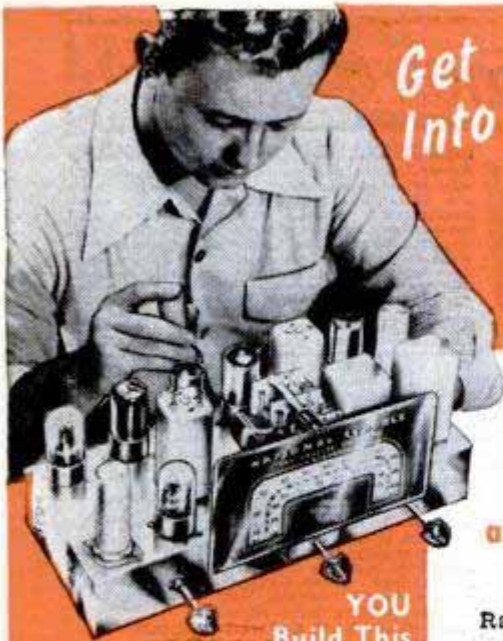

**YOU
Build This
Superheterodyne**

You receive complete standard equipment, including latest type High-Mu Tubes, for building various experimental and test units. You progress step by step until you build a complete Superheterodyne Receiver. It is yours to use and keep.



**YOU RECEIVE THIS
PROFESSIONAL MULTITESTER!**

You will use this professional instrument to locate trouble or make delicate adjustments—at home—on service calls. You will be proud to own this valuable equipment. Complete with test leads.

R. F. OSCILLATOR:

This is one of the interesting units you will build. You learn how audio-frequency energy is generated and radiated by a vacuum-tube circuit.



AUDIO OSCILLATOR:

An electronic device, which produces audio-frequency signals for modulating R.F. (radio frequency) carrier waves, testing A.F. (audio frequency) amplifiers, speakers, etc.



T.R.F. RECEIVER

You build several T.R.F. Receivers, one of which, a 4-tube set, is shown here. You learn construction, alignment, make receiver tests, and do trouble shooting.

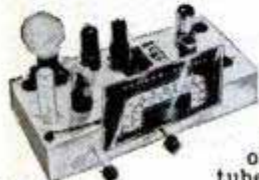

**GOOD PAY
and Unlimited Opportunities
in JOBS LIKE THESE:**

Business of Your Own
Radio Manufacturing, Sales, Service
Broadcasting Telecasting
Television Manufacturing,
Sales, Service
Laboratories: Installation, Maintenance of Electronic Equipment,
Electrolysis, Call Systems
Garages: Auto Radio Sales, Service
Sound Systems and Telephone Companies; Oil Well and Drilling Companies; Engineering Firms
Theatre Sound Systems Police Radio
And scores of other good jobs
in many related fields

**YOU CONDUCT MANY
EXPERIMENTS LIKE THESE!**

Checking action of condensers
Experiments with cathode-ray principles
Experiments with resonance
Producing beat frequencies
Calibrating oscillators
Experiments with diode, grid-bias, grid-leak and infinite impedance detectors
Practical experience in receiver trouble shooting
Application of visual tester in checking parts and circuits
Experiments with inverse feed-back
Advanced trouble-shooting
... and many, many others

Complete Training by Practical Resident Trade School, Est. 1905

The same highly trained faculty, instruction materials and methods used here in our large, modern resident school, are adapted to your training in your own home. Shop Method Home Training has been proved by hundreds of successful graduates.

**Both Resident and Home Study
Courses Offered**

YOU LEARN BY DOING

You receive special laboratory experiment lessons to show you how to build with your own hands various experimental units such as those shown at left, and how to conduct many tests.

**Get Complete Training. You Receive and Keep All
Equipment, Parts and Lessons. No Extra Charges.**

You will find all lessons easy to understand because they are illustrated throughout with clear diagrams and step-by-step examples that you work out yourself. Every piece of the equipment and complete lesson material we send you is yours to keep and enjoy, including the multitester, experimental equipment, all parts of the Superheterodyne, tube manual, radio dictionary, and complete, modern Television texts. All parts are standard equipment.

Shop Method Home Training . . . Earn While You Learn

With our practical resident Shop Method Home Training, you study in your spare time. You receive Spare Time Work Lessons, which show you how to earn while you learn. Service neighbors' radios and TV receivers, appliances, etc., for extra money and experience. Many National students pay all or part of their training with spare time earnings!

**DON'T DELAY! The Radio-Television
Industry needs trained men NOW!**

**APPROVED
FOR
VETERANS!**
Check coupon below!

For quick action,
mail coupon
today and we'll
rush you full information.

Free!

**NEW, ILLUSTRATED
OPPORTUNITY
BOOK AND SAMPLE
LESSON SHOW YOU
HOW WE TRAIN
YOU . . . SEND FOR
THEM TODAY! NO
COST. NO
OBLIGATION.**



NATIONAL SCHOOLS

LOS ANGELES 37, CALIF. • EST. 1905

FIND OUT NOW . . . MAIL COUPON TODAY

National Schools, Dept. 10-PM
4000 South Figueroa Street
Los Angeles 37, California

Send me your FREE book "Your Future in Radio" and the sample lesson of your course. I understand no salesman will call on me.

NAME _____ AGE _____
ADDRESS _____
CITY _____ ZONE _____ STATE _____

Check here if Veteran of World War II

Mail in envelope
or paste on
penny postal.

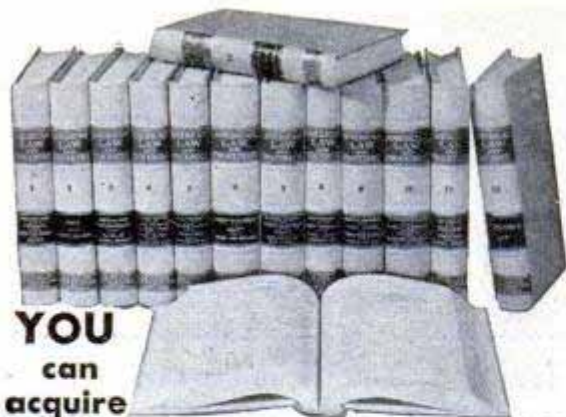

YOU
can
acquire

LAW NIGHTS AT HOME! L. B. DEGREE

LaSalle's famous Law Library—used as reference in many Law libraries and Law offices—has enabled thousands to master Law surprisingly fast, in spare hours at home, for business and professional advancement.

These 14 remarkable volumes, compiled by leading professors and lawyers, cover the whole basic field of Law in condensed, orderly, simplified manner.

You advance rapidly with this great library, plus special lectures furnished. We guide you step-by-step with personalized Problem Method of instruction... you learn by doing—handling legal problems—not by memorizing rules.

Send for two FREE 48-page booklets, "Law Training for Leadership," and "Evidence," answering questions about Law and its value to you, and telling how LaSalle Law graduates are winning rapid advancement in business and public life. Mail coupon below. No obligation.

LA SALLE EXTENSION UNIVERSITY

A Correspondence Institution

417 S. Dearborn St. Dept. 1064-L Chicago 5, ILL.

Send me your two FREE booklets described above, without obligation.

Name..... Age.....

Street.....

City, Zone & State.....

ENGINEERING DEGREE IN 27 MONTHS

Big Demand for Graduates

Aeronautical, Chemical, Civil, Electrical, Mechanical and Radio Engineering (including Television)

Hundreds of young men are earning engineering degrees in this recognized institution each year—continuous operation. New terms start quarterly. Many students earn a major part of their college expenses in this large industrial center.

Low tuition. Competent instruction. Thorough intense practical program. Modern laboratory facilities including new physics lab. and modernized wind tunnel. Individualized instruction emphasized.

Approved for Veterans. Engineering preparatory courses. Students from 48 states and 21 foreign countries. Enter December, March, June or September. Send coupon for free catalog and full information. Enroll now.

SEND COUPON TODAY

INDIANA TECHNICAL COLLEGE

5109 E. Washington Boulevard
Fort Wayne 2, Indiana

Please send me free information on B.S. Engineering Degree in 27 months as checked.

Aeronautical, Chemical, Civil, Electrical,
 Mechanical, Radio-Television.

Name.....

Address.....

10,000 HELPS TO BE YOUR OWN BOSS. IN THIS BIG BOOK!



PRACTICAL IDEAS—QUICK RESULTS
Never before such a book of helps for you who wish extra money quick. In this book are formulas, recipes, secrets that have amazed the world. Use these ideas and make many needed money-making products. Experts wrote this book in simple terms, with supply sources for materials, shortcuts and methods for profitable results.

Included "Knowledge is Power" containing more than 170 sure-fire opportunities to promptly increase income and permanent security.

FREE!

Lots of profitable businesses have started with a single recipe. Choose from the 162,000 facts and 10,000 formulas such as: — Adhesives, Cosmetics, Beverages, Candy, Ceramics, Cheese, Cleaners, Concrete, Dentifrices, Dyes, Depilatories, Enamels, Flavors, Foods, Gum, Home formulas, Inks, Insecticides, Lacquers, Linoleums, Lubricants, Metals, Mirrors, Oils, Ointments, Paints, Perfumes, Plastics, Polishes, Remedies for Man, Beast & Fowl, Soaps, Solders, Varnishes, etc. 1000's of others to make all sorts of profitable items.

WHEN EXTRA \$\$\$ ARE NEEDED

This big book tells what to do and how. No experience needed. You choose from the money-making facts and ideas that are explained in words easily understood. Many fortunes have been made with a single formula. Mail in your order and get started right NOW!

\$3.98 postpaid throughout the world. (C.O.D. plus postage in U. S. only.) Shipped at once.

World-Wide Service — Books on Any Subject

ADAMS BROWN COMPANY, Dept. P109, Boston 67, Mass., U.S.A.



WATCHMAKING

JEWELRY ENGRAVING AND REPAIR

Enter this high-paying, time-honored profession, or prepare for a business of your own. Watchmakers in great demand. More jobs than qualified workers. Study under expert instructors in a long-established, nationally recognized school. Receive recognized diploma and certificate. Placement service. Approved under G. I. Bill. Write for FREE booklet.



The Baronian School, Inc.

2116 WALNUT ST. (DEPT. C) PHILA. 3, PA.

LAW FREE BOOK



Your FREE copy of "The Law-Trained Man" shows how to gain prestige and greater earnings through Blackstone home law study. All instruction material furnished including 18-volume Law Library written by 63 well-known law authorities. Lawyers, judges among our graduates. LL.B. degree. Low cost; easy terms. Write today.

BLACKSTONE COLLEGE OF LAW 225 N. Michigan Ave. Dept. 57, Chicago 1, Ill.

A Correspondence Institution Founded in 1890

STAMMERER?

This new 128-page book, "Stammering, Its Cause and Correction," describing the Bogue Unit Method for scientific correction of stammering and stuttering—successful for 48 years.

Benj. N. Bogue, Dept. 4914, Circle Tower, Indianapolis 4, Ind.



BE A SUPERVISOR

FRANKLIN TECHNICAL INSTITUTE
HELPS YOUNG PEOPLE GET AHEAD



Specialized technical training opens wide the door to well-paid supervisory jobs in industry. 50,000 young men and women have graduated from this Boston school and found good jobs in engineering and technical fields.

Practical two-year day courses in industrial electricity and electronics, industrial chemistry, mechanical and machine design, structural design and architectural drafting, automotive service and management, electric wiring and maintenance. One-year course in professional photography. Also preparatory and evening classes. Approved for veterans. 41st year. Write for catalog.

FRANKLIN TECHNICAL INSTITUTE

43 BERKELEY STREET, BOSTON 16, MASS.

GET INTO

DIESEL-AUTO MECHANICS

Master All Phases

JOB LIKE THESE ARE AVAILABLE TO **TRAINED MECHANICS**. CHOOSE THE FIELD YOU LIKE BEST

Get Complete Training

Diesel Fuel Injection
 Automotive Motor Tune-up
 Diesel Engine Rebuilding
 General Garage Mechanic
 Agricultural Implements
 Auto Engine Rebuilding
 Auto Elec. Service
 Public Utilities
 Parts Dealers
 Bus & Truck Lines
 Industrial Maintenance
 Contracting & Excavating
 Business of Your Own
 AND MANY other similar openings.

As a National Schools graduate, you are trained for ALL opportunities in the Diesel & Auto Industries

EARN WHILE YOU LEARN

With our practical Master Shop-Method Home Training, you study at home in your spare time. You receive Spare Time Work Lessons, which show you how to earn while you Learn . . . for extra money and experience. You Learn by DOING.

TOOLS AND EQUIPMENT

To make your training complete, we give you selected mechanic's tools and equipment, illustrated below, including all-metal toolbox — as a regular part of your instruction.

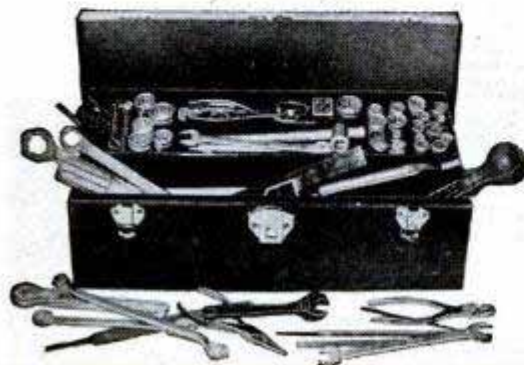

WE GIVE YOU TOOLS OF YOUR TRADE



Shop-Method Home Training by an Established Resident School Prepares you for Many Good Jobs

Opportunity is everywhere for the trained Diesel-Auto Mechanic. Highways throng with cars, busses, trucks, tractors. Garages and Service Stations are kept busy. Factories, ships, farms, railroads, general industry, are dependent upon engine power. Here's a dynamic, fast-growing field that needs trained men who know ALL phases: installation, operation, maintenance and repair. Now—National Schools offers you a practical, all-embracing Diesel-Auto Mechanic's Course, including all of these advantages:

Complete training, covering—Diesels, High Speed and Heavy Duty; Semi-Diesels, Gasoline and Special Fuel Engines AND Allied Mechanics.

- Basic Lesson Texts
- Diesel Installation
- Operation - Maintenance
- Diesel Chart Manual
- Spare Time Lessons
- Engine Service Manuals
- Engine Repair
- Drive Systems
- Diesel Electric Power
- Thermodynamics

TOOLS AND EQUIPMENT

INVESTIGATE

Secure Full Information

NEW, ILLUSTRATED BOOK & SAMPLE LESSON SHOW HOW WE TRAIN YOU . . . SEND FOR THEM TODAY!



NO COST

NO OBLIGATION

APPROVED FOR VETERANS

Check coupon below

NATIONAL SCHOOLS

LOS ANGELES 37, CALIF. • EST. 1905



FIND OUT NOW... MAIL COUPON TODAY

NATIONAL SCHOOLS, DEPT. 10-PMD
4000 South Figueroa Street
Los Angeles 37, California

(Mail in envelope or paste on penny postcard)

Mail me FREE the book, YOUR FUTURE IN DIESEL-AUTO MECHANICS, together with the Sample Lesson. I understand I may keep and use the information with no obligation.

Name _____ Age _____

Address _____

City _____ Zone _____ State _____

Check here if Veteran of World War II

9 BIG BUILDING BOOKS

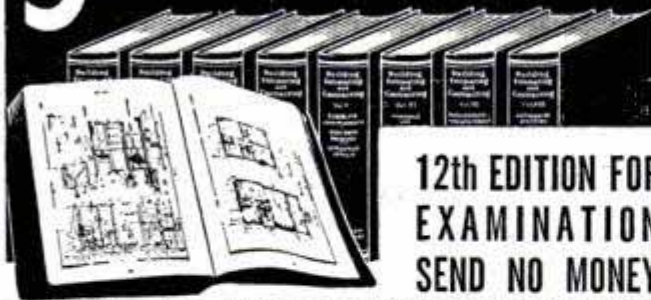

12th EDITION FOR EXAMINATION SEND NO MONEY

Learn to draw plans, estimate, be a live-wire builder, do remodeling, contracting. These 9 practical, profusely illustrated books cover subjects that will help you to get more work and make more money. Masonry, concrete forms, carpentry, steel square, roof framing, construction, plumbing, heating, painting, decorating and many other subjects. More than 4000 pages—2750 illustrations.

BETTER JOBS — BETTER PAY UP-TO-DATE EDITION
 A nationwide building boom is in full swing and trained men are needed. Big opportunities are always for MEN WHO KNOW HOW. These books supply quick, easily understood training and handy, permanent reference information that helps solve building problems. These books are the most up-to-date and complete we have ever published on these many subjects.

Coupon Brings Nine Big Books for Examination

AMERICAN TECHNICAL SOCIETY—Publishers since 1898
 Dept. G719 Drexel at 58th Street Chicago 37, Ill.
 You may ship me the Up-to-Date edition of your nine big books, "Building, Estimating and Contracting," without any obligation to buy. I will pay the delivery charges only, and if fully satisfied in ten days, I will send you \$2.00, and after that only \$3.00 a month, until the total price of only \$34.80 is paid. I am not obligated in any way unless I keep the books.

Name _____
 Address _____
 City _____ State _____
 Please attach a letter stating your age, occupation, employer's name and address, and name and address of at least one business man as a reference. Men in service, also please give home address.

EARN MORE MONEY IN ELECTRICITY!

with APPLIED PRACTICAL ELECTRICITY



Coyne's new set helps men get ahead in Electricity. 8 great books give you complete A to Z know-how, explained in easy-to-follow language with hundreds of charts, examples, pictures. Covers all branches of electricity including appliance repairing; AC and DC equipment; electrical refrigeration; industrial electronics and much more. Brings you 10,500 electrical facts; 3,400 subjects; hundreds of wiring diagrams, tables, formulae, shortcut methods. Backed by 50 years of Coyne experience in training that has put hundreds of men on the road to top earnings.

Sent on FREE TRIAL

USE SET FREE FOR 7 DAYS!

You have to SEE these books to know how much they'll help you. See them FREE! Just fill out coupon below and mail it in. SEND NO MONEY. Examine the set for 7 days AT OUR RISK!

HANDBOOK OF RESIDENTIAL WIRING FREE FOR PROMPT ACTION



Act promptly and we will include FREE, the valuable new booklet, "Handbook of Residential Wiring Design." If you return the Set at our expense in 7 days, you owe nothing. To keep Set, send either \$23.75 in cash or \$3.00 after 7 days and \$3.00 per month until \$25.50 is paid. Either way, you keep the Residential Wiring Book FREE! Coupon below is just a request to see APPLIED ELECTRICITY Set and to get FREE Wiring Book for doing so. Mail coupon AT ONCE!

FREE TRIAL COUPON—MAIL NOW!

Educational Book Publishing Division,
 COYNE ELECTRICAL & RADIO SCHOOL,
 500 S. Paulina St., Dept. 79-R6, Chicago 12, Ill.
 YES! Send Coyne's new, 8 volume set, "Applied Practical Electricity" to me, postpaid, for 7 days FREE TRIAL, per your offer. Include "Handbook of Residential Wiring" FREE.
 Name _____ Age _____
 Address _____
 Town _____ Zone _____ State _____

Command Bigger Money! STUDY LAW

STUDY AT HOME for BUSINESS SUCCESS and LARGER PERSONAL EARNINGS. 40 years expert instruction — over 114,000 students enrolled. LL.B. Degree awarded. All text material furnished. Easy payment plan. Send now for FREE BOOK — "Law and Executive Guidance." It explains the course — how you may enroll and the many ways you can profit from Law Study, Write TODAY to: (GI Approved)

AMERICAN EXTENSION SCHOOL OF LAW
 Dept. 19-PM, 646 N. Michigan Ave., Chicago 11, Ill.

LEARN TO WRITE a Good Hand!

FOR BUSINESS AND SOCIAL SUCCESS!
 Easy to improve your handwriting at home quickly with my new instruction books just off the press. Master all the secrets of better penmanship. Simple and easy, fully illustrated, highly endorsed. Begin today. Write for: New Free Book, "How to Become a Good Penman," or check books wanted, \$1.00 each. Business Writing Artistic Writing Card Writing Engraving Alphabets Bird and Design Flourishing Complete Set \$4.50 Enclose 10c for your name beautifully written and special penpoint for shaded writing. S. A. Ziller, President, TAMBLYN SCHOOL OF PENMANSHIP, 441 Ridge Bldg. In Business Over 52 Years Kansas City, Mo., U.S.A.

MAKE EXTRA MONEY Samples on Approval
SELL NEW SENSATIONAL CHRISTMAS CARDS 50 for \$1, 25 for \$1
 It's easy! Make up to 50% commission. Sell them to your friends, neighbors or fellow workers. 21 card assortments that sell on sight. Most beautiful cards ever designed.
LIBERTY BELL STUDIOS
 Dept. J-1—1013 Filbert St., Phila. 7, Pa.
 With name imprinted FREE SAMPLES

LEARN MEAT CUTTING

through actual practice. Profitable Meat Cutting and Self Service Meats taught easily, quickly, LEARN BY DOING at Toledo in just eight short weeks under actual market conditions. For beginners or men with experience. All subjects taught thoroughly and completely. Diploma, Job help. Get store of own. People must eat. School in operation over 25 years. Approved for GI training. Send today for FREE illustrated catalog. No obligation.
NATIONAL SCHOOL OF MEAT CUTTING, Dept. 50-5, Toledo 4, Ohio

STRENGTHEN Your VOICE!

YES—you can now build yourself a powerful speaking and singing voice with this amazing new scientifically sound tested method. Self-training . . . no music or piano required. Results GUARANTEED. Just send your name for the sensational details. FREE chart of your vocal mechanism included! Please state your age.
PERFECT VOICE INSTITUTE, Studio K-2, 1141 S. Wabash Ave., Chicago 5, Ill.

Learn WOOD PRODUCTION ENGINEERING

VETERANS training is FREE under G. I. BILL
GET THIS FREE BOOK Today

It tells you how you can learn to become a successful **WOOD PRODUCTION ENGINEER . . .** by the Klok Home Study Correspondence Method . . . or by studying here in Grand Rapids in our Resident School . . . Training in **WOOD PRODUCTION ENGINEERING** offers you great opportunities . . . either to get a top position or to operate your own plant successfully.



The Klok Course teaches you **SKETCHING, ROD-MAKING, DETAILING, STOCK BILLING, TIME STUDY, COST and MANAGEMENT.**
 WRITE FOR FREE BOOK TODAY! State preference whether Home Study or Resident course, with name, age, occupation and if veteran.

KLOK INSTITUTE
 LOUIS ST., N.W.
 GRAND RAPIDS, MICHIGAN

NOW! TRAIN FOR BIG PAY IN AUTO BODY and FENDER REPAIR

NEW, "PERSONALIZED" U. E. I. SERVICE BRINGS
INSTRUCTOR'S VOICE INTO YOUR HOME ON RECORDS!

TWO BILLION DOLLAR AUTO REPAIR INDUSTRY NEEDS COMPETENT MEN

Before you get set for your future, compare the opportunities in the Auto Servicing field with those in other trades. Look at the size and income of the industry—over two billion dollars spent there in a year, and it's still growing. Talk to experienced Auto Body and Fender men. They'll tell you that they get about the highest pay in the auto repair field, and many are doing well in shops of their own started "on a shoestring". Read your newspaper's "Help Wanted" ads and you'll see that competent Auto Body and Fender men are in great demand. Then get the facts on how easy it is to prepare for these opportunities with UEI.

EASY LISTENING METHOD SPEEDS PROGRESS

Now! UEI offers a brand-new Audio Service as part of its home training method in Auto Body and Fender Repair. It's like having a private instructor's voice in your home—helping you learn metal work, repairing, refinishing, alignment and other fundamentals of the auto body repair trade.

With this sensational development, you hear your instructor's voice on records—always on hand to go over important parts of your step-by-step, richly illustrated home study lessons—repeating detailed explanations—and helping you learn Auto Body and Fender Work faster and easier!

INTENSIVE PRACTICE INCLUDED

Then you can follow this personalized home-study training with actual practice in our big, modern shops. Here you can work on the repairing and finishing of damaged cars, practicing the use of tools, welding, spray painting, etc., under competent, friendly instructors.

GET FREE FACTS TODAY!

If you are ambitious, reliable and mechanically inclined, you should investigate this opportunity. Fill out coupon below and mail today. See how this school, which has helped thousands of men get ahead in specialized careers since 1927, can help you. MAIL COUPON NOW!

UEI AUDIO Home Study Followed By Shop Training;
ALSO G. I. APPROVED RESIDENT CLASSES

Other UEI Training Programs:

DIESEL ENGINES and SCIENTIFIC MOTOR TUNE-UP
Engine operation, fuel systems, auxiliary equipment, repairs, maintenance.

REFRIGERATION Servicing and installation for all commercial and domestic types.

AIR CONDITIONING Installation, operation, and maintenance of home and commercial equipment.

Utilities Engineering Institute
2523 Sheffield Ave., Dept. XC-4, Chicago 14, Ill.



UEI AUTOCRAFTS TRAINING PAID OFF HERE

Harold Brooks of Illinois, UEI graduate, started his body and fender business under a tree. Two months later, cars were lined up for repair work. Today he has his own large building and the local DeSoto, Plymouth, Geo Truck dealerships. "My UEI training is behind it all", says Brooks!

One Man's Story

"My business gross per month runs around \$3,000 and I recently bought out my partner. I've been in this place nearly two years now and, even with 4 helpers, I'm booked weeks ahead. I think a lot of UEI training because it gives you the know-how and makes the practical part seem

easy. This is just a start. Some day soon I'll really send you a success story."
STEVE STAHL (Ohio)

How About You?

Take ability, determination, and UEI training—add them up and you see what makes Steve Stahl and Harold Brooks the successes they are today. Do you have what it takes, too?

MAIL COUPON NOW!

UTILITIES ENGINEERING INSTITUTE

Autocrafts Division
2523 Sheffield Ave., Dept. XC-4, Chicago 14, Ill.

O.K.! Rush FREE FACTS about UEI training and the opportunities in:

AUTO BODY & FENDER REPAIR
 REFRIGERATION

DIESEL
 AIR CONDITIONING

Please print NAME _____ AGE _____

ADDRESS _____

CITY _____ ZONE _____ STATE _____

Check here for special information if you are under 17.

New Advertising Machine



PRINTS and ILLUSTRATES

1¢ Post Cards

FREE Learn how thousands of business men, in every line, are boosting sales in spite of conditions—with 1¢ messages—printed and illustrated in a few minutes on gov't post cards—with amazing new patented **CARDMASTER**. Your "today's" ideas, read by your prospects next morning. Not a toy, but a sturdy advertising machine, built to last for years. Low price, sold direct. Guaranteed for five years. Send name today.

SEND NAME We'll send **FREE** illustrated book of money-making **IDEAS** for your business and complete, unique advertising plans. **RUSH YOUR NAME TODAY.**
CARDMASTER COMPANY
 1920 SUNNYSIDE, Dept. 1310, CHICAGO 40, ILL.

SHORTHAND in 6 Weeks at Home

Famous Speedwriting system. No signs; no symbols; no machines; uses ABC's. Easy to learn; easy to write and transcribe. Low cost. 100,000 taught by mail. For business and Civil Service. Also typine. 26th year. Write for free booklet to:

Speedwriting

Dept. 1510-9, 55 W. 42 St., New York 18

TRAIN NOW FOR AN AVIATION CAREER IN SUNNY SOUTHERN CALIFORNIA

MAXIMUM TRAINING IN MINIMUM TIME

Specializing in **AERONAUTICAL ENGINEERING** and **MASTER AVIATION MECHANICS** since 1929. America's Finest Aeronautical Institute. 7000 successful graduates. **MAKE MORE MONEY** MAIL COUPON TODAY APPROVED FOR VETERANS. Board and Room now available.

Without obligation, send free catalogue with full information.

NAME _____ AGE _____ PM-10
 ADDRESS _____
 CITY _____ ZONE _____ STATE _____

CAL-AERO TECHNICAL INSTITUTE
 GRAND CENTRAL AIR TERMINAL • GLENDALE 1, CALIFORNIA

Watch Repairing Pays Big Money Learn at home

Free Literature Tells How

Watchmakers in big demand. You train step-by-step under experts. You learn to take a watch apart—repair and put in perfect working order. 10 easy lessons. We furnish all tools, and a 15 jeweled watch. Practicemovement with first lesson.



Turn spare time into cash—perhaps a business of your own. A licensed school. Students 18 to 65 have profited by our training. Low cost.

Write Today for All the Facts—No Obligation

WATCH REPAIRING Dept. PM-10 2870 Elston Ave. Chicago 18, Ill.



ENGINEERING

Building, Drafting, Etc.

Degree in 27 mos. Approved for G.I. Training. Prepare in Chicago, the Industrial Hub. Earn part living expenses. 45th year. Other shorter courses in Air Conditioning, Refrigeration, Radio, Electricity. Enter Jan., March, July, Sept.

Write for catalog

N-83 TECH BLDG., 2000 S. MICHIGAN AVE., CHICAGO 16

REAL ESTATE BE A BROKER

PAYS BIG! SEND FOR FREE, BIG, ILLUSTRATED CATALOG NOW! No obligation. Graduates report making substantial incomes. Start and run **your own business quickly**. Men, women of all ages, learn easily. Course covers Sales, Property Management, Appraising, Loans, Mortgages, and related subjects. **STUDY AT HOME** or in our classrooms in big cities. Diploma awarded. G.I. approved. Nationally known.

WEAVER SCHOOL OF REAL ESTATE (Est. 1936)
 15 E. Pershing Road Dept. PM-10 Kansas City, Mo.

FR. BOOK TELLS HOW

Is Your Life Crowned With Success?

LEXIPOWER



WE THINK IN WORDS. THOUGHT IS POWER. Let this New Science show you how to **WIN WITH WORDS**—financially, socially, culturally. Develop a **MASTERFUL VOCABULARY**. Influence others, improve your personality, manifest your latent ability. You are judged and rated by every sentence you utter. Start using the **POWER OF LEXIPOWER** after the first Lesson. Write **NOW** for **FREE** details about **LEXIPOWER**. Dime-a-Day **LESSON CLUB**.

LEXIPOWER LESSON CLUB

517-H W. Deming Place Chicago 14, Illinois

Start Your Own Money-Making Business

Clean rugs on customers' floors—upholstery in their homes—even painted walls—with highly efficient electric machines which are making big money for others and giving them independence. Write today for complete information. It's **FREE!**

VON SCHRADER MFG. CO., DPT. 1M, RACINE, WIS.

Say You Saw It in Popular Mechanics

BE STRONG USE BARBELLS



95 POUND SET
 Only \$10.80

Extra Plates 10c pound

We have been selling the finest barbell equipment since 1928. We operate our own foundry and sell direct to you at a very low profit. No other company can match our low prices.

Send for our **FREE Barbell Catalog.**

BUR BARBELL CO.
 LYNDBURST 22
 NEW JERSEY

HOW TO DO WONDERS ON AN ACRE!

YOU don't have to pay a small fortune or buy a large farm to make your dream of a practical country home come true. *All you need is a little land!* The "Have-More" Plan shows you how to transform as little as one acre into the best and happiest living any family could want. And you can make that acre *pay for itself!*

You'll be amazed what you can do today on a little land—even in your spare time! You can have a bearing orchard with a fruit crop in just 18 months! You can raise a year's supply of tender chickens in 9 weeks—in a 3x4 foot space. You can raise a pig without buying feed. You can own a small greenhouse—one that anybody can afford—that waters plants and controls heat automatically.

And the best part of it is that you can enjoy this wonderful new way of living on less than \$100 a month. Just a small income—from your Social Security or a part-time job, or a pension—and you can live like a king for the rest of your life!

Ed and Carolyn Robinson have spent six years gathering the newest and best knowledge for you, experimenting at their own little place, "trading" methods and ideas with experts and amateurs all over the world. (Perhaps you've seen the stories about their 2-acre "miniature" farm in the *Saturday Evening Post*, *Reader's Digest*, *Better Homes and Gardens*, etc.) Now let their famous "Have-More" Plan show you how to HAVE MORE in every way on YOUR place!

Everything You'll Ever Need to Know About Successful Country Living!
If you have a garden, farm, or country

home, you'll certainly want a copy of this wonder book. *Reader's Digest* calls it "Good news for the millions who have or want a couple of acres in the country." Or, if you're cooped up in the city, tired of noise, dirt, and high costs, you'll want to see how easily you can afford a little land in the nearby countryside, where you and your wife and children can really begin to live. The Robinsons did. So can you! The "Have-More" Plan tells you just how—step-by-step!

Now You Don't Need a BIG Income to Retire

The "Have-More" Plan will show you just how to pick the right place, how to lay out your grounds and design your house, how to raise much of your food, how to stretch your retirement income into the best and happiest life anyone could want!

Act Now!

Don't hesitate. Make the most of that country place you now have—or expect to have. The "Have-More" Plan will save you endless trouble and expense, solve a thousand problems and answer countless important questions for you. It costs only \$1—**BUT FIRST WE WANT YOU TO EXAMINE IT FREE.** You get complete satisfaction or **DOUBLE** your money back! Mail coupon NOW! **The Country Bookstore, P. O. Box 2710, Noroton, Conn.**



Examine It FREE!
Only \$100 if you decide to keep it

43 Chapters! 255 Illustrations! 70,000 Words! More Than 300,000 Copies Sold!

Same Plan You've Read So Much About

SATURDAY EVENING POST: "To country-minded families with growing children, to couples looking to retirement, the 'Have-More' Plan presents an exciting possibility and a way to achieve it."

READER'S DIGEST: "The 'Have-More' Plan 'a little land... a lot of living,' is the slogan of this energetic young couple who have made a suburban farm pay."

ESQUIRE: "Buy the book. Read the 'Have-More' Plan—give your future a break with this practical, sane approach to intelligent living."

BETTER HOMES AND GARDENS: "Live better on two acres... the 'Have-More' Plan gives practical details and diagrams."

ALL THIS EXPERT ADVICE AND MORE—YOURS FOR ONLY \$1.00

Houses Especially Designed For Country Living
Score Card for Buying Country Property
Your Own Fresh Eggs and Chickens
Scientific Layouts for Small Acreage
Landscaping Your Place
A Better Garden with a Lot Less Work
Quick Freezing is Easy!
Raising Rabbits
Bees for Sugar

Berries and Grapes Money Can't Buy!
Your Miniature Dairy
Keep Pigs On Concrete
Plans For An Ideal Small Barn
Dwarf Fruit Trees
Geese, Turkeys, Ducks
Baby Tractors
Your Own Work Shop
Ham, Bacon, Pork— a Few Cents a Pound
Grow Your Own Fish!

SEND NO MONEY (Unless You Prefer To)

Mail This Coupon NOW

to THE COUNTRY BOOKSTORE, P. O. Box 2710, Noroton, Conn.

Send me the "Have-More" Plan. If I keep it, I'll send one dollar, plus ten cents for postage, packing, handling. If it doesn't please me, I'll send it back, owe you nothing.

YOUR NAME _____

ADDRESS _____

CITY _____ Zone No. _____ STATE _____
(if any)

If you send a dollar now, that will save us record keeping and save YOU the ten cent shipping charge. We'll give you DOUBLE your money back if you return the plan in 10 days! That's how sure we are you'll like it!

INVENTORS

When you are satisfied that you have invented a matter of value—write me, without obligation, for full information as to what steps you should take to secure a Patent.

The usual first step is to have a search of the prior U. S. Patents conducted, so that I can report to you on the question of Patentability.

PATRICK D. BEAVERS

(Formerly RANDOLPH & BEAVERS)
Registered Patent Attorney

934 Columbian Building Washington 1, D. C.

PATRICK D. BEAVERS, Registered Patent Atty.
934 Columbian Bldg., Washington 1, D. C.

Please send me full information on how to secure Patent Protection and Trademark Registration.

Name _____

Street _____

City _____ State _____

HIGHEST ROYALTIES and CASH FOR YOUR INVENTIONS

Write for FREE booklet without obligation
UNIVERSAL MARKETING CO.

354 S. Spring St. (Suite M) Los Angeles 13, Calif.

STEP OUT FOR EASIER WINDOW WORK WITH

WINDOSTEP



Makes all outside window work easy & enjoyable!

SAVES TIME • SAVES MONEY SAVES LADDER-LIFTING!

HELPS YOU Wash windows . . . Hang screens, storm windows & awnings . . . Paint, putty & repair.
IT'S STRONG . . . Supports 1000 lbs.
IT'S STURDY . . . Has steel rail & wood platform.



IT'S PORTABLE . . . Easy to carry . . . Weighs 11 lbs.

IT'S AUTOMATICALLY GRAVITY LOCKED to window sill from inside. (It's installed from inside.)

IT'S GUARANTEED

Or Your Money Back!
Low priced, only \$9.85
Plus C.O.D. & P.P. or \$10.50
Prepaid. Add 50c west of Rockies. Dealer Inquiries Invited. Patent Pending

MORRISON CRAFTERS INC.

711 Miami St., Toledo 5, Ohio

ORDER TODAY!

For Better Housekeeping, Your Home needs a WINDOSTEP!

INVENTING

—FOR PROFIT! If you have an inventive turn of mind, write for free 28-page booklet explaining how the Institute of American Inventors is helping inventors pre-test the profit possibilities of proposed devices to fill today's unprecedented demand for useful new inventions.

INSTITUTE OF AMERICAN INVENTORS

Dept. 4, 1926 Eye St., NW, Washington 6, D. C.

PATENTS AND TRADE MARKS

C. A. SNOW & CO.

REGISTERED PATENT ATTORNEYS

WRITE FOR INFORMATION TO

428 SNOW BUILDING, WASHINGTON 1, D. C.

TRADE MARKS • COPYRIGHTS •

PATENTS

The Time to Contact a Patent Attorney is Promptly After You Have Finished Your Invention

Write for FREE "INVENTOR'S GUIDE" & "Record of Invention"

FRANK LEDERMANN Registered Patent Attorney

154 Nassau St. • 20th Floor • New York 7, N. Y.

INVENTORS

Whether an invention is patentable can be substantially determined by a search of the U. S. Patent records. Without obligation, write for information explaining the steps you should take to secure a patent.

JOHN N. RANDOLPH

Registered Patent Attorney

201 Columbian Building, Washington 1, D. C.

PATENTS PATENT LAWYER

TRADE MARKS

GUSTAVE MILLER
109-PM WARNER BLDG.
WASHINGTON 4, D. C.

ASSOCIATE EXAMINER

U. S. PATENT OFFICE 1922-1929
REGISTERED PATENT ATTORNEY
Send for Form "INVENTOR'S RECORD"

PATENTS

"Proof of Invention" Folder mailed without obligation.

E. E. VROOMAN, Registered Patent Atty.

505 McKim Building, Washington 5, D. C.

BE A DETECTIVE

WORK HOME or TRAVEL. Experience unnecessary.
DETECTIVE Particulars FREE. Write to **GEO. P. M. WAGNER, 125 W. 86th St., N. Y.**

INVENTORS

IF YOU WISH TO PROTECT YOUR INVENTION, You should take steps to protect it by a U. S. Patent. Write me for "Record of Invention" form.

CARL MILLER REGISTERED PATENT ATTORNEY

Woolworth Bldg., 35th Floor, Dept. 109A, New York City
Please send me "Record of Invention" form.

NAME _____

ADDRESS _____

**YOU BUILD THIS
23-TUBE
TELEVISION
RECEIVER**

NOW!

**FOR THE FIRST TIME YOU CAN GET
Real Practical HOME TRAINING In**

TELEVISION

RADIO AND ELECTRONICS

**PREPARE YOURSELF FOR A
PROFITABLE Fascinating FUTURE**

**RTS GIVES YOU
11 BIG KITS**

of TELEVISION and RADIO PARTS

**YOU BUILD A TRF RADIO
RECEIVER PLUS MANY OTHER
PRACTICAL JOBS & EXPERIMENTS**

**YOU WORK AND LEARN
WITH REAL TELEVISION
AND RADIO EQUIPMENT**

RADIO-TELEVISION TRAINING SCHOOL's master Technicians guide you. Located in the very heart of America's Television, Broadcasting, Radio and Sound Industries, RTS is right "on-the-spot" where new technical improvements are first introduced; is in the best possible position to bring students ACTUAL METHODS and practices developed by the RADIO-TELEVISION industry, leading to real money making opportunities. The 11 BIG KITS RTS gives you enable you to do many practical jobs, build the equipment illustrated; perform more than 100 other fascinating, valuable experiments. These jobs you do give you ACTUAL SHOP experience so vitally necessary to your future success. Thus RTS methods assure you BALANCED TRAINING—Theory PLUS Real Experience.

**OPPORTUNITIES NOW
WIDE OPEN FOR
Properly Trained Men**

Latest reports estimate 400 MILLION new television and radio sets will be built in the next 10 years . . . more than 72 million dollars is being spent RIGHT NOW just for radio repairs ALONE! When you are thoroughly trained by RTS Experts—who have their fingers on the pulse of the Radio-Television industry—a field of unlimited opportunities will open up for you in Your Own Radio-Television Sales & Service Business, F.M., Equipment Manufacturing, Communications and allied fields.

**EARN EXTRA MONEY
while learning at HOME**

Under the RTS amazingly easy, practical home-training plan there is no need for you to quit your present job. You study in SPARE TIME ONLY! RTS Experts show you how

to earn WELCOME EXTRA CASH, EVEN BEFORE FINISHING YOUR TRAINING! In fact, when friends and neighbors know you are studying Radio-Television you may—like many RTS students—actually get MORE REPAIR WORK THAN YOU CAN HANDLE.

**27 YEAR
SUCCESS RECORD**

Backed by over a quarter-century of experience in home training, RTS (formerly Radio Training Association of America) offers practical "Learn-by-doing" methods, assuring you quick step-by-step progress. Begin preparing for your future in Radio-Television now while the time is ripe. If you are at all mechanically inclined—and have a grammar school education, RTS can teach you how to MAKE GOOD in Radio-Television.

GET THE FACTS

Send for FREE BOOK which tells you all about the RTS "time-tested" home-training plan, developed by technicians in the heart of the Radio-Television field. Fill out the coupon now—TODAY! and your FREE BOOK entitled "How To Make Good in Radio-Television" will go out to you AT ONCE. No Obligation. No salesman will call. ACT NOW!

**YOU BUILD THIS
6-TUBE STANDARD
RADIO SET with
SHORT WAVE
CONVERTER**

**★
SEND
FOR THIS
30-PAGE
FREE
BOOK
★**



**YOU
KEEP ALL
EQUIPMENT
—it's Yours!**

RADIO-TELEVISION TRAINING SCHOOL

5100 SO. VERMONT AVE., LOS ANGELES 37, CALIF., U.S.A.

ESTABLISHED 1922 — 27 YEARS AGO

formerly RADIO TRAINING ASSOCIATION of AMERICA

RADIO-TELEVISION TRAINING SCHOOL, DEPT. 10-PM
5100 South Vermont Avenue, Los Angeles 37, Calif., U.S.A.

Send FREE Illustrated Book showing how I can make good in TELEVISION and Radio through training under the guidance of expert RTS Technicians. No obligation. (No Salesman will call).

NAME _____ AGE _____
St. & No. _____
CITY _____ ZONE _____
STATE _____

Secure YOUR FUTURE with 3 CAREERS IN 1



WATCHMAKING • JEWELRY- ENGRAVING • STONE SETTING •

Each trade can be a full-time job; together they assure numerous high paying opportunities, or a business of your own. Profit by the *Nationally Recognized Training Methods of the Kansas City School of Watchmaking.* Write today.

Clip and Mail this Coupon Today

KANSAS CITY SCHOOL OF WATCHMAKING
1218 Admiral Blvd.
Kansas City 6, Missouri

Please send me, without obligation, complete information on training in the above courses.

Name _____

Street _____

City _____ State _____

Check if Veteran G. I. Approved

Learn this Profitable Profession



**IN 90 DAYS
AT HOME**

Money-Making Career Open to Men and Women, 18 to 50

Hundreds of men and women between 18 and 50 make \$10 to \$20 in a single day giving scientific Swedish Massage and Hydro-Therapy treatments. There is big demand from doctors, hospitals, sanatoriums and clubs. Graduates earn large full time incomes from these or in private practice in their own offices. Others make good money from home treatments given in spare time. Learn this interesting, money-making profession in your own home, through our home study course. Same instructors as in our nationally known resident school. You can win independence and prepare for future security by qualifying for your Diploma. Course can be completed in 3 to 4 months. Many earn while they learn. Begin your training at once.



Anatomy Charts & Booklet FREE

Enroll now and we will include, at no extra cost, many needed supplies. Fit yourself to help meet growing demand for Scientific Swedish Massage. Send the coupon at once for complete details. Anatomy Charts and 32-Page Illustrated Booklet, FREE, postpaid.

THE COLLEGE OF SWEDISH MASSAGE

Dept. 964M, 41 E. Pearson, Chicago 11, Illinois

Please send me FREE and postpaid, Anatomy Charts, 32-page Booklet and complete details on Home Training.

Name _____ Age _____

Address _____

City _____ State _____

FEET HURT?

Try DR. BARRON'S
New FOOT
CUSHIONS

HELPS WHERE
IT HURTS!

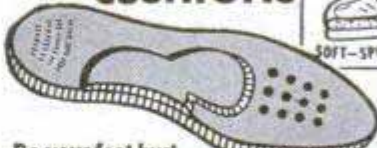

LIKE WALKING
ON A PILLOW!

Do your feet hurt

when you walk or stand? Dr. Barron's NEW FOOT CUSHIONS give blessed relief! Take painful pressure off CORNS, CALLOUSES, SORE HEELS, ACHING ARCHES. CUSHION and relieve sore, painful spots on soles of your feet — help support WEAK ARCHES, absorb foot and body shocks. Light, spongy, ventilated. Wear in any shoes. Get QUICK RELIEF from HEEL TO TOES. Dr. Barron says: "Wonderful for tired, aching feet." Happy customer writes: "The calloused places have disappeared... arches are now strong as ever... I can walk or stand for hours." — T. S. Commerce, Texas. SEND NO MONEY! Pay postman \$1.98 for PAIR plus postage (or send \$1.98, we pay postage). STATE SHOE SIZE AND IF MAN OR WOMAN. 30-DAY TRIAL GUARANTEE. Money back if no blessed relief! FREE — Dr. Barron's "FOOT HEALTH ADVICE" sent with order, to help keep your feet healthy. Beware of imitations! Get GENUINE Dr. Barron's Foot Cushions. ORDER NOW! ORTHO, Inc., Dept. 49M, 2700 Broadway, N. Y. 25, N. Y.

ANY BOOK IN PRINT

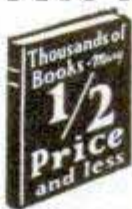

Delivered at your door. We pay postage. Standard authors, new books, popular editions, fiction, reference, medical, mechanical, children's books, etc. Guaranteed savings. Send for Clarkson's 1950 catalog.

FREE Write for our great illustrated book catalog. A short course in literature. The buying guide of 300,000 book lovers. The answer to your Christmas gift problem. Free if you write now—today!

CLARKSON PUBLISHING COMPANY

Dept. PM9, 1257 So. Wabash Ave., Chicago, Ill.

Free Book



RAISE HAMSTERS

The new wonder animals from Syria. Often called Toy Bears. Delightful pets. Everyone wants them. Laboratories need thousands. Clean, odorless. Raise anywhere. A profitable and interesting hobby or business. We furnish breeding stock with manual of instructions.

Write today for free illustrated literature.

GULFHAMSTERY, 1536 BASIL, MOBILE, ALA.

NEW! LOW COST! RESPIRATOR

Wear when sanding, grinding, paint spraying, sweeping, dusting, furnace cleaning, etc. Handy as a pair of glasses. Just keep mouth closed and breathe through nose as all you do to operate. Protects against nuisance dusts, lint, coal, cement, grain dust, hay fever pollen. Has 9 sq. in. filter. For EYE protection against paint spray, dusts, gases, fumes, smoke, order our Fog-Proof Rubber GOGGLES \$1.65 p.p. (All prices postpaid in U.S.A.)



Order Today \$1.00 POST PAID

JERRY BRYANT, Dept. PM 919 N. Michigan Ave. Chicago 11, Ill.

SELL NYLONS GUARANTEED AGAINST RUNS!

Amazing guarantee gives FREE nylons if hose runs or snags within guarantee period to 3 months! All weights, sizes etc, including sheerest 15 denier. Not sold in stores. Nationally advertised in Life, Ladies Home Journal, Saturday Evening Post, McCall's, Women's Home Companion. Awarded Seal of Approval by Good Housekeeping. Also complete line of men's fine hosiery guaranteed ONE FULL YEAR or replaced FREE! No money or experience needed to earn big, steady income writing orders spare or full time. We deliver and collect. Advance cash plus huge bonus. Complete money-making sales outfits FREE and prepaid. No obligation. Rush name to: **KENDEX COMPANY, BABYLON, 246, N.Y.**



Specialize in Fields of Opportunity

EVERY course of study at this school is geared to an expanding industry. Here the young man can secure practical, specialized training in various technical fields, plus a solid educational background in the basic sciences. The curricula keeps pace with technological developments and the demands of industry.

BUILD YOUR CAREER IN 6 TO 36 MONTHS . . .

Because of continuous year-round study, a B.S. Degree may be earned in 36 months. The unique concentric curriculum permits the student to pass step-by-step through a 6-month service

course and on to technician and professional levels. Each course is complete in itself and serves as a prerequisite for higher level study in the school.

To Help Plan Your Future, You are Invited to Request This Free 48-Page Pictorial Bulletin

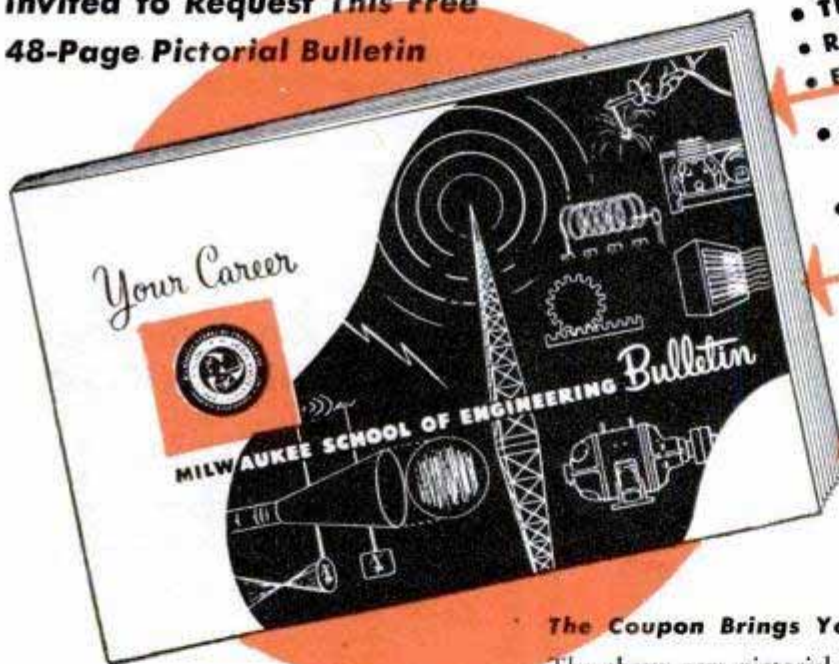

- TELEVISION
- RADIO
- ELECTRONICS
- ELECTRICAL POWER
- ELECTRICAL ENGINEERING
- AIR CONDITIONING
- REFRIGERATION
- HEATING
- WELDING
- METAL FABRICATION

The Coupon Brings You This . . .

The above new pictorial bulletin features 103 action photos of student life, fascinating experiments and well-equipped laboratories. Helpful data is featured on career opportunities in the above mentioned fields.



OVER 1500 STUDENTS are currently enrolled in this non-profit institution. Faculty of 85 specialists. Experts chosen from private business serve on advisory committees. The Board of Regents comprises leaders from commerce and industry. Over 35,000 former students.

ACCREDITATION: The National Council of Technical Schools approves the technician's curricula. Technician courses in the Institute of Electrotechnics are listed by E.C.P.D. Certificates and degrees conferred by authority of the State of Wisconsin Charter.

MILWAUKEE
SCHOOL of ENGINEERING
Founded 1903 by Oscar Werwath

Terms start
Jan., April,
July, Oct.

MILWAUKEE SCHOOL OF ENGINEERING
Dept. PM-1049, N. Broadway & E. State,
Milwaukee, Wis.

Without obligation send me free bulletin "Your Career" and more details on course in

Send 110-Page Catalog

NAME _____ AGE _____

ADDRESS _____

CITY _____ ZONE _____ STATE _____

Check here if World War II Veteran

MORE PAY through HOME STUDY TRAINING in SPARE TIME

Do you want a better position—a larger salary? They are within your reach—now. LaSalle experts will guide you step by step in gaining business training which leads to greater earnings.

The time-saving, interesting LaSalle Problem Method helps you prepare at home, without interference with your present duties.

Simply mark on the coupon the field in which you desire success, and we will mail you a valuable book describing the opportunities in that field—plus "Ten Years' Promotion in One"—a book which has helped many men. Let us tell you how we have started thousands of average men and women on the high road to success and more money. Check and mail the coupon now.

LASALLE EXTENSION UNIVERSITY

A Correspondence Institution

417 S. Dearborn St., Dept. 1064-R, Chicago 5, Ill.

Send me full information regarding the course I have marked—without obligation—plus "Ten Years' Promotion in One."

- | | |
|--|---|
| <input type="checkbox"/> Higher Accountancy | <input type="checkbox"/> Salesmanship |
| <input type="checkbox"/> C.P.A. Coaching | <input type="checkbox"/> Traffic Management |
| <input type="checkbox"/> Bookkeeping | <input type="checkbox"/> Foremanship |
| <input type="checkbox"/> Law: LL.B. Degree | <input type="checkbox"/> Industr'l Management |
| <input type="checkbox"/> Business Management | <input type="checkbox"/> Stenotypy
(Machine Shorthand) |

Name.....Age.....

Address.....

City.....Zone.....State.....

BIG PAY JOBS for men who qualify in DIESEL



ASSURE YOUR FUTURE. Steady, high-pay jobs await men qualified in Diesel, Tractor, and Heavy Equipment. Are you qualified for job and advancement opportunities in this fast-growing field? You can qualify?

COMPLETE DIESEL COURSE NOW AVAILABLE. If you are ambitious and want to get ahead in this big money field, you'll want to know about the complete Diesel home training course now offered by Interstate Training Service. Covers all phases of operation, repair, service. Easy to master in spare time. No interference with present job. Up-to-the-minute. Regularly revised to cover new developments. We invite comparison of material offered. Free placement advisory service.

YOU OWE IT TO YOURSELF to investigate Interstate Training Service Diesel Training. Thousands agree it has helped them to better jobs... better pay. It can do the same for you!

SEND FOR FREE BOOK TODAY!

INTERSTATE TRAINING SERVICE, Portland 13, Ore.

Please see that I receive FREE 24-page book, "Getting Ahead In Diesel." (K-3)



NAME.....AGE.....
ADDRESS.....
CITY.....ZONE.....STATE.....

SHOE REPAIR OFFERS BIG INCOME

LEARN IN 12 WEEKS TIME



You can own your own shop or earn big income as skilled shoe repairman. Growing demand everywhere at top wages for men who know how. We teach you quickly by actually working on shoes and modern machines. School open to all from 18 to 60 years of age. FREE BIG 20 PAGE BOOK explains everything. Send for your copy today. Chicago & Los Angeles schools only approved for Vets.

MODERN SHOE REBUILDING SCHOOL
Established 1927
2937 Belmont Ave., Chicago. Dept. PM
361-12th St., Oakland, Calif.
806 So. Figueroa St., Los Angeles 14, Calif.

TRI-STATE COLLEGE

**B. S.
DEGREE IN
27 MONTHS**

66th Year.
World-Wide
Enrollment

ENGINEERING—Courses in Civil, Elec., Mech., Chem., Aeronautical and Radio, Television. Also Bus. Admin., Acc't. and Sec. Science. Visitors welcome. See beautiful campus, well equipped laboratories. Graduates successful. Enter Jan., March, June, Sept. Write for Catalog. 4109 College Avenue, Angola, Indiana.

LEARN MOVIE PROJECTION THEATRE MANAGEMENT

The Motion Picture Theatre Business offers big opportunities for trained men. Get into a fascinating field with a promising future. Train at home in spare time. Free Catalog. Established 20 years.

THEATRE SCHOOL, 370 Washington St., Elmira, New York

How to Make Money with Simple Cartoons

A book everyone who likes to draw should have. It is free; no obligation. Simply address

FREE BOOK

CARTOONISTS' EXCHANGE
Dept. 910-F Pleasant Hill, Ohio

START YOUR OWN BUSINESS VENDING MACHINES WILL MAKE MONEY FOR YOU!

No selling. No home work. Start a coin machine business spare time. They work while you sleep. A big, proved, profitable field. Start with a few dollars. I did. I'll show you how, too. Send postcard for free folder.

KENNETH J. FLECK COLUMBIA CITY 7, INDIANA

LEFAX POCKET SIZE TECHNICAL DATA BOOKS \$1 EACH

Printed on loose leaf, six hole, 6 3/4" x 3 3/4" bond paper, each book contains about 140 pages of technical data, presenting condensed, accurate and essential data for the student, engineer, technical worker and business man.

Architecture	General Chemistry	Automotive Engineering
Home Heating	Reinforced Concrete	Surveying
Illumination	Building Constr.	Mechanical Drawing
Electrician's Data	Radio	Machine Design
Builder's Data	Television & FM	Machinists Data
Lumber Data	Electricity, AC	Piping Data
Air Conditioning	Electricity, DC	Surveying Tables
General Math.	AC Motors and	Trig-Log Tables
Math. Tables	Generators	Metallurgy
Physics	Transformers, Relays,	Analytic Chemistry
Chemical Tables	Meters	Highway Engineering
Metals	Hydraulics	

Write for FREE catalogs (over 2000 listings). See for yourself how helpful LEFAX can be to you. Send \$1 for each book, (or \$5 for any six books listed above) to

LEFAX, DEPT. PM-2, PHILADELPHIA 7, PA.

IMAGINE THEIR JOY

WHEN THEY FOUND THEY COULD PLAY

This easy as A.B.C. way!



PLAYS ON RADIO

"As a proud student I can't keep from telling you that as a result of my course I have a good position playing from KTHS, Hot Springs, Ark., every morning."

*J. S., Okla.



INVITED TO PARTIES

"I enjoyed taking this course and I get a lot of pleasure out of it. I have made much progress and have many invitations to play at parties. I owe you much for making this possible."

*K. U., N. Y.

LEARNED QUICKLY AT HOME

"I didn't dream I could actually learn to play without a teacher. Now, when I play for people they hardly believe that I learned to play so well in so short a time."

*H. C. S., Calif.



INVESTMENT PAID BACK A THOUSAND FOLD

"Anyone with musical ability should make good with your course. My little investment paid back a thousand fold. I have been playing for 4 years now. Today I play in one of our top bands."

*J. M., San Juan, P. R.

PLAYS AT DANCES

"I have completed your course and your lessons have been most satisfactory. I can play all of the popular songs. I have also earned money playing at dances."

*E. N. J
New York

Thousands Have Learned to Play Quickly, Easily at Home

WHAT instrument would you like to play? We'll show you how you can learn to play it—quickly, easily, in spare time at home for only a FEW CENTS A DAY! Never mind if you don't know one note of music from another—don't worry about "special talent." The truth of the matter is that thousands now play who never thought they could! Yes, men and women everywhere are enjoying the thrilling satisfaction of playing the piano, violin, guitar, saxophone or other favorite instrument. Some of them are playing in orchestras and over the radio; others are teaching music, making money in spare or full time. And thousands are playing for their own enjoyment

and the entertainment of their friends.

It all came about when they wrote to the U. S. School of Music for the Free Booklet that shows you how EASY it is to learn music at home this modern way. No tedious scales, no tiresome exercises. You learn to play by playing—start right in almost at once with the melody of a simple tune! It takes only a few minutes a day and the cost is trifling; you save the expense of a private teacher. Does it sound too good to be true? Mail the coupon and get the FREE PROOF! (Our fifty-first year—Est. 1898.) U. S. School of Music, 710 Brunswick Bldg., New York 10, N. Y.

NOTICE

Please don't confuse our method with any systems claiming to teach "without music" or "by ear." We teach you easily and quickly to play real music, any music, by standard notes . . . not by any trick or number system.

SEND TODAY ➔

FOR COMPLETE DETAILS

• You'll open your eyes when you find how quickly and easily you can learn to play your favorite instrument. Don't doubt; don't hesitate. Send for the fascinating illustrated booklet that answers all your questions; let the free Print and Picture Sample show you how this method actually works. If interested, mail the coupon NOW.

*Actual pupils' names on request. Pictures by professional models.

FREE! Print and Picture Sample

U. S. SCHOOL OF MUSIC 710 Brunswick Bldg., New York 10, N. Y.

I am interested in music study, particularly in the instrument checked below. Please send me your free illustrated booklet, "How to Learn Music at Home."

Piano	Saxophone	Modern Elementary
Guitar	Trumpet, Cornet	Harmony
Hawaiian Guitar	Reed Organ	Clarinet
Violin	Tenor Banjo	Practical Finger
Piano Accordion	Mandolin	Control
		Other Instrument

Have you instrument? _____

Mr. _____
Miss _____
Mrs. _____ (Please Print)

Address _____

City _____ State _____

NOTE: If you are under 16 years parent must sign coupon.

Save 2c—Stick coupon on penny postcard.



AUTO BOOKS ON APPROVAL



SEND NO MONEY. Just mail the coupon for a complete set of 4 Big, Thick Auto Books. 20th Edition. Over 2700 Pages! Whether you are a mechanic or helper, expert or apprentice, auto owner or driver, take immediate advantage of this **FREE EXAMINATION OFFER.**

MAKE GOOD MONEY NOW HOLD A PERMANENT JOB

America wants its automobiles kept in good repair. Men with "know how" are in demand, at big pay. These books will help you get and hold an important job, or give you a chance to go into business for yourself now or later. Any man who half tries to improve himself can learn auto servicing and repairing by this quick reference method. Use the **JIFFY INDEX** to find easily understood answer to any auto problem. These wonder books prepared by eleven of America's great automobile engineers. Many hundreds of valuable illustrations. Send the coupon **TODAY.**

A year's consulting privileges with our engineers now given with these books without extra charge.

Publishers Since 1898

CAN YOU FIX IT?

These wonder books tell step by step **HOW** to make difficult repairs and adjustments, how to keep a car at maximum efficiency, including latest improvements in car design and operation. Engine troubles and how to correct them well covered.

4 BIG, THICK VOLUMES

Over 2700 pages, 2000 illustrations, wiring diagrams, etc. Beautiful modernistic, washable cloth binding.

AMERICAN TECHNICAL SOCIETY, Dept. A719
Drexel Ave. at 58th St., Chicago 37, Ill.

I would like to examine your 4-Volume Set of Auto Books. I will pay the delivery charges only, but if I choose I may return them express collect. If after 10 days' use I prefer to keep them, I will send you \$2 and pay the balance at the rate of only \$3 a month until \$24.80 has been paid. Include consulting service as offered above.

Name _____
Address _____

City _____ State _____

Please attach letter stating age, occupation, employer's name and address and name and address of at least one business man as reference. Men in service, also please give home address.

Don't Envy The PLUMBER-Be One

Make \$15 to \$50 a Day

Every skilled workman will tell you Plumbers have the best of it. **WINTER** and **SUMMER** the Plumber is busy at top wages. No skilled Plumber is ever out of a job. Compare his opportunities with any trade. To the man with know how, Plumbing means profit. Investigate Universal Plumbing School. Not a "war born School," but a plumbing school developed and operated by plumbers since 1923.



Own Your Own BUSINESS

Have your own business and big profits with little other than training and a kit of tools.

JOURNEYMAN Gets Good Salary

Master Plumbers own their own shop. A Journeyman works for a Master. With this training journey-men can depend on high wages.

G. I. Approved. Established 1923

UNIVERSAL PLUMBING SCHOOL

877 Holmes Street

Kansas City, Mo.

BE A PLUMBER IN JUST 32 WEEKS

Learn With Tools—Not Books
No need ever serve an apprenticeship. Don't envy the plumbers big profits—enjoy them. Learn every trick of the trade—Leadwork—Blueprint for plan reading, etc. under Licensed Master Plumbers.

Over 7,000 Successful Plumbers Recommend This School

This system has made more than 7,000 plumbers. Investigate our past performance. If you like to work with tools this is your opportunity. Become a Plumber in America's largest and only school devoted exclusively to plumbing. Write today for **FREE** information.

Famous BAILEY TECHNICAL SCHOOLS

OFFER THE FOLLOWING COURSES:

COMMERCIAL ELECTRICITY

PRACTICAL DIESEL ENGINEERING

Your future success depends largely on the reputation of the school you attend. Don't take chances! Train at America's foremost school of mechanical specialization. Bailey is recognized and approved by industry. Bailey graduates get the top pay jobs! Send for **FREE** Catalog. State name of course in which you are interested. G. I. Approved.

BAILEY TECHNICAL SCHOOLS

1656 S. Grand Blvd., St. Louis 4, Mo.

100,000 WASHER REPAIR PARTS

Start Your Own Washing Machine Repair Business

RETAIL CUSTOMERS MAIL IN OLD PARTS OR MODEL NO. OR SERIAL NO.

Tremendous field, excellent profits! Get our large complete wholesale catalogue showing thousands of repair parts illustrations; wringer rolls, V-belts, motors, gears, etc. Price \$2.00 per copy postpaid in U.S. Send check or money order today—price of catalogue refunded on first \$20.00 order. Established 20 years

WESTERN APPLIANCE Co., Inc.
5650 GRAND RIVER AVE., DETROIT 8, MICH.



LOTS \$300 LOW TERMS

In California's loveliest Garden Spot, on scenic shores of beautiful Morro Bay. Enjoy future independence with excellent soil, soft water, wonderful fishing, hunting, boating, bathing, etc. Grow fruits, vegetables, poultry. Perfect temperate climate. Congenial community. Finest investment. Free literature.

RICHARD S. OTTO

DEPT. M

SAN LUIS OBISPO, CALIFORNIA

WOULD \$400 PER MONTH INTEREST YOU?



It is easily possible to earn \$400 to \$500 a month raising **ANGORA RABBITS**. No experience required. Wool brings top price. Plenty markets. **WRITE TODAY** for **FREE** INFORMATION, PRICES and **WHERE** to SELL.

WHITE'S RABBITRY
NEWARK 10, OHIO

FIX ANYTHING ELECTRICAL!

Insure against hard times with amazing new electrical appliance repair method. Even beginners can fix electrical appliances double quick. At sensational low price, you get training course and new simplified electrical tester. Send postal card for details. No obligation.

FEILER ENGINEERING CO., Dept. 10PM9, 945 George St., Chicago 14, Ill.

BIG PAY TRADE AIR-CONDITIONING REFRIGERATION

Mastered by Mail

HOME STUDY COURSE

Teaches Air Conditioning and Refrigeration . . . the field of the future with a future. Get in now on the ground floor. Restaurants, taverns, stores, theaters, etc., all need and are installing air conditioning. Maintenance men will be needed for Big Pay Jobs. Learn at Home in your spare time. Four week practical training period in the great modern shops of ACRI in Baltimore included in course. For details—Write—

ACRI, 110 N. Poca St., Baltimore 1, Md.

YOU are in demand if you can DRAW!



Make Money with Your Brush and Pen

If you like to DRAW, SKETCH, or PAINT, write for TALENT TEST. NO FEE!

ART INSTRUCTION, INC. DEPT. 10139C MINNEAPOLIS 15, MINN.
Please send me your FREE Talent Test

Name _____ Occupation _____
Address _____ Phone _____
City _____ Zone _____ County _____ State _____ Age _____

Watchmakers MAKE MONEY!

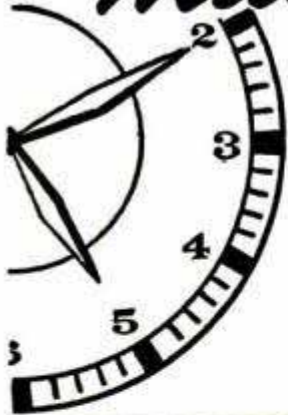

Large earnings with no dull seasons, professional dignity, a steady secure future are yours as a Master Watchmaker! You can

choose a fine job or go into your own business. The famous Sweazey System teaches you . . . expertly, quickly, successfully.

SEND FOR FREE BOOK NOW →

Since 1908, Chicago School of Watchmaking graduates have been in constant demand. Write today for your free copy of our new illustrated book about the big opportunities in watch repairing, gem setting and engraving.

CHICAGO SCHOOL OF WATCHMAKING, 1608 Milwaukee Avenue, Chicago 47, Illinois, Dept. 1109

Please send your new book, "Master Watchmakers Wanted" without cost or obligation.

- I am interested in attending residence school.
 I am interested in home study.
 I am a veteran. I am a non-veteran.

NAME _____
ADDRESS _____
CITY _____ ZONE _____ STATE _____

U. S. GOVERNMENT JOBS!

**AS HIGH AS \$3,351 FIRST YEAR
RAILWAY POSTAL CLERKS
Veterans Get Special Preference**



—etc. Prepare now for next Examinations.

Many other Government Jobs, City and Rural Carriers —

Postoffice Clerks — Meat Inspectors

—Accountants—Stenographers — Typists

**FRANKLIN INSTITUTE
DEPT. W84, Rochester 4, N. Y.**
(Not Government Controlled)

Sirs: Rush to me, without charge, copy of 40-page book, "How to Get a U. S. Government Job," list of positions, and full particulars telling how to qualify for them.

Name _____

Address _____ Vet? _____

AUDELS Carpenters and Builders Guides 4 vols. \$6

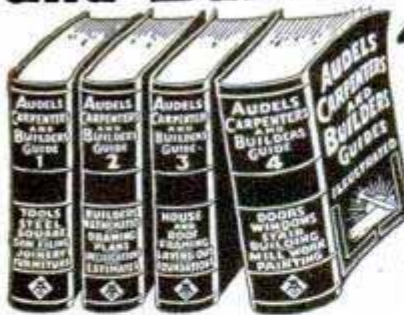

Inside Trade Information for Carpenters, Builders, Joiners, Building Mechanics and all Woodworkers. These Guides give you the short-cut instructions that you want—including new methods, ideas, solutions, plans, systems and money saving suggestions. An easy progressive course for the apprentice and student. A practical daily helper and Quick Reference for the master worker. Carpenters everywhere are using these Guides as a Helping Hand to Easier Work, Better Work and Better Pay. To get this assistance for yourself, simply fill in and mail **FREE COUPON** below.

Inside Trade Information On:

How to use the steel square—How to file and set saws—How to build furniture—How to use a mitre box—How to use the chalk line—How to use rules and scales—How to make joints—Carpenters arithmetic—Solving mensuration problems—Estimating strength of timbers—How to set girders and sills—How to frame houses and roofs—How to estimate costs—How to build houses, barns, garages, bungalows, etc.—How to read and draw plans—Drawing up specifications—How to excavate—How to use settings 12, 13 and 17 on the steel square—How to build hoists and scaffolds—skylights—How to build stairs—How to put on interior trim—How to hang doors—How to lath—lay floors—How to paint.



AUDEL, Publishers, 49 W. 23rd St., New York 10, N. Y. Mail Audels Carpenters and Builders Guides, 4 vols., on 7 days' free trial. If OK I will remit \$1 in 7 days and \$1 monthly until \$6 is paid. —Otherwise I will return them. No obligation unless I am satisfied.

Name _____
 Address _____
 Occupation _____
 Employed by _____ PM

No Shop Needed

Operate YOUR OWN Business



Clean and Mothproof Rugs and Upholstery

• See our Column Service "ad" in October issue of Liberty •
 Can you qualify? . . . If you are dependable, honest and willing to work, send for **FREE** Booklet explaining how you can become "your own boss" in a growing business of your own. You'll use proven successful methods of established **DURACLEAN** Dealers. Service rendered "in the home," offices and public buildings. Easy to learn. No experience necessary.

DURACLEAN cleans by absorption! No scrubbing. No soaking or shrinkage. Fabrics dry in just a few hours. Dirt, grease and many unsightly spots vanish as if by magic . . . colors revive. Upholstery and floor coverings last longer.

DURAPROOF kills moths and carpet beetles. Makes material resistant to both! Another year 'round service. **DURAPROOF**, to our knowledge, is the only moth proof service backed by a National Money Back, 4 YEAR WARRANTY.

These services are Nationally Advertised! Leading furniture and department stores recommend **DURACLEAN** Dealer's service. Almost every building in your territory houses a potential customer. Even auto dealers buy your service to revive upholstery in used cars. You get many voluntary and repeat orders.

Some dealers establish a shop or an office after business has grown. Others continue to operate from their own home. Profits up to \$15 and \$20 for a day's service on EACH of your service men. Territories are limited! Write now for **FREE** Booklet explaining details of these Nationally Advertised services.

DURACLEAN CO., 9-160 Duraclean Bldg., Deerfield, Ill.

RUPTURED?

Get Relief This Proven Way

Why try to worry along with trusses that gouge your flesh—press heavily on hips and spine—enlarge opening—fail to hold rupture? You need the Cluthe. No leg-straps or cutting belts. Automatic adjustable pad holds at real opening—follows every body movement with instant increased support in case of strain. Cannot slip whether at work or play. Light. Waterproof. Can be worn in bath. Send for amazing **FREE** book, "Advice To Ruptured," and details of liberal truthful 60-day trial offer. Also endorsements from grateful users in your neighborhood. Write:

CLUTHE SONS, Dept. 31, Bloomfield, New Jersey

LOOK WHAT SANTA HAS FOR YOU!

There's big money for you in selling Artistic Christmas Cards. Lovely **FEATURE** Assortment of 21 Folders is stand-out seller at \$1 retail. Up to 100% is your profit on each **FEATURE** box you sell! 32 other money-makers—Silverglo, Everyday, Gift Wraps, Religious, Newest Plastic Christmas Greetings, etc. Name-Imprinted Christmas Cards, 50 for \$1 up. **FREE** Samples. Other new selections: complete line imprinted Stationery, Decorated Personal Napkins. Start money-making at once. Send for **FEATURE** box on approval and **FREE** Imprint Samples. Do it NOW!
ARTISTIC CARD CO., Inc., 460 Way St., Elmira, N. Y.



NEW BATHROOM DEODORIZER

Secret chemical invention automatically banishes unpleasant odors in bathroom, kitchen, anywhere. Gives off refreshing fragrance. Just hang on wall. No liquids, sprays, or wicks. Needs no attention. *Beautifully designed!*
SAMPLES for AGENTS Sample offer sent immediately to all who send name at once. Hurry—postcard will do. **SEND NO MONEY—just your name.**
KRISTEE CO., 686 Bar St., Akron, Ohio

YOU CAN MAKE MONEY IN CERAMICS!

It's easy to make beautiful objects at home in spare time—objects that sell at high profits, or beautify your own home. No kiln needed—use your kitchen oven. Thousands make up to \$20 weekly in spare time. Friends will be amazed. Get our complete instruction catalog. Send 10c, stamps or coin, with ad.
Ceramics Supply Div., Dept. CM10, 4707 Euclid Ave., Cleveland, Ohio

LEARN AERONAUTICAL ENGINEERING

Aircraft and Engine Mechanics (A & E)

Train at the Flying Wing school—New classes starting soon. Write for illustrated catalog.

Northrop Aeronautical Institute

APPROVED FOR VETERANS DIVISION OF NORTHROP AIRCRAFT, INC.
 1527 E. Broadway, Hawthorne, Los Angeles County, California

PLAY GUITAR LIKE THE COWBOYS DO... A LESSON

Just out—very latest guaranteed, simple, easy method. Play cowboy songs the Western way in a few minutes by ear. Surprise and amaze your friends. Be in big demand at parties, camps, public entertainments, on the radio, etc. 12 Complete Lessons.
SEND NO MONEY. Pay postman only \$1.00 plus postage and C.O.D. charges, or send \$1.00 and get **EXTRA SONGS** all postpaid. (Canada, \$1.25 money order only.) Nothing else to buy. Positive money back guarantee. *Rush order today.*
WESTERN RANGER STUDIO, Dept. 1510, Hutchinson, Kan.

SAY YOU SAW IT IN POPULAR MECHANICS

Learn BAKING At Home

Baking is one of America's high industries in wages. Nearly depression-proof. Thorough basic home course lays sound foundation. If you have aptitude, write for **FREE** BOOKLET, "Opportunities in Commercial Baking."
National Baking School, 1315 Mich. Ave., Dept. 1357, Chicago 5



STUDY AT HOME

With An Educational Institution

Men with specialized training win higher positions, insure larger earnings, and are bigger successes in business and public life. Opportunities NOW greater than ever before. Send for our Catalog.

ARTS and SCIENCES

Courses in Philosophy; Education; Letters; Public Health; Medical Jurisprudence; Psychology; Sociology; Physics; Chemistry; Geology; Political Science; Theology; Business and Commerce; Accounting; Mathematics; Statistics; Agriculture.

ENGINEERING

Courses in Electrical, Civil Mechanical, Drafting, Architectural, Steam, Aeronautical, Radio, Structural, Mining, Industrial, Petroleum, Marine, Chemical, Diesel, Automobile, Refrigeration, and Air Conditioning Engineering.

LAW

Complete Professional Law Course includes 18 Hornbook Series college grade textbooks. Courses also in Commercial Law, Patent Law and Medical Jurisprudence.

McKinley-Roosevelt Incorporated, 4610-K, Sheridan Rd., Chicago 40, Ill.

Are You a "One-Date Dick" or a

KING OF MUSCLE?



YES!—and in just 5 Minutes every other day, YOU, too, can have a new physique, added height, glowing health and vigor, with world-famous Paramount Bar Bells. At any age, you can gain new popularity, and probably boost your own paycheck through the sheer vitality of a powerful new build. Send now for FREE Paramount "Self-Check Chart." Learn sensational new low prices of Paramount Bar Bells, sold at direct-from-factory savings. Get started NOW to be a King of Muscle! Act TODAY!

GIFT CHART - FREE!

AS LOW AS
\$8.95

Paramount Bar Bells, Dept. 10
2416 E. 23rd St., Los Angeles 11, Calif.

Rush Info and "Self-Check Chart," FREE!

Name _____
Address _____
City _____ Zone _____ State _____

BE A LOCKSMITH



Learn Locksmithing and Keyfitting from experts in your spare time at home. Uncrowded field! No layoffs, no slow seasons. AGE OR PHYSICAL HANDICAP is no disadvantage. Year round steady income in this permanent, respected career. Full or part time. Practical, easy lessons show how to make money even while learning! ALL MATERIALS AND SPECIAL TOOLS SUPPLIED.

write DEPT. P2

Locksmithing Institute, Inc.

55 Park Ave. Rutherford, New Jersey

LOOSE DENTAL PLATES

RELINED AND TIGHTENED AT HOME \$1.00



NEWLY IMPROVED DENDEX RELINER, a plastic, builds up (refits) loose upper and lower dentures. Really makes them fit as they should without using powder. Easily applied. No heating required. Brush it on and wear your plates while it sets. It adheres to the plates only and makes a comfortable, smooth and durable surface that can be washed and scrubbed. Each application lasts for months. Not a powder or wax. Contains no rubber or gum. Neutral pink color. Sold on MONEY-BACK GUARANTEE. Not sold in stores. Mail \$1 for generous supply, brush and directions and we pay postage. Charges extra on C.O.D. orders.

Proved by 10 years of Consumer Use

DENDEX COMPANY, Dept. 52

2024 W. 6th St. Los Angeles 5, Calif.

SAY YOU SAW IT IN POPULAR MECHANICS

CAUGHT BY THEIR FINGER PRINTS



During the past 32 years the I. A. S. has trained hundreds of men at home to fill positions of responsibility and steady pay as finger print experts. This fascinating, profitable profession can be learned at home during spare time. More than 800 American Identification Bureaus employ I. A. S. graduates or students. Write today for complete list of these Bureaus.

Can Train for
CRIMINAL INVESTIGATION
and IDENTIFICATION
WORK AT HOME!

Send Now for "BLUE BOOK of CRIME"
Thrilling, inspiring, helpful. Be sure to
state your age when sending for book. **FREE!**

INSTITUTE OF APPLIED SCIENCE
Dept. 1357, 1920 Sunnyside Ave., Chicago 40, Ill.

SAVE ON REMODELING



IT'S a cinch to remodel any room in the house or build extra ones with Gold Bond Gypsum Wall-board. Costs little and it's easy to apply. Big, fireproof panels nail up in a jiffy.

Can be papered or painted. Use Gold Bond Sunflex paint... dries in one hour! See your local Gold Bond Lumber and Building Supply Dealer today!

FREE BOOK OF SUGGESTIONS



NATIONAL GYPSUM COMPANY
Dept. E-6, Buffalo 2, New York

Gentlemen: Send free copy of new Booklet, "Modernizing Magic" showing remodeling ideas and methods:

Name

Street

City State

(Please print name and address)

PASSPORT TO ADVENTURE



Let the **WIDE WORLD MAGAZINE** take you every month on a voyage of breathtaking adventure to many strange ports. This unique British publication is famous for its presentation of the world's most exciting experiences from true life. Men who live dangerously in far-off corners of the earth relate their own spellbinding stories, packed with action and vividly illustrated. Every narrative told as it actually happened; every page a thrill.

Join the World-wide Brotherhood of the **WIDE WORLD**. Send Coupon below NOW!

CLIP AND MAIL

Send only \$3 (reduced rate) to George Newnes Ltd., U.S. Subscription Office (W.W.51), 342 Madison Avenue, New York 17, N.Y. for 12 consecutive monthly issues sent direct to your address from London. **Two Years \$5.75** (normal rate \$7).

Name.....
Address.....
City..... State.....

Your stepping-stone to a BETTER-PAYING MACHINIST'S JOB

This big home study and reference course gives you the practical facts on machines and methods you need to advance in machine shop work. Take advantage of the other man's experience as found in books, to solve your problems, increase your efficiency with . . .



NEW LOW PRICE SAVES YOU \$4.75
No money down
Easy payment plan

THE AMERICAN MACHINISTS' LIBRARY

Revised and enlarged • 6 vols. • 2645 pp. • 2747 illus.

This library of machine shop practice was written for practical men. It gives you the best methods for every kind of machine shop work. It fully explains lathes, drills, and other machine tools and their operation, automatic screw machines, speeds and feeds, gear design and production, jigs and fixtures, punch and die work, metal surfacing, etc., etc., All plainly written and fully illustrated.

FREE EXAMINATION

McGraw-Hill Book Co., Inc., 330 W. 42 St., N. Y. C. 18, N. Y. Send me for ten days' free examination the AMERICAN MACHINISTS' LIBRARY. If satisfactory I will send you \$4.00 and \$4.00 monthly until the price of \$20.00 is paid. If not wanted I will return books postpaid.

Name.....
Address.....
City..... Zone..... State.....
Company.....
Position..... PM-10-49

Train for one of these Big Fields in the Largest & Best Equipped School of its Kind

HAT CLEANING AND BLOCKING

Learn by doing in modern training shops under experts. Fine opportunities for good jobs or your own successful business. Have the advantage of going to a big, well established school. **COMPLETE HAT CLEANING AND BLOCKING TRAINING IN ONLY 12 WEEKS.**

G. I. APPROVED

CHICAGO SCHOOL OF SHOE REBUILDING
124 E. 26th Street Dpt. PM-10 Chicago 16, Illinois

Shoe Repairing

Look to the future with confidence. Get into these great fields which are among mankind's oldest and most essential. Trained men needed in practically every locality, the year around. No previous experience or advanced education necessary.

Write for Free Booklet Today

DE LUXE SHEFFIELD CHRONOGRAPH WRIST WATCH



Has everything—plus new low price. It's a timekeeper, stop watch, measures speed of planes, cars, horses, etc. Sweep second hand, chrome case, unbreakable crystal, Swiss movement. Sold to \$29.95. Send cash, check, or C.O.D.

WAYNE SALES COMPANY
423 American Ave., Long Beach 12, Calif.

LIMIT ONE

Guaranteed by mfr. for FULL YEAR

9.75

Plus 9% Tax

YOU CAN BE AN All Around HE-MAN

All 5 famous courses by George F. Jowett, world's greatest body builder in 1 complete muscle building volume (valued at \$5 each) now only 10¢. Packed with How-to-Do-it pictures. 1. How to Mold a Mighty Arm. 2. Mighty Chest. 3. Mighty Back. 4. Mighty Grip. 5. Mighty Legs. Free strong men photo book. Quick results or money back! Send 10¢ name, address, age.

JOWETT INSTITUTE, Dept. PM-910, 230 Fifth Avenue, New York City

10¢

Hobbyist Catalog



64 pages

WE PAY POSTAGE!

SHIP MODELS . . . TRAINS . . . PLANES
Cars . . . Art Supplies . . . Tools . . .
Projects . . . Games.
U.S.A. and Canada Orders Only.

10¢

write **Brown-Craft**

1232 ETOWAH, DEPT. PM-3, Royal Oak, Mich.



ITALIAN ACCORDIONS

Hand Made. Very Best. Lowest Prices. Buy Direct from Factory Representative and Save Money. Send Name and Address for FREE catalog.

ITALIAN ACCORDION MFG. CO.
7600 Cottage Grove Ave., Dept. P.M.-10, Chicago 19, Ill.

Sensational Pocket Size FOLDING COOK STOVE with 15 HEATAB Flame Tablets COOKS • FRIES • BOILS \$1.00 ALL YOURS FOR



So compact you can carry both stove and a supply of miracle HEATAB fuel in your pocket, tackle box, glove compartment of car. Always ready for use. Lozenge-size **SPEAKER HEATABS** give hot, steady, blue flame . . . no smoke, odor, soot or ashes. Use it indoors or outdoors. It's the same **SPEAKER COOKIT** carried by millions of GIs during war. Nothing else like it! Ideal for home emergency service, camping, picnics, starting barbecue fires, heating baby's milk in nursery, sick rooms, etc. Send cash with order. Mailed postpaid anywhere in U. S.

NO. 1118 COOKIT with 15 assorted HEATABS. \$1.00
GIFT COOKIT with 2 extra pkgs. Heatab Fuel (large size). \$2.00

DEALERS: Write on your letterhead for wholesale net price list and catalog sheet.

BROUGHTON SALES & SPECIALTY CO.
4604 Park Ave. So. Minneapolis 7, Minn.

Jig Saw Patterns

Big Bargain Packet

62 SQUARE FEET — Full Size!
50 AMAZING PROJECTS —
ONLY \$3.00 Complete

Every pattern full size ready to paste on wood and cut out. No tracing, no graph square enlarging. It's the new simplified way of making projects in half the time it took you before.

Packet contains Dutch Windmill, Ivy Bracket, plus 49 other exciting things to make, Cradle, Waddling Duck, Pot Holder, Snack Tray, Wall Plaques, Elephant Shell, Bunny Cart, Beverage Server, Costume Jewelry, Seashore Bracket, Bird Garden Cutouts, Airy Wall Shelves, Seattle House Marker, Whisk Broom Holder, Oval Mirror Bracket, Tooth Brush Holder, Wind-Operated "Dog Chases Cat," Stairway to Stars, Lotus Flower Bracket, Swan Plant Bracket, Wall Plaques, many other profitable patterns.

Amazing value. Worth \$10. Send \$3.00 now, or we send COD if you pay postage. HURRY! Order Jig Saw Packet No. 2 now!

CRAFTSMAN PATTERN CLUB

117-PJ2, Worth St., New York 13, N. Y.



Get into BUSINESS for Yourself!

METALIZING BABY SHOES AT HOME IN SPARE TIME



Get facts about amazing money-making *Warner Success Plan* that shows you every easy step in completely charted path to personal independence—with your home as your headquarters... This proved and tested Plan is working like magic. It's backed by an old, reliable company... And we send it to you on a No-Risk Trial Money Back Guarantee.

QUICK CASH WAITING
Demand for METALIZED Baby Shoes and other keepsakes is growing bigger daily. Our Tested Plan Shows How to Do the Work, How to Bring in the Business, How to Make as much as \$5 an Hour. Spare or full time, big steady profits are waiting for you. Send penny postcard or mail coupon for FREE Facts. Act! Time is precious.

FREE
offer of
COMPLETE MONEY MAKING PLAN
•
SEND NO MONEY
Just Mail COUPON

Ray Brandell, Mgr., Warner Electric Co.,
1512 JARVIS AVE., DEPT. 310, CHICAGO 26, ILL.

Please rush complete details about your No-Risk Trial Money Back Plan for Metalizing Baby Shoes. Everything you send is FREE and costs me nothing—now or ever.

NAME _____
ADDRESS _____
CITY _____ ZONE _____ STATE _____

EARN \$50 UP A WEEK... ON THE SIDE!

While You Learn Watch Repairing At Home

WITH OUR NEW 13 ITEM SELF-TRAINING KIT
Containing: AMERICAN JEWELLED WATCH MOVEMENT for practicing—PROFESSIONAL TOOLS: Loupe; 6 Screw Drivers; Tweezers; Material Tray; Case Opener & Knife; Movement Gauge and COMPLETE ILLUSTRATED BOOK ON \$9.35 Post WATCH REPAIRING. Only \$9.35 Paid (C.O.D. plus charges) MONEY BACK GUARANTEE
Tool Catalog FREE with KIT or send \$3.50 credited to 1st order
MODERN TECHNICAL SUPPLY CO.

Dept. 10MMC, 55 W. 42nd St. New York 18, N. Y.

Earn BIG PAY while Learning



VETERANS CAN EARN UP TO \$290.00 per month while training

- Learn By Doing in Our BIG ALLIED SHOPS
- MACHINIST TRADE.
 - TOOL, DIE MAKING & DESIGNING.
 - TOOL ENGINEERING.
 - DRAFTING—ALL BRANCHES.
 - PRODUCT ILLUSTRATION & DESIGN.
- BIG DEMAND FOR TRAINED MEN

Accredited by The American Society of Tool Engineers. Endorsed by Leaders of Industry throughout U.S.A.

FREE Employment Service After Graduation

ALLIED SCHOOL OF MECHANICAL TRADES, Inc.

1338-1340-1342 So. Michigan Avenue
420 Allied Building, Chicago 5, Ill.

Write for FREE Catalog
A 1c Postcard will do.



YOU can draw!

AMAZING NEW HOLLYWOOD PLAN
• Yes, YOU can draw GIRLS, CARS, FRIENDS, even MAGAZINE COVERS. Our plan is EASY—especially designed to help the beginner and advanced student. Many artists make more than \$150.00 per week in advertising and cartoons. Be your own boss, draw for money anywhere. Our Commercial Artists will teach you the secrets from HOLLYWOOD. Drawing materials furnished. Be a success. Write NOW for details and FREE 32-page book.

APPROVED FOR G. I. TRAINING

HOLLYWOOD SCHOOL OF ART

Under direction of Frank Azelson
6533 Hollywood Blvd. Hollywood 28, Calif.

Dept. 4-A
Name _____ Age _____ G.I.
Address _____
City _____ Zone _____ State _____

NATIONALLY RENOWNED SCHOOL
OFFERS YOU THIS FREE BOOK

A WEALTH OF INFORMATION THAT HAS GUIDED THOUSANDS toward Successful Futures

Start toward your success by the same steps thousands have already proved! Hills' is fully accredited and nationally recognized. Free placement service to graduates throughout the nation. Where ever you live, Hills' can train you through our Extension or Residence School. Check your subject below, fill in coupon and send this ad today.

- Accounting
- Bookkeeping
- Accounting & Business Administration
- Salesmanship
- Secretarial
- Stenographic
- Penmanship

Hills BUSINESS UNIVERSITY & EXTENSION SCHOOL

Hills Business University & Extension School
Dept. PM-109, 619 W. Main St., Oklahoma City 2, Okla.
Please send your Free book that fully describes & illustrates the story "Thru Hills to Success".

NAME _____ AGE _____
ADDRESS _____
CITY _____ STATE _____
 G. I. BILL RESIDENT HOME STUDY

EASY-TO-USE COUPON TODAY

Here's How CREI Prepares You for a Professional Career with Industry-Recognized Training in a Minimum of Time

RADIO - ELECTRONICS TELEVISION ENGINEERING

GRADUATES of CREI residence school are preferred by industry because of their training and ability. This recognition is the reason that CREI men quickly find good jobs. With 22 years of practical teaching experience in these highly technical fields, CREI offers an outstanding faculty, modern and complete laboratories, shops and equipment. New students are accepted twice monthly and each may advance as rapidly as he is capable. The basic course with one specialized course requires an average of 20 months to complete.

CREI is recognized as one of the country's leading technical institutes. Its work is of college level. It prepares the young man for a good job in industry in a minimum of time.



Approved for Veterans' Training

CAPITOL RADIO ENGINEERING INSTITUTE

An Accredited Technical Institute Founded in 1927

Mail coupon for Free Catalog

Capitol Radio Engineering Institute, Dept. 1710A
16th & Park Road, N.W., Washington 10, D. C.
Please send me your residence school catalog and complete details. (If interested in Home Study check below.)

Name _____ Age _____

Street _____

City _____ Zone _____ State _____

I am entitled to training under G.I. Bill. Send information on Home Study Courses.

Learn A Trade NOW! PRACTICAL SHOP TRAINING!

In Our Chicago Shops

- | | |
|---|--|
| <input type="checkbox"/> AUTO MECHANICS | <input type="checkbox"/> WELDING—ARC and GAS |
| <input type="checkbox"/> DIESEL MECHANICS | <input type="checkbox"/> MACHINIST |
| <input type="checkbox"/> REFRIGERATION | <input type="checkbox"/> PIANO TUNING |
| <input type="checkbox"/> BODY-FENDER | |

Above Approved For G. I.'s and Civilians
One of America's Leading Practical Schools
7 Floors of Fully Equipped Shops
Over 48,000 Successful Graduates
Expert Individual Instruction
Learn by Doing—Low Living Expense
Established 1902—Day and Evening Classes

Also the following Home Study Courses

- PLASTIC REFRIGERATION DIESEL

—CALL IN PERSON OR MAIL THIS AD TO—

GREER SHOP TRAINING

(Desk 16) 460 South State St., Chicago 5, Ill.

Please send without obligation free information regarding trade checked above. (Specify whether you are a Veteran or Civilian)

Name _____ Age _____

Address _____

City _____ State _____



FREE TO HOME PLANNERS

"Little Blue Booklet" of 29 popular plans sent FREE to acquaint you with our MONEY SAVING home planning service which includes 1200 Tested Designs; beautifully illustrated plan books; working drawings; material lists; specifications—all at LOW COST. Write today for FREE BLUE BOOKLET and complete information. America's pioneer residential plan service.

Small Homes Plan Book — 68 beautiful designs.
Budget Homes Plan Book — 78 economy plans for 1 and 2 story homes. **\$1.00**
BOTH BOOKS FOR

L. F. GARLINGHOUSE CO., Inc., Box PM, Topeka, Kans.

WHAM-O SPORTSMAN*

HITS LIKE A .22 RIFLE—
KILLS RABBITS, SQUIRRELS.
For Hunting, Target,
Routing Posts.

\$1.00
postpaid



Dealers Write

A man's sport!
Powerful, silent, accurate.

Complete with 40 pellets and extra rubber straps. Send \$1.00 today to—

Wham-O Mfg. Co., Box 123, South Pasadena, Calif.

*PROFESSIONAL MODEL USED BY MEMBERS OF NAT'L SLINGSHOT ASSN

Learn REFRIGERATION and AIR CONDITIONING

Prepare yourself for a fine paying job. Get practical training at home—plus 4-full weeks in the ITI Shops. Job placement help. FREE book—write INDUSTRIAL TRAINING INSTITUTE Dept. B-1, 2130 Lawrence Ave., Chicago 25, Ill.



SEND FOR THIS FREE!

Make money. Know how to break and train horses. Write today for this book FREE, together with special offer of a course in Animal Breeding. If you are interested in Gaiting and Riding the saddle horse, check here () Do it today—now.

BEERY SCHOOL OF HORSEMANSHIP

Dept. 11010-D Pleasant Hill, Ohio

WE'LL PAY YOU for 3 gallons of "WORN OUT" motor oil from your own auto, truck or tractor engine. Details, page 30 in our FREE BOOK—"Oil Facts."

RECLAIMO MFG. CO., 5083 Elston Ave., Dept. 12, Chicago 30, Ill.

GET THIS FINE SUIT NO MONEY TO PAY!



BIG CASH EARNINGS, TOO!

Big News! This fine tailored suit yours without paying one cent—and big cash earnings, too! It's easy! Just take a few orders. Earn up to \$10 in a day and get your own suit as extra bonus. Over 100 rich new fabrics, superbly tailored in latest styles, at low prices produce orders on sight. Money-back guarantee. FREE SAMPLES! Write today giving name, address, age, etc. for big complete outfit of actual samples and details of amazing new Bonus Suit and money-making plan. —All Sent Free! No experience. SEND NO MONEY!

W. Z. GIBSON, Inc., 500 S. Throop St., Dept. X-516, Chicago 7, Ill.

SAVE BIG MONEY ON HOME HAIRCUTS!



Guaranteed Home Methods of Haircutting with the Amazing Star Electric Hair Clipper!

This wonderful, new electric hair clipper pays for itself in 10 haircuts! Anyone can cut hair neatly with the Star Clipper. It does everything — cuts, trims, tapers. No shears needed. Easy to handle. Safe — shock and fool-proof. Works on either AC or DC. Cuts the family's hair quickly. Saves money and time. Thousands in actual use. Convince yourself — order one today! Guaranteed to satisfy — or your money back! Free instructions with each clipper. Furnished with special tapering comb. All for only \$9.98. If your local dealer cannot supply you, write direct to:

ALLOVER MFG. CO. • Dept. PM • RACINE, WISC.



SUCCESS · SECURITY · RESPECT
as a Master Watchmaker!

APPROVED FOR VETERAN TRAINING

Learn today's top mechanical profession at the world's largest, best-equipped school of its kind. Individual instruction, day or evening classes. You graduate with complete watchmakers' tools, ready to start your own business or work for established jewelers.

SEND FOR FREE 116-PAGE INFORMATION PACKET

WESTERN PENNSYLVANIA
HOROLOGICAL INSTITUTE
WORLD'S LARGEST WATCHMAKING SCHOOL



DESK 40, 808 RIDGE AVE., PITTSBURGH, PA.

ANALYZE Handwriting

Try it FREE, use it — to understand yourself and others in business and social life — more clearly than you ever thought possible. Many use their knowledge of handwriting to make more money full or part time. Simply send your name today for FREE ILLUSTRATED lesson. No obligation. Must be over 21.

INTERNATIONAL GRAPHO ANALYSIS SOCIETY, INC.,
203 Wilhoit Building Springfield 4, Mo.

HOW TO MAKE MONEY IN PLASTICS

Learn Plastics at home, in spare time. You get 7 Big Plastics Material KITS with training course. Make useful, valuable articles as you learn. Send today for free illustrated catalog.

PLASTICS INDUSTRIES TECHNICAL INSTITUTE

Dept. of West Coast University

1601 S. Western Ave., Dept. PM-109, Los Angeles 6, Calif.



\$\$\$ in HAMSTERS

Make big money, full or part time! Raise and sell Golden Syrian Hamsters, world's fastest breeding mammals. Big laboratory, pet shop demand. Easy, fun, no experience needed. Thrive indoors. Send for FREE BOOK. Enclose \$5 for pair and get started NOW!

AZALEA CITY HAMSTERY
1583 FORREST STREET MOBILE 18, ALABAMA

LEARN MEAT CUTTING EASILY - QUICKLY

At Home — In Spare Time



The steady, dependable trade of Meat Cutting taught easily, quickly by improved HOME METHOD. National School, established over 25 years, has organized its famous "Learn By Doing" Classroom, Cutting room and Retail Market training system into sound, practical HOME STUDY form.

Now, by the miracle of this EXTENSION TRAINING you can prepare in Your Spare Time At Home, for a better job, bigger responsibilities or success and security in a store of your own. Remember, PEOPLE MUST EAT!

Buying, cutting, percentage, pricing, advertising, selling — a complete meat education. For beginner or men with ex-

EARN MORE IN DRAFTING



Steady
Employment
•
More
Opportunities
for Promotion

"Here I am at work making good money as a draftsman. I'm glad I sent the coupon to Chicago Tech for that Free Trial Lesson and found out how easy it is to learn Drafting in spare time at home. Today I feel secure in my job because the draftsman's work comes first on any new project. And, in addition, draftsmen can't be replaced with machines. What's more, I feel I'm slated for promotion and more pay, because I see so many draftsmen advancing to high-pay jobs."

LEARN IN SPARE TIME — AT HOME!

(or at the College in Chicago)

A few hours of pleasant home study every week — that's all. No interference with your present job. All the tools you need; drawing outfit included. With Chicago Tech's help, you train yourself step by step. This tested method — developed over 45 years of C.T.C. progress — prepares men quickly for good positions in industry.



FREE INFORMATION — SEND COUPON

To prove to you how easy it is to learn Drafting at home by the Chicago Tech method, we will send you this FREE TRIAL LESSON. No charge for this lesson, now or later. Fill out and mail coupon, or send post card today.

CHICAGO TECHNICAL COLLEGE

N-212 Tech Bldg., 2000 So. Michigan Ave., Chicago 16, Illinois

Mail me FREE Lesson with information about big opportunities in DRAFTING.

Name _____ Age _____

Address _____

City _____ Zone _____ State _____

perience. Thousands of successful graduates. Send coupon for FREE Bulletin NOW!

MAIL THIS COUPON TODAY FOR FREE BULLETIN

National School of Meat Cutting Div. U-109, Toledo 4, Ohio

Send me your FREE Bulletin on Meat Cutting and Meat Merchandising. No obligation. No Salesman will call.

Name _____

Street _____

City _____ State _____

Learn to MOUNT Birds and Animals

FUN • PROFITS

Send Today for Free Book

Old reliable school (250,000 students) will teach you **AT HOME** to mount **BIRDS, ANIMAL HEADS, FISH and TAN SKINS and FURS.** Write now—at once.

SPORTSMEN: Save your trophies. Game is growing scarcer—every **Specimen** is valuable. Keep them—save them—mount them. Decorate your den. Fun and fascination. Profits, too.

TAN heavy and light skins and furs. Make real **HARNESSES, LEATHER, BUCK SOLE LACE, ETC.** Best method known, but easy and simple. Don't sell those hides cheap. Tan them for your own use. Make leather vests, belts, gloves, etc. **TAN FOR OTHERS.**

FUR-WORK for men and women. Tan and make up scarfs, capes, coats, muffs, mitts, trimmings. Quickly, easily learned.

EXTRA MONEY \$40 to \$80 a month, even more some students report. Big demand for **TAXIDERMISTRY, TANNING AND FUR-WORK.** A real spare-time business—good in every community. If you need extra money, **WRITE!**

FREE BOOK

48 pages, 100 beautiful pictures, tells **ALL** about Taxidermy, Tanning, Fur-Work. Write **Today**—this minute for this **STRANGE, MARVELOUS FREE BOOK.** A postal will do. State **AGE.**

N. W. School of Taxidermy, 2510 Elwood Bldg., Omaha, Neb.



DIRECTION SIGNAL

Flashes Your Turns Automatically

No more winter window cranking for arm signals. The new **AUTO-TURN DIRECTION SIGNAL** fits any car. Flashes parking and tail lights 60-80 times a minute. No interference with regular lights, no extra lights to mount for most late cars. Works similar to factory-installed models. All parts furnished—install it yourself. **SPECIFY MAKE AND YEAR.** For cars earlier than 1942, write for price. **MONEY BACK GUARANTEE.** Agents and dealers wanted.

\$8.95 Postpaid in U. S. Send check or money order. Postage extra on C. O. D.'s.

The **LESTER Company** Box M-10, 820 W. JACKSON, CHICAGO 7, ILL.

Learn to Write at Home in spare time

Write for **FREE BOOK**, "How to Become an Expert Penman," which shows how others have learned by taking my Courses at home in spare moments. You, too, can greatly improve your penmanship, or become an Expert Penman. Check or state Courses interested in: Business Writing Ornamental Writing Bird, Eagle and Swan Flourishing. Send 10c for Special Penpoint and your name with a flourished bird written on a card.

WRITE TODAY Box 25K, CHILLICOTHE, MO.

FREE BARGAIN CATALOG of BOOKS

25,000 books of all publishers listed in our 55th Annual Bargain Catalog of 256 pages. Old-time favorites—latest "best sellers." Reference, Fiction, Juvenile, History, Scientific, etc. Supplying schools, colleges, libraries and thousands of individual customers. Send postcard today for our new 1950 catalog, "Bargains in Books."

THE BOOK SUPPLY COMPANY, DEPT. 130
564-566 West Monroe St. Chicago 6, Ill.

LEARN ADVERTISING ART

Free portfolio "Your Career in Art" gives complete details. Write for combined talent and instruction test to judge your ability and our course.

APPLIED ART STUDIO, 1662 Lincoln Ave., Dept. A, Cleveland 7, Ohio

EASY TO LEARN CODE

Learn or increase speed with an Instructograph—the Radio-Telegraph Code Teacher that takes the place of an operator-instructor and enables anyone to master code without further assistance. Available tapes from beginners alphabet to typical messages on all subjects. Speed range 5 to 40 WPM. Always ready—no QRM. Thousands have "acquired the code" with the Instructograph System. Write today for convenient rental and purchase plans.

INSTRUCTOGRAPH COMPANY
4701-V Sheridan Road, Chicago 40, Illinois

SAY YOU SAW IT IN POPULAR MECHANICS

5 YEAR WRITTEN GUARANTEE

17 JEWEL CHRONOGRAPH

2 PUSH BUTTON

ORIGINALLY \$71.50

War Surplus Now Only **\$21.95** Plus \$2.20 Tax

- WRISTWATCH
- STOPWATCH
- TELEMETER
- TACHOMETER

Precision 4 in 1 Timepiece. Incalculable shock resistant feature. Sweep Second hand. Anti-magnetic. Radium Dial. Stainless steel back. Unbreakable crystal. Perfect for physicians, scientists, technicians, engineers, aviators, photographers, broadcasters, navigators, sportsmen, servicemen, etc. Thousands sold at \$71.50. Order now while they last at this record breaking low price. Send only \$1 down payment with order. Pay balance to postman on arrival plus postage. Or we pay postage if you include full payment plus tax with your order.

FREE! HANDSOME EXPANSION BAND INCLUDED. Money back in 5 days if not delighted. Order now!

MARYLAND DISTRIBUTORS, Dept. 115, 501 E. Baltimore St., Baltimore 2, Md.

Do you want

- ..to go to College?
- ..or to enter a Profession?
- ..or get an Office Position?

(Such as Accounting, Architecture, Nursing, Dentistry, Teaching, Social Work, Osteopathy, Beauty Culture, Optometry, Embalming, Chiropody, Law, Medicine, etc.)

To get anywhere, you practically **MUST** finish High School **FIRST.** You can complete our simplified High School Course in **SPARE** time at home, as **FAST** as your time and abilities permit. Equivalent to resident school work—prepares you for college, pre-professional examinations, business, industry. Standard texts furnished. Diploma. Credit for H. S. subjects already completed. Single subjects if desired. Low tuition, easy terms. American School, Chicago, est. 1897—endorsed by educators. Finish your high school education **NOW, Write TODAY!**

High School Course at Home

Many Finish in 2 Years

American School, Dept. H745, Drexel Ave. at 58th St., Chicago 37, Ill.

Gentlemen: Send me **FREE** information covering special training in subjects checked below. No obligation on my part.

<input type="checkbox"/> High School Course	<input type="checkbox"/> Diesel Engineering
<input type="checkbox"/> Architecture and Building	<input type="checkbox"/> Drafting and Design for Men & Women
<input type="checkbox"/> Automotive Engineering	<input type="checkbox"/> Plastics
<input type="checkbox"/> Business Management	<input type="checkbox"/> Private Secretary
<input type="checkbox"/> Electrical Engineering	<input type="checkbox"/> Mechanical Engineering
<input type="checkbox"/> Elec. and Gas Refrigeration	<input type="checkbox"/> Aviation
<input type="checkbox"/> Air Conditioning	<input type="checkbox"/> Salesmanship
<input type="checkbox"/> Railway Training	<input type="checkbox"/> Radio
<input type="checkbox"/> Electronics, Industrial	

Name.....

Address.....



FULLY GUARANTEED TIRES COST LESS!

Nationally famous FIRESTONE, GOODRICH, U. S. ROYAL, GOODYEAR, and other makes. Trucking Fleets, Busses, Hospitals and Schools buy from PYRAMID with confidence. Every tire selected and inspected for your safety!

Tube Given Free With Every Tire — 10% Discount to Veterans

550x16 3.25	700x15 3.70	700x20 8.65	34x7 9.45
600x16 3.45	700x16 4.95	32x6 (8) 8.65	825x20 11.45
650x16 3.45	750x16 6.45	32x6 (10) 9.45	900x20 11.60
650x15 3.45	600x20 7.15	750x20 (8) 8.20	1000x20 12.60

AAA Premium Grade — Guaranteed to Give Longer Service			
600x16 5.45	700x16 6.95	700x20 10.95	34x7 12.95
650x16 5.45	750x16 7.95	32x6 (8) 11.90	825x20 14.95
650x15 5.35	600x16(6) 6.95	32x6 (10) 12.45	900x20 14.95
700x15 5.45	600x20 9.95	750x20 (8) 10.95	1000x20 15.95

MILITARY "ALL-PURPOSE" TREADS			
900x16 8.65	750x20 8.95	1100x20 16.95	
900x20 13.95	1000x20 14.95	1400x20 22.95	
600x16 MILITARY "NEW TREAD" TIRES 7.95			
750x20 MILITARY "NEW TREAD" TIRES 19.45			

Largest stock of used tires in the East. Thousands of satisfied customers. Tires shipped to all parts of the world. Mail orders given personal attention. SEND MONEY ORDER OR CHECK WITH ORDER.

PYRAMID TIRE CO.

1333-35 North 5th St. Dept. M, Phila. 22, Pa.



EXTRA MONEY—LOADS of FUN! MAKING TRUE-TO-LIFE MASKS

As a hobby or business you'll enjoy this fascinating art. Friends—relatives—acquaintances—they're all potential customers. Inexpensive to make, no special skill required. Cash in now in fun or money. Be first in your community. Send \$1.00 for complete instructions and sketches on how to make true-in-detail LIFE MASKS. Offer expires soon—so order now.

KEARNEY & CLARK
Box 1308 Akron 9, Ohio

Say You Saw It in Popular Mechanics



Plastic Everguard Cover for Your Convertible Top

Protects against snow, rain, road dirt, cold. Keeps top looking like new for years. Tailored for your convertible of heavy Vinylite plastic. New metal clips assure snug fit, lasting tightness. Full rear window visibility. \$18.95 last year. NOW only \$12.95 by mail post-paid. Save \$6. Send money today. Satisfaction guaranteed or money refunded. Postage extra if C.O.D. SPECIFY model no. and year of your car; also choice of color: clear, black, gray or tan. EVERGUARD PLASTICS INC., 164 Colgate Ave., Buffalo 20, N. Y.

PLASTICAST

THE GREATEST THING IN PLASTICS!



A NEW HOME INDUSTRY AND HOBBY!

We have combined two of our most popular Kits into one GIANT COMBINATION PLASTICAST OUTFIT as described; PLASTICAST . . . a transparent liquid plastic; can be poured into ANY kind of mold or container. Hardens in a few minutes into a beautiful transparent solid, clear-as-glass, tough-as-steel plastic! No tools, equipment or skill required. Our casting plastics are as easy to use as pouring water out of a glass! Ideal for imbedding pretty flowers, butterflies, photos, souvenirs, biological specimens, etc. Makes a PERMANENT and ATTRACTIVE display! Make beautiful jewelry, novelties, etc. Casts easily into any shape or form.

HERCULOX . . . liquid plastic; works same as above but hardens in 5 minutes into a very attractive white opaque solid. A general all-purpose plastic. Can easily be made to imitate Ivory, Onyx or Marble. May be dyed any color, cast into ANY shape, used for ANY purpose. Extremely hard and durable. Ideal for statuary, figurines, novelties, gadgets, models, tools . . . a million useful things! In addition, COMBINATION OUTFIT contains 3 attractive molds for making about \$100.00 worth of novelties, dye, pipette, hardeners, measure, imbedding material, jewelry accessories and instruction manual.

COMBINATION PLASTICS OUTFIT, Cat. No. 636, postpaid . . . \$4.95
PLASTICAST OUTFIT ONLY, complete with 3 molds . . . \$3.50
HERCULOX OUTFIT ONLY, complete with 3 molds . . . 3.30

FREE!

Let us show you how extremely easy it is to make beautiful and useful things out of LIQUID PLASTICS, LIQUID MARBLE, LIQUID IVORY, LIQUID GLASS, CERAMICS, ETC. . . as easy as pouring water out of a glass! Make novelties, jewelry, gifts, artwork, gadgets, toys, ceramics . . . a million useful things! We supply everything—MATERIALS, INSTRUCTIONS AND BUYERS! Send only 25c for 1. Big catalog of 300 casting materials, molds, and accessories, 2. A beautiful CAMEO free (to show you what you can do), and 3. Actual INSTRUCTIONS on how to cast and start in the CASTING BUSINESS! Send 25c today—this may be the lucky coin that will start the most fascinating and profitable phase of your life! (Catalog only—10c) TERMS: We pay the postage (U.S.A. only) if full cash accompanies order. C.O.D. accepted (U.S.A. only) if \$1.00 deposit included for each item ordered.

DEALERS: WRITE FOR CATALOG, DISCOUNTS & PROMOTIONAL MATERIAL. PLASTICAST COMPANY (DEPT. C) 4637 N. Kedzie Ave. Chicago 25, Ill. (Write to nearest address) P. O. Box 987 Palo Alto, Calif. CANADIAN CUSTOMERS, please order directly from: CANADIAN INDUSTRIAL PLASTICS, LTD., 1056 1/2 Pender West, Vancouver, B. C.



UP TO \$500 an Hour In a Business of YOUR OWN!

ONLY A FEW DOLLARS PUTS YOU IN BUSINESS! Many clearing high as \$20 to \$30 a day—cleaning Rugs, Carpets, Upholstery, Auto Upholstery—by amazing, new, quick, easy method. No machines or equipment to lease or buy. Step into pleasant, dignified, BIG-PAY BUSINESS OF YOUR OWN—offering steady, year-around income. Work full or spare time from your own home—in small town or big city. No previous experience needed. Easy to learn. We send you complete instructions and quick cleaning supplies so you can start making money the first day. Quick method

cleans Rugs, Carpets like new—without taking off floors. Also cleans Upholstery, Wallpaper, Walls. Big Money using our Moth-proofing Method, too. Tremendous demand in homes, hotels, apartments, offices, stores, public buildings. Steady, repeat business. Territories going fast. Write today for FREE information about quick, easy way to get started. No obligations. Rush letter or postcard to: AMERICLEAN CO., INC., Dept G-24, 211 North 7th St., St. Louis 1, Mo.

DRAW for MONEY... Be an ARTIST!

Trained Artists are Capable of Earning \$65, \$80 and MORE a WEEK!

YOU CAN learn to draw at home in your spare time the well-known WSA way, COMMERCIAL ART, DESIGNING, CARTOONING all in ONE complete course. No previous Art experience necessary—we teach you step-by-step. Prepare for a fascinating hobby or profitable career. Good art jobs await artists in advertising, television, publishing, etc. For 35 years WSA graduates have been making good—WHY NOT YOU?



VETERANS! WSA Approved for Training Under G. I. Bill. Write for FREE BOOK, "Art for Pleasure and Profit," fully describes course, our method of instruction and commercial opportunities for you. TWO ART OUTFITS included with training. Low cost—only \$5 monthly.

MAIL COUPON TODAY FOR DETAILS.

WASHINGTON SCHOOL OF ART, Studio 1210R 1115—15th St., N.W., Washington 5, D. C.

Please send me full information and your Free Book, "Art for Pleasure and Profit." (please print)

Name _____ Age _____
Street _____
City _____ Zone _____ State _____

Amazing New **LOW PRICED** Electric Sprayer For Home Use **Makes Painting Easy!**

SAVE MONEY, TIME, WORK! GET PROFESSIONAL SPRAYING RESULTS!

- Paint Floors, Ceilings, Walls, Woodwork, Furniture, Toys
- Enamel Auto Bodies and Fenders, Storm Windows, Screens
- Varnish Table Tops, Linoleum
- Spray Moth-Proofing Liquids in Closets and Attics
- Spray Flit or Other Insect and Pest Solutions
- Spray Insecticides on Flowers, Plants, Shrubs
- USE VIBRO SPRAYER for EVERY Job of Painting and Spraying in and Around the Home
- Self-Contained Unit—No Motor, No Compressor, Produces Equivalent of 40 lbs. Pressure!



HOUSEHOLD ITEMS—It's easy to paint clothes hampers, kitchen chairs, shelving, partitions, slat fences, metal trash drums, etc., with Vibro-Sprayer!



OUTDOOR FURNITURE—Just the thing for painting rustic chairs, reed furniture, brickwork, boats, wagons, and other equipment!



ROUGH SURFACES—Makes quick work of painting concrete, rough wood or window screening!



INSECT CONTROL—Efficiently aids extermination of roaches, waterbugs, flies, mosquitoes and other pests. Fine for mothproofing clothes!



AUTOMOBILE MAINTENANCE—Provides the answer to quick, smooth touch-up work on fenders and body. Sprays light oils for under-chassis lubrication.



GARDEN PEST CONTROL—Ideal for spraying insecticides and fungicides on flowers, plants and shrubs.

JUST PLUG IN—
PULL THE TRIGGER
& PAINT OR SPRAY!

TRY IT 10 DAYS FREE IN YOUR OWN HOME!

Yes, now you can do a professional painting job on everything in and around your house with this amazing, brand new, self-contained electric paint sprayer. Just fill the big, 25-ounce capacity, interchangeable mason jar with any kind of ordinary oil-base liquid—lacquer, glossy paint, enamel, varnish, shellac, residual type insecticides, light oils, moth sprays, disinfectants, etc. Then plug the 8-ft. insulated cord into any 110-volt A.C. household outlet—pull the trigger—and get satin-smooth, professional results every time!

SAVE MONEY, TIME AND WORK

VIBRO-SPRAYER paints twice as fast as a brush, saves strain, fatigue, backache and sore muscles. Paint goes on **FASTER, SMOOTHER** and far more **EASILY** than with a brush. Adjustable spray control allows wide or narrow spray, thick or fine, as the job requires. Spray radius is always under complete control. VIBRO-SPRAYER cannot clog or drip—and is amazingly simple to clean. What's more, VIBRO-SPRAYER is **SAFE!** Will never break in use as there is **NO** pressure in the jar.

COSTS LESS THAN A GOOD BRUSH

Not only does VIBRO-SPRAYER paint faster, smoother, more easily than a good brush, but it actually costs less! And because VIBRO-SPRAYER applies paint more evenly and uniformly, you use **LESS PAINT**—save the cost of the sprayer in just a few months! In addition, VIBRO-SPRAYER shoots a fine, even spray into deep crevices where ordinary paint brushes can't reach, makes short work of rough or pebbled surfaces that are so difficult to brush.

MADE BY A FAMOUS COMPANY

VIBRO-SPRAYER is manufactured by the world-famous Burgess Battery Company, makers of popular auto and flashlight batteries. Every VIBRO-SPRAYER is guaranteed by the manufacturer to be free of mechanical defects. In addition, we guarantee that VIBRO-SPRAYER will give you exactly the professional, fast, labor and money saving results you desire, or you may return your sprayer within 10 days for full purchase price refund. You get **FULL PROTECTION** under this **DOUBLE GUARANTEE!**

SEND NO MONEY

Send only the coupon, now. When your VIBRO-SPRAYER arrives, pay the postman only \$12.95 plus small delivery charge—or enclose full payment now and we pay all delivery charges. In either case you are fully protected by the manufacturer's guarantee of mechanical perfection, and our guarantee of complete satisfaction, or return your VIBRO-SPRAYER within 10 days for full purchase price refund. Send the coupon **AT ONCE!**

FOSTER PRODUCTS, INC.
179 Wooster St., New York 12, N.Y.

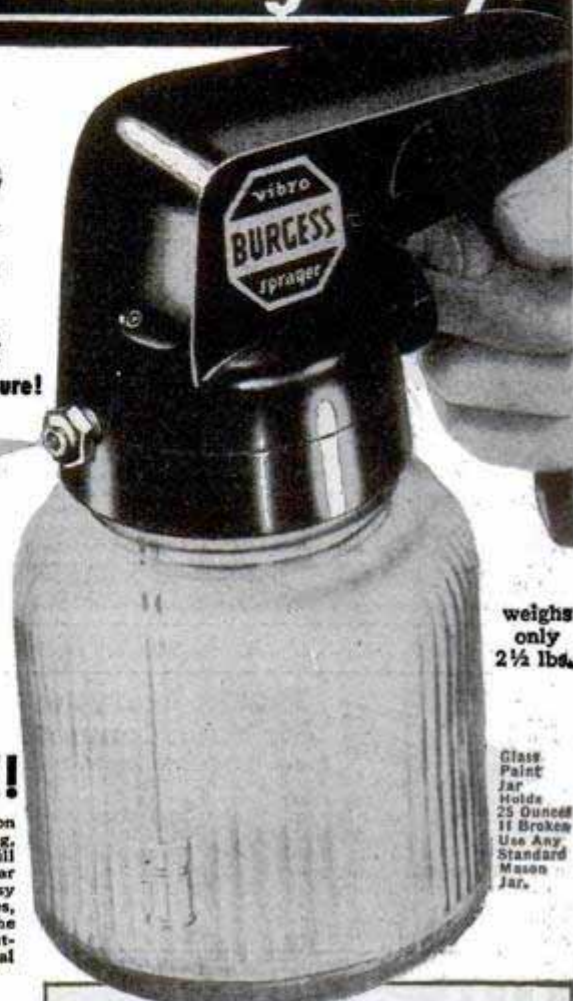

weighs only 2 1/2 lbs.

Glass Paint Jar Holds 25 Ounces If Broken Use Any Standard Mason Jar.

Comes Complete—All Ready to Use—No Extras to Buy!

ONLY **\$12.95**

VIBRO-SPRAYER is completely self-contained—the **ONLY** unit of its kind on the market. Nothing else to buy, no hose, compressor, motor, tank, etc. Just pour liquid into paint jar, (25 ounce capacity) plug in and press the trigger! Size 8 3/4" high, 6 1/2" deep, 4" wide. Works on activated piston and suction principle. Built like professional equipment—does the work of a \$100.00 unit producing 40 lbs. pressure!

FREE TRIAL COUPON—MAIL NOW!

FOSTER PRODUCTS, INC., Dept. SG-168
179 Wooster St., New York 12, N. Y.

Please send a VIBRO-SPRAYER for 10 days no-risk examination. On arrival I will pay the postman only \$12.95 plus small delivery and handling charge.

Check here if you enclose \$12.95 now. We pay all delivery and handling charges.

Name

Address

City..... Zone..... State.....

NOTE: Whether you order C.O.D., or prepaid, you receive the full protection of our **GUARANTEE** of satisfaction or money back!

**WORLD'S
BEST
WANT AD
MEDIUM**

CLASSIFIED Advertisements



Advertisements in this section 75 cents per word, each insertion, minimum 10 words, payable in advance
To be inserted under proper classification, copy must be in our office the 22nd of the
second month preceding date of issue

F. W. Johnson, Manager, Classified Advertising
Popular Mechanics Magazine, 200 East Ontario Street, Chicago 11, Illinois

1131

CLASSIFIED ADVERTISEMENTS

1131

OPPORTUNITIES FOR YOU

AUTOMOBILES, MIDGET CARS

NEW Ford Hotrod Manual. 128 pages chock full of cutaway construction drawings, photos, and valuable easy to read and understandable technical data. Neatly bound with colorful eye-catching cover. Includes complete data on installing V-8 motor in model A chassis, hydraulic brakes for any Ford, roadster and fast road car info. How to rework these engines for speed: V-8, Merc., Ford 6, Zephyr, Model A. Guaranteed the finest manual of its type published to date. Sent postpaid for \$2.00. California Bill, Box L-1B Eaglerock, Los Angeles 41, Calif.

NEW Catalog every American car. 120 photographs, specifications. All G-M, Ford, Chrysler and independents including Del Mar, Playboy, Gregory, Tucker, Davis, Keller. Compare all cars in one book. \$2.00 postpaid. Clymer, Dept. 10A, 1268 S. Alvarado, Los Angeles 6, Calif.

"SPEED & Power" Handbook—50 chapter library edition! Breathtaking methods — authentic — direct from California! Covers Fords to Cadillacs — all makes! Build your own dual manifolds! Superchargers! Hot Cams! Water injectors! Hi-compression heads! Mileage devices! Save many dollars! Get racing speed, lightning acceleration, dynamic power increases from any make automobile! Build fast stock cars! California roadsters! 150 MPH rods! Get construction drawings! Tuning techniques! Speed tricks! Picture catalogues! Economy secrets! Ingenious formulas! Including "Racing Frames," "Reciprocating Masses," "Jet Engines," "Braking Characteristics," "Dynamometers." Also dual pipes, gears, fuels, porting, relieving, lowering, balancing! Includes "California Automobile Customizing," glossy photographs! Diagrams! Very newest ideas! Conversions! Re-styling all makes! Streamlining! Chopping! Channeling! Customizing! Complete \$1.98 postpaid. Newhouse Automotive Industries, 5805-B2 East Beverly, Los Angeles 22.

LIFE OF Ted Horn, American Automobile Racing Champion \$2.00—Hot Rod Pictorial \$1.50—How to Build Racing Automobile \$2.00—Indianapolis Race History Book since 1909, 360 large pages, 1100 illustrations \$3.50—Power and Speed \$2.50—Postpaid. Clymer, Dept. 10A, 1268 S. Alvarado, Los Angeles 6, Calif.

MAKE Your Model "A" do 100 m.p.h. Lightning acceleration, breath-taking top speed. Complete details, photographs. \$1 postpaid. Four Barrel, Box L-1, Eaglerock, Los Angeles 41, Calif.

CALIFORNIA Custom accessory headquarters. Buy direct from original designers and save. Solid hood sides, grille panels, lowering kits, fender skirts, dual pipes, chrome motor accessories, speed equipment. 32 page illustrated catalog, jam-packed with California accessories; 25c. Eastern Auto Supply, 3319-A South Grand, Los Angeles 7, California.

CLYMER'S Steam Traction Engine & Threshing Machine Book \$2.50—No. 5 Scrapbook Antique Cars \$2.00—Steam Automobile Scrapbook \$2.00—Motor History of America Book \$3.00—Life of Henry Ford \$3.00—All postpaid. Clymer, Dept. 10A, 1268 S. Alvarado, Los Angeles 6, Calif.

INSTALL V-8 engine in your Model A for extreme acceleration, more top speed, smoother performance. Complete details, photographs. \$1 postpaid. A-V-8, Box L-1, Eaglerock, Los Angeles 41, Calif.

"SPEED And Mileage" manual! 140 illustrations! Most authoritative and widely read book of its kind! Easily gain up to 40% more speed, power, mileage, from any automobile! Complete instructions on building inexpensive speed equipment! Fast sports cars! "California hot rods!" 155 m.p.h. conversions! Superchargers! Dual manifolds! Twin mufflers! "Water injectors!" Heads! Economizers! All about fast engines; speed tuning; restyling; "customizing;" gas saving; "racing tricks;" cams; fuels; ratios; "stock car speed secrets!" Latest California methods! "Custom styling information!" Streamlining sport changes! Lowering! Working diagrams! "Hollywood roadster plans!" Speed conversions! Drawings! Charts! Photographs! All cars! "Complete manual" plus "Hot Rod Handbook" and equipment catalog. All three \$1.98. (Satisfaction guaranteed). Almqvist Engineering, Milford 22, Pennsylvania.

FORD Owners Handbook. Service information all 1932-1949 models \$1.50—Model "A" Handbook \$1.00—Model "T" Handbook \$1.50—Motor's Automobile Repair Manual \$7.00—Motor's Flat Rate \$7.50—Chevrolet Car & Truck Book 1930-1940 \$3.50—Outboard Handbook \$3.50—all postpaid. Clymer, Dept. 10A, 1268 S. Alvarado, Los Angeles 6, California.

MAKE Your Ford fast! Complete details, photographs. How to construct 120 m.p.h. Hotrod. \$1 postpaid. California Bill, Box L-1, Eaglerock, Los Angeles 41, Calif.

CALIFORNIA Speed equipment, custom doll 'em up chrome accessories, dual, single, Hollywood mufflers, skirts, lowering kits; save freight cost. Midwest warehouse. Latest 32 page, illustrated catalog 25c. Von Esser's, 2840 No. Kedzie, Chicago 18, Ill.

1949 INDIANAPOLIS Race Yearbook. Just out. Complete information, articles, photographs. Postpaid \$1.50. Clymer, Dept. 10A, 1268 S. Alvarado, Los Angeles 6, Calif.

"HOLLYWOOD" Deeptone mufflers. Powerful "straight-thru" design increases efficiency, speed, acceleration, mileage! Singles, all cars \$4.85, V-8 duals \$15.90. Satisfaction guaranteed. Speed equipment catalog 25c. Dealers wanted. Almqvist Engineering, Milford 22, Pennsylvania.

"SPEED Equipment" bargains! "California" mufflers \$4.50, V-8 duals \$15.90, famous racing heads \$45.00, chrome carb stacks 98c, echo cans \$1.65, dual manifolds \$9.95, octa-gane water injectors \$17.50, gas savers \$1.50, lowering kits \$2.95. Many others! Illustrated "Speed Catalog" 25c. Dealers wanted. Almqvist Engineering, Milford 70, Pennsylvania.

NEW Chevrolet speed manual! 90 pages of accurate information you can really use! How to increase speed and acceleration of any Chevrolet 1937 thru 1949. How to install late engines in pre-1937 chassis. Full data on cams, high compression, multiple carburetion, supercharging, ignition, etc. We guarantee this to be the finest manual of its type! Prove that your Chevrolet can have power and speed formerly associated with other cars. Sent postpaid for only \$2.00. California Bill, Box L-1B, Eaglerock, Los Angeles 41, Calif.

AUTOMOBILE Racing, sixth edition, 100 illustrations, Drawings, building instructions Ford-60 midget, California roadster, Offenhauser racer, World's record 158.5 m.p.h. car. \$2.00 postpaid; \$2.40 c.o.d. Ray Kuns, Department 63, Cincinnati 27, Ohio.

"VAPO-STEAMATIC" Water injector. Easily built! Finest automatic "Moist-Humidity" system! Engineering triumph—Gets up to ten extra miles per gallon! Tremendously increases horsepower! Eliminates ping, carbon, overheating! Reduces wear—Lengthens engine life! Copyrighted "Water Injection Handbook"—with working drawings covering automobiles, motorcycles, airplanes, tractors! Includes plans, catalogues, diagrams, instructions — \$1.00 complete. Newhouse Automotive Industries, 5805-B1 East Beverly, Los Angeles 22.

BONNEVILLE National Speed Trials photographs, details, story, compiled by California hotrod expert. Action photos, details of timing methods, records, engines used by winners! Foreign cars, streamliners, roadsters, track jobs, competition coupes, and many others. Chock full of pictures, both action and stills. Comparisons of speeds attained by expensive foreign jobs and homemade U. S. hotrods. Sent postpaid for \$1.00. California Bill, Box L-1, Eaglerock, Los Angeles 41, Calif.

"HOT Rod" handbook plus California Speed Manual and "Racing Equipment" catalog. All three only \$2.00. Speed Publications, Port Jervis 30, New York.

"WATER Injection." Free descriptive, illustrated information. Neher Industries, La Verne, California.

CUSTOM-RETYLING, Super handbook. Brand new! 200 graphic photographs, sketches, Medley cutaways. Thousands ideas! Guaranteed! Biggest, best buyable, \$2 postpaid, including catalog. Post Publications, Box 723-KE, Arcadia, California.

SEE Our ad under motorscooters for midget car bargains. Midget Motors Directory, Athens, Ohio.

NEW Sensational seat cover. Mono, 6545 Santa Monica Blvd., Hollywood, California.

AUTOMOBILE Racing book, fifth edition, well illustrated. Building bodies, frames, engines, Ford conversions. Plans. Roadsters. Indianapolis cars. \$1.00 postpaid. Ray Kuns, Dept. 47, Cincinnati 27, Ohio.

RUSTED-OUT Bodies, doors, fenders repaired without welding, soldering. Professional results. Write, Gibes, 2134 Had-don, Chicago 22.

DUALTONE Crystalline packed California mufflers and dual sets. California chromed accessories, lowering blocks all automobiles. Speed and doll-up equipment. Catalogue 20c, streamlining manual \$2.00. Dealers request dealership information. Dualtone Mufflers, 2636C India Street, San Diego 1, California.

RACING Car equipment for all cars, engines, racing heads, manifolds, carburetors, mufflers, etc. Speed instructions and literature \$1.00—refunded first order. Lee Motorcraft Co., 1412-D Great Northern Bldg., Chicago 4, Ill.

WE Sell direct to customers over 200 speed equipment parts manufactured by us. Ford A-B-V8-6-4- (Ferguson) Studebaker Champion, Chevrolets and Willys. Cylinder heads, dual intake manifolds, lyntite flywheels, oversize valves, compound springs, camshafts and other supplies. Complete engines ready for race for cars, boats and midgets. \$1.00 to cover illustrated literature and price sheet. R & R Mfg. Co., Robert M. Roof, Box 546, Anderson, Indiana.

FROM Speedway to roadway! Track-proved hi-speed heads and manifolds now available for your passenger car! No special tools needed! Increase horsepower 25%! Astounding getaway! Free illustrated catalog. Speedsport, 6215AA Diversey, Chicago 39.

AUTO SUPPLIES AND EQUIPMENT

VOLTAGE Regulator; generator tester. Variable resistance enables quick and accurate adjustment. Will test voltage drop of batteries, cables, cable connections and full circuits. \$22.50. Details and pictures free upon request. Don Engineering Co., 197 E. Huron St., Pontiac 16, Mich.

WELDING Pays good profits. Bodies, blocks, frames, fenders; easy with Hobart Welders. Low cost. Easy terms. Free catalog. Write Hobartweld, Box M-1092, Troy, Ohio.

AUTOMOBILE Glass! Direct savings! Write requirements. Cooper's, 3124 Lawrence, Chicago 25.

SERVICE Stations, garages, and agents-sellers sell nationally advertised Plexiglas windows for cars, trucks, buses and boats. Aberdeen Auto Parts, Box 283-D, Aberdeen, Maryland.

AUTO And truck parts. New and used. Lowest prices. Complete stock. Prompt replies. Babbitt Auto Parts, 2833 Chicago Ave., Chicago 22, Ill.

"SMITHYS Mufflers." Send for list. Bucks Auto Parts, 1296H, Merced 12, California.

NEW Sensational automatic thief chaser burglar alarm. A life guarantee. Electrical unit installed on any car or building. Once installed it works automatically. Only \$4.98. Easily installed. Free literature. Dealer inquiries invited. Novak Manufacturing Company, 1358 Chase, Gary 1, Indiana.

SPECIAL Prices, pistons, valves, rings, for cars, trucks; 1916-1949. Send sample valves. Zrubek, Pratt, Kansas.

NEW Grilles for all cars. Wagner Grille Co., Route 2, Bernville, Penna.

OVERDRIVE! Does your car have overdrive? Write for free money-saving information. Hill, 5227C Parker, Chicago, Ill.

SNAP-ON Convertible top covers. Plastic fabric. \$19.50. Vassar, Cleveland 5, Ohio.

HEAT Your car seconds after starting with Super Heater, booster for all water heaters. Fits around exhaust pipe, water runs from motor through Super Heater into car heater. Quicker, hotter heat. Easy to install. \$7.50 postpaid. Dealers wanted. Caughron Engineering Co., 217 Merchandise Mart, Oklahoma City, Oklahoma.

AUTO Bells: The newest warning signal. Two tones. \$8.50. Details free. Write: Bermuda Auto Bells, D-25, 16 Concord St., West Hartford 7, Conn.

"ANTI-SWAY Bar" for rear end of Ford's and Mercury's 1935 to 1941. Eliminates road sway at high speeds or in cross winds. Prevents body and fenders rubbing on tires in turns when long spring shackles are installed. Complete kit with instructions for easy installation only \$7.95. Many other high quality items including "Belond" racing exhaust heaters for all Ford's and Mercury's, complete exhaust systems, Mello-Tone single and dual mufflers, chrome extensions, shackles, skirts, etc. Send 25c in coin for our fully illustrated catalog now and be on our mailing list for new items in the future. Discounts to the auto trade. Southern California Muffler Co., 11142 Washington Place, Culver City, California.

LAUGH At glaring headlights with the O.W. Glare Eliminator. Designed for drivers who regularly travel long distances on open country roads at night. Based on a new principle. Sold by mail only. No tools. \$15.00 postpaid. Satisfaction or refund. O.W. Automotive Devices Co., 4413 Underwood St., Hyattsville, Md.

MASTER Cylinders: Bronze sleeved for lifetime dependable service—\$10.00 complete. Specify make, model of car. E & M, 1157 Felipe, El Monte, Calif.

SAVE Gasoline! Quick starting! "Air-flow needles." \$1.50. Free trial! Specify car, carburetor. Neher Industries, La Verne, California.

NEW And used guaranteed parts for civilian and army cars and trucks. Largest stock in America. Mail orders. Pioneer Auto Wrecking Co., 734 W. 13th Ave., Denver, Colorado.

LACHAPPELLES Motor and motor fuel treatment (patented), stops ping, gives more miles per gallon, more miles per motor. 100,000 miles treatment. \$3.00 postpaid. Ferns Products, 8120 Walnut Dr., Los Angeles 1, Calif.

"LEKTRON" Atomic coil booster saves gas! Instant starting, smoother power. Easily installed. \$2.00. Money-back guarantee. Specify car. Electronic Industries, Cleveland 11, Ohio.

RADIATORS, Ford, Chevrolet. New in original cartons. Give year and model; buy direct; save, factory outlet. Guaranteed Radiators, 8815 De Havilland, Los Angeles 45, California.

V8 FORD Owners. High output generators, 35 amp., with voltage control and wiring ready to install. All standard parts. Money back guarantee. \$25.00 cash. Shipping weight 20 lbs. Ace Auto Elec., 2322 W. Spokane St., Seattle 6, Wash.

PISTONS, American, foreign and racing. Catalog 10c. Merryman Co., Lawndale, Calif.

SPEEDOMETERS—Any make completely rebuilt. Including parts, labor \$4.95 ppd. Unconditional new factory guarantee. Mail your defective speedometers to: Western Speedometer Rebuilders, 10452 Magnolia Blvd., No. Hollywood, Calif.

WILL You be the next to have an accident due to dry front wheel bearings? Get Douglass inside grease seals for the front wheels of your car and be safe. Distributors wanted. Luberretain, \$2.85 a set factory to you. Weichhart Mfg. Co., 237 Natoma St., San Francisco 3, Calif. No c.o.d.

SAVINGS To 50% on generators, starters, voltage regulators, 6-32 volts, distributors, armatures, magnetos, carburetors, fuel pumps, windshield wipers, radiators. "Old models in stock" free list. State Ignition, 2521 Indiana, Chicago 16.

AUTO Parts. Buy direct. Get dealers' prices. Represent us in your territory. Write requirements. Specify car make. Mechanics Auto Parts, Factory Warehouse, 3807-PM N. Ashland, Chicago 13.

BUICK Parts—Enjoy new-car pep and power in your old Buick. Same day service from world's largest stock of new (not rebuilt) Buick parts and engines. Ship anywhere. Write today. Robertson Buick Co., 1001 S. Wabash Ave., Chicago 5, Ill.

CHEVROLET Parts. Scarce motor, body, sheet metal parts. Grossman Chevrolet, Minneapolis, Minnesota.

HARD-TO-GET Auto body parts. We supply. Miller Auto Parts Service, 192 N. Clark Street, Chicago.

BRUSH Plating outfits connect to a battery. No tanks or shop required. Free particulars. Gunmetal Co., Avenue J, Decatur, Illinois.

AUTO TRAILERS

CONVERT Box trailer or pick-up to folding camper sleeping four. Plans \$1.00, guaranteed. Trail Hut, 600 Sixteenth Street, Oakland 12, Calif.

TRAILER Coaches. Save money. Buying? Building? Sound engineering construction, chassis, bodies, furnishings. Travel, dwelling, trailer plans. \$1.50 postpaid. Ray F. Kuns, Cincinnati 27, Ohio.

BUILD Your own trailer! Save money! Have every feature you want! Plans for house, sport, camp and utility trailers. Catalog describing 9 models 10c. 15c in Canada and overseas. Jim Dandy, Box 125-A, Wausau, Wisconsin.

HOUSE-TRAILER. Complete housekeeping facilities built into this beautiful trailer. Size 7½x17 by 6 ft. 4" inside measurements. Sleeps 4 comfortably. All steel chassis. Our plans make it easy to build. Complete plans \$1.50. Popular Mechanics Press, 200 East Ontario St., Chicago 11, Ill.

MOTORCYCLES, BICYCLES, MOTORSCOOTERS AND SUPPLIES

BICYCLE Repairing made easy. Illustrated "Bicycle Repair Manual," \$1.00. Klausner Cycles, Shelbyville, Ill.

BICYCLE Supplies. Wholesale, retail list 10c. Universal, 4713 Virginia, St. Louis, Missouri.

NEW Harley "74" engine. Jess Ecker, 913 Sherman, Bay City, Mich.

WHEELS! Build wagons, scooters, mowers, trailers, wheelbarrows, grocery carts, 4" to 16". Free list. T & H Mfg. Co., Inc., Dept. CPA-10, 811 East 31st, Kansas City, Mo.

MIDGET Car \$5, motorbike conversions \$5, brand new Regal motorscooters \$37.50 less motors, Indian motorcycle \$25, midget car \$20, Custer motorscooter \$26, all complete. Gasoline engines \$2 up. Super-cycles, Cushmans, Salsburys. Plenty new motorscooters, midget cars, homebuilders parts, automatic clutches, transmissions, engines, tires, etc. at factory prices. Special sale! Four balloon tires for \$3. Over 5500 tires in stock. Mailorder only. Send 25c for big war-bargain catalogue just out listing these and hundreds of other bargains. (35c by first class mail.) Midget Motors Directory, Athens, Ohio.

POWERCYCLES. New—Factory overstock. Latest models. \$98.50 up plus tax and freight. Regular \$179.50 to \$267.50 values. Amazing buy. Regular factory warranty. Send for free catalog. R. C. Cheney Co., Mfg. Division, La Crosse, Wis.

MOTORCYCLE Journal—Worldwide coverage. Illustrated. Year's subscription \$1.00. Sample 15c. Motorcycle News, 5424-A Sawyer, Chicago 25.

TIRES And industrial wheels, suitable for scooters, wheelbarrows, farm equipment, etc. All sizes. Bicycles and accessories. Send dime for list. Cycle Transport Company, 1241 So. Michigan Ave., Chicago 5, Illinois.

CUSHMAN Motorscooter (4 H.P. motor) \$19.98 complete; Midget car (leather seat) \$25.00; Motoscoot \$15.00; 1946 Whizzer \$35.00; Motorbike outfit \$5.00; Indian motorcycle \$30.00. Other motorscooters \$8.00 up, motors \$3.00 up. Send 25c for new summer catalog listing many other sensational bargains in used motors, motorscooters, motorcycles, parts, etc. Associated, Box 1764-CS, Toledo, Ohio.

HARLEY-DAVIDSON 125—America's outstanding lightweight powercycle. Floor models and demonstrators at a saving. Send 10c for bulletin. Knuth's, 1753 Muskego, Milwaukee, Wis.

HARLEY-DAVIDSON Parts, accessories, oil, expert service. Tires all sizes. Send \$2.25 for Army 45 motorcycle manual. 25c for accessory catalog and bulletins. Knuth's (Harley-Davidson Dealers), 2491 Fondulac, Milwaukee, Wis.

WHIZZER Bike-motor \$25.00; Cushman motorscooter \$15.00; midget racer \$40.00; Shaw bicycle-motor \$15.00; Harley-Davidson motorcycle \$15.00; Smith motor-wheel \$25.00; Good motorscooter (twist grip) \$22.50. Rush 25c for new catalog #14 listing many other amazing bargains in motorscooters, used motors, midget cars, parts, wheels, etc. Gail, 538 Erie, Toledo, Ohio.

HARLEY-DAVIDSON Parts, accessories, batteries, and tires, 24 hour service. Authorized factory dealer. Philadelphia Harley-Davidson Company, 857 North Broad Street, Philadelphia 23, Penna.

MOTORSCOOTERS, New design, 6 big features. Literature 10c. Rollaway Motors, Lancaster, N. H.

RECONDITIONED Motorcycles and motors. Chromium accessories. Complete stock Indian parts. Expert rebuilding. Fast service. Indian Motorcycle Sales, Kansas City 1, Mo.

AVIATION

PROPELLERS, Plans, skis, engines, for snow sleighs, air boats. Literature 10c. Banks-Maxwell, Box 3301E, Ft. Worth.

JET Engine \$3.00; plans \$1.00; literature 10c. N.E.W., 526 Sexton Building, Minneapolis 15, Minn.

MICROPHONES, throat, Kellog, T-30-R, fifty cents postpaid. Flares, fusee, red, five minute burning, \$10.00 per 100. Harry Boggess, Liberty, Missouri.

ICEBOAT Engine, complete with motor mount and propeller, ready to go! 225 horsepower Jacobs airplane radial type, ideal for your iceboat. Special \$68.00. Estimated original cost \$4000.00. Hurry! They won't last long. Gaare Supply, Box 1377, Vernon, Texas.

PROPELLERS—2-3 Blade for sleds, air-drive boats. Catalog. Standard Aero Craft, Box 387, Ft. Worth, Texas.

BATTERIES, GENERATORS

BUILD—1,000 Watt 110 volt A.C. generator from old 12 volt Dodge generator. Constant voltage with volt regulator. Variable speed. Plans and instructions guaranteed. \$1.00. A. J. Allen Service, P.O. Box 1432, Del Valle Station, Dept. P.M., Los Angeles 15, Calif.

EDISON Non-acid lifetime storage batteries for home lighting, motors, industrial uses, radios, etc. Free interesting literature. Hawley Smith Co., Croton Falls 1, N. Y.

ELECTRICAL SUPPLIES

ELECTRONIC Door lock! Sensational! Invisible! Positive protection! Inexpensive! Tremendous profits! Free details! Aynsworth, 17544 Raymer, Northridge, Calif.

OIL Lamps—Electrify them in 1/2 minute. Catalog all lamp parts and instructions 10c. Gyro Lamps, 5402P Clark, Chicago 40.

NEW G.E. motors 1/2 horsepower \$12.50, other bargains. Free literature. Plenge, 9 Stuyvesant Oval, New York 9, New York.

LAMPS—Build own originals, parts wholesale, any amounts. Catalogue 10c. Brown Lamp Co., Box 501, Wellston, St. Louis 12, Mo.

BUY Lamp parts wholesale—Parts you need for building, repairing, or assembling. Save money on large or small orders. New catalog for 10c. Gearon Company, Dept. 300-B10, 27 South Desplaines, Chicago 6, Ill.

WATTHOUR Meters. Reconditioned, guaranteed. Ideal for cabins, trailers, shops. \$2.95. T. Price, 310-14th, Raymond, Wash.

MAGNET Wire—#33 D.C.C., \$1.00 per pound. Harry H. Van Dick, Little Falls, New Jersey.

SURPLUS Bargains. Save money. Light plants 800 watts \$145.50, 1000 watts \$165.50 and up. 110 volt A.C. gasoline engine driven new units, custom built and guaranteed. Many other reduced price items. Send for listing today. MDSE & Equipment Mart, 51 E. 99 St., Cleveland, Ohio.

ELECTRIC Pencil: Engraves all metals \$1.25. Beyer Mfg., 10511-H Springfield, Chicago 43.

SILICON Transformer lamination cut to order. Magnet wire, supplies. Send for bulletin 42949M. Morton Electrical Service, Maywood, Ill.

WELDING, SOLDERING, PLATING

WELDING—A profitable trade. Learn quickly at best equipped school in U. S. Low cost. G.I. approved. Free catalog. Write Hobartweld, Box M-1095, Troy, Ohio.

A.C. Welders; wholesale, retail. Free literature. Holgeron Service, Canton, Kans.

WELDERS For all requirements. Free catalog. Write Hobartweld, Box M-1094, Troy, Ohio.

BANDSAW Owners—Repair broken blades 4c each. Special silver solder, flux, instructions \$1.00. Literature free. Products Supply Service, 24310-B Mary, Inkster, Michigan.

ACETYLENE Welding outfits, new \$45.00, used \$25.00; arcwelders \$46.50. Eagle Welding, Dept. PM, 5085 Broadway, Chicago 40, Ill.

SOLDERING Paste, two ounce can, 100 post paid U.S.A., \$7.50. Harry Bogges, Liberty, Missouri.

"BANTAM-CHAMP" Welder starts you in profitable welding business. Pay only \$16 monthly. Write for information on this new, low-cost 200 amp. welder and free "Guide to Better Welds." Hobartweld, Box M-1093, Troy, Ohio.

ELECTROPLATING Units—Complete \$2.00 and up. Free literature. Regency Sales, 5316 S. Justine, Chicago 9, Illinois. Dept. M.

RADIATOR Repairing books, supplies, equipment, gasoline torch. Write, Curfman Co., Maryville, Mo.

WELDERS 110V. Welds 1/2" steel, \$29.50. Morris Welding Service, 1850A State, Schenectady 4, N. Y.

BUY Direct from factory. Welding and cutting equipment. All makes of equipment repaired. Established 1913. Box 331, Hamilton, Ohio.

RECTIFIERS 0-4 V.D.C. \$9.50, 0-8 V.D.C. \$12.50, 0-12 V.D.C. \$18.50. All 0-100 amps. Starkweather, Ottawa, Kansas.

ELECTROPLATING Salts and rectifiers. Mirror resilvering and chipped glass nameplate supplies. John Sprinkle, V55, Marion, Indiana.

RADIATOR Repairing, cleaning, recording. How to equip small shop at low cost. Supply sources, trade secrets, instructions. Now only \$3.50 postpaid. Radiator Service, McBain, Mich.

BOOKS—All Kinds—Homecraft, Radio, Plastics, Boat Building, Photography, Model Building. Catalog free. Popular Mechanics Press, 200 E. Ontario St., Chicago 11, Ill.

MACHINERY, TOOLS, SUPPLIES

HOME Lathe owners—Build your own attachments. Send for picture, sample of work and list of blueprints. Cut gears, ratchets, etc. Make neat screws easy way. The Home Shop, 415 Raymond Ave., Glendale 1, Calif.

WHOLESALE Prices—Power tools! Save 30% on standard, heavy-duty, guaranteed bandsaw, circle saw, jointer, sander, etc. Opportunity of a lifetime to completely "power-ize" your home or farm workshop at wholesale prices. Act fast! Send postcard for free information. Western-Standard Co., Dept. M, 3005 Hennepin Ave., Minneapolis 8, Minnesota.

BAND And jig saw ripping fence. Circular. Wasco, Box 111, Blue Island, Ill.

"BUILD-UR-OWN" Welder—A.C. power combination. Portable—Welding plus a.c. power anywhere. Your engine plus Hobart generator saves \$350. Free instruction book. Write Hobartweld, Box M-1096, Troy, Ohio.

ARMY Weasels. Snow sleds. Symington's, Union Bay Place, Seattle 5, Wash.

CONCRETE Mixers—New low prices, \$49.00 up. Write for literature and price sheet. Muller Machinery Company, Inc., Dept. PM, Metuchen, New Jersey.

INDEX Heads for the lathe, drill-press, milling machine, etc. Very reasonable. Write for free folder. Long's Index Heads, Box 534, Torrington, Wyo.

TOOL Steel, high-grade waterhardening, 9/16" sq. x 9" long, 1/2" Dia. Shank 2" long. Ideal for pneumatic or hand tools. Ea. 50c; 10, \$4.50; 100, \$40.00 postpaid. S & N, 918 Wolfram St., Chicago 14, Ill.

BALL Bearings 1/4 list price. Free list. Burgess, Box 168, Ferguson, Mo.

DRILL Grinder for twist drills, \$2.95. See ad on page 287.

WAR Surplus in small tools for machine shop. Send 15c for bulletin. Travers Tool Co., Dept. P, 5 Court Square, Long Island City 1, N. Y.

CLOSEOUT Electric drill presses, 1/4" Jacob chuck, \$10. Tilt-arbor bench saws including 8" blade, \$25. New! Guaranteed! \$5 with order, balance collect. Corday Motors, Wellington, Ohio.

MAKE Money at home—Cut grinding costs. Belsaw powered saw, gumming machine precision joints, gums, sharpeners circular saws 8 to 48-in. diameter. Portable, fast, accurate. Catalog. Belsaw, 315-H Westport Rd., Kansas City, Missouri.

WINCHES For contractors, farmers and shops. 1/4 and 3/4 ton; electric steel; bargains. For literature and prices write, Gold Foundry & Machine Works, 1622 South Osage, Independence, Missouri.

14"x6" HENDEY Engine lathe \$625.00. 18"x8" American GH screw cutting lathe \$350.00. #1 1/2 Valley universal milling machine \$425.00. 15" Potter Johnston metal shaper \$490.00. 20" Barnes drill press \$55.00. Cincinnati Machinery Co., Dept. B, 217 2nd St., Cincinnati, Ohio.

POWER Tools, equipment wholesale prices. Free bulletin. Homecrafters Cooperative, Grand Rapids 6, Michigan.

BOATS, OUTBOARD MOTORS

KNOCK-DOWN Boat kits. Outboards, inboards, sail, hydroplanes. Easy to assemble, minimum cost. Catalog with specifications, prices, 25c. Brooks Boat Company, Carrollton P9, Michigan.

OUTBOARD Motor parts, new-used. Save money, write for price quotation. Cylinders rebored, new pistons, all makes. Outboard Motor Mart, Inc., 309 Atlantic Avenue, Boston 10, Mass.

CONVERSION Parts for all engines, marine manifolds, transmissions changed to high-speed reverse, propellers, shafts, couplings, etc. Money back guarantee. Conversion Parts Co., 278 Adams Street, Boston 22, Mass. U. S. A.

TWENTY Plywood boat plans \$1.00. Catalog of boatbuilding plans 10c. The Rudder, 15 Murray Street, New York 7.

P38 BELLY Tanks, steel, 10 foot, unused, \$9.95. Anzio Boat Co., 1625 T, Merced, Calif.

BUILD Marine motors, Ford or Jeep. Federal Marine Motors, 9011 Cottage Grove, Chicago 19, Ill.

SAVE 2/3 Cost. Build your own boat with our ready cut parts by the Welch system. No experience necessary. Rowboats to cruisers. Illustrated catalog 25c. Midwest Boat Company, Menomonee Falls, Wisconsin.

OUTBOARD Motors—Used bargains, \$45 up, free list. Used parts, most models, save money! Boat and motor equipment and accessories. Big catalog, send dime. Crandall-Hicks, 911 Commonwealth, Boston, Mass.

NEW, Used, rebuilt marine motors. Marine conversions, fittings. Free catalog. Stokes Marine Supply, Dept. 24, Coldwater, Michigan.

MARINE Conversions for Ford and Jeep engines. Catalog 10c. Lehman Manufacturing Company, Department D, Newark 2, New Jersey.

STEERING Wheels, windshield brackets, from \$6.95. Modern fittings at lowest prices. Complete pre-cut plywood boats. Bargains galore. Folder 10c. Marine, Box 681, Mendota, Minnesota.

ENGINES, MOTORS, DYNAMOS

"BUILD-UR-OWN" Welder. Hobart generator plus auto engine saves \$350. Free instruction book. Write Hobartweld, Box M-1097, Troy, Ohio.

MOTORS 1/2 Horse, 1725 speed repulsion induction \$15. 3/4 horse \$22. 1 horse \$30. Butler, 1885 Milwaukee, Chicago 47.

ARMATURE Winders, write for winding and testing bulletins. Motor Industries, Quincy, Illinois.

WINDING Data, listing 225 motors, single and three phase, \$1.00. Motor Data Co., Box 7631, Kansas City 3, Mo.

ATHLETIC EQUIPMENT, BODY BUILDING COURSES

HOW To chin yourself with one hand! 10c. Sports Centre, PMX, 204 East 81, New York 28, N. Y.

6 BODY Building courses, four barbell, two dumbbell, in 53-page muscle building book with six illustrated wall charts, \$1. Paramount, 2420 E. 23rd, Los Angeles 11, Calif.

DEADLY Judo—Piercing fighting technique. Trick knockouts. (Over 200 illustrated pictures.) Expert instructions; three volumes. Complete \$2.25. Variety House, Box 46-B Wall Station, New York 5.

BARBELLS—Finest quality \$8.98 up. Free catalog. Lurie Barbell Co., 1729-M9 Rockaway Parkway, Brooklyn, New York.

BARBELLS, Dumbbells. Inquiries invited. York Barbells (Canada), Scarborough Bluffs, Ontario, Canada

BARBELLS! Muscular physique, strength. Send stamp. Jackson Barbells, Springfield, N. J.

BARBELLS, Exercise equipment. Courses. Free booklet. Good Barbell Co., Reading, Penna.

SPORTING GOODS, GUNS, FISHING TACKLE, ARCHERY, TRAPPING

ENFIELDS, 30/06. Excellent condition \$39.50. Pre-war short Mauser '98 actions \$28.50, std. model '98, \$28.50. All orders f.o.b. L. A. Western Arms, Dept. 4, 1206 Maple, Los Angeles 15, Calif. Dealer inquiries invited.

BUILD Your own trout rods from packaged kits. Start \$8. Free list. Lumbard & Co., San Marino, Calif.

SPORTSMEN! Send for big money-saving catalog; guns, sporting goods. Enclose 10c. Woodland Sports, Woodland Hills 2, Calif.

1/2" WHITE All wool woven felt can easily be cemented to outside soles and heels of fishing boots and waders to prevent slipping. 10" by 14" sufficient for pair of boots \$2.50. Send check or m.o. Henry M. Nagel, Box 125, Boulder, Colorado.

NEW Riflescopes, mounts, and shooting accessories, latest models, lowest prices. New catalog with bargain discount sheet 10c. Acme, 389 Champion, Battle Creek, Michigan.

MOLDS For fishermen's sinkers. Ocean City Sinker Mold Co., 649 Wilcox Ave., New York 61, N. Y.

AAA Sport Centre, Bayonne 13, N. J. Sports catalog 10c. \$3.00 hunting knife, \$2.00 postpaid in U. S. No c.o.d. Gift with knife.

FREE Catalog (new fall edition) of guns, fishing tackle, athletic goods, camping equipment, cameras, western goods. Write Andy Anderson's Sporting Goods Co., 120-A W. Grand Ave., Oklahoma City, Okla.

LAMINATED Stocks—Beautiful, warp-proof, inexpensive; blanks, semi-finished, finished. Target blanks any dimensions. Literature. Banks-Maxwell, Box 3301E, Ft. Worth.

FISHERMEN—Make your own sinkers with our molds. Free illustrated booklet. Reading Instrument Co., Box 78, Reading, Penna.

ALL Sizes fishermen's sinker molds. Illustrations, Schiercke, 5 Fullerton, Albany, New York.

AMMUNITION Prices slashed. American and foreign loads below retail. Dime for list. Central Sports, Delphos, Ohio.

INTERESTED In gunsmithing as a profession? Details and copy monthly gun magazine 25c. Gunsmith, Box 636, Palatine, Illinois.

190 PROFUSELY illustrated pages antique and modern pistol, sword, etc. values, 50c. Robert Abels, A860 Lexington Ave., New York 21.

MOLDS For fishermen's sinkers, squids, and jigs. Sweet's Molds, Tonawanda, N. Y.

BOWS, Arrows. Quality archery equipment. Popular prices. Catalog 10c. Illustrated archery instruction book 50c. Archery, 617-K So. State, Chicago 5.

5000 BARGAINS. Firearms, binoculars, war relics. Catalog 40c. Smith Firearms, Runnede, New Jersey.

SHOTGUNS. Rifles, revolvers, over 500 modern, obsolete. Also cartridges, list 10c coin. Ed Howe, 52 Main, Coopers Mills, Maine.

TAXIDERMY

"MODERN Taxidermist Magazine," Greenfield Center, N. Y. Devoted exclusively to taxidermy. Two sample copies 25c.

BINOCULARS, TELESCOPES, MICROSCOPES, MAGNIFIERS

SAVE 50% on new Binoculars! Free catalog and booklet "How to Select Binoculars." Write today! Bushnell Importers, 43-M10 East Green, Pasadena 1, California.

WAR Surplus bargains, binoculars, telescopes, sextants, millions of lenses, prisms, reticles, eyepieces, objectives, etc. Request free "Catalog CH." Send \$1.00 for stock CH—10-piece lens kit and big instruction booklet. Edmund Salvage Co., Barrington, N. J.

BINOCULARS: Lowest prices. Write for list. Louis Domingues, Kerrville 5, Texas.

POWERFUL Astronomical telescopes easily made. Perfect lenses and instructions. 100X \$3.00, 100X and 200X \$4.00, 100X, 200X and 400X \$6.00. Clear vision, full power guaranteed. Instructions alone 10c. Suffolk Science Service, Box 208, Man-orville, N. Y.

BINOCULARS, Telescopes, watches, guns. Buy, sell, trade. Schweer's, Donnellson, Iowa.

"TERRIFIC" Bargains—Government surplus telescopes, binoculars. Send \$1.00 for 10 piece hobbyist lens set. Contains magnifying and reducing lenses. Send stamp for "bargain" list. P. Jaegers, 93-08 95th Ave., Ozone Park 16, N. Y.

REFLECTING Telescopes, 60X, completely assembled \$25.00. Guaranteed observatory clearness. Free information. Skyscope, 475 Fifth Avenue, New York 17.

ASTRONOMICAL Telescopes, binoculars, microscopes; bought, sold, repaired. Books. Lists 10c. Rasmussen-Reece, Amsterdam, N. Y.

TELESCOPES, Binoculars, microscopes, big bargain catalog free. Brownscope Company, 24 West 45th Street, New York.

DOGS, PETS, BIRDS, RABBITS

MAKE Money! Raise Chinchilla rabbits. Experience unnecessary. Valuable breeders. Extra profit from laboratories, furs, delicious meat. Pleasant hobby. Write today! Willow Farm, Sellersville 15, Penna.

HAMSTER Manual. Complete hamster raising information, many pictures. One dollar postpaid. Thielle Enterprises, Columbia, Illinois.

MINK Raising information free. Complete. Lake Superior Mink Farm, Superior, Eel, Wisconsin.

HAMSTERS: Choice quality breeders and pets. \$2.50 pair; \$3.75 trio. Free literature. Valley Hamstery, 734 North Milam, San Benito, Texas.

\$400 MONTHLY Raising Angora rabbits. No experience required. Details free. White's Rabbitry, Newark, Ohio.

RAISE Guinea pigs. Make extra money. Booklet free. Taylor, Box 426A, Hapeville, Georgia.

HAMSTERS—High production breeders, pets, laboratory stock. Wholesale and retail. Reasonable. Pyle Hamstery, Okmulgee, Oklahoma.

HAMSTERS—Finest pedigreed stock. Reasonably priced. Free illustrated literature. Mount Clemens Hamstery, 94 Church, Mount Clemens, Mich.

MAKE Extra cash. Raise Giant Chinchilla rabbits. Waters Rabbit Farm, Glennville, Ga.

HOHL'S Hamsters. A million laughs, hours of fun. Literature free, "Ideas for Markets" 10c. Pets, quality breeding stock. Box 695, Newark, Ohio.

SEE Gulf Hamstery ad on page 38. Shows picture of Hamster.

GRINSTEAD'S Famous Angoras! Giant Chinchillas! World's most profitable rabbits. Finest pedigreed, heavy-producing, prize-winners. Literature free. Grinsteads, Edwardsville, Illinois.

RAISE Rabbits. Four pound fryers in eight weeks. Ready market for meat, fur, wool. Illustrated book, describing leading breeds, housing, breeding, feeding, marketing. By America's largest rabbit association. 10 cents. American Association 12, AR & CBA Building, Pittsburgh 17, Pennsylvania.

SPORTSMEN: 200 Pointers, setters, straight cooners, combination hunters, rabbit and fox hounds. Reasonable. List free. Ramsey Creek Kennels, Ramsey, Ill.

\$300 MONTHLY Raising Angoras for our market. Particulars free. Wilson, Stanton, Calif.

INCREASE Your income by raising domestic rabbits. Small space needed. Ready market for delicious meat, fur and wool. Largest magazine in the industry tells you how. \$1.50 per year. Sample 15 cents. No stamps. Small Stock Magazine, Lamoni 20, Iowa.

FARMS, FARM LANDS, REAL ESTATE

FARMS, Ranches, lodges, resorts. Big selection. Milwaukee Road territory, Washington, Idaho, Montana, Dakotas, Minnesota, Iowa, Missouri, Michigan, Wisconsin, Illinois, Indiana. Free colorful descriptive folders, price lists. L. H. Robbins, 736Z Union Station, Chicago 6, Illinois.

BIG Free fall catalog! Farm and country real estate bargains, good pictures, many states, easy terms, many equipped, crops included. For special service, state requirements, desired location. United Farm Agency, 1408-P4M Consumers Bldg., Chicago 4, Ill.

RAYBURN'S Ozark guide, Eureka Springs, Arkansas. Homeseekers; tourists magazine. Year, \$1.50.

STROUT'S Farm catalog! Time and money-saver; free! Describes 2790 bargain properties. 35 states coast-to-coast. Write today for your free copy! Strout Realty, 255-P 4th Ave., New York 10, N. Y.

\$5.00 MONTHLY Buys 40 acres. Near town; price \$200.00. Free list. Box 425-P, Carthage, Mo.

FLORIDA Campsites—\$75.00 at \$5.00 monthly buys nice, high dry lot in Lake County (world's best bass fishing) near Ocala National Forest. St. Johns River, beautiful lakes, pavement, electricity. Folder free. Howard Vernor, DeLand, Florida.

GOVERNMENT Lands \$2.00 acre up. Information all states twenty-five cents. National Tax Service, 901-A Majestic Bldg., Detroit.

GOOD Farms—Ranches. Washington, Minnesota, Montana, Idaho, Oregon, North Dakota. Dependable crops, favorable climate. Write for literature, lists describing typical farm opportunities. Specify which state. J. W. Haw, 119 Northern Pacific Railway, St. Paul 1, Minn.

SOLD For taxes. Calif., Oregon, Washington timber, grazing, ranch and mining lands. 25c to \$3 acre min. bid. 10c (coin) brings circulars, photos, maps. Pacific Lands, Box 2350-PM, Hollywood, Calif.

LOTS \$300—Convenient payments. California's finest garden section. On Morro Bay's scenic shores. Wonderful fishing, hunting, boating, bathing. Fertile soil, softest water, temperate climate, congenial community. Free literature. Richard Otto, Department M, San Luis Obispo, California.

POULTRY, FARM SUPPLIES

RAISE Fryers new easy way. One man home plant earns \$500 monthly. Circular free. Poultryman's Institute, 1046-A So. Olive, Los Angeles 15, Calif.

EARN \$4 To \$12 hourly. Chick sexing, culling and caponizing. G.I. approved. Pilch's School, Box PM, Thompsonville, Connecticut.

GROW Chicken of tomorrow today with chicks from Pilch's Famous Old Hen Breeders. You too will like Pilch's chicks because so many other people do. 14,000 Pullorum Clean Breeders, Reds, Rocks, Crosses, Sex-Links, White Rocks, Hamps, Started Pullets, Started Chicks, Capons. Write for valuable '49 calendar. Pilch's Chicks, Box M, Thompsonville, Conn.

KNOW How to raise poultry for profit. Read Northeastern Poultryman. Every issue packed with helpful hints and practical suggestions. Latest articles on breeding, feeding and management. Subscribe now. 1 year 65c. 2 years one dollar, foreign subscriptions \$1.00 a year. Northeastern Poultryman, Dept. P.M., 376 Boylston St., Boston 16, Mass.

PROFITABLE OCCUPATIONS

MEN—Women. "Everybody likes candy." Learn to make professionally. Our 39th year. Ragsdale Candies, D6, East Orange, New Jersey.

YOUR Own office supply business offers increased income, independence, unlimited opportunities. Details free. Write Jackson, 1813 Liberty St., Allentown, Penna.

HAVE Your own portable 16mm. movie theatre. Big profits. Also sell 16mm. sound projector. Write George Jessen, 5 S. Wabash, Chicago 2, Illinois.

\$400 MONTHLY Raising Angora rabbits. No experience required. Details free. White's Rabbitry, Newark, Ohio.

"WATERLESS Hand Cleaner." Make, sell. No machinery. Build profitable business. Complete formula \$1.00. Ideal Service, Park Ridge 2, Illinois.

WANTED. Be exclusive agent in the plant where you work, for the jet pipe the pipe smokers are looking for. P. Desjardins & Son, Webster St., Fall River, Mass.

FOREIGN Employment. Construction men, building trades mechanics, helpers, office men. Good workers needed for oil projects, mining, pipe lines, dams, power plants, roadways, shipping, etc. Transportation and quarters furnished; high wages. Listings of firms actively working and hiring on projects in South America, Arabia, Asia, Africa, Alaska, Central America, etc. Send \$1.00 for foreign construction compendium and application forms. Foreign Service Bureau, Dept. P.M.10 (Employment), P.O. Box 295, Metuchen, New Jersey.

FREE Book "372 Unusual Worldwide Businesses!" South America, New Zealand! Work delightful, "different" plans home (U.S.A.). Publishers 7P, Carlsbad, Calif.

BE An invisible re-weaver—Learn profitable trade, earn over \$20 daily, full or part time; repair cuts, tears, burns in clothing or any fabric so damage cannot be seen. Big demand, big profit, uncrowded field. Complete low-cost home-study course includes lifetime equipment. Easy-to-learn, pay-as-you-earn; can mean lifetime income. Details free. Fabricon, Dept. N, 8342 S. Prairie Ave., Chicago 19, Ill.

MUSHROOMS Grown, boxes, barrels. Instructions 50c. Spawn \$1.00. Manureless process \$2.00. Gordons, 553 William, Win-nipeg, Manitoba.

MAKE Flexible molds! Cast plaques, novelties, bookends! Free sample! H. Tooker, Hamilton 9, Ohio.

FOR Extra money, sharpen and gum cross cut saws. One man and two man types. Also circular saws. Build power sharpening machine yourself at small cost. Plans, illustrations, instructions \$1.00. Satisfaction guaranteed. Charles Lashley, Wellington 3, Ohio.

LEARN Photo offset printing. Uncrowded field. Build your own simple equipment. Interesting literature. John L. Moon, Box 1775, Spokane, Washington.

WOULD You pay 3%—First \$350 made? Illustrated book "505 Odd, Successful Enterprises" free! Work home. Expect something odd! Pacific, Oceanside, Calif.

PROFIT And pleasure raising tropical plants. Details 25c. Tropic Kit, P. O. Box 2412, Orlando, Fla.

HOLIDAY Flower, novelty making. Wonderful home business pays excellent profits. Literature free. Velva Artcrafts, 324-M East 14, New York 3, N. Y.

INEXPENSIVE Manual teaches air conditioning. Write Don Nelson, Warner Robins, Georgia.

OUTDOOR Work for extra income. Information free. Morris, 328-A Parkway NE, Atlanta 5, Georgia.

RAISE Ginseng roots, markets guarantee you \$10 pound, seeds for fall planting. Cir. free. Fezler Seed Co., Patchogue, N. Y.

CHENILLE Machines and materials for manufacturing bedspreads, rugs, etc. Sims Textiles, Dalton, Georgia.

"HOW To Raise Worms for Bait." Booklet, 25c coin. Ross, 749-A Rincon, El Sobrante, California.

"FROG-RAISING"—New book explains everything! Marlboro-A, Box 7002, New Orleans 19, Louisiana.

INTERESTED In Latin American and foreign employment? \$1.00 brings copyrighted "Foreign Service Directory" with complete listing of firms in oil, mining, aviation, construction, steamship, manufacturers, importers and exporters with hot tips for immediate application. Published since 1944. Global Reports, P.O. Box 883-P, Hollywood 28, Calif.

FOREIGN Employment? Latest bulletin, overseas directory and application forms: \$1.00. (C.O.D. \$1.32.) Foreign Service Institute, P.O.B. 3934, Miami, Fla.

\$46 FROM Square foot plywood; jigsaw necessary. Write, Woodarts, P-38, Bridgewater, Mass.

OWN And operate mirror shop! Supplies for resilvering mirrors, making chipped glass nameplates and electroplating. John Sprinkle, V50, Marion, Indiana.

RAISE Fishworms. Easy, profitable. Send 25c in coin for complete instructions. Huffman Worm Ranch, Rives Junction, Mich.

TYPISTS. Profitable business at home. Complete copyrighted information 50c. Rosdahl Industries, 72-A W. Washington St., Chicago 2, Ill.

MAKE Greaseless doughnuts at home. New amazing electric machine. You'll coin money selling to grocers, drug stores, cafes, hamburger stands. Low cost will surprise you. Experience unnecessary. Send for free recipes and plans. Morgan Ray Co., 3605 South 15th Ave., Minneapolis 7, Minn.

WANTED—Purchasing agents. No money or experience required. Write Dept. C, Purchasing Manager, 2719 Lawrence, Chicago, Ill.

ALASKA—The Last Frontier offers unlimited opportunities, \$1 brings government map and directory listing firms in fishing, construction, mining, aviation, fish and game rules, homestead data. Alaska Opportunist, Box 883-M, Hollywood 28, Calif.

YOU Can make real money raising Golden Hamsters. New tiny animal. Easily raised at home. Write for details. Hudson Hamstery, Newfoundland 1, N. J.

BE The Popular Mechanics representative in your neighborhood and earn big profits in your spare time. Write Popular Mechanics Magazine, Room 408M, 200 E. Ontario St., Chicago, Ill.

\$40.00 WEEKLY Made growing mushrooms, fresh, dried. Dominion patent 331583. Free spawn. North American, 169P Yonge, Toronto, Canada.

BOOKS, PERIODICALS, PICTURES, POSTCARDS

QUICK Profits taking magazine subscriptions, handling greeting cards. Cassell Publishers Service, Westfield, New Jersey.

BOOKS Found! All subjects. Paramount Book Service, 39 Hopedale, Allston 34, Mass.

HOME Craft course series. 29 books, step by step easy to follow instructions. Many illustrations, some in full color. Write Mrs. Keyser, Plymouth Meeting, Penna.

BOOKS. Out-of-print. Hard-to-find. Banker Book Co., Dept. G, Sherman Oaks, Calif.

FICTION Lovers. Send five books plus one dollar, we return five others and bonus book. Address, Book Haven, 70 Walcott Terr., Newark 8, N. J.

JOB Seeker's handbook \$1. Dept. G, Craft Publish. Co., 601 S. Vermont, Los Angeles 5, Calif.

10c CARTOON Joke gag magazine. Laughs! Fun! Send dime and stamp. Kayo Harris, Box 550, Palm Springs, California.

HOW To Make Friends and Keep Them. \$2.50 per copy postpaid. Free sample print upon request. New 1950 desk appointment diaries with bookmark pencil and holder, only \$1.00. Both for \$3.40 if ordered together. Send check or money order only, to The Hess Company, 3517 Parklawn Ave., Baltimore 13, Maryland. Please order early. Supplies are limited and cannot be guaranteed.

FOR Free catalog, or to obtain any book you see, hear of, or read about, send your order or inquiry to A. Faller Company, 201 Dewey Street, Newark 8, New Jersey.

READ Britain's famous technical monthly, Practical Mechanics, appealing to homecraftsmen everywhere. Latest inventions; special home workshop and model-making sections. Profusely illustrated. Annual subscription (12 consecutive issues direct to your address from London) only \$2.00 from George Newnes Ltd., U. S. Subscription Office (PM. 16), 342 Madison Avenue, New York 17. Two years \$3.75. Three years \$5.50.

INTERESTED In America? Books on the Pilgrims, Cape Cod. 25c to \$1.50. List free. Department A, Mayflower Press, Plymouth, Massachusetts.

JOURNALISTIC Photography by McKay, Has, Black, Hesse, other experts. 14 profusely illustrated handbooks, covering every phase of money-making photography. \$7.95. Documentary military photography 75c. Mogull's, 112-114 W. 48th Street, New York 9.

READ Prophetic Years 1947-1953. Progress, 4033-R Chowen, Minneapolis 10, Minn.

BOOKFINDERS! (Scarce, out-of-print, unusual books). Quickly supplied. Send wants. Clifton, Box 1377-PM, Beverly Hills, Calif.

NATIONAL Geographic Magazines 1888-1949. Any issue. Box 327-PM, Periodical Service, Swarthmore, Penna.

SELF-EXPLAINING Bible: Illustrated circular free. Box 446-P, Minneapolis, Minn.

BOOKHUNTERS! All subjects. Send wants! Jaher Book Service, 620-P East 178 Street, New York 57.

GAMES, ENTERTAINMENT

WORLD'S Largest kite. Only \$20. Cost government \$108. Literature. Great-Northern Mart, North Adams, Mass.

MAGIC TRICKS, PUZZLES, JOKER NOVELTIES

FUN For everyone. Trick cards \$1.50 per deck, the mystic mummy 50c, razzberry cushion 35c, large rubber ears 50c, squirting magnifying glass 25c, disappearing flower 75c, Swiss warbler imitate birds 25c. Behnke Sales, 5721 Leland, Chicago 30, Ill.

LARGE 160 Page catalog, just published, 35c. We have supplied the best tricks to beginners and professionals for 38 years. Chicago Magic Company, 2300-D No. Mason Avenue, Chicago 39.

JOIN Magicians' fraternity! Sample trick magazine and details. 25c. International Magicians, Mt. Morris, Illinois.

SEND 10c for latest novelty and circulars of 200 tricks, jokes, puzzles, card tricks. Laramie Sales, 4800 S. Laramie Ave., Chicago, Ill.

200 ELECTRIC Stunts, 110 volts, \$1.00. Kutting Sons, Los Altos 2, Calif.

400-PAGE Catalogue of 2000 tricks, pocket, parlor, stage. World's finest magic. Send \$1.00 for catalogue (refunded first \$5.00 order). Kanter's, M-1311 Walnut, Philadelphia 7.

LARGE Catalogue of the best magic for professionals and amateurs. Send 35c. Mazda Magic Co., 1135 Westgate Ave., Oak Park, Ill.

500 TRICKS You can do! Send 10c for Douglas famous catalog, best in magic at lowest prices. Unequaled service to magicians for 30 years. Douglas Magicland, Dept. 1, Dallas, Texas.

MAGIC Tricks, puzzles, books, cards, punch boards. Catalog 10c. Specialty, Box 671, St. Louis 1, Mo.

500 TRICKS Catalog and book "84 Card Tricks," both only 50c. Robbins Co., 152-P West 42nd Street, New York.

LEARN Magic, ventriloquism, mind-reading. Write for particulars. Quackenbush, Big Flats, N. Y.

AMAZING Ghost quarter trick free if 25c is sent for big illustrated catalog listing 500 wonderful magic tricks. Rush 25c now. The Magician, 2463-P Kensington Ave., Philadelphia 25, Penna.

WORLD'S Largest professional magic shop, keeps you in touch with latest tricks. To receive mailings, send 50c for new catalog. Holden's, M220 West 42nd St., New York.

16 CARD Tricks and catalog 25c. Sterling Magic, Royal Oak, Mich.

BE A magician. Large professional magic catalog of latest tricks, 35c. Ireland, C-109 North Dearborn, Chicago 2.

PROFESSIONAL Catalog. 124 pages, 25c. Williams, 900 Plymouth, Ellwood City, Penna.

VENTRILLOQUISM Taught. 3c stamp bring particulars. Smith, 801 Bigelow, Peoria 5, Ill.

STAMP COLLECTING

VICTORY Packet free—Includes stamps from Tanganyika, British Cayman Islands, animal, scarce babyhead, Coronation, early Victorian, airmail, map stamps. Including big illustrated catalogue. Send 5c for postage. Gray Stamp Company, Dept. PM, Toronto, Ontario.

FREE—Famous Americans set, Flag set, National Parks set, and Presidential set to \$5.00. A total of 90 stamps free to customers for our unsurpassed U.S. and foreign selections. Send 3c for 15 of the above stamps and full particulars. Triboro Stamp Co., 145 Nassau St., Dept. 110, New York.

SCARCE Zanzibar stamp, Mozambique snake triangle, China ship set, Gandhi memorial stamp, Costa Rica diamond shaped air set, plus stamps cataloging over \$1, 3c with approvals, Moublow, 740 Hegney, Bronx 56.

200 BRITISH Empire stamps! Norfolk, Tokelau Islands, Grahamsland, Pakistan, Nepal, big stamp of murdered Mahatma Gandhi; many others. Stamps cataloging up to 20c each! Only 10c! Kenmore Stamps, Arlington 74-A8, Mass.

FREE. Absolutely free. \$22.50 catalogue value in better grade stamps, including airmails, pictorials, commemoratives. Also free. International albums and Scott catalogues. Free hinges. Free mystery sets to \$1.00 value. Free \$5.00 Presidential. All free to approval applicants buying under colossal Raymax plan. Raymax, 123-Z William St., New York City 7.

STAMPS 100 Years old. Every collector should have at least a few stamps nearly 100 years old. Although hard to get, we offer a wonderful selection of ten old 19th century foreign stamps and also the blue re-issue of the 100 year old first U. S. stamp, the famous 5c Franklin. All for only 10c. Kindly state whether approvals shall consist of U. S. or foreign stamps or both. Globus Stamp Company, 268 Fourth Avenue, Dept. 212, New York 10, N. Y.

200 DIFFERENT Foreign stamps. Contains old and new, commemoratives, pictorials. Only 15c. No approvals. N. Ennis, 636 Grider Street, Buffalo 15, New York.

NEW Type approvals. Premiums given. Trans-Globe Stamp Co., Box 958, Newark 2, New Jersey.

200 DIFFERENT Including Abyssinia, Seychelles, Perak, many others only 10c with approvals. Richtmyer, 2901 22 South, Seattle 44, Wash.

FINE Approvals. Fast, personal service. What countries do you prefer? I'll send their stamps. Skinner, 438 Locust, Long Beach 12, Calif.

STOP! 500 Different 50c to approval applicants only. 1000 only \$1.00. Superior Stamp, 6908 Zoeter, Cleveland 3, Ohio.

FREE With approvals. British, Spanish, French Colonies, Vatican, Hitler heads, and airmail packet. Pan-American Stamp Co., Box 145, New York 33, N. Y.

UNUSED Commemorative stamp collection including airmails, pictorials, high values, sets. Only 3c. Approvals. Sunlite, Box 1259-M, Grand Central, New York 17.

AROUND The world—30 different countries; Basutoland, Nyassaland, Tangier, Cyprus, St. Helena, 10c with approvals. Excello Stamps, P.O. Box #95, Hackensack, N. J.

RARE Bargain. 300 world, 25 Vatican City, all different, only 10c to approval applicants. Stamp Mart, 1412 Great Northern Bldg., Chicago.

FREE! Airmail set. Bargain approvals. Premiums. Verne, 916-B Fallowfield, Charleroi, Penna.

FLAG Stamp free, if you request my U. S. approvals. Wenigman, 1933 Patterson, Chicago.

MINT Dahomey set free to approval applicants. Stanfield, Rogersville, Tennessee.

NEW Issue, 11 French Colonies, 3 values each, 33 mint stamps, 10c, approvals. Southworth, Weston, Mich.

FREE U. S., foreign, illustrated lists. Schneider, Box 555, Route 3, McHenry, Ill.

CANADA Peace set 10c with attractive approvals. Rheume, 8949 Routhier, Montreal 12, Canada.

ASK For penny foreign approvals and some higher. Return postage prepaid. C. Ritchie, Watertown, South Dakota.

100 DIFFERENT Hungarian 20c. Roush Stamps, 51 Chestnut, Mansfield, Ohio.

100 DIFFERENT Foreign 10c. Approvals. Karr Ross, Dept. A, Box 3266, Washington 10, D. C.

25 DIFF. 19th Century given to approval applicants. Rossum, 218 West 59th St., Chicago 21, Ill.

FREE. Illustrated U. S. price list. Collectors service. Sophus Jenssen, Coupeville, Washington.

FREE! Tiny Chinese "midget" war set. Approvals, Seminole, Leeds, Alabama.

GET India, 20 diff., 5c, with approvals. Edward Piegzik, 5227 Altgeld, Chicago 39, Illinois.

FREE! United States Allied Occupation Block, Russia airmails packet, approvals. Greenwood, 263 Meridian, Miami Beach, Florida.

400 FOREIGN 47c, 200 27c. Pacific, P.O. Box 5704, Los Angeles, Calif.

U. S. Mixture 70c pound; foreign 1/2 lb. \$1.00. Nichols, 746 River, Mattapan 26, Mass.

PROFUSELY Illustrated U. S. catalogue 10c. Miller Stamp Company, Malden 48, Massachusetts.

MINT Black Harding 10c. Approvals sent. Louis Merrill, 1623 5th, Portsmouth, Ohio.

100 DIFFERENT U. S. commemoratives \$1.00. Includes SPA, CIPEX sheets. Miller, Box 172, Manheim, Penna.

INTERNATIONAL Mission mixture! 500 stamps 25c. Garrow, Montevista, Chula Vista 1, Calif.

U. S. Or foreign approvals. Fine stamps, low priced. R. Hagemann, 6139 Ridge Ave., Cincinnati 13, Ohio.

GOYA Nude (2) 5c. Approvals, Hanney's, 310 Quail, Albany 3, N. Y.

MIQUELON—Set of five colorful sailing ship stamps. 10c. Ed. Keller, 304 Belonda, Pittsburgh 11, Penna.

\$15,000 CHINESE Set plus gigantic price list 5c. Martin Band, 4143E 39th Place, Sunnyside, New York.

RUSSIA 25 Different 10c to approval applicants. Douglas, Hawkesbury, Ontario.

1862 PRINCE Edward Islands. Just 3c with approvals. Viking, 130-Z Clinton St., Brooklyn, N. Y.

1000 World with valuable prize set \$1.00. Donovan, Drawer 62, Bayside, N. Y.

FREE! Complete Balkan aviation set with approvals. Beaman, Leeds, Alabama.

SENSATIONAL! \$1.00 Packet, 10c! Approvals. Atlas, 3210-M Republic, Racine, Wisconsin.

100 DIFFERENT U. S. stamps 20c, with approvals. Robert Anderson, Route #1, Madrid, Iowa.

TOPS! Our book "How To Collect Stamps." Send for your free copy today! Littleton Stamp Co., Littleton 37, N. H.

750 FRANCE And colonies stamps 10c. Littleton Stamp Co., Littleton 25, N. H.

50,000 STAMP Grabbags 25c each. Anderson, 630 Bingham, Reading, Penna.

SAVE One dollar! Scarce 100M and 200M Egyptian postally used high value airmails cataloging \$2.25 for only 25c. Our regular price \$1.25. Approvals. Garcelon, Calais, 101, Maine.

72 DIFFERENT U. S., 10c with approvals. Album Service, Soledad 22, Calif.

8 U. S. Commemoratives 10c. Approvals. Turbyfill, 513 West 29th, Norfolk 8, Va.

AROUND The globe—100 pictorials from 100 different countries 25c with approvals. Fields, 1939 E. 85, Cleveland 6, Ohio.

ELEGANT Offer! Includes Norfolk, Brunel, Kedah, Nigeria, Cook, etc. 10c to approval applicants. Val Stamps, 16 Powell, Evansville 9, Indiana.

SELECTED U. S. mint Roosevelt and Flag sets. Both only \$1.00. Approvals. Quinn, 570, Madison 1, Wisconsin.

U. S. Price catalogue free. S. Stone, 618 Washington, Dorchester 24, Mass.

SIBERIA, Land of exile. 4 stamps from this cold bleak country free to approval applicants. Stampchest, Box 164-M, Teaneck, New Jersey.

WHOLESALE U. S. price list. Postage 3c. Thrifty Stamps, Silver Spring, Maryland.

UNHINGED Approvals! Good, clean selections of foreign sets and singles. Sawpit Stamp Co., Box 224, Port Chester, N. Y.

EXOTIC Collection—Fezzan Ghadames, Togoland, Cameroons, Andorra, Reunion, Miquelon, Algeria, Somalis, Guadelope, Guiana, Natives, maps, ships, idols, snakes, rhinoceros, others 5c. Imperial Stamps, Tampa, Florida.

CHILEAN Antarctic. Zanzibar Sultan, African Springbok, Congo Tiger. Fascinating, others 5c. Approvals. Stamp-Ingrouds, Whiting Road, East Hartford 8, Conn.

GERMANY 100 Different commemoratives, pictorials; approvals, 10c. William Deems, Ravenswood, West Virginia.

100 U. S. Commemoratives, airs, etc., 10c; 300-25c. Box 457, Newark 1, New Jersey.

1000 WELL Mixed U. S. 25c. Monjar, 1750 Fairmount, Cincinnati 14, Ohio.

FREE Colored filters with E-Z-C stamp viewer. Dollar postpaid. Free literature. Calgadco, 424 North Edinburgh, Los Angeles 48.

BOMBING Pearl Harbor! Also three nudes! 3c. Approvals. Grabin, Box 1111, Sioux City 6, Iowa.

GIFT Six Roosevelts San Marino to approval applicants. Deane Stamps, Box 87, Miami 35, Florida.

118 WORTHWHILE Stamps, including Chinese hunger stamps, strange countries, pictorials plenty. Only 10c with surprise-packed approvals. Atlas Stamps, 4220 West 16th, Little Rock 22, Arkansas.

BEAUTIFUL Japanese souvenir sheet, 10c. Approvals. Hart, 3612 Darwin, Cincinnati 11, Ohio.

ALBUMS, New, used, 25c up. Lists free. Stamp bargains also. Alatel, Maynard, Massachusetts.

SILVER Weddings—5 desirable beauties only 10c. Approvals. Wilhelm, 14646 58th Road, Flushing, N. Y.

25 DIFFERENT India 3c to approval applicants. Kingman, Highbridge, Box 42, New York 52.

FREE! Volcano pictorial! Madagascar! Burmese! Nigeria! Approvals. Keating, 637-P Bergen, Jersey City, New Jersey.

STAMP Magazine! Copy free! "Stamp Post." South Catalina, Pasadena 1, Calif.

COSTA Rica mint diamond airmail set, 10c with approvals. Vargo Stamps, 6044 South Fairfield, Chicago 29, Illinois.

BOLIVIA "Torch of Knowledge" triangle, Britain Silver Jubilee set, Costa Rica bi-color diamond, F.D.R., Stalin, Churchill, Venezia Giulia air, Georgia, Fezzan, others. All 5c. Approvals. Colonial, Box 326, Passaic, N. J.

EIGHT Bi-colored French colonies free. Approval applicants. Everglades, 279 Northwest 57th St., Miami, Florida.

MAGNIFIER. Big stamp magazine; first U. S. commemorative; plus unused \$5000 Foreign Legion, diamond, giant, and other worthwhile stamps. Everything free to approval buyers. Capital Stamp Company, Little Rock 2, Arkansas.

FREE! Asia, Africa, Europe packet. Approvals. Standard Stamp, Barneveld, N. Y.

PICTORIAL Set six, 10c. Ten other sets free. Newstamps, 6884 Briand, Montreal 20.

AIRMAIL Approvals. Profit sharing discounts. French, Box 864, Lakeland, Fla.

10,000 PENNY Approvals waiting for you. Many from exotic countries, pictorials, airmails, new issues. Tilbury, Box 862, Newark 1, N. J.

VERY Fine U. S. mixture, plenty commemoratives, high values, old issues. 2 lbs. \$1.50; 5-\$3.00; 10-\$5.75; 25-\$13.50. Halay, 132-J West 63rd, New York 23.

\$1.00, \$2.00, \$5.00 U. S. Free. Approval applicants. Flamingo, Box 4038, Miami 38, Florida.

FREE "Stamp Finder." Tells instantly country to which any stamp belongs. 36 pages profusely illustrated. Approvals. Garcelon, Calais, 17, Maine.

DIRECT From war-torn China! 100 airmails, pictorials, war issues, high values, etc. Just 5c if you request approvals. Star Stamp Company, Jamestown, New York.

25c BUYS Approval (European) applicants complete mint set colorful commemoratives. Romania, #558-67, B251. GeeKay, 13 Overlea Ave., Baltimore 6, Md.

\$5.00 CATALOG Price for 10c! (1) Big collection 112 all different stamps from Africa, South America, South Sea Islands. (2) Four desirable unused U. S. cataloging 40c. (3) Fine packet 25 British Colonies; Burma, Solomon Islands, etc. (4) U. S. \$5.00 high value. Everything (all four items) only 10c with approvals. Crystal, Littleton 41, New Hampshire.

TOP Stamps for middle collectors at bottom prices. Free premiums. Approvals. Moore, Box 623, Oildale, Calif.

GIGANTIC Bargain. 10 interesting nineteenth century United States plus special delivery, dues, wines, playing cards, teographs. Also \$1, \$2, \$4, \$5, \$10 stock transfers. Everything 25c to approval applicants. Jerry Whitehead, 315P So. 5th Ave., Canton, Illinois.

FREE: China navigation issue with foreign approvals. Modern Stampco, Box 12B, Wakefield Station, N. Y.

307 ALL Different free. Commemoratives, triangles, bicolored beauties, high values. Strange countries. New varieties galore. Free to approval buyers. Garcelon, Box 500, Calais, Maine.

BARGAINS! 2000 Foreign stamps \$1.00, 5000 \$2.00, 2000 U. S. \$1.00, 5000 \$2.00. Post-All, 930-F Street, Washington 300, D. C.

ALL Stamps at 1c each. Collection of 10,000 different, divided in 20 \$5 lots each containing 500 stamps. You just buy one lot at a time as often as you like. Each lot delivered as soon as paid for. No contract. No obligation. Real savings. N. V. Robillard, 812 West Vantrees Street, Washington, Indiana.

DESIRABLE Mounted collection—U. S., Cuba, Philippines. All different. Including airmails! Commemoratives! High-values! Only 10c to "Gold Nugget" approval applicants. Kessel's, Folsom, California.

WORLDWIDE Stamps. All different. 200-25c; 500-50c; 1000-\$1.25; 2000-\$3.00; 5000-\$15.00. Beacon Sales, Maynard 2, Mass.

YOU'LL Like our American and British Colonial approvals. Write now. Chesapeake Stamps, 748 Overbrook, Baltimore 12, Maryland.

50 DIFF. France, only 5c to new approval applicants. Bert Soika, Box 146M, Jackson Heights, N. Y.

SATISFACTION Guaranteed, they're great! Our penny approvals. Roscoe Stamp, 1321 Roscoe, Chicago 13.

100 ASSORTED U. S. old and new. 25c. Weatherby, Medina, Ohio.

ZEPPELIN, Roosevelt, Columbian, Hitler airmail, etc., sent for 10c. Approvals included. Thirco, 101 3rd Ave., Newark, New Jersey.

4 TRIANGLES And 20 French Colonias free! Approvals. Gordon Davison, Box 1019H, Manchester, N. H.

ILLUSTRATED Stamp magazine. 26 weeks 25c. Stamp Journal, Kalamazoo, Michigan.

FAMOUS Americans \$1.49, flags 90c, presidentials \$1.25, parks 45c; approvals accompany. Thomson, 4060P Elbertson, Elmhurst, N. Y.

FREE "Round the World" packet to approval applicants. Lange, Box 21, Hub Station, New York 55.

FREE! Fifteen different Luxembourg to approval applicants. Litten, 318 N. Fifth Avenue, Maywood, Ill.

300 DIFFERENT Given free with approvals. Postage 3c. Windsor Stamps, 1435 East 67th Place, Chicago 37.

FREE—Illustrated catalog! Kenmore Stamps, Arlington 74-C7, Mass.

FREE! Powerful magnifying glass—To approval applicants; also big bargain lists. Jamestown Stamp Co., Dept. 207, Jamestown, New York.

GENUINE "Goya Nude" set (catalogs 55c) 15c. Approvals. Royal Stamp Company, Tamaqua, Penna.

543 BARGAIN Offers, free! Kenmore Stamps, Arlington 74-D3, Mass.

200 DIFFERENT Stamps 10c with approvals. 500 mixed United States 25c. Carlton's, Tujunga, Calif.

10 ASSORTED U. S. Commemorative stamps 15c. Five U. S. Air Mail 15c. Both 25c. Ideal Stamp, Box 179H, Park Ridge, Illinois.

66 DIFFERENT Stamps, including U. S. battleships 6c. Worldwide approvals. Telic-Arts, Devon, Conn.

TRAINS! Trains! Trains! 12 train stamps and packet of 100 different stamps for 10c with approvals. Reich Stamp Company, 4647 Kenmore, Dept. M20, Chicago 40, Illinois.

DEALERS—Wholesale list. Postage 3c. Frank, 5031 Queensberry, Baltimore 15, Md.

OLD Scarce U. S. seconds on approval. Slightly defective, bargain prices. Hernefield, Clintonhill Station, Newark 8, N. J.

25 ALL Different stamps 10c. Tunis. Wakeman Ave., Newark 4, New Jersey.

POUND Stamps containing thousands \$1.00. Longacre Shop, 103 West 42nd, New York 18.

ZOWIE-E! A barrel of fun for only a dime. 500 United States stamps—absolutely unpicked and unsorted—just as received from church missions. Many varieties, including large commemoratives, airmails, high denominations up to \$5.00! Stampdom's biggest package of fun—and you might find something really valuable! Price only 10c to serious approval service applicants. Money back if not delighted. Illustrated bargain lists with each order. Mystic Stamp Company, Dept. 80, Camden, New York.

1c EACH And less! Thousands of bargains! Cole, 43-A Rinewalt, Buffalo 21, New York.

YOU Need these! All six for 10c! To introduce our exceptional approval service, we'll send you: 1. Pocket stock book. 2. Watermark detector. 3. Stamp tongs. 4. Perforation gauge. 5. Book for duplicates. 6. Package of stamp hinges. All only 10c to approval applicants. Free! Big list other bargains. Jamestown Stamp Co., Dept. K, Jamestown, New York.

FREE! United States commemorative price list. Historical Stamp Co., 1280 Ocean Ave., Brooklyn 30, N. Y.

50 DIFFERENT U. S. 10c. No approvals. Pricelist free. Seidenberg, Cassopolis, Mich.

PENNY Approvals by country. M. H. Hoerning, 15, Farmington, Ark.

AIRMAIL Packet—Worldwide. Big bargain. With approvals 5c. A. Wirth, Norwichtown, Conn.

CASH For your duplicates! Particulars free. Goliath, Bethlehem 7, N. H.

128-PAGE United States catalog—1000 illustrations, 25c. Harris & Co., 202 Transit Bldg., Boston.

FREE! Illustrated United States catalog. Low prices! Americo, Bristol, Conn.

WOW! \$10.00 Worth of fun 10c! What a treasure hunt! Big package 500 foreign stamps, including airmails, pictorials and others from the world over; stamps worth up to 25c each. This offer sent for 10c to approval applicants only. Jamestown Stamp Co., Dept. 22, Jamestown, New York.

UNITED States approvals complete coverage, fine quality, attractive prices. Seminole Stamps, Box 1138-P, Coral Gables, Florida.

"MAN Size" United States approvals! Illustrated catalog! Sullivan, Endicott Arcade, St. Paul 1, Minn.

50,000 STAMP Grabbags 25c each. Anderson, 630 Bingham 1, Reading, Penna.

U. S. Price list. Send postage. State Stamp Service, 1225 Park Building, Pittsburgh 22, Penna.

200 DIFFERENT Including Roosevelt triangle, 5c to approval applicants. M. Avalon Stamp Company, Springfield, Mass.

FREE! Crystal-mount samples! Harrioco, 202 Transit Bldg., Boston.

FREE U. S. price list, postage 3c. Mark Hanna, 335 5th Ave., Pittsburgh 22, Penna.

WORLD—500 Diff. 50c, 1000 \$1.25, 75 Canada 25c, approvals, lists. Victoria Stamp Co., London 4, Canada.

WORLD'S Largest stamp (7½x14 inches). A real curiosity! Retail for 50c, only 3c to approval applicants. Tatham Stamp Co., Springfield 30, Mass.

STAMP Collections wanted. Complete collections, duplicate lots, surplus stock, mint and used. Prefer trade for printing or other items, buy outright if priced right. What have you, what's wanted? Vanroy Shirk, Lebanon, Penna.

FREE! 100 Worldwide different stamps to approval buyers. Big U.S. and illustrated bargain lists sent with approvals. Bookman, Maplewood, N. J.

UNITED-States commemorative collection. Thirty-three different unused. Columbians to 1943 issues only. Price \$1. Request approvals. "Stamps," Albany 4, New York.

COINS, TOKENS, CURRENCY

IRISH Set 8 animal coins \$3.95. 100 different foreign coins \$3.95. Giant guidebook \$1.50, handbook 75c, catalogue 15c. Bebee Coin Company, 1180 East 63rd, Chicago 37, Illinois.

OLD Money wanted. Will pay fifty dollars for nickel of 1913 with Liberty head (no buffalo). We pay cash premiums for all rare coins. Send 4c for large coin folder. May mean much profit to you. Numismatic Co., Dept. 20, Fort Worth, Texas.

100 COINS, \$2.50. 100 Bills, \$1.00. 20 coins and bills, 25c. Oddehon, Box 482, St. Louis, Mo.

16 PAGE Coin bargain list and Mexican 10 peso bill, all for dime. Coin Shop, 31 North Clark, Chicago 2, Illinois.

CANADIAN Coin bargains. Catalogue 10c. Coin Exchange, Box 35, Terminal A, Toronto, Canada.

COIN And souvenir collectors attention; beautiful Mexican silver peso sent anywhere postpaid, \$1.00. Surprise gift included. P. O. Box 84, San Ysidro, Calif.

CIRCULATED Coins. Write your needs to: P. Yuncker, 11 Parkway, Mapleridge, Muncie, Indiana.

UNITED States rare coin value guide. Profusely illustrated. 50c per copy. Johnny Flood, 826 So. Wabash Ave., Chicago.

FREE Foreign coin and banknote with giant bargain list 10c; 4 Whitman coin albums \$1.00; 1949 Whitman handbook 75c; 256 page U. S. guidebook \$1.50. Olson, 5800 Lake, Chicago.

UNCIRCULATED Foreign coin and banknote with huge price list 10c. Toussseau Coins, 109 Mathilda Avenue, Sunnyvale, California.

COINS Wanted: Itemized list 20c. Eisholz, Box 9014-M, Pittsburgh 24, Penna.

FOREIGN Bills, 10 diff. 15c lists. Oliver Arnold, Macon, Mo.

43 MIXED Indian pennies \$1.00. 33 different foreign coins \$1.00. Chelsea, 40 West 18, New York City 11.

MAGNIFICENT Stock of U. S. coins. All series. Catalogue listing 2500 coins 15c. \$50,000.00 stock of gold coins. Worldwide selection. Catalogue 15c. James Randall, 116 South Michigan Avenue, Chicago 3, Illinois.

GET Profit and pleasure in collecting old coins. Send 10c for 56 page illustrated coin catalog. You'll be delighted with it. Send for it now. B. Max Mehl, 370 Mehl Bldg., Fort Worth, Texas. Largest rare coin establishment in U. S. Established 49 years.

FREE! Foreign coin, banknote and coin collectors illustrated catalog to approval service applicants. Send 3c postage. Tatham Coinco, Springfield 30, Mass.

COINS Wanted, will pay up to \$2000 for certain coins, send 25c for catalogue. Burton's, 111 So. Third, Columbus, Ohio.

COMMEMORATIVE ½, Oregon, Texas, Kentucky, Cleveland, Long Island, \$2.00 ea. Illustrated catalogue 25c. Norman Shultz, Salt Lake 9, Utah.

ANTIQUES, RELICS, INDIAN GOODS, CURIOS

10 ANCIENT Indian arrowheads \$1.00. Tomahawk \$1.00. List free. Lear's, Kirby, Arkansas.

PRECIOUS STONES, MINERALS

ZIRCONS, Diamond-like white, blue, or golden, carat gem plus 2 sparkling Zircon side stones \$3.85. C.O.D.'s accepted, \$1.00 deposit. Imhusex, Armonk, N. Y. Agents wanted.

NEW Desert scenic stone, special, five square inch slab \$1.25. Six slabs all different \$5.00. Prospector, Winston, New Mexico.

2 CARAT, Diamond-like, cut, polished, Ceylonese, Water Sapphires \$2.50. Rush, limited quantity. C.O.D.'s accepted, \$1.00 deposit. Huse, Armonk, N. Y.

GEMSTONES, Mineral specimens. Every variety. Lowest prices. Postcard brings free list. Plummer's, 2177C Bacon, San Diego 7, California.

GEMS, Precious and semi-precious, all genuine, from world wide sources. Deal direct, no overhead, save money. Catalog 10c. Hill Co., Route 7, Salem, Oregon.

METAL Detectors. The very latest circuit. Send 25c for literature. Hedden Metal Detectors, 3329 Liberty Ave., Pittsburgh 1, Penna.

HOBBIES AND COLLECTIONS

RUG Hookers! Catalog "Old South" designs, dye instructions, price list of patterns \$1.00. Colonial Rugs, 810 N. 3rd, Monroe, Louisiana.

50 DIFFERENT Army embroidered patches \$1. Other bargains. Insignia Mart, 703A Broadway, New York 3, N. Y.

PENNANTS For your walls! Impress your friends, be popular! Write today for free list. Komar Sales Company, LaPorte, Indiana.

NEW—15 Different match covers 10c. Box 202, Rochester 1, N. Y.

UNPAINTED Plaster ornaments, Loxite for moulds. Free literature. Midwest Novelty Manufacturers, Box 788-A, Anaconda, Montana.

WANTED Old cigarette cards. Write Charles Bray, East Bangor, Penna.

THREE Military emblems and price list 10c. Hobbyguild, 57B Sumner Ave., Brooklyn, N. Y.

UNUSED Matchbook covers—100 different \$1.00. Catalog 10c. Charles Edelman, 1311C East 84, Cleveland 3, Ohio.

INVENTING Can be an interesting and profitable hobby. Write for complete particulars. Institute of American Inventors, Dept. 40-E, 1926-Eye St. N. W., Washington 6, D. C.

CAMERAS, PHOTO SUPPLIES

ENLARGERS, All sizes, lowest price. Booklet "A" free. J. B. Photo, 41-09 19th Ave., Long Island City, N. Y.

KODACHROME 2x2 Slides—Join the West-View Color Slide Club and receive monthly approval selections. Club membership is free. Write today for first approval slides. No obligation. West-View, Dept. L, 1518 Montana Ave., Santa Monica, Calif.

NEW, Photocraft kit includes camera, complete darkroom equipment: enlarger, easel, paper, chemicals, tank, trays, etc. Only \$12.95. Write Tam Products P10, 3814 Wrightwood, Chicago 47.

BARGAINS—Roll film, popular sizes 19c each, 35mm film, 36 exposures not reloads. Weston 80, 3 for \$1.00. Bulk 35mm Safety Pan film 400' \$7.75. Surplus contact and enlarging paper 8x10—10x10 \$2.19 gross, 20x24—\$3.98 half gross. Pan heads \$2.27, reflector clamp lights \$2.25. Developer 28c gallon, 6 for \$1.39. Kodachrome 3½x 4¼, 6 sheets, processing included \$1.75. Kodacolor 1948 dates 116 and 616 \$1.69, 120—\$1.29. Equipment bought, sold, traded. Lists free. Mogull's, 112-114 W. 48th St., New York 19.

MINIATURE Camera 4.5 lens, case and 5 rolls of film, \$6.95; excellent enlargements. Additional roll film, 10 exposures, 20c. Fotosonic, 132 W. 43 St., New York City.

LEATHER Bellows installed in any foreign or domestic camera. Prices on request. W. I. Willin & Co., 102 S. Stone-man, Alhambra, Calif.

CAMERA—50c. Rent new Argoflex camera, for indoors and outdoors, 50c for 10 day period. Write for free application blank. Fotosonic, 132 W. 43rd St., New York City.

PHOTOGRAPHY For pleasure or profit. Learn at home. Practical basic training. Long established school. Write for free booklet. American School of Photography, 1315 Michigan, Dept. 343C, Chicago 5.

BASS Says: Bargaingram 257 ready and waiting for you. The book which tells all. The finest in new and used camera equipment, a veritable encyclopedia. Write, phone or call the sign of the old "Horse Trader." 39th year of satisfaction or your money back dealing. Bass buys, sells and trades. Bass Camera Company, Dept. AG, 179 W. Madison St., Chicago 2.

PHOTOCOPY Anything, papers, books. No darkroom. 8½ x 11" complete, \$6.95. Potoflek, 4801 Yarmouth, Cincinnati 29, Ohio.

PHOTO FINISHING

FREE 5 x 7 Enlargement with each roll developed and printed, 6 or 8 picture roll 35c. 12 or 16 picture roll 55c. Send coin with roll. No c.o.d. If you fail to get pictures on your roll of film, we will mail a new roll to you at no additional cost. Overnight service. Mailable sent free on request. Deluxe Film Service, Box 1268, Shreveport, Louisiana.

35MM. Rolls developed — Enlarged 3½ x 5 prints, 36 exposures \$1.00, 20 exposures 65c. 8-exposure rolls developed, printed oversize 30c. 12 exposures 45c, 16 exposures 55c. MacDonald's Photos, Box 228-J, Congress Park, Illinois.

JUMBO Prints, 8 exposure roll 30c; 12 ex. 40c; 16 ex. 50c. Overnight service. Satisfaction guaranteed. Twin Ports Photo, Superior 1, Wis.

SPECIAL! Five 8" x 10" quality enlargements \$1. 40 reprints \$1. Surgals, 3300 Beach, Chicago 51.

ROLL Developed and 8 prints 25c. Smart Photo, Winona, Minnesota.

ONE Roll or 8 reprints finished complete including one enlargement 36c. U-Save Film Service, P.O. Box 379, Pasadena, Calif.

ENLARGEMENTS! Quality 5" x 7", 15c; 8" x 10", 25c. Oil coloring, 50c. New negatives, 50c. Brandt Photo, Box 2221, Kenilworth, Illinois.

UNBEATABLE For quality and price. You will be surprised and pleased with the beautiful results from our celebrated jumbo oversize finishing. New low prices, same as contact. 8-exp. roll superline finish only 30c. 12-exp. 45c. 16-exp. 55c. 36-exp. \$1.25. Oversize reprints 4c each. Send us your order, you will be delighted. Free mailers. Mailbag Film Service, Box 5440A, Chicago 80, Ill.

16 CONTACT Prints from 8 exposure roll 35c. Reprints 3c each; 40-\$1.00. Jumbo prints on individual papers. 8 exposure roll 35c; 12-50c; 16-65c; reprints 4c each; 30-\$1.00. Apex Photo Service, Box 197, Bronx 51, N. Y.

WALLET photos and cards sealed in plastic are moistureproof and soildproof. Three for \$1. Mankato Plastic Seal, Mankato Minnesota.

PHOTOGRAPHY For pleasure or profit. Learn at home. Practical basic training. Long established school. Write for free booklet. American School of Photography, 1315 Michigan, Dept. 345C, Chicago 5.

FREE Price list on quality developing, printing, enlarging. Write for it today. Bryan's Photo Shop, Dept. M, Panama City, Florida.

8 HOUR Service, Box 468, San Francisco. Your 8 exposure roll printed jumbo or regular size 30c; 12 exposures 35c; 16 exposures 50c; 36 exposures \$1.00. Reprints, jumbo or regular 3c. Regular prints deckled. Fine grain developing. Send for free mailers. Quality Photo Service, Box 468, San Francisco 1, Calif.

16 ENLARGED, Jumbo, oversize deckled prints from any 6-8-12-16-20 or 36 exposure roll film developed only 35c and this ad. Electronically exposed. Enlargement coupon free. Skrudland, 6444-R Diversey, Chicago.

8 BEAUTIFUL Double size pictures and roll developed 30c. 8 hour service. Free mailers. Pacific Photo Service, Box 666, San Francisco, Calif.

EXPERT Finishing. Roll developed and 8 prints 30c. Rancho Photo, Dept. P, Ontario, Calif.

2 BEAUTIFUL Hi-Gloss prints each good negative and enlarging coupon with each 8 exposure roll developed 28c. Free mailers. Owlphoto Co., Weatherford, Oklahoma.

MOTION PICTURES AND SOUND EQUIPMENT

NEW 8MM. full color fine grain movie film (not surplus or re-spooled seconds) 25 ft. double roll, including processing, tax and postage, only \$3! Guaranteed. Send cash, check or money order. Dynacolor, Dept. M-4, Rochester 3, N. Y.

BARGAINS 16MM. sound and silent film, miscellaneous, "as is" penny a foot. Sound features from \$22.50, shorts from \$2.50. 1600' reels \$1.35, storage cans, take two 1600' reels, 95c. Eastman film cement 97c pint. Bell & Howell film cleaner 60c. Wire belts 49c. 400' reel, can sets 44c. Include postage. Films, equipment bought, sold, exchanged. Lists free. Mogull's, 112-114 W. 48th St., New York 19.

1c HOME Movie film sale. Send 10c for 1949 photographic catalogue. Sterling's, 679 Northampton, Easton, Pennsylvania.

BARGAINS In 16mm. sound films. Big new list out each month. Blackhawk Films, Davenport, Iowa.

TITLE Making booklet, ten simple rules just a dime. Westwood Company, 635 Victoria Street, San Francisco, California.

35MM. And 9½mm., silent 16mm.-8mm. films \$1.00 per reel up. Hundreds of color films. Bought, sold, traded. Lists free. Mogull's, 112-114 W. 48th St., New York 19.

RENT 16MM. sound films. Complete programs features; shorts low as \$4.95. Write our nearest office for complete list. Dept. PMB, Eastin Pictures, Davenport, Iowa; Colorado Springs, Colo.; Chattanooga, Tenn.

FREE Films for collectors of unique home movies. MRS Sales, 126 Lexington Avenue, New York 16.

BETTER 8MM. and 16mm. movie camera film. Lower prices. Better Films, 742 New Lots, Brooklyn 7, N. Y.

"EXQUISITE" Party movies. Equipment. Free catalog. Home Pix, 1674 Broadway, New York 19.

SOUND Projectors, 16, 35mm. from \$97.50. Screens, reels, cans, editors, amplifiers, speakers, microphones, spicers, processing equipment, lenses, cameras, bought, sold, traded. Free lists. Mogull's, 112-114 W. 48th St., New York 19.

RENT 16MM. sound films, 50c reel. Large selection; free catalog. Film Service, 128 Chestnut, Roselle Park, N. J.

FILMS And equipment exchanged or bought for cash. Sound, silent. Bargains. Lists free. Frank Lane, Little Bldg., Boston, Mass.

85 KODACHROME Movies! War, atom bomb, travel, air, national parks. Catalog, 3c stamp, 2 scene "Waikiki" sample, \$1.00. Specify 8 mm. or 16 mm. World in Color Productions, Elmira, N. Y.

8-16MM. Silent-sound films. Complete rental library. All latest subjects. Free catalogue, (sample film 10c). Garden Film, 317 West 50th, New York 19.

MOTION Picture technique at home. Big money. Special registration for veterans. Free catalog. Motion Picture Institute, Birmingham 4, Mich.

FREE Movies. Thousands of subjects. Interesting. Entertaining. Fascinating. New directory—only 50c. International Cine Society, Dept. 102-M, 1300 Taylor N. W., Washington 11, D. C.

GUARANTEED Fresh 25' spools double 8 mm full color film! Processing free! \$3.80 each, 3 spools \$11.00. Catalog. Filmcraft, 47th Holly, Kansas City 2, Mo.

GUARANTEED Fresh anti-halo outdoor movie film! Weston 12! Daylight loading! Processing free! Three spools double 8 mm, \$3.45! Six single 8 mm. for Univex, \$4.60! Postpaid! Catalog. Filmcraft, 47th Holly, Kansas City 2, Missouri.

BASS Says: 39 years of leadership guarantees satisfaction. Finest cine equipment, 8mm., 16mm., and 35mm., silent and sound. Write the old "Horse Trader." Satisfaction or your money back always! Bass Camera Company, Dept. A, 179 W. Madison St., Chicago 2.

LEARN Movie projection, management. Free catalog. Theatre Institute, Elmira, N. Y.

I BUY, Exchange, swap movies. What have you? What do you want? Lowest exchange rates in world. Catalogue \$1.00. Refundable. Harvey Iris, Box 539, Brockton, Mass.

MUSIC AND MUSICAL INSTRUMENTS

PHONOGRAPH Records 15c. Catalogue. Paramount, TA-313 East Market, Wilkes-Barre, Penna.

PHONOGRAPHS Repaired: Springs, reproducers, parts. E. J. Volkart, 106 West 36 Street, Kansas City 3, Mo.

HILLBILLY. Polka records—Late, old 29c. Catalog 3c. P-L Shop, Box 19-L, New York City 35, N. Y.

SONGWRITERS — 585 Top recording artists who plug songs. List 50c. Songs, 931-A White Street, Dubuque, Iowa.

POEMS Wanted. Percentage basis collaboration. Terry Tune Master, 709½ PM North Broadway, Oklahoma City 2.

SONGWRITERS Best opportunity, details free. H. Brown, 390 N.E.E. Linton, Ind.

BLANK Music sheets. They're new, different. Post card brings free samples. Hebert Printing, 1445 Notre Dame Street, Lechine, Quebec, Canada.

LOCAL Salesman. Musical knowledge. Box 367, Decatur, Ill.

BUY Everything at wholesale prices! Radio parts, equipment for the amateur, service man and experimenter. Lowest prices anywhere; fast delivery! Write Mid-America, Dept. M-109, 2412 S. Michigan, Chicago 16, Ill.

VOICE "Effortless control!" 15 lessons \$10.00. Cor-Studio, 14356A Jersey Ave., Norwalk, Calif.

SONGWRITERS! Outstanding, ethical offer. Hibbeier, C5, 2157 N. Avers, Chicago 47.

MUSIC Arranged, songs printed. Frank Wildt, Music Publisher, Lancaster, Penna.

YOUR Poems set to music, recorded. Free booklet, attractive offer. Write Songland, 331-C West 46th, New York.

SONGWRITERS-Publication collaboration. Newart Publishers, G.P.O. Box 1226, Syracuse, N. Y.

WRITE Songs. Big money and reputation. Write for information, J. Gordon Pub. Co., 201 N. Hoyne Ave., Chicago.

SONGWRITERS Attention! The amazing demand for phonograph records, accelerated by countless juke-boxes, warrants your immediate investigation. We are offering new writers the rare opportunity of having celebrated "hit" composer furnish music on reduced percentage basis for any likely poems received this month. Phonograph records are outselling piano copies 5 to 1. Recola Records, Hollywood 28, Calif.

POEMS Wanted for musical setting. Send poems for free examination. Five Star Music Masters, 630 Beacon Bldg., Boston, Mass.

POEMS Wanted to be set to music. Free examination. Send poems. McNeil, Master of Music, 510-PM S. Alexandria, Los Angeles, California.

RADIOS, SUPPLIES, INSTRUCTION

FIX Any radio. Amazing new instrument locates radio troubles double quick. Simple instructions show you how. Thousands now in use. Free—write today for 28-page illustrated technical manual, "The Inside Story." Feiler Engineering Company, Dept. 10PM9, 945 George St., Chicago, Illinois.

NEW Cleartone line noise eliminator reduces distracting radio noises. \$1 each (2 for \$1.75) plus postage. Send cash, save postage. Money back if dissatisfied. Rand Sales, Dept. N, Des Plaines, Ill.

SNOOPERSCOPE Tube. Permits nighttime vision. Tube and complete instructions \$14.95. Limited quantities. Filters 15c. Voltmeter, oscillator kit \$2.95. Precise, 942 Kings Highway, Brooklyn 23, New York.

15 TESTED One-tube circuits, including "Radiobuilder," Catalog—25c. Laboratories, 578-C, San Carlos, California.

FREE. International Morse code chart. Sending and receiving code easily learned on low priced sensational code practice oscillator. Write. Unusual literature. Transoceanic Communications, 141M Summer Street, Lowell 10, Mass.

FREE—Money Saving Bargain Catalogs in radio and television sets, record changers, tubes, parts, amplifiers, speakers, etc. Write today. Radionic Equip't Co., Dept. 1507, 170 Nassau St., New York 7, N. Y.

HEADPHONES. Guaranteed U. S. Signal Corps used headsets with adjustable leather headbands and black Bakelite earphones. Special now \$1.99. Allen Radio, Dept. HPM, Clinton, Missouri.

MAKE Simple, tubeless, batteryless, distance-getting crystal radios. Crystal and illustrated instructions 25c postpaid. Allen, 427-P, Clinton, Missouri.

BUSINESS OPPORTUNITIES

SAVE Time, uniform set, no eyestrain on any saw filed with the Foley Filer. Write to Stadick Mfg. Co., Searles, Minn.

TRADE Magazines — Current copies. Business, professions, agriculture, live stock, sports, hobbies—all fields. Free price-list. Commercial Engraving Publishing Co., 34C North Ritter, Indianapolis 19, Indiana.

ANNOUNCING A new mail order opportunity. Have your own profitable business. Literature free. Carey, 25 Waverly Place, Melrose 76, Mass.

BE Independent — Operate America's lowest price penny vending machine. Big profits. Immediate shipments. Write for bulletin and prices. Fielding Mfg. Co., Desk 109, Jackson, Mich.

SPRING Towchain eliminates all yanking. Large dealer profits. Sample \$4.85. Barnorari Industry, 19338 Griggs, Detroit, Michigan.

EARTHWORM Breeding. Valuable bulletins on successful methods mailed free. Earthmaster Publications, Dept. 14, Sun Valley, Calif.

START Home manufacturing business making cleaning compounds, soaps, insecticides, cosmetics, polishes, food flavors. No machinery. Literature free. Kemix, Park Ridge, Ill.

YOUR Own business. Easy made and sold. Different, amazing profits. Belmont, Garrett, Ind.

OPERATE Profitable mail order business. Splendid opportunity. Write—Harold Peterson, RD #6, Wellsboro, Penna.

"ELECTROPLATING-Know-How" includes baby shoe metalizing and other lucrative fields for you. Write for my free illustrated booklet! Joseph B. Kushner, Electroplating Consultant, Stroudsburg 21, Penna.

UNPAINTED Figurines. List, instructions, dime. Perry Novelty Co., Perry, New York.

MEN - Women — "Everybody Likes Candy." Learn to make in a professional manner. (Our 39th year.) Ragsdale Candies, D5, East Orange, New Jersey.

COMMERCIALIZE Earthworms. Illustrated system \$1. Literature, stamp. Stoners, Chattanooga 4, Tenn.

OPERATE A credit-collection office. We train you. Write for free booklet "Collect & Grow Rich." T. J. Surface, Pres., Surface Building, Roanoke 4, Va.

METAL Mountings for bronze baby shoes. Also shoe plating for the trade. Urbans, 2806 Holliday, Wichita Falls, Tex.

ANYONE Can learn to use an Acme Saw Sharpener. Many profitable businesses have been built around this versatile machine. Send for free literature. Enclose 25c coin if you would also like a copy of our new instruction booklet. Max Manufacturing Co., 138 Stockton Avenue, San Jose 11, California.

FOR An extremely profitable lifetime business, operate a collection agency-credit bureau. Easily learned. Free folder. Cole & Associates, Syracuse 2, New York.

SOAP From kitchen fats. Big profits. Mutual exchange. Details, sample bar, 25c. Cater, 638 West Colfax, Denver 4, Colorado.

ALUMINUM Name plates. Polished letters. Etched background. \$1.50. Agents wanted. Jack Kester, Deckerville, Mich.

"WATERLESS Hand cleaner." Make, sell. No machinery. Build profitable business. Formula \$1.00. "Wax-o-Glass" cleans glass; polishes metals. Formula \$1.00. "Wipe-on auto paint" formula \$1.00. Metalizing baby shoes, complete process \$1.00. All four formulas only \$2.00. Satisfaction guaranteed. Ideal Formula Service, Park Ridge 10, Illinois.

HIGHEST Quality liquid rubber for molds. Free sample. Kendall, 108-M Central, Jersey City 6, N. J.

10,000 FORMULAS And trade secrets. Free literature. Stillman Co., 555 Kingston Ave., Brooklyn 3, N. Y.

NATURAL Molding Latex. Extra thick. Free sample. W. Woolley, 115-A Donald, Peoria, Ill.

INDUSTRIAL Hand cleaner! (Without ammonia—kerosene!) 400% profit manufacturing—distributing. Sample, \$1, refunded, first order. Information free. Rythmo-C-Ex, Kingsport, Tennessee.

COSTS 5c. Sells \$1.00 by mail. Sample 10c. Joyner, Box 3143, Charlotte 3, N. C.

START Home plaster novelty business. Amazing course tells how. Literature free. Kemo-Courses, 4862 Catalpa, Chicago 30, Illinois.

GET Into better mailorder business. I received 200 orders from first small ad. Demand growing daily. Grant Lovell, 2166 South Shore, Erie 21, Penna.

ESTABLISH Wholesale agency. Large commissions. Write, Lashman, 1636-M Shatto, Los Angeles 14.

LIFETIME Repeat orders! Sell business cards by mail. "Starter" plan. Lynn, 5711 Bankfield, Culver City, California.

PROFITS In mail selling. Spare or full time. Mail Order Service, Box 3923, Portland 8, Ore.

START A Christmas card imprinting business. Write Dunbar, Sanford, Florida.

NUSILVER Plating liquid. Apply with cloth. Renews silverware. Silverplates brass, copper. Easy seller. NuSilver, 508-9PMB New York St., Aurora, Illinois.

BABY Shoe electroplating rectifiers, supplies, chemicals, mountings. Foster's, 1520 Ardmore, Chicago 26.

MAKE New auto product at home. Sells on sight. Box 552, Memphis 1, Tenn.

BE Independent, be secure, have your own profitable business—earn \$10.00 and more a day making beautiful, fast-selling lamps at home. No equipment needed. Illustrated course teaches you quickly. Course, parts catalog, wholesale price list, only \$2.00. Gearon Company, Dept. 200-B10, 27 South Desplaines, Chicago 6, Ill.

MANUFACTURE At home! Make and sell waterless and dry mechanics soaps. Cleans dirtiest hands. Tested formulas, home equipment. Directions easily followed. Two profitable formulas one dollar. Desert Soap Co., Box 89, Phoenix, Arizona.

START Your own business on credit. Always your own boss. 1554 dealers, sold \$5,000 to \$26,500 in 1948; their average \$6,742. We supply stocks, equipment on credit. 200 home necessities. Sales experience not needed to start. Wonderful opportunity to own pleasant, profitable business backed by world-wide industry. Write Rawleigh Co., Dept. J-U-PPM, Freeport, Illinois.

SPECIAL Rubber for making molds. Literature and sample free. Universal, Box 1076-A, Peoria, Ill.

MAKE Money at home decorating greeting cards. We supply instructions. Powell, 5713-C Euclid, Cleveland 3, Ohio.

FREE Book "372 Unusual Worldwide Businesses." Successful! Australia, South America, Work home (U.S.A.)! Delightful plans. Get surprise! Publishers-7R, Carlsbad, Calif.

MAKE Perfume—Learn profitable business; free; men; women. Write "International," 6347 Parnell-PM-10, Chicago 21, Illinois.

MILLION Articles wholesale. "Supply Source Directory," 25c. Publisher's, Box 1302-P10, Detroit 31.

SAWDUST. Turn it into cash. Six methods. Instructions 25c. Charles, 12-APJ, Norwood, Ohio.

TIN Cans. Turn them into cash. Nine methods. Instructions 50c. Charles, 12-APK, Norwood, Ohio.

FISHWORMS. Easy raise, sell hundreds, millions. Surface without digging. Instructions 50c. Charles, 12-APM, Norwood, Ohio.

PERFUME Manufacturing business. Small capital. Big profits. Instructions 25c. Robert Celaya, Brownsville, Texas.

OWN Your mail business. No investment. Omaha Envelope, 4721-H California, Omaha 3, Nebraska.

HOME Workers. Hand-spin Angora wool into yarn. Either sex. House of Angora, PM, Springfield, Illinois.

NEED Spending money. Magazine of Opportunities 10c. Sunrae, Ogema, Wisconsin.

PROFITABLE Home business. Start in spare time. Experience unnecessary. Complete information. Useful Products Co., 166-29 88th Ave., Jamaica 3, N. Y.

EARN Extra money working with figures. Jimmy Sherrod, Pavo 1, Ga.

SELL By mail. 10c brings sixty page trade magazine packed with "know how" information. Isbell, Suite 619-PM, 216 West Jackson, Chicago 6, Ill.

HOW To sell profitably by mail. Tested money making 12,000 word booklet only 25c. Free State Press, 2831 Guilford Avenue, Baltimore 18, Maryland.

MAKE Flexible molds! Cast plaques, novelties, bookends! Free sample! H. Tooker, Hamilton 4, Ohio.

START Profitable mail order business. Good profits; literature free. United Mail Service, Box 355, Roselle, Ill.

MAKE Big money as I do by mail! Peterson, Box 598, Minneapolis, Minn.

METALLIZE Baby shoes. Excellent profits. New system assures success. Free details. Treasures Forever, 89-B Henry Ave., Lynn, Mass.

52 MAIL Selling propositions. 10c. Wehner, Box 142-A, Roxbury 19, Mass.

PROFITABLE Information — Lowest prices! Locksmithing secrets illustrated! Opening, repairing, etc., \$1.00. Thousands articles wholesale directory, 10c. Mineral locating. 10,000 formulas, trade secrets. Mailorder. Others. Free details. National, 378-P Hooper Street, Brooklyn 11, New York.

BIG Money regraining, refinishing automobile interior trim. Fascinating, undeveloped field. Write Outman Service, 4323 South 38th, St. Louis 16.

41 WAYS Of raising capital. Business or inventions. Write, Director White, P-3439 Michigan, Chicago, Ill.

100 BUSINESS Ideas; 10,000 formulas. Mail order; farm; workshop. Particulars free. Flasco Sales, 2505VT 150 Street, Flushing, New York.

WOULD You pay 3%—first \$350 made? Illustrated book "505 Odd, Successful Enterprises" free! Work home. Expect something odd! Pacific, Oceanside, Calif.

MAKE Rich profits selling by mail—the "Natural" way. Hundreds successful! Interesting details free. E. Lay, 3819 North Kenmore, Chicago 13.

GOLDEN Opportunity to start profitable business of your own with Rite-N-Raise home embossing sets. Surprise Specialties, 749-B Broadway, New York 3, N. Y.

CHRISTMAS Lycopodium. Wreaths makers course. Supplies. Samples 25c. Lycopodium Foundation, St. Paul 8, Minn.

NOW, \$12.00-to-\$18.00 yearly, rents business office under your name. Established 1926. Co-operative Office Service, 126 Lexington Avenue, New York 16.

FIRST Steps in Mail Order tells how to start a mail order business the right way. Will save you hundreds of dollars in costly mistakes. Send 25c for this 35-page book now. Ralph A. Long, 208 West Broad St., Tamaqua 2, Penna.

CAN The boss! Make strange plastic of waste. Makes attractive floors, walls, roofs, built-ins. Build durable homes \$150.00 room. Bays Laboratory, Oklahoma City 9.

MAKE Big money in home mail business! Few dollars starts you—interesting, profitable! Write: Smith, Box 2592-A, Hines, Illinois.

SELL Merchandise by mail. Big profit business! Everything furnished—orders filled for you! Easy, pleasant. Write: National, Box 88-Y, Dorchester 22, Mass.

HAVE Home mail business of your own—Run Ads. Mail literature. Very profitable! Write: Ted Gordon, 711-P East 40th, Chicago 15.

GET Orders by mail for real merchandise. Plenty first—repeat business. Everything furnished. Write: Edgar Burdeau, 32-P Walnut, Northampton, Mass.

\$3.41 PROFIT Per hour interest you? Easy amazing process velvetizes interiors, signs, novelties, radios, autos, at low cost. Free sample. Sparks, 1145 Queen Anne, Los Angeles 6.

HOW And where to obtain capital. Small and large loans. Free particulars. Star Service, Wapakoneta, Ohio.

FORGE Ahead financially! Start big profit business, mail order or locally. Amazing invention. Free sample offer. Consolidated Equipment, 781 Guardian Bldg., Cleveland, Ohio.

START Home mailorder business—Details. Gedgard, Box 798, New York 1, N. Y.

CONSULTING Engineer will start you in your own business with a simple method guaranteed to cut heating costs up to 35%. Every home, apartment, store and factory needs you. Full instructions \$1.00. Air Conditioning Center, Fidelity Bldg., Cleveland, Ohio.

NEED More money? Get new mail-order plan for increasing income. Free details. Perry Publications, 910-A Wenatchee, Wenatchee, Wash.

UNSUCCESSFUL Small mail order business for sale cheap. P. O. Box 804, Newark 1, N. J.

EARN At home casting novelties. Free instructions using latex molds. Major Chemical Company, 164 Portland St. Cambridge, Mass.

EXCELLENT Profit. Autos must use it. Retail for over \$3.00, easy mixed for 39c; sell wholesale, no extra equipment needed. Formula and instructions, \$1.00. R. E. Wallin, Mooresville, Ind.

YOUR Future and the right job. Better position. Increase earnings. Tested job getting plan. Details free. Pacific Personnel Counsellors, 609½ N. Croft Ave., Los Angeles 48, Calif.

FIX Typewriters, full or part time. Inexpensive copyrighted home study course quickly trains you for high earnings. Factory methods cover all phases with drawings and illustrations. No curiosity seekers. Typewriter Repair, 9915 Corbet, Tarentum, Pennsylvania.

"HOW To start a successful mail order business." The guide to sound profitable mail merchandising 25c. Manhattan House, 126-B Lexington, New York 16, N. Y.

SELL By mail. Get started right. Details and informative trade magazine containing tips, plans, supply sources sent for 10c. Shaw, Box 438, Coconut Grove, Fla.

BIG Money, Spare or full time in your home. No selling! Spray new miracle finishes, plush and suede, on signs, radios, automobiles, figurines, lamps, toys, etc. Our business is booming. Help us fill huge demand. New easy Flok-Kraft methods. Material costs few pennies. You get dollars. Free samples, complete powerful money making plan free. Write now! Coast, 1010 S. Los Angeles St., Los Angeles 15.

LIQUID Rubber, make flexible molds. Free sample. Chaney, 1130 E. 16th St., Jacksonville 6, Fla.

HOUSEHOLD Specialty, 150% profit. Ideal for mail order. Flinson, Box 4333-B, Kansas City 1, Mo.

YOU Can operate a profitable mail order business. Write for free literature. Bruce Brown, 170 Hancock Street, Brooklyn 16, New York.

DRESDEN Craft figurine molds and many others, natural liquid rubber, statuary plasters, flock finishes, etc. Illustrated catalog and "Plastercraft" manual free. Blue Rapids Supply, Blue Rapids, Kansas.

EXPORT-Import! Represent manufacturers. Conduct barter exchange business without capital. Two bulletins supplying hundreds overseas connections \$1. Money refunded if unsatisfied. International Trade, 246-P, New York 1.

USE Your home as magazine subscription station. Represent all magazines. Liberal commissions. Supplies furnished. Big Christmas gift business now. Catalog, full details, free. McGregor Magazine Agency, Dept. 509B, Mount Morris, Ill.

WANTED Unused U. S. postage stamps, small discount. Advance Stamp Co., 24 East 23rd St., New York.

OWN A printing business. Good profit printing cards, stationery, etc., in spare time. Easy rules furnished. Have home shop. Write for details. Kelsey Corp., Meriden 24, Conn.

GET "How To Sell by Mail and Win." Literature free. Lexington Mail Service, 5538 Lexington, Chicago 44, Ill.

EXTRA Money. No selling; operate vendors. Amazing profits, details free. Silver King, Suite B, 622 Diversey, Chicago 14.

EARN Money at home with your typewriter! Full, spare time. Details free! Edwards, 3915-P 12th, Des Moines 13, Iowa.

UNPAINTED Bookends, plaques, statues, figurines. List. Haverty Products, 1219 8th Ave., Altoona, Penna.

LIQUID Marble—Colorful, glossy! Molded, brushed, sprayed! Cast novelties, statuary, colored tiles. Flexible molds. Composition floors. Particulars free. Marbleizing Service, Edwardsville, Illinois.

BABY Shoe mountings; book ends; frames; etc. St. Albans Plating & Casting, 135-17 135 Ave., So. Ozone Park, New York.

RICHS In your own business. Let me show you how. Addison, Box 1153, Hot Springs, Ark.

BRONZED Baby shoe mountings, equipment and supplies. We manufacture world's largest assortment of all metal mountings. Wholesale only. Ramyr selenium platers \$39.95. Gold and silver plating assemblies low as \$97.50. Write for free copy of electroplating instructions. Tech. Dept., Hollywood Bronze Supply, 1770 N. Vermont Ave., Hollywood 27, California.

MAIL Order offers increased income, independence, unlimited possibilities. Free literature. Manhattan House, 126 Lexington, New York 16.

MAIL Order News (55th year) brings you the mail order ideas you're looking for. Copy 25c. Clarence Woodfall, Publ., Route 3, Charleston, Ill.

RESILVER Mirrors at home. Formula 25c. Ideal Service, Park Ridge 8, Illinois.

UNPAINTED Figurines. Free list. Progress Company, 4033-P Chowne, Minneapolis 10, Minnesota.

HOW To set up and run a mirror shop! Resilver mirrors. Make chipped glass nameplates. Electroplating salts and rectifiers, John Sprinkle, V60, Marion, Indiana.

MAKE Money spare or full time, casting metal toys and novelties. Big wholesale and chain store demand for cast metal autos, soldiers, ashtrays, banks, etc. keeps manufacturers busy. Production moulds furnished for up to 100 and more castings per hour. No experience or special place necessary. "Cash-in" on holiday orders now being placed. Write for full information and illustrations of patterns needed. Metal Cast Products Co., Dept. A, 1696 Boston Road, New York 60, N. Y.

LEARN Piano tuning, repairing at home. Tremendous field! Piano parts, tools furnished. Established 1935. Empire School of Piano Tuning, 606-B East University Ave., Champaign, Illinois.

LEARN Sewing machine repairing at home. Install our wholesale motor kits. Make \$125 to \$300 in a week. Free particulars. Taylor Service Co., Hamilton PM, Ohio.

NEW Industrial hand cleaner. Free manufacturing-distributing plans. Unusual money-making proposition. "Acro-Sol-Ex," 623 West 14th Ave., Denver 4, Colorado.

DOLLARS in personalized baby record books. Sell by mail. Use same literature we do. No-Co-Ro, Oakland 6, California.

UNPAINTED Figurines—Wholesale, retail. Illustrated list free! Oman, 642L Broadway, St. Paul 1, Minnesota.

CO-PUBLISH And advertise in The Central Mail Advertiser. Sample copy 10c. Low rates. Large circulation. Bagby Printing Co., Georgetown, Ohio.

BIG Money! Made in lettershop operation! Easy pleasant work. Free details! Woods Letter Service, Bedford, Penna.

MAKE Rubber stamps, metalize baby shoes, repair dolls, silver mirrors, make plaster novelties. Catalogue of "30 ideas" free! Universal, Box 1076-A, Peoria, Ill.

SELL Jewelry by mail. Everything furnished ready to go. Orders filled; small capital. Tremendous possibilities! Jomay, Box 1224-A, Toledo 3, Ohio.

CASH For your idea, 280 manufacturers need inventions, patented or unpatented. List free. Invention Bureau, 208M Clinton, Oak Park, Illinois.

MAKE Money making new greaseless doughnuts at home on electric machine. Wholesale at grocers, drug stores, cafes, hamburger shops. Send for free recipes and plans. M. Ray Company, 3605 South 15 Ave., Minneapolis 7, Minnesota.

RECAST Old batteries into new. Latest achievements. Battery Laboratories, Minneapolis.

"SPECIALTY Manufacturing" Big money business. Start on small capital with dependable formulas. Send for free interesting booklet. Howard Robinson, Ph. G., 1300-A South Ohio Street, Sedalia, Mo.

MAILING Postcards selling repeat merchandise is profitable. Everything supplied. Details free. Gordan Publishers, Box 23, Pawtucket, R. I.

ENVELOPES Addressed accurately, reasonably. Fast service. We have capable addressers in your city. Glenway System, 5713-Y Euclid, Cleveland 3, Ohio.

HOME Business making statuettes, plaques, artificial marble, rubber molds. Metalizing baby shoes. Silvering mirrors. Formulas. Folder free. Creative, 236-I-Winnetka, Illinois.

VENDING Machines earn big money! An investment as low as \$10.50 will start you in this fascinating, profitable business that can lead you to the road of success and independence. Routes can be established and operated in either full or spare time with no experience needed. Write for full details and our free catalog illustrating our nut, candy, gum and stamp vendors; also pin ball machines, music boxes, etc. Write immediately to Parkway Machine Corporation, Dept. 7, 623 W. North Avenue, Baltimore 17, Maryland.

YOUR Own profitable home business. Preserve live flowers to last forever. New simple discovery. Enormous demand all year 'round. Tremendous profits! Light fascinating work. Send \$2.00 for working equipment, instructions, and valuable sales plans. Satisfaction guaranteed or money promptly refunded. Alfred Hermansen, 210 Fifth Ave., Suite 1102A, New York 10, N. Y.

I MAKE Big money in the mail-order business. You can do the same at home with copyrighted system. Write me. I'll tell you how. F. Little, R.D. #1, Glenshaw, Penna.

POPCORN Equipment, potato chip outfits. Long Eakins Company, 4960 Hi Street, Springfield 99, Ohio.

READ "Advance"—The voice of mail order. Offers money-making opportunities, sources of supply, personal guidance, etc. Issued monthly. Sample copy 25c. Yearly subscription \$2.00. Advance Publishing Company, 313 East 21st Street, Suite 450, New York 10, N. Y.

A BUSINESS in your own home! Our chemicals, plus free water and cheap "grocery store" materials can bring you over \$500 monthly earnings. Plans and formulas free. Chemicala Division, 1269 S. Norton, Los Angeles 6.

A FACTORY in your home garage! Mfg. and sales rights, mechanics' waterless hand cleaner. \$500-\$800 monthly. No special equipment necessary. Formula free. Western Aircraft Mfg., Dept. D. Los Angeles 6, Calif.

START Mailorder bookshop—Everything furnished. 25c brings booklet, samples, exciting ideas. General Publications, Ossining, N. Y.

OPERATE Profitable mail order business. Write Walter Service, 4159-A East 112th, Cleveland 5, Ohio.

COLORGLAZED Concrete pottery made without molds. Patented method. Cemetery products, novelties, tiles. Basement leak-sealing. Money-making projects. Booklet, details free. Men only. National Potteries Company, Grand Rapids, Minnesota.

\$25 WEEKLY Working two hours daily. No canvassing. No manufacturing. Lycke, Box 2471, Cleveland 12, Ohio.

137 WAYS To make money, in home or office, business of your own. Full particulars free. Elite Co., 220 Grand St., New York 13.

BRUSH Plating outfits connect to a battery. No tanks necessary. Good paying business at home plating autoparts, bathroom fixtures, bicycles, reflectors, silvering mirrors. No shop or experience required. Outfits furnished. Free booklet. Gunmetal Co., Ave. H, Decatur, Ill.

COPUBLISH Leading m.o. paper. Latest copy Mail Sale Advertiser and proposition, dime. Vanroy W. Shirk, Lebanon, Penna.

MONEYMAKING OPPORTUNITIES

SECRET Investigations. Experience unnecessary. Write, George Wagner, 125-M West 86th, New York 24.

150% PROFIT. Two sensational new non-competitive low priced items for all salespeople. Cobrecite Corp., 335 W. Washington, Pasadena 3, Calif.

DEPRESSION Insurance! Own profitable business. Information free. Pru-A-Ex, Kingsport, Tennessee.

MAKE Money with imprints. Instruction book and big mail 25c. J. M. Stenger, 500 20th St., Rock Island, Ill.

NEW, Highly profitable, easily sold packaged button assortments. More than doubles your money. Write Capital Findings, 475-P Fifth Ave., New York 17.

WIN Cash, cars in prize contests! Write for copy filled with current contests, winning hints and tips. Send only 25c. Wright Contest Digest, Dept. 17-K, P.O. Box 2266, St. Louis 9, Missouri.

FREE Book "372 Unusual Worldwide Businesses." Successful! Australia, South America. Work home (U.S.A.)! Delightful plans. Get surprise! Publishers-7S, Carlsbad, Calif.

PRACTICAL Money-making opportunities. Details free. Resco, 308 East 6th, New York 3.

MAKE Money with easily installed weatherstripping. Double Seal Co., 2725 Ross, Waco, Texas.

TIP Top salesman magazine for money-making. Trial three months subscription 25 cents. "Superlux Opportunities" included. Louis J. Wiltsch, Co-Pbl., Steelville, Mo.

FREE Money-making literature. Plain. Sensible. Sure. Granite House, 675 Congress Street, Portland, Maine.

FREE Samples—Engraved wedding invitations, 100 for \$8.50. Berlin, 166 Keap St., Brooklyn 11, N. Y.

ODD, Unique and unusual items. Profit 100% up. Details, imprinted weather forecaster 10c. Refundable. Central, Simpson 1, Kansas.

YOUR Mail order business now ready. A. S. Spencer, Mokena 6, Ill.

HAVE Your own big-money business! Others are making up to \$500 monthly in waterproofing and cement painting. Let me prove you may do as well! Few dollars starts you. Interesting facts, free. Write today! Edgar W. Thomas, Barnesville, Ohio.

BUY, Sell, trade, thru the Trading Post Magazine. Free offer! Thorne's, 525-Z Dewey, Jackson, Michigan.

UNUSUAL Backyard money-making opportunities! Fully outlined! Pickett's, 62-M Sanders, Florence, Ky.

EARN Money evenings, copying and duplicating comic cartoons for advertisers. Adservice, Argyle 1, Wisconsin.

SELL A new product by mail. Big profits. Everything furnished. Write Home City Services, Box 1062PM, Springfield, Mass.

WOULD You pay 3%—first \$350 made? Illustrated book "505 Odd Successful Enterprises" free! Work home. Expect something odd! Pacific, Oceanside, Calif.

15 MINUTES Masters advertising and sign lettering, complete system; sign painters' secrets; cartooning book; all three, \$1. Free circular. Abenterprises, Box 875-M, Peoria, Illinois.

PROFITS and fun with your pen. Sensational raised letter engraving. Gold, silver or copper. Engrave Christmas cards, stationery, invitations. Simple as writing. Amaze your friends and make money. Free sample! Specialties Clearing, 5520 Ethel Ave., Van Nuys, Calif.

WIN Contest prizes regularly! Others do! 10c brings latest issue "Contest Payer," other revealing information. Lawrence, 687 Morgan, Camden 4, N. J.

MAKE Extra dollars! Full, spare time, home mail business. Start small, grow. Easy, pleasant. Facts free. Kanick, 261-A East Abbott, Lansford, Penna.

\$50 WEEKLY While learning watch repairing. See ad page 47.

\$25.00 CASH For handing out only 10 coupons on cheap oil burner for cooking, heating stoves and furnaces. Write today for details. Northwest Mfg. Co., Dept. 801, Mitchell S. Dak.

EARN Money at home! Thousands do! "Home Worker Magazine" tells how. Sample, 25c. Sizemore, Box 7, 4917 Kostner, Chicago 30, Ill.

SCHOOL Seniors—Sell classmates America's most beautiful graduation name cards. Largest selection. 40% commission. Outsell all others. Free sample kit. Printercraft, Dept. M, 1425 E. Elm St., Scranton 5, Penna.

MAKE Money at home as renewal headquarters for all magazines. Big profit in Christmas gift sales. Liberal commissions. Supplies furnished. Catalog free. Write McGregor Magazine Agency, Dept. 509C, Mount Morris, Ill.

\$100.00 PLUS 24 card tables. Churches—organizations write for particulars. Box 392, Clementon, New Jersey.

EXCEPTIONAL Money-making opportunity making life-like dwarf trees. Tremendous market! Big profit! Complete sample kit \$3.95. Oriental Gardens, 1491 E. Colorado, Pasadena, California.

THOUSANDS Articles wholesale. "Supply Source Directory" 10c. Ideal Service, Park Ridge 30, Illinois.

DOLLARFUL Ideas for you every month in advance—"Voice of Mail Order." Leads the field in exclusive supply sources. Plans for mail order operation; new products, etc. Details free. Advance Publishing Company, Suite 350, 313 East 21st Street, New York 10.

START Profitable home business in spare time. Make extra money raising Golden Hamsters. Small, clean, odorless. New. Unlimited market. Literature free. Golden Gate Hamstery, 631-H Richmond Street, El Cerrito, California.

READ Progressive Mailtrade, the magazine that tells how to make money by mail. Dime brings sample and special offer. Progressive Mailtrade, Box 357, Sheboygan, Wisconsin.

PROFIT With Larson Leathercraft. Belts, purses, 100 other ideas. Largest supply in U. S. Catalog 10c. Larson, Dept. C, 824 S. Tripp, Chicago 24.

WIN Contest money. General Contest Bulletin gives hundreds of tips. Lists current contests and rules. Sample 25c. General Contests, 1609½ East 5th, Duluth, Minn.

PUBLISH Your own magazine. Hand-some 52 page format, well edited, illustrated. Cost low as \$1.00 month. Brings you prestige, profits. 25c brings sample, details. National Ord. Nebr.

PRIZE Contest bulletin gives various contests now operating, and valuable hints. 3c stamp. National Contest Bulletin, Box 2685P, Miami, Florida.

FORMULAS, PLANS, ETC.

10,000 FORMULAS And trade secrets. Free literature. Stillman, 555 Kingston Ave., Brooklyn 3, N. Y.

FREE Formula catalog. Anything analyzed \$20.00. Western Chemical, Salem, Oregon.

MAKE—Sell cleaners, soaps, polishes, flavors, cosmetics. No machinery. Formula literature free. Kemico, Park Ridge 16, Illinois.

PRODUCTS Analyzed. Duplicated. Improved. Formulas. Consulting Scientific Company, Swarthmore, Pennsylvania.

FORMULAS For nearly everything. Catalog free. Write Creative, Winnetka, Ill.

TESTED Formulas. Interesting descriptive booklet free. Pont, Box 635-PM, Terre Haute, Indiana.

REAL Manufacturing formulas. Lists free. Cummings, Chemist, Gordon Ave., Syracuse 4, N. Y.

PLASTICS

WHOLESALE Plastics supply catalog. 10c. Lucite, clear, colored. Metallic Acetate. Complete Castolite line, phosphorescent, pearling pigments, dyes. Metal findings. Tools. Ideas and bargains galore. Fast delivery from stock. Gem-O-Lite, Box 686-10E North Hollywood, Calif.

HOW To make money in plastics. Learn plastics at home, in spare time. You get 7 big plastics material kits with training course. Make useful, valuable articles as you learn. Send today for free illustrated catalog. Plastics Industries Technical Institute, Dept. of West Coast University, 1601 S. Western Ave., Dept. CPM-109, Los Angeles 6, Calif.

PLASTIC Engineer and consultant. Will solve your plastic problems. Fee reasonable. 65 E. Rich Street, Columbus 15, Ohio.

MOULD Sparkling plastic. complete instructions. \$1.00 cash. Money order. D. O. Ford, 201 Dullnig Ct., San Antonio 10, Tex.

CASTING Plastics: Cold curing, transparent and colors. Information 10c. Alan Plastics, Dept. P2, Box 3564, Cleveland 18, Ohio.

INJECTION Molding press—Do injection molding of all thermoplastics in your work shop. The Plasti-Jector injects ¼ oz. plastic per shot and up to 75 shots per hour. Fits in drill press or arbor press. Stock lead molds from \$1.00 to \$5.00. Sent postpaid cash with order or C.O.D. \$19.75 plus mailing cost. Guaranteed. Merman Products Company, Box 67, Mercer, Penna.

LUCITE, Plexiglas. Any size sheets, masked. Square foot (12 x 12) cost, 1/16", 96c; ¼", \$1.25; 3/16", \$1.52; ¼", \$1.80. Colors add 10%. Include 10% postage. Almac Plastics, 230 Fifth Ave., New York 1, N. Y.

INTERNAL Carved roses, orchids, swans, goldfish, butterflies, etc. Jewelry and gifts. Crystal Floral Novelty Co., Bound Brook, New Jersey.

PLASTIC, Sheets, rods, tubes, etc. Free list. Plastic Supply Co., 2901 N. Grand Blvd., St. Louis 7, Mo.

CHEMISTRY

SUPPLIES, Chemicals. Catalog 10c. Atlantic Laboratory Supply, 21 Wenham, Boston, Mass.

NEW Laboratory supply catalog of chemicals and apparatus. Contains many thousands of items with illustrations. Send 25c. Standard Science Supply Company, 1232 N. Paulina St., Chicago 22, Ill.

NEW Idea chemical and apparatus outfits for home experimenting. Photo-scales, microscopes, chemicals, biological and laboratory supplies in small quantities. Catalog 15c. Established 1931. John H. Winn, 124A West 23rd Street, New York, N. Y.

NEW Catalog: Chemistry, mineralogy, biology. 10c. Tracey Laboratories, Evanston, Illinois.

CHEMICALS And apparatus for industrial, analytical, and private laboratories. Catalog 15c. Dept. M-50. Biological Supply Co., 1176 Mt. Hope Ave., Rochester, N. Y.

HELP WANTED

BOYS Wanted. Over \$2.00 hour! Sell name plates for front doors. Free sample. Write Dept. 53, National Engravers, 214 Summer, Boston, Mass.

AGENTS WANTED

WORK Garments and embroidered uniforms, wool or cotton. Thousands of prospects. Outfit furnished. Dodson Sales, Box 480C, Roanoke, Virginia.

WONDER Metal (putty). Fill holes, leaks and cracks in all metal articles. Fireproof. Applied with fingers. Hardens like iron. Repaired articles can be used at once. Cooking utensils, hot water heaters. Boilers. Tanks. Radiators. Pipes. Salesmen's large size 25c. Home Chemical Co., 143 West Florence, Los Angeles, Calif.

AT Last! Something new and sensational in Christmas cards. Show gorgeous satins, velours and plastics never before offered. Gets easy orders fast! Pays big profits. Free samples of Christmas cards with name 50 for \$1, imprinted stationery, floral charmettes, napkins. 50 other assortments 60c to \$1.25. Samples on approval. Write. Puro Co., 2801 Locust, Dept. 940-M, St. Louis, Mo.

FREE! "How to Make Money" booklet with fast-selling Christmas cards on approval. Credit to clubs. Writwell, 2110 Transit Building, Boston 15, Mass.

PLASTIC Christmas, Christmas wrap-pings, complete line, everyday & Christmas including 25 and 50 for \$1.00 imprints. Gaycraft, 4228 Paul, Phila. 24, Penna.

"GEM-LITE" Luminous paint (glows in dark) colors; blue, green, yellow, violet. Jar \$1.00. Complete kit \$3.50. Folders. Gem-Lite Products, 12691 Charest, Pm., Detroit 12, Mich.

\$1.00 STARTS You in business. Sell men's neckwear full or part-time. Low investment, big profits. Send \$1.00, receive two sample ties, plus free catalogue, color pictures, selling plan. Radio City Neckwear, Dept. M3, 112 W. 50th St., N. Y. C.

NYLON Uniforms. Immediate delivery, immediate profits. Sell to doctors, dentists, nurses, waitresses, beauticians, housewives. Free sales kit. Super or Fabrics, Dept. P10, 3936 Market, Philadelphia 4, Penna.

WEDDING Invitations—Lowest prices, 24 hour service, free samples. Sperry-Print, Williamsport, Penna.

EARN Extra money. Sell our perfumed air fresheners. A useful household deodorant in a decorative wall plaque. Many beautiful styles to choose from. Wonderful Xmas line. Big profits plus bonus. Write today for details. Sydray Company, 1186 Broadway, Dept. M, New York 1, N. Y.

BIG Extra income! Sell friends nylon hosiery, lingerie, blouses. Values supreme! Free sample displays. Christmas, everyday greeting cards, gift wraps. Christmas samples on approval. Special outfit offers. Wear Wright, 1709 Arch St., Dept. B, Philadelphia, Pennsylvania.

DOUBLE Your income selling sportswear, shirts, pajamas; Nylon lingerie, hose, housedresses. Free outfit. Jarod Manufacturing, Rockville Centre 88, New York.

100% PROFIT—Sureseal steel bottle recapper and opener. Retail 25c. Sells on sight. Agents selling dozens daily. Sole distributor, G. Kearney, 180-7th Ave., New York 11.

EXTRA Money yours—Easy! Profits to 100%. Sell thrilling value plastic Christmas cards, 50 for \$1.00. Personals, everyday, religious, children's, gift wrap assortments. Request deluxe 21-card \$1.00 Christmas assortment, name imprinted Christmas cards, stationery samples on approval. Holiday Card Co., 463 Congress St., Dept. C, Portland, Maine.

BUY Thousands of nationally advertised products direct from manufacturers and distributors. Write for "Buy Direct and Save." Service Publishing, 218-A Investment Bldg., Pittsburgh 22, Penna.

CHRISTMAS Cards. Earn \$5.00 with every ten 21 card \$1.00 boxes you sell. Also new \$1.00 plastic cards, personalized cards, and stationery, note paper and wrappings. Send for samples today. Howard P. Ellis, Dept. PM-10, Pitman, N. J.

25c SCISSORS Sharpeners. Fine sales in every home. Campbell Doggins, Box 949, Lexington, Ky.

AMAZING Offer—\$40 is yours for selling only 50 boxes Christmas cards. Also 50 and 25 for \$1.00 with or without name. Free samples. Other boxes on approval, including entirely new, different deluxe assortment with feature television card. Cute plastic assortments. Write today. It costs nothing to try. Cheerful Card Co., 981, White Plains, N. Y.

STEADY Profits selling new sensational Lico fountain pens. Liberty International, 8 Bridge St., New York 4, N. Y.

NEW "Sponge" dish cloth. Replaces messy dishrags. Banishes dishwashing drudgery. Lightning seller. Samples sent on trial. Kristee 136, Akron, Ohio.

MAKE Money easily. New spare time plan. Up to 100% profit. No experience. Show unusual Christmas, everyday card assortments, plastics, Gleam and Glo, kiddies cards, wrappings. Attractive gift items. Bonus. Special offers. Send today for free samples 30 different Christmas cards with name 50 for \$1.00 up, stationery, coasters. Thomas Terry Studios, 102 Union Ave., Westfield, Mass.

MOVIE Projector 16mm sound. Sell churches, schools, industry. Big profits. Write L. Jessen, 5 S. Wabash, Chicago 2, Illinois.

MORE Money—Yours! Sell "guaranteed comfort" Air Cushion shoes. Big advance commissions, bonuses. Special shoe offers. New style sensations. Complete line. Experience unnecessary. Free outfit. Merritt Shoes, PM9, Brockton, Mass.

NUSILVER Plating liquid. Apply with cloth. Renews silverware. Silverplates brass, copper. Easy seller. NuSilver, 508-10PMA New York St., Aurora, Illinois.

WANTED! Direct from factory to customer salesmen for guaranteed shoe line. Unusual factory fitting service. \$1.00-\$3.00 advance commissions. Bonuses. Experience unnecessary. Free starting outfit. Mench Shoes, 10D, Brockton, Mass.

SELL New clothing. Lowest prices. Operate from home, auto, store. Enormous profits. Big catalog free. National Mail Order, 1219-A So. Jefferson, Chicago 7, Illinois.

MANUFACTURE Foam cleaner at home. Gallon costs 5c—sells for \$1.69. Full details with 1/2 gallon size 25c. Kohne, 506 West 45th, Chicago 9.

WANT Some money quick? California sweet smelling beads sell on sight. Big profit. Particulars free. Mission, 2328P West Pico, Los Angeles 6, Calif.

BEAUTIFUL Mexican bird pictures. Hand made of real feathers. Profitable. 9" x 11" sample \$1.00. Refundable. Miciak, 241-25 85th Ave., Bellrose, N. Y.

LOOK Here! Wanted—Men and women to start in business on credit. Sell some 200 farm-home products. Thousands our dealers now make quick sales, big profits. For particulars write Rawleigh's, Dept. J-192-PPM, Freeport, Ill.

A Dress yours with every 3 you order for yourself and family. Amazing new bonus plan. Everything free. Harford Frocks, Dept. A-535, Cincinnati, Ohio.

"CLEAN Dry" clothes brush. Chemically treated. Cleans clothes while brushing. Lightning seller. Samples sent on trial. Kristee 135, Akron, Ohio.

SPARE Minutes bring dollars selling this new burn ointment. Free details. Clover Products, 11860M Mississippi Ave., Los Angeles 25.

SHARPMASTER Reflexor—Amazing new invention that will keep double edge razor blades sharp indefinitely. Feather-light shaves without nicks or skin irritation. Satisfied customers say: Magnetic shaving is out of this world. Whirlwind seller wherever demonstrated. Beautifully packaged. Unconditional money-back guarantee. Exclusive sales contract for livewires. Send \$2.00 for sample, complete information and quantity prices today. Rhoads & Associates, Dept. 101, Box 1711, Detroit 26, Michigan.

DISTRIBUTOR Agents for patented Frost Proof shut-off valves and yard hydrants. Small capital and stock required. Miller Frost Proof Valve Co., Ironton, Mo.

ASSEMBLE And sell electric bed warmers. 400% profit. Aitozee Co., 7811 Guthrie, Cleveland 2, Ohio.

AGENTS Make big money selling exciting new game. It's sensational! No competition! Everybody wants one. Free information on how to make \$30.00 or more a day. E. G. Stadler Co., 1142 North Vermont, Los Angeles 27, California.

SELL Scots guard automatic fire alarms. Retail for only \$3.95. Write for details. Royal Scot, Waterbury, Conn.

MUSIC Greeting cards. All occasions. Dorby Music Cards, P.O. Box 738, Morristown, New Jersey.

AMBITIOUS Agent's opportunity! No initial investment. No overhead. Hundreds of profitable gift, household products! 38th year. Toby of Chicago, 14 W. Lake St., Chicago 1, Ill.

FREE Nylons given if Kendex hosiery runs or snags! World's only women's hosiery sold with written guarantee amazing everybody. Mere words could not express unbelievable money-making opportunity. Fantastic earnings become reality. Armstrong earned \$202 in 9 days. Watkins sent 92 orders in one day. Imagine replacing hosiery free regardless of cause—whether use or abuse! Truly sales dynamite for terrific profits. Even if you never sold before, three magic words: "Guaranteed Against Everything" will open doors for you—make women listen and pour money in your pocket. Nationally advertised in Life, Ladies Home Journal, Saturday Evening Post, McCall's and Woman's Home Companion. Awarded Seal of Approval by Good Housekeeping. 75 million readers will see Kendex advertising to help you make quick sales and big money. Complete line from sheerest 15 denier 51 gauge to heavy 70 denier service. Sizes 8 1/2 to 11 1/2; lengths 28 to 35 inches; latest fashion colors plus white; full fashioned seamed and seamless. No competition because Kendex nylons are not sold in stores. Also complete line men's hosiery actually guaranteed for one full year or replaced free. Nothing like this anywhere. Includes rayon, nylon, lisle, wool, cotton, mixtures etc. All styles, patterns, colors, prices to please everybody. 200,000 pairs constantly in stock for fast delivery. Thousands shipped daily. Over 30 years in business. You need no money or experience. Nothing to pay now or later. Just show free outfits. Write orders. We deliver and collect. Big advance cash plus huge bonus. Earn money spare or full time—exclusively or as side line. No restrictions. Become manager—appoint others to sell for you—earn steady income on their sales. Man or woman, young or old, experienced or beginner, you can make money and friends writing orders. Everything you need is furnished free, including sales books in color, samples of hosiery materials etc. Simply write your name and address on postcard and make money next week with money-making outfits sent free and prepaid. No obligation. Kendex Company, Babylon 13, N. Y.

SELL New item to grocers, butchers, delicatessens. Good sideline, no competition. 30% commission. 3 sales daily nets over \$10. Send card McArthur Price Tag Holder, 102 W. Summit St., Souderton, Pennsylvania.

ATTENTION Picture men: Air brush portraits. Frames. Tinted prints. Commercial Copy Co., Box 1695, Chattanooga, Tennessee.

WRIST-WATCHES, Reversible neckties, Nylons, blades, pens, cameras, typewriters. Simms, Warwick, N. Y.

YOUR Own successful business—Experience unnecessary. Big profits waiting. Make 1001 items for sale. Do profitable business with manufacturers. Help fill huge demand. New Miracle Finish makes old items beautiful, new items worth much more. It is easy. Write now. Free samples and booklet containing powerful money-making plan. Coast, 1004H So. Los Angeles St., Los Angeles 15.

BABY'S Footprint reproductions in bronze relief. Solid metal, hanging ring and easel stand. Liberal commissions and protected territories. Write to Hanson Arts, 253 Ruggles Street, Boston 15, Mass.

PROFITABLE Business selling creme, waxes, polishes. Samples \$1.00 postpaid. Refundable. Valtex Company, Rochester 7, New York.

BIG Money—Fast! Sell plastic tablecloths (from \$3.50 doz.), drapes, aprons, over 300 other items. Cash advanced daily. Lowest factory prices, highest quality plastics! Huge selling kit free! The Dur-Ever Co., 2781-G Atlantic Ave., Brooklyn 7, N. Y.

PAINTS—Enamels. Roofing 65c gallon up. Also outdoor toilet cleaners. Certified Products, 812e 38th, Louisville, Ky.

MEXICAN Feather pictures Christmas novelty. \$1.00 (stamps) brings \$2.00 worth samples, details. Refunded if unsatisfied. Aztec Art-P, Apartado 762, Mexico City.

PERFO—The leader in its field—has full line of custom-built rubber mats with inlaid names, numbers and trademarks. Big commissions paid in advance to hundreds of successful representatives. Write for details on this year 'round business today. Perfo Mat & Rubber Company, Inc., Dept. PM-1, 281 Fifth Avenue, New York 16, New York.

BIG Money selling tooth powder. J. Walker, 633 Plymouth Ct., Dept. 1, Chicago 5, Ill.

AMAZING New Sahara Waterless Hand Soap. Sell to jobbers, stores, factories. Exclusive territory. Sahara Waterless Soap Co., Grand Rapids, Michigan.

SELL Ultra-blue stock signs to stores. 1000 slogans, comedy, general, religious. "7x11" cost 6c, sells 35c. Make money. 15 samples ultra-blue signs "7 x 11" \$1.00 postpaid. Lowy, 8 West Broadway, Dept. 494, New York City 7.

QUALITY Plastics at lower prices! Proven hits in tablecloths, aprons, garment bags, utility covers. Free catalogue M910. Acclaim Products, 49 West 24th St., New York 10, N. Y.

MAKE Big easy money—Now! Make up to 100% profit. Sell new Xmas cards in boxes, plastic and regular. 43 famous assortments. Splendid opportunity for clubs, churches, to raise funds easily, quickly. Sample on approval. George Creed, 22 S. 10th St., Philadelphia 7.

NOGRIND Faucet stopper. Stops leaky faucets right now. Send \$1.00 for four assorted sizes and low agents' prices. F. K. Mfg. Co., 240 Pulaski Rd., Calumet City, Ill.

DON'T Sell our signs! They sell themselves. Your profit 400% while having fun. Colorful 7" x 11" signs. Slogans, comic, functional, novelties for every business—\$1.00. Generous starting selection. Retail for \$5.00. All Ready Signs, 501-A Piper Blvd., Detroit 15, Mich.

SELL Big money-maker to men and women. Easy handwork makes fast-selling useful articles. Sunmade Company, Brockton 64, Mass.

AMAZING Profits—Up to \$600.00 month working with churches, civic clubs, legion, money raising organizations. Easy, fascinating, permanent employment. Details free. Kraft, Aurora 3, Mo.

\$100.00 WEEKLY Selling 6 pair Paragon Cushion shoes daily. No investment. Experience unnecessary. Free outfit. Samples. Advance commissions, bonus. Paragon Shoes, 739 Columbus, Boston.

BE Renewal headquarters for all magazines. Big profit in Christmas gift sales now. No experience, no capital needed. Free catalog tells how. Write: McGregor Magazine Agency, Dept. 509A, Mount Morris, Illinois.

SCHOOL Seniors—Earn 40% commission selling classmates America's most beautiful graduation name cards. Largest selection. Outsell all others. Free sample kit. Printcraft, Dept. M, 1425 E. Elm St., Scranton 5, Penna.

IDENTIFICATION Tags for dogs, keys, luggage. Write: DuRaney, Johnstown, Pennsylvania.

SCHOOL Seniors! Your postal will bring our wonder, Kwick-Sell cardalog of popular graduation name cards. Biggest profits! Only firm giving free souvenir chest and card case. Don't miss out! Hurry that postal! Craftcards, Box 235 (L), Pittsburgh 30, Pennsylvania.

BIG Money taking orders: Shirts, ties, socks, pants, jackets, sweaters, shoes, uniforms, etc. Sales equipment free. Experience unnecessary. Nimrod, 4922-BQ Lincoln, Chicago.

AGENTS: Stamping names on key protectors. Sample 25c. Stamping outfits, checks, social security and name plates. Hart Mfg. Co., 303 Degraw St., Brooklyn, N. Y.

\$5-\$25 DAILY. Full, sparetime or sideline. Pocket samples free. Embocards, 3333 Neenah, Chicago 34.

EASY To sell Bible text pencils, mottoes, charms, direct or to stores. Write, Al Hawkins Company, Sioux City 7, Iowa.

BIG Bargains for big profits. Over 100 sensational values. Men's used suits \$2, pants 35c, topcoats \$1.25, overcoats \$2, shoes 20c. Experience unnecessary. Free wholesale catalog. Superior, 1250-A Jefferson, Chicago 7.

A SURE Way to make money. No exp. needed; Christmas cards sell fast! From 50 for \$1.00 with name! Big line box assts; profit up to 100%. Write for samples on approval. Mandler Art Company, 37A Pearl Street, Boston, Mass.

1949 CHRISTMAS Card catalog now ready! Earn more money! Be a wholesale jobber! A large selection of box assortments. Imprint lines, religious, personalized cards and Christmas novelties. Three sample boxes, retailing for \$2.60, only \$1.00 postpaid. Catalog free! Elfko, 440 North Wells, Chicago 10.

HOTTEST 39c item on the market. Write National Sales & Service, Greenville, Penna.

FREE Samples. Big profits showing amazing Glow-in-the-Dark specialties. House numbers, pictures, plastic novelties, religious and nursery objects, etc. Large manufacturer. Madison Plastics, 303 Fourth Ave., New York 10, N. Y.

ABSOLUTELY Free! Big package actual sample fabrics and style presentation of dresses, lingerie, hosiery, etc. Take orders. Commissions big. Send no money. Melville Co., Dept. 5103, Cincinnati 3, Ohio.

LOOK! Make money all year round selling personal initialed individualized belts, buckles, cap badges, western buckles, tie holders, name plates. 2000 emblems to choose. Big profits, whole or part time. Please write today special outfit offer. Hook-Fast Specialties, Box 1425, Dept. 6, Providence, R. I. Established 1926.

SEWING Machine electrification kit. Nationally advertised. Has Good House-keeping Guaranty Seal. Can be demonstrated and sold in 5 minutes. Make at least \$5 per sale. For complete details write today to Brownell Distributors, Inc., Dept. PM, 308 Canal St., New York 13, N. Y.

FREE Water and our concentrates, make flavors, lotions, shampoos, 125 products, labels, bottles supplied. Qualco, E20030 Russell, Detroit.

BE First! Clean up selling brilliant new, metal Christmas cards featured in America's greatest box assortment line. Special metal, plastic, foil and novelty assortments. Five portfolios of personal cards. Fast imprint service. Free samples. Elmcraft Chicago, 5930 South Western, Chicago 36, Ill.

MAGIC Cleaner—Laundry soap deal. Hotter than a firecracker. Big profits. Sample free. Bestco, 4642 No. Central, Chicago.

PHOTO-Salesmen-agents. Sell beautiful hand-colored plastic enlargements. Collect deposit, we deliver. Profitable sideline. Send card, for free sample kit. Novel Portrait Co., 3343 North Ave., Chicago, Ill.

GOLD Lacquered window sign letters. Large sizes penny each. New foils. Absolutely beautiful. Free samples. Atlas, 544 W. 79th, Chicago 20.

AGENTS—300% Profit selling genuine gold window letters; stores and offices. Free samples. Metallic Letter Co., 438-B North Clark, Chicago.

EXCELLENT Sideline for printing and advertising salesmen. Decalomania name plates in small quantities. Great demand. Also, make money with our line of automobile initials and sign letters. Free samples. "Ralco" XL-Roxbury, Boston 19, Mass.

HIGH-GRADE SALESMEN

ADVERTISING Book matches—Cash in on big demand; sell union label matches. Cuts for all businesses and political parties. Free powerhouse selling kit, low prices, protection guaranteed on repeat orders. Cash commissions. Superior Match Co., Dept. M-109, 7530 Greenwood, Chicago.

WHAT Will you be doing at 50? Start own business spare time, for security now and later. Sell nationally advertised shoes. Free selling outfit. Consolidated Shoe System, Dept. S-418, Chippewa Falls, Wis.

EXCELLENT Sideline for salesmen. If any of your customers use felt send us samples and details except names. Contact all factories in your area. Henry M. Nagel, Box 125, Boulder, Colorado.

MAKE Big money selling automatic door seals. Proven device stops under-door drafts. Every home a prospect. Bern-El Co., 4719 W. Washington Blvd., Los Angeles, Calif., Dept. C-10.

SALESMEN. Earn \$100.00 weekly, selling only six pair shoes daily. Commission and bonus. Wide variety for men, women, children. No investment. Experience unnecessary. Free catalog. Tanners Shoes, 514, Boston, Mass.

WANT To make real money? You can positively make \$50.00 a day and up selling a brand new item going to every type of food and beverage store, factories, laboratories, hospitals, etc. First time advertised. Write for free details today to Johnson-Hill, 53 West Jackson Blvd., Dept. PM-10, Chicago 4, Illinois.

EARN Big money fast! Sell finest-quality advertising work uniforms to garages, factories, filling stations, etc. Free selling kit. Topps, Dept. PM-109, Rochester, Ind.

SCREAMIN' Meanies! Balloons that fly and scream. Hottest item. 70c dozen—7.20 gross. Ellswood's Balloon Headquarters, Pueblo, Colorado.

NEW Jobs open in selling! Send name, address for five free issues of Opportunity Magazine's money-making guide, listing hundreds of companies who'll pay you well, full or part-time. No experience needed. Opportunity, 28 E. Jackson, Dept. 17, Chicago 4, Ill.

JEWELRY Factory desires salesmen, distributors, jobbers. Pickcraft, 180 North Main, Attleboro, Mass.

UP To \$50.00 in a week and tailored suit for yourself without paying one cent. Write for plan. Pioneer Tailoring Co., Dept. X-1117, Congress & Throop, Chicago 7, Ill.

STOP! Want to make money all year round selling a complete line, wool and cotton embroidered uniforms for summer and winter wear, uniform trousers, shirts, caps, ties, badges, 2000 emblems, personal initialed buckles, belts, and hundreds of other easy-to-sell items? Sales kit furnished. Please write today. Hook-Fast Company, Box 480PM, Roanoke, Va.

BIG Money taking orders. Shirts, ties, socks, pants, jackets, sweaters, shoes, uniforms, etc. Sales equipment free. Experience unnecessary. Nimrod, 4922-AN Lincoln, Chicago.

EDUCATIONAL AND INSTRUCTION

IT'S New, fascinating, profitable. A complete home study course in all phases of the jeweler's art. Gem-setting. Write for free booklet. Beaudet's Jewelers Arts, Inc., 1940-P North 3rd Street, Milwaukee 12, Wisconsin.

CHANGING Times bring keen competition for the better-type jobs. Why not fortify your personal success with a practical knowledge of trigonometry? New Method Trig-Essentials (based upon 18 years of practical experience) simplifies this important training to an extent requiring only a few hours of interesting home-study plus the ability to multiply and divide. This compact handbook (suit-coat pocket size with sturdy flexible binding) is superbly suited for self-instruction and for everyday use in practical work. Outstanding features include: All six functions tabulated for each half-minute of angle (180 pages of Main Tables with Graphical Outline and Quadrant Table for every degree); new and advantageous Right Triangle methods; complete Oblique Triangle formulas (cyclic changes unnecessary); timesaving procedures and tables for Interpolation and Circular Segment problems; etc. These features include all essential and helpful information, examples, etc., to enable intelligent self-study by easy steps. And for all these desirable and worth-while facilities, your investment is remarkably moderate (the equivalent, possibly, of just one evening's entertainment). Postpaid if \$3.75 (full price) accompanies order. If c.o.d., you pay charges. Williams Publications, 1770 South Downing St., Denver 10, Colo.

STUTTERING Or stammering corrected at home. Amazingly successful method. Send for free literature showing how you, too, may overcome stuttering at home. The Athenaeum, PM-102, 1714 Chestnut, St. Louis 3, Mo.

VOICE—Strengthen, train your voice this tested, scientific way. Self-instruction course; no music or piano required. Silent exercises develop your voice power. Results guaranteed! Sensational details free. State age. Perfect Voice Institute, 1141 Wabash, Dept. 2K-2, Chicago 5.

"HOW To Break and Train Horses"—A book every farmer and horseman should have. It is free; no obligation. Simply address Beery School of Horsemanship, Dept. 11010C, Pleasant Hill, Ohio.

BE A real estate broker through home study or classroom instruction. Write for free book. Approved for veterans. Weaver School of Real Estate, 15 E. Pershing Rd., Box CP-10, Kansas City 8, Missouri.

EXPORT! Learn at home from established world trader. Big paying positions. Your own profitable world-wide business by mail order without capital; or travel abroad. Experience unnecessary. Free booklet. Mellinger, 110W, Los Angeles 24, California.

SPANISH! It's easy with "Speed-O-Way." \$7.95 complete. Free folder. Speed-O-Way, 116, Box 2301, Houston 1, Texas.

USED Correspondence courses and educational books, bought, sold, rented. Catalog free. Educational Exchange, Summerville, Ga.

GRADUATE Work in all subjects. Degrees available in one year. Resident and extension classes. Golden State University, Hollywood, Calif.

BOOKKEEPERS—Operate own book-keeping service. Complete course of instructions \$3.50. J. Hawthorne, Public Accountant, Decatur, Ala.

SCIENCE Of memory simplified. "The Art of Memory Development" free. Memory Studio, 2016-P Sunnyside Ave., Chicago 25, Illinois.

USED Correspondence courses bought, sold, rented. Literature free. Baker, 5509-B Winthrop, Chicago 40.

STUDENTS, Clerks, typists upgrade yourselves. Learn Triplespeed, the NUABC shorthand. Join Selfstudy Club. Earn course. Capital City College, Washington 5, D. C.

AMERICA'S Fastest selling Bible story book. New! Write for circular. L. L. Deitz, Box 247, Syracuse 1, N. Y.

U. S. Civil service jobs. Secure positions. Start high as \$64.44 week. Many openings expected. Write for free 40-page book, shows jobs, salaries, sample tests. Franklin Institute, Dept. X-24, Rochester, N. Y.

LEARN The simple and easy rules of money, that will make you prosperous. Write for free information. L. & E. Publishing Company, 1719 Thomas Place, Fort Worth 7, Texas.

LEARN Lettering. Design stationery, advertising, signs. Start own business. Instruction manual, 75 alphabets, 250 designs \$1.00. Literature free. Major-Art, 3510-W Palmer, Chicago 47.

MAKE Up to \$35-\$45 week as a trained practical nurse! Learn quickly at home. Booklet free. Chicago School of Nursing, Dept. M-10, Chicago.

PHOTOGRAPHIC Mind with Super-memory. Write Thor Books, P-10, Box 1210, Chicago.

SHORTHAND In one week! Easy long-hand system \$1.48. Zinman, 215 West 91, New York 24, New York.

GRADUATE Degrees, psychology, divinity, others. Directed home study. Free bulletin. Central Ecumenical College, Inc., Dept. PM, 14 N. East Street, Indianapolis, Indiana.

BETTER Jobs—More pay. Learn beautiful handwriting. 100% improvement few days. Easy method complete \$1.00. Bradley, Box 559-A, Linwood, Penna.

LEARN Auctioneering. Either by mail or in resident classes. Hundreds successful graduates. Sample lesson free. Nelson Auction School, Renville, Minnesota.

DENTAL Technician's Manual. Authentic details, how to make plastic plates, gold bridgework, etc. \$2.00 postpaid. Grant Laboratory, S-219 W. 7th, Los Angeles, California.

MEDICAL Laboratory Technicians in great demand. We train you in your own home. Catalogue free. Imperial Technical Institute, Box 973-J, Austin, Texas.

DRAW Portraits for pleasure and profit. New book by nationally known artist shows how. Send \$1.00 to Richmond Books, Box 307A, La Canada, Calif.

LEARN Free-hand technical sketching. Easy, no talent required. Free lesson. Acme, 1413 Butler, Easton 4, Penna.

FALL Classes in air conditioning, refrigeration, heating and heat pump engineering are forming now. Write for free information. Detroit Air Conditioning Institute, Dept. B, 4125 Grand River, Detroit, Michigan.

PIANO Tuning pays. Learn this profitable profession at home. Our Tonometer and mechanical aids make learning easy. No knowledge music necessary. Diploma granted. Largest and oldest school—51st year. G.I. approved. Write for booklet. Niles Bryant School, 78 Bryant Bldg., Washington 16, D. C.

BUILD a writing career in trade journalism. The best field for the beginning writer. Good pay, huge markets, little competition. Send for details. John F. Bristol, 23 Wayne Road, Bridgeton, New Jersey.

HOME Study course, drugless therapy. Free literature. Institute of Drugless Therapy, Tama, Iowa.

INVESTIGATOR Training. Phillips Secret Service System, 1917B North Kenneth, Chicago 39, Illinois.

BOOKKEEPERS! Increase your earnings! Operate your own simplified "Dollar-A-Week" bookkeeping and tax service. Full or spare time. Details free. No obligation. Ellis, Box 200, Cedar Grove, North Carolina.

LINGUAPHONE Makes languages easy. At home learn to speak Spanish, Portuguese, Italian, French, German, Russian, by quick, easy Linguaphone Conversational Method. Save time, work, money. Linguaphone correspondence courses are available to veterans under G.I. bill of rights. Send for free book. State if G.I. Linguaphone Institute, 83 RCA Bldg., New York, 20, N. Y.

USED Correspondence courses and books bought, sold, rented and exchanged. Catalog free. Lee Mountain, Pisgah, Alabama.

PLAYS, STORIES, MANUSCRIPTS

SEND 3c Stamp for "Column Writing That Pays." Ben Arid, 1141-7th St., Hermosa Beach, Calif.

BUILD Salable short stories new sure way. Method and work sheets \$3.00. J. H. VanNise, 512 Sommer Building, San Diego, California.

I WANT New writers to cash checks of \$1 to \$100 offered daily. The easiest way to write for pay. No previous experience necessary. Free details. Saunders M. Cummings, 468-11 Independence Bldg., Colorado Springs, Colo.

BUSINESS SERVICE

CHICAGO Mail address. Branch office service. Faultless, P-3539 Michigan, Chicago 16.

WE Receive, remail letters \$2.00 monthly or 25 each. "Samson," 7425 Henri-Julien, Montreal 10, Canada.

INCORPORATE Your business, free details. Tax Research Bureau, Inc., Delaware Trust Building, Wilmington, Delaware.

SPECIAL SERVICES

WHAT Can I do for you in Kansas City? Personal-business information, representation, purchasing, mail forwarding. Crown, Box 7041, Kansas City 2, Mo.

FLORIDA Address. Letters remailed. 25c each. Box 1411, St. Petersburg, Fla.

POSTMARKED Miami, cards 10c, letters 25c. 10 Miami post cards 10c. Stone, Box 604, Miami 34, Florida.

HONOLULU: Letters received, remailed; 25c each. Pacific Forwarders, 1933 Young Street, Honolulu, Hawaii.

LETTER Rемаiled 25c (coin). Moran, 117 East 11, Davenport, Iowa.

WE Receive, remail letters; \$3.00 monthly or 25c each. Turcliff, 3528 Clifftmont Ave., Baltimore 13, Md.

INFORMATION

FOREIGN Employment for you. Excellent permanent job opportunities for U. S. citizens. Wages at least 20% higher, less taxation, lower living costs. Improved social position. Transportation and housing furnished. Choice of climate and location. South and Central America, Far East, China, Alaska, Australia, New Zealand, Africa. Send \$1.00 for copyrighted digest showing oil, shipping, construction, mining, etc., companies working and hiring. Includes sample application letter, advice on wages, tips, etc. World Wide Company, Dept. PM-10, Madison 1, Wisconsin.

ALASKA—The new frontier. Free homestead lands for farming, timber, mining. Wonderful hunting and fishing. Parts of Alaska have year around temperate weather. You can drive there over new road. Jobs in construction, mining, oil, etc. Book by expert gives up-to-date information. Only \$1.00. Large government map of Alaska included free. World Wide Company, Dept. PM-10, Madison 1, Wis.

CARTOONING, COMMERCIAL ART, SHOWCARD WRITING, SIGN PAINTING

INTERESTED In cartooning? Write, Cartoons, P.O. Box 3291, San Francisco 19, Calif.

SIGN Painting—Quick, easy method, \$2 complete. J. F. Blackwell, Upper Marlboro, Maryland.

CARTOONS Drawn to your gags \$1. Cartooniscribe, 232 Grant St., Cincinnati, Ohio.

"HOW To Make Money With Simple Cartoons"—A book everyone who likes to draw should have. It is free; no obligation. Simply address Cartoonists' Exchange, Dept. 910-C, Pleasant Hill, Ohio.

BARGAINS, Quick landscape painting. Poster art-lettering, art lessons, catalog 10c. Art Book Shop, Arnold 9, Missouri.

LEARN Sho-card writing. Hollywood Sho-Card School, Box 710, Alhambra, Calif.

CARTOONING—Complete 35 lesson course. 700 illustrations \$1.00. Cartoonland Schools, 1056 Hollywood, Grand Rapids 5, Michigan.

LEARN Lettering, advertising layout. Practical, personal instruction by mail. Details free. Joseph Bolger, 148 Concord, River Edge, N. J.

9 ALPHABET 3 Numeral pattern sets and catalog, \$1.00. Sign Letter Distributors, P.O. Box 101, Mineola, N. Y.

CHALK Talks. Laugh producing program, \$1.00. Catalog 10c. Balda The Cartoonist, Oshkosh, Wisconsin.

ADVERTISING AGENCIES, LETTER WRITERS, FOR ADVERTISERS

DOUBLE The results from your advertising after reading Successful Advertising. Only \$2.00, postpaid. Satisfaction guaranteed. William Bennett, 114-35G 116th Street, Ozone Park 16, New York.

NEW Mothers names clipped from daily newspapers. \$10.00 per thousand. Maywood Industries, Inc., Maywood, Illinois.

FREE! 1949 Advertisers Rate and Data Directory. 52 pages! E. H. Brown Advertising Agency, 20 N. Wacker, Chicago 6.

MAILING Lists; \$5.00-1000 up. Write Dixie Service, King, N. C.

ADVERTISE: 24 Words, 40 newspapers \$3.50. Lists free. Advertising Bureau, 10511-C Springfield, Chicago 43.

AVOID Costly advertising mistakes. Get enlightening Ad-Guide and Ratebook leading newspapers, magazines, mailing lists, 10c. Chicago Advertising Agency, (Established 1900), Chicago 4.

ADVERTISERS! Reach nearly 18,000,000 readers. 25 Sunday national key newspapers, 18 words, \$51.50. "Terrific pullers," 20 popular newspapers, \$10.00. "Free booklet," Special—One inch display 2,-821,198 circulation, \$48.30. Newmark's Advertising Agency, (Established 1893), 217-7th Ave., New York 11.

24 WORDS In 50 weeklies, \$4.96. J. Darnell, 730 Hays, Jackson, Tennessee.

ADS Placed in out of town newspapers and magazines. Low rates. Catalogue free. Ideas that pay. Baker Advertising Agency, Successors Ankrum Agency, 189 W. Madison, Chicago 2.

TYPEWRITERS, DUPLICATORS, OFFICE DEVICES

TYPEWRITERS \$17.50. Duplicators \$9.75, adders \$12.50, burglar alarms \$2.95; ship anywhere. Typewriters, 118 Spruce, Wichita 7, Kansas.

RECONDITIONED Typewriters, printing devices. Write Dixie Service, King, N. C.

ADVERTISE. Increase business. "Printomatic" selffeeding "mimeograph" post card duplicator prints, reproduces, thousands anything typewritten, handwritten, \$13.50. Literature. Pittsburgh Typewriter Company, 336-3 Fourth Avenue, Pittsburgh 22, Penna.

RUBBER STAMPS AND OFFICE SUPPLIES

LINE 20c; 2-35c; 3-50c. Stamp Works, Auburn, Nebraska.

MIMEOGRAPH Paper, 68c ream, request samples. Brookman, 56-A West 24th, New York 10.

3 LINES 45c; indexed 55c; pads 35c. Stamp-Right, Wauwatosa, Wis.

BLANK Legal documents, deeds, mortgages, leases, contracts etc. Legal Document Service, Williamstown, N. Y.

SPECIAL! 3-Line deluxe stamp and pad, \$1.00. Letterheads, envelopes, 250, \$1.98. Catalogue. Johnson Press, Box 6-A, New York City 26.

PRINTING, MULTIGRAPHING, MIMEOGRAPHING, GUMMED LABELS

MIMEOGRAPHING, 250 8½ x 11, \$2. Samples, prices, free. Mimeographing, Madison, Tennessee.

LOOK! All this for \$1.00! You get 100 sheets personal stationery and 50 envelopes. Each piece printed with your name, address. Printer Jacoby, 488 41st St., Oakland, Calif.

1000 BUSINESS Cards \$2.50. Prepaid samples free. Reliable Print Shop, 905 E. Jefferson, Louisville 6, Ky.

SPECIAL: 100 8½ x 11 Hammermill letterheads, 100 envelopes, 5 lines, \$2.00. R. Cook, Dept. 2109, 730 West Gift, Peoria 5, Illinois.

PREPARE Your own illustrated copy for inexpensive photo offset printing. No cuts necessary. Folder free. Pengad Offset, Bayonne 4, New Jersey.

QUALITY Printing! Free price list. Nationwide Printing Company, Dept. PM, 2337 Bath Avenue, Brooklyn 14, N. Y.

TWO Color printing for one color price. Samples for 3c stamp. Otanocop, Box 114E, Akron 5, Ohio.

BUSINESS Letterheads, envelopes, cards. Samples. Crow, 533 18 St., Huntington 3, W. Va.

GLO-BRITE Letterheads "increase" business. Beautiful samples free. Rienzi Press, 24 North 7th St., Newark 7, New Jersey.

125 LETTERHEADS (8½ x 11 Hammermill) \$1.00, postpaid. Envelopes, business cards, same. Race Printers, Hudson, New York.

1000 ENVELOPES Printed. Five lines. 6¼ size, white wove. \$5.00 prepaid. Hatch Press, Meriden 1, Connecticut.

"HOW To Save On Printing and Office Supplies." New illustrated catalog. 10c refunded first order. Eddy Company, Southington 10, Conn.

PRINTING? Lowest prices. Samples free. Churchill, Box 194A, West Medway, Massachusetts.

BUSINESS Cards, \$2.25 thousand; 5 lines. 3 x 6 circulars 150 words limit, 5000 \$7.50. Wilson Printing, Montezuma, Indiana.

BETTER Grade printing reasonable. Estimates on anything. Economic Press, Leonia, N. J.

BUSINESS, Personal stationery. State requirements. Samples. Mero Products, 100 Morrison, Punxsutawney, Penna.

MIMEOGRAPHING Specialists—Finer impressions. Reasonable. Mailers Service, Box 606-E, Chicago 90, Illinois.

SUPERIOR Mimeographing—Bargain prices! Topical Emprise, 1527 Highland, Box 42 M, Louisville 4, Kentucky.

QUALITY Printing. We specialize in publications, newspapers, tabloids. Send copy for estimate. Bagby Printing Co., Georgetown, Ohio.

100 8½ x 11 HAMMERMILL Letterheads and 100 envelopes \$1.85. Herbert Hudson, Centredale, R. I.

ENVELOPES. All kinds, letterheads printed black or colors. Lowest prices, prepaid. Samples free. Shoreland Press, 55 East Washington, Chicago 2, Ill.

125 HAMMERMILL Letterheads 8½x11 \$1.00 postpaid. Envelopes same. Odom, Box 9345, Tampa, Florida.

100 ENVELOPES Printed, 2-colors \$1.00. Box 523, Rochester 2, N. Y.

SEND 10c Now, for our 48 page 1949 price list—refunded first order. McCall Press, 1326 South 27th, Omaha, Nebraska.

500 ¾x2¼ FOUR Line gummed stickers 35c; red border 50c. Moritz Printery, Saginaw, Mich.

MIMEOGRAPHING—Letters, pricelists, formulas, instructions. Lowest prices. Lem's Letter Shop, 5710 Stanton, Detroit 8.

PRINTING OUTFITS AND SUPPLIES

PRINTING Presses, type, supplies. Details free. Kelsey Presses, K-11, Meriden, Conn.

MAKE Your own rubber printing cuts. Self-molding process. Plexirubber, Argyle 1, Wisconsin.

PRESSES, Type, cabinets, supplies. List for stamp. Lincoln Press Company, 220D Hartwell, Fall River, Mass.

PRESSES, Type, supplies. Catalog 10c. Printers Supply, 211, Springfield, Missouri.

USED Type, printing presses, type cabinets, etc. cheap. Visit our store. Edward Van Dillen, Inc., 74 Beekman St., New York 7, N. Y.

PRINTING Presses, type, supplies. Lists 3c. Turnbaugh Service, Loysville, Penna.

PATENT ATTORNEYS

INVENTORS: Learn how to protect your invention. Unless the inventor is familiar with patent matters, he should engage a competent registered patent attorney or agent to represent him. We are registered to practise before the U.S. Patent Office and prepared to serve you in handling your patent matters. "Patent Guide for the Inventor" containing detailed information concerning patent protection and procedure with "Record of Invention" form will be forwarded to you upon request—without obligation. Clarence A. O'Brien & Harvey Jacobson, Registered Patent Attorneys, 91B-K District National Building, Washington, D. C.

INVENTORS—Patent laws encourage the development of inventions. The Rules of Practice of the U. S. Patent Office advises—unless an inventor is familiar with such matters; that he employ a competent registered attorney or registered agent, as the value of patents depends largely upon the skilful preparation of the specifications and claims. Write for further particulars as to patent protection and procedure and "Invention Record" form at once. No obligation. McMorrow, Berman & Davidson, Registered Patent Attorneys, 134-H Victor Building, Washington 1, D. C.

INVENTORS—If you have a valuable invention, the usual procedure is to authorize a preliminary search through appropriate classes of U. S. patents. This firm is registered to practice before the Patent Office, is available to make such a search and report to you concerning the probable patentability of your invention. Booklet and convenient "Evidence of Invention" form sent upon request. Victor J. Evans & Co., 431-L Merlin Building, Washington 6, D. C.

HERMAN Lewis Gordon, registered patent attorney. Patent investigations and opinions. Warner Building, Washington, D. C.

PETER Fries, Jr., Registered Patent Attorney. Patents, trademarks, novelty searches, copyrights. 110 East 42nd Street, New York City.

PATENTS, Trade marks. Sanders, 6430 Evans, Chicago. (Registered U. S. Patent Office.)

PATENTS. "Proof of Invention" folder mailed without obligation. E. E. Vrooman, Registered Patent Attorney, 507 McKim Building, Washington 5, D. C.

PATENTS—Trade marks. Gustave Miller, Registered Patent Attorney, 69-A Warner Building, Washington 4, D. C. Patent Lawyer.

CANADA—Ramsay Company Registered, 273 Bank Street, Ottawa, Canada.

PATENTS—Trade marks. Irving L. McCathran, 315 McLachlen Bldg., Washington 1, D. C. Registered Patent Attorney.

C. A. SNOW & Co.—M-427, Snow Building, Washington 1, D. C. Registered Patent Attorneys. Write for information.

INVENTORS: When you are satisfied that you have invented something of value write me, without obligation, for information as to what steps you should take to secure a patent. Write Patrick D. Beavers (Formerly Randolph & Beavers) Registered Patent Atty., 935 Columbian Bldg., Washington 1, D. C.

INVENTORS: Without obligation, write for information explaining the steps you should take to secure a patent. John N. Randolph, Registered Patent Attorney, 203 Columbian Bldg., Washington 1, D. C.

"INVENTOR'S Guide" free on request. Frank Ledermann, Registered Patent Attorney, 154 Nassau St., New York 7, N. Y.

INVENTORS: Write for free brochure "Evidence of Invention." Labiner, World Building, New York 7.

PATENT Practice before U. S. Patent Office. Validity and infringement investigations and opinions. Booklet and form "Evidence of Conception" forwarded upon request. Lancaster, Allwine & Rommel, Registered Patent Attorneys, Suite 411, 815-15th Street, N.W., Washington 5, D. C.

INVENTORS. For "Record of Invention" form, contact Carl Miller, Registered Patent Attorney, Woolworth Building, New York.

FOR INVENTORS

INVENTORS: Learn how to protect your invention. Unless the inventor is familiar with patent matters, he should engage a competent registered patent attorney or agent to represent him. We are registered to practise before the U.S. Patent Office and prepared to serve you in handling your patent matters. "Patent Guide for the Inventor" containing detailed information concerning patent protection and procedure with "Record of Invention" form will be forwarded to you upon request—without obligation. Clarence A. O'Brien & Harvey Jacobson, Registered Patent Attorneys, 91A-K District National Building, Washington, D. C.

MAN With ideas wanted to create novelty items of brass, metal, wood, flat glass, and mirrors for sale to the lower priced chain stores. Write Bienenfeld, 252 Beach 129 Street, Belle Harbor, Long Island, New York.

INVENTORS Having inventions for sale, patented or unpatented. Write, Schrieber, Nashville, Illinois.

INVENTORS—If you consider your invention to be something of importance, you may take steps to protect it with a U. S. Patent which gives you the right to exclude others from making, using and selling your invention as claimed. "Patent Protection for Inventors" booklet outlining steps to take to secure patent protection will be mailed promptly without obligation. Victor J. Evans & Co., Merlin M. Evans, Registered Patent Attorney, 432-L Merlin Building, Washington 6, D. C.

INVENTORS—Patent laws encourage the development of inventions. The Rules of Practice of the U. S. Patent Office advises—unless an inventor is familiar with such matters; that he employ a competent registered attorney or registered agent, as the value of patents depends largely upon the skilful preparation of the specifications and claims. Write for further particulars as to patent protection and procedure and "Invention Record" form at once. No obligation. McMorrow, Berman & Davidson, Registered Patent Attorneys, 134-G Victor Building, Washington 1, D. C.

PATENT Search, analysis your invention, \$6.00. Includes patent copies. Inventions, patents marketed. Protection forms free. Industrial Patent Reports, Box 1081, Massachusetts Avenue and North Capitol, Washington 13, D. C.

ATTENTION Inventors—Toy and novelty manufacturers. We are looking for inexpensive toys or novelties having child appeal in age group 6 to 12 years to be used as premiums. Nationwide distribution would assure large volume for items selected. Write giving description, prices, deliveries on your items. P.O. Box #4296, Philadelphia 44, Penna.

PATENT Searches \$5.00. Reports airmailed within 4 days. Invention protection forms free. Write Miss Ann Hastings, Patent Searcher, P. O. Box 176, Washington 4, D. C.

INVENTORS! Have you good, patentable ideas? Write Patent Agent Metzler, 11 West 42nd, New York.

SEARCHES \$5.00. Includes patent copies. Same reliable search that we conduct for patent attorneys. Free protection forms. 48 hour service. Patent Service Institute, 945-A Pennsylvania Avenue, Washington 4, D. C.

INVENTIONS Promoted. Details free. Or send \$2 for great book—"Dollars In Inventions." Adam Fisher Co., 61 Enright, St. Louis 8, Mo. (Est. 1911).

PATENT Searches \$5.00. Reports airmailed within 4 days. Invention protection forms free. Write Raymond L. Smith, Patent Searcher, 410 Bond Building, Washington 5, D. C.

PATENT Owner Representative. Years of experience. Can I help you? Charles A. Scott 773PM Garson Avenue, Rochester 9, N. Y.

PATENT Search \$5.00. Confidential. Reliable. Individual service. Prompt report. P. Davis-Carrington, Box 7530, Washington 4, D. C.

PATENT Searches \$5.00. Includes nearest patent copies. 48-hour service. Free protection forms. Patent Research Engineering, 318 Evans Building, Washington 5, D. C.

SEE Our ad under "Models" in which we tell you the story of our activities for many years. The Gent Machine Co., 443 Green Rd., South Euclid 21, Ohio.

INVENTORS: Without obligation, write for information explaining the steps you should take to secure a patent on your invention. John N. Randolph, Registered Patent Attorney, 202 Columbian Bldg., Washington 1, D. C.

CASH For your idea, 280 manufacturers need inventions, patented or unpatented. List free. Invention Bureau, 208M Clinton, Oak Park, Illinois.

INVENTORS: If you have an invention for sale, patented or unpatented, write Institute of American Inventors, Dept. 40A, 1926 Eye St. N.W., Washington 6, D. C.

"INVENTOR'S Guide" free on request. Frank Ledermann, Registered Patent Attorney, 154 Nassau St., New York 7, N. Y.

"INFORMATION For Inventors." Send \$1.00 for book. Design, patent, royalty, manufacturing, marketing problems explained. Houston Technical Research Co., Box 15098, Houston 20, Texas.

INVENTORS: The usual first step is to have a search of the U. S. Patents conducted, so I can report on patentability. Write, without obligation, Patrick D. Beavers (Formerly Randolph & Beavers), Registered Patent Atty., 936 Columbian Bldg., Washington 1, D. C.

INVENTORS. For "Record of Invention" form, contact Carl Miller, Registered Patent Attorney, Woolworth Building, New York.

INVENTIONS WANTED

INVENTIONS—Charges from royalties only. Inventors Manufacturers Associates, 5 Beekman Street, New York.

HIGHEST Royalties—Cash. Request free Booklet "M." Universal Marketing Co., 354 South Spring St., Los Angeles 13, Calif.

LARGE National direct sales organization wants newly patented labor time or money saving specialty. Write Johnson-Hill, 53 W. Jackson, Chicago 4.

EARN Up to \$2,000 year, inventing simple items. Special cash markets. Hendrickson, Argyle 1, Wisconsin.

INVENTORS—What have you, patented, patent pending to offer manufacturers? Request free copyright booklet Market Contacts, 11106-A2 Longwood, Chicago 43.

LARGE Well-equipped mechanical rubber manufacturer seeks suitable patents. Items to manufacture. Confidential. Complete details in first letter. Box 688, 1474 Broadway, N. Y.

SMALL Inventions wanted by manufacturers. I'll help you sell your invention. Write for circular. Stanley Hull, 7829 Euclid, Cleveland 3, Ohio.

INVENTORS: Hundreds of manufacturers have requested our assistance in locating marketable new products. Complete information, free. Institute of American Inventors, Dept. 40-D, 1921-Eye St. N.W., Washington 6, D. C.

CASH For your idea, 280 manufacturers need inventions, patented or unpatented. List free. Invention Bureau, 208M Clinton, Oak Park, Illinois.

INVENTIONS Wanted. Patented or pending only. Inventors' Exchange-B, Hartford 1, Conn.

PATENTS FOR SALE

FOR Sale—Automotive wheel replacer patent rights, royalty or other basis. A. G. Jackson, East Tawas, Mich.

SPRING-Driven screw driver. Patent 2474626, cash or royalty. Gunning, 3001 Vintage, Houston 16, Texas.

WEATHER Stripping, adjustable to various size windows, outright or royalty. Mc Donough, 5101B-39 Ave., Long Island City 4, New York.

INVENTORS: Test the commercial value of your patented or unpatented inventions, quickly and inexpensively. Write for free information. Institute of American Inventors, Dept. 40-B, 1926-Eye St. N.W., Washington 6, D. C.

MANUFACTURING

MODELS. Experimental work; designing; manufacturing. Henry, Engineer, 2815 Hudson Blvd., Jersey City 6, N. J.

MODELS. Tools, dies, design, experimental work, light stampings and manufacturing. The Artisans' Co., 3322 Franklin St., Omaha 10, Nebr.

DEPENDABLE Source. Tools, dies, stampings, manufacturing designing. Porsberg, Northfield, Ohio.

WANT Something made? We'll make it. Consultation free. Write Jayenn Company, Burlington, Kentucky.

MODELS—Small lot manufacturing. Metals, plastics, etc. Milburn, Burlington, Kentucky.

MODELS, MODEL SUPPLIES

READY! Our 1950 catalog of ship model kits and fittings; sail, steam, diesel. Send 25c for catalog. Model Shipways Folio, 476 Main St., Fort Lee 60, N. J.

STEAM Locomotives, 1½", ¾", ½", ¼" scales. Castings, parts, rail, steam fittings! Thorough drawings with instructions. Catalog 35c. Little Engines, Lomits, Calif.

SHIP Models; fittings. 120 page catalog, refundable coupon 35c. Send self-addressed envelope. Trix H.O. Tintplate Train Circular. Polk's, 314 Fifth Ave., New York 1.

NEW Midget steam engines. Single or V-type. Literature free. R. Looker, Box 105, Michigan City, Indiana.

STEAM Engines, boilers, castings. Catalog 25c. Anton Bohaboy, 2297 Price, Rahway, N. J.

RAILROADERS—50c Gets 1949 catalog reference manual. State O or HO gauge. Walther's, 247 Erie, Milwaukee 2, Wis.

SHIP Modelers—Are you looking for authentic, precision-made kits? Send 35c for richly illustrated catalog describing more than 30 models retailing from \$3.95—Clipper ships to modern cruisers—also decorative authentic naval and field gun kits from \$4. Address Marine Model Co., Dept. B, Halesite, Long Island, N. Y.

BUILD Model buildings—Frame to finish. Built with contractors build them. Particulars. Mayberry's, Beverly Farms, Mass.

HOW To color and age ship models. Supply catalog, both 50c coin. Roy Hancock, 323 Douglas Ave., Portsmouth, Virginia.

LIONEL Trains catalog 10c. 36 pages illustrated. Hobby Shop, 72 West Washington, Chicago 2, Illinois.

DOWMETAL Magnesium for all model makers. Rod, bar, sheet and scale structural shapes. The Craftsmiths, 15427 Robson, Detroit 27, Michigan.

BUILD Historic ship models, complete kits, 39c to \$9.00. Catalog 10c. Ideal Models, 19 West 18, New York 11, N. Y.

FIRE Engines. Famous Will-O-Line 1/2" scale kits. Ladder, Chemical, Steamer. Others. Conestoga Wagon. Stamp for circular. Bay Models, Box 1012, Braintree 84, Massachusetts.

INVENTIONS Developed: The specialists are at your service who can develop auto accessories, gasoline engines, automatic cigarette-making machines; weighing, vending and automatic photograph machines; electric scales; turbines; air, electric and steam motors and other intricate devices. We can handle your development drawings, experimental work, patterns, models, special tools, dies, stampings, castings, plating, forging and spinning. Can make any metal novelty. Complete organization for developing and manufacturing. Advice backed by 50 years' experience. Send drawings or samples. The Gent Machine Company, 445 Green Road, South Euclid, 21, Ohio.

STEAM Marine engines, boilers, casting kits. Box 326, Evanston, Illinois.

SHIP And yacht model fittings; blueprints. Send 25c for illustrated catalog No. 24—listing hundreds of items. A. J. Fisher, 1002-1 Etowah Ave., Royal Oak, Mich.

SHIP Models and yacht supplies complete. Large 64 page catalogue 30c. Bill Wild's, 510 East 11 St., New York City 9.

KEEP In touch with the activities of the British modelmaking fraternity. Send a dollar bill for year's subscription (4 issues) Modelcraft Magazine and list. 77 Grosvenor Road, London, S. W. 1.

HOME CRAFTSMEN

LEATHER. Retail, mail orders, catalog, tools, lacing, supplies. National Handicraft Co., 30 Frankfort St., New York City 7.

AMAZING Value, new combination 8" bench saw, 9" disc sander, with tilting, adjustable tables. Also has drilling, grinding, polishing features. Agents wanted. Write today. Duo Master Industries, Dept. P-1, Sparta, Mich.

LEATHERCRAFT. Monthly price list guarantees best prices. Catalog free upon request. Tandy Leather Company, Dept. PM-109, P.O. Box 397, Tulsa 1, Oklahoma.

FREE Catalog: make money by making beautiful, dainty sea shell jewelry. Artcraft Shell Supply, P.O. Box 2181, Sarasota, Florida.

LAWN Ornaments. Ready cut patterns, full size. 20 assorted \$1.00 postpaid. Lincoln Craft Studio, Farmington, Conn.

LEATHERCRAFT. Copper tooling, textile painting. Materials, tools, supplies. Free illustrated catalog. Kit Kraft, Dept. AC10, 7377 Melrose, Los Angeles 46, Calif.

LAWN Chairs, garden figures, furniture, novelties, toys, etc. 68 popular plans with full size patterns, \$1.00. Mastercraft, 10M1, 7041 Olcott, Chicago 31, Illinois.

LARGE Pieces all woven felt for rubbing fine furniture with pumice and oil and for polishing, \$2.50. Send check or m.o. Specify thickness preferred. Henry M. Nagel, Box 125, Boulder, Colorado.

WOOD Signs; novelties. Complete course, patterns. Winkler, 3167 So. 13, Omaha, Nebr.

ALUMINUM Tubing, sheets, etc. Lists free. Willard Radcliff, Fostoria, Ohio.

8 BEAUTIFUL Full-size whatnot patterns only 25c. Joannes, P.O. Box 141-M, Omaha 7, Nebr.

OZARK Wood samples. Eleven useful identified varieties. Prepaid \$1.25, check or cash to Davis Lumber, Cabooli, Mo.

50 FULL Size, new 1950 novelty and lawn ornament patterns, up to 20" high, only \$1.00. Pattern Service, Medway 7, Massachusetts.

CRAFT Supplies. Sea shells, all plastic and metal parts. Artificial flower supplies. Materials for beautiful woven bird. Free catalog. Herbert Diamond Co., Box 4619, Miami 31, Fla.

MAKE Christmas gifts now! Trial box genuine leather pieces, assorted varieties, 2 pounds \$1.00; 10 pound box, \$3.00; 20 pound box, \$5.00 No catalogs. Satisfaction guaranteed. Send order today. Leathercrafters, Box 11, Lake Bluff, Illinois.

SWISS Music movements, assorted tunes, \$1.90. Direct from manufacturers agent. Helax Company, 233 West 72 Street, New York.

PLASTICO Rok. Makes model-making easy! 1000 practical uses for hobbyists, homefixers. Decorates, fills, stencils, seals, repairs. Craft Kit contains 7 3-oz. tubes: 6 colors, waterproof white, applicator, instructions. \$2.10 pp. No c.o.d.'s. Technical Supply Company, Dept. P, Palo Alto, California.

SHELLCRAFT! Income or hobby. Largest catalogue ever published illustrating supplies, designs for shellcraft, novelties, scalecraft, sequinraft, etc., including brooch or novelty kit (state choice), \$1.00 postpaid, satisfaction or refund. Pace's, Cortez 7, Fla.

BUY Sea shells thru (co-op). Dixie Shell Service, Lakeland, Fla.

CRAFT Supplies—Leather, metal, plastics, tools. Free catalog. Kale Crafts, 2250 Milwaukee, Chicago 47, Illinois.

LEATHERCRAFTERS: Belt kits, projects, leather, supplies. Free catalog. Art Leather, 411 Joseph Ave., Rochester 5, N.Y.

HEMOCRAFTSMEN—Finish hard maple salad bowls for profit or gifts. 6" unsanded, unfinished, \$4.20 doz. Retail approximately \$1.00 each. Lacquer available. Ottawa Woodcraft, Grand Haven, Michigan.

LIFE Masks, more personal than any photograph! Profit possibilities unlimited! Cost only few cents to make. Complete instructions \$1.00. Komar Sales Company, LaPorte, Indiana.

LEATHERCRAFT. Quality leather, lacing, tools and accessories at bargain prices. Free catalog. Frisco Crafts, Dept. A, Box 3016, Rincon Annex, San Francisco 5, California.

LEATHERCRAFT Bargain list! Francis Byrd, 3406 Montrose Ave., Richmond, Virginia.

LEATHERCRAFTERS! Free catalog! Leathers, tools, supplies. Rosenblum Leather, 518 N. 8th, Sheboygan, Wisconsin.

SHELLCRAFT. Create attractive jewelry from sea shells. Instruction book free, or send \$1.00 for 250 Caribbean shells and findings to make \$6.00 worth. Shell Company, Miami 32, Florida.

SPECIAL 80 Full sized patterns, lawn ornaments, toys and novelties. \$1.00. Modern Woodcraft, Saginaw, Michigan.

SPECIAL Offer: 80 full size toy, novelty, and lawn ornament patterns only \$1.00 postpaid. Lynds, Box 193D, Medway, Mass.

CRAFT Catalog free. "Artcraft's Little Giant." 6500 items covering several crafts. "Tops in our field." Artcraft Leather, Dept. PM, 271 12th St., Oakland 7, Calif.

46 FROM Square foot plywood. Jigsaw necessary. Write, Woodarts, C-38, Bridgewater, Mass.

KNOCKDOWN Cedar chests. Lumber and veneers. Free price list. Giles & Kendall Company, Huntsville, Ala.

PROFIT With Larson Leathercraft. Belts, purses, 100 other ideas. Largest supply in U. S. Catalog 10c. Larson, Dept. C, 824 S. Tripp, Chicago 24.

JEWELRY Findings, rhinestones, pearls, sequins, cameos. J & M Novelties, Box 464P, Griffith, Ind.

MAKE Your own jewelry! All types of findings, metal and plastic; cameos, beads, shell kits, illustrated catalog. 20c. Hobby Art, P.O.B. 276, Dept. 7, New York 18, N. Y.

BUILD Modern console type radio cabinet with sliding free-panel, doors of natural wood. Simple, easy-to-read blueprints. Order number 1100. 25c. Popular Mechanics Press, 200 E. Ontario, Chicago 11, Ill.

MAKE IT YOURSELF

JUST Off the press—8-page folder illustrating 6 beautiful, popular lamps you can make; for yourself, for Xmas gifts, or to sell others. It's fun, highly profitable; as hobby, or part or full time basis. 8-page folder, 32-page parts catalog, wholesale price list only 25c; refundable first order. Gearon Company, Dept. 400-B10, 27 South Desplaines, Chicago 6, Ill.

BUILD Block, brick, tile machine, sell 15 items; good profit. Build low cost home. Two blocks per minute; simple, inexpensive. Write, U-Build-It, P.O. Box 7026, Tampa 3, Fla.

BUILD Your own "tractor" Plans, walking, riding. Send postcard. Free information. Ellsworth Tractor Co., D-1, Camptonville, California.

HAND Truck, farm carryall, disc sander, wood lathe; all four plans \$1.00. M. Randle, 625 Gerard, Santa Rosa, Calif.

BUILD Concrete block machine. Easy, inexpensive. Motor or hand. Literature, dime. C. Lee, Mountain View, Okla.

NEW Different beautiful pottery salt pepper shakers miniature vases. Complete kit and instructions \$3.50 or 25c for manual. Potporce, River Forest, Illinois.

WANT To have a merry Christmas? Send for Popular Mechanics Christmas Handbook which is guaranteed to help you. Contains hundreds of ideas, gifts, decorations and toys — you can make. Paper edition only 60c Cloth \$2.00. Makes a perfect gift. Popular Mechanics Press, 200 East Ontario Street, Chicago 11, Ill.

FLOOR Plan, elevations, sections and dimensions for building a modern two bedroom concrete block home \$6.00 postpaid. Home Plans, 511 Onate Place, Santa Fe, N. M.

FREE Handbook, build sawmills, block machines, freezers, tractors, scooters, 250 shop, farm, home machines. Nichols Co., Dept. C-101, Purvis, Miss.

SOLAR Water heater systems efficient any locality. Standard materials, low cost. Free facts. Solar Water Company, Box 175, Coral Gables, Florida.

HOME Freezer and cool room plans and price list \$1.00. Farm Freezer Equipment Company, Route 7, Box 1038, Vancouver, Washington.

"CONCRETE Block Homes." 32 page booklet on how to build. \$1.00. H. C. Lightfoot, Civil Engineer, Richboro 1, Penna.

WATCHES, OLD GOLD, JEWELRY

WATCHMAKERS Tools. Supplies. Sold, bought. Catalogue! Bengal Company, Culver City, California.

JEWELRY Making. Illustrated. Catalog 20c. George Sassen, 154 Nassau St., New York City.

WATCHES Cleaned and repaired—1 year guarantee! \$5.95 each. Shipping containers \$1.00 deducted from cost of repairs. American Watch Co., 320 Fabyan Place, Newark, New Jersey.

NEW And rebuilt watches, all makes, styles, \$9.95 up; guaranteed. Brookins, B-1975AK, Little Rock, Ark.

WATCHMAKERS! Beginners! Watches, movements. Descriptive list, 15c. Box 1874, Chicago 90, Illinois.

EXPERT, Guaranteed watch repairing; all type watches. Chronographs our specialty. Send your trial order. Estimate submitted before proceeding. Miller's, 749 Broadway, New York, New York.

STUN Your friends with genuine, sparkling, brilliant-white zircons. Cut, polished, mounted just like diamonds. Amazing diamond-like appearance. Top-quality. Hard for even experts to tell the difference. Beautiful settings 14K gold. Over 100 gorgeous latest-style rings to choose from. Attractive low prices. Send for big free catalog. U. S. Zircon Syndicate, 139 N. Clark, Dept. 34, Chicago 2.

HIGHEST Prices paid for old gold, silver, platinum, diamonds, watches, gold teeth, old jewelry. Send now. Cash immediately. Goods returned if offer is not satisfactory. Government License TGL12. United Smelting Works, (The Old Reliable), 39-B South State, Chicago 3.

HIGHEST Cash for old, broken jewelry, gold teeth, watches, silverware, diamonds, spectacles. Free information. Satisfaction guaranteed. Government licensed. Rose Smelting Company, 29-A East Madison, Chicago.

SURVEYING INSTRUMENTS

GUARANTEED Factory rebuilt transits and levels, sale or rent, with purchase option. We will repair, trade or buy old instruments. Write for list M-49. Warren-Knight Co. (Manufacturers of Surveying Instruments), 136 North 12th St., Philadelphia 7, Penna.

TOBACCO, SMOKERS' SUPPLIES

FREE Literature: Finest imported briar pipes (unfinished) \$1.00 postpaid. Carvings, 2829-G Dixie, Hamilton, Ohio.

CIGARETTES—Popular brands \$1.51 per carton postpaid. West of Mississippi add 7c per carton. Min. order 3 cartons. Send check or money order. King Co., Box 1713-D, Baltimore, Maryland.

RAZORS, BLADES, SHARPENING

SAFETY Razor Co., Box 14, New York City 14. Guarantees 200 regular or 100 single-edge or 50 stainless steel blades \$1.

FOR THE HOME

DISTINCTIVE Gifts, free catalogue. Si. Friend, 218-14 67th Avenue, Bayside, N. Y.

FORMICA Table-top chrome dinette sets. Buy direct from factory and save up to 50%. Write for free catalogue. Moderne Chrome Mfg. Co., 1533 N. Milwaukee Ave., Chicago 22, Ill.

NEW Invention—A-Just-O Paint-Can Handle. Fits quarts, pints, 1/2 pints, 1/4 pints. Prevents accidents. Every home needs one. 25c postpaid. Doty, Box 448, Port Richmond, Staten Island 2, N. Y.

FOR SALE—MISCELLANEOUS

SAILOR Uniforms. Complete. \$12.50 includes new white pistol belts, leggings, hats, ties, reclaimed, wool middies, pants, rifles, excellent condition; shipping free; state sizes chest, shoulder, waist. Tee Shirts 49c. Imperial Outlet Co., 529 Nostrand Ave., Brooklyn 16, New York.

HOSIERY, Sheets, print cloths, etc.! Wholesalers write for prices. Spartan Hosiery Company, Spartanburg, S. C.

USED Vending machines. Largest selection. Satisfaction guaranteed. Vassar, Cleveland 5, Ohio.

FREE Catalog! War surplus clothing. Men's, women's. Amazing bargains. N. Y. Clothing Co., New York 29.

BARGAINS Galore—Power lawn mowers, shop equipment, machinery, hand tools, million other surplus items. Atlas Equipment, 229B Southwest Blvd., Kansas City, Mo.

WANTED—MISCELLANEOUS

WANTED Manufacturer or distributors to supply us with direct mail merchandise. Send information Box 257, Pender, Neb.

BUY, Sell, exchange, swap anything. You furnish what have you. We furnish swapper. Free details. U-Swap-It, 209 Cleveland, Amarillo, Texas.

QUICKSILVER (Mercury) urgently needed! Immediate payment. Wholesale Terminal, Norwood, Massachusetts.

PERSONAL

STUTTERING Or stammering corrected at home. Amazingly successful method. Send for free literature showing how you, too, may overcome stuttering at home. The Atheneum, PM-101, 1714 Chestnut, St. Louis 3, Mo.

Do You want success? Send for complete step-by-step course. Only \$1.00. Institute of Applied Philosophy, Dept. B, P.O. Box 1429, St. Louis, Mo.

PERSONALIZE Your shirts, blouses, handkerchiefs with initials. Easily applied. \$1.00 brings 48 sets of 3 initials; blue, brown, red. Schein, 81 North Portland Avenue, Brooklyn 1, N. Y.

"1,000 ITEMS Free." latest edition, plus 500 big mails (you count 'em), \$1.00. Particulars with supermails, 25c. Dealership. Wright Publications, 2270-P Hubbard, Memphis 8, Tenn.

MIAMI Postmark! Letters 25c each. McDowell, 504 Pacific Building, Miami 32, Florida.

REMAILING Letters 25c, postcards 10c. Polzin, Box 1069, Milwaukee, Wis.

"INTERESTING Mails"—25c keeps name on mailing lists three months. Bentz, Jr., Desk A-22, Chatawa, Miss.

BORROW By mail. Loans \$50.00 to \$300.00 to employed men and women. Easy, quick. Completely private, confidential. No endorsers. Repay in convenient monthly payments. Details free in plain envelope. Write State Finance Co., 210 State Finance Bldg., Dept. A-14K, Des Moines 9, Iowa.

UP To \$50 paid for old books, almanacs. List 10c. P. O. Box 425-F, Coeur d'Alene, Idaho.

LETTERS Forwarded, received, 25c each. Monthly rates, special services. "Gilbert," M-3519 Reta, Chicago 13.

HOW To gain self-confidence, get ahead in your job, win social success. Free "Personality Chart" and information. Self-Help Foundation, 746T So. Lake Street, Los Angeles 5.

MEXICAN Law. General practice attorney, 1203 Arizona Street, El Paso, Texas.

MEXICAN Mailing. Letters received, forwarded 20c. Photographic postcards 10c. Apartado 1405. Guadalajara, Jalisco, Mexico.

"HOW Can I find out?" You can! Information discreetly developed. Any matter, person, problem, anywhere. Worldwide. Officially licensed, bonded service. Established 1922. Reasonable. Confidential. William Herman, 170 Broadway, New York.

MISCELLANEOUS

FRESH California dates, all varieties, wholesale and retail. Gift packs our specialty. Sedwell's, 2802 South La Cienega Blvd., Los Angeles 34, California.

WATERSCOPE (Telescope), invented by police for under water search. Sensational for recovering lost articles, under water photography, fishing, camping, a hundred and one uses for young and old. Assembled in a jiffy. Only \$1.00 postpaid. Arvak, Inc., Dept. A-19 Ave. and 38 St., Long Island City 5, New York.

MEN! Large size shoes, large size socks! We specialize in large sizes 10 to 16, widths AAA-EEE. Dress, sport, work shoes. Guaranteed. Write for free catalog. King-Size, Inc., 197, Brockton, Mass.

MAKE Your will. You owe it to your family. Blank legal will document with instructions for making out your own legal will. \$1.00. Saves many court costs. Legal Document Service, Williamstown, N. Y.

GIANT Coconut, about foot in diameter \$1.00 postpaid. Smith's Patio, 2412 N.W. 79th St., Miami, Fla.

GEIGER Counters for locating uranium; metal detectors for gold, silver and minerals. Lightweight, low cost, ultra-sensitive. None finer at any price. Free information. Detron Company, 5637 Cahuenga, North Hollywood, Calif.

URANIUM Prospector's handbook \$1. Details free. Craft Publications, 601 S. Vermont, Los Angeles 5, Calif.

TREASURE Finders! Goldak's 11 pound featherweight gold, silver and mineral locator. Guaranteed superior to any other device. Also Geiger counters for uranium prospectors. Free information. The Goldak Co., 1542 West Glenoaks Blvd., Glendale 1, Calif.

1000 ITEMS Absolutely free for postal card request big mails, opportunities samples, books, magazines, seeds, catalogs. Other useful articles, wonder book of year, satisfaction guaranteed. Mail \$1.00 cash, check, m.o. Heaney Sr., 2950X Clark, Chicago 14, Illinois.

MILLION Articles wholesale. "Supply Source Directory" 25c. Publisher's, Box 1302-P10, Detroit 31.

WHOLESALE Paints, varnishes, enamels, lacquers, paint remover, Garnet paper, belts, etc. Catalog free. Ace Chemical Company, 1821 Chestnut St., Dallas, Texas.

STAMMER? Correct stammering at home by simple method. Information free. Arthur Bunker, Box 1132, Chicago 90.

URANIUM Prospector's Handbook \$1. Free data. Craft Publications, 601G S. Vermont, Los Angeles 5, Calif.

CHILDREN'S Combination roller and ice skates for beginners \$1.69. Ferritto's, 745 So. Western Ave., Los Angeles 5, Calif.

GEIGER Counters \$48.50 and \$70, complete. Prepaid. Guaranteed uranium spinthariscopes (scintilliscopes) with samples \$6. Western Radiation Laboratory, 1107 West 24th Street, Los Angeles 7, Calif.

SOMETHING To cherish. Send \$2.00 for 4 books of comfort and inspiration. Money back guarantee. Direct Mail Service, 14575 Madison, Cleveland 7, Ohio.

VERMONT Maple syrup and sugar, 100% pure, list. H. Marshall, Foultney, Vt.

BUY Best English suitings direct. Send for free patterns. Mullen, 117 Watchfield, Chiswick, London, England.

SLIPPERY Steps made safe! Basement, kitchen, wood, metal, concrete or any steps. Do it yourself. Easy. Tested materials, instructions \$2.00. Barcanic, 7655-A Farragut, Chicago, Ill.

GOING To build or remodel? You need HomOgraf Planner Kit. Everything necessary to make professional looking drawings of floor plans and exteriors. See exactly how it will look, plan every detail now, save costly changes later. 100-page, \$1 Planner book included, shows 100 home designs, many variations. Complete kit, including book, only \$1.98, money order or check. HomOgraf Planner Corp., 11703 E. Eight Mile Road, East Detroit, Mich.

DO You need money? Raise your own capital! Simple, easy, sure method. Details free. Fenninger, 4219 Berkeley, Chicago 15.

LUMINOUS Water repellent glow in the dark pigment. Newest development! Reflective Glo-Beads! Daylite glow paper! Three sensational moneymakers for \$1.00. Order today! Research, 1842-PM Byron, Chicago 13, Ill.

CERTIFIED Graphoanalytical psychologist unfolds improved personality, better social relations, greater success. Free details of remarkable service. Ries, 533 W. 112, New York 25.

GREAT Values for family's safety. Comfort, convenience. Write, free particulars. H. C. Bailey, 2450 Amber St., Philadelphia, Penna.

URANIUM! Exploration, detection, recognition methods understandably explained. Particulars free. Woodwid Industries, 5217-A Hollywood Boulevard, Hollywood 27, California.

SAVE Money—Buy everything wholesale. Free information. Orysen, 1147 Sunkist, Waukesha, Wis.

SQUARE Dance instructions. 40 dances, \$1.00. Wesley Rader, 1922 Grant, Denver, Colorado.

START Mailorder business. Get details concerning beginners booklet guide. Wayne Berger, Baltic, Ohio.

URANIUM Explained. 9,500 word prospecting manual plus simplified Geiger counter plans \$2.00. Literature free. Klondike Instruments, Box 486, Detroit 31, Michigan.

"RECEIVE Mail." Moneymaking offers, opportunities, catalogs. Name listed 10c. Ideal Service, Park Ridge 10, Ill.

GEIGER Counters. Uranium quickly located with new, super-sensitive, 5 lb. detector. Sensational low price. The Detron Company, 5637 Cahuenga, North Hollywood, California.

TREASURE Locators. New electronic lightweight M-Scope mineral and metal finders are now available for immediate shipment. Built for arctic-tropic use. Revolutionizes locating of minerals, gold, silver, metal objects. Unsurpassed efficiency, factory guaranteed. Low prices, time payment plan available. Send for free 16-page illustrated booklet. Fisher Research Laboratory, Inc., Palo Alto, California.

NECKTIES Exchanged! Mail us six you're tired of. Pronto you receive six different cleaned ties. Pay postman \$1. Tie Exchange, 3, Watertown, S. D.

URANIUM Prospector's Handbook \$1. Craft Publications, 601 S. Vermont, Dept. G, Los Angeles 5, California.

70 BIBLE Lessons, 25c. Bulletin, Box 87, Cathedral Station, New York 25.

LEATHER Jackets renovated, cleaned, dyed, repaired, relined, expertly, reasonably. Send for itemized price list No. 8. Berlew Mfg. Co., Freeport, N. Y.

TATTOOING Outfits, supplies. Illustrated list free. Zels, 728 Lesley, Rockford, Illinois.

SQUARE Dance instructions. Calls, 25 sets, \$1.00. Rayburne, Eureka Springs, Arkansas.

GRAVITY—If you are interested in gravity, write us. No expense to you. Gravity Research Foundation, New Boston, N. H.

GEIGER Counters for finding uranium ores. Simple operation. Low prices. Interesting literature free. Fisher Research Laboratory, Inc., Palo Alto, California.

TATTOOING Machines, outfits. Free catalogue. Jensen, 120 West 83rd Street, Los Angeles 3.

ELECTRIFY YOUR OLD SEWING MACHINE

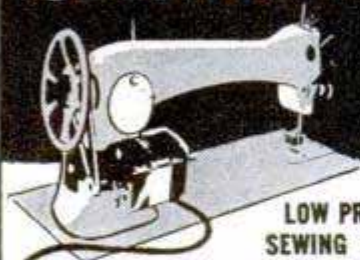

in 3
minutes

AMAZING NEW
LOW PRICED INVENTION MAKES
SEWING EASIER, FASTER, BETTER

- COMES FULLY WIRED AND CONNECTED!
- EASILY ATTACHED! • 1 YEAR GUARANTEE ON ALL PARTS!

At last an invention that ends tiresome foot pedaling. Electrifies your sewing machine—regardless of age, make or type—in 3 minutes! Just snap the BROWNELL MOTOR KIT in place, plug it into any standard 110-volt AC or DC outlet and presto! — a modern electric sewing machine! Handy foot control regulates machine speed to your needs. Kit is complete—nothing else to buy. Only \$16.75 for everything! FREE — a useful \$2.75 value SEW LIGHT, if you order today!

Send No Money
Mail coupon at once
for prompt delivery.
Money back
if not delighted.



AGENTS—MAKE UP TO \$25 A DAY

BROWNELL DISTRIBUTORS, INC., Dept. EM 13
308 Canal St., New York 13, N. Y.
Rush me your sewing machine motor kit at \$16.75 complete with gift lamp. Make of my machine is

- Handwheel turns toward me away from me
- Send postpaid. I enclose \$.....
- Send C.O.D. I'll pay postman \$16.75 plus C.O.D. If not fully satisfied, I may return kit within 10 days for full refund.

Name

Address

City Zone State

Send details of agent selling plan.

K-R-O KILLS RATS

• K-R-O BIS-KITS are ready-made, easy to use; containing fortified red squill, they're safer around livestock, pets, and poultry. K-R-O POWDER is 100% fortified red squill; economical to use in badly infested areas when mixed with natural baits. BIS-KITS, 35c and \$1.00; POWDER, 75c at drug, seed, and feed stores. Money-back guarantee. The K-R-O Company, Springfield, Ohio.

FLASH Your Turns



THE SIMPLEX DIRECTIONAL SWITCH

eliminates hand signaling. A safe and comfortable way of signaling your intention of making a right or left turn. Flashes from 60-80 times per minute. Either of our two models will fit most cars from 1942 to 1949.

SHIPMENTS ARE MADE FROM STOCK

Kits furnished with all necessary material for a perfect installation. No outside mounting of any kind. We make use of your present parking and tail lights.

Specify year and make of car. Money back guarantee. Tested and Approved to meet SAE requirements.

DEALERS INQUIRIES INVITED

\$8.95
Post-paid
in U.S.

Send check or money order.
Postage extra on C.O.D.'s

SIMPLEX SALES COMPANY 1303 W. JACKSON BLVD., CHICAGO 7, ILLINOIS



Bar Bells

COMPLETE 53 PAGE TRAINING COURSE

Get fast results with these six scientific body-building courses. 4 bar bell and 2 dumbbell courses. Illustrated charts make training easy. Postage prepaid. Regular price \$1.98. Send just \$1.00 to

Only
\$1.00

PARAMOUNT BAR BELLS
2436 East 23rd St., Los Angeles 11, Calif.

Learn PHOTOGRAPHY

There's big money in PHOTOGRAPHY — and an action-packed career for you. Our HOME STUDY COURSE—famous throughout the world—is your spare-time SHORT CUT TO SUCCESS! Or if you wish . . . PERSONAL ATTENDANCE TRAINING at our famous New York Studios is available with subsistence under the G. I. BILL. Our 40th year. Write immediately!

NEW YORK INSTITUTE OF PHOTOGRAPHY
Dept. "49", 10 W. 33 St., New York 1, N. Y.

EARN HIGH SCHOOL DIPLOMA AT HOME

Guided study permits you to complete High School education in shortest possible time. Modern methods make it interesting, easier. Prepare for better jobs, pre-professional, college entrance exams. Recognition for H.S. credits already earned. Books supplied. Low tuition, easy terms. Write for Free Information.

HOME STUDY INSTITUTE
209 VINE AVENUE DEPT. PM-10 PARK RIDGE, ILL.

LEATHERCRAFT COPPER TOOLING TEXTILE PAINTING

Make your spare time PROFITABLE. Send today for FREE illustrated catalog showing everything you need.
KIT KRAFT, 7377 Melrose Ave., Dept. AD-10, Los Angeles 46, Calif.

REMEMBER THIS

You can't Buy a \$20 Goldpiece for \$10. So It's Dangerous to Pay Less—If You Want Safe, Balanced, Matched Tires.

WE REPEAT Consider Your Family's Safety—Not Just Price! You See Our Reliable Adv. Month After Month. Take 10%. Not Recaps.

GOODYEAR Goodrich, Firestone, U. S. & Others. Original High Tread, Slightly Worn. Pass. & Truck 30,000 Miles Golden Rule Guar. Genuine Factory Adjusted "All-Purpose" "AAA" Tires Read That Top Line Again! You'll Save More than \$

600-16	\$5.50	650-16	\$5.75	700-15	\$6.00
600-16 (6)	8.50	650-16 (6)	6.75	650-15	5.75
700-16	8.50	750-16	7.75	550-17	7.75
700-16 (6)	7.50	475-19	5.50	525-18	6.75

WE ARE TRUCK-TIRE EXPERTS. Matched Tires

600-20	\$9.00	32x6 (8)	\$9.95	900-20	\$15.95
690-20	9.50	32x6 (10)	10.95	1000-20	16.95
700-20	10.50	825-20	14.95	1100-20	17.95
34x7 (10)	13.50	1000-22	17.95	1100-22	18.95

GOOD USED TIRES Any Car \$3.25. 12,000 Miles Guarantee

MILITARY TREAD

750-16	900-16	750-20
Super \$ 8.75	Super \$ 6.95	Super \$ 8.48
Top Grade 12.00	Top Grade 10.75	Top Grade 13.00

Send ck. or money order for rush shipment. And this ad. We won't ship a tire we wouldn't use ourselves. Instant shipment down South. Far West, and the world over. The Name to trust in Rubber.

BLATT GIRARD & LANCASTER AVE. DEPT. PM
BLATT BLDG., PHILADELPHIA 31, PA.

All weather protection for your convertible top . . .



The Robbins
TOPPER

TOUGH, TIGHT-FITTING, HEAVY VINYL

Here's what you need this winter to protect your expensive convertible top. Get a Robbins "TOPPER". It's a tough vinyl plastic top cover that's *tailored to fit!* No universal models—there's a beautiful "TOPPER" for your convertible.

KEEPS TOP CLEAN IN ALL WEATHER

"TOPPER" is easy to install, and fits like a glove. No more weather stains, grease stains, and quick top deterioration to spoil your convertible's looks. Get your "TOPPER" now (order direct if your dealer can't supply) and be ready for bad weather. Be sure to specify make and year of your convertible.

ONLY \$25⁰⁰

Postpaid

ORDER YOUR "TOPPER" TODAY!

JIM ROBBINS CO.

21722 Woodward Avenue, Detroit 20, Mich.

NOW! Your garden hose sprays RICH SUDS



New SUDS-O-MATIC also sprays fertilizer!

Your hose becomes your handiest household tool when you attach the amazing new SUDS-O-MATIC twin nozzle gun! Blasts dirt with soap and rinses thoroughly in one easy operation—ideal for cleaning house, car, porch, basement, garden furniture, screens, etc. Also sprays fertilizer on your lawn or garden. Fits any standard hose, never clogs or sticks. More than 20,000 homeowners already using SUDS-O-MATIC year 'round for countless household jobs. Send check or M.O. for your SUDS-O-MATIC gun today—

\$4.95

Load Suds-O-Matic with our fertilizer pellets and spray on lawn or garden. Bottle of 75 pellets, \$1.00.

complete, with generous supply of detergent pellets, only . . .

THE TRU-VALU CO.

818 Wyandotte Kansas City, Mo.

"HOW TO MAKE MONEY AND PLENTY OF IT"

A new book for the small businessman and everybody who is interested in making more money. Just one idea learned from this book may change your entire life. Tells you how to make money and how to sell. Never before has there been a book just like it. Practical, plain talk instructions. Easy to follow. 172 pages full of rules for success in your business or for salespeople. A must for the small storekeeper. Two sizes—DeLuxe Edition, hard cover, \$2.95; soft cover \$2.00. Sent postpaid or from your bookstore. Money refunded if returned within 5 days.

John Rissman & Son, 305 W. Adams St., Dept. P, Chicago 6, Ill.

SAY YOU SAW IT IN POPULAR MECHANICS

PRINT POSTCARDS • CIRCULARS

Fast! Easy! with E-Z PRINT

Complete Outfit Only

Print with E-Z PRINT—your own postcard size circulars, notices, price lists, announcements, advertisements, i.e. government postcards. Save money, time, work. E-Z PRINT Stencil Printer (not a toy) has dozens of uses every day in stores, offices, factories, churches, clubs, institutions, homes. Anyone can use it. Make money doing printing for others. Only \$3.95 complete with supplies and instructions. Order today.

\$3.95



STRADER MFG. CO.

Dept. B-259, 259 Strader Ave., Cincinnati 26, Ohio



Step Up to TOP PAY in

AUTO SERVICE Management

Auto Mechanics!

Station Owners!

Get This Sensational Book — Learn How to Make More Money in Service Work

Here it is! A big 478 page book of vital facts! This is the book that will put you right out in front in the business end of auto service-station operation. It tells how to organize a business—how to get the necessary capital—what equipment you need and how to get it—how to get business and hold customers. It tells you what to do—when to do it—how to do it—how to make money as a service shop, garage or station owner or as a manager in charge for others.



A Few of the 48 Chapters That Show You How to Make Money and Keep What You Make!

Your Own Shop
Financing Your Business
Choosing Your Location
Exterior Layout and Appearance
Interior Arrangement
Advertising and Promoting Your Shop
Services to Feature
Sources of Business
Where to Buy Tools and Equipment
Building Goodwill
Meeting the Customer
Selling Service
Figuring Service Prices
Increasing the Average Sale
Follow-Up on Jobs
More Profitable Buying
Managing Your Stockroom
Employing Helpers
Expense Control

All The Methods of The Successful Operators

"Know how" and mechanical skill are important in auto service work. But to get full pay for your efforts—to succeed as a "boss"—or make money as an owner—you must know the facts of management too, and "Automobile Service Management" is the only book that will give them to you. Get this great book today, with 223 illustrations, charts, tables and 478 pages of the most valuable information that will insure your business success. It is the combined experience of hundreds of outstanding shop operators, arranged for quick reading and easy use and can easily be worth many hundreds of dollars to you.

5 Day Trial — Money Back if Not Satisfied

Mail the coupon. Send no money if you prefer for we will send C.O.D. anywhere in U.S.A. Use book 5 days and if not delighted, return by mail and we will promptly refund purchase price. Goodheart-Willcox Co., Inc. (Publishers of Dyke's Famous Auto Book), 1321 S. Michigan Ave., Chicago.

Mail Coupon for Examination

**GOODHEART-WILCOX CO., Dept. 517
1321 S. Michigan Ave., Chicago 5**

Send Automobile Service Management subject to 5 days approval. If not satisfactory I will return book and you are to refund my money.

I enclose \$5.00 for postpaid delivery.
 Send C.O.D. I will pay postman.

Name _____

Address _____

City _____ State _____

**FREE
10-DAY TRIAL**

HOUSE CARPENTRY and Joinery Work

**DO IT YOURSELF
AND SAVE MONEY!**

Every step of carpentry in and around a house is clearly explained and illustrated in this big, useful book. Shows you how to build forms for foundations, footings, walls, steps, walks—How to build sills, girder supporting posts and girders—How to figure loads for house framing—How to layout, cut and erect floor joists—How to lay sub-flooring—How to frame outside and inside walls, allowing for openings—How to check the plumb of studs—How to brace and sheathe up outside walls—How to erect ceiling joists—How to frame around a chimney and stair well—How to lay out rafters for a gable roof, dormer roof, porch roof—How to sheathe gable ends and rafters—How to build cornices—How to lay shingles—How to build porches and bays—How to apply siding—How to frame up inside walls—How to construct stairs—How to place trim around windows and doors—How to fit and hang sash—How to hang doors—How to make closets, shelving and built-in equipment—How to lay finished wood flooring, linoleum flooring—How to hang a set of garage doors—How to insulate.

**OVER 600 ILLUSTRATIONS SHOW YOU
JUST WHAT TO DO AND HOW TO DO IT**

If you have a hammer, saw and plane, just follow the step-by-step directions and do any house carpentry job from foundation forms to interior trim. Here, in one remarkable volume, is the practical know-how that saves you time and money on house carpentry jobs of every description.

"I built my entire 5-room house myself with no other instruction except your book." — James Sidwell, Twin Falls, Idaho.

USE IT FOR TEN DAYS FREE

Don't send us a penny. Just mail coupon and get "HOUSE CARPENTRY" for 10 days FREE trial. If not delighted, send book back to us and owe nothing. If you keep it, entire cost is only \$3.98, plus a few cents postage. Fill in and mail coupon for your free-trial copy, now.

**SEND NO
MONEY**

MAIL THIS COUPON

SIMMONS-BOARDMAN PUBLISHING CORP., Pop. Mech. 10-49
30 Church Street, New York 7, N. Y.

Send for 10 DAYS' FREE TRIAL, "House Carpentry and Joinery Work." I will either return it in 10 days and owe nothing, or send only \$3.98 (plus shipping charges) in full payment.

Name _____

Address _____

City and State _____

NEW! **FOR PROFIT & PLEASURE**
**IN COPPER TOOLING
AND ETCHING**
No Experience Needed



DO IT AT HOME

At last a way to get in on the Big Money made every day in Copper Art. You make plaques — Bowls — Trays — Gifts — Souvenirs of all kinds. Art talent not necessary. Our New Method makes it easy to learn. Big Markets waiting. Anyone can learn quickly—you start making money right from the start. Don't miss this opportunity to cash in at once on this big-paying easy to operate business. Be your own boss. **SEND NO MONEY—Act Now** to get all the free details—just send your name on a penny postcard today—**Do it Now!** Write Today—Money-Back Guarantee.

HOLLYWOOD COPPER ART STUDIOS, Dept. PM-10
4257 BEVERLY BLVD., LOS ANGELES 4, CALIF.

**BE A GOVERNMENT LICENSED
AIRPLANE AND ENGINE MECHANIC**
Train Now at **LINCOLN**



**EARN BIG PAY IN
AVIATION**

Start your aviation career by enrolling in our **MASTER AVIATION MECHANICS**, CAA Approved 1 Year Course, a complete course in both airplanes and airplane engines. Our **REFRESHER AIRPLANE & ENGINE MECHANICS COURSE** is designed for veterans or others with aviation mechanics experience. Either course is available to veterans under the G.I. Bill of Rights. Write today for complete information.

LINCOLN AVIATION INSTITUTE
UNION AIR TERMINAL DEPT. F-10 LINCOLN, NEBRASKA

MAKE EXTRA CASH FAST!



Show Housewives How To Iron Faster, Easier

Big cash profits for you introducing amazing new **COPPER COTE** Ironing Pad. Cuts ironing up to 20%—presses both sides at once—saves money, work. Sells fast at \$3.95 with up to 100% profit! Guaranteed. Also sensational **CLEEN COTE** Fabric Tablecloth. Wipes clean. No experience needed. **FREE** Sample Offer. Write.

THE SHELDON CO., 1223 S. 23rd Street
DEPT. F-10 MILWAUKEE 4, WIS.

**GET
FREE
SAMPLE
OFFER PLAN**

**Your YOUNGSTER WILL
LOVE IT!**



Give your youngster a **TRACTALL** for the joy-ride of a lifetime! Looks just like a man-size Tractor. The perfect gift for boys, girls, up to 12 years old. Pedal-driven. Sold only direct from factory. Write for Literature, **FREE** trial offer.

INLAND MFG. CORP., Dept. PM10, 164 Ellicott St., Buffalo 3, N. Y.

**How to Make Money with
Simple Cartoons**



A book everyone who likes to draw should have. It is free; no obligation. Simply address **FREE BOOK**

CARTOONISTS' EXCHANGE
Dept. 910-D Pleasant Hill, Ohio

RADIO ENGINEERING. Broadcasting, Television, FM, Servicing, Electronics, Aviation, Marine & Police Radio taught thoroughly. Engineering course equivalent to 3 years' college radio work. Approved Veteran Training. Catalog free.

VALPARAISO TECHNICAL INSTITUTE, Dept. D, Valparaiso, Ind.

SAY YOU SAW IT IN POPULAR MECHANICS

**TRANSPARENT PLASTIC UTILITY BOXES
FOR 1001 USES**

#3450—8" x 4" x 1 1/4"—has 8 compartments and hinged cover. Perfect for mechanics, repairmen and sportsmen, etc. Everything within sight for easy reference. At low price of **\$1.00** pre-paid.



Keep your small parts in this handy mechanical aid. Available in variety of shapes and sizes, with tight fitting covers. Special Offer—25 boxes in as-sorted sizes..... **\$3.00** pre-paid.

Remit with order—Order from this ad **SATISFACTION GUARANTEED!**

BRADLEY'S, Dept. PM
1652 N. DAMEN CHICAGO 47, ILLINOIS

Be Your Own Boss

Learn How to Run a MAIL ORDER Business from Your Home

**BIG PROFITS
SMALL INVESTMENT**

No limit to opportunities in Mail Order selling. Only IDEAS count! Get orders and money by mail—ship by mail—get your goods from manufacturers at wholesale—sell at retail. All the profit is yours to keep. Learn the "inside angles" at home in spare time from an expert Mail Order operator who now runs a highly profitable M. O. Business. Send no money—All facts FREE—Rush name on penny postcard for inside information.

The L. W. BUREAU Dept. 110
4737 Broadway, Chicago 40, Ill.



Repeating Slingshot

ACCURATE! • POWERFUL!

Amazing NEW repeating slingshot. Shoots 150 BB shot. Loads from handle. Just the thing for hunters and trappers, young and old. Shoots thru ordinary 100-page magazine. More powerful than an air rifle. Send \$1.00 and we will include 100 BB's No C.O.D.'s.

THE SLINGO CO.

Dept. B-10 Alexandria, Va.

ELECTRICAL TRAINING

Intensive 32 weeks' residence course in fundamentals of industrial electrical engineering, including radio, electronics. Prepares for technician, engineering aides. Approved for veteran training. 57th year. Enter Mar. 6. Catalog.

BLISS ELECTRICAL SCHOOL

7642 TAKOMA AVENUE
WASHINGTON 12, D. C.



ELECTRIFY your SEWING MACHINE



NEW REDUCED PRICE

\$12.95

1 YEAR GUARANTEE
ON MOTOR AND CONTROL

Now, make mother's or
wife's sewing a pleasure.
Easy to install. Fits ALL machines.

- Motor & Bracket
- 7 Speed Foot Control
- AC-DC 60c. 115v.
- Cord Set
- PULLEY & BELT
- Complete Instructions

SEND NO MONEY . . . 10 DAY FREE TRIAL

pay postman plus COD or enclose money order and we'll pay postage. MONEY BACK on kit in 10 DAYS if not completely satisfied. State whether wheel on your machine turns towards or away from you. Shipping wt. 6 lbs. LUGGAGE CARRYING CASE \$9.95 Specify base width, length and make of your machine. Wt. 11 lbs.



FREE CHROME plated SEW-LITE (as illustrated) completely eliminates eyestrain.

CONTINENTAL SALES CO.

Dept. PM4, 83 Graham Ave., Brooklyn 6, N. Y.

Now! FOREDOM offers 2 NEW ATTACHMENTS

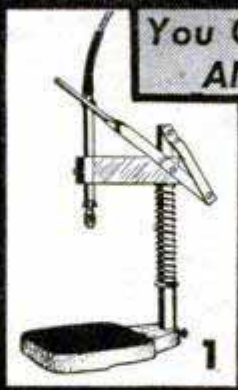

You Get Unexcelled UTILITY
AND VERSATILITY . . .
AT SMALL COST!

DRILL PRESS ATTACHMENT

1 Now Foredom offers you a DRILL PRESS ATTACHMENT for use with Model 100 (see below) and for the many thousands of Foredoms already in use. Handpiece quickly clamps in place and drill press is ready for use, ready to pay for itself over and over again! PRICED AT A MERE \$4.95.

--- but there's more!

B-R-S ATTACHMENT

2 The new Foredom 2 B-R-S ATTACHMENT (Bench Stand, Router, Shaper). Speedily clamp handpiece in place and magically you have one unit which serves as a bench grinder with angular adjustment, a router (complete with detachable guide for routing borders) and shaper. Can be used with Model 100 and thousands of Foredoms now in use, providing endless hours of fun and profit. TRIPLE UTILITY FOR ONLY \$3.50.



And there's still more --- FOREDOM'S NEW MODEL 100 FLEXIBLE SHAFT MACHINE

Model 100 Flexible Shaft Machine with all-metal PENCIL SIZE HANDPIECE equipped with CHUCK GUARD to PROTECT YOUR FINGERS and provide SENSITIVE, POSITIVE, FINGER-TIP CONTROL for the most delicate tasks. Husky little high-speed universal motor. Foredom's quarter-century reputation for precision workmanship goes with each machine. Other heavier duty models at proportionately reasonable prices. No. 25 Accessory Set (a truly versatile assortment) \$5.50 extra. Also No. 1000 Kit, comprises No. 100 Machine illustrated and set of 12 accessories, all in wooden case for only \$21.50. 6-step Foot Rheostat \$4.85. USE IT TO GRIND, POLISH, DRILL, SAW, SAND, CARVE, MILL, CLEAN, ETCH, ENGRAVE, ETC. on all metals, wood, plastics, glass, leather, linoleum, etc.

35"
FLEXIBLE
SHAFT

\$16.95

COMPLETE
WITH
MOTOR



And here's another Amazing Foredom Product

FOREDOM PRESTO-FLEX with PENCIL-SIZE handpiece

Quickly Converts Motors or Drills into Flexible Shaft Tools **\$5.95**



Now turn your old motor, drill press or electric drill into a Flexible Shaft Tool. Simply attach it and presto—a flexible shaft machine! Off again in a jiffy! Pencil-Size handpiece gets into tight places. Handy 35" overall length. And . . . only \$5.95 complete! Precision made. Order NOW. If ordered for use on motor, specify motor shaft diameter and add 50c for coupling (Available for 1/4, 5/16, 3/8, and 1/2" shafts). No. 50 Accessory Set available \$1.50 extra. Order TODAY at your dealer's or use coupon below.

--- SEND NO MONEY ---

FOREDOM ELECTRIC CO., Dept. 1122-E Mail Coupon
27 Park Place, New York 7, N. Y. Now!

Please send me FOREDOMS checked below on 10-day trial

- | | |
|--|--|
| <input type="checkbox"/> Drill Press Attachment (\$4.95) | <input type="checkbox"/> B-R-S Attachment (\$3.50) |
| <input type="checkbox"/> Presto-Flex Tool (\$5.95) | <input type="checkbox"/> No. 50 Accessory Set (\$1.50) |
| <input type="checkbox"/> Motor Coupling (50c) | <input type="checkbox"/> No. 25 Accessory Set (\$5.50) |
| <input type="checkbox"/> Specify motor shaft dia. _____ | <input type="checkbox"/> Foot Rheostat (\$4.85) |
| <input type="checkbox"/> No. 100 Machine (\$16.95) | <input type="checkbox"/> No. 1000 Kit (\$21.50) |
| <input type="checkbox"/> Send C.O.D. plus postage. I will pay postman. | <input type="checkbox"/> Free Catalog |
| <input type="checkbox"/> I enclose payment. Send postpaid. | |

(MONEY BACK EITHER WAY IF NOT DELIGHTED)

NAME _____
ADDRESS _____
CITY & ZONE _____ STATE _____

BUDGET-SAVING HAIR CLIPPER



THE VERSATILE

Cadet (R)

ELECTRIC HAIR CLIPPER

Put the practical "Cadet" Electric Hair Clipper to work . . . saves time and money for the whole family! You'll find this strong, yet inexpensive electric hair clipper mighty handy for removing superfluous hair, too. Has special design blade for clean, close cutting. Operates on 110 V., 60 cycle A.C. Fully approved by Underwriters' Laboratories. Only \$9.95 at barber and beauty shops, and drug, department, hardware and electric appliance stores. If your dealer cannot supply you, order direct from factory. Send check or money order. Money back if not delighted after 5-day trial.

ONLY
\$9.95
AT YOUR
DEALERS

ELECTRO TOOL CORPORATION

DEPT. 529-K • RACINE, WISCONSIN

FULLSIZE, CUT-TO-SHAPE BOAT PATTERNS

and specifications. Designed by Naval Architect. Cruisers, runabouts, sloops, outboards, sailing canoes, etc. Low prices. Send 25c (coin) for illustrated catalog. SPECIAL: Send \$1.00 for "HOW TO BUILD BOATS" book, postpaid. PolyWog Houseboat Plans, \$10. Marine Catalog \$1. Cleveland Boat Blueprint Co., Dept. 666, Cleveland 13, Ohio

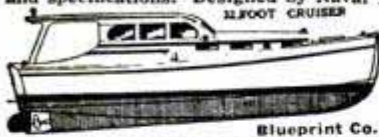

SAY YOU SAW IT IN POPULAR MECHANICS

NEW—Money Making Sign Painting Book for Students, Apprentices, Sign Painters, Retail Stores and Others



Learn Sign Painting for profit, or as a hobby. This is the book you have waited for. By Duvall, famous "Signs of Times" contributor. Covers sign painting and sign fabrication as it is being done today in the leading shops across the nation. A complete guide for the beginner and hobbyist, from simple letter construction through development of advanced skills and ability. A time-saving, money-making reference book for sign painters, merchants and others who want to learn new techniques and methods. Fully illustrated. Bound in durable cloth. Price only \$3.00. Sent C.O.D. if you prefer. Order on 5-day money back guarantee.

F. DRAKE & CO., Dept. 17, 117 Green Bay Road, Wilmette, Ill.

How to get finishes like PROFESSIONAL DECORATORS



Use "TACK CLOTH" Before You Paint or Varnish and get a PERFECT FINISH EVERY TIME!

You've admired the beautiful results Professional and Industrial Finishers always get. Now you can get this same "professional finish" when you paint, varnish or lacquer woodwork or furniture at home. Just do like Professionals do—always use "TACK CLOTH" before you paint. This removes every trace of lint, dust or sand, so the finish never shows a sign of a speck, or spot. Saves hours of pre-cleaning time, too! Get "TACK CLOTH" today. To introduce to home users send only \$1 for 4 large 18" x 36" cloths. Same as those supplied by millions to Industrial finishers. Just send name and \$1.

4 FOR ONLY \$1
LARGE SIZE
18" x 36"
4 cloths should last Several Months

BAUGHN CHEMICAL PRODUCTS CO.
7025 N. Ravenswood Ave. Dept. 210
Chicago 26, Ill.

Wheels Wheels Wheels Wheels



5" Disc Wheel	5 1/2" Tire	5/16" or 3/8" Sleeve	30c ea.
6" " "	3 1/2" "	3/16" or 3/8" Sleeve	35c ea.
7" " "	3 3/4" "	3/8" Sleeve	45c ea.
8" " "	1 1/2" "	1/2" Sleeve	70c ea.
7" " "	1" "	1/2" ball bearing	80c ea.
8" " "	1 1/2" "	1/2" ball bearing	\$1.00 ea.
8" " "	2" "	semi-pneum. T. 1 1/2" B.B.	\$1.35 ea.
10" " "	1.75 "	1/2" B.B.	\$1.50 ea.

Above wheel prices includes hub cap.
10" Aluminum Wheel 2 3/4" semi-pneum. T. 1 1/2" B.B. \$4.50 ea.
Plus Postage, 20%. C.O.D.'s accepted.

UNITED WHEEL STAMPING CO.
2756 W. 115th STREET PM-10 CHICAGO 43, ILLINOIS

SAY YOU SAW IT IN POPULAR MECHANICS

APTITUDE TESTS

discover the kind of work or studies best for your success! You get a personal report—a guide for life—more happiness—more prosperity. For men, women, boys and girls. Write for complete facts.

VOCATIONAL COUNSELING INSTITUTE
956 Maccabees Bldg., Detroit 2, Michigan

MAKE CERAMICS FOR FUN AND PROFIT



No experience needed. Our easy-to-follow instructions show you how to make beautiful California-designed ash trays, cigarette boxes, figurines, dishes, hundreds of items for home, for gifts, to sell to stores. Open your own gift shop. Send TODAY for Big KIT of ceramic materials, tools and illustrated course. ONLY \$7.95 POSTPAID. (if C.O.D., charges added.) MONEY BACK IF NOT SATISFIED. Illustrated Catalog FREE with Kit. Or send 25c credited to first order.

LEARN AT HOME SPARE TIME

WESTWOOD CERAMIC SUPPLY CO. Dept. P-10
BOX 575, WEST LOS ANGELES, CALIFORNIA

HOW TO BE A VENTRILOQUIST . . . in 30 to 60 days!

Entertain at lodges, clubs, parties! Mysterious! Exciting! Have fun! Make Money! Be popular everywhere! Professional instruction—Results guaranteed. Write, state age, get eye-opening literature FREE.

FRED MAHER, Ventriloquist

Box 36 M 109, Kensington Station Detroit 24, Michigan

ATTENTION FOOTBALL FANS, HUNTERS!

SAVE UP TO 50% THE WORLD'S Greatest VALUES in BINOCULARS

GERMAN TYPE BRAND NEW, DELUXE LEATHER CASE INCLUDED. Built to rapid military specifications. Never before at these prices! Free Catalog. Fully Guaranteed. OFFER IS LIMITED TO 1000. 6 x 25 \$28.00 with Coated Optics \$32.50 8 x 30 \$33.00 with Coated Optics 39.50 7 x 50 \$25.50 with Coated Optics 48.50 10 x 50 \$29.00 with Coated Optics 62.00 Many other models. Largest Stock in the West. ORDER TODAY! Send check or money order. \$2.00 Deposit on C.O.D.'s. MONEY-BACK GUARANTEE! Deposit on C.O.D.'s. Add 20% Fed. Tax. Postage Included.

"HOW TO SELECT BINOCULARS" Free Book
SIX POWER Pocket Binocular WITH DELUXE LEATHER CASE, LIGHT • COMPACT • TAKE IT EVERYWHERE - 6 x 15 with COATED OPTICS. Weighs only 5 ounces! Size 2 x 3 1/4 inches. A high quality prism binocular (German design) with precision ground achromatic lenses. Field of view, 370 feet at 1000 yards. MADE TO SELL FOR \$28.95 ORDER TODAY! with Coated Optics \$18.50 Dept. M10 BUSHNELL Importers 43 E. Green Pasadena 1, Cal.



Only \$18.00...

DELIVERED TO YOUR DOOR POSTAGE PREPAID!

**MAIL ORDERS
WE PAY POSTAGE ON ALL ARTICLES**

ARMY SURPLUS
\$8.95 VALUE!

BOOTS

IDEAL ALL WEATHER BOOT FOR WORK — SPORTS

LEATHER UPPERS—RUBBER BOTTOM

- Flexible double chrome, tanned, tough wearing leather uppers!
- Leak-proof gusset tongue!
- Non-skid heavy duty rubber soles.

\$3.45
WE PAY POSTAGE

10" 12" Tops



Reconditioned and LOOK LIKE NEW!

SIZES
6-7-8-9-10
11-12-13

NEW POLISHED STEEL

ALL PURPOSE HOUSEHOLD

MEAT CLEAVERS

IDEAL KITCHEN SIZE



\$2.95 Value

Fine quality cutlery steel riveted hardwood handle. Polished blade 11-inches long, 1/2-inch thick—For meat, fish, fowl — every kitchen use.

COMPLETE WITH ALL LEATHER SAFETY SHEATH

\$1.15

Delivered to You We Pay Postage

**Genuine ACTIVATED CARBON
KILLS ODORS!**

97¢ VALUE

29¢
In Refrigerator Ice Boxes, Coolers, Freezers We Pay Postage

Absorbs unpleasant odors of fish, meat, onions, garlic, etc. Made to rigid U.S. specifications! Absolutely harmless. Just place it inside the refrigerator and it goes to work. GUARANTEED ONE YEAR!



**NEW—100% WOOL
BLANKETS**

62" x 82" \$7.95 VALUE



\$5.25
WE PAY POSTAGE

Soft, fleecy, warm. Closely woven nap, whipped ends. Ideal for every purpose. Choice of GREY or KHAKI (30% Pure Wool—70% Pure Processed Wool)

SEND FOR FREE CATALOG — AMAZING VALUES!

UNIVERSAL ENTERPRISES

DEPT. 10PM 946 S. MAIN ST. LOS ANGELES 15, CALIF.
WE PAY POSTAGE, TAXES, INSURANCE ON ALL ARTICLES.

SAY YOU SAW IT IN POPULAR MECHANICS



**PRESERVE REAL FLOWERS
in Crystal Clear Plastic**

Now create many lovely and unusual things like the distinctive coaster shown—made by embedding real flowers in Castolite—the "magic" liquid casting plastic. Comes crystal clear, or may be dyed to produce gorgeous color effects. Make really different jewelry, book ends, picture frames, candle sticks, figurines. Embed real flowers, butterflies, coins, medals, photos, for novel plaques, paper weights, tiles, other art objects. Use only home utensils. Follow simple step by step method. New pleasure, fine profits are possible. Send 25¢ for exciting picture-packed new Home Project Manual showing how to get started. Write today.



THE CASTOLITE COMPANY, Dept. L-1, Woodstock, Illinois

Chronograph Wrist Watch

LOWEST MARKET PRICE
\$7.25



—Sweep Second Hand; Precision Workmanship; Rugged Shock-resistant case; Radium hands and numerals; Leather strap. It measures distance, speed of cars, planes, horses and other moving objects. It's a time keeper, stop watch, telemeter, tachometer. ONE YEAR WRITTEN GUARANTEE and full operating instructions enclosed with each watch. SEND NO MONEY. Mail your order today. Pay postman \$7.25 plus 10% Federal tax. Total \$8.00 plus postage. Or send cash (money order or check) with your order and save postage charge.

MARDO SALES CO., Dept. 1702

480 LEXINGTON AVE. NEW YORK 17, N. Y.

**FREE! MY
PLAN FOR YOUR
SUCCESS**



Learn
**ELECTRICAL
APPLIANCE
REPAIR
and
SERVICING**

**SPARE OR
FULL TIME**



Want a good-paying business — a job in a fast-growing industry? Learn electrical appliance repair and service. I will teach you this interesting, good-paying business. The EASY step-by-step home study method, taught by PTS, prepares you NOW to reap lush profits to be made in this unlimited field. Have YOUR OWN BUSINESS — spare or full time — prepare for one of the man openings for trained men...

ACT NOW

Millions of new appliances in homes — millions of new homes being wired for electricity assures hundreds of customers in nearly every neighborhood.

EASY TO LEARN!

Men of all ages, yes, even the man of 60 can get into this ever expanding field—a business well suited to men who like to use their hands—a REAL OPPORTUNITY for the practical man who is not happy in his present job. Get started NOW—send for FREE BOOK giving all details.

**OPEN YOUR
OWN SHOP**

PTS training is more than a home study course in electric appliance repair and service. It gives you the know-how on the operation of your shop from a business standpoint—what to charge — how to get customers. Everything possible is done to assist you to start on the road to your success.

**EARN WHILE
YOU LEARN**

You can actually start earning before your course is finished. I send you your first lesson showing you easy jobs that can be done in your SPARE TIME AT HOME. Remember, one good repair job will pay for the cost of your course. NO BIG OVERHEAD needed. Start in your garage, basement, attic or spare room. When you are ready to expand, I will give you the benefit of my advice and experience.

Yours! AT NO EXTRA COST
Big kit of tools and ELECTRICAL APPLIANCE TESTER

YOU LEARN TO REPAIR

- Vacuum cleaners,
- Washing machines,
- Lamps, Motors, Irons,
- Ranges (gas and electric),
- Auto electricity, Garbage disposal units, Fluorescent lights, Electric shavers,
- Refrigeration, House Wiring.

Free!
Big book containing all of the details of my plan for your success. WRITE NOW!

USE THIS COUPON

PACIFIC TRAINING SCHOOL — Dept. P910
7217 So. Broadway, Los Angeles 3, Calif.

Please send me your FREE BOOK.

NAME _____ AGE _____
ADDRESS _____ ZONE _____
CITY _____ STATE _____



START YOUR OWN BUSINESS,

FULL OR PART TIME

Don't work for "small wages." Get in on the Big Money by learning Electrical Appliance Repairing NOW in your spare time. Learn it the simple, easy way by working with your hands building, testing, checking. We supply you with valuable Kits that will give you that all-important "know how."

More men are needed immediately. Millions of refrigerators, motors, washing machines, irons, vacuum cleaners, house wiring need fixing. This demand must be met! Rush name today for **FREE ILLUSTRATED BOOK** and special form for paying us later from cash earnings!

CHRISTY TRADE SCHOOL
2835 N. Central Ave. Dept. D-7403 Chicago 34

Learn UPHOLSTERING At Home!



A Money-Making Business of Your Own or a Hobby that Pays

Re-upholster your chairs, sofa, etc. — earn extra money in a Spare or Full Time Money-Making Business. We show you how through practical Home Training.

Course Offers Professional Upholsterer's Tools

With your interesting lessons you receive tools, material, and detailed instructions to do actual upholstering. Throughout your course you receive professional guidance to help you do the kind of upholstering that gives satisfaction and makes you money.

YOU GET THIS OTTOMAN



With your first lesson you receive the Frame, Springs, Webbing, Padding, etc. — all necessary materials to make and upholster this ottoman. Other jobs come easy.

SEND FOR COMPLETE INFORMATION TODAY

West Coast University, Extension Dep't. PM-109
1601 S. Western Avenue, Los Angeles 26, California

Please send me free illustrated booklet describing your Upholstering Course.

I am interested in upholstering as a career as a hobby

Name _____

Street _____

City _____ Zone _____ State _____

YOU CAN MAKE THESE WITH POPULAR MECHANICS PLANS AND BLUEPRINTS

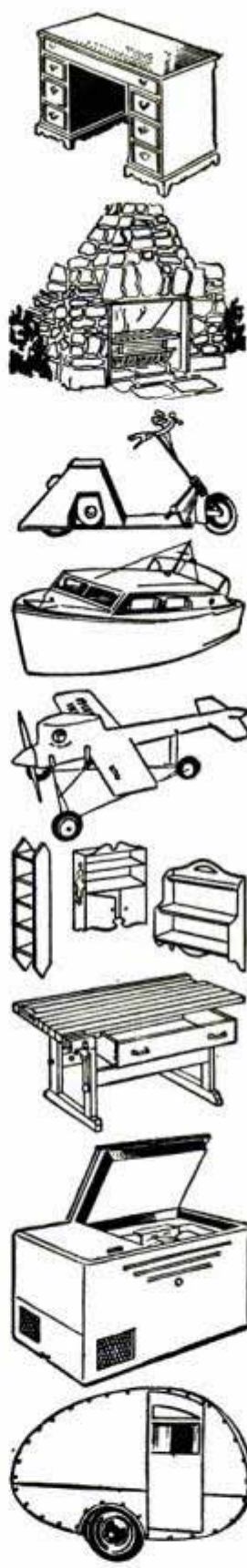

- 501—Colonial Grandfather's Clock. 25c
- 507-508—Doll-House, 5-Rooms, Open staircase, fireplace. 50c
- 526—Queen Anne Coffee Table: True replica of antique. 25c
- 528—Duncan Phyfe Console Table: 30 in. high. 25c
- 529—Lawn Chair: Southern style. 25c
- 593—Three Attractive Corner Shelves: Scroll-sawed. 25c
- 596—Three Hanging Type Shelves: Hold books, china, etc. 25c
- 661—Rocking Horse: Scroll-sawed from plywood. 25c
- 707—12 Ft. Rowboat: Flat-bottom, four seats. 25c
- 795—Two Handsome Cedar Chests. 25c
- 811-812—16 Ft. Canoe: Canadian type, cedar planking. 50c
- 813-814—Pops Outboard Racer: 10 ft. long, stepped bottom. 50c
- 828-835—Sovereign of the Seas: English warship model. \$2.00
- Sovereign of the Seas: Instruction Book. \$1.00
- 836—12 in. Bandsaw: Uses plywood, cuts two in. stock. 25c
- 839—Melrose Corner Cabinet: Old Colonial design. 25c
- 846-848—Governor Winthrop Desk: True copy of original. 75c
- 896-897—Three Easily Made Workbenches—Simplified construction. 50c
- 906-909—Midget Auto: 58 in. wheelbase, 1/2 to 3/4 h.p. \$1.00
- 910—Circular Saw Table: Hardwood, 24" x 36". Stationary. 25c
- 917—Outdoor Fireplaces: Several simple but practical. 25c
- 920-922—Lawn and Garden Furniture: Swings, arbors, tree seat. 75c
- 923—Indoor Fireplaces: Standard Sizes. 25c
- 926-927—Venetian Blinds: Three different styles. 50c
- 930—Hooked Rug Frame—Quilting Frame. 25c
- 933—Cape Cod Cupboard: 4 ft. wide, 5 ft. 8 in. high. 25c
- 935—Knee-Hole Desk: 40 in. long, 30 in. high, 31 1/2 in. wide. 25c
- 936—Modern Coffee Table: 24 in. long, 15 in. wide. 25c
- 952—Child's Cradle in Maple. 25c
- 958—Colonial Corner Cupboard: 6 ft. 8 in. high. 25c
- 961—Hanging China Cabinet: 38 in. long, 40 in. high. 25c
- 969—Combined Chest and Writing Desk: 35 1/4 in. high. 25c
- 970—Modern Clothes Chest: Built of Plywood. 25c
- 977—Bookcase in Chippendale Style: 47 in. high, 10 in. wide. 25c
- 978—Lawn Chair on Wheels: Lightweight, easy to wheel. 25c
- 981—Colonial Wall-Shelf: 30 in. high, 19 in. wide. 25c
- 984—Duncan-Phyfe Drop-Leaf Table: Reproduction of historic piece. 25c
- 986-987—Utility Trailers: Built of old auto parts. 50c
- 989-990—Speedy Motor Scooter: Gas engine, 40 to 60 miles on gal. of gas. 50c
- 991—Gun Cabinet: Handy cabinet includes rack for rifles. 25c
- 993—Twin-Deck Beds: 6 ft. 4 in. long, 3 1/2 ft. wide. 25c
- 1106-1112—SEACRAFT—25 Ft. CABIN CRUISER: Adaptable as sport fisher, express cruiser, or utility boat. Cruises at 15 knots with marine engine or converted auto engine. Cabin sleeps four. Galley has fresh-water tank, sink, and cook stove. Set of seven large-sized blueprints scaled 1 in. per ft. plus 40-page two-color illustrated booklet, only. \$10.00
- 1011—Fireplace Fittings: Andirons, log rack, etc. 25c
- 1080-1081—Banta: 12 Ft. Plywood Runabout: Vee-Bottom, 3-passenger. 50c
- 1086—Black Forest Corner Shelf: Scroll-sawed. 25c
- 1089-1090—Home-Constructed Freezing Unit: reaches 30 degree temp. 50c
- 1091-1096—17 ft. trailer, 7 ft. wide, Steel chassis. \$1.50
- 1102-1105—Midget Trailer: "Teardrop" body. Sleeping quarters for two. \$1.00
- 1113-1114—Gold Rush of '47: The A.M.A. Open Class B Record Holder Plane Model. \$1.00

FILL OUT AND MAIL THIS COUPON NOW

POPULAR MECHANICS CO.
200 E. Ontario St., Chicago 11

Please send the following plans _____

I am enclosing \$ _____

Name _____

Address _____

FAST PUSH-BUTTON POWER CAR!

ALL ELECTRIC REMOTE CONTROL

1951 AUTO SENSATION!

- Driven By Powerful Remote Control
- Powered with Electric Mini-Motor
- Latest All Electric Marvel
- Balloon-type Rubber Tires

Push The Button!

IT STARTS! REVERSES! STOPS! STEERS!

Imagine only **\$3.49** COMPLETE!

The greatest new electrical toy since the electric trains. REMOTE CAR is a thrillingly realistic scale model, made of colorful shining plastic. It runs and steers by remote control—no wind-up or friction motor, but an ALL-ELECTRIC PRECISION-MADE MOTOR, powered by 2 long lasting flashlight batteries. Push the magic rheostat button, and you really make things happen. Here's real action to fascinate every child, and daddy too. RUSH YOUR ORDER TODAY! SEND NO MONEY! Remit with order and we pay postage, or C.O.D. plus postage.

NOVELTY MART - 59 East 8th Street, Dept. 342 New York 3, N. Y.

ARTISTS MAKE MONEY

Do you like to draw? Send name, address, age and occupation for FREE ART TEST, to find out your ability.

ART INSTRUCTION, Inc.
10139 ART INSTRUCTION BLDG., MINNEAPOLIS 15, MINN.

STAMP COLLECTORS SENSATIONAL \$1.00 SALE!

ROOSEVELT ISSUES of many Nations. 31 scarce Historic stamps. Net \$2.15! AXIS PUPPETS on stamps of Italy, Germany, Bohemia and scarce occupation issues of Ukraine & Ostland. Value \$2.98! MAMMOTH COLLECTION of many hundreds fine stamps. War issues, Airmails, Pictorials, African Colonies, Vatican City, etc.! Regular Value \$6.41! ALL THREE LOTS (Regular net Value \$11.54) only \$1 during this SALE. Fine approvals included. MONEY BACK GUARANTEE

NATIONAL STAMP SALES, Dept. 209
140 W. 44th NEW YORK 18, N. Y.

LOCKSMITHING & KEYSMAKING

PRACTICAL HOME TRAINING OUTFIT INCLUDES EVERYTHING NECESSARY TO GET STARTED IN YOUR OWN BUSINESS
Excellent full or part time earning opportunities. Professional outfit includes supplies, tools, key cutting machine. Get practical training from Master Locksmiths on house locks, auto locks, padlocks, etc. Learn to cut keys by code, master locks, change combinations, quickly, identify key blanks, many profitable "tricks of the trade." Booklet of Information FREE. Write today. UNITED SUPPLY & SERVICE, 3327 Madison St., Dept. PM-10, Chicago, Illinois.

SAY YOU SAW IT IN POPULAR MECHANICS

HANDI-SCOPE

POWERFUL MICROSCOPE

For Machinists, Hobbyists, Photographers, Doctors, Engineers, Students, etc.

- Sharp Fine-Focus Adjustment
- 20-Power, Compound System
- Wide Undistorted Field
- No Special Light Source Needed

ORDER NOW!

Hundreds of practical uses in home, school, office, shop, farm, etc. Easy to use—handy to carry. Sold on money-back guarantee. Send check or money order TODAY!

\$4.95 POSTPAID

BUHL OPTICAL COMPANY
Box C-118, 1009 Beech Avenue, Pittsburgh 12, Pa.

YOUR OWN BUSINESS WITH A FUTURE!

Get the facts FREE!

a few cents worth of materials BRINGS YOU DOLLARS!!

Rich profits are waiting to be tapped in this new field. New MIRACLE finish gives a velvety, luxurious surface to radios, lamps, toys, signs, store displays, figurines, auto dashboards, and hundreds of other items. Make old objects beautiful and saleable — make new things worth much more with this soft, rich covering that can be applied to any surface, even if old and worn.



Have Your Own Lasting, Successful Business—Be Your Own Boss—Help Fill Huge Demand ... No Experience Is Necessary

Yes, you can learn in a few days to start MAKING MONEY! Everything you need is furnished, including fully detailed, illustrated instructions that are complete and easy to understand. Every point is explained, to show you how to start on the road to big money, full or spare time, right in your own home.

EVERYTHING COMPLETE

In addition to full instructions, you get all materials that will enable you to start at once. A few cents worth of materials can mean many dollars in return. You can earn up to \$5.00 per hour and more spare or full time. Boost your present income or start your own profitable business.

ACT NOW

Grasp this opportunity TODAY — start your own business. It's too good to miss! SEND NO MONEY — fill out the coupon and stick it on a post card or in an envelope and mail today for full details, FREE sample of FLOK-KRAFT covered material, and hundreds of useful and profitable IDEAS. Do it NOW — be first!

USE THIS COUPON SEND NO MONEY

COAST INDUSTRIES
Dept. 2A, 1004 So. Los Angeles St., Los Angeles 15, Calif.
Please rush me all the details!

NAME _____
STREET _____
CITY _____
STATE _____



- TOYS
- JEWELRY BOXES
- DISPLAY PIECES
- LAMPS
- CAR DASHBOARDS
- CAR TRUNKS
- Covers: Wood, Fabric, Metal, Plaster, Plastic, Glass, or any Surface



Learn A Trade NOW! PRACTICAL SHOP TRAINING!

In Our Chicago Shops

- | | |
|---|--|
| <input type="checkbox"/> AUTO MECHANICS | <input type="checkbox"/> WELDING—ARC and GAS |
| <input type="checkbox"/> DIESEL MECHANICS | <input type="checkbox"/> MACHINIST |
| <input type="checkbox"/> REFRIGERATION | <input type="checkbox"/> PIANO TUNING |
| <input type="checkbox"/> BODY-FENDER | |

Above Approved For G. I.'s and Civilians
One of America's Leading Practical Schools
7 Floors of Fully Equipped Shops
Over 48,000 Successful Graduates
Expert Individual Instruction
Learn by Doing—Low Living Expense
Established 1902—Day and Evening Classes

Also the following Home Study Courses

- | | | |
|----------------------------------|--|---------------------------------|
| <input type="checkbox"/> PLASTIC | <input type="checkbox"/> REFRIGERATION | <input type="checkbox"/> DIESEL |
|----------------------------------|--|---------------------------------|

—CALL IN PERSON OR MAIL THIS AD TO—

GREER SHOP TRAINING

(Desk 10) 460 South State St., Chicago 5, Ill.

Please send without obligation free information regarding trade checked above. (Specify whether you are a Veteran or Civilian)

Name _____ Age _____
Address _____
City _____ State _____

Can a Man MY Age Become a HOTEL EXECUTIVE

Even Though He Has No Previous Hotel Experience?

Would you like to step into a well-paid position as Hotel, Club, Restaurant or Inn Manager, Purchasing Agent, Social Director, Assistant Manager? Would you like to be able to look forward happily to the future? The success of Lewis graduates from 18 to 50 PROVES you can — though you have no experience in hotel work.



Louis C. Schmitz, Driver-Salesman, Now Assistant Manager, Although He Knew Nothing About Hotel Work

"I was a driver-salesman. My earnings were fairly satisfactory, but I wasn't happy. So I enrolled for Lewis Training. Before graduating, I secured a good position. Less than five months later I became Assistant Manager."

Step Into a Well-Paid Hotel Position FREE Book Gives Fascinating Facts

Our FREE Book, "Your Big Opportunity," explains how you can qualify for a well-paid position at home, in leisure time; tells how you are registered FREE of extra cost in the Lewis National Placement Service; shows how you can be a Lewis Certified Employee — certified to "make good" when placed in a position. Mail the coupon NOW!

Course Approved for Veterans' Training

LEWIS HOTEL TRAINING SCHOOL
Room PR-324, Washington 7, D. C.

34th SUCCESSFUL
YEAR

Send me the Free Book, "Your Big Opportunity," without obligation. I wish to know how to qualify for a well-paid position at home, in my leisure time.

Name _____
Address _____
City _____ Zone _____ State _____
 Check here if eligible under G.I. Bill of Rights.

GOLD FOR HOBBY FOR PROFIT

New Book—"What the Beginner Needs to Know"—36 pages
Mailed You Postpaid for 25 Cents. Coin or Stamps.
Catalogue included of Beginners Supplies — Maps of Where to Go — Blueprints of Machines You Can Build — Geiger Counters — Mineralights — Mining Books. A Good Way to Supplement That Pension.

OLD PROSPECTOR - 8300 - DUTCH FLAT, CALIF.

NATION'S
LARGEST
EXCLUSIVE
ELECTRICAL
SCHOOL

"LEARN-BY-DOING"

ELECTRICITY

PRACTICAL TRAINING
NOT "HOME STUDY"

G.I. APPROVED Get actual experience in great shops of M.T.I. Learn all phases Practical Electricity; Housewiring, Motors, Const., Maintenance, etc. Living arrangements, Part-time jobs, etc. A post card brings the story.
MICHIGAN TECHNICAL INSTITUTE, Dept. PM-10
2281 W. Fort St., Detroit 16, Michigan

WAR SURPLUS VALUES!



Zipper Field Jacket—Water repellent, wool lined, action back, sizes 32-42 \$2.45
Army Wool Pants (28-38 waist) 2.95
Army Wool Shirts (sizes 13 1/2 to 16) 2.25
Army Jacket (34-42) H.B.T. 1.29
Army Pants (28-36) H.B.T. 1.39
Army Wool Blankets 3.95
Army Raincoats (Rub.) sizes 36-46) 1.95
Army Combat Boots, sizes 6-11 3.95
Satisfaction Guaranteed or Money Back.
Send money and we pay postage—or send \$1 deposit, balance COD plus postage.

SEND FOR
FREE
CATALOG
For Family

GUILD, Dept. 243, 120 E. BROADWAY
NEW YORK 2, N. Y.

AMAZING MYSTERY BUTTON



Startles Everybody. With this Electronic Button you can make your own Telephone — Amplifier — Detector — phone. Attach this button to piece of cardboard—transmit conversation to another room. Music also transmitted to distant places. Most interesting electrical apparatus ever discovered. Enables you to perform hundreds of experiments. So tiny it can be concealed in dozens of places. A Pre-War Product. Electronic Button including 5000 word instruction booklet with 60 illustrated experiments, postpaid, only \$1.00
Electronic Products Company, Saint Charles 7, Ill.

Learn CARTOONING

HAVE FUN! MAKE MONEY! Cash in on your sense of humor at HOME-BY MAIL. No experience needed to start. Write today for FREE TRIAL LESSON and full particulars.



MOON Gag Cartoon School, Dept. E, Fall Creek, Wis.

LOW FIRE PROTECTION



Prevent loss and tragedy in your home with Therm-o-larm. This new fire detector warns of overheated conditions. Easily connected to your doorbell wires. Sounds alarm continuously when fire danger exists. Enjoy the security this fire guard gives you while you sleep.

PRICED AT ONLY \$2.00

WRITE FOR FREE FOLDER

Opportunity for men to demonstrate and install. Write for information.

THERM-O-LARM CORP.

Pat. 2,418,384

3133 Fairfax Rd.

Cleveland 18, Ohio

HELPFUL BOOKS

Send post card asking for FREE catalog
Popular Mechanics Press, 200 E. Ontario, Dept. 601, Chicago 11



WASHES DISHES IN JIFFY!

BRAND NEW... Nothing else like it. Amazing "Sponge" Dish Cloth washes dishes lightning fast. Replaces messy dishrag. Suction action works like magic. Dishes gleam like a mirror. Truly a Godsend to busy housewives.
SAMPLES FOR AGENTS
Sample offer sent immediately to all who send name at once. A penny postal will do. SEND NO MONEY—JUST YOUR NAME.
Kristee Co., 685 Bar St., Akron, Ohio



ALL OVER AMERICA Operators are Making
BIG PROFITS with "FRENCH-BOY"
 - DAY AND NIGHT - HOT POPCORN DISPENSER

Easy Way To—MAKE BIG STEADY PROFITS

- IOWA CITY, Operator, "Net \$90.00 in 1 1/2 day's time"
- OSHKOSH, Operator, "Net \$780.00 in 4 day's time"

SMALLEST BIG MONEY MAKER ON THE MARKET

"A new and most profitable business ever to reach the market, easy to operate, non coin-operated Dispenser—no service calls. We ship you the machine and the ready-to-eat popcorn, no intricate parts, simply pour in the popcorn, plug in and you are immediately in business and realizing large profits. Do Not Delay—be the first popcorn magnate in your area, write for full details today."

Part Time or Full Time Prepoped Corn Shipped Anywhere in U.S.A. in Moisture-Proof Bags

Manufactured by: —Write For FREE Particulars NOW—TODAY!

A. B. C. POPCORN CO., 3441 West North Ave., Dept. P-10, CHICAGO 47 (Wholesale Popcorn and Supplies)

For—
 TAVERNS
 THEATRES
 DRUG STORES
 CANDY STORES
 BOWLING ALLEYS
 RECREATION HALLS
 CARNIVALS
 FOOD SHOPS
 LIQUOR STORES
 5 & 10c STORES
 COCKTAIL LOUNGES
 AMUSEMENT PARKS
 Etc., Etc.



Economical to operate

Delivers HOT Popcorn INSTANTLY



Train Now for Big Pay Open to

Carpenters & Brick Masons

IN A FEW SHORT MONTHS IN MODERN WELL EQUIPPED

Midwest Shops

Approved for Veterans. Non-veterans may pay tuition by the month. MAIL COUPON TODAY FOR FREE INFORMATION.

Get into the billion dollar building trades. Demand widespread, check your own neighborhood for shortages of carpenters and brick masons. Our graduates are actively employed in the Building Trades, stepping directly from school into jobs or business of their own in various parts of the country. Many of our students supplement their income with part time earnings while attending school. Pleasant inexpensive living quarters in beautiful, healthful surroundings. Enroll now. Limited classes. MSBT teaches building trades only. If you prefer, you can begin your training at home.

MIDWEST SCHOOL OF BUILDING TRADES
 411 N. Center St. Dept. PM-10 Bloomington, Ill.

MIDWEST SCHOOL OF BUILDING TRADES

Dept. PM-10
 411 N. Center Street, Bloomington, Ill.

Please send me free information about training in the field I have checked:

- Carpentry Masonry

Name _____

Address _____

City _____ State _____

Are you a veteran? Yes No

HIGH INCOME TRAVEL ABROAD

LEARN EXPORT

Tired of humdrum, low-paid, overcrowded vocations? U. S. A. Export-Import volume was over \$19 Billion during the year ending last July. Compare the few listings of World Traders in your phone book against the hundreds in struggle-to-live lines. Men and women have room to prosper and opportunities to travel abroad in World Trade.

EXPORT MANAGERS MAKE UP TO \$12,000 A YEAR... and even more. But the sky's the limit in your own business. Commissions of \$10,000 to \$20,000 or more a year are possible. Customers in other lands tell you what they want. You buy FOR them—ship at their expense at handsome profits. Big profits in Imports too.

PAST EXPERIENCE UNIMPORTANT. No previous experience or special education is necessary when you learn by simple methods based on my 25 years' practical experience.

I TEACH YOU AT HOME. I have trained others in as little time as one month because my methods are direct, free of non-essentials and red tape. You can start your own mail order Export business at home on practically no investment—FULL OR SPARE TIME!

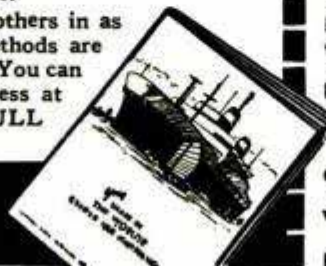

Write for FREE BOOK

NEW QUICK WAY



PRACTICAL—NO THEORY. Twenty clear, fascinating lessons, full year's consultation service included, also full year membership in International Traders' Guild which puts you in contact with traders the World over. **WORLD TRADE CERTIFICATE AWARDED.** Money-Back Agreement.

START TODAY—GET FREE BOOK!

Rush coupon today for illustrated FREE book. No obligation. No salesman will call. Airmail reaches us overnight.

B. L. Mellinger, Director, The Mellinger Co.
 1422-15 Westwood Blvd., Los Angeles 24, Calif.

MAIL COUPON NOW

B. L. Mellinger, Director, The Mellinger Co.
 1422-15 Westwood Blvd., Los Angeles 24, Calif.

Please send FREE BOOK showing how I may enter the profitable career of World Trade.

Name _____

Address _____

City _____ State _____

Veteran? _____ Occupation? _____ Age? _____

Location preferred? _____

NEW
Edition

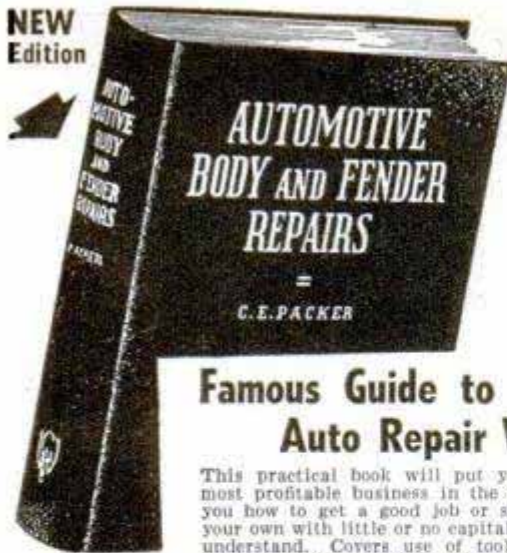

**NOW
HAS
325
PAGES
232
ILLUS.
\$3.50
Total Cost**

Famous Guide to Best Pay Auto Repair Work

This practical book will put you right into the most profitable business in the auto field. Shows you how to get a good job or start a business of your own with little or no capital. Easy to use and understand. Covers use of tools and equipment, gives approved methods, describes materials and shows you how to actually do a professional job, operate a shop, etc. The very latest information and pictures on all interior and exterior body work and fender repairs—the kind of work people everywhere want and will pay big for when you can do it. Mail coupon now. Use book 5 days and if not O.K. return it and we will refund your money.

**Most
Complete
Information
Ever
Published**

GOODHEART-WILCOX CO., Dept. 17
1321 S. Michigan Avenue, Chicago 5

**MAIL ORDER
COUPON**

Send Auto Body and Fender Repairs C.O.D., I will pay postman plus charges. (C.O.D. in U.S. only.) Remittance for \$3.50 enclosed, send postage paid. If not O.K. I will return in 5 days and you will refund purchase price.

Name _____

Address _____

City _____ State _____

SAY YOU SAW IT IN POPULAR MECHANICS

PRINT YOUR OWN POST CARDS

**COMPLETE
OUTFIT
only
\$7.50**

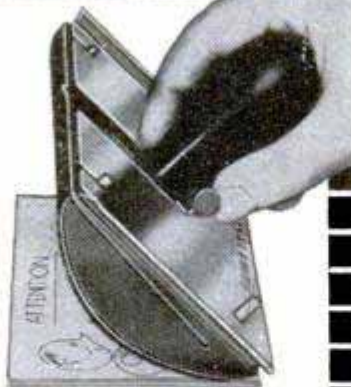

Amazing results in sales, inquiries and contacts with the new GEM STENCIL DUPLICATOR. Saves time and money. Very easy to use on any paper; no gears or moving parts to get out of order. Ideal for *Announcements, Notices, Advertising, Labels, Forms, Price Lists*—hundreds of uses for every type business and organization. Comes complete with all supplies, instructions and 60-page illustrated Book of Ideas. The GEM is unconditionally guaranteed forever.

FREE TRIAL OFFER: Try it before you buy it! Write and a GEM OUTFIT will be sent you postpaid. After 10 days, send only \$7.50 or return the GEM, no questions asked. The GEM must sell itself; you be the judge.

BOND EQUIPMENT CO. • Dept. 94
6633 Enright • St. Louis 5, Mo.

SEND NO MONEY • FREE TRIAL OFFER

PAY RAISING—EXTRA MONEY BOOKS

Use these books to prepare for a better job—bigger pay—to start a profitable spare time or full time business of your own, improve your home, start a hobby. Popular Mechanics specializes in supplying outstanding self-help books on many subjects. Send for our FREE catalog.

- Outdoor Sports Manual
Hunters, Fishermen, Trappers, Campers, Archers, Bowmen. Here is your book! \$2.00
- Shop Notes Library
4 Vols. — 1949, 48, 47, 44, (No. Dup. Mat.) \$2.48
- Painting, Furniture Finishing and Repairing \$1.50
- Rewinding and Servicing Electric Motors (No. 75) 25c
- Photo Handbook
An entirely new and different book from our Popular Photo Guide. It's a complete guide to better pictures and dark-room technique, and features dozens of handy gadgets you can make yourself! \$2.00
- Motor's Truck Repair Manual
Mechanics, Truck Specialists, Service Stations, Fleet Owners! Here is your book. Covers every job on every truck made since 1936 — 1400 pictures, 952 Pages \$8.00
- Garden Book
Build own trellises, lawn furniture, fireplaces, ornaments, etc. \$1.25
- Diving, Cutting and Welding in Underwater Salvage Operations
Only book of its kind .. \$2.00
- Picture Framing
Modern methods for making and painting picture frames. Fully illustrated, \$2.75
- If You Want to Write You Can Write! Learn through actual examples \$1.75
- Modern Illustration
A practical art course covering all branches of commercial drawing, painting and methods of reproduction \$3.00
- 210 Deluxe Small Homes, \$1.00
Into the Freezer and Out
A complete handbook on the home freezing of foods. \$2.50
- Concrete Handbook
New book on using concrete around home, garden, farm \$1.50
- Zero Storage in Your Home
How to prepare, store and freeze food properly... \$2.50
- This Way Up
The successful philosophy of practical business men \$2.00
- Welding, Brazing and Soldering
How to build own equipment and how to use it effectively \$1.25
- Modern Refrigeration
Electric, Gas, Be service expert \$5.00
- Dyke's Auto Ency. (includes Diesels, airplane engines)
New 20th Ed. World's greatest book for mechanics \$7.50
- Household Mechanics
The "fix-it" book to end all "fix-it" books. Covers electric appliances, painting, carpentry, etc. \$2.98
- Oil Burner Handbook \$2.50
- Build Your Own Boat
Describes 17 popular boats—rowboats, sailboats, plywood outboard, etc. 192 pages \$1.50
- House Wiring (No. 89) ... 25c
- Turn Scrap Into Money
Convert old auto generators into motors, welders, etc. \$1.00
- Popular Mechanics Farm Manual
Packed with practical ideas and usable information that can easily be worth hundreds of dollars to every farm family and to homeowners everywhere. Send for free descriptive folder giving complete contents! \$3.00
- Woodworking for Every-body \$2.75
- Sheet Metal Work \$3.00
- Tool and Saw Sharpening (No. 92) 25c
- Forging Practice \$1.50
- Action Toys (No. 66)
Plans for 21 easy-to-make toys 25c
- Foundry Work \$2.25
- Pattern Making
Wood, metal \$2.25
- Forty Power Tools
Build own saw, drill, lathe, sander, etc., from scraps—save money! \$1.50
- Carpentry \$2.50
- The Young Craftsman
Over 450 things boys can make \$1.50
- Five Acres and Independence
How to make money on small farm \$2.50
- Your Home and How to Build It Yourself
Step by step construction of the famous POPULAR MECHANICS house. Wonderfully illustrated \$3.00
- Drake's Householders' Encyclopedia
This is the time to save money on those necessary home repair jobs—Repairing, Remodeling, Carpentry, Painting, Decorating, Plumbing, Heating, Electric Wiring and Appliance Repairs. Furniture Repair—This new book covers them all \$5.00
- Motorist's Handbook
Popular Mechanics scores again. A 160 page guide to automotive happiness .. \$2.00
- Knots, Ties and Splices
For everyone who uses rope \$1.25
- What to Make for Children
Jugw- tough on toys? Build big things that will last. \$2.00
- LeJay Manual of Homemade Electric Equipment
How to construct 100 items that are scarce and valuable \$1.50
- How to Estimate for the Building Trades: Material and labor costs for masonry, plumbing, electricity, carpentry, heating, hardware, painting, etc. 628 pp. \$5.50
- Rabbits for Food and Fur \$2.50
- Tool Making \$4.00
- Tool Design \$4.50
- Plumbing Installation & Repair \$2.00
- Ropp's Calculator
Figuring made easy... 75c
- Slide Rule Simplified \$2.75
- Drake's Refrigeration Service Manual \$2.00
- Primer for Home Builders
All the information you need to know in building a house \$2.50
- How to Read Aircraft Blueprints \$4.40
- America's Best Low Cost Homes
125 popular practical designs \$1.00
- Toys You Can Make of Wood \$2.50
- A.B.C. of Poultry Raising \$2.50
- Ice Cream for Small Plants
Some technical formulas for ice cream, ices and frozen desserts on a commercial scale \$2.50
- Furniture Joinery \$2.00
- Essentials of Upholstery \$3.25
- Radio Physics Course
A thorough training in radio fundamentals \$5.00
- Lessons in Ornamental Penmanship
You can easily learn to write beautifully. Delight and amaze your friends with the skill you can acquire by using this book—Only \$1.50

MAIL THIS COUPON TODAY

Check the books you want, write your name and address below, and mail this advertisement with money order or check. Outside U. S. A. include 15% additional for shipping charges.

Books selected will be mailed promptly on our "money back if you're not entirely satisfied" guarantee.

Name _____

Address _____

City _____ State _____

Mail to **POPULAR MECHANICS PRESS**

Dept. 700-200 East Ontario St., Chicago 11, Ill.

POPULAR MECHANICS

FAMOUS MAKE What a Watch! What a Buy!
17 JEWELS • 2 PUSH BUTTONS

CHRONOGRAPH

formerly up to \$71.50 **\$24.95**
• WRITTEN GUARANTEE

A precision instrument. 10% Fed. tax plus
Wrist watch, stop watch, tachometer, tele-
meter all in one. Sweep-second hand, Radium
dial, stainless steel back. Ideal for
mechanics, sports, science, medicine, engi-
neering. 10-day money-back guarantee of
satisfaction.

FAMOUS MAKE
DURABLE, PRECISE, 17 JEWEL
GUARANTEED SWISS WATCH

- Water-resistant • Shock-resistant
- Radium Dial • Anti-Magnetic
- Sweep-Second Hand

\$49.50 RETAIL VALUE... only \$19.75
HANDSOME thin-model, expensive-looking, with matching expansion bracelet. Chromed top with stainless-steel back. Inca-
ble shock-feature found only in more ex-
pensive watches. 10-day money-back guar-
antee of satisfaction.

Smallest AUTOMATIC, SELF-WINDING, WATER RESISTANT Watch Obtainable \$62.50 RETAIL VALUE... ONLY \$28.75
Famous make! Sweep-second hand! 17 Jewel! Radium dial! Leather strap! This smart-looking all stainless steel watch is equipped with a shock resistant "F-cable" feature. NE-
• REVOLUTION-ARY! It winds itself with the motion of your wrist.
Sent C.O.D. or pay in advance and we pay postage or try our
LAYAWAY PLAN—Send a little each month till purchase price is accumulated. We reserve your watch for you. No extra charge.

SUPERIOR WATCH DISTRIBUTORS
580 FIFTH AVE., NEW YORK 19, N. Y.
Department PM2

locksmithing and key making

PRACTICAL UP-TO-DATE COURSE
How to pick locks, de-code, make master-keys, install, service, etc. New, self-instruction lessons for every handyman, home-owner, carpenter, mechanic, service station operator, fix-it shop, hardware dealer, gunsmith, cycle shop. Good steady money-making trade!

53 EASY ILLUSTRATED LESSONS
Full price only \$3.95, nothing more to pay. Satisfaction or your money back. Fill in coupon at bottom of page and mail today.
NELSON-HALL CO.
1139 S. Wabash Ave. Chicago 5, Ill.

watch and clock repairing

LEARN AT HOME—IN YOUR SPARE TIME
Prepare now for a happy future of pros-
perity, security. Fascinating high-grade
occupation for men of almost any age
or physical condition. You can earn
while you learn.

PRACTICAL COURSE IN HOROLOGY How-to-
do-it lessons for beginners as well as those
already in the trade. Thorough self-in-
struction training in American and Swiss
watches, clocks. Contains a wealth of
helpful photos, drawings, diagrams,
charts, etc. Only \$4.95 for everything,
complete. Satisfaction or refund guaran-
teed. Mail no-risk coupon below.

practical RADIO servicing

SELF-INSTRUCTION COURSE Teaches you
the practical side of radio... repair, adjust-
ment, operation, alteration, trouble-shooting.
No previous knowledge necessary. Prepare to
set up a shop of your own—or train for the big
industrial electronics field. Simplified lessons,
including mathematics, review questions, prob-
lems, answers. Up-to-date! Only \$3.95, com-
plete. Money-back guarantee. Use coupon below.

REAL ESTATE BUSINESS

The foundation of all wealth is land! Train your-
self for a career in this booming profession. Here
is the information you need on how to get started
and how to get ahead in real estate. Includes in-
structions in appraisals, valuations, management,
investments, practical real estate operating, low
cost housing, the law on real estate transactions in-
cluding legal forms, etc., salesmanship, and many other subjects a success-
ful real estate man must know. Strictly up-to-date. Complete, only \$6.95.
Money-back guarantee. Use No-Risk coupon below.

MAKE MONEY!
RAISE CHIN-CHIN
CHINCHILLA RABBITS
Pedigreed! Valuable Breeders!
PROFITABLE! EASY! PLEASANT!
Free illustrated booklet—WRITE TODAY!
WILLOW BROOK FARM, SELLERSVILLE 36, PA.

BABY SHOE METALIZING BUSINESS

PROFITABLE - SIMPLE - PLEASANT
The Vari-Plater technique for metalizing baby shoes. Complete FREE Course, 116 illustrated pages and text with each plating set-up order. Write today for free details and descriptive literature.
LEWIS ELECTRICAL MFG. CO.
1943 Walton Ave., N.Y. 53, N.Y.

MAKE BIG MONEY LEARN TO REBUILD SEALED REFRIGERATION UNITS
LEARN NOW—WE TEACH YOU HOW MILLIONS of Sealed Units will need rebuilding. Factories usual charge is \$80 to \$100 per unit. We offer a Post-Graduate Course (18 weeks) to graduates of schools or those with few years service experience. **START YOUR OWN BUSINESS.**
PRACTICAL TRADES INSTITUTE, Inc. 25 University Ave., S.E., Dept. P-10, Minneapolis 14, Minn. **WRITE TODAY**

"IDEAL" PRECISION RANGE FINDER

Get professional, sharp, clear pictures from your movie or still camera with the beautiful precision built "IDEAL" Only Range-Finder." Easy to use —guarantees perfect focusing. **\$2.95**
Works the same as \$15.00 incl. Tax models. Highest quality optical system. Three year guarantee with each instrument. If your dealer cannot supply send direct.
FEDERAL INSTRUMENT CORP.
14-02 Broadway, Dept. 22, L. I. C. 6, N.Y.

Short-Cut Mathematics

COMBINED WITH
Practical Mechanics Simplified

Be a "master mind." Learn how to juggle figures, do baffling tricks with numbers. Add long columns of figures this lightning-quick, short-cut way. Multiply 4 figures by 4 figures without old-fashioned multiplication. Here are speedy, simplified systems used by stage "wizards," expert accountants, engineers. Only \$1.49. Course includes illustrations, problems, answers. Mail coupon below!

COMPLETE BLUEPRINT READING COURSE

Interesting, simplified self-instruction lessons for builders, mechanics, electricians, plumbers, welders, carpenters, automotive & aviation workers, etc. 24 volumes include over 600 actual blueprints, diagrams, other instructive step-by-step pictures. Unusual bargain for any practical man. Complete, only \$6.95, postpaid. Satisfaction or refund. Coupon below.

BUILD IT YOURSELF

Be a practical handyman. Save time and money with these professional Tricks-of-the-Trade. Carpentry made easy! New self-instruction course in one handy volume, complete with full page photographs, diagrams, etc. Teaches woodworking, painting & decorating, upholstering, power tools, cabinet making, etc. Full price only \$1.98. Money-back Guarantee. Mail coupon today!

Mail This No-Risk Coupon—Quick Action!
NELSON-HALL Co., 1139 S. Wabash Ave., Dept. K-2, Chicago 5, Ill.
Please rush me the items I am checking below. It is understood that if I am not 100% satisfied I will send the material back within 10 days and you will make full immediate refund, without question or quibble.

Watch & Clock Repairs.....	\$4.95
Locksmithing & Key Making.....	3.95
Practical Radio Servicing.....	3.95
Real Estate Business.....	6.95
Short-Cut Mathematics.....	1.49
Blueprint Reading Course.....	6.95
Build It Yourself.....	1.98
Apartment House Management.....	5.95
Jewelers' Encyclopedia.....	1.69
How to Sell Life Insurance.....	6.95
Complete Shorthand Course.....	4.95

I enclose \$..... in full payment. Ship postpaid.
 Ship COD for \$..... plus postage and COD charges.

Name.....
Address.....



of Aluminum, Brass, Copper, Stainless Steel

*Easily! Quickly!
at Low Cost!* For beginners and experienced craftsmen—here's a complete supply of quality metals pre-cut to the size you want . . . and at lowest metal warehouse prices!

ALUMINUM and COPPER CIRCLES, RECTANGULAR SHEETS of Aluminum, Brass, Copper and Stainless Steel. Easy to work, ready to be formed into trays, coasters and hundreds of useful items and gifts.

BRACELET BLANKS of Aluminum, Brass, Copper and Stainless Steel. Perfect for jewelry, ornaments . . . simple to work into attractive handicraft.

FREE BOOKLETS! "Making Aluminum Trays and Coasters", and "Copper Metalcraft" give complete directions for making beautiful metalcraft items easily and quickly. Send for your Free Copy Today!



METAL GOODS CORPORATION

Dept. PM 5239 Brown Ave. St. Louis, Mo.

WORK FOR THE



GOVERNMENT

START AS HIGH AS \$3,351 YEAR

Veterans Get Special Preference

MEN — WOMEN

Railway Mail Clerks
Postoffice Clerks, Carriers
Liquor Inspectors
Stenographers-Typists
Meat Inspectors
Many Other Jobs

PREPARE IMMEDIATELY FOR NEXT EXAMS
Common Education Often Sufficient

Mail Coupon TODAY



Franklin Institute
Dept. W83
ROCHESTER 4, N. Y.
(Not Government Controlled)

Gentlemen: Rush to me, FREE of charge, list of U. S. Government big pay jobs. Send FREE 40-page book describing salaries, vacations, hours, work. Tell me how to qualify for one of these jobs.

Name _____

Address _____ Vet? _____

The Wonder Book of Useful Household Hints

SHORT CUTS to Better Housekeeping



DON'T BE A SLAVE TO DOMESTIC DRUDGERY!

1000 Ways to Save TIME • MONEY • LABOR

IF YOU HAD THREE LIFETIMES you couldn't amass the practical wisdom packed into the pages of Popular Mechanics' **SHORT CUTS to Better Housekeeping**. Here is the cream of the household lore that has appeared in Popular Mechanics Magazine, PLUS new material prepared especially for this book.

THE PRICE OF THE BOOK is saved for you on every page of **SHORT CUTS to Better Housekeeping**. Each of the more than 1000 ideas is designed to save you money, time or useless labor—often all three aims are accomplished!

NO PHASE OF HOUSEKEEPING is overlooked—here are sections on Food Preparation, Sewing and Mending, Laundering, Ironing, Removing Spots and Stains, Caring for Clothing, Making Household Accessories Last, Home Formulas You Can Make, Household Repairs, How to Deal With Insect Pests, Caring for Your Pets, Interior Decoration.

DO YOU KNOW HOW TO: measure cooking ingredients quickly and accurately? . . . dress poultry without muss or fuss? . . . remove fish scales easily? . . . cut a hot cake? . . . open cans and jars with ease? . . . use spring clothespins in a dozen novel ways? . . . cut your laundry chores in half? . . . polish any metal? . . . thread a needle quickly? . . . baste seams without pins? . . . banish household odors? . . . get rid of ants? . . . make an endless clothesline? . . . refinish floors? . . . repair a broken chair? . . . remove furniture spots and rings? . . . clean ivory? . . . make perfect jelly? . . . keep a new kitten or puppy quiet at night? . . . repair cracked linoleum? . . . smooth a scratched mirror? . . . weatherproof a window? . . . **SHORT CUTS to Better Housekeeping** answers these and hundreds of other questions.

NO OTHER BOOK has such a wealth of information, or such positive solutions to household problems. 160 pages, only 60c. Get **SHORT CUTS to Better Housekeeping** at your nearest newsstand or your favorite food market! Or obtain by mail from

POPULAR MECHANICS PRESS
200 East Ontario Street Chicago 11, Ill.

FURNITURE for YOUR BEDROOM



SAVE MONEY, be the envy of your neighbors by making this beautiful bedroom suite yourself! Only a power saw and jointer are needed to turn out this smart suite, featuring bed with storage space, three-piece vanity with cosmetic compartment and makeup mirror, Mr. and Mrs. dresser, and twin night stands with drawers. Letters demanding detailed plans poured in after this furniture was pictured in Popular Mechanics Magazine. Now the 4 plans are ready—easy-to-follow scale drawings—and they're yours for only \$2.00! Send for a complete set today.

POPULAR MECHANICS PRESS
200 EAST ONTARIO STREET, CHICAGO 11, ILL.

Build Your Own Motorized Workshop

This Famous Book Shows How to DO IT!



NEW EDITION



Easy-to-Make 40 Different Power Machines

Make them yourself—lathes, drill presses, sanding machines, shaper, circular, band and scroll saws and other power tools— from wood, pipe, and discarded parts that cost little or nothing. Get the new edition of "Forty Power Tools You Can Make" even though you have the older edition. This new book has 20 new tools. Make yourself up-to-date, efficient power machines that will save you hundreds of dollars. Send \$1.50 with order and save high C. O. D. charges. Your money back if not satisfied.

POPULAR MECHANICS PRESS, 200 E. Ontario St., Chicago 11, Ill.

**NEW for
1950**

MIDWEST

Celebrates its 30th YEAR of FACTORY-TO-YOU
Selling with a Sensationally NEW 1950 LINE of

TELEVISION

CONSOLES *and* Complete CHASSIS

New GIANT 16" PICTURE TUBE

Here is Television at its finest! . . . brought to you by Midwest, for 30 years a leader in the field of radio and electronics. Immense 151-square-inch screen on new 16" metal-glass tube . . . clear, steady, bright pictures . . . Synchronized sound and picture that a child can tune in perfectly . . . Highest quality FM sound . . . Big 12" Electro-Dynamic Panasonic Speaker. Available in beautiful Consoles or in complete chassis as illustrated (not a kit, but a complete Television receiver ready to plug in and play) to place in your own cabinet. And you can buy Midwest Television at Low Factory Prices, with Low Down Payment and Long Easy Terms — and on 30 Days Trial!



NEW LOW
Down Payment
Long EASY
TERMS



LOW
FACTORY-TO-YOU PRICE
30 DAYS TRIAL

Not a KIT... This is a Completely assembled Receiver

... also a Magnificent Line of NEW 1950
MIDWEST RADIOS
featuring the latest Improved FM Circuit
and the New 3-SPEED RECORD PLAYER

Powerful new 1950 Series 16 and Series 12 AM-FM Radio in complete chassis. Also beautiful new Console models including the magnificent Symphony Grand Radio-Phonograph with latest FM circuit and new 3-Speed Automatic Record Player. New portable and Table Models also available.

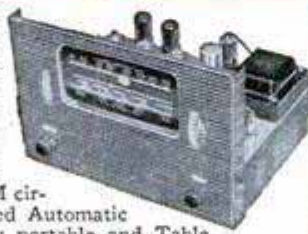

BUY DIRECT FROM THE MIDWEST FACTORY and SAVE!

MIDWEST RADIO & TELEVISION CORP.

Dept. X253, 909 Broadway, Cincinnati 2, Ohio

SEND FOR
FREE
32-Page
Full Color
CATALOG



Write in Name and Address (Please Print) on Coupon or 1c Postcard.

MIDWEST RADIO & TELEVISION CORP.
Dept. X253, 909 Broadway, Cincinnati 2, Ohio
Please send me your new FREE 1950 Catalog.

NAME _____
ADDRESS _____
CITY _____ ZONE _____ STATE _____

SENSATIONAL INVISIBLE BELT HOLDS PANTS UP AND SHIRT DOWN!

It does away with suspenders. Old style outside belt not needed. Eliminates continuous belt adjustments. Slims your waist.

INVISIBELT IS GUARANTEED

to do everything we say it will, or your money back!



- ★ Worn inside pants over the shirt.
- ★ 6 Plastic Uprights snap onto the 6 suspender buttons.
- ★ Holds the shirt down.
- ★ Drapes your trousers perfectly.
- ★ Prevents waistline sag—your pants stay where you put them.
- ★ Relieves pressure on your stomach.
- ★ Gives luxurious waistline comfort.

- ★ Economical — will outwear any leather belt — will outwear two pairs of suspenders.
- ★ Endorsed by Hollywood Screen Stars.

ORDER YOUR INVISIBELT TODAY

Small size for waistlines 28 to 32" — Medium, 32 to 36" — Large, 36 to 40" — Extra Large, 40 to 44". Every Invisibelt adjustable to 4 waist lengths. **\$2 Post-paid**

INVISIBELT

5028 Hollywood Blvd., Dept. F
Hollywood 27, California

Send size Small, Med., Large, Ext. Lge.
Enclosed is \$2, Cash, Money Order.

Name

Address

City State

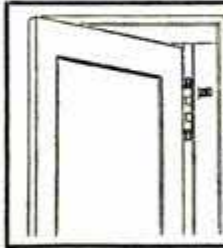

DOOR HINGE TIGHTENER

For loose door hinges, strike plates, door locks, garage door hinges, etc., where screw holes have become worn and no longer hold. Can be attached in a few minutes with hammer and screwdriver without removing trim. No plugging of holes or blocking behind hinges necessary. Price for 8 Tighteners and screws (enough for 4 loose hinges) \$1.00—prepaid; no C.O.D.

ELREDNE CO., Box 69, Irvington 11, N.J.

MECHANICAL DRAFTING LAYOUT AND DESIGN

Many opportunities exist for well trained men in this field. For a few cents a day you can study at home in your spare time. Thorough, practical work assignments in blueprint form. Small student body assures "personal instruction" to each student. Course includes necessary drawing board mathematics. Quality instruments and everything supplied. Standard industrial practices taught by State-approved instructor. Pay-as-you-learn. Get the Colonial story first. Write for Free Catalog today. Please state your age.

APPROVED BY STATE OF NEW JERSEY
COLONIAL SCHOOL OF MECHANICAL DRAFTING
Morris Plains, New Jersey

LEARN WATCHMAKING JEWELRY REPAIRING

Start your training now for a better paying job or your own profitable business. Intensive practical training by experienced craftsman. Write for free catalog. APPROVED FOR VETERANS.

SCIENTIFIC SCHOOL OF WATCHMAKING, DEPT. PM-10
3923 SAN FERNANDO ROAD GLENDALE 4, CALIFORNIA



Happy Highways Ahead!

With Popular Mechanics new **MOTORIST'S HANDBOOK**. 160 pages of authoritative advice to keep your car rolling smartly—longer. Brakes, body, spark plugs, battery, starter—every automotive part is covered in this up-to-the-minute manual of year 'round driving pleasure.

Your news dealer has the 60c paper edition. Order the clothbound \$2.00 volume from

POPULAR MECHANICS PRESS
200 E. ONTARIO ST. CHICAGO 11

Handy Mail Order List

Little Library of Useful INFORMATION

5 for \$1.00
12 for \$2.00
25¢ Each

Here at amazingly low cost is the practical help and information you have always wanted. Articles in previous issues of Popular Mechanics have been classified according to subject and are now available in these handy reprint booklets.

- How to Use Measuring Tools—Micrometers, Calipers, etc.—106.
- Power Driven Saws—74.
- Drill Presses, Grinders, Etc.—79.
- Wood, Metal Turning-Lathes—81.
- Filing Machine, Hacksaw, Cutoff Wheel, Shaper—82.
- Lathe Tools You Can Make—101.
- Workbenches—Tool Cabinets—47.
- Spray Painting—94.
- From Pattern to Casting—91.
- Tool and Saw Sharpening—92.
- Sharpening Drills, Wood Bits—90.
- Successful Wood Turning—32.
- How to Read Blueprint—71.
- Metal Turning Lathes—99.
- Operating a Metal Lathe—100.
- Heat Treating, Hardening—102.
- Working With Glass—103.
- Servicing Elec. Motors—75.
- Electromagnets & Solenoids—44.
- Transformer Construction—41.
- The Boy Electrician—43.
- Soldering and Brazing—17.
- Arc and Spot Welders—5.
- Electroplating With Nickel, Chromium, Cadmium, Etc.—86.
- Plating Leather, Wood, etc.—87.
- Lower Your Fuel Costs—31.
- Curing Leaky Basements—45.
- Fitting Home Game Room—55.
- Indoor & Outdoor Fireplaces—88.
- Backyard Gardening—39.
- Lawn and Garden Novelties—72.
- Trellises, Pergolas, Fences—76.
- Lawn and Garden Furniture—77.
- Playground Equipment—73.
- How to Use Your Drill Press—125.
- Making Serving Trays—53.
- Knots and Ropework—105.
- Sanders—80.
- House Wiring—89.
- Hanging Wallpaper—38.
- Built-in Fixtures—78.
- Bird Houses—7.
- Magazine Racks—49.
- Clock Cases—50.
- Book Ends—52.
- Small Tables—54.
- Smoking Stands—56.
- Desks—58.
- Book Cases—59.
- Action Toys—66.
- High Flying Kites—67.
- Telescopes—20.
- Metal Craft—28.
- Small Looms—37.

- Working With Plastics—61.
- Simple Home Improvements—104.
- Ridding Home of Insect Pests—107.
- Children's Room Furniture—51.
- Jigsawed Novelties—57.
- Doll House & Doll Furniture—60.
- 25 Shelves You Can Make—64.
- Novelties Turned on Lathe—62.
- Inlay Pictures—Veneering—63.
- Wood, Soap Carving—65.
- Windmills & Weather-vanes—68.
- Lamps from Wood, Metal—69.
- Rustic Furniture—18.
- Wood Finishing—40.
- How to Fix Electrical Appliances—111.
- Painting Your House—117.
- Build Your Own Relay—123.
- Rowboats, Small Dinghy—83.
- Small Sail Boats—84.
- Two Outdoor Runabouts—85.
- Build Own Canoe, Kayak—30.
- Build Class-E Ice Yacht—22.
- Auto Kinks, Shortcuts—10.
- Lawn and Garden Equipment—124.
- Motor-Driven Midget Cars—34.
- Stop Auto Elect. Troubles—95.
- Photo Printers and Dryers—25.
- Photo Darkroom Equipment—96.
- Trick and Table Top Photos—97.
- Home Movie Equipment—118.
- Poultry Houses—108.
- Guns and Decoys—109.
- Re-Silvering Mirrors—70.
- Chemical Experiments—93.
- Log Cabins, Tourist Houses—14.
- Using Basic Tools—120.
- Farm and Garden Tractors—8.
- Building Extra Attic Rooms—23.
- Attractive Basement Rooms—24.
- Gem Cutting—42.
- Photo Enlargers—1.
- Photo Kinks—98.
- Cleaning Formulas—11.
- Taxidermy—9.
- Photo Lighting—119.
- Training Dogs—35.
- Small Furnaces—36.

Check Titles Wanted, Clip, Mail with Remittance to

POPULAR MECHANICS PRESS, Dept. 635, 200 E. Ontario, Chicago 11

Say You Saw It in
POPULAR MECHANICS

BE A PHOTO-ENGRAVER

We furnish complete equipment and supplies. Learn at home or in our modern, friendly APPROVED school in MISSOURI. Get into this big demand, high profit, high wage field. You can start your own profitable, full time or part time PHOTO-ENGRAVING business right in your own home.

THE AURORA SCHOOL OF PHOTO-ENGRAVING,

Be independent, be your own boss or pave the way to a high pay job with experience gained in your own shop.

TASOPÉ TRAINING and TASOPÉ EQUIPMENT has enjoyed world wide recognition since 1931. Write for descriptive literature today. No obligation.

DEPT. 9PM., TASOPÉ BLDG., AURORA, MO,

We can't



STOP THE PRESSES!

There's so much demand for the practical "how-to-do-it" books published by Popular Mechanics Press! The big fall list contains one or more fascinating and profitable books for every one of the family.

4 NEW BOOKS

4 ANNUALS



Money-Making Hobbies. Shows 132 ways to earn extra income! Hundreds of useful and beautiful things to make. 160 pages. On Sale Now! 60c.

Shop Notes. 1950 edition of an old favorite for men who use tools. A manual of time and labor-saving hints. 240 pages. \$1.00. On Sale Now!



Short Cuts to Better House-keeping. No other book like this! 1000 ways to save your time, labor and money. 160 pages. 60c. On Sale Sept. 15.

What to Make. Vol. 11 of this famous series of best projects from Popular Mechanics' Craft articles. 240 pages. \$1.00. On Sale Sept. 15.



Christmas Handbook. Gifts you can make, decoration ideas, how to make Xmas cards, hints for entertaining, etc. 144 pages. 60c. On Sale Oct. 1.

Home Kinks. Popular Mechanics annual collection of short cuts to home repairs and maintenance jobs. 112 pages. 35c. On Sale Oct. 15.



Planning Your Home Workshop. Sam Brown reveals secrets of getting the most out of your workshop. 128 pages. 60c. On Sale Oct. 15.

Useful Ideas. Another famous PM annual with helpful hints for homemakers, gardeners, mechanics, sportsmen, motorists. 112 pages. 35c. On Sale Nov. 15.



Get these helpful books at your favorite newsstand. If not available, write—

POPULAR MECHANICS PRESS
200 East Ontario Street
Chicago 11, Illinois

SAY YOU SAW IT IN POPULAR MECHANICS

OCTOBER 1949

PEARL

FINISHING OFFERS YOU

BIG MONEY

RIGHT AT HOME

AMAZING NEW PEARL FINISH can be instantly applied to any article—leather—wood—plastic—glass—metal, etc.

BABY SHOES preserved for life in beautiful Baby Pink, Blue, and Ivory thrill mothers and bring immediate sales.

Nothing else like it! Costume jewelry, buttons, earrings, treasured mementos, etc., etc., take on new splendor and beauty at once.

TREMENDOUS DEMAND—Help us fill it—Fantastic profits await those who act NOW. Be First! Scoop the market. Never before has such an opportunity been offered. Never before such Big Profits made so quickly.

DON'T PASS THIS UP—It costs Absolutely Nothing to get the FREE FACTS that show you the EASY WAY to QUICK, BIG MONEY overnight. Mail Coupon TODAY!

PEARL-KOTE CO., Dept. 2
2111 W. Manchester Ave., Los Angeles 47, Calif.
Okay! RUSH me FREE FACTS at once.

Name _____
Address _____
City _____ Zone _____ State _____

\$100.00 A DAY
Yes! \$100⁰⁰ a day!

Sensational "walk-in, walk-out" 10-second demonstration makes possible 30 to 50 calls a day. Sell 1 out of 3 for a daily profit of \$100 or more.

Spectacular Invention

You write on glass in 5 colors with "Magic Crayon." Then watch letters "catch fire" and burn like brilliant Neon! Merchants amazed... snatch crayon out of your hand... start writing themselves! NOTHING BEFORE LIKE LITEWRITER PROFITS ever thrilled salesmen.

Rush Coupon for FREE Offer on the most Breath-taking Money Maker of the Day!

Salesmen, Distributors, Crew Managers try out Litewriter for one day—then drop everything for this astounding money-maker. It's patented—hence exclusive with Maxilume men. No competition. Quick sales come easy. Many merchants buy three or four. Many salesmen close 1 out of 3 demonstrations. **Don't waste time.** Wire, phone or airmail name for facts. ALL FREE. If you have crew, ask for Exclusive Territory information. This is the biggest thing of the year. Don't miss it!



L. B. Patterson, MAXILUME CO., Dept. L-310,
125 W. Hubbard St., Chicago 10, Illinois

Rush complete information on Litewriter, Free Selling Kit, Free offer of Demonstrator and instructions for making "walk-in, walk-out" demonstration. No charge now or at any other time.

Name _____
Address _____
City _____ Zone _____ State _____

PLASTI-LINER

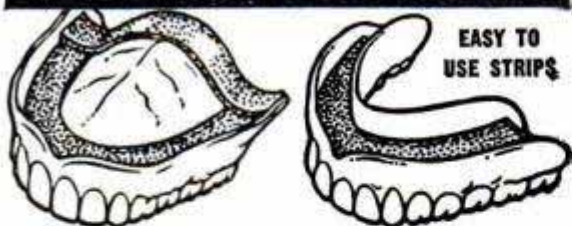

EASY TO
USE STRIPS

One application MAKES FALSE TEETH FIT for the life of your plates

If your plates are loose and slip or hurt, use this amazing, pliable, non-porous strip to refit them yourself, for instant and permanent comfort. It's easy. Just lay the strip on your upper plate or lower plate, then bite and it molds perfectly. Hardens for lasting fit and comfort. Helps stop the embarrassment of slipping, rocking plates or the misery of sore gums. Eat anything and talk freely without fear your teeth will loosen. Ends forever the mess and bother of temporary applications that last only a few hours or months.

EASY TO RE-FIT AND TIGHTEN FALSE TEETH
PLASTI-LINER is tasteless and odorless. Won't injure your plate. Guaranteed to give satisfaction or your money back. Removable as per directions. Users say: "Until I used Plasti-Liner I used several kinds of liners without success. Now I can eat anything." H. H. M. "My plates are now better fitting than new." E. H. C.

SEND NO MONEY Just order a \$2.25 package of PLASTI-LINER to reline both upper and lower plates, or \$1.25 to reline one plate. Deposit money with your postman when he delivers. Or send the money now, and save C. O. D. charges. Generous sample of special plate cleaner supplied free.

PLASTI-LINER COMPANY, 1740 Bailey Avenue
Buffalo 11, N. Y., Dept. 43-K

Say You Saw It in Popular Mechanics



Modernizing?
Remodeling? Use..
CHROMTRIM
"Trim-it-Yourself"
METAL MOULDINGS

You'll find hundreds of uses for this handy metal trim around your home. Kitchen, bathroom, stairs or attic can be streamlined in a jiffy. Chromtrim comes in convenient 6' lengths, 12 shapes, all ready to tack on.

Chromtrim is easy to cut - Economical to use - Bends simply to any shape.

Send 10¢ for "Trim Ideas" - 16 pages brimming with Chromtrim projects, ideas, and directions for use.

R. D. Werner Co., 291 Fifth Ave., N. Y. 16
Enclosed is 10¢ for CHROMTRIM "Trim Ideas" booklet PM-10

Name _____
Address _____
City _____ Zone _____ State _____

R. D. WERNER CO., INC.
295 Fifth Avenue, New York 16, N. Y.

"SEA CRAFT" BLUEPRINTS READY NOW!

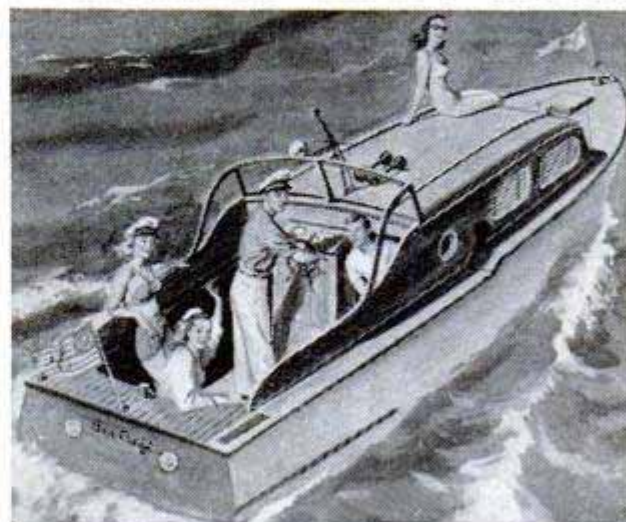

Build this luxurious cabin cruiser yourself and save money. What a beauty it is! A 25-foot boat readily adaptable as a sport fisher, express cruiser, or utility boat. Cruises effortlessly at 15 knots with a marine engine or converted auto motor. Its spacious cabin sleeps four and has a galley complete with fresh-water tank, sink, and cook stove. Has open cockpit large enough for fishing, lounging, etc.

During war the Coast Guard used "Sea Craft" for ship-to-shore travel. Order today your complete set of seven large-size blueprints scaled 1 inch to the foot. These, plus a 40-page two-color illustrated booklet giving step-by-step instructions, only \$10.00.

POPULAR MECHANICS PRESS
200 EAST ONTARIO ST. CHICAGO 11, ILL.

THEY MAKE JOBS EASIER
-HELP ME EARN MORE!

SAVE MONEY ON
Popular Mechanics
SHOP NOTES
for a limited time!

3 Latest Volumes Only **\$1.98** Postpaid

Now you can get three of Popular Mechanics famous, practical and helpful year books for the price of two. Every man who uses tools needs Shop Notes—packed with hundreds of ideas and kinks for machinists, auto workers, sheet metal men, painters, carpenters, plumbers, electricians, home repairers, home craftsmen and others. Every page of every volume is filled with money-saving and money-making facts for both professional and amateur mechanics, that you can use every day.

Start your Shop Notes Library now while our limited supply of the three latest volumes lasts. Rush coupon today with \$1.98 for 1948 and 1949 volumes and we will include 1947 FREE. Send only \$1.98 for all three volumes.

**688 PAGES
OVER 2000
Illustrations**
Written in Popular Mechanics' famous style—Easy to Read—Easy to Understand—Easy to Use.

POPULAR MECHANICS PRESS, Dept. 400, 200 E. Ontario St., Chicago 11
Rush Shop Notes volumes as checked. Remittance enclosed for

\$ _____
 Special Offer: 1949-1948 and 1947 volumes—\$1.98
 1949 Volume—\$1.00
 1948 Volume—\$1.00
 1947 Volume—60¢

Name _____
Address _____
City _____ Zone _____ State _____

Free!
7-Day Trial
 Just Mail Coupon NOW

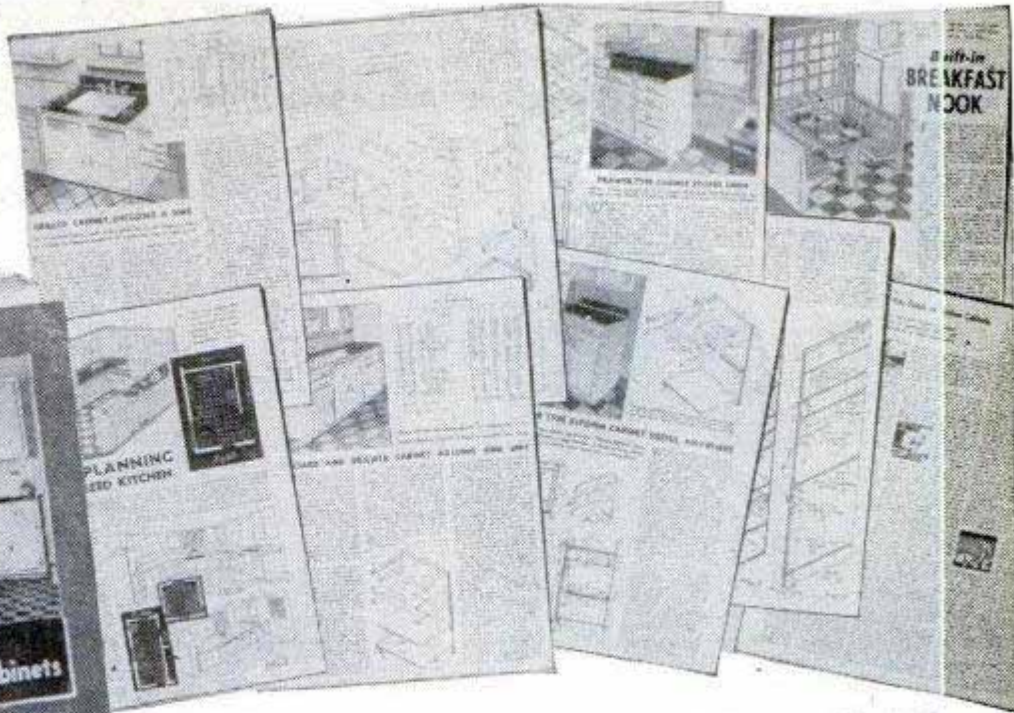

How Thousands Are Now Getting NEW KITCHENS This Easy Way! Amazing New Book Shows How to Plan the Space—Build the Cabinets, Install and Finish Like a Professional

Which of these
**MODERN
 KITCHENS**
 do YOU want?



TYPICAL kitchen schemes shown here are but a few of many—many combinations you can have by selecting cabinets for your own special needs and in widths that fit your available space.



PLAN A is a suggested arrangement if you have two adjacent walls for cabinets. PLAN B gets a wide variety of cabinets into compact space along one wall. PLAN C has broom closet.



PLAN D has cabinets along one wall and utilizes corner for convenient dinette. PLAN E is laid out on the efficient U principle around three walls. Built-in breakfast nook included.

"How to Build Modern Kitchen Cabinets" can also make your dream kitchen come true! Thousands have ordered this wonderful book on FREE TRIAL. Hundreds have written of amazing results. And no wonder! For it guides you every step. Helps you pick best cabinets for special needs. Then shows how to install, finish for a perfect job. Now let "Modern Kitchen Cabinets" give you, too, the kitchen cabinets you need. Send for it now on free trial.

Save Money Building Your Own!
 Shows you how to build one cabinet, at a time, or combination. A style for every purpose, a size for every kitchen.
 When you're ready, simply measure space, refer to "Modern Kitchen Cabinets" complete lumber list of sizes. Easy as that! Simplified—all the help you need. Units designed to be assembled in workshop and brought to kitchen ready to install.

Secrets of Planning Revealed
 Should cabinets be near door? Sink? Work counters? Where should dishes be kept? Answers are in your copy of "Modern Kitchen Cabinets." An architect works with the same facts you find here. Read chapter on "Secret of Planning a Modernized Kitchen" and you, too, will learn fundamentals.

Then select the RIGHT CABINET'S and locate them to save steps. You'll pick the best combination to fit your space. Be sure of work counters where needed!

To save time and error, the designer has prepared a cutting list in chart form. There's a chart for each cabinet, complete for whatever size you choose. This alone cuts work in HALF. All you do is cut single pieces of wood to sizes given. When all are ready, assemble into a finished cabinet!

Gives You the Answer to Every Problem

Every step, every operation fully described. Every detail clearly shown. How to cut joints, what size to cut every piece in every style. Nothing missing! Plywood or solid wood; plastic or metal moulding. Reveals types, how to install hardware. How to hang cabinet. How to cement linoleum to tops. How to insert grilles. How to ventilate. Special drawer-runner construction. Beautiful, lifetime hard-cover binding.

Mail Free Examination Coupon Now

Will be sent for 7 days' free trial. Now you, too, can build the kitchen cabinets you need. You, too, can plan your own kitchen. Why delay? Why be old-fashioned? Get started now!

SEND NO MONEY JUST MAIL COUPON

Pay postman only \$1.50 plus postage, or send \$1.50 (check or money order) and WE pay postage. Read and study it for 7 days at our risk. If not delighted—if not worth every penny of \$1.50 to you, send it back at our expense. We will refund your \$1.50 by AIR MAIL.
"HOW TO BUILD MODERN KITCHEN CABINETS" was compiled by the Editors of CRAFTSMAN PUBLISHING.
 CRAFTSMAN PUBLISHING CO.
 115 Worth Street, Dept. PM10
 New York 13, N. Y.

What Two Out of Hundreds say:
 "I have made quite a few from plans. I received 15 more orders."
 —M. F., New Jersey.
 "I am in the midst of making a complete set using the plans which I find excellent. You have set them forth in such complete detail—greatly appreciated."
 —W. J. R., Absecon, N. J.

Craftsman Publishing Co., Dept. PM-10
 115 Worth St. New York 13, N. Y.

Send me, too, "How to Build Modern Kitchen Cabinets" on 7 days' Free Trial. If I am not delighted, you will refund my \$1.50 at once.

Name _____
 Address _____
 City _____ Zone _____ State _____
 I enclose \$1.50 Send postpa.d.
 Send C.O.D. I will pay postman \$1.50 plus postage.

Wide Variety of Floor and Wall Models

- 1—Sink.
- 2—Drawer and cupboard.
- 3—Single door.
- 4—All drawer.
- 5—Double door.
- 6 & 9—Corner.
- 7—Double door wall unit.
- 8—Single-door wall.
- 10—Broom closet or storage.
- 11—Desk and storage.

EVERY STYLE CABINET!



R. J. Reynolds Tobacco Co.,
Winston-Salem, N. C.

P.A.* means **P**ipe **A**ppeal
P.A. means **P**rince **A**lbert

A pipe-smoking man scores a hit with the ladies. And Prince Albert—America's largest-selling smoking tobacco—scores with pipe smokers who demand a mild, rich-tasting tobacco. P.A.'s choice, crimp cut tobacco is *specially treated to insure against tongue bite*. Get P.A.!

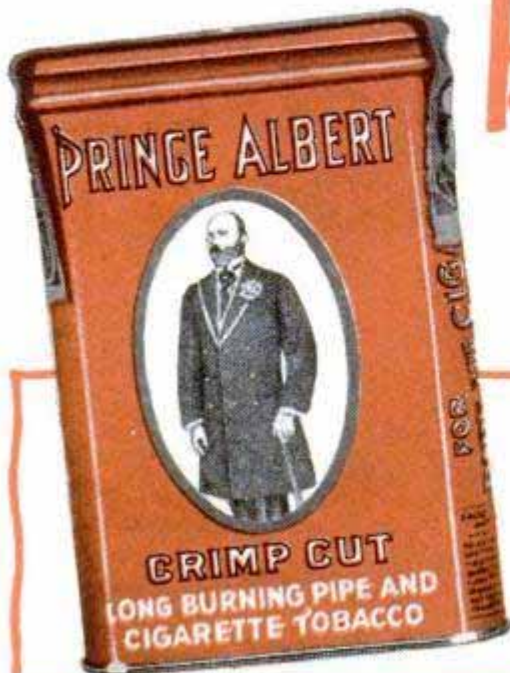

*GRAND FOR ROLLING YOUR
OWN CIGARETTES, TOO!*

The National Joy Smoke



POPULAR OCTOBER 1949
MECHANICS

WRITTEN SO YOU CAN UNDERSTAND IT
VOL. 92 NO. 4

Million-dollar baby of the atom age

By **Wayne Whittaker**

NEW YORK CALLING," said the operator. James A. Schoke, 25-year-old president of the Nuclear Instrument and Chemical Corporation in Chicago, picked up his telephone. An executive of a large sporting goods house was on the other end of the wire.

"When can you deliver 200,000 portable

Geiger counters?" the New York man wanted to know.

Even the youthful president of a business which has mushroomed in three years from a one-room store operation to a company with an annual sale of one million dollars in instruments was taken aback. What would a sporting goods firm want

James A. Schoke, 25-year-old president of thriving "atom age" company, tests vacuum system in laboratory

Photos by John Drew Atkin

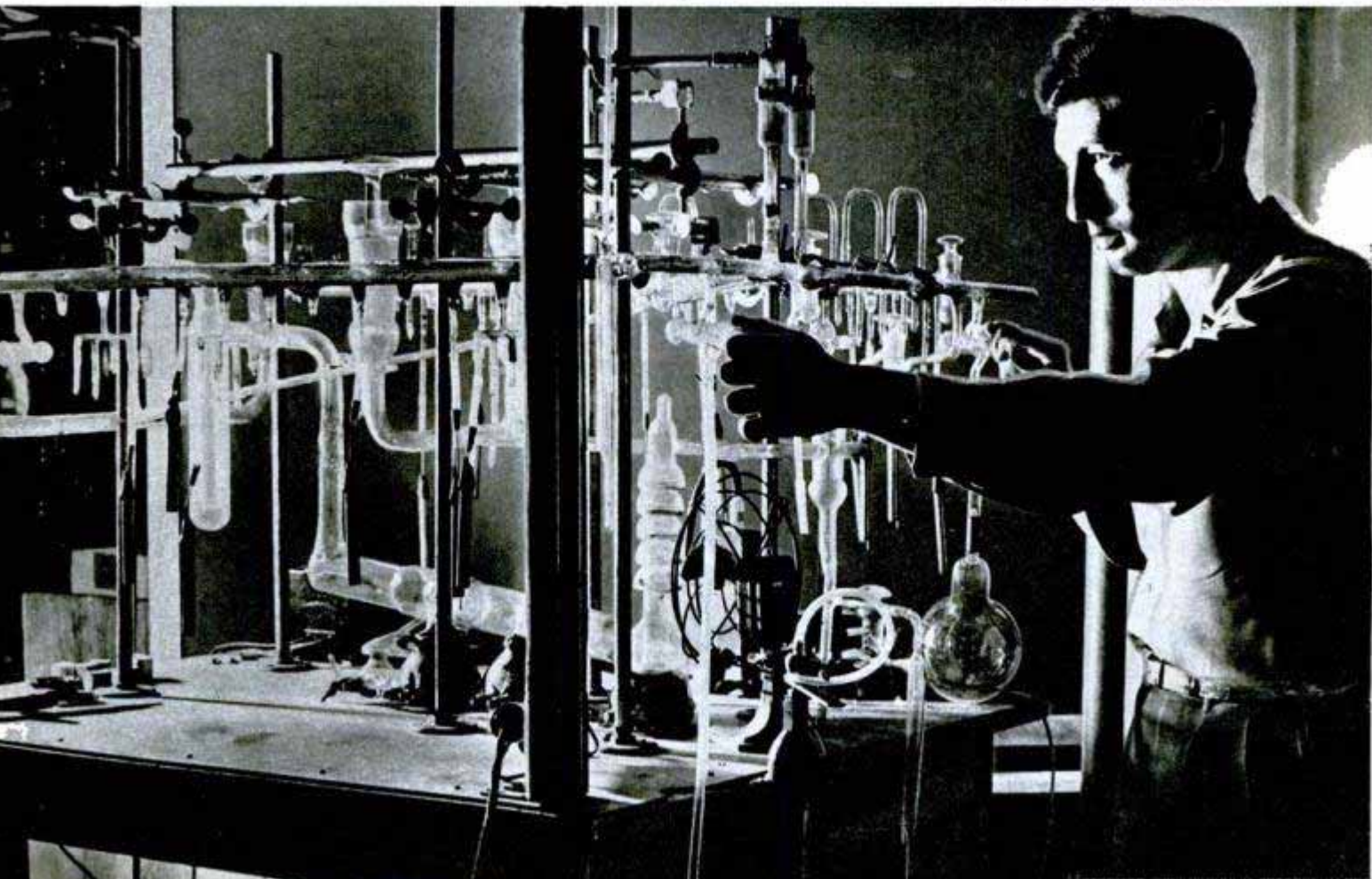

with 200,000 Geiger counters? The counters are used for detecting radioactivity. Portable sets are popular with uranium-ore prospectors.

"We plan to make radioactive golf balls," said the sports executive, "and want the Geiger counters so players can find them in the rough. Do you think it's practical?"

Schoke thought a moment. "Possibly," he said.

Next year small metal boxes slung over the shoulders of thousands of caddies may

be the result of that long-distance telephone conversation.

Every day in some part of the world a new business is discovering jobs for radioisotopes. The rays loosed by cracked atoms perform wonders and new industries founded on nuclear fission have mushroomed almost overnight.

Nuclear is one of these companies. It was started in 1946 by four young scientists who helped build the atom bomb on the Manhattan Project at the University of

Chicago. After the war they rented a small space near the university and their business has flourished at such a rate that they will sell a million dollars worth of instruments this year.

Geiger counters are just one of their products. Their special instruments range from miniature tubes used in medical research to a huge 48-channel differential analyzer built to order for the Nuclear Institute at the University of Chicago. One of the smallest instruments made by the company will be inserted in a dog's abdomen to study the rate of blood flow.

In addition to Schoke, the other executives and co-owners are John L. Kuranz, 27, a physicist, vice-president and sales manager; Thomas E. Mitchell, 27, an electrical engineer and accountant, executive vice-president and general manager; and Emil Hinspater, 35, vice-president, engineer and production manager. The others occasionally call Emil "Gramp" due to his "advanced" age. Schoke, Kuranz and Mitchell were in the Corps of Engineers while working on the atom bomb and Hinspater served as a civilian.

The four young men learned to respect each other's abilities in the metallurgical laboratories of the project. Each had a different specialization and when Dr.

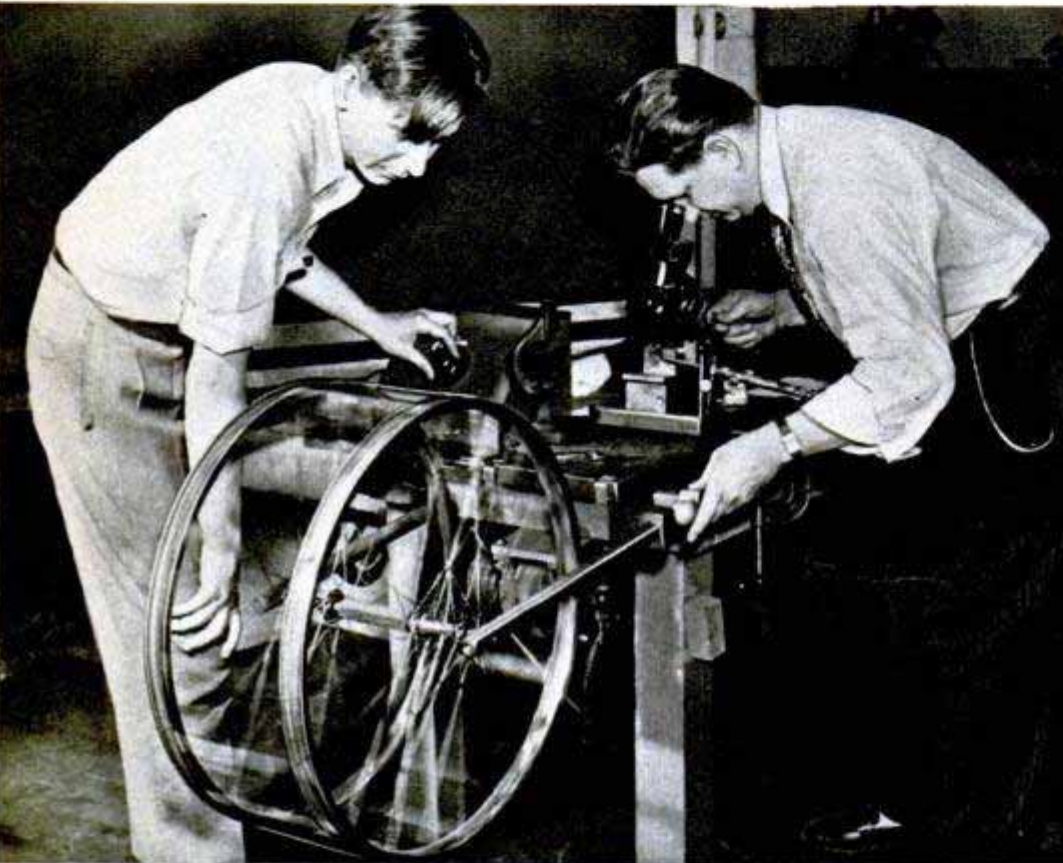

Emil Hinspater (right) company vice-president, calls this outfit his "mechanical spider." He built it for making fine quartz fibers. Here he is watching blob of molten quartz from which the strands are made as fine as 2/100,000 inch in diameter. Below, a close-up of coarse strands of the spun quartz

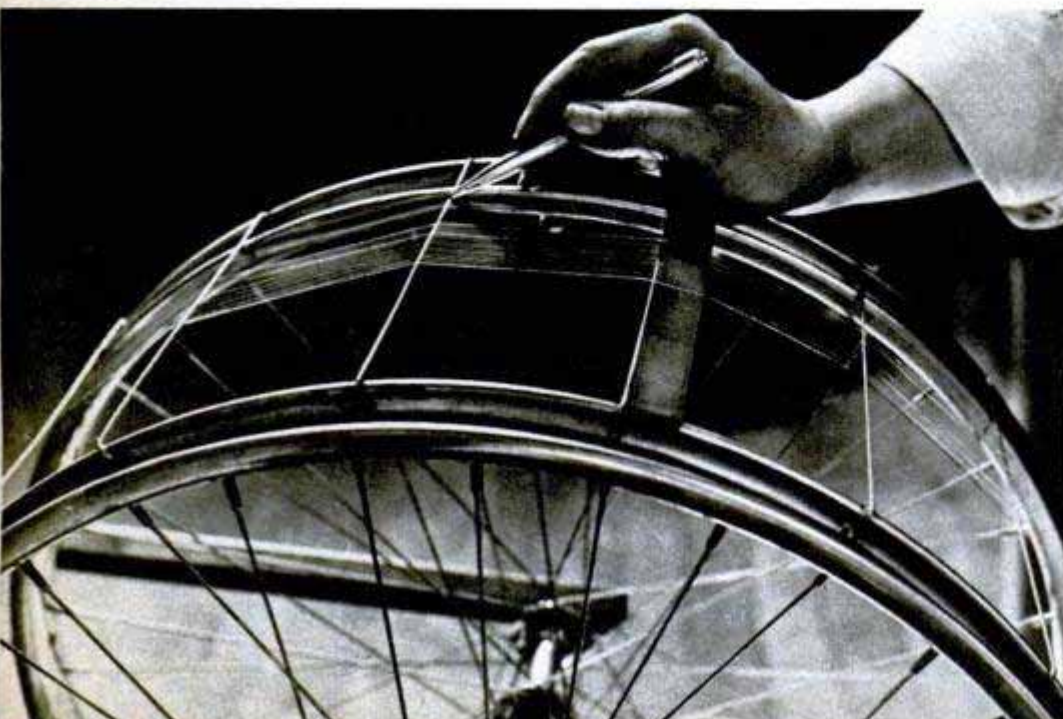



Farrington Daniels, director of the laboratory, suggested that various groups should pool their efforts after the war, the four thought it an excellent idea.

"We knew all about the isotopes and their uses but did not know for sure that they would be made available," said Kuranz. "We used to sit around a little room I had in the basement of Eckhart Hall on Saturday afternoons and talk about the future. It all concerned what you could do with those radioactive isotopes for civilians. At that time we didn't own a soldering iron between us."

Schoke laughed. "If we had had any business experience we wouldn't have dared attempt what we did. In our one-room store we had to compete with multi-million-dollar concerns with huge labs and big reputations."

But these four men had something their rich competitors could not buy: know-how acquired on the atom-bomb project and friends who had scattered to strategic laboratories—many operated by the Atomic Energy Commission. Mitchell refers to this as a "chain reaction that worked in our favor." Today their long list of customers looks like a Who's Who of world business.

"I'll never forget our first sale," said Schoke. "We had worked for months without taking in a penny. A biochemist at the University of Wisconsin who had worked on the bomb project bought an electronic scaler. It amounted to \$280 and, believe

Girls on the assembly line are all specially trained and quality, not quantity, is the rule here. All four top executives of the company have worked on line

This 48-channel differential analyzer was built to record varied radiations of radioactive materials

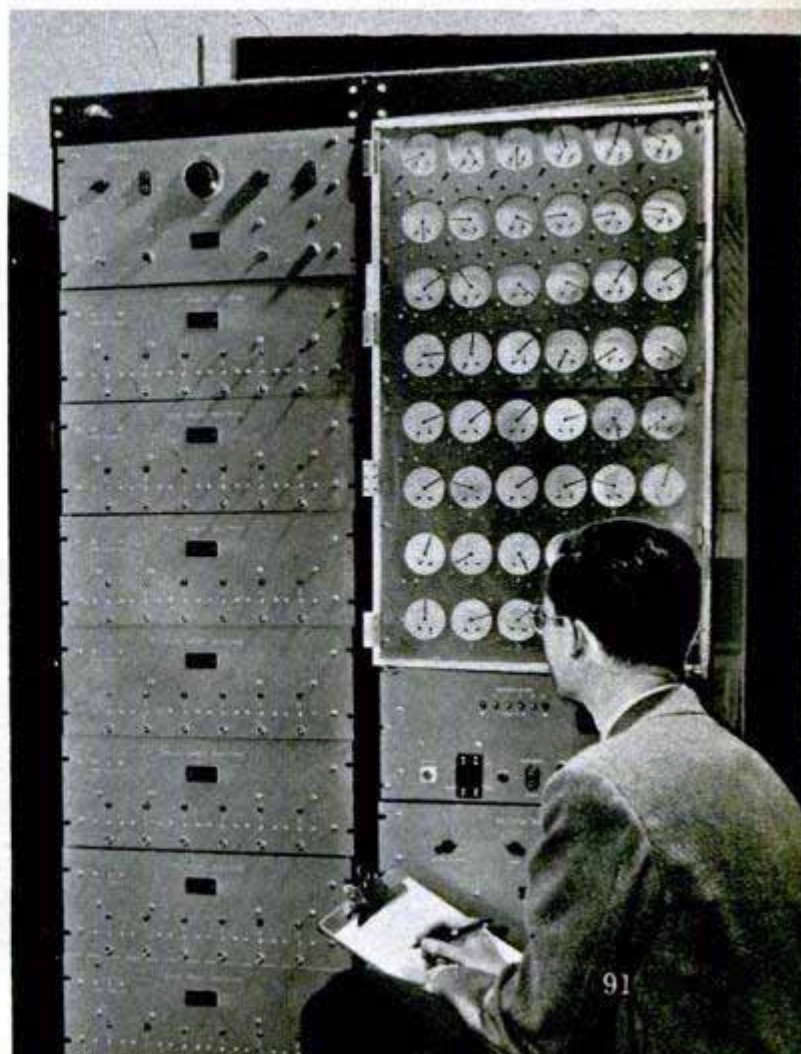

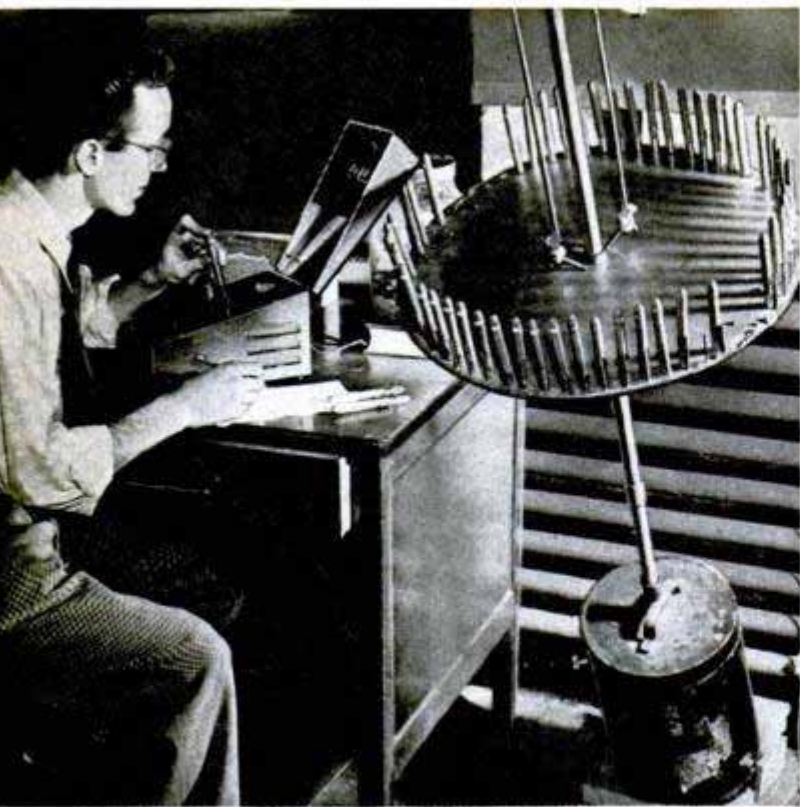

John Kuranz testing pocket chamber such as is used by atom-laboratory workers to detect radioactivity

me, that seemed like a fortune in those early days."

They all refer to 1946 as "the early days."

Kuranz took up the story: "At that time the University of Chicago would not do business with us. We were so small they were afraid of us and you can't blame them. Mitchell kept saying, 'If we could just make one big sale to the Atomic Energy Commission our troubles would be over'."

All that first summer Nuclear concentrated its energies on an AEC sale. The four wrote to every man they could think of in AEC describing their facilities for

manufacture and listing machines they could build.

"By September things looked a bit grim," said Schoke. "All our bonds had been cashed long ago. Then one beautiful morning we heard a whoop from Kuranz who was opening the mail. It was a good-sized order from the revered AEC for some electronic equipment they couldn't get anywhere else. Would we like to try our hands at designing and building same? Would we!"

That was what Nuclear's executives refer to as their first "hump." They crossed it with colors flying and before Christmas of 1946 they had a backlog of orders which has increased steadily. However, after orders began to pour in there was the new headache of obtaining materials. Shortages gradually eased and in August, 1947, the company moved to its present location on Chicago's near north side where Nuclear now occupies 14,000 square feet of manufacturing space.

Each of the partners can still perform almost any job in the place—and occasionally does. None of their 65 employees is surprised to find the president or a vice-president working beside him on a rush order.

The first machine sold by the company—an electronic scaler—remains their "bread and butter" instrument. Kuranz describes the scaler as a "basically simple" instrument whose sole purpose is to make recordable the pulses that correspond to radioactivity. These pulses occur so fast that no mechanical means can do the recording and scientists must employ electronic memory circuits to do the job. For every 64 pulses that come into the instrument just one is registered mechanically.

Although Nuclear now has a modern

"Windowless" radiation counter permits samples being tested to be taken directly inside the instrument and detects "soft" radiation of the useful Carbon 14. The Q-gas developed by Nuclear is kept in tank at rear



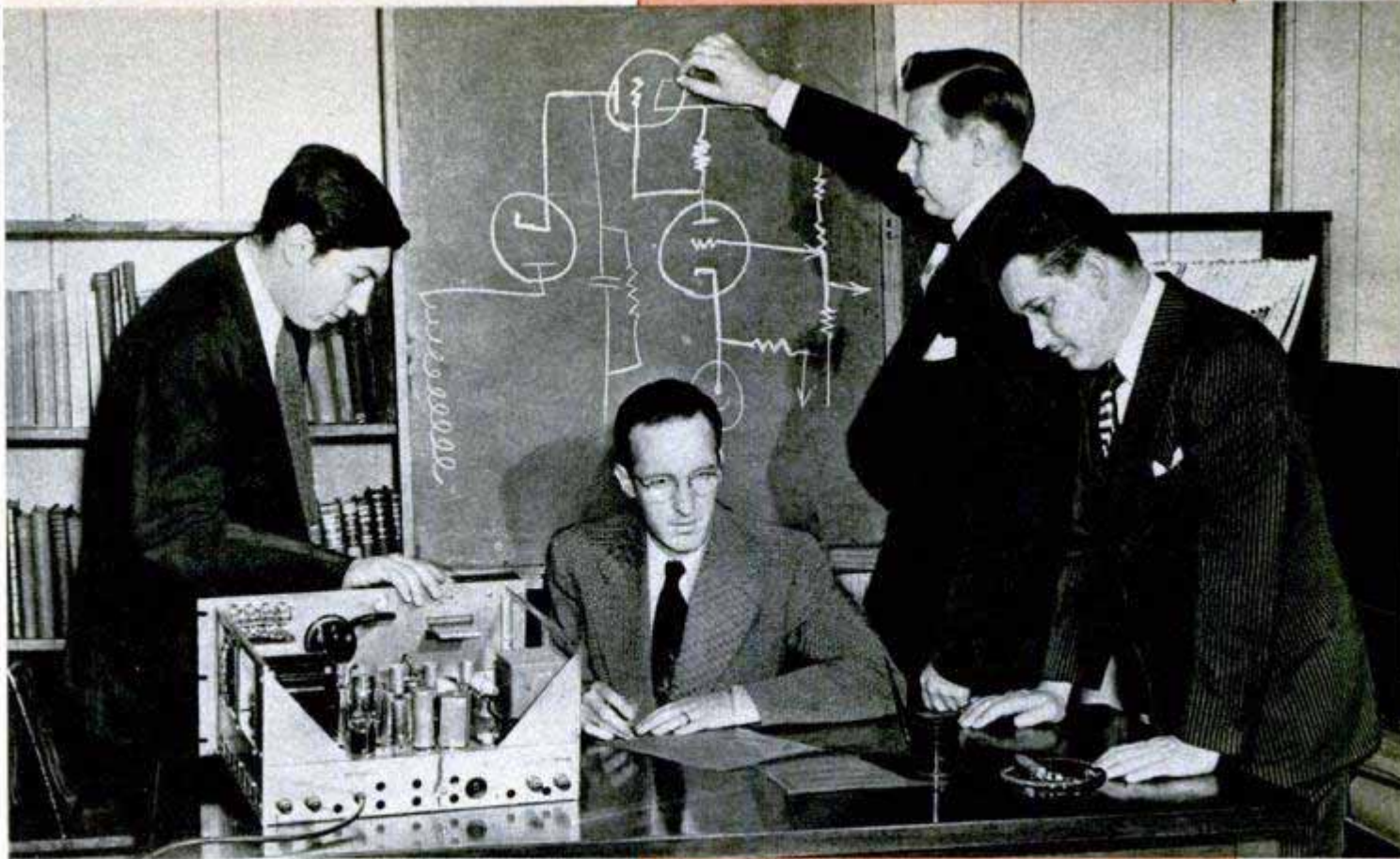

Nuclear executives (left to right) Schoke, Kuranz, Mitchell and Hinspater hold consultation over minor change in an instrument. Below, portable Geiger counter called Sniffer

assembly line and excellent research laboratories, its four founders occasionally resort to ingenious and unorthodox methods and materials for getting results. When it was impossible to secure quartz fibers at a diameter of less than $2/100,000$ inch, Hinspater produced them on what he calls a "mechanical spider." His partners recall their consternation when he walked into the laboratory one day with two bicycle wheels, a bunch of rubber bands, cellulose tape, a $1/10$ -horsepower electric motor, a small lead burning torch, bench plate, a few bolts and other odds and ends. He brushed aside their suggestions that he should take a long restful vacation and instead set to work building his "spider." The torch is used to heat the end of a pure quartz rod into a tiny molten blob. A strand from this blob is carefully "threaded" onto the bars between the bicycle wheels which are slowly turned by the electric motor. The tape is used to hold the first "pulling" of threaded fiber from blob to wheel. This process requires infinite patience and perfect timing. When the fibers are removed from the wheel they are iridescent and almost invisible. Before they are used in instruments the fibers are platinum plated by a special process in a vacuum chamber. They are used in fine instruments to cast a shadow by means of an optical system on scales.

Things are moving so fast in the field of nuclear research and development that several instruments developed by Nuclear

(Continued to page 266)



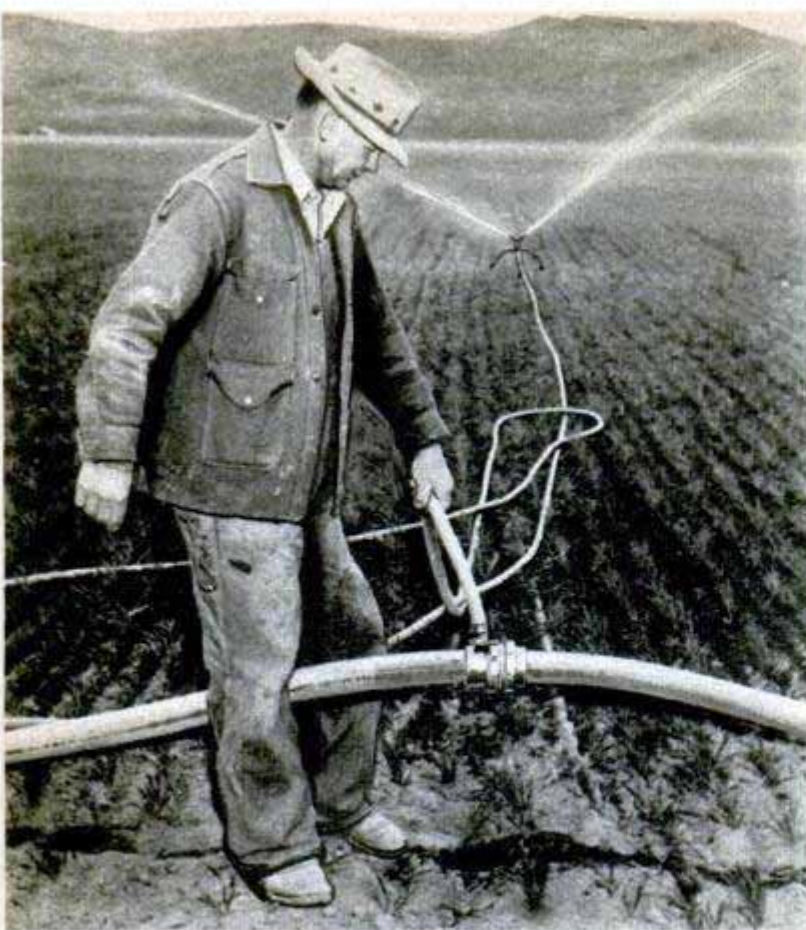

Ludwig couples his 100-foot feeder lines made of garden hose into the fire hose at 50-foot intervals

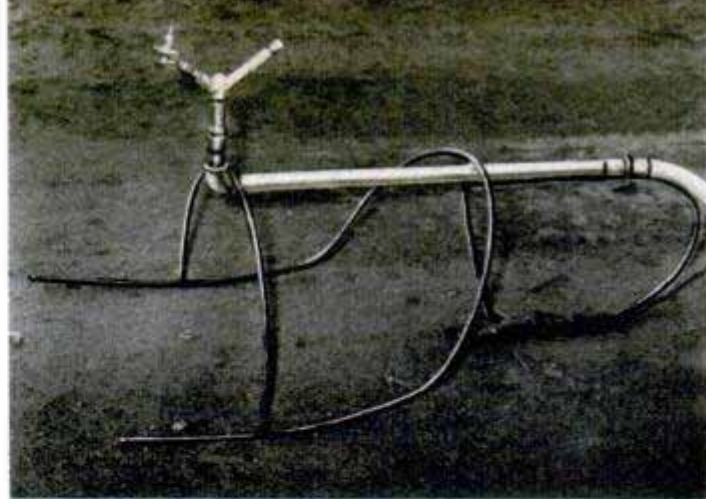

Sprinkler heads are mounted on sled-runner supports so they can be pulled several feet without tipping

Reel-Up Irrigation System

IT'S EASY for W. F. Ludwig, a Washington farmer, to move his irrigation system from one field to another—he just reels it up and takes it with him. By connecting fire and garden hose with water hydrants, Ludwig has worked out a portable irrigation system. He first designed it as a temporary measure but the system works so well he has decided to use it permanently. When he wants to irrigate a portion of his land he runs out a 1650-foot length of fire hose mounted on a reel on his Jeep. Feeder lines made of 100-foot sections of garden hose couple into the fire hose at 50-foot intervals, reaching out into the field to supply 34 sprinkler heads. These sprinklers are mounted on sled runners so they can be pulled several feet to a new location without tipping over. Ludwig moves the water about 30 feet every 12 hours by traveling along the main hose line and tugging on the feeder lines. It takes only 30 minutes to make the change. This method puts water on 10 acres of land with a single setting of the fire hose. After moving the laterals eight times over a period of four days, Ludwig climbs in his Jeep, reels up the fire hose and moves on to another field. He points out that his method has three advantages over a pipe system: low initial cost, sprinklers can be changed many times before moving the main line, and the equipment is easily transported.



To move his irrigation system, he drives across the next field and unreels the garden hose. Below, the water area is changed by tugging on the feeder lines

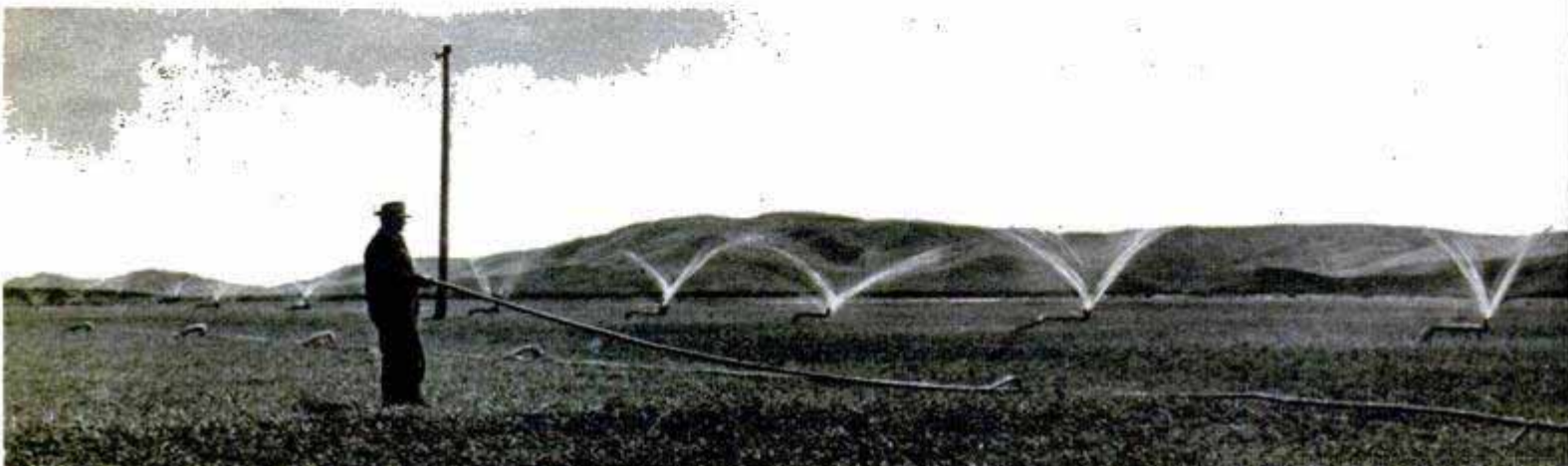

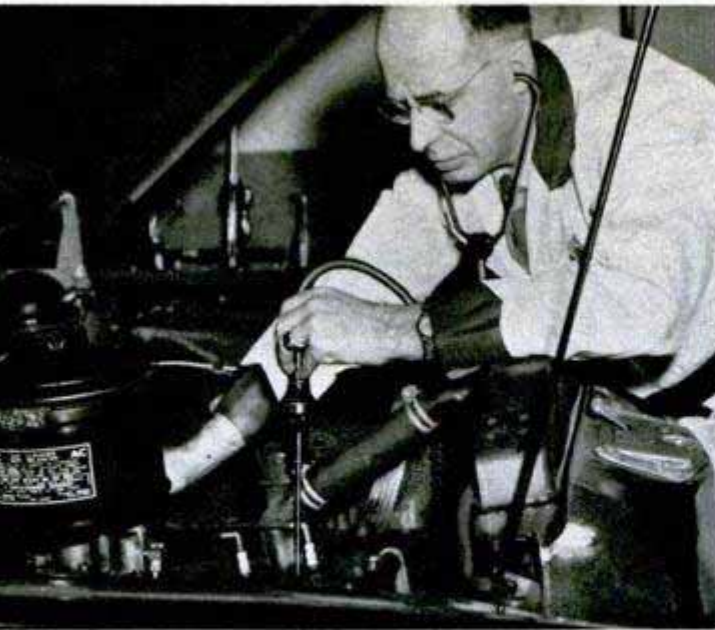

Mechanic's Stethoscope

Mechanics, like doctors, now can use stethoscopes to diagnose the troubles of ailing automobiles. A slender probe rod picks up the internal sounds of the engine, body and gearboxes and transmits them to the mechanic's ears through flexible sound tubes, similar to those on a doctor's stethoscope. The instrument is shockproof, so there is no danger in probing while the engine is running.

Spray-On Car Wax

Motorists can spray a new wax on their cars by pressing a button atop the container. The propellant used in the container evaporates upon exposure to the air, leaving nothing but wax on the surface. When the surface appears dusty, it is allowed to dry for about five minutes. Then the dust is wiped off, leaving the coat of wax.

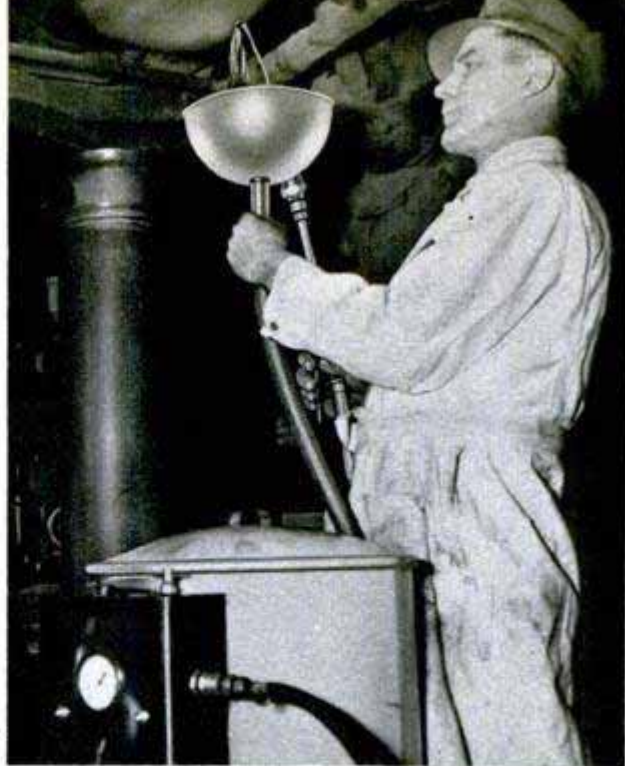

High-Pressure Machine Cleans Inside Engines

Sludge deposits inside automobile engines are dissolved and washed away by a high-pressure detergent spray that cleans crankcases and other internal parts without disassembly. To clean the crankcase, you merely remove the drain plug and insert the pressure nozzle in the opening. Sludge is washed out into the funnel of the return pipe. Valve chambers are cleaned without removal of side plates, simply by taking out one stud and inserting the nozzle. The machine runs on any air compressor that produces 150 pounds pressure and is also used for cleaning air filters, transmissions and differentials.

Arm Locks Wheels for Repairs

Front wheels that are being repaired can be locked in any desired position by an adjustable arm that fastens to the steering wheel. A suction cup holds one end of the arm against the windshield and a clamp holds the steering wheel rigid, preventing the front wheels from moving. The wheels can be turned to a new position by loosening a wing nut, turning the steering wheel and tightening the nut.

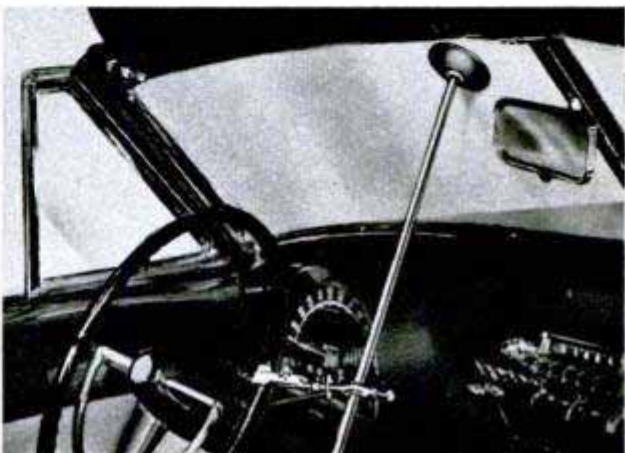



Left, Robert Cubitt, "vorpal sword in hand," slays the Jabberwocky. Right, Alice, played by Sylvia Cubitt, watches the Gryphon dance to the very sad song, " 'Will you walk a little faster?' said a whiting to a snail"

Alice Poses in WONDERLAND

"There was a dispute going on between the executioner, the King and the Queen, who were all talking at once" about how to behead the bodyless Cheshire Cat. The problem was solved when the cat's head vanished in air





Cubitt's wood-carving and photographic hobbies combine as he illustrates Alice's story with slides. Here, he snaps Father William and son in the kitchen. Behind him in silhouette, the Carpenter sheds "a bitter tear"

THERE'S a real live Alice in Wonderland in Rochester, N. Y. She is Sylvia, daughter of an engraver, Michael R. Cubitt, whose twin hobbies, wood carving and photography, have resulted in a beautiful set of slides illustrating the Lewis Carroll masterpiece, "Alice in Wonderland." There are 42 slides in the set and Sylvia plays the role of Alice throughout. She and her brother, Robert, are the only real people in a cast of characters that includes 64 figurines carved by their father.

So skillfully done are the characters and settings that Cubitt has become famous around Rochester for his work and he is having copies of his slides made in response to many requests.

By selecting the most interesting scenes in the well-known children's fantasy, Cubitt has brought the story to vivid and colorful life on his slides. Included among the carvings are four of Father William and four of Father William's son in different poses. He also has made three of the White Rabbit, two each of the Queen of

Hearts, the King, the flamingo and the Gryphon—all in various poses. The Jabberwocky, of "Through the Looking Glass," is another and, of course, the Mad Hatter, the March Hare and the Dormouse could not be left out.

The majority of Cubitt's characters are carved from wood, but the lobsters appearing in his scenes are real crawfish caught in the creek behind his home and his life-size flamingo is made of papier-mache. The figurines average six inches in height, except for the foot-high Jabberwocky.

Cubitt uses oil paints, plastics, metallics and cloth materials to dress his characters in suitable finery. He painted the Queen of Hearts and added paper hearts for additional decoration. She also wears a child's locket and a diamond crown, both of which he found in a 10-cent store.

When looking around for props to complete his settings, Cubitt discovered that white plastic thimbles were just the right size to make teacups for the Mad Tea Party. Buttons serve as plates and saucers. The



Left, Cubitt does some touching up on the Queen and her flamingo. The finished slide is shown at the right

lawn is a strip of green carpeting. Evergreen trees are simply sponges trimmed and tinted green.

Cubitt's daughter, Sylvia, playing the role of Alice, was photographed in 20 different positions in front of a black background. When the story-telling slides were made, he added her figure to the scenes by projecting the image on a screen and double-exposing the projected image and the set to form one composite slide. In a few cases, he had to triple-expose his film

to achieve the exact effects he desired.

The camera Cubitt uses is a combination of a Kodak Bantam and a 3¼ by 4¼ double-extension camera with a color-slide adapter back. The Kodachrome slides are 2 by 2 inches for use with a home projector. Since he conceived the idea four years ago, Cubitt's production of this illustrated story of Alice has been his recreation. Alice is as familiar around the Cubitt home as if Sylvia were the little girl who inspired Lewis Carroll's masterpiece years ago.

Drinking tea with March Hare, Dormouse and Mad Hatter, Alice is puzzled by the watch that is two days slow





Extra Rear Wheels Make Bicycles Safe

Bicycles are made as safe as tricycles for small children when a pair of extra wheels is fastened to the rear hub to keep the bike upright at all times. A bent steel rod goes up over the rear wheel, serving as both axle and bracket for the extra wheels, which can be raised off the ground when not needed. With the small wheels in a lowered position, any bike becomes as stable as a tricycle. The wheels can be raised slightly off the ground to teach youngsters how to balance on two wheels. Should they lose their balance, the extra wheels prevent them from falling.



Sealed-Beam Lamp Triples Bike Light

After-dark cycling will be safer with a new sealed-beam bicycle headlamp developed by General Electric engineers. It is a small edition of the type now used on automobiles. The volume of light cast is three times greater than that thrown by present bicycle headlamps, which put little more than a spot of light on the road ahead. The lamp can be mounted either on the handle bars or atop the front fender.

Folding Motor Bike for "In Between" Transportation

Only a few seconds are needed to unfold and start a collapsible motor scooter that fits in a space 14 by 18½ by 23½ inches. Designed for airfield or dock-to-town

transportation for flyers and boating enthusiasts, the steel-framed scooter travels 20 miles an hour and will go 100 miles on a gallon of gasoline.

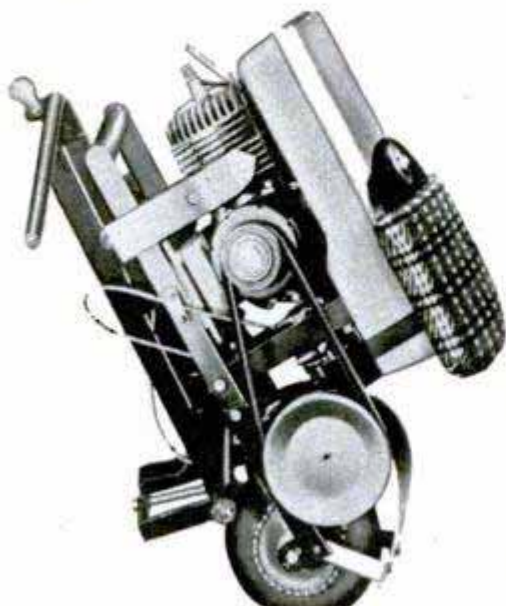



Herds of elk in the large meadows of Jackson-Hole Wildlife Park in Wyoming are a delight to visitors. Fences are "invisible"

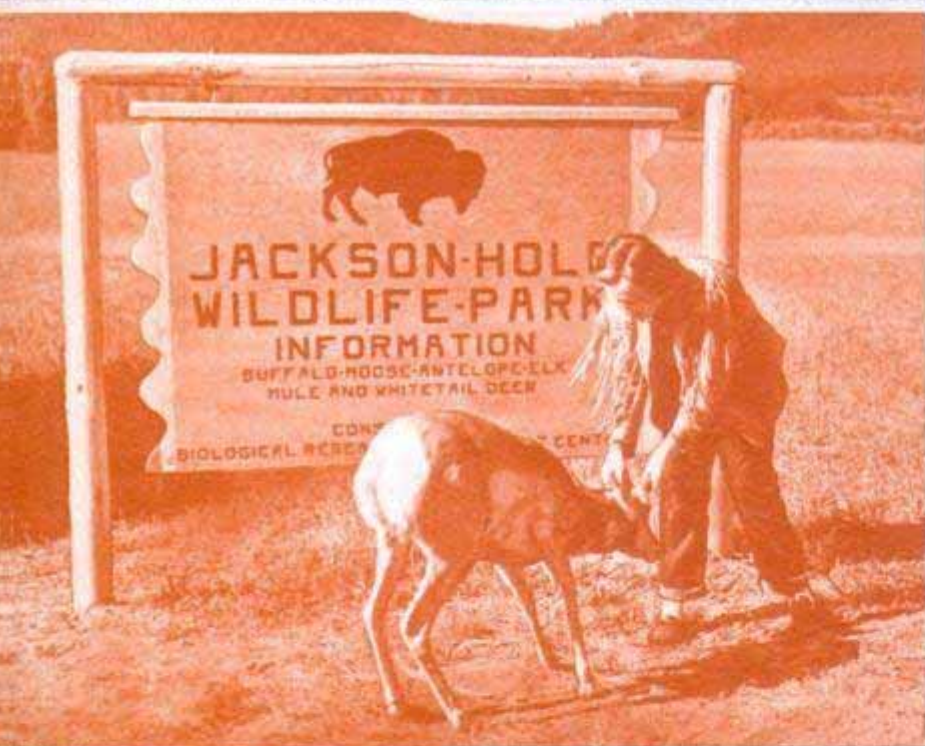

Left, many of the animals in the park are not afraid of people and this antelope is proving it by playing with young tourist

Team and sled carry hay to buffalo after heavy winter snow while an antelope tags along. The winter menu: 110 tons of hay



Big game "at home" ***to visitors***

By Tom McHugh

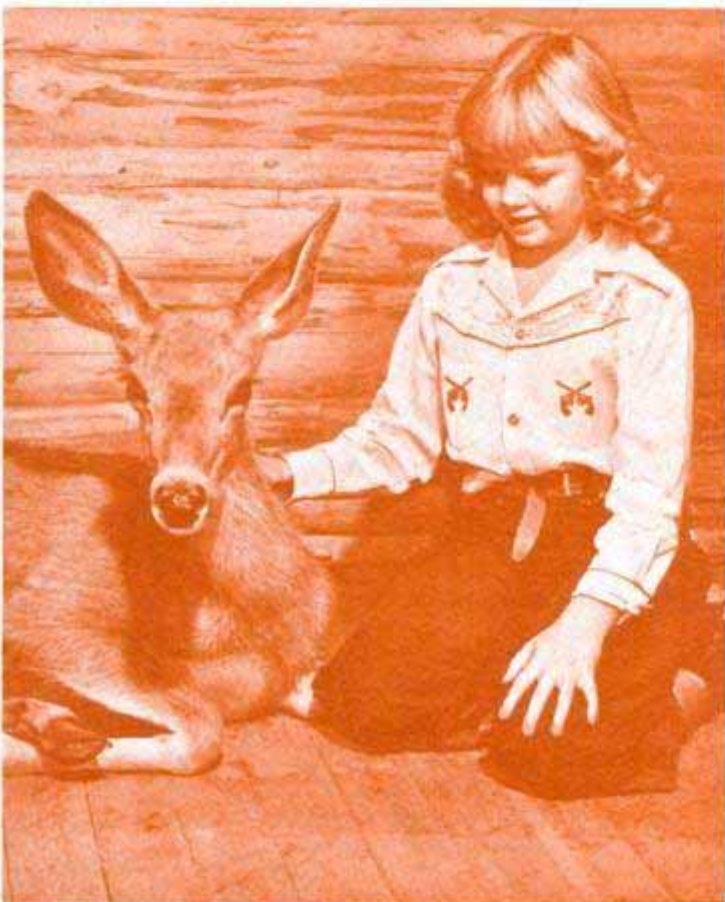

A MERICA'S first natural wildlife park was recently opened to the public near Moran, Wyo. The Jackson-Hole Wildlife Park, as it is called, has earned this distinction by displaying big game in a vast, apparently unfenced area.

An "invisible fence" is the unusual device used by the park to enclose more than 100 big-game animals. The fence has been so well camouflaged that it remains almost completely hidden. This was accomplished by concealing it in wooded areas or behind hills.

Buffalo, antelope, elk, moose and deer can be seen by the motorist as he drives through the park amidst herds of these creatures. The beasts seem to be little bothered by their intruders and carry on as if they had complete freedom. Last summer they produced more than 20 young in the park.

Capturing such an array of big game created quite a problem for the Wyoming

Left, one of the park's tame mule deer spends his spare time in the information booth where he enjoys attention. Below, the so-called "invisible" fence is concealed behind wooded area or the hills





This is one of many homeless fawns given to the park to be raised. This one takes his vitamins by bottle

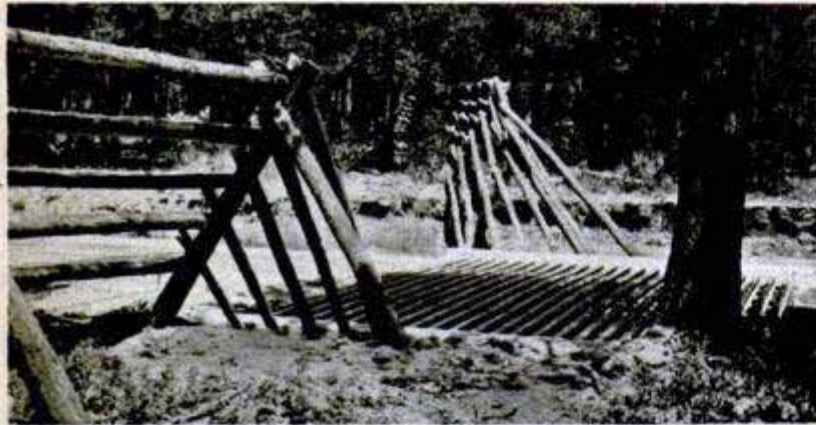

Gates are always open because the animals refuse to walk across gaping railroad rails over small pit

Game and Fish Commission, one of the sponsors of the park. Their game wardens used a different method to catch alive and without injury each of the types of animals.

Antelope, with a speed of almost 55 miles an hour, were the most difficult quarry. Since they typically dwell on vast open plains, they can seldom be cornered. Game men solved the puzzle by erecting a large funnel-shaped trap. It was constructed of fish netting so that these fast but fragile beasts would not be injured. A pocket at the end of the funnel held the animals until they were loaded into crates.

Airplanes were then used to discover herds of antelope. Once located, the herds were driven into the trap by careful maneuvering of the planes.

Elk were captured as they migrated past the wildlife park on their way to winter feed grounds in southern Jackson Hole. The park gates were opened until enough elk had wandered in. Closing the gates trapped the unsuspecting animals.

Moose are the only animals that can jump over the seven-foot fence surrounding the wildlife park. Since ponds inside the park are so attractive to moose, a few of these large antlered animals can always be seen.

With such a wealth of wildlife as a background, the Jackson-Hole Wildlife Park has also launched a biological field station that will search the Rocky Mountain area for new facts about our wildlife. Thus, the park is serving conservation both by displaying wildlife to the public and by uncovering new data to aid in wildlife preservation.

Gathered around the hay shed are two helpers, antelope, deer, moose and four of park's prize buffalo

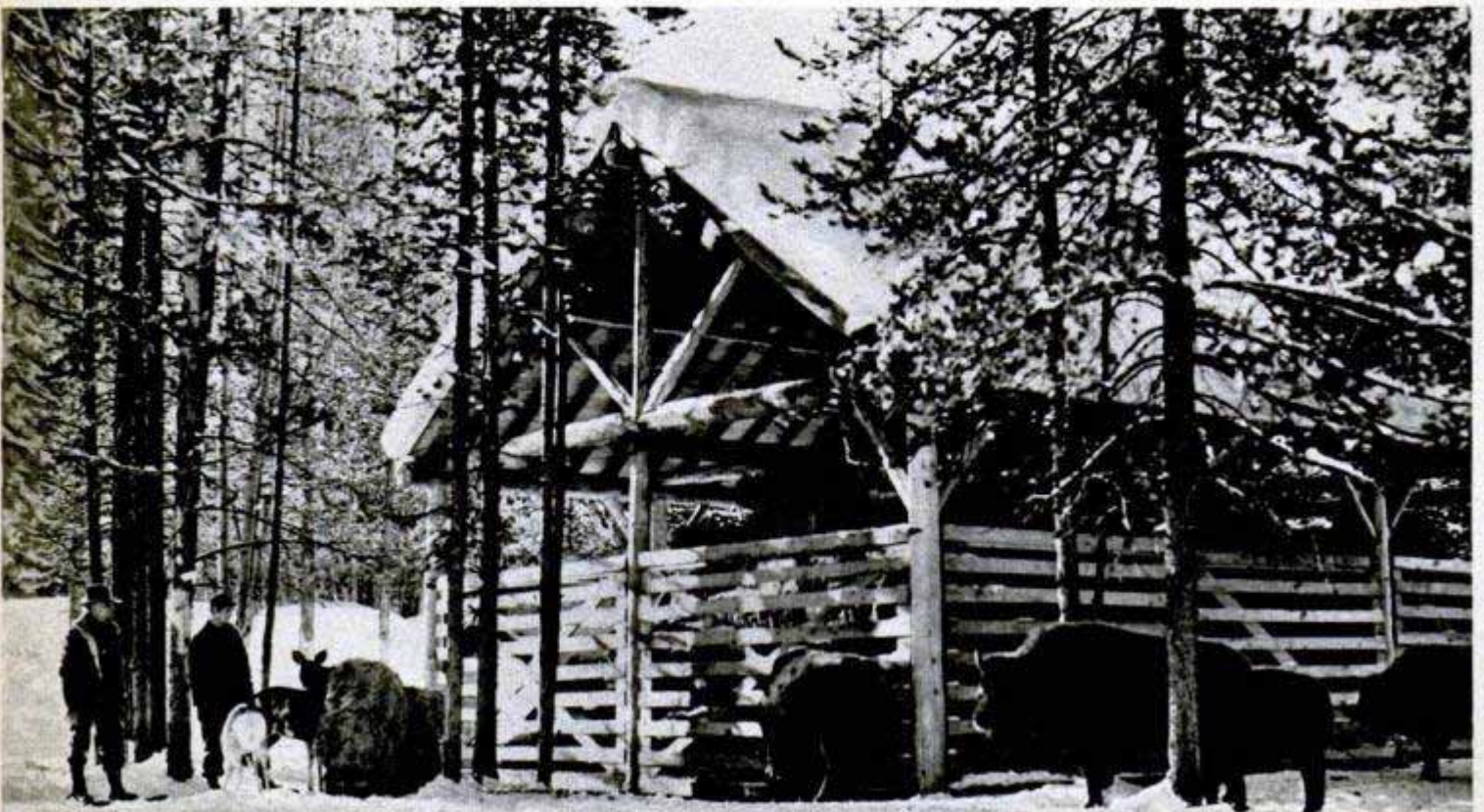



Auto-Wheel Balancer

Any motorist or filling-station attendant can balance automobile wheels with a new bubble-level tool. The user places the balancer on the floor, chooses the proper ring to fit the size of the wheel and places the



ring over a spring in the tool. He then lowers the wheel into place. The weight compresses the spring and the side of the wheel that is too heavy drops below horizontal, as indicated by the bubble level. Weights then are installed on the opposite side to balance the wheel.



Fiberglas Assault Boat

Made of glass and plastic, an experimental assault boat is undergoing Army tests at Fort Belvoir, Va. The boat's plastic hull is reinforced with Fiberglas. It weighs

300 pounds and carries 15 men with their equipment. A plywood assault boat used during the war weighed 410 pounds and carried 12 men. Power for the experimental craft is provided by a 33-horsepower out-board motor.

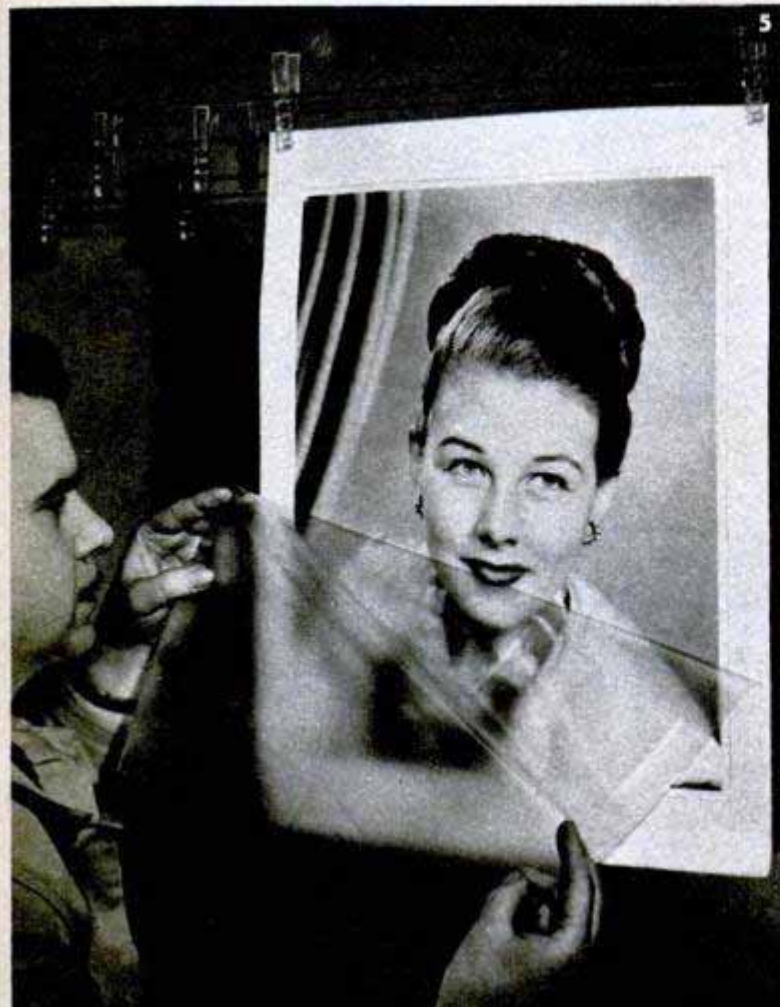
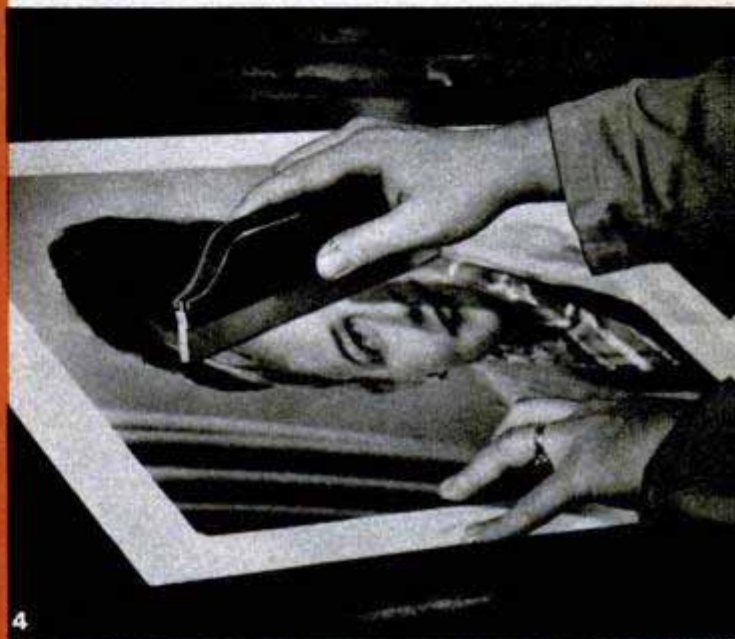
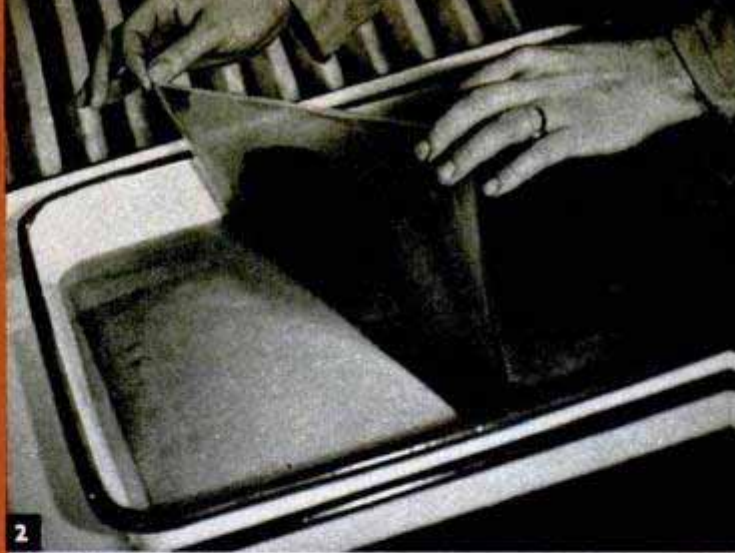

Color Magic

1. This is the first step in preparing a Kodak Flexichrome print for coloring. A print is made on Flexichrome film and after the film is bleached the image is dyed with a special modeling agent

2. After a warm bath the emulsion on the film is stripped from the film base. (These prints can be made from ordinary black-and-white negatives in any regular projector or any contact printer)

3. Here the emulsion from the film base is transferred to a sheet of photographic paper which has been thoroughly fixed and washed. (If a transparency is wanted, the gelatin is put on a clear glass)

4. Using a transparent transfer sheet to protect the emulsion, a squeegee is used to assure firm contact between the emulsion from film and the photo paper to which it has been transferred

5. When the print is hung up to dry, the transfer sheet is stripped from the photo. After drying, the print is ready for color. These photos show only the most important steps in the new process

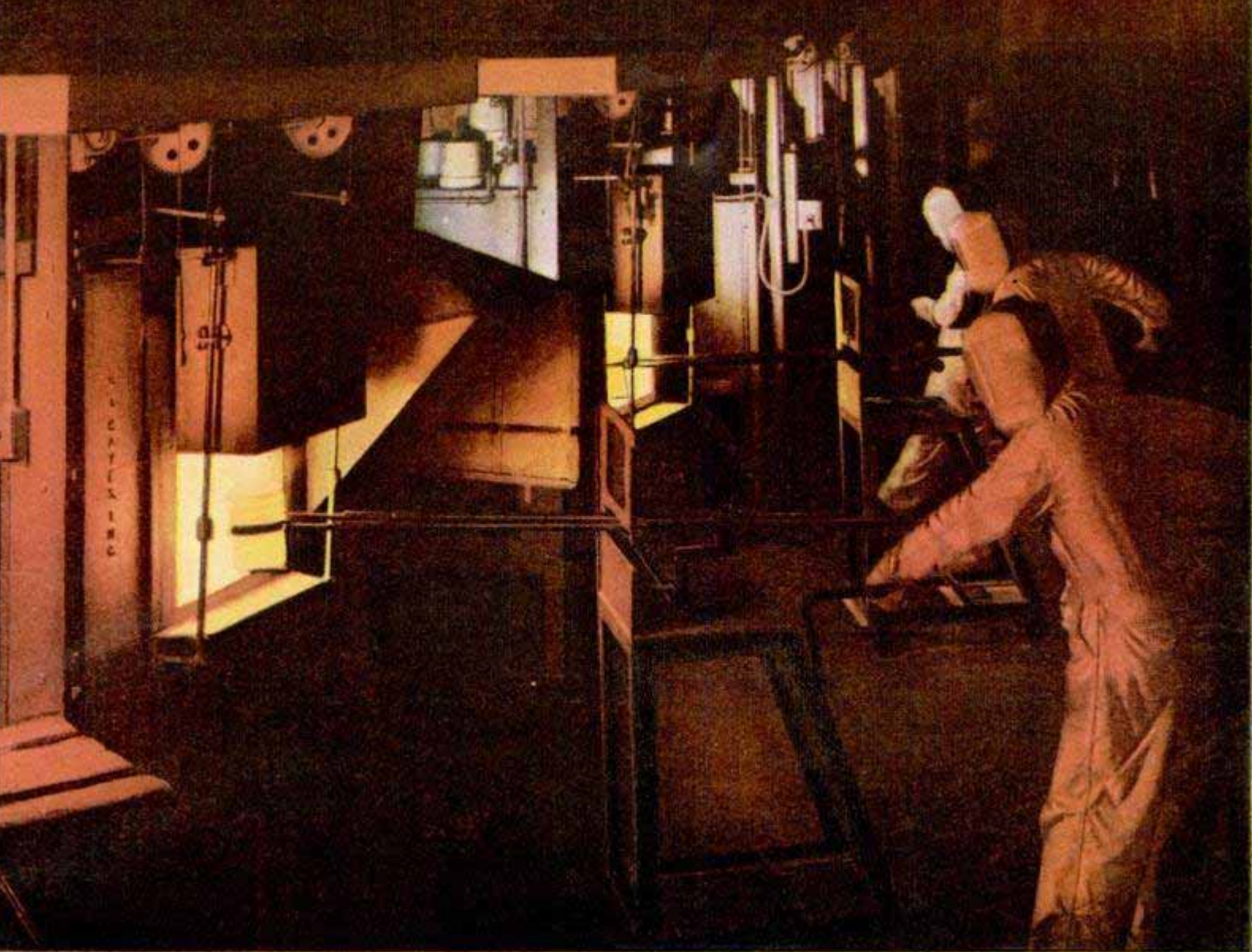

This Flexichrome color picture was made from a black and white taken in lighting unfavorable for color photo

From Black and White

By Richard F. Dempewolff

EVERYONE in the studio was in a sweat. The big New York advertising photographer hunched behind his color camera muttering darkly. The model, wearing a jaunty Easter bonnet dripping with plastic berries for a magazine cover, looked grim. Perspiration glistened over her upper lip again from the batteries of close, hot lamps. All day they'd been stopping, mopping, applying fresh make-up, trying again. Waste-baskets spewed dead flash bulbs across the studio floor.

Everything was ready for the last weary shot to complete the three perfect exposures needed in the elaborate color-print process. Then it happened. The sprightly berries gave up the fight and melted.

Photographer Jack Crawford slammed his cloth on the floor, his hat on his head and stalked out. A \$50 Easter hat ruined! A \$100 model fee down the sewer! Reams of special color film, 200 flash bulbs and

a whole studio day shot to blazes! What's more, he'd probably lose his client.

He did. But that's what started Jack Crawford thinking after that black day in 1932. And the thinking congealed into an idea.

Today, Crawford's idea is the hottest news in professional color photography. What he dreamed up out of his frustration, probably is the most flexible color-print process ever devised. All the professional photographer needs is a single black-and-white exposure, taken with usual lighting in the usual way. In a few hours he can wind up with a print in gorgeous full color. Small flaws can be covered. And if the cameraman or his ornery client doesn't like the shade of the backdrop, the make-up, or the color of a rose, it can be switched or toned with ridiculous ease. This can be accomplished on any part of the picture and any number of times. The process is



The pictures across the top of this page show how a black-and-white print is transformed into a full-color picture which only an expert could tell from a genuine color photo. The first picture above is a Flexichrome black-dyed relief print. The center picture shows how color mixed with a weak solution of acetic acid is applied to a local area. The third picture shows how the other local areas are colored

Robert Korta, Popular Mechanics artist, at work on the background of photo shown at top of next page

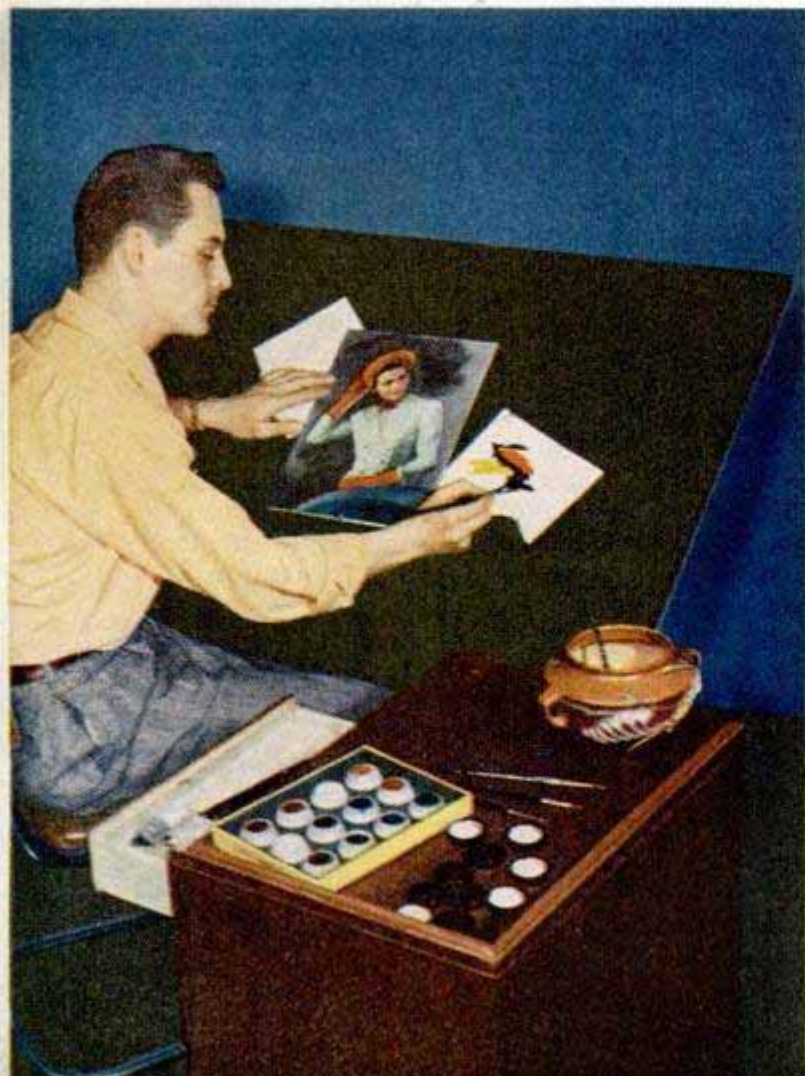

so flexible that the Eastman Company, in whose laboratories Crawford's process was finally perfected for marketing, calls it "Flexichrome."

Basic principle of Flexichrome lies in the use of color dyes—not paint—on a special kind of black-and-white print. The print automatically takes the dye and automatically shades itself, so the person applying the brush need be no artist.

A curious thing about the dyes is that they replace each other. Anyone knows that if you put blue paint on yellow, the result is green. But on a Flexichrome print you'll get blue. The last dye applied washes the first one out of the gelatin. Smear enough black dye all over a finished Flexichrome print and, instead of a horrible mess, you'll wind up with a black-and-white print again.

Among the beauties of the process is that subjects, which for technical reasons could never be photographed well in color before, can now be color pictures. High-speed action, for instance—racing cars, Ted Williams whipping one over the fence, President Truman pitching a horseshoe, jet planes stopped in mid-air—anything possible in black and white but very difficult in color. They can be opaque or transparent. They can be done in one color, two colors or full color at will. In short, pick your flavor.

Making a Flexichrome color print begins with preparation of the special black-and-white print. This can be made from an ordinary black-and-white negative, in any ordinary darkroom projector or contact printer.

Instead of printing on paper, the photographer prints through the back of a special



“relief stripping film,” timing his exposure about the same as he would for bromide paper. He can “dodge” or control his light as he would in making any enlargement.

The exposed film is then developed in a special developer containing a tanning agent. The tanner acts on the highly exposed, or darker, portions of the picture in such a way as to harden them and make the gelatin surface of the film swell up in those spots. The lighter, or less exposed areas, are less affected by the tanner and the gelatin remains soft and soluble.

After developing, this soft gelatin is washed away by rinsing the film in a hot-water bath.

When the film is pulled from the hot water, it is no longer a flat-surface print. Instead, if you cut out a slice and magnified a cross section a hundred or so times, it would look like a relief map; the mountains represented by dark areas, the valleys by lighter areas. Actually, the picture has become a bas-relief, chemically carved into the gelatin surface on the film.

The film print is now run through a bleach. This removes the silver, which gives any print its visible black-and-white appearance. What comes out of the bleach is enough to give any uninitiated photographer the shuddering horrors. It looks like a sheet of window glass—barely a trace of a picture anywhere to be seen. But it's there, all right, permanently carved in the transparent gelatin. If you don't believe it, the next step proves it, for the film is now immersed in black Flexichrome dye.

Since the highlights are the valleys, they do not absorb much dye. There isn't enough gelatin to retain the particles of color. So they stay light. The thicker

The fourth photo in the panel shows almost a finished effect but note the difference after a heavy wash (center) has been added to the background to deepen the hue and the face has been worked over for a more natural coloring. The final print at right is dipped in lacquer and hung up ready to dry. At any time in process excess color is removed by blotting surface. Repeated applications of color determine intensity

Kodachrome or Flexichrome? Picture of Golden Gate bridge is Flexichrome color made from special print

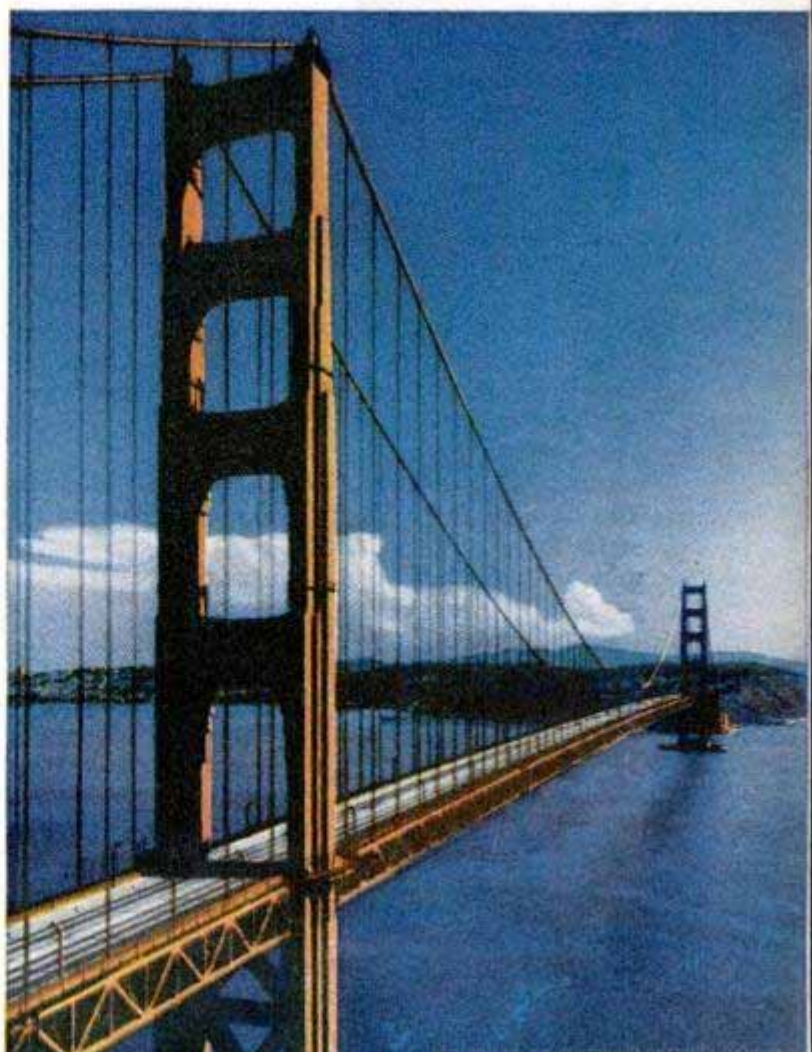



Color film captures only what the camera sees; with Flexichrome, the advertising artist can vary background

gelatin layers soak up the dye, however, and get blacker and blacker according to their varying thicknesses. In a few minutes, the picture is as plain as it was before the bleach—only now it's dye and not silver that makes the image visible.

The picture still is on a film, and therefore transparent. It must be put on an opaque background to make a color print. So, once more it goes into warm water until the thin gelatin surface is loosened from its film backing. The gelatin layer is then stripped off and transferred to its final white paper backing—which may be standard photo paper with any surface texture desired. If the photographer wants a transparency instead of a print, he simply transfers the gelatin to clear glass or good clear film instead of paper.

When the paper mount dries, the photographer has his basic Flexichrome print, ready for coloring. Perhaps it sounds involved, trailing itself out in words. Actually, from enlarger to drying rack is a matter of about 15 minutes.

Technique for painting a Flexichrome print can be summed up in four steps: 1. Take a color and smear it over the print with a water-color-type brush; 2. Blot up

the mess; 3. Rinse with two percent acetic acid; 4. Blot. The result is startling, to say the least. Every place where the color contacted the print, it has become a delicately shaded tone through no fault of the painter. And it has replaced the black dye, which was simply applied as a "modeling agent" so the photographer could see where he was putting his color.

As the colors are applied, they become an integral part of the picture, preserving the photographic definition of the image. Shadows are not black, as in water-colored prints, but a dark, dark shade of whatever color they should be. In a forest scene, for instance, the shadows will become a dark green in whatever shade is applied, replacing all of the black modeling agent. Where does the black go? Up in the blotter. It may take several applications in very dark shadows, but eventually after painting and blotting repeatedly, the green wins.

It is the repeated application of a color to any area that determines its intensity. The first dose usually results in a pale tone. And what if you smeared pink over an area that should be blue? Nothing to worry about, of course. The blue will gradually

(Continued to page 254)



SELF-PROPELLED AQUAPLANE

Motorized aquaplanes, skimming along at 30 miles an hour, provide all the thrills of water skiing and aquaplaning without the expense of a speedboat. Called a Skim Boat, the water toboggan has a 7½-horsepower outboard motor in a watertight hull forward. The propeller is located under the bow. The fast-turning craft is steered by a combination of weight shifting and rudder movement. To prevent the boat from running away, an automatic shutoff stops the motor should the rider fall off





Twin tubes present two different images. The stereoscope viewer produces the three-dimensional effect



Electrodes on patient produce three-dimension electrocardiograph. Diagram below shows stereoscope effect

RADAR in three dimensions

IN A CLUTTERED laboratory room at the University of Minnesota there's an instrument that can present radar or television in three dimensions. But that's only the beginning — the instrument also can rotate these pictures in any direction. The observer can produce the effect of walking around the object, climbing up over it, crawling under it or plunging into it.

The implications of the instrument are big. For example, with the instrument coupled to radar, the observer could tell whether two planes are on a collision course. Or, if a group of planes is picked up on the radar screen, the observer can go around, above or under them to discover their exact flight pattern.

The instrument is the work of Prof. Otto H. Schmitt of the university's biophysics department, who has adapted the principle of Grandma's old-fashioned stereoscope to two cathode-ray tubes. To the tubes he has coupled a series of resistors and potentiometers. When he feeds electronic information into the instrument, it paints a picture on each of the tubes. But the two pictures are slightly different. A composite of both pictures produces a sense of depth. Professor Schmitt's instrument shows one of the pictures to one eye and the other to the other eye. Thus the instrument fools the observer into believing he is viewing a single three-dimensional object.

For such a wizard as Professor Schmitt,

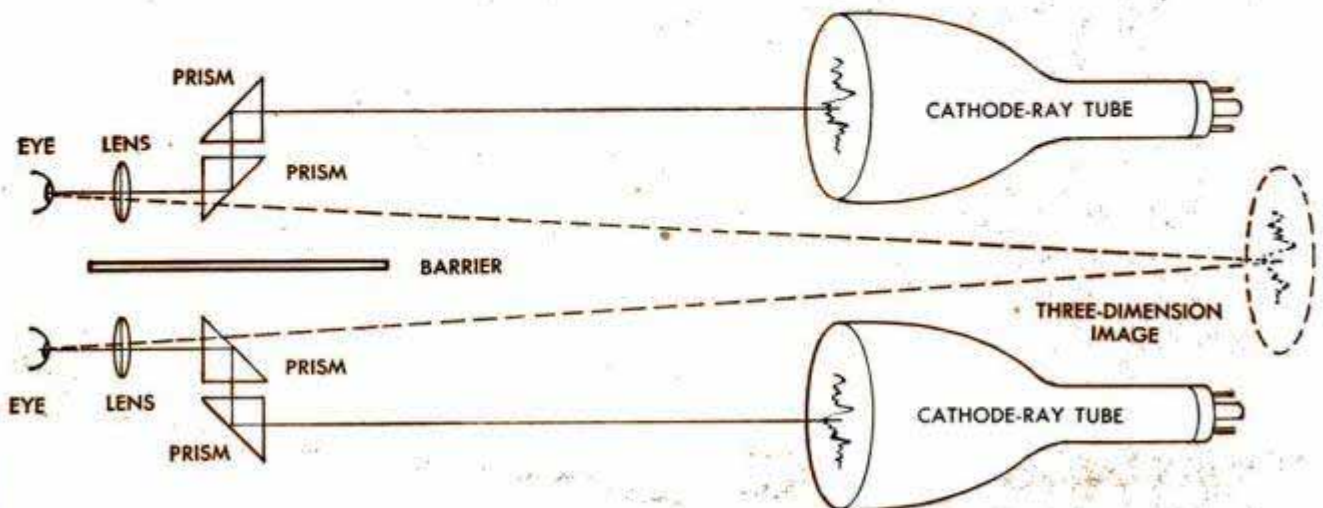

it is relatively easy to enlarge or reduce the picture so that the observer seems to be approaching or walking away from it. Naturally, this also means that the slight difference in the two pictures must be varied accordingly.

By turning azimuth or elevation knobs, Professor Schmitt changes the electrical data going into the tubes and the picture rotates vertically or horizontally.

Professor Schmitt started devising the instrument when he wanted to solve mathematical problems involving three variables. To get the answers he had to draw a series of three-dimensional mathematical pictures. The problem could be solved but required a great deal of time. He decided that the ideal method would be to draw, somehow, a mathematical picture and then rotate it at will. About this time he sensed that a possible answer might be to utilize a combination of Grandma's stereoscope, two cathode-ray tubes and the electronic instruments that could convert measurements into geometric forms.

The physicist is more interested in the instrument as a tool of mathematics than as a development in radar or television. Scientists engaged in heart-disease research are excited about the results he has obtained by connecting the instrument with an electrocardiograph. The throbbing voltage of the heart has been measured for years as a means of detecting heart ailments. Electric leads are strapped to the patient to check the voltages. Heretofore it has been possible only to see three voltages as three separate pictures. Now Professor Schmitt, using six electrodes, can show the entire heart action as a three-dimensional picture which can be rotated for examination.

On upper screens are three variables. Lower screens combine information into slightly different pictures

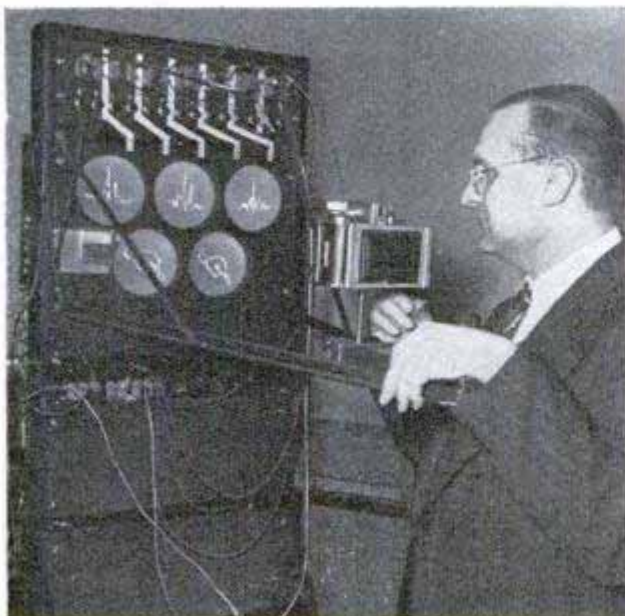

Twin Fruit-Picking "Baskets"

Twin containers that fit against the hips add safety and speed to fruit picking, replacing the old familiar bucket. Often it is difficult for the picker to grasp the tree and a conventional bucket and still keep one hand free to pick the fruit. The two hip-fitting containers are held by a shoulder and waist harness. The containers are made of sheet aluminum with canvas sides next to the body and canvas drop bottoms which fold down, allowing the fruit to roll gently into the boxes. Fruit is measured during the picking because two of the containers fill one fruit crate.

Fluorine Released In Air Hazard to Livestock

Fluorine, released in the air by industrial plants, damages crops, poisons livestock and etches glass windows, but it does no lasting damage to the soil. These facts were reported by a University of Tennessee professor who studied the effects of fluorine released in the air by large aluminum plants in Tennessee. Two of the richest food-producing counties in that state have been rendered unfit for profitable livestock and dairy farming by the highly corrosive fluorine compounds. When absorbed by the soil, fluorine has little effect on growing crops, but when present in the air it does render grass and hay toxic to animals.

☛ American manufacturers produce about 500,000 fishhooks each day, and about 50 percent of them reach amateur anglers.



Two-Section Boat Is Its Own Trailer

At home on land or water, a two-section boat has a retractable carriage that lowers automatically when the boat is folded for land travel. An Arizona sportsman, weary of the inconveniences of boat trailers and car-top carriers, built the boat to his own design. The hinged stern section swings up to rest on the bow, shortening the boat for towing and, by lever action of the undercarriage, lowering the two wheels to the ground. When the boat is opened out, the two sections are locked into a solid unit by pins inserted in two hinges near the water line. Bulkheads make each section a watertight unit that would float alone. The wheels ride above the gunwales when the boat is afloat. The trailer hitch is attached permanently to the bow.



Typewriter Feeder

Typing production is increased by a device that automatically feeds business forms and carbon inserts into typewriters and billing machines. The typist presses a button and the machine drops a complete set of forms in place, aligned and in register for instant use. A full day's work can be stacked into the feeding compartment at one time. It handles forms of from 2 to 20 parts, up to 9 inches in width and 14 $\frac{3}{4}$ inches long.



Rats Grow to Giant Size In Hormone Experiment

Giant rats, old by normal standards but still possessing the characteristics of youth, have been produced in experiments with the growth hormone. Although the rats live to extreme old age, they continue to grow throughout their lifetimes and average almost twice as much in weight as normal rats. Their organs vary in size, some keeping pace with their body growth, others remaining normal, while

still others are slightly reduced in size. The experiments, conducted at the University of California, suggest that there is no substance in the body which can check the growth hormone.

Hydra-Matic Drive Featured on '50 Nash

Three transmissions—Hydra-Matic, automatic overdrive, and standard—are available in the 1950 Nash. Hydra-Matic Drive is a new feature for Nash, as is overdrive, and is optional on the Ambassador. Overdrive is optional on all models. Another addition to the Ambassadors with Hydra-Matic is a new starter control, actuated by lifting the direction control lever. A new member of the Nash family, the Statesman, is replacing the 600 series. The 1950 Ambassadors are powered by high-compression 6-cylinder overhead-valve engines developing 112 hp., a motor which has been designed to operate with a high degree of efficiency using regular gasoline. The Nash Airflyte Statesman is powered by an L-head type, 6-cylinder engine. Nash again offers full-length twin beds, and a new reclining front right seat with five positions. The rear window is much wider and the bumper guards are enlarged.

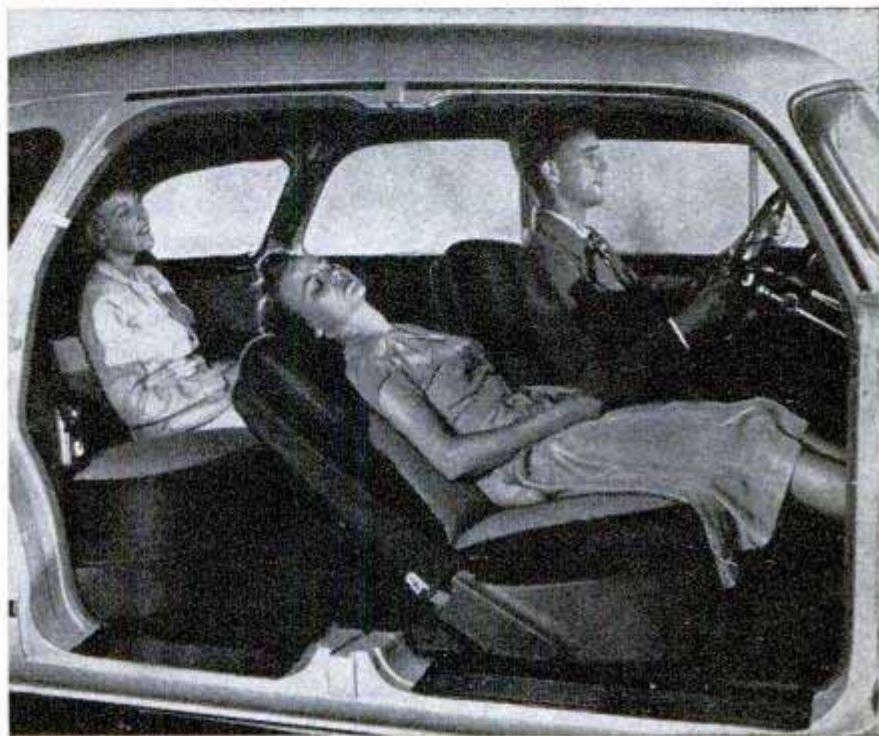

The 1950 Nash offers greater visibility than any previous model. A new feature of the Nash "bed" is a reclining front seat with five positions



Sikorsky Aircraft photo

Amphibious Helicopter Has Wheels and Floats

With floats for water and wheels for land, the Sikorsky H-5H becomes the world's first amphibious helicopter. The new combined gear cancels out the disadvantages each has when used solely and independently. Floats permit water landings, but present problems in power-off landings ashore. Without wheels, handling for maintenance work and storage is more difficult. Another change in the H-5H, used by the U. S. Air Force for search and rescue missions, is the relocation of its three litter compartments. In the new version, they run from side to side, two in the front cabin and one at the rear of the engine. A hydraulic hoist is permanently installed.



They pilot sky-piercing rockets

By Thomas E. Stimson, Jr.

ANOTHER "Bumper" was on its way! Driven by its roaring jet, the great two-stage rocket rose from the desert floor.

The take-off was slow but due to its tremendous acceleration the rocket was traveling 3600 miles per hour within 60 seconds. By then it was 20 miles up and at that point the ground observers could see, through their telescopes, the little "Wac Corporal" break away from the nose of the larger rocket. Spewing its own jet of flame, it gradually climbed

Although the rocket won't land for another five minutes, this instrument, an impact-point predictor, has determined exactly where it will land. Below, diagram shows how the "Bumper" is soaring to new heights. Below, right, recently the Air Force has been firing rockets which contain parachutes. Chute eases the instrument section to the ground

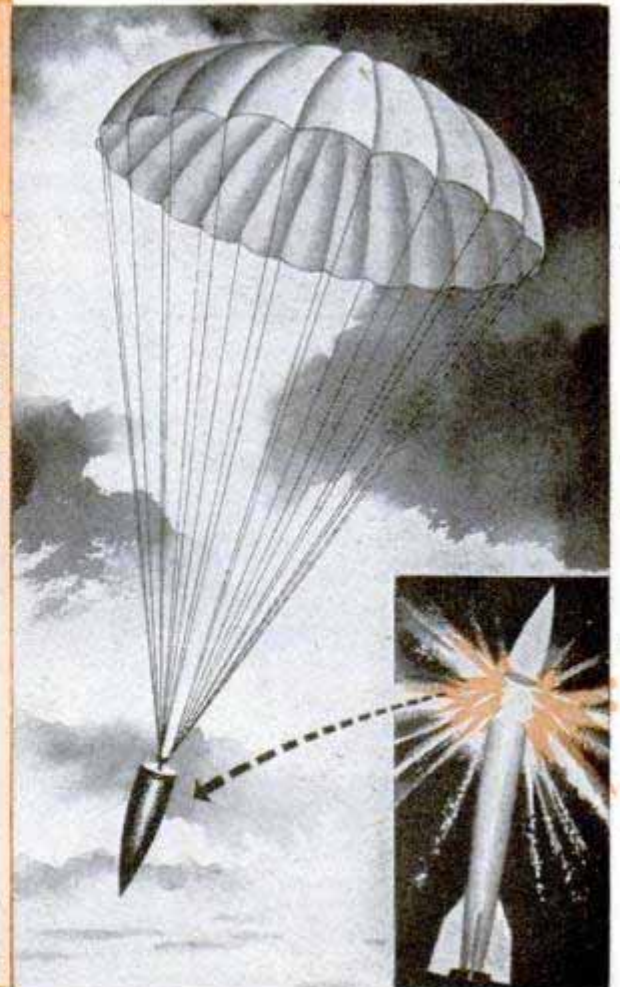
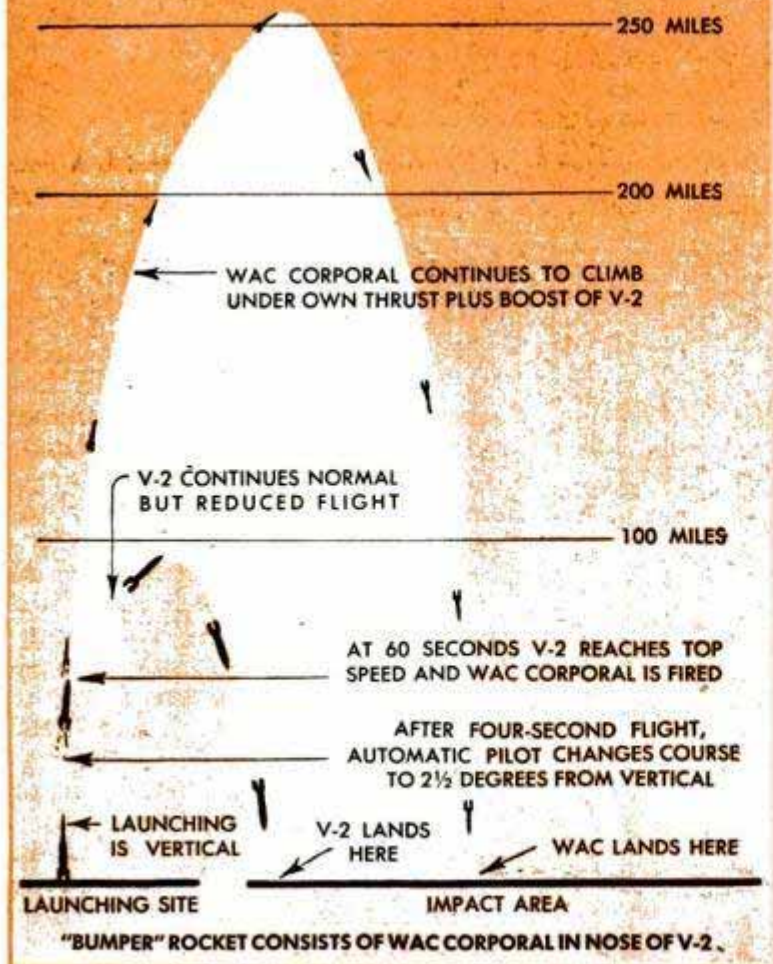

away from the still-ascending V-2 rocket.

At that instant, at South Station three miles from the launching site, a pen that was moving across a paper chart came to an abrupt stop. The men who had been standing in tense attitudes around the instrument relaxed in smiles and one of them pointed to the pen. "That's where the V-2 will land, in about five minutes," he said. "Well inside the range and safe."

The impact-point predictor is an ingenious device into which speed, acceleration and angle of climb information are fed. In turn, it answers the question: "Where will the rocket land if its power is cut off at this instant?" The predictor makes the calculations and moves its traveling pen to the right location. It draws a continuous line on a piece of paper upon which the confines of the rocket range are marked. When the rocket motor is cut off, the pen stops and the technicians need only a glance to see where the missile will land.

Meanwhile, on automatic plotting boards alongside the predictor, other pens were creeping across their papers, translating radar impulses from the rockets into lines that showed altitudes and courses. The

Below, tracker sights up sky screen as rocket is fired. If missile doesn't climb within wires, its motor is cut so it will land within the range. Right, the Bumper rises pompously from its launching site



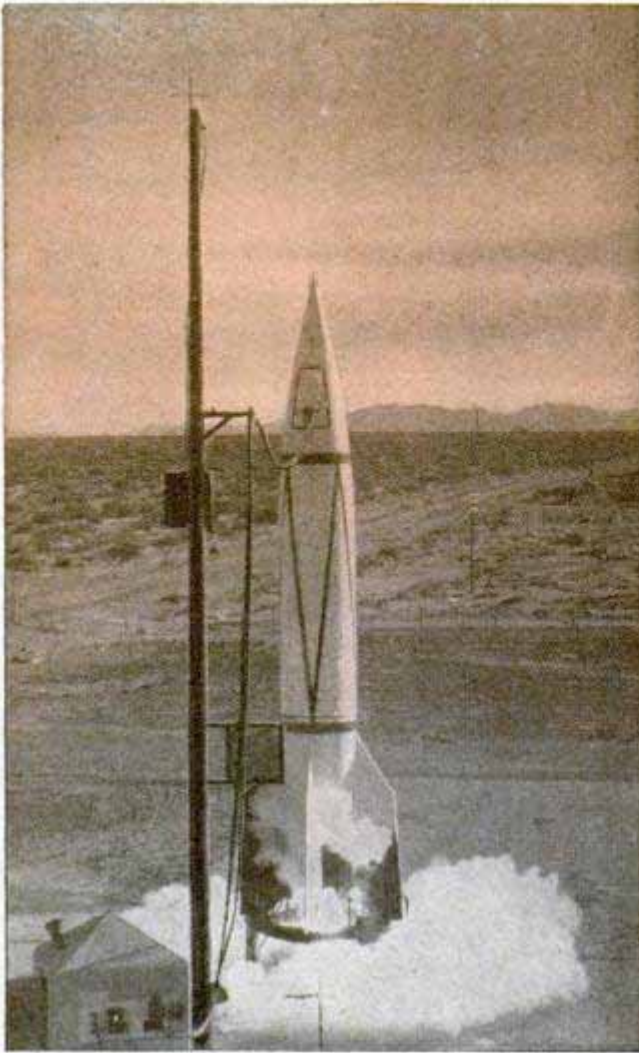

Motor is operated at reduced thrust for moment before take-off while all parts are checked. Below, Karsch checks course on radar plotter while assistant stands by, ready to blow up rocket if necessary

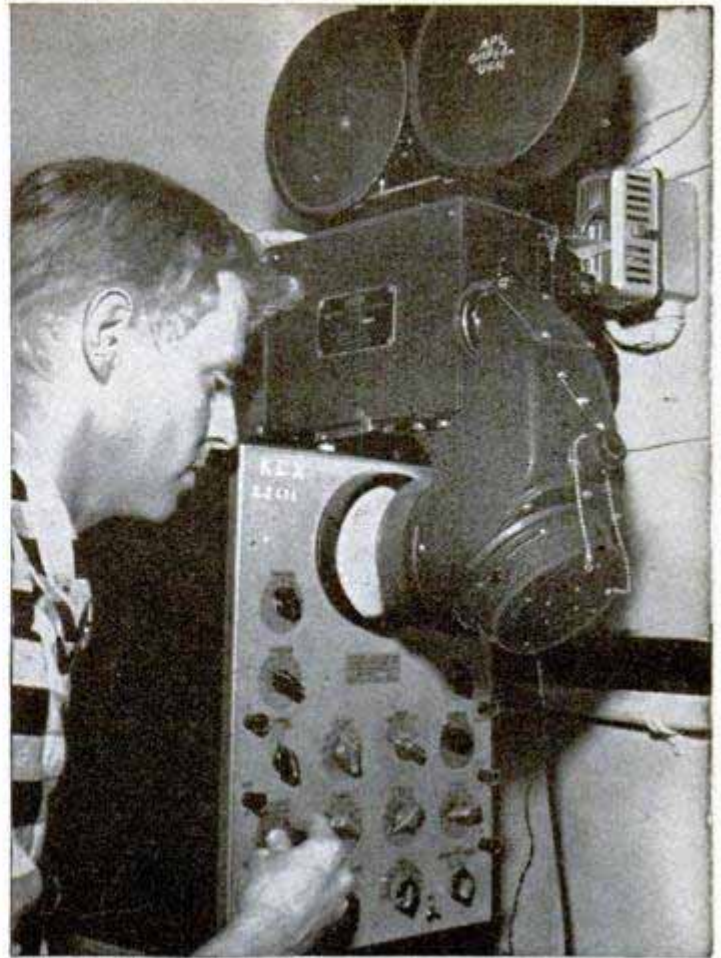

Inside telemetering trailer a movie camera records instrument readings from rocket during its flight

V-2 pens stopped just six minutes after the take-off. That rocket had landed, and the pens showed that it had hit the earth at the exact spot that had been forecast by the impact-point predictor.

The Wac Corporal pens were still moving and they would continue to trace their lines for another eight minutes or so. During that time the missile would attain an altitude of 250 miles and then would plunge back down through the atmosphere again. According to calculations, it would land inside an impact area that measured about 40 miles on a side.

When the Army's Ordnance Department fires a high-climbing rocket at its White Sands Proving Grounds in New Mexico, much more than the half-million dollars that the rocket may have cost plus months of work are at stake. If anything goes wrong, the missile may not fly true. Conceivably, it could fall in a built-up area. By impact alone, without explosives, it could do considerable damage.

To prevent any such calamity the rocket technicians have invented an elaborate system of safeguards. The rocket motor can be shut off by radio before its prearranged burn-out time, reducing the distance that the rocket will travel. The rocket can be blown to pieces in flight,

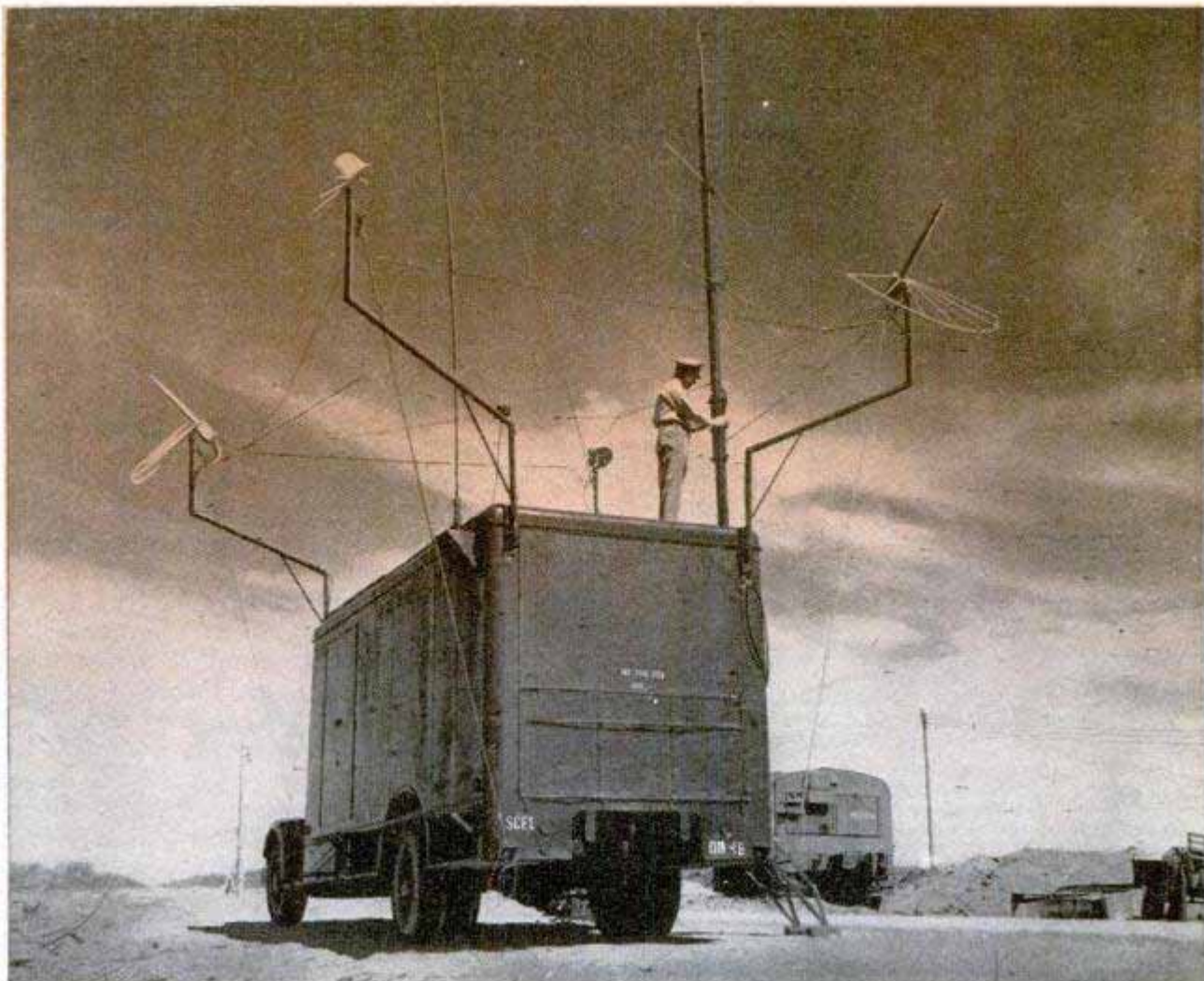

Trailer, festooned with antennas, monitors signals to and from rocket. Below, diagram shows how rocket is controlled in case it deviates from its course

somewhat reducing the impact force when it lands.

The responsibility of keeping the rockets within bounds rests on Herbert L. Karsch, civilian safety officer. At his headquarters at South Station he is the focal point of a complex radio and visual tracking network. At the South Station headquarters, at Hueco Station 22 miles south of the launching site and at West Station six miles to the west of the launching site, men sit behind sky screens that consist of three wires stretched in front of them on large frames. The center wire marks the path that the rocket should follow, as viewed from that location, and the others mark the maximum deviations that are permissible. If all goes well, the observer merely reports "The rocket is climbing right up the wire!" If it deviates from its intended course, the observer reports the fact at once, for every second counts if the rocket's course is to be altered.

The sky screens are backed up by other optical devices such as telescopes that track in elevation only and that contain in their fields a number of parallel vertical lines. The rate at which the rocket crosses the lines indicates its lateral velocity and whether or not it is on course.

IF ENTIRE ROCKET IS EXPLODED IN UPPER AIR, ALL ITS PARTS CONTINUE IN APPROXIMATELY THE SAME TRAJECTORY AND LAND AS A SHOWER OF FRAGMENTS

100 MILES

A

NORMALLY THE WAR-HEAD IS BLOWN OFF THE BODY OF THE ROCKET AT 40-MILE ALTITUDE, ALLOWING BODY TO FALL TO EARTH AT REDUCED SPEED OF 100 M. P. H. WARHEAD STRIKES AT MORE THAN 2000 M.P.H.

B

ROCKET'S MOTOR IS SHUT OFF AT THIS ALTITUDE, OR BEFORE IF THE FLIGHT IS ERRATIC

20 MILES

LAUNCHING SITE

IMPACT AREA

A-NORMAL FLIGHT OF ROCKET

B-IN CASE OF DEVIATION IN FLIGHT, MOTOR IS KILLED AT LOW ALTITUDE, RESULTING IN LOWER, SHORTER FLIGHT

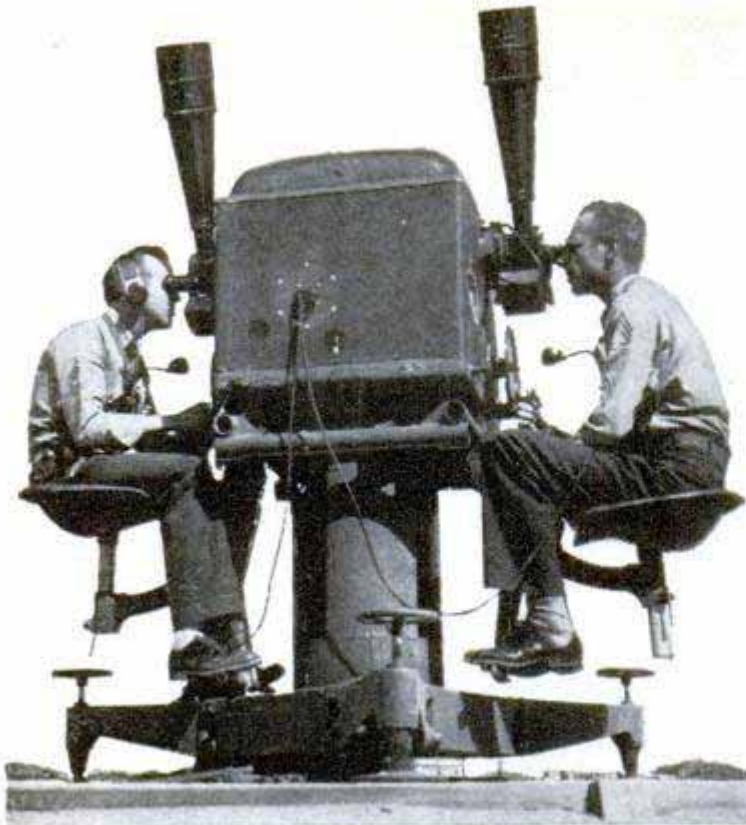

Optical trackers pick up the rocket and follow it during the powered portion of the flight. Below, no explosive made this deep crater. V-2 warhead, minus TNT, plowed deep into ground

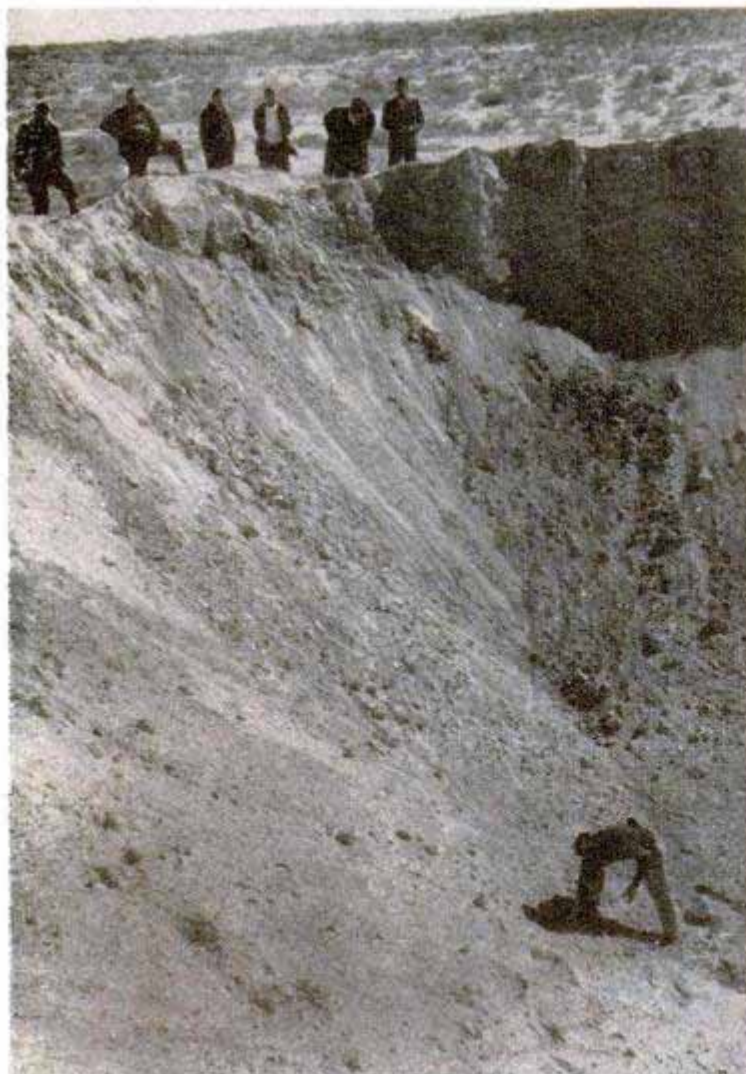

At South Station, in addition, is the radar tracking equipment. This actuates a transmitter that is installed on the rocket and causes it to radiate signals to the ground. These are decoded by electronic devices into velocity, altitude and direction, and are automatically transcribed onto the plotting boards. Radar is more accurate than the optical tracking devices; the optical methods serve simply as a stand-by in case the radar happens to fail.

When word arrives that a missile is about to be launched, Karsch puts on earphones to which radio or phone circuits from all three safety stations are connected, and hovers over the impact-point predictor or one of the nearby automatic plotting boards.

Beside him stands a companion who holds in his hands a switch box that is connected by means of five audio-tone radio channels to radio receivers on the missile. If he pulls the switch one way, three channels are affected that close the rocket's steam valves, shutting off its fuel supply. If he moves the switch in the other direction, signals are sent out that blow up eight $\frac{1}{2}$ -pound blocks of TNT that are attached just behind the warhead. These explosions separate the warhead from the airframe.

Karsch has less than 60 seconds in which to make his decisions aft-

"Cannon ball" now under development will be ejected to check upper-air temperatures



er the rocket leaves the ground. He can do little to alter its flight after the normal burn-out period. Normally, the missile flies true and the radio reports that come in from the outlying safety stations merely confirm the evidence on the plotting boards in front of him.

But if the rocket starts going bad, possibly 30 seconds after take-off, Karsch must think and act fast. His first duty is to prevent the missile from landing outside the range. At the same time he must allow it to attain the maximum altitude that can be reached with safety. Each rocket is a research vehicle, packed with instruments, and the whole rocket program might be retarded if it is brought down too soon.

"We talk it around by radio," Karsch says. "and if it is apparent that the rocket is headed off the range, we chop the motor at 40 or 50 seconds, depending on the rocket's lateral velocity. With its thrust cut off, the rocket climbs to a reduced altitude and then falls back to earth, inside the range.

(Continued to page 260)

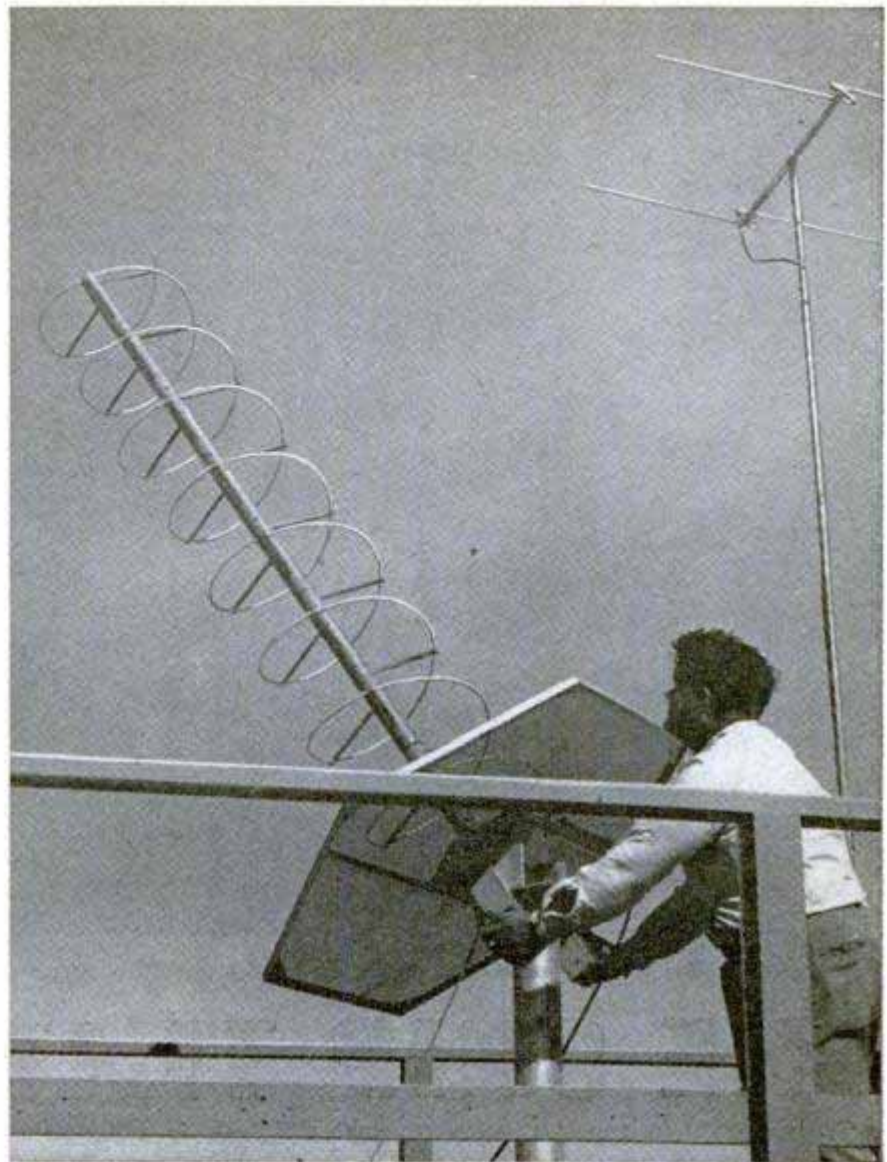

Spiral antenna is aimed at the missile throughout the flight. It receives telemetering signals which are recorded to give information about the flight. Below, here's just part of the radar equipment used to track the rocket, control its flight and receive signals from the missile's radios

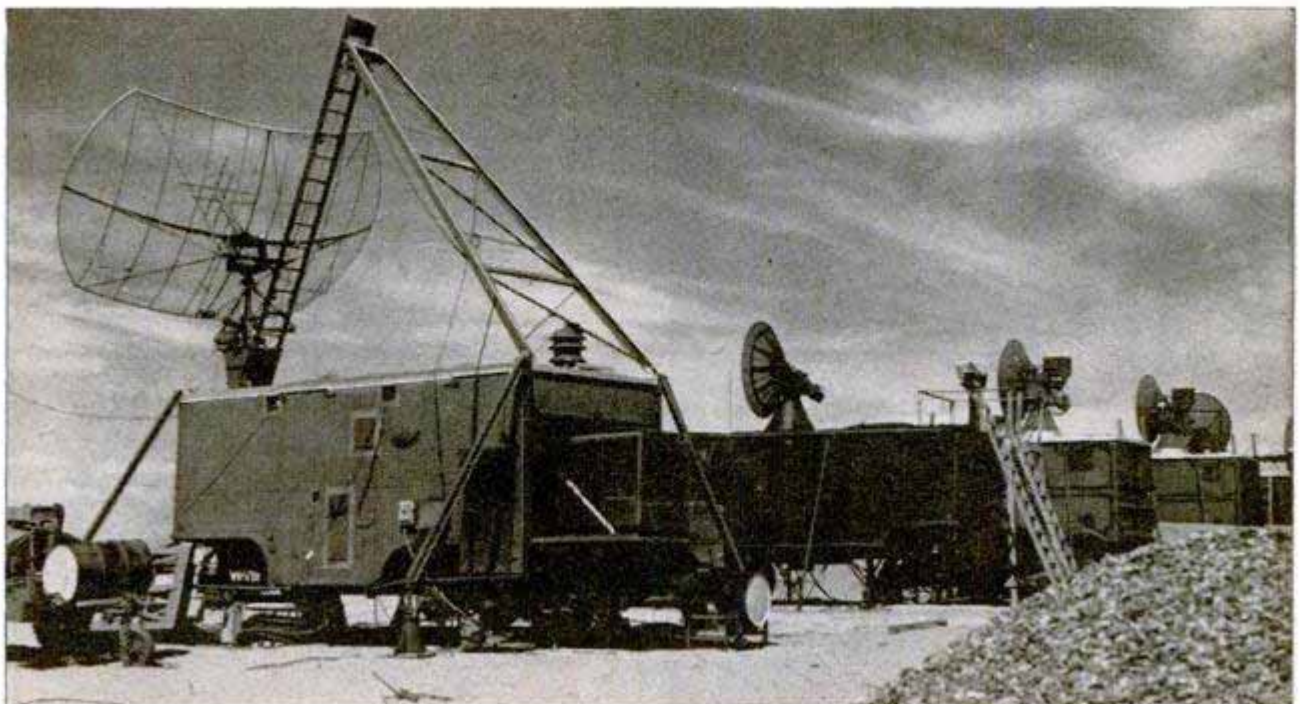



Stern view of Gar Wood's Venturi shows huge "wind tunnel" between twin hulls. Air in tunnel cushions ship

THE SHIP THAT RIDES

Gar Wood on deck of Venturi operates remote-control electronic unit which changes pitch of propellers to reverse ship when docking. Engines have no reverse



FROM AROUND a point of palm-fringed Fisher Island, off the south end of Miami Beach one day last August, came two deep-bellied toots, ushering in what may well mark the start of a brand new era in ship design. They were followed immediately by the monster they announced—a weird 188-foot craft that slid into Biscayne Bay like some giant ferryboat on stilts. No ferryboat ever behaved like this, however.

Two catamaran-type hulls knifed the waves like paper-thin steel blades at a cool 30-mile-per-hour clip, leaving a wake so flat it could barely be seen. Despite a sharp 90-degree turn it was making, its flat aircraft-carrierlike deck was almost parallel with the distant Miami horizon, showing no heel at all.

Long thin hulls thrust forward through the air to bridge the wave crests, sending the strange craft skimming over the sea like a monstrous sled. There was no pitch, roll or up and down motion to this floating "wind tunnel," for she was equipped with built-in knee action. Her shock absorber was a column of air, rushing through the Venturi-shaped passage between her hulls, which squeezed the breeze and made it

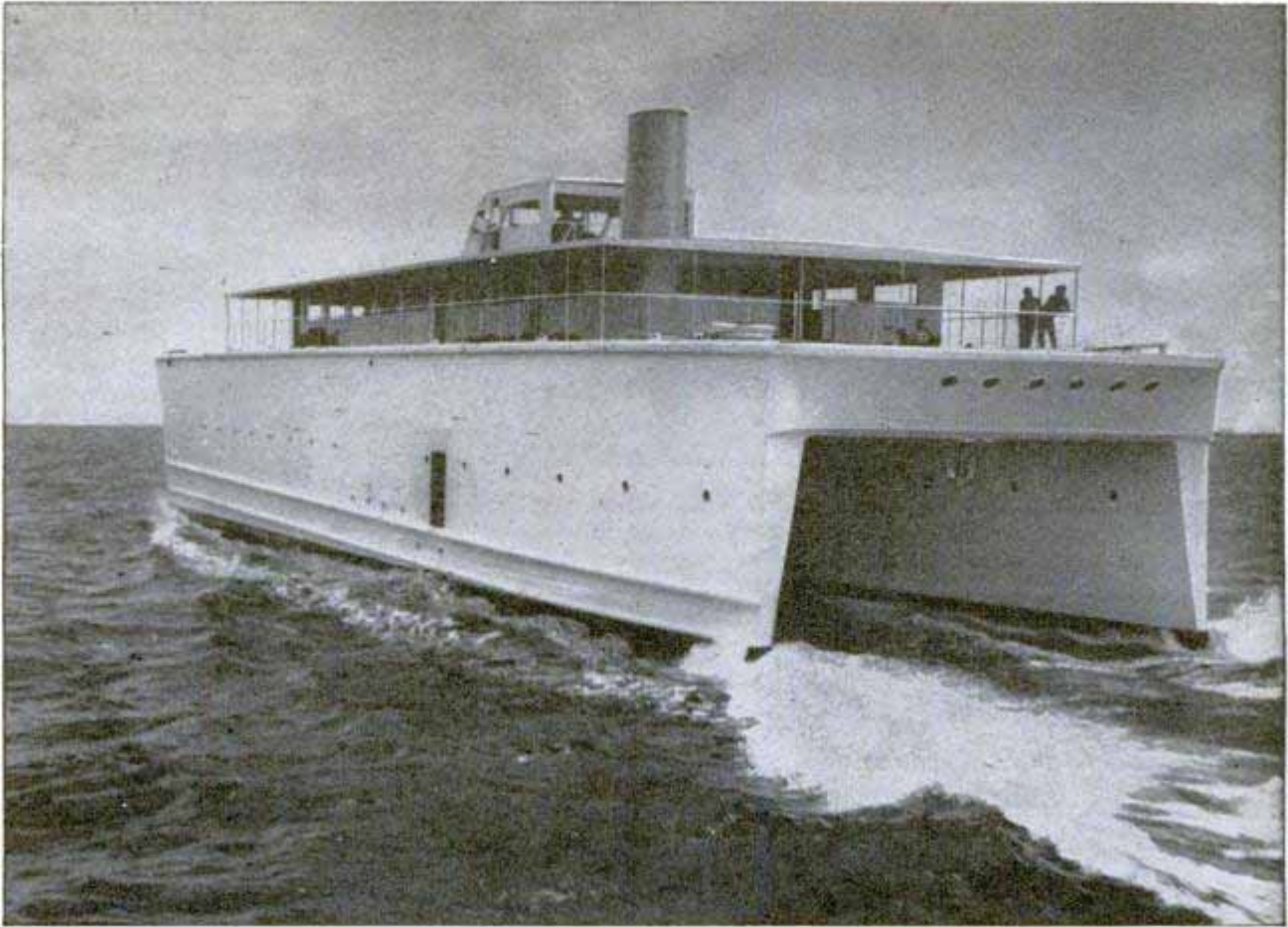

Cruising at 26 knots, Venturi's twin hulls draw six inches of water at the bow and four feet at the stern

By
Richard F. Dempewolff

buoy up the 120-ton ship. She was, in fact, riding more on air than water.

From this wind tunnel the ship derives her name—Venturi. She is the culmination of 28 years of experimentation by her inventor, Garfield A. (Gar) Wood, international dean of motorboat racing.

Today, the fantastic result of all those experiments is going through tests in the Gulf Stream and proving the Venturi as good if not better than Wood's wildest expectations. Cruising at 26 knots, her twin hulls draw only six inches of water at the bow and four feet at the stern—practically nothing for a ship so big, and a vital factor in cutting that speed and power killer, "skin friction." Tank tests conducted by the wiry, white-haired inventor already indicate that bigger ships in the Venturi pattern can revolutionize aircraft carriers, providing pilots with a flight deck that will stay put even in heavy seas. Ocean liners of Venturi design would be palaces of comfort. A 16,000-ton vessel, for instance, could provide roomy accommodations in unlimited tiers of decks above the roof of the odd Venturi tunnel—enough, in fact, to carry 4000 passengers, with all the stability and comfort

Diagram shows how Wood plans to introduce air under the flat-bottom Venturi hulls to reduce friction

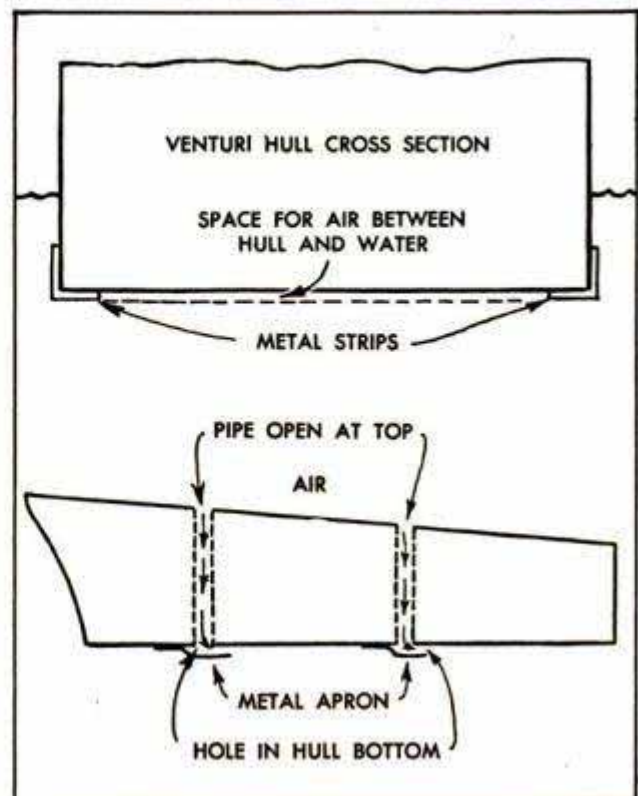



In these three photos, Gar Wood shows the basic principle of his Venturi-type construction which is designed to prevent rolling and pitching. With model above he shows how easily ordinary hull tips



Here Wood has split the boat hull lengthwise and reversed the two halves, placing the curves on the inside. Outside curves cause yawing. Below, he has bridged the split hulls to make them stand up

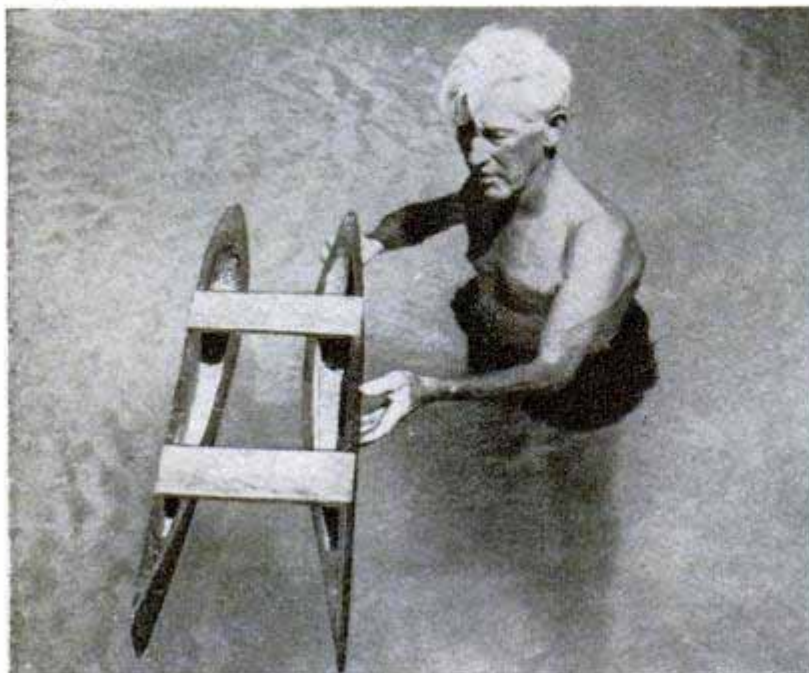

of a Waldorf-Astoria Hotel, and at a speed of more than 40 knots. What's more, its engines would have to deliver only 120,000 horsepower to do the job! Compare this with the mighty Queens, which carry 2000 passengers, weigh almost 90,000 tons and need 200,000 horsepower to drive them through the seas at 32 knots. Reason?

"These ships," Wood explains, "have massive hulls that crash and plow along, digging great holes in the water ahead of themselves, and then pulling the hole shut astern. Think of all the wasted power required just to climb waves and push aside thousands of tons of water. With the Venturi, the faster she goes, the farther out of the water she is pulled by air rushing through her airfoil tunnel, and the less resistance and friction she gets from the water."

Germ of the Venturi idea was born in 1921, after Gar Wood had captured the coveted Harmsworth trophy in the first of his 10 famous Miss America speedboats, hitting the then incredible speed of 61.51 miles an hour. (Later, he more than doubled it.)

To achieve such super speeds, the inventor was always fooling with unconventional ideas. Typical was the time when, as a kid racing standard boats on the Great Lakes, he put his fuel in a common oilcan, inverted it over the air intake, and roared away from his astonished rivals with a burst of unexpected speed. Without knowing it, he'd invented down-draft carburetion.

Similarly, he experimented with hull design to lick water-resistance problems, and out of it came the Venturi.

"Yawing" has always been a headache to yachtsmen. This phenomenon, in which the bow shifts back and forth at its own whim, requires constant attention from the helmsman who must correct each shift, and is a dangerous thing at high speed. Wood figured it was caused by the curves

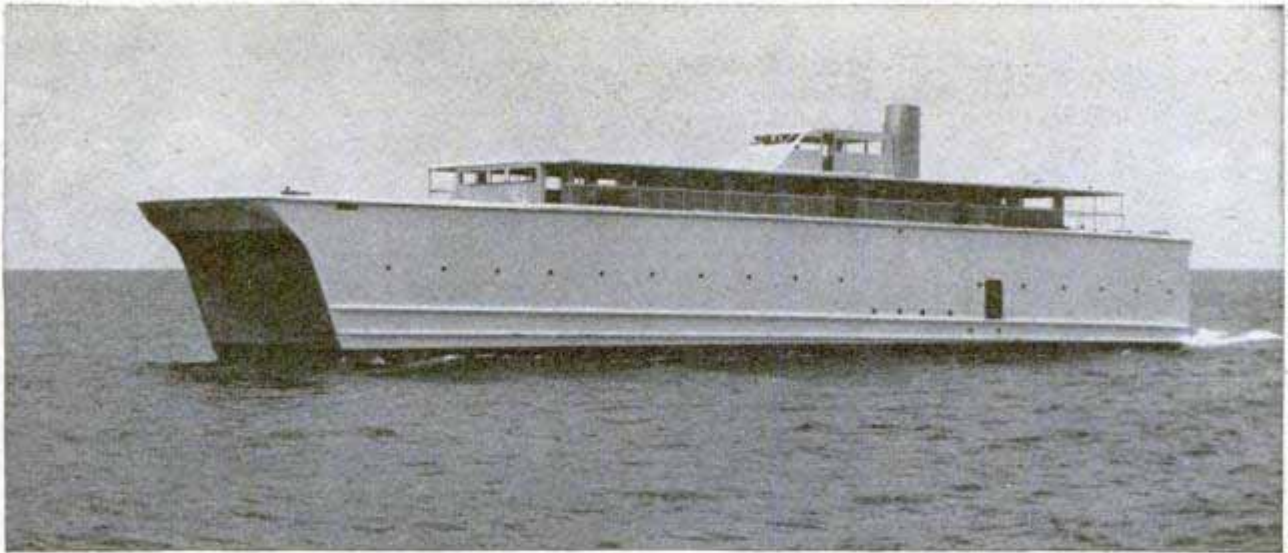

As 188-foot Venturi cuts through the waves the wind rushes through tunnel. Outer sides of hulls are straight

which the conventional bow presents to the waves. As a boat rolls due to heavy seas, the low side presents more bow curve to the water than the high side. This acts like a rudder in reverse, scooting the boat off in the direction opposite to the roll. He knew, too, that the longer and skinnier the craft, the less it yawed—and he guessed it was just the long lateral keel that kept it in line.

To prove his point, he took a 20-foot motor launch, chopped off about 10 feet of stern, and ran it. The thing skittered around like a demented water bug, spinning in circles, flying off in all directions, paying no attention to the rudder at all.

Now, Wood decided, if the bow had a reverse curve on each side—with the bow resembling the open end of a “V”—yawing could be completely eliminated. For instance, when the starboard side dipped, the boat would be pulled toward starboard instead of port as in the other type—but since that motion would tend to pull the port side deeper, its reverse curve would counteract the motion instantly, and the ship would just move straight ahead.

But, with such an odd “V” in front, a boat would have a tough time getting anywhere.

Port engine room looking forward. If one 1200-hp. diesel fails, the other carries on. The ship has four engines

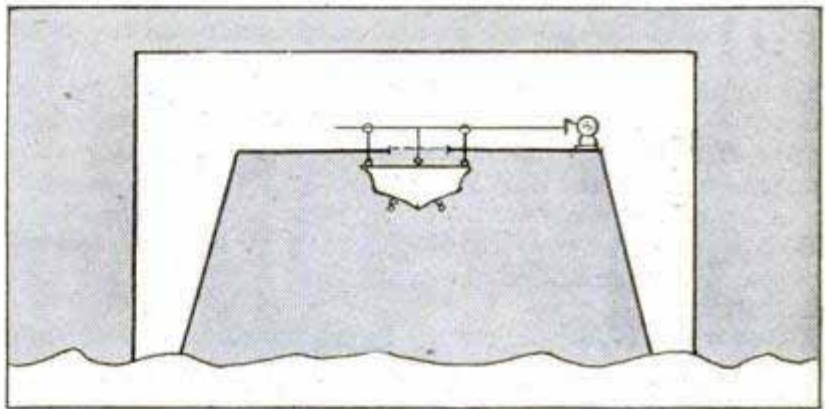

Wood is building a 20-foot fishing cruiser which will be suspended, as the diagram shows, in Venturi tunnel. It will be boarded by a hatch in the tunnel ceiling and lowered by winch-and-cable unit

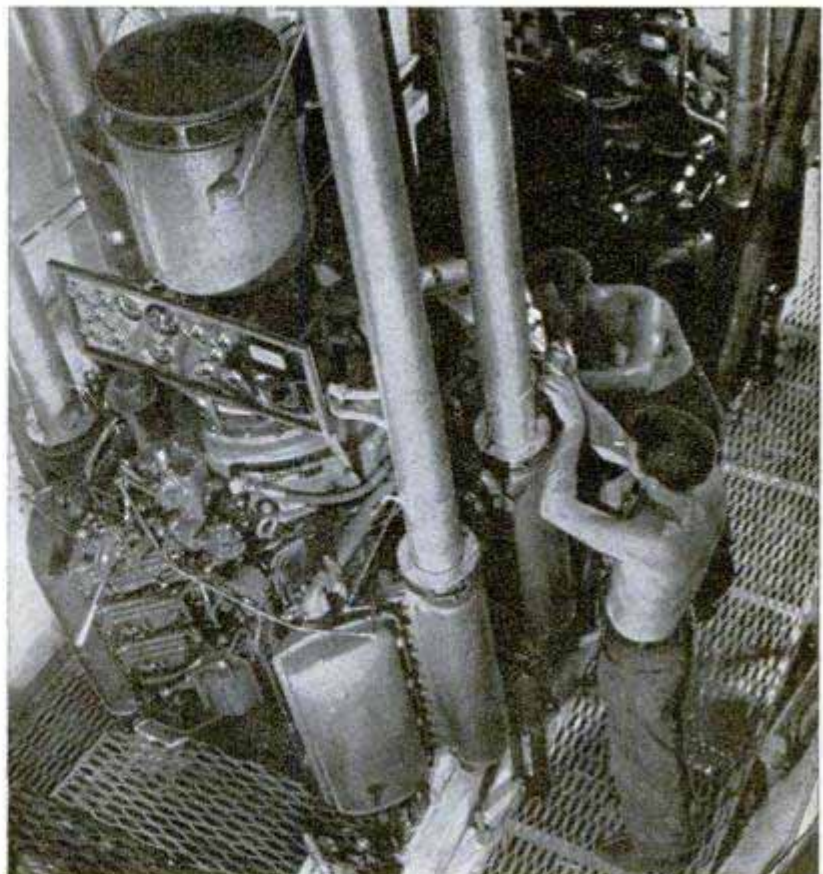

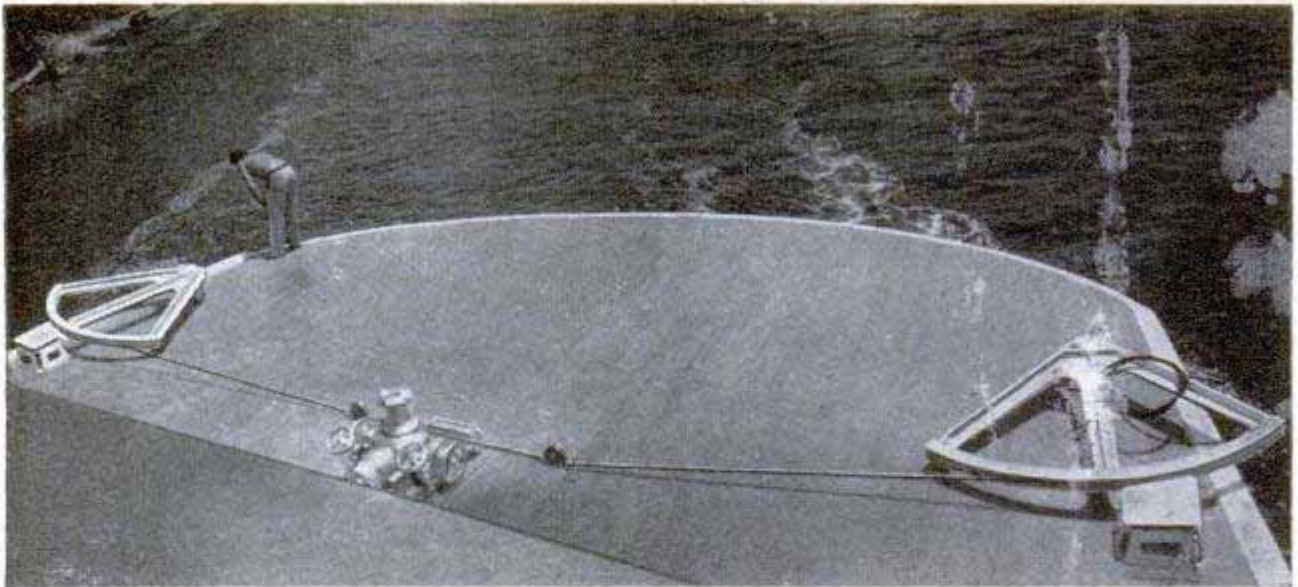

Steering device on two-rudder Venturi consists of rudder rods which are run up stern to the deck and fastened to big metal quadrants which are tied together with stout cable. When one quadrant turns the other goes with it

Water must flow past the curves—not into a trap—in order for the idea to work. The only answer was catamaran hulls, spaced apart—an ancient hull form used by Polynesian fishermen hundreds of years ago. But no one had ever applied aerodynamic principles to it, and that's what Gar Wood had in mind.

Wood went to work with balsa models. He took a conventional flat-bottom hull, so slim and racy that the scale model capsized instantly when put in water. This he split lengthwise along the keel line, then exchanged sides, putting the port side on the starboard, and leaving a sizable space between them. Thus, the long, sloping curves of the hull lines bellied toward each other

Motorboat takes a run through the Venturi tunnel. The hulls are only eight feet across at widest part and the over-all beam of ship is 40 feet

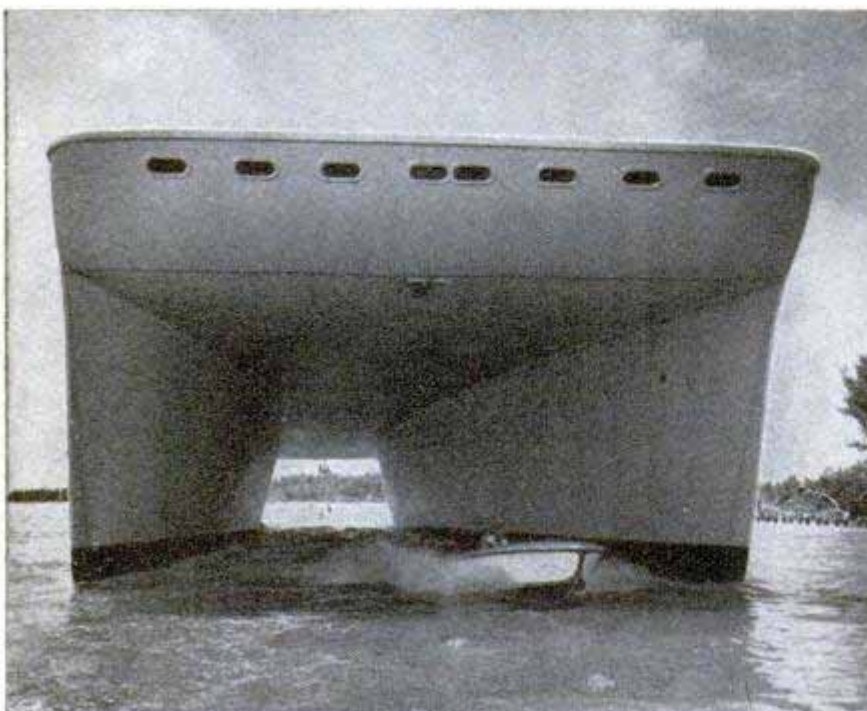

along the inside of the passageway between the halves, forming a Venturi-shaped tube after the two hulls were bridged with a deck section made of old car-box tops. The outboard sides were perfectly straight and flat.

By 1939, the experiment had resulted in a 36-foot model that had stability and speed out of all proportion to its size. There was only one trouble. Wood, who never swears, explains it thus: "The goldarn thing wouldn't turn a darn."

Those straight outboard sides wouldn't give the double rudders a chance. By 1944, Wood had licked the problem by building a slight inward curve near the stern on each outboard side. Now, when the rudder turned, it became an extension of this new curve and the boat could almost spin around on a dime. The more pronounced that curve, Wood found, the shorter the turning radius of the boat.

In building a big 188-footer in such a revolutionary pattern, Wood had to give plenty of thought to stress and strain. No one was better equipped to do it. His Miss Americas had to be acmes of perfection in strong, paper-thin construction. "At a hundred miles an hour," he recalls grimly, "water has as much 'give' as a goldarn concrete slab."

In Miss America VI, he was making a test run

(Continued to page 276)

Water Jet Sprayer Washes Cars

One man can wash an entire car without moving his feet with a machine that shoots jets of water and soap on all surfaces. The washer is connected to existing water and air lines and has its own supply of soap. An eight-foot steel arch and pivoting wash arm span the car. The operator merely swings the counterbalanced arm, first left and then right over the car. The soap and water rinses shoot down against the surfaces. Provided with the unit are "plug in" sponges for touching up the car if an exceptionally clean wash job is desired.



Designed for filling stations and garages, the machine can wash 50 cars per day with little manual effort.

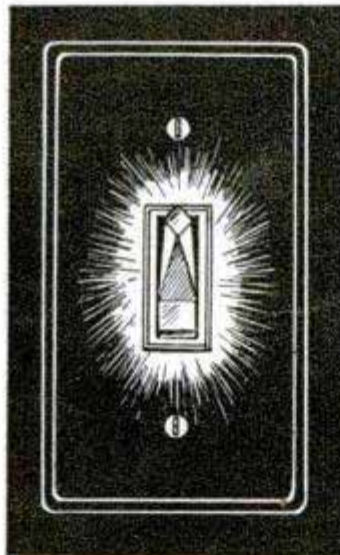

Light Switch Glows When Off

Built into a new toggle switch is a tiny neon lamp that glows whenever the lights are off, eliminating fumbling in the dark. The little lamp is seated within the switch housing and automatically comes to life when the switch is turned off. The glow is reflected out through the transparent switch handle. The neon lamp uses less than 10 cents worth of electric current a year in a community with average rates.

(1) DONALD S. CHAM, SPRINGFIELD, MISS.
 PAT. 4R, 2,776,700
 (Stainless steel now can be made a lustrous black instead of its natural dull silver tone by immersing it in a bath containing four chemicals and heating it to a temperature of 250 degrees Fahrenheit.)

Tiny French Car

Just about the smallest production car in existence is the Flea-Way, produced in France by the S. T. R. O. J. Company. The tiny auto is made of aluminum. A one-horsepower engine drives the midget at a top speed of 45 miles an hour.

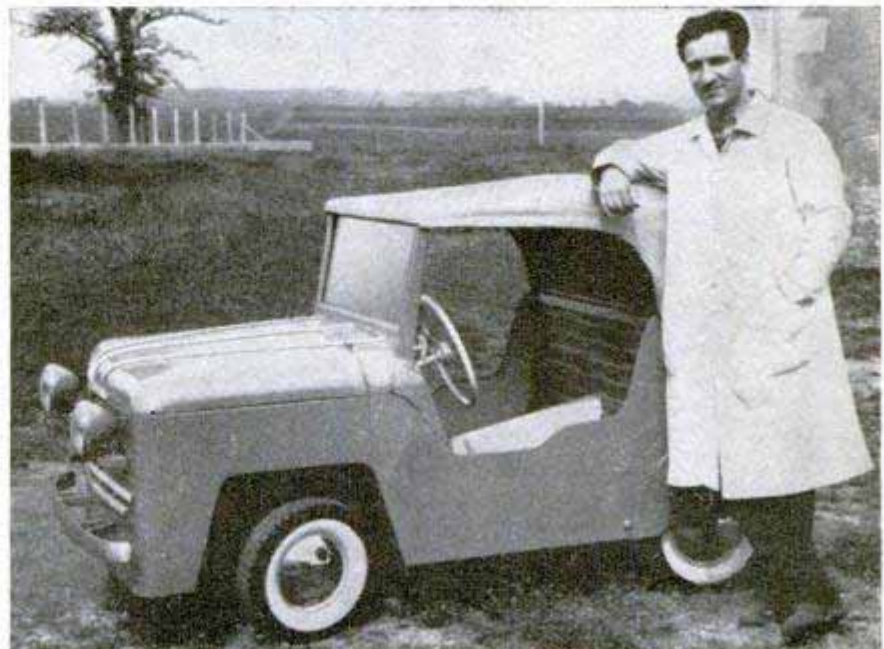

The WHERE-TO-FIND-IT INDEX, available without cost from Bureau of Information, 200 E. Ontario St., Chicago 11, lists sources of further information not given in the index on pages 10, 14 and 24

Sighting-In the "BIG 5"

PROBING the outer reaches of space with its photographic eye, a giant telescope-camera of unusual design is "scouting" the heavens for the world's largest telescope, the 200-inch reflector on Palomar Mountain.

Known as the "Big S" because it is the largest Schmidt telescope ever built, the mortarlike telescope-camera takes sharp, wide-angle photographs of the heavens. From these pictures, astronomers select unusual phenomena for intensive, pin-point study with the 200-inch giant. Said to penetrate about 10 times deeper into the heavens and cover 1000 times more space than previous telescope-cameras, the Schmidt is a 36-ton, streamlined marvel housed in its own dome. A combination reflector and refractor, the Schmidt uses a 48-inch correcting plate or lens at the "muzzle" of its 24-foot tube to spread incoming light rays uniformly over a 72-inch mirror at the breech. The mirror reflects the light rays back up to the photographic plate.

It is this correcting lens which is the key to the wide-angle, distortion-free coverage of the camera. Based on a design developed by Bernard Schmidt in Germany in 1930, the lens is high in the center on both faces, then dips in equal hollows away from the center and rises again at the edges.

One of the first discoveries made with the Palomar Schmidt was a tiny and previously unknown planet or asteroid having a diameter of about a mile. Now the instrument is being used to make a complete photographic survey of three fourths of the heavens, a task that will require about four years. Reaching into space a distance of 300,000,000 light-years, it is spotting "targets" for its 200-inch Palomar partner.

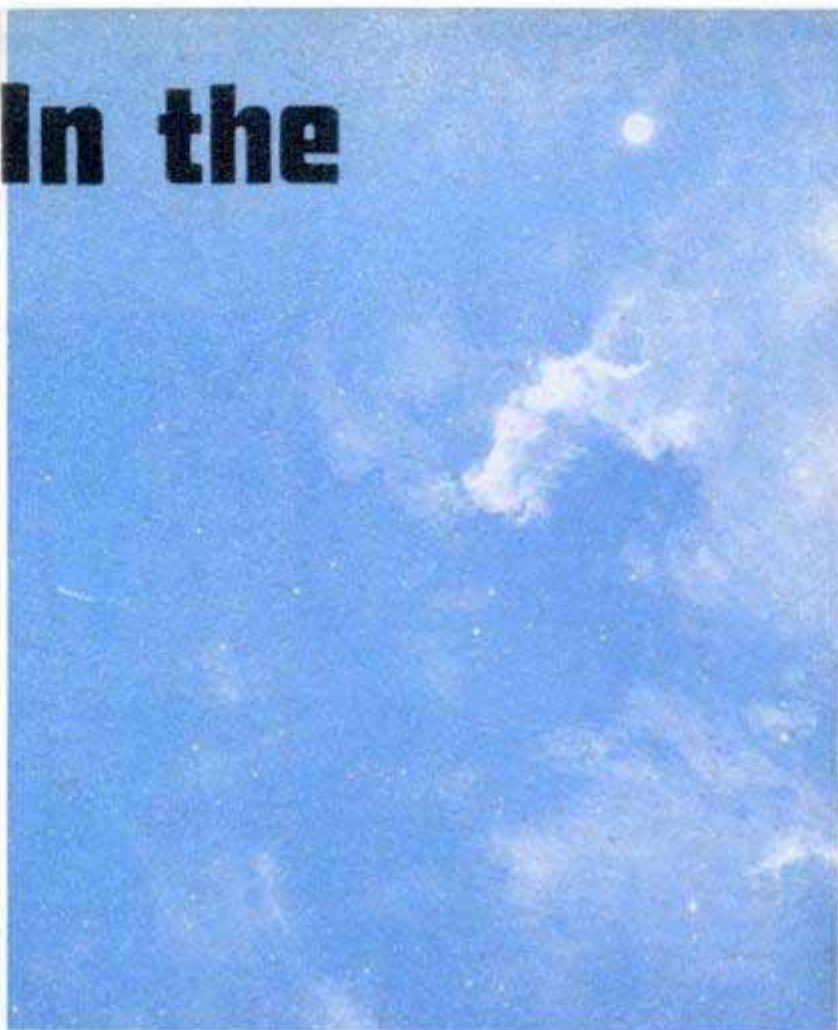

Above, the North American Nebula of the Milky Way, as photographed by the "Big S." Below, the main control panel of the Schmidt with the telescope-camera visible in the background



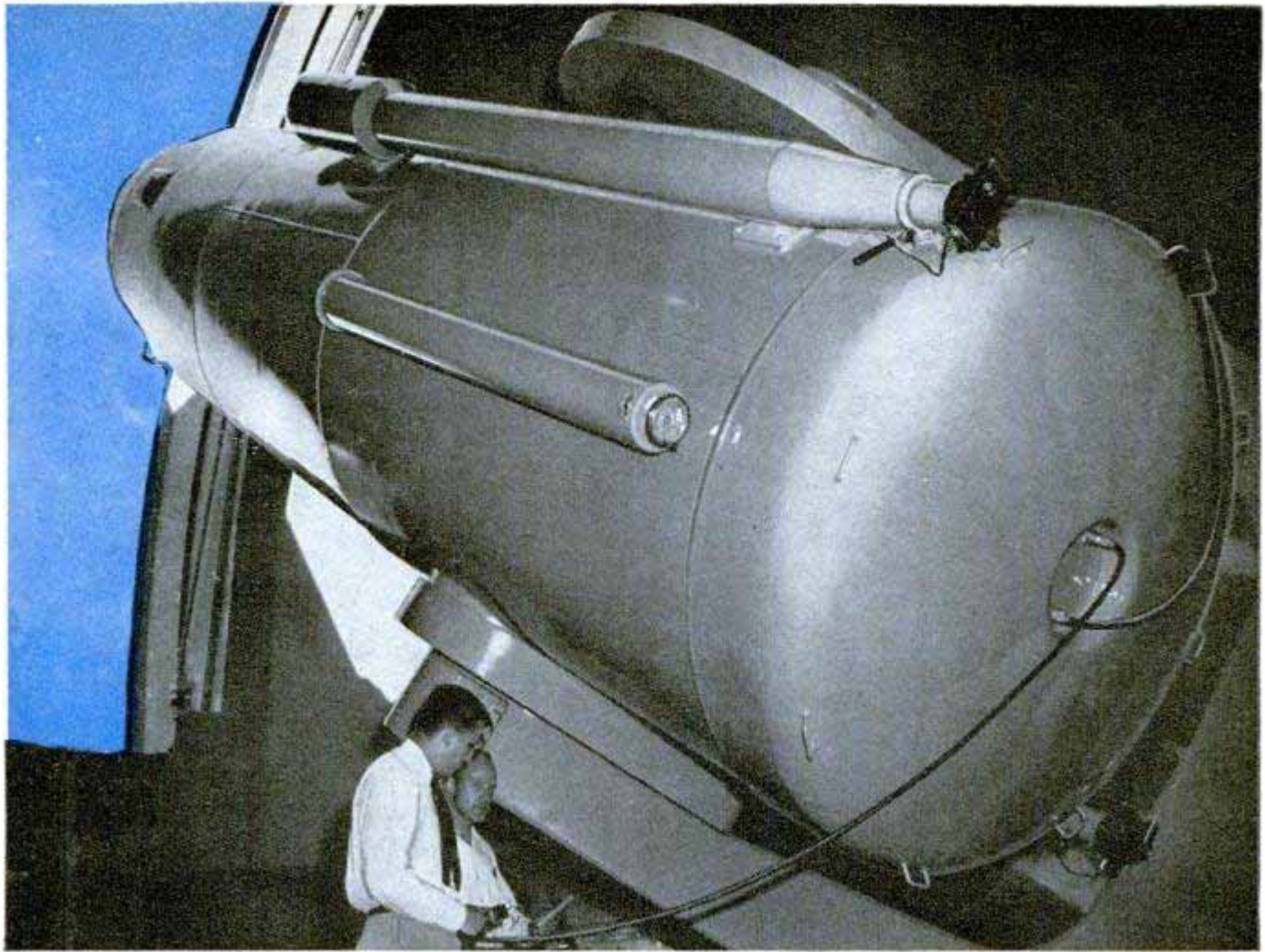

Above, the 48-inch Schmidt looks like a streamlined mortar as it points toward the heavens. Below, cutaway drawing of the "Big S," which acts as a scout for the giant 200-inch Hale telescope at Palomar. Notice the location of the 48-inch correcting lens and the 72-inch reflector. The photoplate is in the center

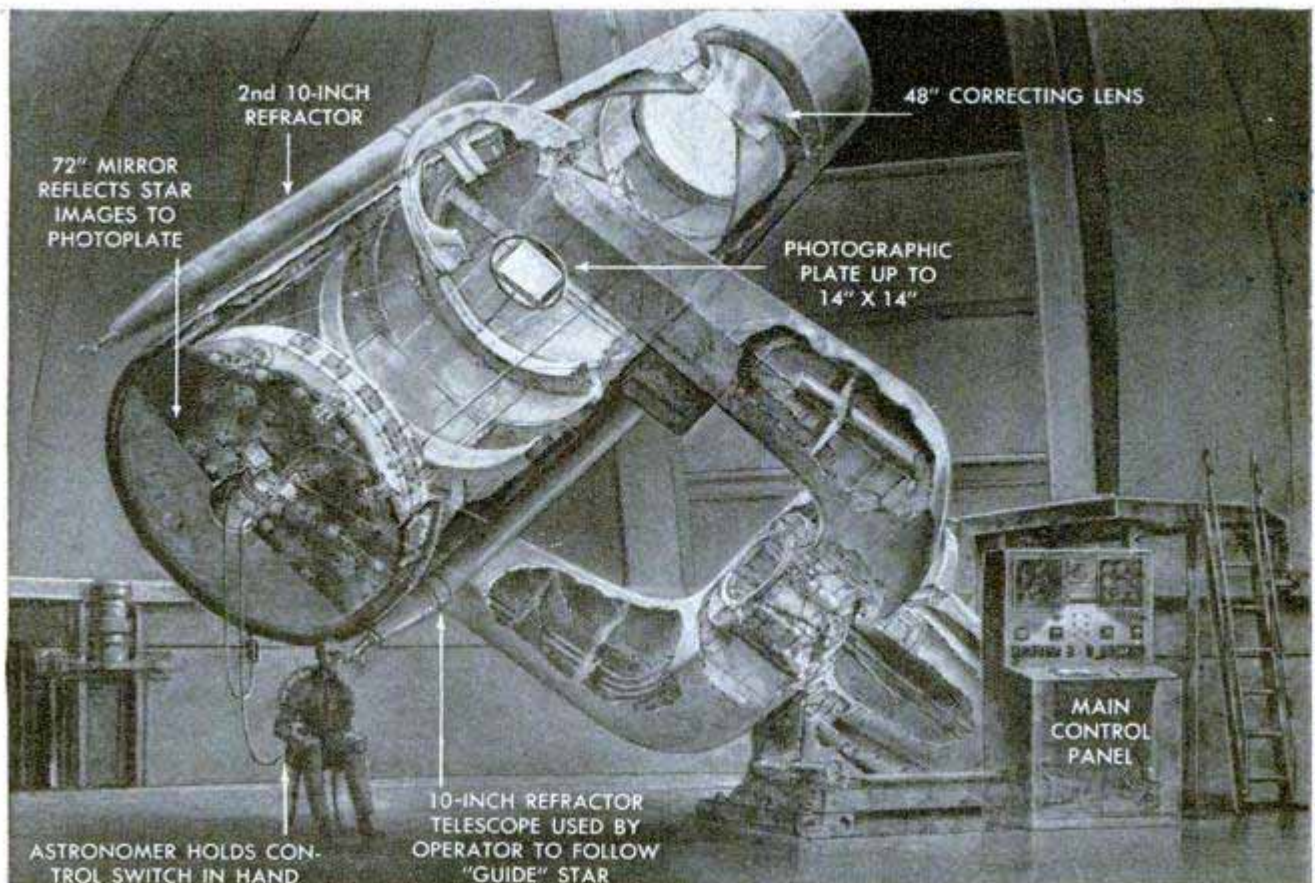

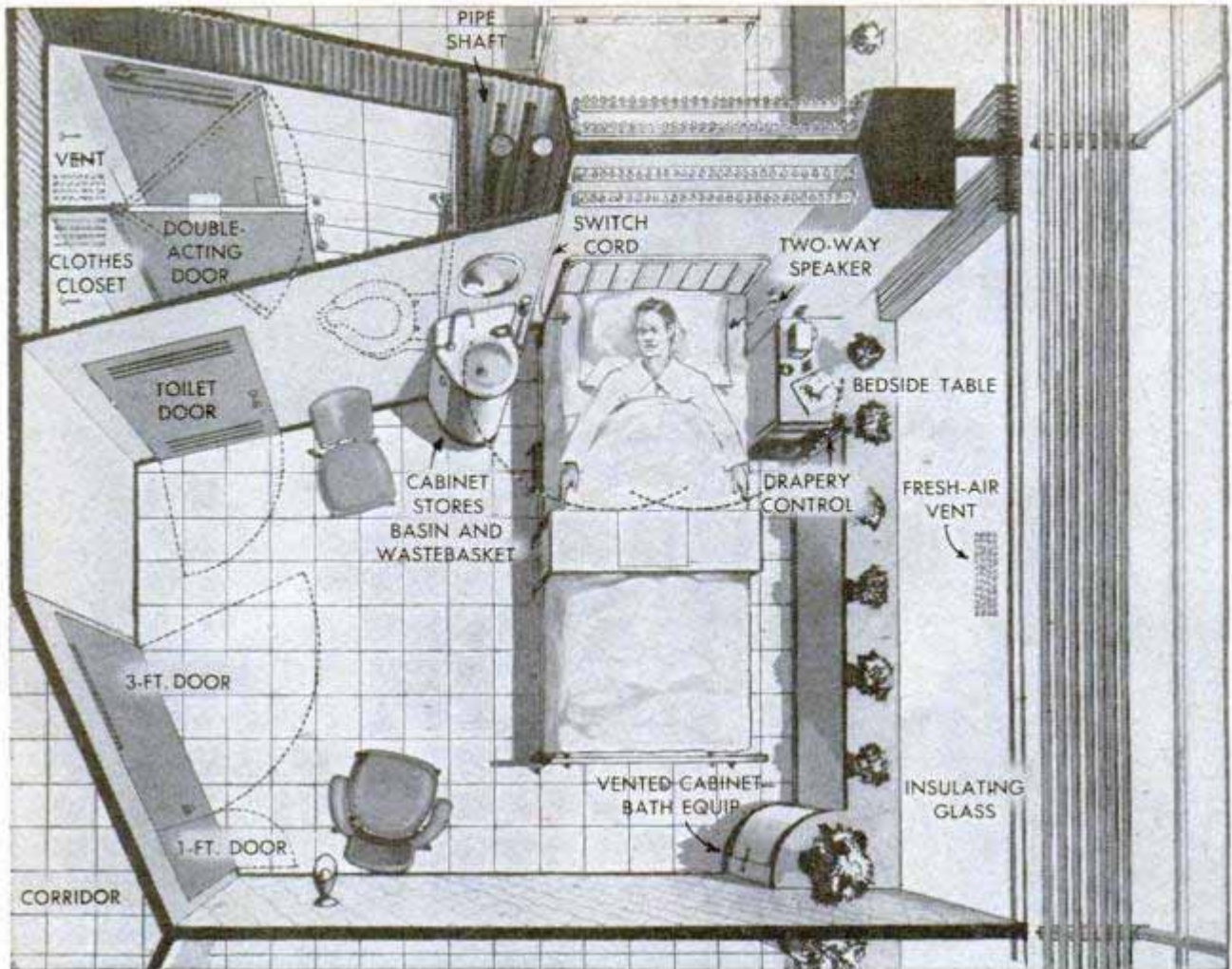

Self-Help Hospital Room

Patients in hospital rooms of a new design can help take care of themselves, thus giving nurses more time and cutting the cost of hospital operation. The room also requires about 30 percent less space than the minimum now recommended. The private room was designed by Marcus and Nocka for the Peter Bent Brigham Hos-

pital to be built in Boston, Mass. All mechanical services including oxygen, suction, electric wires, telephone outlets and plumbing are installed in a central shaft near the head of the bed. The patient can even adjust the window shades and operate light switches without calling the nurse. A two-way speaker in the wall gives him direct contact with the nurse's station. One bath is installed between two rooms.

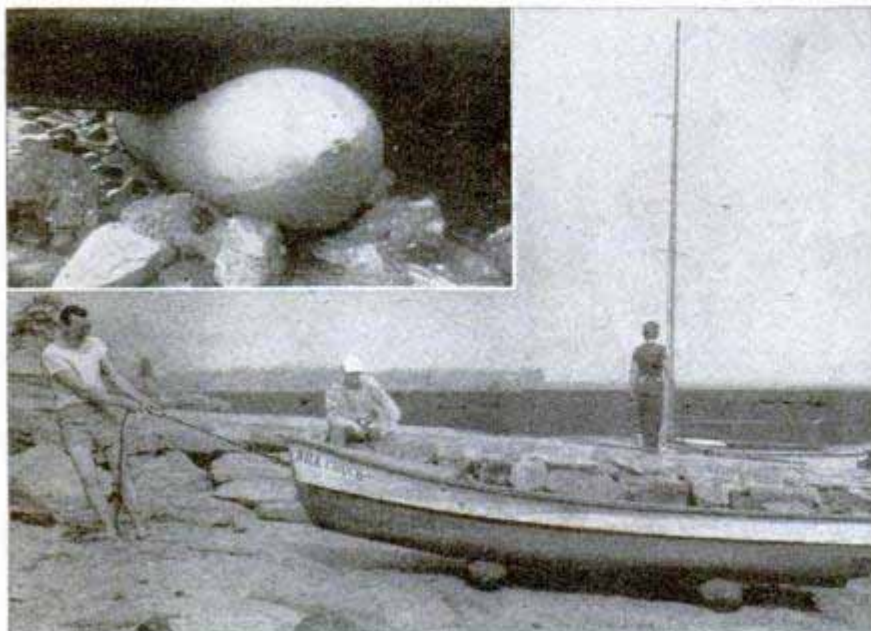

Air-Filled Rollers Help Beach Boat

Boats weighing up to 1000 pounds can be rolled up on the beach by one man when a pair of air-filled "cushion" rollers are used. Made of rubber and canvas, they function like roller bearings. Low air pressure allows them to conform to both the hull's shape and to stones and depressions on the beach. The rollers can be inflated by lung power and when deflated a pair requires less space than a shoe box.

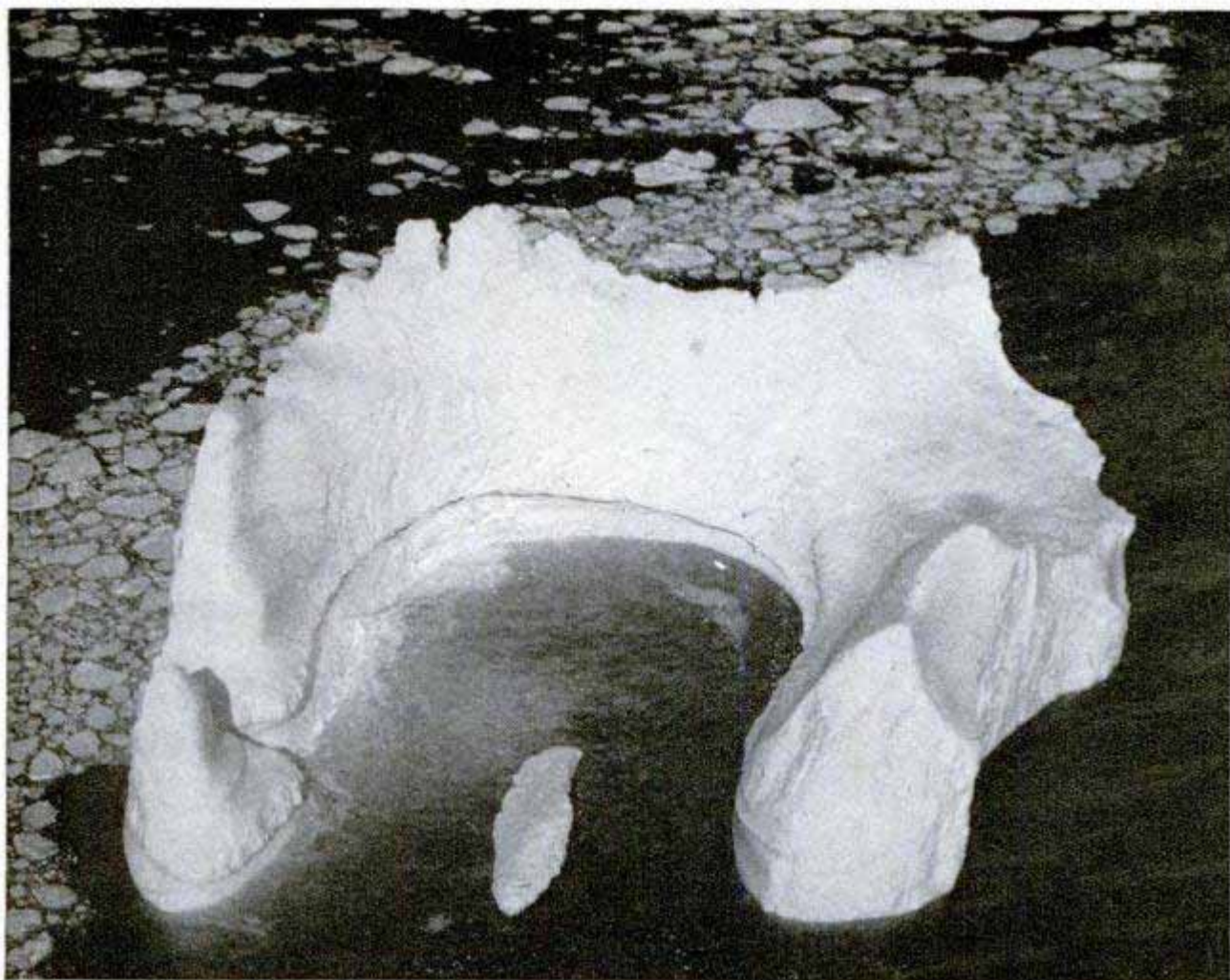

Giant's "False Teeth" Float Through Busy Sea Lane

Shaped like Paul Bunyan's lower plate, complete with eight-story-high bicuspid, a colossal iceberg was "frozen" in its tracks by a U. S. Coast Guard photographer flying over the North Atlantic sea lane. Icebergs, denture-shaped or not, are a menace to ships and the International Ice Patrol, operated by the Coast Guard, makes regular

flights over the North Atlantic during the iceberg season to spot and report the floating menaces. The unusual berg, shaped by the swirling sea, was photographed in the Grand Banks area, through which passes the world's heaviest sea-borne traffic. Ships are kept informed of the location of icebergs by Coast Guard radio.

Cars By the Pound—Latest Price Idea

Now you can buy used cars like meat—just pay a certain price per pound. Bob Portwood of Decatur, Ill., originated the idea of selling cars by the pound. His prices vary from 3 to 79 cents a pound, depending upon the age and condition of the car. His sales have climbed 50 percent.

On turf runways, the average airplane tire will last three times longer than on concrete strips.

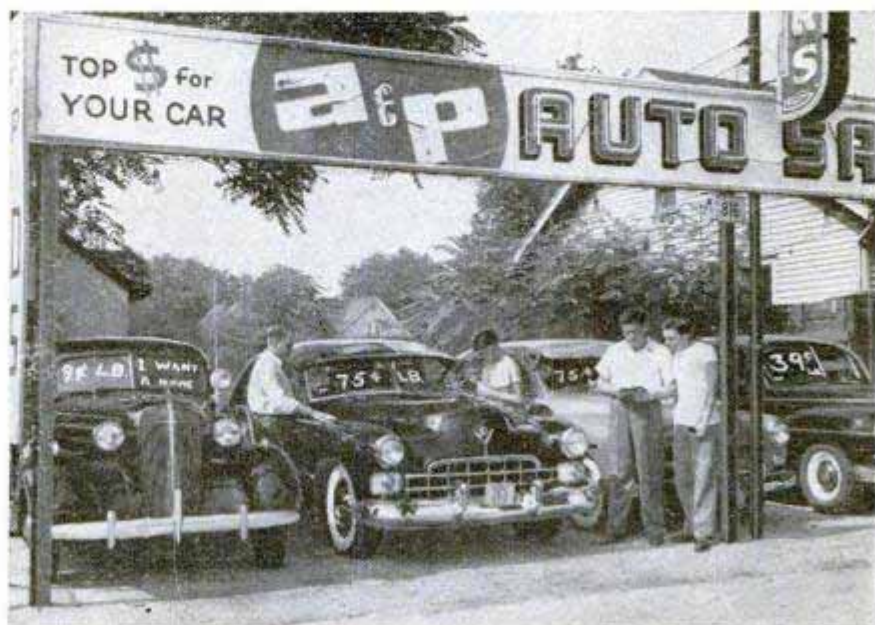

WHAT'S NEW For Your Home

A four-page "shopping section"
dedicated to modern homemakers



CLOTHESLINE LOCK, right, holds a line as taut or as slack as you want it and it can't slip. You just put the rope over a pulley at one end of the lock, flip down a lever and the line is held tight



VENETIAN BLIND, below, has no cords. You raise and lower it as you do a window. Slats can be removed for cleaning (see inset). Grooves on sides of window keep blind from flapping in the wind



SEWING TABLE, above, is designed to hold a portable sewing machine flush with the top. Sliding panel keeps material off the floor. The sturdy table doubles for bridge games. Its legs fold for storage

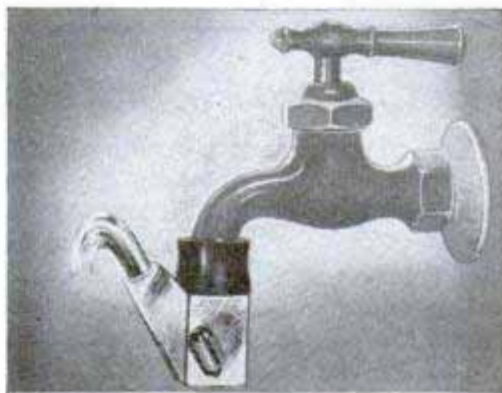

FOUNTAIN NOZZLE, above, converts faucet into a bubbler. Normally, nozzle directs water straight down, but when a lever is raised, it diverts water upward



CANDLE GRIPPER takes the wobble out of candles. Pushed into the candlestick, it grips the candle base as it is turned

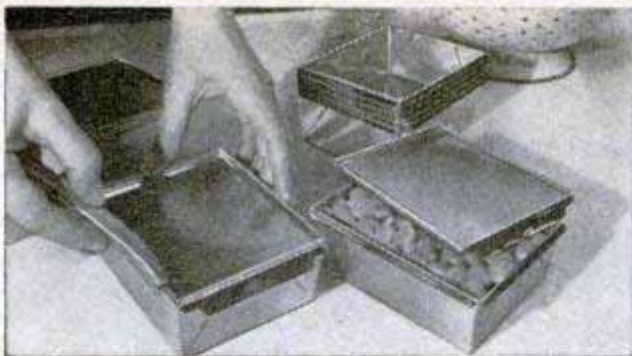

ALUMINUM TRAYS for home freezing have a fast-sealing feature. They can be heated without damage



SERVING TONGS are formed by a plastic spoon and fork hinged at one end. They can be used separately



REVOLVING BRUSH, driven by air pressure from tank-type vacuum cleaner, scrubs and polishes floors

DISAPPEARING CLOTHESLINES roll up like a window shade inside an aluminum housing to stay clean and out of sight. On washday, the crossarm is pulled out and hooked to a tree or wall, unreeling 150 feet of line

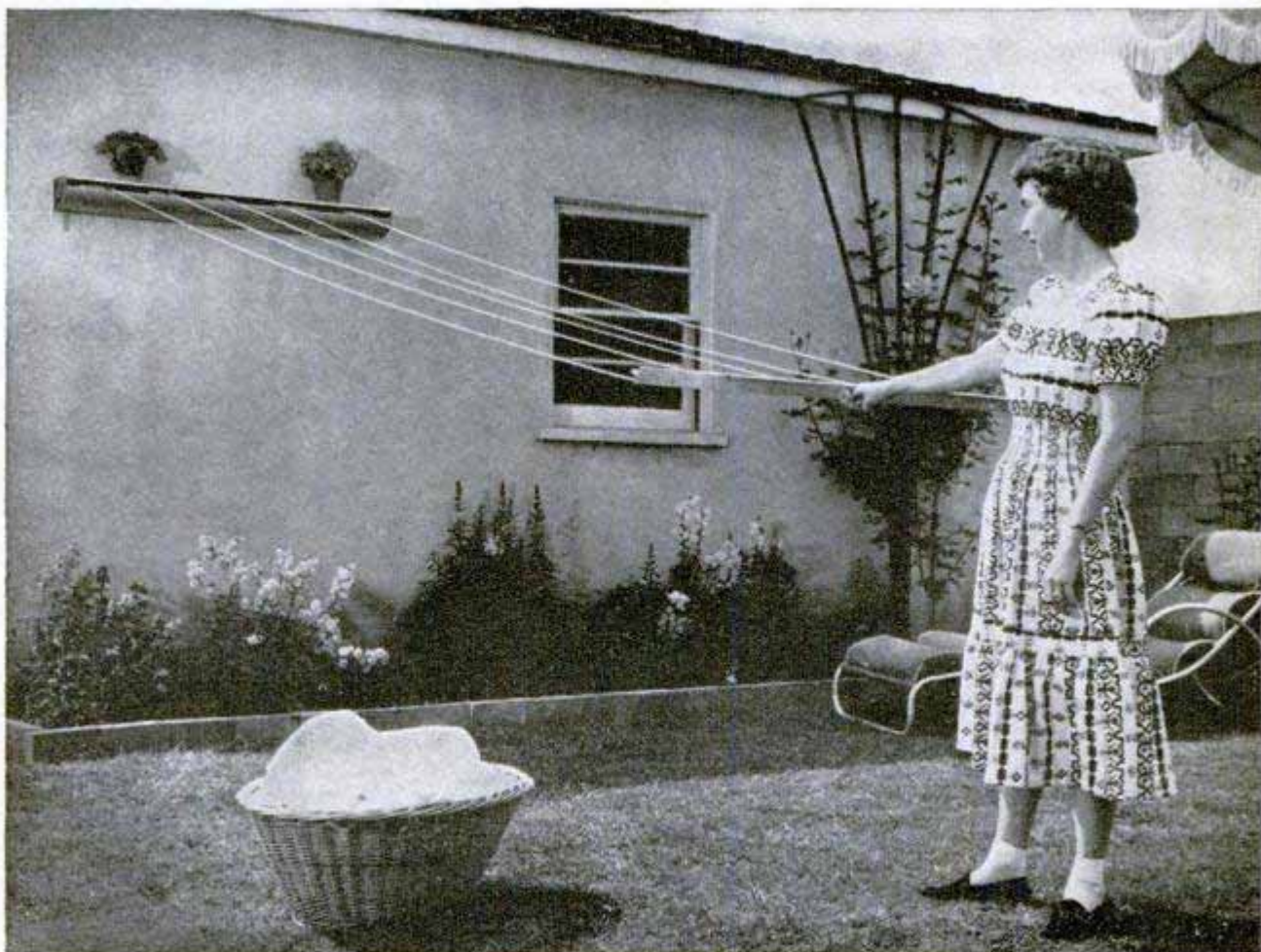

WHAT'S NEW *For Your Home*

Continued from preceding page

VEGETABLE REAMER, below, pulps and juices onions, potatoes and other foods as it hollows them for salads and baking. Twisting the tool in the vegetable does the trick

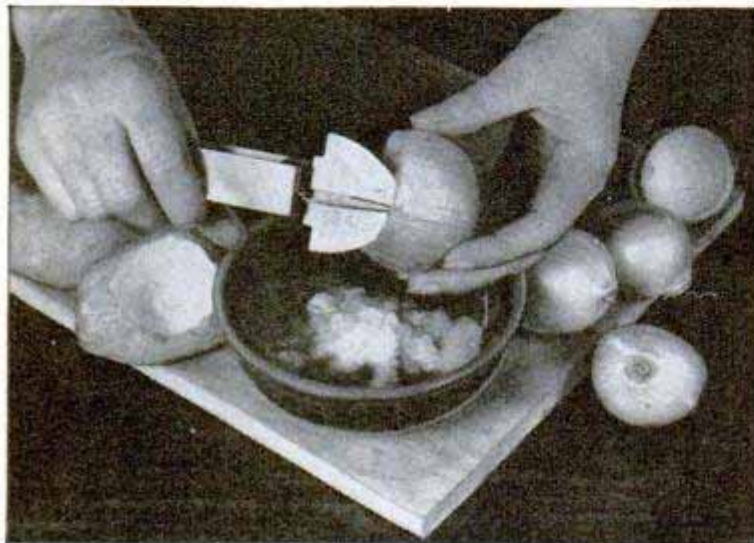

AUTOMATIC WATER HEATER, below, fits in a corner of the kitchen, providing work space on its table top and using "dead" corner space. It is electrically heated and holds 50 gallons



HOT OR COLD, this picnic basket will keep food and drinks either way. Vinylite plastic liner is insulated with Fiberglas

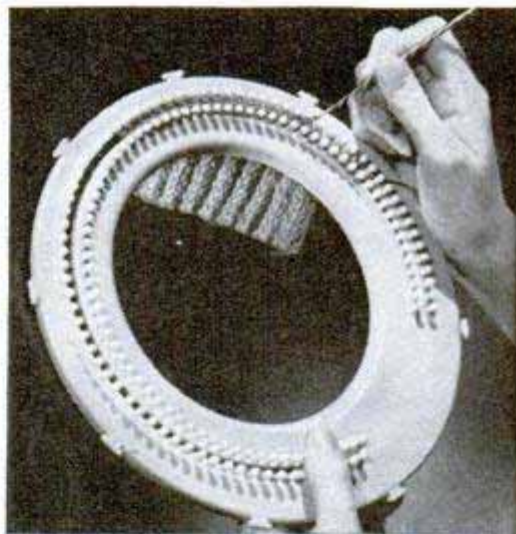

KNITTING requires no skill or needles with a peg-studded Tenite hoop. You wind yarn around the pegs, lift it from one row of pegs to the other with a hook and the knitted work comes out a center slot

TOWEL HOLDER has four rubber grippers that work with a gentle push of a finger





ARMCHAIR CRIB is a space saver. Days, it's an armchair. Nights, it becomes a crib



PANCAKE GRIDDLE has a thermometer built into the handle so you know when it is at the correct heat for best results

INDOOR FIREPLACE GRILL, below, fits any fireplace. It swings out for convenient inspection of food and slips off for storage

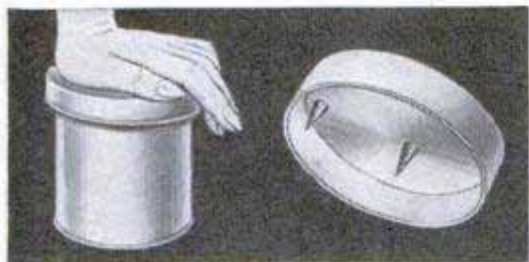

CAN PUNCHER pierces the top of a tin can in two places when you press it down



SUITCASE CRIB is a boon to parents who want to travel. It all folds up to form a neat suitcase in less than one minute





Above, inspecting camera installation for filming tractor-type landing-gear tests. Below, track tread area is three times that of double tires
Boeing Aircraft photos



Portable Airport In Bomber Gear

Motion pictures made by a camera attached to the plane's nose recorded the first tests of track-tread landing gear on a bomber. The gear was installed experimentally on a Boeing B-50 Superfortress, weighing 164,000 pounds, to investigate the possibilities of using unimproved runways for warplanes. The gear serves as a portable airport and the camera recorded the first taxi trials.

Hand Cutter Drills Holes in Glass

Held and rotated like a screwdriver, a cutting tool drills holes in glass, plastics or ceramics. Provided with the tool is a fluid to drop into the hole being drilled, preventing the drill from becoming dull. The drills are available in $\frac{1}{4}$ and $\frac{3}{8}$ -inch sizes, with special sizes furnished upon request. They also are available without the handle for use in such drilling fixtures as breast drills and power drills.

☐ On the average, 40 persons in every 100 are subject to seasickness and usually 35 of these unfortunates get over it after a few days at sea, but the remaining 5 never seem to become accustomed to the roll of the ocean.

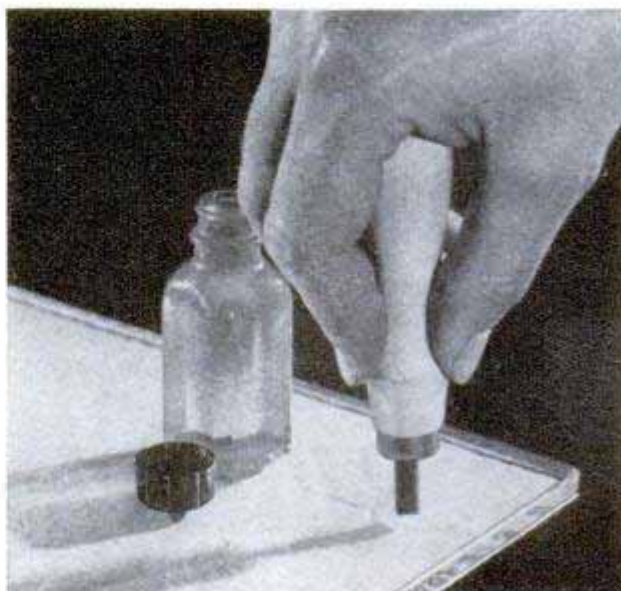

Small Bench Press Has One-Ton Punch

Although it packs a punch of 2000 pounds, a self-contained hydraulic press that plugs into a standard household outlet handles materials with kid gloves. There is no shock load of damaging impact. Instead, the bench-type press builds up pressure after the ram meets the work. Length of stroke, speed and pressure are preset to meet the requirements of the job. If desired, a special control valve gives the press a vibratory action, delivering short, repeat strokes of a preset pressure. This action is used in working certain metals and granular materials. Dual control levers require two-handed operation, an important safety factor that keeps the hands away from the

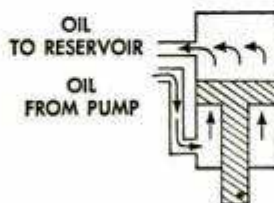
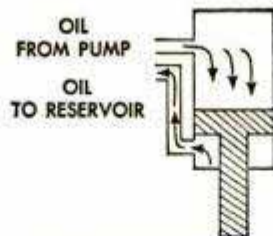

work area. The press is used for blanking plastic novelties, embossing leather, stamping and dry-pressing ceramic articles.

Automatic Pilot for Light Planes Weighs Only 20 Pounds

Some Beech and Cessna models will introduce a new "flyweight" automatic pilot for light planes. Invented by Bert Carlson of Cleveland, it weighs only 20 pounds in

contrast to the 140-pound instruments used in larger craft. A turn-and-climb knob maneuvers the plane and an altitude switch maintains it at the desired height.

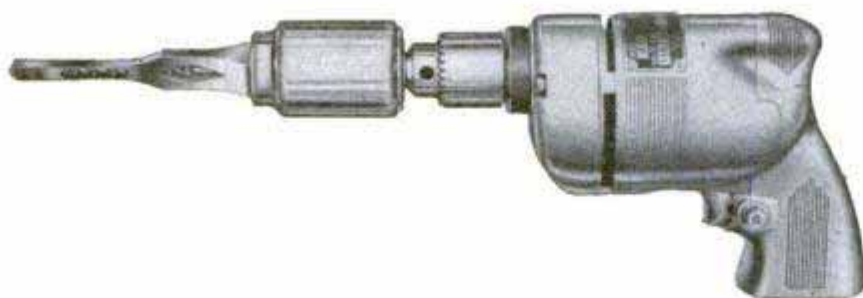

Hand-Drill Adapter Cuts Mortises

Mortises are cut on the job by a portable electric drill equipped with a new adapter that fits any standard chuck. It takes only a few seconds to make the change and any mortising chisel can be used. The tool is especially useful for mortising doors for locks, and for other work when the parts already have been assembled. As a router, the tool does the work of a chisel in much less time. The adapter also can be chucked in a drill press, eliminating much of the time required for installing conventional mortising attachments. The adapter and three chisels are available in kit form.

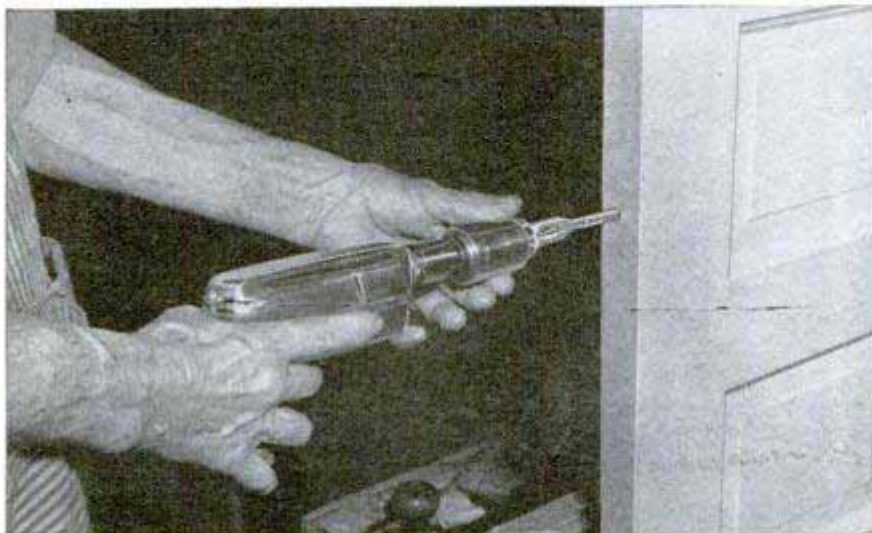

Deep-Sea Diver—4500 Feet

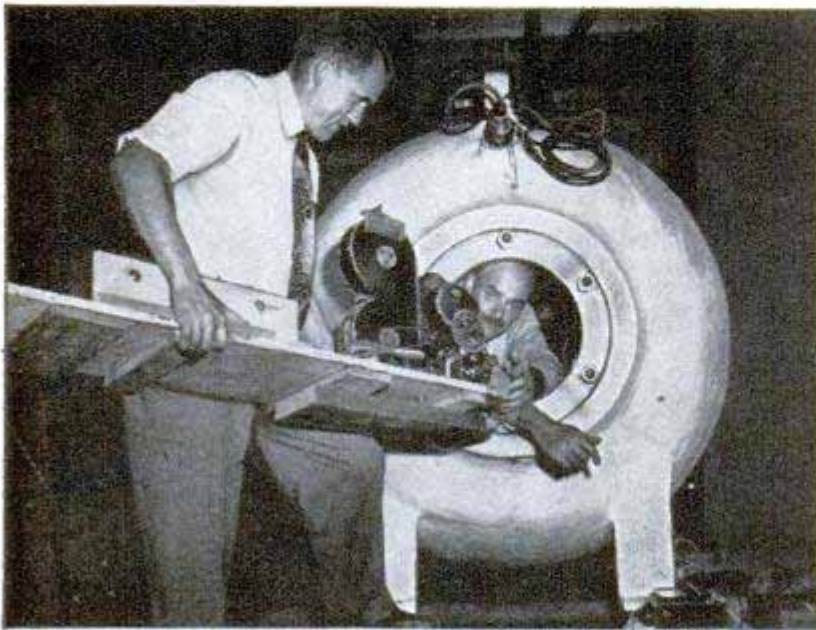

Barton pulls the 35-mm. camera into the steel ball. It can be operated manually or by remote control. Below, undersea explorer practices installing metal plug in window in case glass starts cracking

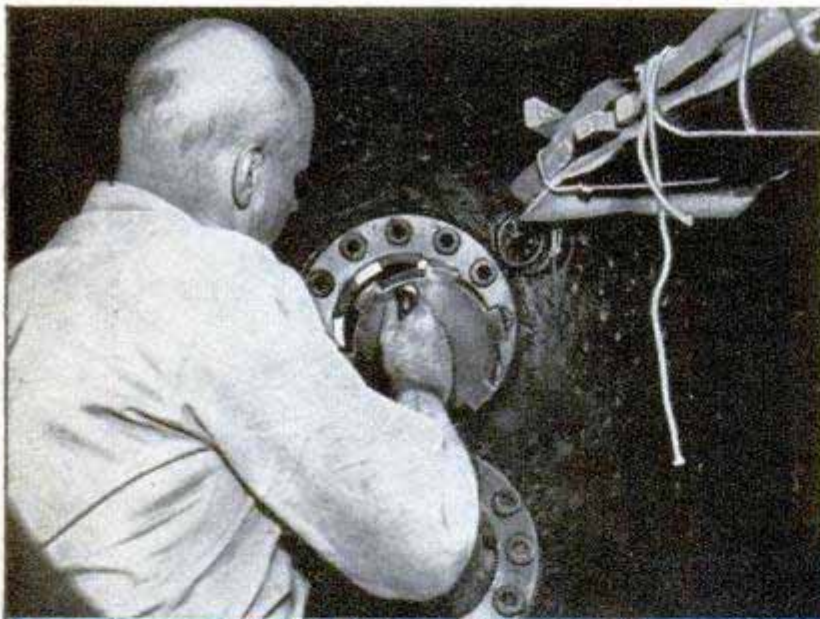

THROUGH chattering teeth Dr. Otis Barton said, "Let's hold up here. There are so many things going by it kind of makes me dizzy."

Topside, the winch ground to a halt and the steel cable no longer rolled off the drum. Dangling from the other end of the slender thread was a steel ball, and inside the ball crouched Barton, 4500 feet beneath the surface of the ocean. The scientist, who now rested far deeper than man had ever penetrated before, surveyed an eerie world of liquid shadows.

It had been that way during most of the descent. At 2500 feet he spoke into the telephone. "I see a barrage of luminescent, spiraling shrimp beating against the window. They seem to splash when they hit. . . . It's getting colder by the minute. . . . A long, thin, brilliantly lighted fish went by. It looks like an eel."

When he passed the old record of 3028 feet he reported that he was crouching in the middle of "an unbelievable world." At 4100 feet his lights suddenly went out, but he continued to drop to 4500 feet in the fluid darkness.

Listeners topside heard him say, "The ball is jumping up and down. . . . There goes a



Down

big jellyfish. I never saw anything like that before. There's a spot of light with a circle around it. . . . I see all forms of luminous sea life. I am amazed to see so many luminous things at this depth. The water is beautifully, unexpectedly clear, as clear as it was at Bermuda."

During the descent the scientist took photographs of this strange world. This was Barton's third attempt to drop 6000 feet into the blue Pacific off Santa Cruz Island, Calif. The first time the lights of his wondrous steel ball failed at the 2500-foot level. The second effort ended when a floodlight was smashed at 400 feet.

Barton's ball, known as a benthoscope, weighs 7000 pounds. Made of cast steel, it is 57½ inches in diameter and is dropped on a slender 5/8-inch cable from a crane on a barge. Power and telephone lines are fastened to the cable.

The heavy little sphere is the end product of years of study to discover a means to penetrate the seas to depths never before visited by man. Barton was associated with Dr. William Beebe in the bathysphere descents in the Atlantic 15 years ago. At one

point during his record trip Barton remarked, "I wish Doctor Beebe were here with me. He might know what some of these things are. I don't recognize them." The benthoscope is designed for use in depths of 6500 feet, twice the record depth to which the bathysphere was lowered.

But Barton didn't design the benthoscope merely as an elevator which would lower

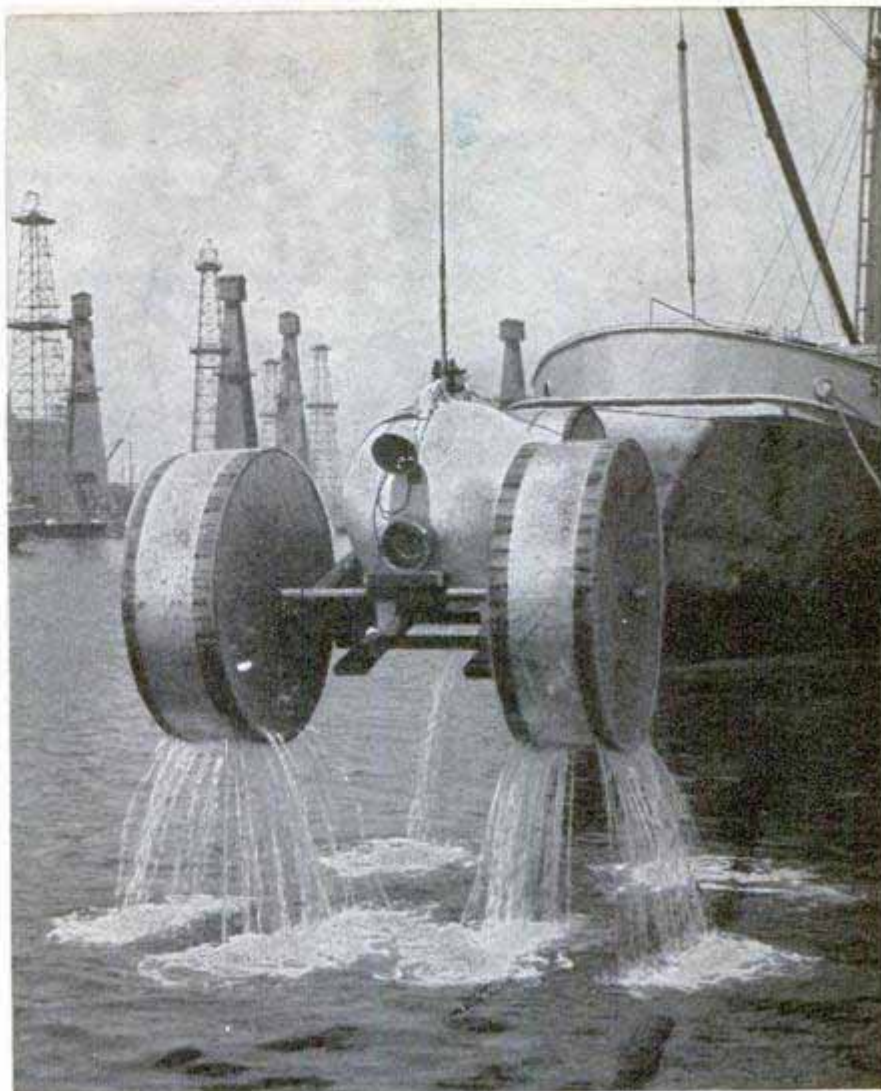

Water sprays from the strange craft's wooden wheels as benthoscope is hauled in after test. Undercarriage wasn't used during the record dive



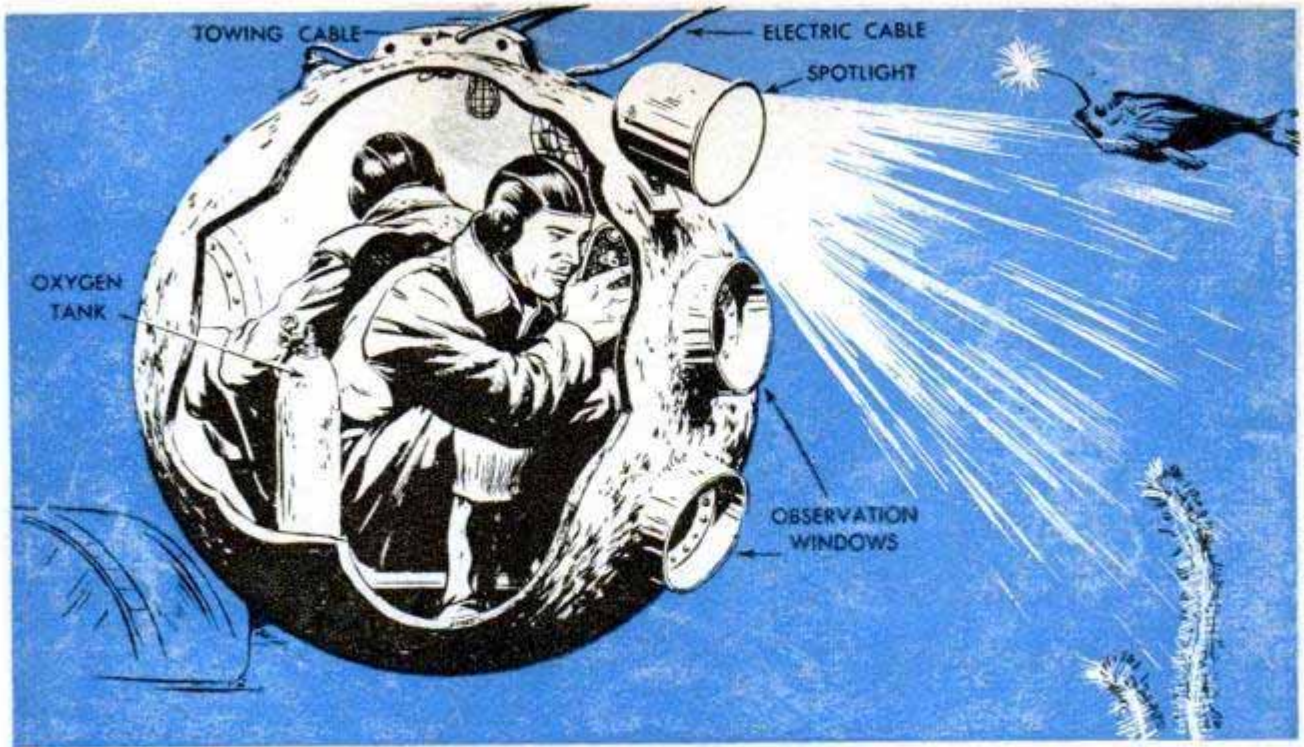

It's not exactly comfortable inside, but Doctor Barton's steel ball is built to carry two undersea explorers

him into the Pacific and then return him to the surface. The steel sphere actually is an undersea vehicle which will be towed across the canyons of the ocean floor. The record test was made without the undercarriage which makes movement possible.

When used as a vehicle, the hollow steel ball is mounted on two huge wheels and a roller. As an undersea tractor it will roam the mile-deep submarine canyons that are oceanic counterparts of land valleys.

Eventually it will be used for close-up visual and photographic studies of the floors and walls of several of the great canyons such as those off La Jolla, Redondo and Monterey, Calif. Until now these canyons could be explored only by soundings. One typically large canyon is clearly traceable 70 miles offshore. Such canyons usually appear at the mouths of present or ancient land river systems.

(Continued to page 270)

Undersea wagon has two wooden wheels in front, a roller behind. Sphere can be wrenched free in an emergency

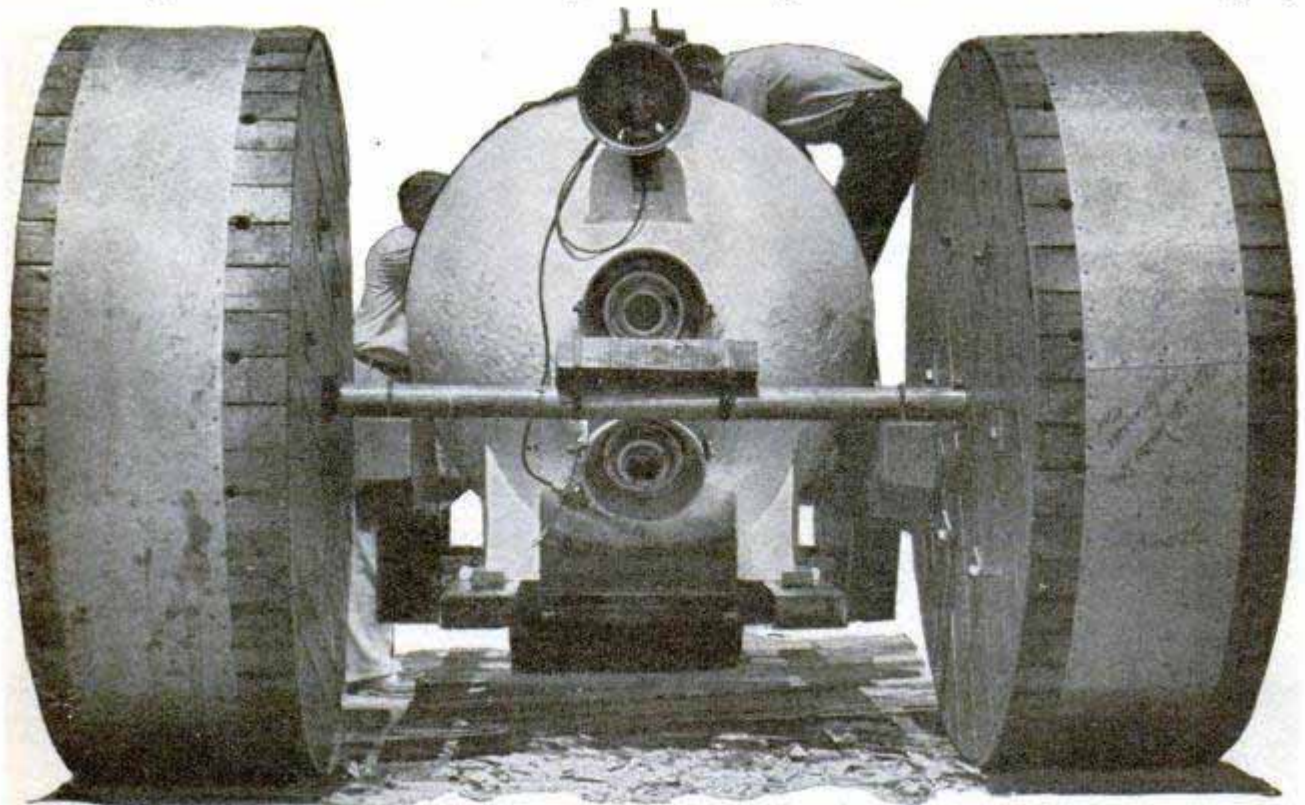



Helio Corporation photos

Both leading-edge slats, left, and full-span flaps (arrows), right, increase lifting ability of Heliplane wing

Slow-Speed Plane Lands and Takes Off From Tennis Court

Slowness, not speed, is the outstanding feature of a new light plane that flies under perfect control at as little as 27 miles an hour. Conventional craft approach dangerous stalls at 50 miles an hour. Called the Heliplane because of flight characteristics similar to both the helicopter and airplane, it was designed by two college professors, Otto Koppen of Massachusetts Institute of Technology and Lynn Bollinger of Harvard. Both are pilots. It can land in a space

the size of a tennis court, yet has sufficient power to take off and climb from the same small area at an 18-degree angle, about three times the usual rate. It is both stall and spinproof. The design combines an out-size, slow-turning, high-thrust propeller with such known high-lift devices as leading-edge slats and full-span flaps, and a unique control system with a split rudder. Noise is almost eliminated by gearing down the propeller and using a "hush box."

Bomb Experts Use Television "Eyes" for Dangerous Work

Danger is eliminated by television cameras that act as "eyes" for operators working by remote control on shells and bombs for the Army Ordnance Department. It is the first known industrial use of television. The camera is mounted on the danger side of a heavy concrete barricade, focused for close-ups of the removal of fuses or high-

explosive boosters or complete disassembly of missiles. The tools are manipulated by remote control. A single camera transmits identical images over a coaxial cable to viewers at as many as 10 different locations, and over a mile away. It replaces experiments with mirrors which did not produce clear images at a safe distance.

U. S. Army photos

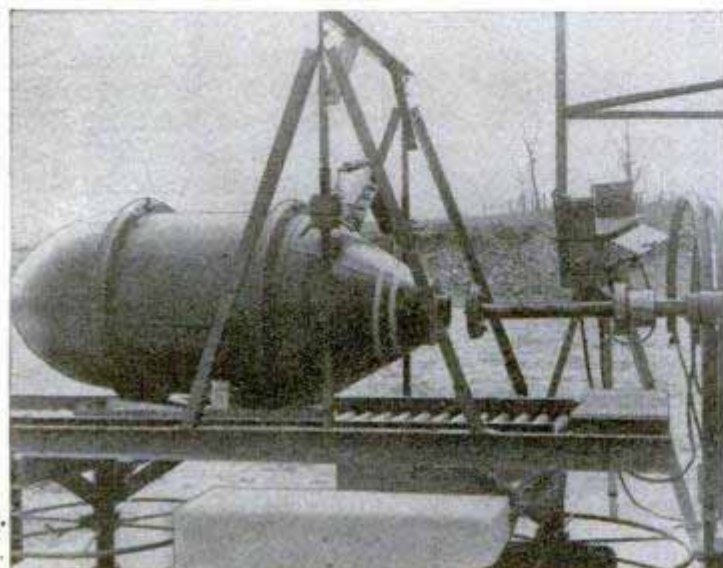

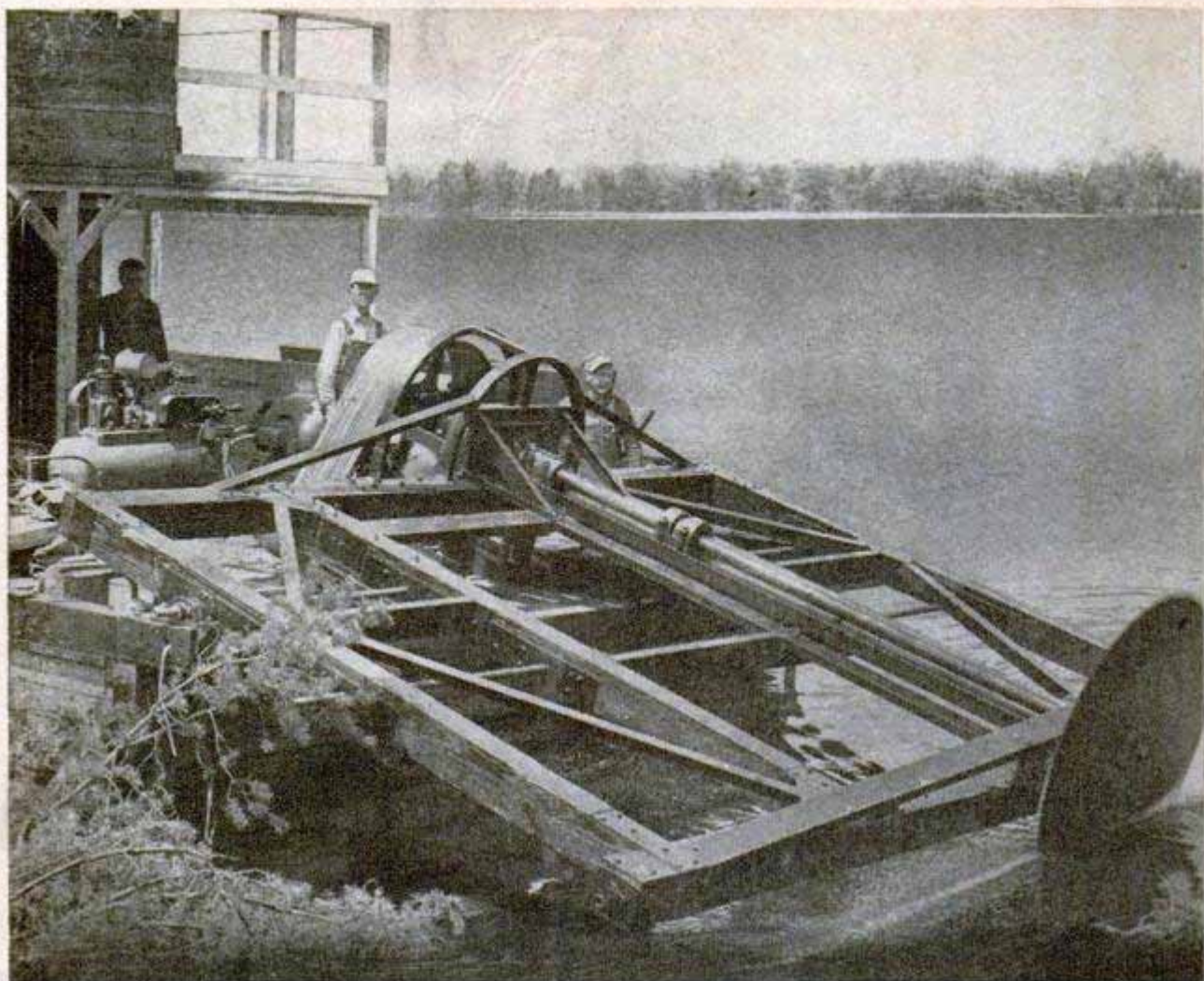

Above, the 60-inch disk saw spins out of water when the boom is raised. Below, a tree falls as it is cut six feet below the surface of the lake



Lumberjacks Go to "Sea"

Lumberjacks have turned sailors on the 21,-000-acre reservoir formed by the Petenwell Dam on the Wisconsin River as they cut down standing timber with a submarine saw. Driven by a 75-horsepower electric motor, a 60-inch disk saw mounted on a boom on the bow of a barge reaches six feet underwater to saw off trees. Four paddle wheels give the barge great maneuverability in carrying the saw blade to the trees. As the trees are cut, they are hauled ashore by tugboats. The barge, called the Swordfish, was built for the job by the Wisconsin River Power Co. The trees are being cut to open the huge lake for recreational purposes.

Bowling's Mr. Big



By Aubrey O. Cookman, Jr.

THREE easy-to-correct faults are usually the difference between poor and good bowlers, according to Connie Schwoegler, world match-game champion.

Connie should know. Son of an American Bowling Congress titleholder, the husky, blond star from Madison, Wis., began as a pinboy to make his career by studying the game from both ends of the alley. His 217.18 average in the 72-game All-Star tournament of 1949 is the highest ever rolled in a meet that annually attracts the world's greatest bowlers.

One of the most common mistakes, Schwoegler says, is allowing the ball to come down on the alley too soon. Bowlers should toss the ball well out ahead of them, from 12 to 18 inches beyond the foul line, to have it work most effectively against the pins.

A correctly thrown ball skids part way, then changes over to a rolling motion that makes struck pins topple over at an

Above, world match-game titlist Connie Schwoegler follows through on a strike delivery. Below, stroboscopic camera catches a perfect 1-3 strike hit. For special PM photos, from one to six lines were drawn around six front pins to indicate their original positions. All stroboscopic photographs by Jay B. Leviton.

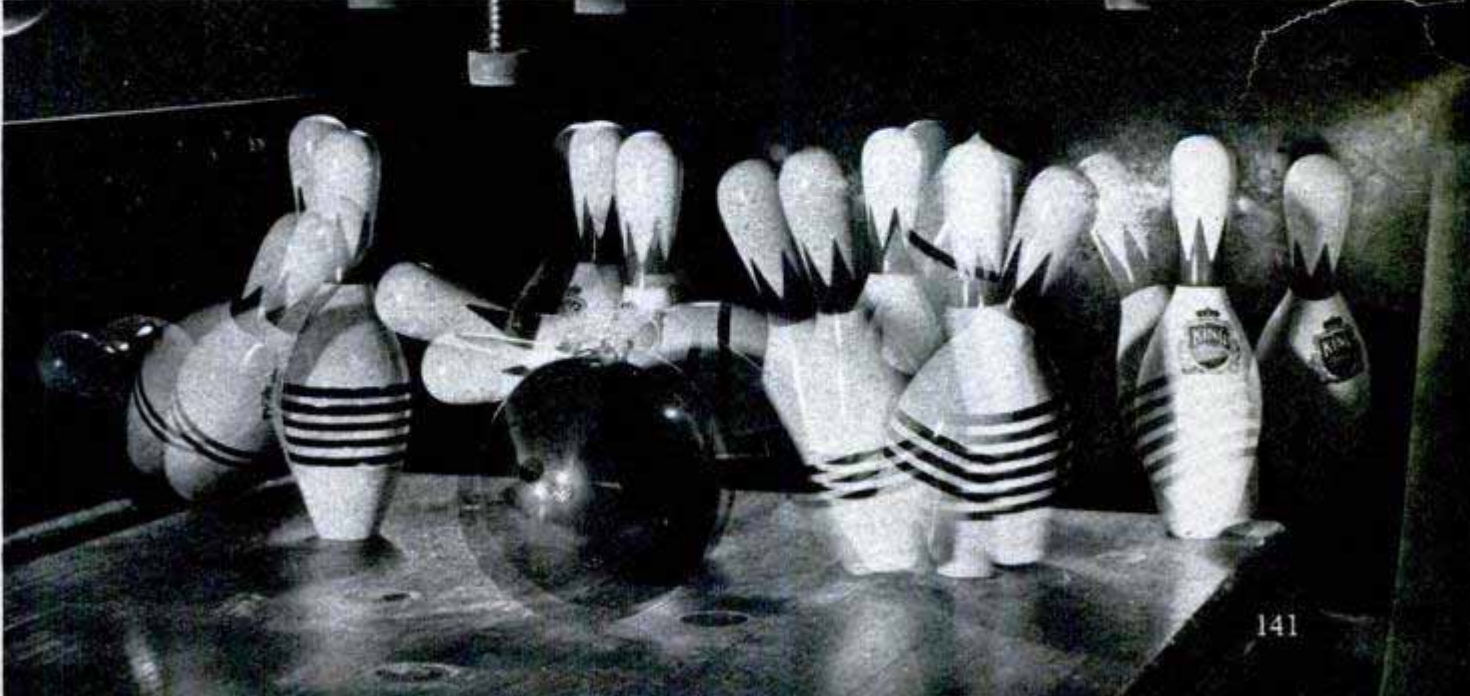

angle and—in turn—knock down other pins. It slides in the direction it is released, then revolves in the direction given it by the fingers when it leaves the hand. The rolling begins after friction has gradually overcome the slide's initial force. With a good "fighting" or "mixer" ball, the few pins actually struck sweep those that remain off the alley.

A ball thrown too speedily skids the entire distance, smashing struck pins off the alley while they are still upright, before they assume their more potent, horizontal pin-hitting angle. At the other extreme, a "slow poke" ball begins the rolling phase too early, dissipating its effectiveness before reaching the pins. Somewhere between those two extremes every bowler must experiment to find the medium speed best for him.

Here is how Connie plays for the 1-2-4 and 2-4-5 spare setups. He favors having the ball strike as many pins as possible, instead of relying on caroms

Racing up to the foul line is a second frequent and harmful error, the champ says. A hurried approach spoils the rhythm of the delivery. Moving toward the release point at a medium pace provides enough momentum and doesn't upset the timing. It likewise conserves energy, important when you remember the average bowler repeats that approach 50 or more times every night he rolls.

Avoid crowding the foul line. The few inches closer it brings the kegler to his target means nothing, compared to the constant mental hazard of penalties for overstepping the line. Allow a safe margin of four or five inches between your toe and the alley's start.

Connie believes failure to follow completely through on the delivery motion is the costliest mistake of all. He insists a bad-

Roll diagonally across alley for side-pin "leaves." With a head-on approach there is always danger of ball dropping into gutter or hooking too sharply

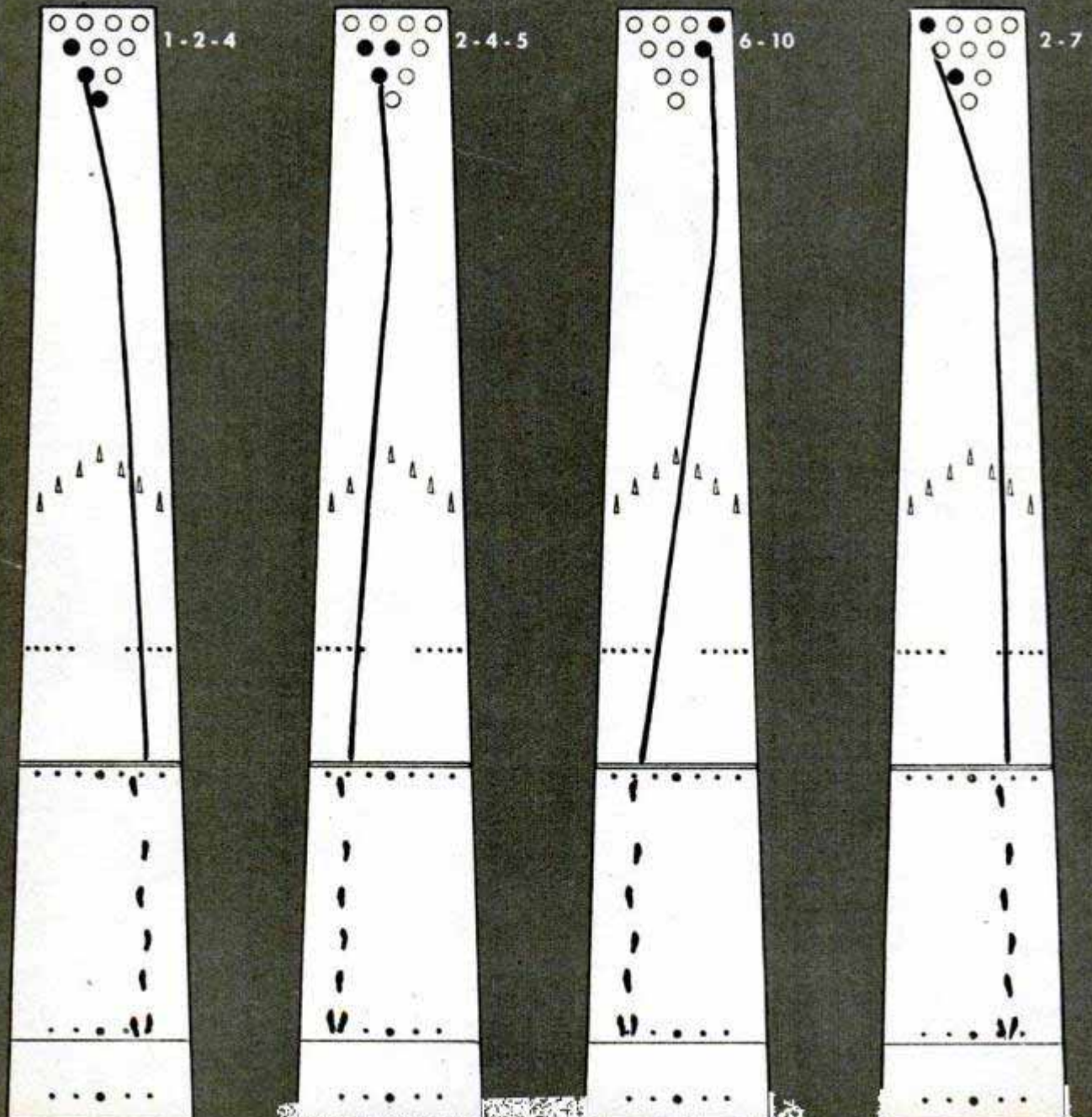

acting ball can't be thrown if the hand is allowed to continue its normal arc after releasing the ball.

As the ball is thrown the wrist is turning inward, from right to left for a right-hander, and the palm is facing the pins when the arm swing ends. This produces either a hook, which veers sharply to go between the 1 and 3 pins for a "pocket" hit, the prize strike-getting target, or a curve if the wrist turning is done more slowly.

Careful attention to the follow-through is also the best way to detect and then eliminate a "back up" delivery, which produces a less-effective ball that breaks in an opposite direction from a curve. With a back-up, the wrist turns outward instead of inward at release time and the palm faces upward as the follow-through ends. Women, generally having weaker wrists than

men, are especially disposed to this error.

On the subject of deliveries, Connie has perfected a unique finger-tip grip that prevents sore knuckles—an "occupational disease" among tournament bowlers. He also thinks it helps those who can't throw a hook with a conventional grip.

Schwoegler began experiments with it after an exhausting exhibition tour following his first All-Star victory. Bowling two and three times daily for weeks, with two fingers, had left him with a painfully sore middle-finger knuckle, so swollen he couldn't hold a ball comfortably.

What he eventually hit upon was a three-finger grip, with a quarter-inch vent connecting the bottoms of the thumb and second finger's holes. The air channel eliminates the vacuum effect on the thumb and provides air circulation to help keep it dry.

Cutaway shows ¼-inch vent between thumb and second-finger holes in Schwoegler grip. Bottom, comparison of new grip, left, with the older type

Brunswick-Balke-Collender photos

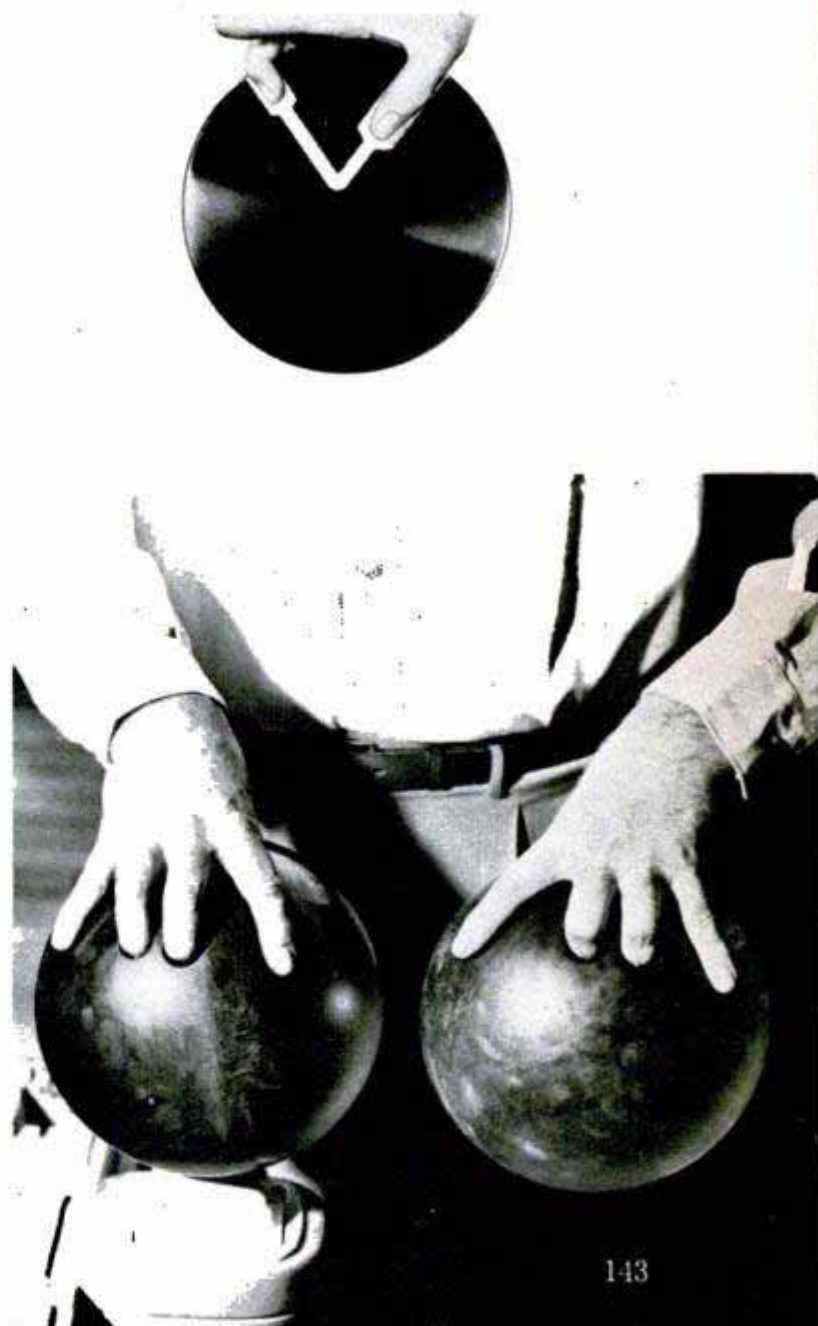
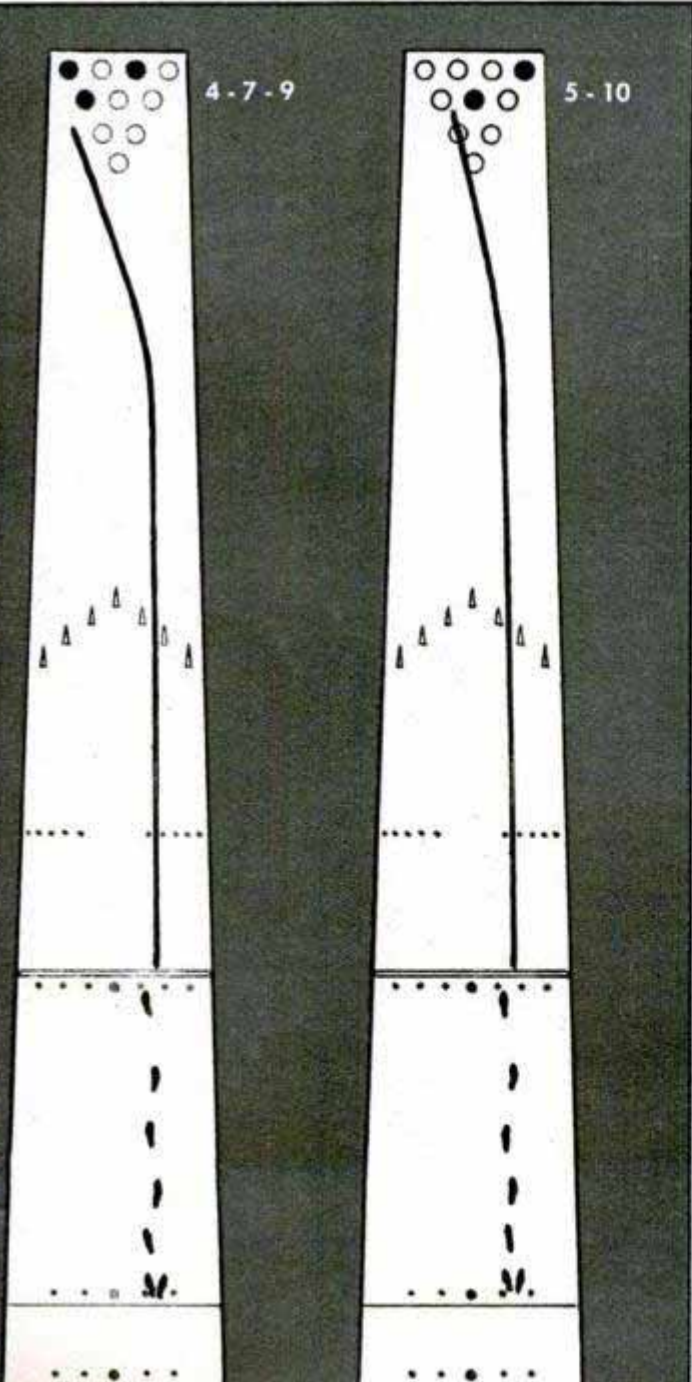



Multiple-exposure photo of champion Schwoegler from beginning to the end of his rhythmical five-step delivery. He stops several inches short of the foul line and throws the ball from 12 to 18 inches out ahead

The thumb, which leaves the ball first, is inserted all the way into its hole, while the two fingers go into theirs only as far as the last joint. The third-finger hole is conventional, with no vent.

Connie "warmed up" with his finger-tip grip for last year's championship, rolling successive scores of 299, 278, and 279 for an amazing near-perfect performance. When the actual tournament began, he shot his eighth 300-game, the first ever made in the finals of bowling's "World Series."

Since then, coaching and making personal appearances all around the country for Brunswick-Balke-Collender, bowling-equipment manufacturers, Schwoegler hasn't had a trace of sore fingers. He gives full credit to the new grip.

In a sport marked by few changes over the years, the sharp trend from two to three-finger balls is surprising. About four fifths of the game's top stars now hold the ball with three instead of the long-favored, two-finger grip. The former allows two fingers to share the strain of the lifting action that otherwise is on the second finger alone. Only one star bowler, Ed Botten of East Orange, N. J., uses a four-finger grip.

While the champion uses a five-step approach on delivery, he doesn't insist on that for others. The four-step approach is about equally popular with topnotchers.

"Your height and general build should generally determine how many steps are best for you," he says. "I'm big, six feet three inches and 212 pounds, but I have a habit of leading off with a very short step—almost a shuffle—and I need five to reach the foul line comfortably. Also, I start farther back than most men. The big things to remember are to move forward in a straight

line and to have the body in perfect balance on that final step—with both shoulders in line and squarely facing the pins—when you let go of the ball."

Despite his big frame, Connie glides up to the foul line smoothly. Occasionally, he admits, he has to remind himself not to approach too slowly. After he has rolled a half dozen or so balls to find out where the alley ranks between "fast"—a slick surface on which hooks won't take readily, or "slow"—a lane on which they "grab" and break more than usual, he sights a spot about 16 feet ahead for his ball to cross on its way to the pins. With that as an aiming point, Schwoegler can ordinarily roll eight out of 10 balls into or very near the pocket.

Shooting for spares, Schwoegler says his main object is to hit as many pins as possible. "That sounds obvious," he explains, "but you'd be surprised how many bowlers disregard it and gamble with fancy carom shots. Wood that your ball actually hits won't stay up, while you can't depend 100 percent on pins doing what they are supposed to do on carom shots.

"Many pretty fair strike bowlers never get out of the novice class because they don't take time to figure out the surest hits for spare setups. Educate yourself on how pins behave when struck. It helps, when you're a spectator or waiting to roll, to study various spare combinations on the alleys and decide how you'd play them. Then compare your decisions with the other fellows' results, the way they actually played the 'leave.'

"For example, I make my usual straight-line approach from the left and throw diagonally across the alley for pins left standing on the right, like the 10. When

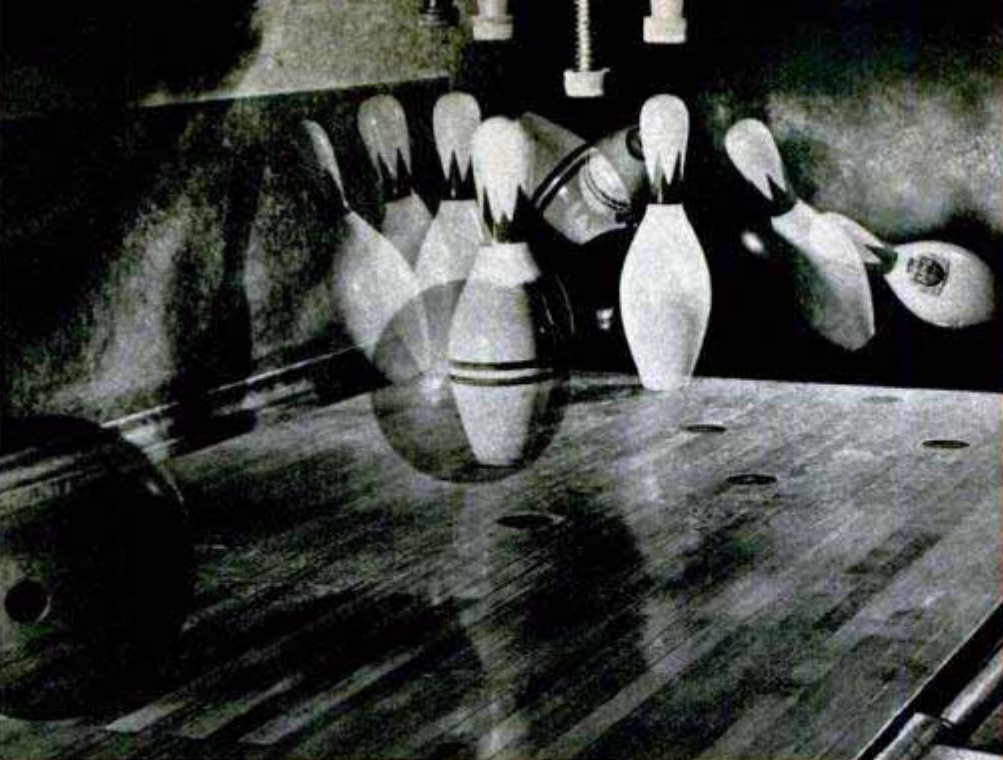

Above and right are illustrations of how tricky 2-7-8 split is played and made. The 2 pin is hit and deflected against the 7, while the ball itself carries through to knock down 8. Timing is vital on this shot

corner pin leaves are approached head-on there is too much danger of the ball dropping into the gutter, only a few inches away, or hooking too sharply to the left. For pins on the left, like the 7, I simply reverse this and roll from well over on the right.

"On the 1-2-4 spare, often left when the ball doesn't hook enough, I play my shot on the left side of 1, hard on the 2 pin.

"Don't switch back and forth between different styles of delivery for various spare setups. Learn to control one, preferably the hook because it is the most reliable strike-getter, and use it—with slight variations—for all situations. The sharpness and amount of the ball's break, as I have pointed out, depend on how quickly and how much you roll your hand over on release.

"Above all, think before you throw!"

One of the familiar "baby split" combinations, the 3-10, is being made in stroboscopic photo and diagram, below and right. After hitting 3 on the right side, the ball is deflected slightly and smashes full against 10

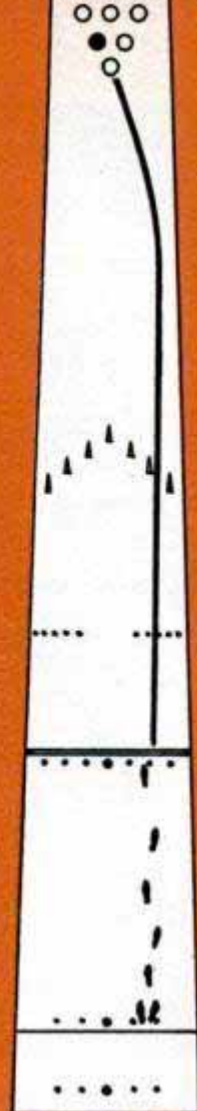
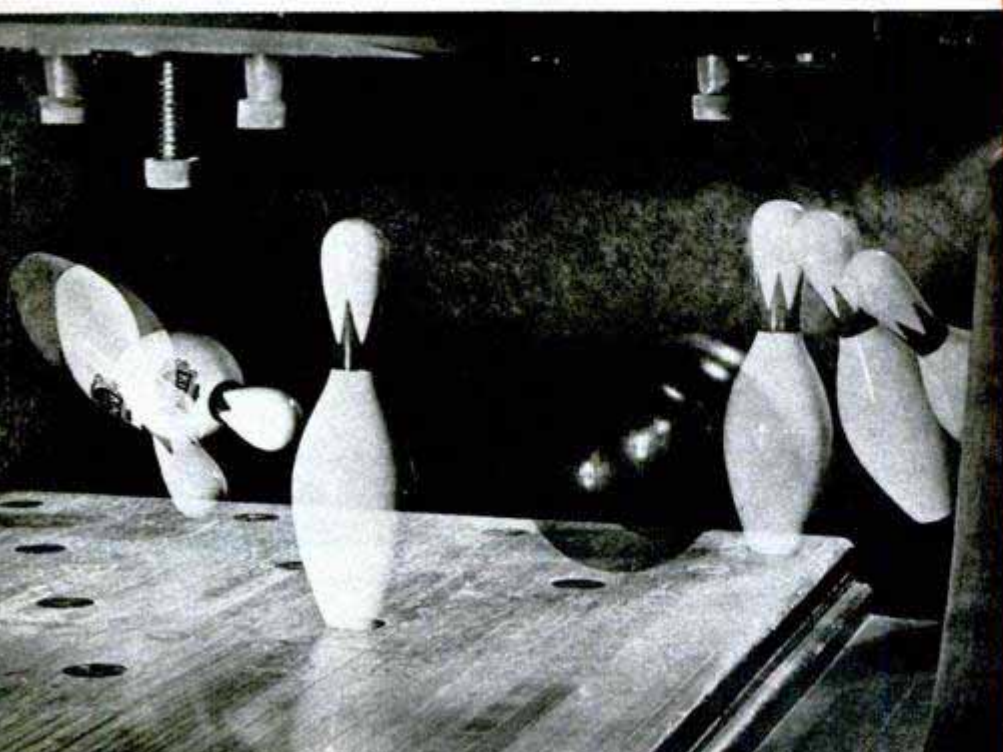

2-7-8



3-10



Hydraulic Loader

Hydraulically operated, a loading device for trucks makes light work of raising and lowering heavy barrels, crates and other bulky items. The operator rides on the platform with the material and controls the movement of the elevator by a convenient hand lever. When not in use, the platform swings up against the side of the body, adding only a few inches to the width of the truck.

Metal Coated With Powder

One metal is coated on another by a new method in which a layer of metal powder is rolled into the base metal. The powder-coated metal is heated to a degree just below the melting point of the two metals in an atmosphere of pure hydrogen to prevent oxidation of the powder. Then the powder is "cold rolled" into the base metal forming a coating, the thickness of which is determined by the depth of the powder layer.

Old Swedish Mines Converted Into Bombproof Oil Depots

Two old feldspar mines in Sweden have been converted into underground oil depots that are considered practically bombproof. A unique feature of the oil "tanks" is that the fuel floats on a few feet of salt water and can be skimmed off to within

$\frac{1}{2}$ inch of the water level. The old mines have a total capacity of about 14 normal tanker cargoes of oil. A copper heating coil installed in the mine maintains the oil at a suitable viscosity. Oil is pumped directly from tankers into the mines.

Shelf-Size Loran

Loran, the war-born navigational system, now has been redesigned into a compact unit for small-ship use. The system is effective in any kind of weather to locate the ship's position without celestial observations. The new unit, employing miniature tubes, is so small that it can be mounted on a table or shelf. It is used by fishermen to "mark" profitable fishing grounds.



Safety Car-Door Handle

Children can't open the door when a car is in motion if a new handle is installed in place of the original one. Inside the handle is a lock operated by a key. A turn of the key makes it impossible to open the door from the inside, yet it can be opened from the outside.

Robot "Nurse" Sings to Baby

When junior wakes at 3:00 a.m., all set for a party, mother may soon be able to ignore the lusty bellows. She'll just flick a switch, roll over and go back to sleep as the yelling is replaced by soothing strains of soft melody drifting from the nursery. At least that's the theory behind Dr. Sydney Norton Baruch's "Night Nurse." His mechanical crib, powered by a $\frac{1}{10}$ -horsepower motor, sways with the motion of a mother's own arm-rocking. Simultaneously, a sound unit starts playing a lullaby recording of mother's voice. An automatic, preset timer determines the length of time the equipment is in action and the whole mechanism is put in motion by a switch at mother's bedside. Doctor Baruch, inventor of a depth bomb that was used successfully against submarines

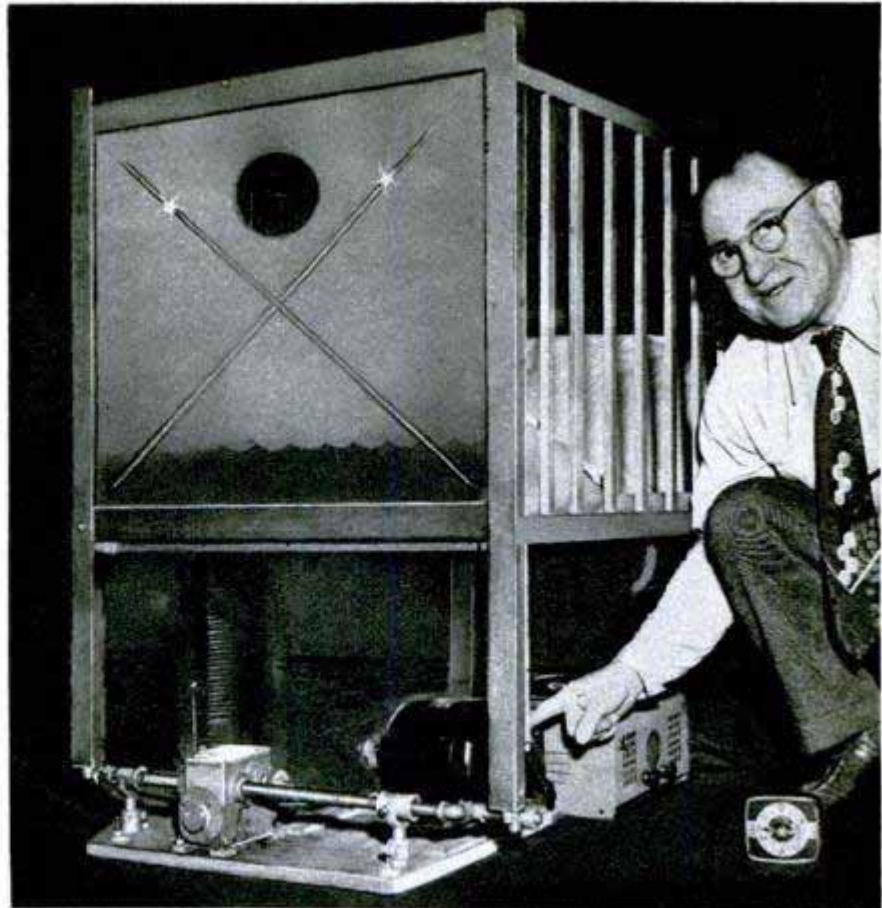

Acme photo

in both wars, expects the Night Nurse to sell for approximately \$85 when it goes into production.

Process Borrowed From Mining Cuts Cost of Canned Peas

First used in the mining industry to remove foreign material from ores, the froth-flotation process may save over a million dollars every year in the cost of processing peas for canning or freezing. Cracked

peas, pea skins and other materials are floated out of batches of peas much faster than is possible with previous separation methods. The new technique was developed by the Department of Agriculture.

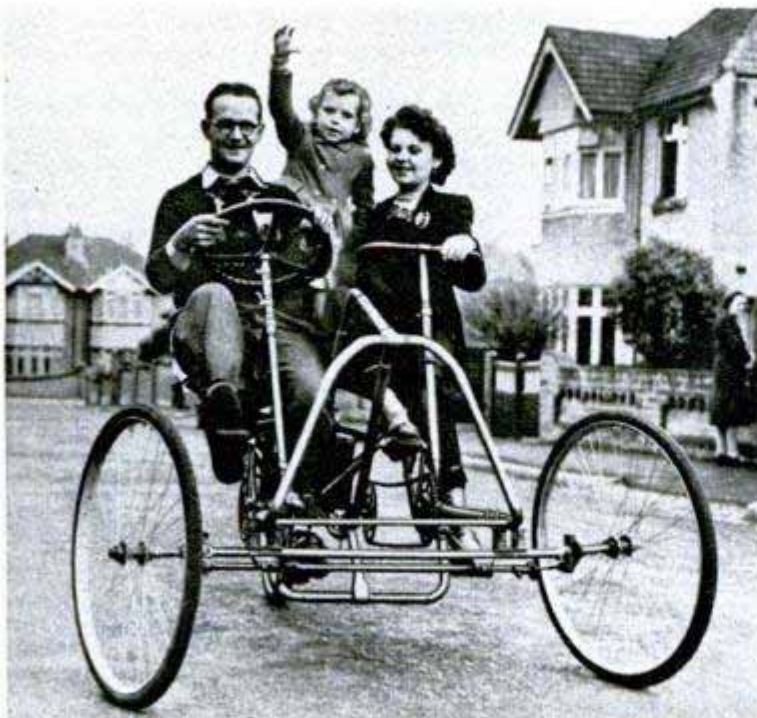

Cycle for Three

Three wheels and three seats—that's a description of a strange vehicle built by Louis Richard of Southampton, England, to provide transportation for his family. Built from spare parts, the machine is pedaled like a bicycle and travels about 15 miles an hour. The saddle-type seats are detachable for use at picnics. Richard plans to reduce pedaling by equipping the vehicle with a one-horsepower motor.

Information not listed on articles in the index, starting on page 10, frequently is listed in the WHERE-TO-FIND-IT INDEX, which is available without charge from Bureau of Information, Popular Mechanics Magazine, 200 E. Ontario, Chicago 11, Illinois

Follow the ducks

By Ed Neal

PROBABLY every businessman in America, chained to a desk and tired of the high tempo of modern life, has wanted at one time or another to chuck it all and go fishing. Not for a day or two, but for weeks or months.

Not one in a hundred thousand transmits that desire into action. One rare individual who has is 43-year-old Harold Siebens, a "retired" St. Louis sporting-goods executive. Siebens frankly admits he is tired of modern business. He took to heart the old adage "all work and no play makes Johnny a dull boy." In fact, he improved upon it. Siebens sold out his interest last year in a St. Louis sporting-goods firm, the fifth largest in the country, and took off on a two-year hunting and fishing trip.

Where it'll lead him, not even he knows. In less than a year he's covered the greater part of the Western United States, has fished inside the Arctic Circle and made a brief excursion into Mexico.

A radio "ham" himself, he's known to other amateur operators of the air lanes as "the guy who gets around." That cognomen was given him by a Danville, Ill., "ham" who talked to Siebens four times—twice when he was in Alaska, once in the state of Washington and once in San Francisco.

He's logged nearly 20,000 miles on North American roads, on everything from super-highways to dusty trails. He travels in a redesigned four-wheel-drive truck, towing a 25½-foot house trailer. Most amazing thing, Siebens admits, was the fact the trailer took all sorts of rough country with but two breakdowns.

One was on the Alaska Highway, 493 miles north of Dawson Creek, when the trailer broke an axle. During the two weeks before another arrived from Tulsa, Okla., Siebens went fishing. "After all," he explained, "that's why I'm taking this trip." Another time the trailer threw a wheel, halting the trek for five days.

That specially built truck is the key to his success. It's loaded with contrivances to make travel easier. A special power plant handles all electrical needs and a filtering outfit purifies the water wherever necessary. There are radios in both the truck cab and the trailer. Compartments in the truck hold hunting and fishing gear. This includes a sectional plastic boat, two outboard motors, three rifles, three shotguns and two pistols. There are also 14 rods (three fly, four casting, one spinning and six salt-water) and 12 reels.

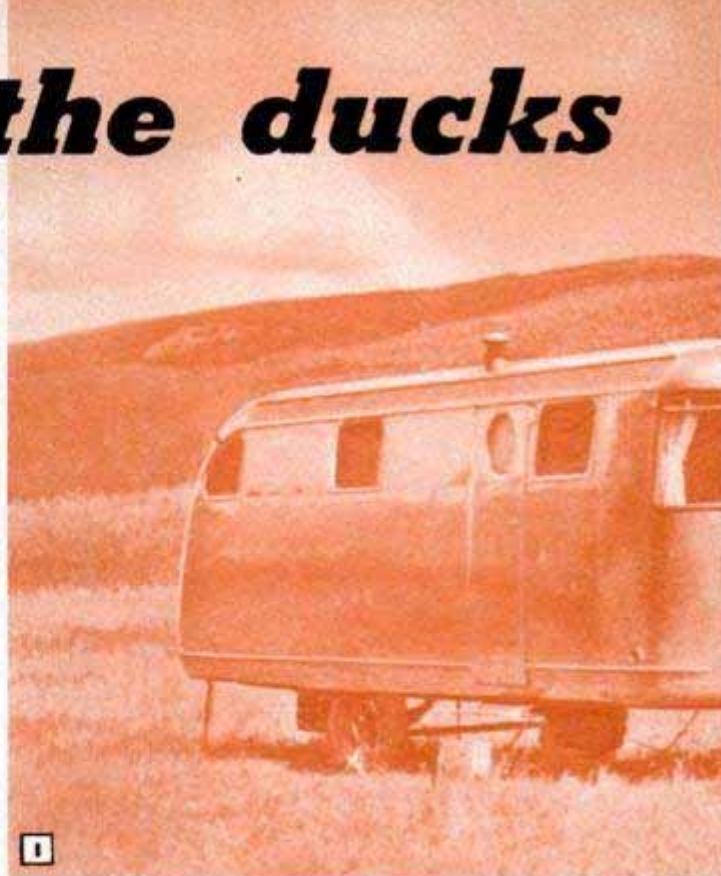

1. Siebens' truck and trailer "home" is equipped for comfort—and all emergencies. Here a water purifier unit is being set up in Glacier National Park

2. Fellow "ham" radio operators are gradually getting accustomed to picking up the St. Louis sportsman at odd, faraway places. He takes two sets along

3. Harold and his son Bill assembling their sectional plastic boat at Kluane Lake, well up on the Alaska Highway. They also carry a pair of outboard motors

4. Via two-way radio equipment installed in the dashboard of his truck, Siebens chats with friends in St. Louis during a brief layover in San Francisco

5. In a mobile "arsenal" compartment of the truck, the retired sporting-goods-firm executive always keeps three shotguns, three rifles and a pair of pistols

6. While logging 20,000 miles on North American roads, from superhighways to rutted trails, Siebens had only two mechanical mishaps and no accidents



by trailer

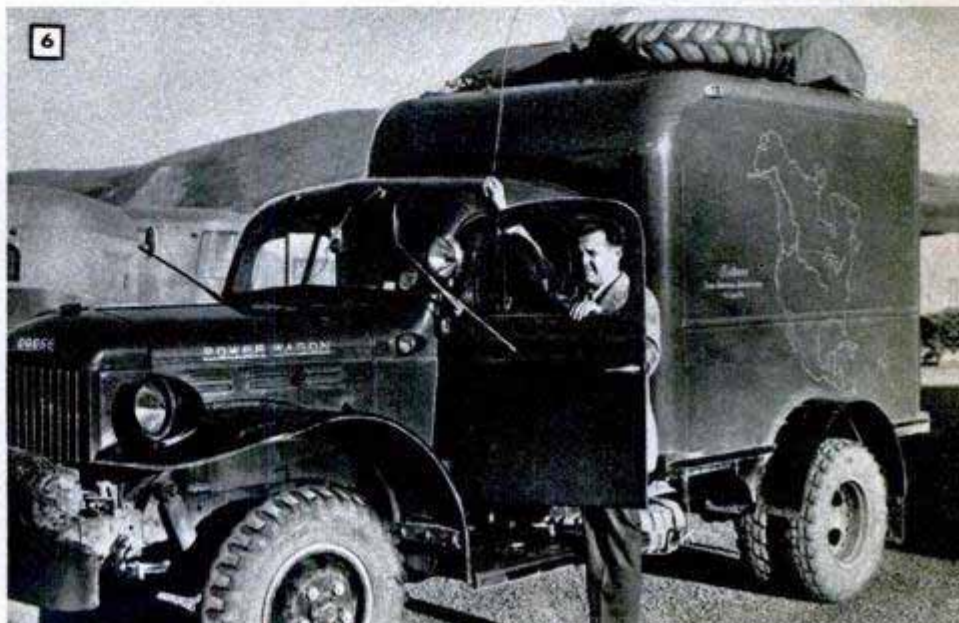



Bird in a Gilded Cage— Trailer Carries Ostrich

Probably the only man in the world to carry an ostrich in a house trailer is Dr. Wendell Hansen of West Sturgeon Bay, Wis. Doctor Hansen is a bird trainer who travels around presenting an act at church programs. He travels from city to city in a house trailer. When Doctor Hansen acquired an ostrich he had no way of moving the large bird from place to place. His solution was to build a special room on the front end of the trailer. The ostrich fits neatly inside and gazes out through a Plexiglas dome. One section of the roof slides down for ventilation. During cold weather heat is piped into the private apartment through a window in the trailer.

← Milwaukee Journal photos

Boys in Houseboat Cruise "Ole Miss"

Four adventure-bound boys recently made their way down the Mississippi River in a houseboat they built themselves from \$75 worth of materials. The youths, who live in Bowling Green, Ky., made a safe voyage and eventually tied up at New Orleans. Their ingenious floating home was powered by an out-board motor.

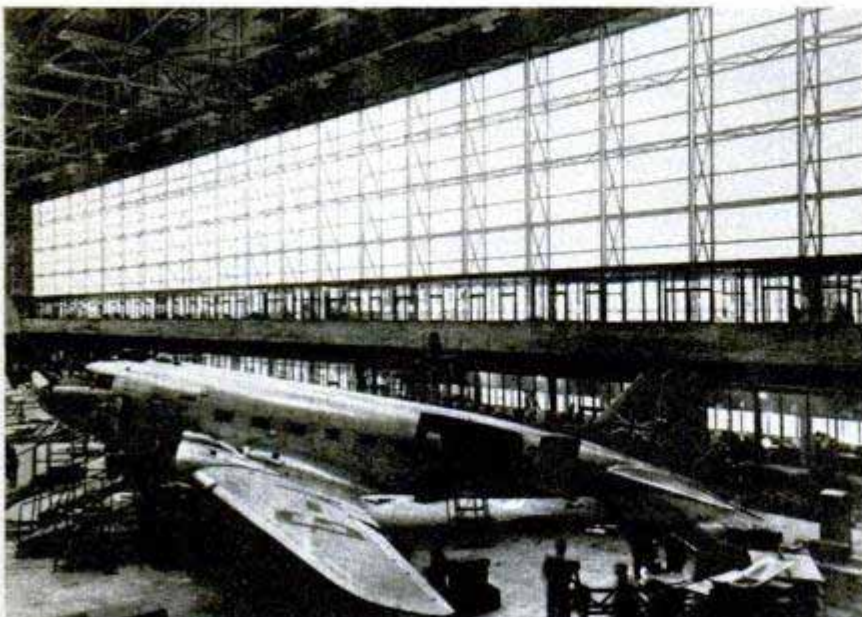
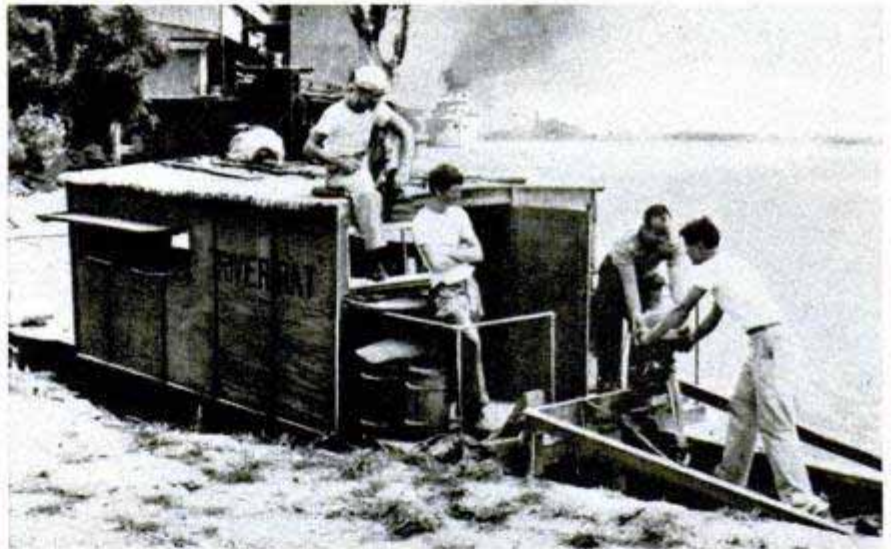

1000-Foot-Long Window

Winds up to 150 miles an hour can be withstood by a plate-glass window 1000 feet long and 50 feet high, covering one entire side of a Bristol, England, aircraft plant. Needing no putty and no initial or subsequent painting, the cost of maintaining the window is very low.

☞ Scientists aboard a laboratory ship recently discovered that the Hudson River Valley extends 225 miles out into the Atlantic Ocean, 105 miles beyond the point it previously was believed to end.

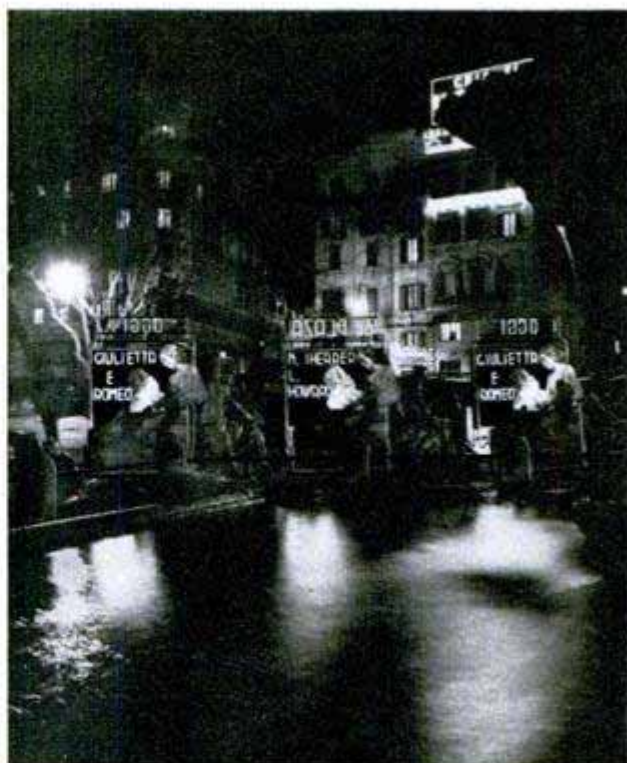
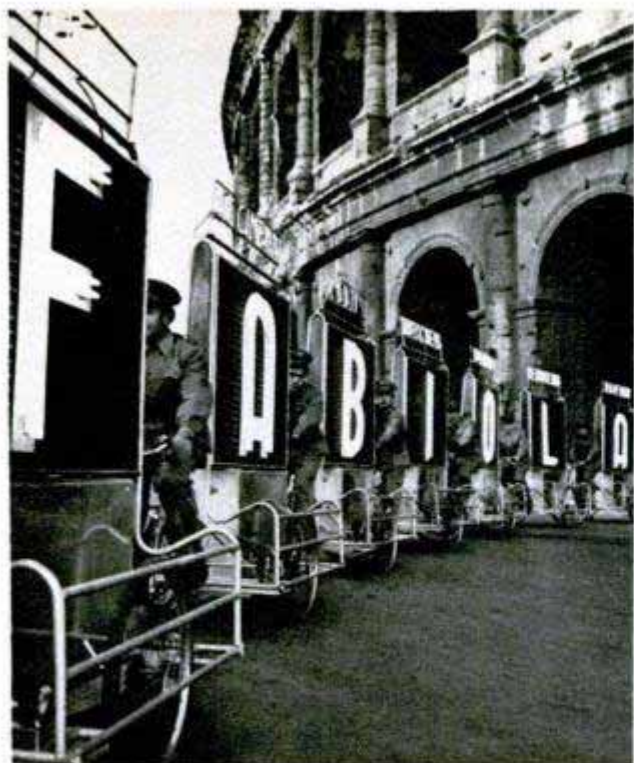

Cycling Signs Advertise Movies

Billboards on bikes are pedaled around Rome to advertise the latest motion pictures. Promoters hire uniformed riders to tour the streets at night on bicycles fitted

with neon signs. Automobile batteries on the bikes provide enough current to maintain the signs for eight hours. Frequently, motion-picture theaters hire as many as 10 cyclists at once, each exhibiting one letter in the title of a movie.



Tripod for Telescope Is Auto Window

With a swivel-headed mount that can be used with any camera or telescope having a standard tripod socket, you can use the window of your car as a tripod. The mount can be swung in any direction and is raised and lowered by the window crank. Movie fans will find it valuable for taking "pan" shots.

Door-Straightening Set →

Damaged automobile doors are returned to their original contours by a set of three clamps and a bar that operate entirely from the outside. Thus, glass and upholstery need not be stripped from the doors during the repair work. The clamps are fastened to the edges of the door and positioned so they will pull the metal panel back to its original shape. The set of tools can be used with any existing shop equipment, either mechanical or hydraulic.





Elementary school pupils are right at home inside a C-46. It serves as a classroom for their courses in aeronautics

By
Ewart Thomas

READING, WRITING AND AVIATION

WHEN an 11-year-old lad from Weedpatch casually remarks that he has been taxiing an AT-6 airplane or complains of the way he overcontrols a Link trainer, you can believe him. If he says that he just reassembled a 1000-horsepower aviation engine, he's speaking the gospel truth.

He's a student at the Sunset Elementary School, a public grade school that has its own landing field plus 1¼ million dollars worth of war-surplus aircraft. He studies aviation along with the three Rs.

Weedpatch is a small community on the road between Rockpile and Punkin

At the school air strip, pupils learn the correct way to pull a propeller through on their C-46

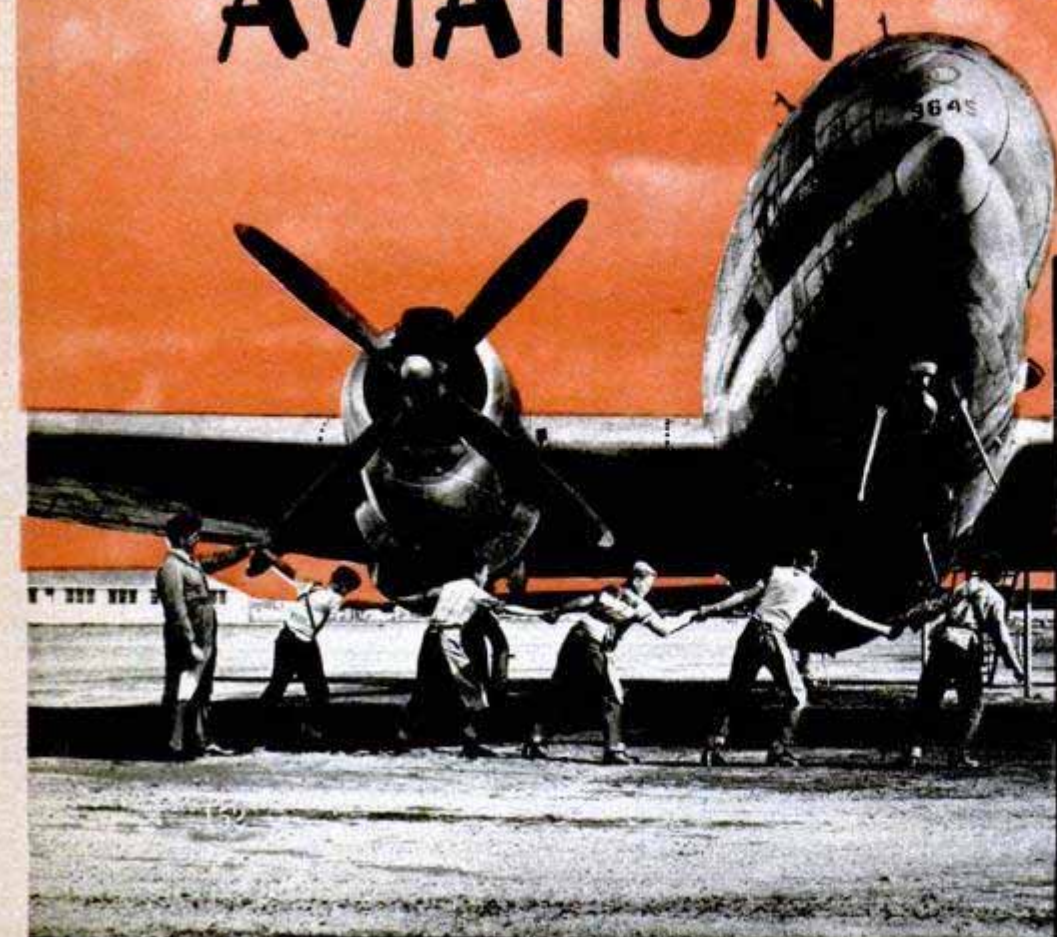



Fifth graders go to class inside a C-46. Bought as war surplus, the big plane was flown in by the teacher

Center, near Bakersfield in California's San Joaquin Valley. Most of the people of the neighborhood are seasonal agricultural workers who migrated west during the dust-bowl days. Nearly all of them are poor and few have had much education. Some hate to spare their children from the fields to attend school. Numbers of the children won't keep on with their education after they finish the eighth grade.

So, while they have their hands on them, the Sunset instructors drill reading and writing and arithmetic into their students and also teach a few subjects that aren't ordinarily offered in grammar school. The teachers reason that this will help inspire the students to continue on to high school and that it will widen the knowledge and points of view of those who do not.

That explains why seventh and eighth graders study aviation. There's a big thrill in overhauling an airplane engine and meanwhile the students learn a lot about internal-combustion engines that will help them when they drive automobiles or repair farm tractors. Indirectly, they learn the proper way to use tools, the value of maintenance schedules and the reasons for safety precautions.

The same applies to lectures on how airports are operated and the mechanics of how an aircraft flies. Some of the talks are given while the students are grouped around an AT-6, some are delivered inside a classroom that consists of a transport fuselage in which the students sit in bucket seats with their desks in front of them.

As a sort of graduation present at the end of the course, each of the students is allowed to sit in the cockpit of one of the school's aircraft, go through the warm-up procedure and taxi the plane the length of

the school's runway with an instructor in aviation riding along as safety man.

Ninety students are enrolled in the pre-flight and aviation mechanics courses under Charles Blair and George P. Valos, instructors. The school obtained from the federal government, as war-surplus material to be used for educational purposes, a C-46 transport and two AT-6s, all in flight condition, as well as the shell of another transport. A Link flight trainer, a stock of assorted engines and miscellaneous equipment including a couple of buildings from a flight-training field were also obtained.

Some of this equipment was trucked to the school, some of it was flown in after teachers and students had measured off and graded an air strip alongside the school grounds. The strip is 100 feet wide and 1600 feet long, lined with boundary markers, and with a windsock at one end. It is used for ground instruction purposes only, but it has been a boon to aircraft in the vicinity. Five emergency landings, including one by a DC-3 transport, have been made on the field since it was built.

Jet and rocket planes are studied in theory; however, this homemade model brings the theory down to earth





With the help of this model airport, pupils study the use of landing patterns to control airplane traffic

Basically, the Sunset school is a typical rural school, a part of the California school system. Three hundred and eighty students, ranging from 10 to 14 years of age, attend the fifth to eighth grades.

All students receive the standard instruction courses in traditional elementary subjects. All of them, in addition, are allowed elective subjects at which they spend a maximum of 80 minutes a day, four days a week. The school has classes in typewriting, drama, public speaking and music, among other elective subjects. It has its own band. The choice of interesting subjects is one of the reasons why absences from school amount to only .04 percent aside from absences due to illness.

The fact is that the school deliberately tries to capture the interest of its students. To build up this attitude, the school trustees chose young administrators who are filled with enthusiasm and fresh ideas. Peter A. Bancroft, superintendent, is 31. Harley Thompson, assistant superintendent and principal of Sunset Senior Elementary, is 32. The average age of all the teachers is 36, considerably lower than the national average. Teachers are chosen with care and are paid from \$3000 to \$5000 per year. Bancroft and Thompson require, first of all, that each teacher be a student leader. The faculty members dress informally and comfortably and the men usually teach classes in slacks and sport shirts.

The school began its progressive program about seven years ago by offering agriculture as an elective subject. The principles of good farming are discussed in class and the students learn the proper ways of doing farm chores. Under the supervision of Glenn Walsh, instructor, the 50 agricultural students operate their own 15-acre

farm that adjoins the school's air strip. The ground is partly in fruit trees and vegetable plots, but most of it is planted in barley. This grain helps feed the six cattle that the agriculture department owns. Other livestock that the students tend include half a dozen hogs, three sheep and pens of chickens and rabbits. The department owns its own truck and tractor and most of the students, from 10 years on up, have learned how to drive.

Recently, the young farmers acquired an old frame building from an Army training

By working on this in-line aviation engine, pupils learn the mechanics of internal-combustion engines



camp and one of their projects for this year is to remodel it into a classroom. They are learning a lot about construction by preparing the foundation, laying the floor and refinishing the interior.

Home economics, or homemaking, was started as a parallel subject for girl students at the same time that the farming classes were inaugurated. At first, it was necessary to hold classes in two old boxcars that were hauled to the school grounds. More recently, the department has moved into a wing of one of the new school buildings. Forty girls are studying cooking and sewing. Mrs. Jeanette Clark's cooking classroom contains four modern kitchen units each equipped with an electric or gas range, a sink, cupboards and utensils. Adjoining the units is a dining area where the girls serve the food, then sit down to sample it. The students are taught something of nutrition and what constitutes a proper meal and they take home with them recipes that have been made up to fit the numbers of people in their own families so that they can try out their meals at home.

The fundamentals of sewing are taught by Mrs. Madge Norton and the subject in-

cludes the different stitches, operation of machines, weaving on hand looms, the uses of different fabrics and the proper combinations of colors. This in turn leads to styling. The girls are encouraged to make their own clothes in class and at the end of the term they hold their own fashion show, modeling the articles they have made.

As an allied subject, Mrs. Barbara Sabovich teaches the girl students how to make and use their own cosmetics. Here again, the students learn more than the subject suggests, for the emphasis is on hygiene and good grooming. The girls compound



As a graduation "present," pupils taxi the AT-6 down the 1600-foot runway

Class is in session at the end of the landing strip. The crippled C-46 in background is used as a classroom

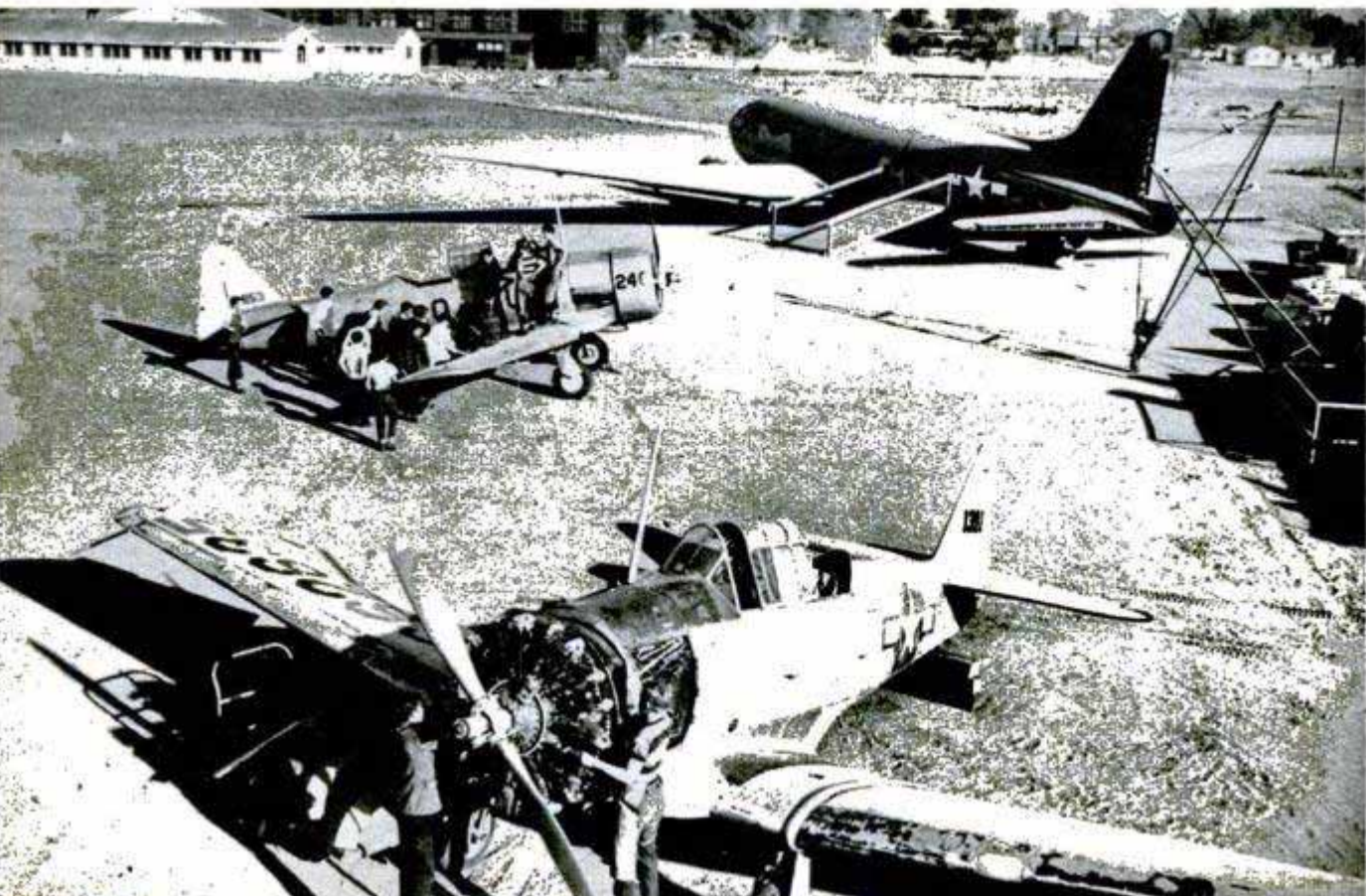



Tractor operation and maintenance are also taught at the school. Two students load lumber for use in converting an old Army building into a classroom



lipstick material from a stock formula and they also mix the ingredients for making their own toothpastes, deodorant creams and shampoo preparations.

The Vineland school district, in which the Sunset school is located, doesn't have enough funds for expensive educational buildings and the student population has been growing faster than the income from school taxes. To get some of the things the school has wanted, its teachers and students have planned and worked together.

(Continued to page 274)

Girl students get more than book training, too. At left, two girls are learning to operate this hand loom. Below, the boys learn by doing as they lay flooring in a new classroom, bought as war surplus

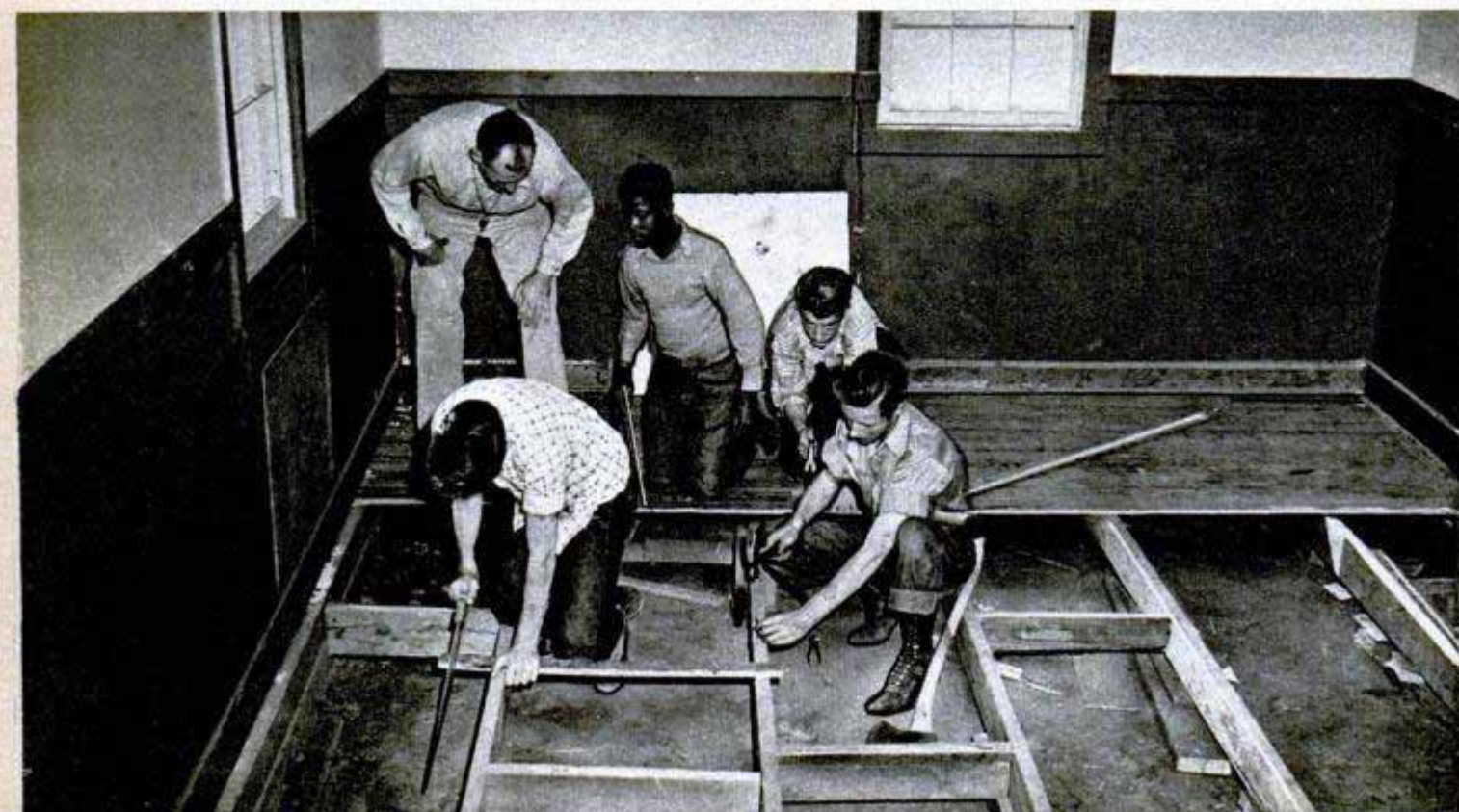

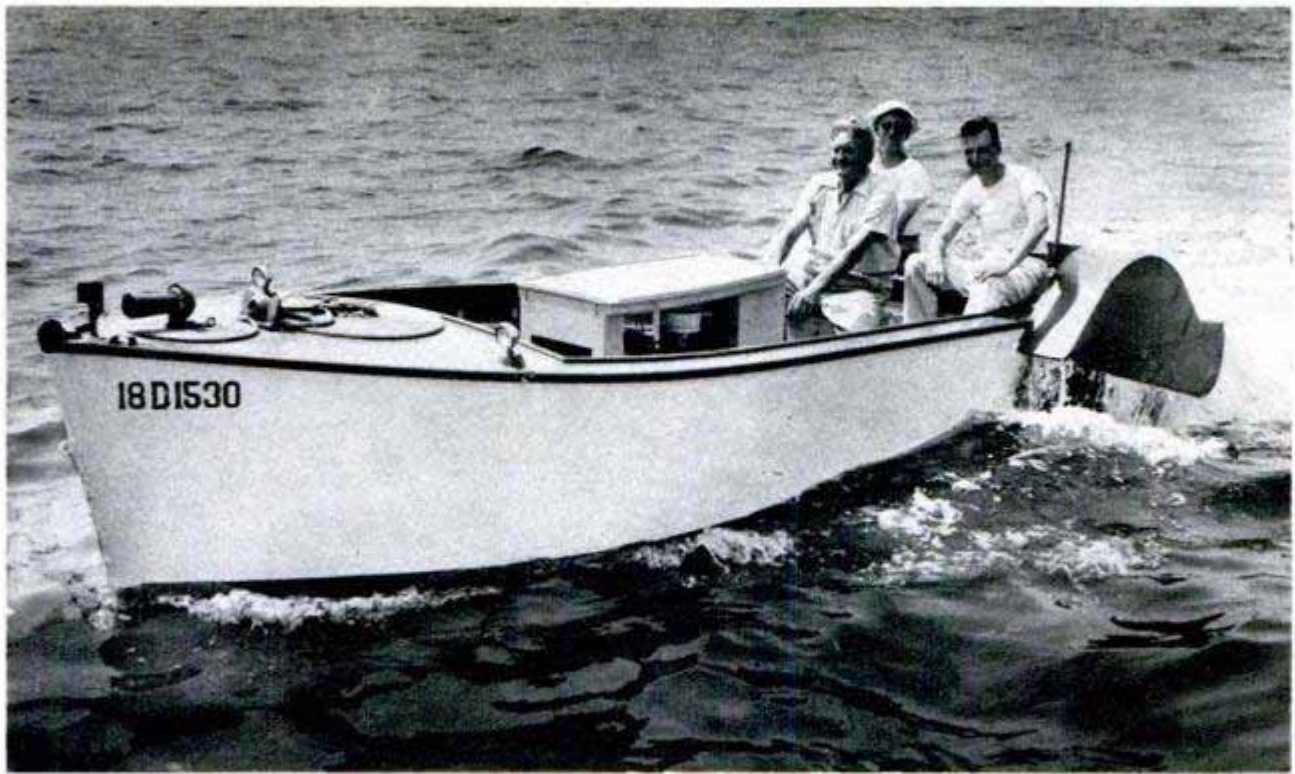

"Automoboat"

Equally at home on the water or the highway is an "Automoboat" built by Herbert J. Farrar of Miami, Fla. The 20-foot craft has two heavily ribbed tires which propel it either ashore or afloat. A smaller front wheel steers it on land and two rudder boards guide it in the water. Farrar spent two years in building the craft.

Top, when the craft is afloat the ribbed tires cut into the water like paddle wheels. Right, a smaller front wheel steers the vehicle when it is being driven on land



Easy-Aiming Rifle Has Hinged Grip

For greater aiming stability, the hinged forearm of a new .22-caliber rifle swings down to a vertical position, forming a comfortable handgrip or ground rest. The rifle is a carbine type weighing five pounds and measuring only 37 inches long. The magazine holds seven rounds and the rifle is chambered for short and long cartridges.

Ⓜ Nails so small that it takes 95,000 of them to weigh a pound are made by the steel industry.

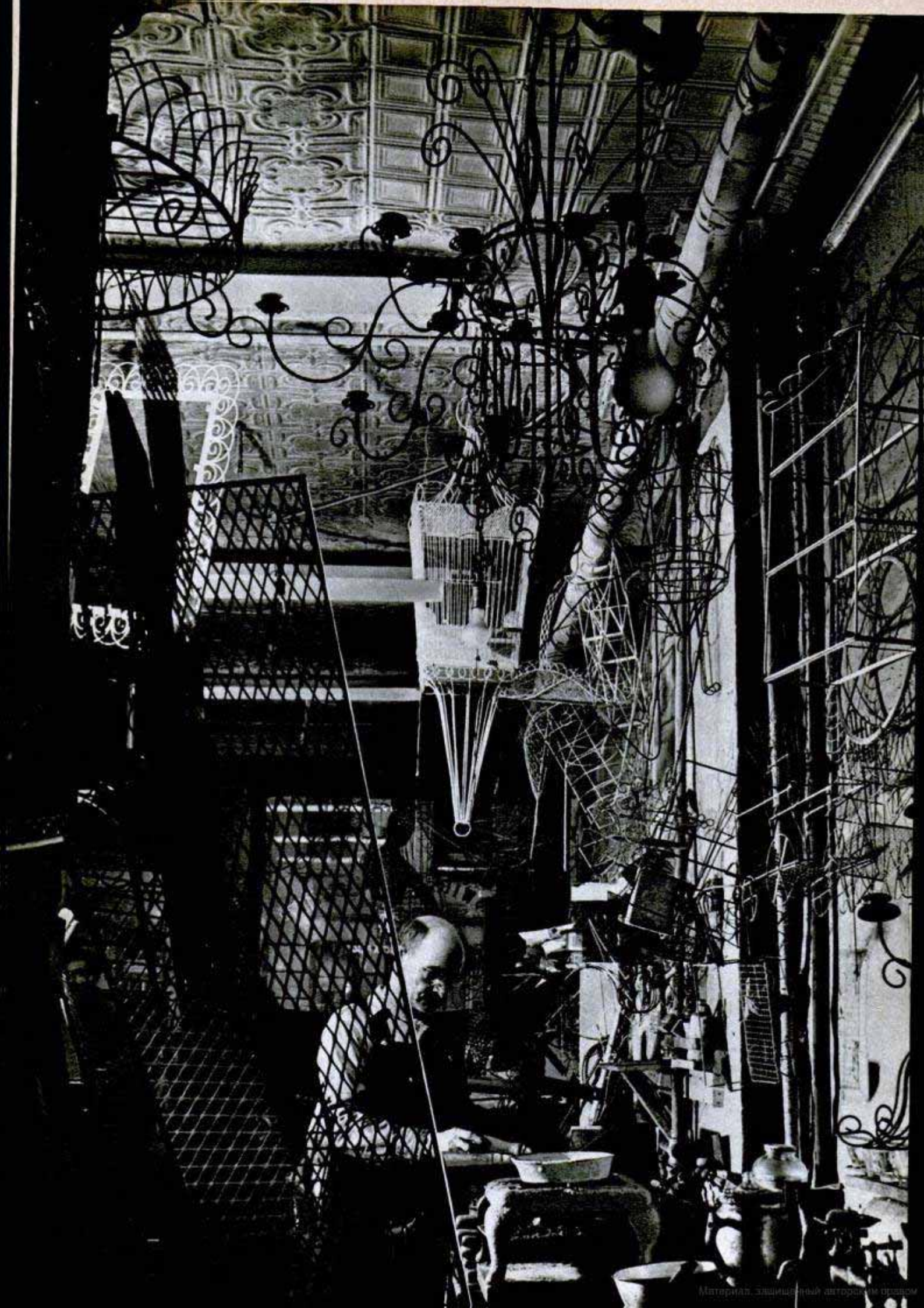

WIRE WORKS OF ART—and utility—in an infinite variety of shapes and sizes pour from a combination shop and factory in New York. These masterpieces in wire find their way all over the world.

The telephone directory lists the establishment simply as "Philip Huncik, frames," but this craftsman has long since outgrown that brief designation. Thirty-nine years ago he started in business making the wire forms for floral pieces—the backbones for wreaths, crosses, horseshoes for good luck and gates ajar for goodbye.

This was all right as far as it went, but soon women customers were demanding that he make lamp-shade frames of special sizes and shapes; then interior decorators, ever on the lookout for something novel and attractive, began ordering custom-built tables, baskets and shelves.

One thing led to another and today an order for a 16-foot backdrop for a display or for several thousand containers for merchandise doesn't faze Huncik a bit, despite the fact that his "factory" only occupies space equivalent to that of two retail stores.

As with many other crafts, working with wire is both an art and a science. A man lacking artistic sense could readily turn out work fit only for a chamber of horrors if his medium demanded as much sense of proportion and feeling for form as wire. A glance at the photographs showing the work sets any such fears at rest.

Science is also required. Almost everything that is made demands a large number of very exact curves, and steel wire does

not lend itself to exact treatment when the only tools are a hand and a pair of pliers.

To lick the problem, Huncik has assembled a collection of hundreds of jigs and fixtures which, when secured in vises, permit him to make any type of simple or complex curve. An "S" curve can be made by a child with the jigs, but to hold the steel wire in the hand and bend it with pliers is enough to make a strong man gasp.

Spot welders are also valuable aids, permitting wires to be joined at any angle in a few moments—a much faster and less messy job than the soldering which preceded it. Hacksaws for cutting wire, tin-smiths' shears for cutting liners, drills and an assortment of hammers comprise the remainder of the equipment.

The development of welding apparatus that would work on home current has fostered wire-working as a homecraft activity—and one which meets with hearty approval from the women, since so many decorative and useful objects result.

While Huncik executes a wide variety of orders for individuals, a majority of his commissions come from department stores and others concerned with displays.

Perhaps the biggest job was a canopy, almost 20 feet long, which was used by a manufacturer of bed linens and towels to decorate a display of merchandise. The same company once ordered 8000 white wire baskets in which selections of bath towels were sold as Christmas gifts. They packaged the same product in 4000 wire shelves which Huncik made.

Left, "wonderland of wire" describes the workshop of Philip Huncik in New York. He started 39 years ago making wire forms for floral pieces, later branched off into making fancy lamp shades for women customers. Below, he shapes a window fixture for a department store



ARTIST
WITH
WIRE

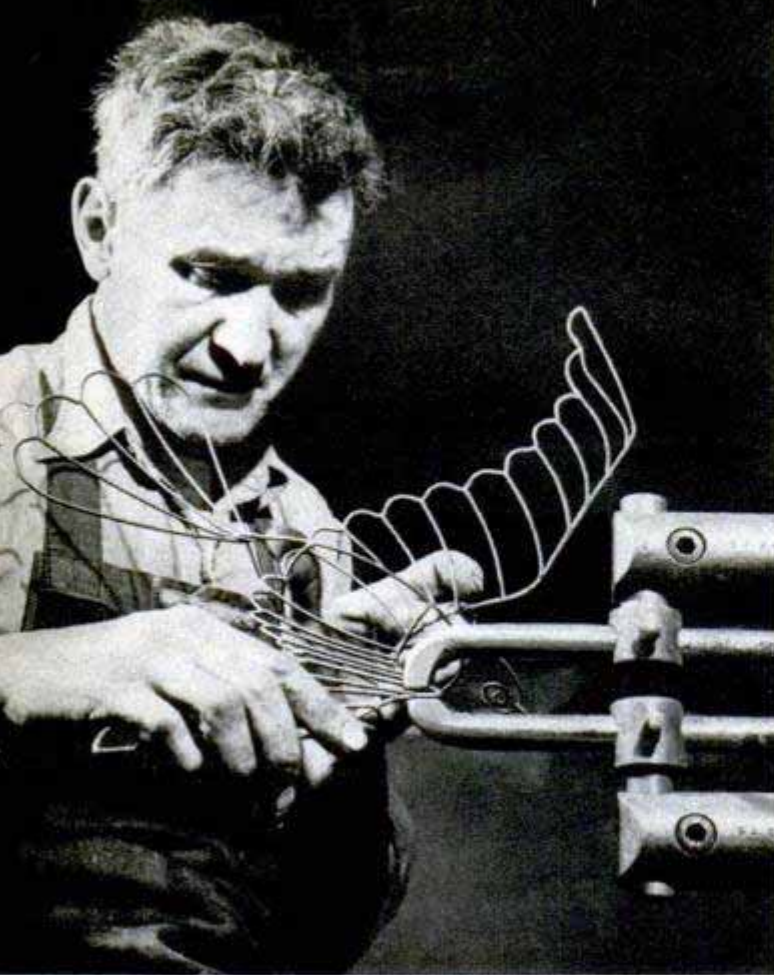

Above, wire-working requires a sense of proportion and a feeling for form. Here Huncik creates a bird

The 16-foot wreath which hung over the entrance of the Empire State Building last Christmas was a Huncik product, and one which he was glad to deliver. "It took up so much room in the place we could hardly move around," he said.

His work appears in the best stores, from Saks Fifth Avenue in New York to Bullock's in Los Angeles and it is highly seasonal. Wire eggs for Easter, turkeys and pumpkins for Thanksgiving, and wreaths, Santas and sleighs at Christmas.

An order for an eight-foot wire hand, to be gloved and displayed, doesn't surprise him a bit and he'll copy an antique bird cage built in the form of a castle for \$125 as readily as one for a few dollars.

His work has been sent to China, where they have a strong preference for delicately constructed butterflies and animals, and a chap from Australia dropped by one day with an order for a Sydney department store. Cuba, Canada and England have also seen his work.

The business has grown steadily, except for the war period when he lost all his help to essential industries. Huncik soon became one of these by making hooks used to lash cargo to ship decks. But he prefers making beautiful bird cages.

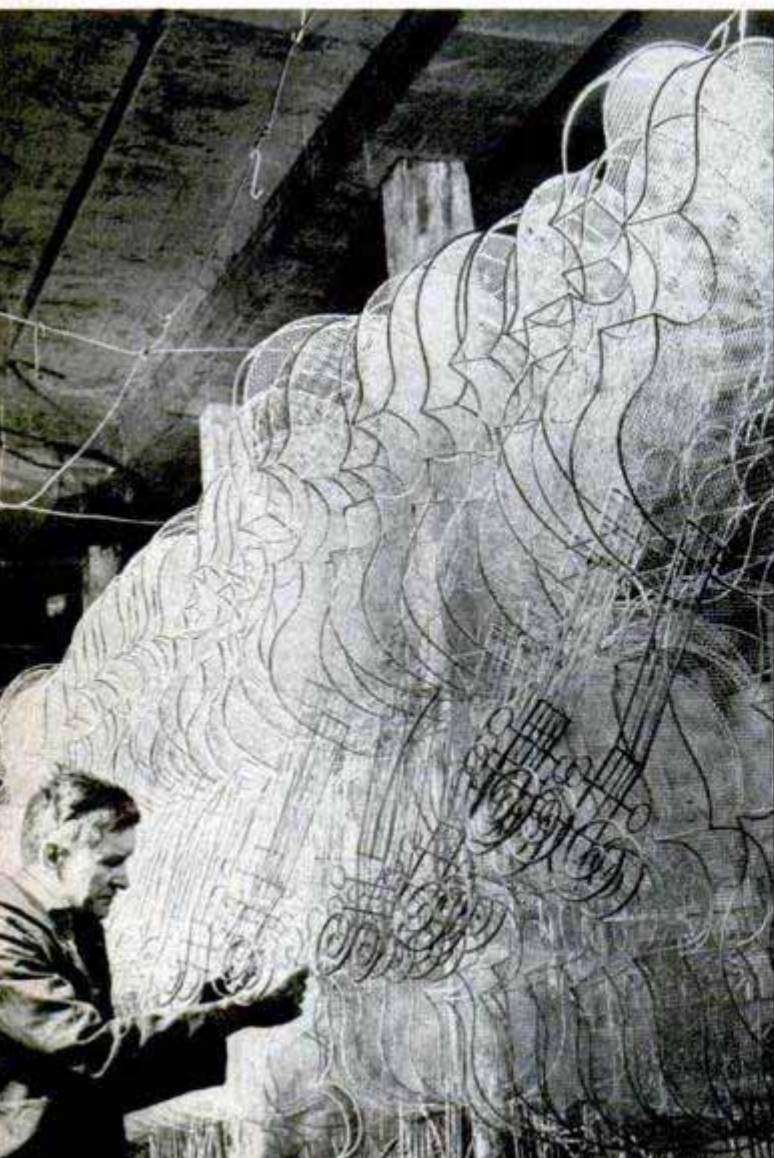

Left, Huncik inspects a row of wire cellos made for a department-store window display. His orders range from tiny wire baskets to giant Christmas wreaths for the Empire State Building or a 20-foot canopy

Heavy steel wire is bent in metal forms (below) to carry out the intricate designs Huncik is asked to make by an international clientele. Tools include spot welders, hacksaws, shears and assorted hammers

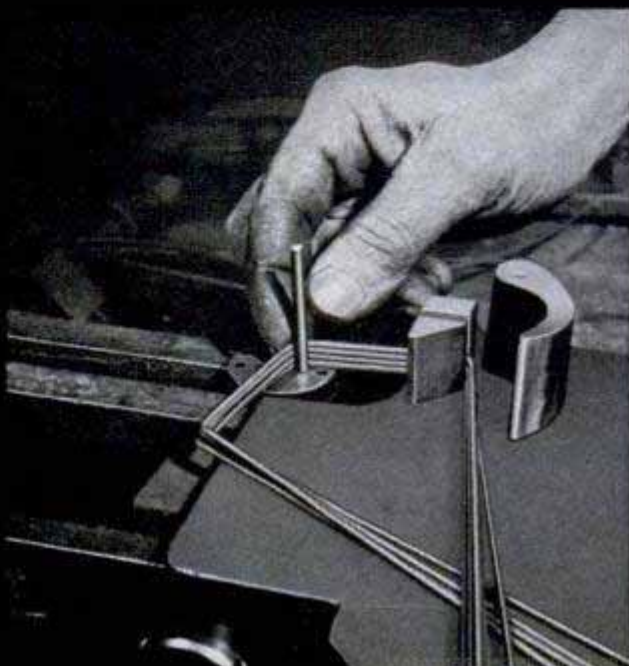

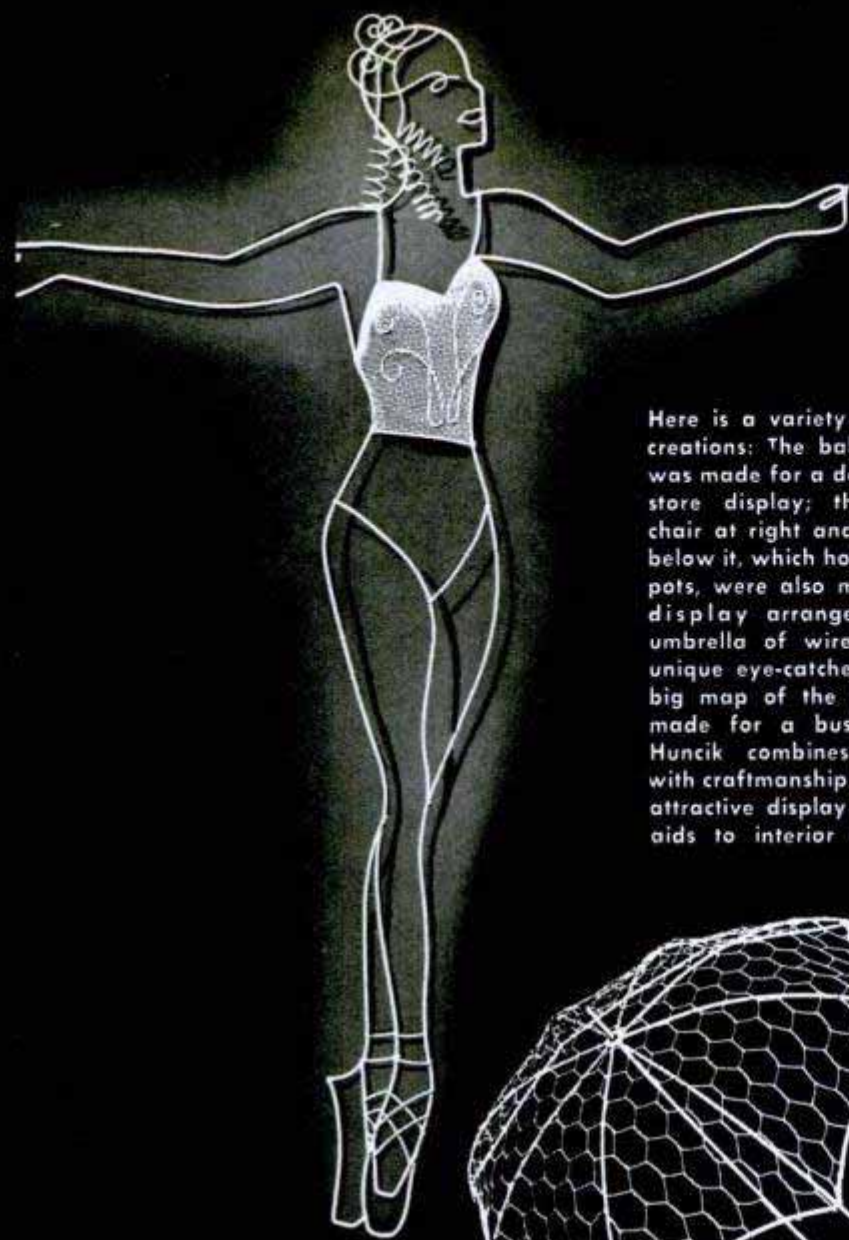

Here is a variety of Huncik creations: The ballet dancer was made for a department-store display; the garden chair at right and the table below it, which holds flower-pots, were also made for a display arrangement; the umbrella of wire makes a unique eye-catcher, and the big map of the U. S. was made for a bus terminal. Huncik combines fine art with craftsmanship to produce attractive display items and aids to interior decorators

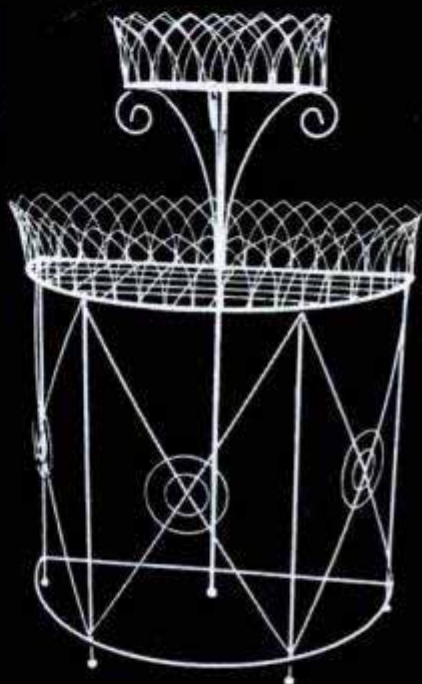



Outboards Distribute Fish Poison

Conservationists now are using outboard motors to distribute poison throughout lakes inhabited by undesirable rough fish. Lakes chosen for stocking with game fish sometimes support a large population of rough fish which would eat the fingerlings soon after they were placed in the water. Before stocking the lake, conservationists

poison the existing fish by distributing rotenone through the water. In one technique, a large burlap bag filled with poison is towed behind a boat at slow speed. The turbulence of the wake left by the outboard motor distributes the rotenone uniformly. In another method a large outboard is anchored in a few feet of water and the poison poured just in front of the propeller, which fans it out into the lake.

Tram-Rail Crane Rotates and Tilts Load As It Moves Along Track

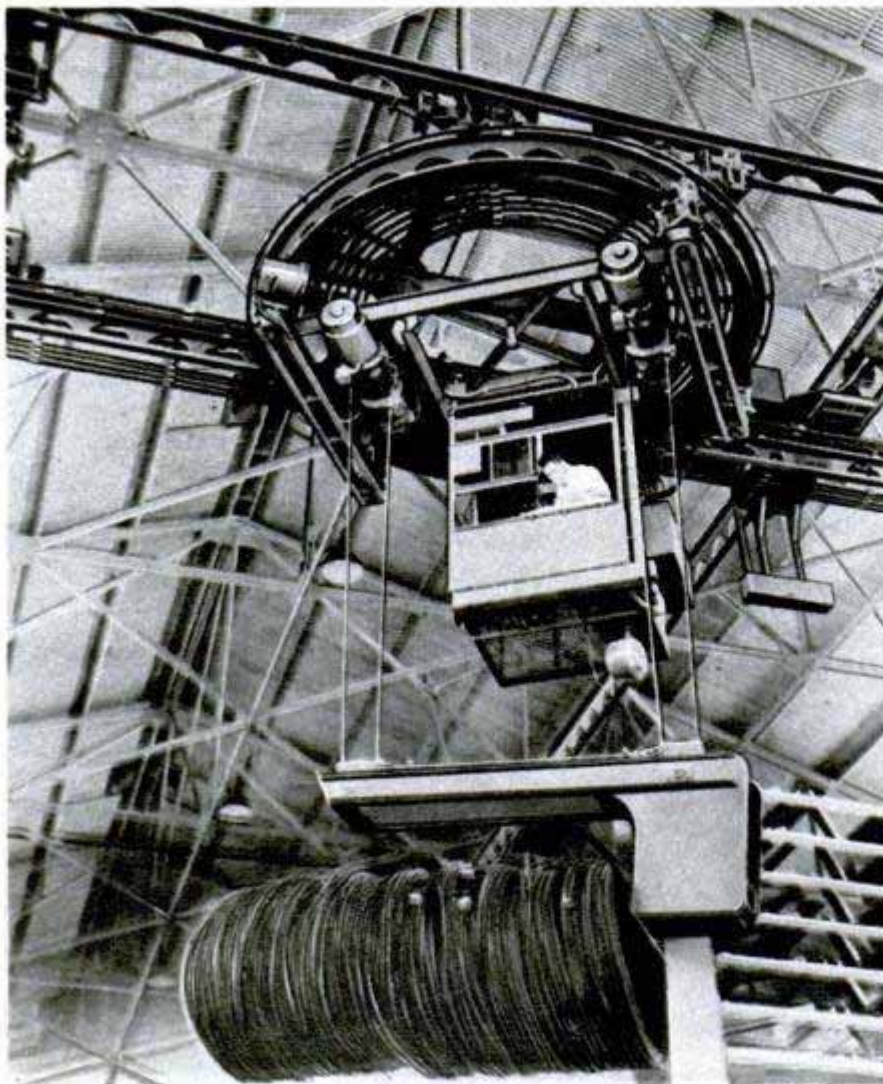

Loads lifted on a new tram-rail-type crane can be rotated as well as tilted and moved along the bridge. The crane has a carrier that turns in either direction. The hairpin hook is designed to handle coiled material such as wire. It is inserted through the coils, tilted up slightly to prevent them from falling off, and then moved as desired. At the other end of the trip, the carrier is rotated until the stacks can be dropped in the correct position. The crane's open-type cab has glass flooring to give the operator a clear view in all directions.

As protection for a national shrine, even the trees at George Washington's Mount Vernon home are guarded against lightning by wires running from the ground up the trunks to provide a good conducting path should they be struck.



Left, ends of the framework members fit into sockets in the special shoes. Center, the shoes are welded to an outer support ring. Right, after the framework has been built, aluminum sheet is welded to cover it

"Mushroom" Roof Supports Itself

No supports are needed for a new aluminum roof developed in England. Designed to cover oil and chemical-storage tanks, the roof is held up by its own framework and is said to be as strong as a similar steel structure. An experimental model 83 feet in diameter was tested by covering it with bricks and taking vertical-deflection readings. Despite the load of 27 pounds per square foot, the deflection was negligible.

The framework for the roof was made of square aluminum tubing, curved to a radius of 100 feet. Tenon joints connect the tubes at all intersections. Shoes welded to an outer support ring hold the ends of the tubes. After the framework is built, aluminum sheet is welded in place to cover the structure. Aluminum roofs of this type are said to be capable of a span between 500 and 600 feet.

Completed framework is made of square aluminum tubing connected at all intersections with tenon joints

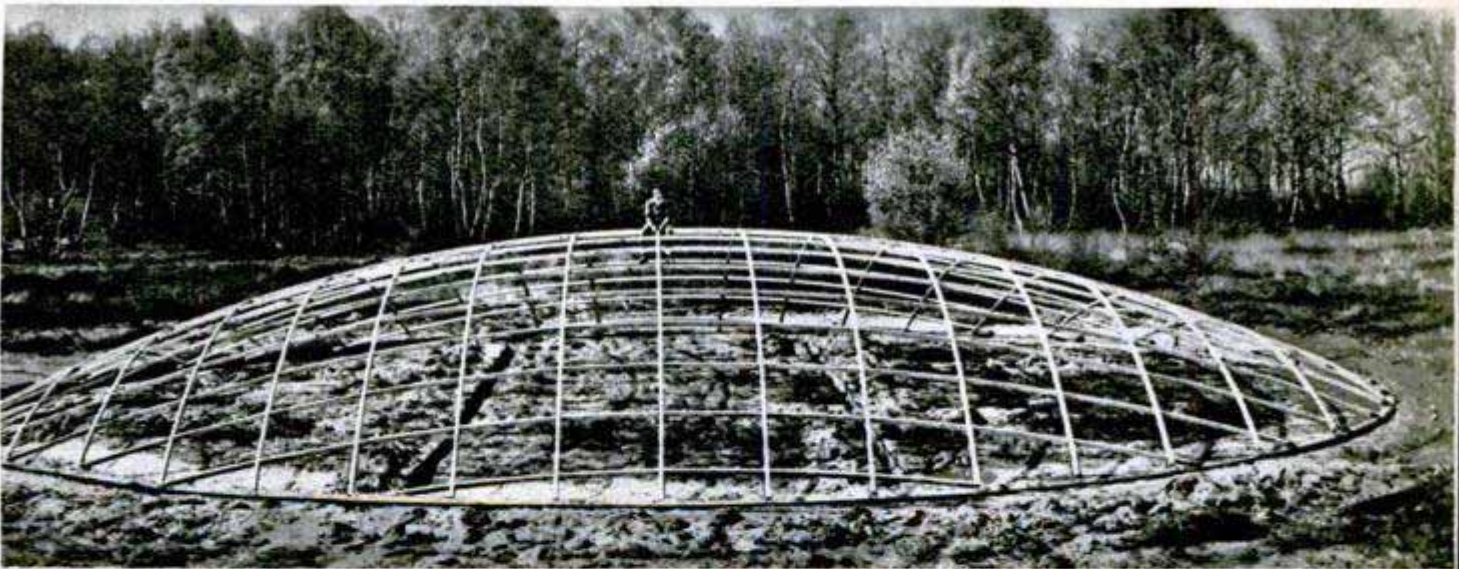

Roof is tested by covering it with bricks. A load of 27 pounds per square foot produces little deflection

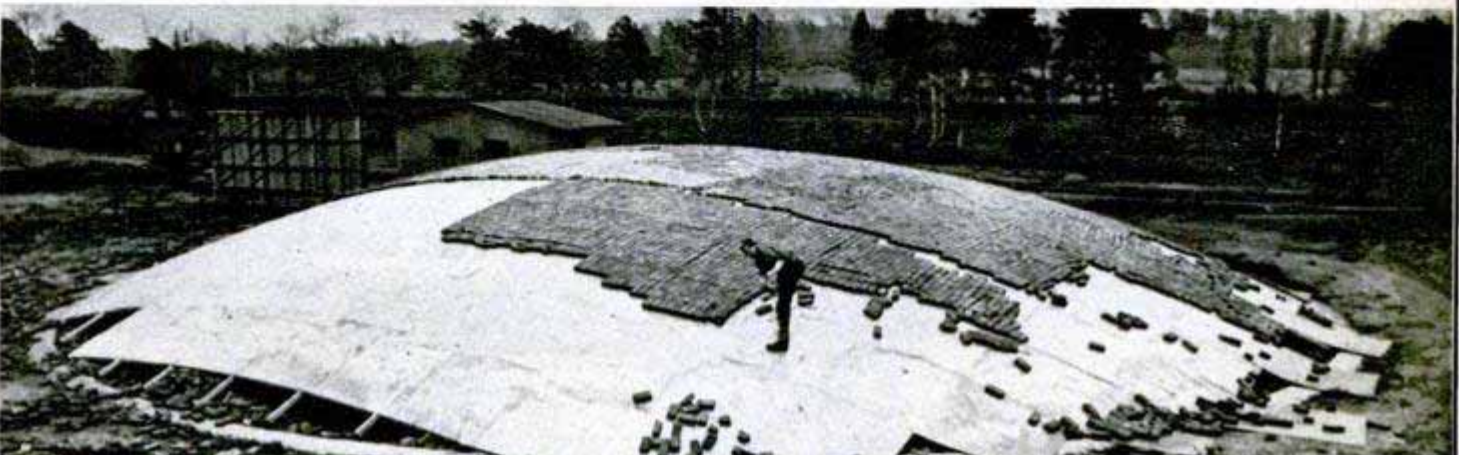



Rotofoto typesetting system starts by making a punched-paper record of the text (right) on keyboard machine

Setting Type With a Camera

EVERY hundred years or so some inventor finds a new way of setting type. Gutenberg invented movable type back in 1450 and Mergenthaler perfected the intricate Linotype in 1885. Recently, an Englishman, George Westover, came up with a process involving three machines which sets type by photography. While the Linotype produces castings for each line of type in metal, Westover's automatic system, called Rotofoto, produces positives or negatives of each line without the setting of any metal type.

The Rotofoto equipment has three main components: the keyboard (which resembles that of the Linotype), the line-projector and the make-up machine. First, a punched-paper record of the text is produced on the keyboard machine. The paper roll is then transferred to the line-projector. Although the projector contains some of the mechanism of a Linotype caster, a

Five-station make-up machine produces final film. By revolving wheel, corrections, heads or subheads are projected to film

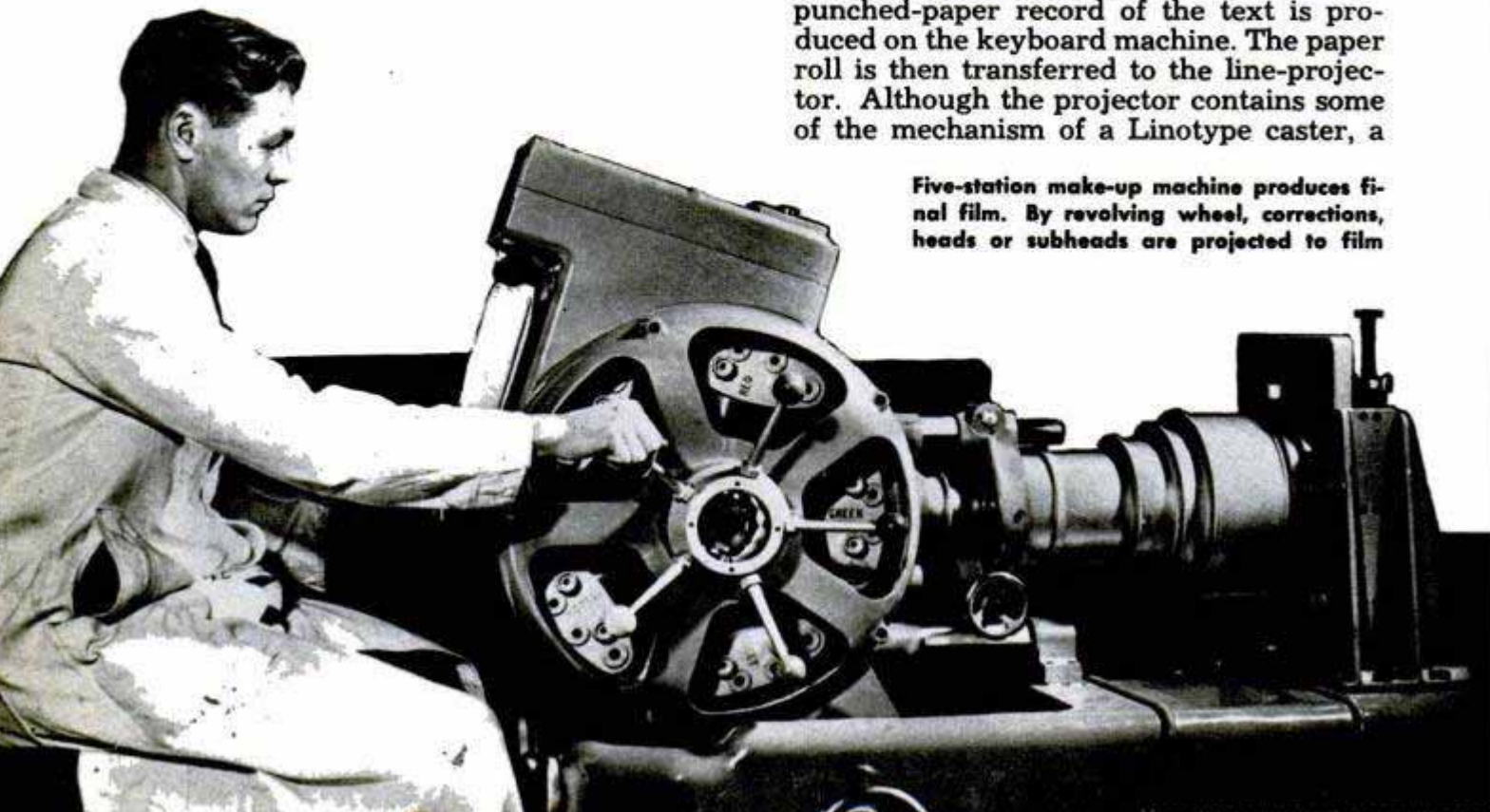

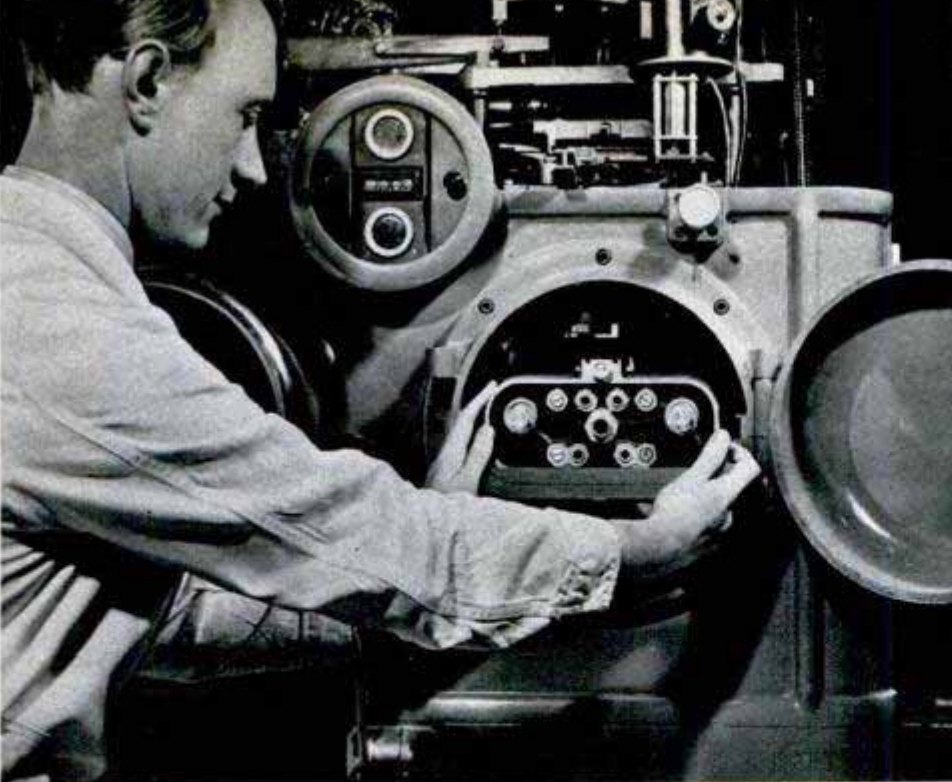

The line-projector is used in second step to transfer punched-paper record onto film, one letter at a time

photographic negative is substituted for the bronze matrix. The letters are photographed, one by one, on a roll of 35-mm. film carried in a camera. After developing, a photographic image of the lines appears on the film. Proofs are produced by projecting the film onto a roll of sensitized paper. Any line containing a correction is retapped on the keyboard and reset on the projector. All corrections appear on one or more separate rolls of film.

The last process is carried out on the make-up machine which consists of a cylindrical lamp housing around which are located five stations. Each station takes a roll of 35-mm. film. One of the stations contains the film with the main text matter, the next the film with the corrections, another the headings or subheads and so forth. The main text is then projected onto the final film transparency a line at a time. This projection is entirely automatic and is continued until a line requiring correction is encountered. To effect the correction,

the film holder is revolved and the corrected line is projected onto the transparency. When this is completed the holder is turned back to the main text to resume projection. Finally, the transparencies are used for making the printing plates and the printing process begins.

Westover cites these advantages of his Rotofoto system: eliminates metal type, makes possible the changing of type size by simple magnification, saves storage space (a book text is contained in a few narrow rolls of film) and produces a highly readable finished product.

Below, inspecting the finished transparency which will be used for making the printing plates. Right, a sample of the final product which is neat, sharp and can be easily read

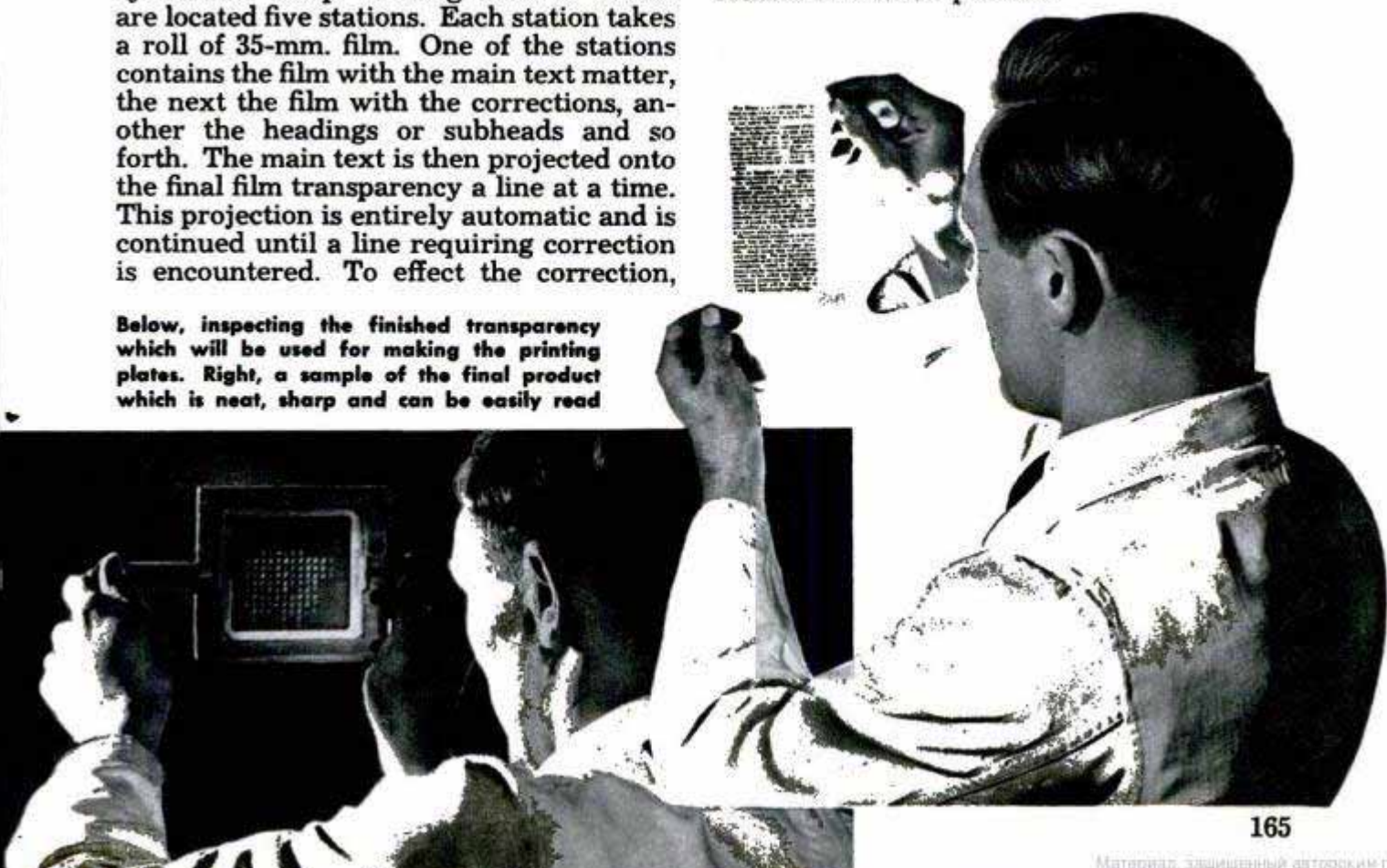



Rate Controller Speeds Reading

By forcing a person to read faster, a mechanical controller increases his reading rate. The machine, designed by Dr. Guy T. Buswell of the University of Chicago, has consistently raised the reading rate of grammar-school students, Army personnel and others. An aluminum screen which moves down, line by line, covers up the reading material at a controlled rate of speed. As the reader increases his rate, he gradually accelerates the movements of the screen. Students at the Air Command and Staff School, Maxwell Field, Ala., showed a 100-percent increase after a six-week course in using the controller.

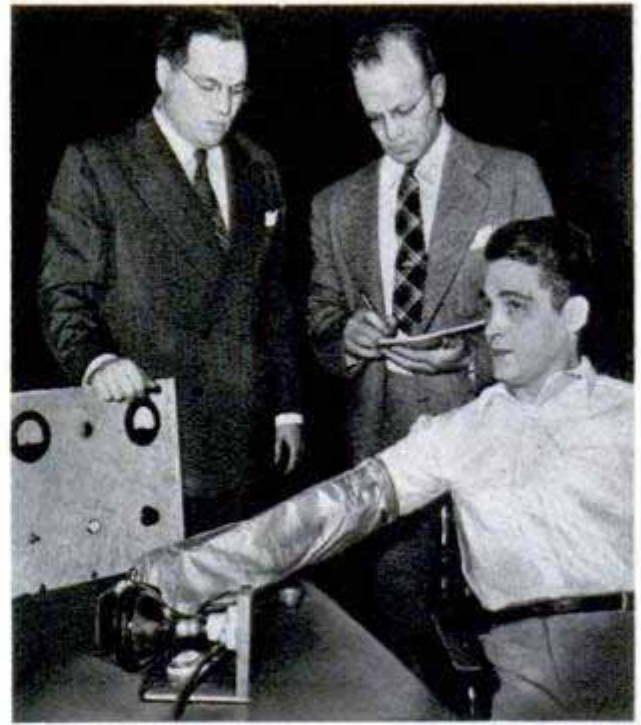

Aluminum-Plastic Cloth

Ordinary bed sheets, when coated with a special paint, become as warm as heavy woolen blankets, according to the inventor. He has also developed a cloth for lightweight winter garments that may revolutionize the clothing industry. Both the cloth and paint keep the wearer warm by reflecting the radiant heat of the body. The cloth is made from powdered aluminum with a Vinylite-plastic base. It can be made to sell for about one tenth the cost of woolen material. Tests made with a special mechanical sleeve have proved that the new cloth has an extraordinary ability to reflect back the heat generated by the body.

Midget Greenhouses Made of Glass Protect Tomato Plants



Tiny greenhouses, made by cutting the bottoms off glass jugs, protect tender tomato plants from damaging frosts in the garden of D. J. Palumbo of Dunmore, Pa. Stoppers are removed from the jugs to permit the circulation of air around the plants. By using these jugs, Palumbo can set out his plants early in the season.

Stainless steel has permitted industrial designers to reduce the weight of a modern railroad passenger car as much as 25 tons.



Billions of particles from this smoke generator can trick cloud vapor into freezing, creating a snowstorm

Weather a la Carte

By Clifford B. Hicks

WHEN Vincent Schaefer dropped a few pellets of Dry Ice from an airplane to spill his first cloud in November, 1946, he triggered more than a first-rate snowstorm. The General Electric scientist touched off a research program that now is unlocking some of Nature's basic weather secrets and may give man the audacity to tamper with the daily weather.

Schaefer and his fellow scientists have been quietly skywriting weather history for the past two and one half years. After tapping the secret of making rain, they decided to penetrate the fog that shrouds Nature's own weather processes. They had, they believed, attacked the problem backward. While they could cause rain to fall, they did not know just how Nature

herself pulled the trigger on a rainstorm.

Recently through their research program they have come up with information less spectacular than rain making but data

This "racetrack in the clouds" was formed by seeding with Dry Ice. The straightaways are 20 miles long. The cloud vapor has frozen and fallen

U. S. Signal Corps photo



which throws significant light on natural weather processes. They also are making some sparkling new suggestions on how to use this basic weather knowledge and how to apply older principles of rain making.

One of Schaefer's ideas is that man can steal the thunder from electrical storms by scattering thunderheads before they become dangerous. The U. S. Forest Service cooperated with him last summer in testing this idea at the Priest River Experimental Forest in Idaho.

The Forest Service is vitally interested in the suggestion because a large number of destructive forest fires are touched off by lightning. And what causes lightning? No one knows for sure, but Schaefer believes that when a large cloud supercools to a high degree it packs up such a wallop of energy that an electrical storm is the result. If man can control supercooled clouds, why can't he control lightning and the particular supercooled clouds which produce hail and severe cloudbursts?

H. T. Gisborne, Chief of the Division of Fire Research, is in charge of the Forest Service's part of the experiments. Only when weather conditions produce two similar clouds of the necessary type is he making the dissipating tests. Thus one cloud can be treated while the other is observed as to what would have happened if the target cloud had not been altered.

COLUMNAR snow crystals are tailor-made by introducing acetone vapor into laboratory cold chamber

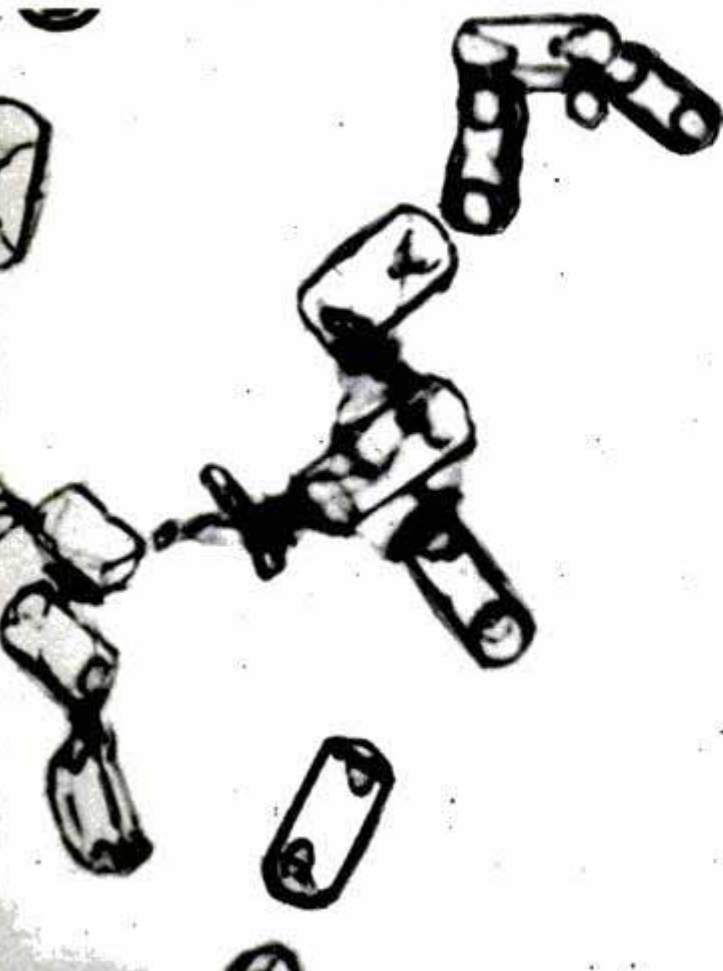

In their experiments Schaefer and Gisborne are using a needle-sharp instrument in series with a micro-ammeter to measure atmospheric electricity in a lightning storm in the same way an electrocardiograph measures electric potential in the heart. As Gisborne puts it, "We seem to be getting the pulse beats of a lightning storm but we can't interpret the significance of all the pen deflections yet. It seems to me that our knowledge of these pen deflections is just about comparable to that of the doctors 30 years ago when they first applied an electrocardiograph to a human being. When we can interpret those deflections we should be able to rate the intensity of violence or menace of each lightning storm."

The plan for dissipating a thunderhead differs from ordinary rain making. The objective is to turn the water droplets of the cloud into fine snow that will fuzz out and drift away. This is accomplished by over-seeding the cloud.

Gisborne emphasizes that clouds must be of the right type. In fact, he feels that the phrase "triggering a cloud" is a lucky choice of words because you can trigger an unloaded gun forever with no results; in the same way, some clouds are "loaded" for rain making or lightning dissipation and some aren't.

Take a look now at how Schaefer's team

HEXAGONAL crystals are usual type formed in the laboratory. Now they can be converted to other types



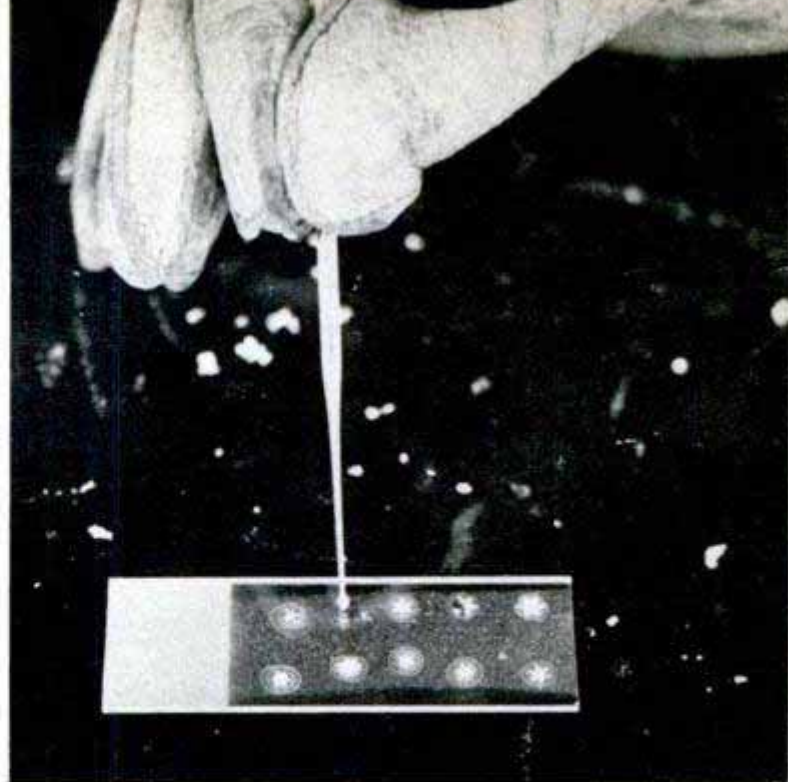

Snowflakes that won't melt: Schaefer captures the shape of individual flakes by dropping the crystals into a plastic solution. Solvent eventually evaporates, leaving plastic shell which is a replica of the snowflake

is ferreting out Nature's basic secrets.

Latest of the successful research programs is the work in waterdrops. What is the nature of a waterdrop? The question seems so simple that apparently science overlooked it until the General Electric team decided to find out just how a raindrop behaves.

Surprisingly, they found that a water-

STELLAR crystals are produced by use of acetic acid. Vapors in atmosphere may change natural snowflakes

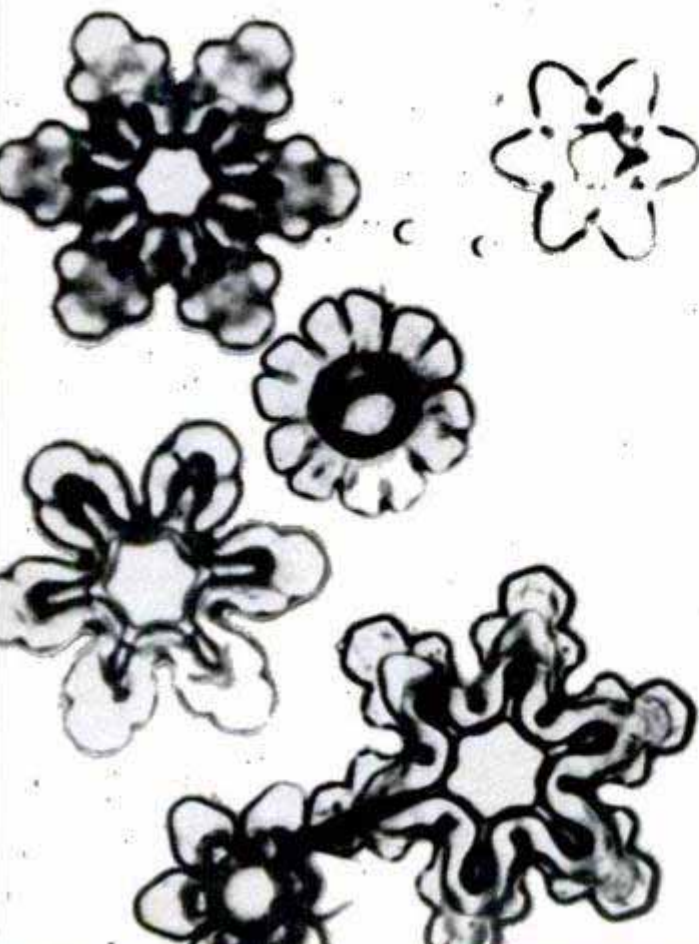

drop is not tear-shaped, and neither would a tear be if it fell farther than the end of your nose. Raindrops change shape as many as 50 times per second and in the course of a fall they may resemble a pancake, peanut, jellybean, duck, hot dog, telephone receiver, caterpillar, or even your foot.

Most raindrops which break up first are transformed into a variety of shapes but eventually look like a dumbbell with two bulging ends. In the tests, 89 percent of such drops broke at the neck to form two separate drops, with the neck splitting off into a third smaller drop. In eight percent of the tests the drops exploded or shattered.

The information gives the weather scientists insight into what happens after a cloud is triggered, either by Nature or by man. Each drop may grow by accretion, split into smaller drops and then repeat the same cycle again.

G. E. scientists developed an ingenious instrument known as a drop controller to make these tests. The instrument, similar to a vertical wind tunnel, blows an upward current of air against a drop of water. By regulating the current, the observer is able to hang the drop in mid-air for periods of several minutes, watching and photographing it as it undergoes transformation.

The scientists also are probing the phenomena of supercooling. They recently succeeded in supercooling water 71 degrees below its ordinary freezing point before it turned into ice. Such research may show how Nature supercools rainclouds and then triggers them with natural nuclei. The scientists report that they have made "clouds" of supercooled gallium, tin

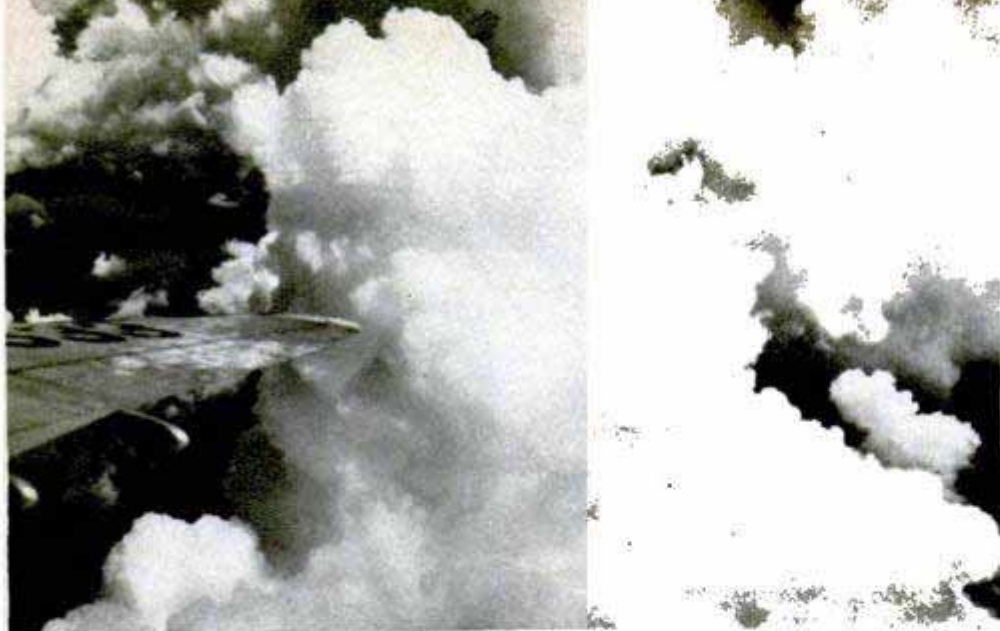

Series of pictures show how a rainstorm was created artificially. Scientists now propose that when a landing field is closed in by supercooled fog or rain clouds, the aviator could dissipate them within a few minutes. Photo above shows the cloud before treatment



Above, this picture was taken immediately after the cloud was seeded with Dry Ice. Note how some parts already are fuzzing out into precipitation. Photo below was made during the rainstorm that followed. Overseeding can produce tiny ice crystals that drift away



and mercury by dispersing these metals in liquid form as minute droplets suspended in oil. Although the droplets may contain nuclei, the freezing that begins in the liquid metal can't spread through the oil and thus can't precipitate the rest of the "metal cloud."

How about the structure of a snowflake? As a result of recent studies, Schaefer not only can produce his own snow but can choose the particular brand of flakes he desires. He can change a snow crystal from one shape to another merely by introducing foreign vapors into the cold chamber. Under ordinary conditions cold-chamber snow crystals are hexagonal. By introducing butyl-alcohol vapor in small quantities, Schaefer can change them into columns and prisms. Other vapors produce other snow families such as ice needles, triangular plates, capped columns and freak forms. As vapors are present in the atmosphere, this may be one of the answers to the riddle of how Nature shapes snow crystals.

Schaefer has developed a unique system for preserving snowflakes indefinitely. He blankets the desired flake with a solution of Formvar, a transparent plastic resin. When the solvent evaporates, the snowflake is encased in a hard shell that will preserve the shape of the crystal for an indefinite time.

An instrument recently developed by the weather scientists "fingerprints" a snowstorm. Falling flakes strike the instrument's dye-coated paper. A small amount of heat melts the flakes immediately, leaving dark blue impressions on the paper. The strip is exposed for one minute at 15-minute intervals. When the storm is over, the paper shows how big the flakes were, what kind they were, how many fell in a given area and how long the storm lasted.

Through their laboratory

research work, the G.E. scientists now know that, given the proper kind of cloud, they can drum up a shower or snowstorm in four different ways: by sowing Dry Ice through the cloud; by flooding the cloud with billions of foreign nuclei, each capable of growing into a snowflake; by simply dropping water into the top of one kind of cloud; and by the sudden expansion of air within a cloud.

Dr. Bernard Vonnegut, one of the youngest scientists in the project, felt for some time that a supercooled cloud could be transformed into a swirling snowstorm by loaning the cloud billions of particles which would trick the water vapor into gathering and freezing into flakes. He succeeded in producing a laboratory snowstorm with silver iodide, which is practically a twin of ice in crystal dimensions.



Scientists watch as a single drop of water hovers in air. Controller blows air up against the drop, suspending it so its development can be studied

Vonnegut then came up with a generator for broadcasting the particles. The machine, which burns charcoal impregnated with silver iodide, cooks up a hundred million million particles per second. The scientists have calculated that a system of generators spaced 20 miles apart across the country would be able to sow a silver

Photographic record shows various drops as they undergo change. The test reverses normal direction as drops fall "up" from force of air. Left drop maintains shape, center drop splits, and right one splits and shatters

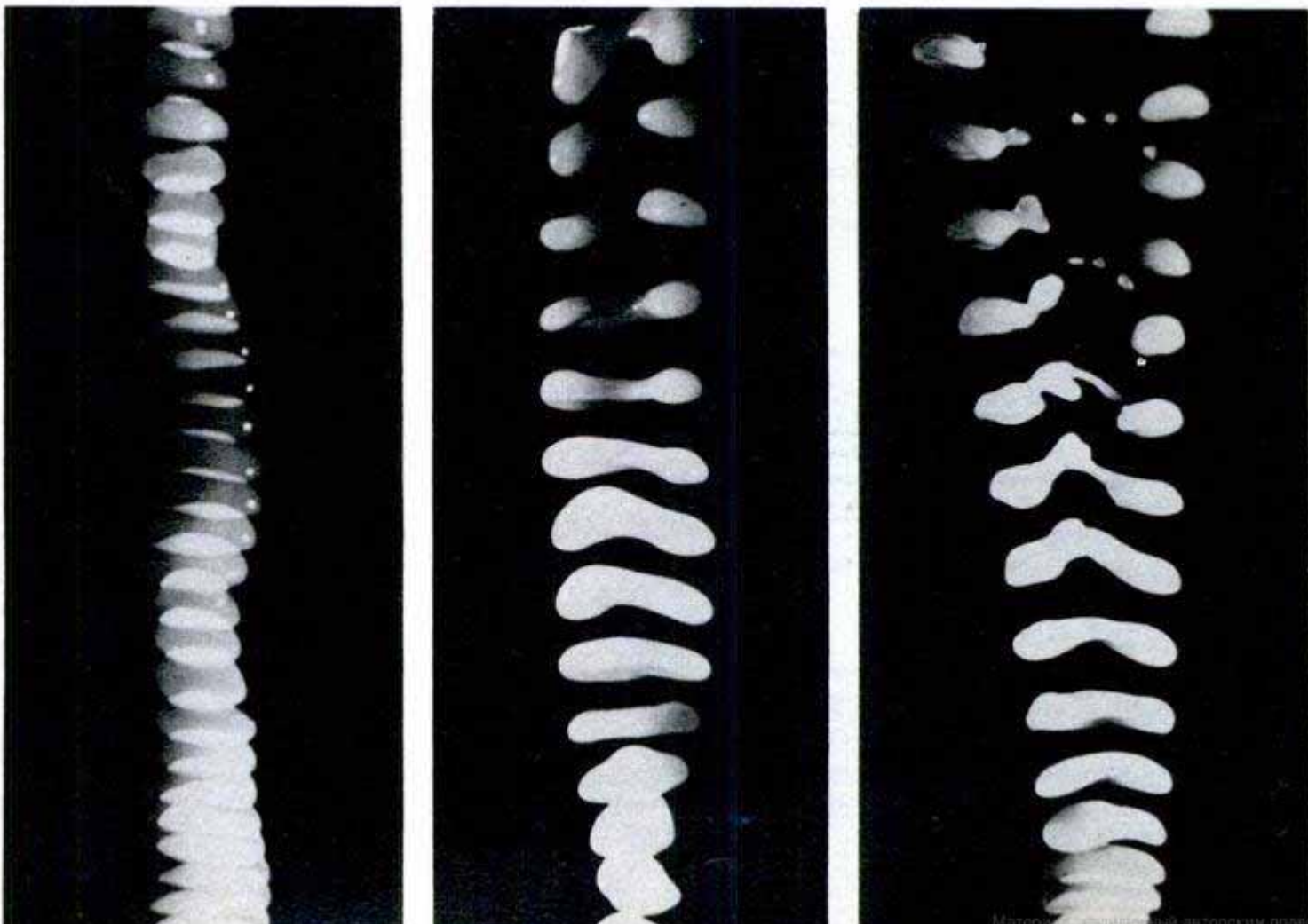



Schaefer examines point of instrument used with a micro-ammeter to make "electrocardiogram" of storm

lining into every supercooled cloud above the United States. Many such clouds could be precipitated, increasing the amount of sunlight reaching the ground and thereby raising the winter temperature.

Dr. Irving Langmuir has made the surprising statement that it's possible to squirt an eye dropper of water into the top of the proper kind of cloud (not even a supercooled one) and the cloud will col-

This instrument "fingerprints" a snowstorm by recording the shape, size and frequency of fall of flakes



lapse into a rainstorm. Here's the kind of a cloud you will need to turn this fascinating trick: a fairly common type of cumulus cloud five thousand feet thick or more with fairly large cloud droplets and an updraft of at least five miles an hour.

When you squirt a large drop of water into the top, it starts falling through the cloud, collides with smaller droplets and grows to a critical size when surface tension no longer can hold it together. At this point it splits into smaller drops, and, being lighter, they are carried aloft again by the updraft until they grow large enough to fall once more. This spreads into a chain reaction until all the water is in drops too heavy to stay aloft and the cloud collapses.

This theory has been proved under natural conditions. It is significant to note that this type of nonsupercooled cumulus cloud is fairly common over the United States throughout the summer.

Vonnegut squeezes still another type of cloud trigger in the laboratory. He uncaps a bottle of soda water or bursts a toy balloon inside the chamber. The sudden expansion of air produces a sharp drop in the temperature, causing the water vapor to form into millions of ice nuclei, the nuclei grow and presto—you have a man-made snowstorm.

According to the scientists, these four triggers—Dry Ice, artificial nuclei, water and the expansion of air—can be pulled in a fascinating number of ways to affect man's environment. If a cloud is overseeded, it will turn into billions of ice crystals, thus preventing rain—a technique that might be a potent military weapon. Under the right conditions, clouds could be dissipated until crops are harvested. Or some of the numerous clouds on the west side of the Rockies, converted to crystals, would float across the mountains under the proper wind condition.

There also may be experiments to trigger snowstorms across the countryside before the clouds drift over cities. Farmers often need snow, but city folk don't like to shovel it. New York's annual snow removal bill is about seven million dollars.

Rockets have been proposed by Schaefer to dissipate the supercooled fog around airports. They would climb above the fog and explode into a curtain of Dry Ice pellets that would trigger the murk into a snowfall lasting only a short time. Behold—a clear airfield. Successive upwind treatments would keep the airfield clear.

These are not the idle dreams of men with their heads in the clouds. Each of these schemes has been proved possible in the laboratory, and many such experiments have been successfully performed under natural conditions.

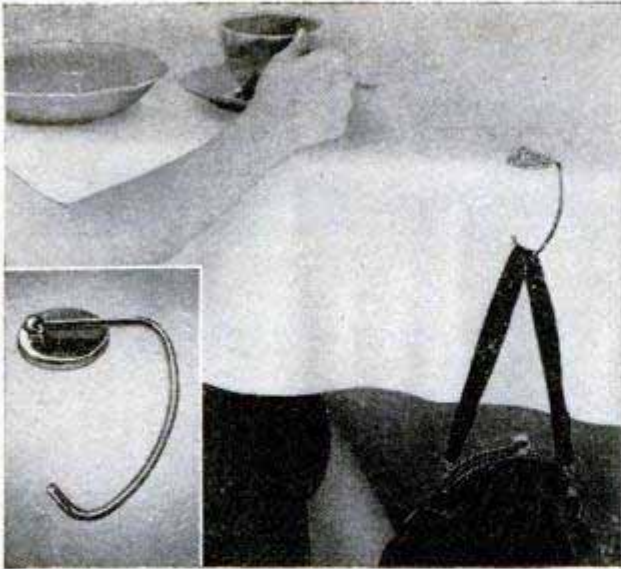

Holder for Handbags

Handbags and umbrellas can be hung from the edge of any shelf on a portable holder small enough to fit into the purse. The holder rests over the edge of the shelf with the hook dangling beneath. A rubber pad on the holder prevents it from marring the surface.

Film in Rocket Will Photograph Ultraviolet Rays of the Sun

Rockets sent high into the atmosphere may soon carry a new photographic emulsion that is sensitive to light far into the ultraviolet as scientists seek more information about the sun. Developed for identifying atoms or chemicals by analyzing their radiant energies, the emulsion has extremely close-packed silver grains with very little gelatin. Being supersensitive to ultraviolet rays, the emulsion will photograph accurately the sun's rays at extremely high altitudes where ultraviolet rays are intense because there is little atmosphere to filter them.



Major inspects the squirter that quieted his bark. At night, the nozzle is placed inside the doghouse.

Electronic Shower Quiets Dog

When his pet dog, Major, insisted on barking at 4:30 every morning, W. J. McGoldrick of Minneapolis decided something had to be done to stop the sleep-disturbing habit. Being an engineer, he solved the problem electronically with an automatic device that squirts an annoying stream of water in the dog's face whenever he barks. An amplifying circuit picks up the sound of the bark and turns on the water. When the barking stops so does the water. In a few nights, Major learned how to keep from being soaked, and now McGoldrick and the neighbors sleep without any disturbance from the dog.

Roller Punches Holes in Ground to Prevent Erosion by Rainfall

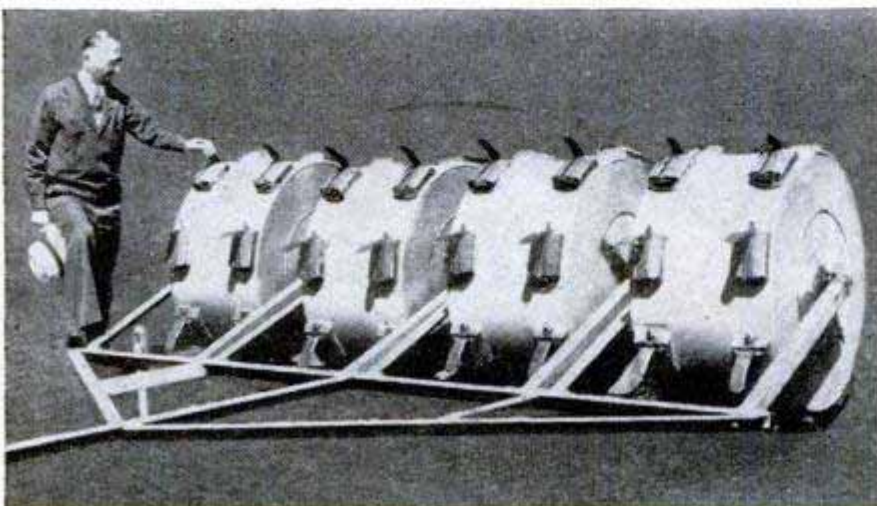

Punching thousands of holes in the soil prevents erosion by absorbing rainfall before it can carry off topsoil, according to Homer K. Shonts, a Washington wheat farmer who invented a machine that digs 28,000 holes per acre. The machine is a heavy roller composed of four sections. Two rows of steel teeth on each section dig into the ground, punching pores in the soil.

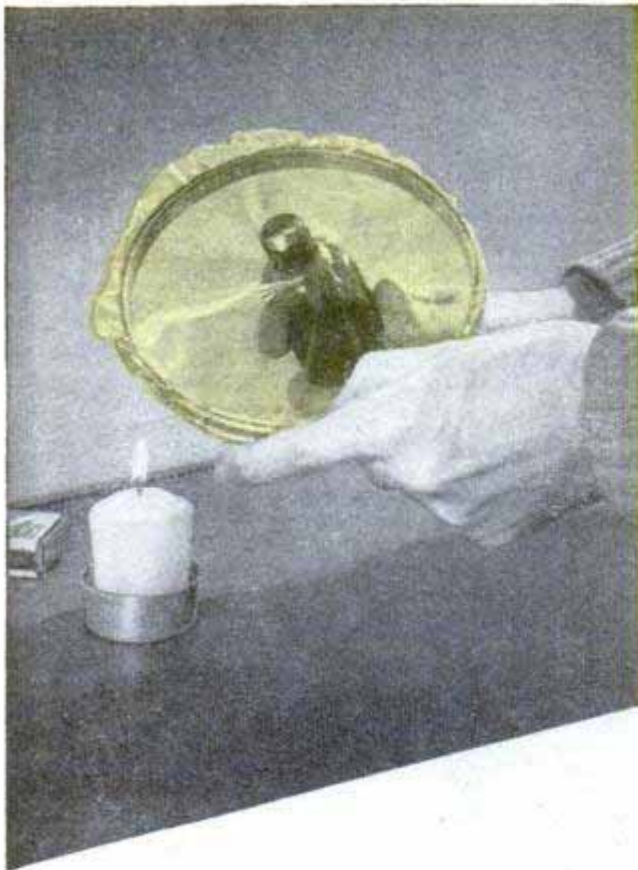

To stretch-wrap bottle cap, the film is placed in an embroidery hoop and warmed over a candle. Then the cap end of bottle is thrust into film and given a twist. Below, Goodyear Pliofilm holds margarine

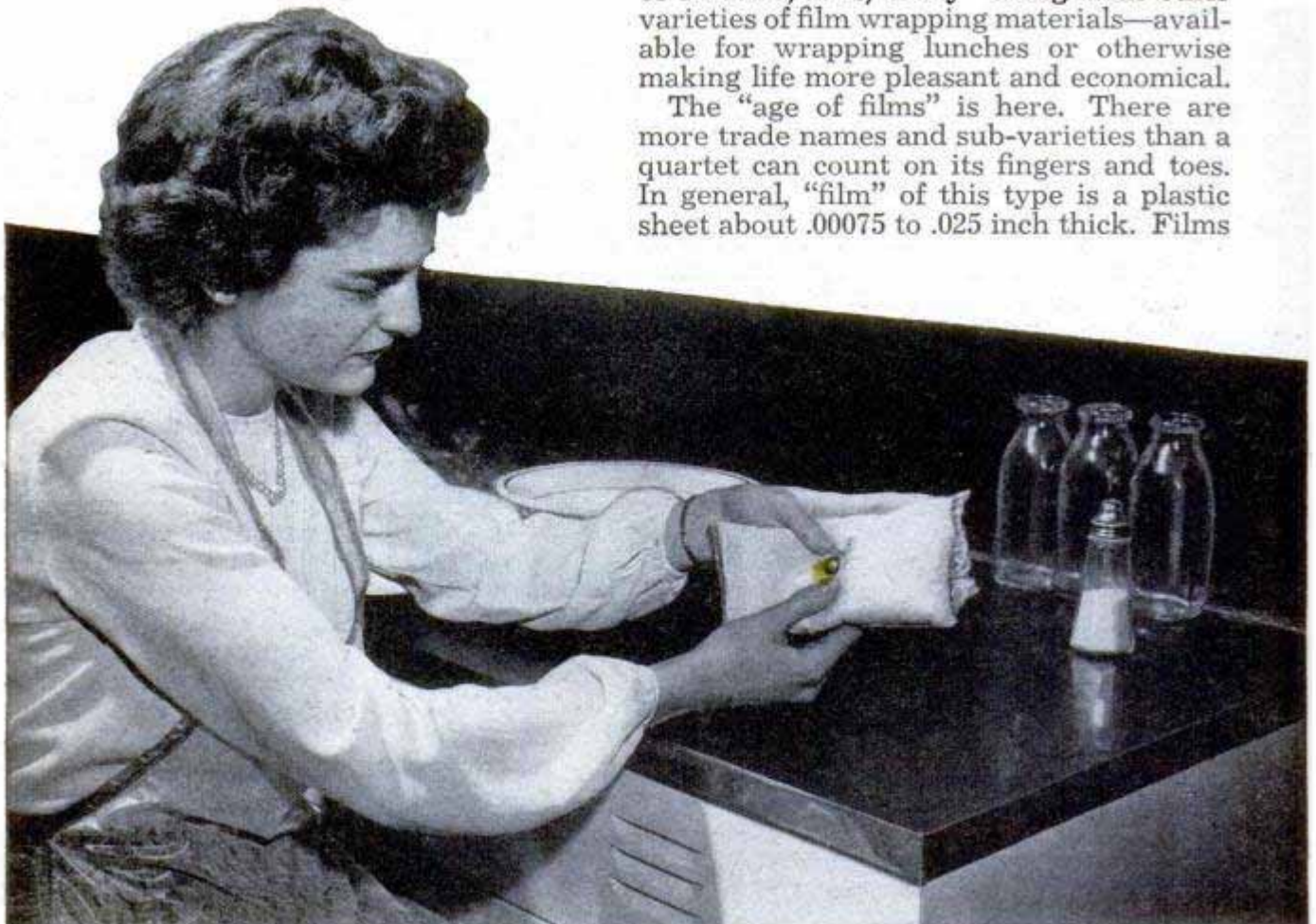

Seal It With Rubber

By Walter E. Burton

A WARTIME office worker aroused the envy of the other employees each noon with a lunch that included oven-fresh pie and sandwiches containing unwilted lettuce and bread that lacked the customary air-hardened shell. The secret, the other workers eventually learned, was a sheet of flexible, transparent film.

"Where do you buy it?" they all asked; but in that period of shortages none of the magic film could be found. Still, the office worker, month after month, kept appearing with a film-fresh lunch using the same wrapping over and over. The film was washed each evening and dried.

That film happened to be made of rubber hydrochloride, a chemically altered form of crude rubber. Marketed under the name of Pliofilm, it is, today—along with other varieties of film wrapping materials—available for wrapping lunches or otherwise making life more pleasant and economical.

The "age of films" is here. There are more trade names and sub-varieties than a quartet can count on its fingers and toes. In general, "film" of this type is a plastic sheet about .00075 to .025 inch thick. Films

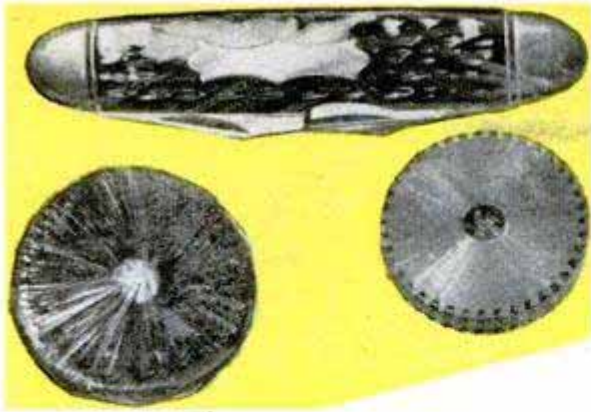

Hundreds of items such as knives, wire brushes and small gears are wrapped in Pliofilm to prevent rust

are made of many different materials. Cellulose nitrate was one of the first forms. Its brother, cellulose acetate, is familiar to millions as the film part of safety-base photographic films. In various thicknesses it is being used for packaging and similar applications. Another form is cellulose acetate butyrate. A relative old-timer is transparent cellulose film. Rubber derivatives, obtained by chemically altering crude rubber, form another source of films. Vinyl resins provide an important assortment, such as films made from plasticized polyvinyl chloride. Vinylidene chloride is still another film material. There are numerous others.

The names of these magic films do not necessarily represent single packaging materials, but instead may denote whole families of materials having wide ranges of properties. In order to assure the best results, a film should be selected or made specifically for a certain purpose.

One day early in October of last year, I wrapped several apples individually in Pliofilm (rubber hydrochloride), sealed them here and there (but not enough to

make the wrapping air-tight) with cellulose tape, and placed them in a refrigerator. From time to time during the next several weeks I would take out an apple and eat it. But one big, red Delicious specimen found its way back into a corner where it successfully hid every time I was apple-hunting. Towards the end of June someone reminded me that there still was an apple in the refrigerator. Assuming that it would be spoiled after nearly nine months in the cooler, I tore off the wrapping and found, not a shriveled, rot-pitted apple, but one as firm and fresh-looking as the day it was placed in its film jacket. It tasted even better than it looked!

This is a small-scale example of what has been going on for several years in the apple industry. The Goodyear Tire & Rubber Company has been supporting, at the University of Iowa, a research program aimed at finding the best ways of wrapping apples so they can be stored longer, shipped farther, and kept more free than unwrapped fruit of such ailments as dry rot, Jonathan spot and shriveling.

Each kind of apple, it was found, reacts

Tests at Iowa State College show that Pliofilm-protected apples (left) are in good condition after storage for six months. Apples at right were picked from same tree and kept under like conditions but in paper liner

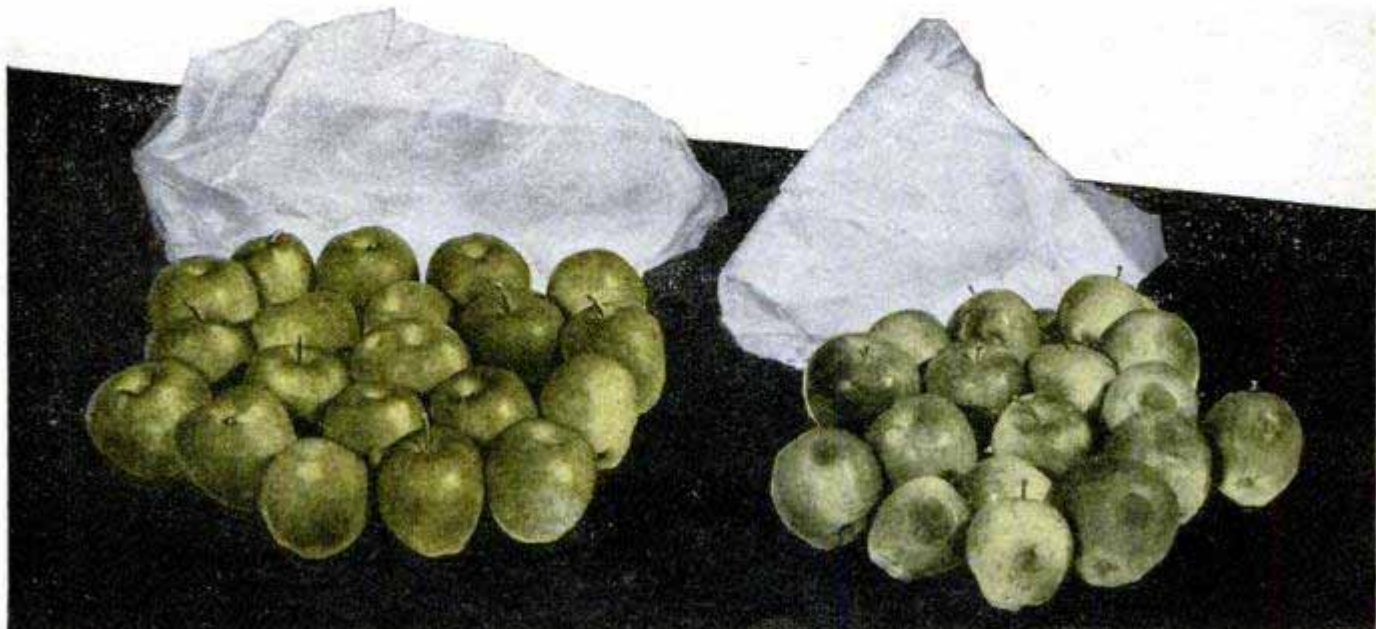



The shine on these oranges is from their transparent "second skin" of Pliofilm which retains tree freshness of fruit. The machine can wrap 800 a minute. Below, barbecue sauce is canned in Pliofilm bag



differently when packaged in film; and apples of one kind but from different localities behave in different ways. Jonathan apples from the West Coast have been packaged successfully in Pliofilm, and oranges are being preserved in a similar way.

Keeping an apple or any other "living" material in a film wrapper may not be as simple as it appears. Even though an apple, peach, ear of corn, or any other fresh fruit or vegetable has been detached from the plant that produced it, it still is a living organism that undergoes a chemical change known as catabolism. This process, which causes fruit to ripen after picking, requires oxygen and consumes energy stored in the fruit itself, and it produces carbon-dioxide gas.

By slowing the catabolic process, food can be kept almost in a state of suspended animation, and its eventual spoilage postponed considerably. This slow-down can be accomplished in two steps: (1) By wrapping the fruit or vegetable in a protective film

having suitable properties or by placing it with others of its kind in a container lined or wrapped with the film. (2) By storing the package or wrapped pieces of food at a low (but not freezing) temperature.

The wrapping must allow the fruit or vegetable to "breathe." That is, some oxygen must be permitted to reach it, and some of the carbon-dioxide gas it generates must be allowed to escape. At the same time, to prevent shriveling, the escape of water vapor must be discouraged. Too much CO₂ will smother the fruit, too little will permit decay. If the fruit is simply wrapped and kept at ordinary temperatures, spoilage may be delayed a while, but fungi and bacteria will get in their work too soon. By refrigerating the wrapped or packaged fruit, usually at a temperature such as 36 to 38 degrees Fahrenheit, action of these decay organisms is arrested.

Food products that do not have to breathe can be packaged in gas-tight film and the seams sealed tightly. Cheese, meats, dried vegetables, cooked foods, soups and oils are among the things that can be preserved in this way. Here, again, temperature may have to be lowered to prevent molding or other spoilage. Red meat has been a problem. When wrapped in transparent film (which must be uncolored), meat gradually darkens. It is thought that this is a result of light action in which oxygen is involved. Research has been done in an attempt to develop a film that will preserve red meat without allowing it to discolor. Another problem with some kinds of meat is the accumulation of a slimy

(Continued to page 256)



Nonmoistureproof Cellophane is used to make dustproof covers for laboratory glasses. It is first soaked in water, then held with rubber bands

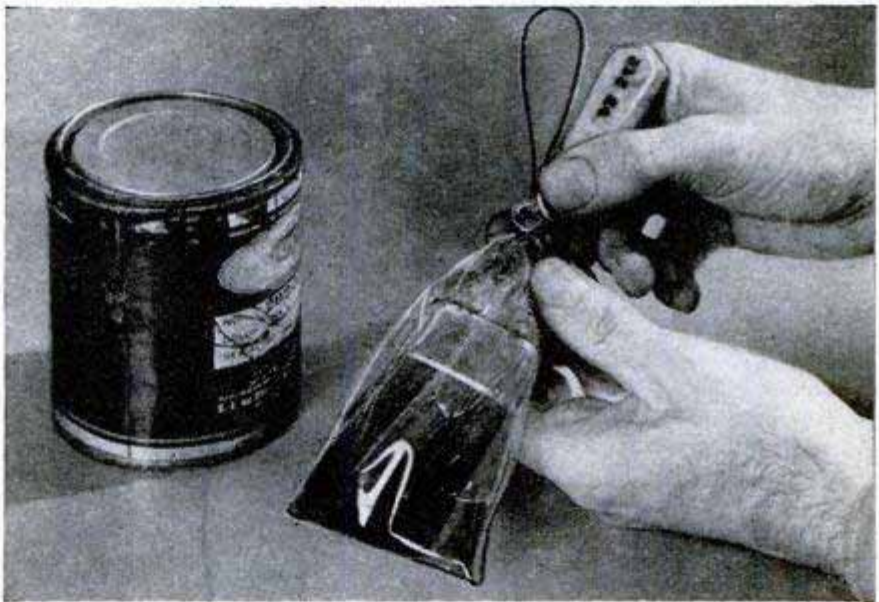

Paintbrush is kept from drying out in Pliofilm bag. If storage is for a few days, paint is left in bristles; if for a long period a thinner should be added. Below, film seals the cap on a film-splicing cement bottle

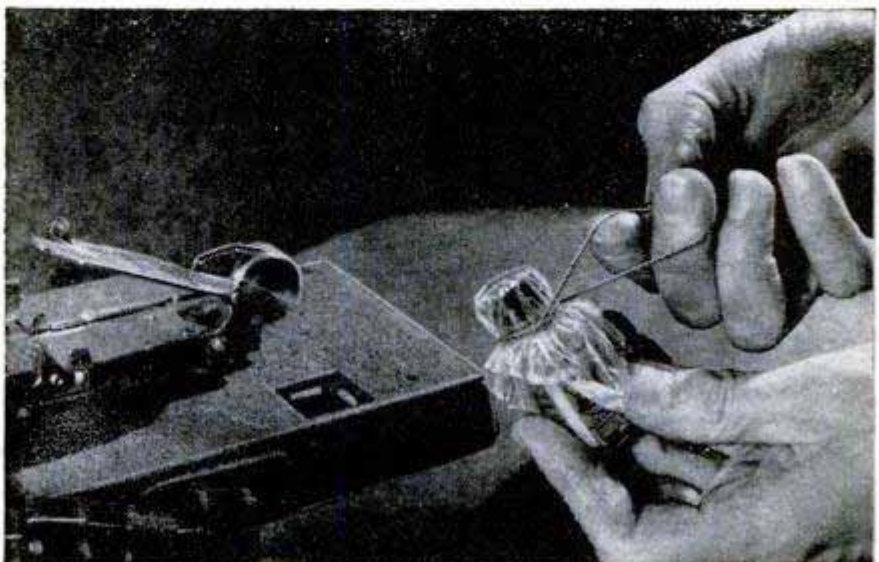

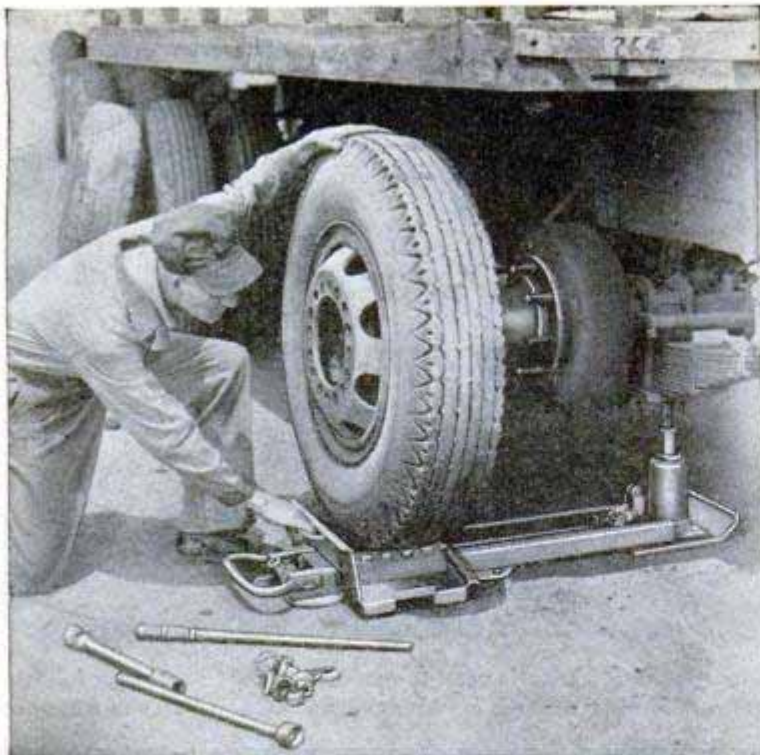

Dolly and Jack Team Up To Change Truck Tires

Changing tires on a heavy truck is an effortless operation with a jack and dolly combination that eliminates lifting the wheels. The wheel is driven up on the dolly, which rolls on a track extending from the base of the hydraulic jack. When the axle has been raised by the jack, the lugs are removed and the wheel slides off the axle as the dolly is pulled forward on the track. The wheel is then rolled off the dolly and the spare wheel rolled up in its place. When the dolly is pushed back under the axle, the wheel can be rotated on rollers in the cradle to line up with the lug bolts. The axle can be jacked up first and the dolly swung under the wheel after the tire is off the ground.

Safety Electric Outlet Won't Shock Probing Children

Accidental shocks to curious children are almost impossible in an electric outlet which is not energized until both prongs of a plug are inserted. Four insulated rollers in the socket complete the circuit when forced aside by the prongs, pushing two shunts against live contacts. Since the top rollers complete the lower circuit, there is no shock when an object is forced into one of them.

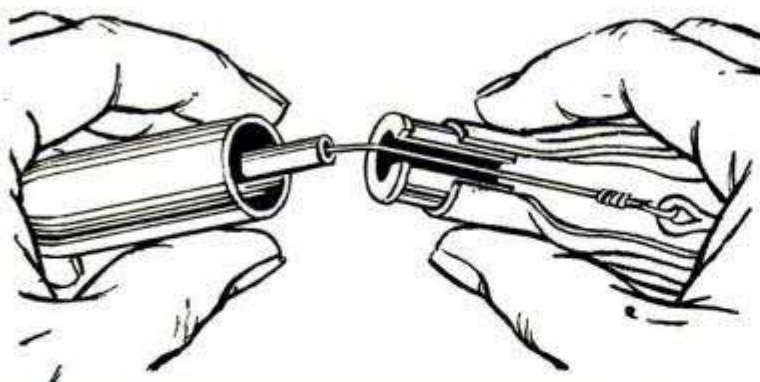
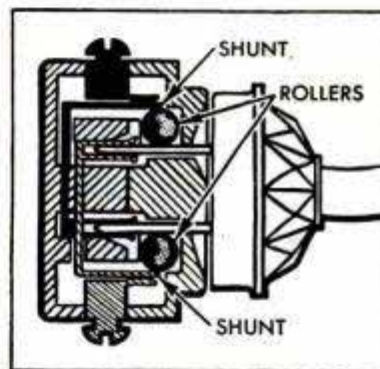
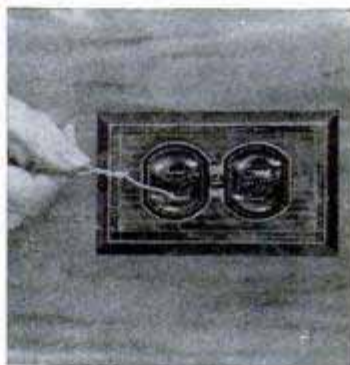

Snap-On Trolling Lure

Plastic "skirts" of various colors snap onto the head of a new trolling lure, making it possible to change baits within a few seconds. The skirt is slotted and fastens to the leader simply by pinching one end and inserting it into the head. Spring action snaps it into position. Thus, only the skirt need be changed when a lure is damaged or when the fisherman decides to try a new color combination to tempt the fish.

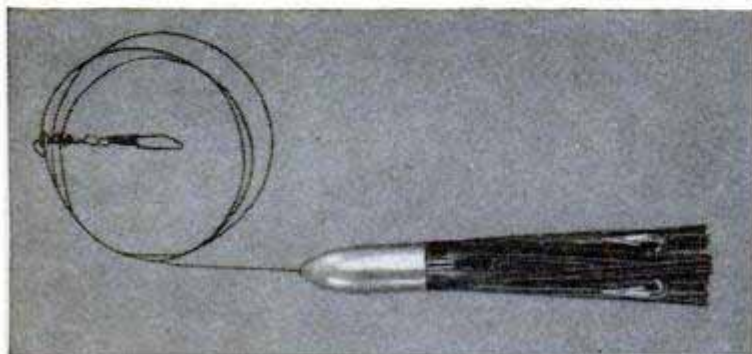

Because summer temperatures soar up to 130 degrees in the shade and the cold winds of winter are almost unbearable, the miners at Coober Pedy, Australia, the richest known opal field in the world, live and work in a complete underground town.

No-Dip Paintbrush

Painters can work without dipping their brush with an outfit that feeds paint directly into the bristles. The paint is gravity-fed from a bucket through a flexible hose and into the base of the bristles. A cutoff clip on the hose gives the painter control of the flow. During overhead work, the painter squeezes an impulse bulb which forces paint up the hose and into the brush.

Chemicals From Stumps

Pine-tree stumps, once considered worthless and bothersome, now are providing millions of dollars worth of rosin, turpentine and pine oil. A new process recovers about 400 pounds of these products from a ton of stump wood. The stumps are rooted out by special tractors, split into small pieces, cleaned by water jets and shredded into particles



the size of sawdust. A high-temperature solvent then penetrates the particles to bring out the turpentine and other oils.

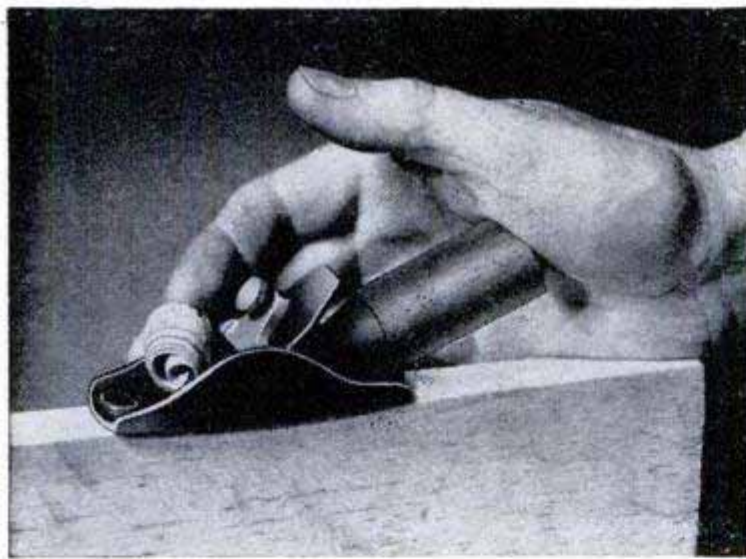

Tiny Plane Has Extra Handle

Only $3\frac{1}{4}$ inches long, a pocket-size plane has an extension handle that fits the palm of the hand to provide a sure grip. The little plane is designed for fitting and finishing work. Although it is only $1\frac{1}{4}$ inches wide, the tool is built for heavy use. It has a blade of tool steel specially treated to hold its edge. The extension handle fits on the rear of the plane and provides a maximum of leverage when pressed by the heel of the hand. Both the midget plane and the handle can be slipped into the pocket when the tool is not in use.

Front-Wheel Grease Seals

Front-wheel bearings of automobiles need attention less frequently, yet are assured of proper lubrication, when inside grease seals are used. The leather seals, held snugly against the inner and outer bearings by a coil spring, keep the grease where it is needed in the bearings. The complete seal unit revolves with the wheel. One model fits almost all makes of cars in use today.

☐ About 567 billion gallons of water are required annually to supply the needs of U. S. railroads.

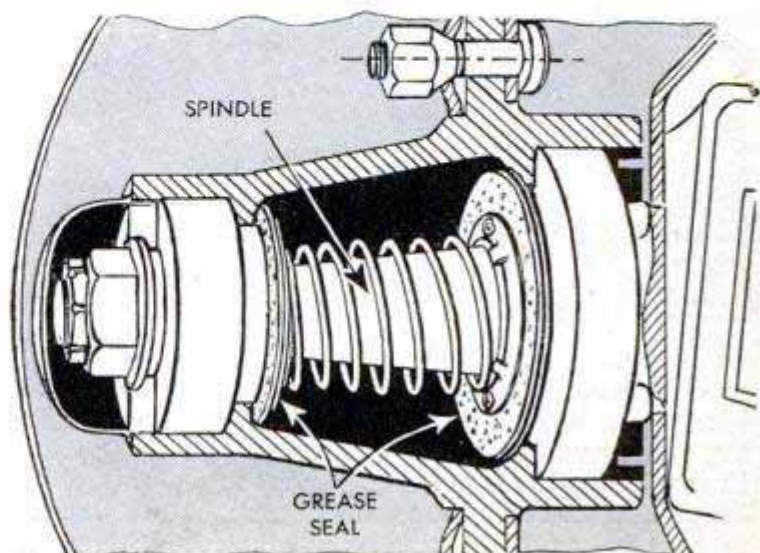

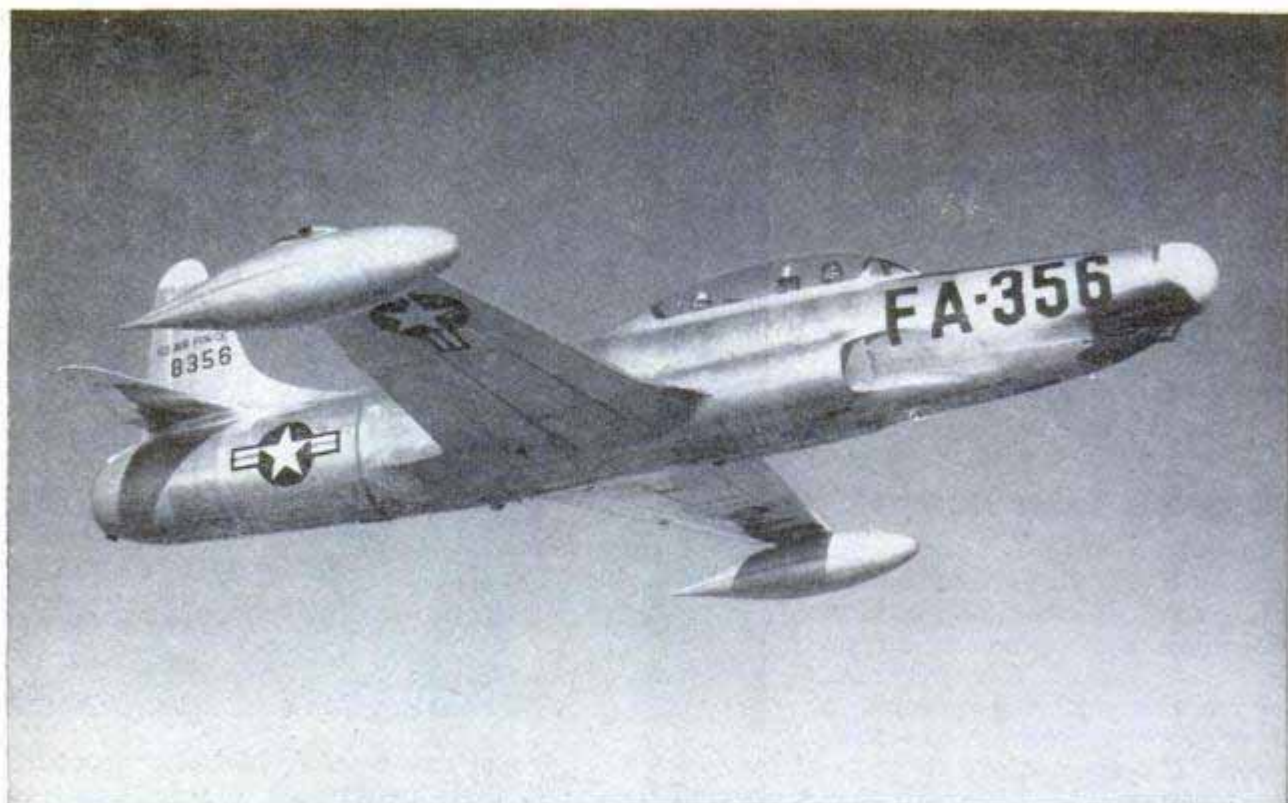

'Round-the-Clock Fighter

High-altitude interception, night or day and in any kind of weather, is the work cut out for the Air Force's new Lockheed F-94 jet fighter. A second flyer in a cockpit behind the pilot operates radar that permits

location and interception of enemy aircraft, even under completely blind flying conditions. The plane is in the 600-mile-an-hour class. Using a new technique of "afterburning," the plane provides added power by spraying fuel into the path of hot exhaust gases from the jet engine.



Rubber Lifeboat Inflates Itself

Inflating itself automatically when a ripcord is pulled, a rubber lifeboat sheds its carrying case and rights itself without taking on any water. Within 30 seconds of the time the ripcord is pulled, the boat is ready for use. It will accommodate 12 persons inside and has handrails alongside for 13

others. Inflated by carbon-dioxide cylinders, the two tubes that form the sides of the boat are divided into compartments for greater safety. The complete weight, including emergency rations and equipment, is only 186 pounds. Four paddles are included, two of which can be used as masts to support a cover. Equipment includes a signal kit, fishing tackle and sea markers.

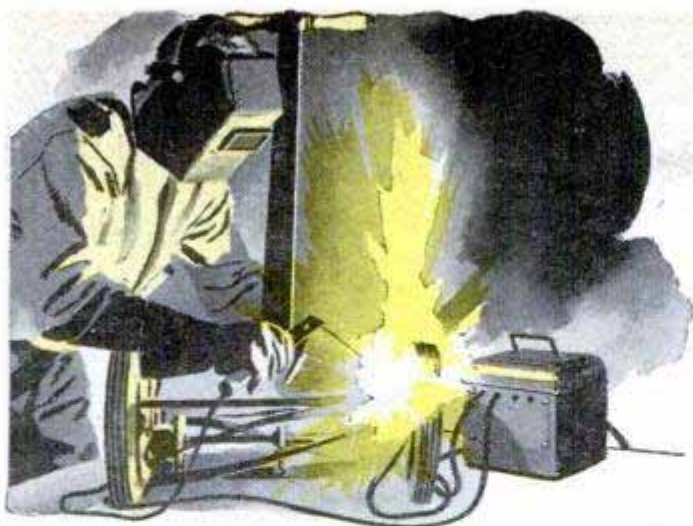

ARC WELDING



HEATING MAINTENANCE

The *Craftsman*

★ High-efficiency airfoil of the special hook-sail rig combines with sensitive jib-sail steering to give "Scoot" something new in iceboat performance. A detailed construction story begins on page 190

★ The series on home maintenance continues with a discussion of heating-plant servicing and repair. Feature on page 210 tells how the average homeowner can get the most from his heating system

★ Beginning on page 230 a practical shop feature in two parts authoritatively covers both theory and practice of arc welding—a thorough-going reference work for beginners and weld shops

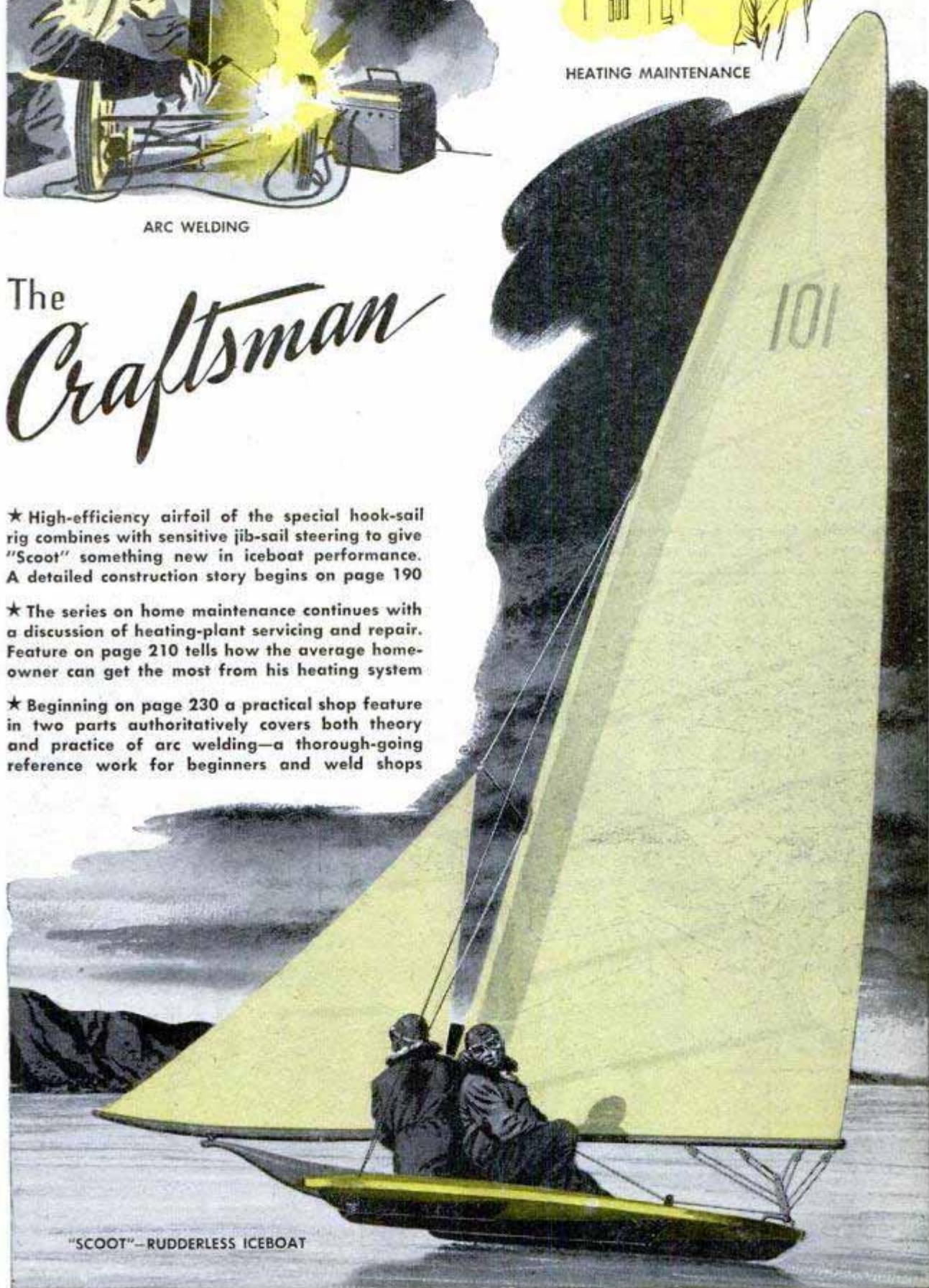

"SCOOT"—RUDDERLESS ICEBOAT

WTM-51

MUSICAL

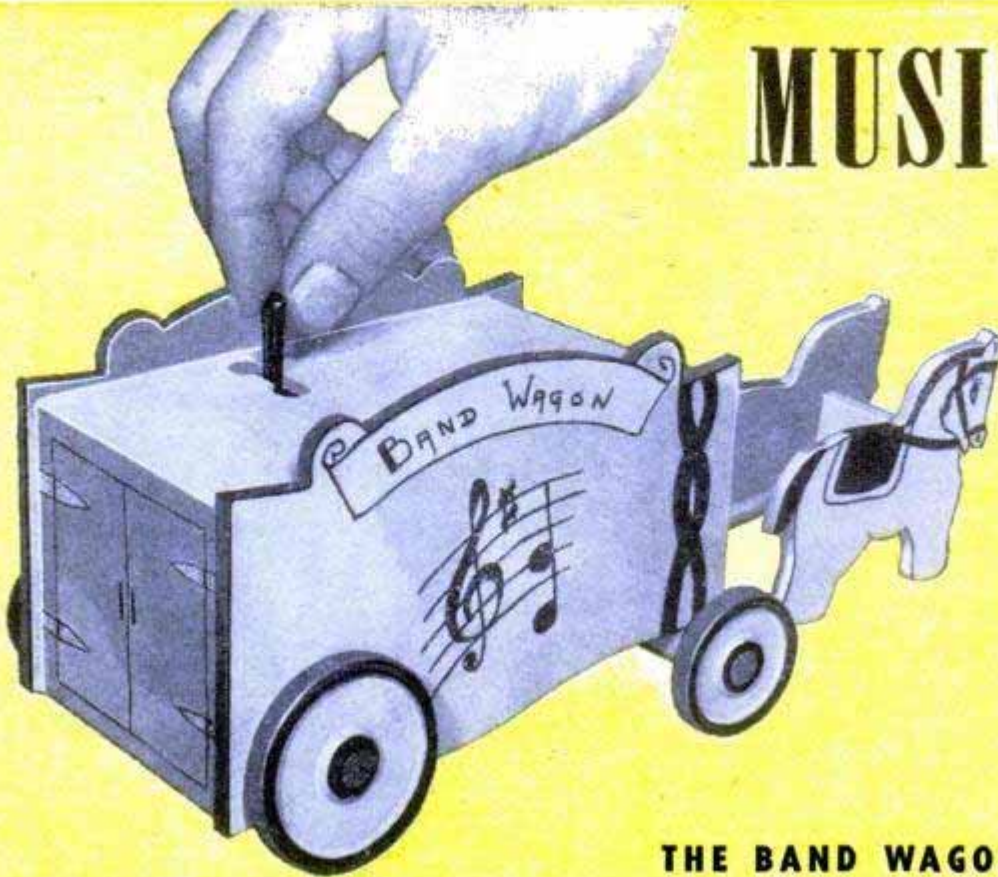

THE BAND WAGON

Not only does the spring movement provide music for this little circus band wagon, but it propels it slowly as the spring unwinds. The rear doors on the wagon are represented by merely ruling lines on the wood

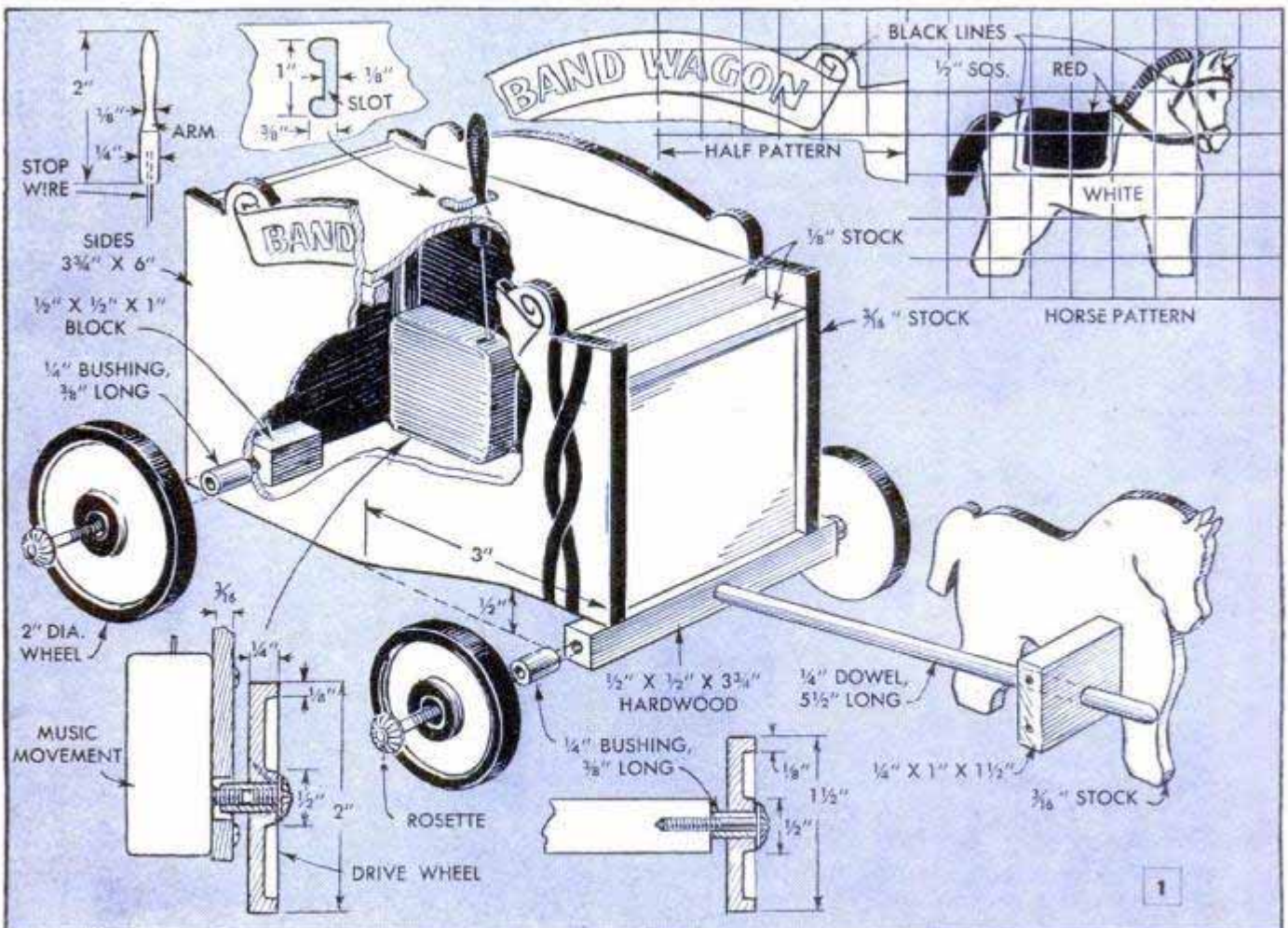

NOVELTIES



THE "RADIO" BIRDHOUSE

By R. J. DeCristoforo

USUALLY found in fancy powder boxes, jewel cases, etc., Swiss musical movements are put to a new use in these two intriguing novelties. For, in addition to playing a tinkling tune, the spring action of the movements is utilized to drive a small band wagon and to turn the animated dial of a toy radio. While the movements are available in various sizes, small units are recommended for both of these novelties.

The band wagon is designed so that the musical movement propels the wagon by driving the left-rear wheel as the spring unwinds. Consequently, this wheel is used to rewind the spring movement. Fig. 1 details the assembly of the wagon. Use cigar-box wood to make it as lightweight as possible so as not to tax the power of the tiny spring movement. The movement is mounted so the winding stem projects through an oversize hole in the side of the wagon and is fastened in place by drilling and tapping two holes in the casing for small machine screws. The stop or shutoff wire of the unit projects through the top of the wagon. By bending the wire toward the rear of the wagon, sufficient tension is had to hold the stop in a set position. Rosette-headed machine screws are used to attach the wheels. Note in the case of the drive wheel that the screw is cut off and merely cemented in place. The drive wheel is attached to the

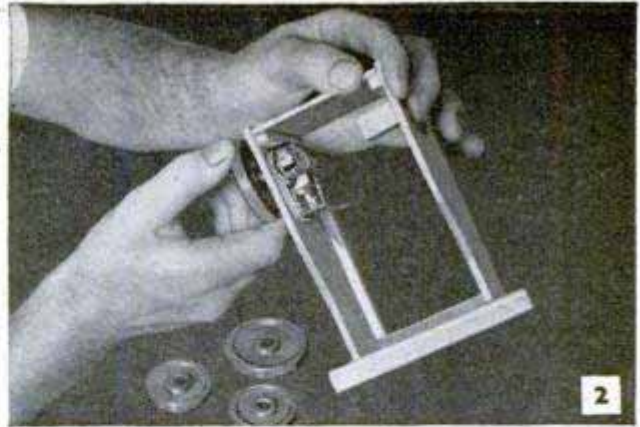

Left rear wheel is the drive wheel on band wagon and serves as winding knob for music movement

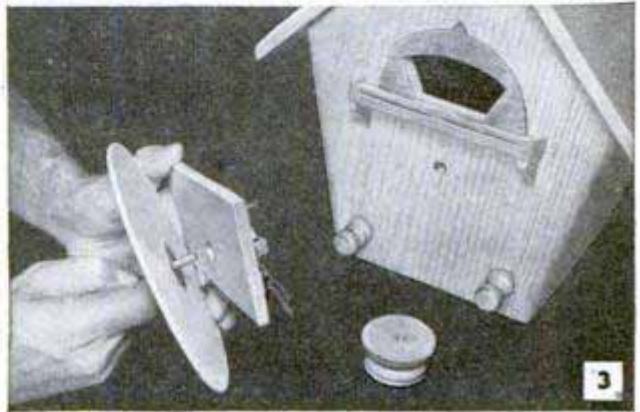

The shaft of the plastic radio dial is turned half-way through a threaded bushing on winding stem

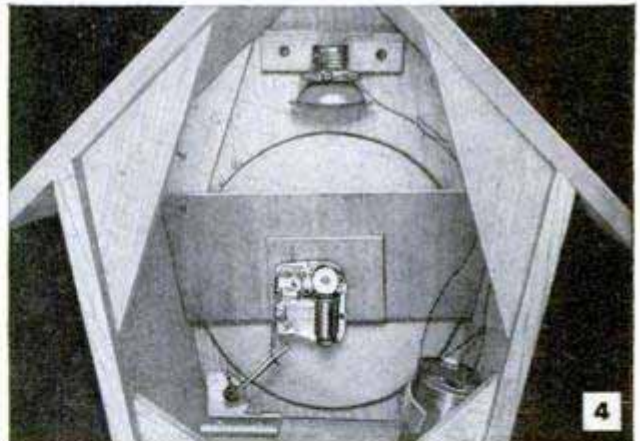

Above, how stop wire of the movement is controlled by a trip lever. Below, the flashlight batteries supply current to light the dial lamp mounted above window

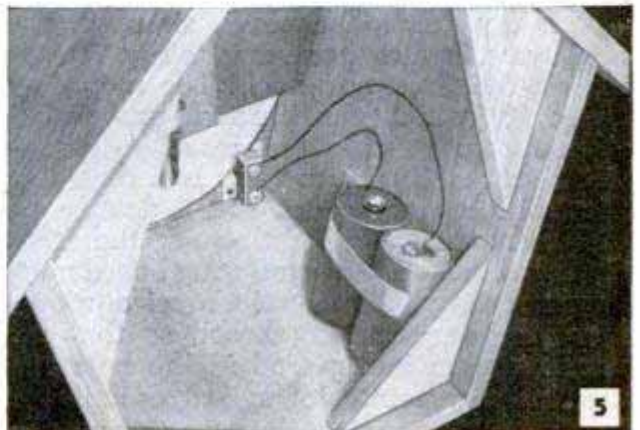

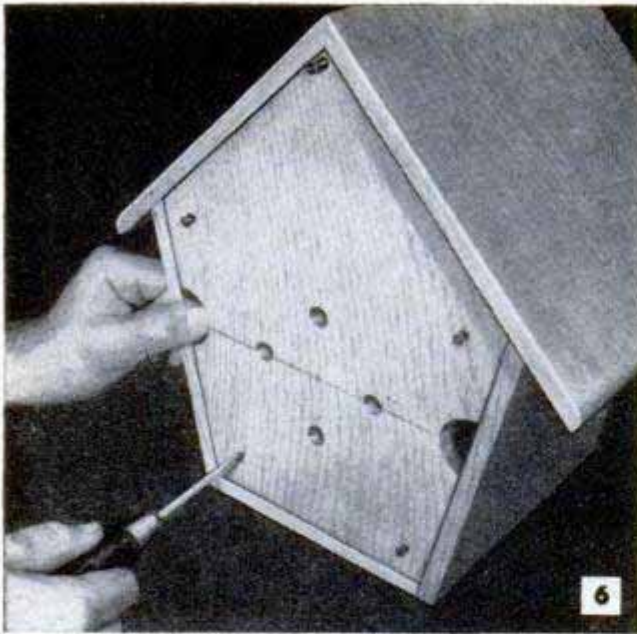

6

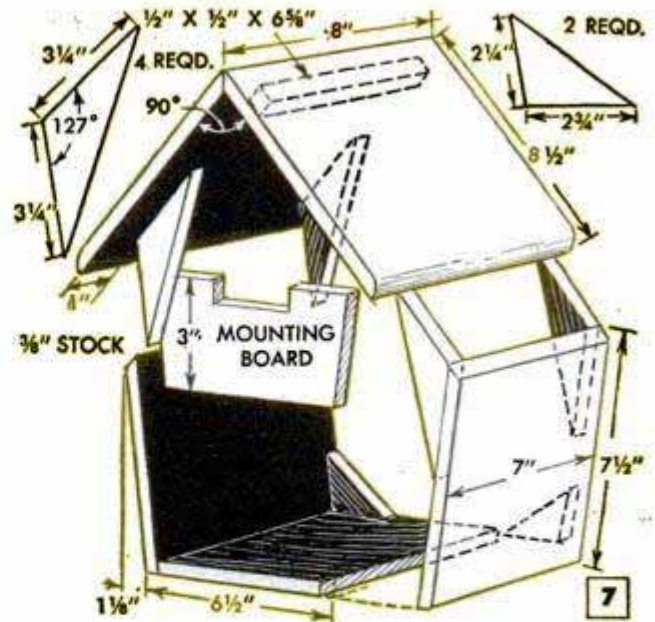

7

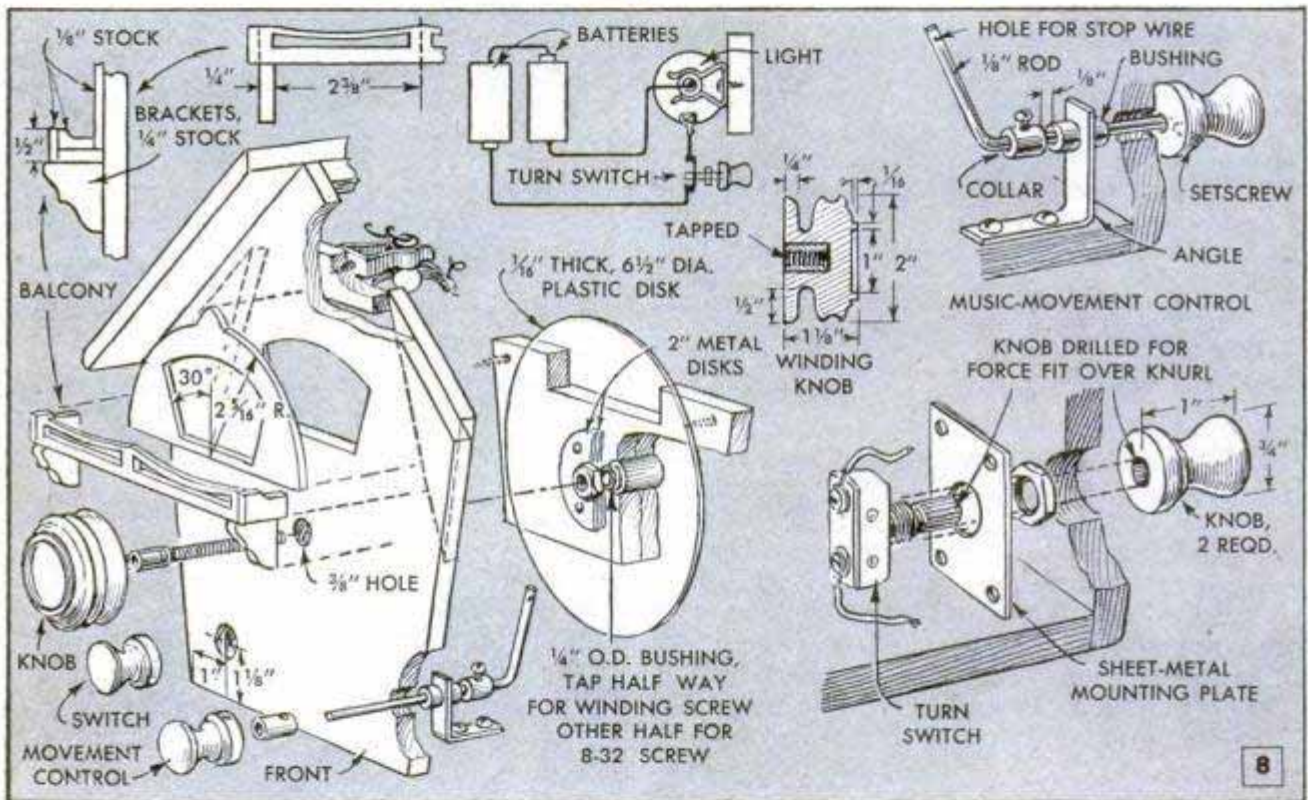

8

movement by forcing it over a short bushing which, in turn, is forced over the winding stem, Fig. 2.

The toy "radio" cabinet, simulating a birdhouse, is made according to Fig. 7, leaving off the front and back. The mounting board, to which the musical unit is attached, consists of two pieces of 1/4-in. plywood and in final assembly is screwed to the front corner braces. Fig. 8 details the dial mechanism. Holes through the front of the cabinet and the mounting board must align accurately. Fasten the musical movement to the mounting board so that the winding stem is centered in the hole and the stop wire points downward, as in Fig. 4, to contact a trip wire. Note that a bushing,

threaded internally, rotates within a bushing which is pressed in the hole in the mounting board. The inner bushing is threaded halfway for the winding stem and halfway for the dial screw. Now, using a temporary cardboard disk, Fig. 3, test the assembly. If the cardboard disk rotates freely, it is replaced with a permanent plastic one and the face of the cabinet is glued and nailed in place. Colored plastic is used for the permanent disk with small animal decals affixed on a radius that permits them to be viewed through the balcony window when illuminated from behind. A small switch connected to flashlight batteries is used to control a flashlight bulb, Fig. 5. Finally, the back, Fig. 6, is screwed in place.

Permanently fastened to the top of a workbench, this inexpensive disk sander is excellent for shaping small pieces of wood. The base, disk table and motor-mounting bracket are made from $\frac{3}{4}$ -in. scrap lumber, and the unit is set up so that the motor can be hung vertically over one end of the bench. A $\frac{1}{2}$ -in. steel shaft for the sanding disk revolves in bronze bushings, a steel ball at the base of the shaft providing a lower bearing. This ball can rest directly on the surface of the workbench, or the lower bushing can be set in a wooden block so the ball will ride on the sander base. A collar fastened to the shaft just under the upper bushing keeps the shaft from moving upward. Either a wooden or standard metal sand-

Horizontal Disk Sander Mounted on Workbench Provides Handy Tool for Forming Small Work

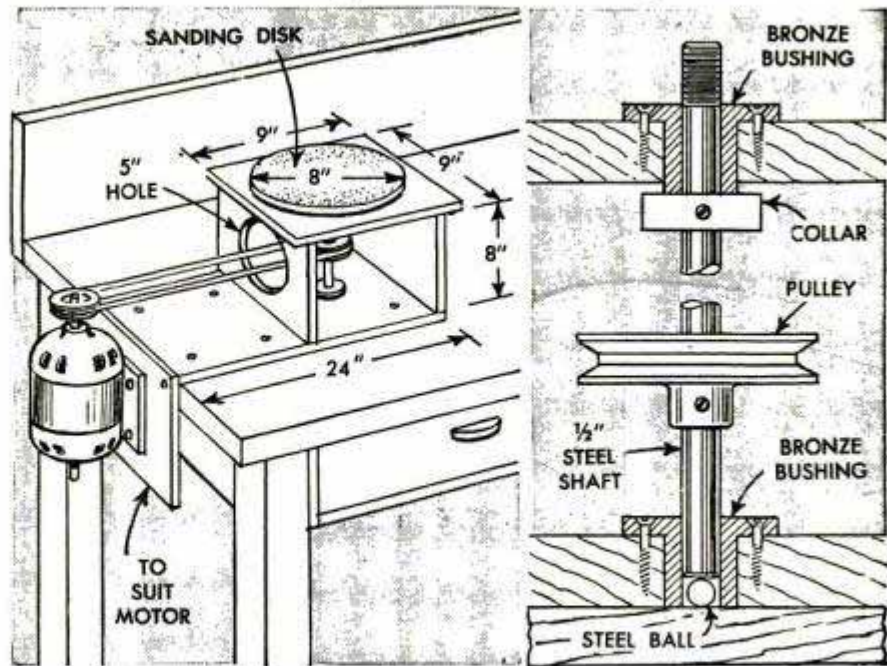

ing disk can be used. If a wooden disk is used, a flange is screwed to the center.

Marvin Hartley, Chicago.

House Numbers Are Readily Visible When Jigsawed in Novel Wooden Gate

In many cases where the design of a building makes it difficult to display house numbers so they can be easily seen from

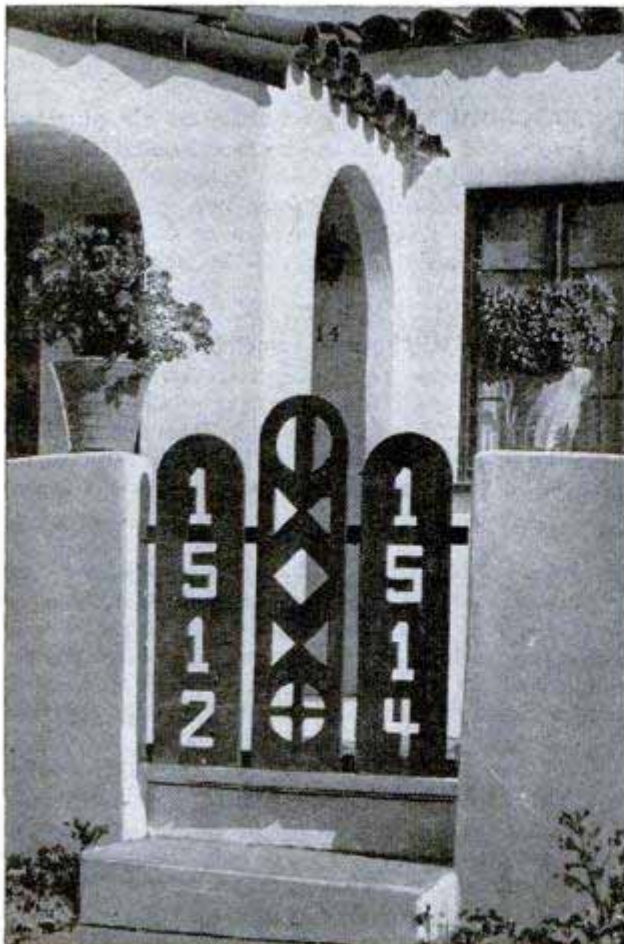

the sidewalk, the numbers can be incorporated in an attractive porch or garden gate where they are clearly visible. The construction of the gate shown is extremely simple, as it consists merely of three upright boards supported by two crosspieces. As the house pictured is a duplex, the numbers were jigsawed in the side boards and an interesting design cut in the center one. For a single dwelling unit, the address can be cut in the center panel and the side boards either left plain or decorated to suit. The gate should be painted to contrast with the background in order to increase the prominence of the house numbers.

Eda Johnstone, Los Angeles, Calif.

Screen-Door Catch Holds Papers

Fastening a screen-door catch to a plywood base provides an excellent paper holder for use at the desk, on the job or when carrying a quantity of loose papers in the car. Cut a

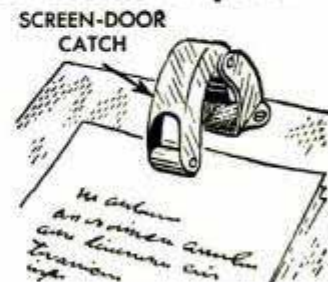

piece of plywood to a convenient size and then screw the catch to the top of the panel. This arrangement will keep a considerable number of papers neatly together for easy selection.

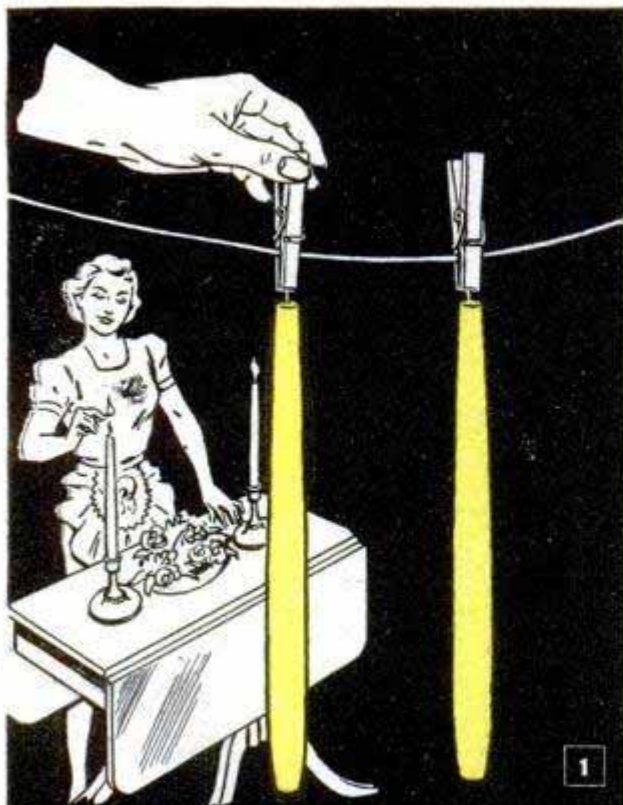

1

Solving HOME PROBLEMS



2

1 STORING LONG TAPERS so they remain straight in hot weather is a problem. Putting them away in a box doesn't always do the trick as, being tapered, they are still likely to bend. The best way to store them perfectly straight is to hang them by the wicks with spring clothespins that are threaded on a string

2 PARING KNIVES STAY SHARP longer when kept in a holder, especially if it is filled with sand. The sand tends to sharpen the cutting edges and keeps the blades separated. Such a holder can be made by slitting the top of a baking-powder can for inserting the knives and then decorating it with decalcomanias

3 STEPS CAN BE SAVED in determining whether a furnace-room light has been left burning by sticking a small tab of adhesive tape to the switch. Applied over the "on" position stamped on the toggle, the tape serves as a telltale which can be seen from a distance when the light itself is not visible

4 LINING IN SPECTACLE CASE, if badly worn, may result in scratching the lenses of your glasses unless renewed. To avoid this until new lining can be inserted, use a pipestem cleaner. The cleaner, which is shaped as shown, provides a temporary lining to cushion the lenses and prevent possibility of scratches



5 MATCHING BUTTONS cut from an old garment and saved for reuse can be found quickly in sewing box if held together with cellulose tape. The buttons are sandwiched between two strips of transparent tape so they can be seen at a glance. The buttons are merely snipped off the strip as needed

6 A MIXER STUNT worth remembering is one that prevents batter from being thrown from the bowl. Take a paper pie plate and make a hole in the center for the beaters. Then cut a slot in from the edge to meet the hole. Placed over bowl, the plate serves as a cover to catch any batter tossed by the beaters

7 A GOOD HIDING PLACE for small valuables is at the rear of a dresser or vanity drawer. Usually there is enough space behind drawer to accommodate a flat can, such as a tobacco can, which is fastened with screws. A turn-button stop attached to face of drawer back prevents unauthorized drawer removal

8 INEXPENSIVE SKIRT MARKER can be improvised from a yardstick, two metal corner plates, two corner braces and a small stove bolt. The metal items are assembled as shown to form a base for the yardstick. Original holes in the corner plates are used, but new aligning ones must be made in braces

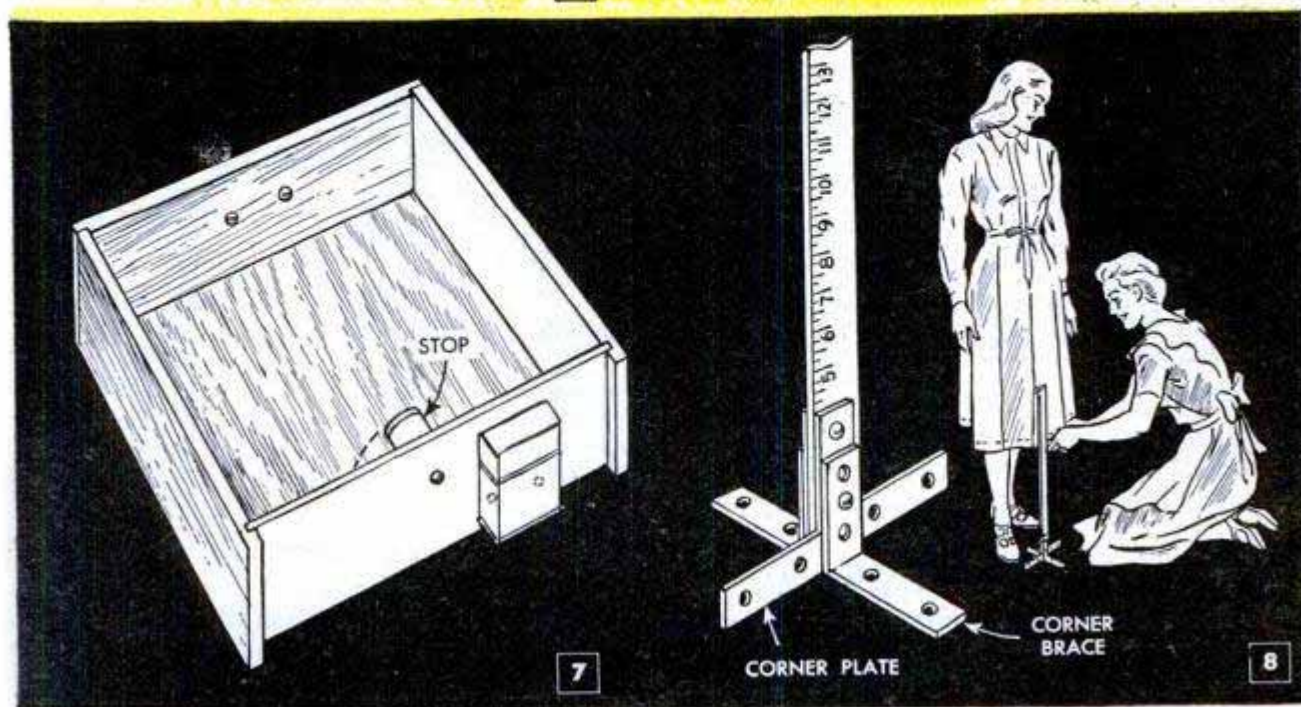
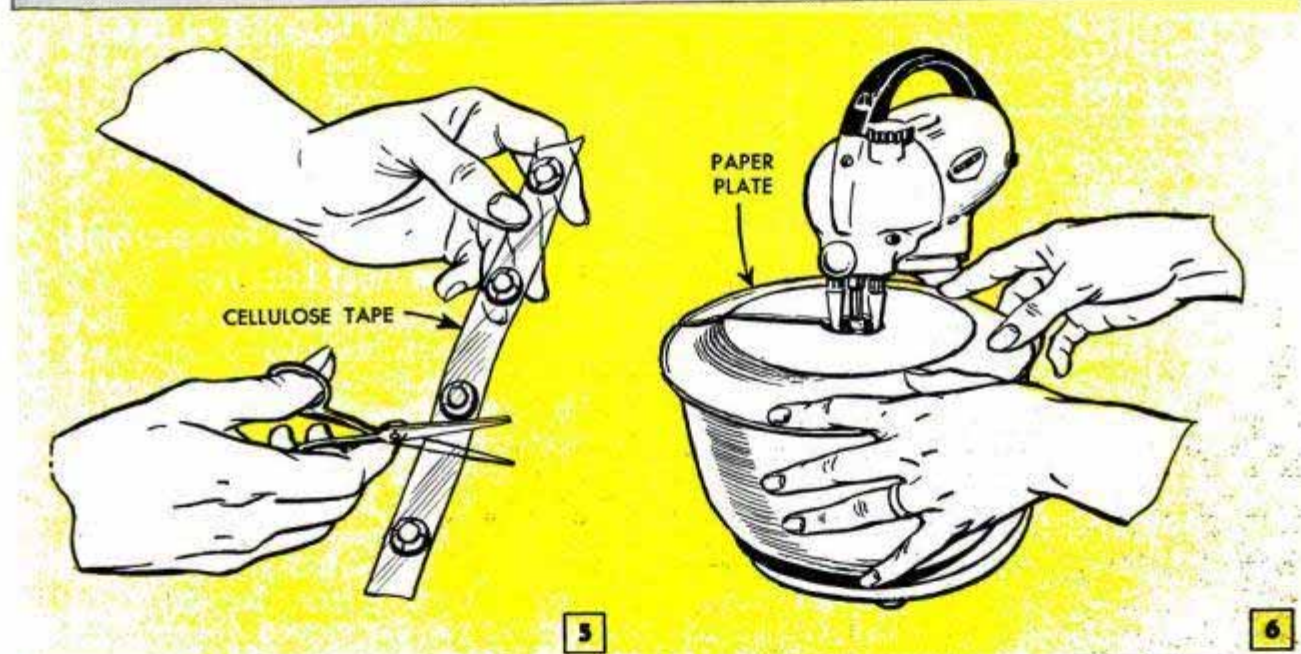
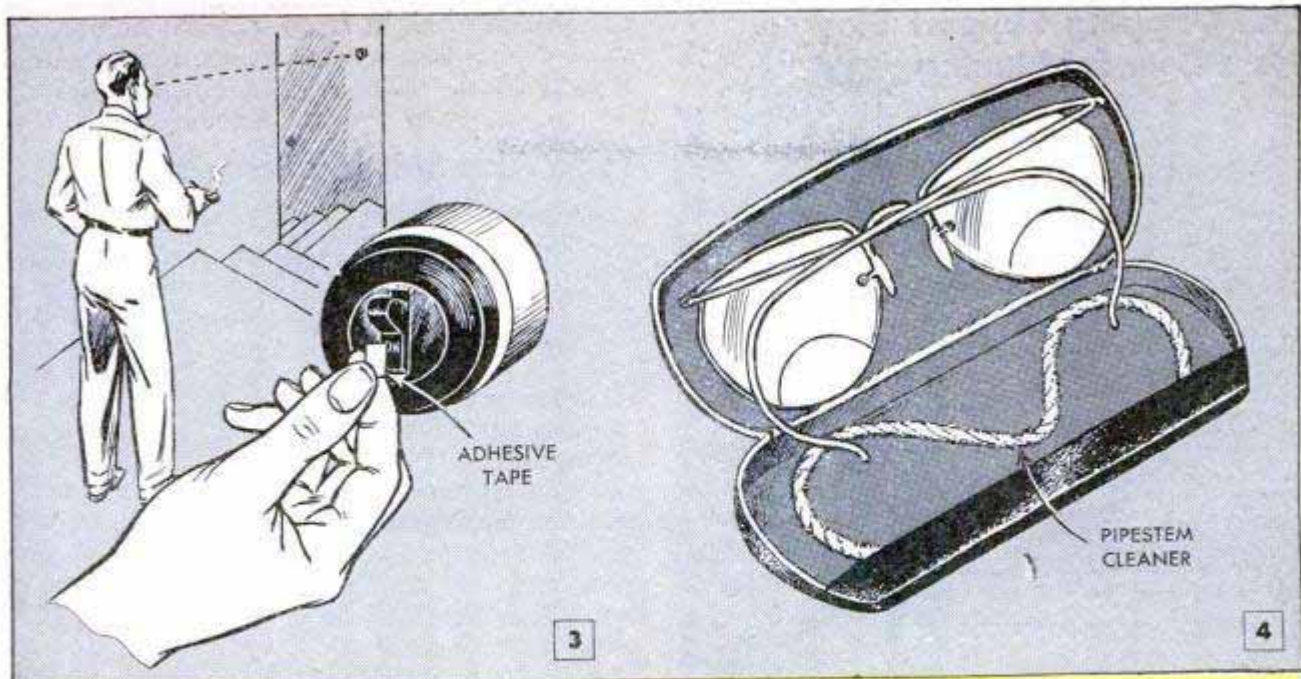

Self-Gripping Support Blocks Hold Door for Planing



Consisting of four wooden blocks and two strap hinges, this pair of jacks makes it easy to support a door on edge for planing. The weight of the door resting on the hinges causes the jacks to close so they clamp the sides of the door tightly, providing a solid base. A 2 x 4 is placed between the end of the door and a wall to permit planing the full length of the door.

C. E. Lehman, Fresno, Calif.

Tire Chains Carried in Oilcan

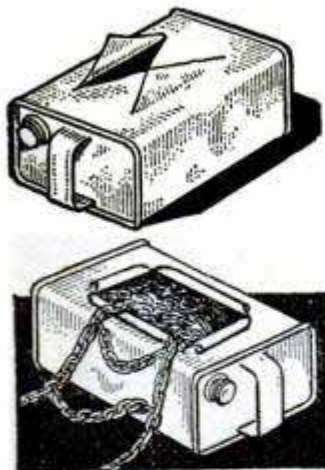

Tire chains can be carried neatly in the trunk of your car without rattling and, at the same time, be kept from rusting if you store them in a motor-oil can. Cut an "X" design in one side of the can, roll back the four triangles of sheet metal and press flat with pliers. Sprinkle a few

drops of motor oil over the stored chains to prevent rusting. The container also is an excellent place to keep a tow cable.

Arthur Gamlin, Kansas City, Mo.

Keep Fire Extinguisher Handy

A fire extinguisher kept in a handy spot in the house may prove to be your most valuable possession. Hang the extinguisher

at shoulder height from a closet or pantry wall where you can reach it quickly when it is needed.—Michael Ligocki, Gary, Ind.

Tape Aids Starting Screws

In places where screws cannot be held in starting position with the fingers, they can be started easily if they are taped to the tip of the screwdriver. With the tip in the screw slot, a small piece of cellulose tape is wrapped around both the head of the screw and the end of the screwdriver. The greater width of the tape should be stuck to the screwdriver blade so that when the latter is pulled from the screw the tape will be removed with it.



Victor H. Lamoy, Upper Jay, N. Y.

Thermostat Mounted Temporarily To Determine Best Location

The most efficient location for a furnace thermostat can best be determined by mounting it for a few days in different parts of the house. To do this without damaging the walls, fasten the thermostat to a block of wood and tack a piece of sheet metal to the back of the block. Then wedge the sheet metal between the interior trim of the room and the wall, leaving the thermostat control wires free. In this way, the thermostat can be moved about until the best location is determined and then mounted permanently on the wall.

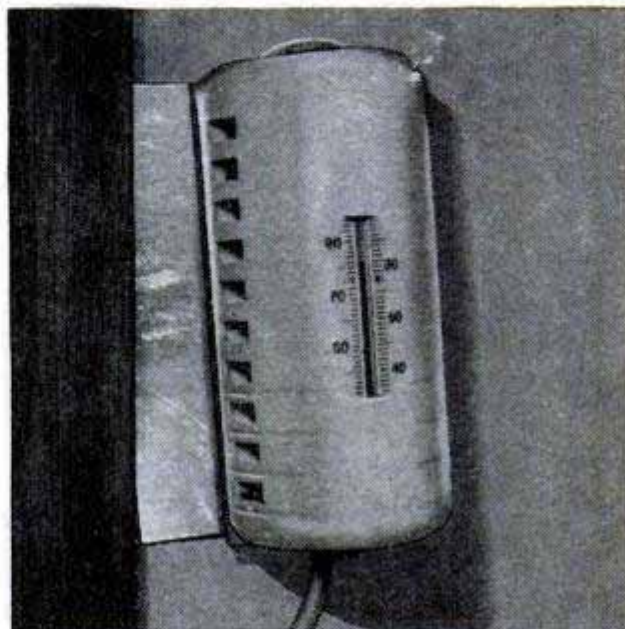

GUN CABINET

THIS OPEN cabinet provides rack storage for six of your favorite shotguns and rifles in the minimum of floor space. There also are pegs for hanging handguns and drawers storage for ammunition and accessories. Maple in ruddy color or knotty pine finished natural are the best choices in woods. Use two pieces of $\frac{1}{2}$ -in. plywood for the back and lay out and cut the top piece in the simple broken-pediment design detailed at A in the drawing below. The sides and top shelf are scroll-cut from solid stock as in details B and C. Assemble the drawer rail and runner frames. Then dowel top and bottom shelves and drawer frames to the sides, using a waterproof glue in the joints. The scrolled apron is doweled to the lower drawer rail as shown in detail D. The gunstock rack is made from measurements taken directly from the individual guns. Line the notches with $\frac{1}{8}$ -in. red felt. Make drawers with rabbeted and grooved joints as in the lower detail below. Sand all parts thoroughly.

Hi Sibley, Nuevo, Calif.

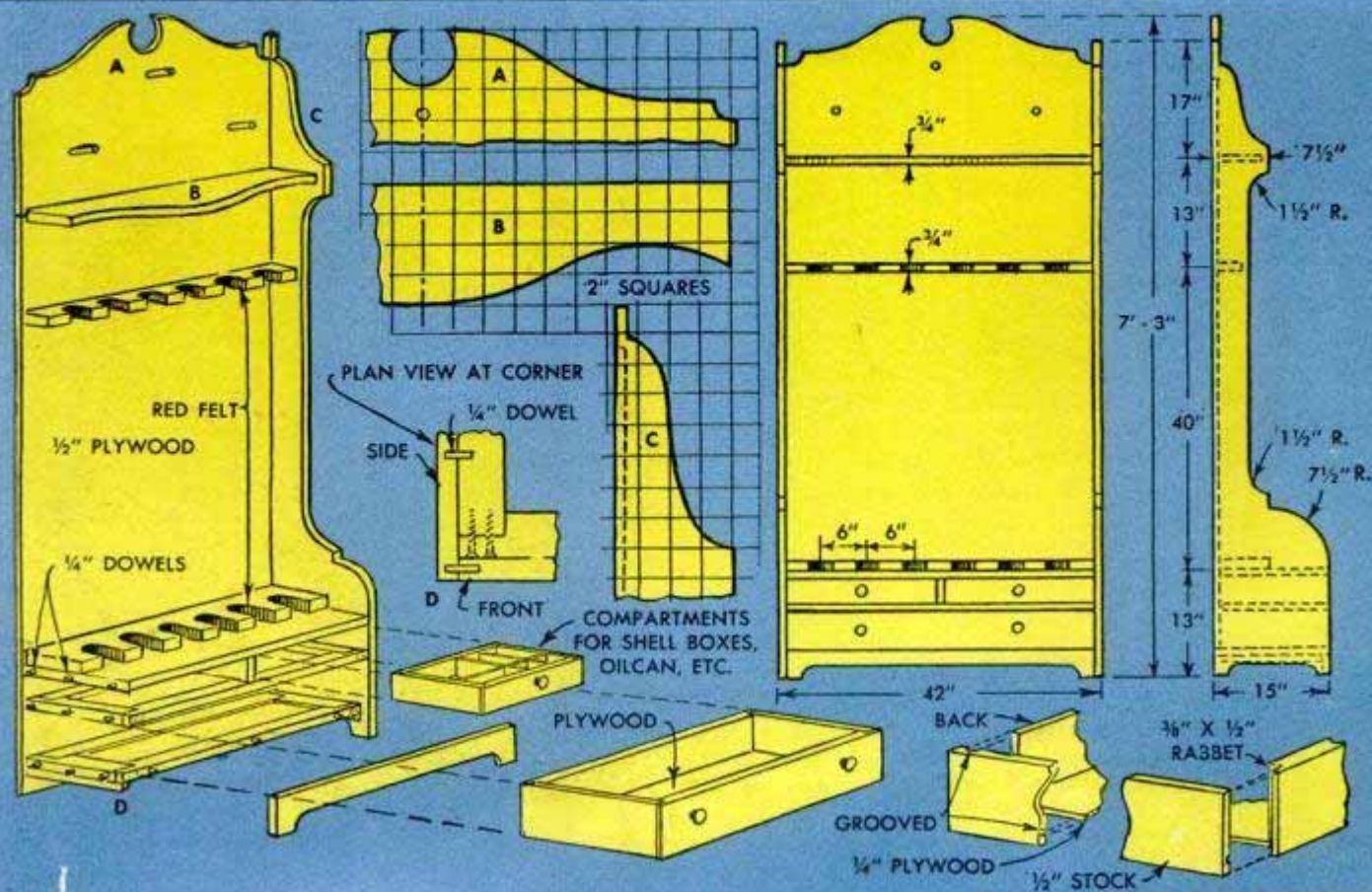
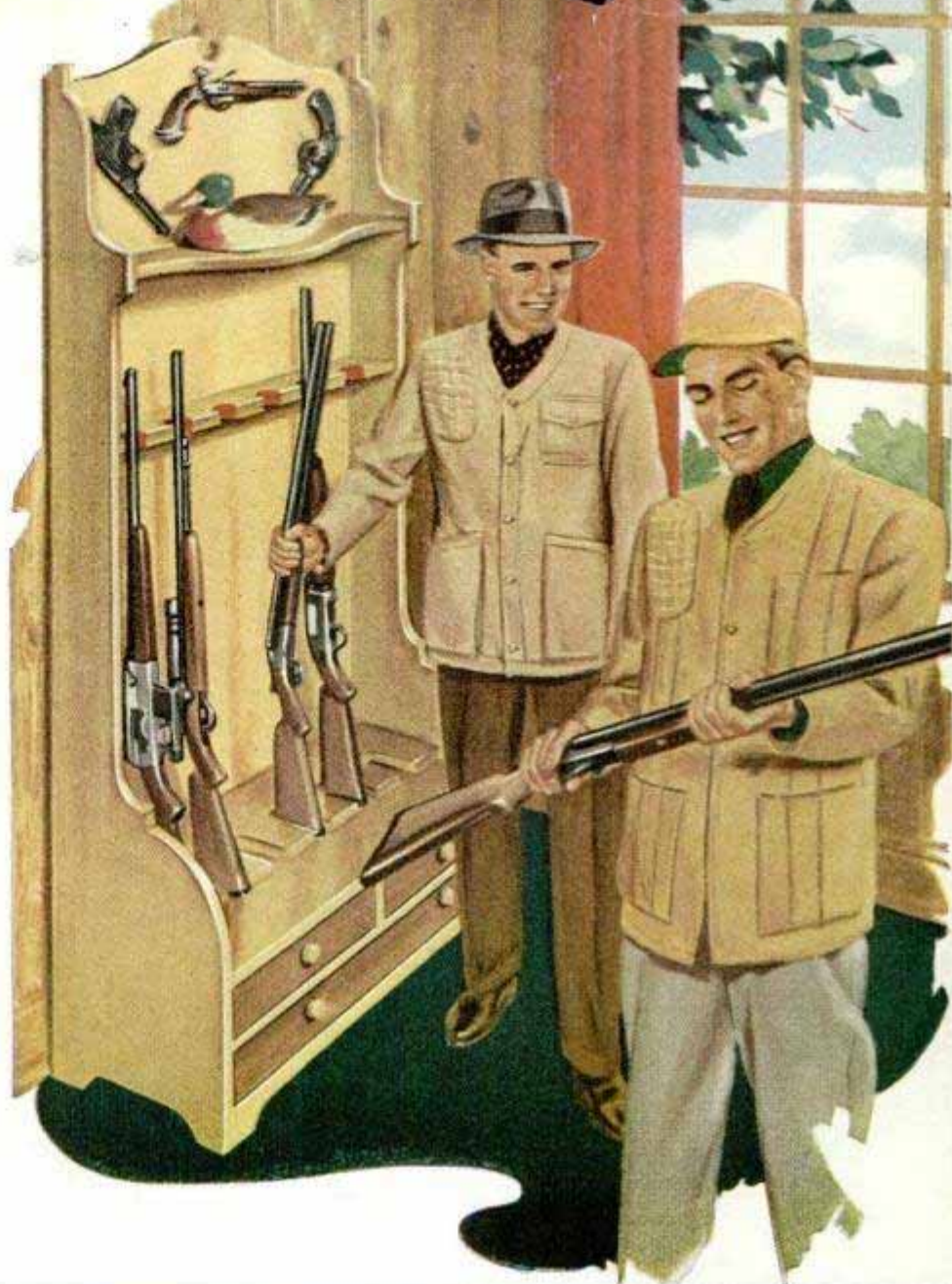

Rep - 23 Boats you can build.



Your Iceboat "Scoot"

By Doug Rolfe

PART I

FEATURING rudderless steering and a flat, shell-type hull, here's a unique 15-ft. racing iceboat, the original of which dates back historically to early days when it was used in lifesaving work on the Great South Bay. Born of the necessity of being able to cross the bay even when it was only partly frozen, "Scoot," in addition to its high speed and extraordinary maneuverability, is noted for its ability to take to open water, if necessary, in hurdling large patches of broken ice. Speeds greater than 80 m.p.h., achieved with as many as four passengers, put Scoot in the racing class and, as a result of its four-point runner suspension, its maneuverability is extremely flexible, permitting sharp turns without danger of capsizing or skidding. Steered by

manipulating a large-size jib sail, Scoot can be held on an arrow-straight course or turned almost literally on a dime.

As designed and built by Bill Harless, noted racing champion, this version of the scooter-type iceboat is the result of prolonged experimentation and development. The hook sail rig used is, in effect, a high-performance airfoil and, because of it, Scoot glides along effortlessly in the mildest breeze and literally scoots past competition with a strong wind. The boat is moored by merely tipping it on edge with the sails flat on the ice. Except where modified to simplify construction, the plans presented here were taken directly from the actual boat. Original hardware, which was especially designed and cast in brass, has been replaced with less expensive fittings that can readily be improvised from common

Nothing in fast-action outdoor sports quite equals the smooth, swift flight of "Scoot"—a shell-type racing iceboat. Designed to hurdle patches of broken ice, Scoot features extraordinary maneuverability, rudderless steering, a hook sail rig, a nonslip deck and a 15-ft. planked hull with four-point runner suspension





parts easily obtainable.

Part I details construction of the hull, while the second and final installment, appearing next month, will discuss the making of the masts and the unusual hook sail rig.

The first step in building the hull is to draw the mold frames and the plan and profile views full size on heavy building paper, Fig. 3. The plan view is drawn by following the half-width dimensions given in Fig. 4, while the profile and mold frames are drawn by referring to the table of offsets in Fig. 1 and the body plan, Fig. 2. The body plan is an end view of the plan and profile. Note, in Fig. 4, that half-width dimensions are given to the inner face of the inside chine which is the line from which the mold frames are laid off. Offsets are given to the outside of the planking, so remember to deduct the thickness of the planking. In laying out the lines full size, use a long batten to fair out the curves. Any good boat-building book will show you how this is done. Considerable tolerance is permissible in establishing the lines as long as you do not exceed

1 TABLE OF OFFSETS—Measurements From Base Line to Bottom of Hull*								
STATIONS	Bow	1	2	3	4	5	6	Stern
Deck crown line	0-10-0	0-6-0	0-5-2	0-5-0	0-5-2	0-6-0	0-7-2	0-10-0
" buttock 9" out	—	0-6-6	0-5-3	0-5-0	0-5-3	0-6-2	0-7-3	—
" buttock 18" out	—	0-9-6	0-6-2	0-5-5	0-6-1	0-7-4	0-9-3	—
" buttock 27" out	—	—	0-9-0	0-7-4	0-10-1	—	—	—
Deck sheer line	0-10-0	← STRAIGHT →						0-10-0
Chine line	0-11-6	← STRAIGHT →						0-11-6
Bottom buttock 27" out	—	—	1-0-7	1-2-4	1-1-7	—	—	—
" buttock 18" out	—	0-11-7	1-4-1	1-4-7	1-4-3	1-3-0	1-0-1	—
" buttock 9" out	—	1-3-2	1-4-5	1-5-0	1-4-5	1-3-6	1-2-2	—
" at center line of hull	0-11-6	1-3-6	1-4-5	1-5-0	1-4-5	1-3-6	1-2-2	0-11-6

* As the hull is built in an inverted position, measurements or heights are given from the base line, Fig. 2, to the bottom of the hull. Dimensions are in feet, inches and eighth inches to the outside of the planking. All plus or minus dimensions are to be converted as required when laying out full-scale lines. Half-width dimensions for mold frames are given to the inner face of the inside chine. This apparently complicated method of establishing the mold-frame dimensions is necessitated by the characteristics of the hull, which is of the carvel type. All were taken from the original boat

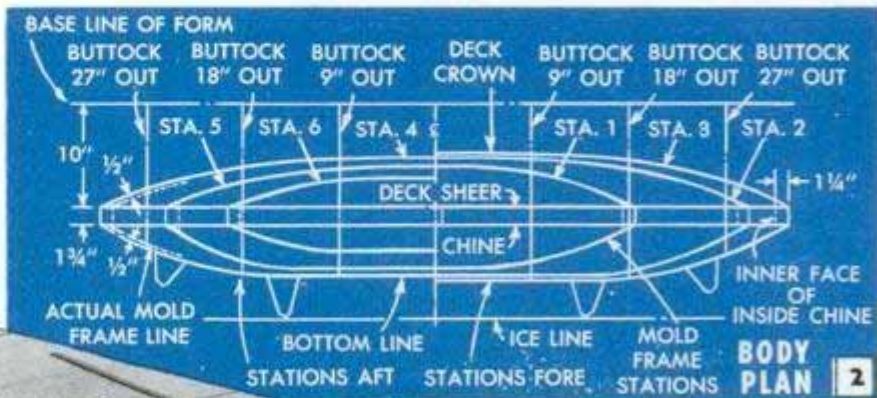
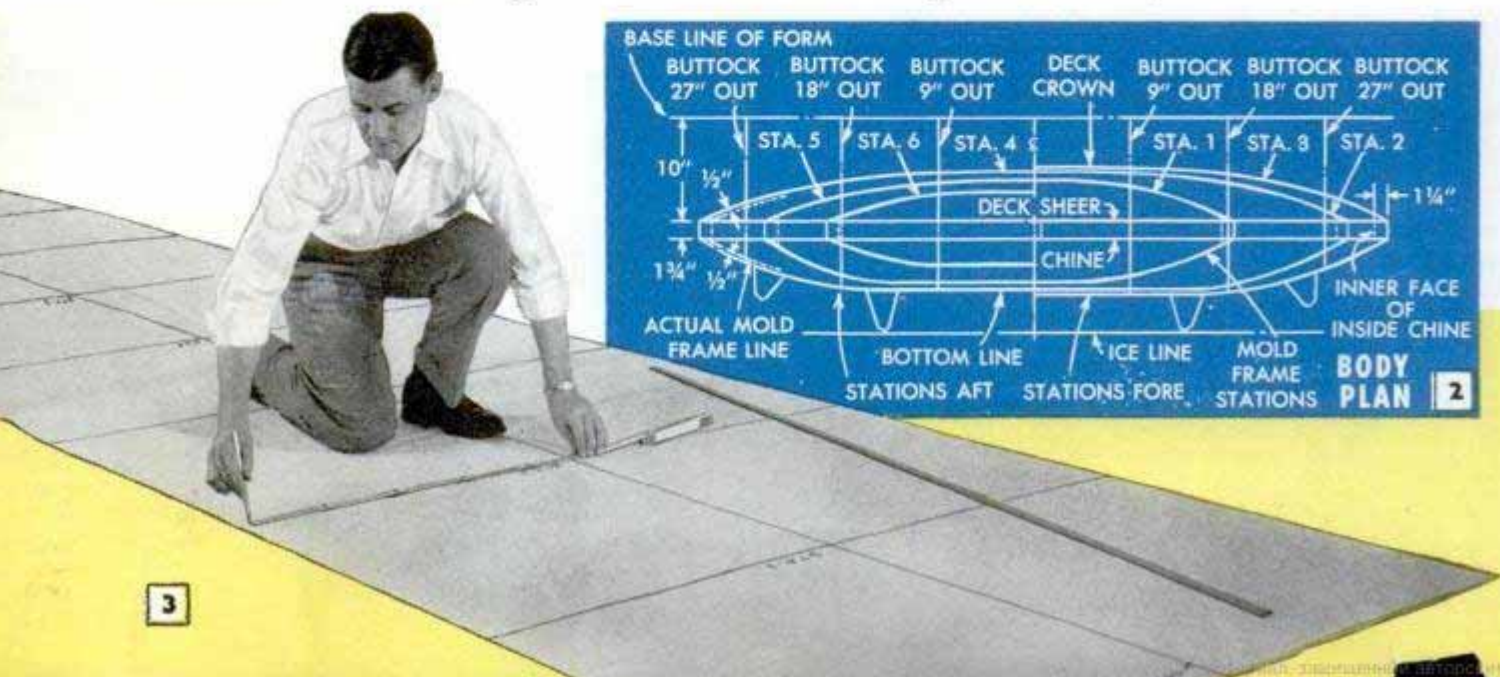

EVOLUTION OF "SCOOT"

Unique in man's long search for ways to improve wind-driven ships, the scooter-type iceboat first came into being on the Great South Bay of the New Jersey coast. Born of necessity when a means was needed to cross the bay even when only partly frozen, the forerunner of Scoot was put to work in life-saving service. It at once proved superior to the flat-runner punts which had been piked across the ice and sculled through water at arduously slow speeds. After a few runs, a small sprit was added to the sail rig of Scoot. From sprit to gaff was but a step, followed by the Gunther and modified Marconi and, finally, by the double-luff sail and hook mast. This led to rigging a blade on an oar handle to serve as a rudder, and later the addition of a jib. By carefully balancing the rig, it was found that steering could be done entirely by manipulating the jib. Then came the change-over from flat to angle-type runners which helped hold a straight course when sailing on hard ice. To improve the jib, a boom was laced along the foot. Later, the lashing was moved aft of the jib boom to permit the jib to swivel. It was then that the scooter came of age in both speed and maneuverability, and soon baymen began racing their unusual craft, joining sportsmen in organized competition.

the maximum dimensions given in the plan.

The hull is built in an inverted position on a building form, Fig. 5. While the form can be supported in the manner shown, it

also can be mounted on regular sawhorses. The center deck strake is fastened temporarily to the form with C-clamps and screws and then the mold frames are set on the strake at the station points as in Fig. 7. Note here that the mold frames are leveled carefully and are held in position laterally with braces running to the floor. Next, inside chine stringers, which are $\frac{3}{4}$ in. thick, are nailed temporarily to the ends of the mold frames. The ends of the chines are pulled inward at the bow and stern with rope slings and are fastened permanently to the breasthook and stern block with brass screws. After this, a $\frac{1}{2}$ x 6-in. keel apron is tacked temporarily to the mold frames and fastened permanently to the breasthook and stern block, Fig. 7.

Permanent frames consisting of bottom timbers and deck beams are made next. While best construction calls for steaming and bending these pieces in jigs, they can be bandsawed to shape if steaming facilities are not available. The permanent frames are installed by placing them 9 in. apart on the strake and holding them in position with two temporary longitudinal battens. Then they are screwed to the deck strake, chines and keel apron. With this done, the inside chine pieces are beveled to conform with the frame lines and then notches are cut in the chines for chain plates, Fig. 8.

Now the bottom planking is laid. The photo, Fig. 6, shows the planking partially completed. As the hull does not have to be

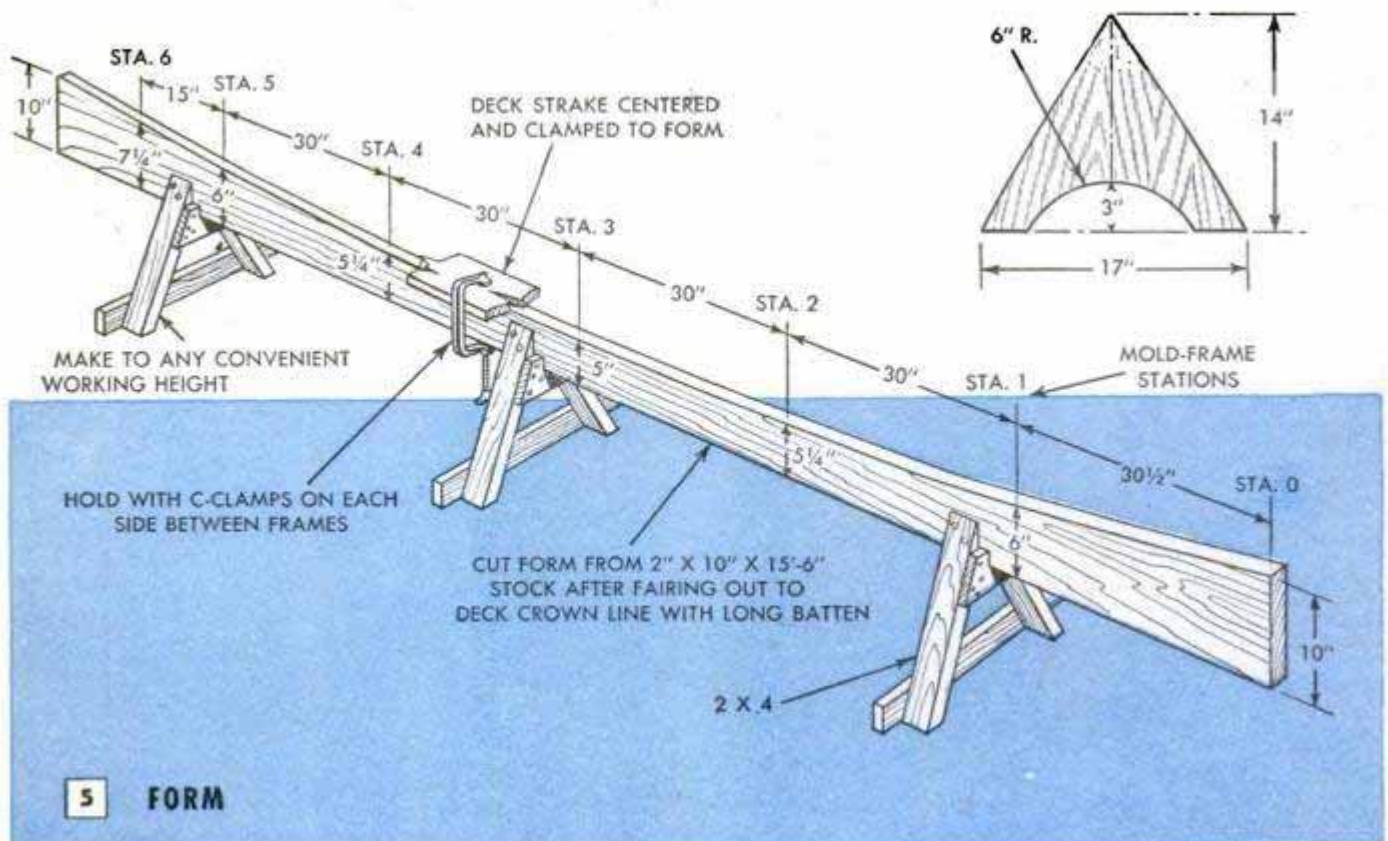

absolutely watertight, calking is not required. However, the planks should be shiplapped, or tongued and grooved at the joints. The planking is begun at the keel apron and, when completed, it is trimmed off flush with the outer edge of the inside chines.

The hull can now be removed from the form. The mold frames and their bracing are removed and the hull is supported right side up on sawhorses. The main and bilge-runner clamping pieces come next. These are fastened to each frame and holes are drilled in them for the runner bolts. The holes are located either aft or forward of each bottom timber as indicated in Fig. 10. Do not pass the bolts through the bottom timbers.

The mast step block is fastened to the bottom timbers as shown in Figs. 9 and 11. The mast step itself is a length of $\frac{3}{4}$ -in. galvanized pipe. This is threaded into a standard pipe flange and the flange is screwed securely to the mast step block. The pipe should be just long enough to pass

through the mast partner, which provides an upper step, and the deck strake, coming flush with a flange screwed to the strake.

Cockpit framing and the stanchions which support it are installed next. Note that stanchions also are installed at the center of the frames, fore and aft of the cockpit. The ends of the stanchions are cut to lap the face of the frames as shown in



Original "Scoot" under construction. Note that the bottom planking is being applied after deck planking, a reverse procedure used by builder. It was found, however, more practical to plank the hull as described

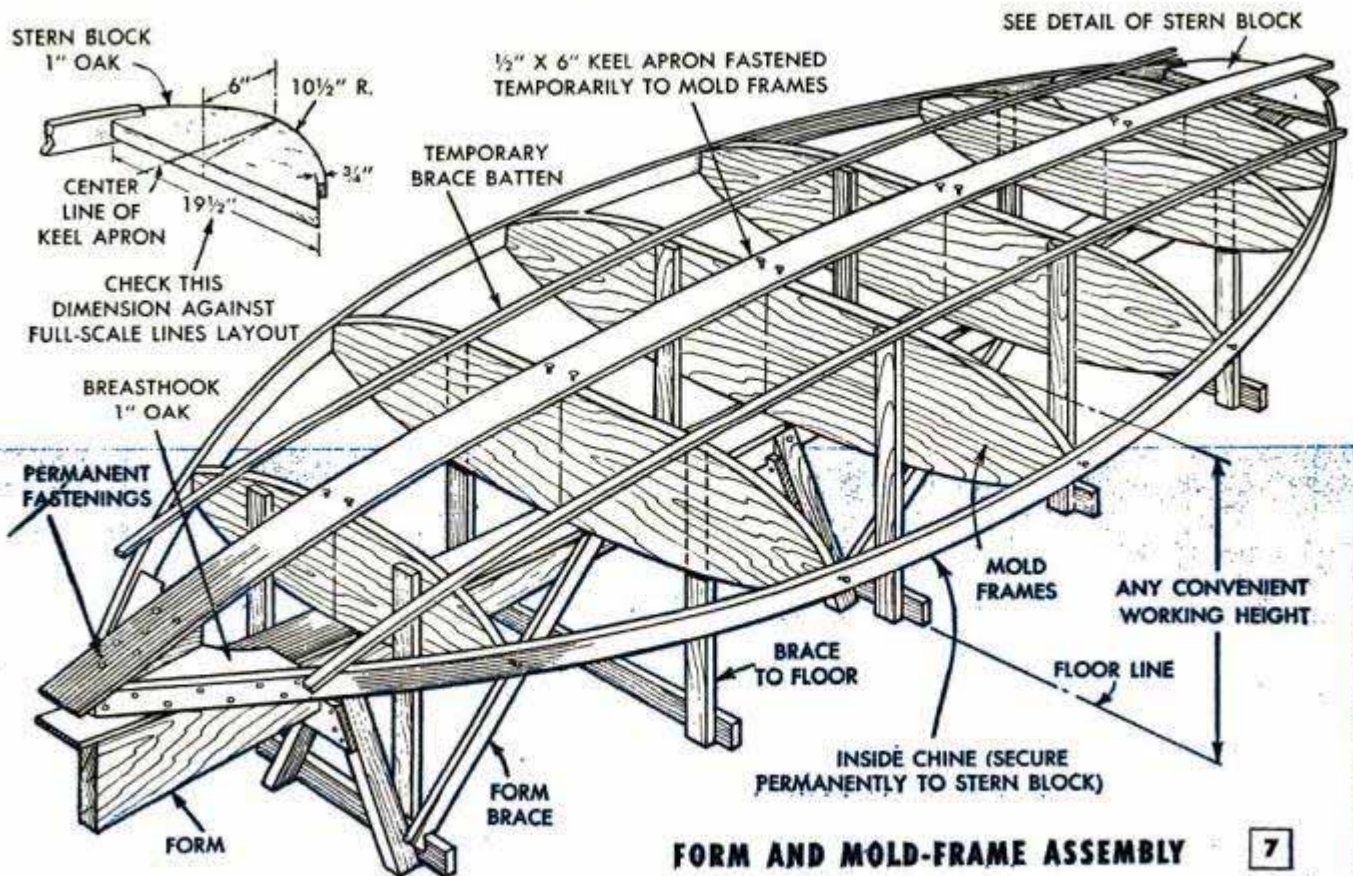

FORM AND MOLD-FRAME ASSEMBLY 7

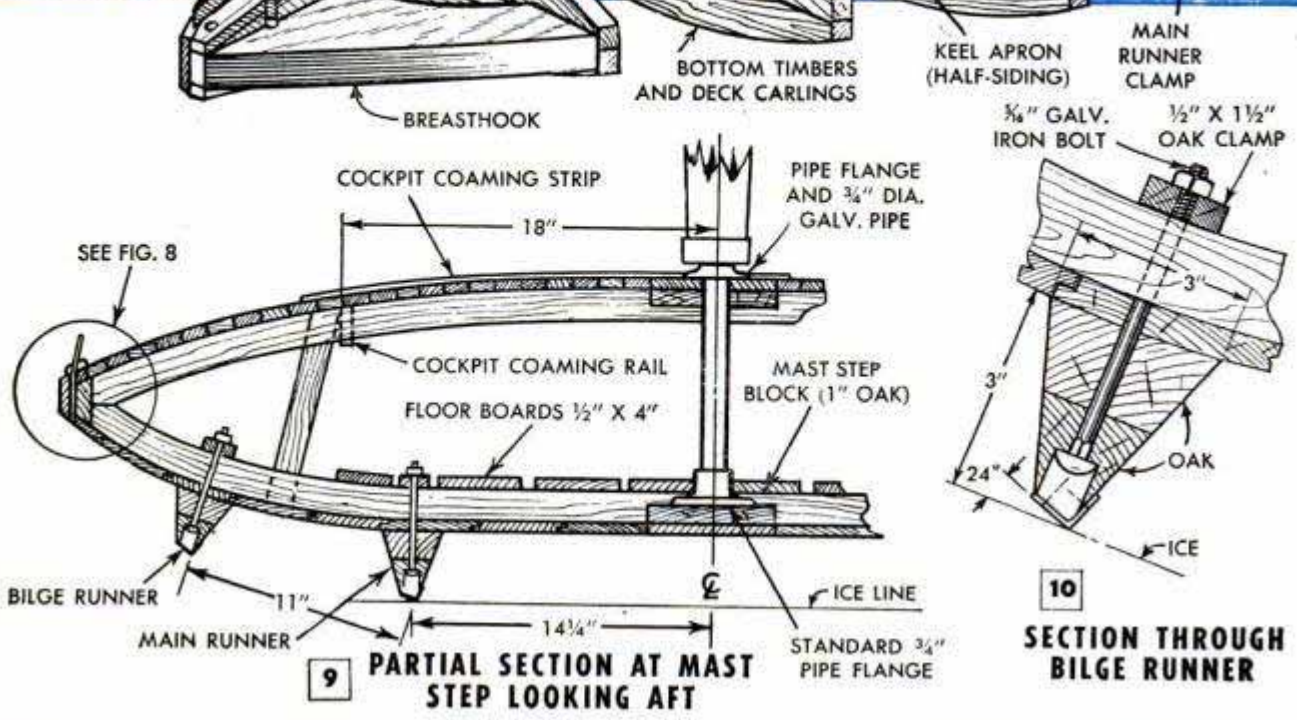
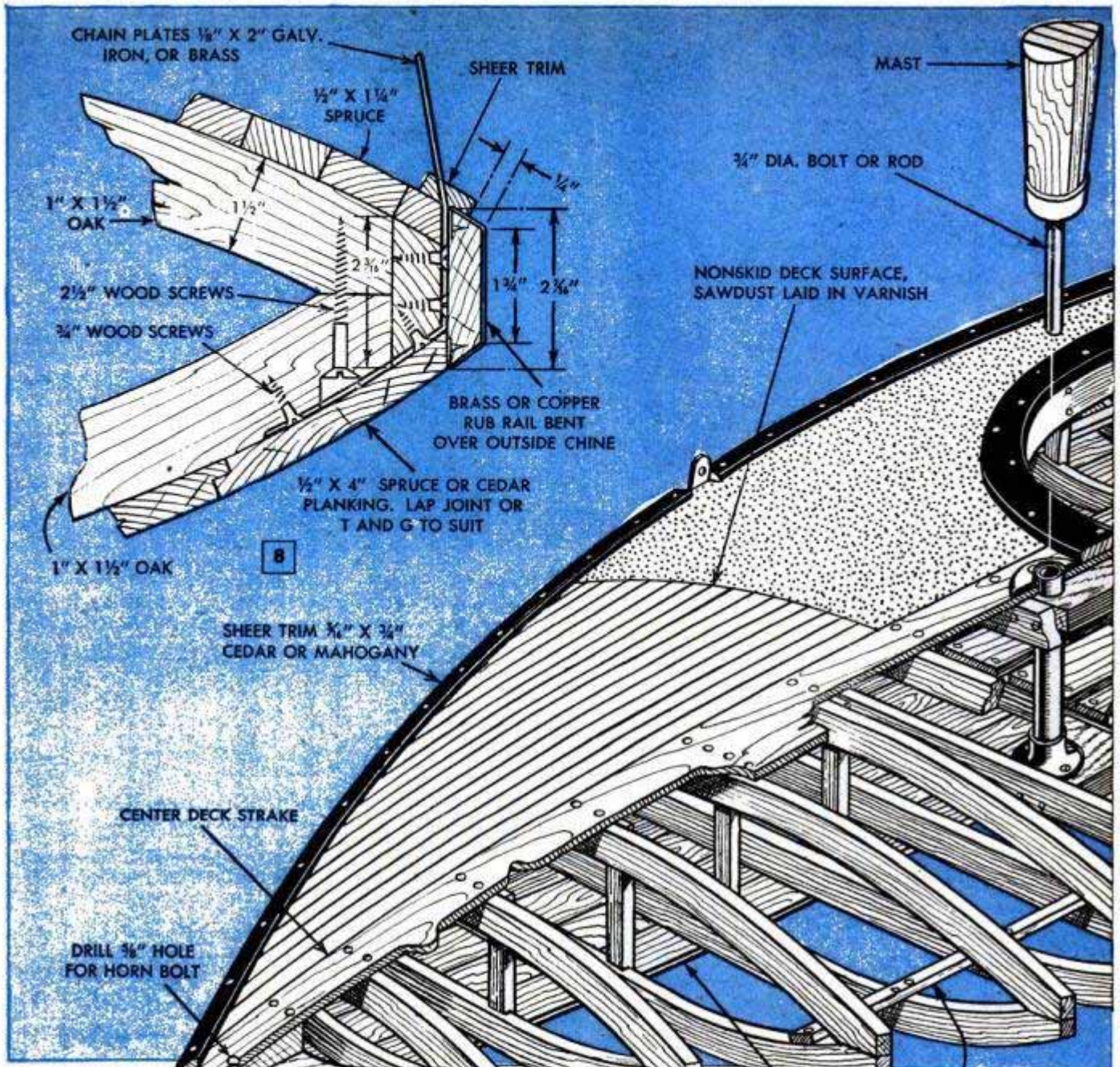

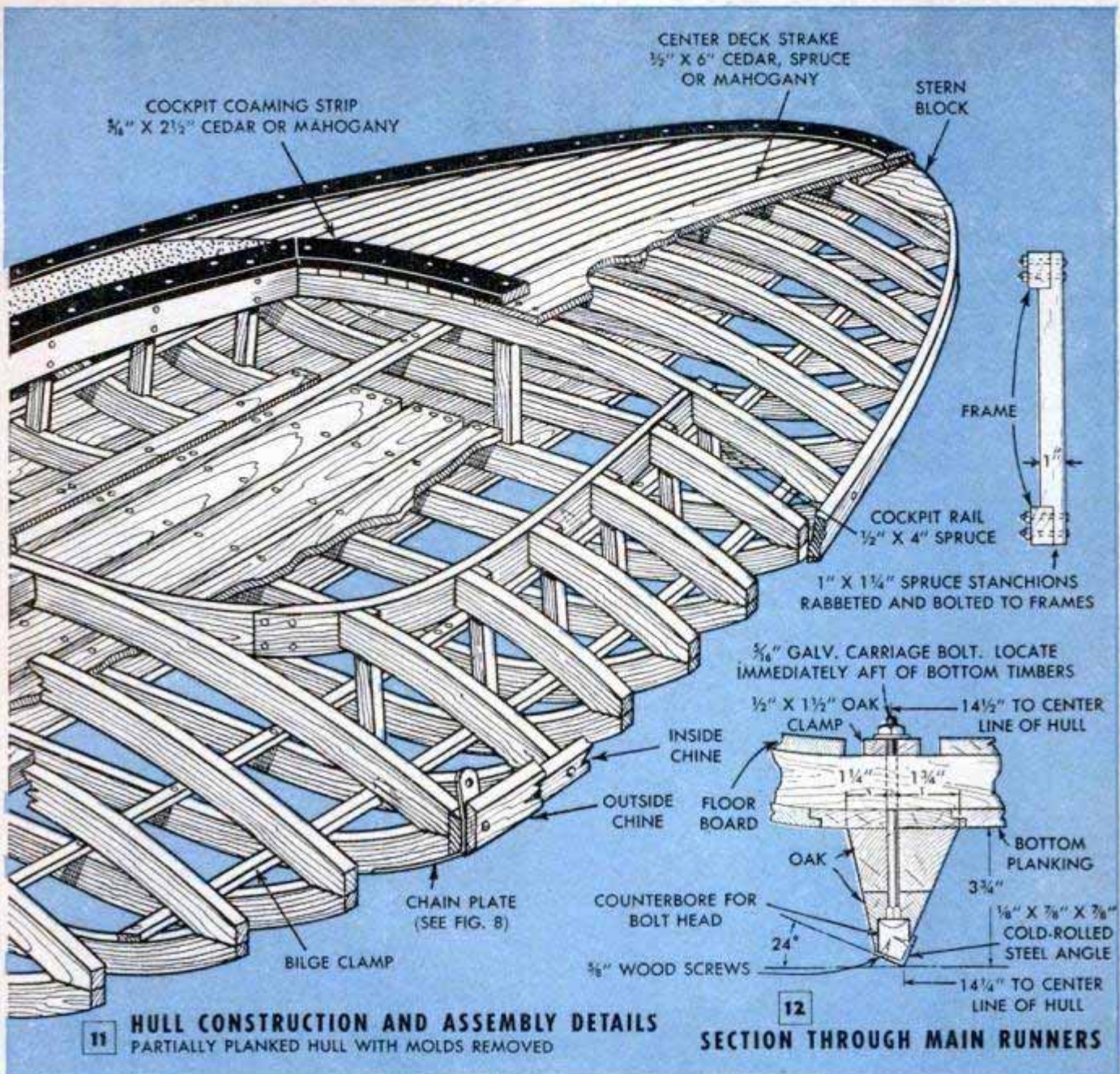

11 HULL CONSTRUCTION AND ASSEMBLY DETAILS
PARTIALLY PLANKED HULL WITH MOLDS REMOVED

12 SECTION THROUGH MAIN RUNNERS

the detail above Fig. 12. With all interior framing completed up to this point, the decking is laid. Narrow planks, 1 1/4 in. wide, make this a simple job. The same procedure is followed here as was used in planking the bottom, working outward from the deck strake and trimming off the planks flush with the inner chines. For a neat job, countersink all screws and fill with wood putty. As will be noted in Figs. 8 and 11, the face of the inside chines and the edges of the deck and bottom planking are covered with an outside chine piece, 1/2 in. thick, which also is beveled off flush with the deck and bottom planking. Before fastening the outside chine, the rub rail should be flanged over and tacked to the inside face of the chine. The rub rail, of brass or copper, is applied to the chine from the mast station to the aft end of the cockpit and prevents scuffing when the hull is heeled over. After the outside chine

has been fitted, the sheer trim is attached. This is set inward about 1/4 in. and covers the joint between the decking and the outside chine. Completion of the hull involves fitting a coaming strip around the cockpit and installing the flooring, Fig. 9. Note that the screws in the floor boards are driven in countersunk holes and puttied over.

The bilge and main runners may be shaped from solid stock or built up of two or more laminations. All runners have a slight curve or rocker, 5/8 in. in 11 feet. They are bolted to the hull according to the dimensions given in the plan and profile views, Fig. 4. Note in Figs. 10 and 12 that the runner shoes, which are angle iron, toe inward. This is important and has a definite bearing on the performance of the iceboat. The shoes are fastened to the runners with screws, spaced 6 in. apart and staggered on each side.

(To be continued)

W T M 51

Football Tee Made From Plunger

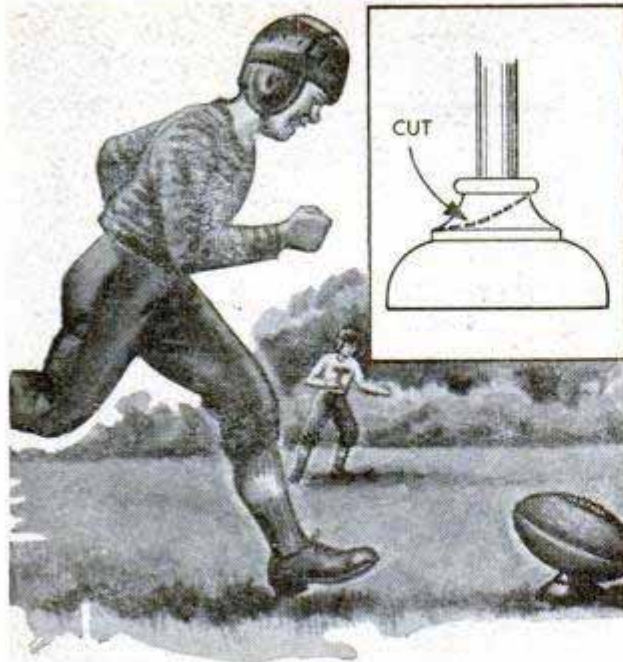

The suction cup of a drain plunger provides an ideal kickoff tee for youngsters' football games. After removing the handle from the plunger, cut the neck of the suction cup so that the football will be balanced at the proper angle.

Arthur Trauffer, Council Bluffs, Iowa.

Syrup Pitcher Dispenses Salt

Salt and flour are conveniently dispensed at the kitchen range if they are kept in no-drip syrup pitchers. The covered pitchers keep the items dry and clean and permit pouring with one hand.

Thin Board Held Under Work Insures Smooth End Cutting

When using a jigsaw to cut a thin strip from the end of a board, small pieces of stock ordinarily break off, resulting in a ragged edge. A smooth, even cut can be

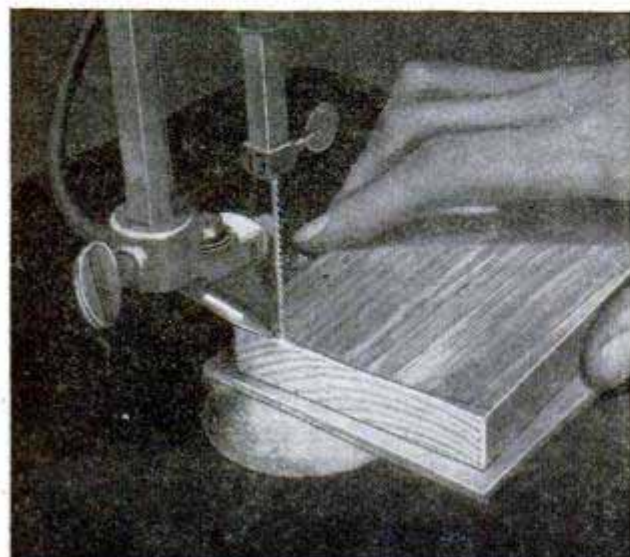

made if a second piece of wood is held under the work so it extends beyond the saw cut. This piece will guide the saw blade, allowing the operator to follow the cutting line accurately.

Richard Hanscom, Elmhurst, Ill.

Water Pressure Read at Hydrant By Gauge Mounted on Cap

One city water department solved the problem of obtaining quick pressure readings by fitting a water-pressure gauge permanently to an extra fire-hydrant cap. The cap is simply screwed to a hydrant outlet and the hydrant turned on to give the pressure reading. In this way, the water pressure can be checked at any strategic point in the system without disrupting service.



Lewis F. Garber, Blacksburg, Va.

Copper Float Provides Candy Dish

Something novel in the way of covered candy dishes can be had by assembling a flush-tank float, a lamp-base cap and a knob-type drawer pull. The seam around the center of the copper float is first broken with a file to separate the float into two parts. This leaves a small lip around the rim of each half. A 1/4-in. copper strip is soldered around the inside of the rim of the bottom half, which will serve as the bowl. The strip should project slightly above the rim to aid in locating the upper half of the float, or cover. The lamp-base cap is fastened to the threaded stud at the bottom of the bowl with a screw and washer. Then, a hole is drilled through the top of the cover to permit attaching the drawer pull. If all parts are of copper, simply polish the candy dish, but if different metals are used, it is best to have the unit plated.—S. S. Palestrant, Bronx, N. Y.



When using a jigsaw to cut a thin strip from the end of a board, small pieces of stock ordinarily break off, resulting in a ragged edge. A smooth, even cut can be

☞ A layer of heavy brown wrapping paper placed on the table under a new oilcloth will make the cloth wear longer.

WALNUT Picture Frame

By Benjamin Nielsen

HOME DECORATORS appreciate the adaptability of a round picture frame, especially when displaying informal portraits either individually or in groupings. This one consists of a turned ring of selected walnut and a disk, or picture backing, held together by a sliding dovetail joint. The outside ring which forms the frame is turned first. Before parting the ring from the waste, the dovetail groove is formed with a tool made from a discarded file. The ring also is sanded and shellac-finished before parting. The backing disk is turned to the shape shown in the left-hand sectional detail below. A matching dovetail is formed on the edge and the groove for the glass is undercut in the corner of the recess as shown. The exposed edge of the disk is sanded in the lathe and shellac-finished. Then the ring and disk are sawed in half and equally spaced shallow saw cuts are made across the outer face of the ring as indicated. Cut a circular piece of glass to the same radius as the undercut groove in the backing disk, and trim the picture to the same diameter as the glass. Then place the parts in the position shown in the lower right-hand photo. Slide them together and, gripping the backing disk and the glass between the fingers and thumb of one hand, give the outer frame a quarter turn. This movement locks the parts together so the joints are barely noticeable.

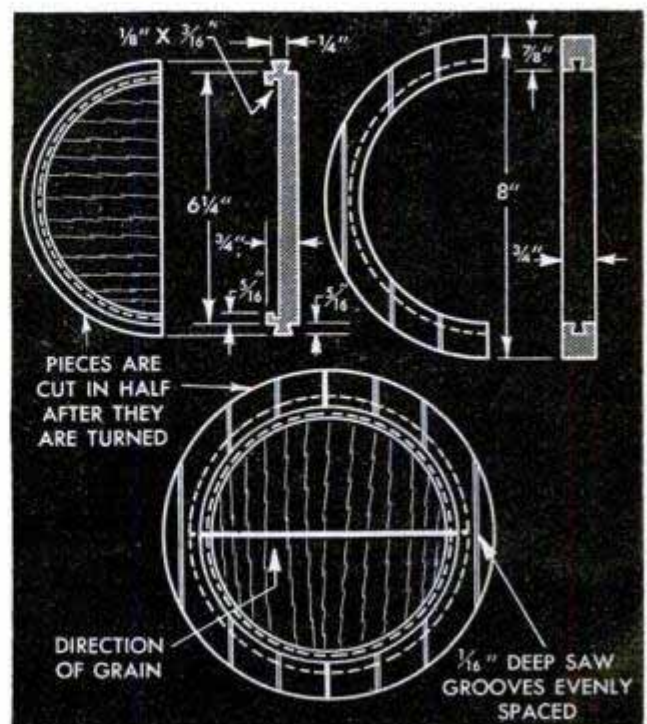
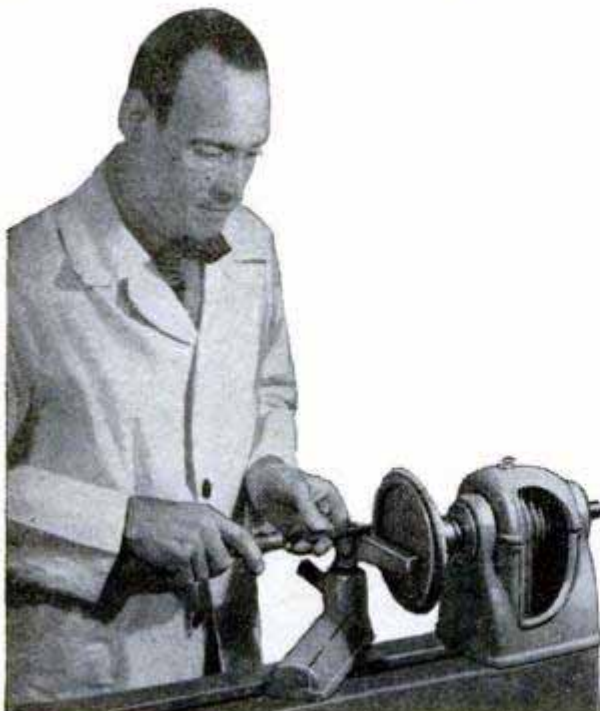
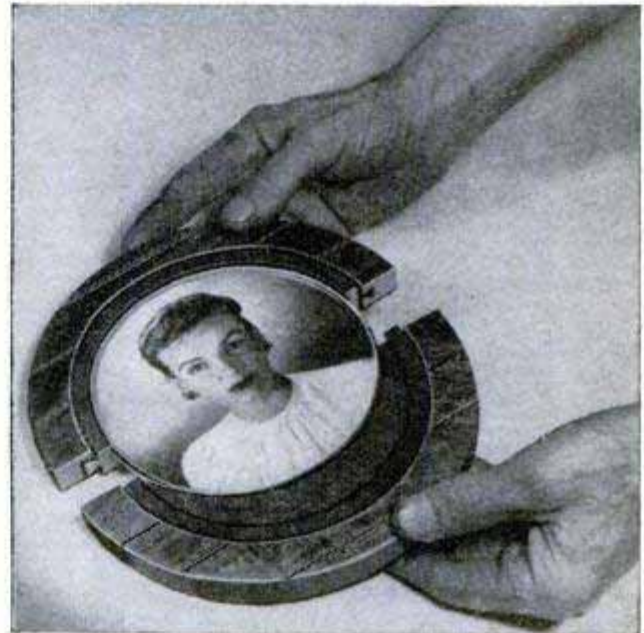

Bobby Pin Secures Lapel Button



If you want to be sure that a loose-fitting service or lodge lapel button does not drop off, lock it in the buttonhole with an ordinary bobby pin. Slip the pin between the underside of the lapel and the back of the button as shown in the detail. In addition to holding it in place, this also keeps the button from turning.

F. Wyman Johnson, Weston, Mass.

Safe Jack-o'-Lantern for Halloween



Inserting a flashlight in the mouth of a paper bag is an easy way to make a perfectly safe jack-o'-lantern that will delight the youngsters. Select a large paper bag, preferably white, and paint a comical face on one or both

sides. Then insert the flashlight, leaving the switch exposed, and tie it in place with string or ribbon.

Mrs. Cherie L. Howard, Memphis, Tenn.

Leave House Key in Mailbox

It is sometimes necessary to leave the front-door key where a member of the family will be likely to find it. An excellent way to do this is to place the key in an envelope addressed to the person for whom it is intended. Then, slip the envelope in the mailbox. As most people habitually check the mail when they come home, the

key ordinarily will be found, although its presence will not be noticed by a stranger who might come to the door while you are gone. It is best to wrap the key in a piece of heavy paper before placing it in the envelope.—Pat Fey, New York City.

Steel Wool Prevents Shifting When Clamping Glued Joints

A few shreds of steel wool placed between pieces of wood when gluing bite into the wood to prevent shifting while pressure is applied and also result in a stronger joint. Just sprinkle the shreds over the glue-covered surface before clamping the parts together. Grains of sand or metal filings will serve the same purpose.



Benj. Nielsen, Aurora, Neb.

Nail Polish Cements Watch Crystal

When a watch crystal becomes loose, it can be recemented in place with a few drops of clear nail polish. Remove the crystal and brush the polish around the inside of the retaining ring of the watch. Then, snap the crystal in the ring and wipe off any excess polish before it has a chance to dry. Allow the polish to dry for an hour or so before wearing the watch.

Harry C. Aichner, Jr., Erie, Pa.

Labels Printed on Glass Jars With China-Marking Pencil

To label glass jars before storing on a shelf or when taking small quantities of foodstuff on a trip, print the label directly on the glass with a china-marking pencil. Cover the lettering with a strip of cellulose tape to keep it from being rubbed off.



W T m - 5 . 1 . . .

Six-In-One PUZZLE

By Allan Carpenter

HERE ARE six exciting picture puzzles, all on one set of blocks. You can easily make the puzzle in one evening and everyone in the family will have hours of fun working out the six combinations. The puzzle pictured is made from 25 hardwood blocks, each 1 in. square. Fewer blocks, 16 for example, form a simpler puzzle for small youngsters. If you do not have a circular saw for cutting the blocks to exact size, suitable blocks in various sizes are available from toy stores. Use any type of picture, such as scenic views, photos, maps or flags. Maps, flags and similar pictures give the puzzle educational value, and each of the six pictures can be of a different type if desired. Assemble the blocks in a square and hold them with a rubber band as in Fig. 1. Coat the upper surface of the blocks with a quick-setting adhesive, such as rubber cement. Apply the cement to the back of the picture and place it over the blocks, pressing it firmly and smoothly in place. Then mark the picture both ways on the joint lines of the blocks and, following the lines, cut through the picture with a razor blade as in Fig. 3. When the blocks have been cut apart, press down the cut edges of the picture segments on each block. Assemble the blocks into another square with the blank faces up. Cement another picture to the surface of the blocks and cut apart as before. Continue this process until all six sides of each block are covered with parts of pictures. To solve the puzzle, the blocks must be placed in a square with the correct face up so that they form one complete picture. Pictures which are too large can be trimmed, or cropped, to retain the most interesting part.

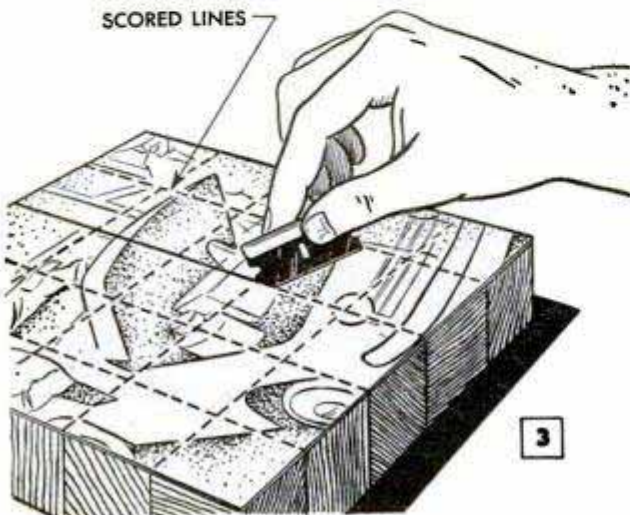

3

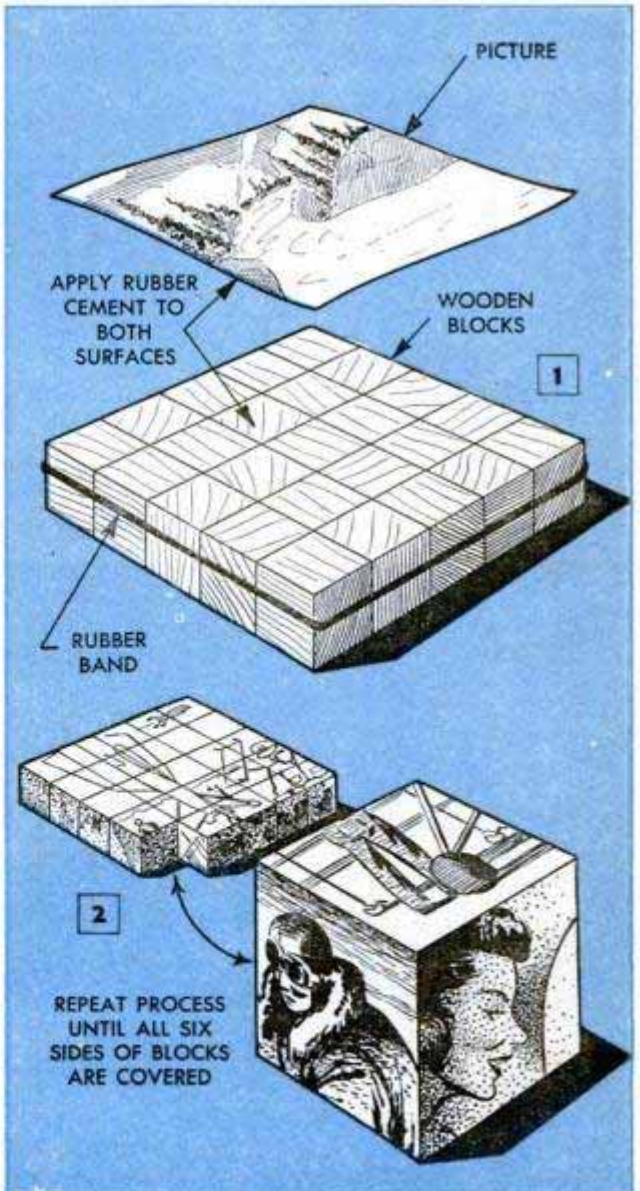

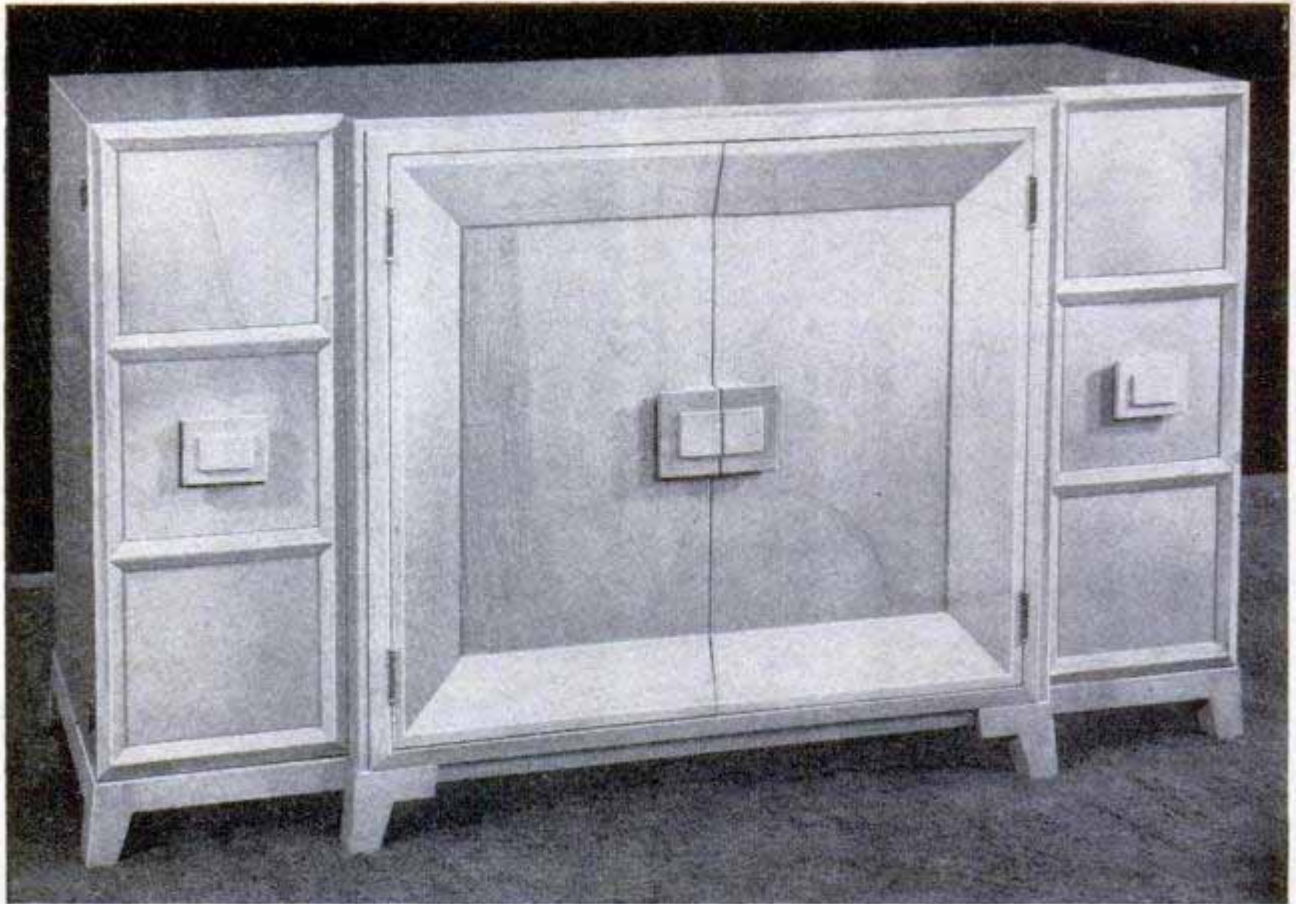

COMPLETING YOUR DINING-ROOM FURNITURE

By Wayne C. Leckey

Part II

WITH THE table and chairs completed as detailed in Part I, you should be ready to tackle the more pretentious pieces of the dining-room group—the credenza and the china cabinet. Construction of the

credenza is fairly simple as revealed in the cutaway drawing in Fig. 28. Over-all dimensions for this piece are given in Fig. 26, and a view of the interior, Fig. 27, shows how the doors are hinged, where friction catches are installed and how finger pockets in the rails are provided to facilitate

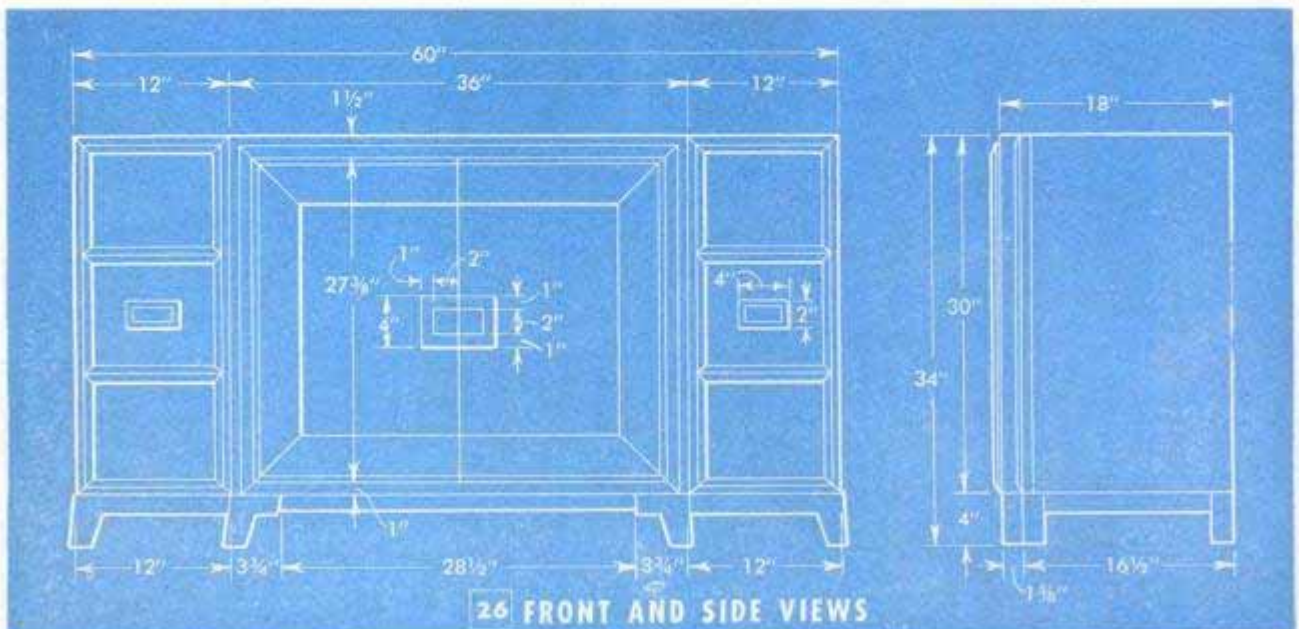

removal of the two silverware drawers.

Start the credenza by making the base framework. Each end is made up exactly the same, right and left hand, and then joined together with front and rear members. Section A-A in Fig. 28 gives the sizes of these members and shows how they are screwed together. Note that the $\frac{3}{4}$ x $1\frac{1}{2}$ -in. strip placed on edge runs the full length of the base and is glued and doweled to the two rear legs. All legs are the same size and shape, six being required, three of which are made for the right side and three for the left. All are doweled to the rails. Note that the outside faces of the end rails are beveled to match the flare of the legs. Section D-D shows how intermediate rails are rabbeted along one edge to receive $\frac{1}{4}$ -in. plywood bottoms. Cleats are fitted on the three other rails to support the plywood. Center legs of the credenza are doweled to the face of the front rails 12 in. in from the corner. Then, the 1 x $1\frac{1}{8}$ -in. strip is screwed to the projecting ends of the rails and small overlay blocks are used to conceal the screwheads. Section A-A shows how the back rail is built up of two additional pieces, both being the same length and set between the intermediate rails.

Next, the side members of the end compartments are installed. These are cut to size from $\frac{3}{4}$ -in. plywood. The upper ends of the outside panels are mitered 45 deg., while the lower ends are trimmed off squarely and bored for three $\frac{1}{4}$ -in. dowels, which are located in the base to bring the outer panels flush with the rail. The rear edges of the two outer panels are rabbeted for a $\frac{1}{4}$ -in. plywood back. The inner panels of each compartment are made $\frac{3}{4}$



in. shorter than the outer ones and narrower to permit covering the plies of the wood with a $\frac{3}{4}$ x $1\frac{5}{8}$ -in. strip of solid stock as detailed in section B-B. This strip is edge-glued and may be doweled for additional strength. The two panels of each unit are held together at the top with a frame of $\frac{3}{4}$ x $1\frac{1}{2}$ -in. stock. Front and rear pieces of the frame are grooved on the inside edges for tenons on the sidepieces. The frame is screwed in place through the edge so it is even with the bottom of the miter and flush with the top of the inner

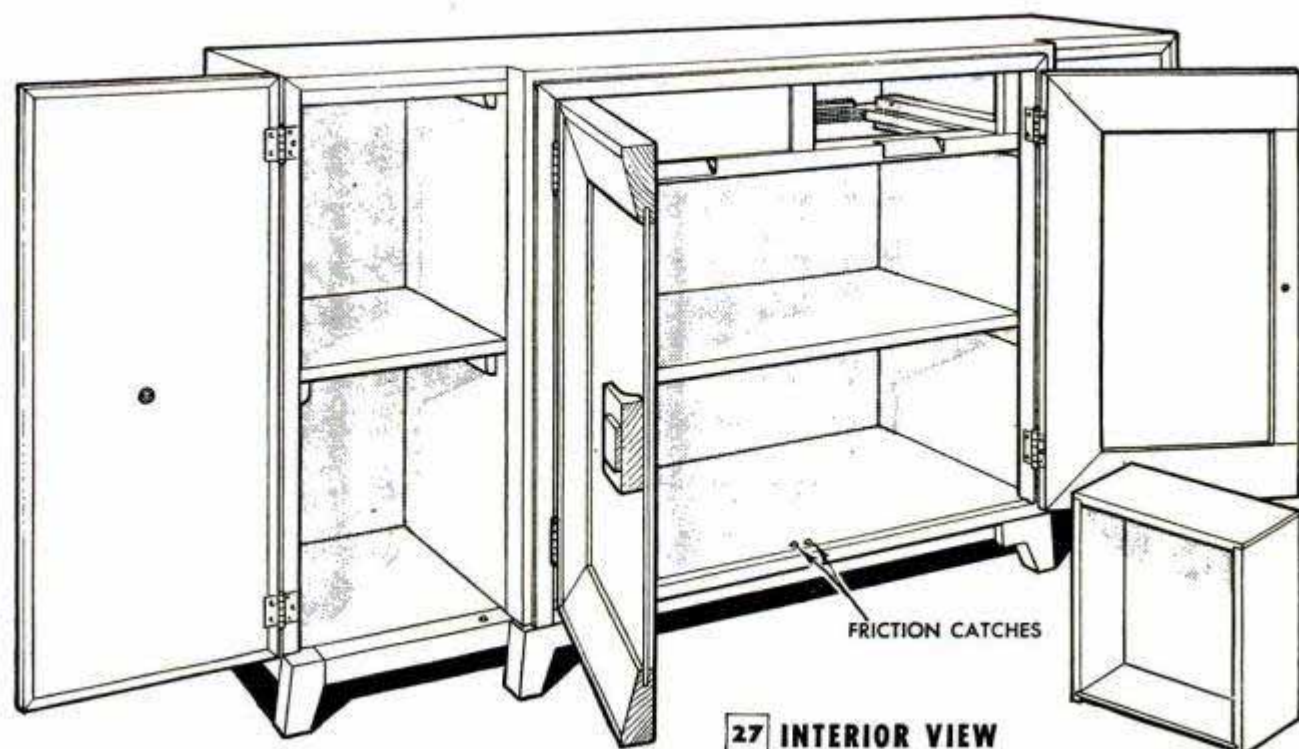

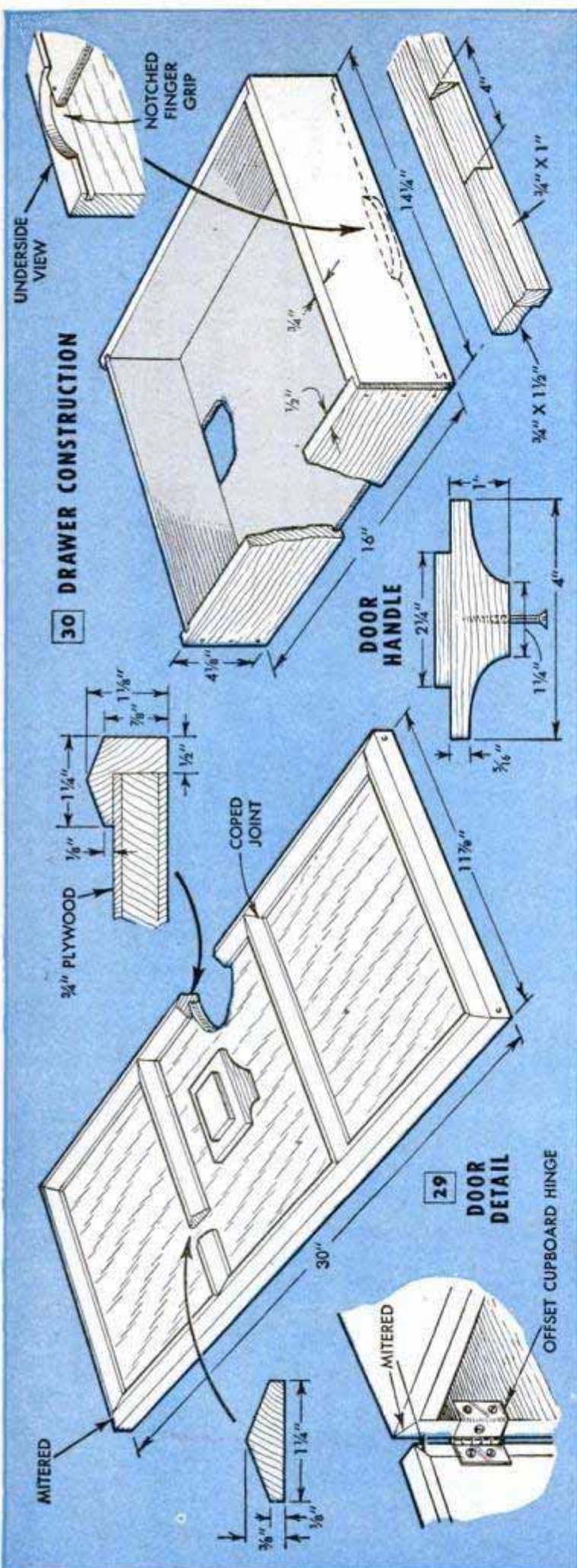

panel. The plywood back is added next to strengthen the assembly. This is nailed into the rabbets of the outer panels, to the edge of the inner panels and to the framing at the top and bottom.

Next comes the top. This is cut $15\frac{3}{4}$ in. wide and is mitered at each end to make a perfectly fitting joint with the end panels. As in the case of the inner panels, a $\frac{3}{4} \times 1\frac{5}{8}$ -in. strip of solid stock is edge-glued to the top to build it out flush with the sides. With this done, the center door molding is applied. Sections A-A and B-B give the size of the molding. The side and top members are rabbeted on the outer edge to fit over the edge of the top and inner panels, while the bottom member is rabbeted to take a $\frac{1}{4}$ -in. plywood bottom panel. Facing edges of the molding are beveled according to the sectional views and mitered to fit perfectly at the corners. Note, however, that the center shelf and the drawer frame should be installed before the molding is applied.

The drawer frame is made similarly to the frames at the top of the end units. Drawer runners are installed in the center and at each side after the frame is in place. Note that the front edge of the frame is faced with a hardwood strip which is notched at a 45-deg. angle to provide a finger pocket for each drawer. While the dimension for this is missing in Fig. 28, it is included in Fig. 30. The center doors are built up according to section C-C. They can be made in one piece by framing $\frac{1}{4}$ -in. plywood with a heavy molding grooved to fit over the edge and then sawing in half. A $\frac{3}{8} \times 1\frac{1}{2}$ -in. strip is used to reinforce the plywood along each side of the saw cut. Construction of the doors for the end units is detailed in Fig. 29. Plywood is framed with a rabbeted molding to conceal the laminations, and overlay strips, coped at the ends, are surface-glued to the plywood to divide the doors into three equal panels. Regular offset cupboard hinges are used on the end doors, while 3-in., loose-pin hinges are used on the center doors.

The china cabinet consists of two separate units which are held together at the back with a cleat. If space is so limited that you can accommodate neither the large credenza nor the complete china cabinet, just the base of the latter can be built and used as a small server. Fig. 31 shows the general construction of both units of the cabinet. Top, sides, back and dust panels of the lower unit are $\frac{1}{4}$ -in. plywood. Top and bottom frames are joined at the back with $\frac{3}{4} \times 1\frac{3}{4}$ -in. posts which are notched for the shelves and two drawer frames. Fig. 32

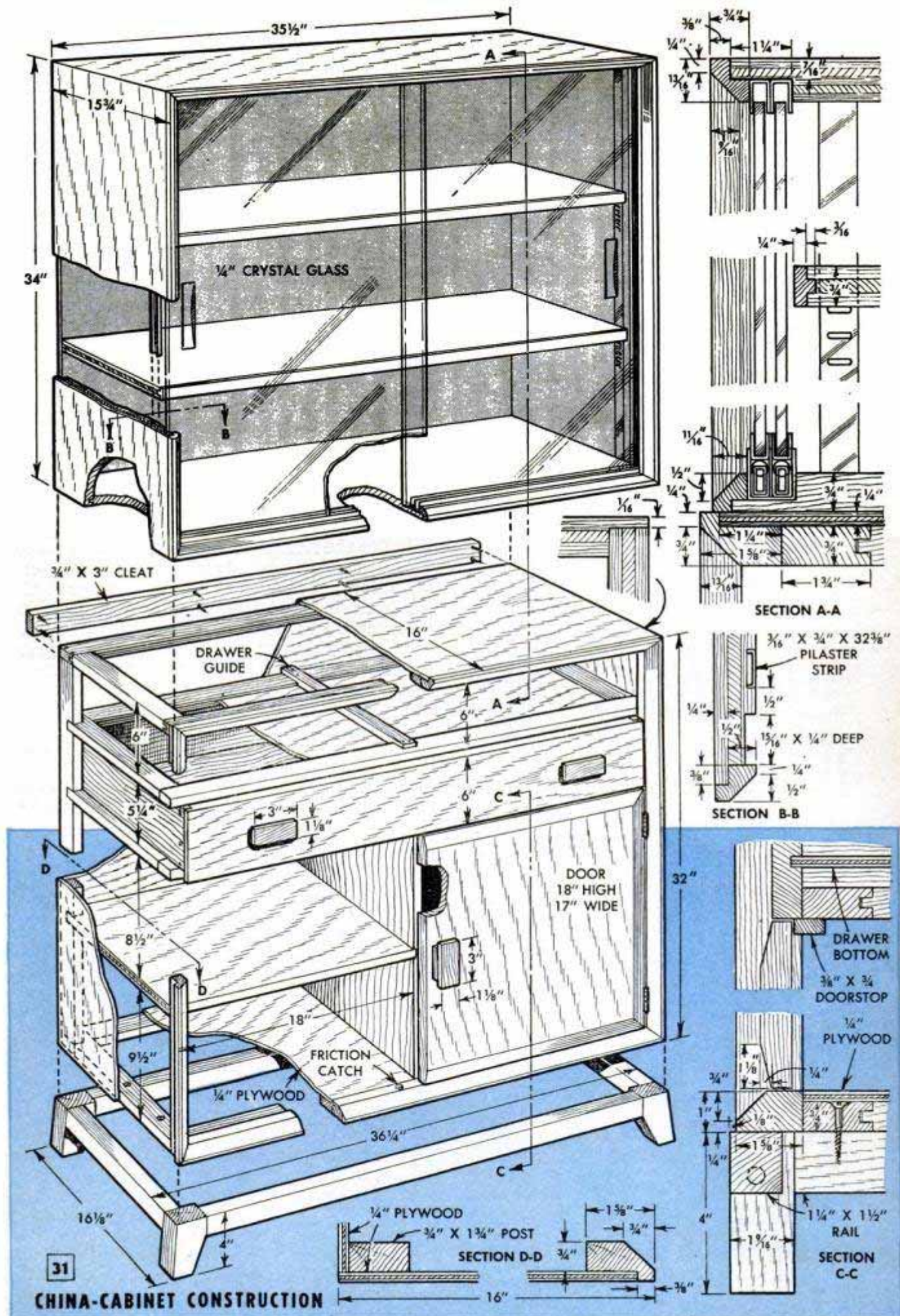

shows how the drawer frames are assembled. The top and bottom frames are supported at the front by a rabbeted molding which is mitered and assembled as a picture frame and then glued to the front edges of the frames at top and bottom. Side and top panels fit the rabbeted molding as shown in section D-D. Section C-C shows how the bottom frame is screwed to the base. Note that the top panel is rabbeted at each end to overlap the side panels. Drawers are assembled as in Fig. 30 and made to fit the openings. A grooved runner which rides on the guide is nailed to the underside of each drawer. Fig. 34 shows the simple wooden drawer pull. If desired, a silverware drawer can be included, Fig. 33. A bevel is run around the outer edges of the doors $\frac{1}{4}$ in. deep and $1\frac{1}{8}$ in. wide to give a raised panel effect.

The top unit of the cabinet is made like a box from $\frac{3}{4}$ -in. plywood. Sections A-A and B-B show how the pieces are rabbeted at the front edge to receive a molding which covers the laminations. Note that the rabbets at the top and bottom are made wide enough to house a standard showcase door track (see section A-A) and that rabbets also are made along the sidepieces to provide end grooves for the sliding glass doors. Note in section B-B that a groove is run at the front and back edges of the sidepieces for a standard adjustable shelf pilaster. In ordering glass panels for the doors, notice in section A-A that they must be short enough to permit inserting in the top track and then down into the lower one. Use crystal glass as it is less expensive. Any glass shop can grind the finger grips.



The china cabinet makes the seven-piece group complete. Featuring sliding glass doors, it's designed as two separate units to simplify moving and to permit base alone to be built and used as dinette server

32 TYPICAL FRAME CONSTRUCTION

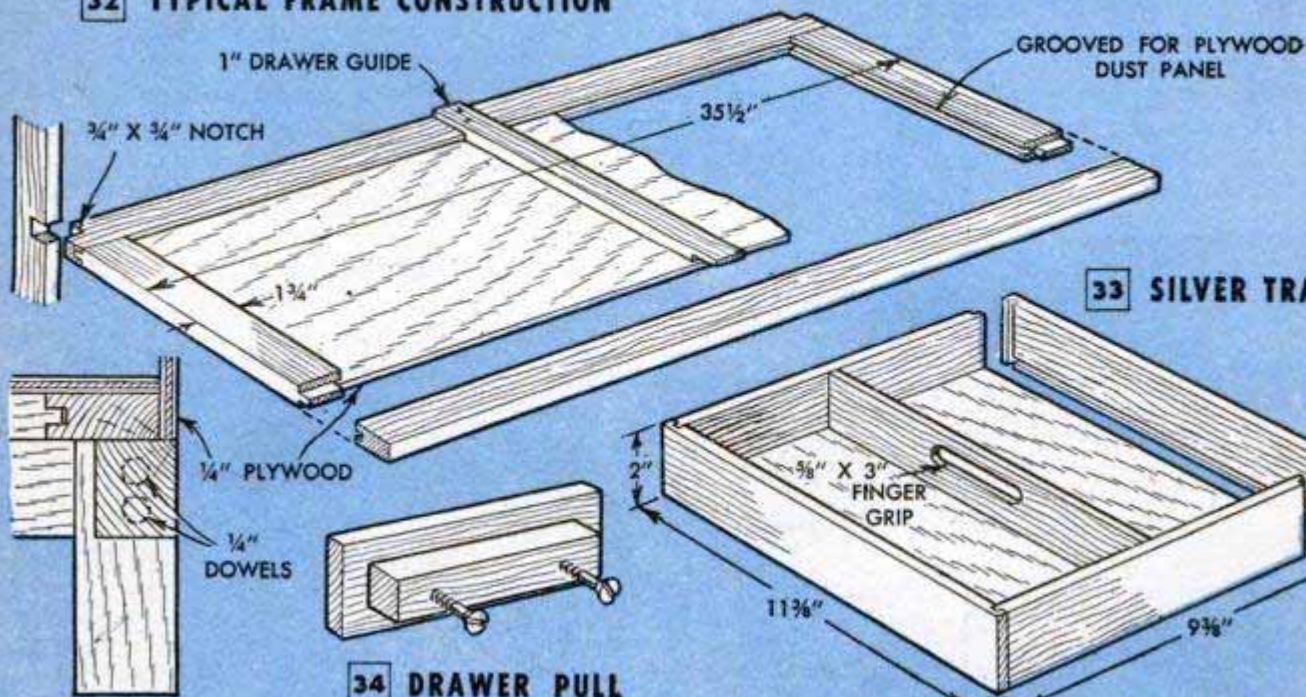

33 SILVER TRAY

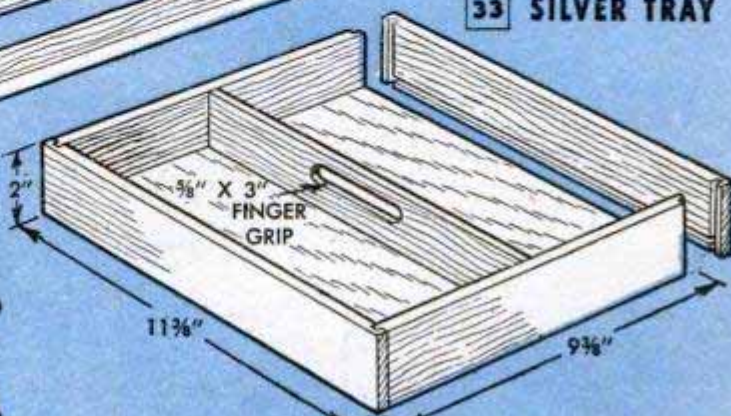

34 DRAWER PULL

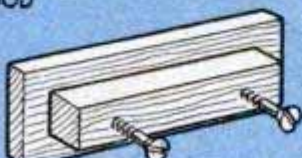

U. I. '51

Milk Carton Provides Road Flare For Changing Flat Tire



If you have to stop on a darkened highway to change a flat tire, burn an empty milk carton to warn approaching motorists and also to furnish plenty of light to facilitate working. One of these wax-paper flares will usually burn long enough to allow you to complete the job but, just in case, wash out a couple of the cartons and store them in a corner of the car trunk.

Fulton H. Travis, Yakima, Wash.

Pocket Sewing Kit Improvised From Dental-Floss Container

Needles, thread, small safety pins and straight pins are carried compactly in a pocket sewing kit improvised from a dental-floss container. A piece of cellulose tape



on the inside of the container cap keeps the needles from slipping out, and the tiny lips on the outside of the cap are handy for cutting thread.

Bookmark Indicates Exact Line

Made of heavy paper or thin sheet plastic, this novel bookmark has a movable line guide that indicates the exact spot where reading was interrupted. The top of the bookmark is folded to slip over the edge of the page and the bottom is cut in the form of a large half circle to keep the line guide from slipping off. The guide is simply a small piece of paper or plastic pointed at each end and slotted to slide along the marker.

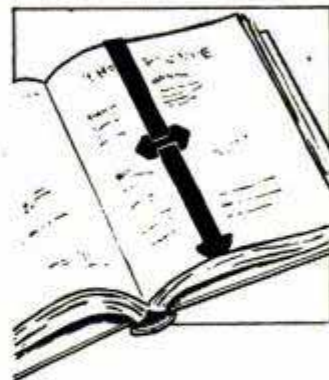

Ever-Ready Glue Brush

You won't have to search for a usable glue brush or take time to clean one that has hardened if you use this handy applicator. It's ready in just the time it takes to pull a piece of sash cord a half inch or so out of a wooden handle and then cut off and fray out the end of the cord. The handle is a piece of broomstick which is drilled lengthwise through its center for the sash cord. The latter is held in place with a nail pressed through a small hole drilled through the side of the handle.

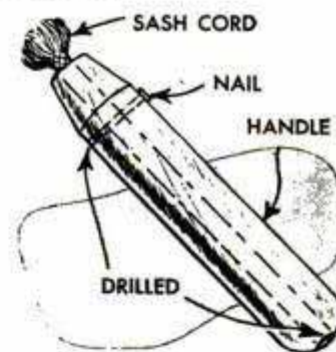

Stanley R. Welling, Racine, Wis.

Cardboard Relieves Sore Feet

When breaking in a new pair of shoes, my feet usually develop sore spots at the tops of the heels. Now, when this happens, I relieve the pain by inserting a folded piece of cardboard under the heel of my foot. This lifts the foot slightly, raising the sore spot above the point of contact.

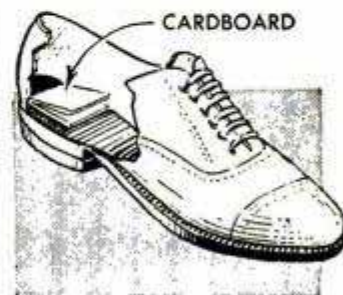

W. F. Schaphorst, Newark, N. J.

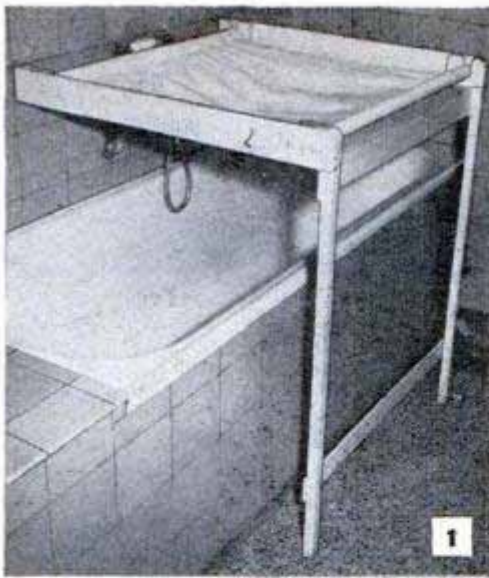

DRESSING TABLE for BABY

MOTHER and baby alike will appreciate the convenience of this simple dressing table. It swings down over the bathtub as in Figs. 1 and 2 and folds against the wall as in Fig. 3. Use hardwood as the strength of the unit depends on rigidity of the joints. Follow constructional details in Fig. 4. Note that the canvas top is supported by two 1-in. dowels which pass through hems sewed in the fabric. Flats on the ends of the dowels permit them to drop into slotted sockets. Attach the unit to a tiled wall by first drilling small holes in the cemented joints and inserting expanding fiber plugs. Then turn screw hooks into the plugs. After screw eyes at the rear corners of the table have been placed over the hooks, close the hooks with pliers so the screw eyes cannot slip out.

Jens Bastholm, Odense, Denmark.

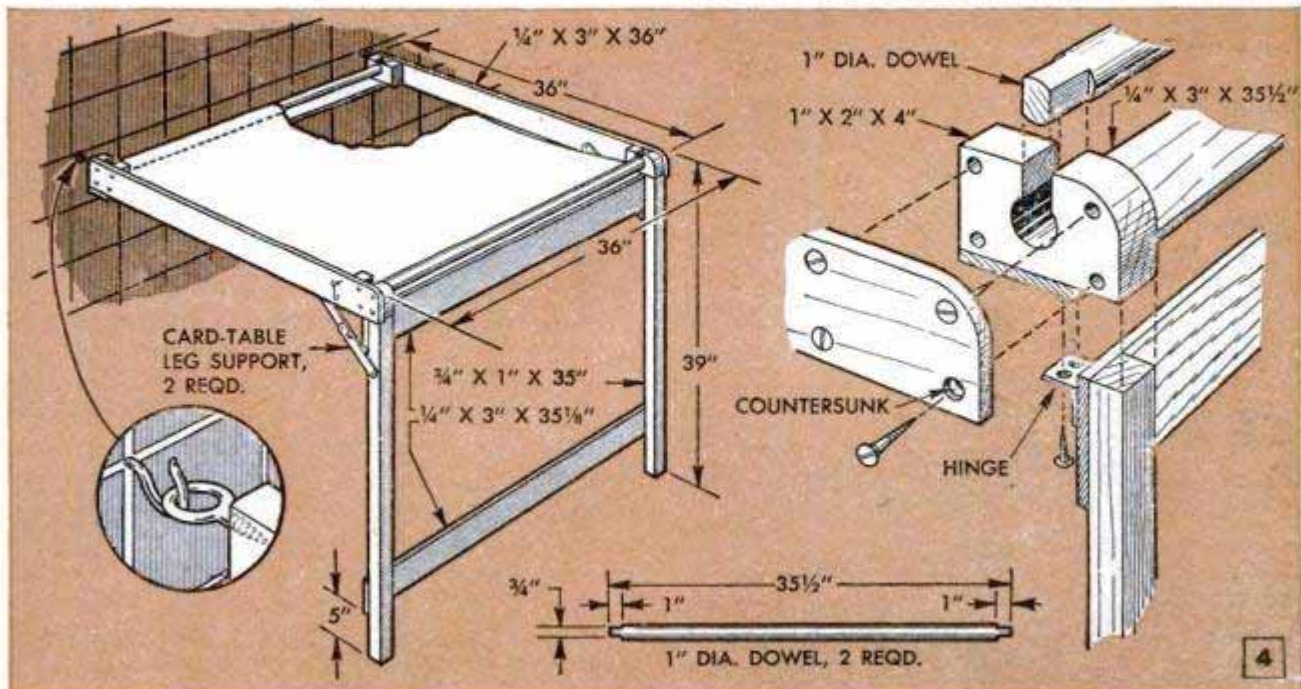
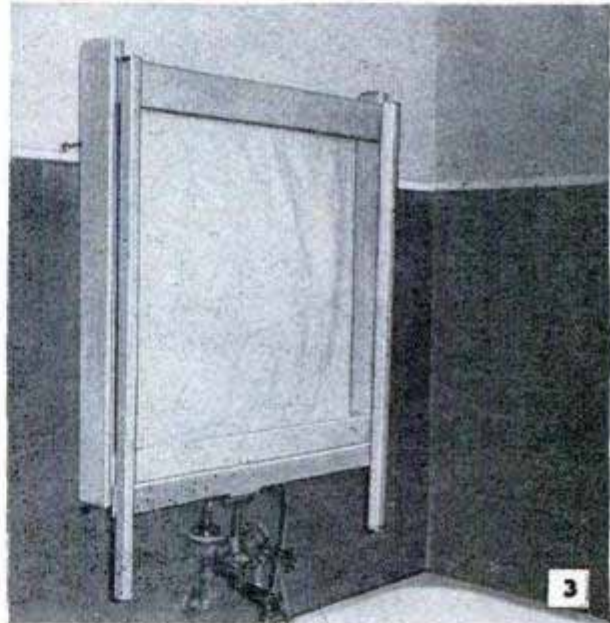

Better performance from HEATING SYSTEMS

By E. R. Haan

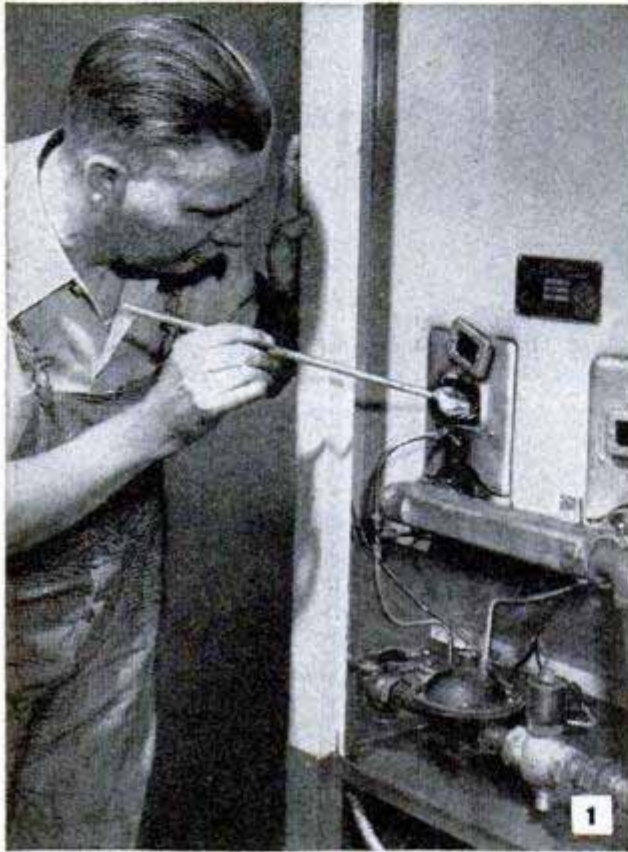

Before starting the automatic gas-heating plant, see that unit is thoroughly clean and that mechanism has been checked over by a competent serviceman

When the oil-fired heating plant is idle during summer months, fuel and electrical supplies are shut off. Check and lubricate working parts before starting



ALL HEATING PLANTS, including modern automatic units, require regular attention to keep them operating efficiently and economically. Minor repair and servicing at the beginning of the season can prevent service interruptions and even breakdowns during the peak heating load of the winter months and also will help to prevent fuel waste and costly repair over longer periods of time.

Gas-fired heating units: Gas-fired systems require very little attention other than annual cleaning and inspection and a periodic check to see that the correct ratio of the air-gas mixture is maintained. Usually expert servicemen from the local utility company will attend to this adjustment for a nominal charge, but keeping a check on certain operating details is up to the individual owner. When starting a gas burner, the pilot light is ignited immediately after the gas has been turned on. (*Caution:* Never allow unburned gas from the pilot to accumulate in the flame chamber before igniting it. If this should happen, shut off the gas to the pilot and open the drafts and inspection door and allow time for the unburned gas to dissipate.) If the pilot burner cannot be reached conveniently with an ordinary match, use a piece of newspaper rolled up tightly to form a lighting torch 8 to 10 in. long, Fig. 1. Water vapor—one of the products of the combustion of gas fuel—unites with other waste products in the flue gases to form an acid which attacks the mortar joints in unlined brick chimneys. Because of this, vitreous-enameled or stainless-steel flue linings should be installed in old chimneys to prevent rapid disintegration.

Oil-fired heating units: When the unit is idle during summer months, the fuel and electrical supplies should be shut off. The fuel tank is filled to prevent moisture in the air from condensing in the tank during temperature changes. Water in the oil may interfere with the operation of older-type burners. When the burner is correctly adjusted, the oil-air mixture will burn with a clean, bright flame resulting in a minimum loss in the flue gases and negligible deposits of coke and soot on the walls of the flame chamber and flue. Among the

Although a competent serviceman should be called to inspect and make any major adjustments and repairs necessary to ready your heating plant for the coming season, there are a number of minor adjustments and points to check on automatic units that you can do yourself

several causes of a smoky, stratified flame are insufficient air, flame chamber too small, or burner nozzle projecting too far into the chamber. Too much air may extinguish the flame entirely or cause objectionable sputtering and roaring while the burner is operating. Inadequate draft control also can cause similar symptoms. All moving parts of the burner requiring lubrication should be carefully checked at the start of the season and inspected at regular intervals thereafter, Fig. 2.

Coal stokers: To avoid recurring trouble with a stoker, it is important to use coal of the recommended grades and lump sizes. High-grade stoker coals contain the minimum of noncombustible materials and are mixed with large and small particles in the proper ratio to quantity. If the coal is too fine, air passage through the retort will be restricted and the combustion process retarded. On the other hand, unduly large lumps may bridge at the bottom of the hopper and either jam the feed screw, causing the shear pin to break or the clutch to disengage, or may block off the supply of fuel to the retort entirely and cause the fire to go out. Other than use of the proper grades of fuel, servicing of the stoker-fired plant is simple. Fly ash and soot are cleaned regularly from the furnace or boiler as in Figs. 5 and 8. Removal of the clinker usually is daily routine. Beyond this, a stoker fire should be disturbed as little as possible.

Hand-firing: In addition to firing by approved hand methods, economical operation of the plant

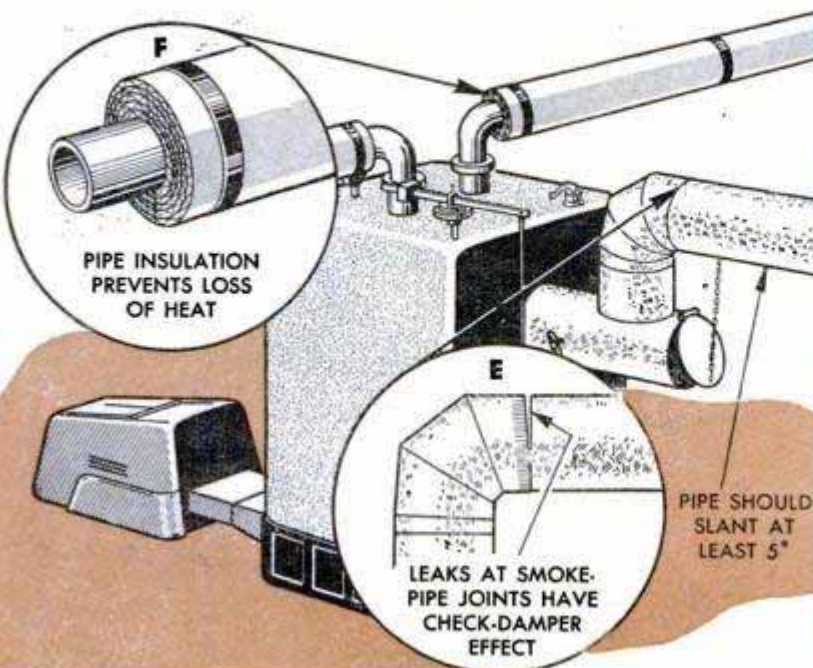

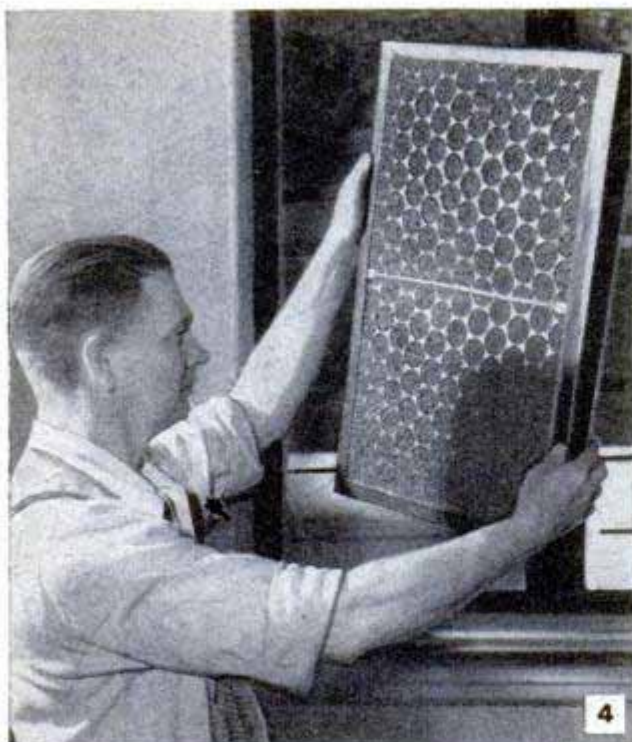

depends on keeping the equipment in serviceable condition. All doors into the furnace either above or below the fire should close tightly. If necessary, tighten up the hinge pins and file or scrape the meeting surfaces of doors and frames to reduce air leaks to the minimum. An excessive air leak around the cleanout door above the fire will act as a partial check, while leakage through the ashpit door or the draft door will make the fire difficult to control. Clean the furnace periodically throughout the heating season to prevent accumulations of ash and soot which act as insulation on heat-transfer surfaces. Check carefully at the end of the season for cracks in the firebox and for warped or cracked grates, Fig. 6.

Smoke pipe: During mild weather, the slow rate of ignition of the lower grades of solid fuels produces considerable soot which coats the inside surfaces of the

smoke pipe. As long as the pipe is hot, corrosion of the metal progresses at a very slow rate but, when the fire is allowed to go out in the spring, moisture collects in the pipe and combines with the soot coating to form highly corrosive acids. These acids quickly destroy the effectiveness of ordinary galvanized sheet-metal pipe. If a check shows the smoke pipe to be badly corroded, it should be renewed. Although much more expensive, cast-iron or stainless-steel smoke pipe resists corrosion and will last for 10 years or more. In any case, when installing new pipe be sure that the slip joints are tight and fully joined, Fig. 3, E. Use draw bands on all joints and support the pipe with metal bands or wires attached to the basement ceiling. Smoke pipe should clear woodwork by at least 15 inches.

Chimneys: To avoid draft interference, the chimney should have a separate flue for each heating unit. Unused openings into flues should be bricked up or closed with metal flue stops. Smoke-pipe joints at the chimney are closed with mortar to prevent air leakage. The end of the smoke pipe should come flush with the inside of the flue, Fig. 3, D. Top of the chimney should be at least two feet above the ridge of a peaked roof, Fig. 3, B. Remove tree branches or other obstructions to air movement above or near the chimney. Cleaning the flue can be done with a burlap bag filled with rags, straw or sawdust and a couple of bricks for weight. This "sweeper" is lowered into the chimney by means of a rope or heavy cord and worked up and down to dislodge soot and other loose particles. After cleaning the flue in this manner, remove the accumulation of soot and other debris through the cleanout door. See that the latter closes tightly. In time, mortar joints disintegrate on the part of the chimney which is exposed. Old chimneys re-

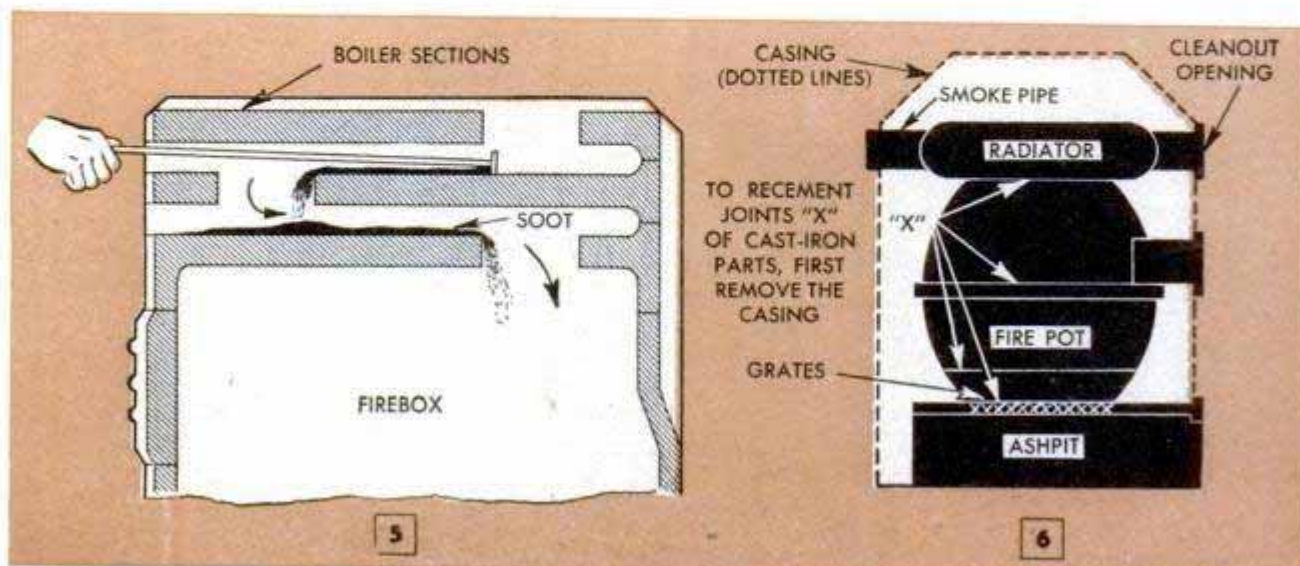

quire tuck pointing occasionally to preserve them in serviceable condition, Fig. 3, C. Loose mortar is scraped away and the open joints are soaked with water before pointing with new mortar (1 part cement to 3 parts sharp sand). The joint between the chimney cap and the projecting tile flue, Fig. 3, A, should be made watertight by calking.

Locating thermostat: The best-quality thermostatic-control units are extremely sensitive to changes in temperature and should never be located near an outside door, window, fireplace, radiator or above a lamp, Fig. 9. The best location is on an inside wall where the unit will be shielded from drafts through hallways, stairways or windows. Blow the dust out of the unit occasionally and remove the outer housing and clean the contact points as directed by the manufacturer. See that the hole where the connecting wire comes through the plaster is plugged tightly. An air leak at this point will affect the operation of the unit, possibly causing it to vary as much as 10 deg. from the true inside temperature. If the heating unit is equipped with an astat or aquastat, these units should be serviced in much the same manner. Check all electrical connections to see that they are clean and tight.

Warm-air heating systems: Unlike the older gravity warm-air systems, the late-model warm-air furnaces have forced-air circulation. Some forced-air systems bring air in from outside, but most all ordinary installations simply recirculate the air in the house as the normal air exchange in the average home is sufficient for good health. As the air is drawn through the cold-air returns, it passes through one or more filters. The renewable-type filters are replaced at least once during the average heating season. The replaceable filter should be renewed when light cannot be



Corrugated insulation on warm-air ducts stops any heat loss to the basement. Seal joints in the covering with gummed paper or cloth tape applied tightly

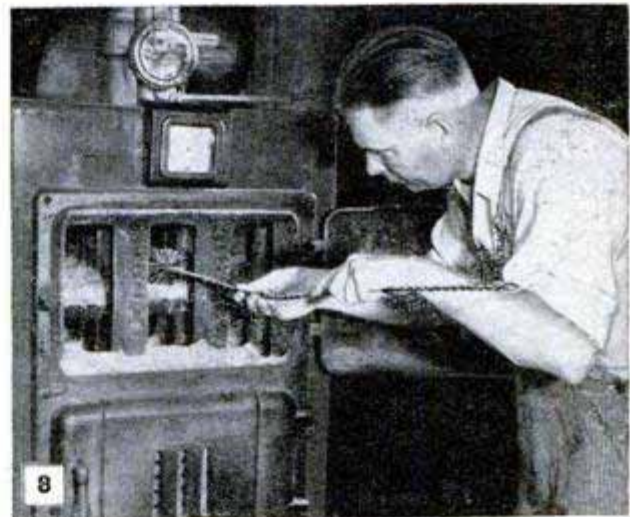

Heat-transfer surfaces of hand or stoker-fired boilers must be kept free from soot and fly ash. Use a wire flue brush having a flexible handle like that shown

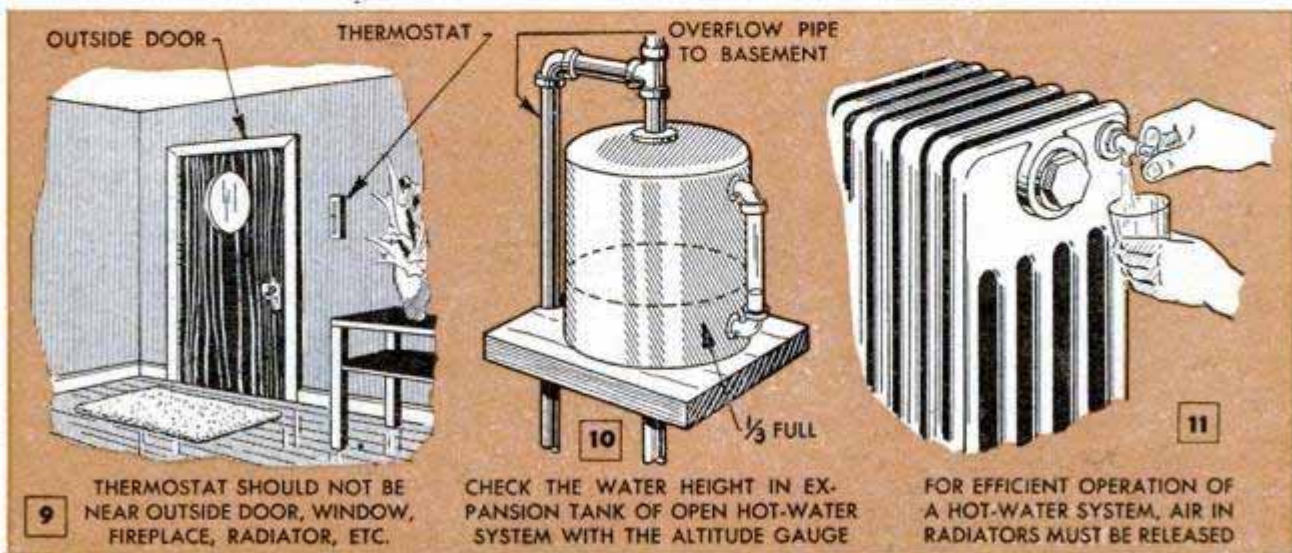

9 THERMOSTAT SHOULD NOT BE NEAR OUTSIDE DOOR, WINDOW, FIREPLACE, RADIATOR, ETC.

10 CHECK THE WATER HEIGHT IN EXPANSION TANK OF OPEN HOT-WATER SYSTEM WITH THE ALTITUDE GAUGE

11 FOR EFFICIENT OPERATION OF A HOT-WATER SYSTEM, AIR IN RADIATORS MUST BE RELEASED



12 Older-type boilers should be covered with a 1-in. layer of asbestos cement which will reduce loss of heat

seen through it, Fig. 4. Joints in cast-iron furnaces, Fig. 6, should be recemented after three to five years of use. It's a simple job to remove the sheet-metal casing and lift off the separate sections down to the ashpit. Clean out all the old cement and brush dirt and loose particles out of the joints before recementing. Be sure to relocate the parts in exactly the same position. A chalk mark across each of the joints makes this easy. Excess cement forced from the joints as the parts are replaced is wiped off and the joint is smoothed with a brush or cloth. To prevent heat loss, cover warm-air ducts with corrugated asbestos paper as in Fig. 7, using gummed paper or cloth tape to seal the joints.

Hot-water systems: Do not flush a hot-water heating unit unless this is necessary in making repairs or when cleaning sediment out of the boiler. "Stale" water contains the minimum of oxygen and lime and will cause less corrosion of metal parts than fresh water. Before starting the season with a hot-water system having an open expansion tank, Fig. 10, check the water level with the altitude gauge to see that the system is full. On the dial-type gauge, the red arrow is set to the required water height and water is added until the black arrow is brought to the same height as the red arrow. On a closed-type system, the water level is maintained automatically and forced-circulation systems have automatically controlled circulating pumps.

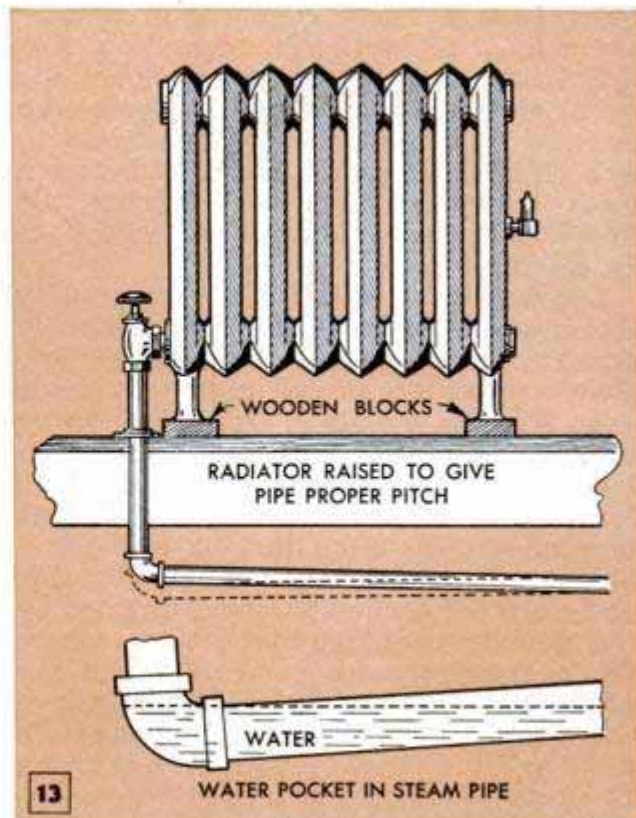

13 Use blocks to raise a steam radiator and restore the drainage pitch of pipe lowered by settling of house

Air entrapped in the hot-water system impedes water circulation. Pressure is relieved by bleeding the entire system at the radiator valves as in Fig. 11. Bleeding off the air will lower the water level. Check and add fresh water if necessary. Then bleed the system again after a week or so to remove any air carried into it with the fresh water which was added.

Steam-heating systems: In the newer one-pipe steam system, a single pipe conducts live steam to each radiator and returns condensate to the boiler. When the radiators of the one-pipe system fail to heat, the cause usually is faulty air valves. Lime deposits and corrosion cause sticking of the moving parts, preventing air from escaping and steam from entering the radiator. Sometimes the faulty valves can be repaired but, as a rule, it will pay to replace them. Pounding or hammering in a one-pipe steam system usually is caused by water trapped in the radiators or somewhere in the return pipes. Settling of buildings often lowers a pipe below the correct drainage pitch and water collects in the low end beneath the radiator. Hammering is caused by steam being forced through the water in intermittent spurts. The simplest remedy is to raise the radiator on small wooden blocks as in Fig. 13. Hammering also is caused by water collecting in a steam valve that is only partly opened. Be sure the steam valves are either fully opened or closed at all times. Sediment

collects in both hot-water and steam boilers after years of use and is removed by draining and flushing the system with clean water. Never drain the boiler when it is fired. If an emergency repair makes drainage necessary, draw the fire and wait until the system has cooled to room temperature before draining and refilling. Small quantities of water can be added while the system is in operation should it be necessary to replenish the water supply, but the fire should be low and the water added slowly to avoid a sudden temperature change which might crack the boiler castings.

Vapor-vacuum systems: This type of heating plant is practically trouble-free unless air leaks develop. These can occur at the radiator and boiler valves, at the water gauge and the diaphragm joint of the damper regulator and, more rarely, at pipe connections. Operation of the system is controlled by a vacuum valve on each radiator which is actuated by steam pressure. When the pressure drops, the valve closes and prevents air from entering the radiator. Leaks in the vacuum system generally are easy to locate when the boiler is carrying a full head of steam. The method of repair will depend on the location and nature of the leak. Liquid compounds are available which are effective in sealing small leaks in both steam and vacuum-heating systems. Of course, excessive leaks at the water gauge, around valves, at the damper regulator, or in a pipe joint are permanently repaired only by replacement of the defective parts.

Insulating pipes and boilers: Long runs of both hot-water and steam pipes should be insulated to prevent heat loss with a ready-formed insulating covering as in Fig. 3, F. Asbestos cement is applied to the pipe fittings and valves. Late-model boiler units are provided with insulation, but older boilers should be coated with asbestos cement to reduce heat loss to the basement. A 100-lb. bag of this special cement will cover the average boiler of either the square or round type. Mix the cement with water to form a thick paste and trowel it on the boiler to a thickness of about one half inch. Cover this first coating with 1-in. wire mesh, as in Fig. 12, and then apply another ½-in. layer to cover the wire. Smooth the job with a wet sponge and cover with muslin or cheesecloth pressed onto the cement while it is still wet.

Radiators: As a rule, it is not advisable to cover older-type radiators in any way, as coverings tend to retard air circulation. Nor is it advisable to coat old radiators with bronzing paints, as the metallic pigments in these paints tend to overlap on drying and form a reflecting surface which retards heat transfer.

Inexpensive Power-Tool Stands From Sewing-Machine Legs



Merritt L. Beeson of Dodge City, Kans., has found a new practical use for the cast-iron framework of old treadle sewing machines. Stripped of all mechanical parts and then fitted with heavy plank tops, the frameworks provide exceptionally rigid power-tool stands which can be rolled easily when necessary to suit the particular job. Some of the frameworks were dismantled even further by removing the center bracing to permit housing a three-drawer cabinet in the base of the stand. This made it especially handy to keep related accessories near the tool mounted on the stand. Firms specializing in modernizing old treadle-type sewing machines usually will give you discarded frameworks.

Coins Taped Inside Match Book Are Mailed Safely

When sending coins through the mail, tape them to the inside of an empty match book. Use cellulose tape to secure the coins and close the cover before inserting the book in the envelope.



❏ Instead of rubbing clothes by hand when washing, use a stiff brush to remove spots. This is fast and easy on the hands.

Photo Kinks

wlm-57

X260

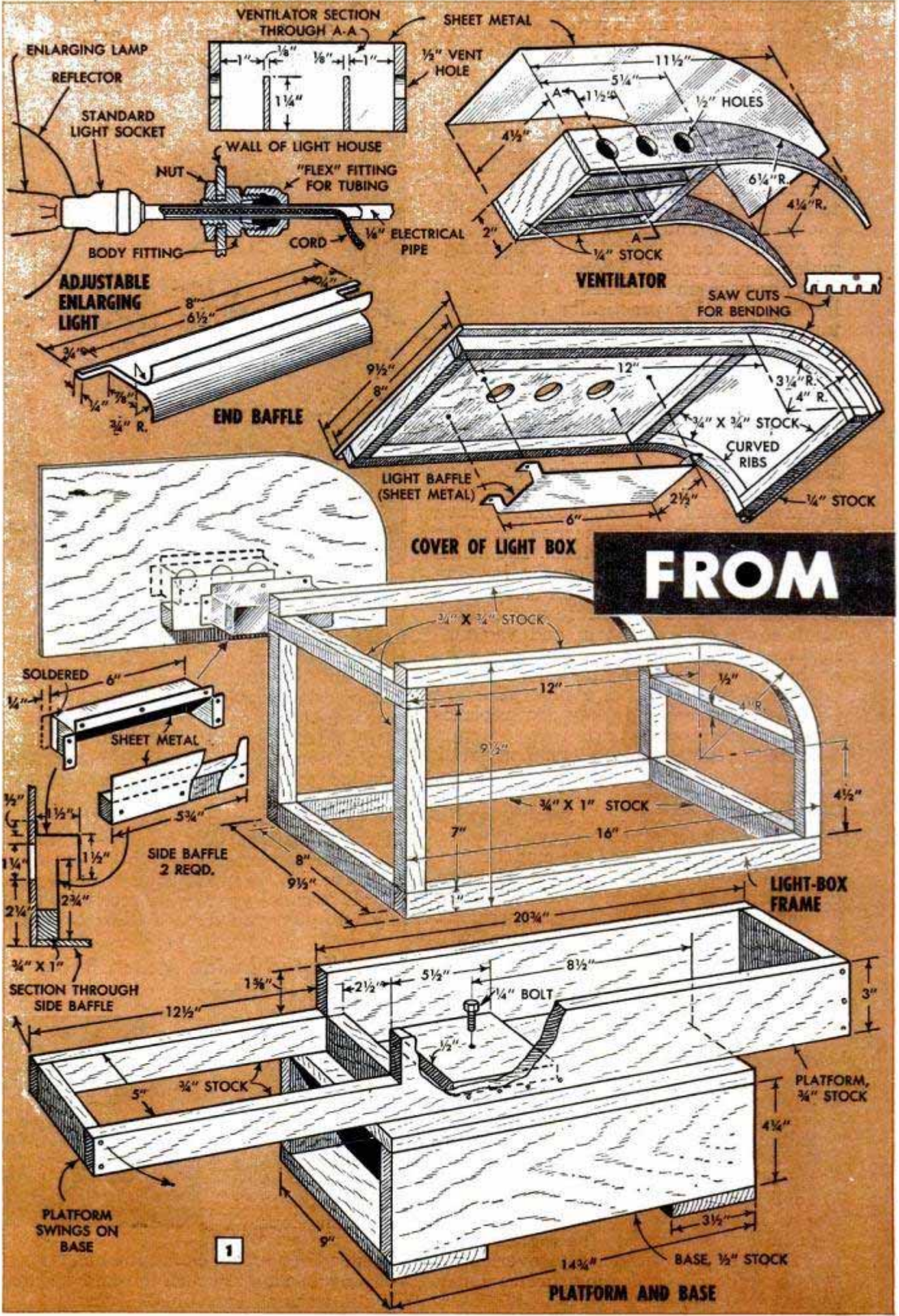



CAMERA TO ENLARGER

By Walter T. Warde

INEXPENSIVE to build, the horizontal enlarger shown in Fig. 2 utilizes an old 5 x 7 or 4 x 5 view camera as a projector. It is of the semidiffused type preferred for all-purpose work, and uses 6½-in. condensers with a diffused light source. The enlarger will accommodate negatives up to 4 x 5 in. with either of the above cameras.

Construction of the light box, swinging platform and base is detailed in Fig. 1. The curved plywood lid is saw-cut, or kerfed, to permit easy bending and is glued to the bandsawed ribs. The adjustable enlarging light is made as indicated in the upper left-hand detail, the electrical pipe being passed through a "flex" fitting. Note that the cord from the light socket runs through a hole in the side of the pipe and, in Fig. 6, that the end of the pipe is fitted with a round wooden handle. The reflector for the original unit was spun on a wood-turning lathe and satin-polished with fine steel wool. However, if a lathe is not available, a polished metal dish will serve the purpose. The enlarging lamp itself is a 175-watt opal projector bulb. The holes leading to the ventilator and those in the sides of the light box are covered with sheet-metal baffles to prevent the loss of any light. An end baffle, shown in Figs. 1 and 6, fits across the back of the light box at the cover joint to prevent light leakage at this point. The

platform and base are simple box construction, using solid stock throughout.

Fig. 3 details the condenser housing, which is made in three sections. Note that the outside of the right-hand unit is pictured and that this must be turned around when it is assembled to the center section. Strips of felt about ½ in. wide are glued around the inside edges of the 6¼-in. holes and the housing is assembled with screws to facilitate removal of the condenser for cleaning. The housing is attached to the light box with brass spring clips, and felt strips between the two units help prevent light leakage. This also is offset by the wooden baffles glued to both sides of the condenser housing.

The connecting unit, Fig. 4, serves as a slide for the revolving negative carrier. This is mounted between the condenser housing and the projection camera and must be made to fit the back of the camera. The unit is merely screwed to the condenser housing but it is both glued and screwed to the camera.

The revolving negative carrier, detailed in Fig. 5, is more difficult to make than a stationary one, but the extra effort is well worth-while when it comes to making corrections between the horizontal and vertical. The carrier is made in three sections and uses a ¾ x 4 x 5-in. wooden retainer to hold the negative against a 3¾ x 4¾-in. opening cut in a 7-in. plywood disk at the

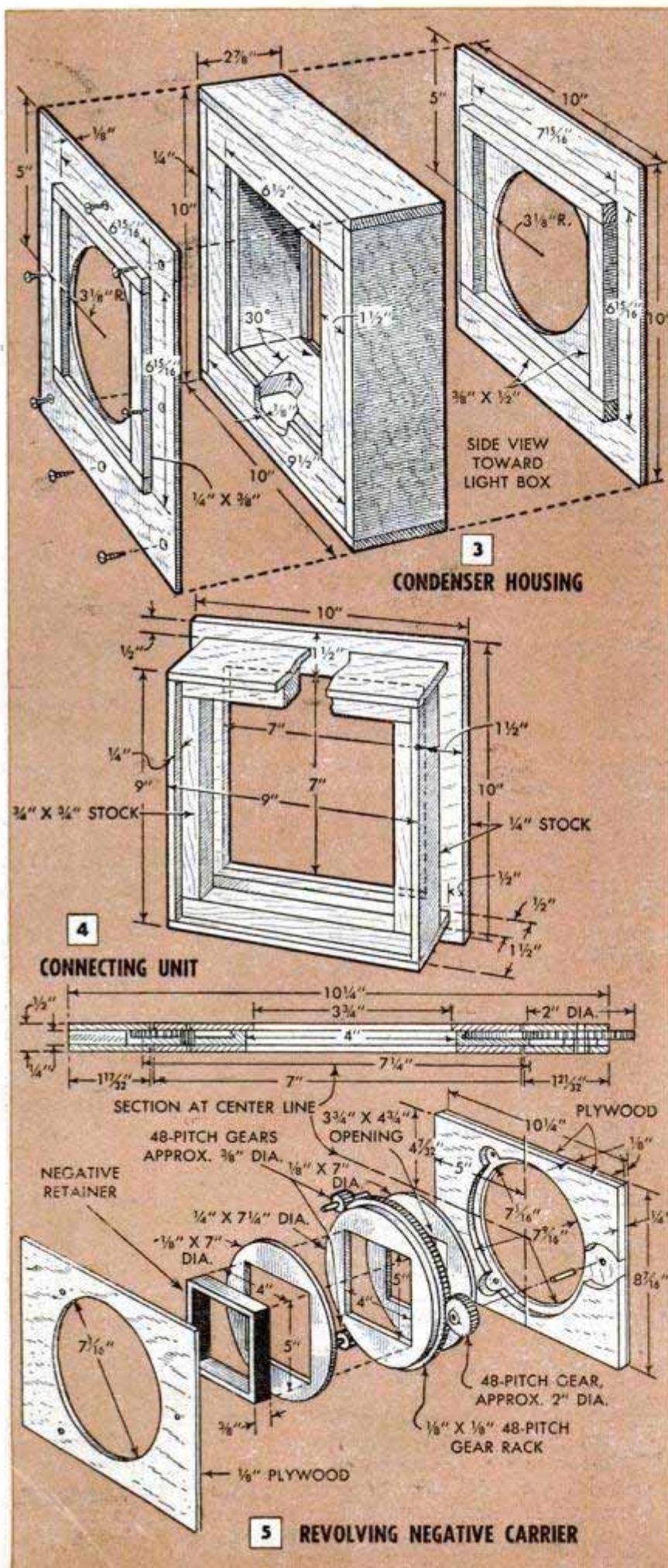

front of the unit. The two 7-in. disks of 1/8-in. plywood are glued to both sides of a center disk which is 1/4 in. thick by 7 1/4 in. in diameter. The 1/8 x 1/8-in. gear rack is bent around a 4-in.-dia. circle jig, which allows for spring, and is then screwed around the edge of the center disk so it is flush with the front face. This is done before the 7-in. disks are glued in place. The front section of the carrier is made by cutting a rectangular piece of 1/4-in. plywood to receive the center section of the three gears. After assembling the revolving unit and the gears, a 1/8-in. plywood facing, which is the same size as the rear section of the carrier, is glued over the face of the front section. The 7-in. plywood disk glued to the front of the revolving unit will fit flush with the facing piece. It is best to screw the plywood facing and rear section temporarily in place and check the operation of the revolving unit before gluing them to the 1/4-in. plywood. Some pressure should be necessary on the 2-in. gear to turn the revolving unit as, otherwise, it may slip out of position. The negative retainer is made of 1/8-in. plywood and should be a friction fit within the negative carrier.

The easel detailed in Fig. 7 features quick change of paper carriers from one size to another and from the horizontal to the vertical, micrometer accuracy in raising or lowering the paper carrier by means of racks and pinion gears, and an easily operated tilting device to permit correction of perspective distortion in the negative. It moves readily, running on four small wheels in an angle-iron track and has a positive locking device. The easel

boards are made first, using three layers of $\frac{1}{4}$ -in. plywood for both the main board and the sliding center board. To make this a snug sliding fit, a thin paper shim is sandwiched between the laminations of the main board but left out of the sliding board. The latter is grooved on the back side to receive two lengths of $\frac{1}{8} \times \frac{1}{8}$ -in. brass gear track. Accurate drilling of the sidepieces is essential so that the shaft carrying the two pinion gears permits them to mesh with the rack without binding or slipping. To lock the sliding board in position, the adjustable wheel is screwed on the shaft until tight. A tilting screw enters a tapped hole in the wooden easel base and the entire easel is tilted forward to correct distortion simply by turning the screw. Metal paper carriers, painted flat white, are available in a number of sizes at most photo-supply houses. A $\frac{3}{4} \times \frac{3}{4}$ -in. wooden cleat is fastened to the back of each carrier, using flat-headed screws driven through countersunk holes drilled in the metal. Two brass

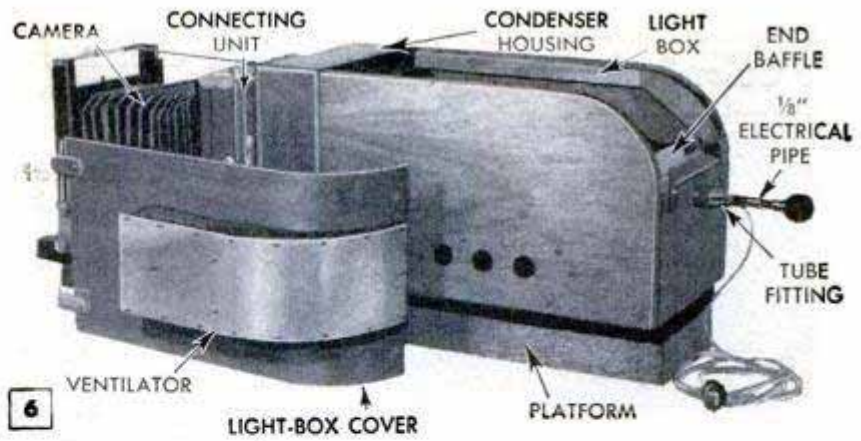

angles are screwed to the cleat so they hook snugly over the top of the sliding board between the gear racks. This permits quickly changing the paper carriers. Two carriers of each size should be used, one of them fitted for horizontal suspension and the other for vertical suspension. In this way, they can be interchanged in a moment. The easel rolls back and forth between two angle-iron rails and is locked in place by turning a knob at the base. This tightens the spring-brass track clamps over the upper portion of the rails. The clamps spring away from the rails when the tension on the knobs is released.

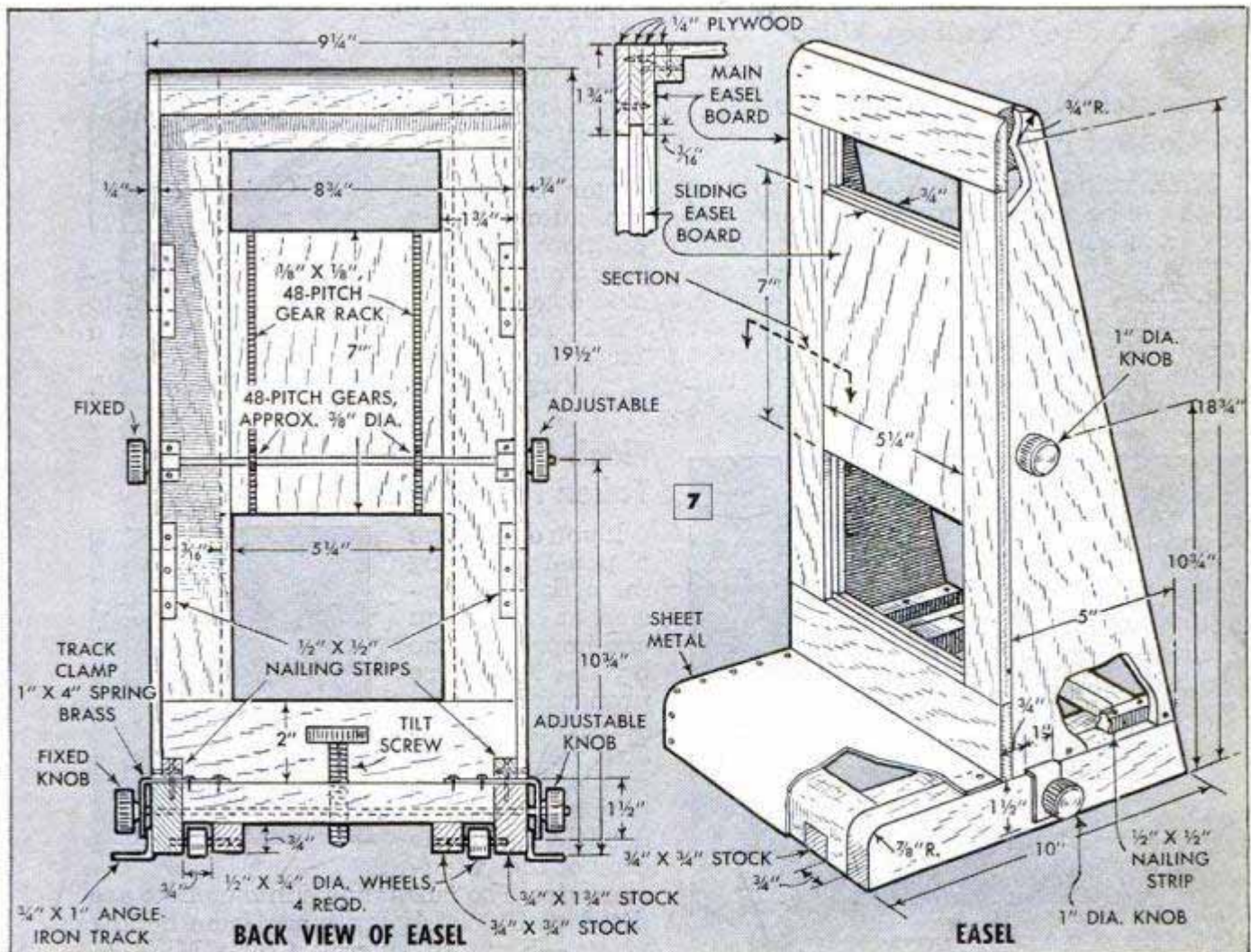

Clamps Hold Camera Back Rigid For Color-Separation Work

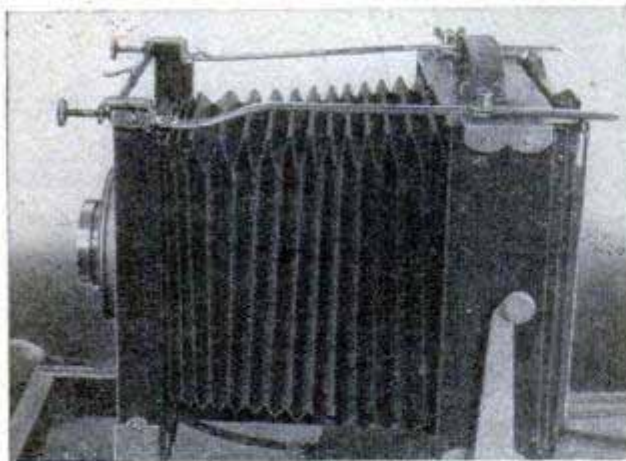

This adjustable clamp, which is made from tripod stays or braces, holds the back of a view camera rigid when it is necessary to make several color-separation negatives. The slotted arms of the stays are clamped securely to the front of the camera. Then, after focusing, thumbscrews turned into the top of the camera back are tightened over the slotted arms. This locks the back and the lens board in the same relative position and keeps the negatives in exact register.

Godfrey Lundberg, Winnetka, Ill.

Receptacle Box Has Toggle Switch To Control Photoflood Lamps

When using two photoflood lamps, many steps can be saved by turning them on and off simultaneously with a single toggle switch located conveniently near the camera. The unit is compact and inexpensive, consisting merely of a duplex receptacle fitted with a standard toggle switch and a length of power cord. A slot for the switch and a hole for the cord are cut through the

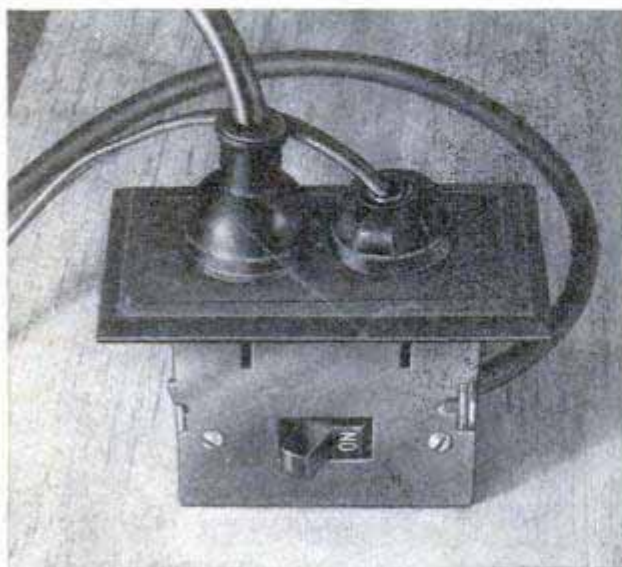

sides of the receptacle box. Then, the power cord is wired through the switch.

Richard C. Collins, Jr., Elizabeth, N. J.

Permanent Darkroom Thermometer Indicates Solution Temperatures

By immersing a thermometer in water and keeping it in the darkroom, the temperature of the photo solutions stored in the room can be noted at a glance. Although the thermometer shown is placed in a graduate, it is best to immerse it in a jar filled with water. The jar can be capped tightly so the water will not evaporate. Accurate readings are had if the thermometer is set on the same shelf, or at the same level, as the solutions.



Borderless Prints Made Quickly With Improved Easel

A fast way of making borderless prints with an enlarger is to use an empty printing-paper box for an easel. Thumb-tacked to the enlarger base, the box automatically positions the paper.

To avoid possible flare, paint the inside edges of the box a dull black and, to aid in removing the exposed print, cut a finger notch in the front of the box.

Virginia Hanson, Santa Monica, Calif.

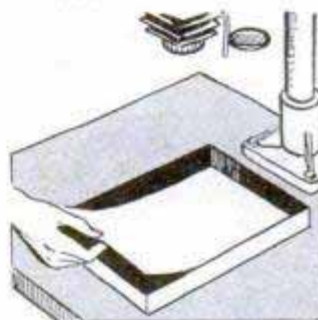

Flash-Extension Plug Jacks Taken From Radio Tube

If you don't have a pin-type plug for a flash extension at hand, you can improvise one by using the prongs from a discarded radio tube. Just remove two prongs from the tube base and solder them to the ends of the extension wire. The jacks shown in the photo are fitted with finger grips made from hollow rivets.—Kenneth Murray, Colon, Mich.



SHOP NOTES

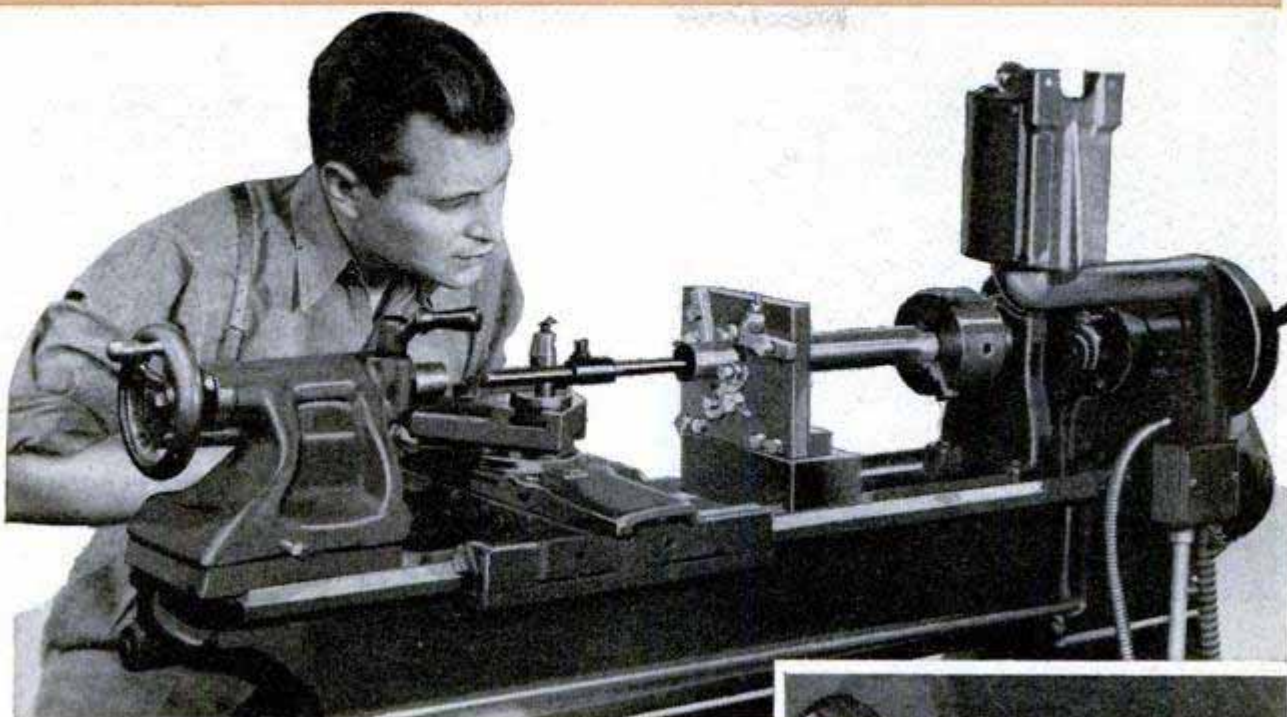

Ball-Bearing CENTER REST

By P. F. Fink

TWO SPECIAL features make this ball-bearing center rest outstanding in performance, particularly on work of small diameter. Location of the bearing-support arms provides a clamping action on the work which does away with troublesome chatter, and the rolling contact of three ball bearings eliminates friction and scoring. Adjustment screws, running down on the bearing-support arms, Fig. 1, provide a delicate slow-motion movement

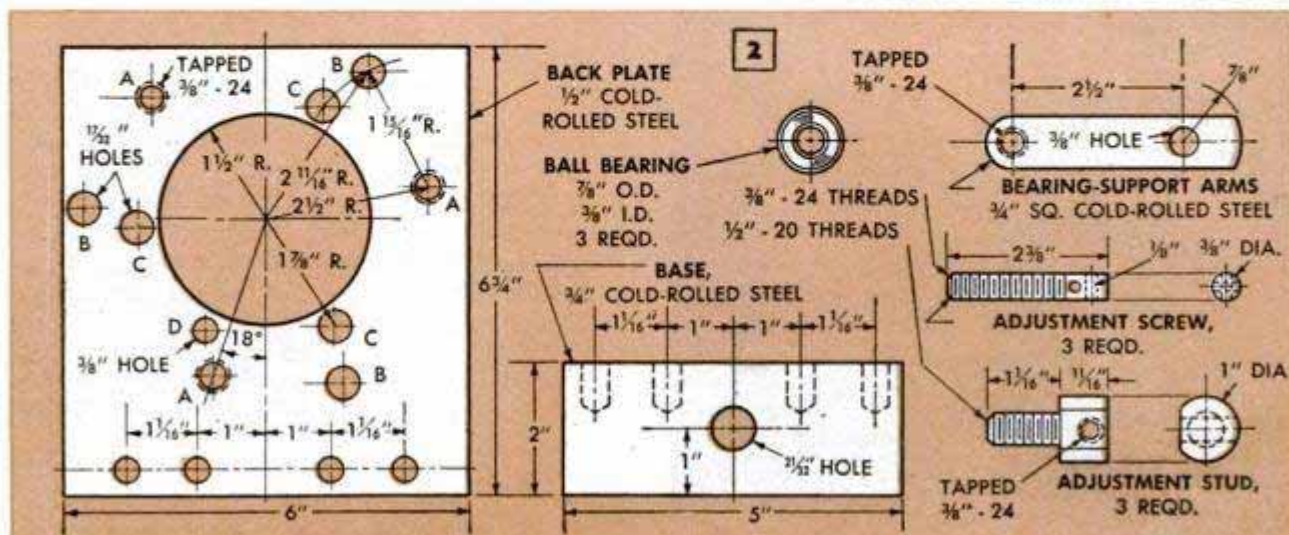
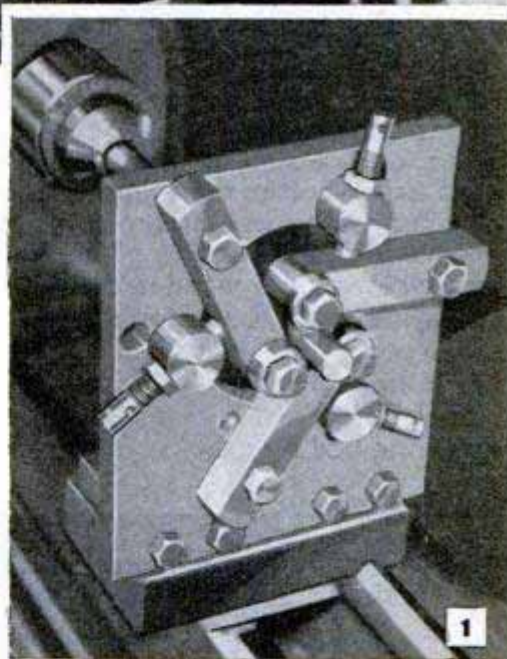

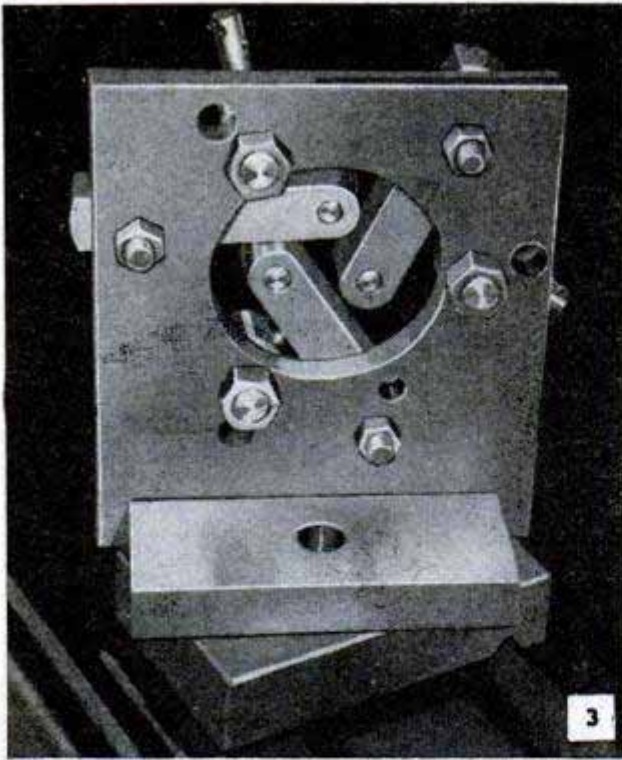

for centering the work and also adjusting bearing pressures to just the right degree. Once the work is in position, jam nuts on the screws are tightened to hold the adjustment. It has been found that an adapter plate, or subbase, of hardwood serves as well as, or better than, one of metal. This eliminates the necessity of milling a V-groove in a metal subbase. The V-groove is easily sawed in a wooden block. Length of the wooden subbase should be sufficient to cross both the V-way and the flat way of the lathe bed as in Figs. 1 and 3. When assembled, the rest is clamped in position on the lathe bed by a $\frac{5}{8}$ -in. bolt which passes

through the base, subbase and through a $\frac{1}{4}$ -in. steel clamping plate, as in Fig. 1. These parts are not detailed, as they must be made to fit the lathe on which the rest is used. Locate the center of the 3-in. hole through the back plate and then lay off and prick-punch centers of holes A, B, C and D, Fig. 2. Lay off, punch and drill the four holes at the bottom of the plate for the $\frac{3}{8}$ -in. cap screws with which it is attached to the base. Drill holes A, B, C and D and tap holes A. Then bolt the work to the lathe faceplate, blocking out for clearance and inserting the faceplate bolts through hole D and through hole C near the top of the plate. Center the plate and bore the 3-in. work hole through it. Break, or chamfer, the corners of the hole after boring so that the sharp edges do not cause injury. Drill and tap the base as detailed and bolt the parts together. Making the bearing-support arms is a simple drilling, tapping and filing job, but the adjustment studs should be turned and threaded in the lathe, after which they are drilled in a V-block and tapped. File or grind a flat on each stud to provide a seat for the jam nut on the adjustment screw. Note that two $\frac{1}{8}$ -in. holes are drilled transversely at 90 deg. through the end of each adjusting screw. In use, a small pin is inserted in these holes to tighten or loosen the screws when making adjustments. When the clamping studs are placed in the holes C, Fig. 2, the adjustment will provide for work from $\frac{1}{2}$ to 1 in. in diameter. When the arms are moved to the holes B, the adjustment range is from 1 to $2\frac{3}{4}$ in. in diameter. Ball bearings preferably should be of the grease-sealed type which are dustproof and do not require periodic lubrication.



Lettering Truck Doors Speeded With Paper Pounce Pattern

Lettering truck doors can be done more quickly if the spacing layouts are made with perforated paper patterns. Several standard layouts are sufficient to handle most any job requiring only plain lettering. The lines are drawn on heavy paper and the perforations are made with a sign-painter's pounce wheel or a dressmaker's wheel. Then the back side of the paper is sanded to remove the waste from around the holes. In use, the pattern is taped in position on the door and the layout is pounced with a bag of powdered whiting or talcum powder. In addition to saving time, this also protects the paint of the truck.

Elmer Vandrey, Truman, Minn.

☐ An ordinary salt shaker is a handy dispenser for applying lice powder to cattle. Use a large metal shaker for this purpose.

H 10-51

Hung with these novel pin-type hinges, garage doors not only may be swung both inward and outward but they can be lifted slightly for the full length of the door. This permits them to be opened outward even though there is a thin layer of ice or packed snow on the driveway. As the hinges are simply pivot pins attached to the top and bottom of the door and inserted in holes in the top jamb and sill, the weight of the door will not cause sag. Each hinge is made simply by welding a short length of 5/8-in. rod to an angle bracket. The latter, which should be 1/8 in. thick or more, can be either cut from angle iron or bent from flat iron. The top hinge pin is inserted in a hole drilled in the doorjamb header, and the bottom pin fits in a lead-lined hole in the concrete sill. After a square hole is chipped in the concrete, the end of a length of rod is wrapped with paper. This is centered in the hole and held slightly above the bottom while molten lead or Babbitt metal is poured into the hole. When the metal has hardened, the rod is removed from the hole, leaving a bearing surface for the hinge pin and also for a metal washer on which the angle bracket rotates. Before hanging a door, insert the upper hinge pin in the hole in the jamb header and hold it

Pin-Type Hinges for Swinging Garage Doors Prevent Sag and Permit Lifting to Clear Ice

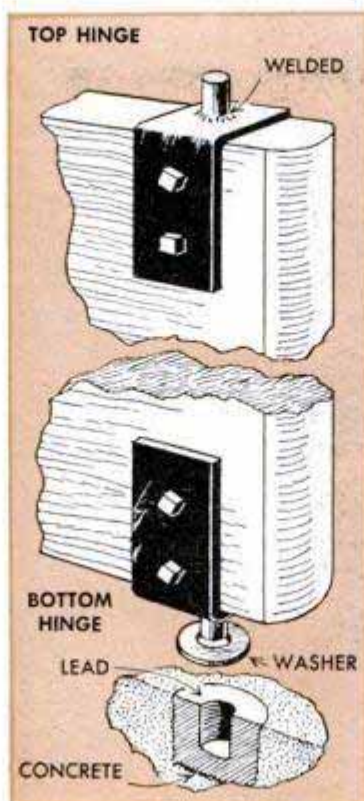

in place with tape. Then, screw the bottom hinge to the door, slip the washer over the pin and lower the pin into the hole in the sill. Using wooden wedges to prop the door in position, fasten the upper hinge bracket to the door. Note that the hinged edge of the door is curved to a radius so it does not bind, and also that some space must be allowed between the upper hinge bracket and the jamb to permit lifting the door when it is necessary to clear ice or snow. Apply a little chassis lubricant to the hinge pins to prevent rusting.

Paul Gardner, Seal Rock, Ore.

Paul Gardner, Seal Rock, Ore.

H 10-51

Improved Protractor Formed by Combining Folding Rule With Inch Scale

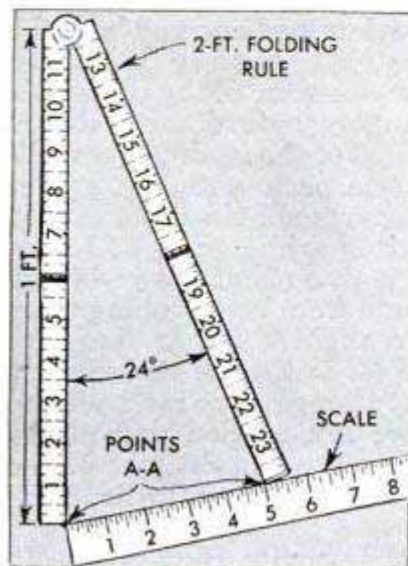

POINTS A-A	ANGLE
2 3/32"	10°
3 1/4"	15°
3 13/32"	16°
3 7/16"	17°
3 3/4"	18°
3 15/16"	19°
4 5/16"	20°
4 1/2"	21°
4 19/32"	22°
4 25/32"	23°
5"	24°
5 3/16"	25°
5 13/32"	26°
5 19/32"	27°
6"	29°
6 7/32"	30°
8"	39°
10 1/8"	50°
12"	60°

If a job requires laying out angles and you do not have a protractor handy, you can determine the angles with a 2-ft. folding rule and a scale. Just measure the distance between the inside edges of the folding rule when it is folded at an acute angle. Checking the measurements with the above table will give you the angle at which the rule is set. It is a good idea to memorize three or four of the more important angles and their corresponding dimensions on the rule, such as, 15 deg.—3 1/8 in., 30 deg.—6 7/32 in. and 60 deg.—12 in.

☞ To keep birds from eating grapes, place a length of black garden hose in the vines. The length of hose, which looks like a snake, will frighten away the birds.

Sturdy Wheel Bench for Farm Shop Made From Old Wagon Tires



Although it was originally made for use when setting metal tires and repairing wooden wagon wheels, this sturdy wheel bench has other uses in the farm shop. It's made entirely from old wagon wheel tires bent and welded to form a skeleton top, four legs and a bottom brace. The legs can be welded to the top members and brace, or they can be bolted in place to permit dismantling.—Charley Cole, Graham, Ala.

Acetone Aids Drying Glassware

To dry laboratory glassware quickly, rinse with acetone after washing. The acetone evaporates rapidly leaving a dry surface, and the excess that drains off the glass can be retrieved for future use. Remember to keep the acetone away from an open flame.—Helen Lemberger, Chicago.

Renewing Stripped Brass Fittings

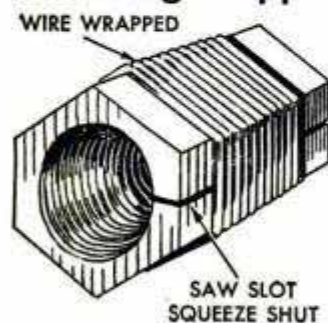

When threads of a brass fitting on an engine gas or oil line are stripped, it is, of course, best to obtain a new fitting. However, if a replacement of the proper size cannot be found, the old fitting can be repaired for further service. To renew the fitting, cut it lengthwise with a hacksaw and squeeze it to close the slot. Then bind the fitting neatly with brass wire and

sweat-solder it in place. If the wire is wrapped carefully, a wrench still can be used for tightening and removing the fitting.—Ed Packer, Chicago.

U-Shaped Rod Prevents File Nicks When Sharpening Cordwood Saw

File nicks in the gullets between the teeth of a cordwood saw often are responsible for cracks and breakage. Slipping a U-shaped rod into the gullet will effectively prevent the file from nicking the adjacent tooth.—G. E. Hendrickson, Argyle, Wis.

Ratchet-Grip Stud Wrench Does Not Mar Surface

Removing or installing heavy studs without leaving wrench marks on the unthreaded sections is no trick at all with this special ratchet-grip wrench. The wrench consists of only three parts and can be made any suitable size. A single piece of tool steel slotted through and shaped in profile as indicated in the side view above forms the swinging jaw. The ratchet jaw, which is part of the handle, is notched on

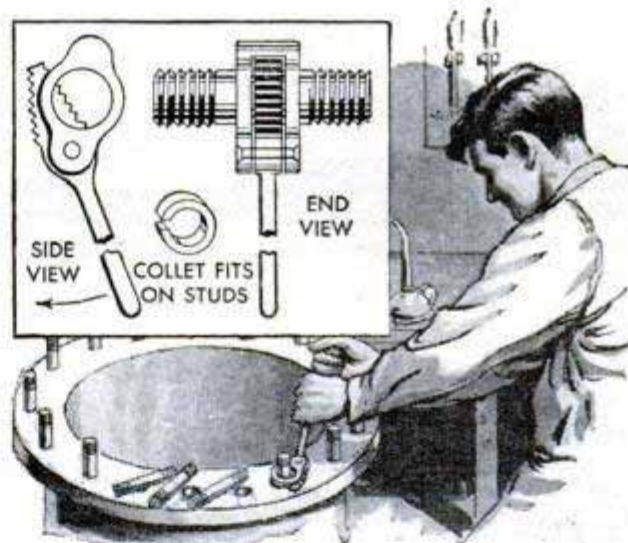

both sides at the flattened end and both the swinging and ratchet jaws are drilled for a pivot pin. The diameter of the large hole through the swinging jaw ordinarily should be about twice that of the stud. After drilling and fitting the parts with the proper clearance, both parts should be hardened to prevent burring while in use. In assembling,peen both ends of the pivot pin. The collet is made from brass tubing of an inside diameter slightly larger than the diameter of the stud. To use the wrench, the collet is first slipped over the stud and the wrench jaws are opened and placed over it. Swinging the ratchet jaw of the wrench causes the collet to grip the body of the stud tightly.

Louis E. Lebovitz, Burlington, Vt.

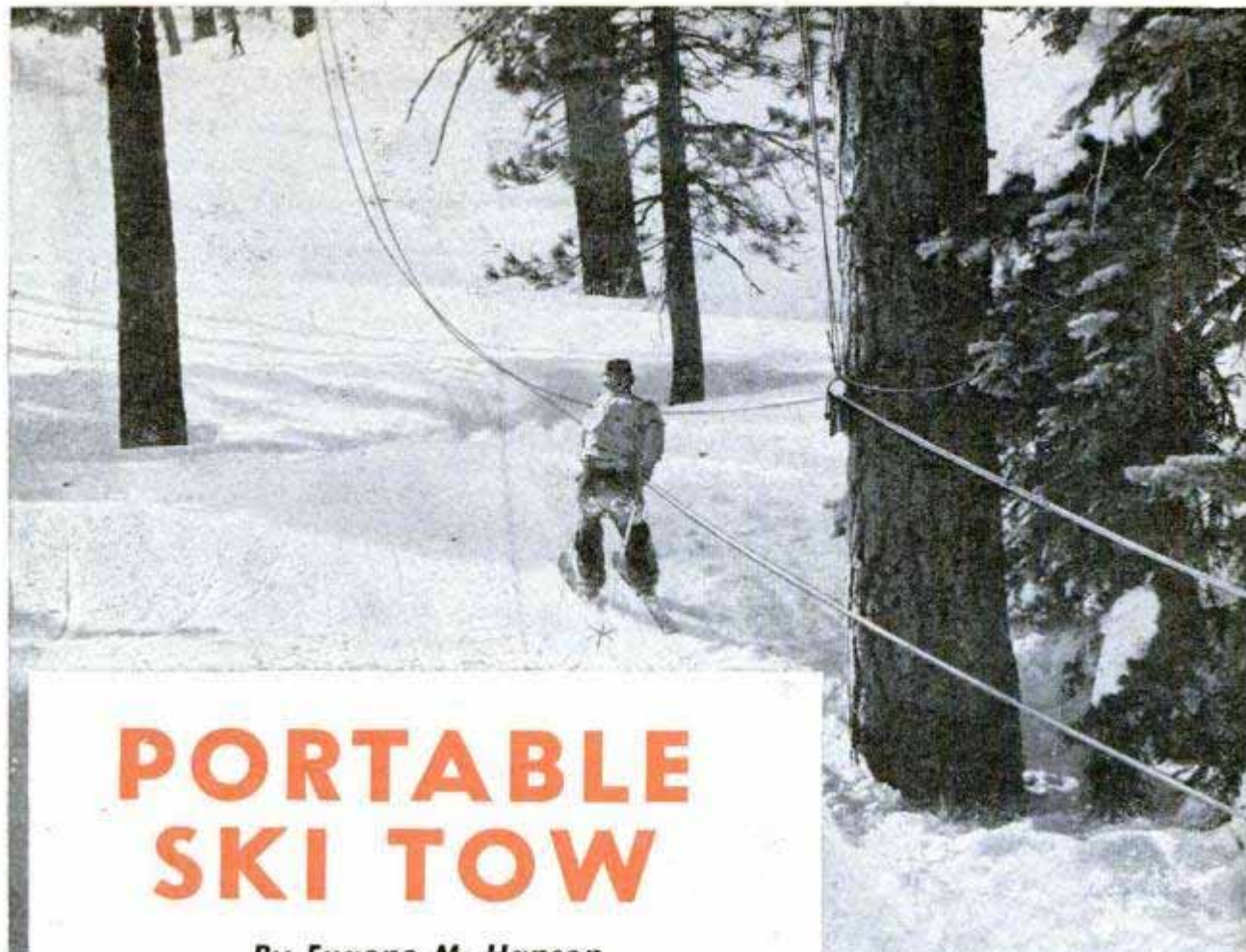

PORTABLE SKI TOW

By Eugene M. Hanson

A PORTABLE ski tow that can be set up for a group of skiers wherever and whenever skiing conditions are best takes care of the uphill transport problem at a minimum cost. The power unit, Fig. 1, is mounted on skids so that it may be either blocked or bolted onto an ordinary toboggan for easy transport over soft snow. In use, the unit is anchored on the slope and the endless loop of $\frac{1}{2}$ -in. rope is unrolled down the hill to its full length. Flanged sheaves, Fig. 4, already on the rope, are

Photos by Cecil Charles

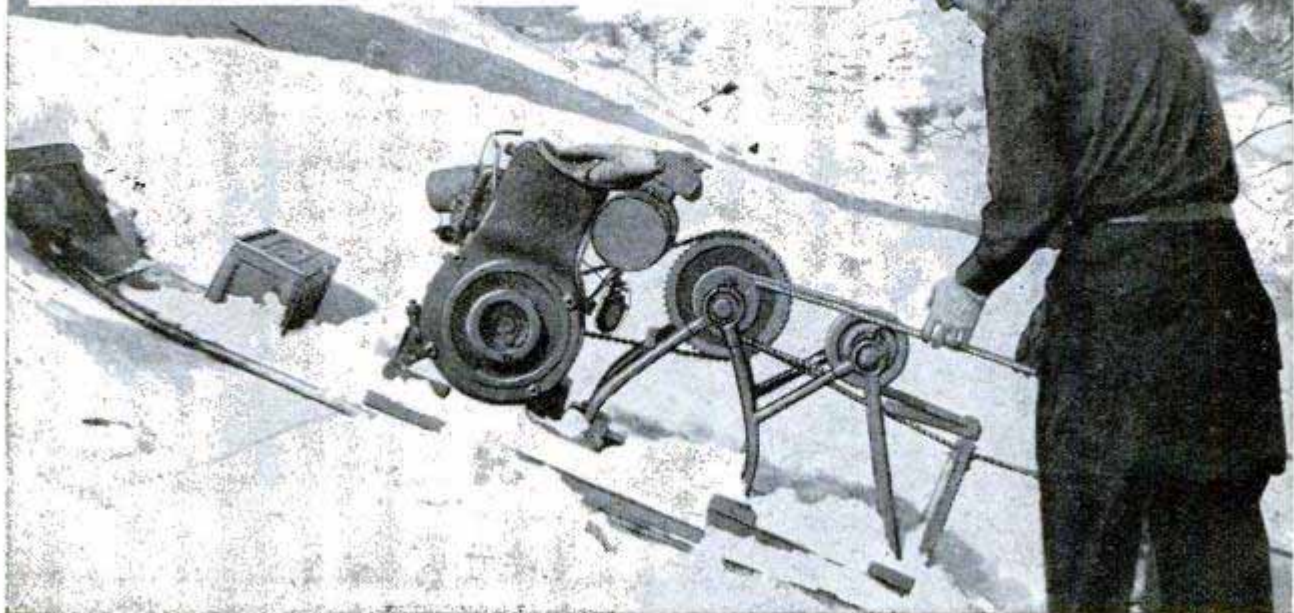

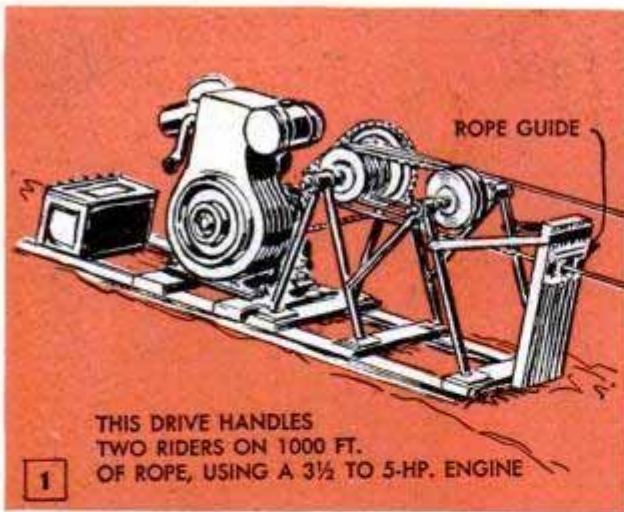

THIS DRIVE HANDLES TWO RIDERS ON 1000 FT. OF ROPE, USING A 3 1/2 TO 5-HP. ENGINE

The self-contained power unit is mounted on skids which can be bolted or blocked on ordinary toboggan

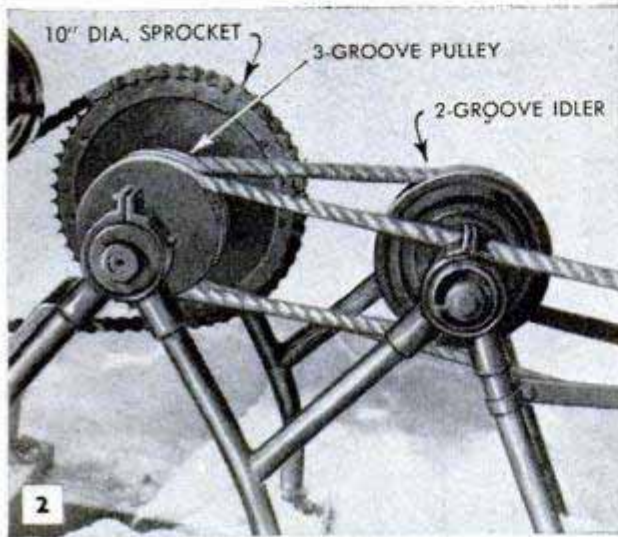

Rope-drive mechanism is arranged to give double purchase in manner quite similar to a tackle block. This type drive prevents slippage and fraying of rope

attached to trees that happen to be fairly close in line. A single sheave at the looped end of the rope is spring-tensioned to take up excessive slack, thus preventing long sections of the rope from dragging in the snow and increasing the load on the engine. The rope drive is arranged as in Figs. 1, 2 and 3 to give a double purchase over V-pulleys in a manner similar to that of a tackle block, eliminating slippage even when the rope is snow-covered. Coating the rope with pure beeswax protects it from rapid deterioration and fraying. Driving from a 2-in. sprocket on the engine through a roller chain to a 10-in. sprocket on the rope drive gives the tow a moderate and safe rate of travel. Of course, a V-belt drive also will operate satisfactorily and is somewhat less expensive.

The drive-shaft and idler-pulley assemblies are carried on a double A-frame made up from 1-in. pipe as in Fig. 3. Lengths given for the various pieces of pipe required are only approximate as some grinding and filing will be necessary in fitting the parts preparatory to welding. Pipe tees are turned tightly onto four of the slanting uprights, two of the short ones and two of the long ones. Ends of the four remaining uprights are filed to fit the contour of the tees so as to form a rigid welded joint. The tees are reamed for bronze bushings and each is drilled and tapped for a setscrew which holds the bushing in place. For convenience in lubricating the bearings, each one should be provided with a grease fitting. Collars placed either inside or outside of the bearings take up any end play in the shafts. The lower ends of six of the slanting uprights are welded to pads cut

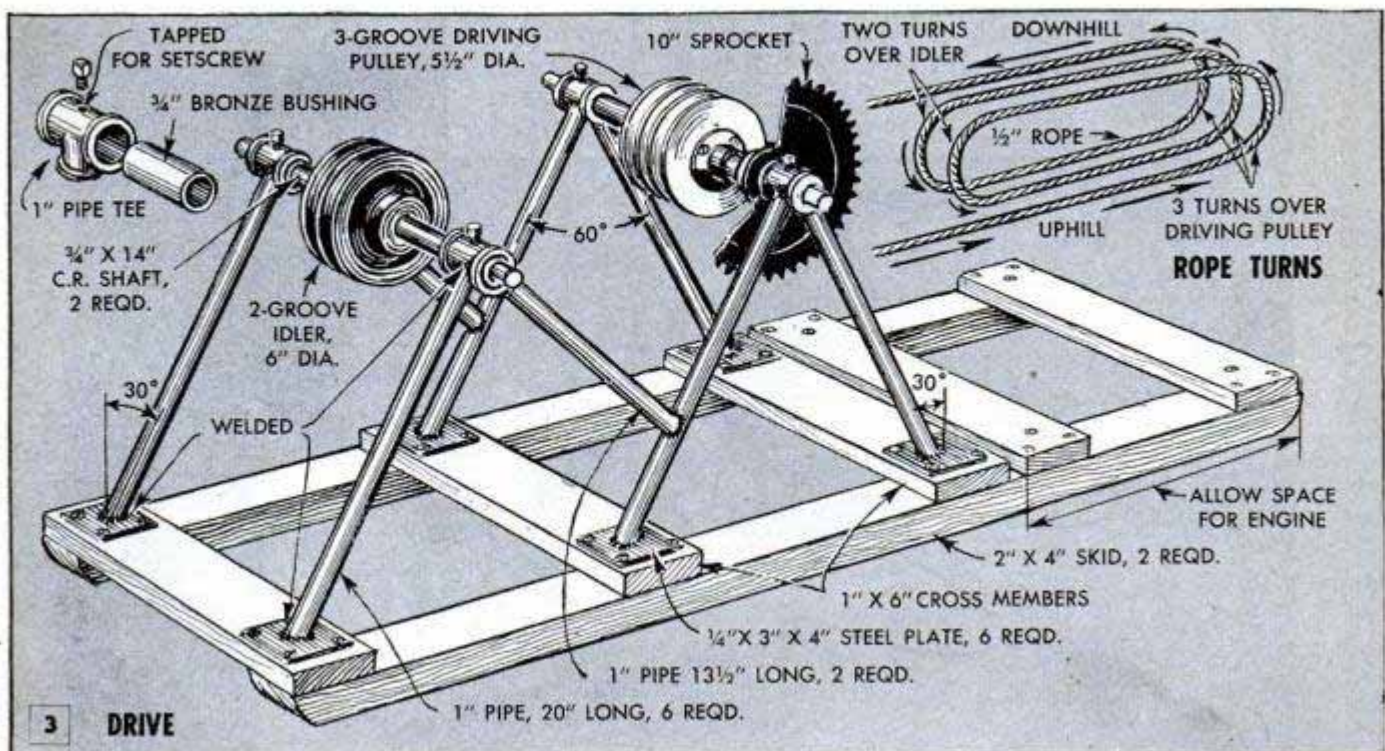

3 DRIVE

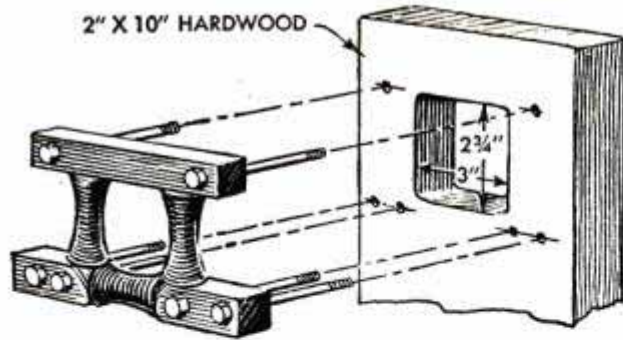

ROPE-GUIDE ASSEMBLY

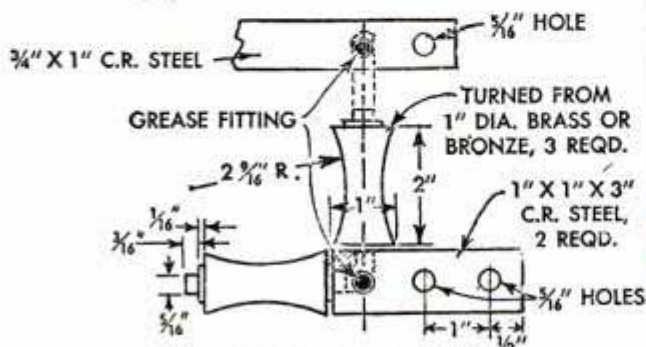

ROPE-GUIDE DETAIL

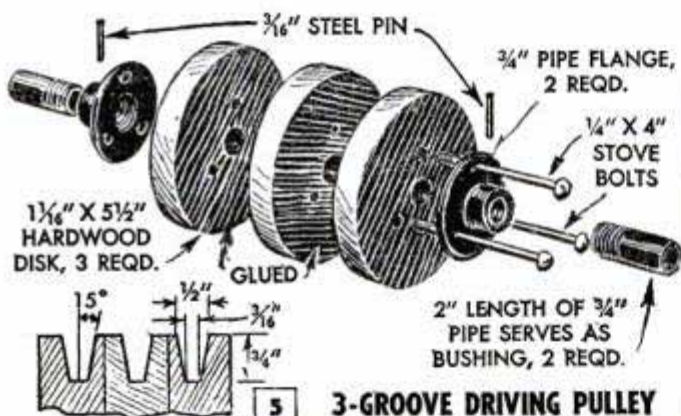

3-GROOVE DRIVING PULLEY

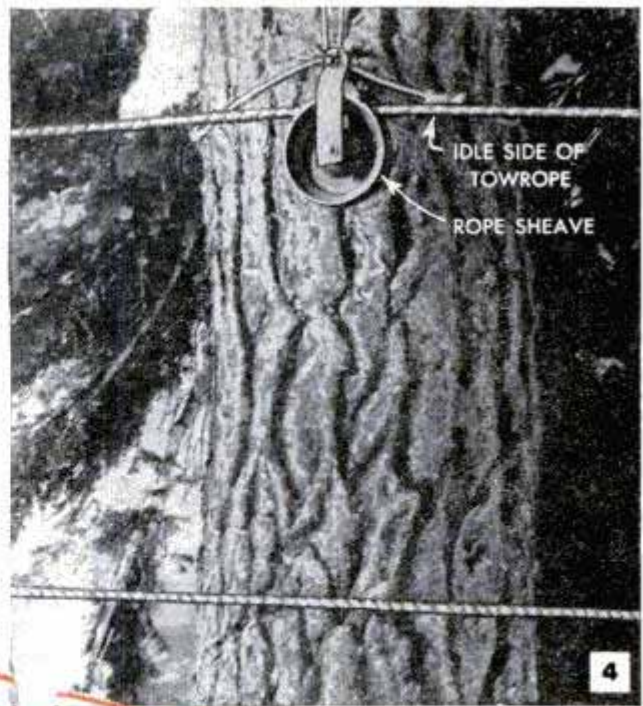

from 1/4-in. steel. The pads are drilled so that they may be screwed or bolted to the wooden cross members of the skid frame. When assembling, be sure that the shafts are parallel and that they turn freely in the bearings. It may be necessary to bend the supports slightly to align them after welding has been completed.

Fig. 5 details the rope guide and the 3-groove driving pulley. Both are simple lathe jobs. Three 1 1/8-in.-thick hardwood disks are glued together to get the required width for the 3-groove pulley. After turning and grooving in the lathe, the pulley is center-drilled for the shaft and also for three stove bolts, equally spaced. These bolts pass through 3/4-in. pipe flanges which form the pulley hub. Short lengths of 3/4-in. pipe screwed into the flanges serve as bushings to true the pulley on the shaft. Note that both flanges are pinned to the shaft. The pins pass through the flange, pipe

bushing and shaft and should be a fairly tight, drive fit. The rope guide is assembled from short lengths of cold-rolled steel, a length of 2 x 10-in. hardwood and three rollers turned down from 1-in.-dia. brass or bronze. Two of the rollers are mounted vertically and one horizontally as shown in Fig. 5. It will be necessary to turn the rollers to the dimensions given as these are not stock items. All three are identical in size. Install grease fittings in the positions indicated so that the rollers can be adequately lubricated. Use a 3 1/2 to 5-hp. engine of the self-contained air-cooled type. In setting up the unit for use for the first time, lead one end of the rope through the guide, over the pulleys as in Fig. 3 and through at least three flanged idler sheaves, Fig. 4, and the spring-tensioned end sheave around which the loop passes at the bottom of the slope. Then splice the rope in an approved manner to make a smooth splice that will pass through the sheaves and over the driving pulleys. Locate the tow so that skiers coming up on the rope can release it and ski away on snow which is fairly level.

Corners Cut From Cardboard Box Align Paper When Stapling

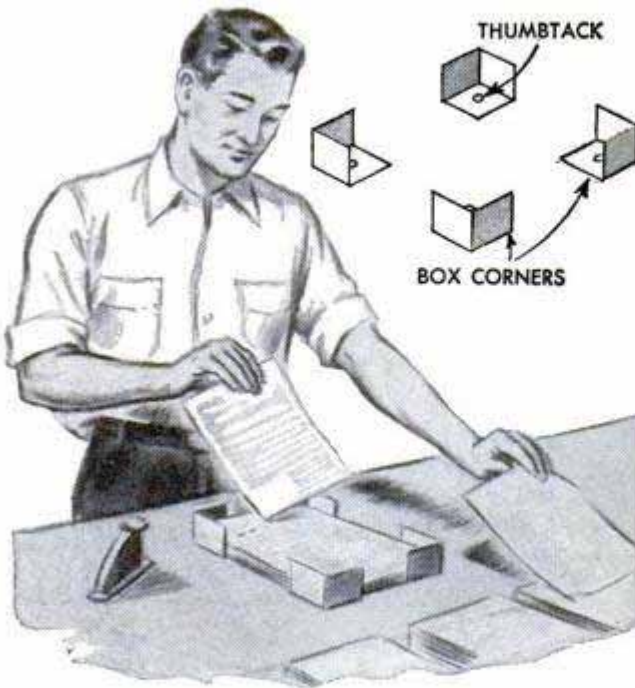

Stapling together sets of printed forms or instruction sheets is speeded considerably if the sheets are sorted and aligned for stapling in the same operation. This can be done simply by placing the sheets in a jig made from cardboard box corners. The corners are cut as indicated, spaced so they will contain the sheets in a neat pile and fastened to the table top with thumbtacks.

Opie Read, Jr., Chicago.

Wooden Wheels on Farm Wagon Adapted for Rubber Tires

One farmer converted the wooden wheels on his wagon to rubber-tired ones at little cost. He obtained some old auto-wheel



rims and cut off the wagon-wheel spokes to the same diameter as the inside of the rims. After drilling the necessary holes through the rims, he fastened them to the spokes with wood screws.

A. M. Wettach, Mt. Pleasant, Iowa.

Concrete Splash Block Under Pump Keeps Well Platform Dry

To keep a well platform dry, one farmer set a concrete splash block directly below the pump spout. The center of the block is concave to form a bowl and the water is drained through a length of pipe entering the bottom of the bowl. The block



can be cast in a mold dug in the ground, a mound being left in the center of the hole to form the concave portion of the block. After the concrete has set, the block is lifted from the mold and is ready for use.

Baiting Coyote Traps

When the bait for a coyote trap is placed on the ground, the clever animal often evades the trap and steals the bait. To overcome this, some trappers hang the bait from a tree limb so it is directly over the trap and almost out of the coyote's reach. This forces the animal to jump several times for the bait and, in doing this, he will usually step into the trap.

William Allen Ward, Dallas, Tex.

Green Feed Grown in Poultry Yard Protected With Hardware Cloth

Small grain sown in a cultivated section of the poultry yard will continue to produce green feed for some time if the planted area is protected with a hardware-cloth screen immediately after sowing.

The hardware cloth is stretched across a wooden frame made from 1 x 4-in. stock. This keeps the chickens from scratching up the seed before it has had time to sprout, and also permits the poultry to eat only that portion of the feed which grows above the wire screen.



CHASSIS CHATTER

Giant C-Bracket on Chain Hoist Speeds Installing Truck Engine

Made from old plow beams, this adjustable C-bracket simplifies engine removal and installation in cab-over-engine trucks. The arms of the bracket are bolted together with steel plates or lengths of angle iron, the distance between them depending upon the height of the cab over the engine opening. The hoist can be moved along the upper arm to balance engines of varying weights and sizes, and the lower arm is bolted to the top of the engine.

L. H. Houck, Jefferson City, Mo.

Oilcan for Priming Carburetors Has Special Safety Features

To introduce gasoline into a carburetor after an engine overhaul, one mechanic uses this specially fitted oilcan to do the job safely. First, a piece of very fine mesh copper screening is soldered over the threaded end of the spout to prevent possible flash back. Then, to make sure no one tries to oil machinery with gasoline, a cotter pin is soldered over the small end of the spout. This prevents the spout from being inserted in an ordinary oilhole. Finally, the can is painted red as a warning.

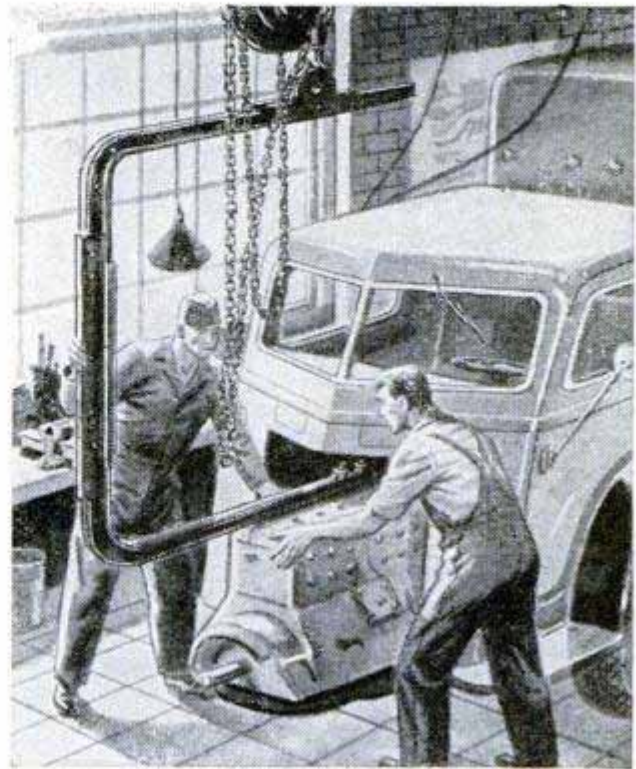

Fumes Piped From Valve Cover

Exhaust fumes escaping from the vents in the overhead-valve cover were seeping into my car causing considerable annoyance. I corrected the trouble by soldering the vents closed and piping

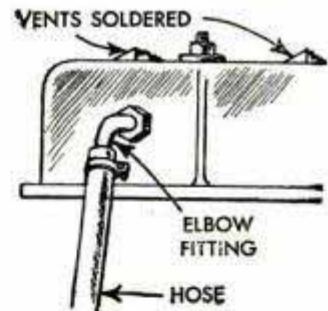

the fumes to the underside of the car. A 90-deg. elbow fitting mounted in the side of the valve cover toward the rear of the engine permitted attaching a 4-ft. length of garden hose. The hose was clamped to the fitting and the free end wired to the car frame.—W. F. Kearney, Seattle, Wash.

Keeping Spark-Plug Contacts Clean

If you twist spark-plug caps several times whenever the hood is raised, the contact surfaces will remain clean, insuring the delivery of full current to the plugs.—R. Hertzberg, Jackson Heights, N. Y.



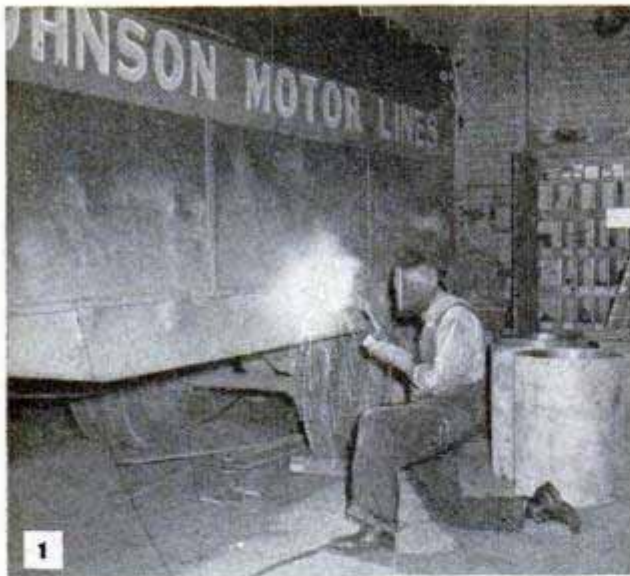

Arc welding offers a quick and economical method for making repairs on automobile and truck frames

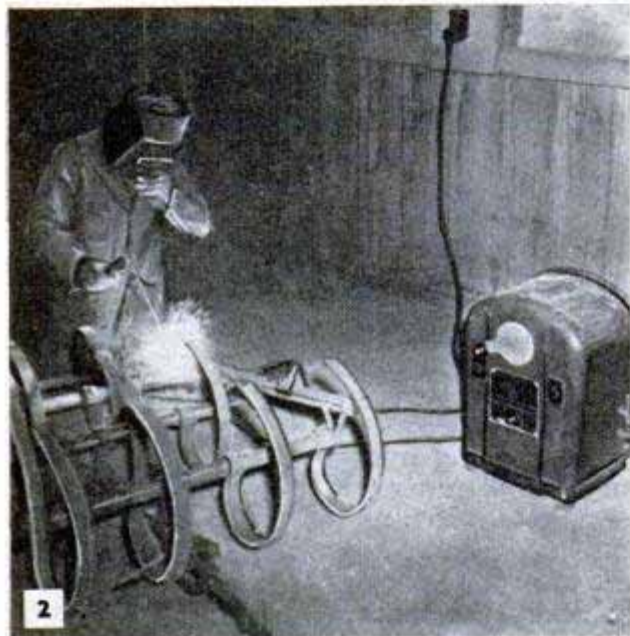

Above, repairing spring-tooth harrow with 180-amp. a.c. welder. Below, using portable d.c.-type welder for on-the-spot repairing of tandem disc harrow



ARC WELDING for beginners

By A. E. Youngquist

PART 1

METALWORKING industries have for many years used electric arc welding as a means of fabricating metal parts. Recently this fast and economical method of joining metal has been made available to the home craftsman, job shop, garage owner and farmer in the form of small arc-welding machines, which cost no more than average home-workshop power tools.

Basically, an arc welder is a tool for making things of metal which is used in much the same way as screws, bolts, nails or glue are used when working with wood. A weld properly made is as strong or stronger than the metal which is welded and, in addition, it can be made watertight or airtight. Although welding machines are used principally for joining metals, the heat of the welding arc often is employed for cutting. Heating small metal parts for bending, forging and heat treating is another use for the versatile welder.

Welding machines are of two general types—those that supply an alternating welding current, which are commonly called a.c., and those that supply direct welding current, called d.c. Most a.c. machines have transformers designed and built for a specific current input. For example, the machine shown in Fig. 6 A will supply a maximum of 60-amp. welding current when connected to a 110-volt power line protected with a 30-amp. fuse. This low current input makes a welder of this size an ideal machine for the home craftsman when repairing such equipment as the lawn mower, shown in Fig. 4, or when building new things of sheet metal, pipe and light structural iron. The garage mechanic or sheet-metal worker will find a welder of this size very useful for repairing

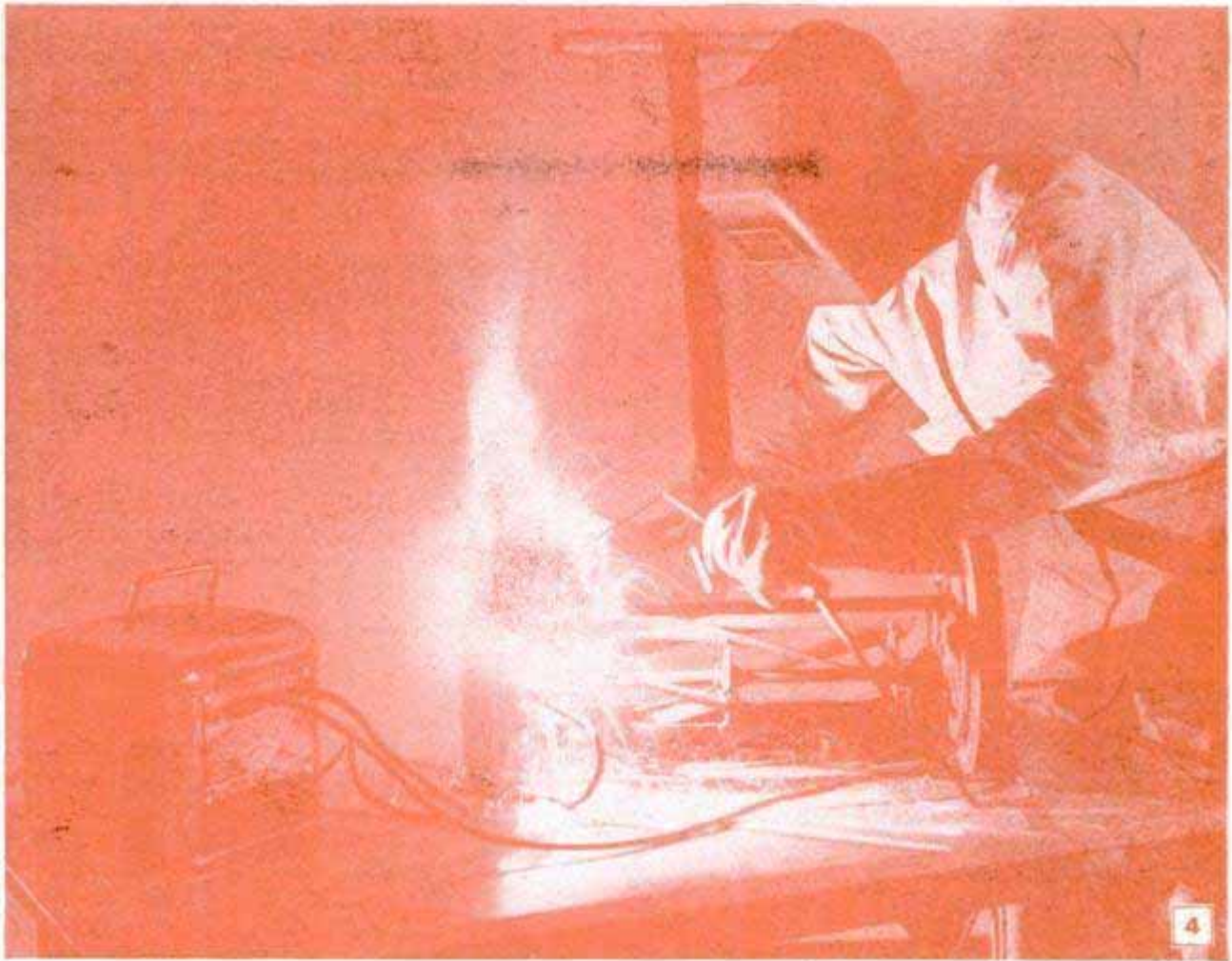

Small 60-amp. welder is ideal for home craftsmen when repairing or making things of metal around the house

damaged car bodies and fenders made of material as thin as 20 gauge. The machine, shown in Fig. 6 B, is also an a.c. transformer type having a rated output of 180-amp. welding current. Since it draws only a maximum of 37.5 amp. from the power line, this welder can be used on most 230-volt rural power lines having a power-line transformer of 3 kva or larger. A welder of this size is sufficiently large to handle all types of farm welding, Fig. 2, automobile and truck repair work, Fig. 1, and light manufacturing.

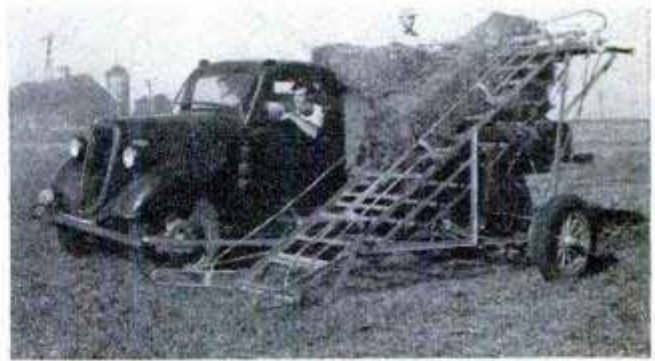

180-amp. welder is sufficiently large to handle all farm welding jobs from the building of a baled-hay loader, above, to making small repairs on a hand rake, below

A d.c. welder consists of an electric generator, which produces d.c. for arc-welding. It is driven either by an electric motor or a gasoline engine as shown in Fig. 6 C. Although higher in initial cost, the engine-driven d.c. welder has a distinct advantage over an a.c. transformer-type welder in that the d.c. generator is not dependent upon an outside source of electrical energy to produce the welding current. This makes it self-contained and, therefore, portable. When mounted on wheels, Fig. 3, the engine-driven d.c. welder can be towed to the location of the job to be welded. Thus, it is especially useful for farmers and job-shop operators for repairs on large-size machines which

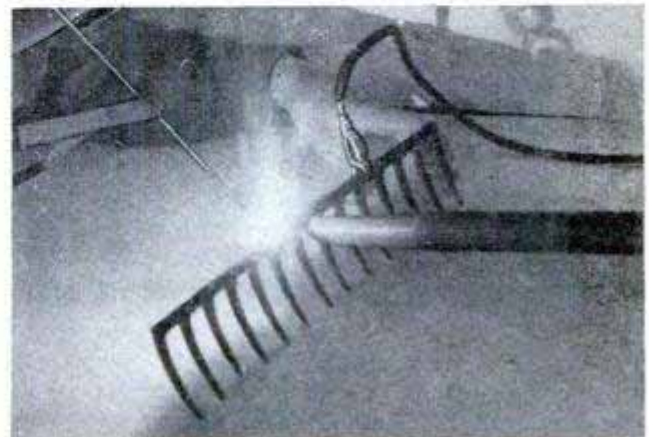

Int'l. - Inverness Elec. Co.
13010 Cit. Rd.
Cleveland, O.

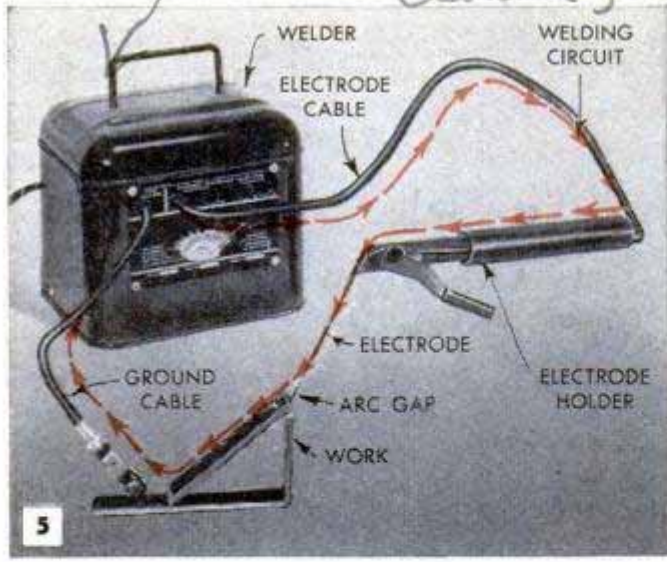

Red arrows indicate path of current, or welding circuit. If welder is a.c. type, direction of current alternates or reverses each time current flow makes complete cycle

cannot be moved, or for doing emergency repair work on farm equipment out in the field, as shown in Fig. 11.

Regardless of the type of arc-welding machine used, the metal being welded must become a part of an electric circuit. To do this, the ends of two insulated flexible cables are connected to terminals on the welding machine or, if the machine is the type shown in Fig. 5, the cables are connected with jack and plug fittings on a control panel. The other end of one of these cables is connected to the work to be welded and this is known as the ground cable. The other end of the second cable, known as the electrode cable, is connected to an electrode holder, which is held in the operator's hand. An electrode, or welding rod, which is a metallic rod incased in a flux coating, is clamped in the electrode holder. When

6 TYPES OF WELDERS



A 60-AMP. A.C. TRANSFORMER-TYPE WELDER



B 180-AMP. A.C. TRANSFORMER-TYPE WELDER

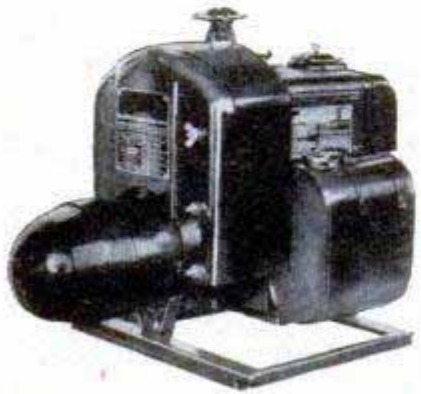

C 180-AMP. D.C. ENGINE-DRIVEN WELDER

7 PROTECTIVE CLOTHING



8 TOOLS AND ACCESSORIES

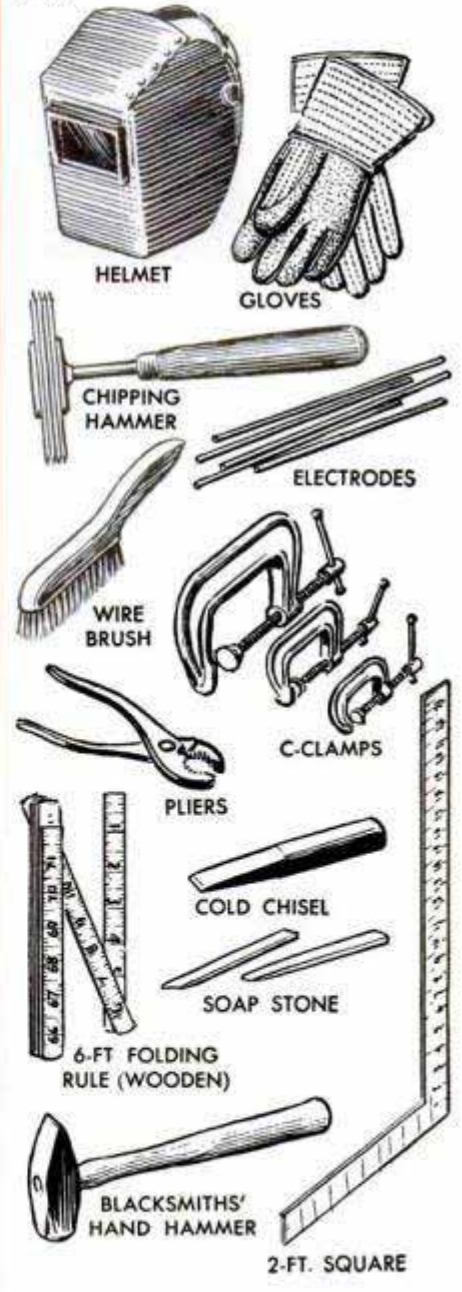

welding, the electric current flows from the machine to the electrode holder and through the welding rod. As the tip of the rod is brought momentarily in contact with the work and then immediately raised to form a small gap between the work and the rod tip, the current jumps the small gap and the welding arc is created. The current is then carried through the metal of the work and back to the welding machine through the ground cable as shown in Fig. 5. This is called the welding circuit.

As the heat of the welding arc is very intense and highly concentrated, it is ideally suited for its purpose because the arc can be directed and confined to only that area of the metal being welded.

Fundamentally, arc welding is accomplished by heating the adjoining edges of the workpieces to the melting point and then adding enough molten metal from the electrode to reinforce and fill up any gap or space between the parts being welded, Fig. 10. To learn how to arc-weld, an understanding of what happens within the arc, Fig. 9, is necessary. The moment an arc is struck between the tip of the electrode and the base metal or work, a small pool of molten metal is formed directly beneath the electrode tip. This pool is called the crater, the depth of which is the distance the weld extends into the work and is known as the penetration of the weld. Simultaneously with the formation of the crater, the tip of the electrode is melted and forced across the arc into the crater where it combines with the base metal to form the weld. As the welding rod melts, a portion of the flux coating burns off, forming a gaseous smoke screen which envelops the arc, thereby protecting the molten metal from contamination by the oxygen and nitrogen present in the surrounding atmosphere. The remaining portion of the flux coating melts and is carried to the crater where it combines with any impurities in the molten metal. This action results in a slag which floats to the surface of the molten weld metal and solidifies as the weld cools. The slag coating thus formed covers the deposited weld metal and further protects it from the atmosphere as it cools.

Many different chemicals are used in compounding the flux coatings. Some coatings contain as few as five different chemicals, while others contain as many as

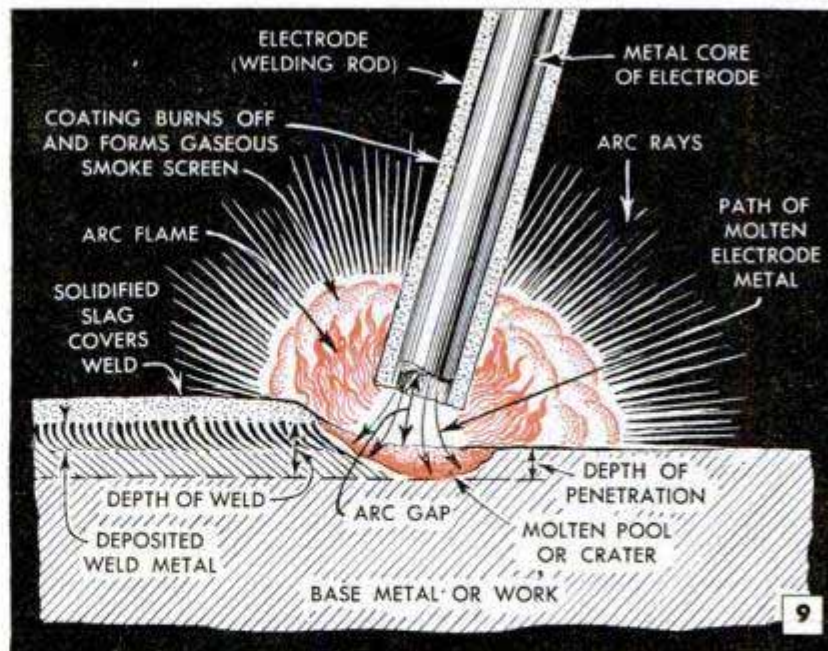

thirty-five. The type of flux coating largely determines the operating characteristics of the electrode; for example, its stability, position of the rod in relation to the work, penetration of the weld metal into the work and the shape of the finished weld making it either concave or convex. Another important operating characteristic determined by the rod coating is polarity. When the electrode cable is connected to the negative terminal on a d.c. welder, the polarity is known as "electrode negative." If the electrode cable is connected to the positive terminal, the polarity is said to be "electrode positive." Some electrodes will operate only on one specified polarity, while others will operate on either polarity. Electrodes used with a.c. welding machines must be the type that will operate with either polarity since a.c. alternates from negative to positive each time the flow of current makes a complete cycle. Therefore, a.c. electrodes can be used with d.c. welders on either polarity. However, d.c. electrodes

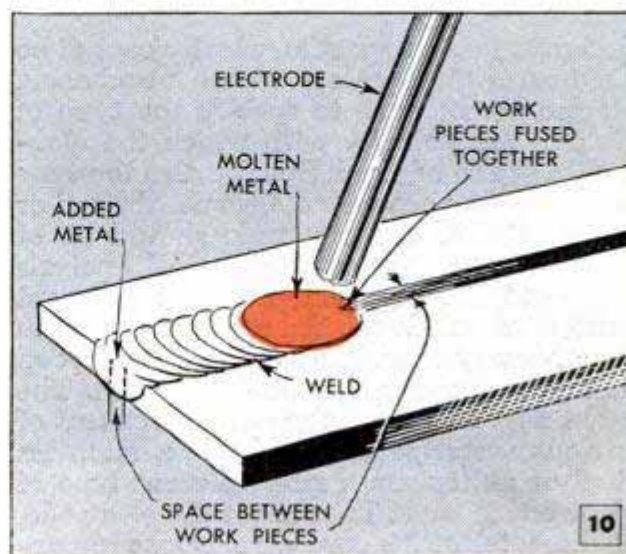

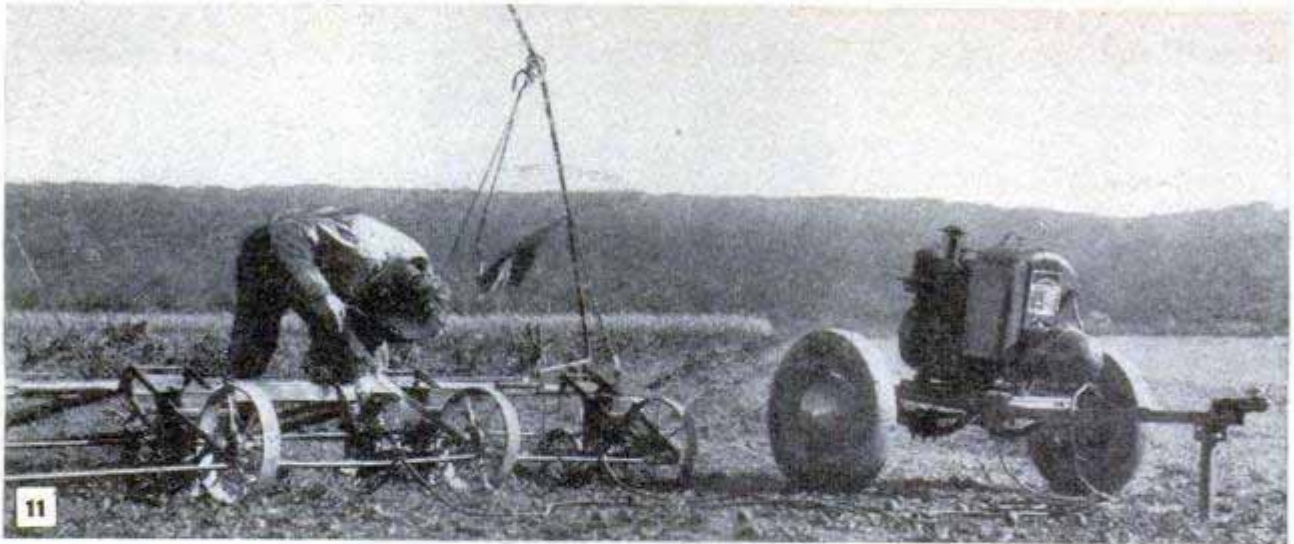

Gasoline-engine-driven d.c. welder mounted on auto front-axle assembly can be towed to location of the job

12 MATERIALS USED TO MANUFACTURE FARM EQUIPMENT	TYPE OF STEEL			
	Low Carbon	Med. Carbon	High Carbon	Cast Iron
SHEET METALS (FENDERS ETC.)	X			
ANGLE IRON	X			
PIPE (PLUMBING)	X			X
MACHINERY FRAMES (AGR'L)		X		
HARROW DISCS			X	
HAYRAKE TEETH			X	
FORGINGS	X	X		
PLOW SHARES			X	X
FILES AND CHISELS			X	
ROUGH GEARS AND SPROCKETS		X		X
MOWER WHEELS				X
ENGINE BLOCKS AND HEADS				X
FURNACE GRATES AND BOWLS				X
I-BEAMS AND CHANNELS		X		
SPLINESHAFTS AND AXLES		X		
SPRINGS			X	
BUMPERS			X	
SHOVELS		X		
BOLTS	X			
RIVETS	X			
MACHINED GEARS (HARDENED)		X		

designed for one specific polarity cannot be used with a.c. welders. When purchasing electrodes, be sure to specify the type of welder and polarity with which the electrodes are to be used. Specify also the type of material to be welded, because the rod or core metal of the electrode should be of approximately the same chemical analysis as the metal being welded. Thus, a different kind of electrode is used for cast iron than for ordinary steel. The amount of carbon in the steel must also be considered. The table, Fig. 12, shows the carbon content of various metal parts. For bronze, stainless steel or aluminum a still different type of electrode is used. The size of the electrode, or diameter of the core wire, is also impor-

tant. Many sizes are available ranging from $\frac{1}{16}$ -in.-dia. to $\frac{3}{8}$ -in.-dia. core wires. The smaller diameter rods cannot carry as much current as the larger rods and are used for welding thin material where less amperage is needed to melt the metal.

In addition to the welding machine and electrodes, a few other accessories are needed. A helmet or face shield, Fig. 8, should always be used when arc welding. Do not attempt to arc-weld with goggles alone. Helmets are made of lightweight, heat-resisting black fiber, and have a fitting to hold an especially colored glass which permits the user to view the arc safely during the welding process. The helmet also has an adjustable headband with a tilting device to allow the face shield to be swung up clear of the face when the actual welding process is stopped momentarily to place a new electrode in the holder. It is advisable to wear a skull cap beneath the helmet. Ordinary work clothing, when worn as shown in Fig. 7, is best for welding, and

gauntlet-type gloves, Fig. 8, should be worn. For light welding, combination canvas and leather gloves will do. A welder's chipping hammer to remove the slag coating from the welds and a wire brush to clean the welds and material to be welded will be needed. A number of C-clamps of various sizes to hold the work before welding and a pair of pliers or tongs to handle hot pieces of metal after welding are also needed. For measuring, marking and assembling metal parts, a 6-ft. folding rule, some sticks of soapstone and a 2-ft. carpenter's square will come in handy. Other tools in Fig. 8 will also be found useful.

Photos Courtesy The Lincoln Electric Co.

(To be continued)

If you sometimes have to drive your car off the beaten path and over muddy or sandy terrain, you will find that a pair of these unique sand tracks will save many hours of toil should you become bogged down in loose soil. Although the sand track shown was made 36 in. long, it can be any reasonable length. Note that the track folds into a compact bundle for carrying and storage. The track is simply a number of short lengths of rod and pipe linked together with pieces of flat iron. The rod is cut into 8-in. lengths and a transverse hole for a cotter pin is drilled $\frac{1}{8}$ in. from each end. A 7-in. length of $\frac{1}{2}$ -in. pipe is slipped over each rod. The flat-iron links of $\frac{1}{8}$ -in. stock are cut to the dimensions given in the lower left-hand detail, $\frac{1}{2}$ -in. holes being drilled at each end so they will fit over the rod. With the pipe serving as a spacer between the links, the latter are slipped over the rod ends, as shown, and are locked in place with washers and cotter pins. In use, the pipe sections rotate around the rods. This is particularly helpful when pulling out of deep holes, as it allows just enough movement to prevent stalling the engine when

Roller Sand Tracks for Off-Highway Driving Rescue Car Mired in Muddy or Soft Ground

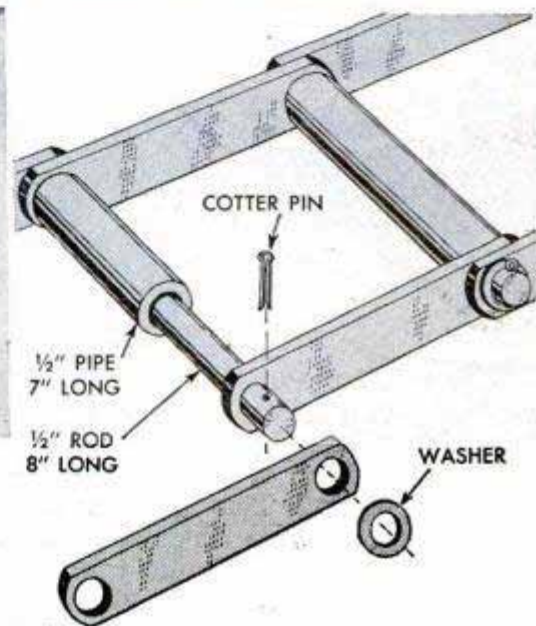
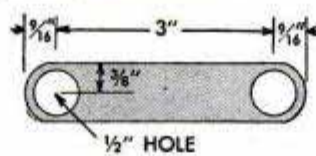

the clutch is released. If you wish to use one section of the track as a carrying handle, install an odd number of crosspieces so the section will fold outward neatly.

Walter B. Ford, Los Angeles, Calif.

Graduated Carpenter's Gauge of Sheet Metal Speeds Laying Out Mortises

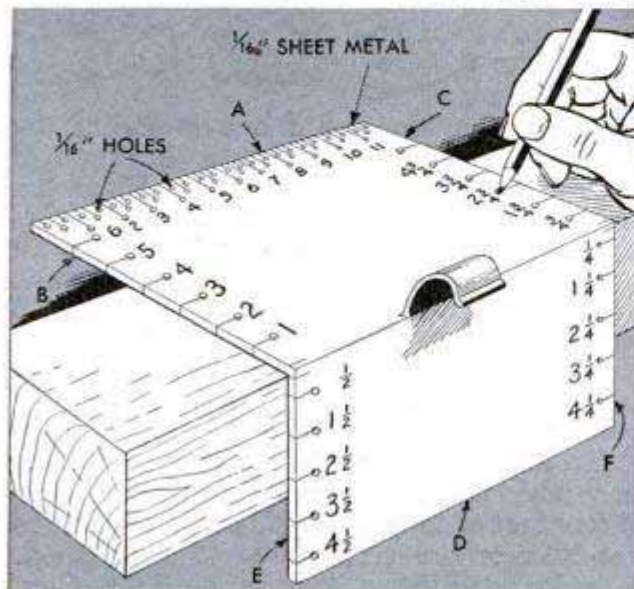

This sheet-metal carpenter's gauge is especially handy to speed layout work when marking mortises. The gauge is a piece of sheet metal bent at right angles, one side being somewhat longer than the other. The metal is cut straight so that any edge will serve as a try square and the edges are graduated in inches and fractions of an inch. At the end of each mark, a $\frac{1}{16}$ -in. hole is drilled to receive the point of a pencil. Edge A, which should be as long as the widest board likely to be worked, is graduated in $\frac{1}{4}$ -in. units. Edge B is marked off in inches. C is graduated in inches beginning with $\frac{3}{4}$ in., E in inches beginning with $\frac{1}{2}$ in. and F is also in inches starting with $\frac{1}{4}$ in. Edge D is left blank or graduated in metric units if desired.

Wm. P. Houser, Organ, N. Mex.

Water System for Brooder House Has Barrel Reservoir

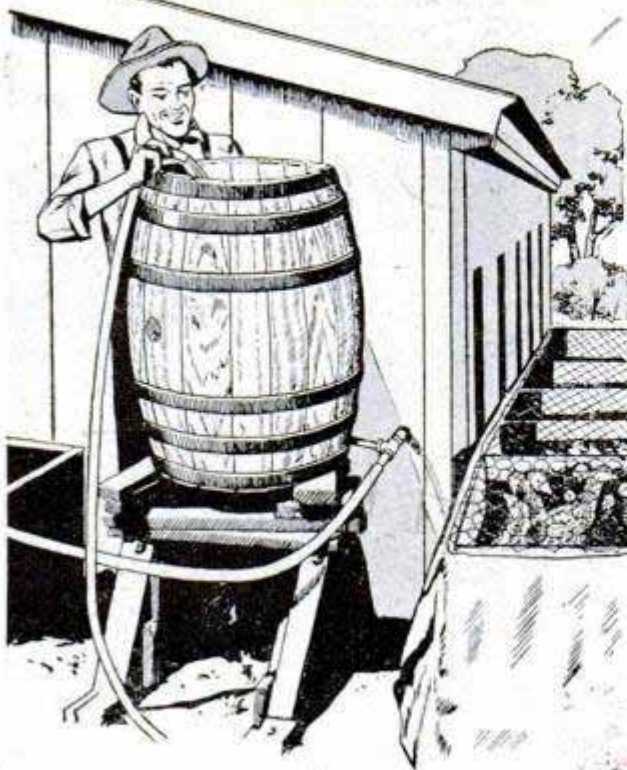

One poultryman installed a gravity-fed water system in his brooder house, utilizing a large barrel as a reservoir. An outlet at the bottom of the barrel is equipped with a T-fitting. Two hoses connected to the fitting carry the water to a run of pipe along each side of the house from which the water is distributed to individual drinking fountains in the pens. The barrel is filled with water by hand, using a length of hose attached to the well pump.

Individual Spark-Plug Cleaner Chips Away Carbon Deposits

When shaken violently, the needles in this spark-plug cleaner chip away the carbon deposits on and around the terminals. Not only is it excellent for cleaning car spark plugs, but it is especially handy for

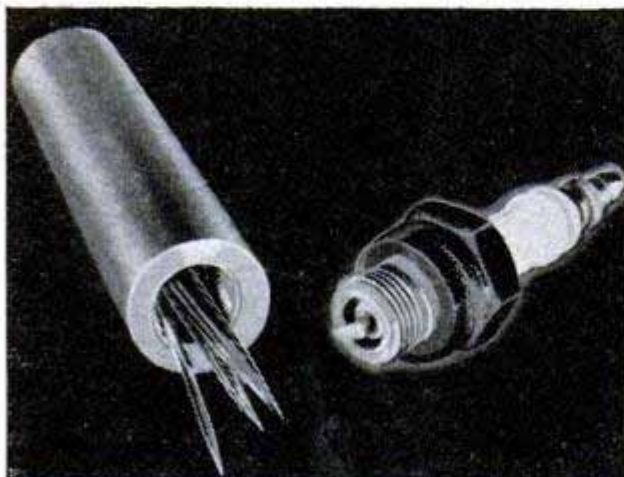

cleaning outboard-motor plugs which often become fouled at low trolling speeds. The container is a 5-in. length of steel rod which is bored to about $\frac{1}{8}$ in. from the bottom. The open end is tapped to receive the spark-plug threads. Eight or ten heavy needles are dropped into the container, pointed-end-up, and the spark plug is turned into the threaded end.

Cleats Nailed to Fence Posts Provide Convenient Stiles

You can climb over a farm fence at a number of places if several of these simple stiles are nailed to the posts at intervals along the fence. The stiles are made by nailing wooden cleats to the posts on opposite sides of the fence to form miniature ladders. The posts must be notched for the cleats to prevent the nails from being pulled loose.

Charles E. Mason, California, Mo.

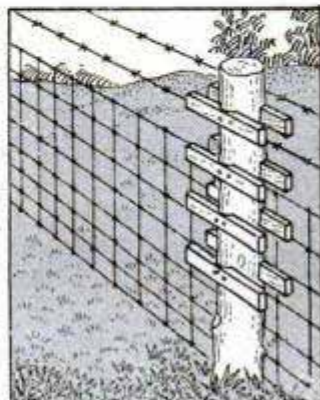

Weed Killer Applied With Brush

If fear of injuring valuable plants keeps you from spraying near-by weeds with 2,4-D, you can apply the solution to the weeds with a paintbrush. By painting a half dozen leaves of a poison-ivy vine, for instance, enough of the 2,4-D will be absorbed



to kill the entire vine. When spreading the weed killer, be careful not to get any of it on the leaves of plants or bushes. Clean the brush afterwards and soak it for 24 hours in a weak ammonia solution to remove all traces of the 2,4-D. If a brush is not handy, a wad of cotton on the end of a stick will serve as an applicator.

Spare Tape Kept Under Car Hood

To make sure he has some friction tape available when needed, one motorist keeps a few feet of tape wrapped around a radiator hose or brace rod under the car hood.

Gordon Wilson, Myrtle Sta., Ont., Can.

Radio Television Electronics

SUB-MINIATURE-TUBE RECEIVERS

PRACTICAL self-contained battery-operated pocket receivers employing the sub-miniature war-developed tubes are now appearing on the market for about \$20.00. They will be in demand at sports events, on fishing trips or any place out of doors. Business and professional people will find them useful, the mailman on his route and the farmer in the field will be able to listen to their favorite broadcast programs and, because of their personal and private nature, they may be used in hospitals or sickrooms without disturbing others. The tiny "Privat-Ear" portable illustrated in photos A and B weighs less than 6 ounces; it is $2\frac{1}{4}$ in. wide, $5\frac{3}{4}$ in. long and $\frac{7}{8}$ in. thick. It is equipped with a volume control and station selector. The antenna is a telescoping type, and reception is obtained through a small earphone which the user inserts in his ear.

Housed in an attractive plastic case, the "Micro Pocket Radio" shown in photos C and D employs three of the sub-miniature tubes and weighs only $5\frac{1}{4}$ ounces complete with self-contained batteries, antenna and listening device. The cost of operation is claimed to be very low.

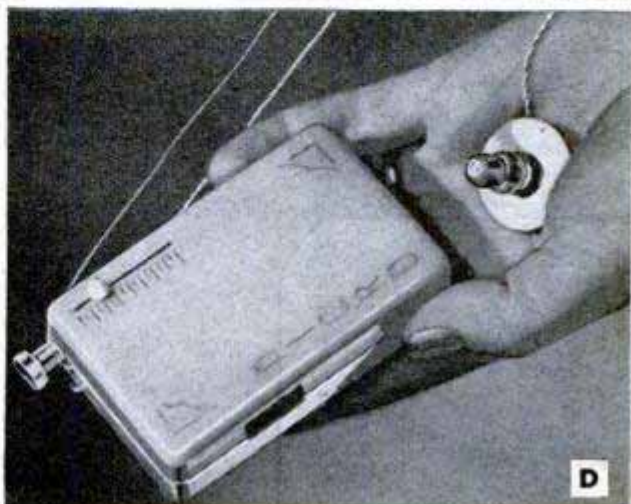
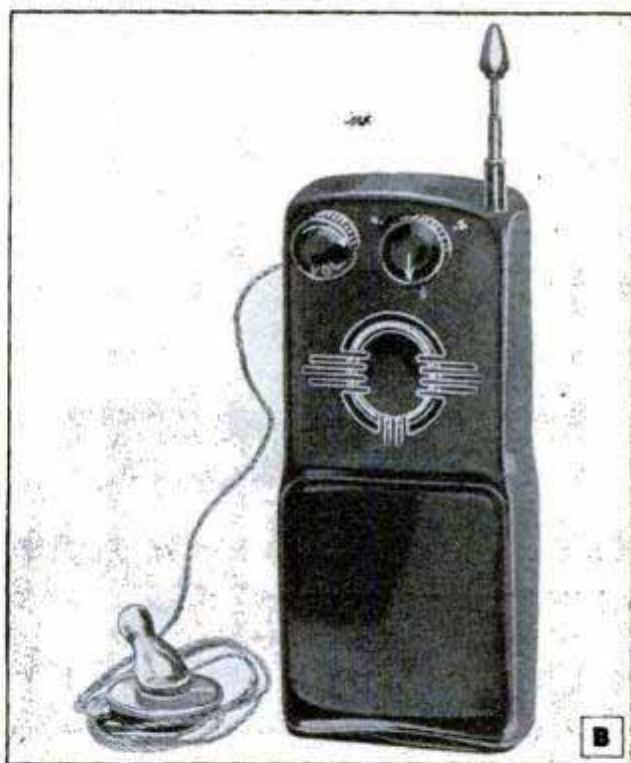

TWO-TUBE "MINI-PAL" PORTABLE

By S. A. Johnson

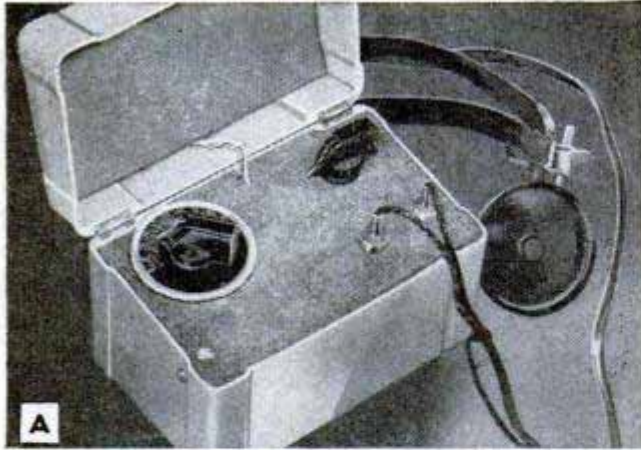

ALTHOUGH only two tubes are used in this small broadcast receiver, and despite its simplicity, it has a host of interesting features. It is attractive in appearance, thanks to the fact that it is built into a colorful plastic filing-card case. The case is available from dime stores throughout the country for 50 cents. It is 5¼ in. long, 3¼ in. wide and 3¾ in. high with the lid closed. A standard portable-type 45-volt B-battery, and an ordinary 1½-volt flashlight cell for the A-battery, fit snugly in the bottom of the case.

Tested initially in Denver, Colo., the original model received all five of the local stations at night even when

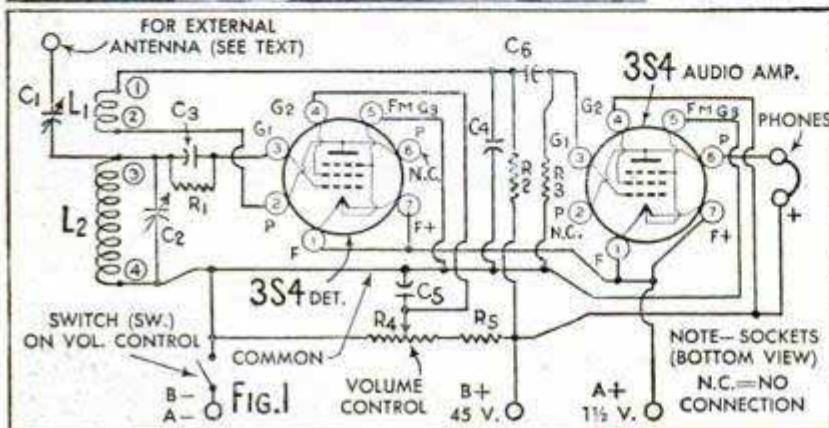

- RESISTORS**
 R1=1 megohm, ½-watt carbon
 R2=100,000 ohms, ½-watt carbon
 R3=270,000 ohms, ½-watt carbon
 R4=0-100,000-ohm volume control, audio taper, with S.P.S.T. switch
 R5=100,000 ohms, ½-watt

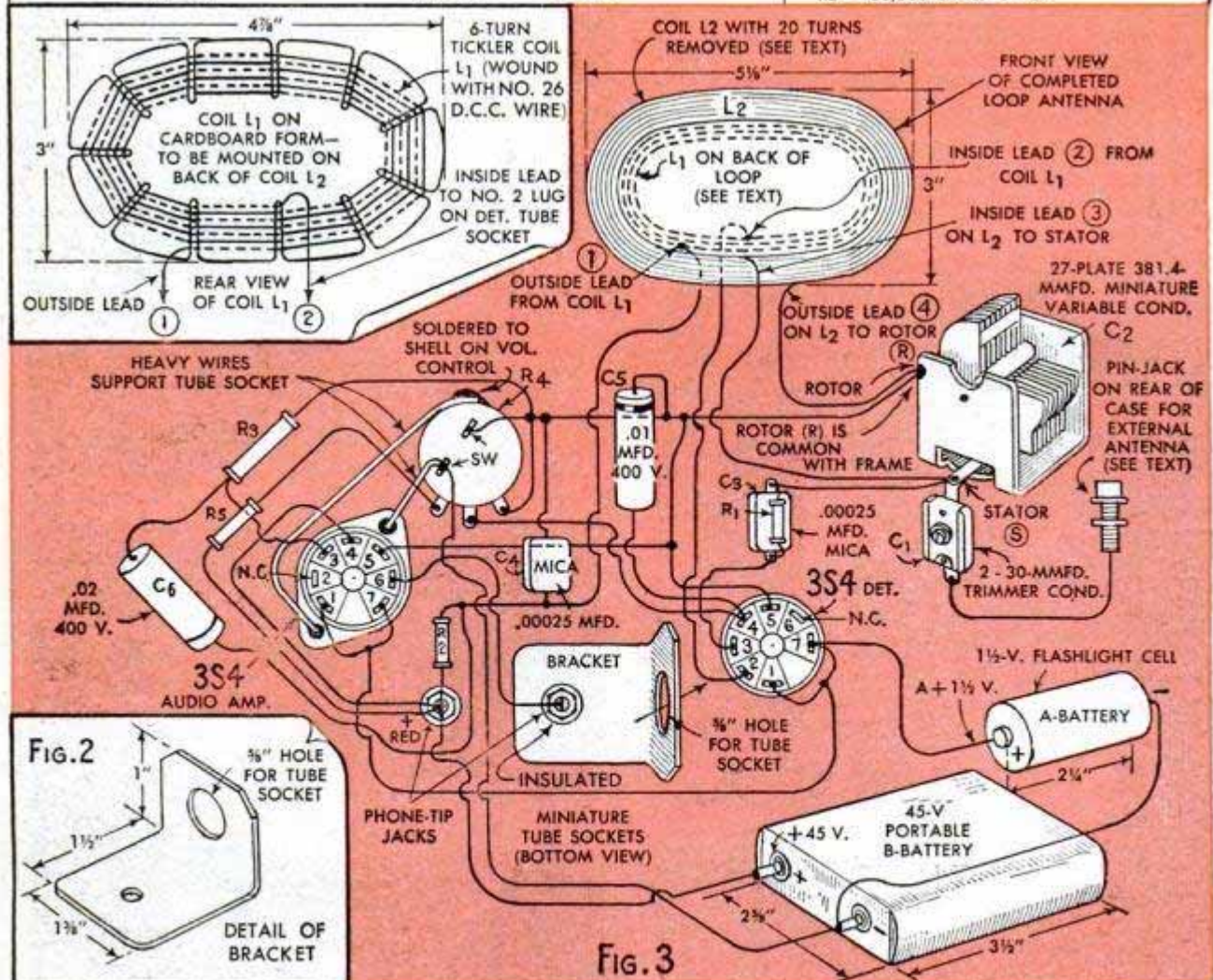

HAS BUILT-IN LOOP ANTENNA

operated in a deep basement. Upstairs in the house it would bring in quite a number of out-of-town stations with only the built-in loop antenna. When an outside antenna wire was connected to the antenna post on the rear of the case, and condenser C1 was adjusted, stations over a thousand miles away were tuned in. All of the component parts are mounted on the underside of the $\frac{1}{8}$ -in. Masonite hardboard chassis base which is cut to fit neatly into the top of the case where it is screwed to two wooden mounting blocks. The compact loop antenna is an Allied No. 51-035 miniature replacement type with 20 turns removed from the center of the coil in order to make it tune properly with the miniature variable condenser specified. Any similar miniature loop that will tune the broadcast band with a miniature variable condenser may be used. It is only necessary to experiment by taking off turns from the center of the coil, which is indicated as L2, until it will cover the band correctly. As the loop fits inside the lid of the case, it must be about the dimensions given in Fig. 3. Coil L1 is wound on a separate cardboard form and is fastened to the back of L2 with cellulose tape. Coil L1 is a 6-turn "tickler" which provides the regeneration that is responsible for the sensitivity of the set. As will be noted in Photo A, the completed loop in the lid is concealed with a piece of cardboard. The T.R.F.-type midget variable tuning condenser C2, and midget volume control R4, are mounted 1 inch from the top of the

(Continued to page 242)

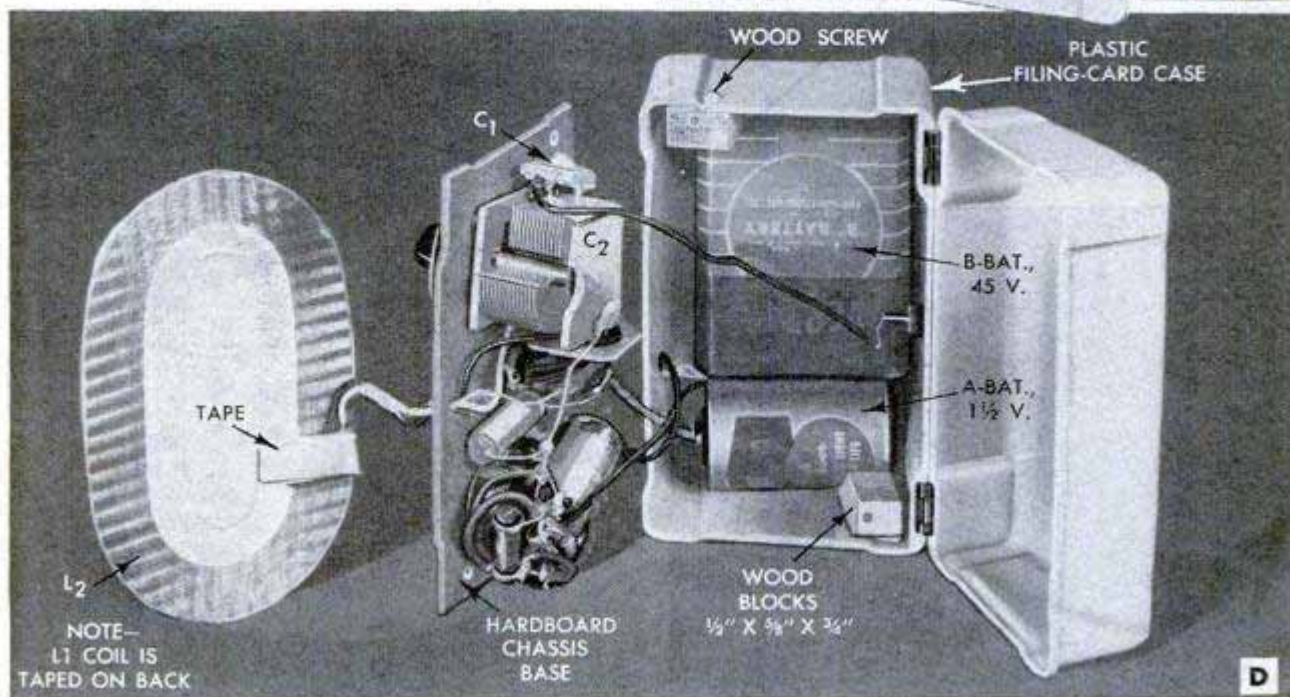
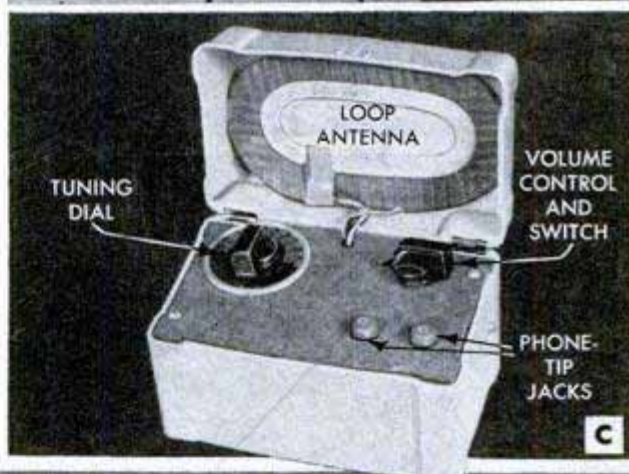

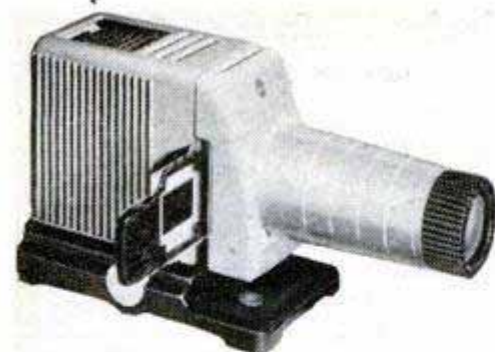

Kodaslide Projector, Model 2A—Lumenized Kodak Ektanon 5-inch *f*/3.5 Lens. Adjustable tilt control. \$47.50.



Kodaslide Projector, Master Model—1000-watt lamp. Superb optical system. \$181 to \$295, depending on lens choice.



Kodaslide Projector, Model 1A—Projects bright images up to 7 feet wide. Efficient, yet inexpensive. \$27.50.

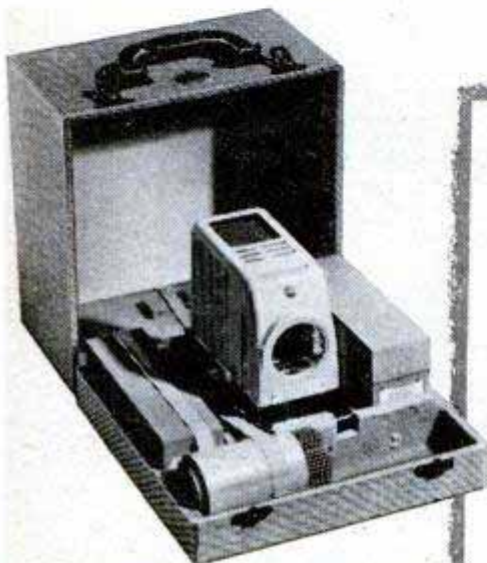

Combination Case (for Model 2A)—Holds Kodaslide Projector, Kodaslide Changer, lens, Kodaslide Sequence Files or Kodaslide File Boxes. \$15.

**IT'S KODAK
FOR BRILLIANT
COLOR SHOWS**
*... everything you need for
miniature-slide projection*

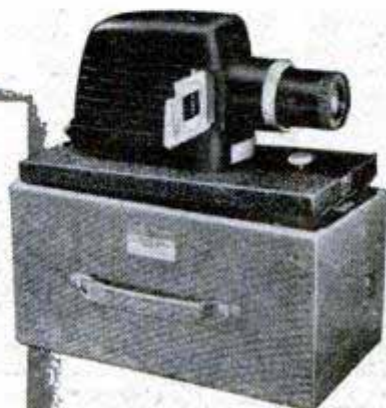

Projecto Case (for Model 1A)—For carrying, storage, and projection. \$10.

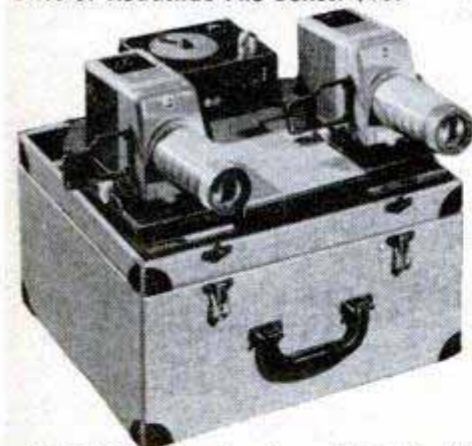

Kodaslide Dissolve Control Outfit—For "fade-in-fade-out" effects with Kodaslide Projectors, Models 1, 2, 2A. \$50.



Kodaslide File Box—Protects 140 cardboard slides, 55 glass slides, keeps them organized. \$1.15.



Kodaslide Table Viewer—Screen, projector, and slide changer all in one unit. \$95.



Kodaslide Changer—Simplifies changing slides. Gives a smooth show. \$17.50.



Kodak Slide Kit—Glass, masks, and binding tape for 50 slides. \$2.90.



Kodaslide Compartment File—Slide compartments swing out. Holds 240 cardboard slides. \$3.75.

Your Kodak dealer has everything you need for color shows—visit him today.
EASTMAN KODAK COMPANY, ROCHESTER 4, NEW YORK

Kodak
TRADE-MARK

Starrett

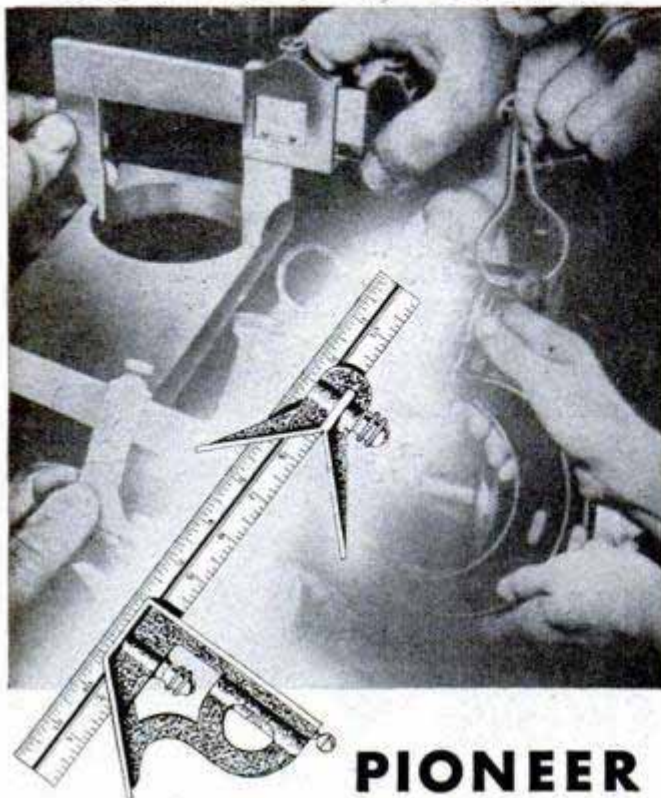

PIONEER

in Precision Craftsmanship

Starrett's first contribution to better craftsmanship, the Combination Square, has been a favorite since 1880. Like the more than 3000 Starrett Precision Measuring Tools developed since then, its lasting value is based on superior design, dependable accuracy, and fine workmanship. If your job calls for skill and precision, you'll do more work with greater pleasure and profit with Starrett Precision Tools.



"THE STARRETT STORY"

It's Free — Write for your copy

The fascinating story of the company whose name means "precision measuring tools". Write for it today. Address Dept. "AP."

THE L. S. STARRETT CO., ATHOL, MASSACHUSETTS, U. S. A.

TRADE MARK
Starrett
REG. U. S. PAT. OFF.

World's Greatest Toolmakers—Since 1880

Mechanics' Hand Measuring Tools and Precision Instruments • Dial Indicators • Steel Tapes • Hacksaws and Band Saws • Precision Ground Flat Stock

Buy Through Your Distributor

Turntable for TV Receiver

(Continued from page 240)

is clearly shown in photo C. The trunk rollers are mounted in their slots on washers at the correct height, as indicated in photo E, so that the brass center plates will clear. The turntable is handy when making necessary tuning adjustments on the back control panel as the set can be rotated to face a mirror, thus bringing the screwdriver adjusted controls within easy reach of the operator, as illustrated in photo D.

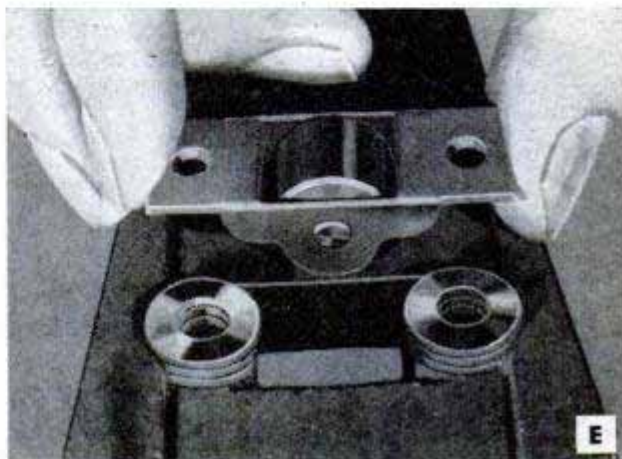

Two-Tube "Mini-Pal" Portable Has Built-In Loop Antenna

(Continued from page 239)

hardboard panel, and 1¼ inches from each side. The exact placement of the parts is not critical; the only unusual thing is the method employed in mounting the tube socket for the amplifier tube. This socket is soldered to a pair of stiff wires which are soldered in turn to the volume control at convenient points. These wires support the socket close to the volume control in the position shown in photo F. The detector tube socket is mounted on the angle bracket detailed in Fig. 2. The miniature type 3S4 tubes were selected for the circuit as this is one of the cheapest of the low-voltage d.c. tubes; it is an excellent detector and also a very good audio-amplifier tube. These tubes have a filament tap, and can be wired for either 1½ or 3 filament volts. The schematic circuit diagram appears in Fig. 1, and the pictorial wiring diagram is shown in Fig. 3. Photos C, D, E and F show various views of the completed assembly.

Wiring the set is easy if you are careful, and avoid making mistakes. Be especially careful in wiring the battery leads as an error at this point may burn out the tubes. It is also a good idea to prevent a possible short by completely covering with tape the

(Continued to page 246)

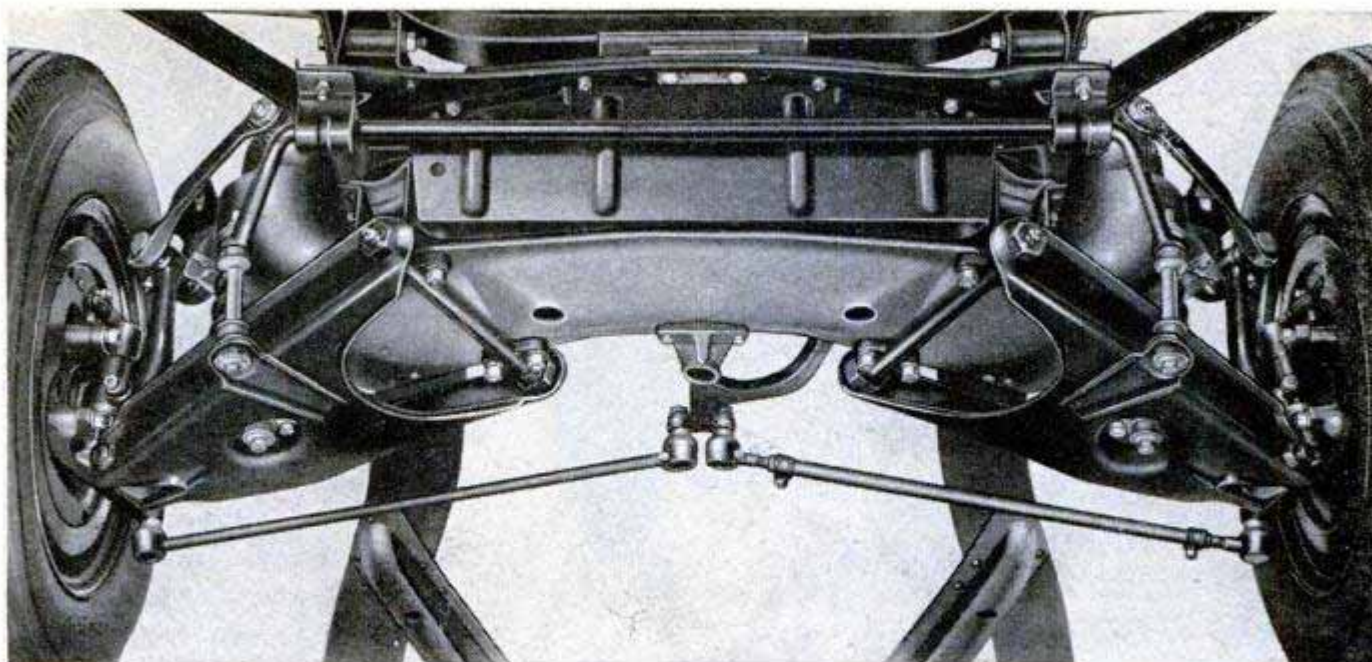

Chevrolet's Unitized Knee-Action, showing new Center-Point steering linkage.

Every car has riding qualities— CHEVROLET HAS A QUALITY RIDE



Airplane-type double-acting shock absorbers, mounted inside front coil spring.

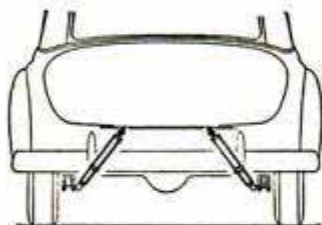

Rear shock absorbers, mounted diagonally, both ease the ride and resist sideway.

New Suspension Boosts Comfort and Smoothness



The ride's the thing! And with the 1949 Chevrolets, it's the thing that sets them apart from other cars in their field. For the Chevrolet ride—like Chevrolet's chassis and its Body by Fisher—has quality *built into* it. It's a quality ride from the ground up, starting with its extra-low-pressure tires that buoy you over big and little bumps. On top of that you have the new Center-Point design—including Center-Point seating, Center-Point rear suspension—and a lower center of gravity without loss of road clearance. You have all that—plus Chevrolet's Unitized Knee Action, long famous for its superior riding qualities, now improved to make the ride even better. Yes, the ride's the thing! Try it now—and see, also, the many other extra values that make Chevrolet "the most beautiful buy of all." Visit your Chevrolet dealer, now.



CHEVROLET MOTOR DIVISION, General Motors Corporation,
DETROIT 2, MICHIGAN

CRAFTSMAN Motors and Power Tools

REG. U. S. PAT. OFF.



We believe these are America's greatest motor values . . . for **GUARANTEED** quality, superior features, extra power, and rugged long service!

Look at the low prices of these typical SEARS motor values!

CRAFTSMAN

Ball Bearing Capacitor Motors
110-120-volt, 60-cycle A. C.

1/2-H.P. 1750 R.P.M. **\$24⁹⁵** Cash

1/3-H.P. 1750 R.P.M. \$21.95

1/2-H.P. 3450 R.P.M. \$27.95

3/4-H.P. 3450 R.P.M. \$36.95

As low as \$2.50 Down
on Easy Terms

Look at these superior features!



New Departure sealed precision ball bearings!



Built-in overload protector prevents motor burn-outs!



Nylon insulation resists abrasion and heat better!



Shaft extends on both ends; makes motor more useful!



Convenient on-off switch built into motor base!



Heavy 8-ft. rubber-covered cord; unbreakable plug!

We know of **NO** other motors of this **CRAFTSMAN** quality selling at such low prices!

Expertly engineered for better, longer service at the lowest prices possible . . . CRAFTSMAN capacitor motors have plus-features giving you more for your money! Built-in condenser permits starting loads 50% greater than split-phase motors of the same capacity. Specially designed fan and baffles keep all parts of motor cool. Operate in any position; easily reversed. Guaranteed for one year! See them today at SEARS . . . America's motor headquarters for capacitor, split-phase, R-I, and 3-phase types . . . in a complete range of sizes to meet your particular motor needs perfectly . . . at less cost!

DUNLAP 1/4-H.P. Electric Shop Grinder

REG. U. S. PAT. OFF.

Here's the efficient, sturdy grinder you need in your shop for those small grinding jobs; for general maintenance work. Look at these features! Precision ball bearings, dirt-protected. Adjustable shatterproof glass shields and tool rests. Cast iron frame, with built-in on-off switch. DUNLAP 1/4-H.P. 3450 R.P.M. split-phase motor with new Nylon insulated windings, for 110-120-volt, 60-cycle A.C. Rubber-mounted, 5/8-in. steel shaft, 1/2-in. at ends. 8-ft. rubber-covered cord; unbreakable plug. 8 3/4 in. high; 11-in. clearance between wheels. With cast iron guards and two 6x3/4-in. vitrified aluminum oxide grinding wheels; one fine, one coarse.

SEARS Easy Terms make it easier to have the tools you need in your shop NOW . . . pay for them while you are using them!

ONLY **\$25⁹⁵** Cash
Only \$3.00 Down
on SEARS Easy
Terms



CRAFTSMAN Hand and Power Tools . . . sold by **SEARS, ROEBUCK and CO.**

REG. U. S. PAT. OFF.

give you **MORE** for your Money!

ACTUAL TESTS PROVE
the exceptional strength,
accuracy, and outstanding
durability of this great
new **CRAFTSMAN** Band Saw!

Blade is super-strong . . . cut over 2 miles of 2-inch yellow pine with no sign of blade failure. Machine is sturdiest ever . . . ran continuously and perfectly for more than 500 hours while cutting over 25 miles of 1-inch yellow pine!



FOR ONLY

\$3988 Without motor
Cash

(\$41.88 West of Rockies)

Only \$4.00 Down on SEARS Easy Terms

\$53.00 with motor,
motor-pulley, and V-belt
(\$55.50 West of Rockies)

NEW! CRAFTSMAN REG. U.S. PAT. OFF. **3-Wheel Band Saw**

Exclusive features . . . sensational performance . . . make it the finest 3-wheel saw we've ever offered!

Vastly improved over other models! Precision-built, for hairline accuracy; smoother operation! Ideal for model-makers, wood-working and pattern shops, and cabinet makers. Streamlined! SAFER! Completely enclosed, except for actual cutting edge of blade! If blade ever breaks, it can't fly out! The only saw on the market with as low a center of gravity, and a 12-in. throat! Cuts to center of 24-in. circle; makes curved or irregular cuts in wood up to 4 in. thick. Double-row ball bearings mounted integrally with shaft, assuring perfect alignment; minimum vibration. Double-row needle bearings on idler wheels. Proper blade tension is positively determined by direct, built-in reading scale (holds firmly; prevents any tension change during operation). Rubber tires, ground true; die-cast wheels machined to close limits, assuring concentricity. 12x12-in. table, mounted on double trunnions, with 4 points of support instead of 2, for greater rigidity; tilts 0 to 45°. Heavy cast iron frame, scientifically designed for maximum rigidity and fewer parts. 1/4x62-in. blade; 4-in. machine pulley. (1/3-H.P. 1750 R.P.M. split-phase, sleeve bearing motor, for 110-120-volt 60-cycle A.C., 3-in. motor pulley and 1/2x54-in. V-belt sold separately at extra cost.)

See . . . and buy these super-value power tools at your nearest SEARS, ROEBUCK and CO. Retail Store TODAY!

Clip this Coupon NOW! It's worth money to you!

SPECIAL OFFER!

Get this sensational CRAFTSMAN Key Knife and Chain at your nearest SEARS Retail Store TODAY!



Actual Size!

NOW yours, with the purchase of \$1.00 or more, at any SEARS Hardware Dept. . . . this handy, sharp Key Chain Knife (actually worth 49c)! Yours, at no extra charge, if you clip out and present this coupon at time of purchase. Get your Key Knife TODAY! This offer expires Oct. 31, 1949.

Famous for fine quality .. precision performance .. low price!

DARKNESS MEANS... DANGER

BOND
No. 102
Fresh
SUPER POWER
BATTERY
BOND ELECTRIC CORPORATION

Protect yourself after dark
with **REAL LIGHT**

WINCHESTER
No. 1511
Fresh
HI-POWER
Super
BATTERY
WINCHESTER REPEATING ARMS CO.

GUARANTEED BY OLIN

Specialists in electro-chemistry and metallurgy:

Winchester Repeating Arms Co.
Bond Electric Corp.
Western Cartridge Co.
Liberty Powder Co.
Western Brass Mills
Equitable Powder Mfg. Co.
Columbia Powder Co.
Egyptian Powder Co.
Texas Powder Co.

OLIN INDUSTRIES, INC.

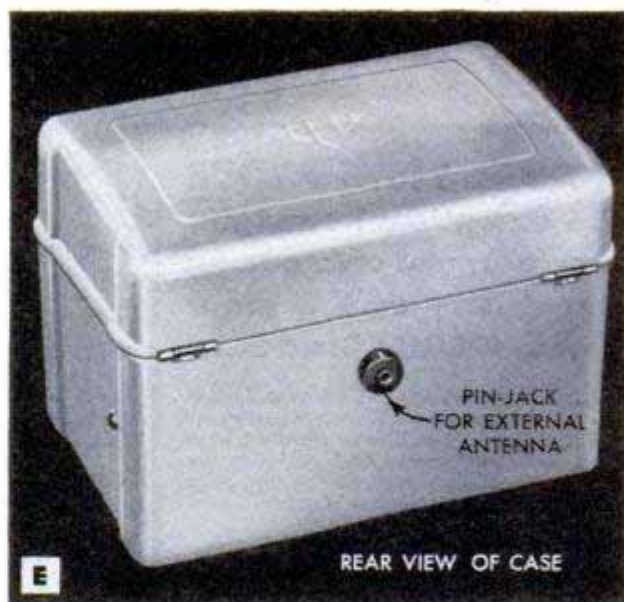

positive 45-volt terminal on the B-battery. With the wiring completed, check and recheck for possible errors before inserting the tubes in their sockets. To test the set, plug in a pair of 2000-ohm headphones and turn the switch on; then advance the volume control to the full "on" position. Next rotate the variable condenser C2. "Whistles" indicate stations; if no whistles are heard, reverse the connections on the tickler coil L1 only. When a station is tuned in, "back off" the volume control until it comes in with good clarity and volume. If,

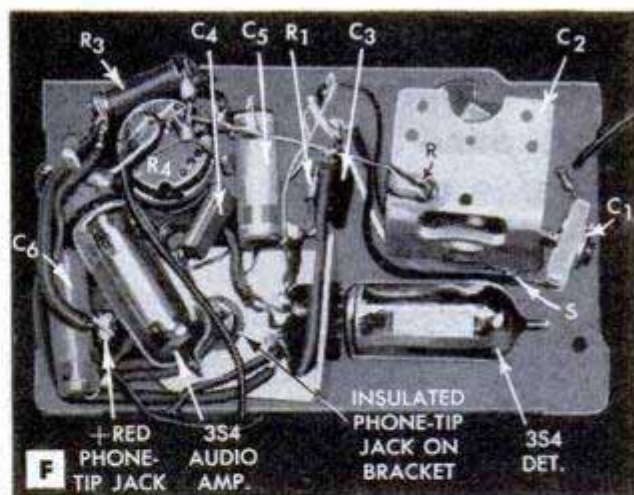

when you tune in a station at about 550 kc. at the low end of the broadcast band, the variable condenser is not quite fully closed, you may have to take off a few more turns from the inside of coil L2 in order to make the set tune in the high end of the band. Remove the turns one at a time and check until the band is fully covered. Detailed student material list R-382 is available from Popular Mechanics Radio and Electronics department upon receipt of ordinary letter postage.



No. 132. LIONEL TRAIN STATION
Exact copy of rural wayside stations. Illuminated windows. Colorful, Realistic.

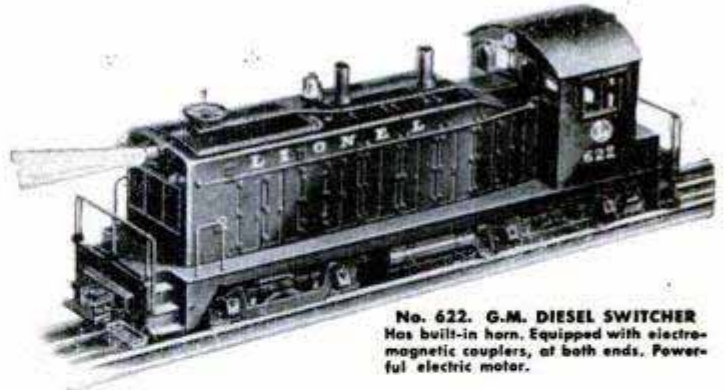

No. 622. G.M. DIESEL SWITCHER
Has built-in horn. Equipped with electromagnetic couplers, at both ends. Powerful electric motor.



No. 395. LIONEL FLOOD LIGHT TOWER
Tall steel structure with platform and ladder, with four swivelling spot lights for illuminating railway yard.

New
LIONEL
Items for
1949



No. 394. LIONEL ROTARY BEACON
A miniature rotary beacon used to define air lanes, with revolving search light.

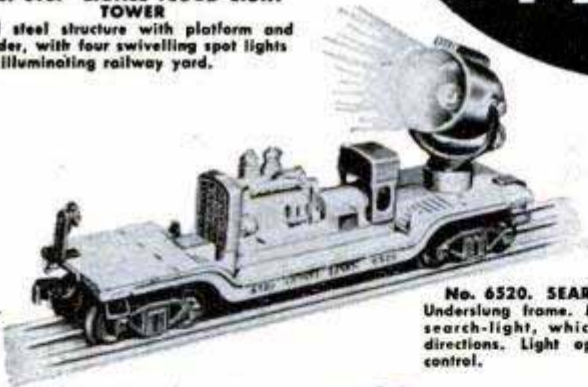

No. 6520. SEARCH LIGHT CAR
Underslung frame. Mounts a powerful search-light, which swivels in two directions. Light operated by remote control.

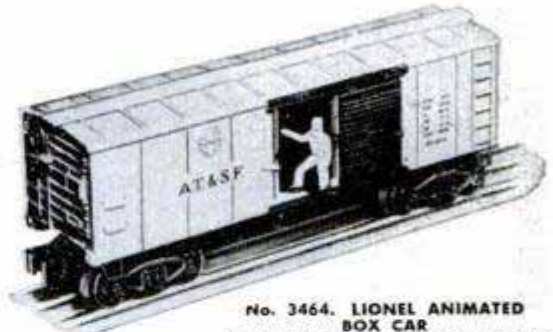

No. 3464. LIONEL ANIMATED BOX CAR
A semi-automatic accessory. A figure within the car pushes open the sliding door and appears at the entrance. Controlled by press button.

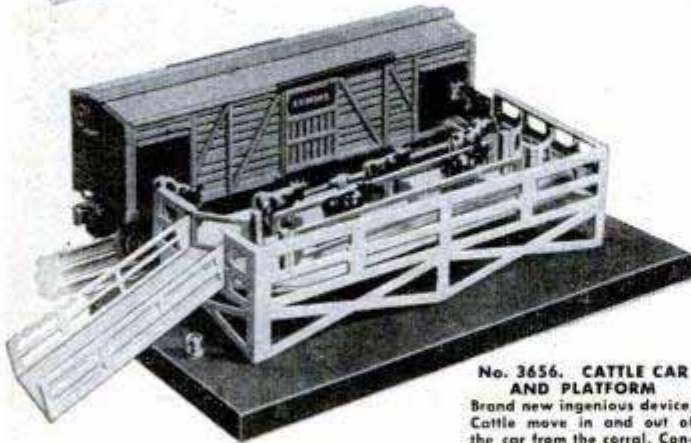

No. 3656. CATTLE CAR AND PLATFORM
Brand new ingenious device. Cattle move in and out of the car from the corral. Controlled by push button.

See Lionel trains at your favorite store.

LIONEL TRAINS, P. O. BOX 228
Madison Square Station, New York 10, New York

I enclose 10c. Please send me the new 40-page, full-color Lionel Train Catalog for 1949.

Name _____
Address _____
City _____ Zone _____ State _____

Write for the Catalog Today!

now

PAINT EASIER!
PAINT SMOOTHER!
PAINT CLEANER!
PAINT FASTER!



No streaks!
 No splashing!
 No waste paint!
 No dripping!
 No bristles
 to fall out!

Rubberset's amazing new self-feeding FLO-MATIC Pressure Roller lets you paint smooth as a professional painter!

Lays smoothest coat of paint you ever saw! Now you can paint as expertly as a Master Painter! Actually paint *twice* as fast . . . and with results that any professional painter would be proud of!

Carries its own paint supply! Why fuss with dripping brushes? Rubberset's FLO-MATIC carries its own paint supply in the high-strength aluminum alloy cylinder handle. Takes only seconds to fill, paints continuously!

Easy as pressing a button! One coat covers perfectly! Just press gently on the pressure valve tube and r-o-l-l the paint on *any* surface—smooth or rough, interior or exterior!

Save money! Save time! Save effort! Not one drop of paint is wasted when you paint with FLO-MATIC! And FLO-MATIC lays such a smooth, even coat of paint that the paint goes further!
Only \$29.75



Easiest way to paint ceilings—
 No dripping! No splashing!

Don't paint an inch until you get full information about this newest, easiest way to paint! Mail the coupon today!

Rubberset Co.
 146 Haynes Ave.
 Newark 5, N. J.

PM-109
 (Mail in envelope or
 paste on postcard)

Mail me FREE complete information about the FLO-MATIC Pressure Paint Roller that lets me paint as expertly as a professional painter.

Name.....
 Address.....
 City.....Zone.....State.....
 Name of your Paint Dealer.....
 Address of your Paint Dealer.....

Rubberset Co. World-famous for the finest in painting tools

Clinic



for Homemakers

As a service to our readers in solving the hundreds of problems pertaining to a home—inside or out—the editors of *Popular Mechanics* invite you to present your problems to The Clinic Editor for help and advice. Address your questions to The Clinic Editor, *Popular Mechanics Magazine*, 200 East Ontario Street, Chicago 11, Ill.

Plywood Applied Over Plaster

Q—I am planning to finish two walls of a room with knotty-pine plywood. The walls are plastered and papered. It has seemed to me that it would be quite simple just to screw the plywood panels directly to the plastered wall, using screws long enough to reach through to the lath. Can I do this, or must furring strips be installed?

L.D., Pittsfield, Mass.

A—You can, of course, install the plywood panels as you suggest but we would not recommend this as an orthodox procedure. On an outside wall especially, there is danger of moisture condensation in the restricted space between the back of the panel and the surface of the wall. However, if the plywood panels are to be applied only to inside walls there is much less danger of moisture collection behind the panels. In this case, the installation made as you have suggested would probably be satisfactory.

Paint Mildew

Q—I painted my home about a year ago and recently I have noticed dark-brown spots on the siding under the cornices, under a hanging bay window and above a basement window. What is this discoloration, and how can I remove it?

E.B., Portland, Me.



A—Although there could be other causes, of course, it is quite likely that the discolorations, or spots, you describe are caused by paint mildew. This is more commonly seen on the inside of sash frames where moisture condenses on the glass and runs down on the painted frames, keeping the paint constantly wet. However, it does appear in more rare instances on exterior painted surfaces. It is simply a mold growth—often a common food mold—which forms on the paint film. It usually develops during long periods of relatively high humidity or any other condition which subjects the paint to moisture for a considerable length of time. Fortunately, true mildew growths do not damage the paint directly. They are merely unsightly. However, damage to the paint may result from the moisture present and from attempts to remove the growth. If the surface is moist, the mold can be wiped off quite easily with a dry cloth but, if the surface is dry, it will be necessary to use

(Continued to page 250)

DEPENDABLE

CHAMPION

SPARK PLUGS

America's Favorite



**FOLLOW
THE EXPERTS**
use the spark plugs
champions use

These first crisp days of the football season should remind you that hard starting weather is just ahead, and to have your Champion dealer check your spark plugs. There's nothing like a new set of dependable Champion Spark Plugs to revitalize a sluggish and gas wasting engine. Perhaps they'll only need cleaning and adjusting—but if you find you need new ones, be sure you get Champion, America's Favorite Spark Plug for over a quarter century. CHAMPION SPARK PLUG COMPANY, TOLEDO 1, OHIO.

Listen to the CHAMPION ROLL CALL . . . Harry Wismer's fast sportscast every Friday night, over the ABC network

Modernize

**YOUR KITCHEN
THIS MONEY-SAVING WAY**



PATTERN NO. 201



It's simple with *Easi-Bild*
**Build It Yourself* Pattern
and Kintrim Metal Mouldings**

• No previous experience needed to build these modern wall and base cabinets. Amazing new Easi-Bild pattern tells what materials to buy, and how to use them. Trace full-size pattern on wood, saw and assemble according to simplified, step-by-step directions. For a really professional job, apply Kintrim Metal Mouldings with linoleum or plastic covering on sink counter. All you pay is cost of pattern and materials. Save more than half! Send \$1.00 for your pattern today, use coupon below.

Where to Buy



KINTRIM METAL MOULDINGS

Look for this MONEY-SAVING display at all good floor-covering, building material, and hardware dealers. Ask for easy-to-install Kintrim mouldings.



KINKEAD INDUSTRIES

440 WEST SUPERIOR STREET, CHICAGO

SEND COUPON TODAY FOR PATTERNS

Kinkead Industries Pattern Dept. P-109
P. O. Box 215, Pleasantville, N. Y.

Enclosed is \$.....for material requested below.

- | | | |
|---|--|---|
| <input type="checkbox"/> Easi-Bild pattern
No. 201, Kitchen
wall and base cabi-
net.....\$1.00 each. | <input type="checkbox"/> 24-page pattern
book illustrating
over 100 projects
.....20c each. | <input type="checkbox"/> FREE descrip-
tive literature on
Kintrim Mould-
ings. |
|---|--|---|

Name.....

Address.....

City..... Zone..... State.....

*Trade Mark, Easi-Bild Pattern Co.

either a paint cleaner, household ammonia or a mild solution of trisodium phosphate to remove the growth. Where possible, the causes of the mold should be eliminated.

Coated Clothesline

Q—I leave my aluminum clothesline up permanently and, lately, each time before hanging a washing I have to clean the line with a strong household cleaner, as a black coating forms on it which soils the clothes. How can I prevent this coating from forming?
J.S., Philadelphia, Pa.

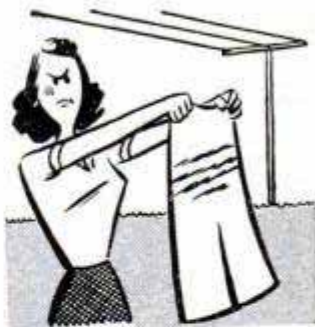

A—The "black" coating you refer to probably is caused by alkali in the cleaning solution. Such solutions should not be used for cleaning aluminum clotheslines. Some users of these lines report good success in the prevention of discoloration by coating the line with ordinary paste wax. Although we have no data on the corrosion-preventive qualities of paste wax when used for this particular purpose, the idea at least seems reasonable. Of course, it is doubtful if the wax coating would withstand weathering for any length of time. It probably would have to be renewed frequently. We do not believe you will have further trouble if you simply clean the line by rubbing lightly with a mild soap solution and thereafter just wipe the line with a soft cloth each time before hanging the clothes.

Faulty Radiator

Q—A year ago we moved into a house which is heated with a conventional steam boiler. One radiator in a first-floor bedroom does not heat. I replaced the air valve and checked the control valve. The latter proved to be in good order. Still no heat. What can be wrong?
R.M., Bay City, Mich.



A—There are several possibilities, but did you check the level of the steam pipe leading to the radiator? Occasionally this pipe is lower at the radiator than at the opposite end of a horizontal run. This condition might have resulted from a faulty installation, settling of the building or some change made in the steam lines after the unit was installed. At any rate, it is a fairly common cause of the trouble you describe. Check the branch steam line with a level. It should incline upward from the main line to the radiator about one half inch or so for each 10 feet of length. If it inclines downward, raise the radiator on blocks or change the pipes to correct the condition.

Thermostat Setting

Q—A year ago I installed an automatic draft control on my hand-fired furnace. Last winter I noticed that the thermostat did not seem to operate properly. For some reason, the thermostat thermometer registered about the same as the dial setting, but a separate thermometer placed nearby registered 7 to 10 deg. higher. Fuel consumption was high until I set the thermostat back to 65 degrees. Then the wall thermometer registered about 72 to 73 deg. What is wrong with this thermostat?
C.T., Topeka, Kans.

A—Probably nothing is wrong with the thermostat mechanically. It is noted from your description that the thermostat thermometer registers very nearly the same temperature as the dial setting calls for, but that the wall thermometer registers 7 to 10 deg. higher. This fact may be the clue to the cause. It is suggested that you carefully remove the thermostat and tightly plug the hole in the plaster through which the wires were led to the thermostat. Cold air coming through this hole can affect the operation of the thermostat.

YOU WON'T GET ANYWHERE UNLESS YOU START



WHEN IT'S AN *Exide* ... YOU START

No one loves a late-comer. Nor do waiting friends care to divide attention between an interesting game and a tale of car-starting trouble. It's no excuse to them . . . shouldn't be for you, because it need not occur.

To arrive on time, be sure your car will start. When you buy a battery for your car, buy *starting assurance*. **REMEMBER**, a single starting failure can be far more costly than the little extra you pay for a trustworthy Exide Battery.



1888... DEPENDABLE BATTERIES FOR 61 YEARS... 1949 "Exide" Reg. Trade-mark U. S. Pat. Off.

THE ELECTRIC STORAGE BATTERY COMPANY, Philadelphia 32
Exide Batteries of Canada, Limited, Toronto

ONLY \$199.50 FOR A COMPLETE POWER WORKSHOP



Your complete power workshop in just 18" x 60" floor space. With ½-hp. ball-bearing motor illustrated, \$199.50.



FOR less than \$200—and with eight square feet of floor space—you can have a power shop second to none in capacity, accuracy and flexibility. It's SHOPSMITH—five heavy-duty, extra-feature tools in one unit so beautifully engineered, so ingeniously designed that you can convert from tool to tool in less than 60 seconds.

NEVER BEFORE SUCH AMAZING CAPACITY

Imagine a circular saw that cuts to center of 8' plywood panels . . . a lathe that takes work up to 15 inches in diameter . . . a drill press that mortises doors and panels as easily as it drills miniature parts . . . a disc sander that squares, miters and

finishes with "try square" accuracy. You get these, and more, with SHOPSMITH.

OUTPERFORMS SINGLE-PURPOSE TOOLS

Compare SHOPSMITH with any combination of single tools at any price. Compare it for accuracy, capacity, all-round utility. You'll see why the thousands of men who own SHOPSMITH praise it so enthusiastically. On display at any Montgomery Ward store and at leading hardware or department stores. SHOPSMITH, complete with attachments, costs \$169.50. With heavy-duty ½-hp. ball-bearing motor, \$199.50.

5 RUGGED POWER TOOLS IN 1

1 EIGHT-INCH CIRCULAR SAW

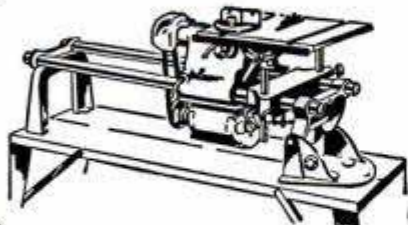

Effective table width up to 56". Maximum depth of cut, 2 1/4". Machined tilting table, ribbed for extra strength. Precision-tooled rip fence and miter gauge. Unique micro-adjustment permits extremely accurate ripping.

2 TWELVE-INCH DISC SANDER

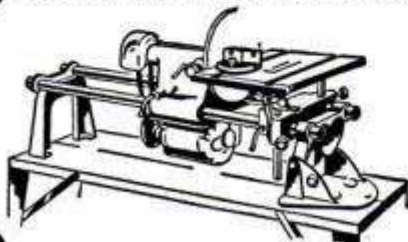

Cast-aluminum disc easy to attach and remove. Extra-large, adjustable table measures 14 1/2" x 17". Miter gauge and rip fence can be used for accurate squaring and jointing. Has features found in no other disc sander.

3 HORIZONTAL DRILL PRESS

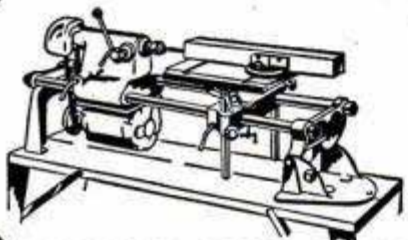

Extremely useful operation possible only with SHOPSMITH. 4" quill feed, automatic stops. Permits large, heavy pieces to be drilled or mortised quickly and accurately. Eliminates need for jigs. Length of work limited only by size of room.

4 VERTICAL DRILL PRESS

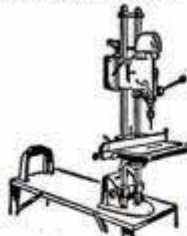

SHOPSMITH drills to the center of a 15" circle, has a maximum clearance table to chuck of 27". Jacobs key chuck takes drills from 5/64" to 1/2" diameter. Rugged, six-spline spindle with 4" feed. Variable speeds 875 to 3500 rpm.

5 THIRTY-THREE-INCH WOOD LATHE

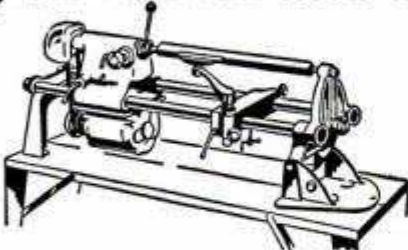

With a 15" swing, SHOPSMITH has greater capacity than most other heavy-duty lathes. Distance between centers, 33". Swivel-arm tool rest always slides parallel to ways—no need for constant adjusting. Has 4" quill feed. Quickly adaptable for oversized faceplate work.

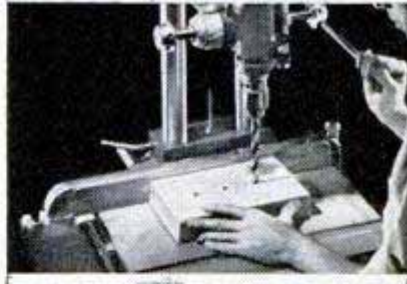
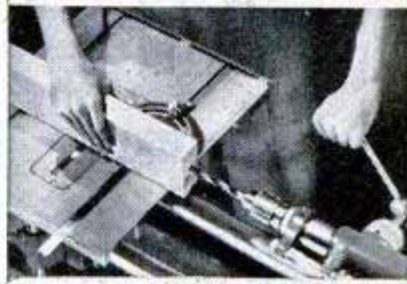
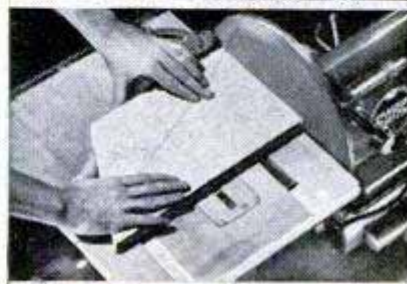
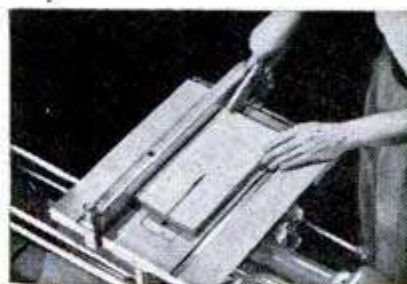

AND THAT'S NOT ALL! WE'VE MORE TO TELL YOU, BUT NO MORE SPACE TO TELL IT HERE. IT'S ALL COVERED IN AN ATTRACTIVE, ILLUSTRATED BOOKLET. WRITE FOR YOUR FREE COPY TODAY!

Address SHOPSMITH, Dept. 102-B,
at factory nearest you.
12819 Coit Rd., Cleveland 8, Ohio, OR
417 Montgomery St., San Francisco, Calif.

I'm interested in SHOPSMITH. Please send me a free copy of the descriptive booklet. And tell me where I can see SHOPSMITH demonstrated.

Name _____

Address _____

City _____ State _____

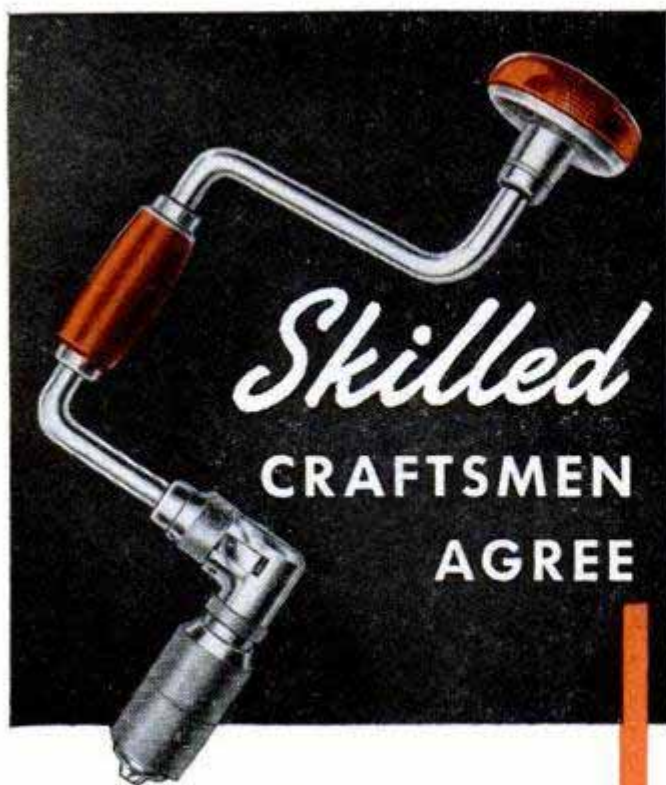

It's Millers Falls for the finest braces made

Every field has its leader, and when it comes to bit braces, that means Millers Falls. For quality, performance and value, this famous line has been accepted for years as tops the world over.

There's a size and type that's right for every purpose and every pocketbook. Each is designed and built to give you the utmost for your dollar. Each incorporates the advanced features and superb workmanship that are a traditional part of all Millers Falls Tools.

Choose your next bit brace from the great Millers Falls line. It's on display at your hardware dealer's. Stop in and look it over. And remember, in bit braces, you can't beat Millers Falls.

**MILLERS FALLS
TOOLS**

SINCE
1868

MILLERS FALLS
COMPANY

GREENFIELD
MASSACHUSETTS

Color Magic From Black and White

(Continued from page 108)

replace it after a few smears and blots.

Kodak announces in its careful instructions that "smearing" is the best way to paint the print. Any unevenness is smoothed out by the acetic-acid rinse after the first blot. The acid not only "evens out" but "fixes" the dye so it won't be too unstable as the painting goes on.

Borderlines between colors are no problem. They can be melted together or, if the line is sharp, its very sharpness indicates a dark shadow line, and the darker color can be brought right up to the edge of the lighter color with utmost ease. Even the hazy line between hair and forehead is easily blended.

A big brown splotch accidentally dropped on the nose of a pretty lady in a portrait would be disastrous in a regular print-coloring process. If it happens with Flexichrome, the chagrined photographer just smears a little black dye over the affected area and starts over. If the mistake is more serious, he can smear the whole print with the modeling agent and try again. This can be done as often as desired.

For fussy people, there is also a "reducer," which is the "white" of the Flexichrome process. Though it is absolutely colorless, it acts like other colors in that it replaces whatever color you smear it on, leaving only the clear white paper base showing through the gelatin.

It has a lot of uses. Sparingly applied, it can tone down a too deep shade. It is handy for vignetting, putting in highlights or clouds.

After 17 years, Jack Crawford is watching his brain child roar into mass production. All the necessary ingredients now are available at professional photographic supply stores. But you'll be seeing the results in almost every national magazine on the newsstands.

"It sure does away with a lot of the grief we used to have," Crawford recalls with a faraway look. "I can remember the trouble I had with water. It had to be Simon pure and clear of dirt for process color. My studio plumbing was fitted with filters on top of filters—and still the water stayed dirty. One speck of soot or grease could ruin a whole week's work, too."

But it's the simplicity of his process that pleases Crawford most. "All a photographer needs," he points out, "is an original black-and-white negative—showing good detail in both the shadows and highlights, with lots of middle tones. If he has this, he's all set. Flexichrome will do the rest."

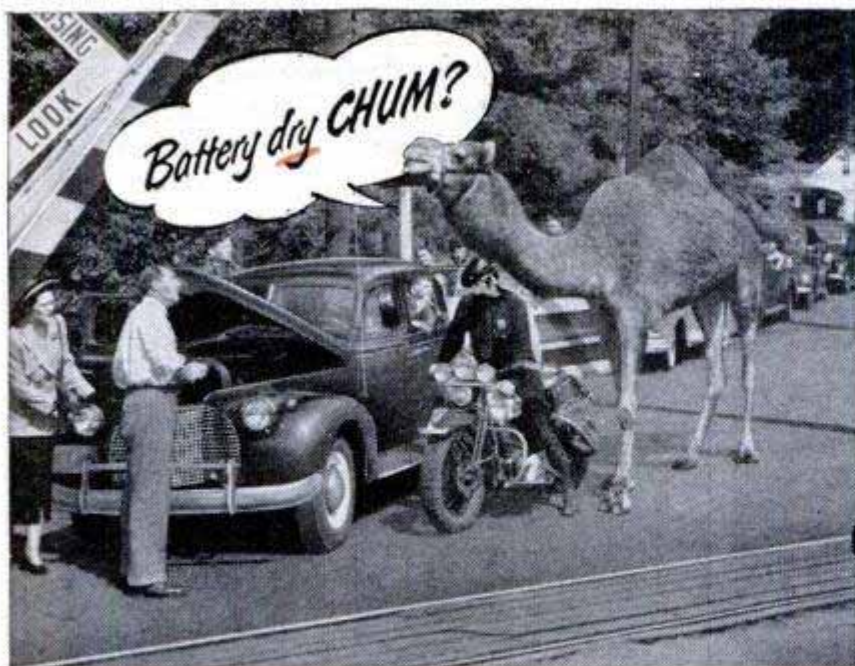

Avoid battery troubles—buy a Prest-O-Lite Hi-Level Battery. Gives up to 70% longer average life as shown in tests conducted in accordance with S.A.E. life cycle standards. See your Prest-O-Lite Hi-Level dealer today.

Toledo 1 PREST-O-LITE BATTERY COMPANY, INC. Ohio

prest-o-lite *hi-level batteries*

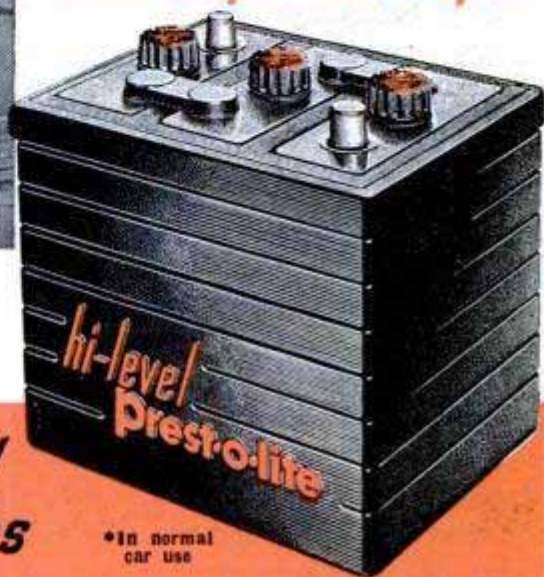

*In normal car use



"But I always carry Weldwood Glue; it's wonderful for emergencies."



Remember Weldwood Glue when you need dependable wood-to-wood bonds. Quick and easy to mix with cold water . . . tremendously strong . . . stain-free . . . rot-proof . . . and *permanent*. At paint, hardware, variety stores and lumber yards. 15¢, 35¢, 65¢, 95¢ and larger sizes.

WELDWOOD PLASTIC RESIN GLUE

United States Plywood Corporation, New York 18, N. Y.

OCTOBER 1949

BUY

Prest-o-lite
hi-level batteries... need
water only 3 times a year*

**ALSO HANDY FOR
WOOD HOBBYISTS!**



Firzite
— to give you smooth finishes on fir plywood and other soft woods.

A pre-finishing material that seals the wood pores... tames the wild grain . . . virtually eliminates checking and grain raising. An excellent base for stain, paint or enamel. White or clear. White Firzite provides an easy, low-cost way to achieve "blond," "bleached" or "wiped" finishes.



Satinlac
— to preserve the beauty of all woods.

An inexpensive coating for the proper finishing of Weldwood Hardwood Plywood and similar woods. Clear. No brush marks. Brings out all the natural beauty of wood. Does not yellow or darken with age.

FIRZITE and SATINLAC are available from paint, hardware and lumber dealers. Write for leaflet No. 3 on finishing plywood.

For a new experience
in sanding

try

ADALOX®

the abrasive paper that
cuts sharper and faster

Here's the professional woodworker's paper now available to everyone. ADALOX Paper cuts faster because it's coated with hard, sharp Norton aluminum oxide "grinding wheel grit" that takes a real bite and keeps on doing it, eliminating much "time-out" for changing paper. ADALOX produces a more uniform finish, too, for every grain is electrostatically placed, sharpest end up. Whether you're sanding by hand, disc, or mechanical sander, you'll get a better result faster with ADALOX Paper. At better hardware stores everywhere.

ADALOX DISCS

with slotted center holes fit all 5-inch portable disc sanders and attachments. Sturdy, flexible backing; fine, medium and coarse grits. Assortment or single grit packs.

ADALOX SHEETS

3½" x 9", fit all popular mechanical sanders and homecraft drill adaptors. Ideal for hand sanding. Ten sheets to a pack—fine, medium and coarse. Assortment or single grit packs.

SEND FOR

"SANDPAPER—Its How and Why"

This free booklet is full of helpful information on how to choose and use abrasive paper.



BEHR-MANNING

NORTON®
abrasives

TROY, N. Y.

ALSO QUALITY SHARPENING STONES

Seal It With Rubber

(Continued from page 177)

layer on the surface, beneath the film, as a result of the presence of excess water. This is lessened by a wrapping that permits some moisture to escape.

There are numerous ways of using films in the home. Did you ever start to make breakfast toast and discover that the bread-box contained only a slice and a crust of half-dried bread? This need never happen if you have one or more loaf-sized bags made of moistureproof film. Slip each loaf of fresh bread into a bag, make two folds to close it, secure the folds with a paper clip or two, and place the package in a refrigerator—and you can open it many days later and take out a loaf virtually as fresh as the day it was baked. If you were to enclose the bread in film and keep it at room temperature, it might mold—refrigeration retards mold growth. This method can be used for preserving other kinds of baked goods, film authorities say.

Many housewives use transparent film to wrap freshly laundered sheets, towels, blankets, seasonal clothing and other articles that are to be stored a while before use. The system is particularly useful in guest rooms. Such wrapping also is an effective way of keeping moths from attacking woollens, but the material to be stored must be free of moth eggs and larvae before wrapping.

The little matter of keeping a paintbrush from drying out between coats, or even for weeks or months of idleness, has been made simpler by the introduction of a Pliofilm envelope equipped with an elastic tie string. The brush is inserted, after excess paint has been drained off, into an envelope and the string used to bind the film tightly around the handle. By keeping out oxygen, the envelope prevents the paint in the bristles from hardening. If desired, a little turpentine can be placed in the bag.

The makers of Pliofilm like to demonstrate a method for sealing bottles, wrapping soap and similarly sealing all kinds of things to retain moisture and to keep dirt out. The process is called stretch wrapping, and anyone can do it with a match and three hands, or with only two hands, the match and an embroidery hoop. Pliofilm is a thermoplastic material, which means that it softens when heated. To stretch-wrap the cap end of a bottle, hold a piece of the film taut and horizontal, or place it in an embroidery hoop to maintain tautness. Hold a lighted match or candle so the flame is a few inches below the film, moving it around so an area perhaps three

(Continued to page 258)

GREATEST MOTORCYCLE YET

NEW 1950 HARLEY-DAVIDSON *HYDRA-GLIDE*

It's the finest performing Harley-Davidson of all time! New, flashing acceleration that shoots you ahead like a rocket; new, increased power that whisks you over hills like the wind; effortless steering; positive stopping; road-hugging stability; oil cushioned riding comfort! You'll thrill to every moment in the saddle as you take in exciting race meets, hill-climbs, gypsy tours and sight-seeing trips. There's no sport like motor cycling, no fun like owning a Harley-Davidson! And it's so easy on convenient terms. See your dealer. Mail coupon now.



YEARS AHEAD!

- More Power
- Greater Acceleration
- Remarkable Stability
- Feather Touch Steering
- Positive Braking
- Amazing Comfort

HARLEY-DAVIDSON MOTOR CO., Dept. P, Milwaukee 1, Wis.

Send free copy of ENTHUSIAST Magazine filled with motorcycle action pictures and stories; also literature on new 1950 models.

Name.....

Address.....

City..... State.....



DEALERS: Valuable franchises available for the full line of Big Twins and lightweight. Write today!

IT PAYS TO BUY SPORTING GOODS AT STORES DISPLAYING THE *irha* EMBLEM



➔ Generations of value-wise, quality-conscious men have relied on their local hardware stores for the best in hunting and sporting equipment! . . . Experience directs them to the friendly, home-town hardware retailer who is most familiar with their needs. It pays to look for the *irha* Symbol of Service displayed by the good hardware men in your community—pays in quality and satisfaction gained.

● BUY AT THE STORE DISPLAYING THIS EMBLEM

You'll also find this hardware retailer—with his complete and varied stock—equally helpful in supplying other fall needs . . . and tools and materials for your repair jobs.



© 1948, 1949, NATIONAL RETAIL HARDWARE ASSOCIATION

inches in diameter is heated. You can see the film change in appearance as it becomes plastic. Quickly bring the bottle beneath the film, force the cap upward through the heat-softened spot, give the bottle a twist and immediately pull it downward. After a little practice you can make a neat seal every time.

Nonmoistureproof cellulose film can be used to make a skin-tight seal over bottles, jars, jelly glasses, tubing ends and various other openings. Dip the film into water, squeeze or wipe off the excess wetness, place the piece over the opening and fold its edges down or back like a cap and secure them with a rubber band or string. The film shrinks in drying, producing a tight cover.

When sealing bottles, there may be cases when the bottle contents give off fumes or vapors that might damage some film materials, causing the film to fail. Containers sealed with film derived from rubber should not be kept in strong light if it is desired to preserve the seal on the containers for a year or more.

Films resistant to moisture and greases are helping factories and home workshops fight corrosion. A mechanic desiring to protect a threading tap can coat it with oil or grease and wrap it in an oilproof film. If the film is thermoplastic, he can heat-seal the wrapping. Another way of preventing corrosion of a tool or other article is to seal it in an air and moistureproof film container along with a quantity of a moisture-absorbing material such as silica gel.

Film-wrapped materials suitable for home and hobby-shop use are usually obtainable from local department stores, hardware, drug or novelty stores. Manufacturers should be consulted for information concerning industrial applications involving specialized uses of film materials. Film to be used in contact with food should be a type suitable for that purpose.

Constant research is producing forms of film wrapping materials that promise even greater wonders. Tensitized Pliofilm, for example, is a special form of extreme thinness. One of its abilities is to let carbon-dioxide gas diffuse through it at about the correct rate required for normal breathing of apples and other living foods wrapped in it. An edible type of film made from pectinates derived from fruits is being studied in connection with food preservation and protection.

☐ Built to haul fresh meat from Australia, a new British ship is really two ships in one, as it has an inner and outer hull which are separated by a layer of granulated cork to keep tropical heat out.

AMAZING NEW LOW-PRICED ELECTRIC SPRAYER

makes painting **EASY!**

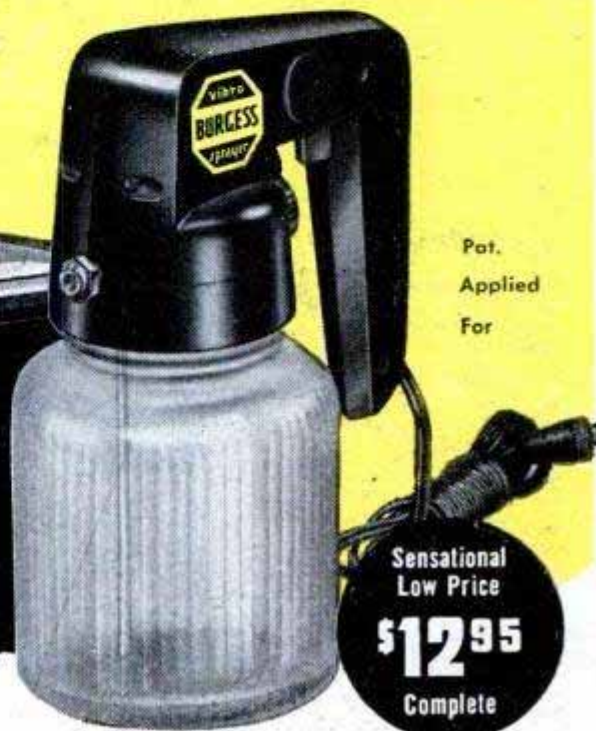
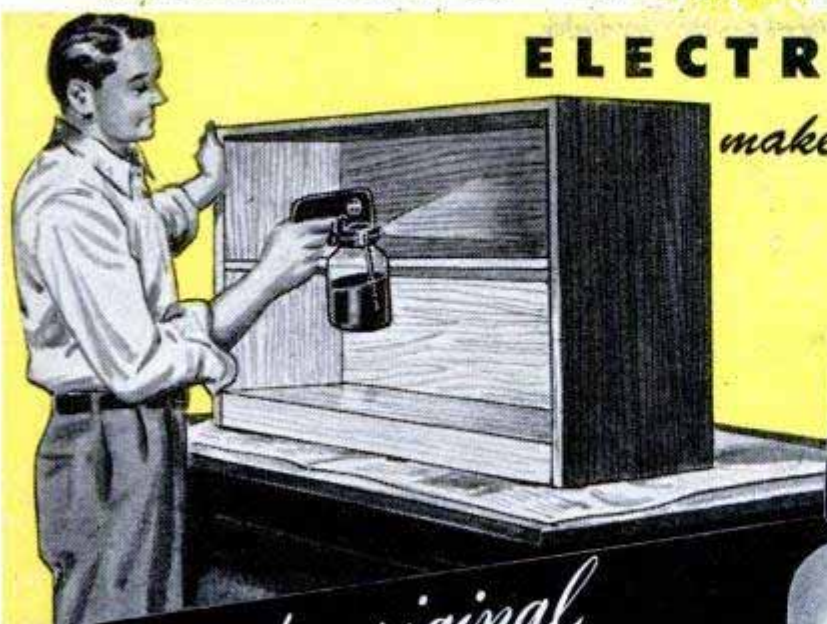

the original
BURGESS
vibro-sprayer

NO MOTOR...NO COMPRESSOR...
NO "EXTRAS" TO BUY

Just Plug In and Spray!

Easy, economical paint spraying is now as convenient as your nearest electrical outlet. Just plug the sensational Burgess Vibro-Sprayer into any 110 volt A.C. socket, press the trigger and spray. You get a beautiful, smooth finish on tables, chairs, bookcases, toys, fences, screens, floors...almost anything around the home or shop... in minutes instead of hours. Refinishes car bodies and fenders, too. And Vibro-Sprayer handles enamel, lacquer, varnish, shellac...plus light oils, insecticides. Weighs only 2½ lbs. Comes complete with 25 oz. Mason-type jar and 8 ft. cord. Fully guaranteed.

Write for **FREE Literature**

Unique **BURGESS**
vibro-tool
adds **POWER**
to *hand skills!*



This revolutionary marking tool delivers 7200 vertical strokes per minute to write like a pencil on hardest steel, mark tools, decorate glass, engrave plastics, tool leather, chisel wood or linoleum blocks, emboss metal foil, cut balsa wood, cork and cardboard. Specially designed kits for general use, leather tooling, and simple marking and engraving. All-purpose Master Craft Kit with 9 attachments shown, only...**\$9.95**
Leather Craft Kit plus 9 attachments...**\$9.95**
Marking Kit including Vibro-Tool and hard tantalum carbide point...**\$7.50**
3 different kits... each packed in sturdy, attractive storage case

BURGESS BATTERY COMPANY, Handicraft Division
155 RAND ROAD, LAKE ZURICH, ILLINOIS

Please send me full information on: Vibro-Sprayer,
 Master Craft Kit, Leather Craft Kit, Vibro-Tool and Point.

My Name _____

Street Address _____

City _____

Zone _____

State _____



BURGESS BATTERY COMPANY HANDICRAFT DIVISION
LAKE ZURICH, ILLINOIS

SELF-CONTROL STARTS HERE



and to restore
CAR PERFORMANCE

OIL-CONTROL STARTS HERE

TO STOP OIL-PUMPING, REPLACE WORN
ENGINE CONNECTING ROD BEARINGS

Poor car performance can tie your temper in knots, too! When your car engine pumps oil, **PERFORMANCE GOES UP IN SMOKE!** Oil-pumping starts with worn engine bearings. The best of new piston ring jobs won't correct oil-pumping caused by worn engine bearings. Give new rings a chance—check for worn bearings, too! Replace in sets with Genuine Federal-Mogul Oil-Control Bearings. Ask your mechanic!

FEDERAL-MOGUL SERVICE
(Division of Federal-Mogul Corporation)
DETROIT 13, MICHIGAN



CONTROL OIL-PUMPING
WHERE IT STARTS—WITH

FEDERAL-MOGUL

OIL CONTROL BEARINGS

1899 • FIFTY YEARS OF CONTINUOUS BEARING EXPERIENCE • 1949

They Pilot Sky-Piercing Rockets

(Continued from page 119)

Our decisions must be made before the normal burn-out time because after its fuel is cut a rocket behaves like an artillery shell. It continues to fly in a trajectory that was determined by the thrust of its motor. Virtually nothing can be done to affect this trajectory."

Detonating the blocks of TNT behind the warhead simply reduces the impact when the missile lands. Breaking up the rocket does not bring it down short of the target area although the pieces do not land at the exact point that would be hit by the whole missile. Even if the warhead and body were blown into small bits this debris would continue on an almost normal trajectory.



Body of the rocket falls to earth at about 100 m.p.h. Though crushed, it protects the instruments inside

There is a difference, however, in the speed at which the pieces would land.

If Karsch explodes the TNT when the rocket is 50 or 100 miles up, practically nothing happens at the time. The warhead and the airframe are moved apart by a few inches or a few feet but the rocket continues along its trajectory just as if nothing had happened, due to the lack of air resistance. The airframe falls behind when it reaches a low altitude. Spoiled of its streamlined shape, it slows down, tumbles and spins, and lands at about 100 miles per hour somewhat short of the point at which the warhead smashes to earth. The warhead hits at nearly its normal velocity, something under 2500 miles per hour.

Karsch blows off the warhead on most flights as a matter of course, at about 40 miles altitude on the downward plunge. This allows the airframe to land as gently as possible. Test and research instruments

(Continued to page 262)

something **NEW** on this .22!
EASIER, FASTER LOADING



with the
Special
MAGAZINE EJECTOR



"PLAINSMAN"

MODEL 865
BOLT ACTION REPEATER

\$23⁹⁵

FEATURE for FEATURE
 you get top value at moderate price!

H & R PLAINSMAN

Smooth action, flush-to-stock bolt handle, balanced weight, sporting rear and H & R cottontail front sight, shoots .22 short, long or long rifle cartridges — regular or high speed, genuine American walnut stock.

Tired of fumbling and "digging" to remove magazines? The H & R "Plainsman" is your dish! Flick the release lever . . . the magazine glides into position for easy removal. Slip in another magazine and fire.

Ask your gun dealer for a demonstration of the speedy magazine ejector on the H & R "Plainsman."

Exclusive H & R "BULL'S-EYE" BROACH RIFLING gives greater accuracy. All six rifling grooves cut at once. No deviation between grooves . . . no distortion of bullet's flight.

BRAND NEW — FREE TO YOU Write for new H & R catalog on all fine quality H & R arms.

HARRINGTON & RICHARDSON ARMS CO.
 431 PARK AVENUE, WORCESTER 2, MASS.

17-JEWEL WATERPROOF WRIST WATCH

- 1. SHOCK PROOF
- 2. WATER RESISTANT
- 3. SWEEP SECOND HAND
- 4. LUMINOUS DIAL
- 5. ANTI-MAGNETIC
- 6. STAINLESS STEEL BACK

Made to retail at \$49.75 **SPECIAL NEW LOW PRICE \$14.95** (PLUS \$1.50 FED. TAX)

LADIES 17-JEWEL WRIST WATCH \$14.95
 (PLUS \$1.50 FED. TAX)

GENT'S AUTOMATIC (SELF-WINDING) 17-JEWEL WATERPROOF WRIST WATCH \$24.75
 (PLUS \$2.48 FED. TAX)



\$1.00 Deposit Will Hold Any Watch Until Xmas

GUARANTEED SATISFACTION or Money Refunded Within 10 Days

Send Cash or Money Order to **INTERNATIONAL WATCH CO.** 8512 S. VERMONT AVE. LOS ANGELES 44, CALIF.

M-SCOPE TREASURE-MINERAL LOCATORS

WRITE FOR FREE, ILLUSTRATED 16-PAGE BOOKLET

M-SCOPE TREASURE-MINERAL LOCATORS. Low priced, unsurpassed efficiency, lightweight models. Factory guaranteed. Immediate shipment. Credit plan available. Write for free 16-page booklet.

GEIGER COUNTERS for finding Uranium ores. Several models, Simple operation. Low priced. Immediate shipment. Interesting free literature.



URANIUM

FISHER RESEARCH LAB, INC., PALO ALTO, CALIF.

GOLD



Just dial ANY WIDTH CUT
ON YOUR SAW



WITH

Warren

DADO SAWING WASHERS

Cut clean, accurate, parallel grooves—12 widths, any angle. No chatter, burning, chewing—or sanding! No more blade vibration—no screws to fuss with—just four balanced washers. Simply dial desired width with Micro-matic adjustment. Can be left on blade for straight cuts. Available in 5 sizes— $\frac{1}{2}$ ", $\frac{3}{4}$ ", $\frac{5}{8}$ ", 1", $1\frac{1}{8}$ ". A perfect gift for woodworkers. See your dealer or write—

\$4.95
SET

WARREN WASHERS CO.

Dept. 30 • 70 Medbury • Detroit 2, Mich.

are carried in the body of the rocket as well as in the warhead, and when the body drifts down relatively slowly, all or most of the instruments it carries are unharmed.

A V-2 or a Bumper rocket or any of the new American high-altitude missiles is a very busy vehicle in flight. Numerous instruments are at work and a multitude of radio circuits are in continuous operation.

Grenades may be fired from a rocket at various altitudes so that observers can note the time that elapses between the sight and the sound of the explosions. Aircraft components may be carried aloft for testing their aerodynamic behavior at tremendous altitudes. Parachutes are discharged from the rockets, high in the sky, to learn the speeds with which the parachutes open and the accelerations that are imposed on them.

Samples of the upper atmosphere are taken, photographs of the earth are made, cosmic radiation is recorded, the solar spectrum is observed and many kindred experiments are performed, all by automatic equipment contained in the rocket. In some cases, the results are recorded on photographic negatives that are then moved through light-trapped openings into sturdy steel drums. After the drums are recovered intact, when the rocket lands, they are opened in a darkroom.

Now under development by Dr. Severin Raynor and his team of scientists and engineers at Armour Research Foundation is a "cannon ball" which will be shot from the V-2 to measure the heat radiated from the sun, the earth and from space. Such measurements can't be made by the rocket itself because it spins and twists after the fuel is exhausted.

About 60 miles in the air a door in the rocket will open and the cannon ball will be ejected. It is a sphere stabilized during flight by three gyroscopes. Located around the skin of the sphere are 14 thermocouples which measure heat radiation that falls on them. When the cannon ball is ejected, it continues in a trajectory almost identical with that of the rocket, but the gyroscopes prevent it from spinning in the air. Thus the particular thermocouple facing the sun will continue to face the sun throughout the flight.

Measurements are recorded on 16-mm. film by a camera inside the sphere. During the fall the camera itself is blown out of the sphere and eased to the ground by a ribbon parachute.

The information about the upper air which will be provided by the sphere will be "the kind of things a man on a trip to the moon would need to know," according

(Continued to page 264)



**STOP DRAFTS
DUST, COLD!
FROM UNDER DOORS**
WITH MICHAEL d AUTOMATIC DOOR SEAL

Install in
minutes with
screwdriver

It's easy now to
free your home of
annoying drafts, dust
and cold. Simply
install the new
Michael d Door Seal
and end these dis-
comforts AT ONCE.
This amazing device . . .

**LOWERS AUTOMATICALLY WHEN DOOR CLOSES
. . . RAISES ABOVE RUG WHEN DOOR OPENS**

These dependable, proven Door Seals will fit all door sizes to close that door-to-floor gap. A thin, sturdy, ornamental metal plate 2 inches high — simply mounted to either side of any door. Automatic spring drops and raises a rubber sealing strip. Requires no oiling — no maintenance.

MONEY BACK GUARANTEE!

Agents Wanted. Large profits
— Big Demand — Quick Sales
— WRITE FOR DETAILS

Order
by mail
\$3.95
Post Paid
(If C.O.D.,
you pay
postage)

Measure your
door width and
send it with
your order
TODAY!
Only \$3.95
FREE folder!

BERN-EL COMPANY, Dept. P. 10

4719 WEST WASHINGTON BLVD., LOS ANGELES 16, CALIF.

BUILD DUTCH WINDMILLS
Lighthouses, Lawn Figures, Lawn Chairs,
Trellises, Etc., Beautify Your Garden

Model B-35 Windmill 24" high. Blueprints...50c
Wings operate farmer at backsaw. Blueprints...50c
Model B-10 Windmill hexagon style, 49" high
overall. A beautiful model. Blueprints...75c
Model H-10 Lighthouse, 49" high. Blueprints...75c
Comfortable, Sturdy Cape Cod Lawn Chair.
Blueprints...50c
12 Artistic Trellises. Blueprints all 12 only...50c
Special All Blueprints mentioned above
for only \$2.50



"Over 35,000 Satisfied Customers"
Send 10c for Illustrated Catalog.
CRAFTSMAN'S MODEL CO.
Dept. P9
2030 N. 41st St., Milwaukee 8, Wis.

MONEY for MEN ALL DATA FREE

THE PLASTEX Industry needs manufacturers on small scale and for big production of Lamp and Clock Stands, Art Goods and Novelties in Plastex and Marble imitation. Experience unnecessary. 1/2c material makes regular 10c store sellers. Rubber moulds furnished for speed production. Small investment brings good returns. Big chain store orders now being placed. Ambitious men have chance for real prosperity. Our Free booklet will interest and benefit you.

PLASTEX INDUSTRIES, Dept. A
3400 Third Ave. New York 56, N. Y.

Do a Better Job
WITH ONE OF THESE
EMPIRE LEVELS

EMPIRE TORPEDO LEVEL
Smallest, most handy and accurate Level made. "Cigar-shaped" — no sharp corners to tear pocket. Aluminum stock. Only 3 oz. wt., 9" long. Has Level, Plumb, 45° Vials.
No. 26 \$2.00

ALUMINUM LEVEL — No. 151
Cast and Machined, a Beautiful Tool, with Patented, Removable Level and Vial.
With 2 Plumb, 2 Levels, 2 — 45° Vials. 18" \$6.40
24" \$6.80 28" \$7.80

Order EMPIRE LEVELS from your local dealer.
Write direct for literature.

EMPIRE LEVEL MFG. CO.
BOX 97, DEPT. P-254 MILWAUKEE 13, WISCONSIN

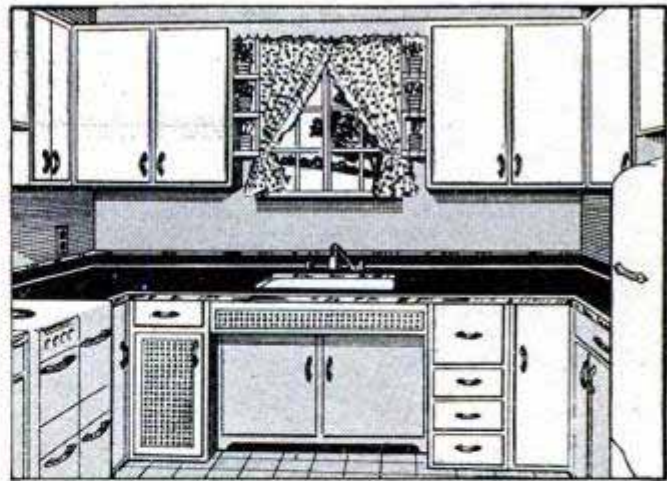

MAKE YOUR KITCHEN MODERN

. . . this low-cost easy way
. . . including today's new counter top

To help you modernize your kitchen the easiest possible way—and save up to 75%—we offer the famous Easi-Bild Build It Yourself* patterns for base and wall cabinets.

By this method, we help you discover the miracle counter top: Micarta . . . the plastic surface so smooth, so tough and lustrous, it resists any scratching, denting, or chipping—can't be stained or discolored by boiling fats, alcohol, fruit juices, greases or oil—so beautiful and colorful it's the choice of today's leading architects.

You can buy Micarta at your local lumber yard, already mounted on 3/4" waterproof Weldwood plywood. Ask for Micarta panels. They can be sawed, trimmed, planed and drilled by ordinary hand tools.

DO IT YOURSELF... SAVE BIG MONEY

And, to take all the mystery out of building Base and Wall Cabinets for your kitchen, child's room, playroom or bedroom, send for the patterns below. With them you buy only the materials the patterns clearly specify—at your local lumber dealer. You cut each piece exactly as the easy-to-follow, step by step directions indicate, then fasten into the positions shown by the "easy-as-pie" assembly illustrations. No special tools or skill are required.

Over a million Easi-Bild Patterns have been sold because they make your project easy, inexpensive and professionally perfect. Buy them at your lumber or hardware dealer or order them in the coupon below.

*TRADE MARK, Easi-Bild Pattern Company

WESTINGHOUSE
MICARTA is manufactured by WESTINGHOUSE and sold for decorative purposes only, by UNITED STATES PLYWOOD CORP.

ATTACHMENT OF BUREAU OF METERS
Guaranteed by Good Housekeeping
NOT AN ADVERTISED MECHANIC

UNITED STATES PLYWOOD CORPORATION
PATTERN DEPT. P.O. Box 215, Pleasantville, N. Y.

Enclosed is \$_____ for items checked below.

Send FREE sample of Micarta
 Kitchen Base and Wall Cabinet Patterns No. 201 at \$1.00
 Service Counter Pattern No. 80 at 60c
 Easi-Bild Pattern Catalogue illustrating over 100 other "Build It Yourself" projects at 20c

Name _____
Address _____
City _____ State _____

P.M.M. 10-40

SAY YOU SAW IT IN POPULAR MECHANICS

Lafayette

RADIO ELECTRO NEWS

★ 29th YEAR SERVING AND SAVING YOU MONEY

NEW YORK: 100 Sixth Avenue and 542 E. Fordham Road
 CHICAGO: 901 W. Jackson Blvd. and 229 W. Madison St.
 BOSTON: 110 Federal Street NEWARK: 24 Central Avenue
 ATLANTA: 265 Peachtree Street

Best Buys You Can Get—Now Yours From Lafayette

CATHODE RAY TUBE



Brand new 5BP1 cathode ray tubes, perfect for oscilloscope use. Green fluorescence with medium persistence. Large five-inch screen, medium shell magnal 11 pin base. 6.3 volt heater, anode No. 2 voltage 2500 volts. Each tube is

individually boxed. Weight 3 lbs.

No. 99N9559.....Lafayette's Price Only **\$2.95**

AMAZING INSTANT-HOT SOLDERING IRON



Flick the switch and it's *soldering-hot in split seconds*. Heat is concentrated in flat non-corrosive nickel alloy tip. No filing or tinning necessary. Weighs only 6 ozs.; fine for hard-to-get-at places. ON-OFF switch in easy-grip plastic handle. Pays for itself over and over in time saved. AC-DC.

No. 18H15189—List Price \$7.95 Lafayette's Price Only **\$5.30**

"SELF-POWERED" PHONE SYSTEM



No batteries or current needed! The power for this phone system is generated by your voice alone! You can have perfectly clear 2-way conversations as far as 25 miles apart! Ideal where you need a portable communications system that can be quickly set up. Especially useful when installing TV antennas, because you can use the antenna wire as the phone line! Also practical for intercom use around the home, shop, farm, or office. They're being snapped up at Lafayette's bargain price.

No. 32H14015 (Weight 1½ lbs.) **\$8.75** per phone

FREE! 164 PAGE BARGAIN CATALOG

NEW 1950 EDITION

Why pay more when you can buy for less from Lafayette's New 1950 Bargain Catalog, just off press. 164 pages packed with latest model, famous-make equipment in TELEVISION, RADIO, TOOLS, PUBLIC ADDRESS SYSTEMS, HIGH FIDELITY, RECORD CHANGERS, HAM GEAR, PARTS, etc. Thousands of radio men will save millions of dollars buying from Lafayette this year—as in the past 29 years! A letter or penny postcard brings yours.



LAFAYETTE RADIO, Dept. LJ9
 901 W. Jackson Blvd., Chicago 7
 100 Sixth Avenue, New York 13

MAIL THIS FOR FREE CATALOG AND TO ORDER

Check here for FREE Catalog. (Please don't check if already on our mail list.)

Please fill my order for items checked above for which I enclose \$..... in postal note, money order or check. Please include shipping charge based on weight and zone.

NAME.....

ADDRESS.....

CITY..... ZONE..... STATE.....

to Doctor Raynor. He points out that rocket scientists need more information about the climate encountered by rockets in the upper air.

Other information, particularly concerning the behavior of the missile itself, may be reported back to earth by telemeter radio circuits. A few years ago only a few simultaneous telemeter circuits could be employed at one time; now 40 or more channels may be used at once because of improved techniques.

One of the most advanced telemetering installations, developed by the applied physics laboratory of Johns Hopkins University, is contained in a mobile tractor and trailer, air conditioned, that may be driven to the site from which a rocket is to be flown.

The station can receive telemetered information from an airborne vehicle over as many as 50 channels at one time. It is a dual recording station because more than one carrier wave may be used on a single channel. It records much of the information by a high-speed camera that is focused on an oscillograph and that consumes five feet of 35-mm. film per second. Additional channels are fed to strips of photographic paper. Disk recorders are used to make duplicate, audible records.

An amazing amount of information can be recorded during the few minutes or portion of an hour that a missile is in the air. In the past it has required months of tedious work to translate all the data from one flight alone into understandable graphs and figures. This is too slow from the research standpoint, so engineers of Douglas Aircraft Company early this year developed a special mechanical brain, now in use, that digests the entire mass of data and presents it in usable form in less than half a day.

All this work is contributing to the program of developing larger, multi-stage rockets that can be guided to distant points and that sometime may be able to leave the earth and ride off into space.

Injections for Leaky Dams

Leaky earth dams are made watertight by an asphalt emulsion injected into the ground. Metal pipes first are driven into the earth. Then the asphalt preparation, mixed with water, is pumped through the pipes and emerges from the other end, spreading out through the earth. Chemicals cause the asphalt particles to combine, producing a mass that water can't penetrate. After the first injection, the pipes are raised and an additional emulsion applied atop the first until the dam is leakproof.

Snap-on's Famous Ferret Set



Rugged tools . . . twice as strong as you would expect such slim, streamlined handles and thin-walled sockets to be.

"The Choice of Better Mechanics"

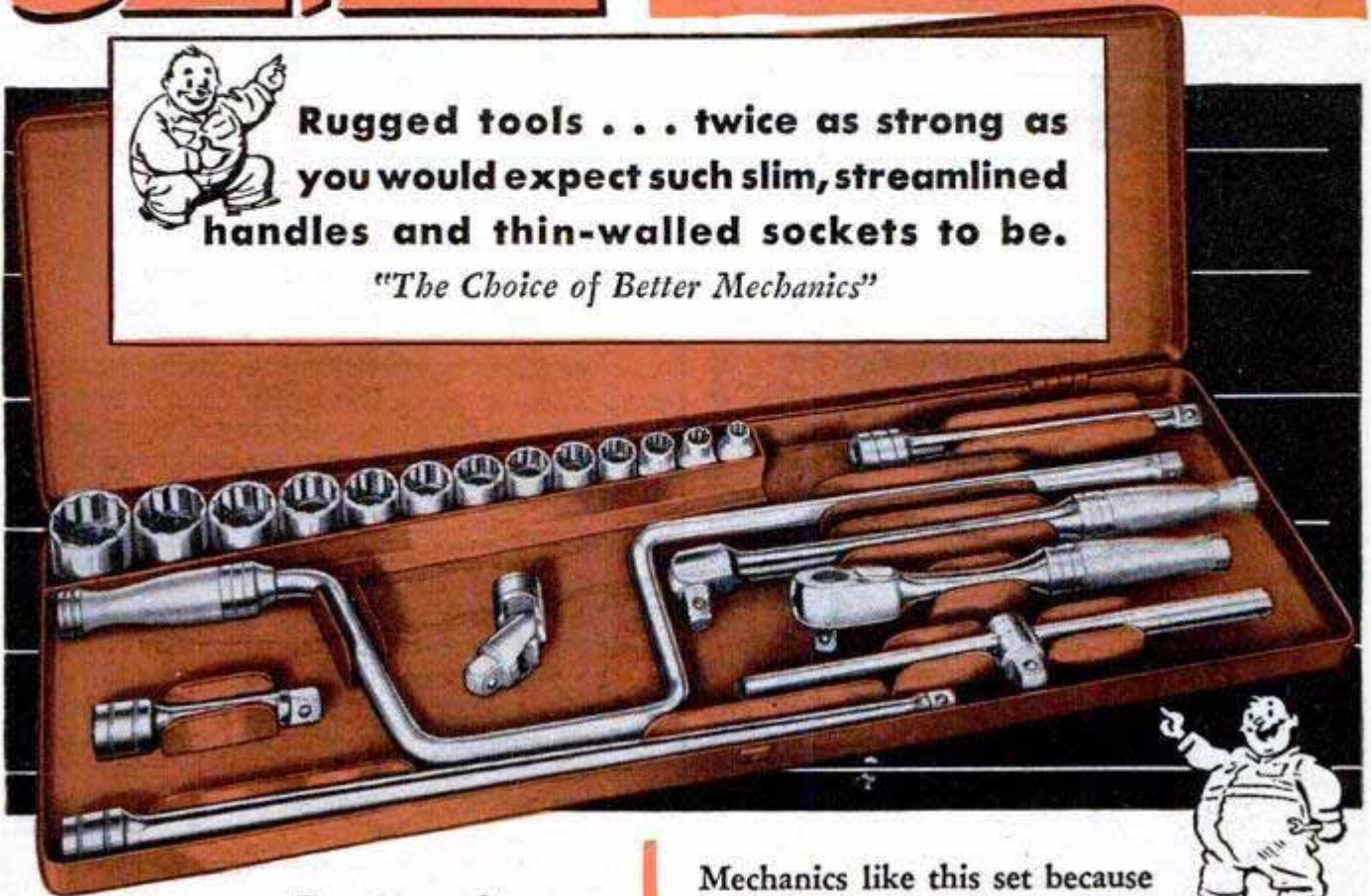

Present Owners:
Supplement your basic set with these Special Ferret tools . . .

CLUTCH-TYPE SCREW DRIVER



Handles clutch-type (figure 8) head screws. Built short for easy operation in close quarters.

RATCHET ADAPTOR



Converts any combination of Ferret handle, extension and socket into a reverse action ratcheting tool.

PLASTIC GRIP HANDLE



A shockproof, plastic handle, 5 1/8" long that is ideal for electric work. Makes your Ferret Set more useful.

DOUBLE HEX FLEXOCKETS



Saves a lot of tough work fumbling for hard to get at studs and bolts. Eight sizes: 1/8" to 3/4".

Mechanics like this set because it is way over par in performance . . . the tools are strong and easily adaptable to a variety of jobs.

They squeeze into tight places and get those hard-to-reach nuts and bolts that defy the ordinary type wrench. Recently designed by Snap-on engineers, they have the new features that make fast, easy work of the tough jobs.

INCLUDED IN THE SET: 1/4" and 5/16" single broached sockets; 11 double broached sockets from 3/8" to 7/8"; a speeder wrench, sliding tee, 8" reversible ratchet, nut spinner and universal joint, plus a 3", 6" and 12" extension. All complete in a metal box for only.....

\$27.65

Add Local Sales Tax

Snap-on Tools
THE CHOICE OF BETTER MECHANICS

... are available only from the local Snap-on man ... Snap-on Branch Offices ... or direct-by-mail. You will not find them at hardware stores. Use coupon.

SNAP-ON TOOLS CORPORATION
8062-J 28th Avenue, Kenosha, Wisconsin

- Enclosed find check Money Order or Company Purchase Order for the \$27.65 Snap-on Ferret Set.
 Please send illustrated brochure describing 109 individual Ferret units.

Name.....
Address.....
City..... State.....



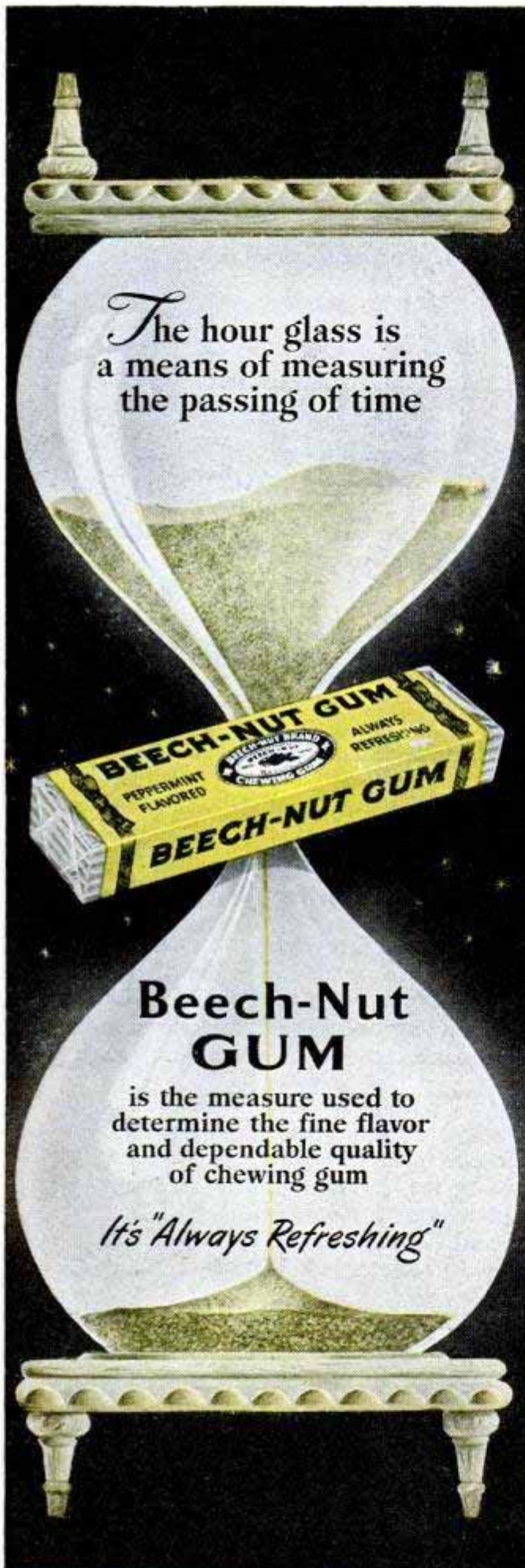

Million-Dollar Baby of the Atom Age

(Continued from page 93)

were shelved before they got into production. One instance was a box for reading the penlike monitors worn by workers in plants using radioactive materials. Before the first design was in production an electronic reader was perfected to replace it.

The partners have discovered that like nuclear fission, almost everything they have developed in their plant operates in a chain reaction. Take Q-gas.

"We needed a detector for counting soft radiations," said Kuranz. "The ordinary Geiger tube is a cylinder with an axial wire running down the center at high voltage. The inside of the cylinder is a near-vacuum. As rays from disintegrated atoms enter this chamber, positive and negative ions are formed to create a pulse of current. The vacuum necessitates a container that will withstand atmospheric pressure. The thickness of this container is enough to absorb weak radiation before it can get inside the counter. We figured a mixture of the right gases would serve as well as a vacuum. Our present Q-gas—developed with the help of one outside scientist—is composed of an argon and butane mixture, but we are still experimenting and may find something even better.

"After we got a tube to work at atmospheric pressure, we developed our windowless Geiger counter. Samples of radioactive material can be introduced directly into the machine to detect soft rays."

One of the many advantages of the windowless counter is that it can pick up the weak radiations from Carbon 14. This is a favorite radioactive material for medical experiments with laboratory animals and plants. Formerly in studying liver action in rats, lethal doses had to be given because such small amounts of the carbon went to the liver. Now the rats can be kept alive and the liver action studied under normal conditions of body chemistry. This is a tremendous boon to many phases of medical research—including cancer.

The windowless counter was followed by the new Q-gas Geiger tube which in turn brought about the remodeling of Nuclear's portable Geiger counter. Nuclear's old portable contained the conventional costly Geiger tube and high-voltage batteries. The new Geiger counter, which they call Sniffer, is powered by only two small flashlight batteries.

"Our future plans are dependent on how radio-isotopes are applied," said Schoke. "Right now the main application is in the

(Continued to page 268)

HEY! MY BIKE LOOKS LIKE A JET PLANE WITH MY NEW STRATO-JET BIKE EXHAUST PIPE

You'll be the envy of your neighborhood when you ride out with a Strato-Jet on your bike! This snappy chrome-plated accessory is easily attached to back wheel of any make of bicycle—it will add tremendously to your biking fun. Be the first to have a Strato-Jet on your bike—order today! Send check or money order. Money back if you are not completely satisfied.



ONLY \$2.45
POSTPAID

LEA ASSOCIATES, BOX 86, HAZEL PARK, MICH.



YOU NEED THESE THINGS

IN THE FILES YOU BUY:

STRAIGHTNESS — for holding the filing stroke "to the line" when necessary.

ACCURATE CUT — teeth of even height, sharpness and spacing — to assure full, smooth bite.

UNIFORM HARDNESS — to avoid "skips" and "grabs" and uneven wear.

PROPER BALANCE — for steady filing strokes.

GOOD STEEL — for long file life.

AND YET you don't have to be a "file expert" to detect these qualities . . . you can be sure of getting them by simply asking for Nicholson or Black Diamond brands. They have all the features that enable the world's foremost file manufacturer to guarantee you *Twelve perfect files in every dozen*. Good hardware stores prefer to sell them because they give you the most for your money.

• FREE 48-page book, "FILE PHILOSOPHY," on kinds, use and care of files. Send for your copy.

NICHOLSON
U.S.A.

NICHOLSON FILE CO.

22 Acorn Street
Providence 1, R. I.

(In Canada, Port Hope, Ont.)

BLACK DIAMOND
TRADE MARK

NICHOLSON FILES FOR EVERY PURPOSE



**OUT OF PAWN
GENUINE DIAMONDS**

SAVE UP TO 50% AND MORE

Unmatched values in genuine blue white diamonds. Each diamond sold with a written iron-clad money back guarantee. All diamonds set in gorgeous new mountings. Send today for beautiful, illustrated catalog showing values from \$10.00 to \$10,000. Over 100,000 satisfied customers have bought Diamonds from Berman's. Our reference—your own bank or any mercantile agency.

BERMAN'S DIAMOND LOAN BANK
DEPT. P — BERMAN BLDG. BALTO. 1, MD.

Send today for
**Illustrated
FREE
Catalog**
NO OBLIGATION

BRASS NAME PLATES OR KEY TAGS

40c each—3 for \$1.00

QUANTITY PRICE — SAME STAMPING
8 for \$2. - 15 for \$3. - 25 for \$4. - 50 for \$6.
LARGER QUANTITIES ON REQUEST

TAGCO, BOX 38X, WINGDALE, N. Y. STAMPING EQUIPMENT

Easy and Cheap to Operate

SAVE TIME, WORK, MONEY!

SHAW "DU-ALL"

and "PEPPY PAL" TRACTORS

These rugged walking or riding tractors are ideal for farm, truck garden, orchard, poultry farm. Operate on a few cents an hour. A child can handle them.

DO DOZENS OF JOBS Both riding and walking tractors quickly and easily plow, cultivate, harrow, disk, bulldoze, spray, haul, grind, saw wood, etc.

LOW FACTORY PRICES Buy direct or through your dealer. Year's guarantee!

RIDING TRACTORS 4 models from 5 to 12½ H.P., 53 in. wheelbase, 36 to 52 in. wide, 24 in. plant clearance. Hand or electric starter. Walking Tractors 1½ to 5 H.P.

FREE Illustrated folders giving complete details and price lists—write today!

4510 FRONT ST., GALESBURG, KANS.
668G NORTH 4TH ST., COLUMBUS, O.

SEE OUR EXHIBIT AT:
KANSAS MANUFACTURERS' SHOW
Wichita, Kansas, Spaces 67 & 68D, Forum Exposition Building, October 18-23

Ed. Hofzigan

Smooth Going

After a... 

CASITE TREATMENT

A PINT THROUGH
THE AIR INTAKE

A PINT IN THE CRANKCASE



● Revive your engine with a CASITE TREATMENT. A pint through the air intake quickly frees sticky valves and rings, gives old-time zip and power.

A pint in the crankcase *keeps* your engine clean and free running—speeds up lubrication—retards engine wear and cuts repair bills.

That's the CASITE TREATMENT... That's the way to smoother, happier miles.

Get a CASITE TREATMENT today... from any garage, service station or car dealer.

THE CASITE CORPORATION, HASTINGS, MICHIGAN
Casite Division, Hastings Ltd., Toronto

BETTER AND SMOOTHER PERFORMANCE
or-Double-Your-Money-Back

field of research—medical, biological, and to a small degree industrial. We feel that the versatility of radio-isotopes as a tool is tremendous and when industry begins to apply the isotope to its problems, big things are going to happen."

Nuclear is planning a service for studying specific applications for the use of radio-isotopes. Meanwhile many industries are already presenting their problems to the company. One large concern is treating a certain material in 25,000-gallon vats and the problem is to measure the effects of the process.

What do these young and practical scientists think about the future of atomic energy and its applications to our daily life? Will the atom be powering our planes, ships, submarines, automobiles and locomotives and heating our homes?

"We feel that the atom will take its place with other sources of power," said Kuranz, "and not necessarily replace coal, oil or other sources. Atomic power will only compete where it is economically feasible. For example, water power is too cheap ever to be threatened by the atom. In the case of public utility power plants, the biggest cost factor is distribution and that will apply to the atomic power plant as well as the conventional plant of today.

"A lot of research is now being done on shielding. Everybody is familiar with the thick shielding now required in atomic power plants to afford protection from deadly radiation. It is possible that a nuclear reaction may convert this radiation into something more absorbable. A neutron can go through a great thickness of steel but thin sheets of cadmium or boron will do a lot to stop it by converting the energy to some other form of radiation. If the deadly gamma ray can be converted to some harmless soft ray it may be possible to build a small atomic engine for a plane or car. The cost factors involved here should be a comfort to the auto builders in Detroit for years to come.

"We feel the big future of atomic power will be in ships and submarines and in packaged power plants. The latter could be used in regions where cheap water power or coal is unavailable.

"In time we hope the public will become more familiar with the wonders of nuclear fission—the things you can do by splitting atoms. Actually it's as simple as electricity and one of these days the word isotope will be as common in our language as radio or television. Electricity can get complicated while an isotope is merely an upset atom that emits useful rays that can be put to work."

KING MIDGET

HOME ASSEMBLED MIDGET AUTO



WORLD'S LOWEST PRICED AUTOMOBILE!

80-90 MI. PER GAL.—45-50 MI. PER HR.
Drive this car for as low as 50c per week. Precision built parts direct from factory with beautiful all steel body. Get all the facts on this amazing small auto—send 25c for detailed circular with large picture, 4 view drawings and price of all parts, or send \$1 (refunded first order) for this plus actual assembly book with 42 photos, drawings; blueprints of snow and ice conversions, etc.

MIDGET MOTORS MFG. CO., ATHENS 1, OHIO

SEND FOR FULL INFORMATION TODAY!

King Midget is the ideal small car for errands, sports use, short business or pleasure trips, delivery service or second-car utility for the whole family. Comfortable—room for husky six footer.

PAGE GARDEN TRACTOR

WRITE FOR FREE CATALOG!



Make fall plowing easier! Riding and walking models, 1½ to 5 HP. Complete gear drive—no belts or chains. Low prices, easy terms... \$188 to \$396 with cultivator. Write now!

PAGE DAIRY and FARM EQUIPMENT

1904 S. 81st Street • Milwaukee 14, Wis.

A \$50 A DAY BUSINESS IN YOUR SPARE TIME

FREE BOOK

Take BELSAW Portable Sawmill right to the trees—turn out valuable lumber for local yards—do "custom sawing" for neighbors. BELSAW lasts a lifetime. No crew needed. Power with old auto engine or tractor. Beginners get excellent results. \$62.50 down. Send postcard for FREE BOOK, "How To Make Lumber."

BELSAW MACHINERY CO.

811-V Field Bldg, 315 Westport Rd, Kansas City 2, Mo.

STRIPE WITH PAINT EASY AS USING A PENCIL

PAINTERS' STRIPING TOOL

NOW you can do your own expert striping on furniture, bikes, model planes, bulletins, autos, toys, signs, linoleum, wall board... make plain walls look like tile! It's easy to paint straight, curved, circular, even parallel lines with any color. Handiest paint tool in your workshop! Type "M" Master Painters' Striping Tool complete with tip for 1/16" stripe, \$1.00. Tool with choice of 1/64", 1/32", 3/64", 5/64", 3/32", 1/8" tip—\$1.50... all tips 75c ea. Tool with complete set of 7 tips \$5.00. (COD's postage collect.) WENDELL MFG. CO., 4234-B Lincoln Ave., Chicago 18, Ill.

A TOOL... NOT A BRUSH



\$1.00 POST PAID

Dealers Write Today!

FOR FAST ACCURATE BORING



No. 923 Bit Brace
Heavy-duty. Steel clad, ball bearing head. Cocobolo hardwood handle and head. Strong, sturdy box ratchet. Entire chuck locks in place. Forged Universal jaws hold auger bits and drills from 1/8" to 1/2".



No. 617 Hand Drill
Strong, lightweight, all-steel frame. Large, comfortable handle and knob. 1/4" capacity. 3 1/2" solid speed gear. Heavy-duty chuck with tool hardened jaws. Protected jaw springs.

NEW PROJECT PLANS... EARLY AMERICAN DESIGNS
Set of 15 plans 25¢



SERIES A: Cricket, spice cabinet & mirror, knife & fork box, match box, miniature blanket chest, nutmeg box, wall rack, napkin holder, colonial mirror, desk box, miniature cradle, mirror, shelf & drawer, tray, pipe & match box, candle stand. **SERIES B:** Miniature cradle tray, trinket box, miniature chest of drawers, spice chest, spice box, corner candle stand, coffee table, book shelf, spice cabinet, salt box, string box, shoeshine cabinet, footstool, kindling box, treasure box.

STANLEY

Reg. U.S. Pat. Off.

THE TOOL BOX OF THE WORLD
Hardware • Hand Tools
Electric Tools • Steel Strapping

SEND THIS COUPON... TODAY!

Stanley Tools, 1109 Elm St., New Britain, Conn.
Please send me Series A () and Series B () of the new Early American project plans. I enclose 25¢ for each set.

Name.....

Street.....

City and State.....

Free...

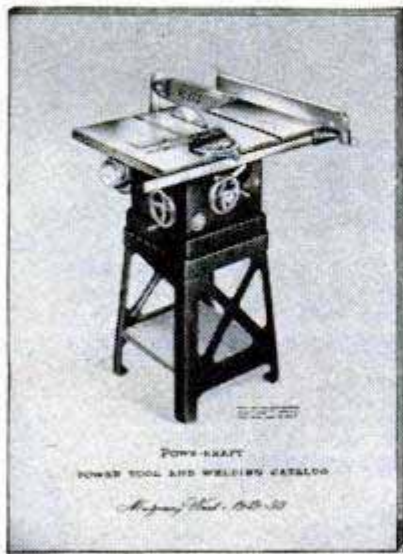

NEW POWER TOOL AND WELDING EQUIPMENT BOOK

Beautiful rotogravure 52-page book contains hundreds of illustrations, descriptions and specifications of Wards well-known Powr-Kraft line of tools for wood and metal, and motors. Also shows the nationally-known Logan Metal Lathes, Mall Electric Saws, Burke Milling Machines, Burgess Hand Tool Kits, deluxe quality Beaver Power Tools, etc. Book features the popular Shopsmith, a complete 5-tool-in-1 workshop. All tools may be purchased on convenient monthly payments at Wards Mail Order Houses, Catalog Order Offices or Retail stores.

Every power tool beginner, advanced hobbyist and production shop should have a copy of this money-saving catalog. Use coupon for your free copy now!

Montgomery Ward

Chicago • Albany • Baltimore • Denver • Ft. Worth
Kansas City • Oakland • Portland, Ore. • St. Paul
Mail Coupon to Your Nearest Ward house—NOW.

MONTGOMERY WARD, Dept. 84PM-10
Please send me free Power Tool and
Welding Catalog.

Name _____

(Print Plainly)

Street Address,
Route, Box _____

Post Office _____ State _____

Phone _____

Deep-Sea Diver—4500 Feet Down

(Continued from page 138)

The benthoscope is designed to carry two undersea explorers. Every inch of space is utilized. Two large containers give off oxygen for the two men. Carbon dioxide and water vapor are absorbed by soda lime.

The 1¾-inch wall of the benthoscope theoretically will withstand a pressure of 7000 pounds per square inch, which provides a margin of safety to a depth of two miles. The explorer looks out through two windows made of fused quartz glass three inches thick. They are equipped with metal emergency plugs that can be screwed tightly into place in an instant if the glass begins to crack from the pressure.

Illumination of the weird undersea world is provided by a 500 and a 1000-watt lamp mounted inside water-filled pyrex tubes for protection against pressure. The lamps are fastened just outside the windows.

In studying a canyon, the benthoscope will be dropped down one canyon wall and then towed across the floor and up the other slope. A powerful tug serves as the mother vessel, with the Velero IV, deep-sea research ship of the Allan Hancock Foundation, University of California, standing by. In case of emergency, the tug is capable of wrenching the sphere free of its wheels and raising it to the surface.

Doctor Barton has made one disappointing observation as a result of his record descent. "I think marine life in the Pacific is much more interesting at 2000 feet than at 4500."

Spark Plug Produces "Halo" Spark

With a factory-set gap that remains constant during the life of the plug, a spark plug of unusual design delivers a 360-degree halo of fire instead of the single spark of the conventional plug. Because of this larger spark area, the new plug is said to produce more complete combustion, burning even the oil vapors which often cause fouled plugs. The radial cathode is made of Nichrome and the plugs are guaranteed for 15,000 miles.



Greenland's icecap is estimated to be 5000 feet thick.

You Can Be the Local Manufacturer



More local plants are badly needed to make Dunbrik-Dunstone — America's finest masonry. Smart—modern—colorful. Yet costs less than lumber. Millions used annually for homes, stores, factories, public buildings. etc.

Write for portfolio "Blueprints for Profit"

With Dunbrik-Dunstone you can ride the tide of the biggest building cycle in history. Local plant—local materials—local labor. Equipment costs moderate. Liberal sponsor co-operation. 100%—150% mark-up on basic costs. Write at once.

W. E. DUNN MFG. CO.
600 W. 24th St., Holland, Michigan



DUNBRIK DUNSTONE

MODERN LAWN MOWER SHARPENER

FOR LAWN MOWER SHOPS
FIX-IT SHOPS

GOLF COURSES • PARKS
101 OTHER JOBS

Sharpens All Reel Type Mowers • Hand, Power or Gang • 10 to 20 Minutes • No Dismantling • No Extra Attachments Needed.

All reel type mowers, from 5-inch edgers to 36-inch power mowers, are quickly sharpened to extreme ends of both left and right twist blades.

Handle, wheels, roller and motor remain in place when sharpening is in process. Bed knife is sharpened in same brackets. Grinding head rides on five ball bearing races. Easy to operate. Also sharpens chisels, jointer knives, planer blades. Big profit maker. Own your own business. Send Today for FREE Illustrated Bulletin No. 10-C

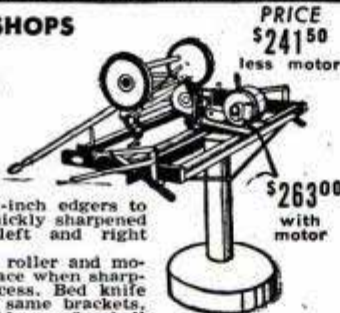

ORDER NOW
Immediate Delivery

MODERN MFG. CO. 100 N. FAIR OAKS AVE. PASADENA, CALIFORNIA

FOR HANDY, EASY TO USE CONVENIENCE
YOU CAN'T BEAT A...

CARLSON RULE

WITH 10-SECOND
BLADE CHANGE



And with a Carlson Rule you can buy an extra blade for about half the cost of a new rule. When a blade is accidentally damaged or numerals become worn, you don't have to buy a new rule. Just get an extra blade and insert it without opening the case. Presto, in 10 seconds a "new" rule for half the cost!

ASK YOUR HARDWARE DEALER

CARLSON STEEL TAPE RULES
MONROVIA • CALIFORNIA



Here's your future

- * \$35 TO \$50 A DAY
- * STEADY WORK * LIFETIME SECURITY * PLEASANT INDOOR WORK * SMALL INVESTMENT
- * NO SPECIAL SCHOOLING
- * NO TIME CLOCK TO PUNCH
- * YOU ARE BOSS!

with American

This wonderful future can be yours—as a floor surfacing contractor with an American Machine! We have the "formula" that has brought success to thousands—it can do the same for YOU. Floor sanding is a down-to-earth service that's needed every day. No big overhead... no large investment (a new car costs 3 times as much). Easy to operate an American Sander. Plenty of prospects—new or old homes—a year 'round opportunity to make BIG MONEY and be your own boss! Send for "money-making" booklet entitled "Opportunities in Floor Surfacing"—use coupon and enclose 25c in coin or stamps to cover handling.



AMERICAN FLOOR MACHINES

The American Floor Surfacing Machine Co.
535 So. St. Clair St., Toledo 3, Ohio

Enclosed find 25c in stamps or coin for booklet "Opportunities in Floor Surfacing," telling me how I can start my own floor sanding business.

Name
Street
City State



SAY YOU SAW IT IN POPULAR MECHANICS

FREE

get it now—

ALLIED'S NEW 1950 RADIO CATALOG!

196 PAGES OF
BIG VALUES

EVERYTHING
IN RADIO AT
LOWEST PRICES



TELEVISION AND
HOME RADIOS



SERVICE SUPPLIES
BUILDERS' SUPPLIES



AMATEUR GEAR



AMPLIFIERS, P.A.
SYSTEMS, RECORDERS

Send for Radio's Leading Buying Guide

Save money on every radio need! Get the new 196-page 1950 ALLIED Catalog, preferred and used by everyone in radio. See the world's largest stocks of top-quality equipment, all at low, money-saving prices! Latest TV releases, home radios and radio-phonos, Amateur equipment, PA systems and High-Fidelity Sound, recorders, test instruments, builders' kits—plus thousands of parts, tubes, tools, books and diagrams. Have all the advantages of quick delivery, complete selections, big savings and expert personal help from the World's Largest Radio Supply House. Send today for your FREE copy of the 1950 ALLIED Radio Buying Guide!

ALLIED RADIO

ALLIED RADIO CORP.
833 W. Jackson Blvd., Dept. 5-KK-9
Chicago 7, Illinois

Rush FREE 1950 ALLIED Catalog

Name

Address

City.....Zone.....State

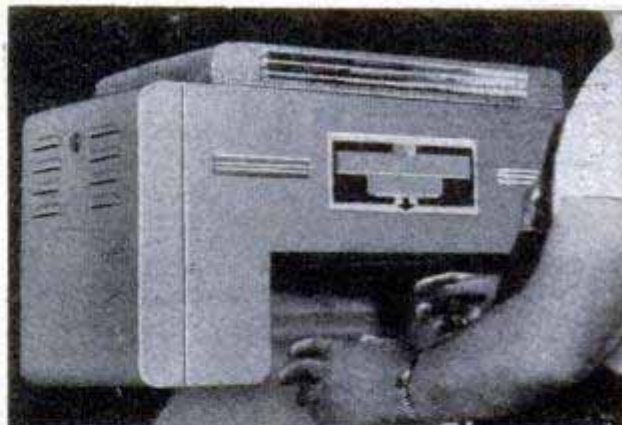

Electronic Towel

Germs don't have a chance when you dry your hands with an electronic towel that uses ultraviolet rays to evaporate the moisture in less than 30 seconds. There are no switches to operate. You place your wet hands in the horizontal opening under the wall-mounted machine and it turns itself on automatically. When you remove your dried hands, the machine shuts itself off.

Coffee Roasted by Infrared Rays

Coffee can be quickly roasted while you wait by infrared rays with a newly developed machine. It roasts a pound of coffee a minute and is completely automatic. A button is pressed, and the coffee is measured, roasted and released.



2 DRILLS IN 1



This attachment gives you two drills in one.

It converts any 1/4 inch electric drill to 1/2 inch capacity. Reduction gears reduce the drill speed 5 to 1, the average speed of a 1/2 inch drill, and thereby increases the power. Absolutely indispensable for all shop work and home craftsmen. Satisfaction guaranteed. Order yours now

\$11.95
post paid

Send check or Money Order with order. Jobbers write for special information.

G. M. CO. MANUFACTURING, INC.

1308 43rd Ave.

Long Island City 1, New York



\$39⁵⁰ F. O. B.

Kalamazoo, Mich.
Price includes motor rail, belt, pulley, mitre gauge, fence, splitter, guard — less motor. Extensions \$3.50 each.

THE NEW *Atlas* POWER KING 3001

Yes, this is it! Today's outstanding saw value. The new 3001 ball-bearing tilt/arbor Power King . . . with big saw features. . . yet priced so low it pays for itself on your first few projects! Send postcard for catalog today.

BIG SAW FEATURES!

- ★ **Tilt/Arbor Construction** — for safer angle sawing.
- ★ **Sealed Ball Bearings** — for smooth, lasting accuracy.
- ★ **Big Capacity.** Cuts 2 1/4" deep, 7 1/8" area ahead of blade. 12" x 16" table.
- ★ **Precision-Ground Grey-Iron Table.** Heavy cast iron table with precision ground easy-sliding surface.
- ★ **Rigid Rip Fence** — full table length, locks securely at both ends, releases instantly for positioning.
- ★ **Table Extensions** — 6 3/4" x 16" added on sides give you 25 1/2" wide table — 12" from blade to fence!

SPINDLE SHAPER

Cuts joints, grooving, mouldings, and edge work to add factory-like beauty to furniture and furnishings projects. The PK wood shaper is low cost, with many extra features. See it at your Power King dealers.



12" WOOD LATHE
36" between centers, 4 speeds, threaded for outboard turning, ball bearings. A most unusual value!

ATLAS PRESS COMPANY

1035 N. Pitcher St., Kalamazoo, Mich.



MATCHED PRECISION TOOLS FOR WOODWORKING AND METALWORKING

AMAZING INVENTION

SOLDER-MATIC AUTOMATIC SOLDERING IRON

AUTOMATICALLY FEEDS SOLDER TO THE TIP OF THE IRON
LEAVES ONE HAND FREE TO HOLD WORK
HOLDS OVER 6 FEET OF SOLDER 1/8" TO 3/16" DIA.
FEED ATTACHMENT REMOVABLE IN A MATTER OF SECONDS, FOR USE ON OTHER IRONS FROM 75 TO 250 WATT-SIZES. Slight pressure on trigger brings solder to the tip of the iron in the exact quantity needed. Speeds production in workshop or factory. Comes complete with instructions. Underwriter Approved 85-watt precision electric iron and six feet of solder. Fully guaranteed—money back in five days, if not satisfied.

C. O. D. add postage — prepaid, we pay postage.
ACT TODAY
THE STERN CORPORATION
219 A1 Investment Bldg.
Pittsburgh 22, Pa.

DEALER INQUIRIES INVITED

ONLY **\$5.95** COMPLETE

HOME WORKSHOP TOOLS at lowest prices!

CIRCULAR SAW BLADES

"HOME WORKSHOP" — of TOUGH Special Purpose Steel. Ideal for Hobbyists!

4" Crosscut	\$.38	"HYCARBON"—MASTER QUALITY, of finest TEMPERED HYCARBON STEEL, HANDFILED	4" Crosscut	\$1.60
6" Comb., Rip, Crosscut	1.00	6" Comb., Rip, Crosscut	2.00	
7" Comb., Rip, Crosscut	1.35	7" Comb., Rip, Crosscut	2.50	
8" Comb., Rip, Crosscut	2.00	8" Comb., Rip, Crosscut	3.00	

BLADES WITH 1/2", 5/8", 3/4" BORE ("Hycarbon" also for Mill, Skil, Thor Saws 30c more.)

EVERY ELECTRIC DRILL A SANDER AND POLISHER

Simonize cars, sand floors, walls, furniture, remove paint.
4" ROTARY SURFACE SANDER — boxed with tube of cement and 12 sanding discs, 1/2" or 1 1/2" shank **\$3.50**
Features: Sponge Rubber Cushion, Speed Cement for immediate replacement of discs.
5" POLISHING BONNET of superior quality High Pile Lambswool **\$1.25**
At your dealer, Or Order Direct, Postpaid. No C.O.D.—Send Check or Money Order TODAY!

ARROW METAL PRODUCTS CO.

Dept. A, 140 West Broadway, New York 13, N. Y.

Reading, Writing and Aviation

(Continued from page 156)

The school couldn't afford a swimming pool, for instance, yet it has a modern pool today simply because building one was made an instructional project.

A combination auditorium and gymnasium was far beyond the school's purse, but it has one. An old recreation building was found at an Army camp, bargained for, and hauled piecemeal to Weedpatch and re-erected. It's a wooden structure and not fireproof, but its only floor is at ground level. All the wiring has been inspected and plenty of exit doors provided. From the

standpoint of student safety, it will do very well until a permanent building is built.

The modern trend in education is to introduce advanced subjects to school children at an early age and the progressive country school at Weedpatch is demonstrating that the idea works. Academically, the Sunset students are as well grounded in reading and writing and other subjects as any school groups in their county. On top of that, educators who visit the school say that the students at Weedpatch are better mannered, more alert and better informed than most students their age. The school kids themselves agree that "going to school isn't as bad as it might be, after all."

The Most Versatile Tool a Man Can Own DREMEL *Electric* MOTO-TOOL

The "Pocket Size
Machine Shop"

Grinds, Routs, Drills,
Carves, Engraves,
Cleans, Polishes,
Finishes

APPROX.
27,000
R.P.M.



MOTO-TOOL KIT NO. 2
With 23 Accessories
(High-Speed Steel Cutters,
Grinding Wheels,
Polishing Accessories)
\$23.50



MOTO-TOOL NO. 2
with one emery wheel point
\$16.50



Great for
Hobbyists

Saves Time
and Labor

10 REASONS WHY MOTO-TOOL IS A BETTER BUY

Here's what you get in a Dremel No. 2 Moto-Tool: Oil-less, sealed bearings
• Patented automatic chuck lock pin
• Oversize armature shaft, hardened, ground, polished
• Shockproof, bakelite housing
• Dust filtered air cooling system
• Dynamically balanced armature (for vibrationless operation)
• Exclusive hanger hook
• Sturdy 110-120 Volt AC-DC motor
• Weight only 13 oz.
• Cutters in Kit No. 2 are made of high speed steel (not common high carbon steel) for longer life, faster cutting.

Moto-Tools, Kits and Accessories should not be confused with "bargain offers." We invite you to compare Dremel Products feature for feature with other similar equipment. If you are not fully convinced ours are far superior in quality, design and performance, we don't want you to buy.

WIDELY USED IN INDUSTRY — Moto-Tool is a precision-built electric tool, backed by over 13 years of industrial use in such plants as: GENERAL ELECTRIC • FORD • REMINGTON ARMS • NASH-KELVINATOR • WESTINGHOUSE • DOUGLAS AIRCRAFT, etc.

PRE-WAR PRICES STILL PREVAIL

MOTO-TOOL KIT NO. 2 with 23 accessories including high-speed steel cutters and Model 2 Moto-Tool in natural finish hardwood case..... **\$23.50**

MOTO-TOOL NO. 2 with one emery wheel point..... **\$16.50**

WHERE TO BUY — Buy Moto-Tool from your dealer. If he cannot supply you, send check or M. O. for items desired and we will ship postpaid. Or, send only \$2 now and pay postman balance plus postage on delivery. **MONEY-BACK** if not delighted after 5 days' trial. Catalog of Dremel Tools **FREE**.

DREMEL MFG. CO., Dept. T119-K, Racine, Wis.

BIG VALUE!



MODEL NO. 1

MOTO-TOOL KIT
Only **\$17.50**

Moto-Tool Kit No. 1 contains the lighter Model No. 1 Moto-Tool and 34 practical accessories (steel cutters, grinding wheels, etc.) in an attractive, lacquer-finish wood case. It's the biggest bargain **\$17.50** in the field.....
MOTO-TOOL NO. 1 with one emery wheel point... **\$9.85**

Portable DRILL PRESS

Add all-around versatility to your Moto-Tool with this 12" high drill press. Just the thing for creating costume jewelry, model making, carving, routing, drilling, etc. Utilizes No. 2 Moto-Tool, which can be raised, lowered or swung in any direction. Weighs 3½ lbs.

Only **\$9.95**
(Less Moto-Tool)



THREE TOOLS IN ONE



Only
\$14.85

POSTPAID



DREMEL *Electric* SANDER

Popular Labor Saver for the HOME and SHOP



MAKES PLAY OF WAX POLISHING



SOOTHES TIRED MUSCLES BY MASSAGE

The popular Dremel Electric Sander is more than a sander . . . it's also a polisher and massager. This miracle machine is so easy to handle, a child can use it. It delivers 14,400 strokes per minute. (1) As a sander, it gets into tight corners, takes the effort out of sanding walls, woodwork, furniture, workshop projects, etc. Its straightline (non-rotary) action will not burn or scratch surfaces. (2) As a polisher, it does a professional job on waxed surfaces of cars, furniture, refrigerator cabinets, etc. (3) As a massager, it's ideal for tired or sore muscles of the back, legs or arms. Users testify it is more effective than machines made expressly for this purpose.

LOOK AT THESE DREMEL FEATURES

Dremel Electric Sander does all the work . . . you merely guide it. It weighs only 2½ lbs.; it's foolproof (has only two moving parts . . . never needs oiling). Quick-change clamps firmly hold abrasives and pads. Dremel Sander is sturdily built to give long, trouble-free service. Operates on 110-120 Volt, 60 Cycle, AC. Thousands and thousands of satisfied users prove its outstanding value.

WHERE TO BUY IT — Dremel Electric Sander comes complete with 6 sheets assorted grade Garnet Paper for sanding, plus felt pad and sheepskin for polishing. Buy it from your dealer. If he cannot supply you, use coupon below to order direct from factory. We ship postpaid if you send check or money order in full. Or, send \$2 now and pay postman balance plus postage, on delivery. Money back if not delighted after 5 days' trial.

If Your Dealer Cannot Supply You USE THIS HANDY COUPON ORDER FORM

DREMEL MFG. CO. • Dept. S119-K • Racine, Wisconsin

- Enclosed find \$_____ (Check or M. O.) in full payment for items checked below. Ship postpaid at once.
- Enclosed find \$2.00 in part payment for items checked below. I agree to pay postman balance plus postage, on delivery.
- Dremel Electric Sander \$14.85 Dremel Electric Coping Saw \$5.85
- Free catalog of Dremel Electric Tools.

Name _____

Address _____

City _____ Zone _____ State _____

FUN FOR BOYS FROM 8 TO 80

DREMEL *Electric* COPING SAW

CUTS SCROLLS LIKE MAGIC—SANDS AS IT SAWS

BLADE FACES 4 WAYS

SAFE!
AS A
HANDSAW

JUST
GUIDE IT!

Only
\$5.85
with 3 new blades

For men who harbor a hobby or do their own repair work . . . for boys who like to make things . . . no other tool will give as much pleasure and satisfaction in the home or workshop for the small amount of money invested as a Dremel Electric Coping Saw. It works in any direction . . . delivers 7,200 strokes per minute . . . so easily, there is no effort . . . so smoothly, work needs no sanding. Makes child's play of tricky scroll designs . . . saws through ¾" medium hard wood at a foot-a-minute speed. Touch-of-the-trigger, foolproof action. Saw has only two moving parts . . . never needs oiling. Operates on AC current. Thousands and thousands of satisfied users.

WHERE TO BUY IT—Buy Dremel Electric Coping Saw from your dealer. If he cannot supply you, use the coupon to order direct from factory. We ship postpaid if you send check or money order in full. Or, send \$2 now and pay postman balance plus postage, on delivery. Money back if not delighted after 5 days' trial.

Plan for making six useful decorative projects packed with each Dremel Electric Coping Saw.



DREMEL MFG. CO. • Dept. S119-K • Racine, Wis.

It's FALL...Time to Change your Oil Filter!

A refill now cuts repair bills later



MONEY-SAVING TEAM
New oil and a Purolator Micronic Refill to keep it free from abrasives. Result, top engine performance, lower repair bills.

DON'T TAKE A CHANCE, TAKE A LOOK. Sludge and abrasives play hob with engines, lead to expensive repairs. Replace that choked-up oil filter now!



QUICK-CHANGE, SMALL-CHANGE JOB. Your favorite serviceman inserts a Purolator Micronic Refill in a few minutes. Traps all the abrasives; costs only \$1.38 to \$3.*

● If your car is not equipped with an oil filter, \$6.50 or a bit more* buys the best there is, a Purolator Oil Filter. See your service man soon. Purolator Products, Inc., Newark 2, N. J., and Windsor, Canada.

(*Depending on make of car.)

Purolator

MICRONIC OIL FILTER

*Clean oil - a clean engine -
lower repair bills*



The Ship That Rides on Air

(Continued from page 124)

with his mechanic, Orlin Johnson, on the Detroit River. They were drumming over 105 miles an hour when suddenly the boat disintegrated. Engines, splinters and men went flying in all directions. Wood came to under water, battered by debris, and floated to the top where he was rescued. Johnson had to be hauled up, unconscious, with smashed jaw and cut neck. Johnson, his head in a cast, and Wood, smothered in bandage and tape, built another boat and won the Harmsworth a few weeks later. That boat did not disintegrate. "You don't forget those things," he notes.

All his savvy in construction detail went into the new *Venturi*. Her hulls are planked in 5/8-inch mahogany plywood, with a double thickness of 3/4 inch below the waterline. Cross trussing, connecting the deck across the two hulls is of one by five-inch oak boards, bolted and spaced on three-foot centers. He was careful to distribute masses of the two hulls so that the center of gravity would not put too great a stress on the upper or lower chords of the cross trusses. "Most people," he says, "—including an admiral who should have known better—think there's danger of the *Venturi* doing a sort of 'split.' They forget there's no such outward strain, because there's just as much water on one side of each hull as is on the other." Distribution of weight is such as to place the lower chords of the trusses in compression and the upper chords in tension. Thus, wave action against the inside of the hull bows automatically neutralizes the stresses.

The *Venturi's* beam is 40 feet, and breadth of each hull at the widest place is eight feet. This is about two thirds of the way aft, where the engines are located. The main deck is about 22 feet off the water.

The ship was first launched in 1944, presumably to be used as a radio-controlled target vessel for bombers. She was strong enough to support 46,000 pounds of armor plate, and still have a safety factor to spare—in spite of the fact that her truss spacing and timber sizes are what you might usually find on a ship half her size.

Wood had quite a time retrieving her after the war, simply because of her queer looks. The maritime commission had her listed in its inventory as "a shelter for small boats." He finally recovered her this summer, and in typical Wood fashion, practically rebuilt her.

Today, the *Venturi* is full of Gar Wood tricks. Instead of installing big, flat fuel tanks, he has 12 vertical drums perched in

(Continued to page 278)



Now—a genuine Delta® Homecraft Tilting-Arbor Saw for only \$64⁹⁵!

(without side-table extensions, saw guard and splitter, or motor)

New 8" bench model Only \$6.50 down

A genuine Delta Homecraft tool at an amazingly low price! One of the most versatile tools a hobbyist can own — for woodworking fun and healthful relaxation . . . for saving money on repairs around the house!

A Real Value

You'd expect to pay much more for this new Delta Homecraft bench model. Here's why:

1. All working surfaces are *cast iron*, for maximum rigidity.
2. Its saw arbor runs on lubricated-for-life ball bearings.
3. It performs all operations commonly done by larger, more expensive machines of its type.
4. It cross-cuts and rips stock up to 2 $\frac{1}{4}$ " thick; it miters and bevels.
5. Accessories are available for all dado and moulding operations.

From start to finish, it's a machine you can be proud to own!

Put It In Your Shop

Your Delta Homecraft dealer can show you this new bench-model Delta Homecraft 8" Tilting-Arbor Saw. See a demonstration at your dealer's today!

If you don't know who your Delta Homecraft dealer is, send coupon below to us. We'll send you your dealer's name and address — and also a free book, "How to Start Your Home Workshop."

POWER TOOL DIVISION
 **Rockwell**
 Manufacturing Company
 MILWAUKEE 1, WISCONSIN

TEAR OUT COUPON AND MAIL TODAY!

Power Tool Division
 ROCKWELL MANUFACTURING CO.
 6814 E. Vienna Ave., Milwaukee 1, Wis.

Send me the name and address of my Delta Homecraft dealer — and also your free book, "How to Start Your Home Workshop."

Name.....

Address.....

City.....(.....) State.....

NM-71



Free Book

"How to Start Your Home Workshop"

Page after page of ideas, tips, and pictures to help you in planning and getting started. Tells about shop location, lighting, hand tools, etc. For your copy, send coupon at right.

GROBAN'S WAR SURPLUS SPECIALS!

Be Prepared with an Auxiliary AC LIGHT PLANT GENERATOR

IDEAL FOR: • Home Lighting • Hunting Lodges • Stand-by electricity • Running all AC electrical appliances incl. fans, motors, electric razors, refrigerators, incubators, etc.

Protection for emergencies to operate oil burner, stoker, freezer, water pump and lights. These units built to exacting Signal Corps specifications are the answer to your lighting needs. Drive it with a 2 1/2 H.P. gasoline engine at 1800 R.P.M.

• 800 watts • 0-150 voltmeter with regulator • 110 volts-60 cycle. AC. Ship. wt. 60 lbs.

(ITEM #67).

\$59.50

AN OUTSTANDING VALUE for.....

F.O.B. Chicago

BRAND NEW



Hydraulic Cylinders-Air or Oil



Use hydraulics on arbor presses, hydraulic presses, hay lifts, manure loaders, lift trucks—push or pull, tilt or turn, press or squeeze, open or close, lift or lower—and other hydraulic and industrial applications. Use with either air or oil . . . of finest precision workmanship.

BRAND NEW

ITEM #4—Double action, 1" bore, 3" stroke, will lift 770 lbs. in 1/10 of a second using Logan Pump. All steel barrel. Ideal for controls, door openers, post-tensioning, etc. An \$18.00 value postpaid **\$4.95**

ITEM #32—Double action, 1 1/2" bore, 9" stroke will lift 1760 lbs. in one second with Logan Pump. **\$10.95**
Wt. 4 lbs. A \$43.00 value postpaid

ITEM #16—Use these cylinders on farm trucks, bulldozers, hay lifts, manure loaders, etc. Double action, 1 1/2" bore, 27" stroke. (Will lift 1760 lbs. in 2 seconds with Logan Pump). Wt. 8 lbs. A \$55.00 hydraulic cylinder value for only postpaid **\$12.95**

ITEM #17—Double action, 2 3/4" bore, 8" stroke. (Will lift 4400 lbs. in one second with Logan Pump). Will withstand 1500 P.S.I. against wall. Wt. 7 lbs. A \$65.00 value postpaid **\$14.50**

ITEM #20—Double action 2 3/4" bore, 4" stroke, two-way solid 5/8" alloy steel shaft (will lift 4400 lbs. in one second with Logan Pump). postpaid **\$16.50**
A \$73.00 value

ITEM #15—Double action, 3" bore, 8 1/2" stroke. All steel hydraulic cylinder, will lift up to 12,000 lbs. (7000 lbs. in 3 seconds with Logan Pump). Complete with fittings. Wt. 12 lbs. A \$78.00 value postpaid **\$19.50**

ITEM #31—Double action, 3 1/2" bore, 11" stroke. (Will lift 9800 lbs. in 7 seconds using Logan Pump.) Complete with fittings. Wt. 15 lbs. A \$92.00 value postpaid **\$22.50**

ITEM #6—Double action, 3" bore, 23" stroke, hydraulic cylinder will lift 7070 lbs. in 3 1/2 seconds using Logan Hydraulic Pump. Especially suited for farm and construction machinery. Clevis mounting for easy use. Wt. 22 lbs. A \$145.00 value. **\$27.50**

F.O.B. Chicago

ITEM #42—Double action hydraulic cylinder. 4" bore, 18" stroke. Rated lift capacity with 1000 P.S.I. input is 12,560 lbs. using Logan Pump. Ship. wt. 30 lbs. F.O.B. Chicago. **\$32.50**

AN EXCELLENT VALUE for.....

HI-PRESSURE FITTINGS for cylinders and valves available at 35c ea. for 3/8" pipe and 50c ea. for 1/2" pipe.

HYDRAULIC CONTROL VALVES

LOGAN Heavy Duty Oil HYDRAULIC CONTROL VALVE



BRAND NEW control valve with built-in adjustable relief valve, will operate one double-acting hydraulic cylinder or two cylinders as one or a reversible hydraulic motor. Valve handle latches in neutral position. Made of rugged cast aluminum alloy. Open center unloads the pump in neutral position. Throttling control allows operator to regulate the speed of movement of the hydraulic cylinder or motor. Has removable mounting brackets with 4 bolt holes, 3/8" pipe thread connections. Overall dimen.: 12 1/2" H x 8 1/4" D x 8" W. Ship. Wt. 17 lbs. Govt. Acquisition Cost over \$100.00. **\$21.95**

(ITEM #37) AN EXCELLENT BUY FOR..... F.O.B. Chicago

Brand New



ITEM #24—Four way control valve for use with double action hydraulic cylinder, may be used with 1500 P.S.I. hydraulic system to open and close hydraulic cylinders. Brand new. Ship. **\$7.95**
wt. 4 lbs. A \$38.00 value postpaid

ITEM #26—Four-way control valve for use with two hydraulic double action cylinders. Each cylinder may be operated independently of the other or in conjunction with the other. Oil may be locked in any of the cylinders to hold the piston at any required position. Brand New. **\$10.95**
Ship. Wt. 6 lbs. A \$60.00 Value postpaid

ITEM #28—A two cylinder double action valve with a unique arrangement, allowing the operator to raise both cylinders simultaneously, to lower them simultaneously or to raise one and lower the other at any predetermined rate and speed. Brand New. Ship Wt. 8 lbs. A \$75.00 value postpaid **\$14.95**

GROBAN SUPPLY CO.

DEPT. PM-10, 1507 S. MICHIGAN AVE., CHICAGO 5, ILLINOIS

the 27-foot hull spaces, holding from 1200 to 2000 gallons each. Thus, he eliminated the necessity of building complicated baffles to keep the liquid from shifting around. The ship has a cruising range of 3000 miles.

The engines are another Wood innovation. Each propeller is driven by a pair of 1200-horsepower G.M. pancake diesels in tandem. To make two engines work on one propeller, he used a system he had devised for the Miss Americas. One drives directly on the main shaft; the other turns a short shaft that goes into a gearbox which, in turn, delivers belted power to the main shaft. Thus, two engines turn one shaft without having to be in perfect "synch." No real speed tests have been run yet, but Wood expects "to get her up over 40."

Both propellers have variable pitch, electrically controlled from the bridge. The engines have no reverse gear, but by simply reversing the propeller pitch, Wood can back up quickly and easily without, as he says, "a lot of engine-room acrobatics and bell banging." For docking, he has a portable pitch-control lever which he carries out on deck, trailing wires, so he can look over the side and see how close he's coming.

Though the ship has a conventional wheel on the bridge, the inventor hasn't bothered to hook it up yet. Rudders are turned electrically. "It's so goldarn much easier," he explains, "but we'll keep the wheel for tradition's sake."

With two rudders to consider, the speedboat king wanted no complicated synchronizing apparatus that might go out of whack. So he ran simple rudder rods up the stern to the deck and fastened them to big metal quadrants, which are tied in together with cable. When one turns, the other goes with it.

With all these innovations, Gar Wood is not finished improving his dreamboat. "The reason she rides so smoothly," he points out, "is because she's half airplane. All her surfaces are airfoils. The tunnel gives her 'lift' which keeps her from bobbing, pitching or rolling. In 10-foot seas, as much as 60 feet of her hulls have been out of water, bridging wave crests without dropping down. She's riding mostly on air, and we're going to make the Venturi ride on even more air."

Here's how he'll do it: Edges of the long, flat bottoms of the hulls are bound to the hull sides by protective L-shaped metal strips, 1/8 inch thick. This means there's a hull-wide groove 1/8 inch deep running the whole length of each bottom, and the inventor has devised a way to fill it with air. Holes will be drilled along the bottoms

(Continued to page 280)

All Merchandise Brand New - Order Today - Satisfaction Guaranteed!

LOGAN Heavy Duty Oil HYDRAULIC PUMP

BRAND NEW . . . for operating hydraulic cylinders and hydraulic motors on tractors, bulldozers, construction machinery, lift trucks, industrial applications, etc. Delivers 8 GPM at 1200 RPM at 1000 P.S.I. using 5 H.P. Has 1 1/2" pipe thread inlet, 3/8" pipe thread outlet, 3/4" shaft with flat and key-way for direct or pulley drive. Has flange with 4 bolt holes for convenient mounting. Ship. wt. 22 lbs. Overall dimen.: 7" L x 5 1/2" H x 5 1/2" W. A \$105.00 value. FOR ONLY

\$22.50



F.O.B. Chicago (ITEM #29)

HANNA AIR CYLINDER

Used for heavy duty industrial applications on shop air lines or with low pressure systems. With 100 lbs. of air pressure, will deliver 1900 lbs. pressure at the ram shaft. All steel construction. Adjustable cushions at both ends of cylinder. Shaft dia. 1 1/2". Foot mounting with clevis on ram shaft. 2 1/2" double-acting stroke; 5" bore, 40 1/2" overall length closed, 7" overall width. 89 1/2 lbs. net wt. Gov't. acq. cost \$101.85. AN EXCELLENT VALUE for F.O.B. Chicago



\$39.50

VICKERS MF9 HYDRAULIC PUMP or MOTOR

complete with mounting kit ready to install



\$19.90

POST-PAID \$75.00 value

Pump is compact, powerful, rated 1,000 P.S.I., .507 cu. in. per revolution. 8 gal. per min. at 2750 RPM. Change rotation by reversing flow. Delivers up to 6 H.P. Requires 1/2 to 6 H.P. to drive directly or by pulley. BRAND NEW. Mounting kit has been especially designed to provide maximum utility and ease of mounting MF Series Vickers Pumps. Brackets are constructed of heavy steel plate; shaft is made of 1/2" steel with one end splined to fit pump; other end of shaft has machined flat for mounting a standard pulley with 1/2" hole. Shaft runs in oilite bronze bearings. PUMP ONLY (ITEM #18). \$14.95 postpaid MOUNTING KIT ONLY (ITEM #38) \$ 4.95 postpaid BOTH AS COMPLETE UNIT (ITEM #39) \$19.90 postpaid

ADJUSTABLE RELIEF VALVE. (ITEM #34) \$2.95 post-paid

HYDRAULIC FLUID. (ITEM #53) \$1.75 Per gallon F.O.B. Chicago

10 ft. length of Hi-Pressure HYDRAULIC HOSE, with 1/4" female pipe thread fittings. (ITEM #27). \$3.95 F.O.B. Chicago

Brand New HYDRAULIC TANK, 3 gallon capacity with oil-indicator cap. 4" x 12" x 13 1/2". Ship. wt. 13 lbs. NOW AT THIS LOWEST PRICE. (ITEM #58). \$4.95 F.O.B. Chicago

Brand New Gear Type INSECTICIDE PUMP

All Manganese Bronze for spraying D.D.T., 2-4D, Sulphur Compounds, Etc. Pressures up to 150 lbs. to 14 gallons per minute—1500 RPM. Will not rust, pit, foul or freeze up. Use rubber hose inlet pipe or tubing outlet. Equipped with 1 1/2" standard pipe thread port. Wt. 10 lbs. Dimen.: 8" x 5" x 6 1/4". Standard 1" manganese bronze shaft with key-way. U. S. Gov't. Acquisition Cost. \$62.00. NOW ONLY (ITEM #50) \$15.00 F.O.B. Chicago

CENTRIFUGAL PUMP BELT DRIVEN

Ready for use on any Liquid Pumping Need

Use it for DRAINING BASEMENTS HOME WATER SYSTEMS IRRIGATION STOCK WATERING FIRE PROTECTION DRAINING PONDS, TANKS, etc. INDUSTRIAL PUMPING

A super value for all types of intermittent service in pumping large volumes of liquid in home, farm and industrial service. Ideal for home water systems, draining basements, fire protection, etc. On the farm for watering stock, draining ponds, sprinkling, etc. In shops and factories for all types of pumping service.

MOVE LARGE VOLUME QUICKLY

When operated at 1750 RPM, will pump 42 gallons per minute on a 23 foot head; at 3600 RPM on 52 foot head will pump 88 gallons per minute. May be run with electric motor, gas engine or power take-off on tractor.

COMPLETE ENGINEERING REPORTS AND OPERATING INSTRUCTIONS FREE WITH PUMP

Pump has cast aluminum housing—accurately machined bronze impeller vanes. Complete with mounting bracket and 3 1/2" V belt pulley. Shaft rotates on sealed ball bearings with grease gun fitting. Has 1 1/2" threaded intake flange, two 1 inch outlets. Use one or both, as necessary. Made for Packard Motor Car Co. for use in Rolls-Royce Merlin Aircraft engines.

GREATEST PUMP VALUE IN YEARS

Shipping weight 23 lbs. You can't beat this value at anywhere near this price. Satisfaction guaranteed. Original Cost Approx. \$147.00. (ITEM #64)

NOW . . . It's Easy to Weld with this handy Electric ARC WELDER

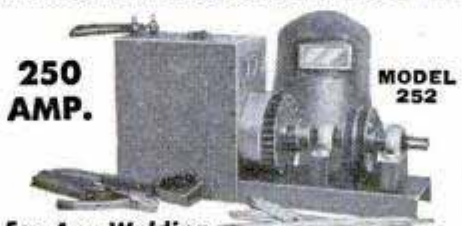

250 AMP. MODEL 252

For Any Welding job, light or heavy

Designed for many years of trouble-free service! Handles anything from light gauge sheet metal to 1/2" plate. This precision-engineered direct current ELECTRIC ARC WELDER is offered at but a fraction of its original value. It can be mounted permanently or easily transported for portable use. Does the job instantly, where and when you need it.

The War Surplus generators for these Arc Welders were built by General Electric, Westinghouse, and Delco-Remy at a cost of over \$300.00. They are light in weight; have oversized lifetime grease-sealed ball bearings; air-cooled commutator; dial type rheostat for easy pinpoint control; high-low range switch; reactor coil for even arc; handles 1/16 to 3/16" rods. Run welder at 2500 R.P.M. from drive pulley or power take-off of tractor, a 7 1/2 H.P. electric motor or a 10 H.P. gas engine. Use one or two V-belts, or flat belt (on pulley). Continuous welding rating—200 amps.; intermittent rating—250 amps.; 0-40 volts.

Now . . . AT A FRACTION OF \$99.50 ITS VALUE

Price includes double V or flat belt pulley and instruction book. Ship. wt. 95 lbs. F.O.B. Chicago. (ITEM #65)

Only one or two jobs will pay for entire welder. ACCESSORY KIT including welding helmet, electrode holder, two 10 ft. cables with clamp, and 5 lbs. of assorted welding rods. (ITEM #66). \$10.50 F.O.B. Chicago

REMEMBER, SATISFACTION IS GUARANTEED

FREE CATALOG!

Write for free copy of our 40 page catalog including Hydraulic Manual featuring diagrams, photographs and instructions. Catalog lists excellent war surplus values: pumps, valves, hydraulics, lights, motors, etc.

ROSS 4-Way Foot Operated AIR VALVE

MODEL 398 BRAND NEW. For double-acting pneumatic devices. Fine for operating presses, air vises, air machinery of many types. Heavy duty cast construction. No neutral position. Maintains pressure against the piston when the foot control is in the "Up" position. Threaded for 1 1/2" pipe. Dimensions of valve body: 7 3/4" L x 4 1/2" W x 7 1/2" H. Net wt. 28 lbs. A \$64.00 value for only \$19.50 (ITEM #60) F.O.B. Chicago

LOGAN 4-Way Foot Operated AIR VALVE

MODEL 6520 BRAND NEW. For double-acting pneumatic devices. Fine for operating air vises, presses, air machinery of many types. Heavy cast construction. Threaded for 1 1/2" pipe. Dimensions of valve body: 8 1/2" L x 5 3/4" W x 7 1/2" H. Net Wt. 28 lbs. Gov't acquisition cost \$42.00. AN OUTSTANDING BUY AT \$15.00 (ITEM #59) F.O.B. Chicago

G-1 STAINLESS TANK

Use these tanks on compressors, for tire inflators, pulsation chambers, floats, buoys, hydraulic reservoirs, fluid and milk containers, fuel containers, etc. Tough, light. 450 lbs. P.S.I. Aviators Breathing Oxygen bottles, type G1. 2100 cu. in. (approx. 9 gallons) int. vol. 24" x 12", 1/4" threaded openings at ea. end. Wt. 19 lbs. .051" thick. (ITEM #63) \$4.95 F.O.B. Chicago

Brand New General Electric 8" Sealed Beam UTILITY SPOTLIGHT

300 Watts, 110 Volts, A.C., D.C. Workshops • Driveways • Outdoor advertising • Displays • Beach lighting • Private air ports • Photography Wherever you need flood-lighting! Bought by the U. S. Army for signal use. This is the greatest surplus bargain ever offered. Lens, reflector and electrode vacuum sealed in one dustproof, air tight unit. 300 Watts, 110 Volts. Weighs only 2 1/2 lbs. List price \$10.50. (Lamp A TREMENDOUS VALUE for only) (ITEM #8) 12 or more \$2.50 ea. postpaid \$2.75 EA. POSTPAID

MINIATURE High Speed ELECTRIC MOTOR

IDEAL FOR MODEL BUILDERS, MODEL RAILROADERS, EXPERIMENTERS, HOBBYISTS. AC or DC. Reversible, speed may be regulated by varying voltage. Has miniature Klixon thermostat switch. All connections are external and accessible. Has 3 mounting feet for easy installation. Double-end ball bearing supported shaft with small gear on one end. Die-cast housing with laminated field. Overall Dimen.: 3 1/4" long x 2 3/4" wide x 1 3/4" high. Net wt. 12 oz. A \$22.00 value. (ITEM #5) \$2.95 post-paid

SCREW JACK

Ideal for raising, lowering, leveling and adjusting. Use on tables, machine tools, toys, etc. Overall length closed 9 inches, open 14 inches. Worm gear box with 54 to 1 reduction, with double end drive shaft. Use either end or both. Extension screw shaft 30 to 1 reduction. \$35.00 value. AN OUTSTANDING BUY. (ITEM #45) \$3.95 postpaid

GROBAN SUPPLY CO. 1507 SOUTH MICHIGAN AVE. Chicago 5, Ill. Dept. PM-10

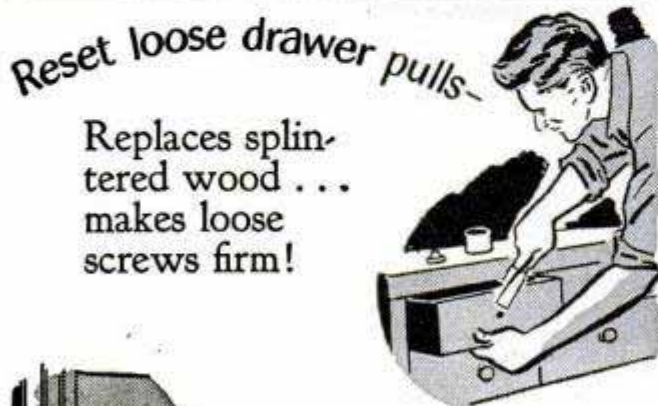

Reset loose drawer pulls—

Replaces splintered wood . . . makes loose screws firm!



Seal drafty cracks—

Fills openings easily . . . dries tight and hard! Resists weather!

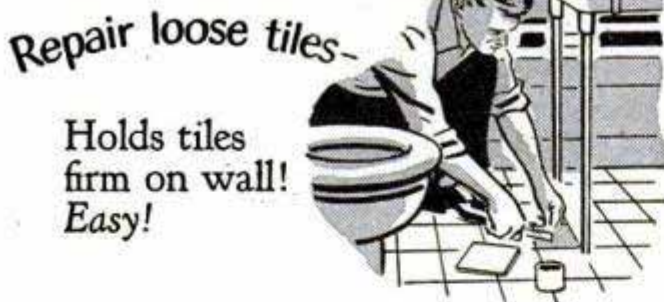

Repair loose tiles—

Holds tiles firm on wall! Easy!

Also useful in filling cracks in floors, nail and screw holes, repairing broken toys. Handles like putty . . . hardens into wood!

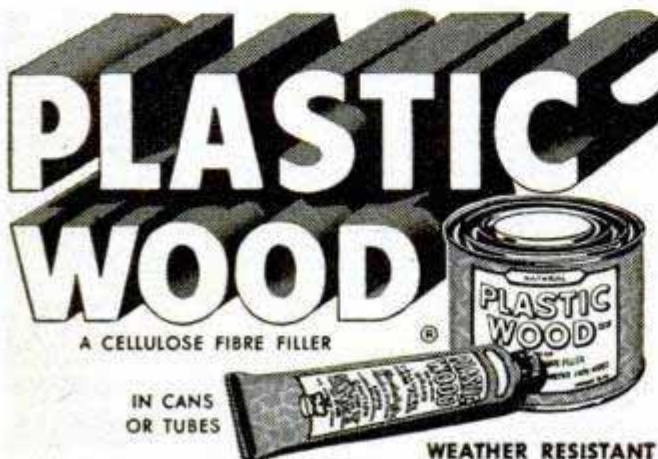

of the hulls and pipes fitted into them. The pipes will run up to a point above the waterline, so the ship won't sink. Then, the holes will be covered on the hull bottom with metal scoops, opening aft. As the ship moves forward, a vacuum will be created behind each scoop, sucking air out of the hull and along the flat bottom. "We'll practically be flying then," says Wood.

With so shallow a draft, and so much of the Venturi out of water, Wood has had to figure a way to keep a stiff wind from pushing her around. The solution is a hydraulic arm—like an aircraft's landing gear—which will lower into the water from the ship's Venturi tunnel roof. Instead of a wheel at the bottom, there will be an outboard motor on a swivel. Its propeller will dip into the water in the direction of the wind, and its speed regulated exactly to counteract the wind. The device is expected to be a big asset in docking and, on larger Venturi ships, might even eliminate the necessity for tugs.

Wood is also building a 20-foot, twin-screw fishing cruiser with a collapsible flying bridge. This will fit on block-and-tackle slings snug against the Venturi's tunnel ceiling. A hatch through the ceiling will permit the fishing party to climb into the cruiser. "Then," says Wood, "I'll just push a button, start a winch, and we'll be lowered into the water without lifting a finger."

Right now the inventor is busy completing a livable deck, with cabins and a bow end entirely of glass. Its forward end will have an airfoil curve to complement the winglike lift of the tunnel. All cabin partitions, unlike most boats, will tie into the bracing structure and add strength and support to the whole ship—rather than just weight.

Wood likes to remind enthusiasts, however, that the Venturi is still experimental. "We still don't know all the things she'll do or won't do," he says.

During the test runs last month, for instance, the propeller-pitch gadget conked out momentarily, and the ship whammed into the dock. "We'll make some pitch controls in our own shop, goldarnit," he shouted, "and then they won't give us trouble."

He's just the man who can do it. Gar Wood is a firm believer in self sufficiency, and he has a formula for how to be happy. "All any man needs," he says, "is four things—a good job, good health, a good religion and one goldarn good hobby."

☐ Built by a 17-year-old American, a model plane recently set a new world record for speed in a straight line. The gas-powered model, traveling 81.587 miles per hour, was 15 m.p.h. faster than the old record.

BOYS! This coupon may send you to college!

It gets you started on a model car that can win a \$4,000 University Scholarship—a cash award—a tool chest—or all-expense convention trip! It's your first step in the 1950 Fisher Body Craftsman's Guild Competition—734 awards—\$65,000!

SEND COUPON NOW FOR

★ FREE Guild membership!
Craftsman's button and card!
Plans on building model!

If you were between 12 and 20 years of age on Sept. 1, 1949, this may be the biggest thing in your life.

For in the 1950 Fisher Body Craftsman's Guild Competition, you've a chance to win one of 8 University Scholarships, worth up to \$4,000. Also—expense-paid trips, generous cash awards, tool chests—altogether 734 awards worth \$65,000.

No Entry Fees! No Special Tools! Send in the coupon for your FREE membership in the Guild, FREE Craftsman's button, FREE instructions. Then, using balsa or any suitable material and the simplest tools, you simply make a solid scale model of your idea of a modern car.

So Get Started Now! It's not work—it's fun! Fill in and mail that coupon. It may make a college man of you!

LOOK AT THESE AWARDS

8 University Scholarships—worth from \$1,000 to \$4,000 each. All-expense trips to the Guild Convention. Cash awards—up to \$150 each, Model Builders' Tool Chests.

A Grand Total of 734, Worth \$65,000

Identical awards for Juniors and Seniors

(If the son of a General Motors employe wins, a duplicate award is given.)

LOOK AT THE EASY RULES

You're eligible if you were at least 12 but not yet 20 years old on Sept. 1, 1949. You compete against boys in your own age group—there is a Junior Division (12 to 15 years inclusive) and a Senior Division (16 to 19 years inclusive). You build a solid model of a car. No special tools needed.

FISHER BODY CRAFTSMAN'S GUILD, Dept. H

General Motors Building, Detroit 2, Michigan

Please enroll me in the Fisher Body Craftsman's Guild Competition for 1950. Also—send the Craftsman's button and membership card plus complete instructions for building a model. All this will be sent FREE and without obligation to me.

Name _____

Address _____

City and Zone _____ State _____

I was born on the _____ day of _____, 19____

Parent or guardian _____

Name of my school _____

Town _____ State _____

10 SHELF PLANS

NEW FULL SIZE

\$1

New, full size, easily built, beautiful wall shelf plans ready to trace on lumber, cut out and assemble. Corner and wall racks with 1 to 3 shelves. Stores charge about \$75.00 for these shelves. Make money selling them. Finest selection available. PLUS BONUS of 48 other novel cut-outs, Dutch Boys, Girls, Toys, etc., etc. PLUS FREE new 1949 Handicraft Catalog. Send only \$1 to

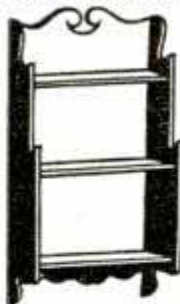

JACKSON, Dept. 11

5440 N. Shoreland Ave.
Milwaukee 11, Wis.

World Famous EASY TO ASSEMBLE PACKAGED BOAT KITS

18 models—8 to 18 Ft.

1949 line—many new models—increased performance—simplified assembly. All parts pre-cut, frames pre-assembled. Send 25c (coin) for literature. Literature plus booklet "Plywood Boats." \$1.00.



BOAT PATTERNS—BLUE PRINTS

100 designs by Deed, Lord, Crandall, etc., plank, steel, and plywood types 6-35 ft. Detailed blue-prints, full-size paper patterns. Catalog 35c (coin). Catalog and booklet "Boat Building" \$1.00.

MARINE MART—DEPT. 24—BUFFALO 7, N. Y.

WANT A BASEMENT WORKSHOP?



BUILD a handy workshop easily with Gold Bond Gypsum Wallboard, at low cost. Big, lightweight panels are fireproof, moisture resistant, and easy to nail. Decorate with Gold Bond Sunflex, the low-cost, one-hour wallpaint. Get both at your local Gold Bond Lumber and Building Material Dealer's.

Free Book of suggestions



NATIONAL GYPSUM COMPANY,
Dept. E-5, Buffalo 2, N. Y.

Gentlemen: Send free copy of new Booklet, "Modernizing Magic" showing remodeling ideas and methods:

Name _____

Street _____

City _____ State _____

(Please print name and address)

STOP FURNACE LEAKS

Save
Fuel Costs

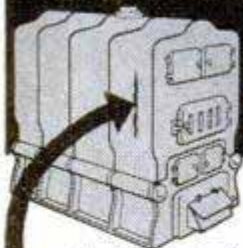

Seal up every heat-wasting crack, opened seam and other leak in your furnace, boiler, tank, radiators and piping tight—as professional repair men do—with Smooth-On No. 1 Iron Cement. Do it yourself—now—and cut this winter's fuel bills. You apply Smooth-On like putty, it hardens like metal, and stays tight, because it expands slightly as it sets. Buy Smooth-On No. 1 in 1 3/4-oz., 7-oz. or 1-lb. size at your hardware store. If they haven't it, write us.

FREE Repair Handbook

40 pages of ingenious, tested, short-cut repairs. Simple directions. 170 illustrations. Write today for YOUR free copy of the Smooth-On Handbook.

SMOOTH-ON MFG. CO., DEPT. 37K
570 Communipaw Ave., Jersey City 4, N. J.

Do it with

SMOOTH-ON

THE IRON CEMENT OF 1 000 USES



Make 100% to 150% Profit!

MANUFACTURE BUILDING BLOCKS

In Your Own Back Yard



AMAZING GENERAL
BLOCK MACHINE
CAPACITY 1000 BLOCKS PER DAY

Only \$199 LESS MOTOR
F.O.B. PLANT

SHIPPING WEIGHT 400 lbs.

Here is an outstanding opportunity for men of vision and small capital. Cinder and concrete blocks are in great demand. Millions used for homes, factories, public buildings. Sell all you produce at 100% to 150% mark-up.

PEAK BUILDING DEMAND!

The General Block Machine is amazingly practical, foolproof. Simple to operate indoors or outdoors. Rugged all steel construction. Vibrator mounted in sealed ball bearings. Produces up to 1,000 blocks per day. Superior 3 Core Type that meets all building code requirements. Can produce 4 x 8 x 16, 8 x 8 x 16, 12 x 8 x 16 blocks. All materials obtainable anywhere. All operating instructions and mixing formulas supplied. Full details FREE without obligation.

Wonderful
Book Written
& Illustrated
by Experts

HOW TO
BUILD
YOUR OWN
CONCRETE
BLOCK
HOME
Only 1 Prepaid

GENERAL ENGINES CO.

DEPT. P1 • DREXEL BLDG. • PHILADELPHIA 6, PA.

Includes floor plans for 6 beautiful, easy to build concrete block bungalows. Shows ways to save money. How to lay blocks, lay out building lines, mix concrete, build steps, porches and concrete floors. Mail coupon at once with \$1.

Name.....
Address.....
City.....Zone.....State.....

BUILD and repair em YOURSELF

with **PEMCO** wheels
Unconditionally Guaranteed

COMPARE THESE REDUCED PRICES!

SEMI-PNEUMATIC—LOAD TESTED
SEND CHECK OR MONEY ORDER TODAY.

Size	Azle	Bearing	Price Ea.
6" x 1.50"	1/2"	Oilite	\$1.35
8" x 1.75"	1/2"	Ball	1.85
8" x 1.75"	5/8"	"	2.00
8" x 2.00"	1/2"	"	2.00
8" x 2.00"	5/8"	"	2.15
10" x 1.75"	1/2"	"	2.30
10" x 1.75"	5/8"	"	2.40
10" x 2.00"	1/2"	"	2.50
10" x 2.00"	5/8"	"	2.70

Postage Collect on delivery
DEALERS AND QUANTITY BUYERS—
WRITE FOR SPECIAL PRICES!



PARAMOUNT ENGINEERING & MFG. CO.
1874 RAVINE ROAD, KALAMAZOO, MICHIGAN

HUNDREDS OF ITEMS AND IDEAS
FOR THE **WOODWORKER**

HARD TO FIND
LUMBER

Top Grade Kiln Dried
A Board or a Carload

Big New 144 Page Catalog No. 16

UNEQUALED
BARGAINS

OF HARD TO FIND WOODWORK ITEMS, HARDWARE AND SUPPLIES, the finest craftsman catalog Harold Hunt ever published—32 rare and fancy woods in natural colors—also in color, 43 matched veneer designs, multi-colored bandings, inlays, overlays, scroll patterns, etc. Only 10c, rebated on first order.

RAFTSMAN WOOD SERVICE CO.
2729 S. Mary St. Dept. A-10 Chicago 8, Ill.

WALNUT,
MAHOG.,
CHERRY,
MAPLE,
WH. HARD
AND SOFT,
POPLAR,
PL-OTR.
OAK,
AROMATIC
RED CEDAR

NOW! Amazing New Vinyl Plastic Finish for

WANTED!

Men with fore-
sight to make big
profits selling this
new product.
FREE sample
and information!

LINOLEUM & FLOORS!

- Laboratory tests prove it out-wears other treatments as much as 2 to 1!
- Resists boiling water, acids, gasoline
- Comes in clear or solid colors
- Easy to apply — brush it on

Leather-New Products 6082 Sunnyslope,
Kansas City, Mo.

NEWEST OTTAWA LOG SAW

SELF-PROPELLED — MOVES
ANYWHERE ON OWN POWER

World's fastest Log Saw. Powerful 6 H-P air-cooled motor. Attachments for sawing down trees, buzzing limbs, post hole digging and pulley for belt jobs. Big demand for wood, pulp, posts. Make big money sawing wood this easy way. Low factory-to-user prices. Nothing like it. FREE details.

OTTAWA MFG. CO., 7-927 Pine St., Ottawa, Kansas



S **AGENTS** 300% Profit **SIGN LETTERS**
For Store Fronts and Office Windows. Anyone can put them on. Free Samples. Liberal Offer to General Agents.
METALLIC LETTER CO., 430 N. Clark, Chicago 10

Say You Saw It in
POPULAR MECHANICS

STOP TAPPET NOISE!

Install **ADJUSTABLE TAPPETS**

for **FORD** and **MERCURY V-8's (85-100 HP)**



Johnson Adjustable Tappets guarantee better engine performance! Nothing complicated . . . no extra labor involved. Simple and easy to install during valve grinding jobs.

NEW PRICE ONLY **85¢** each

ASK YOUR SERVICE MAN
OR NEAREST AUTOMOTIVE JOBBER TODAY
JOHNSON PRODUCTS INC. Muskegon,
Michigan

SORE MUSCLES?



BODY ACHES?

When muscles are stiff and sore from unusual exercise or strain, use HEET®, the liniment that's *strong* yet does not burn the skin. Wonderful relief from muscular soreness comes as comforting HEET quickly starts to *penetrate*. Just brush it on with the applicator. HEET starts at once to ease muscular pain and *keeps on working* for hours, warms and soothes the painful area.

NOW! More Shooting Fun



with
**Crosman's New \$14.95
"Town & Country Jr." RIFLE**

Expert or beginner—you'll like this rifle for year 'round shooting indoors and out. Accurate, hard hitting, yet safe to use anywhere thanks to Crosman's "controllable power" feature. Has rifled barrel; standard sights. Weighs only 4 lbs. 7 ozs. Available in .177 and .22 cal. single shot models at your dealer. Write for literature.

Crosman Arms Co., Inc. 3 HENRIETTA STREET
ROCHESTER 7, N. Y.

BUILD YOUR POWER TOOLS

WITH POLY BALL BEARING ARBORS

HEAVY DUTY GRINDER

3/4" x 17 1/2" precision spindle, self-lubricating ball bearings, heavy casting, V belt, 3 step pulley driven through rear or base.

ONLY
\$18.25



Model D-12
Pictured

FREE!
Write for
POLY illustrated
literature.



Ship. wt. 13 pounds

POLY BALL BEARING ARBORS

C4-1/2x12 1/2 spindle, housing 2x8, \$7.95 pp.

C5-5/8x12 1/2 spindle, housing 2x8, \$8.45 pp.

C6-3/4x12 1/2 spindle, housing 2 1/2x8, \$9.45 pp.

D8-1x17 1/2 spindle, housing 2 5/8x11, \$18.75 pp.

SHAPER ARBORS—Free literature on request.

POLY PRODUCTS, 2032-A E. Walnut, Pasadena 8, Calif.



BIG MEN

Send For

FREE CATALOG showing smart

Clothing & Haberdashery in sizes 48 to 60. Low Prices.

BURNS MARTIN, 147 Summer, Dept. 33, Boston, Mass.

MAKE THESE WOOD SHAPES

With Your Drill Press and
This LOW COST TOOL

Your drill press and this tool does all types of wood shaping—Routing, Tongue and Groove, Fluting, Notching, Inlay and any type of joint. Make window stiles, cabinets, doors, grooved sash, etc.

Complete with fence and platform to run professional work without slipping.

Write today for FREE facts about this unit, and special offer.



Complete
with 3 blades



T & H Mfg. Co., Dept. SPA-10, 811 East 31st, Kan. City, Mo.

BASIC TOOL FOR HOME, FARM, SHOP



Make all your shop tools more valuable with this rugged, versatile, economy-priced vise. Only Desmond-Simplex gives you all the necessary quality features, at low cost. If your hardware dealer cannot supply you write the factory. The Desmond-Stephan Mfg. Co., Urbana, Ohio.

DESMOND - SIMPLEX VISES

- Steel slide, strongest longest-wearing
- Hardened steel jaws, replaceable
- Cut-off tool for cutting wire
- Pipe jaws
- Anvil with horn
- Enclosed screw protected by slide
- Positive-locking swivel base, extra heavy
- Semi-steel body castings
- One piece non-pinching type handle



That's nothing!
My **REGENS** is completely
automatic, too!

- Single motion lights and closes
- "Slide-out" tank lights pipe, too
- Windproof "weather-guard" design
- Easy-filling removable tank
- Precision made of solid brass
- Guaranteed for one full year



STILL THE BEST LIGHTER BUY



In nickel, chrome, enamel, \$1.50 to \$5.00 etched or rhodium finish



For best results with any lighter use Regens Yellow Flints, Regens Lighter Fluid
AT BETTER JEWELRY, DRUG, TOBACCO AND DEPT. STORES

Regens Lighter Corporation
2 East 46th Street, New York 17

Keep Brushes like New

BEFORE  **AFTER** 

● 5c
● 10c
● 25c

**DICA-DOO
PAINT
BRUSH
BATH**

Clean and Restore
PAINT BRUSHES

At Paint, Hardware, Dept., and 5 & 10c Stores
Patent Cereals Co. Geneva, N. Y.

PRESSURE PRINCESS Makes every job EASIER

YOU have never seen a single cylinder portable air compressor that packs so much power as this one. Built by the makers of the famous 4 cylinder Pressure Queen, the Princess will do any job, from inflating tires to painting buildings. Compact, simple and rugged, it will last your lifetime and pay for itself over and over again.

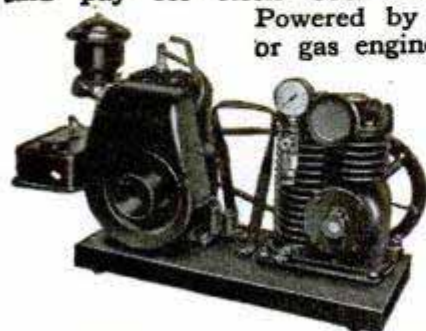
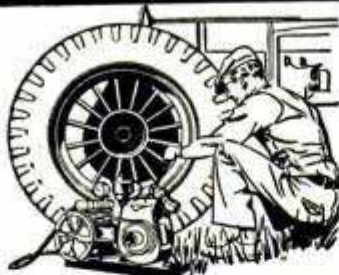

Powered by electric motor or gas engine.

Write for
Literature
and Prices

THE CAMPBELL-HAUSFELD CO.
1046 Railroad Avenue Harrison, Ohio

REAL DIESEL ENGINE

\$2.95

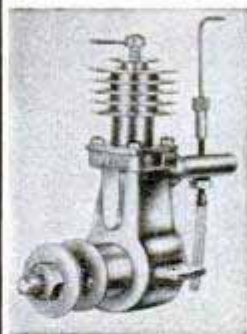

WE'RE CRAZY, they tell us, giving away a real diesel engine, complete with cylinder and piston, carburetor, crankshaft and connecting rod. All parts completely machined, ready for easy assembly. **ONLY \$2.95.** How do we do it? We're selling thousands of **DEEZILS**. So production's up; costs tumble down. **DEEZIL** is a precision engine. Actually runs at 7500 RPM. Produces 1/7 HP. Ideal for planes, boats, midget cars. Send \$2.95 plus 25c postage today.

GOTHAM HOBBY CORP.

107 East 126th Street New York 35, N. Y. Dept. "P"

FIX HOLES, Rusted SECTIONS on CAR and FENDERS with Amazing FABRIC-METAL PATCH



Easy, quick, inexpensive. Simply dip patch in solvent, apply to any metal—quickly hardens into toughness of steel. Cover with Auto Solder, then sand smooth. No skill, heat or tools needed. Satisfaction guaranteed. Large, complete Crosby Kit—enough to repair car, and other metal articles. Directions included. Postpaid. **\$4.95**

Crosby Products Co., 1531 Hamilton, Cleveland 14, Ohio



ENJOY MAKING YOUR OWN TOOLS

Machine your own lathe attachments from semi-finished castings of proven design. Faceplates, Carriage Stops, Boring Bar Holders, Tailstock Drill Pads, etc. All can be completed on your own lathe. Complete drawings and details. Save over 50%. Write for information. Give size, make and model of lathe.

THE VESTA ENGINEERING CO.
5226 N. Hollywood Ave. Milwaukee 11, Wis.

WOODWORKERS ... Get this

CONSTANTINE MASTER MANUAL

Get the Most Fun From Your Hobby Indispensable to woodworkers. Newest, biggest edition, more pages, more color, helpful how-to-do-it articles, pre-war and new items, more bargains. Send 25c today and we will include **FREE! FULL YRS. SUBSCRIPTION** to Chips and Chats, published bi-monthly. Keeps you up-to-date on everything in woodworking, offers big money-saving bargains. Send now.

ALBERT CONSTANTINE & SON, Inc.
791-D East 135th Street, New York 54, N. Y.



OWN A Printing Business

Cards, Tickets, Stationery, etc. Good profit in spare time. **PRINT YOUR OWN** greeting cards, movie titles, church work, etc. Save money. Easy rules supplied. Raised printing like engraving too. Have home shop. Sold direct from factory only. Pays for itself in short time. Write for free catalog of outfits, and all details. **KELSEY PRESSES, O-37, MERIDEN, CONNECTICUT**

Say You Saw It in Popular Mechanics

SAVE UP TO 25% ON QUALITY BALL-BEARING WHEELS!

Bilt-Rite wheels roll smoothly and easily, are semi-pneumatic, ball-bearing, painted red; guaranteed top quality—and you save up to 25%! Compare Bilt-Rite's quality and price—then get your order in today! Dealer inquiries invited.

BILT-RITE BARGAINS on BALL-BEARING WHEELS			
(For 1/2-inch Axles)			
6 x 1.00\$1.30	10 x 1.25\$1.95
8 x 1.25 1.65	10 x 1.75 2.15
8 x 1.75 1.80	10 x 2.00 2.45
6 x 1.50\$1.50			
(For 3/8-inch axle)			
6 x 2.00\$3.95	8 x 2.50\$4.45
10 x 2.75Only \$4.65!			



Bilt-Rite Guarantee
No better wheels are made regardless of price; 10 day return privilege.

If size you need isn't listed, write for Folio A
ORDER TODAY—Send cash, check, or M.O.—Pay postage on arrival.
BILT-RITE WHEEL COMPANY
520 EAST MISSOURI AVE. KANSAS CITY 6, MISSOURI

EARN BIG MONEY
AND BE YOUR OWN BOSS
Sharpening Lawn Mowers

**Build a Business of Your Own With
A UNIVERSAL GRINDER**

In your own garage or basement, and earn \$25.00 a day or more. Mr. Hardy writes, "I am doing a fine business with the UNIVERSAL GRINDER. One customer sends another. I spent 40c for a newspaper ad and have done nearly \$500.00 worth of business." Mr. Helmek of Canada writes, "We sharpened 750 mowers last year and are 1056 on this years run. The Universal surely makes customers." Mr. Barton of California says, "The mower business, with the Universal Grinder, has been a gold mine these last two years."



Only on the UNIVERSAL GRINDER can the inside face and edge of the stationary blade, as well as the reel blades, be ground to proper clearance ALL IN ONE SET-UP without removing any blade from the mower.

WRITE FOR FREE FOLDER TODAY!

ROGERS MFG. CO., Dept. M-109, Lindsey, Ohio



NO DISAPPOINTMENT
With the New Wizard Metalastic Truss. Entirely new principle of soft web construction with stainless steel helical coils. Constant gentle pressure on light rubber cushion will hold your rupture. The most original truss improvement in 50 years. First time at this low price.

WIZARD METALASTIC OR YOU CAN ORDER
Single Truss double for
ONLY \$6.00 POST-PAID ONLY \$9.00 POST-PAID

SURGICAL SPECIALTIES SALES COMPANY.
5415 W. North Ave. Chicago 39, Ill.

Say You Saw It in Popular Mechanics



WANTED MAN WITH CAR TO RUN STORE ON WHEELS

USE OUR CAPITAL

NO SALES EXPERIENCE NEEDED

The biggest opportunity ever, to quickly establish a money-making, lifetime business, now awaits you as a McNess Dealer. Sell things farmers need and use up. Serve same families year after year. Pleasant work--no bosses--easy to do. We supply capital to work on. Also provide offers--advertising--premiums and trade secrets that bring sales.

First to apply get best trading areas. Don't wait--write us today for McNess proposition. Tell us county and state you want to serve. Ask for free McNess Book. 7

The McNESS CO., 816 Adams St., Freeport, Ill.

**Better in-
Better for-
THE LONG
RUN**

Hoover Motors are engineered to carry emergency overloads without overheating, and deliver years of economical, dependable service.

But then you'd naturally expect a rugged, reliable motor from the makers of the famous Hoover Cleaner.

See if there isn't a Hoover Motor for your power jobs:

- Capacitor-start, split-phase and poly-phase types
- Ratings from 1/4 to 1 1/2 H.P., some with double-end shafts
- Single or dual voltage, 1725 or 3450 R.P.M.
- Ball or sleeve bearings
- Rigid or resilient mounts that meet NEMA specifications
- Service and parts available from authorized agencies and dealers

Look at this
for Hoover value

only
13⁹⁵



This is the new Hoover 1/4-H.P., 1725-R.P.M., split-phase motor. Ideal for easy-to-start, quick-to-accelerate applications, such as fans, blowers and light machine tools, etc. Rotation can be reversed. Fully ventilated. 115 volt, 60 cycle, AC only. See it at your dealer's today!

HOOVER MOTORS

Made in capacities of 1/4 to 1 1/2 H.P.
Product of Kingston-Conley Division
THE HOOVER COMPANY, North Canton, Ohio



Hobby-Lite
Designed especially for
HOME CRAFTSMEN

The Handy "Seeing-Tool" for spotting light exactly as you want it!

MODEL A

Cool, fluorescent quality, fluorescent light. Complete with 2 four watt fluorescent lamps and one slip-in base bracket.

\$14.95

MODEL B

Reflector accommodates 40, 60 or 75 watt A-19 incandescent lamp. Complete with one slip-in base bracket.

\$6.80

AT YOUR DEALER OR SHIPPED PREPAID. Send check or money order, today.

What is your hobby—wood or metal working, amateur lapidary, modeler, stamp collector, coin collector, artist, fitter, watchmaker, or just the man who tinkers around? You really need the helpfulness of a "Hobby-Lite" because good light is the most important tool for any job.

Serves Many Uses

One "Hobby-Lite" takes care of all those seeing needs. By installing the handy slip-on base bracket wherever you need light, you can transfer your "Hobby-Lite" from one base bracket to another as you move from job to job. Just order the number of extra base brackets you need.

Complete Flexibility of Adjustment

"Hobby-Lite" has instantly adjustable arms with full swivel ball and socket joints. Exterior finish is baked metallic bronze. Completely wired with socket, switch and oil resistant cord with plug. Rugged, beautifully engineered, "Hobby-Lite" is a "must" for your workshop.

*FREE folder on request

THE FOSTORIA PRESSED STEEL CORPORATION
FOSTORIA, OHIO



she's some **SMOOTHIE!**
(YOUR CAR, THAT IS!)

when equipped with
ADVANCE "ULTRA DEEP-TONE" MUFFLERS
DUAL OR SINGLE STRAIGHT-THRU

Rich, low, mellow tone. Also greater power, speed, and economy result from reduced back pressure. Rugged steel tube, blow-out proof. Simple to install. No welding. Dual set comes complete with rubber mounted clamps, fittings.

ADVANCE FENDER SKIRTS

These heavy duty steel skirts will beautify and streamline your car. Tight fit, no rattle, easy to install, prime pointed. Real top quality, not to be confused with cheaper, light weight makes.

ADVANCE KI-YI AND RAZZ HORNS

Get these novelty horns for laughs.

MAIL COUPON BELOW

DEALER INQUIRIES INVITED

ADVANCE MUFFLER CO. of Los Angeles Dept. PM-109
1458 E. COMPTON BLVD., COMPTON 3, CALIF.

Send check, money order, or we will mail C.O.D. You pay postage upon receipt.
 Dual Muffler Set (Ford, Mercury only) \$19.95
 Single Muffler (other makes) \$5.50
 Single Muffler (Ford, Chev., Plym.)... 4.86
 2 1/2" Chrome tail pipe tips, ea. 1.75
 Fender skirts, pr. 12.95
 Ki-Yi Horn, each 3.25
 Razz Horn, each 3.25
 Send free catalog showing complete line.

Car make _____ Year _____ Model _____
 Name _____
 Address _____ City _____ State _____

PRINT ANY PHOTO
on Paper, Cloth, Leather or Wood

SIMPLE, EASY TO USE!

Magic liquid takes only 2 minutes to reproduce any snapshot you have onto stationery, handkerchiefs, ties, scarfs, etc. Use same picture over and over again if you wish. Won't wash off. Won't hurt negative or fabric it's used on. Personalize your belongings! An ideal gift. Complete outfit enough to transfer 100 photos—only \$1.95 post paid. Sent C.O.D. for \$2.23.

TIFFANY'S
2128 MONTROSE JF, CHICAGO 18, ILL.

AMAZING NEW CHEMICAL MAKES OLD BUMPERS LIKE NEW!

Not a Paint! Not a Polish! Looks like expensive chrome plating!

Wonderful new chemical puts chrome-like finish on car bumpers, door handles, trim, etc. No electricity—no plating tanks—no acids needed. Just smooth it on and watch it gleam! Takes a brilliant polish JUST LIKE CHROME—so simple a child can do it. REFINISH BUMPER IN 10 MINUTES! WORKS LIKE MAGIC—finish lasts for years. Increases resale value of your car and adds NEW beauty to other chrome plated or metal items. TRY AT OUR RISK! SEND NO MONEY! Just send name and address. Pay postman amazing low price of \$1.00 plus few cents postage for each kit ordered, or send cash and we pay postage. Try kit 10 days. If not delighted return for instant refund! **JACK G. ERMAN, Box 147, Hamtramck, Mich.**

\$1.00

MACHINE SHOP EQUIPMENT

The 1949 edition of the famous Center Tool Co. Catalog is now ready! Every workshop owner should have a copy. 240 pages full of illustrations, descriptions, and prices of the latest tools made by best known manufacturers in U. S. You pay the cost of printing—50c. We refund your 50c with your first order of \$10.00 or more. Prompt delivery on most tools. Send check or money order today!

CENTER TOOL CO.
153 Centre Street, Dept. C, New York 13

MEN'S WRIST WATCH
IDEAL XMAS GIFT
Only \$5.95

... with gleaming, stainless steel Expansion Band. Amazing value—1 year guarantee. Jeweled, smart chrome case, radium dial-hands, sweep second hand; shock resistant. Wear with pride or give as a gift. Send \$5.95, plus 10% Federal Tax, postpaid. Or order C.O.D. plus postage. Satisfaction guaranteed.

MUDIAL WATCH HOUSE
330 S. Wells St., Dept. A, Chicago 6, Ill.

LEATHER or STAINLESS STEEL EXPANSION BAND FREE OF EXTRA COST

MAGNETS OF ALL TYPES—10c UP
AMAZINGLY POWERFUL!!

4 oz. Alnico Magnet, lifts 10 lbs.
 1 lb. Our Leader, 15 oz. Magnet, lifts 40 lbs. \$2.50. New alloy—will not weaken! Useful for lifting valves from tanks, lakes, or rivers easily! 7 small magnets \$1.10 with list of many shop and home uses. Satisfaction guaranteed.
R. EYRICH, 2566 N. 49TH ST., MILWAUKEE 10, WIS.

SAY YOU SAW IT IN POPULAR MECHANICS

BUY DIAMONDS
at WHOLESALE PRICES
Save UP TO 50%

Learn how to benefit from Loan Foreclosures and Estate Liquidations. All Diamonds reset in new mountings. Your bank is our reference.

CITIZENS Diamond Brokers
Dept. C • 195 Mitchell St. • Atlanta, Ga.

EST. 1914

WRITE FOR FREE CATALOG

Now—anyone can REMOVE PAINT



Stripping finishes no longer means hours of arm-tiring work. Wonder-Paste Remover has changed all that!

WONDER-PASTE

Equally effective on paint, varnish, enamel, lacquer, or shellac. Simply apply this powerful solvent with a paint brush. Allow time for it to penetrate completely. Then remove the soft, sludgy mass with a putty knife. Leaves the surface clean and smooth—no sanding needed.

Get Wonder-Paste at your paint or hardware store. Or write us for leaflet.



Wilson-Imperial Company, 119 Chestnut Street, Newark 5, N. J.

NONE BETTER! SUPER DRILL GRINDER



Sharpens round shank drills from 3/32" to 1/2" in diameter, up to 6" long. Grinds old drills like new in 4 different point angles, using hand or power grinding wheels. Money-back guarantee.

Price only \$2.95
At Dealers or Postpaid

CRANDALL MFG. CO. 1512 W. Slauson, Dept. FA-44, Los Angeles 44, Calif.

Spray away Starting Troubles



SEND \$1 FOR SPECIAL INTRODUCTORY CAN (REGULAR \$2.35 VALUE)

SHORTSTOP IGNITION SPRAY
ELIMINATES SHORT CIRCUITS IN MOTORS

ZACO LABS • 1360 W. 9th • Cleveland, O.

ORDER DIRECT TODAY!

Pioneers

Leaders

AIR RIFLES

BENJAMIN

AIR PISTOLS

WITH SAFETY LOCK

SEND FOR FREE FOLDER OF LATEST MODELS TODAY

If you want a REAL GUN for PRACTICAL USE inside or outdoors, get a SAFE—CLEAN—ECONOMICAL—BENJAMIN with Adjustable Power and Amazing Accuracy. Use BENJAMIN H-C PELLETS for BEST RESULTS in all rifled models. WRITE AT ONCE.

BENJAMIN AIR RIFLE CO., 812 MARION ST., ST. LOUIS 4, MO.

FIBRE ARMS AND LEGS!



Light, correctly fitted, strong and comfortable. Natural appearance. Braces for all deformities. Scientific design. Fair Terms.

BUCHSTEIN-MEDCALF

223 S. 6th St., Minneapolis, Minn.

SAY YOU SAW IT IN POPULAR MECHANICS



**ONAN Portable
ELECTRIC PLANTS**

FOR CABINS, TRAILERS,
CONTRACTORS, BOATS

Light weight, compact, air-cooled engine-driven. Furnish regular city-type A.C. electricity for lights, appliances, radios, etc. Can be carried by hand. Fit trunk of car. Plug-in receptacles on plant. Larger models for farms, homes, businesses beyond highlines. Catalog shows over hundred models. 350 to 55,000 watts.

Gasoline or Diesel Powered

WRITE FOR CATALOG

D. W. ONAN & SONS INC.

5826 Royalston Ave., Minneapolis 5, Minn.



**YOU'RE
ALWAYS
SURE OF
A JOB...**

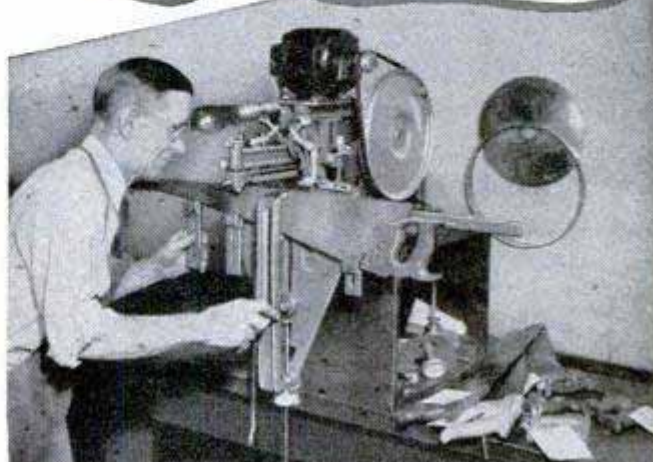

.. if you have your own
SAW FILING BUSINESS

Make up to \$2 or \$3 an hour with the FOLEY SAW FILER

Be your own boss! There's nothing like the satisfaction of seeing pleased customers come back time after time. Then you won't worry about your present job or future income. Start in spare time with a Foley Saw Filer—set it up in your garage or basement. No canvassing necessary—"I advertised in our local paper and got in 93 saws"—says M. L. Thompson. "I made \$765 last year filing saws—I do this work in spare time", writes J. B. Williams. And listen to this from Chas. C. Hough, a full-time operator: "Last year's profits amounted to \$3000—not so bad for a one-man outfit!"

Get this book

"INDEPENDENCE AFTER 40"

You can file hand, band and cross-cut circular saws with a Foley Saw Filer. This book shows how you can get business from home owners, farmers, carpenters, schools, factories, etc. With a small investment, no overhead, no stock of goods to carry, you can get right into a cash business—and possibly later on develop into a full-time repair shop. Send coupon today for Free Book. No salesman will call.

FOLEY MFG. CO., 1016-9 Foley Bldg.,
Minneapolis 18, Minnesota

Send FREE BOOK—"Independence
After 40"

Name _____

Address _____

**FREE
BOOK
shows How
to Start**



MAIL COUPON FOR FREE BOOK

SAVE MONEY while Living Better!

A furnished Schult offers big value in all-season comfort for living or travel. Innerspring beds, private bedrooms, shower, toilet, etc. Electric refrigerator and oven range. Three-year written warranty. One monthly payment buys all!

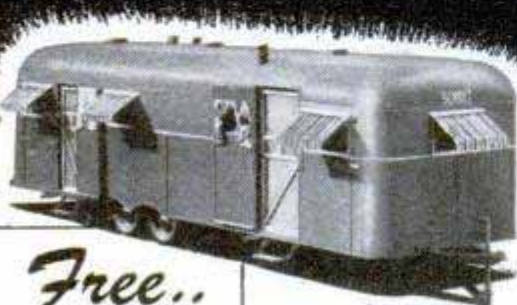

Free..

"HOW TO BUY A TRAILER COACH"

Send today for new booklet. Tells what to look for... how to judge values... protect your investment... and make your dollars go farther.

NEW MODELS... NEW ECONOMY!

Write for free catalogs showing latest models. Convenient floor plans, unique features for all-year living and travel.

SCHULT CORP., Dept. 3210, Elkhart, Ind.
In Canada: John Inglis Co., Ltd., Toronto



SCHULT Trailer Coaches
Member T.C.M.A.

SAY YOU SAW IT IN POPULAR MECHANICS

SANDEE

Mufflers—All Ford, Chev., Ply. \$4.45
All Buick, Pont., Olds., Chrys.,
Dodge, Hudson, K.F., Pack., etc. \$5.45
V-8 and Merc. Duals
(32-49 incl.)
\$15.95



DURABILITY

SPORTONE MUFFLERS
(Pat. Pend.)

DEALERS WANTED

Beautiful SANDEE Fender Skirts
\$16.95

A SANDEE Sportone will outlast two ordinary mufflers and give More Power! More Speed! More Mileage!—plus a tone quality unsurpassed.

Please ship (item): _____ Price _____
Car and Year _____ Name _____
Address _____

SANDEE MUFFLER CO. 5643 Corryne Pl. Culver City, Calif.

NEEDLESS TO PAY MORE RISKY TO PAY LESS

TUBE GIVEN WITH EVERY TIRE
Why Pay More?



VETS — GARAGES
Service Stations
Take 10% DISCOUNT
ON 1 TO 100 TIRES

OUR GUARANTEE
OUR TIRES must make good or WE WILL
If You Want SAFE TIRES

Be Wise—See Us Before You Buy
Our Experience Insures Your Safety
You get what we advertise
USED TIRES — ORIGINAL TREAD
BUY IN CONFIDENCE safe dependable
selected POPULAR BRANDS—Guaranteed
to give A-1 SERVICE. These tires are
absolutely NOT Re-caps or Re-molds.

REMEMBER: Tube SENT with EVERY tire regardless of PRICE or GRADE

SELECTED for TOUGHEST JOBS Not just good... THE BEST
These are genuine Values! One Trial will CONVINCE YOU

TOPS IN VALUE		TOPS IN SAFETY	
600-16	...\$5.02	650-16	...\$4.72
650-15	...4.72	700-15	...5.02
		750-16	...\$6.02
			...7.62

World's Best Truck Tire Values		Top Service Minimum Prices	
6.00-20(6)	\$9.22	8.25-20(10)	15.52
6.50-20(6)	9.22	9.00-20(10)	15.52
7.00-20(8)	10.52	11.00-22(12)	18.42
7.50-20(8)	10.52	32x6	(8) 10.02
		32x6	(10) 12.82

750-20 MILITARY 8 PLY REGULAR \$9.62—SUPER \$12.92
900-16 MILITARY 8 PLY REGULAR \$8.72—SUPER \$10.92

ONE QUALITY THE BEST AVAILABLE

HERE'S MAXIMUM QUALITY IN THESE O.K. SAFE TIRES			
600-16	...\$3.42	650-16	...\$3.62
650-15	...3.62	700-15	...3.72
		750-16	...\$4.42
			...5.62

Thousands of Tires Shipped to Satisfied Customers Throughout United States and Many Distant Points. Please Note: We've made Thousands of Friends by giving a Tube with Passenger and Truck Tires. MAIL ORDERS given Personal Attention—Send This Ad with Check or Money Order. Dep't. 2

STANDARD 834 N. Broad St., Philadelphia 30, Pa.

Practical Economical Winter Travel



CallAir SnowCars acclaimed by users everywhere. Attain high speed and travel rough steep country. Plans \$10.00. Complete machines from \$1550.00 up. Two, three and four place jobs with engines from 65 to 125 h.p.

CALLAIR, Afton, Wyoming



GENUINE BRAND NEW GOV'T SURPLUS

Excellent for Ice Fishing, Outdoor Wear, Hunting and Sportswear

ORDER BY MAIL
A-8 Down-filled Flight Pants, size 40. Fits 34 to 40 waist. \$8.95
A-11 Alpaca-lined Flight Pants, size 30-32. Fits 34 to 40 waist. 5.95
N-1 Blanket-lined Bib Pants. Small, medium or large size. 4.95

Write for FREE Surplus List

Shipped Postpaid Except C.O.D. These items cost Gov. over twice these prices.
BEN'S SURPLUS 138 Michigan St., Dept. B-1 Grand Rapids, Mich.

GARDEN TRACTOR



3-4 and 5 HORSEPOWER

Over 30 attachments with QUICK HITCH—Change from one to another in seconds
Plow 4 to 9 1/2 inch furrow 4 to 8 inches deep.

Special discount if you order direct from factory. Send penny postcard today for big FREE catalog

RED-E TRACTOR CO.
237 Ford Ave. Racine, Wis.

NEW HOPE FOR

RUPTURED

New invention for control of reducible rupture by a 43 year old company is acclaimed by many as the outstanding improvement of modern times. Works on entirely new principle. Air cushion adjustable seal pad (patent applied) holds the rupture at its source, with greater comfort, greater security, greater benefit. Banishes torturous trusses and inefficient elastic supports. FREE 30 DAY TRIAL. Satisfaction guaranteed. Write today for full information in plain envelope.

FREE 30 DAY TRIAL

Dr. K. L. STORM SUPPORTS

DEPT. PM, 1701 DIAMOND ST., PHILA. 21, PA.

MOTOR — GENERATORS

\$1

For One Dollar you receive a surplus Motor, Dynamotor, or Generator that you'll agree gives you exceptional value for your money besides being useful. Unit will be new or used and operate from 6, 12, or 24 Volts AC or DC. Items cost Govt. many, many times this small purchase price.

Order No. PM-1910 Only \$1

CAR SHAVER MOTOR

Now — astonish your friends — use your electric shaver in your car! Dynamotor will supply 110 Volts, 10 Watt current from 6 Volt DC — and will operate most types of AC-DC shavers. Used by Govt. to supply voltage for radio equipment.

\$2

Order No. PM-2910 Only \$2

AC ELECTRIC MOTOR

110 Volt 60 cycle ball bearing motor approx. 3500 RPM. 1/25 HP. Shaft size: 3/16" x 5/8". Motor size: 7" x 4". Converted from Govt. surplus. Ideal for models, fans, etc.

Order No. PM-3910 Only \$3

GASOLINE ENGINE GENERATORS: HOMELITE

Gasoline Engine Generator—30 Volt DC 50 ampere (1500 Watt) generator driven by single cylinder, two cycle air-cooled gas engine approx. 3 HP. Rope or electric starting. From unused Govt. vehicles. Re-conditioned. Order No. PM-4910

\$49.50

DELCO ENGINES: Gasoline Engine Generator—12 Volt DC 750 Watt generator driven by a one cylinder, four cycle air-cooled gas engine approx. 2 HP. with self starter, voltage regulator, output meter, and on-off switch. Rope or electric start. Govt. surplus—Reconditioned.

\$59.50

Order No. PM-5910.

SEND FULL REMITTANCE ON \$1, \$2, & \$3 ITEMS. ENGINES 25% DEPOSIT, BAL. C.O.D. • SHIPPING CHARGES C.O.D.

FAIR RADIO SALES

132 SOUTH MAIN ST.

LIMA, OHIO

BURR HAND SAW FILER

Makes More PROFITS

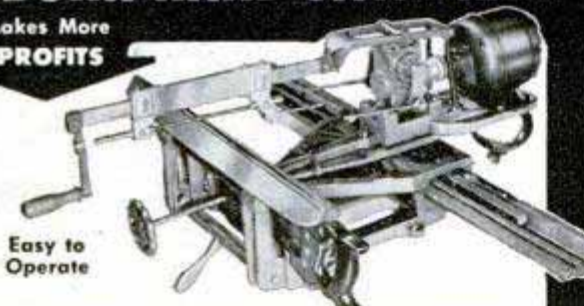

Easy to Operate

Fast, accurate, will file from both sides. Operator controls file arm. No saw carrier or adjusting screws to fuss with. A money-maker in any shop.

BURR MFG. CO.

8933 VENICE BOULEVARD
LOS ANGELES 34, CALIF.

WRITE TODAY!

Sensational New Electric

1 WELDER 2 CUTTER!

FOR 110-115 AC or DC • WELD—BRAZE—CUT—SOLDER—HEAT TREAT BOTH only \$12

The WELDRITE Combination—tested and proved by countless commercial and amateur users, is now offered direct to you at the amazingly low price of only \$12.00. No Gas—No Gauges—No Spark Lighter needed. Always ready for immediate use—Just plug WELDRITE into 110-115 AC or DC outlet. Uses standard welding and brazing materials. WELDRITE furnished complete with Converter Unit, #1 Single Holder for welding metal to 3/8" thickness, using up to 3/32" rod, and #2 Double Holder with Copper Coated Carbon Electrodes for Brazing, Cutting, Heat Treating, etc. Starting welding materials and instructions included. Ideal for home workshop. Invaluable for garages, repair shops, farms, etc.



SEND NO MONEY! 10 DAY TRIAL. Order your WELDRITE Electric WELDER—BRAZER—CUTTER C.O.D. today. Pay postman \$12 plus postage charges (wt. 4 lbs.) or send \$12 and we pay postage. Either way, if not satisfied, return WELDRITE in 10 days for refund, less postage charges. WELDER HOOD—Approved Arc Welding lens—only \$3.95. Calif. orders add 2 1/2% tax. 448 So. Hill • Los Angeles 13, Dept. A-10

FREE!

Illustrated Folder

CALIFORNIA TECHNICAL PRODUCTS CO.

A New Principle in Radius Gages

PIONEERED BY

LUFKIN

... Providing 5 Applications for Each Radius

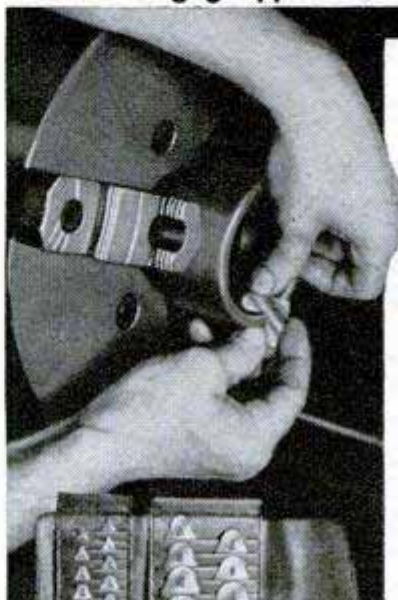

Determining radius of inside corners or fillets. Straight sides of gage are at 90°.



Taking radius of outside corners; also checking sides for 90° and tangent to circle.



Checking work on glass; checks convex parts with unusual projections.



For use on concave cutter (1/2 or less of circle).



Checking one-half of circumference.

HANDY KIT FOR EASY USE

Offered in 5 different sets in durable red leatherette kit, with pockets protecting against loss of blades and making selection easy. Range of blades from 1/4 to 1 inch.

These advancements in Lufkin Radius Gages typify the superior design and features which distinguish over a thousand other Lufkin measuring devices. "Lufkin" makes accuracy easy, fast, and sure. See your dealer this week.

Write Department M for fascinating booklet, "The Amazing Story of Measurement". Enclose 10c (no stamps) to cover handling and mailing.



Buy LUFKIN

Precision Tools • Tapes • Rules • FROM YOUR DEALER
The Lufkin Rule Co. • Saginaw, Michigan

STOP GOO

MILANO

LOCKMOUNT

a more enjoyable pipe
for 4 good reasons

1. LOCKMOUNT guarantees tight fit
2. LIFETIME HESSON GUARD stops goo
3. PERMANENT CORK SEAL keeps shank clean, dry
4. Sweet-smoking IMPORTED BRIAR



MILANO
LOCKMOUNT
\$150

Milano Standard
Mount . . . \$1

Variety of shapes

WM. DEMUTH & CO., INC., 5th AVE., NEW YORK 22

AMES

UNIVERSAL DIAL INDICATOR SETS

New Surplus

Dial indicator — face 2 1/4", graduated in 1/1000ths. Dial reading 0-50-0; spindle travel — 1/4"; can be used on stationary or revolving parts on lathes, milling machines, drill presses, etc., and for automotive work. Comes complete with dial gage, hole attachment, bar with upright, clamp sliding swivel, dial holding rod and 3 contact points — with case shown.

Reg. Sold
\$23.00

NOW
\$15.00

VETERAN TOOL AND SUPPLY CO.
88 BAXTER STREET NEW YORK 13, N. Y.

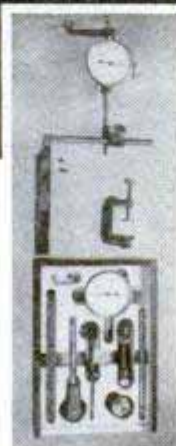

ELECTRIC SIREN



6 volt. Complete with push button . . . \$10.95

Fender Skirts for All Cars



Give year, make & model of car when ordering. All Metal. Prime finish. Rubber beading prevents rattle. Easy to install. \$12.95 PAIR.

1935-48 FORD V8 & 1939-48 MERCURY
DUAL MUFFLERS
Increases power. Reduces back pressure. Saves gas. \$14.95
#RD20N-208— Complete Set
DUALS FOR 1949 FORDS, Set \$19.95

GUTTED MUFFLERS FOR ALL CARS

Gives that Motorboat Tone. Universal type to fit all cars, ea. . . . \$4.95

We Can Supply NEW CONVERTIBLE TOPS & REBUILT MOTORS for all Cars. Write for Prices.

Send 25% Cash With All Orders, Balance C.O.D.

J. C. WHITNEY & CO.
1917 ARCHER AVE. CHICAGO 16, ILL.

Surplus Bargains

JAMMED PACKED WITH BARGAINS on shop and machinery equipment, hobby supplies, aircraft parts, etc.

FOR 64 PAGE **ATLAS EQUIP. CO.**
10c **CATALOG** 229 S. W. BLVD. KANSAS CITY, MO.

ELECTRIC MOTOR BARGAINS!

 1/2 HP. 1750 RPM. \$16.50; 3450 RPM. \$20.00
3/4 HP. 3450 RPM. \$26.00
Every Motor Fully Guaranteed
Heavy Duty, Repulsion Induction—Capacitor Types, Standard Makes (G.E., Westinghouse, Leland, Wagner, etc.), 110-220 V, 60 Cy., 1-phase.

Rush your order TODAY—or write for our FREE listing of other OUTSTANDING BARGAINS on Motors for ALL purposes. All Prices FOB.
ROBERTS ELEC. CO., 7232 Madison, Forest Park 3, Ill.

BURIED TREASURE. MINERALS AMAZING NEW GOLDAK LOCATORS

SENSATIONAL NEW MODEL!
ONLY 11 pounds weight! One hand operation! Money-Back Guarantee of Superiority. Write for full details.

THE GOLDAK CO.
1542 WEST GLENOAKS BLVD.
GLENDALE 1, CALIFORNIA

World's largest maker of fine locators.



DRAINS CELLARS, WASH TRAYS CIRCULATES OIL

 Pumps 1800 GPH 300 gal. 30' high, use 1/8 to 1/2 HP motor. Will not clog. \$6.50

Postpaid if cash with order. (Add 50c for west of the Mississippi.)

Thousands in use since 1936
LABAWCO PUMPS, BELLE MEAD 7, N. J.

Say You Saw It in POPULAR MECHANICS

NEW GOVT. SURPLUS HOIST and WINCH

Originally made to be used on B-29s for lifting bombs. Mounted on welded steel base, can be attached to truck body or any solid base. Ideal for lifting or moving loads onto trailers, trucks or tractors or for machine shops, garages or warehouses. Capacity 2,000 lbs. Equipped with ratchet for holding load and 18 ft. 3/16" steel cable. Shipping weight 50 lbs. FOB, Kansas City, Mo. \$29.95



Send check or M.O. for immediate delivery. No COD's
AMERICAN AUTO PARTS CO., INC.
1830 LOCUST DEPT. PM9 KANSAS CITY, MO.

SHOPMASTER will redeem this coupon for \$2.50 in Shopmaster "Build-it-Yourself" Plans

GOOD FOR
\$2.50

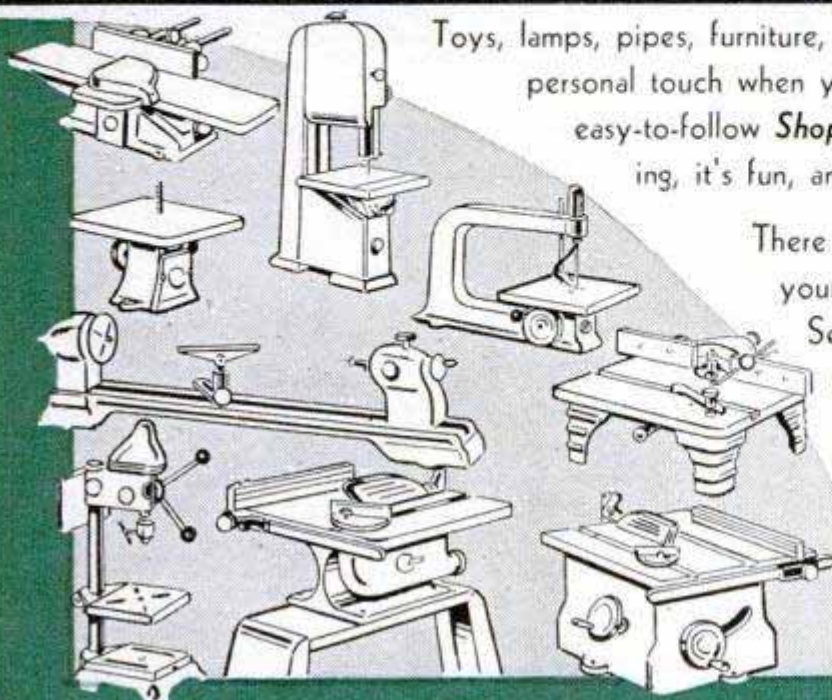

Toys, lamps, pipes, furniture, etc., will have that personal touch when you create them with easy-to-follow *Shopmaster* Plans. It's relaxing, it's fun, and it's profitable.

There is a famous *Shopmaster* Tool for your use, priced for your pocketbook. See your dealer, or write *Shopmaster, Inc.* for your copy of the new 28-page full-color illustrated catalog showing a complete line of tools and accessories.

With the purchase of a *Shopmaster* Tool, your *Shopmaster* dealer or the factory will redeem this coupon for \$2.50 worth of *Shopmaster* plans of your choice. Take this coupon to your dealer and purchase a tool today. If your dealer does not have the plans, he may sign the coupon with the registration number of your tool and mail it to the factory. Your plans will be sent to you immediately.

- 50c Plans**
- 65 Smoking Pipes
 - 66 Modern Table Lamp
 - 68 Five-in-One Coffee Table
 - 69 Lawn Chairs
 - 70 Modern Coffee Table

- 52 Roller Toy
- 53 Child's Wagon
- 54 Coaster Set and Rack
- 55 Toy Duck
- 56 Broom Holder
- 57 Novelty Tie Rack
- 58 Bouncing Dog Toy
- 59 Pull Toy Train
- 60 Gun Rack
- 62 Bird House
- 63 Rolling Hobby Horse

- 64 Kiddie Car
- 67 Picket Fences
- 71 Picnic Table
- 72 Silver Chest
- 73 Baby's Crib
- 74 Child's Table and Chairs
- 75 Child's Play Pen
- 76 Three-in-One Decoy

- 25c Plans**
- 51 Nut Bowl and Mallet



SHOPMASTER, INC.
1214 SOUTH THIRD ST.
MINNEAPOLIS 15, MINNESOTA

(Dealer Note: Shopmaster will replace all plans, free of charge, to your plan rack, on redemption of this coupon.)

CERTIFICATE

This certificate entitles you to \$2.50 worth of *Shopmaster* Plans with the purchase of any *Shopmaster* Tool. Circle the plan numbers desired. Your *Shopmaster* Dealer or *Shopmaster, Inc.*, will redeem this coupon. One to a customer. Coupon void after Dec. 31, 1949.

Tool Purchased _____ Registration Card No. _____
 Dealer _____ Buyer _____
 Address _____ Address _____
 Signature _____ City and State _____

Redemption made by Dealer _____ Plans to be mailed direct to customer _____

51 52 53 54 55 56 57 58 59 60 61 62 63 64 65 66 67 68 69 70 71 72 73 74 75 76

This coupon is void if prohibited, licensed, or taxed in your state or locality.

TWO FIFTY

Flex-O-Shaft

HANDLES LIKE
A PEN*

\$35.00



FLEX-O-SHAFT is an improved all-purpose machine for homes, schools, shops, or factories. The slender, light-weight aluminum hand piece is ideal for grinding, drilling, sawing, buffing, scoring, etching, polishing, and scores of other uses. There is no bulky, throbbing, pulling motor in your hand. The light-weight motor can hang on the wall, or can be set down on working table. Speed is controlled by foot-operated rheostat, leaving hands free. This precision ball-bearing tool is as easily guided as a pen, speeding up operation because of ease in handling. It is a wonderful, compact, power house for making all kinds of objects. This unit consisting of Flex-O-Shaft with 6-ft. cord, 1/16 H.P. Motor, Rheostat with cord and plug, all for \$35.00. Write today!

FLEX-O-SHAFT
and complete
Tool Kit with
66 accessories
ONLY

\$50.00

F. W. STEWART MFG. CORP.
Dept. A, 4311 Ravenswood Ave.
Chicago 13, Ill.



HIGH POWER TELESCOPE

60 POWER - ALUMINUM TUBES - OPENS TO 33"

Variable Power Eyepiece Adjustable
to 15X, 30X and 60X.

\$4.50



5 Sections. 4 Ground & Polished Lenses. Also used as 50X Microscope. Ready to use, only \$4.50 POSTPAID.
BROWSCOPE CO. Dept. 10M, 24 W. 45th St.
NEW YORK 19, N. Y.

MAKE and REPAIR Your Own Band Saw Blades with

The ERWOOD *Electro*
Band Saw Brazer...

No more slowdowns it takes less than TWO MINUTES to repair a blade with the Erwood Band Saw Brazer. And you save money too do inside contour sawing easier and faster. No wasting broken blades. make your own band saws from coil stock. 110 or 220 volt. Complete with kit.

\$19.75



THE *Erwood* COMPANY

209 WOODSTOCK ST., CRYSTAL LAKE, ILLINOIS

ELECTRICIANS RADIO REPAIR SLICK 3-11 PAT. Driver APPLIANCE MEN PEND. CONTROL WORK

Not just another screw holding device but a real lifetime production tool. Bits are replaceable. You actually can start screws by pushing. White plastic handle for rapid detection. Fully insulated to end of shank. Just as handy for exposed as for inaccessible work. Terminal and sheet metal screws handled 25% faster. No dropping. Very little time required to master the technique of handling. Really a wonder tool. A lifetime tool priced to sell. We want you to have one. See prices opposite. Direct sales only. No COD. Cash with order. Recommended for mechanics only. Order to-day.



For use on #4, 6, 8, & 10 screws order Slick #3632 @ \$1.50; #5632 @ \$1.65 or #7632 @ \$1.80 (above 3 1/2", 5 1/2" & 7 1/2" long resp.); For use on #10, 12 & #14 screws order Slick #9244 (9 1/2" long) @ \$1.90; Extra bits for the above are \$.25 pair.

ESLICK PRODUCTS INC. 1312 Hawthorne Road
Grosse Pointe Woods 30, Michigan

U-MAK-IT BOAT KITS EASY TO BUILD

- 5 ROWBOATS 8 TO 14 FT.
- 6 OUTBOARDS 12 TO 16 FT.
- 3 INBOARDS 16 TO 23 FT.
- & CABIN CRUISER



SEND 25c (coin) ORDER YOUR CATALOGS TODAY
U-MAK-IT PRODUCTS 703P-WHITTIER ST.
New York 59, N. Y.

LAWN ORNAMENT-NOVELTY PATTERNS

28 Lawn Ornament Patterns, 25c. Other patterns: 15-20" high; Dutch Girl, Dutch Boy, Pirate, Bull Terrier, Mexican Girl, Mexican Boy, Dwarf, Penguin, Flower Girl, 10c each. 25 Novelty Patterns, 30c. All 62 Full Size Patterns, \$1.00 Postpaid. Strother Pattern Service, Dept. 86-8, Box 128, Belington, W. Va.

SAVE with a HULL MILES TIME WORRY MONEY AUTOMOBILE COMPASS

Beaconlite Illuminated, \$5.95.
Streamline Standard \$3.95. At your dealer's. Write for literature.

HULL MFG. CO. P. O. Box 246-D10
Warren, Ohio



Guaranteed Rebuilt Transmissions

PLYMOUTH-DODGE 35-39 FORD
Exch. Price **\$22.95**
Also transmissions for all other cars. Write for our low prices on other parts you need.
All Parts F.O.B. Chicago, Ill.
WORLD AUTO PARTS CO., Dept. A
2200 N. Ashland Ave., Chicago 14, Ill.

Guaranteed Rebuilt GENERATORS
Chevrolet-Plymouth-Ford 35-39
Exch. Price **\$5.95**
We can furnish you with any part you need from our large stocks. Our prices are the lowest possible. Write us your needs today.

WEATHERSTRIP YOUR HOME

Amazing -E-Z-ON- All metal interlocking Weatherstrip saves fuel bills. Increases comfort. Keeps heat in! Keeps cold out! Easily installed outside or inside without removing sash. Anyone can do it. Quickly pays for itself and produces worth while savings for life of building. Complete set for windows up to 30" width only \$2.11, 30" to 36" \$2.42, 36" to 42" \$2.75. Doors \$3.26. Order right from this ad or write for illustrated circular.

ROBERT N. BALTZ & CO., Inc. 1931
1009 HARVARD TERRACE EVANSTON 6, ILL.

Say You Saw It in Popular Mechanics

MYSTERIOUS DEVICE WELDS ANYONE CAN OPERATE BRAZES SOLDERS & CUTS

This newly invented FOUR-WAY PORTABLE ELECTRIC WELDER will do brazing, soldering, welding and cutting on brass, bronze, iron, steel, cast iron and other metals. It's easy to use. WORKS INSTANTLY off any properly wired 110 VOLT A.C. OR D.C. LINE. Does a thousand and one professional type repair jobs. SAVES TIME AND MONEY on auto, home appliance, farm and shop repairs. It's indispensable for maintenance men, farmers, repair shops, engineers, tin smiths, home and auto owners, bicycle and fix-it shops, etc. **THE FOUR-WAY 10 DAY TRIAL OFFER COMES COMPLETE WITH ALL SUPPLIES READY TO OPERATE INCLUDING SIMPLIFIED INSTRUCTIONS. IT'S FULLY GUARANTEED.** Order one today for 10 DAY TRIAL or write for FREE particulars. **FOUR-WAY WELDER CO., Dept. PMF-109**
2326 S. Michigan Ave., Chicago 16, Ill.



HOLIDAY... every day!

To MAKE NEW FRIENDS FOR HOLIDAY
Cool-smoking aluminum pipe with genuine imported briar bowl

Here's a Sensational PIPE OFFER!
3.50 only 50¢ plus the inside paper wrapper from 12 tins of Holiday Pipe Tobacco.
Offer limited to U.S.A. Expires Dec. 31, 1949
Send to Holiday, Dept. PM-1, Richmond, Virginia

Also in vacuum pounds

HOLIDAY AROMATIC PIPE MIXTURE

Enjoy that real Holiday feeling 365 days a year with HOLIDAY—the aromatic High Grade pipe mixture—at a popular price. Only 15 cents!

AN ADVENTURE IN GOOD SMOKING

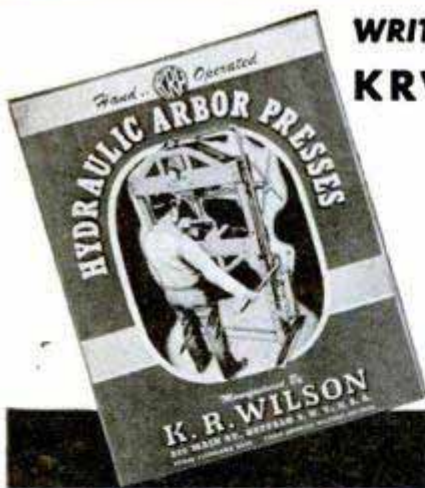

WRITE FOR YOUR **FREE** COPY OF THE NEW **KRW HYDRAULIC PRESS BOOK**

Describes all manner of Production and Shop Work on KRW Hydraulic and Bench Type Presses. Illustrates the new KRW Hand-operated, Electric-operated and Air-operated Hydraulic Presses. 25 to 100-ton capacities.

Write for your copy today.



K. R. WILSON, DEPT. 17, 215 MAIN ST., BUFFALO 3, N. Y.

Glaze with Magic "33"
MILES AHEAD OF ANY PUTTY

"Never again will I use putty," you'll say after trying Armstrong's "33" Compound — for glazing repairs on wood and metal windows.

FUN TO WORK WITH

Unlike putty, "33" goes on smoothly (not messy or lumpy) — and it STAYS put! Won't

"run" or slop over. You can paint immediately after application.

NEVER GETS ROCK-HARD

Most amazing of all, "33" remains permanently E-L-A-S-T-I-C. Won't dry out in opened can. Despite years of weathering, won't crack, chip or crumble. Infinitely longer service — yet costs little. Try it.

The ARMSTRONG CO., 4067 S. LaSalle St., CHICAGO 9



SPECIAL OFFER!
2 lb. Can only 50¢
POSTPAID

If your hardware or lumber dealer hasn't "33" Compound in stock, send us 50¢ and get 2-lb. can by return mail, postpaid. Money back if not entirely pleased. (Offer limited to U. S.)

**"NEW"
Better-Than-Ever**

**Atlas
DRILL
PRESSES**

**7 TOOLS IN!
For Your Shop**

★ **NEW**
4 Ball Bearing
Equipped Head

★ **NEW**
Direct Reading
Depth Stop

★ **NEW**
Extra Heavy
Construction

★ **NEW**
Operating
Smoothness



The finest low-priced drill press in America is ready for your inspection! Industrial, commercial, and home shop men have long known the many quality features of the Atlas drill press. Now come new improvements that make it better than ever.

Four ball bearings in the head give you a "floating drive" that is smoother and dependably accurate for years. The new depth stop is more convenient, and the heavier construction adds to smoothness and accuracy on heavy drilling in metal or high speed work on wood.

It's a perfect tool to add new work-range to your home shop. With low-

cost attachments it drills, taps, sands, carves, mortises, shapes... gives you clean, precision workmanship on metals, woods, and plastics... makes your workshop hours more productive than ever.

Three sizes are available. 12 $\frac{3}{4}$ " bench model, and 15" in bench or floor models. Send the coupon today—see all of the exclusive and special features of the Atlas—before you select the drill for your shop this year.



Atlas 8" TILT/ARBOR SAW

Draw an area 26 $\frac{3}{4}$ " x 22" (table size of this saw, as shown) and you'll quickly see why it's the most popular low-cost circular saw on the market. Use the coupon for latest catalog with full details.

SEND FOR FREE CATALOG

ATLAS PRESS COMPANY

1043 N. Pitcher St., Kalamazoo, Mich.

Please send me latest literature on the new Drill Presses and on 8" and 10" saws

Name _____

Address _____

City, State _____

ATLAS PRESS COMPANY

1043 N. Pitcher St., Kalamazoo, Mich.



**MATCHED PRECISION TOOLS FOR
WOODWORKING AND METALWORKING**

NOW! Sensational Cheap Oil Burner!

FOR COAL AND WOOD STOVES—FURNACES

HEAT YOUR HOME COOK YOUR MEALS
with **CHEAP FURNACE OIL**

NO MORE SHOVELING COAL OR ASHES—No Chopping Kindling—No Slow Fires to Build—An oil burner entirely different—easy to install—easy to operate. Sets in the fire or ash box of your coal or wood range, cook stove, heating stove, laundry stove—larger size for furnaces, boilers. Makes one of the quickest, hottest fires known. Use No. 1 Furnace Oil, Distillate, Diesel, Range, Heater Oil and Kerosene. Simply turn a valve, light the Fuelizer Starter—a great heat for cold winter, moderate heat or just a simmering heat for slow cooking or chilly fall and spring weather.



BIG PROFITS QUICK!
Distributors Salesmen Agents
"Sold 10 first day," says D. E. PRICE
"Started selling yesterday, sold six," says J. KLAPPENSTEIN
"Sold 30—all satisfied," says Rev. R. O. BAKER
Reap BIG CASH PROFITS Write today for details.

TRIAL OFFER QUICK-HEAT Oil Burner carries famous Iron Clad Lifetime Guarantee. So confident are we of the unusual satisfaction given by the QUIK-HEAT that we make \$1.00 BONUS OFFER FOR TESTING and let you try it in your own stove or furnace for one month. Get yours for introducing—big profits QUICK. Be first. Write today for details. DO IT NOW.

NORTHWEST MFG. CO.

Dept. 701-M Mitchell, So. Dak.

LATHE CUTTER BIT GRINDING GAUGE
For checking clearance and rake angles.
50¢ postpaid
SOUTH BEND LATHE WORKS
455H E. MADISON ST., SOUTH BEND 22, IND.

HEAVY CAST ALUMINUM BLOWER, NOW ONLY \$9.75
SINGLE EXHAUST BLOWER, DELIVERS APP. 100 CFM. For workshops, labs, kitchens, refrigeration, air conditioning. Ready to install yourself with any household tools. 110V AC 50-60 cycles cont. duty motor.
DOUBLE EXHAUST BLOWER—with 2 housings on extended shaft motor. Now only \$15.
Also LARGE 275CFM BLOWERS.
DUST-O-VAC—Picks up & bags shavings and dust from all machines, for home workshops & industry, only \$19.95.
FREE literature. Send check, M.O. All shipments F.O.B. Yonkers, N. Y. Pay postman delivery charges.
UNIVERSAL YONKERS CORP., (M10) 137 Alexander St., Yonkers 2, N. Y.

GEIGER COUNTERS TREASURE DETECTORS
Sensational new low cost detectors. Light weight, portable, highly sensitive. Low operating cost. None finer REGARDLESS OF COST.
Write TODAY for FREE literature.
The DETECTRON Company
5637 Cahuenga Rd., North Hollywood, Calif.

BUILD-ARC WELDER FROM OLD GENERATOR
For Light or Heavy Work. 75-200 amps. No previous experience needed. Complete PLANS and valuable Catalog 35c.
LEJAY MANUFACTURING CO.
1347 LeJay Bldg., Minneapolis 8, Minn.

Say You Saw It in
POPULAR MECHANICS

ELECTRIC SHEAR SHARPENER
Over 65,000 Sold—It Must Be Good!



Genuine Carborundum wheel ideal for shop or home use. Send remittance with order and shipment will be made at once, prepaid to your door, complete with electrical goods catalogue.
Motor driven
\$9.75 complete with vise

WILLIAM MARVY COMPANY
477 St. Peter Street St. Paul 2, Minn.

HOW TO GIVE QUICK REST TO TIRED EYES

• Eyes tired? Feel as if you can't work, can't enjoy yourself? Then give them a quick rest—



• Put two drops of gentle Murine in each eye. It cleanses and soothes.



• In seconds, your eyes feel rested. Murine's seven ingredients help your eyes feel fine.



MURINE
FOR YOUR EYES



Now! ANOTHER QUALITY-FAMOUS SHERIDAN Pneumatic Rifle

The "SILVER STREAK"

Only \$19.95 RETAIL

The Finest Low-Cost Pneumatic Rifle Ever Built

Here's a quick-handling, easy-operating, trouble-free pneumatic rifle you'll be proud to own. "Silver Streak's" quality, accuracy, controlled power and shooting economy make it the best buy on the market. Ideal for target or small game shooting, it pays for itself in low-cost ammunition (\$2.15 per 500 rounds)!

See the "SILVER STREAK" at Your Dealer's!

Ask your dealer to show you this dependable addition to the famous Sheridan line. If he cannot supply you, mail check or money order direct. Money refunded if not satisfied upon inspection.

Dealers! Wholesalers! Write for our new profit plan.

SHERIDAN PRODUCTS INC.
Dept. 159-K • RACINE, WISCONSIN

MASTER HOBBY ARBOR TOOL KIT AT THE GIVE-AWAY PRICE \$5.95

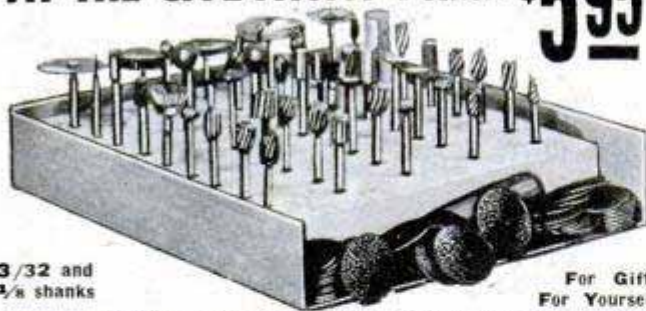

3/32 and
3/8 shanks

For Gifts
For Yourself

A 50c FOUNTAIN PEN FREE WITH ORDER. The best gift you can give to the hobby worker. We give you saws, drills, routers, carvers, emery disks, polishing compound, reamers, borers, shapers, stone points, grinding points. About 150 pieces that we went out and priced in other stores for over \$20.00 for half of what we sell for \$5.95. In addition to the above we include a dozen saws and a 60c mandrel. After receiving set, if you don't think it is worth what we say, send it back. Your money refunded.



BURGESS ELECTRIC SPRAYER (Complete)

Just plug it in and spray. 24 oz. capacity. Fast, economical for paint, varnish, oils, insecticides, etc.

\$12.95

25 ASSORTED SAWS

Some slightly off color, but all perfect and new. 2 mandrels included worth 60c each. Total value \$15.00. All this for only **\$1.95**

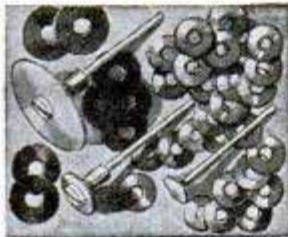

Get our 100 page catalog. Send 25c, your money refunded with first order.

All above items shipped P.P. Prepaid. Send check, Money Order or C.O.D. to Dept. P.M.

GENERAL AIRE CO.

447 W. NORRIS ST. • Dept. PM • PHILA. 22, PA.



ELECTRONIC AIR SANITIZER

Do you suffer from Asthma, Hay fever, or Sinusitis? Is your home, office, or work shop, musty, damp or troubled with odor? Try Air-Tron for 10 days. Money back if not fully satisfied. \$9.95 prepaid. Ozonaire Company, 5645 N. Central Park, Chicago 45, Illinois.

Write for
FREE
Literature

MICRO-VOX THE WIRELESS "MIKE"

Broadcasts Over Any
Radio Within 75 Feet!

Here's a fascinating complete miniature transmitting system that will delight everyone! Round table discussions . . . Baby listener . . . Practical jokes and dozens of other uses that will astonish one and all! Complete with tube, batteries, tuner and built-in high-fidelity microphone. Clear, Life-like tone. Easy to operate!

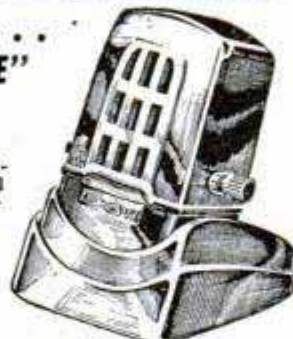

SAVE MONEY! Send Check or M.O.
We Pay Postage. C.O.D. Plus Postage.

\$6.95 COMPLETE

SMALL 6 VOLT D.C. MOTOR

Ideally suited for Buffers, Grinders, Fans, home-built gadgets and small vehicles. Hobbyists, Mechanics: here is the small high powered unit that fits your specific need! 6 volt D.C. 3500 R.P.M. (12 volts A.C.)

\$2.95 each **\$2.50 in lots of 10 or more**



TRUSOUND, INC. (Dept. PM-10) 630 W. Randolph St. Chicago 6, Ill.

PARTS FOR MILITARY TRUCKS

4 or 6 Wheel Drive at a SAVINGS—
1/4 ton to 20 ton.

Parts List Available on Most Military Trucks and Jeep Models



JEEP TOP and SIDE CURTAINS, Complete, O.D. Color. **\$39.50**

TRAILER AXLES 12,000 lb. capacity, Duals **\$69.50**

WINCH CABLE 1/2", 200 ft. **\$25.00** 250 ft. **\$30.00**

Hundreds of Other Truck & Jeep Parts and Supplies
All prices quoted good 30 days FOB, Kansas City, 25% Deposit Required on All Orders.

American AUTO PARTS CO.
1830 LOCUST — DEPT. PM
KANSAS CITY, MISSOURI.



HYDRAULIC BRAKE CONVERSION KITS



A-B & thru '38. Install Hydraulic Brake system now—Be SAFE. Complete kit includes everything needed—Cylinders, backer plates, lines, brackets, hoses, easy to follow instruction. Easy to install in 8 hours. Satisfactory operation guaranteed. Order Direct! Complete kits only **\$75.00**. Los Angeles. \$25 deposit on C.O.D. Return old backer plates for \$10.00 refund.

Hot Rods and Race Cars
DUAL MANIFOLDS, HEADS and CAMS for all makes & models
HOLLYWOOD CHROME TRIM LOWERING SHACKLES Set of 4 (Fords) \$1.50 State 4" or 6" & year

Send for HISTORY of HOT ROD & MIDGET RACING with 32 page illustrated Equipment Catalog. . . . 25c
ANSEN AUTOMOTIVE ENGINEERING CORP.
3801 W. Jefferson PM-10 Los Angeles 16, Calif.

HANDY SEWING AWL



Patented lock-stitch awl, complete with 2 needles and reel of waxed thread at this special price! Satisfaction guaranteed, or money back. HUNDREDS OF USES—sewing and repairing leather goods, tents, belting, awnings, saddles, sporting goods and others. Complete instructions. Send currency, check or money order. Postpaid. **\$1**

RADEN SALES COMPANY

Dept. M, Box 5601, Dallas, Tex.

RUPTURE RELIEF

Advanced method. No leg straps, no elastic, no steel. Entirely different. Guaranteed. Write:
SMITH MANUFACTURING COMPANY
DEPT. PM PRESTON, ONT., CAN.

Say You Saw It in Popular Mechanics

SURPLUS BARGAINS



LINEMAN'S TOOL & SAFETY BELT

Brand new web type belts in the original package. **ONLY \$3.95**

POLE AND TREE CLIMBERS

Without straps Used, good **ONLY \$1.50 Per Pair**

HAYDON TIMING UNIT

Excellent as an automatic timing device for turning off electric signs, store lights, etc. Hundreds of other uses.

110 V. — 60 cycle — 2 watts
1/10th rev. per hour



BRAND NEW!
\$2.95

Send 10c for our Jam-packed Catalog!
Enclose full amount with order. All Equipment F.O.B.

C & H SALES COMPANY

2176 M-10 E. COLORADO ST. • PASADENA 8, CALIF.

GOLD BOND
BUY AT WHOLESALE



WHOLESALE SLIGHTLY USED TIRES DIRECT TO YOU

10% discount on 2 or more tires if you send this ad with order

TUBE DELIVERED WITH TIRE AT NO EXTRA COST FOR 15" OR 16" TIRES

Safe — Our tires used on school buses and ambulances
All good tires with a

GOLD BOND GUARANTEE FOR 12 MONTHS

550-16 \$3.54	30-5 \$ 7.98	1200-20 \$18.78
600-16 3.59	650-20 7.69	750-24 (36-6) 12.21
650-16 3.89	700-20 (8) .. 9.29	38-7 (825-24) 13.75
700-16 4.59	700-20 (10) .. 12.48	1000-22 17.70
550-15 3.79	750-20 (8) .. 8.19	1100-22 16.89
650-15 3.89	750-20 (10) .. 9.19	900-24 (40-8) 21.60
700-15 3.98	825-20 11.19	900-16 8.98
550-17 5.69	900-20 11.89	825-15 (14 ply) .. 14.10
750-16 8.40	1000-20 12.89	750-15 (12 ply) .. 11.30
600-20 7.98	1100-20 13.89	

Exceptionally good tread — No recaps — With a **GOLD BOND GUARANTEE FOR 24 MONTHS**

600-16 .. 6 ply Military—Mud and Snow Tire..... \$6.37		
550-16 \$5.19	525-18 \$ 6.69	700-15 \$ 5.29
600-16 5.29	550-17 7.99	600-20 9.75
650-16 5.29	650-15 4.98	650-20 9.75
700-16 6.29	825-20 15.98	700-20 10.98
550-15 4.81	900-20 15.98	32-6 (8) .. 10.49
	1000-20 16.89	

GOLD BOND SPECIAL — 750-20 MILITARY TIRES
Will fit 650 x 20 700 x 20 (8 & 10 ply) 34 x 7 (8 & 10 ply)

Special \$10.49	Guaranteed 12 months
Superior Quality ... 12.98	Guaranteed 18 months
Gold Bond Finest... 14.98	Guaranteed 24 months
900 x 16 Special.... 9.03	900 x 16 extra.. 11.19

Send check or money order with this ad

GOLD BOND TIRE CO., Dept. PM 24
512 NORTH 1ST ST., RICHMOND, VA.
"A gold bond written guarantee with every tire"

BUILD YOUR OWN TILTING ARBOR SAW!

Exclusive GIL-BILT Build-It-Yourself Features

- No machining—build easily with hand tools only
- No blueprint reading—step-by-step pictorial plans, full scale patterns, actual photographs
- Sturdy wood, aluminum, and steel construction
- Capacity and performance of commercial saws selling for \$60 and up

SAVE \$50 OR MORE

GIL-BILT 10-INCH TILTING ARBOR SAW



- 27x28 in. table, 13½ in. capacity in front of blade
- 10 in. blade cuts ¾ in. deep, tilts full 45 degrees
- Floor model 34" high, table always stays level
- New Departure ball bearing arbor, ¾" precision shaft turned down for 5/8" bore blades, alum. housing, shipped ready to run
- Jackscrew and 4½ in. dia. handwheel lowers and raises blade
- Cast aluminum miter gauge and self-aligning rip fence guide

GIL-BILT Metal Parts Kit includes Plans, ball bearing arbor, miter gauge and bar, rip fence guide, dado insert, lock knobs, jack screw mechanism and handwheel, and all other metal parts (less blade) \$20.95
Same Kit with 10" Combination Blade \$24.90
Same Kit with 8" Combination Blade \$23.90

GIL-BILT 12-INCH BAND SAW



- Cuts to center of 24 inch circle
- Handles stock up to 6 inches thick
- 18x18 inch table tilts 45 degrees
- Lower wheel and drive pulley runs on sealed New Departure Ball Bearings; Upper wheel runs on two 5/8" bore Oilite Bronze bearings
- Upper wheel tension and tilt mechanism of cast aluminum, completely assembled.
- Upper and lower blade guides. Each has ball thrust bearing, self-lub bronze jaws
- Rubber tired wheels. Choice of cast aluminum or make-your-own wood wheels on metal hubs
- Uses standard 78 inch blades up to 3/4 in. wide
- Fully enclosed mechanism for utmost safety

GIL-BILT Metal Parts Kit includes Plans, rubber tires, ¼ inch blade, hubs for wood wheels, ball bearing spindle, tilt mechanism, guides, table tilt segments and all other metal parts \$16.95
Same Kit with two machined ready-to-install 12" cast aluminum wheels \$20.95
Return in 10 days for full refund if not satisfied.
(Prices include postage within 500 miles. Over 600 add 5%)

Also available—Plans and Parts Kit for 8" Tilt/Table saw. Order Plans at \$1.00 each—sent postpaid anywhere in the world or write for FREE descriptive catalog.

GILLIOM POWER TOOLS P. O. Box 1-PK, Lambert Field St. Louis 21, Missouri

SYNCRO 3
Presents **3**
NOVEL Electrical GIFTS
For HOME and WORKSHOP!



A few of the hundreds of articles Syncro—and only Syncro—can hone sharp safely!

1. New All-Purpose Hone Sharpener

Here's the first and ONLY HONE Electric Sharpener—the only ALL-PURPOSE machine that gives you 14,400 gentle, genuine HONING strokes a minute! Invaluable for kitchens, workshops, homes, cafes, commerce and industry! A novel, practical GIFT. SAFE. No belts, gears, wheels! 60 cycle, 110-120 volt AC. Insist on SYNCRO ALL PURPOSE Electric HONE Sharpener! With 3 Honing Stones, cord, plug, switch, only..... **\$10.50**

2. New Sander-Polisher!

New SYNCRO does better, faster job. Light. For light sanding—polishing autos, shoes, etc. 14,400 "POWER" Motion strokes a minute! 60 cycle, 110-120 volt AC. With 9 sheets Aluminum Oxide sandpaper, felt and virgin lambswool pads, 8 ft. cord, plug. **\$14.50**



3. Safe Electric Jig Saw

Safe for children yet power enough for adult workshop. Portable. THOUSANDS SOLD. Adjustable arm permits any length cut. Not for "lumber-cutting" ... for fine craft work on wood, plywood, thin metal, plastic. Complete with built in motor, **\$17.50**



With Cord, Plug, 3 blades

DEALERS! Write for new SYNCRO "BIG 3" Profit Facts.

SYNCRO
QUALITY ELECTRIC PRODUCTS
SYNCRO CORP., DEPT. H-109, ROCHESTER, MICHIGAN

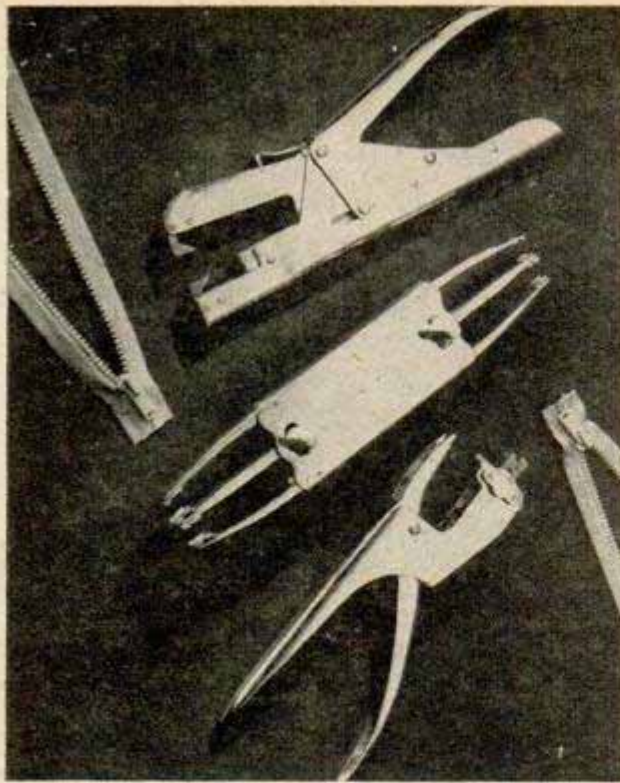

Zipper Repair Kit

Zippers that have jammed due to fabric being caught between the teeth are released and returned to perfect working order in less than a minute by a three-piece repair kit. Designed for use in cleaning, luggage and tailoring shops, the kit does not damage the fabric while unjamming the fastener. The tools are also used for replacing broken teeth, remeshing teeth and replacing damaged slides.

Army Hushes Generators

Army engineers have developed a silencer box for engine generators that makes them inaudible at distances over 100 yards. It is designed to make detection and spotting of noisemaking military equipment more difficult. The box is aluminum, with a two-inch-thick lining of glass fiber and a one-inch thickness of the same material cemented to the walls of the air-intake and exhaust ducts.

IT'S Sale! MONTH at C & H - WAR SURPLUS

Table Saws, Wheels, Arbors

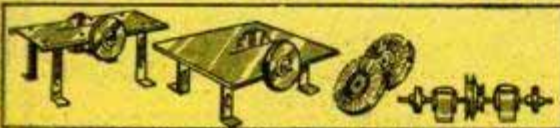

All steel table saws, 10" high, 1 1/4" thick table is 13 1/4" x 27". Saw comes with 7" combination blade, 6" grinding wheel, double end ball bearing arbor 1/2" shaft & steady rest for grinding. Makes 2 1/2" cut. Will take 10" blade. Included are the nuts & bolts, all holes are drilled and the saw is ready to assemble. **Stock #556. Our Price is only \$9.95**

Table saw. Steel table top 3/4" thick with solid hardwood veneer center, size is 19 1/2" x 22"-10" high. The 7" comb. blade, 6" grinding wheel, double end ball bearing 1/2" shaft arbor and steady rest for grinding are included. Saw comes with nuts & bolts, all holes drilled ready to assemble. Will take 10" blade. **Stock #555. Priced for the buyer at \$11.95**

Saws are complete - NOTHING else to buy

EXTRA ACCESSORIES
6" wire wheel..... 90c 22" V belt..... 75c
1/2 HP heavy duty motor with capacitor..... \$17.50

Saw Blades
Made of tough steel. Teeth set for side clearance for wood cuts. High carbon hand filed are 1 1/2" or 3/4" shaft size.
Work Shop High Carbon
7" comb..... \$1.35 7" comb..... \$2.50
8" comb..... \$2.00 8" comb..... \$3.00
All blades are postpaid.
DOUBLE END BALL BEARING ARBOR. Half inch shaft 11 1/2" long. Bearing alone worth \$10.00. **Stock #305. Only \$4.95**

ALL BRONZE GEAR PUMP

All bronze corrosion resistant gear pump. Lifts water 25'. Delivers 1020 gal. per min. at 1200 RPM. Develops 110 lbs. pressure or 250' head. Self locking packing nuts, drain cock, reversible head. Will pump brine, salt water, oil, vinegar, gasoline, etc. Dimensions: 10"L x 7"H x 5 1/2"W. Base holes 1 3/4" x 3". Shaft 1 1/8". 1" x 1" inlet & outlet. Wt., 24 lbs. Mfg. by Sherwood Brass Works. All pumps belt driven. All bronze gear pump with 8" V pulley. **PUMP ONLY. Stock #2314 \$24.00**

Same pump as above, with motors, (electric). **Stock #549.**
1/2 HP..... \$67.00 1 HP..... \$89.00
3/4 HP..... \$74.00

Same pump with Briggs-Stratton gas engine. **Stock #550.**
1 1/2 HP..... \$ 89.50 2 1/2 HP..... \$135.00
3 1/2 HP..... \$165.00 6 HP..... \$195.00
The MORE HP the more PRESSURE.
CENTRIFUGAL PUMP with 2" intake 1 1/2" discharge with 6" variable speed pulley. **Stock #557 \$35.00**

HALES FIRE PUMP

For fire depts., factories, forest fire prevention, etc. 600 gal. per min. Can be operated with a four or six cylinder gas engine, 4 1/2" intake, 2-2" outlets, 265' head at 120 lbs. pressure. Passed by national board of fire underwriters. **NEW. \$149.50**
Stock #407. Price..... \$149.50

Utility Polisher & Buffer

Fits any 1/4" drill. Polishes, sands and grinds. Sheepskin, 4" rubber disc. Complete. **Stock #553. \$1.95**
Imagine it's only..... \$1.95
Extra sanding discs 8.75 a dozen. Add \$8.25 postage for handling.

Chimes or Call System

Navy type. Good for schools, hospitals, office, homes, etc. 110 Volt AC or DC. Weather proof. List price \$15.00. **Stock #552. Super value at only \$1.95**
Add \$8.25 postage for handling.

WESTINGHOUSE

3 phase motors. All models 1/2 HP to 1 1/2 HP. 220 volts. Motors totally enclosed-ball bearing. **Stock #541. 40% off list prices.**

AIR COMPRESSORS

All ratings from 1/2 HP to 10 HP—new and rebuilt. Write for free details.

HOSE 20' LENGTHS

Gas, oil, or water resistant. Neoprene treated. 1 1/4". Male & female brass connectors. Standard filling station size. Value **\$7.50**
\$20.00. Stock #528. Our price..... \$7.50
Foot valve..... \$3.00

PLASTIC TUBING

Good for water, oil, air, electrical installations & radio work. Available in 100 ft. lengths. Min. order 50'.
3/4", 3/8", 1/2" 7/16"..... 4c
per ft..... 2c per ft..... 4c
5/16", 3/8" 1" 3 ft. lengths..... 6c
per ft..... 3c only. Per ft..... 6c
1 1/2"..... 8c
per ft..... 8c

Stainless Steel Flat Tops

Stainless steel one side, 1/4" veneer center, overall 3/4" thick. Ideal for shelves, back bar work board, work table, etc. **Stock #411**
22 x 19 1/4"..... \$1.95 22 x 21 1/4"..... \$1.95
22 x 34"..... \$3.45 22 x 37"..... \$3.95

CLUTCH

For Motor-scooters, Motorbikes, Lawn Mowers, etc. Mercury centrifugal clutch for use with any small gas engine. "A" belt pulley, 5/8" & 3/4" bore. **Stock #400. \$9.95**
Brand new only..... \$8.00
In lots of 12. Each..... \$8.00
Add \$8.25 postage for handling.

SPECIAL AC ARMY GENERATORS

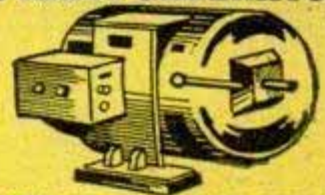

300 Watt, 12 volt DC, 2000 RPM. Heavy duty with current cut out relay. High and low switch, 30 amp. meter. Can be bought less shaft and base to be used directly mounted to a Briggs & Stratton 1 HP engine. Tapered shaft engine required. **Stock #323. NEW only \$7.00**

Complete with shaft base and bearing. **Stock #324..... \$15.95**

300 Watt, 110-220 volt AC generator. Mfg. by Electric Specialties Co. Weighs 20 lbs. **Stock #416. \$29.50**
NEW only..... \$29.50

1000 Watt, 110 volt AC, 60 cycle generator with built in radio filter. Leland ball bearing 1800 RPM. **Stock #526..... \$89.50**

1500 Watt, same as above. **\$99.50**
Stock #527..... \$99.50

2500 to 3000 Watt, Leland generator 110 volt 60 cycle. Self exciter, radio filter, junction box for plug in. **\$145.00**
Stock #525. New..... \$145.00

3000 Watt, Delco, 110 volt DC. Plug in, ball bearing 2800 RPM. List price \$343.00. Used but like new. **\$99.50**
Stock #321..... \$99.50

RUBBER WHEELS

Good for boats, scooters, wheelbarrows, etc. **Stock #536.**

2"x10", 1/2" bore \$ 1.95
2.75 x 10 3/4" & 1/2" bore..... \$ 4.50
4.00 x 8 5/8"..... \$10.95

10 1/2" x 4, 6 ply 8 1/2"..... \$ 8.95
14 1/2" x 5, 6 ply 1 1/2"..... \$10.95

New airplane tires, tubes and wheels with high speed Timken Hyatt ball bearings. **Stock #544.**

800 x 5, 6 ply 1 1/2"..... \$14.50
1700 x 20" 12 ply tubes..... \$44.50
Stock #545..... \$44.50

for earthmovers, trucks, \$300 value.
56" 16 ply Bomber TIRES and TUBES only \$600 value, for tractors, etc. **\$59.50**
Stock #546. Our price..... \$59.50

AIRPLANE TIRES with landing gear hydraulic strut. Firestone and Goodyear standard tires, 8 ply 27", 29" high. Hydraulic strut is 4 1/2" long, 3 1/2" dia. Can be made into heavy duty trailer. **Stock #551. Price \$22.50 each**

C & H Electric Co.

Sonic Washing Machine

Invented by two Australians, a new washing machine produces sound waves which clean clothing. The cylindrical washer is placed in the center of a tubful of clothes. An electromagnet vibrates a diaphragm, and sound waves produced by the diaphragm cause tiny waves in the water. The clothes and water oscillate about 100 times a second. The vibration shakes loose the dirt particles and holds them in suspension. One batch of clothing can be washed in less than five minutes.

Putting Pecan Shells to Work

Only a few years ago, one Texas businessman's biggest problem was disposing of 10 tons of pecan shells a day. The shells were a waste product of his pecan-shelling plant. Today, he spends his time looking for more shells because he converts them into toiletries, mechanics' soaps, plastics and even some types of explosives.



& OTHER ITEMS at LOWEST PRICES Sale!

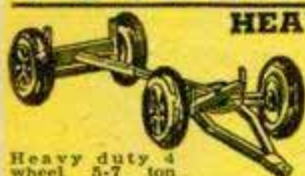

HEAVY DUTY FARM WAGON
5 to 7 ton capc.

Heavy duty 4 wheel 5-7 ton trailer, 27" high, rack size is adjustable 12 to 20 feet. Built of heavy 6" I beam channel iron and a 3" dia., seamless tube. Double bronze king pins, heavy duty hitch, double high speed Timken bearings. Width of track is 6'. This trailer will not whip & has been tested at speeds up to 50 MPH. Use it for chopper wagon, boat trailer, machine mover, logging, construction work. Trailer comes with 4 wheels and spare tire. All tires are airplane type and are GUARANTEED. Value is approx. \$500. Stock #558. OUR PRICE IS ONLY..... **\$179.50**

HALF TON WAGON



Half ton wagon with plate aluminum body 24" x 42", 5/8" steel axle. Stock #332. Write for details.

4 Wheel Army Bomb Trailer

Costs less than price of tires. Can be used for compressors, const., work, light plants, foundries, machinery, etc. Wgt. 375. Goodrich & Firestone 6 x 9 tires 21" high. Trailer is 6' 5" long. Axle size 1 3/4". Cone ball bearing race. 3" center channel 36" wide. Pay load 1 ton, will take 2 ton. 36" tongue. Zerk fittings. Tires list at \$28.00 each. Stock #559. **\$90.00** Our price for complete trailer is...

HORNS and HOWLERS

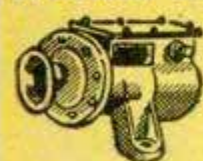

Motor driven (not a vibrator). Heavy duty with great power and long life. Adjustable for high, medium or low tone. 100 volt AC current. Weather proof. For alarm or signal horn on boats, school yards, factories, etc. List price \$47.00. NEW Stock #302. OUR PRICE.... **\$9.45**



Electric Rubber Cable (all new) CORD SETS

Extension cords 100 ft. Heavy duty. Plug, socket, and guard. No. 16 wire. Worth at least \$10.00. Stock #310. Our price..... **\$4.95** Same as above 50' lengths.... **\$3.95**

HEAVY DUTY ELECTRIC CABLE

3 wire #10 super cable. Stock #351. **\$13.00** 65' with lugs. Value \$26.00. Our price
3 wire #10 government submarine type. Use underground, underwater, overhead. Cost U. S. 90c ft. Stock #542.

OUR PRICE
100 ft. **\$24.00** 500 ft. **\$100.00**
250 ft. **\$55.00** 2900 ft. reel **\$530.00**
2 conductor rubber cable #4-stranded-75 ft. length with connectors. Stock #543. **\$80.00**
List price \$177.00. Our price.....
4 wire #6 stranded heavy duty. List price \$2.36 per ft. Stock #547. **\$35.00**

OUR PRICE
50 ft. **\$5.00**
100 ft. **\$5.00**
250 ft. **\$12.00**
500 ft. **\$225.00**
1000 ft. **\$400.00**
225 ft. lengths 3 wire #10 rubber cable, two male connectors. Value \$109.50. **\$35.00**
Stock #554. Price

Electro-Lift

HOIST

500 lb. Electro-Lift Hoist. 17 ft. of cable—up and down button and trolley. 3 phase, 220 or 440 volt, 60 cycle. Used in A-1 shape. List price \$185.00. Stock #560. Specify **\$75.00** 220 or 440 volt. Our price

GEAR HEAD MOTOR 1/20 HP

Holtzer Cabot 110 volt AC 60 cycle. Can be used for turn tables, television agitator, telescope drives, etc. Approx. 1/20 HP. Output shaft—50 RPM. **\$14.95** Stock #406. New only....

DEADLINE FLASH

Apex Universal joint 1 1/2" female socket, 1 1/2" stud, overall length 5 1/2". Will fit any 1 1/2" shaft motor & can be used as an agitator for milk, paint, pump or in any spot that needs a universal joint. List \$4.00. Stock #562. Our price 95c plus 10c for postage.
Woodruff keys in assorted package of 50. 5/32", 3/16", 7/32", 5/16", 3/8" sizes. Now only **\$1.50** per package. Add 25c for postage. Stock #563.

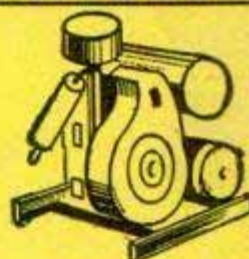

AC ARMY LIGHT PLANTS

300 watt, 110-220 volt AC, 60 cycle light plant powered by 1 HP gas engine, direct drive. Mounted base weight 40#. Stock #409..... **\$89.50**

500 watt, 110 volt AC, 60 cycle. Onan direct connected. Stock #414. **\$149.50**

New 1000 watt, 110 volt 60 cycle AC plant with Briggs & Stratton directly coupled to a Leland generator. Stock #351..... **\$189.50**

New 1500 watt, 110 & 220 volt 60 cycle, AC plant with Briggs & Stratton directly coupled to a Master generator. Stock #352..... **\$209.50**

2500 watt, 110 volt AC 60 cycle with Briggs & Stratton Model Z and Leland generator. Stock #317. Used but like new **\$225.00** New **\$295.00**

Add \$10.00 for tools and spare parts
5000 watt, 110 volt AC, 60 cycle with automatic remote control. Powered by 4 cyl. Jeep gas engine. Used but like new. **\$595.00** Stock #318.....

7500 watt, 110 volt AC, 60 cycle powered by a VE 4 Waukesha 4 cyl. gas engine. Continental or Hollinsworth generator. Remote control starting. Complete with switchboard. **\$675.00** Used but like new. Stock #347... **\$675.00**

Add \$65.00 for transformer to make this plant 3 phase 220 volt. **\$800.00**

10,000 watt, 110-220 volt AC, 60 cycle. Remote control. Powered by a Jeep 4 cyl. gas engine. Used but like new. **\$800.00** Stock #319.....

New job original crate, **\$1100.00** only

25,000 watt, 220 volt AC, 3 phase. Spare parts. New packed for export. **\$2150.00** Stock #415.....

Lineman's Pliers

High quality Krutter side cutting pliers. Stock #561.
6 1/2" 8" 7" diagonal cutter
\$1.50 \$2.10 \$1.85
new new new

Over 4,000 items in Stock. Write for Circular

ALL ITEMS GUARANTEED C & H ELECTRIC Co. AS REPRESENTED

434 W. JUNEAU AVE. MILWAUKEE 3, WISCONSIN

All prices F.O.B. Milwaukee, 25% deposit required on all C.O.D. orders. No C.O.D.'s under \$10.00. Use stock number when ordering. Many other bargain items not listed—write for our free circulars.



Now everyone can afford a new top quality Radiant glass-beaded projection screen!

If you have been putting up with a makeshift, discolored, or worn-out screen—here's good news! Now you can get a new Deluxe "CHAMPION" Radiant screen with more new features, more improvements, more real quality than ever before . . . for as low as \$15.00.

Enjoy brighter, more contrasty pictures every time! Radiant's "Million Mirror" screen fabric has millions of tiny glass beads embedded in the pure white surface . . . millions of tiny mirrors that reflect all the crisp detail of black-and-whites, all the warm, glorious beauty of color pictures.

MAKE THIS FREE "SCREEN TEST." Prove in your own home how much more brilliant all of your pictures appear on the new "Radiant Million Mirror" screen. Send for FREE sample swatch of Radiant screen fabric today!

RADIANT

PROJECTION SCREENS

RADIANT MANUFACTURING CORPORATION
1257 South Talman Avenue, Chicago 8, Illinois

\$15
30"x40" size — other models as low as \$6.75

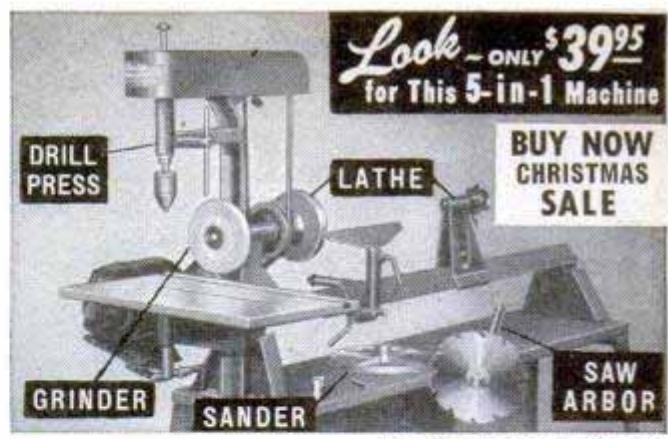

POWER TOOL COSTS DOWN 75%

Have fun. Save money on home repairs. Operate profitable part-time business. Get heavy-duty Emrick Lathe, Drill Press, Saw Arbor, Grinder, Sander—all in ONE machine, using ONE motor. Equals in performance equipment costing \$200 or more. Direct Factory Price only \$39.95 cash, or on Easy Payments. 10-Day FREE Trial. MONEY-BACK GUARANTEE. Thousands of satisfied users. Our 51st year. Write today for FREE Catalog, and learn about our Big 15-Day Pre-Christmas Sale.

EMRICK, INC., 1851 Clinton, Kalamazoo, Mich.

HOT-START COIL



GIVES YOUR CAR THE EXTRA SPARK THAT ASSURES A POSITIVE START

Here is the new Hot-Start Coil that gives you a hotter spark for starting. Overcomes normal voltage drop from starter. Easy to install, fits all cars specify make and model. Order today.

\$11.95
Postpaid or C.O.D. plus charges

Dealers Wanted
STERNALL MFG. CO.
3505 Rodeo, Los Angeles 16, Calif.

JACOBS SAFETY WONDER SAW

WORLD'S GREATEST SAW INVENTION

TWIN BLADES TURN IN OPPOSITE DIRECTIONS

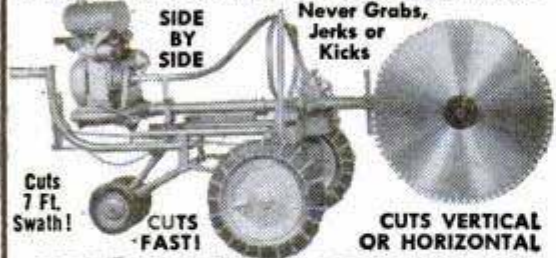

Cuts 7 Ft. Swath!

CUTS -FAST!

CUTS VERTICAL OR HORIZONTAL

FARMERS! RANCHERS!

Stop paying taxes on idle brush and timberland. Turn it into pasture or crop land quickly, easily and at low cost. The greatest brush and timber clearing saw invention in America. No other saw ever built can equal its operating advantages and features. Self-propelled by hydraulic oil transmission. Saw in horizontal position swings to cut 7 ft. swath. DEALERS: WRITE FOR TERRITORY!

WRITE FOR FREE FOLDER!



JACOBS WIND ELECTRIC CO., INC.
Industrial Division
Minneapolis 11, Minn.

SPRAY-PAINT OLD BUMPERS

MARVELOUS, EASY REFINISHING JOB



WITH **ZACO ALUMINUM**

Self-propelled PAINT SPRAY

ZACO LABORATORIES
1360 W. 9th ST. CLEVELAND 13, OHIO

SEND \$1 FOR SPECIAL INTRODUCTORY CAN



\$500,000.00 INVENTORY for QUICK LIQUIDATION

Surplus items—hundreds of them for home, shop, factory, farm and outdoor use. New items, used items, reconditioned items—all at tremendous savings—all priced for quick sale.

Page After Page of Values

This big catalog shows page after page of amazing money saving values. Write for your copy today. Send 10c to cover postage, mailing, etc. Write today!

SEND TODAY FOR YOUR COPY **10c**

STARK'S Dept. 509 So. STATE STREET
PM10 CHICAGO 5, ILLINOIS

choose your ANTI-FREEZE

now!

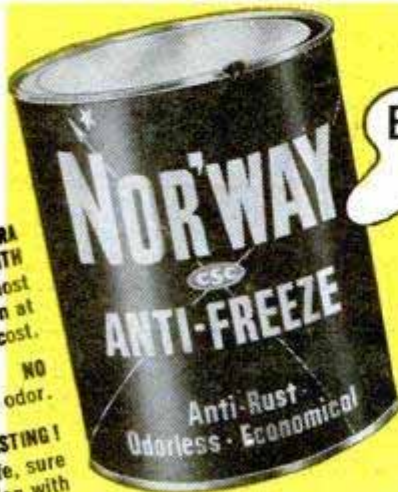

ECONOMY
TYPE

PERMANENT
TYPE



EXTRA
STRENGTH
gives the most
protection at
the lowest cost.

NO
disagreeable odor.

LONG LASTING!

Safe, sure
protection with
only an occasional
check-up.

PREVENTS CORROSION of all cooling
system metals!

WILL NOT
BOIL AWAY!
Guaranteed
protection for a
full winter
driving season.

NON-CORROSIVE!
PEAK is fully
inhibited to
prevent cooling
system corrosion.

WILL NOT LEAK from any cooling
system tight enough to hold water.

HARMLESS if spilled! Will not
injure automobile finish.

NORWAY® PEAK®

PRODUCTS OF COMMERCIAL SOLVENTS CORPORATION

SAVE \$35 ON NEW NAVY SURPLUS VISES

Take advantage of sensational close-out price on NEW, all-steel Vises built to rigid Navy specifications. Check all these outstanding features: Full swivel—Unbreakable, all steel—Removable pipe jaws open 1/8" to 4"—Removable 4 1/2" milled jaws, 6" opening—Navy gray finish—Polished handle, heavy screw clamp—Extra heavy wide base—Jaws fitted with polished and tempered steel

knurled faces—Milled and fitted polished slide—Weight 85 lbs.

Ideal for plumbers, garages, machinists, manufacturers, etc., for heavy duty use. **ORDER TODAY. LIMITED SUPPLY. SEND ONLY \$39.95 and we pay freight in U.S., or send \$10 deposit, pay balance C.O.D. plus freight.**

QUONSET TRADING CO., 829 Broadway, Santa Monica, Calif.

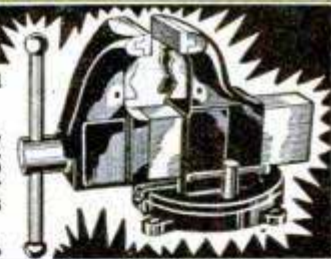

MP*

Dynasaw

Satisfaction
Guaranteed or Money Back

- 2" capacity
- Cuts to center of 48" circle
- Cuts 1/4" Steel—Brass—Aluminum
- Cuts 1" wood freely
- 10" x 10" Precision Ground Grey Iron Table
Tilts to 45°



Write for free catalogue on DYNASAW and other MP tools.

\$14.95

F. O. B. ROYERSFORD, PA.

* MARCUS-POLLAK, DEPT. 1, ROYERSFORD, PA.



Dealer Inquiries Invited

SET THE PACE WITH THE

- Cruises at 45 MPH—with faster pickup than car
- 39" high, 71" long over-all, wt., 190 lbs.
- 8 HP motorcycle engine
- 50 miles to the gallon
- Automatic clutch
- Internal expanding brakes—handle-grip throttle controls

POWELL MANUFACTURING COMPANY

DEPT. PM1049 • COMPTON, CALIF.

Powell
P-81!

ONLY
\$247³⁴
AT COMPTON, CALIF.
EXCISE TAX
INC.

Write for FREE folder and name of nearest dealer

Famous CASCO ELECTR-O-TOOL



In New
PLASTIC
CHEST
at Same
Low Price!

25-PIECES... Only \$14.95

Most terrific value ever! Electr-O-Tool now comes in a smart, jade-green plastic chest that lasts a lifetime! And at *no increase in price!* Full assortment of most popular accessories! Genuine Casco Power-Head! Fractional HP, AC-DC motor. On-off switch. Unbreakable plastic Tenite case. Special safety-sleeve. Non-slip chuck. (Free 36-page Project Book with every Kit!)



Drills!
Carves!
Sands! Saws!
Sharpens!
Polishes!
Etches!
Grinds!
Buffs! Cuts!
For Wood, Metal,
Plastics, Fibre,
Glass, Leather.

Now at Dept., Hardware, Auto Supply, Appliance, Jewelry Stores.

CASCO CASCO Products Corp.
Bridgeport 2, Conn.

New To Sharpen
Carbide Tip Tools,
All Types of Cutters
and Circular Saws
A PRECISION
FIXTURE Only \$29.95

This all-purpose sharpening fixture is the only one of its kind. Easiest, simplest, fastest sharpening method available. Assures cleaner cuts. Save money and make money by sharpening tools and saws for yourself and others. Precision built at surprisingly low prices. Send check or money order... money-back guarantee... nothing to lose... shipped prepaid.

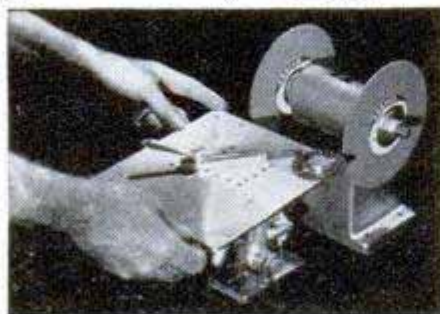

Model 135 only \$29.95 for 1 1/2" to 12" diameter saws and cutters. Table tilts either side almost to 80°.
Model 160 only \$49.50 for 1 1/2" to 16" diameter saws and cutters. Table tilts either side over 30°.
Model 280 only \$11.95 for 7" to 8" diameter saws.
Model 100 only \$14.95 for 7" to 10" diameter saws.
Model 120 only \$16.95 for 7" to 12" diameter saws.
Model 130 only \$23.50 for 2" to 12" diameter saws.
Dust Proof Ball Bearing Grinding Wheel Stand with 23" "V" Belt \$14.95.
2 grinding wheels \$5.00 extra.

TREYCO PRODUCTS

262 Hartford Avenue—Dept. PM-10—Buffalo 17, N. Y.

New LOW-COST, TOP-QUALITY 1/4" Electric Drill

ONLY
\$10.95
PREPAID



Powerful, Lightweight

This new 1/4" drill is "tops" in construction and performance. Drills wood, metal, plastics, etc. Gleaming, chrome-steel finish; die-cast handle and case; pistol grip; trigger switch. An unbeatable buy at this price. Factory guarantee.

Supply Limited
ORDER TODAY

Shipped postpaid if check or M. O. sent with order. (25% deposit on C.O.D. orders — you pay postage)

E. F. SLATTERY CO.

713 W. RANDOLPH ST.

CHICAGO 7, ILLINOIS

BRUSH PLATING OUTFITS

● for re-plating articles in the home and ● shop. No tanks necessary. Free particulars.

GUNMETAL CO., AVE. M, DECATUR, ILLINOIS

BARGAIN!

HIGH SPEED ROTARY FILES

Set of 5 Assorted.....	\$ 2.00
" " 10 "	3.75
" " 20 "	7.25
" " 30 "	10.00

1/4" shank



WE BUY SURPLUS TOOLS

SID TOOL CO., 183 Grand St., N. Y., N. Y.

make your own *Gems* 29.50 F.O.B.

All necessary lapidary equipment is furnished, including a super-charged diamond blade for sawing, and all wheels for grinding, shaping and polishing; also complete instructions. The complete equipment as shown, less motor and belt, for only \$29.50, f.o.b., Burlington, Wisconsin. Write today for information and literature.

B&I MANUFACTURING CO.
Dept. S Burlington, Wis.

Build your own JET ENGINE!

Order these plans today

1. JET PROPELLED BICYCLE. Assemble your own. Photo and instructions \$1.00.
2. HOW TO MAKE EXPERIMENTAL JET ENGINES. Seven sheets drawings with information and instructions \$2.95.
3. BOTH OF ABOVE in one order \$3.75.

SEND NO MONEY. Order both at once \$3.75 C.O.D. in USA plus c.o.d. postage. Send check or Money Order and we pay postage. Get other information too. Rush Order.

J. HOUSTON MAUPIN, Dept. 55, Tipp City, Ohio

Only \$498

OTTAWA Mule Team Tractor

Finest low-cost tractor. Costs too little to do without. Engines burn gasoline or kerosene. Starter and lights available. Other larger Models to choose from. Over 4,000 in world-wide use. Time-proved and tested. At low cost they easily mow, plow, disc, harrow, plant, cultivate, etc. Sold only direct to user. Write for FREE details.

OTTAWA MFG. CO., 2-927 Garden St., Ottawa, Kansas

AMAZING ELECTRIC MAGIC MOTOR

Drives toys from ordinary flashlight batteries. Have fun with this real, powerful electric motor. Easily assembled with your own hands, without tools, screws, nuts, nails or glue. Made of plastic and metal parts. Any child can build it. Drives most any free running toy. No transformer or house current needed. Complete with full instructions. \$1.25 postpaid. Money Back Guarantee.

**WILKIT TOY CORPORATION, Dept. P-10
20 N. Wacker Dr., Chicago 6, Ill.**

LITTLE THINGS HARD TO FIND?
GET YOURSELF A
HANDI-CHEST
FOR AS LITTLE AS
\$3.95
POSTPAID

32
DRAWERS
ALL METAL
\$8.95
POSTPAID



DRAWERS
Uniform in all chests
... are 1 1/2" deep, 2 1/4"
wide, 3 1/2" long. 1-piece
aluminum units have
removable dividers to
make 3 bins; index
cards on front. Kraft-
board drawers have
metal pull tabs.

YOUR MONEY BACK if you are
not satisfied with your HANDI-CHEST.

NOW with three times the "bins," HANDI-CHEST is a must for home, office, shop. Ideal kit for small parts, hobby needs, sewing, fishing, etc. Steel spot-welded cabinets; metal drawer guides, pleasing grey finish, rubber feet that won't mar any surface. Aluminum or Kraft-board drawers. Manufacturer ships promptly, direct, postpaid. Send check or money order. No C.O.D., please. Ohio orders add 3% sales tax. Ask about quantity discounts.

- 16 drawers** Steel Cabinet is 6" deep, 8 1/4" high, 12 1/2" wide. 48 compartments in aluminum drawers. Model 16A HANDI-CHEST complete **4.95**
Model 16K HANDI-CHEST, same size as above, with heavy Kraft-board drawers, metal pull tabs, complete **3.95**
- 32 drawers** Steel Cabinet is 6" deep, 15 1/4" high, 12 1/2" wide. 96 compartments in aluminum drawers. Model 32A HANDI-CHEST complete **8.95**
Model 32K HANDI-CHEST, identical in size, with heavy Kraft-board drawers, metal pull tabs, complete..... **5.95**
- 64 drawers** Steel Cabinet is 6" deep, 15 1/4" high, 24 1/2" wide. 192 compartments, aluminum drawers. Model 64A HANDI-CHEST complete **15.95**
Model 64K HANDI-CHEST, same dimensions as 64A, sturdy Kraft-board drawers, metal pull tabs, complete **9.95**

ALL HANDI-CHESTS ARE SHIPPED POSTPAID IN U. S. A.
TIBBITS MFG. CO., Dept. 10E, Alliance, O.

Every man's a handy man with
SKIL Home Shop Tools



6 in. SKIL Home Shop Saw
Fully adjustable for depth and bevel cutting

Now—a fully adjustable low-priced saw. Big 6-inch blade cuts through wood, metals, plastics. Fast, perfect balance for easy handling. Safe telescoping guard. Quality construction.

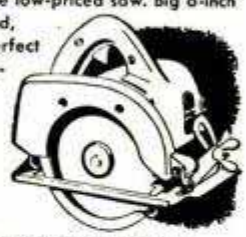

6 in. SKIL Home Shop Sander-Polisher

IT SANDS! IT DRILLS! IT POLISHES!
You'll find hundreds of uses for this wonder-worker. Polishes cars, furniture, woodwork. Cleans and scours pots and pans. Burnishes metals. Drills, sands, grinds, sharpens. Big 6-inch pad. 50% more powerful AC-DC motor.

Sold by
leading hardware
stores

2 1/2 in. SKIL Home Shop Belt Sander

Takes the work out of sanding!
Removes paint and varnish fast. Produces satin-smooth finishes easily. Eliminates hours of tedious hand sanding. Light, compact, powerful.



Made only by SKILSAW, INC., leading maker of tools for industry.

for AUTOS... TRUCKS... TRACTORS



DON'T "CURSE" WINTER STARTING!
INSTALL A
SHUR-HETE No. 5 MOTOR WATER HEATER

Get easy starts and actually save money this winter. How? By installing a Shur-Hete No. 5 — it will keep your engine warm all night long by heating the liquid in the water jacket. Operates on regular 110V, AC or DC electric current... consumes only 300 watts per hour.

Fits
"Freeze Plug"
Opening
Takes Only 15
Minutes to Install

Save Time and Money with Shur-Hete No. 5
Eliminate run-down batteries... towing charges... needless engine wear... and wasted gas. Uses about 5 cents worth of electric power for overnight protection. Safe to use with any standard anti-freeze. Will not overheat engine or burn out.

GUARANTEED only \$13.95
Shipped-parcel post prepaid if remittance is enclosed; otherwise COD with postage added.

Dealerships Open!

JOHANSON MOTOR HEATER CO. 818 W. Webster St. Chicago 14, Illinois

LUMINESCENT PRODUCTS
• LIGHT REFLECTING CRYSTALS
• COLORED GLASS CRYSTALS
• LUMINOUS POWDERED PIGMENTS
COMBINATION TRIAL ORDER & LISTING \$1.25 POSTPAID
ORDER TODAY
GLOWELL COMPANY
475 FIFTH AVE • DEPT. MP • NEW YORK 17, N. Y.

GIGANTIC MAIL SALE! CLOSEOUT WAR SURPLUS ITEMS

WELDING GENERATORS! G. E. D-C
275 to 375 Amp.
ORIGINAL COST over \$275.00
Brand New, Genuine G.E. Generators. Ready to operate. Build and repair your own machinery. Do professional work for pay. Drive with tractor, old auto engine, or electric motor. Hundred uses. Complete with instructions on "How to Weld."
Sale price, frt. pd. **\$89.90**
• Same unit with helmet, rods, holder, cables, etc., frt. pd. **\$104.50**

INDUSTRIAL CAPSTAN WINCH 3000 LBS.

MOUNT ON TRUCK, TRACTOR, BOAT, ETC.
Finest steel and bronze drive gears. 80 to 1 power ratio. Useful for farmers, truckers, merchants, factories, etc. Used by leading truck lines for loading. Excellent for hay hoists. Drive with old car 6-volt starting motor, power take-off, fan pulley, etc. Instructions.
HUNDREDS OF USES
Easily mounted on tractors, trucks, docks, jeeps, etc. Many practical uses. Pays for itself quickly. Original cost over \$75.00 . . . Sale price, frt. pd. **\$24.95**

3000 W 110V-60C POWER PLANT

IDEAL FARMERS, SPORTSMEN, CONTRACTORS
110-volt, 60-cycle, 3000 watt. Remote switch, electric self-starter. Easily made automatic start. Fine instrument control panel. Army's finest plants. Full maintenance—operation instructions. New condition. Cost Gov't, \$756.00. This marvelous plant—freight prepaid—... **\$345.00**
Also lower price plants (Write for details).

- Other Items Include:
- Briggs 3.5 h.p. Gas Engines with utility clutch. **\$77.50**
 - Reconditioned Briggs ZZ 6.5 h.p. engine. **\$6.90**
 - Portable Power Air Compressor and Engine. **\$9.50**
 - Multi-speed (4-shaft) 110-v., 60-c. motor. **8.75**
 - Telephones. **\$4.99**, Rotary Pump. **\$3.95**, Selsyn Motors, Pair. **3.39**
 - Dozens other sale items. Radio, electronic, electrical, etc.

Order from ad or write for illustrated sales catalog. We pay all freight to you.
BURDEN SALES CO., 8th & "O" St., PM-10, Lincoln, Nebraska
(Formerly Leco Engineering Company)

World's Largest Stocks
of Jeep Parts

The King of Jeeps



**LOWEST PRICES IN AMERICA ON
GUARANTEED JEEP PARTS!**



COMPLETE DIFFERENTIAL ASSBY.
A788-GPW4207
\$22.50
Complete with Pinion.



HUB & DRUM ASSBY.
A1690-GP1102
New
\$9.35
Reprocessed
\$6.50



Rebuilt
\$22.50

RADIATOR ASSEMBLY Heavy Duty
A1214-GPW8005A
New
\$27.50
Also interchangeable with Civilian Jeep #640145-640146



Rebuilt
\$22.50

BRAKE SHIELDS AND SHOE
A1496
\$6.95



Rebuilt
\$22.50

OIL PAN GASKET
639980-GPW6710
12c
VALVE REGROUND GASKET SET
A1537-GPW18387
75c



Rebuilt
\$22.50

CARBURETOR REPAIR KIT
A6840-GPW-18357B
\$4.35



Rebuilt
\$22.50

CYLINDER HEAD
A1534-GPW6050
New
\$8.40
Reprocessed
\$6.95



Rebuilt
\$22.50

SEAL BEAM UNITS
A1033-GPW13007
\$1.65



Rebuilt
\$22.50

8-PC. BRAKE LINING SET
116600-GPW18367
\$3.50



UNIVERSAL JOINT
Journal Service Package
A1433-GPW18397
\$3.50



WATER PUMPS
639992-GPW8501
New
Outright... \$6.75
Exchange... \$5.75
Reprocessed
Outright... \$5.50
Exchange... \$4.50



TRAILER LIGHTING CABLES
with one socket
A6019-GPW14407
\$4.00

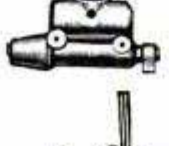

MASTER CYLINDER Complete
A856-GPW2140
\$5.95



COMPLETE TRANSFER CASE
A1195-GPW7700
\$120.00
(Exchange) \$95.00



STARTER-Auto Lite
No. M24113
A1245-GPW11001
New
\$26.50
(Replacement Type) \$18.50



BELL CRANK
A1211-GPW3131
\$4.65



BELL CRANK SHAFT
A855-GPW3165
\$0.80



BELL CRANK BEARING
A857-GPW3171
\$0.40 2 RE-QUIRED



CLUTCH PRESSURE PLATE ASSEMBLY
638992-GPW7563
Outright
\$7.60
Exchange
\$6.50

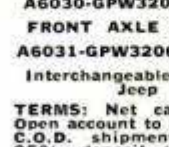

CLUTCH DISK
638755-GPW7550
Outright
\$5.50
Exchange
\$4.75



FRONT AXLE SHAFT-LONG
A6030-GPW3207
\$27.00
FRONT AXLE SHAFT-SHORT
A6031-GPW3206A
\$27.00
Interchangeable with Civilian Jeep CJ2A

TERMS: Net cash with order. Open account to rated firms only. C.O.D. shipments should have 25% deposit with order. All prices are F.O.B. our yards, Chicago, Illinois

WINTER SPECIAL
Used Canvas Tops
Slightly Soiled
A3218-GPW1152700
\$12.50

First Time AT THIS Low Price! **TEN INCH BAND SAW**

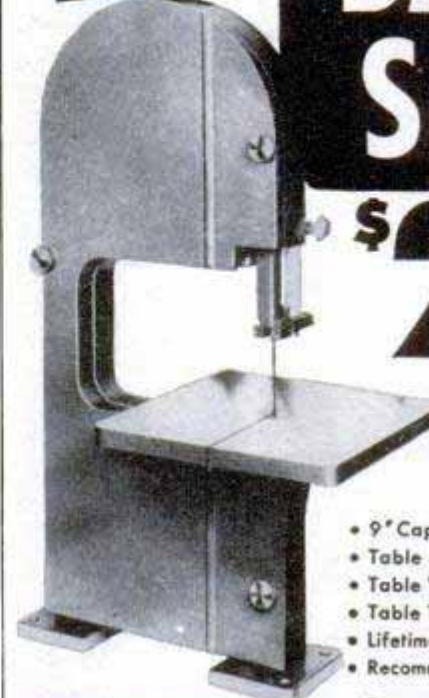

\$29.95

Includes Blade
Special offer! Save \$12.55 on this all-aluminum saw, a regular \$42.50 value!

- 9" Capacity, Blade to Frame.
- Table Size, 11" x 11".
- Table Working Area, 11" x 14 1/2".
- Table Tilts to 45° Angle.
- Lifetime Oilite Bronze Bearings.
- Recommended Motor, 1/4 to 1/2 H.P.

Guaranteed or Money Refunded
MAIL ORDERS EARLY TO
3607 ZENITH AVENUE NORTH
MINNEAPOLIS, MINNESOTA

BUSSE & CO.



NOW! FILE YOUR OWN SAWS

Do expert saw filing at home. Precision filing easy without experience. Two simple adjustments. Keeps any hand saw extra sharp and true-cutting. Complete with file. Money back guarantee. Cash with order, prepaid. (COD postage extra.) Order today. \$2.95.

SPEEDCOR PRODUCTS, Dept. PM
512 N.E. 73 Ave., Portland 16, Oregon

SAVE MONEY on TRAILER BUILDERS' SUPPLIES! BUILD, REPAIR or MODERNIZE! We are the largest and most complete trailer supply house in the States. Get our New Large 1949 Catalog 10c; blue prints and building instructions 25c.



National Trailer Equipment Co., 1007 N. Water St., Milwaukee 2, Wisc.

SPECIAL OFFER! **LOCK-STITCH SEWING AWL** **\$1. Postpaid**

Famous, patented lock-stitch sewing awl complete with needles, waxed thread and direction folder. Hundred uses — sewing, repairing leather goods, canvas, belting, harness, saddles, gun cases, awnings, golf bags. Extra needles and thread available. Satisfaction guaranteed or money back. Send currency, check or money order. Yates Mfg. Co., 611-H Main St., Lake Geneva, Wisconsin

Say You Saw It in POPULAR MECHANICS

EXTRA PROFITS! Flocks & Sandblasts

Dual Purpose Spray Gun Uses only 25 lbs. Air Pressure
• Thousands of uses in Home, Shop, Industry: Makes Auto Interiors Clean & New. Lines drawers, Marproofs lamp bases, Refinishes any object. All in colorful Flock. Etch & Frost windows, glassware, etc. Removes Paint & Rust from Autos. Tools. Guaranteed! Send \$19.75 or write for free information. Plocking supplies!
BLASTO SPRAY GUN MFG.
Dept. M-Oct, 7007 Haas Avenue, Los Angeles 47, Calif.



Only \$19.75 Complete

BIG, FREE CATALOG
Write For Your Copy Today
Thousands of other parts and accessories available. SHOP BY MAIL — Order direct from this ad today.

BERG TRUCK & PARTS CO., INC.
1606 So. Wabash Avenue Chicago 16, Illinois
Cable Address . . . JEEP KING

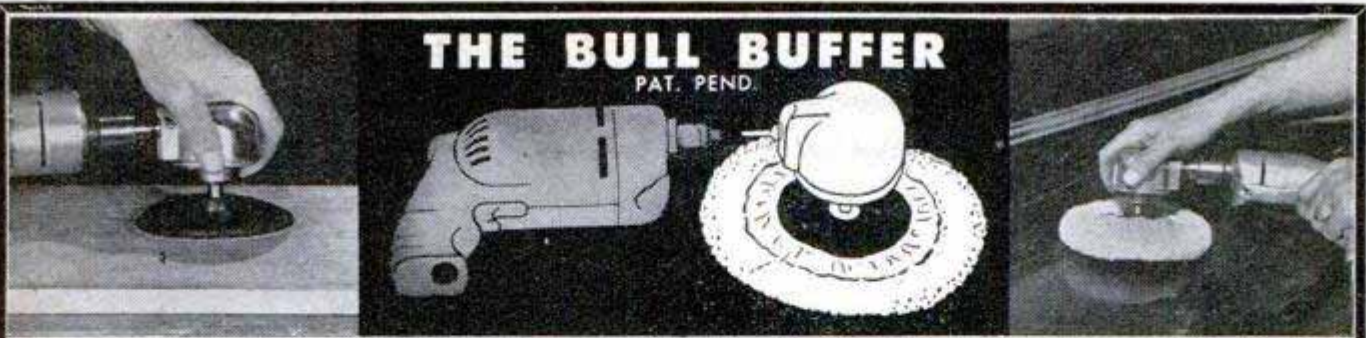

THE BULL BUFFER

PAT. PEND.

You polish and sand faster, easier — do beautiful, professional work—with this amazing new attachment for your hand drill. And it more than pays for itself the very first time you polish and sand your car, floors, woodwork, furniture.

(or flexible shaft). It's the only buffer you can turn in a complete circle while you hold your hand drill stationary. Reaches all curved and flat surfaces. It's packed with power, built of lifetime materials and guaranteed.

The Bull Buffer fits any chuck on an electric drill

Order today—at your dealer, or send cash, check, or money order for your Bull Buffer, complete as pictured below, each.....

\$9.95

ORDER THESE ACCESSORIES FOR YOUR BULL BUFFER:

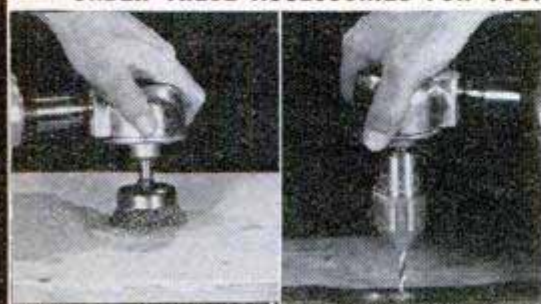

- Bull Buffer car cleaner\$.50
- Bull Buffer car polish 1.00
- Extra sheepskin bonnet 1.25
- Extra sanding discs (0000-000-00-0-1-2 1/2-3-4) each10
- 1/2" Jacobs No. 6425 key chuck (see photo) .. 5.00
- 2 1/2" cup wire brush (see photo) 1.75
- Adapter B set for sanding at twice drill speed ... 2.00

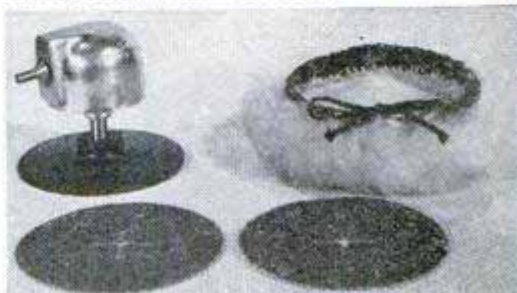

Bull Buffer comes complete with 5-inch rubber disc, sheepskin bonnet, and 2 sanding discs, only \$9.95.

BERTRAM W. ENGINEERING COMPANY
 3121 MAIN ST. Dealers, Write for name of nearest wholesaler **KANSAS CITY, MO.**

TODAY'S BIGGEST PREFAB BOAT BUY... \$73.50 COMPLETE

Exclusive! Only Ozarka gives you pre-formed and mortised, laminated oak rib construction. No shrink! No warp! No weakness! No extra cost to you!

Build a better boat than you can buy. Save up to 55%. Pictured is OZARKA's Model 12-A—a trim, top quality 12-footer with laminated rib construction, all oak frame, finest marine plywood. Takes up to 16 H. P. motor. A cinch to assemble, a joy to own.

Before you buy or build a boat, investigate Ozarka's handy car-top models and beautiful mahogany-decked runabouts, at \$39.50 to \$199.50 complete. Send 10c for descriptive literature. OZARKA... 6109 BORDEN STREET, WOODSTOCK, ILL.

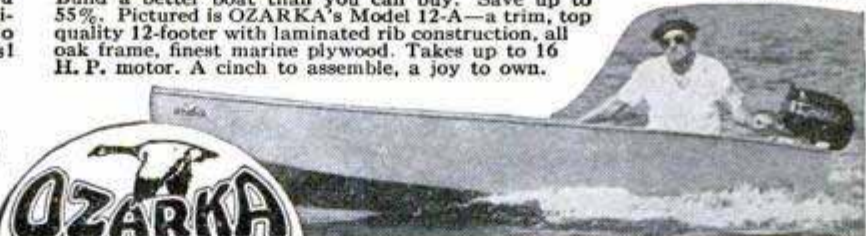

OZARKA

JET PERFORMANCE FOR YOUR CAR WITH VAPOJET



This aircraft developed water-oil vapor injector is designed to give faster pick-up, smoother running power, and tends to eliminate carbon, vapor lock and overheating. Users of the new Vapojet report up to 25% more mileage per gallon of regular gas. Complete, easily installed kit fits all car, tractor, boat or stationary engines. Agents Wanted.

MONEY BACK SATISFACTION GUARANTEE
 (If returned within 30 days)
 Order today. Only \$9.75 ppd. Send check or money order & save postage, \$1 deposit on C.O.D.

VAPOJET MFG CO., 11424 Biona Dr., Dept. PM-10, Los Angeles 34, Calif

MAIL COUPON TODAY

Rush me _____ Vapo-Jet Kits including carburetor adaptor, copper tubing, fittings, etc. and illustrated instructions. Enclosed is my check or money order for \$_____

Name _____

Car _____ No. of cyl. _____ Year _____

Street _____

City _____ State _____

Sensational Bargains: LOWEST PRICES! All Items Guaranteed As Represented

WORKSHOP MOTOR BARGAIN COUNTER

1/2 H.P. \$19.75 General Electric, Leland, Delco, Westinghouse, Sunbeam, Brown, Brockmeyer and others. Repulsion induction and capacitor induction type motors, alternating current, 60 cycle single phase. Like New, Fully Guaranteed, some shop worn, many brand new, every one a whale of a bargain.

No.	H.P.	Volts	RPM	PRICE
12	1/4	110	1725	\$11.75
13	1/4	110	1725	\$14.75
14	1/2	110	1725	\$19.75
15	1/2	110	3450	\$19.75
16	3/4	110/220	1725	\$32.50
17	1	110/220	1725	\$42.50

Order by number. We have large stock of standard & special motors, all sizes. Write for prices. Write for our BARGAIN FAN & MOTOR Circular and SAVE MONEY

THE VAPORITE Automatic HUMIDIFIER for Warm Air Furnaces . . .

BARGAIN GASOLINE ENGINES

THERMOSTATICALLY controlled water supply puts more moisture in the air. Gives healthier air. Easily installed in bonnet of air furnace. Complete with Thermostat Water Control Valve, Tubing and parts for complete installation. POSTPAID ONLY \$7.50 Prepare Now For Winter



BALL BEARING MANDREL

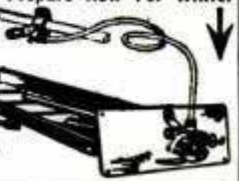

High speed precision bearings for sawing, grinding, buffing, polishing, etc. 12"x3/8" shaft, threaded 1/2"x20 L.H. with flanges and nut, complete with 2 inch pulley. \$1.00 Mandrel Only \$4.95 FOB Chicago

C. MARSHALL SALES, 3546 W. Fullerton Ave., Dept. P-10, CHICAGO 47, ILL.

ARMY FIELD *Telephones*



& WIRE

Compact - Rugged - Portable

Anyone can install and operate

Just hook up terminals of two or more phones to any 2-conductor wire and you are ready to talk up to 17 miles! Powered by standard flashlight batteries. **HUNDREDS OF USES** for quick, dependable communication in **HOME, SHOP, FARM, INDUSTRY**. Complete with self-contained, hand-operated ringer. Checked for perfect operation and guaranteed.

USED, excellent condition, Each..... **\$9.95** Two **\$18.50** for

LIKE NEW, each phone undergoes thorough performance check in our reconditioning shop to assure peak operating efficiency. Best appearance of handsets and chassis **\$12.95** Two **\$24.50** units is restored **LIKE NEW**. Each for 6 phones on one line makes excellent intercom.



TELEPHONE WIRE

Weatherproof, durable, 2-conductor, twisted, communication wire, insulated, stranded 7X.013, reinforced with steel strands for extra tensile strength (3 copper & 4 steel).

W-110B. Unused, new, stored in open. Half-mile reels (2500 to 2750 feet). Wt. 85 lbs. Each **\$14.25**

ONE-MILE REEL..... **\$27.50**

500 ft. coil (14 lbs.)... **\$3.95** .. 1000 ft. coil (28 lbs.) **\$7.25**
NEW W-130 Lightweight. Half-mile (16 lbs.)..... **\$15.00**

—Telephone parts available • Write for Free Folder—

All prices FOB Sacramento. No COD. California residents add 3% for sales tax. Small orders sent postage collect plus small handling charge.

SEND CHECK OR MONEY ORDER **LORIS SALES**

P. O. Box 1896-B9-10 Sacramento, California

WE FURNISH ALL MACHINED METAL PARTS, EVERY SCREW, NUT, BOLT, WASHER, AND COMPLETE PLANS FOR THIS...

BIG 10" POWER SAW

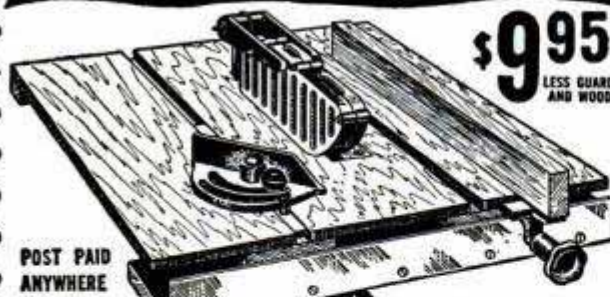

\$9.95
LESS GUARD AND WOOD

POST PAID ANYWHERE IN U.S.A.

FULL \$9.95 REFUND IF NOT SATISFIED WITHIN 10 DAYS

ASSEMBLE IT YOURSELF WITH SIMPLE HOUSEHOLD TOOLS!

TABLE 24" x 20" • TILTS TO 45"
 CUTS 0" TO 3/4" DEEP • TAKES 10" BLADE

COMPLETE PLANS (WITHOUT PARTS) 10c

MARCUS • POLLAK DEPT. 44 ROYERSFORD, PA.

BIG FREE CATALOG of WAR SURPLUS OPTICAL BARGAINS

Build Your Own RIFLESCOPE, BINOCULARS, TELESCOPES, ETC.
 We Furnish Optics and Instructions

- LENSES, PRISMS & RETICLES
- EYEPIECES and OBJECTIVES

Send \$1.00 for Stock #2-H 10-Piece Lens Kit and Big Instruction Booklet.

We Have Numerous TYPES of Assembled Optical Instruments Including **BINOCULARS** and **RIFLESCOPES**. CHECK OUR BARGAINS . . . Request CATALOG H

EDMUND SALVAGE COMPANY
 BARRINGTON, NEW JERSEY



Free Sample!

Big profits showing amazing **GLOW-IN-THE-DARK SPECIALTIES**. House numbers, pictures, plastic novelties, religious and nursery objects, etc. Large manufacturer. Enormous demand. Sell on sight. Write at once for **FREE SAMPLES**.

MADISON MILLS, Dept. B-4
 303 Fourth Ave. NEW YORK 10, N. Y.

PISTONS

ALUMINUM ALLOY. For Auto, Truck, Tractor, Motorcycle, Scooter, Outboard, Marine, Compressor, Industrial Engines. **EVERY MAKE, ANY YEAR**, odd or foreign. Send sample or specifications.
JUDSON MFG. CO., 4527 Hedge St., Phila. 24, Pa.

SAY YOU SAW IT IN POPULAR MECHANICS

New Improved DRILL GRINDER



\$2.95

SHARPENS DRILLS IN 30 SECONDS
 NOW! New precision lock insures factory accuracy at no extra cost. Sharpens 3/32" to 1" drills like new. Aluminum and steel construction. Used by thousands for production and home workshop. No experience necessary. Instructions included. \$2.95 prepaid. C.O.D., postage extra. Money back guarantee.

SPEEDCOR PRODUCTS
 512-P.N.E. 73rd AVENUE PORTLAND 16, OREGON

World Famed Skill Home Shop Sander

For carpenters, homeowners and cabinetmakers. Sands and polishes wood, metal, plastic, removes paint and varnish. A few minutes of practice makes you an expert. Equipped with resilient backed metal pad. 7 ft. rubber cord, connector, lubricant and one belt. Weight 9 1/2 lbs. Size 3 3/4" x 12" x 7" high. **\$64.50**
 Model #525—115 volt

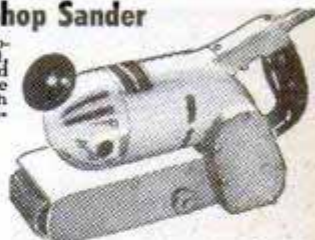

Send check or money order.
WOODWORKERS' TOOL WORKS
 Jefferson & Quincy Sts., Chicago, Ill.

Performance that excels • Stamina that endures

DOUGLASS Steel-Pack MUFFLERS



FOR ALL MAKES AND MODELS

Rugged construction. Steel tubing. Straight-thru-design. Solid tube with steel packing. "Throbbing Deep Tone." Complete for Easy Installation

32-40 FORD V-8	\$5.95	29-49 CHEVROLET	\$5.96
41-49 FORD V-8	6.85	31-41 PLYMOUTH	5.96
39-49 MERCURY	6.85	42-49 PLYMOUTH	6.85
35-48 FORD & MERCURY DUAL SETS			\$21.00
49 FORD & MERCURY DUAL SETS			25.00

Specify Year and model • Satisfaction Guaranteed
 Enclose Full Amount With Order All Equipment F.O.B.
 1949 COMPLETE RACING EQUIPMENT CATALOG 25c

DOUGLASS MUFFLER MANUFACTURING COMPANY
 1914 W. VALLEY BLVD., Dept. M-10, ALHAMBRA, CALIF.

The JIFFY metal CABINET

YOUR ANSWER TO SMALL ITEMS STORAGE

at home, office, and shop
(ideal gift, too)

So handy to keep nuts, bolts, screws, nails, parts, washers, stamps, hobbyists' needs, etc., at your fingertips.



THIS 32 DRAWER UNIT ONLY \$5.95 POSTPAID

Stop searching, get a 32 or 64 drawer Jiffy to keep those small items that usually get mislaid. Spot welded steel, gray enamel finish, metal drawer guides. Dividers included with aluminum drawers make possible three compartments per drawer. Looks good anywhere. Send check or money order, please—no C. O. D.'s. Prices below. Your money refunded if not satisfied. Dealers write for quantity discount.

SPECIFICATIONS	WITH ALUMINUM DRAWERS	WITH CARDBOARD DRAWERS
32 Drawer Unit	Dividers and Index Cards Included	
6" Deep	One piece rustproof aluminum drawers for heavy service—good for work bench and industry use.	Suitable for most home uses. Heavy board kraft covered. Metal drawer pulls.
12 3/4" Wide		
15 1/4" High		
64 Drawer Unit	32 drawer - \$8.95	32 drawer \$5.95
6" Deep	64 drawer - \$15.95	64 drawer \$9.95
25 1/2" Wide	Marproof Rubber Feet included with all cabinets	
15 1/4" High	POSTAGE PAID	POSTAGE PAID
Drawer Size		
1 1/4" Deep		
2 3/4" Wide		
6" Long		

KAYTEE PRODUCTS, Dept. M, Box 588, Canton, O.

\$100.00 PILOT'S OXYGEN KIT (WAR SURPLUS) only \$7.95

Outfit includes 6 x 24 inch lightweight, shatterless breathing oxygen steel bottle; canvas case; demand type regulator with 0-500 gauge and type A10 mask with hose. Net weight 7 lbs. Regulator automatically delivers what oxygen you demand when you breathe into mask. Complete kit, empty \$7.95. Same but filled with oxygen (express only) \$2.00 extra. Unused condition. AERO PARTS SUPPLY, Dept. PM10, Municipal Airport, Houston, Tex.



ELECTRIC MOTORS — 1 H.P. for LESS THAN 1/2 PRICE

New 1 H.P. electric motors, heavy duty. Single phase 110-220 volts. Capacitor type 60 cycle A.C. 1750 R.P.M. Sleeve bearing. Standard 3/4" shaft. Standard Nemo frame. Nationally known. Mfg. by Elcorn for Corenent Corp. List price \$81.00. Our price \$40.25. 3/4 H.P. same as above, our price \$36.95. All new in original crates. Send check or money order. 25% required on C.O.D.

C & H ELECTRIC CO.

434 W. JUNEAU ST.

MILWAUKEE 3, WIS.

NOW YOU TOO CAN BUILD 15 RADIOS

COMPLETE KIT \$14.75



Absolutely No Knowledge of Radio Necessary

You Need NO Additional Parts

The PROGRESSIVE RADIO KIT

is THE ONLY COMPLETE KIT. Contains everything you need. Instruction Book, Metal Chassis, Tubes, Condensers, Resistors and all Radio parts.

The 36-Page Book written by Expert Radio Instructors teaches you to build radios in a Professional Manner. You start with a 1-tube receiver. Before you are done with this kit, you will have built 11 Receivers, 1 Public Address System and 3 Transmitters. **SPECIAL FREE OFFER!**

Electrical and Radio Tester sent absolutely FREE with each Progressive Radio Kit. PLUS FREE membership in Progressive Radio Club. Entitles you to free expert advice and consultation service with licensed radio technicians.

Write for further information, or ORDER your KIT \$14.75 NOW! ONLY

Postage prepaid with check or money order (Postage not prepaid with C.O.D. orders)

PROGRESSIVE ELECTRONICS CO., Dept. PM-29
497 Union Avenue Brooklyn 11, N. Y.

Now... the New Lorraine



Perfect Night-Driving Companion



- New Rotary Switch
- Sealed Beam
- Wireless Construction
- 360-Degree Turning Radius
- Fits Every Car and Truck

Your fingers flick the positive-action Rotary Switch. A powerful sealed beam snaps into action... lights up the road a full half-mile in front of your car! You roll the lamphead smoothly through a full 360 degrees. Street signs, house numbers, road signals, obstacles—all become brightly visible, unmistakably clear. That's your Lorraine Driving Light performing, giving you greater night-driving safety than ever before!

WORLD'S FINEST DRIVING LIGHT!

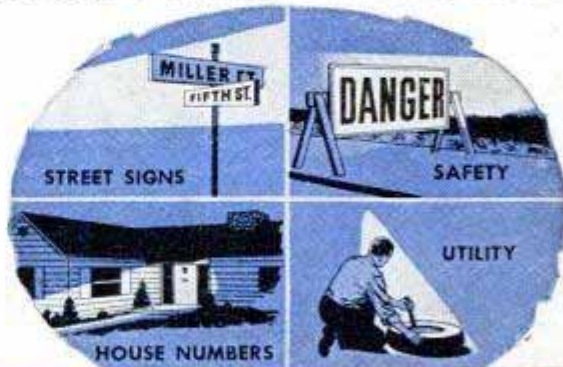

APPLETON ELECTRIC COMPANY

1713 WELLINGTON AVENUE • CHICAGO 13, ILLINOIS

Manufacturers of Lorraine and Appleton Spotlights
Industrial Lighting Equipment • Conduit Fittings • Reelites

HERE YOU ARE! THE LOWEST PRICES ON THE MARKET Quality Merchandise

FLEXIBLE POLISHING & SANDING KIT

with rubber head for curved or flat surfaces. Converts your electric drill into a power-polisher and power-sander. Great time-saver.

Eliminates drudgery in polishing, buffing, waxing automobiles, furniture, floors, woodwork, silverware, linoleum, etc.

Use it for Sanding and Grinding. Remove rust and paint from auto bodies easily. Quickly and smoothly sand woodwork, floors, plastics. Use like grindstone with emery; sanding discs to grind down metal and to sharpen tools.



Only \$1.39 post-paid.

With 6 assorted sanding discs. \$1.79 post-paid.

Kit contains:— Flexible rubber polishing head and sanding adapter on 1/4" shank which fits any electric drill chuck; Sanding Disc, Emery, 5" dia.; Genuine Lambswool Polishing Bonnet, 5 3/4" dia.

Aircraft Quality Fiber Pulleys (AN-210-1A), 1 1/4" O.D. with 3/16" I.D. ball bearings. This is a terrific buy for any cable control. Can be used as splendid wheels for models, pull toys, etc. **\$1.00 for 8** post-paid.

Double Action Micro Switches The best switch for automatic current control on countless applications such as:—

Automatic Stops & Signals, Timing Devices, Closet and Cupboard Lights, Foot Switches, etc.

This remarkable switch will carry 10 amps. on 110 volt house current. It can be connected either normally open or normally closed, or to switch current from one circuit to another simultaneously.

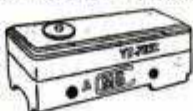

3 for \$1.00 post-paid. **10 for \$2.90**

FASCINATING MINIATURE INSTRUMENT LIGHTS



G. E. Mazda #326, 2.5 volt—can be used in series for higher voltages. There are many clever uses for this ingenious little lamp, known as the "Grain of Wheat," it measures only 3/8" dia. x 1/2" high including the threaded base. Wonderful for Christmas decorations and all model lighting.

Only \$1.25 for 10 post-paid.

WHEN YOU ORDER, ask for our free catalog and receive our future valuable bargain offers.

PLEASE INCLUDE PAYMENT with order. We GUARANTEE Full Satisfaction or money back on anything returned within 15 days. All orders are filled as soon as received.

DIRECT SYSTEM Corp. 62 Gill, Buffalo 13, N.Y.

HELPFUL BOOKS

Send post card asking for **FREE** catalog

Popular Mechanics Press, 200 E. Ontario, Dept. 601, Chicago 11

END GENERATOR REGULATOR BATTERY TROUBLE!!

REPLACE YOUR VOLTAGE REGULATOR WITH **AMAZING WATTAGE REGULATOR**

The greatest advancement in Auto-ignition since the self-starter . . .

DRIVE WITH OR WITHOUT YOUR BATTERY. GUARANTEED 100,000 MILES OR ONE YEAR.

WRITE FOR FREE CATALOG TODAY.

Scientific Electric Co. P. O. Box 2162P Sta. H. Cleveland 8, Ohio

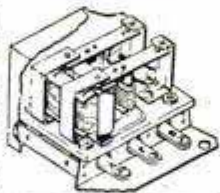

SAY YOU SAW IT IN POPULAR MECHANICS

FREE! Learn how to fix flat tires *before* they happen, get protection against dangerous blowouts, and save money at the same time! Send Coupon for free book. Seiberling Rubber Co., Dep't. MRH, Akron 9, Ohio.

Name _____
Address _____
City _____ State _____

BUILD THIS HOUSE Yourself



The Famous Popular Mechanics House

The picture below is from an actual photograph of the Build-It-Yourself House with breezeway and garage, as built by Jack Brownson, 23-year-old veteran, in Aurora, Illinois.

Designed by Popular Mechanics and Famous Architects. Every Detail Simplified and Explained. No Previous Experience Needed!

Can you use everyday tools as well as the average Popular Mechanics reader? Then you, too, can easily build this modern house in any of its five designs, doing every part of the job yourself. The new Popular Mechanics Book, "Your Home—How to Build it Yourself" will show you how.

Space for Living and Family Growth

This beautiful, modern house is 1 1/2 stories, with basement, living room, kitchen, dining nook, two bedrooms, bath, plenty of closets and space for two additional bedrooms on second floor. The house itself is 35' 9"x28' 11"; breezeway 20' 10"x8'; garage 20' 10"x12'.

The House That Has Everything

Designed for easy construction and the most living space for the least cost, the Build-It-Yourself House is also most attractive and suitable for any community and most income groups. The basic plan is adaptable to four other exterior designs.

Get Book and Plans Now—Build When You Can

You may never have thought about actually building a house yourself, but now that building restrictions have been lifted, it is easier than you think. So order book and plans today. Even if you engage a contractor to build for you, you will need the plans. And you certainly will want the book which can easily save you hundreds of dollars, whether you build this or any other house.

Mail Coupon for New Book and Plans!

Build It Yourself or Have It Built — Save Hundreds of Dollars!

PLANS YOU CAN READ AND FOLLOW

Plans consist of ten working-size blueprints — floor plans, elevations, construction notes, framing, joints, lumber and mill list, specifications, plumbing and wiring diagrams. Every measurement is marked — every detail made clear as ABC. Book has 100 pages — three-fifths are photographs and drawings. Some sections in colors, showing just how your house will look when finished.

BIG BOOK 8 1/2 x 11 inches



MAIL COUPON FOR BOOK AND PLANS

POPULAR MECHANICS PRESS

200 E. Ontario St., Chicago 11

I enclose \$_____ Send me the items checked at once.

- Your Home and How to Build It Yourself..... \$ 3.00
- Complete set of plans for Popular Mechanics Home.. 12.50
- Book and plans at reduced price..... 14.00
- Duplicate sets of plans..... 5.00

Name _____
Address _____
City _____ Zone _____ State _____



"First in the field"

NEW

STEVENS MODEL 820

**World's Greatest Slide Action
Repeating Shotgun Value**



Here it is — the brand new Stevens Model 820 Slide Action Repeating Shotgun — the "world's greatest 'pump' gun Value." It's fast handling, smooth operating . . . built to give you years of dependable service and top shooting satisfaction. But, don't take our word for it. You won't know what a great, *low cost value* this gun really is until you see it . . . handle it . . . throw it to your shoulder. See the new Stevens Model 820 at your dealers. Write for free catalog of Savage and Stevens shotguns and rifles.

SAVAGE ARMS CORPORATION

Firearms Division
Chicopee Falls, Mass.

QUALITY GUN FEATURES AT LOW COST

Barrel — Compressed forged steel, proof tested. 28", 12 gauge only. Improved cylinder, modified or full choke.

Action — Polished and blued receiver — solid frame, side ejection. Independent, push button safety. Magazine holds 5 shells, with one in chamber, making six-shot capacity. Plug furnished to reduce capacity to 3 shots.

Stock and Fore-end — of durable, service-proven, beautiful TENITE. Fine checkering and capped full pistol grip give stock custom built features and appearance.



THE BIGGEST SURPLUS BARGAINS IN YEARS

ELECTRIC MOTOR 1/2 H. P. 27 V.D.C. R. P. M. 4000 No. 750. For Intermittent or Continuous Duty 5/8" SHAFT. VARIABLE SPEED MOTOR CAN BE ADAPTED, TO 110V.A.C. or R.E.A. line by simple arranging armature brush leads. UNUSED. Instructions \$5.50 incl.

ELECTRIC MOTOR 1/2 H.P. 24 V. D.C. R.P.M. 2500 #HCA24 O. Gov't. cost \$75.00. BRAND NEW. **\$3.50**

ELECTRIC MOTOR 1/4 H.P. 28 Volt D.C. R.P.M. 4000 #2832 with simple instructions to convert to 28-32 Volt A.C. Gov't. cost \$82.84. Brand New. **\$3.50**

WEAVERS HYDRAULIC HAND PUMP — BRAND NEW. For hydraulic Jacks, presses, hoist, etc. For operating hydraulic cylinders, to pump oil or hydraulic fluid under pressure. Has built in check valve, and is capable of delivering 1000 lbs. pressure. Wt. 10 1/2 lbs. A \$50.00 value. Instructions incl. **\$8.50**

VICKERS CONSTANT DISPLACEMENT HIGH PRESSURE PUMP. Use it for any type liquid pumping job 375 gal. per hr. at 3750 R.P.M. 1000 pounds pressure per sq. in. Can be used as hydraulic motor O. Acq. \$100.00. **\$8.95** post-Brand new directions incl. Wt. 7 lbs. paid

BRAND NEW CHECK AND RELIEF VALVE \$2.50 Post-paid

VICKERS UNLOADING VALVE. Brand New—By passes full amount output of the pump while the cylinder is not in operation. Takes starting load off of electric motor driving the pump. Price. **\$4.95** post-motor paid

BRAND NEW HYDRAULIC CONTROL VALVE. This is a TWO CYLINDER DOUBLE ACTION VALVE with unique arrangement allowing the operator to raise both cylinders simultaneously, to lower them simultaneously or to raise one and lower the other at any predetermined rate and speed. A \$75.00 value. **\$8.95** Post-paid

ADEL PRECISION VALVE BRAND NEW. This is for a double end cylinder control or for two single cylinders that are to work in opposition to each other. When pressure is applied on one line, it will open opposite check valve so that pressure in that line can be relieved. **\$5.50** Post-No. 10335. Now only. paid

THOMPSON BOOSTER PUMP. Use them for Homes, Farms, Ranch, and Shop. Motor driven centrifugal pump will empty 50 gal. drum of water in approx. 20 min. Runs on 24V. D.C. A.C. **\$7.50** New.

LUBE PUMP. BRAND NEW. Precision Gear Impeller Pump. Pumps liquids up to 3 gal. per minute. Pressure up to 200 lbs. per sq. in. S't'd 1/2" Threaded and keyed shaft. Instructions incl. Wt. **\$3.95** 4 lbs. Price. plus postage

D. C. GENERATOR BRAND NEW. For Farm, Home, Ranch or Shop. Delivers 430 Volts at 3450 R.P.M. Ball bearing supported, air cooled armature. Self lubricating, base mounted. Drive it off farm tractor, gas engine, etc. Wt. **\$5.50** approx. 23 lbs. #2111220-A. Now Only

SENSATIONAL FASCINATING MYSTERIOUS SELSYN. Two or more connected together, work perfectly on 110 V.A.C. For weather vanes rotating directional antennas or controlling distance operations. Complete with diagram and instructions. Wt. 3 1/2 lbs. **\$3.50** PER PAIR plus postage

VALUABLE GEARS BARGAINS SPEED REDUCER 10-1 or 5-1 ratio, 90 degree angle. Shaft Driven 1 1/2" spline Shaft with 3 mounting holes 5/16". Gears held in forged and machined aluminum housing with two needle bearings, one bronze bearing, and three high speed shielded bearings. Sealed self lubricating chamber. **\$3.50** Price.

NEW PUROLATOR GASOLINE FILTER. Aircraft type. Today's advanced gasoline Re-refining filter for all cars, Trucks, Tractors and all Motor Boats. Cleans and refines gasoline as you drive. Removes solids, water and prevents sludge formation. Install at home in a few minutes. STOP GASOLINE WASTE AND EXPENSE. Instructions incl. Permanent, needs no re-placements. Ea. **\$4.95**

NEW CUNO OIL FILTER, aircraft type. Filters oil without cartridge replacements. For Autos, Trucks, etc. Install at home in a few minutes. STOP CHANGING MOTOR OIL. Instructions incl. Ea. **\$4.95**

WRITE FOR HYDRAULIC LISTING
Send check or Money order. No c.o.d.'s. Prices f.o.b. K.C. except when marked postpaid.

GENERAL SALVAGE COMPANY
Dept. 17, 2922 E. 27th St. Kansas City, Mo.

Start Quickly BIG MONEY ROLLING WITH **LIFE CHARGE**

MAKE PLEASANT, DIGNIFIED CONTACT

The MIRACLE Chemical that helps Batteries stay AUTOMATICALLY charged. Adds Months of useful service. Eliminates freezing, overheating and cable corrosion. Revives old Batteries. Saves time and money for user. EAGER BUYERS EVERYWHERE! Fleet owners, garages, service stations and individuals all buy. **FOUR EASY SALES A DAY NETS YOU \$144.00 WEEKLY!** Advertising and Promotional Material free. Sold on satisfaction guaranteed or money back plan. Send \$1.00 for special sample offer enough for two batteries, or write for free details. **GET IN THE BIG MONEY FIELD! DO IT NOW. DON'T DELAY...WRITE TODAY!**

BATTERY CHARGE PRODUCTS COMPANY
728 W. Peachtree Street, Dept. M Atlanta, Georgia

DESK MODEL TELEPHONES \$17.95 for 2 OF EITHER MODEL

Telephones are complete with power, wire, hook-up instructions etc. Any number of telephones can be connected in circuit. Common ringing. Simple installation, absolutely no technical knowledge required. 25% deposit with order, balance C.O.D., F.O.B. Brooklyn. **FREE: Fine Descriptive Folder.** Dept. PM-3, 320 18th St., Eastern Telephone Co., Brooklyn 15, N. Y., South 8-6161

SHARPEN CIRCULAR SAWS LIKE AN EXPERT

No experience needed. Two simple adjustments. Gets hollow-ground, cross-cut or combination saw blades true and sharp. Fits 6" to 12" blades with 1/2" to 13/16" centers. Includes file and complete instructions. \$6.95 postpaid. (Check or money order) C.O.D. postage extra. Guaranteed—Money back if not satisfied after 10 day trial. A money maker for fix-it shops. Soon pays for itself. Order today.

\$6.95

SURE SHARP MFG. CO., Dept. M-109, P. O. Box 24, Santa Ana, Calif.

MARCOT KEY MACHINE

Immediate Delivery

MARCOT No. 8 KEY MACHINE, mounted on Cabinet, less motor, \$ 95.00
Auto Code Book and Depth Keys. 12.50
100 Ds. Popular Key Blanks. 60.00
Set — Key File, Follow-Through Rods, Lock Picks, Bit Key Gauge, Thimble, Pins, Springs. 10.50
"Locksmith Trade Books": 6.75
How to Open Locks without Keys or Picks; Secret of Locksmithing; How to Make Keys by the Impression Method; Master Key Systems.
TOTAL COST \$184.75

A. J. MARCOTTE CO., 1200 N. Kedzie Ave., Dept. PM, Chicago 51, Ill.

\$4.95 REAL ENGINE VALUE

A miniature gas engine that really operates. Thousands of Buzz "B" gasoline engines have been sold at twice the price. Now is your chance to buy a real 1/6 H.P. gas engine for only \$4.95. Turns up over 8,000 r.p.m. For Boats, planes, midjet cars, etc. Guaranteed and ready to run. Includes Champion spark plug and tank. Send only \$1.00, engine shipped collect for balance, same day.

WRITE FOR FREE CATALOG OR SEND 10c FOR NEW MAMMOTH ILLUSTRATED CATALOG OF THOUSANDS OF HOBBY ITEMS.

America's Hobby Center, Inc., Dept. B-109, 156 West 22nd St., N. Y. 11

Say You Saw It in Popular Mechanics

Start a NEW BUSINESS Or Add to Your Present Repair Business

Sharpen Dull Pipe Wrenches
Pipe Taps & Dies
"Gum" Circular Saws

Pat. applied for

Write for information. P. O. Drawer 276 FREDONIA, PA.

J. C. MOORE INDUSTRIES

HOURS of EXCITING FUN BUILDING REAL-LIFE REPLICAS...

It's fun! Try your hand at these famous scale model souvenirs of early settler days. Complete kits with authentic miniature details, precision cut parts. Order now—save at combination prices.

Buckboard Kit . . \$1.00 (Plus 15c postage)
Stage Coach Kit . \$1.50 (Plus 15c postage)

HANDY BUILDER'S TOOL!

New long-nose Glue Gun puts a daub of cement just where you want it—tight corners, edges, etc. 75c Postage 15c (With any kit order, postage free)

Covered Wagon Kit . . . \$1.50 (Plus 15c postage)
All 3 for Only \$3.75 (Plus 25c postage)

HOLLYWOOD MODELS Dept. 4, Post Office Box 389, Burbank, California

WAR SURPLUS AND OTHER BARGAINS

PNEUMATIC AIR TOOLS

Made by Chicago Pneumatic and other Manufacturers

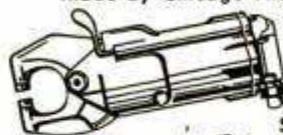

Squeeze Riveter with Alligator Yoke

For all types of metal and auto body work. Purchased from an active gov't. tool crib. Original cost about \$80. Like new. Wgt. 4 lbs. Ea. **\$12.95.**



C-Type Yoke Riveter Compression Squeeze Type

Like new. Wgt. 5 lbs. . . Each **\$12.95.**



Pistol Grip Riveter & Chipping Hammer

Mfd by Ingersoll-Rand, Chicago Pneumatic and Thor

Ideal for fender, brake lining, concrete breaking work. Like new. Six rivet sets and bucking bar included, making a complete combination. Wgt. 9 lbs. . . Each **\$6.95.**



HIGH SPEED DRILL BITS

ALL NEW! Fractional and numbered. Original value \$15. 30 assorted sizes and lengths **\$3.50**



MICROMETERS

Chrome plated, precision engineered and carefully tooled to give long life. All new. 0-1" capacity . . . each **\$2.25**
1-2" capacity . . . each **3.50**
2-3" capacity . . . each **5.50**
3-4" capacity . . . each **6.50**

EXPANSION REAMERS



Spiral Flute. Mfd. by Alvord Polk Tool Co. All New, original pack. 1/4"-3/8"-7/16" Recommended expansion limit, .006". Original value \$12. Set of 3 **\$4.95**

TRANSFORMERS

Jefferson Electric step-up or step-down transformer. Input, primary 110-117 Volts A.C. Output, from 5 Volts to 650 Volts. Suitable for use with war surplus gadgets, heater relays, radio test filaments, electric trains, house chimes, etc. Weight 10 pounds. New! Each **\$7.95**



Stalle Engineering Co. Transformer. Primary Input, 115 Volts. 60 Cycles. Flexible color-coated leads. Output, 6-12-24 Volts. Will work aircraft gadgets, heater relays, signal systems, radio test filaments, home chimes, etc., off house current. A good item for the home gadgeteer. Weight 7 pounds New. Each **\$7.95**

Stalle Engineering Co. Transformer. Output 12-24-32 V. Otherwise same as above. Weight 15 pounds **\$14.95**

SEND 10c FOR ILLUSTRATED CATALOG

Send check, money order or cash. 25% deposit required on C. O. D. orders. All prices F. O. B. Culver City, Calif.

AIRBORNE SALES CO., INC. DEPT. PM 10-9 CULVER CITY, CALIF.

HELPFUL BOOKS

Send post card asking for FREE catalog

Popular Mechanics Press, 200 E. Ontario, Dept. 601, Chicago 11

MAKE ANY CUT WITH THESE NEW WOODSHAPERS for YOUR CIRCLE SAW or DRILL PRESS!



MODEL #60—Originally designed for heavy industrial use, now priced for home workshop. Can be attached directly in chuck of your drill press. Exclusive pilot bearing (see illustration) eliminates side thrust, chatter and vibration—assures smooth cutting action. Blades can't come out—set screws hold them securely. Complete, with YOUR CHOICE OF ANY 6 PAIR DOUBLE-GROUND BLADES SHOWN BELOW, only **\$12.95.**

MODEL #50—Same as Model #60 but without exclusive pilot bearing. Designed for intermittent shaping; over 100 different shapes can be cut. Complete, with ANY 6 BLADES OF YOUR CHOICE SHOWN BELOW, only **\$8.95.**

All Aladdin tools are guaranteed. Postage prepaid with all cash orders. C. O. D. plus postage. GET YOUR ORDER IN TODAY.

ALADDIN MFG. CO., INC.

3121 Main Street Kansas City, Missouri
Dealers Write Today

Speedy Power Tool Does 1000 Jobs In a Jiffy!



Removing Paint

Polishing Car



HOME-UTILITY
5" Electric SANDER-POLISHER
\$29.95

Waxing Furniture (with sanding-polishing attachments)

No Handier Tool for Your Home-Farm Use!

Polishing cars and silverware; waxing furniture; removing paint—you can speed up a raft of jobs with attachments supplied with this versatile Tool! A 1/4" Jacobs Chuck (only \$3.45) converts it for drilling in metal, wood, plastics. Other low-cost attachments, equip it for sharpening tools, cutlery, mower blades; removing rust; grinding, buffing and burnishing. Quality-built for A.C. or D.C. use by BLACK & DECKER, world-famous maker of electric tools for over 39 years!

Try it at your hardware, electrical or implement dealer. Write today for your free copy of our brand-new "How-To-Do-It" booklet. Gives many helpful hints on building and repair jobs! Write to: THE BLACK & DECKER MFG. CO., Dept H10M, Towson 4, Maryland.

Products of The BLACK & DECKER Mfg. Co.

ELECTRIC HOME-UTILITY TOOLS

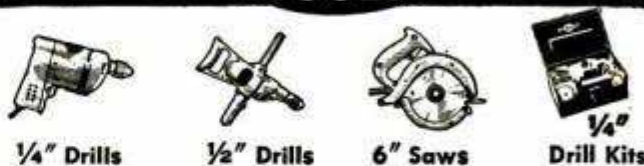

ALADDIN WOODSHAPING BLADES



For Your Circle Saw

MODEL SA-10—Heavy-duty, industrial-type shaper of solid steel, now priced in home workshop range. Absolutely safe—blades locked in position with screws all the way through. In ordering, state diameter of shaft. Complete WITH ANY 6 PAIR OF READY-GROUND BLADES SHOWN BELOW, only **\$14.95.**

Specify by number the blades you want. Additional blades \$1.50 each. \$3.00 per set.



GIVE YOUR CAR THE 1950 LOOK WITH

'50 TURBO TUBES



Made to original car-model specifications. Gleaming chrome-plated brass—won't rust. They'll make your car look like a million dollars! Fit all cars; theft-proof, moulded rubber gaskets supplied.



only—
SET OF 6 **\$3.95**
POSTPAID

MAKE YOUR CAR LOOK LIKE A CUSTOM MODEL WITH

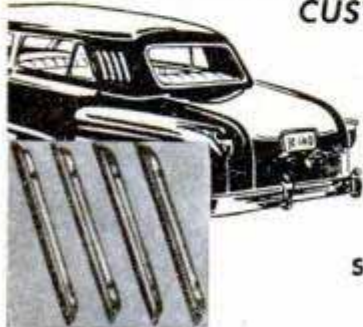

TRIM TABS

They're gleaming chrome on brass—they won't rust. Identical with car manufacturer's specifications. Easy to install; template furnished. Fit all cars.

only—
SET OF 8 **\$2.75**
POSTPAID

BEAUTIFY and PROTECT YOUR FENDERS WITH

FEND-A-GUARDS

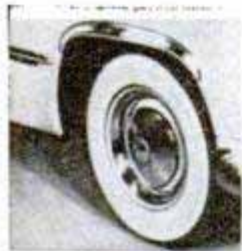

Ultra-modern equipment that gives style, protection and beauty. Chrome-plated high tensile strength metal made to car manufacturer's specifications. Fits most cars; easy to install; theft-proof.

only—
SET OF 2 **\$6.95**
POSTPAID

YOU'RE SURE YOUR CIGARETTES ARE OUT WITH THE

SNUF-A-PUFF



Just pop it onto your dashboard (its rubber suction cup holds it there securely) and insert your cigarette butt into it when you're through smoking. You're sure it's out with the aluminum SNUF-A-PUFF—no lighted cigarette will blow into the back seat or next to your pants! Every motorist needs one—order today!

only—
\$1.00 POSTPAID

HOW TO ORDER: Send check or money order. All merchandise guaranteed to satisfy or your money refunded.

LEA ASSOCIATES

BOX 86, HAZEL PARK, MICH.

First with the finest in accessory styling.



GEIGER COUNTERS

for locating Valuable
RADIOACTIVE MINERALS

There is a model to exactly fit YOUR requirements.....

While today's prices are low, don't miss this opportunity to buy at a discount.

OMAHA SCIENTIFIC SUPPLY CO.
Dept. T, 3601 N. 24th, Omaha 10, Nebraska

*

YOU'LL NEVER HAVE BUT ONE HEAD OF HAIR

*Will You Give 3 Minutes a Day To Take Care of It?

Take advantage of this opportunity to learn more about the new electric-automatic Vita-brush that turns 20 minutes of tedious, tiresome hand brushing into just 3 minutes of restful, stimulating fun. Handy as an electric razor, Vita-brushing does these things well:

- Gets your scalp refreshingly clean, removing itching dandruff scale, accumulations, dust.
- Distributes the natural oils, "polishing" the hair . . . making it softer, glossier and easier to manage.
- And, in addition, stimulates the circulation of the blood supply in your scalp.

Don't delay. Send for full information on how Vitabrush can help you in caring for your scalp and hair. Just say, "Tell me about Vitabrush."

Hershey Mfg. Co., 157 S. La Salle St., Chicago 3

Save Money—Make Money with LARSON Leathercraft

For gifts or for sale—make easy-to-assemble leather items. Complete stock leathers, tools, accessories.

Send ten cents for new catalog of 101 money-making ideas.

J. C. LARSON CO. 824 S. Tripp Ave. Chicago 24, Illinois

LIQUID MARBLE

COMPOSITION FLOORS FLEXIBLE MOLDS
MOLD Novelties, Statuary, Art Goods in Flexible Plastic Molds; 5c material makes \$1 seller. Make Marbleized floors, Tile Walls. Colorful, glossy, amazing! Easily learned; start in garage or basement. Particulars free.

MARBLEIZING SERVICE, Dept. 10-F, Edwardsville, Ill.

MAKE THIS SUIT YOURS NEW PLAN

EARN CASH SHOWING TO FRIENDS!
Write at once if you want this fine made-to-measure suit! You can get it by taking a few orders from friends, and earn up to \$10, \$12 in a day. Your bonus suit helps you take more orders with latest style, made-to-measure **guaranteed suits** at amazingly low prices. Also complete line of Ladies' Tailored Suits. No experience, no money needed. Write TODAY for FREE SAMPLES—telling about yourself—age, etc. No obligation!

PIONEER TAILORING CO. Congress and Throop Streets, Dept. X-1116 Chicago 7, Ill.

MAKE MONEY AT HOME

MAKE Greaseless Doughnuts at home. New amazing electric machine. You'll coin money selling to grocers, drug stores, cafes, hamburger stands. Low cost will surprise you. Experience unnecessary. Send for free recipes and plans.

MORTON RAY CO.
3605 SO. 15th AVE. MINNEAPOLIS 7, MINN.

SAY YOU SAW IT IN POPULAR MECHANICS

ACE TOOLS

No. 8-A SET

Be permanently toolled-up for every operation on your Metal Cutting Lathe.

No. 8-A Ace Tool Set for 9" and 10" Swing Lathes—fits shank size 3/4" x 3/4". Includes Turning, Cutting-off, Boring, Knurling and Threading Tools with high speed cutters, blades and wrenches. 8 complete tools in fitted steel case—nothing else to buy. See your local dealer or order direct.

ARMSTRONG BROS. TOOL CO.
5268 W. Armstrong Ave., Chicago 30, Ill. **\$24²⁵**

NOW a DYNAMIC HEAVY DUTY INDUSTRIAL WELDER

ONLY \$28.50 COMPLETE
FOR AUTO—HOME APPLIANCE & FARM IMPLEMENT REPAIRS!
WORKS ON IRON, STEEL & other metals . . . does work you'd expect from a larger, costlier machine; portable, easily carried; OPERATES FROM ANY properly wired 110 VOLT LINE. Also available for 220 volt operation at slight additional cost; has 8 metallic & carbon arc welding heat stages. EASY TO OPERATE TRANSFORMER TYPE WELDER—If inexperienced you can learn to do professional work by following the SIMPLIFIED WELDING & OPERATING INSTRUCTIONS FURNISHED—comes complete ready to operate with helmet, rods, cable, instructions. SAVE TIME AND MONEY—Do your own welding—Just a few repair jobs will pay for this machine. A practical and profitable machine tool for any workshop. Make money doing repair work for others. Costs a few cents to operate.



SPECIAL GIFT OFFER! WORTH \$6.80 ARC TORCH YOURS at NO EXTRA COST!

Write today for FREE DETAILS, ARC TORCH GIFT OFFER and DYNAMIC WELDER 10-Day Trial Offer.

DYNAMIC WELDER CO., Dept. TD-109
 15 EAST 23rd STREET CHICAGO 16, ILLINOIS

SPEED-MILEAGE MANUAL

EASILY OBTAIN GREATER SPEED, MILEAGE, RACING PERFORMANCE FROM ANY AUTO-MOBILE! Famous New Book Shows Soup Up Methods; Speed Tuning; Mileage Secrets; Speed Equipment Plans; "Customizing Ideas!" Photographs! Complete Instructions on Building Inexpensive Power Equipment! Economizers! Superchargers! Manifolds! "Water Injectors!" Mufflers! How to build FAST CONVERSIONS! "HOT RODS!" CUSTOM SPORTS CARS! All About Engines, "Economy Tuning," Compression, Fuels, Trials, "Racing Tricks!" Latest "Hollywood Stylizing!" Streamlining! Sport Changes! Simple Conversions! California Roadster Plans! Parts List! Speed Catalogues! Folios! 125 Illustrations! Working Drawings! Complete data! PLUS "Beautiful Custom Car and Hot Rod Pictorial Supplement!"

ONLY \$1.98 POST PAID Satisfaction Guaranteed **ALMQUIST ENGINEERING** MILFORD 23, PENNSYLVANIA

DUAL CROSS and ROTARY FEED

PALMGREN ROTARY, INDEX, MILLING TABLE No. 83
 Has 8" table, 360° movement and 4" cross feed travel. Adjusting wheels and dials graduated in degrees and thousands. Slotted for bolting to table. No. 83 Priced \$49.50. No. 82 without rotary feed \$39.75.
 Write for Circular No. 10
CHICAGO TOOL and ENGINEERING CO.
 8365 South Chicago Ave., Chicago 17, Ill.



Drive a FORD and Feel the DIFFERENCE!

The Ideal Gift for the Home Owner

NO COMPRESSOR HOSE • MOTOR WIRES • PUMP

BECKER Self-Contained SPRAY GUN

Take it Anywhere for

- Painting
- Rust-Proofing
- Varnishing
- Starching
- Humidifying
- Moth-Proofing
- Insecticiding
- Fire-Proofing



Only \$18.50

Here is the first completely self-contained and fully portable spray gun . . . needs no wire or hose, no compressor or motor. Take the Becker gun anywhere to do dozens of spray jobs . . . in the house, workshop, garage or garden. Spraying pressure is provided by an inexpensive, easily replaced CO2 cartridge. One cartridge will spray up to 21 ounces of liquid (depending on viscosity). The Becker Spray Gun comes complete with 3 cartridges. Send only \$18.50 and we ship post-paid. Or, send only \$2 now and pay postman balance plus postage. MONEY BACK if not delighted after 5 days' trial. (Extra CO2 cartridges, 10 for \$1, postpaid.)

SULLIVAN-BECKER CO. • Dept. 119-K • Kenosha, Wis.

Get "PROFESSIONAL RESULTS" WITH THE SAWS PROFESSIONALS USE



ATKINS "Silver Steel" No. 400

The saw any carpenter is proud to own! Hardened, tempered, mirror-polished blade is taper ground. Teeth accurately fitted for fast true cutting. Perfection pattern rose-wood handle prevents wrist strain.

● Help yourself to added workshop pleasure with famous Atkins "Silver Steel" Saws — the saws built to out-cut and out-wear ordinary saws by a wide margin. You'll get better cutting, spend less time finishing and smoothing, turn out professional calibre work easier . . . Atkins Saws are priced to give you a big dollar's worth for every dollar you pay. Your hardware dealer has, or can get you, the Atkins Saws you need. Tell him what you want next time you are in his store.

ATKINS MECHANIC-KUT CIRCULAR SAWS



No finer circular saw for the home craftsman. Accurate, fast-cutting, razor keen. "Silver Steel." Rip, cut-off or combination patterns. Six to 10 inch diameters. Individually packaged, furnished with one bushing. Another great Atkins value.



ATKINS "Silver Steel" BAND SAWS

Scientifically tempered and heat-treated for long service. Variety of tooth patterns, in widths 1/8 to 1 3/4 inches. The same band saw used in woodworking shops all over the country.



E. C. ATKINS AND CO.

402 S. Illinois Street, Indianapolis 9, Indiana

Buy the Best... WISS!



for all sheet metal cutting

WISS Metal Master Compound Action Snips

#M-3. Easily cuts 18 gauge sheet metal. Cuts curves and circles as well as straight. Ideal for the home workshop. \$4.25. Rubber grips recommended, 60¢ extra.

WISS Straight Cut Snips

#9. Crucible steel inlaid blades. The basic snips for straight metal cutting. Gun metal handles. Overall length 12½". \$4.25.

WISS Combination Snips

#V-13. Solid steel, gray japanned handles. Cuts curves and irregular shapes with ease. Handy pocket size, 7" long. Accurately tempered jaws and strong bolts. \$1.75.



Prices slightly higher Denver and West



Quality for more than a Century

J. WISS & SONS CO. • NEWARK 7, N. J.



If you like fine tools

... then you'll really enjoy the smooth, fast action of the "GREENLEE 22" Solid-Center Auger Bit. And you know it reaches you "factory sharp," for each is Plastic-Sealed with a special protective coating. Ask your hardware dealer for "GREENLEE 22."



SPECIAL OFFER... WOODWORKING CALCULATOR... 10¢. Quick solutions to countless problems... converting linear to board feet, nail and bit sizes, etc. Send 10c to Greenlee Tool Co., 2110 Columbia Ave., Rockford, Ill.

AMAZING NEW LOW PRICE

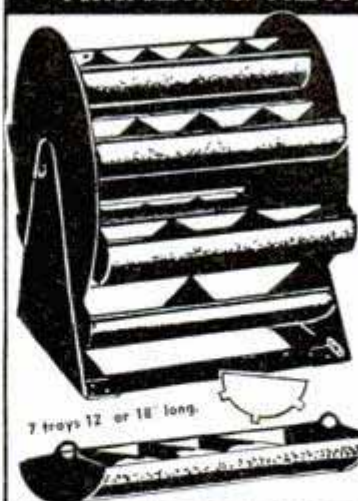

REVOLVING GADGET TRAY

For Carpenters, Machinists, Mechanics, Cobblers, and Hobbyists.

Keeps bolts, nuts, screws, nails and small parts at your finger tips for easy picking. Comes in two sizes, each having 7 trays 12 or 18" long. Built of durable lifetime steel with adjustable, removable tray separators. Can be set on workbench or hung from wall. Sold on money back guarantee.

12" SIZE \$3.88
18" SIZE \$5.88

HOMERY INDUSTRIES
P.O. BOX 981 WARREN, OHIO

New MILLING ATTACHMENT



SIZES for 8" to 16" METAL LATHES

Build it yourself from our sets of semi-machined castings and save \$8. Can be finished on your lathe alone. Complete drawings and instructions furnished with castings.

Mill keyways, slots, splines, dovetails, flutes for reamers, special cutters. Produce gears, ratchets, racks; bore, face, etc., with this precision attachment.

FREE Illustrated folder and price list of castings, milling cutters, etc. Write today. Mention your lathe.

HURON MACHINE AND TOOL CO.
YALE 4, MICHIGAN

SPEED AND POWER HANDBOOK



Build fast Stock Cars! California Roadsters! 150 MPH Rods! Covers Fords to Cadillacs—all makes! Breathtaking methods—Authentic—Direct from California!

SAVE MANY DOLLARS

Build your own Dual Manifolds! Superchargers! Hot Cams! Water Injectors! Hi-Compression Heads! Mileage Devices! Get racing speed, lightning acceleration, dynamic power increases from any make passenger automobile! Get construction drawings! Tuning techniques! Speed tricks! Picture catalogues! Economy secrets! Ingenious formulas! Including—"Racing Frames"—"Reciprocating Masses"—"Jet Engines"—"Braking Characteristics"—"Dynamometers"—"Dual Pipes, Gears, Fuels, Manifolds, Porting, Relieving, Lowering, Balancing!" Includes "CALIFORNIA AUTOMOBILE CUSTOMIZING"—Glossy photographs! Diagrams! Newest ideas! Conversions! Re-Styling! all makes! Streamlining! Chopping! Channeling! Customizing!

50 CHAPTER LIBRARY EDITION—complete—\$1.98 Postpaid.

NEWHOUSE AUTOMOTIVE INDUSTRIES
5805-B4 EAST BEVERLY LOS ANGELES 22, CALIF.

BATTERIES!—START

—a factory at home and re-cast junk batteries into new; latest achievement. We supply complete instructions and everything needed. Big Profits!

BATTERY LABORATORIES, Dept. PM, Minneapolis 4, Minn.

SAY YOU SAW IT IN POPULAR MECHANICS

Save Fingers



with Steel-Grip Finger Guards

Hundreds of factories save time and injuries and speed production by protecting workers with Steel-Grip Finger Guards. Used for handling rough or sharp articles, for buffing, grinding, sanding, polishing, punch press work and hundreds of other jobs. Protect fingers or thumb, front or back, from cuts, abrasions or blisters. Made of durable leather with elastic web back for snug, cool, comfortable fit. Easy on and off. One size fits all, men or women. Send 10c each for samples or trial order box of 50 at \$4.50 less 10%.

Catalog of Steel-Grip Safety Apparel free on request

INDUSTRIAL GLOVES CO.
1404 Garfield, Danville, Illinois
(In Canada: Safety Supply Co., Toronto)



YOU CAN Get in this Growing Industry

The great building industry is your profitable market for masonry products. Low investment . . . high returns . . . wide-open opportunity to establish a lifetime business.

The biggest building years in the nation's history are just beginning. New construction, involving billions of dollars, means huge demands for block, drain tile, and other masonry products which YOU can manufacture locally, from local materials with local labor for local consumption. Remember, MASONRY products mesh with today's building demands.

Use our modern machines and equipment to insure the finest quality products at pared-to-the-bone manufacturing costs. Sold direct from factory to you. Backed by 40 years of pioneering and manufacturing. Liberal selling cooperation.

Write for catalog.
Gives prices and
full information.

CONCRETE EQUIPMENT CO.
512 Ottawa Ave., Holland, Mich.

Prices Slashed on UNUSED BRIGGS & STRATTON ENGINES!

New Briggs & Stratton engines as received from the factory in their original containers. Adaptable to scooters, lawn mowers, air compressors, hundreds of uses. 4-cycle, air-cooled, complete with muffler, rope starter. Factory guarantee.

MODEL AP: 2 1/4 H.P.	\$44.95
MODEL B: 3 H.P.	\$54.95
MODEL ZZP: 6 1/2 H.P.	\$68.95



SEND CHECK OR M.O. FOR FULL PRICE WITH ORDER.
SHIPPED F.O.B. OSHKOSH, WIS.

Geer-Murray Co., P.O. Box 797, Oshkosh, Wis.

SAVE MORE THAN 1/2 PRICE

**BUILD THIS NEW, ROOMY
10 FT. PRE-BILT OUTBOARD** for only **\$59.50**



**STRONG ONE-PIECE BOTTOM, ALL PARTS
PERFECTLY CUT FOR EASY ASSEMBLY
WITH SIMPLE TOOLS IN A SINGLE DAY.**

Also 12 and 14 ft. deluxe, decked V-Bottom Models

Write BAY STATE BOAT CO.

27 Main St., Cambridge, Mass.

for name of nearest dealer.

FOR LOCKS — NEW Graphited LOCK FLUID

best protection against

**STICKING
FREEZING
RUST**



LOCK-EASE does a job on all stuck or stubborn locks — indoors and out — any time of the year. Contains Colloidal Graphite; also special rust inhibitor. Try it on your car locks, padlocks, cylinder locks, etc. Mail coupon today! 50c*

4 oz. Controlled Flow Can.
Delivers a drop at a time or pressure stream to flush out dirt.

American Grease Stick Co., Muskegon, Mich.

Enclosed is *50c for 4 oz. Lock-Ease, including postage and handling.

Name _____

Address _____

City _____ Zone _____ State _____

NEW for HOME SHOPS

DoALL World-Famous BANDSAW BLADES

These revolutionary, hard-tooth blades pioneered and perfected by DoALL have transformed cutting practices in industry — now available in sizes to fit home size bandsaws.

FOR WOOD, PLASTICS, METAL

DoALL Bandsaw Blades are unique — nothing like them for fast, smooth and straight or curved cutting of all kinds of metal, wood, plastics and other materials.

COST MUCH LESS!

The razor-sharp teeth are hard as a file, yet the bands are flexible to insure long wear. And imagine this — no resharpening is ever required. DoALL Blades outlast ordinary blades many times, are replaced when worn. This longer life means their cost becomes so much less that you can't afford not to use them. Available widths 1/8", 3/16", 1/4", 3/8", 1/2". Be sure to give length of your blade accurately.

66" to 94" lengths cost only \$1.45 each. 3 blades for \$4.00.

SEND COUPON TODAY

The DoALL Co., Des Plaines, Ill. P.M. 10-49

Enclosed is \$.....for.....blades

Length..... Width..... To cut.....

Name.....

Address.....

City.....State.....

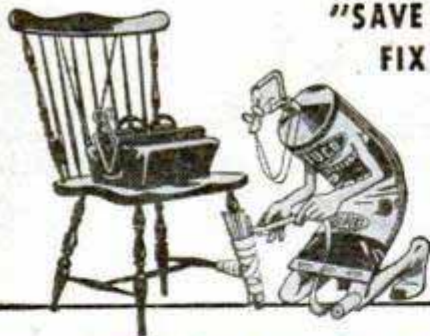

"SAVE IT AND
FIX IT"

FIXES

FURNITURE, DISHES, TOYS
BOOKS AND GLASSWARE

It's transparent, waterproof,
flexible and durable.
Get a tube
today.



DUCO CEMENT

REG. U. S. PAT. OFF.

**PORTABLE
HEAT**

that's EFFICIENT,
AUTOMATIC, SAFE



Listed by
Underwriters' Laboratories, Inc.

Ideal for:
Bedrooms • Rumpus Rooms • Bath-
rooms • Nurseries • Sick Rooms •
Work Shops • Sun Porches • Camps
and Offices

BURNHAM Portable ELECTRIC STEAM RADIATOR

Burnham Corporation, Electric Radiator Div.
Irvington, N. Y. Dept. PM109
Please send folder telling more about the Burnham
Portable Electric Steam Radiator.

Name _____
Address _____
City _____ State _____



**6 POWER
PRISM
BINOCULARS**

**VEST
POCKET
IN SIZE**

COATED LENSES! Dynamic in power and range. At 1,100 yards has sharp, clear field of 370 feet! Made to military specifications. Moisture-proofed — Dust proofed! All metal construction. Individual eye focussing. Adjustable for all eye widths! A compact, durable, all-purpose, achromatic prism binocular. NOT a field glass. Economy priced at fraction of what similar glasses sell at retail! Complete with quality leather, plush-lined case and straps only \$19.95 plus 20% Federal tax. Cash orders sent postpaid. On C.O.D.'s include \$2.00 deposit. **GUARANTEED.** Try for 20 days at our risk and expense.

UNITED PRODUCTS CO.
7941 S. Halsted Dept. ARF-1308 Chicago 20
Reference Dun & Bradstreet

500 Pages, 7000 Novelties

Send 10c for mammoth, amazing catalog of 7000 novelties. 1-inch thick, roto picture section, 6-color cover, Carnival, circus, world's fair & science exhibit rolled into one! Includes live animals & pets, scientific supplies, hobbies, funmakers, planes & boats, looms, magic tricks, joke articles, unusual seeds, gadget timesavers, cameras, optical goods, projectors, movies, lucky jewelry, religious novelties, telegraph sets, disguises, musical instruments, stamps, coins, puzzles, fortune tellers, radios, experimental sets, auto & bike accessories, Western wear, telescopes, magnifiers, compasses, banks, smokers' gadgets, artists' supplies, printing sets, engines, motors, shockers, knives, billfolds, fireworks, guns, rifles, sports, money makers, swimming helps, 1000 fascinating books, games, locks, live chameleons, rings, exercisers, curious plants, etc., etc. (DeLuxe Hard Bound Library Edition 25c Postpaid.) Regular paper covered edition 10c. (Stamps accepted.) Sent Air Mail, \$1.00. **JOHNSON SMITH & COMPANY, Dept. 159, DETROIT 7, MICHIGAN**

10c

30" SHEET METAL BRAKE

Forms angles, flanges, seams. Bends 26 gage steel. Heavier copper and aluminum. Cam locking. Portable, can be clamped to edge of truck. All steel. Shipping wt. 42 lbs. Shipped **\$24.50** express collect. 30" size...



12" BRAKE. Fits in vise to form difficult compound bends, up to 20 gage steel. \$12.50 PP.
CUTTER. Cuts 18 gage steel any length and width. \$12.50 PP.
SHEET METAL PLIERS. 2 1/2" wide, \$2.00; 5", \$3.00.
PLASTIC BAR BENDER. 1/4x8 capacity. \$1.00.
IRON BENDER. Forms hooks, braces, eyelets. Bends 1/4x2, \$10.00.
Immediate delivery. Order direct, cash or C.O.D., or send for folder.
VISE BRAKE MFG. CO. 1116 So. 27th St., Omaha 5, Nebr.

Make Personalized HOUSE, LAWN MARKERS For Fun Or Profit



17 new silhouette cutouts (3 shown plus 14 other novel designs) complete alphabet and numbers, ready to trace onto wood. Sawing is easy. Marker with name or address is distinctive personalized markers for fun and to sell.

gift or addition to your own home. Make markers for fun and to sell. Set of 17 full-size, ready-to-use patterns, alphabet numbers, only \$1.00, postpaid. Money Back Guarantee.
Clip This Ad and Mail With **CRAFTPLANS** Dept. P-146, Chicago 5, Ill.
Dollar Bill or Check TODAY 1321 S. Michigan Ave.

SAY YOU SAW IT IN POPULAR MECHANICS

10 TIMES FASTER

WITH
**25PB
DAKE
PRESS**



Man-Killing Job Eliminated
At Shenango Tube Co., Sharon, Pa., Dake 25PB now performs flaring and flattening tests of tube welds. Grueling hand tests are eliminated. Time cut from 10 to 1 minute. Write for descriptive folder of Dake Presses. Dake Engine Co., Grand Haven, Mich.



O.D. WOOL SHIRTS
13 TO 15
244

PANTS
28 TO 32
266

Used, reg. issue, perfect condition 100% wool serge. Cleaned & pressed by Q.M. Corp. Add 12c ea. post.

BRAND NEW KHAKI SHIRTS-PANTS
14 to 17
259

Genuine S.2 chino khaki suntan material. Pants with cuffs. Add 11c post. per garment.

GEN. NYLON 50 FT
39¢

PARACHUTE CORD
3/16" dia. White or khaki. 550 lb ten strength. For clotheslines, venetian blind and drapery cords and other uses. Add 4c post.

50% WOOL HOSE
NEW. Medium weight, rugged and warm. Post 3c. **39¢**

CUSHION SOLES
NEW. 63% wool, double sole. These are known as the desert sock. Khaki and white. Add 4c postage per pr. **49¢**

WAR SURPLUS
AND OTHER **ORDER FROM THIS AD PLEASE**

BARGAINS

MAIL ORDERS
Please send remittance with order. Include postage. Guaranteed satisfaction. You are privileged to return an unsatisfactory purchase for refund.

WATCH CAPS
77¢

NEW Navy watch caps. Color, blue. 100% pure wool knit. Please add 6c postage each.

all wool WRISTLETS
13¢ 8 PAIR \$1.00

NEW 100% O.D. wool knit. Ideal for glove and mitt inserts, wristlet replacements, etc. Worth 75c per pair. Add 3c postage per pair.

12.99

B-15 Style FLIGHT JACKET

NEW Renders greatest warmth per oz of weight. Mountain cloth outside, pile lined body and sleeves. Genuine mouton Collar, 4 pockets—2 outside, 2 inside. Wool knit cuffs and waistband. Add 27c postage.

NAVY T-SHIRTS
WHITE
59¢

NEW. Combed yarn, full cut, small, medium, and large. 5c postage.

SIZZLING SPECIALS

ARMY STYLE 688 COMBAT BOOTS

NEW For sportsmen and outdoor wear, 10" high. Reversed uppers, full oak leather sole, with composition outer sole. Add 27c post.

6 TO 12

DUST MASKS
33¢

New \$1.50 value. Ideal for millers, farmers, paint and insecticide spraying. Add 6c postage for each.

GREATEST WATCH VALUE IN U.S.A.

17 JEWEL Military Style WRIST WATCH

BRAND NEW GEN. INCABLOC WATERPROOF SHOCKPROOF

Non-magnetic, radium dial, sweep second hand. St. steel case. Complete with leather strap. Guaranteed Swiss 17 Jewel movement. A truly remarkable value. Add 15c post.

1995 PLUS 10% FED TAX

WAR SURPLUS CIRCULAR

SEND FOR FREE

Over 200 War Surplus and other outstanding bargains

SIoux FALLS SURPLUS STORE
113 NO. PHILLIPS SIoux FALLS, S. DAK.

NAVY SUN GLASSES
66¢

Navy Issue. Ground & polished lenses, plastic frame, wire center. \$4.00 value. Add 6c post.

AVIATORS 24K Style GOLD PLATED RIMS
1.33

Large size. 52mm lenses. Shuts out max violet & infra red ray. Pearl sweatband. Comp. with handsome case. Add 7c post.

OUR BETTER QUALITY.....2.55

A MAN'S BEST FRIEND IS HIS POCKET KNIFE

Blades hand honed, hand stropped. Many styles, at your dealer's. \$1.50 up.

CAMILLUS
has the edge!

No. 22
2 13/16" closed

CAMILLUS CUTLERY COMPANY, N. Y. 17, N. Y.

Special Offer to Ford-Mercury Owners '41-'48 Incl.

FENDER GUARDS - \$4.00 a set

Add beauty and protection from gravel, etc. with a set of high-polished Stainless Steel fender guards.

AVAILABLE FOR IMMEDIATE SHIPMENT.

AKRON METAL STAMPING, INC.
2705 Wingate Ave.
Akron 1, Ohio

Gentlemen: Please send me one set of Gravel Guards for my _____ (year and make of car).
Enclosed find check or money order for \$4.00.

WITH MOLLY YOU CAN FASTEN ANYTHING

and do it quickly, neatly and safely, MOLLY will hold fixtures securely to floors, ceilings or any hollow wall construction... Simple to install, all you need is a screw driver.

Sold by leading hardware and lumber dealers everywhere.

Write for Free Descriptive Folder

NO SPECIAL TOOLS NEEDED!

WHERE SCREWS WON'T HOLD... USE MOLLY'S

MOLLY SCREW ANCHORS

MOLLY CORPORATION 522 COURT ST. READING, PA.



Drive the **CROSLEY**

Hotshot

America's own sport car!

Again Crosley makes automotive history—this time with the daring HOTSHOT—a new thrill in motoring! High in style, amazingly low in price—even less than other Crosley passenger models!

The Crosley HOTSHOT follows the dashing lines of racing cars, but will collect a crowd on Main Street or at the club. It's light, fast, economical. For those who want to participate in track racing, road racing or hill climbing competitions, the engine may be souped up as high as 12 or 14 to 1 compression ratio. Also, the windshield, bumpers, top and headlights are removable. Quickly detachable side doors, not shown, as well as top and side curtains, are standard equipment.

Powered by the amazing CIBA (cast iron block) overhead cam shaft engine—the only light, high speed, high compression, racing type engine built in quantity in this country. Equipped with Crosley's revolutionary Hydradisc Brakes—the ultra modern airplane type hydraulic brake now standard equipment on all Crosley cars.

Drive the new Crosley HOTSHOT. Learn about the hundreds of spectacular improvements in the entire Crosley line. For free literature describing the HOTSHOT and the 5 other Crosley models, including Station Wagon illustrated, write Crosley Motors, Inc., 2530-HK Spring Grove Ave., Cincinnati 14, Ohio.



CROSLEY a FINE car

"You See Them Everywhere"

Easy, Thrifty Way to

ELECTRIFY

YOUR OLD TREADLE

SEWING MACHINE

CONVERTS ANY MACHINE, no matter how old. Makes it a modern electric sew machine.

READY TO ATTACH. Even a child can do it! All parts wired and connected! Anyone can attach it in a few minutes!

GUARANTEED FOR 1 YEAR!

KIT INCLUDES: AC-DC Mercury Motor, Speed Control Rheostat, Non-glare deluxe sew light, 3 rubber belts, steel pulley, two mounting brackets, cord set with plug and socket, instruction sheet.

FREE TRIAL OFFER — If not satisfied, return kit in 10 days for full refund.

Order by mail. Postpaid except on C.O.D.'s

MORSE SEWING MACHINE & SUPPLY CORP.
Dept. H 40 W, 27th St., New York, N. Y.

NEW MERCURY MOTOR KIT

\$14.95

Complete with Lamp. Saves you cost of new machine!

LAWNMOWER SHARPENER OPERATORS

Increase your output...
Year 'round business!

NEW BED KNIFE GRINDER

sharpens all STRAIGHT EDGE TOOLS

New Ideal Bench Grinder

doubles your output of sharpening jobs, speedily grinds straight blade knives. Sharpens all kinds of straight edge tools and ice skates. Write for FREE, fact-filled folder.

THE FATE-ROOT-HEATH COMPANY
Dept. D-3, Plymouth, Ohio

Sand Casting — Forging — Heat Treating — Case Hardening

BRONZE FOUNDRY

In your own workshop allows you to design and build your own GASOLINE ENGINES, STEAM ENGINES, STATUARY, ART OBJECTS, SPECIAL TOOLS, NEW INVENTIONS, ETC. You can also make forgings and case harden steel. Your shop is not complete without a FOUNDRYETTE. Three sizes are available capable of making bronze castings of 1½, 3 and 6 pounds weight, aluminum, copper, brass, etc., \$22.50, \$29.50, \$42.00 f.o.b. Kansas City. Domestic gas supply and 110 volt AC or DC energy required for operation. Write for circular.

KANSAS CITY SPECIALTIES CO.
Box 6022, Dept. P-9 Kansas City, Mo.

RUPTURE

RELIEF...OR YOUR MONEY BACK

A simple... sturdy truss support built nature's way by old surgical appliance manufacturer. You risk nothing... relief or your money back. Send now for free booklet.

WEB TRUSS CO. Dept. M-84 Hagerstown, Md.

Every mechanic needs a

PERRY SCREW STARTER

Saves time, effort, and tempera in getting those hard-to-get-at screws started. Light, compact. No outside clips to interfere in close places. Automatically releases when screw is slightly tightened. Pre-heated steel with Duralumin handle. Sold on money-back guarantee. Send check or money order. No C.O.D.'s.

No. A-25	5/16" bit	2 1/2" length	\$1.00 p. p.
No. A-35	5/16" bit	3" length	\$1.10 p. p.
No. A-105	5/16" bit	10" length	\$1.20 p. p.

PERRY MFG. CO. 2525 - 26th AVE. S., MINNEAPOLIS 6, MINNESOTA

75 POWER MICROSCOPE

\$20

Postpaid in U.S.A.

Leading microscopist says: "Best on the market under \$59."

ENJOY the thrill of exploring new worlds. Precision lens, achromatic objective, standard optical threads, 45° tilting stand and hairline adjustment. KIT includes Pliofilm Cover, Slides, Specimens, Balsam, Tweezers and Dissecting Tool. With 150 power objective. \$24.50. Send check or money order today!

MONEY BACK GUARANTEE
Money refunded if microscope returned prepaid within 10 days' trial.

W. E. ROWE CO., Dept. P. M.
P. O. Box 1, Brighton Station, Rochester 10, N. Y.

New HOBBY-TOOL GRINDER

More power . . . more capacity
 . . . More value for your money!

DRILL
GRIND
SAW
BUFF
POLISH
BURR
ETCH
SAND
SHARPEN
CARVE
ROOT
ETC.

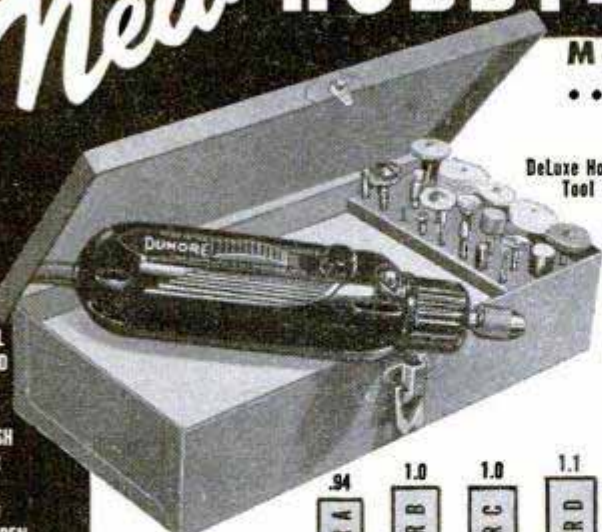

DeLuxe Hobby Tool

Comparative Torque
 in Ounce-Inches At
 15,000 R. P. M.

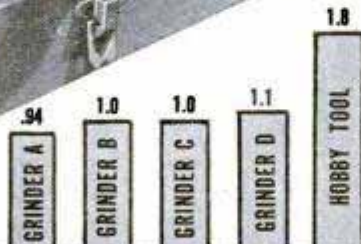

Here's the light-weight, popularly-priced handgrinder that really has "guts" (see graph) . . . handles all 1/8" and 3/32" mounted accessories . . . gives you all the smooth trouble-free performance you've come to expect from Dumore. You'll be proud to work with . . . proud to own the Hobby Tool!

- Full 1/40 h.p. Dumore Motor . . . 28,000 r.p.m.
- Highest maximum power.
- Most power on continuous duty.
- Handsome styling . . . a beauty!
- Push-button tool lock . . . no wrenches.
- Handy, fast thumb switch.
- "No-tire" shape fits your hand.
- 1/8" and 3/32" chuck capacity.

Hundreds of uses in your shop and around the house. See it at your hardware dealer, or mail coupon today.

The DUMORE COMPANY

Dept. K-51, Racine, Wis.

- Please send complete information on the NEW Hobby-Tool Handgrinder.
- Send me DeLuxe Hobby Tool with 50 accessories (as illustrated); \$23.50 enclosed.
- Send me Standard Hobby Tool with 2 accessories; \$16.50 enclosed. (All shipping charges C.O.D.)

NAME.....
 ADDRESS.....
 CITY..... ZONE..... STATE.....
 DHT-1

HOME MACHINE SHOP KIT



- 36 excellent items necessary in every home machine shop.
 - 10 different size high speed steel drills up to 1/2".
 - 2 new 5/16" high speed steel bits 2 1/2" long.
 - 10 different size taps.
 - 7 new small grinding stones.
 - 2 new files.
 - 2 high speed steel reamers.
 - 2 round thread dies.
 - 1 heavy duty hack saw blade.
- Over \$50 worth of tools for only **\$4.95** post-paid

BRAND NEW

CO-AXIAL SOUND CABLE RG-7U

Just the thing for mikes, intercom boxes, etc.
 10' for \$.50. 25' for \$1.00.
 Available in lengths up to 300 feet at 4c per foot.

PRESSURE GAUGES



NEW MARSH Fig. 1DP, 0-160#, 2 1/2" dial. 1/4" pipe bottom connection. Ideal for air compressor sprayers. **\$1.00 each postpaid.**

Brand New 0-200# U. S. Pressure Gauges Fig. 500, 3 1/2" dial. 1/4" pipe bottom connection. **\$1.65 each postpaid.**

Write for catalog describing thousands of other gauges of all makes and pressures.

DRAFTSMAN DIVIDERS



Brand new 7" chrome plate, precision dividers.

Only **\$1.25** each postpaid.

TAPER SHANK DRILLS



10 Different Size HIGH SPEED STEEL Morse Taper Shank Twist Drills (used surplus) up to 1". Over \$40 worth of drills for only **\$5.95** postpaid. Also 10 Carbon Steel Morse Taper Shank Twist Drills up to 1-5/16". **\$6.98** FOB, Tulsa.

All merchandise here listed whether brand new or used surplus is offered with a money-back guarantee of satisfaction.

STAR DRILLS



Four brand new heavy duty industrial Star Drills up to 1/2".

\$.98 post-paid

NEW High Test Mildew-Resistant treated twist rope.

100 feet for **\$1.25**

Lengths from 200' to 1800'; 1c per foot postpaid.

1000# Heavy Duty Brass Needle Valves, 3/8" Pipe Connection **\$1.65** post-paid

15" Monkey Wrench **\$1.25** post-paid. Auto-type

T&T TOOL

101 W. ARCHER TULSA, OKLA.

GOVT. COST

~~\$28.25~~



NOW **\$19.75**

CHRONOMETRIC TACHOMETER

U. S. NAVY SURPLUS — ACCURACY — PRECISION — GUARANTEED

For PRECISION timing of all rotating mechanisms. Incomparable GUARANTEED ACCURACY of 1/10 of 1%. An RPM counter and surface speed indicator combined with chronometric operation which AUTOMATICALLY computes period of test in EXACTLY 6 SECONDS. No stop watch or personal equation necessary. UNSURPASSED for cameras, projectors, gen-

erators, motors, sanders, turbines, saws, shafts, looms, fans, lathes, etc. Packed in plush-lined, simulated leather case. UNCONDITIONALLY GUARANTEED subject to your inspection and approval. Manufactured by JAEGER and TOTCO, leaders in field of exacting measuring devices. Only \$19.75 Shipped postpaid in U.S.A. on cash orders.

ELGIN — WALTHAM — WRIST WATCH

WATERPROOF — SHOCKPROOF A-11 Hack watch. 16 Jewel, black dial, white numerals, sweep second hand. Used by A. A. F. Add **\$19.75** \$1.98 Fed. Tax



KOHLSMAN ALTIMETER



Ideal for Auto or Airplane. Used but GUARANTEED accurate. Don't wait. Order NOW. Original Govt. Cost **\$9.95** \$168.00—each

Order these surplus bargains today. We pay postage on cash orders. Add postage to other items. 20% dep. on C.O.D.'s

Semlers' ASSOCIATED SURPLUS CO. 5720 WILSHIRE BLVD., LOS ANGELES 36, CALIF.

150 PIECE BARGAIN

GRINDING WHEELS, TOOLS, ABRASIVES \$6.25
\$25.00 Value at . Post Paid in U.S.A.

- 12 Assorted Grinding Wheels 1" to 4"
- 1 Rotary File 1/4"
- 8 Mounted Stones on 1/4" & 1/8" arbor
- 10 Assorted Cut-off Wheels 1" to 4"
- 5 Rubber Wheels 1" to 2"
- 5 Felt & Leather Bobs
- 60 Sanding Discs & Butterflies 1" to 7"
- 1 Drum Sander 3/4 x 1/2 on 1/8" arbor
- 10 Bands for Sanders
- 5 Honing & Sharp Stones
- 5 Felt Wheels 1"
- 2 Muslin buffs 8" x 1/2" thick
- 25 Abrasive Cartridges asst. Grits
- 2 Abrasive belts
- 1 Circular saw 4"



Rush Check or M.O. for this big value!



18 ROTARY CUTTERS \$5.85
\$13.50 Value Post Paid in U.S.A.

Assorted sizes cutter on 1/8" or 3/32" shank. Will fit all hand grinders. Ideal for cutting wood, metal, or plastic. Brand new.



2 CIRCULAR SAWS on 2 Mandrels—Both At One Record Breaking Price \$1.50 Post Paid in U.S.A.

4 in. CIRCULAR SAWS, 1/2" arbor holes. 2 for \$1.50



SURPRISE VALUE 100 Pieces \$1.00 Post Paid in U.S.A.

SCHUPACK SUPPLY CO., 7331 Cottage Grove, Dept. M9, Chicago 19, Ill. ILLUSTRATED BARGAIN CATALOG FREE



Better Sights FOR BETTER "SHOTS"

Sheard "Gold" Front Sight \$1.75

Standard Front Sight \$1.25



Marble's Flexible Rear Sight, with automatic spring joint. Can be locked down. With 2 discs. Price \$5.50.

At your dealer, or write for Catalog Marble Arms & Mfg. Co. 578 Delta Ave. Gladstone, Mich.

For faster, more accurate sighting equip with a combination of

MARBLE'S SIGHTS

Flat Top Rear. Price \$2.00

Semi-Buckhorn Rear Price \$2.00

No. 69 Flat Top Sporting Leaf. \$2.00



(222)

MAKE YOUR OWN!

WITH

Griffin READYCUT LEATHER PROJECTS

Over 100 KITS in every kind of Tooling and Carving Leather, accurately cut, all parts included Only Top Grade Leathers used You do the choosing. You do the tooling, carving, stamping, the punching and assembling



SEND FOR COMPLETE CATALOG Please send 10c to cover mailing.

SINCE 1924

OUT OF THE WEST, THE HOME OF LEATHER CARVING

Griffin Craft Supplies

5515-A GROVE STREET OAKLAND 9, CALIFORNIA

EVERYTHING FOR THE LEATHER WORKER

Largest, most complete stock of Leathercraft Tools and Accessories in U.S.A.



HIDES AND SKINS of every kind if you prefer to cut your own.

3-Pc PAINT STRIPE SET Only \$1.00



3 SEPARATE TOOLS—Each makes different width

Stripe perfect lines—straight, curved, with any paint, lacquer, enamel, easy as drawing lines with ruler! Beautify furniture, toys, autos; make signs and imitation tile. Simple instructions included.

SEND NO MONEY. Mail order. Pay postman only \$1.00 plus postage. If not delighted return in 5 days for money back. Order Now.

STRADER MFG. CO.

259 Strader Ave. Dept. F-351 Cincinnati 26, Ohio

MONEY BACK GUAR.



7x50 PRISM BINOCULARS PRECISION OPTICS—BRAND NEW

\$36*

6x50 ACHROMATIC FIELD GLASSES \$16*

*20% Federal Tax

Send for Free Catalog of Binoculars, Telescopes and Microscopes

BROWNSCOPE CO.

Dept. 10M, 24 W. 45th St., New York 19, N. Y.

FREE PLANS

BUILD YOUR OWN OVER-HEAD GARAGE DOORS

Now you can have over-head door convenience for your garage at the cost of "old-fashioned" doors. "Over-the-Top" Door Equipment by Frantz permits designing and building garage doors to harmonize with your residence design. Write for full information and FREE door plans.

Frantz Mfg. Co., Dept. 109-K, Sterling, Ill.

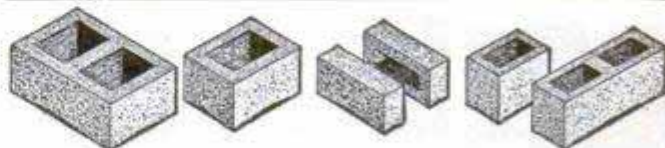

Make Concrete Blocks and Bricks

New superior method makes square, true, easy-to-lay units which will pass any building code. Small investment, high production, big profits. One \$30.00 machine will make four 5"x8"x12" blocks per minute—1000 per day. Pays for itself in a few days. Sell blocks or save 2/3 building cost by making and laying your own.

POST CARD BRINGS FREE FOLDER

Economy Manufacturing Company Dept. P Stone Mountain, Georgia

STOP CHANGING MOTOR OIL!



End this needless waste and expense forever with **RECLAIMO** Today's Most Advanced Oil RE-REFINING Filter

Continuously cleans and RE-REFINES motor oil as you drive (by utilizing motor heat)—keeps oil in high grade lubricating quality at all times! Proves conclusively that "Oil Does Not Wear Out Mechanically" as stated by U. S. Bureau of Standards, (Bulletin 86).

NEW ADDED FEATURE!
Gas-Moisture Vapor Injector
Increases Mileage with Smoother Performance

- REMOVES SOLIDS (by filtration)
- REMOVES WATER (by distillation)
- PREVENTS Excess Fuel Dilution
- PREVENTS Acid and Sludge Formation

MAINTAINS Stable Viscosity **ELIMINATES** All Oil Changes
CAR • TRUCK • TRACTOR OWNERS!

FREE 32-PAGE BOOK "OIL FACTS" (with bonafide \$1000.00 offer on page 30), gives you the complete "Reclaimo" story and details of our extraordinary 90-DAY NO-RISK TRIAL OFFER! Write for your copy TODAY!

RECLAIMO MFG. CO.
5083 ELSTON AVE., Dept. 10, CHICAGO 30, ILL.



Small down payment starts you in a highly profitable WELDING BUSINESS!

Low monthly payments
"Pay-out-of-profits" TERMS

You deal directly with factory. No red tape. No third party involved.



FREE particulars on "How to Start and Operate an Arc Welding Business"

LET HOBART HELP YOU GET STARTED AT ONCE



Hobart A.C. Transformer Welders are made in 180 to 500 ampere size.

MAKE BIG MONEY

Cash in now on the terrific demand for arc welding. Opportunity awaits in almost every locality.

EASY TO START

Average mechanical ability and a little practice lets you do good welding quickly. Latest developments in Hobart exclusive features make top quality welding easy.

USE EITHER A.C. OR D.C.

Equip for either shop or field welding. Complete Hobart welder line lets you pick welder to suit needs.

"BUILD-YOUR-OWN" AND SAVE \$\$\$\$

Generator only used with your own gas engine saves \$\$\$ and gives you money making portable welder.

HOBART WELDING SCHOOL

Complete or partial courses on every phase of welding taught by experienced instructors.

Low cost. G. I. approved.

HOBART Brothers Company
Box M-109, Troy, Ohio

HOBART

"one of the world's largest builders of arc welders"

HOBART BROTHERS CO., Box M-109, TROY, OHIO

Please send information on how I can make big money with welding, pay for equipment out of profits. Also information on items checked:

- Hobart A. C. Welders "Build-Your-Own" Welders
 Hobart D. C. Welders Hobart Welding School

NAME _____

ADDRESS _____

Hydraulic SPEED REDUCER of many uses

Variable Speeds and INSTANT REVERSE

INPUT SPEED UP TO 700 R.P.M.

For LATHES, REAMERS, TRANSMISSION, MIDGET CARS, MILLING MACHINE TABLE, SHAPER, THREAD MILLING FIXTURES, HOME MADE WOOD WORKING LATHES, EXHAUST FAN, PUMP, HOIST, GENERATOR, OVERHEAD TROLLEY, PRODUCTION BELT, OPENING and CLOSING DOORS, and MANY OTHER USES. Industrial or Home Use. Cost Government \$300.00. High Quality Precision Workmanship. Case measures 7 1/2" Long, 7" High, 6 1/2" Wide. Input and Output Shafts 3/4" diameter. Beautiful Red Crackle Finish Case. For use with 1/3 to 1 1/2 H.P.

OUTPUT TORQUE ADJUSTMENT UP TO 180 IN. PDS.

FINGER TIP CONTROL

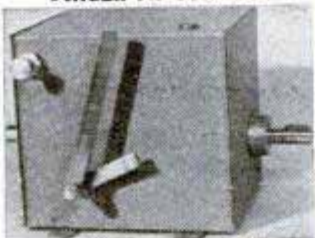

Shipping Wght. 25 pounds Only \$54.50

If C.O.D. is requested a 10% Deposit must accompany order and we ship F.O.B. Chicago. PREPAID 2 quarts oil included FREE

DIRZIUS MACHINE SHOP O, 1423-25 So. 52nd Ave., CICERO 50, ILL.

FILE SAWS FOR PROFIT!

NEW BeMaCo Rapid Saw Filer opens the door to extra income. Easy to operate. Fast, efficient power filer. Priced right! Does a beautiful job. Operator has complete control.

BeMaCo Rapid Saw Set—Finest Automatic Saw Set on the market. Manufactured exclusively by Beaver Mfg. Co. Sets 400 teeth a minute. No tooth breakage. For hand saws or band saws. Start earning now.



Write for details today!

NEW BeMaCo Rapid Saw Filer

BEAVER MFG. CO.

802-G South Isis Avenue • Inglewood, California

NEW 5 lb., 37" **CARBINES**
with **HINGED FOREND**

\$21.95 MODEL #142
(Illustrated)
.22 cal. bolt action,
7-shot repeater.
\$22.95 west of Rockies

\$26.95
MODEL #152
.22 cal. 7-shot
automatic.
\$27.80 west
of Rockies.

Scope
extra
\$9.35

*Insist on a
Mossberg, at
your dealer's.*

FREE ... Send for
catalog with full story
of Mossberg rifles,
shotguns, scopes.
No sales at factory

O.F. Mossberg
& SONS, INC.

96510 St. John St., New Haven 5, Conn.

**FINE TOOLS
NEED
FINE OIL!**

- Lubricates
- Prevents Rust
- Cleans • Polishes

SOLD EVERYWHERE.

3-IN-ONE Oil

**DIE-LESS
DUPLICATING**

with **DI-ACRO SHEAR**

Many small parts can be rapidly duplicated without dies, to accuracy of .001" with DI-ACRO "Die-Less Duplicating" Machines — Benders, Brakes, Shears, Rod Parters, Notchers, Punches. Save die expense and time delay. For experimental work, samples, models, etc., as well as regular production runs. Write for "Die-Less Duplicating" circular.

O'NEIL-IRWIN MFG. CO., 341 8th AVE., LAKE CITY, MINN.

**BUILD SCALE MODELS
with TOOTHPICKS!**

Barry's
WINDMILL
designed and
built by
Barry Pariser
America's
most
publicized
"toothpick
technician"
(see July
Popular
Mechanics
page 112)

Fun
For
The
Entire
Family

Complete kit of materials and tools plus a specially designed plan to build a working model of an authentic Dutch windmill. Join Barry's "PICK-A-PROJECT" Club today!

\$1 POST PAID includes **FREE** membership

BARRY ENTERPRISES, INC.
Box 87 Prince Sta., Dept. P., New York 12

**WORLD'S LOWEST PRICED
ADDING MACHINE** Vest Pocket Size **FREE TRIAL**

IDEAL XMAS GIFT! **\$2.95**

GUARANTEED ACCURATE. Not a toy. Operates with only a finger flick, only Adds, subtracts, multiplies, divides. Counts up to one billion. Pays for itself over and over. Ideal Gift — for Business, Income Tax and School use. **SEND NO MONEY BACK GUARANTEE.** Send name and address. Pay postman only \$2.95 plus postage. (Send full cash if outside U.S.) Beautiful rich-looking Leatherette Case included at no extra cost. Money back in 10 days if not delighted. **AGENTS WANTED.**

CALCULATOR MACHINE CO., (Mfrs.)
Dept. 219, P.O. Box 248
Glenview, Illinois

**\$14.00 UNIVERSAL PRECISION
CHUCK ONLY** **\$2.95**

2 inches with hardened steel jaws, perfectly balanced for trueness, made by nationally known chuck manufacturers. Every craftsman, machine shop, should own one at this unusually low price. Send check or money order to **HAR-MUR • 2349 W. Devon Ave. • Chicago 45, Ill.**

Say You Saw It in Popular Mechanics

**ARC WELDING
FOR PROFIT OR PLEASURE**

60 LBS. OF READY MADE PARTS Only **\$24.95**

**BUILD YOUR OWN
HEAVY DUTY WELDER** **SAVE** Buy Only NECESSARY PARTS

All parts Ready-Made and easy to assemble. You can do all around welding on steel, cast iron and other metals after only a few hours practice. Illustrated instruction manual included. Sold on 30-Day Money-Back Guarantee!

FREE: Write today for fully illustrated Pamphlet P-10

ATOMIC ARC WELDER CO.
1037 So. 19th St. OMAHA, NEBR.

Gives 100% penetration. Welds are stronger than original metal. Operates on 110 or 220 AC.

SAVE 1/2 ... BUILD Modern Kitchen Cabinets YOURSELF

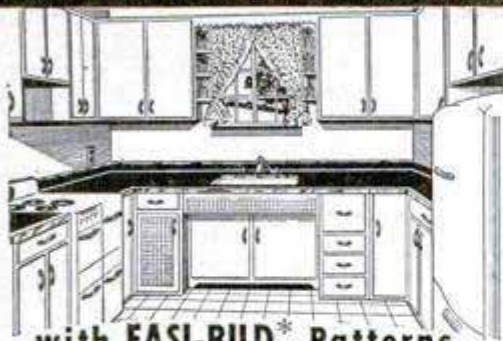

with EASI-BILD* Patterns

Now you can have modern, professional looking cabinets with gleaming Stanley Cabinet Hardware in your kitchen, bathroom or playroom. It's easy—and inexpensive—when you use the Easi-Bild "Build-It-Yourself" Pattern Method of construction. Simplifies making base and wall cabinets with hand tools. Complete step-by-step directions, patterns, assembly illustrations explain how to build cabinets to exact size needed. Send only \$1.00 for Easi-Bild Base and Wall Cabinet Pattern, No. 201. EASI-BILD PATTERN CO., Dept. PM, P. O. Box 215, Pleasantville, N. Y.

STANLEY

Reg. U.S. Pat. Off.

*Copr. 1949, Easi-Bild Pattern Co.

Pint Sized Power Miracle

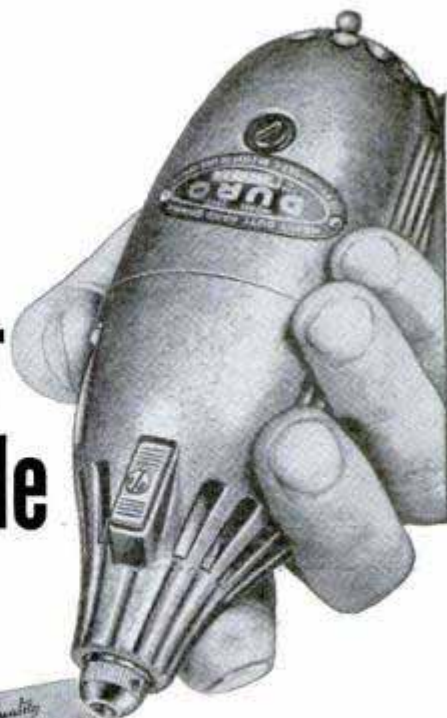

Complete Super Power
Tool Kit—Only

\$18.55

Contains power unit with cord, 5 abrasive points and cutting burrs, full operating instructions—all in one case.

New Duro Super Power Unit—the tool you'll use in a 1000 ways!

This is the kind of lightweight, perfectly balanced hand power tool that hobbyists and home craftsmen dream about! A compact fistful of super power, it runs cool and smooth at 20,000 RPM, develops 42 watts output. With it, you can do clean, professional-looking sanding, polishing, grinding, engraving, carving... and scores of other operations.

Start with this low cost tool kit and build a complete home workshop! One Duro Super Power Unit is used on all of these home workshop tools! You may buy them singly—or in a group.

Grinder & Shaper
Only \$8.80



Drill Press
Only \$11.95

Router
Only \$8.15



Lathe—Only \$10.15

Ball Bearing Flexible
Shaft Doubles the Fun



New Duro flexible shaft fits over nose-piece of power unit, makes free-hand carving, engraving, lots more fun. Flexible shaft, complete with hanger, only.....\$15.55

Write for Free Illustrated Circular giving full details about the Duro Super-Power Unit and the low cost workshop units. Circular also shows almost a score of pictures and details about operations that you can do with these amazing power tools.

DURO METAL PRODUCTS CO.
2659 N. Kildare Ave., Chicago 39, Ill.

Gentlemen: Send me free circular giving full details on the Duro Super-Power Unit and the low cost workshop units.

Name.....

Address.....

SAY YOU SAW IT IN POPULAR MECHANICS

DELCO FAN MOTORS BOOSTER FANS FOR HEATING or COOLING

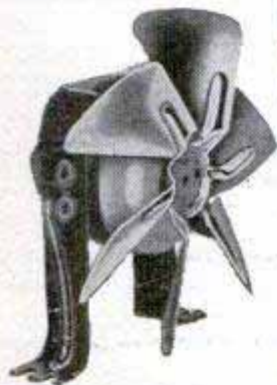

Get immediate heating or cooling with this easy to install booster fan that really moves the air. Heavy duty Delco Motor, sturdy and quiet, assures excellent performance and long life. Has a 7 3/4" D.—6 blade fan. Operates on 110 V. 50-60 Cycle A.C. current at a speed of 1500 R.P.M. Has horseshoe steel base with triple rubber mounts. A real buy. Money back guarantee. Shipping weight 6 lbs. **\$4.75**

No. 9989, only.....

Send check or money order plus postage

DEALERS WRITE for FREE CATALOG

G & E EQUIPMENT SUPPLY COMPANY

1390 WEST FULTON STREET CHICAGO 7, ILLINOIS

Clean-up Time

...for car cooling systems, too!

Avoid engine overheating on hot summer days

with Warner care



WARNER RADIATOR CLEANER—Thoroughly cleans cooling system of rust, oil-muck and grease. Harmless to metals, hose and car finish.

WARNER COOLING SYSTEM PROTECTOR—Prevents rust and corrosion—keeps cooling system clean for maximum efficiency.

"Just Shake . . . Pour . . . and Fret No More!"
See your service man or do it yourself.



Warner-Patterson Company, 920 S. Michigan Ave., Chicago 5

BARRON Drill Press TOOLS

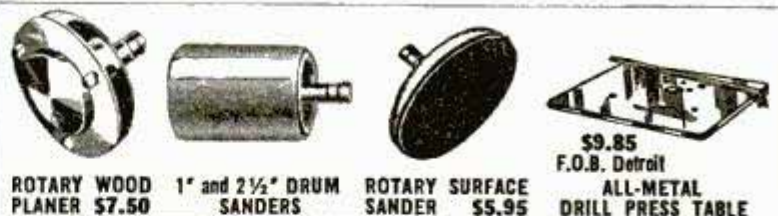

ROTARY WOOD
PLANER \$7.50

1' and 2 1/2' DRUM
SANDERS

ROTARY SURFACE
SANDER \$5.95

\$9.85
F.O.B. Detroit
ALL-METAL
DRILL PRESS TABLE

ALL-METAL
SHAPER FENCE
\$8.25
F.O.B. Detroit



ROUTER &
MORTISING
BITS
\$9.50
per set of six

SHAPER
CUTTERS
\$9.00
including
3 sets Blades



15 ESSENTIAL WORKSHOP OPERATIONS . . .

You can convert any standard make drill press into your most versatile, useful, low cost workshop tool. Barron Precision Tools now enable you to perform 15 indispensable shop operations—surface-plane woods and plastics—rabbet—tenon—panel—bead—groove—bevel—mortise—route—cut dovetail—sand surfaces and contours—shape—cut moldings—grind and buff. Over 200,000 Barron Tool users. Every tool sold on full 10 day money back guarantee.

See Your Dealer . . . Or Write Direct

BARRON TOOL COMPANY, INC.
569 Architects Bldg., Detroit 1, Mich.

FREE
Workshop
Guide &
Catalog

PISTON TYPE COMPRESSOR



EASY PROFIT IN PAINT SPRAYING

Paints walls, ceilings, screens, furniture and machinery faster, better. All complete as shown less motor. Carry anywhere. Fully guaranteed. Could be used with 1/4 H.P. motor or less. Price \$35.00 less motor F.O.B. Chicago, \$5.00 deposit balance C.O.D. or see your dealer. With motor \$55.00.

IDEAL AUTOMATIC PUMP CO., Dept. P.M. 8
801 W. Washington Blvd. Chicago 7, Ill.

Build your own ALL ALUMINUM 12 cu. ft. FREEZER CABINET. 75 sq. ft.—3 sheets 30 in. x 10 ft. of embossed aluminum, beautiful pattern, heavy gage, high thermal reflectivity—for outside shell and inside food liner—\$37.50. Premarked for cutting and bending. Due to low cost this offer, enclose \$1.00 (will be credited if purchase is made) for complete information, including drawings, compressor performance data F-12 and F-22 to use in unit selection, technical design data, and information on liquidated compressors and parts at 1/3 to 1/2 off. Data and design by recognized authorities. Freezer, Dept. A, Box 1191, Cincinnati, O.

BUILD YOUR OWN ENLARGER



Enjoy Photography's most fascinating hobby at a fraction of usual cost. With simple step-by-step instructions and diagrams plus a screwdriver and pliers you assemble your own Enlarger and Save! Get all features of more expensive Enlargers: precision machined aluminum alloy castings, 90° tilt for wall projection of prints, spherical aluminum lamphouse, helical rack and pinion focusing with extra large knobs, unconditional guarantee. For 35mm to 2 1/4 x 3 1/4 negatives. Time payment plan.

Write Today for Free Illustrated Folder
CALIFORNIA TECHNICAL PRODUCTS CO.
448 S. Hill, Dept. M-10, Los Angeles 13, Calif.

BULLETIP

(Reg. U.S. Pat. Off.) by

SANDEE
Exclusively

2 1/2" diam. \$1.95
3" diam. \$2.95

Heavy Western Chrome Plate
SANDEE MUFFLER CO., 5643 Corryne Place
Culver City, Calif.

AMERICA'S MOST-WANTED SMALL TRACTOR!

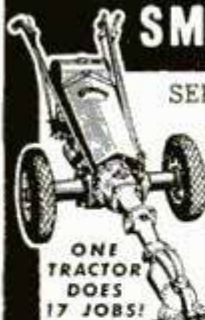

SEE THE POWERFUL
5-H. P. GRAVELY—

the world's finest, yet most moderately priced Garden Tractor. Complete line of exclusively designed power tools for every Garden, Lawn and Field job.

GRAVELY TRACTOR

FIELD-TESTED FOR 27 YEARS

MAIL NOW! FOR NEW FREE BOOKLET!

GRAVELY MOTOR PLOW & CULTIVATOR CO
BOX 1063 DUNBAR, W. VA.

NAME _____
ADDRESS _____
TOWN _____ STATE _____

SOLVING YOUR LAWN & GARDEN PROBLEMS

★ **ELIMINATE 1000 NEEDLESS STEPS!** Money-back guarantee

SAHARA Will Remove Without Water
Paint, Tar, Grease, Grime, Pipe Compound,
Printer's Ink, Linoleum Paste, Pitch, etc.
SEND FOR TWO 60¢ TUBES POSTPAID

AVAILABLE IN TUBES, ONE POUND CONTAINERS, AND PAILS. AGENTS WANTED
Sahara Waterless Soap Co. — Grand Rapids, 2 Mich.

GERSTNER Tool Chests
have served Toolmakers and Machinists for 43 years. Better, finer chests shown in free catalog.

GERSTNER TOOL CHESTS
449 Columbia St. Dayton 7, Ohio

POWER HACKSAW \$47.25

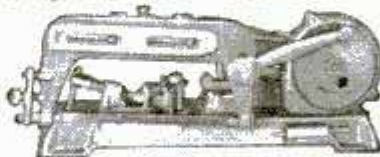

LESS MOTOR
F. O. B. Benton Harbor

- Rugged cast iron construction. Wt. 56 lbs. bronze bearings. Draw cut. Auto. return lift. Auto. shut-off. Vise swivels 45°. Cap. 4" x 4".

Send for full details and name of nearest dealer.
EXCEL MACHINE TOOLS BENTON HARBOR, MICHIGAN Dept. PM-109

THE CHALLENGER MINIATURE RACING CAR



POWERED BY PRECISION DIESEL ENGINE

- only 11" long
- speeds up to 65 mph
- starts with a push
- only 6" circle needed

Complete Ready to Run
EXPRESS \$2250 POSTPAID
Collect. #22 581 104 M.C.O.D.

A. L. MAXEY MFG. COMPANY
909-11 N. LAKE ST., BURBANK, CALIF. 10 DAY MONEY BACK GUARANTEE ORDER BY MAIL

"Wellworth" Sensational Offer! Reg. \$60.50 WESTINGHOUSE AIR COMPRESSOR

2-CYLINDER PISTON TYPE

Operates with 1/2 H.P. Motor or equivalent gas engine.

Complete outfit consisting of compressor, pressure tank, air gauge, air chuck, 20-ft. hose, pop valve, copper tubing with 4 brass flared fittings for connecting compressor to tank, 4-way cross and 3 nipples. Complete outfit of 7 items..... ONLY

COMPRESSOR SEPARATELY..... \$21.50

IDEAL for HOME • FARM • FACTORY
Wherever Compressed Air is Needed

For spraying paints, insecticides, etc.; inflating tires, operating air tools and many more uses. Automatic clutch makes it suitable for mounting and operating from trucks, tractors, etc. Instructions furnished. A fortunate purchase from the government enables us to offer you this amazing buy. All brand new equipment. Replacement parts available.

This low price is but a fraction of the price of manufacturer and of leading mail order houses.

\$29.95
SHIPPING WT. 40 LBS.

Equipment less compressor.... \$10.50 WT. 15 lbs.

THE COMPRESSOR

Piston Type, 2-cylinder, 2 inch bore, 1 1/4" Stroke Ball Bearing. 3.27 C.F.M. at 600 R.P.M. Capacity up to 6.54 C.F.M. Suggested operating pressure 75 P.S.I. DIMENSIONS: 9" wide, 11 3/4" high, 6 3/4" deep. Wt. 26 lbs.

TANK and ACCESSORIES

6" x 24" stainless steel tank suitable for 150 lb. pressure. Two 1/4" openings. Air gauge, pop valve, air chuck, 20 ft. hose, Copper tubing and fittings as shown. Wt. 15 lbs.

Model T-1
Brand New!

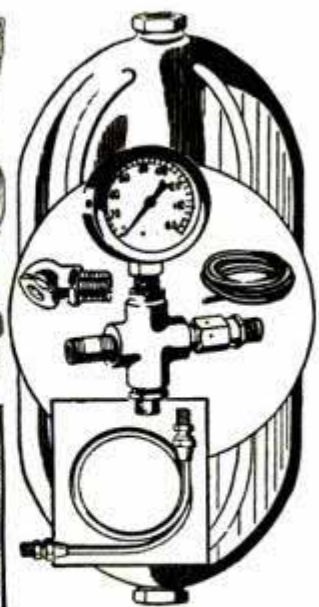
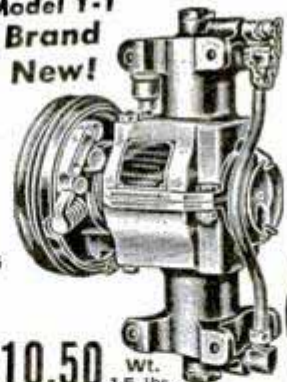

"Wellworth" BLOWER at a Bargain Price

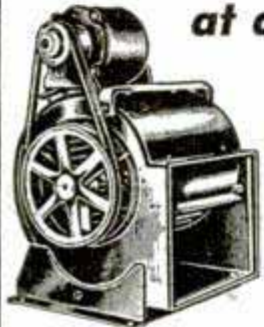

Quiet operating. Double wheel inlet, double width blower. For heating, ventilating, cooling, air washing, exhausting and forced draft.

DIMENSIONS: 10" wheel; outlet 13 1/2" x 11 3/4"; inlet 8 3/4". Height 19". Width 18". Depth 16 1/2". C.F.M. 1/4" S.P. 1600; outlet vel. 1575; motor 1/4 H.P. with overload relay; cord & plug, 110 v. 60 cy. AC. \$39.50
Ship. Wt. 67 lbs. Special price...

AUTOMATIC COMPRESSOR UNIT

1/3 H.P. heavy duty capacitor motor AC 110/220 volt 60 cycle, 2 x 1 3/4 inch piston type compressor, splash feed lubrication, 12 x 24 inch tank, automatic pressure switch, pressure range 100 to 125 lbs., CFM 2.2, check valve, safety valve, air regulator with gauge and filter, 20 ft. air hose with air chuck for inflating tires. V. belt drive. Shipping wt. 90 lbs.

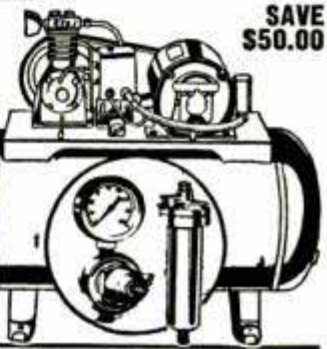

Special Price \$79.50
Same unit as above with 1/2 H.P. motor, furnished with 13" x 24" tank, CFM 2.8 at 125 lb. pressure, Shipping wt. 125 lbs. \$98.50

SAVE \$50.00

"Wellworth" External Atomizing SPRAY GUN

Flat and round spray, quart cup. Requires 2 c.f.m. at 35 to 40 lbs. pressure. Ideal for spraying lacquer, synthetic enamel, lead paint, etc.

Spray gun with 20 ft. hose and fittings. Wt. 7 lbs... \$12.95
Spray gun only; wt. 5 lbs..... \$10.00



140 CFM "WELLWORTH" BLOWER

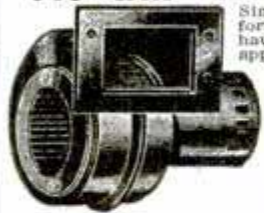

Single-inlet blower that gives top performance on heating, ventilating, exhausting, cooling, drying and similar applications. 5 1/4 x 4" mounting flange with 2 1/2" square discharge. 3 1/2" dia. blower wheel powered by direct-connected 1/15 H.P., 110V., 60C., A.C. motor with conduit box and 20' leads. 7 1/2" wide less flange by 7 1/4" H. x 6 3/4" D. Suited for hundreds of new and replacement uses. Shpg. wt. 6 lbs. \$16.50

PNEUMATIC AIR TOOLS USED, GUARANTEED LIKE NEW.

CHICAGO PNEUMATIC RIVETER & CHIPPING HAMMER
CP4X Pistol grip handle. Takes up to 3/16" rivet. Weight 6 lbs. List price \$73.00.
SPECIAL PRICE..... \$10.95
Same as above, brand new..... \$22.50
Size CP3. Takes 5/32" Rivet.... \$8.95

Chicago Pneumatic Lever Type AIR DRILL
With 1/4" Jacob Chuck. Wt. 2 lbs. List price \$14.95 \$55.00. Only.....
Ingersoll Rand AIR DRILL
With 1/4" Jacob Chuck. Wt. 2 lbs. List price \$14.95 \$55.00. Only.....

300 GAL. COOLANT PUMP A HEAVY-DUTY PUMP AT 40% LESS

You pay less and get a larger, higher pressure, higher capacity, heavy duty coolant-type, recirculating pump. Also extensively used on evaporative coolers. Will deliver 60 gal. per hr. at 8 ft. head and 300 GPH at no head. Heavy duty 1/30 H.P. totally enclosed, 110V., 60C. motor with long life oiling. Noncorrosive shaft and pump. 10 1/2" high, 3/8" I.P.T. Ship. wt. 12 lbs. \$19.50



AUTOMATIC PRESSURE SWITCH WITH UNLOADER
Double pole, with 2 way release valve. Set at 125 to 150 lbs. pressure. Wt. 4 lbs. \$10.25
Only..... \$7.50
Same without unloader..... \$5.50
Switch—20 to 40 lb. adjustable to 80 lbs. For air or water

"Wellworth" Check Valves
Dash pot type Quiet operating
1/4" valve \$2.75
1/2" valve \$4.50

"Wellworth" 1/4" REDUCING VALVE & GAUGE
Oil resistant, pressure 0-to-200 lb. Reduced pressure 0-to-75 lb.; 3 outlets 1/4". \$5.75
Wt. 2 lbs.

6 FT. STOW FLEXIBLE SHAFT
Heavy Duty, 3/8" Core. Best piano wire. Ball bearing handle and arbor, rubber covered housing; for 1/2" motor shaft; for 1/2" bore wheels. Operates on 1/4 H.P. Motor at 1725 or 3450 R.P.M. \$29.00 Value, \$14.50. Wt. 8 lbs.
Reduced Price Only \$14.50

1/30 H. P. MOTOR BARGAIN
12 volt D.C. motor, 2450 R.P.M. 2.0 amps. 1/4" shaft. Size overall 3" x 4". Weight 3 lbs. USE AS 6 VOLT GENERATOR. \$2.75 ea.
QUANTITY PRICES
4 for... \$7.50 24 for... \$36.00 100 for... \$135.00



Prices f.o.b. Chicago. Immediate delivery. All items sold on money back guarantee. Send check or money order today. Catalog FREE.

WELLWORTH TRADING CO.
1831 S. STATE ST. DEPT. D-10 CHICAGO 16, ILL.

GADGETEERS! HERE ARE THOSE TERRIFIC MIX VALUES

GADGET MIX Especially prepared for the HOBBYIST. Rivets, Spacers, Bolts, Screws, Gears, Etc. A Gold Mine. #106. 5 lbs. **\$1.19**

BEARING MIX #170A
A PALLEY SPECIAL!! Approx. 20 Needle, Ball & Roller Bearings, New & Used - Sizes 1/2" to 4". Some of these cost Gov't \$10 apiece. Never such a value! **\$1.59**
5 lbs. . . ONLY

HINGE MIX #170H.
12 pairs of strap & butt hinges. Sizes 1" x 1" to 1 3/4" x 4" in length to 8" strap. A \$3.00 VALUE for ONLY **\$1.09**

ABRASIVE AND GRINDING WHEEL MIX
50 Pieces including honing stone, pencil rolls, wheels, Abrasive sheets, etc. A sharp value. #170AG **99c**

SPRING MIX #206
Torsion, Compression & Tension Springs, asstd. sizes. A treasure trove for emergencies. 2 lbs. for ONLY . . . **89c**

COMBO-MIX Comb. of all above in one pkg. Special deal. **\$5.59**

SWITCH MIX #SM-1
12 assorted types of Aircraft Switches, including double & single throws, double & single poles & multiples. Voltage ratings from 5 to 20 amps, 125 Volts A.C., 35 amps, 24 Volts D.C. 1001 Uses . . . **\$2.95**

FILE MIX
Ten Assorted Files of 6", 8", 10", 12", includes 3 Vixens, half rounds, bastards, mills, etc. in seconds and used but in good condition, 1 Vixen alone worth our price for entire mix. #F-1 **99c**

PULLEY MIX #PM-1
You'll want this one around. 10 micarta and metal pulleys ranging from 1" to 5" with ball and one piece bearings. These are aircraft pulleys, the best made, with 100's of uses. A WONDERFUL BUY @ **\$2.95**

COUNTERSINK MIX
#168 - Countersink Assortment. Excellent condition. High speed steel. Assortment of ten 100° and 110° with pilot sizes ranging from 3/32" to 3/16". #CM-1 **\$2.69**

ELECTRIC SOLDERING IRON
110 Volt A. C. ESSICO 75 Watt **\$1.69**

PALLEY SUPPLY COMPANY
6321 SAN FERNANDO RD.
DEPT. P.M.10 GLENDALE 1, CALIF

SAVE UP TO 85% IN WAR SURPLUS

WHEELS For Wagons, Dollys, Handtrucks, Wheelbarrows, etc. 10" dia., with 7/16" center hole. (can be drilled out to take 5/8" axle) Wheel is 1/8" steel with 10 x 1.75 heavy duty, semi-pneumatic cushioned rubber tire. EA. **\$1.75**

PNEUMATIC AND AIR TOOLS
10,000 in various popular makes, sizes, types, Cleco, Aro, Ingersol Rand, Chicago, Pneumatic, Buckeye, etc.

RIVET GUNS
Pistol & Gooseneck Type #181 PISTOL

PALLEY OCTOBER BARGAINS

PEXTO PLIERS
Side cutting beveled head
a \$3.50 value. **\$1.79**

15" MONKEY WRENCH
Adjustable 4" Jaw opening Drop forge Auto type. Cad. Plated . . . **89c** Black **79c**

RAWHIDE MALLET
For working light metals, wood or plastic. Head dia. 1 1/4" x 4" **\$1.09**

METAL SNIPS
Hard steel blades. Compound action. Expansion spring. Lock device. Rt. & Left Hand . . . **\$2.59**

101 Uses, Chipping, Riveting, Hammering. Breaking cement. Auto body work. Chicago Pneumatic, Cleco, Ingersoll-Rand Makes, E3, E2, 3X, 2X, 0Y.

#180 Gooseneck
\$80 Value **\$15.95**
#186 Squeezer PNEUMATIC ALLIGATOR SQUEEZER

OXYGEN & ACETYLENE REGULATORS

OXYGEN REGULATOR - Bottle Press. Gauge - 0-3000 PSI. Regulating Press. Gauge - 0-400 PSI
ACETYLENE REGULATOR - Bottle Press. Gauge - 0-500 PSI. Regulating Pressure Gauge - 0-50 PSI.
AIRCO & Other Popular Makes to fit ALL Standard Bottles - ALL NEW!! **\$12.95**
A Real Buy at or Both for **\$25.00**

High Pressure Oxygen Bottle New. Will hold up to 3,000 PSI, with Co2 used as tire inflator or fire extinguisher, with oxygen for sick room or deepwater diving, etc. Completely equipped with brass valve, 36" hose, Dial gauge, & canvas bag. **\$2.29**

NEW PRESSURE TANKS
Stainless steel - Shatterproof. Rustless. 10,000 available in 6 different sizes. 1001 Uses.

G-1... 12 1/2 x 24 inches - 2100 Cu. In. capacity 29 Cu. Ft. **\$4.75**
D-2... 6 1/2 x 24 in. 500 Cu. In. capacity 7 Cu. Ft. Corrosion resistant steel. **2.49**
D-2... Stainless Steel **3.49**
F-2... 6 x 45 in. 1000 Cu. In. capacity 14 Cu. Ft. **3.95**
A-4... 5 x 8 in. - 104 Cu. In. capacity **1.35**

Ideal for painting, cooking, spraying, ocean buoys, underwater fishing, or diving.

PIANO HINGE

Overall	Width	Length	Price Ea.
1 1/4"	(5/8" side)	72" alum.	\$1.00
1 1/2"	(3/4" side)	72" alum.	\$1.19
1 3/4"	(3/4" side)	53" cad. steel	\$0.75

SASH BRUSH - Handy for cleaning parts in home & Mach. shop. **27c**

REAMER MIX
168 - Reamer Assortment: Special Taper line finish Reamers - High Speed Steel. Slightly used but in excellent condition. Ten assorted sizes ranging from .168 x .165 and .244 x .215 to .425 x .385 and .432 x .403. One alone worth our selling price of ten. For set of ten Reamers. **\$4.49**

THE LARGEST FIRM OF ITS TYPE IN THE WORLD

AIR DRILLS OR MOTOR SPECIAL
with 1/4" Jacobs Chuck **\$15.00**

THOR #210R Model 4526 2300 RPM REVERSIBLE AIR DRILL
Excellent for Tapping. **\$19.95**

\$12.50 PNEUMATIC ANGLE DRILL
each
With Terry Adapter
Send for Catalog and List of Other Sizes, Types of Pneumatic Tools.

NAVY Sealed Beam LAMP
US Navy Portable Pistol Grip, Sealed Beam, Search, Spot or Emergency Lite. 12 volt. Light weight. Ideal for Auto, Boat, Trailer, Farm, etc. Cost Gov't \$35. OUR PRICE **\$2.95**
Set of 3 extra filters, Red, Grn, Amber **99c**

ADJUSTABLE TAP WRENCHES
Jaws are made of tool steel, hardened & tempered. Won't break or get out of line.
#7 Threadwell Cap. 1/4" to 1 1/8" Length 19" @ **\$2.49**
#8 Vermont Cap. 3/4" to 1 5/8" Length 40" @ **\$3.49**
#24 Greenfield Cap. 1 3/4" to 4" Length 72" @ **\$6.49**

AIRCRAFT CABLE
Alloyed steel, rust resistant. 3/16" ea. 18 ft. long, with turnbuckle ends. **99c ea.**
Preformed 7 x 19 strand - on reels
in any length
1. 16" 3¢ ft. 1/4" 8¢ ft.
3. 3/32" 4¢ ft. 9. 3/32" 9¢ ft.
1. 8" 4 1/2¢ ft. 3. 8" 12¢ ft.
5. 3/32" 5¢ ft. 1. 2" 15¢ ft.
3. 1/16" 6¢ ft. 1. 4" Bronze 10¢ ft.

OXFORD BRG & TOOL SCRAPERS
Complete set of 8 Tools packed in Grained Wood Case.
Contains 1 ea. 8", 10", 12", 14" half round scraper. 1-6" Three square Scraper. 1-12" Double end Scraper. Made of Finest Tool Steel. SET Forged, Tempered, and Hollow Ground. An Unheard of Price! **\$2.49**

ORDER BY MAIL from "GADGETEERS HEAVEN"

ALL ENGINES READY TO RUN.

New Hydraulic Cylinders, Valves, Pumps, Fittings, Hose and Tanks
51 SIZES AND TYPES. WORLD'S LARGEST SUPPLY. 1001 Labor Saving Adaptations for Pulling, Pushing, Lifting Operations. Finest Precision workmanship and materials. Liquid and/or Air Operation.
 20,000 Available. Write for Catalog. Priced to sell at 15% Gov't Cost.

Hydraulic PUMPS
MP-5 - For operating hydraulic system on tractors, trucks, construction & industrial machinery, etc. Delivers 8 GPH at 1200 RPM at 1000 PSI on 5 HP. . . . 3/8" and 1/2" threaded standard pipe ports - 3/4" keyed shaft for pulley or gear drive - 4 mounting holes. 7" L x 5 1/2" W x 5 1/2" H - Used but guaranteed condition. Originally cost over \$100 ... Now Only **1750**

P-1 PESCOTYPE - Positive displacement gear type. Capacity: 1 gal. per minute, at 1500 RPM at 1500 PSI. Operating speed: 3700 RPM intermittent max. 4500 RPM. Rotation: either direction with slight adjustments. **\$9.49**

ROMEC FUEL PUMP
 800 GPH at 30 PS.L, can also be used as hydraulic for 4 GPM at 400 PS.L or for Vacuum drawing 15" mercury at 1500 RPM. **\$6.29**

VALUABLE GEAR BARGAINS!
 #112 8 to 1 ratio, spindle drive
 #110 \$2.98
 6 to 1 with screw shaft
 #111 \$4.98
 #112 85 to 1 (can be used for radio, antennae, etc.) . #112 . . \$3.95
 #G-11 - 10-1 gear ratio \$3.95

D. C. GENERATORS
 Suitable for adaption to home welding units, portable and rural lighting, power plant on boats, etc

TYPE	AMPS	VOLTS	
New T1	25	12	\$13.95
Used but Guaranteed Condition			
G1	140	27	\$17.95
P1	200	27 1/2	\$22.50
R1	300	30	\$29.75
E5A	50	12	\$17.95

D. C. METERS

AMMETERS	0 - 120	VOLTMETERS	
-30 - 0 - 30+	0 - 240	0-30	\$3.95
-60 - 0 - 60+	0 - 300		\$3.95 ea.
	0 - 350		

All 2" face except 0-300 which is 3" face.

COMBINATION VOLT-METER - AMMETER
 30V - 30 AMP **\$4.95**
 30V - 60 AMP

SHUNTS - Required for use with D.C. Ammeters 30-60-120-240-300-350. **\$1.00**

Palley POWER PARADE

NEW BRIGGS & STRATTON MOD. "A"

GAS ENGINE That nationally known "workhorse" of single cylinder engines! 2.10 HP-4 cycle, air cooled. Economical & Easy to Operate. Drives small pumps, boats & farm equipment. Brand New - Still in Original Crates. **BS-A ONLY \$62.95**

CONTINENTAL The famous 4 cycle, aircooled-"L" head gas engine, 1 1/2 to 2 HP. Cheap power for Farm, Factory, Shop---ONLY **\$47.95**

Ellinwood "44" A Real Buy!! 4.4 to 5 HP with optional power take-off from crankshaft, 1-1 speed from camshaft 2-1 reduction. Lightweight & of finest component parts-Bendix, Timken, Air Maze, etc. A Terrific Gas Engine Value . . . **\$69.95**



POWER UNIT PU-1
 Complete Model GKB 12-24-100 consists of sgl. cyl., 4 cycle, air cooled Briggs-Stratton Gas Engine directly connected to 2800 watt generator. Engine is 6 HP governed between 2500-3200 RPM. Generator rated 28.5 V - 100 A. Unit mounted 4 rubber shock mts., channel iron base & wheels. Use as Lighting or Power Plant The Buy Of The Century **\$109.89**
 Good Cond. - Overhauled

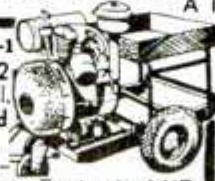

10 H. P. CONTINENTAL GAS ENGINE
 4 cylinder - Water cooled - Complete with Radiator, Tachometer, Magneto ignition & built-in gas tank - Mounted on heavy steel frame for portability - A very powerful, smooth running job. Used but in guaranteed condition. **\$175.00**

Electronic Transmission Gear Train
 GT-1 Containing approx. 50 Bronze Spur & Pinion Gears ranging from 3/8" to 4" dia., 5 sets of 7 cluster gears, 2 complete worm & worm gear drive sets, 40 N.D. ball bearings from 1/2" to 1 1/2" dia. watch springs, bushings, posts, face plates, housings, Micro Switches, etc. All gears are in multiple size and sequence with identical teeth ratio giving hundreds of ideal gear reduction combinations. 19 lbs. of Pleasure and profit. A Tremendous Gadget Mine. ONLY **\$8.49**

New Electric Motors
 #500 new 1/2 HP - 27 Volt DC 24 Volt AC. This motor can be readily adapted to deliver up to 1/2 HP on 110 Volts AC by the simple method of rearranging armature brush-leads. Free diagram with each order. A Sensational Value **\$5.95**
 #500A Converted to 110 Volts-AC. Equipped with plug and 3 1/2 ft. Heavy Duty Cord **\$8.49 ea.**
 #501 - 1/6 HP - 24 Volt DC. Motor. Series wound. NEW- **\$3.95 ea.**
 #502 - 2 HP - 24 V DC used **\$8.95**



1/4" Black & Decker ELECT. DRILL Drills all materials, polishes, buffs, sands & grinds, Strong, light die-cast Aluminum housing, fast operating Jacobs hex-key type chuck, instant release trigger switch, hard wearing gears, pinions & bearings, Operates on 110 Volt AC or DC, 7-5/8" long-wt. 3 1/4 lbs **\$18.95**

FIRE EXTINGUISHER
 Kiddie Lux C-2 Type. Built to Gov't Spec. Shatter-proof, heavy case. Fully re-charged, with Horn.
 4 lb. 18" x 5" - Wheel Control with horn... 4-TB Type. A \$25.00 Value. #601-B **\$13.25**
 7 1/2 lb. - \$35 Value. #602A **14.75**
 10 lb. - A \$65.00 Value - #603 **\$25.75**
 15 lb. - New. Break Disc Type. - A \$75.00 Value. #605-A **29.75**
 15 lb. Wheel Control Type. #605-B **32.95**
 15 lb. New. Squeeze Grip Type. - \$85.00 Value. - #605-C **\$39.95**



Vickers Hydraulic Transmission
 Self contained, 2 H.P. constant torque at all speeds with variable volume reversible, piston pump (controlled by outside lever) supplying piston hydraulic motor. Automatic pressure, dash pot for smooth control. Power output R.P.M. - 0 to 1/3 input R.P.M. in both directions. Input R.P.M. 1800 continuous 4000 intermittent. Dash pot can be removed for greater R.P.M. Ideal for Lathes, Duplicator Setup on Mills, Conveyors, Small Cars, Drives, Gearing, etc. **COST GOV'T APP. \$400.00. \$19.50**

GEAR BOXES VTG-1 - 90°, bevel gear 1 1/2 to 1 reduction, size 7" x 6". A Lifetime Value. **\$3.95**
 VTG-2 - Inline spur gear 16 to 1 reduction, thru 4 gears. Final take-off 4 1/2" dia, 26 tooth. 3/4" Alum. spur gear. . **\$6.49**
 Both above gear boxes have lever control for engaging & disengaging positive clutch. Dust proof housing. Prelubricated bearings. Both can be adapted to Vickers Transmission.

92 PG. 1949 CATALOG
 10,000 Bargains in War Surplus Tools, Machinery, Raw Materials, Clothing, etc. 92 Pages, Illustrated with valuable information tables, charts & data. Send 25¢ to cover handling and postage.

Order from this Ad. All sales final. All Prices F.O.B. Los Angeles. Pay by M.O. or Check. P.O.'s Accepted from D & B firms. 1/2 deposit with C.O.D.'s.

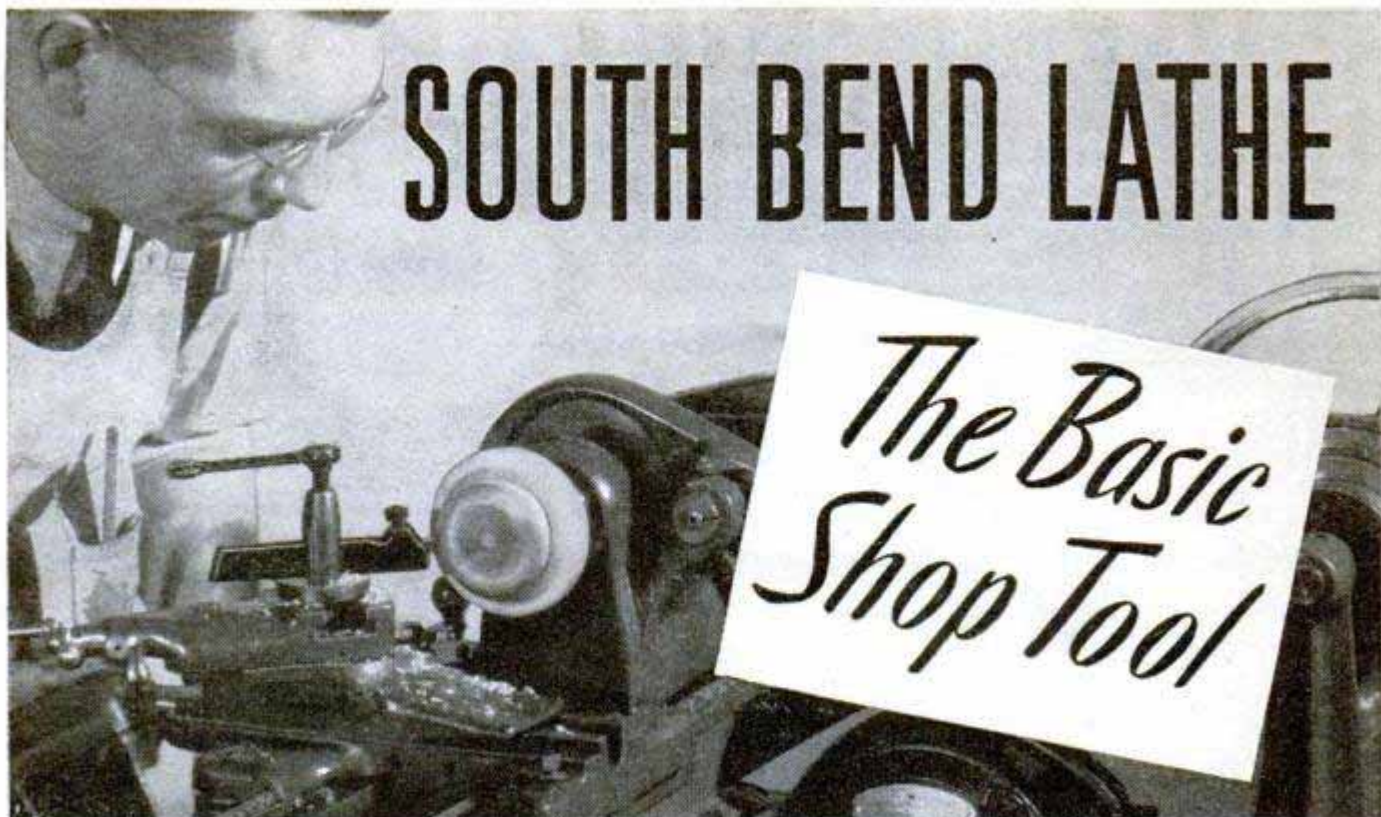

SOUTH BEND LATHE

The Basic Shop Tool

A FEW
OF THE MANY
OPERATIONS
YOU
CAN PERFORM



TURNING

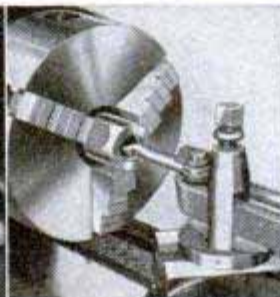

BORING



THREADING



FACING



MILLING



GRINDING

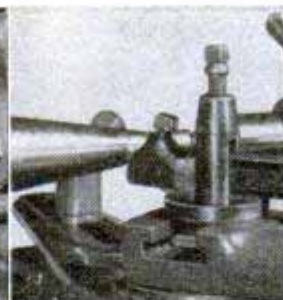

TAPER TURNING

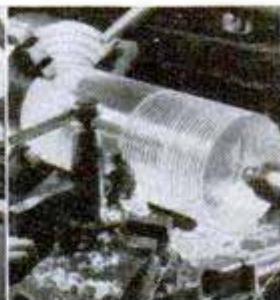

PLASTICS WORK

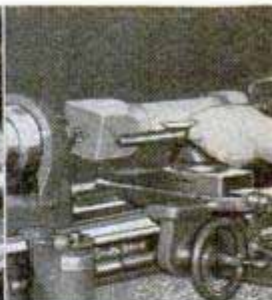

WOOD TURNING

A South Bend Lathe is the basic tool for your shop. It enables you to accurately perform the same full range of machining operations that are done on South Bend Lathes in the toolrooms and machine shops of industry.

With a South Bend Lathe as the basic tool in your shop, greater value for each dollar invested is assured. Write today for catalog

—please mention the size lathe you require; 9", 10", 13", 14½", 16" or 16/24" swing.

We also manufacture 14" Drill Presses, bench or floor models, and 7" Bench Shapers. Information on request.

Any South Bend Machine Tool can be purchased on time payments—25% down, 12 months to pay balance. Moderate finance charge.

BUILDING BETTER TOOLS
SINCE 1906



SOUTH BEND LATHE WORKS

455 EAST MADISON STREET • • SOUTH BEND 22, INDIANA

Printed by Popular Mechanics Company, Chicago, Ill., U. S. A.

SURE CURE FOR

Oil Waste



Gas Waste



and Failing Power



Our Challenge

There are thousands of designs of piston rings made by 77 manufacturers—BUT this Sealed Power MD-50 Steel Oil Ring has no equal for oil control in badly tapered and out-of-round bores. Paste the coupon on a postal card and mail it for positive proof!

SEALED POWER PISTON RINGS

Save Gas! Save Oil! Seal Power! In badly tapered, out-of-round bores.

Worn cylinders become tapered. They get out of round. Reboring to correct these conditions costs a lot of money. But the Sealed Power MD-50 Steel Oil Ring has the needed pressure and flexibility to control oil even in badly tapered and out-of-round bores. It is the best ring built for this purpose. Mechanics from coast to coast tell us the Sealed Power MD-50 does the job where other rings fail. Mail the coupon today!

There is a Sealed Power Set specifically engineered for your car, truck or tractor—whatever the make, model, or engine condition!

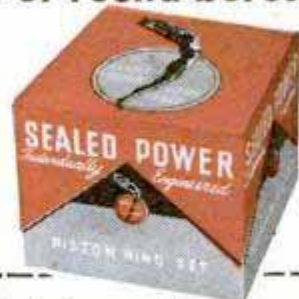

Sealed Power
PISTON RINGS
BEST IN OLD CARS! BEST IN NEW CARS!



Mail coupon for
FREE BOOKS!

SEALED POWER CORPORATION,
Dept. G 10, Muskegon, Michigan
Please send me your two FREE books, "Proof!"
and "Seven Ways to Save Oil."

Name _____

Address _____

(Paste coupon on penny postal card)

When safety's a must, it's **PRESTONE**[®] ANTI-FREEZE

**YOU'RE SAFE
FROM FREEZE-UPS**
no matter how cold it gets!



**YOU'RE SAFE
FROM BIG BILLS**
due to frozen radiator or cracked engine!



**YOU'RE SAFE
FROM BOIL AWAY**
no matter how warm it gets
between cold spells!



One shot lasts all winter!

Now, more than ever, with cars a major investment, it makes sense to have the safest, surest anti-freeze in your car!

THERE'S NOTHING ELSE LIKE IT!

"Prestone" anti-freeze, America's Number One brand, is made to an exclusive formula. No other anti-freeze offers you the same protection. Year after year, more motorists depend on "Prestone" brand anti-freeze for safe, sure, all-winter protection.



**NO RUST • NO FOAM
NO FREEZE • NO FAILURE**
GUARANTEED! Ask your dealer to show you the guarantee. It's your assurance of all-winter safety.

The registered trade-marks "Prestone" and "Eveready" distinguish products of
NATIONAL CARBON COMPANY, INC.
30 East 42nd Street, New York 17, N. Y.
Unit of Union Carbide and Carbon Corporation

**\$3.50
PER GALLON**

"PRESTONE" BRAND

AMERICA'S LARGEST-SELLING ANTI-FREEZE