

ANC



POPULAR MECHANICS

MAGAZINE

WRITTEN SO YOU CAN UNDERSTAND IT

MADE IN GREAT BRITAIN, NO. 410825



BEACHHEAD FLYING BOAT

Page 133

TELEVISION INTERFERENCE

In many areas, a car with the motor running can ruin a television program. Ordinary spark plugs broadcast a signal which interferes with television reception. A switch to Auto-Lite Resistor Spark Plugs will check this annoyance.



Checked b

British Bill Would Curb Spark Plug Interference With Television

London—The Government announced tonight that it is enacting legislation making persons subject to \$400 fine and possible jail sentence of three months for causing interference during peak radio and television periods. For example, motorists will be asked to fit suppressors to their motors.

HERE'S THE PROBLEM

Few people realize that a major cause of faint television reception, particularly in areas where the television signal is weak, originates not at the set itself but from ordinary spark plugs on nearby automobiles. This poor reception, justifying and wobbling in the image, comes from the radiation of the electrical discharge in passing vehicles—your car, your neighbor's, or delivery cars or traffic on your street. The ordinary automobile spark plug acts as a miniature broadcasting station that frequently spoils what would otherwise be clear, sharp television images.

It can happen here!

Read What Television Experts Say:

FRANK STANTON, President, Columbia Broadcasting System: "There is no question in my mind that ignition interference is a contributory cause to poor television reception. The resistor type spark plug appears to be the answer."



J. R. POPPELE, President, Television Broadcasters Association of America: "Interference by automobile ignition systems to television is quite common and is often very severe in outlying areas. I have witnessed tests in which the new Auto-Lite Resistor Spark Plug was very effective in reducing interference to television receivers under such conditions."



W. R. MacDONALD, President, Radio-Television Institute: "The sooner every car and truck in America is equipped with the new Auto-Lite Resistor Spark Plug, the better it will be for the television industry and everyone who owns a television set."

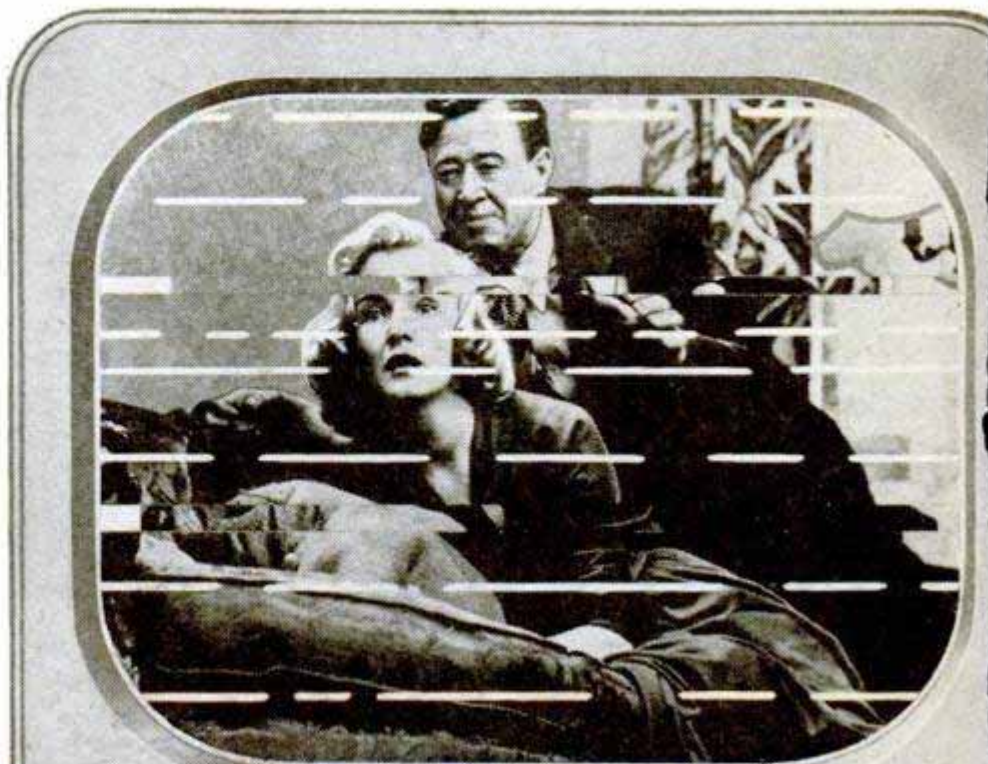

An authoritative article, "Television Brings Change in Car Ignition Behavior," reprinted from the S.A.E. JOURNAL published by the Society of Automotive Engineers, is available without charge.

The effect of ordinary spark plugs on the TV image is shown in this scene from Auto-Lite's "Suspense!" show, "The Creeper" starring Nina Foch and Anthony Ross.

Popular Mechanics Magazine

Registered in U. S. Patent Office and Canada

H. H. WINDSOR, *Founder*

H. H. WINDSOR, JR., *Editor and Publisher*



this month's cover

A TWIN-HULLED giant of the skies swoops down on the water and rams up against the enemy beach. Ramps pivot down from the huge fuselages and men and armored equipment pour ashore. That's the way the beachhead of the future will be taken, according to a man who should know. He's Ernest G. Stout, head of naval aircraft research for the Consolidated-Vultee Aircraft Corporation, and therefore a top expert on huge flying boats. Stout believes that such planes may be the ships of the future. He points out that in the event of war, submarine packs may well eliminate ordinary shipping. In order to discover the behavior patterns of such huge planes, Convair has built complete miniature aircraft powered by their own tiny engines and controlled by radio. It takes a hot pilot to bring them in for a landing. This important research is described by Ewart Thomas, who visited the Convair research laboratory, in a feature on page 133

Published monthly by Popular Mechanics Company, 200 E. Ontario St., Chicago 11, Ill. H. H. Windsor, Jr., president; William Harrison Petridge, vice president; D. F. Windsor, vice president and secretary-treasurer; Clover L. Perkins, advertising manager; Alan M. Deyoe, circulation manager. Single copy in the United States and Canada, 35 cents; subscription rates in United States and possessions, Canada, Philippines and countries of the Pan-American Postal Union, 1 year, \$3.50; 2 years, \$6.00; 3 years \$8.00. To all other countries add \$1.00 a year over United States prices for overseas postage. If you plan to move, notify us at least 30 days in advance so you will not miss an issue. Give both old and new addresses. Entered as Second Class Matter, September 15, 1903, at the Post Office at Chicago, Illinois, under Act of March 3, 1879. Entered as Second Class Matter at Post Office Dept., Canada. Copyright 1949 by Popular Mechanics Company, Copyright under International Copyright Union. Copyright in France. All rights reserved under Pan-American Copyright Union. Printed in the United States of America.

Volume 92 SEPTEMBER 1949 Number 3

Managing Editor.....Roderick M. Grant
 Assistant Managing Editor.....Wayne Whittaker
 Shop Notes and Crafts Editor.....James R. Ward
 Radio-Television, Electronics Editor.....Frank L. Brittin
 Associate Editor, AviationAubrey O. Cookman, Jr.
 Associate Editor.....Clifford B. Hicks
 Eastern Editor.....Richard F. Dempewolff
 Western Editor.....Thomas E. Stimson, Jr.
 Art Director.....Frank Beatty

Assistant Editors

Donald R. Brooks Dorothy E. Hoffmann Arthur R. Railton

Assistant Editors, Shop Notes and Crafts

W.Clyde Lamme Wayne C. Leckey Frank N. Stephany A.E. Youngquist

IN THIS ISSUE

Deep-Sea Mystery Story	- - - - -	81
They Keep the Old West Alive	- - - - -	92
Artists With Straw and Feathers	- - - - -	97
Hot Rods and Electrons	- - - - -	106
"Dust Bowl" Laboratory	- - - - -	114
First of the '50 Cars	- - - - -	118
Call Out the Mules and Beetles	- - - - -	128
From Model to Monster	- - - - -	133
High-Voltage Magic	- - - - -	140
Hospital for Sick Cars	- - - - -	144
The Tool That Surprised Its Makers	- - - - -	158
Gems From Turkey Gizzards	- - - - -	166

For the Craftsman

Salad-Bowl Novelties	- - - - -	174
Dining-Room Furniture—Part I	- - - - -	182
Repainting the Outside	- - - - -	194
Don't Let This Happen to You	- - - - -	201
Viewer for Large-Size Color Slides	- - - - -	209
Jointing on Your Bench Saw	- - - - -	213
Better Boring	- - - - -	218
Sewage-Disposal System for Rural Homes	- - - - -	224
Radio-Television, Electronics	- - - - -	229
Clinic for Homemakers	- - - - -	240

Other items, and manufacturers of available products described, are listed on pages 10, 12 and 14



**A MUST FOR EVERY FARM FAMILY!
SAVES MONEY FOR HOME OWNERS
A PRICELESS GIFT TO SEND TO
A FAMILY ON THE FARM!**

**Farm Help That Works
Every Day in the
Year For
Only \$3**

*A Thousand and
One Ideas You Can
Use on the Farm!*

Popular Mechanics Farm Manual is packed with practical ideas and usable information that can easily be worth hundreds of dollars to every farm family and to home owners everywhere. Here are a few of the things it covers:

Farm Machinery and Implements

How to make tractors, scoops, scrapers, cordwood saws, buckrake, power driven elevator, "Farm-ette"—odd job tractor, hoists, dump trucks, spreaders, seed-grain duster, posthole auger, etc.

Farm Workshop Equipment and Repairs

Welding on the farm, soldering, workshop power saws, home built air compressor, small shop forge, workbenches, curing gas engine troubles, hydraulic rams, drive your own wells, etc.

Poultry and Livestock

How to build poultry houses, incubators, brooders, at low cost, feeding, stock care hints, hog care gadgets, etc.

Vegetable Storage — Processing

All-winter vegetable storage, preparing food for home-freezer storage, how to make your own home freezer, charts, guides.

Farm Home Improvement

Fencing, repairing electrical appliances, plumbing, electrical wiring, saving coal, painting, curing leaky basements, hanging wall paper, making garden tools, garages, working with concrete, painting, etc.

Farm Hints and Kinks

Forty pages of illustrated practical ideas, short cuts, etc., that will save time, labor and money around every farm and city home.



**POPULAR MECHANICS
FARM
MANUAL**

**Use This Book to Step up Farm Efficiency—
Increase Farm Production—Improve Farm
Appearance—Save Time, Labor, Money!**

This is the book that thousands of farmers and home owners have waited for. It is the experience of hundreds of successful operators brought together in one handy, easy-to-read, easy-to-use, working handbook by the editors of Popular Mechanics. It is brimful of short cuts, labor-saving ideas, ingenious apparatus and methods that will simplify the day's work and lighten some of the more tedious chores, make money and save money for you.

**284 FACT
PACKED PAGES
•
HUNDREDS OF
ILLUSTRATIONS
•
FULL SIZE
Library Binding**

HELPS IN THE FIELD — IN THE BARN — IN THE HOME

Every department of the farm is covered in the Farm Manual. Every member of the family will find in it something that he or she can use to tremendous advantage in farm operation, maintenance and improvement, from the building and care of equipment to painting the farm home and fast freezing fruits and vegetables. It covers all farm buildings, the farmhouse and other homes and is of interest equally to the woman looking for home improvement, beauty and convenience and the man striving for easier and more profitable operation.

ORDER TODAY — FOR YOURSELF — FOR A GIFT

Use the coupon below. Mail it today. Book will be sent at once, post-paid if you include payment with your order. If you don't think the Farm Manual is worth even more than you paid for it after five days' use, send it back by mail and your money will be refunded. This may be the best investment you ever made. Rush coupon today.

MAIL COUPON • Money Back if Not Satisfied

Popular Mechanics Press, Dept. 49C
200 East Ontario St., Chicago 11, Ill.

Send _____ copies of the Farm Manual at once.
 Remittance (\$3.00 each) enclosed. Send postpaid. Add 15% if outside U.S.A.
 Send C.O.D. (\$3.00 each) plus delivery charges. U.S.A. only.
(If sent as a gift to another, send name and address on separate sheet.)

Name _____
Address _____
City _____ Zone or Route _____ State _____



RCA Laboratories developed a copper mesh with 2,250,000 tiny openings to the square inch for the television camera "eye."

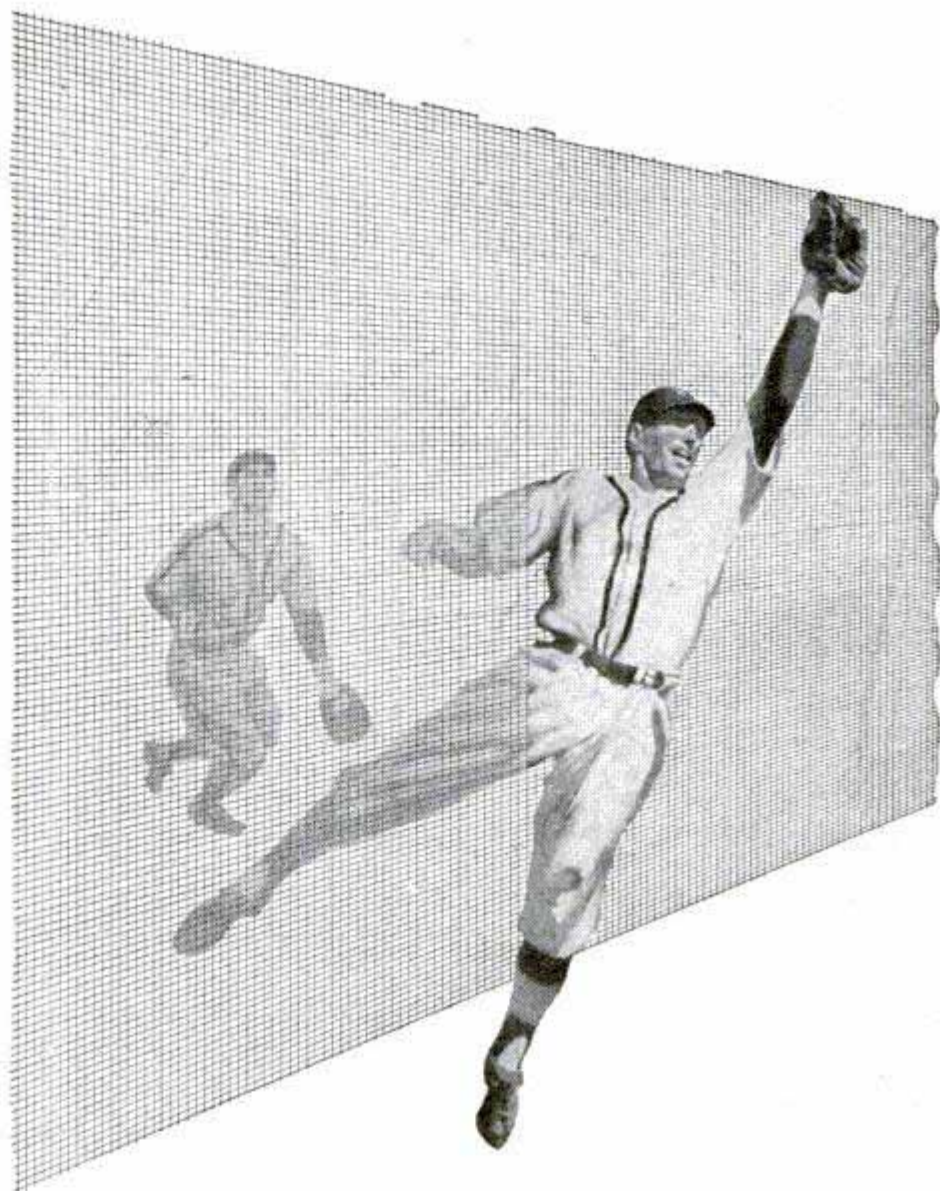

You get finer television pictures through this super-fine mesh

In RCA Image Orthicon television cameras you will find a super-fine copper mesh. Until a new technique for making this type of screen was discovered at RCA Laboratories, only coarse and irregular mesh—which obstructed 60% of the picture—was available.

Today, through RCA research, such mesh can be made with 1500 gossamer wires to

the linear inch. An ordinary pinhead will cover about 7000 of its tiny openings.

By RCA's technique—now producing commercial quantities of 200- and 500-mesh screens—the mesh is so fine, so regular in structure, that it is invisible on home television receivers . . . and as much as 85% more television picture passes through.

You benefit—many times

This new type of super-fine wire mesh, like most major

developments in all-electronic television, is another RCA Laboratories first. Leadership in science and engineering adds *value beyond price* to any product or service of RCA and RCA Victor.

* * *

The newest developments in radio, television, and electronics may be seen in action at RCA Exhibition Hall, 36 West 49th Street, N. Y. Admission is free, and you are cordially invited. Radio Corporation of America, Radio City, N. Y. 20.



RADIO CORPORATION of AMERICA

World Leader in Radio — First in Television

This One





Shift gears as in a car



**2-SPEED MAGIC
on your bike!**

Easy does it when you have a New Departure "Speed Changer" for your bike.

It works like a gear shift on a car—*low speed* for quicker getaway, easier pedaling on the hills, better control in traffic; *high speed* for making time on level stretches.

Your bicycle dealer will fit the "Speed Changer" right into the New Departure Coaster Brake on your bike. Ask him about it today!

On your new bike insist on America's favorite

New Departure COASTER BRAKES

FREE! Have fun mystifying your friends! Guess their ages, read their minds! Send a postcard for Magic Packet P5. Address:

**NEW DEPARTURE • DIVISION OF GENERAL MOTORS
BRISTOL, CONNECTICUT**

1868

in this corner.....

THE EDITORS



Portrait in Popotes

When one of our executives opened a parcel from Mexico and found therein a portrait of himself done in bits of colored straw, we detected a story. So Thomas E. Stimson, Jr., was dispatched from Los Angeles (formerly known as La Ciudad de Nuestra Señora la Reina de los Angeles) to Mexico, D. F., to see how this ultra-painstaking art is achieved. His story appears in full color starting on page 97 in this issue. . . . The executive's portrait, by the way, was an amazing likeness copied from a black-and-white photograph. His blue eyes turned out to be brown, however, in the Mexican version.

* * *

Cargador Plays Rondador

In case you don't recognize it, the accompanying picture is of a cargador playing his rondador. The photograph was sent in by one of our many South American readers in Quito, Ecuador. He explains that a cargador is a native who carries

(Continued to page 8)



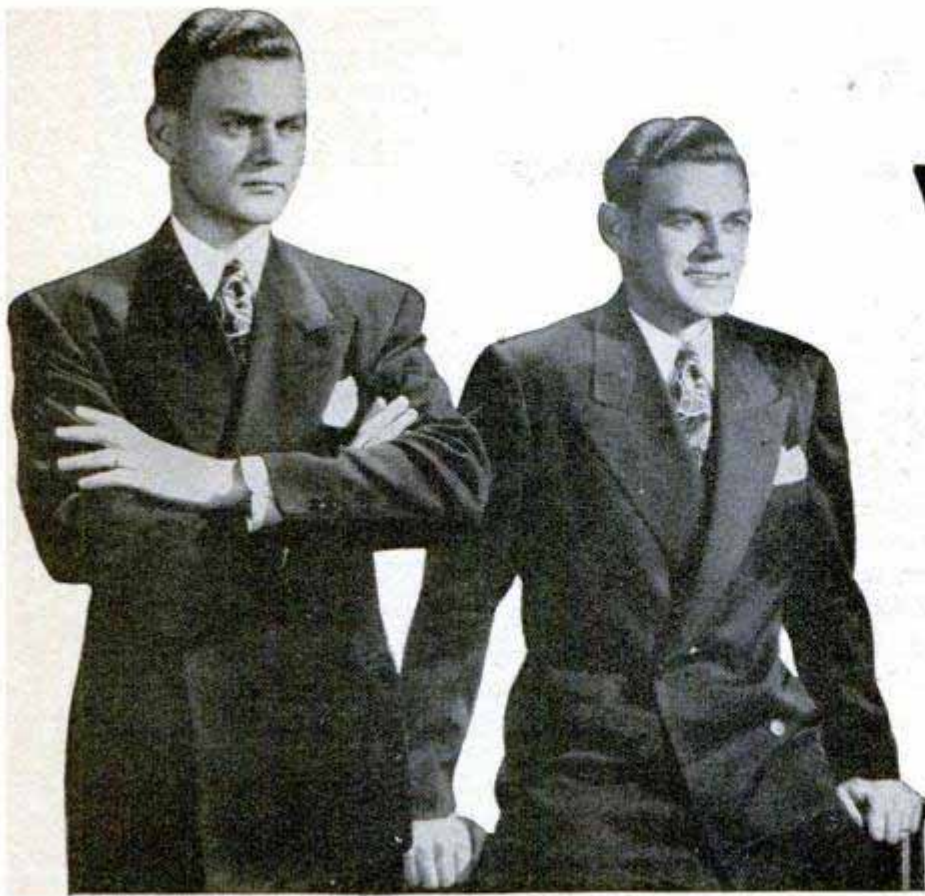

If YOU were Boss would YOU promote "YOU"?

Business is always willing to pay the man who knows—and pay him well. The man who is ready and will-

Be honest now—

suppose that a better job had opened up in your company—carrying with it promotion and more money—could you qualify?

If you were boss, would you select "YOU" for that better job?

Consider before you answer.

First of all, could you *fill* the job? Has your experience fitted you for the step forward—have you been preparing for promotion apart from experience gained on the job?

Or have you just been filling a niche, doing daily tasks well but making no real and intelligent effort to learn and qualify for the job ahead so that if an opening should occur you would be ready to fill it?

The man who gets real promotion is the one who makes his own breaks—the man who slaves in the ordinary job at low pay just wishes and dreams of promotion and more money. Which are you?

ing to take responsibilities—and capable of directing the efforts of other men is a valuable asset to any business organization. He never wants for a good job and above average earnings. He gets ahead.

We have helped thousands of men achieve promotion and more money—success sometimes beyond their dreams—a success that was started by a coupon similar to the one below.

Get out of that rut—don't be satisfied with a mediocre job at small pay—be a success in business—this coupon may be your first step.

Mail the coupon and we'll include "Ten Years' Promotion in One"—a book which has helped many men. Do it today—tomorrow never comes for the man who consistently puts things off.

LASALLE EXTENSION UNIVERSITY A Correspondence Institution

Dept. 964-R, 417 S. Dearborn, Chicago 5, Ill.

Please send me your free 48-page booklet telling how I can succeed in the field I have checked below—plus "Ten Years' Promotion in One" without obligation.

- | | |
|--|--|
| <input type="checkbox"/> Higher Accountancy | <input type="checkbox"/> Traffic Management |
| <input type="checkbox"/> C.P.A. Coaching | <input type="checkbox"/> Foremanship |
| <input type="checkbox"/> Bookkeeping | <input type="checkbox"/> Industrial Management |
| <input type="checkbox"/> Law: LL.B. Degree | <input type="checkbox"/> Stenotypy |
| <input type="checkbox"/> Business Management | <input type="checkbox"/> (Machine Shorthand) |
| <input type="checkbox"/> Salesmanship | |

Name..... Age.....

Address.....

City, Zone, State.....

LASALLE EXTENSION UNIVERSITY

A Correspondence Institution

Dept. 964-R

Chicago 5, Illinois

PYROIL WINS AGAIN! 8 out of 10 Winners in the 500 Mile Memorial Day Race at Indianapolis used Pyroil

The going's rough on the Indianapolis Speedway—where performance, endurance, dependability and top lubrication count most. That's why year after year, the professional drivers who are the winners in the famous 500 mile Memorial Day Classic insist on Pyroil.

On the speedway or highway—Pyroil improves lubrication by providing a protective film of oil on cylinder walls. Pyroil prevents sludge and gum formation, assuring your car a free flow of lubrication at all times.

To win miles of added driving comfort—add Pyroil—add miles to your car.

Pyroil for Aircraft Engines

Use Aircraft Pyroil B for lubricating oil, Aircraft Pyroil A for gasoline.

GIVEN! An attractive Pyroil metal savings bank—takes coins up to 50c pieces. **MOTORISTS**, it's yours for the asking—sent postage paid.

Manufactured and Guaranteed by Pyroil Company, 95 Pyroil Bldg., La Crosse, Wisconsin.

Canadian Distributors: Central Purchasing Agencies, Ltd. Toronto, Ontario



PYROIL COMPANY

95 Pyroil Bldg., La Crosse, Wisconsin

I want my car to last and run properly. Please tell me more about Pyroil and how it can accomplish this for me.

Name _____

Address _____

City or Town _____ State _____



(Continued from page 6)

anything from a basket of groceries up to a 200-pound sack of rice. Most cargadores are small men of Quichua blood, the race of the once-proud Inca Empire. The rondador is a popular homemade musical instrument, a sort of bamboo flute made from different lengths of small bamboo tied together by two half strips of the same material. You do not blow into a rondador, but purse the lips and blow over the open tubes as the instrument is moved back and forth like a mouth organ. The music, says our correspondent, Pancho Vega, is soft and mellow and the length of a tune is determined only by the player's wind.

* * *

Our Ads Have a Long Pull

It doesn't naturally follow that an advertisement in *Popular Mechanics* will always bring you an invitation to a wedding in India, but it has happened. Back in November 1947 the Belsaw Machinery Company of Kansas City, Mo., advertised a multi-duty planer. Not long ago an answer came from Bombay, traced by a key number to that 1947 ad. It was addressed to the Belsaw Company and contained the following invitation:

"The General Manager and Partners of the firm of Messrs. P. Desai Corporation request the pleasure of the company of the Manager and Staff Members at the Wedding Ceremony of Shri Prataprai Desai (Partner and Sales Manager) with Kumari Mira, daughter of Shri Kanaiyalal Venilal Desai on Thursday the 3rd of February 1949."

Unfortunately, the Messrs. Belsaw could not attend. The invitation arrived a month after the ceremony. But E. S. Field, Jr., general manager of Belsaw, was glad to see his company's advertisement was still pulling, 15 months later.

* * *

Next Month

Next month's color feature describes the new Eastman Flexichrome process by which vividly real color pictures are produced by a simple, all but foolproof, method starting with an ordinary black-and-white photograph. Here is a process that may soon revolutionize the art of color printing—even that of the amateur camera fan, when Flexichrome becomes more readily available to him.

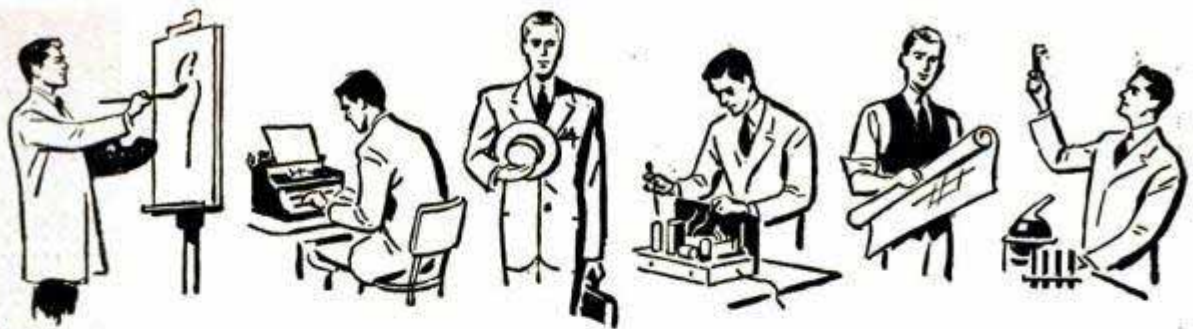

CASH IN on your HIDDEN TALENTS

Locked in your mind may be the germ of a valuable idea . . . an undeveloped aptitude . . . a hidden talent. And the key that can help unlock those capabilities of yours is *training*—sound, practical, down-to-earth training!

Helping men and women bring out the best that's in them has been the job of I. C. S. for more than 57 years. In every field of industry, you'll find leaders whose skills were developed through study with I. C. S.

They are the ones who sensed a latent ability within themselves—and who proceeded to do something about it. While others (equally gifted, perhaps) plodded along in routine jobs, they mastered I. C. S. Courses . . . qualified themselves for rich rewards.

You can develop your hidden talents the same way they did. Start *today* and be ready for tomorrow's opportunities. Here's the coupon to mail:

INTERNATIONAL CORRESPONDENCE SCHOOLS

APPROVED
under the
G. I. BILL

BOX 5659-K, SCRANTON 9, PENNA.

Without cost or obligation, please send me full particulars about the course BEFORE which I have marked X:

- | | | | |
|---|---|---|---|
| <ul style="list-style-type: none"> <input type="checkbox"/> Air Conditioning and Plumbing Courses <input type="checkbox"/> Air Conditioning <input type="checkbox"/> Heating <input type="checkbox"/> Refrigeration <input type="checkbox"/> Plumbing <input type="checkbox"/> Steam Fitting Chemical Courses <input type="checkbox"/> Chemical Engineering <input type="checkbox"/> Chemistry, Analytical <input type="checkbox"/> Chemistry, Industrial <input type="checkbox"/> Chemistry, Mfg. Iron & Steel <input type="checkbox"/> Petroleum Refining <input type="checkbox"/> Pulp and Paper Making <input type="checkbox"/> Plastics Civil Engineering, Architectural and Mining Courses <input type="checkbox"/> Architecture <input type="checkbox"/> Architectural Drafting <input type="checkbox"/> Bridge and Building Foreman <input type="checkbox"/> Building Estimating <input type="checkbox"/> Civil Engineering <input type="checkbox"/> Coal Mining <input type="checkbox"/> Contracting and Building <input type="checkbox"/> Highway Engineering <input type="checkbox"/> Lumber Dealer <input type="checkbox"/> Reading Structural Blueprints <input type="checkbox"/> Sanitary Engineering <input type="checkbox"/> Structural Drafting | <ul style="list-style-type: none"> <input type="checkbox"/> Structural Engineering <input type="checkbox"/> Surveying and Mapping Communications Courses <input type="checkbox"/> Electronics <input type="checkbox"/> Practical Telephony <input type="checkbox"/> Radio, General <input type="checkbox"/> Radio Operating <input type="checkbox"/> Radio Servicing <input type="checkbox"/> Television <input type="checkbox"/> Telegraph Engineering Electrical Courses <input type="checkbox"/> Electrical Drafting <input type="checkbox"/> Electrical Engineering <input type="checkbox"/> Electric Light and Power <input type="checkbox"/> Lighting Technician <input type="checkbox"/> Practical Electrician Internal Combustion Engines Courses <input type="checkbox"/> Auto Technician <input type="checkbox"/> Aviation <input type="checkbox"/> Diesel-Electric <input type="checkbox"/> Diesel Engines <input type="checkbox"/> Gas Engines Mechanical Courses <input type="checkbox"/> Aeronautical Engineer's, Jr. <input type="checkbox"/> Aircraft Drafting <input type="checkbox"/> Flight Engineer <input type="checkbox"/> Forging <input type="checkbox"/> Foundry Work <input type="checkbox"/> Heat Treatment of Metals <input type="checkbox"/> Industrial Engineering <input type="checkbox"/> Industrial Instrumentation | <ul style="list-style-type: none"> <input type="checkbox"/> Industrial Metallurgy <input type="checkbox"/> Machine Shop <input type="checkbox"/> Mech. Drafting <input type="checkbox"/> Mechanical Engineering <input type="checkbox"/> Mold-Loft Work <input type="checkbox"/> Patternmaking—Wood, Metal <input type="checkbox"/> Reading Shop Blueprints <input type="checkbox"/> Sheet-Metal Drafting <input type="checkbox"/> Sheet-Metal Worker <input type="checkbox"/> Ship Drafting <input type="checkbox"/> Ship Fitting <input type="checkbox"/> Tool Designing <input type="checkbox"/> Toolmaking <input type="checkbox"/> Welding Engineering <input type="checkbox"/> Welding—Gas and Electric Railroad Courses <input type="checkbox"/> Air Brake <input type="checkbox"/> Car Inspector <input type="checkbox"/> Diesel Locomotive <input type="checkbox"/> Locomotive Engineer <input type="checkbox"/> Locomotive Fireman <input type="checkbox"/> Locomotive Machinist <input type="checkbox"/> Railroad Section Foreman <input type="checkbox"/> Steam-Diesel Loco. Eng. Stationary Eng'r's Courses <input type="checkbox"/> Boilermaking <input type="checkbox"/> Combustion Engineering <input type="checkbox"/> Engine Running <input type="checkbox"/> Marine Engineering <input type="checkbox"/> Power Plant Eng'r'g <input type="checkbox"/> Steam Engr. | <ul style="list-style-type: none"> Textile Courses <input type="checkbox"/> Cotton Manufacturing <input type="checkbox"/> Loom Fixing <input type="checkbox"/> Rayon Weaving <input type="checkbox"/> Textile Designing <input type="checkbox"/> Woolen Manufacturing Business and Academic Courses <input type="checkbox"/> Accounting <input type="checkbox"/> Advertising <input type="checkbox"/> App. Psychology <input type="checkbox"/> Bookkeeping <input type="checkbox"/> Business Administration <input type="checkbox"/> Bus. Correspondence <input type="checkbox"/> Bus. Law <input type="checkbox"/> Certified Public Accounting <input type="checkbox"/> Commercial <input type="checkbox"/> Commercial Art <input type="checkbox"/> Cost Accounting <input type="checkbox"/> Federal Tax <input type="checkbox"/> First Year College <input type="checkbox"/> Foremanship <input type="checkbox"/> French <input type="checkbox"/> Good English <input type="checkbox"/> High School <input type="checkbox"/> Higher Mathematics <input type="checkbox"/> Illustration <input type="checkbox"/> Industrial Supervision <input type="checkbox"/> Motor Traffic <input type="checkbox"/> Postal Civil Service <input type="checkbox"/> Retailing <input type="checkbox"/> Retail Bus. Management <input type="checkbox"/> Salesmanship <input type="checkbox"/> Secretarial <input type="checkbox"/> Sign Lettering <input type="checkbox"/> Spanish <input type="checkbox"/> Stenography <input type="checkbox"/> Traffic Management |
|---|---|---|---|

Name _____ Age _____ Home Address _____

City _____ State _____ Working Hours _____ A.M. to _____ P.M.

Present Position _____ Employed by _____

Length of Service in World War II _____ Enrollment under G.I. Bill approved for World War II Veterans. Special tuition rates to members of the Armed Forces. Canadian residents send coupon to International Correspondence Schools Canadian, Ltd., Montreal, Canada.

4 Keys to SUCCESS IN AVIATION

Through **Embry Riddle Training**

1 AIRCRAFT & ENGINE MECHANICS

We have hundreds of urgent requests for A. & E. Mechanics -- key men in Aviation -- from airlines, oil companies, fixed base operators, etc., both U. S. and Overseas. Training in a C. A. A. approved school is the quickest way to get ahead. Embry-Riddle students learn fast with modern equipment... working on live aircraft in airline-size hangars.



2 ENGINEERING

Embry-Riddle's Design Engineering and Maintenance course offers you eligibility for A. & E. certification plus necessary basic engineering knowledge required to fill positions such as Maintenance Foreman or Field Service, Project or Sales Engineer. If your aim is high, take this course.



A.&E. COMBINED WITH COMMERCIAL

Pilot Mechanics who can test fly the ships they repair... executive pilots able to service their own aircraft -- airmen with dual ability are needed by aviation companies and operators. Embry-Riddle combination training offers you the most in your aviation career.



3 COMMERCIAL PILOTS

Flying holds a real future for Embry-Riddle trained pilots. A quarter-century of experience with 30,000 students... the best instructors, up-to-date aircraft, superb year-round flying weather... qualifications unexcelled anywhere. Instrument and instructor's ratings are also available.



Aviation needs you now! Never has there been such opportunity for you in Aviation. Start your career now at Embry-Riddle -- living facilities directly on the Airport. Write today for full information and proof of job opportunities.

AUTHORIZED G. I. TRAINING

Dean of Enrollments - Dept. 99
Embry-Riddle School of Aviation
Miami 30, Florida

Please Print

NAME _____

ADDRESS _____

City _____

State _____ Age _____

I am interested in...

- A. & E. Mechanic
- Commercial Pilot
- Engineering
- A. & E. Combined with Commercial Pilot
- Flying Mechanic
- Drafting & Design

Check One Veteran Non-Veteran

TRAIN IN MIAMI--AIR CAPITAL OF THE WORLD

WHERE-TO-BUY-IT INDEX

Source of supply appears after items commercially available. For additional information on articles, write Bureau of Information, Popular Mechanics, 200 E. Ontario St., Chicago 11

AUTOMOTIVE

Oldsmobile Holiday coupe (Oldsmobile Division of General Motors Corp., Lansing, Mich.).....	104
DeSoto Carry-All (DeSoto Motor Corp., Detroit, Mich.).....	104
Crosley roadster-racer (Crosley Motors, 2537 Spring Grove Ave., Cincinnati 14, Ohio).....	104
Nonslip clamp tightens rope to tie load atop car (Ty-Down Company, 16801 Euclid Ave., Cleveland 12, Ohio).....	113
Automobiles climb hotel wall (Globe Hoist Company, 1000 E. Mermaid Lane, Philadelphia 18, Pa.).....	122
Rolling stool for mechanic (Clinton Products Co., Clinton, Mich.).....	122
Bolted tires, free retreats.....	126
Fire extinguisher for vehicles (Red Comet, Inc., Red Comet Bldg., Littleton, Colo.).....	139
Hill-test trailer for level ground.....	153
Diesel-powered car (Mercedes-Benz Werke, Unterturkheim, Germany).....	156
Car lighting system serves as turn indicator (Kilmur Corp., Kilkenny, Minn.).....	156

FARM

Homemade cutter "mows" treetops.....	126
Two-engine tractor.....	153
Computer cuts farm figuring.....	157
Steel skid behind garden tractor hauls heavy loads (Meyer Snow Plow Co., 3599 E. 82nd St., Cleveland 5, Ohio).....	163
Orchard crews work on hydraulic "ladders" (Harold Brock, Brock Inc., 105 S.E. Yamhill St., Portland, Ore.).....	163
Jeep trench digger (Auburn Machine Works Inc., Auburn, Neb.).....	164
Shotguns blast pollen into western fruit trees (The Borden Company, 350 Madison Ave., New York City 17).....	165
"Chemical frost" strips leaves from cotton plant (Koppers Co., Inc., Koppers Bldg., Pittsburgh 19, Pa.).....	264

FISH AND FISHING

Jar top catches minnows (Champ-Items, Inc., 6191 Maple Ave., St. Louis 14, Mo.).....	105
Bait box skims surface of water when boat is in motion (Machine & Welding Company, 318 18th Ave. South, St. Petersburg, Fla.).....	131
Boat carries fishline (Carya-Line, Inc., 4144 Lankershim Lane, North Hollywood, Calif.).....	260

HOUSE AND HOME

Is radiant heating modern?.....	96
"Homogenized" heat (The Coleman Company, Inc., Wichita 1, Kans.).....	117
Handy hanger for ironing board (Sav-A-Step Corp., 228 Main St., Peoria 2, Ill.).....	124
Bottle stopper tightened with wing nut (Hobby Hill, 175 N. Michigan Ave., Chicago 1).....	124
Appliance makes biscuits or waffles (Lewis Electrical Mfg. Co., Cleveland 8, Ohio).....	124
Dependable clothesline prop (Lindcraft Products, 3520 Wismer Road, Overland 14, Mo.).....	124
Lamp keeps toothbrushes germ-free (Stanley J. Pask Assoc., 74 Laight St., New York City).....	124
Package sealer for quick freezing (Sears, Roebuck and Co., Chicago).....	125
Noodles and spaghetti made at home (Aurelio Tanzi Corp., 430 Jefferson St., Brooklyn, N. Y.).....	125
Watering can for hard-to-reach pots (Dazey Mfg. Co., 2214 Stoner Ave., Los Angeles 25, Calif.).....	125
Moistureproof lining for baby's creepers (Miller Art Mfg. Co., 1370 Broadway, New York City 18).....	125
Coiled spring beater (Palma-Knapp Assoc., 185 N. Wabash Ave., Chicago).....	125
Coilless radiant heating (Scott-Newcomb, Inc., 1442 S. Boyle Ave., St. Louis 10, Mo.).....	132
Automatic electric plug (Academy Electrical Products Corp., 4849 Broadway, New York City 34).....	139
Steel cabinet fronts (Western Metalcraft, Inc., Olympia, Wash.).....	157
Low-pressure oil burner consumes crankcase drainings (U. W. Machine Corp., Lebanon, Ind.).....	169
Motor flange fits most oil burners (J-B Products, 79 Waydell St., Newark 5, N. J.).....	260
Valve for hot-water radiator vents automatically (J-B Products, 79 Waydell St., Newark 5, N. J.).....	262

TACO HORTERS INC., 137 SOUTH ST., PROVIDENCE 3, R.I. INDUSTRY

New lugs vulcanized on tires (American Tire Machinery, Inc., 724 S. Elliott St., Muncie, Ind.).....	86
Color computer (General Aniline & Film Corp., 230 Park Ave., New York City 17).....	87
Super lubricants from chemicals?.....	101
Nine-foot production line (Bartelt Engineering Co., Rockford, Ill.).....	102
Tractor winch unloads gravel from gondolas.....	113
Hardening steel (Wilson Carbon Co., 60 E. 42nd St., New York City).....	138
Truck's 12-ton load carried in sling.....	151
Underground steam may drive turbines.....	153
The rails will click no more in the Cascade Tunnel.....	154
Industrial accidents decrease.....	163
Prefab for use where mercury hits 112 below zero.....	164
Adjustable cargo cable locks like key chain (Peck & Hale, Inc., MacArthur Airport, Sayville, L.I., N. Y.).....	170
Low-pressure chamber serves as "flying kitchen".....	170
More powerful diesels.....	256

(Continued to page 12)

WHAT Every AUTO MECHANIC Wants to Know

A motor vehicle is a machine of many parts, each part designed and constructed for its own special function. All good mechanics, like good doctors, should know the working theory and operation of each part and understand what causes trouble and how to remedy it.

LET AUDELS AUTO GUIDE SOLVE YOUR PROBLEMS

Every auto mechanic, helper, serviceman and operator can use AUDELS AUTO GUIDE. The information it gives saves time, money and worry. Highly endorsed by all users. It presents the whole subject of auto mechanics from A to Z in plain language and simple terms.

This Big Practical Book gives full information with working diagrams covering the principles, construction, ignition, service and repair of modern cars, trucks and buses.

A complete Guide of 1800 pages, with over 1500 illustrations showing inside views of the working parts, with instructions for service jobs. Diesel engines, Fluid and Hydra-matic drives fully explained.

IT PAYS TO KNOW HOW TO

How to fit pistons—How to locate engine knocks—How to fit connecting rod bearings—How to service main bearings—How to recondition valves—How to time valves—How to adjust fan belts—How to adjust carburetors & chokes—How to rebuild a clutch—How to service automatic transmissions—How to service brakes—How to adjust steering gear—How to cope with ignition troubles—How to service distributors—How to time ignition—How to "tune up" an engine.

INFORMATION IN A HANDY FORM

73 INTERESTING CHAPTERS—Read this partial list of subjects on which practical information is fully given for quick reference under the headings as shown below. Ready Reference Index.

All Parts of an Automobile—Automotive Physics—The Gas Engine—Gas Engine Principles—Multi-Cylinder Engines—Horse Power—Automobile Engines—Stationary Parts—Moving Parts—Pistons—Piston Rings—Connecting Rods—Crank Shafts—Valves—Valve Gear—Cams and Cam Action—Valve Timing—Cooling Systems—Fuel Feed Systems—Dual Fuel Feed—Mixture—Carburetors—Carburetor Service—Automatic Choke—Super-Chargers—Transmissions—Special Transmissions—Fluid and Hydra-matic Drives—Clutches—Universals and Propeller Shafts

A Ready Reference

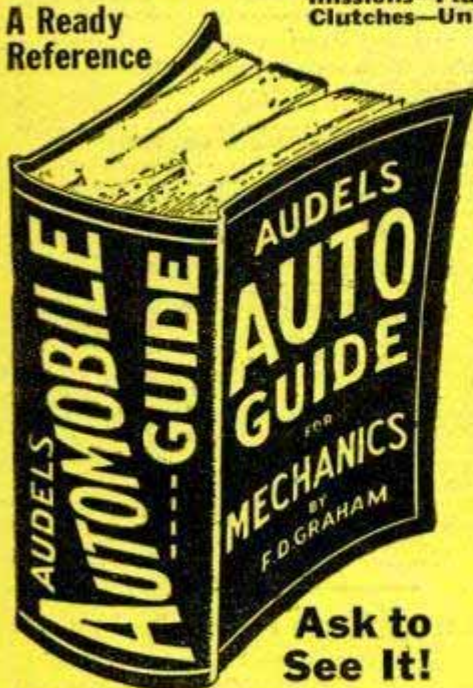

Ask to See It!

—The Differential—Rear Axles—Rear and Front Suspension—Running Gear—Brakes—Wheel Alignment—Knee Action—Steering Gear—Tires—Lubricants and Lubrication—Automotive Electricity—Ignition Systems—Magneto Ignition—Spark Plugs—Ignition Coils—Distributors—Automatic Spark Control—Ignition Timing—Generators—Starters—Generator and Starter Testing—Lighting Systems—Storage Batteries—Charging and Testing—Diesel Engines and Trouble Shooting.

7 DAYS' FREE TRIAL
TO GET THIS ASSISTANCE FOR YOURSELF SIMPLY FILL IN AND MAIL COUPON TODAY.

\$4 COMPLETE
PAY \$1 A
ONLY 1 MO.



Sent on 7 Days Approval

Step up your own skill with the facts and figures of your trade. Audels Mechanics Guides contain Practical Inside Trade Information in a handy form. Fully illustrated and Easy to Understand. Highly Endorsed. Check the book you want for 7 DAYS FREE EXAMINATION. Send No Money. Nothing to pay postman.

CUT HERE MAIL ORDER

AUDEL, Publishers, 49 W. 23 St., NEW YORK 10, N. Y.

Please send me postpaid for FREE EXAMINATION books marked below. If I decide to keep them I agree to mail \$1 in 7 Days on each book or set ordered and further mail \$1 monthly on each book or set until I have paid price, otherwise I will return them.

- AUTO GUIDE**, 1800 Pages **\$4**
- DIESEL ENGINE MANUAL, 400 Pages 2
- WELDERS GUIDE, 400 Pages 1
- MACHINISTS Handy Book, 1600 Pages 4
- POWER PLANT ENGINEERS Guide, 1500 Pages 4
- ENGINEERS & FIREMANS EXAMS, 528 Pages 1
- PUMPS, Hydraulics & Air Compressors, 1658 Pgs. 4
- MARINE ENGINEERS Handy Book, 1280 Pages 4
- ENGINEERS & Mechanics Guides (8 Book Set) 12
- Answers on Practical ENGINEERING, 254 Pages 1
- ELECTRIC WIRING DIAGRAMS, 210 Pages 1
- ELECTRICIANS EXAMINATIONS, 250 Pages 1
- ELECTRICAL DICTIONARY, 9000 Terms 2
- ELECTRIC MOTOR GUIDE, 1000 Pages 4
- HANDY BOOK OF ELECTRICITY, 1440 Pages 4
- ELECTRICAL POWER CALCULATIONS, 425 Pgs. 2
- RADIOMANS GUIDE, 914 Pages 4
- ELECTRONIC DEVICES, 216 Pages 2
- ELECTRIC LIBRARY, 7000 Pages (12 Book Set) 18
- Vols. I, II, III, IV, V, VI, VII, VIII, IX, X, XI, XII \$1.50 Ea. 1
- OIL BURNER GUIDE, 384 Pages 4
- HOUSE HEATING GUIDE, 1000 Pages 4
- CARPENTERS & Builders Guides (4 Book Set) 6
- PLUMBERS & Steamfitters Guides (4 Book Set) 6
- MASONS & Builders Guides (4 Book Set) 6
- BLUE PRINT READING, 416 Pages 2
- PAINTERS & DECORATORS MANUAL, 450 Pgs. 2
- GARDENERS & GROWERS Guides (4 Book Set) 6
- REFRIGERATION & Air Conditioning, 1280 Pgs. 4
- SHEET METAL WORKERS Handy Book, 388 Pgs. 1
- SHEET METAL PATTERN LAYOUTS, 1100 Pgs. 4
- AIRCRAFT WORKER, 240 Pages 1
- MECHANICAL DRAWING GUIDE, 160 Pages 1
- MECHANICAL DRAWING & DESIGN, 480 Pgs. 2
- MATHEMATICS & CALCULATIONS, 700 Pgs. 2
- MECHANICAL Dictionary, 968 Pages 4
- MILLWRIGHTS & Mechanics Guide, 1200 Pgs. 4

Name _____
Address _____
Occupation _____
Employed by _____ PM

AUDEL, Publishers, 49 W. 23 St., New York 10, N. Y.

FREE

ALLIED'S NEW 1950 RADIO CATALOG!



SEND FOR THIS
196-PAGE BOOK

Save on Everything in Radio



Get Radio's Leading Buying Guide!

Get everything you need from the world's largest radio supply house—and save money on every purchase! ALLIED's new 196-page 1950 Buying Guide offers widest selections of top quality equipment—ready for speedy, dependable shipment at lowest prices. Have the advantages of expert, friendly service, and guaranteed satisfaction on every purchase. To get more for your radio dollar, send today for your FREE 1950 ALLIED Catalog, the preferred Buying Guide to everything in radio and electronics.

**BUILDERS' KITS
TELEVISION SETS
HI-FIDELITY SOUND
AMATEUR GEAR
THOUSANDS OF PARTS
TUBES, TOOLS, TESTERS
BOOKS & DIAGRAMS**

Everything for
Servicemen, Engineers,
Experimenters, Builders,
Soundmen, Amateurs

ALLIED RADIO

ALLIED RADIO CORP.
833 W. Jackson Blvd., Dept. 5-J-9
Chicago 7, Illinois

Rush FREE 196-Page Catalog

Name.....

Address.....

City.....Zone.....State.....

FREE
CATALOG

(Continued from page 10)

LAWN AND GARDEN

Light canvas cart for garden chores (The Special Products Division, The Lodge & Shipley Company, 8th and Evans Sts., Cincinnati 4, Ohio).....126
Lawn machine cuts up leaves (Roncco Products, Inc., 1209 Glenwood Ave., Minneapolis 5, Minn.).....131
"Wick" stakes repel animals (Triangle Engineering & Mfg. Co., Terminal Arcade Bldg., 14131 Woodward Ave., Detroit 3, Mich.).....132
Strawberry wall.....138

MEDICAL

The hospital comes to the patient.....88
Wooden head is target for X-ray research.....90
Glycol-vapor dispenser (Air Purification Service, 82 Plane, Newark, N. J.).....90
Collapsible stretcher on wheels (Emergency Aid Company, 2201 W. Winona St., Chicago 25).....91
Portable respirator (Sanberg Hospital Equipment Co., 2011-13 Cedar Springs Ave., Dallas 1, Tex.).....143
Ointment for insect bites.....258

OFFICE

Hand mallet moistens stamps (Hollywood Mailing Products Co., 6808 Sunset Blvd., Hollywood 28, Calif.).....87
Compact duplicating machine (Visirecord, Inc. 32-36 47th Ave., Long Island City 1, N. Y.).....122
Desk-pad intercom (Robert H. Rigby Corp., 101 Park Ave., New York City 17).....156

PHOTOGRAPHY

Panorama on a giant screen (The Vitarama Corp., 1925 New York Ave., Huntington Station, New York City).....110
Multi-purpose tripod extension (Photographic Products, Inc., 955 N. Mansfield, Hollywood, Calif.).....116
Push-button camera takes identification photos (Photographic Products, Inc., 955 N. Mansfield, Hollywood, Calif.).....150
New York "bombed" for night photos.....169

RECREATION

Machine speeds pin setting (Brunswick-Balke-Collender Co., 623 S. Wabash Ave., Chicago).....87
Complete sports clock (International Business Machines Corp., 590 Madison Ave., New York City 22).....101
Golf cart rolls to your car (The Rutledge Company, Beckley-Ralston Div., 3333 Belmont Ave., Chicago 18).....123
Stick-on football cleats (Bur-Kleets, 361 Davis Road, Mansfield, Ohio).....172

TOOLS

Contour cutter speeds lathe work (Dernehl Design and Development Service, 9559 N. Lake Drive, Milwaukee 11, Wis.).....105
Portable machine tool (Precise Products Co., 1328-30 Clark St., Racine, Wis.).....116
Double saw blades prevent bucking (Jacobs Wind Electric Co., 2111 Washington Ave. No., Minneapolis 11, Minn.).....138
Chain-hoist accessory tips and holds load (Manning, Maxwell & Moore, Inc., Muskegon, Mich.).....139
Combination drill jig and drill-press vise (Pneu-trol Devices, Inc., 3122 N. California Ave., Chicago 18).....143
Multi-head welder makes wire mesh (Sciaky Brothers, Inc., 4915 W. 67th St., Chicago 38).....151
Injection molder for workshop use (Plastics Development Corp., 225 Lafayette St., New York City 12).....264

TOYS AND NOVELTIES

Model tractor is steamer.....87
Tiny electric motor makes matchbox look huge.....150
Repeater pellet pistol (Hy-Score Arms Corp., 25 Lafayette St., Brooklyn 1, N. Y.).....164

MISCELLANEOUS

Egg-shaped wheels pull through mud without chains.....86
Giant traction dynamometer.....91
Powered cradle launches lifeboat in five seconds.....105
Return of the Vikings.....112
Dual controls on motorcycle (Jawa Motorcycle Co., 2432 Grand Concourse, New York City 57).....116
Touch museum for sightless.....122
Flashlight holder (H. D. Valentine, Wellsville, Mo.).....123
Tray on trestle serves at drive-in.....127
Visual tuning aid (Ardell Manufacturing Co., 1217 Newport Ave., Long Beach 4, Calif.).....133
Cable lock (Reese Padlock Co., 124 Sherman St., Lancaster, Pa.).....139
Midget teakettle measures altitude.....143
Aircraft turntable checks compass (Wakefield Engineering Co., Box 471, Coeur D'Alene, Idaho).....151
Television in a diving suit.....152
Dry-Ice box in rail diner (American Car and Foundry Co., 36 Church St., New York City).....157
Mechanical beachcomber (Sanitized Beaches, Inc., 1567 W. 215th St., Los Angeles, Calif.).....171
Gas under pressure operates lighter (Marcel P. Labourdette, 44 E. 52nd St., New York City 22).....172
Underground radio waves.....172
"Vacuum cleaner" pulverizes leaves (Good Roads Machinery Corp., Minerva, Ohio).....172
Adjustable metal watch band (L. H. Knibb Co., 122 S. Michigan Ave., Chicago 3).....262

Craftsman and Shop Notes Index

AUTOMOTIVE

Tent stretched between car seats confines dog to rear floor.....189
Suction cups form pipe rack for car windshield.....206
Plow snow with your car.....215
Silencing fan-belt squeak.....223

(Continued to page 14)

I WILL SEND YOU BOTH FREE

64 PAGE BOOK

Illustrated book tells how I give you practical experience with MANY KITS of Parts I send. Read how you make EXTRA MONEY fixing Radios in spare time while learning.

Read letters from men I trained, telling what they are doing and earning. See the fascinating jobs RADIO-TELEVISION offers. Book FREE with coupon below.



ACTUAL RADIO LESSON

Same coupon entitles you to actual lesson, "Getting Acquainted With Receiver Servicing" also FREE. Shows you that learning Radio-Television at home is easy, practical. Lesson tells how "superhet"

circuits work, three reasons why tubes fail, how to locate defects, repair loudspeaker, etc. Many pictures, diagrams. Get lesson FREE with coupon below.

See for yourself how I train you at home to BE A RADIO-TELEVISION TECHNICIAN

Want a good-pay job in the fast growing RADIO-TELEVISION industry? Want a money-making Radio-Television shop of your own? Here's your opportunity. I've trained hundreds of men to be successful Technicians. . . MEN WITH NO PREVIOUS EXPERIENCE. My tested and proved train-at-home method makes learning easy. You learn Radio-Television principles from illustrated lessons. You get practical experience building, testing, experimenting with MANY KITS OF PARTS I send. All equipment yours to keep.

MAKE EXTRA MONEY IN SPARE TIME

The day you enroll, I start sending SPECIAL BOOK-LETS that show you how to make \$5, \$10 a week or more EXTRA MONEY fixing neighbors' Radios in spare time while learning. From here, it's a short step to your own shop or a good-pay Radio-Television servicing job. Or be a licensed Radio-Television Operator or Technician.

TELEVISION OFFERS BRIGHT FUTURE

Today there are nearly 2700 Radio stations on the air—and within three years experts predict there will be over 1000 Television Stations. Then add developments in FM, Two-Way Radio, Police, Marine, Aviation and Microwave Relay Radio! Think what this means. New jobs, more jobs, good pay for qualified men.

MAIL COUPON FOR BOOKS FREE

Act now! Coupon entitles you to actual lesson, "GETTING ACQUAINTED WITH RECEIVER SERVICING," and my 64-page book, "HOW TO BE A SUCCESS IN RADIO-TELEVISION." Send coupon in envelope or paste on penny postal. J. E. SMITH, President, Department 9JP, National Radio Institute, Pioneer Home Study Radio School, Washington 9, D. C.



You Build This MODERN RADIO with Parts I Send

As part of my Servicing Course, you build this complete, powerful Radio. Brings in local and distant stations. N.R.I. gives you ALL the parts . . . including speaker, tubes, chassis, transformer, sockets, loop antenna, etc. You also assemble many other circuits with Kits of Parts I send you.

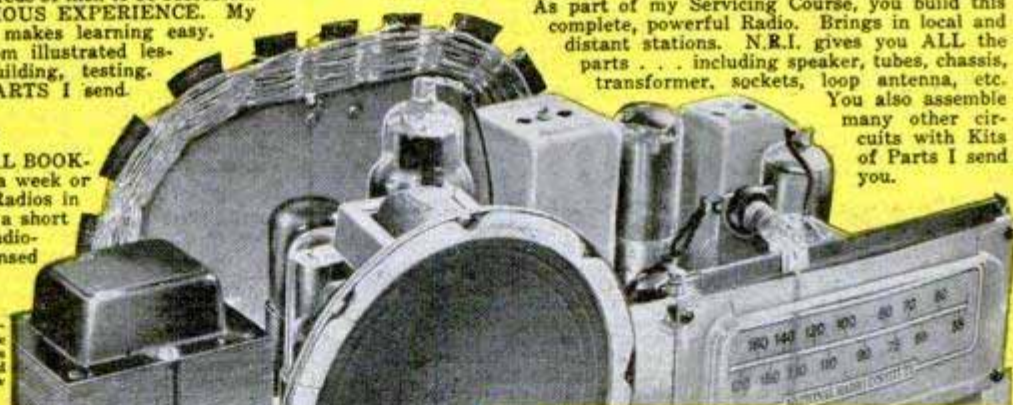

You Build This TRANSMITTER with Parts I Send

As part of my new Communications Course, you build this low-power Broadcasting Transmitter. You also build many other circuits with Kits of Parts I send you, that bring to life Radio-Television theory you learn.

MAIL NOW

NEW

I TRAINED THESE MEN



"Today I am considered an expert Radio and Television Technician. Have 4 employees working for me." —Paul Miller, Toledo, O.



"Halfway thru N.R.I. course, I made about \$8 a week in spare time fixing Radios." —E. Streitenberger, New Boston, O.



"Was a bookkeeper with a hand-to-mouth salary. Now a Radio Engineer with ABC Network." —N. Ward, N. J.



"I have my own shop, am making more money now than ever before." —Curtis Staeth, Ft. Madison, Iowa.

Actual Lesson and 64 Page Book FREE

MR. J. E. SMITH, President, Dept. 9JP National Radio Institute, Washington 9, D. C.

Mail me Sample Lesson and 64-page Book about How to Win Success in Radio-Television—both FREE. (No salesman will call. Please write plainly.)

Name..... Age.....
 Address.....
 City..... Zone..... State.....
 Check if Veteran Approved Under G. I. Bill

VETERANS

GET THIS TRAINING WITHOUT COST UNDER G. I. BILL

MEN-IF YOU VALUE Your Future- read this FREE BOOK

SEND
FOR IT
Today!



Tells You How to Win Bigger Pay and Real Security

This book is yours without a penny of cost. "Your Future in Refrigeration and Air Conditioning" tells you what's in store for you in this fast moving, big pay field. No obligation. We want you to have this big, fascinating book. We want you to have the opportunity to read it—and to decide for yourself whether this is the field for you. You'll see pages of interesting pictures showing men on-the-job in Refrigeration and Air Conditioning. You'll read all about the fine opportunities in this amazing industry. This can easily be the most important book you'll ever receive and read—because it concerns your own future! Refrigeration and Air Conditioning has plenty of room for trained men—to handle good paying jobs in the many branches of this great industry. Almost unlimited future for men who know this work. Now you may learn Refrigeration and Air Conditioning at home in spare time. No need to give up present job or income while preparing to step into a better job. Act now! Simply write your name and address on the coupon below and mail today. Get your free copy at once . . .

INDUSTRIAL TRAINING INSTITUTE

2150 Lawrence Avenue, Dept. A-1, Chicago 25, Ill.

MAIL COUPON NOW No Cost
No Obligation

Mr. C. H. Smith, President,
Industrial Training Institute, Dept. A-1
2150 Lawrence Avenue, Chicago 25, Illinois

Please send me a FREE COPY of "Your Opportunity in Refrigeration and Air Conditioning" by return mail.

Name _____
Address _____
City and Zone _____ State _____

(Continued from page 12)

FARM

Grain binder tops smartweeds to aid harvesting soybeans.....	214
Auto-trunk lid on grain bin forms rodentproof cover.....	216
One-man spray rig.....	217
Portable posts for electric fence supported with concrete.....	223
Measuring total rainfall.....	228

HOUSE AND HOME

Washer improves worn faucet.....	176
Shoe bag stores cleaning items.....	178
Delinter for woolen garments.....	178
Netting held securely to baby crib.....	178
Clear plastic makes quilt-block pattern.....	178
Cutlery box serves as tray sewing kit.....	179
Rickrack kept from shrinking when laundered.....	179
Hint for keeping peeled onions in refrigerator.....	179
Wire coat hanger bent to form hat rack.....	179
Storing flower bulbs.....	179
Candles can be made drip-proof.....	179
Guest costumer.....	181
Moving day for trees.....	190
Siphoning aquarium facilitated by strainer.....	192
Turn button on garbage can keeps contents from spilling.....	199
Sugar deodorizes teapot.....	199
Ridge hook holds ladder safely on gable roof.....	206
Cleaning eaves trough facilitated by easily made tools.....	206

NOVELTIES

Bird-cage novelty.....	177
Twin spheres form mysterious letter holder.....	192
Chinese coin disappears into wooden box for amusement of both young and old.....	193

OFFICE, SHOP AND STORE

Extension cords stored safely by winding on metal spool.....	180
Partitions inserted in cigar box divide it into sections.....	189
Metal tray filled with linseed oil keeps paintbrushes in good condition.....	193
Reflector on basement ceiling directs light to workbench.....	200
Stacked pipe prevented from rolling.....	214
Cork fastened on drawing board forms thumbtack "pin-cushion".....	223
Tabs raise draftsman's triangle to prevent blotting work.....	223
Headlight shell provides bowl for inexpensive fountain.....	228

OUTDOOR RECREATION

Mooring ring for rowboat improvised from piston.....	180
Hand drill clamped in vise aids winding trotline.....	200
Cooking with Indian meat spit.....	200
Milk bottles set in pail of water provide handy camp cooker.....	206

PHOTOGRAPHY

Tank holds several rolls of film for simultaneous developing.....	208
Turn button locks wall switch.....	208
Increasing flash-bulb efficiency in photoflood reflector.....	208
Old print checks easel masks to insure uniform border.....	208
Cable release clamped to camera is operated with left thumb.....	211
Tape on edge of paper cutter keeps prints from slipping.....	211
Handle for photoflood reflector.....	211
Cable release mounted in plug provides flash synchronizer.....	212
Oil corrects tripod-head slippage.....	212
Preventing scratched negatives.....	212
Camera settings checked quickly.....	212
Tin-can holder for photo spot.....	212

TOOLS

Scored lines on saw clamp check proper filing angle.....	176
Wooden chuck speeds setup when turning duplicate pieces.....	176
Improvised stop for workbench.....	176
Files cleaned with adhesive tape.....	176
Four ways to remove frozen nuts without using cutting torch.....	180
Hammer handles kept in condition.....	180
Locator marks work for drilling registering holes.....	215
Hint for sawing metal.....	216
Improvised drill-bit extension.....	216
U-shaped jig holds beaded ceiling.....	223
Expansion reamer forms mandrel.....	228
Cover protects small motor.....	228

MISCELLANEOUS

Paper bags tied to stovepipe retain soot during removal.....	192
Pearls strung on nylon fishline.....	193
Safety pin braces photo frame.....	200
Telescope tripod.....	207
Sack held open with stick is filled easily.....	216
Light aids reading water gauge.....	216
Balancing impeller of scooter motor.....	228

Radio-Television, Electronics

Plastic console for TV set (Admiral Corp., 3800 Cortland St., Chicago).....	229
How to build a remote "slave" flash synchronizer.....	230
Radio and electronics today (Portable tape recorder, Stancil-Hoffman Corp., 1016 N. Highland Ave., Hollywood, Calif.; television antenna has interchangeable parts, Westinghouse Electric Corp., Pittsburgh, Pa.; "Playtalk" electronic toy, General Electric Co., Electronics Park, Syracuse, N. Y.; turntable for table-model TV sets, Krenco Mfg. Co., 231 S. La Salle St., Chicago 4; frequency multiplier for amateur transmitter, Barker-Williamson Inc., 235 Fairfield Ave., Upper Darby, Pa.; console with 16-in. picture tube, Westinghouse Electric Corp., Pittsburgh 30, Pa.; all-channel TV and FM indoor antenna, Stroba Mfg. Co., Inc., 2-4 Howard St., New York City).....	232

IMPORTANT NOTICE—It is the intention of this magazine to provide its readers with information regarding the latest developments in the mechanical arts. We take no responsibility as to whether the disclosures contained in our articles are covered by patents and advise readers to investigate this subject before making, using, or selling any of the products, machines, or processes described in order to avoid possible liability for patent infringements.



INVENTORS



Learn how to protect your invention. The U. S. Patent Laws provide that any new and useful art, machine, article of manufacture, or composition of matter, or any new and useful improvement thereof, may be patented if the act of invention is involved. Therefore, every inventor with a valuable invention should take advantage of the Patent Laws and proceed for patent protection in order to safeguard his rights.

A patent gives the inventor the exclusive right to prevent others from making, using, or selling the invention claimed in the patent for a period of seventeen years.

The Patent Laws were enacted for the benefit of the inventor to give him protection for the features of his invention which are patentable. These features must be properly and concisely set forth and claimed in a formal application for patent, in order to comply with the requirements of the Patent Laws. For that reason, unless the inventor is familiar with patent matters, he should engage a competent registered patent attorney or agent to represent him. We are registered to practice before the U. S. Patent Office and are prepared to serve you in the handling of your patent matters.

A specially prepared booklet entitled "Patent Guide for the Inventor", containing detailed information with respect to patent protection and procedure, together with a "Record of Invention" form will be promptly forwarded to you without obligation upon request.

CLARENCE A. O'BRIEN & HARVEY JACOBSON

Registered Patent Attorneys

91-J DISTRICT NATIONAL BUILDING • WASHINGTON 5, D. C.

Patents
Trademarks
Copyrights

CLARENCE A. O'BRIEN & HARVEY JACOBSON
Registered Patent Attorneys
91-J District National Bldg., Washington, D. C.
Please send me copy of "Patent Guide for the Inventor" and also
"Record of Invention" form. This request does not obligate me.

Name _____

Address _____

City _____ State _____

(Please write or print plainly.)

IT'S EASY TO LEARN A GOOD TRADE!



HOW TO TRAIN YOURSELF FOR A BETTER JOB - OR A BUSINESS OF YOUR OWN - IN WEEKS!

You can bring a "happy ending" to your search for a better job—or a business of your own—by learning a good trade! And the sooner you begin your training the better—because *job opportunities have never been as great as they are today*. But, remember, these chances for a successful future and security are open only to *trained men who know their jobs—and know them well!*

The easy and quick way to prepare yourself for better income is through C.T.I. This nationally-known, well-established institution offers you two ways to train: At home thru C.T.I.'s Shop-Proved Home Training Method, or at our big, fully-equipped resident trade school in Chicago. Either way, your training is *practical and thorough*—and it's easy because you learn in step-by-step stages.

Note, at right, the varied opportunities that are offered you. Choose the course you like best and write C.T.I. or mail coupon for a big, illustrated FREE BOOK-LET *Don't delay, act today!*

COMMERCIAL TRADES INSTITUTE Dept. E2-9
1400 Greenleaf Chicago 26, Ill.



R. C. ANDERSON,
President

- C.T.I. OFFERS PRACTICAL TRAINING IN
- AUTOMOTIVE MECHANICS
 - BODY & FENDER REBUILDING
 - DIESEL MECHANICS
 - REFRIGERATION & AIR CONDITIONING
 - ELECTRICITY & ELECTRONICS
 - RADIO & TELEVISION
 - BUILDING CONSTRUCTION
 - MECHANICAL DRAFTING

HOME OF C.T.I.



FILL OUT - CUT OUT - MAIL TODAY

MR. R. C. ANDERSON, President
COMMERCIAL TRADES INSTITUTE, Dept. E2-9
1400 W. Greenleaf, Chicago 26, Ill.

Send free illustrated Brochures and other information about the field I have checked below:

<input type="checkbox"/> Automotive Mechanics	<input type="checkbox"/> Electricity & Electronics
<input type="checkbox"/> Body & Fender Rebuilding	<input type="checkbox"/> Radio & Television
<input type="checkbox"/> Diesel Mechanics	<input type="checkbox"/> Building Construction
<input type="checkbox"/> Refrigeration & Air Conditioning	<input type="checkbox"/> Mechanical Drafting

Name _____
Address _____
City _____ State _____

FACTS FREE FOR
MEN WHO WANT
TO GET AHEAD

VETERANS
C.T.I. approved. Just mail coupon we will handle all details.

NON-VETERANS
Investigate our low Easy-Payment Plan and our Pay-After-Graduation Plan.

INVENTORS

Patent laws encourage the development of inventions.

We recommend that an inventor employ a registered Patent Attorney or agent, if the inventor is not familiar with patent matters. This is because the value of a patent depends largely upon the skillful preparation of the specification and claims in the patent application.

The firm of McMorrow, Berman and Davidson is registered to practice before the United States Patent Office. Additionally it engages patent attorneys able to readily understand inventors' disclosures, to advise concerning patentability, and to prepare appropriate specifications and claims.

If an inventor believes he has an invention, a search of the most pertinent prior U. S. patents should be made and a report obtained relative to its patentability. Where such report indicates that the invention appears patentable, in order to secure protection, diligence should be exercised in making application for a patent.

Send for a copy of Patent Booklet entitled "How To Protect Your Invention." This booklet contains information on patent protection and procedure. You will also receive an "Invention Record" blank. This will be promptly forwarded to you upon request—no obligation.

McMORROW, BERMAN & DAVIDSON

Registered Patent Attorneys

PATENTS • TRADE MARKS • COPYRIGHTS

1354 VICTOR BUILDING, WASHINGTON 1, D. C.

McMORROW, BERMAN & DAVIDSON

Registered Patent Attorneys

1354 Victor Building, Washington 1, D. C.

Send me your Patent Booklet, "How To Protect Your Invention", and also "Invention Record" form at once. I understand this request does not obligate me.

Name.....

Address.....

City.....

(WRITE OR PRINT NAME CLEARLY)

The 97 Pound Weakling

who became "The World's Most Perfectly Developed Man"

"I'll Prove that YOU, too, can be a NEW MAN!"

Charles Atlas

I KNOW, myself, what it means to have the kind of body that people pity! Of course, you wouldn't know it to look at me now, but I was once a skinny weakling who weighed only 97 lbs. I was ashamed to strip for sports or undress for a swim. I was such a poor specimen of physical development that I was constantly self-conscious and embarrassed. And I felt only HALF-ALIVE.

Then I discovered "Dynamic Tension." It gave me a body that won for me the title "World's Most Perfectly Developed Man."

When I say I can make you over into a man of giant power and energy, I know what I'm talking about. I've seen my new system, "Dynamic Tension," transform hundreds of weak, puny men into Atlas Champions.

Only 15 Minutes a Day

Do you want big, broad shoulders—a fine, powerful chest—biceps like steel—arms and legs rippling with muscular strength—a stomach ridged with bands of sinewy muscle—and a build you can be proud of? Then just give me the opportunity to prove that "Dynamic Tension" is what you need.

No "ifs," "ands," or "maybes." Just tell me where you want handsome, powerful muscles. Are you fat and flabby? Or skinny and gawky? Are you short-winded, peeps? Do you hold back and let others walk off with the prettiest girls, best jobs, etc.? Then write for details about "Dynamic Tension" and learn how I can make you a healthy, confident, powerful HE-MAN.

"Dynamic Tension" is an entirely NATURAL method. Only 15 minutes of your spare time daily is enough to show amazing results—and it's actually fun! "Dynamic Tension" does the work.

Send for FREE BOOK

Mail the coupon right now for full details and I'll send you my illustrated book, "Everlasting Health and Strength." Tells all about my "Dynamic Tension" method. Shows actual photos of men I've made into Atlas Champions. It's a valuable book! And it's FREE. Send for your copy today. Mail the coupon to me personally, CHARLES ATLAS, Dept. 8X, 115 East 23rd Street, New York 10, N. Y.

CHARLES ATLAS, Dept. 8X, 115 East 23rd St., New York 10, N. Y.

I want the proof that your system of "Dynamic Tension" will help make a New Man of me—give me a healthy, husky body and big muscular development. Send me your free book, "Everlasting Health and Strength."

Name _____ Age _____
 Address _____
 City _____ State _____



CHARLES ATLAS
 Holder of title "The World's Most Perfectly Developed Man."



Sensational New Electric ① WELDER ② CUTTER!
 FOR 110-115 AC or DC • WELD—BRAZE—CUT—SOLDER—HEAT TREAT
 INSTRUCTIONS INCLUDED • LOWEST PRICE IN HISTORY! **BOTH only \$12**

The WELDRITE Combination—tested and proved by countless commercial and amateur users, is now offered direct to you at the amazingly low price of only \$12.00. No Gas—No Gauges—No Spark Lighter needed. Always ready for immediate use—Just plug WELDRITE into 110-115 AC or DC outlet. Uses standard welding and brazing materials. WELDRITE furnished complete with Converter Unit, #1 Single Holder for welding metal to 3/16" thickness, using up to 3/32" rod, and #2 Double Holder with Copper Coated Carbon Electrodes for Brazing, Cutting, Heat Treating, etc. Starting welding materials and instructions included. Ideal for home workshop. Invaluable for garages, repair shops, farms, etc.

SEND NO MONEY! 10 DAY TRIAL. Order your WELDRITE Electric WELDER-BRAZER-CUTTER C.O.D. today. Pay postman \$12 plus postage charges (wt. 4 lbs.) or send \$12 and we pay postage. Either way, if not satisfied, return WELDRITE in 10 days for refund, less postage charges. **WELDER HOOD**—Approved Arc Welding lens—only \$3.95. Calif. orders add 2 1/2% tax. 448 So. Hill • Los Angeles 13, Dept. A-9

FREE!
 Illustrated Folder

CALIFORNIA TECHNICAL PRODUCTS CO.

SUCCEED IN THE POULTRY BUSINESS!

Poultry is providing many trained men and women with a good, comfortable living, either part or full time. For 28 years our Home Study Course has been helping thousands obtain training and "know how" that means extra income from the start. Don't delay—Write today for prospectus describing courses, methods, service, opportunities.

NATIONAL POULTRY INSTITUTE
 DEPT. 50 ADAMS CENTER, N. Y.

SHORTHAND in 6 Weeks at Home

Famous Speedwriting system. No signs; no symbols; no machines; uses ABC's. Easy to learn; easy to write and transcribe. Low cost. 100,000 taught by mail. For business and Civil Service. Also typing. 26th year. Write for free booklet to:

Speedwriting
 Dept. 1509-9, 55 W. 42 St., New York 18

ENGINEERING Building, Drafting, Etc.

Degree in 27 mos. Approved for G.I. Training. Prepare in Chicago, the Industrial Hub. Earn part living expenses. 45th year. Other shorter courses in Air Conditioning, Refrigeration, Radio, Electricity. Enter Jan., March, July, Sept.

Chicago TECH College
 Write for catalog
 M-83 TECH BLDG., 2000 S. MICHIGAN AVE., CHICAGO 16

Learn WOOD PRODUCTION ENGINEERING

VETERANS training is FREE under G. I. BILL.

GET THIS FREE BOOK Today

It tells you how you can learn to become a successful WOOD PRODUCTION ENGINEER . . . by the Klok Home Study Correspondence Method . . . or by studying here in Grand Rapids in our Resident School . . . Training in WOOD PRODUCTION ENGINEERING offers you great opportunities . . . either to get a top position or to operate your own plant successfully.

The Klok Course teaches you SKETCHING, ROD-MAKING, DETAILING, STOCK BILLING, TIME STUDY, COST and MANAGEMENT.

WRITE FOR FREE BOOK TODAY! State preference whether Home Study or Resident course, with name, age, occupation and if veteran.

KLOK INSTITUTE
 LOUIS ST., N.W.
 GRAND RAPIDS, MICHIGAN



**USE IT
OR
LOSE IT!**

Veterans:

This lifeline has a *deadline!* Grasp it and you're on your way to greater job security, more responsible work, higher pay. Delay and you're apt to lose out. For training under the G. I. Bill is a limited offer. To benefit you've got to *act.*

You have 400 famous I.C.S. Courses to choose from. The coupon brings full information. Take a minute *right now* to check the course that interests *you.*

INTERNATIONAL CORRESPONDENCE SCHOOLS

APPROVED
under the
G.I. BILL

BOX 5660-K, SCRANTON 9, PENNA.

Without cost or obligation, please send me full particulars about the course BEFORE which I have marked X:

- | | | | | |
|---|--|---|---|--|
| <p>Business and Academic Courses</p> <ul style="list-style-type: none"> <input type="checkbox"/> Accounting <input type="checkbox"/> App. Psychology <input type="checkbox"/> Business Administration <input type="checkbox"/> Bus. Correspondence <input type="checkbox"/> Certified Public Accounting <input type="checkbox"/> Commercial <input type="checkbox"/> Commercial Art <input type="checkbox"/> Cost Accounting <input type="checkbox"/> Federal Tax <input type="checkbox"/> First Year College <input type="checkbox"/> Foremanship <input type="checkbox"/> Good English <input type="checkbox"/> Higher Mathematics <input type="checkbox"/> Industrial Supervision <input type="checkbox"/> Motor Traffic <input type="checkbox"/> Retailing <input type="checkbox"/> Salesmanship <input type="checkbox"/> Sign Lettering <input type="checkbox"/> Spanish <input type="checkbox"/> Advertising <input type="checkbox"/> Bookkeeping <input type="checkbox"/> Bus. Law <input type="checkbox"/> Bus. Management <input type="checkbox"/> French <input type="checkbox"/> High School <input type="checkbox"/> Illustration <input type="checkbox"/> Postal Civil Service <input type="checkbox"/> Retail Bus. Management <input type="checkbox"/> Secretarial <input type="checkbox"/> Stenography <input type="checkbox"/> Traffic Management | <p>Chemical Courses</p> <ul style="list-style-type: none"> <input type="checkbox"/> Chemical Engineering <input type="checkbox"/> Chemistry, Analytical <input type="checkbox"/> Chemistry, Industrial <input type="checkbox"/> Chemistry, Mfg. Iron & Steel <input type="checkbox"/> Petroleum Refining <input type="checkbox"/> Plastics <input type="checkbox"/> Pulp and Paper Making <input type="checkbox"/> Civil Engineering, Architectural and Mining Courses <input type="checkbox"/> Architecture <input type="checkbox"/> Architectural Drafting <input type="checkbox"/> Building Estimating <input type="checkbox"/> Civil Engineering <input type="checkbox"/> Coal Mining <input type="checkbox"/> Contracting and Building <input type="checkbox"/> Highway Engineering <input type="checkbox"/> Lumber Dealer <input type="checkbox"/> Reading Structural Blueprints <input type="checkbox"/> Sanitary Engineering <input type="checkbox"/> Structural Drafting <input type="checkbox"/> Structural Engineering <input type="checkbox"/> Surveying and Mapping | <p>Electrical Courses</p> <ul style="list-style-type: none"> <input type="checkbox"/> Electrical Drafting <input type="checkbox"/> Electrical Engineering <input type="checkbox"/> Electric Light and Power <input type="checkbox"/> Lighting Technician <input type="checkbox"/> Practical Electrician <input type="checkbox"/> Power House Electric <input type="checkbox"/> Ship Electrician <input type="checkbox"/> Internal Combustion Engines Courses <input type="checkbox"/> Auto Technician <input type="checkbox"/> Diesel-Electric <input type="checkbox"/> Diesel Engines <input type="checkbox"/> Aviation <input type="checkbox"/> Gas Engines | <p>Mechanical Courses</p> <ul style="list-style-type: none"> <input type="checkbox"/> Aeronautical Engineer's, Jr. <input type="checkbox"/> Aircraft Drafting <input type="checkbox"/> Forging <input type="checkbox"/> Heat Treatment of Metals <input type="checkbox"/> Industrial Engineering <input type="checkbox"/> Industrial Instrumentation <input type="checkbox"/> Industrial Metallurgy <input type="checkbox"/> Machine Shop <input type="checkbox"/> Machine Shop Inspection <input type="checkbox"/> Mechanical Drafting <input type="checkbox"/> Mechanical Engineering | <p>Other Courses</p> <ul style="list-style-type: none"> <input type="checkbox"/> Mold-Loft Work <input type="checkbox"/> Patternmaking—Wood, Metal <input type="checkbox"/> Reading Shop Blueprints <input type="checkbox"/> Sheet-Metal Drafting <input type="checkbox"/> Sheet-Metal Worker <input type="checkbox"/> Ship Drafting <input type="checkbox"/> Ship Fitting <input type="checkbox"/> Tool Designing <input type="checkbox"/> Toolmaking <input type="checkbox"/> Welding Engineering <input type="checkbox"/> Welding—Gas and Electric <input type="checkbox"/> Railroad Courses <input type="checkbox"/> Air Brake <input type="checkbox"/> Car Inspector <input type="checkbox"/> Diesel Locomotive <input type="checkbox"/> Locomotive Engineer <input type="checkbox"/> Locomotive Fireman <input type="checkbox"/> Locomotive Machinist <input type="checkbox"/> Railroad Section Foreman <input type="checkbox"/> Steam and Diesel Loco. Eng. <input type="checkbox"/> Stationary Engineering Courses <input type="checkbox"/> Boilermaking <input type="checkbox"/> Combust. Engrg. <input type="checkbox"/> Engine Running <input type="checkbox"/> Marine Engineering <input type="checkbox"/> Power Plant Engr. <input type="checkbox"/> Steam Engineer <input type="checkbox"/> Textile Courses <input type="checkbox"/> Cotton Manufacturing <input type="checkbox"/> Loom Fixing <input type="checkbox"/> Rayon Weaving <input type="checkbox"/> Textile Designing <input type="checkbox"/> Woolen Manufacturing |
|---|--|---|---|--|

Name _____ Age _____ Home Address _____

City _____ State _____ Working Hours _____ A.M. to _____ P.M.

Present Position _____ Employed by _____

Length of Service in World War II _____ Enrollment under G.I. Bill approved for World War II Veterans. Special tuition rates to members of the Armed Forces. Canadian residents send coupon to International Correspondence Schools Canadian, Ltd., Montreal, Canada.

INVENTORS

A patent is a valuable right. On the basis of a constitutional provision Congress has established a system under which inventors may secure the exclusive right to prevent the unauthorized use, manufacture and sale of their inventions for periods of seventeen years. The inventor secures this protection by obtaining a patent.

Unless an inventor is thoroughly familiar with such matters, he is advised to employ a competent registered patent attorney or registered patent agent, as the value of patents depends largely upon the skillful preparation of the specification and claims.

This firm is registered to practice before the U. S. Patent Office and is available to assist inventors in the preparation and prosecution of their cases. Detailed information and the preliminary steps to take to obtain patent protection will be furnished upon request.

Form below for mailing convenience

VICTOR J. EVANS & Co. *Merlin M. Evans*
REGISTERED PATENT ATTORNEY
430-K MERLIN BUILDING, WASHINGTON 6, D. C.

• • • • •

• VICTOR J. EVANS & CO. •

• 430-K Merlin Building, Washington 6, D. C. •

• Please send me without obligation a copy of your •

• booklet "Patent Protection For Inventors" together •

• with your convenient "Evidence of Invention" form. •

• Name..... •

• Address..... •

• City and State..... •

• • • • •

PATENTS TRADEMARKS COPYRIGHTS

WIN SUCCESS · SECURITY · RESPECT
as a Master Watchmaker!
APPROVED FOR VETERAN TRAINING

Learn today's top mechanical profession at the world's largest, best-equipped school of its kind. Individual instruction, day or evening classes. You graduate with complete watchmakers' tools, ready to start your own business or work for established jewelers.

SEND FOR FREE 116-PAGE INFORMATION PACKET

WESTERN PENNSYLVANIA HOROLOGICAL INSTITUTE
WORLD'S LARGEST WATCHMAKING SCHOOL
DESK 40, 808 RIDGE AVE., PITTSBURGH, PA.



"HOW TO MAKE MONEY AND PLENTY OF IT!"

A new book for the small business man and everybody who is interested in making more money. Just one idea learned from this book may change your entire life. Tells you how to make money and how to sell. Never before has there been a book just like it. Practical, plain talk instructions. Easy to follow. 172 pages full of rules for success in your business. A must for the small storekeeper. Sent for \$2.95 postpaid, or from your bookstore. Money refunded if returned within 5 days. JOHN RISSMAN & SON, 305 W. Adams, Dept. G, Chicago 6, Ill.

MAKE MONEY IN LANDSCAPING

Thorough training by Internationally known Landscape Architect to start your own business, improve your home or advance in this well paid field. Many Opportunities. Approved for Veterans. Send for FREE BOOK.

NATIONAL LANDSCAPE INSTITUTE
Dept. P-9, 310 So. Robertson Los Angeles 36, Calif.



Is Your Life Crowned With Success?

LEXIPOWER

WE THINK IN WORDS. THOUGHT IS POWER. Let this New Science show you how to WIN WITH WORDS—financially, socially, culturally. Develop a MASTERFUL VOCABULARY. Influence others. Improve your personality, manifest your latent ability. You are judged and rated by every sentence you utter. Start using the POWER of LEXIPOWER after the first Lesson. Write NOW for FREE details about LEXIPOWER. Dime-a-Day LESSON CLUB.

LEXIPOWER LESSON CLUB
517-G W. Deming Place Chicago 14, Illinois



What Is a Tachometer? WHAT IS A TELEMETER? See Page 261

Command Bigger Money! STUDY LAW

STUDY AT HOME for BUSINESS SUCCESS and LARGER PERSONAL EARNINGS. 40 years expert instruction — over 114,000 students enrolled. LL.B. Degree awarded. All text material furnished. Easy payment plan. Send now for FREE BOOK — "Law and Executive Guidance." It explains the course — how you may enroll and the many ways you can profit from Law Study. Write TODAY to: (G.I. Approved)

AMERICAN EXTENSION SCHOOL OF LAW
Dept. 18-PM, 646 N. Michigan Ave., Chicago 11, Ill.

THESE MEN ARE GETTING PRACTICAL TRAINING

IN ELECTRICITY



On Real:

**A.C. and D.C. MOTORS
GENERATORS
SWITCHBOARDS
CONTROLLERS
WIRING JOBS
APPLIANCES
ELECTRONIC UNITS**

(Shown at left—Instructor demonstrating latest type of Test Unit for checking the efficiency of a Motor.)

AND RADIO-TELEVISION

On Real:

**TELEVISION SETS
RADIO RECEIVERS
F.M. (Frequency Modulation)
RECORD CHANGERS
AUTO RADIOS
AIRPLANE RADIOS
PUBLIC ADDRESS Systems**

(Right—Instructor explaining operation of 20-inch Cathode Ray tube used in Dumont Television Set.)



Just Like YOU Can Get in the Great SHOPS of COYNE

Prepare NOW for a real future the quick, practical way. Come to the Great Shops of COYNE in Chicago. Largest and best equipped school of its kind—now celebrating our 50th Anniversary. GI approved. Finance plan for non-veterans. Mail coupon.

NOT "HOME-STUDY" COURSES! At Coyne you learn on real, full-size equipment. Trained instructors show you how, then you do typical jobs yourself. We don't teach by mail.

CLIP COUPON NOW for big new illustrated Coyne book on either **ELECTRICITY** or **RADIO-TELEVISION**. Both books sent FREE if you wish. No obligation; no salesman will call. Get the facts now!

COYNE **ELECTRICAL & RADIO SCHOOL**
500 S. Paulina St., Dept. 69-72H
Chicago 12, Ill.



Mail Coupon for
2 FREE BOOKS!



B. W. COOKE, President
COYNE ELECTRICAL &
RADIO SCHOOL, Dept. 69-72H
500 S. Paulina St., Chicago 12, Ill.

Send FREE, the book or books checked below, and details of your training offer. This does not obligate me and no salesman will call.

ELECTRICITY RADIO-TELEVISION

NAME

ADDRESS.....

CITY.....STATE.....

YOU Need My PRACTICAL Training to Make Money in

TELEVISION- RADIO and ELECTRONICS!



I'll Send You
8 BIG KITS of
Radio Parts and Equipment

Learn at
HOME
IN YOUR
SPARE TIME

Now is the Time to Get Into This Fast
Growing Industry—Prepare for a Fine
Paying Job or Your Own Business!

I have trained hundreds of men to become technicians—and I'm ready to do the same for you. Whether your goal is a fine paying job in one of Radio's many branches—or a successful Radio and Television business of your own—you need the kind of training I offer! My training is practical and down to earth. **YOU NEED NO PREVIOUS EXPERIENCE.** I start you with basic fundamentals and give you plenty of practical shop-bench training with many kits of parts I send you. This is the training that sticks with you and makes money for you on the job!

GET PAID FOR SPARE TIME WHILE LEARNING

Soon after you start training I send you my famous **BUSINESS BUILDERS** that show you how to make money in spare time doing interesting Radio jobs. I send you 8 big kits of Radio parts and equipment and help you build step-by-step a powerful 6-tube superhet radio, a 16-range test meter, plus other mighty useful equipment for Radio and Television servicing. You will perform over 175 fascinating experiments while training. You will learn about Television—so that you will be qualified to step into this fast growing, profitable field. I also send you many valuable service manuals, diagrams, and my book telling exactly how to set up your own Television and Radio shop. Clip and mail the coupon below for my two big **FREE** Radio books. I employ no salesmen—and nobody will call on you

HAVE A BUSINESS OF YOUR OWN

A profitable Radio and Television Service Shop may be started with little capital. I will show you how to get started. At left is pictured one of my graduates, Mr. Merrit C. Sperry, Fairmont, Minn. in his own shop.



All Kits Are YOURS TO KEEP

Each of the hundreds of Radio parts and other items I send my students is theirs "for keeps." You may use this equipment in your Radio and Television service work and save many dollars by not having to buy expensive "ready-made" test equipment.



CALVIN SKINNER of New Orleans, La. tells us he makes \$5 to \$10 in spare time repairing radios. He is now also working with a Television set.



LOREN D. SAUCIER of Coloma, Mich. reports that my training has made it possible for him to repair large numbers of Radio and Television sets.

Radio and Television Industry Booming

You couldn't pick a better time to get into Radio-Television and Electronics. New Television stations are going off the air to serve every major city—hundreds of new AM and FM Radio broadcasting stations are also on the air. All this creates new and bigger opportunities for the trained man who knows Radio-Television and Electronics

VETERANS

THIS TRAINING AVAILABLE TO YOU UNDER THE G.I. BILL

RUSH COUPON Today!

SPRAYBERRY ACADEMY of RADIO, Dept. 10-A
111 North Canal Street,
Chicago 6, Illinois

Please rush my **FREE** copies of "How To Make Money In Radio-Television and Electronics" and "How To Read Radio Diagrams and Symbols."

Name.....Age.....

Address.....

City.....State.....

() Check here if you are a Veteran

My Training Includes...
Television,
FM (Frequency Modulation),
Public Address and High Frequency Applications



These Two Big FREE! Radio Books

Just mail coupon for a **FREE** sample Sprayberry Lesson and my big **FREE** book, "How To Make Money In Radio-Television and Electronics." Learn why my really practical training is best of all for you. Discover what's ahead for you in Radio-Television and Electronics. No obligation. Don't delay! Mail the coupon now—and count on me for fast action.

SPRAYBERRY ACADEMY OF RADIO
111 N. CANAL, DEPT. 10-A, CHICAGO 6, ILL.

GET INTO

DIESEL-AUTO MECHANICS

Master All Phases

JOB LIKE THESE ARE AVAILABLE TO **TRAINED MECHANICS**. CHOOSE THE FIELD YOU LIKE BEST

Get Complete Training

Diesel Fuel Injection
 Automotive Motor Tune-up
 Diesel Engine Rebuilding
 General Garage Mechanic
 Agricultural Implements
 Auto Engine Rebuilding
 Auto Elec. Service
 Public Utilities
 Parts Dealers
 Bus & Truck Lines
 Industrial Maintenance
 Contracting & Excavating
 Business of Your Own
 AND MANY other similar openings.

As a National Schools graduate, you are trained for ALL opportunities in the Diesel & Auto Industries

EARN WHILE YOU LEARN

With our practical Master Shop-Method Home Training, you study at home in your spare time. You receive Spare Time Work Lessons, which show you how to earn while you Learn . . . for extra money and experience. You Learn by DOING.

TOOLS AND EQUIPMENT

To make your training complete, we give you selected mechanic's tools and equipment, illustrated below, including all-metal toolbox — as a regular part of your instruction.

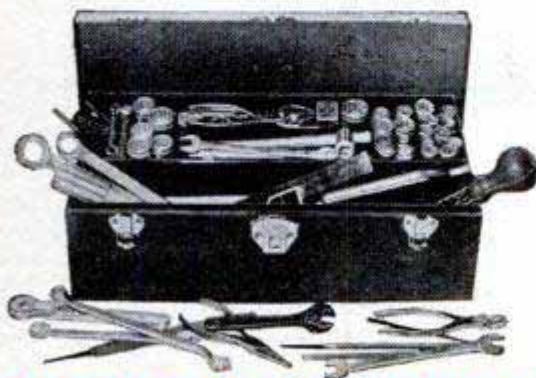

WE GIVE YOU TOOLS OF YOUR TRADE

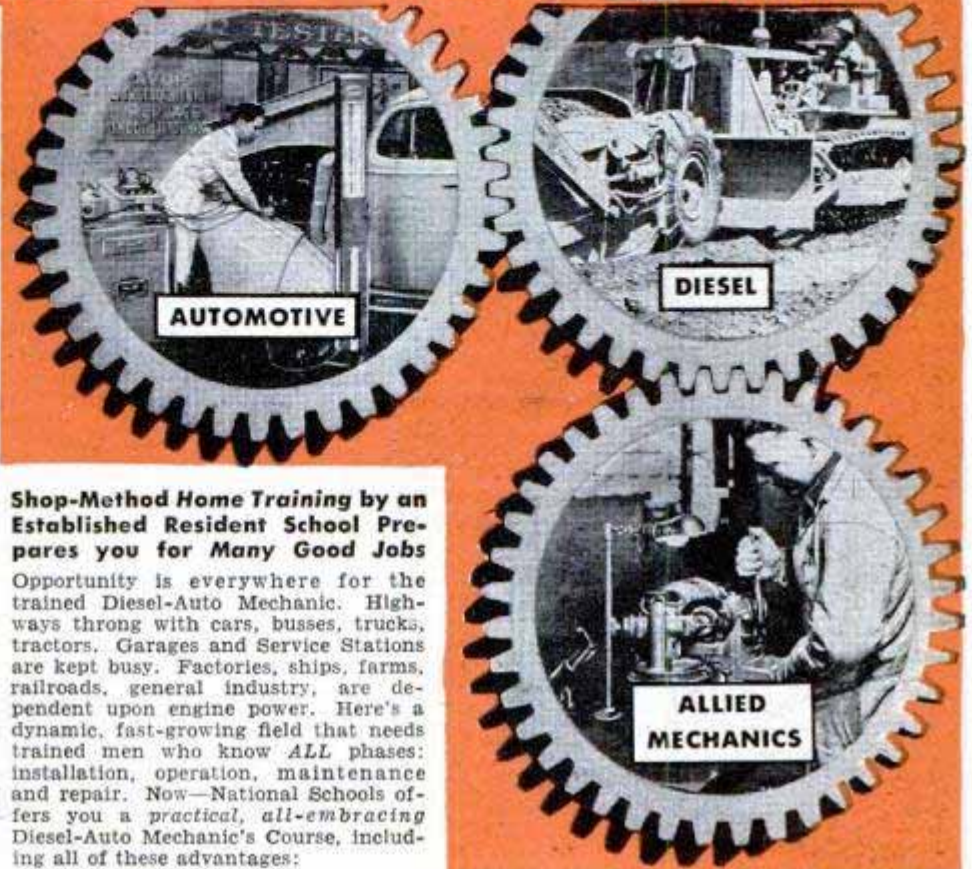

Shop-Method Home Training by an Established Resident School Prepares you for Many Good Jobs

Opportunity is everywhere for the trained Diesel-Auto Mechanic. Highways throng with cars, busses, trucks, tractors. Garages and Service Stations are kept busy. Factories, ships, farms, railroads, general industry, are dependent upon engine power. Here's a dynamic, fast-growing field that needs trained men who know ALL phases: installation, operation, maintenance and repair. Now—National Schools offers you a practical, all-embracing Diesel-Auto Mechanic's Course, including all of these advantages:

Complete training, covering—Diesels, High Speed and Heavy Duty; Semi-Diesels, Gasoline and Special Fuel Engines AND Allied Mechanics.

- Basic Lesson Texts
- Diesel Installation
- Operation - Maintenance
- Diesel Chart Manual
- Spare Time Lessons
- Engine Service Manuals
- Engine Repair
- Drive Systems
- Diesel Electric Power
- Thermodynamics

TOOLS AND EQUIPMENT

INVESTIGATE
Secure Full Information

NEW, ILLUSTRATED BOOK & SAMPLE LESSON SHOW HOW WE TRAIN YOU . . . SEND FOR THEM TODAY!

NO COST NO OBLIGATION

APPROVED FOR VETERANS
Check coupon below

NATIONAL SCHOOLS

LOS ANGELES 37, CALIF. • EST. 1905



FIND OUT NOW... MAIL COUPON TODAY

NATIONAL SCHOOLS, DEPT. 9-PMO
4000 South Figueroa Street
Los Angeles 37, California

(Mail in envelope or paste on penny postcard)

Mail me FREE the book, YOUR FUTURE IN DIESEL-AUTO MECHANICS, together with the Sample Lesson. I understand I may keep and use the information with no obligation.

Name _____ Age _____

Address _____

City _____ Zone _____ State _____

Check here if Veteran of World War II

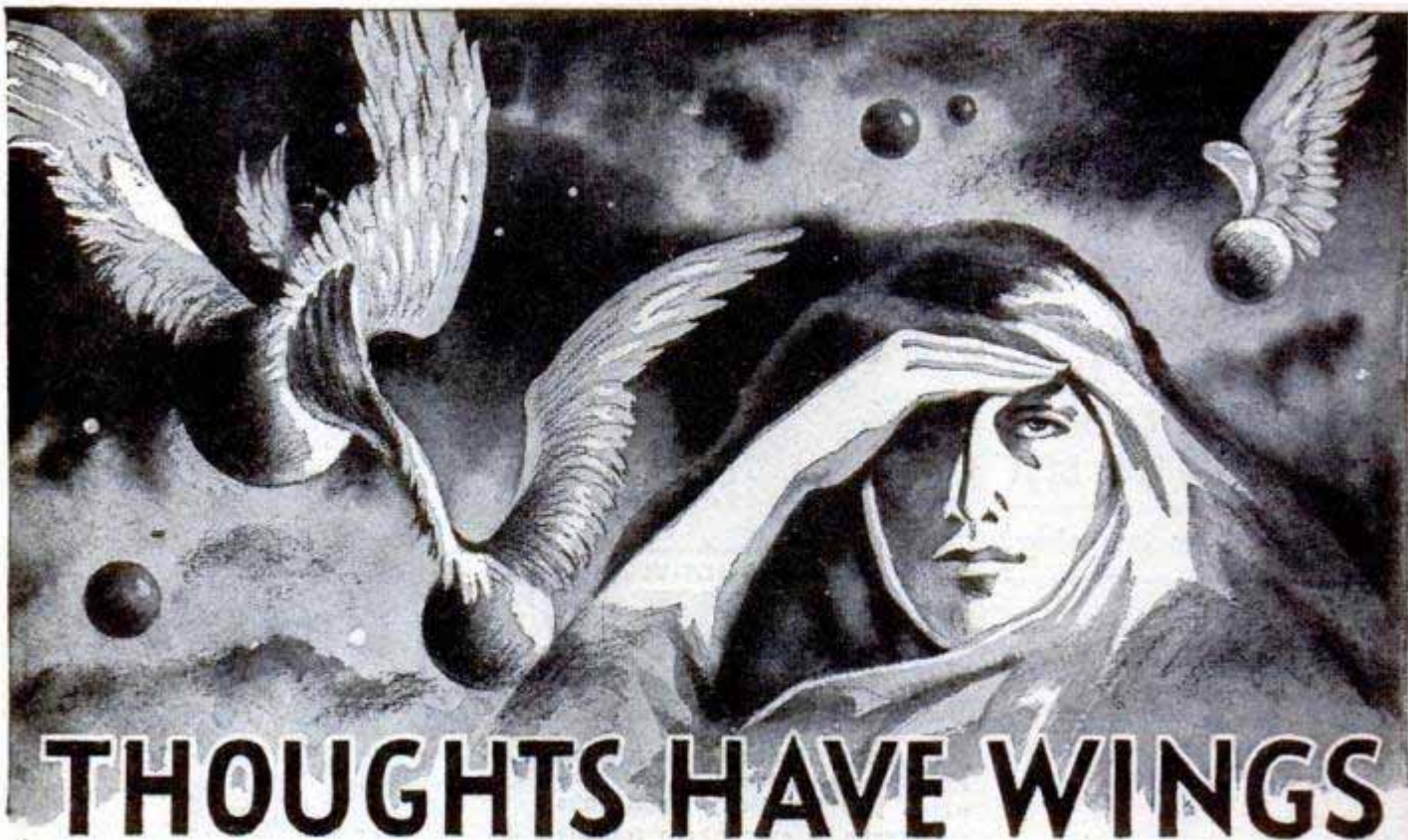

THOUGHTS HAVE WINGS

You Can Influence Others With Your Thinking!

TRY IT SOME TIME. Concentrate intently upon another person seated in a room with you, without his noticing it. Observe him gradually become restless and finally turn and look in your direction. Simple—yet it is a *positive demonstration* that thought generates a mental energy which can be projected from your mind to the consciousness of another. Do you realize how much of your success and happiness in life depend upon your influencing others? Is it not important to you to have others understand your point of view—to be receptive to your proposals?

Demonstrable Facts

How many times have you wished there were some way you could impress another favorably—*get across to him or her your ideas*? That thoughts can be transmitted, received, and understood by others is now scientifically demonstrable. The tales of miraculous accomplishments of mind by the ancients are now known to be fact—not fable. The method whereby these things can be *intentionally*, not accidentally, accomplished has been a secret long cherished by the Rosicrucians—one of the schools of ancient wisdom existing throughout the world. To thousands everywhere, for centuries, the Rosicrucians have

privately taught this nearly-lost art of the practical use of mind power.

This Free Book Points Out the Way

The Rosicrucians (not a religious organization) invite you to explore the powers of your mind. Their sensible, simple suggestions have caused intelligent men and women to soar to new heights of accomplishment. *They will show you how to use your natural forces and talents to do things you now think are beyond your ability. Use the coupon below and send for a copy of the fascinating sealed free book, "The Mastery of Life," which explains how you may receive this unique wisdom and benefit by its application to your daily affairs.*

The ROSICRUCIANS (AMORC)

Scribe L. B. S., The Rosicrucians, AMORC,
Rosicrucian Park, San Jose, California.

Kindly send me a free copy of the book, "The Mastery of Life." I am interested in learning how I may receive instructions about the full use of my natural powers.

Name.....

Address..... State.....

SENSATIONAL

New Training Offer!

NOW you build and keep a top quality

TELEVISION

RECEIVER

to help you prepare for a real job in

TELEVISION

RADIO-ELECTRONICS



Choice of 10, 12 or 16 INCH TELEVISION PICTURE TUBE

Now you can get this amazingly practical aid for learning Television at home, to help you get started toward **FASCINATING WORK.. GOOD MONEY THRILLING FUTURE**—in a real job, or your own sales and service business. • When you complete our regular home training—described below—you can build and keep a top quality commercial-type Television Receiver. Standardized chassis is adaptable for a 10, 12 or 16 inch direct view tube that gives big, bright, sharp, steady pictures. This is an optional training advantage—designed to provide the utmost in practical "learn-by-doing" home training in Television. Mail coupon for complete details. See why you owe it to your "Television Future" to enroll for DeForest's Training, Inc.

Mail Coupon NOW for FREE Information!

See how D. T. I.'s amazingly effective methods help start you toward a **GOOD JOB** or your **OWN BUSINESS** in one of America's most promising fields—including Television, F. M. Radio, Aviation, Train, and Taxi Radio, Broadcast Radio, Industrial Electronics. Get modern lessons... plus 16 shipments of Radio-Electronic parts. Work over 300 experiments and projects—including building of (1) commercial-type **OSCILLOSCOPE** for practical T-V circuit training, (2) double-range **R-F SIGNAL GENERATOR**, (3) jewel-bearing **MULTIMETER**, (4) quality **6-tube SUPERHET RADIO**. Then build and keep that big new Television Receiver. Here's **EVERYTHING YOU NEED** for real laboratory-type training.. **AT HOME!**

YOU ALSO BUILD AND KEEP THIS PROFESSIONAL TYPE EQUIPMENT!



Modern Chicago Laboratories

★ If you prefer, you can get ALL your preparation in our new, Chicago training laboratories... one of the finest of its kind. Ample instructors... modern equipment. Write for details!

Employment Service

★ When you complete your training, our effective Employment Service helps you get started toward a real future in Television—Radio—Electronics.



You also use HOME MOVIES!

• D. T. I. Exclusive!

D. T. I. alone includes the modern, visual training aid... **MOVIES**... to help you learn faster, easier at home. See electrons on the march and other fascinating "hidden action"—a remarkable home training advantage that speeds your progress.

MAIL THIS COUPON TODAY!

DeFOREST'S TRAINING, INC.
2533 North Ashland Avenue, Dept. PM-F9
Chicago 14, Illinois

Without obligation, give me complete facts showing how I may make my start in Television-Radio-Electronics.

Name _____ Age _____
Street _____ Apt. _____
City _____ Zone _____ State _____

De FOREST'S TRAINING, INC.

CHICAGO 14, ILLINOIS
A DE VRY Institution

Become an Expert ACCOUNTANT

The Profession that Pays

The demand for skilled accountants—men who really know their business—is increasing. National and state legislation is requiring of business much more in the way of Auditing, Cost Accounting, Business Law, Organization, Management, Finance. Men who prove their qualifications in this important field are promoted to responsible executive positions.

Send for This Book—It's Free

Knowledge of bookkeeping unnecessary. We train you from ground up, or according to your individual needs. Low cost; easy terms.

Send for free 48-page book describing the LaSalle accountancy training and the opportunities in this highly profitable field—plus "Ten Years' Promotion in One," a book which has helped many men.

LASALLE EXTENSION UNIVERSITY
A Correspondence Institution

Dept. 964-HR

Chicago 5, Ill.

LASALLE EXTENSION UNIVERSITY
A CORRESPONDENCE INSTITUTION

-----417 S. Dearborn Street-----
Dept. 964-HR Chicago 5, Ill.

Please send me "Accountancy, the Profession that Pays"—plus "Ten Years' Promotion in One"—without obligation.

- Higher Accountancy
- C.P.A. Coaching
- Bookkeeping
- Law: LL.B. Degree
- Business Management
- Salesmanship
- Traffic Management
- Foremanship
- Industrial Management (Machine Shorthand)
- Stenotypy



Name..... Age.....
Address.....
City, Zone, State.....

ENGINEERING DEGREE IN 27 MONTHS

Big Demand for Graduates

Aeronautical, Chemical, Civil, Electrical, Mechanical and Radio Engineering (including Television)

Hundreds of young men are earning engineering degrees in this recognized institution each year—continuous operation. New terms start quarterly. Many students earn a major part of their college expenses in this large industrial center.

Low tuition. Competent instruction. Thorough intense practical program. Modern laboratory facilities including new physics lab. and modernized wind tunnel. Individualized instruction emphasized.

Approved for Veterans. Engineering preparatory courses. Students from 48 states and 21 foreign countries. Enter September, December, March or June. Send coupon for free catalog and full information. Enroll now.

--- SEND COUPON TODAY ---

INDIANA TECHNICAL COLLEGE

599 E. Washington Boulevard
Fort Wayne 2, Indiana

Please send me free information on B.S. Engineering Degree in 27 months as checked.

- Aeronautical, Chemical, Civil, Electrical,
- Mechanical, Radio-Television.

Name.....
Address.....



HERE'S EVERYTHING YOU NEED TO LEARN THE MATCHLESS ART OF LEATHER CARVING—AT HOME

Now carve your own beautiful bags, bill-folds, belts, moccasins, key cases—anything from leather—at one-tenth the cost. We supply everything: patterns, tools, leathers, fittings, instruction books for craftsmen. Turn hobby into a business. Send \$1 for big set patterns, or

Send Only 25c for New Catalog #102

BURTONS LTD. 1755 1/2 GLENDALE BLVD. LOS ANGELES 26, CALIF., DEPT. E

FALSE TEETH

KLUTCH holds them tighter

KLUTCH forms a comfort cushion; holds dental plates so much firmer and snugger that one can eat and talk with greater comfort and security; in many cases almost as well as with natural teeth. Klutch lessens the constant fear of a dropping, rocking, chafing plate. 25c and 50c at druggists... If your druggist hasn't it, don't waste money on substitutes, but send us 10c and we will mail you a generous trial box. © I. P. INC.

KLUTCH CO. Box 4993-I ELMIRA, N. Y.

100 GAMES ON HORSEBACK

Games from MEXICO • ARABIA • INDIA • • Cowboy Sports
Learn to play — scoring — Fields and Courses
Exhibitions — Over 100 Games and Contests described
ANIMAL LOVERS BOOK STORE • Box KA 111, TARZANA, CALIF. **ONLY \$1.50**

CARPENTRY BRICKLAYING

APPROVED FOR VETERAN TRAINING • FREE CATALOG

PENNSYLVANIA INSTITUTE SCHOOL OF TRADES
30th & MARKET STS. PHILA. 4, PENNA.

Big money in spare time! \$ learn at home Tune pianos in 30 days \$

No musical knowledge needed. Piano tuners in great demand everywhere. Train under experts. Learn with phonograph recordings in 30 days. We furnish recordings, instruction books and professional tools (including record player if needed). We show you how to line up part or full time work for big earnings. Send for FREE literature today.

CAPITOL CITY TUNING SCHOOL
Dept. 934 211 E. Michigan Ave., Lansing, Michigan

LEARN Photo-Engraving

You can get into this big demand, high profit, high wage field. Learn at home or in our modern, friendly, approved school in Aurora where training costs you less than \$1.00 per hour with everything furnished.

Famous Tasope' photo-engraving plants are again available. You can start your own full or part time photo-engraving business right in your own home. With the Tasope' plant there is profit and fun for the whole family. Be independent, be your own boss or pave the way to a high pay job with experience gained in your own shop. Write to-day for details. No obligation.

The Aurora School of Photo-Engraving
Dept. P9M, Tasope' Bldg. Aurora, Missouri

NOW YOU CAN "Breeze Through" ANY AUTO REPAIR JOB!

DOGGONE! THIS JOB HAS ME LICKED! CAN'T FIGURE HOW TO FIX IT!



LET ME TAKE A CRACK AT IT!



10 MINUTES LATER—
GOLLY! SHE'S PURRIN' LIKE A KITTEN! HOW'D YOU DO IT?

LISTEN, PAL—ANY JOB IS TWICE AS EASY WITH ONE OF MoToR'S REPAIR MANUALS!

FREE
7-DAY TRIAL

MOTOR'S AUTO REPAIR MANUAL

NEW!

Yes—EVERY Auto Repair Job is a "Snap"—with This Big, BRAND-NEW, Time-Saving, Money-Saving Manual. Shows You How to Service and Repair ANY Part of ANY Standard Car, Including 1949 Models!

DON'T waste time and patience trying to "dope out" difficult car repairs! Just look up make, model, and job in MoToR's AUTO REPAIR MANUAL—and you can "whiz" through ANY job in almost no time. Clear, illustrated instructions lead you step by step all the way.

WORTH BIG MONEY TO: Mechanics, Handymen, Garagemen, Farmers, Repair Men, Service Station Operators, Taxi Owners.

See How Much You Get!

This BIG, brand-new 795-page book combines information from over 150 official Factory Shop Manuals. OVER 200,000 service, repair, tune-up facts—35,000 essential dimensions—on all makes and models, 1935 thru 1949! More than 2100 cut-away photos, diagrams show you exactly WHAT to do and HOW to do it. Used by the U. S. Army, tech schools; thousands of auto servicemen.

Win Prestige! Earn More Money!

MoToR's Manual makes every operation so easy that you'll find yourself tackling jobs you wouldn't think of doing before. And you'll win added prestige and more money in the bargain.

Beginners will find usable helpful guidance on every kind of repair and service job imaginable. Experts will be amazed by the time and labor-saving short cuts they'll discover.

SEND NO MONEY

Without risk, see for yourself how easily, clearly this book covers every job on every car! Just mail coupon—without money—for FREE 7-Day Trial. Unless you're convinced it's worth many times its cost, return book in 7 days and pay nothing! MoToR Book Dept., Desk 19, 250 W. 55th Street, New York 19, N. Y.

Published by MoToR, The Leading Automotive Business Magazine.



Used by U. S. Army and Navy

COVERS ANY CAR BUILT SINCE 1935!

- Auburn De Soto
- Austin Dodge
- Buick Ford
- Cadillac Frazer
- Chevrolet Graham
- Chrysler Hudson
- Cord Hupmobile
- Crosley Kaiser
- Lafayette
- La Salle
- Lincoln
- Mercury
- Nash
- Oldsmobile
- Packard
- Pierce
- Arrow
- Plymouth
- Pontiac
- Reo
- Studebaker
- Terraplane
- Willys



ABOVE: Showing operation of Buick Dyna-Flow—and, BELOW: How to adjust Ford Clutch. Every moving part is covered in simple words and BIG, CLEAR Pictures.

Just 2 of the Many Letters of Praise



"MoToR's Manual paid for itself on the first 2 jobs, and saved me valuable time eliminating guess-work."—W. SCHROP, Ohio



"Instructions so clear have no trouble learning anything about any car. Now working as mechanic in big plant."—SAM ORDONEZ, Cal.

Same FREE Offer on MoToR's TRUCK MANUAL

Covers EVERY job on EVERY truck made from 1936 thru 1946! 1400 pictures, 952 pages, 300,000 facts. All types Gasoline Engines, Truck Diesels, Hesselmanns, Fuel Systems, Governors, Lubrication, Ignition, Starters, Clutches, Axles, Brakes, etc., etc.

ALSO covers many buses, tractors, contractor and road building equipment, stationary power machinery. Check box in coupon.

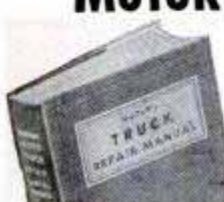

MAIL COUPON NOW FOR 7-DAY FREE TRIAL

MoToR BOOK DEPT.
Desk 19, 250 W. 55th St., New York 19, N. Y.

Rush to me at once (check box opposite book you want):
 MoToR's New AUTO REPAIR MANUAL. If O.K., I will remit \$1 in 7 days (plus 35c delivery charges), \$2 monthly for 2 months and a final payment of 95c one month after that. Otherwise I will return the book postpaid in 7 days. (Foreign price, remit \$8 cash with order.)
 MoToR's TRUCK REPAIR MANUAL. (Described at left.) If O.K., I will remit \$2 in 7 days, and \$2 monthly for 3 months, plus 35c delivery charges with final payment. Otherwise I will return book postpaid in 7 days. (Foreign price, remit \$10 cash with order.)

Print Name..... Age.....

Print Address.....

City..... State.....

Check box and save 35c delivery charge by enclosing WITH coupon entire payment of \$5.95 for Auto Repair Manual (or \$8 for Truck Repair Manual). Same 7-day return-refund privilege applies.



YOU CAN LEARN TO BE AN ARTIST

ENJOY THIS FASCINATING HOBBY—TRAIN FOR A PROFITABLE CAREER

Your future is in your own hands. Prepare yourself now in **COMMERCIAL ART, DESIGNING and CARTOONING**—all in ONE complete home study course. Trained artists are capable of earning \$65, \$80 and more a week. No previous art experience necessary—we teach you step-by-step for a fascinating hobby and a profitable career. For 35 years WSA graduates have been "making good"—**WHY NOT YOU?** Many pleasant art positions available in Television, Publishing, Advertising, etc. **FREE BOOK, "Art for Pleasure & Profit"** fully describes course, service and commercial opportunities. **TWO ART OUTFITS** included with training.

LOW COST — \$5 ONLY MONTHLY!
(VETERANS! Course G.I. approved)



FREE BOOK gives details!

WASHINGTON SCHOOL OF ART,
Studio 129R, 1115 15th St., N. W., Washington 5, D. C.

NAME _____ AGE _____

Address _____

City _____ Zone () State _____

I am entitled to training under the G. I. Bill.



Do you want

→ ..to go to College?

→ ..or to enter a Profession?

(Such as Accounting, Architecture, Nursing, Dentistry, Teaching, Social Work, Osteopathy, Beauty Culture, Optometry, Embalming, Chiropody, Law, Medicine, etc.)

→ ..or get an Office Position?

To get anywhere, you practically **MUST** finish High School **FIRST**. You can complete our simplified High School Course in **SPARE** time at home, as **FAST** as your time and abilities permit. Equivalent to resident school work—prepares you for college, pre-professional examinations, business, industry. Standard texts furnished. Diploma. Credit for H. S. subjects already completed. Single subjects if desired. Low tuition, easy terms. American School, Chicago, est. 1897—endorsed by educators. Finish your high school education **NOW**, Write **TODAY!**

High School Course at Home **Many Finish in 2 Years**

American School, Dept. H645, Drexel Ave. at 58th St., Chicago 37, Ill.

Gentlemen: Send me **FREE** information covering special training in subjects checked below. No obligation on my part.

- | | |
|--|--|
| <input type="checkbox"/> High School Course | <input type="checkbox"/> Diesel Engineering |
| <input type="checkbox"/> Architecture and Building | <input type="checkbox"/> Drafting and Design for Men & Women |
| <input type="checkbox"/> Automotive Engineering | <input type="checkbox"/> Plastics |
| <input type="checkbox"/> Business Management | <input type="checkbox"/> Private Secretary |
| <input type="checkbox"/> Electrical Engineering | <input type="checkbox"/> Mechanical Engineering |
| <input type="checkbox"/> Elec. and Gas Refrigeration | <input type="checkbox"/> Aviation |
| <input type="checkbox"/> Air Conditioning | <input type="checkbox"/> Salesmanship |
| <input type="checkbox"/> Railway Training | <input type="checkbox"/> Radio |
| <input type="checkbox"/> Electronics, Industrial | |

Name.....

Address.....



SECRETS OF MAGIC!

1000 MYSTIFYING
ROUTINES, TRICKS,
ILLUSIONS IN OUR
400 pg. CATALOG

\$1.00

Actually FREE—your \$1.00 refunded with first \$5.00 order.

Amaze and mystify your friends. Over 1000 professional routines, tricks, illusions described and illustrated.

LOUIS TANNEN

World's Most Modern Magic Studio
Dept. P, 120 West 42nd St., N. Y. 18, N. Y.



Learn to Write at Home in spare time

Regardless of how you Now write, you can become an Expert Penman at home in spare moments by my Simplified Method, as hundreds of others have done, who never before thought they could learn. Good penmanship pays big dividends and helps you win success.

Write for Full Details and my **FREE BOOK**, "How to Become an Expert Penman," which contains specimens of penmanship and shows what others have accomplished by taking my Courses at home in spare moments. If you wish, enclose 10c for Special Penpoint and your name with a flourished bird written on a card. Write **TODAY**.

McDevis Box 25K, CHILLICOTHE, MO.

LOTS \$300 LOW TERMS

In California's loveliest Garden Spot, on scenic shores of beautiful Morro Bay. Enjoy future independence with excellent soil, soft water, wonderful fishing, hunting, boating, bathing, etc. Grow fruits, vegetables, poultry. Perfect temperate climate. Congenial community. Finest investment. Free literature.

RICHARD S. OTTO

DEPT. M SAN LUIS OBISPO, CALIFORNIA

LEARN WATCH REPAIRING



AT HOME. By our modern and original system of instruction you can learn every part of the **WATCH REPAIRING TRADE AT HOME.** Prepare yourself for a well-paying position or start in business after completing our course of instruction. Good watch repairers are in demand and generally earn very good salaries. For particulars apply to the **Wisconsin School of Watch Repairing** 759 North Milwaukee St., Milwaukee 2, Wis.

MAKE EXTRA MONEY

Selling Christmas Card Box Assortments, also 25 and 50 cards for \$1.00 with name imprinted. Personalized stationery. Rush name. Samples on approval.

GENERAL ART CO., 225 - 4th Ave., N. Y. 3, N. Y.

RUPTURED?

Get Relief This Proven Way

Why try to worry along with trusses that gouge your flesh—press heavily on hips and spine—enlarge opening—fall to hold rupture? You need the Cluthe. No leg-straps or cutting belts. Automatic adjustable pad holds at real opening—follows every body movement with instant increased support in case of strain. Cannot slip whether at work or play. Light. Waterproof. Can be worn in bath. Send for amazing **FREE** book, "Advice To Ruptured," and details of liberal truthful 60-day trial offer. Also endorsements from grateful users in your neighborhood. Write:

CLUTHE SONS, Dept. 31, Bloomfield, New Jersey



Get
Into

RADIO, TELEVISION and ELECTRONICS Master ALL Phases

**YOU
Build This
Superheterodyne**

You receive complete standard equipment, including latest type High-Mu Tubes, for building various experimental and test units. You progress step by step until you build a complete Superheterodyne Receiver. It is yours to use and keep.



YOU RECEIVE THIS PROFESSIONAL MULTITESTER!

You will use this professional instrument to locate trouble or make delicate adjustments—at home—on service calls. You will be proud to own this valuable equipment. Complete with test leads.

R. F. OSCILLATOR:



This is one of the interesting units you will build. You learn how audio-frequency energy is generated and radiated by a vacuum-tube circuit.

AUDIO OSCILLATOR:

An electronic device, which produces audio-frequency signals for modulating R.F. (radio frequency) carrier waves, testing A.F. (audio frequency) amplifiers, speakers, etc.



T.R.F. RECEIVER



You build several T.R.F. Receivers, one of which, a 4-tube set, is shown here. You learn construction, alignment, make receiver tests, and do trouble shooting.

Get Complete Training. You Receive and Keep All Equipment, Parts and Lessons. No Extra Charges.

**GOOD PAY
and Unlimited Opportunities
in JOBS LIKE THESE:**

Business of Your Own
Radio Manufacturing, Sales, Service
Broadcasting Telecasting
Television Manufacturing,
Sales, Service
Laboratories: Installation, Maintenance of Electronic Equipment, Electrolysis, Call Systems
Garages: Auto Radio Sales, Service Sound Systems and Telephone Companies; Oil Well and Drilling Companies; Engineering Firms
Theatre Sound Systems Police Radio
**And scores of other good jobs
in many related fields**

**YOU CONDUCT MANY
EXPERIMENTS LIKE THESE!**

Checking action of condensers
Experiments with cathode-ray principles
Experiments with resonance
Producing beat frequencies
Calibrating oscillators
Experiments with diode, grid-bias, grid-leak and infinite impedance detectors
Practical experience in receiver trouble shooting
Application of visual tester in checking parts and circuits
Experiments with inverse feed-back
Advanced trouble-shooting
... and many, many others

Complete Training by Practical Resident Trade School, Est. 1905

The same highly trained faculty, instruction materials and methods used here in our large, modern residence school, are adapted to your training in your own home. Shop Method Home Training has been proved by hundreds of successful graduates.

**Both Resident and Home Study
Courses Offered**

YOU LEARN BY DOING

You receive special laboratory experiment lessons to show you how to build with your own hands various experimental units such as those shown at left, and how to conduct many tests.

You will find all lessons easy to understand because they are illustrated throughout with clear diagrams and step-by-step examples that you work out yourself. Every piece of the equipment and complete lesson material we send you is yours to keep and enjoy, including the multitester, experimental equipment, all parts of the Superheterodyne, tube manual, radio dictionary, and complete, modern Television texts. All parts are standard equipment.

Shop Method Home Training . . . Earn While You Learn

With our practical resident Shop Method Home Training, you study in your spare time. You receive Spare Time Work Lessons, which show you how to earn while you learn. Service neighbors' radios and TV receivers, appliances, etc., for extra money and experience. Many National students pay all or part of their training with spare time earnings!

**DON'T DELAY! The Radio-Television
Industry needs trained men NOW!**

**APPROVED
FOR
VETERANS!**
Check coupon below!

For quick action,
mail coupon
today and we'll
rush you full information.

Free!

**NEW, ILLUSTRATED
OPPORTUNITY
BOOK AND SAMPLE
LESSON SHOW YOU
HOW WE TRAIN
YOU . . . SEND FOR
THEM TODAY! NO
COST. NO
OBLIGATION.**



NATIONAL SCHOOLS

LOS ANGELES 37, CALIF. • EST. 1905



FIND OUT NOW . . . MAIL COUPON TODAY

National Schools, Dept. 9-PM
4000 South Figueroa Street
Los Angeles 37, California

Send me your FREE book "Your Future in Radio" and the sample lesson of your course. I understand no salesman will call on me.

NAME.....AGE.....

ADDRESS.....

CITY.....ZONE.....STATE.....

Check here if Veteran of World War II

Mail in envelope
or paste on
penny postal.



HIGH PAY • SECURITY
When You
LEARN A TRADE

Get ready for a well-paid, lifetime job or a business of your own in one of these **FIVE ESSENTIAL TRADES**. Complete training under expert instructors with practical experience prepares you to step into a good paying job with a future and security.

ELECTRICITY: Basic electricity, Residential and Industrial Wiring and Appliance Repair.

PLUMBING: Every phase — pipe cutting and threading to complete installations, blue print reading.

AUTOMOTIVE & TRACTOR: Engine overhaul, Transmissions, Carburetion, Generator-Ignition Systems, Tune Up.

DRAFTING: College level training in general Machine and Architectural Drafting

SHOE REPAIRING: Complete practical training includes reconditioning and rebuilding.

Approved For Veteran's Training

NATIONAL TRADE SCHOOL

2610 Grand • Kansas City 8, Mo.

Without obligation to me please send full information on the course checked.

.....Automotive and Tractor Technician ... Drafting
.....PlumbingElectricityShoe Repairing

Name..... Age.....

Address.....

City..... State.....

Veteran?.....

Learn this Profitable Profession



IN 90 DAYS AT HOME

Money-Making Career Open to Men and Women, 18 to 50

Hundreds of men and women between 18 and 50 make \$10 to \$20 in a single day giving scientific Swedish Massage and Hydro-Therapy treatments. There is big demand from doctors, hospitals, sanatoriums and clubs. Graduates earn large full time incomes from these or in private practice in their own offices. Others make good money from home treatments given in spare time. Learn this interesting, money-making profession in your own home, through our home study course. Same instructors as in our nationally known resident school. You can win independence and prepare for future security by qualifying for your Diploma. Course can be completed in 3 to 4 months. Many earn while they learn. Begin your training at once.



Anatomy Charts & Booklet FREE

Enroll now and we will include, at no extra cost, many needed supplies. Fit yourself to help meet growing demand for Scientific Swedish Massage. Send the coupon at once for complete details. Anatomy Charts and 32-Page Illustrated Booklet, **FREE, postpaid.**

THE COLLEGE OF SWEDISH MASSAGE

Dept. 964L, 41 E. Pearson, Chicago 11, Illinois

Please send me **FREE** and postpaid, Anatomy Charts, 32-page Booklet and complete details on Home Training.

Name..... Age.....

Address.....

City..... State.....

There's **CASH** in **CHRISTMAS CARDS!**

Easiest money-maker out! Everybody buys Christmas Cards. They'll buy from you when you show smartly designed Folders low as **50¢ for \$1** with **NAME**. You make fine profit on every order. Up to 50¢ is yours on quick \$1 sales of stunning **LEADER 21-Card Christmas Assortment**. Many other money-making assortments: Silverglo, Religious, Gift Wraps, Everyday, over 20 others. **Name-Imprinted Floral Notes, Personal Stationery. Get FREE Imprint Samples, LEADER on approval. Write NOW!**

FRIENDSHIP STUDIOS, INC. **50¢ for \$1 with Name FREE Samples**
726 ADAMS STREET • ELMIRA, N.Y.

LAW FREE BOOK



Your **FREE** copy of "The Law-Trained Man" shows how to gain prestige and greater earnings through Blackstone home law study. All instruction material furnished including 18-volume Law Library written by 65 well-known law authorities. Lawyers, judges among our graduates. **L.L.B. degree. Low cost; easy terms. Write today.**
BLACKSTONE COLLEGE OF LAW 225 N. Michigan Ave. Dept. 56, Chicago 1, Ill.
A Correspondence Institution Founded in 1890

WOULD \$400 PER MONTH INTEREST YOU?



It is easily possible to earn \$400 to \$500 a month raising **ANGORA RABBITS**. No experience required. Wool brings top price. Plenty markets. **WRITE TODAY** for **FREE INFORMATION, PRICES** and **WHERE TO SELL.**

WHITE'S RABBITRY
NEWARK 10, OHIO

RUPTURE RELIEF

Advanced method. No leg straps, no elastic, no steel. Entirely different. Guaranteed. Write:
SMITH MANUFACTURING COMPANY
DEPT. PM PRESTON, ONT., CAN.

LEARN TO WRITE a Good Hand!

FOR BUSINESS AND SOCIAL SUCCESS!
Easy to improve your handwriting at home quickly with my new instruction books just off the press. Master all the secrets of better penmanship. Simple and easy, fully illustrated, highly endorsed. Begin today. Write for: **New Free Book, "How to Become a Good Penman,"** or check books wanted, \$1.00 each. **Business Writing** **Artistic Writing** **Card Writing** **Engraving Alphabets** **Bird and Design Flourishing** **Complete Set \$4.50** **Enclose 10¢ for your name** beautifully written and special penpoint for shaded writing.
S. A. Ziller, President, TAMBLYN SCHOOL OF PENMANSHIP
441 Ridge Bldg. In Business Over 52 Years Kansas City, Mo., U.S.A.

TRAINED MEN GET THE BETTER JOBS PRACTICAL SHOP TRAINING

in AUTOMOTIVE MECHANICS BODY and FENDER REBUILDING
If interested write for catalog or wire
ATLANTA MOTIVE TRADES INSTITUTE
Dept. P, 254 IVY St., N.E., Atlanta, Georgia
Member of the Southern Association of Private Trade Schools
Veterans ask about G I Training

REAL ESTATE BE A BROKER

PAYS BIG! SEND FOR FREE, BIG, ILLUSTRATED CATALOG NOW! No obligation. Graduates report making substantial incomes. Start and run your own business quickly. Men, women of all ages, learn easily. Course covers Sales, Property Management, Appraising, Loans, Mortgages, and related subjects. **STUDY AT HOME** or in our classrooms in big cities. Diploma awarded. **G.I. approved. Nationally known.**
WEAVER SCHOOL OF REAL ESTATE (Est. 1936)
15 E. Pershing Road Dept. PM-9 Kansas City, Mo.



Learn BAKING At Home

Baking is one of America's high industries in wages. Nearly depression-proof. Thorough basic home course lays sound foundation. If you have aptitude, write for **FREE BOOKLET, "Opportunities in Commercial Baking."**
National Baking School, 1315 Mich. Ave., Dept. 1356, Chicago 5



Want to be in **BUSINESS** for **YOURSELF**

or Get a Good Pay Job?

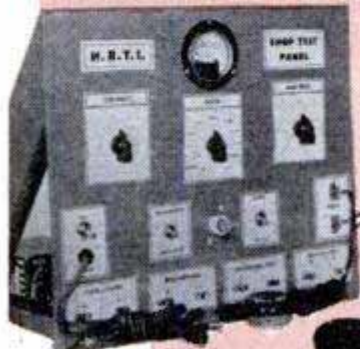

You Construct the Multi-purpose Shop Test Panel Shown at Left and Build SCORES of Radio Circuits Like Those Shown Below With the Parts I Send You.



Since 1929 I have been training men ALL OVER THE WORLD for success in radio. Find out how easy it is to learn right in your home through my two-way method - lessons plus actual practice. Send for big FREE book, TODAY.

H.R.T.I. Trained Men Win in Big Contest

FIRST, SECOND and FOURTH prizes in open contest for best Radio Technicians in Cuba WERE WON BY HRTI students and graduates! In fact, SEVEN of the first ten prizes were won by HRTI trained men! Over 250, graduates from many schools, as well as professional radio technicians, competed! Convincing proof of the quality of HRTI training. Get the facts about this amazing contest in my big FREE book.

APPROVED FOR VETERANS
CHECK COUPON

BIG BOOK FREE

Sending for this book has marked the turning point in the lives of many men. You owe it to your future to find out about H.R.T.I. Training. Mail the coupon TODAY.



LEARN **Radio and Television**

Make Money in Spare Time While Learning at Home

Want to make more money? Want to be your own boss - have your own money-making business - with your future assured? Then learn Radio & Television with my proven 2-Way Method that can help you get into this great and growing business QUICKER.

Many of my students make money, some even start their own business in spare time - while learning.

Take the first step toward a successful career - NOW - send for my big 56-page illustrated book that tells how my home training can help prepare you to cash in on Radio and Television's opportunities. It's free, but it may mean your future success!

You Learn by Doing!

YOU GET 10 KITS OF RADIO PARTS!

YOU DO OVER 300 FASCINATING TESTS



You Build This 3 Tube Experimental Receiver (above) and This A-C Power Supply (right)

During your training you get 10 big kits of radio parts with which you perform hundreds of tests and experiments, build scores of circuits and testers, to help you learn faster, more thoroughly.

You learn first hand, by doing.

You Also Construct This Powerful, Four-Band, Six-Tube, A-C or D-C Superheterodyne Receiver



MAIL COUPON NOW

C. H. MANSFIELD, Pres., Dept. A-18
Hollywood Radio and Television Institute, Established 1929
810 West Sixth St., Los Angeles 14, California, U.S.A.

Send me your FREE book, "Your Opportunities in Radio, Television and Electronics," which explains your 2-way home study training method. No salesman will call.

NAME _____

ADDRESS _____

CITY _____ STATE _____

If a veteran of World War II, check here

HOLLYWOOD RADIO & TELEVISION INSTITUTE
810 West 6th St., Los Angeles 14, California, U.S.A.



**I CAN TEACH YOU
WATCH REPAIRING
AT HOME!**

Here is a wonderful opportunity to get into this top-pay, easy-to-learn, uncrowded field thru my unique 10-lesson home study course. Watchmakers in big demand. You train under experts—learn to take a watch apart, repair and put it in perfect running order. Get out of the rut—turn spare time into cash—perhaps a business of your own. More jobs than men to fill them. We have students 18 to 65 who have profited by our training. No interference with present job. We furnish all tools, 15-jewel watch and practice movement. A licensed school.

If more interested in clock repairing or jewelry repair and design, check coupon below and mail at once.

MAIL COUPON TODAY

Mr. E. King, President Dept. PM-9
Illinois School of Watch Repairing
2870 Elston Avenue, Chicago 18, Ill.
Send me at once without obligation free literature on
 Watch Repairing Clock Repairing
 Jewelry Repair & Design
Name.....
Address.....
City.....Zone.....State.....

Here's How CREI Prepares You for a Professional Career with Industry-Recognized Training in a Minimum of Time

**RADIO - ELECTRONICS
TELEVISION ENGINEERING**

GRADUATES of CREI residence school are preferred by industry because of their training and ability. This recognition is the reason that CREI men quickly find good jobs. With 22 years of practical teaching experience in these highly technical fields, CREI offers an outstanding faculty, modern and complete laboratories, shops and equipment.

New students are accepted twice monthly and each may advance as rapidly as he is capable. The basic course with one specialized course requires an average of 20 months to complete.

CREI is recognized as one of the country's leading technical institutes. Its work is of college level. It prepares the young man for a good job in industry in a minimum of time.



Approved for Veterans' Training

CAPITOL RADIO ENGINEERING INSTITUTE

An Accredited Technical Institute Founded in 1927
Mail coupon for Free Catalog

Capitol Radio Engineering Institute, Dept. 179A
16th & Park Road, N.W., Washington 10, D. C.
Please send me your residence school catalog and complete details. (If interested in Home Study check below.)
Name.....Age.....
Street.....
City.....Zone.....State.....
 I am entitled to training under G.I. Bill. Send information on Home Study Courses.

Be an INVESTIGATOR

JAMES S. BOLAN, FORMER POLICE COMMISSIONER OF NEW YORK CITY offers MEN & WOMEN an attractive opportunity to prepare for a future in *Investigation & Criminology* by comprehensive Home Study Course. Free placement service assists graduates to obtain jobs. APPROVED UNDER G. I. BILL OF RIGHTS.
Write for Free Booklet PM.

THE BOLAN ACADEMY, INC.
EMPIRE STATE BLDG., NEW YORK 1, N. Y.



**WASHES DISHES
IN JIFFY!**

BRAND NEW... Nothing else like it. Amazing "Sponge" Dish Cloth washes dishes lightning fast. Replaces messy dishrags. Suction action works like magic. Dishes gleam like a mirror. Truly a Godsend to busy housewives.

SAMPLES FOR AGENTS

Sample offer sent immediately to all who send name at once. A penny postal will do. SEND NO MONEY—JUST YOUR NAME.
Kristee Co., 684 Bar St., Akron, Ohio



**LEARN
MEAT CUTTING**

through actual practice. Profitable Meat Cutting and Self Service Meats taught easily, quickly. LEARN BY DOING at Toledo in just eight short weeks under actual market conditions. For beginners or men with experience. All subjects taught thoroughly and completely. Diploma. Job help. Get store of own. People must eat. School in operation over 25 years. Approved for GI training. Send today for FREE illustrated catalog. No obligation. NATIONAL SCHOOL OF MEAT CUTTING, Dept. 50-R, Toledo 4, Ohio

**NEW! LOW COST!
RESPIRATOR**

Wear when sanding, grinding, paint spraying, sweeping, dusting, furnace cleaning, etc. Handy as a pair of glasses. Just keep mouth closed and breathe through nose is all you do to operate. Protects against nuisance dusts, lint, coal, cement, grain dust, hay fever pollen. Has 9 sq. in. filter. For EYE protection against paint spray, dusts, gases, fumes, smoke, order our Fog-Proof Rubber GOGGLES.....\$2.00 p.p.
JERRY BRYANT, Dept. PM
919 N. Michigan Ave. Chicago 11, Ill.



Order Today \$1.00 POST PAID



RAISE HAMSTERS

The new wonder animals from Syria. Often called Toy Bears. Delightful pets. Everyone wants them. Laboratories need thousands. Clean, odorless. Raise anywhere. A profitable and interesting hobby or business. We furnish breeding stock with manual of instructions.

Write today for free illustrated literature.

GULFHAMSTERY, 1536 BASIL, MOBILE, ALA.



**"LEARN-BY-DOING"
ELECTRICITY**

PRACTICAL TRAINING NOT "HOME STUDY"

G.I. APPROVED Get actual experience in great shops of M.T.I. Learn all phases Practical Electricity; Housewiring, Motors, Const., Maintenance, etc. Living arrangements, Part-time jobs, etc.

Send coupon TODAY.

MICHIGAN TECHNICAL INSTITUTE Veteran
2281 W. Fort St., Detroit, Mich., Dept. PM-9
Name.....
Street.....
City.....State.....

They Never Knew It Was SO EASY To Play

**Thousands Now Play Popular Songs
Who Didn't Know a Note of Music Before**

**You, too, can learn your favorite
instrument at home, without
a teacher, this quick,
easy, money-saving way**

THINK of the fun YOU are missing! The popularity, friendship, good times! Why? Because you think it's hard to learn music. You have an idea that it's a slow, tedious task, with lots of boring drills and exercises.

That's not the twentieth-century way! Surely you've heard the news! How people all over the world have learned to play by a method so simple a child can understand it—so fascinating that it's like playing a game. Imagine! You learn without a teacher—in your spare time at home—at a cost of only a few cents a day! You learn by the famous print-and-picture method—every position, every move before your eyes in big, clear illustrations. You CAN'T go wrong! And best of all, you start playing real tunes almost at once, from the very first lesson.

No needless, old-fashioned "scales" and exercises. No confused, perplexing study. You learn to play by playing. It's thrilling, exciting, inspiring! No wonder hundreds of thousands of people have taken up music this easy way. No wonder enthusiastic letters like those reproduced here pour in from all over the world.

Sound interesting? Well, just name the instrument you'd like to play and we'll prove you CAN! (Instruments supplied when needed, Cash or Credit.) Mail the coupon or write. Do it now! 51st year.

**U. S. SCHOOL OF MUSIC
79 Brunswick Bldg.
New York 10, N. Y.**



Music is the magic key to friendship, fun, romance. The person who can play a musical instrument is always sure of a welcome. Why not let music open up a new world for you. Thousands have discovered unexpected pleasure and profit in music, thanks to the unique method that makes it amazingly easy to learn.

**Send for FREE Booklet and
Print and Picture Sample**

See for yourself how this wonderful self-instruction method works. Sit down, in the privacy of your own home, with the interesting illustrated booklet, "How to Learn Music at Home." No salesman will call—decide for yourself whether you want to play this easy way.



Learned Quickly at Home. "I didn't dream I could actually learn to play without a teacher. Now when I play for people they hardly believe that I learned to play so well in so short a time." *H. C. S., Calif.



Invited to Parties. "Before I took your course I didn't know one note of music. Then three months later I started to play for dances. I've been invited to many parties. The course is easy and interesting." *R. M., Vancouver, B. C.

Well Worth Money. "The course is fully self explanatory. When one is finished with it there is little one need to learn. It is well worth the money and I fully believe you have the finest course on the market today." *R. E. G., Clarksburg, W. Va.

Surprised Friends. "People who hear me play don't understand how I do it. They ask if I haven't had lessons from a teacher. To their surprise they find I haven't. I'm glad to be a student of your School." *M. H., Athol, Kans.

**U. S. SCHOOL OF MUSIC
79 Brunswick Bldg., New York 10, N. Y.**

I am interested in music study, particularly in the instrument indicated below. Please send me your free booklet, "How to Learn Music at Home" and the free Print and Picture Sample.

- | | | |
|-----------------|-------------|------------------|
| Piano | Reed Organ | Modern |
| Guitar | Tenor Banjo | Elementary |
| Hawaiian Guitar | Ukulele | Harmony |
| Violin | Clarinet | Mandolin |
| Piano Accordion | Trombone | Practical Finger |
| Saxophone | Flute | Control |
| Trumpet, Cornet | Piccolo | |

Mr. _____ Have You
Miss _____ This Instr.?
Mrs. _____ (PLEASE PRINT)

Address _____

City _____ State _____

Note: If you are under 16 yrs. of age, parent must sign coupon.

*Actual pupils' names on request. Pictures by Professional models.

SAVE 2c—Stick coupon on penny postcard.

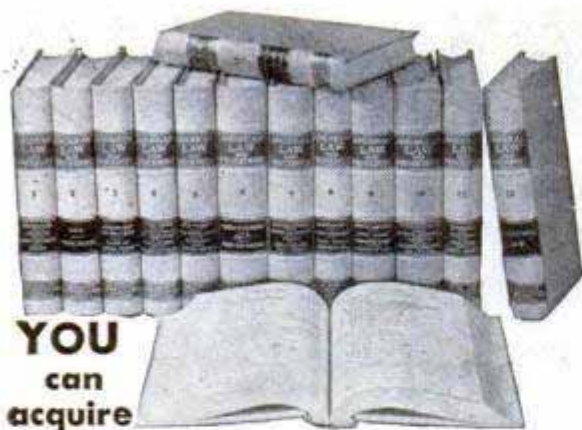

YOU
can
acquire

LAW NIGHTS AT HOME! L. L. B. DEGREE

LaSalle's famous Law Library—used as reference in many Law libraries and Law offices—has enabled thousands to master Law surprisingly fast, in spare hours at home, for business and professional advancement.

These 14 remarkable volumes, compiled by leading professors and lawyers, cover the whole basic field of Law in condensed, orderly, simplified manner.

You advance rapidly with this great library, plus special lectures furnished. We guide you step-by-step with personalized Problem Method of instruction . . . you learn by doing—handling legal problems—not by memorizing rules.

Send for two FREE 48-page booklets, "Law Training for Leadership," and "Evidence," answering questions about Law and its value to you, and telling how LaSalle Law graduates are winning rapid advancement in business and public life. Mail coupon below. No obligation.

LA SALLE EXTENSION UNIVERSITY A Correspondence Institution

417 S. Dearborn St. Dept. 964-L Chicago 5, ILL.

Send me your two FREE booklets described above, without obligation.

Name.....Age.....

Street.....

City, Zone & State.....

This Modern Masonry Has High Earning Power

An Outstanding
Manufacturing
Opportunity
for Right Man



Tie in with today's demand for smart, colorful, low-cost masonry for homes and other buildings. Dunbrik-Dunstone has beauty, strength, modernity. Easily America's finest masonry, with tremendous appeal to building owners. Yet costs less than lumber because locally manufactured from local materials by local labor for local consumption.

More local plants are needed. You can be one of a national chain. Simple, compact equipment. Moderate investment. 100%—150% mark-up on basic costs. Broad protection and liberal cooperation. Write for "Blueprints for Profit."

W. E. Dunn Mfg. Co.
600 W. 24th St., Holland, Mich.

DUNBRIK DUNSTONE

Tells How You Can Learn to FREE BOOK MOUNT BIRDS!



Learn At Home

Men, Boys, Hunters, Fishermen, mount and save your lovely wild-game trophies. Be a Taxidermist. Mount Birds, Animals, Heads, Fish, Tan skins. YOU learn easily, quickly in spare time. Have a grand home-museum. The finest and the greatest hobby known, for sportsmen. Fun, real profits.

FREE BOOK

You FREE. Beautiful strange, valuable BOOK, telling all about Taxidermy. Contains over 100 beautiful game-pictures. And it's yours FREE, if you rush your request. You can mount all kinds of wild-game, and common specimens too. We can positively TEACH YOU. So GRASP this opportunity. RUSH letter or postal for this amazing FREE BOOK. Don't delay. State your AGE. N. W. SCHOOL OF TAXIDERMISTRY, 2509 Elwood Bldg., Omaha 2, Neb.

"Fleas Don't
Bother Me
I'm Dusted with
PULVEX DDT"



PULVEX ... KILLS FLEAS
FLEA POWDER ... KEEPS 'EM OFF

MAKE
EXTRA
MONEY

Samples on
Approval

SELL NEW SENSATIONAL CHRISTMAS CARDS

It's easy! Make up to 50% commission. Sell them to your friends, neighbors or fellow workers. 21 card assortments that sell on sight. Most beautiful cards ever designed.

LIBERTY BELL STUDIOS
Dept. J-1-1013 Filbert St., Phila. 7, Pa.

50 for \$1
25 for \$1
With name
imprinted
FREE
SAMPLES

BOYS-IT'S FREE!

Exciting, new book tells about
"ATOMIC ENERGY"
and "THE WONDERS OF CHEMISTRY"

Also shows how to amaze friends with Chemcraft magic and do many exciting home experiments. Free. Send today!



THE PORTER CHEMICAL CO., 22 Prospect Ave., Hagerstown, Md.

What Is a Tachometer?

WHAT IS A TELEMETER? See Page 261



TRAIN TO BE A TOP-NOTCH

DENTAL TECHNICIAN

Day &
Evening
Courses

FOR A BRIGHTER FUTURE

Study at a modern, well-equipped school under skilled, professional teachers. Approved for Veterans.

KERPEL SCHOOL OF DENTAL TECHNOLOGY—309 S. BROAD ST.
PHILADELPHIA 7, PA. — KI 5-6760

WHICH OF THESE *Opportunities* INTERESTS *You* MOST?

● Today, choose the job you want—and prepare for it. Or if you are already engaged in the work you like best, start training now for quicker promotion. Acquire the knowledge that will help you to get ahead faster, make more money and have greater security.

American School, founded in 1897 as an educational institution *not for profit*, can help you to reach your goal just as it has helped others during the past fifty-two years. Check the coupon at right, add your name and address and mail it at once. The school will send you details on its training plan and outline of study prepared by specialists. There is no charge, no obligation, so send the coupon immediately.

CHECK, CLIP AND MAIL COUPON NOW

AMERICAN SCHOOL, Dept. G-645, Drexel at 58th, Chicago 37, Ill.
Without obligation, Please send FREE and postpaid, bulletin and details of the Subjects checked:

- | | | |
|--|--|--|
| <input type="checkbox"/> PLASTICS ENG'R | <input type="checkbox"/> Accounting | <input type="checkbox"/> Drafting and Design for Men and Women |
| <input type="checkbox"/> Refrigeration | <input type="checkbox"/> Electrical Engr. | <input type="checkbox"/> Radio |
| <input type="checkbox"/> Architecture and Building | <input type="checkbox"/> Electricity-Pract. | <input type="checkbox"/> High School |
| <input type="checkbox"/> Contracting | <input type="checkbox"/> Electronics, Industrial | <input type="checkbox"/> Air Conditioning |
| <input type="checkbox"/> Practical Plumbing | <input type="checkbox"/> Bookkeeping | <input type="checkbox"/> Mechanical Eng. |
| <input type="checkbox"/> Automotive Engr. | <input type="checkbox"/> Private Secretary | <input type="checkbox"/> Shop Management |
| <input type="checkbox"/> Aviation Drafting | <input type="checkbox"/> Diesel Engineering | <input type="checkbox"/> Tool Making |
| <input type="checkbox"/> Aviation | <input type="checkbox"/> Sheet Metal Pattern | <input type="checkbox"/> Better Foremanship |
| <input type="checkbox"/> Business Management | <input type="checkbox"/> Drafting | <input type="checkbox"/> Machine Shop Operations |
| | <input type="checkbox"/> Railway Training | |

Name _____ Occupation _____
Address _____ Age _____
City _____ State _____

AMERICAN SCHOOL
Dept. G-645, Drexel at 58th Street, Chicago 37

EARN \$10,000 A YEAR

Many excellent opportunities for over 100 occupations including clerks, mechanics, engineers, electricians, apprentices, laborers, etc. You can earn \$2700 to start — quarters and subsistence furnished. TRAVEL, ADVENTURE, FUN, PROFIT, EDUCATION are yours with a career in the American Merchant Marine—Absolutely Non-Military. Write for your Free booklet today.

INTERNATIONAL MARITIME INSTITUTE
79 WALL STREET NEW YORK 5, N. Y.



"How to Make Money with Simple Cartoons"
A book everyone who likes to draw should have. It is free; no obligation. Simply address **FREE BOOK**

CARTOONISTS' EXCHANGE
Dept. 99-F Pleasant Hill, Ohio

LEARN MEAT CUTTING EASILY - QUICKLY At Home - In Spare Time



The steady, dependable trade of Meat Cutting taught easily, quickly by improved HOME METHOD. National School, established over 25 years, has organized its famous "Learn By Doing" Classroom, Cutting room and Retail Market training system into sound, practical HOME STUDY form.

Now, by the miracle of this EXTENSION TRAINING you can prepare in Your Spare Time At Home, for a better job, bigger responsibilities or success and security in a store of your own. Remember, PEOPLE MUST EAT!

Buying, cutting, percentage, pricing, advertising, selling—a complete meat education. For beginner or men with ex-

perience. Thousands of successful graduates. Send coupon for FREE Bulletin NOW!

MAIL THIS COUPON TODAY FOR FREE BULLETIN
National School of Meat Cutting Div. U-108, Toledo 4, Ohio
Send me your FREE Bulletin on Meat Cutting and Meat Merchandising. No obligation. No Salesman will call.

Name _____
Street _____
City _____ State _____

INVENTORS

When you are satisfied that you have invented a matter of value—write me, without obligation, for full information as to what steps you should take to secure a Patent.

The usual first step is to have a search of the prior U. S. Patents conducted, so that I can report to you on the question of Patentability.

PATRICK D. BEAVERS

(Formerly RANDOLPH & BEAVERS)

Registered Patent Attorney

934 Columbian Building Washington 1, D. C.

PATRICK D. BEAVERS, Registered Patent Atty.
934 Columbian Bldg., Washington 1, D. C.

Please send me full information on how to secure Patent Protection and Trademark Registration.

Name _____

Street _____

City _____ State _____

INVENTORS

IF YOU WISH TO PROTECT YOUR INVENTION, You should take steps to protect it by a U. S. Patent. Write me for "Record of Invention" form.

CARL MILLER REGISTERED PATENT ATTORNEY

Woolworth Bldg., 35th Floor, Dept. 99-A, New York City
Please send me "Record of Invention" form.

NAME _____

ADDRESS _____

PATENTS

"Proof of Invention" Folder mailed without obligation.

E. E. VROOMAN, Registered Patent Atty.

505 McKim Building, Washington 5, D. C.

TRAIN NOW FOR AN

AVIATION CAREER

IN SUNNY SOUTHERN CALIFORNIA

MAXIMUM TRAINING IN MINIMUM TIME

Specializing in AERONAUTICAL ENGINEERING and MASTER AVIATION MECHANICS since 1929 America's Finest Aeronautical Institute 7000 successful graduates. MAKE MORE MONEY. MAIL COUPON TODAY APPROVED FOR VETERANS. Board and Room now available.

Without obligation, send free catalogue with full information.

NAME _____ AGE _____ PM-9

ADDRESS _____

CITY _____ ZONE _____ STATE _____

CAL-AERO TECHNICAL INSTITUTE

GRAND CENTRAL AIR TERMINAL • GLENDALE 1, CALIFORNIA

WATCHMAKING

JEWELRY ENGRAVING AND REPAIR

Enter this high-paying, time-honored profession, or prepare for a business of your own. Watchmakers in great demand. More jobs than qualified workers. Study under expert instructors in a long-established, nationally recognized school. Receive recognized diploma and certificate. Placement service. Approved under G. I. Bill. Write for FREE booklet.



The Baronian School, Inc.

2116 WALNUT ST. (DEPT. C) PHILA. 3, PA.

HIGHEST ROYALTIES and CASH FOR YOUR INVENTIONS

Write for FREE booklet without obligation

UNIVERSAL MARKETING CO.

354 S. Spring St. (Suite M)

Los Angeles 13, Calif.

INVENTORS

Whether an invention is patentable can be substantially determined by a search of the U. S. Patent records. Without obligation, write for information explaining the steps you should take to secure a patent.

JOHN N. RANDOLPH

Registered Patent Attorney

201 Columbian Building, Washington 1, D. C.

TRADE MARKS •
COPYRIGHTS •

PATENTS

The Time to Contact a Patent Attorney is Promptly After You Have Finished Your Invention

Write for FREE "INVENTOR'S GUIDE" & "Record of Invention"

FRANK LEDERMANN Registered Patent Attorney

154 Nassau St. • 20th Floor • New York 7, N. Y.

Say You Saw It in
POPULAR MECHANICS



PATENTS

AND TRADE MARKS

C. A. SNOW & CO.

REGISTERED PATENT ATTORNEYS

WRITE FOR INFORMATION TO

428 SNOW BUILDING, WASHINGTON 1, D. C.



INVENTING

—FOR PROFIT! If you have an inventive turn of mind, write for free 28-page booklet explaining how the Institute of American Inventors is helping inventors pre-test the profit possibilities of proposed devices to fill today's unprecedented demand for useful new inventions.

INSTITUTE of AMERICAN INVENTORS

Dept. 4, 1926 Eye St. NW, Washington 6, D. C.

PATENTS PATENT LAWYER

TRADE MARKS

GUSTAVE MILLER
99-PM WARNER BLDG.
WASHINGTON 4, D. C.

ASSOCIATE EXAMINER

U. S. PATENT OFFICE 1922-1929
REGISTERED PATENT ATTORNEY

Send for Form
"INVENTOR'S RECORD"

**YOU BUILD THIS
23-TUBE
TELEVISION
RECEIVER**

NOW!

FOR THE FIRST TIME YOU CAN GET
Real Practical HOME TRAINING In

TELEVISION

RADIO AND ELECTRONICS

PREPARE YOURSELF FOR A
PROFITABLE Fascinating FUTURE

**RTS GIVES YOU
11 BIG KITS**
of TELEVISION and RADIO PARTS

**YOU BUILD A TRF RADIO
RECEIVER PLUS MANY OTHER
PRACTICAL JOBS & EXPERIMENTS**

**YOU WORK AND LEARN
WITH REAL TELEVISION
AND RADIO EQUIPMENT**

RADIO-TELEVISION TRAINING SCHOOL'S
Master Technicians guide you. Located
in the very heart of America's
Television, Broadcasting, Radio and
Sound Industries, RTS is right "on-
spot" where new technical im-
provements are first introduced; is
the best possible position to bring
students ACTUAL METHODS and prac-
tices developed by the RADIO-TELE-
VISION industry, leading to real money
making opportunities. The 11 BIG
RTS KITS GIVES you enable you to
do many practical jobs, build the
equipment illustrated; perform more
than 100 other fascinating, valuable
experiments. These jobs you do give
you ACTUAL SHOP EXPERIENCE so val-
uably necessary to your future suc-
cess. Thus RTS methods assure you
BALANCED TRAINING—Theory PLUS
Real Experience.

to earn WELCOME EXTRA CASH, EVEN
BEFORE FINISHING YOUR TRAINING! In
fact, when friends and neighbors
know you are studying Radio-Tele-
vision you may—like many RTS
students—actually get MORE REPAIR
WORK THAN YOU CAN HANDLE.

**27 YEAR
SUCCESS RECORD**

Backed by over a quarter-century of
experience in home training, RTS
(formerly Radio Training Associa-
tion of America) offers practical
"Learn-by-doing" methods, assuring
you quick step-by-step progress.
Begin preparing for your future in
Radio-Television now while the
time is ripe. If you are at all me-
chanically inclined—and have a
grammar school education, RTS can
teach you how to MAKE GOOD in
Radio-Television.

GET THE FACTS

Send for FREE BOOK which tells
you all about the RTS "time-tested"
home-training plan, developed by
technicians in the heart of the
Radio-Television field. Fill out the
coupon now—TODAY! and your FREE
book entitled "How To Make Good
in Radio-Television" will go out to
you AT ONCE. No Obligation. No
salesman will call. ACT NOW!

**OPPORTUNITIES NOW
WIDE OPEN FOR
Properly Trained Men**

Latest reports estimate 400 MILLION
new television and radio sets
will be built in the next 10 years
more than 72 million dollars is
being spent RIGHT NOW just for
radio repairs ALONE! When you
are thoroughly trained by RTS
Experts—who have their fingers on
the pulse of the Radio-Television
industry—a field of unlimited oppor-
tunities will open up for you in
our Own Radio-Television Sales
Service Business, F.M., Equip-
ment Manufacturing, Communica-
tions and allied fields.

**EARN EXTRA MONEY
while learning at HOME**

Under the RTS amazingly easy,
practical home-training plan there
is no need for you to quit your pres-
ent job. You study in SPARE TIME
ONLY! RTS Experts show you how

**YOU BUILD THIS
6-TUBE STANDARD
RADIO SET with
SHORT WAVE
CONVERTER**

★
**SEND
FOR THIS
30-PAGE
FREE
BOOK!**
★



**YOU
KEEP ALL
EQUIPMENT
—it's Yours!**

RADIO-TELEVISION TRAINING SCHOOL
5100 SO. VERMONT AVE., LOS ANGELES 37, CALIF., U.S.A.
ESTABLISHED 1922 — 27 YEARS AGO
formerly RADIO TRAINING ASSOCIATION of AMERICA

RADIO-TELEVISION TRAINING SCHOOL, DEPT. 9-PM
5100 South Vermont Avenue, Los Angeles 37, Calif., U.S.A.

Send FREE Illustrated Book showing how I can make
good in TELEVISION and Radio through training under
the guidance of expert RTS Technicians. No obligation.
(No Salesman will call).

NAME _____ AGE _____
St. & No. _____
CITY _____ ZONE _____
STATE _____

**"TOOK IN \$217
FIRST 10 DAYS"**

**Some Make More,
Some Less... We Help
You to Start Your
Own All-Year
Business, Make
Big Money!**

With our easily operated, highly efficient wall washer, Chas. Stelle took in \$217 gross in first ten days. E. L. Goss took in more than \$10,000 in one year. E. C. Taber wrote, "I made \$400 gross in two weeks." And no wonder — this machine washes walls 6 times faster and better than by hand.

Your Money-Making Opportunity

We want more men to go into this profitable business for themselves and enjoy independence. There are customers everywhere—homes, offices, schools, churches, hotels, stores, etc. What you take in is mostly profit, for material costs are low. And there's no need to rent a shop or office. Operate your business from your home.

Loss no time. Get all facts without obligation. **WRITE FOR FREE INFORMATION.** Ask for Wall Washer Details at once.

VON SCHRADER MFG. CO., C691, RACINE, WIS.

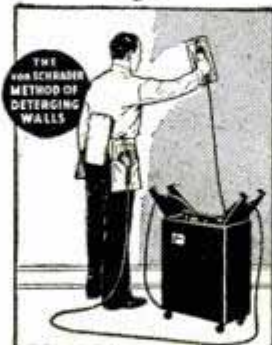

**AUTO
BOOKS ON APPROVAL**

SEND NO MONEY. Just mail the coupon for a complete set of 4 Big, Thick Auto Books. 20th Edition. Over 2700 Pages! Whether you are a mechanic or helper, expert or apprentice, auto owner or driver, take immediate advantage of this **FREE EXAMINATION OFFER.**

**MAKE GOOD MONEY NOW
HOLD A PERMANENT JOB**

America wants its automobiles kept in good repair. Men with "know how" are in demand, at big pay. These books will help you get and hold an important job, or give you a chance to go into business for yourself now or later. Any man who half tries to improve himself can learn auto servicing and repairing by this quick reference method. Use the **JIFFY INDEX** to find easily understood answer to any auto problem. These wonder books prepared by eleven of America's great automobile engineers. Many hundreds of valuable illustrations. Send the coupon **TODAY.**

A year's consulting privileges with our engineers now given with these books without extra charge.

Publishers Since 1898



CAN YOU FIX IT?

These wonder books tell step by step **HOW** to make difficult repairs and adjustments, how to keep a car at maximum efficiency, including latest improvements in car design and operation. Engine troubles and how to correct them well covered.

4 BIG, THICK VOLUMES
Over 2700 pages, 2000 illustrations, wiring diagrams, etc. Beautiful modernistic, washable cloth binding.

AMERICAN TECHNICAL SOCIETY, Dept. A619
Drexel Ave. at 58th St., Chicago 37, Ill.

I would like to examine your 4-Volume Set of Auto Books. I will pay the delivery charges only, but if I choose I may return them express collect. If after 10 days' use I prefer to keep them, I will send you \$2 and pay the balance at the rate of only \$3 a month until \$24.80 has been paid. Include consulting service as offered above.

Name _____
Address _____
City _____ State _____

Please attach letter stating age, occupation, employer's name and address and name and address of at least one business man as reference. Men in service, also please give home address.

**No Waiting to LEARN
START NOW TO EARN!
This BIG BOOK SHOWS HOW**



PRACTICAL IDEAS—QUICK RESULTS
Never before such a book of helps for you who wish extra money quick. In this book are formulas, recipes, secrets that have amazed the world. Use these ideas and make many needed money-making products. Experts wrote this book in simple terms, with supply sources for materials, shortcuts and methods for profitable results.

Included FREE! "Knowledge is Power" containing more than 170 sure-fire opportunities to promptly increase your earnings and your security.

924 BIG PAGES ILLUSTRATED
Lots of profitable businesses have started with a single recipe. Choose from the 162,000 facts and 10,000 formulas such as: — Adhesives, Cosmetics, Beverages, Candy, Ceramics, Cheese, Cleaners, Concrete, Dentifrices, Dyes, Depilatories, Enamels, Flavors, Foods, Gum, Home formulas, Inks, Insecticides, Lacquers, Linoleums, Lubricants, Metals, Mirrors, Oils, Ointments, Paints, Perfumes, Plastics, Polishes, Remedies for Man, Beast & Fowl, Soaps, Solders, Varnishes, etc. 1000's of others to make all sorts of profitable items.

EXTRA MONEY IN SPARE TIME
This big book tells what to do and how. No experience needed. You work from the money-making facts and ideas that are explained in words easily understood. Many fortunes have been made with a single formula. Mail in your order and get started right NOW!

**POSTPAID
\$3.98
ANYWHERE IN THE WORLD**

\$3.98 postpaid throughout the world. (C.O.D. plus postage in U. S. only.) Shipped at once.

World-Wide Service — Books on Any Subject

ADAMS BROWN COMPANY, Dept. P99, Boston 67, Mass., U.S.A.

WHY DON'T YOU WRITE?

Writing short stores, articles on business, sports, travel, hobbies, shop crafts, local and club activities, etc., will enable you to earn extra money. In your own home, on your own time, the New York Copy Desk Method teaches you how to write the way newspaper men learn—by writing. Our unique "Writing Aptitude Test" tells whether you possess the fundamental qualities essential to successful writing. You'll enjoy this test. Write for it, without cost or obligation.

Veterans: This course approved for Veterans' Training.

NEWSPAPER INSTITUTE OF AMERICA
SUITE 5599-P, ONE PARK AVENUE, NEW YORK 16, N. Y.

APTITUDE TESTS discover the kind of work or studies best for your success! You get a personal report—a guide for life—more happiness—more prosperity. For men, women, boys and girls. Write for complete facts.
VOCATIONAL COUNSELING INSTITUTE
956 Maccabees Bldg., Detroit 2, Michigan

DE LUXE SHEFFIELD CHRONOGRAPH WRIST WATCH



Has everything—plus new low price. It's a timekeeper, stop watch, measures speed of planes, cars, horses, etc. Sweep second hand, chrome case, unbreakable crystal, Swiss movement. Sold to \$29.95. Send cash, check, or C.O.D.

9.75
Plus 97c Tax

WAYNE SALES COMPANY
423 American Ave., Long Beach 12, Calif.

LIMIT ONE

Guaranteed by mfr. for FULL YEAR



CARTOONING

HAVE FUN! MAKE MONEY! Cash in on your sense of humor **AT HOME—BY MAIL.** No experience needed to start. Write today **FOR FREE TRIAL LESSON** and full particulars.

Moos Gag Cartoon School, Dept. D, Fall Creek, Wis.

**BE STRONG USE
BARBELLS**

95 POUND SET
Only \$10.80

Extra Plates 10c pound

We have been selling the finest barbell equipment since 1928. We operate our own foundry and sell direct to you at a very low profit. No other company can match our low prices.

Send for our **FREE Barbell Catalog.**

BUR BARBELL CO.
LYNDHURST 21
NEW JERSEY



FASCINATING WORK

RICH REWARDS

IN AERONAUTICAL ENGINEERING

The swift, spectacular progress of Aviation is unfolding right before your eyes... sensational new speed records... ever-expanding, world-wide commercial airlines... spectacular new military aircraft. Back of the countless new aircraft and new achievements yet to come there must be trained *Aeronautical Engineers*. Here is a ringing challenge to the man of imagination and ambition. Here is a career field where your talents — whether *creative* or *practical* — can have full play. In *Aeronautical Engineering* you can enjoy the ideal combination of unlimited opportunity, fascinating work, and good pay from the start.

Northrop training equips you to make the most of this magnificent opportunity. Here at *Northrop* — birthplace of some of Aviation's greatest achievements — you have the priceless advantage of training in an actual industry environment. The outstanding record of *Northrop* graduates — in winning choice jobs and fast advancement — proves the opportunity for YOU. Learn all about it. Get full details on *Northrop's* 2-year Engineering Course. You can start your training soon — classes start every 8 weeks.

SEND COUPON FOR CATALOG NOW

NORTHROP AERONAUTICAL INSTITUTE
1527 East Broadway, Hawthorne, Los Angeles County, Calif.

Please send information on opportunities in Aeronautical Engineering, your catalog, and starting dates of classes. I am interested in:

Aeronautical Engineering Aircraft & Engine Mechanics

Name _____ Age _____

Address _____

City _____ Zone _____ State _____

Check one: Veteran Non-Veteran

APPROVED FOR VETERANS

Northrop Aeronautical Institute

Division of Northrop Aircraft, Inc. ★ James L. McKinley, Managing Director

1527 EAST BROADWAY, HAWTHORNE, LOS ANGELES COUNTY, CALIF.

Northrop student engineers consult on new type control system for student-designed private plane. Complete metal mock-up was fabricated and assembled by students as part of training.

As another practical training project typical of Northrop instruction methods, engineering students developed this light-weight turbo-jet aircraft engine by adapting a turbo-supercharger.

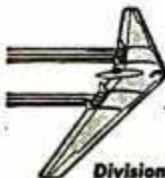

Specialize in These Expanding Fields —

▷ AIR CONDITIONING ▷ HEATING

▷ REFRIGERATION

In 6 to 24 months you can prepare for a substantial opportunity in industry or a business of your own. This 46-year-old non-profit school of technology offers world-famous concentric training programs in these fascinating fields. Experts chosen from private business cooperate with faculty specialists to keep courses geared to industrial developments. Laboratories and shops are superbly equipped. Specialized technical training is coupled with solid education in basic sciences and related arts. Because of the unique "Concentric Curriculum," you pass step-by-step to certificates of "Refrigeration Serviceman" in 6 months — "Refrigeration and Heating Serviceman" 6 months later — "Refrigeration, Heating, Air Conditioning Technician" in 12 additional months.

Write for free 48-page Pictorial Bulletin, "Your Career," and 110-page catalog.

MILWAUKEE SCHOOL OF ENGINEERING
Founded 1903 by Oscar Werwath

MILWAUKEE SCHOOL OF ENGINEERING
Dept. PM-949, N. Broadway and E. State, Milwaukee, Wis.
Send me free 48-page pictorial bulletin, "Your Career," and 110-page catalog. I am interested in course on.....
NAME.....AGE.....
ADDRESS.....
CITY.....ZONE.....STATE.....
() Check If Veteran of World War II

Courses Offered by This College and Technical Institute

SERVICE—6 to 12 months

- Electricity • Welding
- Refrigeration, Heating

TECHNICIAN—12 to 24 months

- Radio - Television • Electronics • Electro-technics • Refrigeration, Heating, Air Conditioning • Welding

PROFESSIONAL—36 months

- Electrical Engineering (Major in Electronics or Power)—B. S. Degree

—Alma mater of 30,000
—Terms start Oct., Jan., April, July



PLASTI-LINER

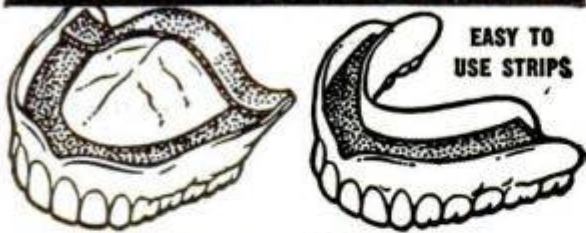

EASY TO
USE STRIPS

One application MAKES FALSE TEETH FIT for the life of your plates

If your plates are loose and slip or hurt, use this amazing, pliable, non-porous strip to refit them yourself, for instant and permanent comfort. It's easy. Just lay the strip on your upper plate or lower plate, then bite and it molds perfectly. Hardens for lasting fit and comfort. Helps stop the embarrassment of slipping, rocking plates or the misery of sore gums. Eat anything and talk freely without fear your teeth will loosen. Ends forever the mess and bother of temporary applications that last only a few hours or months.

EASY TO RE-FIT AND TIGHTEN FALSE TEETH

PLASTI-LINER is tasteless and odorless. Won't injure your plate. Guaranteed to give satisfaction or your money back. Removable as per directions. Users say: "Until I used Plasti-Liner I used several kinds of liners without success. Now I can eat anything." H. H. M. "My plates are now better fitting than new." E. H. C.

SEND NO MONEY Just order a \$2.25 package of PLASTI-LINER to reline both upper and lower plates, or \$1.25 to reline one plate. Deposit money with your postman when he delivers. Or send the money now, and save C. O. D. charges. Generous sample of special plate cleaner supplied free.

PLASTI-LINER COMPANY, 1740 Bailey Avenue
Buffalo 11, N. Y., Dept. 43-J

PUT YOUR FUTURE IN BRIGHT LIGHTS!

LEARN
NEON
TUBE BENDING
AND
NEON SIGN
FABRICATION

You can earn \$100 weekly or better as one of the hundreds of properly trained men now desperately needed by the neon sign and fluorescent lighting industries. The demand for skilled neon mechanics grows steadily.

Our GI-approved resident courses offer the most thorough institutional training available in this field. Over 1800 hours of individual instruction and bench work covers every phase of luminous tube bending and installation — nothing is held back for "special courses." This is not a correspondence course.

Enrollment is strictly limited to those who are willing to undergo 15 months of thorough non-technical training. To date, not one single graduate has failed to qualify for or hold a well-paying job in the industry. For information, write for Bulletin "M." State whether or not you are a veteran.

**GENERAL INDUSTRIAL
TRAINING INSTITUTE**
STEUBENVILLE, OHIO

OWN Your Own Business



PATENTED
PORTABLE
EQUIPMENT

Lifetime Income

Clean and mothproof rugs and upholstery "in the home" or public buildings. Start full or part time. Gross profits up to \$15 and \$20 a day on EACH of your service men. Easy to learn . . . quickly established.

DURACLEAN cleans by absorption! No scrubbing, soaking or shrinkage. Dirt and grease vanish . . . matted pile rises . . . colors revive. Furnishings used again same day.

DURAPROOF resists moths and carpet beetles. Your service backed by a National Money Back 4 Year Warranty.

We furnish enough material to return your total investment. EASY TERMS. Territories limited. Send for FREE booklet . . . full details.

Duraclean Co. 9-169 Duraclean Bldg.
Deerfield, Ill.

Learn To Be a BUSINESS BROKER

**HOW
TO
BUY
AND
SELL
STORES
AND
BUSINESSES**

HERE is an opportunity to learn how to enter a BIG PAYING BUSINESS . . . Learn how to appraise any type of business . . . Learn the knack of selling and buying and reap a Big Brokers Fee of 10% and more . . . Profits pile up quicker in this field because all types of businesses are BOUGHT and SOLD. Simple. Easy Home Study Lessons. FREE Booklet. WRITE TODAY.

AMERICAN BUSINESS BROKERS SCHOOL
1925 West Wisconsin Ave., Milwaukee 3, Wisc.

LEARN MOVIE PROJECTION THEATRE MANAGEMENT



The Motion Picture Theatre Business offers big opportunities for trained men. Get into a fascinating field with a promising future. Train at home in spare time. Free Catalog. Established 20 years.

THEATRE SCHOOL, 370 Washington St., Elmira, New York

GREAT PROFITS
MAKE YOUR OWN
RUBBER
MOLDS

X.L. RUBBER MOLDS
will realize your great profits quickly!
WRITE FOR NEW FREE CATALOG

YOU can EASILY learn to cast thousands of perfect plaques, book ends, figurines, ash trays, etc. IT'S EASY, FUN, PROFITABLE!
X.L. Rubber, Pts. \$2.00;
Qts. \$3.50; Gallons \$8.95;
Models and enough rubber for 3 molds \$1.30 postpaid.

SEND FOR FREE FACTS

PLASTIC ARTS STUDIO • Route 5 • Dept. 21 • Muncie, Ind.

ELECTRICIANS' SCHOOL

HOUSE AND COMMERCIAL WIRING • MOTOR REPAIR
AND REWINDING • ELECTRIC REFRIGERATION

Approved for Veterans Training

PENNSYLVANIA INSTITUTE SCHOOL OF ELECTRICITY
42nd and SPRUCE STS. PHILADELPHIA 4, PENNA.

SHOE REPAIR OFFERS BIG INCOME LEARN IN 12 WEEKS TIME



You can own your own shop or earn big income as skilled shoe repairman. Growing demand everywhere at top wages for men who know how. We teach you quickly by actually working on shoes and modern machines. School open to all from 18 to 60 years of age. FREE BIG 20 PAGE BOOK explains everything. Send for your copy today. Chicago & Los Angeles schools only approved for Vets.

MODERN SHOE REBUILDING SCHOOL
Established 1927
2937 Belmont Ave., Chicago. 361-12th St., Oakland, Calif. Dept. PM
806 So. Figueroa St., Los Angeles 14, Calif.

PRINT YOUR OWN POST CARDS

COMPLETE OUTFIT
only
\$7.50

Amazing results in sales, inquiries and contacts . . . saves time and money . . . very easy to use GEM STENCIL DUPLICATOR is ideal for Advertising, Announcements, Notices, Labels, Forms, Price Lists—hundreds of uses for every type of business and organization. Comes complete with all supplies, instructions and 60-page Book of Ideas.

FREE TRIAL OFFER: Try it before you buy it! Write and a GEM OUTFIT will be sent you postpaid. After 10 days, send only \$7.50 or return the GEM, no questions asked. The GEM must sell itself; you be the judge.

BOND EQUIPMENT CO. • Dept. 135
6633 Enright • St. Louis 5, Mo.

SEND NO MONEY • FREE TRIAL OFFER

WALKIE TALKIES

A COMPLETE 2 WAY COMMUNICATIONS SYSTEM

Don't let this unbelievable low price fool you! A genuine two way Sound Powered System operating on an Electro-Sonic principle used extensively by the U. S. Armed forces. Amazing clarity and high volume level makes it effective for all types of work. Two complete units included.

Nothing to build — Nothing to buy Guaranteed to work — Indoors, Outdoors It's a natural for TV Antenna orientation C.O.D.'s, send \$1.00 deposit, pay \$2.95 post postman balance plus postage. **\$2.95** paid
NORTH EAST SALES CO., Dept. PM-1
366 Madison Ave. New York, N. Y.



SNOW AGENTS WANTED Amazing Profits!

No experience needed. BIG money spare time now to Xmas. Your own business. Every store, home, ripe prospect, big orders. Thousands made last fall! \$1 deposit (refunded on first order) brings you free trial sales kit — one giant pkg. snow, one small pkg. snow, arrangements, stars, holly, crescent, berries, leaves, cones, ornaments. Money back if not thrilled! Order NOW from **O. E. LINCK CO., Dept. PM9, Clifton, N. J.**

WHAM-O SPORTSMAN*
BITS LIKE A .22 RIFLE—KILLS RABBITS, SQUIRRELS. For Hunting, Target, Routing Posts.

\$1.00 postpaid

A man's sport! Powerful, silent, accurate. Complete with 40 pellets and extra rubber straps. Send \$1.00 today to—
Wham-O Mfg. Co., Box 121, South Pasadena, Calif.

Dealers Write
HEAVY DUTY STOCK

*PROFESSIONAL MODEL USED BY MEMBERS OF NAT'L SLINGSHOT ASSN

BIG FREE CATALOG of WAR SURPLUS OPTICAL BARGAINS

Build Your Own RIFLESCOPE, BINOCULARS, TELESCOPE, ETC. We Furnish Optics and Instructions

- LENSES, PRISMS & RETICLES
- EYEPIECES and OBJECTIVES

We Have Numerous Types of Assembled Optical Instruments including BINOCULARS and RIFLESCOPES.

CHECK OUR BARGAINS . . . Request CATALOG H
EDMUND SALVAGE COMPANY
P.O. AUDUBON, NEW JERSEY

DIESEL IS GOING PLACES ARE YOU?

Look around—you will see Diesel Power in action all about you! In tractors, trucks, buses, trains, boats, power and lighting plants, farm and road equipment. Diesel's the Field of the Future! Low cost dependable power—new uses are constantly developing—and every Diesel engine increases the need for Diesel-trained men!

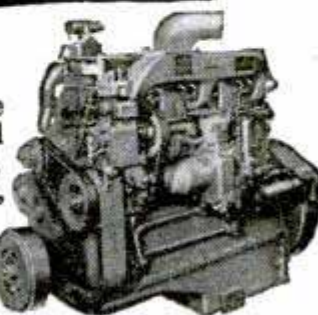

LEARN DIESEL AT HOME IN SPARE TIME!

If you are over 17, under 60, and mechanically inclined, you can get thorough Diesel instruction right at home. With U.E.I. balanced training, you learn fundamentals first, through home study. Practical, easy-to-understand lessons explain DIESEL operation . . . fuel systems . . . how to make repairs . . . auxiliary equipment, etc.

ACTUAL SHOP PRACTICE



Then, you finish your training on actual engines in our Shop. You work on costly equipment under expert Diesel men who know latest techniques. On graduation, you get job-placement assistance. U.E.I. has 20 years of successful experience in fitting thousands for employment in new opportunity fields.

GET THE FACTS It costs you nothing to get full information on Diesel opportunities and how they can apply to you! **FULL FACTS SUPPLIED FREE.** Simply mail the coupon below now!

START AT HOME FINISH IN OUR SHOP UTILITIES ENGINEERING INSTITUTE DIESEL DIVISION

GET THE FACTS FREE

FOUNDED 1927

MAIL THIS COUPON TODAY!

UTILITIES ENGINEERING INSTITUTE, Diesel Division, Dept. DC-4
2521 SHEFFIELD AVE., CHICAGO 14, ILLINOIS

Please send me FREE FACTS about U.E.I. Training Opportunities. I am interested in:

DIESEL REFRIGERATION
 AUTO BODY & FENDER REPAIR AIR CONDITIONING

NAME _____

ADDRESS _____

CITY _____ ZONE or COUNTY _____ STATE _____

Check here for special information if you are under 17.

SAY YOU SAW IT IN POPULAR MECHANICS

**FIND OUT
FREE!**

**HAVE YOU
GOT WHAT
IT TAKES?**



SUCCESS
HOME STUDY
WILL TO WIN
CHARACTER
HEALTH

to be a
**FINGER PRINT EXPERT or
TRAINED INVESTIGATOR?**
Send for free IAS
Qualification Question-
naire. If in our opinion
your answers indicate
that you "have what it
takes," then you will
receive absolutely free
the famous "Blue Book
of Crime" . . . plus full
details on how to train
at home in Crime De-
tection and Finger
Printing! IAS gradu-
ates are key men in
over 800 Police Bu-
reaus. See if YOU can
train for this exciting,
steady, "good pay"
work! No obligation.
No salesman will call.
Write today, stating age.

INSTITUTE OF APPLIED SCIENCE

1920 Sunnyside Ave., Dept. 1356, Chicago 40, Ill.

INSTITUTE OF APPLIED SCIENCE
1920 Sunnyside Ave., Dept. 1356, Chicago 40, Ill. *

Gentlemen: Without obligation or expense on my part, send me your qualification questionnaire. I understand that upon receipt of my answers you will immediately advise me if you think they indicate that I have a chance to succeed in criminal investigation or finger print work. Then I will receive FREE the "Blue Book of Crime," and information on your course and the 800 American Identification Bureaus employing your students or graduates.

Name _____
Address _____ RFD or Zone _____
City _____ State _____ Age _____

IDENTIFY IT - MAKE IT LAST LONGER
1 Physical Protective



A PLASTIC FINISH
To preserve the surface, color, luster and life of practically any finished material with a colorless, transparent film of long-lasting beauty. One coat lasts for months—years.

A few months ago the scientific world was amazed with news of a product developed for war purposes . . . now released for home use. Makes surfaces resistant to damage by water, alcohol, alkalis, sun fading, stains, dirt, scuffing, heat, cold, etc. Will not chip, crack, flake or peel. Skid-resistant. Just wipe, brush or spray it on. No rubbing needed. Touch dry in 20 minutes. Hard dry in 8 hours. Quart covers 400 sq. feet. Mfg. under U. S. Dept. of Commerce Natl. Bureau of Standards letter #820.

MONEY BACK GUARANTEE

If you are not delighted with results, return empty can within 7 days for money back.

AUTHORIZED DEALERS:
Write for quantity discount schedule.

If your dealer can not supply you, send coupon.
P.T.A. PLASTIC CO.
29 N. Summit Ave.
Hardwick, Minn.

1001 USES

- Floors
- Furniture
- Autos
- Boats
- Screens
- Leather
- Walls
- Tools

Any non-absorbing material, finished or unfinished.

Now You Can Throw Your Can of Wax Away.

P. T. A. PLASTIC CO., Dept. 199, Hardwick, Minn.

Please send me postpaid (number) _____ pints @ \$2.10, _____ quarts @ \$3.95 of P.T.A. Liquid Plastic under your money back guarantee. I enclose \$_____ (cash, bank check or money order) as full payment.

NAME _____
Address _____
City _____ State _____

STUDY AT HOME

With An Educational Institution

Men with specialized training win higher positions, insure larger earnings, and are bigger successes in business and public life. Opportunities NOW greater than ever before. Send for our Catalog.

ARTS and SCIENCES

Courses in Philosophy; Education; Letters; Public Health; Medical Jurisprudence; Psychology; Sociology; Physics; Chemistry; Geology; Political Science; Theology; Business and Commerce; Accounting; Mathematics; Statistics; Agriculture.

ENGINEERING

Courses in Electrical, Civil Mechanical, Drafting, Architectural, Steam, Aeronautical, Radio, Structural, Mining, Industrial, Petroleum, Marine, Chemical, Diesel, Automobile, Refrigeration, and Air Conditioning Engineering.

LAW

Complete Professional Law Course includes 18 Hornbook Series college grade textbooks. Courses also in Commercial Law, Patent Law and Medical Jurisprudence.

McKinley-Roosevelt Incorporated, 4610-K, Sheridan Rd., Chicago 40, Ill.

LEARN DIESEL AT HOME
the famous HEMPHILL WAY

Get big, FREE, Illustrated catalog
Shows opportunities in growing Diesel Industry—
Trains, trucks, construction equipment, ships, drilling rigs, logging equipment, etc., all use Diesels. Get the training to enter the field of your choice.

HEMPHILL DIESEL AND AUTOMOTIVE SCHOOLS
Department of West Coast University
1601 S. Western Ave., Dept. PM-99, Los Angeles 6, Calif.

**EXPORT
PAYS BIG**



World Trade firm offers men and women plan for big pay positions or unlimited-profit businesses of their own in Export-Import Mail order World-wide without capital, from home, or travel abroad. Write today for Free Book State if veteran. Airmail reaches us over night. The Mellinger Co 1422-HU Westwood, Los Angeles 24, Calif

LEARN PLASTICS AT HOME

GET 7 BIG KITS WITH COURSE — MAKE USEFUL ATTRACTIVE ARTICLES
Write for free catalog.

PLASTICS INDUSTRIES TECHNICAL INSTITUTE
Dept. of West Coast University
1601 South Western Avenue, Dept. PM-99
Los Angeles 6, California

ELECTRICAL TRAINING

Intensive 32 weeks' residence course in fundamentals of industrial electrical engineering, including radio, electronics. Prepares for technician, engineering aides. Approved for veteran training. 57th year. Enter September 6, Mar. 6. Catalog.

BLISS ELECTRICAL SCHOOL

7640 TAKOMA AVENUE
WASHINGTON 12, D. C.



500 Pages, 7000 Novelties

Send 10c for mammoth, amazing catalog of 7000 novelties. 1-inch thick, roto picture section, 6-color cover. Carnival, circus, world's fair & science exhibit rolled into one! Includes live animals & pets, scientific supplies, hobbies, funmakers, planes & boats, looms, magic tricks, joke articles, unusual seeds, gadget timesavers, cameras, optical goods, projectors, movies, lucky jewelry, religious novelties, telegraph sets, disguises, musical instruments, stamps, coins, puzzles, fortune tellers, radios, experimental sets, auto & bike accessories, Western wear, telescopes, magnifiers, compasses, banks, smokers' gadgets, artists' supplies, printing sets, engines, motors, shockers, knives, billfolds, fireworks, guns, rifles, sports, money makers, swimming helps, 1000 fascinating books, games, locks, live chameleons, rings, exercisers, curious plants, etc., etc., etc. (DeLuxe Hard Bound Library Edition 25c Postpaid.) Regular paper covered edition 10c. (Stamps accepted.) Sent Air Mail, \$1.00. **JOHNSON SMITH & COMPANY, Dept. 155, DETROIT 7, MICHIGAN**

10c



NEW Coprion SEAMLESS BELL



MAKES YOUR PLAYING Easier! Better!

First and only seamless bell, of superior new metal, made by electro-mechanical process. Impossible to overblow or crack a note! Gives amazingly greater flexibility, richer tone quality, easier response. Exclusive on Conn trumpets, cornets, trombones. Most important development in years. Preferred by leading artists. See your Conn dealer or write us. Please mention instrument. Conn Band Instrument Div., C.G. Conn Ltd., 931 Conn Bldg., Elkhart, Ind.



Write FOR FREE FOLDER

HYDROPONICS

24 Page FREE Illustrated Book

Grow out-of-season vegetables, rare flowers or house plants by hydroponics WITHOUT SOIL. Start a fascinating hobby or profitable business in your home. No experience needed for top results. Small space gets BIG RETURNS. Easy, clean, pleasant way to grow any plant indoors or out every day in the year. Fast growth, increased yields, unlimited PROFIT OPPORTUNITIES. Send postcard today for free illustrated book showing how others from every state are succeeding in this wide open field.

CHARLES C GILBERT & CO., 824 W. IVY STREET, SAN DIEGO 1, CALIF.

ARTISTS MAKE MONEY

Do you like to draw? Send name, address, age and occupation for FREE ART TEST. to find out your ability.

ART INSTRUCTION, Inc.

9139 ART INSTRUCTION BLDG., MINNEAPOLIS 15, MINN.

Learn MASONRY CARPENTRY



Big money in the building trades. Learn now while opportunities are greatest. Train in our completely equipped shops under expert instructors, or by Home Study. Vets attending school entitled to G.I. Benefits.

MIDWEST SCHOOL OF BUILDING TRADES, Dept. PM-9
411 N. Center St., Bloomington, Ill.

What Is a Tachometer?

WHAT IS A TELEMETER? See Page 261

SEND THIS ON 1c POST CARD FOR

FREE CATALOG

(NEW FALL EDITION)

of Guns, Fishing Tackle, Athletic Goods, Camping Equipment, Cameras, Western Goods.



ANDY ANDERSON'S SPORTING GOODS CO.

120-124 West Grand - - - Oklahoma City, Oklahoma PM

Name

Address

City..... State.....

THIS MONEY-MAKING BUSINESS CAN BELONG TO YOU!



MAKE BIG COMMISSIONS — LEARN REAL ESTATE AT HOME

WHETHER OR NOT YOU'VE HAD REAL ESTATE EXPERIENCE you can make BIG MONEY by studying the Weaver Real Estate course in your spare time at home, or in classes in leading cities. YOU DON'T NEED A LOT OF MONEY to start your own Real Estate business ... all you need is the knowledge the Weaver Real Estate course gives you. EASY TO UNDERSTAND lessons are prepared by experienced licensed Real Estate operators ... you learn quickly, easily, accurately.

NATIONAL PLACEMENT SERVICE

SINCE 1936 graduates have secured their state licenses and earned big profits in their own Real Estate businesses. Others have good jobs with Abstract Companies, Appraisal Offices, Building and Loan Companies, etc. You can have the same success ... mail the coupon for complete information! No obligation.

Weaver Diploma Key To Success

The Weaver diploma is widely recognized ... it proves you know your business, starts you earning right away. Send the coupon for full information and free book NOW!

APPROVED FOR G. I. TRAINING

Established 1936

WEAVER SCHOOL OF REAL ESTATE

15 E. Pershing Rd., Dept. P., Kansas City, Missouri

Name

Address

City..... State.....

Present Position

Veteran?..... Non Veteran?.....

FREE BOOK TELLS HOW!



SEND FOR THIS FREE!

Make money. Know how to break and train horses. Write today for this book FREE, together with special offer of a course in Animal Breeding. If you are interested in Galting and Riding the saddle horse, check here () Do it today—now.

BEERY SCHOOL OF HORSEMANSHIP

Dept. 1109D Pleasant Hill, Ohio

Photography



for PLEASURE or PROFIT

Learn at home. Spare time. Practical basic training. Long-established school. Many have earned while learning. Send coupon below for free booklet, "Opportunities in Modern Photography" and full particulars.

AMERICAN SCHOOL OF PHOTOGRAPHY

1315 Michigan Avenue Dept. 133C Chicago 5, Illinois

Send booklet, "Opportunities in Modern Photography," full particulars and requirements. No salesman will call.

Name..... Age.....

Address.....

City..... Zone..... State.....

NATIONALLY RENOWNED SCHOOL

OFFERS YOU THIS FREE BOOK



A WEALTH OF INFORMATION THAT HAS GUIDED THOUSANDS toward Successful Futures

Start toward your success by the same steps thousands have already proved! Hills' is fully accredited and nationally recognized. Free placement service to graduates throughout the nation. Where ever you live, Hills' can train you through our Extension or Residence School. Check your subject below, fill in coupon and send this ad today.

- Accounting Salesmanship Stenographic
 Bookkeeping Secretarial Penmanship
 Accounting & Business Administration

Hills BUSINESS UNIVERSITY & EXTENSION SCHOOL

Hills Business University & Extension School
 Dept. PM-99, 619 W. Main St., Oklahoma City 2, Okla.
 Please send your Free book that fully describes & illustrates the story "Thru Hills to Success".

NAME _____ AGE _____
 ADDRESS _____
 CITY _____ STATE _____
 G. I. BILL RESIDENT HOME STUDY

EASY-TO-USE COUPON TODAY

THE OPPORTUNITY OF A LIFETIME



For the electrical man who is prepared for advancement

WAS there ever such an opportunity to get started in electrical maintenance and repair—and at top-notch wages? Are you ready—with experience and ability—to cash in on it? Others are getting just the sort of background needed—quick! practical!—to handle the great variety of electrical maintenance and repair work **TODAY**—from this well-known electrical library. You can too!

THE LIBRARY OF ELECTRICAL MAINTENANCE AND REPAIR

5 vols., 1913 pages, 1729 illustrations

Gives you the "know-how" to tackle any wiring or motor job. Five books show you **HOW**—to install all types of motor and generator units—to inspect and repair motor starters and generators—to diagnose motor and generator troubles—to rewind small two and three phase motors—small DC and AC windings—to locate faults in small motors—test induction motors, etc., etc. One book is full of troubleshooting charts that show quickly symptoms, causes, specific remedies, etc.

Take the first step toward improving YOUR future—Mail this coupon TODAY

No money down—special price—easy payments—FREE trial

McGraw-Hill Book Co., 330 W. 42 St., New York 18, N. Y.

Send me for ten days' free examination the Electrical Maintenance and Repair Library. If satisfactory I will send you \$2.50 in 10 days and \$3.00 monthly until the price of \$17.50 is paid. If not wanted I will return books postpaid.

Name _____
 Home Address _____
 City _____ Zone _____ State _____
 Company _____
 Position _____ PM-9-49

Earn BIG PAY while Learning

VETERANS CAN EARN UP TO \$290.00 per month while training

Learn By Doing in Our BIG ALLIED SHOPS

- MACHINIST TRADE.
- TOOL, DIE MAKING & DESIGNING.
- TOOL ENGINEERING.
- DRAFTING—ALL BRANCHES.
- PRODUCT ILLUSTRATION & DESIGN.

• **BIG DEMAND FOR TRAINED MEN**

FREE Employment Service After Graduation

ALLIED SCHOOL OF MECHANICAL TRADES, Inc.
 1338-1340-1342 So. Michigan Avenue
 429 Allied Building, Chicago 5, Ill.

Accredited by The American Society of Tool Engineers. Endorsed by Leaders of Industry throughout U.S.A.

Write for **FREE Catalog**
A 1c Postcard will do.

BE A TILE SETTER

LEARN TILE SETTING AT HOME. Ever increasing demand for tile setters. Easy to learn! Big money! Even as a sideline you can make \$75 and up each week. Write today for details.

INTERNATIONAL TILE INSTITUTE
 P. O. BOX 6961 LOS ANGELES 22, CALIFORNIA

Learn PHOTOGRAPHY

There's big money in PHOTOGRAPHY—and an action-packed career for you. Our **HOME STUDY COURSE**—famous throughout the world—is your spare-time **SHORT CUT TO SUCCESS!** Or if you wish . . . **PERSONAL ATTENDANCE TRAINING** at our famous New York Studios is available with subsistence under the G. I. BILL. Our 40th year. Write immediately!

NEW YORK INSTITUTE OF PHOTOGRAPHY
 Dept. "49", 10 W. 33 St., New York 1, N. Y.

BE A NOTARY PUBLIC

Old legal-supply house, 22 cities, helps you get appointment by governor if you qualify, equips you fully. Pay after appointment (2 payments \$12.50 each). Respected public office. You certify legal papers, use official seal made with your name, collect your fees. Easy. Inquire—

STATIONERS EXCHANGE BOERNE 39, TEXAS

COMMERCIAL TRADES'

GRADUATES GET THE BETTER JOBS

PRACTICAL SHOP TRAINING IN
 AIR CONDITIONING — REFRIGERATION
 ELECTRICITY MAJOR APPLIANCES
 SERVICE, MAINTENANCE & INSTALLATION

Write for Catalog PM4

COMMERCIAL TRADES INSTITUTE
 200 SOUTH 20th ST. BIRMINGHAM, ALA.
 Member: Southern Association of Private Trade Schools
 An approved school to TRAIN Veterans & Non-Veterans

RAISE Money Making CHINCHILLAS

Several females and a male start a large herd which will furnish you an income for years. Just a few feet of space are required. No experience needed. We furnish all instructions. Write world's largest breeder today for free details.

WILLOW BROOK FARM, R-36, Sellersville, Pa.



NEW IMPROVED...AMERICANIZED JUDO

TWO BIG BOOKS FULLY ILLUSTRATED
 1220 SHOW-HOW PHOTOS. 71 LESSONS
 MANY NEW HOLDS

Protect yourself and others. Size and strength mean nothing. Knowledge and skill enable you to master any situation even against biggest bullies or armed thugs. Written and illustrated by one of the world's great Judo experts. Volume 1, basic and advanced holds, Volume 2, very advanced . . . each volume \$1.50.

BOTH BOOKS \$2.50 POSTPAID
 OR C.O.D. PLUS POSTAGE
5-day Money Back Offer. ACT NOW!

DEPT. PM-9
IMPROVED JUDO, INC. P. O. Box 7355, Sta. L, Los Angeles, Calif.

Big Combination Offer!
SAVE...



Famous BAILEY TECHNICAL SCHOOLS

OFFER THE FOLLOWING COURSES:

COMMERCIAL ELECTRICITY
PRACTICAL DIESEL ENGINEERING

Your future success depends largely on the reputation of the school you attend. Don't take chances! Train at America's foremost school of mechanical specialization. Bailey is recognized and approved by industry. Bailey graduates get the top pay jobs! Send for FREE Catalog. State name of course in which you are interested. G. I. Approved.

BAILEY TECHNICAL SCHOOLS
1656 So. Grand Blvd., St. Louis, Mo.

FOR MORE MONEY LEARN FINANCE

It's easy to multiply your earnings and profits. Write for Free copy of "The Source of Wealth and Individual Fortunes."

WALL STREET BUSINESS INSTITUTE
79 Wall Street New York 5, N. Y.

TRI-STATE COLLEGE

B. S. DEGREE IN 27 MONTHS

66th Year.
Students from all over the world.

ENGINEERING—Courses in Civil, Elec., Mech., Chem., Aeronautical and Radio, Television. Also Bus. Admin., Acc't. and Sec. Science. Visitors welcome. See beautiful campus, well equipped laboratories. Graduates successful. Enter Sept., Jan., March, June. Write for Catalog. 499 College Avenue, Angola, Indiana.

STRENGTHEN Your VOICE!

YES—you can now build yourself a powerful speaking and singing voice with this amazing new scientifically sound tested method. Self-training . . . no music or piano required. Results GUARANTEED. Just send your name for the sensational details. FREE chart of your vocal mechanism included! Please state your age.

PERFECT VOICE INSTITUTE, Studio H-2, 1141 S. Wabash Ave., Chicago 5, Ill.



AMAZING NEW MAGIC CATALOG

350 pages of mystifying, easy-to-do tricks and illusions. 600 illustrations. Send \$1.00 now for

catalog, credited on your first \$5.00 purchase.

NATIONAL MAGIC CO.

119 S. State St. Dept. M-9 Chicago 3, Ill.

PLASTICAST

THE GREATEST THING IN PLASTICS!



A NEW HOME INDUSTRY AND HOBBY!

We have combined two of our most popular Kits into one **GIANT COMBINATION PLASTICS OUTFIT** as described:

PLASTICAST . . . a transparent liquid plastic; can be poured into ANY kind of mold or container. Hardens in a few minutes into a beautiful transparent solid, clear-as-glass, tough-as-steel plastic! No tools, equipment or skill required. Our casting plastics are as easy to use as pouring water out of a glass! Ideal for imbedding pretty flowers, butterflies, photos, souvenirs, biological specimens, etc. Makes a **PERMANENT** and **ATTRACTIVE** display! Make beautiful jewelry, novelties, etc. Casts easily into any shape or form.

HERCULOX . . . liquid plastic; works same as above but hardens in 5 minutes into a very attractive white opaque solid. A general all-purpose plastic. Can easily be made to imitate Ivory, Onyx or Marble. May be dyed any color, cast into ANY shape, used for ANY purpose. Extremely hard and durable. Ideal for statuary, figurines, novelties, gadgets, models, tools . . . a million useful things! In addition, **COMBINATION OUTFIT** contains 3 attractive molds for making about \$100.00 worth of novelties, dye, pipette, hardeners, measure, imbedding material, jewelry accessories and instruction manual.

COMBINATION PLASTICS OUTFIT, Cat. No. 636, postpaid . . . \$4.95
PLASTICAST OUTFIT ONLY, complete with 3 molds . . . \$3.50
HERCULOX OUTFIT ONLY, complete with 3 molds . . . \$3.50

FREE!

Let us show you how extremely easy it is to make beautiful and useful things out of **LIQUID PLASTICS, LIQUID MARBLE, LIQUID IVORY, LIQUID GLASS, CERAMICS, ETC.** . . . as easy as pouring water out of a glass! Make novelties, jewelry, gifts, artware, gadgets, toys, ceramics . . . a million useful things! We supply everything—**MATERIALS, INSTRUCTIONS AND BUYERS!** Send only 25c for 1. Big catalog of 300 casting materials, molds, and accessories. 2. A beautiful **CAMEO** free (to show you what you can do), and 3. Actual **INSTRUCTIONS** on how to cast and start in the **CASTING BUSINESS!** Send 25c today—this may be the lucky coin that will start the most fascinating and profitable phase of your life! (Catalog only—10c)

TERMS: We pay the postage (U.S.A. only) if full cash accompanies order. C.O.D. accepted (U.S.A. only) if \$1.00 deposit included for each item ordered.

DEALERS: WRITE FOR CATALOG, DISCOUNTS & PROMOTIONAL MATERIAL.

PLASTICAST COMPANY (DEPT. C)

4637 N. Kedzie Ave. (Write to P. O. Box 987
Chicago 25, Ill. nearest address) Palo Alto, Calif.

CANADIAN CUSTOMERS, please order directly from: CANADIAN INDUSTRIAL PLASTICS, LTD., 1056 1/2 Pender West, Vancouver, B. C.

Here's a Profitable BUSINESS FREE

MONEY MAKING OPPORTUNITY FOR YOU WITHOUT INVESTMENT!

No experience needed to act as our Local Dealer for **MASTER Work Uniform** garments. Every business concern a prospect. Advertising embroidered on garments is a big sales feature. Easy, pleasant work. You receive cash commissions daily. You can easily earn up to many thousands of dollars per year. We supply all Sales Equipment **FREE**. Write

GEO. MASTER GARMENT CO., Dept. 390
Ligonier, Indiana



Watchmakers MAKE MONEY!

Large earnings with no dull seasons, professional dignity, a steady secure future are yours as a Master Watchmaker! You can choose a fine job or go into your own business. The famous Sweazey System teaches you . . . expertly, quickly, successfully.

SEND FOR FREE BOOK NOW →

Since 1908, Chicago School of Watchmaking graduates have been in constant demand. Write today for your free copy of our new illustrated book about the big opportunities in watch repairing, gem setting and engraving.

CHICAGO SCHOOL OF WATCHMAKING, 1608 Milwaukee Avenue, Chicago 47, Illinois, Dept. 199

Please send your new book, "Master Watchmakers Wanted" without cost or obligation.

- I am interested in attending residence school.
 I am interested in home study.
 I am a veteran. I am a non-veteran.

NAME _____

ADDRESS _____

CITY _____ ZONE _____ STATE _____

EARN MORE



\$\$\$

SEND FOR THIS FREE BOOK NOW!

● Increase your earning power. Become thoroughly trained in a well-paid profession. Without obligation, find out about the opportunities in Electrical, Mechanical, Plastics, Civil, Mining and other engineering fields. Our free 118-page handbook, lists details of home study courses, compiled by world authorities. See for yourself how you can soon earn more dollars. Write today, to: Canadian Institute of Science and Technology, Ltd., 485 Century Building, 412, 5th Street, N.W., Washington, D. C.

Special discounts for Veterans and Servicemen

MAIL THIS COUPON NOW

Canadian Institute of Science & Technology, Ltd.,
485 Century Building, 412, 5th Street N.W.,
Washington, D. C.

Please forward free of cost or obligation of any kind your 118-page handbook "Engineering Opportunities."

Name _____ Age _____

Address _____

CANADIAN ENQUIRIES: 263 Adelaide St. W, Toronto



ONLY
2 SHINES A YEAR
AND SHE
GLEAMS LIKE NEW!



Yes, sir — give your car the glow that rests your elbow! Use LACQUERWAX — the peerless auto finish protector. It's 5 times faster and easier to apply than ordinary paste waxes — and one treatment lasts 4 to 6 months!

LACQUERWAX contains no lacquer, but this hard, liquid wax is CLIMATE-PROOF! Its brilliant luster shines right through hot sun and driving rain. You can't wash it off... it won't spot! It brings out and preserves the full beauty of your car's finish. Only \$1.00 for a pint can. Mail coupon NOW!

LACQUERWAX CO. Dept. P.M.-9
HARTFORD 3, CONN.

Gentlemen: My check, cash or money order for \$_____ is enclosed, covering cost of _____ can(s) of LACQUERWAX. Please send my order to:

Name _____

Address _____

City _____ Zone _____ State _____

LACQUERWAX

LACQUERWAX CO. HARTFORD 3, CONN.

SURPLUS HIGH SPEED DRILLS MICROMETERS

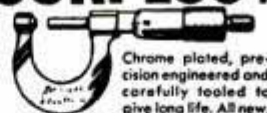

Chrome plated, precision engineered and carefully tooling to give long life. All new.

0-1" capacity . . . each \$2.25
1-2" capacity . . . each 3.50
2-3" capacity . . . each 5.50
3-4" capacity . . . each 6.50



All New Drills! Fractional and numbered. Original value \$15.00. Thirty assorted sizes and lengths . . . \$3.50

EXPANSION REAMERS



Spiral Flute. Mfd. by Alvard Polk Tool Co. All New, original pack. 1/4"-3/8"-7/16" Recommended expansion limit, .006". Original value \$12. Set of 3 . . . \$4.95

SEND 10c FOR ILLUSTRATED CATALOG

Send check, money order or cash. 25% deposit required on C. O. D. orders. All prices F. O. B. Culver City, Calif.

AIRBORNE SALES CO., INC. DEPT. PM
CULVER CITY, CALIF.

EARN \$50 UP A WEEK... ON THE SIDE!

While You Learn Watch Repairing At Home

WITH OUR NEW 13 ITEM SELF-TRAINING KIT
Containing: AMERICAN JEWELRY WATCH MOVEMENT for practicing—PROFESSIONAL TOOLS: Loupe; 6 Screw Drivers; Tweezers; Material Tray; Case Opener & Knife; Movement Gauge and COMPLETE ILLUSTRATED BOOK ON \$9.35 Post WATCH REPAIRING Only \$9.35 Paid (C.O.D. plus charges) MONEY BACK GUARANTEE
Tool Catalog FREE with KIT or send \$5.50 credited to 1st order
MODERN TECHNICAL SUPPLY CO.
Dept. 9MMC, 55 W. 42nd St. New York 18, N. Y.

SPRAY-PAINT OLD BUMPERS



MARVELOUS, EASY REFINISHING JOB

WITH
ZACO ALUMINUM
Self-propelled PAINT SPRAY

ZACO LABORATORIES
1360 W. 9th St. CLEVELAND 13, OHIO

SEND \$1 FOR SPECIAL INTRODUCTORY CAN

LOCKSMITHING & Key Making



PRACTICAL UP-TO-DATE COURSE—ONLY \$3.95

Easy-to-learn modern information for instruction. How to work on locks, decode, make master-keys, repair, install, service, etc. For every handyman, home owner, carpenter, mechanic, service station operator, fix-it shop, hardware dealer, gunsmith. 53 plain illustrated lessons. FULL PRICE ONLY \$3.95. SEND NO MONEY. Just pay postman plus C.O.D. postage. Or send \$3.95 order, we'll ship postpaid. Satisfaction guaranteed or refund.
NELSON-HALL CO., 1139 S. Wabash Ave., Dept. J-2, Chicago 5, Ill.

EXTRA MONEY—LOADS of FUN!

MAKING TRUE-TO-LIFE MASKS



As a hobby or business you'll enjoy this fascinating art. Friends—relatives—acquaintances—they're all potential customers. Inexpensive to make, no special skill required. Cash in now in fun or money. Be first in your community. Send \$1.00 for complete instructions and sketches on how to make true-in-detail LIFE MASKS. Offer expires soon. so order now

KEARNEY & CLARK
Box 1308 Akron 9, Ohio

Train for one of these Big Fields in the Largest & Best Equipped School of its Kind

HAT CLEANING AND BLOCKING

Shoe Repairing

Learn by doing in modern training shops under experts. Fine opportunities for good jobs or your own successful business. Have the advantage of going to a big, well established school. COMPLETE HAT CLEANING AND BLOCKING TRAINING IN ONLY 12 WEEKS.

Look to the future with confidence. Get into these great fields which are among mankind's oldest and most essential. Trained men needed in practically every locality, the year around. No previous experience or advanced education necessary.

Write for Free Booklet Today
G. I. APPROVED
CHICAGO SCHOOL OF SHOE REBUILDING
124 E. 26th Street Dpt. PM-9 Chicago 16, Illinois

New! CHORE-BOY

THE UTILITY CARRIER WITH 100's OF USES.

Only \$17.95 complete

Originally \$27.50

"Chore-Boy" handles loads up to 200 pounds. With bag attached, it's ideal for laundry, waste paper, rubbish, leaves, etc. Remove bag and you have a sturdy hand truck for hauling ash barrels, cordwood, beer cases, milk cans, bales of hay, steel drums and other bulk objects. It's balanced...rolls easy...up or down stairs.

"Chore-Boy" has a strong, green enamel steel body and semi-pneumatic, rubber tired 10" wheels. Height 46", base width 22". Tough, detachable canvas bag is 24" in diameter, 36" deep. Extra bags are available.

Order your "Chore-Boy" today at this special price. Send check, or specify C.O.D.



Send For Literature

Sales Representatives Wanted

HARTMAN Corp.

1100 S. Kirkwood Rd., St. Louis County 22, Mo.

SELL NYLONS AGAINST RUNS!

Amazing guarantee gives FREE nylons if hose runs or snags within guarantee period to 3 months! All weights, sizes etc. including sheerest 15 denier. Not sold in stores. Nationally advertised in Life, Ladies Home Journal, Saturday Evening Post, McCalls, Women's Home Companion. Awarded Seal of Approval by Good Housekeeping. Also complete line of men's fine hosiery guaranteed ONE FULL YEAR or replaced FREE! No money or experience needed to earn big, steady income writing orders spare or full time. We deliver and collect. Advance cash plus huge bonus. Complete money-making sales outfits FREE and prepaid. No obligation. Rush name to KENDEX COMPANY, BABYLON, 146, N.Y.



ANALYZE Handwriting

Try it FREE, use it — to understand yourself and others in business and social life — more clearly than you ever thought possible. Many use their knowledge of handwriting to make more money full or part time. Simply send your name today for FREE ILLUSTRATED lesson. No obligation. Must be over 21.

INTERNATIONAL GRAPHO ANALYSIS SOCIETY, INC.,
203 Wilhoit Building Springfield 4, Mo.

SAVE UP TO 25% ON QUALITY BALL-BEARING WHEELS!

Bilt-Rite wheels roll smoothly and easily, are semi-pneumatic, ball-bearing, painted red; guaranteed top quality—and you save up to 25%! Compare Bilt-Rite's quality and price — then get your order in today! Dealer inquiries invited.

BILT-RITE BARGAINS on BALL-BEARING WHEELS (For 1/2-inch Axles)			
6 x 1.00.....	\$1.30	10 x 1.25.....	\$1.95
8 x 1.25.....	1.65	10 x 1.75.....	2.15
8 x 1.75.....	1.80	10 x 2.00.....	2.45
6 x 1.50.....\$1.50			
(For 3/4-inch axle)			
6 x 2.00.....	\$3.95	8 x 2.50.....	\$4.45
10 x 2.75.....Only \$4.65!			



Bilt-Rite Guarantee
No better wheels are made regardless of price; 10 day return privilege.

If size you need isn't listed, write for Folio A
ORDER TODAY—Send cash, check, or M.O.—Pay postage on arrival.
BILT-RITE WHEEL COMPANY
520 EAST MISSOURI AVE. KANSAS CITY 6, MISSOURI

Are You a "One-Date Dick" or a KING OF MUSCLE?



YES!—and in just 5 Minutes every other day, YOU, too, can have a new physique, added height, glowing health and vigor, with world-famous Paramount Bar Bells. At any age, you can gain new popularity, and probably boost your own paycheck through the sheer vitality of a powerful new build. Send now for FREE Paramount "Self-Check Chart." Learn sensational new low prices of Paramount Bar Bells, sold at direct-from-factory savings. Get started NOW to be a King of Muscle! Act TODAY!

GIFT CHART—FREE!

AS LOW AS \$8.95

Paramount Bar Bells, Dept. 10
2416 E. 23rd St., Los Angeles 11, Calif.

Rush Info and "Self-Check Chart," FREE!

Name _____
Address _____
City _____ Zone _____ State _____



START AS HIGH AS \$3,351 YEAR

Many early Examinations Expected. Prepare NOW! Veterans Get Special Preference! 40-Page Civil Service Book FREE

Franklin Institute
Dept. T83
Rochester 4, N. Y.

(Not Gov't Controlled)
Gentlemen: Rush to me FREE of charge, list of U. S. government big pay jobs. Send FREE 40-page book describing salaries, vacations, hours, work, etc. Tell me how to qualify for one of these jobs.

Mail Coupon Today SURE
Name _____
Address _____ Vet? _____

New Advertising Machine



PRINTS and ILLUSTRATES

1¢ Post Cards

FREE

Learn how thousands of business men, in every line, are boosting sales in spite of conditions—with 1¢ messages—printed and illustrated in a few minutes on gov't post cards—with amazing new patented **CARDMASTER**. Your "today's" ideas, read by your prospects next morning. Not a toy, but a sturdy advertising machine, built to last for years. Low price, sold direct. Guaranteed for five years. Send name today.

SEND NAME We'll send **FREE** illustrated book of money-making **IDEAS** for your business and complete, unique advertising plans. **RUSH YOUR NAME TODAY.**

CARDMASTER COMPANY
1920 SUNNYSIDE, Dept. 139, CHICAGO 49, Ill.

THERE'S MONEY IN CARTOONS!

RAYE BURNS will teach you HOW to CREATE ORIGINAL CARTOONS at home that you may SELL! Course contains 26 lessons and over 600 illustrations. All for Only... **\$2.85**

Send name and address for free details.
RAYE BURNS SCHOOL, Dept. M, Box 3583, Cleveland, Ohio

WANTED MAN WITH CAR

No Time Like Now to Get In **McNess Business**

It's no trick to make good money when you use your car as a McNess "Store on Wheels." Farmers buy everything they can from McNess Men because McNess Products are tops in quality, represent extra values. Attractive business-getting prizes and premiums; also money-saving deals to customers make selling McNess daily necessities a snap.

We Supply Capital—Start Now!

There's no better work anywhere. Pays well, permanent, need no experience to start, and we supply capital to help you get started quick. You begin making money first day. Write at once for McNess Dealer Book. It's **FREE**. Tells all—no obligation. (1)

THE McNESS CO., 815 Adams St., Freeport, Ill.



Use Your **CAR** to Raise Your **PAY**

HANDI-SCOPE

POWERFUL MICROSCOPE

For Machinists, Hobbyists, Photographers, Doctors, Engineers, Students, etc.

- Sharp Fine-Focus Adjustment
- 20-Power, Compound System
- Wide Undistorted Field
- No Special Light Source Needed

ORDER NOW!

Hundreds of practical uses in home, school, office, shop, farm, etc. Easy to use—handy to carry.

Sold on money-back guarantee. Send check **\$4.95** or money order **TODAY!** **POSTPAID**

BUHL OPTICAL COMPANY

Box C-118, 1009 Beech Avenue, Pittsburgh 12, Pa.



BE A LOCKSMITH

Learn Locksmithing and Keyfitting from experts in your spare time at home.

Uncrowded field! No layoffs, no slow seasons. **AGE OR PHYSICAL HANDICAP** is no disadvantage. Year round steady income in this permanent, respected career. Full or part time. Practical, easy lessons show how to make money even while learning! **ALL MATERIALS AND SPECIAL TOOLS SUPPLIED.**

write **DEPT. P1**

Locksmithing Institute, Inc.

55 Park Ave. Rutherford, New Jersey

HOT-START COIL

GIVES YOUR CAR THE EXTRA SPARK THAT ASSURES A POSITIVE START



Here is the new Hot-Start Coil that gives you a hotter spark for starting. Overcomes normal voltage drop from starter. Easy to install, fits all cars except Ford, Merc Order direct today

\$11.95

Postpaid or C.O.D. plus charges

Dealers Wanted

STERNALL MFG. CO.

3505 Rodeo, Los Angeles 16, Calif.

YOU CAN BE AN **All Around HE-MAN**

All 5 famous courses by George F. Jowett, world's greatest body builder in 1 complete muscle building volume (valued at \$5 each) now only 25c. Packed with How-to-Do-it pictures. 1. How to Mold a Mighty Arm. 2. Mighty Chest. 3. Mighty Back. 4. Mighty Grip. 5. Mighty Legs. Free strong men photo book. Quick results or money back! Send 25c. name, address, age. **JOWETT INSTITUTE, Dept. PM-99, 230 Fifth Avenue, New York City**

25c

SAY YOU SAW IT IN POPULAR MECHANICS

BE A **GOVERNMENT LICENSED AIRPLANE AND ENGINE MECHANIC** Train Now at **LINCOLN**



EARN BIG PAY IN **AVIATION**

Start your aviation career by enrolling in our **MASTER AVIATION MECHANICS**, CAA Approved 1 Year Course, a complete course in both airplanes and airplane engines. Our **REFRESHER AIRPLANE & ENGINE MECHANICS COURSE** is designed for veterans or others with aviation mechanics experience. Either course is available to veterans under the G.I. Bill of Rights. Write today for complete information.

LINCOLN AVIATION INSTITUTE
UNION AIR TERMINAL DEPT. F-9 LINCOLN, NEBRASKA

REPLACE THAT CLUMSY STOVE ...

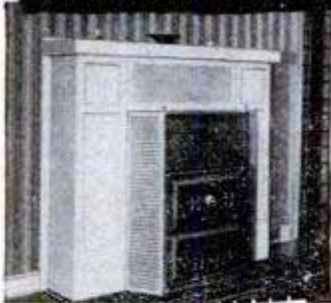

with a BEAUTIFUL **FIREDAIRE**

COMBINATION FURNACE AND FIREPLACE

A living-room furnace with removable doors for use as a real open fireplace, too! Comes prefabricated, steel mantel to tile-like hearth, in many designs. Saves space, stays in place, fits any chimney, burns any fuel.

INSTALL YOURSELF IN 2 TO 3 HOURS

No damage to walls or floor, no extra masonry. Heats 4 to 7 rooms on 1 to 2 floors. Adds beauty and value to your home. Models also available for use as fireplace only. Priced as low as \$89.50.

DEALERS ... DISTRIBUTORS ... AGENTS

There's nothing else like Fireaire. Nationally advertised. Eligible for FHA financing. Virgin territory available. Earn liberal profit on sales, installation. Write for offer.

DEPT. HB, ANDERSON STOVE COMPANY, ANDERSON, IND.

EARN MORE IN DRAFTING



Steady
Employment
•
More
Opportunities
for Promotion
•

"Here I am at work making good money as a draftsman. I'm glad I sent the coupon to Chicago Tech for that Free Trial Lesson and found out how easy it is to learn Drafting in spare time at home. Today I feel secure in my job because the draftsman's work comes first on any new project. And, in addition, draftsmen can't be replaced with machines. What's more, I feel I'm slated for promotion and more pay, because I see so many draftsmen advancing to high-pay jobs."

LEARN IN SPARE TIME—AT HOME! (or at the College in Chicago)

A few hours of pleasant home study every week—that's all. No interference with your present job. All the tools you need; drawing outfit included. With Chicago Tech's help, you train yourself step by step. This tested method—developed over 45 years of C.T.C. progress—prepares men quickly for good positions in industry.



FREE INFORMATION—SEND COUPON

To prove to you how easy it is to learn Drafting at home by the Chicago Tech method, we will send you this FREE TRIAL LESSON. No charge for this lesson, now or later. Fill out and mail coupon, or send post card today.

CHICAGO TECHNICAL COLLEGE

M-212 Tech Bldg., 2000 So. Michigan Ave., Chicago 16, Illinois
Mail me FREE Lesson with information about big opportunities in DRAFTING.

Name _____ Age _____

Address _____

City _____ Zone _____ State _____

ELECTRIC APPLIANCES REPAIRED YOUR NAME

Start YOUR OWN BUSINESS!

Repair electrical appliances of friends and neighbors. Service electrical equipment in factories, stores, etc. Work full or part time!

New Shop Method home-training system. Rush name today for **FREE BOOK** and special form for getting Electronic Kit, Special Service Kits, Armature Growler, Illustrated Instructions on new easy-payment plan. Pay us later with your **EARNINGS WHILE LEARNING**. Rush name.

CHRISTY TRADES SCHOOL
2835 N. Central Ave., Dept. D-7303, Chicago 34

EARN HIGH SCHOOL DIPLOMA AT HOME

Guided study permits you to complete High School education in shortest possible time. Modern methods make it interesting, easier. Prepare for better jobs, pre-professional, college entrance exams. Recognition for H.S. credits already earned. Books supplied. Low tuition, easy terms. Write for Free Information. **HOME STUDY INSTITUTE**
209 VINE AVENUE DEPT. PM-9 PARK RIDGE, ILL.

17-JEWEL WATERPROOF WRIST WATCH

1. SHOCK PROOF
2. WATER RESISTANT

3. SWEEP SECOND HAND
4. LUMINOUS DIAL

5. ANTI-MAGNETIC
6. STAINLESS STEEL BACK

Made to Retail at \$49.75

SPECIAL NEW LOW PRICE \$16.95
(PLUS \$1.70 FED. TAX)

* Ladies 17-Jewel Wrist Watch \$16.95
(PLUS \$1.70 FED. TAX)

* Gent's Automatic (Self-Winding) 17-Jewel Waterproof Wrist Watch \$24.75
(PLUS \$2.48 FED. TAX)

GUARANTEED SATISFACTION or
Money Refunded Within 10 Days

Send Cash or Money Order to **INTERNATIONAL WATCH CO.** 8512 1/2 S. VERMONT AVE.
LOS ANGELES 44, CALIF.



EARN \$3800.00 A YEAR! ADVANCE TO \$7000.00

A CRITICAL SHORTAGE OF STATION AGENTS and TELEGRAPHERS EXISTS!
ATTEND THE WORLD'S LARGEST RAILROAD SCHOOL

VETERANS! NON-VETERANS! *THIS IS IT! Thousands of trained men are needed by all U.S. Railroads because of new 40 hour week provision, and men reaching retirement age. Assure yourself of immediate employment after graduation ... attend the school endorsed by the ORDER OF RAILROAD TELEGRAPHERS. Gale Institute has placed over 1,000 men in the past 18 months. YOU MUST ACT NOW—CLASSES ARE LIMITED. WRITE TODAY!

IN RAILROAD WORK YOU GET:

- Free travel passes
- Vacation with pay
- Low cost insurance
- Advancement opportunity
- Retirement fund

NOT A SEASONAL JOB—
A LIFETIME OPPORTUNITY

GALE INSTITUTE, 1400 West Lake St., Minneapolis 8, Minn.

G. I. APPROVED

NEW
Edition



**NOW
HAS
325
PAGES
232
ILLUS.
\$3.50
Total Cost**

Famous Guide to Best Pay Auto Repair Work

This practical book will put you right into the most profitable business in the auto field. Shows you how to get a good job or start a business of your own with little or no capital. Easy to use and understand. Covers use of tools and equipment, gives approved methods, describes materials and shows you how to actually do a professional job, operate a shop, etc. The very latest information and pictures on all interior and exterior body work and fender repairs—the kind of work people everywhere want and will pay big for when you can do it. Mail coupon now. Use book 5 days and if not O.K. return it and we will refund your money.

**Most
Complete
Information
Ever
Published**

GOODHEART-WILLCOX CO., Dept. 16
1321 S. Michigan Avenue, Chicago 5

**MAIL ORDER
COUPON**

Send Auto Body and Fender Repairs C.O.D.,
I will pay postman plus charges. (C.O.D. in
U.S. only.) Remittance for \$3.50 enclosed, send postage paid. If
not O.K. I will return in 5 days and you will refund purchase price.

Name _____
Address _____
City _____ State _____

Learn A Trade NOW! PRACTICAL SHOP TRAINING!

In Our Chicago Shops

- | | |
|---|--|
| <input type="checkbox"/> AUTO MECHANICS | <input type="checkbox"/> WELDING—ARC and GAS |
| <input type="checkbox"/> DIESEL MECHANICS | <input type="checkbox"/> MACHINIST |
| <input type="checkbox"/> REFRIGERATION | <input type="checkbox"/> PIANO TUNING |
| <input type="checkbox"/> BODY-FENDER | |

Above Approved For G. I.'s and Civilians
One of America's Leading Practical Schools
7 Floors of Fully Equipped Shops
Over 48,000 Successful Graduates
Expert Individual Instruction
Learn by Doing—Low Living Expense
Established 1902—Day and Evening Classes

Also the following Home Study Courses

- PLASTIC REFRIGERATION DIESEL

—CALL IN PERSON OR MAIL THIS AD TO—

GREER SHOP TRAINING

(Desk 16) 460 South State St., Chicago 5, Ill.

Please send without obligation free information regarding trade checked above. (Specify whether you are a Veteran or Civilian)

Name _____ Age _____
Address _____
City _____ State _____

EVERYBODY KNOWS You can't Buy a \$20 Goldpiece for \$10.
REMEMBER THIS So It's Dangerous to Pay Less—if you
Want Safe, Balanced, Matched Tires.
Consider Your Family's Safety—Not Just Price! You See Our Ad
Every Month! Vets Take 10%. We Owe Our Prosperity to You!



GOODYEAR Goodrich, Firestone, U. S. & Others.
Original High Tread, Slightly Worn,
Not Recaps — Not Remolded — Not Retreads
Pass. & Truck 30,000 Miles Golden Rule Guar.
Genuine Factory Adjusted "All-Purpose" "AAA" Tires
Read That Top Line Again! You'll Save More than \$

600-16	\$5.50	650-16	\$5.75	700-15	\$6.00
600-16 (6)	6.50	650-16 (6)	6.75	650-15	7.75
700-16	6.50	750-16	7.75	550-17	7.75
700-16 (6)	7.50	475-19	5.50	525-18	6.75

WE ARE TRUCK-TIRE EXPERTS. Matched Tires

600-16	\$8.90	32x6 (8)	\$10.00	900-20	\$12.95
650-20	9.15	32x6 (10)	11.95	1000-20	13.20
700-20	10.80	825-20	12.78	1100-20	14.85
750-20 (8)	9.00	34x7 (10)	13.00	1000-22	17.95

GOOD USED TIRES Any Car \$3.25. 12,000 Miles Guarantee

MILITARY TREAD "SUPER" GUAR. 12 Mos. Top Grade Guar. 30 Mos.

750-16	Super \$ 8.75	900-16	Super \$ 6.96	750-20	Super \$ 8.48
Top Grade	12.00	Top Grade	10.75	Top Grade	13.00

Send check or money order & this ad for rush shipment. We won't ship a tire that WE wouldn't use. The name to trust in rubber.

BLATT GIRARD AVE. TO LANCASTER AVE. DEPT. PM
BLATT BLDG., PHILADELPHIA 31, PA.

Save Money—Make Money
with **LARSON Leathercraft**
For gifts or for sale—make easy-to-assemble leather items. Complete stock leathers, tools, accessories.
Send ten cents for new catalog of 101 money-making ideas.
J. C. LARSON CO. 824 S. Tripp Ave. Chicago 24, Illinois

Rebuilt Transmissions PLYMOUTH — DODGES \$25.95 Exch. Price 35-39 only.
F.O.B. Chicago Guaranteed
Also Transmissions for all other cars
REBUILT GENERATORS
Chevrolet — Ford — Plymouth
Exch. Price \$6.95 Guaranteed
F.O.B. Chicago.
We carry a full line of automotive parts, starters, transmissions, rear-ends, and generators at tremendous savings. Rebuilt by factory trained experts. **LOWEST PRICES IN MIDWEST**
WORLD AUTO PARTS CO. ORDER from one of the nation's largest replacement dealers
2200 N. Ashland Chicago 14, Ill.

LEARN WATCHMAKING JEWELRY REPAIRING
Start your training now for a better paying job or your own profitable business. Intensive practical training by experienced craftsman. Write for free catalog. APPROVED FOR VETERANS.
SCIENTIFIC SCHOOL OF WATCHMAKING, DEPT. PM-9
3923 SAN FERNANDO ROAD GLENDALE 4, CALIFORNIA

Automobile Vapor Injector
\$8.00 complete. 10 day trial, refund.
... Cools engine and gives top performance.
A metering airfoil pump automatically controls vapor injection as it integrates radiator water temperature with the engine load.
TENCO, INC., P.O. Box 5528, Washington 16, D.C.

FIX ANYTHING ELECTRICAL!
Insure against hard times with amazing new electrical appliance repair method. Even beginners can fix electrical appliances double quick. At sensational low price, you get training course and new simplified electrical tester. Send postal card for details. No obligation.
FEILER ENGINEERING CO., Dept. 9PM9, 845 George St., Chicago 14, Ill.

NEWEST B-M POWER MOWER
For Modern Lawn Care
Newest addition to our family of fine power lawn mowers. Light, 3-wheel, rotary blade mower. Lifetime construction. Powerful 1 1/2 h.p. 4-cycle engine. Self-propelled and other models available, including 3 h.p. 22 inch mower.
Write for FREE Literature
B-M MOWER CO., Box 66-PM, Blue Mound, Kans.

Now I remove paint the EASY WAY!

Homemakers everywhere are discovering what painters have known for years—that Wonder-Paste does a quicker, cleaner removing job every time!

WONDER-PASTE

Applied directly over the old finish, Wonder-Paste penetrates right through to the surface. Reduces the toughest finish to an unresisting sludge that peels off like putty! Leaves surface clean and smooth—with no sanding needed.

Get Wonder-Paste at your paint or hardware store. Write us for Wonder-Paste leaflet and for information about your removing problem.

WILSON-IMPERIAL COMPANY
119 Chestnut Street, Newark 5, N. J.



NEW ROCKET

JET PROPULSION.
FOR FUN OR
EXPERIMENT.
Zooms over
200 feet
high.

25,000 M. P. H.

Speed a rocket must attain to escape from the earth. Many other facts supplied with full instructions. Special launching stand. Can be used repeatedly. Send \$2.95 we pay postage. Sent C.O.D. for \$3.50.

\$2.95

WALSH PRODUCTS INC.

209 -M9 N. Maple Ave., East Orange, N. J.

LOCKSMITHING & KEYMAKING

PRACTICAL HOME TRAINING OUTFIT INCLUDES EVERYTHING NECESSARY TO GET STARTED IN YOUR OWN BUSINESS. Excellent full or part time earning opportunities. Professional outfit includes supplies, tools, key cutting machine. Get practical training from Master Locksmiths on house locks, auto locks, padlocks, etc. Learn to cut keys by code, master locks, change combinations, quickly, identify key blanks, many profitable "tricks of the trade." Booklet of Information FREE. Write today. UNITED SUPPLY & SERVICE, 3327 Madison St., Dept. PM-9, Chicago, Illinois.

BULLETIP

(Reg. U.S. Pat. Off.) by

SANDEE

Exclusively

2½" diam. \$1.95

3" diam. \$2.95

Heavy Western Chrome Plate

SANDEE MUFFLER CO., 5643 Corryne Place, Culver City, Calif.

BIG MONEY...FOR MEN & WOMEN, SPARE or FULL TIME

NO EXPERIENCE NECESSARY. BIG PROFITS in new "MIRACLE FINISH." Give velvety, luxurious surface to radios, lamps, toys, signs, store displays, auto trunk interiors, dash boards. Learn in few days. Our business is booming. Help us fill HUGE DEMAND New method. EASY TO LEARN. Write for FREE details and SAMPLE. Do it now. Be first! COAST INDUSTRIES, Dept. 29, 1004 S. Los Angeles St., Los Angeles 15, Calif.

WAR SURPLUS BARGAINS

Substantial Savings on WAR SURPLUS and other MERCHANDISE OVER 200 TIMELY ITEMS
FREE CIRCULAR FOR SIOUX FALLS SURPLUS STORE SIOUX FALLS S.D.

Be A MASTER PLUMBER

Earn \$15 To \$50 A Day

DON'T ENVY THE PLUMBER - BE ONE

Every skilled workman will tell you that Plumbers have the best of it. WINTER and SUMMER the Plumber is busy at top wages. No skilled Plumber is ever out of a job—compare his opportunities with any trade, plus the opportunities of having your own shop. We teach you Plumbing with TOOLS (not books) under Licensed Master PLUMBERS in one of the finest equipped schools in America. We make you a Plumber, every branch is taught thoroughly—Lead Work—Blueprint for plan reading—all other tricks.

LEARN IN 30 WEEKS WITHOUT PREVIOUS EXPERIENCE

If you like to work with tools you owe it to yourself to investigate. No need to ever work as an apprentice. Get free bulletin. Write now! G.I. APPROVED. Our 24th year.

UNIVERSAL PLUMBING SCHOOL
877 HOLMES STREET KANSAS CITY, MO.

YOU ARE IN DEMAND IF YOU CAN Draw!



If you like to sketch, write for FREE TALENT TEST. Splendid opportunities for trained artists. Find out if you have talent worth developing.



ART INSTRUCTION, INC.

Dept. 9139-C Minneapolis 15, Minnesota

Send me your FREE Talent Test.

Name _____ Age _____

Address _____

City _____ Zone _____

County _____ State _____

Occupation _____ Phone _____

GAME ROOM

build your own



It's fun building a game room, and inexpensive too, when you use Gold Bond Gypsum Wallboard. Strong, lightweight, easy to nail. Moisture resistant, fire-proof. Decorate with Gold Bond Sunflex, the low-cost wall paint that dries in one hour. Get both at your local Gold Bond lumber and building material dealer.

Free book of suggestions



NATIONAL GYPSUM COMPANY
Dept. E-3, Buffalo 2, New York

Gentlemen: Send free copy of new booklet, "Modernizing Magic" showing remodeling ideas and methods:

Name _____
Street _____
City _____ State _____

(Please print name and address)

NOW AT MY RISK!
I want you to read the
WARNER SUCCESS PLAN



It shows you how to...
METALIZE BABY SHOES
AND OTHER KEEPSAKES

- how you can start in spare time with your home as headquarters.
- how to build—step by step—to big profits and personal independence.

This is the famous Warner Success Plan—the Plan for Personal Success in your own fascinating business that many men, married couples credit with freeing them from the limits of a pay check and from the drudgery of a time clock.

It gives the exact step by step instructions for starting a business in spare time—without risking the job or steady pay. It shows with pictures, photographs, and drawings exactly how to Metalize Baby Shoes and other keepsakes. It shows how to get the orders coming in—how to expand—how to get others working for you—how to be SURE of at least twice your present pay before you give up your job for a life of personal independence.

15 Million Prospects

There are 15 MILLION pair of Baby Shoes in the country right now ready to be Metalized. Last year alone, more than THREE MILLION more babies were born.

There's not one of these mothers who doesn't want her baby's first shoes preserved forever. The Business is tremendous... and never ending.

The Warner Success Plan shows you how to turn this exciting opportunity into cash. Shows exactly how to prepare the shoes, how to put on them a coating of genuine gold, silver, or bronze metal by simple Warner Electroplating process. Shows how to get the business coming in, how to start in spare time, how to pyramid profits. Shows you how the whole family can have fun while building for an independent future. My own Shop here in Chicago does a Big Business by the very secrets I will now unfold to you.

Read The True Facts

Don't say "Yes" now. You must have ALL THE FACTS. Then decide. First, I want you to read the entire Plan—at my risk. After investigating—after discussing it with your family—then and only then do you decide whether to use the plan and make the small investment necessary to start.



\$5⁰⁰ An Hour PROFIT

Yes, even in spare time it is possible for a man to finish enough work to pay \$5.00 an hour for his time. Think what this can pyramid into when the family helps.

3c MAY START A FORTUNE

Today I want you to do only one thing. Send the coupon. Let me give you all the facts. Remember, what I send you does not cost you a cent beyond the postage you put on your letter to me. With an opportunity like this, a man who has a serious interest in his future MUST investigate. MAIL the COUPON TODAY and see for yourself why so many families have called the WARNER SUCCESS PLAN a "godsend".

DON'T SEND A PENNY
JUST MAIL THIS COUPON TODAY!

Raymond E. Brandell, Mgr., WARNER ELECTRIC CO.
1512 Jarvis Ave., Dept. 39, Chicago 26, Ill.

As long as it doesn't cost me a cent, I am willing to read the facts, investigate, then give you my decision. Send the facts by next mail. Everything you send now is FREE!

NAME _____

ADDRESS _____

CITY _____ Zone _____ STATE _____

MAKE 12 TIMES
YOUR MATERIAL COSTS

Remember, the Warner Process is not a cheap imitation "PAINT" process. It is the genuine METALIZING through real Electroplating. And in spite of being the best, your materials cost so little that your profits are 12 Times your material cost. Then, when mothers order the shoes mounted as book-ends, as pictures, as ash-trays or pen sets, you make the BIG EXTRA PROFITS on the beautiful mounts.

WARNER-ELECTRIC CO.
1512 Jarvis Avenue
DEPT. 39
Chicago 26, Illinois



WE SUPPLY ALL MATERIALS

You don't have to go "hunting" when Warner is behind you. We supply all materials, all mounts, chemicals, and metals. And you get the low prices made possible by our big quantity purchases and our own manufacture. You send for just what you need and never have any big investment tied up in stock.

**WORLD'S
BEST
WANT AD
MEDIUM**

CLASSIFIED Advertisements



Advertisements in this section 75 cents per word, each insertion, minimum 10 words, payable in advance
To be inserted under proper classification, copy must be in our office the 22nd of the
second month preceding date of issue

F. W. Johnson, Manager, Classified Advertising
Popular Mechanics Magazine, 200 East Ontario Street, Chicago 11, Illinois

1077

CLASSIFIED ADVERTISEMENTS

1077

OPPORTUNITIES FOR YOU

AUTOMOBILES, MIDGET CARS

NEW Chevrolet speed manual! 90 pages of accurate information you can really use! How to increase speed and acceleration of any Chevrolet 1937 thru 1949. How to install late engines in pre-1937 chassis. Full data on cams, high compression, multiple carburetion, supercharging, ignition, etc. We guarantee this to be the finest manual of its type! Prove that your Chevrolet can have power and speed formerly associated with other cars. Sent postpaid for only \$2.00. California Bill, Box L-1, Eaglerock, Los Angeles 41, Calif.

"SPEED And Mileage" manual! 140 illustrations! Most authoritative and widely read book of its kind! Easily gain up to 40% more speed, power, mileage, from any automobile! Complete instructions on building inexpensive speed equipment! Fast sports cars! "California hot rods!" 155 m.p.h. conversions! Superchargers! Dual manifolds! Twin mufflers! "Water injectors!" Heads! Economizers! All about fast engines; speed tuning; restyling; "customizing;" gas saving; "racing tricks;" cams; fuels; ratios; "stock car speed secrets!" Latest California methods! "Custom styling information!" Streamlining sport changes! Lowering! Working diagrams! "Hollywood roadster plans!" Speed conversions! Drawings! Charts! Photographs! All cars! "Complete manual" plus "Hot Rod Handbook" and equipment catalog. All three \$1.98. (Satisfaction guaranteed). Alquist Engineering, Milford 12, Pennsylvania.

"HOLLYWOOD" Deaptone mufflers. Powerful "straight-thru" design increases efficiency, speed, acceleration, mileage! Singles, all cars \$4.85, V-8 duals \$16.95. (Satisfaction guaranteed). Speed equipment catalog 25c. Dealers wanted. Alquist Engineering, Milford 12, Pennsylvania.

"SPEED Equipment" bargains! "California" mufflers \$4.50, V-8 duals \$16.95, famous racing heads \$45.00, chrome carb stacks 98c, echo cans \$1.65, dual manifolds \$9.95, octa-gane water injectors \$17.50, gas savers \$1.50, lowering kits \$2.95. Many others! Illustrated "Speed Catalog" 25c. (Dealers wanted). Alquist Engineering, Milford 52, Pennsylvania.

TEST Report Book 1949 Chevrolet, \$1.50. 1949 Indianapolis Race Year Book, \$1.50. Postpaid. A. Clymer, 1268 South Alvarado, Los Angeles 6, Calif.

"WATER Injection." Free descriptive, illustrated information. Neher Industries, La Verne, California.

"VAPO-STEAMATIC" Water injector. Easily built! Finest automatic "Moist-Humidity" system! Engineering triumph—Gets up to ten extra miles per gallon! Tremendously increases horsepower! Eliminates ping, carbon, overheating! Reduces wear—Lengthens engine life! Copyrighted "Water Injection Handbook"—with working drawings covering automobiles, motorcycles, airplanes, tractors! Includes plans, catalogues, diagrams, instructions—\$1.00 complete. Newhouse Automotive Industries, 5805-B1 East Beverly, Los Angeles 22.

CUSTOM-RETYLING. Super handbook. Brand new! 200 graphic photographs, sketches, Medley cutaways. Thousands ideas! Guaranteed! Biggest, best buyable. \$2 postpaid, including catalog. Post Publications, Box 723-KE, Arcadia, California.

SEE Our ad under motorscooters for midget car bargains. Midget Motors Directory, Athens, Ohio

"SPEED & Power" Handbook—50 chapter library edition! Breathtaking methods—authentic—direct from California! Covers Fords to Cadillacs—all makes! Build your own dual manifolds! Superchargers! Hot Cams! Water injectors! Hi-compression heads! Mileage devices! Save many dollars! Get racing speed, lightning acceleration, dynamic power increases from any make automobile! Build fast stock cars! California roadsters! 150 MPH rods! Get construction drawings! Tuning techniques! Speed tricks! Picture catalogues! Economy secrets! Ingenious formulas! Including "Racing Frames," "Reciprocating Masses," "Jet Engines," "Braking Characteristics," "Dynamometers." Also dual pipes, gears, fuels, porting, relieving, lowering, balancing! Includes "California Automobile Customizing," glossy photographs! Diagrams! Very newest ideas! Conversions! Re-styling all makes! Streamlining! Chopping! Channeling! Customizing! Complete \$1.98 postpaid. Newhouse Automotive Industries, 5805-B2 East Beverly, Los Angeles 22.

NEW Sensational seat cover. Mono, 6545 Santa Monica Blvd., Hollywood, California.

AUTOMOBILE Racing book, fifth edition, well illustrated. Building bodies, frames, engines, Ford conversions. Plans. Roadsters. Indianapolis cars. \$1.00 postpaid. Ray Kuns, Dept. 47, Cincinnati 27, Ohio.

AUTOMOBILE Racing, sixth edition. 100 illustrations. Drawings, building instructions Ford-60 midget, California roadster, Offenhauser racer. World's record 158.5 m.p.h. car. \$2.00 postpaid; \$2.40 c.o.d. Ray Kuns, Department 63, Cincinnati 27, Ohio.

THE Roar of the Mighty Midgets. Second edition, biographies of leading race drivers, coast to coast, pictures, action shots. Postpaid \$1.25. Bob Murphy Publications, Box 2581, Paterson, N. J.

CALIFORNIA Custom accessory head-quarters. Buy direct from original designers and save. Solid hood sides, grille panels, lowering kits, fender skirts, dual pipes, chrome motor accessories, speed equipment. 32 page illustrated catalog, 200 custom accessories—25c. 3319-A South Grand, Los Angeles 7, Calif.

RUSTED-OUT Bodies, doors, fenders repaired without welding, soldering. Professional results. Write, Gibes, 2134 Hadson, Chicago 22.

NEW Ford Hotrod Manual. 128 pages chock full of cutaway construction drawings, photos, and valuable easy to read and understandable technical data. Neatly bound with colorful eye-catching cover. Includes complete data on installing V-8 motor in model A chassis, hydraulic brakes for any Ford, roadster and fast road car info. How to rework these engines for speed: V-8, Merc., Ford 6, Zephyr, Model A. Guaranteed the finest manual of its type published to date. Sent postpaid for \$2.00. California Bill, Box L-1, Eaglerock, Los Angeles 41, Calif.

TOOL Pouch, heavy waterproof canvas duck, wide zippered opening. Keeps tools safe, convenient, dry, in home, car, garage. 4 1/2 x 9, \$1.00; 5 1/2 x 12, \$1.25; 7 1/2 x 17, \$1.60. Lafayette Supply Co., West Lafayette, Ohio.

HOT ROD—The only monthly magazine about building roadsters, streamliners, etc. Sample copy 25c, \$3.00 yearly. Hot Rod, 7164 Melrose, Hollywood, Calif. Dept. PM.

NEW Clymer Books. Catalog of 1949 automobiles, 120 photos every American car with complete specifications, compares all cars in one book. \$2.00. Ford Owner's Handbook gives complete servicing information all Fords 1932-1949, \$1.50. Complete Service Manual Model "A" Ford \$1.00, Model "T" \$1.50. Life of Ted Horn, three-time American Automobile Racing Champion, \$2.00. Complete Outboard Service Manual covers all makes, \$3.50. Revised Hot Rod Book 1946, 1947, 1948 records, \$1.50. Steam Traction Engine Album, 160 pages describes, illustrates 105 historical steam vehicles, \$2.50. How to Build Racing Automobile, \$2.00. All postpaid. Specify books wanted. Floyd Clymer, Dept. A-FC, 1268 So. Alvarado, Los Angeles 6, California.

DUALTONE Crystalline packed California mufflers and dual sets. California chromed accessories, lowering blocks all automobiles. Speed and doll-up equipment. Catalogue 20c, streamlining manual \$2.00. Dealers request dealership information. Dualtone Mufflers, 2636C India Street, San Diego 1, California.

RACING Car equipment for all cars, engines, racing heads, manifolds, carburetors, mufflers, etc. Speed instructions and literature \$1.00—refunded first order. Lee Motorcraft Co., 1412-D Great Northern Bldg., Chicago 4, Ill.

WE Sell direct to customers over 200 speed equipment parts manufactured by us. Ford A-B-V8-6-4- (Ferguson), Studebaker Champion, Chevrolets and Willys. Cylinder heads, dual intake manifolds, lynite flywheels, oversize valves, compound springs, camshafts and other supplies. Complete engines ready for race for cars, boats and midgets. \$1.00 to cover illustrated literature and price sheet. R & R Mfg. Co., Robert M. Roof, Box 546, Anderson, Indiana.

FROM Speedway to roadway! Track-proved hi-speed heads and manifolds now available for your passenger car! No special tools needed! Increase horsepower 25%! Astounding getaway! Free illustrated catalog. Speedsport, 6215AA Diversey, Chicago 39.

AUTO SUPPLIES AND EQUIPMENT

ORIGINAL Equipment piston rings. 85% cars, trucks, tractors. Complete coverage engine parts, brakes, bearings. Furnish make, year, model, engine number. Immediate shipment. Mobile Automotive Machinists, 1650 N. Francisco, Chicago 47, Illinois.

PARTS—New, used for all cars and trucks. Auto Parts Service, 111 Sunset Ave., Fairfield, Conn.

"SMITHYS Mufflers" for all cars. Free list. Buck's Auto Parts, 1296H, Merced 10, California.

1949 SUPERIGNITIONER. Starting, pep, mileage \$4.50. EG Mfg., Elmsford, New York.

WELDING Blocks, bodies—Repairing frames, fenders—easy with Hobart welders. Adds \$\$\$ to profits. Low cost. Terms. Free catalog. Write Hobartweld, Box M-992, Troy, Ohio.

SAVE Gasoline! Quick starting! "Air-flow needles," \$1.50. Free trial! Specify car, carburetor. Neher Industries, La Verne, California.

AUTOMOBILE Glass! Direct factory savings! Write requirements, Cooper's, 3124 Lawrence, Chicago 25.

NEW And used guaranteed parts for civilian and army cars and trucks. Largest stock in America. Mail orders. Pioneer Auto Wrecking Co., 734 W. 13th Ave., Denver, Colorado.

NEW Sensational automatic thief chaser burglar alarm. A life guarantee electrical unit installed on any car or building. Once installed it works automatically. This is the cheapest insurance against thieves that can be found. Will protect your entire car. Only \$4.98. Easily installed. Free literature. Dealer inquiries invited. Novak Manufacturing Company, 1358 Chase, Gary 1, Indiana.

GASOLINE Saver. Chevrolet, 1933-1947. Ford, Mercury, V8, 1935-1948. \$1.00. Walert Co., 3429 North Tenth, Milwaukee 6, Wis.

LACHAPPELLES Motor and motor fuel treatment (patented), stops ping, gives more miles per gallon, more miles per motor. 100,000 miles treatment. \$3.00 post-paid. Ferns Products, 8120 Walnut Dr., Los Angeles 1, Calif.

POWER And speed equipment for all cars and boats. Increase your power and economy with our equipment. Cams, flywheels, heads, manifolds and all hot rod accessories. Send for price list. Schiefer's Automotive, 4192 30th St., San Diego 4, Calif.

"LEKTRON" Atomic coil booster saves gas! Instant starting, smoother power. Easily installed. \$2.00. Money-back guarantee. Specify car. Electronic Industries, Cleveland 11, Ohio.

NEW Grilles for all cars. Wagner Grille Co., Route 2, Bernville, Penna.

RADIATORS, Ford, Chevrolet. New in original cartons. Give year and model; buy direct; save, factory outlet. Guaranteed Radiators, 8815 De Havilland, Los Angeles 45, California.

V8 FORD Owners. High output generators, 35 amp., with voltage control and wiring ready to install. All standard parts. Money back guarantee. \$25.00 cash. Shipping weight 20 lbs. Ace Auto Elec., 2322 W. Spokane St., Seattle 6, Wash.

PISTONS, American, foreign and racing. Catalog 10c. Merryman Co., Lawndale, Calif.

MUFFLERS, Bass tone \$4.00, stainless steel \$5.50; visors \$6.90; steel fender skirts \$10.00; accessories. Free catalog. Calcraft Co., Box 648, Los Angeles 34, Calif.

SPEEDOMETERS—Any make completely rebuilt. Including parts, labor \$4.95 ppd. Unconditional new factory guarantee. Mail your defective speedometers to: Western Speedometer Rebuilders, 10452 Magnolia Blvd., No. Hollywood, Calif.

CONVERTIBLE Top covers. Protects-insulates. Plastic fabric. Clipon snap fasteners. All convertibles \$19.50. Satisfaction guaranteed. Vassar, Cleveland 5, Ohio.

GANE Aero jets save gas. Sent postpaid for free trial with directions for installing your car. Pay postman nothing. If not delighted after ten days return them and you owe nothing. Send make car and carburetor today. Advanced Automotive Products Co., 563 Lake Road, Webster 5, N. Y.

WILL You be the next to have an accident due to dry front wheel bearings? Get Douglas inside grease seals for the front wheels of your car and be safe. Distributors wanted. Luberretain, \$2.85 a set factory to you. Weichhart Mfg. Co., 237 Natoma St., San Francisco 3, Calif. No c.o.d.

SAVINGS To 50% on generators, starters, voltage regulators, 6-32 volts, distributors, armatures, magnetos, carburetors, fuel pumps, windshield wipers, radiators. "Old models in stock" free list. State Ignition, 2521 Indiana, Chicago 16.

ATTENTION Garagemen, truck owners and automobile dealers. Lowest prices. Auto and truck parts. Complete stock. Prompt replies. Babbitt Automotive, 2833 Chicago Avenue, Chicago 22.

AUTO Parts. Buy direct. Get dealers' prices. Represent us in your territory. Write requirements. Specify car make. Mechanics Auto Parts, Factory Warehouse, 3807-PM N. Ashland, Chicago 13.

BUICK Parts—Enjoy new-car pep and power in your old Buick. Same day service from world's largest stock of new (not rebuilt) Buick parts and engines. Ship anywhere. Write today. Robertson Buick Co., 1001 S. Wabash Ave., Chicago 5, Ill.

AUTOMOTIVE Surplus tool specials! Pullers, wrenches, socket sets, reamers, other bargains. Nationally advertised merchandise. Free catalogue. Glenco Supply, 7519 Myrtle Avenue, Glendale 27, N. Y.

GOVERNMENT Surplus. Low voltage circuit tester in steel box. Cost \$202.00. Our price \$27.50. Will test batteries, starters, generators, voltage regulators, grounds, short circuits. Wilt Electrical Company, 7829 S. Racine Ave., Chicago 20, Ill.

CHEVROLET Parts. Scarce motor, body, sheet metal parts. Grossman Chevrolet, Minneapolis, Minnesota.

HARD-TO-GET Auto body parts. We supply. Miller Auto Parts Service, 192 N. Clark Street, Chicago.

BRUSH Plating outfits connect to a battery. No tanks or shop required. Free particulars. Gunmetal Co., Avenue J, Decatur, Illinois.

AUTO TRAILERS

TRAILER Coaches. Save money. Buying? Building? Sound engineering construction, chassis, bodies, furnishings. Travel, dwelling, trailer plans. \$1.50 post-paid. Ray F. Kuns, Cincinnati 27, Ohio.

TRAILER Plans—House, utility, boat, etc. Axles, chassis, hitches, windows, etc. Catalog with booklet, "Trailer Hints," \$1.00. Catalog only, 50c. Marine Mart, Buffalo 7-B, N. Y.

BUILD Your own trailer! Save money! Have every feature you want! Plans for house, sport, camp and utility trailers. Catalog describing 9 models 10c. 15c in Canada and overseas. Jim Dandy, Box 125-A, Wausau, Wisconsin.

FREE Lowbed trailer plan. Dept. 7, Airplane Tire Co., Tulare 2, California.

MOTORCYCLES, BICYCLES, MOTORSCOOTERS AND SUPPLIES

BICYCLE Supplies. Wholesale, retail list 10c. Universal, 4713 Virginia, St. Louis, Missouri.

WE Buy and sell motorcycles and parts. 5205 S. Honore, Chicago.

MIDGET Car \$5, motorbike conversions \$5, brand new Regal motorscooters \$37.50 less motors, Indian motorcycle \$25, midget car \$20, Custer motorscooter \$25, all complete. Gasoline engines \$2 up. Super-cycles, Cushman's, Salsburys. Plenty new motorscooters, midget cars, homebuilders parts, automatic clutches, transmissions, engines, tires, etc. at factory prices. Special sale! Four balloon tires for \$3. Over 5500 tires in stock. Mailorder only. Send 25c for big war-bargain catalogue just out listing these and hundreds of other bargains. (35c by first class mail.) Midget Motors Directory, Athens, Ohio.

MOTORCYCLE Journal—Worldwide coverage. Illustrated. Year's subscription \$1.00. Sample 15c. Motorcycle News, 5424-A Sawyer, Chicago 25.

TIRES And industrial wheels, suitable for scooters, wheelbarrows, farm equipment, etc. All sizes. Bicycles and accessories. Send dime for list. Cycle Transport Company, 1241 So. Michigan Ave., Chicago 5, Illinois.

WHEELS! Build wagons, scooters, mowers, trailers, wheelbarrows, grocery carts, 4" to 16". Free list. T & H Mfg. Co., Inc., 811 East 31st, Kansas City, Mo.

MOTORCYCLE Pistons and parts, new, used. Harley, Indian, Henderson, Super-X. List 10c. Ballak, 811 N. 9th, St. Louis 1, Missouri.

POWERCYCLES. New—Factory overstock. Latest models. \$98.50 up plus tax and freight. Regular \$179.50 to \$267.50 values. Amazing buy. Regular factory warranty. Send for free catalog. R. C. Cheney Co., Mfg. Division, La Crosse, Wis.

WORLD'S First jet turbine bicycle engine. Fits any bike. Smooth, economical. \$150.00. Dealers wanted. Literature 25c. Jet Engine Co., St. Augustine, Fla.

CUSHMAN Motorscooter (4 H.P. motor) \$19.98 complete; Midget car (leather seat) \$25.00; Motoscoot \$15.00; 1946 Whizzer \$35.00; Motorbike outfit \$5.00; Indian motorcycle \$30.00. Other motorscooters \$8.00 up, motors \$3.00 up. Send 25c for new summer catalog listing many other sensational bargains in used motors, motorscooters, motorcycles, parts, etc. Associated, Box 1764-CS, Toledo, Ohio.

HARLEY-DAVIDSON 125 — America's outstanding lightweight motorcycle. Floor models and demonstrators at a saving. Send 10c for bulletin. Knuth's, 1753 Muskego, Milwaukee, Wis.

HARLEY-DAVIDSON Parts, accessories, oil, expert service. Tires all sizes. Send \$2.25 for Army 45 motorcycle manual. 25c for accessory catalog and bulletins. Knuth's (Harley-Davidson Dealers), 2491 Fondulac, Milwaukee, Wis.

COMPLETE One stop Harley Davidson sales service. Comprehensive accessory catalogue 25c. 813 Ohio St., Wichita Falls, Texas.

WHIZZER Bike-motor \$25.00; Cushman motorscooter \$15.00; midget racer \$40.00; Shaw bicycle-motor \$15.00; Harley-Davidson motorcycle \$15.00; Smith motor-wheel \$25.00; Good motorscooter (twist grip) \$22.50. Rush 25c for new catalog #14 listing many other amazing bargains in motorscooters, used motors, midget cars, parts, wheels, etc. Gail, 538 Erie, Toledo, Ohio.

HARLEY-DAVIDSON Parts, accessories, batteries, and tires. 24 hour service. Authorized factory dealer. Philadelphia Harley-Davidson Company, 857 North Broad Street, Philadelphia 23, Penna.

MOTORSCOOTERS, New design, 6 big features. Literature 10c. Rollaway Motors, Lancaster, N. H.

RECONDITIONED Motorcycles and motors. Chromium accessories. Complete stock Indian parts. Expert rebuilding. Past service. Indian Motorcycle Sales, Kansas City 1, Mo.

AVIATION

AVIATION Ratings obtained with famous "Zweng Manuals." Mechanic Ratings \$3.00; Flight Engineer \$4.00. (Free catalog.) Pan American Navigation Service, 12021-6 Ventura Blvd., North Hollywood, Calif.

PROPELLERS, Plans, skis, engines for snow sleighs and air boats. Catalog 10c. Banks-Maxwell, R.F.D. 12, Ft. Worth.

JET Engine \$3.00; plans \$1.00; literature 10c. M.E.W., 387 University, St. Paul, Minn.

JET Engine: Build the miniature M.E.W. 601, requires only hand tools. Construction plans \$1.00; parts available. Send 10c for illustrated literature and parts list. Minnesota Engine Works, Dept. PM, 387 University Ave., St. Paul 3, Minnesota.

PROPELLERS—2-3 Blade for sleds, air-drive boats. Catalog. Standard Aero Craft, Box 387, Ft. Worth, Texas.

BATTERIES, GENERATORS

BUILD—1,000 Watt 110 volt A.C. generator from old 12 volt Dodge generator. Constant voltage with volt regulator. Variable speed. Plans and instructions guaranteed. \$1.00. A. J. Allen Service, P.O. Box 1432, Del Valle Station, Dept. P.M., Los Angeles 15, Calif.

EDISON Non-acid lifetime storage batteries for home lighting motors, industrial uses, radios, etc. Free interesting literature. Hawley Smith Co., Croton Falls 1, N. Y.

ELECTRICAL SUPPLIES

ELECTRIC Pencil: Engraves all metals \$1.25. Beyer Mfg., 10511-H Springfield, Chicago 43.

LAMP Parts—Twenty-four hour service from most complete stock. Catalog 10c. Gyro Lamps, 5402P Clark, Chicago 40.

HEAVY Duty mechanical rectifier easily constructed from 1/4 h.p., sixty cycle split phase motor and material from junk box. Instructions \$2.00. N. G. Simpson, Box 225, Randsburg, Calif.

LAMPS—Build own originals, parts wholesale, any amounts. Catalogue 10c. Brown Lamp Co., Box 501, Wellston, St. Louis 12, Mo.

MAGNET Wire—#55 D.C.C., \$1.00 per pound. Harry H. Van Dick, Little Falls, New Jersey.

SILICON Transformer lamination cut to order. Magnet wire, supplies. Send for bulletin 42949M. Morton Electrical Service, Maywood, Ill.

ELECTRIC Pencil—Writes, engraves all metals. 6 volt model \$1.25; 110 volt model, \$2.95. Reb Industries, 265-DX, Elmhurst, Illinois.

WATT HOUR Meters. Reconditioned, guaranteed. Ideal for cabins, trailers, shops. \$2.95. T. Price, 310-14th, Raymond, Wash.

BUY Lamp parts wholesale—Parts you need for building, repairing, or assembling. Save money on large or small orders. New catalog for 10c. Gearon Company, Dept. 300-B9, 27 South Desplaines, Chicago 6, Ill.

WELDING, SOLDERING, PLATING

ELECTROPLATING Units — Complete \$2.00 and up. Free literature. Regency Sales, 5316 S. Justine, Chicago 9, Illinois. Dept. M.

WELDERS For all requirements. Free catalog. Write Hobartweld, Box M-994, Troy, Ohio.

RADIATOR Repairing books, supplies, equipment, gasoline torch. Write, Curfman Co., Maryville, Mo.

"BUILD-UR-OWN" portable arc welder. Save \$350. Easy with Hobart generator plus auto engine. Free instruction book. Write Hobartweld, Box M-993, Troy, Ohio.

WELDERS 110V. Welds 1/2" steel, \$29.50. Morris Welding Service, 1850A State, Schenectady 4, N. Y.

WELDING—Profitable trade. Learn quickly at low cost. G.I. approved. Best equipped school in U. S. Free catalog. Write Hobartweld, Box M-995, Troy, Ohio.

A.C. Welders direct from manufacturer. Save. Holgerson's Service, Canton, Kans.

ACETYLENE Welding outfits; new \$45.00, used \$25.00. Arcwelders, \$46.50. Eagle Welding, Dept. PM, 5085 Broadway, Chicago 40, Ill.

BUY Direct from factory. Welding and cutting equipment. All makes of equipment repaired. Established 1913. Box 331, Hamilton, Ohio.

RECTIFIERS 0-4 V.D.C. \$9.50, 0-8 V.D.C. \$12.50, 0-12 V.D.C. \$18.50. All 0-100 amps. Starkweather, Ottawa, Kansas.

ELECTROPLATING Salts and rectifiers. Mirror resilvering and chipped glass nameplate supplies. John Sprinkle, V55, Marion, Indiana.

RADIATOR Repairing, cleaning, recoring. How to equip small shop at low cost. Supply sources, trade secrets, instructions. Now only \$3.50 postpaid. Radiator Service, McBain, Mich.

MACHINERY, TOOLS, SUPPLIES

SPIRAL Hack-saw blades saw in any direction; any pattern. Cut hard metals like magic. Money back guarantee. Send \$1 for set. Agents and exporters wanted. Hunter Tool Co., Los Angeles 35, Calif.

YOUR Shop needs our machines. Lathes, drills, millers, shapers. Accurate, low prices, immediate delivery. Money back guarantee. Conversion Parts Co., 278 Adams Street, Boston 22, Mass. U.S.A.

AMAZING Wood-turning tools, sharpen every ten years. Tungsten carbide tipped. Razor-like edge turns wood; plastics; soft metals. Free literature. Johns Mfg., Dunellen 3, N. J.

ELECTRIC Tools. Big discount. New, guaranteed. Catalog 10c. Box 1161, Oklahoma City, Oklahoma.

WELDERS For all requirements. Free catalog. Write Hobartweld, Box M-997, Troy, Ohio.

BALL Bearings one-fourth list price. Free list. Burgess, Box 168, Ferguson, Mo.

CLOSEOUT Electric drill presses, 1/4" Jacob chuck, \$10. Tilt-arbor bench saws including 8" blade, \$25. New! Guaranteed! \$5 with order, balance collect. Corday Motors, Wellington, Ohio.

CONCRETE Block machines. Standard sizes. \$39.50 machines average 400 daily. Free catalog. Concrete Machine Company, 5129 South Compton, St. Louis 11, Mo.

MAKE Money at home—Cut grinding costs. Belsaw powered saw, gumming machine precision joints, gums, sharpens circular saws 8 to 48-in. diameter. Portable, fast, accurate. Catalog. Belsaw, 315-H Westport Rd., Kansas City, Missouri.

SURPLUS Bargains. \$14.00 value, 2" precision universal chuck, hardened steel jaws \$2.95 ea. 6 volt motors, value \$4.00 ea. \$1.00; 3 for \$2.50. Transformers vari voltage, value \$1.50 ea.; 3 for \$1.00. Send check or money order. Har-Mur, 2349 W. Devon Ave., Chicago 45, Ill.

WINCHES For contractors, farmers and shops. 1/4 and 3/4 ton; electric steel; bargains. For literature and prices write, Gold Foundry & Machine Works, 1622 South Osage, Independence, Missouri.

BENCH Grinder, 1/2 h.p., double shaft. Complete \$26.50. Robert, 7232 Madison, Forest Park 3, Ill.

14"x6" HENDEY Engine lathe \$625.00. 18"x8" American GH screw cutting lathe \$350.00. #1 1/2 Valley universal milling machine \$425.00. 15" Potter Johnston metal shaper \$490.00. 20" Barnes drill press \$55.00. Cincinnati Machinery Co., Dept. B, 217 2nd St., Cincinnati, Ohio.

LATHE Owners. Complete drawings and instructions for making five different sizes of pneumatic cylinders, \$1.00. Money refunded unless satisfied. Harco Products, Box 431, Huntington Park, Calif.

POWER Tools, equipment wholesale prices. Free bulletin. Homecrafters Cooperative, Grand Rapids 6, Michigan.

BOATS, OUTBOARD MOTORS

KNOCK-DOWN Boat kits. Outboards, inboards, sail, hydroplanes. Easy to assemble, minimum cost. Catalog with specifications, prices, 25c. Brooks Boat Company, Carrollton P8, Michigan.

TWENTY Plywood boat plans \$1.00. Catalog of boatbuilding plans 10c. The Rudder, 15 Murray Street, New York 7.

BUILD A better boat than you can buy for the money! Save 35-55%. Exclusive laminated-rib construction, for longer life under hardest usage, pre-fabricated for easy assembly. All popular types, from simple car-top models to mahogany-decked runabouts, at \$39.50 to \$199.50. Send 10c for literature. Ozarka 699, Borden Lane, Woodstock, Ill.

P38 BELLY Tanks, steel, 10 foot, unused, \$9.95. Anzio Boat Co., 1625 T, Merced, Calif.

RUSSCRAFT Boats trail backward on retractable wheel at stem. No trailer or cartop required. Shipped knockdown. Literature 10c. Russ-Craft, Black River Falls, Wisconsin.

BUILD Marine motors, Ford or Jeep. Federal Marine Motors, 9011 Cottage Grove, Chicago 19, Ill.

WATER Ski shoes. Adjustable firm fitting, complete with fastenings ready to mount. \$6.95 pair postpaid. Ski-Ez, 9108 S. Vermont, Los Angeles, California.

BOAT Builders' guide—250 pages, 15,000 items pictured, priced, deliverable. Send \$1.00. Marine Mart, Buffalo 7-B, N. Y.

BOAT Plans: Wood-steel. Catalog. John B. Clark, Yacht Designer, 329P Kenmore, Bay Village, Ohio.

PACKAGED Lumber—Marine plywood, seasoned oak and cedar, sized, selected. Send \$1.00 for booklet, "Plywood Boats," with quotation form and literature. Forms and literature, 25c. Marine Mart, Buffalo 7-B, N. Y.

SAVE 2/3 Cost. Build your own boat with our ready cut parts by the Welch system. No experience necessary. Rowboats to cruisers. Illustrated catalog 25c. Midwest Boat Company, Menomonee Falls, Wisconsin.

OUTBOARD Motors—Used bargains, \$45 up, free list. Used parts, most models, save money! Boat and motor equipment and accessories. Big catalog, send dime. Crandall-Hicks, 911 Commonwealth, Boston, Mass.

NEW, Used, rebuilt marine motors. Marine conversions, fittings. Free catalog. Stokes Marine Supply, Dept. 24, Coldwater, Michigan.

MARINE Conversions for Ford and Jeep engines. Catalog 10c. Lehman Manufacturing Company, Department D, Newark 2, New Jersey.

MARINE Specialties and motor conversions catalog. Sixty pages of struts, finishes, hardware, plexiglass windshield kits, electric tachometers, inboard and outboard air cooled motors, etc. Immediate delivery. Catalog with booklet, "Conversion Hints," \$1.00. Catalog only, 50c. Marine Mart, Buffalo 7-B, N. Y.

STEERING Wheels, windshield brackets, from \$6.95. Modern fittings at lowest prices. Complete pre-cut plywood boats. Bargains galore. Folder 10c. Marine, Box 681, Mendota, Minnesota.

ENGINES, MOTORS, DYNAMOS

ELECTRICAL Portable tool rewinding, maintenance and trouble shooting book. Fully illustrated. Guaranteed. \$1.00 per copy. E. A. Western, Box 1902, Phoenix, Arizona.

WELDERS For all requirements. Free catalog. Write Hobartweld, Box M-996, Troy, Ohio.

ARMATURE Winders, write for winding and testing bulletins. Motor Industries, Quincy, Illinois.

MOTOR Bargains. 1/2 horse, 1725 speed repulsion induction, \$15. 1 horse \$30. Fans 32 volt \$3.75. Butler, 1885 Milwaukee, Chicago 47.

MOTORS. New. 3/4 hp., 3450 r.p.m., \$26.00; 1/2 hp. \$20.00; 1/2 hp., 1750 r.p.m., \$18.50. Roberts, 7232 Madison, Forest Park 3, Ill.

MOTORS! 1/2 H.P. D.C. converted to A.C. All new. High speed 110 volt, 25 or 60 cycle, ball bearing motors. Actual value about \$75.00. Now \$15.00 each or 3 for \$40.00. Countless uses for home mechanics. Can be used in any position. Order today! Immediate delivery! No c.o.d. orders. "Amazing Bachman's," 27 Herman Street, Rochester 5, New York.

WINDING Data, listing 225 motors, single and three phase, \$1.00. Motor Data Co., Box 7631, Kansas City 3, Mo.

ATHLETIC EQUIPMENT, BODY BUILDING COURSES

NOW! The way to develop your muscles quickly. Details. Sports Centre, 204 East 81, New York 28, N. Y.

DEADLY Judo—Fiercest fighting technique. Trick knockouts. (Over 200 illustrated pictures.) Expert instructions; three volumes. Complete \$2.25. Variety House, Box 46-B Wall Station, New York 5.

BARBELLS—Finest quality \$8.98 up. Free catalog. Lurie Barbell Co., 1729-M9 Rockaway Parkway, Brooklyn, New York.

BARBELLS, Dumbbells. Inquiries invited. York Barbells (Canada), Scarborough Bluffs, Ontario, Canada

BARBELLS! Muscular physique, strength. Send stamp. Jackson Barbells, Springfield, N. J.

BARBELLS, Exercise equipment. Courses. Free booklet. Good Barbell Co., Reading, Penna.

SPORTING GOODS, GUNS, FISHING TACKLE, ARCHERY, TRAPPING

INFRA Red Snooperscope tube. Permits nighttime vision. Tube and complete instructions \$14.95. Very limited quantity. Precise, 942 Kings Highway, Brooklyn 23, New York.

ARCHERY Catalog 50c. Beautifully illustrated. Gassman's, 1724 Fredericksburg, San Antonio 1, Texas.

MOLDS—For fishermen's sinkers. Ocean City Sinker Mold Co., 649 Wilcox Ave., New York 61, N. Y.

AMMUNITION Prices slashed. American and foreign loads below retail. Dime for list. Central Sports, Delphos, Ohio.

INTERESTED In gunsmithing as a profession? Details and copy monthly gun magazine 25c. Gunsmith, Box 636, Palatine, Illinois.

NATIONALLY Known shotgun or rifle recoil pads, slightly imperfect. While they last \$1.25. Also seconds but very top quality, while they last, \$1.00. Mershon Company, Inc., 511 East Broadway, Glendale 5, California.

HUNTING, Fishing, camping, tents, guns. Free catalogue. Morsan, 10-19E 50th Avenue, Long Island City 1, N. Y.

190 PROFUSELY Illustrated pages antique and modern pistol, sword, etc. values, 50c. Robert Abels, A860 Lexington Ave., New York 21.

USED Guns—Close-out bargains. List 10c. Rywell, Harriman, Tenn.

SEND 10c For list 100 used guns. Frayseth's, Willmar, Minn.

MOLDS For fishermen's sinkers, squids, and jigs. Sweet's Molds, Tonawanda, N. Y.

BOWS, Arrows. Quality archery equipment. Popular prices. Catalog 10c. Illustrated archery instruction book 50c. Archery, 617-K So. State, Chicago 5.

5000 BARGAINS. Firearms, binoculars, war relics. Catalog 40c. Smith Firearms, Runnemed, New Jersey.

SHOTGUNS. Rifles, revolvers, over 500 modern, obsolete. Also cartridges, list 10c coin. Ed Howe, 52 Main, Coopers Mills, Maine.

TAXIDERMISTRY

"MODERN Taxidermist Magazine." Greenfield Center, N. Y. Devoted exclusively to taxidermy. Two sample copies 25c.

BINOCULARS, TELESCOPES, MICROSCOPES, MAGNIFIERS

POWERFUL Astronomical telescopes easily made. Perfect lenses and instructions; 100X \$3.00. 100X and 200X \$4.00. 100X, 200X and 400X \$6.00. Clear vision, full power guaranteed. Instructions alone 10c. Suffolk Science Service, Box 208, Manorville, N. Y.

4-POWER Plastic magnifier. Greatly enlarges any print. Makes reading without glasses easy. Fits vest-pocket. 50c. Magnifier Co., 576 S. Falmouth Drive, Cleveland 16, Ohio.

POWERFUL Astronomical telescope, equatorial mounting, two eyepieces, \$16.50. Blum Optical Laboratories, 4213 Gifford Avenue, Cleveland 9, Ohio.

WAR Surplus bargains, binoculars, telescopes, sextants, millions of lenses, prisms, reticles, eyepieces, objectives, etc. Request free "Catalog CH." Edmund Salvage Co., Audubon, N. J.

SAVE 50% On new binoculars! Catalog, free booklet. "How To Select Binoculars." Write today! Buschneil Importers, 194 Palmetto, Pasadena 2, California.

BINOCULARS, Telescopes, watches, guns. Buy, sell, trade. Schweer's, Donnellson, Iowa.

"TERRIFIC" Bargains — Government surplus telescopes, binoculars. Send \$1.00 for 10 piece hobbyist lens set. Contains magnifying and reducing lenses. Send stamp for "bargain" list. P. Jaegers, 93-08 95th Ave., Ozone Park 16, N. Y.

REFLECTING Telescopes, 60X, completely assembled \$25.00. Guaranteed observatory clearness. Free information. Skyscope, 475 Fifth Avenue, New York 17.

ASTRONOMICAL Telescopes, binoculars, microscopes; bought, sold, repaired. Books. Lists 10c. Rasmussen-Reece, Amsterdam, N. Y.

TELESCOPES, Binoculars, microscopes, big bargain catalog free. Brownscope Company, 24 West 45th Street, New York.

DOGS, PETS, BIRDS, RABBITS

SAINT Bernard and Boxer puppies. AKC registered. Schwarzwald Hof Kennels, 5136 Cascade Road S.E., Grand Rapids 6, Mich.

RAISE Hamsters and read: "American Hamster and Pet Journal." Mobile, Alabama. \$1.00 yearly.

HOHL'S Hamsters. Clean, quiet, odorless pets. Photo, literature free. Lab. Stock, 317-M Mt. Vernon Road, Newark, Ohio.

HAMSTERS — Beautiful odorless pets. Profitable. Easily raised. Small space required. Pyle Hamstery, Okmulgee, Oklahoma.

RAISE Guinea pigs. Make money at home. Booklet free. Taylor, Box 426A, Hapeville, Georgia.

ANGORA Rabbits for pleasure and profit. Fred Wellen, Elkhart, Iowa.

\$400 MONTHLY Raising Angoras. Details free. White's Rabbitry, Newark, Ohio.

BEAUTIFUL Pure white pedigreed police pups. Ansonia Kennels, Mose, N. Dak.

GRINSTEAD'S Famous Angoras! Giant Chinchillas! World's most profitable rabbits. Finest pedigreed, heavy-producing, prize-winners. Literature free. Grinsteads, Edwardsville, Illinois.

SEE Gulf Hamstery ad on page 32. Shows picture of Hamster.

HAMSTERS: Finest pedigreed breeding stock, reasonably priced. Mount Clemens Hamstery, 94 Church, Mount Clemens, Michigan.

RAISE Chinchilla rabbits. Year-round money-makers from furs, meat, breeders. Experience unnecessary. Write today. Willow Farm, Sellersville 15, Penna.

RAISE Rabbits. Four pound fryers in eight weeks. Ready market for meat, fur, wool. Illustrated book, describing leading breeds, housing, breeding, feeding, marketing. By America's largest rabbit association. 10 cents. American Association 12, AR & CBA Building, Pittsburgh 17, Pennsylvania.

SPORTSMEN: 200 Pointers, setters, straight cooners, combination hunters, rabbit and fox hounds. Reasonable. List free. Ramsey Creek Kennels, Ramsey, Ill.

\$300 MONTHLY Raising Angoras for our market. Particulars free. Wilson, Stanton, Calif.

MINK Raising information free. Complete. Lake Superior Mink Farm, Superior, EEl, Wisconsin.

INCREASE Your income by raising domestic rabbits. Small space needed. Ready market for delicious meat, fur and wool. Largest magazine in the industry tells you how. \$1.50 per year. Sample 15 cents. No stamps. Small Stock Magazine, Lamoni 20, Iowa.

\$3000 YEARLY Raising Angora rabbits. We buy your output. Contract particulars free. Kise's Enterprises, St. Paul 8, Minn.

PLANTS, SEEDS, NURSERY AND GARDEN SUPPLIES

CACTUS (Thornless)! Miniatures. 25-1.25 postpaid. Gifthouse, Box 4550-C2, Coral Gables, Fla.

FARMS, FARM LANDS, REAL ESTATE

\$5 MONTHLY Buys my Ozark retirement site. Armstrong, Shook, Missouri.

FREE Fall catalog, farm bargains, many equipped, illustrated, several states! United Farm Agency, 1408-PM Consumers Bldg., Chicago 4, Ill.

STROUT'S Farm catalog! Time and money-saver; free! Describes 2790 bargain properties. 35 states coast-to-coast. Write today for your free copy! Strout Realty, 255-P 4th Ave., New York 10, N. Y.

FLORIDA Homes, groves, farms, business opportunities. H. L. Chambers, Realtor, Wauchula, Florida.

\$5.00 MONTHLY Buys 40 acres. Near town; price \$200.00. Free list. Box 425-P, Carthage, Mo.

ACREAGE, Missouri. Unencumbered \$37.00 acre. National Petroil, 6126 Michigan Avenue, Chicago, Ill.

FLORIDA Campsites—\$75.00 at \$5.00 monthly buys nice, high dry lot in Lake County (world's best bass fishing) near Ocala National Forest, St. Johns River, beautiful lakes, pavement, electricity. Folder free. Howard Vernor, DeLand, Florida.

SPECIAL Ozark land buys. Free descriptions. Write Armstrong, Shook, Mo.

WEST'S New time and money saving catalogue, over 1000 farm and business bargains. Free. West's Farm Agency, CK-2, Pittsburgh 17, Penna.

GOVERNMENT Lands \$2.00 acre up. Information all states twenty-five cents. National Tax Service, 901-A Majestic Bldg., Detroit.

GOOD Farms—Ranches. Washington, Minnesota, Montana, Idaho, Oregon, North Dakota. Dependable crops, favorable climate. Write for literature, lists describing typical farm opportunities. Specify which state. J. W. Haw, 119 Northern Pacific Railway, St. Paul 1, Minn.

SOLD For taxes. Calif., Oregon, Washington timber, grazing, ranch and mining lands. 25c to \$3 acre min. bid. 10c (coin) brings circulars, photos, maps. Pacific Lands, Box 2350-PM, Hollywood, Calif.

OZARK Magazine, Eureka Springs 11, Arkansas. For homeseekers, tourists. Year. \$1.50.

LOTS \$300—Convenient payments. California's finest garden section. On Morro Bay's scenic shores. Wonderful fishing, hunting, boating, bathing. Fertile soil, softest water, temperate climate, congenial community. Free literature. Richard Otto, Department M, San Luis Obispo, California.

POULTRY, FARM SUPPLIES

GROW Chicken of tomorrow today with chicks from Pilch's Famous Old Hen Breeders. You too will like Pilch's chicks because so many other people do. 14,000 Pullorum Clean Breeders, Reds, Rocks, Crosses, Sex-Links, White Rocks, Hamps, Started Pullets, Started Chicks, Capons. Write for valuable '49 calendar. Pilch's Chicks, Box M, Thompsonville, Conn.

KNOW How to raise poultry for profit. Read Northeastern Poultryman. Every issue packed with helpful hints and practical suggestions. Latest articles on breeding, feeding and management. Subscribe now. 1 year 65c. 2 years one dollar, foreign subscriptions \$1.00 a year. Northeastern Poultryman, Dept. P.M., 376 Boylston St., Boston 16, Mass.

EARN \$4 To \$12 hourly. Chick sexing, culling and caponizing. G.I. approved. Pilch's School, Box PM, Thompsonville, Connecticut.

PROFITABLE OCCUPATIONS

HOLIDAY Flower, novelty making. Wonderful home business pays excellent profits. Literature free. Velta Artcrafts, 324-M East 14, New York 3, N. Y.

MEN; Women—"Everybody likes candy." Learn to make professionally at home. (Our 39th year.) Ragsdale Candies, D6, East Orange, New Jersey.

INEXPENSIVE Manual teaches air conditioning. Write Don Nelson, Warner Robins, Georgia.

LOCKSMITHING Secrets! Key fitting, lock repairing, opening; prices, sources. Illustrated book \$1.00. Wechsler, 7 West 36, New York City.

FREE Book "372 Unusual Worldwide Businesses!" South America, New Zealand! Work delightful, "different" plans home (U.S.A.). Publishers-F1, Carlsbad, Calif.

OUTDOOR Work for extra income. Information free. Morris, 328-A Parkway NE, Atlanta 5, Georgia.

MUSHROOMS Grown. Boxes. Barrels. Instructions 50c. Spawn \$1.00. Manureless process \$2.00. Gordons, 553 William, Winnipeg, Manitoba.

UNLIMITED Earnings operating new contest game; better than bingo. Reynolds, 5510 Le Moyne, Chicago 51.

\$400 MONTHLY Raising Angoras. Details free. White's Rabbitry, Newark, Ohio.

RAISE Ginseng roots, markets guarantee you \$10 pound, seeds for fall planting. Cir. free. Fezler Seed Co., Patchogue, N. Y.

CHENILLE Machines and materials for manufacturing bedspreads, rugs, etc. Sims Textiles, Dalton, Georgia.

DOMESTICATED Earthworms — Raise your own in backyard, garage, basement. Sensational returns. Particulars 10c. Midwest Earthworm Farms, Box 999, Wichita, Kansas.

"HOW To Raise Worms for Bait." Booklet, 25c coin. Ross, 749-A Rincon, El Sobrante, California.

FOREIGN Employment. Construction men, building trades mechanics, helpers, office men. Good workers needed for oil projects, mining, pipe lines, dams, power plants, roadways, shipping, etc. Transportation and quarters furnished; high wages. Listings of firms actively working and hiring on projects in South America, Arabia, Asia, Africa, Alaska, Central America, etc. Send \$1.00 for foreign construction compendium and application forms. Foreign Service Bureau, Dept. P.M.9 (Employment), P.O. Box 295, Metuchen, New Jersey.

"PROG-RAISING"—New book explains everything! Mariboro-A, Box 7002, New Orleans 19, Louisiana.

INTERESTED in Latin American and foreign employment? \$1.00 brings copyrighted "Foreign Service Directory" with complete listing of firms in oil, mining, aviation, construction, steamship, manufacturers, importers and exporters with hot tips for immediate application. Published since 1944. Global Reports, P.O. Box 883-P, Hollywood 28, Calif.

FOREIGN Employment? Latest bulletin, overseas directory and application forms: \$1.00. (C.O.D. \$1.32.) Foreign Service Institute, P.O.B. 3934, Miami, Fla.

\$46 FROM Square foot plywood; jigsaw necessary. Write, Woodarts, P-38, Bridgewater, Mass.

OWN And operate mirror shop! Supplies for resilvering mirrors, making chipped glass nameplates and electroplating. John Sprinkle, V50, Marion, Indiana.

LEARN To hang wallpaper like professional. Easy, profitable. Complete illustrated instructions \$1.00. Practical Decorator, Box 582, Lewistown, Penna.

RAISE Fishworms. Easy, profitable. Send 25c in coin for complete instructions. Huffman Worm Ranch, Rives Junction, Mich.

TYPISTS, Profitable business at home. Complete copyrighted information 50c. Rosdahl Industries, 72-A W. Washington St., Chicago 2, Ill.

MAKE Greaseless doughnuts at home. New amazing electric machine. You'll coin money selling to grocers, drug stores, cafes, hamburger stands. Low cost will surprise you. Experience unnecessary. Send for free recipes and plans. Morgan Ray Co., 3605 South 15th Ave., Minneapolis 7, Minn.

NO Work or cost. Make fabulous money growing dwarf trees in your room. Free details for stamp. American, 385 La Tijera Station, Los Angeles 43, California.

WANTED—Purchasing agents. No money or experience required. Write Dept. C, Purchasing Manager, 2719 Lawrence, Chicago, Ill.

ALASKA—The Last Frontier offers unlimited opportunities, \$1 brings government map and directory listing firms in fishing, construction, mining, aviation, fish and game rules, homestead data. Alaska Opportunist, Box 863-M, Hollywood 28, Calif.

YOU Can make real money raising Golden Hamsters. New tiny animal. Easily raised at home. Write for details. Hudson Hamstery, Newfoundland 1, N. J.

BE The Popular Mechanics representative in your neighborhood and earn big profits in your spare time. Write Popular Mechanics Magazine, Room 408M, 200 E. Ontario St., Chicago, Ill.

\$40.00 WEEKLY Made growing mushrooms, fresh, dried. Dominion patent 331583. Free spawn. North American, 169P Yonge, Toronto, Canada.

BOOKS, PERIODICALS, PICTURES, POSTCARDS

QUICK Profits taking magazine subscriptions, handling greeting cards. Cassell Publishers Service, Westfield, New Jersey.

ATOMIC Germ warfare. Get facts! \$1.00 postpaid. Free circular. L. L. Deitz, Box 247, Syracuse 1, N. Y.

DYNAMIC! Powerful! "Gold ahead" for money-getters. Other books. Send for "Pointers to Prosperity." Louis J. Wiltsch, Steelville, Mo.

SEND Us 10 or more pocket novels plus 10c for each. We return same amount. All different. Harlos, Dept. A10, Campbellsport, Wisconsin.

READ Prophetic Years 1947-1953. Progress, 4033-R Chouwen, Minneapolis 10, Minn.

BOOKFINDERS! (Scarce, out-of-print, unusual books). Quickly supplied. Send wants. Clifton, Box 1377-PM, Beverly Hills, Calif.

NATIONAL Geographic Magazines 1888-1949. Any issue, Box 327-PM, Periodical Service, Swarthmore, Penna.

SELF-EXPLAINING Bible: Illustrated circular free. Box 446-P, Minneapolis, Minn.

BOOKHUNTERS! All subjects. Send wants! Jaher Book Service, 620-P East 178 Street, New York 57.

MAGIC TRICKS, PUZZLES, JOKER NOVELTIES

LARGE 160 Page catalog, just published, 35c. We have supplied the best tricks to beginners and professionals for 38 years. Chicago Magic Company, 2300-C No. Mason Avenue, Chicago 39.

400-PAGE Catalogue of 2000 tricks, pocket, parlor, stage. World's finest magic. Send \$1.00 for catalogue (refunded first \$5.00 order). Kanter's, M-1311 Walnut, Philadelphia 7.

VENTRILQUISM—Free information. State age. Maher, Box 36-M99, Kensington Station, Detroit 24, Mich.

12 LATEST Joker's novelties; free catalog; 25c. Laramie Sales, 4800 S. Laramie Ave., Chicago, Ill.

LARGE Catalogue of the best magic for professionals and amateurs. Send 35c. Mazda Magic Co., 1135 Westgate Ave., Oak Park, Ill.

DRIVE A car blindfolded. Complete instructions \$1.00. Free literature. Mann, Box 6521, Los Angeles, Calif.

ATTENTION Amateur magicians! Genuine magic hats, featuring famous "disappearing glass of water" trick, and completely equipped with; magic bouquet-of-flowers, rabbit, bird, gun, wreath and flag. Professional equipment, but amazingly low price. Write for free descriptive booklet. Aim Magic Company, 143 Verona Ave., Newark 4, New Jersey.

MAGIC Made easy! 60 fascinating, mystifying tricks. 50c. Doyle's, 32 American, Long Beach 2, California.

500 TRICKS You can do! Send 10c for Douglas famous catalog, best in magic at lowest prices. Unequaled service to magicians for 30 years. Douglas Magicland, Dept. 1, Dallas, Texas.

MAGIC Tricks, puzzles, books, cards, punch boards. Catalog 10c. Specialty, Box 671, St. Louis 1, Mo.

500 TRICKS Catalog and book "84 Card Tricks," both only 50c. Robbins Co., 152-P West 42nd Street, New York.

AMAZING Ghost quarter trick free if 25c is sent for big illustrated catalog listing 500 wonderful magic tricks. Rush 25c now. The Magician, 2463-P Kensington Ave., Philadelphia 25, Penna.

JOKER Novelties. Laugh, have fun. List, catalogue 10c, refund first order. Novelty Sales, 112 Moore, Sanford, N. C.

MAGIC Books, magazines, bought, sold, exchanged. Russell Duck, Philipsburg, Penna.

BE A magician. Large professional magic catalog of latest tricks. 35c. Ireland, C-109 North Dearborn, Chicago 2.

PROFESSIONAL Catalog. 124 pages, 25c. Williams, 900 Plymouth, Ellwood City, Penna.

VENTRILQUISM Taught. 3c stamp bring particulars. Smith, 801 Bigelow, Peoria 5, Ill.

WORLD'S Largest professional magic shop, keeps you in touch with latest tricks. To receive mailings, send 50c for new catalog. Holden's, M220 West 42nd St., New York.

LEARN Magic, ventriloquism, mind-reading. Write for particulars. Quackenbush, Big Flats, N. Y.

16 CARD Tricks and catalog 25c. Sterling Magic, Royal Oak, Mich.

STAMP COLLECTING

U. S. price catalogue free. S. Stone, 618 Washington, Dorchester 24, Mass.

ALL Stamps at 1c each. Collection of 10,000 different, divided in 20 \$5 lots each containing 500 stamps. You just buy one lot at a time as often as you like. Each lot delivered as soon as paid for. No contract. No obligation. Real savings. N. V. Robillard, 812 West Vantrees Street, Washington, Indiana.

FREE—Famous Americans set, Flag set, National Parks set, and Presidential set to \$5.00. A total of 90 stamps free to customers for our unsurpassed U.S. and foreign selections. Send 3c for 15 of the above stamps and full particulars. Triboro Stamp Co., 145 Nassau St., Dept. 109, New York.

SIX-FINGERED Roosevelt stamp (engraving error) plus 100 different stamps only 5c with six-ways-better approvals. Frank B. Nagel, 674 Franklin, Denver 3, Colo.

DESIRABLE Mounted collection—U. S., Cuba, Philippines. All different. Including airmails! Commemoratives! High-values! Only 10c to "Gold Nugget" approval applicants. Kessel's, Folsom, California.

ILLUSTRATED Album with spaces for 2000 stamps, plus stamps cataloging over \$1; hinges, gauge, 10c with approvals. Moulblow, 740 Hegney, Bronx 56.

FREE. Absolutely free. \$22.50 catalogue value in better grade stamps, including air mails, pictorials, commemoratives. Also free; International albums and Scott catalogues. Free hinges. Free mystery sets to \$1.00 value. Free \$5.00 Presidential. All free to approval applicants buying under colossal Raymax plan. Raymax, 123-Z William St., New York City 7.

GIGANTIC Bargain. 10 interesting nineteenth century United States plus special delivery, dues, wines, playing cards, telegrams. Also \$1, \$2, \$4, \$5, \$10 stock transfers. Everything 25c to approval applicants. Jerry Whitehead, 315P So. 5th Ave., Canton, Illinois.

10,000 PENNY Approvals waiting for you. Many from exotic countries, pictorials, airmails, new issues. Tilbury, Box 862, Newark 1, N. J.

ANTIQUES! 50 Different stamps over 50 years old (including 15 U. S.). 10c to approval applicants. Standard Stamp, Barneveld, N. Y.

FREE! Canadian sets, royal visit. George VI, George V, coronation, jubilee, others, to approval applicants. Ensign, Box 118-M, South Orange, N. J.

WORLDWIDE Stamps. All different. 200-25c; 500-50c; 1000-\$1.25; 2000-\$3.00; 5000-\$15.00. Beacon Sales, Maynard 2, Mass.

GIVEAWAY! Souvenir sheet; three colorful mint sets, plus 100 different worldwide; 10c with approvals. Brooks, 2352B East 23rd Street, Brooklyn 29, New York.

YOU'LL Like our American and British Colonial approvals. Write now. Chesapeake Stamps, 748 Overbrook, Baltimore 12, Maryland.

ABSOLUTELY Free—Gilbert Ellice, Cook Islands, Tonga, Seychelles, Ascensions—free to approval applicants. Viking, 130-Z Clinton St., Brooklyn, N. Y.

200 DIFFERENT Stamps 20c. Approvals. Hodgson, Sunset Road, Newark, Delaware.

ROOSEVELT Commemoratives—Just 3c with approvals. Ken Hunter, Farmingdale, N. Y.

250 MIXED Stamps 10c with approvals. Robert Hovell, 209 Maple Ave., Lansdowne, Penna.

FREE Constitution souvenir sheet. Approvals. Hurt & Fosse, Blue Ridge, Virginia.

GIFT. Roosevelt, Greece, complete mint set to approval applicants. Deane Stamps, Box 87, Miami 35, Florida.

10 MAGNIFICENT Vatican city stamps; 5c! Approvals. Colonial, Box 326A, Passaic, N. J.

FREE! 25 Diff. stamps from 25 diff. countries to approval applicants. Ciula, P.O. Box 2511, Paterson, N. J.

FAMOUS Approvals. Free premium your choice. Berthal, 3219 H, Bellingham, Wash.

100 DIFFERENT U. S. stamps 20c, with approvals. Robert Anderson, Route #1, Madrid, Iowa.

\$50.00 BRITISH Guiana #13; facsimile, 3c! Approvals. Ajax, Mission, Kansas.

EXCHANGE Stamps universe. Particulars free. "Exchangers," Bry 126, Seine, France.

1000 DIFFERENT Stamps given to approval applicants sending 25c. Stampco, 6800 Oakman, Dearborn, Michigan.

50 DIFF. France, only 5c to new approval applicants. Bert Soika, Box 146M, Jackson Heights, N. Y.

FREE Stamps, Approvals. Ren Stamp Co., 11407 Kinsman, Cleveland 4, Ohio.

SATISFACTION Guaranteed, they're great! Our penny approvals. Roscoe Stamp, 1321 Roscoe, Chicago 13.

STAMPS—Superior mixtures, U. S. or foreign, \$1.00 per 1000. C. W. Ritchie, Watertown, South Dakota.

TEN Sets 10c to approval applicants. Walker's, 321 Willow, Mayfield, Ky.

100 ASSORTED U. S. old and new. 25c. Weatherby, Medina, Ohio.

DISCONTINUING Business. All approvals at cost. Wood, 1930 Texas, San Antonio 1, Texas.

LIBERIAN Triangulars, 10c with approvals. Vargo Stamps, 6044 South Fairfield, Chicago 29, Illinois.

FREE! 25 China. Approvals. Each stamp from different country! 200-\$2; 100-\$1. Weckerling, 516½ So. Adams, Tucumcari, N. M.

500 MIXTURE Stamps with prize. 10c to approval applicants. Morrell, 203 Fenimore St., Brooklyn 25, N. Y.

LARGEST Diamond, tiniest triangle, etc., 3c. Pettibone, 411 S. Washington, Moorestown, N. J.

MIQUELON—Set of five colorful sailing ship stamps. 10c. Ed Keller, 304 Belonda, Pittsburgh 11, Penna.

INDIA. 25 Different 3c to approval applicants. Kingman, Highbridge, Box 42, New York 52.

FREE, Fifteen different Switzerlands with approvals. Stampchest, Box 164-M, Teaneck, New Jersey.

ZEPPELIN, Roosevelt, Columbian, Hitler airmail, etc., sent for 10c. Approvals included. Thirdeco, 101 3rd Ave., Newark, New Jersey.

SENSATIONAL! Capejuby, Brunel, Perak, Honduras, Paraguay, Nigeria, and over 100 different others. Everything 10c with approvals. D. O'Keefe, 7517 Merrill Ave., Chicago 49, Ill.

CONFEDERATE Stamp or German sets 10c. Approvals. Stampinggrounds, Whiting Road, East Hartford 8, Conn.

50 DIFFERENT Foreign, many mint. 5c to approval applicants. James Service, Prospect Park, Penna.

AMAZING Bargain. 25 gorgeous Vatican's only 10c. Approvals. Wilhelm, 14646 58th Road, Flushing, New York.

\$1-\$2-\$5 UNITED States, commemoratives, airmail, high values in large collection United States stamps only 5c to applicants United States approvals. Metropolitan, 140B Nassau, New York 7.

4 TRIANGLES And 20 French Colonials free! Approvals. Gordon Davison, Box 1019H, Manchester, N. H.

ILLUSTRATED Stamp magazine, 26 weeks 25c. Stamp Journal, Kalamazoo, Michigan.

154 U. S. Commemoratives, etc. 10c. Approvals. Dorenbusch, 501 Ridgeway, Cincinnati 29, Ohio.

FREE "Stamp Dealing Without Investment." Polzin's, 1138 North 21 Street, Milwaukee, Wisconsin.

FIFTY Stamps from 50 countries 10c. Garrow, Montevista, Chula Vista 8, Calif.

FREE! 50 Different France. Send name, address on postal. Bob Harris, 1325 Lopez Road, Albuquerque 4, New Mexico.

FREE—Complete China "Great Wall" airmail set. Approvals. Sanders, 6126-W Carpenter, North Hollywood, Calif.

FREE "Stamp Finder." Tells instantly country to which any stamp belongs. 36 pages profusely illustrated. Approvals. Garcelon, Calais 17, Maine.

307 ALL Different free. Commemoratives, triangles, bicolored beauties, high values. Strange countries. New varieties galore. Free to approval buyers. Garcelon, Box 500, Calais, Maine.

FAMOUS Americans \$1.49, flags 90c, presidentials \$1.25, parks 45c; approvals accompany. Thomson, 4060P Elbertson, Elmhurst, N. Y.

ALBUMS, New, used, 25c up. Lists free. Alatelo, Maynard, Massachusetts.

STAMP Catalog profusely illustrated. 3c. Century, Box 418, Beverly Hills, California.

FREE—Mint set with approvals. Department PM, 1267 Tutwiler, Memphis 7, Tennessee.

FREE "Round the World" packet to approval applicants. Lange, Box 21, Hub Station, New York 55.

FREE! Fifteen different Luxembourg to approval applicants. Litten, 318 N. Fifth Avenue, Maywood, Ill.

CASH Payment for stamps and envelopes. Miller Stamp, Malden 48, Massachusetts.

300 DIFFERENT Given free with approvals. Postage 3c. Windsor Stamps, 1435 East 67th Place, Chicago 37.

FREE—Illustrated catalog! Kenmore Stamps, Arlington 74-C7, Mass.

CANADA 100 Different 50c. Approvals. Queensway Stamps, 41B Rothson, Toronto 14, Canada.

PICTORIAL Set; six 10c. Ten other sets free. Newstamps, 6884 Briand, Montreal 20.

GIBRALTAR Packet free—Nice collection Gibraltar, New Zealand Centennial, British Uganda, French Colonials, early British Colonial, West Indies, South American, war stamps plus Philatopic Monthly Magazine. All for 5c postage. Empire Stamp Company, Dept. PM, Toronto 5, Ontario.

FREE! Powerful magnifying glass—To approval applicants; also big bargain lists. Jamestown Stamp Co., Dept. 207, Jamestown, New York.

PHILIPPINES On approval. Over 50% catalog discount. References. Afran Stamp, Box 1338, San Francisco, Calif.

SAN Marino. 50 different mint commemoratives, pictorials, etc. Approvals 10c. William Deems, Ravenswood, West Virginia.

PENNY Approvals that satisfy. Neil Gronberg, Box 5441-P, Philadelphia 43, Penna.

GENUINE "Goya Nude" set (catalogs 55c) 15c. Approvals. Royal Stamp Company, Tamaqua, Penna.

543 BARGAIN Offers, free! Kenmore Stamps, Arlington 74-D3, Mass.

FREE: China navigation issue with foreign approvals. Modern Stampco, Box 12B, Wakefield Station, N. Y.

200 DIFFERENT Stamps 10c with approvals. 500 mixed United States 25c. Carlton's, Tujunga, Calif.

50 INDIA 10c plus big packet pricelist. Chase, 1026 Walker Avenue, Oakland 10, California.

STAMP Wallet brimful of gorgeous pictorials free with approvals. Granada, 4891A Southwest Fifth Street, Miami 44, Florida.

200 BRITISH Empire stamps plus valuable publications; only 3c! Kenmore Stamps, Arlington 74-B17, Mass.

10 ASSORTED U. S. Commemorative stamps 15c. Five U. S. Air Mail 15c. Both 25c. Ideal Stamp, Box 179H, Park Ridge, Illinois.

66 DIFFERENT Stamps, including U. S. battleships 6c. Worldwide approvals. Telic-Arts, Devon, Conn.

TRAINS! Trains! Trains! 12 train stamps and packet of 100 different stamps for 10c with approvals. Reich Stamp Company, 4647 Kenmore, Dept. M20, Chicago 40, Illinois.

FREE! Mint United States block, Russia airmails packet, approvals. Greenwood, 263 Meridian, Miami Beach, Fla.

250 DIFFERENT U. S., \$2.00. Contains 110 commemoratives. Approvals on request. Harman Stamp Co., Dept. P, Box 515, Port Jervis, N. Y.

BARGAIN! Assortment triangles, assortment Africa, \$2,000,000.00 stamp, \$5.00 U. S. stamp, 10 different Bohemia, Brunei, Iceland, etc. Eckerman, 7830 Paso Robles, Van Nuys, Calif.

TOPS! Our booklet "How To Collect Stamps." Send for your free copy today! Littleton Stamp Co., Littleton 37, N. H.

1c EACH And less! Thousands of bargains! Cole, 43-A Rinewalt, Buffalo 21, New York.

FREE 500 Hinges and 25 different Hungary with approvals. Jaydee, 218 W. Dickinson, Grand Rapids 7, Mich.

COLLECTION Of French Colonies, 50 different pictorials, 10c with approvals. Fields, 1939 E. 85, Cleveland 6, Ohio.

UNITED States stamps nearly 100 years old, Roosevelt set, others, 40c value—only 5c to applicants. United States approvals. Wakonda, 140G Nassau, New York 7.

YOU Need these! All six for 10c! To introduce our exceptional approval service, we'll send you: 1. Pocket stock book. 2. Watermark detector. 3. Stamp tongs. 4. Perforation gauge. 5. Book for duplicates. 6. Package of stamp hinges. All only 10c to approval applicants. Free! Big list other bargains. Jamestown Stamp Co., Dept. K, Jamestown, New York.

FREE! United States commemorative price list. Historical Stamp Co., 1280 Ocean Ave., Brooklyn 30, N. Y.

50 DIFFERENT U. S. 10c. No approvals. Pricelist free. Seidenberg, Cassopolis, Mich.

PENNY Approvals by country. M. H. Hoerning, 15, Farmington, Ark.

AIRMAIL Packet—Worldwide. Big bargain. With approvals 5c. A. Wirth, Norwichtown, Conn.

CASH For your duplicates! Particulars free. Goliath, Bethlehem 7, N. H.

128-PAGE United States catalog—1000 illustrations, 25c. Harris & Co., 202 Transit Bldg., Boston.

EXOTIC Pictorial collection; Sakalava Chieftain, Fezzan Ghadames, Djibouti, Togoland, Reunion, Andorra, Algeria, Miquelon, Tunisia, Monaco, Guadeloupe, Martinique. Many others. Everything 5c. Imperial Stamps, Tampa, Florida.

FREE! Illustrated United States catalog. Low prices! Americo, Bristol, Conn.

WOW! \$10.00 Worth of fun 10c! What a treasure hunt! Big package 500 foreign stamps, including airmails, pictorials and others from the world over; stamps worth up to 25c each. This offer sent for 10c to approval applicants only. Jamestown Stamp Co., Dept. 22, Jamestown, New York.

UNITED States approvals complete coverage, fine quality, attractive prices. Seminole Stamps, Box 1138-P, Coral Gables, Florida.

\$1.00, \$2.00, \$5.00 U. S. Free. Approval applicants. Flamingo, Box 4038, Miami 38, Florida.

"MAN Size" United States approvals! Illustrated catalog! Sullivan, Endicott Arcade, St. Paul 1, Minn.

FLAG Stamp free with U. S. approvals. Wenigman, 1933 Patterson, Chicago.

50,000 STAMP Grabbags 25c each. Anderson, 630 Bingaman 1, Reading, Penna.

U. S. Price list. Send postage. State Stamp Service, 1225 Park Building, Pittsburgh 22, Penna.

200 DIFFERENT Including Roosevelt triangle, 5c to approval applicants. M. Avalon Stamp Company, Springfield, Mass.

FREE! Crystal-mount samples! Har-risco, 202 Transit Bldg., Boston.

FREE U. S. price list, postage 3c. Mark Hanna, 335 5th Ave., Pittsburgh 22, Penna.

WORLD—500 Diff. 50c, 1000 \$1.25, 75 Canada 25c, approvals, lists. Victoria Stamp Co., London 4, Canada.

WORLD'S Largest stamp (7½x14 inches). A real curiosity! Retail for 50c, only 3c to approval applicants. Tatham Stamp Co., Springfield 30, Mass.

FREE! 100 Worldwide different stamps to approval buyers. Big U.S. and illustrated bargain lists sent with approvals. Bookman, Maplewood, N. J.

STAMP Collections wanted. Complete collections, duplicate lots, surplus stock, mint and used. Prefer trade for printing or other items, buy outright if priced right. What have you, what's wanted? Vanroy Shirk, Lebanon, Penna.

UNITED-States commemorative collection. Thirty-three different unused. Columbians to 1943 issues only. Price \$1. Request approvals. "Stamps," Albany 4, New York.

DEALERS—Wholesale list. Postage 3c. Frank, 5031 Queensberry, Baltimore 15, Md.

OLD Scarce U. S. seconds on approval. Slightly defective, bargain prices. Herr-nfeld, Clintonhill Station, Newark 8, N. J.

25 ALL Different stamps 10c. Tunis, Wakeman Ave., Newark 4, New Jersey.

POUND Stamps containing thousands \$1.00. Longacre Shop, 108 West 42nd, New York 18.

ZOWIE-E! A barrel of fun for only a dime. 500 United States stamps—absolutely unpicked and unsorted—just as received from church missions. Many varieties, including large commemoratives, airmails, high denominations up to \$5.00! Stamp-dom's biggest package of fun—and you might find something really valuable! Price only 10c to serious approval service applicants. Money back if not delighted. Illustrated bargain lists with each order. Mystic Stamp Company, Dept. 80, Camden, New York.

NICARAGUA "Tin Pan Alley" diamond, Ecuador showing George Washington, and American flag in natural colors, Fezzan, Trieste, "American Army" stamp, first U. S. commemorative, \$100.00 Shanghai, Corsica, Anzac, Antique, others. All 5c. Approvals. Capital Stamp Co., Dept. 2, Little Rock, Ark.

COINS, TOKENS, CURRENCY

OLD Money wanted. Will pay \$100.00 for 1894 dime, S. mint, \$50.00 for 1913 Liberty head nickel (not buffalo). Big premium paid for all rare coins. Send 4c for large coin folder. May mean much profit to you. Numismatic Co., Dept. 20, Fort Worth, Texas.

TOKEN Collectors. Let's trade tax tokens. Send 10c coin or stamps for particulars. Cook, 1301 West Adams, Phoenix, Arizona.

RARE Foreign money, American wooden nickel, and "World's Greatest Magazine for Coin Collectors," 10c. Lawrence Brothers, Anamosa, Iowa.

100 DIFFERENT Foreign coins \$3.00. Parker, 1254 Market, San Francisco 2, Calif.

FREE Foreign coin and banknote with giant bargain list 10c; 4 Whitman coin albums \$1.00; 1949 Whitman handbook 75c; 256 page U. S. guidebook \$1.50. Olson, 5800 Lake, Chicago.

UNCIRCULATED Foreign coin and banknote with huge price list 10c. Tousseau Coins, 109 Mathilda Avenue, Sunnyvale, California.

COINS Wanted: Itemized list 20c. Elsholz, Box 9014-M, Pittsburgh 24, Penna.

FOREIGN Bills. 10 diff. 15c lists. Oliver Arnold, Macon, Mo.

LARGE \$1.00 Bill \$1.60; large \$2.00 bill \$3.40; Booker T. Washington half dollar \$1.15. 4 Whitman albums \$1.00. Handbook 75c. Guidebook \$1.50. Giant catalogue 15c. Bebee Coin Company, 1180 East 63rd, Chicago 37, Illinois.

100 COINS And bills, \$1.00. Oddehon, Box 482, St. Louis, Mo.

43 MIXED Indian pennies \$1.00. 33 different foreign coins \$1.00. Chelsea, 40 West 18, New York City 11.

MAGNIFICENT Stock of U. S. coins. All series. Catalogue listing 2500 coins 15c. \$50,000.00 stock of gold coins. Worldwide selection. Catalogue 15c. James Randall, 116 South Michigan Avenue, Chicago 3, Illinois.

FREE: Mexican ten peso bill and coin list. Send self-addressed stamped envelope. Ben's Coin Company, 31 North Clark, Chicago 2, Illinois.

GET Profit and pleasure in collecting old coins. Send 10c for 56 page illustrated coin catalog. You'll be delighted with it. Send for it now. B. Max Mehl, 370 Mehl Bldg., Fort Worth, Texas. Largest rare coin establishment in U. S. Established 49 years.

FREE! Foreign coin, banknote and coin collectors illustrated catalog to approval service applicants. Send 3c postage. Tatham Coinco, Springfield 30, Mass.

COINS Wanted, will pay up to \$2000 for certain coins, send 25c for catalogue. Burton's, 111 So. Third, Columbus, Ohio.

COMMEMORATIVE \$½, Oregon, Texas, Kentucky, Cleveland, Long Island, \$2.00 ea. Illustrated catalogue 25c. Norman Shultz, Salt Lake 9, Utah.

PRECIOUS STONES, MINERALS

GEMS—Save money buy direct. Zircons, and other semi-precious stones. Catalog free. J. Lavering, 1140 Adams, Redwood City, California.

ZIRCONS, Alexandrites, rubies, others. Sparkling gems direct from oriental Siamese mines, cut and polished. Wholesale. Send \$2.65 for fiery carat zircon. Imhusex, Armonk, N. Y. Agents wanted.

PROSPECTORS—Rockhounds. Your hobby pays with real professional instruments! 10X Hastings triplet hand lens. Tops \$12.00. 10X doublet hand lens \$5.00. 6X field telescope, coated optics, 315 ft. field at 1000 yards \$10.00. 40X pocket microscope. Beautiful! \$15.00. Mineral hardness test set with Moh's scale, magnet, streak plate \$2.00. 12" gold pan \$2.00. Factory shipments, guaranteed for life! Free price list. No c.o.d.'s. Mohave Instrument Co., 1861A Hillhurst, Los Angeles 27, Calif.

BEAUTIFUL Collection of 40 different minerals of many colors from various parts of the country. Packed in very attractive box with descriptive list. \$2.00 postpaid. The Bonanza Mineral Co., 609 South Clark Ave., Butte, Montana.

GEMSTONES, Mineral specimens. Every variety. Lowest prices. Postcard brings free list. Plummer's, 2177C Bacon, San Diego 7, California.

GEMS, Precious and semi-precious, all genuine, from world wide sources. Deal direct, no overhead, save money. Catalog 10c. Hill Co., Route 7, Salem, Oregon.

METAL Detectors. The very latest circuit. Send 25c for literature. Hedden Metal Detectors, 3329 Liberty Ave., Pittsburgh 1, Penna.

HOBBIES AND COLLECTIONS

WANTED Old cigarette cards. Write Charles Bray, East Bangor, Penna.

KIAORA Exchange Club, Box 1588, Auckland, New Zealand. Dollar, year subscription; your hobby wants published.

NEW—15 Different match covers 10c. Box 202, Rochester 1, N. Y.

UNPAINTED Plaster ornaments, Loxite for moulds. Free literature. Midwest Novelty Manufacturers, Box 788-A, Anaconda, Montana.

UNPAINTED Figures and novelties, new original designs. Illustrated folder free. Creekturn Pottery, Hainesport, N. J.

100 UNUSUAL Buttons for collectors and hobbyists! Strange, curious, rare, fascinating! Hand-picked for unusualness! Only \$1.00. Button Mart, Dept. 152-J, 510 St. Charles, St. Louis, Mo.

THREE Military emblems and price list 10c. Hobbyguild, 57B Sumner Ave., Brooklyn, N. Y.

UNUSED Matchbook covers—100 different \$1.00. Catalog 10c. Charles Edelman, 1311C East 84, Cleveland 3, Ohio.

INVENTING Can be an interesting and profitable hobby. Write for complete particulars. Institute of American Inventors, Dept. 40-E, 1926-Eye St. N. W., Washington 6, D. C.

CAMERAS, PHOTO SUPPLIES

ENLARGERS, All sizes, lowest price. Booklet "A" free. J. B. Photo, 41-09 19th Ave., Long Island City, N. Y.

MINIATURE Camera 4.5 lens, case and 5 rolls of film, \$6.95; excellent enlargements. Additional roll film, 10 exposures, 20c. Fotosonic, 132 W. 43 St., New York City.

LEATHER Bellows installed in any foreign or domestic camera. Prices on request. W. I. Willin & Co., 102 S. Stone-man, Alhambra, Calif.

NEW. Photocraft kit includes camera, complete darkroom equipment: enlarger, easel, paper, chemicals, tank, trays, etc. Only \$12.95. Write Tam Products P9, 3814 Wrightwood, Chicago 47.

CAMERA—50c. Rent new Argoflex camera, for indoors and outdoors, 50c for 10 day period. Write for free application blank. Fotosonic, 132 W. 43rd St., New York City.

PHOTOGRAPHY For pleasure or profit. Learn at home. Practical basic training. Long established school. Write for free booklet. American School of Photography, 1315 Michigan, Dept. 343C, Chicago 5.

BASS Says: Bargaingram 257 ready and waiting for you. The book which tells all. The finest in new and used camera equipment, a veritable encyclopedia. Write, phone or call the sign of the old "Horse Trader." 39th year of satisfaction or your money back dealing. Bass buys, sells and trades. Bass Camera Company, Dept. AG, 179 W. Madison St., Chicago 2.

PHOTOCOPY Anything, papers, books. No darkroom. 8 1/2 x 11" complete. \$6.95. Fotoflek, 4801 Yarmouth, Cincinnati 29, Ohio.

PHOTO FINISHING

GREAT News! New low price on our famous jumbo oversize finishing. New Chicago plant with latest, exclusively-improved equipment produces new high-quality work. 8-exp. roll deluxe finish only 30c. 12-exp. 45c. 16-exp. 55c. 36-exp. \$1.25. Oversize reprints 4c. Send us your next order, magnificent results will delight you. Century Photo Service, Box 5208, Chicago 80, Ill.

ONE Roll or 8 reprints finished complete including one enlargement 36c. U-Save Film Service, P.O. Box 379, Pasadena, Calif.

PHOTOGRAPHY For pleasure or profit. Learn at home. Practical basic training. Long established school. Write for free booklet. American School of Photography, 1315 Michigan, Dept. 345C, Chicago 5.

EMBOSS Christmas cards from your own negative. For samples, send negative and 25c. Film Capital Service, 818 Dewey Avenue, Rochester 13, N. Y.

16 CONTACT Prints from 8 exposure roll, 35c. Reprints 3c each; 40-\$1.00. Jumbo prints on individual papers, 8 exposure roll 35c; 12-50c; 16-65c. Reprints 4c each; 30-\$1.00. Apex Photo Service, Box 197, Bronx 51, N. Y.

SPECIAL! Five 8" x 10" quality enlargements \$1. 40 reprints \$1. Surgals, 330 Beach, Chicago 51.

FREE Price list on quality developing, printing, enlarging. Write for it today. Bryan's Photo Shop, Dept. M, Panama City, Florida.

8 HOUR Service, Box 468, San Francisco. Your 8 exposure roll printed jumbo or regular size 30c; 12 exposures 35c; 16 exposures 50c; 36 exposures \$1.00. Reprints, jumbo or regular 3c. Regular prints deckled. Fine grain developing. Send for free mailers. Quality Photo Service, Box 468, San Francisco 1, Calif.

16 ENLARGED, Jumbo, oversize deckled prints from any 6-8-12-16-20 or 36 exposure roll film developed only 35c and this ad. Electronically exposed. Enlargement coupon free. Skrudland, 6444-R Diversey, Chicago.

8 BEAUTIFUL Double size pictures and roll developed 30c. 8 hour service. Free mailers. Pacific Photo Service, Box 666, San Francisco, Calif.

EXPERT Finishing. Roll developed and 8 prints 30c. Rancho Photo, Dept. P, Ontario, Calif.

2 BEAUTIFUL Hi-Gloss prints each good negative and enlarging coupon with each 8 exposure roll developed 28c. Free mailers. Owiphot Co., Weatherford, Oklahoma.

8 PRINTS All enlarged to nearly postcard size from your roll or negatives 25c; 16-50c. (Trial offer). Willard Studios, Box 3535A, Cleveland, Ohio.

QUICK Service—Snappy album pictures (enlarged) from your film, 8 exposures 30c. 16-50c. Pittsburgh Photo Lab., Pittsburgh 26, Penna.

MOTION PICTURES AND SOUND EQUIPMENT

BARGAINS In 16mm. sound films. Big new list out each month. Blackhawk Films, Davenport, Iowa.

WE Buy, sell, rent, exchange home movies. Details for dime. Midland, Box 429, Oak Park 4, Ill.

PROCESS Your own movie film. Free literature. Duro, 1519 Eggert, Buffalo 21, N. Y.

SUMMER Sale! Want a real buy in 16mm. sound films? Take advantage of the I.C.S. 1949 summer sale of 16mm. sound films—features, comedies, educational, cartoons, novelties, etc. Send for our giant list "A" today stating machine you own (make and model). Institutional Cinema Service, Inc., 1560 P.M. Broadway, New York 19, N. Y.

"EXQUISITE" Party movies. Equipment. Free catalog. Home Pix, 1674 Broadway, New York 19.

RENT 16MM. sound films. Complete programs features; shorts low as \$4.95. Write our nearest office for complete list. Dept. PMA, Eastin Pictures, Davenport, Iowa; Colorado Springs, Colo.; Chattanooga, Tenn.

RENT 16MM. sound films, 50c reel. Large selection; free catalog. Film Service, 128 Chestnut, Roselle Park, N. J.

FILMS And equipment exchanged or bought for cash. Sound, silent. Bargains. Lists free. Frank Lane, Little Bldg., Boston, Mass.

NEW 8 MM. full color movie film, 25 ft. double roll, including processing, tax and postage, only \$3! Guaranteed. Send cash, check or money order. Dynacolor, Dept. M-3, Rochester 3, N. Y.

"THE World's Greatest Passion Play." 8mm, 16mm, and 35mm. Specify silent or sound. Rent or purchase. Hemenway Film Co., 33-F Melrose St., Boston 16, Mass.

85 KODACHROME Movies! War, atom bomb, travel, air, national parks. Catalog, 3c stamp. 2 scene "Waikiki" sample, \$1.00. Specify 8 mm. or 16 mm. World in Color Productions, Elmira, N. Y.

8-16MM. Silent-sound films. Complete rental library. All latest subjects. Free catalogue, (sample film 10c). Garden Film, 317 West 50th, New York 19.

8MM. 16MM. Magazines B & W. \$3. Includes processing. Dephoto, 648 Helen, Detroit 7, Mich.

MOTION Picture technique at home. Big money. Special registration for veterans. Free catalog. Motion Picture Institute, Birmingham 4, Mich.

FREE Movies. Thousands of subjects. Interesting. Entertaining. Fascinating. New directory—only 50c. International Cine Society, Dept. 102-M, 1300 Taylor N. W., Washington 11, D. C.

SEND 10c for 1949 photographic catalogue. Bargain list included. Sterling's, 679 Northampton, Easton, Pennsylvania.

GUARANTEED Fresh 25' spools double 8 mm full color film! Processing free! \$3.80 each, 3 spools \$11.00. Catalog. Filmcraft, 47th Holly, Kansas City 2, Mo.

GUARANTEED Fresh anti-halo outdoor movie film! Weston 12! Daylight loading! Processing free! Three spools double 8 mm. \$3.45! Six single 8 mm. for Univex. \$4.60! Postpaid! Catalog. Filmcraft, 47th Holly, Kansas City 2, Missouri.

BASS Says: 39 years of leadership guarantees satisfaction. Finest cine equipment, 8mm., 16mm., and 35mm., silent and sound. Write the old "Horse Trader." Satisfaction or your money back always! Bass Camera Company, Dept. A, 179 W. Madison St., Chicago 2.

TITLE Making, free booklet. Westwood Company, 635 Victoria Street, San Francisco, California.

LEARN Movie projection, management. Free catalog. Theatre Institute, Elmira, N. Y.

I BUY, Exchange, swap movies. What have you? What do you want? Lowest exchange rates in world. Catalogue \$1.00. Refundable. Harvey Iris, Box 539, Brockton, Mass.

MUSIC AND MUSICAL INSTRUMENTS

MUSIC Lovers add a comic album to your collection. Amos 'n' Andy; Jack Benny; Edgar Bergen; Burns & Allen; Eddie Cantor; Ed. Gardner; Fibber McGee & Molly. Regular \$4.50; now \$3.95. Ferritto, 745 So. Western, Los Angeles 5, Calif.

HILLBILLY, Polka records; late, old, 29c. Catalogue 3c. F-L Shop, Box 19-L, New York 35, N. Y.

GUARANTEED Quality instruments. Bargains by mail. Catalog 10c. Harden's Music, Marion, Mo.

VOICE "Effortless control!" 15 lessons \$10.00. Cor-Studio, 14356A Jersey Ave., Norwalk, Calif.

SONGWRITERS! Outstanding, ethical offer. Hibbeler, C5, 2157 N. Avers, Chicago 47.

LEARN Song writing! Fun-profitable. Wonder Wheel jiffy composer, perfect harmony, any note, any chord. Folders free. Barnes, Box 490, Times Square Station, New York 18, N. Y.

SONGWRITERS Investigate new offer. Submit poems, honest criticism, copies furnished. Nat Gardner, 1650T Broadway, N. Y.

MUSIC Arranged, songs printed. Frank Wildt, Music Publisher, Lancaster, Penna.

POEMS Wanted. Percentage basis collaboration. Terry Tune Master, 709 1/2 PM N. Broadway, Oklahoma City, 2.

YOUR Poems set to music, recorded. Free booklet, attractive offer. Write. Songland, 331-C West 46th, New York.

SONGWRITERS—Publication collaboration. Newark Publishers, G.P.O. Box 1226, Syracuse, N. Y.

WRITE Songs. Big money and reputation. Write for information. J. Gordon Pub. Co., 201 N. Hoyne Ave., Chicago.

SONGWRITERS Attention! The amazing demand for phonograph records, accelerated by countless juke-boxes, warrants your immediate investigation. We are offering new writers the rare opportunity of having celebrated "hit" composer furnish music on reduced percentage basis for any likely poems received this month. Phonograph records are outselling piano copies 5 to 1. Recola Records, Hollywood 28, Calif.

POEMS Wanted for musical setting. Send poems for free examination. Five Star Music Masters, 630 Beacon Bldg., Boston, Mass.

ACCORDIONS, Mikes, amplifiers. Save up to 50%, cash or terms. Buy direct, save middle man's profits. Del Principe, 307 South Wabash, Chicago.

POEMS Wanted to be set to music. Free examination. Send poems. McNeil, Master of Music, 510-PM S. Alexandria, Los Angeles, California.

LYRIC Writers—Free musical setting, recording \$10. Turner, P.O. Box 2201-M, Bridgeport 2, Conn.

RADIOS, SUPPLIES, INSTRUCTION

MAKE Loudest crystal radio. Instructions, loudest crystal. Catalog, 25c. Amorse, Route Four, Richmond, Virginia.

"RADIOBUILDER," 3 Issues 25c. Sample free. Catalog. Laboratories, 578-C, San Carlos, California.

COAXIAL Cable—100 feet \$3.00; sample 10c. Harry H. Van Dick, Little Falls, New Jersey.

TELEVISION Wiring diagrams—Set of ten, only \$1.00 postpaid. Melpo Co., P.O. Box 40, Bay Ridge Station, Brooklyn 20, N. Y.

HEADPHONES. Guaranteed U. S. Signal Corps used headsets with adjustable leather headbands and black Bakelite earphones. Special now \$1.99. Allen Radio, Dept. HPM, Clinton, Missouri.

BE A television announcer, director, actor or writer. Learn in Hollywood. Complete courses in school established 20 years. Radio Television Arts Academy, 3819 Wilshire, Hollywood 5, California. Approved for veterans.

MAKE Simple, tubeless, batteryless, distance-getting crystal radios. Crystal and illustrated instructions 25c postpaid. Allen, 427-P, Clinton, Missouri.

FREE—Money saving bargain bulletins in radio and television sets, record changer, tubes, parts, amplifiers, speakers, etc. Write today. Radionic Equip't Co., Dept. 2006, 170 Nassau St., New York 7, N. Y.

BUSINESS OPPORTUNITIES

TRADE Magazines—Current copies. Business, professions, agriculture, automotive, aviation, radio, refrigeration, advertising, sports, hobbies and all other fields. Free price list. Commercial Engraving Publishing Co., 34C North Ritter, Indianapolis 19, Indiana.

FIX Typewriters, full or part time. Inexpensive copyrighted home study course quickly trains you for high earnings. Factory methods cover all phases with drawings and illustrations. No curiosity seekers. Typewriter Repair, 9915 Corbet, Tarentum, Pennsylvania.

START Your own business on credit. Always your own boss. 1554 dealers, sold \$5,000 to \$26,500 in 1948; their average \$6,742. We supply stocks, equipment on credit. 200 home necessities. Sales experience not needed to start. Wonderful opportunity to own pleasant, profitable business backed by world-wide industry. Write Rawleigh Co., Dept. I-U-PPM, Freeport, Ill.

"ELECTROPLATING-Know-How" includes baby shoe metallizing and other lucrative fields for you. Write for my free illustrated booklet! Joseph B. Kushner, Electroplating Consultant, Stroudsburg 20, Penna.

BE Independent—Operate America's lowest price penny vending machine. Big profits. Immediate shipments. Write for bulletin and prices. Fielding Mfg. Co., Desk 99, Jackson, Mich.

NEW Patented screw-holding screw drivers! Removes, inserts screws difficult places; 137% profit! Stores, factories, garages buy quantities; exclusive distributor. Manf'r., 402 Summit, Brookline, Mass.

SURPLUS, New OCD, steel helmets. Ten for \$1.95. Marsden Supplies, 1010 Wyoming, Dayton 10, Ohio.

START Home manufacturing business making Cleaning Compounds, Soaps, insecticides, Cosmetics, Polishes, Food Flavors. No machinery. Literature free. Kemix, Park Ridge, Ill.

"HOW To start a successful mail order business." The guide to sound profitable mail merchandising 25c. Manhattan House, 126-B Lexington, New York 16, N. Y.

START A Christmas card imprinting business. Write Dunbar, Sanford, Florida.

SELL By mail. Get started right. Details and informative trade magazine containing tips, plans, supply sources sent for 10c. Shaw, Box 438, Coconut Grove, Fla.

BECOME An expert mail order worker. Information free. Surprise gift included if you send 2c stamp. J. W. Stenger, 500 20th St., Rock Island, Ill.

"UNBELIEVABLE!" Postwar hand cleaner. Without ammonia-kerosene! Postal brings complete moneymaking information. Rythmo-C-Ex, Kingsport, Tennessee.

BIG Money. Spare or full time in your home. No selling! Spray new miracle finishes, plush and suede, on signs, radios, automobiles, figurines, lamps, toys, etc. Our business is booming. Help us fill huge demand. New easy Flok-Kraft methods. Material costs few pennies. You get dollars. Free samples, complete powerful money making plan free. Write now! Coast, 1010 S. Los Angeles St., Los Angeles 15.

"OPPORTUNITIES Preferred" tells how to make money by mail. Latest issue 25c. Griffin Company, 756 Broadway, Everett 49, Massachusetts.

SELL Handi-Grip to homes, stores, theatres, etc. Unique forceps eliminate stooping. Fogarty Engineering Co., Baldwin, N. Y.

HOUSEHOLD Specialty, 150% profit. Ideal for mail order. Flinson, Box 4333-B, Kansas City 1, Mo.

"I Can get it for you wholesale." That's what you tell your customers. You save them money and make a good income yourself. We tell you how. Write today for free information. Atam Mail Service, 3511-C West 63rd, Chicago 29, Ill.

LIQUID Rubber, make flexible molds. Free sample. Chaney, 1130 E. 16th St., Jacksonville 6, Fla.

START Your own profitable business, be independent, stimulate existing business. Over 225 new, different, practical ideas. Your opportunity. \$3.00 per copy. Business Enterprises, Muncie, Ind.

GOLD Mine—Sell 96c worth exquisite fern-like green forest moss for \$16.00 by mail. Enormous demand for floral, window decorations, hanging flower baskets, etc. Start immediately. Complete sales outfit \$2.00. No duty. Moneyback guarantee. Merchandise sample 10c. Northwoods Products, Fort Clements, British Columbia.

TRADE Magazine Directory. Classified, listing 4,364 publications. New edition. \$1.50 postpaid. Commercial Engraving Publishing Co., 34C North Ritter, Indianapolis 19, Indiana.

BRONZING Baby shoes is big business, start your own business for \$4.95; includes materials to bronze 10 baby shoes, instructions. No equipment required. Particulars free. Box 2095, Wichita, Kans.

FOR An extremely profitable lifetime business, operate a collection agency; credit bureau. Easily learned. Free folder. Cole & Associates, Syracuse 2, New York.

ELECTRONIC Door lock! Sensational! Invisible! Positive protection! Inexpensive! Tremendous profits! Ameswerth, 17544 Raymer, Northridge, California.

OPERATE Profitable mail order business. Splendid opportunity. For details write Carl E. Rieman, 409 Lynn Street, Woodville, Ohio.

OPERATE Profitable home mail-order business. Write Lawson, Box 1302-P9, Detroit 31.

BETTER Mailorder business. I received 200 orders first month. Folio 25c. Grant Lovell, 2166 South Shore, Erie 10, Penna.

HIGHEST Quality liquid rubber for molds. Free sample. Kendall, 108M Central, Jersey City 6, N. J.

"WATERLESS Hand cleaner." Make, sell. No machinery. Build profitable business. Formula \$1.00. "Wax-o-Glass" cleans glass; polishes metals. Formula \$1.00. "Wipe-on auto paint" formula \$1.00. Metallizing baby shoes, complete process \$1.00. All four formulas only \$2.00. Satisfaction guaranteed. Ideal Formula Service, Park Ridge 7, Illinois.

START Home plaster novelty business. Amazing course tells how. Literature free. Kemo-Courses, Dept. A, 4862 Catalpa, Chicago 30, Ill.

"DEPRESSION Insurance!" Postal brings free moneymaking information. Pru-A-Ex, Kingsport, Tennessee.

DELIGHTFUL Plans from Australia, South America! Free book "372 Unusual Worldwide Businesses." \$800 month reported (exceptional). Work home (U.S.A.)! Prepare for surprise! Publishers-F8, Carlsbad, Calif.

SAVE Money! Million articles wholesale. Directory 25c (refundable). Publisher's, Box 1302-P9, Detroit 31.

WANT Profitable home work? Write Sunrae Products Co., Ogema, Wis.

BRONZED Baby shoe mountings, metals, onyx, plastics, hardening solution, supplies. We manufacture and wholesale. Free illustrated catalogue. Box 2095, Wichita, Kans.

SAWDUST. Turn it into cash. Six methods. Instructions 25c. Charles, 12-APH, Norwood, Ohio.

YOU Can operate a profitable mail order business. Write for free literature. Bruce Brown, 170 Hancock Street, Brooklyn 16, New York.

IDEAS, Magazine, opportunities. Samples free. Lincoln, Box 449, Irwin, Penna.

DRESDEN Craft figurine molds and many others, natural liquid rubber, statuary plasters, flock finishes, etc. Illustrated catalog and "Plastercraft" manual free. Blue Rapids Supply, Blue Rapids, Kansas.

EXPORT-Import! Represent manufacturers. Conduct barter exchange business without capital. Two bulletins supplying hundreds overseas connections \$1. Money refunded if unsatisfied. International Trade, 246-P, New York 1.

USE Your home as magazine subscription station. Represent all magazines. Liberal commissions. Supplies furnished. Big Christmas gift business now. Catalog, full details, free. McGregor Magazine Agency, Dept. 509B, Mount Morris, Ill.

ANNOUNCING Home study course in commercial baking. Practical basic training. Good field for those with aptitude. Nearly depression proof. Send for free booklet "Opportunities in Baking Industry." National Baking School, 1315 Michigan Ave., Dept. 343B, Chicago 5, Ill.

HOME Business opportunities. Mail-local. Details free. Etterman, 1991-B9 Lake, Muskegon, Mich.

GET "How To Sell by Mail and Win." Literature free. Lexington Mail Service, 5538 Lexington, Chicago 44, Ill.

UP TO 442% profits selling "Quick Silverware De-Tarnishing Plates." Instantly cleans silverware, gold, platinum, jewelry, metals. Simply dip, rinse, dry. Sensational demonstrator. Wholesale, retail, sideline, sparetime, fulltime. Protected. Manufacturers, 508-PMBO, New York Street, Aurora, Illinois.

FORGE Ahead financially! Start big profit business; mail order or locally. Amazing invention. Free sample offer. Consolidated Equipment, 781 Guardian Bldg., Cleveland, Ohio.

WANTED Unused U. S. postage stamps, small discount. Advance Stamp Co., 24 East 23rd St., New York.

OWN A printing business. Good profit printing cards, stationery, etc., in spare time. Easy rules furnished. Have home shop. Write for details. Kelsey Corp., Meriden 24, Conn.

EARN \$200 Weekly installing new amazing "Styron" plastic wall tile in homes, offices. Easily applied. Tile your own kitchen, bathroom, too. Instructions, everything furnished. Literature free. U. S. Tile Co., 30 W. Washington St., Chicago 2, Ill.

POSTCARDS Bring orders galore with 75c, \$1.25 and \$1.50 profit per order. New, nothing like it elsewhere, dignified, no stock to buy or carry. Stamp addressed envelope brings free data. R. Conner, Beatrice, Nebr.

NEED More money? Get new mailorder plan for increasing income. Free details. Perry Publications, 15-A Chapala, Santa Barbara, Calif.

RUBBER—Liquid, molds, models, casting, finishing metalizing materials. Wholesale catalog sample free. New Era Plastic Products, 1321-W3 Belmont, Chicago.

100 BUSINESS Ideas, 10,000 formulas. Mail order. Farm; workshop. Particulars free. Flasco Sales, 2505VR 150 Street, Flushing, New York.

SELL By mail! Ideas galore! Join club! Details free! Wehner, Box 142-A, Roxbury 19, Mass.

PROFITABLE Repeat business selling shampoos. Laurine, Inc., 4846 Polk, Chicago.

EXTRA Money. No selling; operate vendors. Amazing profits, details free. Silver King, Suite B, 622 Diversey, Chicago 14.

GET Into a well-paying business of your own. Write for free information on my treatise "Making Dough with Doughnuts." Husted Enterprises, P.O. Box 1847, West Palm Beach, Fla.

SELL By mail—Unusual opportunities. 10c brings 56 page informative trade magazine. Isbell, Suite 619-PM, 216 West Jackson, Chicago 6, Ill.

BABY Shoes electroplating rectifiers, supplies, chemicals, mountings. Foster's, 1520 Ardmore, Chicago 26.

MAKE Perfume. Learn profitable business free. Men; women; write. "International," 6347 Parnell-PM-9, Chicago 21, Illinois.

"1,000 ITEMS Free." A book you can sell. Write, Round-The-World-Press, Department PMM, Buckeye Lake, Ohio.

FORMER Government employe may be able help your business in Washington. Many interesting possibilities. 2000 word folder 10c. Washington Comm. Co., 1200 Fifteenth St. N.W., Washington 5, D. C.

EARN Money at home with your typewriter! Full, spare time. Details free! Edwards, 3915-P 12th, Des Moines 13, Iowa.

MAKE Amazing new personalizing plastic decals with anyone's initials inlaid in gold. Stick permanently to anything. Spare or full time in home, office or room brings you dollars; material costs few pennies. Exclusive; no competition. Clean, easy, fascinating. Exciting samples plus our new exclusive money-making plan air-mailed to you free, if you hurry. Write Goldcraft Plastics, Box 228, Long Beach 1, Calif.

UNPAINTED Bookends, plaques, statues, figurines. List. Haverty Products, 1219 8th Ave., Altoona, Penna.

LIQUID Marble—Colorful, glossy! Molded, brushed, sprayed! Cast novelties, statuary, colored tiles. Flexible molds. Composition floors. Particulars free. Marbleizing Service, Edwardsville, Illinois.

\$3.41 PROFIT Per hour interest you? Easy amazing process velvetizes interiors, signs, novelties, radios, autos, at low cost. Free sample. Sparks, 1145 Queen Anne, Los Angeles 6.

BABY Shoe mountings; book ends; frames; etc. St. Albans Plating & Casting, 135-17 135 Ave., So. Ozone Park, New York.

BE Independent, be secure, have your own profitable business—earn \$10.00 and more a day making beautiful, fast-selling lamps at home. No equipment needed. Illustrated course teaches you quickly. Course, parts catalog, wholesale price list, only \$2.00. Gearon Company, Dept. 200-B9, 27 South Desplains, Chicago 6, Ill.

METAL Mountings for bronze baby shoes. Also shoe plating for the trade. Urbans, 2806 Holliday, Wichita Falls, Tex.

MANUFACTURE At home! Make and sell waterless and dry mechanics soaps. Cleans dirtiest hands. Tested formulas, home equipment. Directions easily followed. Two profitable formulas one dollar. Desert Soap Co., Box 89, Phoenix, Arizona.

RICHES In your own business. Let me show you how. Addison, Box 1153, Hot Springs, Ark.

NEW Products, ideas, opportunities in German monthly "Oversea Post," English printed copy \$1.00. Keller, P.O. Box 415, Flushing, N. Y.

EARN At home casting novelties. Free instructions using latex molds. Major Chemical Company, 164 Portland Street, Cambridge 39, Mass.

OPPORTUNITIES Course on manufacturing, mail order, formulas, supply source. Free information. Roberts Publications, 433-A East Galena Street, Butte, Montana.

MAKE Big money as I do by mail! This pays off in cash. Literature free. Write me! D. Peterson, P.O. Box 598, Minneapolis, Minn.

BRONZED Baby shoe mountings, equipment and supplies. We manufacture world's largest assortment of all metal mountings. Wholesale only. Ramyrselenium platers \$39.95. Gold and silver plating assemblies low as \$97.50. Write for free copy of electroplating instructions. Tech. Dept., Hollywood Bronze Supply, 1770 N. Vermont Ave., Hollywood 27, California.

INTERESTING, Profitable money makers. Particulars free. Dawson, 1308F, The Dalles 3, Oregon.

AMAZING New hobby or business. Complete information and catalog, free. How to make break resisting ornaments with plastic-modeling powder; new way rubber molds, perfume candies, etc. Children can do it. Hobby Rubber Craft, Lake Villa, 257, Illinois.

EVERYBODY Likes candy—Learn to make professionally. (Our 39th year.) Ragsdale Candies, D5, East Orange, New Jersey.

BE Independent—Own and operate routes of automatic popcorn and chewing gum machines. Will accept foreign coins. Also hand operated photo machines, peanut roasters, hotdog machines, snow ball machines, candy floss machines. Also supplies. Immediate delivery. Reference—Dun-Bradstreet. Prices—Factory to you. Coastal Photo Supply Co., Export Dept., Wallace, N. C.

"**HOW** To Get The Job You Want." Amazing plan. Works wonders. Secrets revealed. Write. Parker, Box 576-B, Cleveland, Tenn.

METALLIZE Baby shoes. Excellent profits. New system assures success. Free details. Treasures Forever, 89-B Henry Ave., Lynn, Mass.

MAIL Order offers increased income, independence, unlimited possibilities. Free literature. Manhattan House, 126 Lexington, New York 16.

MAIL Order News (55th year) brings you the mail order ideas you're looking for. Copy 25c. Clarence Woodfall, Publ., Route 3, Charleston, Ill.

RESILVER Mirrors at home. Formula 25c. Ideal Service, Park Ridge 8, Illinois.

MAKE Money spare or full time, casting metal toys and novelties. Big wholesale and chain store demand for cast metal autos, soldiers, ashtrays, banks, etc. keeps manufacturers busy. Production moulds furnished for up to 100 and more castings per hour. No experience or special place necessary. "Cash-in" on holiday orders now being placed. Write for full information and illustrations of patterns needed. Metal Cast Products Co., Dept. A, 1696 Boston Road, New York 60, N. Y.

UNPAINTED Figurines. Free list. Progress Company, 4033-P Chowen, Minneapolis 10, Minnesota.

10,000 **FORMULAS** And trade secrets. Free literature. Stillman Co., 555 Kings-ton Ave., Brooklyn 3, N. Y.

HOW To set up and run a mirror shop! Resilver mirrors. Make chipped glass nameplates. Electroplating salts and rectifiers. John Sprinkle, V60, Marion, Indiana.

NEED Money? Make and sell glamorous, sparkling costume jewelry. Complete kits with full instructions. Free literature. Jewel-Craft, Vanceburg, Ky.

LEARN Piano tuning, repairing at home. Tremendous field! Piano parts, tools furnished. Established 1935. Empire School of Piano Tuning, 606-B East University Ave., Champaign, Illinois.

AMAZING Marble-glazed cement pottery, Hollywood style, without moulds. Benches, fountains, stucco-rock walls, garden ornaments; chemically colored. Dime brings sample, pictures. Hollywood Cementcraft, 8527-R Wonderland, Hollywood 46, California.

PROFITABLE Business making and building with easy-laying interlocking building blocks. Rex Products, Dept. 10, Piqua, Ohio.

FREE Particulars of money making plans. Pierce, Box 235, St. Louis 3, Mo.

RAISE Earthworms. Easy, profitable. Send for free literature or send dollar bill for illustrated book. Money back guarantee. Earthworm Culturists, Dept. P, Box 83, Station C, Atlanta 5, Ga.

LEARN Sewing machine repairing at home. Install our wholesale motor kits. Make \$125 to \$300 in a week. Free particulars. Taylor Service Co., Hamilton PM, Ohio.

GET Free literature. Wholesale supply sources. Money making items. Formulas. Allen Service, 245 Main, Ganges, Mich.

NEW Industrial hand cleaner. Free manufacturing-distributing plans. Unusual money-making proposition. "Acro-Sol-Ex," 623 West 14th Ave., Denver 4, Colorado.

DOLLARS In personalized baby record books. Sell by mail. Use same literature we do. No-Co-Ro, Oakland 6, California.

UNPAINTED Figurines—Wholesale, retail. Illustrated list free! Oman, 642L Broadway, St. Paul 1, Minnesota.

CO-PUBLISH And advertise in The Central Mail Advertiser. Sample copy 10c. Low rates. Large circulation. Bagby Printing Co., Georgetown, Ohio.

BIG Money! Made in lettershop operation! Easy pleasant work. Free details! Woods Letter Service, Bedford, Penna.

MAKE Rubber stamps, metalize baby shoes, repair dolls, silver mirrors, make plaster novelties. Catalogue of "30 ideas" free! Universal, Box 1076-A, Peoria, Ill.

NATURAL Molding Latex. Extra thick. Free sample. W. Woolley, 115-A Donald, Peoria, Ill.

SPECIAL Rubber for making molds. Literature and sample free. Universal, Box 1076-A, Peoria, Ill.

SELL Jewelry by mail. Everything furnished ready to go. Orders filled; small capital. Tremendous possibilities! Jomay, Box 1224-A, Toledo 3, Ohio.

CASH For your idea, 280 manufacturers need inventions, patented or unpatented. List free. Invention Bureau, 208M Clinton, Oak Park, Illinois.

MAKE Money making new greaseless doughnuts at home on electric machine. Wholesale to grocers, drug stores, cafes, hamburger shops. Send for free recipes and plans. M. Ray Company, 3605 South 15 Ave., Minneapolis 7, Minnesota.

RECAST Old batteries into new. Latest achievements. Battery Laboratories, Minneapolis.

"**SPECIALTY** Manufacturing." Big money business. Start on small capital with dependable formulas. Send for free interesting booklet. Howard Robinson, Ph. G., 1300-A South Ohio Street, Sedalia, Mo.

MAILING Postcards selling repeat merchandise is profitable. Everything supplied. Details free. Gordan Publishers, Box 23, Pawtucket, R. I.

ENVELOPES Addressed accurately, reasonably. Fast service. We have capable addressers in your city. Glenway System, 5713-Y Euclid, Cleveland 3, Ohio.

HOME Business making statuettes, plaques, artificial marble, rubber molds. Metallizing baby shoes. Silvering mirrors. Formulas. Folder free. Creative, 236-L Winnetka, Illinois.

VENDING Machines earn big money! An investment as low as \$10.50 will start you in this fascinating, profitable business that can lead you to the road of success and independence. Routes can be established and operated in either full or spare time with no experience needed. Write for full details and our free catalog illustrating our nut, candy, gum and stamp vendors; also pin ball machines, music boxes, etc. Write immediately to Parkway Machine Corporation, Dept. 7, 623 W. North Avenue, Baltimore 17, Maryland.

YOUR Own profitable home business. Preserve live flowers to last forever. New simple discovery. Enormous demand all year 'round. Tremendous profits! Light fascinating work. Send \$2.00 for working equipment, instructions, and valuable sales plans. Satisfaction guaranteed or money promptly refunded. Alfred Hermansen, 210 Fifth Ave., Suite 1102A, New York 10, N. Y.

I MAKE Big money in the mail-order business. You can do the same at home with copyrighted system. Write me. I'll tell you how. F. Little, R.D. #1, Glen-shaw, Penna.

POPCORN Equipment, potato chip outfits. Long Eakins Company, 4960 Hi Street, Springfield 99, Ohio.

READ "Advance"—The voice of mail order. Offers money-making opportunities, sources of supply, personal guidance, etc. Issued monthly. Sample copy 25c. Yearly subscription \$2.00. Advance Publishing Company, 313 East 21st Street, Suite 450, New York 10, N. Y.

A BUSINESS In your own home! Our chemicals, plus free water and cheap "grocery store" materials can bring you over \$500 monthly earnings. Plans and formulas free. Chemica Division, 1289 S. Norton, Los Angeles 6.

A FACTORY In your home garage! Mfg. and sales rights, mechanics' waterless hand cleaner, \$500-\$800 monthly. No special equipment necessary. Formula free. Western Aircraft Mfg., Dept. D, Los Angeles 6, Calif.

START Mailorder bookshop—Everything furnished. 25c brings booklet, samples, exciting ideas. General Publications, Ossining, N. Y.

OPERATE Profitable mail order business. Write Walter Service, 4159-A East 112th. Cleveland 5, Ohio.

COLORGLAZED Concrete pottery made without molds. Patented method. Cemetery products, novelties, tiles. Basement leak-sealing. Money-making projects. Booklet, details free. Men only. National Potteries Company, Grand Rapids, Minnesota.

\$25 WEEKLY Working two hours daily. No canvassing. No manufacturing. Lycke, Box 2471. Cleveland 12, Ohio.

137 WAYS To make money, in home or office, business of your own. Full particulars free. Elite Co., 220 Grand St., New York 13.

BRUSH Plating outfits connect to a battery. No tanks necessary. Good paying business at home plating autoparts, bathroom fixtures, bicycles, reflectors, silvering mirrors. No shop or experience required. Outfits furnished. Free booklet. Gunmetal Co., Ave. H. Decatur, Ill.

COPUBLISH Leading m.o. paper. Latest copy Mail Sale Advertiser and proposition. dime. Vanroy W. Shirk, Lebanon, Penna.

SUCCEED Because you know your hidden strengths. Send \$1.00 for psychologist's new type tests. Satisfaction guaranteed. Mayflower Press, 23 Middle Street, Plymouth, Massachusetts.

FREE Test sample! Big profits selling new water repellent. Makes clothes, hats, shoes, etc., shed water like a duck's back. Convince yourself. Send \$1.00 for sprayer top bottle and details. Returnable for refund or credit. United Technical Labs., Box 425-H, Morristown, N. J.

MAKE Over \$100 week, at home, renewing small auto part for wholesale trade. Exclusive, non-competitive. No machinery or skill required. No sales calls to make. Complete data and sample, 25c. Xcello Co., 921 Walnut, Kansas City, Mo.

MONEYMAKING OPPORTUNITIES

IT'S New-Beautiful-Sensational. 9 out of 10 homes use coffee and will welcome our new Meas-U-Rite coffee dispenser for that perfect cup of coffee everytime. Keeps coffee fresh. No waste. No guessing. Measures accurate. Saves coffee. Territories now being assigned. Mel-Gauge Company, East Haven, Conn.

SELL Proven revolutionary wood awl. For home or woodworkers. Details and sample 50c. Metal Items, 820 - 6th Street, Racine, Wis.

LIFETIME Repeat orders! Sell our business cards by mail, your territory. Small "starter" plan. Lynn Products, 5711 Bankfield, Culver City, California.

1000-\$2.85! SELL \$3.85 up! "Raised-print" Business Cards, 8307 $\frac{3}{4}$ San Pedro, Los Angeles 3.

FREE Book "372 Unusual Worldwide Businesses." Successful! Australia, South America! Not hokum. Work home (U.S.A.). "Different" plans. Prepare for surprise! Publishers-F9, Carlsbad, Calif.

400% PROFIT Making signs, posters, etc., for business places. Simple process. Folder free. Ryane's, Box 16, Buffalo 15-M, New York.

OPERATE Profitable mail order business. Free details. Edkap Service, 5115 New Hampshire Avenue, N.W., Washington 11, D. C.

CAN The boss! Make strange plastic of waste. Makes attractive floors, walls, roofs, built-ins. Build durable homes \$150.00 room. Bays Laboratory, Oklahoma City 9.

EARN Money at home! Thousands do! "Home Worker Magazine" tells how. Sample, 25c. Sizemore, Box 7, 4917 Kostner, Chicago 30, Ill.

SCHOOL Seniors—Sell classmates America's most beautiful graduation name cards. Largest selection. 40% commission. Outsell all others. Free sample kit. Printercraft, Dept. M, 1425 E. Elm St., Scranton 5, Penna.

PAINT—New type, plastic, Christmas cards, 18 with envelopes \$1. Van Delinda, 1562 Main St., Springfield, Mass.

MAKE Money at home as renewal headquarters for all magazines. Big profit in Christmas gift sales. Liberal commissions. Supplies furnished. Catalog free. Write McGregor Magazine Agency, Dept. 509C, Mount Morris, Ill.

EARN Money evenings, copying and duplicating comic cartoons for advertisers. Adservice, Argyle 1, Wisconsin.

15 MINUTES Masters advertising and sign lettering; complete system; sign painters' secrets; cartooning book; all three, \$1; free circular. Abentierprizes, Box 875, Peoria, Illinois.

\$100.00 PLUS 24 card tables. Churches-organizations write for particulars. Box 392, Clementon, New Jersey.

MAKE Money with easily installed weatherstripping. Double Seal Co., 2725 Ross, Waco, Texas.

BRONZING Shows profits. Consultation, materials, instruction supplied. Free literature. Luther Jones, Box 7283, Ft. Worth, Texas.

EXCEPTIONAL Money-making opportunity making life-like dwarf trees. Tremendous market! Big profit! Complete sample kit \$3.95. Oriental Gardens, 1491 E. Colorado, Pasadena, California.

HOW To look ahead and make money. No one ever made money or advanced in his job, unless he knew how to look ahead. Our books, as low as \$1.00, teaches you how. Send for free money-making literature. Granite House, Book Publishers, 675 Congress Street, Portland, Maine.

YOUR Mail order business now ready. A. S. Spencer, Mokena 2, Ill.

\$50 WEEKLY While learning watch repairing. See ad page 46.

HOME Mfg. enterprises. 70 projects, large variety, 500% profit. 100 illustrations. 56 pages, \$1.00. Home Industries, Omaha 5, Nebr.

THOUSANDS Articles wholesale. "Supply Source Directory" 10c. Ideal Service, Park Ridge 30, Illinois.

MONEY-Making opportunities galore including magazines, 10c. Wilbur Erickson, Englishtown 12, New Jersey.

DOLLARFUL Ideas for you every month in advance—"Voice of Mail Order." Leads the field in exclusive supply sources. Plans for mail order operation; new products, etc. Details free. Advance Publishing Company, Suite 350, 313 East 21st Street, New York 10.

POPCORN Poppers, vendors, peanut roasters, copper kettles, bottled gas, gasoline burners; new, used. Northside Sales, Indianola, Iowa.

UNUSUAL Back yard money-making opportunities! Fully outlined! Write: Pickett's, 62-A Sanders, Florence, Kentucky.

START Profitable home business in spare time. Make extra money raising Golden Hamsters. Small, clean, odorless. New. Unlimited market. Literature free. Golden Gate Hamstery, 631-H Richmond Street, El Cerrito, California.

READ Progressive Mailtrade, the magazine that tells how to make money by mail. Dime brings sample and special offer. Progressive Mailtrade, Box 357, Sheboygan, Wisconsin.

PROFIT With Larson Leathercraft. Belts, purses, 100 other ideas. Largest supply in U. S. Catalog 10c. Larson, Dept. C, 824 S. Tripp, Chicago 24.

WIN Contest money. General Contest Bulletin gives hundreds of tips. Lists current contests and rules. Sample 25c. General Contests, 1609 $\frac{1}{2}$ East 5th, Duluth, Minn.

PUBLISH Your own magazine. Handsome 52 page format, well edited, illustrated. Cost low as \$1.00 month. Brings you prestige, profits. 25c brings sample, details. National, Ord. Nebr.

PRIZE Contest bulletin gives various contests now operating, and valuable hints. 3c stamp. National Contest Bulletin, Box 2685P, Miami, Florida.

RUSH Card—Five profitable small capital mail sales propositions free. Schenck, 717-P W. Penn, Butler, Penna.

FORMULAS, PLANS, ETC.

AMAZING New products. Write Dr. Hertstein, 519 Sheldon, Grand Rapids, Michigan.

FREE Formula catalog. Anything analyzed \$20.00. Western Chemical, Salem, Oregon.

UNUSUAL Formulas with moneymaking sales appeal. 15 only \$1.00. Jacobs, 620 East 20, New York 9, N. Y.

FAMOUS Formulas. Large folio free. D. Moore, Route 3, Box 568, Orlando, Fla.

MAKE—Sell cleaners, soaps, polishes, flavors, cosmetics. No machinery. Formula literature free. Kemico, Park Ridge 16, Illinois.

24 MONEYMAKERS—Tested formulas for home manufacturing, 25c. Satisfaction guaranteed. Details free. Nelson, Howel, Kentucky.

PRODUCTS Analyzed. Duplicated. Improved. Formulas. Consulting Scientific Company, Swarthmore, Pennsylvania.

10,000 FORMULAS And trade secrets. Free literature. Stillman, 555 Kingston Ave., Brooklyn 3, N. Y.

FORMULAS For nearly everything. Catalog free. Write Creative, Winnetka, Ill.

TESTED Formulas. Interesting descriptive booklet free. Pont, Box 635-PM, Terre Haute, Indiana.

REAL Manufacturing formulas. Lists free. Cummings, Chemist, Gordon Ave., Syracuse 4, N. Y.

PLASTICS

CASTING Plastics: Cold curing, transparent and colors. Information 10c. Alan Plastics, Box 3564, Cleveland 18, Ohio.

SENSATIONAL— $\frac{1}{4}$ " 12" x 12" prime plexiglas \$1.75, include 10% postage. Free catalogue. Craft Plastics, Somerville, New Jersey.

FREE Catalog—Plastic materials, cements, jewelry and hobby supplies. Crescent Engineering, 1130D Fair Oaks, South Pasadena, California.

LUCITE, Plexiglas. Any size sheets, masked. Square foot (12 x 12) cost, 1/16", 96c; $\frac{1}{8}$ ", \$1.25; 3/16", \$1.52; $\frac{1}{4}$ ", \$1.80. Colors add 10%. Include 10% postage. Almac Plastics, 230 Fifth Ave., New York 1, N. Y.

INTERNAL Carved roses, orchids, swans, goldfish, butterflies, etc. Jewelry and gifts. Crystal Floral Novelty Co., Bound Brook, New Jersey.

"PLASTIC Engineer and Consultant" will solve your plastic problems. Fee reasonable. 65 E. Rich St., Columbus 15, Ohio.

PLASTIC, Sheets, rods, tubes, etc. Free list. Plastic Supply Co., 2901 N. Grand Blvd., St. Louis 7, Mo.

CHEMISTRY

BOOKS, Equipment, catalog 10c. Atlantic Laboratory Supply, 21 Wenham, Boston, JP, Mass.

NEW Laboratory supply catalog of chemicals and apparatus. Contains many thousands of items with illustrations. Send 25c. Standard Science Supply Company, 1232 N. Paulina St., Chicago 22, Ill.

HANDBOOK For chemical experimenters, illustrated, hundreds of experiments, 50c. Experiment booklet, 15c. Reading Scientific Company, Reading, Penna.

NEW Idea chemical and apparatus outfits for home experimenting. Photo-scales, microscopes, chemicals, biological and laboratory supplies in small quantities. Catalog 15c. Established 1931. John H. Winn, 124A West 23rd Street, New York, N. Y.

NEW Catalog: Chemistry, mineralogy, biology. 10c. Tracey Laboratories, Evanston, Illinois.

CHEMICALS And apparatus for industrial, analytical, and private laboratories. Catalog 15c. Dept. M-50, Biological Supply Co., 1176 Mt. Hope Ave., Rochester, 7, N. Y.

HELP WANTED

BIG Money making plan for individuals, clubs, churches, schools, selling Christmas cards to friends, others. Feature box, plastics, personals 50 for \$1.00 up, stationery, everyday wrappings. Special offer. Bonus. Request samples. Heather Greetings, B-49, Springfield, Mass.

BOYS Wanted. Over \$2.00 hour! Sell name plates for front doors. Free sample. Write Dept. 52, National Engravers, 214 Summer, Boston, Mass.

BOYS Make \$3.00 per hour showing Pedaling Pete the tight-rope riding clown. Send \$1.00 for sample. Western Arts Company, Box 2124, Reno, Nevada.

AGENTS WANTED

SHOW Our tailored plastic raincoats to friends, strangers, and you are in business. Classiest garments introduced this year. Durable, yet fold into handbag or pocket. Priced for family buying. Terrific seller. Long profit. Secure territory now. Carson Products, 15-A East 8th St., Kansas City 6, Mo.

EXTRA Money yours—easy! Profits to 100%. Sell thrilling value plastic Christmas cards, 50 for \$1.00 personals, everyday, religious, children's, gift wrap assortments. Request deluxe 21-card \$1.00 Christmas assortment, name imprinted Christmas cards, stationery samples on approval. Holiday Card Co., 463 Congress St., Dept. C, Portland, Maine.

QUICK, Easy, cash for you! Sell amazing variety new Christmas cards. Profits to 100%. Novel plastic, 3-dimension "Stage Set," metallic, Christmas carol cards. Gift wraps, animated books, table settings, 8 special offers. Bonus. Write for feature samples on approval and free samples 4 different name imprinted Christmas card lines, floral and personal stationery. Elmira Greeting Card Co., MC-109 Elmira, N. Y.

BIG Extra income! Sell friends nylon hosiery, lingerie, blouses. Values supreme! Free sample displays, Christmas, everyday greeting cards, gift wraps, Christmas samples on approval. Special outfit offers. Wear Wright, 1709 Arch St., Dept. B, Philadelphia, Pennsylvania.

DEVELOP Your own business in Venetian blinds. Simple procedure. Write for particulars. Mohawk Venetian Blind Mfg. Co., 207 Bridge St., Cambridge, Mass.

\$1.00 STARTS You in business. Sell men's neckwear full or part-time. Low investment, big profits. Send \$1.00, receive two sample ties, plus free catalog, color pictures, selling plan. Radio City Neckwear, Dept. M-2, 112 W. 50th, New York City.

EXTRA Money! Sell friends Christmas cards—including fascinating plastics. 100% profit. Request free samples exclusive name-imprinted Christmas cards, stationery unobtainable elsewhere with Christmas and everyday assortments on approval. Regal Greetings, Dept. PM-9, Hazel Park, Mich.

AMAZING Offer—\$40 is yours for selling only 50 boxes Christmas cards. Also 50 and 25 for \$1.00 with or without name. Free samples. Other boxes on approval, including entirely new, different deluxe assortment with feature television card. Cute plastic assortments. Write today. It costs nothing to try. Cheerful Card Co., 911, White Plains, N. Y.

AT Last! Something new and sensational in Christmas cards. Show gorgeous satins, velours and plastics never before offered. Gets easy orders fast! Pays big profits. Free samples of Christmas cards with name 50 for \$1, imprinted stationery, floral charmettes, napkins. 50 other assortments 60c to \$1.25. Samples on approval. Write. Puro Co., 2801 Locust, Dept. 940-L, St. Louis, Mo.

NEWEST Money making sensation! Sell hand painted ties with personal initial. Experience unnecessary. Write for free 16 page catalog complete line ties. Philip's Neckwear, 20 West 22nd Street, Dept. K-37, New York 10.

NEW "Sponge" dish cloth. Replaces messy dishrags. Banishes dishwashing drudgery. Lightning seller. Samples sent on trial. Kristee 134, Akron, Ohio.

SELL Big money-maker to men and women. Easy handwork makes fast-selling useful articles. Sunmade Company, Brockton 64, Mass.

MAKE Money easily. New spare time plan. Up to 100% profit. No experience. Show unusual Christmas, everyday card assortments, plastics, gleam and glo, kiddies cards, wrappings. Attractive gift items. Bonus. Special offers. Send today for free samples 30 different Christmas cards with name 50 for \$1.00 up, stationery, coasters. Thomas Terry Studios, 101 Union Ave., Westfield, Mass.

PLASTIC Tablecloth covers, curtains, drapes, baby pants, bowl covers and other plastic articles selling like wildfire! Make big money now! Free details. Write L & M Co., Dept. 58-J, 510 St. Charles, St. Louis, Mo.

FRIENDLY Social visits bring you big Christmas card profits. Take easy orders wonderful new type plastic, metallic assortments. Send at once for free 48-page catalog, feature samples on approval and free name imprinted Christmas card sample portfolios. Special offers. New England Art Publishers, North Abington 51, Mass.

LOOK Here! Wanted—Men and women to start in business on credit. Sell some 200 farm-home products. Thousands our dealers now make quick sales, big profits. For particulars write Rawleigh's, Dept. I-192-PPM, Freeport, Ill.

CHRISTMAS Cards. Earn \$5.00 with every ten 21 card \$1.00 boxes you sell. Also new \$1.00 plastic cards, personalized cards, and stationery, note paper and wrappings. Send for samples today. Howard P. Ellis, Dept. PM-9, Pitman, N. J.

DOUBLE Your income selling sport, dress shirts, pajamas, nylon lingerie, hose, housedresses. Free outfit. Jarod Manufacturing, Rockville Centre 9, New York.

STEADY Profits selling new sensational Lico fountain pens. Liberty International, 8 Bridge St., New York 4, N. Y.

BIG Profits—Taking orders from friends, neighbors. 50 super value Christmas folders \$1.25, with name. America's leading \$1 box 21 French folders. Christmas Holly box—lined envelopes. Also: gift wrappings, plastics, religious, kiddies, napkins, stationery, etc. Samples on approval. No investment. Sunshine Art Studios, Dept. PM-9, 115 Fulton St., New York 8, N. Y.

BRAND New! Amazingly different and smart Christmas cards bring you big money! Take easy orders for sensational new Christmas cards. Amazing values. Pays up to 100% cash profit. Big line of Christmas, everyday assortments from 60c up. Christmas cards with name 50 for \$1. up. Imprinted stationery, floral charmettes, napkins. Get samples on approval, imprints free. Write North Star, 31 Glenwood, Dept. B-18, Minneapolis, Minn.

CHRISTMAS Cards—Earn selling personals, boxed assortments, novelties, plastics, stationery. Lincoln Press, 949, Fall River, Mass.

A Dress yours with every 3 you order for yourself and family. Amazing new bonus plan. Everything free. Harford Frocks, Dept. A-435, Cincinnati, Ohio.

CALL On friends with sensational Christmas cards in handy assortments. Sell for \$1.00. Profit up to 50c. Also popular-priced personal Christmas cards, everyday assortments, stationery, imported napkins. Samples on approval. Wallace Brown, Dept. C-4, New York 10, N. Y.

SHINE Shoes without polish. New invention. Lightning seller. Shoes gleam like mirror. Samples sent on trial. Kristee 133, Akron, Ohio.

AGENTS. Nothing like it. The Mechanical Bird. A new novelty sensation. Free details. Toy Art Co., 110 Monroeville Ave., Turtle Creek, Penna.

AGENTS Wanted to sell our line of novelties. Behnke Sales, 5721 Leland, Chicago 30, Ill.

SELL Fluorescent plastic signs. Iwano Plastic Products, 9108 Olivet Avenue, Detroit 9, Michigan.

AMAZING Profits—Up to \$600.00 month. Working with churches, civic clubs, legion, money raising organizations. Easy, fascinating, permanent employment. Details free. Kraft, Aurora 3, Mo.

PAINTS-Enamels. Roofing 65c gallon up. Also outdoor toilet cleaners. Certified Products, 812e 38th, Louisville, Ky.

\$100.00 WEEKLY Selling 6 pair Paragon Cushion shoes daily. No investment. Experience unnecessary. Free outfit. Samples. Advance commissions, bonus. Paragon Shoes, 739 Columbus, Boston.

BE Renewal headquarters for all magazines. Big profit in Christmas gift sales now. No experience, no capital needed. Free catalog tells how. Write: McGregor Magazine Agency, Dept. 509A, Mount Morris, Illinois.

SCHOOL Seniors—Earn 40% commission selling classmates America's most beautiful graduation name cards. Largest selection. Outsell all others. Free sample kit. Printeraft, Dept. M, 1425 E. Elm St., Scranton 5, Penna.

BUY Thousands of nationally advertised products direct from manufacturers and distributors. Write for "Buy Direct and Save." Service Publishing, 218-A Investment Bldg., Pittsburgh 22, Penna.

EARN Spare time cash. Sell Christmas, everyday cards, stationery, specialties. Profits to 100%. Bonus. Box sent on approval. Birchard, 27C Lester St., Springfield, Mass.

EXTRA Cash selling Christmas cards, wrappings, stationery. Request catalog, special offer. Atlantic Cards, 3525-M Reisterstown Road, Baltimore 15, Md.

UP To 233% profits selling genuine, guaranteed, "Silver Plating Polish" Rub-on method, apply with cloth. Renews silverplated ware, articles, pieces. Silverplates brass, copper, bronze. Stores, offices, shops, homes. NuSilver, 508-9PMA New York Street, Aurora, Illinois.

IDENTIFICATION Tags for dogs, keys, luggage. Write: DuRaney, Johnstown, Pennsylvania.

SCHOOL Seniors! Your postal will bring our wonder, Kwick-Sell cardalog of popular graduation name cards. Biggest profits! Only firm giving free souvenir chest and card case. Don't miss out! Hurry that postal! Craftcards, Box 235 (L), Pittsburgh 30, Pennsylvania.

SELL New liquid cleaner concentrate. Repeat business, top profits. Every store, home, office a prospect. Glo-Brite Sales Co., 8921 Loomis, Chicago 20.

MUSIC Greeting cards. All occasions. Dorby Music Cards, P.O. Box 738, Morristown, New Jersey.

BIG Money taking orders: Shirts, ties, Sox, pants, jackets, sweaters, shoes, uniforms, etc. Sales equipment free. Experience unnecessary. Nimrod, 4922-BG Lincoln, Chicago.

SENSATIONAL 1950 Models. Power mowers. Farm Products, M-2009, Excelsior Springs, Mo.

\$100 WEEKLY—New complete, modern plastic line. Tablecloths, etc.; over 25 items. Every home prospect. 100% profit. Free samples. Carwell, 6828-C South Chicago Avenue, Chicago 37.

AGENTS: Stamping names on key protectors. Sample 25c. Stamping outfits, checks, social security and name plates. Hart Mfg. Co., 303 Degraw St., Brooklyn, N. Y.

NYLON, Poplin, rayon uniforms, white and colors. Immediate delivery, immediate profits. Sell to doctors, dentists, nurses, waitresses, beauticians, housewives. Free sales kit. Superior Fabrics, Dept. P-9, 3936 Market St., Philadelphia 4, Penna.

\$5-\$25 DAILY. Full, sparetime or sideline. Pocket samples free. Embocards, 3333 Neenah, Chicago 34.

AMAZING New plastic paint brush bag keeps paint brushes soft and pliable for months. Sells on sight. Good profit. Send 25c for sample package and details. Baldwin Sales, 20 Herkimer Place, Brooklyn 16, N. Y.

AGENTS Wanted: Sanitary toilet bowl brush holder. Modern household necessity. 50c for sample and details. Upper Midwest Specialties, Mankato, Minn.

GUARANTEED Tire patch. Sell garages, filling stations, etc. Protected territory. Economy Rubber Prod. Co., Riverdale Station, Box 552-O, Dayton 5, Ohio.

BIG Money—Fast! Sell quality plastic tablecloths, (from \$4 doz.), curtains, aprons, etc. Factory prices. Free samples. Durever, 282C Albany Ave., Brooklyn 13, New York.

AMAZING "Dooroscope" protects the home. Sells on sight. See visitors, unseen. Also talk, receive messages—with door locked! Underwriters approval. Vodean Associates, 165 Broadway, New York 6, New York.

AGENTS. Sell finest food products direct to homes. Successfully sold for 25 years. Big profits. Powerful combination sale plans make sales easy. Permanent repeat business. Samples furnished. Live territories open to distributors. Mother Hubbard Products Co., 4139 Grand, Dept. P.M., Chicago.

EASY To sell Bible text pencils, mottoes, charms, direct or to stores. Write, Al Hawkins Company, Sioux City 7, Iowa.

SELL Window streamers to stores. 400% profit. Biggest demand now. Free details. Rogers, 1613a Prospect Place, Brooklyn 33, N. Y.

TOP Year 'round earnings with oldest line of quality bronzed baby shoes and home gift items. No investment. Send for free selling ads. Jane Adams, Inc., PM-1, 108 Massachusetts Avenue, Boston, Mass.

FREE! Win television set and big cash prizes! Sensational offer. Make more money selling plastic Christmas cards, 50 and 25 for \$1.00, imprinted. Fast selling line, bonus. Free contest entry and portfolios. Richar's, 16AT East 18th, New York.

EARN Extra money easily, sell new Christmas cards and gifts-'n-things. 21 folder ass't. sells for \$1.00, sent on approval; no investment. Get \$50 or more selling only 100 boxes. Amazing sample offers. Headquarters for new 3-dimensional Christmas cards. Plastics, genuine engraved etchings. We send free samples of easy-to-sell personal Christmas cards and stationery. Pen 'n Brush Studios, Dept. PM-9, 139 Duane St., New York 13, N. Y.

AMAZING Spare time earnings. Sell Christmas cards, stationery, napkins; 50 with name \$1.00. Complete line Christmas, everyday boxes. Profits to 100%. Write for samples. Empire Card, 135 Fox, Elmira, N. Y.

BIG Bargains for big profits. Over 100 sensational values. Men's used suits \$2, pants 35c, topcoats \$1.25, overcoats \$2, shoes 20c. Experience unnecessary. Free wholesale catalog. Superior, 1250-A Jefferson, Chicago 7.

A SURE Way to make money. No exp. needed; Christmas cards sell fast! From 50 for \$1.00 with name! Big line box assts; profit up to 100%. Write for samples on approval. Mendler Art Company, 37A Pearl Street, Boston, Mass.

FREE Nylons given if Kendex hosiery runs or snags! World's only women's hosiery sold with written guarantee amazing everybody. Mere words could not express unbelievable money-making opportunity. Fantastic earnings become reality. Armstrong earned \$202 in 9 days. Watkins sent 92 orders in one day. Imagine replacing hosiery free regardless of cause—whether use or abuse! Truly sales dynamite for terrific profits. Even if you never sold before, three magic words: "Guaranteed Against Everything" will open doors for you—make women listen and pour money in your pocket. Nationally advertised in Life, Ladies Home Journal, Saturday Evening Post, McCall's and Woman's Home Companion. Awarded Seal of Approval by Good Housekeeping. 75 million readers will see Kendex advertising to help you make quick sales and big money. Complete line from sheerest 15 denier 51 gauge to heavy 70 denier service. Sizes 8½ to 11½; lengths 28 to 35 inches; latest fashion colors plus white; full fashioned seamed and seamless. No competition because Kendex nylons are not sold in stores. Also complete line men's hosiery actually guaranteed for one full year or replaced free. Nothing like this anywhere. Includes rayon, nylon, lisle, wool, cotton, mixtures etc. All styles, patterns, colors, prices to please everybody. 200,000 pairs constantly in stock for fast delivery. Thousands shipped daily. Over 30 years in business. You need no money or experience. Nothing to pay now or later. Just show free outfits. Write orders. We deliver and collect. Big advance cash plus huge bonus. Earn money spare or full time—exclusively or as side line. No restrictions. Become manager—appoint others to sell for you—earn steady income on their sales. Man or woman, young or old, experienced or beginner, you can make money and friends writing orders. Everything you need is furnished free, including sales books in color, samples of hosiery materials etc. Simply write your name and address on postcard and make money next week with money-making outfits sent free and prepaid. No obligation. Kendex Company, Babylon 93, N. Y.

SELL Dress fabrics to friends, neighbors. Stylish, beautiful materials. Year round profits. No experience needed. Free details. National, 640 Broadway, Dept. M, New York 12.

DON'T Sell junk! The Frawley chair-side coin radio is in America's finest hotels. Proven and accepted! Your local hotels, courts, hospitals, resorts, coin operators, investors, radio men, etc. are all prospects. Splendid commissions! Time payment plan and complete sales helps for easy selling. Write today! Hotel Radio Corporation, 3000 E. Jefferson Ave., Detroit 7, Michigan.

1949 CHRISTMAS Card catalog now ready! Earn more money! Be a wholesale jobber! A large selection of box assortments. Imprint lines, religious, personalized cards and Christmas novelties. Three sample boxes, retailing for \$2.60, only \$1.00 postpaid. Catalog free! Elfko, 440 North Wells, Chicago 10.

INCREASE Your income. Sell for manufacturer. Nylon uniforms to waitresses, beauticians, doctors, dentists, nurses. Sales outfit and extra catalogs with your name and address furnished free. Terrific cash commissions. Medikote, Rockville Centre 2, N. Y.

BLIND Workers need your support. Make more money taking orders for floor brushes, rugs, towels, many other items made by the blind people and also help create work for them. Free catalogue. Pacific Blind Products, 1024-M Santee, Los Angeles 15, Calif.

NEW Sensational money maker. "2-in-1" scissors and knife sharpener. Nothing like it before. Proven success. 100% profit. 30 second demonstration gets order. Special trial offer. Barberdier, 918 Eleventh, Sacramento, Calif.

HOTTEST 39c Item on the market. Write National Sales & Service, Greenville, Penna.

FREE Samples. Big profits showing amazing Glow-in-the-Dark specialties. House numbers, pictures, plastic novelties, religious and nursery objects, etc. Large manufacturer. Madison Plastics, 203 Fourth Ave., New York 10, N. Y.

ABSOLUTELY Free! Big package actual sample fabrics and style presentation of dresses, lingerie, hosiery, etc. Take orders. Commissions big. Send no money. Melville Co., Dept. 5103, Cincinnati 3, Ohio.

BE First! Clean up selling brilliant new, metal Christmas cards featured in America's greatest box assortment line. Special metal, plastic, foil and novelty assortments. Five portfolios of personal cards. Fast imprint service. Free samples. Elmcraft Chicago, 5930 South Western, Chicago 36, Ill.

LOOK! Make money all year round selling personal initialed individualized belts, buckles, cap badges, western buckles, tie holders, name plates. 2000 emblems to choose. Big profits, whole or part time. Please write today special outfit offer. Hook-Fast Specialties, Box 1425, Dept. 6, Providence, R. I. Established 1926.

SEWING Machine electrification kit. Nationally advertised. Has Good Housekeeping Guaranty Seal. Can be demonstrated and sold in 5 minutes. Make at least \$5 per sale. For complete details write today to Brownell Distributors, Inc., Dept. PM, 308 Canal St., New York 13, N. Y.

FREE Water and our concentrates, make flavors, lotions, shampoos, 125 products, labels, bottles supplied. Quaioco, E20030 Russell, Detroit.

MEXICAN Feather pictures. Unusual novelty. \$1.00 (stamps) brings \$2.00 worth samples, details. Refunded if unsatisfied. Aztec Art-P, Apartado 762, Mexico City.

MAGIC Cleaner—Laundry soap deal. Hotter than a firecracker. Big profits. Sample free. Bestco, 4642 No. Central, Chicago.

PHOTO-Salesmen-plastics. Sell beautiful hand-colored plastic enlargements. Collect deposit, we deliver. Profitable sideline. Send card, for free sample kit. Novel Portrait Co., 3343 North Ave., Chicago, Ill.

GOLD Lacquered window sign letters. Large sizes penny each. New foils. Absolutely beautiful. Free samples. Atlas, 544 W. 79th, Chicago 20.

AGENTS—300% Profit selling genuine gold window letters; stores and offices. Free samples. Metallic Letter Co., 438-B North Clark, Chicago.

EXCELLENT Sideline for printing and advertising salesmen. Decalcomania name plates in small quantities. Great demand. Also, make money with our line of automobile initials and sign letters. Free samples. "Ralco" XL-Roxbury, Boston 19, Mass.

HIGH-GRADE SALESMEN

AGENTS, Dealers and distributors. Here's the money making item you've been looking for. Acclaimed by users throughout the country. Every housewife, storeowner and janitor a prospective customer. Many states still open (including main cities). Write today. Speed Waxer Company, Dept. PM-4, 4451 Elston Ave., Chicago 30, Ill.

DO You sell to service stations, grocery stores and other soft drink retailers? New, fully patented device makes coin vendor of any soft drink box. Sell and deliver complete unit; make \$5 or more net on every \$12.50 unit sale. Carry as sideline or full time. This machine supported by national advertising. Salesmen and distributors wanted. Write or wire for details on open territories. Pay-Pull Mfg. Co., Dept. P, 720 San Pedro Ave., San Antonio, Texas.

SALESMEN. Earn \$100.00 weekly, selling only six pair shoes daily. Commission and bonus. Wide variety for men, women, children. No investment. Experience unnecessary. Free catalog. Tanners Shoes, 514, Boston, Mass.

SALESMEN—New type lawn tray and other novel appliances. Write for plan. Union Iron Products Co., 1011 East 148th, East Chicago, Indiana.

GOOD Profits selling tooth paste dispensers. A beautiful new invention. Free particulars. Samuelson Specialty Co., 470½, South Mt. Vernon, San Bernardino, California.

ADVERTISING Book matches—Cash in on big demand; sell union label matches. Cuts for all businesses and political parties. Free powerhouse selling kit, low prices, protection guaranteed on repeat orders. Cash commissions. Superior Match Co., Dept. M-99, 7530 Greenwood, Chicago.

SELL DuPont nylon uniforms. Complete line famous exclusive Hoover styled nylon uniforms for beauty shops, nurses, doctors, waitresses, others. Best quality, splendid values. Exceptional income. Real future. Equipment free. Write fully. Hoover, Dept. A-100, New York 11, N. Y.

SALESMEN—(within 1000 miles of Philadelphia) sell printed gummed tape. Part or full time. Good commission. Quaker City Tape, 910 No. 6th, Philadelphia, Penna.

BONUS Suits and big cash profits—Both yours with amazing new plan. Show actual sample woollens, latest styles to friends, neighbors. No money needed. Write for amazing plan. J. C. Field & Son, Harrison and Throop Sts., Dept. W-1817, Chicago 7, Illinois.

DON'T Sell our signs! They sell themselves. Your profit 400% while having fun. Every business waiting to buy. Be first in your town. Rush \$1.00 for generous sample today. All-Ready, 501 Piper, Detroit 15, Michigan.

SELL Calendars now. Be the first in your district. Good sideline or full time. Every business wants them. Few calendar salesmen are on the road now which means more sales for you. Fleming Calendar Co., 6539 Cottage Grove, Chicago 37.

EARN Big money fast! Sell finest-quality advertising work uniforms to garages, factories, filling stations, etc. Free selling kit. Topps, Dept. PM-949, Rochester, Ind.

SALESMEN: \$9 a gross profit on 25 cent food item. Sell 5 gross daily. Exclusive territory. Premium with every package. Free sample. Flavor-tite, 1967 W. Slauson Ave., Los Angeles 44.

CARRY The famous Atlas raincoat line. Sell direct to consumer. Priced low as \$3.95. Newest styles, attractive, colorful patterns. Also men's wool gabardine topcoats. Make up to \$25.00 daily. Commissions advanced. Samples free. Atlas Raincoat Mfg. Co., 819-A Congress, Chicago.

DISTRIBUTORS! Jobbers! Crew managers! Establish permanent business. Fast sellers; Modern Wonder Book, Home Medical, Dictionary, War History, Huribut's Bible Story, illuminated Bibles. Enormous profits. Big cash daily! Amazing offer. Universal House, 1016-0 Arch, Philadelphia.

STOP! Want to make money all year round selling a complete line, wool and cotton embroidered uniforms for summer and winter wear, uniform trousers, shirts, caps, ties, badges, 2000 emblems, personal initialed buckles, belts, and hundreds of other easy-to-sell items? Sales kit furnished. Please write today. Hook-Fast Company, Box 480PM, Roanoke, Va.

300% PROFIT Retailing every auto owner. 100% wholesaling to auto dealers. Enormous repeater. Dorm Chemical Company, Dept. P-9, 624 South Michigan, Chicago.

SELL Ultra-blue stock signs to stores. 1000 slogans, comedy, general, religious. "7x11" cost 6c, sells 35c. Make money. 15 samples ultra-blue signs "7 x 11" \$1.00 postpaid. Lowy, 8 West Broadway, Dept. 488, New York City 70.

BIG Money selling tooth powder. J. Walker, 633 Plymouth Ct., Dept. 1, Chicago 5, Ill.

EXCEPTIONAL Money-making opportunity! Get your share cash profits daily. 1st day results: Steep, \$31.85; Herring, \$21.85; Brown, \$25.55; Crotts, \$44.10. Smashing sellers! Wonder Book of Knowledge, children's educational books, Bibles and Testaments. Write now! Publisher's Agency, 1211-E Chestnut, Philadelphia, Pennsylvania.

FREE \$90.00 Portfolio for producing advertising specialty salesmen. Commission plus bonus to 50%. Rush postal. Howlett, Huntington 3, New York.

NEW Jobs open in selling! Send name, address for five free issues of Opportunity Magazine's money-making guide, listing hundreds of companies who'll pay you well, full or part-time. No experience needed. Opportunity, 28 E. Jackson, Dept. 17, Chicago 4, Ill.

BIG Money taking orders. Shirts, ties, socks, pants, jackets, sweaters, shoes, uniforms, etc. Sales equipment free. Experience unnecessary. Nimrod, 4922-AN Lincoln, Chicago.

WHY Not try selling? Men have succeeded selling shoes who believed they could not sell. Free selling outfit puts you in secure business. Consolidated Shoe System, Dept. S-417, Chippewa Falls, Wis.

EDUCATIONAL AND INSTRUCTION

LEARN Auctioneering. Either by mail or in resident classes. Hundreds successful graduates. Sample lesson free. Nelson Auction School, Renville, Minnesota.

"HOW To Break and Train Horses"—A book every farmer and horseman should have. It is free: no obligation. Simply address Beery School of Horsemanship, Dept. 1109-C, Pleasant Hill, Ohio.

MAKE Up to \$35-\$45 week as a trained practical nurse! Learn quickly at home. Booklet free. Chicago School of Nursing, Dept. M-9, Chicago.

VENETIAN BLIND KITS

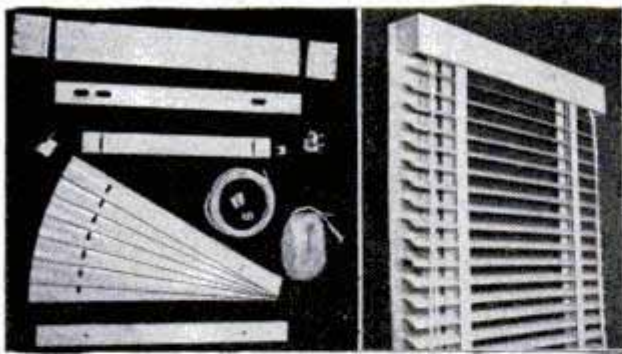

SAVE AS MUCH AS 50%

Assemble your own custom-made Venetian Blinds. Complete Flexolite Venetian Blind Kit takes only a few minutes of your time . . . so simple even a child can assemble it.

NO "EXTRAS" TO BUY! You get beautifully finished aluminum slats, all holes drilled—including screw holes, all hardware, screws, tapes and cord, headpiece, tilt, bottom rail, etc. Pre-painted in our factory. You need only a hammer and screwdriver. Built for a lifetime of service!

Available only by mail from the largest manufacturer of Venetian Blind Kits. Send for complete information today!

FLEXOLITE MFG. CO.

366 Wilson Ave. Brooklyn 21, N. Y.

RUSH COUPON NOW!

FLEXOLITE MANUFACTURING CO.—PM9
366 Wilson Avenue, Brooklyn 21, N. Y.
Please send complete information and prices on Flexolite Venetian Blind Kits.

Name _____
Address _____
City _____ Zone _____ State _____ PM-9

Learn A Trade NOW! PRACTICAL SHOP TRAINING!

In Our Chicago Shops

- | | |
|---|--|
| <input type="checkbox"/> AUTO MECHANICS | <input type="checkbox"/> WELDING—ARC and GAS |
| <input type="checkbox"/> DIESEL MECHANICS | <input type="checkbox"/> MACHINIST |
| <input type="checkbox"/> REFRIGERATION | <input type="checkbox"/> PIANO TUNING |
| <input type="checkbox"/> BODY-FENDER | |

Above Approved For G. I.'s and Civilians
One of America's Leading Practical Schools
7 Floors of Fully Equipped Shops
Over 48,000 Successful Graduates
Expert Individual Instruction
Learn by Doing—Low Living Expense
Established 1902—Day and Evening Classes

Also the following Home Study Courses

- | | | |
|----------------------------------|--|---------------------------------|
| <input type="checkbox"/> PLASTIC | <input type="checkbox"/> REFRIGERATION | <input type="checkbox"/> DIESEL |
|----------------------------------|--|---------------------------------|

—CALL IN PERSON OR MAIL THIS AD TO—

GREER SHOP TRAINING

(Desk 10) 460 South State St., Chicago 5, Ill.

Please send without obligation free information regarding trade checked above. (Specify whether you are a Veteran or Civilian)

Name _____ Age _____
Address _____
City _____ State _____

PISTONS

ALUMINUM ALLOY. For Auto, Truck, Tractor, Motorcycle, Scooter, Outboard, Marine, Compressor, Industrial Engines. **EVERY MAKE, ANY YEAR,** odd or foreign. Send sample or specifications.
JUDSON MFG. CO., 4527 Hedge St., Phila. 24, Pa.

STEEL CLIP-HOOKS—60c per 1000

HUNDREDS OF USES. Rust-resisting, 1 1/2" long, 5/8" wide, 1/8" steel. 6,000,000 in stock. Shipping weight: 8 lbs. per 1000 F.O.B., NYC. Send 10c for 12 samples. **AGENTS WANTED.**

STANDARD CO., 65 Duane St., New York

SCREWMIX—BEARINGS

Mixed screws & metal screws—30c Lb.	Bore	O.D.	Type	Price
Mixed wood screws—Mixed washers—Mixed cotter pins—30c Lb.	5/32"	5/8"	Ball	15c
Mixed nuts—Mixed aluminum rivets—50c Lb. Mixed steel rivets—20c Lb.	3/16"	3/2"	Needle	15c
BARGAIN OFFER (\$2.40 value) one lb. each of above 7 mixtures—\$1.95	1/4"	5/8"	Needle	15c
POSTAGE Screw Mix, Add 5c per lb.	5/16"	3/4"	Ball	22c
POSTAGE Bearings, Add 10c per order, Minimum order \$1.00.	3/8"	7/8"	Ball	35c
	1/2"	1 1/4"	Ball	40c
	5/8"	1 1/2"	Ball	30c
	1"	1 3/4"	Needle	28c

JAY-CEE SALES CO., 4554 Grand River Ave., Detroit 8, Michigan

WE'LL PAY YOU \$1000. for 3 gallons of "WORN OUT" motor oil from your own auto, truck or tractor engine. Details, page 30 in our FREE BOOK—"Oil Facts."

RECLAIMO MFG. CO., 5083 Elston Ave., Dept. 99, Chicago 30, Ill.

EXTRA PROFITS! Flocks & Sandblasts

Dual Purpose Spray Gun! Uses only 25 lbs. Air Pressure
• Thousands of uses in Home, Shop, Industry: Makes Auto Interiors Clean & New, Lines drawers, Marproofs lamp bases, Refinishes any object. All in colorful Flock, Etch & Frost windows, glassware, etc. Removes Paint & Rust from Autos, Tools. Guaranteed! Send \$19.75 or write for free information.
BLASTO SPRAY GUN MFG.
Dept. M-Sep, 7007 Haas Avenue, Los Angeles 44, Calif.

MICROSCOPES SUPPLIES-ACCESSORIES & SCIENTIFIC INSTRUMENTS

B&L SPENCER NEW & USED LEITZ ZEISS
BOUGHT-SOLD-EXCHANGED-REPAIRED
Send for FREE LIST
NATIONAL SCIENTIFIC INSTRUMENT CO. 119 CHAMBERS ST NY?

Save! MANUFACTURER'S SURPLUS

OVER \$3.00 WORTH OF USEFUL SCREWS, BOLTS, WASHERS, RIVETS, NUTS, ETC. 2 1/2 lb. box \$1.00
POST PAID ANYWHERE IN U.S.A.
10 lbs. \$3.25 25 lbs. \$7.50
Send Cash, Check or Money Order.
A really practical assortment for every workshop, hobbyist, or maintenance service men. Satisfaction fully guaranteed. Order today from
ILLINOIS SCREW & NUT COMPANY
3435 Fullerton Chicago 47, Illinois

MAKE BIG MONEY LEARN TO REBUILD SEALED REFRIGERATION UNITS

LEARN NOW—WE TEACH YOU HOW
MILLIONS of Sealed Units will need rebuilding. Factories usual charge is \$80 to \$100 per unit. We offer a Post-Graduate Course (16 weeks) to graduates of schools or those with few years service experience. **START YOUR OWN BUSINESS.**
PRACTICAL TRADES INSTITUTE, Inc. WRITE TODAY
25 University Ave., S.E., Dept. P-9, Minneapolis 14, Minn.

Say You Saw It in
POPULAR MECHANICS

GREAR POWER TAKE OFF

GPW7257 (AMPHIBIOUS TYPE) FOR CIVILIAN AND MILITARY JEEPS
Mounts directly behind transmission. Provides a quick and ready means for auxiliary power use of the jeep engine.
\$34.50
BERG TRUCK & PARTS CO., INC.
1608 So. Wabash Avenue Chicago 16, Illinois

FREE JEEP PARTS CATALOG
1000's of Parts Listed. Wholesale Prices. Write For Your Copy Today!

**NEW for
1950**

MIDWEST

Celebrates its 30th YEAR of FACTORY-TO-YOU Selling with a Sensationally NEW 1950 LINE of

TELEVISION

CONSOLES and Complete CHASSIS

New GIANT 16" PICTURE TUBE

Here is Television at its finest! ... brought to you by Midwest, for 30 years a leader in the field of radio and electronics. Immense 151-square-inch screen on new 16" metal-glass tube ... clear, steady, bright pictures ... Synchronized sound and picture that a child can tune in perfectly ... Highest quality FM sound ... Big 12" Electro-Dynamic Panasonic Speaker. Available in beautiful Consoles or in complete chassis as illustrated (not a kit, but a complete Television receiver ready to plug in and play) to place in your own cabinet. And you can buy Midwest Television at Low Factory Prices, with Low Down Payment and Long Easy Terms — and on 30 Days Trial!



NEW LOW
Down Payment
Long EASY TERMS



LOW
FACTORY-TO-YOU PRICE
30 DAYS TRIAL

Not a KIT... This is a Completely assembled Receiver

... also a Magnificent Line of NEW 1950
MIDWEST RADIOS
featuring the latest Improved FM Circuit
and the New 3-SPEED RECORD PLAYER



Powerful new 1950 Series 16 and Series 12 AM-FM Radio in complete chassis. Also beautiful new Console models including the magnificent Symphony Grand Radio-Phonograph with latest FM circuit and new 3-Speed Automatic Record Player. New portable and Table Models also available.



BUY DIRECT FROM THE MIDWEST FACTORY and SAVE!

MIDWEST RADIO & TELEVISION CORP.

Dept. X252, 909 Broadway, Cincinnati 2, Ohio

SEND FOR
FREE
32-Page
Full Color
CATALOG



Write in Name and Address (Please Print) on Coupon or 1c Postcard.

MIDWEST RADIO & TELEVISION CORP.
Dept. X252, 909 Broadway, Cincinnati 2, Ohio

Please send me your new FREE 1950 Catalog.

NAME _____
ADDRESS _____
CITY _____ ZONE _____ STATE _____



MADE \$14 PER DAY While Still Learning

"By the time I finished half your course, I was making \$14.00 per day. I have made enough on the side to more than pay for the course."
T.E.H.—West Virginia

LEARN ELECTRIC APPLIANCE

We Teach REPAIR & SERVICE

How to Repair
Washing Machines
Vacuum Cleaners
Electric Ranges
Lamps, Motors
Irons, etc.
REFRIGERATION
and
House Wiring
**At Home
In Your
Spare Time!**

For a man handy with tools, and happiest when working with his hands, OPPORTUNITY is Wide Open Today in this great and growing field. Everyone is a customer for the man trained to service electric appliances.

OPEN YOUR OWN SHOP

Our practical HOME COURSE teaches you this business from A to Z—preparing you to take a well paid job or open your own shop. You can actually start in your basement or garage with the tools I send you . . . before finishing.

We Include An
**ELECTRICAL
APPLIANCE
TESTER**
A Big Kit
of Tools at
NO EXTRA COST

MAIL THIS COUPON for FREE BOOK

PACIFIC TRAINING SCHOOL
7217 So. Broadway, Dept. P-99, Los Angeles 3, Calif.

Dear Sirs: Please send me, without obligation, your free booklet and complete details.

Name

Address Zone

City State

TODAY'S "GOLD MINE" A REAL BONANZA!

SENSATIONAL INVENTION Proved All-time Best Seller!

Ends cleaning drudgery forever! This amazing Artmoore invention Fully Patented, scrubs, sweeps, mops, washes walls, waxes floors! No stooping or kneeling! Wrings automatically. Hands never touch water. Hundreds of thousands sold until war cut off materials. **NOW BACK AGAIN and Selling Faster Than Ever.** Former distributors ordering again in one, two and three gross lots. New dealers and distributors clamoring for rush orders. Hurry! GET THE FACTS ABOUT THE BIGGEST MONEY MAKER OF THE YEAR.

Exclusive Territory to Responsible Distributors and Crew Managers

Nothing so sensational in years! Guthmuller sold 21 in a single order. Boehme, took 20 orders from 17 customers. McIntyre cleared \$800 in one month. Many others producing top earnings of their lives. A chance for DISTRIBUTORS and CREW MEN to make similar sensational returns in EXCLUSIVE and PROTECTED territories. Mail coupon today!

A. L. MOORE, Pres., ARTMOORE COMPANY
Dept. 49, 1319 N. 3rd St., Milwaukee 12, Wis.

Rush full particulars about the New Art Cleaner, and details of your exclusive territory Offer for Distributors and Crew Men. No cost or obligation in getting the facts. No franchise is sold.

A. L. MOORE, Pres.
ARTMOORE CO., Dept. 49,
1319 N. 3rd St., Milwaukee 12, Wis.

Name

Address

City Zone State

National Advertising supports you

GOOD HOUSE-KEEPING
BETTER HOMES & GARDENS
FARM JOURNAL
POPULAR MECHANICS

Mail this for **FREE** Information

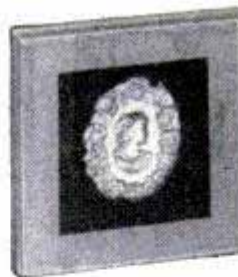

Sensational News! PLASTIC TILES, PLAQUES with INTAGLIO designs

Internal Carving Effects
Easy to Mold and Finish

NOW—at home, without special tools, make exquisite multi-color tiles and plaques, like internal carving but in a fraction of the time, and without the skill or work! It's easy with NEW, IMPROVED CASTOLITE, the "magic" liquid plastic. Easy pouring, quick-setting. Make hundreds of other things: embed real flowers, coins, medals. Make low-cost duplicates of expensive jewelry, novel paper weights, art objects, etc. Easy instructions show how. Make and sell at big profit. Send only 25c for picture-packed manual. Limited copies. Rush!
THE CASTOLITE CO., Dept. K-1 Woodstock, Ill.



STAMMER?

This new 128-page book, "Stammering, Its Cause and Correction," describes the Bogue Unit Method for scientific correction of stammering and stuttering—successful for 48 years. Benj. N. Bogue, Dept. 4914, Circle Tower, Indianapolis 4, Ind.



MAKE BIG MONEY!

Be a floor surfacing contractor and sand both new and old floors. Sanders are easy to operate and better still, you're your own boss. Write for latest "tell-all" booklet entitled "Opportunities in Floor Surfacing", enclosing 25 cents in coin or stamps to cover handling.

AMERICAN
FLOOR SURFACING MACHINE CO.
335 So. St. Clair Street - Toledo 3, Ohio

BE A DETECTIVE

WORK HOME or TRAVEL. Experience unnecessary. DETECTIVE Particulars FREE. Write to **GEO. P. M. WAGNER, 125 W. 86th St., N. Y.**

TOOL AND DIE DESIGN



FREE COPY of our catalog explains comprehensive 12 month course in tool or die design. Expertly planned curriculum. Highly individualized instruction. Housing, employment problems aided.

Write today for complete information.
TECHNICAL EDUCATION, INC. (Acme School)
Dept. PM, 2804 Belmont Chicago

Earn While You Eat!

Make extra money — sell our complete line of Restaurant Supplies to every eating place. Huge demand, quick profits, steady, permanent business. No investment, no experience needed. Write today for FREE Sales Kit.

MICHAEL LEWIS CO.

Dept. 91-PM, 408 S. Green St. Chicago 7, Ill.

What Is a Tachometer?

WHAT IS A TELEMETER? See Page 261

Say You Saw It in Popular Mechanics

HOW TO CUT RAFTERS

New vest pocket book gives lengths, side cuts, plumb cuts, deductions. For all rafters for any building from one inch to forty feet wide. Gives numbers to cut on square. Also degrees for same cuts for Radial Saws. All standard pitches from 1/4 to 5/8. Just open book to pitch page and there are your lengths, side cuts, etc. Anyone who knows what a Jack rafter is can frame a roof if he has this great book. Price \$1.50 prepaid. Builders' Topics, Dept. M, Lock Box 828, Seattle, Washington. CARPENTERS, PLUMBERS, PLASTERERS, ELECTRICIANS, ETC. subscribe for Builders' Topics, the monthly magazine for HE-MAN CONSTRUCTION WORKERS. Only \$2.00 per year. Sample copies 25c.

3-way vise holds work where you can reach it!

Saves time and work in welding, carpentry, cabinet making, home workshops, garages.

Why tie yourself in knots trying to reach work held in a vise? Set up work in any position in half the time with a W&H Visclamp. Holes on all sides make it easy to mount vise flat, on end or back.

Just the thing for precision work—all gripping and mounting surfaces are ground to .005 tolerance. Made from cast carbon steel with precision-cut screw. Weldclamp cast and fitted copper plated screw to avoid fusion.

Jaw opening: 3 1/2". Outside dimensions: 8" x 5" x 1". Wgt. 4 1/2 lbs.

Order today with understanding you'll receive money back if not 100% satisfied. No postage if cash accompanies order.

Terr. open—Agents

Visclamp machined to close tolerance \$7.75 Post pd.
Weldclamp cast with copper plated screw \$5.75 Post pd.

Send _____ Visclamp @ \$7.75
 _____ Weldclamp @ \$5.75
 Enclosed \$ _____ Ship C.O.D.
 Name _____
 Address _____
 City _____ Zone _____ State _____

Williams and Hussey Machine Co., Inc.
 Box P, Wilton, N. H.

HOURS of EXCITING FUN BUILDING REAL-LIFE REPLICAS...

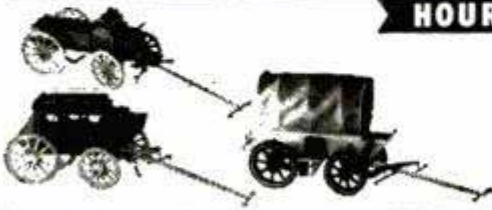

It's fun! Try your hand at these famous scale model souvenirs of early settler days. Complete kits with authentic miniature details, precision cut parts. Order now—save at combination prices.
 Buckboard Kit . . \$1.00 (Plus 15c postage)
 Stage Coach Kit . \$1.50 (Plus 15c postage)

HANDY BUILDER'S TOOL!

New long-nose Glue Gun puts a daub of cement just where you want it—tight corners, edges, etc. 75c Postage 15c (With any kit order, postage free)
 Covered Wagon Kit . . . \$1.50 (Plus 15c postage)
 All 3 for Only \$3.75 (Plus 25c postage)

HOLLYWOOD MODELS Dept. 4, Post Office Box 389, Burbank, California

JET PERFORMANCE FOR YOUR CAR WITH VAPOJET



This aircraft developed water-oil vapor injector gives your car faster pick-up, smoother running power and eliminates carbon, vapor lock and overheating. Many users of the new Vapojet report up to 25% more mileage per gal. of reg. gas. Complete, easily installed kit fits all car, tractor or boat engines. Agents wanted.

MONEY BACK SATISFACTION GUARANTEE
 (If returned within 30 days)

Order today. Only \$9.75 ppd. Send check or money order & save postage. \$1 deposit on C.O.D.

VAPOJET MFG. CO., 11424 Biona Dr., Dept. PM-9, Los Angeles 34, Calif.

MAIL COUPON TODAY
 Rush me _____ Vapo-Jet Kits including carburetor adaptor, copper tubing, fittings, etc. and illustrated instructions. Enclosed is my check or money order for \$ _____
 Name _____
 Car _____ No. of cyl. _____ Year _____
 Street _____
 City _____ State _____

Buy the Best... WISS!

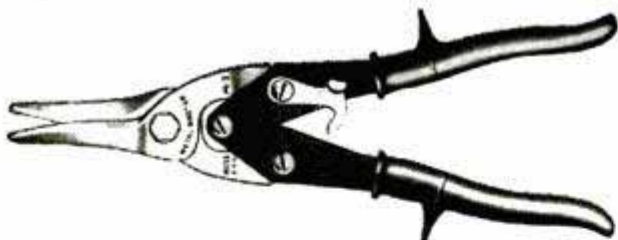

WISS Metal Master Compound Action Snips

#M-3. Easily cut 18 gauge. Cuts curves and circles as well as straight. Ideal for the home workshop. \$4.25. Rubber grips recommended, 60c extra.

WISS Straight Cut Snips

#9. Crucible steel inlaid blades. The basic snips for straight metal cutting. Gun metal handles. Overall length 12 1/2". \$4.25.

WISS Combination Snips

#V-13. Solid steel, gray japanned handles. Cuts curves and irregular shapes with ease. Handy pocket size, 7" long. Accurately tempered jaws and strong bolts. \$1.75.



Prices slightly higher Denver and West



Quality for more than a Century

J. WISS & SONS CO. • NEWARK 7, N. J.
 SEPTEMBER 1949



"GET ON," Uncle Sam's PAYROLL

START as high as \$3,351 Year

Prepare NOW For Next Examinations

VETERANS GET SPECIAL PREFERENCE
 Railway Postal Clerks
 City Mail Carriers
 City Postoffice Clerks
 Stenographers-Typists
 Liquor Inspectors
 Messengers, Etc.

40-Page Book on Civil Service FREE.

Mail Coupon today—SURE

FRANKLIN INSTITUTE

Dept. T84
 Rochester 4, N. Y.

Rush to me, entirely free of charge, 40-page book with: (1) A full description of U. S. Government jobs; (2) A list of U. S. Government jobs; (3) Tell me how to qualify for a job.

COUPON
 Name _____
 Street _____
 City _____ Vet? _____

NEEDLESS TO PAY MORE RISKY TO PAY LESS

TUBE GIVEN WITH EVERY TIRE



Why Pay More?

EVERYONE
TAKE 10% DISCOUNT
ON ALL TIRES

OUR TIRES must make good or WE WILL
If You Want SAFE TIRES

Be Wise—See Us Before You Buy
Our Experience Insures Your Safety

You get what we advertise
Highest Quality Lowest Prices
HIGH ORIGINAL TREADS Slightly Used
BUY IN CONFIDENCE safe dependable
selected POPULAR BRANDS—Guaranteed
to give A-1 SERVICE. These tires are
absolutely NOT Re-caps or Re-molds.

REMEMBER: Tube SENT with EVERY tire regardless of QUALITY — PRICE — or GRADE

SELECTED FOR TOUGHEST JOBS Not just good... THE BEST
These are genuine Values! One Trial will CONVINCE YOU

TOPS IN VALUE		TOPS IN SAFETY	
600-16 \$5.02	650-16 \$4.72	700-16 \$6.02	750-16 \$6.02
650-15 4.72	700-15 5.02	750-16 7.62	

World's Best Truck Tire Values Top Service Minimum Prices			
6.00-20(6) \$9.22	7.50-20(10) \$13.92	11.00-20(12) \$16.42	
6.50-20(6) 9.22	8.25-20(10) 15.52	11.00-22(12) 18.42	
7.00-20(8) 10.52	9.00-20(10) 15.52	32x6 (8) 10.02	
7.50-20(8) 10.52	10.00-20(12) 16.22	32x6 (10) 12.82	

750-20 MILITARY 8 PLY REGULAR \$9.62—SUPER \$12.92
900-16 MILITARY 8 PLY REGULAR \$8.72—SUPER \$10.92
ONE QUALITY THE BEST AVAILABLE

HERE'S MAXIMUM QUALITY IN THESE O.K. SAFE TIRES

600-16 ... \$3.42	650-16 \$3.62	700-16 \$4.42
650-15 3.62	700-15 3.72	750-16 5.62

6.00-20(6) \$7.72	7.50-20(10) 9.02	11.00-20(12) \$13.42
6.50-20(6) 7.52	8.25-20(10) 11.02	11.00-22(12) 15.92
7.00-20(8) 9.02	9.00-20(10) 11.62	32x6 (8) 9.02
7.50-20(8) 8.02	10.00-20(12) 12.22	32x6 (10) 10.92

OUR SPECIALTY—TIRES FOR SCHOOL BUSES AND AMBULANCES

Thousands of Tires Shipped to Satisfied Customers Throughout United States and Many Distant Points. Please Note: We've made Thousands of Friends by giving a Tube with Passenger and Truck Tires. MAIL ORDERS given Personal Attention—Send This Ad with Check or Money Order. Dep't. 2

STANDARD 834 N. Broad St., Philadelphia 30, Pa.

ELECTRIFY your SEWING MACHINE



NEW REDUCED PRICE
\$12.95

1 YEAR GUARANTEE ON MOTOR AND CONTROL

Now, make mother's or wife's sewing a pleasure. Easy to install. Fits ALL machines.

- Motor & Bracket
- AC-DC 60c. 115v.
- PULLEY & BELT
- 7 Speed Foot Control
- Cord Set
- Complete Instructions

SEND NO MONEY, pay postman plus C.O.D. or enclose money order and we will pay postage. MONEY BACK on kit after five days if not completely satisfied. Shipping Wt. 6 lbs. State whether wheel on your machine turns towards or away from you.

LUGGAGE CARRYING CASE \$9.95
Specify base width, length and make of your machine. Wt. 11 lbs.



FREE CHROME plated SEW-LITE (as illustrated) completely eliminates eyestrain.

CONTINENTAL SALES CO.
Dept. PM3, 83 Graham Ave., Brooklyn 6, N. Y.

Special Offer to Ford-Mercury Owners '41-'48 Incl.



FENDER GUARDS — \$4.00 a set
Add beauty and protection from gravel, etc. with a set of high-polished Stainless Steel fender guards.

AVAILABLE FOR IMMEDIATE SHIPMENT.

AKRON METAL STAMPING, INC.
2705 Wingate Ave.
Akron 1, Ohio

Gentlemen: Please send me one set of Gravel Guards for my _____

(year and make of car).
Enclosed find check or money order for \$4.00.

STEP OUT FOR EASIER WINDOW WORK WITH

WINDOSTEP



Makes all outside window work easy & enjoyable!

SAVES TIME • SAVES MONEY
SAVES LADDER-LIFTING!

HELPS YOU Wash windows . . .
Hang screens, storm windows & awnings . . . Paint, putty & repair.
IT'S STRONG . . . Supports 1000 lbs.
IT'S STURDY . . . Has steel rail & wood platform.

IT'S PORTABLE . . . Easy to carry
Weights 11 lbs.

IT'S AUTOMATICALLY
GRAVITY LOCKED to window
sill from inside. (It's installed from inside.)

IT'S GUARANTEED

Or Your Money Back!
Low priced, only \$9.85
Plus C.O.D. & P.P. or \$10.50
Prepaid. Add 50c west of
Rockies. Dealer Inquiries
Invited. Patent Pending

MORRISON CRAFTERS INC.
711 Miami St., Toledo 5, Ohio

ORDER TODAY!

For Better Housekeeping, Your Home needs a WINDOSTEP!

HANDY POCKET SIZE PLANE

DOES WORK OF BIG ONE

Precision made. Easy to grip as big one. 3 1/4" x 1 1/4" face. Can't be beat for fitting and finishing. Pat. extension handle. A "must have" for hobbyists etc. Blade guaranteed to hold edge. Cash with order, ppd. COD postage extra. Order today! \$1.95.



SPEEDCOR PRODUCTS

512-P N. E. 73rd Ave. Portland 16, Ore

LEATHERCRAFT COPPER TOOLING TEXTILE PAINTING

Make your spare time PROFITABLE. Send today for FREE illustrated catalog showing everything you need. KIT KRAFT, 7377 Melrose Ave., Dept. AD-9, Los Angeles 46, Calif.

RADIO ENGINEERING. Broadcasting, Television, FM, Servicing, Electronics, Aviation, Marine & Police Radio taught thoroughly. Engineering course equivalent to 3 years' college radio work. Approved Veteran Training. Catalog free.

VALPARAISO TECHNICAL INSTITUTE, Dept. D, Valparaiso, Ind.

INVENTORS : CRAFTSMEN We Want Ideas

- Novelties
 - Playfield Design
 - Gadgets of All Kinds
- We are manufacturers of Amusement Machines; Pin Balls and Gadgets of All Kinds and are continually inviting inventors for their ideas. If you have such an idea acceptable by us you can turn it into cash. We are a large reputable firm. Address your letter to
Box 101
Forest Park, Ill. Write Today

LOOK! It's New!

MECHANICAL TYPEWRITER ERASER



New all aluminum mechanical typewriter eraser. Convenient 5 1/2" pencil shaped holder. Replaceable slim eraser for letter-width erasures. Works like magic on any number of carbon copies as well as originals. Thumb-pin control for instant supply of fresh eraser. Smart royal blue finish. ONLY \$1.00. Send check or money order. Extra refills \$.25 per tube of 4. SATISFACTION GUARANTEED

STUDWELL PRODUCTS CO., Dept. P
70 EAST 45TH STREET, NEW YORK 17, N. Y.

ONLY
\$1.00
Postpaid

WORK SHIRT BARGAIN

SURPLUS STOCK FROM MID-WEST SUPPLY FIRM!

What a buy! These sturdy, serviceable work shirts, though used, have been washed, sterilized and put in perfect condition. Every shirt is cut from durable wash materials, choice of blue or tan. Well made with reinforced stitching at strain points. Order today at our risk! Money-back guarantee!

69¢

3 for \$1.79

SEND NO MONEY! Just send name, address, neck size and color choice. Pay postman plus postage or send cash and we ship prepaid. Inspect 10 days. Return for refund if not delighted!

WORK PANTS TO MATCH 99¢

Send waist measure and leg length

COVERALLS \$1.49

Send chest measurement

MILCO SALES, Dept. M-2 9350 Roselawn, Detroit 4, Mich.

MAKE SELL TELESCOPING CLOTHES LINE PROPS

Sure Fire, Practical, Durable, Simple Construction, Made of Wood, Adjusts to any height and locks automatically. Costs approx. 30¢ easily retails at 98¢. THOUSANDS OF CUSTOMERS EVERYWHERE. Send \$6.95 for a complete set of working drawings, FULL SIZE SAMPLE, (except lgth.). Instructions, Newspaper Mats, Cards, Circulars, Sales Plans. BE FIRST. Send M.O., Check, C.O.D. Postage extra. Write today.

E-Z SALES CO.

Dept. A., P.O. Box #232, Sta. A St. Petersburg, Fla.

\$100.00 PILOT'S OXYGEN KIT (WAR SURPLUS) only \$7.95

Outfit includes 6 x 24 inch lightweight, shatterless breathing oxygen steel bottle; canvas case; demand type regulator with 0-500 gauge and type A10 mask with hose. Net weight 7 lbs. Regulator automatically delivers what oxygen you demand when you breathe into mask. Complete kit, empty \$7.95. Same but filled with oxygen (express only) \$2.00 extra. Unused condition. AERO PARTS SUPPLY, Dept. PM9, Municipal Airport, Houston, Tex.

Say You Saw It in Popular Mechanics

Hobbyist Catalog

64 pages
WE PAY POSTAGE!
 SHIP MODELS . . . TRAINS . . . PLANES
 Cars . . . Art Supplies . . . Tools . . .
 Projects . . . Games.
 U.S.A. and Canada Orders Only.

10¢ write **Braun-Craft**
 1232 ETOWAH, DEPT. PM-2, Royal Oak, Mich.

END GENERATOR REGULATOR BATTERY TROUBLE!!

REPLACE YOUR VOLTAGE REGULATOR WITH AMAZING WATTAGE REGULATOR
 The greatest advancement in Auto-ignition since the self-starter . . .
 DRIVE WITH OR WITHOUT YOUR BATTERY. GUARANTEED 100,000 MILES OR ONE YEAR. WRITE FOR FREE CATALOG TODAY.

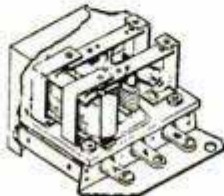

Scientific Electric Co. P. O. Box 2162P Sta. H Cleveland 8, Ohio



Step Up to TOP PAY in

AUTO SERVICE Management

Auto Mechanics!

Station Owners!

Get This Sensational Book — Learn How to Make More Money in Service Work

Here it is! A big 478 page book of vital facts! This is the book that will put you right out in front in the business end of auto service station operation. It tells how to organize a business—how to get the necessary capital—what equipment you need and how to get it—how to get business and hold customers. It tells you what to do—when to do it—how to do it—how to make money as a service shop, garage or station owner or as a manager in charge for others.



A Few of the 48 Chapters That Show You How to Make Money and Keep What You Make!

- Your Own Shop
- Financing Your Business
- Choosing Your Location
- Exterior Layout and Appearance
- Interior Arrangement
- Advertising and Promoting Your Shop
- Services to Feature
- Sources of Business
- Where to Buy Tools and Equipment
- Building Goodwill
- Meeting the Customer
- Selling Service
- Figuring Service Prices
- Increasing the Average Sale
- Follow-Up on Jobs
- More Profitable Buying
- Managing Your Stockroom
- Employing Helpers
- Expense Control

All The Methods of The Successful Operators

"Know how" and mechanical skill are important in auto service work. But to get full pay for your efforts—to succeed as a "boss"—or make money as an owner—you must know the facts of management too, and "Automobile Service Management" is the only book that will give them to you. Get this great book today, with 223 illustrations, charts, tables and 478 pages of the most valuable information that will insure your business success. It is the combined experience of hundreds of outstanding shop operators, arranged for quick reading and easy use and can easily be worth many hundreds of dollars to you.

5 Day Trial — Money Back if Not Satisfied

Mail the coupon. Send no money if you prefer for we will send C.O.D. anywhere in U.S.A. Use book 5 days and if not delighted, return by mail and we will promptly refund purchase price. Goodheart-Willecox Co., Inc. (Publishers of Dyke's Famous Auto Book), 1321 S. Michigan Ave., Chicago.

Mail Coupon for Examination

GOODHEART-WILCOX CO., Dept. 516
1321 S. Michigan Ave., Chicago 5

Send Automobile Service Management subject to 5 days approval. If not satisfactory I will return book and you are to refund my money.

- I enclose \$5.00 for postpaid delivery.
- Send C.O.D. I will pay postman.

Name _____
 Address _____
 City _____ State _____

WhiskER®

THE ELECTRIC SHAVER THAT'S
SOLD BY BARBERS



ONLY
\$12.95
RETAIL

Now! Smooth, Close Shaves . . . For the Man Who
Shaves Once a DAY — or, Once a WEEK

Barbers know a good shave when they see one. That's why they recommend and sell WhiskER. WhiskER whisks away any length beard, clean as a whistle, without pulling or stalling. It uses a time-tested hair clipping principle, with an extremely close-shaving blade. Operates quietly on 110 v, 60 cycle AC; no radio interference. See your barber (or beautician), or send check or money order direct to factory. Money back if not delighted after 5 day trial.

MADE BY WELL KNOWN MANUFACTURER OF
QUALITY BARBER AND BEAUTY TOOLS

. . . that's your guarantee of a precision product and long, satisfactory performance. Ladies: Buy WhiskERs at your favorite beauty shop for gifts or for personal depilatory use.

ELECTRO TOOL CORPORATION
DEPT. W529-J • RACINE, WISCONSIN

BE AN AUTO MACHINIST



Practical Shop Training
Learn to operate the very latest shop machinery. Friendly instructors take a real interest in preparing you for a good job.

Draw Top Pay • No Job Worries

Earn more money in auto mechanics—Specialize! New FREE booklet tells how to prepare for good jobs with high pay and job security. Our modern equipment and practical instructions make it easy to learn—get experience in

**ENGINE REBUILDING or
GENERAL AUTO MECHANICS**

Job
Placement
Service
FREE

VETERANS
American is a G.I.
approved school.

PLANNING
YOUR FUTURE IN
AUTO MECHANICS

WRITE TODAY FOR
FREE BOOKLET

AMERICAN TRADE SCHOOL
2411 McGee Kansas City, Mo.

ATTENTION FOOTBALL FANS . . . HUNTERS!

SAVE UP TO 50% THE WORLD'S
Greatest VALUES
in BINOCULARS



Add 20%
Fed. Tax.
Postage
Included

BRAND NEW, DELUXE LEATHER
cases. Never before at these prices!
OFFER IS LIMITED

6 x 25	\$24.00	with Coated Optics	\$30.00
8 x 30	30.00	with Coated Optics	38.00
7 x 50	49.00	with Coated Optics	48.00
10 x 50	52.00	with Coated Optics	52.00

Many other models. Largest stock in the West.
ORDER TODAY! Send check or money order. \$2.00
Deposit on C.O.D.'s. **MONEY-BACK GUARANTEE!**
Free Booklet "HOW TO SELECT BINOCULARS"

SIX POWER Pocket Binocular

WITH DELUXE LEATHER CASE. LIGHT • COMPACT • TAKE IT EVERYWHERE • 6 x 15 with COATED OPTICS. Weighs only 4 ounces! Size: 2 x 3 3/4 inches. A high quality prism binocular (German design) with precision ground achromatic lenses. Field of view: 370 feet at 1000 yards.

MADE TO SELL FOR \$29.95 **ORDER TODAY!**
BUSHNELL IMPORTERS Dept. M9, 43 E. Green Pasadena 1, Calif.



Only \$18.00...

with Coated Optics \$22.00
Dept. M9, 43 E. Green
Pasadena 1, Calif.

INCREASE SAW SHARPENING PROFITS!

Sharpens
Saws
5"–30"



REYNOLDS CIRCULAR SAW GRINDER
Produces top quality results in fraction of time usually necessary for resharpening, jointing, gumming and tooth forming. Any hook or pitch of tooth and depth of cut is quickly adjusted. Both hands are free to control position of saw while grinding. Write now for free circular!

PROVIDENCE SAW & KNIFE COMPANY
Ship & Eddy Sts. Providence 3, R. I.

NOR'WAY ANTI-FREEZE (R) gives your car the most winter protection at the lowest cost! Extra strength makes Nor'way last longer, means safe, sure protection with only an occasional check-up! No disagreeable odors with Nor'way! Special anti-rust ingredients prevent corrosion of all cooling system metals!

Genuine Swiss **STOP CHRONOGRAPH** \$9.95

Tax included

Sensational watch value with 2 button stop and start for accurately timing races, etc. Also measures speed and distance. Metal stretch band. Radium dial. Sweep second hand. Satisfaction guaranteed. **FREE** handsome plastic gift box given. Send only \$9.95 or order C. O. D.

MARVEL JEWELRY CO. DEPT. C-22
501 Pine Street St. Louis 2, Mo.



Happy Highways Ahead!

With Popular Mechanics new **MOTORIST'S HANDBOOK**. 160 pages of authoritative advice to keep your car rolling smartly—longer. Brakes, body, spark plugs, battery, starter—every automotive part is covered in this up-to-the-minute manual of year 'round driving pleasure.

Your news dealer has the 60c paper edition. Order the clothbound \$2.00 volume from

POPULAR MECHANICS PRESS
200 E. ONTARIO ST. CHICAGO 11

SAY YOU SAW IT IN POPULAR MECHANICS

Build Your Own Motorized Workshop

This Famous Book Shows How to DO IT!



NEW EDITION

Easy-to-Make 40 Different Power Machines

Make them yourself—lathes, drill presses, sanding machines, shaper, circular, band and scroll saws and other power tools— from wood, pipe, and discarded parts that cost little or nothing. Get the new edition of "Forty Power Tools

You Can Make" even though you have the older edition. This new book has 20 new tools. Make yourself up-to-date, efficient power machines that will save you hundreds of dollars. Send \$1.50 with order and save high C. O. D. charges. Your money back if not satisfied.

POPULAR MECHANICS PRESS, 200 E. Ontario St., Chicago 11, Ill.

EXTRA VALUE Here Are Terrific Bargain Values for You While Our Present Stock Lasts

"MARK-TIME" TIMER SWITCH—You set it and current is turned off automatically. Calibrated in minutes up to 1 hour. Excellent for Sunlamps, Radios, Beaters, Washing Machines, etc., etc. Und. Lab. \$2.95 post-rated at 10 Amp. 125 V. A \$5.50 value.

DOUBLE ACTION MICRO SWITCH—Double pole, either normally open or normally closed, or both circuits at one time. Rated at 10 Amp. load on house current.

RED & GREEN LIGHTS FOR AIRCRAFT, BOATS, TRUCKS, etc.—Takes standard 6, 12 and 24 volt bayonet base bulb.

2 UNITS, 1 RED & 1 GREEN FOR ONLY \$1.00 post-paid

INSTRUMENT SPOT LIGHT—Cadmium plated brass construction—Swivel base mounting—Takes standard bayonet base, single contact bulb. **3 for \$1.00** post-paid

60 FOOT SHIELDED POWER CABLE—2 conductor No. 12, stranded copper cable. Heavy extension cord type rubber cover overlaid with diamond braid, cadmium plated steel shielding. Weather-proof outlet box each end and expensive weatherproof plug for each included free. **\$3.50** Add postage for 15 lbs.

BIG LENS AND MOTOR ASSEMBLY VALUE

FAIRCHILD K-8 SIGHT ASSEMBLY—Contains 3 fine lenses, one of them 8.9-52 mm diameter, 91 mm focal length.

2 MOTOR GENERATORS—Ball bearing, and easy to convert to dandy 110 V. AC motors.

Also many other parts. All brand new and packed in plywood case. **All for \$7.50** Add postage for 44 pounds.

When you order ask for our free catalog and be on our mailing list for future valuable bargain offerings. You may include only 20% plus postage (unless postpaid) and we will ship balance C.O.D. We suggest that you include full amount and save the C.O.D. charges. We Guarantee Full Satisfaction or Money Back on anything returned within 15 days.

DIRECT SYSTEM CORP., 62 Gill, Buffalo 13, N. Y.

SLASH TILLAGE YOUR COSTS!

—with the SEAMAN ROTARY TILLER

New, fact-packed book "Benefits of Rotary Tillage" tells you how and why.

Send for it—right away!

SEAMAN MOTORS, INC. 364 North 25th St. Milwaukee, Wis.

ACCURATE 18 INCH WOOD LEVEL FOR ONLY \$1.00

NEVER OFFERED BEFORE AT THIS LOW PRICE! Full size. Carefully machined. Walnut stain or natural blond finish. Two securely set vials—1 level and 1 plumb, brass protecting plate and hand grip. Sent postpaid anywhere in U. S. on receipt of cash or money order.

Also 12 inch Model—50c postpaid

Mfg. by **JOHNSON PRODUCTS CO.** 136 S. First St. Milwaukee 4, Wis.

LUMINOUS HOUSE NUMBERS

6735 Glow in the dark

New Quick Selling Money Maker

Here is a sensational MONEY-MAKER... Needed by every home owner and places of business. Why grope around in the dark looking for numbers on the house. Use Luminous House Numbers.

"PAULITE" Phosphorescent Polystyrene

This NEW development combines a method and formula to secure the maximum initial GLOW as well as the longest AFTER GLOW from phosphorescent pigments with certain plastics. Activated by daylight for the night.

BEAUTIFUL VIOLET-BLUE BACK GROUND PANEL

The daylight color is IVORY and the afterglow is a beautiful Violet-Blue. Its amazing brilliance can be seen at great distance with 3 inch numerals or letters. We prepare and process each panel so that it is delivered complete ready to use. Four screws complete the unit.

OUTSTANDING BRILLIANCE ACTIVATED BY DAYLIGHT

QUICK EASY ORDERS FROM SAMPLE

These New Luminous House Numbers sell like hot cakes. Home owners are enthusiastic... Nothing like it... Simply show the sample and orders are QUICK and EASY. We deliver to your customer. **\$10.00, \$20.00, \$30.00** a day possible.

AGENTS WANTED IN EVERY LOCALITY NOW

We want wide-awake Agents in every locality. GET CHOICE TERRITORY NOW. The particulars are FREE. A Post Card will do.

NEO-ENTERPRISES WRITE TODAY

6735 No. Clark St. Dept. P-9 CHICAGO 26, ILL.

MAKE BIG MONEY AT HOME IN SPARE TIME

CASH IN ON HUGE XMAS DEMAND FOR METALIZED BABY SHOES



\$5 PER HOUR —for just your SPARE TIME hours. Think how this can multiply when the whole family helps.

START MAKING \$\$\$ AT ONCE —No long period of tedious training. I send you everything you need to start earning the VERY FIRST DAY.

PAY DAY EVERY DAY —With YOUR OWN fascinating BIG PROFIT Metalizing Business. Hire others to work for YOU. Watch PROFITS grow. Millions of NEW PROSPECTS yearly.

A FEW CENTS BRINGS MANY \$\$\$

Just think—a BIG PAY Business of YOUR OWN. Double your Income. Be ready for HUGE XMAS demand. For FREE details on the Opportunity of Your Lifetime MAIL COUPON TODAY!

FREE!

MONEY MAKING PLAN

Works Like Magic!

Try It At Our Risk

MAIL COUPON TODAY!

John Kiktavi, KIKTAVI CO.
Dept. PM-9, 2111 W. Manchester, Los Angeles 44
O.K.—as long as it's FREE tell me about it.

NAME _____

STREET _____

CITY _____ ZONE _____ STATE _____

\$100.00 A DAY

Yes! \$100⁰⁰ a day!

Sensational "walk-in, walk-out" 10-second demonstration makes possible 30 to 50 calls a day. Sell 1 out of 3 for a daily profit of \$100 or more.



Spectacular Invention

You write on glass in 5 colors with "Magic Crayon." Then watch letters "catch fire" and burn like brilliant Neon! Merchants amazed... snatch crayon out of your hand... start writing themselves! NOTHING BEFORE LIKE LITEWRITER PROFITS ever thrilled salesmen.

Rush Coupon for FREE Offer on the most Breath-taking Money Maker of the Day!

Salesmen, Distributors, Crew Managers try out Litewriter for one day — then drop everything for this astounding money-maker. It's patented — hence exclusive with Maxilume men. No competition. Quick sales come easy. Many merchants buy three or four. Many salesmen close 1 out of 3 demonstrations. Don't waste time. Wire, phone or airmail name for facts. ALL FREE. If you have crew, ask for Exclusive Territory information. This is the biggest thing of the year. Don't miss it!

L. B. Patterson, MAXILUME CO., Dept. L-89, 125 W. Hubbard St., Chicago 10, Illinois

Rush complete information on Litewriter, Free Selling Kit, Free offer of Demonstrator and instructions for making "walk-in, walk-out" demonstration. No charge now or at any other time.

Name _____

Address _____

City _____ Zone _____ State _____

ELECTRIFY your SEWING MACHINE

★
Guaranteed by
Good Housekeeping
IF NOT AS ADVERTISED THEREON

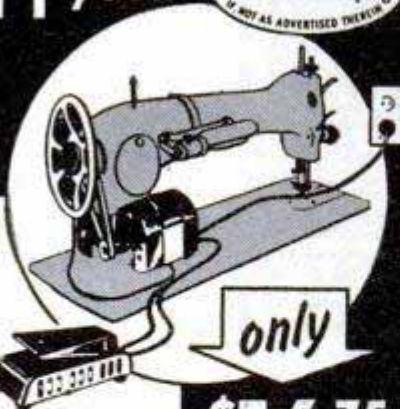

Ideal gift for
Mother, Wife, Sister

NEW
Improved
Brownell

only

\$16⁷⁵

SEWING MACHINE MOTOR KIT

- EASILY ATTACHED IN SECONDS!
- ANYONE CAN DO IT!
- COMES FULLY WIRED & CONNECTED!
- 1 YEAR GUARANTEE ON ALL PARTS!

YOU GET ALL THIS! Powerful Universal AC-DC motor, rheostat that holds to any desired speed, steel pulley, rubber belt, extension cord with plug and double socket, mounting bracket, simple instruction sheet. All parts brand new.

GIFT LAMP, TOO! U. L. Approved sew machine electric lamp, \$2.75 value, given with each order at no extra charge.

COMPLETE WITH
GIFT SEW LIGHT
ILLUSTRATED

ANY MAKE,
no matter how
old, converted to
modern electric
machine.

FREE 10-Day Trial Offer Coupon

BROWNELL DISTRIBUTORS, INC., Dept. EM-7
308 Canal St., New York 13, N. Y.

Rush me your sewing machine motor kit at \$16.75 complete with gift lamp. Make of my machine is.....

.....
Handwheel turns toward me away from me.
 Send postpaid. I enclose \$.....
 Send C.O.D. I'll pay postman \$16.75 plus C.O.D. fee,

Name

Address

City: Zone: State:

If not fully satisfied, I may return kit in 10 days for refund.

Reduce RADIO NOISES

NEW CLEAR-TONE LINE-NOISE ELIMINATOR
SIMPLY PLUG Radio or Appliance cord into Noise Eliminator & plug into wall socket. Enjoy reception FREE from many distracting noises. Send No Money, pay postman \$1 ea. (2 for \$1.75) plus postage or send cash & we'll mail postpaid. Try 5 days, money back if not delighted. RAND SALES, 688 Lee Street, Dept. A, Des Plaines, Ill.

PISTON TYPE COMPRESSOR



EASY PROFIT IN PAINT SPRAYING

Paints walls, ceilings, screens, furniture and machinery faster, better. All complete as shown less motor. Carry anywhere. Fully guaranteed. Could be used with 1/4 H.P. motor or less. Price \$35.00 less motor F.O.B. Chicago. \$5.00 deposit balance C.O.D. or see your dealer. With motor \$55.00.

IDEAL AUTOMATIC PUMP CO., Dept. P.M. 8
801 W. Washington Blvd. Chicago 7, Ill.

Say You Saw It in
POPULAR MECHANICS

Boy! What a Picture!

And boy, what a book is Popular Mechanics new PHOTO HANDBOOK. Gives you the big three of superior photography:

1. The secret of taking better shots.
 2. The technique of clearer developing.
 3. The way to build better photo equipment.
- Be an expert! Have fun! Save money!

Paper covered edition on all newsstands..... 60c
Order colorfully bound library volume from
POPULAR MECHANICS PRESS..... \$2.00
200 E. ONTARIO ST. CHICAGO 11

We can't



STOP THE PRESSES!

There's so much demand for the practical "how-to-do-it" books published by Popular Mechanics Press! The big fall list contains one or more fascinating and profitable books for every one of the family.

4 NEW BOOKS

4 ANNUALS



Money-Making Hobbies. Shows 132 ways to earn extra income! Hundreds of useful and beautiful things to make. 160 pages. On Sale Now! 60c.

Shop Notes. 1950 edition of an old favorite for men who use tools. A manual of time and labor-saving hints. 240 pages. \$1.00. On Sale Now!



Short Cuts to Better Housekeeping. No other book like this! 1000 ways to save your time, labor and money. 160 pages. 60c. On Sale Sept. 15.

What to Make. Vol. 11 of this famous series of best projects from Popular Mechanics' Craft articles. 240 pages. \$1.00. On Sale Sept. 15.



Christmas Handbook. Gifts you can make, decoration ideas, how to make Xmas cards, hints for entertaining, etc. 144 pages. 60c. On Sale Oct. 1.

Home Kinks. Popular Mechanics annual collection of short cuts to home repairs and maintenance jobs. 112 pages. 35c. On Sale Oct. 15.



Planning Your Home Workshop. Sam Brown reveals secrets of getting the most out of your workshop. 128 pages. 60c. On Sale Oct. 15.

Useful Ideas. Another famous PM annual with helpful hints for homemakers, gardeners, mechanics, sportsmen, motorists. 112 pages. 35c. On Sale Nov. 15.



Get these helpful books at your favorite newsstand. If not available, write—

POPULAR MECHANICS PRESS
200 East Ontario Street
Chicago 11, Illinois

15 JEWEL STOP WATCH

U. S. AIR CORPS SURPLUS



Genuine Elgin 15 Jewel movement. Ideal for split second timing in racing, sports, time study, etc. Full sweep split second hand graduated in 1/10th seconds. Stem wind, start, stop and reset. Used but guaranteed perfect.

Wgt. 1 lb.
No. 200—Each..... **\$9.95**

MESS HALL BENCHES

WAR SURPLUS



For picnics, social gatherings, clubs, lodges, etc. Used but perfect. Hardwood top 9 x 72 inches, seats 4 or 5 people. Folding type angle iron legs with metal brace and lock. Best and cheapest seating you ever bought for this money. Weight each 25 lbs. Stock No. 440. Each... **\$2.48**
10 or more, Each.... **\$2.00**

RUBBER OVERBOARD SUIT



Here is a buy! Fits over your regular clothes and shoes. Can be cut apart for waist high waders, hip high or knee high boots, also arm length rubber gloves. Heavy gum rubber over fabric. Fine for commercial fishermen, sewer diggers, etc. Use it as is or cut it up for waders. All brand new! Wgt. 14 lbs. **\$4.95**
No. 183, Each.

Please include 75c for postage.

TRAILER UNDER-CARRIAGE



OVERSIZE TIRES

Build your own trailer for boat, camping gear or delivery service. Fitted with 26 x 2.125 U. S. Royal Tires. Motorcycle type wheels. Solid steel axle, leaf type springs and body mounting brackets. All brand new! Hitch not included. Folds to fit trunk of car. Shipped express collect only. **\$18.95**
No. 199, Ea.....

ALL PURPOSE LIFE PRESERVER BELTS



Brand new! Guaranteed water tight. Use them at the beach on the shore or in the water. Tie together for rafts. Use as canoe stabilizer. Belt consists of two air chambers. Inflate automatically with Sparklet cartridges or manually with attached hose. A real bargain at this price. No. 1261. Each..... **\$1.00**

NUCLEAR "GEOIGER COUNTER" SNIFTER



For locating radioactive minerals. A scientifically designed, highly sensitive instrument incorporating a Geiger counter. Detects most radiation, no matter how deep the deposit may be. Government rewards available now for locating uranium deposits. Simple to use. Audible clicks indicate presence of radioactive substances. Headphones and batteries included. Weight only 2 lbs. Brand new and guaranteed. Stock No. 527. Each complete **\$54.50**

7 LB. EXPERIMENTER PARTS ASSORT. KIT



Valuable radio and electronic parts by weight—resistors, trimmers, condensers, capacitors, etc., plus stamped out metal chassis. Shipped in chassis form with parts ready to demount as needed. A real bargain surprise package. No. 130R—7 lbs. **\$1.79**
No. 130Y—**\$2.95**
12 lbs.

MESS KITS, CANTEENS, ETC.

Regulation two-piece Army Mess Kits with folding handle. Used, but perfect. Weight 2 lbs. No. **69c**
A116—Ea..

CANTEENS

Reg. U. S. issue canteens. Plastic screw top chained to body. Slightly used but perfect. Wgt. 1 lb. 117—Metal **69c**
118—Plastic—Ea.

CANTEEN CUPS

All metal. Folding handle. Wgt. 1 lb. No. A120—Each... **25c**

CANTEEN COVERS

Heavy canvas. Button fastener. New No. 530—Each... **69c**
Used No. 119—Each..... **35c**

U.S. Govt. BOLO KNIFE



Extra heavy. For farm, home or jungle use. Blade of Govt. formula cutlery steel. Walnut riveted handle. 3 1/2 inch hilt. 10 1/2 inch blade. You'll find hundreds of uses for a Bolo knife. Blade will take and hold a keen cutting edge. Wt. 2 lbs. A112—**\$2.95**
with Army Sheath

WIRE CUTTER



Heavy duty, compound leverage. Cuts up to 1/4 inch wire. Upper jaw acts as feeder to cutting edges. Insulated handles. Ideal for farm fence work and shop use. Shp. wgt. 2 lbs. Stock No. 392—Each **\$1.95**

Heavy Duty RUBBER GLOVES



Extra heavy—extra long. Brand new, high quality gum rubber for softness and ease in use. Designed for heavy duty industrial service—protection in handling chemicals, acids, etc. A real bargain at this low price. Stock No. 295—Per Pair, Only **79c**

SILVERED OPTICAL PRISMS



Solid glass, with 1 silvered facet. precision ground and polished—5 1/4" long, base 2 1/2 in. wide, sides 1 1/2 inches. Free from scratches, abrasions and imperfections. Use in any type optical system—photography, telescopes, etc. Weight each 3/4 lb. A \$25.00 value. Stock No. 556. **\$2.00** Four for **\$5.00**

MEDICAL STERILIZER



Consists of alcohol burner and sterilizing tray in hinged metal case 1 1/4 x 1 1/4 x 2 1/4 inches. Burner may be used separately. Bright nickel finish. All brand new. **98c**
A125—Ea.....

CAVALRY SPURS



Genuine Wishbone type cavalry spurs. Nicked brass. A102, Pair... **98c**
A103 Spur straps per set of four... **50c**

POPULAR RECORD ASSORTMENT



Fifty records of modern dance, race, blues and hillbilly selections. No two alike. Famous name bands and artists included. Used in juke boxes, but guar. perfect. Shipped exp. collect only—no exchanges or refunds. Wgt. 28 lbs. No. A303—50 records... **\$9.64**

No. A300—25 Records. All Dance. Wgt. 14 lbs. **\$4.88**
No. A301—25 Records, Hillbilly, Race and Blues. Wgt. 14 lbs. Set... **\$4.88**
No. 302—25 Records. All Hillbilly numbers. Wgt. 14 lbs. Set... **\$4.88**

ELECTRIC MOTOR



Small but powerful. Shaded pole type, designed for fan application. 115 V 60 cycle. Has 1/4 inch shaft, one inch long. Operates at 3150 RPM under no load, 2000 RPM under 3.33 oz. inches load. Full load current .6 amp. Ideal for use on toys, window displays, etc. Shp. wgt. 1 1/2 lb. Stock No. 555—Each **\$1.95** only.....

MCCLELLAN SADDLE



Brand new! Top grade cowhide. 12 inch seat. Hair girth. Has straps for blanket roll and knapsack. Gun boot and sabre loops. Shipping weight 15 lbs. Stock No. A145. Each... **\$16.95**

BAYONET BLADE



Fine forged steel. Ground but not polished. May be made into throwing or hunting knife or spear. Blade 6 3/4 x 7/8 inches, 11 3/4 inches overall. Will take and hold a fine edge. Shp. wt. 1 lb. No. 664-R—Each... **49c**

RAIN SUITS



New 2 piece rain suits. Of durable wear resisting water and wind repellent OD fabric. Bib style pants, zipper fly. Jacket has parka attached. Guaranteed 100% weatherproof. Small, medium and large sizes. Shp. wgt. 3 lbs. No. R549—**\$4.95**
Ea.....

Officers Watch Compass



Brand new gov't. surplus. Army-Navy model. Single jewel mounted needle. Silver colored dial. A splendid value. Shp. wgt. 1 lb. A174—Each... **98c**

OXYGEN TANK



Loaded with aviator's breathing type oxygen at 1800 pounds pressure. Tank measures 13 1/2 x 5 1/2 inches with rounded ends. Tank is of solid metal fitted with brass release valve at top. Brand new! Loaded—ready for all types of emergency use. Shp. Wgt. 13 pounds. Ship exp. only. Stock No. 390—Each... **\$3.50** only.....

RADIO HEAD-PHONES



Extremely sensitive with 4000 ohms resistance. Brand new and fully guaranteed. With moisture-proof cord and phone plug. A splendid value for the radio serviceman and experimenter. A106—PAIR... **\$2.95**

ASTRO COMPASS



A precision navigation instrument for accurately determining direction of travel and for securing a true bearing on distant objects. Ideal for classroom work—on boats, planes, etc. Wgt. 4 1/2 lbs. All brand new. No. R324. Each... **\$9.95**

AVIATION CABLE



Flexible 133 strand wire cable, 5/32 in. diam., 3300 lb. break test. Lengths up to 450 ft. Use for tow rope, guy wire, clothes line, etc. Wgt. per 100 ft. 4 lbs. Specify length wanted. No. 421—Per Ft.... **4c**

ORDER DIRECT FROM THIS AD

Values galore! Hundreds of hard-to-find items for home, shop and outdoors. Make remittances by money-order, bank draft or personal check. Send 25% deposit on C.O.D. orders. No C.O.D.'s on orders for less than \$5.00. Include sufficient postage on parcel-post orders—any overage will be promptly refunded. All quotations F.O.B. Chicago. Used items and materials are guaranteed serviceable and as described. Your money back if not more than satisfied.

NEW CATALOG 10c To Cover Postage and Mailing

STARK'S

Dept. PM9
509 So. State St.
CHICAGO 5, ILL.

PUP TENTS



Regulation Army Pup Tents of durable, brown canvas. Used, but in good condition. Fine for campers, outdoorsmen, boy scouts, etc. Wgt. 8 lbs. A100 Tent only **\$3.95**
A110—Tent, new... **\$7.95**
A101—Ropes, wooden poles and stakes for above. Per set **\$1.00**

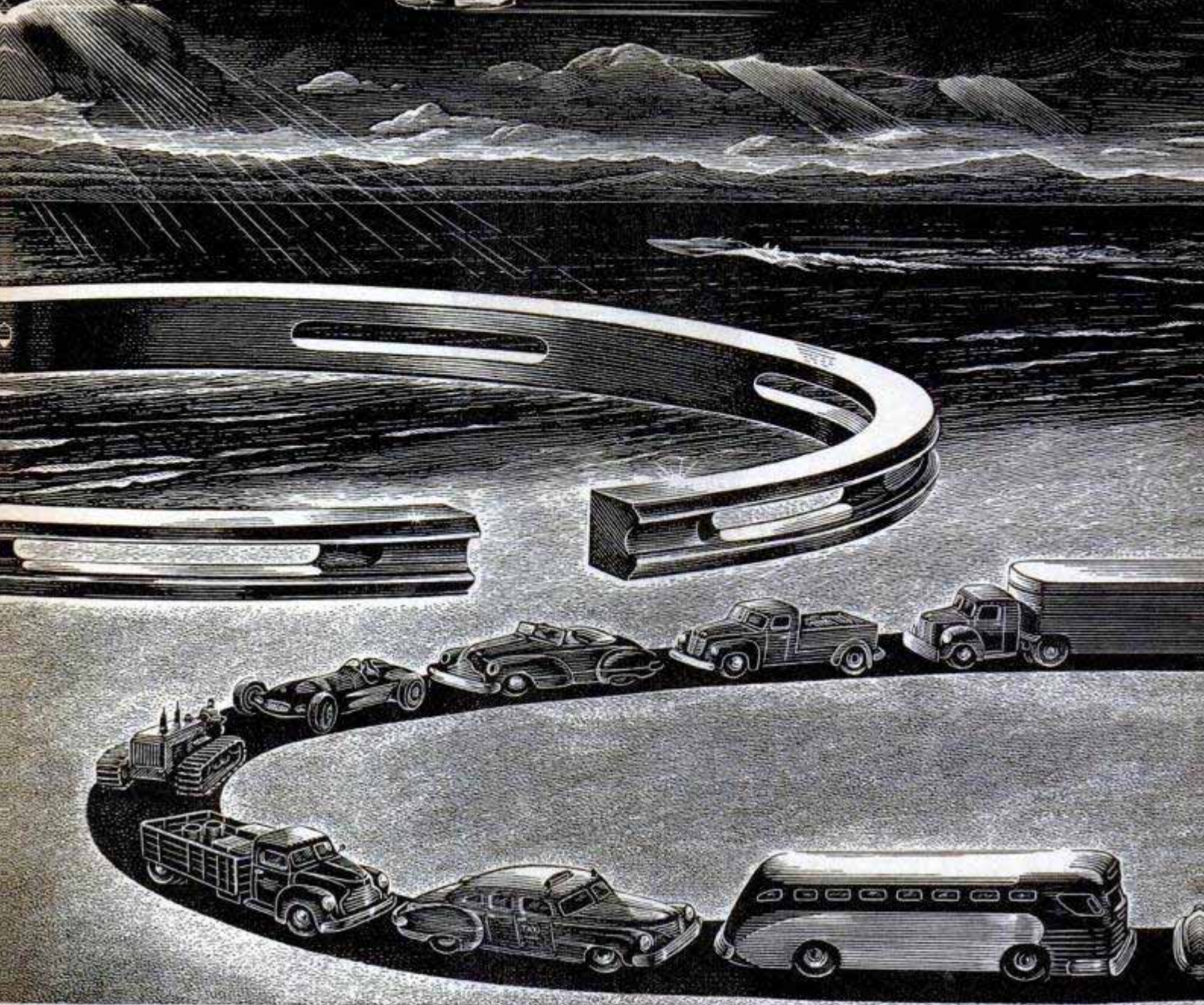

Perfect Circle

The Most Honored Name in Piston Rings

Honored by America's foremost automotive engineers, who acclaimed Perfect Circle Piston Rings as best engineered—4 to 1.*

Honored by Doctors of Motors, America's expert mechanics, who actively express their piston ring preference by installing millions of Perfect Circles every year.

Honored by motor-wise car owners all over America, who in survey after survey have invariably named Perfect Circle their first choice by a wide margin.

Look for this sign (right). It identifies a place where your car will receive expert attention. Your local Doctor of Motors knows your car, knows the value of honest workmanship and reliable parts. He will install a set of Perfect Circle Piston Rings Custom Made for your car to restore power, save gas, stop oil pumping.

Perfect Circle Corporation, Offices: Hagerstown, Indiana and Toronto, Canada. Plants: Hagerstown, Richmond, New Castle, and Tipton, Indiana, and Toronto.

**In an independent survey among automotive engineers—maintenance men, fleet operators and designers of new equipment—Perfect Circle was first choice as the best engineered piston ring—first by more than 4 to 1—and received more votes than ALL other brands combined!*

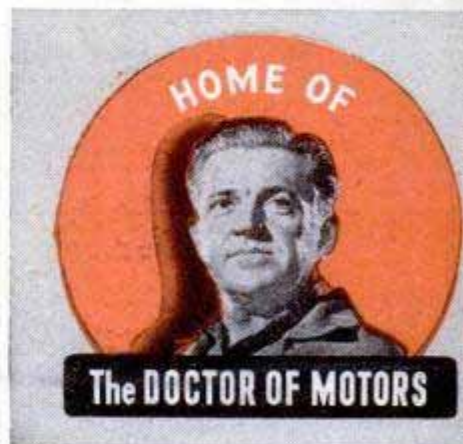

POPULAR SEPTEMBER 1949 MECHANICS

WRITTEN SO YOU CAN UNDERSTAND IT
VOL. 92 NO. 3



Spanish doubloons? No, shells dredged from the ocean to learn more about mysterious deep scattering layer

DEEP-SEA MYSTERY STORY

WHAT is the mysterious layer 1000 feet or so below the surface of the ocean that causes "false bottom" readings on ships' fathometers?

Sometimes it leads mariners to think that they have discovered uncharted shoals in areas that are far from land. Because it creates reflections and reverberations of their sound pings, it is a source of confusion to sonar operators who track submarines.

It seems to exist in all deep oceans from the Arctic to the Antarctic. It is 100 feet or more thick.

Oceanographers know very little about this phantom bottom but they are excited by the possibility that it may consist in part of edible fish. If their surmise is correct, the world has found a new and practically

Patrol craft fitted by Navy Electronics Laboratory with latest instruments seeks answer to the mystery
Official U. S. Navy photo



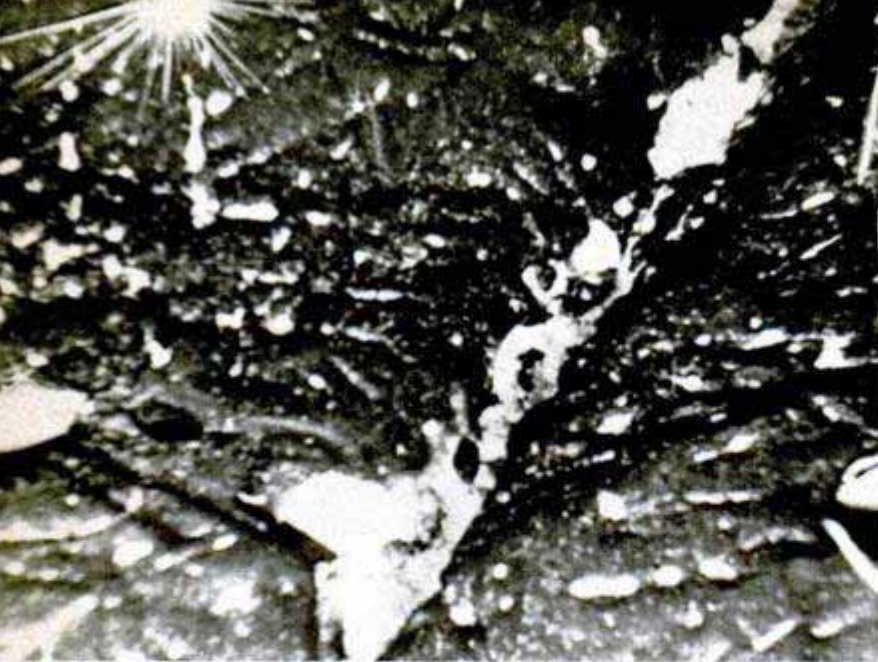

Photo taken on the sea bottom 275 fathoms deep shows a large starlike organism resting on sea ooze atop volcanic rock



Up from the depth of the deep scattering layer came these shrimplike forms and the jellyfish inside the pan. Larger fish also are thought to inhabit the layer. Below, these lobsterlike crustaceans were photographed at 153 fathoms



inexhaustible source of nourishment.

This newest mystery of the deep was first recognized by Drs. Carl F. Eyring, Ralph J. Christensen and Russell W. Raitt while doing naval research off San Diego early in the war. Their project was to measure the reflections and reverberations of the sound beams that are used in underwater echo ranging equipment. Air bubbles, a rough surface on the ocean, suspended matter and the bottom itself all create echoes of the beams.

Day after day, offshore, the scientists were puzzled by echoes that were reflected upward from a depth of about 300 yards. They knew of no physical condition at that depth that might explain the phenomenon, yet all parts of the area in which they worked seemed to have this same reflection stratum. They named it the "deep scattering layer" because of its scattering effect on supersonic signals. Rushed by the war program, they could do little more than speculate on what the layer might be.

Later, Dr. Martin Johnson of the Scripps Institute of Oceanography at La Jolla suggested that the deep scattering layer should be sought after dark and that its nocturnal depth should be compared to its depth in the daytime. He reasoned that if the layer showed any vertical change during a 24-hour period it would be evidence that the layer was composed of living organisms.

Measurements at night, dusk and dawn showed that the layer does indeed migrate. It moves up toward the region of the warm, mixed, surface waters as soon as the sun sets, then descends again with the coming of dawn. Many floating, living organisms such as jellyfish, complete this nightly cycle. Presumably they move upward after dark to feed and then at dawn retreat to depths at which they are safe from predators. When the deep scattering layer proved to have this cycle, the investigators concluded it is made up of living forms.

Studies of trans-Pacific echograms, the records of echo sounding equipment, show strong or weak evidence that the deep scattering layer exists almost unbroken all across that ocean. Comparable records made in the Atlantic also reveal its presence. Echo soundings that have been made up into the

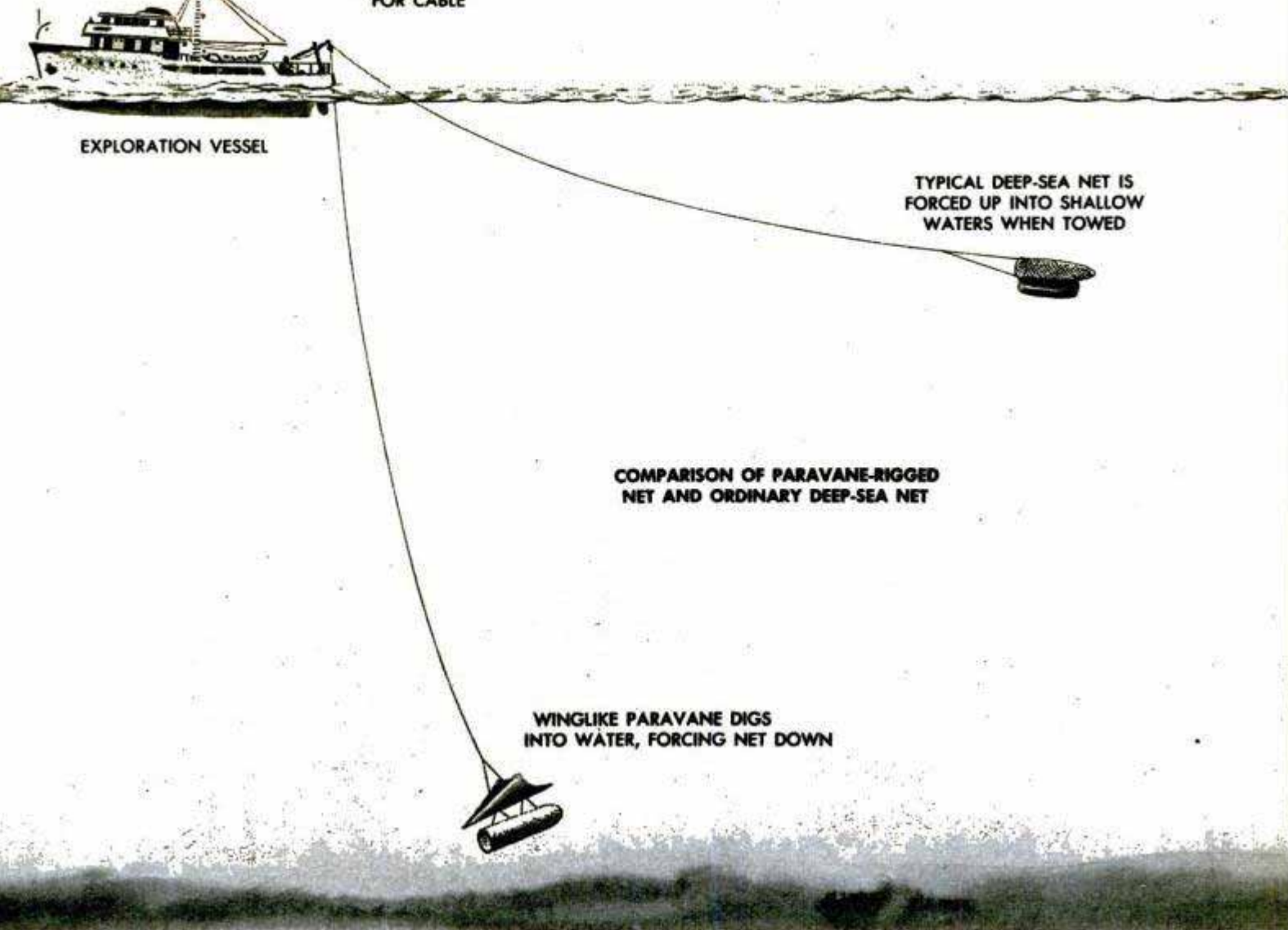

Arctic and down toward the south polar waters likewise almost invariably record its presence.

The depth of the layer seems to vary with the distance that light penetrates into the water. In the tropics the deep scattering layer may lie at a depth of 2500 feet below the surface. In the middle latitudes it is found at only half that depth and toward the poles it is shallower still. Occasionally, two separate layers are recorded, each of which migrates vertically at a different speed. Sometimes, too, the presence of large schools of fish or squid that are swimming some distance above the top of the layer is indicated by carbon markings on the charts.

Today numerous research groups including Scripps, the Woods Hole Oceanographic Institution of Massachusetts, the Navy Electronics Laboratory and the University of California's Marine Physical Laboratory at San Diego are exploring the layer.

After the war ended these groups sent research vessels out into deep water off both the Atlantic and Pacific coasts to sample the layer. The depth of the layer was ascertained by echo-ranging methods and then nets were

Drawing shows how the paravane forces the net deep into the ocean, whereas an ordinary net, even when weighted, is pulled up into shallow waters. Below, echo-ranging equipment on Navy vessel records the mysterious layer

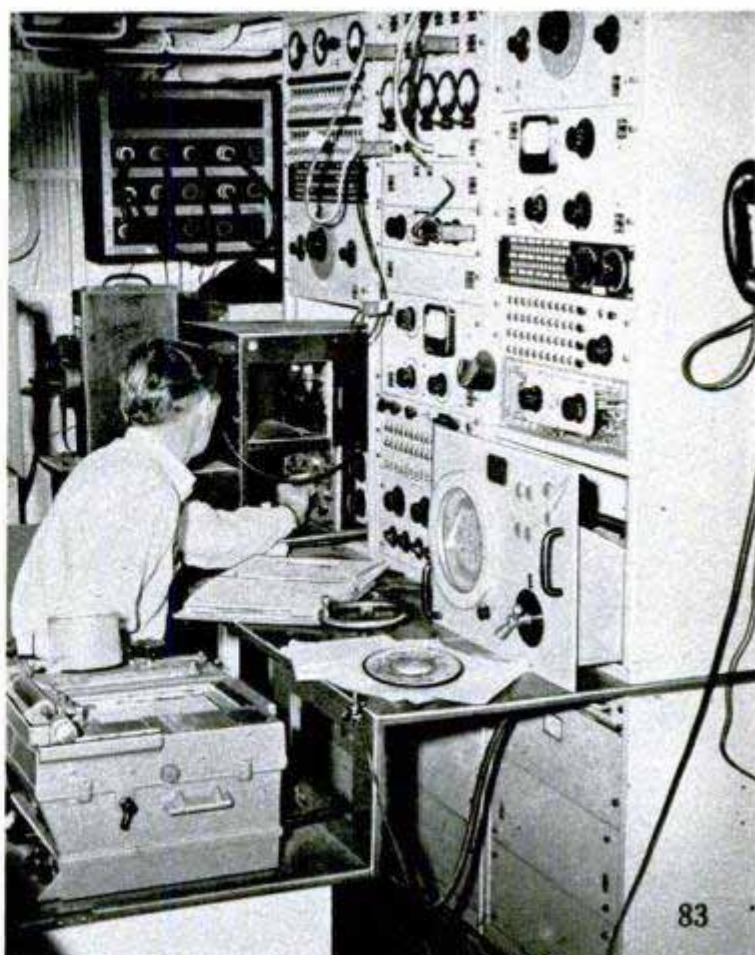

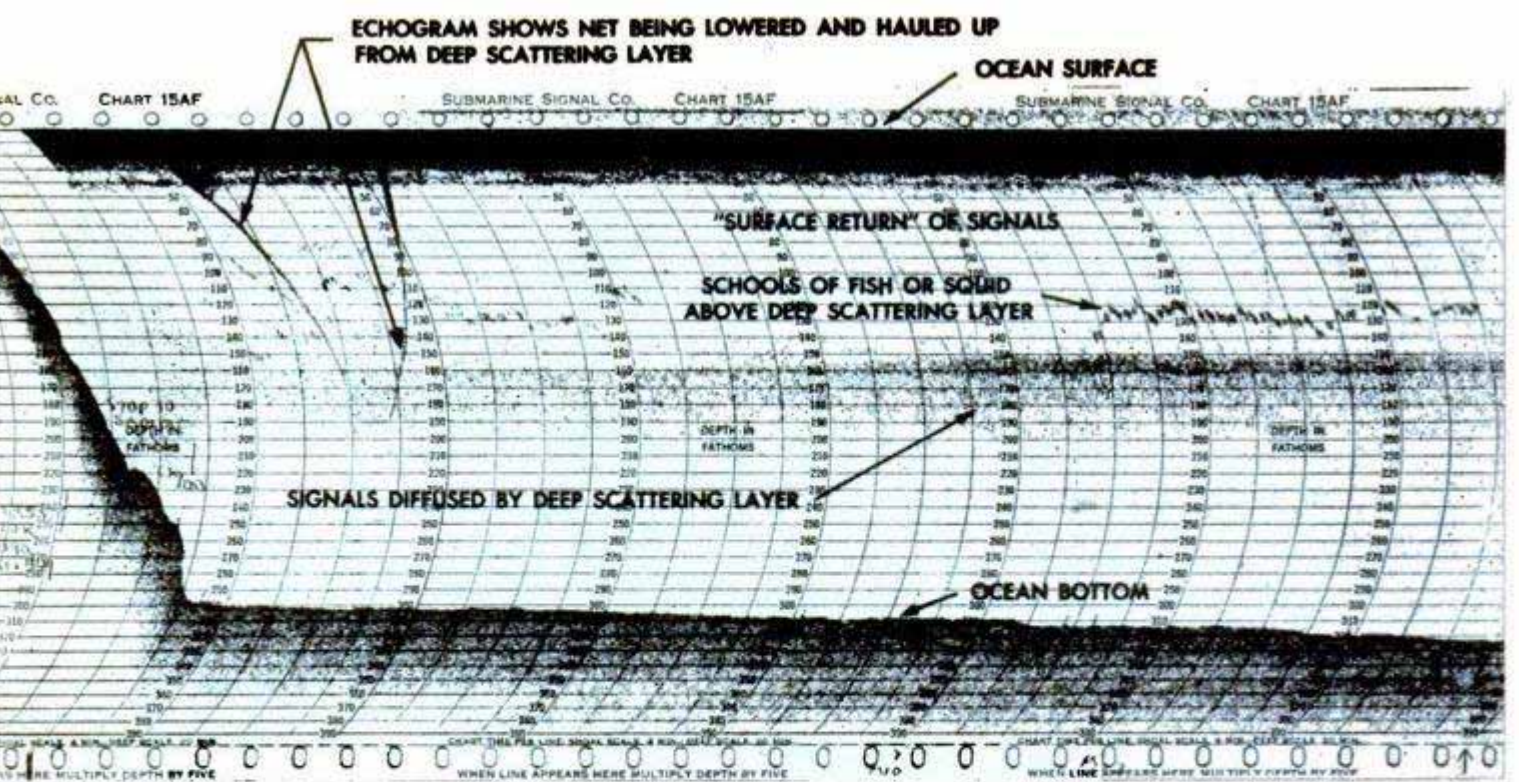

On this echogram are recorded the signals returned by the deep scattering layer as well as the real bottom and schools of fish

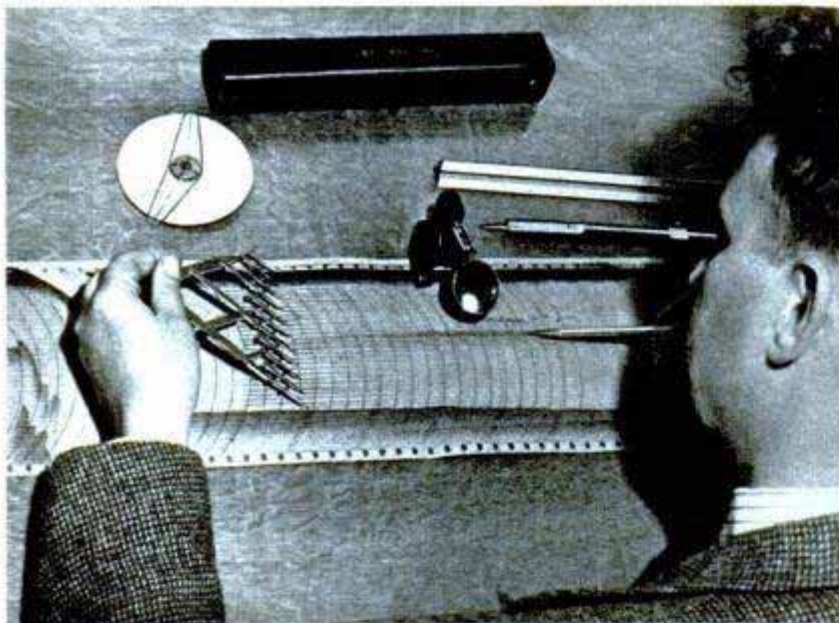

Dr. Dietz of the Navy Electronics Laboratory manipulates the instrument which plots the depth of the layer from the echogram. Below, cameras mounted on this special rig take photos at proper depth. Flash equipment gets pictures before sea life scatters

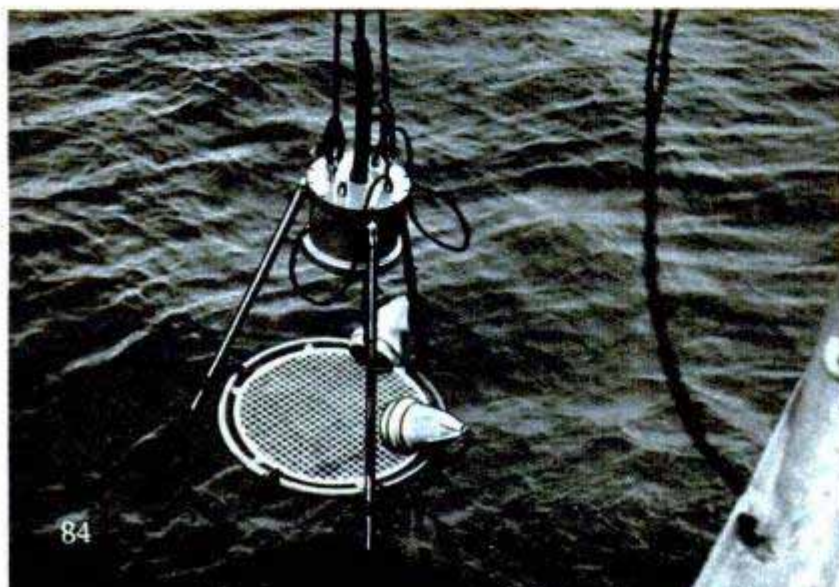

lowered to capture whatever could be picked up at this depth.

All the hauls were successful. In all of the nets the oceanographers found numerous specimens of small shrimps and shrimplike forms of the Euphausia family, as well as numbers of small transparent jellyfish.

That the deep scattering layer contains a concentration of these forms of sea life is important scientific news, but few of the oceanographers are satisfied. They feel that there are other, larger inhabitants of the layer.

In the first place, says Dr. Robert S. Dietz of the Navy Electronics Laboratory, it is unlikely that such small organisms are responsible for the sound-scattering phenomenon that led to their detection. Most of the euphausiids are less than an inch long and may not be large enough to reflect signals of the wave lengths that are used in echo ranging. To reflect the sound pings efficiently, they would need to be at least three or four inches in diameter. Air bubbles such as are contained in the swim bladders of fish are effective scatterers of underwater sound but the euphausiids don't have such bladders.

Too, some of the sea scientists doubt that the shrimplike forms can move at the speed with which the deep scattering layer rises toward the surface at dusk. This rate has been measured at 18 feet



Built like tuna clipper, research craft serves as marine laboratory for University of Southern California

per minute. Another thought is that such a rich belt of life could hardly exist without having attracted larger fish that would live in or adjacent to the layer and feed upon it.

The problem now is to capture specimens of the larger inhabitants of the layer, if such inhabitants exist. New deep-sea equipment is being built for this purpose. The difficulty with the nets and capturing devices that have been used so far is that they can be operated at great depths only when they are motionless or practically motionless. No free-swimming fish is likely to be caught in such a device. If one of the nets is towed behind a vessel at any appreciable speed, it is automatically dragged

up toward the surface even though as much as a ton of weight is attached to it.

To overcome this difficulty, the oceanographers will use a special deep-sea paravane, an underwater kite with flared surfaces that make it dig down into the water when it is towed behind a boat. Such equipment will force the cable down to the deep scattering layer even when towed at speeds of four or five knots.

New types of nets are also being built. Most specimen nets have a bridle attached at the front, and the disturbance that the bridle sets up in the water acts as an alarm to fish in the vicinity. The new nets are held

(Continued to page 238)

Collecting dredge hauls up sea life specimens. Right, cleaned and classified, they aid in studies of ocean

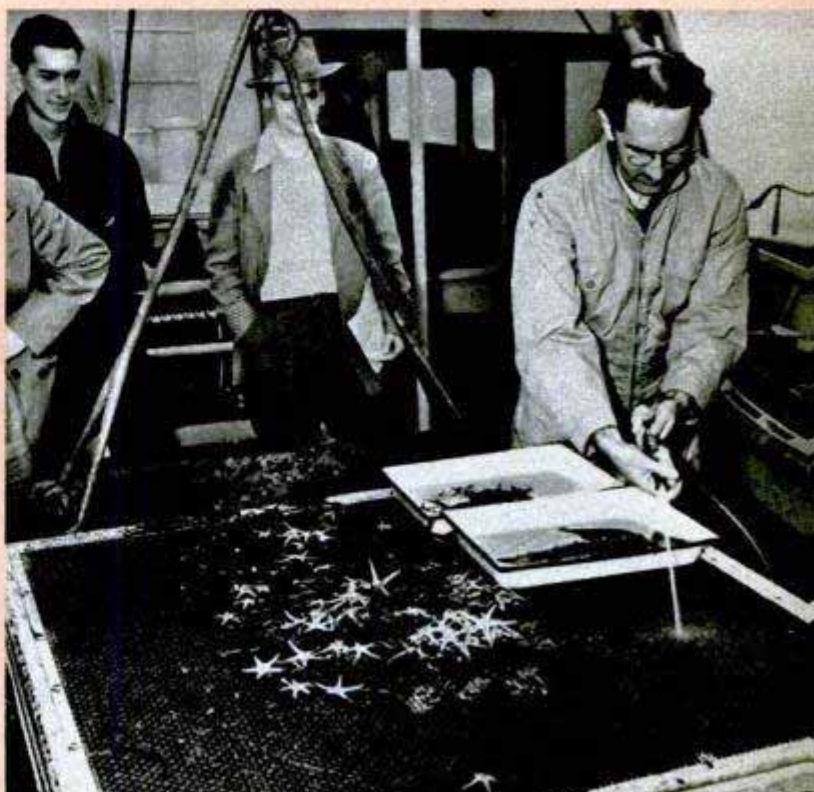
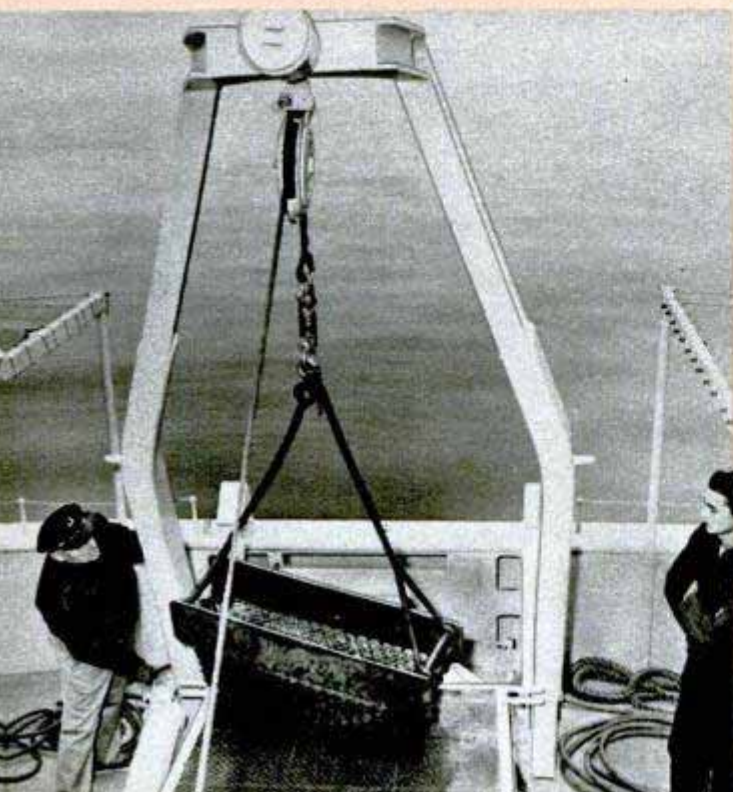

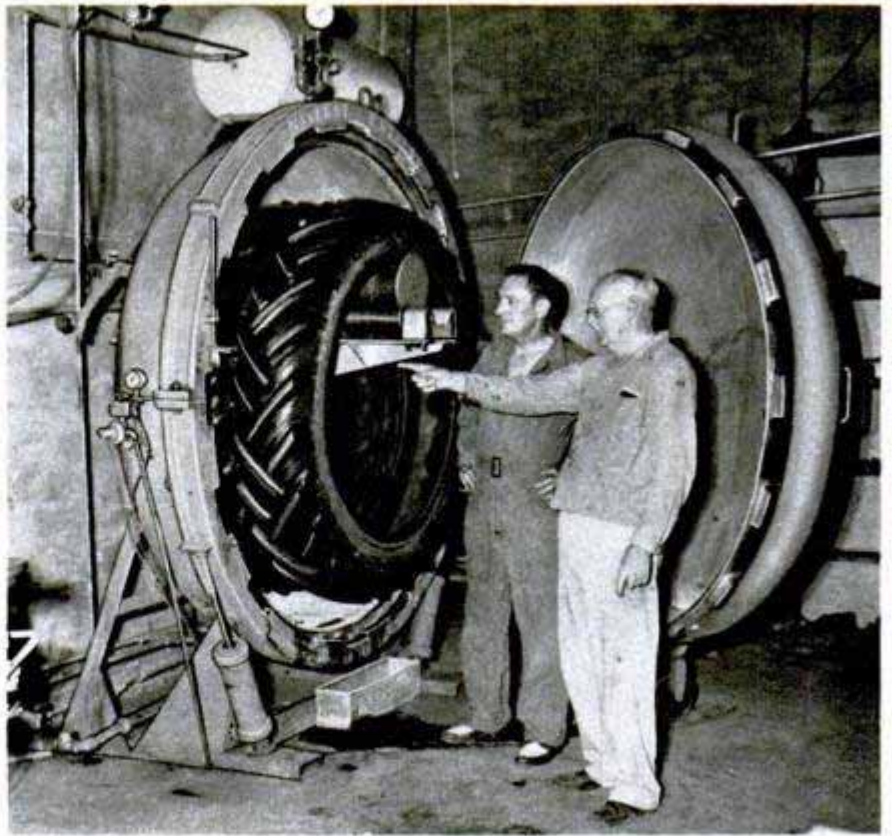

New Lugs Vulcanized on Tires

New lugs are applied to worn tractor and off-the-road tires through a vulcanizing system, thereby giving the farmer good vehicle traction at a fraction of the cost of new tires. In many cases, tractor tires are

still in good shape even though the lugs are worn off. The tire is buffed to a smooth, round surface. New lugs are cut, fastened in place with cement and hammered to provide a tight bond with the tire casing. The tire then is baked inside a steam oven to vulcanize the lugs and the casing.

Egg-Shaped Wheels Pull Through Mud Without Chains

Wheels with "corners" on them may seem useless, but a New York inventor believes such "flat" wheels may replace the track-type drive on military vehicles and tractors. Each driving unit is actually a

pair of oval wheels synchronized with their long axles at right angles to each other. This means that the point of one wheel and the flat part of the other are in contact with the ground at the same time. The wheels

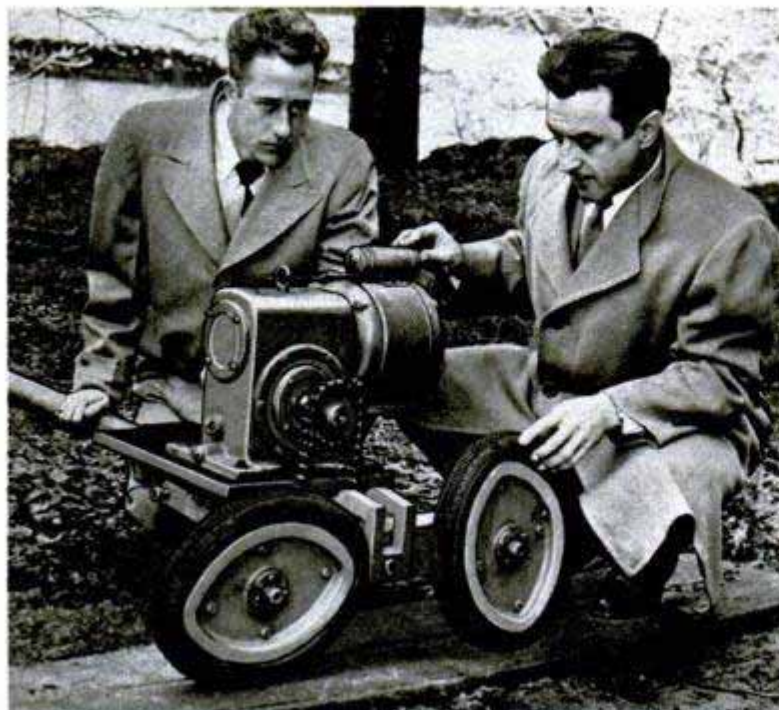

are mounted on a rocker arm attached to the axle, thus the wheel unit rocks up and down while the axle remains steady. Tests in mud and deep ruts show that the wheels do not slip or bog down and, according to the inventor, John F. Kopszynski, they outperform continuous treads used on tanks and bulldozers. On smooth roads, the rocker arm enables the unit to travel up to 25 miles an hour with no unusual vibration. All parts are hermetically sealed and maintenance is simpler and cheaper than on tracked vehicles. Still not in production, the wheels are undergoing extensive tests.

☐ With toll-dialing, the average long-distance phone call is completed in one minute, five times faster than the 1927 average.

Machine Speeds Pin Setting

Pin setting is speeded by a new electric machine that completes the operation without supervision. As soon as the pin boy pulls a lever, he can move to an adjoining alley without waiting to lower the machine and set the pins. Loading is made easier and faster by specially designed pin-spotting collars. A safety release which disengages automatically when there is interference with the downward movement of the pin-setter deck protects the operator and prevents damage to off-spot pins.

Color Computer

How many colors are there? Authorities say that the human eye can see about 10,000,000 colors, but a new automatic instrument is so precise that it can distinguish more than 100,000,000. The machine tells whether a given color matches another color, and describes any differences. The device is a computer that is operated in conjunction with a spectrophotometer, an instrument that measures transmittance.

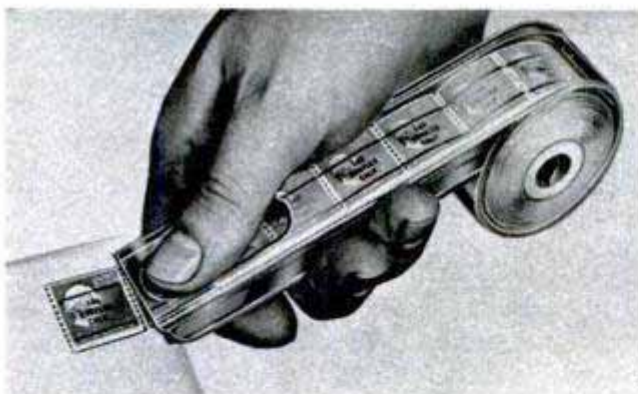
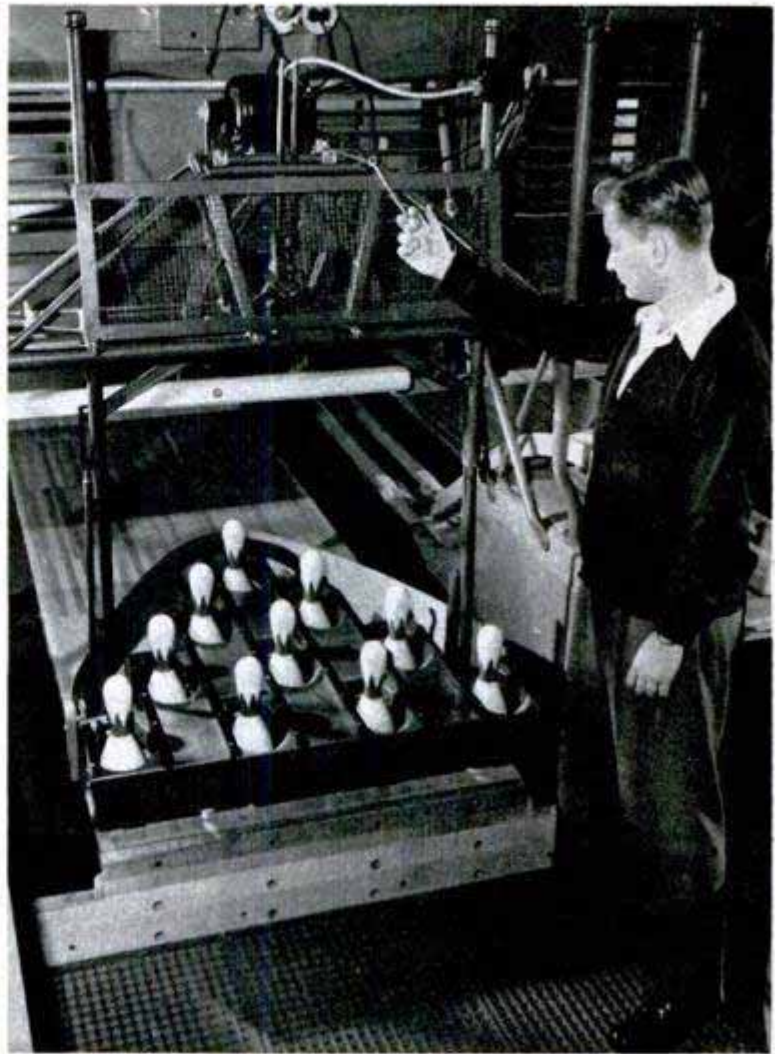

Hand Mailer Moistens Stamps

If you have a large number of letters to mail, you'll save time with a handy mailer that moistens, dispenses and applies stamps to the envelopes. The stamps are pushed across a moistening device with the thumb and then slid onto the envelope. With the mailer you can apply as many as 1500 stamps an hour. It also can be used to moisten the flaps of envelopes without removing the stamps from the holder.

Model Tractor Is Steamer

Burning coal, a model engine built by H. L. Bolton of Reece, Kans., carries 100 pounds of steam and crawls along at one mile per hour. The little power plant weighs 175 pounds. Bolton spent about 1000 hours building it at a cost of \$25 for the valves and fittings.

☐ In 1948, a total of 4,697,405 tons of iron and steel were exported from the United States, of which the largest share went to countries in North and Central America and the West Indies.

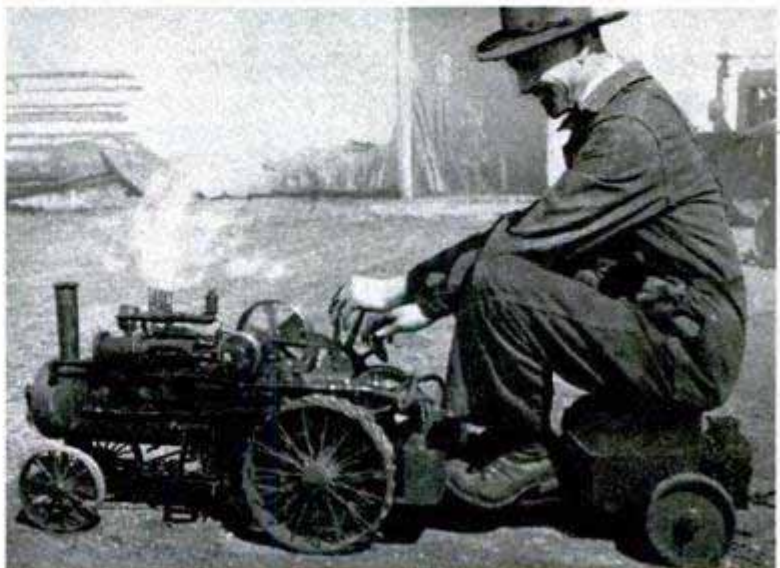

The hospital comes to the patient



Outside patient's home, the doctor unloads the basal-metabolism tester from his hospital on wheels

badly needed hospital beds for patients who were seriously ill and required the close supervision of a hospital staff.

So he bought a secondhand laundry truck (the car shortage was very severe at the time), cleaned it up and painted it white. The inside was equipped to serve as an office and laboratory. The rear compartment was made light-tight so it could be sealed off for use as a darkroom for developing X-ray films.

In one corner are specially designed steel tanks for developing the films. The tanks are eight inches higher than normal and capped with a metal lid to keep liquids from sloshing out as the truck rolls around Cincinnati streets. There are racks for the microscope and other fragile equipment. A special cabinet serves as a workbench as well as storage space. A small stove heats the interior of the truck in winter, eliminating any danger of the developing solutions being frozen.

Today his traveling hospital goes all over Cincinnati, seven days a week, serving patients in their own bedrooms at prices that are about the same as would be charged for the same services in a hospital. Among the services that he offers are on-the-spot X-rays, metabolism tests, blood counts, heart tracings and emergency transfusions. He visits a patient only on request of the patient's regular doctor and, with the use of his laboratory, he is usually able to help the doctor diagnose the case.

When Doctor Albert first announced to Cincinnati's 1100 doctors that he had a hospital ready to roll to the patient's bedside,

By George Laycock

WHEN YOU can't go to the hospital in Cincinnati, the hospital will come to you—right to your door, complete with doctor. It's a new idea in medical care that promises to spread rapidly.

The hospital on wheels resulted when Dr. Irwin C. Albert of Cincinnati returned from the war and resumed practicing. The shortage of space made it difficult for him to get patients into hospitals for X-rays, blood checks and other tests that require equipment usually found only in hospitals and clinics.

It would be fine, Doctor Albert thought, if he could take this equipment to the patient. It would speed treatment and release



The patient, a youngster, has his basal metabolism checked by Dr. Albert without leaving the bedroom

their reactions were varied. Some of them saw little future in a wheeled hospital, but today, even the older doctors, who warned to the plan slowly, point out that the idea is a good one.

Patients with fractured legs, for instance, can often be treated at home instead of in the hospital if they can get an X-ray to show the location and extent of the break. If sent to the hospital they might occupy a bed for 10 weeks or more. Patients with heart ailments can now get a checkup in their own bedrooms, instead of exerting themselves traveling. A suspected pneumonia victim can have his chest X-rayed without going out in the weather. Children, sometimes frightened when told they are "going to the hospital," are more at ease

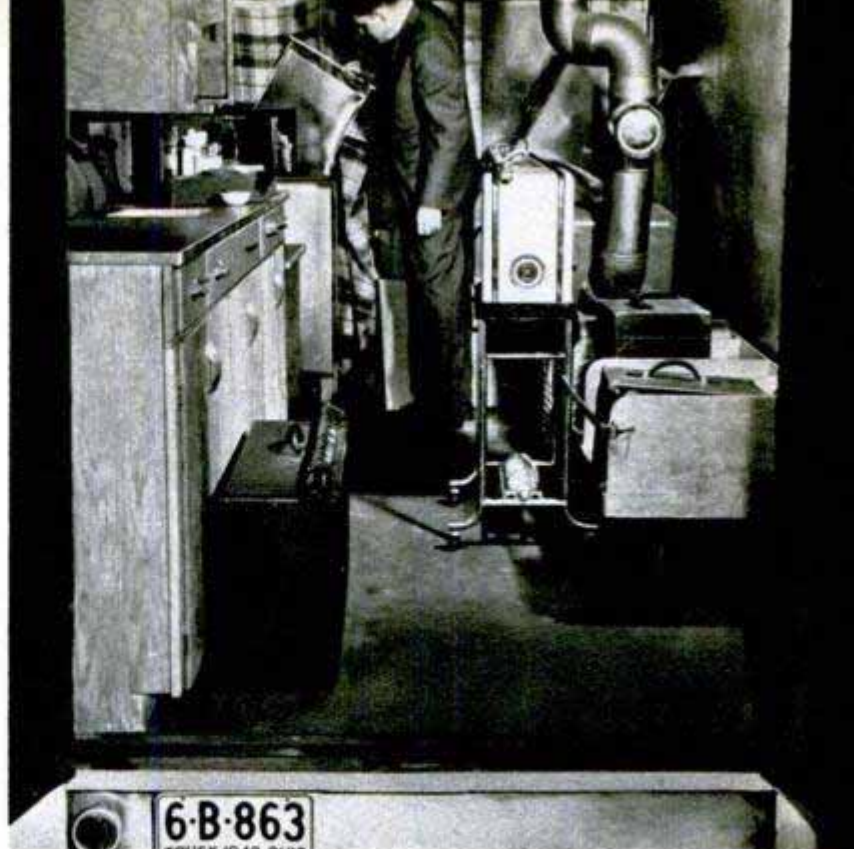

The doctor takes his X-ray machine into the house, shoots the pictures and develops them in the truck

when they are examined in their homes.

Although Doctor Albert gives his report only to the patient's regular doctor, he knows before he leaves the scene what the report will be. He develops his X-rays on the spot and if he finds that he needs another picture he takes it without having to make an additional trip.

The doctor's white truck has become a familiar sight on Cincinnati streets. The demand for its services has grown steadily. It is becoming so popular that the doctor plans to add similar trucks until he has a fleet of traveling hospitals working every part of the city. Because he sees no immediate end to the hospital shortage, he believes his little self-powered hospital is here for a long stay.

With his microscope, Dr. Albert studies a patient's blood. Behind him are tanks for developing X-ray film



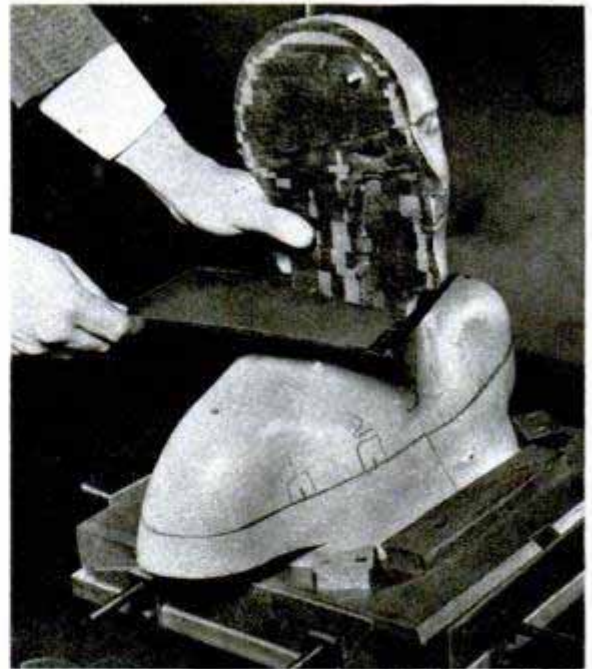

Above, film to record ray penetration goes in the head. Dummy is used to study effectiveness of X-rays in combating diseases of inner body

Wooden Head Is Target For X-Ray Research

Left, M.I.T. scientist adjusts the base of the generator before irradiating the wooden head of "Mr. Cruikshank" with 3-million-volt X-rays

"Mr. Cruikshank's head" probably has been the target of more X-rays than any other human form in the world. Mr. Cruikshank, as he has been dubbed by scientists at the Massachusetts Institute of Technology, is a wooden head and shoulders used as a stand-in for a human being in measuring the penetration of super-voltage X-rays. The dummy head consists of layers

of wood and other porous materials which reproduce the densities of human bones and tissues. X-rays fired at Cruikshank thus can be expected to penetrate about the same distance as they would in a human head. When Cruikshank has been irradiated, films and recording instruments in the wooden head reveal the amount of radiation that reaches various locations.

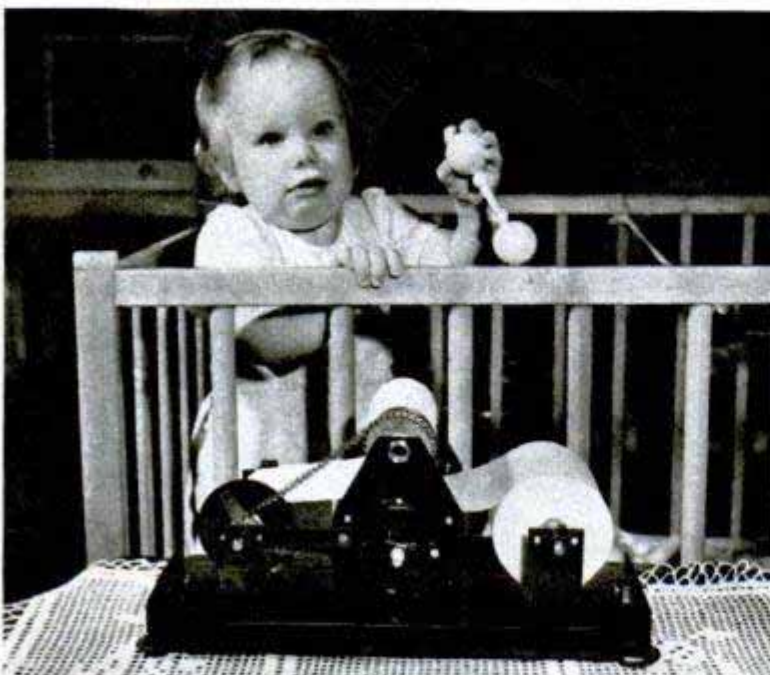

Glycol-Vapor Dispenser

Glycol vapor, being tested as a cold preventive, is released in the air by a dispenser that heats a roll of glycol-impregnated paper, causing it to give off a germ-killing vapor. The paper is placed in the electric dispenser and is passed over a heated roller at a rate of one revolution an hour. Although there is no definite proof as yet that the technique prevents colds, early tests have produced favorable results.

☐ In the 20 years from 1927 to 1947, the percentage of anthracite loaded mechanically in underground mines increased from 2.1 to 43.4 percent.



Collapsible Stretcher on Wheels

Made of aircraft tubing, an all-purpose stretcher carrying up to 400 pounds telescopes into a compact, lightweight unit when not in use. It can be hung on walls or in elevators for emergency use in factories or carried in autos converted into one-patient ambulances. Heavy canvas is sus-

pending hammock fashion over the frame and screws hold the back rest at any angle desired. A collapsing mechanism folds and locks the wheels into position. Twenty inches wide, the stretcher is 75 inches long when fully opened and 48 inches long collapsed. Either swivel-type wheels or crutch-tip uprights can be attached at the foot end of the stretcher.

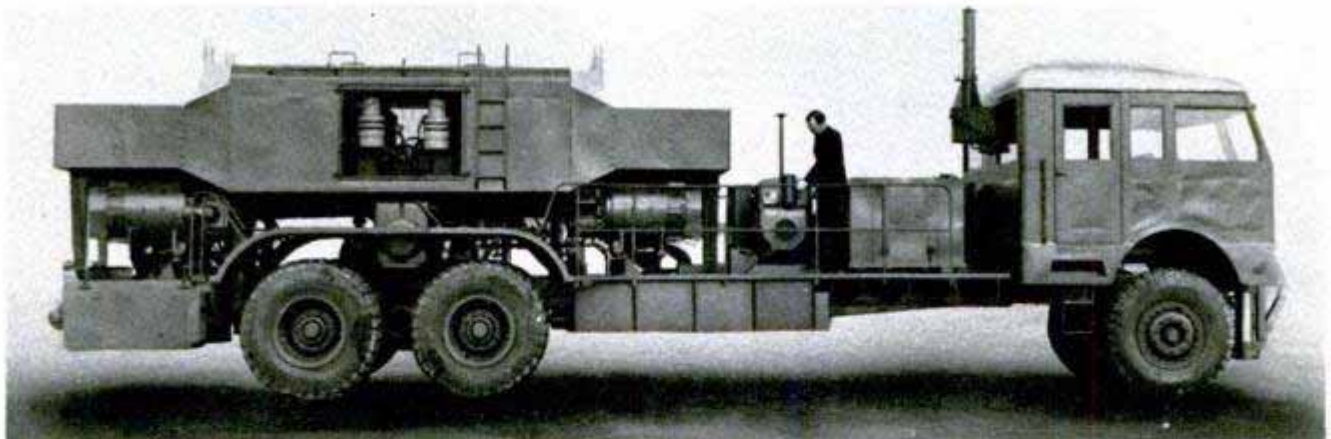

Giant Traction Dynamometer

Big tanks and other military vehicles are tested by the world's largest traction dynamometer, recently put in service by the Army at Aberdeen Proving Ground, Md. The vehicle is nearly 50 feet long, 11 feet wide and 12 feet high and is equipped with 19 electric generators. The new dynamometer can tow test vehicles to the proving ground. There it becomes a towed vehicle, and its electric generators create accurately measured resistance which increases the load on the towing vehicle. Instruments

then record the tractive effort and other phases of the test. Cameras inside the nine-foot-square cab record the instrument readings to give engineers an accurate picture of the capabilities of the vehicle that is under test.

Popular Mechanics provides two sources of further information concerning articles published in each issue: the WHERE-TO-BUY-IT INDEX, starting on page 10, and the WHERE-TO-FIND-IT INDEX, available without charge from our Bureau of Information, 200 East Ontario Street, Chicago 11

They Keep the

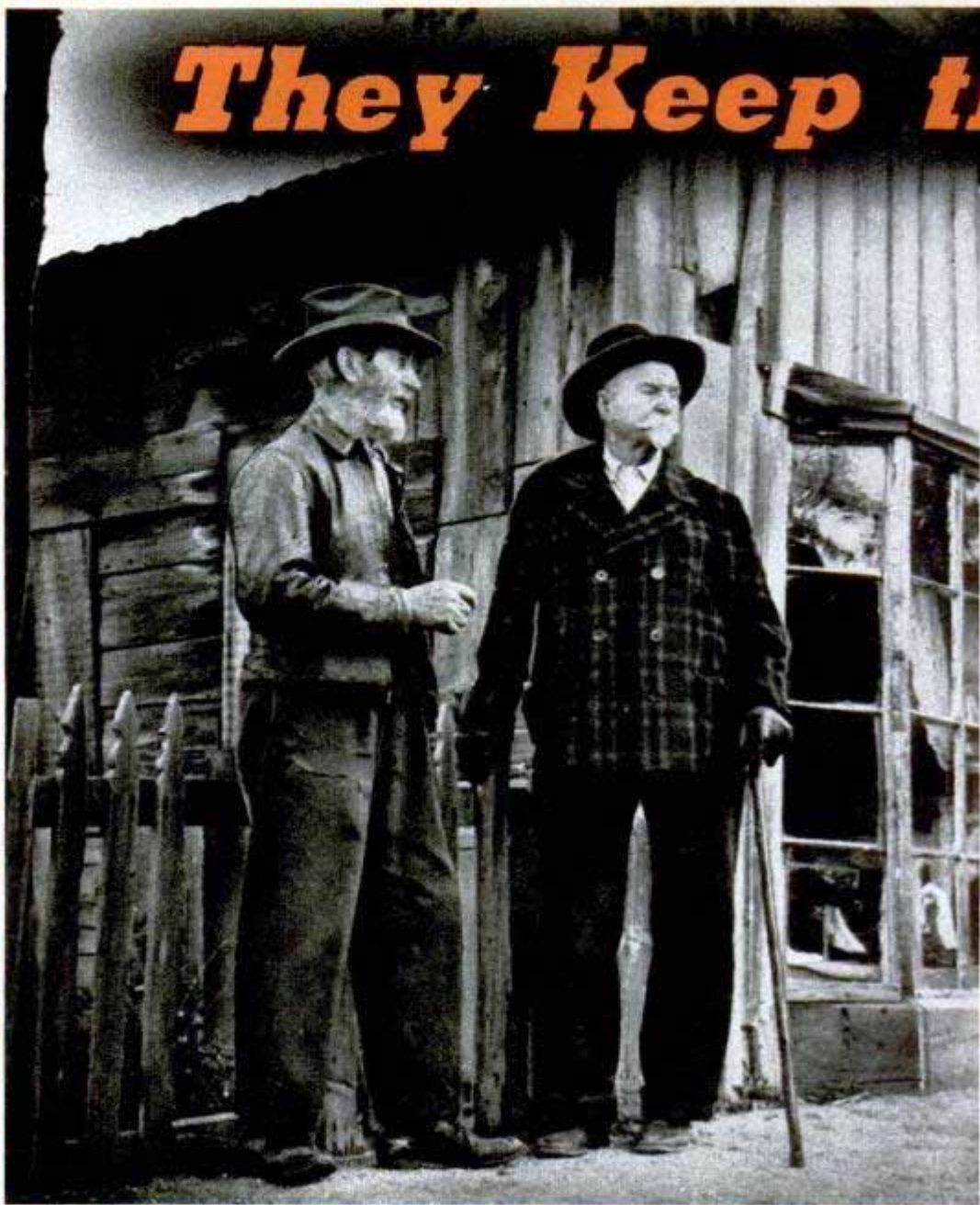

Two bewhiskered residents of Virginia City fit perfectly into its old-time atmosphere

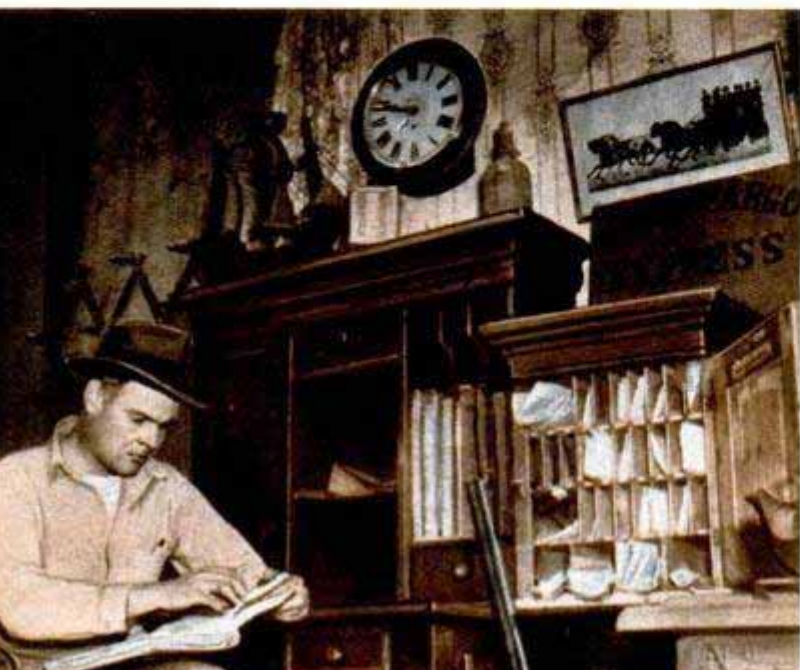

You might call Virginia City, Mont., the Williamsburg of the old frontier. Almost a ghost town when Charlie Bovey first saw it, today, thanks to him, the city is a living museum of hairy-chested Gold-Rush days

This is Charlie Bovey, the man who remade history, looking over the books of the Wells-Fargo Express

POPULAR MECHANICS

Old West Alive

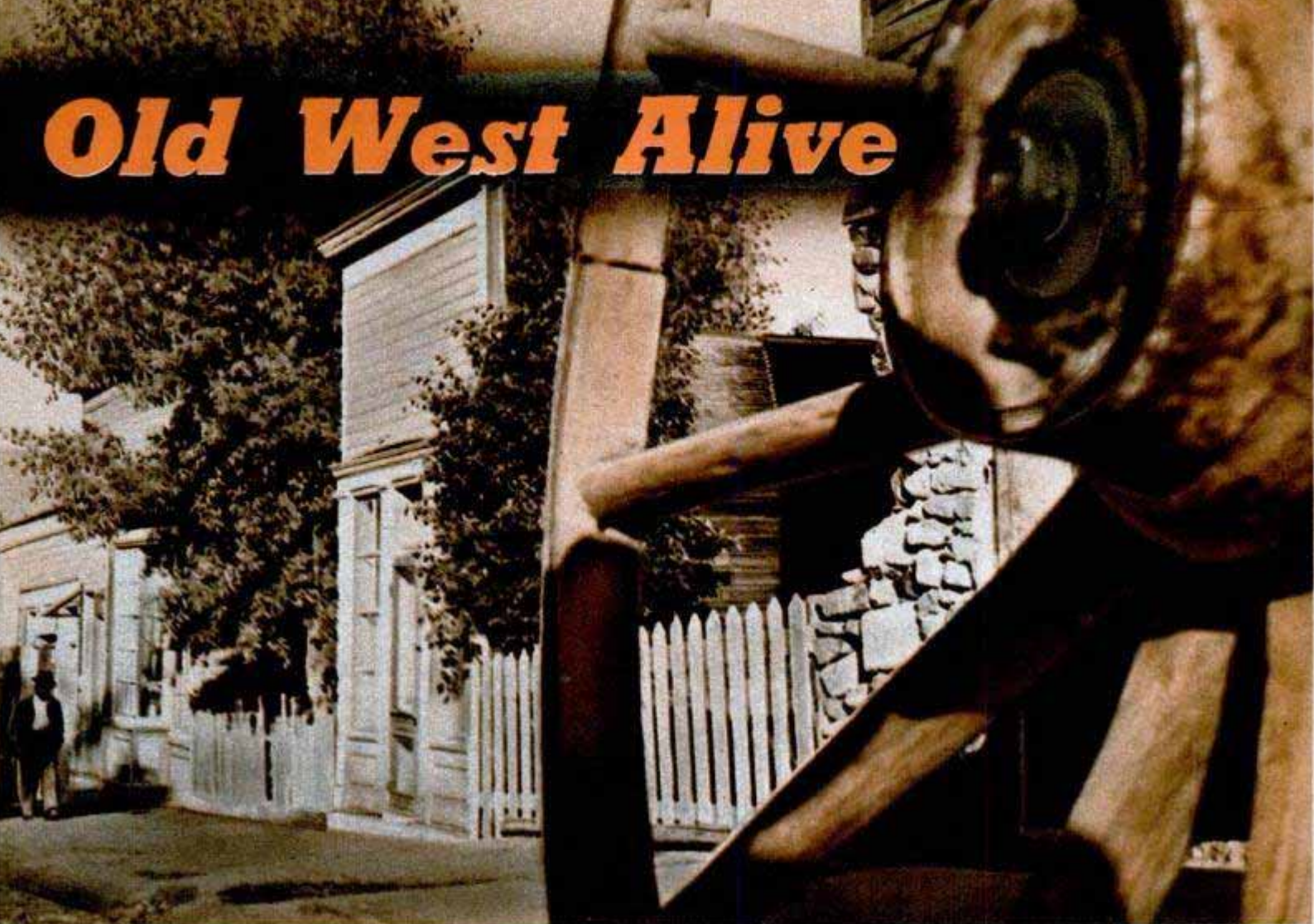

By Rafe Gibbs

Photographs by the Author

ON A Saturday afternoon in 1926, a husky young man was trundling sacks of flour in a mill at Great Falls, Mont. He stopped to inspect a sliver irritating a finger.

"Keep moving!" barked the foreman. "You've got all day Sunday to get that sliver out."

The first inclination of the young man was to quit and leave Montana as far behind as possible. If he had, the state would have lost one of its finest and most unusual historians, for the youth was Charlie Bovey, the man who "brought back alive" the famous old Montana mining town of Virginia City and made it into the Williamsburg of the West.

Virginia City, as dusted off by Charlie, is today one of the most colorful spots on any tourist map. Walk down the wooden sidewalks of the old town and see for yourself.

You will find, for instance, the old Wells-Fargo stage office doing business again with dummies dressed in the clothes of the waning 19th century—a

Above, a section of Main Street in the old western mining town. Below, this well, after years of use by residents, still hasn't run dry. The old oaken bucket on the ground was once used for hauling ore





The "kid at the music box" entertains with a barroom ballad in the saloon, using a one-finger technique

mule skinner in buckskin, a lady in Victorian ruffles, a clerk with collar and mustache to spare. Seems only yesterday that black-bearded, black-booted "Fearless Bill" Fairweather, who made the first gold strike in Virginia City, walked into the Wells-Fargo office to buy a stagecoach ticket to Butte. As he waited for his ticket, he noticed some urchins, white and Indian and Chinese, peering in the doorway.

"Here, kids, scramble!" he said and tossed in the air \$500 worth of gold nuggets.

In the blacksmith shop, shoes are ready for fitting to oxen. At the dressmaker's shop, you can observe the fashionable styles worn by the well-dressed girl of the early West. In the barber shop, with its rows of handsome shaving mugs, a dummy dressed as a prospector waits for the removal of enough beard to nest a couple of flying squirrels.

Historians have described the revived town as a "dyed-in-the-wool, living monument to the frontier West." But Virginia City, with its clocks turned back more than three quarters of a century, is really a monument to the determination of Charlie Bovey, who wanted to be more than a rich man's son.

Charlie's father, C. C. Bovey, a director in General Mills, sent him from Minneapolis to Great Falls in 1926 to study the grass roots of the milling business at the plant there. The idea was that after a brief sojourn in the West, he would return to follow in his father's footsteps at the offices of General Mills.

"But before I had worn out one pair of shoes in Montana," said Charlie, "I had decided to stay."



In gold-rush days, it was fashionable to carry an umbrella, rain or shine, explains the tourist guide

Not only did Charlie stay in Montana, but he married the attractive daughter of a Great Falls banker, left the milling business and struck out on his own as a rancher. A quiet and retiring fellow, he has always been known as a good listener. He listened to Montanans tell about raising wheat and cattle, then went out and raised better and more wheat and cattle.

Charlie's land holdings grew. He became a state senator. While still in his thirties, he was considered to be one of the most successful men in Montana.

But Charlie wanted to accomplish something more. He wanted to do something about Montana's colorful history. He wanted to make that history live again.

Charlie began to look around at ghost towns and semighost towns, and one day in 1945 he drove his station wagon into Virginia City, tooted at a sleeping dog in the street and also disturbed the dozing of an old-timer in a sidewalk chair. Charlie, followed by the curious gaze of the native, proceeded to look over the remains of what was once a gold-happy town.

Back in the spoke-bustin' 90s, Virginia City boasted the richest acre on earth—Bummer Dan's placer gold mine. More than \$150,000,000 in gold was taken from this and other mines that dotted the gulch meandering through the town. Money poured out like water from a rainspout. Flour at one time cost \$150 a 100-pound sack. Dance-hall girls sometimes had difficulty walking because of the gold and silver stuffed in their stockings. But life was cheap. One gang of robbers alone was credited with 102 killings. Prominent citizens organized the Virginia Vigilantes and

strung up 24 of the worst badmen.

In its prime, the town had a population of more than 10,000. Perhaps 2000 were Chinese. The Orientals had their own temple and private tong wars.

No doubt about it. Virginia City's past was colorful, but its future looked drab that day in 1945 when Charlie took his stroll. The town was a ghost—almost. The gold had faded and so had Virginia City. Nine tenths of the buildings still standing were paint-hungry, sway-backed and empty. Population of the town was down to about 300. Only thing that prevented it from curling up completely was the fact that it is the county seat, and a few die-hard prospectors still hoped to find gold the early miners had missed.

Charlie looked mighty pleased with what he saw, however. Ordinarily a man of few words, he became voluble. He talked the Historic Landmark Society of Montana and the Vigilance Club of Virginia City into reviving the old buildings. Then came trouble. Neither the Historic Landmark Society nor the Vigilance Club could round up enough funds to keep the project going and Virginia City was about to turn over and go back to sleep. Charlie wouldn't stand for that. He bought up most of the town, then hired townspeople and folks around to put it back in the shape it was 75 years ago.

Natives shook their heads at the doings of Charlie.

A prospector was tearing down an old shack to supply his wife with firewood during his sojourns in the hills. Charlie raced his car to the shack to halt the destruction. He offered to supply all the

(Continued to page 246)



This is no stage version of "Life With Father." It's a typical scene in the lobby of the Fairweather Inn. Below, the Bale of Hay Saloon is back in business at the same old stand, although it is a lot quieter now than when prospectors came in for their Saturday-night pleasures



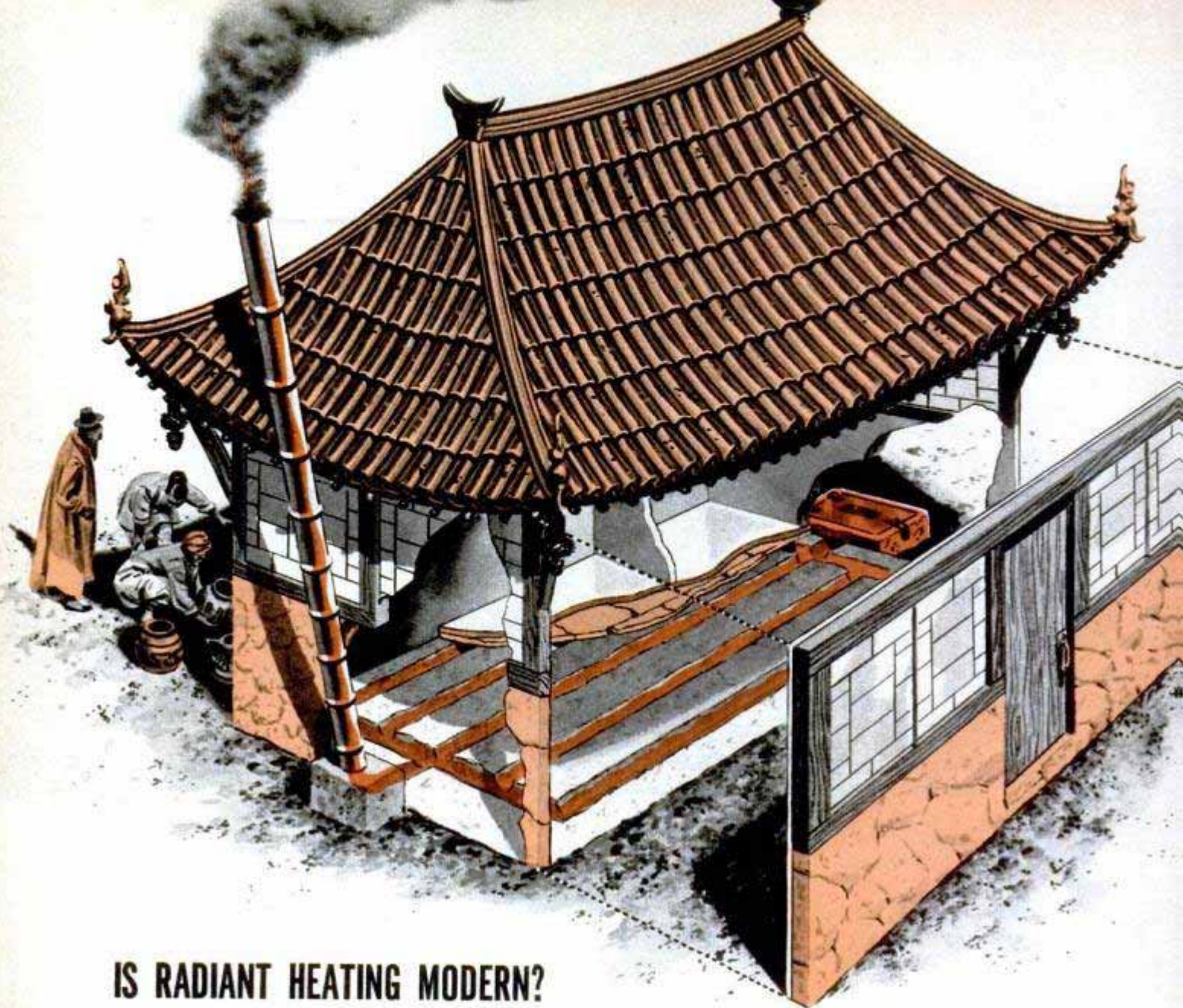

IS RADIANT HEATING MODERN?

Radiant heating—modern by American standards — has been warming Korean homes for more than 2000 years, according to L. G. Nonini, of Wallace, Idaho, who worked in Korea for some time. The home builder first digs ditches along the site of his new home. Over the ditches he lays thin slabs of stone, and over the stone he

smooths a layer of mud. The mud is covered with heavy oiled paper. The ditches are connected to a firebox on one side of the home. Smoke and hot gases pass through the ditches, warming the floor which radiates heat throughout the home. A chimney from 10 to 20 feet high provides sufficient draft to draw heat through the ditches.

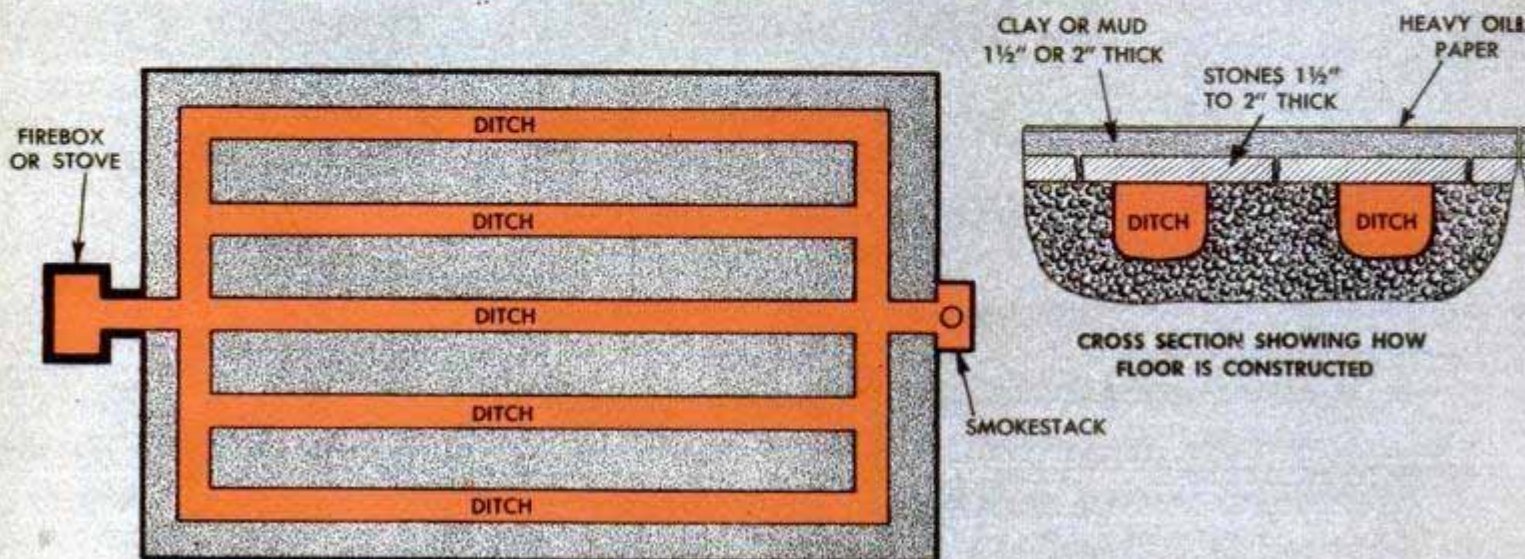



Bits of broomstraw are the paints and a sharp knife is the brush of this artist-craftsman of Mexico City

Artists With Straw and Feathers

By Thomas E. Stimson, Jr.

ONE of the world's most unique hand-crafts, the making of beautiful pictures from tiny bits of colored broomstraw, is a booming business in Mexico. Foreign tourists and Mexicans alike are captivated by the colorful pictures and a score of artist-artisans can hardly keep up with the demand.

Observed at a distance, a straw picture has an extraordinary brilliance almost as if it were illuminated by hidden lights. Close inspection shows that this sheen and a slight third-dimensional effect come from rounded surfaces of thousands of straws that make up the picture.

Most of the pictures

Only the finest bits of straw and more than five weeks of painstaking handwork went into this beautiful religious picture



are of typical Mexican scenes such as a tile-roofed village under snow-capped Popocatepetl or a boatman on the floating gardens of Xochimilco. Any of the master craftsmen, however, will prepare a special picture on order, either of a particular scene or of a portrait. All he needs is a photograph as a guide.

A straw picture of good commercial quality may require a full week of painstaking work and may contain as many as 400 separate glued bits of straw per square inch, some 30,000 or more in an 8 by 10-inch picture. Pictures of the very highest quality in which only the finest straws are used may

represent four or five weeks of work. Fifty or more straws may be glued side by side to make up a lineal inch of the design.

In spite of the amount of work that goes into a picture, prices are surprisingly low because of the favorable rate of exchange. Some of the pictures used to illustrate this article were purchased in Mexico City for \$7.50 in United States currency. Pictures that are made to order of the finest straw can be bought for less than \$50.

Tourists sometimes are told that the manufacture of straw pictures is an old lost art and that only a few samples of the early craft are still available. Such remarks are sales talk—the history of straw work is obscure. Some believe that the craft is less than 50 years old, others insist that the early Aztecs were its inventors. Some of the older craftsmen can tell you only that they learned the trade from their fathers, who in turn learned it from their own fathers. One reasonable suggestion is that straw work had its beginnings in the town of Uruapan, near Paricutin volcano, where single straws were embedded in the thick lacquer surfaces of the wooden trays and boxes for which Uruapan is famous. In any event, the art slowly progressed to its present state. Today the making of straw pictures is centered in Mexico City.

One of the artists, Victor Ramirez Valencia, explains that the "popotes" or broomstraws used for the picture mosaics grow as a tall grass in the state of Guanajuato in central Mexico. The central portions of the finest stalks are laid aside for



Here is a magnified view of a small section of the picture at the right. Note how each of the tiny pieces aids in the shading

picture-making. Bundles of the selected straws are washed, boiled in aniline dyes, dried in the sun and trimmed. Native dyes have been discarded because the new chemical dyes yield a wider variety of colors and are considered more permanent. Some 100 shades are available of which 30 are most com. only used.

Valencia is an expert in creating straw pictures and his brother, Fernando Ramirez Valencia, excels at the old art of feather work. Both, these days, work as agents for groups of straw and feather craftsmen.

In preparing to make a straw picture, the artist first roughs out the main features of

Left, first step is to outline the major areas. Right, straw is laid on tacky surface and cut with a knife



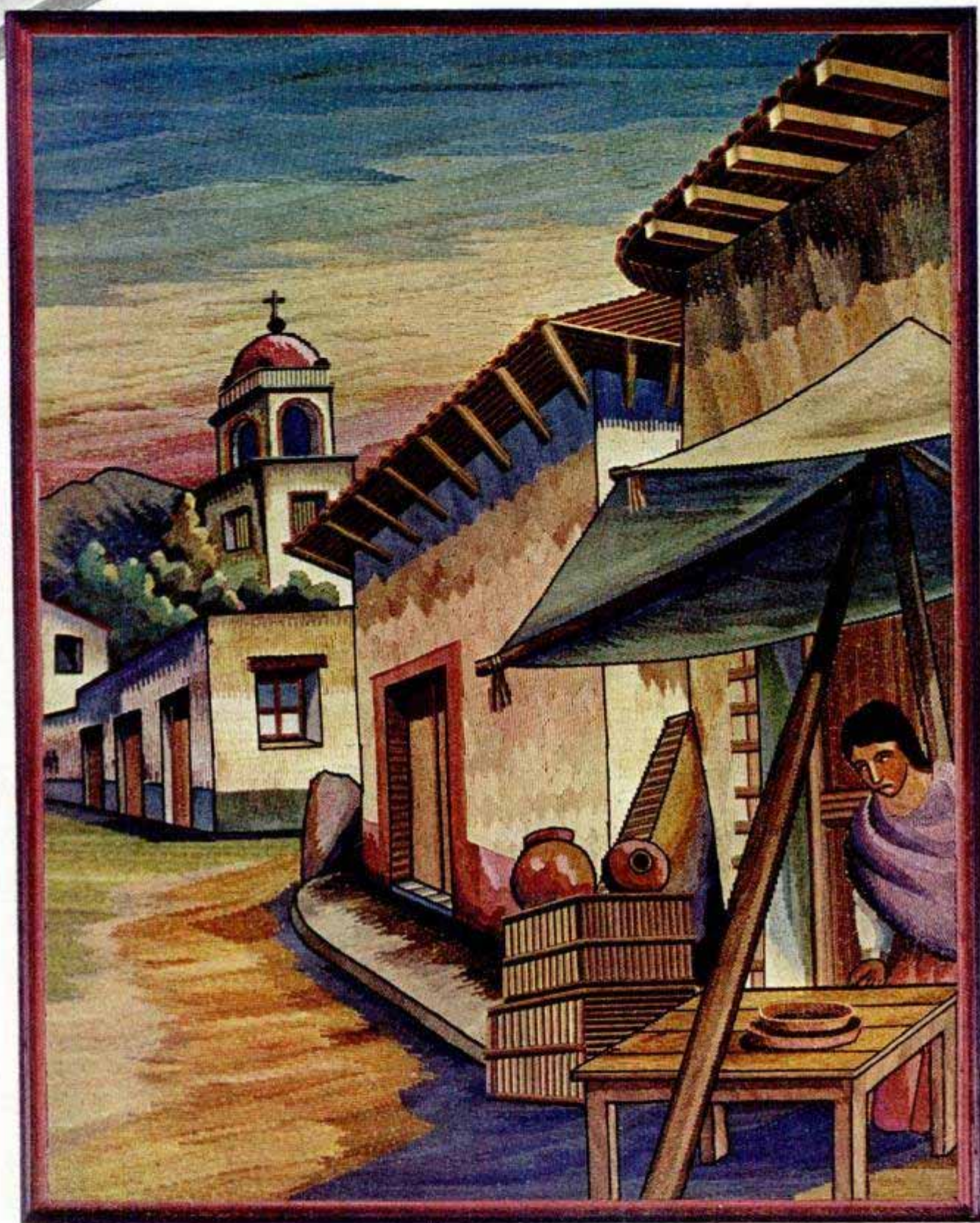

the design in black ink on a sheet of white cardboard, then lays a sheet of transparent paper over the drawing. The sheet has been coated with a mixture of campeche tree wax and beeswax, a combination that forms a tacky, sticky surface to which the bits of straw will adhere permanently.

Usually the artist first fills in some of the main outlines of the picture that are visible through the transparent paper. He selects a straw of the desired shade from the bundles in front of him and lays it down

against the wax-paper surface, cutting off its end cleanly with a sharp knife. Pressed into the wax, the straw sticks in place. A straw of a different color is selected, pressed down and cut off. The preliminary work progresses rapidly. One long straw may serve as the edge of a building but to create the delicate shadings and tones that are common to the best pictures, the artist chops off innumerable short lengths of straw, one at a time. Curved rows of straws each no more than $\frac{1}{16}$ inch long

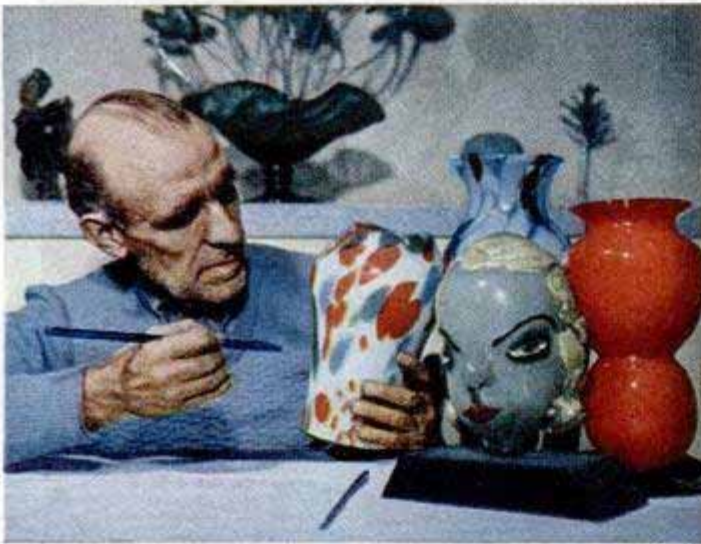

↑ Feather painter presses bits of plumage on a sticky, waxed surface to form a gaudy bird

← Glass artisan removes flakes from a finished piece. Bottom, most straw pictures show Mexican scenes. A few artists paint portraits

may be used to represent tree leaves.

Detail is carried to an extraordinary degree. Even for a small human face that will appear in the finished picture the artist selects straws of different colors to indicate the eyes and eyebrows. The shading of a dress may require bits of straw of a dozen or more different colors. Sixteen or more shades of blues and grays may be selected for filling in a sky. The artist's ability is reflected by his choice of colors and by his skill in the freehand filling-in of picture details.

It's tedious, exacting work. An apprentice learns by working with coarse straw, creating simple little designs that may be glued to cardboard squares and used as place cards or postal cards. Four years of training and practice usually are required before he becomes a good craftsman.

The finished straw picture remains on its wax and paper backing, which usually is glued to a larger sheet of stiff cardboard and mounted in a frame.

Mexico is still a land of many hand-crafts. Most articles from furniture and shoes to serapes and pottery are largely made by hand. Even on such practical articles as these the Mexican workers place a little extra ornamentation or decoration. This artistic bent also is reflected in such typically Mex-

ican crafts as painting entire landscapes on small pumpkin seeds and dressing tiny fleas in full suits of apparel. Some artists create tiny colored figures of glass and arrange them on the tiered glass seats of a miniature bullfighting ring.

In a glass factory where the equipment and methods have remained unchanged for 100 years the proprietor and some of his workmen, after a day of producing commercial glass objects, may keep working for an extra hour or so for the fun of producing artistic glass objects of their own design. One man sits in front of a group of gas jets and produces miniature figures from bits of colored glass, some of the others draw hot gobs of molten glass from the main furnace and work them up with crude iron tools into oddly shaped vases or pitchers.

Similarly a worker in wrought iron, after he has completed his day's work, remains at his forge to hammer out the scrollwork and massive locks that will decorate a cedar chest of medieval design that he is building.

Some of these crafts are virtually unchanged from the days when they were first created; some, like straw work and feather work, have been modernized to meet the changing demands.

Gaudily colored feather robes and plumed feather headdresses were highly prized by the early Aztecs and when Cortes first visited the Aztec capital in 1519 he found many of the nobility had entire wardrobes made up of feather garments. Manufacturing the feather clothes, in fact, was a major native industry that employed thousands of workers. In most cases, the feathers were stitched one at a time to a backing material of cloth or rabbitskin.

Feather garments can be found only in museums today but the old industry has been revived to fulfill the demand for decorative pictures. Images of gaudily colored tropical birds, worked out in feathers, are used as pictures to be hung on the wall, as scenes under glass fruit or candy trays, or to decorate place cards and postal cards.

In pre-conquistador times the plumage of exotic jungle birds was used but now most of the feathers come from ordinary hens and roosters, turkeys, pigeons and ducks. Pictures made with any of these except duck feathers are imported into the United States.

Feathers that are naturally white, brown, gray or black are used without treatment. Green, red and blue feathers usually are dyed after a preliminary washing in hot soapy water to remove the oils. Occasionally the wing of a bat may be used intact to represent the wing of an imaginary

(Continued to page 238)

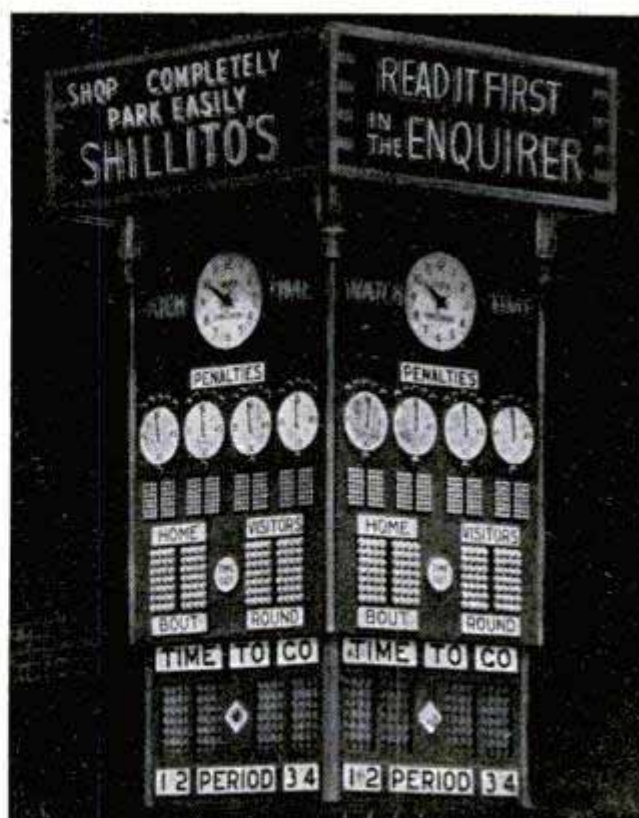

Complete Sports Clock

Hanging in the new Cincinnati (Ohio) Garden is the most complete timing and scoring device ever built for a sports arena. Four-sided and weighing $2\frac{1}{2}$ tons, it cost \$20,000 to build and \$10,000 to assemble. Eleven electrical cables leading into it feed 2200 light bulbs of 6 and 25 watts. It can be raised or lowered by motor or hand-operated crank.

Super-Lubricants From Chemicals?

Fluorocarbons, a versatile new family of chemical compounds, show broad promise of solving many industrial problems. One important application will be as lubricants so stable they will permit construction of engines impossible at present because no known lubricant could withstand their pressure and friction. Other members of the chemical family will be used in anesthetics, insecticides and germicides. Fluorocarbons are similar to hydrocarbons except that the hydrogen is replaced by fluorine. The hydrogen is the point of chemical attack in such compounds. It has been dangerous to make fluorocarbons in the past because free fluorine is the most active of all elements. Now the Minnesota Mining and Manufacturing Company is producing fluorocarbons by an electro-chemical process that eliminates the danger.

☛ Cotton, America's most popular textile fiber, supplied 57.4 percent of the nation's textile needs in 1948, a slight decrease from the 1947 figure of 58.4 percent.

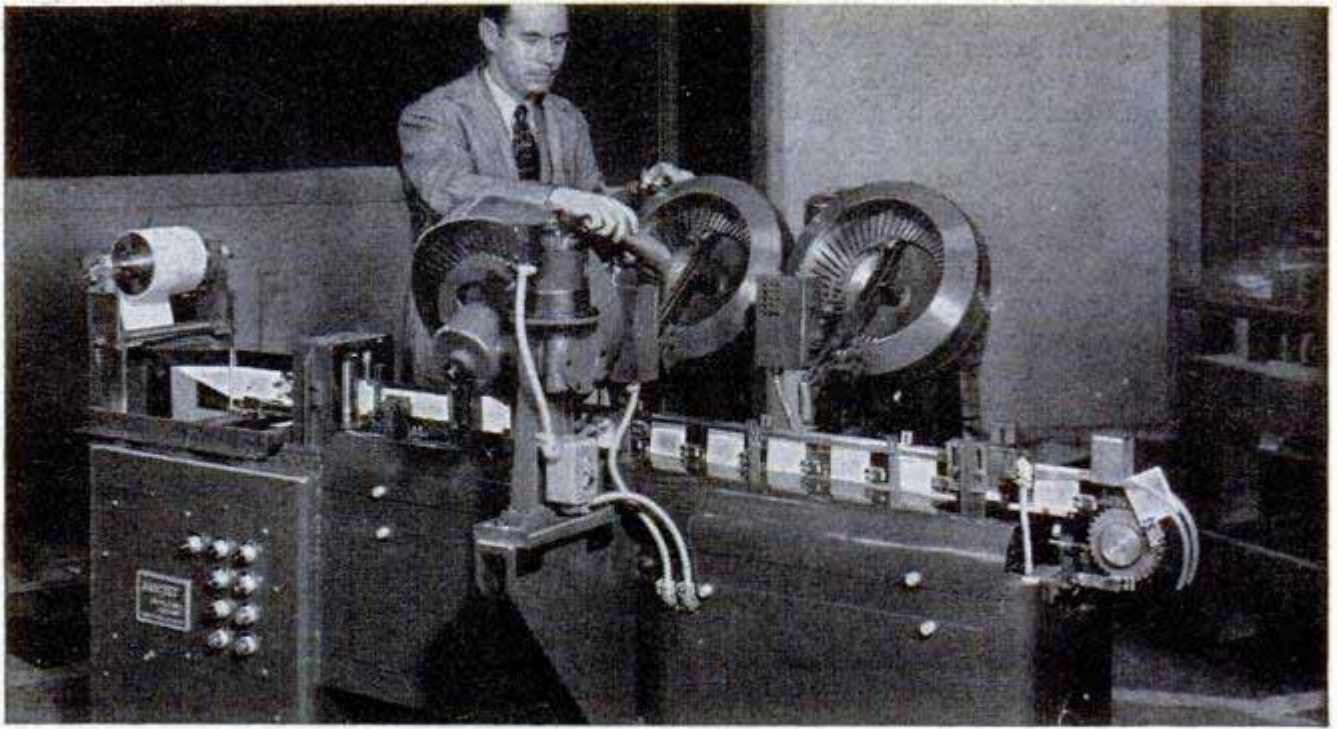

Here's the result—envelopes made, printed, filled with small parts and sealed by machine shown at top

NINE-FOOT PRODUCTION LINE

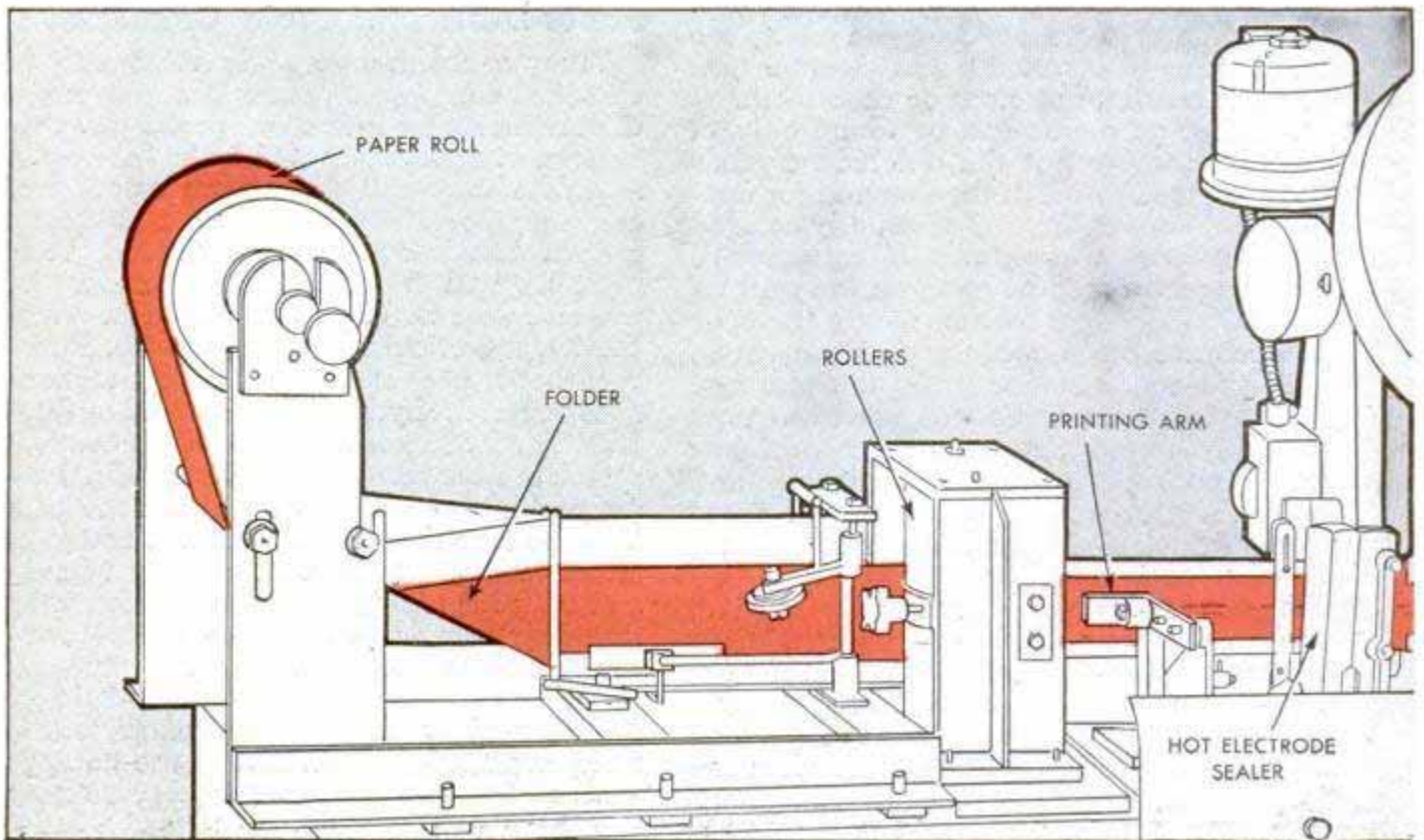

ONLY NINE FEET long, a single new machine performs the following operations precisely and automatically: makes envelopes from a roll of paper; prints addresses, labels or instructions on the envelopes in one or two colors; counts out small items of almost any kind, drops the correct number into the envelopes and then seals the envelopes at a rate of more than 3600 per hour.

A special type of paper from a roll is drawn into the machine and folded once along the bottom. At regular intervals a printing arm stamps the desired information on the folded strip. A separate small printing press can be used in place of the printing arm if more than one color is desired. A hot electrode sealer squeezes the folded paper strip on each side of the printing matter, forming a 1/4-inch seal in the special paper. A knife then splits each of these seals down the center, forming individual envelopes with open tops.

Small parts such as screws, nuts, washers and piston rings slide down chutes from revolving hoppers and are automatically counted. While suction cups hold each envelope open, the parts drop inside in the desired numbers. Another electrode then seals the tops of the envelopes and they are dropped into a container.

Although the machine moves at high speed, the paper is pulled through in steps, with each operation performed as the envelopes pause. A number of different items can be packaged in the same envelope and the size of the finished envelope can be regulated as required.

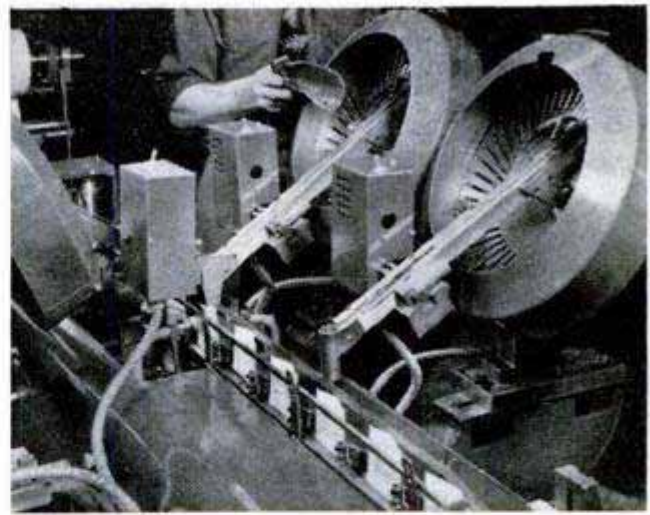

Hoppers are filled with parts. As hopper turns, parts slide down chute, are counted and drop in envelopes

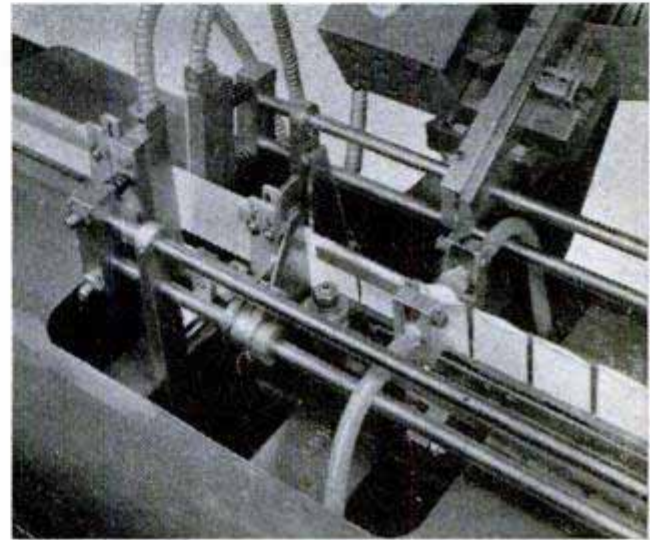

Envelopes at this stage are sealed on three sides. Suction cups hold tops open while the parts drop in

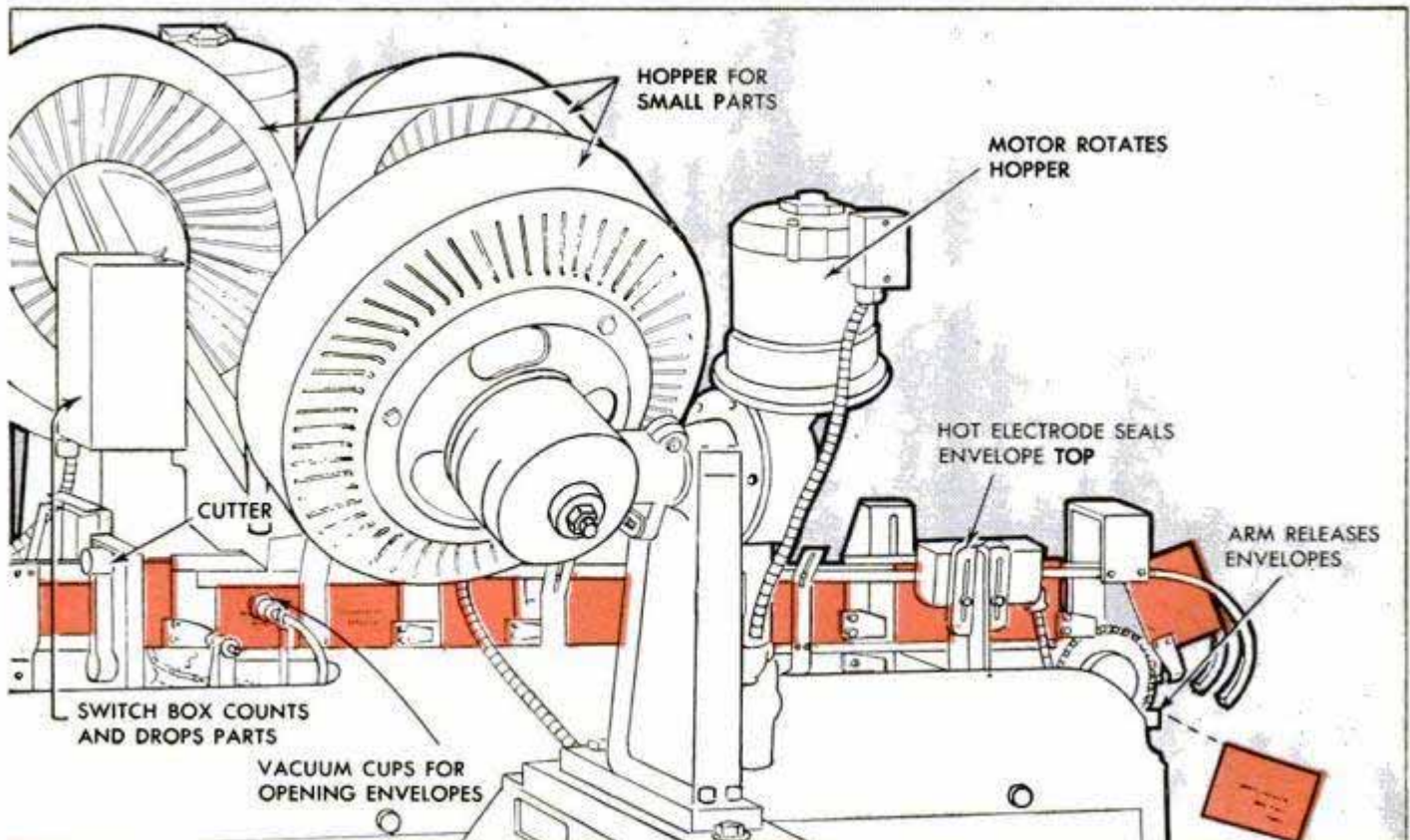



OLDSMOBILE is introducing a new hard-top "convertible" called the Holiday Coupe. In addition to the rigid steel top that provides greater passenger protection, innovations in design include a rear window of curved glass with wide visibility. The support pillars are eliminated between top and lower portion of the body to carry out the convertible design. Holiday Coupes are powered by the Oldsmobile high-compression Rocket engine. Hydra-Matic Drive is standard equipment on this Olds model

DE SOTO'S Carry-All four-door sedan can be converted quickly into a spacious utility car by folding the rear seat down to the floor. The space for luggage then extends all the way from back of the front seat to the rear deck lid. Either rear door, as well as the large luggage compartment opening, can be utilized for loading. The luggage platform, made of wood and fitted with chrome strips, makes it easy for sliding cargo in and out. Almost eight feet of carrying space is available. When the rear seat is up the car looks like a conventional six-passenger sedan. Owners have a choice of long-wearing plastic upholstery designed to harmonize with the special door panels or a combination of plastic and broadcloth. Chrome armrests become the supports for the luggage platform when the rear seat is folded down. The Carry-All was developed in response to the demands of salesmen, businessmen, sportsmen, farmers, suburban residents, vacationists and others who need a car which serves both as family sedan and big cargo carrier. Exterior finish is conventional

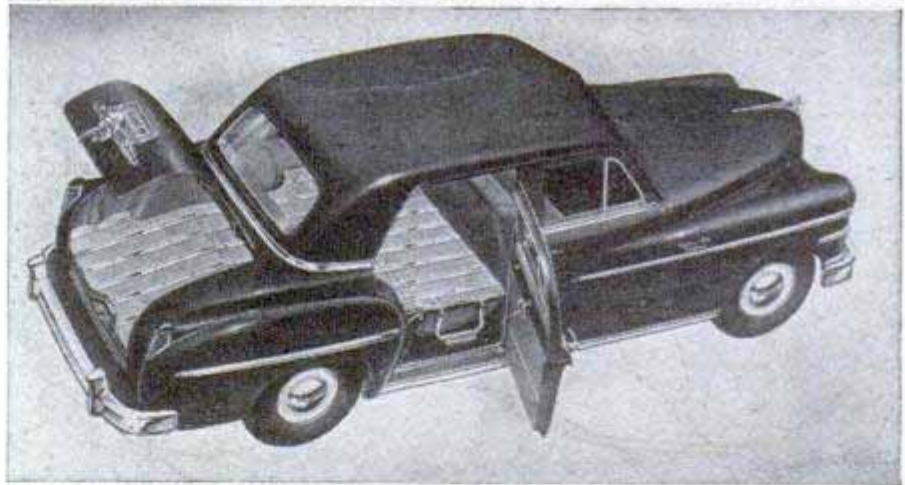
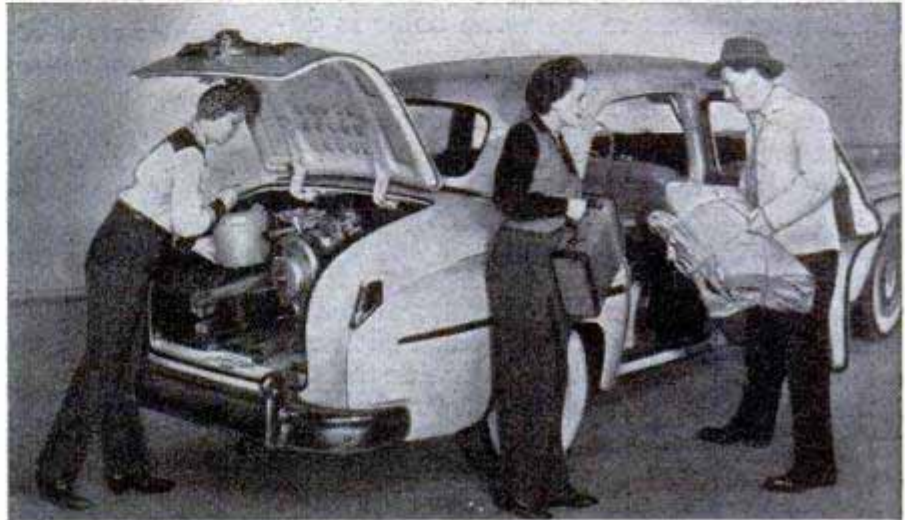

CROSLY Motors calls their new Hotshot the car with a "dual personality" for it doubles as a roadster and racer. The lights, bumper and windshield can be removed for racing and the engine souped up to a high-compression ratio. The car has a low center of gravity and road clearance of seven inches. Seats are aircraft type and comfortable. The Crosley 44-cubic-inch engine with overhead camshaft is the type that powered three motorboats to victory and set two speed records recently. The Hotshot weighs 1000 pounds, goes 35 to 50 miles per gallon



Powered Cradle Launches Lifeboat in Five Seconds

Tested by the U. S. Coast Guard, a new method for lowering and retrieving lifeboats saves time and manpower. A cradle supports the lifeboat aboard ship. When a boat is to be launched, the cradle swings it out and down into the water where it is

released instantly. A winch-powered cable operates the cradle. The conventional method for lowering a lifeboat requires several men and consumes 30 seconds to two minutes. With the new method, the boat hits the water in five seconds.

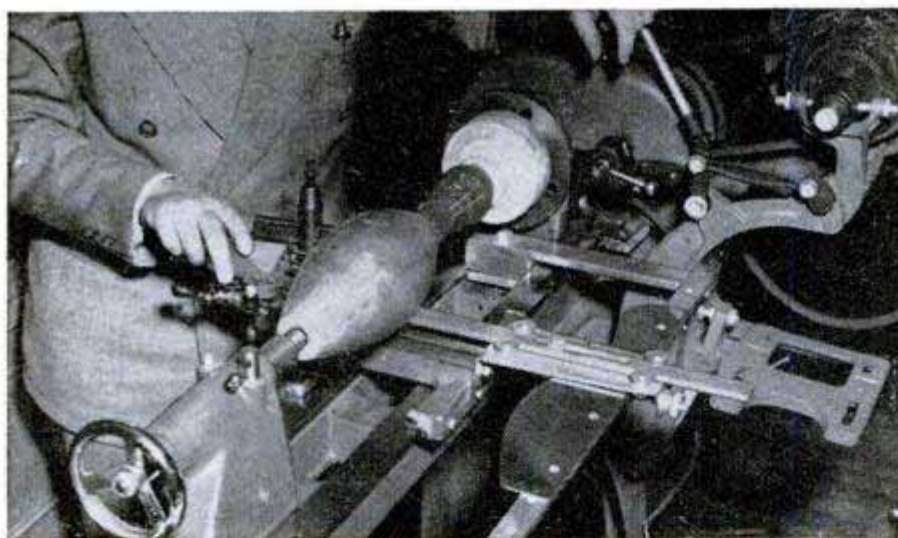

Contour Cutter Speeds Lathe Work

Contours and tapers are cut quickly and accurately when the tool is guided by a contour cutter that is used with any small metal-turning lathe. A follower roller runs along the profile of the pattern, controlling the position of the cutting tools. The cutter handles any diameter within the lathe capacity and is attached in 10 minutes.

Jar Top Catches Minnows

Minnows can be trapped inside an ordinary fruit jar with a funnel-shaped top made of metal and plastic. The jar is placed on the bottom of the stream, where anchor pegs keep it from washing downstream. Cracker crumbs inside the jar attract the minnows, which swim in through the funnel, but can't find their way out.

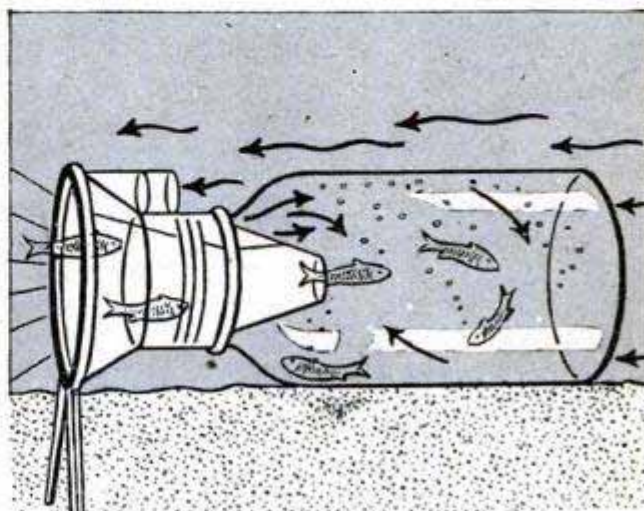

☛ The bat population of Carlsbad Caverns in New Mexico has dropped from 5,000,000 to about 1,000,000 in recent years due, the National Park Service says, to reduction of their insect food supply by drought.

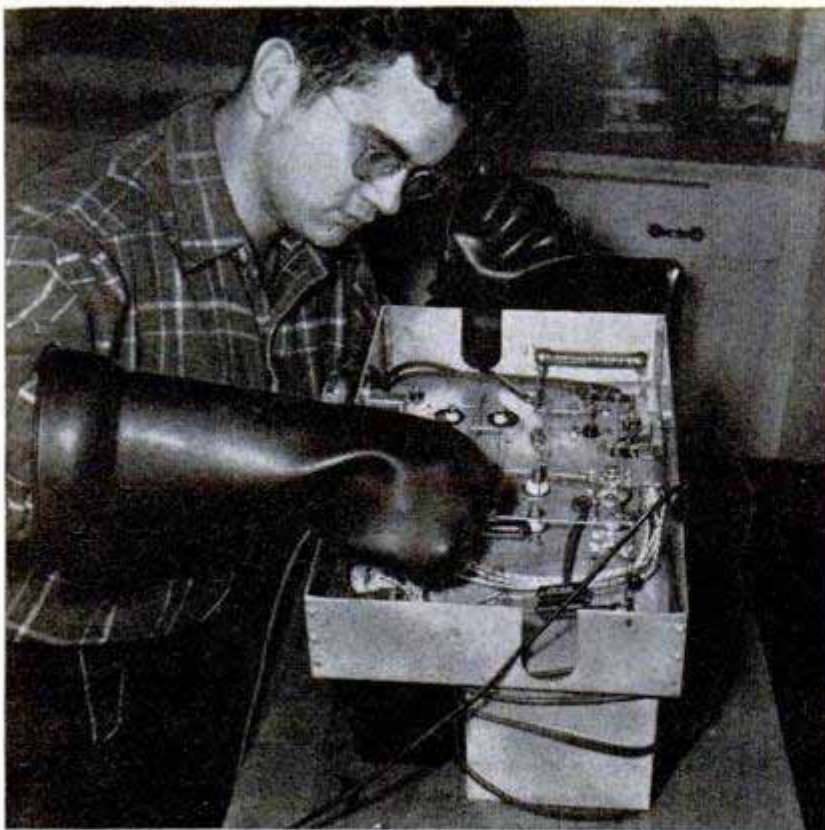

Tenny's experiments carry him into dangerous fields. Here he tests his high-voltage power supply, which furnishes current for his work. Rubber gloves prevent shock which might kill the youth. Below, he letters diagram for navigational computer before submitting it to Army



HHEIGHT, six feet two inches; weight, 200 pounds; age, 17 years; hobbies, hot rods and ice cream; I.Q., somewhere in the genius class. That's Tenny Lode of St. Paul, Minn.

The fact that Tenny could have entered college when he was 12 years old is not particularly unique. Children frequently pop up in the news with high I.Q.s and an ability to digest textbook knowledge at an astonishing rate. What makes Tenny unusual is his singular ability to understand electronics and use this knowledge to develop electronic instruments. He's as familiar with vacuum tubes as baseballs and can read a circuit diagram faster than a comic book.

Take Tenny's aircraft navigational com-

Hot Rods and Electrons

By Clifford B. Hicks

Tenny Lode was an inventor at the age of 10. Today he's the campus genius at the University of Minnesota, with a normal flair for hot rods and an amazing capacity for taming electrons

puter. The 17-year-old senior at the University of Minnesota currently is working on a computer that definitely interests one of the bigger airlines and has attracted the attention of a large manufacturer. The indicator translates ground radio signals into a continuous navigational fix. Not long ago Tenny mailed off preliminary sketches of his computer to the Army Research and Development Board. They shot back a request for further information. As yet, Tenny doesn't know what the board thinks of his latest creation.

"My computer," says Tenny, "compensates automatically for wind and other air disturbances. An instrument now in use for the same purpose is extremely complex and has several tubes, whereas mine is

THREE-DIMENSIONAL MOVIES . . .

Youth has worked out a crude but effective system that requires no special viewing lenses. Diagram at bottom shows, in exaggerated form, how two separate views give us three-dimension sight. Sketch below shows Tenny's setup for exposing two different views on same film

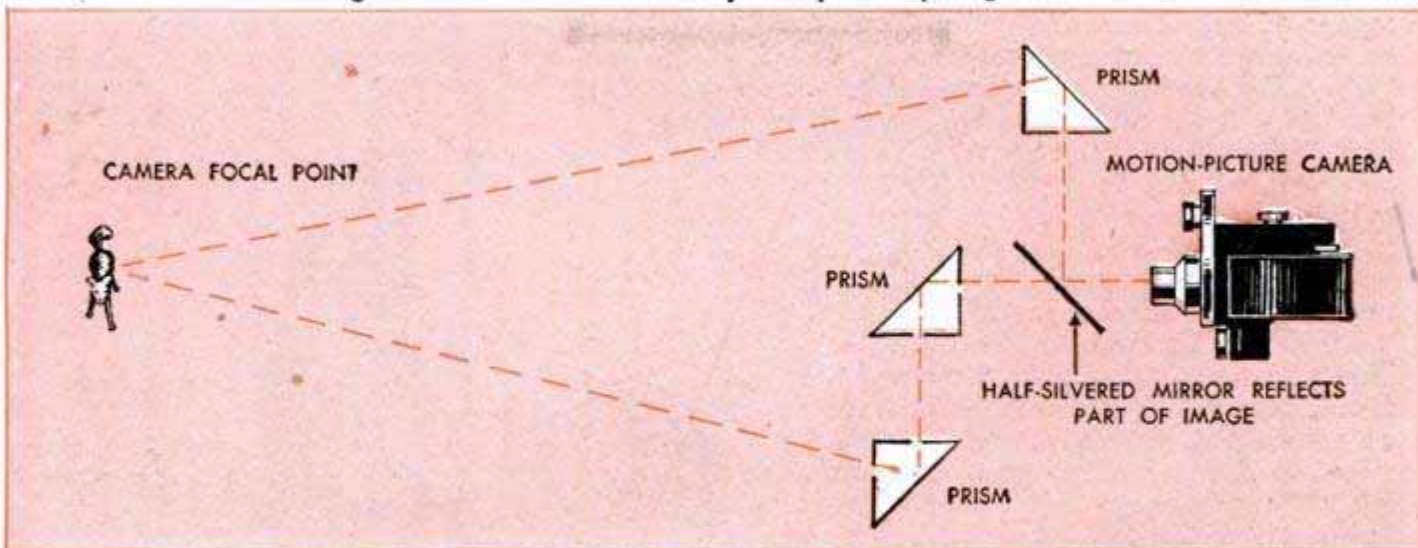

simple and uses no tubes. It performs three jobs: tells the pilot how far he is from his destination; tells him the exact direction to the destination; and operates as an automatic pilot by computing the voltage to be applied to a rudder control."

Last summer the research department of an instrument manufacturing company became interested in the navigational computer and even suggested that Tenny work in the company laboratory. Eventually, though, the legal department of the company turned thumbs down on any business agreement because Tenny is a minor. In Minnesota, a minor can't be bound by a contract.

Tenny has just one complaint in life at present, and it's tied up in the red tape of legal difficulties. "What good do these inventions do me? I'm too young for contracts and too young, according to my patent attorney, to get patents on my instruments without investing a lot of money and a lot of time. I can't afford either."

At the age of 10 Tenny built his first instrument that showed real promise. He was confined to his bed with an attack that combined tuberculosis and a severe case of measles. (The attack left him hard of hearing—he now uses a hearing aid.) He couldn't operate his electric train from the bed except through a conventional remote control, and he figured the control didn't give him enough flexibility of operation. Soon he rigged up his own control on a breadboard—a push-button system that could shuttle the train anywhere on the track.

Visiting railroad fans were so excited about the device that they urged him to submit it to a large company which manufactures model-railroad equipment. The

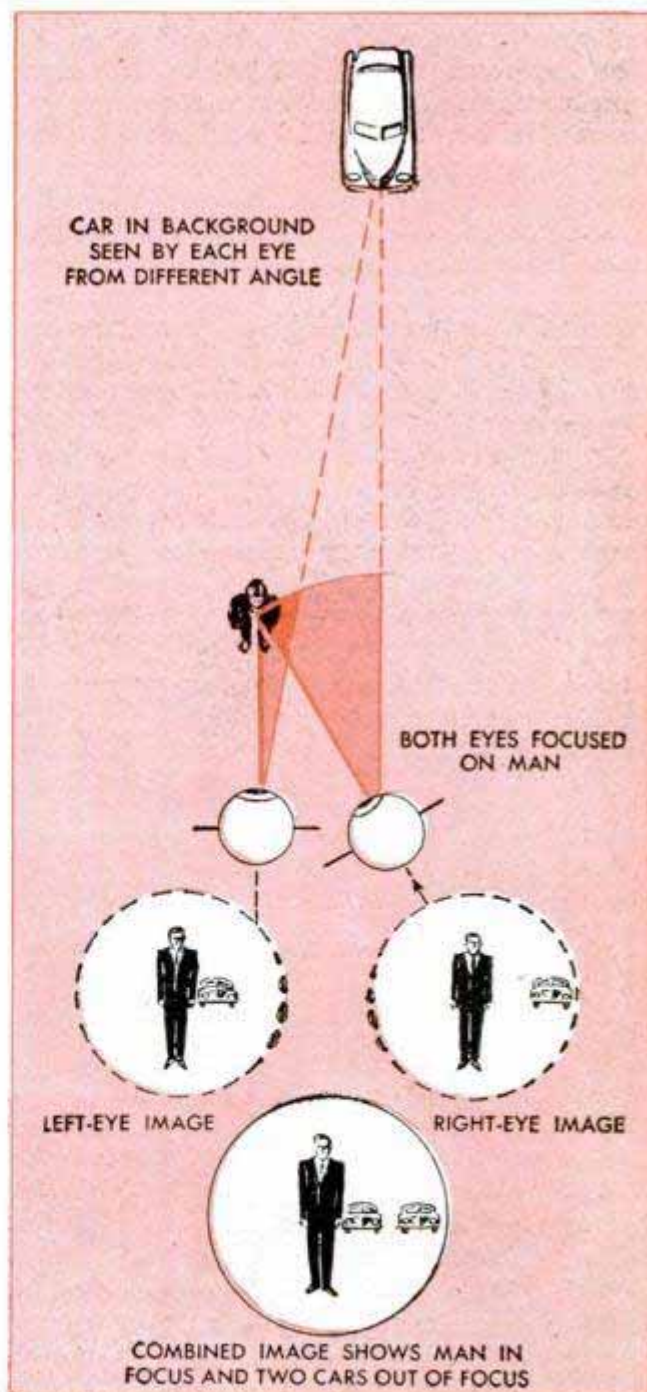

chief of research of the company replied that he had just completed 12 years of work in developing an almost identical control, and that at the time Tenny's suggestion reached his desk he was mailing out the first announcements of the control.

When Tenny was three years old he took his tricycle apart and put it back together again. When he was nine his mother came home one evening to find the 443 parts of the dial telephone scattered across the living-room floor. She was so angry she stalked back out the door, afraid she might say something she would regret. When she returned a half hour later she found Tenny talking to a friend on the phone. Later, when a phone inspector made his visit, he was fascinated by the phone. "The only perfect dial action I've seen in months, lady. Apparently you don't have any kids to tinker with the dial."

At 12 Tenny zipped through a college entrance examination with a score of 99. The examiners were so surprised they gave him another, then told his mother the results. The boy's parents decided their wisest course was to send him through high school on the conventional time schedule, even though college authorities offered to accept the 12-year-old. Even so, Tenny finished high school in three years and entered college at 15. Every time he has taken an I.Q. test he has shot through the ceiling to a height where measurements no longer are valid.

During his high-school days Tenny built a projector for throwing microscope slides on a viewing screen. So efficient was the instrument that his instructor demon-

Youth watches dance of electrons on his oscilloscope. He uses the instrument to observe complex wave forms

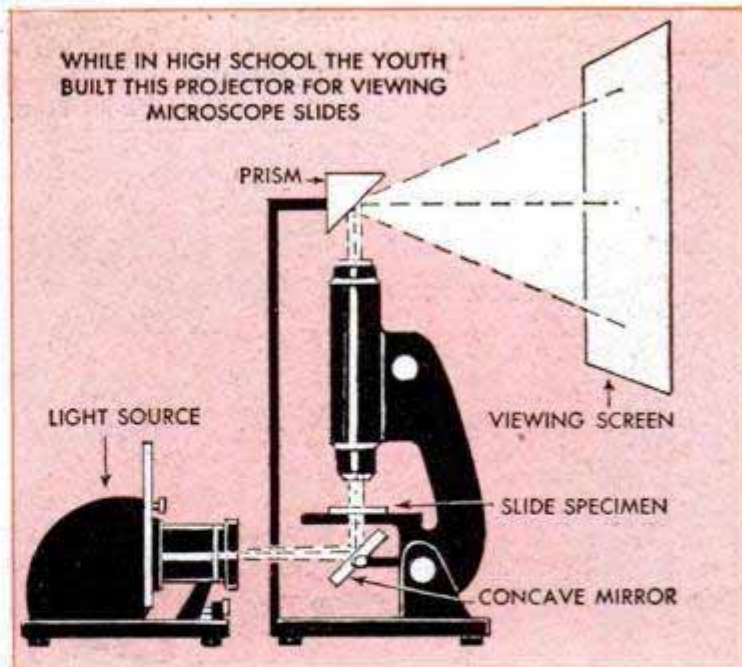

strated it before a national group of science teachers. About this time he also developed a low-cost public-address system, a radio circuit demonstrator and a compact a.c.-d.c. radio capable of operating efficiently in spite of the wide variations in voltage often encountered in small towns. He came up with a "magnetic valve"—a means of controlling magnetic forces—and built his own telephone switchboard. He also devised a low-cost radio-phonograph tone control which gives small sets almost the same tone quality as console models.

"Anything I do has to be inexpensive," says Tenny. "I can't afford a lot of special equipment."

When he was 12 he made an effort to

Tenny checks wide-band transformer he developed. It has frequency response much greater than most types



When taking notes cramped his style, Tenny decided he should be able to write with either hand in case the other was busy. Now his left hand is as efficient as his right



solve this financial problem by starting the Lode Electronic Service — a radio repair shop with headquarters in his bedroom. During the next four years he repaired hundreds of radios and built some 20 radio-phonographs. He's especially proud that three of the sets were purchased by music instructors, and that the Iowa State Teachers College ordered two specially designed jobs from him.

Tenny plowed his profits back into his business, investing in such equipment as an oscilloscope. But his chief tools remain an old screwdriver, a pair of pliers and a soldering iron which he wields with the delicate touch of a surgeon over the kitchen table or a battered bench in his bedroom.

Some of the lad's friends once were annoyed by pigeon roosts, so Tenny whipped

out a pigeon eradicator using high-frequency sound. The noise so disturbed the pigeons that they immediately departed, yet the horn was so high-pitched humans couldn't hear it. Tenny was about to sell this invention when he read of a man out West who had developed a similar instrument. So the pigeon eradicator's parts now are installed in other instruments.

A couple of years ago he worked out a film-developing system, only to discover that the same system had been used 10 years previous.

Tenny's biggest trouble is that frequently he doesn't build a model complete enough to demonstrate to others. Sometimes the reason is lack of funds; often it is because ideas fascinate him but end products hold

(Continued to page 254)

Lode started repairing and building radios to finance his experiments. Here he drills the chassis of a console radio. Headquarters of the Lode Electronic Service is his bedroom

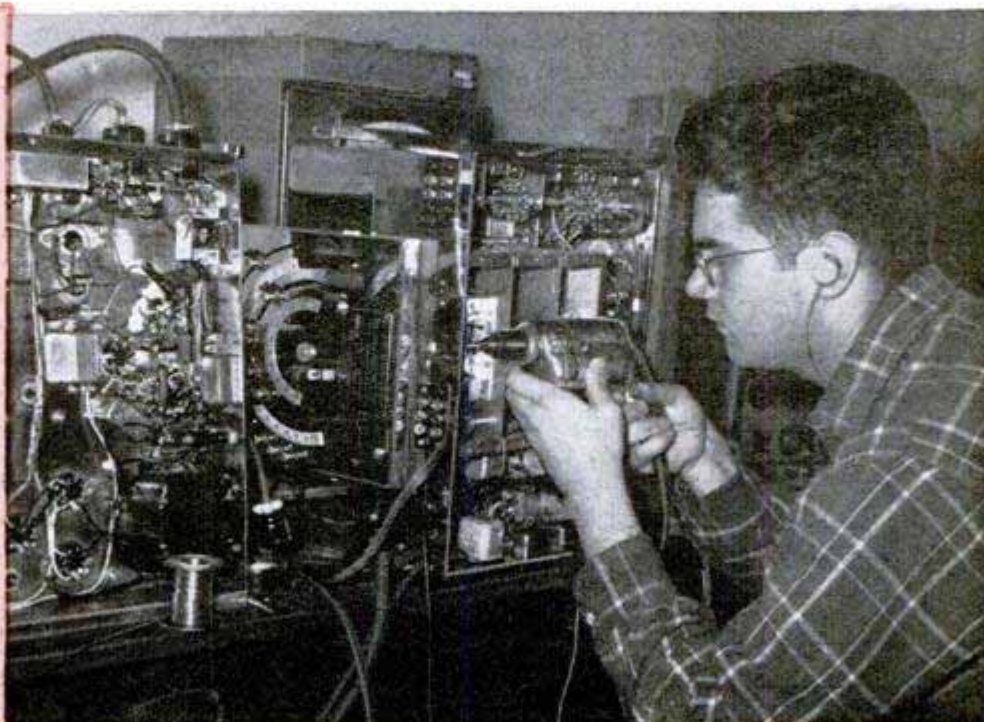

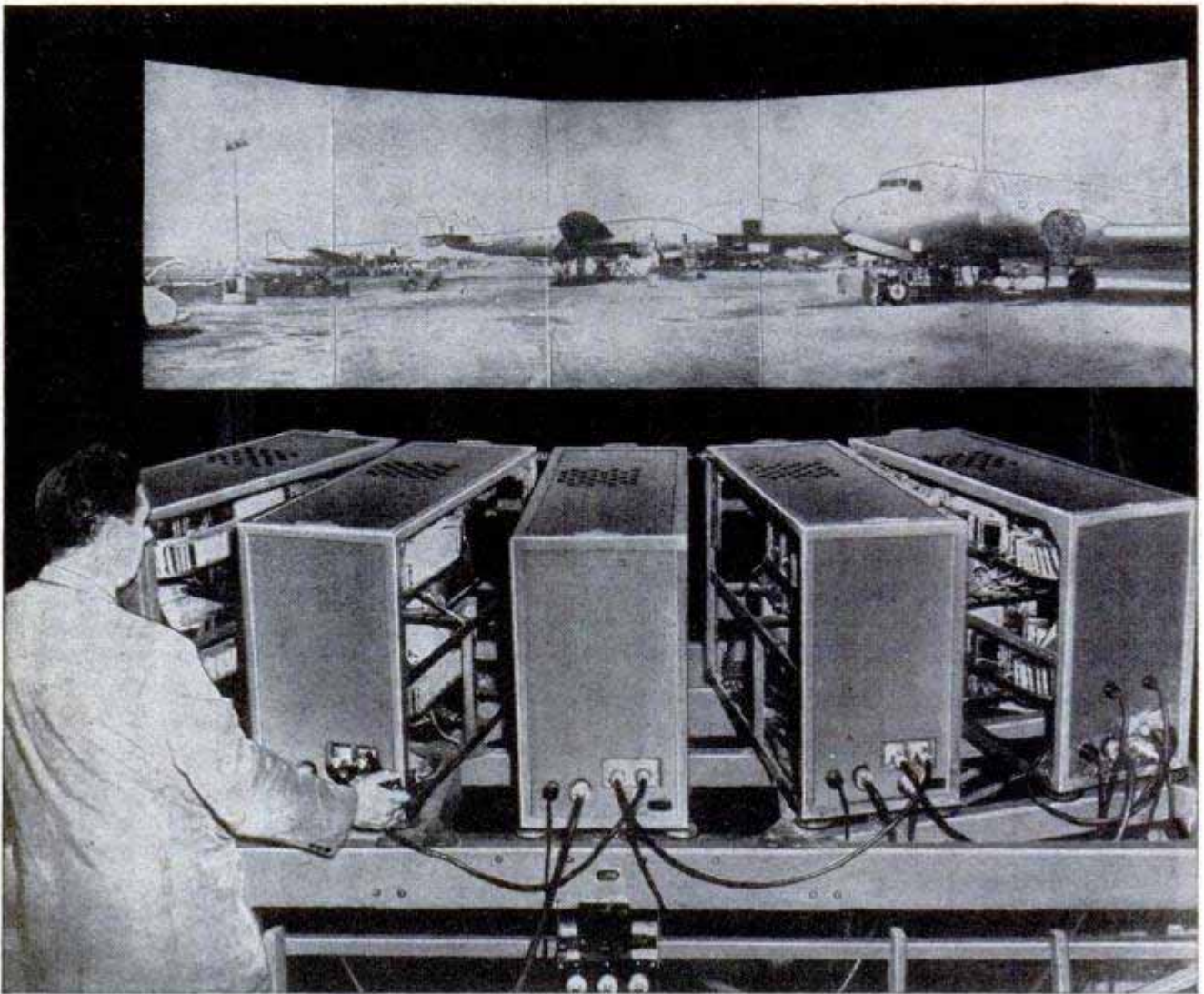

Perfectly aligned, these five separate slides form a giant panorama that is 30 feet wide and 9 feet high

Panorama on a Giant Screen

SIGHTSEEING "trips" to America's beauty spots have been conducted right on the Chicago Railroad Fairground with a projection system that makes color pictures of Niagara Falls seem so real that you wonder why you can't feel the mist on your face. Kodachrome transparencies are projected on the screen five at a time and, so perfectly aligned are the individual pictures, that the effect is of a giant, natural panorama.

Part of the Eastern Railroads exhibit at the fair, the presentation features the Vitarama system of slide projection. Ten separate projectors are used, two being housed in each of five machines. Carefully aligned and synchronized, the 10 projectors provide a sight-and-sound panorama of the East—its natural beauty and its giant industry.

The huge screen, made up of five joined sections, is more than 30 feet long and 9 feet high and occupies the entire front wall of the theater. The tremendous screen width provides an angle of vision approxi-

mately equal to that of the human eye, giving such a natural quality to the scene that the audience feels as though it is seeing the real thing.

A complicated system of shutters and film-transport machinery changes one scene to another so smoothly that you are almost unaware of the change. A recorded commentary with music and appropriate sound effects is played with the show. Triggering signals, recorded on the transcription but inaudible to the audience, operate the slide machinery.

The color pictures were taken on a special tripod with a swivel head to provide the exact angle necessary for multiple projection. The slides are mounted in metal frames, linked together to form a continuous belt and pulled through the projection gate by a small electric motor. Another small motor operates the shutters. As the shutters on the top bank of projectors are closing, those on the lower bank open, thus dissolving one scene into another almost imperceptibly.

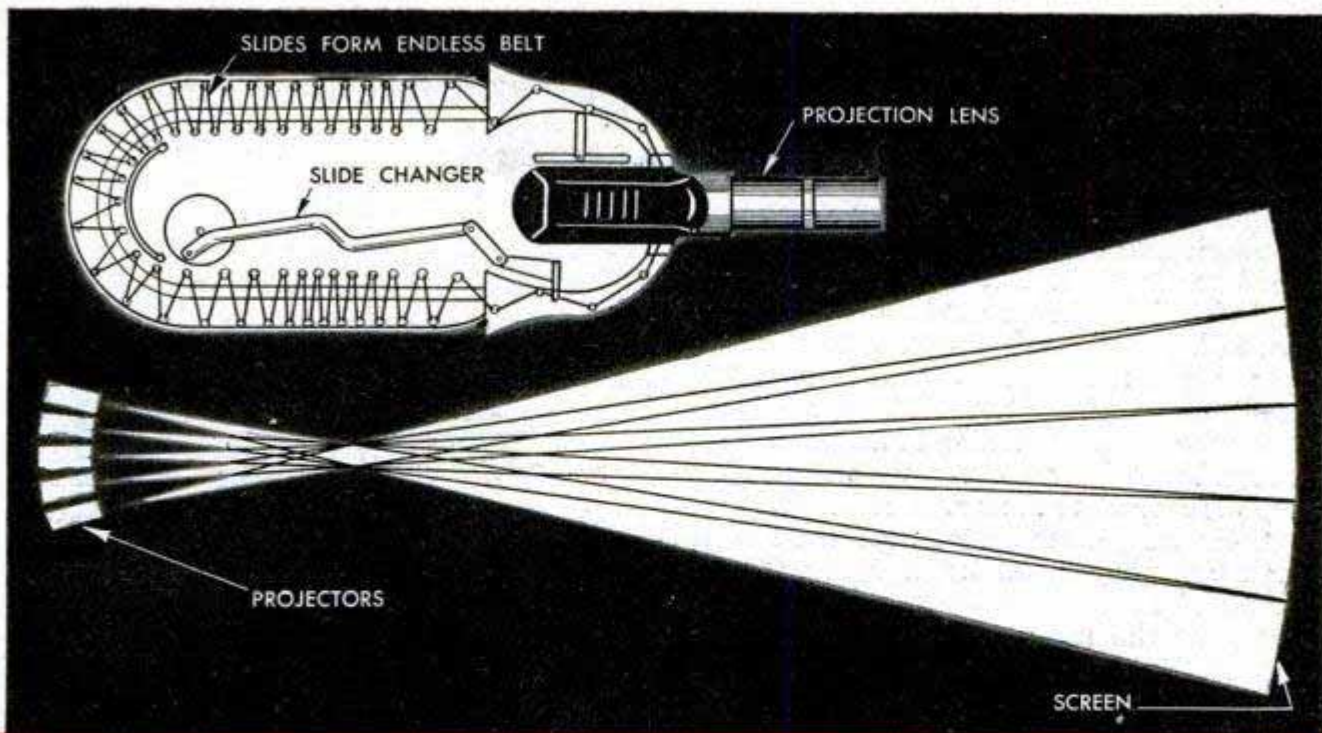

Top, looking down on one projector unit. Notice that the slides are linked together to form a belt. Lower drawing shows how the projected pictures crisscross to form the giant 30-foot-wide panorama

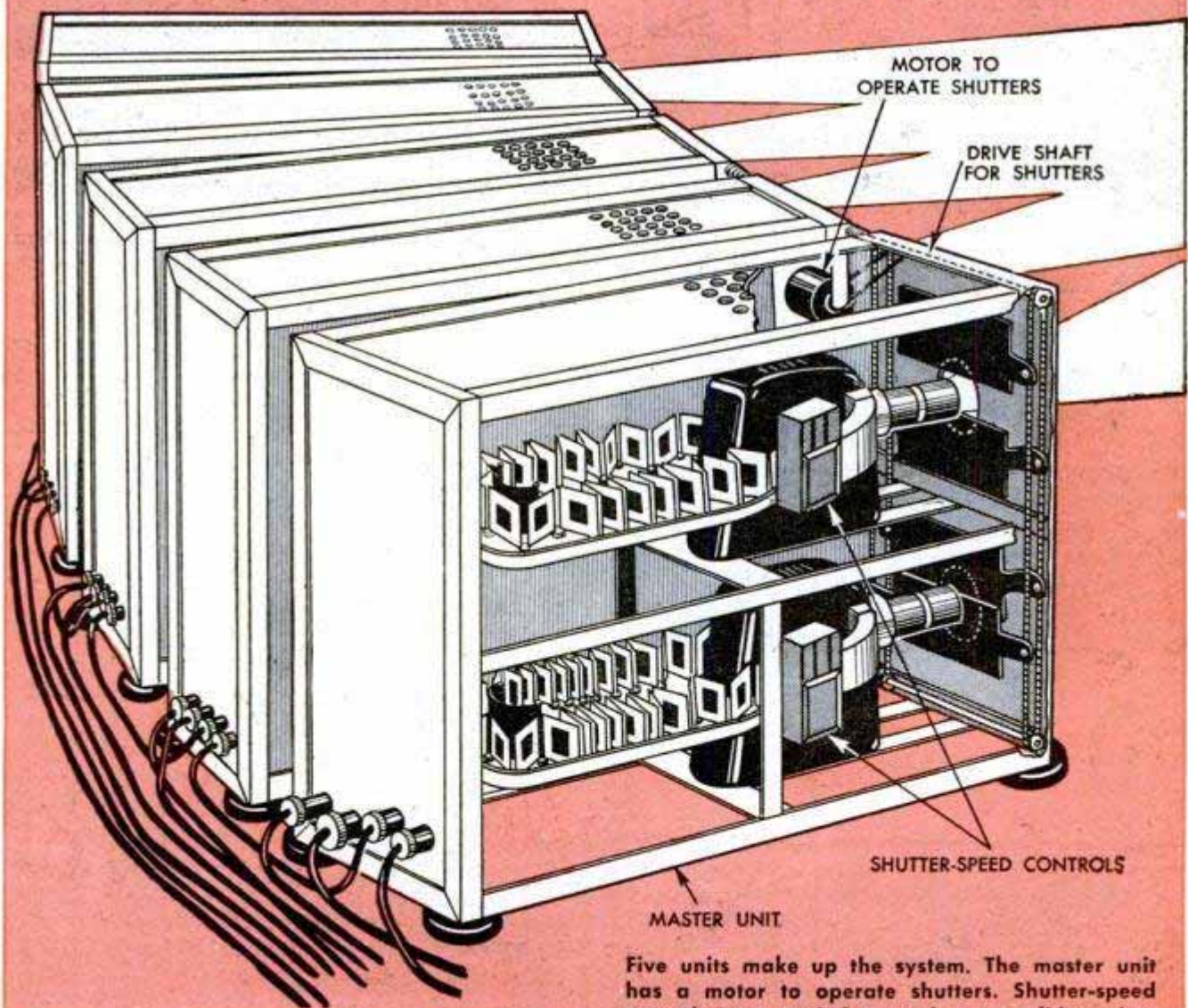

Five units make up the system. The master unit has a motor to operate shutters. Shutter-speed controls, actuated by notches on slides, time the shutter movement for fast or slow dissolves

RETURN OF THE VIKINGS

BATHERS at a holiday resort on the south-east coast of England were puzzled and perhaps a little frightened one day last summer when a strange craft bore down on the beach and discharged 50 young giants in odd battle garb. The ship was an exact copy of old Viking vessels and the men were tall, blond and bearded Danes selected to make the trip. Denmark sent the expedition to celebrate the 1500th anniversary of the Viking invasion of England. The modern Vikings wore costumes and carried weapons correct to the smallest detail. During their dangerous cruise over the rough North Sea they lived upon oysters, ham and mead as their forefathers had done. Next year the men may try to cross the Atlantic. Evidence exists that the Vikings landed in America long before Columbus.



Dragon on prow of the ship and the raven on the flag are copied from early Viking designs. Left, the impressive red-bearded leader of the modern Vikings wears clothing designed to duplicate his forefather's garb to the smallest detail. Below, the ship built in Denmark carries war shields fastened to the gunwales to protect crew from "enemy weapons"

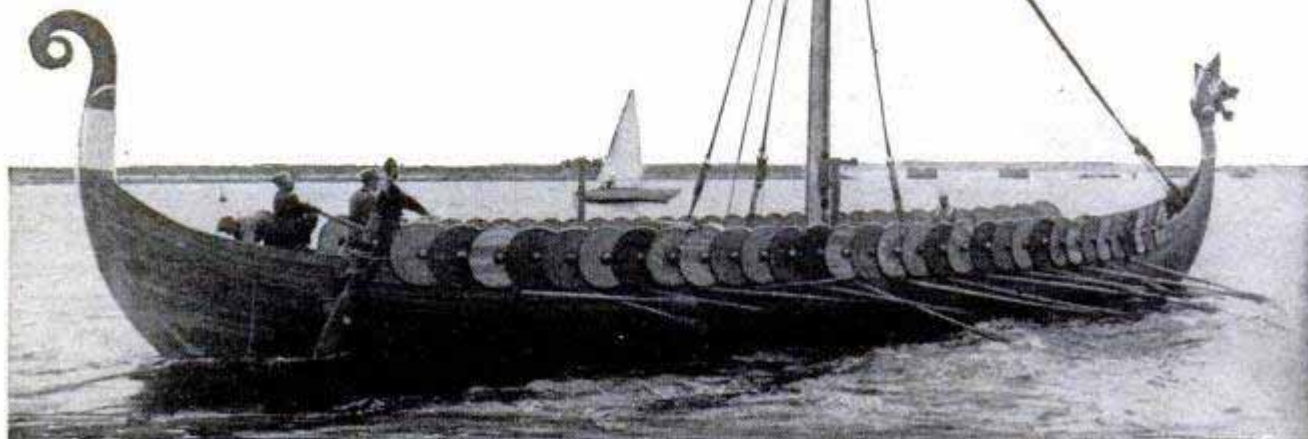

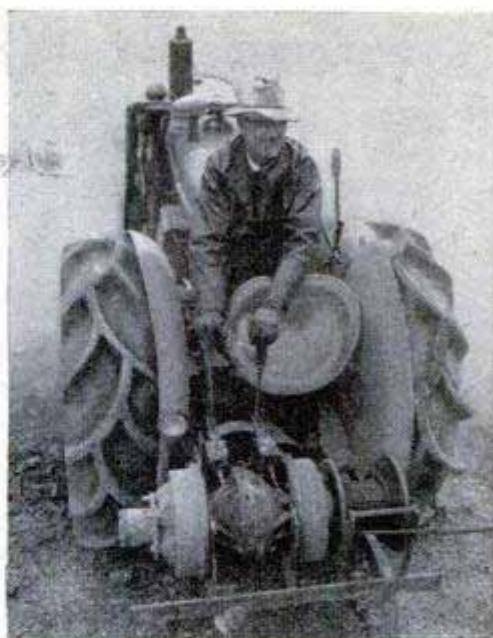
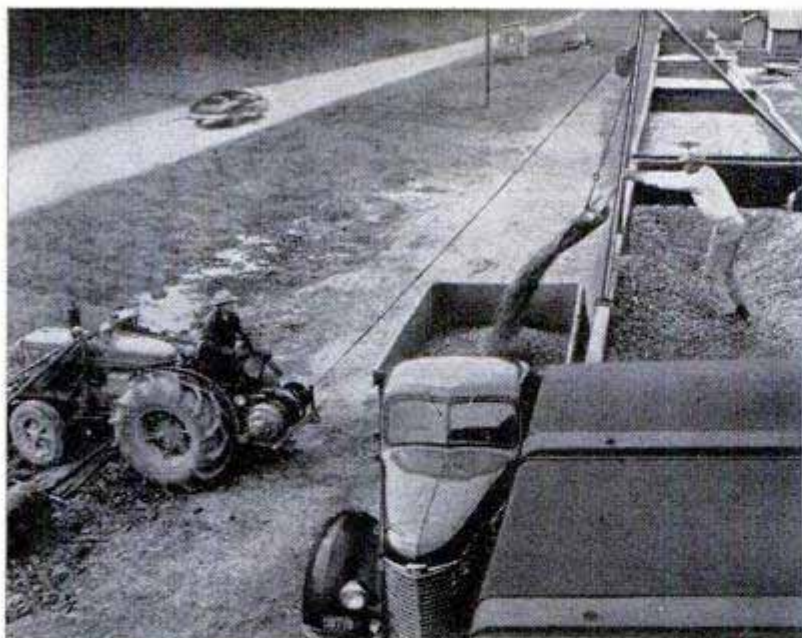

Tractor Winch Unloads Gravel From Gondolas

By adding a truck axle and differential to the power take-off of his tractor, a Texas mechanic adapted the tractor for unloading gravel from gondola cars with a scoop and cable. The cable runs through a pulley mounted on an A-frame that is clamped to the side of the car. Two hydraulic-brake systems, one connected to the cable drum and the other to the idle wheel, control the

winch. When the operator releases both brakes, the scoop can be pulled back, unwinding the cable. When the idle-wheel brake is tightened, the cable winds up on the drum, pulling the scoop forward and up. The cable is locked as the scoop is dumped by applying the brake on the cable drum. The scoop used is an old horse-drawn scraper bucket.

Nonslip Clamp Tightens Rope to Tie Load Atop Car

Tying luggage, ladders or other bulky items to the roof of a car is simplified by a nonslipping device that tightens by means of a metal lever. Two hooks, one on each end of the rope, slip over the rain troughs, holding the load securely in place. The metal lever simultaneously tightens and locks the rope in one quick operation. To release the load, you flip a lock ring back and raise the lever. When not in use, the device fits in the glove compartment.

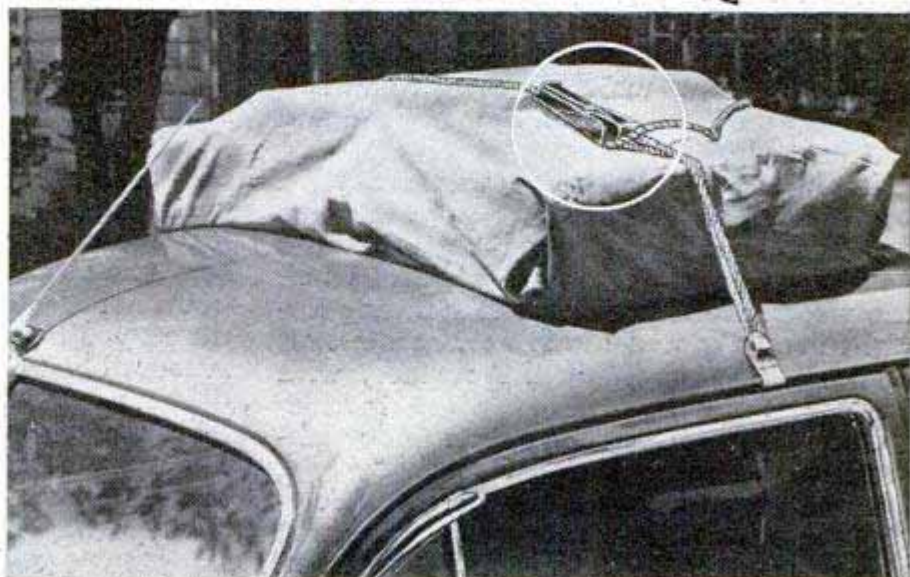
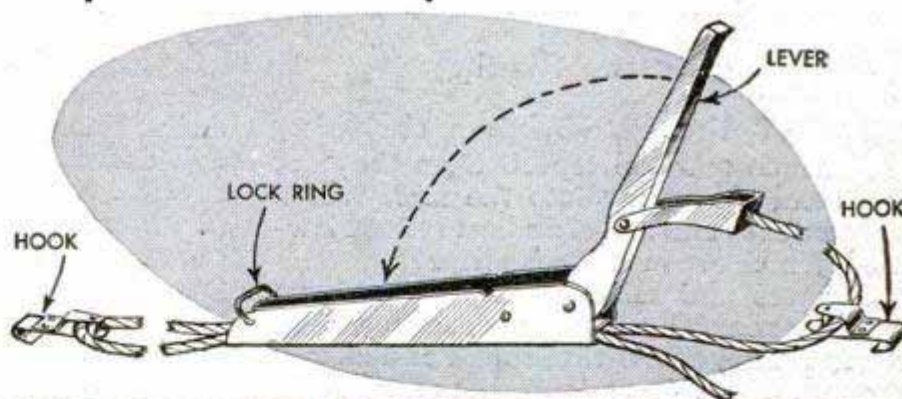

Information not listed on articles in the index, starting on page 10, frequently is listed in the WHERE-TO-FIND-IT INDEX, which is available to readers without charge from the Bureau of Information, Popular Mechanics Magazine, 200 E. Ontario St., Chicago 11

"DUST BOWL" LABORATORY

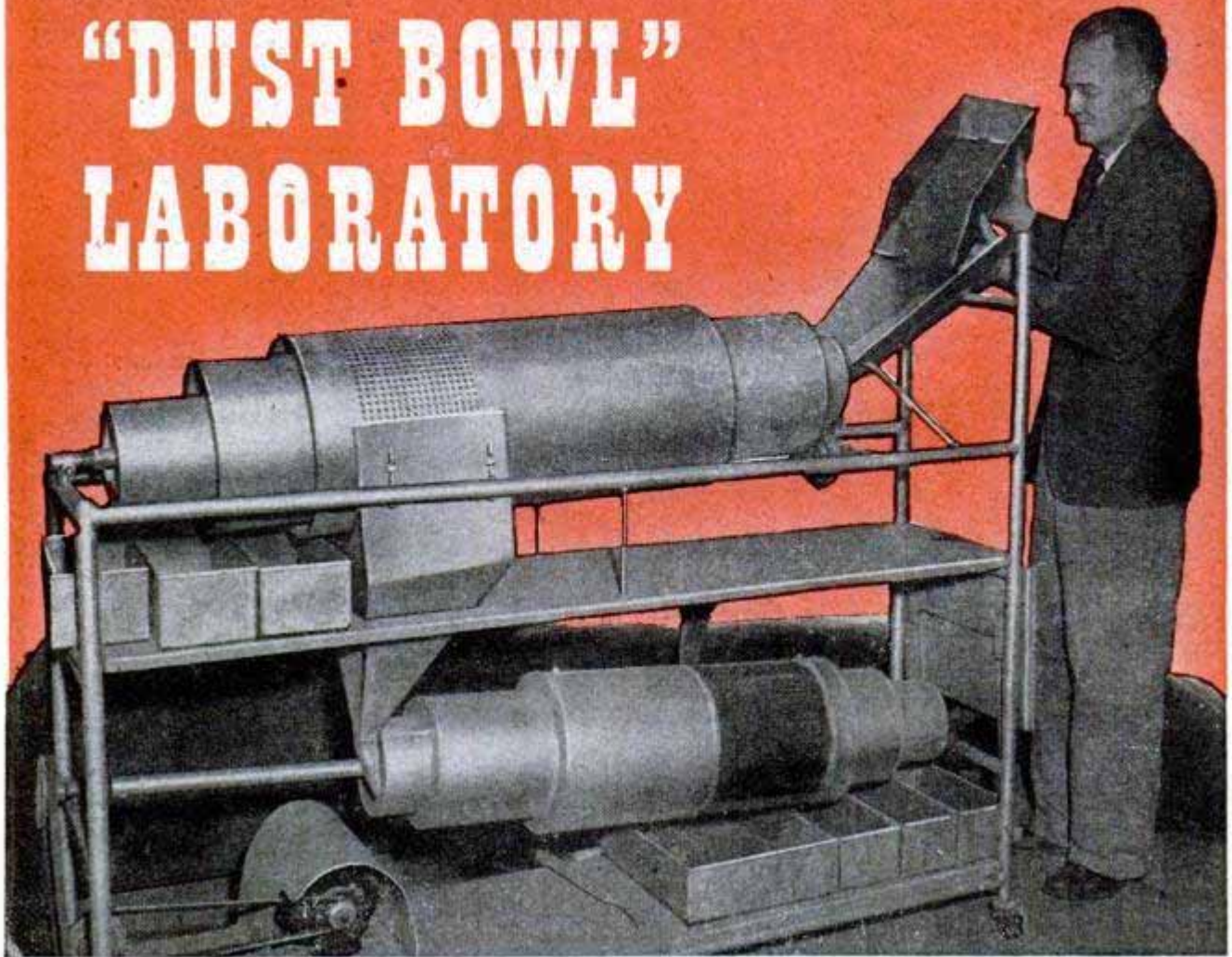

Soil is graded into seven sizes for blowing tests by this sleeve-action separator at Kansas State College

By Roscoe Fleming

WHAT HAPPENS when shrieking winds tear the topsoil from the land and send it hurtling into the air? Which soil textures and soil sizes best resist blowing? Which are most susceptible?

Farmers and soil-salvage experts have learned general rules by observing dust storms. They know that rough and cloddy ground, with crop residues left on top, best resists the wind. For blowing to start, they know that the wind requires a smooth "runway" along which it can propel soil particles until they reach flying speed and are airborne.

In Saskatchewan, which was bedeviled by wind during the drouth decade as were few regions of the United States, it has been found that the soil resists best when the weeds are killed, but left standing upright firmly rooted—such as when cut off an inch or two under the surface, with horizontal chisels.

To observe dust-storm action under laboratory conditions, at Kansas State College, Manhattan, Kans., a wind tunnel and blower have been built which propel winds up to 40 miles an hour shrieking past soil

samples placed in the floor of the tunnel. This velocity is equivalent to a gale outdoors, since wind velocity is much slowed down under field conditions at the earth's surface. Soil samples from all over Kansas, of different sizes, different textures and differing moisture content, are being subjected to the torturing blast at the Kansas State laboratory. Careful notes are made of resistance.

Later it is planned to conduct field tests. The motor and blower in the laboratory are movable—mounted on automobile wheels. They can be detached and wheeled anywhere for use in the field with a lightweight aluminum tunnel to simulate storm conditions.

Dr. R. I. Throckmorton, dean of the college's school of agriculture, who has studied semiarid conditions for many years, points out that long years of cultivation have powdered prairie soil finely, making it more susceptible to blowing. How much wind does it take to move such soil? Does a sharp blast or steady blowing do more damage? How should soil be sized for best resistance to blowing?

Preparing the conditions and building

(Continued to page 258)

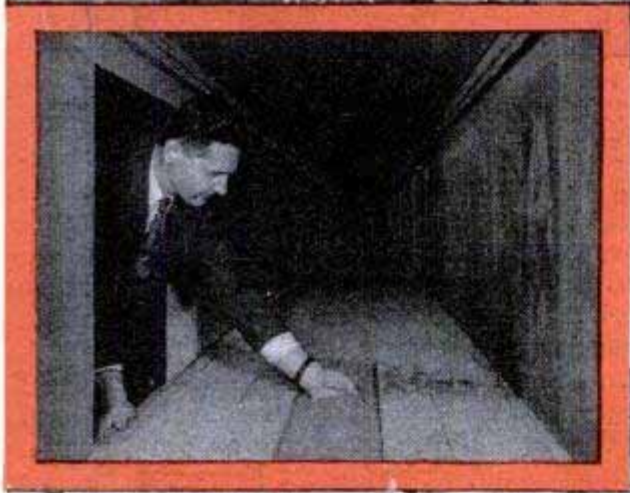
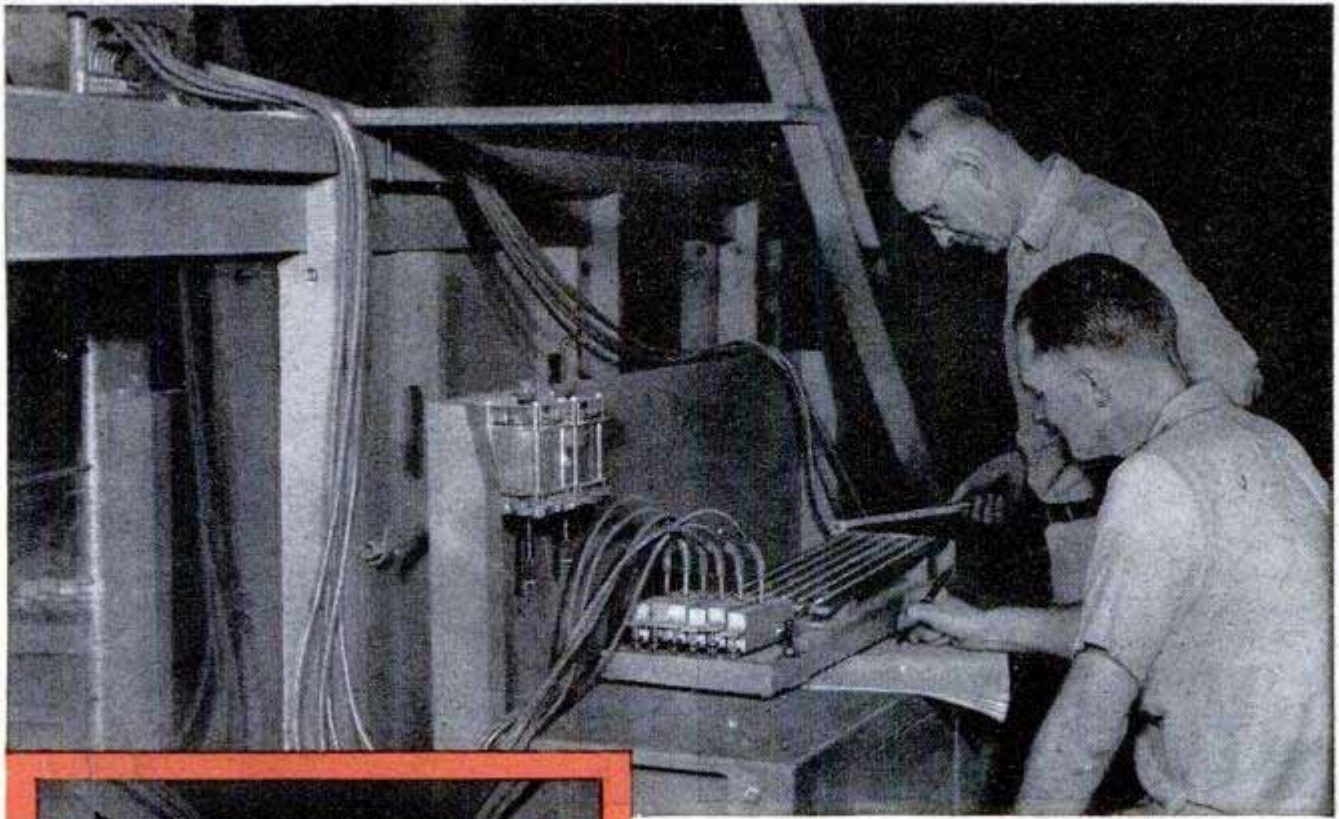

Above, project supervisor A. W. Zingg, sitting, and an agricultural engineer measure tunnel wind velocities by reading fluid levels in six tubes of a manometer. Left, Dr. W. S. Chepil feels the texture of tray of soil placed in tunnel for observation. Below, 56-foot-long "test tube" was built inside laboratory. Both motor and blower, at left, are mounted on auto wheels for use outdoors. Bottom, right, "wind straightener" grille

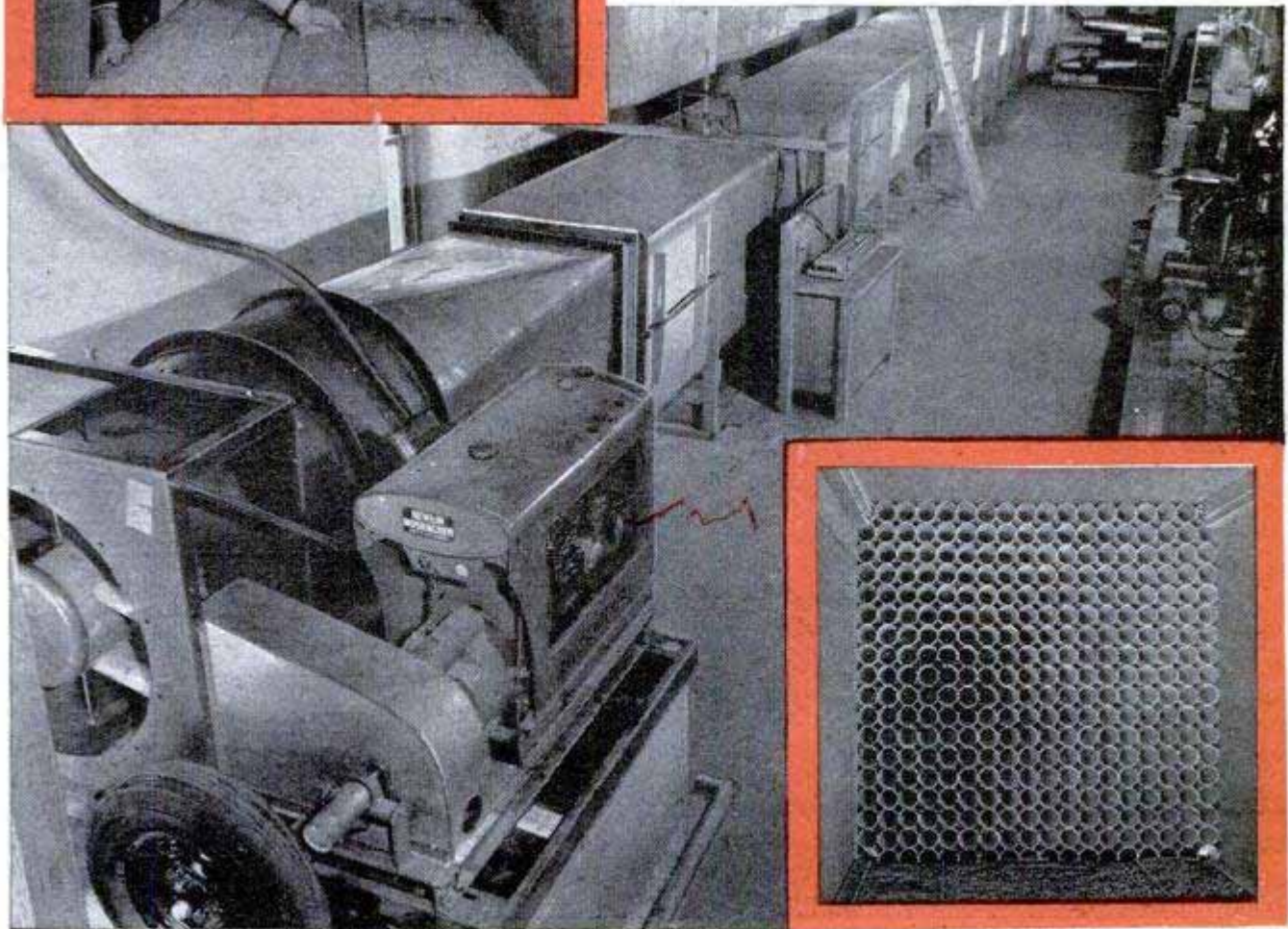

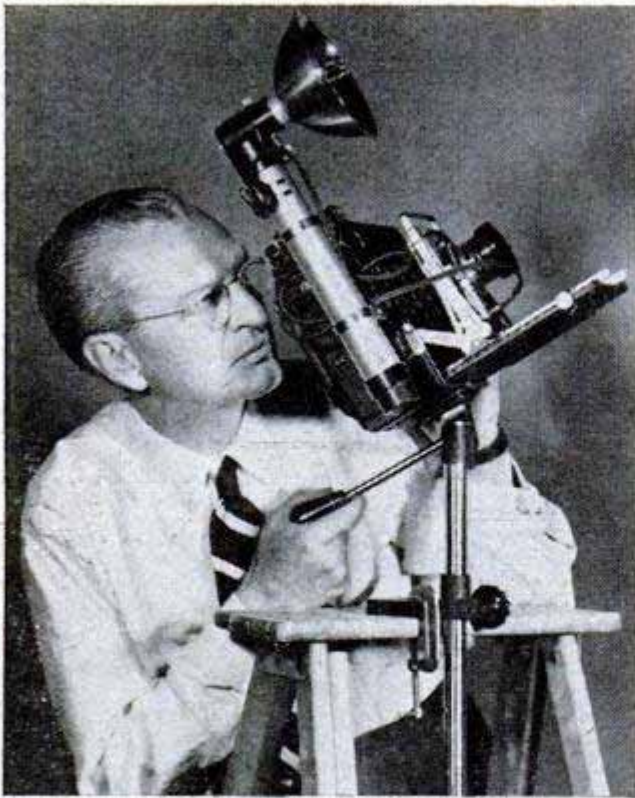

Multi-Purpose Tripod Extension

Mounted on any tripod, an elevating extension enables the photographer to raise or lower his camera without moving the tripod legs. The sliding base of the extension has a standard tripod socket. The extension can also be used without a tripod by clamping it to any convenient support, such as a stepladder, with a C-clamp. It can also be mounted upside down on the tripod so that the camera is held between the legs for low-angle and copying shots. The device permits extension to 18 inches.

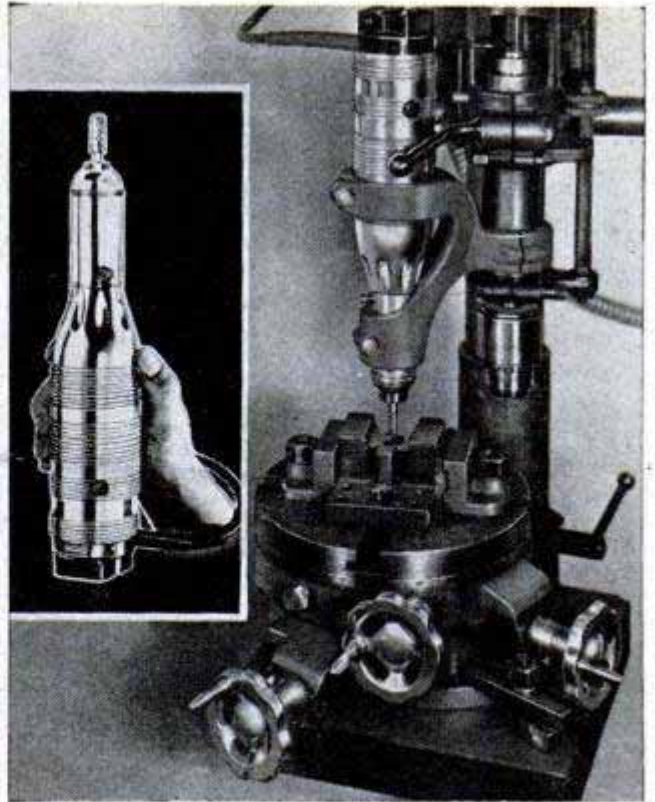

Portable Machine Tool

Running at speeds up to 45,000 revolutions per minute, a portable grinder-miller goes through hardened-steel files as though they were soft steel when used with a tungsten-carbide cutting tool. Various mounts, including lathe stands with built-in speed controls, give the tool wide application in machine shops. The speed control regulates the speed of the tool between 15,000 and 45,000 revolutions per minute. The quill develops almost $\frac{1}{4}$ horsepower at top speed.

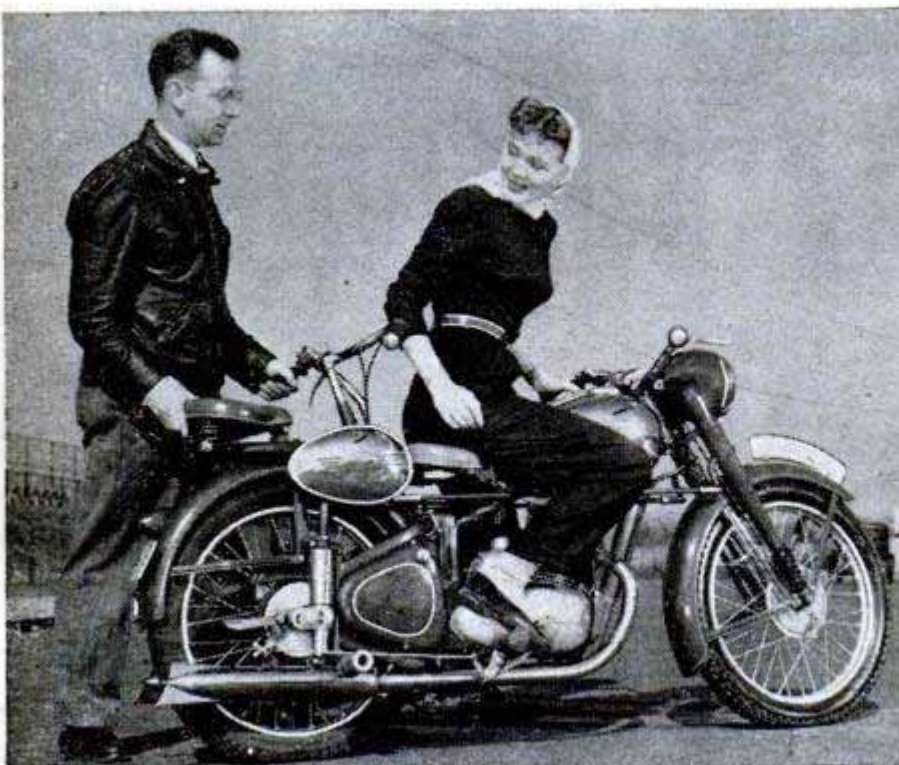

Dual Controls On Motorcycle

Dual controls on a new motorcycle permit either rider to drive the machine. When used as a trainer the motorcycle permits a novice to learn to drive in 30 minutes, according to the manufacturer. The motorcycle has a second seat over the rear wheel with a complete set of controls for the rider.

☐ Highest waterfall in the world is the 2600-foot Angel Falls in a section of the Venezuelan jungle so remote that it was only recently visited for the first time.



“Homogenized” Heat

JUST AS cream won't separate from the milk so long as you shake the bottle, warm and cold air can't stratify or separate in a room heated by a warm-air system that, in effect, “homogenizes” the air. The new system, which cuts installation costs as much as 40 percent, requires only one cold-air return. Continuous recirculation is provided by blenders that mix room air with heated air from the furnace. High-velocity hot air is forced into the blenders where it mixes with cooler air from the room before leaving the register at decreased velocity. There is no cold-air return from each room.

All tailor-made ducts are eliminated. The system uses mass-produced, inexpensive ducts only 3½ inches in diameter, small enough to fit between inside walls. Sections of flexible metal tubing bend around obstacles and a telescopic section eliminates cutting to make precise fits. Concealed blenders between wall studs also telescope to required size. Cabinet blenders can be installed in existing homes without cutting walls.

The single return duct is placed close to the furnace and it provides an ample supply of cold air. There's enough leakage around interior doors to guarantee complete circulation.

The furnace can be installed in the basement or first-floor utility room. It comes in gas or oil-fired models and has a direct-driven blower.

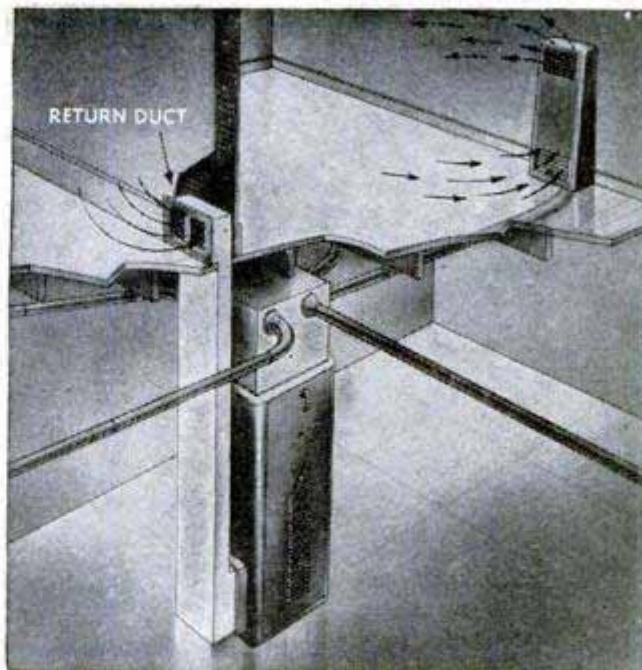

Cabinet blender shown above requires no cutting of walls. Left, the new and old styles in heating ducts

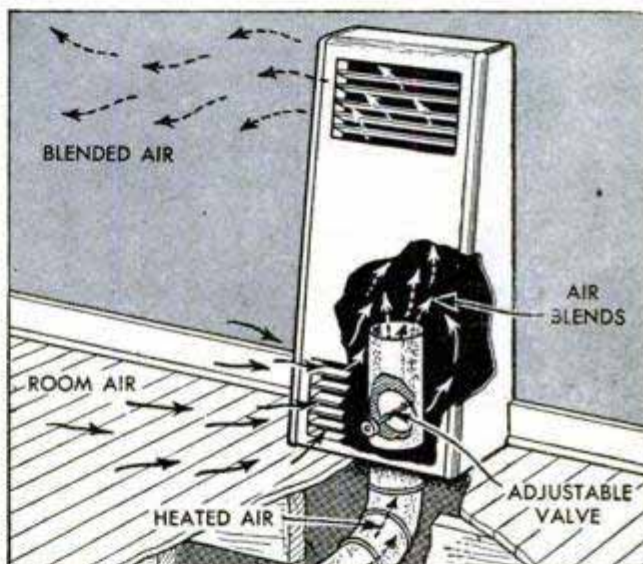

Above, blender valve controls temperature of each room. Below, ducts run in attic of no-basement home. This concealed blender is installed between studs

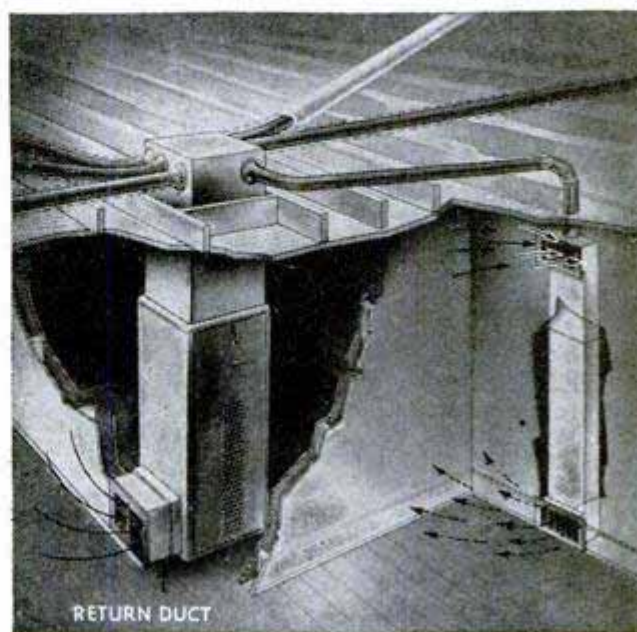



The 1950 Studebaker takes another step into the future with a sleek facade shouting "Speed!" in every line

By Wayne Whittaker

STUDEBAKER AND BUICK are leading the parade of 1950 automobiles with some sleek models that may well be pace-setters for the industry. Studebaker is introducing its complete line for next year and Buick three models of the lower-priced Special, or Series 40.

The big news about the Studebaker is

that the '50s will have an optional automatic transmission, although it is improbable that many will be produced this year. Buick's Dynaflo is optional on the Special.

The 1950 Studebaker answers a question which had been uppermost in the public's mind: Would they rest on their laurels as postwar pioneers or plunge ahead another step with daring innovations? When a manufacturer has a model such as the

Recessed instrument panel of the Champion gives front-seat riders more room and presents a neat appearance

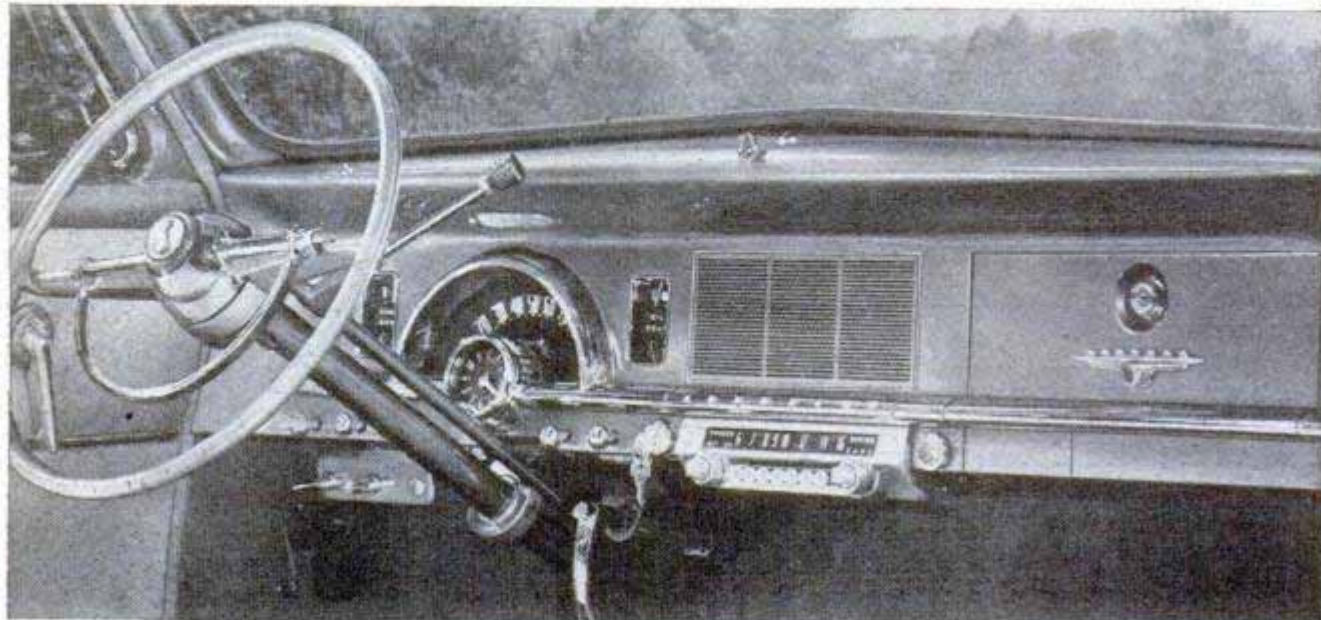

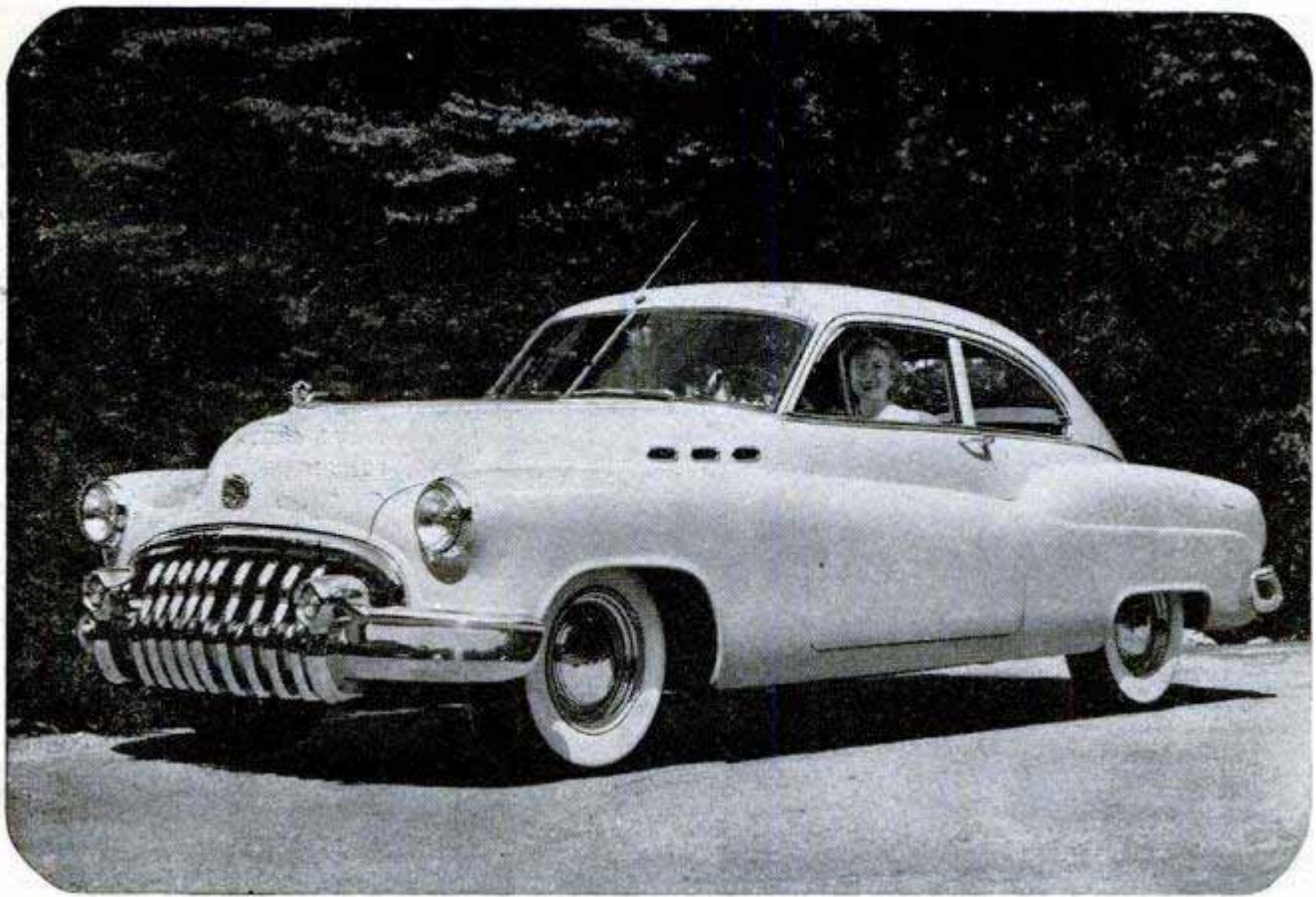

Buick unwraps its new six-passenger, two-door sedan in the Special series. Sloping front fenders have returned

postwar Studebaker, which is well received by the public, he risks millions of dollars with a major model change.

This thought was uppermost in the minds of Studebaker executives when they gathered around to study the new sketches for the 1950 cars by Raymond Loewy Associates of New York. It was Loewy who made automobile history by designing the 1947 Studebaker. Some of his '50 sketches were conservative in that they specified slight changes in the '50 as compared with the '49 model. His most dashing design showed a completely new front end of the car.

"That design makes the car look like it's going 40 miles an hour when it's standing still," commented one observer.

After weeks of deliberation, filled with conferences between Loewy and Studebaker executives and engineers, the die was cast—for the major change. One morning last spring the test drivers gathered at a little elevation overlooking the high-speed track. They were waiting to be shown.

Suddenly around the bend came a maroon streak traveling in the low 70s.

"Gosh, it looks something like a Tucker," said one driver.

"Naw, it's got an airplane nose," said a second.

When the new model was turned over to the drivers, they swarmed over it like bees in the proverbial clover patch.

"Hey, look! It has coil springs in front. Wait till I get her on that corduroy track."

Grille and bumper become a single unit in the new Buick. Vertical grille bars are made of tough metal. Two bumper guards house the parking lights

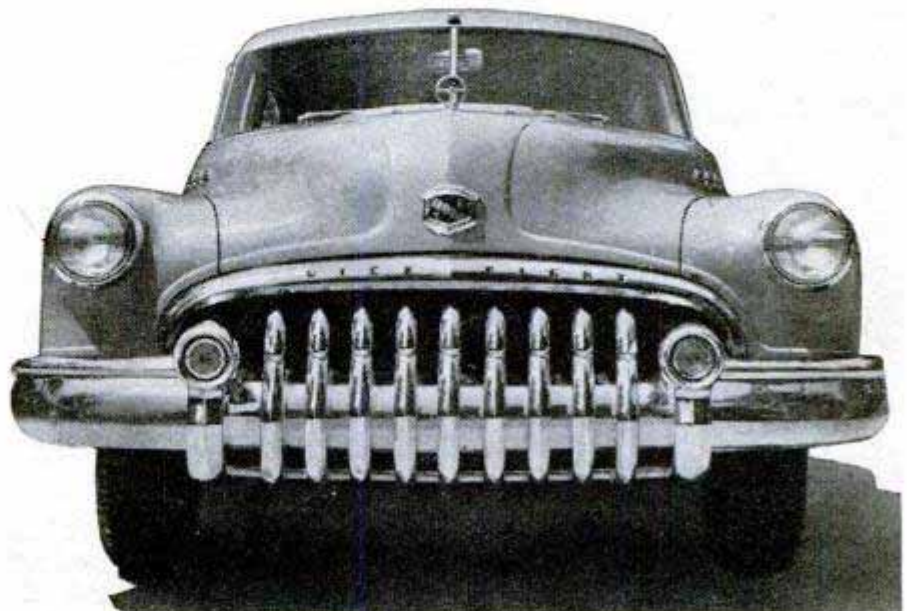



Studebaker Land Cruiser will be recognizable at a glance. An automatic transmission of the torque-converter type will be optional equipment



"New model looks like it's going 40 miles an hour when it's standing still," commented one observer. This is the four-door Champion. Below, the Commander five-passenger coupe offers a low-slung, racy appearance



"Engine changes are only minor," said a youth from under the hood.

"Phooey," said one disappointed driver. "I was sure it would have an automatic transmission."

This criticism was short-lived, for the drivers soon learned that the new transmission is in the offing. However, all of the first 1950 models will have conventional transmissions with optional overdrive as in the past.

When the transmission is available, it will be combined with a torque-converter unit. The torque converter will operate in first, second and reverse gear. The driver will be able to obtain direct drive through a hydraulically operated friction clutch which bypasses the converter.

The manual switch lever will have five positions: park position (a mechanical lock), neutral, forward high and low ranges and reverse.

Engineers consider the automatic transmission-converter the equivalent of a conventional three-speed transmission plus overdrive.

Refinements on all the cars today are pretty well standardized, the engineers say, and there's reason to believe that transmissions will follow the trend. "I predict that in a few years most of the cars will have transmissions as similar as starters are at present," one authority said recently.

The new Special is Buick's all-out bid for third place in the "American league of motordom." According to rumors around Detroit and Flint, Mich., the car will be advertised below \$2000—without radio and heater or any of the frills which have been close to the purse of postwar dealers.

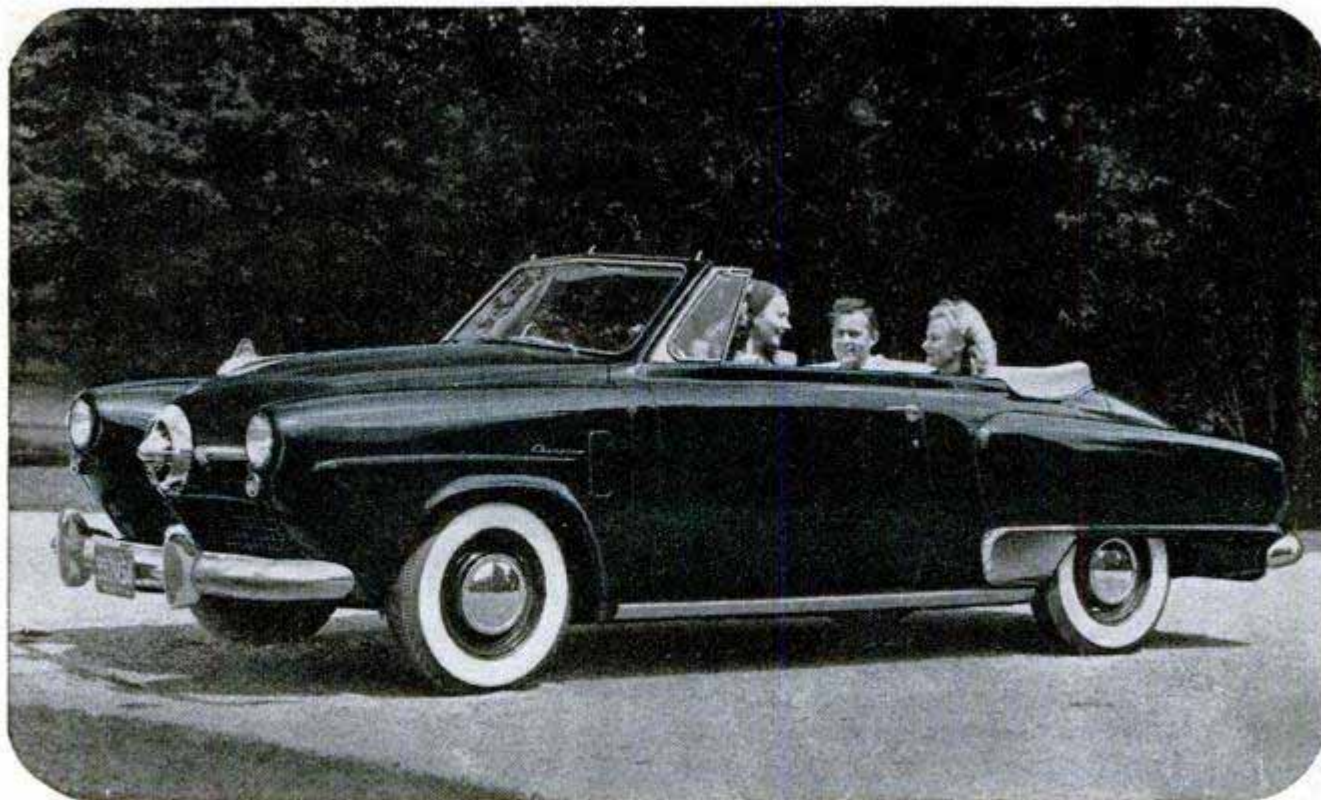

Here's the new Champion convertible. Note swept-back front end and the distinguishing airplane-type ornament

With this model, Buick is undoubtedly offering a sort of preview of its 1950 Roadmasters and Supers. The Special puts the emphasis on fenders. It has dropped the straight body line and returned to the distinctive full "taper through" sloping front fender. This change was actually dictated by dealer protests. You will be able to recognize the new Buick in one glance.

The engine on the Special will be the conventional Buick Eight with a maximum brake horsepower of 100 at 3600 revolutions per minute. Those with Dynaflo Drive will have a horsepower of 120. The new models are lower with a slightly longer wheelbase and at the same time a 3½-inch decrease in total car length. The rear seat has been moved slightly farther ahead of the rear axle to increase riding comfort and permit the rear roof line to be lowered.

The '48 and '49 Buick owners who have complained of heat in the front seat (during summer driving) will cheer the announcement that several changes have been made in the ventilating system. There has been a 78-percent increase in the area of the left-hand duct which delivers air to the driver's side of the car. Ventilation for the right-hand side is conducted by the same large duct that brings air to the defroster core.

In regard to engine cooling, a change has been made in the radiator-core assembly for the Specials equipped with Dynaflo. The frontal area of the radiator has been increased from 419 to 484 square inches which provides greater cooling capacity.

An innovation on the new Special is a combination front grille and bumper. At first glance this looks alarming and you have a vision of a smashed and broken grille. However, close inspection reveals the grille's vertical bars are made of tough bumper metal.

The '50 models consist of a roomy six-passenger four-door sedan, a six-passenger two-door Sedanet and a three-passenger two-door business coupe with spacious luggage room behind the seat in addition to the conventional luggage compartment.

Buick is either making it difficult for its imitators or having a little quiet fun with another model change. Its famous fender holes have been changed in shape from round to rectangular!

Studebaker offers a new suspension system with coil springs on the front wheels for amazingly smooth ride

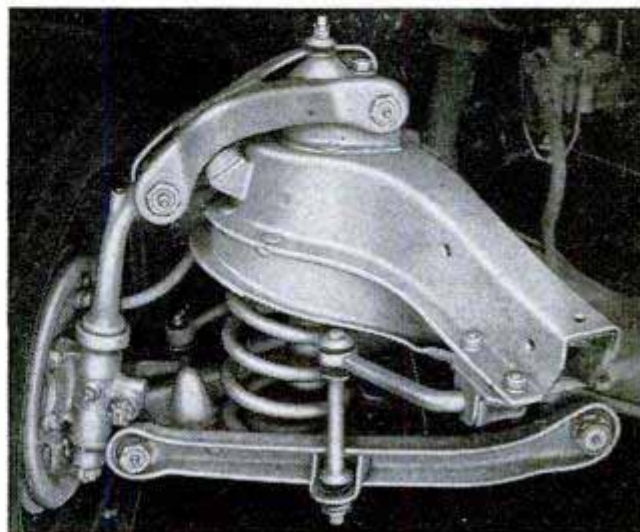



Rolling Stool for Mechanic Carries Tools on Tray

Mounted on easy-rolling casters, a mechanic's seat and tool tray combination makes life more comfortable for the repairman. The sturdy seat is 12 inches from the floor and the tool tray, beneath it, is large enough to hold the tools necessary for most repair jobs. The tilted casters are free-rolling and quick-pivoting.

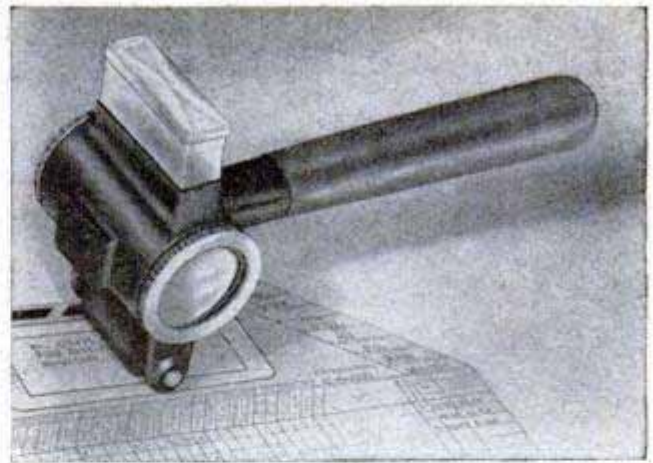

Compact Duplicating Machine

Small enough to be stored in a desk drawer, a new duplicating machine makes as many as 100 imprints from one master copy. The duplicator consists simply of a felt applicator and a small roller mounted on a cylindrical fluid reservoir. The message is typed or written on a master card and, by a carbon backing, the message is printed in reverse on the back of the card. To duplicate the copy, the applicator is drawn over the surface to be imprinted, moistening it with the fluid from the reservoir. When the master card is placed face up on the moistened surface and rolled lightly, the message is transferred from the back of the card to the lower sheet.

Automobiles Climb Hotel Wall and Into Second Floor

Automobiles climb right up the outside wall of an Atlantic City hotel and roll into the second-floor ballroom. Making this possible is an auto-lift elevator that slides upward in two guide-channel uprights fastened to the wall. Power is supplied by an electric motor that drives a chain hoist mounted on top of the guide rails. Controls are located both at ground level and at the second-floor wall opening. The lift was installed for moving automobiles in and out of the hotel ballroom during automobile shows.



Touch Museum for Sightless

Blind persons can "see" the wonders of science in a London museum where an exhibit, said to be the first of its kind in the world, has been set up especially for them. Sixty displays are mounted on tables about waist high so they can be touched conveniently. Braille posters explain each exhibit for the blind visitors.



Golf Cart Rolls to Your Car

Mobile even when collapsed for storage, a new golf cart need never be picked up and carried. Instead of retracting like an airplane's landing gear, the wheels fold inward to a 10-inch span so the cart can be rolled to the clubhouse or car. Made chiefly

of aluminum tubing and bars, it is rust-proof, weighs only 12 pounds and has ball-bearing steel wheels with semipneumatic rubber tires. The cart is folded or opened in a matter of seconds without pushing springs, levers or turning thumbscrews. There is an auxiliary handle for use when the cart is collapsed.

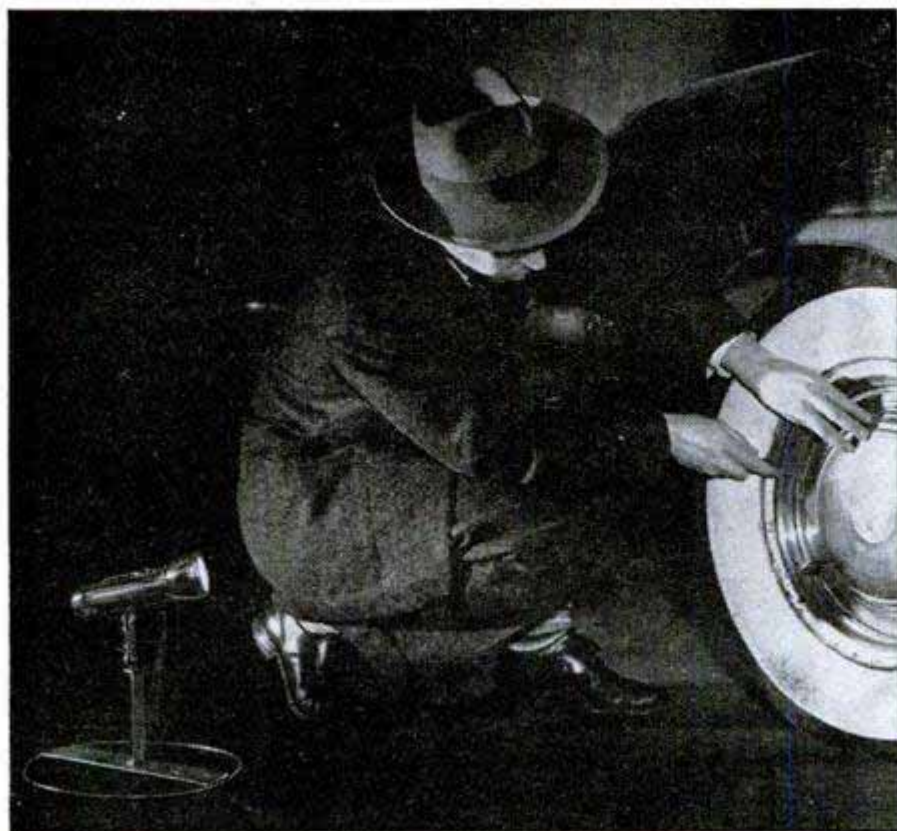

Flashlight Holder

Flashlights are held in any desired position by a clamp that stands on the ground or can be hung from a nail. The clamp is made in the form of a wire circle with a center post that holds the light. Ball-and-socket joints permit the light to be aimed in any direction. The clamp also can be used as a support for a garden hose or as a base for a rifle fired from the prone position.

☐ There are now 441,137 numbered motorboats — recreational craft 16 feet or longer—in use on federal waterways in the United States and its possessions, according to the U. S. Coast Guard.



HANDY HANGER that clamps to the end of the ironing board saves the housewife many steps. As many as 12 garments can be hung on the rack without danger of tipping. The hanger comes apart quickly for storage

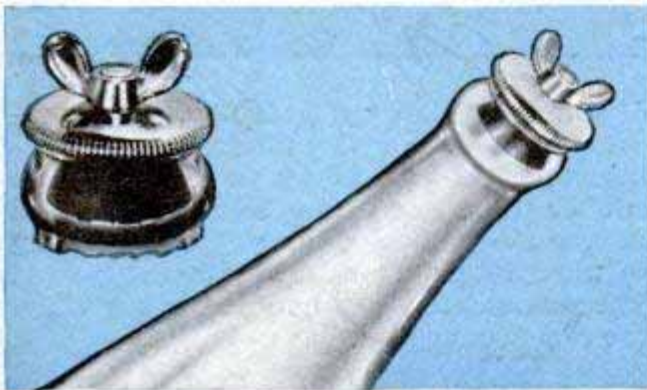

BOTTLE STOPPER seals mouth tightly with a rubber collar that flares out as the wing nut is tightened

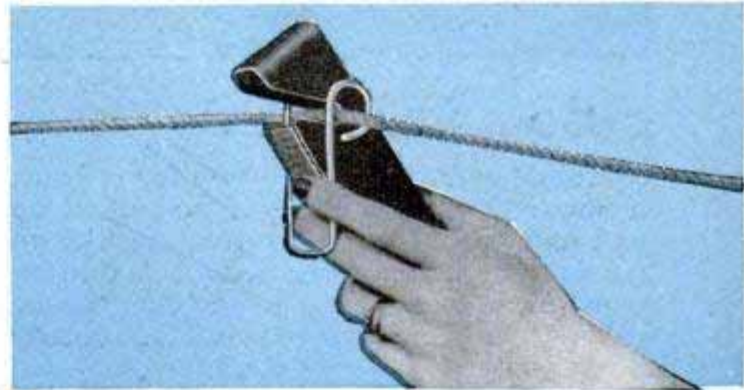

CLOTHESLINE PROP won't topple in the wind if a wire clip is used to keep the line from pulling out

BISCUITS OR WAFFLES, you can bake either on an electric appliance that has interchangeable inserts



GERM-FREE TOOTHBRUSHES are assured when kept in a cabinet that has a built-in ultraviolet lamp

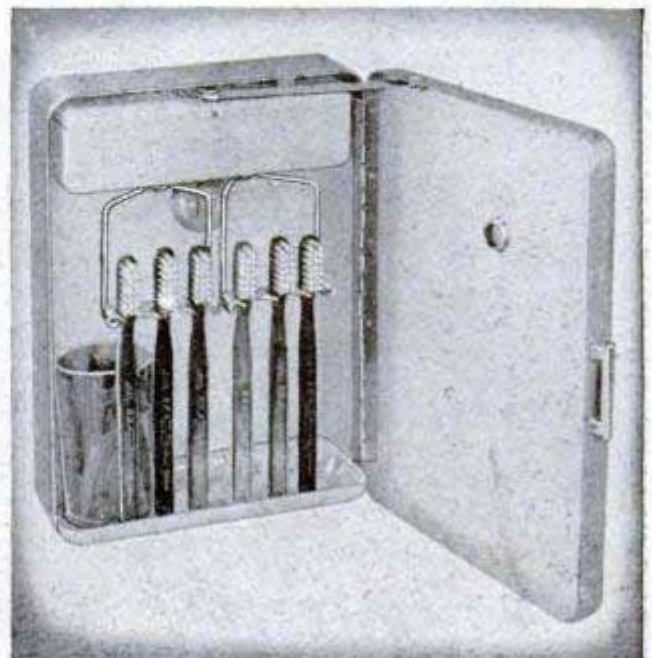



PACKAGE SEALER prepares food bags for quick freezing, sealing the opening by heat and pressure

WHAT'S NEW *For Your Home*

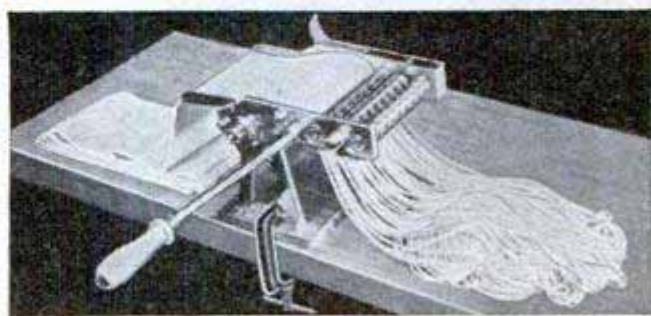

NOODLES AND SPAGHETTI are made at home on a machine that kneads the dough and then slices it



WATERING CAN has a thumb-operated pump so you can water hard-to-reach pots without spilling a drop

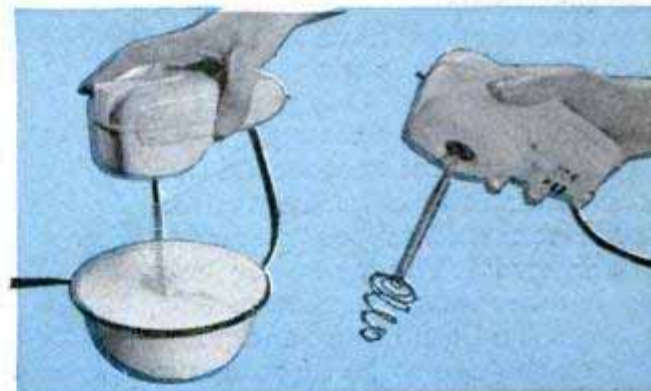

SPRING-SPINDLE MIXER has a coiled-spring beater that whips cream and eggs quickly without splatter

MOISTUREPROOF LINING in baby's creepers eliminates need for separate waterproof pants. Lining is soft, lightweight Vinylite plastic. Triangular-shaped front panel has snap fasteners for quick, easy changes



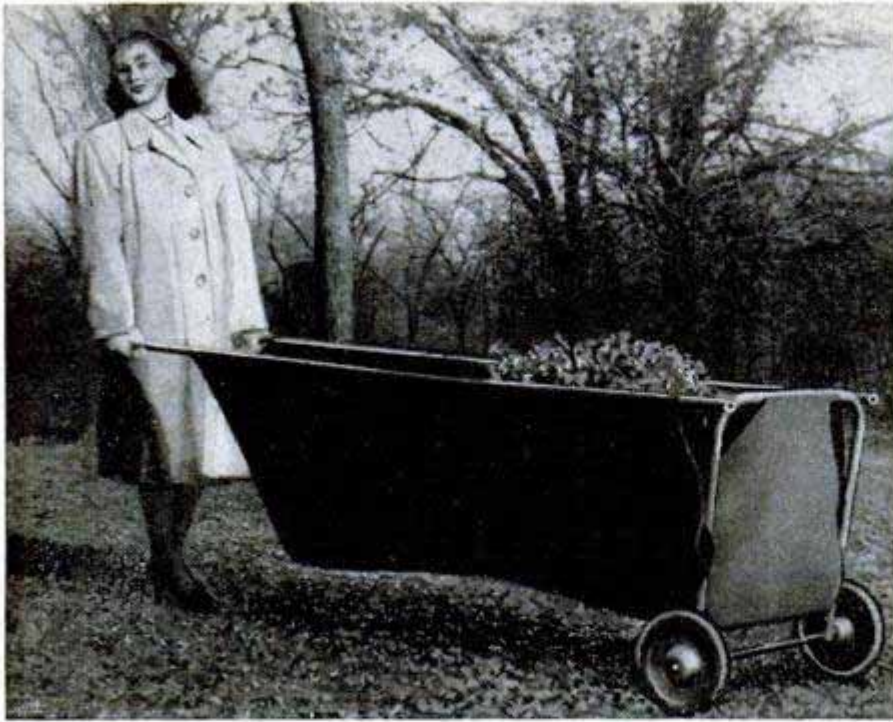

Light Canvas Cart For Garden Chores

Loads three times larger than a wheelbarrow holds are carried in a lightweight, canvas garden cart. Its canvas body, 44 inches long, 18 inches high and 24 inches wide, is supported by metal tubing. One side drops flat for easy loading of leaves or grass clippings to be hauled off the lawn. Oversize wheels protect lawns from marking. The cart can be rolled up and stored flat against the wall of a garage. The front flap unsnaps from the frame for storage.

Bolted Tires, Free Retreads

Down in Ecuador, where there are no tire factories, frugal truck and car owners have developed two systems for getting the most out of their tires. One method is to repair a hole in a casing by bolting in a section of another old tire. The other is to obtain a free retread from wild rubber trees along the highways. The car owner jacks up a wheel, taps a rubber tree, catches the liquid latex and pours it over the tire while he spins the wheel. The retread is usually good for about 1500 miles.

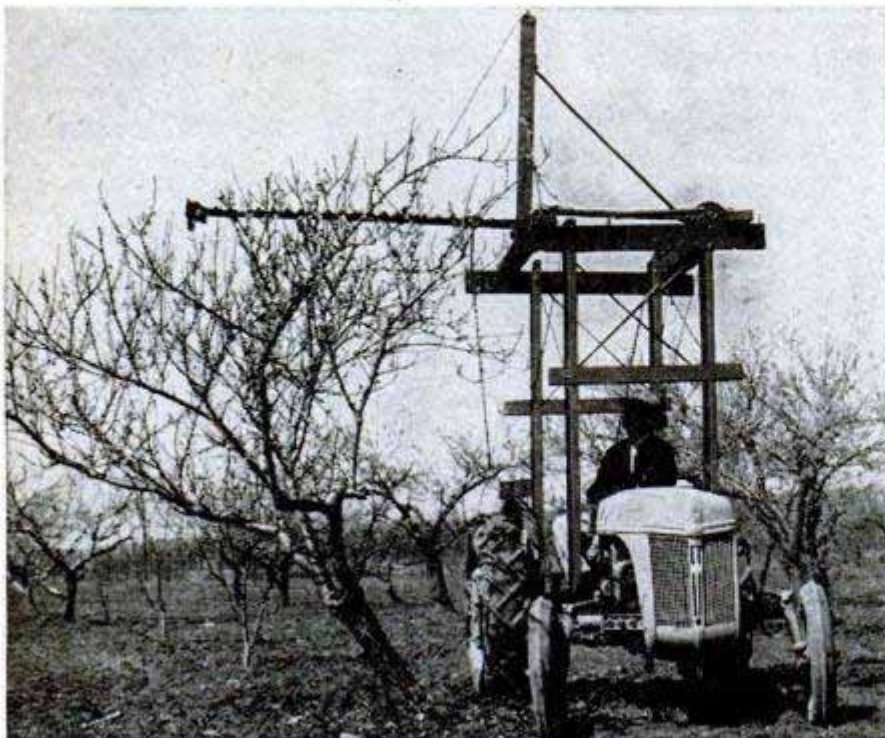

Homemade Cutter "Mows" Treetops

With a Ford sickle bar and a 16-foot belt as the main parts, I. N. Lassiter of Howe, Okla., has invented a machine that "mows" treetops. He says it performs the work of several men in much less time. The machine also cuts trees to a uniform height that permits faster and less costly spraying with a stationary boom.

¶ Two thirds of the pedestrians killed on rural roads were walking on the right side of the highway instead of on the left, facing traffic.

Tray on Trestle Serves at Drive-In

DINE AT a new drive-in restaurant in Los Angeles and your food will come rolling out on a powered tray and stop at your car window. It's the world's first automatic "car-hop" and forerunner of others planned for California. The restaurant employs no car-hops, yet speeds service from 20 to 25 percent while saving 25 percent on labor costs, according to its owners. The patron drives into a stall and comes to a stop headed in toward the kitchen. A trestle extends from the parked car to the service room. A stainless-steel box — the serving tray — travels along the track, powered by a small electric motor. The patron makes his selection from the menu, places his order on the tray and pushes a button. The tray then moves to the service room, where a waitress relays the order to the kitchen. She computes the bill and sends it back to the driver, who returns it with the indicated amount. She makes change if necessary, loads the tray with the order and sends it out to the customer. The average diner stays in the stall only about 20 minutes. The novelty quickly attracted crowds.

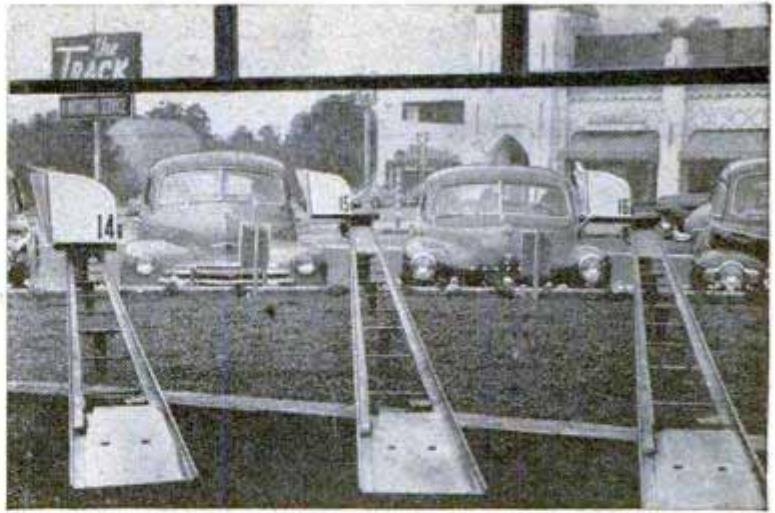

Here's the view the waitress sees as she handles the orders

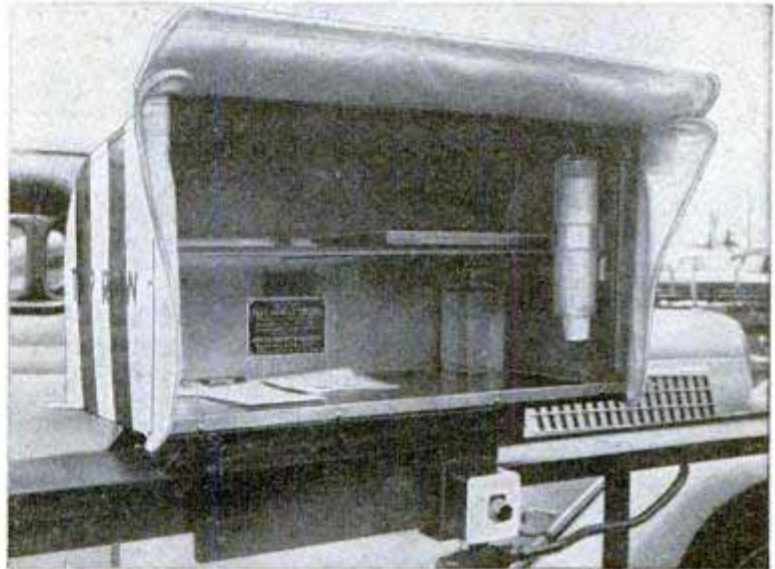

Box-type tray scoots along trestle to fill orders. It can be pulled laterally toward the car window. Below, when all 20 stalls are filled the trays shuttle along tracks continually



.... Call Out the Mules

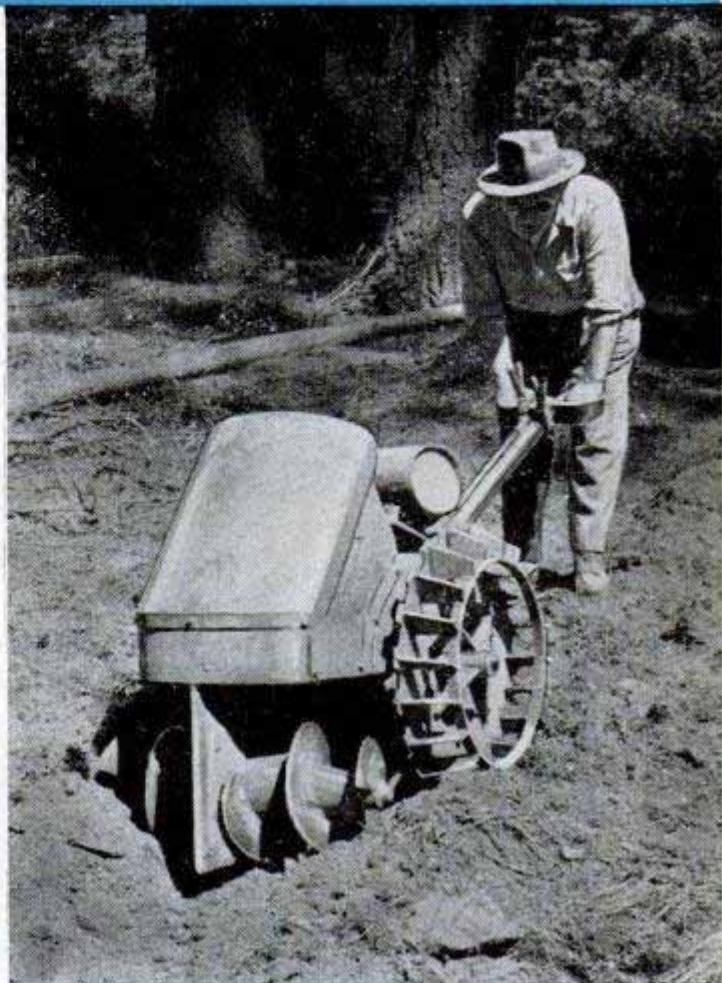
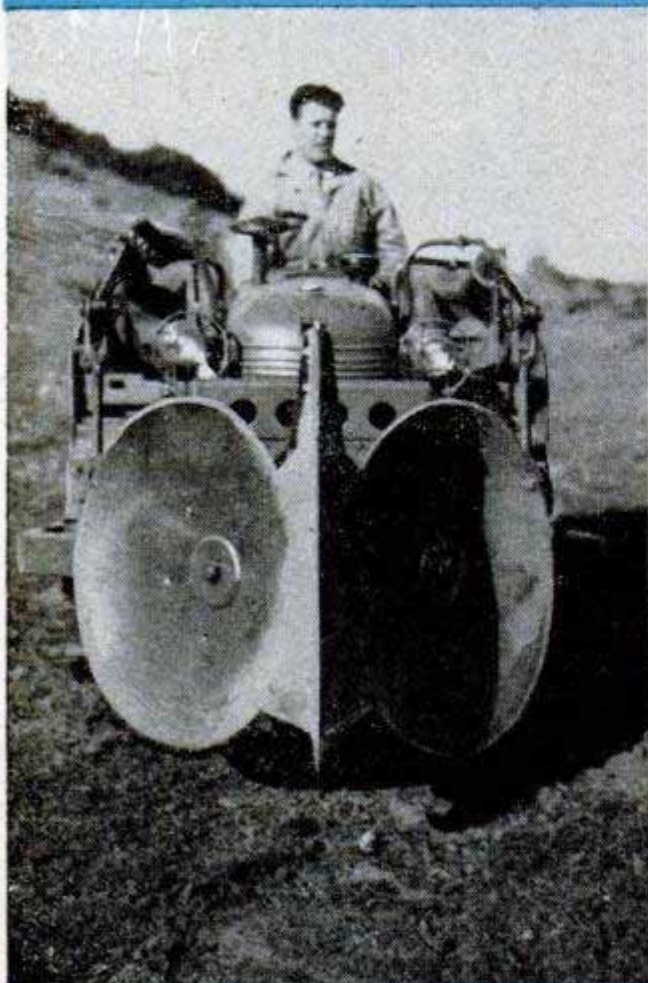

Above, left, adapted from the disk harrow, this Disk Trencher rolls out a wide fire trench. Right, the Walk-Behind Trencher is steered by moving the handle from side to side. Below, a powerful midget, the Beetle



and Beetles



Pack horse of the fire fighters, the Mechanical Mule hauls up to 1200 pounds of men and their equipment

By Tom Riley

WHEN FIRE breaks out in one of our great forests, the Forest Service calls out a Lilliputian fire brigade with a powerful punch. There are no bright-red hook-and-ladders, no giant pumpers. Instead, an agile fleet of mules, beetles and other tiny fire fighters scamper through the wooded trails like rabbits.

This is the mechanized army of the U. S. Forest Service, a brand-new army with all its equipment in miniature. There are such things as the Mechanical Mule. You might say the Mule is a tiny model of the huge, carryall tractors used in highway construction. But the Mule is more than that; it is a baby tractor built on the principles of a carryall, incorporating the advantages of the tractor with the ease of operation of an automobile. With only one axle on the tractor and one on its trailer, it turns around on a five-foot radius and dodges through the forests with ease. It tows one or two trailers, zips up 20 percent grades with an 800-pound load and will carry up to 1200 pounds. It has a Crosley auto en-

gine, transmission and differential and is the equal of eight pack horses.

The Mechanical Mule has an over-all width of only 36½ inches, a tremendous asset in fire fighting. For decades the Forest Service has needed access roads to speed to fires in our timberlands. But the cost of even rough roads throughout all the forests is too expensive, especially in the steep mountains of the West. Trails are not. A good trail does not require wide cuts into rocky hillsides nor expensive fills and culverts. We can have trails through all our forests. With this in mind, the Regional Equipment Laboratory at Portland, Ore., has been working to develop this army of miniature machines, both for carrying fire fighters over present trails and for building more trails through our forests.

To do this, the Portland laboratory has been inventing new machines, adapting others and combining ideas from several fields. The laboratory is not a large organization: its chief, Theodore P. Flynn, has only two assistants, Tom Caldwell and

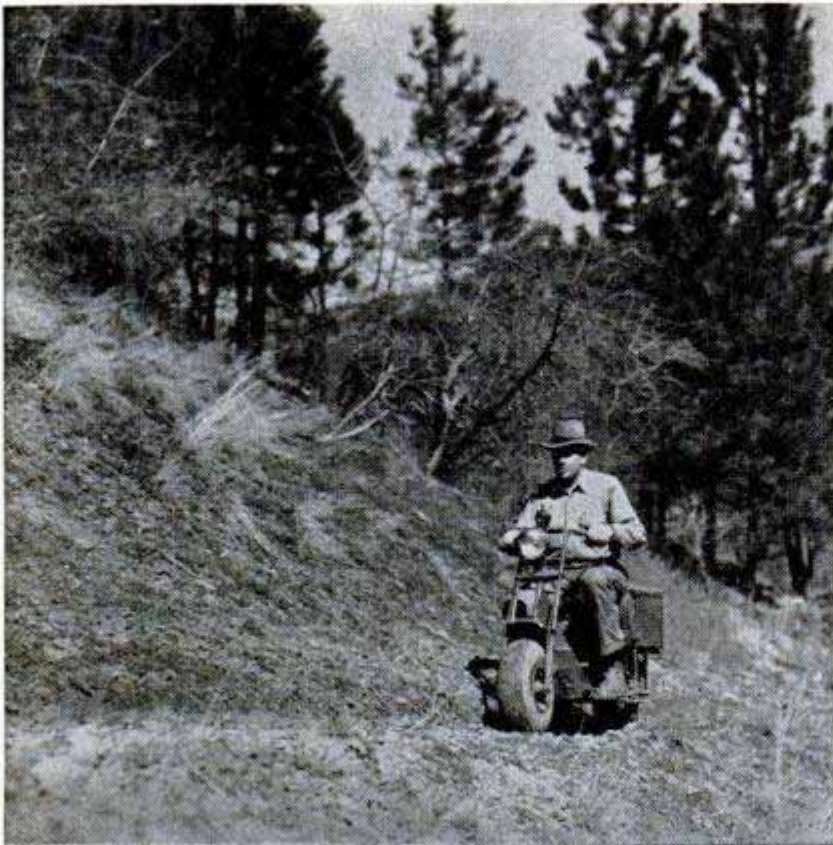

Commercial motor scooters are used by the men of the Forest Service. They are adapted for this rugged work by addition of special gears

Arthur Kelly. These three men have designed and drafted the whole Lilliputian army. They think of a good possibility or someone in the Forest Service suggests a good idea through the regional office. It is roughed out in blueprint form. Then the workability of the machine and all possible improvements are discussed with forest rangers, lumbermen, manufacturers, anyone who might have a suggestion. Not until then are pilot models built with the help of

any kind of rock and rapidly churns out a 24-inch-wide ditch, not only clearing the ditch but throwing the dirt evenly over the grass to each side to make the effective width of the fire trench almost four feet.

The efficiency of the spiral digger exceeded all expectations, but the men also knew that an ordinary garden cultivator has a clumsy method of steering that would quickly fatigue any man pushing it in

(Continued to page 250)

Fire-fighting crews get their orders from a trailer-office that rolls right up into the thick of the fight

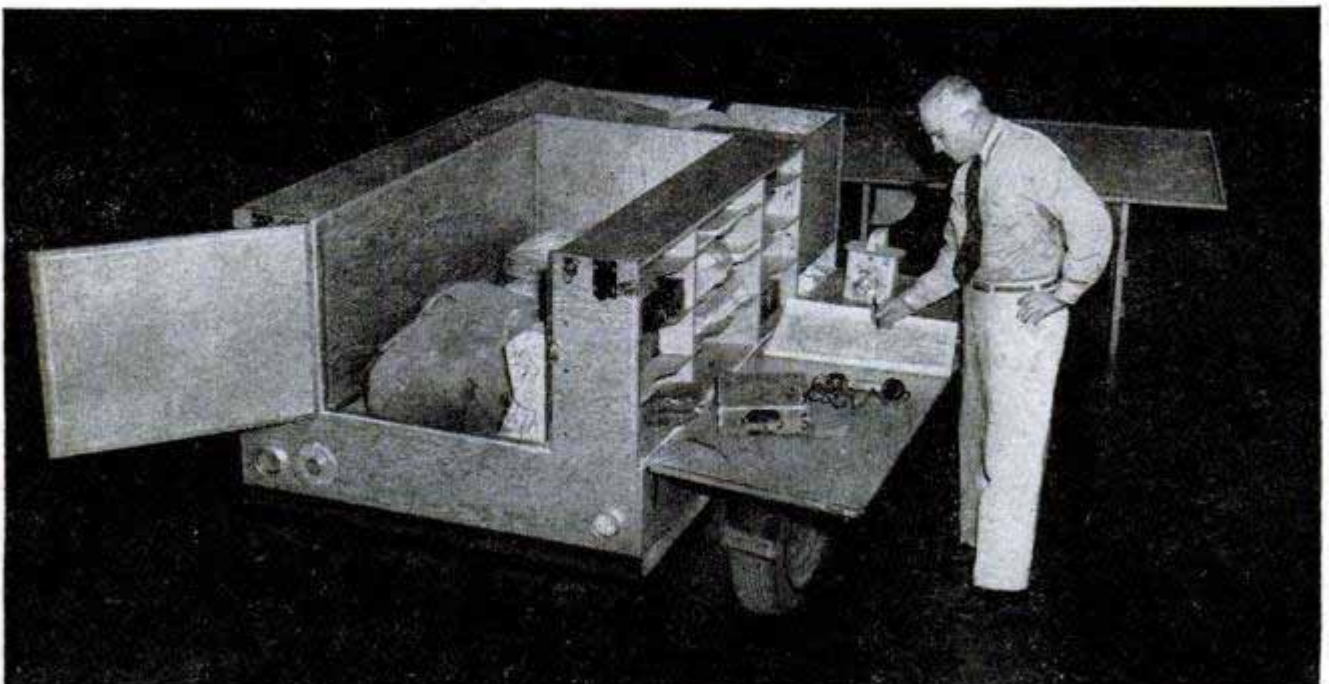

Mill attachment for yard machine picks up leaves, cuts them into shreds and scatters particles across ground

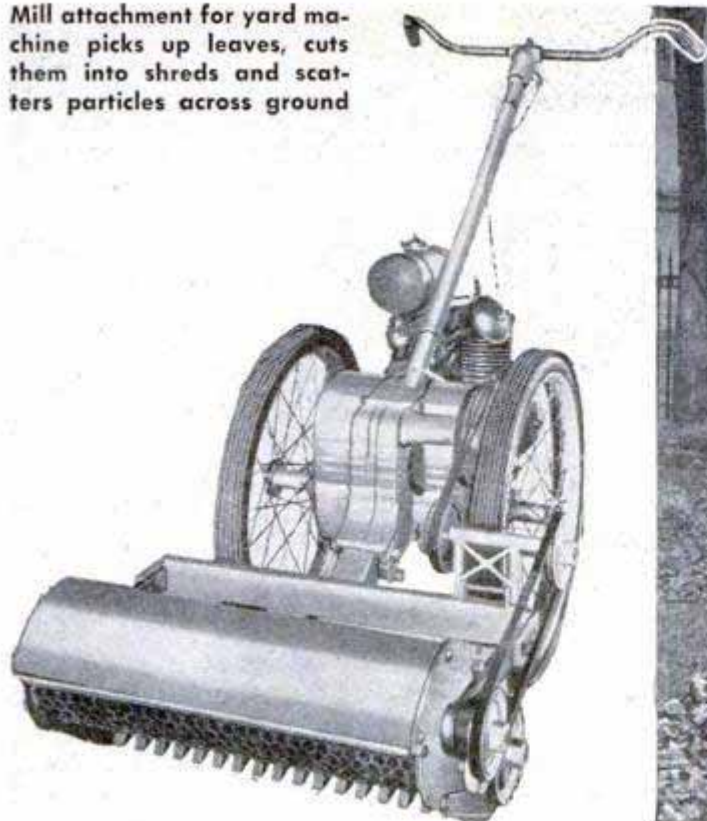

Lawn Machine Grinds Up Dead Leaves to Rebuild Soil

With one of its three attachments a power machine sweeps dead leaves from the lawn, grinds them into particles and drops them back on the grass to rebuild the soil. The machine is mounted on two wheels and powered by a four-cycle air-cooled motor. The leaf attachment automatically ejects

all foreign objects such as stones or pieces of metal that might damage the machine. The other attachments are a lawn mower and a sickle bar. The lawn-mower attachment is available in 20 and 24-inch widths. The basic machine weighs 97 pounds and is operated like a power lawn mower.

Bait Box Skims Surface of Water When Boat Is in Motion

Live fishing bait skims along behind the boat inside a box that scoops up fresh water. The box is held in place by four arms, pivoted both to the boat transom and to the box. When the boat is motionless, the box sinks until the overflow holes are even with the water level. When the boat

is in motion the bait box rises and skims along the surface, with a scoop picking up enough water to keep the box full to the overflow holes. The bait box, which can be painted to match individual boat trim, is available in four sizes, one small enough for outboard motorboats.

Bait box fits on transom of boat. Diagrams show how the craft's forward motion makes box skim the water

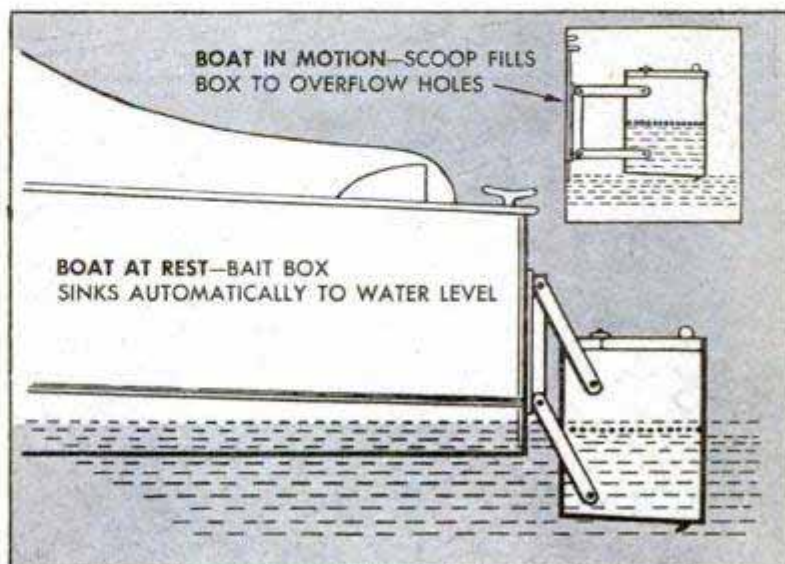

↑ correction in address:
Machine & Welding Co.

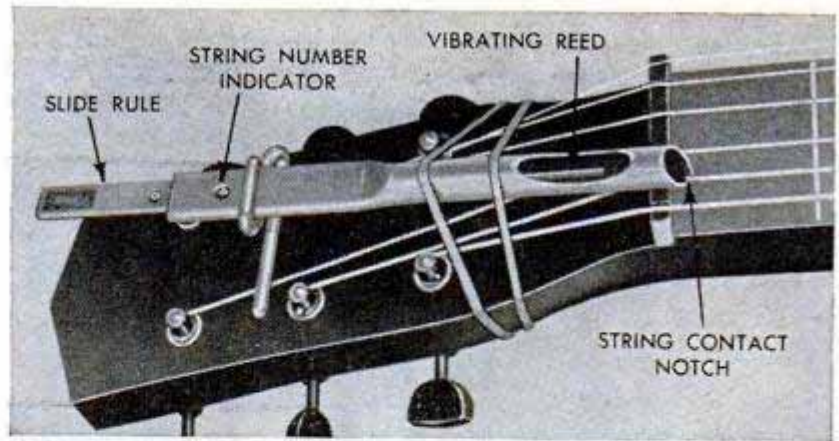

When reed vibrations are widest, the string is exactly in tune. Held in place by rubber bands, the tuner can be set for six pitches

Reed Makes Tuning Visual

Even tone-deaf persons can tune stringed instruments accurately with a visual tuning device that is attached to the strings by rubber bands. A vibrating reed, housed in a metal tube, can be set for any one of six pitches. When the string is plucked, the

reed vibrates visibly if the string is properly tuned. By adjusting the peg until the reed's oscillation is at its widest point, the musician is assured of being on the exact pitch. A numbered indicator allows the musician to select any of six pitches.

Coilless Radiant Heating Warms Space Between Joists

Radiant heating is possible with a heat-distribution system that eliminates floor coils and heats the spaces between floor joists and wall studs. With certain adaptations, it can be installed in any house, new or old and with or without basement. In a typical two-story house, a heat exchanger, mounted only a few feet from the boiler,

warms air from the basement, causing it to rise in a supply duct to the second floor. It spreads along the entire floor, warming both the floor of the room above and the ceiling of the room beneath. Two-by-two strips, nailed to the undersides of the joists, support the ceiling far enough away from the joists to allow passage of the heated air. As it cools, the air returns to the basement through ducts formed by certain wall studs. These return ducts are spaced around the exterior walls to provide even distribution of heat across the entire floor. Fusible links hold open metal fire doors at slots cut into conventional fire stops. Said to be cheaper to install and operate than any other type of automatic heating, the system uses either steam or hot water to heat the exchanger coil.

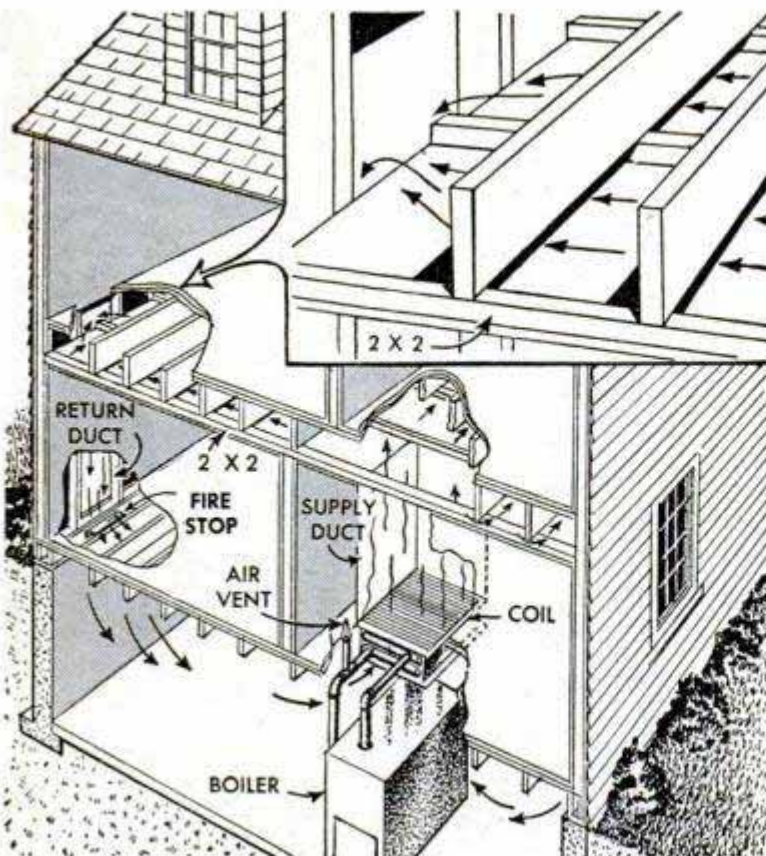

"Wick" Stakes Repel Animals

Dogs, cats and rabbits won't approach trees and gardens which are protected by a stake that gives off an odor inoffensive to humans. Each stake protects an area six feet in diameter for about three months. Atop the stake is a tube containing a wick and a vial of chemical repellent. The vial is emptied into the tube where the chemical is absorbed by the wick.

GIANT twin-hull flying boats, weighing 250 tons or more, may be the amphibious craft for beach landings on hostile shores in future wars. Such huge seaplanes could carry 1000 men plus equipment, would fly at speeds approaching the top speeds of the fastest land aircraft, and upon approaching a hostile shore would land in the water, taxi up to the beach and open armored bow doors to discharge their troops.

If submarines make the seas too dangerous for ordinary shipping, the twin-hull flying boats envisioned above will have to be built, says Ernest G. Stout, head of naval aircraft research for the Consolidated-Vultee Aircraft Corporation. In fact, he says, the aircraft industry could start construction of them at any time that the need arises. All major problems in large flying-boat construction have already been given study.

Flying-boat research was practically abandoned during the last war because of the emphasis on land planes. Since then designers have



from MODEL to MONSTER

By Ewart Thomas

Research for aerial assault boats that will carry up to 1000 men is being carried on with flying miniatures weighing as little as 123 pounds. Above and below are an artist's idea of how tomorrow's 250-ton amphibians will "hit the beach"

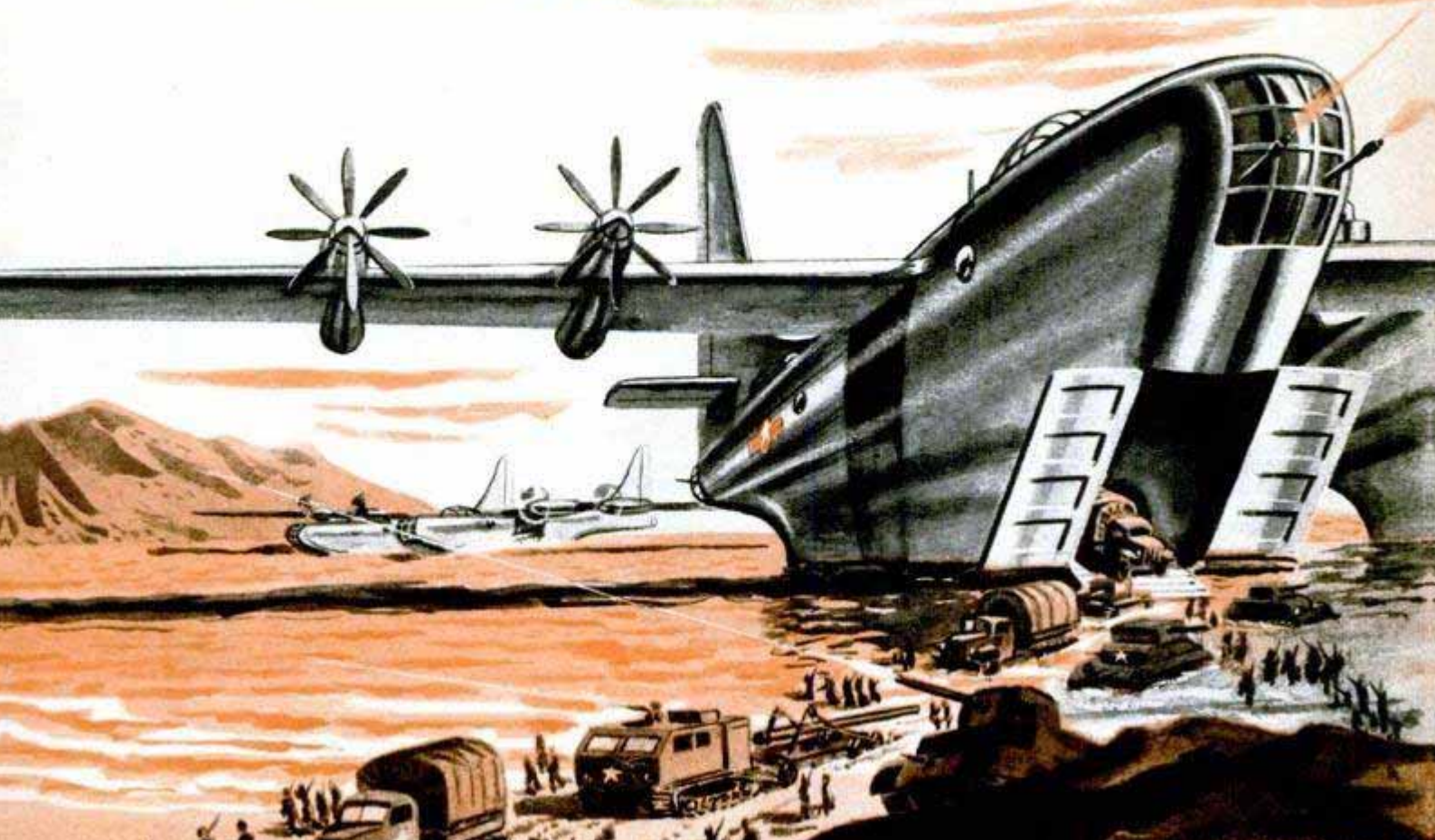

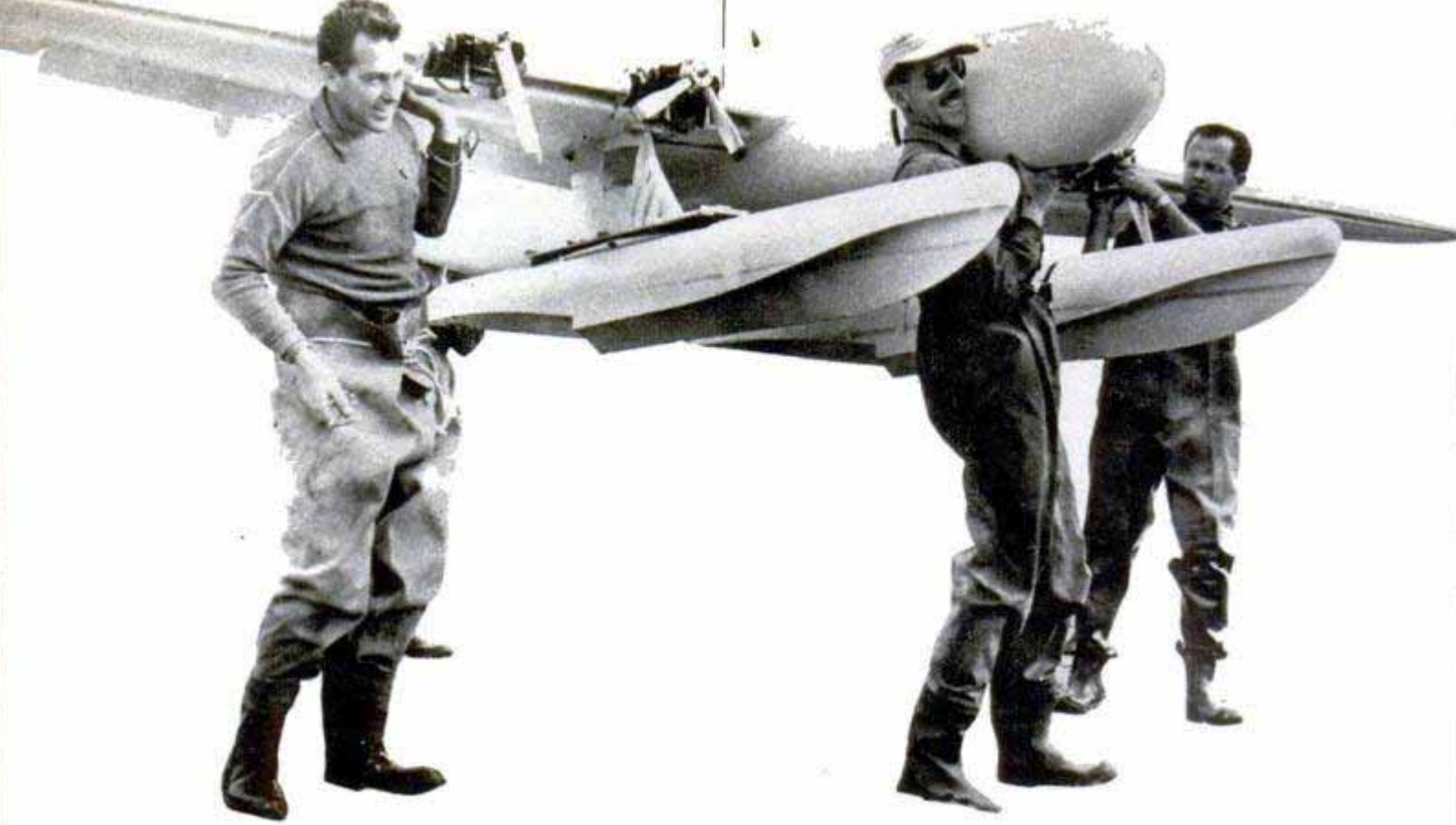

Radio-controlled flying boat being carried to water for test weighs 160 pounds and has a 21-foot wingspan

made considerable progress in refining that type of aircraft. A case in point is the new Convair XP5Y-1 patrol flying boat, powered with four turboprop engines.

Larger than any flying boat previously built by Consolidated-Vultee, the aircraft has twice the seaworthiness and carries 2½ times the load of the Coronado flying boat. The total increase in efficiency amounts to 300 percent, an advance that grew out of a two-year program of flight testing powered models of flying-boat shapes, including numerous different combinations of hull and wing designs.

Convair's model flying boats are not ordinary models. They are complete miniature aircraft that are powered by their own tiny engines and controlled by radio from a ground station. They can be taxied on the water, turned, driven at full power so that they take off and climb into the air for maneuverability tests, and then made to land on the water again exactly as if they had human pilots on board.

Experts of the company's hydrodynamics research laboratory test the small craft on an estuary of San Diego Bay. Motion pictures of the miniature flying boats in action, particularly during water take-offs and landings, provide information that can't be learned theoretically or in wind tunnels or conventional towing basins.

Everything is built precisely to scale. Thus the balance, weight-carrying ability, rate of climb, top speed and other needed information about a huge flying boat can

be learned accurately by flying the models. Changes are made in the models to test new ideas, which then can be adopted or discarded at much less cost than cut-and-try alterations to a full-size experimental craft. At the same time, a model serves to test performance under conditions that



might be hazardous to a human crew.

One of the miniature boats is built to $\frac{1}{10}$ full scale and weighs 123 pounds. It is powered by four two-cylinder engines that develop $1\frac{1}{2}$ horsepower each at 5000 revolutions per minute. They swing four-bladed props. A two-motor type built to $\frac{1}{8}$ scale weighs 90 pounds and has a wingspan of almost 14 feet. Still another, a twin-hull four-motored research model, weighs 160 pounds and has a span of 21 feet.

The small engines are of special design and have complete throttle control. They are started from land by a booster battery. Fuel is delivered to the engines under pressure and enough fuel is carried in the model planes for a half hour of flight.

Control surfaces of the models are actuated by tiny electric motors or by nitrogen pressure servo actuators, all radio-controlled. A miniature Gyropilot keeps the model trimmed in flight up to its top speed of around 50 miles per hour when it is not being maneuvered by radio.



Motion-picture cameras record the water-landing characteristics of nonpowered models shot from catapult. The trials are repeated with various flap settings. Below, loading model on a catapult. Built to scale, their performance gives test observers accurate information

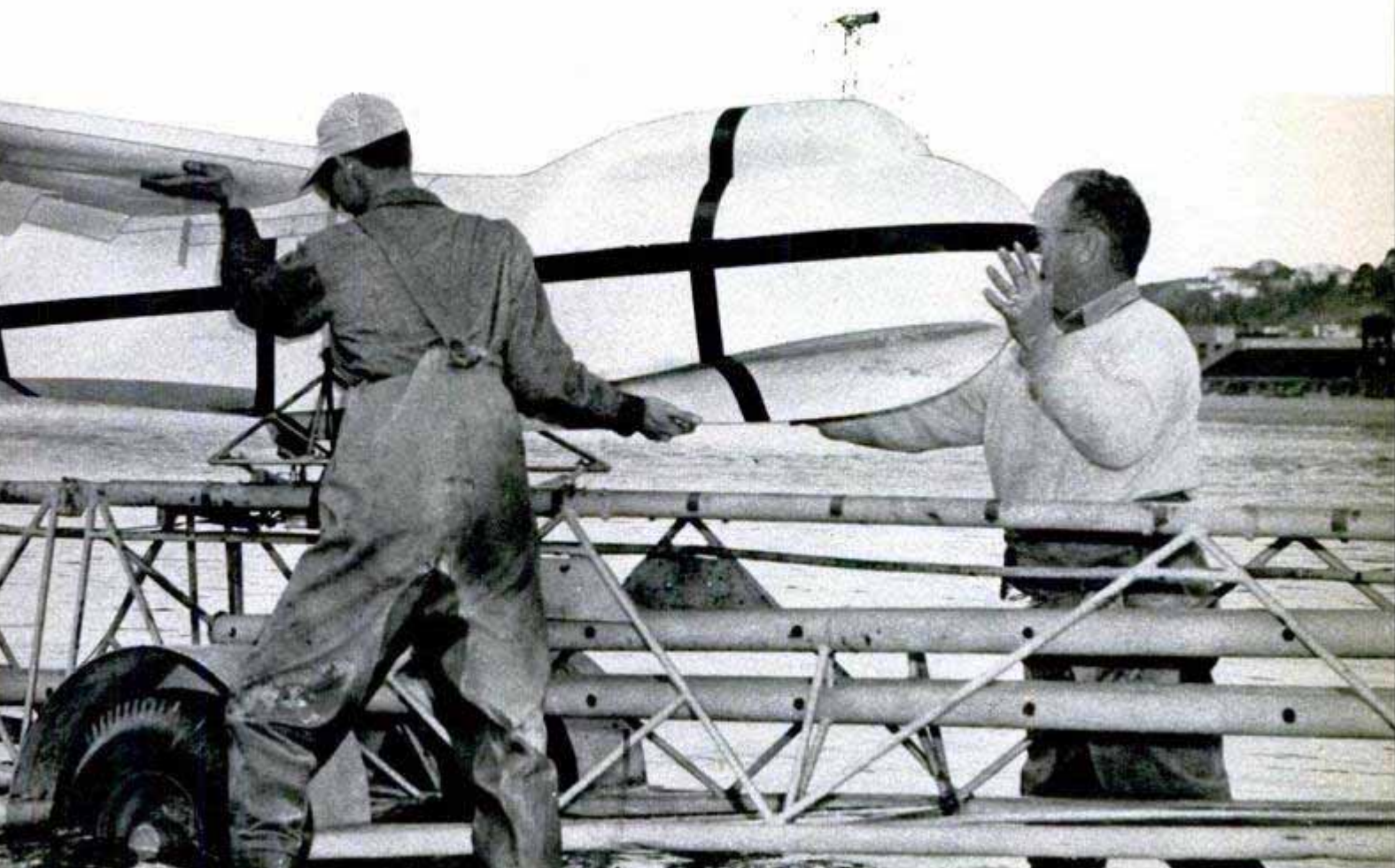

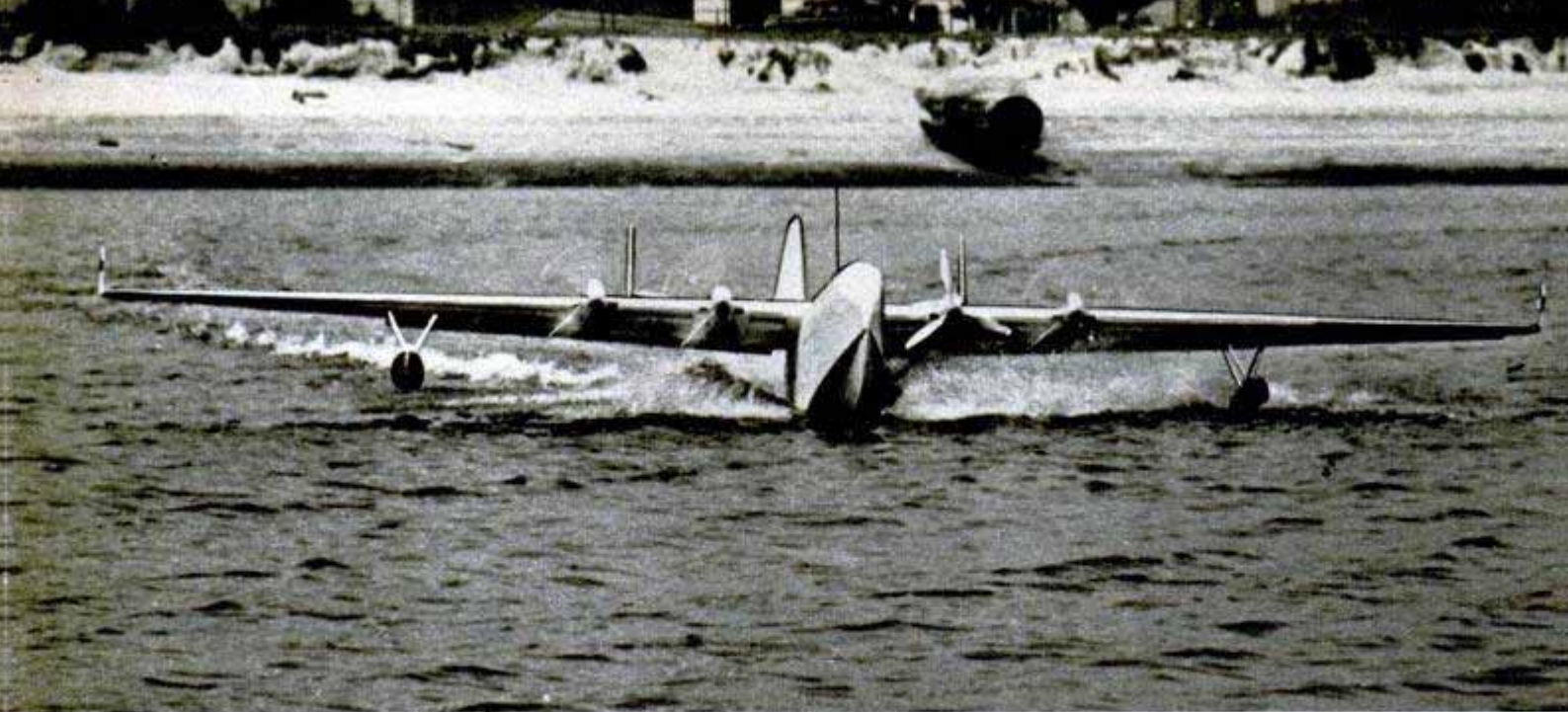

Model cruises back to land after completing test flight. The four two-cylinder gasoline engines each develop $1\frac{1}{2}$ horsepower for the four-bladed props

"Anchor man" holds boat while radio pilot on shore prepares to take over control. The black-and-white markings show attitude of plane during maneuvers

It takes a very hot pilot at the radio cockpit on the beach to fly one of the miniature boats. The scale effect is such that everything happens three times faster than normal. Moderately rough water or rough air is magnified in its effects on the model and take-offs and landings under such conditions require considerable skill.

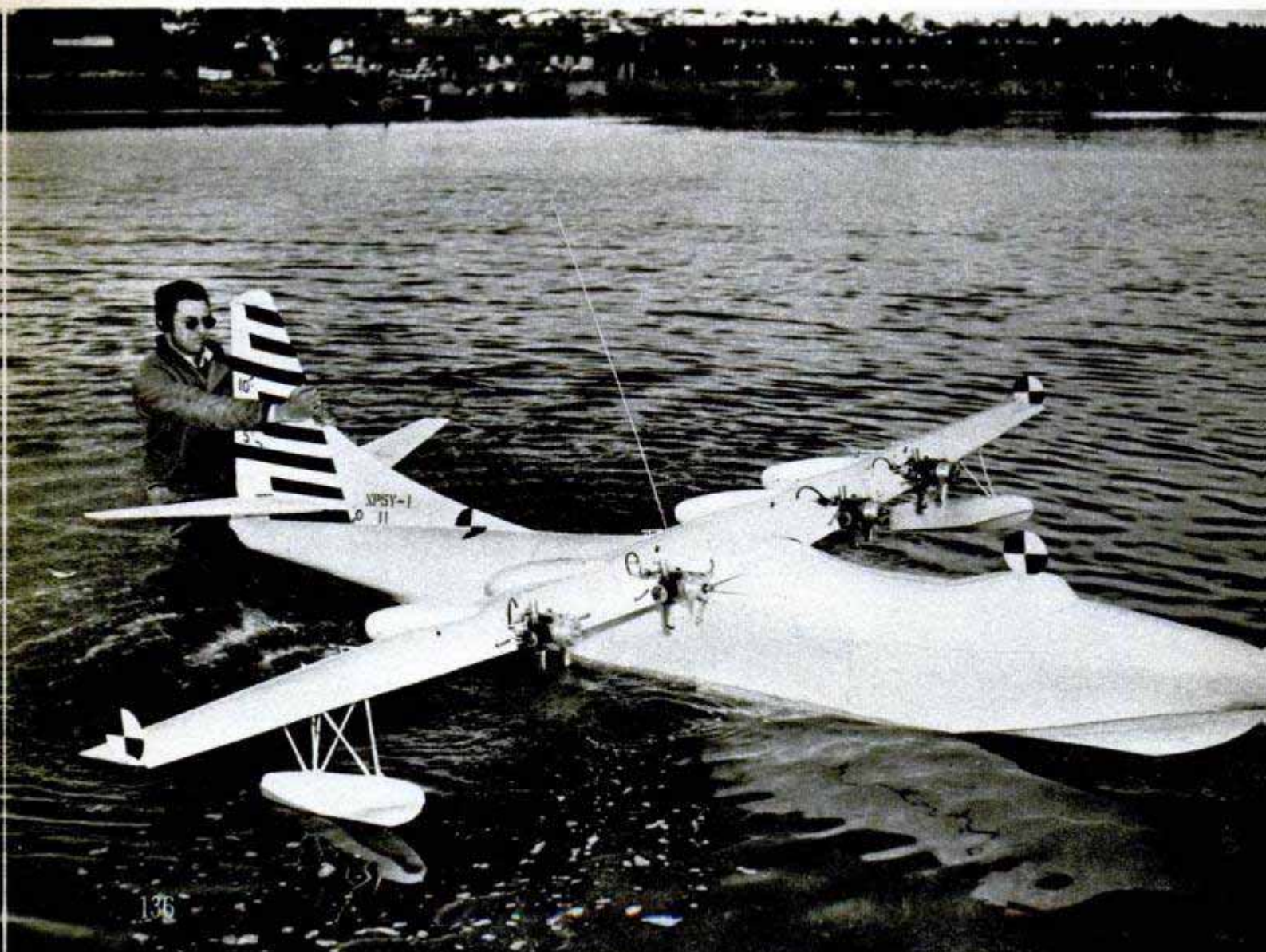

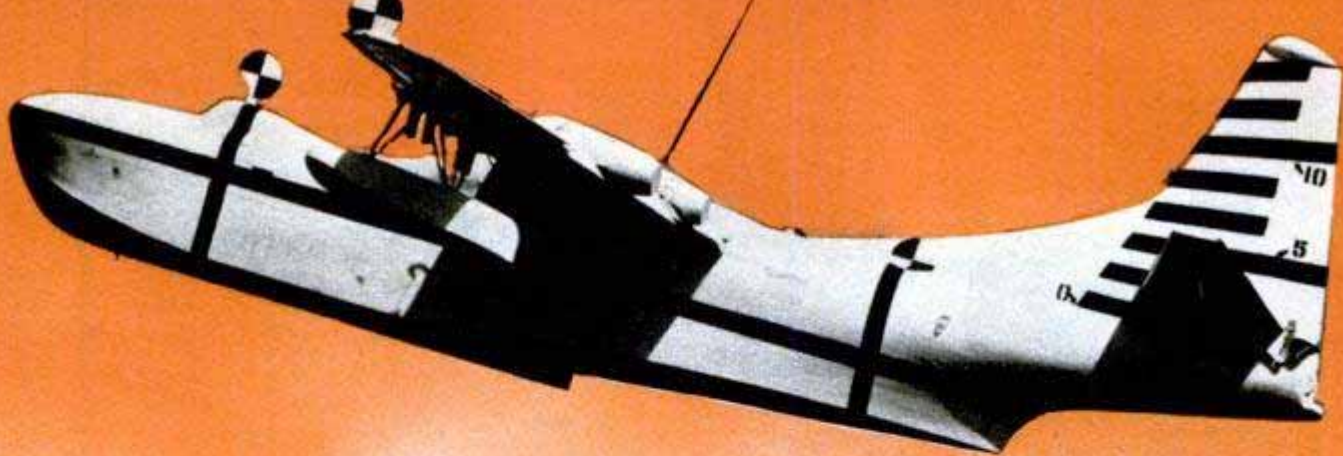

Flight view of the radio-controlled model for Consolidated's XP5Y-1 patrol plane. Tests that might be hazardous for human crew can be made this way in complete safety

The radio-control cockpit has a typical set of full-size flight controls for operating the model, including flaps, ailerons, elevator, rudder, throttles and ignition. A thumb switch is used to cut in the model's automatic pilot. All the pilot's actions are relayed by a 63-watt six-channel transmitter to a receiver in the model, which in turn actuates the flight and engine controls.

For some experiments an 8-mm. camera placed inside the model's fuselage photographs the dials of a tiny instrument panel on which air speed, trim, hull pressure and time are indicated.

Exteriors of some of the hulls are painted with black grid markings to aid in study of

the motion pictures that are made from the beach. Black and white crosses and targets are painted on different parts of the fuselages to show the attitudes of the models in the air during maneuvers.

One nonpowered model, with a wingspan of 14 feet, is thrown from a catapult so that its landing characteristics may be studied under different flap settings.

Virtually any information that is desired concerning a proposed full-size flying boat can be obtained from the "dynamically similar" free-flight models. Convair is continuing its model research program for acquiring basic data on the huge sea-and-aircraft that may be built in the future.

Since scale construction makes things happen three times faster than normal to the models, it takes a "hot pilot" to guide miniature flying boats from landbound cockpit



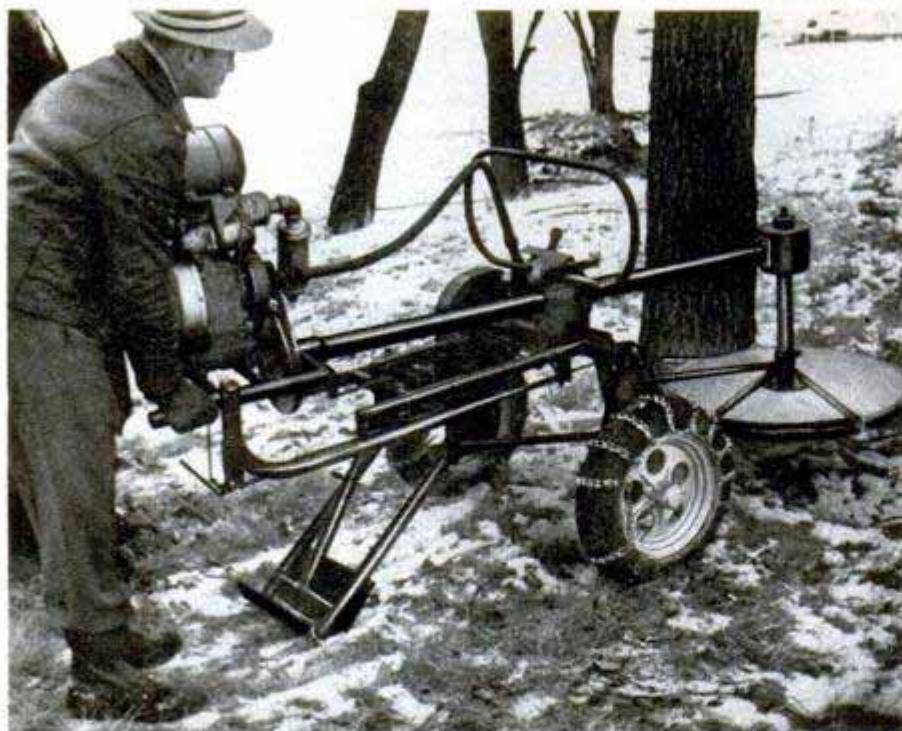

Double Saw Blades Prevent Bucking

Because its twin blades rotate in opposite directions, a new rotary power saw cuts faster than single-blade saws and without any bucking or jumping. In a demonstration, an eight-inch log was placed on a smooth surface and successive cuts were made without any movement of the log or cutoff sections. The saw can be used horizontally or vertically and has a forward and backward movement independent of the wheels, permitting the operator to move the blades as much as seven feet without disturbing the carriage.

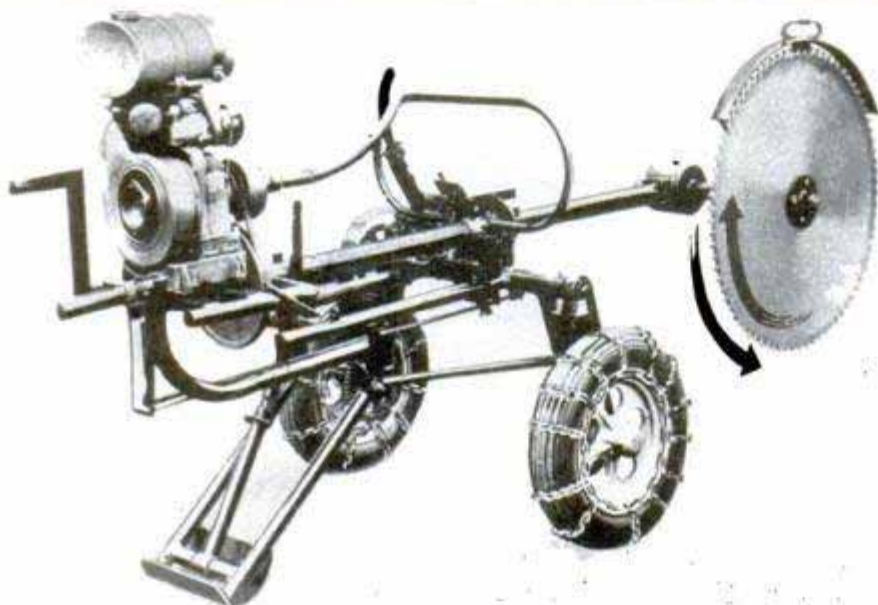

Hardening Steel

Depth-hardening steel requires no special equipment when a chemical compound is used. The object to be hardened is heated to a cherry red, then dipped or rolled in the powdered compound. Heated again, the metal is quenched in cold water or brine. According to the manufacturer, wire nails hardened by this process will cut into an automobile spring leaf.

Strawberry Wall

Strawberries grow from the wall of a stone barbecue built by Maurice R. Phelps of Santa Ana, Calif. When Phelps built the barbecue he left spaces between the stones. Later he filled these crevices with dirt, sand and leaf mold and planted strawberries. The plants grow on the south wall where they absorb a great deal of the sun's heat, and the rocks retain heat during the night.



If you do not find the information you need in the index, sources of further information on articles are available without charge from our Bureau of Information, 200 E. Ontario, Chicago 11

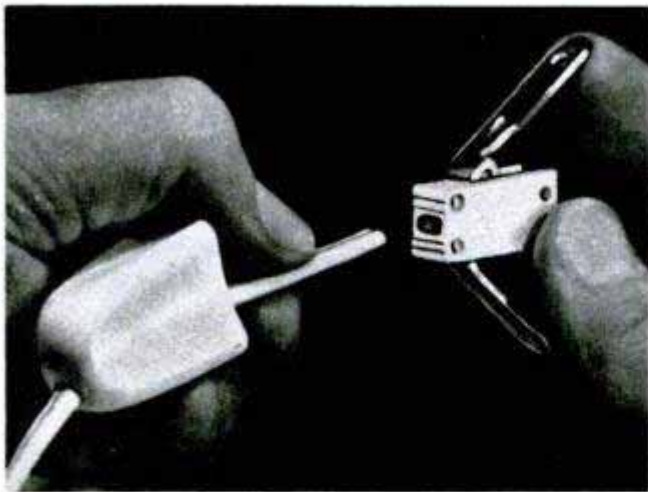

Automatic Electric Plug

You don't have to be an electrician or even a handyman to put a new plug on an electric cord now that an automatic plug is available. The plug comes in two parts, an outer shell and an inner core. When the core is removed, its two prongs pivot outward and the cord is pushed into a center hole without stripping or slitting the insulation. When the prongs are forced back into normal position, two sharp points penetrate the insulation to make the connections. The core is then replaced in the shell.

Fire Extinguisher for Vehicles

Fires that start under the hood of an automobile or truck are put out automatically by the smothering fog that pours from a new extinguisher. The safety device is mounted permanently on the engine side of the car's fire wall. Whenever the temperature under the hood reaches 255 degrees, a fusible clip melts, releasing a coiled spring plunger which shatters a glass grenade filled with carbon tetrachloride. Because the boiling point of this fluid is only 168 degrees, it leaves the container as a vapor which envelops and smothers the flames. The grenade also can be lifted out of the extinguisher and used manually to put out nearby fires.

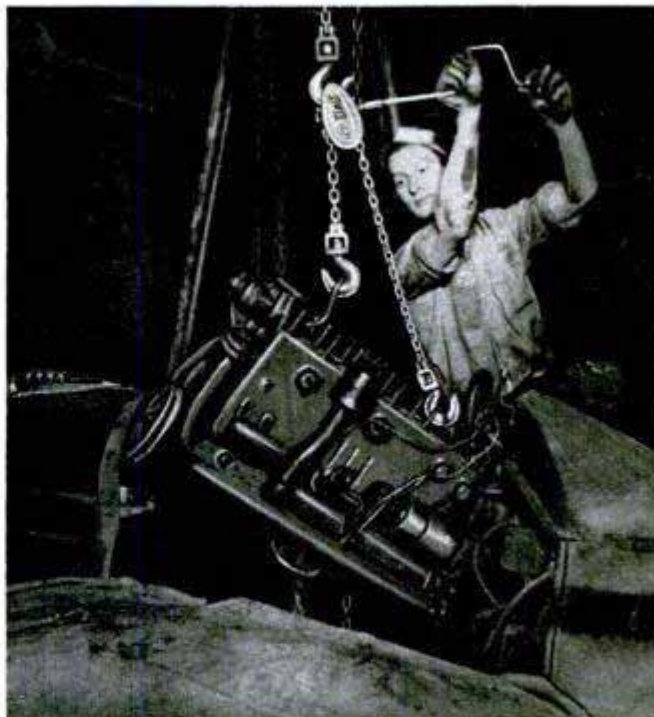

Chain-Hoist Accessory Tips and Holds Load

Heavy loads lifted by chain block or electric hoist are tipped to any desired position and held there by a self-locking worm device attached to the lifting hook. A socket wrench drives the worm gear. With a capacity of 2000 pounds, the device has many applications, although it was designed for auto repair shops where it speeds the pulling and installing of engines.

Cable Lock

Suitcases, bicycles, boats and other movable objects are protected from theft by a new cable lock. The cable, covered with a Vinylite sheath, is 36 inches long. On one end is an aluminum padlock. The other end snaps into the padlock and can be removed by turning a key in the lock.

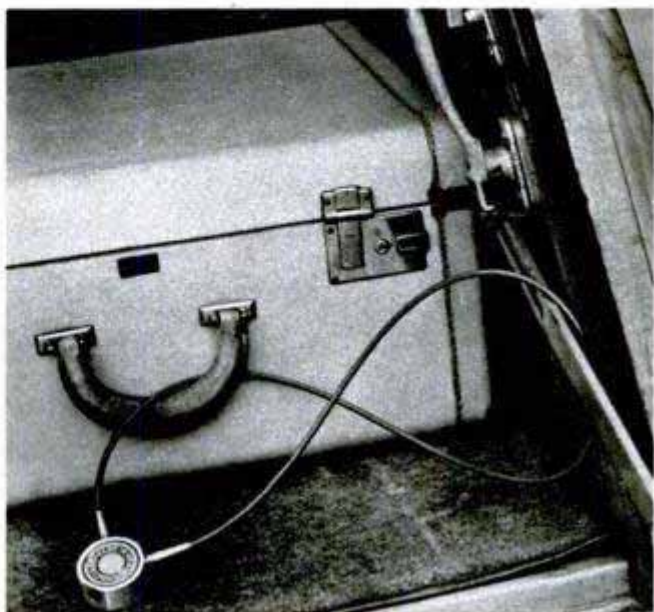

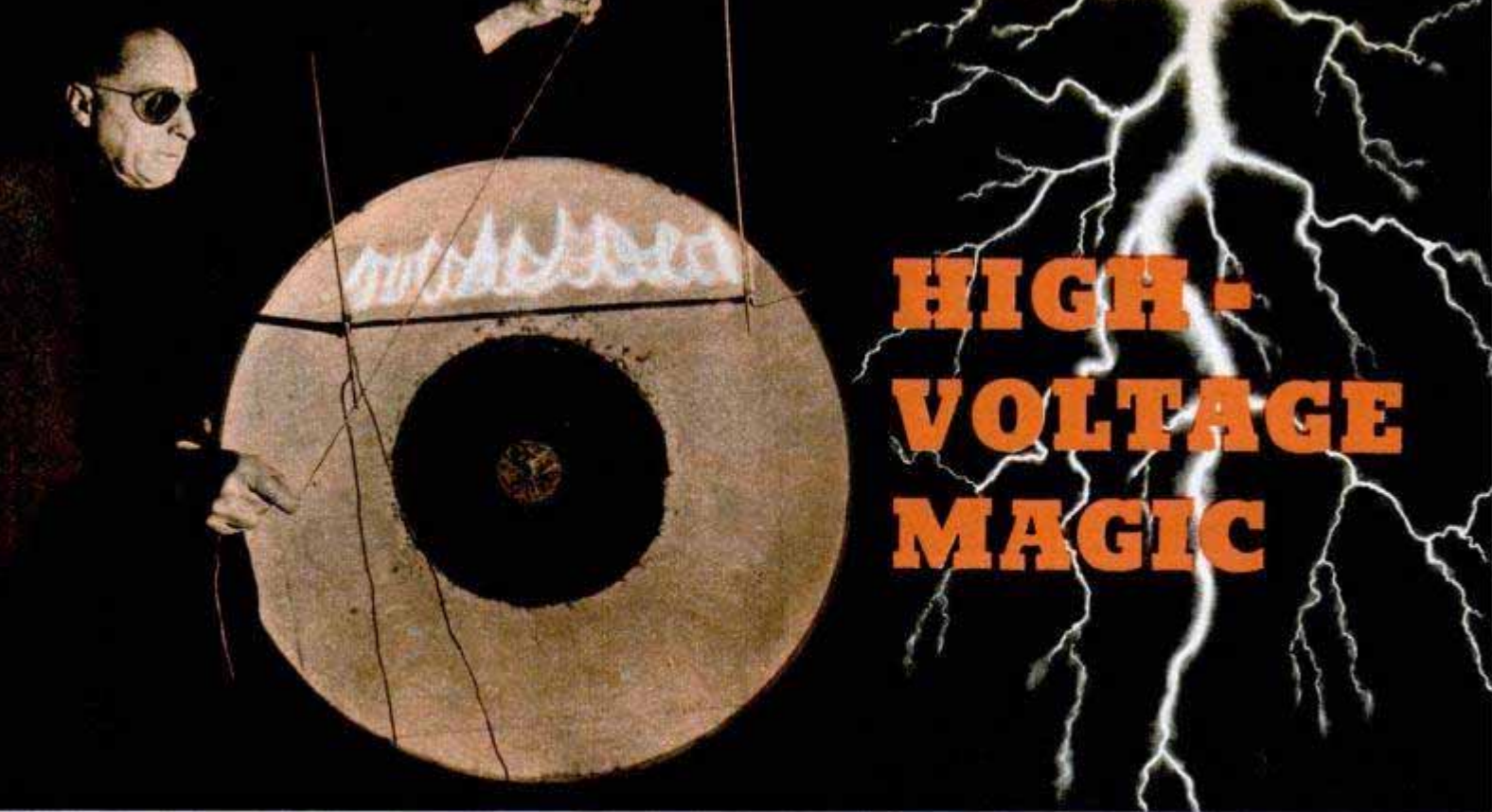

High-voltage current from the screen leaps between two vertical electrodes, causing this electrical flame

By Eugene M. Hanson

Photographs by the Author

WHEN THE mad scientist in the movies pulls the switch and his fantastic machinery begins to hum and glow, causing flashes of man-made lightning to leap and crackle around the room, you can be fairly certain that Kenneth Strickfaden is somewhere in the picture.

Ever since he created the electrical effects for "Frankenstein," Strickfaden's genius has been in great demand among motion-picture producers when spectacular laboratory trickery can be made to fit into the plot.

Strickfaden not only created the effects for "Frankenstein," but also doubled for Boris Karloff in sequences which called for million-volt sparks playing over his body.

Since then, he has added his wizardry to "Son of Frankenstein," "Bride of Frankenstein," and the other sequels; the "Buck Rogers," "Flash Gordon," "Sherlock Holmes," "Chandu," and "Fu Manchu" features—altogether more than 50 movies in the last 15 years.

Although the movie producers insist that Strickfaden is the only man to be trusted with such high-voltage trickery, he says frankly that there are no mysterious secrets to what he does. It's a matter of combining well-known principles of electricity with principles of showmanship.

He has designed machines for producing and controlling extremely high voltage, extremely high amperage and high-frequency electrical currents. He builds all the machinery in his home workshop.

Merely producing the high voltage or high amperage is fairly simple. Any clever student of high-school science might be able to do it, but keeping the currents under control calls for more knowledge. His own apparatus is relatively safe, but Strickfaden warns that high voltage not kept in proper balance can be dangerous.

One of the key pieces of equipment which Strickfaden uses is his million-volt generator. This device produces the biggest sparks, fat, blue flames which stab six feet into the air, and is the most complicated in design of his inventions.

This generator operates from regular alternating current of 110 volts.

As the first stage in the boost to a million volts, the current passes through a transformer which raises it to 20,000 volts. It then enters his multistributor device, a rotary switch which allows a loaded condenser to discharge into the primary circuit of the million-volt resonator.

The multistributor consists of a motor-driven, whirling electrode with five points. At great speed these points pass another electrode with a set of seven points. As each point of one electrode passes a point of the other, a 20,000-volt spark occurs. These sparks form featherlike flashes between the two rings. The inner electrode spins at a speed of about 1000 revolutions per minute.

The make-and-break effect of these sparking electrodes charges and discharges the high-capacity condenser into the 10-

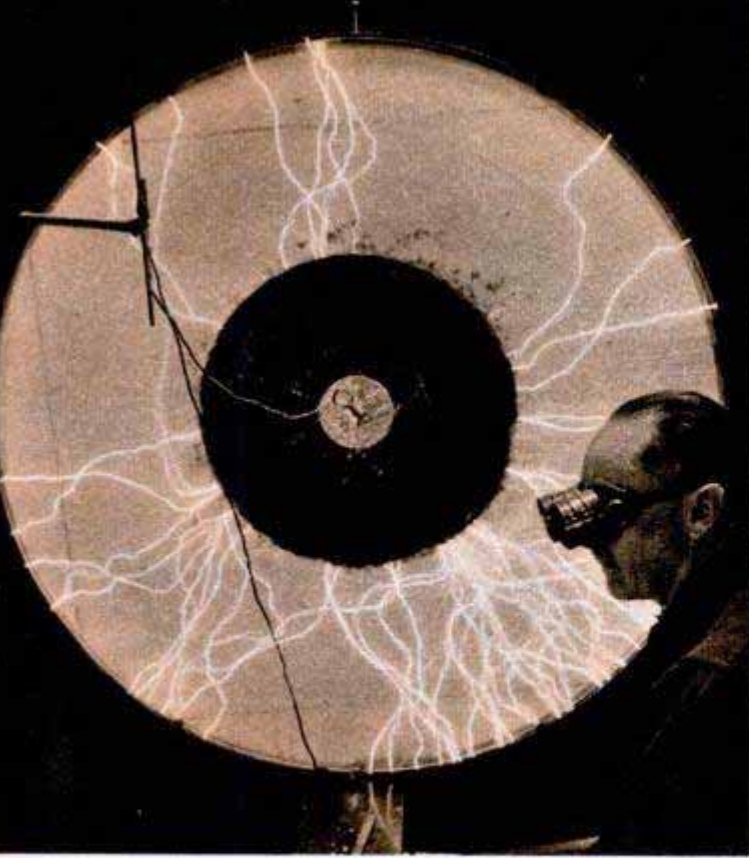

Above, the circular screen has a radioactive coating that holds an image of the lightning after the current is turned off. Above, right, as many as 10,000 amperes are used to produce these electrical fireworks on the pyro-geyser. Below, the multistributor spins 1000 times a minute to form feathery sparks

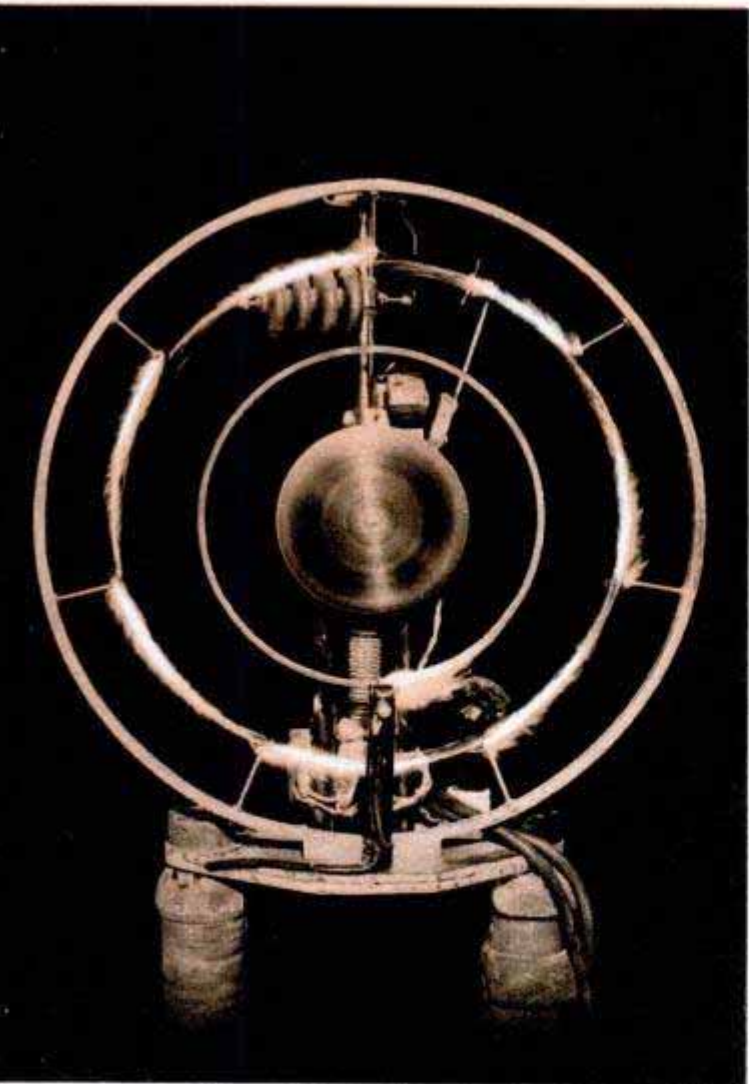
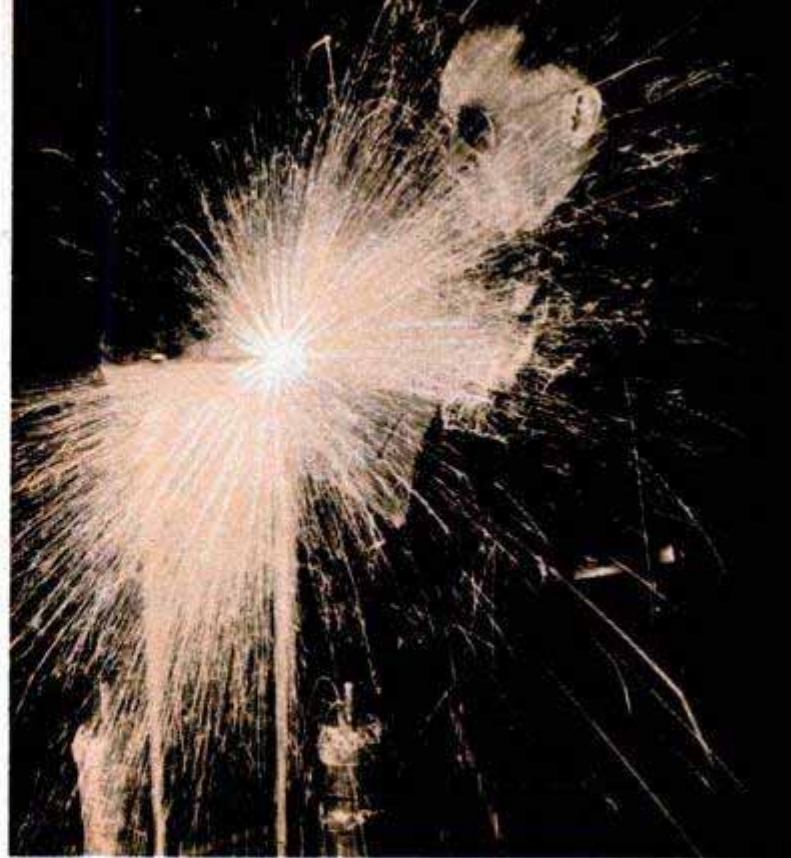

turn primary of the resonator, which has a secondary winding of 1000 turns.

Sparks which leap from the resonator, although they will cross a six-foot air gap, have enough amperage to cause acute discomfort, but could not be considered dangerous, Strickfaden says. A shock from the multistributor part of the circuit, however, would certainly be fatal.

When this huge generator discharges for only a few seconds, the air becomes acrid with the smell of ozone. Radio and television reception is disrupted for blocks.

Actually, the generator is something of a radio station, broadcasting on a frequency of 40 kilocycles. It could be used as a receiving set, if some station were broadcasting on that frequency.

Another device which employs high voltage and which Strickfaden uses for some of his spectacles is called a "lightning screen." This is a high-voltage generator which discharges its sparks across a disk with a radioactive backing. When used on a darkened stage, the radioactive material continues to glow along the path of each spark after the current is turned off.

Current from the same device produces an electrical flame when the current is brought away from the screen to a pair of electrodes. The only connector between the two electrodes is a moistened stick of wood, to provide a path for the spark, which climbs to the top of the upright electrodes.

Extremely high amperage produces sparks in a "pyro-geyser" display that results from the use of a transformer. This particular transformer is somewhat unusual in that there is only one turn in the secondary coil. When the contact is made

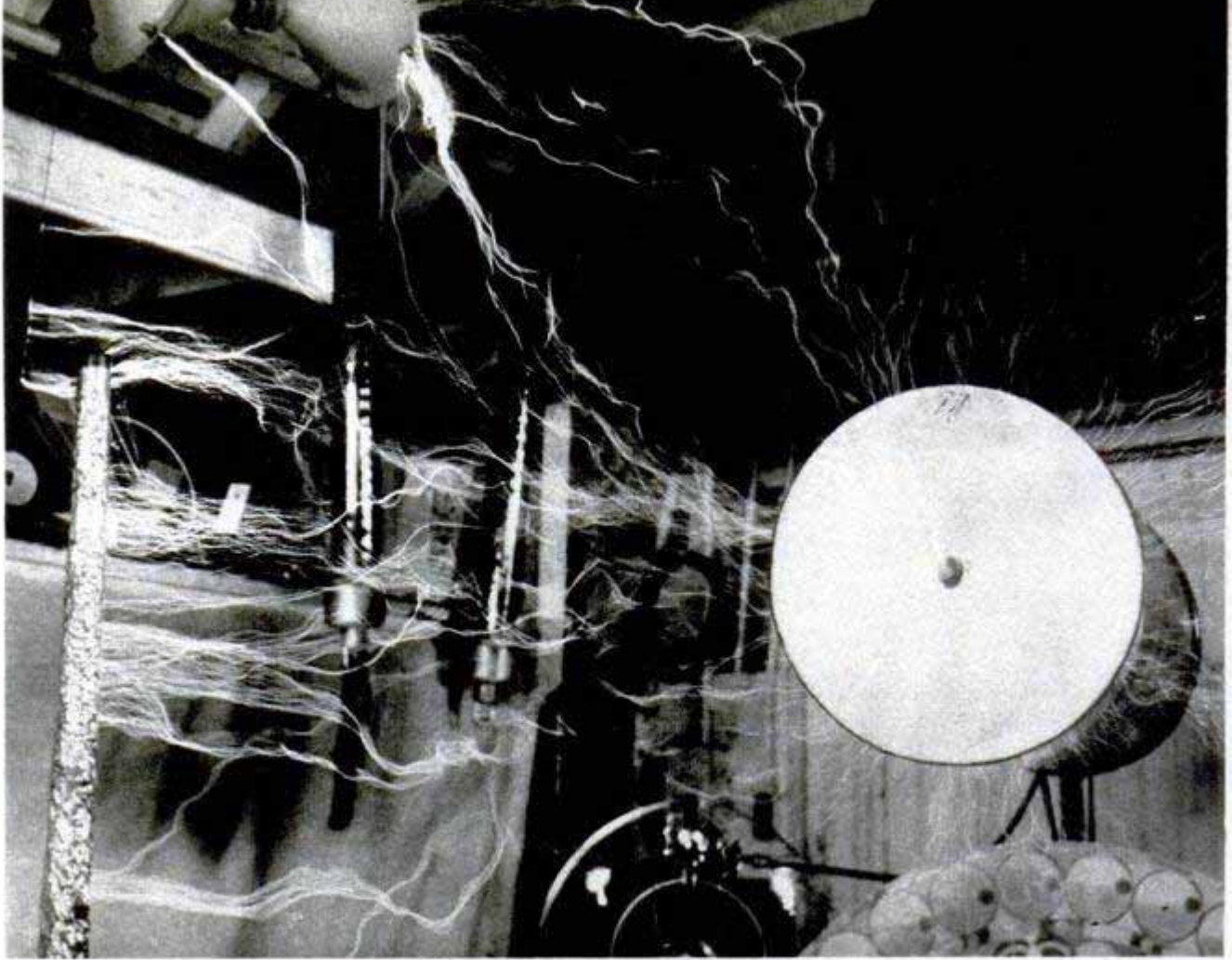

The room is filled with sparks, some more than six feet long, when the million-volt generator is operating

between the two iron points of the pyro-geyser, as much as 10,000 amperes of current can flow, with the resulting flash of vaporizing metal as heat is generated.

This device is similar to an arc-welding machine, except that it employs a much heavier current than the amount consumed by either an a.c. or d.c. welding outfit.

Preparing more magical equipment, Strickfaden uses a torch on a piece of tubing in his workshop lathe



The nature of the sparks thrown out by the pyro-geyser varies with the type of alloy used in the electrodes.

Besides staging electrical phenomena for the movies, Strickfaden designs and builds weird-looking scientific props, such as a Buck Rogers gun for use in the imaginative and futuristic films.

More important to him now than his movie work is his educational career. He presents spectacular science shows for high-school programs throughout the country, explaining each trick in terms linked to the students' own study of physics.

Often, he is called back to repeat his programs, and on those occasions he is pleased when the students can show him small replicas which they have built of his startling machines.

For the school programs, Strickfaden also creates music with electrical instruments of his own design, he demonstrates brilliant lighting effects with ultraviolet light on radioactive materials, baffles the students with his "gravity neutralizer" and broadcasts with a tiny radio station powered by a flashlight battery.

He is planning even more elaborate musical instruments and still more spectacular high-voltage equipment. Most of his spare time now is spent in his home workshop, preparing the various parts which will be used in his coming creations.

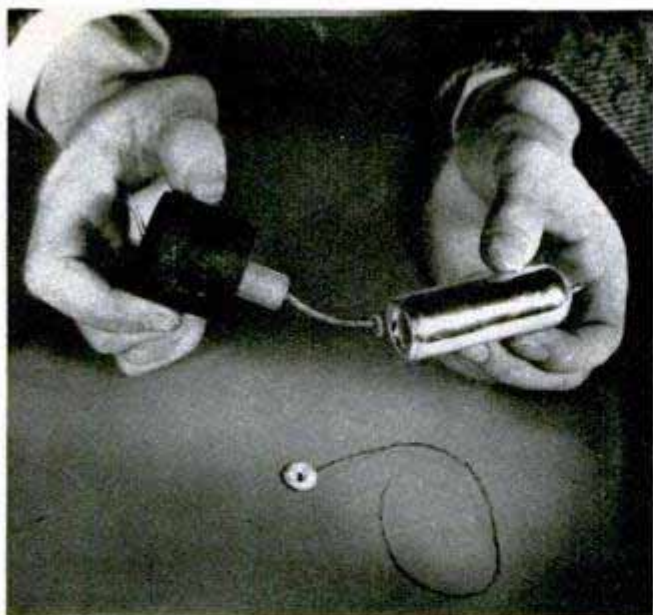

Midget Teakettle Measures Altitude

Water boils and freezes at the same time in a midget teakettle that soars to altitudes of 30 miles in Army weather balloons. Called a hypsometer, the tiny teakettle, which looks like a radio tube, broadcasts altitude reports back to earth during the flight. Operation of the hypsometer is based on the principle that the boiling point of a liquid drops as altitude increases. As the water in the vacuum flask of the teakettle boils, the temperature of the resultant steam changes the electrical resistance of a sensitive resistor. This changing resistance is radioed back to earth where it is converted into temperature reading and altitude. When the balloon reaches heights at which the boiling point of the liquid drops below its ground-level freezing point, ice forms even though the liquid is still boiling. The device is accurate to within 100 feet at heights of 20 miles.



Portable Respirator

Portable and battery-operated in emergencies, a new respirator or iron lung can be adjusted to a baby or an adult and provides a wide range of respiration speeds. Six plastic shells of graduated size are supplied with the respirator. There are no back shields to disturb the patient and the shells cover only a small portion of the body, permitting treatment of the patient. The respirator operates from 110-volt current but in the event of power failure it instantly switches to battery operation. The battery also makes it possible to move the patient by ambulance, train or airplane. As a final safety feature, the unit can be operated by hand if necessary.

Combination Drill Jig and Drill-Press Vise

Small enough to be carried in a tool kit, a versatile tool has many uses ranging from a jig for end-center drilling to a vise for drill-press work. Four sides and one end are milled to assure exact alignment when used with a drill press. Included with the tool are a combination center and centering cone and also a drill-jig bushing. Inner surfaces of the two cross pieces are V-notched for holding square and round stock. The tool also can be used as a clamp for gluing small pieces.

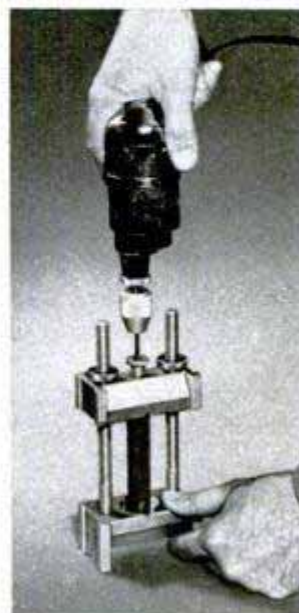
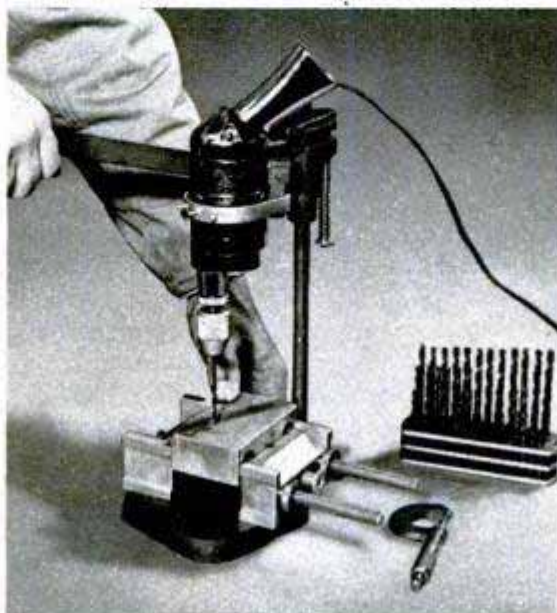



HOSPITAL for sick cars

By Andrew Hamilton

BILL MORGAN is the assistant manager of a chain grocery store in Los Angeles and earns \$3120 a year—pretty close to the average American income. Not long ago he and his pretty wife Marjorie reviewed the family budget to see if they could afford a new car.

Out of the \$60 weekly pay check, income tax, payments on the house, food, utilities, insurance, gasoline, clothing, medical expenses and entertainment came to \$54. That left only \$6 for miscellaneous items.

"Guess we can't buy a new automobile yet," Marjorie said.

"Nope," agreed Bill sadly. "We'll have to make 'Old Betsy' run for a while longer—even though she's 12 years old."

Since the end of World War II, approximately 10,000,000 persons have bought new cars and another 3,000,000 orders are on the books. But what of the remaining 27,000,000 car owners in the United States—about half of them with "over age" vehicles—who can't invest \$1500 to \$2500 in a new automobile? How can they keep their old cars running until they can buy new ones?

A man who has found an answer to these questions is John P. "Jack" Snyder, president of Snyder-Lynch Motors in Burbank,



Calif. He recently opened the Automotive Center—a \$500,000 assembly-line repair and overhaul establishment said to be the largest and most complete in the world. It is a hospital for sick cars, a modern idea in automotive engineering for rejuvenating the millions of old vehicles on America's highways that otherwise would be heading for the scrap heap.

Snyder is a husky, easy-going gent who wears a pearl-gray Western stockman's hat like President Truman. A veteran Ford dealer, Snyder is now up to his ears in the automotive repair business. He's using the same formula that brought success to scores of American business firms: Give the average or low-income worker a decent product at a price he can afford to pay.

Snyder's mechanics will take your car, install a rebuilt motor, tighten up the steering assembly, reline the brakes, put on four new tires, install seat covers, straighten dents in the fenders, put in new floor

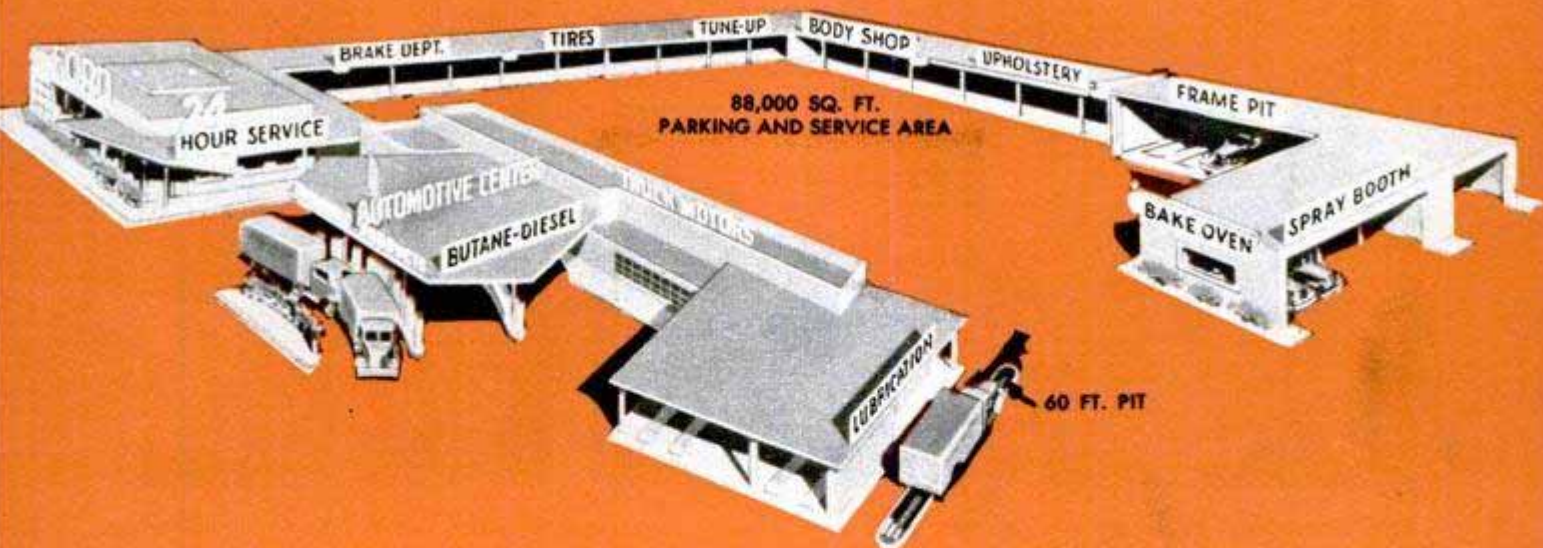

Scientifically designed for assembly-line operation, the Automotive Center spreads out over a city block

coverings, repair the clutch, steam-clean the chassis and give the body a gleaming coat of paint.

"It won't have all the streamlining and fancy accessories of the 1949 models," he said, "but it will be good, sound transportation that will be dependable for years to come."

The cost? Approximately \$350 for the entire job—and less if your car is in better-than-average condition. The complete overhaul can be paid for at \$3.98 per week, a sum which will not put too much of a strain on the average American budget.

Snyder's new Automotive Center is a far cry from the alley garage run by a jack-of-all-trades mechanic and his youthful helper. Snyder has adapted the assembly-line techniques of Detroit to the overhauling and rebuilding of used automobiles. The idea is attracting nation-wide attention. Automotive experts from Canada, Chicago and New York have made special trips to California to look over "Jack Snyder's baby."

SEPTEMBER 1949

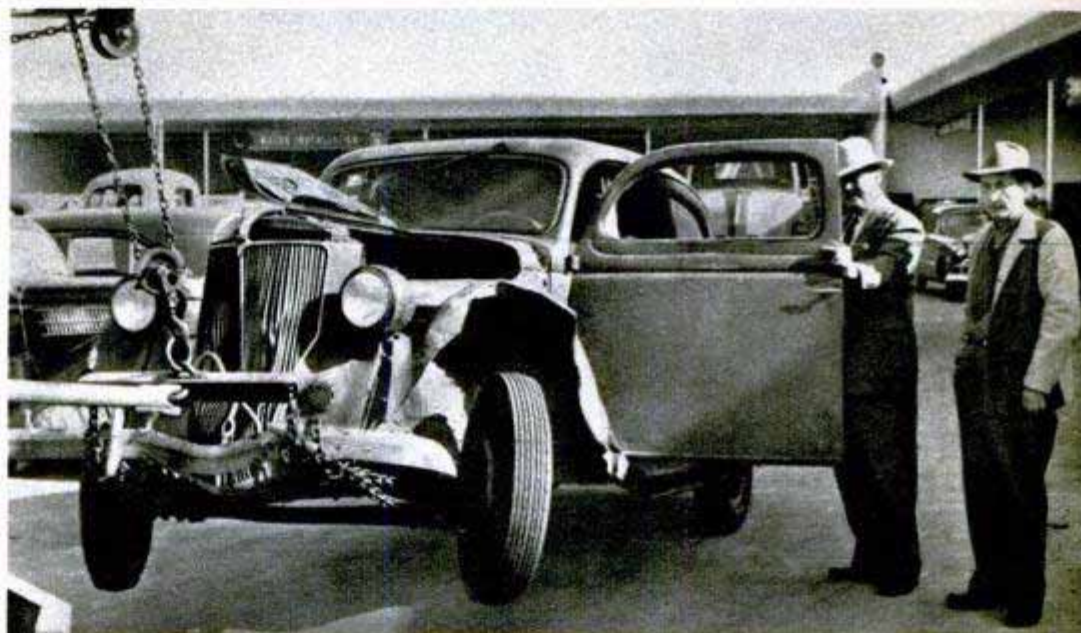

Before and after views of a "patient" offer an amazing study in contrast. Above, a 1936 Ford is towed into the hospital to be rejuvenated. Below, a few hours and \$350 later, the same car starts on its second childhood



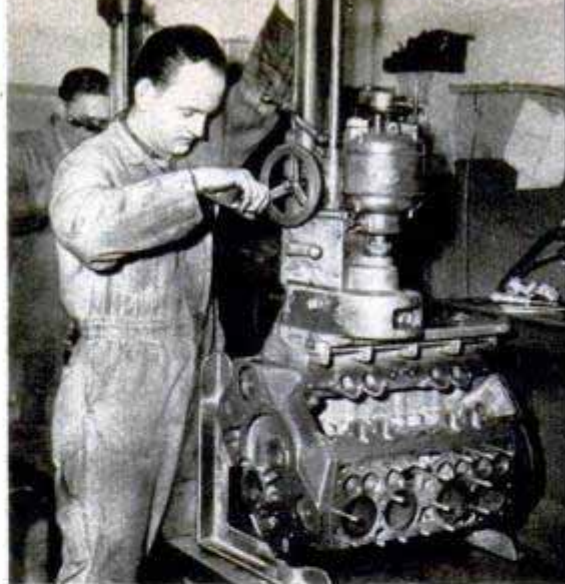
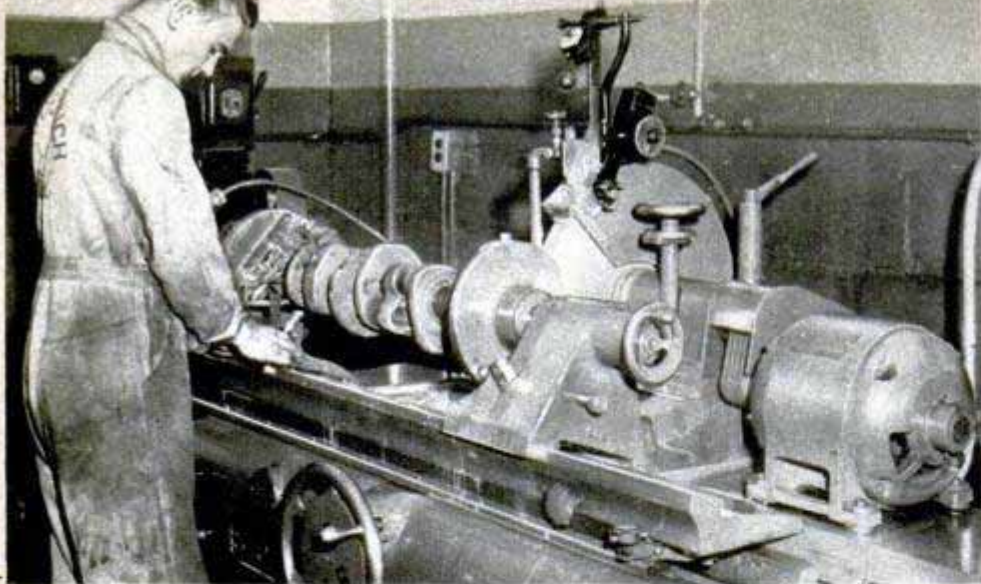

Left, crankshafts come off this grinding machine like new. Right, cylinders are rebored to exact diameters



Above, assembly-line methods are used to speed the reconditioning of engines in the Automotive Center. On wheeled cradles, the motors roll along elevated tracks as parts are added. Below, bushings of connecting rods are reconditioned on a specially designed grinder

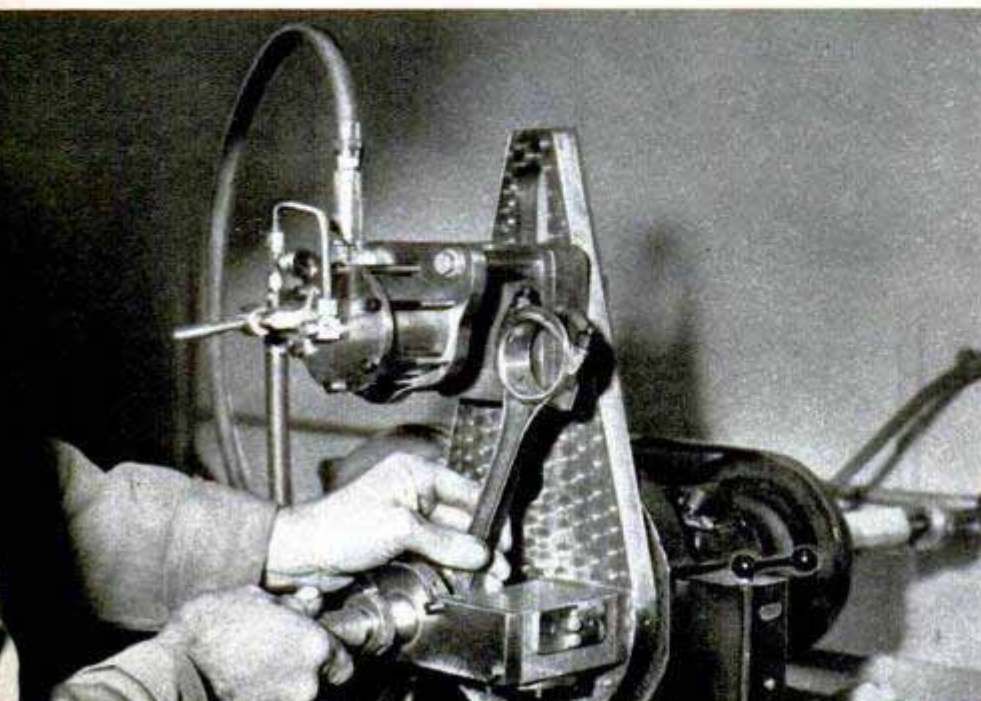

Executed in modern architecture, the Automotive Center covers an entire city block on U. S. Highway 99, one of the heaviest traffic arteries in the nation. It services not only passenger cars, but the biggest trucks on the Los Angeles-San Francisco run as well. Used cars are overhauled for a number of other California dealers because Snyder-Lynch can do the job cheaper than the dealers themselves.

Approximately 150 skilled mechanics (many of them veterans who worked on tanks, trucks, planes and ships during the war) are on the staff. "We train men in our own shops to be top-notch experts in one particular operation," Snyder said. "In a few weeks they become more proficient in their specialty than an all-around mechanic who has spent a whole lifetime learning a hundred repair operations."

Although Snyder is a Ford expert (he's had the Burbank dealership for nine years), the Automotive Center is designed to handle Chevrolets, Plymouths, Pontiacs, Dodges, Oldsmobiles, Buicks, DeSotos, Mercurys, Chryslers, Cadillacs and Lincolns as well as Fords. "That's about 90 percent of the cars on the road today," said Snyder.

The Burbank repair center is in operation 24 hours a day, 7 days a week. Theory behind this round-the-clock



It may be hard to believe, but this is the same car, before and after. Even the new-car smell has been added

schedule is that many persons would be severely handicapped if their transportation were tied up during working hours. Under the assembly-line system of making repairs, a motorist can turn his car over to the mechanics at 7 p.m. and take it away at 7 the next morning.

If it's a small repair job, he may wait in the comfortable, redwood-paneled lounge which offers radio, television, reading matter and a snack bar. Truck drivers may even take a shower while waiting for repairs or a grease job.

"During the war," Snyder explained, "we put on a night shift to accommodate workers of the Lockheed Aircraft plant who could not put their cars in a garage during the day. That gave us the idea that the general public would like overnight service.

"And you'd be surprised at the number of men who like to watch their cars being lubricated. They've put a lot of dough into their buggy and they want to see that it receives the best possible care. We're prepared to take care of these people at night or on Saturdays and Sundays."

To get an idea of how the new automobile hospital works, let's follow Bill Morgan through the Automotive Center and watch his 1936 Ford being reconditioned.

When Bill drove it into the huge establishment, one of the four service managers gave it a careful check-over. He was as thorough as a doctor diagnosing the aches and pains of a sick man. He didn't depend wholly upon his eyes and ears, but used many of the latest mechanical and electrical testing devices.

It was obvious, of course, that Bill's car

needed new tires, upholstery and a paint job. The motor had gone more than 100,000 miles so a rebuilt engine was recommended. The clutch, amazingly enough, was in pretty fair shape and might have lasted for another 15,000 miles. But since the car was in for an overhaul, Bill figured it would be cheaper to get a new clutch now than later.

One of the machines for diagnosing the troubles of a sick automobile is the Weaver

The mechanic is getting ready to straighten a bent axle. A special rack holds the car at working level

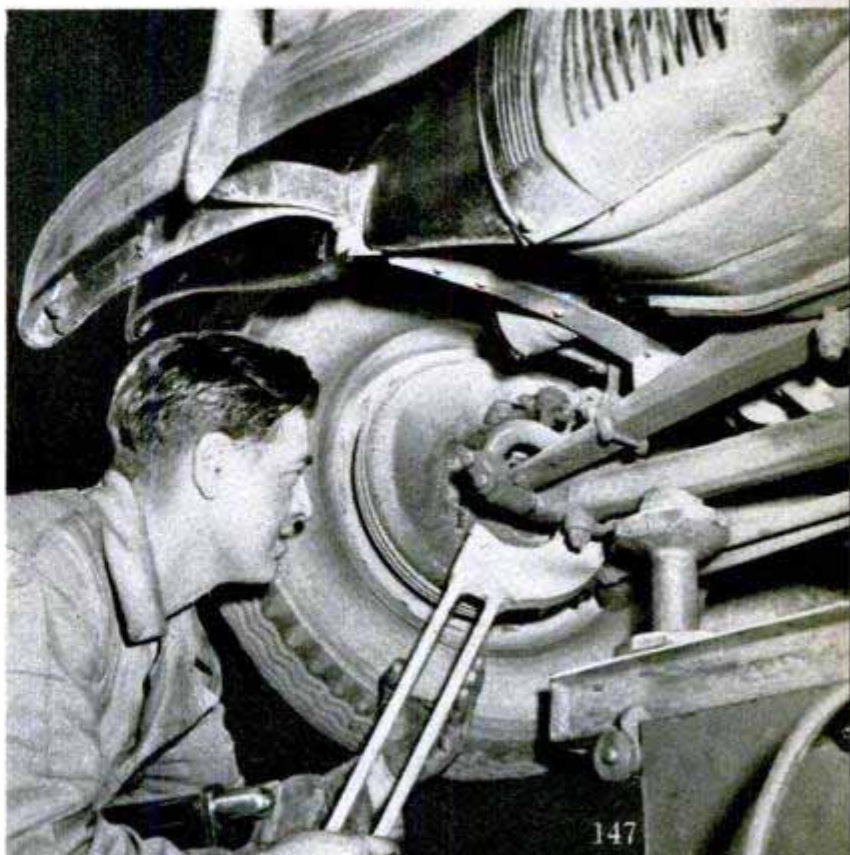

mains inside the water jacket. Once this is removed, the cause of the overheating is gone."

From the engine department, Bill's Ford went to the brake department where new, precision-lined shoes were installed and the brake drums ground smooth on a special lathe. Hand and foot brakes were adjusted. Wheel bearings were cleaned and packed.

Next was the tune-up department where skilled mechanics install new spark plugs and distributors, tighten battery connections, test coils and generators and install carburetors. But since Bill's car was getting a completely rebuilt motor—already tuned to new-car performance—his Ford skipped this stop.

The body shop and frame pit was next. Here a crooked frame and axle were straightened and dents taken out of the fenders. Skilled mechanics, working with the best tools, made the operation look as easy as rolling wrinkles out of a pie crust.

When it came to tires, seat covers and paint job, Bill had a wide choice. He could select what he wanted from among six makes of tires, a dozen kinds of seat covers and for the paint job he could choose from more colors than there are in a Hawaiian rainbow. He settled for a light gray that wouldn't show the dust. Expert painters gave it the same quality paint job it had when it rolled out of the factory.

When his car was ready to be greased, Bill followed it to the 60-foot lubrication pit—big enough to take three ordinary passenger cars or the biggest truck-and-trailer rig on the highway. This specially designed grease rack, in operation day and

Every operation requires its own special piece of equipment. This mechanic is testing wheel balance

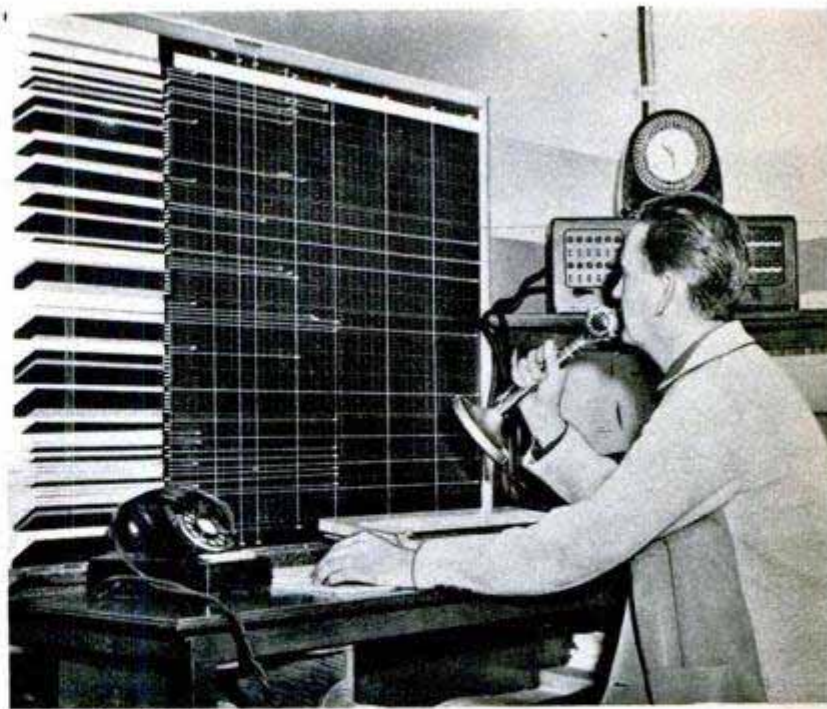
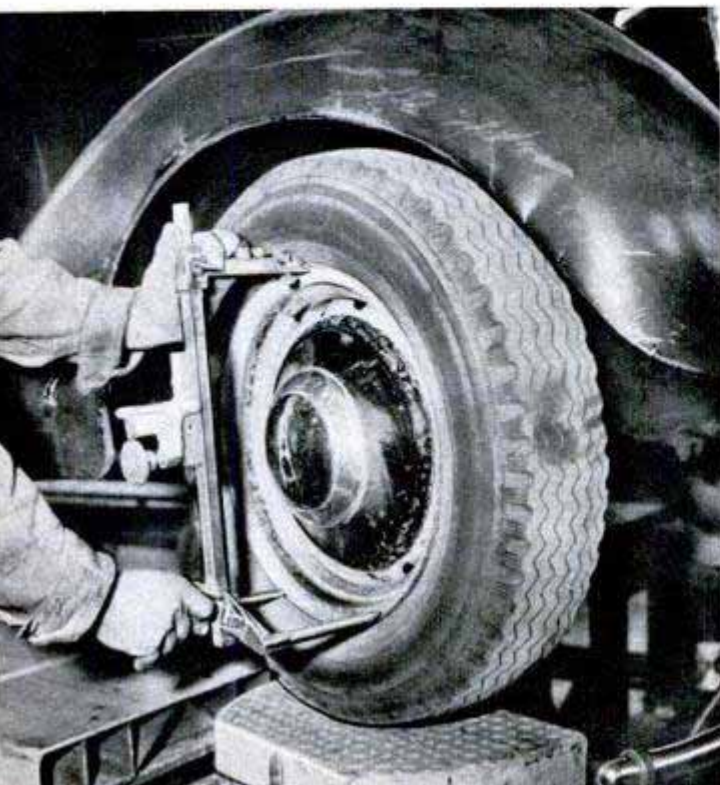

A progress chart is kept on each car. Two-way communications system throughout the shop saves time

night, is illuminated by fluorescent lights. Water, air, oil and grease outlets are wound around overhead reels—a pull-down type of installation that eliminates hoses, tanks and other obstructions on the floor.

Bill's car was ready for delivery. It gleamed with its new coat of paint. The carefully tuned motor purred smoothly and powerfully. The body had a solid feeling about it now that the squeaks and rattles were gone.

"Even has a new-car smell," he observed as he drove his new-old car down the highway to start its second 100,000 miles.

Sixty feet long, the grease pit will handle three cars at a time. Even huge trucks are serviced here

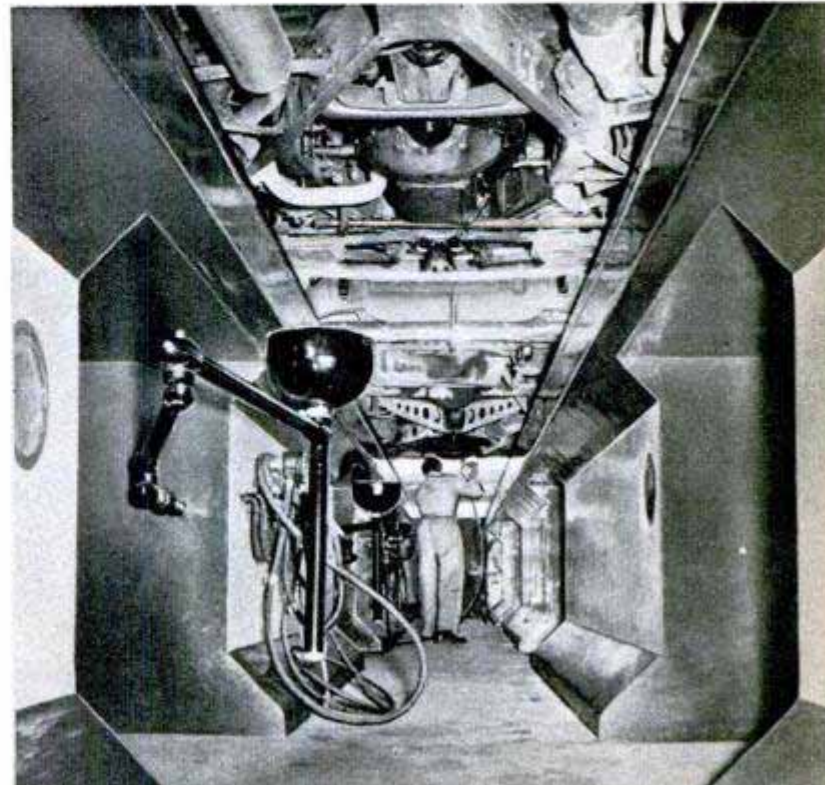

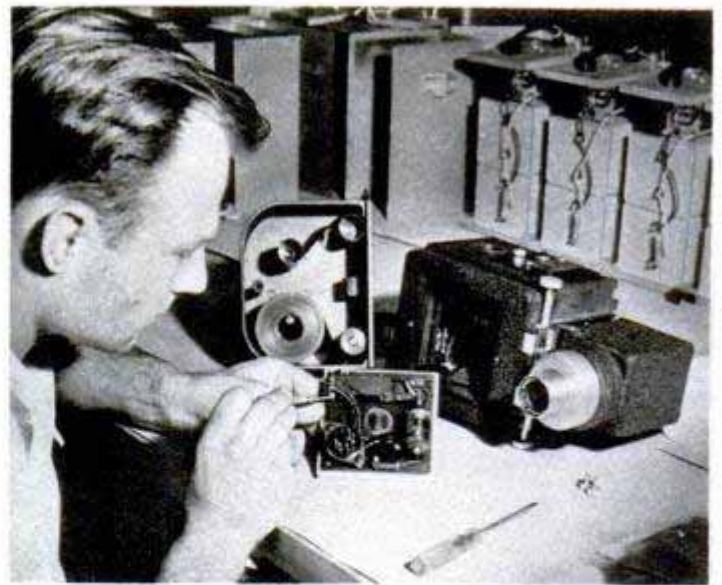

Push-Button Camera Takes Identification Photos

Picture-taking with an electric identification camera is foolproof—all you do is focus and press the trigger. Automatically, the shutter is tripped, flash lamps go off, identification markings are exposed on the negative and fresh film is advanced ready for the next exposure. Especially designed for taking identification photos of large

groups, the camera uses 110-volt current and has a large view finder that is corrected for parallax. In addition, the camera, which takes 70-mm. film in 100-foot rolls, will copy engineering drawings or blueprints up to 34 by 44 inches and will enlarge the negatives up to the original drawing size when used as a projector.

Tiny Electric Motor Makes Matchbox Look Huge

Weighing only .4 gram, a tiny electric motor is said to be the smallest ever built. The magnet of the motor is made of 180 coils of wire, and the entire power plant measures only slightly more than $\frac{1}{4}$ inch high. It makes about 8000 revolutions per minute on $\frac{1}{2}$ -volt, a.c. Johann Schoissengeier of Karlsruhe, Germany, built the motor and another slightly larger model which will operate on either a.c. or d.c. Schoissengeier is an artist who makes the tiny power plants as a hobby.

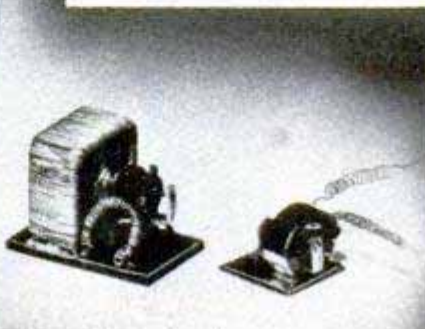
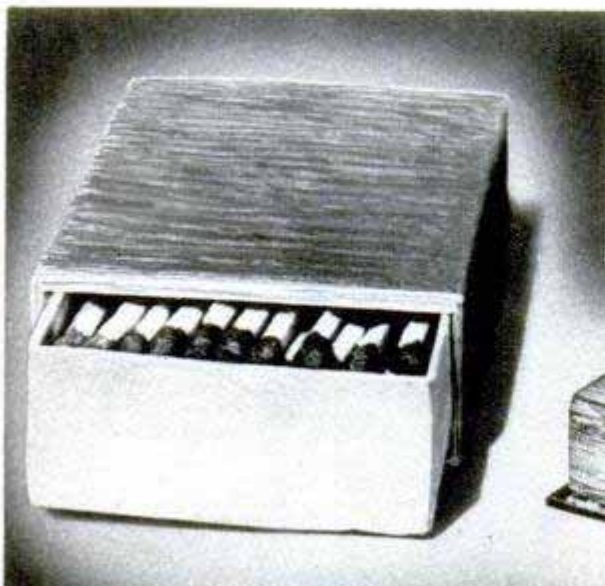

Made by a German artist, this midget electric motor was assembled under strong magnifying glass

Left, a comparison of a matchbox and motors. Three of the motors fit inside a hazelnut shell

Aircraft Turntable Checks Compasses

Aircraft compasses can be quickly checked for accuracy and any errors corrected with a compensator that is embedded in concrete at the airfield. The old method of compensating a compass was to maneuver the plane to definite headings on the ground which were determined by reference lines from a compass rose painted on the field. The new compensator is a bowl-shaped disk free to turn on a base plate which contains a compass rose dial. The aircraft is headed approximately north and one wheel rolled onto the turntable. The plane then is rotated until the heading is magnetic north. With a pointer set at zero, the directions are de-

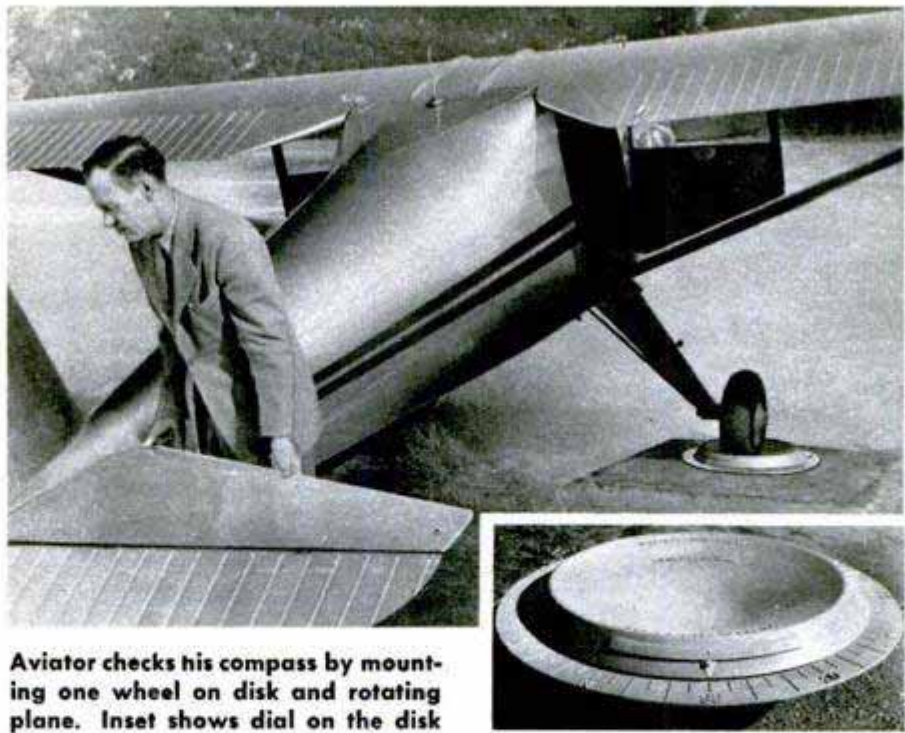

Aviator checks his compass by mounting one wheel on disk and rotating plane. Inset shows dial on the disk

termined by swinging the plane until the pointer indicates the desired reading. The compass is then compensated for error.



Truck's 12-Ton Load Carried in Sling

Hauling pipe sections that weigh 12 tons, a heavy-duty Hyster carries the pipe in a sling between its wheels at speeds up to 55 miles an hour. From a cab high above the load, the operator has an unobstructed view of both ends of the pipe. Part of a New Orleans water main, the pipe comes in sections 40 feet long.

Multi-Head Welder Makes Wire Mesh

Wire mesh is turned out quickly by a flexible machine that has 12 welding heads. Longitudinal wires are guided through the machine while the transverse wires drop into place and are welded at any desired point. Normally, all the welding heads operate simultaneously, but any combination of heads can be made non-operative to vary the pattern of the mat.

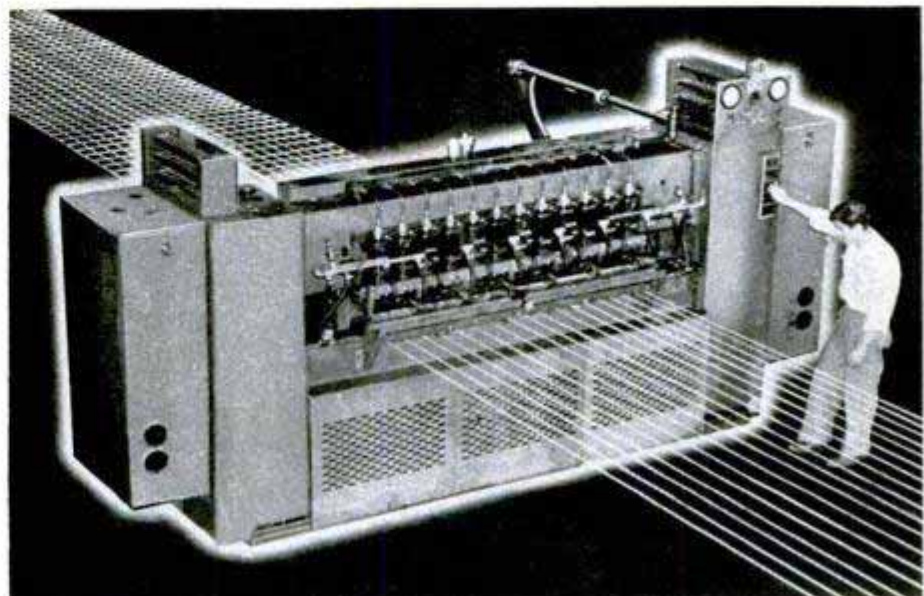

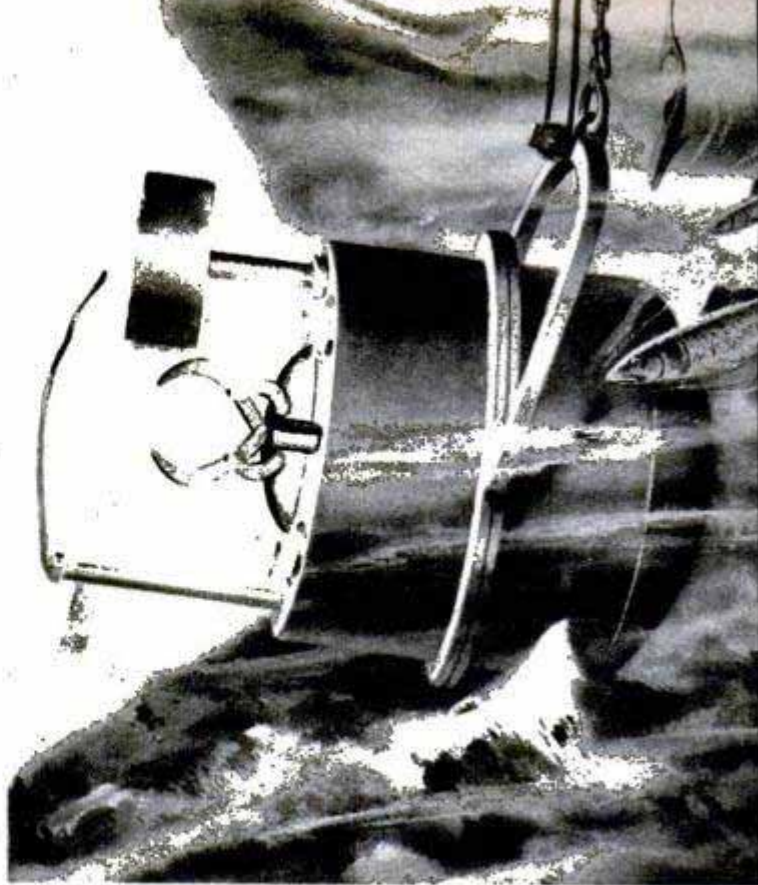
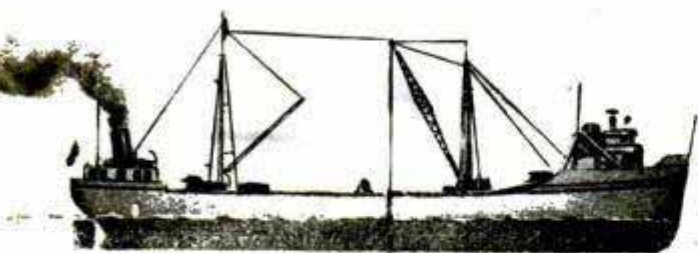

Television in a Diving Suit

Television may soon be going to work dressed in a diving suit, if plans of a German engineer work out. He designed and built a diving bell that can locate and repair ships at depths far below those safe for human divers. A television camera in the bell sends pictures back to the base ship. Four headlights illuminate the work area. A big magnet holds the bell against the sunken ship, above, as the hull is cut open by an electric dissector. All parts of the bell, including the claw, are operated from the base ship. Below, inventor Hans Udo von Schultz poses in front of the bell. The TV "eye" can be seen in the center

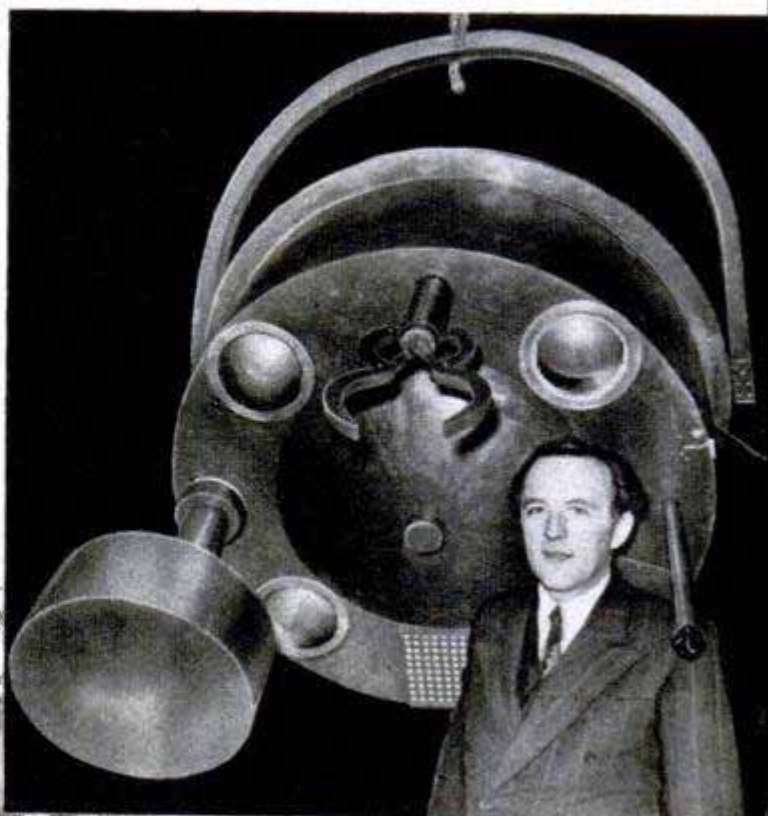
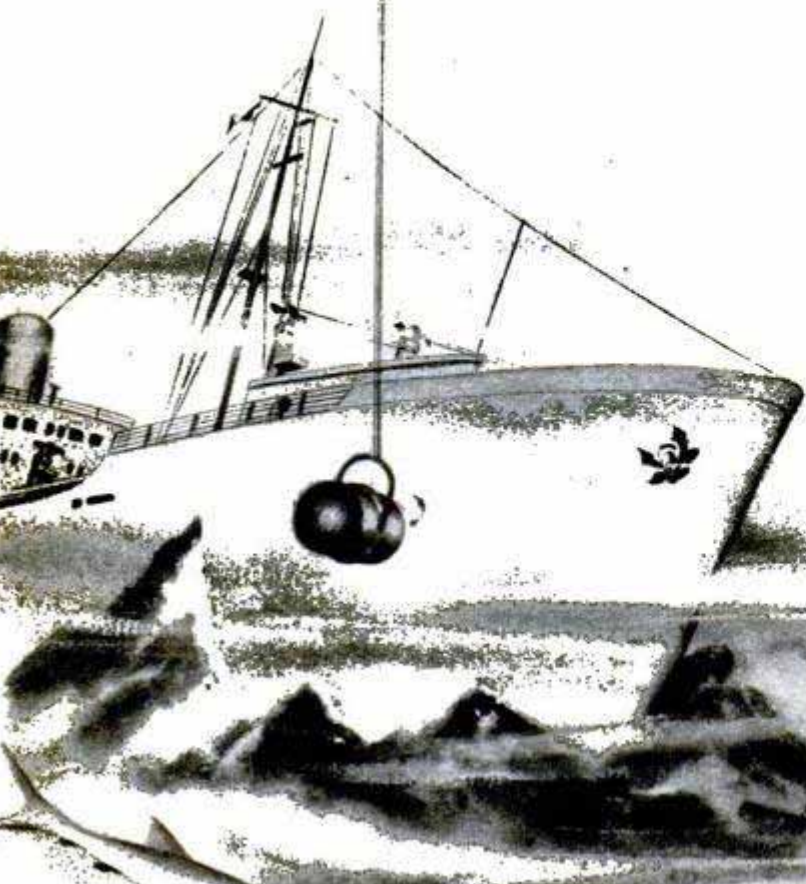

Two-Engine Tractor

Even though it has no steering wheel, a two-engine tractor can turn around in a circle no greater than its width. The tractor, assembled by a New Mexico farmer, consists of two 20-year-old machines coupled at the rear axle. Synchronized by coupled variable-speed regulators, the motors power one rear wheel each and steering is accomplished by changing the speed of the wheels, thus eliminating the need for a steering wheel. Because the operator sits between the two engines, he has much better visibility than on a conventional tractor. Five plow blades are mounted on the single tool bar, enabling the tractor to plow eight acres an hour.

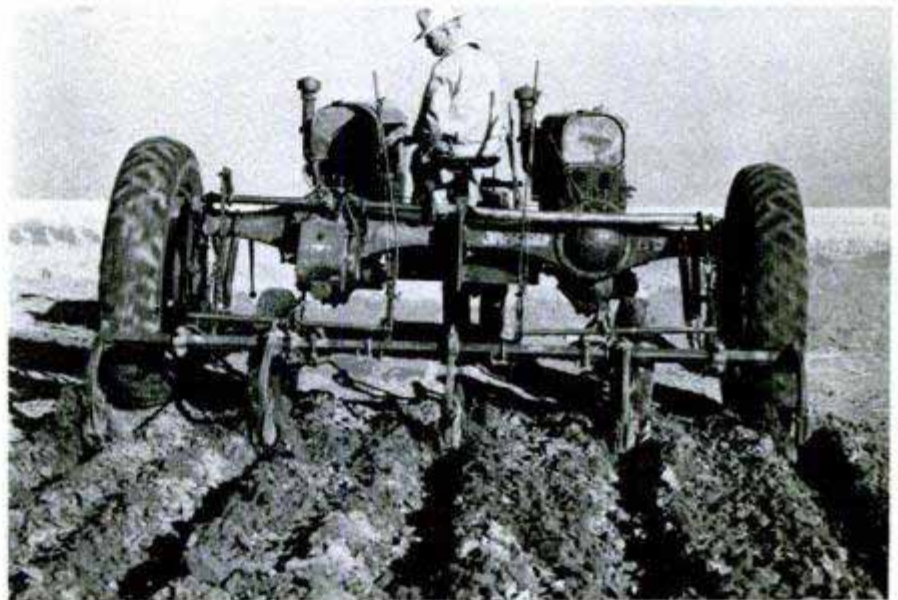

Underground Steam May Drive Turbines

Italian engineers hope to circumvent that nation's coal shortage by tapping underground hot-water reservoirs that will produce high-pressure steam for turning turbine generators. Drill rigs have been ordered from Westinghouse. The engineers calculate that red-hot lava beds near Milan produce hot water under enough pressure to support a one-inch column a mile high.

At the surface, owing to the reduction in pressure, this water will turn to steam which will be piped into turbines.

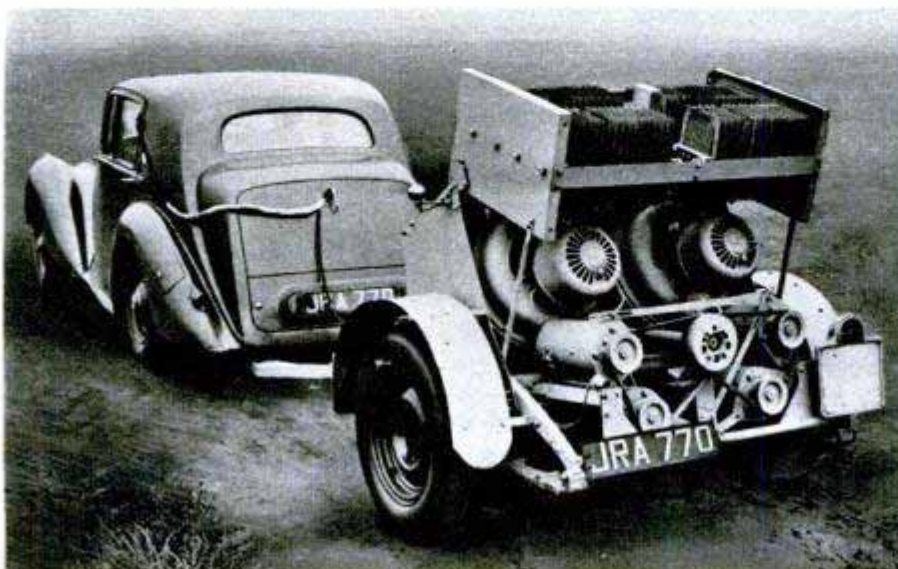

Hill-Test Trailer For Level Ground

Cars are hill-tested on level ground at a British automobile proving ground in Warwickshire, England. To achieve the trick, the car manufacturers devised a power-absorbing trailer which is attached to the auto being tested. Drag produced by the power-sapping machinery makes it possible to determine hill-climbing performance.

The rails will click no more

in the Cascade Tunnel

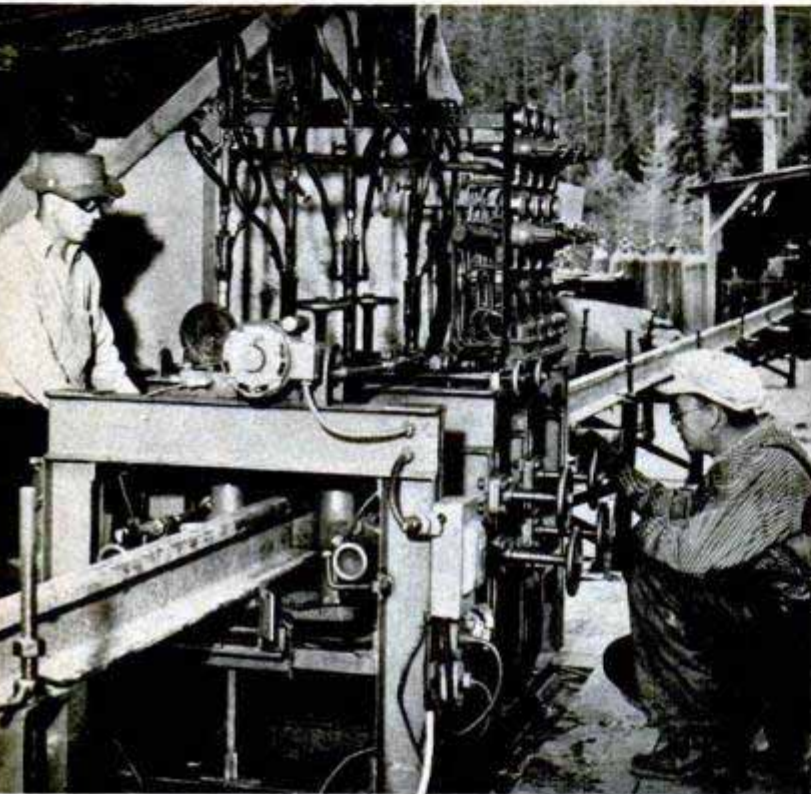

Above, carefully squared, the rail ends are lined up in this pressure-welding machine. Forced together by great pressure, the ends are heated to 2300 degrees with 125 welding tips, a few of which can be seen in photo below

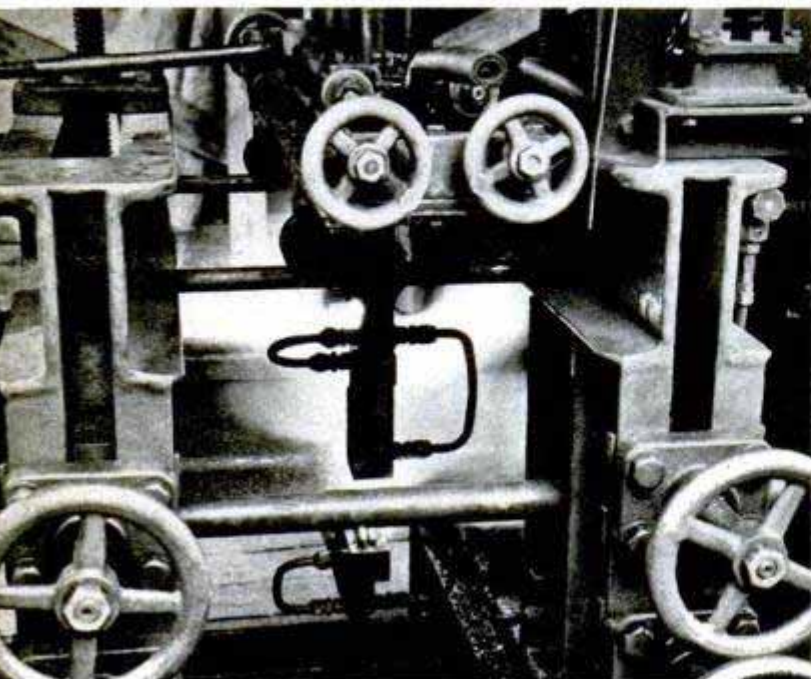

In five minutes, the pressure weld is completed. A hand torch, above, trims excess metal from the weld

SENTIMENTAL rail fans who ride Great Northern trains over the Cascade Mountains of Washington will be nostalgic for an old friend and travel companion — the rhythmic click-click of the rails. The railroad is replacing the track in the eight-mile Cascade Tunnel, the nation's longest railroad bore, with continuous welded track. Open joints between track sections are eliminated and with them has gone the familiar lullaby of the rails, a sound that is music to seasoned travelers.

By using an "assembly line" process of pressure-welding and track-laying, railroad workers are making the change without interrupting regular schedules. The new and heavier rail is welded into 1326-foot lengths on a pressure-welding machine before being hauled into the tunnel on flatcars. When the new rail has been spiked down, the joints between the 1326-foot sections are hand-welded. To the railroad, the new track will mean longer service with less maintenance. For passengers, it means a smoother, quieter ride.



Completed welds are checked by magnetism. Pattern of iron filings on weld under electromagnet reveals any invisible flaws in joint

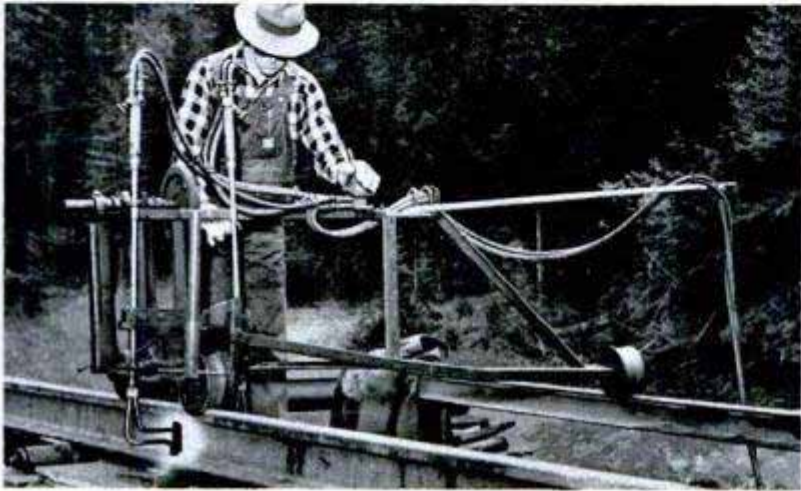

Mill scale is removed from the rail by oxyacetylene flame cleaner. When the rail is spiked down, it is coated with a preservative

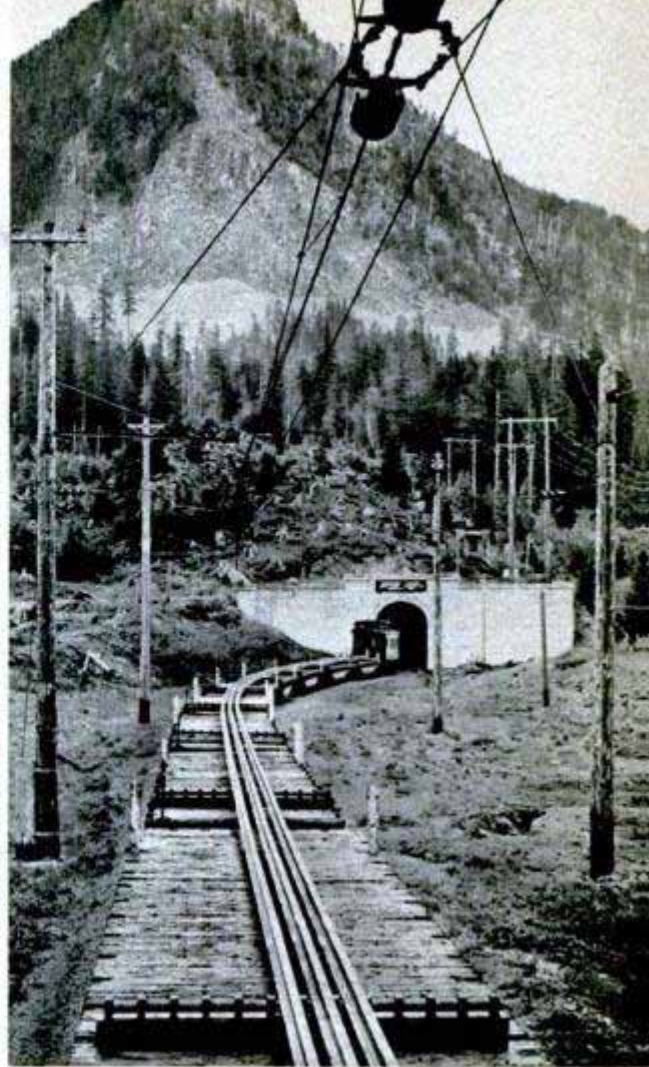

On flatcars, the rails flex easily as they're hauled around curve to tunnel

Welded rail is unloaded by anchoring one end with cable. Flatcars are then pulled out from under the rails





Desk-Pad Intercom

"Talking through your desk pad" is possible with an office intercommunication unit that is housed in a pad only $\frac{3}{4}$ inch thick. Up to five units—each a master station—can be quickly attached by plugging in an extension cable. Each unit can be used to receive or send messages. The conversation is private because communication can be established between any two stations without the others listening in. The desk pad measures 19 by 30 inches.

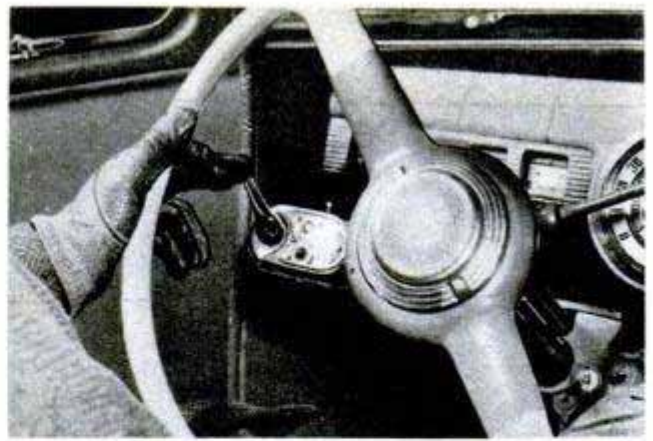

Entire Car Lighting System Serves As Turn Indicator

Headlights, stop and warning lights on any kind of car or truck are synchronized to blink at 70 to 80 flashes per minute by a control operated from a steering-column switch. Existing lights merely are wired through the control. When the driver wishes to turn, he flips the switch, which blinks the proper lights to indicate the direction of turn. Another position of the switch operates the proper lights to warn traffic that the driver intends to back up or stop. A third position blinks every light on the vehicle to warn motorists in all directions. The control is designed for school buses, ambulances, police cars and other vehicles requiring positive visual warnings.

Diesel-Powered Car Goes 40 Miles on Gallon of Oil

Powered by a 38-horsepower diesel engine, a Mercedes-Benz automobile, produced in Germany, promises relief for European motorists who do little joy riding in these days of dollar-a-gallon gasoline. The diesel will do 40 miles on a gallon of diesel oil, which costs much less than gaso-

line. The company says it has eliminated the heavy throb, a characteristic of the truck diesel that has plagued automobile designers for many years. Speeds of 60 miles an hour are possible with the diesel-powered automobile, according to the manufacturer.

Left, an under-the-hood view of the diesel engine that drives the German automobile pictured at the right

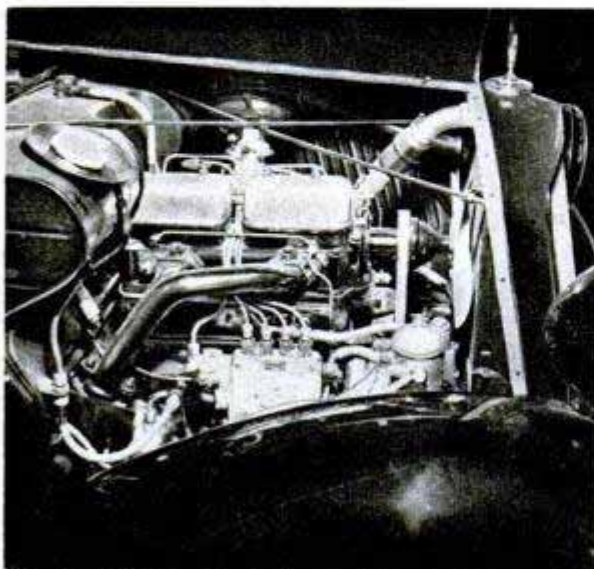

Steel Cabinet Fronts

Home handy men now can build their own kitchen cabinets by using a new line of steel frames and doors. The metal fronts for cabinets are available in a large selection of sizes. The frames are provided with doors or drawers, depending upon whether they are to fit wall or base cabinets. The drawers are suspended on ball bearings and their tracks can be cut with a hacksaw to fit cabinets of any depth. Frames for the doors and drawers are screwed into place. The fronts are available in a white baked-enamel finish or painted with a prime coat.

Dry-Ice Box in Rail Diner

Dry-Ice refrigeration appears on rails for the first time in 17 new dining cars being delivered to the Union Pacific Railroad. The ice compartment holds 100 pounds of Dry Ice. Below the ice are coils which contain $3\frac{1}{2}$ pounds of refrigerant. The Dry Ice chills this liquid, which then passes through a valve. The heat from the food compartment changes the refrigerant into a cold gas which rises upward through pipes, chilling the refrigerator. Having

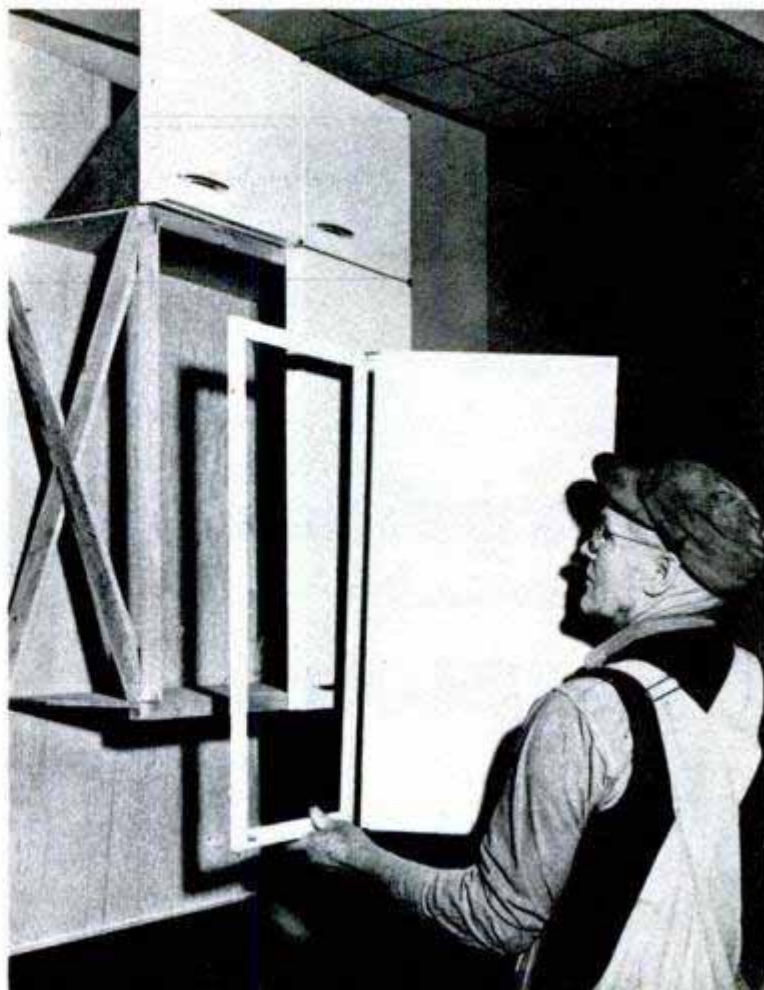

completed its mission, the gas goes into a condenser and is returned to the coils for another trip.



Computer Cuts Farm Figuring

Farmers who dislike paper work now can solve many types of mathematical farm problems with a computer that shows the desired information at a glance. The computer consists of four metal disks containing arrows, figures and windows. By setting up known information on the disks, the farmer can quickly determine the desired figure. For example, the computer will calculate the price of a given weight of any kind of grain, the value of land and livestock, the number of gallons of milk in a given number of pounds and the value of several cases of eggs when the price per dozen is known.

Information not listed on articles in the index, starting on page 10, frequently is listed in the WHERE-TO-FIND-IT INDEX which is available without charge from Bureau of Information, 200 E. Ontario St., Chicago

The Tool That Surprised Its Makers

By Alexander Maxwell

Here's a machine that will slice bolts of cloth or blocks of granite, armor plate or fresh bread. It's the contour saw — three-mile-a-minute cousin of the bandsaw

THE YOUNG SALESMAN was highly enthusiastic.

"This file," he said, "is so hard nothing can touch it. It will shave tool steel like a plane cuts wood."

The shop superintendent listened patiently, then without a word stepped over to the contour machine. The file was pushed against the moving blade, a shower of melted metal cascaded over the table and he returned with the file neatly ripped lengthwise.

"That file," he announced, "was split lengthwise with a saw blade so soft you could tie it into a bow knot."

For many years machinists have dreamed of a device which would perform any cutting operation. There are today but few materials which cannot be cut on a production basis, but until recently most of the cutting had to be done on specialized, one-purpose machines. This meant that a shop working 10 materials needed at least 6 and possibly a full 10 machines. Now the contour machine has come along to cut steel, bread, rubber, cloth and granite in quick succession. All the operator has to do is

This is no sheet of plywood. It's a slab of boiler plate being cut down to shape by a contour cutter

Photos from the DoAll Co.

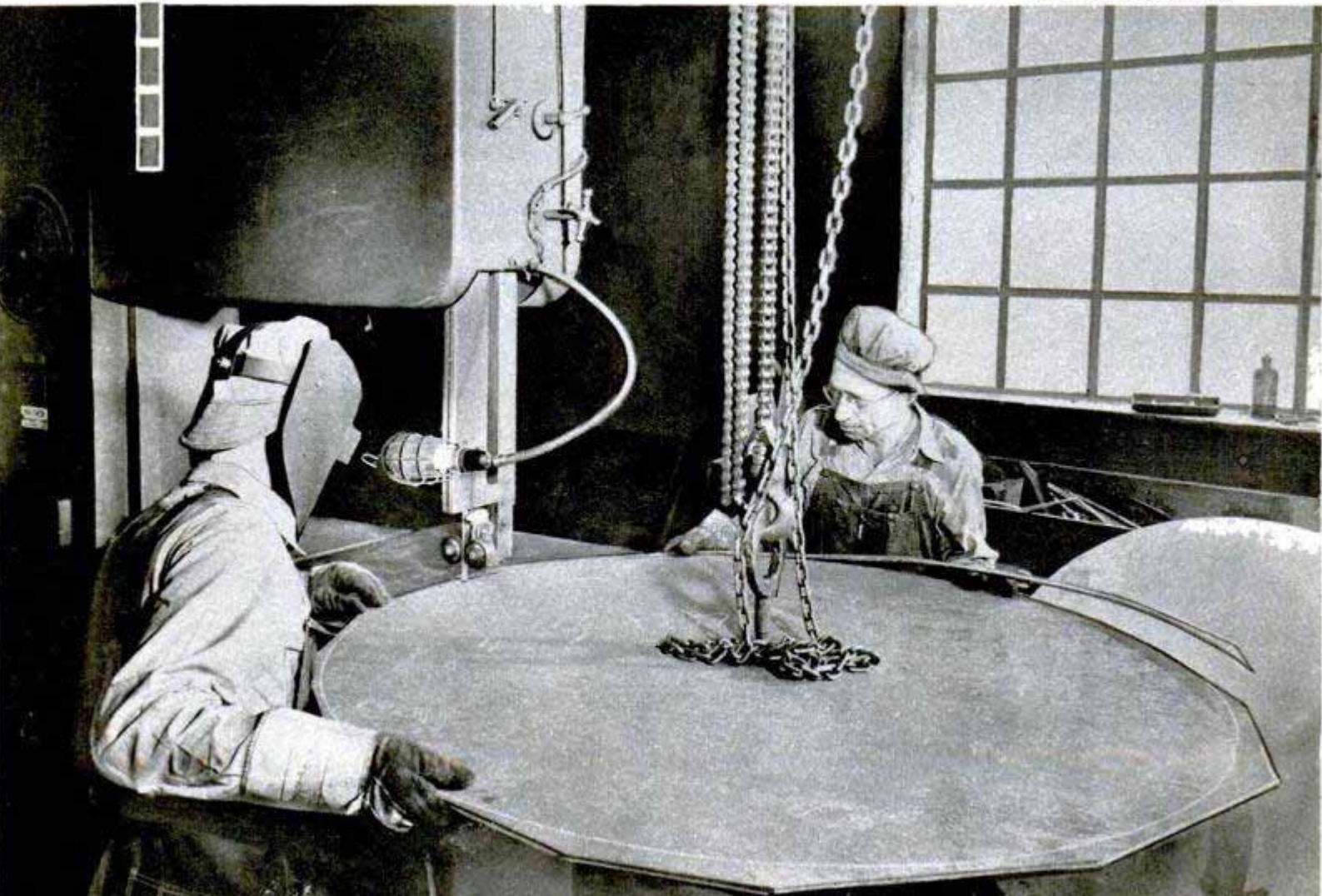

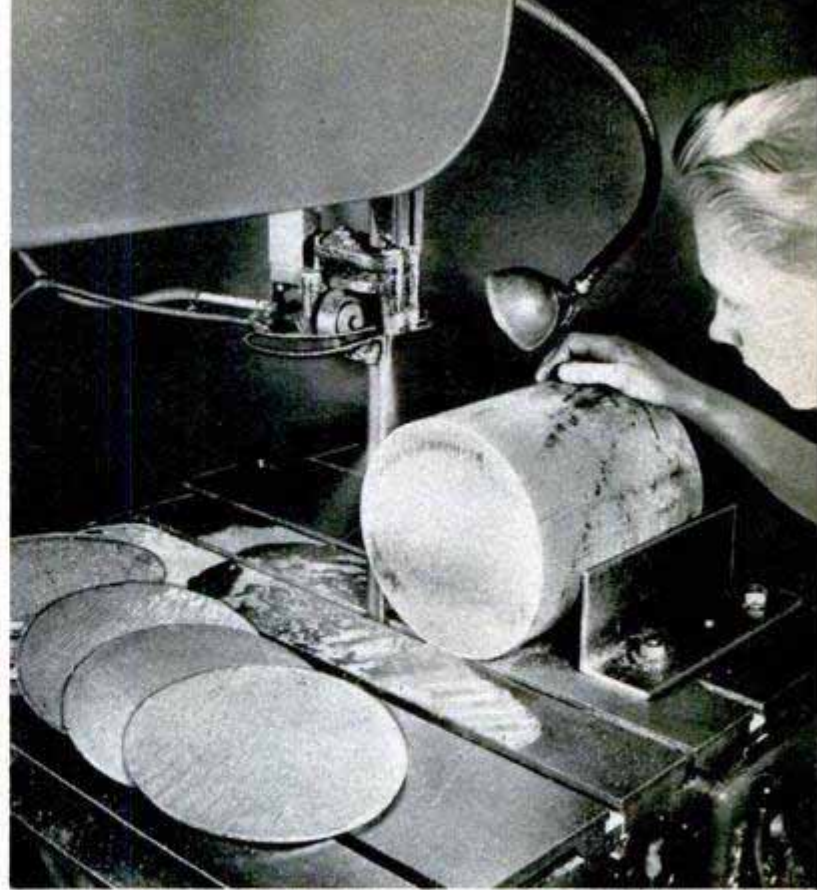
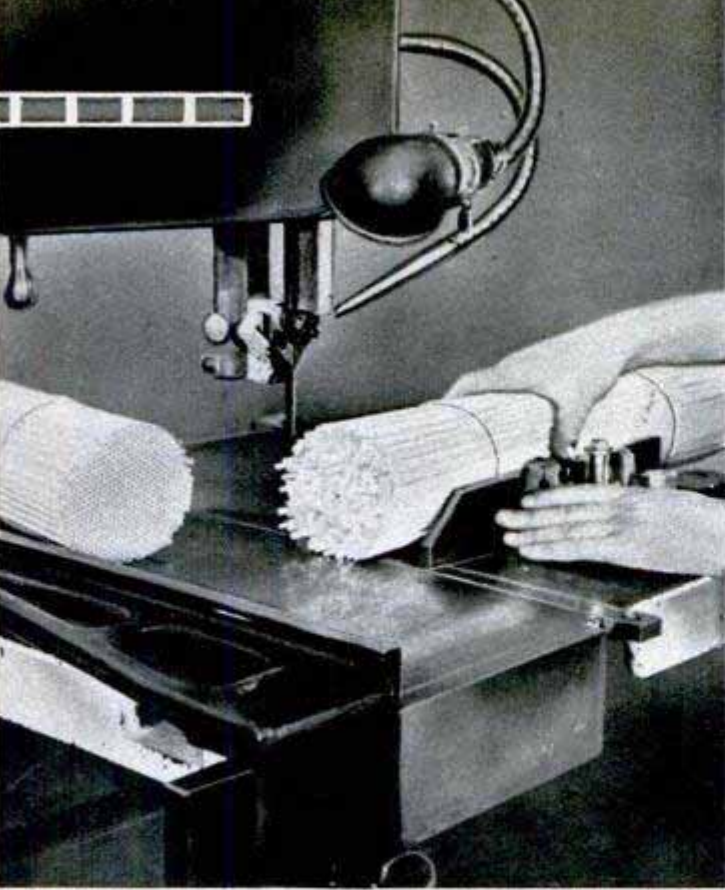

Left, soda straws are trimmed smoothly and, right, aluminum billets sliced like bologna by the amazing saw

install the proper blade and set the drive mechanism at the correct speed—an operation that requires five minutes or less.

The contour machine is one of those strange paradoxes which surprised everyone, including the designers. Shortly before the war, the government was desperately seeking a device which could fabricate armor plate quickly, accurately and economically. Metal tough enough to stop bullets also resists ordinary machining methods. For a while it looked like the old Civil War hot-punch-and-chisel method was still the most practical. Then it was suggested that the metal be sawed while red hot. Results were promising but not practical. The next step was a radical one. It was observed that when turning hard steel, both the bit and shaving were often at red heat. Why not run a bandsaw so fast it would heat the steel by friction, then cut it while in the semifluid stage? There was great speculation as to what would happen to both saw and blade, but the experiment was made. It worked. At a speed of three miles a minute, a precision wood-working blade plowed through ½-inch armor plate faster than tool steel could be cut by ordinary methods. Strangest of all, the blunter the teeth be-

came, the better the band seemed to cut.

Here was the answer. Now to design a machine and a blade for production purposes. The bandsaw has been in common use for almost 70 years, but at best it was a light, rather delicate machine. Even the massive heading saws in the lumber camps, with their foot-wide blades, were on the "gentle" side when it came to plowing into the work.

With the objective already specified, engineers developed a husky, new bandsaw. It had the strength and rigidity of a locomotive. In order to identify the new machine properly, the engineers called it the "Contour" saw. That was originally a trade name like Frigidaire, but it was not long

In Mexico, the saw cut a connecting rod from a billet for ship repairs

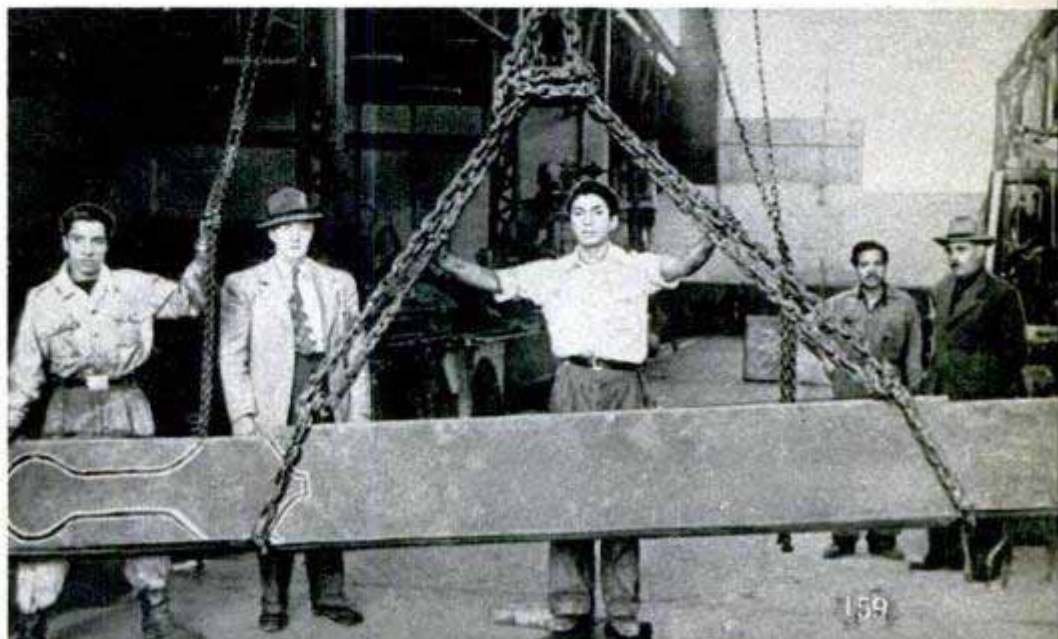

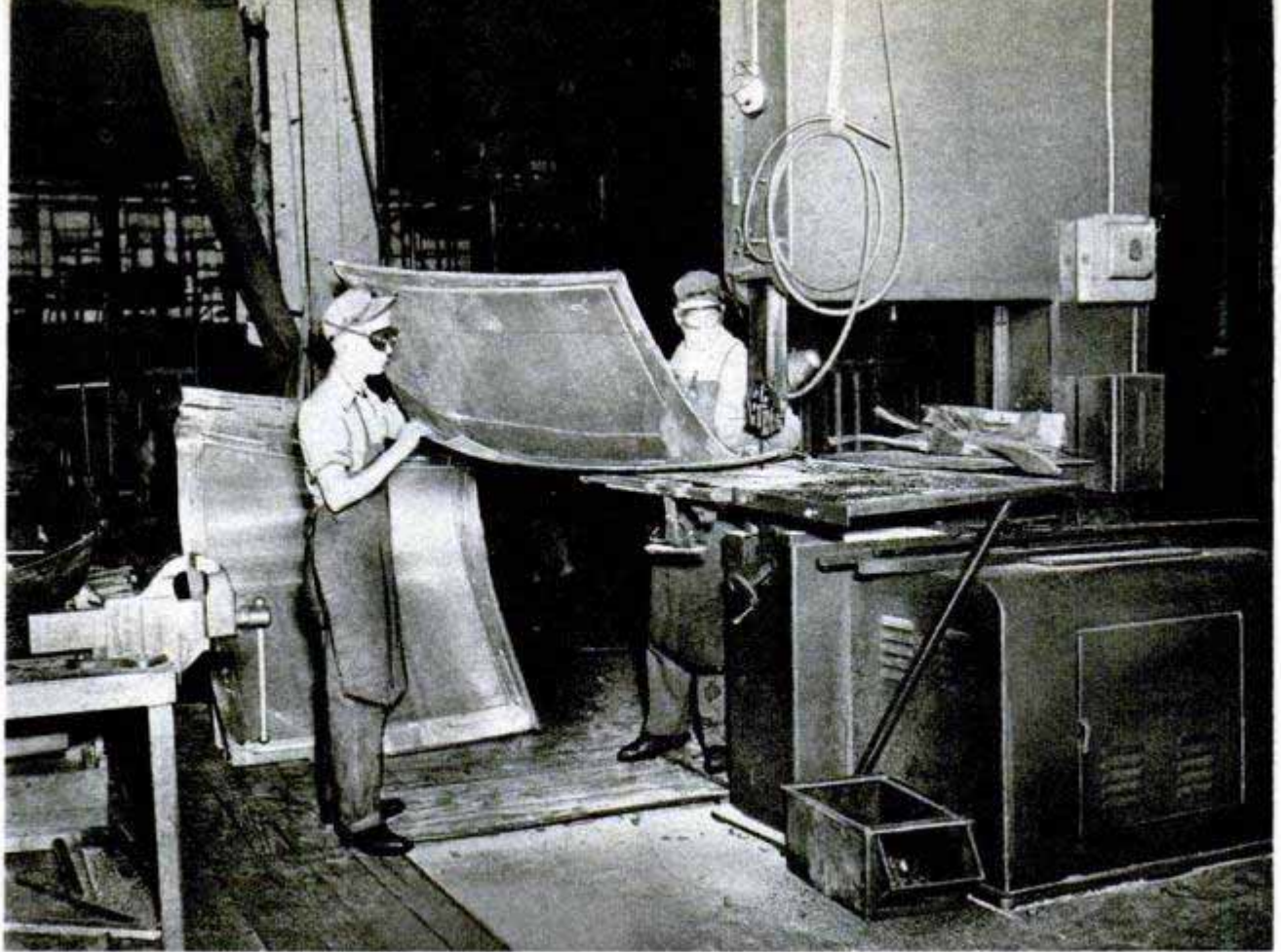

Stainless-steel panels are first pressed to shape and then the hard metal is trimmed on a contour cutter

until it passed into public domain and today a contour machine means a rugged, compact, heavy-duty device which does its cutting with an endless blade.

Various blades were tried and discarded because it was discovered that any hard-tooth, soft-back blade would work for friction-sawing if the speed and feed pressure were sufficient. There is still some question as to exactly what happens when the high-velocity blade cuts the steel plate. Some say the blade never touches the melted metal and cutting is done by a cone of highly compressed air built up ahead of the teeth, others say that the heat softens the plate and then each tooth scoops out globules of white-hot metal. Whichever happens, the cut is clean, well defined, narrow and much faster than either forge or torch cutting. The fact that the blade shows no undue heating or ill effects only makes the cutting mystery the deeper.

Uses of friction-sawing represent almost a cross section of American industry. A maker of transcontinental motor coaches cuts out both frame members and steel skin units on a bank of contour machines. The harder the metal, the easier it cuts, so making springs, valve stems, crankshafts and tempered machine parts is a natural for the saw. While this sawing calls for a machine capable of airplane speed, the same machine operating at a lower velocity will perform many operations long considered the exclusive field of a machine total-

ly different in appearance and operation.

The strength and rigidity needed for high speed also provided the push and stability for the extra-low velocity required in die-making and billet cutting. Formerly, a billet was heated and pounded into shape under a drop hammer. Now it can be sawed cold out of solid steel much like a child's block puzzle. One shipyard in Mexico makes a practice of cold-sawing the complex shapes of gigantic crank arms and connecting rods required in the repair of both steam and diesel marine engines. One rod may weigh two tons, yet it is cut with a blade only $\frac{1}{2}$ inch wide out of a forged billet 12 inches square and 10 feet long. Where tie-up time is of vital importance, the contour machine has cut out-of-service

Crystals for radio use are blanked out on this saw

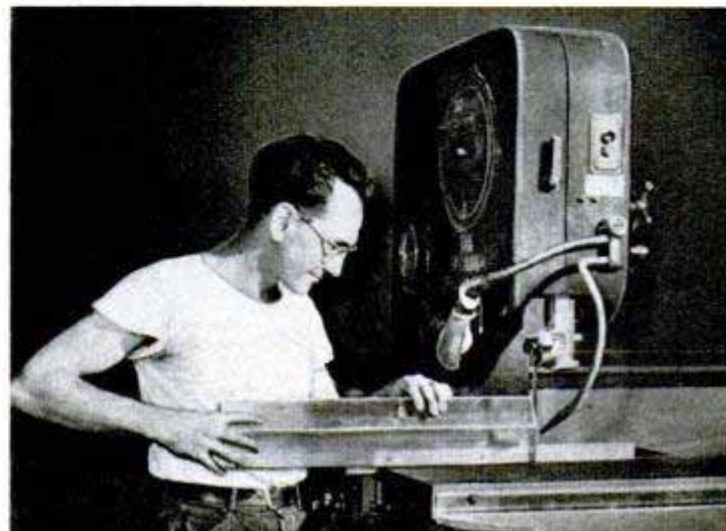

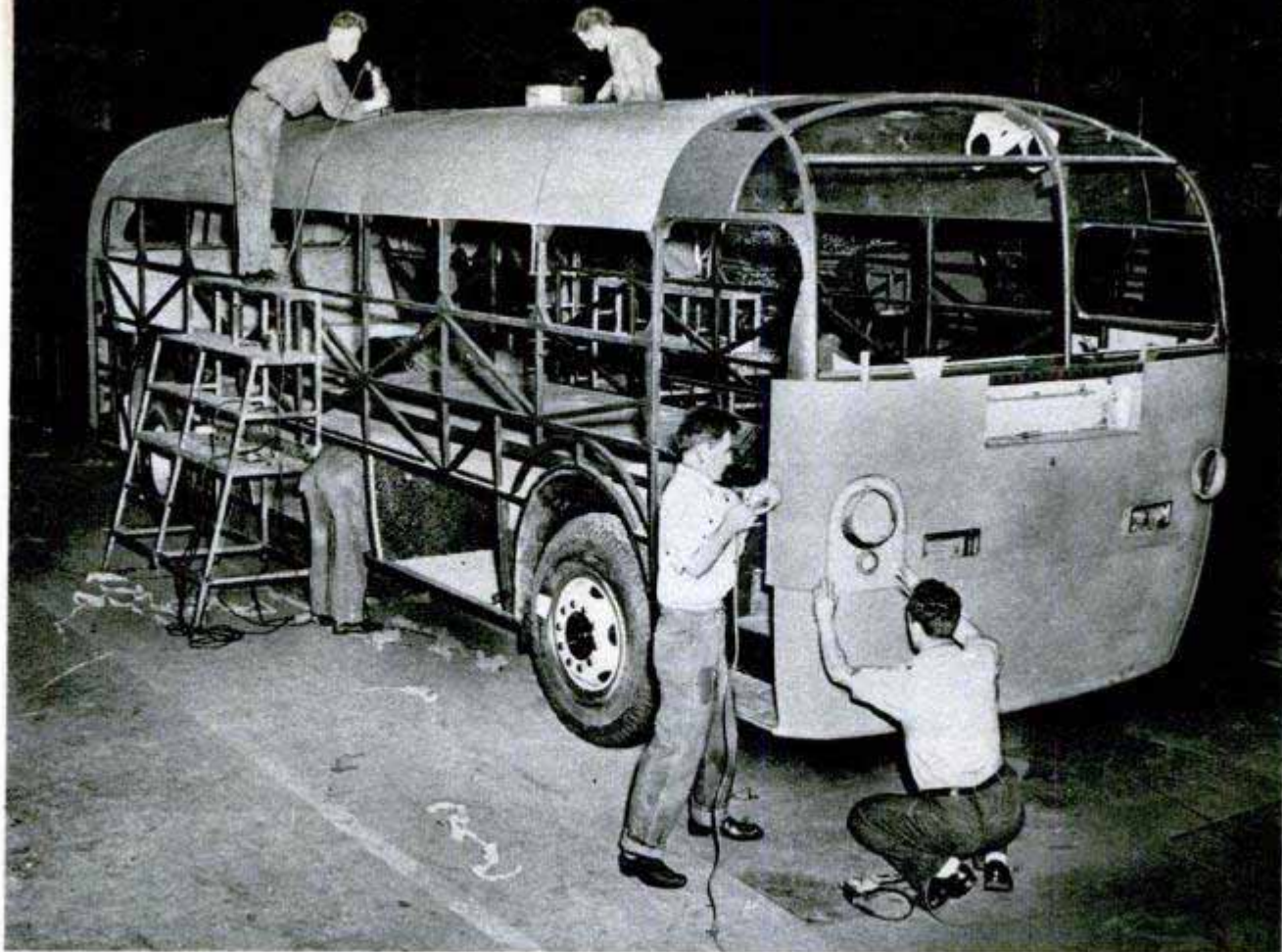

All parts of this bus body were cut to size on contour machines, the versatile tool that surprised its makers

periods from months to hours. Many a ship went back to sea during the war with sawed plates welded over shell holes. There was no tie-up time at all. The plates were cut and welded while the ship was being loaded for the return trip.

A diemaker frequently spent three days drilling and chiseling the slug out of a blank, then filing it to shape. With a contour saw he can cut the same shape, to exact size and angle, in about three hours. Only an hour or two are needed to band file the most complex blanking die. The slug is often used as the punch, saving still more time and material.

Heavy industry is not the only field that profits by using a bandsaw blade in place of a torch, lathe, miller, shaper, grinder or

drop hammer. The identical machine used to form a die or crankshaft can also do a first-rate job of cutting men's shorts a hundred at a time or splitting elusive and hard-to-handle upholstery fringe.

The garment industry has been using bandsaws for 30 years. This statement will come as a surprise to most people, including many in the clothing business. One firm in Brooklyn has done very well buying up obsolete woodworking bandsaws and completely rebuilding them to meet requirements. A Wisconsin manufacturer of wash dresses urgently needed additional equipment. Finding any type of saw or knife hard to obtain, he settled for a contour machine and to his amazement obtained cleaner and faster cuts in deeper lays of material

Left, diamond chips in the blade cut a pitcher in half for inspection. Right, the saw even cuts meat well

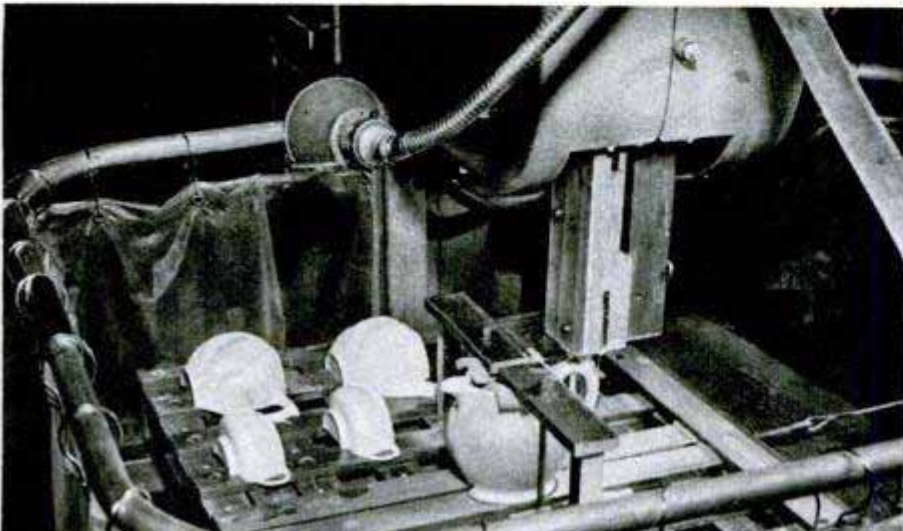

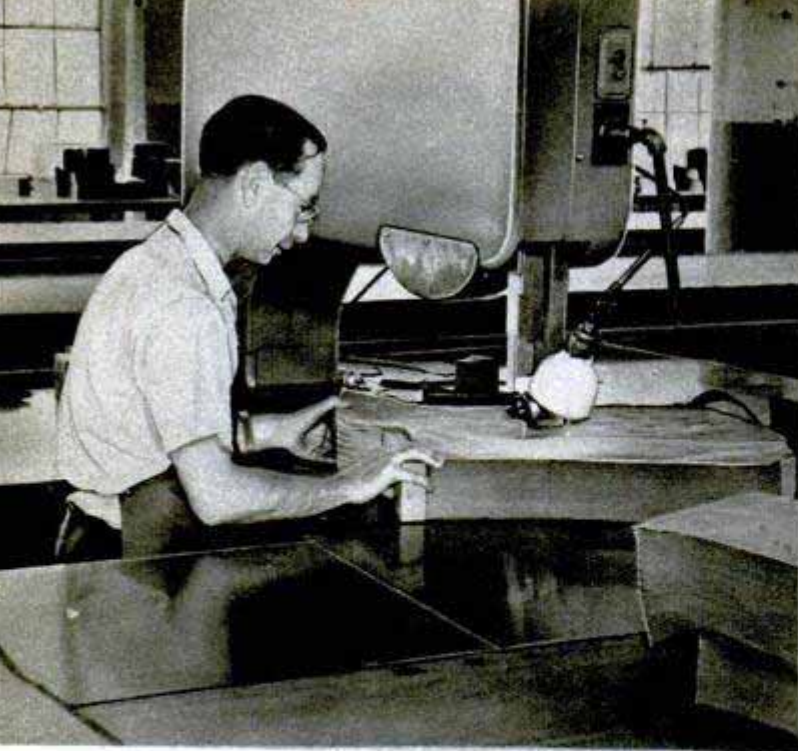

Mounted on a track beside the cutting table, this saw is as necessary as a sewing machine in a clothing factory. It cuts 100 layers of cloth at a time

than ever before. The manufacturers of the contour machine were surprised and after inspecting the installation made the only modification required, an extra large worktable so the cutter could handle 30 by 30-inch cloth blocks, 8 inches deep.

When cutting by hand, the operator had to climb all over the table and his lays of cloth were relatively shallow because of the difficulty of getting a vertical cut when rounding curves. With the contour machine, the only limitation is the ability of the individual material to "stack." In a field where price competition is keen, the more work an operator can do in a single operation, the less the consumer must pay per garment. Output per cutter has been boosted tremendously. A cloth-cutting blade has no teeth. It is either razor-edged or scalloped. The blade is sharpened as it cuts so the edge is always keen.

The same razor-edge blade has eliminated a score of other bottlenecks including the cutting of soda straws without ragging them, the trimming of paper insulation on transformer coils, slicing crude rubber and cutting upholstery fringe. Here we find the mechanical counterpart of the trick Saladin performed during the Crusades, slicing a silk scarf in half with a scimitar as the scarf floated through the air. The secret is to draw the razor-sharp blade rapidly across the nonresisting fabric.

For a machine which will cut anything one would naturally expect to find as many types of blades as a fisherman has lures. There are half a dozen general types of blades and perhaps a dozen sizes of each of the principal metal and woodworking types. There are other less common types

such as a meat cutter, a razor edge, a spiral wire or a diamond saw. Sizes are mainly to provide the proper turning radius. For straight cuts, a ½-inch or one-inch blade is used. All told, anyone who has one each of the principal types can cut any material known to man and do a satisfactory job of it.

There is no great difference between wood and metal saws. Steel can be cut with a razor-sharp claw tooth and wood with a zero-rake buttress. The secret is in the way the blades are made. The teeth are almost as hard as diamonds while the backing is soft as strap iron. This results in a saw capable of flexing repeatedly, absorbing shocks which snap an ordinary type and presenting an unbroken line of teeth harder than any material they are likely to encounter. When cutting wood, striking a nail is no problem at all—the saw cuts off the nail and goes right on. Because different materials do not react alike to impact, speed is much more important than blade type. Some materials cut fastest when the blade is barely moving, others at a medium velocity and still others will take the highest speed possible. In general, the ability to change speeds is more important than having a variety of blades.

Most of the "workable" materials can be cut with an ordinary blade, but then there are the "unworkables," such as glass, pottery, stone, abrasives, petrified wood, meteorites and precious stone. Here a diamond saw band is used. As a diamond is the hardest substance known, and a moving diamond will cut a stationary diamond, this completes the list. Manufacture of a practical diamond-tooth bandsaw blade presented almost unsurmountable obstacles. Ten years were spent in development. The result was a saw completely

(Continued to page 246)

Die cutting is a slow process, but the contour saw saves time here also. One die that took 30 hours to cut is now sawed to exact outline in only 1½ hours





Orchard Crews Work on Hydraulic "Ladders"

Orchard workers prune trees and pick fruit faster from the safety of crow's nests attached to the end of twin hydraulic booms. A four-wheel trailer carries the booms and power plant, an air-cooled gasoline engine. Push buttons on a control panel at the cage enable the workers to di-

rect the booms to any position from 3 feet to 21 feet off the ground. The cages remain level in all positions. During harvesting, special racks attached to the cages hold empty fruit boxes. When a box is full, the picker swings down to ground level, removes the box and picks up an empty.

Steel Skid Behind Garden Tractor Hauls Heavy Loads



Owners of small garden tractors can use them for hauling heavy loads with a new steel skid. The attachment carries loads of 250 to 500 pounds with $1\frac{1}{2}$ to 3-horsepower tractors. It attaches to the tractor hitch by chain. Heavy objects need not be lifted but may be rolled or eased onto the skid, making the tractor useful for moving rubbish, cement bags, rock or dirt, feed bags, firewood, hay bales, garbage cans and bushel-basket loads.

Industrial Accidents Decrease

Industrial accidents decreased 13 percent last year, according to the National Safety Council, with communications the safest of all categories. Lumbering was the highest in frequency; coal mining was next to the highest and had the highest severity rate, with accidents causing 7.61 days lost per 1000 man-hours. The over-all severity rate for industry dropped nine percent.

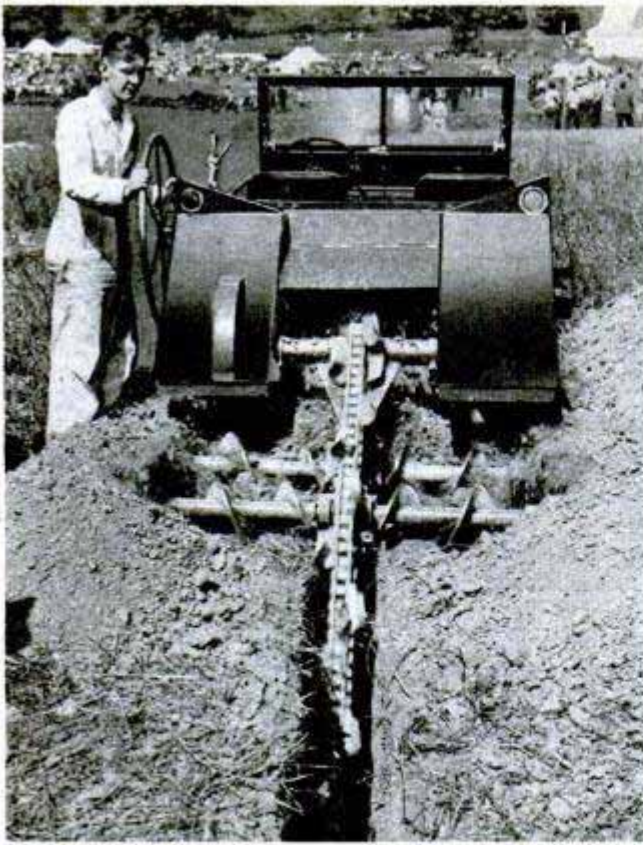

Jeep Trench Digger

Digging 300 feet of narrow trench an hour, a ditching attachment for the Jeep speeds the task of laying draintile, water pipes and power cables. One man operates both the Jeep and trencher from the rear of the vehicle. The trench digger, driven by the power take-off, comes in several sizes. Twin screws force the soil well away from the trench. When not in use, the trencher swings upright and does not interfere with operation on the highway.

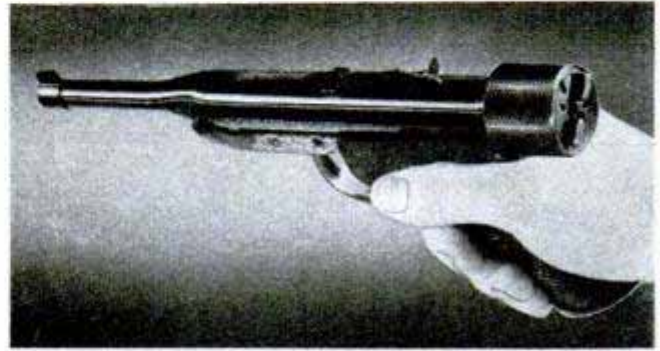

Repeater Pellet Pistol

There is no pumping to a new pellet air pistol. Instead, the shooter merely "breaks" the pistol to cock the gun and move a new pellet into the chamber. The "break" cocks a powerful spring which sets an automatic-type piston. A six-shot magazine eliminates reloading and a yellow indicator shows when the sixth shot has been fired. The bore is rifled for pin-point accuracy at distances up to 30 feet. The gun is available in .177 and .22 calibers as well as BB shot.

Prefab for Use Where Mercury Hits 112 Below Zero

When the temperature reaches 112 degrees below zero it takes quite a building to keep the cold out and the heat in. A struc-

ture built in France is designed to keep out winter colds that reach that temperature in bleak sections of Greenland. The building

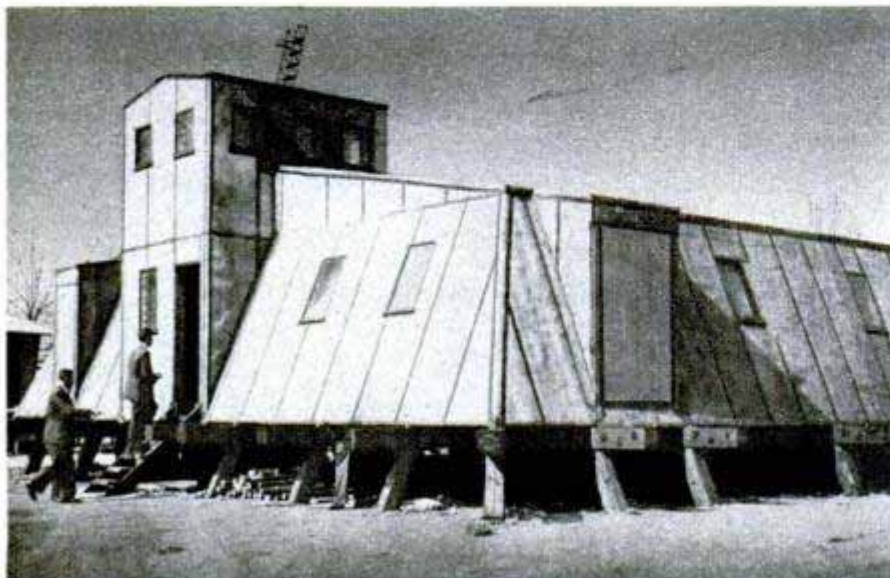

ing will serve as a shelter for an exploring expedition to the island. Prefabricated, it will be dropped by parachute in sections. Secret of the cold-resistant building is the construction of the walls. They are made of two layers of Duralumin, separated by two inches of honeycombed tar paper which in turn is filled with powdered cork.

☐ The Empire State Building was struck by lightning nine times in one storm.

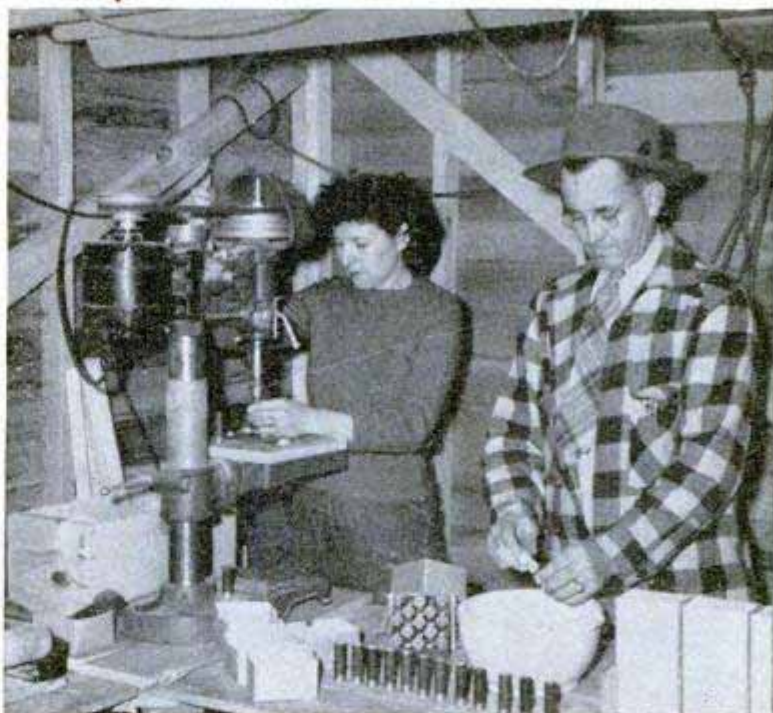

Photos by Herbert Jonas

L. J. Farley, who developed the system, fires a cloud of pollen into a tree neglected by the bees. Right, pollen mixed with casein is loaded into the shells. Casein becomes tacky, prevents pollen from blowing away

First step in the manufacture of the pollen-filled shells is to pick the blossoms. Right, blossoms then are rubbed over fine screen to separate the pollen-bearing anthers from the remainder of the flowers



Shotguns Blast Pollen Into Western Fruit Trees

What the bees won't do for shaded trees, a shotgun can—with the help of shells charged with pollen. Washington State orchardists are firing special pollen-charged shells at their trees. Discharged from the ground, the shells carry the cloud of pollen to treetop height and are particularly effective in shady areas often neglected by bees. The method of pollinization was developed by L. J. Farley of Wapato, Wash. Blossoms that are to be used for cross-pol-

linization are rubbed over fine screens to separate the anthers from the flower. The green anthers are dried and then vibrated on a 100-mesh screen to yield the pure pollen grains. The pollen then is mixed with casein and packed into shells that have a light charge of slow-burning powder and extra filler pads to protect the pollen from the flash of explosion. After the shell is fired, the casein becomes tacky and keeps the pollen from blowing away.

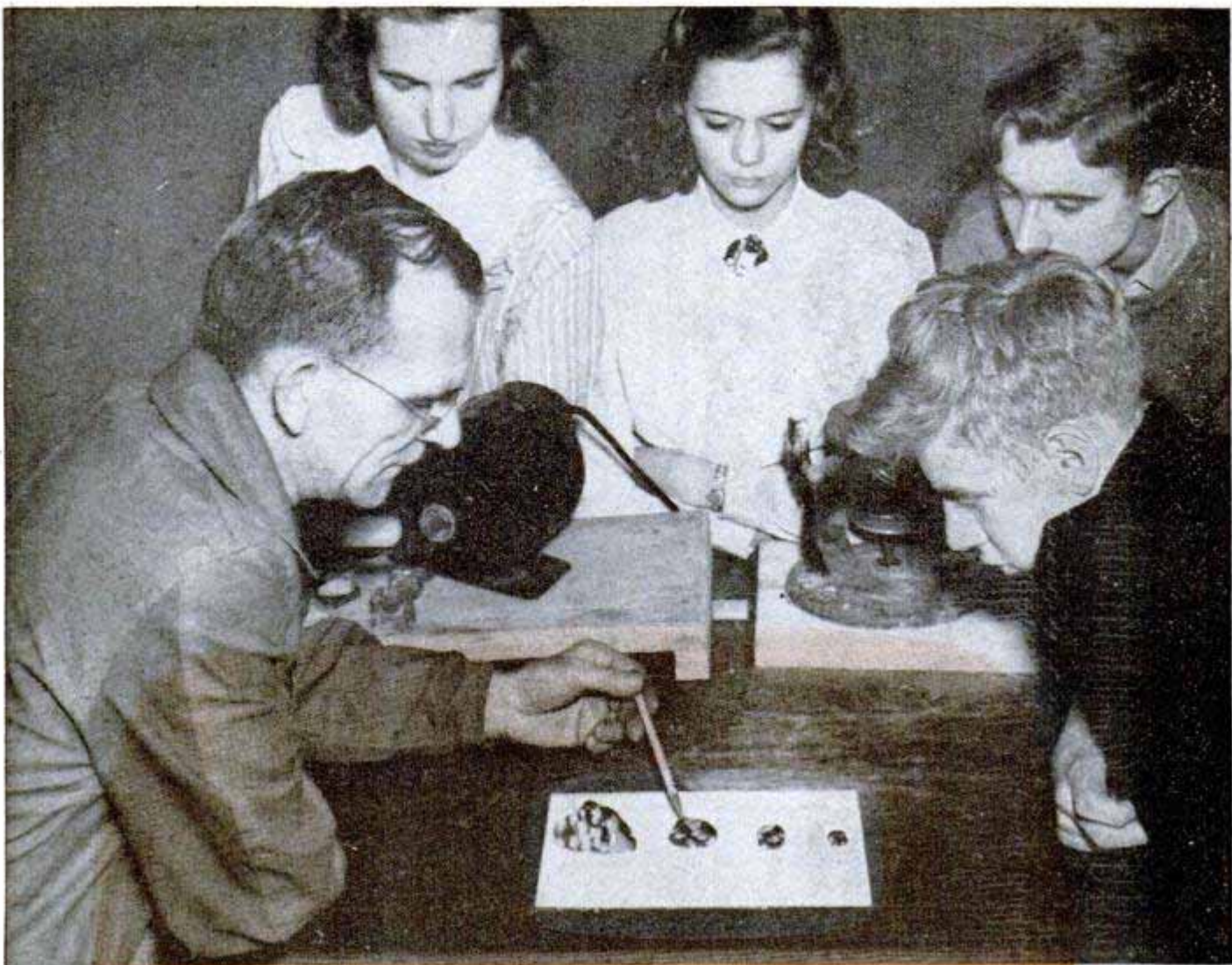

Chandler, organizer of lapidary club, shows members four stages in developing finished gem from rough stone

GEMS from Turkey Gizzards

By William Gilman

ANY VALUE to that stone in the gizzard of your holiday turkey? Yes, say members of the Springfield, Vt., high-school lapidary club, who turn out lustrous gems from the turkey gobblers.

The young gem cutters also make beautiful rings and brooches from jades to the ordinary pebbles you might find in your driveways.

Using tiger-eye stone and \$5 worth of silver, one of the members produced a matched set of gems which a jeweler quickly appraised at more than \$100. Yet tiger-eye, as geologists know, is a common yellow-brown stone.

The young lapidaries concentrate on turning out cabochons—beautifully polished convex stones. And it won't be long

until they will have enough equipment to cut diamondlike facets on their gems.

Harold L. Chandler, head of the school's science department, directs the activities of the club. Through him the members have learned that the ancient art of gem-making isn't so mysterious after all. The club has invested \$29.50 in a small, three-in-one lapidary wheel which has interchangeable parts: a diamond saw for cutting; a Carborundum wheel for grinding or roughing out; and a felt buffer for polishing. With this equipment the high-school set has learned that it can convert a worthless pebble into a gleaming cabochon within an hour. Five hours at the wheel will finish a piece of jade, one of the hardest stones on the lapidary's list.



Close work! First step in making a gem is to cut a slab off the rough rock with a diamond saw. Dripping compound prevents overheating

As for material—the horizon's the limit. Each state, county and township possesses its own stones of gem quality. For example, the best agates are found most often in western states.

The Vermont club made a rich haul simply by going to local butcher shops at Thanksgiving time and emptying gizzards from 50 western-raised turkeys. Those turks had swallowed enough stones, some larger than a robin's egg, to fill a cigar box. The members converted them into a sparkling display of striped and moss agates.

Vermont itself supplies colored marbles and opaque, reddish-brown quartzes known as jaspers. From glacial deposits in Vermont's gravel beds come pebbles ranging from soft, dense opals to serpentines.

A girl member returned from a Maine vacation with a box of beach pebbles which were fashioned into glowing jaspers. One of Chandler's former geology students sent back fine specimens of Alaska jade. Even the flint from an early flintlock gun became a gleaming ornament.

Chandler has taught his young gem cutters that several factors decide a stone's value. Color comes first. Then texture. The harder the stone is, the better polish it will take, although some must be handled very carefully. An example is snowflake obsidian—because of its brittleness it cannot take rough use.

For hard wear, other stones are preferred. Jade is a favorite. Others, in order of hardness, are onyx, agate and petrified wood.

Luster must be judged too, to determine how well the stone will reflect light. Another factor is its structure because density and opaqueness also determine the degree



Club member progresses to the second step in gem work—roughing out the unshaped slab on a Carborundum wheel. Below, in the third step the rough cabochon is further shaped, this time by hand, with various abrasive cloths

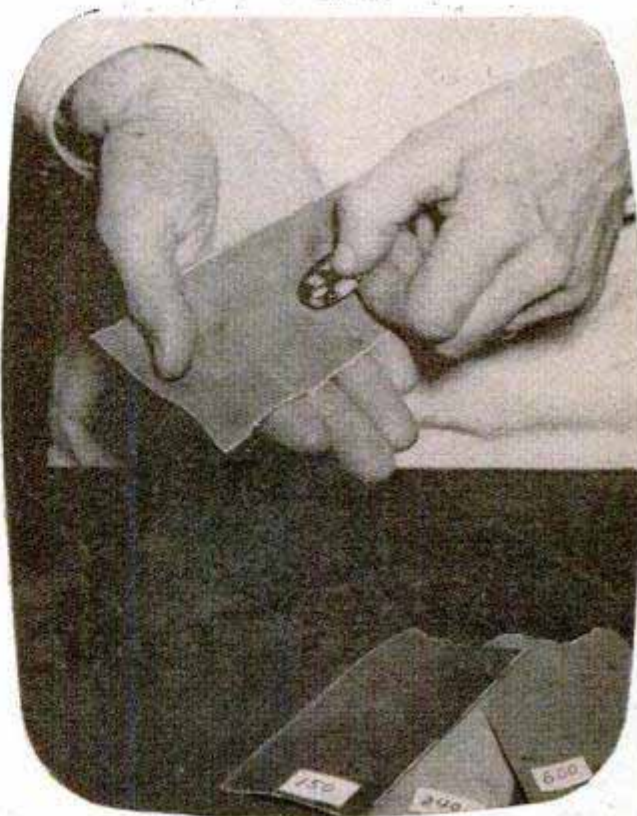



Final polish is given the ornamental gem by holding it against a felt buffer. Below, one member polishes a moss agate while another sands black jade by hand

of reflection. Fracture quality must also be studied for it determines how the stone can best be saved and polished.

The student's first step in a project is to saw the stone. A carriage holds the stone against the revolving diamond saw. Cutting liquid drips on the wheel to prevent overheating and cracking.

The Carborundum wheel then is substituted for the saw and the roughing-out begins. This grinds the stone to the desired design.

Rough finishing is done with abrasive cloth. The final stage is careful polishing against a revolving felt buffer with a fine abrasive powder used first and then tin-oxide polish.

Although still young, the club has made such beautiful sparklers that many adults are interested, so night sessions for these older hobbyists are planned. Money is carefully put aside to buy a larger gem-maker so that several pairs of hands can work on the machine at the same time.

The supply of raw materials doesn't worry Chandler. He has a collection of more than 8000 stones and there are plenty more in the earth's crust.

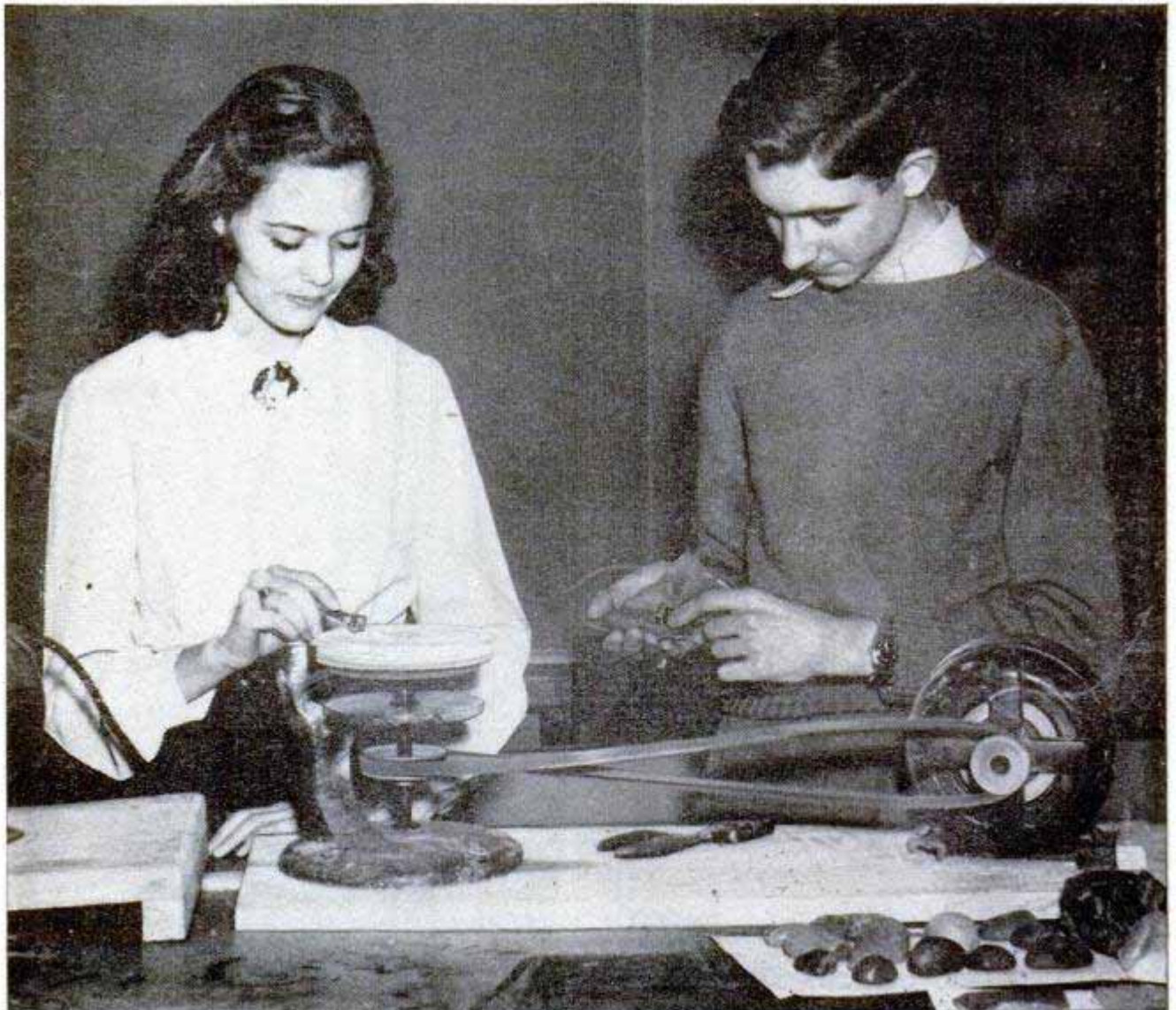



New York "Bombed" For Night Photos

Night aerial photos of New York City, taken through smoky air from 3000 feet with the aid of a series of 50,000,000-candlepower flashes, were so clear that street signs and license numbers in them could be read. It was a test of a new device synchronizing the camera shutter with bright bomb-like bursts of light from 150 instantaneous flashes, dropped at three-second intervals. The equipment is designed to help the U. S. Air Force take pictures over enemy territory in time of war. New Yorkers, forewarned, were not alarmed by test.

Above, looking across New York's East River at chain of flash cartridges set off from plane for night aerial photos. Below, docks, ships, autos and buildings are clearly visible in this view of the Manhattan waterfront

U. S. Air Force photo

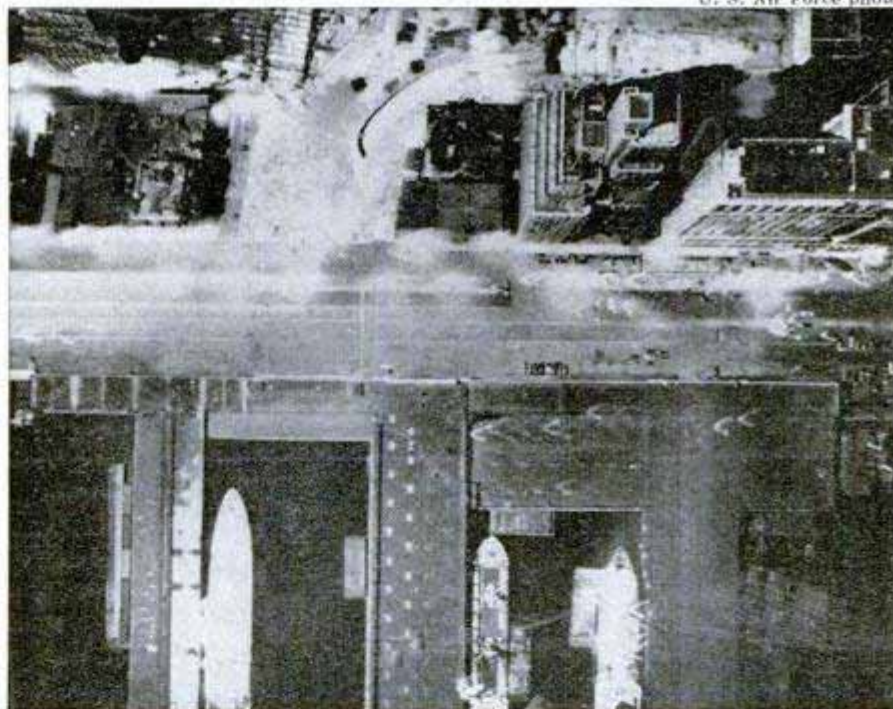

Low-Pressure Oil Burner Consumes Crankcase Drainings

Even crankcase and gearbox drainings can be burned without soot or smoke by a low-pressure oil burner that is said to cut fuel costs at least 30 percent. Mixtures of fuel oil, road oil and water were burned readily in factory tests, the water being introduced in the oil line at the rate of $\frac{1}{4}$ gallon an hour without extinguishing the flame. The burner is especially designed for use with hard-cracked oils and has a

capacity ranging from 2 quarts to $1\frac{1}{2}$ gallons an hour. The oil is thoroughly mixed with air and is kept in this bubbly condition until it is ignited. There are no filters or fine screens to clean and the burner has only two simple adjustments.

Rayon consumption in the United States for 1948 totaled 1,017,000,000 pounds, an all-time high.

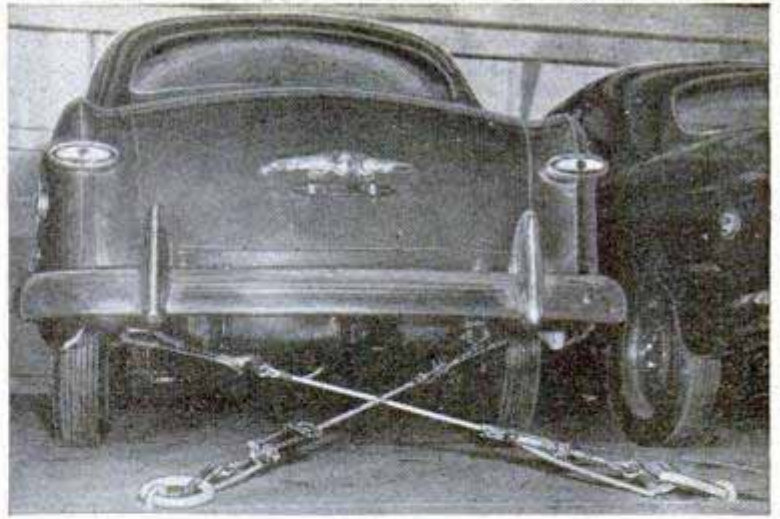
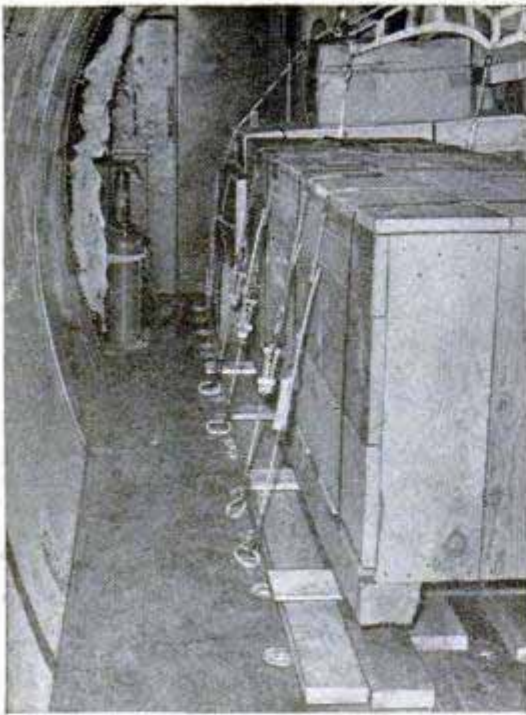

Above and upper right, adjustable cable in use on plane and ship. Right, cable works on beaded key-chain principle, except the beads are movable along a wire-rope core

Adjustable Cargo Cable Locks Like Key Chain

Cargo is lashed securely in planes, ships and trucks by an adjustable cable that works like a beaded key chain—except that the beads are movable along a wire-rope core. In addition to the beaded section, there is another length of unbeaded wire with a toggle lock at the end. After the beaded end is joined to the toggle, the toggle handle is closed, exerting leverage that

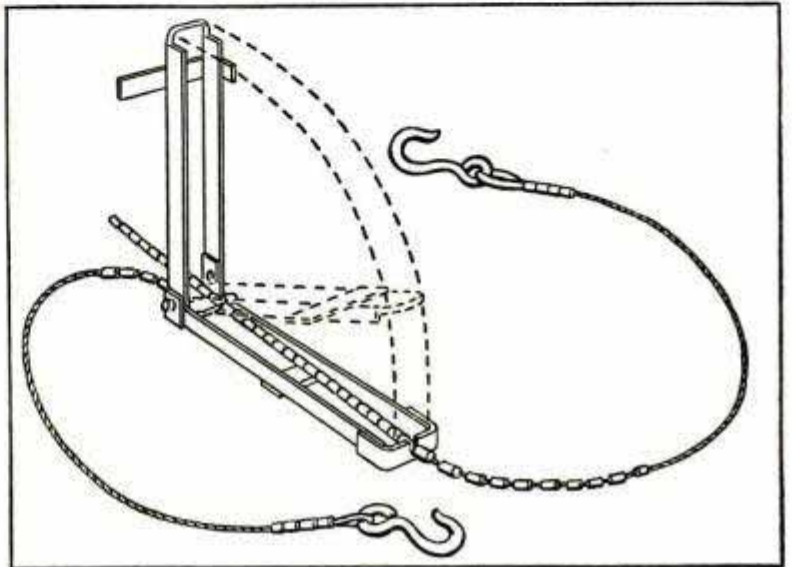

tensions the connection. The handle is moved slightly past dead center and will not open under added stress, or because of vibration. Standard hooks or specially designed fittings make it simple to attach.

Low-Pressure Chamber Serves as "Flying Kitchen"



Pillsbury Mills photo

"Flights" in an earthbound kitchen helped a flour manufacturer solve problems for bakers and housewives in regions like Denver, Colo., and Butte, Mont. In a low-pressure chamber once used by the U. S. Air Force for simulated high-altitude experiments, home economists checked recipe instructions by baking 200 cakes at various heights up to 7000 feet.

Popular Mechanics provides two sources of further information concerning articles published in each issue: the WHERE-TO-BUY-IT INDEX, starting on page 10, and the WHERE-TO-FIND-IT INDEX, available without charge from our Bureau of Information, 200 East Ontario Street, Chicago 11, Illinois

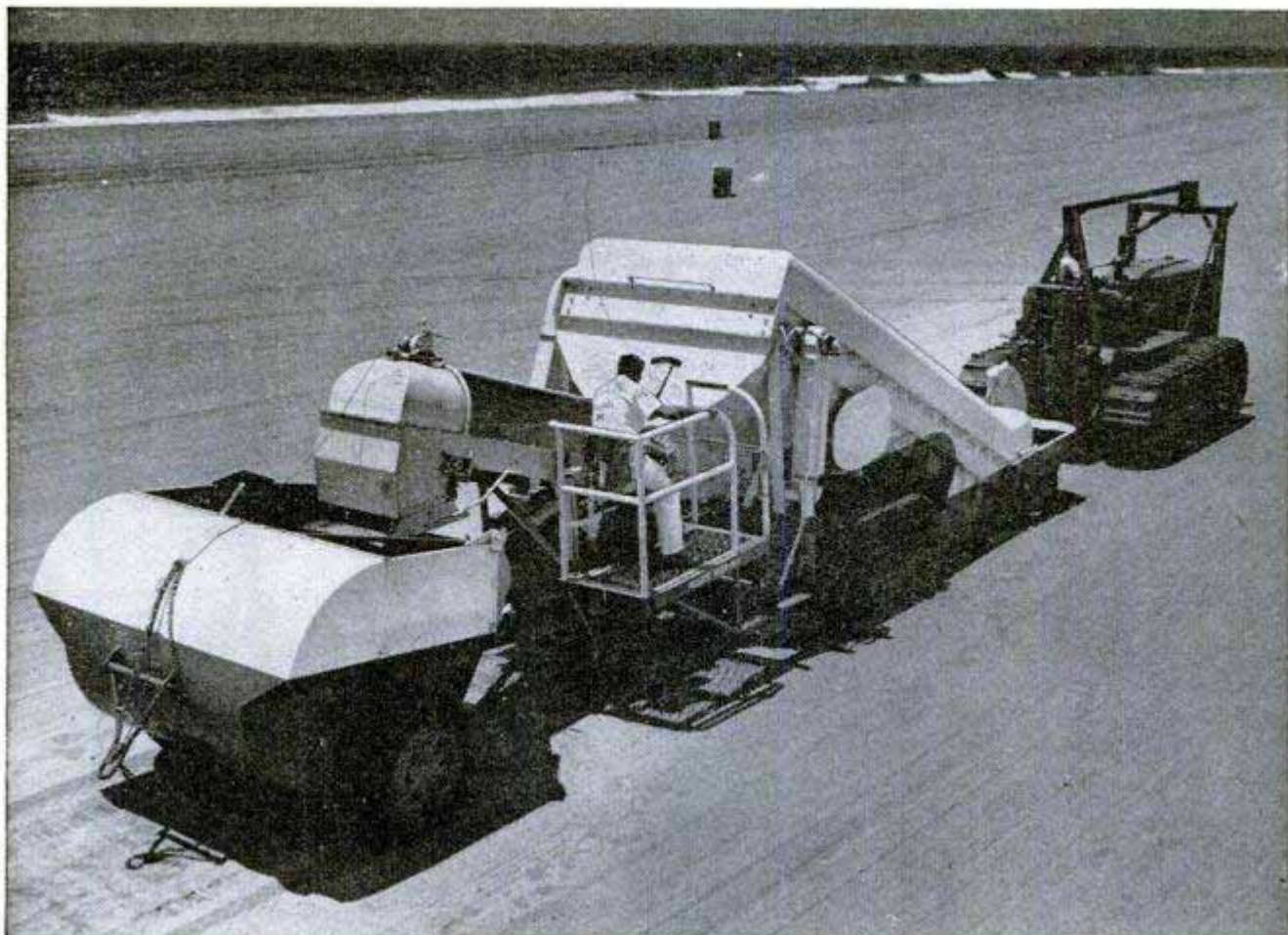

Glass and other foreign matter turned up in sands by nine-ton beachcomber are dumped into trailer at left

Mechanical Beachcomber

Broken glass, rusty nails and other dangerous debris in beach sands are completely removed by a mechanical beachcomber. The machine screens and processes over 3200 square yards of sand per hour, digging to a depth of nine inches. Foreign matter as small as BB shot is extracted and the cleaned sand is restored to place and smoothed down. The processing machine weighs nine tons and is towed by a track-type tractor at up to 1½ miles per hour. Thirty-eight screen buckets, each five feet wide, scoop up the sand. Cleaned sand falls through the screens back onto the beach while all debris is elevated and dumped onto a traveling belt that discharges into a hopper-trailer that is towed behind the machine. Debris can either be deposited in a pile and then bladed into a deep hole or towed in its trail-

er to a dump. A 36-horsepower engine turns the buckets and belt. Working over a public beach for the first time, the machine collects an average of 25 pounds of broken glass and about \$5.00 in small change in an hour. The pilot machine is now operating on public beaches in Los Angeles county.

Cleaned sand falls down through screen bottoms of digging buckets

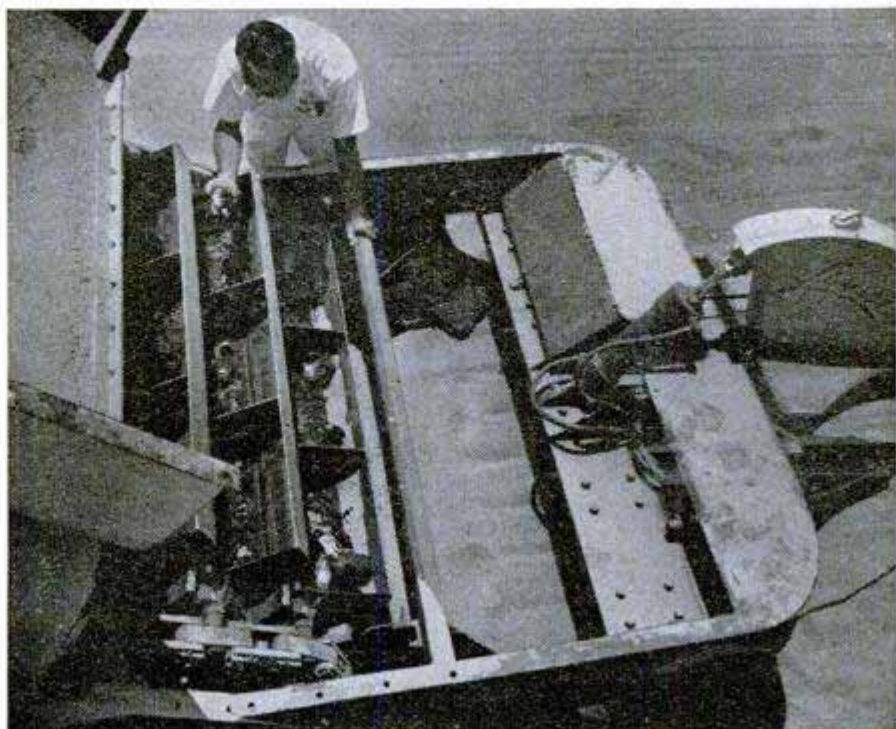

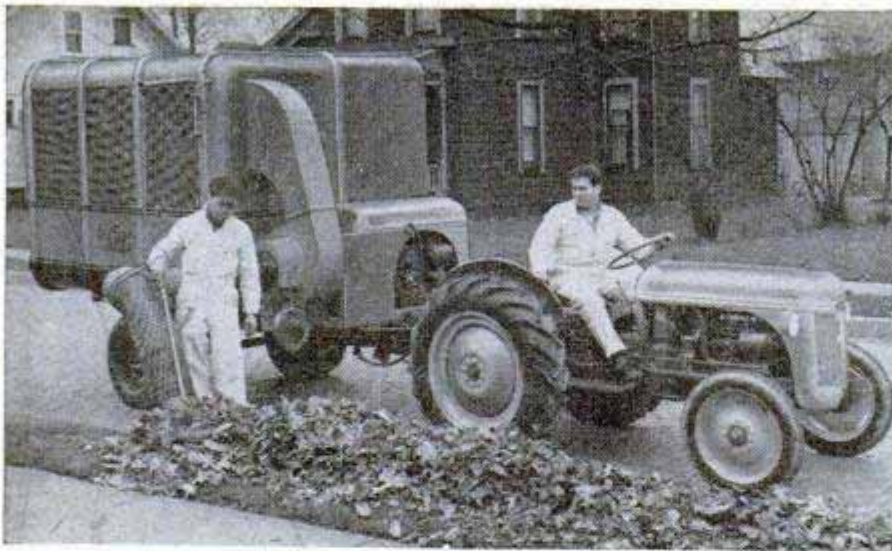

"Vacuum Cleaner" Pulverizes Leaves

Leaves are sucked up rapidly and pulverized for compost by a giant "vacuum cleaner" that has its own hydraulic system. A flexible intake hose with a rubber-tired "snout" collects wet or dry leaves from under automobiles, in gutters, around corners and in catch basins. The collector can be drawn by truck, tractor or jeep.

Stick-On Football Cleats

Ordinary shoes can be made into football shoes by attaching rubber-cleated soles. The 11½-inch-long soles can be cut in two at the arch to be cemented on as separate sections. The soles are also useful on hunting, fishing or ski boots and work shoes used on slippery surfaces.

Underground Radio Waves

Radio waves were received 700 feet within the earth recently. William M. Barret, a geophysicist of Shreveport, La., demonstrated the penetration of the waves in a salt mine at Grand Saline, Tex. A portable transmitter on the earth's surface sent waves at a frequency of 1602 kilocycles to a receiver 700 feet within the mine. According to Barret, radio waves may someday be used in searching for valuable oils and minerals.



Gas Under Pressure Operates Lighter

Butane gas under pressure is the fuel used in a new cigarette lighter that yields more than 3000 lights before the tank is empty. A small knob is pushed with the thumb to release the jet of gas before the spark wheel is spun. When the fuel tank is empty, it is replaced with a new unit. The fuel from one tank will burn for three hours. It provides an odor-free flame and a "tasteless" light.

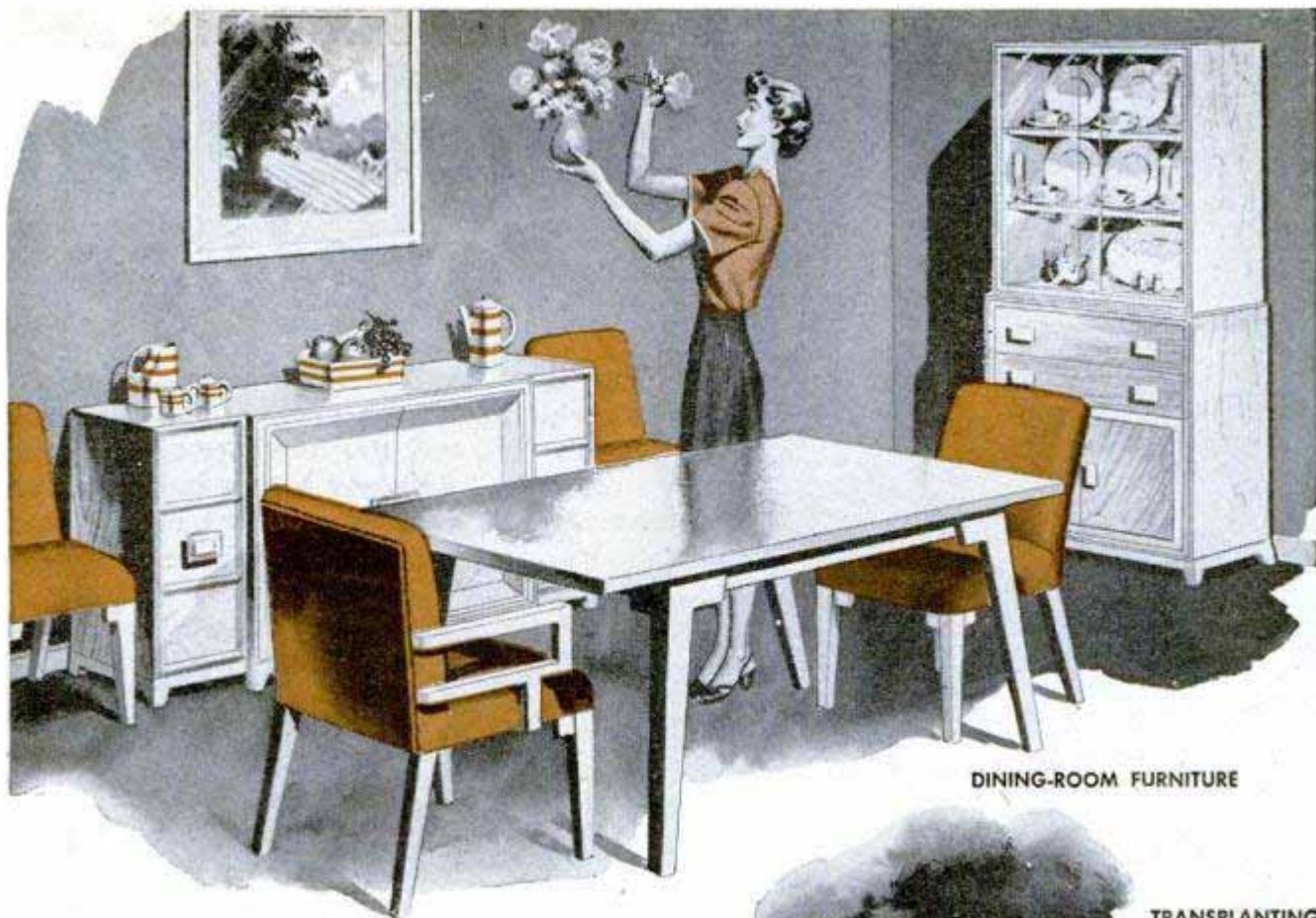

DINING-ROOM FURNITURE

The CRAFTSMAN

★ Want a dining-room suite that's really a "knock-out"? Then build this beautiful seven-piece ensemble from the details given in the full-color story beginning on page 182. It's extremely simple to build, just as the bedroom furniture which appeared in previous issues. Part I of this two-part story covers construction of the table and chairs. Part II will give complete information on building the modern credenza and china cabinet.

★ If a poorly placed tree or shrub is spoiling the looks of your yard, don't chop it down—turn to page 190 and find out how to transplant it to a new location. With a little help and rented equipment you can move the tree in a couple of hours.

★ Regardless of its age, you'll be proud of your home when it's gleaming in a spanking new coat of paint—and you don't have to pay today's high prices. By following the pointers given in the article on page 194, you can easily do the job yourself in your spare time.



TRANSPLANTING TREES AND SHRUBS



HOUSE PAINTING

THERE'S MONEY IN *Salad-Bowl Novelties*

They'll go like hot cakes if sold in a gift shop at Christmas time — and at a nice profit. You buy the bowls and take over from there. Plywood scraps and common hand tools will set you up in business

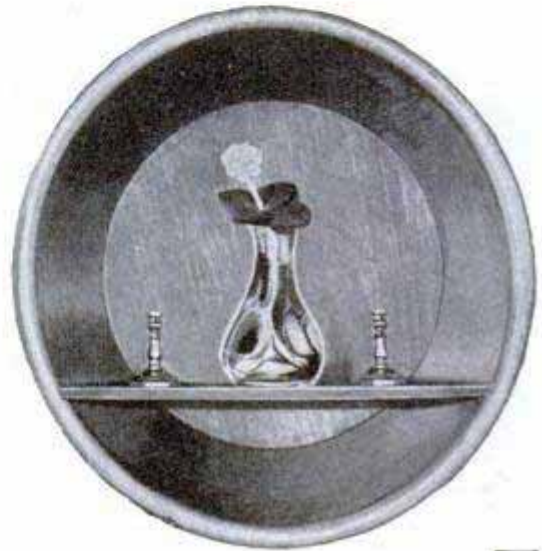
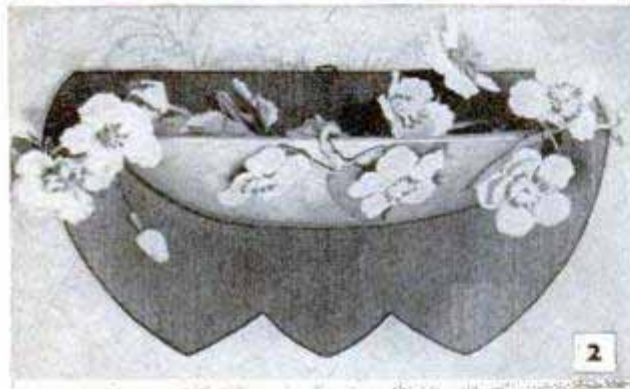
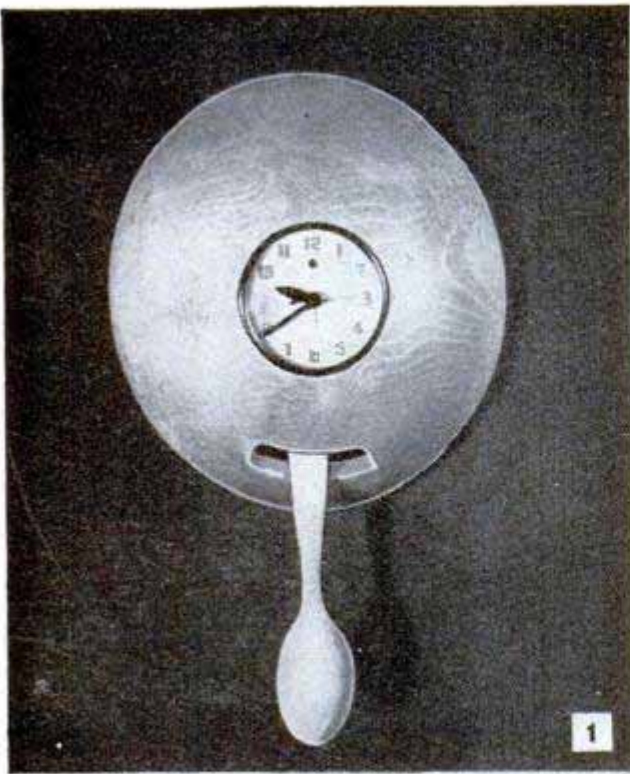

4 *Flower Holder*

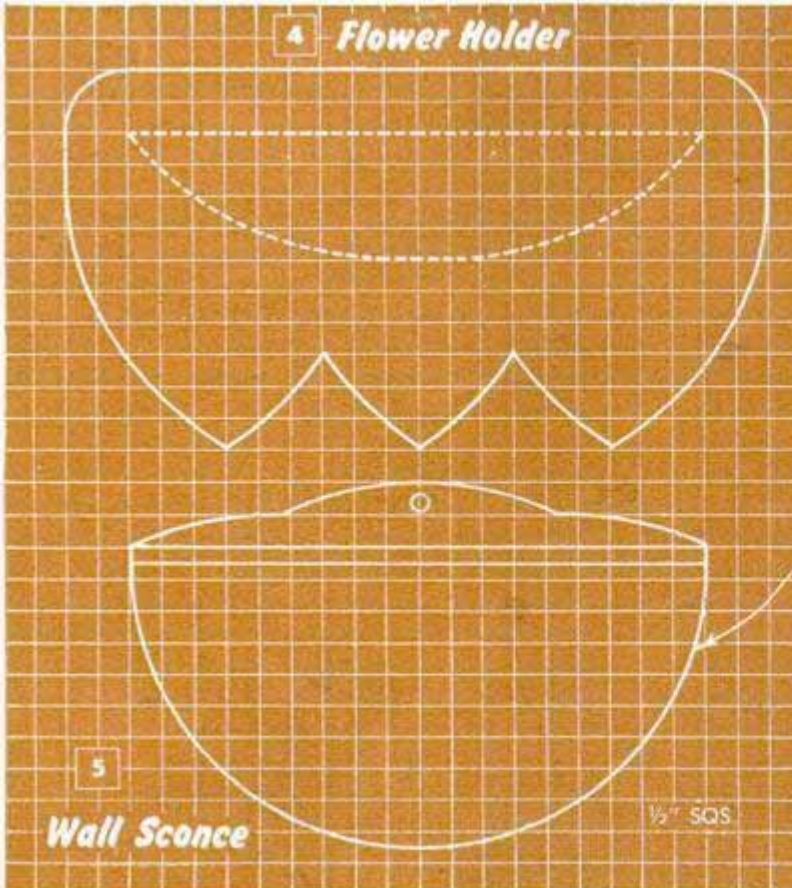

6 METHOD OF SAWING BOWLS IN HALF

BOWL TACKED TO PLYWOOD

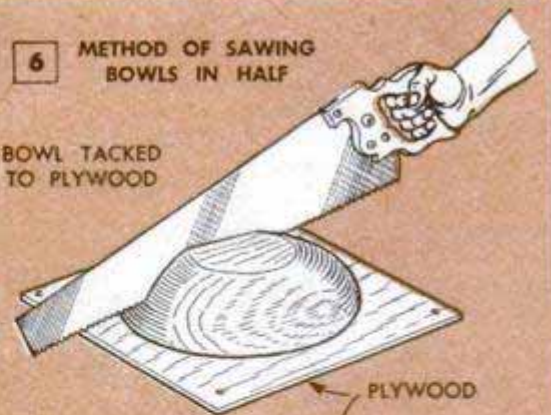

RADIUS TO SUIT CONTOUR OF BOWL

PLYWOOD

NAILED FROM BACK

7 ASSEMBLY OF WALL SCONCE

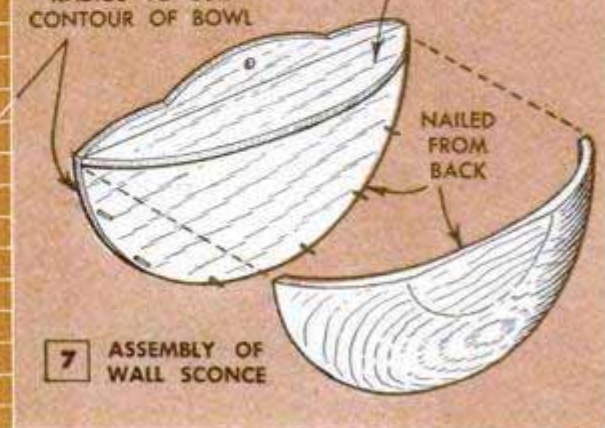

THERE'S spare-time profit galore to be had from the sale of wooden novelties, and sure-fire sellers to add to your line are these novel projects made from wooden salad bowls. The profit is great and the outlay is small for, in addition to the bowls, all you need are a few scraps of plywood and some glue and brads. With a few samples to show, most any gift shop or neighborhood department store will gladly handle them for you on commission.

The projects shown here are but a few of the many useful items that can be made. Half the job is done by buying the bowls and there's no waste. Only one bowl is required to make the flower holder, Figs. 2 and 4, and the wall sconce, Figs. 5, 7 and 8. Likewise, one bowl makes the nut dish, Fig. 9, and the wall shelf, Figs. 3 and 10. In the latter case, the shallow bottom section of the bowl is used for the nut dish. The novel kitchen clock, Fig. 1, is made by installing an electric movement in the center of the bowl and slotting it at the bottom to take a dummy salad-spoon pendulum.

While a bandsaw can be used to saw the bowls in half, an easy way to do this by hand is shown in Fig. 6. A bowl is tacked temporarily to a flat piece of plywood which is tacked to the top of the workbench. To make the nut dish and wall shelf, the bowl is supported for sawing in the manner shown in Fig. 11. Fig. 12 shows how the bowls are marked for sawing.

By R. J. DeCristoforo

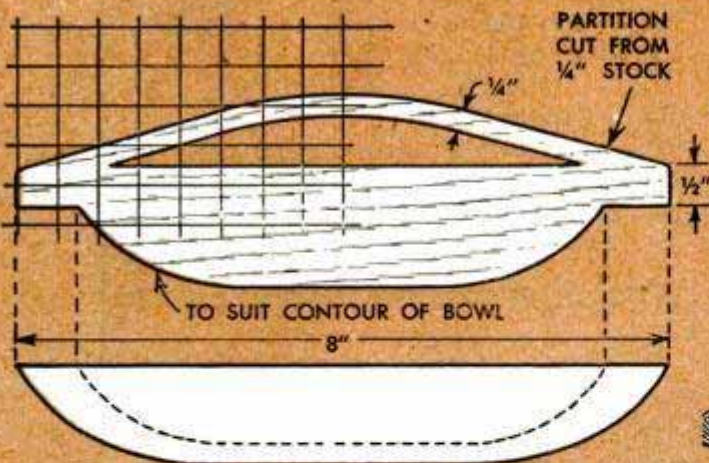
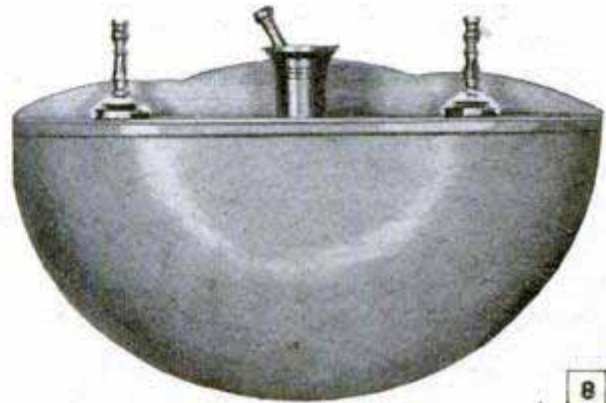
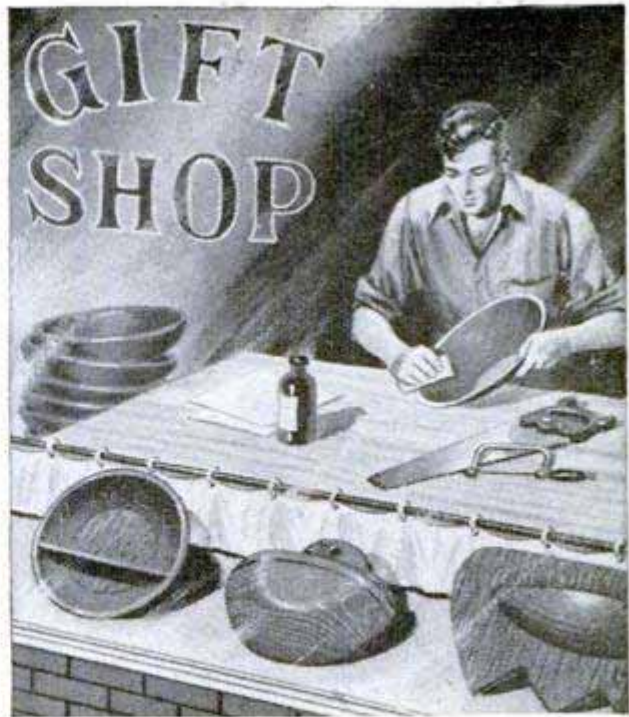

9 Nut Dish

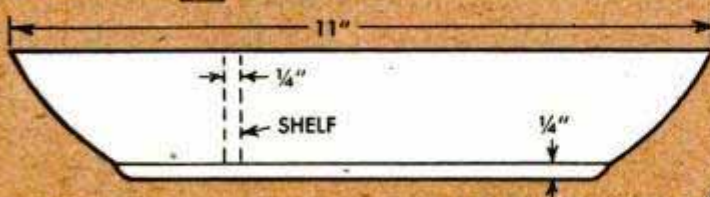

10 Wall Shelf

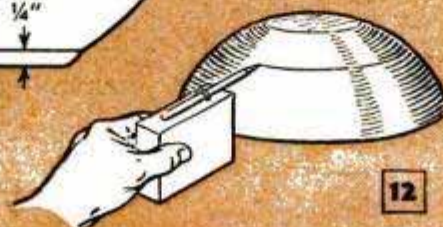
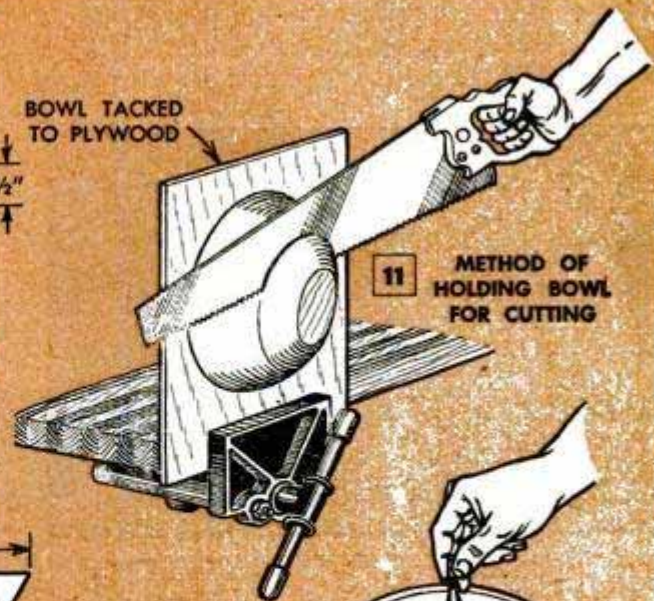

12 MARKING BOWLS FOR SAWING

Scored Lines on Saw Clamp Check Proper Filing Angle



Holding the file at the proper angle when sharpening saws is easy if crisscross guide lines are scored across the top of the saw clamp or vise. The lines are made at the correct filing angle and the position of the file is checked while working merely by glancing downward at the lines.

Ferd J. Haas, Waukesha, Wis.

Wooden Chuck Speeds Lathe Setup When Turning Duplicate Pieces

When turning a number of duplicate parts, such as chair rungs, the setup can be speeded by using a simple wooden chuck. This is turned from a scrap of 1½-in. stock as shown in the detail and a square

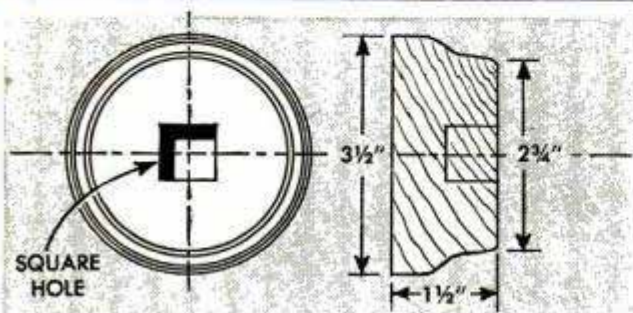

hole is formed in the exact center. The hole should be the same size as the stock to be turned. After the chuck has been screwed to the lathe faceplate, the job is set up by inserting one end of the stock in the chuck and clamping the tailstock in place against the other end.

Files Cleaned With Adhesive Tape

To clean a file, I simply place a strip of adhesive tape lengthwise over the file, rubbing my finger across the tape so the adhesive is pressed between the file teeth, and then pull it loose. This will remove most of the grit and filings from between the teeth but, if necessary, the operation should be repeated until the file is clean.

John R. Hattam, Des Plaines, Ill.



Improved Stop for Workbench

An excellent workbench stop for planing wide boards is obtained by screwing a casement fastener to the end of the bench. The fastener is adjusted to suit the work and, if it is too loose to stay at any set position, the peened end can be hammered to tighten it. The fastener is turned down and out of the way when not in use.

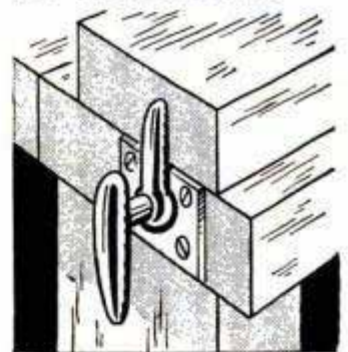

Washer Improves Worn Faucet

If the threads of a faucet spindle become worn and the washer will not seat properly, the operation of the faucet can be improved by adding an extra washer to shim out the regular compression washer. Just place a flat rubber washer between the compression washer and the end of the spindle and tighten the screw.

W. H. McClay, Pasadena, Calif.



Bird-Cage Novelty

Assembled from strips of bamboo without using glue or nails, this novel bird cage can be made tiny enough to fit in the palm of the hand or proportionately larger. Bowed side strips are passed through the corner frame members to hold them in place. A bamboo perch supports a balsa bird

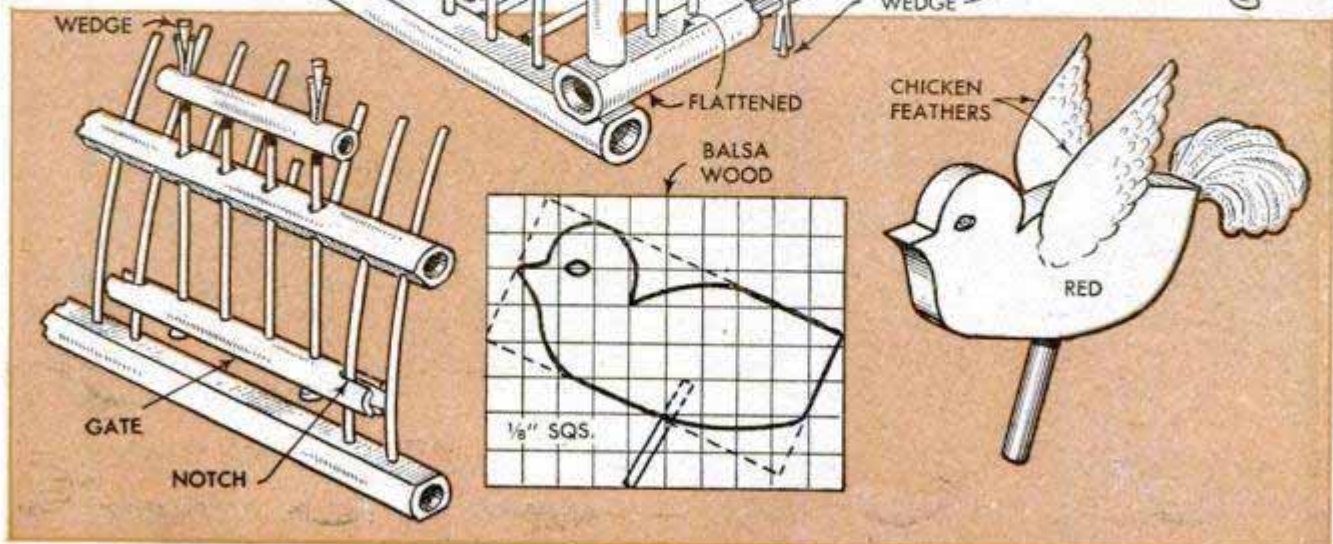
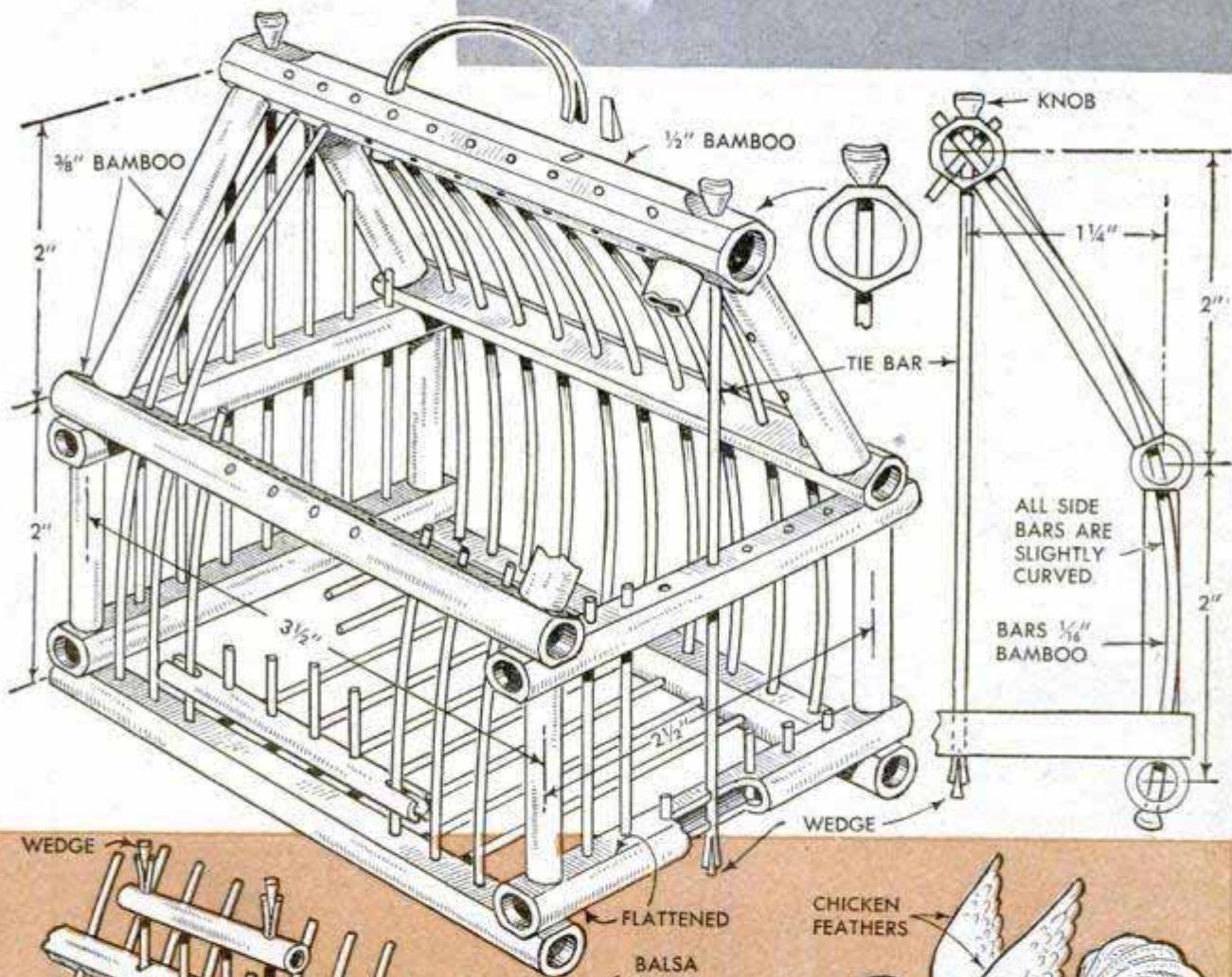
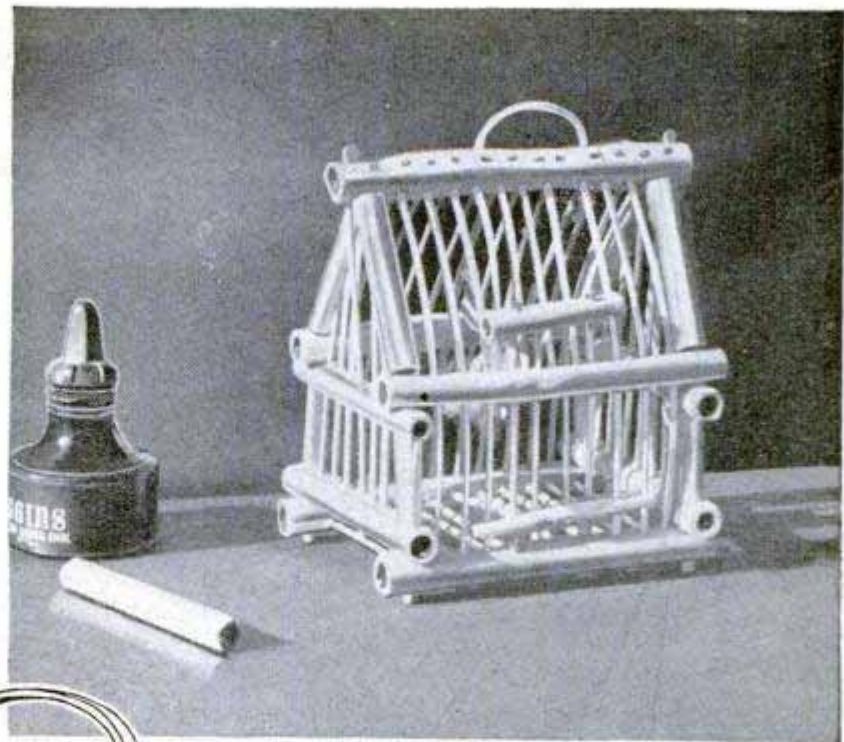

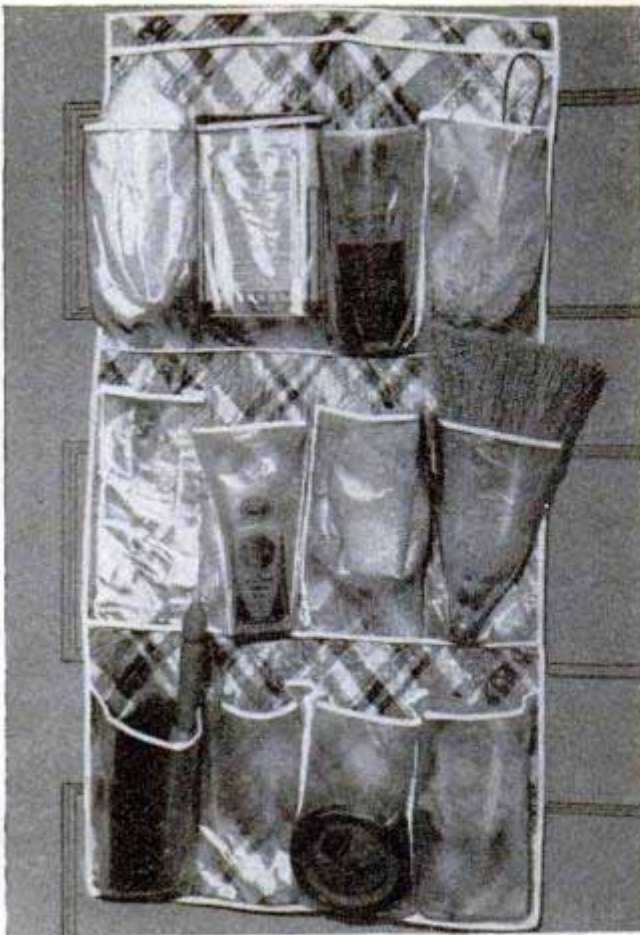

STORING CLEANING ITEMS, such as dustcloths, brushes, wax, etc., in a plastic shoe bag hung on a door solves the problem of inadequate shelf space

IMPROVED DELINTER for woolen garments is made quickly by wrapping adhesive tape, sticky side out, around a broomstick roller with a wire handle

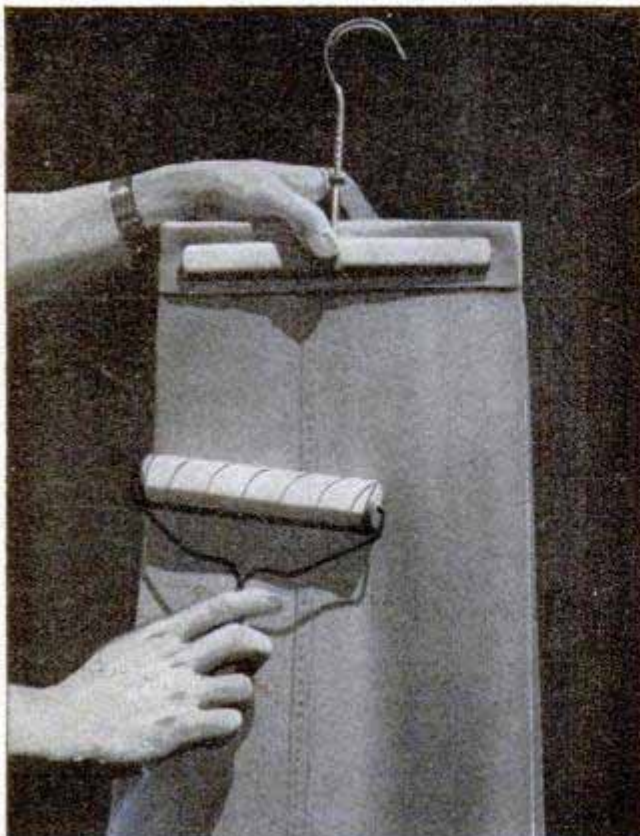

Solving HOME PROBLEMS

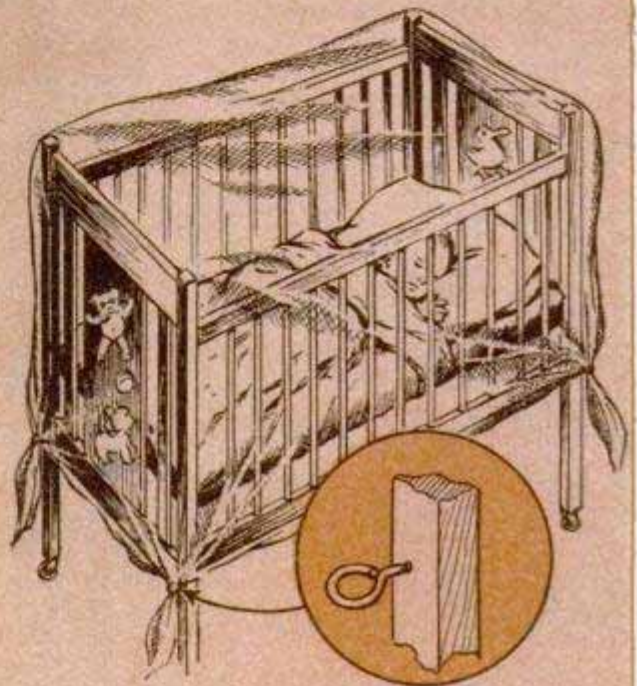

NETTING WON'T BLOW OFF a baby crib if the corners of the material are held in place by pulling them through screw eyes turned in the legs

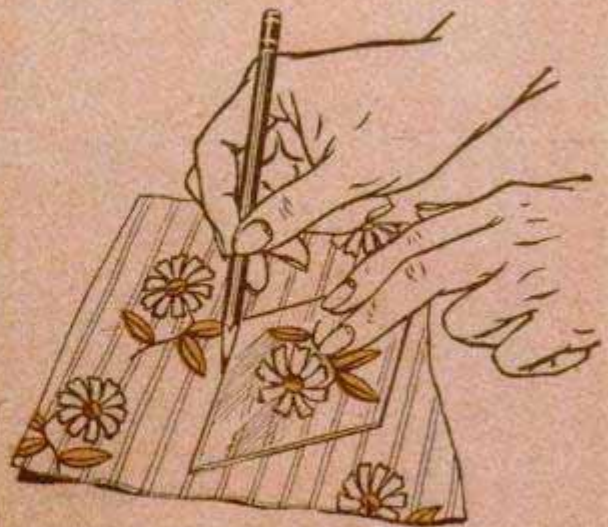

QUILT-BLOCK PATTERN made of clear plastic not only will outlast one of cardboard but facilitates centering over pattern of material

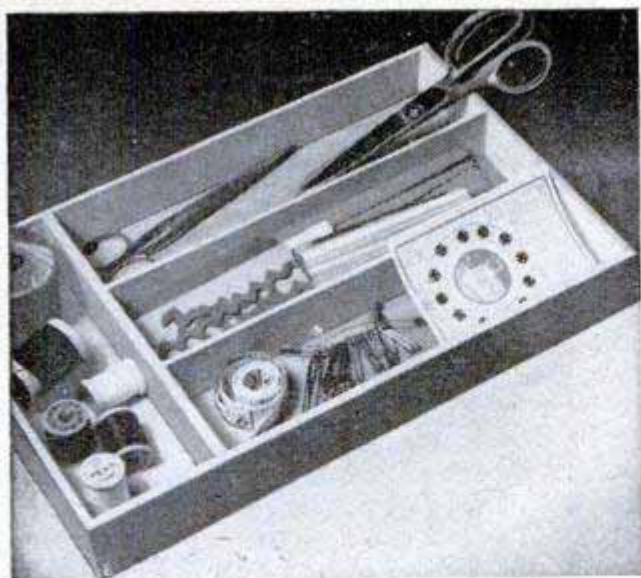

TRAY SEWING KIT with compartments to keep everything in order makes use of wooden or plastic cutlery box. It can be kept in drawer or on shelf



PRESHRINKING RICKRACK by dipping and drying it right on the card will prevent it from puckering the garment when the latter is first laundered

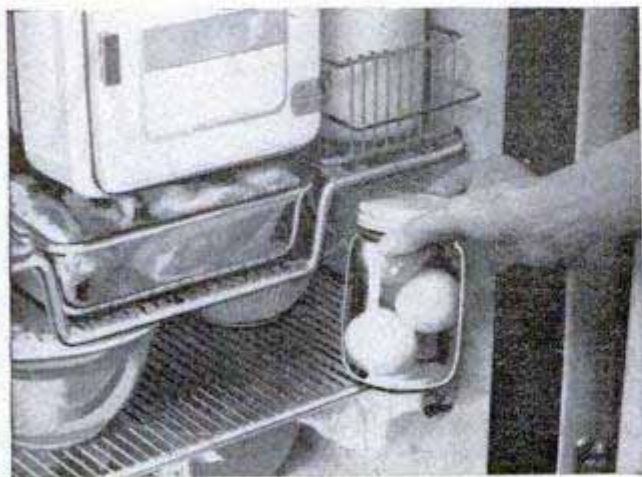

PEELED ONIONS WON'T TAINT other foods in a refrigerator and will stay fresh and crisp for weeks if they are placed in a tightly capped screw-top jar. A pickle or salad-dressing jar is excellent

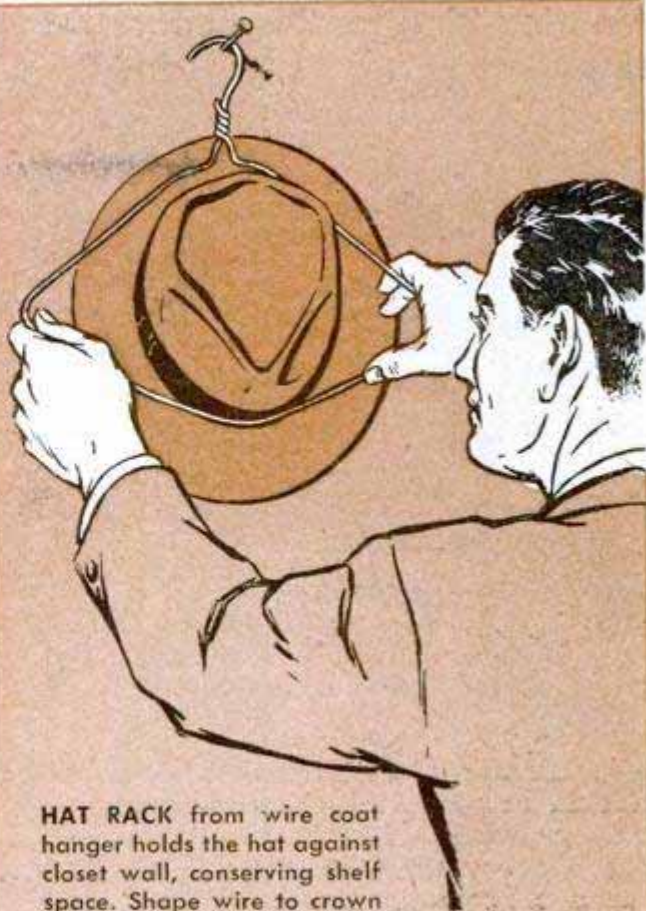

HAT RACK from wire coat hanger holds the hat against closet wall, conserving shelf space. Shape wire to crown

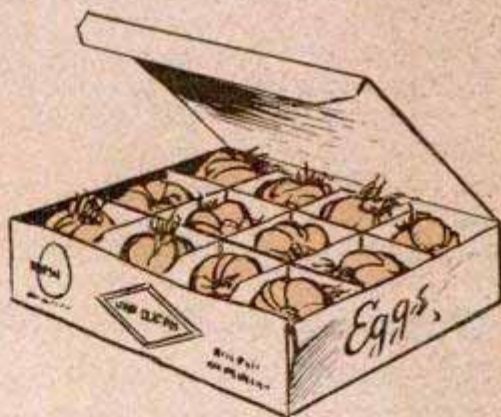

FLOWER BULBS of various varieties are stored conveniently in egg cartons which can be labeled and stacked safely one on top of another

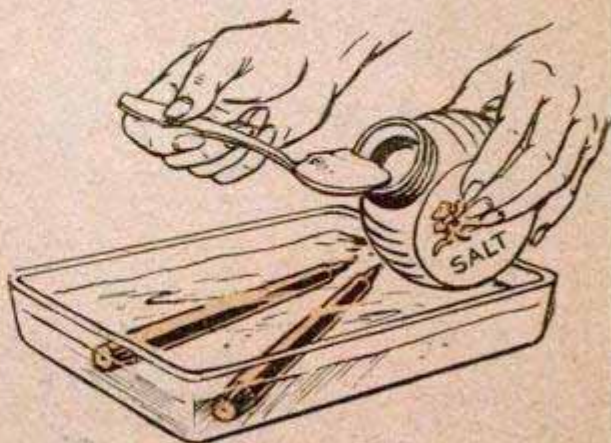

CANDLES CAN BE MADE DRIPPROOF by soaking them in a strong salt-water solution a few hours. Do not wipe them after removing from solution

Mooring Ring for Rowboat Improved From Piston



Using auto pistons with connecting rods attached as mooring rings for a boat, one trapper saves pulling his rowboat onto the shore every time he stops to check his traps. At convenient points along the trap line, the pistons are buried in the ground so the end of the connecting rod is exposed, and a line from the boat is secured to the rod. This method, of course, can only be used in very still water. For more permanent installations where there is a strong current, the pistons and rods can be embedded in concrete.

G. E. Hendrickson, Argyle, Wis.

Four Ways to Remove Frozen Nuts Without Using Cutting Torch

Here are four easy ways to remove a frozen nut when a cutting torch is not available or cannot be used because of fire

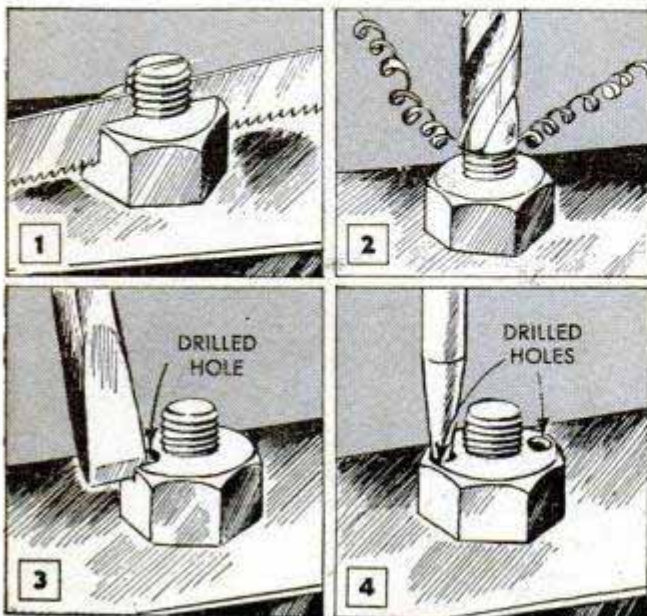

hazard. If there is no objection to damaging the bolt and marring the finish of the work, use a hacksaw to cut down through the bolt and nut as in Fig. 1. Another quick method is shown in Fig. 2. Just select a drill having a diameter slightly larger than that of the bolt and drill out the bolt until the nut falls off. Unless there is a washer under the nut, the work will be marred by this method. If you want to salvage the bolt or stud with less danger of damaging the work, an electric drill and a cold chisel or tapered punch will do the job. Drill a vertical hole through one side of the nut and, using the chisel as a wedge, split open the nut as in Fig. 3. To split the nut with a punch, select a bit of the same diameter as the end of the punch and drill vertical holes on opposite sides of the nut. Then split the nut by driving the punch in one or both of the holes as in Fig. 4. The wedging action will break the thin web easily.

Hammer Handles Kept in Condition

Hammer handles which are permitted to dry out and become brittle are apt to break at the neck. One way to avoid this is to lubricate them with linseed oil. This is done by

drilling a $\frac{3}{8}$ -in. hole, about 6 in. deep, in the end of the handle. Then, the hole is filled with raw linseed oil and plugged with a hardwood cork. The oil gradually works its way throughout the wooden handle, thus keeping it supple, and the hole is refilled with linseed oil as required.—R. F. Donovan, Jersey City, N. J.

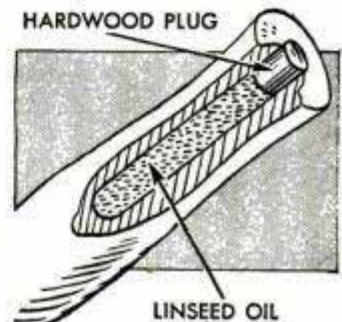

Extension Cords Stored Safely By Winding on Metal Spool

Sharp kinks in extension cords caused by hanging them from hooks or nails are likely to result in broken insulation and dangerous exposure of the wire. The cords can be stored conveniently without kinking or tangling simply

by winding them on discarded metal wire spools. These spools, on which wire is wound for shipment from the manufacturer, can usually be obtained from a local hardware or electrical-supply dealer.

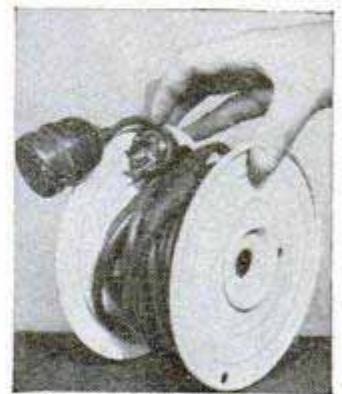



GUEST COSTUMER

RESERVED for guests and last-minute primping, this modern wall costumer is found especially handy when a home is without a hall coat closet. While not intended as a catch-all for members of the family, the costumer incorporates convenient storage space for such items as gloves, rubber footwear, umbrellas and other articles used only occasionally. Painted in a pastel shade to harmonize with the wall, the costumer adds a bright spot of color to an uninviting hallway.

The face panel is cut from a 4 x 6-ft. sheet of $\frac{1}{4}$ -in. plywood and this is nailed to a rough framework assembled with corrugated fasteners. The storage cabinet is assembled as a separate unit and fastened to the plywood covering with flat-headed screws driven from the rear. Coat hooks of the type shown are in keeping with the design. Note that the cross members of the framework are spaced to provide a solid backing for attaching the hooks. A standard 24-in. mirror, beveled or plain, may be hung in place or attached with metal clips made for the purpose. A single screw hidden by the mirror will hold the costumer securely to the wall.

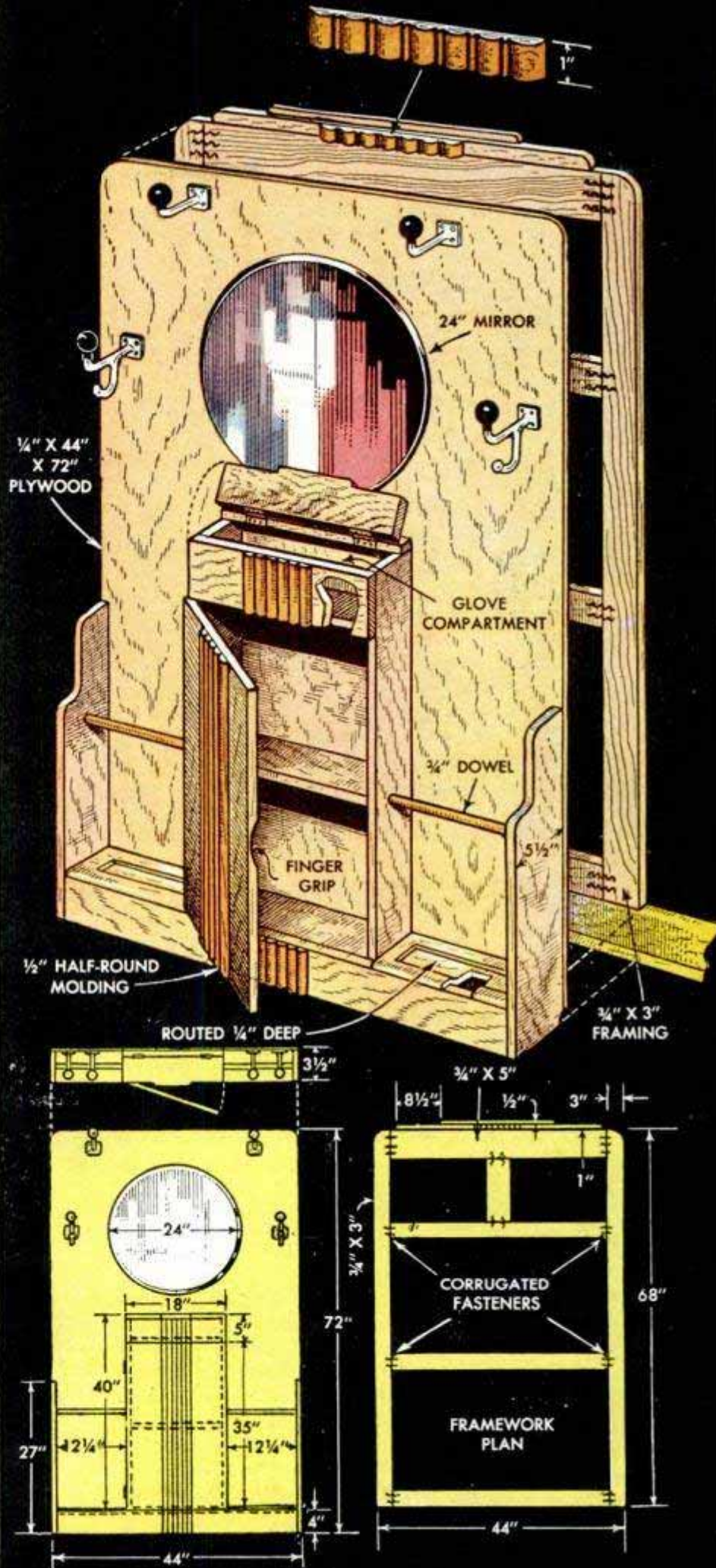

The framework to which the front panel is glued is made shorter than the plywood sheet to permit the costumer to fit over the baseboard and flat against the wall. Each side piece of the unit is notched for the quarter-round



HERE'S YOUR

DINING-ROOM FURNITURE

This smart-looking seven-piece dining-room group—the second in a series of fine furniture for the entire house—is our answer to the tremendous response received for more home-built furniture of good, practical design

By Wayne C. Leckey

Part I

WE ASKED if you wanted more and the answer was overwhelmingly yes—so here is a beautiful modern dining-room suite for your approval. Designed expressly for the basement craftsman working with small home-workshop tools, this group features the same simplicity of line and ease of construction characteristic of the bedroom-furniture series presented in our February, March and April, 1949 issues. The complete ensemble, which is sufficient to furnish a full-size dining room, consists of seven pieces, including an extension table for eight, four chairs, a credenza and a china cabinet. However, if you haven't room for the entire group, you can

eliminate the china cabinet or, in the case of an exceptionally small dinette or dining alcove, the base section of the two-piece china cabinet can be built and used alone as a server to take the place of the large credenza. The table is designed to take an extra leaf which permits serving as many as eight persons, and the seats of the upholstered chairs are spring-filled for real added comfort.

This, the first of a two-part story, details the construction of the table and chairs. Part II, in the next issue, will cover the credenza and china cabinet. For the craftsman who prefers to work from plans larger than magazine size, we have prepared a



The beautiful credenza shown above provides abundant storage space. Matching end compartments contain shelf area for glassware, while the center opens to reveal two drawers for silver and shelf space for linens





Most of the work is done on circular saw

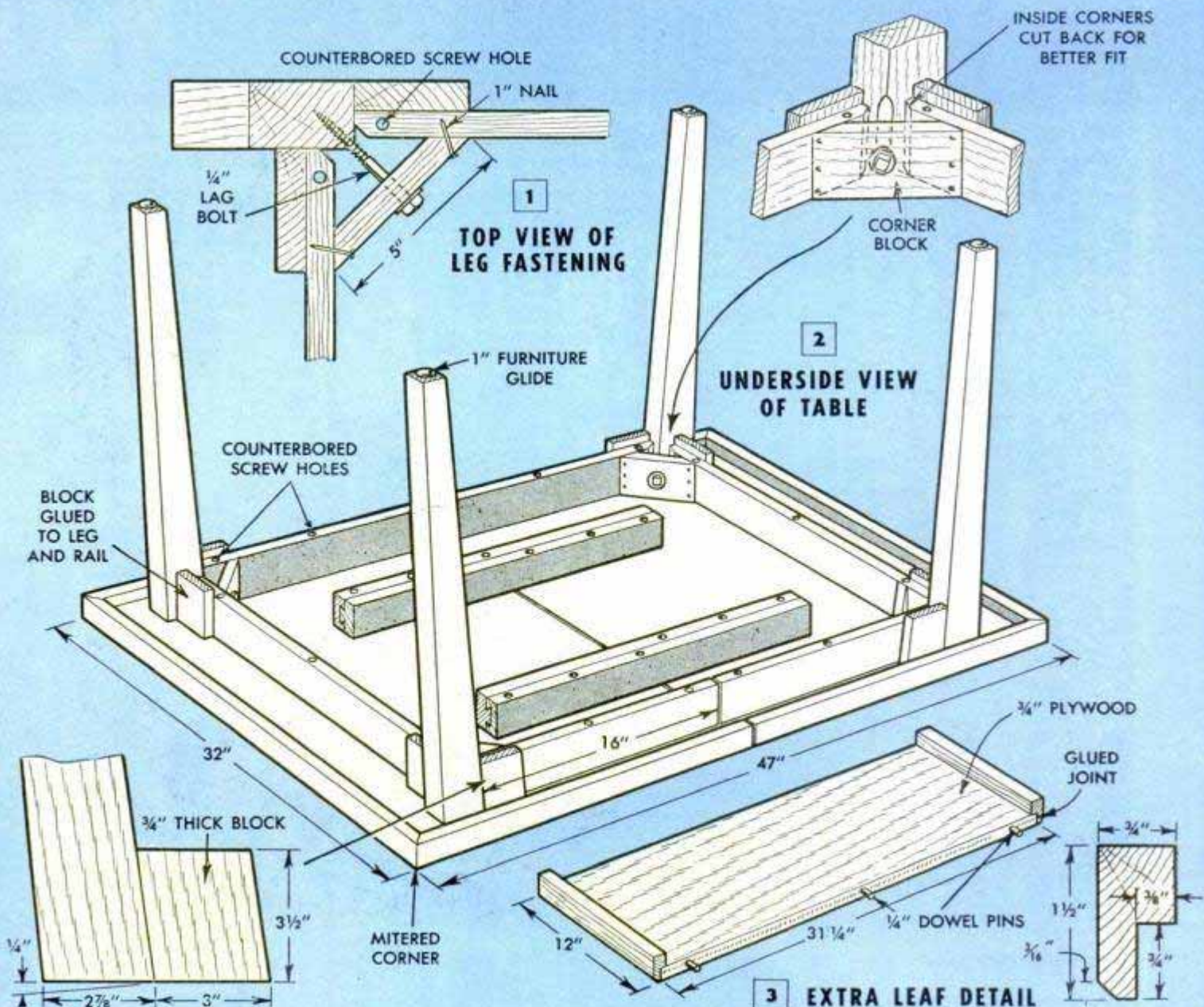

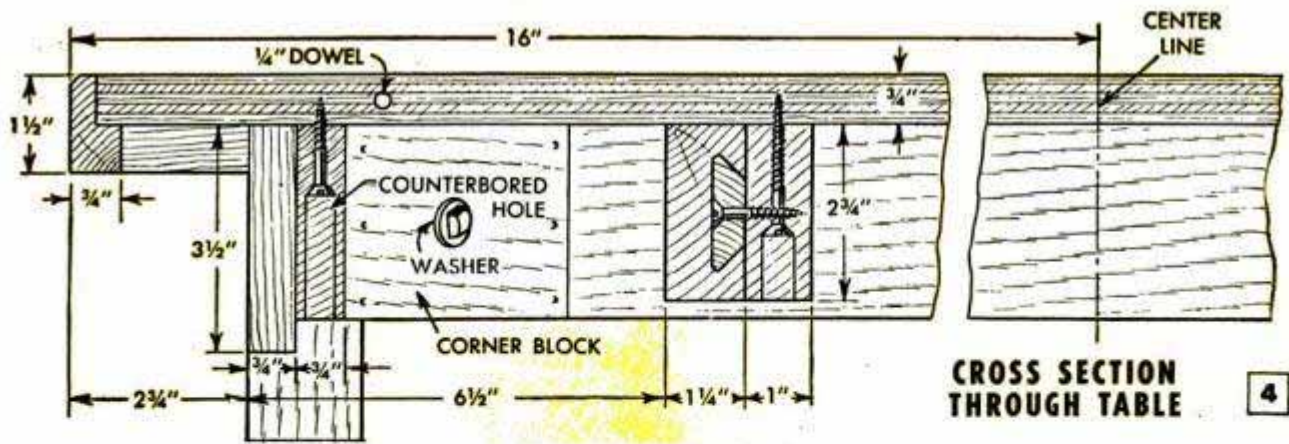

CROSS SECTION THROUGH TABLE 4

set of large blueprints which can be obtained from our book department.

Construction of the table is detailed in Figs. 1 to 7 inclusive. Like the bedroom furniture, which incorporated the use of both plywood and solid stock, the table top and extra leaf are cut from 3/4-in. plywood to save the work of gluing up solid stock. All the rest of the table is made of solid material. A 3/4 x 1 1/2-in. facing or edging strip, mitered at the corners and rabbeted on the back, is glued and nailed to the edge of the plywood to conceal the laminations. The top, of course, consists of two separate sections having the conventional aligning pins and holes in the edges at the joint. The sectional view in Fig. 4 indicates the position of the legs and the slides and also shows how the 3-in. aprons, or rails, are screwed to the underside of the top. The ends of the end aprons are cut off squarely, while the two-piece side ones, which butt together at the joint, are cut at an angle to match the slant of the tapered legs. Locate the side aprons 3 1/2 in. in from the edge of the top and the end ones 6 in. inward. Then glue and screw them securely to the plywood.

The tapered legs, Fig. 7, are cut from 1 3/4-in. stock. Note in the detail at the left of Fig. 3, that the tops of the legs are cut at a 1/4-in. angle. Each leg is placed in the corner formed by the aprons and drawn up rigidly with lag screws. Corner blocks are drilled for the screws and then glued and nailed to the aprons as shown in Fig. 1. The lag screws are the only fastenings the legs require and, if the legs loosen with use, it is easy to make them rigid simply by drawing the lag screws tighter. Additional rigidity is had by the eight overlay blocks which are applied to the face of the aprons at the corners. Note that the blocks at the sides of the table are fitted flush with the face of the legs.

Figs. 4, 5 and 6 show how the dovetail joint is formed in the table slide. The

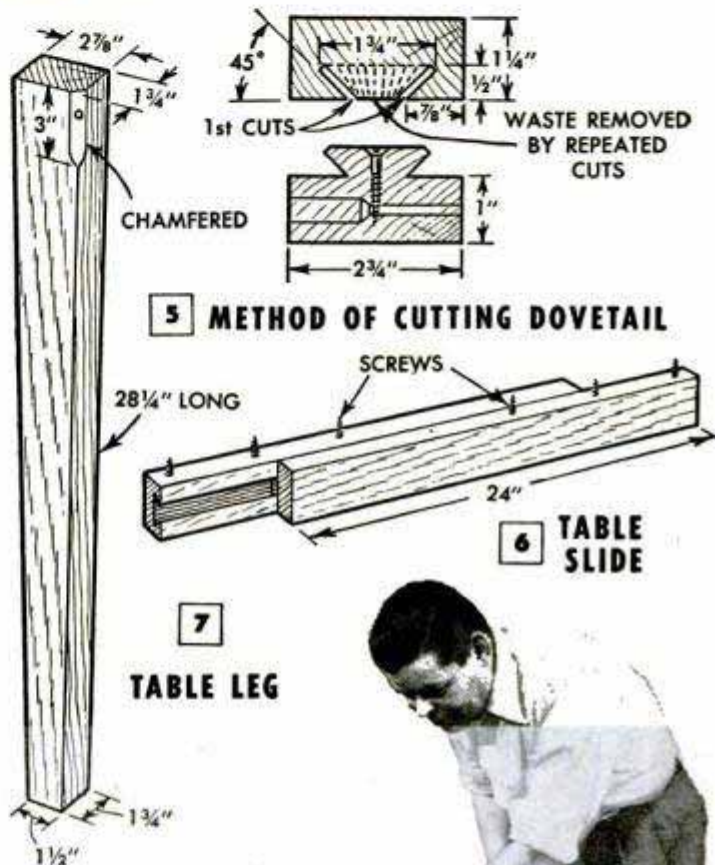

5 METHOD OF CUTTING DOVETAIL

6 TABLE SLIDE

7 TABLE LEG

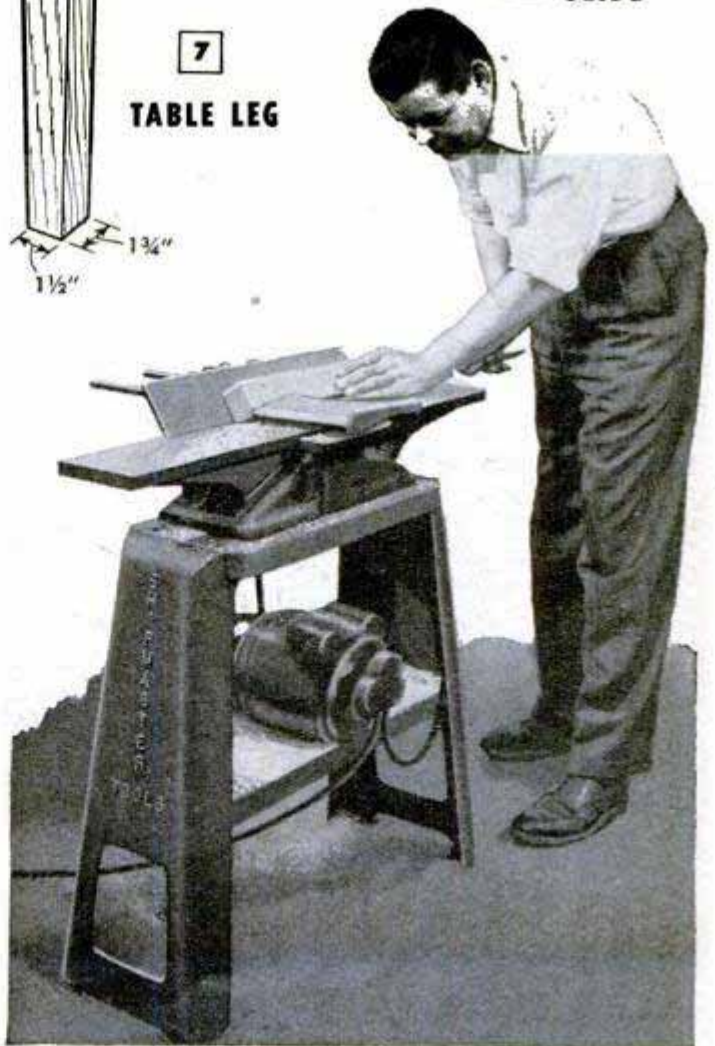



tenon on the male member of the slide consists of a separate strip shaped as shown and screwed to the face of the piece. This strip engages a matching groove in the female member. The groove can be cut on the circular saw by first making the two 45-deg. outside cuts and then removing the waste portion with repeated cuts, varying the angle of the blade slightly each time. The male members of the slide are glued and screwed to one half of the table and the female members to the other, using three screws in counterbored holes. A coating of wax will make the slides work smoothly.

Chair-frame construction is detailed in Figs. 9 to 12 inclusive. Whether four or more chairs are built, at least one should be made a guest, or host, chair by adding arms as shown in Fig. 8 and increasing the width of the front and back, Fig. 11. The over-all height and depth remain the same. Identical parts can be mass-produced to save time by using stops and jigs on the saw. As the legs are the only part of the

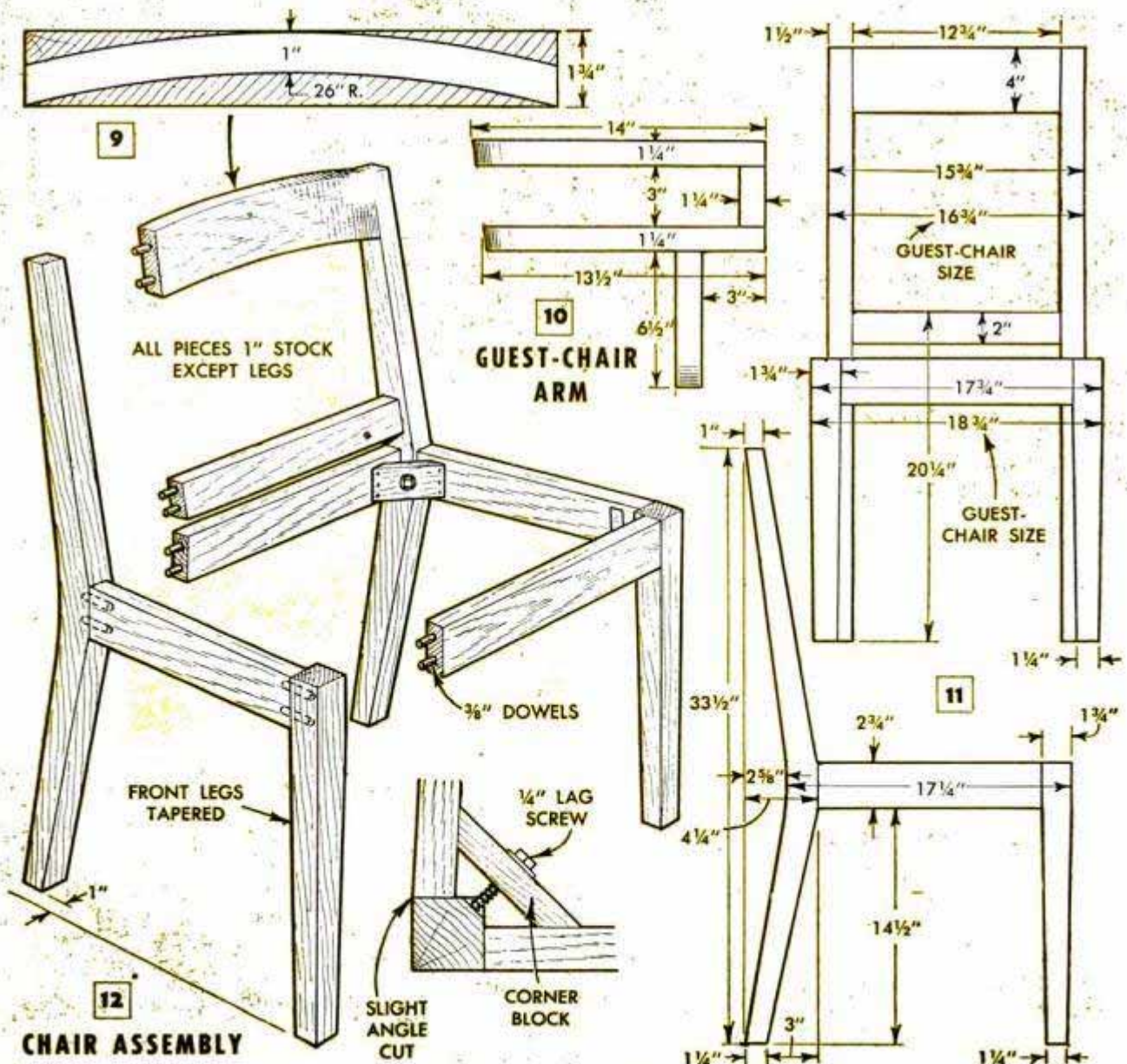

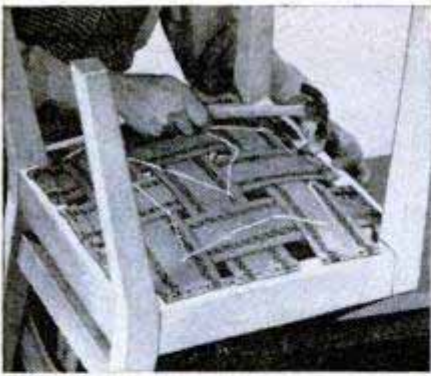

13 WEBBING ENDS DOUBLE-TACKED

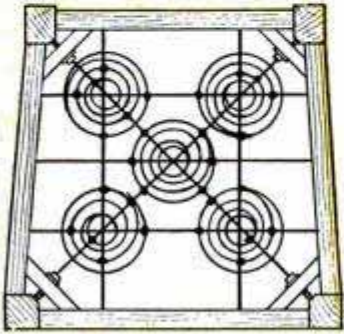

14 SPRINGS CROSSTIED LIKE THIS

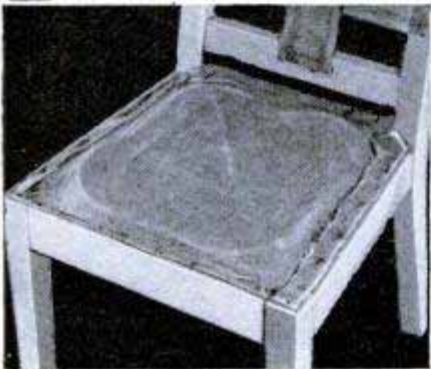
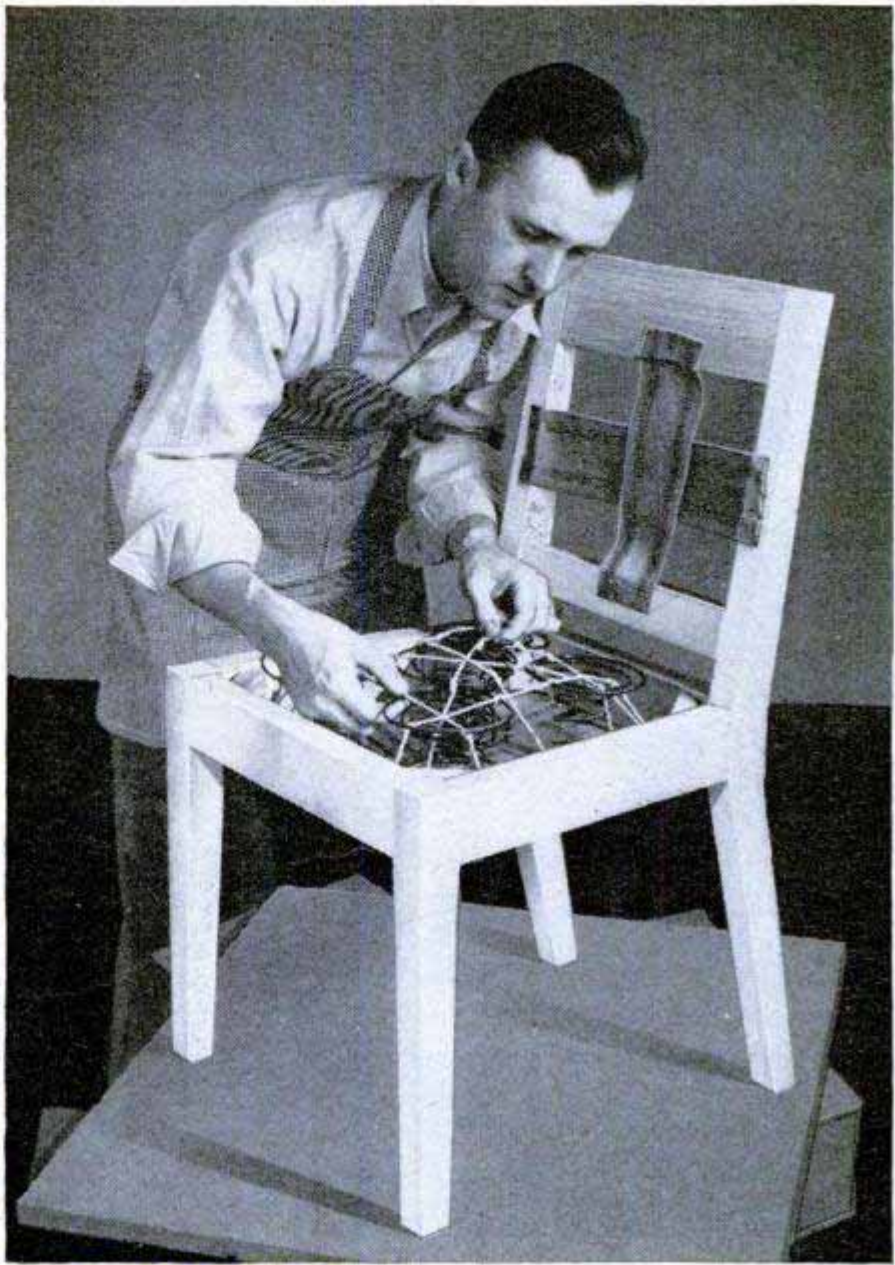

15 BURLAP IS TACKED OVER SPRINGS

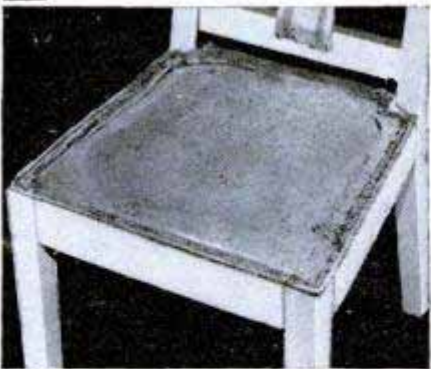

16 THEN FELT IS TACKED TO EDGE

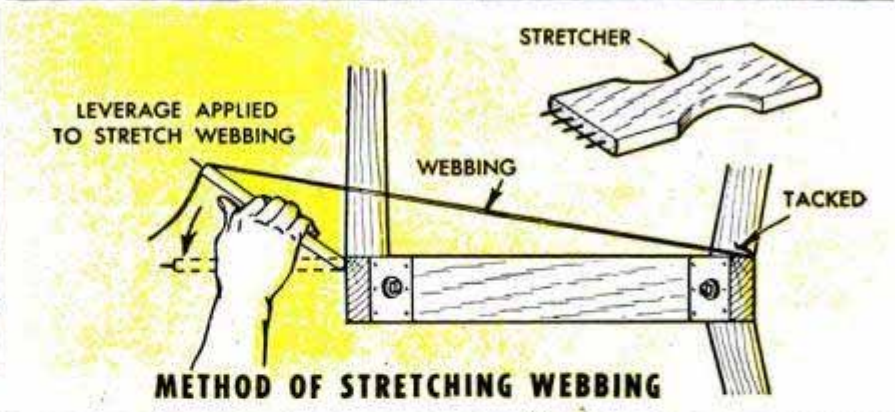

17 MOSS FILLING COMES NEXT



18 THEN IS COVERED WITH COTTON

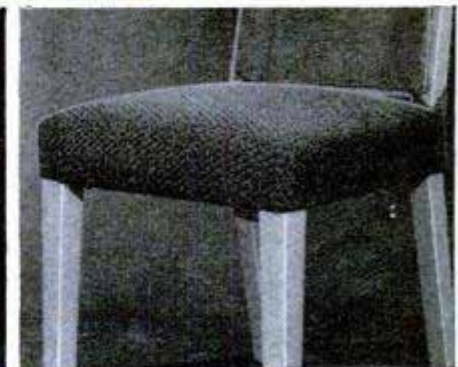

19 AND HERE'S THE COMPLETED SEAT

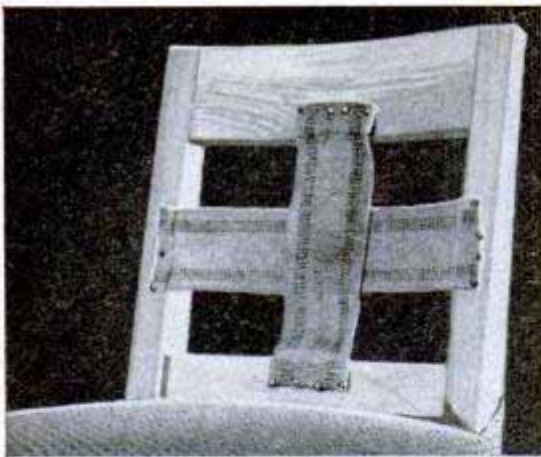

20 FIRST, WEBBING IS APPLIED TO THE BACK

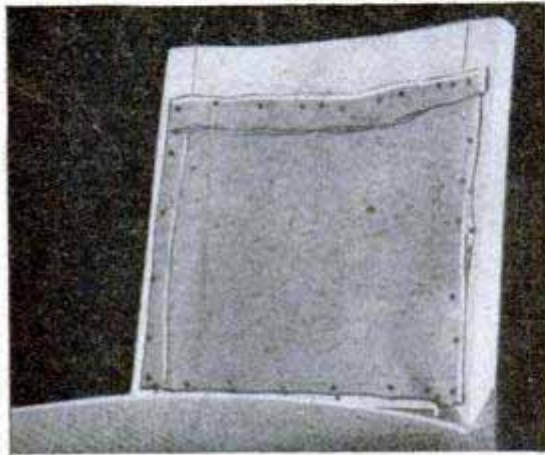

21 THEN WEBBING IS COVERED WITH BURLAP

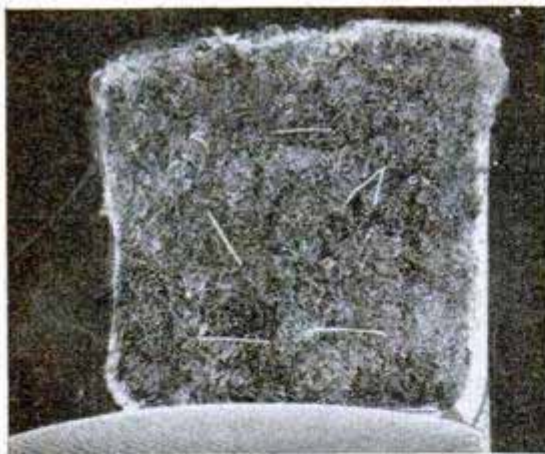

22 LAYER OF MOSS IS TACK-SEWED TO BURLAP



23 COTTON IS ADDED NEXT, THEN THE FABRIC

frame exposed, the rest of the assembly can be rough. The important point is rigidity. Note in Fig. 12 that all members are doweled and each corner of the seat is braced with lag screws the same as the table. The curved back rail is band-sawed from a piece $1\frac{3}{4} \times 4$ in., Fig. 9, while the front legs are tapered on all four faces from a point $2\frac{3}{4}$ in. from the top. The exposed part of the legs should be finished before upholstering.

Upholstering the chairs is a fairly easy job as pictured in the series of photos, Figs. 13 to 23 inclusive. Starting with the seat, the first step is to tack furniture webbing to the bottom, Fig. 13. Six strips are interlaced and stretched tautly in the manner indicated in the detail to the right of Fig. 16. The ends of the webbing are left about 1 in. long for folding back and double-tacking. Five No. 1 plain-end coil springs are used in the seat. These are placed in position, tack-sewed to the

24 PATTERNS

These fabric patterns were taken from the actual covering on one of the chairs and are somewhat approximate in size. While over-all measurements are ample, the various cuts and folds indicated should be made while fitting to avoid an error

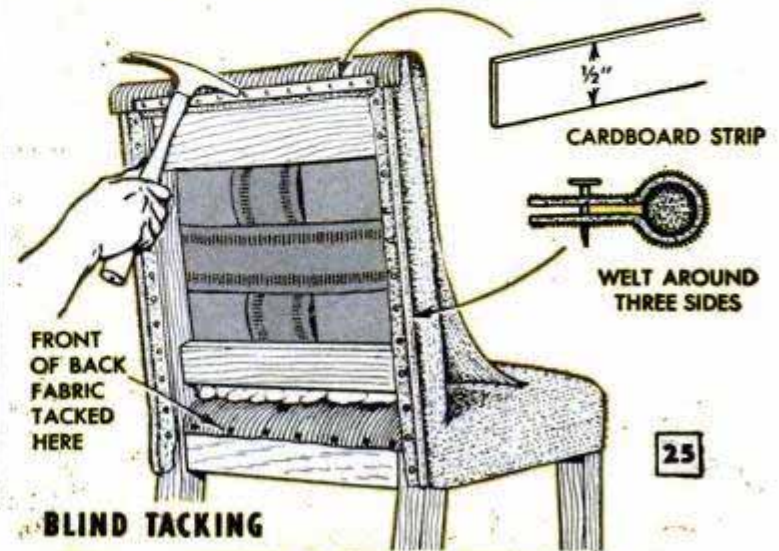
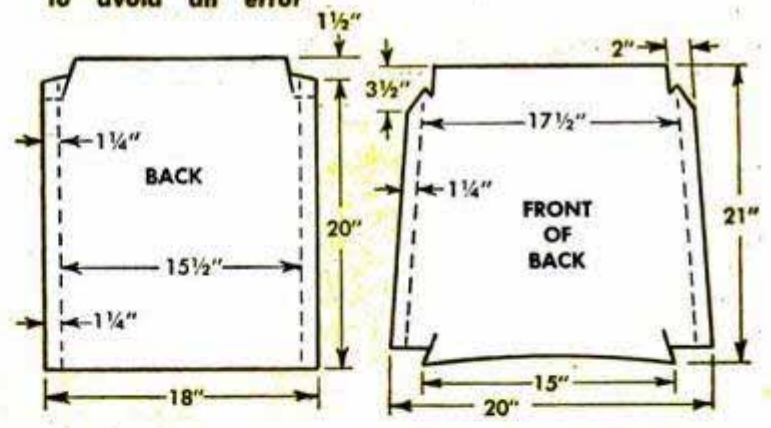
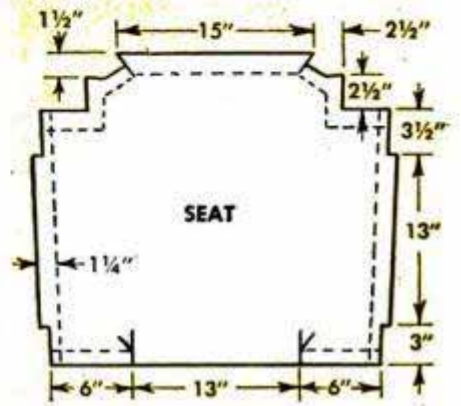

BLIND TACKING

webbing, and then tied and crosstied to the bottom of the seat rails as shown in Fig. 14. The dots in the drawing indicate knots and show the points where they are tied on the coil of each spring. The springs are pulled down or compressed so that the center one is about 1½ in. above the top of the seat. The spring twine is brought down through holes punched in the webbing and tacked securely to the underside of the rails. Next, the springs are covered with burlap, Fig. 15. The edges are tacked, folded over and retacked, and then a welt edging is tacked around the outer edge on three sides, Fig. 16. The welt used here is the same as used later on the back, Fig. 25, except that being hidden it can be made up of scrap material wrapped around a length of ¼-in. rope. Hair, tow or moss filling is added next, Fig. 17. This is held in place by tack-sewing it to the burlap. A layer of cotton is applied over the filling so it covers the sides of the seat rails, Fig. 18. After this, the whole job is covered with the finished fabric, and the completed seat should look like Fig. 19. Patterns for the seat covering as well as the rest of the chair are given in Fig. 24. The various cuts and folds indicated by the dotted lines are merely approximate and should be made as the work progresses. The seat fabric is stitched at the front corners before applying to form a box covering and should fit snugly to give a nicely tailored job. When completed, the underside of the seat is covered with black cambric, the edges being folded under.

The back of the chair, while it contains no springs, calls for a similar procedure. Two strips of webbing are tacked to the back, Fig. 20, and then it is covered with burlap, moss and finally cotton. The cotton is brought around the sides and over the top and the lower edge is folded up under the moss. Note in applying the covering to the front of the back that the fabric is first pulled through and tacked to the face of the rear seat rail, Fig. 25. Before the back covering is applied, a welt made of the finished fabric is tacked to three sides. Then a strip of cardboard, ½ in. wide, is cut to fit across the top between the welt at the sides. The fabric is tacked at the top first, driving the tacks through the cardboard strip as in Fig. 25. This method is called blind tacking, and in addition to concealing the tacks, the cardboard strip provides a firm straight edge so that in pulling down on the fabric there are no irregular pleats in the cloth caused by the tacks. With the top tacked, the fabric is brought down over the back, the edges folded under and hand-stitched to the welt. Blued gimp nails are used in tacking the covering where it passes over the exposed surface of the legs.

(To be continued)

Tent Stretched Between Car Seats Confines Dog to Rear Floor



To bring home a wet dog from a hunting trip or just to keep a shedding dog off the rear seat of the car, confine him to the floor by means of a tent stretched between the seats. Using safety pins, fasten a piece of canvas or a blanket between the bottom of the rear seat and the top of the front seat. The tent should be as wide as possible to keep the dog from getting out, while still allowing plenty of ventilation to keep the animal comfortable.

L. W. Lefler, Abilene, Tex.

Partitions Inserted in Cigar Box Divide It Into Separate Sections

Storing different types of small parts in a cigar box without getting them mixed can be done by dividing the box into separate sections with adjustable cardboard partitions. Cement strips of corrugated cardboard to the inside of the front and back of the box. Then, after cutting pieces of thick cardboard to fit tightly across the width of the box, slip them into the corrugations.

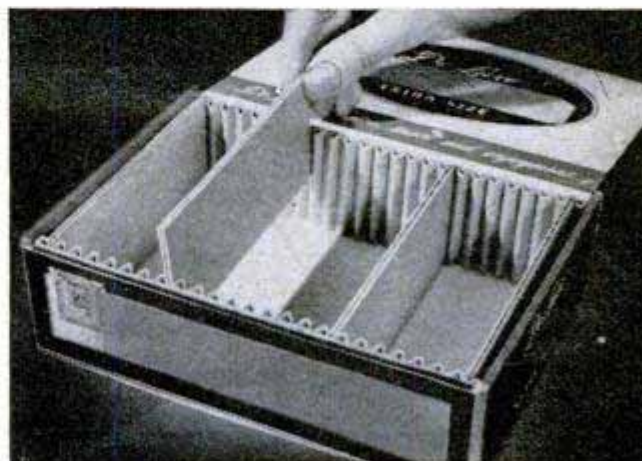

#12-31

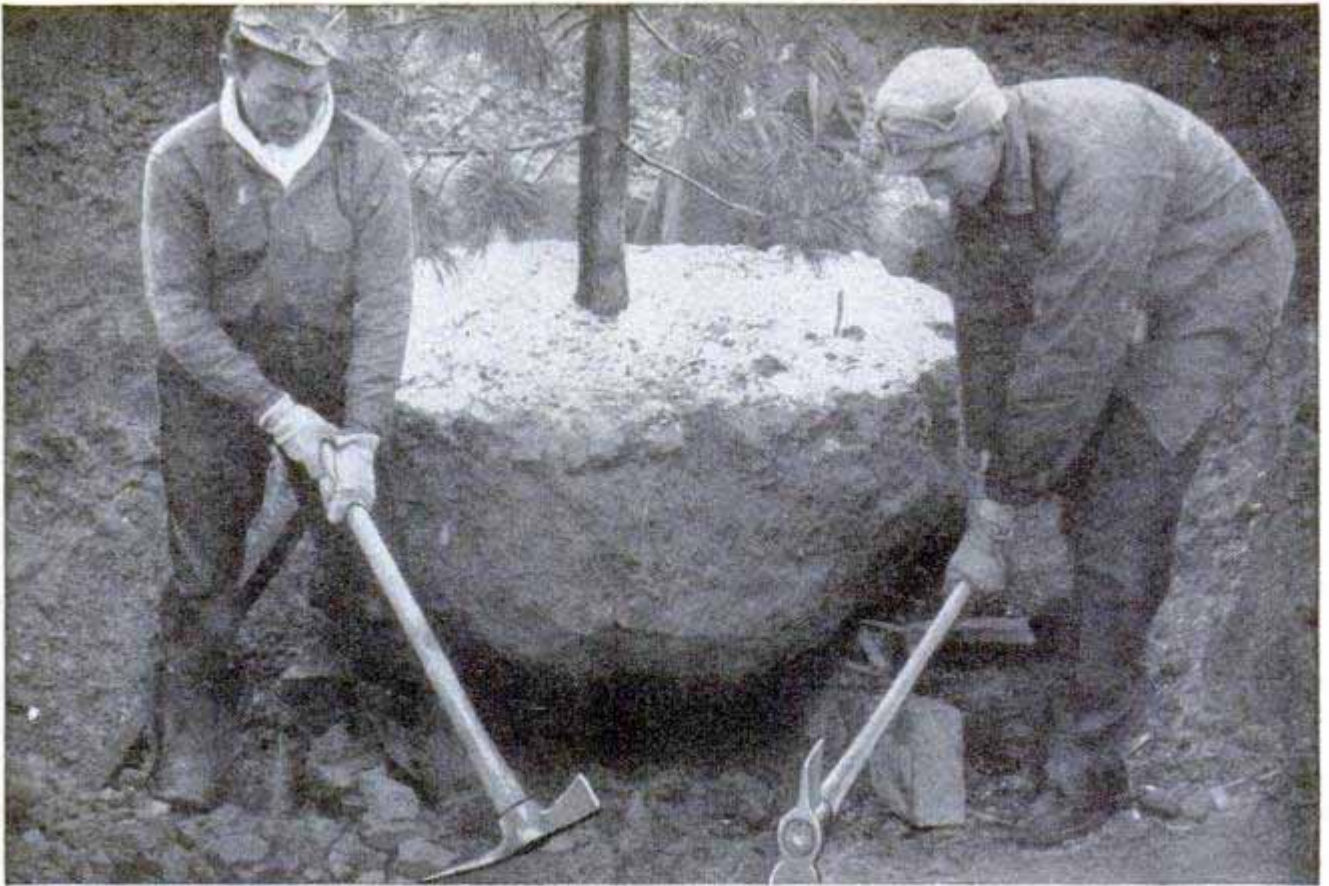

Moving Day for Trees By Robert D. Sawyer

IS THERE a tree or shrub spoiling the looks of your yard—one that you wish were planted elsewhere? Often this is the case, especially around older homes where the landscaping has been neglected. Moving even a fairly large-size tree is a comparatively simple job if done as suggested

by G. W. Longenecker of the University of Wisconsin.

Although deciduous trees and shrubs can be moved at any time, they are more easily handled and are less likely to be damaged if moved while dormant. Evergreens should be moved only during the period of

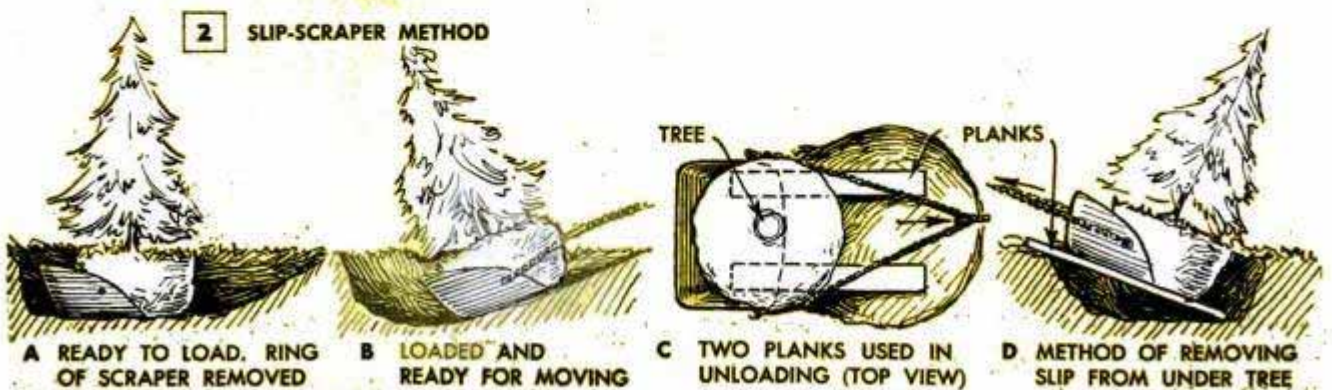

least active growth, that is, in the early spring or, better still in most localities, in August or September. Preparations should be made beforehand. Mulch the area under the tree to prevent deep freezing in winter and retain moisture in spring and summer. This will make digging easier. A good rule for determining the size of the earth ball is to measure the trunk of the tree and for each inch of trunk diameter allow 1 ft. for the diameter of the ball. If the trunk is 4 in. in diameter, the earth ball should be at least 4 ft. in diameter and 30 in. deep. If the tree is one of the evergreen types having a large taproot and is an exceptionally fine specimen, it will be best to go even deeper to include as much of the root system as possible in the earth ball. Surface-rooting trees, such as the maple, require only a shallow ball. In digging the soil away from the ball be careful not to cut the main lateral roots. Dig these up with a spading fork, wrap them in burlap and tie them into the earth ball. The wrappings must be kept moist until the earth ball is cut out completely, wrapped in burlap or canvas and bound ready for moving. When the ball has been prepared, the tree should be moved to its new location and set without delay. Fig. 1, details A, B and C, and Fig. 2, details A to D inclusive, show two acceptable methods of moving small and medium-sized trees. Care must be taken during the operation to prevent breaking the ball of earth. It should be removed and reset intact for best results. The excavation to receive the earth ball should be made beforehand and should be larger than the ball. The top of the ball of earth is set slightly below grade level. After removing the covering, straighten the lateral roots and pack fresh soil around the ball in layers, tamping each layer to eliminate air pockets. If the tree is a fairly large one, it should be guyed, as in Fig. 3, to hold it upright until the lateral roots anchor themselves in the new location. The installation of feeder tile, Fig. 4, is helpful in assuring the rapid recovery of a larger tree after transplanting. Pouring a small quantity of high-nitrogen fertilizer in each tile at regular intervals throughout the first growing season will provide an ample supply of plant food. Add water after placing the fertilizer in the tiles. Mulch an area

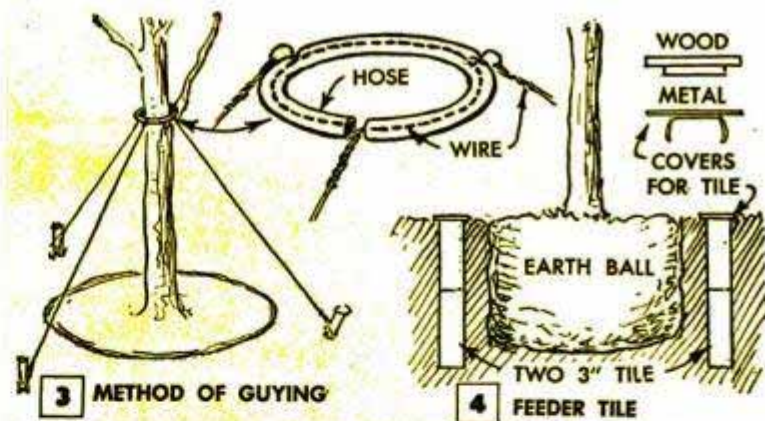
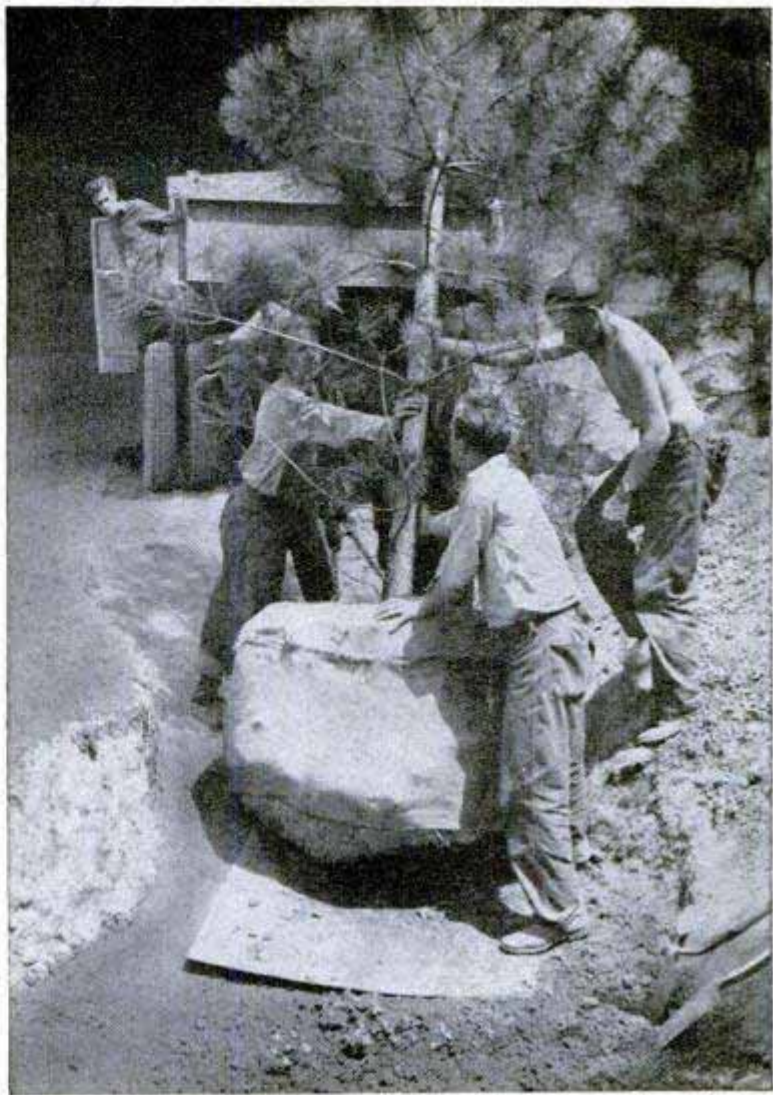

under the tree equal to the spread of the branches and keep this area well watered throughout the first growing season. Shear large arborvitae and juniper after transplanting and restrict new growth of large spruce, pine and fir by pinching out a portion of the lower terminal buds. Remove guy wires after the first growing season and during this time examine the wires occasionally to make sure they are not abrading the bark of the tree. This is quite important for, if the hose pad wears through or breaks, the wires will quickly cut through the bark and leave a wound that will never heal smoothly, especially on large specimens of certain varieties.

Twin Spheres Form Mysterious Letter Holder

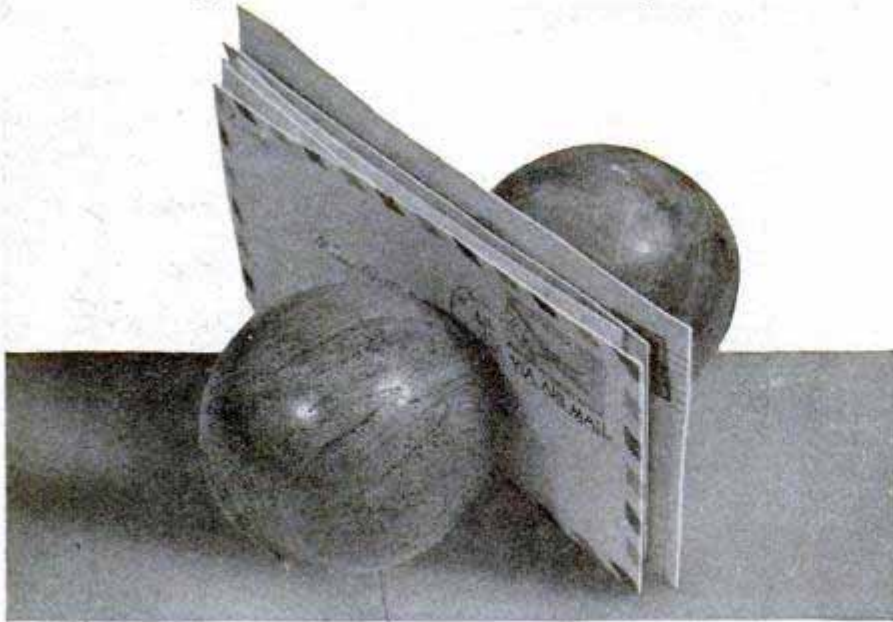

Consisting of two identical spheres which are drawn together by magnetic attraction, this unusual letter holder is a constant source of interest. Each sphere is turned from two blocks of selected crotch or burl walnut. A tongue-and-groove joint is first formed in the blocks and matching recesses are cut for a snug fit for a 4-oz. magnet. Note that the magnets are located off-center to bring them closer to the surface of the wood and also to keep the spheres from rolling when they are separated. With the magnet in place, the blocks are glued together and then mounted in the lathe for turning. A cardboard template is used as a guide and care is taken not to cut into the tongue-and-groove joint. Before the sphere is parted from the waste stock, it is sanded and finished with shellac. The ends are finished by hand.

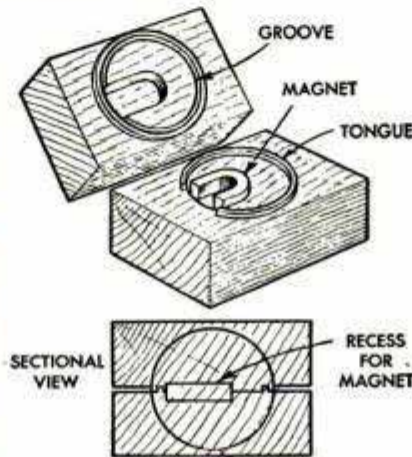

Siphoning Aquarium Facilitated by Strainer Held Over End of Hose

A small tea strainer comes in handy when using a hose to siphon water from a large goldfish aquarium. Holding the strainer over the end of the hose speeds the siphoning operation by preventing plants and fish from being sucked through the hose. Pat Fey, New York City.



Paper Bags Tied to Stovepipe Retain Soot During Removal



When stovepipes are taken down for cleaning, much extra work is saved if soot is kept from spilling by closing the ends of the pipes before carrying them outside. This is done by fastening large

paper bags over the pipe with rubber bands or string. The bags can also be used to collect the soot as it is loosened.

A simple sleight-of-hand trick that is always entertaining, this "magic" Chinese coin disappears just as fast as you can slip the drawer in and out of its box. The idea of the illusion is that when the coin is placed in the hole in the top of the drawer, it rests in one of two holes in a sliding panel. Then the drawer is slipped into the box and a pin pushes the panel to the other end of the drawer, bringing the empty hole in line with the hole in the lid. To make the coin reappear, the drawer is reversed end-for-end and again slipped into the box. The entire unit is built up of

$\frac{1}{8}$ -in. material except for the block at the back of the box, which is $\frac{3}{8} \times \frac{5}{8} \times 1\frac{1}{2}$ in. A piece of stiff wire is inserted tightly into a small hole in the side face of this block so it projects $1\frac{1}{4}$ in. The drawer consists of a bottom and lid separated by $\frac{1}{8}$ -in.-square strips, a hole for the wire being left between the strips at each end of the drawer. A panel retained within the drawer by the strips fits loosely enough to slide back and forth freely. Two 1-in. holes, spaced to the dimensions given in the detail, are drilled through the center of the panel, and a 1-in. hole is drilled through the exact center of the drawer lid. The edges of this

Chinese Coin Disappears Into Wooden Box For Amusement of Both Young and Old

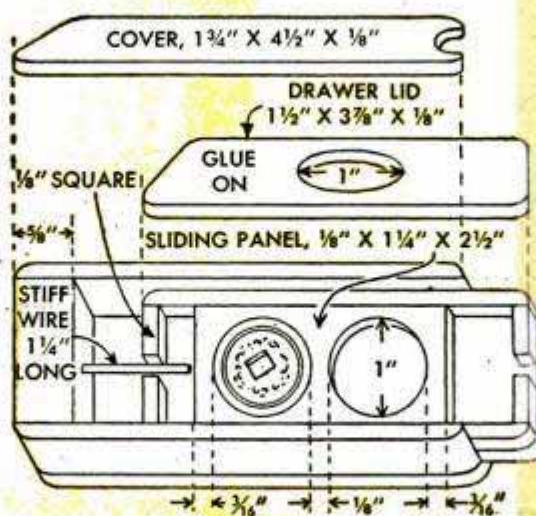

hole must be $1\frac{7}{16}$ in. from each end and $\frac{1}{4}$ in. from each side of the lid. It is important that the holes in the panel and the one in the lid be located very carefully, as one of the holes in the panel must be in exact register with the hole in the lid when the panel is at either end of the drawer. Test the location of the holes before gluing the drawer lid to the spacing strips. The exposed parts of the drawer should be selected for matching grain and the outside sanded carefully so the drawer appears to be a solid block to the audience. Wax applied to the drawer will make it work easily.

Hi Sibley, Nuevo, Calif.

Metal Tray Filled With Linseed Oil Keeps Paintbrushes in Good Condition

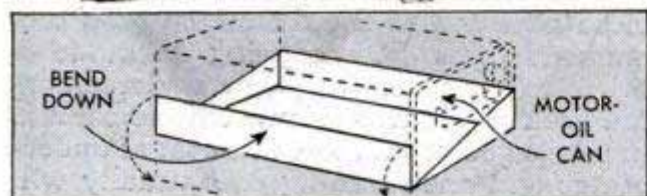

Set on a shelf or bench top, this handy tray keeps paintbrushes in sight for convenient selection even though their bristles are immersed in linseed oil. The tray is made from a motor-oil can by cutting it to provide a trough and a side flap. The latter is bent downward to form a leg which causes the bottom of the tray to slope toward the back. The trough is filled with linseed oil and the brushes are laid in a row with the bristles submerged in the oil. In this way, the ends of the handles project over the front edge of the tray.

Pearls Strung on Nylon Fishline

To hold a string of pearls tightly together, restring them on nylon fishline. If the string is stretched, the nylon will return to its original shape within a short time. At room temperature, the line is firm so that a needle is not required.

William F. Hunter, Minneapolis, Minn.

REPAINTING the OUTSIDE

By E. R. Haan

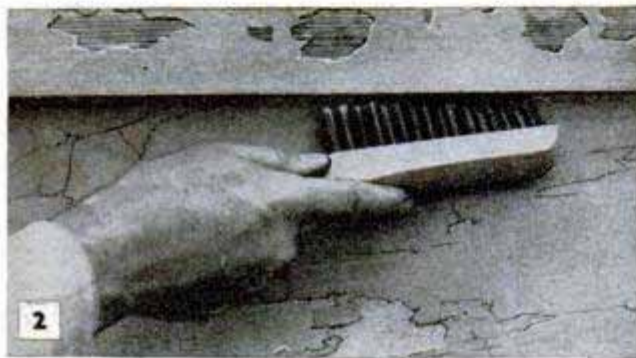

Remove all loose, flaking and blistered paint with wire brush and scraper. Exposed wood is then primed



Above, before painting, dust is brushed from corners and horizontal surfaces where it always accumulates. Below, after loose putty has been removed and the bare wood primed, new glazier's putty is applied



REPAINING the exterior of your home regularly every three to five years is the cheapest home repair. An unbroken film of paint protects the surface against weathering and against changes in temperature and variations in moisture content which cause swelling and checking of wood. Paint also discourages various fungus growths that flourish in the presence of moisture and cause rapid decay of siding and framing. A good paint job increases the appraisal value of the property as much as 10 percent by adding the beauty of durable harmonious color to both new and old homes. A little time spent in learning the proper painting procedures and how to wield a paintbrush with professional skill pays off in substantial cash savings to the homeowner who will tackle the job himself.

When to paint: Just when to paint depends on the local weather conditions but, in general, paint can be applied any time when the surface is dry and the temperature is fairly certain to remain above 50 deg. F. until the paint is dry. Avoid painting on hot, humid days or any time when a high wind is blowing as the freshly painted surface may become coated with dust and, in the summer, with small insects. The best time to paint a house is during a period of clear, cool weather, as the humidity usually is low and the drying conditions are ideal.

Selecting the paint: This depends to some extent on whether the building needs a one, two or three-coat job, and whether the first requirement is a full priming or only a spot priming after cleaning and dusting thoroughly. Manufacturers of paints now supply special primers, or undercoaters, for both new and old work which are especially compounded to "build" a suitable surface over which to apply a finishing coat. When preparing ready-mixed paints for use, pay close attention to the manufacturer's recommendations for reducing them to a brushing consistency. When undercoaters are used on old work on which the paint is in fair to good condition, one coat of undercoater and one finishing coat usually will

67 72 5 1 #1

This is the first of a series of articles on how to make simple inside and outside home repairs, do regular maintenance jobs on schedule and add minor improvements. Each step is clearly described so the homeowner can do the job himself

produce a first-class job. Master painters seldom use three coats except in some cases where it is necessary to remove all the old paint down to the bare wood or, in rare instances, where the color used makes a three-coat job necessary to build a paint film of sufficient body to hide discolorations or other surface defects. Very often one coat will be sufficient to produce a crisp, neat job over old paint of the same color which is in better than average condition.

How much paint: Although there are many factors which will determine the actual amount required for the job, it's easy to get a rough estimate of the number of gallons needed by figuring the number of square feet to be painted. Just multiply the width in feet by the height on rectangular areas. On the gables, multiply the width by one-half the height. Add the results and do not deduct for windows or doors. On a fair to good surface, a gallon of outside paint, or undercoater, will cover with one coat about 600 sq. ft. However, the coverage will vary from 450 to 750 sq. ft. depending on the condition of the surface. On a good surface, the coverage per gallon of the finish coat over an undercoater will probably average 750, and possibly 800 sq. ft. The undercoaters greatly extend the coverage of the finish coat even on surfaces which are in relatively poor condition.

Preparing the surface: Chalking of paint is a normal weathering process unless, of course, the chalking is excessive. On a surface that is chalking normally, a slight rubbing on a small spot will produce a dull luster. If this condition is uniform all over the building a light dusting will prepare the surfaces for painting. On





6
Caulking seals open joints where doors and windows join masonry. A gun applies it easily and quickly



7
FIRST BRUSH DUST FROM CRACKS

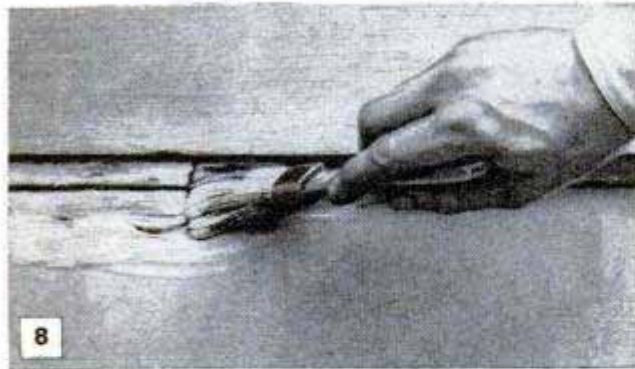

8
NEXT, APPLY PRIMING COAT

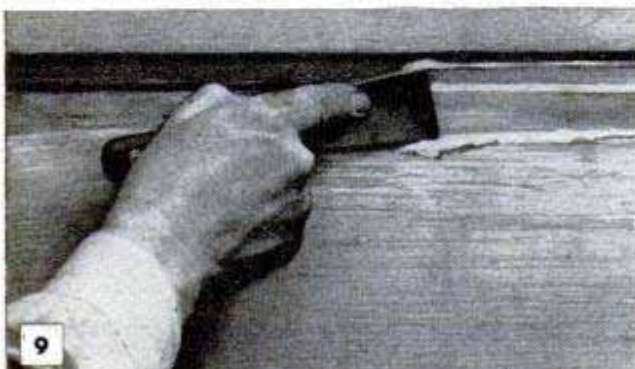

9
THEN FILL WITH "WHITE LEAD" PUTTY

the other hand, if bare patches of wood show here and there and if rubbing the surface fails to produce even a dull luster, wire-brushing will be necessary to clean the surfaces of fine, loose particles and flakes of paint pigment. Two coats will be needed to finish such a surface. If the old paint is broken by fine checks or has blistered and peeled rather badly, then more labor will be required to prepare the building for repainting. All the loose material must be removed by scraping and wire-brushing, Fig. 2. The rough edges of the paint film around the bare spots where blisters have occurred must be leveled by sanding and building up a new film by spot-priming. (Caution: It is advisable to wear a respirator when sanding, scraping or wire-brushing a painted surface.) Areas which are deeply checked by horizontal and vertical cracks—painters refer to this condition as an "alligator" surface—may either be sanded smooth or the paint removed entirely with a paint remover and the paint film rebuilt by prime-coating, followed by the regular undercoater and finish coats applied in the course of painting the whole structure. When preparing the building for repainting, examine the surface closely for the light-brownish discolorations caused by paint mildew. This is more likely to be found on old structures just above the foundation and under a wide cornice, and also on the siding back of large shrubs. The fungi, or molds, which are responsible thrive only in the presence of moisture and the cause should be removed before repainting. The dry mold can be removed by washing with household ammonia or with a solution of trisodium phosphate. Rinse with clear water after washing. All minor structural repairs, such as nailing loose siding, filling cracks and replacing gutters and downspouts which are no longer serviceable, should be made before repainting. Dust window sills as in Fig. 3 and prime and reputty old sash as in Fig. 4. Remove all the loose putty first, then prime the open rabbet before applying new putty. Fill cracks and nail holes, using the procedure pictured in Figs. 7, 8 and 9, with special white-lead putty consisting of 1 part white lead in oil and 2 parts of whiting by volume. This is softened to a working consistency with japan oil. Calk around door and window frames as in Fig. 6, using a gun and caulking compound of gun grade. Spot-prime all areas where the old paint has been removed down to bare wood. Seal any exposed knots and resinous areas with orange shellac.

Brushes and equipment: For the average job you'll need a 1-in. sash brush, a 3-in. brush for doors and trim, and a 4 or 5-in. brush for painting the siding. Carry a dust-

ing brush, a putty knife, a wire brush and a scraper. Ladders needed will depend on the size of the house, of course, but a step-ladder is essential and an extension ladder will be needed to reach the high gables. Usually, painting of the walls can be done faster and safer from a scaffold rigged with heavy planks and ladder jacks. The two sections of the extension ladder can be used for this purpose.

Mixing the paint: Both the undercoater and the finishing paint must be thoroughly mixed before using. Pour the paint from the pail into a larger container and stir with a flat paddle, adding reducer in small quantities as the stirring proceeds. To check the consistency, lift the paddle from time to time. When the mixture has been thinned to the proper brushing consistency, the paint on the paddle will run back into the container in a thin, steady stream which finally breaks into a series of drops. If the paint drips slowly into the container, it is too thick and will drag under the brush.

Where to start: As a rule, one should begin painting at the peak of the highest gable and work down as in Fig. 5. When working from a ladder, it usually is more convenient to bring the trim down on the high gables at the same time the siding is painted. Otherwise avoid working with two colors at the same time. When painting siding, begin at the corner board or, on gables, at the frieze board, and paint the lower edges first as in Fig. 10. Then lay the paint on the flat surfaces and brush it out by using the procedure detailed in Fig. 11, A to D inclusive. When painting siding, do not attempt to cover a panel more than five to eight boards in width. Finish this panel across the wall to a corner, or to a door or window before stopping. If you stop anywhere on the wall for more than a few minutes, the paint will set partially, making it impossible to brush out the lap when you begin again. This lap will show under several coats of any light-colored paint. It's a rule always to finish the panel to a corner or other suitable stopping place before you end work for the day or for other reasons.

Handling the brush: When working from a ladder at the higher levels, it's usually handier to paint above the ladder, as you can reach both ways and thus avoid the labor of moving a heavy ladder frequently. In handling the brush on long strokes, use a free and easy motion of the arm and wrist. The trick in lifting the brush off the painted surface without leaving a mark at the end of the stroke is to turn the brush slightly as it is lifted. This movement lifts the bristles with a wiping motion which does not leave a mark on the fresh paint film. Leveling and finishing strokes should overlap, details C and D in Fig. 11. Finishing

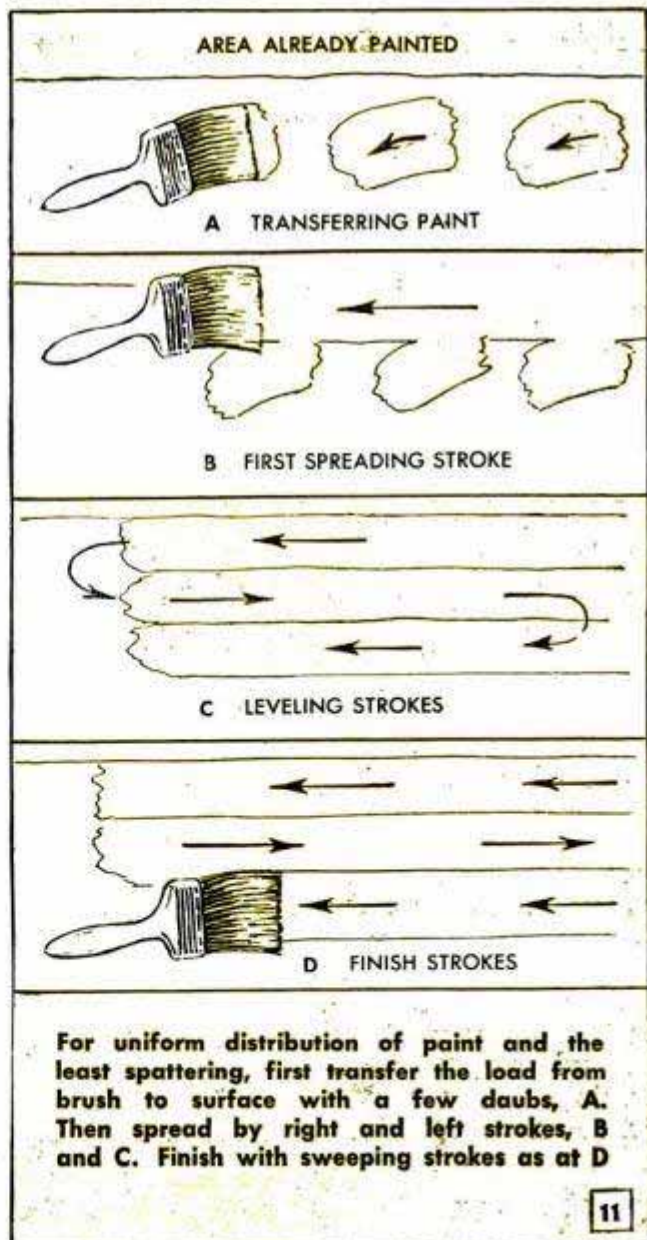
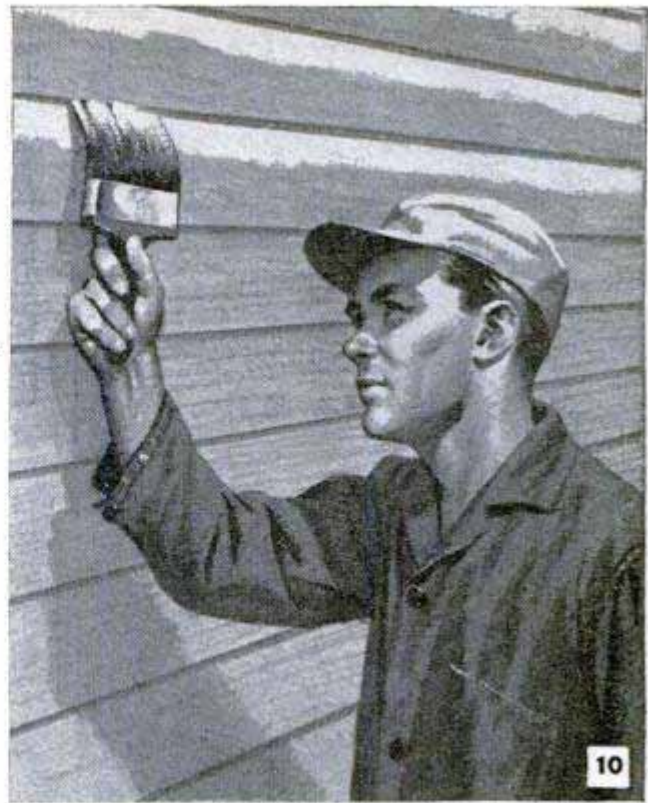



12

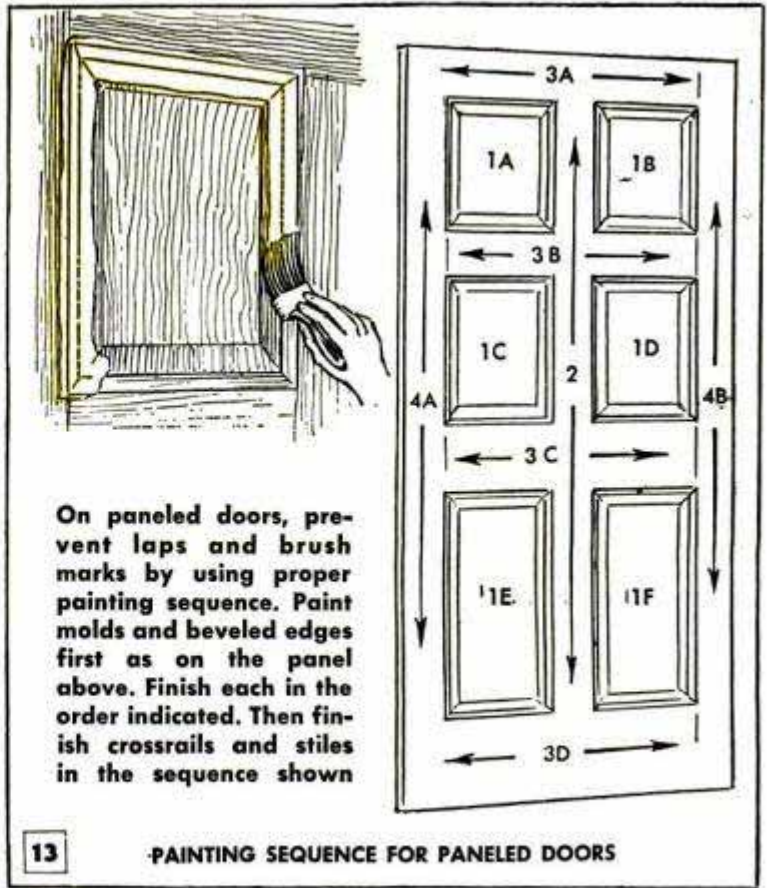

On paneled doors, prevent laps and brush marks by using proper painting sequence. Paint molds and beveled edges first as on the panel above. Finish each in the order indicated. Then finish crossrails and stiles in the sequence shown

13

PAINTING SEQUENCE FOR PANELED DOORS

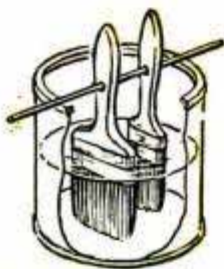

14 A BRISTLES MUST BE SUBMERGED ENTIRELY



B PAINT CLEANED BY STRAINING

strokes should be light to avoid carrying the paint from one area to another, resulting in an uneven coverage. Each time the brush is dipped in the paint, slap the bristles against the side of the pail to remove the excess which may otherwise drip onto the siding below or onto the ground and be wasted. The first coat will require more brushing than the second, or finish, coat. Care must be taken to brush each coat to a uniform thickness. On buildings which have not been painted for a number of years the surface will absorb the oils in the first coat more quickly than will a surface which has been painted recently. Here, special care must be taken to prevent the undercoater from building too fast as it is applied, resulting in a heavy, uneven coating which may wrinkle or break up on drying. One way to avoid trouble under this condition is to cut down on the amount of paint picked up at each dip of the brush. Dust off the surface thoroughly just before applying the undercoat. On a good drying

day, the paint in the pail may tend to thicken somewhat owing to evaporation of a small quantity of its volatile oils, especially toward the end of the day. Add a little reducer and stir occasionally to prevent this. Drying time allowed between coats should never be less than 48 hours. A week to 10 days is better.

Sash, trim and doors: Cutting-in sash, Fig. 1, with a paint either lighter or darker than the trim color requires skillful handling of the sash brush to produce a neat, workmanlike job. It is, of course, much simpler to paint the sash with the trim color, particularly on double-hung wooden sash where otherwise it is essential to cut a sharp color line at the point where the sash stiles and the upper rail meet the stops. When trim color is used this is not necessary. In either case, the first thing to do is lower the upper sash so that you can reach the outer side of the lower-sash check rail. On double-hung sash, this is always painted the outside color as it is exposed to view from the outside when the lower sash is raised. In painting divided-pane sash, cut in the muntins first on both the top and bottom edges. (The muntins are the vertical and horizontal bars which join the stiles and rails of divided, or multiple-pane, sash.) Keep the sash brush well loaded with paint so that it will stroke, or cut, a full-bodied line to an unpainted edge. Paint the sash stiles and rails and the window frames and casings last. If the sash have been scraped and sanded in preparation for repainting, it

will pay to apply an undercoater. This will build a good base over which to apply the finish coat.

The proper painting sequence on a paneled door is pictured in Figs. 12 and 13. If the door and frame are in good condition, about all that will be needed to prepare for painting is a thorough wire-brushing and dusting. Then proceed as in Fig. 12 and the left-hand detail in Fig. 13, by painting the ovolo molds and the rabbeted portion of the raised panel. The proper sequence is shown in the right-hand detail, Fig. 13. Begin with panel 1A and continue in the order indicated until panel 1F has been finished. Cut-in the molds and rabbets first, then finish the entire panel. Next, take the center stile 2 and follow by painting top rail 3A first, then 3B, 3C and 3D. Finish with the outside stiles 4A and 4B. On an outside door, paint the top and bottom edges. If the door swings out, the edge on the lock side also takes the outside color. The outside color line comes to the outside corner of the doorstep all the way around the frame on doors that swing out. On doors that swing in, only the edge to which the hinges are attached takes the outside color. The outside color comes to the inner corner of the stops. To get a neat, sharply cut line around the hinges and lock plate requires careful work. Often it will save time to remove the hinges and lock plates before painting.

Painting metal: Gutters, downspouts and metal porch rails should be carefully wire-brushed to remove scale and rust. If the gutters have been previously primed and painted and the coating is still in good condition, repriming will not be necessary. New galvanized gutters and downspouts should weather six months before priming and painting. However, iron grillwork and railings should be primed with special primers before painting in the color desired.

Paint and brush care: Keep all paint containers closed tightly when not in use. The paint in the container you use regularly becomes contaminated with dust and particles of dirt. Strain frequently into a clean container through a piece of cheesecloth or silk hosiery as in Fig. 14, B. To prevent paint on brushes from hardening overnight hang them in water with the bristles submerged as in Fig. 14, A. If the brushes are out of use for a longer period, hang them in a solution of turpentine and linseed oil, equal parts. When the painting is finished for the season, clean brushes in two or three changes of turpentine, wash in a trisodium-phosphate solution and then in warm, soapy water. Before storing the brushes, rinse them thoroughly and, after drying, wrap them in oiled paper to protect the bristles from dust.

Turn Button on Garbage-Can Cover Keeps Contents From Spilling

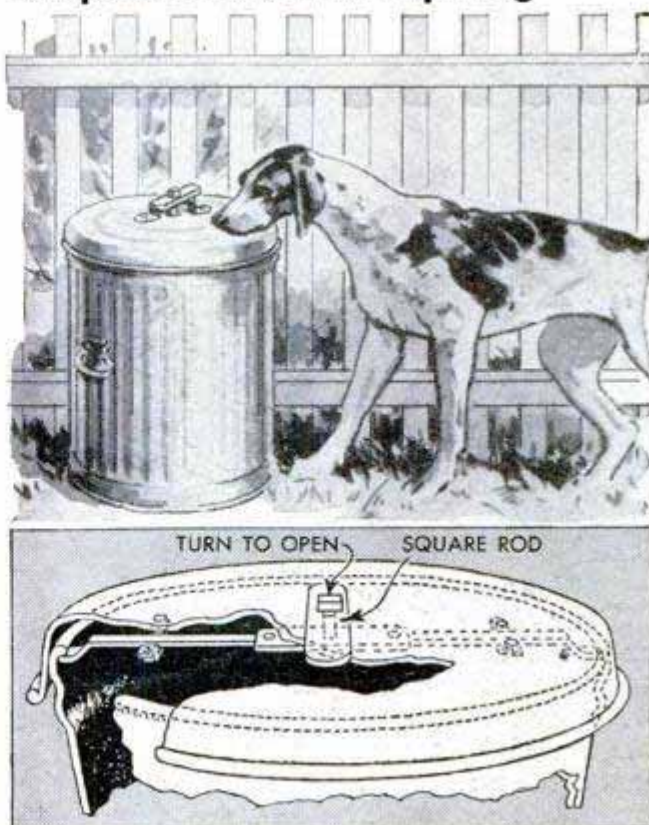

When a garbage can is often upset by stray dogs, the nuisance can be minimized by locking the cover to keep the contents from spilling. This simple locking mechanism, which grips the beading around the inside of the can rim, is operated by a flat-iron turn button. The latter, located on top of the cover handle, is attached with a length of square rod to a flat-iron center-piece located directly under the handle. Square holes to fit the rod are broached in both pieces of flat iron and round holes are drilled through the cover and handle. The ends of the rod are peened to hold it in place. A flat-iron arm is riveted loosely to each end of the center-piece so that turning the latter pulls the arm from under the can beading. Brackets bent from sheet metal or flat iron are riveted to the cover to keep the arms from dropping.

Aurin Warden, Dockton, Wash.

Sugar Deodorizes Teapot



If a teapot is used infrequently, try dropping a lump of sugar into it after washing and drying. Then, even though the teapot is stored on a shelf for weeks at a time, a musty odor will not be apparent.

Reflector on Basement Ceiling Directs Light to Workbench



Even though located right under a window, the workbenches in many basements get little, if any, sunlight, requiring artificial light for close work. To permit working at his bench in natural light, one craftsman installed an adjustable reflector on the basement ceiling. The reflector, which can be a mirror or a sheet of cardboard or plywood painted white, is hung directly opposite the window. The top end is hinged to the joists and the bottom is tied with cord or wire so that it can be raised or lowered. In this way, the greatest amount of sunlight can be directed to different positions on the bench top or to the area immediately in front of the bench.

Rudolph G. Kopp, Milwaukee, Wis.

Cooking With Indian Meat Spit

Stretching a green willow pole across two forked sticks forms an Indian meat spit which is excellent for outdoor cooking. Press the forked sticks firmly into the

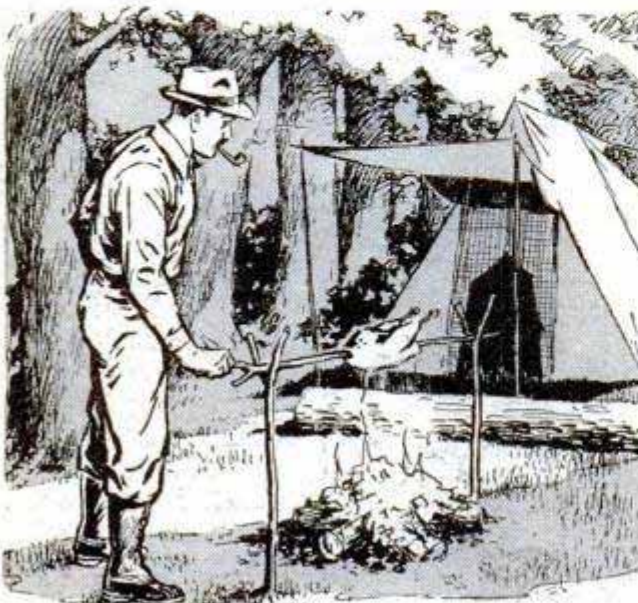

ground on opposite sides of the fire. Then, select a forked willow pole, leaving one arm of the fork longer to serve as a handle, and strip the bark from it. After sharpening the end of the pole opposite the handle, impale the meat on it and lay the pole across the support sticks. First, turn the spit slowly to allow the meat to crisp and seal in the natural juices. While the meat is cooking, rotate the spit every few minutes and baste the meat with bacon grease until done. The upright sticks should hold the spit high enough above the fire so the meat is not burned by the flames.

R. A. Jenkins, St. Louis, Mo.

Safety Pin Braces Photo Frame

To keep an easel-type photo frame from falling and possibly breaking when it is placed on a mantel or table top, use a safety-pin brace to hold the leg in the outward position. After cutting off the catch of the pin, insert the pointed arm under the cloth backing of the frame. Then, swing the pin so its other arm holds the easel leg open.—A. Ferreri, Chicago.

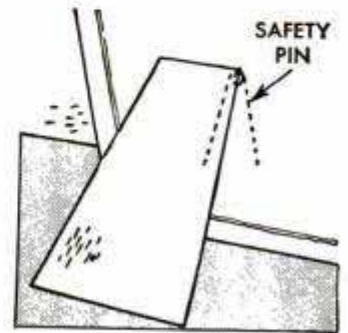

Hand Drill Clamped in Vise Aids Winding Trotline

Winding a trotline on a reel or spool is done quickly with the aid of a hand drill. The spool is slipped over a tight-fitting bit which is chucked in the drill and the side handle is clamped in a vise. The winding is done by turning the drill with one hand while the other guides the line onto the spool. String, thread or wire can be wound on spools in the same manner without kinking or becoming tangled. This is also a fast way to wind radio coils, provided the cores have a hole through the center to take the bit.

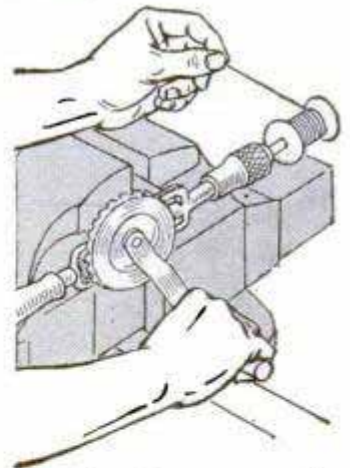

Herbert E. Fey, New Braunfels, Tex.

☐ After the feathers have been picked from game birds or waterfowl, pinfeathers will come out easily if the bird is soaked in water containing a large amount of salt.



Don't Let This Happen to You

You won't be the fellow who's stalled at the curb when the mercury tumbles if you give your car a complete checkup before cold weather sets in. Start planning now to have a car that's as dependable in winter as it is in summer

By Frank N. Stephany

WHEN IT COMES to smooth cold-weather operation, one of the most important parts of the car is the cooling system with its valuable new filling of antifreeze. If you have a late-model car, all that may be necessary to condition the cooling system for winter driving is to clean the radiator with one of the compounds

made for this purpose and flush it out with a garden hose. Simply allow the compound to remain in the system the length of time specified in the directions on the can. Then, disconnect the outlet hose from the bottom of the radiator and insert the garden-hose nozzle into the filler neck, flushing out the radiator with a gentle spray. Be sure to

WINTER CHECK LIST

- | | |
|-------------------------------------|-------------------------------------|
| ✓ Flush radiator and cylinder block | ✓ Drain water from fuel tank |
| ✓ Inspect hoses and connections | ✓ Adjust carburetor |
| ✓ Add antifreeze and rust inhibitor | ✓ Check fuel-line connections |
| ✓ Adjust fan-belt tension | ✓ Inspect exhaust system for leaks |
| ✓ Test battery charge | ✓ Change to winter-grade lubricants |
| ✓ Clean battery terminals | ✓ Equalize brakes |
| ✓ Inspect generator | ✓ Cross-switch tires |
| ✓ Check starter motor | ✓ Lubricate hinges, locks, etc. |
| ✓ Inspect distributor | ✓ Check weather stripping |
| ✓ Clean and adjust breaker points | ✓ Touch-up rust spots |
| ✓ Check condenser operation | ✓ Inspect windshield wipers |
| ✓ Inspect and clean spark plugs | ✓ Check defroster and heater |



Radiators on newer cars can be flushed with a garden hose after cleaning compound has had time to do its work. Hose at radiator outlet is disconnected

Radiator hoses are inspected and defective ones replaced. All hose clamps should be tightened carefully to prevent possible leakage of antifreeze solution

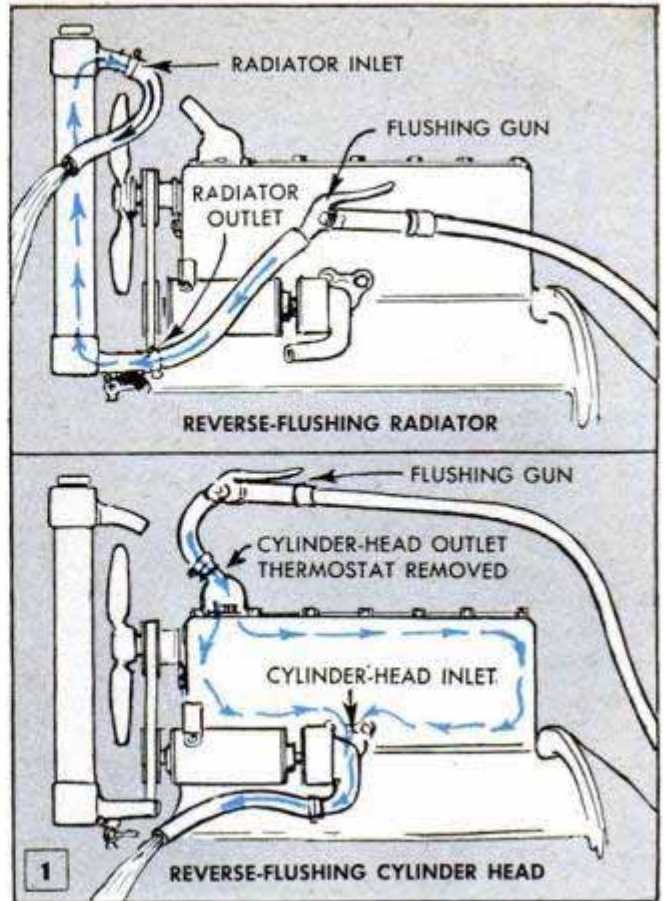

disconnect the lower hose, rather than merely open the drain cock, as the latter will not permit a sufficiently fast flow of water to carry away all the rust and scale loosened by the cleaner. For more efficient cooling-system cleaning on all cars, but especially on older models having small-core radiators, reverse-flush the radiator and cylinder-block water jacket separately, as shown in Fig. 1. These parts are flushed individually so that foreign matter from the cylinder block does not enter the radiator. If one is available, use a flushing gun which combines water and air pressure to facilitate loosening and removing rust and scale. Remember to remove the thermostat from the cylinder-head outlet before flushing the water jacket. To determine if a radiator core is clogged prior to flushing it, disconnect the radiator inlet and outlet hoses and plug the connections tightly. Fill the radiator with water, leaving off the filler cap, and then pull the plug from the bottom, or outlet, connection. If the water gushes out of the opening, the core allows a free flow of water but, if the water flows rather slowly, the core is partially clogged and must be cleaned out.

After the cooling system has been cleaned, inspect the hoses and replace defective ones. When connecting the hoses, make sure that all the clamps are sufficiently tight to prevent leakage of the antifreeze. Also check around the shaft of the water pump for indications of leakage between the shaft and the bearing. If leakage is

evident, the worn parts of the pump should be replaced immediately, as this will not only result in a loss of antifreeze but may draw air into the cooling system. The air increases the volume of the coolant so that some of it is lost through the overflow and it also accelerates the formation of rust in the system. When the cooling system is in shape, add water, antifreeze and rust inhibitor. The latter is included in some antifreeze solutions. The liquid level in the radiator should be approximately 1 in. below the bottom of the filler neck so that when the solution becomes warm and expands it will not drain out through the overflow. The freezing point of an antifreeze solution can be determined by using a hydrometer made specifically for this purpose, Fig. 2. Use the correct hydrometer for the type of antifreeze in the system and test the solution at the particular temperature for which the instrument is calibrated. Don't forget that the efficiency of the cooling system, as well as the operation of the generator, depends on the tension and condition of the fan belt. Replace a worn belt and adjust the tension by swinging the generator on its mounting so the slack in the belt is between $\frac{1}{2}$ and $\frac{3}{4}$ in.

The condition of the battery is the first thing to consider when getting the electrical system in shape for winter driving. Remember that a battery is most efficient at a temperature of about 80 deg. F. and that its efficiency decreases to only 40 percent at a temperature of 0 deg. F. The chart, Fig. 3, graphically illustrates the reduction in cranking power available from a battery as the temperature decreases. Fig. 4 shows the increased power necessary to crank an engine under similar temperature conditions. By comparing these charts, you can realize the necessity for keeping the battery fully charged during the winter months. The battery charge is checked by using a hydrometer to read the specific gravity of the electrolyte solution. Note in the table, Fig. 5, that a fully charged battery cell has a specific gravity of 1.280 at 80 deg. F. However, if you take a hydrometer reading under extreme temperature conditions, be sure to correct it accordingly. Add 4 points (.004) to the reading on the scale for each 10 deg. the tempera-



With a hydrometer made especially for the purpose, check to make sure that the freezing point of the antifreeze solution in the radiator is sufficiently low

ture of the electrolyte is above 80 deg. F. and subtract .004 for each 10 deg. below 80 deg. Allow a battery that has been rapidly discharged to stand for a while before taking a reading. In this way, the reading will be more accurate, as the solution will have had time to remix. Before checking the battery, be sure that the hydrometer is clean and in good condition. If the paper scale inside the float is wet, the float leaks and the hydrometer will not give an accurate reading. When taking the reading, hold the hydrometer vertically and at eye level. Keep the battery terminals clean and the connections tight and recharge or replace the battery as necessary. The distilled-water level should always be about $\frac{3}{8}$ in. above the top of the battery plates.

A frequent cause of hard starting is dirty or wet spark plugs, wires or distributor cap which permit the current to leak away. See that these units are kept dry and clean and also clean the distributor breaker points. At the same time, check the points for pitting and proper spacing. If they are burned and pitted, they should be replaced, as well as the condenser which is the probable cause of this trouble. The specified

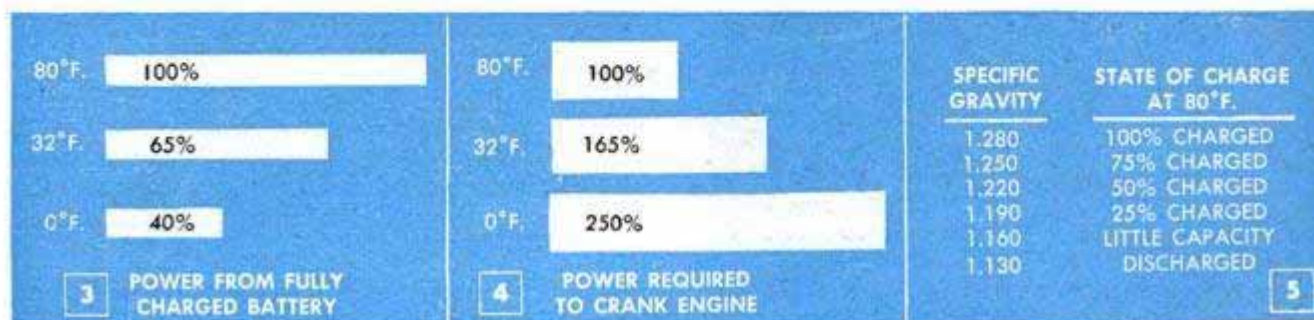



Above, set breaker-point gap by loosening screw on plate and adjusting eccentric. Below, notice dirt accumulation on outside of carburetor air cleaner

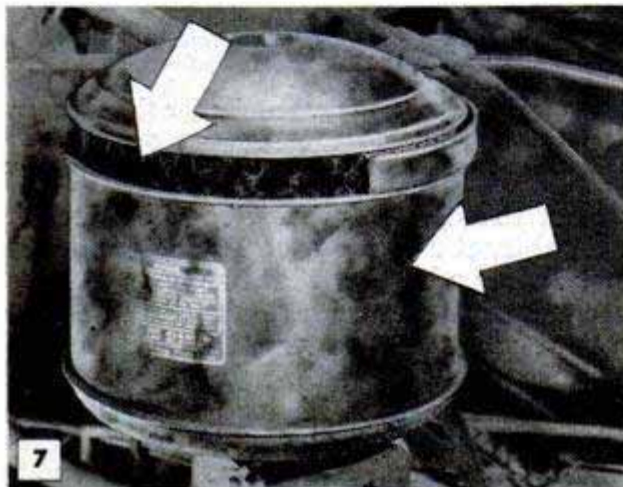

Below, solution can be added to gasoline to absorb water condensation and prevent freezing in fuel line



breaker-point gap will range between .018 and .022 in., depending on the make of car, and it should be set carefully according to the manufacturer's instructions. The gap is checked with a thickness gauge and set by loosening the screw which locks the breaker-point plate and adjusting the eccentric screw, Fig. 6. Check the wires in the distributor for breaks and frayed portions. Examine the top of the distributor cap for cracks and be sure that the spark-plug cables and the center cable from the coil make good contact in the socket terminals. Also inspect the rain guards over the cables to see that they fit tightly and are not cracked. These prevent moisture from entering the distributor and, therefore, are important to good winter performance.

To check the operation of the ignition, disconnect the coil cable at the distributor. Then, while cranking the engine, hold the cable $\frac{1}{4}$ in. from the cylinder-head block. If the spark jumps this gap, the ignition coil and its circuit are in good condition. Clean the spark plugs and space the electrodes by bending the side electrode to obtain the gap recommended by the manufacturer. This ordinarily will be from .025 to .029 in. Clean the electrodes with fine sandpaper and inspect the plug gaskets, replacing any that may be scored. When removing or installing the spark plugs, always use a socket wrench of the correct size to avoid damaging the porcelain. To replace the plugs, turn them into the cylinder head by hand as tightly as possible, and then tighten them one half to three quarters turn with the wrench. Be careful not to make them too tight.

Clean and tighten the generator connections, especially at the cutout, and inspect the brushes. Also see that the contact points on the voltage regulator are clean. Do not overoil the generator. A drop or two of oil on the bearings every thousand miles is sufficient, as too much lubricant coats the commutator with a film which results in arcing and pitting. This film can be removed from the commutator by merely touching the surface with 6/0 sandpaper while the generator is running.

The starter motor must be in good condition for winter driving. If necessary, clean the commutator with sandpaper and replace and align the brushes. Brushes worn to half their original size should be renewed, and they must be replaced parallel with the commutator segments. Polished spots on the armature core or field pieces indicate worn shaft bushings which cause the armature to rub against the field poles. In this case, new bushings should be installed. The starter motor, as well as the generator, is likely to be damaged by excessive oiling. A small amount of light cup grease applied to the bearings, unless they are the self-oiling



type, will furnish satisfactory lubrication.

Carefully check the fuel system to see that it is functioning properly. All the fittings and lines on both the suction and pressure sides of the fuel pump must be tight and in good condition. The carburetor-float level should be set high enough to provide a richer mixture for winter. The automatic choke also is likely to have a winter setting to provide a richer starting mixture. The choke is adjusted by turning the thermostat control slightly, as shown in Fig. 8. Take a look at the carburetor air cleaner. If the outside of the unit is dirty, as indicated by the arrows in Fig. 7, you can be quite sure that the cleaner is no longer operating efficiently and should be removed for a thorough cleaning. Another way to check the cleaner efficiency is to remove it while the engine is running. If the engine speeds up considerably, the cleaner is either dirty or damaged. Should the air cleaner not be dirty after a few thousand miles of service, chances are that it is not working properly because of internal failure or by-passing of the air through a leak in the connection between the cleaner and the carburetor. Drain the fuel tank to remove any water and sediment and, if desired, add a special solution to the gasoline to absorb water condensation. This will prevent accumulated water from freezing in the fuel lines. The crankcase should be drained and flushed to remove sludge and other foreign matter which may clog the oil-filter screen and also cause sticky rings and valves. The crankcase oil should, of course, be changed

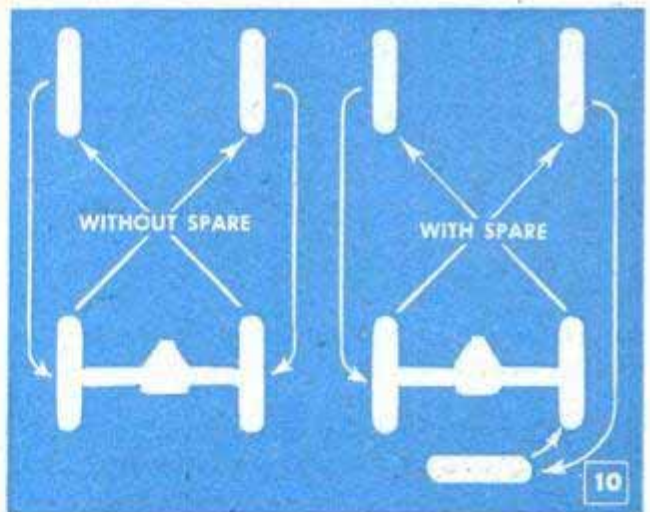

to one of the recommended winter grades.

As even braking is essential for safe driving on slippery pavement, see that the brakes are properly adjusted. Better traction and braking surface can be obtained by cross-switching the tires as shown in Fig. 10. To get maximum wear from your tires, it is a good idea to do this every 3000 to 5000 miles regardless of the season. Check the operation of the heater and defrosters. If you have a hot-water heater, you can increase its efficiency by flushing it out when you are flushing the radiator and cylinder head. Finally, make sure that the windshield wipers will give dependable service during the winter months. On wipers equipped with a water-spray attachment, fill the container with a solution of glycerin, 1 part, and water, 2 parts, as pictured in Fig. 9. This will aid in preventing ice formation on the windshield.

(Certain information and diagrams courtesy Plymouth Motor Corp.)

Ridge Hook Holds Ladder Safely on Gable Roof

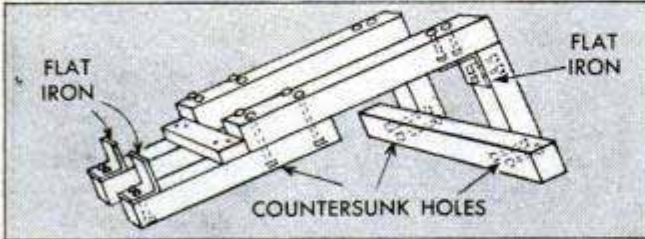
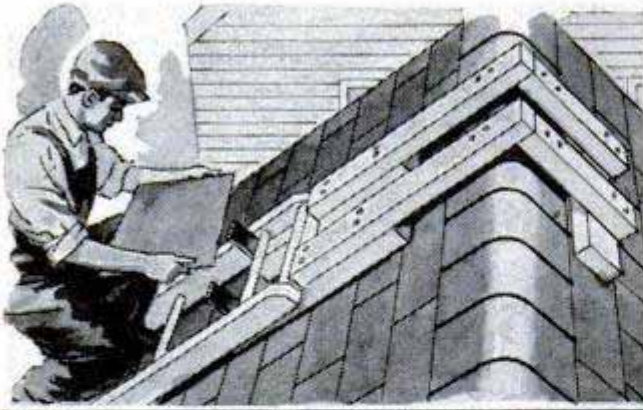

Repairing a roof, cleaning a chimney or painting dormers is done safely and easily if this ridge hook is used to hold the ladder. The hook fits over the ridge so that the weight of the ladder is exerted against the opposite side of the roof. As the hook can be slid along the ridge, the ladder may be used as a work platform at almost any point on the roof. The hook is made of 2 x 4s bolted together, the nuts being countersunk so they will not damage the shingles. The legs of the hook are braced by two angles bent from flat iron and the top rung of the ladder is slipped over two additional flat-iron angles bolted to the hook.

Anthony J. Mazure, Jr., Crown Point, Ind.

Milk Bottles Set in Pail of Water Provide Handy Camp Cooker

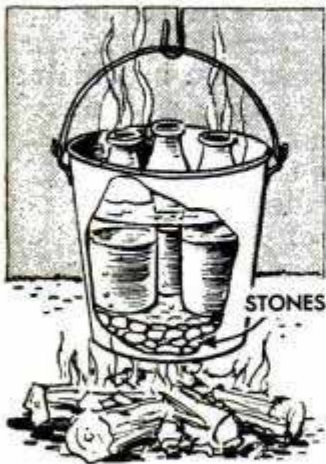

By means of three milk bottles set in a pail of water, an entire meal can be heated simultaneously over a campfire. One of the bottles can be used to heat water for coffee, if the powdered type is used, while the other two contain soup, beans, etc. First, place a 3-in. layer

of small stones in the bottom of the pail so the bottles will not rest directly on the bottom and possibly break. After standing the bottles in the pail, fill it about three-

quarters full of cold water and hang it over the fire. Once the water begins to boil, the food will be heated rapidly.

Suction Cups Form Pipe Rack For Car Windshield

Being an avid pipe smoker, I was at a loss as to where to keep a pipe in my car until I made a handy little pipe rack for the windshield. The rack is a piece of inner tube cemented to two suction cups which are stuck to the windshield. The pipe is slipped between the inner tube and the glass. When mounted at a lower corner, the rack does not interfere with the driver's vision.

Chas. H. Pabst, Pittsburg, Kans.

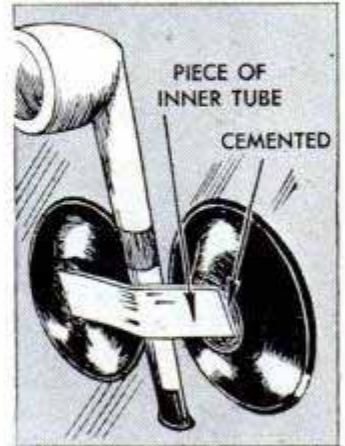

Home Repairs Cleaning Eaves Trough Facilitated By Easily Made Tools

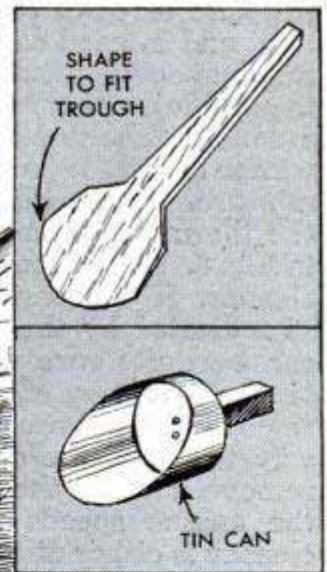

To clean out eaves troughs quickly, one man uses a tin-can scoop and a wooden scraper to loosen the dirt. The scraper is cut from a wooden shingle, the thin end, or blade, being shaped to fit the bottom of the trough. The small scoop is made by cutting off the top and sides of a tin can at an angle and fitting the bottom with a wooden handle. The scraper is especially useful for cleaning under the hangers.

Arthur N. Nelson, Kansas City, Mo.

Unworn portions of table oilcloth can be made into waterproof aprons to be worn when doing the laundry or washing dishes.



TELESCOPE TRIPOD

BECAUSE of its extreme sensitivity to the slightest body movement, a telescope of 15X or greater must be supported by a steady tripod for the best results. Although simply constructed of hardwood, this tripod features a "pan" head having a micrometer adjustment for both vertical and horizontal movement. These adjustments are attained by means of long machine screws removed from toggle bolts which are turned through fixed nuts. The clamps for the telescope are faceplate-turned in one piece for accuracy on the inner surface and then sawed in half. Contours of the outside of the clamps are jigsawed. The movable base members of the head are hinged together for fine vertical adjustment, the raising and lowering mechanism being shown in the lower right-hand detail, Fig. 1. A hinged mounting bracket for the clamps permits fine horizontal adjustment, using a similar screw arrangement. Coarse adjustments are made by rotating the head on the base and changing the height of the front clamp by loosening the wing nut, Fig. 2. Hardwood legs of the tripod are hinged to a circular toppiece.

Willard Allphin, Danvers, Mass.

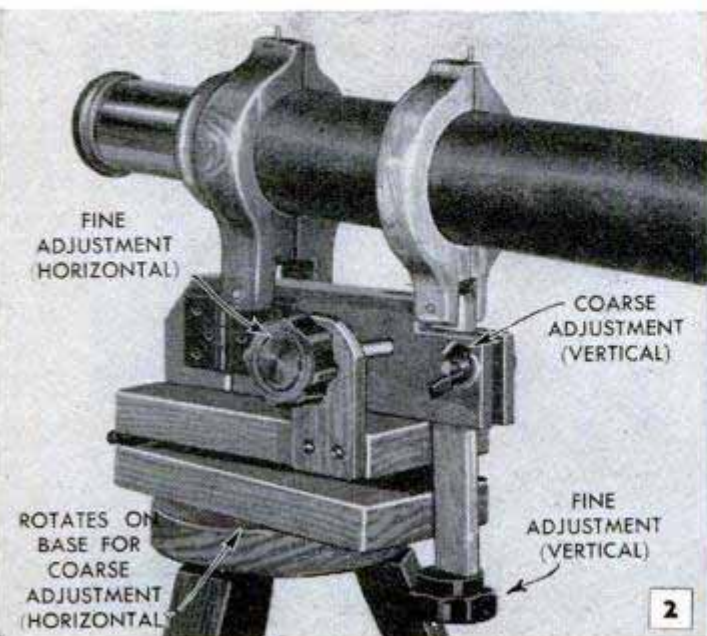
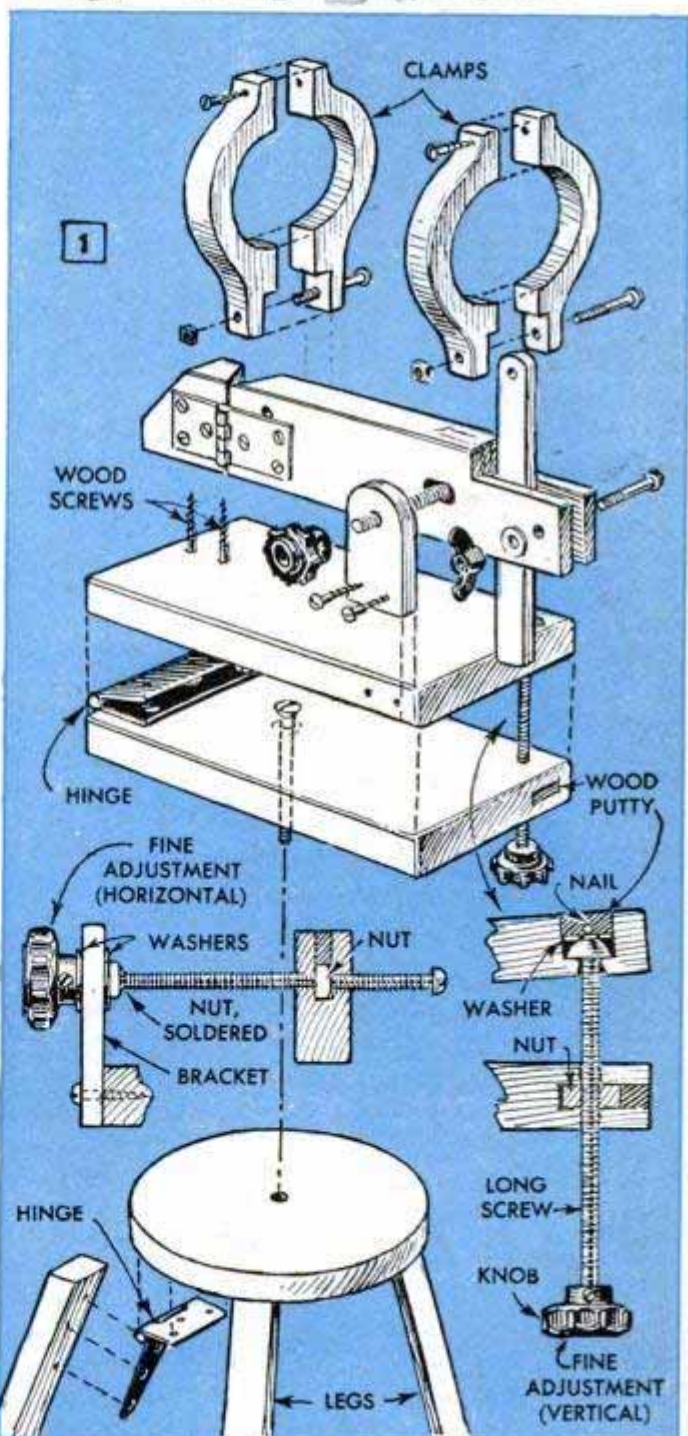

Tank Holds Several Rolls of Film For Simultaneous Developing

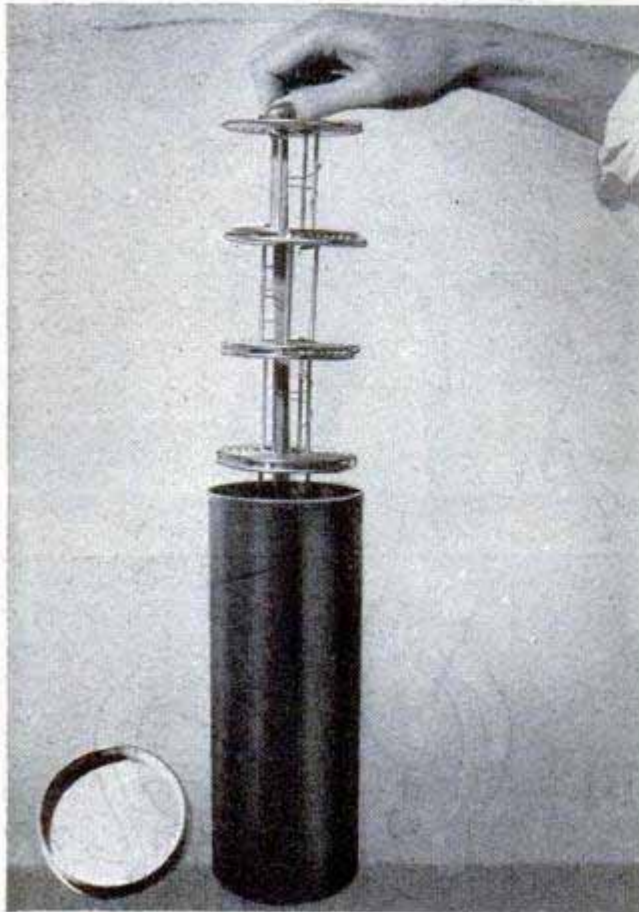

To develop three or four rolls of film at the same time, one photographer purchased several extra reels from a film-tank manufacturer and inserted them in a tank made from seamless stainless-steel tubing. The reels are mounted one on top of the other and are tied together with short lengths of wire. In soldering a bottom to the tubing, the joint must be made on the outside so developing solution will not contact the solder. The tank shown holds four reels and requires less than $\frac{1}{2}$ gal. of developer.

Turn Button Locks Wall Switch

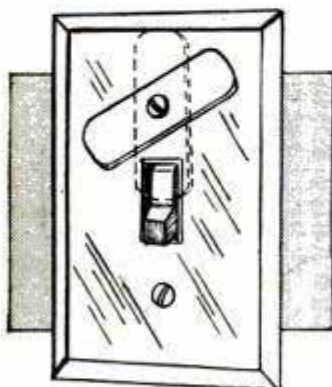

If there is a likelihood of someone snapping on a wall switch in the dark-room, thus spoiling a batch of negatives, guard against this by locking the switch in the "off" position with a turn button. The latter, which can be either a piece of plastic or sheet metal, is held in place by the top screw of the switch plate. The turn button is swung down and against the switch, keeping it from being

pushed up to the "on" position, and is turned to one side when not needed.

Arthur Trauffer, Council Bluffs, Iowa.

Increasing Flash-Bulb Efficiency In Photoflood Reflector

As photoflood reflectors are, of course, designed for photoflood bulbs, considerable efficiency is lost when the shorter flash bulbs are used in them. However, this can be corrected by using an extension to bring the flash bulb out to the approximate length of a photoflood bulb. The extension is simply a plug base and a socket of the type used to plug a lamp bulb into a wall receptacle. These two parts are pressed together and the flash bulb is turned into the extension socket. Then the extension is turned into the reflector socket.

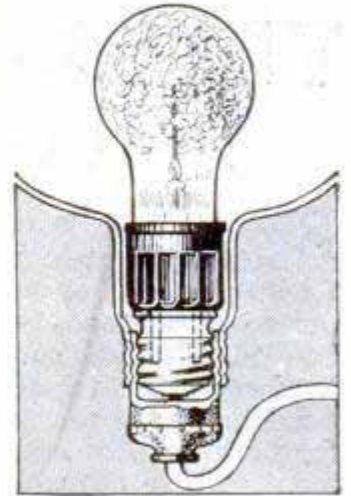

When you want to be sure of having uniform borders on your enlargements without trimming, use the back of an old print to check the positions of the easel masking bands. Select a print of the same over-all size as the ones to be made and place it upside down in the easel. Next, locate the masking bands approximately and draw lines on the back of the print, using the bands as straightedges. This will show you exactly where the border will fall. If the pencil lines indicate that the width of the border is not equal all around, you can adjust the masking bands accordingly.

Old Print Checks Easel Masks To Insure Uniform Border

Virginia Hanson, Santa Monica, Calif.

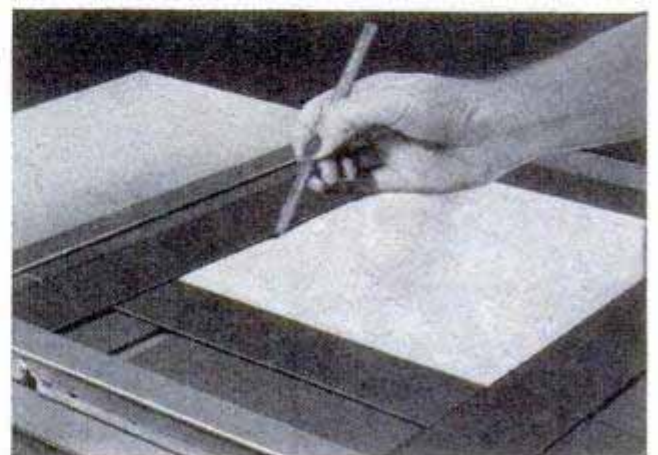

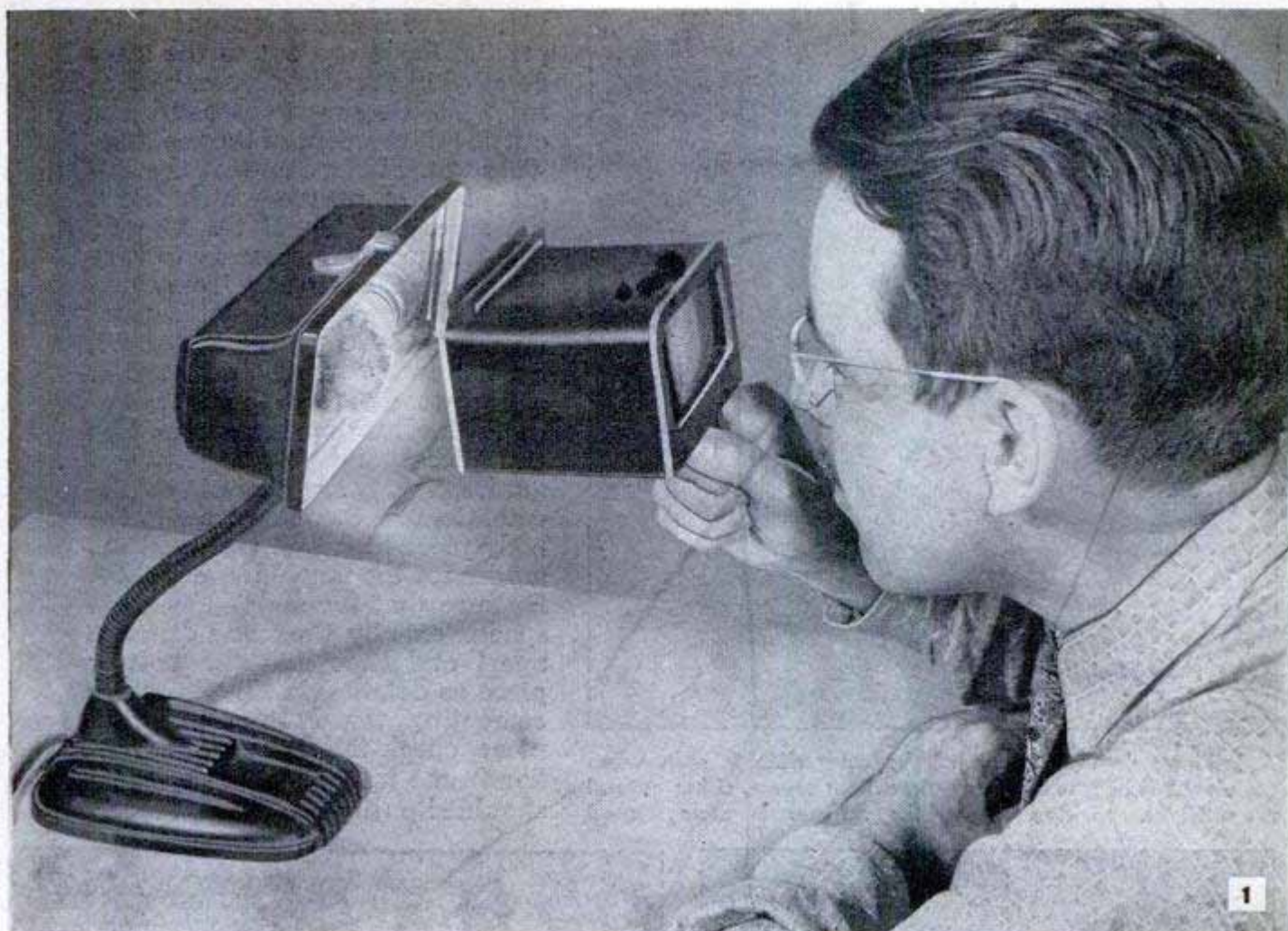

VIEWER FOR LARGE-SIZE COLOR SLIDES

By M. G. Winterton

THIS VIEWER is designed for large color slides, up to $2\frac{1}{4} \times 3\frac{1}{4}$ in., and utilizes an ordinary rectangular reading glass as the magnifier. A removable diffusing glass provides the user with a choice of direct or indirect illumination, a decided advantage when viewing the larger color slides. In use, the viewer is simply held in front of the light source as in Fig. 1 and a magnified image of the color slide appears on the reading glass with exceptional brilliance and clarity of detail. The soft rendering of indirect illumination without need of the diffusing glass is obtained by using the viewer as a table model, placing it over a sheet of white paper so that it picks up reflected light only, Fig. 6. All parts of the

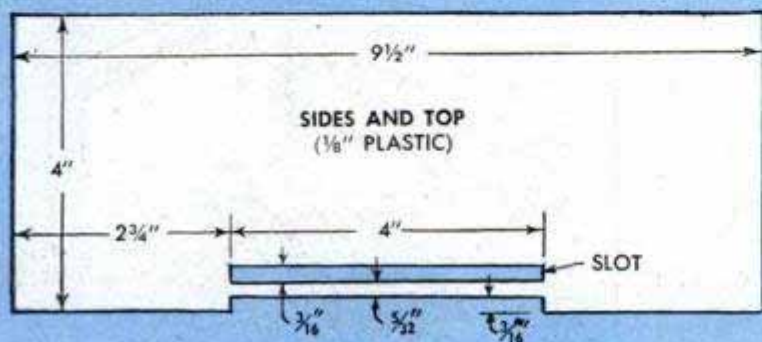
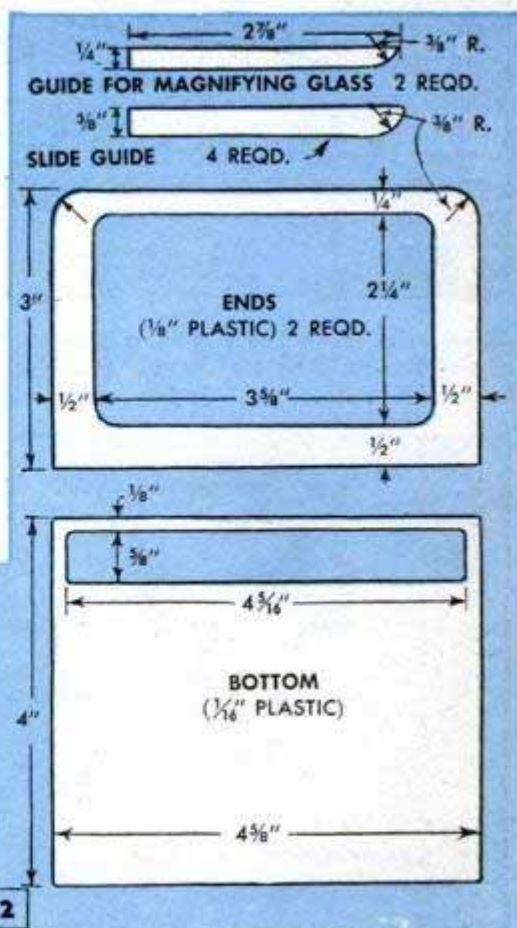

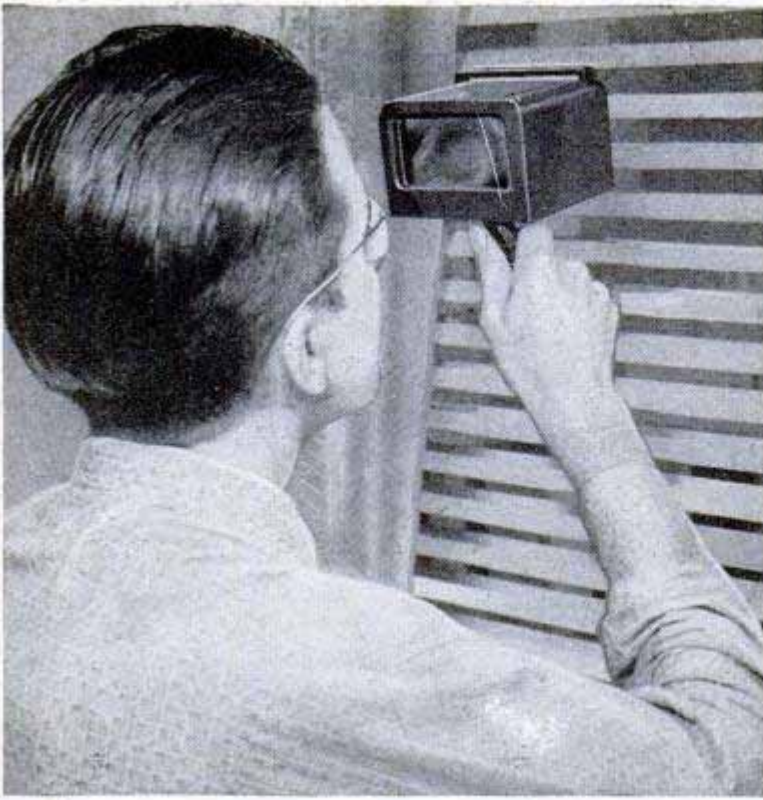

A brilliant, detailed image of the color slide is seen when the viewer is held toward any direct light source, either natural or artificial. In direct light, the diffuser is always used

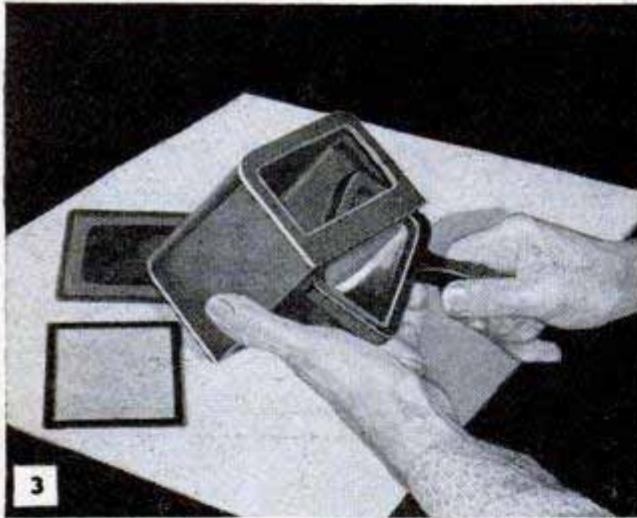

Above, the magnifier fits in a slot cut in bottom of the viewer. Angle of handle provides convenient handhold. Below, slide is inserted in slot at back

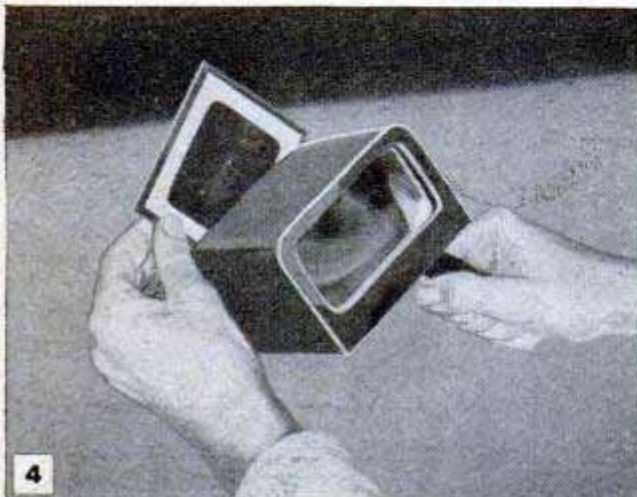

viewer are made of opaque sheet plastic. Parts are cut to the sizes detailed in Fig. 2 and assembled as in Fig. 5. Be sure to measure the outside dimensions of the reading-glass frame before cutting the single piece of plastic which forms the sides and top of the viewer, Fig. 2. It may be necessary to vary the dimensions slightly from those given. After notching, slotting and finishing the edges of the piece, heat it in the oven and bend it over a wooden form to get the required radius on the corners. The end pieces and the two sets of guides, Fig. 2, are made in duplicate. Cement the end pieces to the body piece first, and then add the guides for the magnifier and slide. Be sure that the slide guides are spaced exactly the same distance apart and then slot the bottom piece as detailed in Fig. 2. Before cementing the bottom piece in place, check the fit of the magnifier frame in the slot. The frame should slip through the slot easily

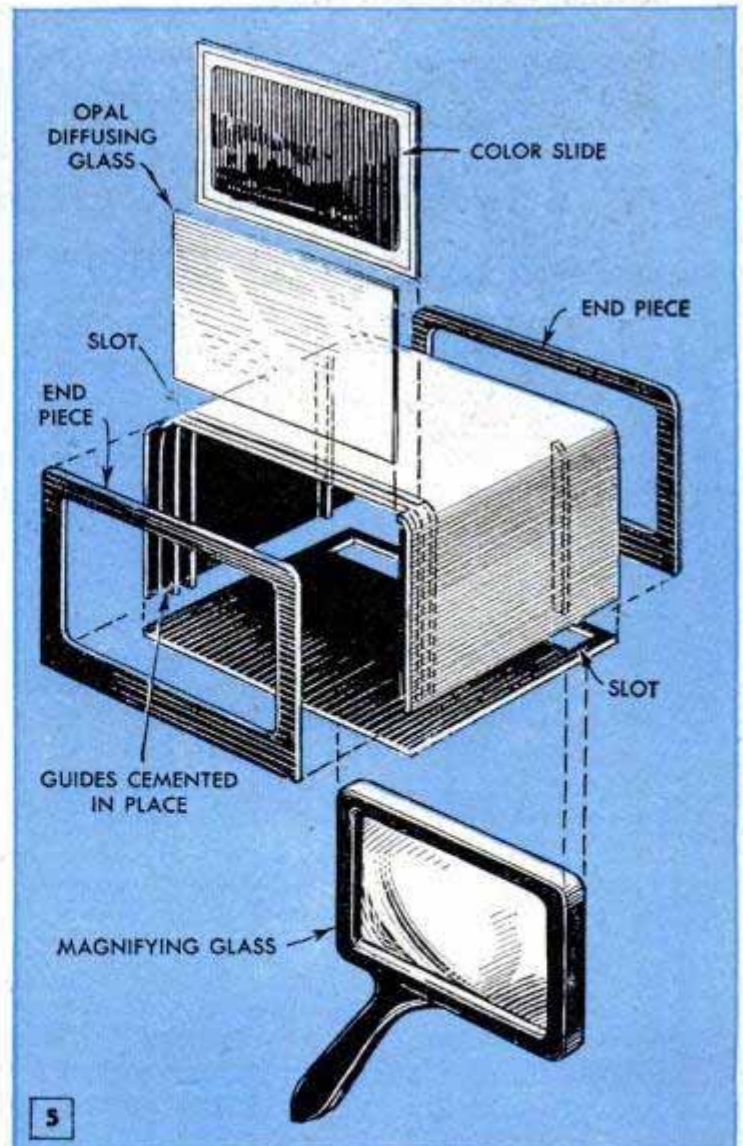

without any side play, Fig. 3. If it binds at any point, remove stock with a fine file either from the magnifier frame or from the slot and polish the edges to remove burrs and file marks. Cement the bottom in place and round over all exposed edges of the assembly by sanding with fine sandpaper. Then buff and polish all the flat surfaces and the edges. This will prevent chipping and scratching of the edges due to handling. The diffuser is cut from ordinary opal glass of the kind sold in photo-supply stores. It should be wide enough so that the top edge can be grasped for easy removal after insertion. Cover the edges of the glass with narrow strips of masking tape. Fig. 4 shows how the slides are in-

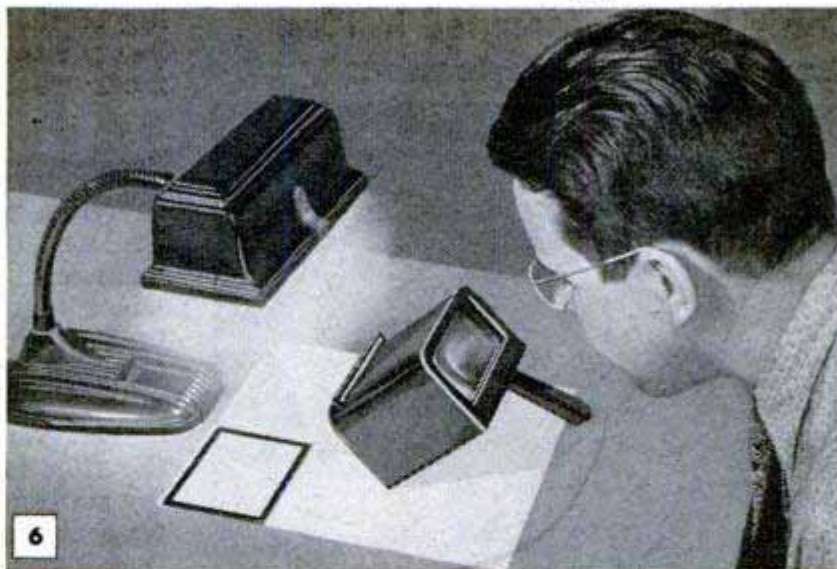

The viewer serves equally well as a table model with indirect illumination. Handle supports the viewer at just the right angle

serted in the oversize slot at the back. Clean the reading glass before using as dust will dull the brilliance of the image.

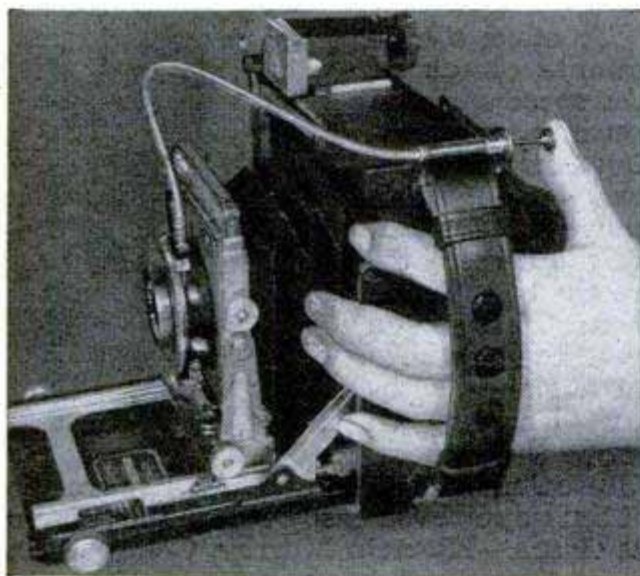

Cable Release Clamped to Camera Is Operated With Left Thumb

Preferring to use the cable release instead of the body release on my Graphic-type camera, I clamped the cable release to the top of the camera so that it can be depressed with the left thumb. This leaves the right hand free to focus the camera and permits the shutter to be released the instant the subject is in focus. The clamp is made from a piece of 1 x 2-in. sheet metal which is bent double at the center. This is done over a piece of rod forming a loop large enough for the cable release to pass through. A hole, drilled through the other end of the clamp, permits bolting it under the top strap hanger. The clamp holds the cable-release button just above the strap.

Meredith T. Thomas, Tucson, Ariz.

Tape on Edge of Paper Cutter Keeps Prints From Slipping

A faster job of trimming prints is had if the paper cutter table has a nonslip surface. This can be obtained by sticking a narrow strip of adhesive tape along the cutting edge of the table.



Handle for Photoflood Reflector

Adjusting a hot photoflood reflector sometimes results in painfully burned fingers. However, the likelihood of being burned can be eliminated by fitting each reflector with a wooden tool handle. The reflector socket is disassembled and the wire removed. Then a hole for the wire is drilled lengthwise through the center of the handle. The metal ferrule at the end of the handle is cut off and the wooden tenon whittled down to fit snugly in the end of the socket. The set-screw will hold it in place. Finally, the wire is passed through the handle and connected to socket terminals.



U.I. '51

Cable Release Mounted in Plug Provides Flash Synchronizer



Inserting the end of a cable release in an attachment plug is a quick way to make an inexpensive passive flash synchronizer. The cable release is wrapped with wire or tape so it is a force fit in the plug, and the prongs of the plug are cut off and bent inward to make contact with the cable-release button. Holes drilled through one side of the plug cover permit the synchronizer wires to be attached to the terminal screws. The length of the plug prongs is adjusted so the cable-release button closes the circuit at the instant the shutter is opened. If desired, the plug may be filled with liquid plastic or sealing wax so the release does not move out of position. However, care must be taken not to interfere with the free movement of the cable-release button.

Enloe C. Crews, Phoenix, Ariz.

Oil Corrects Tripod-Head Slippage



When the tilting action on a friction-type tripod head tends to slip, applying a few drops of oil to the bearing surface will frequently correct the trouble. A film of light machine oil permits positive lock-

ing of the tilting head with considerably less pressure than when the gripping surfaces are dry.

Preventing Scratched Negatives

When making enlargements from roll film, two strips of cellulose tape attached to the bottom of a metal negative carrier will keep the film from being scratched. The tape strips, about 1/2 in. wide, should be positioned as shown so that the film is supported on its edges only. This will not work on the glass-type carrier but only on the type in which the upper plate is lifted when the film is to be advanced.

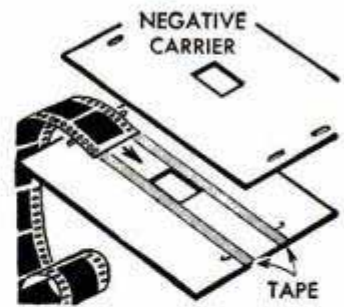

Henry A. Stockert, Pekin, Ill.

U.I. '51

Camera Settings Checked Quickly

To make a last-minute check of the speed and stop settings when using a folding camera, tape a small mirror to the bed of the camera directly below the lens. This gives you the readings at a glance without having to move the camera.

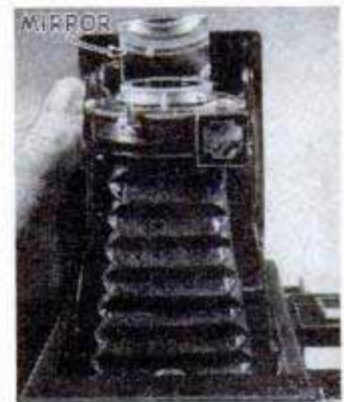

Use cellulose tape to attach the mirror so it can be removed easily before the camera is closed.—Kenneth Murray, Colon, Mich.

U.I. '51

Tin-Can Holder for Photo Spot

A photo spot or reflector-type photoflood can be kept from rolling off a shelf by storing it on end in a shortening can. This type of can is the right size to allow the bulb to rest on the rim.—Harry Aichner, Erie, Pa.

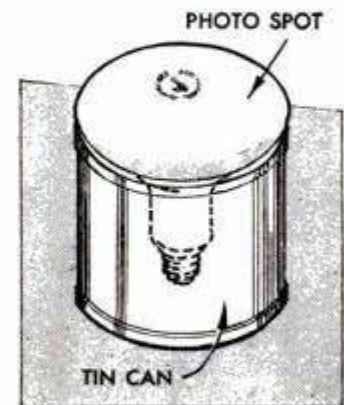

Dark-tinted bleach bottles, which are available in sizes from 1 pt. to 1 gal., provide handy containers for storing dark-room chemicals. Rubber stoppers should be used to replace the metal bottle caps.



JOINTING on your bench saw

By Roy Rogers

HOME CRAFTSMEN who do not have a jointer can adapt the circular saw to do the work of this machine on stock not more than 1 in. thick. A three-knife molding head fitted with a set of straight-edged cutters and three pieces of selected hardwood are all the parts needed to make the setup. The auxiliary wooden guide, Fig. 1, detail C, and the infeed and outfeed tables can be made any convenient length. On most saw tables, it will be necessary to plane the outfeed table to a thickness of $\frac{5}{8}$ in. and the infeed table to a thickness of $\frac{9}{16}$ in. in order to bring the cutting circle to the proper height, as in Fig. 1, detail B. Attach the two tables to the guide with screws. Then attach the unit to the ripping fence with screws or bolts. The meeting ends of the front and rear tables should be directly over

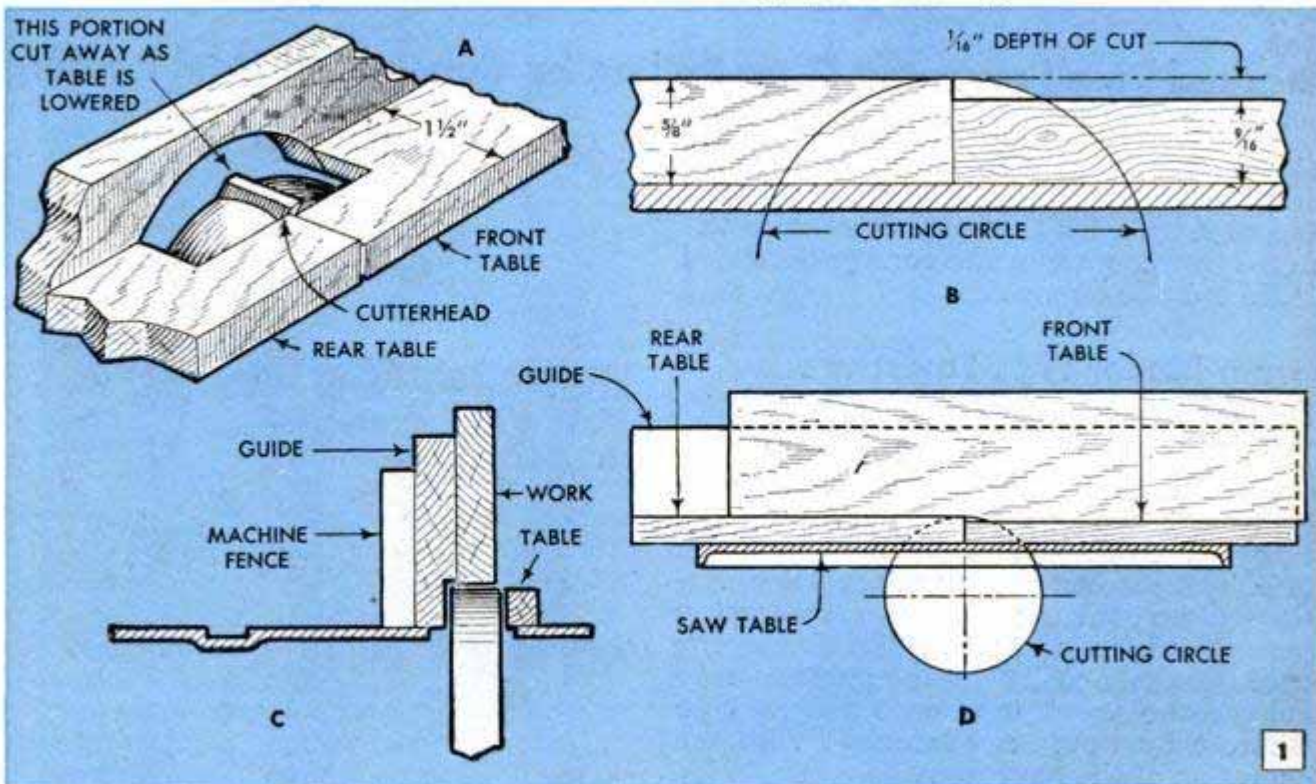

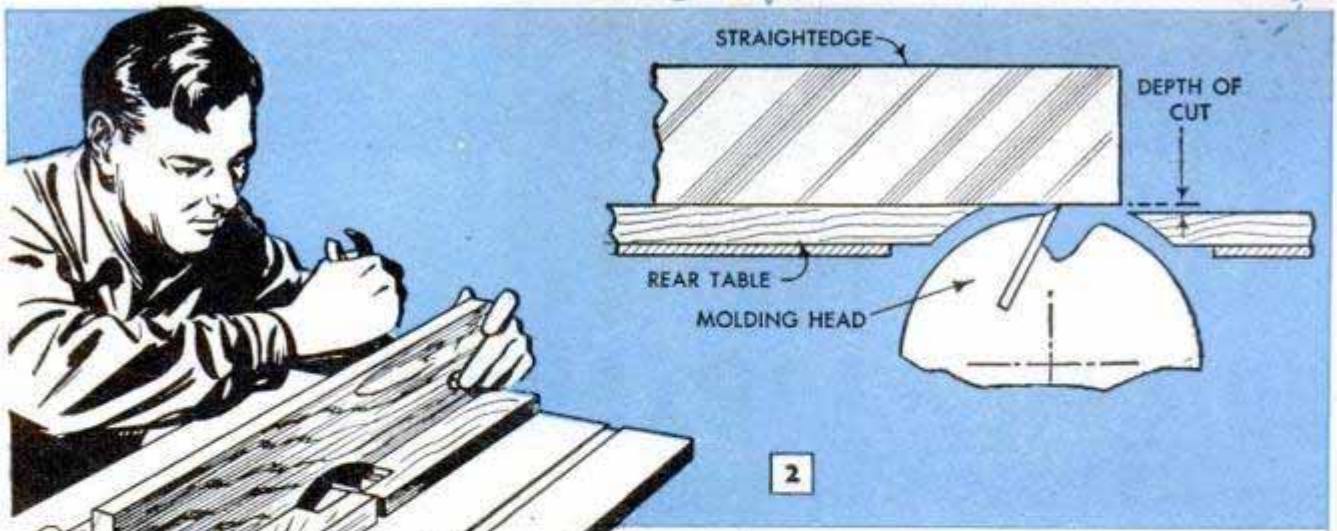

the center of the saw arbor as in Fig. 1, details B and D. Remove the saw-table insert, place the molding head on the arbor, and raise the saw table to its highest position. Move the ripping fence to the left until the inner edge of the wooden guide is flush with the outer edge of the cutters on the molding head. Then lock the ripping fence at both ends, start the motor, and lower the saw table slowly until the molding head cuts through the tables. Stop the motor and again raise the saw table to its full height. Slide the ripping fence to the left until the corners of the molding cutters will just clear it. Again start the motor and lower the saw table the same distance as before.

In this step, the molding cutters will remove a semicircular section of the wooden guide, leaving an opening like that in Fig. 1, detail A. This opening allows plenty of chip clearance. The width of the opening also permits adjustment of the head when jointing thin stock. Each time the attachment is used for jointing, the cutters must be set for proper height with a straightedge as in Fig. 2. Raise the table to the full height, place the straightedge on the out-feed table and turn the cutterhead until one cutter is in the vertical position as shown. Then lower the table until the straightedge just touches the edge of the cutter. When correctly located, each cutter will catch the straightedge and move it forward about $\frac{1}{8}$ in. when the cutterhead is turned slowly. When jointing, hold the stock firmly against the guide and move it slowly and uniformly over the tables. Be sure the ripping fence is locked securely at both ends of the saw table.

Stacked Pipe Prevented From Rolling by Corrugated-Steel Roofing

Lengths of pipe which are stacked for storage can be kept from rolling by using short pieces cut from corrugated-steel roofing as a base for the pile. Just place the first layer of pipe in the corrugations and build the pile on top of it.

Grain Binder Tops Smartweeds To Aid Harvesting Soybeans

Finding that smartweeds had grown several feet taller than his soybeans, thus preventing the combine from harvesting the crop, one farmer used a grain binder to cut off the weeds just above the soybeans. Although the canvases were mounted on the binder, no twine was used. The binder was operated just ahead of the combine so as to deliver the weed tops onto the stubble where they would not interfere with the operation of the harvester.



Reported J.M. 51

PLOW SNOW WITH YOUR CAR

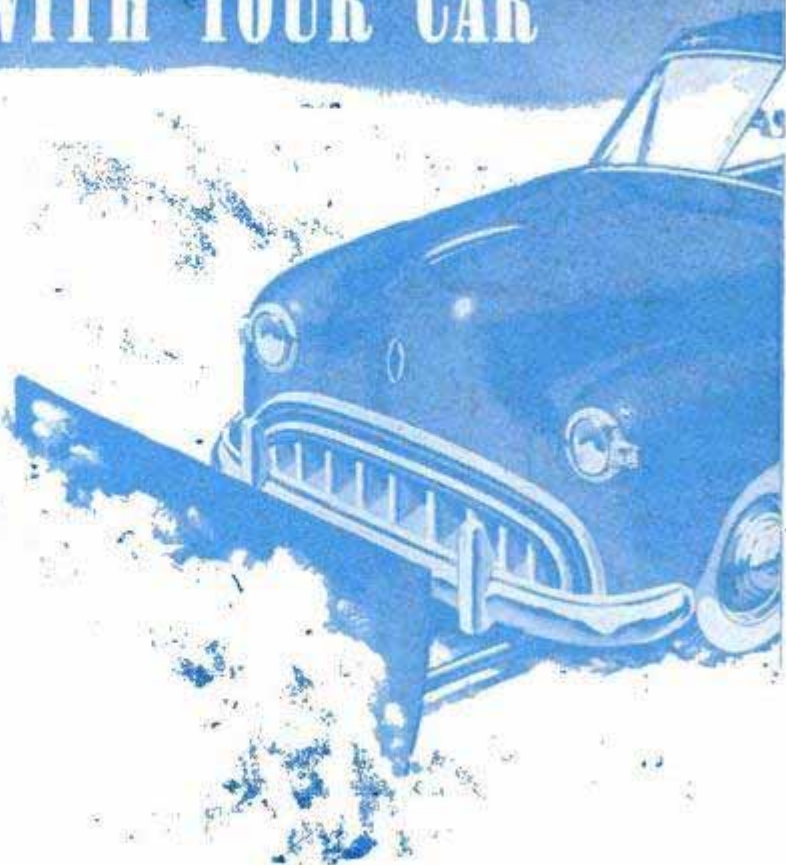

Farm lanes and private roads are opened in a jiffy by using this snowplow mounted on the front of your car. The plow is made of scrap parts, the blade of the original being fashioned from the sides of an old water tank. The blade rides on flat-iron runners and the unit is attached by bolting adjustable arms to the car frame. The arms are lengths of 2-in. pipe slipped over 1½-in. pipe and held with metal pins

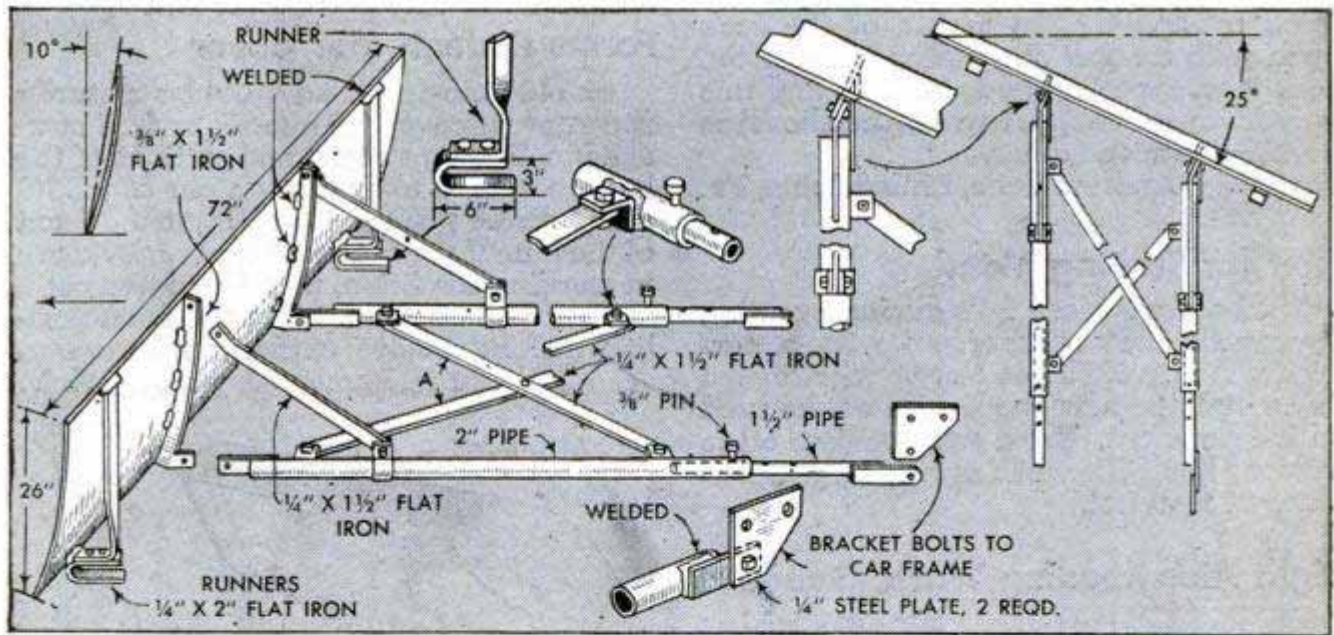

Easily Made Locator Marks Work for Drilling Registering Holes

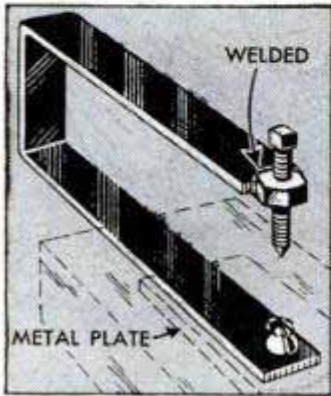

In some jobs, such as truck-body rebuilding, it is often necessary to drill a hole in exact register with a hole already in another part behind the work. This easily made hole locator is just the thing for such

work. To make it, bend a piece of flat iron or spring steel to a U-shape, one arm being slightly longer than the other. Weld a nut to the end of the shorter arm and turn a pointed setscrew through the nut. Then weld a projection, or pivot, on the other arm directly under the setscrew. To use the locator, slip the projection into the hole already in the part and tap the setscrew with a hammer. This will mark the exact spot for drilling the new hole.

W. D. Darnell, Dallas, Tex.

Sack Held Open With Stick Is Filled Easily



Shoveling sand, cement or other bulk material into a cloth or paper sack is facilitated by holding the mouth of the sack open with a small stick. The edge of the sack is wrapped around the stick and this is held with one hand while the shovel is handled with the other.

Andrew Vena, Philadelphia, Pa.

Hint for Sawing Metal

If a hacksaw blade fails during a cutting operation, start another cut with a new blade. As the old blade has work-hardened the metal, the new one should not be used in the same cut. Use a sulphur-base oil to prolong blade life when sawing large quantities of material.

Light Aids Reading Water Gauge

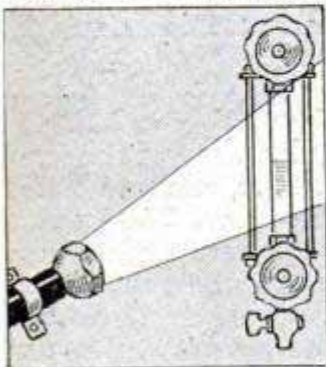

Steam-boiler water gauges that are difficult to read can be read easily if a flashlight beam is played on the glass. If the flashlight is held below the gauge, a little to one side, and directed on the

glass, the water level will stand out in the light beam. The light probably will have to be moved somewhat before the correct position is found. If a post, wall or other

means of support is handy, the flashlight can be fastened permanently in this position and simply turned on when the gauge is to be read.

W. F. Schaphorst, Newark, N. J.

Improved Drill-Bit Extension

When drilling up between floor joists or in other hard-to-reach places, a drill-bit extension often is necessary to permit free rotation of the brace handle. A suitable extension is made from a length of round rod, one end of which is drilled

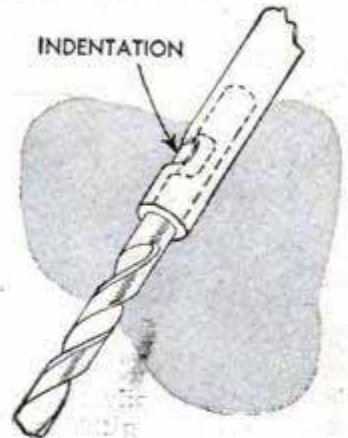

to take the bit. A flat is ground or filed on the bit shank and, after the bit is inserted, the rod is indented to hold it tightly. Use a rod that will leave a wall thickness of about $\frac{1}{16}$ in. after drilling.

Robert J. Lemp, Woodhaven, N. Y.

Auto-Trunk Lid on Grain Bin Forms Rodentproof Cover

An old auto-trunk lid provides a sturdy rodentproof cover for a grain or feed storage bin. The tops of the end sections of the bin are curved to fit the contour of the lid and a strike plate is installed at the front of the bin. If the braces of the trunk lid are in working condition, they should be used, as they will hold the lid in the open position, making removal of the contents easier.

Victor H. Lamoy, Upper Jay, N. Y.



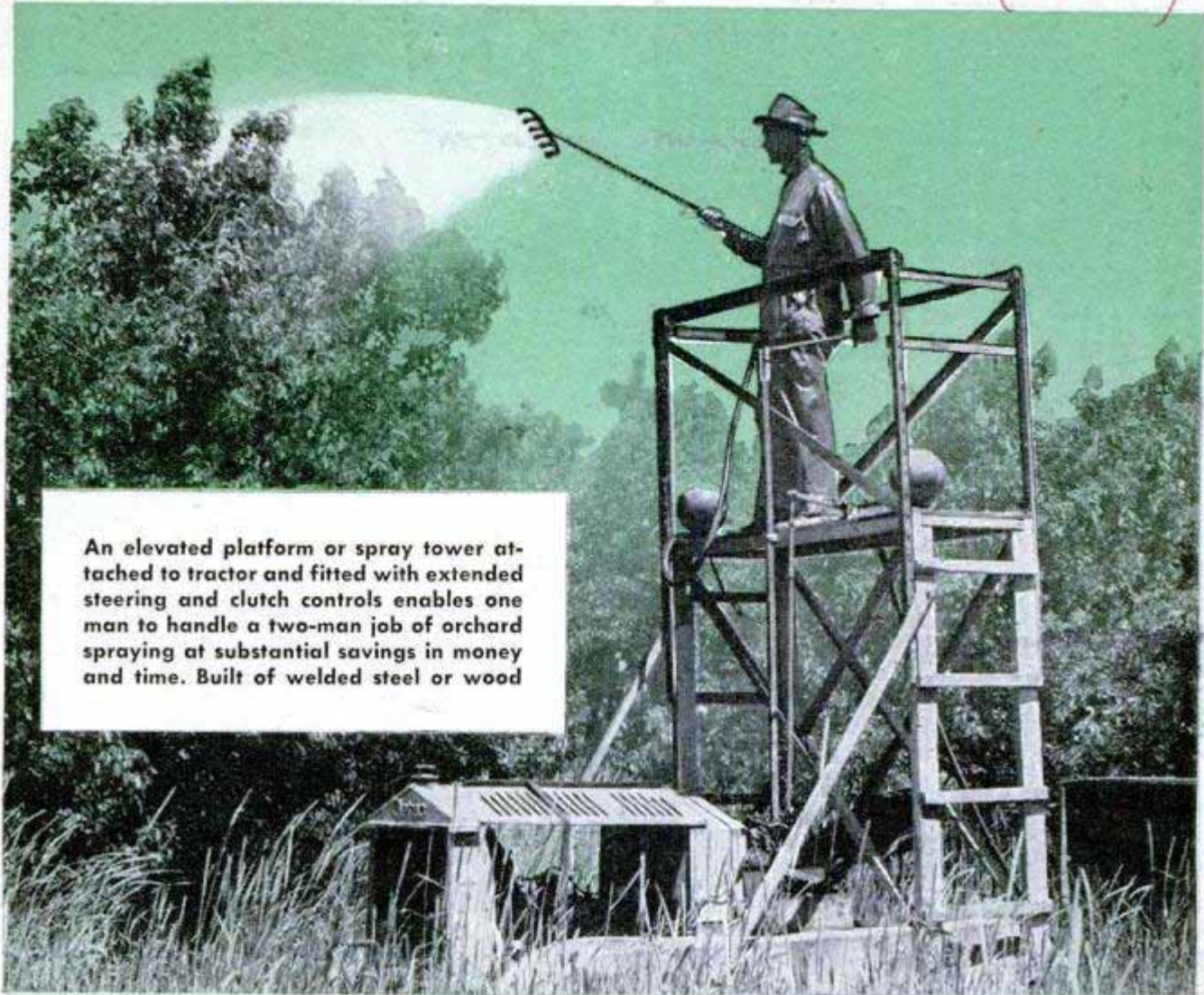

An elevated platform or spray tower attached to tractor and fitted with extended steering and clutch controls enables one man to handle a two-man job of orchard spraying at substantial savings in money and time. Built of welded steel or wood

ONE-MAN SPRAY RIG

By Jack Fletcher

If the tractor is steered by levers, a two-pedal foot control is arranged as detailed below. A third pedal controls the foot-operated clutch. On wheel-steered tractors a steering arm is extended to the platform

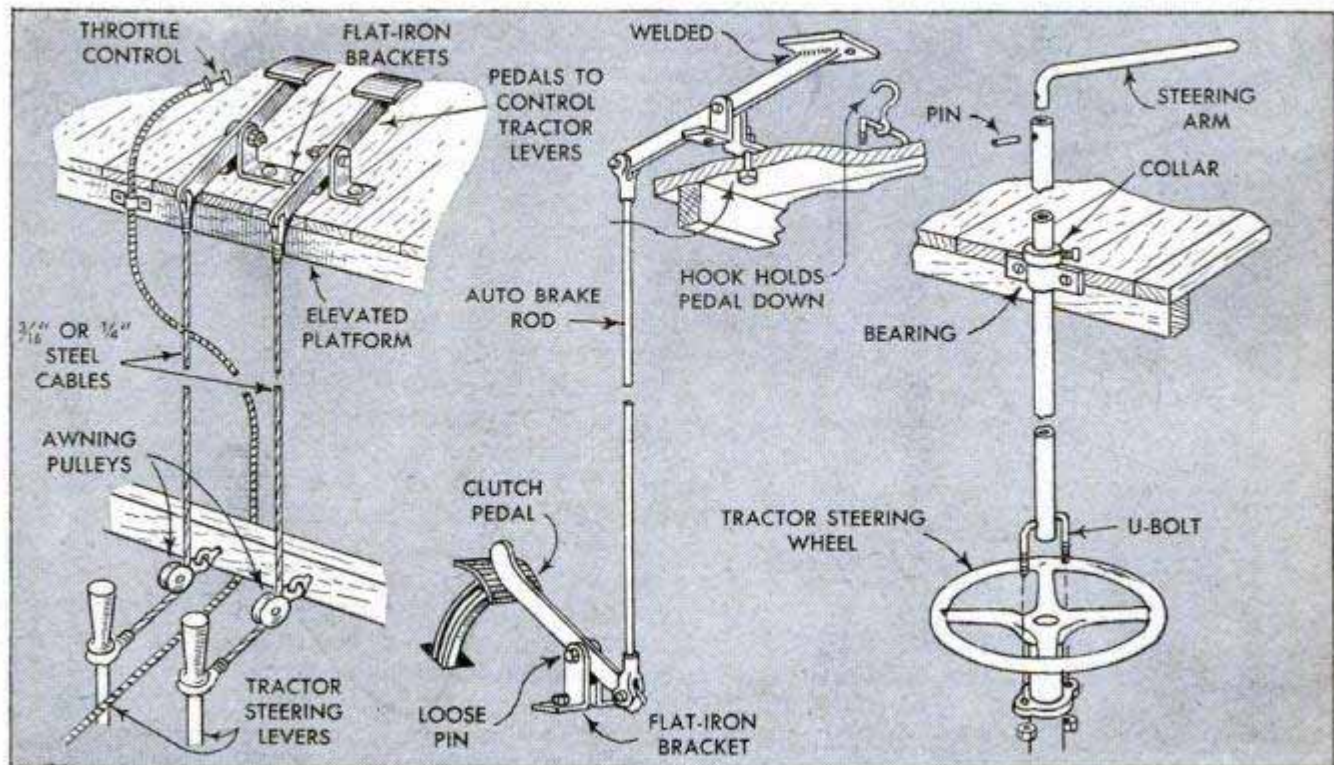

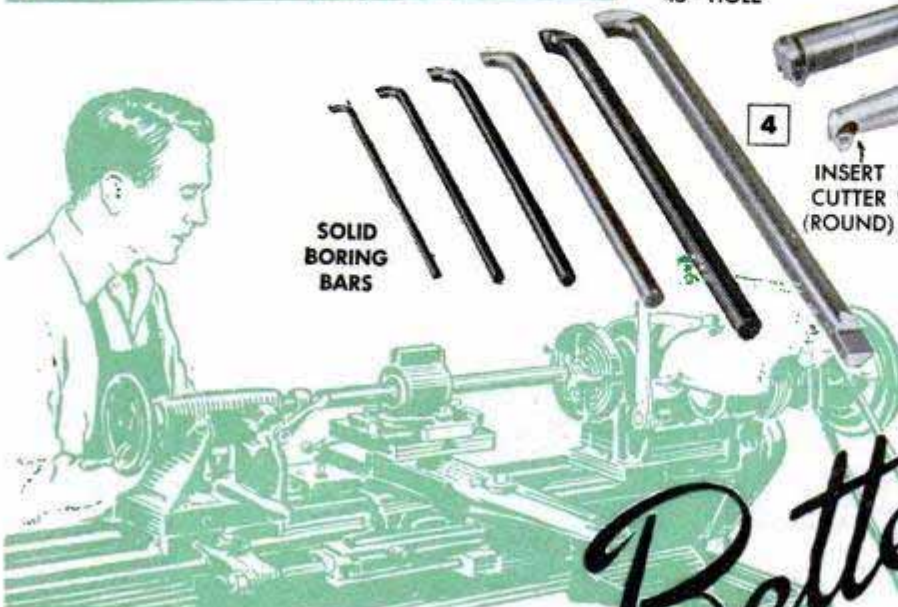
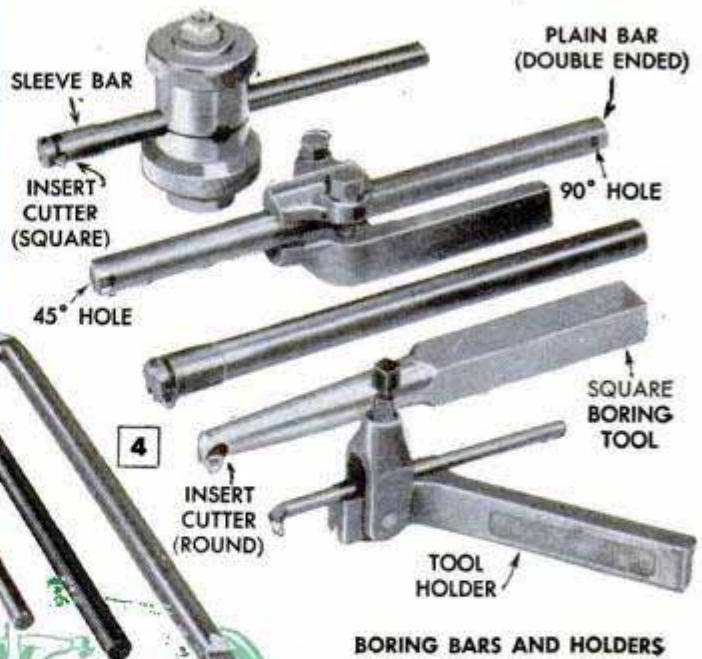
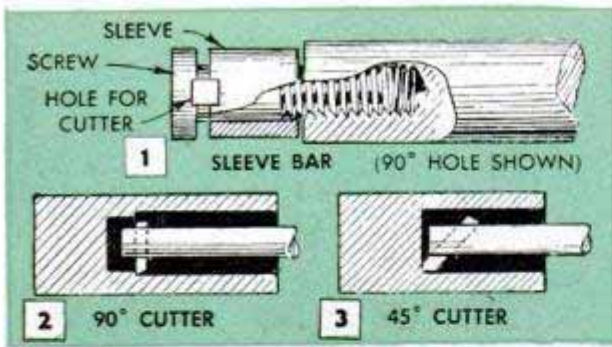

Better Boring

By Sam Brown

ONE SECRET of good boring practice in the metal lathe is in the selection of the right bar for the job. The first rule is to use the largest bar that will fit inside the work, particularly in bores that are longer than their diameter. The large bar is rigid and resists springing on a long overhang. If the bar is too light for the job, it will spring away from the work and you are likely to finish with an undersize hole or one that is slightly tapered. Most lathe operators have at least several of the complete assortment of boring bars shown in Fig. 4. The solid bars are the least expensive, are easy to mount and usually are selected for light work. The bars with inserted cutters are the only choice for boring the larger diameters. These come in the plain type with the cutter held by a setscrew and also in the sleeve type on which the inserted cutter is held by a sleeve and screw, Fig. 1. Note that the drawing shows the hole for the cutter broached 90 deg. but there also is a hole broached 45 deg. in the same setscrew for bottom work. The sleeve-type bar is somewhat more rigid but otherwise it has no particular advantage over the plain bar broached 90 deg. at one end and 45 deg. at the other. The 90-deg. cutter position is always somewhat the stronger and is used for nearly all through boring such as that in rough bushings and in cored holes. However, it will not bore to a corner, Fig. 2. This must be done

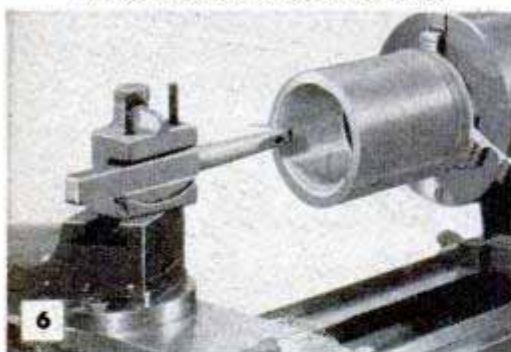
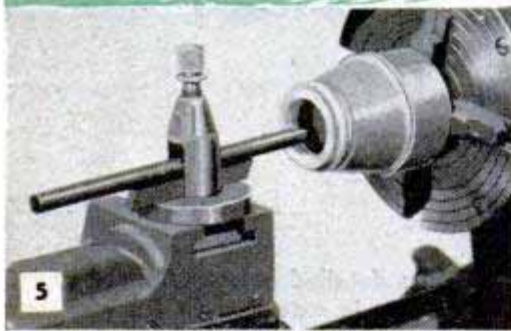

JOB ILLUSTRATED

Simple Job Shows Standard Procedure

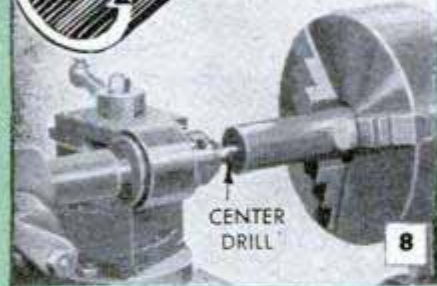
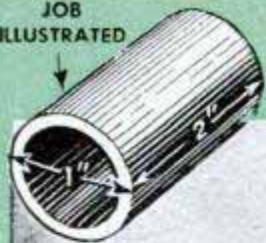

In making a bushing from solid stock, the first step is to spot the end of the work with a center drill so that the drill bit will center accurately. When drilling in the lathe, always maintain a uniform pressure

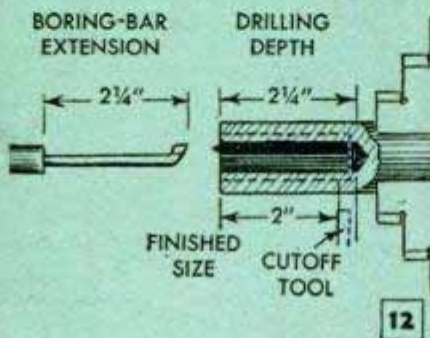
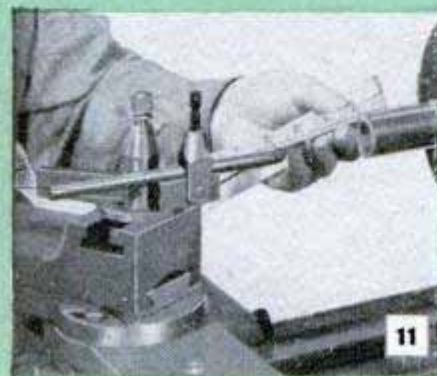

Next, the boring tool is run through in successive passes until the work is near the required finish dimension. Note that allowance is made in the setup for cutting the work to length and for clearance for the bar

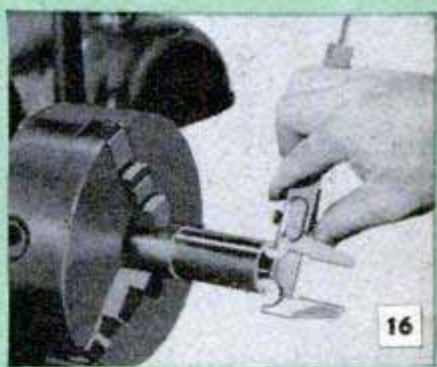
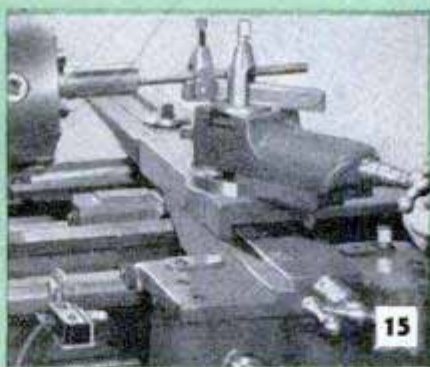

When the boring cuts are started, a push-button switch wired into the motor circuit is located on the lathe bed so that it stops the machine when the tool reaches the required depth on each successive pass through work

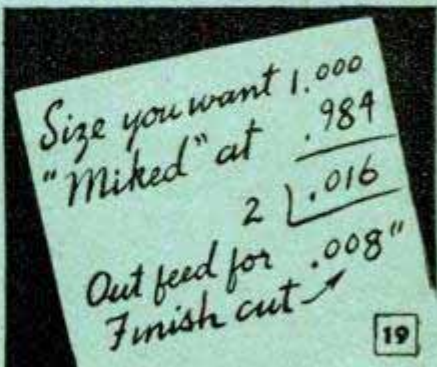
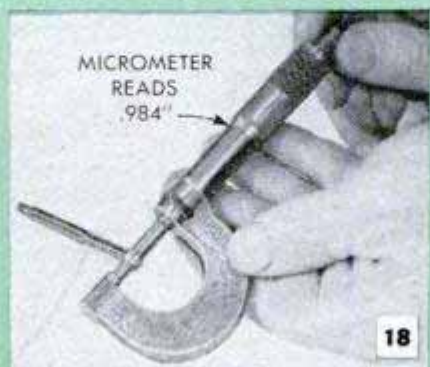

As the inside diameter of the work nears the finish dimension, careful measurements are taken and the required outfeed setting of the crossfeed sleeve for the finish cut is then calculated from these measurements

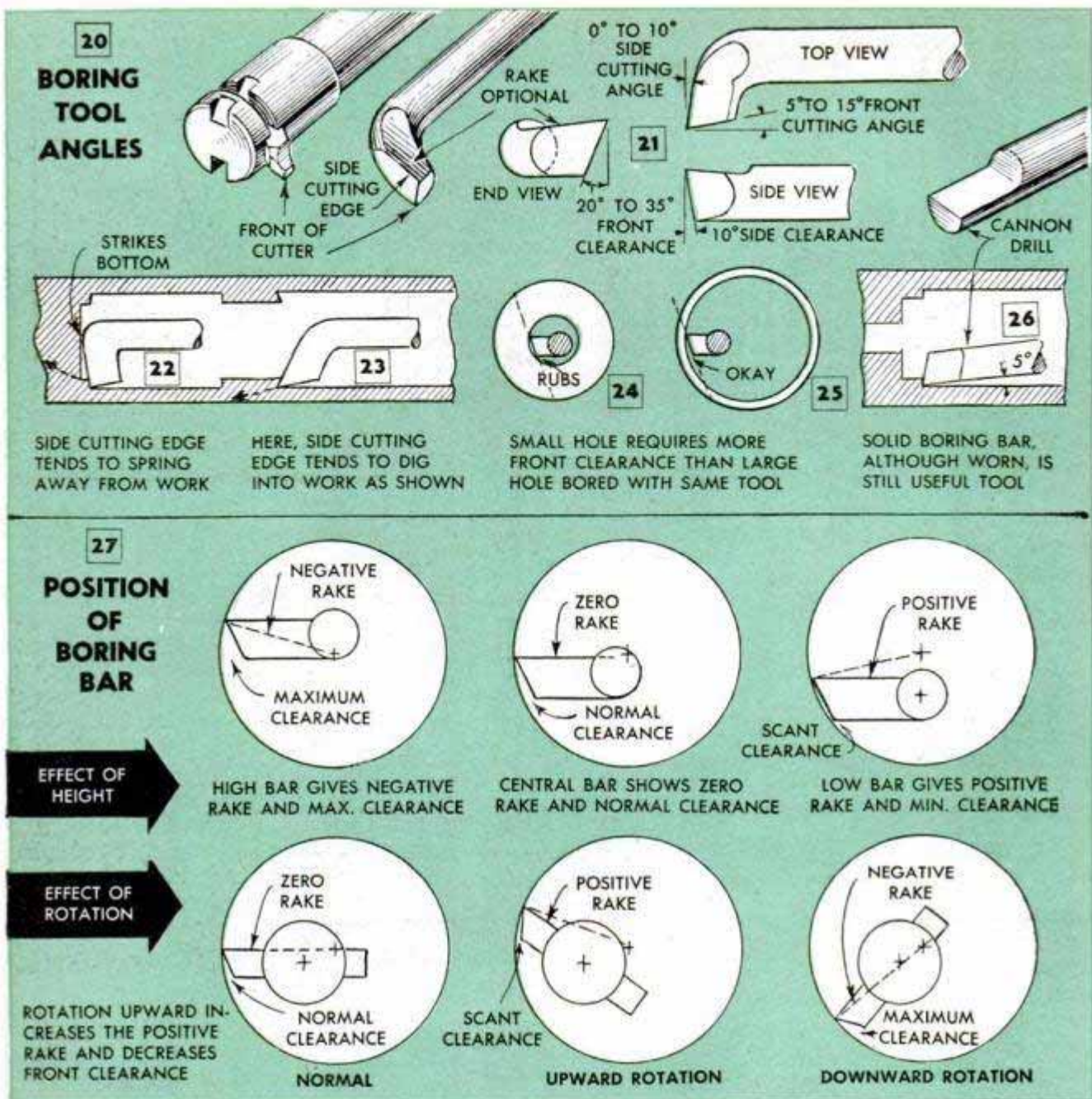

with the 45-deg. cutter as shown in Fig. 3.

Boring a hole: A typical boring operation is pictured in Figs. 8 to 19 inclusive. Key points in the procedure are the 1/4-in. allowance for the boring-bar extension, Fig. 12, the use of an electrical stop switch and use of accurate measuring tools combined with a calculated outfeed measured on the micrometer crossfeed screw of the lathe carriage. The stop switch, Figs. 14 and 15, is a big help as it turns off the motor at the precise instant that the tool reaches the required depth on each successive cut. With the mechanical stop, it is necessary to throw out the power feed just before the tool reaches full depth and finish the cut by running the carriage up to the stop by hand. This procedure can result in an inaccuracy when critical work is near the required finish dimension. Use the cross-feed micrometer sleeve to determine the depth of cut. It's easy and fast. It also is

regular practice to reverse the power feed and back the tool out after running in the final cut. This trues the bore and brings the hole to exact size with a finish practically equal to that produced by reaming.

Mounting a boring bar: The simplest method of mounting a boring bar is in the tool post as in Fig. 5. However, this mounting is suitable only for light work where the hole can be bored to the full depth with a minimum overhang of the tool bar. The three holding devices shown in Fig. 4 are now so universally used as to be classified as standard. A square-shank bar mounted in an open-side holder, Fig. 6, makes the most rigid setup. The lathe milling attachment also makes a good, rigid mounting for large bars and the jaw opening provides space for an additional support bar placed under the regular boring bar as in Fig. 7. This arrangement will help prevent chattering and springing when ex-

cessive tool overhang is necessary.

Boring-tool angles: Common clearance angles for boring tools are given in Figs. 20 to 26 inclusive. In grinding and honing the cutting edges, keep the side-cutting edge very nearly square to avoid undercutting and riding out, Figs. 22 and 23. The correct angles for most types of work are detailed in Fig. 21. The side clearance angle has a more or less fixed value for the common boring operations but it can vary from 0 deg. to 10 deg. The front clearance ranges from 20 to 35 deg., the sharper angle being required in small holes, Figs. 24 and 25. Some lathe operators run boring tools with a 0-deg. rake but a 5-deg. rake is common practice, especially when boring in ferrous metals. In general, the cutting angles are the same for all types of tools and also apply to solid boring bars worn down to the shank but still usable, Fig. 26. When ground as indicated, these bars are often called "cannon" drills.

Position of boring tool: Although the boring tool can contact the work at any point, it is regular practice to run it directly on the horizontal center line of the work. This position gives the best visibility and the greatest accuracy of measurement on the crossfeed micrometer sleeve. Fig. 27 pictures the positions a boring bar can take and still operate satisfactorily. A study of these details will show how the rake angle is changed by moving the cutter up or down or

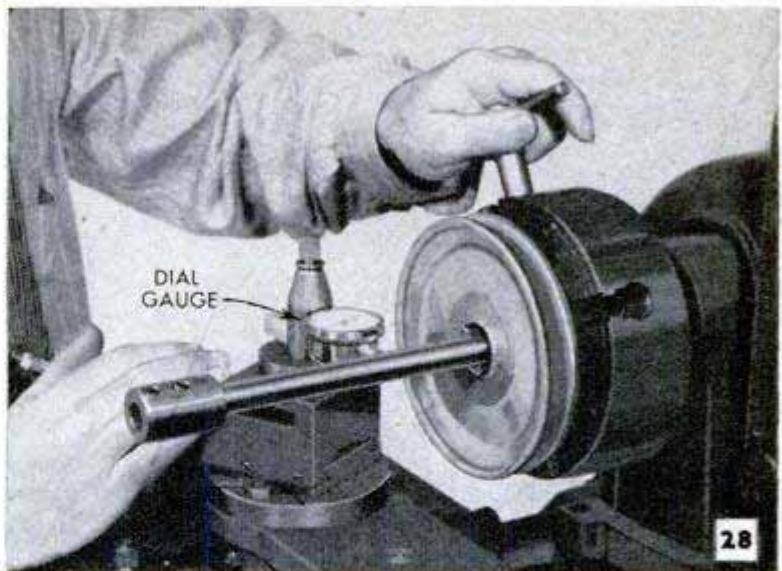

ACCURATE CENTERING IS NEEDED ON REBORING JOBS

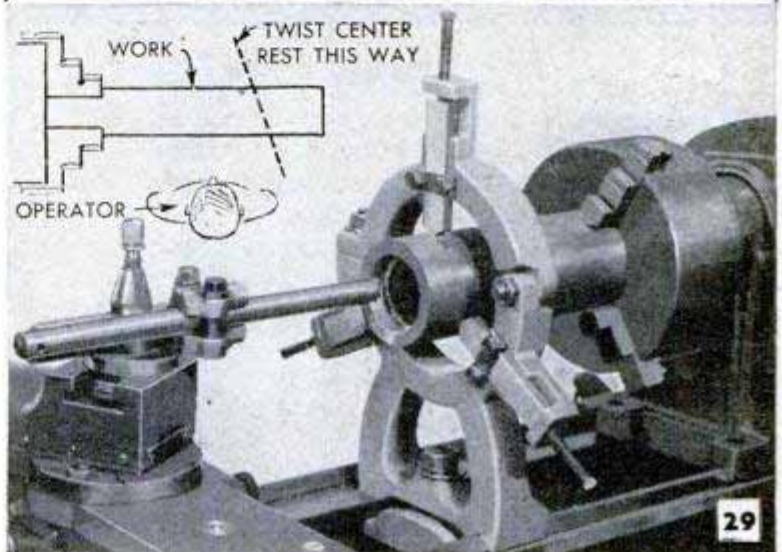

CENTER REST IS ESSENTIAL FOR LONG BORING JOBS

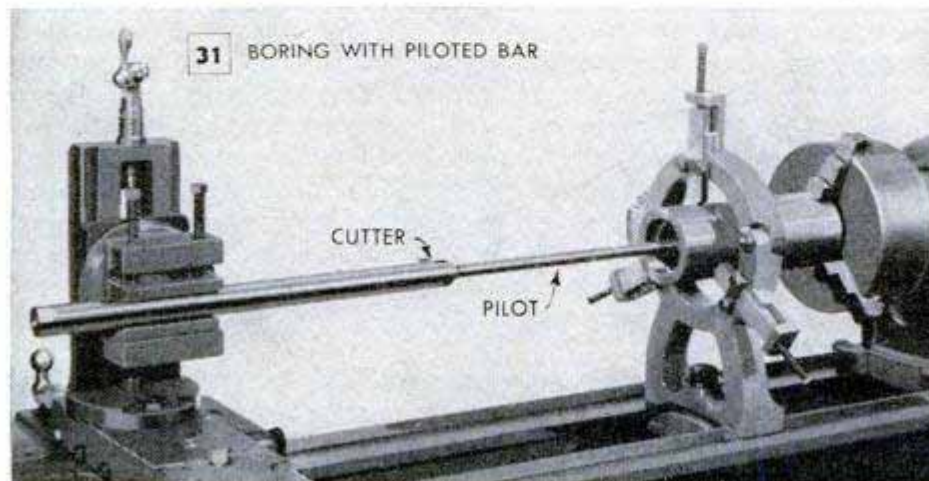
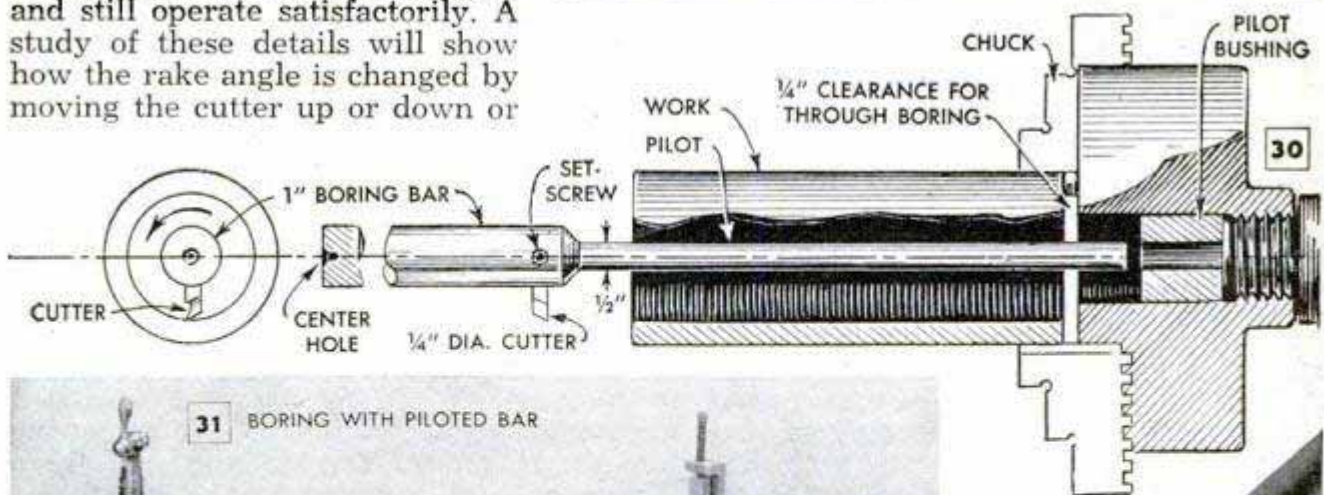

31 BORING WITH PILOTED BAR

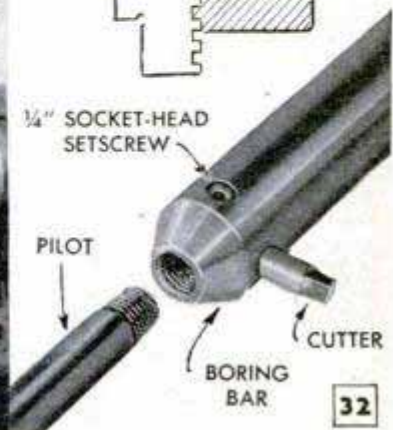

32

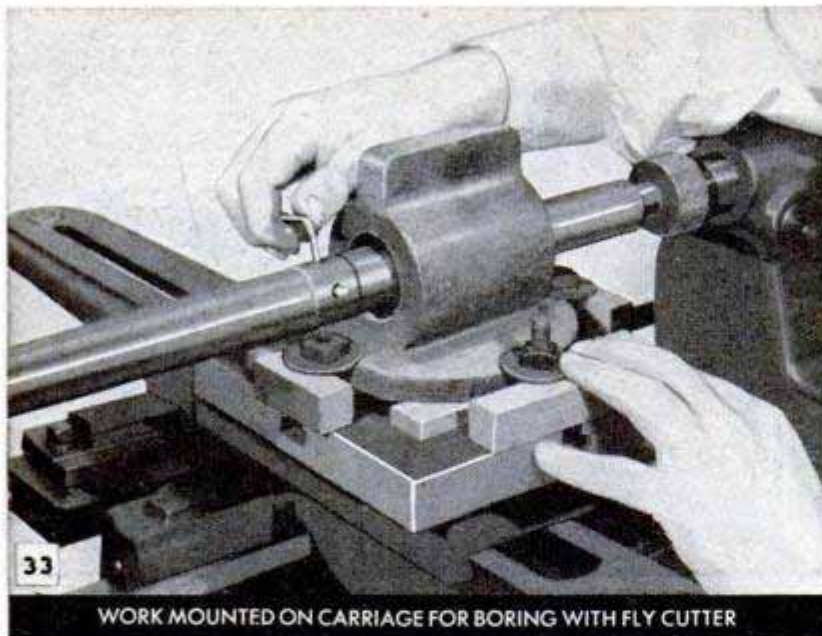

WORK MOUNTED ON CARRIAGE FOR BORING WITH FLY CUTTER

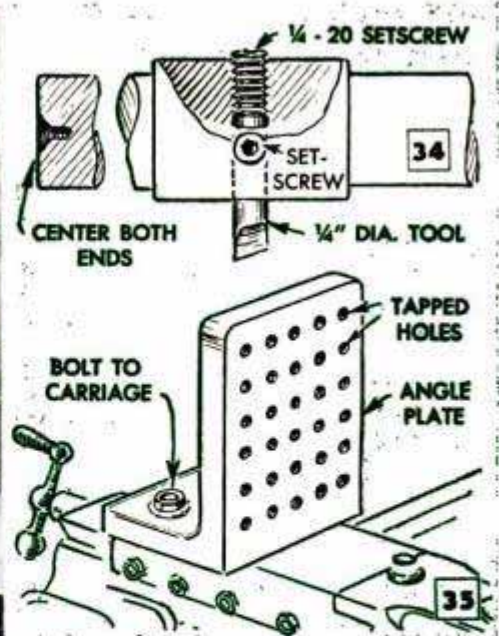

by rotating the bar. With the proper adjustment, one tool can be made to cut all the common materials. Ordinarily the tool is given a negative rake for such materials as plastics and brass, and positive for steel.

Reboring: A reboring job is one in which an existing hole is to be enlarged while its concentricity is maintained. A pulley hub, Fig. 28, is a typical example. Set up this job in a four-jaw chuck with the jaws gripping the outside of the hub. Use a piece of shafting of the same diameter as the hub bore to true the work. Set up a dial gauge and adjust the work in the chuck until the shaft runs dead true. Much the same setup can be followed for all reboring jobs—fit a shaft or a plug in the existing hole and use this to center the work.

Center-rest support: When making a long bore with the work held in a chuck, Fig. 29, it is essential to support the outer end of the work. That's where the lathe center rest comes in handy. One way of adjusting the rest is to place it close to the chuck after the work has been locked in the chuck jaws. After the rest has been adjusted to the diameter of the work, it is pushed along the lathe bed to a position near the outer end of the work. Another way is to true the work first, then carefully adjust the center-rest jaws with the rest in working position. The two lower jaws are brought up into direct contact with the work. The top jaw should be about .002 in. loose and this setting usually is made by slipping a sheet of paper under the jaw before it is locked in place. Place a few drops of oil on the work so that the jaws do not score it.

Boring with piloted bar: With any conventional mounting, a heavy boring bar will take light cuts in bores up to 5 in. long. However, in any bore over this length it will be necessary to use additional support. Often this is done by using a pilot working

through a bushing fitted inside the chuck or in the lathe spindle, Figs. 30, 31 and 32. Fig. 31 pictures the setup, and Fig. 30 sections both the work and the lathe chuck to show the position of the pilot bushing. A preliminary centering of the work is made by fitting the pilot in the bushing and supporting the outer end of the bar on the tailstock center. The milling attachment is then adjusted to clamp the bar and the setup is tested by running the lathe carriage back and forth. The pilot should slide freely through the pilot bushing without binding at any point. As the cutter passes centrally through the bore, it can be operated in any position without changing the cutting angles. The best position is shown in Fig. 30, as this puts the load at the point where the center rest gives the most rigid support.

Boring work on lathe carriage: Work of irregular shape often is fastened to the lathe carriage or to a boring table fitted to the carriage, Fig. 33. Sometimes a special angle plate, Fig. 35, is used. A boring bar is made up in the shop for the carriage jobs as in Fig. 34. The bar should be as large in diameter as the rough bore will permit and still allow clearance for the cutting tool. The length of the bar must be calculated from the length of the bore. The cutting tool, or fly cutter, as it is called, is held in place with a setscrew and adjusted for depth by means of a follower screw. In setting up, the work is carefully blocked and shimmed so that the boring bar is centered through the rough bore. When the setup is correctly made, this method produces very accurate work.

☞ To prevent smudging paper with a typewriter eraser, clean the eraser on an emery board before using. The board is kept handy by taping it to the typewriter.

Cork Fastened on Drawing Board Forms Thumbtack "Pincushion"

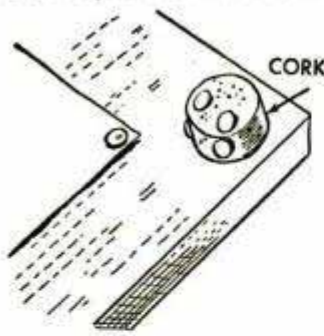

If you want to save the time often spent in searching for thumbtacks, use an ordinary bottle cork as a "pincushion" for the tacks. Glue the cork to the upper right-hand corner of the board

where it is out of the way, and press the tacks into the cork as a drawing is removed from the board. A large cork will hold a considerable number of spare tacks within easy reach when you need them.

Silencing Fan-Belt Squeak

Annoying squeaks that develop in car fan belts can be eliminated quickly by applying hydraulic-brake fluid to the belt. With the motor idling, the fluid is applied to the upper or lower pulley and is absorbed by the belt. This keeps the belt flexible, preventing squeaks, but does not harm it. One application probably will last the lifetime of the belt, although a few additional drops of fluid can be applied occasionally if necessary. When doing this, be careful to avoid the whirling fan blades.

Richard Watkins, Chicago.

Tabs Raise Draftsman's Triangle To Prevent Blotting Work

Small plastic tabs fastened to both sides of a draftsman's triangle hold it above the paper to prevent blotting the work when inking. Strips of $\frac{1}{16}$ -in.-thick plastic, about $\frac{1}{4} \times \frac{3}{4}$ in., are cemented at the corners and at the center points of the legs. These are located about $\frac{1}{8}$ in. in from the edge of the triangle. In addition to facilitating inking, the tabs make it easier to pick up the triangle and also help keep the drawing clean when doing pencil work.

Eldon Schiel, Chicago.

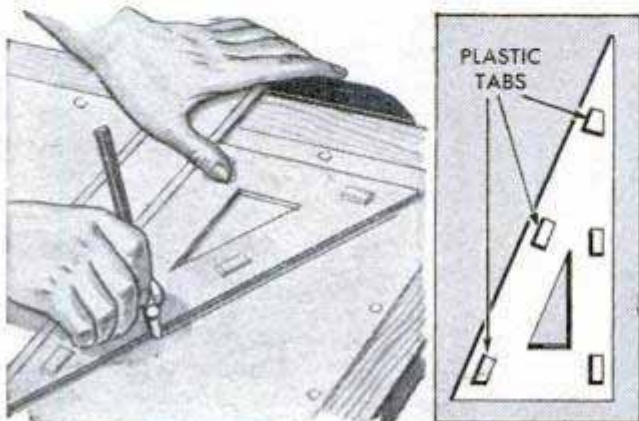

U-Shaped Jig Holds Beaded Ceiling When Nailing Single-Handedly

Nailing long lengths of beaded ceiling can be done single-handedly with the aid of a wooden jig or clamp. It consists simply of two parallel arms joined at one end with a short crosspiece. The arms should be far enough apart to slip over the ceiling and their length should be equal to the width of two lengths of ceiling. As each succeeding strip of ceiling is set in place, the clamp is slipped over its edge. By using the clamp, the preceding length of ceiling supports the weight of the next length until it is nailed in place. Then the clamp is removed and the operation repeated.

Grover Brinkman, Okawville, Ill.

W.T.M. Concrete Portable Posts for Electric Fence Supported With Concrete Blocks

Electric fences can be shifted easily if the posts are supported with concrete blocks instead of being set in the ground. Each post is driven into the center hole of a block, the end of the post being hewn, if necessary, to fit tightly in the hole. Anchored in this way, the entire fence can be moved a short distance or several sections shifted without taking down the wire.

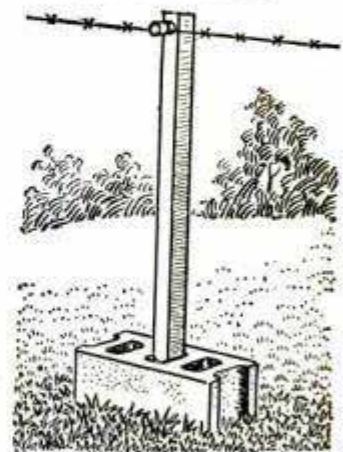

SEWAGE-DISPOSAL SYSTEM for rural homes

IN BUILDING or modernizing farm homes, lake cottages and suburban homes in areas where public sewers are not available, the septic-tank system provides a safe, reliable and inexpensive installation for the disposal of household wastes. The operation of the tank is almost wholly automatic, as it disposes of bathroom and kitchen wastes by a process of bacterial disintegration and releases only liquid residues, or effluent, to the drainage field. Here, the effluent is dispersed through a system of drainage tile where it is absorbed by the soil and is eventually made harmless by the action of soil bacteria. A two-compartment tank of average size is detailed in Fig. 6. It is of monolithic concrete construction and has a capacity of over 600 gallons, which is sufficient for a family of four to six persons.

By Edward R. Lucas

A typical layout of separate disposal systems for the kitchen and bathroom of a rural home is shown in Fig. 3. Tile in the drainage field can be arranged as a series of branches in alternate directions from a main tile line, as in Figs. 1 and 3, or as a Y-branch connected into parallel lines of dispersal tile, as in Fig. 2. Where it is necessary to install the disposal field on rolling ground or a fairly steep slope, the main outlet tile from the septic tank often is led into a concrete distribution box from which dispersal tile lines are taken off at approximately right angles with the slope. In locating the tank, the minimum distance from the house foundation to the tank is 5 ft., Fig. 1. In most cases, it is better to locate the tank 10 ft. from the foundation and at least 50 ft. from any source of water supply. Usually the

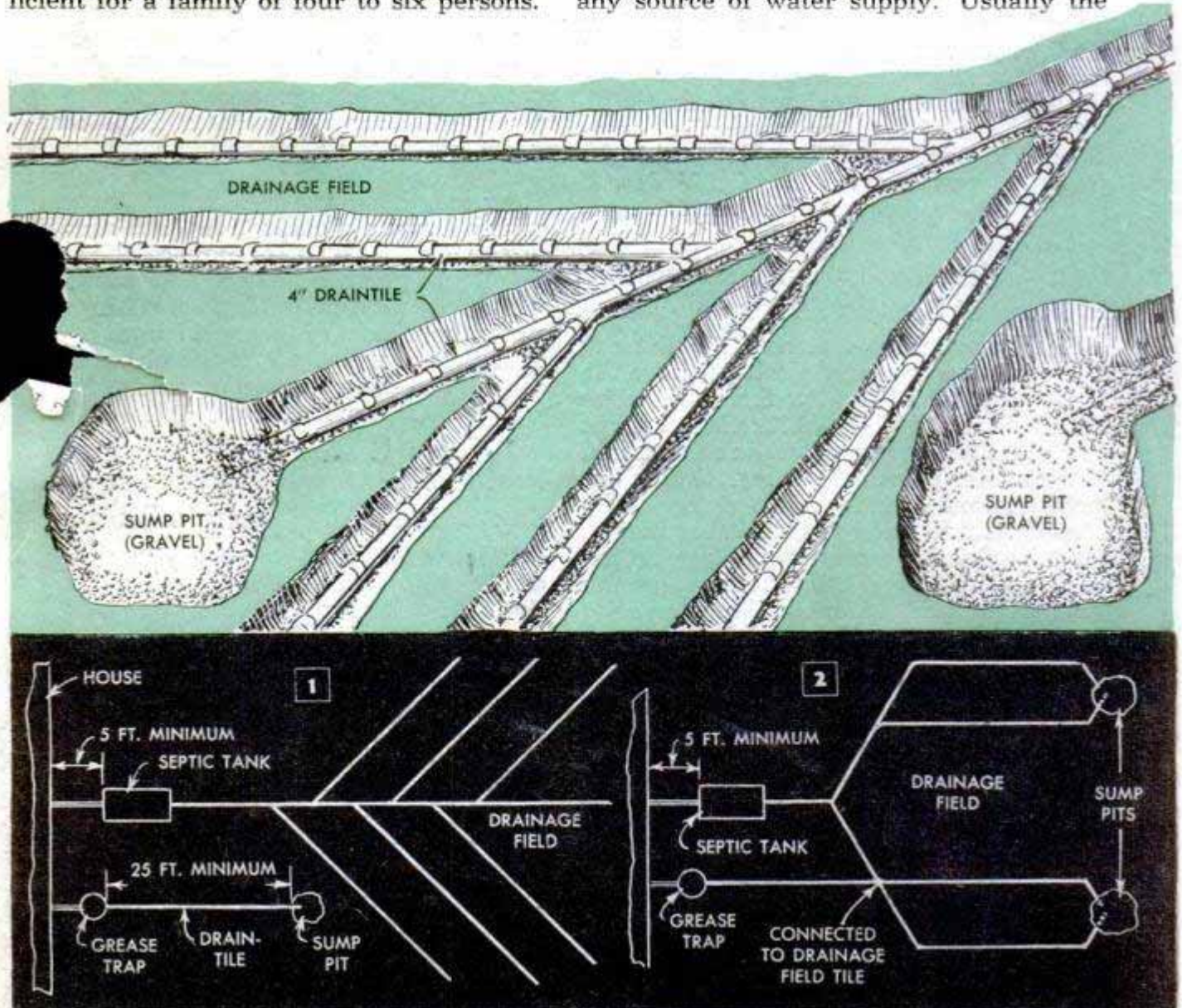

earth can be made to serve as the outside form for the tank. The tank excavation should be straight-sided and dug to the same size as the over-all dimensions of the tank. The fall from the house to the tank determines the level of the intake tee. This measurement plus the distance from the intake tee to the bottom of the tank determines the depth of the excavation. Note that the center of the outlet tee is 2 in. below the center of the intake. When pouring the walls of the tank, tamp and spade the cement mix thoroughly so the tank will be watertight. Trowel the floor level with the bottom edge of the forms so that the latter are not embedded at any point. As

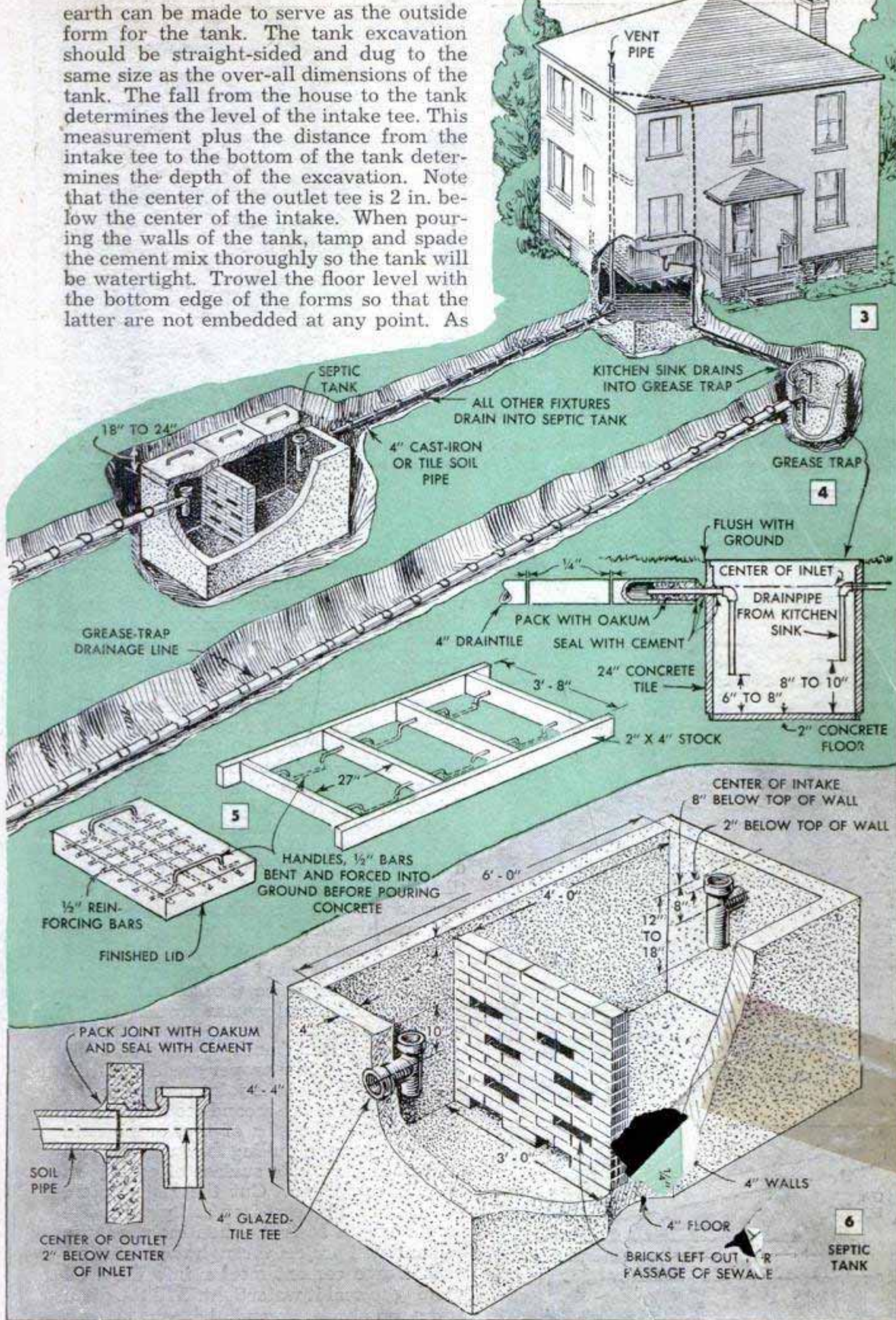



A long guide board fitted with sharpened stakes is an aid in digging a straight trench to correct grade



In heavy soils where the natural drainage is slow, disposal tile should be embedded in washed gravel

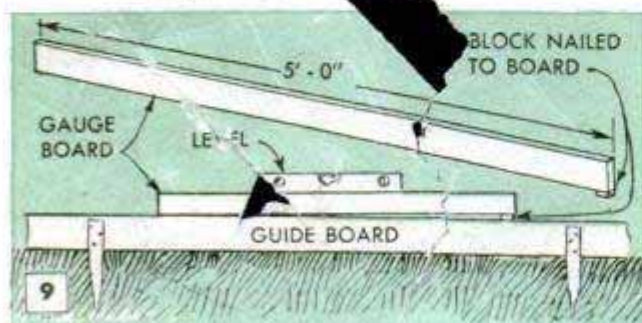

soon as the concrete has set (allow 36 to 48 hrs.) remove the forms and cover the excavation and the tank with boards and a light covering of earth. Allow the concrete to cure for at least a week. Then lay up a brick wall inside the tank 4 ft. from the intake end, leaving openings in the wall as indicated in Fig. 6 to allow passage of the liquids from one compartment to the other.

Before beginning construction of the sewer line from the house to the tank, be sure that the trench is dug with the correct slope. Fall for the 5 or 10-ft. run from the house to the tank should not exceed $\frac{1}{4}$ in. per ft. If the sewer line passes under a driveway or if it is likely at any time to be subjected to a heavy weight, use cast-iron soil pipe for the full run. Otherwise use ordinary bell tile. Make the first joint to the tile tee as in the left-hand detail in Fig. 6. Force a tight-fitting swab, such as a burlap bag, into the bell end of the tile, or pipe. Trowel cement mortar (equal parts cement and sharp sand) into the lower part of the bell end. Then place the second section and force additional mortar around the inserted end of the tile until the space is completely filled. Check to make sure the tile section is on the proper grade and then pull the swab past the joint and up to the open bell end of the second section. Install the remaining lengths of tile, or pipe, in the same manner, pulling the swab through to smooth the inside surface of each joint as it is completed. Cut the last section, which should be cast-iron soil pipe, to the proper length so that, when installed, the bell end will project through the basement wall. Force cement mortar into the wall opening to seal it watertight. Fill the ditch to the top of the tile and allow the cement



As the open-end tile are laid, each joint is covered with a rectangular piece of extra-heavy tarred paper

mortar to cure. Then use a small tamping stick to tamp the layer of soil firmly, forcing it under the tile. Add another layer and tamp, and repeat until the trench has been filled. This procedure assures that the soil will not settle unduly in the trench and eliminates the danger of the settling breaking the tile joints.

The outlet sewer line and the disposal lines are laid with open-end tile. The fall of the lines should not exceed $\frac{1}{4}$ in. in 5 ft., Fig. 9. Make a guide board and a gauge board, as shown, for laying out and leveling the trenches, Figs. 7, 8 and 9. Dig the trenches body width so you can work easily at the bottom. Lay the tile with joints spaced about $\frac{1}{8}$ in. and check every 5 ft. to make certain that the grade is uniform. Cover each joint with a rectangular section cut from heavy roofing or asphalt-coated paper, Fig. 11. In heavy soils where drainage is slow, tile should be embedded in washed gravel as in Figs. 10, 12 and 13. In addition, many rural builders install a gravel sump pit at the end of the main disposal line as in Figs. 3 and 4. Where natural drainage is good, the sump pit is neither necessary nor advisable as it may accelerate drainage to lower levels and leave the disposal line "dry." Aggregate length of the disposal lines will vary with the general lay of the land, soil permeability and size of the tank, but in no case should the tile line be less than 100 ft. long, with 40 to 60 ft. of disposal tile per person being the safest average. Never discharge disposal lines into a stream, pond or lake, into old wells or onto the surface of the ground. The kitchen disposal line is installed in the same way as the septic-tank system, using a length of concrete tile for the grease trap,



After laying and leveling to grade, tile line is covered with a layer of gravel as shown above and below

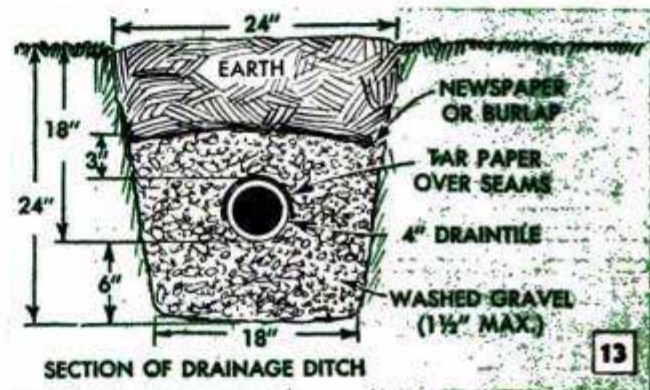

Fig. 4. This is embedded at grade level or a little below and intake and outlet pipes installed as shown. The disposal line should be straight and at least 60 ft. long, Fig. 3. The trap is covered with a cast-iron or cast-concrete lid.

Complete the installation of the system by making the 3-piece cover for the septic tank. This is cast from concrete in a form made as in Fig. 5. Cast two metal handles and reinforcing rods into each unit as indicated. After the castings have cured, place them over the tank and cover with earth to the grade level. Both the grease trap and the septic tank should be vented. If the kitchen sink is some distance from the bathroom, then the grease trap must be vented separately, as long horizontal runs in a vent are not approved. Otherwise both can be vented to a single stack as indicated by the dotted lines in Fig. 3. Inside plumbing must be installed by approved methods and all fixtures should be properly trapped.

Before putting away a garden hose for the winter, protect it by giving it a coating of water-emulsion wax. Then store it in a dark, cool place in the basement.

Headlight Shell Provides Bowl For Inexpensive Fountain



Utilizing a discarded headlight shell and the metal standard from an outdoor sign, one garage owner made an inexpensive and serviceable drinking fountain. The headlight shell is brazed to the top of the sign standard and the water is supplied with $\frac{1}{4}$ -in. pipe. A valve is located at one side of the fountain, and the water drains down through the standard and into a length of $\frac{1}{2}$ -in. pipe near the base.

George T. Hewitt, Salem, Ore.

Expansion Reamer Forms Mandrel

An old expansion reamer forms a satisfactory mandrel for light turning jobs. The reamer is chucked in the lathe and the work is slipped over it. Then the reamer is expanded to grip the work. If the inner surface of the work is highly finished, marring can be prevented by placing a sheet of

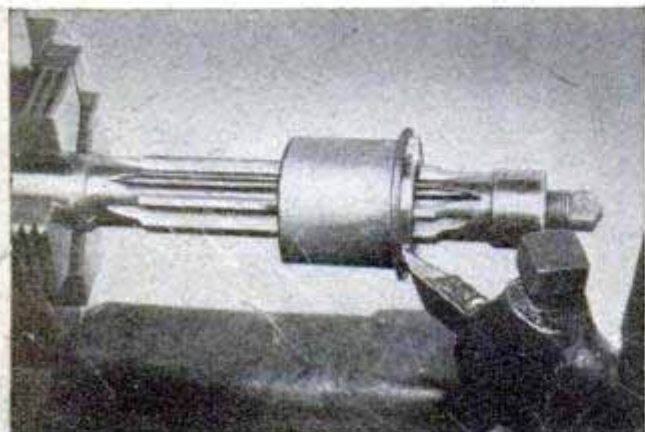

soft brass shim stock over the reamer before it is tightened. In most cases, it is not necessary to support the free end of the reamer.—Ed Packer, Chicago.

Measuring Total Rainfall

To keep a personal record of total rainfall during planting and growing seasons, one farmer collects the water in a glass jar or beaker containing a small amount of motor oil. About $\frac{1}{2}$ in. of oil is poured into a straight-sided jar and this is set in the open where rain can fall into it normally. The oil floats on top of the water, keeping it from evaporating and the depth of the water is easily measured along the outside of the jar. This method, of course, cannot be used during freezing weather.

W. R. Black, Contact, Nev.

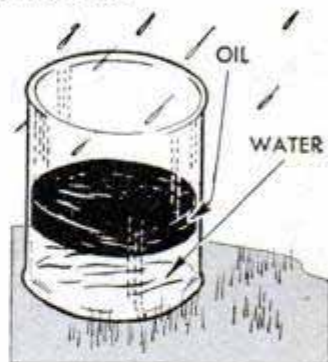

Cover Protects Small Motor

Tacking a piece of linoleum over the edges of two semicircular boards provides a hood which protects a small motor from falling objects. Such is the case where the motor is used to drive a small corn sheller, concrete mixer, fanning mill, etc. The linoleum cover is cut out for the belt and a slit is made from this opening to the bottom edge of the cover. The slot allows the hood to be lifted off the motor for servicing.

Dick Hutchinson, El Monte, Calif.

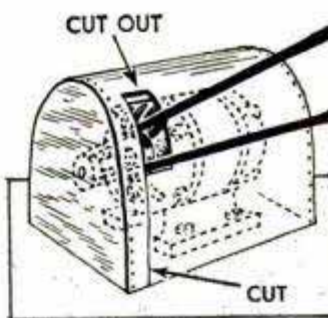

Balancing Impeller of Scooter Motor

Breakage of one fin on the impeller of an air-cooled scooter motor threw the motor out of balance. As a new impeller was not available, the balance of the old one was restored by breaking off the fin directly opposite the damaged one. The impeller then operated satisfactorily without apparent reduction in cooling effect.

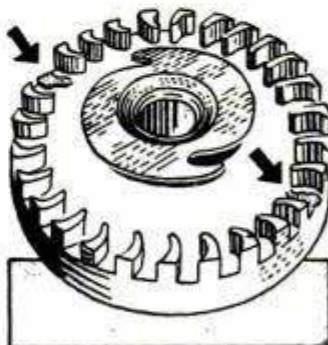

Plastic Console for TV Set

INCORPORATING compound curves (claimed to be impossible with wood), the plastic console cabinet that houses the television receiver illustrated in photo A is a single-piece Bakelite casting weighing 35 pounds. The TV set employs 24 tubes with a 10-in. picture screen covering about 61 square inches.

The special 16,000-pound mold for this unusually large plastic casting and the 2000-ton press used to form it are shown in photos B, C and D. The single 35-pound plastic casting turned out by this combination is said to be about 15 pounds heavier than any achieved before. In photo B the operator is shown laying out the phenolic bricks which must be placed in just the right order to obtain perfect flow and grain. Electronically preheated, the powder bricks are softened so that less pressure per square inch is needed. If cold briquettes were employed, a press of twice the weight would be required. After the phenolic bricks are placed inside, a switch is clicked and the huge press exerts its 2000 tons of pressure. Two men operate the press and turn out one of these Admiral plastic console cabinets every six minutes. The finished product leaves the mold in perfect condition as indicated in photo C. It will resist cigarette burns and is strong enough to support the combined weight of seven husky men. An exploded view of the 16,000-pound mold is shown in photo D.

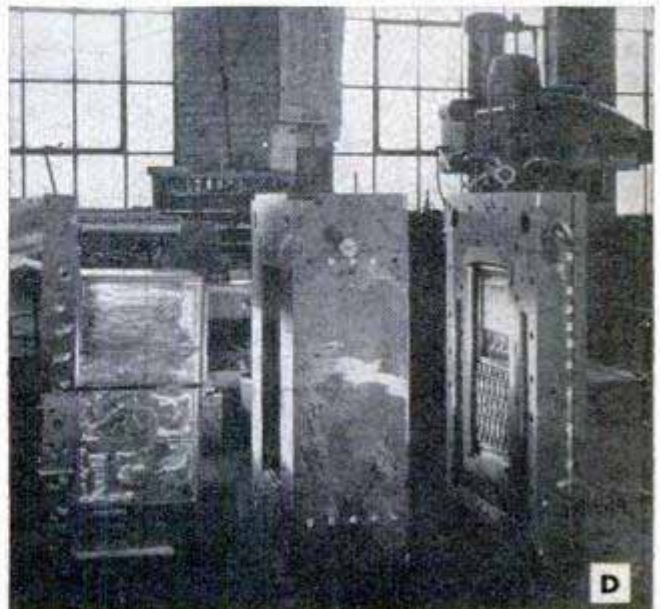
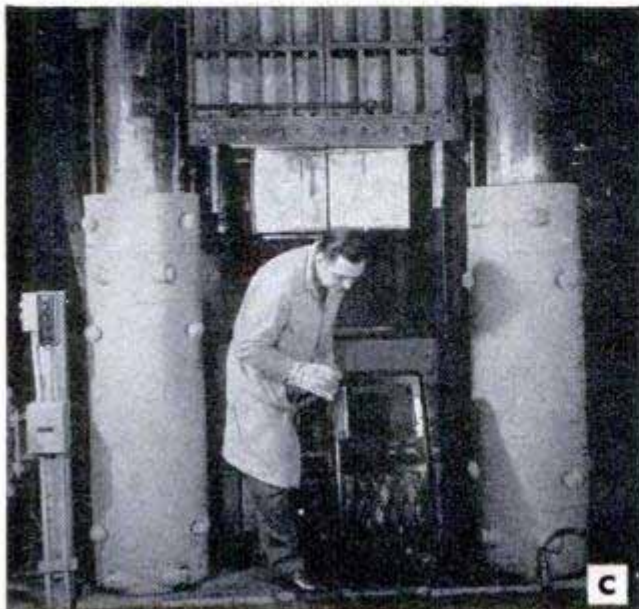
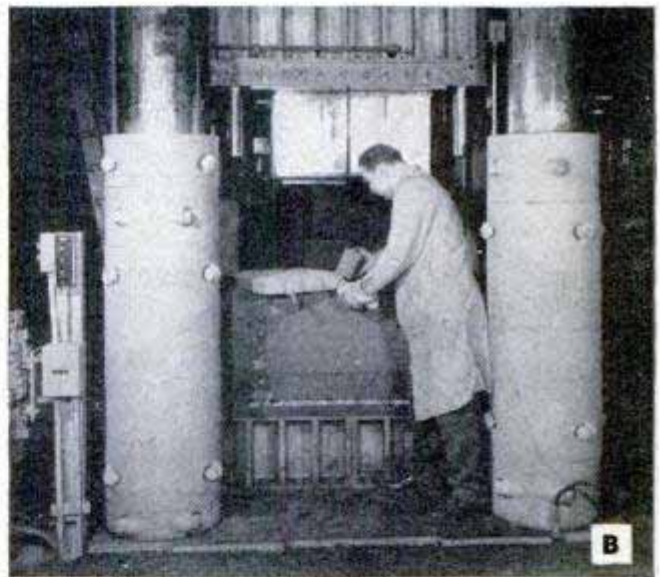
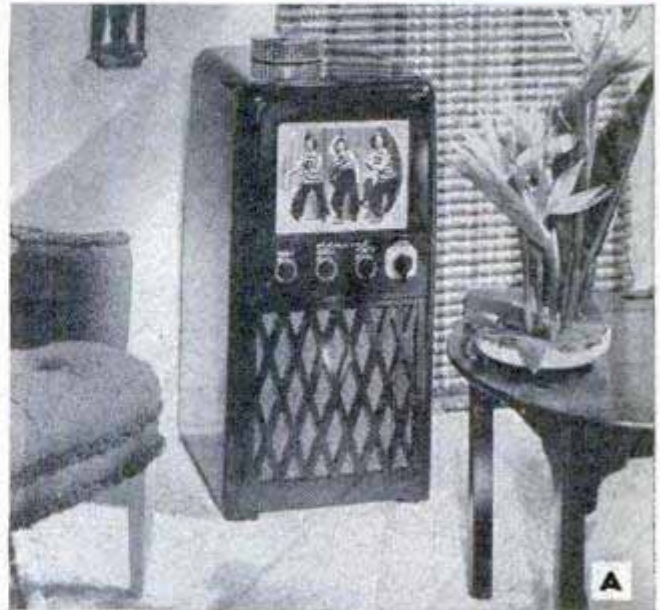

HOW TO BUILD A

By John C. Wade

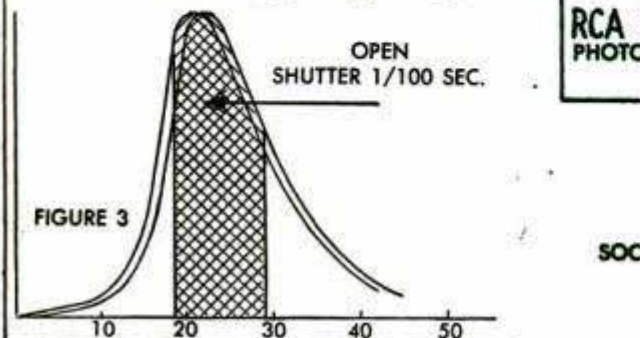
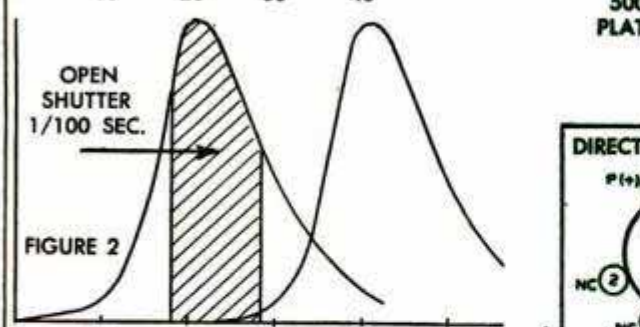
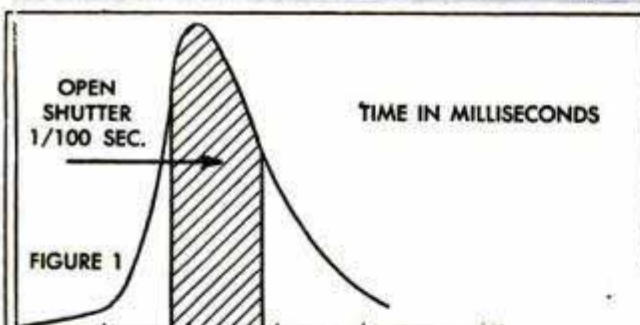
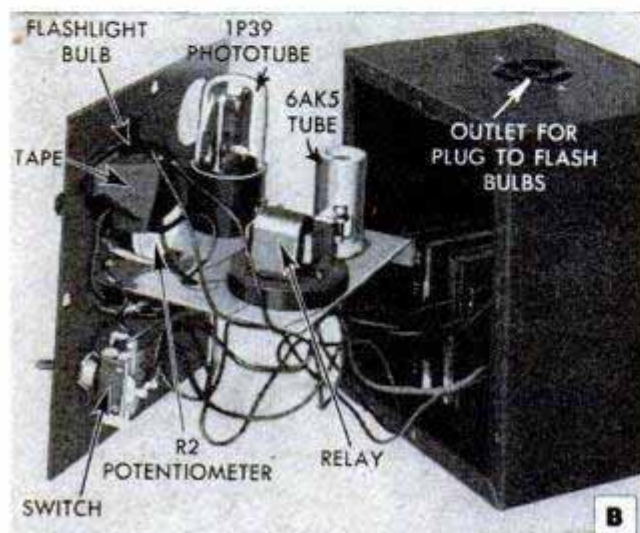

MULTIPLE flash photography has always been a problem of long extension cords and insufficient electrical power to set off camera shutter and flash bulbs in perfect synchronization. The remote flash synchronizer very effectively eliminates these problems and minimizes the drain on flash-gun batteries. It does away with the necessity of laying long lengths of cords from the camera position to additional reflectors and the hazards involved when these cords cross the path of groups or milling crowds.

This electronic remote "slave" flash unit is completely self-contained. Acting as a receiver of light, it instantly converts light rays, given off by the master flash on the camera, into enough energy to set off as many as four or five side-lighting flash bulbs in synchronization with the camera shutter. Extremely sensitive to any change in light intensity, this unit may be placed in an inconspicuous location as it does not need to receive direct rays of light from the master flash to react instantly. The extremely bright light of even the smallest flash bulb reflecting off a wall or ceiling is more than enough light to trigger the miniature relay and set off other flash bulbs placed in locations where they will light up dark areas.

The electronic circuit is quite simple; all materials used in making the unit are

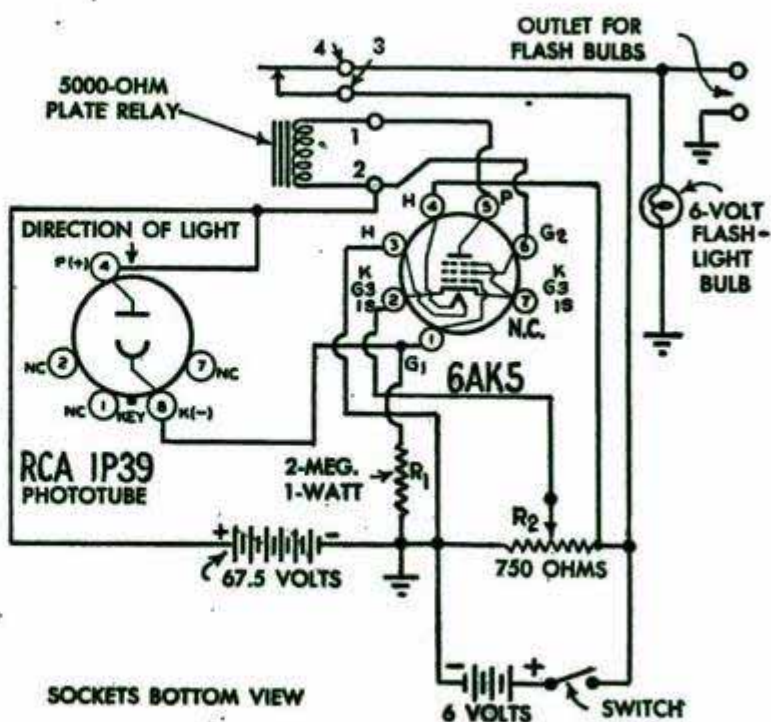
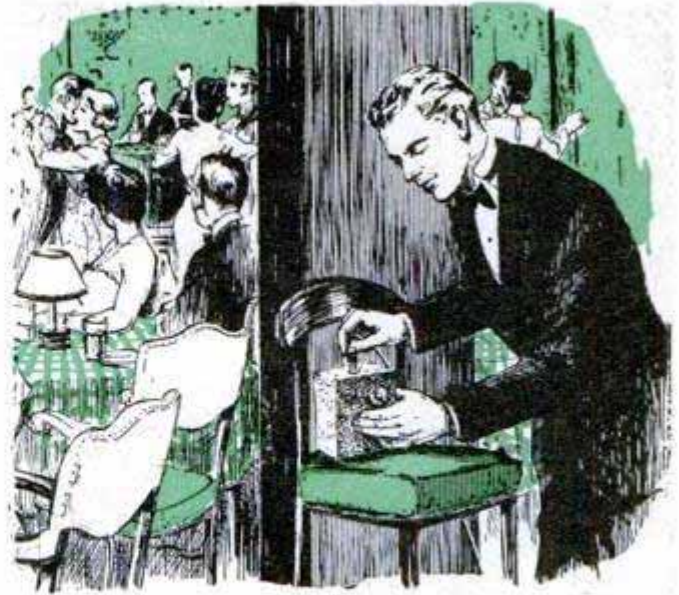

Fig. 4

REMOTE "SLAVE" FLASH SYNCHRONIZER

standard and cost less than \$15.00. The result is an amazingly compact instrument in a standard Bud type CU-729 metal cabinet 4 in. deep, 5 in. wide and 6 in. high. All of the component parts are mounted on the rear of the panel and on the 4 x 4½-in. sheet-metal shelf, or chassis base, shown in the photos. This shelf, or base, is fastened to the panel by means of two ½ x ½-in. angle brackets. Photos B, C, D and E show various views of the completed unit. Photo E shows the underside of the chassis base. A schematic circuit diagram is given in Fig. 4, and a pictorial wiring diagram appears in Fig. 5.



The ultimate object is to make enough current flow through the 6AK5 tube to energize the small relay which is in series with it. When this happens, 6 volts are instantly applied to the flash bulbs. Although a tremendous amount of light is given off by the master flash bulb, the unit must be sensitive enough to react instantly under a very small change. The reason for this can be understood by inspecting diagram Fig. 1. The normal curve of light output versus time of the standard flash bulb shows that this bulb reaches its peak intensity at 20 milliseconds. A shutter, properly synchronized to this bulb, would start to open at around 17 milliseconds, be fully open at 20 milliseconds, and fully closed at 30 milliseconds, when set at 1/100 second. If it required the full peak intensity of the master flash bulb to trigger the remote

(Continued to page 234)

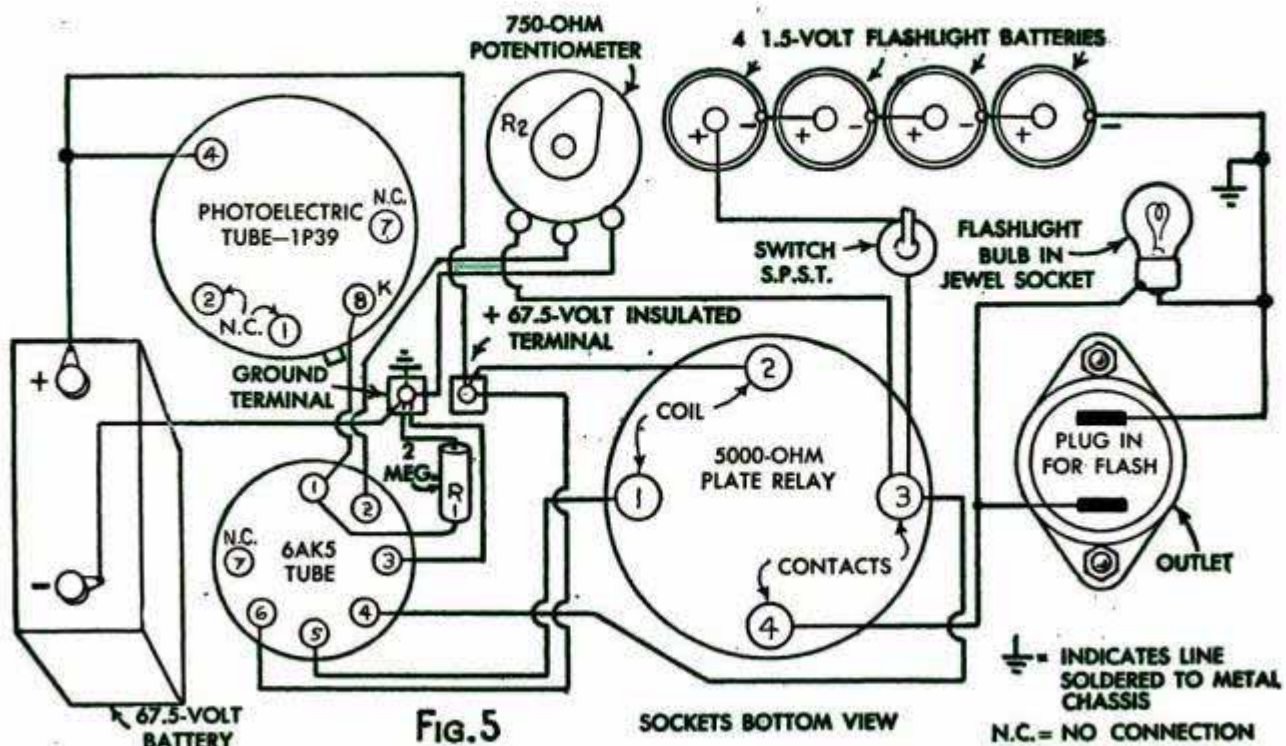



A

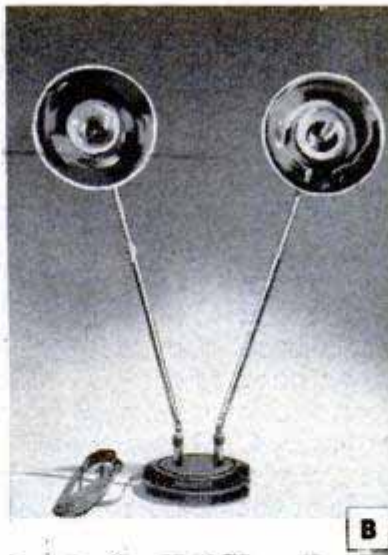

B

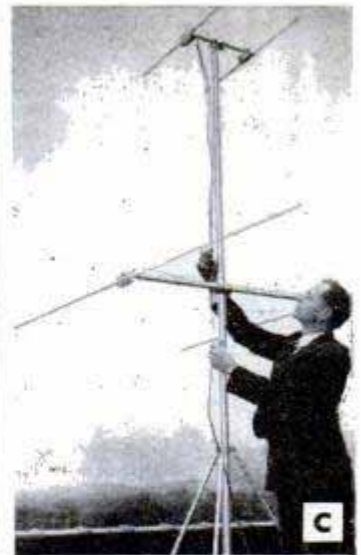

C

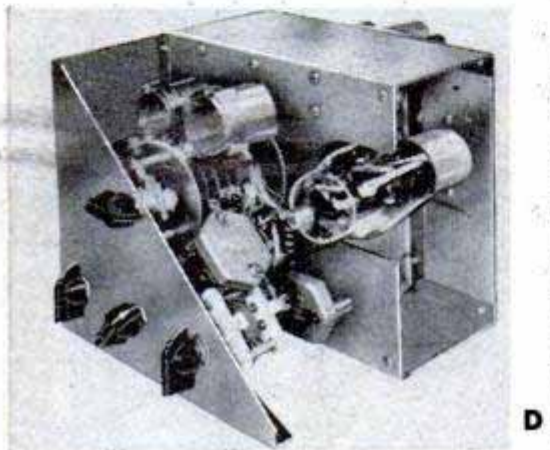

D

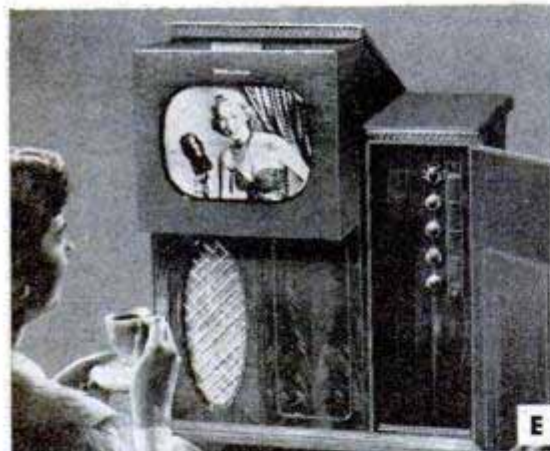

E



F

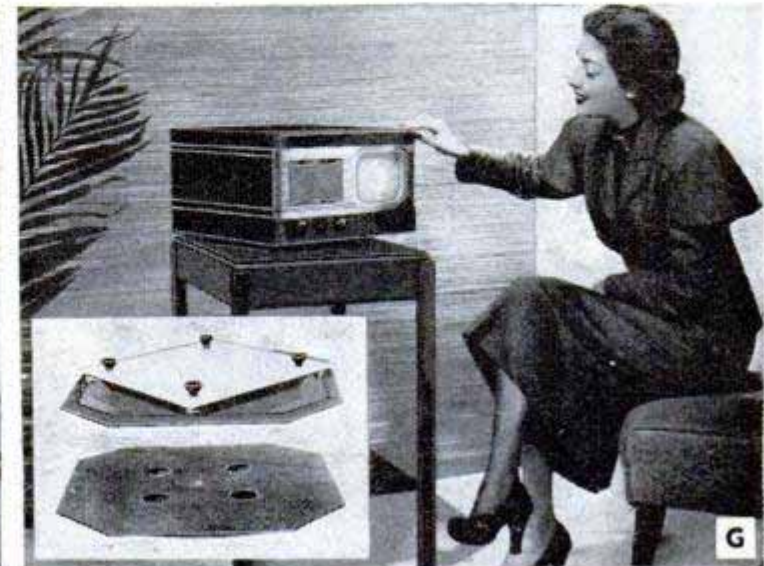

G

RADIO and ELECTRONICS TODAY

A—Twelve-pound self-powered tape recorder swings over the shoulder like a camera case. It is used by newsmen to cover news for the "Mutual Newsreel" programs; the small microphone may be held in the hand, or strapped on wrist

B—All-channel television and FM indoor antenna of unusual design employs parabolic-dipole arrangement on telescoping rods. Swivel joints make numerous adjustments possible

C—TV antenna features interchangeable component parts so that a wide variety of antenna arrays can be constructed to provide the best installation for a particular location

D—Six-band frequency multiplier simplifies developing and constructing the proper frequency setup stages for amateur transmitters. Switches instantly to 80-40-20-15-11 and 10M.

E—Console with 16-in. TV tube features a "rotating elevated mount" for the 22-in.-long picture tube. The tube is installed vertically and is rotated manually into viewing position beyond the front of the console, at proper height

F—"Playtalk" electronic toy for children uses a grooveless paper disk coated with "powdered" iron to record and reproduce magnetically music or voice. Records hold about two minutes of recording; can be "erased" and reused often

G—Turntable for table-model TV sets provides a means for rotating the receiver in any desired direction for viewing

Kodachrome
slides

Kodacolor
snapshots

Kodak
Ektachrome
transparencies

Black-and-
white negatives

Bantam (828)
28 x 40mm.

Half-620
1 5/8 x 2 1/4

Square 620
2 1/4 x 2 1/4

Full 620
2 1/4 x 3 1/4

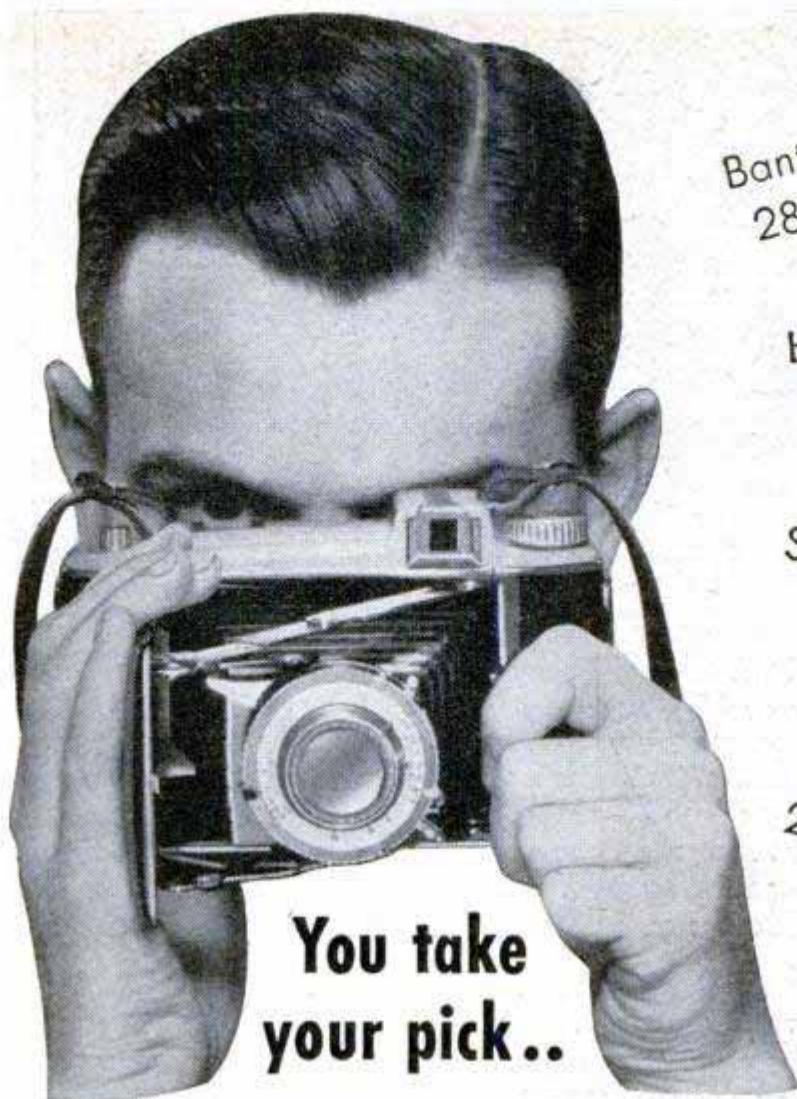

**You take
your pick..**

**with KODAK TOURIST CAMERA f/4.5 or f/6.3
and new Adapter Kit with interchangeable back and masks**

Change-over is quick and easy . . . slip on adapter back, add masks for negative and view finder; for 828 film, add spool baskets as well. Adjust picture-size guide on adapter back. Now you're all set for your choice of a variety of films and kinds of pictures, including miniature Kodachrome slides.

Enjoy other new camera features . . . shutter release set into camera bed; brilliant view finder; built-in exposure guide. Kodak Tourist Adapter Kit, \$14.50, fits these models: Kodak Tourist Camera with f/4.5 lens, \$71; with f/6.3 lens, \$47.50. Prices include Federal Tax. At your dealer's.



SPECIAL BACK . . . without accessories, gives full 2 1/4 x 3 1/4 size . . . 8 shots on black-and-white Kodak 620 Film; 6 on Kodak Ektachrome or Kodacolor Film.

BANTAM ASSEMBLY . . . (28 x 40mm.) . . . 8 shots on black-and-white Kodak 828 Films or Kodachrome Film.

1 5/8 x 2 1/4 MASKS . . . 16 shots on black-and-white Kodak 620 Films, 12 on Kodak Ektachrome or Kodacolor Film.

2 1/4 x 2 1/4 MASKS . . . 12 shots on black-and-white Kodak 620 Films, 9 on Kodak Ektachrome or Kodacolor Film.

"Kodak" is a trade-mark.

Kodak

EASTMAN KODAK COMPANY, ROCHESTER 4, N. Y.



"Yes, it's lovely, I can make it just like new with Weldwood Glue."



Remember Weldwood Glue when you need dependable wood-to-wood bonds. Quick and easy to mix with cold water . . . tremendously strong . . . stain-free . . . rot-proof . . . and *permanent*. At paint, hardware, variety stores and lumber yards. 15¢, 35¢, 65¢, 95¢ and larger sizes.

WELDWOOD PLASTIC RESIN GLUE

United States Plywood Corporation, New York 18, N. Y.

How to Build a Remote "Slave" Flash Synchronizer

(Continued from page 231)

"slave" unit, then the resulting curves of the two flashes would be as seen in Fig. 2. The remote flash bulb would reach its peak fully 10 milliseconds after the shutter had

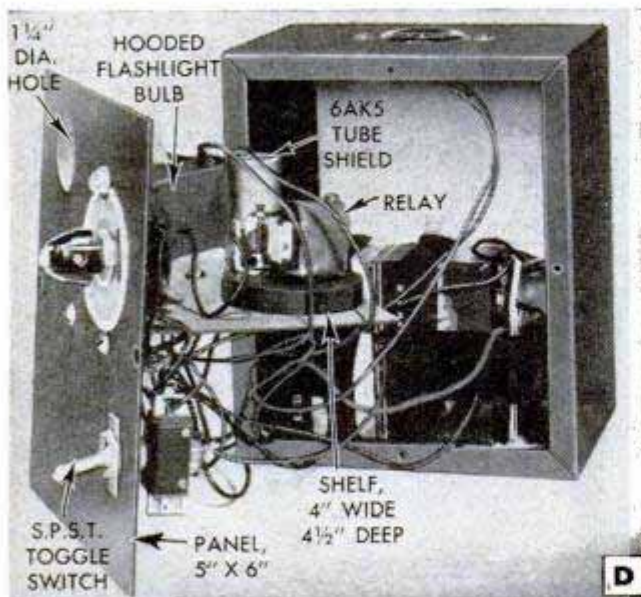

closed. This, of course, would be entirely useless. To be of service, the unit must be triggered by the very first weak output of

ALSO HANDY FOR WOOD HOBBYISTS!



Firzite

— to give you smooth finishes on fir plywood and other soft woods.

A pre-finishing material that seals the wood pores . . . tames the wild grain . . . virtually eliminates checking and grain raising. An excellent base for stain, paint or enamel. White or clear. White Firzite provides an easy, low-cost way to achieve "blond," "bleached" or "wiped" finishes.



Satinlac

— to preserve the beauty of all woods.

An inexpensive coating for the proper finishing of Weldwood Hardwood Plywood and similar woods. Clear. No brush marks. Brings out all the natural beauty of wood. Does not yellow or darken with age.

FIRZITE and SATINLAC are available from paint, hardware and lumber dealers. Write us for leaflet on finishing plywood.

light from the master flash as indicated in the diagram, Fig. 3.

In order to obtain the necessary extreme sensitivity, the operating point of the 6AK5 tube is adjusted by the potentiometer R2 so that it is just a fraction under that required to energize the relay. Light striking the photoelectric tube causes a tiny current to flow. This current sets up a voltage drop across the 2-megohm resistor R1, and the voltage drop is applied to the control grid of the 6AK5 tube. This, in turn, is adjusted by means of the potentiometer. As the 6AK5 tube has very high gain, the current flow is increased with a tremendous surge and the relay is energized, setting off the flash bulbs. All this happens in an extremely short length of time. The following would be the sequence of events: set up the remote "slave" synchronizer unit in the position it is going to occupy when the picture is taken (this may be around a corner, back of a post as indicated in the sketch or in any position just so the opening in the box where light reaches the phototube is facing in a direction where it will pick up either direct light from the master flash bulb on the camera or reflected light from a wall or ceiling); turn on the toggle switch so that the 6AK5 tube will heat up; then adjust the potentiometer R2 so the relay

(Continued to page 236)

Look, No Rivets!

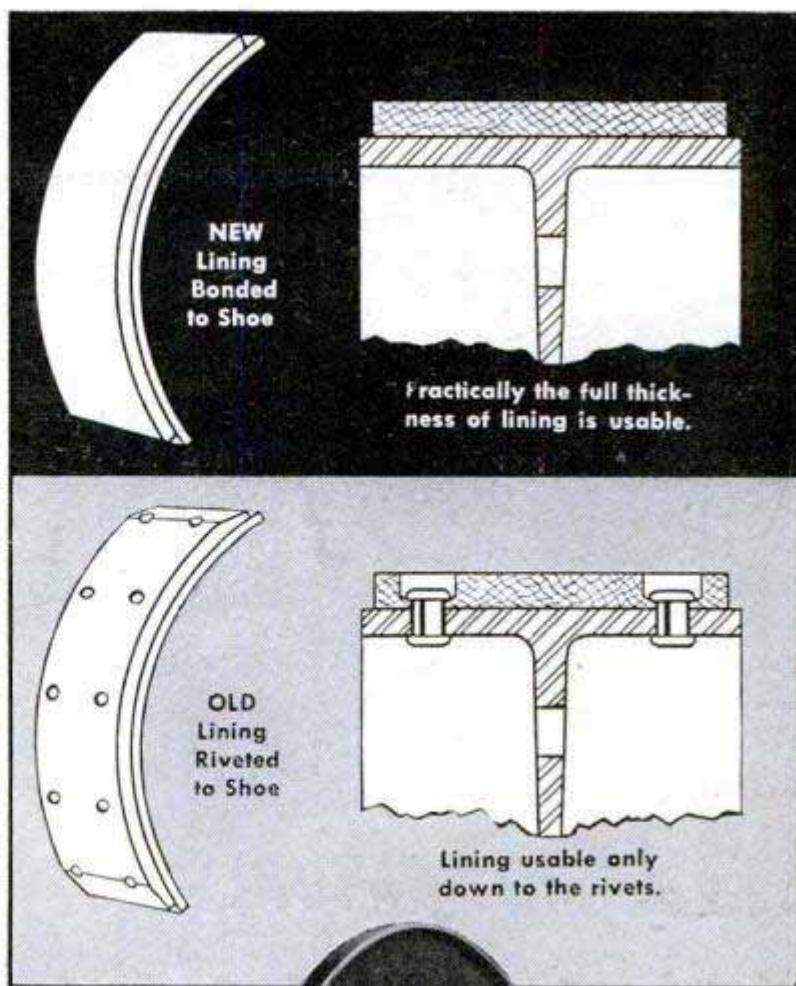

Chevrolet's Perma-Bond Brake Linings Last Twice as Long

Chevrolet, first full-size car to adopt bonded brake-linings, offers the greatest advance in braking since the adoption of hydraulics. Now there are no rivets—and no more rivet-scored drums, no more rivet-squeals. Now, the full lining area is effective. Now, linings last about twice as long, because you can use up virtually their entire thickness, instead of about 60 per cent. And now, when you do need “relining,” you replace with factory-built Perma-Bond Dubl-Life units, shoes and linings combined. . . . And its brakes are only one of many advanced improvements that make Chevrolet the outstanding value in its field. Your Chevrolet dealer invites you to come in and see for yourself “the most beautiful buy of all.”

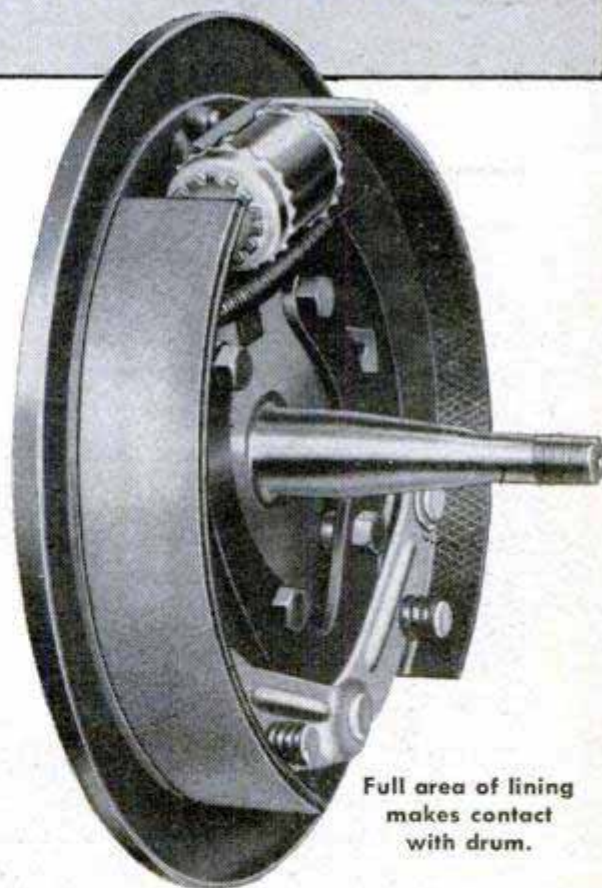

Full area of lining makes contact with drum.



CHEVROLET MOTOR DIVISION, General Motors Corporation, DETROIT 2, MICH.

Only Starrett MICROMETERS Provide These

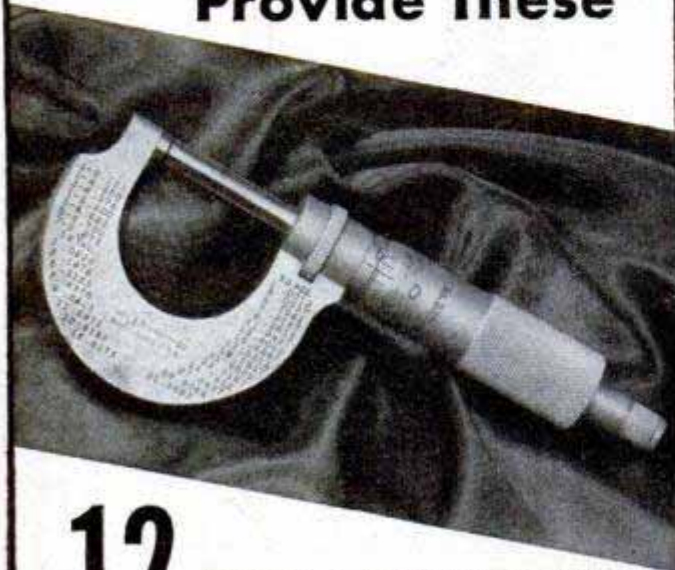

12 BIG FEATURES at no extra cost

- Satin Chrome Finish — No Glare — Resists Rust
- Hi-Micro Mirror Finish — On Anvil and Spindle Faces
- Hardened Threads — Stabilized and Ground From Solid
- One Piece Spindle — Insures Long, Accurate Life
- Quick Reading — Every Thousandth Numbered
- Convenient Decimal Equivalents — On Frame or Thimble
- Simple Sleeve Adjustment — Maintains Starrett Accuracy
- Precision Built — By The World's Greatest Toolmakers

Also available with Starrett Friction Thimble —
"right under your thumb"



Get Your FREE Copy
Starrett Satin Chrome
Micrometer Folder

Write for it today. Address Dept. AP

THE L. S. STARRETT CO., ATHOL, MASSACHUSETTS, U. S. A.

TRADE MARK
Starrett
REG. U. S. PAT. OFF.

Standard of Precision — Since 1880

Mechanics' Hand Measuring Tools and Precision
Instruments • Dial Indicators • Steel Tapes • Hacksaws
and Band Saws • Precision Ground Flat Stock
Buy Through Your Distributor

will just energize, as indicated by the flash-light bulb in the jewel socket lighting up. Note that this bulb is also in the flash-bulb circuit and is hooded with tape so that no light from it reaches the phototube. Now turn back the potentiometer R2 until the flashlight bulb just goes out. The unit is now on the verge of tripping and you are ready to plug in the auxiliary reflectors and flash bulbs. When the flash bulb on the camera begins to fire, the "slave" unit picks up the very first weak output of light and instantly fires the auxiliary flash. So close are the two peaks that a shutter which is open for less than 5 milliseconds will record both peaks. Tests of the original model showed that it could be used effectively at shutter speeds exceeding $\frac{1}{200}$ second, and that it will fire at least four of the largest flash bulbs at one time. Photo A illustrates the results that can be obtained using these

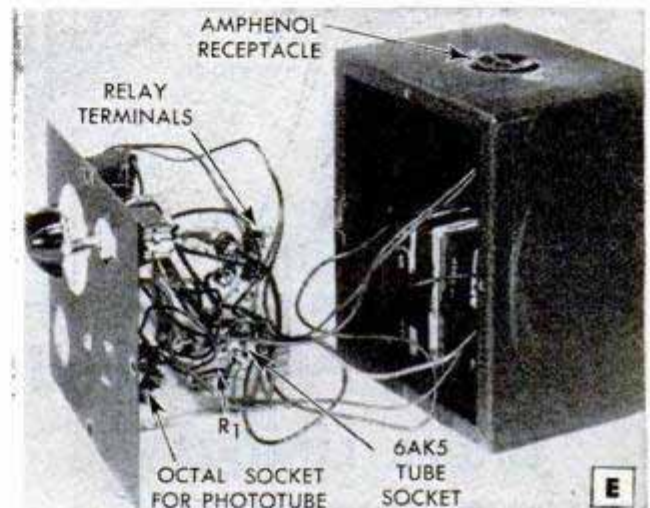

units. Four flash bulbs were employed in taking this photograph in a large dance hall. The room itself was illuminated by ceiling molding lights, entirely insufficient for any type of photograph. Two of the remote units were employed and all were touched off by the master flash which was synchronized to the shutter of the camera. The shutter speed was $\frac{1}{100}$ second.

Any fast-acting relay of the 5000-ohm plate-circuit type may be used if it energizes with from 2 to 7 milliamperes of current. It should have adjustable contacts and the proper setting of these contacts will help reduce any inherent delay. The potentiometer R2 may be either an audio or linear-taper type, the linear being preferred. Special care must be taken to hood the 6-volt bulb in the jewel socket so that no light reaches the inside of the cabinet. Detailed student material list R-381 is available from Popular Mechanics Radio and Electronics department without charge upon receipt of ordinary letter postage.

NEW! **CRAFTSMAN** Tilting-Arbor Saw now Sale-Priced for 30 Days!

COMPLETE! Unlike many other saws, your **CRAFTSMAN** saw is completely equipped . . . NOT a stripped model!

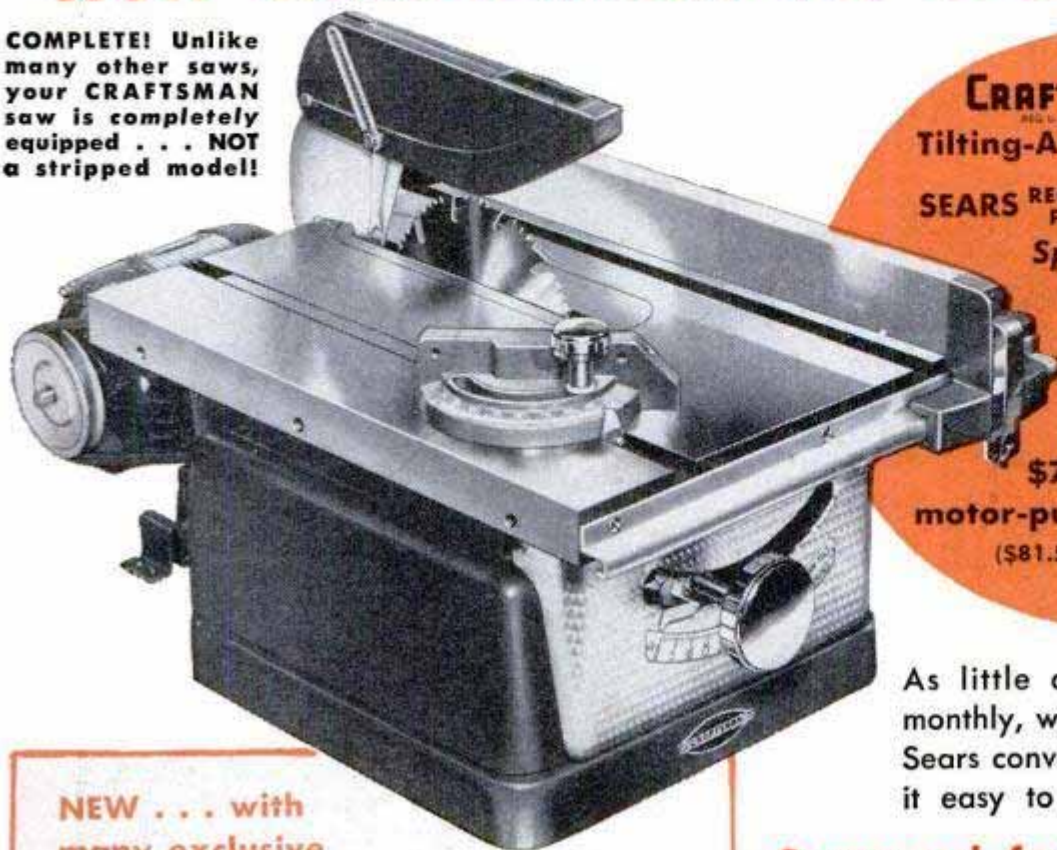

CRAFTSMAN "80"
REG. U.S. PAT. OFF.
Tilting-Arbor Bench Saw

SEARS REGULAR PRICE ~~\$54.50~~

Special 30-day offer

NOW ONLY **\$49.88** Cash

without motor
(\$52.88 West of Rockies)

**\$77.50 with motor,
motor-pulley, and V-belt.**
(\$81.50 West of Rockies)

As little as \$5.00 down, \$5.00 monthly, will put it in your shop on Sears convenient Easy Terms; make it easy to pay while you use it!

NEW . . . with many exclusive features NO other bench saw has!



NEW! Exclusive! Tilting, raising and lowering of blade all controlled by a **SINGLE** hand wheel at front of saw!



NEW! Floating motor mount fastens to bench for easier tilting. Controls belt tension; reduces saw vibration; lessens the strain on saw.

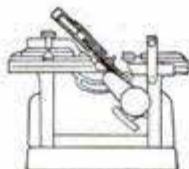

Work stays level! Blade and guard (NOT table and work) tilt to any angle up to 45° . . . for much more accurate, much easier and faster operation!



Side Table Extension available. Of cast semi-steel. 20x17 in. For either or both sides. One extension will double table working area, increasing it to 34x20 in.

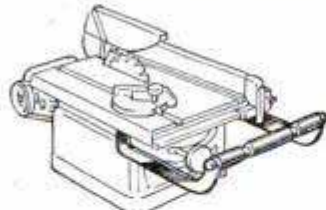

Front or Rear Table Extension available. New roller type . . . increases capacity of saw table without disturbing the rip-fence set-up on the saw.

Compared feature for feature with other saws . . . CRAFTSMAN gives you more for your money!

Extra-value features for more accurate, better work!

- **Double-row, sealed precision ball bearings;** life-lubricated; need no further lubrication — ever!
- **Positive-aligning rip fence;** locks on both ends with **ONE** handle; usable on either side of blade.
- **Special mechanism** tilts the saw arbor faster than on ordinary saws . . . without any loss of accuracy.

A superb heavy duty **CRAFTSMAN** tilting-arbor saw . . . now bargain-priced in this sensational 30-day offer! **New . . .** in design, construction and exclusive features! Exceptionally accurate . . . meets the most rigid requirements of amateur and professional craftsmen and large woodworking shops. Big, 20x17-in., smooth-ground table of cast semi-steel, with removable insert for dadoing or sanding. Depth of cut, up to 2½ in. Over-all length 26-7/32 in.; width 17 in.; height 14¾ in. Complete with automatic leveling guard, non-kickback pawls and splitter; accurate miter gauge; built-in saw-dust chute; motor mount; 2½-in. machine pulley; and 8-in. combination blade (½-in. bore). (½-H.P., 3450 R.P.M. ball bearing capacitor motor for 110-120-volt, 60-cycle, A.C., 2½-in. motor pulley, and ½x40-in. V-belt recommended and sold separately, at extra cost.)

This CRAFTSMAN special offer good for 30 days . . . during the month of September only. See it . . . buy it . . . at your nearest Sears, Roebuck Retail Store TODAY!

CRAFTSMAN Hand and Power Tools by **SEARS, ROEBUCK and CO.**
Famous for fine quality . . . precision performance . . . low price!



SAVE MONEY—

make it with **EASI-BILD* Full-Size Patterns!**

SAVE MORE than $\frac{1}{2}$ store cost—build this 6-foot Workbench and Tool Chest yourself! Easi-Bild Full-Size Patterns require no special tools or skill. Just trace pattern on wood; saw, and assemble with one of the CASCO Glues described below.

*Copr. 1949, Easi-Bild Pattern Co.



How to choose a glue:

For boats, outdoor furniture, sports equipment—joints that must withstand outdoor exposure—**CASCOPHEN** (Resorcin Resin Glue). The first completely durable glue available to homecraftsmen.



For furniture, toys, heavy-duty home repairs—use **CASCAMITE** (Urea Resin Glue) where you want a light-colored or mold-proof glue line. Use **CASCO** (Casein Glue) for loose-fitting joints, general heavy-duty jobs. Both easily mixed in cold water.



SEND COUPON FOR WORKBENCH AND TOOL CHEST PATTERNS TO:

Casco Pattern Dept. PM-99

P. O. Box 215, Pleasantville, N. Y.

Enclosed is \$_____ for material checked below:

- () Handy Workbench, Pattern No. 15—25c
 () Tool Chest, Pattern No. 71—25c
 () 24-page Pattern Book illustrating 94 pattern projects—20c

Name _____

Address _____

City _____ Zone _____ State _____

THE BORDEN CO. • CHEMICAL DIVISION

Makers of Casco Glues

Artists With Straw and Feathers

(Continued from page 101)

bird, and for larger pictures the artist may use the feathers of an entire duck wing.

In demonstrating how feather pictures are made, Fernando Ramirez Valencia uses a metal stencil that has been cut to the size and shape of the bird that is to be represented. The stencil is laid on the cardboard that will be used as the picture backing and campeche wax is smeared through the stencil onto the paper. After the stencil is removed, a wax surface in the form of the bird remains on the paper.

Next Valencia chooses a few brightly colored bits of feather, trims them down and presses them onto the wax image to represent the bird's tail. Thicker, darker feathers are pressed and smoothed into place to form the body and a small, dark bit of plumage is trimmed and smoothed into the shape of the bird's head. The result is a graceful, flowing image of a bird, vividly colored and with the natural opalescence of the feathers.

Legs and feet, eyes and beak, are represented by bits of thin colored paper that are trimmed to shape and glued on. Branches, flowers and other background decorations usually are drawn in with colored inks. Unlike the making of straw mosaic pictures, feather work progresses rapidly and a skilled artist can finish a colorful bird picture in a few minutes. Each craft, however, requires considerable artistic talent as well as skill.

Deep-Sea Mystery Story

(Continued from page 85)

inside containers with the bridle attached near the middle of the container so that the open end of the net moves through the water with minimum warning.

One of the obvious ways of exploring the deep scattering layer is to lower underwater cameras to the correct depth and make photographs. This has been done and nothing can be found on the negatives.

The explanation is that the population of the layer, from the smallest forms upward, have negative phototropism. They avoid light. When floodlamps are lowered among them, they scurry away.

Presumably they can be photographed, however, by the light of electronic speedlamps that emit instantaneous flashes of light without previous warning. NEL's photo technicians have assembled such an instrument, designed especially for investigating the deep scattering layer.

(Continued to page 244)

GET READY



BUY

AC

SPARK PLUGS



LOOK FOR
THIS SIGN

Get ready for cold weather driving! Sharpen up your engine performance with the finest spark plugs ever made . . . AC's with patented CORALOX* Insulator. Instant starting in coldest weather! Steady firing at any engine temperature! Get them from any service dealer who displays the poster with the above picture.

WITH PATENTED CORALOX INSULATOR

*AC's patented processes make Coralox the finest insulator in spark plug history. Improved electrical insulation, no matter how high the temperature. Better heat conduction. Maximum resistance to heat shock. Less fouling, harder, stronger, longer-lived.

AC SPARK PLUG DIVISION • GENERAL MOTORS CORPORATION

Big News!

a different name for your old friends
 You will find **PROTO** tools — formerly **Plomb** tools — everywhere! Over 10,000 better class dealers display them. Since 1907, high quality, superior design and long life have made them the favorites of professionals. Remember, the new name — **PROTO** tools. Buy them from your dealer today.

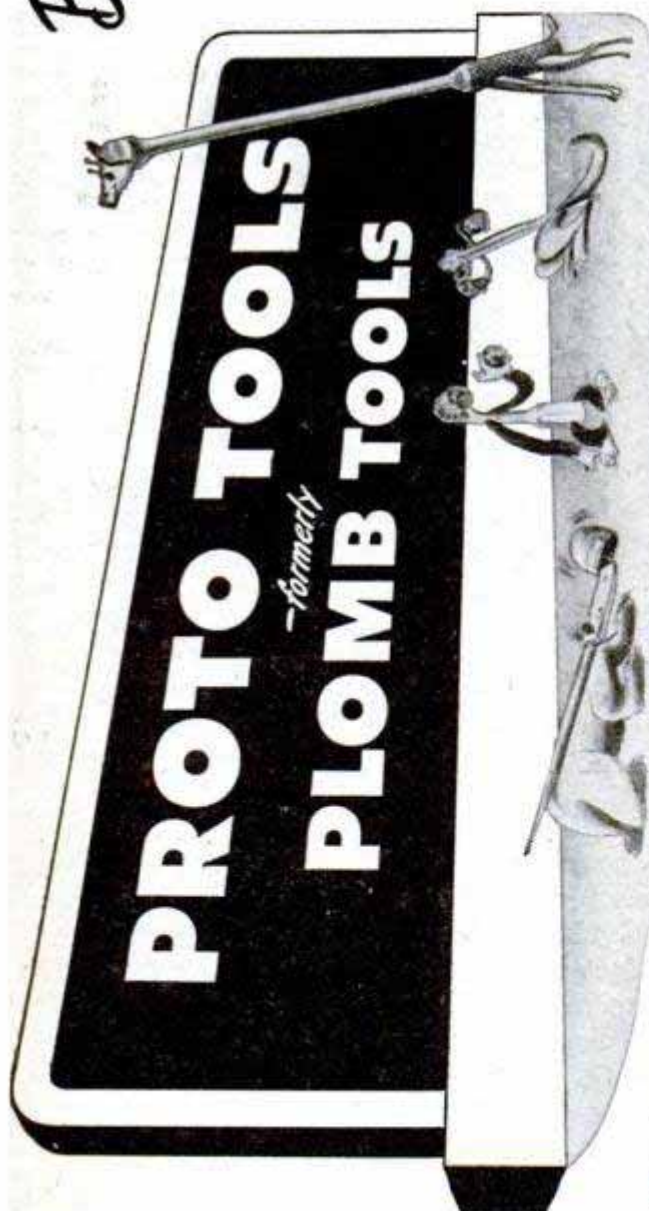

Write for catalog to **PLOMB TOOL COMPANY** 2255N Santa Fe Ave., Los Angeles 54, Calif.

Clinic



for Homemakers

As a service to our readers in solving the hundreds of problems pertaining to a home—inside or out—the editors of *Popular Mechanics* invite you to present your problems to the Clinic Editor for help and advice. Address your questions to The Clinic Editor, *Popular Mechanics Magazine*, 200 East Ontario Street, Chicago 11, Ill.

Oil-Burner Operation

Q—I am thinking of installing an oil burner in a hot-water boiler and I'm puzzled by some of the terms used in describing the operation of the burner. For example, what is meant by "percent excess air," "combustion reaction time" and "water vapor"?

V.D., Grand Rapids, Mich.

A—In oil-burner operation, fuel oil cannot be burned efficiently with only the theoretical quantity of air required to form a combustible mixture, that is, the quantity of air calculated from the carbon and hydrogen content of the fuel. A certain amount of air in excess of the theoretical quantity is required. The term "percent excess air" simply denotes the amount of air actually used by the burner in excess of that which is theoretically required for complete combustion. This varies with different types and sizes of burners but the excess can range as high as 50 percent. The practical meaning of the term "combustion reaction time" is that the combustion chamber, or firebox, must be large enough to give sufficient time for the oil-air mixture to ignite and burn within the chamber itself. The size required depends to a certain extent on the size and type of the burner. Manufacturers specify the dimensions and shape of the flame chamber, or firebox, in the installation manuals they supply. One of the products of the combustion of fuel oil is water vapor. This is formed when the hydrogen in the oil unites with oxygen and burns. The hydrogen is not destroyed in the burning process; only its form is changed.



Watering Evergreens

Q—I have been told that evergreens maintain a certain rate of growth during the winter months and also that it is necessary to water evergreens just before the ground freezes. Is this correct, and if so, why?

M.B.—Northfield, Minn.

A—Correct, with certain modifications. The native evergreen in both the tree and the low-growing types, does not enter a dormant stage in the same manner as deciduous trees. The rate of growth does vary, however, with extremes of temperature range, soil fertility and the amount of rainfall. Also, evergreen plantings about the average home often are subjected to unnatural conditions which may affect the growth and health of

(Continued to page 242)



DO YOU

FOR YOUR MONEY?

Thorogood

First Choice for...

Service Station Workers... Carpenters... Roofers... Tree Surgeons... Television Aerial Installers... Stone Masons and Bricklayers... Metal Workers... Truck Drivers... Steel Workers... Painters... Any High, Dangerous, or Hard Work.



ALL Thorogood
"BRUISERS"
100% Union Made

HI-BRUISER

No. 633 Natural

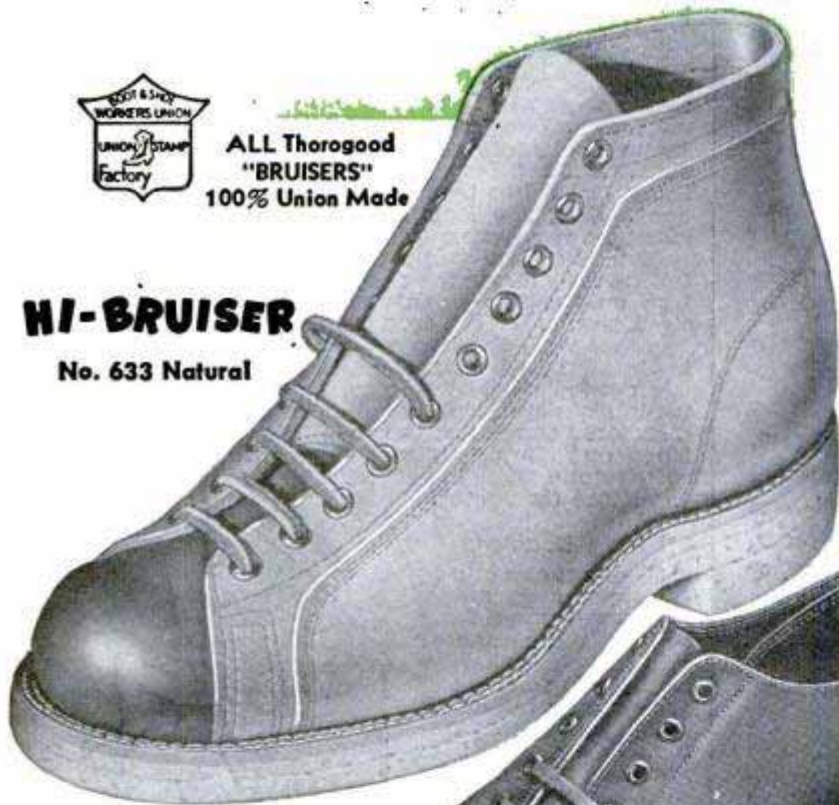

LO-BRUISER

No. 640 Brown
No. 641 Black



We didn't do any favors for the swivel-chair boys when we made these shoes. But, if you do hard, muscle-work for your money and want full value when you spend it, you'll get a real break with the "BRUISER." Check the "BRUISER'S" eight exclusive features against any work shoe you ever wore. Then, see this shoe, at your nearest Thorogood dealer's. Balance it all up, value for value, and you'll buy the "BRUISER"... now... and from now on.

Double-stitched. Oil-resistant. Resistant to nail puncture. Soft, for easy walking and non-skid safety.

in HI-Bruiser model, wrapped around your ankles. The only double-upper shoe made!

In case of accident, cut HI-Bruiser lace and kick off the shoe... in seconds! or steel-capped safety toe, as you prefer.

on HI-Bruiser give more traction on a pitched roof or other incline.

for extra, all-day comfort and better body balance.

No lace hooks to bend shut.

in HI-Bruiser; neat, strong woven lace in LO-Bruiser.

For dress affairs, get

**Bondshire
DRESS SHOES**

They're made by

Weinbrenner



... a name to remember for good!

Albert H. Weinbrenner Co.
2025 North Summit Avenue
Milwaukee 1, Wisconsin

Please tell me at once, *without any obligation*, the name and address of the Thorogood Shoe Dealer nearest my home. If your "BRUISER" is as good as you say it is, I want to see it!

My name is

My address is

City.....Zone.....State.....

Albert H. Weinbrenner Co.

1st place to go for tools with tradition



is where you see this symbol of friendly satisfaction

• There's lots of satisfaction in owning tools which bear a name that has been a synonym for highest quality for generations. You are assured of their dependability . . . of the fine work they'll do for you. You rank such items along with your favorite gun, or rod and reel, or your pet pocket knife in your list of personal belongings. Those are the brands you'll always find at your friendly, independent hardware store. Always go there *FIRST* for what is *FOREMOST* in tools and cutlery.

Your Hardwareman Knows Your Needs



the plants. Evergreens planted near the building foundation, under a wide cornice or near a wall painted white may suffer during the growing season from a lack of moisture and from undue exposure both winter and summer. The foliage should be protected from heat reflected from the wall on extremely hot days and, during dry seasons, the ground around the root system should be thoroughly soaked at regular intervals up until the time of freezing temperatures. This will prevent the soil from freezing "dry" around the feeding roots. Wet the foliage frequently during the summer at the end of a hot day, adjusting the hose nozzle to give a fine, spreading spray. Keep a 2-in. layer of grass clippings, peat moss, leaves or other fine material under the tree to prevent the soil from drying out between the watering times.

Dents Removed From Table Top

Q—I have an old-style walnut dining table. There are several shallow dents in the top similar to those resulting from a hammer blow. Is there any practical way to remove these dents without completely refinishing the top?

W.M., Brooklyn, N. Y.



*A—*There are several methods used by furniture refinishers but perhaps the most practical to apply is that of "ironing" out the dents. If care is used, this process will not appreciably damage the original finish. Dampen a small square of felt (the felt should be $\frac{1}{8}$ to $\frac{1}{4}$ in. thick) and lay this over the dent. Allow a few seconds to elapse, then apply the tip of a hot iron to the felt directly over the dent. Hold the iron in place until most of the moisture has evaporated from the felt. The trick in this is to place only the tip of the iron on the felt directly above the dent. Do not merely set the iron on the felt as this will not achieve the desired result. If the iron is placed properly, heat, together with the live steam generated, swells the fibers of the wood in the affected area and causes the dented surface to rise, thus obliterating the unsightly depression. Generally the finish will be discolored somewhat but as a rule this can be polished out simply by mixing a small quantity of rottenstone with lemon oil and rubbing the area to restore the luster.

Sticking Drawers

Q—What can one do to prevent furniture drawers from sticking during the summer months when there is no heat in the house? We have an old chest, which gives this trouble. I do not wish to plane off much wood as the drawers then are undersize when the wood dries out.

H.T., Springfield, Mo.



*A—*If the drawers stick so tightly that they cannot be removed without prying, planing off some of the wood will be necessary to make them slide freely. Plane off the bottom edge of the sides and front where it does not show. Often a single plane shaving will do it. It is also possible to scrape the runners and the rail with a cabinet scraper and in this way remove enough stock to ease the operation of the drawer. In your case, it might be well to examine the drawers carefully for loose joints. When these loosen and open up, this may increase the width of the drawer enough to make it stick tightly. Cleaning the old glue out of the joints and regluing or renailling them may free the drawers, thus making removal of wood by planing unnecessary. When the drawers stick lightly, dusting the runners with talcum often is sufficient. Rubbing the lower edges of the drawer sides and also the runners with a cake of paraffin will accomplish the same thing.

This is the Life!

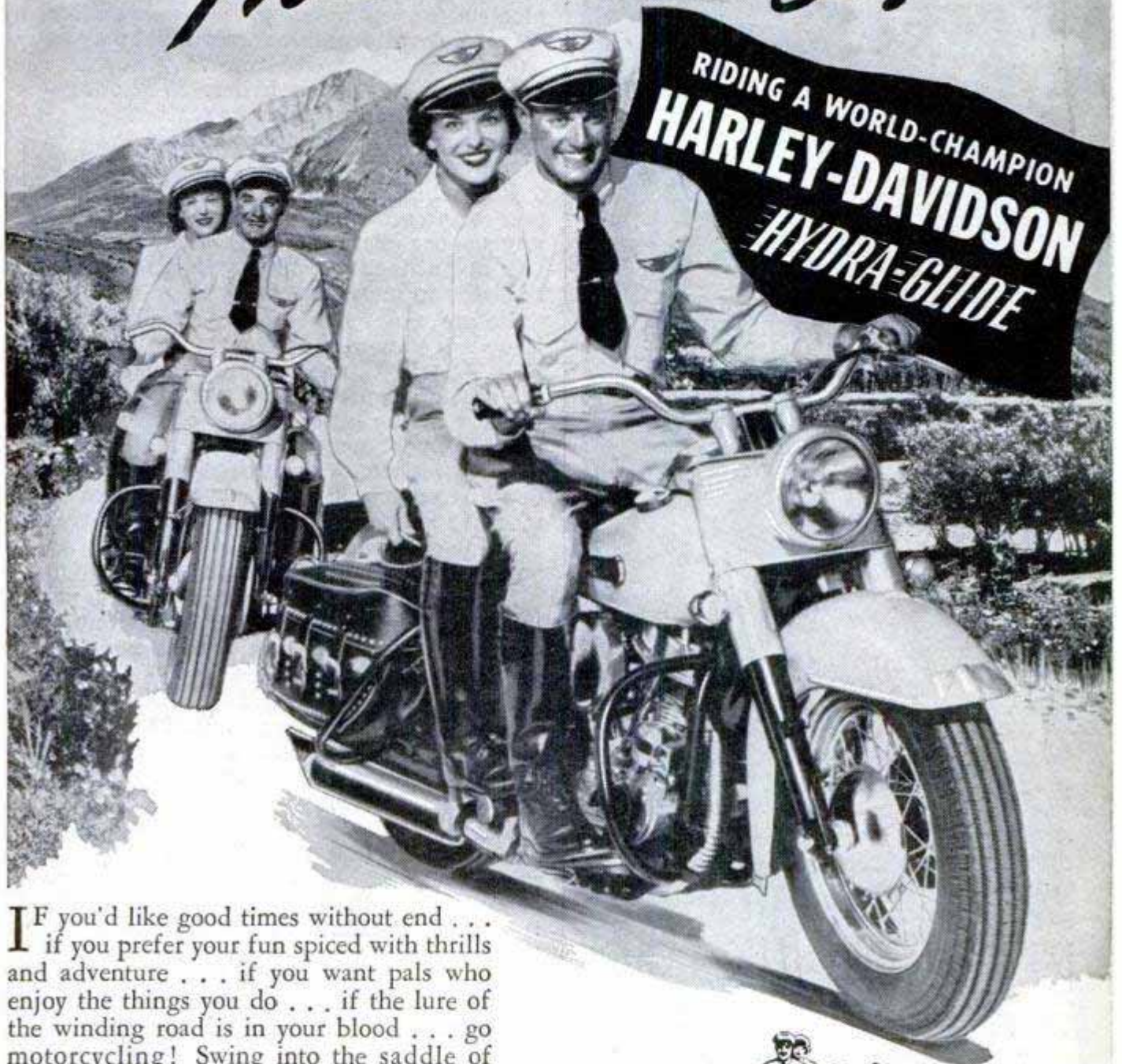

IF you'd like good times without end . . . if you prefer your fun spiced with thrills and adventure . . . if you want pals who enjoy the things you do . . . if the lure of the winding road is in your blood . . . go motorcycling! Swing into the saddle of a Harley-Davidson Hydra-Glide and really start living! Wait until you feel that surge of power under you, smooth, quiet, but lifting you over steepest hills like a breeze . . . purring gently as you loaf along under tree-shaded lanes . . . whistling like a jet plane as you "level off" for the straight-aways . . . floating you cloud-like over roughest roads and bringing you home again fresh as a daisy! Man! There's no sport like motorcycling, no fun like owning a Harley-Davidson! And it's so easy to get started . . . to begin riding *today!* See your Harley-Davidson dealer; mail the coupon now!



HARLEY-DAVIDSON MOTOR COMPANY,
Dept. P, Milwaukee 1, Wisconsin
Send *free* copy of **ENTHUSIAST** Magazine filled with motorcycle action pictures and stories; also literature on latest models.

Name.....

Street or R.F.D.....

City..... State.....

The apparatus consists of a floor or background that is made up of a wire grid painted white. Two speed lamps secured to its frame are pointed at this floor. Four-foot stilts attached to the frame support a watertight and pressurized case containing an electrically operated prefocused aerial camera. An alternative camera that may be used is a single-shot 35-mm. movie camera equipped with a solenoid drive. The equipment is lowered to the deep scattering layer by a special 14-conductor electric cable from a winch on shipboard.

The white wire floor of the apparatus serves as a scale background against which any sea organism that moves into the field will be outlined, permitting its size as well as shape to be recorded.

Before the year is over, possibly, our knowledge about the deep rich belt of marine life will be considerably increased. If the scatterers prove to be fish, it is anticipated that the layer will be of great economic importance when new methods of netting a catch at great depths are developed. It may be that the deep-sea fishermen of the future will lower depth charges into the deeps to stun entire schools, then sweep up the haul in huge nets.

In any event, the discovery of the layer indicates that the amount and distribution of biological life in the oceans is much greater than had been supposed.

One suggestion is that the scattering layer may finally solve the puzzle of the Pacific tuna, an important commercial fish whose life cycle and migration habits are not yet understood.

The quest for tuna, in fact, is considered so important that it is to be one of the prime subjects of research by still another institution, the Allan Hancock Foundation for Scientific Research, an adjunct of the University of Southern California. This year the foundation is preparing a long and varied oceanographic research program for the *Velero IV*, the newest and most complete of the deep-sea research vessels.

Launched last year, the *Velero IV* is a \$600,000 floating laboratory built along tuna clipper lines and equipped for a wide variety of investigations. Now making shakedown cruises in the eastern Pacific, the *Velero IV* is to be equipped with underwater television devices, pressurized traps that will permit the bringing up, alive, of fish from great depths, and coring instruments for taking 60-foot-thick samples of the ocean's floor. This year or next the vessel is to shepherd a new underwater research vehicle named the "benthoscope," a three-ton steel chamber containing two men that can descend 6000 feet and will be towed along the ocean's floor on wheels.

**DARKNESS MEANS
... DANGER**

BOND
No. 102
Fresh
**SUPER
POWER**
BATTERY
BOND ELECTRIC CORPORATION

Protect yourself after dark
with **REAL LIGHT**

WINCHESTER
No. 1511
Fresh
HI-POWER
Super
BATTERY
WINCHESTER REPEATING ARMS CO.

**GUARANTEED
BY OLIN**

Specialists in electro-chemistry and metallurgy:
Winchester Repeating Arms Co.
Bond Electric Corp.
Western Cartridge Co.
Liberty Powder Co.
Western Brass Mills
Equitable Powder Mfg. Co.
Columbia Powder Co.
Egyptian Powder Co.
Texas Powder Co.

OLIN INDUSTRIES, INC.

The car that likes
to be compared

NEW

PLYMOUTH

Yes, it likes to be compared
in ACTION, too!



NERVE center of Plymouth convenience is the new ignition key starting. Turn the key—the engine starts! Only Plymouth, in the lowest-priced field, has this feature.



MUSCLES are huskier. New cylinder head with a compression ratio of 7 to 1 (highest of the leading lowest-priced cars) squeezes more performance from the fuel.

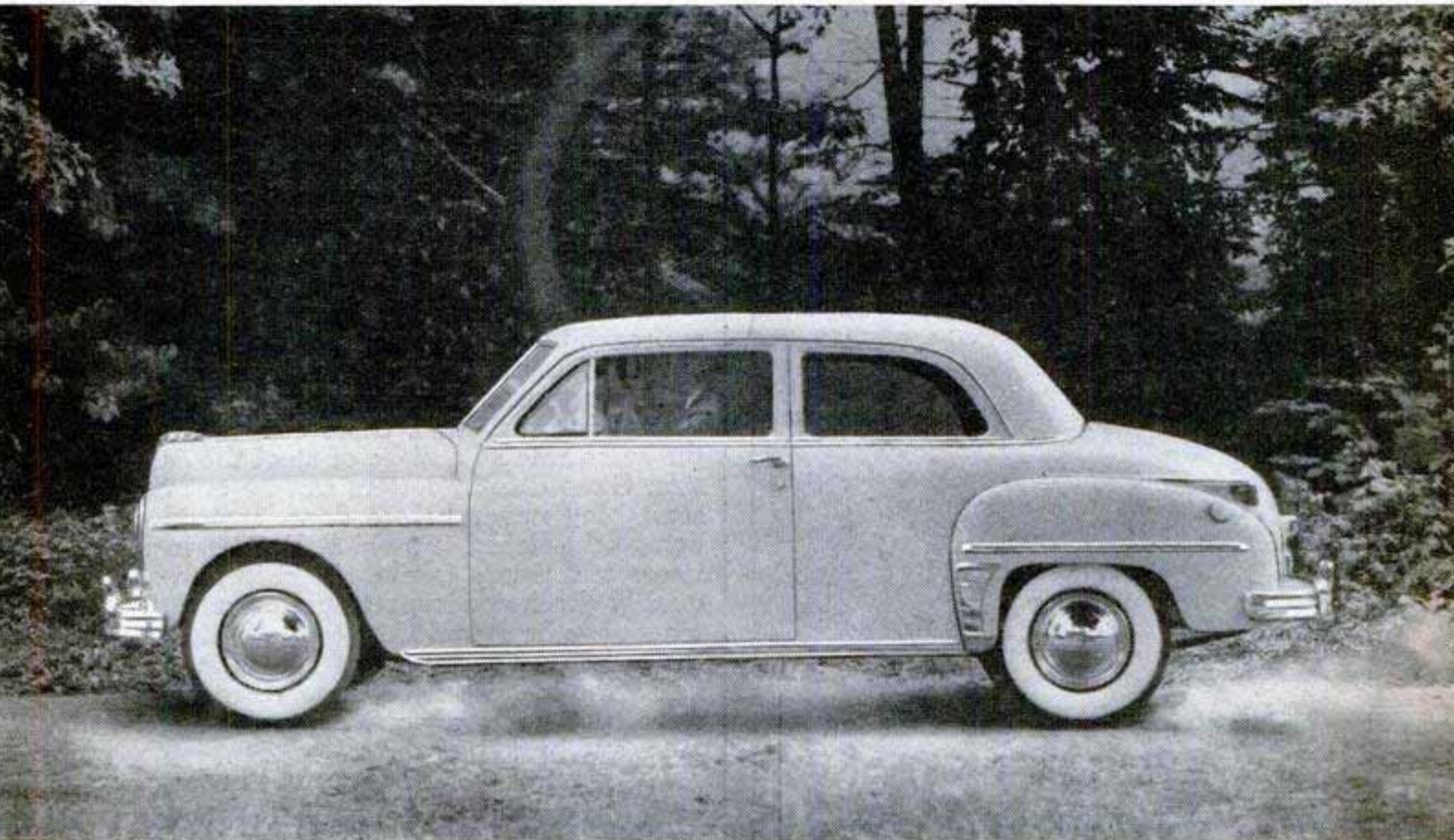

WHITE SIDEWALL TIRES, CHROME WHEEL COVERS, REAR BUMPER GUARDS AND REAR FENDER SCUFF GUARDS OPTIONAL AT EXTRA COST.

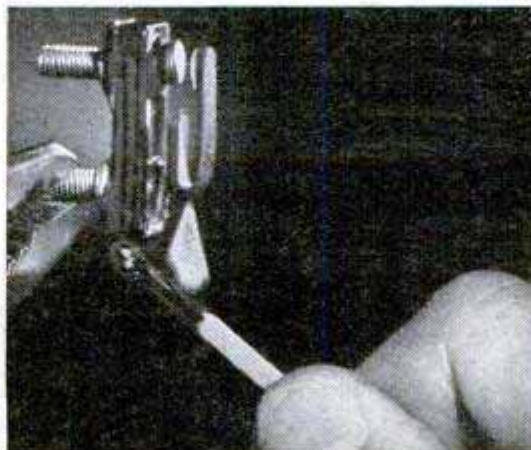

BODY beautiful and *practical*, too! Although the new Plymouth illustrated here has a longer wheelbase, the over-all outside length is less. It's an easier car to park and handle.

THUMB on the circuits is held by this great little firewarden. Heat from a "short" makes it lift and break the circuit until the trouble has gone. No more replacing of fuses!

CHECK ✓

the new Quality Chart at your Plymouth dealer's. Compare the three leading lowest-priced cars. Then drive the great new Plymouth and let the ride decide!

PLYMOUTH Division of CHRYSLER CORPORATION, Detroit 31, Michigan



MOTORISTS WISE SIMONIZ

P.M. REG. U.S. PAT. OFF.

MAKES CARS STAY BEAUTIFUL

*Better than 10
'Here-Today...
Gone-Tomorrow'
Polishings!*

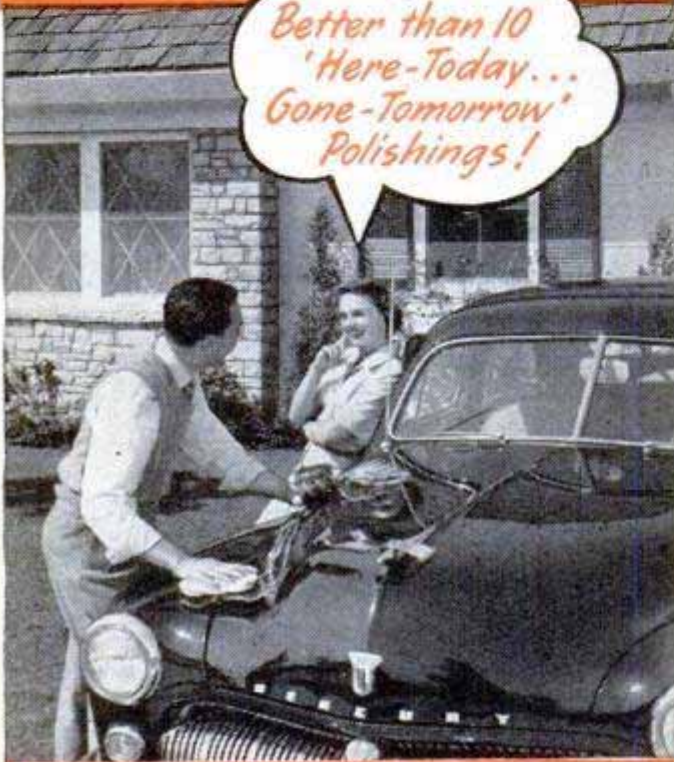

**Simonizing saves you time as
it saves the finish!**

Don't waste your time with 'temporary polishings'! Simonizing gives long lasting beauty... protects the finish and keeps colors from fading. Do as millions of motorists... Simoniz your car. It's easy to do yourself.
THE SIMONIZ COMPANY, CHICAGO 16, ILL.



Use Simoniz Kleener (liquid or paste) to clean finish.
Then Simoniz for lasting beauty. Sold everywhere!

The Tool That Surprised Its Makers

(Continued from page 162)

without precedent. It had no teeth at all. To the edge of a serrated steel band were brazed short lengths of a substance which looked much like broken pencil lead. These were matrices made of a mixture of powdered metal and diamond dust. When baked under pressure they became hard. The matrix was hard enough to prevent the diamonds from sinking under pressure and tough enough to keep them from tearing out and being lost. The structure was so composed that the heat of cutting would not cause the matrix to harden or soften. Matrices are brazed to the backing at odd intervals to prevent any chord or vibration pattern being set up.

Unlike the other saws, the diamond blade works under water. A jet of liquid is turned on the blade, flooding the work. Water is reclaimed, strained and used again. To prevent the coolant from injuring the machinery a quantity of rust preventive is added.

The ability to cut glass opens a brand new approach to an old industry. Thick slabs of optical glass can be sawed to shape instead of being ground down, saving as much as three hours per slab. Glass cuts at about the same rate as a piece of steel the same size. Glass display letters can be cut out, something never before done, instead of being acid-etched or molded. Bottles, insulators and lenses can be sliced in half for quality check and inspection. Now a fragile teapot can be sawed from top to bottom so the maker can check the actual wall thickness. The same can be done with chinaware, pottery, sea shells, mineral specimens and building bricks.

The giant of the bandsaws has become a favorite in industry. If the job is cutting—anything from foam rubber to armor plate—the contour saw will do it, and do it well.

They Keep the Old West Alive

(Continued from page 95)

firewood the prospector's wife would need for two years in exchange for the lumber from the shack, explaining that he wanted it to make repairs in Virginia City.

"But the lumber's no good," puzzled the prospector. "It's old and warped."

"The moss, man. Look at the moss growing on the boards," said Charlie. "They can't even produce historic lumber like that in Hollywood."

Then there was the matter of the Montana Post. Established in Virginia City in 1864, the Post was the first newspaper to

(Continued to page 248)

Before

**YOU BUY
ANY OIL
HEATER**

See the Heater that pays for Itself!

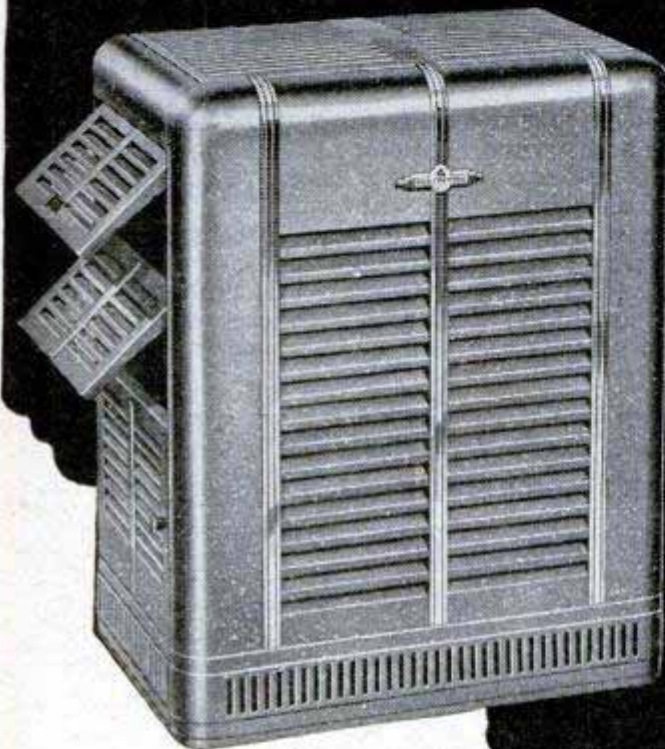

PERFECTION 3155 OIL HEATER
55,000 B.T.U. (up to 6 rooms)

Automatic Controls*

The thermostat takes care of the heat, while you relax in comfort. Automatically cuts fire down to money-saving pilot and back to high or low fire as needed. (*optional)

- ✓ **LARGE HEAT CAPACITY**
- ✓ **LOW OPERATING COST**
- ✓ **SMALL DIMENSIONS**
- ✓ **BEAUTIFUL FINISH**
- ✓ **SIMPLE OPERATION**

PERFECTION'S "MIDGET" PILOT



No other heater has a pilot like this. It runs for hours and hours on a cup of oil, alternates with high or low fire to give just the heat you need. Plenty to keep you cozy on the coldest day, yet never wastes money by overheating on mild days.

PERFECTION'S "FLOOR-FLO" BLOWER*



Concealed in the heater, it circulates heated air out across the floor. Does a *better* job of floor warming, distributes heat more evenly over a wide area. You can't see it, you hardly hear it . . . but you sure can feel the extra comfort it distributes. (*optional)

PERFECTION'S NEW-TYPE HEAT EXTRACTOR



Prevents dollars from going up the chimney. It traps and uses heat that would otherwise be wasted. Combined with the stainless steel construction that allows hotter burner operation, this makes *more* useful heat from every drop of oil.

*Ask your dealer, or let us
send you free Perfection booklet.*

BE SURE YOU GET A

PERFECTION

OIL HEATER

PERFECTION STOVE COMPANY • 7107-A Platt Ave., Cleveland 4, Ohio
Manufacturers of Ranges • Cook Stoves • Home Heaters
Water Heaters • Winter Air-Conditioning Furnaces

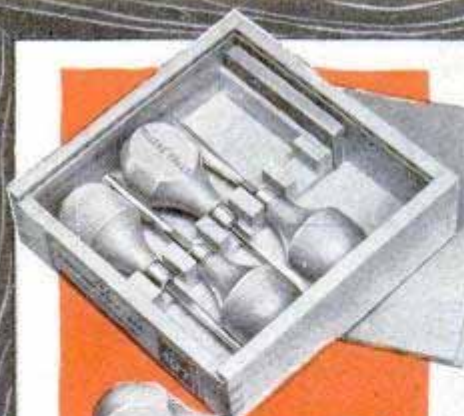

Set No. 107 — 5 tools and stone in sturdy box with slide top. Lacquered, palm-fitting maple handles — forged, heat-treated blades. See it at your hardware dealers today.



CARVE

your Christmas presents early!

This year, delight your friends with gifts you make yourself. It's fun! . . . It's easy! . . . It's profitable! — with a Millers Falls Carving Tool Set.

With these razor-keen, easy-to-handle tools, you can make distinctive bookends and figured cigarette boxes for grown-ups . . . model planes and racing cars for boys . . . costume jewelry and cute animal figures girls will love.

They're perfect, too, for cutting linoleum blocks from which to print your own colorful Christmas cards.

And don't forget, Millers Falls Carving Tool Sets are wonderful gifts themselves — for fellow craftsmen or to start a boy off on a hobby that will give him a lifetime of fun and satisfaction.

MILLERS FALLS COMPANY

GREENFIELD, MASSACHUSETTS

be published in Montana. Although the Post building was still standing in 1945, it had long ago been cleared of its contents.

Charlie wanted authentic type and presses back in the building. He found them in another historic mining town—Virginia City, Nev. There was only one catch. A three-story brick building went with them.

Charlie bought the building, crated up the contents and shipped them from one Virginia City to the other Virginia City. He still owns the building in Nevada, and would listen to a reasonable offer.

Generally, Charlie didn't have to go far afield to find "props" for resetting the stage of Virginia City.

"The dumping ground outside of town assayed pretty rich in relics," said Charlie.

Most important finds were the old, kerosene-burning street lamps. Charlie had them dug out of the frozen earth one winter day. Now renovated, the flickering lamps once more light up the town at night.

Virginia City once boasted the most expensive street-lighting system per lamp in the world, for kerosene sometimes sold for more than \$25 a gallon. It was more expensive than whiskey. Freighters didn't like to haul it over the mountains because if it spilled in a wagon it ruined all the foodstuff.

Some of the old places Charlie actually put back in business. The Bale of Hay Saloon serves drinks across a bar that was hauled over the mountains by ox team. An ancient music box wheezes out ancient tunes. The Saturday-night square dances at the Bale of Hay are something.

At the Wells-Fargo coffee house, you can order from a menu that lists venison, bear, elk and buffalo meat. In the Fair-weather Inn, you can sleep in an old-fashioned four-poster.

A lot of folks wonder how Charlie, who has spent a small fortune in reviving Virginia City, is going to get his money back. Many tourists spend hours in Virginia City and not a dime. There is no charge for visits to any of the historical buildings. Even the Saturday-night old-time dance at the Bale of Hay Saloon is free.

But Charlie isn't worried. He is having a whale of a time reliving the old West, so is all of Virginia City and so are the thousands of tourists who go there.

☐ Here are some weighty facts on the atmosphere: Including its water vapor, it weighs about 5,900,000,000,000 tons; completely dry, it would weigh about 5,000,000,000,000,000 tons; half this mass of air is below an altitude of 3.46 miles above sea level.

What's **NEW**
in Batteries?

AUTO-LITE **Sta-ful** BATTERY...needs water only 3 times a year*

A revolutionary new development, the Auto-Lite "Sta-ful" Battery, protects you against a major cause of battery failure . . . damage to plates due to liquid loss. This new "Sta-ful" Battery design permits a liquid reservoir with 3 times the capacity of ordinary batteries . . . keeps plates fully covered and active months longer in normal car use.

In addition, "Sta-ful" has Fibre-glass mats to hold the power-producing material in the plates for longer battery life. To get more for your battery dollars, replace with an Auto-Lite "Sta-ful". Money cannot buy a better battery.

AUTO-LITE BATTERY CORPORATION
Toledo 1 Ohio



*In normal car use

TUNE IN "SUSPENSE!"
CBS RADIO NETWORK THURSDAYS
CBS TELEVISION TUESDAYS

Because of a unique construction, the new Auto-Lite "Sta-ful" Battery holds more than 3 times the liquid reserve of ordinary batteries.

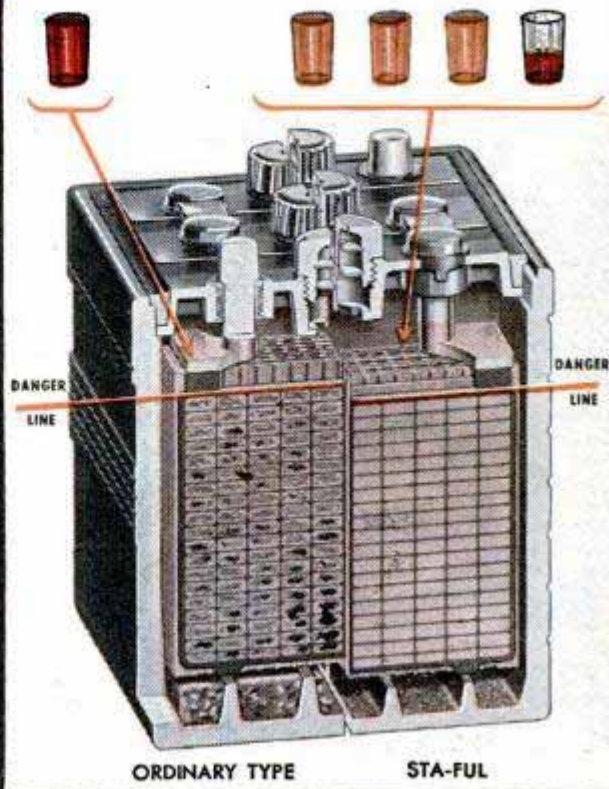

Note how the protective Fibre-glass mat retains the power-producing material in the positive plate while ordinary battery plates shed the active material until it fills the sediment well.

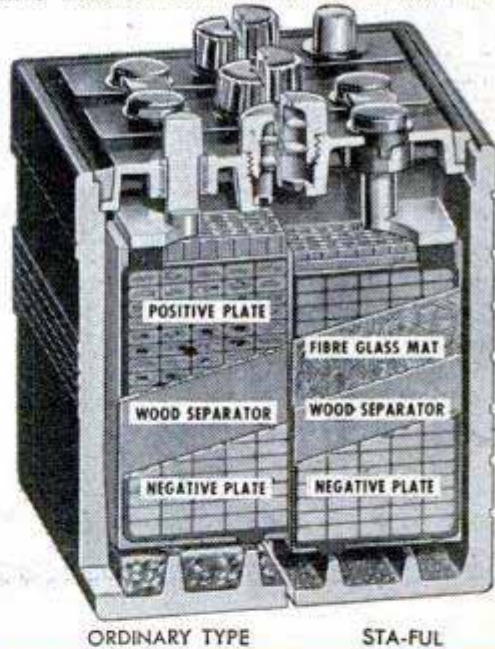

AUTO-LITE **Sta-ful** BATTERIES



Keen edges quick with **NORTON**® abrasives oil-filled bench stones

You'll be amazed at how rapidly the "coarse" side of a NORTON Abrasives CRYSTOLON® stone will take out nicks—and how few strokes are needed on the "fine" side to give you the kind of edge that makes its use a joy to every craftsman.

Every CRYSTOLON bench stone is impregnated with oil at the factory so that it resists "loading," cuts evenly and gives you continuous good service. Another thing—the grit used is CRYSTOLON silicon carbide—a famous NORTON Abrasive product—practically diamond-hard, lastingly sharp and uniformly sized.

Your hardware dealer has CRYSTOLON stones in sizes and forms for all tools. Look them over, select one, take it home and try it. From that day you will be an "edge-conscious" craftsman.

SEND FOR "HOW TO SHARPEN"

48-page booklet packed with diagrams on sharpening home shop tools. For your free copy, address Behr-Manning, Troy, N.Y., Dept. PM-949.



BEHR-MANNING
NORTON® abrasives **TROY, N.Y.**

Call Out the Mules and Beetles

(Continued from page 130)

and out among trees. So they invented a powered, fingertip steering. Shifting a control handle to either side changes the gear ratio of the tractor wheels, the more you move the handle the greater the difference in ratio—one wheel slowing down while the other speeds up, all accomplished by an ingenious expanding-diameter pulley and V-belt drive. And it has a reverse gear. One man can easily operate the lab's Walk-Behind Trencher through a full day of forest-fire fighting.

When a machine is proved practical, it is blueprinted and patented in the name of the United States. This means that patent rights are open to anyone. For any person definitely interested in manufacturing one of the inventions—in large quantities for the Forest Service or for use in other fields—the Portland Equipment Laboratory has blueprints available and will give all the help possible.

Take the tiny bulldozer, an important part of the Lilliputian army. Years ago Flynn invented the first dozer blade for a track-laying tractor and just before the war he developed the first practical bulldozer in a small size. The U. S. Army, searching for a dozer that could be transported in a cargo plane adopted it as the Airborne Tractor. Since then the lab has produced the Beetle, a still better bulldozer and one that is half the size of the Airborne Tractor. It weighs only 2200 pounds and is the new love of the men with pick and shovel on a fire line. One company in Seattle is already manufacturing the powerful Beetle for other uses. Today there are Beetles in Canada, French Equatorial Africa and Alaska as well as in our National Forests; and on our East Coast they lower Beetles into coal barges to scrape up the last few tons of coal.

The Beetle is a perfect little trail builder as well as fire fighter and the lab has other equipment to go with it. There's a compact air compressor that is towed behind either the Mule or the Beetle. Its tubular frame is the air tank and it is used with jack hammers to cut trails through rock and along cliffs. For building lookout stations on rock crags, the air compressors can be disassembled into four parts and carried on four horses.

When the air hammers stop and the Beetle has dug a path along the hillside, a tiny road grader moves forward. An exact miniature of the graders used on our highways, it is hooked behind either a Beetle or a Mule to smooth the cuts into a good

(Continued to page 252)

IF YOUR SOLDERING TURNS
OUT LIKE THIS...IT'S TIME
TO CLEAN THE IRON!

and

IF YOUR CAR FEELS LIKE THIS
...IT'S TIME FOR MARFAK
CHASSIS LUBRICATION

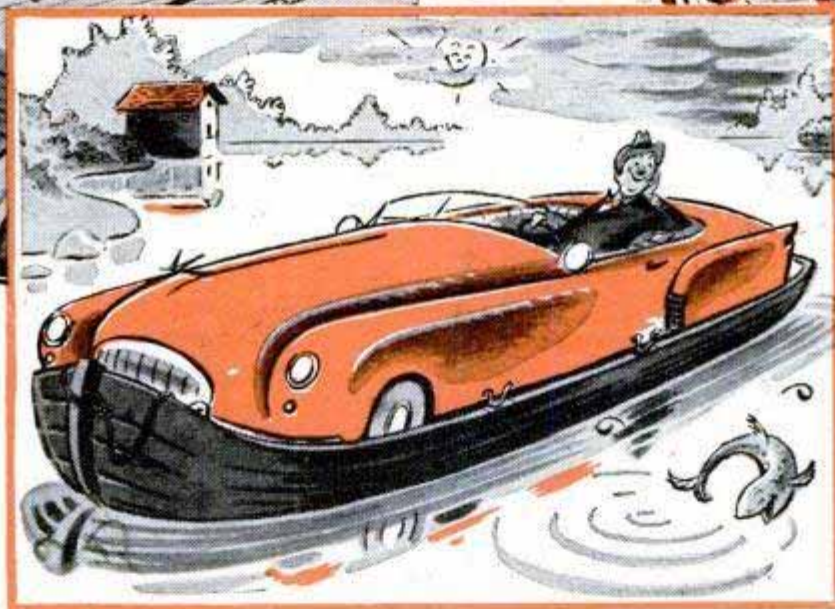

THAT CUSHIONY FEELING LASTS LONGER WITH MARFAK!

There's a world of difference between *Marfak* chassis lubrication and ordinary grease jobs. Tough, s-t-r-e-t-c-h-y *Marfak* clings to wear points and fights friction for 1,000 miles and *more!* And just notice that "cushiony" driving ease that *lasts!* It's your sign that *Marfak* keeps right on protecting. Applied by chart, never by chance. Stop by for *Marfak* lubrication today at your neighborhood Texaco Dealer, *the best friend your car ever had.*



THE TEXAS COMPANY
TEXACO DEALERS IN ALL 48 STATES

Texaco Products are also distributed in Canada

Make \$20 to
\$30 a Week

**EXTRA
MONEY**



MACHINE SAW FILING PAYS UP TO \$2 or \$3 an HOUR

Turn your spare time into CASH — sharpening saws with a Foley Automatic Saw Filer pays up to \$2 or \$3 an hour. You will find you can make \$20 to \$30 a week in your spare time as a starter.

You can work in your basement or garage—no experience necessary. "The first saw I sharpened with my Foley Filer came out 100%"—writes Clarence E. Parsons. No canvassing—"I advertised in our local paper and got in 93 saws"—says M. L. Thompson. The Foley is the only machine with which you can file all hand saws, also band saws and cross-cut circular saws.

SEND FOR FREE BOOK "INDEPENDENCE AFTER 40!"

Shows how you can get business from home owners, farmers, carpenters, schools, factories, etc. With a small investment, no overhead, no stock of goods to carry, you can get right into a cash business—and possibly later on develop into a full-time repair shop. Send coupon today for Free Book.

"Each saw I filed got me six more and business has been picking up that way since a year ago. If it keeps up I will have to buy another Foley Saw Filer." — William C. Baldwin

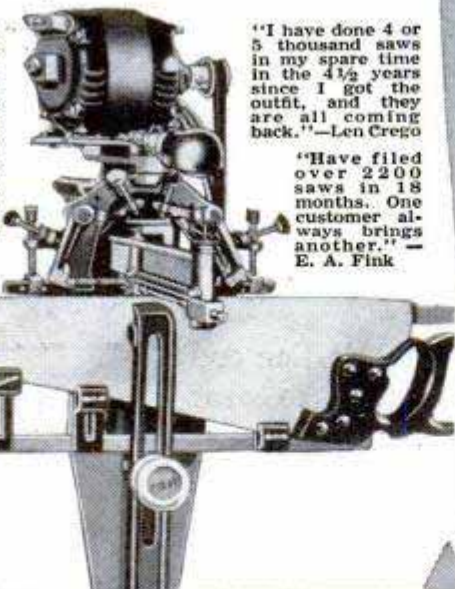

"I have done 4 or 5 thousand saws in my spare time in the 4½ years since I got the outfit, and they are all coming back." — Len Crego

"Have filed over 2200 saws in 18 months. One customer always brings another." — E. A. Fink



SEND COUPON FOR FREE BOOK

FOLEY MFG. CO.

916-9 Foley Bldg., Minneapolis 18, Minnesota

Send FREE BOOK—"Independence After 40."

Name _____

Address _____

trail. No gravel or pavement is needed; the weight of the baby vehicles compacts the new trail into a dry-season fire road 40 inches wide.

As long as there are no fires, the Forest Service's construction crews and stand-by fire crews are busy extending the network of motor trails. But when a fire starts, the Beetles and Mules are immediately called out to make fire breaks and to transport supplies. The Beetle and available larger bulldozers are quickly converted into large-size fire trenchers by replacing the conventional bulldozer blade with two large disks that form a "V" (another of the Equipment Lab's inventions). The tractors peel out a trench as fast as a man can trot.

And other equipment comes into play. Motor scooters have been adapted for courier service over the trails. These are purchased from manufacturers and are the biggest and most powerful scooters that can be found. Flynn and his assistants change only the gear ratio, gearing the scooters down for the steep-trail climbing. They are valuable for patrolling fire breaks and for keeping in contact with all the crews. There are folding trailer-offices for fire-control headquarters, an adaptation of the folding camp trailers that sportsmen use. When a large fire breaks, the nearest trailer-office is rushed to the scene. Accurate accounts of the fire-fighting crews can be kept. Phones, radios and maps are available right at the fire line.

A development still in the testing stage is the Wheelbarrow Saw. The lab has installed a very light and powerful, 2½ kilowatt, gasoline-powered electric generator in a small aluminum wheelbarrow. It powers two lightweight, 14-inch chain saws. One man pushes the wheelbarrow through the forest; two men, each carrying one of the chain saws on a 200-foot cable, range out to each side, cutting down the brush and small trees to make a fire break.

(Continued to page 254)

CHAMPION V-GLOW PLUGS

for model engines only

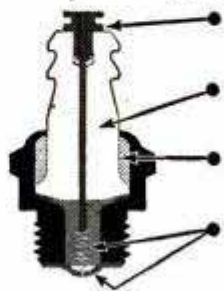

CHAMPION TERMINAL—assures better center electrode seal and provides sturdier electrical connection.

CHAMPION-CERAMIC INSULATORS—proved dependable in millions of Champion Spark Plugs.

CHAMPION SILLMENT SEAL—prevents excessive compression leakage between insulator and shell.

CHAMPION "THERM-O-FLEX" CONSTRUCTION—longer element life, more dependable performance.

Follow recommendations of plug types and fuels approved by engine manufacturer.

CHAMPION SPARK PLUG COMPANY, TOLEDO 1, O.

DEPENDABLE

CHAMPION

SPARK PLUGS

← America's Favorite!

For years square dancing has enjoyed great popularity, but never more universally than today. The same is true of dependable Champion Spark Plugs because they insure topnotch engine performance, with today's performance-loaded fuels. Champion manufactures spark plugs exclusively, and, by virtue of outstanding performance and dependability, Champions have been first in public acceptance for over a quarter of a century. Moreover, Champions have been first by a wide margin among such engine experts as racing champions and master mechanics for a similar period. So when your car needs new spark plugs, follow the experts and insist on America's Favorite Spark Plug!

CHAMPION SPARK PLUG COMPANY, TOLEDO 1, OHIO

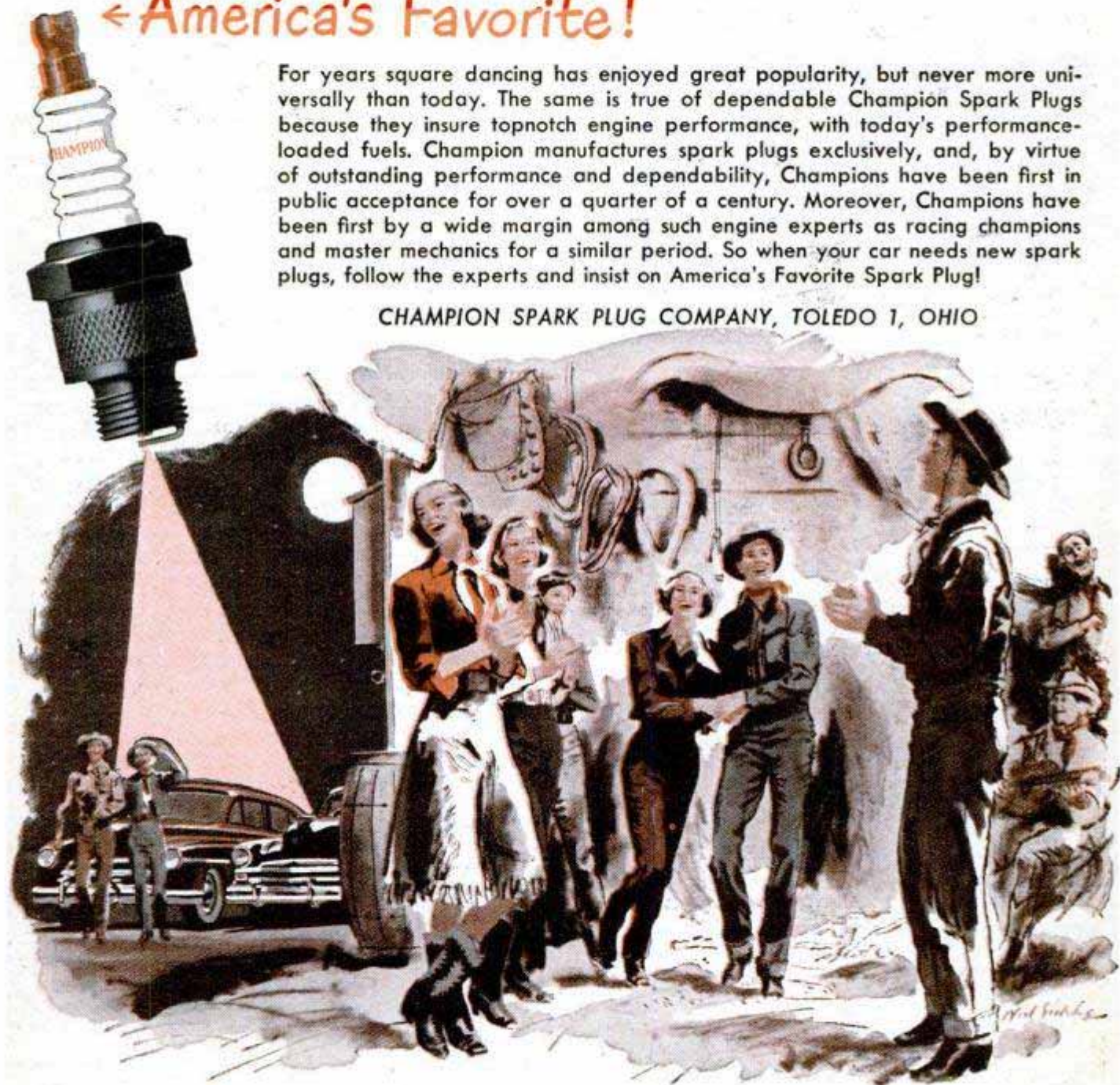

FOLLOW THE EXPERTS
USE THE SPARK PLUGS CHAMPIONS USE!

Listen to the CHAMPION ROLL CALL . . . Harry Wismer's fast sportscast every Friday night, over the ABC network

FREE

get it now—

ALLIED'S NEW 1950

RADIO CATALOG!

196 PAGES OF
BIG VALUES

EVERYTHING
IN RADIO AT
LOWEST PRICES



TELEVISION AND
HOME RADIOS



SERVICE SUPPLIES
BUILDERS' SUPPLIES



AMATEUR GEAR



AMPLIFIERS, P.A.
SYSTEMS, RECORDERS

Send for Radio's Leading Buying Guide

Save money on every radio need! Get the new 196-page 1950 ALLIED Catalog, preferred and used by everyone in radio. See the world's largest stocks of top-quality equipment, all at low, money-saving prices! Latest TV releases, home radios and radio-phonos, Amateur equipment, PA systems and High-Fidelity Sound, recorders, test instruments, builders' kits—plus thousands of parts, tubes, tools, books and diagrams. Have all the advantages of quick delivery, complete selections, big savings and expert personal help from the World's Largest Radio Supply House. Send today for your FREE copy of the 1950 ALLIED Radio Buying Guide!

ALLIED RADIO

ALLIED RADIO CORP.
833 W. Jackson Blvd., Dept. 5-JJ-9
Chicago 7, Illinois

Rush FREE 1950 ALLIED Catalog

Name

Address

City.....Zone.....State



The Wheelbarrow Saw is also a quick way to keep trails clear of brush.

A combination of many new developments is the Slip-On Tank and Pump. The lab designed this equipment so that it can be easily slipped on a Mule trailer or any truck. On the Mule or truck it can be moved along a fire line, pumping either a stream of water or the new fog spray from its own aluminum-alloy tank. Stopping beside a stream, it will quickly fill its tank or, when a valve is turned, will pump steadily from the stream. It has the latest in lightweight, gas-powered pumps, giving a high-pressure head of 150 pounds. Everything possible is made of aluminum alloys, keeping the total weight (empty) down to less than 600 pounds so that it can be dropped from a plane on one parachute. And the pump and hose reel can be instantly detached at any time to be carried by hand into the fire.

This is an army of midgets that fights the biggest of all conflagrations—forest fires. The Beetles and the Mules are just as much at home in the woods as the wild animals. To them, the wooded trail sounds the call of the open road.

Hot Rods and Electrons

(Continued from page 109)

little interest. Once he has determined the validity of an idea, he's off on a new project. If he can prove to his own satisfaction that ultimately the idea will work, he immediately finds something more interesting.

The lad's ideas are not confined to the field of electronics. For example, he's now working on a system for projecting movies in three dimensions without the need for special viewing lenses.

One of the reasons we see in three dimensions, he points out, is that each eye sees a different picture. Actually, when we focus on an object we see two images of every other object within view. If we focus on our forefinger, we see two of everything that appears in the background.

To apply this effect to motion pictures, Tenny has rigged up a mirror and prism arrangement that he places in front of the camera. When the film is exposed and developed, everything on the focal plane of the camera appears in focus, but everything behind or in front of the focal plane appears as two overlapping images, with the distance between the images varying depending upon how far the objects are from the focal plane. When the film strip is run through the projector, there's a definite three-dimension effect. Crude, admits

(Continued to page 256)

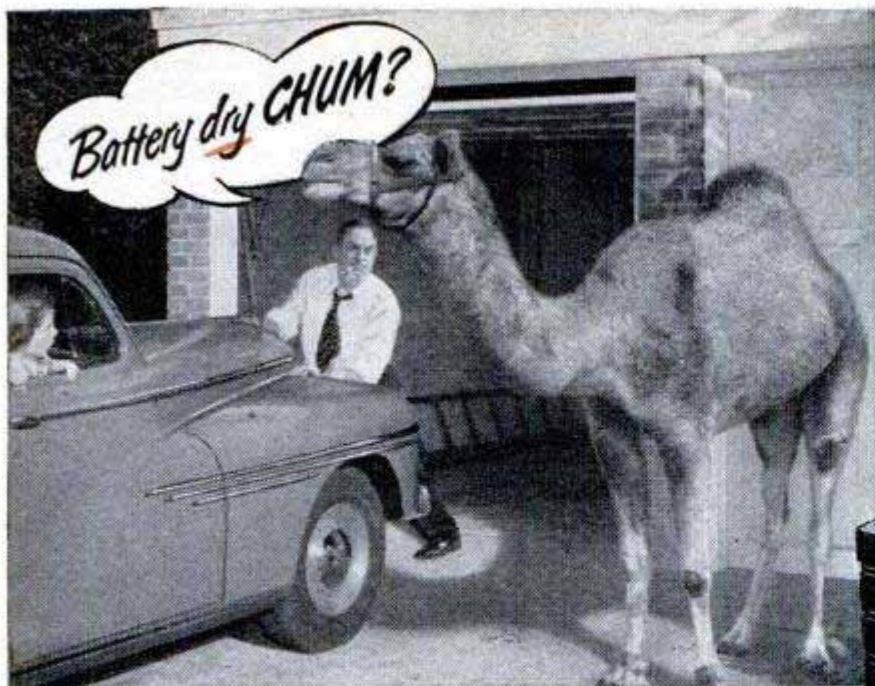

Avoid battery troubles—buy a Prest-O-Lite Hi-Level Battery. Gives up to 70% longer average life as shown in tests conducted in accordance with S.A.E. life cycle standards. See your Prest-O-Lite Hi-Level dealer today.
 Toledo 1 PREST-O-LITE BATTERY COMPANY, INC. Ohio

BUY

Prest-o-lite
 hi-level batteries... need
 water only 3 times a year*

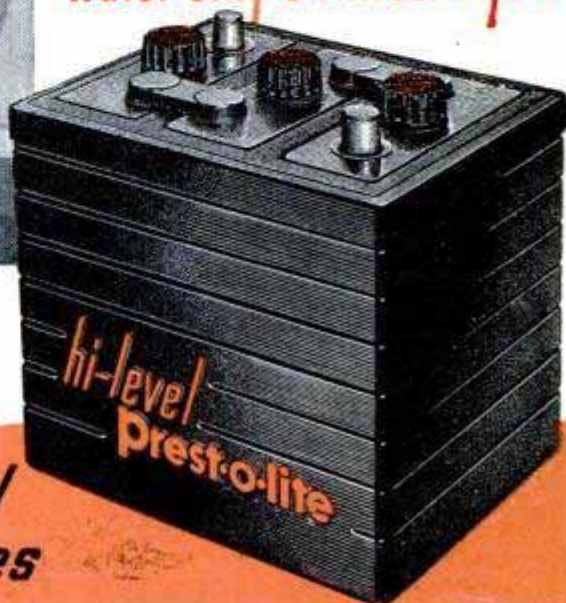

prest-o-lite hi-level
 batteries



FREE parts catalog

Build Better Trailers
 with Safety-Engineered

- ★ Torq-less Axles
- ★ Bull Dog Hitches
- ★ Parking Jacks

... Send for your copy TODAY!



HAMMER BLOW TOOL CO.
 Dept. 134, Wausau, Wisconsin



Don't put that shiny new washer in a dingy cellar! Build a bright, cheery laundry with low-cost Gold Bond Gypsum Wallboard. Big, handy panels are easy to nail up—are fire-proof and unaffected by cellar dampness. Paint it white and you'll have a spick and span laundry room to be proud of! See your local Gold Bond Lumber and Building Material Dealer.

Free Book of suggestions ↓



NATIONAL GYPSUM COMPANY,
 Dept. E-4, Buffalo 2, New York
 Gentlemen: Send free copy of new Book-let, "Modernizing Magic" showing remodeling ideas and methods

Name

Street

City

(Please print name and address)



FOR
 FASTER WORK
 IN HOME OR
 SHOP...

HOLD-E-ZEE
 The Original AUTOMATIC GRIP
 SCREWDRIVERS

See these popular, high-quality drivers with the exclusive Gripper that holds, starts and sets up screws in unhandy places!

New Models FOR RECESSED
 HEAD SCREWS

At Leading Dealers Everywhere
 UPSON BROS., INC., ROCHESTER 4, N. Y.

MECHANICS!

TWO companion tools for taking quick, accurate, inside measurements

LUFKIN TELESCOPING GAGE

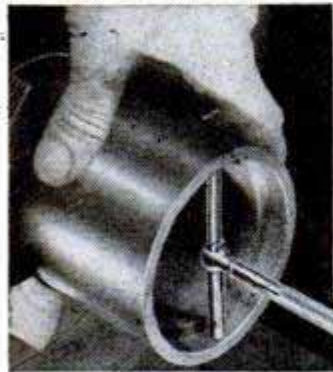

◀ An exclusive design feature is the double telescoping action of the plungers. As a result, the handle is always centered giving perfect balance and "feel" so essential to accuracy



◀ Measurements down to one thousandth inch or less are taken from the gage with a Micrometer.

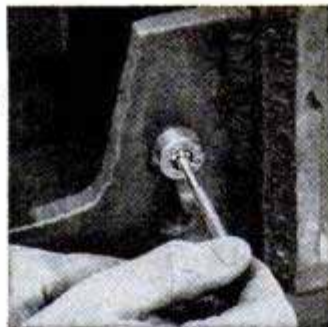

Available individually or in sets. Range $\frac{5}{16}$ to 6 inches. Each gage has its own handle sized in direct proportion to its plunger range, assuring perfect balance found in no similar gage.

THE **LUFKIN** SMALL HOLE GAGE



◀ Ideal companion tool for measuring small holes or slots below the $\frac{5}{16}$ inch range of the Telescoping Gage. Simply insert ball end in hole—turn knurled knob until right "feel" is obtained—then measure ball end with Micrometer. Available individually in four different sizes, or as a complete set with range of $\frac{1}{8}$ to $\frac{1}{2}$ inch.

Write Dept. M for fascinating booklet, "The Amazing Story of Measurement." Enclose 10c (no stamps) to cover handling and mailing.

Buy LUFKIN

Precision Tools • Tapes • Rules • FROM YOUR DEALER
The Lufkin Rule Co. • Saginaw, Michigan



Tenny, but he feels that it may lead to something bigger.

Not long ago Tenny worked out a wide-range transformer. He tried testing it in an electronics laboratory but the instruments there weren't sensitive enough to check the complete range. When he submitted it to a manufacturer he was told, "Your transformer works fine; in fact, it is the best transformer we've seen. The trouble is, we don't need a transformer anywhere near that sensitive."

He now is tinkering with binaural sound effects using only one microphone. Other projects include a precision temperature control he hopes will be efficient to one-thousandth of a degree, and a "memory tube" that would operate through an ordinary vacuum tube instead of the larger tubes used for that purpose in modern computers. He's remodeling his oscilloscope to show five, six or even 10 different wave forms simultaneously for purposes of comparison.

Like many other laboratories across the country, the Tenny Lode bedroom lab is working on an electrostatic loudspeaker for producing high-fidelity sound. Tenny's model, unlike some of the more pretentious instruments, works. Its parts include a sheet of carbon paper and a strip of screen wire. He also has developed a high-fidelity, multi-channel communications system and has an idea for a low-voltage television tube that would slash the cost of television projection in theaters.

Except for his interest in physics and other sciences, the youth is just about as normal as any lad could be. He likes hot-rod racing (he just sold his souped-up '35 car) and has a blond girl friend he'd be "proud to have you meet." He's just as interested in the behavior of players on a football field as gases in a high energy field, and when he's not observing wave forms on his oscilloscope you'll likely find him in the center of a bull session with his cronies.

More Powerful Diesels

Three improved types of diesel locomotives are appearing on the nation's railroads—25 percent more powerful than the models they supersede. Built by the Electro-Motive Division of General Motors, the new diesels have greatly increased hauling capacity and higher train-heating capacity despite the use of cheaper grades of fuel oil. The motors and generators utilize a silicon insulating material that permits a higher load factor, producing a stronger pull. A new injector broadens the range of fuels that may be used.

HOLIDAY... every day!



**TO MAKE
NEW FRIENDS
FOR HOLIDAY**

Cool-smoking aluminum pipe with genuine imported briar bowl

Here's a Sensational PIPE OFFER!

\$3.50 VALUE

only **50¢**

plus the inside paper wrapper from 12 tins of Holiday Pipe Tobacco.

Offer limited to U.S.A. Expires Nov. 30, 1949
Send to Holiday, Dept. PM, Richmond, Virginia



Also in vacuum pounds

HOLIDAY

**AROMATIC
PIPE
MIXTURE**

Enjoy that real Holiday feeling 365 days a year with HOLIDAY—the aromatic High Grade pipe mixture—at a popular price. Only 15 cents!

AN ADVENTURE IN GOOD SMOKING

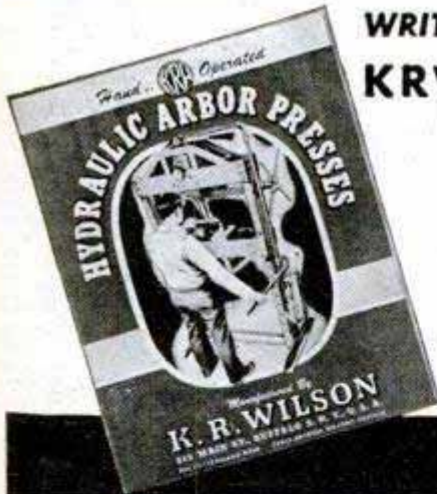

WRITE FOR YOUR **FREE** COPY OF THE NEW **KRW HYDRAULIC PRESS BOOK**

Describes all manner of Production and Shop Work on KRW Hydraulic and Bench Type Presses. Illustrates the new KRW Hand-operated, Electric-operated and Air-operated Hydraulic Presses. 25 to 100-ton capacities.

Write for your copy today.

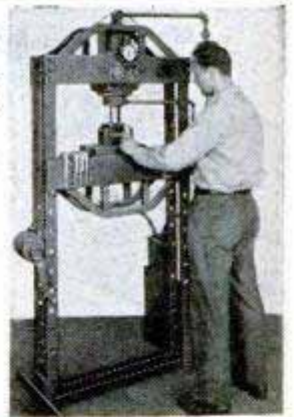

K. R. WILSON, DEPT. 17, 215 MAIN ST., BUFFALO 3, N. Y.

**BASS
IS BEST
WEEJUNS**
LEISURE
COMFORT



**BASS
IS BEST
QUAIL
HUNTERS**
FIELD and STREAM



**BASS
IS BEST
SKI BOOTS**
EXTRA
CONTROL



BASS IS BEST
SPORTCASINS
GOOD GOLF STRATEGY
G. H. BASS & CO.
60 MAIN STREET
WILTON, MAINE



M-SCOPE TREASURE -MINERAL LOCATORS

WRITE FOR FREE, ILLUSTRATED 16-PAGE BOOKLET

M-SCOPE TREASURE-MINERAL LOCATORS. Low priced, unsurpassed efficiency, lightweight models. Factory guaranteed. Immediate shipment. Credit plan available. Write for free 16-page booklet.

GEIGER COUNTERS for finding Uranium ores. Several models, Simple operation. Low priced. Immediate shipment. Interesting free literature.



URANIUM

FISHER RESEARCH LAB., INC., PALO ALTO, CALIF.

GOLD

The easy way to paint!



Speedy Sprayer

Favorite of home owners and craftsmen for 20 years! SPEEDY SPRAYER gives your work that professional paint finish everyone admires. Sprays paint, enamel, varnish, lacquer, etc. . . . 4 to 7 times faster than hand brushing! Lightweight, portable, uses any 1/4 H.P. motor. Improved diaphragm principle assures clean, oil-free air. You'll find dozens of time and money saving uses for SPEEDY SPRAYER, including spraying insecticides 2-4-D and DDT. Complete outfit, without motor, only \$29.95.

ONLY **\$29⁹⁵** LESS MOTOR

At leading hardware, lumber, and auto supply dealers. FREE—write for handy booklet "How to Spray."

W. R. BROWN CORPORATION
5717 Armitage Ave. • Chicago 39, Ill.

"I'll take the WHITE one every time!"



WYTEFACE Steel Tapes, with their jet black markings on a white background, are easier to read in any light. They are rust-resisting, hard to kink and easy to clean.

Protected by U. S. Patent 2,089,209

WYTEFACE
TRADE MARK

STEEL TAPES
KEUFFEL & ESSER CO.

"Dust Bowl" Laboratory

(Continued from page 114)

the equipment has been a long, sizable, research project in itself. Funds for it were set aside as one of the numerous research projects authorized and financed under the U. S. Research and Marketing Act of 1946. Cooperating are the Soil Conservation Service, and the Agronomy Department of Kansas State.

In direct charge is A. W. Zingg, of the Soil Conservation Service. Assisting him is Dr. W. S. Chepil, formerly of the Dominion of Canada Experiment Station at Swift Current, Saskatchewan. Because of Saskatchewan's long and bitter experience, Doctor Chepil has had as much contact with the dust evil as any man alive.

Beside the wind tunnel, which is three feet in cross section and 56 feet long, made of wooden and glass sections for observation, with inlet ports and doors for placing and removing trays of samples, the experimenters had to "custom build" virtually all their other equipment. This includes an ingenious separator made of rotating sleeves, which divides soil into seven sizes; an alcohol manometer for measuring wind-tunnel pressures, and a large electric oven for drying soil samples before testing.

Discharge of a circular fan into a square tunnel caused wind currents and eddies, so the experimenters had to devise a way to make the wind blow "straight." They did this by placing a barrier composed of 324 short two-inch aluminum tubes between the fan and the tunnel proper. This straightened out the wind currents.

The Department of Agriculture is allocating approximately \$30,000 yearly to the work.

Ointment for Insect Bites

Bee stings and some other insect bites become practically painless within a minute after application of an ointment containing one of the anti-allergy drugs. The drug is called thephorin. One doctor has reported a particularly effective case to the American Medical Association. A five-year-old boy walked into a swarm of bees and was stung seven times. Within a minute of the time the doctor applied the ointment the boy stopped crying and said all the pain had disappeared. In seven other cases, patients said the pain seemed to vanish as soon as the ointment was applied.

British researchers have developed light-colored asphalt—green, blue, cream, yellow and red—for experiments in highway building.

LAFAYETTE RADIO

**BARGAIN HEADQUARTERS FOR
500,000 BEGINNERS & HAMS**

29th YEAR of SERVICE

Lafayette shopping scouts comb the country to bring you Best Buys every month, so keep your bargain hunting eye on Lafayette! These are only a few of the super-values you'll find in Lafayette catalogs, bargain flyers and in our retail outlets. Shop Lafayette first!

NEW! DRAFTING MACHINE AN EXCEPTIONAL BUY!

Eliminates use of T-square, protractor, and triangles. Makes sharp, accurate drawings up to 16" x 22". Combination 90° angle, calibrated scale moves at any angle to any point on the masonite board. Includes 17½ x 23½ x ¼" board, steel arms, fittings, rubber feet. No. 18N15092P. Shpg. wt. 8 lbs. \$6.83



FOR MECHANICS, DRAFTSMEN,
DESIGNERS, INVENTORS, ETC.



NICEST IDEA OF THE YEAR BEDLAMP RADIO

It's a beautifully-designed Bed Lamp & Radio combination. Enables her to read under light that's kind to her eyes—while she listens to her favorite band. Superhet circuit. Built in "air-magnet." Complete broadcast band coverage. AC or DC. Lamp has frosted lens for glareless light. Lamp and radio operated separately or together, as desired. Streamlined walnut bakelite. Brackets fit any type of bed. It's a \$29.95 value! No. 1-533P. Shpg. wt. 8 lbs. \$21.75



lowest price in years for a 5-tube SUPERHET KIT!



Lafayette brings back the "good old days" with a spectacular kit value! Looks and plays like a million. Costs you pin money, and you have the fun of putting it together yourself! Smart 2-tone plastic case. Powerful 5-tube AC-DC superhet circuit. Complete with tubes and fool-proof instructions for easy assembling. Send for your kit while the supply holds out! No. 32N24548P shpg. wt. 9 lbs. \$11.95

ORDER BY MAIL OR IN PERSON

LAFAYETTE RADIO

NEW YORK: 100 Sixth Avenue
BOSTON: 110 Federal St.
NEWARK: 24 Central Ave.

CHICAGO: 901 W. Jackson Blvd.
CHICAGO: 229 W. Madison St.
ATLANTA: 265 Peachtree St.
BRONX: 542 E. Fordham Road

BUILD YOUR OWN FILING CABINET



STEEL DRAWERS

Convenient, economical storage for fittings, small parts—no more confusion, wasted time. Each drawer interlocks with others at top, bottom or side. May be fitted to existing fixtures to save space. Each drawer has handy pull and holder for contents card. Steel two-tone green. 2¼" x 2¼" x 5". No. 18N22381P—10 oz. 10 for..... \$3.60

each
40c

WONDER GUN



FOR
BETTER HIGH
SPEED SOLDERING

No waiting for iron to heat—merely pull the trigger. Heats and cools in 5 seconds. New pistol-type grip is easy to hold, easy to handle, even in tight corners. Built-in spotlight prevents "dark-spot" errors. Tips stay tinned, solder easily, bend by hand. 100 watts on 115 V., 60 c. AC. A new low price. No. 18N15183P—3 lbs. Only..... \$11.71
No. 18N15187P—Extra Long Life Tip—2 oz.—4 for 25¢

ELECTRIC SAW



MOTOR-DRIVEN VALUE
Lightning fast—safe as a hand saw. Electrically operated—just guide it! 7200 strokes per min. Saws the most intricate patterns, cuts at any angle—side-ways, back and forth. Automatic switch in handle instantly stops, starts motor. 50/60 c. AC. With cord, plug. No. 18N15352P—with 3 blades—2 lbs. \$5.85
No. 18N15353P—Extra blades—12 for 60¢



BIG NEW BOOK 164 PAGES OF SUPER VALUES

164 pages packed solid with electronic merchandise: every style, every type, every quality, all the big brand names and thousands of special-bargain items of top quality and rock-bottom prices. Prices at Lafayette Radio have now been pared down to within a hairbreadth of our own cost. Our stocks on radio, television, tools, phonographs and players of all types and speeds, recorders, loudspeakers, public address systems, ham gear, etc. are unmatched. Every single item described fully, with all the technical information you want. Yes, you can shop the entire radio world just with this one catalog—and know you're getting the lowest prices anywhere.



FREE

USE THIS COUPON FOR FREE CATALOG NOW!

LAFAYETTE RADIO Dept. LI-9
901 W. Jackson Blvd., Chicago 7
100 Sixth Avenue, New York 13

for ORDERING

...Please send my FREE CATALOG No. 91
...Please fill the following order

- | | |
|---|---|
| <input type="checkbox"/> No. 18N15092P ... \$8.63 | <input type="checkbox"/> No. 18N15183P ... \$11.71 |
| <input type="checkbox"/> No. 1-533P ... \$21.75 | <input type="checkbox"/> No. 18N15187P ... 4 for 25¢ |
| <input type="checkbox"/> No. 32N24548P ... \$11.95 | <input type="checkbox"/> No. 18N15352P ... \$5.85 |
| <input type="checkbox"/> No. 18N22381P .10 for \$3.60 | <input type="checkbox"/> No. 18N15353P ... 12 for 60¢ |

for which I enclose \$..... in postal note, money order, or check.
I will remit few cents postage when order is received.

NAME.....

ADDRESS.....

CITY.....ZONE.....STATE.....

Keep Brushes like New

BEFORE



AFTER

● 5c
● 10c
● 25c

**DICADOO
PAINT
BRUSH
BATH**

*Clean and Restore
PAINT BRUSHES*

KEEPS BRUSHES SPRINGY AND
RE-MAINTAINS

At Paint, Hardware, Dept., and 5 & 10c Stores
Patent Cereals Co. Geneva, N. Y.

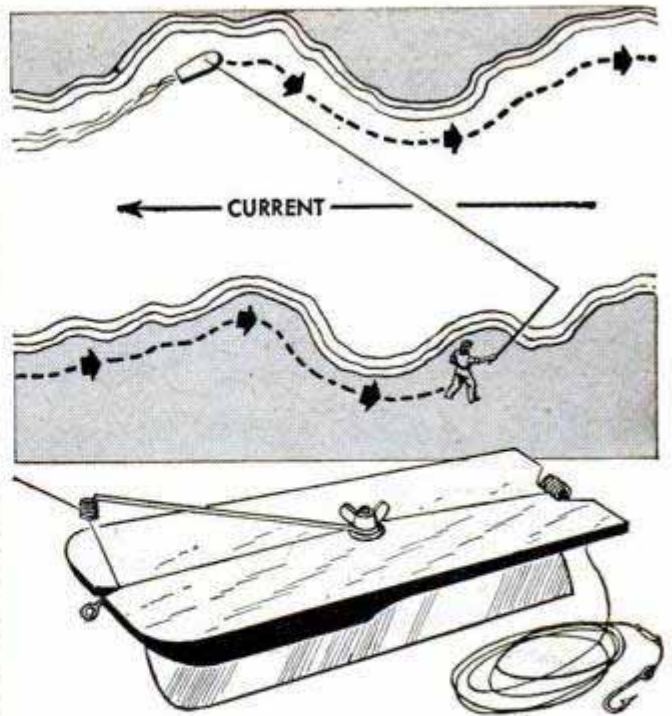

"Boat" Carries Fishline

Still fishermen can send their line scooting out to just the right spot with a boat-like carrier that is driven by the strength of the current. Beneath the carrier is a broad keel. The line is fastened to the carrier and then threaded through a swiveled arm which can be adjusted according to the desired direction of travel. The current strikes the keel at an angle and drives the carrier either upstream or downstream. The carrier can be maneuvered by slight pressure on the line.

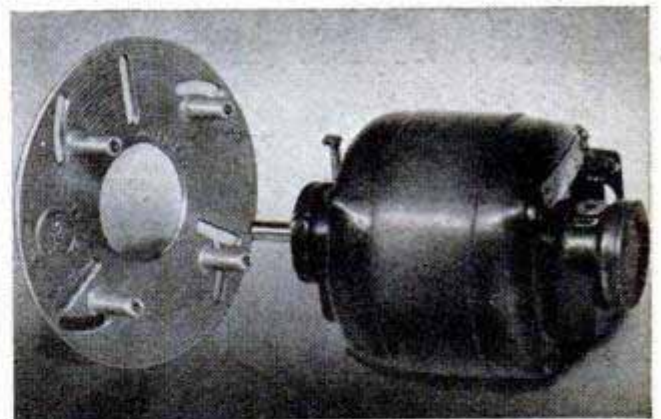

Motor Flange Fits Most Oil Burners

Oil burners that fail can be put back in operation quickly by removing the faulty motor and replacing it with a standard type fitted with a special flange. The flange adapts the motor to most types of oil burners. It is an aluminum casting with protruding lugs that fit the end bolts of the motor. A series of concentric circles on the flange make it easy to align the motor with the pump or fuel unit of the burner.

Make 100% to 150% Profit!

MANUFACTURE BUILDING BLOCKS In Your Own Back Yard

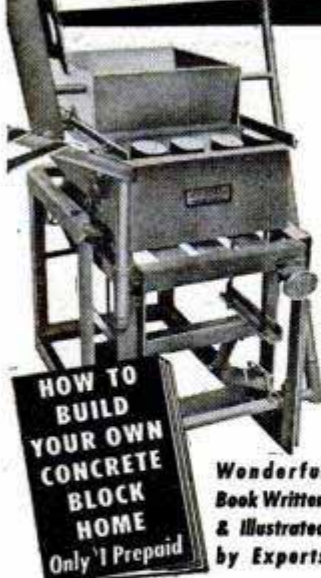

**AMAZING GENERAL
BLOCK MACHINE**
CAPACITY 1000 BLOCKS PER DAY
only \$199 LESS MOTOR
F.O.B. PLANT
SHIPPING WEIGHT 400 lbs.

Here is an outstanding opportunity for men of vision and small capital. Cinder and concrete blocks are in great demand. Millions used for homes, factories, public buildings. Sell all you produce at 100% to 150% mark-up.

PEAK BUILDING DEMAND!

The General Block Machine is amazingly practical, foolproof. Simple to operate indoors or outdoors. Rugged all steel construction. Vibrator mounted in sealed ball bearings. Produces up to 1,000 blocks per day. Superior 3 Core Type that meets all building code requirements. Can produce 4 x 8 x 16, 8 x 8 x 16, 12 x 8 x 16 blocks. All materials obtainable anywhere. All operating instructions and mixing formulas supplied. Full details FREE without obligation.

*Wonderful
Book Written
& Illustrated
by Experts*

**HOW TO
BUILD
YOUR OWN
CONCRETE
BLOCK
HOME**
Only \$1 Prepaid

GENERAL ENGINES CO.

DEPT. 5F • DREXEL BLDG. • PHILADELPHIA 6, PA.

Includes floor plans for 6 beautiful, easy to build concrete block bungalows. Shows ways to save money. How to lay blocks, lay out building lines, mix concrete, build steps, porches and concrete floors. Mail coupon at once with \$1.

Name.....
Address.....
City.....Zone.....State.....

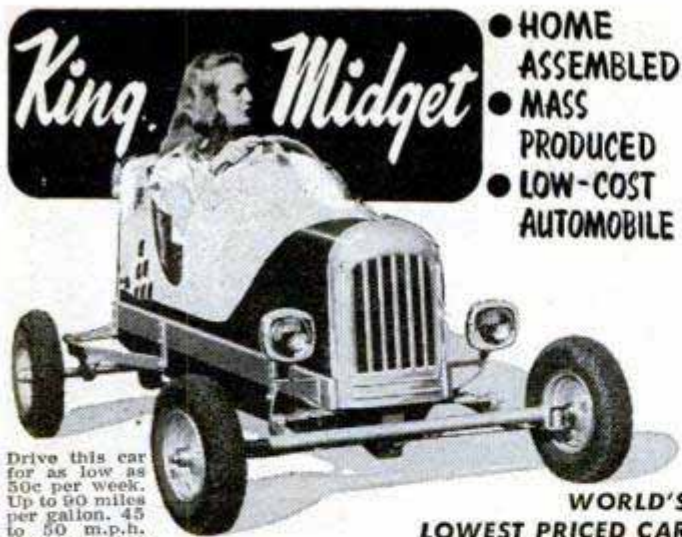

Drive this car for as low as 50c per week. Up to 90 miles per gallon. 45 to 60 m.p.h.

Large enough for a husky six footer. A pleasure to assemble. Just bolt together our precision built parts. Get the facts. Send 25c for detailed circular with large photo, 4 view drawings, price of all parts. Better still, send \$1 (refunded first order) for this plus actual assembly book with 42 photos, drawings; blueprints of snow and ice conversions, etc.

- HOME ASSEMBLED
- MASS PRODUCED
- LOW-COST AUTOMOBILE

WORLD'S LOWEST PRICED CAR

MIDGET MOTORS MFG. CO., Athens 1, Ohio

30 Early American Designs

New designs . . . Early American pieces adapted to modern living . . . in 2 series, A and B. Each packet contains 15 sheets, 8½ x 11", with photos and working drawings. Easy to make Christmas gifts . . . cricket, napkin holder, candle stand, etc. Each packet 25c postpaid. Send for both packets. Stanley Tools, 199 Elm St., New Britain, Conn.

25¢ a packet of 15 plans



STANLEY

Reg. U.S. Pat. Off.

THE TOOL BOX OF THE WORLD



Free Fall Catalog

Just off the Press

Showing Hunting Footwear, Clothing, and fifty-two other leather and canvas specialties of our own manufacture for campers and hunters.

L. L. Bean, Inc.
Dept. R
Freeport, Maine

MAKE YOUR OWN!

WITH

Griffin READYCUT LEATHER PROJECTS

Over 100 KITS in every kind of Tooling and Carving Leather, accurately cut, all parts included. Only Top Grade Leathers used. You do the choosing. You do the tooling, carving, stamping, the punching and assembling

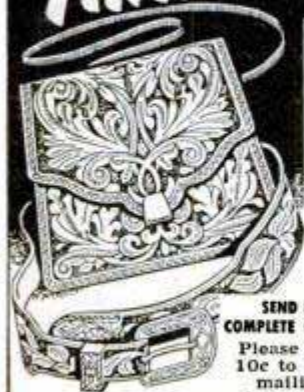

SEND FOR COMPLETE CATALOG Please send 10c to cover mailing.

SINCE 1924

OUT OF THE WEST, THE HOME OF LEATHER CARVING

Griffin Craft Supplies

5515-A GROVE STREET
OAKLAND 9, CALIFORNIA

EVERYTHING FOR THE LEATHER WORKER

Largest, most complete stock of Leathercraft Tools and Accessories in U.S.A.



HIDES AND SKINS of Craft Leathers of every kind if you prefer to cut your own.

RISLONE with your oil guarantees your car smooth, quiet power

You can feel the improvement in 10 miles as it frees your motor of gum and sludge



Rislone's "motor magic" works in cars of any age. It permits driving at normal speeds immediately in new and reconditioned cars. In older cars, Rislone restores

power-surge pick-up, instant starting, and smooth, quiet power at all speeds!

There are no harmful ingredients in Rislone. It's a full-time lubricant, a super oil-alloy that helps any and every motor-oil. It keeps your car at peak performance as you drive, by dissolving gum and sludge to free sticking valves. That eliminates sluggish power, and slow-speed jerkiness.

Prove to yourself the difference Rislone can make in your car. Try it today. Your money back if you don't feel the difference within 10 miles. Available at car dealers, better garages, and service stations everywhere. The Shaler Company, Waupun, Wis.



Whenever you change your oil ..put in a quart of **SHALER**

Rislone

(2 quarts for larger cars). As you add oil, make every fourth quart RISLONE. N-4

SAY YOU SAW IT IN POPULAR MECHANICS

Imported Swiss Stop **CHRONOGRAPH** with 2 push buttons

WRIST WATCH \$6.90

Plus 69c Fed. Tax

WRITTEN GUARANTEE

GIVEN STAINLESS STEEL EXPANSION BAND
Tells Time • Stop Watch • measures SPEED • measures DISTANCE

7-Day Money Back Guarantee

"Wonder" Watch. Used to time autos, airplanes, horse races, athletic events. FREE instructions included.

PLUS 8 BIG FEATURES

• Telemeter • Chrome Plate Case • Attractive Dial • Tachometer • Unbreakable Crystal • Precision Made • Large Red Sweep Hand • Hands & Numbers Glow in Dark. Used by Engineers, Sportsmen, Doctors, Army, Navy, Airforce Officers, Navigators, Photographers. SENT ON APPROVAL. Deposit \$6.90 plus tax and postage with postman or send money order, save postage. (Same money back privilege.)



THE JEWELBOX, Dept. BY, 1674 Broadway, N. Y. 19, N. Y.

BUILD IT — FIX IT WITH AMBROID



"IT STAYS STUCK"

Since 1910 Ambroid Cement has been the Standard product in its field. Ready-to-use, quick drying Ambroid is Waterproof, Transparent, Flexible, Extra Strong. Heat and Corrosion Resistant. Hobby enthusiasts and Industry alike use Ambroid. For assembling and repairing, keep Ambroid handy. At your supplier or send 25c for big 2 oz. tube postpaid. Money back guarantee.

Also 50c 4 oz. tube. Pts. qts., gals., for industrial use.



303 Franklin St., Boston 10, Mass.

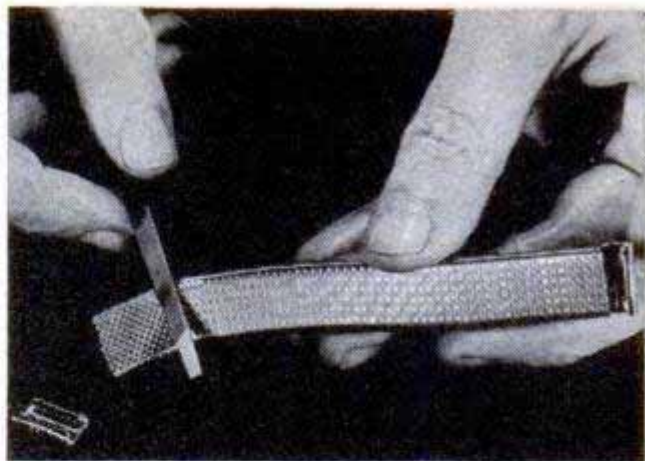

Adjustable Metal Watch Band

Easily shortened by filing through a single strand with a small file, a flexible stainless-steel watch band enables you to adjust it to fit your wrist. The end clip slides off so you can cut away the excess section. The clip is then replaced, hiding the cut, and the band is ready to wear.

**OWN
YOUR
BUSINESS**

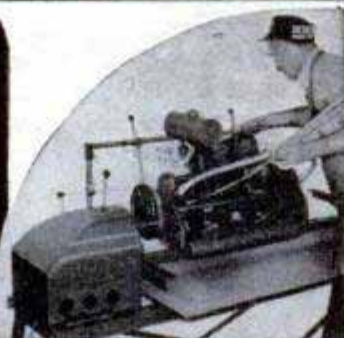

You can start a steady, CASH business at home in spare time, with small investment. The Foley Lawn Mower Sharpener sharpens mowers in 15 or 20 minutes, and 99c out of every dollar is profit. With the Foley Saw Filer you can make up to \$2 or \$3 an hour, filing hand, band and circular saws. Make \$20 to \$30 a week extra money as a starter.

FREE PLAN shows you how to get work without canvassing, and build up your own business. Start with one machine—let it pay for itself and help you buy the other. Send coupon today.

Send Coupon for
FREE PLAN

FOLEY MFG. CO., 907-9 Foley Bldg., Minneapolis 18, Minn.
Send FREE PLAN and information (check one) on

- Foley Lawn Mower Sharpener
 Foley Automatic Saw Filer

Name _____

Address _____

Valve for Hot-Water Radiator Vents Air Automatically

Radiators in hot-water heating systems are always completely filled with water when equipped with automatic air valves that vent air as it accumulates in each radiator. The valve consists mainly of a porous bronze plug and some fiber disks. Air passes through the plug and disks to vent the radiator, but when water is present, the disks swell, sealing the valve. As more air accumulates, the disks dry and shrink, allowing the valve to vent once again.

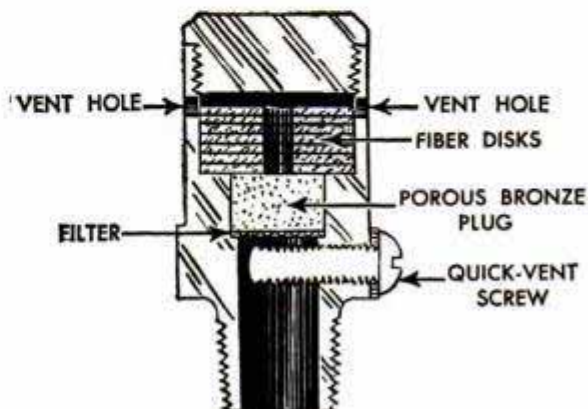

U-MAK-IT BOAT KITS

EASY TO BUILD

5 ROWBOATS 8 TO 14 FT.
Special Models For Fishermen



6 OUTBOARDS
Fast Round or V Bottoms
12 TO 16 FT. Newest
Assembly Methods



**3 INBOARDS
& CABIN CRUISER**
For Fishing, Racing or
Cruising 16 TO 23 FT.
Pre-Fabricated Frames



SEND 25c (coin) ORDER YOUR CATALOGS TODAY
U-MAK-IT PRODUCTS 703P-WHITTIER ST.
New York 59, N. Y.



DURHAM'S
Rock Hard
WATER PUTTY
WILL NOT SHRINK
STICKS AND STAYS PUT

The Modern PLASTIC
for lasting Home Repairs

PERMANENTLY mends cracks or holes in wood, tile, stone or plaster. Sticks and stays put—Does not chip, shrink or fall out. Easy to use. Economical. Mold it, chisel it, polish or paint it. If unobtainable from your lumber, paint or hardware dealer, the big 4-lb. can will be sent you post-paid (in U.S.) for only \$1. Full money-back guarantee, order now.

DONALD DURHAM CO.
Box 804-U, Des Moines, Iowa

SAVE UP TO 50% AND MORE

OUT OF PAWN
GENUINE DIAMONDS

Approx. 1/2 Carat Retail Value \$95
Typical Berman Value \$200

Tax Incl. in All Prices

Over 100,000 Satisfied Customers have bought Diamonds from Berman's

All Diamonds Reset in new Mountings

Reference: Your Own Bank or Any Mortality Agency

BERMAN'S DIAMOND LOAN BANK
Dept. P Berman Bldg., Balto. 1, Md.

Diamonds from estates, banks, unredeemed pledges offered at substantial savings

Iron-Clad Money Back Guarantee

VALUES FROM \$10 TO \$10,000

Send today for **FREE Catalog**

NO OBLIGATION

Save on AUTO VISORS



ORDER BY MAIL \$14.95

Heavy gauge, all steel, streamlined design, chrome trim, adjustable to any angle. **INSTALL WITH ONLY A SCREWDRIVER—NO HOLES TO DRILL.** Neutral metallic color—use as is or can be painted. Send \$5.00 deposit.

WHEEL DISCS
Large, oversize, heavy steel, thick chrome plate with bar. Set of four, \$14.95. Specify 15" or 16" wheels, year & make of car.

MUFFLERS
Soft, mellow tone. Heavy 16 gauge steel. Specify year and make of car. \$4.95 for Ford, Chevy and Plymouth. \$5.95 for all other cars.
Dual Muffler Sets
\$20.00 for Ford and Mercury. \$22.50 for '49 Models.

You'll be Glad
YOU BOUGHT A SCHULT"

Engineered for cool comfort in summer; cozy warmth in winter. Attractive, livable interiors. Outstanding Schult quality and value, backed by the 3-year written warranty of the most famous name in trailering.



Write
FOR FREE BOOK

Describes sparkling new models designed and equipped to meet every demand for luxury and economy, in living or travel. See exclusive Schult "Heat-Saver"—greatest contribution to trailer comfort in years.



SCHULT CORP., Dept. 3209, Elkhart, Ind.
In Canada: John Inglis Co., Ltd., Toronto

SCHULT Trailer Coaches
Member T.C.M.A.

MONEY for MEN ALL FREE DATA

THE PLASTEX Industry needs manufacturers on small scale and for big production of Lamp and Clock Stands, Art Goods and Novelties in Plastex and Marble imitation. Experience unnecessary. 1/2c material makes regular 10c store sellers. Rubber moulds furnished for speed production. Small investment brings good returns. Big chain store orders now being placed. Ambitious men have chance for real prosperity. Our Free booklet will interest and benefit you.

PLASTEX INDUSTRIES, Dept. A
3400 Third Ave. New York 56, N. Y.

FREE SET OF CURB FEELERS
WITH EVERY MAIL ORDER

FENDER SKIRTS
Heavy gauge steel, prime finished with rubber strip-ping, '35 to '49 model cars. Specify year, make and model. \$14.95

Silver Trumpet TAIL PIPE EXTENSION
Deep, mellow tone. Fits all cars. Heavy Chrome Plate. . . . \$2.95

STEERING WHEEL KNOBS
Glamour girl poses laminated in clear tenite. Instantly fastened to any steering wheel . . . \$1.95

KI-YI . . . The Barking Dog Horns . . . whistle like a wolf. . . . \$3.50

FREE!

Enclose check or money order — or 1/3 deposit, pay balance on delivery. **ACE AUTO PRODUCTS** P. O. Box 6675, Dept. PM99, LOS ANGELES 22, CALIFORNIA

The only paint spray that gives you
1 HORSEPOWER PERFORMANCE
AT $\frac{1}{3}$ HORSEPOWER COST



Binks PORTABLE
 PAINT SPRAY
 (DP* unit)

Brand new! Just out after exhaustive field and laboratory tests. Now you can have a really "professional" paint spray made by BINKS, manufacturers of world famous industrial spray equipment.

Compressor weighs only 47 lbs. but delivers 1 h.p. spraying performance for cost of only $\frac{1}{3}$ h.p. unit. Built for easy portability—even up a ladder. For serious finishing, maintenance, craftwork, farm jobs, light production. Handles any finish from undercoater out. Supersafe; all moving parts enclosed. GUARANTEED. Operates on 110-120 v., A.C. Gives 40 lbs. pressure.

Free literature. Send today for free folders telling all about the BINKS new DP compressor, gun, and accessories. Or ask your local dealer to show it to you.

*DP means Direct-drive Piston.



Binks MANUFACTURING COMPANY
 Dept. DP1, 3114 Carroll Ave., Chicago 12, Illinois

LITTLE THINGS HARD TO FIND?
 GET YOURSELF A
HANDI-CHEST

FOR AS LITTLE AS
\$3.95
 POSTPAID



32
 DRAWERS
 ALL METAL
\$8.95
 POSTPAID

DRAWERS
 Uniform in all chests
 ... are 1 1/2" deep, 2 1/4"
 wide, 3 1/4" long. 1-piece
 aluminum units have
 removable dividers to
 make 3 built-in index
 cards on front. Kraft-
 board drawers have
 metal pull tabs.

YOUR MONEY BACK if you are
 not satisfied with your HANDI-CHEST

NOW

with three times the "bins," HANDI-CHEST is a must for home, office, shop. Ideal kit for small parts, hobby needs, sewing, fishing, etc. Steel spot-welded cabinets, metal drawer guides, pleasing grey finish, rubber feet that won't mar any surface. Aluminum or Kraft-board drawers. Manufacturer ships promptly, direct, postpaid. Send check or money order. No C.O.D., please. Ohio orders add 3% sales tax. Ask about quantity discounts.

16 drawers

Steel Cabinet is 6" deep, 8 1/4" high, 12 1/4" wide.
 48 compartments in aluminum drawers
 Model 16A HANDI-CHEST complete **4.95**

Model 16K HANDI-CHEST, same size as above, with heavy Kraft-board drawers, metal pull tabs, complete

3.95

32 drawers

Steel Cabinet is 6" deep, 15 1/4" high, 12 1/4" wide.
 96 compartments in aluminum drawers
 Model 32A HANDI-CHEST complete **8.95**

Model 32K HANDI-CHEST, identical in size, with heavy Kraft-board drawers, metal pull tabs, complete.....

5.95

64 drawers

Steel Cabinet is 6" deep, 15 1/4" high, 24 1/4" wide.
 192 compartments, aluminum drawers
 Model 64A HANDI-CHEST complete **15.95**

Model 64K HANDI-CHEST, same dimensions as 64A, sturdy Kraft-board drawers, metal pull tabs, complete

9.95

ALL HANDI-CHESTS ARE SHIPPED POSTPAID IN U. S. A.
TIBBITS MFG. CO., Dept. 9E, Alliance, O.

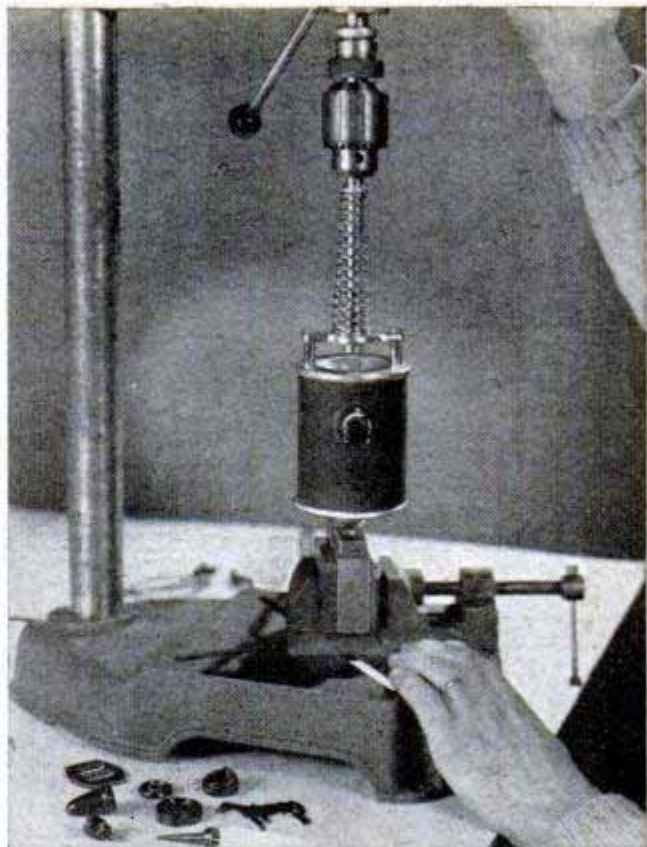

Injection Molder For Workshop Use

Injection molding of Bakelite styrene plastics can be done in the home workshop with a $\frac{1}{4}$ -ounce injection molder that is used in a drill press. Designed for short runs and experimental work, the machine eliminates expensive preparation. It is heated electrically from any standard a.c. outlet and is thermostatically controlled. It is 10 inches high and has a 3-inch stroke.

"Chemical Frost" Strips Leaves From Cotton Plant

Cotton harvest time is hastened by a new chemical that withers and drops the plant's leaves prematurely so that mechanical pickers can operate. The leaves have to be removed first to prevent staining the cotton with leaf juices or contaminating with dried, crushed leaves. Called ammonium thiocyanate, it is the first defoliation chemical applicable as a liquid and the first effective under all climatic conditions. It causes leaves to drop within 15 days after an aerial spraying and meanwhile speeds the development of the cotton bolls. The soil quickly converts the chemical into a nitrogen-bearing plant food.

Ⓞ Norwegian shark fishermen, whose catch provides vitamin-rich shark-liver oil, have discovered a heavily populated shark fishery off the coast of Greenland.

\$154⁵⁵

new!

Complete shop
does 27 big jobs!

Includes drill press, lathe, sander, circular saw, horizontal lathe-drill, line-shaft assembly, nuts and bolts for mounting.
Motors, switch rod, and bench extra
Only 10% down
Easy Time Payments



With Handy-Shop No. 1,
you can do all this:

1. Drill
2. Mortise
3. Rout
4. Drum-sand
5. Shape
6. Carve
7. Grind
8. Spindle-turn wood, metal, plastic
9. Face-plate turn
10. Disk sand
11. Buff
12. Polish
13. Spin metal
14. Drill horizontally
15. Rip
16. Cross-cut
17. Miter
18. Dado
19. Make mouldings
20. Re-saw
21. Joint
22. Abrasive-cut
23. Groove
24. Rabbet
25. Taper-saw
26. Angle-saw
27. Bevel-saw

DELTA MILWAUKEE

Homecraft®

handi-shop no. 1

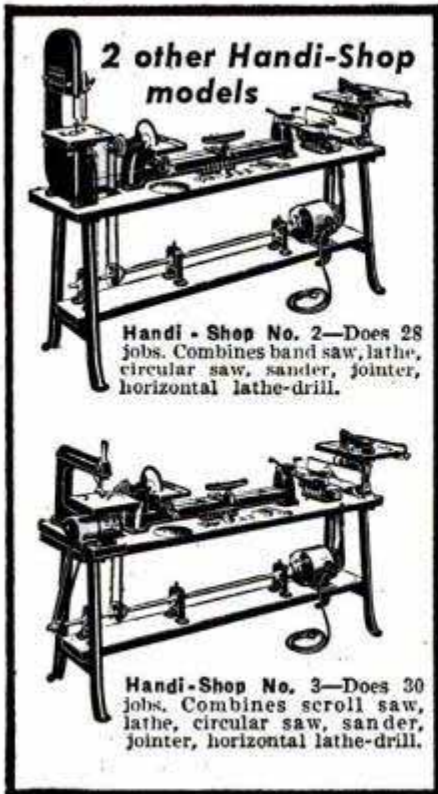

2 other Handy-Shop models

Handi-Shop No. 2—Does 28 jobs. Combines band saw, lathe, circular saw, sander, jointer, horizontal lathe-drill.

Handi-Shop No. 3—Does 30 jobs. Combines scroll saw, lathe, circular saw, sander, jointer, horizontal lathe-drill.

Not just a single machine that you have to set up differently for every operation — but a complete shop of power tools mounted together:

- Drill Press
- Lathe
- Sander
- Circular Saw
- Horizontal Lathe-Drill

A space-saving combination of standard, nationally-advertised Delta Homecraft Power Tools — ready for use *all the time*. You can use the tools separately or together, on 27 different operations. There is no interference between machines; no time-wasting set-ups.

Steel bench legs and lumber for bench available from your Delta Homecraft dealer.

With most work, you can go instantly from one machine to the next, without first having to convert one tool into another — or without having to disturb settings you may need later.

In addition to this 5-tool unit, your nearby Delta Homecraft dealer has two other popular Delta Homecraft Handy-Shop combinations. See the Handy-Shop for yourself today. Learn how it brings you the fun and healthful recreation of woodworking in a limited space. See the Handy-Shop today!



Send coupon for free bulletin that describes Delta Homecraft Handy-Shops in detail!

TEAR OUT COUPON AND MAIL TODAY!



Power Tool Division
Rockwell Manufacturing Company
680K E. Vienna Ave., Milwaukee 1, Wis.

Send me free Delta Homecraft Handy-Shop bulletin AD-485.

Name.....
Address.....
City..... (.....) State.....

HM-70

**SO HANDY FOR
SO MANY USES
AT HOME
OFFICE AND SHOP**

**THE
JIFFY
METAL
CABINET**

**Now you can keep
nuts, bolts, screws,
nails, parts, wash-
ers, stamps, hobby-
ist needs, etc., at your fingertips.**



Just think, 32 or 64 drawer cabinet to keep those small items that usually get mislaid. Spot welded steel cabinet, enamel finish, metal drawer guides. Looks good anywhere. Send check or money order please—no C.O.D.'s. Prices below. Your money refunded if not satisfied.

SPECIFICATIONS	WITH ALUMINUM DRAWERS	WITH CARDBOARD DRAWERS
32 Drawer Unit 6" Deep 12 3/4" Wide 15 1/4" High	One piece rustproof aluminum drawers for heavy service—good for work bench and industry use.	Suitable for most home uses. Heavy board kraft covered. Metal drawer pulls.
64 Drawer Unit 6" Deep 25 1/2" Wide 15 1/4" High		
Drawer Size 1 1/4" Deep 2 3/4" Wide 6" Long	32 drw. \$8.95 64 drw. \$15.95	32 drw. \$5.95 64 drw. \$9.95
	POSTAGE PAID	POSTAGE PAID

KAYTEE PRODUCTS DEPT. M, BOX 588, CANTON, O.

Stop Drafts! Save Fuel!
**WEATHERPROOF YOUR HOME
WITH
Nu-WAY
WEATHER STRIP**

Easiest strip in the world to put on. Can be used on most any type door or window. Wool felt, reinforced with white metal.

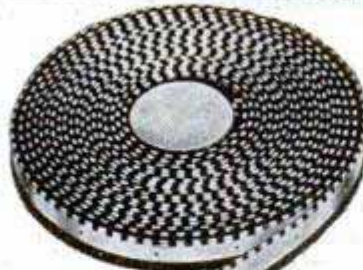

MACKLANBURG-DUNCAN CO.
Oklahoma City 1, Okla.

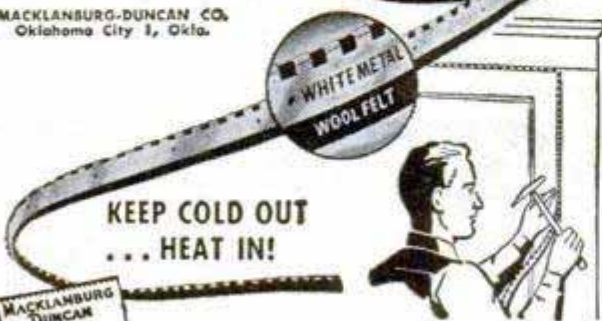

**KEEP COLD OUT
... HEAT IN!**



**BUY AT YOUR LOCAL HARDWARE
STORE, BUILDING SUPPLY DEALER
OR LUMBER YARD**

**PAGE
GARDEN
TRACTOR**

**WRITE FOR
FREE CATALOG!**



Make fall plowing easier! Riding and walking models, 1 1/2 to 5 HP. Complete gear drive—no belts or chains. Low prices, easy terms... \$188 to \$396 with cultivator. Write now!

PAGE DAIRY and FARM EQUIPMENT

1904 S. 81st Street • Milwaukee 14, Wis.

Gets the dirt. Good to your hands

**Eliminate
1000 NEEDLESS STEPS!**
Quick - Easy - Safe
SAHARA



**Will Remove Without Water
Paint, Tar, Grease, Grime,
Pipe Compound, Printer's
Ink, Linoleum Paste, Pitch
and Most Chemical Stains.**

Money-back guarantee AGENTS WANTED

SEND 1/2¢ FOR 1 lb. POSTPAID

AVAILABLE IN TUBS, ONE POUND CONTAINERS, AND PAILS.
Sahara Waterless Soap Co. - Grand Rapids, Mich.

BRONZE FOUNDRY Schools and Home Workshops

Make your own castings of aluminum, copper, bronze, silver. Foundry sets are available in three sizes including 2400 Deg. F. blast Furnaces. \$22.50; \$29.50; and \$42.00, f.o.b. Kansas City. Free Circular.

KANSAS CITY SPECIALTIES CO.

P. O. Box 6022, Dept. P-8

Kansas City, Mo.

NEWEST OTTAWA LOG SAW

**SELF-PROPELLED - MOVES
ANYWHERE ON OWN POWER**

World's fastest Log Saw. Powerful 6 H-P air-cooled motor. Attachments for sawing down trees, buzzing limbs, post hole digging and pulley for belt jobs. Big demand for wood, pulp, posts. Make big money sawing wood this easy way. Low factory-to-user prices. Nothing like it. FREE details.

OTTAWA MFG. CO., 7-927 Pine St., Ottawa, Kansas



BUILD FINE GRANDFATHER CLOCK NOW

The simple sensible Red-i-Kut way as thousands have—SAVE HALF. SHOP TESTED PLANS "SPIRIT OF THE CENTURY" Narrow waist 83" tall or stately "SPIRIT OF AMERICA" straight side model with pictures. EASY-TO-FOLLOW PLANS tell all—plus BROCHURE of heavy brass weight Westminster tube chime, movements, dials, solid mahogany case kits. Send \$1.00 today—Both Plans \$1.50 NOW. KUEMPEL CHIME CLOCK CO., #5 Kuempel Bldg., Minneapolis 16, Minn.



**WHEELS
AT BARGAIN PRICES**

4" Wheel, 1/2" Tire, 5/16 Steel Bearing...	\$0.45 ea.
5" Wheel, 5/8" Tire, 5/16 Shaft Hole.....	0.65 ea.
6" Wheel, 5/8" Tire, 5/16 Shaft Hole.....	0.75 ea.
7" Wheel, 3/4" Tire, 3/8 Shaft Hole.....	0.85 ea.
8" Wheel, 1" Tire, 1/2" Shaft Hole.....	1.25 ea.
8" x 1.25" Wheel, semi-pneumatic, 7/16 ball bearing.....	2.00 ea.
8" x 2" Wheel, semi-pneu., 7/16" Ball Bearing.....	2.25 ea.
10 x 1.25 Wheel, semi-pneu., 7/16 BB.....	2.50 ea.
10 x 1.75 Wheel, semi-pneu., 7/16 or 1/2 BB	2.75 ea.
10 x 2.50 Wheel, semi-pneu., 1/2 or 5/8 BB..	4.50 ea.
10 x 2.75 Wheel, semi-pneu., 1/2 or 5/8 BB..	4.95 ea.
10 x 2.75 Wheel, single tube pneu., 5/8 BB..	5.50 ea.
12 x 1.75 Wheel, semi-pneu., 7/16 or 1/2 BB	3.25 ea.
6 x 2 Wheel, solid tire, 5/8 Ball Bearing...	2.95 ea.

Write for complete "FREE" list—includes Industrial, trailer, wheelbarrow, sizes, etc. To order above wheels, send this ad with check or money order and your name and address.

T & H MFG. CO., Inc., 811 East 31st, Dept. WPA-9, K. C., Mo.

SHOPMASTER will redeem this coupon for \$2.50 in Shopmaster "Build-it-Yourself" Plans

GOOD FOR
\$2.50

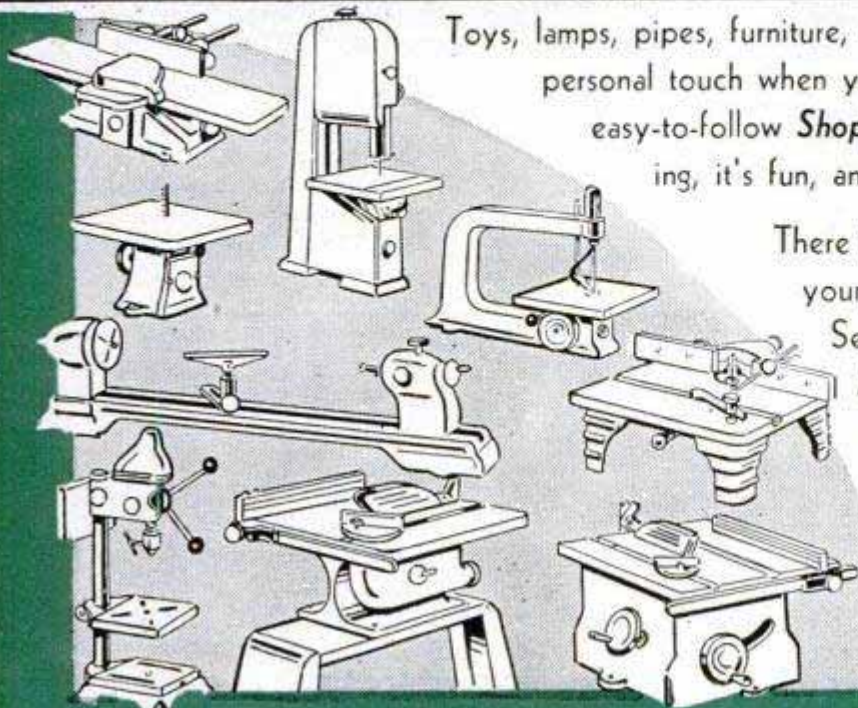

Toys, lamps, pipes, furniture, etc., will have that personal touch when you create them with easy-to-follow *Shopmaster* Plans. It's relaxing, it's fun, and it's profitable.

There is a famous *Shopmaster* Tool for your use, priced for your pocketbook.

See your dealer, or write *Shopmaster, Inc.* for your copy of the new 28-page full-color illustrated catalog showing a complete line of tools and accessories.

With the purchase of a *Shopmaster* Tool, your *Shopmaster* dealer or the factory will redeem this coupon for \$2.50 worth of *Shopmaster* plans of your choice.

Take this coupon to your dealer and purchase a tool today. If your dealer does not have the plans, he may sign the coupon with the registration number of your tool and mail it to the factory. Your plans will be sent to you immediately.

(Dealer Note: Shopmaster will replace all plans, free of charge, to your plan rack, on redemption of this coupon.)

- | | | |
|-----------------------------|-------------------------|-----------------------------|
| 50c Plans | 52 Roller Toy | 64 Kiddie Car |
| 65 Smoking Pipes | 53 Child's Wagon | 67 Picket Fences |
| 66 Modern Table Lamp | 54 Coaster Set and Rack | 71 Picnic Table |
| 68 Five-in-One Coffee Table | 55 Toy Duck | 72 Silver Chest |
| 69 Lawn Chairs | 56 Broom Holder | 73 Baby's Crib |
| 70 Modern Coffee Table | 57 Novelty Tie Rack | 74 Child's Table and Chairs |
| 25c Plans | 58 Bouncing Dog Toy | 75 Child's Play Pen |
| 51 Nut Bowl and Mallet | 59 Pull Toy Train | 76 Three-in-One Decoy |
| | 60 Gun Rack | |
| | 62 Bird House | |
| | 63 Rolling Hobby Horse | |



SHOPMASTER, INC.
1214 SOUTH THIRD ST.
MINNEAPOLIS 15, MINNESOTA

CERTIFICATE

This certificate entitles you to \$2.50 worth of **Shopmaster** Plans with the purchase of any **Shopmaster** Tool. Circle the plan numbers desired. Your **Shopmaster** Dealer or **Shopmaster, Inc.**, will redeem this coupon. One to a customer. Coupon void after Dec. 31, 1949.

Tool Purchased _____ Registration Card No. _____
 Dealer _____ Buyer _____
 Address _____ Address _____
 Signature _____ City and State _____

Redemption made by Dealer _____ Plans to be mailed direct to customer _____

51 52 53 54 55 56 57 58 59 60 61 62 63 64 65 66 67 68 69 70 71 72 73 74 75 76

This coupon is void if prohibited, licensed, or taxed in your state or locality.

TWO FIFTY

POWER
20 lbs. Pressure

NICKEL PLATE GUN
Keeps Clean!

Precision-built
ALL-METAL COMPRESSOR

Fan-cooled
UNIVERSAL MOTOR
A.C.-D.C.

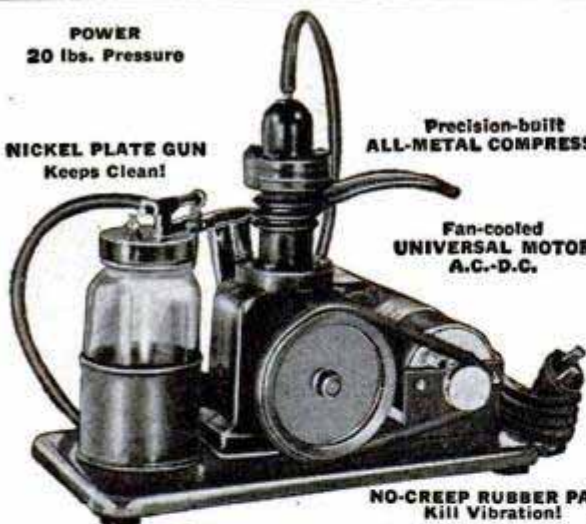

NO-CREEP RUBBER PADS
Kill Vibration!

NEW LOW PRICE HI POWER MOTOR DESIGN FINISH ONE YEAR GUARANTEE only **16.95** Shipped Prepaid in the U.S.A.

Yes, a NEW and IMPROVED complete (with Motor) spraying outfit at a NEW LOW PRICE. (Thousands were sold at 19.95.)

The first Complete PROFESSIONAL TYPE SPRAY UNIT ever offered at such an Amazingly Low Price. NEW MOTOR is fan cooled and works on both AC and DC. This NEW MOTOR has been instrumental in bringing the compressor pressure from 12 h.p. to 20 lbs. If you are already discouraged with the compressorless type sprayer please give this unit a trial. We know that once you own one of the NEW ATLAS SPRAYERS you will not want to part with it. The ONE YEAR GUARANTEE given, just shows what confidence we have in this unit.

EXCELLENT FOR: • Painting • Auto Touch Up • Insecticide Spraying • Deodorizing • Moth Proofing • Reconditioning • Waxing Furniture—Floors • Animal Spraying • Pest Control. You save Money Order Fee and C.O.D. Fee by sending 16.95 with order

MAIL ORDERS TO
CARL-SONS ENTERPRISES

Mail Order Division of Carl-Sons Best Hardware
1627-29 N. DAMEN AVE. CHICAGO 47, ILL.

10 SHELF PLANS

NEW FULL SIZE

New, full size, easily built, beautiful wall shelf plans ready to trace on lumber, cut out and assemble. Corner and wall racks with 1 to 3 shelves. Stores charge about \$75.00 for these shelves. Make money selling them. Finest selection available. PLUS BONUS of 48 other novel cut-outs, Dutch Boys, Girls, Toys, etc., etc. PLUS FREE new 1949 Handicraft Catalog. Send only \$1 to

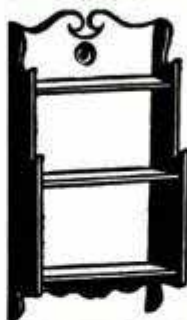

JACKSON, Dept. 10
5440 N. Shoreland Ave.
Milwaukee 11, Wis.

SHINE WITHOUT 'POLISH'

New Invention! • Sells Like Wild

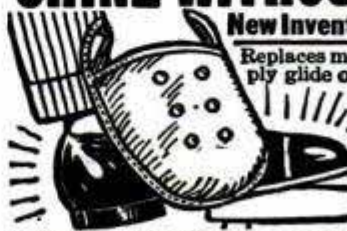

Replaces messy pastes, liquids. Simply glide over shoes—and PRESTO!—you have a lustrous, long-lasting shine. No mess. No fuss. No soiled hands. Clean. Handy. WORKS LIKE MAGIC! For Men's, Women's and Children's Shoes. Low priced. Lightning seller!

SAMPLES FOR AGENTS Sample offer sent immediately to all who send name at once. A penny postal will do. SEND NO MONEY—just your name. KRISTEE CO., 683 Bar Street, AKRON, OHIO

Plastics Supplies Catalog

Just off press. Get details on Plexiglas, Lucite, rods, sheets, tubes, Acetates, cements, dyes, buffs, molding sets, tools, carving kits, everything in plastics. Lowest prices. Price 10c, stamps or coin, with ad for catalog.

Plastics Mfg. & Supply Corp., Dept. PM-9, 4707 Euclid Ave., Cleveland, Ohio

FULLSIZE, CUT-TO-SHAPe BOAT PATTERNS

and specifications. Designed by Naval Architect. Cruisers, runabouts, sloops, outboards, sailing canoe, etc. Low prices. Send 25c (coin) for illustrated catalog. SPECIAL: Send \$1.00 for "HOW TO BUILD BOATS" book, postpaid. PolyWog Houseboat Plans, \$10. Marine Catalog \$1. Cleveland Boat Blueprint Co., Dept. 666, Cleveland 13, Ohio

BURIED TREASURE. MINERALS AMAZING NEW GOLDAK LOCATORS

SENSATIONAL NEW MODEL!
ONLY 11 pounds weight! One hand operation! Money-Back Guarantee of Superiority. Write for full details.

THE GOLDAK CO.
1542 WEST GLENOAKS BLVD.
GLENDALE 1, CALIFORNIA

World's largest maker of fine locators.



When Screws Won't Stay TIGHT, Use SMOOTH-ON

Apply Smooth-On No. 1 Iron Cement to screw threads and into the screw hole. Insert and tighten up the screw. It will take hold and, when set, will STAY TIGHT, for Smooth-On expands slightly as it hardens, wedging the screw in place. This is only one small use for this general-purpose iron cement. With it you can stop leaks and seal cracks in cast metal parts, tighten loose knobs, casters, tool and utensil handles, make many auto repairs. Buy it in 1/4-oz., 7-oz., or 1-lb. size at your hardware store. If they haven't Smooth-On, write us.

FREE 40-page Repair Handbook

Many original uses for Smooth-On around the house, on the car, etc. Simple directions, 170 illustrations. Send postcard for YOUR free copy.

SMOOTH-ON MFG. CO., Dept. 37
570 Communipaw Ave., Jersey City 4, N. J.

Do it with

SMOOTH-ON

THE IRON CEMENT OF 1 000 USES



BE FAIR TO YOUR HAIR Want better looking hair? Embarrassed by falling dandruff, itching scalp? Get the new VITABRUSH, the electric-automatic brush with built-in brush head motor... gives scalp and hair an invigorating "workout" in just 3 minutes. Cleans scalp, stimulates blood supply, distributes the natural oils. Fun to use—relaxing. Write for satisfaction-guaranteed offer—today. Hershey Mfg. Co., 3791 Field Bldg., Chicago 3.



Hunter bags new CROSLLEY record

"I can vouch for Crosley cars being tough and capable", says E. B. Walters of Oxford, Pa. He recently took a hunting trip to the Canadian wilds in his Crosley Station Wagon, pulling a trailer with 1,500 lbs. of equipment, including a boat! (We don't recommend such use of a Crosley... but it certainly demonstrates stamina!)

See the new Crosley with CIBA (cast-iron block) engine and Hydradisc (airplane-type hydraulic) Brakes. Prices range downward from the Station Wagon at \$929 F.O.B. Marion, Ind. For catalog of 6 new models, write Crosley Motors, Inc., 2530-HJ Spring Grove Ave., Cincinnati 14, Ohio.

CROSLLEY
a FINE car

You see them everywhere!



ARC WELDING FOR PROFIT OR PLEASURE

60 LBS. OF READY MADE PARTS **Only \$24.95**

BUILD YOUR OWN HEAVY DUTY WELDER

All parts Ready-Made and easy to assemble. You can do all around welding on steel, cast iron and other metals after only a few hours practice. Illustrated instruction manual included. Sold on 30-Day Money-Back Guarantee!

FREE: Write today for fully illustrated Pamphlet P-9

ATOMIC ARC WELDER CO.
1037 So. 19th St. OMAHA, NEBR.

SAVE
Buy Only NECESSARY PARTS

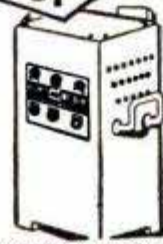

Gives 100% penetration. Welds are stronger than original metal. Operates on 110 or 220 AC.



IF I SEND YOU THIS FINE SUIT—

Will You Wear It and Show It to Friends?
I need a reliable man in your town to get a fine, made-to-measure, all-wool suit without paying cash, but by taking a few orders from friends. Wear it—show it—to help you take more orders with my line of nearly 100 guaranteed quality fabrics. You can make up to \$12 in a day without experience or investment. I supply everything required FREE. Write for FREE outfit. John Grant, STONE-FIELD Corp., 5325 Throop St., Dept. W-816, Chicago 7, Ill.

PAINTERS' STRIPING TOOL

A TOOL... NOT A BRUSH

NEW, IMPROVED

Modern—streamlined—fits the hand like a fountain pen! Easy to use as a pencil. Draws parallel lines—straight, curve or circular. Does expert job on autos, furniture, toys, bikes, model planes, signs, bulletins, linoleum. (Makes wall board look like tile.) Every painter and craftsman needs one! Type "M" MASTER Painters' Striping Tool complete with tip for 1/16" stripe, \$1.00. Tool with choice of 1/64", 1/32", 3/64", 5/64", 3/32", 1/8" tip —\$1.50... all tips 75c ea. Tool with complete set of 7 tips \$5.00. (COD's postage collect.) Paint dealers, write!



WENDELL MFG. CO.
4234-B Lincoln Ave., Chicago 18, Illinois



THIS IS IT! THE LOWEST-PRICED BALL BEARING, TILT/ARBOR SAW IN AMERICA!

\$39.50 F.O.B.

Kalamazoo, Mich.
Price includes motor rail, belt, pulley, mitre gauge, fence, splitter, guard — less motor. Extensions \$3.50 each.

THE NEW Atlas POWER KING 3001

Yes, this is it! The saw thousands of shop owners have been asking for. The new 3001 ball bearing tilt/arbor Power King. A big-capacity saw with big saw features, yet priced so low it pays for itself quickly with the money you save on a few projects alone.

Compare these features and we think you'll agree the new 3001 is today's outstanding circular saw value!

BIG SAW FEATURES!

- ★ TILT/ARBOR CONSTRUCTION — table and work are always flat for safe angle sawing.
- ★ BALL BEARINGS — sealed from dirt and dust, assure smooth running and lasting accuracy.
- ★ BIG CAPACITY. With a 2 1/4" depth of cut, and a 12" x 16" table that has 7 1/8" area ahead of blade, the 3001 handles a broad range of work.
- ★ PRECISION-GROUND GREY-IRON TABLE. Heavy cast iron table is rib-braced and reinforced for absolute rigidity. Precision ground top assures smooth easy sliding surface.
- ★ RIGID RIP FENCE — full table width, locks at both ends, releases instantly.
- ★ TABLE EXTENSIONS AVAILABLE. Exclusive, grey-iron grill type extensions, measuring 6 3/4" x 16"; can be added to the 3001 at low cost. Add one to right side and you can rip to the center of a 24" panel. Add one to each side, and table area is increased to 25 1/2" x 16". Tops are precision ground.

Please send circular on the new Power King 3001 tilt/arbor saw.

Name _____

Address _____

City, State _____

ATLAS PRESS CO.

943 N. Pitcher St., Kalamazoo, Mich.



**MATCHED PRECISION TOOLS FOR
WOODWORKING AND METALWORKING**

SAY YOU SAW IT IN POPULAR MECHANICS

Easy and Cheap to Operate

SAVE TIME, WORK, MONEY!

SHAW "DU-ALL"

and "PEPPY PAL" TRACTORS

PLOW

These rugged walking or riding tractors are ideal for farm, truck garden, orchard, poultry farm. Operate on a few cents an hour. A child can handle them.

CULTIVATE

DO DOZENS OF JOBS Both riding and walking tractors quickly and easily plow, cultivate, harrow, disk, bulldoze, spray, haul, grind, saw wood, etc. **LOW FACTORY PRICES** Buy direct or through your dealer. Year's guarantee!

RIDING TRACTORS 4 models from 5 to 12½ H.P., 58 in. wheelbase, 36 to 62 in. wide, 24 in. plant clearance. Hand or electric starter. Walking Tractors 1½ to 5 H.P.

FREE Illustrated folders giving complete details and price lists—write today!

SHAW MFG. CO.

4509 FRONT ST., GALESBURG, KANS.
668G NORTH 4TH ST., COLUMBUS, O.

See Our Exhibit At

KANSAS FREE FAIR, TOPEKA, KANSAS
Space #101 and #103, Industrial Bldg., Sept. 10-16

OKLAHOMA STATE FAIR & EXPOSITION
OKLAHOMA CITY, OKLA.
Space #9 and #10, Liberal Arts Bldg., Sept. 24-30

STATE FAIR OF TEXAS, DALLAS, TEXAS
Space #414, General Exhibits Bldg., Oct. 8-23

STATE FAIR OF LOUISIANA
SHREVEPORT, LA.
Spaces #55 and #56, General Exhibits Bldg., Oct. 22-31

2 DRILLS IN 1



This attachment gives you two drills in one. It converts any ¼ inch electric drill to ½ inch capacity. Reduction gears reduce the drill speed 5 to 1, the average speed of a ½ inch drill, and thereby increases the power. Absolutely indispensable for all shop work and home craftsmen. Satisfaction guaranteed. Order yours now.....

\$11.95 post paid

Send check or Money Order with order. Jobbers write for special information.

G. M. CO. MANUFACTURING, INC.
1308 43rd Ave.
Long Island City 1, New York

REAL DIESEL ENGINE

\$2.95



WE'RE CRAZY, they tell us, giving away a real diesel engine, complete with cylinder and piston, carburetor, crankshaft and connecting rod. All parts completely machined, ready for easy assembly. **ONLY \$2.95**. How do we do it? We're selling thousands of **DEEZILS**. So production's up; costs tumble down. **DEEZIL** is a precision engine. Actually runs at 7500 RPM. Produces 1/7 HP. Ideal for planes, boats, midget cars. Send \$2.95 plus 25c postage today.

GOTHAM HOBBY CORP.
107 East 126th Street New York 35, N. Y. Dept. "P"



CAPE COD CHAIRS
TRELLISES • ARBORS
DUTCH WINDMILLS

Chairs style B-C-A PLANS 50c Ea., all 3 only \$1.00. 12 different trellis designs PLAN of all 12 only 50c. Authentic 40" high Dutch Windmill Detailed PLAN only 75c. Unique 40" high Light-house having copper lantern, ideal for garden or on lake shore of summer home. Large detailed PLAN 75c.

SPECIAL ALL PLANS ABOVE \$3.00 VALUE ONLY \$2.50
SEND 10c for catalogue of many fine projects.

CRAFTSMAN'S MODEL CO. Dept. PB, 2030 No. 41st Street Milwaukee 8, Wis.

make your own Gems 29.50 F.O.B.

All necessary lapidary equipment is furnished, including a super-charged diamond blade for sawing, and all wheels for grinding, shaping and polishing; also complete instructions. The complete equipment as shown, less motor and belt, for only \$29.50, f.o.b., Burlington, Wisconsin. Write today for information and literature.

B&I MANUFACTURING CO.
Dept. S Burlington, Wis.



A HULL
AUTOMOBILE COMPASS
Makes You Positive of Directions
ALL THE TIME

Beaconlite illuminated, \$5.95. Streamline standard, \$3.95. At your dealer's. Write for circular.

Hull Manufacturing Co., P. O. Box 246-D9, Warren, Ohio



PAINT YOUR CAR WITH WYPE for \$2.95!

There's no brushing, no masking or spraying. Thousands of car owners are delighted with the results. See your local dealer, department store or order direct.

WYPE CORPORATION
DEPARTMENT 16-J 2214 DOLMAN ST. ST. LOUIS 4, MO.

Command Bigger Money!

STUDY LAW

STUDY AT HOME for BUSINESS SUCCESS and LARGER PERSONAL EARNINGS. 40 years expert instruction — over 114,000 students enrolled. LL.B. Degree awarded. All text material furnished. Easy payment plan. Send now for FREE BOOK — "Law and Executive Guidance." It explains the course — how you may enroll and the many ways you can profit from Law Study. Write TODAY to:

AMERICAN EXTENSION SCHOOL OF LAW
Dept. 18-PM, 646 N. Michigan Ave., Chicago 11, Ill.

FOR HANDY, EASY TO USE CONVENIENCE
YOU CAN'T BEAT A..

CARLSON RULE

WITH 10-SECOND
BLADE CHANGE



And with a Carlson Rule you can buy an extra blade for about half the cost of a new rule. When a blade is accidentally damaged or numerals become worn, you don't have to buy a new rule. Just get an extra blade and insert it without opening the case. Presto, in 10 seconds a "new" rule for half the cost!

ASK YOUR HARDWARE DEALER

CARLSON STEEL TAPE RULES
MONROVIA • CALIFORNIA

NEW D.C. ARC WELDER

A \$300 Value at Less Than 1/3rd
200 AMPERES CONTINUOUS DUTY

Up to 250 amperes intermittent duty. Easily mounted on tractor or elsewhere. Welding range by dial-type control from 0- up. Guaranteed one year with money-back 10-day trial period. Write for free literature or save time and order direct from **35c** this ad. Or, send for PLAN "Build Your Own Welder from Surplus Aircraft Generator" and we'll include free literature and catalog.

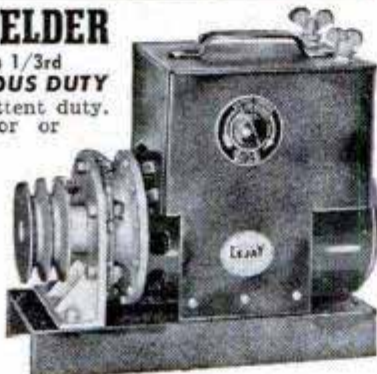

LEJAY MFG. CO., 847 LEJAY BLDG., MINNEAPOLIS 8, MINN.

NEW GOVT. SURPLUS HOIST and WINCH

Originally made to be used on B-29s for lifting bombs. Mounted on welded steel base, can be attached to truck body or any solid base. Ideal for lifting or moving loads onto trailers, trucks or tractors or for machine shops, garages or warehouses. Capacity 2,000 lbs. Equipped with ratchet for holding load and 18 ft. 3/16" steel cable. Shipping weight 50 lbs. FOB, Kansas City, Mo.

\$29.95



Send check or M.O. for immediate delivery. No COD's

AMERICAN AUTO PARTS CO., INC.
1830 LOCUST DEPT. PM9 KANSAS CITY, MO.

← YOUR MOTOR

Foredom PRESTO-FLEX with PENCIL-SIZE Handpiece \$5.95



WITH MARVELOUS EASE, you can grind, polish, drill, rout, mill, saw, sharpen, clean, carve, engrave, etc., etc. — on metal, wood, glass, plastic or linoleum. Simply attach to your electric drill, drill press or motor. Presto—a flexible shaft machine! Off again in a jiffy! Pencil-sized handpiece gives finger-tip control. Gets into tight places. Handy 35" overall length. And—only \$5.95 complete! ORDER NOW. If you order Presto-Flex for use on motor, specify motor shaft diameter. Add 50c for motor coupling. (Available for 1/4", 3/16", 3/8" and 1/2" shafts.) No. 50 Accessory Set available \$1.50 extra. Foredom also makes a complete line of motor driven models at low prices. Write for Catalog E1121 and see the many Foredoms now available.

FINGER-TIP CONTROL

FOREDOM ELECTRIC CO., Dept. E1121
27 PARK PLACE NEW YORK 7, N. Y.

PROFESSIONAL!
PORTABLE!

The PAYSWELL ALL-PURPOSE Sprayer

JUST PLUG IT IN
... AND SPRAY



- Compressor ... motor ... gun ... self contained in one compact unit.
- Applies 1 quart perfectly ... in 3 min. at 50 lbs. pressure.
- Sprays anything that's sprayable.
- Weighs less than 5 pounds.



The PAYSWELL Spray-pak

WORLD'S ONLY COMPLETE SPRAY GUN KIT FOR THE PROFESSIONAL OR THE HANDY MAN.

SPRAY-PAK contains the famous PAYSWELL SPRAYER, 3 interchangeable nozzles; 2 extra shatter-proof canisters, covers, gaskets; 6 strainers; respirator, refills; brush; oil; instruction manual ... all enclosed in a handy metal container. Weight less than 15 pounds.

COMPLETE KIT
ONLY

\$79.95

SPRAYER WITHOUT KIT \$59.95

Write for name of your nearest PAYSWELL dealer.

SELCO CORPORATION
Dept. PM • 801 Andrus Building • Minneapolis 2, Minn.



"SAVE IT AND
FIX IT"

REPAIRS

CHINA, TOYS, FURNITURE
BOOKS AND LUGGAGE

It's transparent, waterproof,
flexible and durable.

Get a tube
today.



DU PONT DU CO CEMENT

REG. U. S. PAT. OFF.

Thousands of Parts For Military TRUCKS



Purchased from U. S. Govt. Our prices can't be beat.

We have for immediate delivery genuine parts for all makes and models, 4x2 - 4x4 - 6-4 and 6x6. All models from 1/4 ton to 20 tons. All makes; Autocar, Blederman, Brockway, Chevrolet, Diamond T, Dodge, Federal, Ford, GMC, International, Mack, Oshkosh, Reo, Studebaker, White, Willys and Jeeps. We have parts lists available on most models. Write stating model of Truck.

JEEP TOPS and CURTAINS

(Weatherizing Kit), complete top with back curtain and side curtains with zip-in-doors. 5 windows. Waterproof O.D. color, shipping weight 40 lbs. Wonderful \$39.50 value. F.O.B. K.C.

TRAILER AXLE

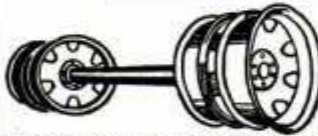

Heavy duty trailer axle suitable for many types of trailer construction. Also excellent for building of heavy farm trailers and wagons. It is a 12,000 lb. capacity square type straight trailer axle complete with Timken roller bearings, hubs, and 6 hole 750 x 20 Budd Wheels. Without brakes. Axle is 2 inches square and 69 inches between wheel mounting flanges. Std. width. AN EXCELLENT BUY.

With Single Wheels. \$59.50 With Dual Wheels. \$69.50

Save \$30.00 On

JEEP Spare Parts KIT

Originally packed for Amphibious Jeeps. Also adaptable for all military and some civilian jeeps. Offered \$8.95 at our low price of.

KIT CONSISTS OF THE FOLLOWING PARTS:

- 4-1177 Retainer Wheel Grease. 1-#2078 Hose Assy.—Rear Brake
- 1-2079 Hose Assy.—Ft. Brake. 1-#2197B Hose Assy.—Axle—Vent
- 2-3135 Seal—Frt.—Axle—Pivot. 1-#4022B Plug Assy.—Axle Vent
- 1-5666 Belt Capstan. 1-#8620 Belt—Fan. 1-#12405 Spark Plug
- 1-13466 Bulb (Black-Out Marker Lamp).
- 1-15480 Belt—Blige—Pump
- 1-13485 Unit Assy. (Rear Lamp Stop). 1-#1752960 Strap Assy.
- 1-13491 Unit Assy. (Rear Lamp Lower)
- 1-18218 Kit—Cotter Pin (asst)
- 1-13494 Unit Assy. (Rear Lamp Service)
- 1-17008 Container Assy. Spare Parts (Water'roof)
- 1-17058 Tape—Friction (3/4"—8 oz.—Roll)
- 1-17060 Wire—Annealed (No. 22—Ga—1/4 No. Roll)
- 1-18320 Kit Tire Valve Core (S-B-1725)
- 1-18322 Kit Tire Valve Cap (S-EPW-1720)
- 1-1711340B Seal Transfer Case Output Shaft Collar
- 1-1711344 Seal—Drive Shaft Housing Gear
- 1-1711346 Seal—Drive Shaft Housing Front
- 1-1711356 Seal—Front Floor Tunnel Drag Link

WIPER BLADE Brand New, 10" O.D. Windshield Blade, Each 19c

UTILITY GAS TANK 6 quarts — New Surplus. Cylindrical 5 1/2" x 15 1/2". Brackets for mounting. Complete with Filler cap, drain plug and pet-cock. Ideal for small gas engines, stoves, etc. \$1.50

SURPLUS POWER WINCHES All new and suitable for front or rear mounting. GARWOOD OR HEIL—15,000 lb. capacity. \$150.00

Surplus WINCH CABLE WHILE THEY LAST

200 ft. length 1/2" cable.	\$25.00	300 ft. length 1/2" cable.	\$35.00
250 ft. length 1/2" cable.	\$30.00	300 ft. length 3/8" cable.	\$40.00

HUNDREDS OF OTHER TRUCK PARTS AND SUPPLIES

All prices quoted good 30 days FOB, Kansas City. 25% deposit required on COD orders.

American AUTO PARTS CO.
1830 LOCUST — DEPT. PM
KANSAS CITY, MISSOURI.



SAY YOU SAW IT IN POPULAR MECHANICS

MONEY BACK GUAR.



7x50
\$36
Illustrated

7x50 PRISM BINOCULARS
PRECISION OPTICS—BRAND NEW
\$36*

6x50 ACHROMATIC
FIELD GLASSES
\$16*

*20% Federal Tax

Send for Free Catalog of Binoculars, Telescopes and Microscopes

BROWSCOPE CO.
Dept. 9M, 24 W. 45th St.,
New York 19, N. Y.

FACTORY-TO-YOU SAVES 40%

MULTI-USE TRUCK



Only \$8.95

Hundreds of uses around Home, Shop or Farm. Easily moves up to 600 pounds. Saves back-breaking effort in moving heavy boxes, barrels, ashcans, feed, cement, etc. Sturdy, lightweight, with 6 x 2 solid rubber, roller-bearing wheels. Fully guaranteed. Nationally advertised at \$14.75. Now Factory-to-You only \$8.95 f.o.b. Cincinnati.

Orders 3 or more shipped prepaid.

S. R. S., INC., 519 Main St., Cincinnati 2, Ohio

BUILD YOUR POWER TOOLS

WITH OUR GUARANTEED INDUSTRIAL POLY BALL BEARING ARBORS



New Departure Self Lubricating Bearings

10,000 R.P.M.



(No extra charge for left hand threads)

C4-1/2" Pictured

- B33—\$5.45 PP. C4-1/2x12 1/2 spindle, housing 2x8... \$7.95 PP.
- 5/8 x 4 1/2 Spindle C5-5/8x12 1/2 spindle, housing 2x8... \$8.45 PP.
- B15 Plain Spindle C6-3/4x12 1/2 spindle, housing 2 1/4x8... \$9.45 PP.
- \$3.95 PP. D8-1x17 1/2 spindle, housing 2 3/4x11... \$18.75 PP.

1 INCH BETWEEN WASHER AND COLLAR SHAPER ARBORS—Free literature on request.

POLY PRODUCTS, 2032-A E. Walnut, Pasadena 8, Calif.

MAKE MONEY AT HOME

MAKE Greaseless Doughnuts at home. New amazing electric machine. You'll coin money selling to grocers, drug stores, cafes, hamburger stands. Low cost will surprise you. Experience unnecessary. Send for free recipes and plans.

MORTON RAY CO.

3605 SO. 15th AVE.

MINNEAPOLIS 7, MINN.



\$2.95 EACH

NOW! FILE YOUR OWN SAWS

Do expert saw filing at home. Precision filing easy without experience. Two simple adjustments. Keeps any hand saw extra sharp and true-cutting. Complete with file. Money back guarantee. Cash with order, prepaid. (COD postage extra.) Order today. \$2.95.

SPEEDCOR PRODUCTS, Dept. PM
512 N.E. 73 Ave., Portland 16, Oregon

Pioneers

Leaders

AIR RIFLES WITH SAFETY LOCK BENJAMIN AIR PISTOLS

SEND FOR FREE FOLDER OF LATEST MODELS TODAY

If you want a REAL GUN for PRACTICAL USE inside or outdoors, get a SAFE—CLEAN—ECONOMICAL—BENJAMIN with Adjustable Power and Amazing Accuracy. Use BENJAMIN H-C PELLETS for BEST RESULTS in all rifled models. WRITE AT ONCE.

BENJAMIN AIR RIFLE CO., 812 MARION ST., ST. LOUIS 4, MO.

BUILD and repair 'em YOURSELF

with PEMCO wheels Unconditionally Guaranteed

COMPARE THESE REDUCED PRICES!

SEMI-PNEUMATIC—LOAD TESTED
SEND CHECK OR MONEY ORDER TODAY.

Size	Axle	Bearing	Price Ea.
6" x 1.50"	1/2"	Oilite	\$1.35
8" x 1.75"	5/8"	Ball	1.85
8" x 1.75"	5/8"	"	2.00
8" x 2.00"	1 1/8"	"	2.00
8" x 2.00"	5/8"	"	2.15
10" x 1.75"	1 1/2"	"	2.30
10" x 1.75"	5/8"	"	2.40
10" x 2.00"	1 1/2"	"	2.50
10" x 2.00"	5/8"	"	2.70

Postage Collect on delivery

DEALERS AND QUANTITY BUYERS—WRITE FOR SPECIAL PRICES!



PARAMOUNT ENGINEERING & MFG. CO.
1874 RAVINE ROAD, KALAMAZOO, MICHIGAN

Stucco Spraying Earns High Incomes

It's today's biggest business opportunity in the building field. High returns from a low investment. Easy, fascinating work. Large waiting market because Colorcrete is applied over all kinds of old and new masonry surfaces — exterior and interior.



Beautifies and Protects All Types of Buildings

Pneumatic pressure sprays plastic-like Colorcrete to give enduring beauty and water-resistant values. Range of 30 gleaming colors; many textures. Easy to wash. Smartly modern. Write or wire today for Opportunity Portfolio.



COLORCRETE COLORCRETE INDUSTRIES, INC.
570 OTTAWA AVE., HOLLAND, MICH.

15 ESSENTIAL WORKSHOP OPERATIONS ON YOUR DRILL PRESS

Barron Precision Drill Press Tools and Accessories—Planers, Rotary and Drum Sanders, Auxiliary Tables, Hi-Speed Router Bits, Shaper Fences, Molding Cutters, Dovetail Cutters—a host of other useful drill press items give complete workshop facilities at 1/4 the cost. Over 200,000 Barron owners. Get the facts on these popular, versatile drill press tools today. Sold on 10 day money back guarantee.

BARRON TOOL CO. Inc.
669 ARCHITECTS BLDG.
DETROIT 1, MICHIGAN

FREE
Workshop
Guide &
Catalog

10^H PORTABLE POWER PLANT from any CAR or TRUCK

Line up with rear wheel, drive on to unit—that's all! Unfailing power where you want it—when you want it! No demounting, no jacking-up! Suitable for any belt-driven, power operation. **NEW, LOW PRICE! ACCESSORIES AVAILABLE:** Generator, Grinder, Centrifugal pump. Illustrated circular on request.

FREE
Illustrated
Circular

ASPEGREN MFG. CO.
1612-M Webster Ave., N. Y. C. 57



Drive a **FORD** and **Feel** the DIFFERENCE!

FREE!
SAMPLE!

That **GLOWS IN THE DARK!**

AN EASY WAY TO MAKE BIG MONEY

Be the first to sell sensational luminous house numbers, light switch plates, wall protectors, cord pulls, novelties, etc. Also luminous pictures, statues, decals, and a host of religious, nursery and other objects **THAT GLOW IN THE DARK.** Sell on sight. Get into this new and growing industry. **ENORMOUS DEMAND... NO COMPETITION... BIG PROFITS.** Represent a large manufacturer, established over 35 years. Write **AT ONCE** for liberal **MONEY-MAKING** offer and **free sample** to show you how they **GLOW IN THE DARK.**
Madison Mills, 303 Fourth Ave., Dept. A-4. New York 10, N.Y.

CARBURETOR YELLO BOLE

REG. U. S. PAT. OFF.

Honey-treated

For the man with a sensitive tongue
CARBURETOR
cools your smoke,
makes it mild

\$2.50

1. Smoke from tobacco

2. Cool air is drawn in through Carburetor

3. Smoke is cooled by mixing with air from Carburetor

Cool air drawn through the patented* Carburetor keeps the bottom of the bowl dry, so there is never a "wet heel". Bowl is treated with honey, helps when "breaking-in" the pipe. A pipe that beginners can enjoy without having to accustom themselves to it. Ask for Carburetor Yello-Bole at dealers, \$2.50. Kaufmann Bros. & Bondy, Inc., Estab. 1851, 630 Fifth Avenue, New York 20.

*U. S. PAT. NO. 2,082,106



This picture of Honey Girl is displayed wherever Yello-Boles are sold.



Identify Yello-Bole pipes by the honey-seal in the bowl. It keeps the honey fresh.

SAY YOU SAW IT IN POPULAR MECHANICS

2 Pages of GROBAN'S WAR SURPLUS SPECIALS!

Model 202 **ARC WELDER**

200 Amp.

For any welding job, light or heavy.

AN EXCELLENT BUY FOR:

- Farmers
- Factories
- Machine Shops
- Home Work
- Shops
- Servicemen
- Repairmen
- Ship yards
- Construction work
- Contractors

WHEREVER YOU NEED WELDING

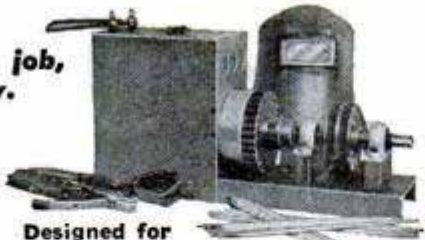

Designed for years of trouble-free service! Handles anything from light gauge sheet metal to 1/4" plate. Precision-engineered direct current ARC WELDER offered at a fraction of value. Can be mounted permanently or easily transported for portable use. Does the job where and when you need it.

War surplus generators, built by General Electric, Westinghouse, and Delco-Remy cost over \$300.00. Is lightweight; for continuous or intermittent work; has oversized grease-sealed ball bearings; no oiling, air-cooled commutator; 4 long life brushes; rheostat for easy control-reactor coil for even arc; handles 1/16 to 1/4" rods. Turn welder at 2500 R.P.M. from drive pulley of tractor, or a 7 1/2 H.P. electric motor or a 10 H.P. gas engine. Use one or two V-belts (on pulley). Continuous welding rating—200; intermittent rating—250 amps. AT A FRACTION OF VALUE . . . with double V pulley and instruction book . . . Ship. wt. 95 lbs. (ITEM #65)

\$99.50

F.O.B. Chicago

ACCESSORY KIT including welding helmet, electrode holder, two 10 ft. cables with clamp, and 5 lbs. of ass'td. F.O.B. Chicago welding rods. (ITEM #66) **\$10.50**

Be Prepared with an Auxiliary AC LIGHT PLANT GENERATOR

IDEAL FOR: • Home Lighting • Hunting Lodges • Stand-by electricity • Running all AC electrical appliances incl. fans, motors, electric razors, refrigerators, incubators, etc. Protection for emergencies to operate oil burner, stoker, freezer, water pump and lights. These units built to exacting Signal Corps specifications are the answer to your lighting needs. Drive it with a 2 1/2 H.P. gasoline engine at 1800 R.P.M. • 800 watts • 0-150 voltmeter with regulator • 110 volts-60 cycle, AC. Ship. wt. 60 lbs.



(ITEM #67). AN OUTSTANDING VALUE for **\$59.50** F.O.B. Chicago

PUMPS for every need

Brand New Gear Type INSECTICIDE PUMP



All Manganese Bronze for spraying D.D.T., 2-4D, Sulphur Compounds, etc. Pressures up to 150 lbs. to 14 gallons per minute—1500 R.P.M. Will not rust, pit, foul or freeze up. Use rubber hose inlet, pipe or tubing outlet. Equipped with 1/2" standard pipe thread port. Wt. 10 lbs. Dimen.: 8" x 5" x 6 1/2". Standard 1" manganese bronze shaft with keyway. U.S. Gov't. Acquisition Cost \$62.00 NOW ONLY (ITEM #50)

\$15.00 F.O.B. Chicago

CENTRIFUGAL PUMP BELT DRIVEN

Ready for use on any Liquid Pumping Need

- Use it for DRAINING BASEMENTS
- HOME WATER SYSTEMS
- IRRIGATION
- STOCK WATERING
- FIRE PROTECTION
- DRAINING PONDS, TANKS, etc.
- INDUSTRIAL PUMPING

A super value for all types of intermittent service in pumping large volumes of liquid in home, farm and industrial service. Ideal for home water systems, draining basements, fire protection, etc. On the farm for watering stock, draining ponds, sprinkling, etc. In shops and factories for all types of pumping service.



Brand New

MOVE LARGE VOLUME QUICKLY When operated at 1750 R.P.M. will pump 42 gallons per minute on a 23 foot head; at 3600 R.P.M. on 52 foot head will pump 83 gallons per minute. May be run with electric motor, gas engine or power take-off on tractor.

COMPLETE ENGINEERING REPORTS AND OPERATING INSTRUCTIONS FREE WITH PUMP Pump has cast aluminum housing—accurately machined bronze impeller vanes. Complete with mounting bracket and 3/4" V belt pulley. Shaft rotates on sealed ball bearings with grease gun fitting. Has 1 1/2" threaded intake flange, two 1 inch outlets. Use one or both, as necessary. Made for Packard Motor Car Co. for use in Rolls-Royce Merlin Aircraft engines. GREATEST PUMP VALUE IN YEARS Shipping weight 23 lbs. You can't beat this value at anywhere near this price. Satisfaction guaranteed. Original Cost Approx. \$147.00. (ITEM #64)

\$29.75 F.O.B. Chicago

PNEUMATIC SPECIALS!

HANNA AIR CYLINDER



Brand New Used for heavy duty industrial applications on shop air lines or with low pressure systems. With 100 lbs. of air pressure, will deliver 1900 lbs. pressure at the ram shaft. All steel construction. Adjustable cushions at both ends of cylinder. Shaft dia. 1 1/2". Foot mounting with clevis on ram shaft. 2 5/8" double-acting stroke; 5" bore, 40 1/2" overall length closed, 7" overall width. 89 1/2 lbs. net wt. Gov't. acq. cost \$101.85.

AN EXCELLENT VALUE for **\$39.50** (ITEM #61) F.O.B. Chicago

Brand New PNEUMATIC COMPRESSION RIVETER

MODEL CP 625-T8112



Made by Chicago Pneumatic Tool Co. Equipped with built-in control valves for use with cable operated remote control. Has 6" dia. actuating cylinder with right angle head. Base is 27 1/2" x 4". Height 40". Ram assembly adjustable for height. Approx. wt. 1300 lbs. A \$1200.00 value. (ITEM #62) NOW

\$169.50 F.O.B. Chicago

ROSS 4-Way Foot Operated AIR VALVE Model 398



BRAND NEW. For double-acting pneumatic devices. Fine for operating presses, air vises, air machinery of many types. Heavy duty cast construction. No neutral position. Maintains pressure against the piston when the foot control is in the "Up" position. Threaded for 1/2" pipe. Dimensions of valve body: 7 3/4" L x 4 1/4" W x 7 1/2" H. Net wt. 28 lbs. A \$64.00 value for only

\$19.50 F.O.B. Chicago

LOGAN 4-Way Foot Operated AIR VALVE—Model 6520



BRAND NEW. For double acting pneumatic devices. Fine for operating air vises, presses, air machinery of many types. Heavy cast construction. Threaded for 1/2" pipe. Dimensions of valve body: 8 1/2" L x 5 3/4" W x 7 1/2" H. Net Wt. 28 lbs. Gov't acquisition cost \$42.00. AN OUTSTANDING BUY AT

\$15.00 F.O.B. Chicago

G-1 STAINLESS TANK



Use these tanks on compressors, for tire inflators, pulsation chambers, floats, buoys, hydraulic reservoirs, fluid and milk containers, fuel containers, etc. Tough, light, 450 lbs. P.S.I. Aviators Breathing Oxygen bottles, type G1. 2100 cu. in. (approx. 9 gallons) int. vol. 24" x 12". 1/4" threaded openings at ea. end. Wt. 19 lbs. .051" thick. (ITEM #63)

\$4.95 F.O.B. Chicago

Low Priced-High Quality

MINIATURE High Speed ELECTRIC MOTOR

IDEAL FOR MODEL BUILDERS, MODEL RAILROADERS, EXPERIMENTERS, HOBBYISTS. AC or DC. Reversible, speed may be regulated by varying voltage. Has miniature Klaxon thermostatic switch. All connections are external and accessible. Has 3 mounting feet for easy installation. Double-end ball bearing supported shaft with small gear on one end. Die-cast housing with laminated field. Overall Dimen.: 3 1/4" long x 2 3/4" wide x 1 3/8" high. Net wt. 12 oz. A \$22.00 value. (ITEM #5)



Brand New

\$2.95 postpaid

BRAND NEW GENERAL ELECTRIC 8" SEALED BEAM FLOODLIGHTS 300 Watts, 110 Volts, A.C. - D.C.

Has countless uses for: • Homes • Garages • Workshops • Driveways • Outdoor advertising • Displays • Beach lighting • Private air ports • Photography Wherever you need flood-lighting! Bought by the U. S. Army for signal use. This is the greatest surplus bargain ever offered. Lens, reflector and electrode vacuum sealed in one dustproof, air tight unit. 300 Watts, 110 Volts. Weighs only 2 1/2 lbs. List price \$10.50. A TREMENDOUS VALUE for (ITEM #8) 12 or more \$2.50 ea. postpaid



\$2.75 EA.

SCREW JACK

Ideal for raising, lowering, leveling and adjusting. Use on tables, machine tools, toys, etc. Overall length closed 9 inches, open 14 inches. Worm gear box with 54 to 1 reduction, with double end drive shaft. Use either end or both. Extension screw shaft 30 to 1 reduction. \$35.00 value. AN OUTSTANDING BUY. (ITEM #45)



Brand New

\$3.95 postpaid

All Merchandise Brand New - Order Today - Satisfaction Guaranteed!

SHOP by MAIL - SAVE at GROBAN'S - Buy Direct from ad!

Hydraulic Cylinders-Air or Oil

- ITEM #4**-Double action, 1" bore, 3" stroke, will lift 770 lbs. in 1/10 of a second using Logan Pump. All steel barrel. Ideal for controls, door openers, positioning, etc. **\$4.95**
An \$18.00 value. postpaid
- ITEM #33**-Double action, 1 1/2" bore, 5" stroke, will lift 1760 lbs. in one second with Logan Pump. Wt. 3 lbs. **\$8.95**
A \$35.00 value. postpaid
- ITEM #32**-Double action, 1 1/2" bore, 9" stroke, will lift 1760 lbs. in one second with Logan Pump. Wt. 4 lbs. **\$10.95**
A \$45.00 value. postpaid
- ITEM #16**-Use these cylinders on farm trucks, bulldozers, hay lifts, manure loaders, etc. Double action, 1 1/2" bore, 27" stroke, (will lift 1760 lbs. in 2 seconds with Logan Pump). Wt. 8 lbs. A \$55.00 hydraulic cylinder value for **\$12.95**
only. postpaid
- ITEM #17**-Double action, 2 3/4" bore, 8" stroke. (Will lift 4400 lbs. in one second with Logan Pump). Will withstand 1500 P.S.I. against wall. Wt. 7 lbs. **\$14.50**
A \$65.00 value. postpaid

Use hydraulics on arbor presses, hydraulic presses, hay lifts, manure loaders, lift trucks—push or pull, tilt or turn, press or squeeze, open or close, lift or lower—and other hydraulic and industrial applications. Use with either air or oil . . . of finest precision workmanship.



- ITEM #20**-Double action 2 3/4" bore, 4" stroke, two-way solid 3/4" alloy steel shaft (will lift 4400 lbs. in one second with Logan Pump). A \$73.00 value. **\$16.50**
postpaid
- ITEM #15**-Double action, 3" bore, 8 1/2" stroke. All steel hydraulic cylinder, will lift up to 12,000 lbs. (7000 lbs. in 3 seconds with Logan Pump). Complete with fittings. Wt. 12 lbs. **\$19.50**
A \$78.00 value. postpaid
- ITEM #31**-Double action, 3 1/2" bore, 11" stroke. (Will lift 9600 lbs. in 7 seconds using Logan Pump.) Complete with fittings. Wt. 15 lbs. A \$92.00 value. **\$22.50**
postpaid
- ITEM #6**-Double action, 3" bore, 23" stroke, hydraulic cylinder will lift 7070 lbs. in 5 1/2 seconds using Logan Hydraulic Pump. Especially suited for farm and construction machinery. Clevis mounting for easy use. Wt. 22 lbs. A \$145.00 value. **\$27.50**
F.O.B. Chicago
- HI-PRESSURE FITTINGS** for cylinders and valves available at 35c ea. for 3/4" pipe and 50c ea. for 1/2" pipe.

HYDRAULIC CONTROL VALVES



LOGAN Heavy Duty Oil HYDRAULIC CONTROL VALVE

BRAND NEW control valve with built-in adjustable relief valve, will operate one double-acting hydraulic cylinder or two cylinders as one or a reversible hydraulic motor. Valve handle latches in neutral position. Made of rugged cast aluminum alloy. Open center unloads the pump in neutral position. Throttling control allows operator to regulate the speed of movement of the hydraulic cylinder or motor. Has removable mounting brackets with 4 bolt holes, 3/4" pipe thread connections. Overall dimen.: 12 1/2" H x 8 1/2" D x 8" W. Ship. Wt. 17 lbs. Govt. Acquisition Cost over \$100.00. **\$21.95**
(ITEM #37) AN EXCELLENT BUY FOR. F.O.B. Chicago



Brand New

- ITEM #24**-Four way control valve for use with double action hydraulic cylinder, may be used with 1500 P.S.I. hydraulic system to open and close hydraulic cylinders. Brand New. Ship. Wt. 4 lbs. A \$38.00 value. **\$7.95**
postpaid
- ITEM #26**-Four-way control valve for use with two hydraulic double action cylinders. Each cylinder may be operated independently of the other or in conjunction with the other. Oil may be locked in any of the cylinders to hold the piston at any required position. Brand New. Ship. Wt. 6 lbs. A \$60.00 Value. **\$10.95**
postpaid
- ITEM #28**-A two cylinder double action valve with a unique arrangement, allowing the operator to raise both cylinders simultaneously, to lower them simultaneously or to raise one and lower the other at any predetermined rate and speed. Brand New. Ship Wt. 8 lbs. A \$75.00 value. **\$14.95**
postpaid

HYDRAULIC PUMPS

LOGAN Heavy Duty Oil HYDRAULIC PUMP

BRAND NEW . . . for operating hydraulic cylinders and hydraulic motors on tractors, bulldozers, construction machinery, lift trucks, industrial applications, etc. Delivers 8 GPM at 1200 RPM at 1000 P.S.I. using 5 H.P. Has 1/2" pipe thread inlet, 3/4" pipe thread outlet, 3/4" shaft with flat and keyway for direct or pulley drive. Has flange with 4 bolt holes for convenient mounting. Ship. wt. 22 lbs. Overall dimen.: 7" L x 5 1/2" H x 5 1/2" W. A \$105.00 value. FOR ONLY **\$22.50**
F.O.B. Chicago (ITEM #29)



HAND HYDRAULIC PUMP Brand New

Used for hydraulic jacks, presses, hoists and other hydraulic applications. For operating hydraulic cylinders to pump oil or hydraulic fluid under pressure. Hand pump has built-in check valve and is capable of delivering 1000 lbs. of pressure. Has alloy aluminum housing. Dimen.: 8" long x 3 1/2" high x 2 3/4" wide. Ship. wt. 3 lbs. A \$45.00 value. (Item #11) **\$8.95**
postpaid

Vickers MF9 Hydraulic PUMP or MOTOR

complete with mounting kit ready to install **\$19.90**
\$75.00 value POST-PAID

Pump is compact, powerful, rated 1,000 P.S.I., .507 cu. in. per revolution. 8 gal. per min. at 3750 RPM. Change rotation by reversing flow. Delivers up to 6 H.P. Requires 1/3 to 6 H.P. to drive directly or by pulley. **BRAND NEW.** Mounting kit has been especially designed to provide maximum utility and ease of mounting MF Series Vickers Pumps. Brackets are constructed of heavy steel plate; shaft is made of 1/2" steel with one end splined to fit pump; other end of shaft has machined flat for mounting a standard pulley with 1/2" hole. Shaft runs in oilite bronze bearings. **PUMP ONLY (ITEM #18) \$14.95 postpaid**
MOUNTING KIT ONLY (ITEM #38) \$ 4.95 postpaid
BOTH AS COMPLETE UNIT (ITEM #39) \$19.90 postpaid

Brand New 18" Wire Spoke WHEEL

For use on motorcycle or adaptable for midget cars, trailers, small trucks, any wheeled vehicle. With bearings, races and gear. Takes 18" tire. Wt. 19 lbs. A REAL VALUE at. **\$3.95**
ea. (ITEM #57) F.O.B. Chicago

FREE: Write for free copy of our 40 page catalog including Hydraulic Manual featuring diagrams, photographs and instructions. Catalog lists excellent war surplus values: pumps, valves, hydraulics, lights, motors, etc.

Excellent Hydraulic VALUES!

BRAND NEW Logan Double-Action Pneumatic — Hydraulic PRESS

\$300.00 value offered at a fraction of original cost

Using air or oil, this device is ideal as a punch press, vise, arbor press, etc. An excellent tool for industrial and shop use. Use 150 lbs. of air pressure or 250 lbs. of oil pressure. Cushioned double action "Logan" Model AC ram, 6" bore and 6" stroke. Capable of up to 4200 lbs. of pressure using air. Has 3" throat. Lubricated ribs provide perfect alignment. Has adjustable work space. Hardened alloy steel piston rod 1" diameter. Frame constructed of cast steel with 3/4" base plate. Manufactured by Sipp-Eastwood Co. Unit is 49" high. Base is 9 1/2" wide by 18" deep. Wt. approx. 360 lbs. AN OUTSTANDING BUY at. **\$79.50**
(ITEM #7) F.O.B. Chicago



- ADJUSTABLE RELIEF VALVE.** (ITEM #34) **\$2.95** postpaid
- HYDRAULIC FLUID.** (ITEM #53.) Per gallon F.O.B. Chicago **\$1.75**
- 10 ft. length of Hi-Pressure HYDRAULIC HOSE,** with 1/4" female pipe thread fittings. (ITEM #27). F.O.B. Chicago **\$3.95**
- Brand New HYDRAULIC TANK,** 3 gallon capacity with oil-indicator cap. 4" x 12" x 13 1/2". Ship. wt. 13 lbs. NOW AT THIS **\$4.95**
LOWEST PRICE. (ITEM #58.) F.O.B. Chicago.

BRAND NEW FIN-COOLED HIGH PRESSURE AIR COMPRESSOR

For pneumatic tools, filling hi-pressure vessels, paint spraying, insecticide vaporizing and other uses. Rated 450 P.S.I. at 1200 R.P.M. Used on Packard Merlin Engine, this aluminum air pump with air filter intake weighs only 4 1/2 lbs. 9" x 5" x 3 1/2". Gov't. Acq. Cost \$185.00. NOW ONLY **\$15.00**
(ITEM #56) postpaid



GENERAL ELECTRIC DC GENERATOR

For Farm—Home—Factory Welding—Light Plants

Delivers 30 volts, 267 amps. at 4000 RPM. Rated 8 Kilowatts, ball-bearing supported. Fan cooled armature. Drive it off of farm tractor, gas engine of 10 H.P. or more. Ship. wt. 65 lbs. U. S. Government acquisition cost—\$277.00. **\$28.50** F.O.B. Chicago (ITEM #51)



SHOCK ABSORBERS

Use them to spring suspend vehicles, hoists, pumps, heavy and light machinery, compressors, etc. 1 1/2" x 2" dia. Welded steel construction for extra strength—U. S. Air Force bought them for bomber gas tank shock absorbers. Rated 2500 lb. Ship. wt. of 4—11 lbs. Each . . . **\$1.50** FOB CHICAGO. **4 for \$5.00**
(ITEM #21) FOB Chicago

new
low-priced
electric
paint sprayer



Only
\$12.95
Complete

for utility
painting of tables—
chairs—screens—
floors—clothes hampers—
car fenders—toys

Built-In-Head Motor and Compressor Unit



Now! An electric sprayer as easy to handle as a brush—and twice as fast! Sprays household enamel, lacquer, varnish, shellac, light oils and insecticides. No extras to buy! 25 oz. jar. 8 ft. cord. Mail the coupon for full information.



BURGESS
vibro-sprayer
Pat. Applied For
Just Plug Into Any 110 Volt
A.C. Socket and Spray



BURGESS BATTERY COMPANY, Handicraft Division
154 Rond Road, Lake Zurich, Illinois

Please send **FREE** 12-page instruction booklet and illustrated circular in color describing the New Burgess Vibro-Sprayer.

Your Name _____
Street Address _____
City _____ Zone _____ State _____



**WHOLESALE SLIGHTLY
USED TIRES
DIRECT TO YOU**

10% discount on 2 or more tires if you send this ad with order

TUBE DELIVERED WITH TIRE AT NO EXTRA COST

Safe — Our tires used on school buses and ambulances
All good tires with a
GOLD BOND GUARANTEE FOR 12 MONTHS

550-16 \$3.54	30-5 \$ 7.98	1200-20 \$18.78
600-16 3.59	650-20 7.69	750-24 (36-6) 12.21
650-16 3.89	700-20 (8) .. 9.29	38-7 (825-24) 13.75
700-16 4.59	700-20 (10) 12.48	1000-22 17.70
550-15 3.79	750-20 (8) .. 8.19	1100-22 16.89
650-15 3.89	750-20 (10) 9.19	900-24 (40-8) 21.60
700-15 3.98	825-20 11.19	900-16 8.98
550-17 5.69	900-20 11.89	825-15 (14 ply) .. 14.10
750-16 8.40	1000-20 12.89	750-15 (12 ply) .. 11.30
600-20 7.98	1100-20 13.89	

Exceptionally good tread — No recaps — With a
GOLD BOND GUARANTEE FOR 24 MONTHS

600-16 .. 6 ply Military—Mud and Snow Tire..... \$6.37		
550-16 \$5.19	525-18 \$ 6.69	700-15 \$ 5.29
600-16 5.29	550-17 7.99	600-20 9.75
650-16 5.29	650-15 4.98	650-20 9.75
700-16 6.29	825-20 15.98	700-20 10.98
550-15 4.81	900-20 15.98	32-6 (8) .. 10.49
	1000-20 16.89	

GOLD BOND SPECIAL — 750-20 MILITARY TIRES

Will fit 650 x 20	700 x 20 (8 & 10 ply)	34 x 7 (8 & 10 ply)
Special \$10.49	Guaranteed 12 months	
Superior Quality .. 12.98	Guaranteed 18 months	
Gold Bond Finest... 14.98	Guaranteed 24 months	
900 x 16 Special.... 9.03	900 x 16 extra.. 11.19	

Send check or money order with this ad

GOLD BOND TIRE CO., Dept. PM 24
512 NORTH 1ST ST., RICHMOND, VA.
"A gold bond written guarantee with every tire"

E-Z CAR WASHER **SOAPS and WASHES**

Can also be used to wash Windows, Walls, Boats, Porches, Cellars, Garage Floors and many other uses.

in one operation

Easily attached to garden hose — 46" aluminum handle
Insert teaspoonful of any household soap powder or detergent in built-in soap pouch.
Replaceable mop
Cars can be washed easily without getting yourself wet

Order Now!

Send \$3.50 check or money order. We deliver post-paid. Money back if not entirely satisfied.



E-Z CAR WASHER

401 West 48th St., Dept. PM3, New York 19

\$3.50
POSTPAID

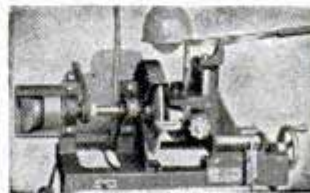

Pat. applied for

Start a NEW BUSINESS
Or Add to Your Present
Repair Business
Sharpen Dull Pipe Wrenches
Pipe Taps & Dies
"Gum" Circular Saws
Write for Information.

J. C. MOORE INDUSTRIES P. O. Drawer 276
FREDONIA, PA.

Spray away Starting Troubles
SEND \$1 FOR SPECIAL INTRODUCTORY CAN (REGULAR \$2.35 VALUE)
SHORTSTOP IGNITION SPRAY
ELIMINATES SHORT CIRCUITS IN MOTORS
ZACO LABS • 1360 W. 9th • Cleveland, O.
ORDER DIRECT TODAY!

HUNDREDS OF ITEMS AND IDEAS FOR THE WOODWORKER
Big New 144 Page Catalog No. 16
OF HARD TO FIND WOODWORK ITEMS, HARDWARE AND SUPPLIES, the finest craftsman catalog Harold Hunt ever published—32 rare and fancy woods in natural colors — also in color 43 matched veneer designs, multi-colored bandings, inlays, overlays, scroll patterns, etc. Only 15c, rebated on first order.
CRAFTSMAN WOOD SERVICE CO.
2729 S. Mary St. Dept. A-9 Chicago 8, ILL.

HARD TO FIND LUMBER
Top Grade Kiln Dried A Board or a Carload
UNEQUALED BARGAINS
WALNUT, MAHOG., CHERRY, MAPLE, WH. HARD AND SOFT, POPLAR, PL-QTR, OAK, AROMATIC RED CEDAR

SAVE MONEY on TRAILER BUILDERS' SUPPLIES! BUILD, REPAIR or MODERNIZE! We are the largest and most complete trailer supply house in the States. Get our New Large 1949 Catalog 10c; blue prints and building instructions 25c.
National Trailer Equipment Co., 1007 N. Water St., Milwaukee 2, Wisc.

For AUTO REPAIRS AT NITE

Change a flat, repair motor, warn traffic, spot road signs, etc.—with brilliant Reddylite beam. "Stays put" at any angle. Buy at hardware, sport or electric store.
Less 6-volt battery **\$3.25**

800 ft. spotlight
360° swing
6-volt battery

Delta REDDYLITE ELECTRIC LANTERN
DELTA ELECTRIC COMPANY, MARION, INDIANA

EARN BIG MONEY
AND BE YOUR OWN BOSS
Sharpening Lawn Mowers

**Build a Business of Your Own With
 A UNIVERSAL GRINDER**

In your own garage or basement, and earn \$25.00 a day or more. Mr. Hardy writes, "I am doing a fine business with the UNIVERSAL GRINDER. One customer sends another. I spent 40c for a newspaper ad and have done nearly \$500.00 worth of business." Mr. Helmeck of Canada writes, "We sharpened 750 mowers last year and are 1056 on this years run. The Universal surely makes customers." Mr. Barton of California says, "The mower business, with the Universal Grinder, has been a gold mine these last two years."



Only on the UNIVERSAL GRINDER can the inside face and edge of the stationary blade, as well as the reel blades, be ground to proper clearance ALL IN ONE SET-UP without removing any blade from the mower.

WRITE FOR FREE FOLDER TODAY!

ROGERS MFG. CO., Dept. M-99, Lindsey, Ohio

POWER TOOL COSTS *Reduced 75%*

**Get This 5-in-1 Machine
 ... Do the Work Yourself**



Save money; have fun! Make your own furniture — handle hundreds of home repair jobs. Emrick 5-in-one Workshop includes big capacity Lathe, Drill Press, Saw Arbor, Grinder and Sander. Only \$39.95 cash, or Time Payments. (Separately such power tools often cost up to \$160.) Send for FREE Catalog and Free Trial plan.

EMRICK, INC., 1835 Clinton, Kalamazoo, Mich.

SANDEE

Mufflers—All Ford, Chev., Ply. \$4.45
 All Buick, Pont., Olds., Chrys.,
 Dodge, Hudson, K.F., Pack., etc. \$5.45
 V-8 and Merc. Duals
 (32-49 incl.)
\$15.95



**SPORTONE
 MUFFLERS**
 (Pats. Pend.)

DURABILITY

TONE
 DEALERS
 WANTED

Beautiful
 SANDEE
 Fender Skirts
\$16.95

A SANDEE Sportone will outlast two ordinary mufflers and give More Power! More Speed! More Mileage!—plus a tone quality unsurpassed.

Please ship (item): _____ Price _____

Car and Year _____ Name _____

Address _____

SANDEE MUFFLER CO. 5643 Corryne Pl. Culver City, Calif.



Fill cracks in chairs—

Makes loose joints firm, sands to a smooth finish!



Reset loose hinges—

Replaces rotted wood, tightens loose screws ... easy to apply!

Repairs broken toys—

Mend cracks, nicks! Smooth finish!



Also useful in filling cracks in floors, nail and screw holes, repairing loose tiles. Handles like putty ... hardens into wood!

PLASTIC WOOD

A CELLULOSE FIBRE FILLER



IN CANS
 OR TUBES



DOZENS OF OTHER USES

Pick up DOLLARS off the floor!



Start your own floor finishing business...
big profits—no overhead—small investment

Yes, YOU can make real money—and put the profits in your own pocket! Now's the time to cash in on new housing and construction. No experience needed. Our booklet instructs you completely in setting up, operating and selling your services. Get started now!



HOLT MANUFACTURING CO.
651 20th Street, Oakland 12, Calif.

Gentlemen: I enclose 25¢ in coin or stamps for your complete booklet: "How to Make Money in the Floor Business." I understand there is no further obligation.

NAME _____
ADDRESS _____
CITY _____ STATE _____



she's some **SMOOTHIE!**
(YOUR CAR, THAT IS)

when equipped with

ADVANCE "ULTRA DEEP-TONE" MUFFLERS
DUAL OR SINGLE STRAIGHT-THRU

Rich, low, mellow tone. Also greater power, speed, and economy result from reduced back pressure. Rugged steel tube, blow-out proof. Simple to install. No welding. Dual set comes complete with rubber mounted clamps, fittings.

ADVANCE FENDER SKIRTS

These heavy duty steel skirts will beautify and streamline your car. Tight fit, no rattle, easy to install, prime painted. Real top quality, not to be confused with cheaper, light weight makes.

ADVANCE KI-YI AND RAZZ HORNS

Get these novelty horns for laughs.



MAIL COUPON BELOW DEALER INQUIRIES INVITED

ADVANCE MUFFLER CO. Dept. PM 99
1458 E. COMPTON BLVD., COMPTON 3, CALIF.

- Send check, money order, or we will mail C.O.D. You pay postage upon receipt.
- Dual Muffler Set (Ford, Mercury only) . \$19.95
 - Single Muffler (other makes) \$5.50
 - Fender skirts, pr. \$12.95
 - Single Muffler (Ford, Chev., Plym.) 4.86
 - 2 1/2" Chrome tail pipe tips . ea. 1.75
 - Ki-Yi Horn, each 3.25
 - Razz Horn, each 3.25
 - Send free catalog showing complete line.

Car make _____ Year _____ Model _____
Name _____
Address _____ City _____ State _____

CHARLEY-HORSE?



SORE MUSCLES?

When muscles are stiff and sore from unusual exercise or strain, use **HEET®**, the liniment that's *strong* yet does not burn the skin. Wonderful relief from muscular soreness comes as comforting **HEET** quickly starts to *penetrate*. Just brush it on with the applicator. **HEET** starts at once to ease muscular pain and *keeps on working* for hours, warms and soothes the painful area.

Order your NEW DEFLECTO

The only Deflector that Really Deflects
BEAUTIFY YOUR CAR. PROTECT ITS FINISH
The most beautiful chrome dome deflector ever produced. Actually deflects gases to roadbed away from car. Guaranteed free of back pressure. Brilliant polished chrome finish on 18 ga. steel. Send year and make of car with order. Price \$2.25 each. Postage Free on Prepaid Orders. 25% deposit on C.O.D.
AUTOMOTIVE MILLINERY OF HOLLYWOOD
P.O. Box 2452 Terminal Annex Los Angeles 54, California



ONLY \$2.25

MAKE!
FOLDING
TABLES-
BENCHES-
HORSES-
IN A JIFFY

FOLD-A-WAY CHANNEL STEEL LEGS

Shipped complete, ready to fasten to your top in a minute. Rubber tipped. Used on the job, in homes, workshops, ping pong tables, trailers, camps, boats, churches, lodges, banquet halls.
Send for free circular.

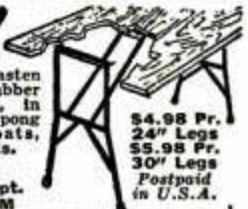

\$4.98 Pr.
24" Legs
\$5.98 Pr.
30" Legs
Postpaid
in U.S.A.

THE DIAMOND MFG. COMPANY
1100 ALYAMONT AVENUE SCHENECTADY 7, N. Y.

SMALL INBOARD



PROPELLERS, SHAFTS, STRUTS, RUDDERS

BY THE MAKER OF FAMOUS
COLUMBIAN PROPELLERS

Send for free bulletin #48-D

COLUMBIAN BRONZE CORPORATION
FREEPORT, L. I., N. Y.

AGENTS 300% Profit SIGN LETTERS

For Store Fronts and Office Windows. Anyone can put them on. Free Samples. Liberal Offer to General Agents.

METALLIC LETTER CO., 430 N. Clark, Chicago 10

Build your own SMITH Compressor

Operates spray guns, rock drills, tampers, paving breakers, sandblasting . . . Uses only 1 gallon of gas an hour!



Save Money—build your own Smith Air Compressor! Famous the world over! Capacity 60 cu. ft.; pressure up to 100 lbs. per sq. inch. Just order the Smith Compressor Head and Accessories with complete instructions for assembling. All you need is a Ford Motor and shop facilities. Head equipped with high speed compressor valves; automatic unloading and idling.

Write for complete information!
GORDON SMITH & COMPANY, Inc.
410 College Street • Bowling Green, Ky.



Handy Flexible SHAFT

Converts any motor, drill press, electric drill, electric fan (10 inch or larger) into a handy rotary tool

ONLY
\$2.95

OLD FAN MOTOR



VACUUM CLEANER MOTOR



Attach ROTA-SHAFT in a jiffy. Use for grinding, polishing, sharpening, cleaning, engraving, making tools, carving on metal, plastic, wood, glass. Convenient handpiece for easy handling... with 1/8 inch Adjustable Chuck. 40-inch overall length. Complete with buff and sanding disc ready to use in a drill press chuck. Order today!

SEND NO MONEY! Mail your order. Pay postman only \$2.95 plus postage on delivery. Try 10 days—if not delighted, return for money-back. For use on motor, add 35c for Special Coupling and state shaft diameter.

STRADER PRODUCTS CO.

DEPT. J-101

259 Strader Ave. Cincinnati 26, Ohio

SPEED AND POWER HANDBOOK



Build fast Stock Cars! California Roadsters! 150 MPH Rads! Covers Fords to Cadillacs—all makes! Breathtaking methods—Authentic—Direct from California!

SAVE MANY DOLLARS

Build your own Dual Manifolds! Superchargers! Hot Cams! Water Injectors! Hi-Compression Heads! Mileage Devices! Get racing speed, lightning acceleration, dynamic power increases from any make passenger automobile! Get construction drawings! Tuning techniques! Speed tricks! Picture catalogues! Economy secrets! Ingenious formulas! Including—"Racing Frames"—"Reciprocating Masses"—"Jet Engines"—"Braking Characteristics"—"Dynamometers"—"Dual Pipes, Gears, Fuels, Manifolds, Porting, Relieving, Lowering, Balancing!"

Includes "CALIFORNIA AUTOMOBILE CUSTOMIZING"—Glossy photographs! Diagrams! Newest ideas! Conversions! Re-Styling all makes! Streamlining! Chopping! Channeling! Customizing!

50 CHAPTER LIBRARY EDITION—complete—\$1.98 Postpaid.

NEWHOUSE AUTOMOTIVE INDUSTRIES

5805-B4 EAST BEVERLY

LOS ANGELES 22, CALIF.

FOR BIG MEN ONLY!



Write for
FREE CATALOG

SIZES WIDTHS
"10 to 16—AAA to EEE"

We specialize in large sizes only—sizes 10 to 16; Widths AAA to EEE. Wing Tips, Loafers, Moccasins, Hand Woven Oxfords, Dress Oxfords, Work Shoes, Sox, Styling specially designed for large sizes. Satisfaction guaranteed. Sold by mail only. \$9.95 and up. Write now for FREE catalog.

KING-SIZE, Inc., 135, Brockton, Mass.

Ball-Bearing SPEED WHEELS



JUVENILE WHEELS

(No bearing, solid tires)

5".....45c 6".....65c
7".....75c

(Semi-pneumatic tire, ball bearing)

8x1.251.85 10x1.252.20
8x1.751.95 10x1.752.30
8x22.20 12x1.753.45

INDUSTRIAL WHEELS FOR HEAVY LOADS

5x1.75 Bolted..3.65 10x2.75 HC.. 5.70
6x2 Welded..3.45 10x2.75 Pne. 7.60
6x2 Bolted..4.35 12x2.00 6.90
8x15.25 12x3.0010.80
8x2.005.20 4.00x8-214.70
8x2.505.40 4.00x8-415.85
10x2.006.10 16x4.0015.15

WRITE US NOW FOR COMPLETE NEW CATALOG

Send check with order. No C.O.D.

JIM BROWN TOY COMPANY

1097 Home Ave.

Akron 10, Ohio

60 Cycle
110-120
Volt AC



NOW SHARPEN ANYTHING WITH NEW ELECTRIC HONE!

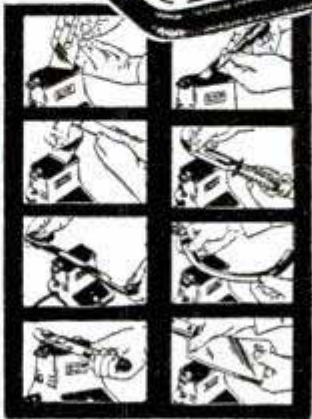

Pictures SHOW YOU how brand-new SYNCRO Electric HONE SHARPENER STARTS sharpening where ordinary electric sharpeners STOP! The ONLY Electric HONE with 14,400 strokes a minute! Invaluable for workshops, homes, kitchens, cafes, industry! A novel Gift. No belts, gears, wheels. HONING is best, safest way. SYNCRO comes with \$10.50 cord, plug, switch...

NEW and BETTER Electric SANDER-POLISHER Ready!

SYNCRO presents a new, superior electric sander-polisher! For light sanding, refinishing, finishing, etc. Polishes furniture, autos, shoes. 14,400 "POWER" MOTION strokes a minute sand or polish better, faster! With 9 sheets Aluminum Oxide sandpaper, felt and virgin lambs-wool pads, 8 ft. cord, plug \$14.50.



WORLD'S SAFEST ELECTRIC JIG SAW!

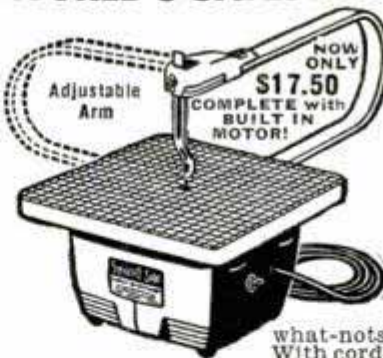

Safe for children, powerful enough for any workshop! Portable. THOUSANDS OF SAFE SYNCROS SOLD! Arm adjusts to permit cutting ANY length material. For delicate work on cardboard, wood, plywood, thin metal, plastic. No belts, no gears. NO OILING. Self-contained motor included. Just plug in any 60 cycle, 110-120 volt AC—and saw SAFELY. Fun and profit making scroll-work, what-nots, photo silhouettes, etc. With cord, plug, 3 blades, only \$17.50.

YOU CAN DO IT BETTER WITH

SYNCRO

QUALITY PRODUCTS FOR

• HOMES • WORKSHOPS • COMMERCE • INDUSTRY

HOW TO GET YOUR SYNCRO:

At your dealers. If dealer hasn't the brand new Sharpener, new Sander-Polisher or Saw, order direct from factory. Send full amount, we'll ship PREPAID.

DEALERS! Write for SYNCRO'S "BIG 3" Profit Facts.

SYNCRO CORP., Dept. H-99, Rochester, Michigan

SAY YOU SAW IT IN POPULAR MECHANICS

AMAZING!
CHEAP!

OIL BURNER

DIRECT TO YOU FROM MANUFACTURER

HEAT YOUR HOME, COOK YOUR MEALS
with CHEAP FURNACE OIL!
NO MORE SHOVELING COAL OR ASHES

This Sensational Universal Oil Burner Fits in All Heating, Cooking Stoves and Furnaces. Turns Cheap No. 1 Furnace Oil, Distillate, Diesel, Range, Heater Oil and Kerosene Into Oil Heat. One of the Quickest, Hottest, Cheapest Fires Known.



LIFETIME GUARANTEE

SAMPLE ON TRIAL

\$1.00 Bonus Offer for Testing
Try this amazing oil burner in your Stove or Furnace for one month. You take orders for burners for cooking and heating stoves at \$14.75 and burners for furnaces and boilers at \$29.50. **BIG DISCOUNT TO YOU ON SAMPLE.** Write for Free Details—a postcard will do.

SEND NO MONEY

Just your name—take orders from home owners, filling stations, railway stations, tourist camps, cafes, garages, offices, stores, churches, schools, etc.

EARN GOOD MONEY. Get the money making details now—write today.



\$29.50

For Furnaces, Boilers, Large Commercial Ranges, Tobacco Barns, etc.

Only \$14.75
For Heating, Cooking, Laundry Stoves, Ranges, Brooder Stoves, Tank Water Heater, Stock Sheds, Circulating Heaters, etc.

Northwest Mfg. Co. DEPT. 634-S MITCHELL, S. DAK.

SAVE \$55.00 ON THE PRICE OF

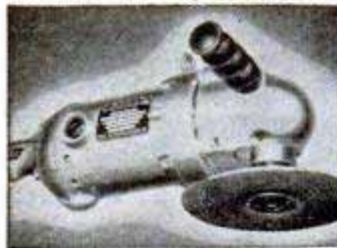

3/4 H. P.
115 v.
AC-DC motor
4200
R. P. M.

THIS
VERSATILE
HEAVY
DUTY
TOOL!

ONLY \$42.50 Direct from mfr.

Get this bargain now! Limited offer from surplus stock. No "catch." Brand new A-1 Spinner. Send check or M.O. today. (No C.O.D.) Money refunded within 10 days if not satisfied.

HOLT MFG. CO., 272 BADGER AVE., 651 20th STREET, NEWARK 8, N. J. OAKLAND 12, CALIF.

One Swipe of **NEW PLASTIC**
Makes these **LEATHER** and
LEATHERETTE Items *LIKE NEW*

Get Into A Money Making Business

Make like new, worn, scuffed or faded leather and artificial leather equipment. Either your own to renew, recolor and beautify, or cafe, restaurant and hotel equipment as a business. Single stroke with a brush renews. Does not crack, peel or scuff. Resists acid, alcohol, caustics and weather. All colors. Mail coupon for free sample.

FREE Sample SHOWS EFFECT



\$50 to \$500 Profit
On One Job Possible

Let me show you how, as I have shown others. Get your own exclusive territory while available. Mail coupon today. I'll do the rest. — Jack Edwards, Sales Mgr.

LEATHER-NEW PRODUCTS,
6082 Sunnyslope, Kansas City, Mo.
Send me without obligation a sample of Leather-New coated material so I can inspect it.

Name _____
Address _____
City _____ State _____

UTICA TOOLS
For More Tool Mileage

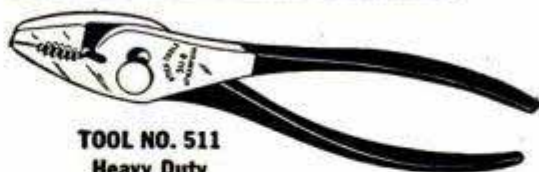

TOOL NO. 511
Heavy Duty
Slip Joint Pliers
6", 8", 10"

SEE
YOUR
DEALER

UTICA DROP FORGE & TOOL CORP.
UTICA 4, NEW YORK

FIBRE ARMS AND LEGS!
Light, correctly fitted, strong and comfortable. Natural appearance. Braces for all deformities. Scientific design. Fair Terms.
BUCHSTEIN-MEDCALF 223 S. 6th St., Minneapolis, Minn.

Genuine Snap-on Tools

Available Only Through Snap-on's
Direct-To-User Tool Service

WRITE FOR INFORMATION
SNAP-ON TOOLS CORP. • Kenosha, Wisconsin

MAGNETS OF ALL TYPES—10c UP
AMAZINGLY POWERFUL!
4 oz. Alnico Magnet, lifts 10 lbs.
\$1.10. Our Leader, 15 oz. Magnet,
lifts 40 lbs. \$2.50. New alloy—will not
weaken! Useful for lifting valuables from tanks,
jakes, or rivers easily! 7 small magnets \$1.10 with
list of many shop and home uses. Satisfaction guaranteed.
R. EYRICH, 2566 N. 49TH ST., MILWAUKEE 10, WIS.

A \$50 A DAY BUSINESS IN YOUR SPARE TIME

FREE BOOK
Take BELSAW Portable Sawmill right to the trees—turn out valuable lumber for local yards—do "custom sawing" for neighbors. BELSAW lasts a lifetime. No crew needed. Power with old auto engine or tractor. Beginners get excellent results. \$62.50 down. Send postcard for **FREE BOOK, "How To Make Lumber."**
BELSAW MACHINERY CO.
811-U Field Bldg, 315 Westport Rd, Kansas City 2, Mo.

METALS FOR HOME WORKSHOPS

Aluminum, Brass, Copper, Monel, Steel and Cast Iron:
In Bars, Angles, Channels, Sheets and Tubes. Sold in
Small Quantities. Write for Free Price List.

CASHMETALS CO. 2720 CALIFORNIA AVE. PITTSBURGH 12, PA.

LAWNMOWER SHARPENER OPERATORS

Increase your output...
Year 'round business!



**NEW
BED KNIFE GRINDER**
sharpens all
STRAIGHT EDGE TOOLS

New Ideal Bench Grinder
doubles your output of sharpening jobs, speedily grinds straight blade knives. Sharpens all kinds of straight edge tools and ice skates. Write for FREE, fact-filled folder.

THE FATE-ROOT-HEATH COMPANY
Dept. D-3, Plymouth, Ohio



PIONEER

MODEL 765

13.50



... the Only single shot bolt action .22 that gives you these features at this LOW price!



LOADING PLATFORM



SELF-COCKING ACTION

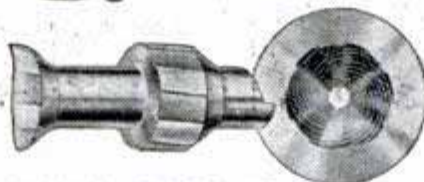

"BULL'S-EYE" BROACH RIFLING & rifling grooves cut at once — an exclusive H & R feature for greater accuracy.

WHY PAY UP TO \$6.45 MORE for a single shot .22 with comparable features? Why pay several dollars more for single shot rifles without these features?

See the H & R "Pioneer" at your gun dealer's. Check its superior features. Throw it to your shoulder and feel that easy, natural balance. Prove to yourself that the H & R "Pioneer" — the lowest priced full-size single shot .22 — is the best buy in its field!

Write today for FREE new catalog with complete descriptions, specifications and prices on all H & R rifles, revolvers, shotguns.

HARRINGTON & RICHARDSON ARMS CO.

442 Park Avenue, Worcester 2, Mass.

NEW POWER LAWNMOWERS



ONLY \$119.50

• Lightweight "easy to operate"

GAS MOWER

With 2½ hp air cooled gas engine. Makes cutting lawns a pleasure



ONLY \$39.95

• Cast aluminum base with 18" Rotary Blade

Make Ur-Own POWER MOWER

Just add up to 2 hp gas engine or ½ hp electric motor Easy to install



ONLY \$69.50

• Ball-bearing rubber tired wheels

ELECTRIC MOWER

Comes complete with ½ hp elec. motor and 75 ft of cord. Just plug it in.

ALL MODELS COME COMPLETE AS SHOWN

Prices F.O.B., K. C. Send check or money order: No COD's:

ATLAS EQUIPMENT CO.

229 S.W. Blvd. Dept. P.M.9 KANSAS CITY, MO.

DIAL your SAW CUTS!



AMAZING NEW

Warren

DADO SAWING WASHERS MAKE ALL THESE CUTS ON YOUR SAW!

Smooth, accurate grooves—12 widths, any angle. No chatter, no burning, chewing, or sanding! Just dial desired width with Micro-matic adjustment! 5 sizes fit any saw arbor— $\frac{1}{2}$ ", $\frac{3}{8}$ ", $\frac{5}{8}$ ", 1", $1\frac{1}{8}$ ". See your dealer or use coupon below! Satisfaction guaranteed.

DEALERS, ORDER DIRECT!

WARREN WASHERS CO., DEPT. 29
70 Medbury Ave., Detroit 2, Michigan

Enclosed \$4.95 for one set of Warren Washers, postpaid. My arbor size is _____

NAME _____

ADDRESS _____

CITY _____ STATE _____



\$4.95 set

pat. pend.

WELD AT HOME

A new, low priced

LINCOLN ARC WELDER of Industrial Construction

- Plugs into the light socket.
- Easy to weld, cut, braze or solder.
- Approved by Underwriters Laboratories.
- Built by The Lincoln Electric Company, world leader in arc welding.



"Lincwelder 60" and accessories

PRICE ONLY
\$45.00

Fill out order and mail to

The Lincoln Electric Company, Cleveland 1, Ohio.

- Ship me the "Lincwelder 60" with accessories \$45.00
Enclosed is check money order
- Send me free bulletin on the new "Lincwelder 60"

Name _____

Address _____

City _____

State _____

193

Engineers All Metal Army Type Hand-Sighting

LEVELS

\$2.00

QUALITY
PRECISION



20 POWER FOUNTAIN PEN TYPE
POCKET MICROSCOPE \$2.95

Useful to Metallurgists, Students, Painters, etc.

Special

40 POWER,

SPECIAL

\$4.95

Send 25c for catalog of new and used guns, ammunition, binoculars and powder flasks.

PUBLIC SPORT SHOPS

11 S. 16th St., Phila. 2, Pa.

No COD's

MIRACLE RANGE - FINDER VALUE

Get professional, sharp, clear pictures from your movie or still camera with the beautiful precision built "IDEAL Range-Finder." Easy to use — guarantees perfect focusing. Works the same as \$15.00 models. Highest quality optical system.

THREE YEAR GUARANTEE

If your dealer can not supply send direct

FEDERAL INSTRUMENT CORP.

14-02 Broadway Dept. 21 L. I. C. 6, N. Y.

only
\$2.95
incl. tax



WORLD'S LOWEST PRICED ADDING MACHINE

Vest Pocket Size
FREE TRIAL

\$2.95

IDEAL FOR BUSINESS AND PERSONAL USE — GUARANTEED ACCURATE. Not a toy. Operates with only a finger flick. Adds, subtracts, multiplies, divides. Counts up to one billion. Pays for ITSELF cost self over and over. Ideal Gift — for Business, Income Tax and School use. MONEY BACK GUARANTEE. Send name and address. Pay postman only \$2.95 plus postage. (Send full cash if outside U.S.) Beautiful rich-looking Leatherette Case included at no extra cost. Money back in 10 days if not delighted. AGENTS WANTED.

CALCULATOR MACHINE CO., (Mfrs.)
Dept. 218, P.O. Box 248 Glenview, Illinois

WHEELS — WHEELS

- 5" Disc Wheel $\frac{5}{8}$ " Tire $\frac{5}{16}$ " or $\frac{3}{8}$ " Sleeve 30c ea.
- 6" Disc Wheel $\frac{5}{8}$ " Tire $\frac{5}{16}$ " or $\frac{3}{8}$ " sleeve 35c ea.
- 7" Disc Wheel $\frac{3}{4}$ " Tire $\frac{3}{8}$ " sleeve 45c ea.
- 8" Disc Wheel $1\frac{1}{8}$ " Tire $\frac{1}{2}$ " sleeve 70c ea.
- 7" Disc Wheel 1" Tire $\frac{1}{2}$ " ball bearing 80c ea.
- 8" Disc Wheel $1\frac{1}{8}$ " Tire $\frac{1}{2}$ " ball bearing \$1.00 ea.
- 8" Disc Wheel 2" semi-pneum. T. $\frac{1}{2}$ " S.S. \$1.35 ea.
- 10" Disc Wheel 1.75 semi-pneum. T. $\frac{1}{2}$ " S.S. \$1.50 ea.

Above wheel prices include hub cap.

10" Aluminum Wheel $2\frac{3}{4}$ " semi-pneum. T. $\frac{1}{2}$ " S.S. \$4.50 ea.
Plus Postage, 20% — C.O.D.'s accepted.

UNITED WHEEL STAMPING CO., PM-9
2756 W. 115th STREET CHICAGO 43, ILLINOIS



ONAN Portable ELECTRIC PLANTS

FOR CABINS, TRAILERS, CONTRACTORS, BOATS

Light weight, compact, air-cooled engine-driven. Furnish regular city-type A.C. electricity for lights, appliances, radios, etc. Can be carried by hand. Fit trunk of car. Plug-in receptacles on plant. Larger models for farms, homes, businesses beyond highlines. Catalog shows over hundred models. 350 to 55,000 watts.



Gasoline or Diesel Powered

WRITE FOR CATALOG

D. W. ONAN & SONS INC.

5825 Royalston Ave., Minneapolis 5, Minn.



WAR SURPLUS AND OTHER ITEMS

CLUTCH for motor scooters, motor bikes, Lawnmowers, etc.
Mercury centrifugal clutch for use with any small gas engine. Belt pulley. $\frac{3}{4}$ " bore. New. Stock #400.....only \$8.95
In lots of 12.....ea. \$8.00

STAINLESS STEEL TABLE TOPS
Polished one side. $\frac{3}{4}$ " veneer center. Ideal for: shelves, back bar work board, work table, etc. Stock #411.
22 x 19 $\frac{1}{2}$ "...\$1.95 22 x 21 $\frac{1}{2}$ "...\$1.95
23 $\frac{1}{2}$ x 27"....\$2.45 22 x 29 $\frac{1}{2}$ "...\$2.95
22 x 34"....\$3.45 22 x 37"....\$3.95

BALL BEARING ARBORS
Grinding and saw arbor, has $\frac{1}{2}$ " double end shaft, 11 $\frac{1}{2}$ " long with 2" center pulley. New Departure double roll ball bearings. Right and left hand thread. Self aligning Dodge pillow block. 10,000 RPM. Bearings alone list at \$10. Complete arbor new. Stock #305. \$4.95
HI-SPEED GRINDER has 2 step pulley driven thru rear or base. Stock #328, only \$10.95

ALL BRONZE GEAR PUMP
All bronze corrosion resistant gear pump. Lifts water 25'. Delivers 1020 gal. per min. at 1200 RPM. Develops 110 lbs. pressure or 250' head. Self locking packing nuts, drain cock, reversible head. Will pump brine, salt water, oil, vinegar, gasoline, etc. Dimensions: 10 $\frac{1}{2}$ " x 7 $\frac{1}{2}$ " x 5 $\frac{1}{2}$ " W. Base holes 1 $\frac{3}{4}$ " x 3". Shaft 1 $\frac{1}{8}$ " x 1 $\frac{1}{8}$ " x 1" inlet & outlet. Wt. 24 lbs. Mfg. by Sherwood Brass Works. All pumps belt driven. All bronze gear pump with 8" V pulley.
PUMP ONLY. Stock #314 \$24.00
\$80 value
Same pump as above, with motors, (electric). Stock #549.
 $\frac{1}{2}$ HP....\$67.00 1 HP....\$87.00
 $\frac{3}{4}$ HP....\$74.00
Same pump with Briggs-Stratton gas engine. Stock #550.
1 $\frac{1}{2}$ HP..\$ 89.50 2 $\frac{1}{2}$ HP..\$135.00
3 $\frac{1}{2}$ HP..\$165.00 6 HP....\$195.00
The MORE HP the more PRESSURE.

RUBBER WHEELS Good for boats, scooters, wheelbarrows, etc. Stock #536.
2.75 x 10 $\frac{1}{2}$ " & $\frac{1}{2}$ " bore.....\$ 4.50
4.00 x 8 $\frac{1}{2}$ ".....\$10.95
10 $\frac{1}{2}$ " x 4, 6 ply.....\$ 8.95
14 $\frac{1}{2}$ " x 5, 6 ply 1".....\$10.95
New airplane tires, tubes and wheels with high speed Timken Hyatt ball bearings.
Stock #544, 800 x 5-6 ply 1".....\$14.50
1700 x 20" 12 ply TUBES. Stock #545. \$44.50 for earthmovers, trucks, \$300 value.
56" 16 ply Bomber TIRES and TUBES only \$600 value, for tractors, etc. Stock #546.
Our price.....\$9.50
AIRPLANE TIRES with landing gear hydraulic strut. Firestone & Goodyear standard tires, 8 ply 27", 29" high. Hydraulic strut is 44" long, 3 $\frac{1}{2}$ " dia. Can be made into heavy duty trailer. Stock #551. **\$22.50 each.**
PRICE.....

HALF TON WAGON
Half ton wagon with plate aluminum body 24" x 42", $\frac{3}{8}$ " steel axle. Stock #332. Write for details.

HALES FIRE PUMP
For fire depts., factories, forest fire prevention, etc. 600 gal. per min. Can be operated with a four or six cylinder gas engine. 4 $\frac{1}{2}$ " intake... 2-2" outlets... 265' head at 120 lbs. pressure. Passed by national board of fire underwriters. NEW. Stock #407. Price. \$149.50

HOSE 20' LENGTHS
Gas, oil or water resistant. Neoprene treated 1 $\frac{1}{4}$ ". Male & female brass connectors. Standard fitting station size. Value \$20.00. Stock #528. Our price.....\$7.50
FOOT VALVE.....\$3.00

Briggs-Stratton GAS ENGINES
SAVE \$25 ON LIST PRICE
All are NEW in original crate. Rope start. 1700 RPM all brand new and guaranteed. 1 $\frac{3}{4}$ to 2 $\frac{1}{2}$ HP Model AP. List price \$102.10. Stock #307. Our price.....\$77.00
3 $\frac{1}{2}$ HP Model BP. List price \$111.50. Stock #308. Our price.....\$86.00
5 to 7 HP Model ZP. List price \$137.00. Stock #309. Our price.....\$102.00

Air Compressors
All ratings from $\frac{1}{4}$ HP to 10 HP—new and rebuilt. Write for free details.

Plastic Tubing
Good for water, oil, air, electrical installations & radio work. Available in 100 ft. lengths. Min. order 50'.
 $\frac{1}{8}$ ", 3/16", 1/4", (your choice) per ft. .2c
5/16", 3/8" per ft. 3c
1" 3 ft. lengths only, per ft.6c
1 $\frac{1}{2}$ " per ft.8c

WRITE FOR FREE CIRCULAR

A. C. ARMY LIGHT PLANTS
300 watt \$ 89.50
500 watt \$149.50
1000 watt \$189.50
1500 watt \$209.50
2500 watt \$295.00
5000 watt \$550.00
7500 watt \$625.00
10000 watt \$900.00
25000 watt \$995.00
Write for Circular

GENERATORS
300 watt, 12V...\$ 7.00
300 watt A.C....\$ 34.50
1000 watt A.C....\$ 89.50
1500 watt A.C....\$ 99.50
2500-3000 watt A.C....\$145.00
3000 watt D.C....\$ 99.50
Write for Circular

Heavy Duty Rubber Cable
3 wire #10 Super cable. Stock #351. 65' with lugs. Value \$26.00. Our price. \$13.00
3 wire #10 government submarine type. Used underground, underwater, overhead. Cost U. S. 90c ft. Stock #542.
100 ft. ...\$24.00 250 ft. ...\$55.00
500 ft. ...\$100.00 2900 ft. reel \$530.00
2 conductor rubber cable #4—stranded—75 ft. length with connectors. List price \$177. Stock #543. Our price.....\$90.00
4 wire #6 stranded heavy duty. List price \$2.36 per ft. Stock #548.
50 ft. ...\$ 30.00 100 ft. ...\$ 55.00
250 ft. ...\$125.00 500 ft. ...\$225.00
1000 ft. reel...\$400.00
3 wire #10 rubber cable two male connectors. Value \$109.50. Stock #554.\$35.00

ALL ITEMS GUARANTEED AS REPRESENTED C & H ELECTRIC CO.
434 W. JUNEAU AVE.
MILWAUKEE 3, WISCONSIN

All prices F.O.B. Milwaukee. 25% deposit required on all C.O.D. orders. No C.O.D.'s under \$10.00. Use stock number when ordering. Many other bargain items not listed—write for our free circulars.

AMES UNIVERSAL DIAL INDICATOR SETS

New Surplus
Dial indicator — face 2 $\frac{1}{4}$ ", graduated in 1/1000ths. Dial reading 0-50-0; spindle travel $\frac{1}{4}$ ": can be used on stationary or revolving parts on lathes, milling machines, drill presses, etc., and for automotive work. Comes complete with dial gage, hole attachment, bar with upright, clamp sliding swivel, dial holding rod and 3 contact points — with case shown.
Reg. Sold \$23.00
NOW \$15.00
VETERAN TOOL AND SUPPLY CO.
88 BAXTER STREET NEW YORK 13, N. Y.

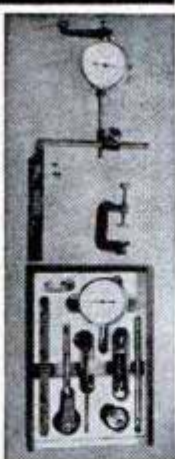

BE A HIGH-PAID MAN IN YOUR COMMUNITY WITH THIS LONG NEEDED INVENTION

Earn up to \$10,000 or more per year! Nothing to invest! Be your own boss!
U.S. Pat. D 153853
D 153854

A worldwide product needed by every home, business and farm...priced to sell quickly! Automatic Red Comet goes into action as soon as fire starts...smothers fire without human aid. It's a sales 'natural'!



FREE SALES KIT
Demonstrator units, sales literature, etc. furnished you FREE. Handsome leather-type kit. Tried and proved, it will make you an independent businessman. ACT NOW! Someone in your community will be appointed soon. Write for details, today!
RED COMET, INC.
143 R. C. Bldg. Littleton, Colorado

"EVEREADY" THE FLASHLIGHT BATTERY WITH "NINE LIVES"

Recovers Power Between Uses—
Bounces Back for Extra Life!



New LABOR SAVER for the HOME
Electric "MOTO-SANDER-POLISHER" ONLY \$14.85 POSTPAID
Say "Good-bye" To Hand Sanding & Polishing! Let speedy "Moto-Sander" do the work while you just guide it. Use for light sanding jobs—finishing, refinishing, redecorating. Moto-Sander quickly and smoothly sands furniture, walls, woodwork, wall board, plaster joints; boats, workshop projects, etc. Straight-line action (non-rotary) will not burn or scratch surface. Also ideal for fast, effortless polishing of furniture, refrigerator cabinets, automobiles, other waxed surfaces. There are dozens of time and money-saving uses in every shop and home for this inexpensive machine. Moto-Sander is the lightest, most practical electric sander & polisher. Gets into tight corners... 7,200 strokes a minute... weighs only 2 $\frac{1}{2}$ lbs. Furnished complete with 6 sheets assorted grade Garnet Paper for sanding, plus felt pad and sheepskin for wax polishing. Operates on 110-120 V., 60 cycle A.C. Thousands of satisfied users.
WHERE TO BUY IT: Buy Moto-Sander at your dealer's. If he cannot supply you, send only \$14.85 (check or M.O.) and we will ship postpaid. Or, send only \$2 now, and pay postman balance plus postage. MONEY BACK if not delighted after 5 days' trial.
DREMEL MFG. CO., Dept. 5P119-J, Racine, Wis.

THE BIGGEST SURPLUS BARGAINS IN YEARS

ELECTRIC MOTOR 1/2 H. P. 27 V.D.C. R. P. M. 4000 No. 750. For Intermittent or Continuous Duty 5/8" SHAFT. VARIABLE SPEED MOTOR CAN BE ADAPTED, TO 110V.A.C. or R.E.A. line by simple arranging armature brush leads. UNUSED. Instructions \$5.50 incl.

ELECTRIC MOTOR 1/2 H.P. 24 V. D.C. R.P.M. 2500 #HCA24 O. Gov't. cost \$75.00. BRAND NEW..... \$3.50

ELECTRIC MOTOR 1/4 H.P. 28 Volt D.C. R.P.M. 4000 #2832 with simple instructions to convert to 28-32 Volt A.C. Gov't. cost \$82.84. Brand New..... \$3.50



WEAVERS HYDRAULIC HAND PUMP — BRAND NEW. For hydraulic jacks, presses, hoist, etc. For operating hydraulic cylinders, to pump oil or hydraulic fluid under pressure. Has built in check valve, and is capable of delivering 1000 lbs. pressure. Wt. 10 1/2 lbs. A \$50.00 value. Instructions incl. **\$8.50**

VICKERS CONSTANT DISPLACEMENT HIGH PRESSURE PUMP. Use it for any type liquid pumping job 375 gal. per hr. at 3750 R.P.M. 1000 pounds pressure per sq. in. Can be used as hydraulic motor O. Acq. \$100.00. **\$8.95** post-brand new directions incl. Wt. 7 lbs. paid

BRAND NEW CHECK AND RELIEF VALVE \$2.50 Post-paid

VICKERS UNLOADING VALVE. Brand New—By passes full amount output of the pump while the cylinder is not in operation. Takes starting load off of electric motor driving the pump. Price **\$4.95** post-paid

BRAND NEW HYDRAULIC CONTROL VALVE. This is a TWO CYLINDER DOUBLE ACTION VALVE with unique arrangement allowing the operator to raise both cylinders simultaneously, to lower them simultaneously or to raise one and lower the other at any predetermined rate and speed. A \$75.00 value... **\$8.95** post-paid

Greatest Value in years **BRAND NEW Hyd. control Valve ADEL PRECISION VALVE #10335.** This is for a double end cylinder control or for two single cylinders that are to work in opposition to each other. When pressure is applied on one line, it will open the opposite check valve so that pressure in that line can be relieved.... **\$5.50** Post-paid

THOMPSON BOOSTER PUMP. Use them for Homes, Farms, Ranch, and Shop. Motor driven centrifugal pump will empty 50 gal. drum of water in approx. 20 min. Runs on 24V. D.C. A.C. **\$7.50** New.....

LUBE PUMP. BRAND NEW. Precision Gear Impeller Pump. Pumps liquids up to 3 gal. per minute. Pressure up to 200 lbs. per sq. in. St'd 1/2" Threaded and keyed shaft. Instructions incl. Wt. **\$3.95** 4 lbs. Price..... plus postage

SENSATIONAL FASCINATING MYSTERIOUS SELSYN. Two or more connected together, work perfectly on 110 V.A.C. For weather vanes rotating directional antennas or controlling distance operations. Complete with diagram and instructions. Wt. 3 1/2 lbs. **\$3.50** PER PAIR..... plus postage

VALUABLE GEARS BARGAINS SPEED REDUCER 10-1 or 5-1 ratio, 90 degree angle. Shaft Driven 1/2" spline Shaft with 3 mounting holes 5/16". Gears held in forged and machined aluminum housing with two needle bearings, one bronze bearing, and three high speed shielded bearings. Sealed self lubricating chamber. **\$3.50** Price.....

NEW PUROLATOR GASOLINE FILTER. Aircraft type. Today's advanced gasoline Re-refining filter for all cars, Trucks, Tractors and all Motor Boats. Cleans and refines gasoline as you drive. Removes solids, water and prevents sludge formation. Install at home in a few minutes. **STOP GASOLINE WASTE AND EXPENSE.** Instructions incl. Permanent, needs no re-placements. Ea. **\$4.95**

NEW CUNO OIL FILTER, aircraft type. Filters oil without cartridge replacements. For Autos, Trucks, etc. Install at home in a few minutes. **STOP CHANGING MOTOR OIL.** Instructions incl. Ea. **\$4.95**



WRITE FOR HYDRAULIC LISTING
Send check or Money order. No c.o.d.'s. Prices f.o.b. K.C. except when marked postpaid.

GENERAL SALVAGE COMPANY
Dept. 17, 2922 E. 27th St. Kansas City, Mo.

FENDER SKIRTS..... \$16.95 PER PAIR
FOR FORD, CHEV., MERC., PLYM., DeSOTO, CHRY., DODGE, KAISER-FRAZER AND BUICK

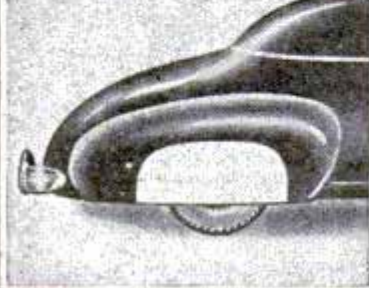

Beautify your car — bring out the flowing lines inherently designed there. Sparkling beauty you'll like. Constructed of heavy gauge body steel, finished in prime. Perfect fit.

SANDEE MUFFLER CO.
Box 296, La Tijera Sta. Los Angeles 43, Calif.
Gentlemen: Please send me one set of Sandee Fender Skirts to fit my _____ (year and make of car)
 Check for \$16.95 enclosed
 Ship C.O.D.

2 BIG UTILITY ITEMS

ORDER NOW! LOWEST PRICES OFFERED!

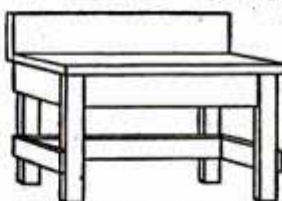

WORK BENCH

Just the thing for Dad or son's basement or garage workshop. Sturdy, steady, and tough. 48" long, 19" wide, 35" high.

only **\$6.75**

(fob Chicago) Wt. 43 lbs.

Both items made of kiln dried white pine... pre-cut and ready to assemble. Use in shop, home, apt., store.

Every housewife will want this handy rack. Fits neatly in closet, basement, garage, etc. Holds 90 qts. or 130 pts. Use also for display or tool rack, bkcase or dozens of other things. 24" wide, 48" high, 12" deep.

JAR STORAGE

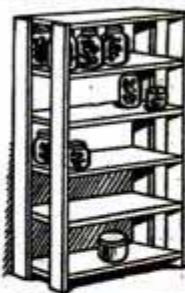

only **\$2.98**

(fob Chicago) Wt. 32 lbs.

GEE LUMBER CO., 2600 W. 79th St., Dept. P-9, Chicago, Ill.



GERSTNER Tool Chests offer extra values because of superior design and construction. Machinists and Toolmakers may choose from Free Catalog.

GERSTNER TOOL CHESTS
449 Columbia St. Dayton 7, Ohio

30" SHEET METAL BRAKE

Forms angles, flanges, seams. Bends 24 gage steel. Heavier copper and aluminum. Cam locking. Portable, held in vise, bolted down, or clamped to edge of truck. All steel. Shipping wt. 42 lbs. Shipped express collect. **\$24.50**



36" size, \$28.00. 30" size **\$24.50**

12" BRAKE. Fits in vise to form difficult and compound bends, up to 20 gage steel, **\$12.50 PP.**

CUTTER. Cuts 16 gage steel any length and width; **\$12.50 PP.**

SHEET METAL PLIERS. 2 1/4" wide, **\$2.00;** 5", **\$3.00.**

NEW SHAPING MACHINE. Does work of metal and wood cut-off, planer, lathe, etc. Notching and grooving up to 30", **\$36.50.**

IRON BENDER. Forms hooks, braces, eyelets. Bends 1/4x2, **\$10.00.**

PLASTIC BAR BENDER. 1/4x8 capacity. Sets on gas stove, **\$1.00.**

Immediate delivery. Order direct, cash or C.O.D., or send for folder.

WISE BRAKE MFG. CO. 1116 So. 27th St., Omaha 5, Nebr.

Free Booklet on FLEX-O-SHAFT

Illustrating this all-purpose power machine with hand-piece that handles as easily as a pen. Motor with switch, foot-operated rheostat, and 66 accessories at special low price. Write

F. W. STEWART MFG. CORP.
Dept. A 4311 Ravenswood Ave. Chicago 13, Ill.

How to Make Money with Simple Cartoons

A book everyone who likes to draw should have. It is free; no obligation. **FREE BOOK**

Simply address **CARTOONISTS' EXCHANGE**
Dept. 99-D Pleasant Hill, Ohio

LIQUID MARBLE COMPOSITION FLOORS FLEXIBLE MOLDS MOLD Novelties, Statuary, Art Goods in Flexible Plastic Molds; 5c material makes \$1 seller. Make Marbleized floors, Tile Walls. Colorful, glossy, amazing! Easily learned; start in garage or basement. Particulars free. **MARBLEIZING SERVICE, Dept. 10-F, Edwardsville, Ill.**

MYSTERIOUS DEVICE WELDS BRAZES SOLDER & CUTS ANYONE CAN OPERATE

ONLY **\$9.95**
FOUR-WAY WELDER
This newly invented **FOUR-WAY PORTABLE ELECTRIC WELDER** will do brazing, soldering, welding and cutting on brass, bronze, iron, steel, cast iron and other metals. It's easy to use. **WORKS INSTANTLY** on any properly wired 110 VOLT A.C. OR D.C. LINE. Does a thousand and one professional type repair jobs. **SAVES TIME AND MONEY** on auto, home appliance, farm and shop repairs. It's indispensable for maintenance men, farmers, repair shops, engineers, tin smiths, home and auto owners, bicycle and fix-it shops, etc. **10 DAY TRIAL OFFER.** The **FOUR-WAY COMES COMPLETE WITH ALL SUPPLIES READY TO OPERATE** including simplified instructions. **IT'S FULLY GUARANTEED.** Order one today for 10 DAY TRIAL or write for **FREE** particulars. **FOUR-WAY WELDER CO., Dept. PMF-99 2326 S. Michigan Ave., Chicago 16, Ill.**

A BIG MONEY MAKER...JUST WHAT ALL DIAL PHONE USERS
QUICK-EASY-SALES ARE LOOKING FOR..

**A MIRACLE FOR HOUSEWIVES,
 STORES AND OFFICES**

for All Square
 Model Phones

HERE is positively the EAS-
 IEST and QUICKEST selling
 item you ever saw! APPEALS
 INSTANTLY. In a BIG DE-
 MAND MARKET it SELLS
 RAPIDLY. You can step along
 from Office to Office, House to
 House and Store to
 Store. They all buy. PREVENTS WRONG NUMBERS

DIAL
 WITH
 EASE
 SAVES
 YOUR
 EYE-SIGHT



THEY ALL BUY WHEN THEY SEE IT

Phone Operators readily see the necessity of using the Stesco. Housewives say — "Just what they need and have been looking for." They buy extra ones for GIFTS. The STESCO is not a gadget. It is practical and useful. **NEEDED ON EVERY DIAL PHONE** Why grope along with some slow selling item when you can join a fast stepping organization of Real Go-Getters. With Millions of prospects and Millions of Dial Phones. Offices buy 2, 4, 6, 8, 10 and more. Some firms need 25, 50, and more.

DISTRIBUTORS ENTHUSIASTIC No wonder... Even Spare Time PAYS BIG. It is possible to MAKE from \$57.60 to \$100. and over a week. Sounds big? yes Sir! This is BIG BUSINESS. Better HURRY!

Reuben Dight Inc.

652-654 Diversey Parkway, Dept. P-9, CHICAGO 14, ILLINOIS

YOU
 SIMPLY
 SNAP
 IT
 ON
 INSTANTLY



No Tools
 Needed

WRITE TODAY for
 FREE PARTICULARS

6 POWER PRISM BINOCULARS

VEST POCKET IN SIZE

COATED LENSES! Dynamic in power and range. At 1,100 yards has sharp, clear field of 370 feet! Made to military specifications. Moisture-proofed — Dust proofed! All metal construction. Individual eye focusing. Adjustable for all eye widths! A compact, durable, all-purpose, achromatic prism binocular, NOT a field glass. Economy priced at fraction of what similar glasses sell at retail! Complete with quality leather, plush-lined case and straps only \$19.95 plus 20% Federal tax. Cash orders sent postpaid. On C.O.D.'s include \$2.00 deposit. **GUARANTEED.** Try for 20 days at our risk and expense.

UNITED PRODUCTS CO.
 Dept. ARF-1208 Chicago 20
 Reference Dun & Bradstreet

7941 S. Halsted

"HOME WORKSHOP" BLADES

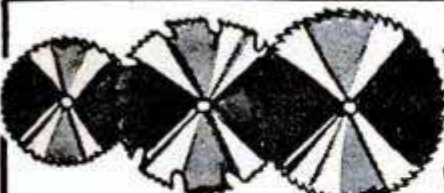

Made of
 Tough Steel, With
 Teeth Set for
 Side-Clearance
 FOR
 WOOD CUTTING

"HOME WORKSHOP"		"HYCARBON"	
No. 244 4 in. Cross...\$.38		HAND FILED	
No. 254 6 in. Cross...\$1.00	No. 254T 6 in. Cross. \$2.00		
No. 264 6 in. Comb...\$1.00	No. 264T 6 in. Comb. \$2.00		
No. 274 7 in. Comb...\$1.35	No. 274T 7 in. Comb. \$2.50		
No. 284 8 in. Comb...\$2.00	No. 284T 8 in. Comb. \$3.00		

Rip and Cross cut Blades, same price as combination, 1/2", 5/8", 3/4" Bores. Allow 15c per blade for postage and handling.

Need AIR COMPRESSOR??? Write for illustrated 12 page "Quincy" Compressor catalog. A Compressor to fit every need.

Write for new 1949—52 page illustrated catalog filled with thousands of new items and War Surplus Bargains. Send 10c to Cover handling and mailing costs.

MIDWEST SALES CO.

2533 INDIANA Dept. PM9 KANSAS CITY, MO.

New HOME-UTILITY
6" Electric Saw
 ONLY
\$59.95
 Cuts to full
 2" depth

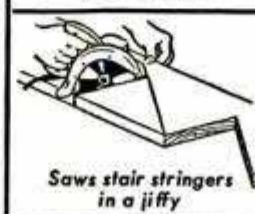

Beats Hand Sawing 10 to 1!

SPEEDS UP general carpentry; home construction, building, alterations.
EASY TO HANDLE: Weighs only 9 1/2 lbs. Perfectly balanced, close coupled. Easy one-hand control.
EASY TO FOLLOW: Guide line always visible, Sawdust blown clear.
SAFE TO USE: Telescoping guard automatically covers blade except when sawing. Instant-release switch.
UNMATCHED QUALITY: Powerful new motor (for A.C. or D.C.). Full-size ball bearings. Tough Gears. Sturdy aluminum housings. Built by BLACK & DECKER, world's largest maker of electric tools.
HUNDREDS OF OTHER USES: Sawing lumber to construction length. Fitting interior trim and moulding. Cuts transite tile, etc., with abrasive discs. Cuts plywood and wallboard panels.

See it at your Hardware, Electrical or Implement Dealer!



Products of The BLACK & DECKER Mfg. Co.
 Dept. H9M, Towson 4, Maryland

ELECTRIC DRILLS • SANDER-POLISHERS • DRILL KITS
 SAY YOU SAW IT IN POPULAR MECHANICS

Need a Chimney? for your home or cabin

YOU YOURSELF CAN INSTALL IT

Van-Packer Prefabricated Chimney shipped complete, all parts ready for immediate installation. • Needs no foundation. **SAFE**... Underwriters and FHA approved. • Any fuel in any home. Safer than brick. • Half the cost. Immediate delivery.

WRITE FOR FREE BOOKLET

Van-Packer Corp. Dept. PM Field Building, Chicago 3

Only with this new **HOME KIT**
can you pick the right speed as you
POLISH, SAND and DRILL



POLISH at 300 r.p.m.



SAND at 3200 r.p.m.



DRILL at 1600 r.p.m.



BULL BUFFER HOME KIT
all for only \$29.95!

There's a *right speed* for polishing, for sanding, for drilling, if you're going to do a *professional* job. And now, for the first time, here's a kit that offers you a *choice of 3 speeds* so you can pick the right speed for any job!

With the new Bull Buffer Home Kit, you polish, sand and drill the *right way*—"the right-angle way"—the only easy, comfortable way to reach all surfaces, curved or flat. Without effort, you get to all those hard-to-reach spots that other polisher-sanders can't touch.

Already Own a Drill?

Order the Bull Buffer, separately. (The right-angle polisher-sander in drill chuck above). **MUST** be good—more than 100,000 now in use. Complete, with 2 sanding discs and sheepskin bonnet, only..... **\$9.95**

Nothing "extra" to buy—the Bull Buffer Home Kit comes to you complete, ready to use, and *guaranteed*. Order today, at your dealer's, or send cash, check or M.O. for only \$29.95.

BERTRAM V. ENGINEERING CO.
3121 MAIN ST. KANSAS CITY, MO.

KIT INCLUDES

- **BULL DRILL** — new streamlined, power packed, 1600 r.p.m. electric drill, with **JACOBS GEARED CHUCK**.
- **BULL BUFFER** — right-angle polisher-sander with gear reduction.
- **ADAPTER SET** — for sanding at twice drill speed.
- **Sheepskin bonnet and 2 sanding discs.**

THAT ACCURATE TOUCH...



with the **FINEST IN STEEL TAPES**

It's easy to be right the first time — it's easy to get "that accurate touch" . . . if your measuring instrument is the Master Streamline. This fine tool simplifies and speeds measuring and cuts down time-wasting errors. Its outstanding features are Streamline's guarantee of better measuring . . . graduations on both sides of blade . . . new lever brake to hold reading . . . direct reading inside measure . . . extra long tip holds blade steady . . . and many others found only in the Master Streamline. See your local hardware dealer or use the coupon.

MASTER

REG. U.S. PAT. OFF.

WOOD AND STEEL TAPE RULES

Master Rule Mfg. Co., Inc. PM-9
201 Main Street, White Plains, N. Y.

I enclose \$2.25 for the 6 ft. Streamline
\$2.50 for the 8 ft. Streamline
Engrave my name (75c extra). Please print clearly:

NAME.....
ADDRESS.....
CITY..... STATE.....

OVER 250 SURPLUS BARGAINS



GENUINE M-6 COMPASS \$5.95

A real precision instrument made to rigid Govt. specifications. Universal bracket easily mounts on cars, trucks, boats, planes, etc. Nite lite, instruction book and calculator included.

GENUINE G. E. 2 H.P. 4-CYCLE GASOLINE ENGINES

Brand new! In original factory cartons. Complete with oil air filter, dustproof magneto, gas tank, shaft pulley, throttle control, etc. Excellent for mowers, boats, saws, etc. Ship. wt., 37 lbs. Shipped express collect. \$69.50 value.



Mail orders add sufficient postage unless otherwise noted.
Write for Big FREE CATALOG Today!

FISLER SALES CO. 723 Walnut St. Kansas City 6, Mo.



DUST-O-VAC FOR ALL MACHINES \$19.95

For Home Workshops & Industry. **DUST-O-VAC** collects & bags wood & plastic chips, wood & metal dust, wood shavings. Free Bag. Attaches to circular saw, planer, band saw, grinder, belt or disc sander, shaper, drill press with shaper or sander attachment, spindle shaper, wood lathe, jig saw. 110 A.C., D.C. Send for mounting instr. for all machines.

Free Ship. cost of Miss. West of Miss., add \$1. Check, M.O.

HEAVY CAST ALUMINUM BLOWER — ONLY \$9.75
110V. AC 50-60 cycles, cont. duty motor, deliver approx. 100 C.F.M. For workshop, lab, kitchen, cellar, etc. Install yourself. Send for circular.

UNIVERSAL YONKERS CORP., 137 Alexander St., M9, Yonkers 2, N. Y.

Build your own JET ENGINE!

Order these plans today

1. **JET PROPELLED BICYCLE.** Assemble your own. Photo and instructions \$1.00.
2. **HOW TO MAKE EXPERIMENTAL JET ENGINES.** Seven sheets drawings with information and instructions \$2.95.
3. **BOTH OF ABOVE** in one order \$3.75.

SEND NO MONEY. Order both at once \$3.75 C.O.D. in USA plus c.o.d. postage. Send check or Money Order and we pay postage. Get other information too. Rush Order.

J. HOUSTON MAUPIN, Dept. 55, Tipp City, Ohio

SPECIAL OFFER! LOCK-STITCH SEWING AWL \$1. Postpaid

Famous, patented lock-stitch sewing awl complete with needles, waxed thread and direction folder. Hundred uses — sewing, repairing leather goods, canvas, belting, harness, saddles, gun cases, awnings, golf bags. Extra needles and thread available. Satisfaction guaranteed or money back. Send currency, check or money order. Yates Mfg. Co., 611-H Main St., Lake Geneva, Wisconsin

World Famous EASY TO ASSEMBLE PACKAGED BOAT KITS

18 models—8 to 18 Ft.
1949 line—many new models—increased performance—simplified assembly. All parts pre-cut, frames pre-assembled. Send 25c (coin) for literature. Literature plus booklet "Plywood Boats," \$1.00.

BOAT PATTERNS—BLUE PRINTS

100 designs by Deed, Lord, Crandall, etc., plank, steel, and plywood types 6-35 ft. Detailed blueprints, full-size paper patterns. Catalog 35c (coin). Catalog and booklet "Boat Building" \$1.00.

MARINE MART—DEPT. 24—BUFFALO 7, N. Y.

MAKE MONEY at HOME

FULL or PART TIME

Start your own business making beautiful, salable, wood or plastic carvings in your own home, full or part time. With the amazing new Carvit Duplicator it's easy and fun to be your own boss, or supplement your pay with easy, interesting work at home.

MAKE and SELL

Ash Trays Ad Displays Carved Pipes
Book Ends Jewelry Religious Articles
Plaques Signs Wooden Dishes

Sell homes, friends, gift stores, department stores, novelty shops, mail order, offices, etc. Big profits... steady repeat business!

20 MINUTES - YOU'RE an EXPERT

That's all it takes to be an expert on the Carvit. From one inexpensive, dime-store master model, you can create scores of beautiful carvings in rare woods, exotic plastics, each worth many times the cheap original. Don't miss this opportunity for fun and profits. Order today from your local hardware dealer or send coupon.



CUT COUPON and MAIL TODAY



The DUMORE COMPANY

Dept. J-51 Racine, Wisconsin

- Please send complete information on the Carvit and indexing attachment for 3-dimensional carving.
 - Please send one Carvit. \$48.50 enclosed.
 - Please send one Carvit with index attachment for 3-dimensional carving. \$58.25 enclosed.
- Shipping charges C.O.D.

NAME.....
ADDRESS.....
CITY..... STATE.....

C-1

TURN YOUR SPARE TIME INTO CASH!

BUY DIRECT FROM THE

LEADING MANUFACTURER OF PRECISION ALL-PURPOSE

WHEELS Save From \$2 to \$7 each

ALL TYPES AND SIZES FROM 3" TO 23" DIAMETER

Mail Money Order or Check for \$30.00 and we will send you TWO 4.00 x 8 x 16" Diameter Wheels... High Tensile Steel... Grease Sealed Timken High Speed Taper Roller Bearings for 1" Diameter Straight Axle... Four Ply Grade "A" High Speed Goodrich Heavy Duty Tires (700 lb. Load per wheel) And Inner Tube. The Finest Quality Money Can Buy... VALUE \$22.00 Each. Add 10% if you wish shipment sent Prepaid in U.S.A.

DESCRIPTIVE CIRCULARS AND LISTS OF OUR PRODUCTS WILL BE MAILED PROMPTLY IF YOU ENCLOSE 10c IN YOUR LETTER.

We need more space to produce our New Sensational Fire Engine that carries 25 children for Fairs and Amusement Places. Therefore we offer to those who are making their own Small Autos, Trucks or Amusement Devices: ONE Brand New Model ZZ Briggs & Stratton 7.7 H.P. Engine AND FOUR of our 4.00 x 8 x 16" dia. WHEELS as shown (Value \$224.00) **\$159.95** Only..... ALSO ONE 40" overall Front Auto Type Axle: ONE 40" Rear Axle and ONE Complete Steering Assembly WITH 14" dia. Steering Wheel (Value \$43.50). **\$29.95** Only.....

SMALL AUTOS FROM \$59.00 up with and without power

Attention - SPECIAL

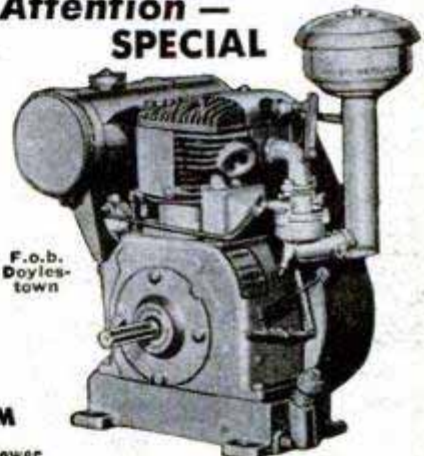

F.o.b. Doylestown

BRIGGS & STRATTON MODEL ZZ 7.7 H.P.

OSBORN WHEEL CO., 115 So. Main St., Dept. P-9, DOYLESTOWN, PENN.



Sensational Low Cost Geiger Counters & Treasure Detectors

LOW COST BATTERIES • LIGHT WEIGHT • 3-WAY SIGNAL • GTD. 1 YR.

DETECTRON GEIGER COUNTERS

includes headset, meter, flash indicator. Carrying belt. Sensitive to all radioactive minerals. Outperforms regardless of cost.

DETECTRON TREASURE DETECTORS

reach deeper. Lightweight, portable, yet positive. Highly sensitive. Low operating cost. No expensive batteries. None finer.

Write Today for Free Descriptive Literature

The DETECTRON Company, 5637 Cahuenga Road, North Hollywood, Calif.



Earn \$300⁰⁰ to \$500⁰⁰ extra profit monthly with low cost A.C. arc welding

EASY "Payout of profits" TERMS No third party involved. Make direct payments to factory.

Cash in on big demand for fast service welding. Use single phase power in your own shop. Welding skill is built in.

Faster, better, more economical. FREE Booklet on "How to start and operate your own welding business."

HOBART Industrial Type A.C. 300 and 500 amp. arc welders.



HOBART Brothers Co., Box M-991, Troy, Ohio "One of the world's largest builders of arc welders"



SET THE PACE WITH THE

- Cruises at 45 MPH—with faster pickup than car
- 39" high, 71" long overall, wt., 190 lbs.
- 8 HP motorcycle engine
- 50 miles to the gallon
- Automatic clutch
- Internal expanding brakes—handle-grip throttle controls

POWELL MANUFACTURING COMPANY

DEPT. PM949 • COMPTON, CALIF.

Powell P-81!

ONLY \$247³⁴ AT COMPTON CALIF EXCISE TAX INC.

Write for FREE folder and name of nearest dealer

Dealer Inquiries Invited

TRIUMPH

**1st
CHOICE**

for **SPORT**
and **LOW COST**
TRANSPORTATION

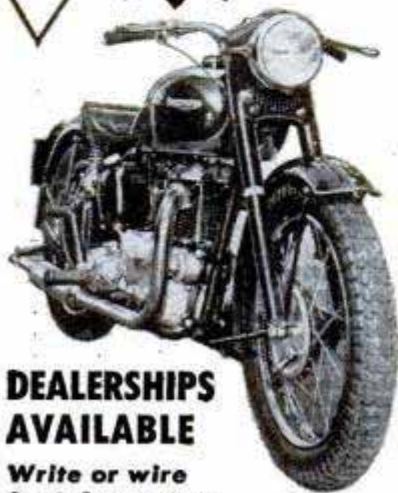

**DEALERSHIPS
AVAILABLE**

Write or wire
for information

Try a Triumph and learn why these great machines are preferred by experienced riders throughout the world... Compare it with the other makes for speed, ease of handling, economy, and safety. Ask a Triumph owner about the dependable trouble free service he enjoys... Get the facts, and you'll get a Triumph.

Exclusive Distributors for the U.S.A.

Johnson Motors, Inc.

267 W. Colorado Street • Pasadena 1, California

RIEDEL WORK GLOVES
"The Right Glove for Every Job"
Riedel Textile Corp.

342 Madison Ave. • New York 17, N. Y.

GIGANTIC MAIL SALE! CLOSEOUT WAR SURPLUS ITEMS



WELDING GENERATORS! G.E. D-C 275 to 375 Amp.
ORIGINAL COST over \$275.00

Brand New. Genuine G.E. Generators. Ready to operate. Build and repair your own machinery. Do professional work for pay. Drive with tractor, old auto engine, or electric motor. Hundred uses. Complete with instructions on "How to Weld."

Sale price, frt. pd. \$89.90
• Same unit with helmet, rods, holder, cables, etc., frt. pd. \$104.50

INDUSTRIAL CAPSTAN WINCH 3000 LBS.

MOUNT ON TRUCK, TRACTOR, BOAT, ETC.

Finest steel and bronze drive gears. 80 to 1 power ratio. Useful for farmers, truckers, merchants, factories, etc. Used by leading truck lines for loading. Excellent for hay hoist. Drive with old car 6-volt starting motor, power take-off, fan pulley, etc. Instructions.

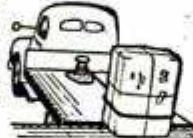

HUNDREDS OF USES

Easily mounted on tractors, trucks, docks, jeeps, etc. Many practical uses. Pays for itself quickly. Original cost over \$75.00... Sale price, frt. pd. \$24.95

BRIGGS 3.5 H.P. GAS ENGINES



Brand new, heavy duty, single cyl. air-cooled, flame arrester, thrust bearing, standard shaft, etc. Excellent farm or industrial use. Ideal for grain elevators, pumps, sprayers, scooters, lawn mowers, saws, etc. Complete instructions. Original cost over \$130.00. Sale price, frt. pd. \$77.50 (with utility clutch) \$87.50

Other Items Include:

- Power Plant, 3000 w., 60-c., 110-v., with 4-cyl. eng. \$345.00
- Reconditioned Briggs ZZ 6.5 h.p. engine. \$86.90
- Portable Power Air Compressor and Engine. \$99.50
- Multi-speed (4-shaft) 110-v., 60-c. motor. \$8.75
- Also telephones \$4.99, Rotary Pump \$3.95,
- Dozens other sale items. Radio, electronic, etc.

Order from ad or write for illustrated sales catalog. We pay all freight to you.
BURDEN SALES CO., 8th and "O" St., PM-9, Lincoln, Nebraska
(Formerly Leco Engineering Company)

Hydraulic SPEED REDUCER of many uses
Variable Speeds and INSTANT REVERSE

INPUT SPEED UP TO 700 R.P.M.

For LATHES, REAMERS, TRANSMISSION, MIDGET CARS, MILLING MACHINE TABLE, SHAPER, THREAD MILLING FIXTURES, HOME MADE WOOD WORKING LATHE, EXHAUST FAN, PUMP, HOIST, GENERATOR, OVERHEAD TROLLEY, PRODUCTION BELT, OPENING and CLOSING DOORS, and MANY OTHER USES. Industrial or Home Use. Cost Government \$300.00. High Quality Precision Workmanship. Case measures 7 1/2" Long, 7" High, 6 1/2" Wide. Input and Output Shafts 5/8" diameter. Beautiful Red Crackle Finish Case. For use with 1/3 to 1 1/2 H.P.

If C.O.D. is requested a 10% Deposit must accompany order and we ship F.O.B. Chicago.

FINGER TIP CONTROL

OUTPUT TORQUE ADJUSTMENT UP TO 180 IN. PDS.

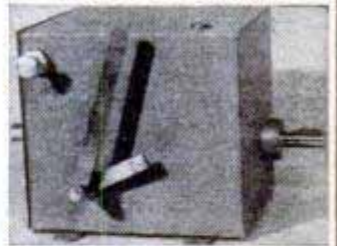

Shipping Wght. 25 pounds

Only \$54.50

1 1/2"-8 thread Lathe Chuck Adapter, \$3 extra

PREPAID 2 quarts oil included FREE

DIRZIUS MACHINE SHOP M, 1423-25 So. 52nd Ave., CICERO 50, ILL.

GARDEN TRACTOR



3-4 and 5 HORSEPOWER
Over 30 attachments with QUICK HITCH—Change from one to another in seconds.
Plow 6 to 9 1/2 inch furrow 4 to 8 inches deep.

Special discount if you order direct from factory. Send penny postcard today for big FREE catalog.

RED-E TRACTOR CO.
236 Ford de Lee Rd. • Richfield, Wisconsin

CRESCENT TOOLS

Give Wings to Work

ASK YOUR
HARDWARE
DEALER

HIGH POWER TELESCOPE
60 POWER - ALUMINUM TUBES - OPENS TO 33"

Variable Power Eyepiece Adjustable to 15X, 30X and 60X.

\$4.50

5 Sections. 4 Ground & Polished Lenses. Also used as 50X Microscope. Ready to use, only \$4.50 POSTPAID.
BROWSCOPE CO. Dept. 9M, 24 W. 45th St., NEW YORK 19, N. Y.



GEIGER COUNTERS

for locating Valuable
RADIOACTIVE MINERALS

There is a model to exactly fit YOUR requirements.....

OMAHA SCIENTIFIC SUPPLY CO.
Dept. S, 3601 N. 24th, Omaha 10, Nebraska



LAWN ORNAMENT-NOVELTY PATTERNS

28 Lawn Ornament Patterns, 25c. Other patterns; 15-20" high; Dutch Girl, Dutch Boy, Pirate, Bull Terrier, Mexican Girl, Mexican Boy, Dwarf, Penguin, Flower Girl, 10c each. 25 Novelty Patterns, 30c. All 62 Full Size Patterns, \$1.00 Postpaid. Strother Pattern Service, Dept. BF-8, Box 128, Belington, W. Va.

NOW - AMAZING NEW LOW PRICE

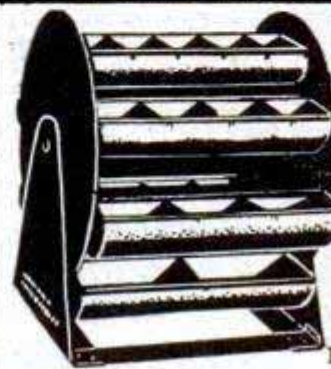

REVOLVING GADGET TRAY
for Carpenters, Machinist, Mechanics, Cobblers and Hobbyist.

FOR BOLTS, SCREWS, NAILS AND SMALL PARTS

\$5.88
K.D.

MILITARY GRADE STAINLESS STEEL FOR LIFE-WE USE

HOMERY INDUSTRIES

BOX 981 WARREN, OHIO

300 PIECE ELECTRIC GRINDER OUTFIT

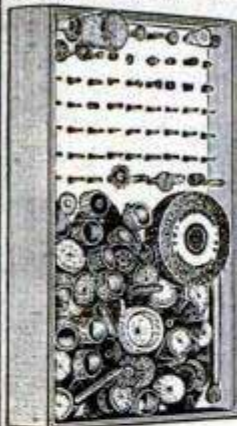

THE MASTER KIT

fits all hand grinders
for CUTTING,
SHAPING, GRINDING,
POLISHING Wood,
Metal or Plastic

\$9.75
Post
Paid
in
U.S.A.

\$50 VALUE

- 1 High Speed Steel Rotary File
- 3 Grinding Wheels 1 to 3" in diameter
- 12 Mounted Stones 1/8, 3/32, 1/4" Shanks
- 9 Rotary Cutters 1/4 and 3/32 Shanks
- 30 Miniature Rotary Cutters 3/32 Shank
- 10 Cut off Discs and Grinding Wheels
- 1 Drum Sander 1/8" Shank
- 15 Abrasive Bands for Drum Sander
- 15 Leather and Felt Polishing Wheels 1/2 to 1" in diameter
- 15 Felt Polishing Cylinders with Mandrel
- 25 Abrasive Sanding Discs 1 1/2 to 2" dia.
- 3 Rubber Wheels 7/8" diameter
- 3 Speed Drills 3/32 Shank
- 2 Mandrels 1/4 and 3/32" Shanks
- 3 Bristle Brushes
- 1 Rotary Wire Wheel Brush
- 1 Circular Saw on Mandrel 1/8" Shank
- 2 Rubber Cylinders with 3/32" Mandrels
- 150 other items—all new and valuable

2 CIRCULAR SAWS

AT A RECORD BREAKING
PRICE—BOTH AT ONLY... **\$1.50**
1" diameter saws on 1/8" Mandrels. For cutting wood, plastic, or soft metals. Order at once! Send Check or Money Order for this big bargain.

Post
Paid
in
U.S.A.

SCHUPACK SUPPLY CO., 7331 Cottage Grove, Dept. MB, Chicago 19, Ill.



FREES YOUR HANDS FOR ACTION!

**TINY LINEMASTER
COMPACT
FOOT SWITCH**

ideal for power tools
Weight: 6 1/2 oz. • \$3.75

No home workshop should do without it—finest electric treadle switch ever developed! Built to exacting specifications of hard-headed industrial purchasing agents.

Rugged and inexpensive. Sensitive, fool-proof actuating mechanism. Adaptable for operation by foot, finger, knee, elbow. Heavy gauge steel. Non-skid safety base.

Order your "COMPACT" Switch TODAY, \$3.75 postpaid
Money back if not satisfied. **SIMONDS MACHINE CO., INC.**
160 President Ave., Southbridge, Mass.



MODEL 60
F.O.B. CHICAGO *Mall Saw*
**\$54.95 Cuts Everything
from Wood to Steel**

6-in. blade cross cuts, rips, angle cuts rough or dressed lumber up to 2-in., grooves mortar joints, cuts and scores tile, concrete. Bevel depth attachment \$7.00.

MALL TOOL CO.
7805 South Chicago Ave., Chicago 19, Ill.

ELECTRIC SIREN



6 volt. Complete with push button... **\$10.95**

Fender Skirts for All Cars

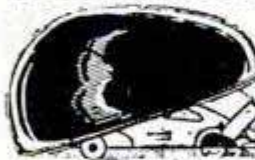

Give year, make & model of car when ordering.
All Metal. Prime finish. Rubber beading prevents rattle.
Easy to install. **\$12.95 PAIR**

1935-48 FORD V8 &
1939-48 MERCURY
DUAL MUFFLERS
Increases power. Reduces back pressure. Saves gas.
MD20N-208—
Complete Set... **\$14.95**

DUALS FOR 1949 FORDS, Set... **\$19.95**

GUTTED MUFFLERS
FOR ALL CARS
Gives that Motorboat Tone. Universal type to fit all cars, ea... **\$4.95**

We Can Supply NEW CONVERTIBLE TOPS & REBUILT MOTORS for all Cars. Write for Prices.

Send 25% Cash With All Orders, Balance C.O.D.

J. C. WHITNEY & CO.

1917 ARCHER AVE.

CHICAGO 16, ILL.

Look what you can get for only... **1395**

This is the new Hoover 1/4-H.P., 1725-R.P.M., split-phase motor. Ideal for easy-to-start, quick-to-accelerate applications, such as fans, blowers and light machine tools, etc. Rotation can be reversed. Fully ventilated. 115 volt, 60 cycle, AC only. See it at your dealer's today!



**Hitch up a HOOVER®
and you hitch up
THE BEST!**



If you want a motor that will deliver long, dependable service, even under the toughest conditions of continuous use, hitch up a Hoover.

More than ten million various-type electric motors have been made by the makers of the famous Hoover Cleaner.

Check these features of the Hoover line:

- Capacitor-start, split-phase and poly-phase types
- Ratings from 1/4 to 1 1/2 H.P., some with double-end shaft
- Single or dual voltage, 1725 or 3450 R.P.M.
- Ball or sleeve bearings
- Rigid or resilient mounts that meet NEMA specifications
- Service and parts available from authorized agencies and dealers

HOOVER MOTORS

Made in capacities of 1/4 to 1 1/2 H.P.

Product of Kingston-Conley Division

THE HOOVER COMPANY, North Canton, Ohio

MOTOR — GENERATORS

\$1

For One Dollar you receive a surplus Motor, Dynamotor, or Generator that you'll agree gives you exceptional value for your money. Besides being useful, unit will be new or used and operate from 6, 12, or 24 Volts AC or DC. Items cost Govt. many, many times this small purchase price.

Order No. PM-1909 Only \$1

CAR SHAVER MOTOR

Now — astonish your friends — use your electric shaver in your car! Dynamotor will supply 110 Volts, 10 Watt current from 6 Volt DC — and will operate most types of AC-DC shavers. Used by Govt. to supply voltage for radio equipment.

\$2

AC ELECTRIC MOTOR

110 Volt 60 cycle ball bearing motor approx. 3500 RPM. 1/25 HP. Shaft size: 3/16" x 5/8". Motor size: 7" x 4". Converted from Govt. surplus. Ideal for models, fans, etc.

Order No. PM-3909 Only \$3

GASOLINE ENGINE GENERATORS: HOMELITE

Gasoline Engine Generator — 30 Volt DC 50 ampere (1500 Watt) generator driven by single cylinder, two cycle air-cooled gas engine approx. 3 HP. Rope or electric starting. From unused Govt. vehicles. Re-conditioned. Order No. PM-4909

\$49.50

DELCO ENGINES: Gasoline Engine Generator — 12 Volt DC 750 Watt generator driven by a one cylinder, four cycle air-cooled gas engine approx. 2 HP. with self starter, voltage regulator, output meter, and on-off switch. Rope or electric start. Govt. surplus — Reconditioned.

\$59.50

SEND FULL REMITTANCE ON \$1, \$2, & \$3 ITEMS ENGINES 25% DEPOSIT, BAL. C.O.D. • SHIPPING CHARGES C.O.D.

FAIR RADIO SALES

132 SOUTH MAIN ST.

LIMA, OHIO

NEW for HOME SHOPS

DoALL World-Famous BANDSAW BLADES

These revolutionary, hard-tooth blades pioneered and perfected by DoALL have transformed cutting practices in industry — now available in sizes to fit home size bandsaws.

FOR WOOD, PLASTICS, METAL

DoALL Bandsaw Blades are unique — nothing like them for fast, smooth and straight or curved cutting of all kinds of metal, wood, plastics and other materials.

COST MUCH LESS!

The razor-sharp teeth are hard as a file, yet the bands are flexible to insure long wear. And imagine this — no resharpening is ever required. DoALL Blades outlast ordinary blades many times, are replaced when worn. This longer life means their cost becomes so much less that you can't afford not to use them. Available widths 1/8", 3/16", 1/4", 3/8", 1/2". Be sure to give length of your blade accurately.

66" to 94" lengths cost only \$1.45 each. 3 blades for \$4.00.

SEND COUPON TODAY

The DoALL Co., Des Plaines, Ill. P.M. 9-49

Enclosed is \$.....for.....blades

Length..... Width..... To cut.....

Name.....

Address.....

City..... State.....

BURR HAND SAW FILER

Makes More PROFITS

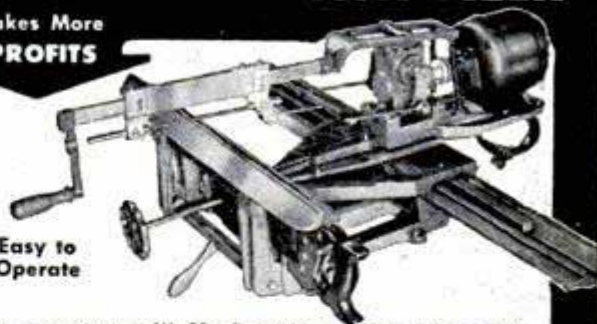

Easy to Operate

Fast, accurate, will file from both sides. Operator controls file arm. No saw carrier or adjusting screws to fuss with. A money-maker in any shop.

BURR MFG. CO.

8933 VENICE BOULEVARD
LOS ANGELES 34, CALIF.

WRITE TODAY!

MODERN LAWN MOWER SHARPENER

FOR LAWN MOWER SHOPS FIX-IT SHOPS

GOLF COURSES • PARKS
101 OTHER JOBS

Sharpens All Reel Type Mowers • Hand, Power or Gang • 10 to 20 Minutes • No Dismantling • No Extra Attachments Needed.

All reel type mowers, from 5-inch edgers to 36-inch power mowers, are quickly sharpened to extreme ends of both left and right twist blades.

Handle, wheels, roller and motor remain in place when sharpening is in process. Bed knife is sharpened in same brackets. Grinding head rides on five ball bearing races. Easy to operate.

Also sharpens chisels, joiner knives, planer blades, Big profit maker. Own your own business. Send Today for FREE Illustrated Bulletin No. 10-C

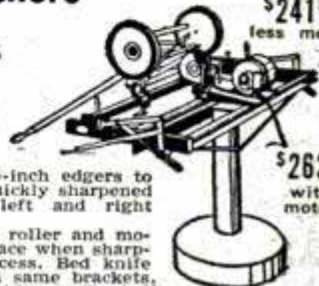

PRICE \$241.50

less motor

\$263.00 with motor

ORDER NOW

Immediate Delivery

MODERN MFG. CO. 160 N. FAIR OAKS AVE. PASADENA, CALIFORNIA

RESIZE YOUR OWN PISTONS!

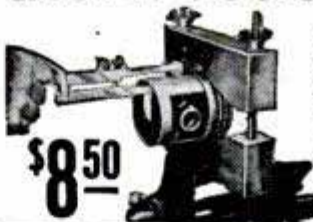

\$8.50

A bargain for mechanics

Sealed Power Piston Resizer equals work of machines costing hundreds of dollars. Simple to operate. Results permanent. Thousands now in use. Uses swaging action inside piston skirt, compressing action outside. Resizes steel, cast iron, aluminum pistons. Wood vice included. Satisfaction guaranteed. Send \$8.50, check or M. O. to Sealed Power Corporation, Muskegon 61, Mich.

Say You Saw It in POPULAR MECHANICS

WESTINGHOUSE

Air Compressor

WITH 20 FT. AIR HOSE
AND
DETACHABLE TIRE CHUCK **\$22.95**

2-CYLINDER PISTON TYPE

Spray paint your buildings, cars, trucks, machinery, etc.

Inflate tires, grease machinery, spray insecticides.

Built to sell for 3 times our low price. Operates from 1/4 h.p. motor or equivalent gas engine. Or may be run from truck, tractor, jeep power take-off or fan belt; designed for easy mounting. Capacity up to 6 1/2 cu. ft. 100 lb. pressure. Delivers filtered "Oil free air". Air output double that of similar compressors. Rugged, super-efficient, portable.

Special \$22.95 price F.O.B. Chicago area includes compressor, 20 ft. double braid heavy duty air hose, Schrader Air Chuck. You save over 1/2. Act now! Money back guarantee. Send check or money order to:

A & K EQUIPMENT & SUPPLY COMPANY

Dept. 33, Burlington, Wis.

POPULAR MECHANICS

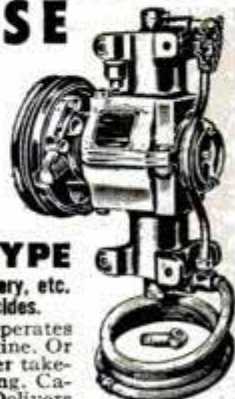



... Quick Easy Way to BIG PROFITS

Read What Others Are DOING!

"Enclosed you will find 56 orders representing 9½ hours' work on Monday and Tuesday."

"Enclosed are twelve orders secured after supper this p.m."

Housewives are Enthusiastic

Everyone that sees this outstanding Cell-U-Mop immediately wants one . . . That's the reason why our distributors are so successful . . . You also have the advantage of our other QUICK SELLING PRODUCTS that step up your Volume Sales and Profits.

Hands Never Touch the Water—Can be put in Boiling Water. Housewives Like It.

48" Long Handle

Sales QUICK, EASY Every Locality

SALES ARE EVERYWHERE . . . Sells quick to Taverns, Clubs, Hotels, Hospitals, Stores, Restaurants, Large and Small Buildings and the Homes . . . Scores can be sold on a single street . . . Note the Drain Bracket in the illustration . . . This squeezes out the water so thoroughly that HANDS NEVER TOUCH THE WATER . . . Makes no difference what you ever sold, you will like this proposition . . . Your name on a Post Card will bring you FREE PARTICULARS. GET CHOICE TERRITORY NOW.

CELL-U-MOP CO., Dept. P-9, FREEPORT, ILL.

• We Teach You How •

Gets down under and around for MOPPING, DUSTING or WASHING

DOES THE WORK OF 6 TOOLS IN 1

Cell-U-Mop is made of DuPont Cellulose Sponge. It is not rubber.

Holds 20 times its weight in water.



Sensational Bargains: LOWEST PRICES! All Items Guaranteed As Represented



HOME WORKSHOP MOTORS
 ¼ H.P. 1725 RPM. Fob. **\$11.95**
 ½ H.P. 1725 RPM. Fob. **\$13.75**

BARGAIN WORKSHOP MOTORS
 Westinghouse . . . Leland . . . G.E. & Sunbeam, etc. ½-110V. A.C. 60 cy., 1 phase, 1750 RPM. Capacitor & Repulsion Induction types. Like New. Fully Guaranteed. **\$19.75**

Fob. Only
 General Electric . . . Delco . . . Leland & Others
 ½ H.P. A.C. 110 V 60 cy., 1 phase 3450 RPM. Capacitor & Repulsion Induction Types. Fully Guaranteed. Fob. Only **\$22.50**

Write for our BARGAIN FAN & MOTOR Circular and SAVE MONEY • RUSH ORDER TODAY

C. MARSHALL SALES, 3546 W. Fullerton Ave., Dept. P-9, CHICAGO 47, ILL.

BARGAIN GASOLINE ENGINES

Jacobsen 2 cycle ¾-1 H.P. Ball Bearing. Less Gas Tank. Shop-worn but never used . . . Fob. each **\$22.50.**

BRAND NEW BROWN & BROCKMEYER MOTORS
 ¾ H.P. A.C. 110-220 V. 60 cy. 1 phase 1750 R.P.M. Ball Bearing Repulsion In-duction Type. Fob. Only **\$34.50**

Clearance of Late SUMMER BREEZE BARGAINS

BUILD YOUR OWN Window Fan, Attic Fan or Night Air Cooler . . . All parts Torrington; Deep Pitch Blade. Shaft Bearings, Pulleys, Belt, etc. #F-20. \$12.50
FAN KIT, 20", 5000 C.F.M. only . . . Fob. \$15.00
#F-24. 24" FAN KIT, 6200 C.F.M. only . . . Fob. \$15.00

Completely Assembled Ball Bearing Belt Driven Fans
 F-C #24 . . . 24" . . . 6200 C.F.M. Only **\$32.50 Fob.**
 F-C #30 . . . 30" . . . 8500 C.F.M. Only **\$36.00 Fob.**
 F-C #36 . . . 36" . . . 9600 C.F.M. Only **\$39.75 Fob.**
 Add \$11.75 if Motor is desired on Above Fans.

16" 3 Speed Oscillating Fans . . . Gen'l Electric, Robbins & Myers Makes; Like New . . . List Price \$45.00. Only \$22.50 Fob. Same As Above.
1 Speed 16" Non-Oscillating. 110 V. A.C. Only \$15.00 Fob.
16" Westinghouse Exhaust Fans #388 W. 110 V. A.C. Only \$18.00 Fob.

BUILD HEAVY DUTY MACHINES

SAVE UP TO 90%—You can build, using read plans, all kinds of machines, for home, farm or shop—scooters, portable sawmills, metal working machines, concrete machinery of all kinds, printing equipment, woodworking machines, midget autos, dish washers, farm equipment, freezers, tractors.

FREE CATALOG HANDBOOK
 183 SETS OF PLANS
 VALUABLE INFORMATION

NICHOLS EQUIPMENT COMPANY
 D-2610 PURVIS, MISS.

SAY YOU SAW IT IN POPULAR MECHANICS

BUILD YOUR OWN TILTING ARBOR SAW!

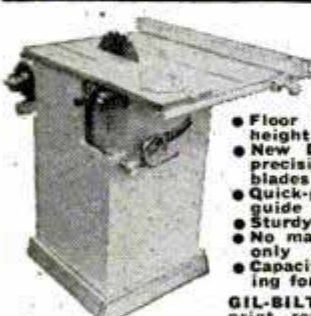

• 27x28 in. table stays level. Blade tilts full 45 degrees
 • 10 in. blade cuts ¾ in. deep, jackscrew depth adjustment
SAVE \$50 OR MORE

- Floor model, 34 in. table height
 - New Departure ball bearing arbor, ¾ in. precision shaft, ready to run, ½ in. bore blades
 - Quick-positioning, self-aligning rip fence guide
 - Sturdy wood, steel and aluminum construction
 - No machining—Build easily with hand tools only
 - Capacity and performance of floor saws selling for \$150.00 and up!
- GIL-BILT Step-by-Step pictorial plans (No blueprint reading required), full scale patterns, 11 actual photographs. \$1.00**

GIL-BILT Metal Parts Kit—includes Plans, ball-bearing arbor, cast aluminum miter gauge and bar, rip fence guide, machined lock knobs, jackscrew mechanism with 4½ in. handwheel, and all other metal parts including every screw, bolt, nut and washer (less blade). \$29.95
 Same Kit with 10" combination blade. **\$25.90**
 Same Kit with 8" combination blade. **\$24.90**

Returns in 10 days for full refund if not satisfied. (Prices include postage up to 600 miles.)

Also available—Plans and Metal Parts Kits for 8" Tilt/Table Saw and 12" Band Saw. Order Plans at \$1.00 each—sent postpaid anywhere in the world, or write for FREE descriptive Catalog.

GILLIOM POWER TOOLS P.O. BOX 1-PJ, LAMBERT FIELD ST. LOUIS 21, MISSOURI



DRAINS CELLARS, WASH TRAYS CIRCULATES OIL

Pumps 1800 GPH 300 gal. 30' high, use ¼ to ½ HP motor. Will not clog. **\$6.50**

Postpaid if cash with order. (Add 50c for west of the Mississippi.)
 Thousands in use since 1936

LABAWCO PUMPS, BELLE MEAD 7, N. J.

FURNITURE MAKING and CABINET WORK

By B. W. PELTON

Complete Step-by-Step Directions for making Every Type of Furniture —Including Built-in Conveniences and Home-remodeling Jobs

Here, in a great new handbook is everything you want to know about furniture making; cabinet work, repair jobs, and remodeling projects. Accurate drawings and practical instructions show you all the tricks of the trade and the real professional methods of repairing, refinishing and reupholstering worn or broken pieces. And there are complete directions for every type of home-remodeling project. Every job is explained in careful detail by a master craftsman who gives you authentic instructions on exactly how to carry out each step in the work—from obtaining the materials to the final finishing operations; staining, varnishing, waxing, etc.

MAIL THIS COUPON

D. VAN NOSTRAND COMPANY, INC. 250 Fourth Avenue, New York 3, N. Y. Examine This Great New Book FREE!

Please send me a copy of "Furniture Making and Cabinet Work." Within 10 days I will either return the book, or send you \$2.95, plus postage, as a down payment, and \$2.00 a month for two months until the total price of \$6.95, plus postage, is paid. (If you send entire amount of \$6.95 with this coupon, we will pay postage. Same return privilege and refund guarantee if not completely satisfied.)

SEND NO MONEY NAME _____ ADDRESS _____ CITY _____ ZONE _____ STATE _____ Pop. Mechanics—Sept.

WE FURNISH ALL MACHINED METAL PARTS, EVERY SCREW, NUT, BOLT, WASHER, AND COMPLETE PLANS FOR THIS...

BIG 10" POWER SAW



\$9.95
LESS GUARD AND WOOD

POST PAID ANYWHERE IN U.S.A.

FULL \$9.95 REFUND IF NOT SATISFIED WITHIN 10 DAYS



ASSEMBLE IT YOURSELF WITH SIMPLE HOUSEHOLD TOOLS!

TABLE 24" x 20" • TILTS TO 45°
CUTS 0" TO 3/4" DEEP • TAKES 10" BLADE

COMPLETE PLANS (WITHOUT PARTS) 10c

MARCUS • POLLAK DEPT. 44 ROYERSFORD, PA.

GRIP "Hard-to-reach" NUTS THIS EASY WAY

Here's a real time and temper saving wrench that solves the problem of getting at those "hard-to-reach" nuts on radios, electric appliances, automobile bodies, other sheet metal products.

If you've ever fumbled a nut in the tight spots (and who hasn't!), here's your answer. No more unnecessary disassembly of confining parts in working areas either! This wrench slips on your finger and lets you get right at those nuts and bolts with your finger tip. Strong. Sturdy. Flanges adjust for snug fit on any size finger.

For a set of 4 wrenches that fit the 4 most popular hex nut sizes. — 1/4", 5/16", 11/32", 3/8" across the face.

Ask your hardware dealer. If he can't supply you, order direct. Send 39¢ plus 1¢ for postage—coin, check or money order. No C.O.D.'s, please.



TOUCH'N'GRIP

FINGER TOOLS
F. E. REDFIELD
31 Colonial Drive, Dumont, N.J.

"Wellworth" COMPRESSORS SINGLE-STAGE DUPLEX CYLINDER

Build your own compressor unit. Sizes 12, 17.3, 30 and 45.7 c.f.m. at 100 lbs. per sq. inch. Timken bearings, splash lubrication, automatic unloading and idling. Built-in loadless starting for automatic stop and start operation, or constant speed suction unloader for continuous operation.

Size	C.F.M.	Price	Shp. Wt.	Motor Required
2 1/2 x 2 1/2	12	\$102.05	140	2 HP
3 x 3	17.3	113.75	160	3 HP
3 1/2 x 3	30	153.85	210	5 HP
4 x 3 1/2	45.7	246.55	310	7 1/2 HP

Two Stage Compressors for 200 lbs. Pressure				
3 x 4 1/4	2 1/2	5	110.35	140 1 HP
3 1/2 x 4 1/4	2 1/2	10	124.45	160 2 HP
4 x 4 1/4	3	19.8	152.60	235 5 HP
4 1/2 x 4 1/4	3 1/2	30	302.55	310 7 1/2 HP
5 1/4 x 4 1/4	3 1/2	36	328.00	350 10 HP
7 1/2 x 4 1/4	4	78	653.10	575 15 HP
7 1/2 x 4 1/4	4	92	653.10	575 20 HP

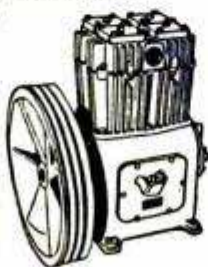

State if desired for automatic stop and start or continuous operation with constant speed unloader. Belts, pulleys, motors and gasoline engines available. Prices upon request.

WELLWORTH TRADING CO. • 1831 S. State St. • Dept. D-9 • Chicago 16, Ill.

G.E. MOTORS

• 1/2 hp • 60 cycles A.C.
• 115 volts • 1725 rpm

This G.E. ball-bearing motor is especially suited for home workshop use on power saws, grinders, buffers, edgers, sanders, joiners, planers, lathes, drill presses, paint sprayers and many similar devices. It has a double shaft and comes complete with switch cord and plug. Thermal overload. Order yours now. Postpaid in \$29.95 U.S.A.



STANDARD ELECTRIC MFG. CO., INC.
West Berlin, New Jersey

SURPLUS BARGAINS



LINEMAN'S TOOL & SAFETY BELT
Brand new web type belts in the original package. ONLY \$3.95

POLE AND TREE CLIMBERS
Without straps ONLY \$1.50
Used, good Per Pair

SEND 10c for our jam-packed catalog! Enclose full amount with order.

C & H SALES COMPANY
1850 M-9 E. COLORADO ST. PASADENA 8, CALIF.

BARGAIN!

HIGH SPEED ROTARY FILES

Set of 5 Assorted.....\$ 2.00
" " 10 " 3.75
" " 20 " 7.25
" " 30 " 10.00
1/4" shank



WE BUY SURPLUS TOOLS

SID TOOL CO., 183 Grand St., N. Y., N. Y.

SHARPEN CIRCULAR SAWS LIKE AN EXPERT



No experience needed. Two simple adjustments. Gets hollow-ground, cross-cut or combination saw blades true and sharp. Fits 6" to 12" blades with 1/2" to 1 1/16" centers. Includes file and complete instructions. \$6.95 postpaid. (Check or money order) C.O.D.s postage extra. Guaranteed—Money back if not satisfied after 10 day trial. A money maker for fix-it shops. Soon pays for itself. Order today.

\$6.25 SURE SHARP MFG. CO., Dept. M-99, P. O. Box 24, Santa Ana, Calif.

Say You Saw It in Popular Mechanics

BRUSH PLATING OUTFITS

• for re-plating articles in the home and shop. No tanks necessary. Free particulars. GUNMETAL CO., AVE. M, DECATUR, ILLINOIS

"WELLWORTH" TWO STAGE COMPRESSOR UNIT

Ideal for paint spraying and general use

Compressor: Size 3 1/2 x 2 x 2 1/2 with unloader for continuous pressure service; displacement 10 C.F.M. at 200 lbs. pressure. Unloader set at 150 to 165 lbs. Compressor idles when 165 lbs. is reached, starts pumping again when pressure is down to 150 lbs. Wisconsin Gasoline air cooled, easy starting engine, 3 1/2 H.P. at 1800 R.P.M. 4.1 H.P. at 2400.

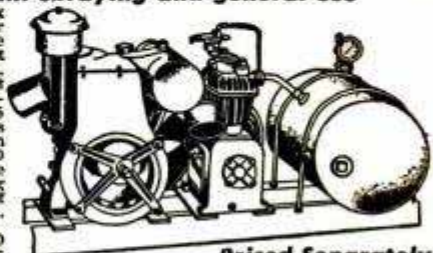

Priced Separately

Air Tank: A.S.M.E. 200 lbs. working pressure; size 16" x 20" with safety valve, drain, two 3/8" globe valves and pressure gauge. 2 "V" belts and pulley. 40 ft. air hose and fittings. Reg. price \$409 less mounting base Shipping wt. 350 lbs.

Compressor with unloader, wt. 160 lbs. \$124.00
Engine only, wt. 90 lbs. 87.50
Tank only, wt. 110 lbs. 52.50

Price F.O.B. Chicago. Sold on money back guarantee. Send check or money order today. Prompt shipment. Catalog free.

\$225 WELLWORTH TRADING CO. • 1831 S. State St. • Dept. D-9 • Chicago 16, Ill.

"Wellworth" Sensational Offer! Reg. \$60.50 WESTINGHOUSE AIR COMPRESSOR

2-CYLINDER PISTON TYPE

Operates with 1/2 H.P. Motor or equivalent gas engine.

Complete outfit consisting of compressor, pressure tank, air gauge, air chuck, 20-ft. hose, pop valve, copper tubing with 4 brass flared fittings for connecting compressor to tank, 4-way cross and 3 nipples. Complete outfit of 7 items..... ONLY

\$29.95
SHIPPING
WT.
40 LBS.

COMPRESSOR SEPARATELY..... **\$21.50**

IDEAL for HOME • FARM • FACTORY
Wherever Compressed Air is Needed

For spraying paints, insecticides, etc.; inflating tires, operating air tools and many more uses. Automatic clutch makes it suitable for mounting and operating from trucks, tractors, etc. Instructions furnished. A fortunate purchase from the government enables us to offer you this amazing buy. All brand new equipment. Replacement parts available.

This low price is but a fraction of the price of manufacturer and of leading mail order houses.

Model T-1
Brand
New!

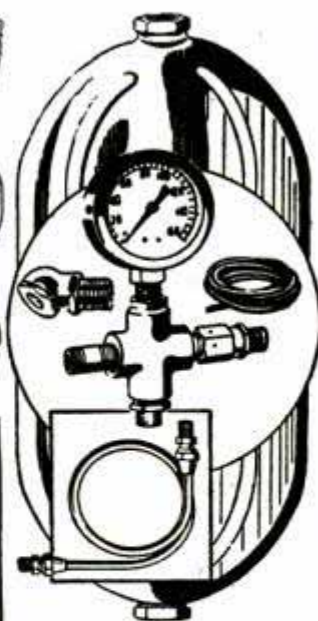
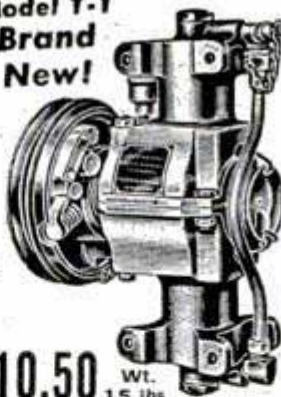

Equipment less compressor.... **\$10.50** Wt. 15 lbs.

THE COMPRESSOR

Piston Type, 2-cylinder, 2 inch bore, 1 1/4" Stroke Ball Bearing, 3.27 C.F.M. at 600 R.P.M. Capacity up to 6.54 C.F.M. Suggested operating pressure 75 P.S.I. DIMENSIONS: 9" wide, 11 1/2" high, 6 3/4" deep. Wt. 26 lbs.

TANK and ACCESSORIES

6" x 24" stainless steel tank suitable for 150 lb. pressure. Two 1/2" openings. Air gauge, pop valve, air chuck, 20 ft. hose, Copper tubing and fittings as shown. Wt. 15 lbs.

PORTABLE SPRAY OUTFIT

Best Buy of the Year

1/4 H.P. Heavy
Duty External
Atomizing Gun



None Better
at Double
This Price

Paint Sprayer mounted on 6 x 24 inch tank, 1/4 H.P. 110 V. 60 cy. Heavy duty motor with overload relay, 10 ft. cord and plug, V Belt drive, Piston type Compressor with 2 Compression rings, 1 oil ring, 2 inch Bore, 1 3/4 inch stroke, displacement 2.88 C.F.M. at 60 lbs. pressure, Safety Valve. Gun external atomizing. Flat and round spray, quart cup; maintains 35 to 40 lbs. working pressure. Oil and water extractor, 1 air gauge, 20 ft. heavy duty 2-braid air hose with leak proof fittings, complete with carrying handle. Net weight 54 lbs., ship. wt. 60 lbs.....

\$57.50

Outfit less motor. Wt. 30 lbs..... **\$47.50**
Compressor only. Wt. 14 lbs..... **17.50**
Spray gun and 20 ft. hose. Wt. 7 lbs... **12.95**

140 CFM "WELLWORTH" BLOWER



Single-inlet blower that gives top performance on heating, ventilating, exhausting, cooling, drying and similar applications. 5 1/2 x 4" mounting flange with 2 1/2" square discharge. 3 1/2" dia. blower wheel powered by direct-connected 1/15 H.P., 110V., 60C., A.C. motor with conduit box and 20" leads. 7 1/2" wide less flange by 7 1/4" H. x 6 3/4" D. Suited for hundreds of new and replacement uses. Shpg. wt. 6 lbs.....

\$16.50

PNEUMATIC AIR TOOLS

USED, GUARANTEED LIKE NEW.



CHICAGO PNEUMATIC RIVETER & CHIPPING HAMMER

CP4X Pistol grip handle. Takes up to 3/16" rivet. Weight 8 lbs. List price \$73.00.

SPECIAL PRICE..... **\$14.50**

Same as above, brand new..... **\$22.50**

Size CP3. Takes **\$10.95**

5/32" Rivet.....

Chicago Pneumatic Lever Type AIR DRILL



With 1/4" Jacob Chuck. Wt. 2 lbs. List price **\$17.50** \$55.00. Only.....



Ingersoll Rand AIR DRILL
With 1/4" Jacob Chuck. Wt. 2 lbs. List price **\$17.50** \$55.00. Only.....

AUTOMATIC COMPRESSOR UNIT

1/3 H.P. heavy duty capacitor motor AC 110/220 volt 60 cycle, 2 x 1 3/4 inch piston type compressor, splash feed lubrication, 12 x 24 inch tank, automatic pressure switch, pressure range 100 to 125 lbs., CFM 2.2, check valve, safety valve, air regulator with gauge and filter, 20 ft. air hose with air chuck for inflating tires. V. belt drive. Shipping wt. 90 lbs.

Special **\$79.50**
Price

Same unit as above with 1/2 H.P. motor, furnished with 13" x 24" tank. CFM 2.8 at 125 lb. pressure. Shipping wt. 125 lbs..... **\$98.50**

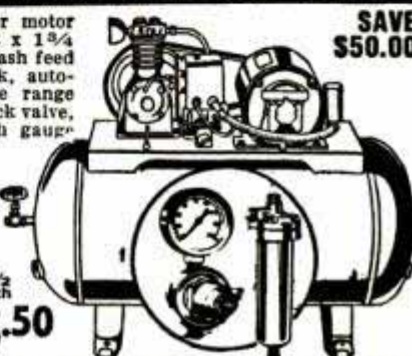

SAVE **\$50.00**

300 GAL. COOLANT PUMP

A HEAVY-DUTY PUMP AT 40% LESS

You pay less and get a larger, higher pressure, higher capacity, heavy duty coolant-type, recirculating pump. Also extensively used on evaporative coolers. Will deliver 60 gal. per hr. at 8 ft. head and 300 GPH at no head. Heavy duty 1/30 H.P. totally enclosed, 110V., 60C. motor with long life oiling. Noncorrosive shaft and pump. 10 1/2" high, 3/8" I.P.T. Ship. wt. 12 lbs.

\$19.50



AUTOMATIC PRESSURE SWITCH WITH UNLOADER

Double pole, with 2 way release valve. Set at 125 to 150 lbs. pressure. Wt. 4 lbs. Only..... **\$10.25**

Same without unloader..... **\$7.50**

Switch—20 to 40 lb. adjustable to 80 lbs. For air or water **\$5.50**



"Wellworth" Check Valves



Dash pot type Quiet operating
1/4" valve **\$2.75**
1/2" valve **\$4.50**

"Wellworth" 1/4" REDUCING VALVE & GAUGE

Oil resistant, pressure 0-to-200 lb. Reduced pressure 0-to-75 lb.; 3 outlets 1/4". **\$5.75** Wt. 2 lbs.



Reduced Price
Only **\$14.50**

6 FT. STOW FLEXIBLE SHAFT

Heavy Duty, 3/8" Core. Best piano wire. Ball bearing handle and arbor, rubber covered housing; for 1/2" motor shaft; for 1/2" bore wheels. Operates on 1/4 H.P. Motor at 1725 or 3450 R.P.M. \$29.00 Value, **\$14.50**. Wt. 8 lbs.

1/30 H.P. MOTOR BARGAIN

12 volt D.C. motor. 2450 R.P.M. 2.0 amps, 1/4" shaft. Size overall 3" x 4". Weight 3 lbs. USE AS 6 VOLT GENERATOR. **\$2.75** ea.



QUANTITY PRICES
4 for... **\$7.50** 24 for... **\$36.00** 100 for... **\$135.00**

Prices f.o.b. Chicago. Immediate delivery. All items sold on money back guarantee. Send check or money order today. Catalog FREE.

WELLWORTH TRADING CO.
1831 S. STATE ST. DEPT. D-9 CHICAGO 16, ILL.

**NOW! USE YOUR ELECTRIC DRILL for
POLISHING!
GRINDING!
SANDING!**

**Work on curved
or flat
surfaces**

You can use it to fix bodies, fenders; wax; polish cars, floors, linoleum; re-finish furniture, wood, metal surfaces; smooth, reduce welds, etc.

**FITS ANY 1/4 IN. CHUCK or DRILL,
FLEXIBLE SHAFT, MOTOR, etc.**

Designed and engineered for high speed sanding, polishing, finishing, etc. Full 6 1/2 inch rubber face plate bends into curved surface. New clamp arrangement mounts sanding discs instantly—no cementing. Draw-string lamb's wool bonnet slips on for high speed polishing, finishing, etc. Outfit includes 6 1/2" flexible rubber disc with 1/4" metal shank, fibre backed sanding disc and heavy lamb's wool polisher. Equals \$75.00 outfits in performance. You'll find hundreds of time saving uses for it. Fully guaranteed. Shp. wgt. 2 lbs. F.O.B. Chicago. Shipment in U.S.A. only.

6 1/2 in. heavy \$4.95 5 in. size for light \$2.49
duty type. Each hand drills. Each

At your favorite hardware store or direct.

PREHLER PROVED PRODUCTS

Division Norbert Prehler & Co.

1623-25 Milwaukee Ave. Dept. PM9 Chicago 47, Illinois



Bends To Take Curved Surfaces



On Flat Surface



On Curved Surface



Polishes

War Surplus—DYNAMOTORS



D-2 Converts to 110 V AC in ten minutes, diagram included, contains integral gear box having four 1/4" drive shafts turning simultaneously at the following speeds:
4000 RPM—Grinders, buffers, flexible shaft tools, etc.
150 RPM—Wrapping fishing rods, slow speed tools.

Adv. Disp. Beams, A Thousand Other Uses Around the Work Shop. ONLY \$5.95

D-1 Converts to 110 V AC in ten minutes, diagram included, has shaft with squirrel cage blower, also gear reducer with 2 shafts and pulleys at the other end. 1001 uses. New \$4.95

6 V. MOTOR A real beauty, removed from aircraft. Type used for auto fan. Many uses. Ea. \$1.50

PORTABLE FIELD TELEPHONE

An ideal portable field telephone. Complete in a rugged steel case for years of wear. Ringer circuit and TS-13 handset. 5"x8"x9". Simple two wire operation. 15 miles distance and upwards. Can be used for television installation, intercom system, construction companies outside and inside work, etc. 13 lbs. As good as new, each \$9.95 2 for \$18.95

HEADSETS HS-23 and 33... Used... 98c
HS-30 NEW... \$1.59

All prices F.O.B. Chicago. 80% deposit required on all C.O.D. Orders. Write for free catalog.

NESCOR ELECTRONICS Dept. PM9, 2635 W. Grand Ave. Chicago 12, Ill.



**NOW a DYNAMIC
HEAVY DUTY
INDUSTRIAL WELDER**

FOR AUTO—HOME APPLIANCE & FARM IMPLEMENT REPAIRS! \$28.50 ONLY
WORKS ON IRON, STEEL & other metals... does work you'd expect from a larger, costlier machine; portable, easily carried; OPERATES FROM ANY properly wired 110 VOLT LINE. Also available for 220 volt operation at slight additional cost; has 8 metallic & carbon arc welding heat stages. EASY TO OPERATE TRANSFORMER TYPE WELDER—If inexperienced you can learn to do professional work by following the SIMPLIFIED WELDING & OPERATING INSTRUCTIONS FURNISHED—comes complete ready to operate with helmet, rods, cable, instructions. SAVE TIME AND MONEY—Do your own welding—Just a few repair jobs will pay for this machine. A practical and profitable machine tool for any workshop. Make money doing repair work for others. Costs a few cents to operate.



**SPECIAL GIFT OFFER! WORTH \$6.80
ARC TORCH YOURS at NO EXTRA COST!**

write today for FREE DETAILS. ARC TORCH GIFT OFFER and DYNAMIC WELDER 10-Day Trial Offer.
DYNAMIC WELDER CO., Dept. TD-99
15 EAST 23rd STREET CHICAGO 16, ILLINOIS

**MICRO-VOX....
THE WIRELESS "MIKE"**

**Broadcasts Over Any
Radio Within 75 Feet!**

Here's a fascinating complete miniature transmitting system that will delight everyone! Round table discussions... Baby listener... Practical jokes and dozens of other uses that will astonish one and all! Complete with tube, batteries, tuner and built-in high-fidelity microphone. Clear, Life-like tone. Easy to operate!

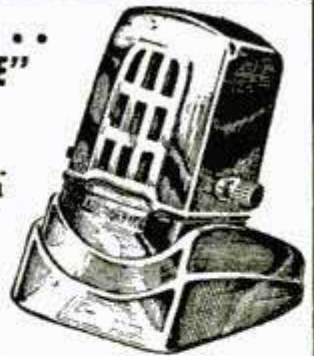

**SAVE MONEY! Send Check or M.O.
We Pay Postage. C.O.D. Plus Postage.**

\$6.95 COMPLETE

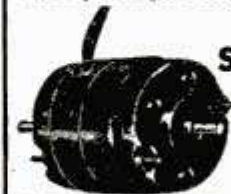

SMALL 6 VOLT D.C. MOTOR

Ideally suited for Buffers, Grinders, Fans, home-built gadgets and small vehicles. Hobbyists, Mechanics: here is the small high powered unit that fits your specific need! 6 volt D.C. 3500 R.P.M. (12 volts A.C.)

\$2.95 each \$2.50 in lots of 10 or more

TRUSOUND, INC. (Dept. PM-8) 630 W. Randolph St. Chicago 6, Ill.

Print Your Own

Cards, stationery, circulars, tags, labels, photo and movie titles, advertising, etc. Save money. Print for Others, Good Profit; easy rules sent. Raised Printing like Engraving, too. Sold direct from factory only. Write for free catalog of outfits and all details. **KELSEY PRESSES, M-37, Meriden, Conn.**



Unbreakable Fire-Safe Amber Hammer Proof Shock Proof
TOOL STEEL PRICED FROM 5c TO \$1.00 EACH

**Ask Your Hardware Store for
FULLER'S
Unbreakable Amber Handle
SCREW DRIVERS**

America's most popular line of moderately-priced screw drivers! Wide range of sizes. FULLER TOOL COMPANY, Inc. 911 Faile St. New York 59
World's largest makers of Amber-Handle Tools

LATHE CUTTER BIT GRINDING GAUGE
For checking clearance and rake angles.
50c postpaid
SOUTH BEND LATHE WORKS
455H E. MADISON ST., SOUTH BEND 22, IND.

SAY YOU SAW IT IN POPULAR MECHANICS

MARCOT KEY MACHINE



MARCOT No. 8 KEY MACHINE, mounted on Cabinet, less motor, \$98.00
Auto Code Book and Depth Keys. \$12.50
100 Dr. Popular Key Blanks... 60.00
Set—Key File, Follow-Through Rods, Lock Picks, Bit Key Gauge, Thimble, Pins, Springs... 10.50
"Locksmith Trade Books"... 6.75
How to Open Locks without Keys or Picks; Secret of Locksmithing; How to Make Keys by the Impression Method; Master Key Systems.
TOTAL COST \$184.75

A. J. MARCOTTE CO., 1200 N. Kedzie Ave., Dept. PM, Chicago 51, Ill.

EASY-TO-BUILD WORKBENCHES



Constructional details on 13 sturdy, easy-to-build benches... large cabinet bench with 18 drawers, tool cabinet with 29 drawers, streamlined cabinet bench, drop-down bench for narrow garage, portable apr. bench, carpenters' fold-in-leg bench, etc. Send dollar bill today.
CRAFTPLANS, Dept. P-144, 1321 S. Michigan Ave., Chicago 5, Ill.

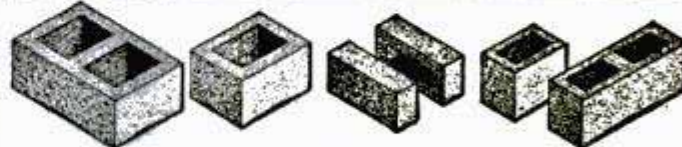

Make Concrete Blocks and Bricks

New superior method makes square, true, easy-to-lay units which will pass any building code. Small investment, high production; big profits. One \$30.00 machine will make four 5"x8"x12" blocks per minute—1000 per day. Pays for itself in a few days. Sell blocks or save 1/3 building cost by making and laying your own.

POST CARD BRINGS FREE FOLDER
Economy Manufacturing Company
Dept. P Stone Mountain, Georgia

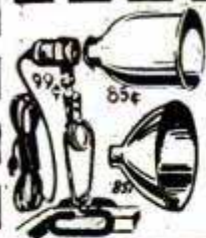

CLAMP-ON ANYWHERE LAMP

WITH ADJUSTABLE BALL AND SOCKET SWIVEL HEAD. LONG RUBBER COVERED CORD AND WALL PLUG. The All Purpose Lamp. Wonderful for indoor Photography, Floodlights, Baby Spot or Large Spot, Personal Bed Reading, Workbench, Garage, etc. Lamp Alone **99c**
Highly Polished 9" diameter Parabolic Reflector or 5" diameter Spot Reflector at ONLY **85c ea.**

SAVE UP TO 85% IN WAR SURPLUS AT "GADGETEER'S HEAVEN"



16 POCKET VEST

Sturdy, Yet Light Wt. Satin Lined with Tie Straps, 14 Outside Pockets, Plus Knife, gun, or Tool Leather Holder, 2 large 11" x 8" Pockets

Inside, Wonderful Hunting, Fishing, or Mechanic. A Steal at **\$2.79**



Sperry Aircraft Directional GYRO COMPASS

Precision made for Positive Direction. 360° swing calibrated in 1/10° (6 min). Built in bank indicator, lum.dial. 4 1/2" sq. with 3" dia. face. Vacuum operated. Ideal for autos, planes, boats. Can be used in autos and boats by attaching one tube to intake manifold. Complete with re-set & caging knob. ONLY **\$4.49**



Genuine ARMY AIR FORCES SUNGLASSES THE REAL McCOY!

AAF 6 Base, Precision Polished and Ground, Glare-Free lens with leather case that can be attached to belt. Gold plated adjustable frame. Pearlloid sweat bar and pads. A real Palley **\$3.95**
\$17.50 Value for Only

ARMY AIRFORCE TYPE SUNGLASSES

93% ultra-violet ray free. Polished & Ground 4 base lenses. Gold plated frame, Pearlloid bar and pads. Handsome leatherette case. **\$2.39**
OUR SPECIAL PRICE...

HUNTING KNIFE 6" chrome vanadium

blade, handle, leather grip. In leather sheath

\$5.98 Value for ONLY **\$1.89** (Like Above) 5", polished blade **\$1.69**
With Parkerized blk. Finish **\$1.49**

BOLO KNIFE

10" x 2" Parkerized blade. 5" Gripped Handle. Weight 1 1/2 lbs... Ideal for Hunting, Clearing Brush or Trails. With Case . . . **\$1.19 ea.**

NYLON FISHLINE Special

STRONG - LIGHTWEIGHT - 2 PLY Nylon Fishing Line.. ROTPROOF & WATERPROOF!! Treated for strength & long life. ON SPOOLS 10# TEST, 2500 ft - Black or White **1.69**
25# Test, 1000 ft - Sea Green . . **1.59**
25# Test, 1500 ft - White **1.89**
45# Test, 750 ft - Green **3.19**

Genuine LEATHERETTE to cover Chairs, Patio Furniture, Nooks, Auto Seats, etc. 10 colors at a BARGAIN PRICE.

WIDTH	COLORS	PRICE (per run. yd.)
36"	Grey, Brown, Black	\$1.19
36"	Lt. Green, Dark Green, Blue	1.65
54"	Red, Grey, Lt. Blue, Ivory, Yellow	1.89

FAM RUBBER CUSHIONS Molded and pre-shaped. Cement or cut to fit. For chair auto & truck seats, trailer & boat seats.

17" x 22" x 4" **\$4.89 ea.** 36" x 18" x 4" **\$5.39 ea.**
62" x 2" x 24" **\$8.50**

Loose Leaf BINDER 3 metal post. Cylindrical locking heavy duty 3/16" fabricated hinged cover. End identification window

Ideal for price books, salesmen catalogues, photo albums, students, publications, Reference books, etc. Will hold 500 sheets, 8" x 11". **59c ea.**
A \$5.00 Value

PALLEY SEPTEMBER BARGAINS!

NAVY BATTLE LANTERN

This powerful battle tested lantern complete with 2 standard 1 1/2 volt dry cell batteries. Size 6" x 7" x 4" with a 4" dia. reflector. **\$3.29**

Plexiglas Window 12 1/2" x 9" - 3/8" thick with aluminum piano hinge **\$1.69**

Chronograph WRIST WATCH

17 jewel - One of the finest made anywhere. Cased in Switzerland. Sweep sec. hand, stop & re-set buttons. Measures distance, airspeed, groundspeed. Ideal for the sportsman. **Sept. Only... \$22.50**



PLASTIC KITS

HERE ARE UNSURPASSED VALUES for ARTISTICALLY INCLINED HOME HOBBYIST! Start Planning Novel Xmas Gifts Now! Kit #1 contains 2 lbs. plexiglass & Lucite sheet in various shapes, 1 oz. bottle of clearset cement, and 5 bottles of colors in Orchid, Red, Yellow, Peach, etc. Also a Plastic Handbook of uses & instructions. This set easily worth \$5.50. Our Price . . . **\$2.19**
Kit #2 contains 1 1/2 lbs. of plastic sheet, a 1 oz. bottle of clearset cement, and the Plastic Handbook. A \$2.50 Value for ONLY **99c**

Plexiglass & Nascolite clear plastic shts. NASCOLITE - Full sheets app. 1/8" x 37 1/2" x 49 1/2", app. 10 1/2 lbs. each **\$12.50**

PLEXIGLASS - Full Sheet 5/16" x 36" x 24" . . . Per Sheet.. **\$13.00**
5/16" x 36" x 48" . . . Per Sheet.. **\$25.00**
Fabricators write in for our special quantity prices, all above are new & masked. Also inquire about other large stocks of Plastics.

NEW TARPS - HEAVY CANVAS

Mildew & Flame Resistant 9' x 16' **\$11.95 ea.**
Cheap outside storage!! They are really moving at these prices: **\$3.95**
5 ft. x 7 ft. size **\$3.95**
8 1/2' x 16' **\$8.50** 16' x 22' **20.95** 16' x 32' **29.95**
NEW Rubberized Linen Tarp - 7' x 11' Waterproof, weighs only 3 lbs. **\$5.95**
Ideal for outside car storage.

KLEER-VUE NIGHT DRIVING GLASSES

With 57mm yellow amber - 6 base lenses. PRECISION GROUND & POLISHED to reduce Glare of oncoming headlights. Sharpens 'object focus' more clearly during night driving.

In Men's size or Ladies Harlequin style. A \$16.00 VALUE . . . **\$5.89**

SAME GLASSES but clip-ons. Fit-over style without temple bars **\$4.59**

Hand COMPASSES

#151 - MARCHING - Lensite, with Luminous Dial . . **\$1.59**
#152 - MATCHBOX - both jewel & liquid floating dial **39c**
#153 - NEW!!! JEWEL Watch Pocket Compass **1.59**
#154 - WRIST STRAP Compass **69c**

NAVIGATORS MAGNETIC COMPASS TYPE D-12

Rotating verge range ring, calibrated in 1 degree increments from 0 to 360°. Two parallel grid wires for N-S line alignment. Rubber lined. Fine for Boats, Aircraft, etc. **\$14.95**

HS 33 NEW LOW IMPEDENCE RADIO HEADSET

Latest & most improved style. Currently in use in aircraft. Packed in original boxes. Leather hd. band, sponge rubber ear pads. Includes Card & Jack High-Low Impedence Adapter . . **35c ea.**

Hand Mike Highly Sensitive with thumb control button on handle. Ideal for home recorders, public address systems, etc. Comp. with 2 ft. rub. cd. & phone plug. **\$1.19**

with knobs and rubber pads for non slippage on each section. A must for navigators, mechanics, draftsmen, and engineers . . . You've never seen 'em at **97c ea.**

PALLEY SUPPLY COMPANY
6321 SAN FERNANDO RD.
DEPT. PM9 GLENDALE 1, CALIFORNIA

FREE! 1949 CATALOG
10,000 Bargains in War Surplus
92 Page, illustrated with valuable information tables, charts & data. Send 25c to cover handling and postage.

PLASTIC PARALLEL STRAIGHT EDGE
with knobs and rubber pads for non slippage on each section. A must for navigators, mechanics, draftsmen, and engineers . . . You've never seen 'em at **97c ea.**

THE LARGEST FIRM OF ITS TYPE IN THE WORLD ORDER BY MAIL
Order from this Ad. All sales final. All Prices F.O.B. Los Angeles. Pay by M.O. or Check. P.O.'s Acctd. from D & B firms. 1/2 deposit with C.O.D's.

SOUTH BEND 9" LATHES

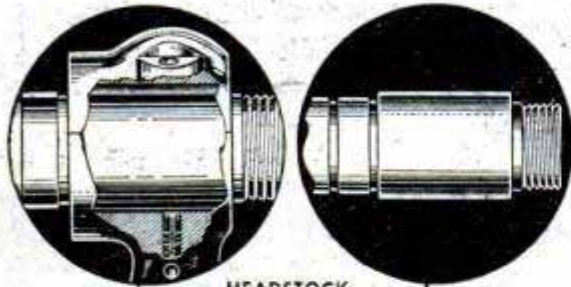

HEADSTOCK

Bearings are line bored and bearingized for precision fit. Ample lubrication from oil reservoirs. Spindle is carburized, hardened, and ground; with bearing surfaces super-finished to .000005" rms.

BELT RELEASE

Instant release of belt tension for speed changes. Proper tension of headstock spindle drive belt is easily adjusted.

TAILSTOCK

Has set-over for taper turning. Graduated spindle has witness mark for aligning cutter bit. Hardened center self-ejecting.

BED

Three V-ways and one flat-way are hand-scraped entire length for precision alignment of headstock, tailstock, and carriage.

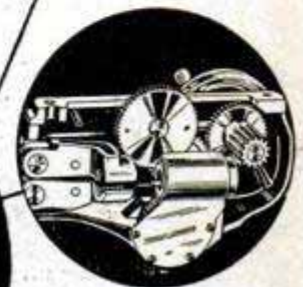
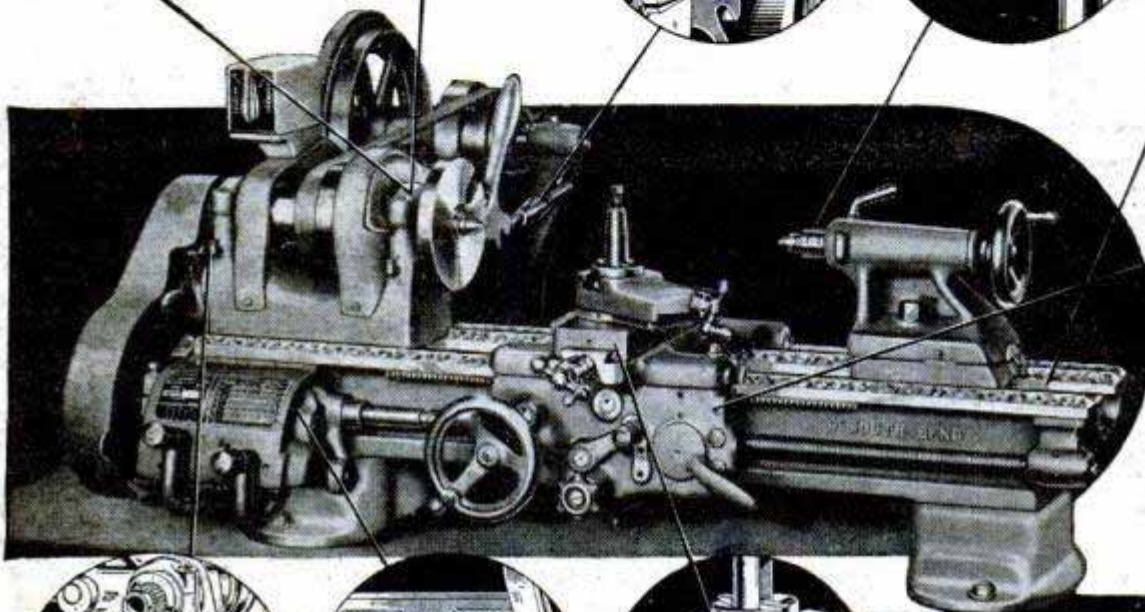

APRON

Has powerful friction clutch and large half-nuts. Safety interlock prevents engaging opposing feeds. All gears machine cut.

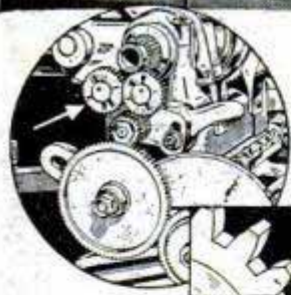

REVERSE GEARS

Easily shifted for reversing lead screw rotation and feeds, positive lock. All the gears used in this lathe are machine cut.



GEAR BOX

Screw threads and power feeds selected by shifting two tumblers as indicated on index chart. All gears machine cut steel.

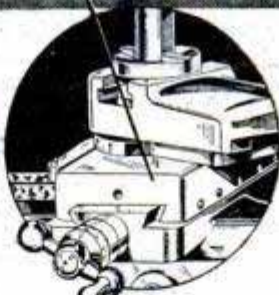

CARRIAGE

V-ways and dovetails hand-scraped. Engine divided micrometer collars on feed screws. Compound Rest base graduated 180 degrees.

Specifications...

South Bend 9" Model A Lathe

- SWING over bed—9-1/4"
over cross slide—5"
- BED LENGTHS . . . 3, 3-1/2, 4, and 4-1/2 feet
- DISTANCE BETWEEN CENTERS . . 16" to 34"
- SPINDLE SPEEDS (12) . . 41 to 1270 r.p.m.
- POWER FEEDS:
Longitudinal (48)0015" to .0853"
Cross-feed (48)0004" to .0252"
- THREADS (48 pitches) . . . 4 to 224 per inch
- MAXIMUM COLLET CAPACITY . . . 1/2 inch
- SPINDLE BORE 3/4 inch
- TAILSTOCK TOP SET-OVER 5/8 inch

SOUTH BEND LATHE WORKS

435 East Madison Street, South Bend 22, Indiana, U. S. A.

Please send catalog(s) checked:

- Catalog No. 9 — all models of South Bend 9" Lathes.
- Catalog No. 100 — all sizes of South Bend Lathes.
- Catalog No. 400 — South Bend Precision Drill Presses.
- Catalog No. 500 — 7" Bench Shaper.
- Catalog No. 77 — Attachments and Accessories.
- Time Payment Plan.

NAME _____
STREET _____
CITY _____ STATE _____

9" x 3' Model A Bench Lathe, illustrated (Cat. No. 644-Y), with 12-speed horizontal drive, motor, and control — less bench . . . **\$340.45***

Time Payment Terms — \$85.45 down, 12 monthly payments of \$22.52.

Other models of South Bend 9" Lathes, priced from \$187.35* to \$805.45*, may also be purchased on time payment terms of 25% down with balance in 12 monthly payments, small finance charge.

*Prices, f.o.b. factory, include 1 phase, 60 cy., 115-V. motor and control.



SOUTH BEND LATHE WORKS

BUILDING BETTER TOOLS SINCE 1906

*Piston Rings
need replacing,
too!*

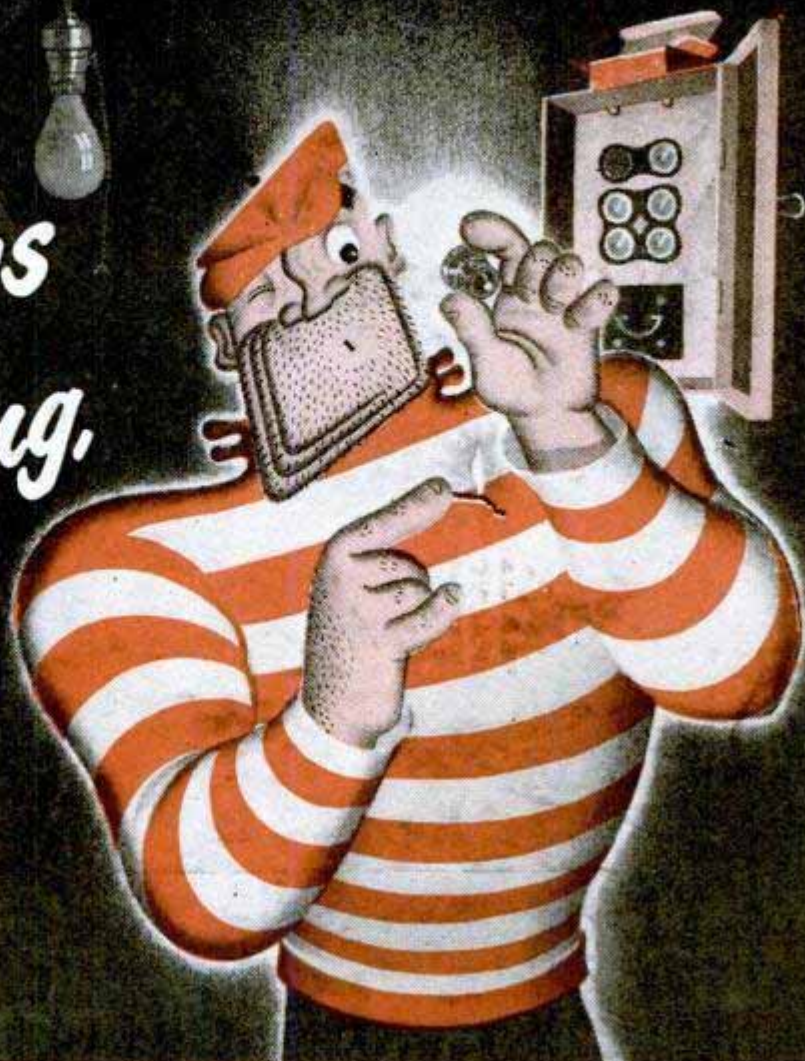

OIL-PUMPING is a symptom of piston ring wear. And by the time you notice it, your rings will be pretty badly worn. They should be replaced immediately.

Hastings Piston Rings are designed especially for replacement service... So ask for

Hastings—the replacement ring that *stops* oil-pumping, *checks* cylinder wear and *restores* performance. It's the best money you can spend on your car.

HASTINGS MANUFACTURING COMPANY
HASTINGS, MICHIGAN
Hastings Ltd., Toronto

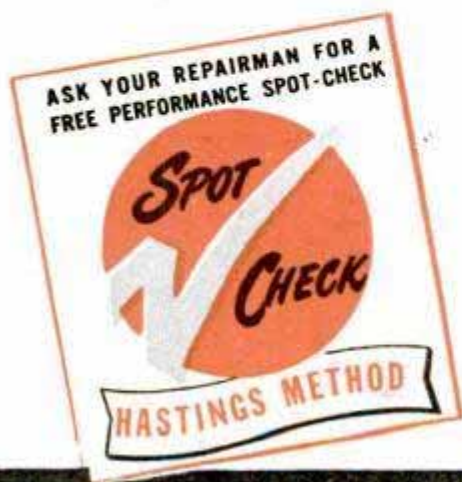

HASTINGS

STEEL-VENT PISTON RINGS

"TOUGH... BUT OH SO GENTLE"

TOUGH on oil-pumping — GENTLE on cylinder walls

30-DAY TEST REVEALED

NOT ONE SINGLE CASE OF THROAT IRRITATION

due to smoking

CAMELS!

DOCTORS REPORT

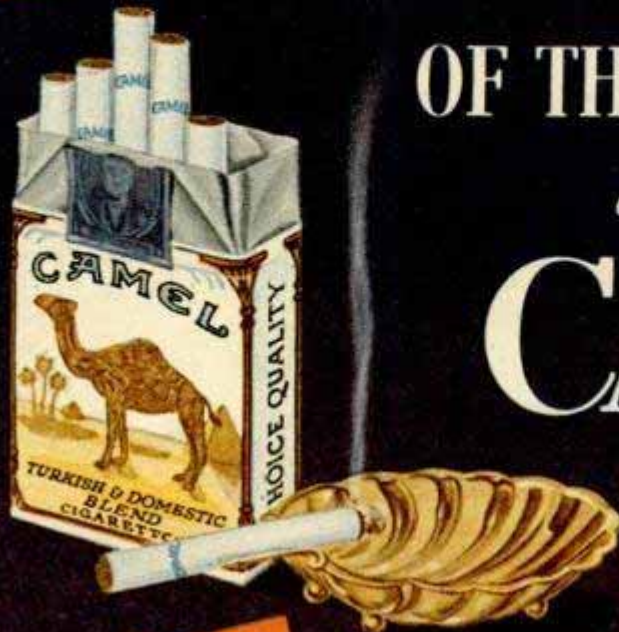

Yes, that's what noted throat specialists reported after making weekly examinations of the throats of hundreds of people, from coast to coast, who smoked Camels, and only Camels, for 30 consecutive days!

SMOKERS REPORT



MRS. ARTHUR O'NEILL, housewife: "I made the Camel 30-Day Test and enjoyed it! For taste *and* flavor, it's Camels every time!"



STEEL WORKER Cyril Byrne: "On my job, a cigarette is a friend. I made the 30-Day Test - now Camels are my smoke for keeps!"



COLE PORTER, song writer: "The doctors' report *proves* what I've known about Camels for years. They're *mild* ... they are *flavorful*!"



TELEPHONE OPERATOR Rita Edwards: "The 30-Day Test convinced me! Camels are the mildest cigarette I've ever smoked!"



WILLIE HOPPE, master of the cue: "My test of Camels covers 20 years. I *know* how good Camels taste...how mild Camels are!"



JINX CLARK, show-skater: "I put Camels to the test in my 'T-Zone.' Nothing like them for flavor. And Camels are so mild!"



STOREKEEPER Bernard Unger: "Camels are a standout for flavor! And they're *mild*. I know...I smoke over a pack a day."



BOBSLED ACE Francis Tyler: "I'm talking from experience when I say Camels are mild. I've smoked them for years!"



Make your own
Camel 30-Day Test in your "T-Zone"

● Over and beyond the reports of noted throat specialists, the final authority on Camel mildness and flavor is your own "T-Zone" (T for taste, T for throat). Test Camels yourself for 30 days.