

POPULAR MECHANICS

MAGAZINE

WRITTEN SO YOU CAN UNDERSTAND IT

REG'D. TRADE MARK. GREAT

REG. U.S. PAT. OFF.



POCKET SOS
Page 102

YOU WON'T GET ANYWHERE UNLESS YOU START

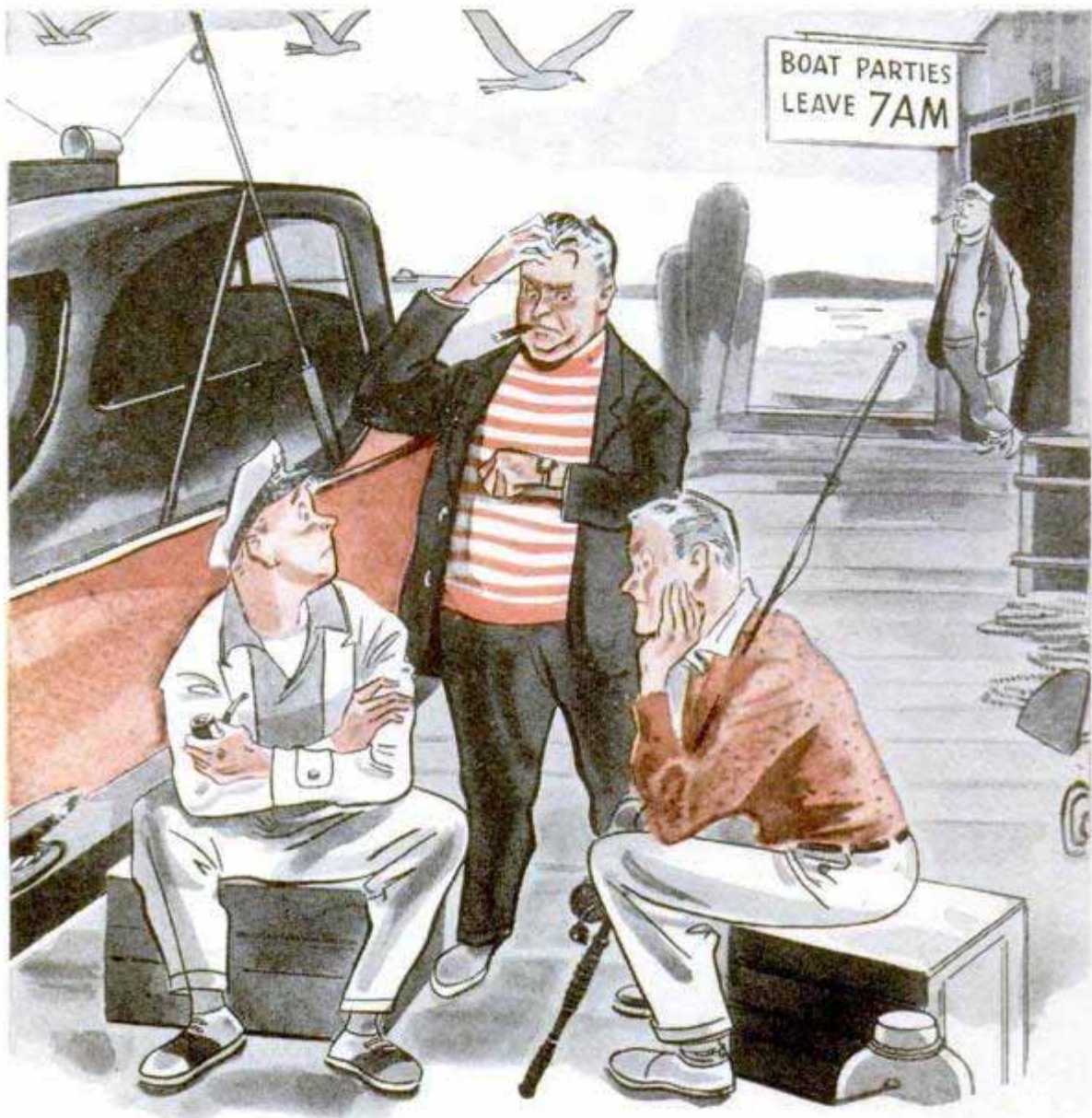

WHEN IT'S AN *Exide* ...YOU START

To delay your friends . . . on fishing, hunting or other trips . . . is an offense that few things can excuse. Least of all the complaint "I couldn't start my car" . . . for such failures need not happen.

To arrive on time, start on time. When you buy a battery for your car, buy *starting assurance*. **REMEMBER**, a single starting failure can be far more costly than the little extra you pay for a trustworthy, long-lasting Exide Battery.



1888... DEPENDABLE BATTERIES FOR 61 YEARS... 1949 'Exide' Reg. Trade-mark U. S. Pat. Off.

THE ELECTRIC STORAGE BATTERY COMPANY, Philadelphia 32
Exide Batteries of Canada, Limited, Toronto

A Straight Steer About the NEW FORD "FEEL"



Take the wheel...

Steering ratio is increased nearly 10% for even easier steering control.

Yet Ford's "Finger-Tip" Steering is only one of the many advancements that combine to produce the new Ford "Feel"—the "Feel" that drivers acclaim as being revolutionary in the field.

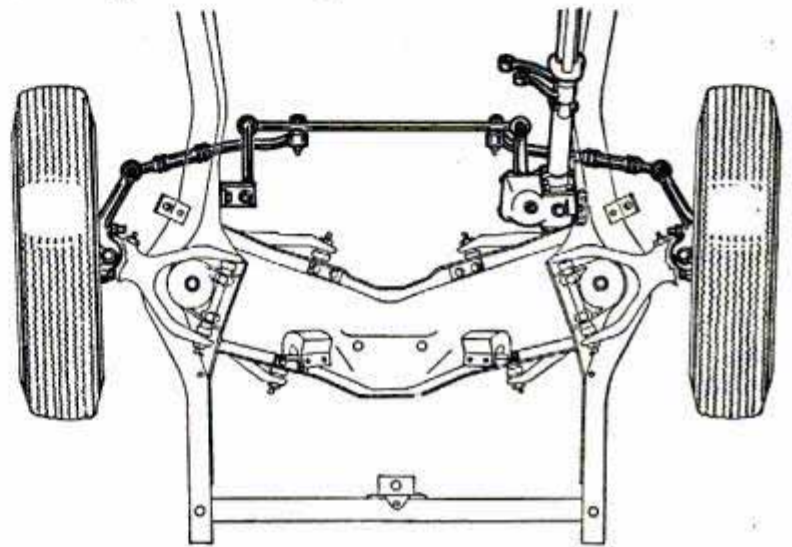

Symmetrical steering linkage permits up and down wheel movement without affecting steering accuracy.

... of the '49 Ford and you'll sense in a minute that here's a new "feel" in driving. That's because, for one thing, the '49 Ford has practically effortless "Finger-Tip" Steering—a new, symmetrical steering linkage combined with new independent front wheel suspension and extra-large worm and roller type steering gear. Either wheel is free to move up and down without affecting steering. Pitman and idler arms are of equal length and parallel. Tie-rods and lower control arms move through similar arcs to preserve steering accuracy at all times.

And the precision-built steering gear uses a large triple-tooth roller, mounted on two sets of needle bearings, to eliminate sliding friction.

In flashing performance... solid roadability... and reassuring security, too, the '49 Ford has literally brought a new "feel" to driving. Now—today—take the wheel and try the new Ford "Feel!"



White sidewall tires, optional at extra cost

There's a ^{NEW} Ford in your future

Awarded the Fashion Academy Gold Medal as the "Fashion Car of the Year"

This One



YOU'RE
"ADVENTURE BOUND"

ON A
HARLEY-DAVIDSON
WITH THE NEW
HYDRA-GLIDE FORK

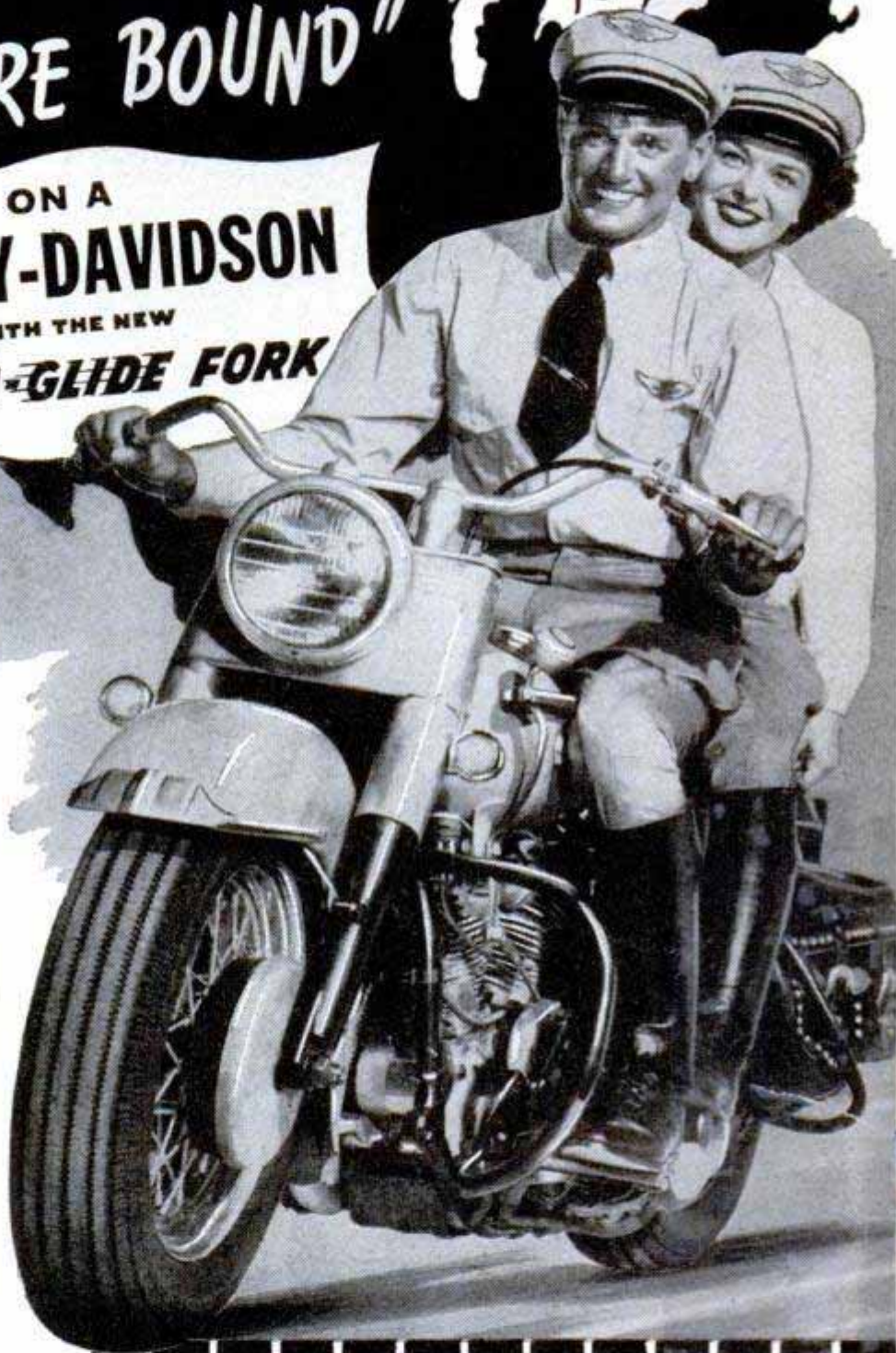

GET away from hum-drum living and hit the adventure trail on a Harley-Davidson Hydra-Glide! Explore back country roads that lead to rare scenic splendors, hidden valleys, little known hamlets and historic places, out-of-way lake and mountain areas — so hard to reach by other transportation. See great cities, fascinating rural regions, glamorous resorts and vacation spots. New thrills, new friends, new pleasures await you at every turn . . . at gypsy tours, exciting race meets, endurance runs, hill climbs, club gatherings of every kind. There's no sport like motorcycling; no fun like riding a sleek, swift, "comfort-cruising" Harley-Davidson! See your dealer today. Mail the coupon now.



HARLEY-DAVIDSON MOTOR CO., Dept. P, Milwaukee 1, Wis.

Send *free* copy of ENTHUSIAST Magazine filled with motorcycle action pictures and stories; also literature on latest models.

Name.....

Street or R.F.D.....

City.....Zone..... State.....

Popular Mechanics Magazine

Registered in U. S. Patent Office and Canada

H. H. WINDSOR, Founder

H. H. WINDSOR, JR., Editor and Publisher



this month's cover

PUT THE PILOT in a mighty rough situation, we instructed Bob Barker, the artist who drew the cover. Up he came with a painting that fills the bill. Barker crashed the poor pilot in desert country with miles and miles of nothing around him and, we imagine, some injured crewmen. A mighty bleak situation. But wait! Our hero pulls from his pocket a remarkably compact little instrument, straps part of it to his head, pushes up an antenna and starts turning a small crank. Although he can't hear a thing, the air waves are filled with a distress hum that can be picked up by planes flying at 2000 feet as far as 50 miles away. The personal SOS is designed to be carried in the pocket of every member of the crew to supplement the wartime Gibson Girl, a 40-pound job that is too bulky and heavy for anything but large aircraft. For more complete details of this pocket lifesaver developed by the U. S. Air Force, flip over to page 102

Published monthly by Popular Mechanics Company, 200 E. Ontario St., Chicago 11, Ill. H. H. Windsor, Jr., president; William Harrison Petridge, vice president; D. F. Windsor, vice president and secretary-treasurer; Clover L. Perkins, advertising manager; Alan M. Deyoe, circulation manager. Single copy in the United States and Canada, 35 cents; subscription rates in United States and possessions, Canada, Philippines and countries of the Pan-American Postal Union, 1 year, \$3.50; 2 years, \$6.00; 3 years \$8.00. To all other countries add \$1.00 a year over United States prices for overseas postage. If you plan to move, notify us at least 30 days in advance so you will not miss an issue. Give both old and new addresses. Entered as Second Class Matter, September 15, 1903, at the Post Office at Chicago, Illinois, under Act of March 3, 1879. Entered as Second Class Matter at Post Office Dept., Canada. Copyright 1949 by Popular Mechanics Company. Copyright under International Copyright Union. Copyright in France. All rights reserved under Pan-American Copyright Union. Printed in the United States of America.

Volume 92 AUGUST 1949 Number 2

Managing Editor.....Roderick M. Grant
 Assistant Managing Editor.....Wayne Whittaker
 Shop Notes and Crafts Editor.....James R. Ward
 Radio-Television, Electronics Editor.....Frank L. Brittin
 Associate Editor, Aviation.....Aubrey O. Cookman, Jr.
 Associate Editor.....Clifford B. Hicks
 Eastern Editor.....Richard F. Dempewolf
 Western Editor.....Thomas E. Stimson, Jr.
 Art Director.....Frank Beatty

Assistant Editors
 Donald R. Brooks Dorothy E. Hoffmann Arthur R. Railton
 Assistant Editors, Shop Notes and Crafts
 W.Clyde Lammey Wayne C.Leckey Frank N.Stephany A.E.Youngquist

IN THIS ISSUE

How the Atom is Working for You	- - -	73
High-School Assignment: Build a House	- -	84
They Spin Wire by the Mile	- - - - -	89
War Horses Still Fight Out the Air Derby	- -	98
Old-Timers Come to the Fair	- - - - -	106
Rocket Test Stand	- - - - -	110
You Can Scream in Safety	- - - - -	116
Arctic Adventure With a Camera	- - - - -	125
Mountain-Top Lighthouse Tender	- - - - -	132
Daniel Boones on the Rifle Range	- - -	136
Auto Race to the Clouds	- - - - -	142
Flowers That Never Fade	- - - - -	153

For the Craftsman

Modern Book Ends	- - - - -	166
How to Weave a Reed-Bottom Chair	- -	174
Wave-Powered Motor Propels Model Boat	-	182
Strikes and Spares in Miniature	- - - - -	187
Periodic Checks Prevent Ignition Breakdown		190
Movie Titles From Your Vacation Album	-	197
Hi-Power Attachment for Binoculars	- - -	203
Cut Your Own Molding	- - - - -	206
Precision Casting by the Lost-Wax Process	-	213
Radio-Television, Electronics	- - - - -	217
Clinic for Homemakers	- - - - -	228

Other items, and manufacturers of available products described, are listed on pages 10, 12 and 14

Build This 5-Room Concrete Block House Yourself - Complete for less than \$3650

Popular Mechanics Home of the Year

Has All These Features

- ★ Five Finished Rooms plus Bath and Three Closets
- ★ Concrete Block Walls—Poured Concrete Floors—Vapor-Sealed Walls Stuccoed Outside—Fully Plastered Inside
- ★ Complete Heating and Plumbing Equipment and Electric Wiring
- ★ Modern Cabinet Kitchen
- ★ Insulated Ceiling

Build-It-Yourself Book and Set of Building Plans, Only \$12.50

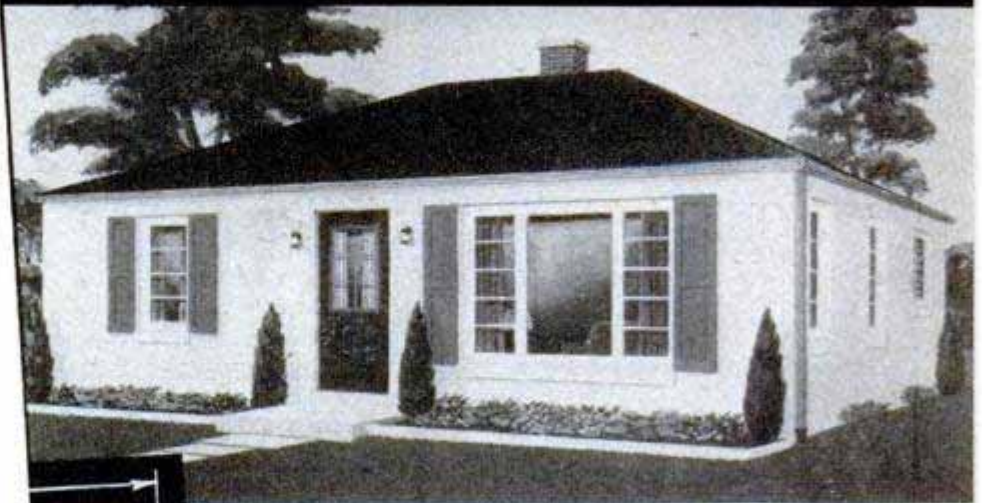

Beat the High Cost of Home Owning! No Experience Needed! Follow Book and Plans! Save Thousands of Dollars!

If you can mix a batch of concrete following simple instructions, and saw a board straight you can build this new Popular Mechanics concrete block house yourself. Yes Sir! In a few months of spare time you can laugh at the housing shortage and save several thousand dollars while acquiring a home you will be proud to own.

Like Popular Mechanics' famous Build-It-Yourself frame house introduced in 1947, a new BUILD-IT-YOURSELF BOOK for this five room Concrete Block House is now ready, along with a full size set of building blueprint plans. The book covers every construction detail and the plans are so simplified, so easy to follow, that you need have no experience to do a fine workman-like job. On the other hand, if you want to hire a contractor or an ordinary builder, have him follow these plans and still enjoy a tremendous saving. Read further about this fine permanent type house. See how easy you can build it and own it yourself. Order book and plans on coupon below.

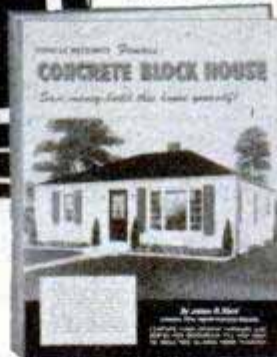
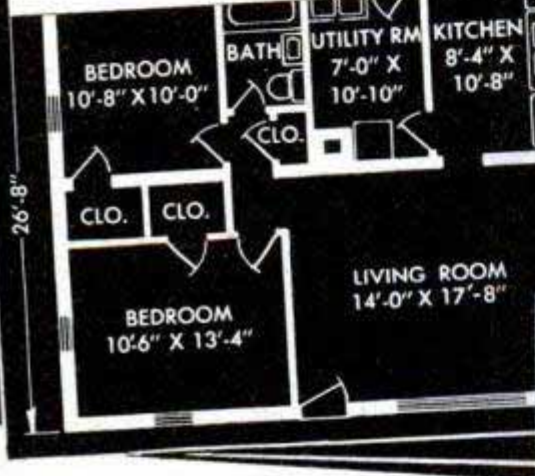

Start Planning Now!

It's Easier Than You Think to Own Your Home

IDEAL FOR FAMILY OF FOUR

Popular Mechanics Build-It-Yourself Concrete Block House is 26'-8" deep by 32'-8" wide. It has 675 square feet of comfortable living space—living room, two bed rooms, cabinet kitchen, utility room, bath and three closets. Built in a Chicago suburb, a relatively high price region, in a high price year, its total cost was less than \$3650.00 including all material, heating, plumbing and electrical equipment and outside labor for installing the equipment and plastering all rooms. In many localities it can be built for even less and additional savings can be made by using less expensive bath and kitchen equipment.

LONG LIFE MATERIALS — EASY UPKEEP

Construction is concrete throughout—poured concrete floors and concrete block walls—both vapor sealed for insulation—construction that requires no special skill. Walls are furred-out and plastered inside, stuccoed outside. Ceiling is insulated. Only a very minimum of carpentry is required—

simple shingled hip roof, door frames and trim, which almost anyone can do. Interior doors are new flush type. Hot air heating plant may be gas, oil or coal-fired. Hot air ducts terminate in ceiling, cold air ducts are tile laid under the floor.

EASY TO BUILD — EASY TO OWN

Every part of the construction is simplified and thoroughly explained in the BUILD-IT-YOURSELF Book, from the turning of the first shovel full of earth to the last flick of the paint brush. It is written in plain, understandable terms and packed with pictures and diagrams that make every construction detail simple as ABC. The book also tells how to make your own concrete blocks, how to select and buy a lot and how to build a house of bricks. Book and set of ten working blueprint plans are all you need to get started and enjoy the thrills of home owning, doing the job yourself and saving money too. Book, \$2.00. Set of plans, \$12.00. See coupon for special money-saving offer when both are ordered together.

USE THIS COUPON TO GET BUILD-IT-YOURSELF BOOK AND PLANS

Popular Mechanics Press, Dept. 600
200 East Ontario Street, Chicago 11

Send postpaid, the items checked. Remittance for \$_____ enclosed.

- Build-It-Yourself Concrete Block House Book \$ 2.00
- Set of 10 Builders Blueprint Plans 12.00
- Book and Plans ordered together (Save \$1.50) 12.50
- Extra sets of plans—each 5.00

Name _____

Address _____

City _____ Zone _____ State _____

**CRAFTSMEN
RECOGNIZE
QUALITY**

by these fine features in

ADJUSTABLE WRENCHES

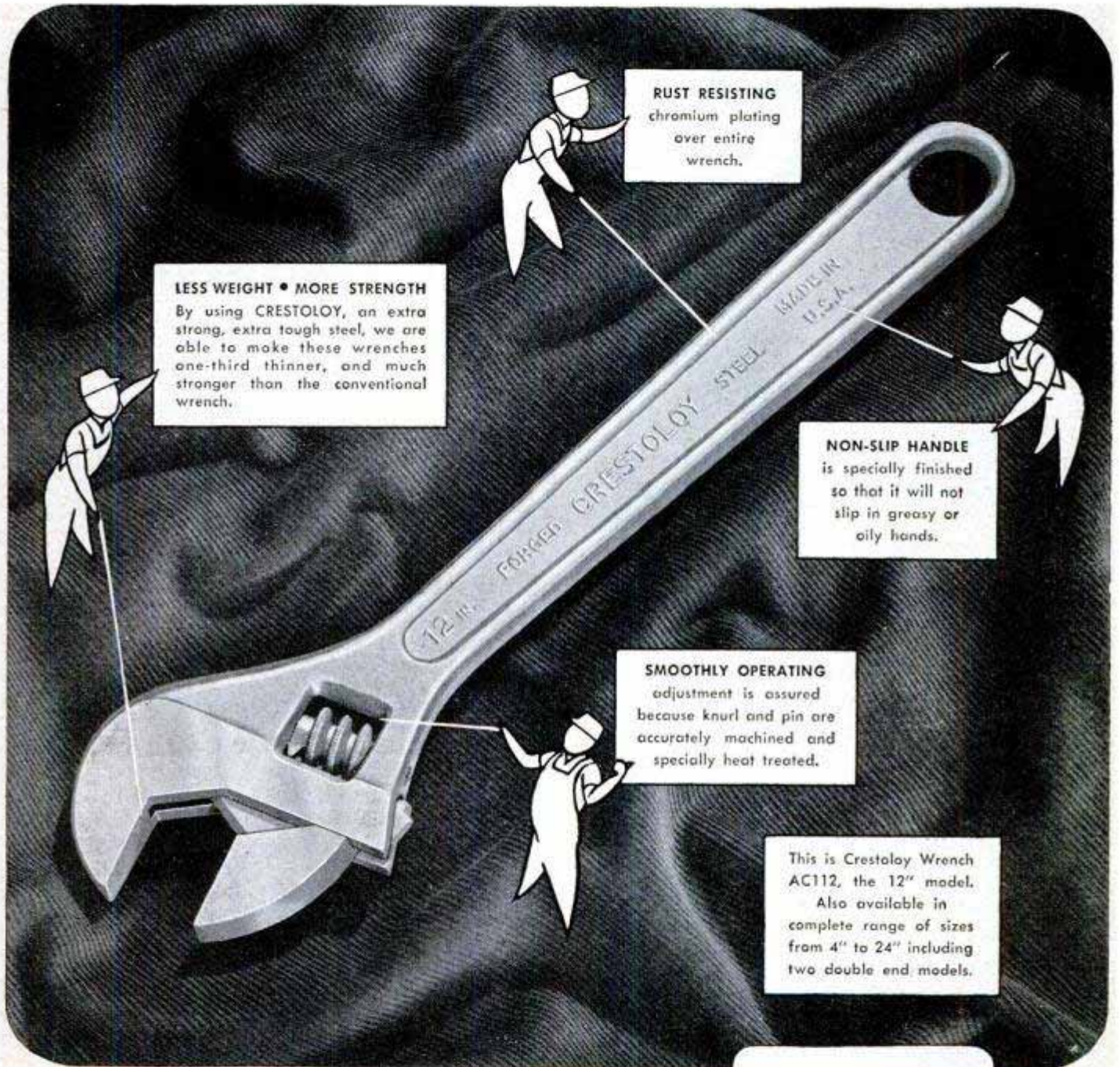

LESS WEIGHT • MORE STRENGTH
By using CRESTOLOY, an extra strong, extra tough steel, we are able to make these wrenches one-third thinner, and much stronger than the conventional wrench.

RUST RESISTING
chromium plating
over entire
wrench.

NON-SLIP HANDLE
is specially finished
so that it will not
slip in greasy or
oily hands.

SMOOTHLY OPERATING
adjustment is assured
because knurl and pin are
accurately machined and
specially heat treated.

This is Crestaloy Wrench
AC112, the 12" model.
Also available in
complete range of sizes
from 4" to 24" including
two double end models.

**EVERYBODY
RECOGNIZES
QUALITY**

by this Trade-mark

CRESCENT TOOLS



*Sign of the Artisan
Symbol of Excellence*

"Crescent" is our trade-mark, registered in the United States and abroad, for wrenches and other tools. Sold by leading distributors and retailers everywhere and made only by
CRESCENT TOOL COMPANY, JAMESTOWN, NEW YORK

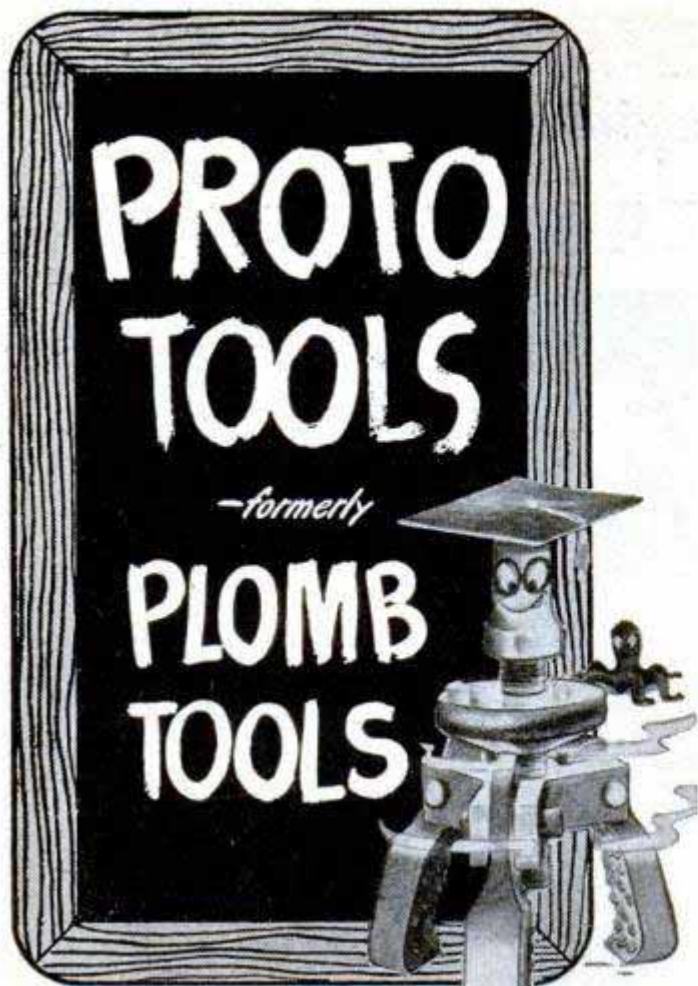

NOW!

**a different name for
your old friends!**

In PROTO tools—formerly Plomb tools—you get just what the name means, PROfessional TOOLS. They have the designs, special steels, scientific heat treating and over-all quality that have made them professionals' favorites for 42 years. Buy the best! Buy PROTO from your dealer now.

Write for catalog to

PLOMB TOOL COMPANY

2255P Santa Fe Ave., Los Angeles 54, Calif.

4987



in this corner.....

**THE
EDITORS**

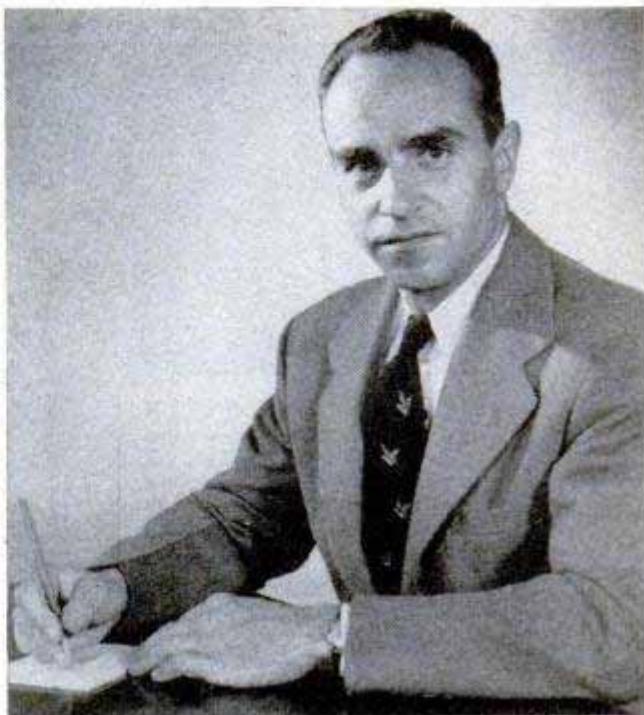

New Eastern Editor

Meet Richard F. Dempewolff, our new eastern editor at New York, whose by-line you will be seeing on many forthcoming articles. Mr. Dempewolff, a native New Yorker, comes to *Popular Mechanics* with a brilliant background as a writer and editor. During the war, when he served as a lieutenant in the Navy, he was roving correspondent and technical editor for a naval aviation publication. In his spare time he wrote his second book, "Animal Reveille," a story of animals that were helping win the war. His first book was "Famous Old New England Murders." After graduating from Middlebury (Vt.) College in 1936, Mr. Dempewolff went to work for the *Literary Digest*. He later served as an editor for *Newsweek* and as managing editor of *True* and *Pic*. His articles have appeared in many leading magazines including the *Saturday Evening Post*, *Collier's* and *Reader's Digest*. Mr. Dempewolff will have offices in the Empire State Building and his coverage for *Popular Mechanics* will extend over the eastern seaboard. He makes his home in Chappaqua, a suburb of New York, where he lives with his wife, Rita, and 5-year-old daughter, Judy. His hobbies include movie and still photography, flying and hunting.

(Continued to page 8)



To the man who wants to enjoy
an ACCOUNTANT'S CAREER



IF you're that man, here's something that will interest you.

Not a magic formula—not a get-rich-quick scheme—but something more substantial, more practical.

Of course, you need something more than just the desire to be an accountant. You've got to pay the price—be willing to study earnestly, thoroughly.

Still, wouldn't it be worth your while to sacrifice some of your leisure in favor of interesting home study—over a comparatively brief period? Always provided that the rewards were good—a salary of \$3,000 to \$10,000?

An accountant's duties are interesting, varied and of real worth to his employers. He has *standing!*

Do you feel that such things aren't for you? Well, don't be too sure. Very possibly they *can* be!

Why not, like so many before you, investigate LaSalle's modern Problem Method of training for an accountancy position?

Just suppose you were permitted to work in a large accounting house under the personal supervision of an expert accountant. Suppose, with his aid, you studied accounting principles and solved problems day by day—easy ones at first—then more difficult ones. If you could do this—and could turn to him for advice as the problems became complex—soon you'd master them all.

That's the training you follow in principle under the LaSalle Problem Method.

Over 2800 Certified
 Public Accountants among
 LaSalle alumni

You cover accountancy from the basic Principles right up through Accountancy Systems and Income Tax Procedure. Then you add C. P. A. Training and prepare for the C. P. A. examinations.

As you go along, you absorb the principles of Auditing, Cost Accounting, Business Law, Statistical Control, Organization, Management and Finance.

Your progress is as speedy as you care to make it—depending on your own eagerness to learn and the time you spend in study.

Will recognition come? The only answer, as you know, is that success *does* come to the man who is really *trained*. It's possible your employers will notice your improvement in a very few weeks or months. Indeed, many LaSalle graduates have paid for their training—with increased earnings—before they have completed it! For accountants, who are trained in organization and management, are the executives of the future.

Write For This Free Book

For your own good, don't put off investigation of *all* the facts. Write for our free 48-page book, "Accountancy, The Profession That Pays." It'll prove that accountancy offers brilliant futures to those who aren't afraid of serious home study. We'll also include "Ten Years' Promotion in One"—a book which has helped many men. Send us the coupon *now*.

**LASALLE EXTENSION
 CHICAGO 5, ILL.**

Other LaSalle Opportunities

- Higher Accountancy
- C.P.A. Coaching
- Bookkeeping
- Law: LL.B. Degree
- Business Management
- Salesmanship
- Traffic Management
- Foremanship
- Industr'l Management
- Stenotypy
 (Machine Shorthand)

LASALLE EXTENSION UNIVERSITY A CORRESPONDENCE INSTITUTION

417 S. Dearborn St. Dept. 864-HR Chicago 5, Ill.

I want to be an accountant. Send me without obligation, "Accountancy, the Profession that Pays"—also "Ten Years' Promotion in One."

Name.....Age.....

Address.....

City, Zone & State.....



Insure performance WITH Pyroil

When you ask your gas station attendant to add Pyroil, you're really adding performance insurance. Insurance against corrosion, battery drain, sludge and gum formation . . . which means long-life for your car . . . all wrapped up in an economical package called Pyroil.

Because Pyroil gives oil the property of clinging to cylinder walls, it is your assurance of constant lubrication *at all times*. That's why Pyroil is the best life insurance for your car. Make it your policy to add Pyroil . . . add miles of driving enjoyment.

PYROIL FOR AIRCRAFT ENGINES

Use Aircraft Pyroil B for lubricating oil, Aircraft Pyroil A for gasoline.

GIVEN! An attractive Pyroil metal savings bank—takes coins up to 50c pieces. **MOTORISTS!** It's yours for the asking—sent postage paid.

Manufactured and Guaranteed by Pyroil Company, 94 Pyroil Bldg., La Crosse, Wisconsin.

Canadian Distributors: Central Purchasing Agencies, Ltd., Toronto, Ontario



PYROIL COMPANY

94 Pyroil Bldg., La Crosse, Wisconsin

I want my car to last and run properly. Please tell me more about Pyroil and how it can accomplish this for me.

Name _____

Address _____

City or Town _____ State _____



Letter to the Editor:

I have had the occasion to see in the French edition, *Mecanique Populaire*, of which I am a steady reader, the pictures of a modified jeep. In return, I am sending you pictures of a jeep arranged according to the ideas of an engineer and of a body maker; the chassis has been elongated a little, as in the Jeepster.



The body is the shell of a front-drive Citroen. The hood and the front fenders are those of a 202 Peugeot. The trunk is from a 1938 Hotchkiss. The hood decoration comes from a 1939 Opel Kapitän. The steering wheel is the steering wheel of a 1940 Delahaye. As for the bumpers, not yet placed, they will be those of a 1936 Chrysler.

Hoping that this photo will interest you and perhaps you will publish it, I am

Very truly yours,
Frederic Orth,
Meylan, Isere, France.

* * *

Next Month

Oceanographers bring to the surface for you exciting information about the existence of a mysterious deep stratum in the ocean, to be told in next month's "Deep Sea Mystery Story." Official U. S. Navy photographs permit you to look over the shoulders of the scientists as they explore the depths. If you are among the millions curious about the automotive industry's plans for 1950, you'll want to see and read about what two of the major companies are leading off with for new-car buyers. A story on how to paint your house starts a series of articles on home repairs in the Craftsman section. Another feature, by a well-known authority on car care, lists the essential points to cover in preparing your car for winter driving. Photography fans will find an inexpensive remote "slave" flash synchronizer in the Radio and Electronics section next month.

What's ahead ?

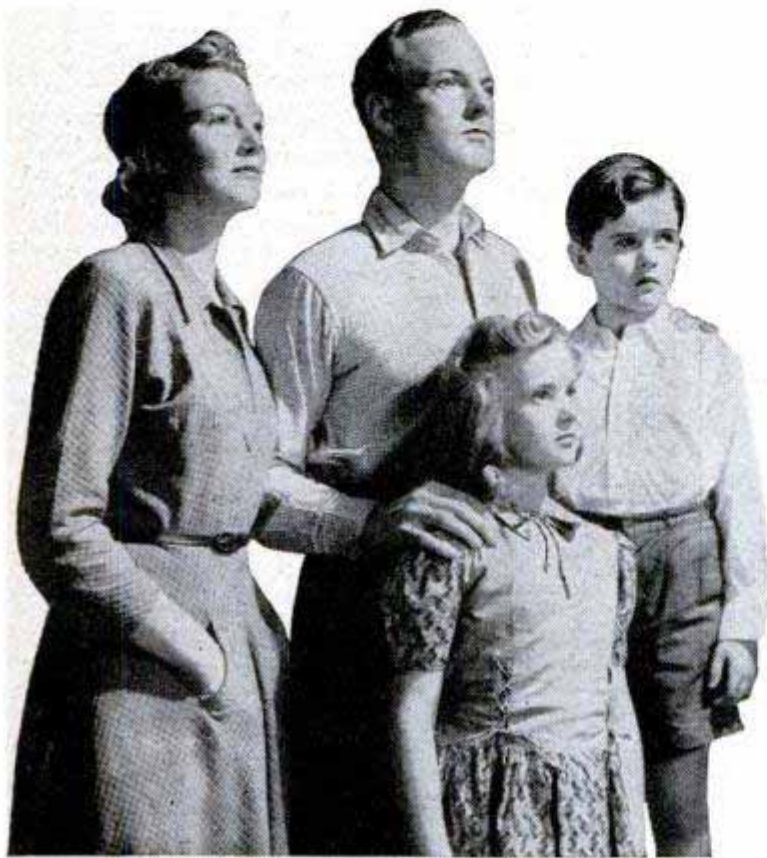

A world of rapid changes and new economic problems, that's certain. Just as surely, however, there's *one* thing that will be unchanged. In the near future and the long future, the important positions will be held by *trained men*.

You want security for your family . . . freedom from financial worry . . . your own home . . . perhaps your own business. The surest route to them is specialized *training* that pays out in promotions and increased income.

Thousands of I. C. S. graduates have proved the truth of this. In a single 30-day period, these famous Schools have received as many as 635 student letters reporting advancements in salary and position. In a period of 120 days, we've recorded 1,920 such reports.

The few dollars these men and women paid for I. C. S. *training* have proved to be the best investments of their lives. You have the same opportunity. Act *now* to prepare for the future. Mail the coupon for full information on practical, authoritative *training* in any one of more than 400 business and technical subjects.

INTERNATIONAL CORRESPONDENCE SCHOOLS

APPROVED
under the
G.I. BILL

BOX 5657-K, SCRANTON 9, PA.

FREE, 100-PAGE
VOCATIONAL GUIDE!

**LOOKING
AHEAD**



FOR THE MAN WHO IS PLANNING HIS FUTURE . . .

What fields offer you the greatest opportunities? How can you qualify for high-pay positions? What kind of training do you need to win success? You'll find the answers to these questions—and many more—in this fact-packed, 100-page, *free* book. Send for your copy today!

Without cost or obligation, please send your new vocational guide—**LOOKING AHEAD**.

Name _____ Age _____

Home Address _____

City _____ State _____

Present Position _____ Working Hours _____ A.M. to _____ P.M.

Employed by _____

IF A VETERAN: Length of Service in World War II _____

4 Keys to SUCCESS IN AVIATION

Through **Embry-Riddle** Training

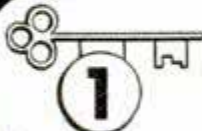

AIRCRAFT & ENGINE MECHANICS

1 We have hundreds of urgent requests for A. & E. Mechanics -- key men in Aviation -- from airlines, oil companies, fixed base operators, etc., both U. S. and Overseas. Training in a C. A. A. approved school is the quickest way to get ahead. Embry-Riddle students learn fast with modern equipment... working on live aircraft in airline-size hangars.



ENGINEERING

2 Embry-Riddle's Design Engineering and Maintenance course offers you eligibility for A. & E. certification plus necessary basic engineering knowledge required to fill positions such as Maintenance Foreman or Field Service, Project or Sales Engineer. If your aim is high, take this course.



A.&E. COMBINED WITH COMMERCIAL

Pilot Mechanics who can test fly the ships they repair... executive pilots able to service their own aircraft -- airmen with dual ability are needed by aviation companies and operators. Embry-Riddle combination training offers you the most in your aviation career.



COMMERCIAL PILOTS

Flying holds a real future for Embry-Riddle trained pilots. A quarter-century of experience with 30,000 students... the best instructors, up-to-date aircraft, superb year-round flying weather... qualifications unexcelled anywhere. Instrument and instructor's ratings are also available.



Aviation needs you now! Never has there been such opportunity for you in Aviation. Start your career now at Embry-Riddle -- living facilities directly on the Airport. Write today for full information and proof of job opportunities.

AUTHORIZED G. I. TRAINING

Dean of Enrollments - Dept. 99
Embry-Riddle School of Aviation
Miami 30, Florida

Please Print

NAME _____

ADDRESS _____

City _____

State _____ Age _____

I am interested in...

- A.&E. Mechanic
 Commercial Pilot
 Engineering
 A.&E. Combined with Commercial Pilot
 Flying Mechanic
 Drafting & Design

Check One Veteran Non-Veteran

TRAIN IN MIAMI--AIR CAPITAL OF THE WORLD

WHERE-TO-BUY-IT INDEX

Source of supply appears after items commercially available. For additional information on articles, write Bureau of Information, Popular Mechanics, 200 E. Ontario St., Chicago 11

AUTOMOTIVE

Economy auto uses standard parts (Del Mar Motors, Inc., 4205 Pacific Highway, San Diego, Calif.).....	78
Quick-change license holder (Ajay Specialty Co., 159 Shephard Ave., Newark 8, N. J.).....	79
Front-vision mirror (Passing Eye, Inc., Schwartz Bldg., Kenosha, Wis.).....	83
Auto clothes rack can be carried into hotel (M. C. Flynn, Inc., 43 E. 59th St., New York City 22).....	109
Tubes made punctureproof by sealing compound.....	130
Car for errands carries three (Pup Motor Car Co., Inc., Spencer, Wis.).....	135
Sign reminds driver to dim headlights (Collins Dim-Lite Co., 4329 Lovers Lane, Dallas 5, Tex.).....	146
Autos turned on "spit" for rustproofing.....	152
Belly-tank auto travels 45 m.p.h.....	159
Upper-cylinder lubricator (Automotive & Marine Products Corp., 87 Harvard Ave., Boston 34, Mass.).....	162
Tire-changing light (Alden Products Co., 117 N. Main St., Brockton 64, Mass.).....	164
Dashboard hill holder (Sharp Manufacturing Co., Nelsonville, Ohio).....	164
Auto transport carries five cars (LaCrosse Trailer Corp., 418 Gould St., LaCrosse, Wis.).....	164

AVIATION

Pulsejet helicopter (American Helicopter Co., 3613 Aviation Blvd., Manhattan Beach, Calif.).....	82
Pocket SOS.....	102
Heavyweight for long-range blows (Lockheed Aircraft Corp., Burbank, Calif.).....	114
Airfield at Rock of Gibraltar.....	124
Pressurized crate protects jets during shipment.....	141
Tiny plastic "wing".....	149
Crash radio for aircraft.....	162

BOATS

Pins drop in oar sockets to moor small boat (Marine Products Co., 6314 W. Burnham St., Milwaukee 14, Wis.).....	103
Boat glows at night (Lawter Chemicals, Inc., 3550 Touhy Ave., Skokie, Ill.).....	103
Pontoon-type sailboat (Alcort, Inc., 1172 N. Main St., Waterbury, Conn.).....	105
Car-top boat carrier (Wuest Brothers, 10th and Hill Sts., Louisville, Ky.).....	158
One hand rows boat with oar joiner (J. Kosten, 3134 Lake Michigan Drive, Grand Rapids, Mich.).....	159

FARM

Recorder checks eggs to eliminate lazy hens.....	101
Portable electric fence post (Portable Electric Fence Post Co., Inc., Graettinger, Iowa).....	109
Automat for hens shoves mash along trough.....	124
Farm accidents costly.....	152
Mailbox "hangs" atop chain.....	158

HOUSE AND HOME

Lightweight sinks of plastic (American Plastics Products, Inc., Millburn, N. J.).....	101
Jet drain opener (Tom Jones Co., Inc., 3rd Floor Murray Bldg., Grand Rapids 2, Mich.).....	103
Electric generator for hot-water heat (Precision Parts Corp., 402 N. First St., Nashville 7, Tenn.).....	105
Metal plate burglarproofs door (Project Protective Device Co., Inc., G.P.O. Box 477, Brooklyn, N. Y.).....	108
"Tugboat" catches mice (Fisher Manufacturing Co., 2804 S. San Gabriel Blvd., San Gabriel, Calif.).....	108
"Insect gun" swats flies between two paddles.....	113
Electrical tube in water tank prevents scale from forming (Aqua Electrical Scale Control, Inc., Society for Savings Bldg., Cleveland 14, Ohio).....	148
Motorized window (Vita Automatic Window, Smithtown Branch, N. Y.).....	152
Pressure cooker (Burpee Can Sealer Co., Barrington, Ill.).....	160
Quick juicer (National Die Casting Co., 3635 W. Touhy Ave., Lincolnwood, Ill.).....	160
Serving tray is heated by electricity (Salton Mfg. Co., Inc., 74 Reade St., New York City 7).....	160
Paring knife (Scott & Camden Co., 201 E. Washington St., Jackson, Mich.).....	160
Plastic stand for floral arrangements (The Post Mart, Inc., 260 E. 78th St., New York City 21).....	160
One-hand bottle opener (Talbot Crown Seal Bottle Opener Co., 58 Dwight St., New Britain, Conn.).....	161
Comb-brush cleaner (The Jay Company, Washington, N. J.).....	161
Scalloper for home sewing (The Elizabeth Institute, 850 Euclid Ave., Cleveland 15, Ohio).....	161
Pop-down toaster (Delta Mfg. Corp., 611 N. 40th St., Philadelphia 4, Pa.).....	161
Automatic porch light (Lynd-Lyte Mfg. Co., 5011 Clark Ave., Cleveland 2, Ohio).....	161

INDUSTRY

Hydraulic truck loader (H. C. Kaplan, Hykap, Inc., 3430 W. 38th St., Chicago 32).....	82
Mask protects against heat without obstructing vision (Mine Safety Appliances Co., Braddock, Thomas and Meade Sts., Pittsburgh 8, Pa.).....	97
Whole eggs frozen.....	101
Fresh orange juice holds flavor for weeks.....	115
Concrete sprayed in trench makes irrigation pipe.....	120
Sprayed coating reduces glare (Minnesota Mining & Mfg. Co., 900 Fauquier Ave., St. Paul 6, Minn.).....	121
Plastic insulation is lightest solid.....	135

(Continued to page 12)

WHAT Every AUTO MECHANIC Wants to Know

A motor vehicle is a machine of many parts, each part designed and constructed for its own special function.

All good mechanics, like good doctors, should know the working theory and operation of each part and understand what causes trouble and how to remedy it.

LET AUDELS AUTO GUIDE SOLVE YOUR PROBLEMS

Every auto mechanic, helper, serviceman and operator can use AUDELS AUTO GUIDE. The information it gives saves time, money and worry. Highly endorsed by all users. It presents the whole subject of auto mechanics from A to Z in plain language and simple terms.

This Big Practical Book gives full information with working diagrams covering the principles, construction, ignition, service and repair of modern cars, trucks and buses.

A complete Guide of 1800 pages, with over 1500 illustrations showing inside views of the working parts, with instructions for service jobs. Diesel engines, Fluid and Hydra-matic drives fully explained.

IT PAYS TO KNOW HOW TO

How to fit pistons—How to locate engine knocks—How to fit connecting rod bearings—How to service main bearings—How to re-condition valves—How to time valves—How to adjust fan belts—How to adjust carburetors & chokes—How to rebuild a clutch—How to service automatic transmissions—How to service brakes—How to adjust steering gear—How to cope with ignition troubles—How to service distributors—How to time ignition—How to "tune up" an engine.

INFORMATION IN A HANDY FORM

73 INTERESTING CHAPTERS—Read this partial list of subjects on which practical information is fully given for quick reference under the headings as shown below. Ready Reference Index.

All Parts of an Automobile—Automotive Physics—The Gas Engine—Gas Engine Principles—Multi-Cylinder Engines—Horse Power—Automobile Engines—Stationary Parts—Moving Parts—Pistons—Piston Rings—Connecting Rods—Crank Shafts—Valves—Valve Gear—Cams and Cam Action—Valve Timing—Cooling Systems—Fuel Feed Systems—Dual Fuel Feed—Mixture—Carburetors—Carburetor Service—Automatic Choke—Superchargers—Transmissions—Special Transmissions—Fluid and Hydra-matic Drives—Clutches—Universals and Propeller Shafts

A Ready Reference

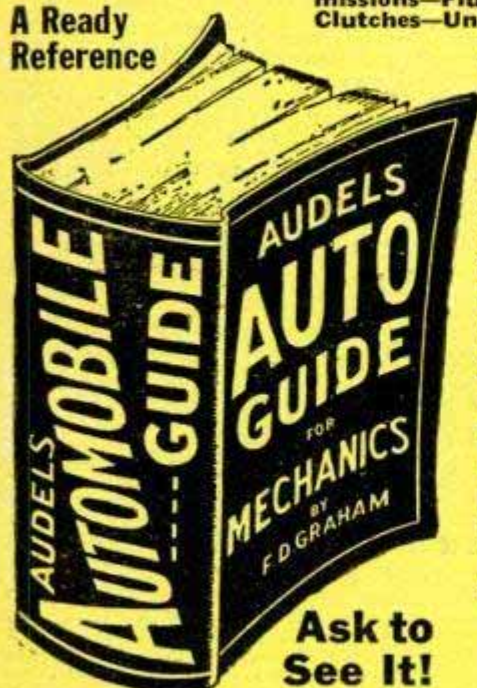

Ask to See It!

—The Differential—Rear Axles—Rear and Front Suspension—Running Gear—Brakes—Wheel Alignment—Knee Action—Steering Gear—Tires—Lubricants and Lubrication—Automotive Electricity—Ignition Systems—Magneto Ignition—Spark Plugs—Ignition Coils—Distributors—Automatic Spark Control—Ignition Timing—Generators—Starters—Generator and Starter Testing—Lighting Systems—Storage Batteries—Charging and Testing—Diesel Engines and Trouble Shooting.

7 DAYS' FREE TRIAL
TO GET THIS ASSISTANCE FOR YOURSELF SIMPLY FILL IN AND MAIL COUPON TODAY.

\$4 COMPLETE PAY \$1 A ONLY 1 MO.



Sent on 7 Days Approval

Step up your own skill with the facts and figures of your trade. Audels Mechanics Guides contain Practical Inside Trade Information in a handy form. Fully illustrated and Easy to Understand. Highly Endorsed. Check the book you want for 7 DAYS FREE EXAMINATION. Send No Money. Nothing to pay postman.

CUT HERE MAIL ORDER

AUDEL, Publishers, 49 W. 23 St., NEW YORK 10, N. Y.

Please send me postpaid for FREE EXAMINATION books marked (X) below. If I decide to keep them I agree to mail \$1 in 7 Days on each book or set ordered and further mail \$1 monthly on each book or set until I have paid price, otherwise I will return them.

- | | | |
|--------------------------|---|------------|
| <input type="checkbox"/> | AUTO GUIDE, 1800 Pages | \$4 |
| <input type="checkbox"/> | DIESEL ENGINE MANUAL, 400 Pages | 2 |
| <input type="checkbox"/> | WELDERS GUIDE, 400 Pages | 1 |
| <input type="checkbox"/> | MACHINISTS Handy Book, 1600 Pages | 4 |
| <input type="checkbox"/> | POWER-PLANT ENGINEERS Guide, 1500 Pages | 4 |
| <input type="checkbox"/> | ENGINEERS & FIREMANS EXAMS, 528 Pages | 1 |
| <input type="checkbox"/> | PUMPS, Hydraulics & Air Compressors, 1658 Pgs. | 4 |
| <input type="checkbox"/> | MARINE ENGINEERS Handy Book, 1280 Pages | 4 |
| <input type="checkbox"/> | ENGINEERS & Mechanics Guides (8 Book Set) | 12 |
| <input type="checkbox"/> | Answers on Practical ENGINEERING, 254 Pages | 1 |
| <input type="checkbox"/> | ELECTRIC WIRING DIAGRAMS, 210 Pages | 1 |
| <input type="checkbox"/> | ELECTRICIANS EXAMINATIONS, 250 Pages | 1 |
| <input type="checkbox"/> | ELECTRICAL DICTIONARY, 9000 Terms | 2 |
| <input type="checkbox"/> | ELECTRIC MOTOR GUIDE, 1000 Pages | 4 |
| <input type="checkbox"/> | HANDY BOOK OF ELECTRICITY, 1440 Pages | 4 |
| <input type="checkbox"/> | ELECTRICAL POWER CALCULATIONS, 425 Pgs. | 2 |
| <input type="checkbox"/> | RADIOMANS GUIDE, 914 Pages | 4 |
| <input type="checkbox"/> | ELECTRONIC DEVICES, 216 Pages | 2 |
| <input type="checkbox"/> | ELECTRIC LIBRARY, 7000 Pages (12 Book Set) | 18 |
| <input type="checkbox"/> | Vols. I, II, III, IV, V, VI, VII, VIII, IX, X, XI, XII \$1.50 Ea. | 1 |
| <input type="checkbox"/> | OIL BURNER GUIDE, 384 Pages | 4 |
| <input type="checkbox"/> | HOUSE HEATING GUIDE, 1000 Pages | 4 |
| <input type="checkbox"/> | CARPENTERS & Builders Guides (4 Book Set) | 6 |
| <input type="checkbox"/> | PLUMBERS & Steamfitters Guides (4 Book Set) | 6 |
| <input type="checkbox"/> | MASONS & Builders Guides (4 Book Set) | 6 |
| <input type="checkbox"/> | BLUE PRINT READING, 416 Pages | 2 |
| <input type="checkbox"/> | PAINTERS & DECORATORS MANUAL, 450 Pgs. | 2 |
| <input type="checkbox"/> | GARDENERS & GROWERS Guides (4 Book Set) | 6 |
| <input type="checkbox"/> | REFRIGERATION & Air Conditioning, 1280 Pgs. | 4 |
| <input type="checkbox"/> | SHEET METAL WORKERS Handy Book, 388 Pgs. | 1 |
| <input type="checkbox"/> | SHEET METAL PATTERN LAYOUTS, 1100 Pgs. | 4 |
| <input type="checkbox"/> | AIRCRAFT WORKER, 240 Pages | 1 |
| <input type="checkbox"/> | MECHANICAL DRAWING GUIDE, 160 Pages | 1 |
| <input type="checkbox"/> | MECHANICAL DRAWING & DESIGN, 480 Pgs. | 2 |
| <input type="checkbox"/> | MATHEMATICS & CALCULATIONS, 700 Pgs. | 2 |
| <input type="checkbox"/> | MECHANICAL Dictionary, 968 Pages | 4 |
| <input type="checkbox"/> | MILLWRIGHTS & Mechanics Guide, 1200 Pgs. | 4 |

Name _____

Address _____

Occupation _____

Employed by _____

AUDEL, Publishers, 49 W. 23 St., New York 10, N. Y.

Want **BIG PROFITS** IN YOUR OWN BUSINESS? NEW "MIRACLE FINISH" MAKES IT EASY



SPARE TIME — FULL TIME

HELP FILL HUGE DEMAND—Yes rich profits are waiting to be tapped in this NEW field. New MIRACLE FINISH gives a velvety, luxurious surface to radios, lamps, toys, store displays, figurines, auto dash boards and hundreds of other items. Make old objects beautiful and saleable—make new things *worth much more* with this soft, rich covering that can be applied to *any* surface.

START RIGHT AWAY—You can learn in a few days to start MAKING MONEY! Everything you need is furnished including fully illustrated instructions that are *complete* and EASY to understand. Every point is explained, to show you how to start on the road to BIG MONEY, spare or full time *right in your own home*.

RADIOS **JEWELRY BOXES** **LAMPS** **TOYS**
CAR TRUNKS **CAR DASHBOARDS** **DISPLAY PIECES**

BE A MODERN ALADDIN
Flok-Kraft makes old things new! Covers: Wood, Plastic, Fabric, Metal, Glass, Plaster—any surface.

EVERYTHING COMPLETE—In addition to full instructions, you get a complete set of materials that enable you to start at once. A few cents worth of materials can mean many dollars in return to you. \$5.00 per hour and more is easy—Add to your income from regular job or start your own business.

ACT NOW—grasp this opportunity TODAY—Start your own business. It's too good to miss! SEND NO MONEY—Mail coupon today for full details and free sample of FLOK-KRAFT covered material and hundreds of useful and profitable ideas. Do it NOW— be first!

SEND NO MONEY

MAIL COUPON NOW!

COAST INDUSTRIES Dept. 28
1004 S. Los Angeles St., Los Angeles 5, Calif.
Gentlemen: Please rush me all the details.

NAME _____
STREET _____
CITY _____
STATE _____

(Continued from page 10)

LAWN AND GARDEN

Compost processor shreds and mixes in one operation (Royer Foundry and Machine Co., 158 Pringle St., Kingston, Pa.)	97
Container blows seed over lawn (L. Teweles Seed Co., 222 S. Third St., Milwaukee 1, Wis.)	108
Old hose made into sprayer (Lubprodc Co. Manufacturing Co., 5605 Herman Ave., Cleveland 2, Ohio)	109
Sod cutter slices turf into even strips (Merle E. Lint, San Diego, Calif.)	131

OUTDOOR RECREATION

Bad-weather football (Wilson Sporting Goods Co., 2037 N. Campbell Ave., Chicago 47)	83
Outboard-motor pushcart (Handi-Tote Carriers, 409-11 W. Madison St., Maywood, Ill.)	115
Marked trolling line (The Weber Lifelike Fly Co., Stevens Point, Wis.)	115
Fishline unwinds off reel for casting without rod (Handicast Co., 316 Marion Bldg., Cleveland 13, Ohio)	120
Cleanup brush inside golf ball (Birdie-Brush Manufacturing Co., 1539 Nelson Ave., Toledo 9, Ohio)	158

PHOTOGRAPHY

Phosphorescent material "previews" photo prints (Novelty Scientific Products, R.R. 2, St. Paul 6, Minn.)	78
Camera checks on a champ diver	88
Chest-pod for reflex camera (William V. McNelly Co., 411 Horace St., Cincinnati, Ohio)	121
Aquarium keeps camera dry for underwater shot	146
Slide makers "freeze" bugs with synchronized flash (E. Leitz, Inc., 304 Hudson St., New York City 13)	162

TOOLS

Power keyhole saw (The Forsberg Manufacturing Co., Bridgeport 1, Conn.)	83
Circular gas torch is plumber's helper (Cedarberg Manufacturing Co., Inc., Dept. U, 529 S. Fourth St., Minneapolis 15, Minn.)	101
Multi-bladed scraper (Heller Brothers Co., Newark 4, N. J.)	108
Saw-blade shear makes square cut (The DoAll Co., Des Plaines, Ill.)	113
Clamp holds drills for sharpening (Up-To-Date Tool Co., Box Station A, Worcester 8, Mass.)	130
Quick-acting C-clamp (Richards' Industries, Inc., 20 Leonard St. N.W., Grand Rapids 5, Mich.)	141
Air-driven hand tool (Ferriot Brothers, Inc., 2700 Mogadore Rd., Akron, Ohio)	146
Midget woodworking shop (Paulite Products, Box 277, Galt, Ontario, Can.)	152
Hoist-jack lifts 2000 pounds (Coffing Hoist Co., Danville, Ill.)	157
Guide for sharpening saws adjusts to any tooth size (Nu-Art Products, 607 47th St., Brooklyn 20, N. Y.)	157
Pliers that pulverize can't damage machinery (Osborn Manufacturing Co., 204 Argonne Road, Warsaw, Ind.)	162
Plow on fire-fighters' jeep cuts four-foot furrow (Flynn Mfg. Co., Alexandria, La.)	163

MISCELLANEOUS

Concrete building without walls holds 360 cars	78
Low-slung Spanish train is "zippered" together	79
Listen to the FAX	80
Flint-type lighter for lanterns (Timcor, Inc., 1430 W. 29th St., Cleveland 13, Ohio)	83
Neon sign has plug-in letters (Neco Manufacturing Co., Inc., Auburn, Ind.)	97
Single drafting aid combines four drawing instruments (Anderson-Reading, Inc., 16181 Hamilton Ave., Detroit 3, Mich.)	104
Camera goes to sea to televise boat race	104
Toy "prefab" building kit (Paul E. Oliver, 4164 34th St., San Diego 4, Calif.)	105
Code taught in hour by "sight" method (Otto H. Luther, New Preston, Conn.)	113
Electronic detector finds football leaks	115
British fire fighters ride special train to blaze	121
Transparent navy	122
Modern Tokyo office building	130
Model engine scoots scooter (Duro-Matic Products Co., 1039 N. LaBrea, Hollywood 38, Calif.)	130
Drive-in theaters to get heaters	131
Truck tracks (P & G Supply Co., 615 S.E. Market St., Portland 14, Ore.)	131
Roof calculator (Edward Weyer, 40 W. 77th St., New York City 24)	135
Life preserver built into jacket (Neptune Specialties, Inc., Columbia Heights, Brooklyn, N. Y.)	141
Mid-ocean weatherdrome	147
Key chain comes apart with finger-tip pressure (Carey-McFall Co., 2156 E. Dauphin St., Philadelphia 25, Pa.)	148
Stop lights change to green when they "hear" fire trucks	148
"Radium" train	149
Huge drawing guides mosaic	156
Plastic "tarpaulin" protects linemen (Plastic Sheeting Co., 1205 S.E. Grand Ave., Portland 14, Ore.)	156
Suitcase handle is electric iron (Janis Corp., Bedford St., Manchester, N. H.)	156
Old-time pumpers built from kits (William H. Los Co., Braintree 84, Boston, Mass.)	159
Nonelectric light bulb glows when it is shaken	163

Craftsman and Shop Notes Index

AUTOMOTIVE

Trailer held against garage wall requires little storage space	172
Dashboard tray increases comfort on long trips	173
Car-top carrier permits easy handling of light boat	177
Tab fastened to car-door switch keeps interior lights off	179
Balancing rubber fan blades	180

BOATING, CAMPING AND FISHING

Brush jungles in cool water improve midsummer fishing	168
These special baits are sure to tempt carp	176

(Continued to page 14)

I Will Train You at Home for Good Jobs in **RADIO- TELEVISION**



**I Send You Many
KITS OF PARTS
for practical experience**

You conduct many tests and experiments with equipment built from materials I furnish. Some of the equipment from my Servicing Course and some from my Communications Course is shown below. Everything I send is yours to keep.

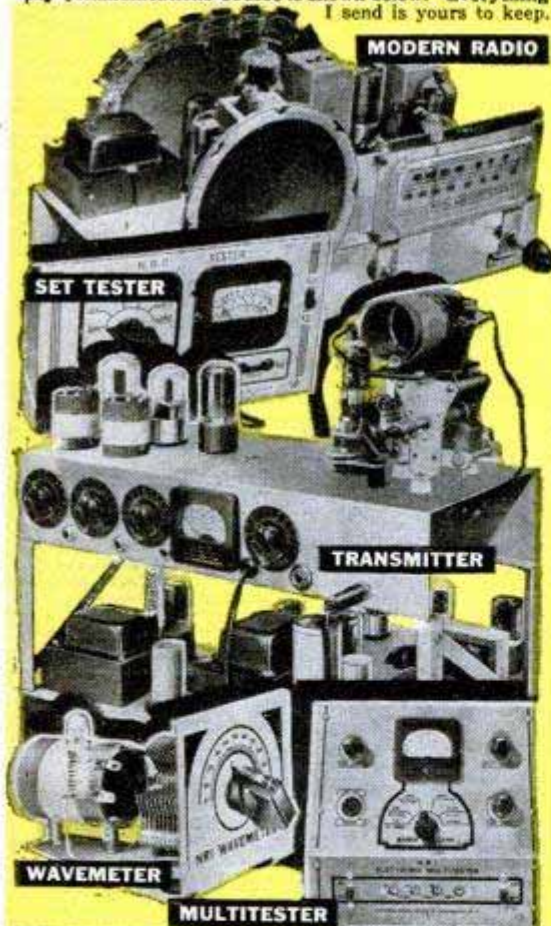

VETERANS GET THIS TRAINING
WITHOUT COST
UNDER G. I. BILL

America's Fastest Growing Industry Offers You **GOOD PAY--SUCCESS**

Want a good-pay job in the fast growing **RADIO-TELEVISION** Industry? Want a money-making Radio-Television shop of your own? Here's your opportunity. I've trained hundreds of men to be successful Technicians. . . . **MEN WITH NO PREVIOUS EXPERIENCE.** My tested and proved train-at-home method makes learning easy. You learn Radio-Television principles from illustrated lessons. You get practical experience building, testing, experimenting with **MANY KITS OF PARTS** I send. All equipment yours to keep.

MAKE EXTRA MONEY IN SPARE TIME

The day you enroll, I start sending **SPECIAL BOOKLETS** that show you how to make \$5, \$10 a week or more **EXTRA MONEY** fixing neighbors' Radios in spare time while learning. From here, it's a short step to your own shop or a good-pay Radio-Television servicing job. Or be a licensed Radio-Television Operator or Technician.

TELEVISION OFFERS BRIGHT FUTURE

Today there are nearly 2700 Radio stations on the air—and within three years experts predict over 1000 Television Stations. Then add developments in FM, Two-Way Radio, Police, Marine, Aviation and Microwave Relay Radio! Think what this means. New jobs, more jobs, good pay for qualified men.

ACTUAL LESSON **FREE**

Act now! Send for my **FREE DOUBLE OFFER.** Coupon entitles you to actual lesson, "GETTING ACQUAINTED WITH RECEIVER SERVICING." It shows you that learning at home is easy, practical. You also get my 64-page book, "HOW TO BE A SUCCESS IN RADIO-TELEVISION." It tells what my graduates are doing and earning. Send coupon in envelope or paste on penny postal. **J. E. SMITH, President, Dept. 9HP, National Radio Institute, Pioneer Home Study Radio School, Washington 9, D. C.**

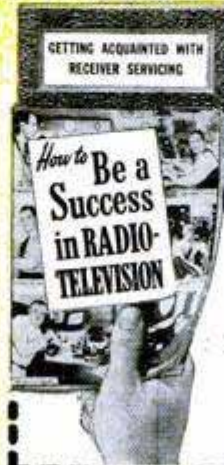

I TRAINED THESE MEN



"Before finishing course, I earned as much as \$10 a week fixing Radios at home in spare time. Recommend N. R. I."—**S. J. Petruff, Miami, Florida.**

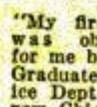

"My first job was obtained for me by your Graduate Service Dept. Am now Chief Engineer, Police Radio Station WQOX."—**T. S. Norton, Hamilton, Ohio.**



"N. R. I. was my stepping stone from a few hundred to over \$4,000 a year as a Radio Engineer. Make extra money servicing Radios."—**A. B. Michaels, Trenton, Ga.**

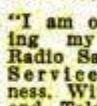

"I am operating my own Radio Sales & Service business. With FM and Television in the offing, we have a very profitable future."—**A. Patrick, Tampa, Fla.**

Good for Both—**FREE**

**MR. J. E. SMITH, President, Dept. 9HP
National Radio Institute, Washington 9, D. C.**

Mail me Sample Lesson and 64-page book about How to Win Success in Radio-Television—both **FREE.** (No salesman will call. Please write plainly.)

Name..... Age.....

Address.....

City..... Zone..... State.....

Check if Veteran Approved Under G. I. Bill



The Dark Continents of Your Mind

DO YOU struggle for balance? Are you forever trying to maintain *energy, enthusiasm, and the will to do*? Do your personality and power of accomplishment ebb and flow — like a stream controlled by some unseen valve? Deep within you are minute organisms. From their function spring your emotions. They govern your *creative ideas and moods* — yes, even your enjoyment of life. Once they were thought to be the mysterious seat of the soul — and to be left unexplored. Now cast aside superstition and learn to direct intelligently these *powers of self*.

Accept this Free Book

Let the Rosicrucians, an age-old fraternity of thinking men and women (not a religion), point out how you may fashion life as you want it — by making the fullest use of these little-understood *natural faculties* which you possess. This is a challenge to make the most of your heritage as a human. Write for the Free Book, "The Mastery of Life." Address: Scribe J.K.Y.

The ROSICRUCIANS

San Jose (AMORC) California

(Continued from page 12)

Driving tent stakes to hold in wind.....	177
Pocket kit for young fishermen carries necessary equipment.....	177
Stopping outboard motors properly.....	186
Boy-scout lantern made from tin cans.....	189
FARM	
Sulphur fumes piped to dens kill ground hogs.....	205
Timely suggestions for better farming.....	211
Oil drums form diverting gates at irrigation-ditch branch.....	212
Magnet aids filling cistern pail.....	212
HOUSE AND HOME	
Wall bracket holds flowerpot.....	168
Durable aluminum canopy resembles awning.....	169
Garment hanger secured on clothesline.....	170
Tilting improves use of food grinder.....	170
Substitute for picture wire.....	170
Storing oilcloth.....	170
Potato removes shiny areas on clothing.....	170
Double boiler improvised with aid of fruit-jar lids.....	170
Plunger facilitates laying linoleum.....	171
Straightening plastic knitting needles.....	171
Safety extension on folding gate.....	171
Dry paint removed from window glass.....	171
Washing machine churns butter.....	179
Aluminum foil speeds ironing.....	181
More room on indoor clothesline provided by wooden slats.....	184
Child-size mirror and towel rack in bathroom encourages habits of personal cleanliness.....	196
Doorstops raise youngster's table.....	196
LAWN AND GARDEN	
Garden hose reinforced with tape to prevent kinking.....	173
Bird feeder from gallon can.....	180
Self-locking garden reel aids row marking.....	196
PHOTOGRAPHY	
Radiator holds ferrotype tins to serve as print drier.....	198
Emergency ground glass.....	198
Adjustable photo-light stand of pipe fittings rolls on casters and is disassembled easily.....	199
Hardboard easel for enlarger permits contact printing.....	199
Cellulose tape masks paper for multiple printing.....	200
Cardboard clamped to reflector shields lens.....	200
Enlarger vibration reduced by felt pads under base.....	200
Scale on camera focusing knob indicates flash exposure.....	200
Cotton serves as tissue to clean lenses.....	200
Apartment photo lab.....	201
Camera fitted with hand mirror used for direct copying.....	202
Switch on contact printer operates light automatically.....	202
Plastic bag protects camera.....	202
Photo-paper box made lightproof by adding second cover.....	202
TOOLS	
Bobby pin holds brads for easy starting.....	173
Portable small-parts tray utilizes milk cartons.....	177
Table on electric coping saw permits mounting in vise.....	180
Toggle-switch extension improvised from fuller ball.....	184
Dowel chucked in drill press serves as spindle sander.....	186
Inside measurements taken quickly by means of folding rule.....	186
Wooden drill jig facilitates locating centers of dowels and round stock.....	194
Scriber for fitting linoleum improvised from marking gauge.....	205
Heat-hardening polished steel without damaging finish.....	212
Angle setting of worn knurling tool prevents overlapping.....	212
TOYS AND NOVELTIES	
Giggle-getter model airplane.....	178
Swordfish paper knife forms attractive desk accessory.....	184
Two-way candlesticks.....	185
Modern picture frame in plastic supported by wire stand.....	189
Cigarette case is tooled to simulate fine leather.....	194
WOODWORKING	
Segments cut from flanged disk provide modern drawer pulls.....	172
Lasting filler for wood cracks.....	180
Well pump modeled in walnut forms lamp base.....	181
Renewing screw-hole threads.....	186
MISCELLANEOUS	
Flashing compound applied with kerosene-dipped paddle.....	168
Sturdy louvers for barn or garage have sheet-metal slats.....	168
Adapter on photo-light stand holds microphone.....	169
Staples form temporary hinge.....	172
Film cartridge dispenses stamps.....	172
Eraser clamps furnish propellers for solid model airplanes.....	172
Armload of books carried easily.....	176
Magazine pages removed neatly.....	179
Food bag keeps flashlight dry.....	180
Hook bent from wire coat hanger eliminates flush-tank leak.....	181
Refinishing plastic novelties.....	184
Trapping frogs with oilcan.....	186
Cardboard inserted under hinge corrects binding door.....	189
Cloth placed over putty knife removes excess paint.....	194
"21" game combines squash and table tennis.....	195
Anchors for cemetery vases cut from coat hangers.....	195
Metal funnel locates keyhole.....	196
Display sign for garage made from old auto tire.....	204
Shading with yellow pencil produces neater tracings.....	204
Estimating tonnage in coal piles.....	205
Removing cap from paint tube.....	212

Radio-Television, Electronics

High-speed communication (Consolidated-Vultee Aircraft Corp., San Diego, Calif.).....	217
How to build an inexpensive signal tracer for radio servicing.....	218
Demonstration panels for teaching TV and electronics (Thymo-trol electronic demonstration panel, General Electric Co., Schenectady, N. Y.; television dynamic demonstrator, Radio Corporation of America, Camden, N. J.).....	220

IMPORTANT NOTICE—It is the intention of this magazine to provide its readers with information regarding the latest developments in the mechanical arts. We take no responsibility as to whether the disclosures contained in our articles are covered by patents and advise readers to investigate this subject before making, using, or selling any of the products, machines, or processes described in order to avoid possible liability for patent infringements.



INVENTORS



Learn how to protect your invention. The U. S. Patent Laws provide that any new and useful art, machine, article of manufacture, or composition of matter, or any new and useful improvement thereof, may be patented if the act of invention is involved. Therefore, every inventor with a valuable invention should take advantage of the Patent Laws and proceed for patent protection in order to safeguard his rights.

A patent gives the inventor the exclusive right to prevent others from making, using, or selling the invention claimed in the patent for a period of seventeen years.

The Patent Laws were enacted for the benefit of the inventor to give him protection for the features of his invention which are patentable. These features must be properly and concisely set forth and claimed in a formal application for patent, in order to comply with the requirements of the Patent Laws. For that reason, unless the inventor is familiar with patent matters, he should engage a competent registered patent attorney or agent to represent him. We are registered to practice before the U. S. Patent Office and are prepared to serve you in the handling of your patent matters.

A specially prepared booklet entitled "Patent Guide for the Inventor", containing detailed information with respect to patent protection and procedure, together with a "Record of Invention" form will be promptly forwarded to you without obligation upon request.

CLARENCE A. O'BRIEN & HARVEY JACOBSON

Registered Patent Attorneys

91-H DISTRICT NATIONAL BUILDING • WASHINGTON 5, D. C.

Patents
Trademarks
Copyrights

CLARENCE A. O'BRIEN & HARVEY JACOBSON
Registered Patent Attorneys
91-H District National Bldg., Washington, D. C.
Please send me copy of "Patent Guide for the Inventor" and also
"Record of Invention" form. This request does not obligate me.

Name _____

Address _____

City _____ State _____

(Please write or print plainly.)

HOW TO GET THE THINGS YOU REALLY WANT

— this **PROVEN, EASY** way

NOW ONLY \$2 if you decide to keep it after 10 Days **FREE TRIAL**

SUCCESS STORIES

you can't afford to miss

JOB-SEEKERS!

Read the thrilling story of Edwin C. Barnes. Out of work, he used this formula to get a job with Thomas A. Edison, and later became his partner.



SALESMEN!

Read the famous story of Darby, who at one time was "three feet away" from being a millionaire, and then converted this experience to become a very successful salesman.



SPEAKERS!

Read the almost fantastic story of Charles M. Schwab's after-dinner speech which sold an idea worth millions of dollars. Fame and riches came as a direct result.



MINISTERS!

Read the story of the sermon that brought a million dollars. These stories are but a handful that demonstrate the effectiveness of the formula set forth in "Think and Grow Rich!"



How large a home do you want to own? How popular do you want to be? How much money would you like to have? What are your ambitions in business or profession? Set your goal—and set it high! You can win it thanks to the proved formula for success dynamically explained in "Think and Grow Rich!" Suppose your goal has been to have \$10,000 or \$50,000 in the bank. Why have you failed to get the money you want? Time and again the answer is—failure to use the formula by which big money is made!

Too many people think—falsely—that mere will-power or dogged hard work can gain a fortune. You can get rich only by using the formula for getting rich. And the same thing goes for other goals you may have. You can get ahead in your business or profession only by using the formula for getting ahead. You can become popular only by using the formula for gaining popularity or fame.

That's why "Think and Grow Rich!" can mean so much to you. It reveals in specific detail the very formula necessary for success in gaining whatever goal you're after! In fact, it gives you the personal formula of Andrew Carnegie himself—The secret of achievement used by the Steel King in making hundreds of millions of dollars for himself and many more millions for others!

HERE IS THE SIMPLE FORMULA THAT HAS BROUGHT WEALTH AND FAME TO THOUSANDS

Coronet Magazine Reports:

Coronet Magazine asked 300 successful young people: "What book or books most influenced your life and contributed to your success?" Among the books most frequently mentioned was "Think and Grow Rich!"

F. W. WOOLWORTH wrote, "By applying your philosophy we have built a great chain of stores. The Woolworth Building might properly be called a monument to the soundness of your principles."

WM. WRIGLEY, JR., wrote, "Whatever success I have attained I owe, entirely, to the application of your principles of success."

Nearly **ONE QUARTER** OF A MILLION COPIES SOLD

ONLY \$2 if you keep it

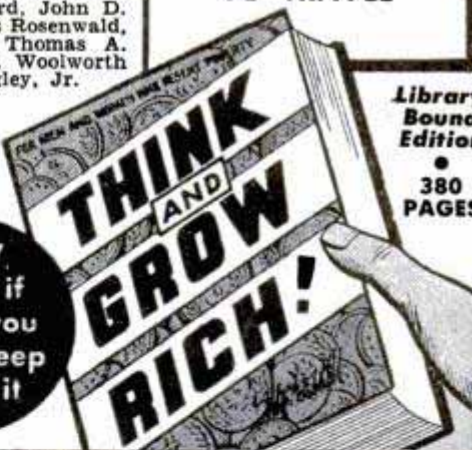

Library Bound Edition • 380 PAGES



FREEDOM FROM MONEY WORRIES



A BIGGER JOB



A BETTER HOME



TIME AND MONEY TO TRAVEL

FREE TRIAL COUPON

RALSTON PUBLISHING CO.

128 Engineers Bldg., Cleveland, Ohio

Send me a copy of "Think and Grow Rich!" for FREE TRIAL. I will pay postman \$2, plus postage, on delivery with the understanding that if I return the book in 10 days you will refund my purchase price.

Name _____

Address _____

City & Zone _____ State _____

SAVE MONEY. We mail book postpaid if you enclose \$2 now. Same free trial and refund privilege.

MAIL COUPON NOW

"THINK AND GROW RICH" MUST HELP YOU

OR YOU GET YOUR MONEY BACK

In just one hour you can learn enough about the formula for success to start it working for you. The formula is revealed step by step, exactly as told by Carnegie. Let us show you how to turn failure into success... how to get whatever it is you really want. In 10 days you can know how effectively the formula is working—and whether it is worth the small cost of only \$2. You're the sole judge! You risk nothing. Mail the FREE-TRIAL coupon NOW!

RALSTON PUBLISHING CO.
128 Engineers Bldg., Cleveland, O.

SHOWS WHAT TO DO AND HOW TO DO IT

PAGE 328—The Six Basic Fears and How to Overcome Them • PAGE 370—57 Famous Alibis for Failure—What You Can Do About Them • PAGE 74—Formula for Gaining Self-Confidence • PAGE 178—Formula for Easily Correcting One or All of the 30 Causes for Failure • PAGE 42—Formula for Transmuting Your Desire for Riches Into Real Money • PAGE 187—Self-Analysis Questionnaire for Taking Your Personal Inventory.

INVENTORS

Patent laws encourage the development of inventions.

We recommend that an inventor employ a registered Patent Attorney or agent, if the inventor is not familiar with patent matters. This is because the value of a patent depends largely upon the skillful preparation of the specification and claims in the patent application.

The firm of McMorrow, Berman and Davidson is registered to practice before the United States Patent Office. Additionally it engages patent attorneys able to readily understand inventors' disclosures, to advise concerning patentability, and to prepare appropriate specifications and claims.

If an inventor believes he has an invention, a search of the most pertinent prior U. S. patents should be made and a report obtained relative to its patentability. Where such report indicates that the invention appears patentable, in order to secure protection, diligence should be exercised in making application for a patent.

Send for a copy of Patent Booklet entitled "How To Protect Your Invention." This booklet contains information on patent protection and procedure. You will also receive an "Invention Record" blank. This will be promptly forwarded to you upon request—no obligation.

McMORROW, BERMAN & DAVIDSON

Registered Patent Attorneys

PATENTS • TRADE MARKS • COPYRIGHTS

1353 VICTOR BUILDING, WASHINGTON 1, D. C.

McMORROW, BERMAN & DAVIDSON

Registered Patent Attorneys

1353 Victor Building, Washington 1, D. C.

Send me your Patent Booklet, "How To Protect Your Invention", and also "Invention Record" form at once. I understand this request does not obligate me.

Name.....

Address.....

City.....

(WRITE OR PRINT NAME CLEARLY)

Lend Me 15 Minutes A Day



*..and I'll prove
I can make you
a NEW MAN*

I'M trading in old bodies for new! I'm taking men who know that the condition of their arms, shoulders, chests and legs—their strength, "wind," and endurance—is not 100%. And I'm making NEW MEN of them!

If you can simply raise your arm and flex it, I can add SOLID MUSCLE to your biceps—yes, on each arm—in double-quick time! I can broaden your shoulders, strengthen your back, develop your whole muscular system INSIDE and OUTSIDE!

What Only 15 Minutes a Day Can Do

I can add inches to your chest, give you a vise-like grip, make those legs of yours lithe and powerful. I can shoot new strength into your old backbone, exercise those inner organs, help you cram your body so full of pep, vigor and red-blooded vitality that you won't feel there's even "standing room" left for weakness and that lazy feeling! Before I get through with you I'll have your whole frame "measured" to a nice, new, beautiful suit of muscle!

I Was a 97-lb. Weakling

All the world knows I was ONCE a skinny, scrawny 97-pound weakling. And NOW it knows that I won the title, "The World's Most Perfectly Developed Man." Against all comers! How did I do it? How do I work miracles in the bodies of other men in only 15 minutes a day? The answer is "Dynamic Tension," the amazing method I discovered and which changed me from a 97-pound weakling into the champion you see here!

FREE THIS FAMOUS BOOK "EVERLASTING HEALTH AND STRENGTH"

Almost two million men have sent for and read my book, "Everlasting Health and Strength." It tells you exactly what "Dynamic Tension" can do. And it's packed with pictures that SHOW you what it does. Results it has produced for other men.

RESULTS I want to prove it can get for YOU! Learn how you can actually become a NEW MAN, right in the privacy of your own home and in only 15 minutes a day! Mail this coupon NOW! CHARLES ATLAS, Dept. 8W, 115 East 23rd St., New York 10, N. Y.

Charles Atlas

Actual photo of the man who holds the title, "The World's Most Perfectly Developed Man."



**CHARLES ATLAS, Dept. 8W,
115 East 23rd St., New York 10, N. Y.**

I want the proof that your system of "Dynamic Tension" will help make a New Man of me—give me a healthy, husky body and big muscular development. Send me your free book, "Everlasting Health and Strength."

Name _____ Age _____
(Please Print or Write Plainly)
Address _____
City _____ State _____

BE A SUPERVISOR

FRANKLIN TECHNICAL INSTITUTE
HELPS YOUNG PEOPLE GET AHEAD



Specialized technical training opens wide the door to well-paid supervisory jobs in industry. 50,000 young men and women have graduated from this Boston school and found good jobs in engineering and technical fields.

Practical two-year day courses in industrial electricity and electronics, industrial chemistry, mechanical and machine design, structural design and architectural drafting, automotive service and management, electric wiring and maintenance. One-year course in professional photography. Also preparatory and evening classes. Approved for veterans. 41st year. Write for catalog.

FRANKLIN TECHNICAL INSTITUTE
43 BERKELEY STREET, BOSTON 16, MASS.

SHORTHAND in 6 Weeks at Home

Famous Speedwriting system. No signs; no symbols; no machines; uses ABC's. Easy to learn; easy to write and transcribe. Low cost. 100,000 taught by mail. For business and Civil Service. Also typing. 26th year. Write for free booklet to:

Speedwriting
Dept. 1508-9, 55 W. 42 St., New York 18

LAW STUDY AT HOME for Business Success and LARGER PERSONAL EARNINGS. 40 years expert instruction—over 114,000 students enrolled. LL.B. Degree awarded. All text material furnished. Easy payment plan. Send for FREE BOOK—"Law and Executive Guidance," NOW!
AMERICAN EXTENSION SCHOOL OF LAW
Dept. 17-PM 646 N. Michigan Ave. Chicago 11, Ill.

**ENGINEERING—
Building, Drafting, Etc.**
Degree in 27 mos. Approved for G.I. Training. Prepare in Chicago, the Industrial Hub. Earn part living expenses. 45th year. Other shorter courses in Air Conditioning, Refrigeration, Radio, Electricity. Enter Jan., March, July, Sept.
Chicago TECH College
Write for catalog
K-83 TECH BLDG., 2000 SO. MICHIGAN AVE., CHICAGO 16

APTITUDE TESTS discover the kind of work or studies best for your success! You get a personal report—a guide for life—more happiness—more prosperity. For men, women, boys and girls. Write for complete facts.
VOCATIONAL COUNSELING INSTITUTE
956 Maccabees Bldg., Detroit 2, Michigan

"LEARN-BY-DOING"
ELECTRICITY
PRACTICAL TRAINING NOT "HOME STUDY"

G.I. APPROVED Get actual experience in great shops of M.T.I. Learn all phases Practical Electricity; Housewiring, Motors, Const., Maintenance, etc. Living arrangements, Part-time jobs, etc.

Send coupon TODAY. Veteran
MICHIGAN TECHNICAL INSTITUTE
2281 W. Fort St., Detroit, Mich., Dept. PM-8

Name _____
Street _____
City _____ State _____

I. C. S. STUDENT JUDGED BEST APPRENTICE IN THE NATION

**Ex-G.I. Took Course in
Electrical Engineering**

I. C. S. Training proves its worth. Recently, Robert M. Hutchison of Evansville, Ind., was picked as "the best electrical apprentice in the nation." He had studied Electrical Engineering with the International Correspondence Schools.

The award was made by the National Electrical Contractors Association. Hundreds of apprentices from every section of the country figured in the competition.

The same training that brought "Bob" Hutchison national recognition is available



"Here's why I consider I. C. S.

Courses exceptional:

- 1 I. C. S. texts are easy to understand; explanations are very clear.
- 2 The student determines his own progress; gets a real sense of achievement.
- 3 Textbooks and lesson material make a valuable set of reference books."

ROBERT M. HUTCHISON

to you. If you want the security and rewards that come with sound, practical training, mark and mail the coupon *today*. Find out what I. C. S. can do for you.

INTERNATIONAL CORRESPONDENCE SCHOOLS



BOX 5658-K, SCRANTON 9, PENNA.

Without cost or obligation, please send me full particulars about the course BEFORE which I have marked X:

- | | | | |
|--|--|--|--|
| <p>Air Conditioning and Plumbing Courses</p> <p><input type="checkbox"/> Air Conditioning <input type="checkbox"/> Heating
<input type="checkbox"/> Refrigeration <input type="checkbox"/> Plumbing
<input type="checkbox"/> Steam Fitting</p> <p>Chemistry Courses</p> <p><input type="checkbox"/> Chemical Engineering
<input type="checkbox"/> Chemistry, Analytical
<input type="checkbox"/> Chemistry, Industrial
<input type="checkbox"/> Chemistry, Mfg. Iron & Steel
<input type="checkbox"/> Petroleum Refining <input type="checkbox"/> Plastics
<input type="checkbox"/> Pulp and Paper Making</p> <p>Civil Engineering, Architectural and Mining Courses</p> <p><input type="checkbox"/> Architecture
<input type="checkbox"/> Architectural Drafting
<input type="checkbox"/> Bridge and Building Foreman,
<input type="checkbox"/> Building Estimating
<input type="checkbox"/> Civil Engineering
<input type="checkbox"/> Coal Mining
<input type="checkbox"/> Contracting and Building
<input type="checkbox"/> Highway Engineering
<input type="checkbox"/> Lumber Dealer
<input type="checkbox"/> Reading Structural Blueprints
<input type="checkbox"/> Sanitary Engineering
<input type="checkbox"/> Structural Drafting</p> | <p><input type="checkbox"/> Structural Engineering
<input type="checkbox"/> Surveying and Mapping</p> <p>Communications Courses</p> <p><input type="checkbox"/> Electronics
<input type="checkbox"/> Practical Telephony
<input type="checkbox"/> Radio, General
<input type="checkbox"/> Radio Operating
<input type="checkbox"/> Radio Servicing
<input type="checkbox"/> Telegraph Engineering</p> <p>Electrical Courses</p> <p><input type="checkbox"/> Electrical Drafting
<input type="checkbox"/> Electrical Engineering
<input type="checkbox"/> Electric Light and Power
<input type="checkbox"/> Lighting Technician
<input type="checkbox"/> Practical Electrician</p> <p>Internal Combustion Engines Courses</p> <p><input type="checkbox"/> Auto Technician <input type="checkbox"/> Aviation
<input type="checkbox"/> Diesel-Electric <input type="checkbox"/> Diesel Engines
<input type="checkbox"/> Gas Engines</p> <p>Mechanical Courses</p> <p><input type="checkbox"/> Aeronautical Engineer's, Jr.
<input type="checkbox"/> Aircraft Drafting <input type="checkbox"/> Flight Engineer
<input type="checkbox"/> Forging <input type="checkbox"/> Foundry Work
<input type="checkbox"/> Heat Treatment of Metals
<input type="checkbox"/> Industrial Engineering</p> | <p><input type="checkbox"/> Industrial Metallurgy
<input type="checkbox"/> Machine Shop
<input type="checkbox"/> Mechanical Drafting
<input type="checkbox"/> Mechanical Engineering
<input type="checkbox"/> Mold-Loft Work
<input type="checkbox"/> Patternmaking—Wood, Metal
<input type="checkbox"/> Reading Shop Blueprints
<input type="checkbox"/> Sheet-Metal Drafting
<input type="checkbox"/> Sheet-Metal Worker
<input type="checkbox"/> Ship Drafting <input type="checkbox"/> Ship Fitting
<input type="checkbox"/> Tool Designing <input type="checkbox"/> Toolmaking
<input type="checkbox"/> Welding Engineering
<input type="checkbox"/> Welding—Gas and Electric</p> <p>Railroad Courses</p> <p><input type="checkbox"/> Air Brake <input type="checkbox"/> Car Inspector
<input type="checkbox"/> Diesel Locomotive
<input type="checkbox"/> Locomotive Engineer
<input type="checkbox"/> Locomotive Fireman
<input type="checkbox"/> Locomotive Machinist
<input type="checkbox"/> Railroad Section Foreman</p> <p>Steam Engineering Courses</p> <p><input type="checkbox"/> Boilermaking
<input type="checkbox"/> Combustion Engineering
<input type="checkbox"/> Engine Running
<input type="checkbox"/> Marine Engineering
<input type="checkbox"/> Steam Electric <input type="checkbox"/> Steam Engr.</p> | <p>Textile Courses</p> <p><input type="checkbox"/> Cotton Manufacturing
<input type="checkbox"/> Loom Fixing <input type="checkbox"/> Rayon Weaving
<input type="checkbox"/> Textile Designing
<input type="checkbox"/> Woolen Manufacturing</p> <p>Business and Academic Courses</p> <p><input type="checkbox"/> Accounting <input type="checkbox"/> Advertising
<input type="checkbox"/> Bookkeeping
<input type="checkbox"/> Business Administration
<input type="checkbox"/> Business Correspondence
<input type="checkbox"/> Certified Public Accounting
<input type="checkbox"/> Commercial <input type="checkbox"/> Commercial Art
<input type="checkbox"/> Cost Accounting
<input type="checkbox"/> Federal Tax <input type="checkbox"/> First Year College
<input type="checkbox"/> Foremanship <input type="checkbox"/> French
<input type="checkbox"/> Good English <input type="checkbox"/> High School
<input type="checkbox"/> Higher Mathematics
<input type="checkbox"/> Motor Traffic <input type="checkbox"/> Postal Civil Service
<input type="checkbox"/> Retailing
<input type="checkbox"/> Retail Store Management
<input type="checkbox"/> Salesmanship <input type="checkbox"/> Secretarial
<input type="checkbox"/> Sign Lettering
<input type="checkbox"/> Spanish <input type="checkbox"/> Stenography
<input type="checkbox"/> Traffic Management</p> |
|--|--|--|--|

Name _____ Age _____ Home Address _____

City _____ State _____ Working Hours _____ A.M. to _____ P.M.

Present Position _____ Employed by _____

Length of Service in World War II _____ Enrollment under G.I. Bill approved for World War II Veterans. Special tuition rates to members of the Armed Forces. Canadian residents send coupon to International Correspondence Schools Canadian, Ltd., Montreal, Canada.

INVENTORS-PATENTS

Unless an inventor is thoroughly familiar with such matters, he is advised to employ a competent registered patent attorney or agent as the value of patents depends largely upon the skillful preparation of the specification and claims.

For his guidance, the following are the usual preliminary steps which the inventor takes toward patent protection.

The "Evidence of Invention" form mentioned below is offered as a convenience to the inventor in making his disclosure of invention.

The inventor should date and sign his disclosure and have it witnessed by two or more persons who are capable of understanding his invention. The disclosure should then be mailed to the registered patent attorney or agent whom he selects to assist him. The disclosure should be accompanied by a letter authorizing the patent attorney or agent to conduct a preliminary search among previously granted U. S. patents for similar types of invention. The patent attorney or agent then prepares a report of the probable patentability of the invention and recommends the further course the inventor should take, provided the report indicates possible patentability.

This firm is registered to practice before the U. S. Patent Office and is available to assist inventors in the preparation and prosecution of their cases. The coupon below is suggested as a convenience to the inventor in starting action on his invention.

VICTOR J. EVANS & Co. *Merlin M. Evans*
REGISTERED PATENT ATTORNEY
430-J MERLIN BUILDING, WASHINGTON 6, D. C.

• • • • •

VICTOR J. EVANS & CO.
430-J Merlin Building, Washington 6, D. C.

Please send me without obligation a copy of your booklet "Patent Protection For Inventors" together with your convenient "Evidence of Invention" form.

Name.....

Address.....

City and State.....

• • • • •

PATENTS TRADEMARKS COPYRIGHTS

OUT OF PAWN
GENUINE DIAMONDS

SAVE UP TO 50%
AND MORE

Money-Back Guarantee



Approx. 1/2 Ct. Incl. Tax
\$95
\$200 VALUE

SEND FOR **FREE**
Diamond Catalog

BERMAN'S
Illustrated Catalog

Diamonds from estates, banks, unredeemed pledges offered at substantial savings

VALUES FROM \$10 TO \$10,000

All diamonds reset in new mountings.

BERMAN'S DIAMOND LOAN BANK
DEPT. P
BERMAN BLDG., BALTO. 1, MD.
Reference: Your Own Bank or Any Mercantile Agency

Learn **PHOTOGRAPHY**

Win success in photography by spare time Home Study or at our famous Resident School in the heart of New York. Commercial, Advertising, Portrait, Color, etc. 39th year. Write today!

NEW YORK INSTITUTE OF PHOTOGRAPHY

Dept. "49", 10 W. 33 St., New York 1, N. Y.

TRI-STATE COLLEGE

B. S. DEGREE IN 27 MONTHS

66th Year.

Students from all over the world.

ENGINEERING—Courses in Civil, Electrical, Mechanical, Chemical, Aeronautical and Radio (including Television). Also Bus. Admin., Acc't. and Sec. Science. Low living costs. Modern cafeteria on campus. Graduates in demand. Enter Sept., Jan., March, June. Write for Catalog. 489 College Avenue, Angola, Indiana.

ARTISTS MAKE MONEY

Do you like to draw? Send name, address, age and occupation for FREE ART TEST. to find out your ability.

ART INSTRUCTION, Inc.
8139 ART INSTRUCTION BLDG., MINNEAPOLIS 15, MINN.

DEPRESSION INSURANCE!!

Earn well even in hardest times by saving other people money! People pay up to \$5.00 or more per hour to have their vacuum cleaners, irons, refrigerators fixed, houses wired, etc. When money is tight, millions of appliances will be repaired rather than replaced. Make Money Now in your spare time with new system. Learn Electrical Appliance Repairing by making actual repairs! Pay us later for kits, illustrated lessons, etc., from earnings while learning. Write for FREE Book. CHRISTY TRADES SCHOOL, 2835 N. Central Ave., Dept. D-7203, Chicago 34.

E-Z CAR WASHER

SOAPS and WASHES

Can also be used to wash **Windows, Walls, Boats, Porches, Cellars, Garage Floors and many other uses.**

in one operation

Easily attached to garden hose —46" aluminum handle
Insert teaspoonful of any household soap powder or detergent in built-in soap pouch.
Replacable mop
Cars can be washed easily without getting yourself wet

Order Now!
Send \$3.50 check or money order. We deliver post-paid. Money back if not entirely satisfied.



\$3.50

POSTPAID

E-Z CAR WASHER

401 West 48th St., Dept. PM2, New York 19

Prepare in our
Big Training
Shops for these

GREAT OPPORTUNITY FIELDS!

ELECTRICITY OR **RADIO TELEVISION**



This big fire-proof building is occupied entirely by Coyne.

FIVE BIG FLOORS PACKED WITH MASSIVE EQUIPMENT

Thousands of men and young men have come to our big training shops where we have floor upon floor packed with massive equipment to train with, to prepare for good jobs and real futures in the opportunity fields of Electricity and Radio-Television. For many years, these fields have offered great opportunities to trained men. With new developments, including Electronics and Television, they will continue to grow and offer even greater opportunities. Why be satisfied with a "no future" job? Many "one operation" jobs that exist today will not last. Prepare for a good job with a real future for steady pay and advancement by training NOW in the great training shops of COYNE in Chicago.

NOT "HOME-STUDY" COURSES

Our famous Radio-Television Practical-Technical method gives you practical experience on a massive outlay of equipment. Not by correspondence, but actual shop work plus necessary technical training. You are trained right here in the great Coyne shops that have been training men and young men for over 50 years.

ELECTRICITY RADIO-TELEVISION

INCLUDING INDUSTRIAL ELECTRONICS

Big future in Power Plant Work, Motors, Armature Winding, Home and Factory Wiring, Appliances, Refrigeration, Maintenance, Illumination, etc. Electricians are in demand everywhere —lifetime job service to Coyne graduates. Send for BIG FREE BOOK.

A great field now, even greater growth ahead. Here at COYNE you're trained for Construction, Testing, Trouble-Shooting on Radio, Public Address, Sound Units. Training includes FM, Television Servicing, etc. Many Coyne trained men in good jobs or own well paying Radio-Television businesses of their own.

LARGEST, OLDEST, BEST EQUIPPED SCHOOL OF ITS KIND IN THE U.S.

Mail Coupon for
Big FREE Book!

Whether you prefer Electricity, or Radio-Television, train on actual equipment at Coyne. We have a big, fully illustrated book on each course, and we'll send you the one you want, or both if you want to consider both fields, without obligation. Mail coupon—TODAY.

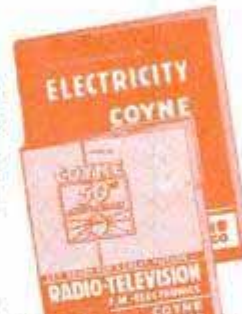

ELECTRIC REFRIGERATION

This valuable training now included with either course means added opportunities.

G. I. APPROVED

NON-VETERANS who are short of cash can finance most of their tuition and pay in easy monthly payments after graduation. Many earn while learning.

B. W. COOKE, President

COYNE ELECTRICAL AND RADIO SCHOOL
500 So. Paulina St., Dept. C9-72H, Chicago 12, ILL.

B. W. Cooke, President
COYNE ELECTRICAL AND RADIO SCHOOL
500 S. Paulina St., Dept. C9-72H Chicago 12, Ill.

Send me the book, or books, checked below and details of your training offer. This does not obligate me and no salesman will call.

ELECTRICITY RADIO-TELEVISION

NAME.....

ADDRESS.....

CITY.....STATE.....

BE A WINNER AT ANYTHING YOU TACKLE WITH **PROGRESSIVE POWER**



"The Jowett System is the greatest in the world!" says R. F. Kelly, Physical Director, Atlantic City



George F. Jowett

Whom experts call "Champion of Champions"

- World's wrestling and weight lifting champ at 17 and 19.
- World's Strongest Arms.
- 4 times World's Perfect Body — plus other records.

10 DAY TRIAL!
Think of it—all five of these famous courses now in one picture-packed muscle-building volume for only 10c. If you don't actually FEEL results within ONE WEEK, send it back and your money will be promptly refunded! Photo Book of Famous Strong Men!

FREE!



Photos that inspire you to might and muscle. Free with order.

FREE GIFT COUPON!

Jowett Institute of Physical Culture DEPT. PM-98
230 Fifth Avenue, New York 1, N. Y.

Dear George:—Please send by return mail, prepaid, **FREE** Jowett's Photo Book of Strong Men, along with all 5 Muscle Building Courses. 1. Molding a Mighty Chest. 2. Molding a Mighty Arm. 3. Molding a Mighty Grip. 4. Molding a Mighty Back. 5. Molding Mighty Legs. Now all in One Volume "How to Become a Muscular He-Man." Enclosed find 10c for postage and handling. No C.O.D.'s.

NAME _____ AGE _____
(Please Print Plainly, Include Zone Number)
ADDRESS _____

Amazing get-acquainted offer—YOURS for only

10c

INSTEAD OF \$1 FOR ALL 5 COURSES

Let's Go, Pal! I'll prove I can make YOU an **"ALL-AROUND" HE-MAN**

FAST—OR NO COST!
says George F. Jowett
World's Greatest Body Builder

Enjoy My "Progressive Power" Strength Secrets! Give Me 10 Easy Minutes a Day—Without Strain! I'll teach you the "Progressive Power Method" through which I rebuilt myself from a physical wreck the doctors condemned to die at 15, to the holder of more strength records than any other living athlete or teacher! "Progressive Power" has proven its ability to build the strongest, handsomest men in the world. And I stand ready to show you on a money back basis—that no matter how flabby or puny you are I can do the same for you right in your own home. Let me prove I can add inches to your arms, broaden your shoulders, give you a man-sized chest, powerful legs and a Rock-like back—in fact, power pack your whole body so quickly it will amaze you! Yes, I'll join you with power and confidence to master any situation—to win popularity—and to get ahead on the job! Through my proven secrets I bring to life new power in you inside and out, until YOU are fully satisfied you are the man you want to be.

PROVE IT TO YOURSELF IN ONE NIGHT
Send only 10c for my 5 easy-to-follow, picture-packed courses now in 1 complete volume "How to Become a Muscular He-Man." Try it for one night! Experience the thrilling strength that surges through your muscles.

I am making a drive for thousands of new friends fast—REGARDLESS OF COST!

SO GET NOW MY 5 Muscle Building COURSES
(Valued at \$5 each)
All in 1 Great Complete Volume Packed With How-To-Do-It Pictures!

Now, this "get-acquainted," extremely low price of only 10c is your chance to build a body you'll be proud of! Follow Jowett's easy method of muscle building NOW!

For **Only 10c**

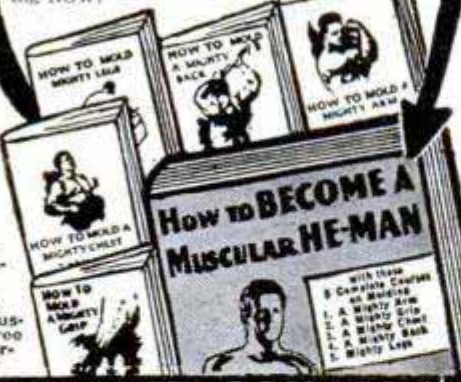

AVIATION

Aeronautical University Approved Training meets exacting standards of aviation industry, prepares for key positions, big opportunities.

Courses in:
AERONAUTICAL ENGINEERING, B.S. degree.
AERONAUTICAL ENGINEERING DRAFTING
CERTIFIED AIRPLANE AND ENGINE MECHANICS ADMINISTRATION—including sales.
PRE-ENGINEERING: Special course for high school graduates and veterans needing math and science.

Also refresher courses for Gov't Airplane and Engine Mechanics Licenses for those with aviation experience.

Oldest fully approved aviation school. Outstanding faculty, modern equipment, outside employment, placement service. Day, evening. Approved for Veterans. Send for FREE catalog. Opportunities in Aviation. 20th anniversary.

AERONAUTICAL UNIVERSITY

Dept. 79, 116 S. Michigan Ave., Chicago 3, Ill.

FOUNDED BY CURTISS-WRIGHT



LEARN MEAT CUTTING At Home—In Spare Time

Get into the vital meat industry. Concise, practical Home Training based on 25 years proven instruction methods used at National's famous resident school. Prepares you for bigger pay as Meat Cutter, Supervisor, market manager or more money in your own store. Go as rapidly as your spare time permits. Diploma. Start NOW to turn your spare hours into money. Send for FREE bulletin today. No obligation.

NATIONAL SCHOOL OF MEAT CUTTING, INC., Div. U-108, Toledo 4, Ohio



COMPLETE COURSE IN AUTO BODY REPAIR

Do your own auto body and fender repairs, or learn high profit body repair business. Fully illustrated, step by step procedure from damage analysis to metal finishing. For beginners or experts. Send for "The Key to Metal Bumping."

ONLY \$1

MANZEL, INC., 315 Babcock St., Buffalo 10, N. Y.



DIESEL TRAINING

Get set NOW for steady, big-pay jobs in Diesel, Tractor and Heavy Equipment. Interstate's practical home training gives you the "know-how" for success and security. Investigate!

SEND POST CARD FOR FREE INFORMATION

INTERSTATE TRAINING SERVICE

Dept. 3-H 4035 N.E. SANDY BLVD., PORTLAND 13, OREGON

MAKE EXTRA MONEY

Selling Christmas Card Box Assortments, also 25 and 50 cards for \$1.00 with name imprinted. Personalized stationery. Rush name. Samples on approval.

GENERAL ART CO., 225 - 4th Ave., N. Y. 3, N. Y.

SAY YOU SAW IT IN POPULAR MECHANICS



LEARN Photo-Engraving

You can get into this big demand, high profit, high wage field. Learn at home or in our modern, friendly, approved school in Aurora where training costs you less than \$1.00 per hour with everything furnished.

Famous Tasope' photo-engraving plants are again available. You can start your own full or part time photo-engraving business right in your own home. With the Tasope' plant there is profit and fun for the whole family. Be independent, be your own boss or pave the way to a high pay job with experience gained in your own shop. Write to-day for details. No obligation.

The Aurora School of Photo-Engraving
Dept. P9M, Tasope' Bldg. Aurora, Missouri

WHICH OF THESE *Opportunities* INTERESTS *You* MOST?

● Today, choose the job you want—and prepare for it. Or if you are already engaged in the work you like best, start training now for quicker promotion. Acquire the knowledge that will help you to get ahead faster, make more money and have greater security.

American School, founded in 1897 as an educational institution *not for profit*, can help you to reach your goal just as it has helped others during the past fifty-two years. Check the coupon at right, add your name and address and mail it at once. The school will send you details on its training plan and outline of study prepared by specialists. There is no charge, no obligation, so send the coupon immediately.

CHECK, CLIP AND MAIL COUPON NOW

AMERICAN SCHOOL, Dept. GC45, Drexel at 58th, Chicago 37, Ill.

Without obligation, Please send FREE and postpaid, bulletin and details of the Subjects checked:

- | | | |
|--|--|--|
| <input type="checkbox"/> PLASTICS ENG'R | <input type="checkbox"/> Accounting | <input type="checkbox"/> Drafting and Design for Men and Women |
| <input type="checkbox"/> Refrigeration | <input type="checkbox"/> Electrical Engr. | <input type="checkbox"/> Radio |
| <input type="checkbox"/> Architecture | <input type="checkbox"/> Electricity-Pract. | <input type="checkbox"/> High School |
| <input type="checkbox"/> and Building | <input type="checkbox"/> Electronics, Industrial | <input type="checkbox"/> Air Conditioning |
| <input type="checkbox"/> Contracting | <input type="checkbox"/> Bookkeeping | <input type="checkbox"/> Mechanical Eng. |
| <input type="checkbox"/> Practical Plumbing | <input type="checkbox"/> Private Secretary | <input type="checkbox"/> Shop Management |
| <input type="checkbox"/> Automotive Engr. | <input type="checkbox"/> Diesel Engineering | <input type="checkbox"/> Tool Making |
| <input type="checkbox"/> Aviation Drafting | <input type="checkbox"/> Sheet Metal Pattern | <input type="checkbox"/> Better Foremanship |
| <input type="checkbox"/> Aviation | <input type="checkbox"/> Drafting | <input type="checkbox"/> Machine Shop Operations |
| <input type="checkbox"/> Business Management | <input type="checkbox"/> Railway Training | |

Name _____ Occupation _____

Address _____ Age _____

City _____ State _____

AMERICAN SCHOOL

Dept. GC45, Drexel at 58th Street, Chicago 37

IMAGINE THEIR JOY when they found they could play this easy-as-ABC way!



LEARNED QUICKLY AT HOME

"I didn't dream I could actually learn to play without a teacher. Now, when I play for people they hardly believe that I learned to play so well in so short a time."

*H.C.S., Calif.



PLAYS AT DANCES

"Your lessons have been most satisfactory. I can play all of the popular songs. I have earned money playing at dances."

*E.N.J., New York.



PLAYS ON RADIO

"I can't keep from telling you that I have a good position playing from KTHS, Hot Springs, Ark., every morning." *J. S., Okla.

What Instrument Would You Like to Play?

JUST name your instrument and we'll show you how you can learn to play it—quickly, easily, in spare time at home. Never mind if you don't know one note of music from another—don't worry about "special talent." And forget all you've ever heard about music being hard to learn.

The truth of the matter is that thousands now play who never thought they could! Yes, men and women everywhere have discovered this amazingly easy way to learn music at home.

Now they are enjoying the thrilling satisfaction of playing the piano, violin, guitar, saxophone or other favorite instruments. Some of them are playing in orchestras and over the radio; others are teaching music, making money in spare or full time. And thousands are having the time of their lives playing for their own enjoyment and the entertainment of their friends.

No tedious study and practice, no tiresome exercises. You learn to play by

Easy as A-B-C



playing—start right in with the melody of a simple tune! It takes only a few minutes a day; the cost is trifling. Does it sound too good to be true? Mail the coupon and get the FREE PROOF!

SEND FOR FREE PROOF

Fascinating illustrated booklet answers all your questions; free Print and Picture Sample shows how method works. If interested, just mail coupon. U. S. School of Music, 78 Brunswick Bldg., New York 10, N. Y. 51st Successful Year.

*Actual pupils' names on request. Pictures by professional models.

FREE! Print and Picture Sample

U. S. School of Music, 78 Brunswick Bldg., New York 10, N. Y. Please send me Free Booklet and Print and Picture Sample. I would like to play instrument checked below.

- | | | |
|--|--|---|
| <input type="checkbox"/> Piano | <input type="checkbox"/> Saxophone | <input type="checkbox"/> Modern Elementary |
| <input type="checkbox"/> Guitar | <input type="checkbox"/> Trumpet, Cornet | <input type="checkbox"/> Harmony |
| <input type="checkbox"/> Hawaiian Guitar | <input type="checkbox"/> Reed Organ | <input type="checkbox"/> Mandolin |
| <input type="checkbox"/> Violin | <input type="checkbox"/> Tenor Banjo | <input type="checkbox"/> Practical Finger Control |
| <input type="checkbox"/> Piano Accordion | <input type="checkbox"/> Clarinet | |

Name _____ Have You Instrument? _____

Address _____

City _____ State _____

Save 2c—Stick Coupon on Penny Postcard

Do you want

- ➔ ..to go to College?
- ➔ ..or to enter a Profession?
- ➔ ..or get an Office Position?

(Such as Accounting, Architecture, Nursing, Dentistry, Teaching, Social Work, Osteopathy, Beauty Culture, Optometry, Embalming, Chiropody, Law, Medicine, etc.)

To get anywhere, you practically **MUST** finish High School **FIRST**. You can complete our simplified High School Course in **SPARE** time at home, as **FAST** as your time and abilities permit. Equivalent to resident school work—prepares you for college, pre-professional examinations, business, industry. Standard texts furnished. Diploma. Credit for H. S. subjects already completed. Single subjects if desired. Low tuition, easy terms. American School, Chicago, est. 1897—endorsed by educators. Finish your high school education **NOW**, Write **TODAY!**

High School Course at Home

Many Finish in 2 Years

American School, Dept. HC45, Drexel Ave. at 58th St., Chicago 37, Ill.
Gentlemen: Send me **FREE** information covering special training in subjects checked below. No obligation on my part.

- | | |
|--|--|
| <input type="checkbox"/> High School Course | <input type="checkbox"/> Diesel Engineering |
| <input type="checkbox"/> Architecture and Building | <input type="checkbox"/> Drafting and Design for Men & Women |
| <input type="checkbox"/> Automotive Engineering | <input type="checkbox"/> Plastics |
| <input type="checkbox"/> Business Management | <input type="checkbox"/> Private Secretary |
| <input type="checkbox"/> Electrical Engineering | <input type="checkbox"/> Mechanical Engineering |
| <input type="checkbox"/> Elec. and Gas Refrigeration | <input type="checkbox"/> Aviation |
| <input type="checkbox"/> Air Conditioning | <input type="checkbox"/> Salesmanship |
| <input type="checkbox"/> Railway Training | <input type="checkbox"/> Radio |
| <input type="checkbox"/> Electronics, Industrial | |

Name.....

Address.....

Learn this Profitable Profession



IN 90 DAYS AT HOME

Money-Making Career Open to Men and Women, 18 to 50

Hundreds of men and women between 18 and 50 make \$10 to \$20 in a single day giving scientific Swedish Massage and Hydro-Therapy treatments. There is big demand from doctors, hospitals, sanatoriums and clubs. Graduates earn large full time incomes from these or in private practice in their own offices. Others make good money from home treatments given in spare time. Learn this interesting, money-making profession in your own home, through our home study course. Same instructors as in our nationally known resident school. You can win independence and prepare for future security by qualifying for your Diploma. Course can be completed in 3 to 4 months. Many earn while they learn. Begin your training at once.

Anatomy Charts & Booklet FREE

Enroll now and we will include, at no extra cost, many needed supplies. Fit yourself to help meet growing demand for Scientific Swedish Massage. Send the coupon at once for complete details. Anatomy Charts and 32-Page Illustrated Booklet, **FREE**, postpaid.



THE COLLEGE OF SWEDISH MASSAGE
Dept. 964K, 41 E. Pearson, Chicago 11, Illinois
Please send me **FREE** and postpaid, Anatomy Charts, 32-page Booklet and complete details on Home Training.

Name..... Age.....

Address.....

City..... State.....

LEARN AT HOME TO MOUNT BIRDS



Animals, Heads, Fishes, Pets; to **TAN**. Be a Taxidermist. Profit and **FUN**.

Hunters, save your valuable **TROPHIES**. Mount ducks, squirrels, everything. Learn to **TAN** for leather and furs. Wonderful **HOBBY** Have a **HOME MUSEUM**.—**BIG PROFITS** mounting for others. **INVESTIGATE NOW**.

FREE BOOK With 100 fine game pictures. **NOW** absolutely **FREE**. Write **TODAY**.

Send Postal **TODAY** for **FREE BOOK**. State **AGE**. **N. W. SCHOOL OF TAXIDERMISTRY**, Dept. 2508, Omaha, Neb.



LEARN AERONAUTICAL ENGINEERING

Aircraft and Engine Mechanics (A & E)

Train at the Flying Wing school—New classes starting soon. Write for illustrated catalog.



Northrop Aeronautical Institute

APPROVED FOR VETERANS DIVISION OF NORTHROP AIRCRAFT, INC.
1527 E. Broadway, Hawthorne, Los Angeles County, California

BARGAIN BAR BELLS! 895 UP



BUILD your chest, arms, neck, shoulders, thighs as Nature intended! Have a magnificent new body in Less Than 3 Months.—Only 5 Minutes a Day! 4 Million Men, Coast to Coast, 8 to 80, are doing this—**YOU CAN, TOO!** Get details about Paramount Bar Bells and System—**finest** on the market—at **Factory-Price Savings up to 30%**. Send **NOW** for your "Power-Thru-Paramount" Self-Check Health Chart. Just say—"Send Chart." It's **FREE!** Write **TODAY!!**

INDEPENDENT IRON WORKS, Dept. B
12416 E. 23rd St. Los Angeles 11, Calif.

WOULD \$400 PER MONTH INTEREST YOU?



It is easily possible to earn \$400 to \$500 a month raising **ANGORA RABBITS**. No experience required. Wool brings top price. Plenty markets. **WRITE TODAY** for **FREE INFORMATION, PRICES** and **WHERE TO SELL**.

WHITE'S RABBITRY
NEWARK 10, OHIO



'CLEAN DRY' CLOTHES BRUSH

Chemically Treated. Cleans clothes **DRY**. Suits, Dresses, Coats, Hats, Ties, Suede Shoes. **Magic Clothes Cleaner**. Simple. Easy. **USE LIKE BRUSH**. Saves drycleaning bills. **Sells like wild!**

SAMPLES FOR AGENTS Sample offer sent immediately to all who send name at once. **Happy—postal will do. SEND NO MONEY—just your name.**

KRISTEE CO., 682 Bar St., Akron, Ohio

Be an INVESTIGATOR

JAMES S. BOLAN, FORMER POLICE COMMISSIONER OF NEW YORK CITY offers **MEN & WOMEN** an attractive opportunity to prepare for a future in **Investigation & Criminology** by comprehensive Home Study Course. **Free** placement service assists graduates to obtain jobs. **APPROVED UNDER G. I. BILL OF RIGHTS**. Write for **Free Booklet PM**.

THE BOLAN ACADEMY, INC.
EMPIRE STATE BLDG., NEW YORK 1, N. Y.

SAY YOU SAW IT IN POPULAR MECHANICS

Learn BAKING At Home

Baking is one of America's high industries in wages. Nearly depression-proof. Thorough basic home course lays sound foundation. If you have aptitude, write for **FREE BOOKLET**, "Opportunities in Commercial Baking." **National Baking School**, 1315 Mich. Ave., Dept. 135C, Chicago 5



See how YOU may get started toward an Exciting Future in

TELEVISION!

RADIO • ELECTRONICS!

MODERN CHICAGO LABORATORIES

Train quickly, using a wide variety of commercial equipment. D. T. I.'s new laboratories are among the finest of their kind. Ample instructors . . . every major training advantage. Write for details!

EMPLOYMENT SERVICE

When you complete your training, our effective Employment Service is available to you without extra cost—a grand aid to help you get started.

YOU ALSO USE HOME MOVIES a D.T.I. Exclusive!

D. T. I., alone, includes the use of one of today's most effective training aids . . . MOVIES . . . to help you learn important fundamentals faster, easier, at home. What an advantage to see electrons on the march, and other fascinating "hidden action"—a remarkable home training advantage that speeds your progress.

OUR GREATEST OFFER IN 17 YEARS!

Here is your big opportunity to get started toward FASCINATING WORK . . . GOOD MONEY . . . a THRILLING FUTURE! Mail the coupon today. See how YOU may prepare to tie in your future with a field that includes one of America's fastest-growing new industries—Television. You'll find out, too, about the many other thrilling opportunities in FM Radio . . . Aviation and Broadcast Radio . . . 2-Way Taxi, Truck and Police Radio . . . Industrial Electronics . . . even the chance to start your own profitable Television-Radio Sales and Service business. And to top it all, you'll see that you don't need to know a thing about this subject at present—that NOW you can get the very training and starting help you need by means of our GREATEST OFFER IN 17 YEARS.

Send for FREE Information

See HOW—in your own home—DeForest's Training, Inc., now brings you one of today's most complete combinations of major home training aids. You (1) Learn-by-Reading from well-illustrated lessons. (2) You Learn-by-Seeing from D.T.I.'s exclusive instructive Home Movies. And (3), you set up your own HOME LABORATORY where you Learn-by-Doing from 16 shipments of Radio-Electronic parts which you use and KEEP to work over 300 instructive . . . fascinating projects. This includes building the valuable 6 tube "Superhet" RADIO and the commercial-type OSCILLOSCOPE, R-F SIGNAL GENERATOR, and Jewel-Bearing MULTIMETER, pictured at the right.

You may use this test equipment to help you earn real money—both in your spare time and later when working full time in the field. Get complete facts. Mail coupon today!



YOU BUILD and KEEP THIS EQUIPMENT TO WORK OVER 300 HOME EXPERIMENTS

OPPORTUNITY COUPON!

DeForest's Training, Inc.
2533 N. Ashland Ave., Dept. PM-FB
Chicago 14, Illinois

MAIL TODAY

Without obligation, send me complete facts showing how I may make my start in Television-Radio-Electronics,

Name.....Age.....

Street.....Apt.....

City.....Zone.....State.....

DeFOREST'S TRAINING, INC.

CHICAGO 14, ILLINOIS

Affiliated with the DeVry Corporation,
Builders of Electronic and Movie Equipment.

a small investment
will establish you in . . .

Your OWN Business

Write for
FREE
Booklet



Patented

We are NOW enlarging our organization of U.S.A. and Canadian DURACLEAN dealers, in territories still open. Here is an opportunity to **BE YOUR OWN BOSS** . . . become financially independent with a business of your own!

You become a fabric specialist, providing the proper cleaning and moth protection for upholstery and floor coverings. You use the proven, successful methods of established dealers. Service is rendered right in the home, office or public buildings without removing furnishings.

DURACLEAN Service was established 19 years ago as an improved method for cleaning and revitalizing rugs and furniture. No harsh machine rubbing. No soaking or shrinking. No inconvenience for your customers. Dirt, grease and many unsightly spots vanish as if by magic. **DURAPROOF** makes fabrics and rugs repellent to moths and carpet beetles. You give a 4-YEAR Warranty of Protection.

These services have a waiting market . . . a big repeat business. Profits up to \$15 and \$20 a day on EACH of your service men. Write today! A letter and 16 page illustrated booklet will explain everything. 19 years of proven success.

- No Overhead Expense
- No Shop Necessary
- No Experience Needed
- You Learn Quickly, Easily
- Short Hours . . . Large Profits
- Service Nationally Advertised

Don't delay! Territories are limited. Remember, just a moderate payment, easy terms, and the opportunity to become financially independent in YOUR OWN BUSINESS! Start full or part time.

DURACLEAN CO., 9-168 Duraclean Bldg., Deerfield, Ill.

Here's How CREI Prepares You for a
Professional Career with Industry-Recognized
Training in a Minimum of Time

RADIO - ELECTRONICS TELEVISION ENGINEERING

GRADUATES of CREI residence school are preferred by industry because of their *training and ability*. This recognition is the reason that CREI men quickly find good jobs. With 22 years of practical teaching experience in these highly technical fields, CREI offers an outstanding faculty, modern and complete laboratories, shops and equipment.

New students are accepted twice monthly and each may advance as rapidly as he is capable. The basic course with one specialized course requires an average of 20 months to complete.

CREI is recognized as one of the country's leading technical institutes. Its work is of college level. It prepares the young man for a good job in industry in a minimum of time.

Approved for Veterans' Training

CAPITOL RADIO ENGINEERING INSTITUTE

An Accredited Technical Institute Founded in 1927

Mail coupon for Free Catalog

Capitol Radio Engineering Institute, Dept. 178A
16th & Park Road, N.W., Washington 10, D. C.
Please send me your residence school catalog and complete details. (If interested in Home Study check below.)

Name _____ Age _____

Street _____

City _____ Zone _____ State _____

I am entitled to training under G.I. Bill. Send information on Home Study Courses.

WATCHMAKING

JEWELRY ENGRAVING AND REPAIR

Enter this high-paying, time-honored profession, or prepare for a business of your own. Watchmakers in great demand. More jobs than qualified workers. Study under expert instructors in a long-established, nationally recognized school. Receive recognized diploma and certificate. Placement service. Approved under G. I. Bill. Write for FREE booklet.



The Baronian School, Inc.

2116 WALNUT ST. (DEPT. C) PHILA. 3, PA.

**SUCCEED IN THE
POULTRY BUSINESS!**



Poultry is providing many trained men and women with a good, comfortable living, either part or full time. For 28 years our Home Study Course has been helping thousands obtain training and "know how" that means extra income from the start. Don't delay — Write today for prospectus describing courses, methods, service, opportunities.

NATIONAL POULTRY INSTITUTE

DEPT. 50

ADAMS CENTER, N. Y.

"RUPTURED"

WRITE for free information on our
"SCIENTIFIC VACUUM PAD TRUSS"

It is something different. No leg straps. Its pad is a NOVELTY. It is a vacuum cushion that stays on its right place. You can bathe with it on, as it is made of plastics, rubber and metal. Invented by a physician who has dedicated his whole life in the treatment of ruptures without surgery.

Write to: "SCIENTIFIC TRUSS"

829 So. Dr. Coss Street

Monterrey, Old Mexico

BE A NOTARY PUBLIC

Old legal-supply house, 22 cities, helps you get appointment by governor if you qualify, equips you fully. Pay after appointment (2 payments \$12.50 each). Respected public office. You certify legal papers, use official seal made with your name, collect your fees. Easy, Inquire—

STATIONERS EXCHANGE

BOERNE 38, TEXAS

GET THIS FINE SUIT NO MONEY TO PAY!



BIG CASH EARNINGS, TOO!

Big news! This fine tailored suit yours without paying one cent—and big cash earnings, too! It's easy! Just take a few orders. Earn up to \$10 a day and get your own suit as extra bonus. Dozens of rich new fabrics, superbly tailored in latest styles, at low prices produce orders on sight. Money-back guarantee. **FREE SAMPLES!** Write today giving name, address, age, samples and details of amazing new **BONUS SUIT** and money-making plan—**All Sent Free!** No experience. **SEND NO MONEY!** W. Z. GIBSON, Inc. 500 S. Throop, Dept. V-516, Chicago 7, Ill.

STAMMER?

This new 128-page book, "Stammering, Its Cause and Correction," describes the Bogue Unit Method for scientific correction of stammering and stuttering—successful for 48 years. Benj. N. Bogue, Dept. 4914, Circle Tower, Indianapolis 4, Ind.



LOTS \$300 LOW TERMS

In California's loveliest Garden Spot, on scenic shores of beautiful Morro Bay. Enjoy future independence with excellent soil, soft water, wonderful fishing, hunting, boating, bathing, etc. Grow fruits, vegetables, poultry. Perfect temperate climate. Congenial community. Finest investment. Free literature.

RICHARD S. OTTO

DEPT. M

SAN LUIS OBISPO, CALIFORNIA

COMMERCIAL TRADES'

GRADUATES GET THE BETTER JOBS

PRACTICAL SHOP TRAINING IN
AIR CONDITIONING — REFRIGERATION
ELECTRICITY MAJOR APPLIANCES
SERVICE, MAINTENANCE & INSTALLATION

Write for Catalog PM4

COMMERCIAL TRADES INSTITUTE

200 SOUTH 20th ST.

BIRMINGHAM, ALA.

Member: Southern Association of Private Trade Schools
An approved school to TRAIN Veterans & Non-Veterans

Now Any AUTO REPAIR JOB Can Be a "Push-Over" for You!

Free
7-DAY OFFER!



IN LESS TIME—WITH LESS WORK—AND MORE PROFITS!

NOW, tackle anything from carburetor to rear end on ANY car built from 1935 thru 1949. And fix it quick, easy, right the **FIRST** time! Just look up make, model, and job in quick index of MoToR's **brand-new** **AUTO REPAIR MANUAL**. Clear, illustrated instructions lead you step by step all the way.

ONLY Manual of Its Kind!

The engineer-editors of MoToR Magazine condensed all the meat of over 150 official factory manuals for you. They dug out all the information you need—made sure every word and picture is crystal clear—and put the whole "works" into this one big 795-page book. Contains 200,000 service, repair, tune-up facts. 35,000 essential dimensions! More than 2100 cut-away photographs, diagrams, charts show what the clear text tells.

Used by
U. S. Army
and Navy

COVERS ANY CAR BUILT SINCE 1935!

- | | |
|-----------|------------|
| Auburn | Frazer |
| Austin | Graham |
| Buick | Hudson |
| Cadillac | Hupmobile |
| Chevrolet | Kaiser |
| Chrysler | Lafayette |
| Cord | La Salle |
| Crosley | Lincoln |
| De Soto | Mercury |
| Dodge | Nash |
| Ford | Oldsmobile |
| | Packard |
| | Pierce |
| | Arrow |
| | Plymouth |
| | Pontiac |
| | Reo |
| | Studebaker |
| | Terraplane |
| | Willys |

Win Prestige! Earn More Money!

MoToR's Manual makes every operation so easy that you'll find yourself tackling jobs you wouldn't think of doing before. And you'll win added prestige and more money in the bargain.

Beginners will find usable helpful guidance on every kind of repair and service job imaginable. Experts will be amazed by the time and labor-saving short cuts.

This **GIANT** Manual is used by Army, Navy, Technical Schools, and thousands of successful auto-repairmen. Now **YOU** can try it **FREE**—for 7 days. Learn first-hand how it can pay for itself the first few times you use it!

SEND NO MONEY

Mail coupon below — *without money!* When your book arrives — *make it show you what it's got!* Unless you agree it's the greatest time and work saver you've ever seen—return book in 7 days and pay nothing. Mail coupon **NOW!** MoToR Book Department, Desk 18, 250 West 55th Street, New York 19, N. Y.



Just 2 of the Many Letters of Praise



"MoToR's Manual paid for itself on the first 2 jobs, and saved me valuable time eliminating guesswork." — **W. SCHROP, Ohio**



"Instructions so clear have no trouble learning anything about any car. Now working as mechanic in big plant." — **SAM ORDONEZ, California**

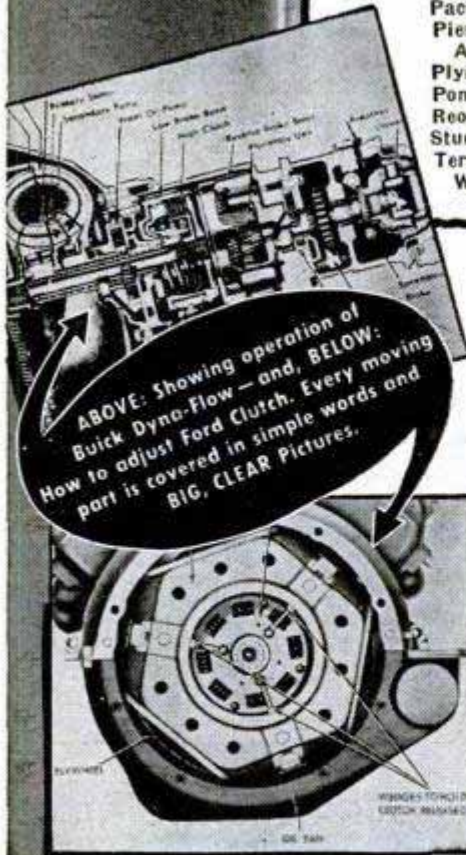

ABOVE: Showing operation of Buick Dyna-Flow — and, BELOW: How to adjust Ford Clutch. Every moving part is covered in simple words and **BIG, CLEAR** Pictures.

Same FREE Offer on MoToR's TRUCK MANUAL

Covers EVERY job on EVERY truck made from 1936 thru 1946! 1400 pictures, 952 pages, 300,000 facts. All types Gasoline Engines, Truck Diesels, Hesselmans, Fuel Systems, Governors, Lubrication, Ignition, Starters, Clutches, Axles, Brakes, etc., etc.

ALSO covers many buses, tractors, contractor and road building equipment, stationary power machinery. Check box in coupon at right for 7-day **FREE** trial.



Published by MoToR, The Leading Automotive Business Magazine.

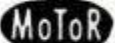

MAIL COUPON NOW FOR 7-DAY FREE TRIAL

MoToR BOOK DEPT.

Desk 18, 250 West 55th St., New York 19, N.Y.

Rush to me at once (check box opposite book you want):
 MoToR's **NEW AUTO REPAIR MANUAL**. If O.K., I will remit \$1 in 7 days (plus 35c delivery charges), \$2 monthly for 2 months and a final payment of 95c one month after that. Otherwise I will return the book postpaid in 7 days. (Foreign price, remit \$8 cash with order.)
 MoToR's **TRUCK REPAIR MANUAL**. (Described at left.) If O.K., I will remit \$2 in 7 days, and \$2 monthly for 3 months, plus 35c delivery charges with final payment. Otherwise I will return book postpaid in 7 days. (Foreign price, remit \$10 cash with order.)

Print Name.....Age.....
 Print Address.....
 City..... State.....

Check box and save 35c delivery charge by enclosing WITH coupon entire payment of \$5.95 for Auto Repair Manual (or \$8 for Truck Repair Manual). Same 7-day return-refund privilege applies.

ARE YOU *NATURALLY* **INVENTIVE?**

"Cash In" On Your Natural Talent By Learning **WHAT** To Invent— **2100 Inventions Needed Now!**

TURN your talents into CASH! Invent the *simple* things that people need and want!

The Kiddie Kar brought its inventor a cool MILLION dollars. A 70-year old grandmother made \$350,000 on an overall buckle. Others became independently wealthy by "dreaming up" the rubber pencil tip, the ordinary paper clip, the hair-pin, etc. YOU can cash in, too—if you concentrate your talent on the inventions that are really NEEDED!

The EASY Way to Get Started



\$250,000

\$135,000

Don't waste time and brain-work on something nobody wants! Find out **WHAT** to invent. A valuable book by Raymond F. Yates, noted science editor and inventor, lists and describes over 2100 PRACTICAL, money-making ideas that are crying aloud to be invented!

These 2100 ideas are the things *most needed and surest to make money*. They are listed under 34 different headings for quick reference: Electrical, Radio, Automotive, Agricultural, Building, Household, Clothing, Toys, Time-Savers, etc.

This book ALSO tells how to think inventively; how to PROTECT your ideas; how to develop an invention STEP-BY-STEP, etc.



\$100,000

\$1,000,000

SEND NO MONEY FREE 5-DAY EXAMINATION

Would YOU like a slice of the \$280,000,000 that American inventors get *each year* in royalties? Get started *now!* Just mail the coupon and get "2100 Needed Inventions," by Raymond F. Yates, for 5 days' FREE trial. If, even in that short time, you are not convinced this book can help you make money—just return it and owe nothing. Otherwise, send only \$2.50, plus few cents postage, as payment in full.



Any one of the 2100 ideas in this book can bring *somebody* a fortune. Maybe it can be YOU! Mail the coupon and get this book on FREE TRIAL at once! Wilfred Funk, Inc., Dept. T498, 227 East 44th Street, New York 17, N. Y.

**WILFRED FUNK, Inc., Publishers, Dept. T498
227 East 44 Street, New York 17, N. Y.**

Please send me 2100 NEEDED INVENTIONS for FREE EXAMINATION. If I keep the book I will send you \$2.50 plus few cents actual postage. Otherwise I will return it within 5 days, without further obligation.

Name _____

Address _____

City _____ Zone No. _____ State _____
(if any)

Check here if enclosing \$2.50 WITH this coupon, and we will pay all postage charges. Same 5-day return privilege, for full refund, applies. (Canadian Orders—25¢ extra for carrying charges. Only U. S. currency accepted.)

win SUCCESS·SECURITY·RESPECT as a Master Watchmaker! APPROVED FOR VETERAN TRAINING

Learn today's top mechanical profession at the world's largest, best-equipped school of its kind. Individual instruction, day or evening classes. You graduate with complete watchmakers' tools, ready to start your own business or work for established jewelers.

SEND FOR FREE 116-PAGE INFORMATION PACKET

WESTERN PENNSYLVANIA HOROLOGICAL INSTITUTE WORLD'S LARGEST WATCHMAKING SCHOOL



DESK 40, 808 RIDGE AVE., PITTSBURGH, PA.

LEARN TO WRITE *a Good Hand!*

FOR BUSINESS AND SOCIAL SUCCESS!
Easy to improve your handwriting at home quickly with my new instruction books just off the press. Master all the secrets of better penmanship. Simple and easy, fully illustrated, highly endorsed. Begin today. Write for: New Free Book, "How to Become a Good Penman," or check books wanted, \$1.00 each. Business Writing Artistic Writing Card Writing Engraving Alphabets Bird and Design Flourishing Complete Set \$4.50 Enclose 10¢ for your name beautifully written and special penpoint for shaded writing. S. A. Ziller, President, TAMBLYN SCHOOL OF PENMANSHIP, 441 Ridge Bldg. In Business Over 52 Years, Kansas City, Mo., U.S.A.

REAL ESTATE BE A BROKER

PAYS BIG! SEND FOR FREE, BIG, ILLUSTRATED CATALOG NOW! No obligation. Graduates report making substantial incomes. Start and run your own business quickly. Men, women of all ages, learn easily. Course covers Sales, Property Management, Appraising, Loans, Mortgages, and related subjects. **STUDY AT HOME** or in our classrooms in big cities. Diploma awarded. G.I. approved. Nationally known.

**WEAVER SCHOOL OF REAL ESTATE (Est. 1936)
15 E. Pershing Road Dept. PM-8 Kansas City, Mo.**



Learn to Service and Repair ELECTRICAL APPLIANCES

Open your own electrical appliance service shop. Complete illustrated course covering washing machines, vacuum cleaners, elec. ranges, motors, house wiring and REFRIGERATION. Appliance tools included. Send today for FREE BOOKLET without obligation.

PACIFIC TRAINING SCHOOL

7217 So. Broadway, Dept. P-98, Los Angeles 3, Calif.

STRENGTHEN Your VOICE!

YES—you can now build yourself a powerful speaking and singing voice with this amazing new scientifically sound tested method. Self-training... no music or piano required. Results GUARANTEED. Just send your name for the sensational details. FREE chart of your vocal mechanism included! **PERFECT VOICE STUDIOS, Studio J-2, 1141 S. Wabash Ave., Chicago 5, Ill.**

TRAIN NOW FOR AN

AVIATION CAREER IN SUNNY SOUTHERN CALIFORNIA

MAXIMUM TRAINING IN MINIMUM TIME

Specializing in AERONAUTICAL ENGINEERING and MASTER AVIATION MECHANICS since 1929 America's Finest Aeronautical Institute 7000 successful graduates. **MAKE MORE MONEY MAIL COUPON TODAY APPROVED FOR VETERANS.** Board and Room now available.

Without obligation, send free catalogue with full information.

NAME _____ AGE _____ PM-8

ADDRESS _____

CITY _____ ZONE _____ STATE _____

CAL-AERO TECHNICAL INSTITUTE
GRAND CENTRAL AIR TERMINAL • GLENDALE 1, CALIFORNIA



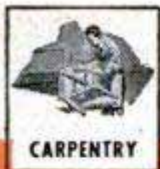

CARPENTRY

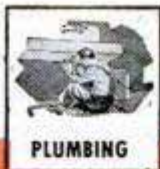

PLUMBING



GARDENING

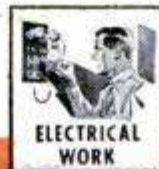

ELECTRICAL WORK

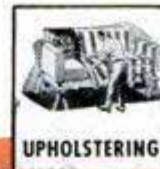

UPHOLSTERING



MAINTENANCE



FINISHING

At Last! The Editors of **POPULAR MECHANICS** Show You **EVERYTHING YOU NEED TO KNOW TO -**

Add New Beauty and Comfort to Your Home!

Try it **FREE 7 Days** THEN DECIDE IF YOU WISH TO KEEP IT!

This Brand New, 508-Page, Complete Homcraft Encyclopedia Makes It FUN and EASY to "Do-It-Yourself" and SAVE on Plumbing, Upholstery, Painting, Electrical Work, Masonry, Building Repairs, etc.



Bent-Tube Garden Furniture. Easy to make—saves you many dollars.

NOW save 60% to 90% on all home repairs, improvements, remodeling, modernization jobs! "Do-it-yourself-and-save!" The editors of *Popular Mechanics* have crammed all the how-to-do-it facts, hints, and directions you need into ONE great new "COMPLETE BOOK OF HOME REPAIRS AND IMPROVEMENTS."



Beautiful Floors. Professional secrets make it easy.

How to Do "1001 Jobs"

Here is how to fix a leaky faucet—build a garden fire-place—install fluorescent lights—lay linoleum—install a hardwood floor—make a cabinet or coffee table—upholster a sofa—hang wallpaper—hundreds of jobs that would otherwise cost you a

"small fortune." For just the cost of materials, you can DOUBLE the value of your home—and have hours of fun in the bargain!

You need no previous training or skills. Simple, easy-to-follow directions and crystal-clear photos, diagrams, drawings show exactly how to be your own plumber, electrician, mason, carpenter, builder, painter, decorator, upholsterer, cabinet-maker *all-in-one!*



Multiple Biscuit Cutter. Use divider from ice-cube tray.



Hand Operated Washing "Machine." Make it from home materials, save cost of expensive machine.

SEND NO MONEY Use It FREE For A Week

Every time you pick up this book and use it, it will mean extra money in your pocket! The publishers invite you to put this to the "acid test" . . . without risking a cent! Examine this NEW book at your local book-seller or, if more convenient, mail coupon now—**WITHOUT MONEY**—if you prefer.

When your book arrives actually TRY some of its ideas. If it doesn't pay for itself in the first 7 days alone—send it back and pay nothing. Mail coupon TODAY! GREYSTONE PRESS, 100 SIXTH AVE., NEW YORK 13, N. Y.



Upholster It Yourself. Book guides you step-by-step.



- JUST A PARTIAL LIST of the Things This Book Shows You How-to-Do**
- INSIDE HOME MAINTENANCE, IMPROVEMENTS**
 - Step-Saving Kitchens
 - Laying Hardwood Flooring
 - Finishing Floors
 - How to Install a Door
 - Air Filters for Your Windows
 - "Built-ins" and Cabinets
 - Cure Leaky Basements
 - Home-Freezer Unit
 - PAINTING, DECORATING, FINISHING**
 - Paint Magic for Walls
 - Hanging Wallpaper
 - Wood Finishing
 - Stains
 - Modern Finishes
 - ELECTRICITY AND PLUMBING**
 - How to Fix Appliances
 - Rewire Your Home
 - HEATING and INSULATION**
 - LAWN and GARDEN**
 - Home Landscaping with Evergreens
 - New Roof
 - Building Sturdy Fences
 - Glass Cutting
 - Made Easy
 - How to Make Concrete
 - Garden Fireplace
 - Tackaway Picnic Furniture
 - Garden Furniture
 - Bent-Tube Furniture
 - Electric Hedge Trimmer
 - Motorize Your Mower
 - WOODWORKING**
 - Work with Inlays
 - FURNITURE**
 - Cutting Tapered Legs
 - Novelty Match Boxes
 - Carved Desk Set
 - Strip-Cut Drawer Pulls
 - Coffee Table
 - Bunks-and-Storage
 - Her Chest of Drawers
 - Kneehole Desk
 - Restoring Antique Furniture
 - Welsh Dresser for China
 - Replating Cane
 - Webbing Upholster It Yourself
 - Easy-to-Make Stool
 - Put It with Foam Rubber
 - HOME WORKSHOP**
 - Power Tool Short Cuts
 - Quick-on Drill Press Clamps
 - Using Cold Chisels
 - Solder It Right
 - Improve Bandsaw
 - From Sewing Machine to Jig Saw
 - Folding Workbench

GREYSTONE PRESS PMS
100 Sixth Ave., New York 13, N. Y.

Without obligation, please send me, prepaid, for one week's FREE EXAMINATION, "Popular Mechanics' Complete Book of Home Repair and Improvements"—508 pages, 6 1/2 x 9 1/4 inches, attractively bound in cloth and showing, in words and over 1000 pictures, how to do my own Carpentry, Plumbing, Gardening, Electrical Work, Upholstering, Painting and Finishing, Handicraft, Insulating, Paperhanging—plus hundreds of ideas for labor-saving devices, handy home improvements, easy-to-build step-savers, and space-savers.

At the end of one week I will either return the book and owe you nothing—OR I will keep it and send \$1 (plus few cents postage charges) as a deposit. Then, one month later, I will send \$1.98 to complete the payment in full.

DE LUXE EDITION. Check here if you prefer the handsome De Luxe edition—attractively bound, stamped in genuine gold, an impressive addition to any home library. Only \$1 extra.

Name _____

Address _____

City _____ Zone No. _____ State _____
(if any)

SAVE SHIPPING COSTS! Check here and enclose full payment (\$2.98 for regular edition, \$3.98 for De Luxe) WITH this coupon. Then WE pay all shipping costs. Same 7-Day Return Privilege, of course.

"TOOK IN \$217 FIRST 10 DAYS"

Some Make More,
Some Less... We Help
You to Start Your
Own All-Year
Business, Make
Big Money!



With our easily operated, highly efficient wall washer, Chas. Stelle took in \$217 gross in first ten days. E. L. Goss took in more than \$10,000 in one year. E. C. Taber wrote, "I made \$400 gross in two weeks." And no wonder — this machine washes walls 6 times faster and better than by hand.

Your Money-Making Opportunity

We want more men to go into this profitable business for themselves and enjoy independence. There are customers everywhere — homes, offices, schools, churches, hotels, stores, etc. What you take in is mostly profit, for material costs are low. And there's no need to rent a shop or office. Operate your business from your home.

Lose no time. Get all facts without obligation. **WRITE FOR FREE INFORMATION.** Ask for Wall Washer Details at once.

VON SCHRADER MFG. CO., CC91, RACINE, WIS.

TWO WAYS TO GET AHEAD!



MARRY THE BOSS' DAUGHTER



OR LEARN A GOOD TRADE!

TRAIN AT HOME OR IN C.T.I. CHICAGO SHOPS

A better income and independence are more likely yours when you "get hitched" to a good trade! You can learn easily at home in spare time thru C.T.I.'s Shop-Proved Home Training Methods, or in our well-equipped, fully-staffed Chicago shops. Check the coupon below. It lists excellent opportunities in a number of expanding fields. C.T.I. graduates everywhere are earning top wages in industry — and many own their own shops. G. I. approved. Finance plan for non-vets. Act now. Mail coupon today!



R. C. Anderson
President

R. C. Anderson, President
COMMERCIAL TRADES INSTITUTE, Dept. E2-8
1400 W. Greenleaf, Chicago 26, Ill.

Send free illustrated Brochures and other information about the field I have checked below:

<input type="checkbox"/> Refrigeration-Air Conditioning	<input type="checkbox"/> Veteran	<input type="checkbox"/> Non-veteran
<input type="checkbox"/> Electricity	<input type="checkbox"/> Automotive Mechanics	
<input type="checkbox"/> Radio Servicing-Television	<input type="checkbox"/> Body & Fender Rebuilding	
<input type="checkbox"/> Diesel Mechanics	<input type="checkbox"/> Building Construction	
	<input type="checkbox"/> Drafting	

Name _____ Age _____
Address _____
City _____ State _____

Midget Camera 99c

TAKE SECRET PICTURES



Midget camera only 2x3 inches! Actually conceal in palm of hand! Easy to carry, easy to use. Black & white or color pictures. Standard Eastman 828 film. Bakelite case, good quality lens and shutter. 8 pictures 1 3/4 x 1 1/2 in. on each roll. Beautiful enlargements. **99c**
SPECIAL CASH PRICE
Carrying Case, 50c; Black & White Film 35c Roll, 3 for \$1.00
Dept. 133 Detroit 7, Michigan

JOHNSON SMITH & CO.



Learn to Write at Home in spare time

Regardless of how you Now write, you can become an Expert Penman at home in spare moments by my Simplified Method, as hundreds of others have done, who never before thought they could learn. Good penmanship pays big dividends and helps you win success. Write for Full Details and my FREE BOOK, "How to Become an Expert Penman," which contains specimens of penmanship and shows what others have accomplished by taking my Courses at home in spare moments. If you wish, enclose 10c for Special Penpoint and your name with a flourish bird written on a card. Write TODAY.

D. McLeis

Box 25K, CHILLICOTHE, MO.

100 GAMES ON HORSEBACK

Games from MEXICO • ARABIA • INDIA • • Cowboy Sports
Learn to play — scoring — Fields and Courses
Exhibitions — Over 100 Games and Contests described
ANIMAL LOVERS BOOK STORE • Box KA 111, TARZANA, CALIF.

ONLY \$1.50

LEARN WATCH REPAIRING



AT HOME. By our modern and original system of instruction you can learn every part of the **WATCH REPAIRING TRADE AT HOME.** Prepare yourself for a well-paying position or start in business after completing our course of instruction. Good watch repairers are in demand and generally earn very good salaries. For particulars apply to the Wisconsin School of Watch Repairing 759 North Milwaukee St., Milwaukee 2, Wis.

LAW FREE BOOK



Your FREE copy of "The Law-Trained Man" shows how to gain prestige and greater earnings through Blackstone home law study. All instruction material furnished including 18-volume Law Library written by 65 well-known law authorities. Lawyers, judges among our graduates. LL.B. degree. Low cost; easy terms. Write today.
BLACKSTONE COLLEGE OF LAW 225 N. Michigan Ave.
Dept. 50-C, Chicago 1, Ill.
A Correspondence Institution Founded in 1890



RAISE Money Making CHINCHILLAS

Several females and a male start a large herd which will furnish you an income for years. Just a few feet of space are required. No experience needed. We furnish all instructions. Write world's largest breeder today for free details.
WILLOW BROOK FARM, R-36, Sellersville, Pa.

"YOU ARE UNDER ARREST!"



Help Bring Crooks to Justice Through Scientific **CRIME DETECTION!**
We have taught thousands this exciting, profitable, pleasant profession. Let us teach you in your own home. Learn Finger Printing, Firearms Identification, Police Photography, Secret Service Methods thoroughly, quickly, at small cost. Over 800 of all American Bureaus of Identification employ I. A. S. students or graduates. We can prepare you for this fascinating work, during spare time. Write today, stating age, for "Blue Book of Crime."

INSTITUTE OF APPLIED SCIENCE, 1920 Sunnyside Ave., Dept. 135-C, Chicago 40, Ill.



LEARN MEAT CUTTING

through actual practice. Profitable Meat Cutting and Self Service Meats taught easily, quickly. **LEARN BY DOING** at Toledo in just eight short weeks under actual market conditions. For beginners or men with experience. All subjects taught thoroughly and completely. Diploma. Job help. Get store of own. People must eat. School in operation over 25 years. Approved for G.I. training. Send today for FREE illustrated catalog. No obligation.
NATIONAL SCHOOL OF MEAT CUTTING, Dept. 50Q, Toledo 4, Ohio

BUILDERS

TRADE GUIDES



AUDELS CARPENTERS AND BUILDERS GUIDES—4 VOLS. \$6

Inside Information for Carpenters, Builders, Joiners, Building Mechanics—all Woodworkers. 1600 pages; 3700 diagrams; flexible; pocket size. Short-cut instructions, new methods, ideas, solutions, plans, systems—money saving suggestions. An easy progressive course for the apprentice. A practical daily helper and Quick Reference for the master worker. A Helping Hand to Easier and Better Work and Better Pay. To get this aid for yourself, simply fill in and mail the FREE COUPON below.

INSIDE TRADE INFORMATION ON:

How to use steel square; How to file and set saws; How to build furniture; How to use mitre box; How to use chalk line; How to use rules; How to make joints; Carpenters' arithmetic; Mensuration problems; Estimating strength of timbers; How to set girders and sills; How to frame houses and roofs; How to estimate costs; How to build houses, barns, garages, bungalows, etc.; How to read and draw plans; Drawing up specifications; How to excavate; How to use settings 12, 13 and 17 on the steel square; How to build hoists and scaffolds—skylights; How to build stairs; How to put on interior trim; How to hang doors; How to lath—lay floors; How to paint.

"Audels Guides worth four times their price—handy too as I carry them in pocket for reference." W. J. Bates, Knoxville, Pa.



AUDELS PLUMBERS AND STEAMFITTERS GUIDES—4 VOLS. \$6

A new edition—just out! A practical, illustrated, Reference Library and Study-Course for Master Plumbers, Journeymen and Apprentice Steamfitters, Gas Fitters and Helpers, Sheet Metal Workers, Draughtsmen, Master Builders, Engineers and all Building Trade Students. 1670 pages; 3642 diagrams; flexible; pocket size. Guides explain all the principles, advances and short cuts of the Plumbing and Heating trade. Contains instructions on how to figure and estimate jobs. Use FREE COUPON below to examine, without obligation, this valuable work.

INSIDE TRADE INFORMATION ON:

Air Conditioning. Soldering, tinning. Joint wiping, bending, beating. Pipe—iron—steel, threading. Mathematics, tables, physics. Materials—iron, steel, copper, brass, lead, tin, antimony. Sheet metal—galvanized—plate. Sanitation, syphonage, tanks. Drainage, sewage, purification. Fixtures—bath—kitchen. Pipe fittings, soil pipe, tools. Laying out work. Roughing. Screwed fittings, flanges, joints. Pipe bending, examples. Elbows, Heating, ven-

"Audels Guides are practical, easy to understand, reliable. Cover the field in plain language." W. F. Arming, Annapolis, Md.



AUDELS MASONS AND BUILDERS GUIDES—4 VOLS. \$6

A complete, illustrated trade reference library, for Bricklayers, Cement Workers, Plasterers, Tile Setters and Stone Masons, including a practical outline of Steel Construction. 1100 pages; 2067 diagrams; flexible; pocket size. A practical Trade Assistant explaining modern methods of masonry construction. Easy to understand and apply. A reliable and authentic reference work and study-course for Master Journeyman and Young Mechanic. Use FREE COUPON below and find out for yourself, without obligation, whether this set will benefit you.

INSIDE TRADE INFORMATION ON:

Bricklaying, tools, materials; Brick designs, patterns, bonds; Setting frames and foundations; Mortars, scaffolds, estimating; Mortars and mortar mixing; Tile setting, mosaic, hollow tile; Straight edge test, trow-

"Audels Masons Guides are the best books on the subject. Have laid brick 12 years and am ablet to judge." H. A. Sonnett, Coriass, Pa.

PRACTICAL ELECTRICITY—1 VOL. \$4

Audels Handy Book of Practical Electricity is a simplified Ready Reference and Study Course in one pocket size volume—for Engineers, Professional Electricians and Students. 1040 pages; 2600 diagrams; flexible bound. A reliable authority and handy helper for every electrical worker. Contains important and valuable wiring diagrams, calculations, machine sketches, helps on maintenance and repair. Use this FREE COUPON today and find out, without obligation, how this handy book will help you in your daily work.



Complete in one handy, red leather bound volume

1040 Pages
2600 Diagrams

INSIDE TRADE INFORMATION ON:

Electro-Therapeutics, X-Rays, Shocks, Welding, Brazing, Radio Hook-ups, Motion Pictures, Telephone, Telegraph, Cranes, Bells, Elevators, Pumps, Tools, Ship Drive, Railways, Vehicles, Automobile Electric Systems, Ignition, Generation, Lighting, Plant Management, Power Plans, Armature Winding, Repairing, A. C. Motors and Apparatus, D. C. Motors and Apparatus, Alternator Construction, Dynamos, Wiring, Diagrams, Sign Flashers, Cable Splicing, Power Wiring, Outside Wiring, Switches, Lighting, Rectifiers, Converters, Transformers, Fuses, Circuit Breakers, Rheostats, Electro Plating, Electrolysis, Storage Batteries, Magnetism, Electrical Energy, Conductors, Insulators, Static, Dynamic, Radio Electricity, Applications, Ready Reference and Index Covering the entire field of Modern Electricity.

Learn More and You Will Earn More!

Know your job and you'll never be without one. The skilled man is always in demand. Knowledge is power. Learn your trade thoroughly by easy reading. This coupon is your opportunity for advancement and better pay. You risk nothing in sending for Audels Guides for free examination. Send it NOW!

FREE EXAMINATION COUPON

THEO. AUDEL & CO.
49 W. 23 ST., NEW YORK CITY

Please mail me for free examination the books marked (x) below. If I find them satisfactory, I agree to mail \$1 in 7 days, on each set ordered, and to further mail \$1 monthly on each set until I have paid the purchase price.

4 CARPENTERS GUIDES \$6 4 PLUMBERS GUIDES \$6

4 MASONS GUIDES \$6 1 ELECTRICIANS HANDY BOOK \$4

NAME.....

ADDRESS.....

OCCUPATION.....

EMPLOYED BY.....

PM

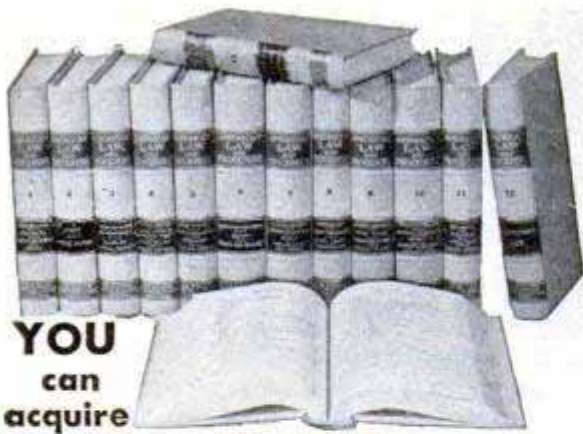

YOU
can
acquire

LAW NIGHTS AT HOME! L. L. B. DEGREE

LaSalle's famous Law Library—used as reference in many Law libraries and Law offices—has enabled thousands to master Law surprisingly fast, in spare hours at home, for business and professional advancement.

These 14 remarkable volumes, compiled by leading professors and lawyers, cover the whole basic field of Law in condensed, orderly, simplified manner.

You advance rapidly with this great library, plus special lectures furnished. We guide you step-by-step with personalized Problem Method of instruction . . . you learn by doing—handling legal problems—not by memorizing rules.

Send for two FREE 48-page booklets, "Law Training for Leadership," and "Evidence," answering questions about Law and its value to you, and telling how LaSalle Law graduates are winning rapid advancement in business and public life. Mail coupon below. No obligation.

LA SALLE EXTENSION UNIVERSITY

A Correspondence Institution

417 S. Dearborn St. Dept. 864-L Chicago 5, ILL.

Send me your two FREE booklets described above; without obligation.

Name.....Age.....

Street.....

City, Zone & State.....

ENGINEERING DEGREE IN 27 MONTHS

Big Demand for Graduates

Aeronautical, Chemical, Civil, Electrical, Mechanical and Radio Engineering (including Television)

Hundreds of young men are earning engineering degrees in this recognized institution each year—continuous operation. New terms start quarterly. Many students earn a major part of their college expenses in this large industrial center.

Low tuition. Competent instruction. Thorough intense practical program. Modern laboratory facilities including new physics lab. and modernized wind tunnel. Individualized instruction emphasized.

Approved for Veterans. Engineering preparatory courses. Students from 48 states and 21 foreign countries. Enter September, December, March or June. Send coupon for free catalog and full information. Enroll now.

SEND COUPON TODAY

INDIANA TECHNICAL COLLEGE

589 E. Washington Boulevard
Fort Wayne 2, Indiana

Please send me free information on B.S. Engineering Degree in 27 months as checked.

- Aeronautical, Chemical, Civil, Electrical,
 Mechanical, Radio-Television.

Name.....

Address.....

SAY YOU SAW IT IN POPULAR MECHANICS

MONEY MEN ALL FREE

THE PLASTEX Industry needs manufacturers on small scale and for big production of Lamp and Clock Stands, Art Goods and Novelties in Plaster and Marble imitation. Experience unnecessary. 1/2c material makes regular 10c store sellers. Rubber moulds furnished for speed production. Small investment brings good returns. Big chain store orders now being placed. Ambitious men have chance for real prosperity. Our Free booklet will interest and benefit you.

PLASTEX INDUSTRIES, Dept. A
3400 Third Ave. New York 56, N. Y.

BRASS NAME PLATES OR KEY TAGS

YOUR NAME
STREET AND NUMBER
CITY AND STATE
PHONE NUMBER

(INDIVIDUAL STAMPING)

40c each—3 for \$1.00

Half actual size

QUANTITY PRICE — SAME STAMPING

8 for \$2. - 15 for \$3. - 25 for \$4. - 50 for \$6.

LARGER QUANTITIES ON REQUEST

TAGCO, BOX 38X, WINGDALE, N. Y. STAMPING EQUIPMENT

RADIO ENGINEERING, Broadcasting, Television, FM, Servicing, Electronics, Aviation, Marine & Police Radio taught thoroughly.

Engineering course equivalent to 3 years' college radio work. Approved Veteran Training. Catalog free.

VALPARAISO TECHNICAL INSTITUTE, Dept. D, Valparaiso, Ind.

TRAINED MEN GET THE BETTER JOBS PRACTICAL SHOP TRAINING

in AUTOMOTIVE MECHANICS
BODY and FENDER REBUILDING

If interested write for catalog or wire

ATLANTA MOTIVE TRADES INSTITUTE

Dept. P, 254 IVY St., N.E., Atlanta, Georgia

Member of the Southern Association of Private Trade Schools
Veterans ask about G I Training

WHY DON'T YOU WRITE?

Writing short stories, articles on business, sports, homemaking, gardening, shop crafts, local and club activities, etc., will enable you to earn extra money. In your own home, on your own time, the New York Copy Desk Method teaches you how to write the way newspaper men learn—by writing. Our unique "Writing Aptitude Test" tells whether you possess the fundamental qualities essential to successful writing. You'll enjoy this test. Write for it, without cost or obligation.

Veterans: This course approved for Veterans' Training.

NEWSPAPER INSTITUTE OF AMERICA

SUITE 5599-M, ONE PARK AVENUE, NEW YORK 16, N. Y.

RUPTURE RELIEF

Advanced method. No leg straps, no elastic, no steel. Entirely different. Guaranteed. Write:

SMITH MANUFACTURING COMPANY
DEPT. PM PRESTON, ONT., CAN.

WATCH REPAIRING

Be a Master Watchmaker! Graduates earn big money—many in business for themselves. The famous Sweazey System of Instruction teaches you quickly and easily. Our 42nd year.

Write today for free information.

CHICAGO SCHOOL OF WATCHMAKING

Dept. 189, 1608 Milwaukee Ave.

Chicago 47, Ill.

SHINE WITHOUT 'POLISH'

New Invention! • Sells Like Wild



Replaces messy pastes, liquids. Simply glide over shoes—and PRESTO!

— you have a lustrous, long-lasting shine. No mess. No muss. No soiled hands. Clean. Handy.

WORKS LIKE MAGIC!

For Men's, Women's and Children's Shoes. Low priced. Lightning seller!

SAMPLES FOR AGENTS Sample offer sent immediately to all who send name at once. A penny postal will do. SEND NO MONEY—just your name. KRISTEE CO., 681 Bar Street, AKRON, OHIO

**10,000 HELPS TO
BE YOUR OWN BOSS,
IN THIS BIG BOOK!**



PRACTICAL IDEAS—QUICK RESULTS
Never before such a book of helps for you who wish extra money quick. In this book are formulas, recipes, secrets that have amazed the world. Use these ideas and make many needed money-making products. Experts wrote this book in simple terms, with supply sources for materials, short-cuts and methods for profitable results.

Included "Knowledge is Power" containing more than 170 sure-fire opportunities to promptly increase your earnings and your security.

FREE!
Lots of profitable businesses have started with a single recipe. Choose from the 162,000 facts and 10,000 formulas such as: — Adhesives, Cosmetics, Beverages, Candy, Ceramics, Cheese, Cleaners, Concrete, Dentifrices, Dyes, Depilatories, Enamels, Flavors, Foods, Gum, Home formulas, Inks, Insecticides, Lacquers, Linoleums, Lubricants, Metals, Mirrors, Oils, Ointments, Paints, Perfumes, Plastics, Polishes, Remedies for Man, Beast & Fowl, Soaps, Solders, Varnishes, etc. 1000's of others to make all sorts of profitable items.

BE READY, IF YOUR JOB FOLDS

This big book tells what to do and how. No experience needed. You work from the money-making facts and ideas that are explained in words easily understood. Many fortunes have been made with a single formula. Mail in your order and get started right NOW!

**POSTPAID
\$3.98
ANYWHERE IN
THE WORLD**

\$3.98 postpaid throughout the world. (C.O.D. plus postage in U. S. only.) Shipped at once.

World-Wide Service — Books on Any Subject

ADAMS BROWN COMPANY, Dept. P89, Boston 67, Mass., U.S.A.

WHAM-O SPORTSMAN*
HITS LIKE A .22 RIFLE—
KILLS RABBITS, SQUIRRELS.
For Hunting, Target,
Revolving Pistols.

**\$1.00
postpaid**



Dealers Write

A man's sport!
Powerful, silent, accurate.

Complete with 40 pellets and extra rubber straps. Send \$1.00 today to —
Wham-O Mfg. Co., Box 12H, South Pasadena, Calif.
*PROFESSIONAL MODEL USED BY MEMBERS OF NAT'L SLINGSHOT ASSQ.

THERE'S MONEY IN CARTOONS!

RAYE BURNS will teach you HOW to CREATE ORIGINAL CARTOONS at home that you may SELL! Course contains 26 lessons and over 600 illustrations. All for Only... **\$2.85**

RAYE BURNS SCHOOL, Dept. M, Box 3583, Cleveland, Ohio

RAISE HAMSTERS



The new wonder animals from Syria. Often called Toy Bears. Delightful pets. Everyone wants them. Laboratories need thousands. Clean, odorless. Raise anywhere. A profitable and interesting hobby or business. We furnish breeding stock with manual of instructions.

Write today for free illustrated literature.
GULFHAMSTERY, 1536 BASIL, MOBILE, ALA.

SAY YOU SAW IT IN POPULAR MECHANICS

Photography
for **PLEASURE or PROFIT**



Learn at home. Spare time. Practical basic training. Long-established school. Many have earned while learning. Send coupon below for free booklet, "Opportunities in Modern Photography" and full particulars.

AMERICAN SCHOOL OF PHOTOGRAPHY
1315 Michigan Avenue Dept. 135C Chicago 5, Illinois
Send booklet, "Opportunities in Modern Photography," full particulars and requirements. No salesman will call.
Name _____ Age _____
Address _____
City _____ Zone _____ State _____

**MEN—IF YOU VALUE
Your Future—
read this
FREE BOOK**

**SEND
FOR IT
Today!**



**Tells You How to Win
Bigger Pay and Real Security**

This book is yours without a penny of cost. "Your Future in Refrigeration and Air Conditioning" tells you what's in store for you in this fast moving, big pay field. No obligation. We want you to have this big, fascinating book. We want you to have the opportunity to read it—and to decide for yourself whether this is the field for you. You'll see pages of interesting pictures showing men on-the-job in Refrigeration and Air Conditioning. You'll read all about the fine opportunities in this amazing industry. This can easily be the most important book you'll ever receive and read—because it concerns your own future! Refrigeration and Air Conditioning has plenty of room for trained men—to handle good paying jobs in the many branches of this great industry. Almost unlimited future for men who know this work. Now you may learn Refrigeration and Air Conditioning at home in spare time. No need to give up present job or income while preparing to step into a better job. Act now! Simply write your name and address on the coupon below and mail today. Get your free copy at once . . .

INDUSTRIAL TRAINING INSTITUTE
2150 Lawrence Avenue, Dept. X-1, Chicago 25, Ill.

MAIL COUPON NOW No Cost No Obligation

Mr. C. H. Smith, President,
Industrial Training Institute, Dept. X-1
2150 Lawrence Avenue, Chicago 25, Illinois

Please send me a FREE COPY of "Your Opportunity in Refrigeration and Air Conditioning" by return mail.

Name _____
Address _____
City and Zone _____ State _____

Your stepping-stone
to a BETTER-PAYING
MACHINIST'S JOB



Master shop work quickly
with these books

This big home study
and reference course gives
you the practical facts on
machines and methods you
need to advance in machine
shop work. Take advantage
of the other man's experi-
ence as found in books, to
solve your problems, increase
your efficiency with . . .

Revised and Enlarged
These 6 volumes give you not
only accepted methods and
practices, but latest develop-
ments in machine shop work,
enabling you to meet today's
shop requirements and needs.

6 volumes, 2645 pages
2747 illustrations

THE AMERICAN MACHINISTS' LIBRARY

This library of machine shop practice was written for
practical men. It gives you the best methods for every kind
of machine shop work. It fully explains lathes, drills, and
other machine tools and their operation, automatic screw ma-
chines, speeds and feeds, gear design and production, jigs
and fixtures, punch and die work, metal surfacing, etc., etc.
All plainly written and fully illustrated.

NO MONEY DOWN—Easy payments

EXAMINATION COUPON

McGRAW-HILL BOOK CO., INC., 330 W. 42 St., N. Y. C. 18, N. Y.
Send me for ten days' free examination the AMERICAN MACHIN-
ISTS' LIBRARY. If satisfactory I will send you \$3.75 and \$4.00
monthly until the price of \$23.75 is paid. If not wanted I will
return books postpaid.

Name _____
Address _____
City _____ Zone _____ State _____
Company _____
Position _____ PM-8-49

Learn A Trade NOW! PRACTICAL SHOP TRAINING!

In Our Chicago Shops

- | | |
|---|--|
| <input type="checkbox"/> AUTO MECHANICS | <input type="checkbox"/> WELDING—ARC and GAS |
| <input type="checkbox"/> DIESEL MECHANICS | <input type="checkbox"/> MACHINIST |
| <input type="checkbox"/> REFRIGERATION | <input type="checkbox"/> PIANO TUNING |
| <input type="checkbox"/> BODY-FENDER | |

Above Approved For G. I.'s and Civilians
One of America's Leading Practical Schools
7 Floors of Fully Equipped Shops
Over 48,000 Successful Graduates
Expert Individual Instruction
Learn by Doing—Low Living Expense
Established 1902—Day and Evening Classes

Also the following Home Study Courses

- | | | |
|----------------------------------|--|---------------------------------|
| <input type="checkbox"/> PLASTIC | <input type="checkbox"/> REFRIGERATION | <input type="checkbox"/> DIESEL |
|----------------------------------|--|---------------------------------|

—CALL IN PERSON OR MAIL THIS AD TO—

GREER SHOP TRAINING

(Desk 16) 460 South State St., Chicago 5, Ill.

Please send without obligation free information regard-
ing trade checked above. (Specify whether you are a
Veteran or Civilian)

Name _____ Age _____
Address _____
City _____ State _____



Learn WOOD PRODUCTION ENGINEERING

GET THIS FREE BOOK
Today

It tells you how you
can learn to become a successful
WOOD PRODUCTION ENGINEER . . . by
the Klok Home Study Correspondence Meth-
od . . . or by studying here in Grand Rapids
in our Resident School . . . Training in
WOOD PRODUCTION ENGINEERING of-
fers you great opportunities . . . either to
get a top position or to operate your own
plant successfully.

The Klok Course teaches you SKETCH-
ING, ROD-MAKING, DETAILING, STOCK
BILLING, TIME STUDY, COST and MAN-
AGEMENT.

WRITE FOR FREE BOOK TODAY! State
preference whether Home Study or Resi-
dent course, with name, age, occupation
and if veteran.

KLOK INSTITUTE
LOUIS ST., N.W.
GRAND RAPIDS, MICHIGAN



HAMSTERS!

• For FUN and PROFIT, raise and
sell prolific Golden Syrian Hamsters.
Friendly, entertaining, clean and
odorless. Fine "apartment-size" pets.
Sell laboratories, pet shops. Send for
FREE BOOK or enclose \$5 for book
and pair. Fine hobby or business
(full or part time.) Start NOW!



AZALEA CITY HAMSTERY, 1583 Forrest St., Mobile 18, Ala.

CARPENTRY BRICKLAYING

APPROVED FOR VETERAN TRAINING • FREE CATALOG

PENNSYLVANIA INSTITUTE SCHOOL OF TRADES
30th & MARKET STS. PHILA. 4, PENNA.

HYDROPONICS\$

Grow out-of-season vegetables, rare flowers or house plants by
hydroponics—WITHOUT SOIL— Start a fascinating hobby or a
profitable business in your own home. No experience needed for top
results. Only small space gets big returns. Easy, clean, pleasant way
to grow any plant indoors or out every day in the year. Fast growth,
increased yields, unlimited profit opportunities. Send today for FREE
16 page picture book showing how others from every state are suc-
ceeding in this wide open field. Send postcard for complete facts.
CHAPMAN-GILBERT, 824 W. IVY, SAN DIEGO, CALIF.

BE A TILE SETTER

LEARN TILE SETTING AT HOME. Ever increasing demand for tile
setters. Easy to learn! Big money! Even as a sideline you can make
\$75 and up each week. Write today for details.

INTERNATIONAL TILE INSTITUTE
P. O. BOX 6961 LOS ANGELES 22, CALIFORNIA

AUTOMOBILE DRIVERS

Flash Your Turns



New Model SIMPLEX DIRECTION
SIGNAL KIT fits most cars. Gives
new safety and comfort when making
turns. Eliminates arm signals. Flash-
ing parking and tail lights show other
cars which way you're going to turn.
Flashes 60 to 80 times a minute.
Works like factory installed models on
expensive cars. Does not interfere with
operation of present lights. Install it
yourself. All parts furnished. For
most 1942 to 1949 cars. SPECIFY
MAKE AND YEAR. Adaptable to
earlier cars at extra cost. MONEY
BACK GUARANTEE. Write for
DEALER INQUIRIES INVITED free information.

\$8.95

Postpaid in U.S.
Send check or
money order.
Postage extra on C.O.D.'s.

The LESTER Company, 820 W. Jackson, Dept. M8, Chicago 7, Ill.



Learn RADIO TELEVISION, ELECTRONICS

by

SHOP METHOD HOME TRAINING

Let NATIONAL SCHOOLS, of Los Angeles, a practical Technical Resident Trade School for almost 50 years, train you for today's unlimited opportunities in Radio

You receive all parts, including tubes, for building this fine, modern Superheterodyne Receiver. This and other valuable standard equipment becomes your property.

these two FREE books will tell you how



Good Jobs Await the Trained Radio Technician

You are needed in the great, modern Radio, Television and Electronics industry! Trained Radio technicians are in constant and growing demand at excellent pay—in Broadcasting, Communications, Television, Radar, Research Laboratories, Home Radio Service, etc. National Schools Master Shop Method Home Study Course, with newly added lessons and equipment, can train you in your spare time, right in your own home, for these exciting opportunities. Our method has been proved by the remarkable success of National Schools-trained men all over the world.

You Learn by Building Equipment with Standard Radio Parts We Send You

Your National Schools Course includes not only basic theory, but practical training as well—you learn by doing. We send you complete standard equipment of professional quality for building various experimental and test units. You advance step by step until you are able to build the modern superheterodyne receiver shown above, which is yours to keep and enjoy. You perform more than 100 experiments—build many types of circuits, signal generator, low power radio transmitter, audio oscillator, and other units. The Free Books shown above tell you more about it—send for them today!



NOW! NEW PROFESSIONAL MULTITESTER INCLUDED



This versatile testing instrument is portable and complete with test leads. Simple to operate, accurate and dependable. You will be able to quickly locate trouble and adjust the most delicate circuits. You can use the Multitester at home or on service calls. It is designed to measure AC and DC volts, current, resistance and decibels. You will be proud to own and use this valuable professional instrument.

GET THE DETAILS—SEND THE COUPON ▶

LESSONS AND INSTRUCTION MATERIAL ARE UP-TO-DATE, PRACTICAL, INTERESTING

National Schools Master Shop Method Home Training gives you basic and advanced instruction in all phases of Radio, Television and Electronics. Each lesson is made easy to understand by numerous illustrations and diagrams. All instruction material has been developed and tested in our own shops and laboratories, under the supervision of our own engineers and instructors. A free sample lesson is yours upon request—use the coupon below.

You Get This and Other Valuable Information in the Free Sample Lesson:

1. Basic Receiver Circuits and How They are Used.
2. Construction of the Antenna Circuit.
3. How Energy is Picked Up by the Aerial.
4. How Signal Currents are Converted into Sound.
5. How the Tuning Condenser Operates.
6. How the R-F Transformer Handles the signal, and other data, with diagrams and illustrations.

Both Resident and Home Study Courses Offered

APPROVED FOR VETERANS CHECK COUPON

NATIONAL SCHOOLS

LOS ANGELES 37, CALIF. • EST. 1905



MAIL OPPORTUNITY COUPON FOR QUICK ACTION

National Schools, Dept. 8-PM
4000 South Figueroa Street
Los Angeles 37, California

(Mail in envelope or paste on penny postcard.)

Mail me FREE the book "Your Future in Radio" and a sample lesson of your course. I understand no salesman will call on me.

NAME _____ AGE _____

ADDRESS _____

CITY _____ ZONE _____ STATE _____

Check here if veteran of World War II

INVENTORS

When you are satisfied that you have invented a matter of value—write me, without obligation, for full information as to what steps you should take to secure a Patent.

The usual first step is to have a search of the prior U. S. Patents conducted, so that I can report to you on the question of Patentability.

PATRICK D. BEAVERS

(Formerly RANDOLPH & BEAVERS)

Registered Patent Attorney

934 Columbian Building Washington 1, D. C.

PATRICK D. BEAVERS, Registered Patent Atty.
934 Columbian Bldg., Washington 1, D. C.

Please send me full information on how to secure Patent Protection and Trademark Registration.

Name _____

Street _____

City _____ State _____

HIGHEST ROYALTIES and CASH FOR YOUR INVENTIONS

Write for FREE booklet without obligation

UNIVERSAL MARKETING CO.

354 S. Spring St. (Suite M) Los Angeles 13, Calif.

New
**Advertising
Machine**



**PRINTS and
ILLUSTRATES
1¢ POST CARDS**

Send
Coupon

**CARDMASTER CO., 1920 Sunnyside
DEPT. 138, CHICAGO 40, ILL. FREE!**

Send FREE Illustrated Book* and complete, unique advertising plans and money making ideas for my business.

* Shows HOW thousands of business men in every line are boosting sales in spite of conditions with 1c messages printed and illustrated in few minutes on gov't post cards—with amazing, new, patented **CARDMASTER**. Your "today's" ideas, read by your prospects next morning. Not a toy, but a sturdy advertising machine built to last years. Sold direct at low price. Guaranteed five years. **SEND NAME TODAY. All FREE!**

NAME _____

ADDRESS _____

CITY _____ ZONE _____ STATE _____

PATENTS

AND TRADE MARKS

C. A. SNOW & CO.

REGISTERED PATENT ATTORNEYS

WRITE FOR INFORMATION TO
428 SNOW BUILDING, WASHINGTON 1, D. C.

TRADE MARKS •
COPYRIGHTS •

PATENTS

The Time to Contact
a Patent Attorney is Promptly
After You Have Finished Your Invention

Write for FREE "INVENTOR'S GUIDE" & "Record of Invention"

FRANK LEDERMANN Registered Patent Attorney
154 Nassau St. • 20th Floor • New York 7, N. Y.

Become a Doctor of PSYCHOLOGY

Win the degree of Ps.D. Teach the secret of contentment, happiness. Solve mental worries. Experience the revelation of truth. Chartered college. Individual help. Write for FREE book. **COLLEGE OF UNIVERSAL TRUTH, 5153-B North Clark St., Chicago.**

INVENTING

—FOR **PROFIT!** If you have an inventive turn of mind, write for free 28-page booklet explaining how the Institute of American Inventors is helping inventors pre-test the possibilities of proposed devices to fill today's unprecedented demand for useful new inventions.

INSTITUTE of AMERICAN INVENTORS

Dept. 4, 1926 Eye St., NW, Washington 6, D. C.

INVENTORS

Whether an invention is patentable can be substantially determined by a search of the U. S. Patent records. Without obligation, write for information explaining the steps you should take to secure a patent.

JOHN N. RANDOLPH

Registered Patent Attorney
201 Columbian Building, Washington 1, D. C.

PATENTS PATENT LAWYER

TRADE MARKS ASSOCIATE EXAMINER
GUSTAVE MILLER U. S. PATENT OFFICE 1922-1929
89-PM WARNER BLDG. REGISTERED PATENT ATTORNEY
WASHINGTON 4, D. C. Send for Form
"INVENTOR'S RECORD"

PATENTS

"Proof of Invention"
Folder mailed without
obligation.

E. E. VROOMAN, Registered Patent Atty.
505 McKim Building, Washington 5, D. C.

INVENTORS

IF YOU WISH TO PROTECT YOUR INVENTION,
You should take steps to protect it by a U. S. Patent.
Write me for "Record of Invention" form.

CARL MILLER

REGISTERED PATENT ATTORNEY

Woolworth Bldg., 35th Floor, Dept. 89-A, New York City
Please send me "Record of Invention" form.

NAME _____

ADDRESS _____

STUDY AT HOME

With An Educational Institution

Men with specialized training win higher positions, insure larger earnings, and are bigger successes in business and public life. Opportunities NOW greater than ever before. Send for our Catalog.

ARTS and SCIENCES

Courses in Philosophy; Education; Letters; Public Health; Medical Jurisprudence; Psychology; Sociology; Physics; Chemistry; Geology; Political Science; Theology; Business and Commerce; Accounting; Mathematics; Statistics; Agriculture.

ENGINEERING

Courses in Electrical, Civil Mechanical, Drafting, Architectural, Steam, Aeronautical, Radio, Structural, Mining, Industrial, Petroleum, Marine, Chemical, Diesel, Automobile, Refrigeration, and Air Conditioning Engineering.

LAW

Complete Professional Law Course includes 18 Hornbook Series college grade textbooks. Courses also in Commercial Law, Patent Law and Medical Jurisprudence.

McKinley-Roosevelt Incorporated, 4610-K, Sheridan Rd., Chicago 40, Ill.

make MONEY CASTING AT HOME



Make your own rubber molds quickly, cheaply with X.L. RUBBER. Cast thousands of perfect figurines, book ends, plaques, ornaments, ash trays, etc. **GREAT PROFITS!**

Write for **NEW Catalog**.
X.L. Rubber, Pts. \$2.00; Qts. \$3.50; Gallons \$8.95; Models and enough rubber for 3 molds \$1.30 postpaid.

PLASTIC ARTS STUDIO • Route 5 • Dept. 2 • Muncie Ind.

Free FACTS SENT

Learn CARTOONING



HAVE FUN! MAKE MONEY! Cash in on your sense of humor at HOME—BY MAIL. No experience needed to start. Write today for FREE TRIAL LESSON and full particulars.

MoeN Gag Cartoon School, Dept. E, Fall Creek, Wis

LEARN MOVIE PROJECTION THEATRE MANAGEMENT



The Motion Picture Theatre Business offers big opportunities for trained men. Get into a fascinating field with a promising future. Train at home in spare time. Free Catalog. Established 20 years.

THEATRE SCHOOL, 370 Washington St., Elmira, New York

BLISS Electrical Training

BLISS ELECTRICAL SCHOOL

Intensive 32 weeks' residence course in fundamentals of industrial electrical engineering, including radio and electronics. Extensive laboratory, shop work, drafting. Prepares for electrical technician and engineering aides

in communications, power, manufacturing, business machines, sales, service. G.I. approved. 56th year. Enter Sept. 6, Jan. 9. Catalog. 7638 TAKOMA AVENUE, WASHINGTON 12, D. C.



NOT A SEASONAL JOB—A LIFETIME OPPORTUNITY

G. I. APPROVED

EARN \$3800.00 A YEAR! ADVANCE TO \$7000.00

A CRITICAL SHORTAGE OF STATION AGENTS and TELEGRAPHERS EXISTS! ATTEND THE WORLD'S LARGEST RAILROAD SCHOOL

VETERANS! NON-VETERANS! THIS IS IT! Thousands of trained men are needed by all U.S. Railroads because of new 40 hour week provision, and men reaching retirement age. Assure yourself of immediate employment after graduation... attend the school endorsed by the ORDER OF RAILROAD TELEGRAPHERS. Gale Institute has placed over 1,000 men in the past 18 months. YOU MUST ACT NOW—CLASSES ARE LIMITED. WRITE TODAY!

IN RAILROAD WORK YOU GET:

- Free travel passes
- Vacation with pay
- Low cost insurance
- Advancement opportunity
- Retirement fund

GALE INSTITUTE, 1400 West Lake St., Minneapolis 8, Minn.

EARN MORE IN DRAFTING



Steady Employment
•
More Opportunities for Promotion
•

"Here I am at work making good money as a draftsman. I'm glad I sent the coupon to Chicago Tech for that Free Trial Lesson and found out how easy it is to learn Drafting in spare time at home. Today I feel secure in my job because the draftsman's work comes first on any new project. And, in addition, draftsmen can't be replaced with machines. What's more, I feel I'm slated for promotion and more pay, because I see so many draftsmen advancing to high-pay jobs."

LEARN IN SPARE TIME—AT HOME! (or at the College in Chicago)

A few hours of pleasant home study every week—that's all. No interference with your present job. All the tools you need; drawing outfit included. With Chicago Tech's help, you train yourself step by step. This tested method—developed over 45 years of C.T.C. progress—prepares men quickly for good positions in industry.



FREE INFORMATION—SEND COUPON

To prove to you how easy it is to learn Drafting at home by the Chicago Tech method, we will send you this FREE TRIAL LESSON. No charge for this lesson, now or later. Fill out and mail coupon, or send post card today.

CHICAGO TECHNICAL COLLEGE

K-212 Tech Bldg., 2000 So. Michigan Ave., Chicago 16, Illinois

Mail me FREE Lesson with information about big opportunities in DRAFTING.

Name _____ Age _____

Address _____

City _____ Zone _____ State _____

Learn JEWELRY MAKING WATCHMAKING ENGRAVING

TRADES WITH
GREATER SECURITY—
HIGHER EARNINGS



Earn MORE All of Your Life

Increasing Demand for Trained Men and Women. No Age Limit. Learn Thoroughly—Quickly by KCSW's Special Application Method. Day and Evening Classes. Write for free Catalog. Approved for Veteran Training.

KANSAS CITY SCHOOL OF WATCHMAKING

1218 Admiral Blvd.

Kansas City 6, Mo.

9 BIG BUILDING BOOKS

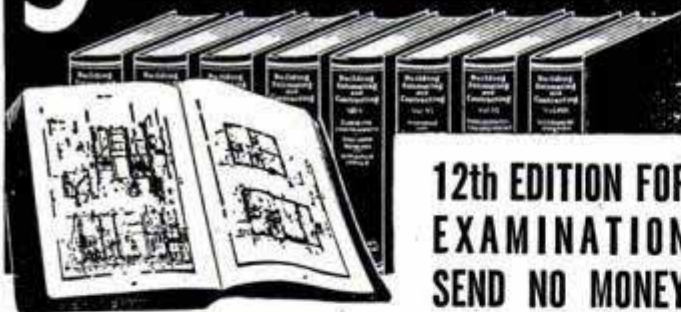

12th EDITION FOR
EXAMINATION
SEND NO MONEY

Learn to draw plans, estimate, be a live-wire builder, do remodeling, contracting. These 9 practical, profusely illustrated books cover subjects that will help you to get more work and make more money. Masonry, concrete forms, carpentry, steel square, roof framing, construction, plumbing, heating, painting, decorating and many other subjects. More than 4000 pages—2750 illustrations.

BETTER JOBS — BETTER PAY UP-TO-DATE EDITION

A nationwide building boom is in full swing and trained men are needed. Big opportunities are always for MEN WHO KNOW HOW. These books supply quick, easily understood training and handy, permanent reference information that helps solve building problems.

These books are the most up-to-date and complete we have ever published on these many subjects.

Coupon Brings Nine Big Books for Examination

AMERICAN TECHNICAL SOCIETY—Publishers since 1898
Dept. GC19 Drexel at 58th Street Chicago 37, Ill.

You may ship me the Up-to-Date edition of your nine big books, "Building, Estimating and Contracting," without any obligation to buy. I will pay the delivery charges only, and if fully satisfied in ten days, I will send you \$2.00, and after that only \$3.00 a month, until the total price of only \$34.80 is paid. I am not obligated in any way unless I keep the books.

Name _____

Address _____

City _____ State _____

Please attach a letter stating your age, occupation, employer's name and address, and name and address of at least one business man as a reference. Men in service, also please give home address.

BIG FREE CATALOG

of WAR SURPLUS OPTICAL BARGAINS

Build Your Own RIFLESCOPE, BINOCULARS, TELESCOPE, ETC.

We Furnish Optics and Instructions

- LENSES, PRISMS & RETICLES
- EYEPIECES and OBJECTIVES

We Have Numerous Types of Assembled Optical Instruments Including Low-Power RIFLESCOPES.

CHECK OUR BARGAINS . . . Request CATALOG H

EDMUND SALVAGE COMPANY
P.O. AUDUBON, NEW JERSEY



BUILD YOUR OWN ENLARGER

Enjoy Photography's most fascinating hobby at a fraction of usual cost. With simple step-by-step instructions and diagrams plus a screwdriver and pliers you assemble your own Enlarger and Save! Get all features of more expensive Enlargers: precision machined aluminum alloy castings, 90° tilt for wall projection of prints, spherical aluminum lamphouse, helical rack and pinion focusing with extra large knobs, unconditional guarantee. For 35mm to 2 1/4 x 3 3/4 negatives. Time payment plan.

Write Today for Free Illustrated Folder
CALIFORNIA TECHNICAL PRODUCTS CO.
448 S. Hill, Dept. M-8, Los Angeles 13, Calif.

ELECTRICIANS' SCHOOL

HOUSE AND COMMERCIAL WIRING • MOTOR REPAIR
AND REWINDING • ELECTRIC REFRIGERATION

Approved for Veterans Training

PENNSYLVANIA INSTITUTE SCHOOL OF ELECTRICITY

42nd and SPRUCE STS.

PHILADELPHIA 4, PENNA.

BE A DETECTIVE

WORK HOME or TRAVEL. Experience unnecessary.
DETECTIVE Particulars FREE. Write to
GEO. P. M. WAGNER, 125 W. 86th St., N. Y.

How to Make Money with Simple Cartoons

A book everyone who likes to draw should have. It is free; no obligation. Simply address

FREE BOOK

CARTOONISTS' EXCHANGE
Dept. 98-D Pleasant Hill, Ohio

Say You Saw It in Popular Mechanics

SHOE REPAIR OFFERS BIG INCOME LEARN IN 12 WEEKS TIME



You can own your own shop or earn big income as skilled shoe repairman. Growing demand everywhere at top wages for men who know how. We teach you quickly by actually working on shoes and modern machines. School open to all from 18 to 60 years of age. FREE BIG 20 PAGE BOOK explains everything. Send for your copy today. Chicago & Los Angeles schools only approved for Vets.

MODERN SHOE REBUILDING SCHOOL
Established 1927 Dept. PM
2937 Belmont Ave., Chicago, 361-12th St., Oakland, Calif.
806 So. Figueroa St., Los Angeles 14, Calif.

GET INTO

DIESEL-AUTO MECHANICS

Master All Phases

JOBS LIKE THESE ARE AVAILABLE TO TRAINED MECHANICS. CHOOSE THE FIELD YOU LIKE BEST

Get Complete Training



Diesel Fuel Injection
 Automotive Motor Tune-up
 Diesel Engine Rebuilding
 General Garage Mechanic
 Agricultural Implements
 Auto Engine Rebuilding
 Auto Elec. Service
 Public Utilities
 Parts Dealers
 Bus & Truck Lines
 Industrial Maintenance
 Contracting & Excavating
 Business of Your Own
 AND MANY other similar openings.

As a National Schools graduate, you are trained for ALL opportunities in the Diesel & Auto Industries

EARN WHILE YOU LEARN

With our practical Master Shop-Method Home Training, you study at home in your spare time. You receive Spare Time Work Lessons, which show you how to earn while you Learn . . . for extra money and experience. You Learn by DOING.

TOOLS AND EQUIPMENT

To make your training complete, we give you selected mechanic's tools and equipment, illustrated below, including all-metal toolbox — as a regular part of your instruction.

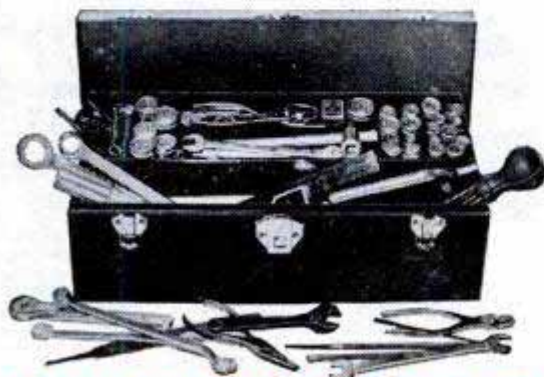

WE GIVE YOU TOOLS OF YOUR TRADE

Shop-Method Home Training by an Established Resident School Prepares you for Many Good Jobs

Opportunity is everywhere for the trained Diesel-Auto Mechanic. Highways throng with cars, busses, trucks, tractors. Garages and Service Stations are kept busy. Factories, ships, farms, railroads, general industry, are dependent upon engine power. Here's a dynamic, fast-growing field that needs trained men who know ALL phases: installation, operation, maintenance and repair. Now—National Schools offers you a practical, all-embracing Diesel-Auto Mechanic's Course, including all of these advantages:

Complete training, covering—Diesels, High Speed and Heavy Duty; Semi-Diesels, Gasoline and Special Fuel Engines AND Allied Mechanics.

- Basic Lesson Texts
- Diesel Installation
- Operation - Maintenance
- Diesel Chart Manual
- Spare Time Lessons
- Engine Service Manuals
- Engine Repair
- Drive Systems
- Diesel Electric Power
- Thermodynamics

TOOLS AND EQUIPMENT

INVESTIGATE

Secure Full Information

NEW, ILLUSTRATED BOOK & SAMPLE LESSON SHOW HOW WE TRAIN YOU . . . SEND FOR THEM TODAY!



NO COST NO OBLIGATION

APPROVED FOR VETERANS

Check coupon below

NATIONAL SCHOOLS

LOS ANGELES 37, CALIF. • EST. 1905



FIND OUT NOW... MAIL COUPON TODAY

NATIONAL SCHOOLS, DEPT. 8-PMD
4000 South Figueroa Street
Los Angeles 37, California

(Mail in envelope or paste on penny postcard)

Mail me FREE the book, YOUR FUTURE IN DIESEL-AUTO MECHANICS, together with the Sample Lesson. I understand I may keep and use the information with no obligation.

Name _____ Age _____

Address _____

City _____ Zone _____ State _____

Check here if Veteran of World War II

Learn AUTO BODY & FENDER REPAIR

This New, Easy Way!



Hear Instructor's Voice At Home!

Get into big money Auto Body and Fender Repair! Take UEI Audio training for basic knowledge which can bring you experience leading to fine pay, perhaps your own profitable shop. Revolutionary new training method brings instructor's voice to your home on records. Easy listening helps you master printed lessons quickly and thoroughly. Keep your present job and LEARN IN SPARE TIME. Follow with actual practice in our shops. Training covers metalwork, welding, painting, etc.

Cash In On This Big Opportunity Trade

Demand—and pay—for trained Auto Body and Fender mechanics is big. If you are mechanically inclined, get the training to make the most of it. National Placement Service or start your own shop. UEI has helped men get ahead in money-making trades since 1927. Get all the facts FREE. Fill out and mail coupon now!

UTILITIES ENGINEERING INSTITUTE
2523 Sheffield Avenue, Dept. XC-3, Chicago 14, Illinois

UTILITIES ENGINEERING INSTITUTE MAIL COUPON NOW!

2523 Sheffield Ave., Dept. XC-3, Chicago 14, Ill.
O.K.! Rush FREE facts about the opportunities in Auto Body and Fender Repair and UEI training with new Audio Service.

Name _____ Age _____
Address _____
City _____ ZONE Or COUNTY _____ State _____
 Check here for special information if you are under 17.

Learn A Trade NOW! PRACTICAL SHOP TRAINING!

In Our Chicago Shops

- | | |
|---|--|
| <input type="checkbox"/> AUTO MECHANICS | <input type="checkbox"/> WELDING—ARC and GAS |
| <input type="checkbox"/> DIESEL MECHANICS | <input type="checkbox"/> MACHINIST |
| <input type="checkbox"/> REFRIGERATION | <input type="checkbox"/> PIANO TUNING |
| <input type="checkbox"/> BODY-FENDER | |

Above Approved For G. I.'s and Civilians
One of America's Leading Practical Schools
7 Floors of Fully Equipped Shops
Over 48,000 Successful Graduates
Expert Individual Instruction
Learn by Doing—Low Living Expense
Established 1902—Day and Evening Classes

Also the following Home Study Courses

- | | | |
|----------------------------------|--|---------------------------------|
| <input type="checkbox"/> PLASTIC | <input type="checkbox"/> REFRIGERATION | <input type="checkbox"/> DIESEL |
|----------------------------------|--|---------------------------------|

—CALL IN PERSON OR MAIL THIS AD TO—

GREER SHOP TRAINING

(Desk 10) 460 South State St., Chicago 5, Ill.

Please send without obligation free information regarding trade checked above. (Specify whether you are a Veteran or Civilian)

Name _____ Age _____
Address _____
City _____ State _____

RUBBER HOSE SALE LESS THAN 1/2 Price



Brand new genuine Neoprene Hose—outlasts ordinary rubber 3 to 1. Reinforced with super tough cotton cord plies. Flexible, easy to handle. Easy Flo brass couplings with standard pipe threads for quick connections, included.

(Inside Diam.)	1 1/2 in.	1 3/4 in.	2 in.
Length	25 ft.	40 ft.	30 ft.
Price	\$8.75	13.75	13.75

Pump water for irrigation, stock, tanks, home, barn, fire fighting, etc.

If specified we will send special hose for gas or oil at same prices. All prices f.o.b. Chicago area. Satisfaction guaranteed. Send check or money order in full, or \$1.00 deposit and balance c.o.d. Master Mechanic Co., Dept. 19, Burlington, Wisconsin

TOOL AND DIE DESIGN



FREE COPY of our catalog explains comprehensive 12 month course in tool or die design. Expertly planned curriculum. Highly individualized instruction. Housing, employment problems aided. Write today for complete information.

TECHNICAL EDUCATION, INC. (Acme School)
Dept. PM, 2804 Belmont Chicago

LEARN PLASTICS AT HOME

GET 7 BIG KITS WITH COURSE—MAKE USEFUL ATTRACTIVE ARTICLES

Write for free catalog.

PLASTICS INDUSTRIES TECHNICAL INSTITUTE
1601 South Western Avenue, Dept. PM-89
Los Angeles 6, California

FOR MORE MONEY LEARN FINANCE

It's easy to multiply your earnings and profits. Write for Free copy of "The Source of Wealth and Individual Fortunes."

WALL STREET BUSINESS INSTITUTE
79 Wall Street New York 5, N. Y.

MAKE MONEY IN LANDSCAPING

Thorough training by Internationally known Landscape Architect to start your own business, improve your home or advance in this well paid field. Many Opportunities. Approved for Veterans. Send for FREE BOOK.



NATIONAL LANDSCAPE INSTITUTE
Dept. P-R, 310 So. Robertson Los Angeles 36, Calif.

Learn TELEVISION-ELECTRONICS

2 Big Books FREE Train at Home—Get Big Kits of Radio Parts! Prepare now in spare time. Practical instruction. Approved for Veterans. Write for details and 2 Radio Books—ALL FREE! Rush name today! SPRAYBERRY ACADEMY OF RADIO Dept. 10-U 20 N. Wacker Drive, Chicago 6, Illinois

BE A GOVERNMENT LICENSED AIRPLANE AND ENGINE MECHANIC

Train Now at LINCOLN EARN BIG PAY IN AVIATION

Start your aviation career by enrolling in our MASTER AVIATION MECHANICS. CAA Approved 1 Year Course, a complete course in both airplanes and airplane engines. Our REFRESHER AIRPLANE & ENGINE MECHANICS COURSE is designed for veterans or others with aviation mechanics experience. Either course is available to veterans under the G.I. Bill of Rights. Write today for complete information.

LINCOLN AVIATION INSTITUTE
UNION AIR TERMINAL DEPT. P-8 LINCOLN, NEBRASKA

Draw me!

COPY THIS GIRL AND TRY FOR A Free \$240 Art Course

5 PRIZES! 5 Complete Art Courses, including
Drawing Outfits! Each Course Valued at \$240

Opportunity of a lifetime, if you dream of being a commercial artist, designer, or illustrator! An easy-to-try way to win FREE art training!

Whether you win or not our instructors will send you their comments on your work, if your drawing shows promise! Trained illustrators and artists now making big money. Find out now if YOU have profitable art talent. You've nothing to lose—everything to gain. Start your drawing now. Mail it today.

RULES: You must be amateur. Our students not eligible. Make copy of girl 5 ins. high. Pencil or pen only. Omit lettering. All drawings must be received by September 30, 1949. None returned. Winners notified. If desired, send stamped, self-addressed envelope for list of winners.



ART INSTRUCTION, INC., Dept. 8139C
500 S. 4th St., Minneapolis 15, Minn.

Please enter my attached drawing in your September drawing contest. (Please Print)

Name _____ Age _____
Address _____ Phone _____
City _____ Zone _____ County _____
State _____ Occupation _____



Start a **profitable welding business** of your own

Earn \$350 to \$550 extra profit monthly

Earn extra money from the **BIG-PAY WELDING JOBS**

..easy pay out of profits—terms. **FREE**

New AC Welder lets you do hundreds of jobs easily and quickly. No special training necessary—no secret to getting established in the welding business. Start now. Let Hobart give you helpful hints.

Hobart Brothers Co., Box M-891, Troy, Ohio
One of the world's largest builders of arc welders

Write for booklet "How to Start a Profitable Welding Business"



Dealer Inquiries Invited

SET THE PACE WITH THE

- Cruises at 45 MPH—with faster pickup than car
- 39" high, 71" long overall, wt., 190 lbs.
- 8 HP motorcycle engine
- 50 miles to the gallon
- Automatic clutch
- Internal expanding brakes—handle-grip throttle controls

POWELL MANUFACTURING COMPANY
DEPT. PM849 • COMPTON, CALIF.

Powell
P-81!

ONLY **\$247³⁴**
AT COMPTON, CALIF.
EXCISE TAX
-INC.

Write for **FREE** folder and name of nearest dealer

FOR ALL MAKES AND MODELS



ORDER NOW!

DOUGLASS Steel-Pack MUFFLERS

Performance that excels • Stamina that endures

Rugged construction. Steel tubing. Straight-thru-design. Solid tube with steel packing. "Throbbing Deep Tone." Complete for Easy Installation Satisfaction Guaranteed

32-40 FORD V-8	\$5.96	29-48 CHEVROLET	\$5.96
41-49 FORD V-8	6.85	31-41 PLYMOUTH	5.96
39-49 MERCURY	6.85	42-48 PLYMOUTH	6.85
35-49 FORD & MERCURY DUAL SETS			\$23.00
49 FORD & MERCURY DUAL SETS			25.00

Specify Year and model • Enclose Money Order or Check with Order.

Dept. M-8

DOUGLASS MUFFLER MANUFACTURING COMPANY - 1916 W. VALLEY BLVD. - ALHAMBRA, CALIF.



1949 COMPLETE RACING EQUIPMENT CATALOG

WRITE RACING EQUIPMENT DIVISION

25c

ORDER TODAY Only \$9.75 POST PAID



Pat. No. 2,188,175

JET PERFORMANCE for your car with VAPOJET

This aircraft developed water-oil vapor injector gives your car faster pick-up, smoother running power and eliminates carbon, vapor lock and over heating. Many users of the sensational new Vapojet report up to 25% more mileage per gal. of reg. gas. Complete, easily installed kit fits all car, tractor or boat engines.

MONEY BACK SATISFACTION GUARANTEE
(If returned within 30 days) Send check or money order & save postage. \$1 deposit on C.O.D.

VAPOJET MFG. CO. 11424 Biona Dr. Dept. PM-8
Los Angeles 34, Calif.

— MAIL COUPON TODAY —

Rush me _____ Vapo-Jet Kits including carburetor adaptor, copper tubing, fittings, etc. and illustrated instructions. Enclosed is my check or money order for \$ _____
Car _____ No. of cyl. _____ Year _____
Name _____
Street _____
City _____ State _____

WORLD'S MOST FAMOUS AUTO BOOK!

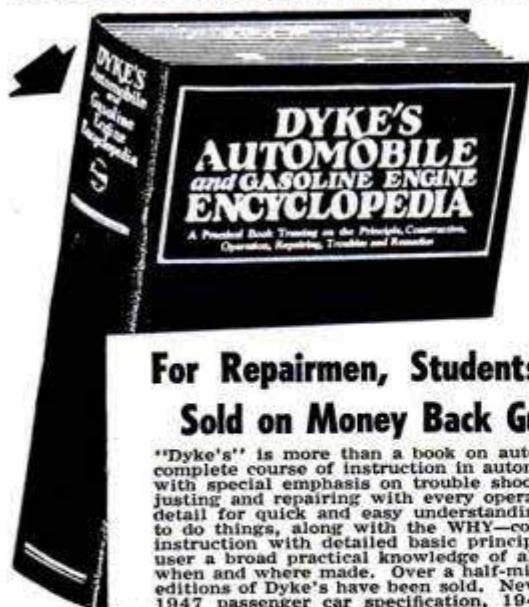

Leader for 32 Years.
Now New 21st Edition.
1483 Pages.
4600 illus.
Weights 6 lbs.

For Repairmen, Students, Owners!
Sold on Money Back Guarantee!

"Dyke's" is more than a book on automobiles. It is a complete course of instruction in automotive mechanics, with special emphasis on trouble shooting, testing, adjusting and repairing with every operation explained in detail for quick and easy understanding. It tells HOW to do things, along with the WHY—combining practical instruction with detailed basic principles that give the user a broad practical knowledge of all cars, no matter when and where made. Over a half-million copies of 20 editions of Dyke's have been sold. New edition includes 1947 passenger car specification, 1948 trucks, buses, tractors and diesels, Buick Dynaflo, farm and outboard motors, new electrical systems, etc. World's biggest book value. Only \$7.50. Send remittance with coupon or we will send C.O.D. Use for 5 days, then if not O.K. return and we will refund money.

MAIL ORDER COUPON

GOODHEART-WILLCOX CO., Dept. 51-C
1321 S. Michigan Avenue, Chicago 5

Send Dyke's Automobile and Gasoline Engine Encyclopedia C.O.D. I will pay postman plus charges. (C.O.D. in U.S. only.) Remittance

for \$7.50 enclosed, send postage paid. If not O.K. I will return in 5 days and you will refund purchase price.

Name _____
Address _____
City _____ State _____

Your Ideas May Be Valuable!

We can help you design, develop, manufacture and market your new product if it lies in our field, and appears to us useful and practical.

Our Company is thirty years old, well established and rated AAA-1. We are manufacturers.

Our interests lie principally in articles which need or must have a good looking, corrosion and heat resistant finish in black, white or colors. We are also interested in Chemical specialties.

If you have ideas along these lines, we would like to talk to you, with the understanding, of course, that you will be protected and treated in confidence whether or not we can use your idea.

G. A. WARREN

1501 Euclid Avenue

Cleveland 15, Ohio

RUPTURE



RELIEF...OR YOUR MONEY BACK

A simple... sturdy truss support built nature's way by old surgical appliance manufacturer. You risk nothing... relief or your money back. Send now for free booklet.

WEB TRUSS CO., Dept. M-84 Hagerstown, Md.



BEE RAISING PAYS BIG PROFITS

Get HOW TO SUCCEED WITH BEES, written by two outstanding experts, which gives more than 190 successful plans to produce big crops of honey. Join the ranks of spare time money-makers and send for this guaranteed 96-page book today. Tells all about queens, equipment, summer, winter and spring management, swarming, increasing colonies, how to produce section honey and extracted honey, etc. 19th edition, fully revised, only \$1.00.

POPULAR MECHANICS PRESS
200 E. Ontario St. Chicago 11, Ill.



POPULAR MECHANICS Outdoor Sports Manual!

All sportsmen, attention! Here are 156 pages of helpful hints for the Hunter, Fisherman, Trapper, Camper, Archer, and Boatman. How to make your own decoys, recondition your fishing rod, outfit the fur bearers, make an insect and vermin proof tent, shoot a modern crossbow, and service your outboard motor. These and a pack bag full of other articles for outdoor men. Your News Dealer has it in the 60c paper edition and we can supply the beautifully bound \$2.00 library edition.

Popular Mechanics Press
200 E. ONTARIO ST. CHICAGO 11

Say You Saw It in
POPULAR MECHANICS

"SEA CRAFT" BLUEPRINTS READY NOW!



Build this luxurious cabin cruiser yourself and save money. What a beauty it is! A 25-foot boat readily adaptable as a sport fisher, express cruiser, or utility boat. Cruises effortlessly at 15 knots with a marine engine or converted auto motor. Its spacious cabin sleeps four and has a galley complete with fresh-water tank, sink, and cook stove. Has open cockpit large enough for fishing, lounging, etc.

During war the Coast Guard used "Sea Craft" for ship-to-shore travel. Order today your complete set of seven large-size blueprints scaled 1 inch to the foot. These, plus a 40-page two-color illustrated booklet giving step-by-step instructions, only \$10.00.

POPULAR MECHANICS PRESS
200 EAST ONTARIO ST. CHICAGO 11, ILL.

EARN \$50 UP A WEEK... ON THE SIDE!
While You Learn Watch Repairing At Home

WITH OUR NEW 13 ITEM SELF-TRAINING KIT ENLARGED KIT Contains: WATCH MOVEMENT for practicing (newest added feature)—PROFESSIONAL TOOLS: Loupe; 6 Screw Drivers; Tweezers; Material Tray; Case Opener & Knife; Movement Gauge and COMPLETE ILLUSTRATED \$9.35 Post BOOK ON WATCH REPAIRING. Only \$9.35 Paid (C.O.D. plus charges) MONEY BACK GUARANTEE Tool Catalog FREE with KIT or send \$5.00 credited to 1st order MODERN TECHNICAL SUPPLY CO. Dept. 8MMC, 55 W. 42nd St. New York 18, N. Y.

LUMINESCENT PRODUCTS

• LIGHT REFLECTING CRYSTALS
• COLORED GLASS CRYSTALS
• LUMINOUS POWDERED PIGMENTS

COMBINATION TRIAL ORDER & LISTING \$1.00 POSTPAID ORDER TODAY

GLOWELL COMPANY
475 FIFTH AVE • DEPT. MP • NEW YORK 17, N. Y.

Wildercraft INDIAN-TYPE MOCASINS

Beautiful soft leather tops, stitched to sturdy soles with tongue and lacing ready to assemble. Solid foot comfort for home, campus or cabin, indoors or outdoors. **\$3.50** GENUINE LEATHER

MONEY BACK GUARANTEE
Send \$3.50 for Ladies or Children. Men's Outfit \$3.75. Add 15c per pair postage. If not delighted, return in 10 days for refund. Ladies—colors White, Brown, Red and Brown & White, Sizes 3 to 8. Boys—Brown only, Sizes 1 to 5. Men's—Brown only, Sizes 6 to 11. Order NOW—TODAY! Catalog FREE. WILDER & COMPANY Dept. A-8 Chicago 10, Ill.



MAKE BIG MONEY LEARN TO REBUILD SEALED REFRIGERATION UNITS
LEARN NOW—WE TEACH YOU HOW MILLIONS of Sealed Units will need rebuilding. Factories usual charge is \$80 to \$100 per unit. We offer a Post-Graduate Course (16 weeks) to graduates of schools or those with few years service experience. **START YOUR OWN BUSINESS.** PRACTICAL TRADES INSTITUTE, Inc. 25 University Ave., S.E., Dept. P-8, Minneapolis 14, Minn. WRITE TODAY

Hobbyist Catalog

64 pages WE PAY POSTAGE!
SHIP MODELS . . . TRAINS . . . PLANES
Cars . . . Art Supplies . . . Tools . . .
Projects . . . Games.
U.S.A. and Canada Orders Only.

10¢ write Braun-Craft
1232 ETOWAH, DEPT. PM-1, Royal Oak, Mich.

SPARE TIME MONEY

NEW BOOK SHOWS HOW
Make extra time mean extra money. New way to fun and profit. Make 1001 thrilling new things. Easy and fascinating, truly different. No tools, no training needed. Make distinctive jewelry, embed real flowers, butterflies, etc. Rush only 25c for your copy now. **THE CASTOLITE COMPANY, Dept. J-1, Woodstock, Ill.**

Plastics Supplies Catalog

Just off press. Get details on Plexiglas, Lucite, rods, sheets, tubes, Acetates, cements, dyes, buffs, molding sets, tools, carving kits, everything in plastics. Lowest prices. Price 10c, stamps or coin, with ad for catalog. **Plastics Mfg. & Supply Corp., Dept. PM-8, 4707 Euclid Ave., Cleveland, Ohio**

Remember This You can't Buy A \$20 Goldpiece for \$10. So it's Dangerous to Pay Less—if You Want Safe, Balanced, Matched Tires. A Full Page Ad couldn't offer more value. We Repeat: Consider Your Family's Safety—Not Just Price! You See Our Reliable Adv. Month After Month After Month!

Vets take 10%. We Owe Our Prosperity to You!
GOODYEAR Goodrich, Firestone, U. S. & Others, Original High Tread, Slightly Worn, Not Recaps — Not Remolded — Not Retreads Pass. & Truck 30,000 Miles Golden Rule Guar.
Genuine Factory Adjusted "All-Purpose" "AAA" Tires Read That Top Line Again! You'll Save More than \$

600-16	\$5.50	650-16	\$5.75	700-15	\$6.00
600-16 (6)	6.50	650-16 (6)	6.75	650-15	6.75
700-16	6.50	750-16	7.75	550-17	7.75
700-16 (6)	7.50	475-19	5.50	525-18	6.75

WE ARE TRUCK-TIRE EXPERTS. Matched Tires
600-20 \$9.00 32x6 (8) \$ 9.95 900-20 \$15.95
650-20 9.50 32x6 (10) 10.95 1000-20 16.95
700-20 10.50 825-20 14.95 1100-20 17.95

750-20 (8) \$9.50 34x7 (10) \$13.50 1000-22 \$17.95 1100-22 \$18.95

Military: 750-16 "AAA" Guar. 14,000 Miles \$9. Premium, Guar. 30,000 Miles, \$11. 900-16 "AAA" Guar. 14,000 Miles \$8. Premium, Guar. 30,000 Miles, \$11. 750-20 Super Guar. 14,000 Miles, \$10. All Purpose Guar. 30,000 Miles \$13.

GOOD USED TIRES Any Car \$3.25. 12,000 Miles Guarantee
Send ck. or money order for rush shipment. Save this ad. We won't ship a tire we wouldn't use ourselves. Instant shipment down South, Far West, and the world over. The name to trust in rubber.
BLATT GIRARD & LANCASTER AVE. DEPT. PM
BLATT BLDG., PHILADELPHIA 31, PA.

Become an **ELECTRICAL ENGINEER**

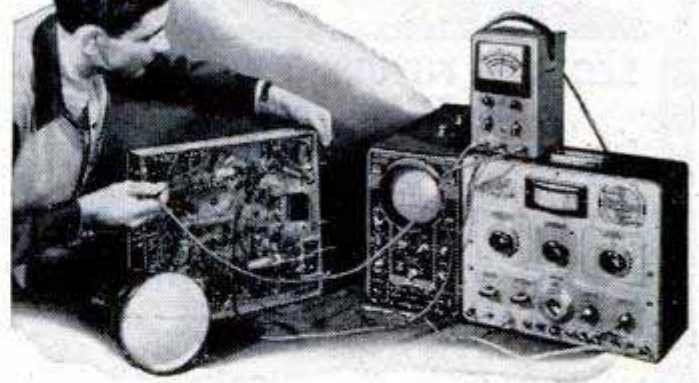

Major in Electronics or Power . . . B.S. Degree in 36 Months

The Electrical Engineering course offered by this non-profit, well-equipped Technical Institute and College is world-famous. Here, you can earn your Bachelor of Science Degree in 36 months of continuous study. You get both practical, specialized training and a solid educational background in the basic sciences and Electrical Engineering. And, under the concentric curriculum, you become a certified Electro Technician or Electronics Technician in 12 months.

Choose the Course That Interests You Most

SERVICE
6 to 12 months
• Electricity
• Welding
• Refrigeration
• Heating

TECHNICIAN
12 to 24 months
• Radio and Television
• Electronics
• Electrotechnics (Power)
• Welding
• Refrigeration, Heating, Air Conditioning

PROFESSIONAL
36 months
• Electrical Engineering —B.S. Degree; Major in Electronics or Power

Radio-Television Technicians

are needed throughout America's fastest growing industry. This certification can be yours in 18 months. All technician courses are credited toward the B.S. Degree.

Practical, military or academic training will be evaluated for advanced credit.

Faculty of 85 specialists. Over 1500 currently enrolled. 35,000 former students.

Terms Begin Oct., Jan., April, July

MILWAUKEE SCHOOL of ENGINEERING
Founded 1903 by Oscar Werwath

MILWAUKEE SCHOOL OF ENGINEERING
Dept. PM-849, N. Broadway & E. State, Milwaukee, Wis.

Without obligation send free bulletin "Your Career" and more details on course in _____

NAME _____ AGE _____

ADDRESS _____

CITY _____ ZONE _____ STATE _____

Check if World War II Veteran

Write for new 48-page Pictorial Bulletin . . . "Your Career"



FREE BOOK
TELLS HOW
TO BE AN . . .

*Accountant
Salesman
Secretary
Stenographer*

**SECURED FUTURE . . .
FREE EMPLOYMENT SERVICE**

Enter one of the "substantial earnings" fields through Hill's "Success Plan" training. A lifetime opportunity to join thousands of successful graduates in positions secured through our nation-wide employment service. No matter where you live, what you are doing now, Hill's can train you by study at home or in the resident school. Big Free book shows you the way to substantial earnings and an assured future. G. I. Approved.

Hill's Extension School & Business University
Dept. PM-89, 619 W. Main St., Oklahoma City 2, Okla.
Please send your free book, "Through Hill's to Success."

NAME _____
ADDRESS _____
CITY _____ STATE _____

Check here if eligible under G.I. Bill.
Please check course and training plan preferred.
Course _____ Resident Home Study

EASY-TO-USE COUPON TODAY

**PAY RAISING—EXTRA MONEY
BOOKS**

Use these books to prepare for a better job—bigger pay—to start a profitable spare time or full time business of your own, improve your home, start a hobby. Popular Mechanics specializes in supplying outstanding self-help books on many subjects. Send for our FREE catalog.

- Outdoor Sports Manual
Hunters, Fishermen, Trappers, Campers, Archers, Boatmen, here is your book! . . . \$2.00
- Shop Notes Library
4 Vols. — 1949, 48, 47, 44, (No. Dup. Mat.) . . . \$2.48
- Painting, Furniture Finishing and Repairing . . . \$1.50
- Rewinding and Servicing Electric Motors (No. 75) . . . 25c
- Photo Handbook
An entirely new and different book from our Popular Photo Guide. It's a complete guide to better pictures and dark-room technique, and features dozens of handy gadgets you can make yourself. . . . \$2.00
- Motor's Truck Repair Manual
Mechanics, Truck Specialists, Service Stations, Fleet Owners! Here is your book. Covers every job on every truck made since 1936 — 1400 pictures, 952 Pages . . . \$8.00
- Garden Book
Build own trellises, lawn furniture, fireplaces, ornaments, etc. . . . \$1.25
- Diving, Cutting and Welding in Underwater Salvage Operations
Only book of its kind . . . \$2.00
- Picture Framing
Modern methods for making and painting picture frames. Fully illustrated, . . . \$2.75
- If You Want to Write You Can Write! Learn through actual examples . . . \$1.75
- Modern Illustration
A practical art course covering all branches of commercial drawing, painting and methods of reproduction . . . \$3.00
- 210 Deluxe Small Homes \$1.00
Into the Freezer and Out
A complete handbook on the home freezing of foods. \$2.50
- Concrete Handbook
New book on using concrete around home, garden, farm . . . \$1.50
- Zero Storage in Your Home
How to prepare, store and freeze food properly. . . \$2.50
- This Way Up
The successful philosophy of practical business men \$2.00
- Welding, Brazing and Soldering
How to build own equipment and how to use it effectively . . . \$1.25
- Modern Refrigeration
Electric, Gas. Be service expert . . . \$5.00
- Dyke's Auto Ency. (includes Diesels, airplanes engines)
New 20th Ed. World's greatest book for mechanics \$7.50
- Household Mechanics
The "fix-it" book to end all "fix-it" books. Covers electric appliances, painting, carpentry, etc. . . . \$2.98
- Oil Burner Handbook . . . \$2.50
- Build Your Own Boat
Describes 17 popular boats—rowboats, sailboats, plywood outboard, etc. 192 pages \$1.50
- House Wiring (No. 89) . . . 25c
- Turn Scrap Into Money
Convert old auto generators into motors, welders, etc. . . . \$1.00
- Popular Mechanics Farm Manual
Packed with practical ideas and usable information that can easily be worth hundreds of dollars to every farm family and to homeowners everywhere. Send for free descriptive folder giving complete contents! . . . \$3.00
- Woodworking for Every-body . . . \$2.75
- Sheet Metal Work . . . \$3.00
- Tool and Saw Sharpening (No. 92) . . . 25c
- Forging Practice . . . \$1.50
- Action Toys (No. 66)
Plans for 21 easy-to-make toys . . . 25c
- Foundry Work . . . \$2.25
- Pattern Making . . . \$2.25
- Forty Power Tools
Build own saw, drill, lathe, sander, etc., from scraps—save money . . . \$1.50
- Carpentry . . . \$2.50
- The Young Craftsman
Over 450 things boys can make . . . \$1.50
- Five Acres and Independence
How to make money on small farm . . . \$2.50
- Your Home and How to Build It Yourself
Step by step construction of the famous POPULAR MECHANICS house. Wonderfully illustrated . . . \$3.00
- Drake's Householders Encyclopedia
This is the time to save money on those necessary home repair jobs—Repairing, Remodeling, Carpentry, Painting, Decorating, Plumbing, Heating, Electric Wiring and Appliance Repairs, Furniture Repairs—This new book covers them all . . . \$5.00
- Motorist's Handbook
Popular Mechanics scores again. A 160 page guide to automotive happiness . . . \$2.00
- Knots, Ties and Splices
For everyone who uses rope . . . \$1.25
- What to Make for Children
Junior tough on toys? Build him playthings that will last. . . \$2.00
- LeJay Manual of Homemade Electric Equipment
How to construct 100 items that are scarce and valuable . . . \$1.50
- How to Estimate for the Building Trades: Material and labor costs for masonry, plumbing, electricity, carpentry, heating, hardware, painting, etc. 62 pp. . . . \$5.50
- Rabbits for Food and Fur . . . \$2.50
- Tool Making . . . \$4.00
- Tool Design . . . \$4.50
- Plumbing Installation & Repair . . . \$2.00
- Ropp's Calculator
Figuring made easy . . . 75c
- Slide Rule Simplified . . . \$2.75
- Drake's Refrigeration Service Manual . . . \$2.00
- Primer for Home Builders
All the information you need to know in building a house . . . \$2.50
- How to Read Aircraft Blueprints . . . \$4.40
- America's Best Low Cost Homes
125 popular practical designs . . . \$1.00
- Toys You Can Make of Wood . . . \$2.50
- A.B.C. of Poultry Raising . . . \$2.50
- Ice Cream for Small Plants
Some technical formulas for ice cream, ices and frozen desserts on a commercial scale . . . \$2.50
- Furniture Joinery . . . \$2.00
- Essentials of Upholstery . . . \$3.25
- Radio Physics Course
A thorough training in radio fundamentals . . . \$5.00
- Lessons in Ornamental Penmanship
You can easily learn to write beautifully. Delight and amaze your friends with the skill you can acquire by using this book—Only . . . \$1.50

MAIL THIS



AIRCRAFT MECHANICS • AIRCRAFT DESIGN
September Classes Filling Rapidly
Limited Enrollment . . . ENROLL NOW!

Modern, practical courses prepare you for jobs in all phases of airplane maintenance and manufacture. Our comprehensive airplane designing course includes thorough design practice plus extensive laboratory experience.

DAY and EVENING CLASSES
Completely equipped airline-type shops and laboratories. Living quarters available. Our graduates employed all over the world since 1932.



High School Diploma Required.
For complete information, write for Catalog Q.

ACADEMY OF AERONAUTICS
LaGUARDIA AIRPORT, NEW YORK

Now you can **MULTIPLY or DIVIDE** in a Flash—
WITHOUT PENCIL OR PAPER
with the **MULTIVIDER**

FASTEST, SIMPLEST CALCULATOR for quick estimates or rough calculations in existence. You can check long lists of calculations in seconds. Can even do problems involving both multiplication and division with a single setting.

Just Turn the Disc There's Your Answer
Anyone with a grammar school education can work it. ENORMOUS TIMESAVER for engineers, contractors, business men, students. Only 5 3/4" in diameter. Light. Handy. Pocket size. Only \$1.00 postpaid, complete with instructions. Satisfaction guaranteed. Money back if returned within 5 days. Order yours today.
MULTIVIDER SALES, Dept. PM-8, Spartanburg, S. C.

MAIL THIS COUPON TODAY

Check the books you want, write your name and address below, and mail this advertisement with money order or check. Outside U. S. A. include 15% additional for shipping charges.
Books selected will be mailed promptly on our "money back if you're not entirely satisfied" guarantee.

Name _____
Address _____
City _____ State _____

Mail to **POPULAR MECHANICS PRESS**
Dept. 700—200 East Ontario St., Chicago 11, Ill.

World Famous EASY TO ASSEMBLE PACKAGED BOAT KITS



18 models—8 to 18 Ft.

1949 line—many new models—increased performance—simplified assembly. All parts pre-cut, frames pre-assembled.

Send 25c (coin) for literature. Literature plus booklet "Plywood Boats." \$1.00.



BOAT PATTERNS—BLUE PRINTS

100 designs by Deed, Lord, Crandall, etc., plank, steel, and plywood types 6-35 ft. Detailed blue-prints, full-size paper patterns. Catalog 35c (coin). Catalog and booklet "Boat Building" \$1.00.

MARINE MART—DEPT. 24—BUFFALO 7, N. Y.

RIEDEL WORK GLOVES

"The Right Glove for Every Job"

Riedel Textile Corp.

342 Madison Ave. New York 17, N. Y.

WHEELS — WHEELS

- 5" Disc Wheel 5/8" Tire 5/16" or 3/8" Sleeve..... 30c ea.
 - 6" Disc Wheel 3/4" Tire 5/16" or 3/8" sleeve..... 35c ea.
 - 7" Disc Wheel 3/4" Tire 3/8" sleeve..... 45c ea.
 - 8" Disc Wheel 1 1/4" Tire 1/2" sleeve..... 70c ea.
 - 7" Disc Wheel 1" Tire 1/2" ball bearing..... 80c ea.
 - 8" Disc Wheel 1 1/8" Tire 1/2" ball bearing..... \$1.00 ea.
 - 8" Disc Wheel 2" semi-pneum. T. 1/2" B.B..... \$1.35 ea.
 - 10" Disc Wheel 1.75 semi-pneum. T. 1/2" B.B..... \$1.50 ea.
- Above wheel prices include hub cap.
- 10" Aluminum Wheel 2 3/4" semi-pneum. T. 1/2" B.B..... \$4.50 ea.
- Plus Postage, 20% — C.O.D.'s accepted.

UNITED WHEEL STAMPING CO., PM-8

2756 W. 115th STREET CHICAGO 43, ILLINOIS

BULLDOG CHROME HOOD ORNAMENTS



Can Be Adapted to Fit All Cars, Trucks and Motorcycles
MASCO Send Check or Money Order
192 N. CLARK ST. CHICAGO 1, ILL.



GIGANTIC WAR EQUIPMENT MAIL SALE

AMAZING VALUES, FRACTION OF ORIGINAL COST

(We pay freight and parcel post charges in the U.S.)

- A-C Power Plants.....\$345.00
- Compressor Sprayers ... 99.50
- Capstan Winches 24.95
- Multi-Speed A-C Motors. 8.75
- Rotary Pump 3.95
- Utility Clutches \$13.95
- Briggs (3.5) Engines..... 77.50
- Briggs (6.5) Engines.... 86.90
- Power Shaft and Stone... 1.29
- D-C Welding Generator... 89.90

Also Hundreds Electrical and Radio Bargains
Send card for complete sales catalog

LECO ENGINEERING CO., BOX 908-PM-21, Lincoln, Nebr.

HELPFUL BOOKS

Send post card asking for FREE catalog

Popular Mechanics Press, 200 E. Ontario, Dept. 601, Chicago 11

Say You Saw It in Popular Mechanics

Make Your Own LOW COST POWER TOOLS

Use Wood, Scrap, Discarded Materials—Make Practical, Proven Machines

Order today the new "Forty Power Tools You Can Make." Even though you have the older edition, get this new book with twenty brand new tools—40 in all. Make your own motorized lathe, drill press, sander, shaper, circular, band, scroll and jig saws from old auto and other discarded parts. Make forty different tools following simple instructions, diagrams and photos and have an efficient, up-to-date shop. Save money, time and hard work and do a better job with low-cost power tools. Sent postpaid for only \$1.50 with order. Avoid high C. O. D. charges.

POPULAR MECHANICS CO. 200 E. Ontario St. Chicago 11, Illinois

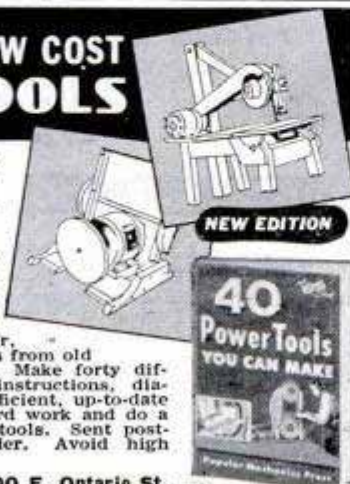

I SHOW YOU HOW TO

1 MAKE MONEY AT ONCE

2 START YOUR OWN BUSINESS

IN 2 WEEKS—
AT HOME
IN SPARE TIME

METALIZE BABY SHOES

IF YOU ACT NOW, I will show you how to start earning extra money immediately—in spare or full time. AND I SHOW YOU HOW to start your own profitable business. With my complete course and easy-to-understand illustrated instructions containing trade secrets of ALL metalizing processes PLUS 2 beautifully processed sample metalized baby shoes AND all my tested and proved methods of operating a successful metalizing business, I show you how to start YOUR OWN profitable, fascinating business right in YOUR OWN HOME. Up to \$5 per hour possible. Absolutely no experience needed. For PROOF send coupon today for FREE details of my MONEY MAKING PLAN for you and be convinced.

FREE!
MONEY MAKING PLAN
Full Details Without Obligation
MAIL COUPON TODAY!

John Kiktavi, KIKTAVI CO.
Dept. PM-8, 2111 W. Manchester, Los Angeles 44
Send me FREE details of your MONEY MAKING PLAN, without obligation.

NAME _____
STREET _____
CITY _____ ZONE _____ STATE _____

WANT A BASEMENT WORKSHOP?



BUILD a handy workshop easily with Gold Bond Gypsum Wall-board, at low cost. Big, light-weight panels are fireproof, moisture resistant, and easy to nail. Decorate with Gold Bond Sunflex, the low-cost, one-hour wallpaint. Get both at your local Gold Bond Lumber and Building Material Dealer's.

Free Book of suggestions



NATIONAL GYPSUM COMPANY,
Dept. E-1, Buffalo 2, N. Y.

Gentlemen: Send free copy of new Booklet, "Modernizing Magic" showing remodeling ideas and methods:

Name
Street
City State

(Please print name and address)

Now Your
Dream Home
Comes True!

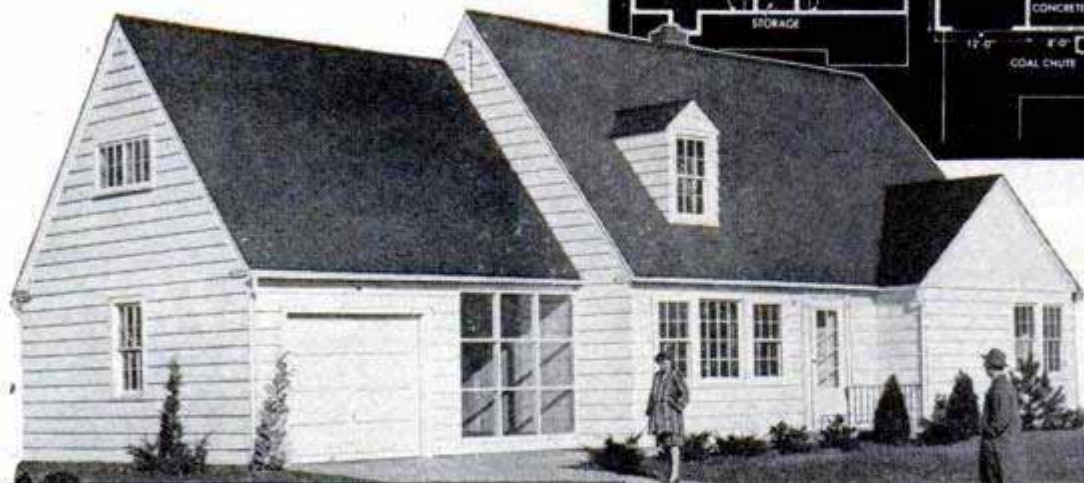
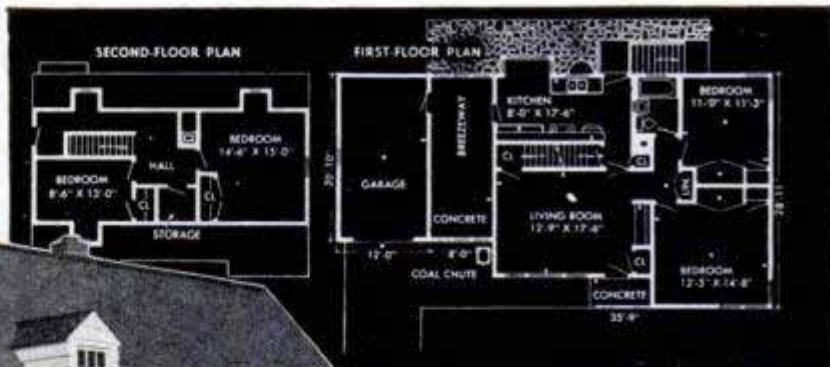

**The House That
Jack Built**

From actual photograph of Build-It-Yourself House with breezeway and garage as built by Jack Brownson, Aurora, Illinois, a twenty-three-year-old veteran.

**YOU CAN BUILD
THIS HOUSE
YOURSELF!**

**GET THE BOOK NOW!
STUDY THE PLANS NOW!**

Start Building When You Can

You can get "Your Home and How to Build It Yourself" and complete plans by mailing the coupon below. Book is plastic bound and contains 100 pages, size 8½ x 11 inches. Three-fifths of the book consists of photographs and drawings. Several sections are printed in extra colors and a four-page, four-color insert shows just how your own house will look in actual colors. Every detail of the house and its construction are discussed in this book with minute details of Build-It-Yourself instruction that will guide you in every step.

**PLANS YOU CAN READ
AND FOLLOW**

Plans consist of ten working size blueprints, giving floor plans, elevations, notes on construction, framing, lumber list, millwork list, specifications, plumbing and wiring diagrams. Every measurement is marked, every detail made as clear as A-B-C. With the book to guide you and the plans to follow, any handyman who can use simple tools can build this remarkable house and enjoy every minute of the work while saving thousands of dollars.



**MAIL COUPON FOR BIG NEW BOOK
AND PLANS • BUILD IT YOURSELF
OR HAVE IT BUILT AT A BIG SAVING!**

Can you use a hammer—saw a board straight—use common, everyday tools as well as the average *Popular Mechanics* reader? Then, startling as it may at first seem, you too, can build this modern house in any of its five designs, and do it easily and quickly, at a tremendous saving. *Popular Mechanics* and a famous firm of architects have designed it and worked out every detail so you can do every part of the job yourself, even though you have no experience whatever.

**SPACE FOR LIVING AND
FAMILY GROWTH**

Illustrated is the *Popular Mechanics* "build-it-yourself" house Jack Brownson built from our plans, in Aurora, Illinois, with one inexperienced helper. This beautiful, modern house is 1½ stories, with basement, living room, kitchen, dining nook, two bedrooms, bath, plenty of closets and space for 2 additional bedrooms on the second floor. The house itself is 35'-9" x 28'-11"; breezeway 20'-10" x 8'; garage 20'-10" x 12 feet.

**THE HOUSE THAT HAS
EVERYTHING**

The big, basic idea behind the design is ease of construction and the most living space and the most useful space, at the least cost, considering attractiveness and suitability for any neighborhood and most income groups. On top of this is its adaptability to other types of architecture, such as modified Dutch Colonial, modified Cape Cod, plain gable roof house without dormer windows, or the house as pictured, but without garage and breezeway.

**USE CONVENIENT ORDER
COUPON**

You may never have thought about actually building your own house, but you can do it. And now that building restrictions have been lifted, it's easier than you think. So send for the big new book—Your Home and How to Build It Yourself, and set of construction plans, today. Even if you engage a contractor or builder to build this house for you, you will need the plans. Then too, you will certainly want the book, which can easily save you countless hundreds of dollars whether you build this house or any other house of your choosing

**100 Pages
52 in Color
60% Illus.
8½"x11"**

MAIL COUPON FOR BOOK AND PLANS

Popular Mechanics Press,
200 E. Ontario Street, Chicago 11.

I enclose \$_____ Send me the items checked at once.

- Your Home and How to Build It Yourself \$ 3.00
- Complete set of plans for Popular Mechanics Home 12.50
- Book and Plans at reduced price 14.00
- Duplicate sets of plans 5.00

Name _____
Address _____ Zone _____
City _____ State _____

New 1950

MIDWEST TELEVISION

with *New Giant* 16" PICTURE

Direct From Factory to You... At Low Factory Prices

MIDWEST

Presents for 1950

THE MOST MAGNIFICENT NEW LINE OF
CUSTOM DESIGNED TELEVISION, RADIOS and RADIO-
PHONOGRAPHS EVER OFFERED IN ITS 30 YEARS OF
MANUFACTURING

**30
DAYS
TRIAL**

Send
For This
FREE
32 Page—4 Color
CATALOG

**ANNIVERSARY
YEAR**

1920 - 1950

RADIO-TELEVISION

A Pioneer in RADIO
ELECTRONICS and TELEVISION
Since 1920

RADIO



TELEVISION



EASY TERMS · 30 DAYS TRIAL · LOW FACTORY PRICES

Buy

**DIRECT FROM
FACTORY
and SAVE!**

**NEW LOW
DOWN PAYMENTS**

**FACTORY
TO YOU
PRICE**

**NO
Middlemen's
Profit**

**EASY
TERMS**

**SEND
THIS
COUPON
TODAY**

Write in Name and Address (Please
Print) on Coupon or To Postcard.

Also a Complete Line of NEW 1950
MIDWEST RADIOS

featuring the New Long Distance FM Circuit
and New 3-SPEED PHONOGRAPH

MIDWEST RADIO & TELEVISION CORP.

Dept. X-251 909 Broadway Cincinnati 2, Ohio

MIDWEST RADIO & TELEVISION CORP.
Dept. X-251, 909 Broadway, Cincinnati 2, Ohio

Please send me your new FREE 1950 Catalog.

NAME _____
ADDRESS _____
CITY _____ ZONE _____ STATE _____

NEW
Edition

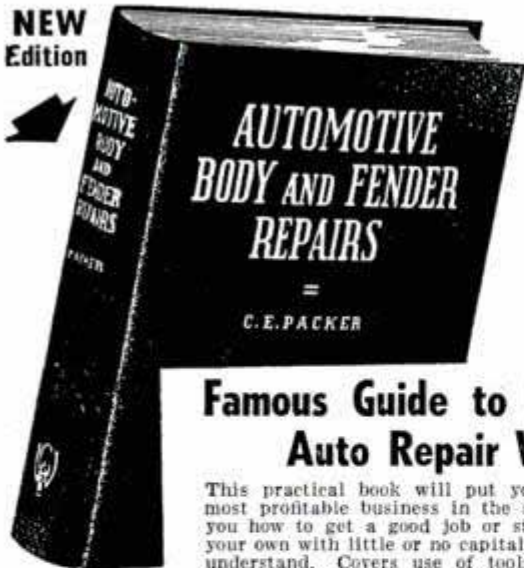

**NOW
HAS
325
PAGES
232
ILLUS.
\$3.50
Total Cost**

**Famous Guide to Best Pay
Auto Repair Work**

This practical book will put you right into the most profitable business in the auto field. Shows you how to get a good job or start a business of your own with little or no capital. Easy to use and understand. Covers use of tools and equipment, gives approved methods, describes materials and shows you how to actually do a professional job, operate a shop, etc. The very latest information and pictures on all interior and exterior body work and fender repairs—the kind of work people everywhere want and will pay big for when you can do it. Mail coupon now. Use book 5 days and if not O.K. return it and we will refund your money.

**Most
Complete
Information
Ever
Published**

**GOODHEART-WILLCOX CO., Dept. 1-C
1321 S. Michigan Avenue, Chicago 5**

**MAIL ORDER
COUPON**

Send Auto Body and Fender Repairs C.O.D., I will pay postman plus charges. (C.O.D. in U.S. only.) Remittance for \$3.50 enclosed, send postage paid. If not O.K. I will return in 5 days and you will refund purchase price.

Name _____
Address _____
City _____ State _____

Get in the BIG MONEY CLASS

USE YOUR SPARE TIME—AT HOME

If you find it difficult to come to our large school classes. Then we offer you the full advantage of the ALLIED PLAN of HOME TRAINING. Under the ALLIED PLAN we give you the same high quality training as we give in our residence school. Therefore, you can take our HOME TRAINING with complete confidence that you are getting the best. You will be amazed at the unique simplicity of this course. No tedious textbook reading is necessary. Your study is reached with practice material in an easy-to-read, simple, direct manner. WRITE for FREE Descriptive Literature NOW. A POST CARD WILL DO.

**NEW—
RAPID,
EASY
WAY
TO
LEARN
DRAFTING
AT
HOME**

ALLIED SCHOOL 1338-40-42 So. Michigan Ave.
of MECHANICAL TRADES, Inc. 428-H Allied Bldg., CHICAGO 5

FREE! Learn how to fix flat tires *before* they happen, get protection against dangerous blowouts, and *save money at the same time!* Send Coupon for free book. Seiberling Rubber Co., Dep't. MRH, Akron 9, Ohio.

Name _____
Address _____
City _____ State _____

**EXPORT
PAYS BIG**

World Trade firm offers men and women quick preparation for big pay positions or unlimited-profit businesses of their own. Mail order World-wide without capital, from home; or travel abroad. Represent manufacturers. Past experience not needed. Write today for FREE BOOK. State if veteran. Airmail reaches us over night. Mellinger Co., 1422-HF Westwood Blvd., Los Angeles 24, California



**FURNITURE
FOR YOUR
BEDROOM**

YOU'LL BE THE ENVY of your neighbors with this beautiful bedroom suite in honey maple, oak or walnut! Here's a bed with storage space... a three-piece vanity with cosmetic compartment and makeup mirror... a Mr. and Mrs. dresser... twin night stands with drawers!



Send for Complete PLANS Only \$2.00

YOU MAKE IT YOURSELF! Only two power tools, a saw and a jointer, are needed to turn out this modern bedroom furniture. No other project of Popular Mechanics Magazine in recent years has captured the fancy of home craftsmen as has this easy-to-build suite. Letters demanding detailed plans poured in after the suite was pictured in Popular Mechanics. And now the plans are ready! They're detailed scaled drawings—a complete set of 4. Send for them today!

**POPULAR MECHANICS PRESS
200 East Ontario Street, Chicago 11, Illinois**

I enclose _____ for a complete set of plans for making the modern bedroom suite illustrated above.

Name _____
Address _____
City _____ Zone _____ State _____

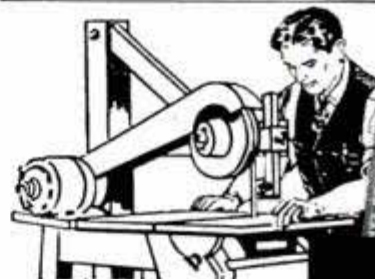

**40 NEW EDITION
Power Tools
YOU CAN MAKE**

**TURN WOOD, SCRAP AND
WASTE INTO PRACTICAL
POWER SHOP TOOLS**

Don't limit your workshop fun to use of hand tools. Get the new edition of "Forty Power Tools You Can Make" with many new tools, and make your own power machines. Step up your fun and production. Do a better job with power tools. Make them yourself from wood and old discarded materials at small cost.

This book gives every detail in plain language you can understand and follow. Hundreds of pictures and plans show every step to follow. Mail coupon with \$1.50 today. Even though you have the old edition get this new book with 20 new tools. Money back if not satisfied.

**40 Power Tools
You Can Make at
Little or No Cost**

Some of the 40 Tools You Can Make

- | | |
|--------------------------------|---------------------------|
| Table Saw with Tilting Arbor | Wood Lathe |
| Saw Sander Unit | Power Hacksaw |
| Drill Press from pipe fittings | Double Duty Sander |
| Bending Brake | Jig Saws |
| Thickness Planer | Band Saws |
| | 40 Different Tools in All |

**POPULAR MECHANICS PRESS, Dept. 4000
200 E. Ontario St., Chicago 11**

Send the new edition of "Forty Power Tools You Can Make."
 Remittance for \$1.50 enclosed.

Name _____
Address _____
City _____ Zone _____ State _____



Triple Chrome Hood Ornament. Fits All Cars. Flying Flamingo. 8" high. 6 3/4" long. Similar to Packard Design. \$3.95

CHROME CUSTOM STYLED

All Metal Automobile Monogram



Specify Initials Wanted

5" long 1 1/4" wide FITS ALL CARS \$1.95 Complete with 3 Initials. Specify initials. SEND CHECK OR MONEY ORDER. WE PAY POSTAGE. DEALERS WRITE ON YOUR LETTERHEAD. U.S.A. ONLY.

AUTOGRAM, Inc., Dept. M., 3242 N. Pulaski Rd., Chicago 41, Ill.

FOAM RUBBER

For CHAIRS, BENCHES, Etc.



Send just 10c for a generous sample and price list of this luxurious padding. Available in all sizes in thicknesses from 1/4" to 1". Set of 4 Foam Rubber Bridge Chair Pads 12 1/2 x 13 1/2 x 1/4" or set of 2 Kitchen or Dinette Chair Pads 15 x 15 x 1/2" each \$2.00 complete. Set of 2 large Dining Room Chair Pads 15 1/2 x 17 x 3/4" just \$3.50—all postpaid. Quotations Submitted. Write!

SANI-SPEED MFG. CO. 723 FERGUSON BLDG. CLEVELAND 14, OHIO

Genuine ONYX

2 SAMPLES

WHITE \$1.00
GREEN



P.O. BOX 35 GROSSMONT, CALIF.

BARBELLS



Save Money—Buy the finest barbell equipment direct from our foundry—No other company can match our low price or value!

Send to-day for our FREE Barbell Catalog

BUR BARBELL CO.
Lyndhurst 20, New Jersey

95 lb. SET \$10.80
Extra plates 10c lb.

THE GREATEST THING IN PLASTICS!

PLASTICAST



A NEW HOME INDUSTRY AND HOBBY!

PLASTICAST is a transparent liquid plastic; can be poured into ANY kind of mold or container. Hardens in a few minutes into a transparent solid, clear-as-glass, tough as steel plastic! No tools, machinery or skill required. IDEAL for imbedding pretty flowers, butterflies, photos, medals, souvenirs, biological specimens, etc. Makes a PERMANENT and ATTRACTIVE display. Make attractive jewelry, gems, lenses, knick-knacks, novelties. Easily cast into sheets, rods, blocks, ANY color, ANY shape! EVERYTHING furnished, including molds, for making about \$50.00 worth of unusual novelties. **PLASTICAST OUTFIT, Complete \$3.50** with 3 molds. Illustrated Instruction Manual included. *Our Casting Plastics are as easy to use as pouring water out of a glass!*

PLASTIDUR . . . (LIQUID IVORY). Ideal for casting all OPAQUE articles. Hardens in a few minutes into an extremely hard IVORY-like plastic! May be dyed any color or cast into any shape. Works in EVERY type of mold! Non-inflammable, waterproof, DURable. Ideal for statuary, novelties, figurines, toys, gadgets, tools, knobs, bases . . . a million useful applications! Outfit comes complete with molds, dyes, accessories, instructions, etc. for making about \$100.00 worth of attractive jewelry, etc! **\$5.00**

PLASTIDUR OUTFIT, Complete with 3 molds \$5.00

TERMS: We pay the postage (U.S.A.) if full cash accompanies your order. C.O.D. accepted (U.S.A. only) if \$1.00 deposit is included for each item ordered. C.O.D. orders not postpaid.

FREE A very attractive novelty made with one of above plastics FREE with our BIG catalog! Catalog lists largest selection of MOLD MAKING and CASTING materials in the WORLD! Liquid Plastics, Liquid Ivory, Liquid Marble, Liquid Glass, Ceramics, Liquid Porcelain, Moulage, Latex, Multiplex, Etc. Also Shellcraft, Internal Carving, Plastics, Glazes, Jewelry Accessories, etc. Price of catalog only 10c U.S.A. (25c Canada).

DEALERS: WRITE FOR ATTRACTIVE WHOLESALE PRICE LISTS

PLASTICAST CO. (Dept. C)
4637 N. Kedzie Ave. Write to P. O. Box 987
Chicago 25, Illinois Nearest Address Palo Alto, Calif.
CANADIAN CUSTOMERS, please order directly from: Canadian Industrial Plastics, Ltd., 1056 1/2 Pender St. West, Vancouver, B. C.

SAY YOU SAW IT IN POPULAR MECHANICS

Sensational New Electric ① WELDER ② CUTTER!

FOR 110-115 AC or DC • WELD—BRAZE—CUT—SOLDER—HEAT TREAT

INSTRUCTIONS INCLUDED • LOWEST PRICE IN HISTORY!

BOTH only \$12



The **WELDRITE** Combination—tested and proved by countless commercial and amateur users, is now offered direct to you at the amazingly low price of only \$12.00. No Gas—No Gauges—No Spark Lighter needed. Always ready for immediate use—Just plug **WELDRITE** into 110-115 AC or DC outlet. Uses standard welding and brazing materials. **WELDRITE** furnished complete with Converter Unit, #1 Single Holder for welding metal to 3/16" thickness, using up to 3/32" rod, and #2 Double Holder with Copper Coated Carbon Electrodes for Brazing, Cutting, Heat Treating, etc. Starting welding materials and instructions included.

Ideal for home workshop. Invaluable for garages, repair shops, farms, etc.

SEND NO MONEY! 10 DAY TRIAL. Order your **WELDRITE Electric WELDER-BRAZER-CUTTER C.O.D.** today. Pay postman \$12 plus postage charges (wt. 4 lbs.) or send \$12 and we pay postage. Either way, if not satisfied, return **WELDRITE** in 10 days for refund, less postage charges. **WELDER HOOD**—Approved Arc Welding lens—only \$3.95. Calif. orders add 2 1/2% tax.

CALIFORNIA TECHNICAL PRODUCTS CO.
Dept. A-8, 448 So. Hill St., Los Angeles 13, Calif.

DRAW for MONEY . . . Be an ARTIST!

Trained Artists are Capable of Earning \$65, \$80 OR MORE A WEEK!

You can learn to draw at home in your spare time the well-known WSA way. COMMERCIAL ART, DESIGNING, CARTOONING—all in ONE complete course. No previous art experience necessary—we teach you step-by-step. Prepare now for a fascinating hobby or profitable career. For 35 years WSA graduates have been making good—WHY NOT YOU?

VETERANS! WSA is approved for training under the G. I. Bill

Write today for FREE BOOK, "Art for Pleasure & Profit." It fully describes our correspondence course, instruction service, and commercial opportunities for you. Two ART OUTFITS and other features included with training.

WASHINGTON SCHOOL OF ART, Studio 128R
1115—15th St., N.W., Washington 5, D. C.

Please send me full information and your Free Book, "Art for Pleasure and Profit."

Name _____ AGE _____
Street _____
City _____ Zone _____ State _____
 I am entitled to training under the G. I. Bill.



115 Booklets filled with Money and Time-Saving Helps

Little Library of Useful INFORMATION

Here at amazingly low cost is the practical help and information you have always wanted. Articles in previous issues of Popular Mechanics have been classified according to subject and are now available in these handy reprint booklets. Check Titles wanted, clip ad and mail today.

* Recent titles.

WORKSHOP EQUIPMENT

Power-Driven Saws—74: Complete details on scrollsaws, two circular saws, sliding cut-off saw, bandsaw.
Drill Presses, Plane, Grinders—79.
Sanders—80: Complete constructional details on 8 useful machines.
Wood & Metal-Turning Lathes—81: Two wood lathes, small metal-turning lathe.
Filing Machine, Hacksaw, Cutoff Wheel, Shaper—82.
Metal Lathe Tools You Can Make—101.
Workbenches & Tool Cabinets—47.
Spray Painting—94: Constructing spray guns, compressor, using spray gun.
From Pattern to Casting—91: How to make your own patterns and small castings.
***Handy Farm Implements—114:** Grain elevator, dump truck, spreader and cover.
***Tractor Attachments—116:** Buckrake, stacker, scoop, auger and spray attachment.
***How to Build a Concrete Block Machine—110.**

SHARPENING—USING TOOLS

Correct Measurement—106: How to use micrometers, gauges, calipers, etc.
Tool and Saw Sharpening—92.
Using & Sharpening Drills & Wood Bits—90.
Successful Wood Turning—32: All the information you need to master this art.
***How to Use Your Drill Press—125:** Includes instructions on preparing the work, methods of clamping, drill speeds and feeds, sharpening twist drills, testing and grinding chucks.
How to Read Blueprints—71: Tells you how to understand signs, symbols, and lines.
Metal Turning Lathe Kinks—99: Simple homemade tools, time and labor-saving shortcuts you can use.
Operating a Metal Turning Lathe—100.
Heat Treating & Case Hardening—102.
Working with Glass—103: Cutting, drilling, etching, blowing.
***Using Basic Tools—120:** How to use hammer, files, screwdriver, and cold chisel.

ELECTRICAL BOOKLETS

Rewinding & Servicing Electric Motors—75: Repairing and rewinding a.c. and d.c. motors. Locating trouble. Converting auto generators into 110 v. a.c. motors.
House Wiring—89: All the information you need to do a complete wiring job or install extra outlets.
Electromagnets & Solenoids—44: Designing and building.
Transformer Construction—41: Easy-to-understand instructions for all transformers.
The Boy Electrician—43: Easy-to-build motors, experiments.
***Build Your Own Relays—123:** Complete instructions, graphs and wiring diagrams for a.c., d.c., and thermal relays.
Soldering & Brazing—17.
Arc & Spot Welders—5: Building and operating 110 v. a. c. arc and spot welders.
Electroplating with Copper, Nickel, Chromium, Lead, Zinc, Cadmium—86.
Plating Leather & Other Non-Metallic Objects—Plating with Gold, Silver, Alloys—87.
***How to Fix Electrical Appliances—111:** Repairing clocks, washing machines, vacuum cleaners, electric irons, cords, small motors, etc.

HOME IMPROVEMENT BOOKLETS

Simple Home Improvements—104: Modernizing; making storm sash, ironing boards, etc.
Building Extra Rooms in Attic—23.

Attractive Basement Playrooms—24.
Lower Your Fuel Cost—31: Practical kinks that will save you hundreds of dollars.
Hanging Wallpaper—38: Tricks of hanging wallpaper, removing old paper, etc.
Curing Leaky Basements—45:
Fitting Home Game Room—55: Construct own game & tennis tables, shuffleboard court, action game, portable playrooms.
Ridding the Home of Insect Pests—107: Exterminating and protecting against moths, flies, termites, mosquitoes, etc.
Built-in Fixtures—78: Step and space-saving kitchen units, built-in beds, corner cabinets, vanities, linen chest.
Constructing Indoor & Outdoor Fireplaces—88: Stone fireplaces, portable mantels, garden fireplaces.
***Painting Your House Inside and Out—117.**

GARDENING BOOKLETS

Back-Yard Gardening—39: Selecting, planning and getting the best results.
Lawn & Garden Novelties—72: Jig-sawed ornaments, parkway numbers, sundials, flower boxes.
Trellises, Pergolas, Fences—76.
Lawn & Garden Furniture—77: Modern bent-tube furniture, arbor and seat combinations, swings, lawn chairs.
***Lawn and Garden Equipment—124:** Complete details for building rotary lawn cutter, hedge trimmer, and lawn edger. Also articles on sharpening and motorizing your lawn mower.
Playground Equipment—73: Two play-houses, ferris wheel, roller coaster, tread-mill, play store, slide, two merry-go-rounds.
Colored Concrete Garden Furniture—6: Garden benches, pottery flower boxes, bird baths and sundial pedestals in colored concrete. How to build small concrete mixer.
Bird Houses—7: Easy to build homes for all kinds of birds.
Farm & Garden Tractors—8: Two tractors you can build from old automobile parts.

CRAFT WORK—HOBBY BOOKLETS

Working with Plastics—61: Using brilliantly colored plastics in craftwork.
Magazine Racks—49: Ten attractive racks.
Clock Cases—50: Large Hall, Colonial wall and mantel, ship's wheel, miniature grandfather, desk, Spanish style banjo.
Serving Trays for Every Occasion—53: Fourteen different designs.
Children's Room Furniture—51: Twelve attractive pieces.
Book Ends—52: Ten designs offer good selection.
Small Tables—54.
Smoking Stands—56: Seven designs given.
Jigsawed Novelties—57: Sewing kits, string holders, place-card holders, plywood kitchenware, plant and flower holders, coin banks.
Desks—58: Colonial writing desk, two modern-type desks, student's study desk of plywood, combined chest and writing desk.
Book Cases—59: Eight designs.
Doll House & Doll Furniture—60.
25 Shelves You Can Make—64.
Novelties Turned on Lathe—62.
Inlay Pictures—Veneering—63.
Whittling and Wood & Soap Carving—65.
Action Toys—66: 21 easy-to-make toys.
High Flying Kites—67.
Windmills & Weather-vanes—68.
Lamps in Wood, Metal, Plastic—69: Selection of 14 designs.

5 for \$1.00
 12 for \$2.00
 25¢ Each

Metal Craft—28: Brass tapping and making of novelties both decorative and useful.
Small Looms—37: Building hand looms for weaving rugs, etc.; leather novelties.
Plain & Novelty Wood Finishing—40.
Gem Cutting—42: How to cut and polish semi-precious stones.
Rustic Furniture—18: How to build chairs, benches, tables, gates, summer house, etc.
***Projects in Plastics—112.** *Saws and Crossbows—115. *Marionettes—113: Designing and operating puppets, how to build stage and backdrops.
***Furniture Upholstery and Repair—122.**
***Novelty Jewelry You Can Make—126.**
***Fun With Your Model Railroad—127.**

BOAT BUILDING BOOKLETS

Build a boat at home—you can do it

14 Ft. Outboard Runabout—2: Here is a low-cost, fast 14-foot V-bottom boat. Suitable for motors of 4 to 24 hp.
Rowboats, Bicycle Boat, Small Dinghy—83.
Small Sail Boats—84: 12-ft. sailing dinghy, 6-ft. "training ship" for young sailors, how to sail a boat.
Two Outboard Runabouts—85: 14-Ft. family outboard weighs about 400 lbs. and 12-ft. plywood outboard weighs about 110 lbs. Both are V-bottom type.
Build Your Own Canoe, Kayak, Surfboard—30: Complete details on 16-ft. Canadian-type canoe, 17-ft. kayak, and 12-ft. hollow surfboard.
Fast Class-E Ice Yacht—22: Build your own Class-E ice yacht.

AUTOMOBILE BOOKLETS

Automobile Kinks and Shortcuts—10: Money-saving hints on upkeep, operation.
Building Trailers—27: Small Streamlined house trailer; several utility trailers.
Motor-Driven Midget Car & Scooter—34: Both use gas engine of washing machine type.
Curing Auto Electrical Troubles—95.
***House Trailer—121:** Complete instructions and diagrams for building modern 17 ft. trailer.

PHOTOGRAPHY BOOKLETS

Photo Enlargers—1: Condenser lens type; simple vertical; horizontal.
Photo Printers & Drier—25: Describes three practical printers, timer and negative drier.
Photo Darkroom Equipment—96: Cabinets, light-tight box, timer, agitator, washer.
Picture Projector, Trick & Table Top Photography—97: Projectors that enlarge magazine illustrations and shop drawings. Tips for table topers, photomontages, tricks.
Photo Kinks—98: 63 time and money-saving ideas you can use.
***Photo Lighting—119.** *Home Movie Equipment—118: Converting projector to sound, making titler, film cleaner, projector stand.

MISCELLANEOUS BOOKLETS

Cleaning Preparations—11: Easy-to-make cleaners for walls, glass, etc. Removing fabric stains.
Re-Silvering Mirrors—70: Formulas for silvering and coloring.
Knots and Ropework—105.
Chemical Experiments—93: Easy-to-perform experiments. Inexpensive lab.
Taxidermy—9: How to prepare skins and obtain life-like poses.
Log Cabins & Tourists Cottages—14: Year-round log cabins; inexpensive tourists' cabin.
Magic for Everybody—29: Simple tricks to puzzle your friends.
Trapping Small Animals—33: How to lure fur bearers, prepare bait and traps, dress skins.
Tricks of Training Your Dog—35.
Small Furnaces—36: Gas or electric.
Telescopes—20: Design and construction.
Poultry Houses—108: Structures, brooders and incubators.
Guns and Decoys—109: Cleaning, shooting, guns; making decoys.

POPULAR MECHANICS PRESS,

200 E. Ontario St., Chicago 11, Ill.

I enclose _____ (U. S. bills may be mailed if carefully wrapped) for "Little Library" booklets numbers:

Name _____

Address _____ Zone _____

City _____ State _____

YOU CAN MAKE THESE WITH POPULAR MECHANICS PLANS AND BLUEPRINTS

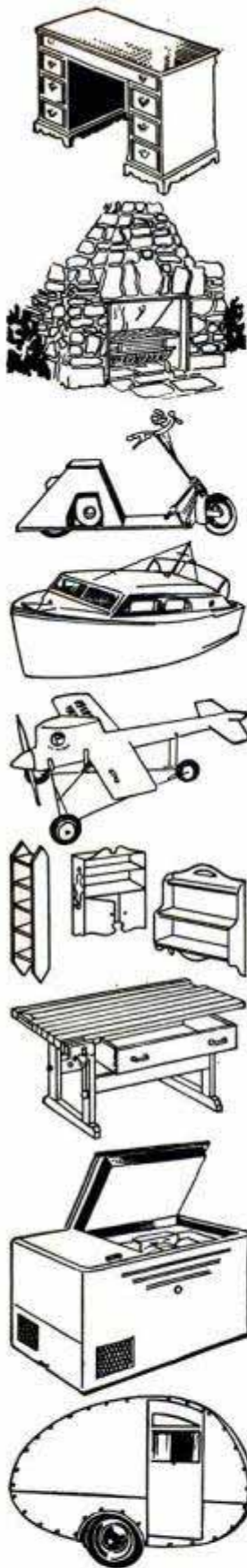

- 501—Colonial Grandfather's Clock...25c
- 507-508—Doll-House, 5-Rooms, Open staircase, fireplace...50c
- 526—Queen Anne Coffee Table: True replica of antique...25c
- 528—Duncan-Phyfe Console Table: 30 in. high...25c
- 529—Lawn Chair: Southern style...25c
- 593—Three Attractive Corner Shelves: Scroll-sawed...25c
- 596—Three Hanging Type Shelves: Hold books, china, etc...25c
- 661—Rocking Horse: Scroll-sawed from plywood...25c
- 707—12 Ft. Rowboat: Flat-bottom, four seats...25c
- 795—Two Handsome Cedar Chests...25c
- 811-812—16 Ft. Canoe: Canadian type, cedar planking...50c
- 813-814—Pops Outboard Racers: 10 ft. long, stepped bottom...50c
- 828-835—Sovereign of the Seas: English warship model...\$2.00
- Sovereign of the Seas: Instruction Book...\$1.00
- 836—12 in. Bandsaw: Uses plywood, cuts two in. stock...25c
- 839—Melrose Corner Cabinet: Old Colonial design...25c
- 846-848—Governor Winthrop Desk: True copy of original...75c
- 896-897—Three Easily Made Workbenches—Simplified construction...50c
- 906-909—Midget Auto: 58 in. wheelbase, 1/2 to 3/4 h.p...\$1.00
- 910—Circular Saw Table: Hardwood, 24" x 36", Stationary...25c
- 917—Outdoor Fireplaces: Several simple but practical...25c
- 920-922—Lawn and Garden Furniture: Swings, arbors, tree seat...75c
- 923—Indoor Fireplaces: Standard Sizes...25c
- 926-927—Venetian Blinds: Three different styles...50c
- 930—Hooked Rug Frame—Quilting Frame...25c
- 933—Cape Cod Cupboard: 4 ft. wide, 5 ft. 8 in. high...25c
- 935—Knee-Hole Desk: 40 in. long, 30 in. high, 31 1/2 in. wide...25c
- 936—Modern Coffee Table: 24 in. long, 15 in. wide...25c
- 952—Child's Crib in Maple...25c
- 958—Colonial Corner Cupboard: 6 ft. 8 in. high...25c
- 961—Hanging China Cabinet: 38 in. long, 40 in. high...25c
- 969—Combined Chest and Writing Desk: 35 1/4 in. high...25c
- 970—Modern Clothes Chest: Built of Plywood...25c
- 977—Bookcase in Chippendale Style: 47 in. high, 10 in. wide...25c
- 978—Lawn Chair on Wheels: Lightweight, easy to wheel...25c
- 981—Colonial Wall-Shelf: 30 in. high, 19 in. wide...25c
- 984—Duncan-Phyfe Drop-Leaf Table: Reproduction of historic piece...25c
- 986-987—Utility Trailers: Built of old auto parts...50c
- 989-990—Speedy Motor Scooter: Gas engine, 40 to 60 miles on gal. of gas...50c
- 991—Gun Cabinet: Handy cabinet includes rack for rifles...25c
- 993—Twin-Deck Beds: 6 ft. 4 in. long, 31 1/2 ft. wide...25c
- 1106-1112—SEACRAFT — 25 FT. CABIN CRUISER: Adaptable as sport fisher, express cruiser, or utility boat. Cruises at 15 knots with marine engine or converted auto engine. Cabin sleeps four. Galley has fresh-water tank, sink, and cook stove. Set of seven large-sized blueprints scaled 1 in. per ft. plus 40-page two-color illustrated booklet, only...\$10.00
- 1011—Fireplace Fittings: And-iron, log rack, etc...25c
- 1080-1081—Banta: 12 Ft. Plywood Runabout: Vee-Bottom, 3-passenger...50c
- 1086—Black Forest Corner Shelf: Scroll-sawed...25c
- 1089-1090—Home-Constructed Freezing Unit: reaches 30 degree temp...50c
- 1091-1096—17 ft. trailer, 7 ft. wide, Steel chassis...\$1.50
- 1102-1105—Midget Trailer: "Bear-drop" body. Sleeping quarters for two...\$1.00
- 1113-1114—Gold Rush of '47: The A.M.A. Open Class B Record Holder Plane Model...\$1.00

FILL OUT AND MAIL THIS COUPON NOW

POPULAR MECHANICS CO.
200 E. Ontario St., Chicago 11

Please send the following plans.....

I am enclosing \$.....

Name.....

Address.....

PROFESSIONAL! PORTABLE!

The PAYSWELL ALL-PURPOSE Sprayer

JUST PLUG IT IN
...AND SPRAY



- Compressor... motor... gun... self contained in one compact unit.
- Applies 1 quart perfectly... in 3 min. at 50 lbs. pressure.
- Sprays anything that's sprayable.
- Weighs less than 5 pounds.

The PAYSWELL Spray-pak

WORLD'S ONLY COMPLETE SPRAY GUN KIT FOR THE PROFESSIONAL OR THE HANDY MAN.

SPRAY-PAK contains the famous PAYSWELL SPRAYER, 3 interchangeable nozzles; 2 extra shatter-proof canisters, covers, gaskets; 6 strainers; respirator, refills; brush; oil; instruction manual... all encased in a handy metal container. Weight less than 15 pounds.

COMPLETE KIT ONLY
\$79.95

SPRAYER WITHOUT KIT \$59.95

Write for name of your nearest PAYSWELL dealer.

SELCO CORPORATION

Dept. PM • 801 Andrus Building • Minneapolis 2, Minn.

HURRY!

Before it's too late—
read page 52, July issue

STEP OUT FOR EASIER WINDOW WORK WITH

WINDOSTEP



ORDER TODAY!

Makes all outside window work easy & enjoyable!

**SAVES TIME • SAVES MONEY
SAVES LADDER-LIFTING!**

HELPS YOU Wash windows... Hang screens, storm windows & awnings... Paint, putty & repair.

IT'S STRONG... Supports 1000 lbs.

IT'S STURDY... Has steel rail & wood platform.

IT'S PORTABLE... Easy to carry • Weighs 11 lbs.

IT'S AUTOMATICALLY GRAVITY LOCKED to window sill from inside. (It's installed from inside.)

IT'S GUARANTEED
Or Your Money Back!
Low priced, only **\$9.85**
Plus C.O.D. & P.P. or \$10.50
Prepaid. Add 50c west of Rockies. Dealer Inquiries Invited. Patent Pending

MORRISON CRAFTERS INC.
711 Miami St., Toledo 5, Ohio

For Better Housekeeping, Your Home needs a WINDOSTEP!

NOW EASY TO START A Big Business ON A SMALL INVESTMENT



WARNER SUCCESS PLAN Gives exact instructions showing you

- How to start in spare time
- How to use home as headquarters
- How to bring in the business
- How to do real METALIZING in genuine GOLD, SILVER, or BRONZE, by the easy Warner Method
- How to start without risking your job
- How to pyramid your profits
- How to be sure of steady, big income.

Don't turn this page until you've given serious thought to your future. In the uncertain years ahead, the men who own their businesses are the ones who will be happiest. A small start now easily can lead you to complete independence, freedom from time clocks, freedom from fear of lay-offs, freedom from the limits of a pay check.

Now, while you can do it without risk—now is the time to investigate the exceptional opportunity offered you by the Warner Success Plan. Looking into the market, checking up on the possibilities for big sales and big profits will not cost you anything. Isn't this the time to lay the foundation for a future of complete independence—a life of happiness—a steady, dependable income?

METALIZING BABY SHOES AND OTHER KEEPSAKES

offers an exciting new opportunity to men or couples who want personal independence

If you'd like the feeling of being boss instead of being bossed—the Baby Shoe business is made to order for you. Just think of the appeal. A mother's love for her child—her desire to preserve forever the tiny shoes in which her baby took its first toddling steps. No wonder orders come easy and fast. No wonder profits are big. Then think of the future. Fifteen Million babies in the last five years—three million last year—millions more next year. As long as babies are born, this business will prosper—in good times or bad. Think of the fun. Every job is different, interesting. And when you deliver a job and collect the money, you get a tremendous glow of satisfaction out of the mother's happy exclamations over your work. There's not another business I know of that offers you such big rewards in cash, in security, in a future, in independence that can be started on such a shoestring. You'll be glad you saw this ad—IF YOU SEND THE FREE COUPON.



READ THE ENTIRE PLAN

7 DAYS AT MY RISK

DON'T SEND A PENNY NOW—Just Send Your Name

This is one of the most fascinating businesses you can imagine. There are 15 MILLION pair of baby shoes waiting right now to be METALIZED. The opportunities are unlimited. The future is very big. And it's a business in which the whole family can have fun helping. A perfect business for man and wife to start—or for two partners. And I want you to read the whole Plan at my risk. Don't spend a cent unless you go ahead.

I want every serious minded man to let me show what I've done in our own shops here in Chicago—reveal the exact facts about the profits to be made and the way to make them. I don't want you to spend a cent for supplies until you've studied the facts, talked them over with the family, and satisfied yourself that this is the ONE BIG OPPORTUNITY FOR YOU. That's why I allow you to read all trade secrets contained in the Warner Success Plan at My Risk. If you don't go ahead, you don't pay a cent.

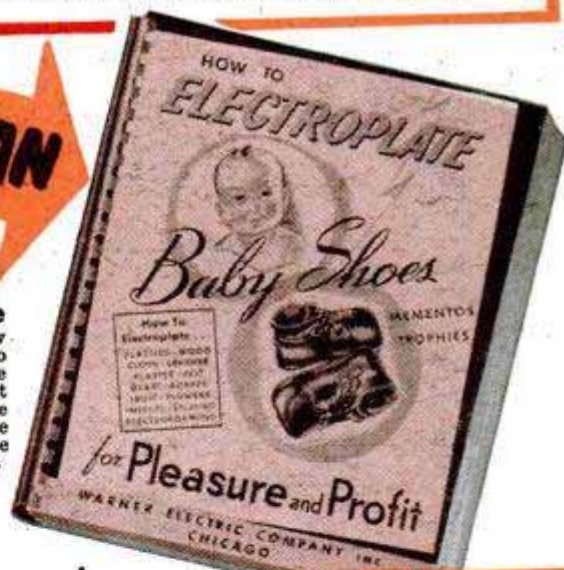

ALL FACTS FREE! MAIL!

Raymond E. Brandell, Mgr., Warner Electric Co.,
1512 Jarvis Ave., Dept. 38, Chicago 26, Ill.

As long as it doesn't cost me a cent, I am willing to read the facts, investigate, then give you my decision. Send the facts by next mail. Everything you send now is FREE!

NAME _____

ADDRESS _____

CITY _____ Zone _____ STATE _____



\$5.00 AN HOUR

Yes, it's possible for one man to turn out enough work to make \$5.00 an hour for his time. Think of how that pyramids when a partner or the whole family works.

Old Established Firm Backs You Up

The Warner Electric Company just celebrated its 26th year of success. You get a Real Start when you "join up with Warner"—you get real Guidance to Success.

Warner Electric Co., Dept. 38
1512 Jarvis Ave., CHICAGO 26, ILL.

WE SUPPLY EVERYTHING

You don't have to go "hunting" when Warner is behind you. We supply all materials, all mounts, chemicals, and metals. And you get the low prices made possible by our big quantity purchases and our own manufacture. You send for just what you need—and never have any big investment tied up in stock.

**WORLD'S
BEST
WANT AD
MEDIUM**

CLASSIFIED Advertisements



Advertisements in this section 75 cents per word, each insertion, minimum 10 words, payable in advance
To be inserted under proper classification, copy must be in our office the 22nd of the
second month preceding date of issue

F. W. Johnson, Manager, Classified Advertising
Popular Mechanics Magazine, 200 East Ontario Street, Chicago 11, Illinois

YOU'LL PROFIT

By reading and answering the classified ads in this section. Hundreds of opportunities for you to make and save money

AUTOMOBILES, MIDGET CARS

"VAPO-STEAMATIC" Water injector. Easily built! Finest automatic "Moist-Humidity" system! Engineering triumph—Gets up to ten extra miles per gallon! Tremendously increases horsepower! Eliminates ping, carbon, overheating! Reduces wear—Lengthens engine life! Copyrighted "Water Injection Handbook"—with working drawings covering automobiles, motorcycles, airplanes, tractors! Includes plans, catalogues, diagrams, instructions—\$1.00 complete. Newhouse Automotive Industries, 5805-B1 East Beverly, Los Angeles 22.

NEW Chevrolet speed manual! Right off the press! Complete data on modifying 1937 thru 1949 engines for speed. How to install late engines in pre-1937 chassis. Full information and complete data on installing cams, dual or triple carburetion, superchargers, speed tuning, high compression, porting, ignition, etc. Answers all your questions on how to build fast Chevrolets. Illustrated with clear cut photographs and detailed drawings. We guarantee this to be the finest, most accurate and most complete manual ever to be published for the Chevrolet. \$2.00 postpaid. California Bill, Box L-1A, Eaglerock, Los Angeles 41, Calif.

CALIFORNIA Custom accessory headquarters. Buy direct from original designers and save. Solid hood sides, grille panels, lowering kits, fender skirts, dual pipes, chrome motor accessories, speed equipment. 32 page illustrated catalog, 200 custom accessories—25c. 3319-A South Grand, Los Angeles 7, Calif.

"SPEED & Power" Handbook—50 chapter library edition! Breathtaking methods—authentic—direct from California! Covers Fords to Cadillacs—all makes! Build your own dual manifolds! Superchargers! Hot Cams! Water injectors! Hi-compression heads! Mileage devices! Save many dollars! Get racing speed, lightning acceleration, dynamic power increases from any make automobile! Build fast stock cars! California roadsters! 150 MPH rods! Get construction drawings! Tuning techniques! Speed tricks! Picture catalogues! Ingenious formulas! Economy secrets! Including—"Racing Frames"—"Reciprocating Masses"—"Jet Engines"—"Braking Characteristics"—"Dynamometers." Also—dual pipes, gears, fuels, porting, relieving, lowering, balancing! Includes "California Automobile Customizing," glossy photographs! Diagrams! Very newest ideas! Conversions! Re-styling all makes! Streamlining! Chopping! Channeling! Customizing! Complete \$1.98 postpaid. Newhouse Automotive Industries, 5805-B2 East Beverly, Los Angeles 22.

1947-1948 FORDS. Four door. Currently operated by an eastern city. \$683.00. See these cars at once. Ogden Auto Mart, Inc., 3161 Ogden Ave., Chicago.

RUSTED-OUT Bodies, doors, fenders repaired without welding, soldering. Professional results. Write, Gibes, 2134 Hadson, Chicago 22.

SPORTS Cars, foreign cars, new automotive developments described in Franston's Weekly Motor News. Write for free sample copy. Box 254, Eugene, Oregon.

PHOTOS: Latest American, foreign sports cars. Large assortment \$1.00. Box 101, 2317 Fruitvale, Oakland 1, California.

"WATER Injection." Free, descriptive, illustrated, instructions Neher Industries, LaVerne 9, California.

"SPEED & Mileage" Manual!—Easily obtain greater speed, mileage, racing performance from any automobile! Famous authentic book shows latest "soup-up" methods; speed tuning; mileage secrets; racing tricks; "customizing plans"! Photographs! Instructions on building inexpensive speed equipment! Economizers! Superchargers! Dual mufflers! Manifolds! Heads! "Water injectors"! Fast conversions! "Hot rods"! Sports cars! All about fast engines, "Economy tuning," restyling, lowering, lubricants, fuels! Latest "Hollywood custom styling information"! Streamlining! Sport changes! Speed conversions! Working drawings! Diagrams! (Plus) California roadster plans! Parts lists! Equipment catalogues! "Hot rod pictorial"! 125 illustrations! Guaranteed most complete book available, \$1.98. Almqvist Engineering, Milford 5, Pennsylvania.

CUSTOM Styling Handbook—140 illustrations! Shows simplified custom styling methods! Speed rebuilding! "California customizing"! Latest streamlining! Sports conversions! Model changes! Lowering! Restyling! Hot rod information! Shows how to quickly make your car look beautifully custom! Fast! Sporty! Scores of photographs! Illustrations! Ideas! Construction drawings! Diagrams! Plans! (Including catalog.) Biggest book available \$2. Almqvist Engineering, Milford 5, Pennsylvania.

"HOLLYWOOD" Deeptone mufflers. Powerful "straight-thru" design increases efficiency, speed, acceleration, mileage! Singles, all cars \$4.85, V-8 duals \$16.95 (Satisfaction guaranteed.) Speed equipment catalog 25c. Almqvist Engineering, Milford 5, Pennsylvania.

SPEED Equipment bargains! "California" mufflers \$4.50, duals \$16.95, famous V-8 heads \$45.00, dual manifolds \$9.95, water injectors \$4.95, chrome echo cans \$1.65, racing stacks \$2.98, gas savers \$1.50, lowering kits \$2.95. Many others! Illustrated "speed catalog" 25c. Almqvist Engineering, Milford 5, Pennsylvania.

NEW Ford Hotrod Manual. 128 pages chock full of cutaway construction drawings, photos, and valuable easy to read and understandable technical data. Neatly bound with colorful eye-catching cover. Includes complete data on installing V-8 motor in model A chassis, hydraulic brakes for any Ford, roadster and fast road car info. How to rework these engines for speed: V-8, Merc., Ford 6, Zephyr, Model A. Guaranteed the finest manual of its type published to date. Sent postpaid for \$2.00. California Bill, Box L-1, Eaglerock, Los Angeles 41, Calif.

NEW Clymer Books. Catalog of 1949 automobiles, 120 photos every American car with complete specifications, compares all cars in one book, \$2.00. Ford Owner's Handbook gives complete servicing information all Fords 1932-1949, \$1.50. Complete Service Manual Model "A" Ford \$1.00, Model "T" \$1.50. Life of Ted Horn, three-time American Automobile Racing Champion, \$2.00. Complete Outboard Service Manual covers all makes, \$3.50. Revised Hot Rod Book 1946, 1947, 1948 records, \$1.50. Steam Traction Engine Album, 160 pages describes, illustrates 105 historical steam vehicles, \$2.50. How to Build Racing Automobile, \$2.00. All postpaid. Specify books wanted. Floyd Clymer, Dept. A-FC, 1268 So. Alvarado, Los Angeles 6, California.

SEE Our ad under motorscooters for midget car bargains. Midget Motors Directory, Athens, Ohio.

OIL Cooler: Water cooled engines. Better lubrication, longer life. Complete \$15.00. Free illustrated folder. Dept. PM, Gilbert Brass Foundry Company, St. Louis 15, Mo.

TOOL Pouch, heavy waterproof canvas duck, wide zippered opening. Keeps tools safe, convenient, dry, in home, car, garage. 4½x9, \$1.00; 5½x12, \$1.25; 7½x17, \$1.60. Lafayette Supply Co., West Lafayette, Ohio.

RADIATORS—Ford, Chevrolet factory outlet. All new in original cartons. Write for price list. Buy direct, save dollars. Guaranteed Radiators, 8815 De Havilland, Los Angeles 45, California.

HOT ROD—The only monthly magazine about building roadsters, streamliners, etc. Sample copy 25c, \$3.00 yearly. Hot Rod, 7164 Melrose, Hollywood, Calif. Dept. PM.

AUTOMOBILE Racing, Sixth Edition. 100 illustrations. Working drawings with building instructions for Ford-60 midget, California roadster, Offenhauser racer. Details on racer parts. Sample entrance blank. World's record 158.5 m.p.h. rear engine four-wheel drive car. Interesting information for fans, drivers, mechanics. \$2.00 postpaid; \$2.40 c.o.d. Ray Kuns, Department 63, Cincinnati 27, Ohio.

DUALTONE Crystalline packed California mufflers and dual sets. California chromed accessories, lowering blocks all automobiles. Speed and doll-up equipment. Catalogue 20c, streamlining manual \$2.00. Dealers request dealership information. Dualtone Mufflers, 2636C India Street, San Diego 1, California.

AUTOMOBILE Racing book, fifth edition, well illustrated. Instructions on building bodies, frames, engines. Ford A and B conversions. Plans. AAA rules, specifications. Roadster racing. Indianapolis cars. \$1.00 postpaid, \$1.40 C.O.D. Ray Kuns, Dept. 47, Madisonville, Cincinnati 27, Ohio.

RACING Car equipment for all cars, engines, racing heads, manifolds, carburetors, mufflers, etc. Speed instructions and literature \$1.00—refunded first order. Lee Motorcraft Co., 1412-D Great Northern Bldg., Chicago 4, Ill.

WE Sell direct to customers over 200 speed equipment parts manufactured by us. Ford A-B-V8-6-4- (Ferguson), Studebaker Champion, Chevrolets and Willys. Cylinder heads, dual intake manifolds, lynite flywheels, oversize valves, compound springs, camshafts and other supplies. Complete engines ready for race for cars, boats and midgets. \$1.00 to cover illustrated literature and price sheet. R & R Mfg. Co., Robert M. Roof, Box 546, Anderson, Indiana.

IT'S Here. The last thing in customizing. Front fender skirts. Unbelievable beauty. Easily made at home. Full plans only 50c. Customcraft Auto Works, Box 1002, Springfield, Mass.

FROM Speedway to roadway! Track-proved hi-speed heads and manifolds now available for your passenger car! No special tools needed! Increase horsepower 25%! Astounding getaway! Free illustrated catalog. Speedsport, 6215AA Diversey, Chicago 39.

AUTO SUPPLIES AND EQUIPMENT

WELDING Bodies, blocks, repairing fenders adds profits. Easy with Hobart Welders. Low cost. Terms. Free catalog. Write Hobart Weld, Box M-892, Troy, Ohio.

HISTORY Of hot rod and midget racing with large illustrated equipment catalog—25c. No c.o.d.'s. Ansen, 3800 W. Jefferson, Los Angeles, Calif.

HAVE Up to 50% brighter lights on your car. Complete kit of parts and full instructions. Can be installed in fifteen minutes. Send make and model of car. Price \$2.95. V. Z. Rains, P.O. Box 974, Marshall, Texas.

SAVE Gasoline! Quick starting! "Air-flow Needles." Free trial! Specify car, carburetor. Neher Industries, La Verne, California.

1949 SUPERIGNITIONITER: Starting, pep, mileage. \$4.35. EG Mfg., Elmsford, New York.

GASOLINE Saver. Chevrolet, 1933-1949. Dodge, Plymouth, 1933-1938. Ford, Mercury, V8, 1935-1948. Buick, Studebaker, EEL-AAV16, 1935-1946. \$1.00. Walert Co., 3429 North Tenth, Milwaukee 6, Wis.

SPEEDOMETERS—Any make completely rebuilt. Including parts, labor \$4.95 ppd. Unconditional new factory guarantee. Mail your worn or broken speedometers to: Western Speedometer Rebuilders, 10452 Magnolia Blvd., No. Hollywood, Calif.

RACING Tone mufflers—All cars \$4.85. V-8 duals \$16.95, speed equipment catalog 25c. Almqvist Engineering, Milford 5, Pennsylvania.

CONVERTIBLE Top covers. Protects-insulates. Plastic fabric. Clipon snap fasteners. All convertibles \$19.50. Satisfaction guaranteed. Vassar, Cleveland 5, Ohio.

FREE Auto accessory catalogue. Big bargains. R & E Sale, Box 611, Grand Rapids, Michigan.

GANE Aero jets save gas. Sent postpaid for free trial with directions for installing your car. Pay postman nothing. If not delighted after ten days return them and you owe nothing. Send make car and carburetor today. Advanced Automotive Products Co., 563 Lake Road, Webster 5, N. Y.

VAPOR Injector, cools and peps up engines. Saves you money on gas and oil. Gives "high test" performance using "regular" gasoline. Ten days trial, refund. \$8.00 complete. Send make and year of car or truck. Tenco, Box 5528, Washington 16, D. C.

WILL You be the next to have an accident due to dry front wheel bearings? Get Dougllass inside grease seals for the front wheels of your car and be safe. Distributors wanted. Luberlain, \$2.85 a set factory to you. Weichhart Mfg. Co., 237 Natoma St., San Francisco 3, Calif. No c.o.d.

SAVINGS To 50% on generators, starters, voltage regulators, 6-32 volts, distributors, armatures, magnetos, carburetors, fuel pumps, windshield wipers, radiators. "Old models in stock" free list. State Ignition, 2521 Indiana, Chicago 16.

SAVE 50% On all metal (chrome trimmed) automobile sun visors—\$5.00, \$7.00, \$10.00, \$15.00. Specify make, year, model. Chrome flying swan ornament, \$2.50. Illuminated auto compasses, \$5.95 value for \$2.75. All items guaranteed. Send for free catalog. Warehouse Distributors (Automobile Division), 5922 N. Clark, Chicago, Illinois.

AUTOISTS! Truck drivers, salesmen, tourists need this convenient pencil, notepad, or map holder on visor. For quick delivery, mail your printed address and forty cents to R. E. K. Manufacturing, 8530 Woodward, Detroit 2, Michigan.

ATTENTION Garagemen, truck owners and automobile dealers. Lowest prices. Auto and truck parts. Complete stock. Prompt replies. Babbitt Automotive, 2833 Chicago Avenue, Chicago 22.

"LEKTRON" Atomic coil booster saves gas! Instant starting. Only \$2.00. Money-back guarantee. Easily installed. Specify car. Electronic Industries, Cleveland 11, Ohio.

BUICK Parts—Enjoy new-car pep and power in your old Buick. Same day service from world's largest stock of new (not rebuilt) Buick parts and engines. Ship anywhere. Write today. Robertson Buick Co., 1001 S. Wabash Ave., Chicago 5, Ill.

AUTO Parts. Buy direct. Get dealers' prices. Represent us in your territory. Write requirements. Specify car make. Mechanics Auto Parts, Factory Warehouse, 3807-PM N. Ashland, Chicago 13.

NEW Patent. Lachapelles motor and motor fuel treatment stops ping, gives more power, more miles per gallon, more miles per motor, enough for 100,000 miles. \$3.00 postpaid. Ferns Products, 8120 Walnut Dr., Los Angeles 1, Calif.

AUTOMOTIVE Surplus tool specials! Pullers, wrenches, socket sets, reamers, other bargains. Nationally advertised merchandise. Free catalogue. Glenco Supply, 7519 Myrtle Avenue, Glendale 27, N. Y.

GOVERNMENT Surplus. Low voltage circuit tester in steel box. Cost \$202.00. Our price \$27.50. Will test batteries, starters, generators, voltage regulators, grounds, short circuits. Wilt Electrical Company, 7829 S. Racine Ave., Chicago 20, Ill.

AUTO Parts for all cars, transmissions, motors, differentials, fenders, carburetors. Security Auto Parts, 1923-PM Grace, Chicago 13.

CHEVROLET Parts. Scarce motor, body, sheet metal parts. Grossman Chevrolet, Minneapolis, Minnesota.

HARD-TO-GET Auto body parts. We supply. Miller Auto Parts Service, 192 N. Clark Street, Chicago.

BRUSH Plating outfits connect to a battery. No tanks or shop required. Free particulars. Gunmetal Co., Avenue J, Decatur, Illinois.

NATIONALLY Known parts at wholesale prices. Give year, make and model. Ship c.o.d. Parts, P.O. Box 325, Willimantic, Conn.

CUSTOM Styled chrome auto accessories. See our ad on page 49. Autogram, Inc., Dept. M, 3242 N. Pulaski Rd., Chicago 41, Illinois.

VAPOJET Gives car jet performance. Saves gas. See page 41.

AUTO TRAILERS

TRAILER Plans—House, utility, boat, etc. Axles, chassis, hitches, windows, etc. Catalog with booklet, "Trailer Hints," \$1.00. Catalog only, 50c. Marine Mart, Buffalo 7-B, N. Y.

BUILD Your own trailer! Save money! Have every feature you want! Plans for house, sport, camp and utility trailers. Catalog describing 9 models 10c. 15c in Canada and overseas. Jim Dandy, Box 125-A, Wausau, Wisconsin.

MOTORCYCLES, BICYCLES, MOTORSCOOTERS AND SUPPLIES

BICYCLE Supplies, wholesale, retail. List 10c. Universal, 4713 Virginia, St. Louis, Missouri.

POWERCYCLES. New—Factory overstock. Latest models. \$98.50 up plus tax and freight. Regular \$179.50 to \$267.50 values. Amazing buy. Regular factory warranty. Send for free catalog. R. C. Cheney Co., Mfg. Division, La Crosse, Wis.

POWERBIKES—Bargain prices. Literature 5c. Johnsons' Scooter Sales, Milford, Indiana.

WORLD'S First jet turbine bicycle engine. Fits any bike. Smooth, economical. \$150.00. Dealers wanted. Literature 25c. Jet Engine Co., St. Augustine, Fla.

USED Motorscooter \$4.50, motorbike \$5, midget racer \$10, new Regal motorscooter \$37.50, less motors. Super-Cycles, Cushman's, Salsburys. Briggs motor \$8, others \$3 up. New motorbike conversions \$5. Plenty of brand new motorscooters, midget cars, homebuilders parts, automatic clutches, transmissions, engines, tires, etc. at factory prices. Special sale: Four balloon tires for \$3. Over 4500 tires in stock. Mailorder only. Send 25c for big war-bargain catalogue number 31, just out, listing these and hundreds of other bargains. (35c by first class mail). Midget Motors Directory, Athens, Ohio.

HARLEY-DAVIDSON Parts, accessories, oil, expert service. Tires all sizes. Send \$2.25 for Army 45 motorcycle manual. 25c for accessory catalog and bulletins. Knuth's (Harley-Davidson Dealers), 2491 Fondulac, Milwaukee, Wis.

MOTORCYCLE Monthly — Worldwide News. Generously illustrated. Year's subscription \$1.00. Sample 15c. Motorcycle News, 5424-A Sawyer, Chicago 25.

HARLEY-DAVIDSON 125 — America's outstanding lightweight powercycle. Floor models and demonstrators at a saving. Send 10c for bulletin. Knuth's, 1753 Muskego, Milwaukee, Wis.

COMPLETE One stop Harley Davidson sales service. Comprehensive accessory catalogue 25c. 813 Ohio St., Wichita Falls, Texas.

COMPLETE Parts for all American motocooters from 1940. Also automatic clutches, generators, tires, chain. Motor parts. Lausen and Briggs and Stratton engines available. Moto-Scoot, Inc., 1323 W. Carroll Ave., Chicago, Ill.

CUSHMAN Motorscooter (4 H.P. motor) \$19.98 complete; Midget car (leather seat) \$25.00; Motocoot \$15.00; 1946 Whizzer \$35.00; Motorbike outfit \$5.00; Indian motorcycle \$30.00. Other motorscooters \$8.00 up, motors \$3.00 up. Send 25c for new summer catalog listing many other sensational bargains in used motors, motorscooters, motorcycles, parts, etc. Associated, Box 1764-CS, Toledo, Ohio.

WHIZZER Bike-motor \$25.00; Cushman motorscooter \$15.00; midget racer \$40.00; Shaw bicycle-motor \$15.00; Harley-Davidson motorcycle \$15.00; Smith motor-wheel \$25.00; Good motorscooter (twist grip) \$22.50. Rush 25c for new catalog #14 listing many other amazing bargains in motorscooters, used motors, midget cars, parts, wheels, etc. Gail, 538 Erie, Toledo, Ohio.

HARLEY-DAVIDSON Parts, accessories, batteries, and tires. 24 hour service. Authorized factory dealer. Philadelphia Harley-Davidson Company, 857 North Broad Street, Philadelphia 23, Penna.

MOTORSCOOTERS, New design, 6 big features. Literature 10c. Rollaway Motors, Lancaster, N. H.

RECONDITIONED Motorcycles and motors. Chromium accessories. Complete stock Indian parts. Expert rebuilding. Fast service. Indian Motorcycle Sales, Kansas City 1, Mo.

WHEELS! Build wagons, scooters, mowers, trailers, wheelbarrows, grocery carts, baby carts, play pens, baby carriages. 4" to 16". Free list. Trulsen Mfg. Co., 811 E. 31, Kansas City, Mo.

TIRES And industrial wheels, suitable for scooters, wheelbarrows, farm equipment, etc. All sizes. Bicycles and accessories. Largest assortment in America. Send dime for list. Cycle Transport Company, 1241 So. Michigan Ave., Chicago 5, Illinois.

AVIATION

JET Engine: Build the miniature M.E.W. 601, requires only hand tools. Construction plans \$1.00; parts available. Send 10c for illustrated literature and parts list. Minnesota Engine Works, Dept. PM, 387 University Ave., St. Paul 3, Minnesota.

PROPELLERS, Plans, skis, engines, for ice-snow sleighs, air boats. Literature 10c. Banks-Maxwell, R.F.D. 12, Ft. Worth.

PROPELLERS—2-3 Blade for sleds, air-drive boats. Catalog. Standard Aero Craft, Box 387, Ft. Worth, Texas.

BATTERIES, GENERATORS

BUILD—1,000 Watt 110 volt A.C. generator from old 12 volt Dodge generator. Constant voltage with volt regulator. Variable speed. Plans and instructions guaranteed. \$1.00. A. J. Allen Service, P.O. Box 1432, Del Valle Station, Dept. P.M., Los Angeles 15, Calif.

EDISON Non-acid lifetime storage batteries for home lighting, motors, industrial uses, radios, etc. Free interesting literature. Hawley Smith Co., Croton Falls 1, N. Y.

ELECTRICAL SUPPLIES

FIX Anything electrical. Amazing new "Electroscope" at unheard of low price—locates electrical troubles double quick. Basic course in electrical repair included free with each "Electroscope." Send penny postcard for full details, no obligation. Feiler Engineering Company, Dept. 8PM9E, 945 George Street, Chicago 14, Illinois.

ELECTRONIC Door lock! Sensational! Invisible! Positive protection! Inexpensive! Ends losing keys. Distributorship available. Send only \$2 for thoroughly engineered drawings—Complete simplified instructions. Satisfaction guaranteed. Aynsworth, 17544 Raymer, Northridge, Calif.

NEW Motors—G.E. 1/2 hp. \$12.50. Others in stock. Free literature. Plenge, 9 Stuyvesant Oval, New York 9, New York.

LAMPS—Build own originals. Parts wholesale, any amounts. Catalogue 10c. Brown Lamp Co., Box 501, Wellston, St. Louis 12, Mo.

BUY Lamp parts wholesale. Parts you need for building, repairing, or assembling. Save money on large or small orders. New catalog for 10c. Gearon Company, Dept. 300-B8, 27 South Desplaines, Chicago, Illinois.

ELECTRIFY Sewing machines. Experience unnecessary. Complete kit only \$17.50. Steelman, 232 So. 4th Ave., Mt. Vernon, New York.

SILICON Transformer lamination cut to order. Magnet wire, supplies. Send for bulletin 42949M. Morton Electrical Service, Maywood, Ill.

ELECTRIC Pencil: Engraves all metals \$1.25. Beyer Mfg., 10511-H Springfield, Chicago 43.

INFINITELY Variable voltage transformer operates from home lighting current. Steps voltage up or down. Vary the speed of motors, dim lights, do radio test work. Copyright data \$1.00. PeJay Engineering, P.O. Box 1172, Oakland 4, Calif.

LAMPS—If you build or repair and had trouble getting parts, your search is ended! 24 hour service from the most complete stock in country. Illustrated catalog 10c. Dealers, send business card for quantity discount. Gyro Lamps, 5402P Clark, Chicago 40.

WELDING, SOLDERING, PLATING

ELECTROPLATING Units—Complete \$2.00 and up. Free literature. Regency Sales, Dept. M, 5316 S. Justine, Chicago 9, Illinois.

"BUILD-UR-OWN" Portable arc welder. Save \$350. Easy with Hobart welder plus auto engine. Send 10c for valuable instruction book. Free catalog. Write Hobartweld, Box M-893, Troy, Ohio.

RECTIFIERS 0-4 V.D.C. \$9.50, 0-8 V.D.C. \$12.50, 0-12 V.D.C. \$18.50. All 0-100 amps. Starkweather, Ottawa, Kansas.

WELDERS 110V. Welds $\frac{1}{2}$ " steel. \$32.50. Unassembled \$22.50. Morris Welding Service, 1850A State, Schenectady 4, N. Y.

WELDER! New portable Champion Special transformer welder; 110/120 volts a.c. develops to 75 amps.; 9 heat stages. Welds, brazes, solders, cuts all metals. Easy to use. Simple instructions. Special flame weld torch free. Splendid for shop, farm, home repairs. Saves hundreds of dollars yearly. Only \$27.50. Also heavier models. 10 day free trial. Magic Welder Co., 239 MP Canal St., New York, N. Y.

WELDERS For all requirements. Free catalog. Write Hobartweld, Box M-894, Troy, Ohio.

REGULATORS. New—Navy surplus. Harris Oxygen regulators \$10.95. Milburn Acetylene regulators \$10.95. Trindl 125 amp. combination 110 or 220 volt welder \$62.50. 50 ft. $\frac{1}{4}$ " twin hose with connections \$11.95; 25 ft. \$5.95. Satisfaction guaranteed. Universal Machinery Co., 1120 Jackson, Chicago 6, Ill.

ELECTROPLATING Salts and rectifiers. Mirror resilvering and chipped glass nameplate supplies. John Sprinkle, V55, Marion, Indiana.

DIAL Heat adjustment rheostat and 0-300 ammeter on panel for mounting on P-1, P-2, R-1, R-2 aircraft gen. welders. \$14.95 postpaid. H & H Welding Supply, Ryus, Kans.

RADIATOR Repairing, cleaning, recoring. How to equip small shop at low cost. Supply sources, trade secrets, instructions. Now only \$3.50 postpaid. Radiator Service, McBain, Mich.

AUTO Radiator repairing supplies, equipment, books, gasoline torch. Write, Curfman Co., Maryville, Mo.

BUY Direct from factory. Welding outfit, \$48.36. Soldering outfits \$7.76 to \$10.16 complete prepaid. Box 331, Hamilton, Ohio.

MACHINERY, TOOLS, SUPPLIES

BENCH Power tools, motors, supplies. Wholesale prices. Homecrafters Co-Operative, Grand Rapids 6, Michigan.

STEEL Shelving, drawer units, parts bins, bench legs, work benches, tool stands, etc., direct to user. Catalog on request. Vimar Manufacturing Co., 210 Loeb Arcade, Minneapolis 2, Minn.

WAR Surplus in small tools for machine shop. Send 15c for bulletin. Travers Tool Co., Dept. P, 5 Court Square, Long Island City 1, N. Y.

SNAP Center finder, \$1.00 postpaid. Earl Engineering Co., P.O. Box 52, Fresno, California.

WELDERS For all requirements. Free catalog. Write Hobartweld, Box M-895, Troy, Ohio.

MAGNETIC Tool holder. Screws on wall. Don't clutter your work table. Guaranteed permanent magnetism. Satisfaction or money refunded. \$2.95, postpaid or c.o.d. Ace Specialties, 435-A Market Street, Bloomsburg, Penna.

$\frac{3}{4}$ " **ELECTRIC** Drill \$8.95. $\frac{1}{2}$ " electric drill \$22.95, $\frac{1}{4}$ hp. bench grinder \$22.95. New and guaranteed, catalog 10c. Box 1161, Oklahoma City, Oklahoma.

THE Acme sharpener will produce a smooth, fast cutting edge on any kind of circular saw. Send for free literature. Max Mfg. Co., 138 Stockton Ave., San Jose 11, California.

PRECISION Tools, used: Micrometers, verniers, etc. H. Riley, 150 East 19th St., Brooklyn 26, N. Y.

CONCRETE Block machines. Standard sizes, economical, dependable, low prices. \$39.50. Free catalog. Concrete Machine Co., 5129 S. Compton, St. Louis, Mo.

BENCHES, Cabinets, drawer cases and complete line of workshop equipment. Free catalog. Burkel Equipment, 1627 W. Fort, Detroit 16, Michigan.

DRILL Grinder for twist drills, \$2.95. See ad on page 253.

BOATS, OUTBOARD MOTORS

BUILD A better boat than you can buy for the money! Save 35-55%. Exclusive laminated ribbed construction, prefabricated for easy assembly. All popular types from simple car-top models to mahogany-decked runabouts, priced from \$39.50 to \$199.50. Send 10c for literature. Ozarka Boats, 689 Borden Lane, Woodstock, Ill.

TWENTY Plywood boat plans \$1.00. Catalog of boatbuilding plans 10c. The Rudder, 15 Murray Street, New York 7.

BOAT Builders' guide—250 pages, 15,000 items pictured, priced, deliverable. Send \$1.00. Marine Mart, Buffalo 7-B, N. Y.

BOAT Plans: Wood-steel. Catalog. John B. Clark, Yacht Designer, 329P Kenmore, Bay Village, Ohio.

KNOCK-DOWN Boat kits. Outboards, inboards, sail, hydroplanes. Easy to assemble, minimum cost. Catalog with specifications, prices 25c. Brooks Boat Company, Carrollton 7, Michigan.

PACKAGED Lumber—Marine plywood, seasoned oak and cedar, sized, selected. Send \$1.00 for booklet, "Plywood Boats," with quotation form and literature. Forms and literature, 25c. Marine Mart, Buffalo 7-B, N. Y.

SAVE $\frac{1}{2}$ To $\frac{1}{3}$ on all our marine conversions. For example: Complete V8 Ford kit for only \$89.50. Illustrations free. Complete catalog beautifully illustrated—25c. Arthur Gershel, 650 Sunrise Highway, Rockville Centre, N. Y.

AIR Boat plans, \$5.00, literature. Banks-Maxwell, R.F.D. 12, Ft. Worth.

GOOD Used marine engines. Bargain catalog free. Lind Supply Company, Coldwater, Michigan.

MARINE Specialties and motor conversions catalog. Sixty pages of struts, finishes, hardware, plexiglass windshield kits, electric tachometers, inboard and outboard air cooled motors, etc. Immediate delivery. Catalog with booklet, "Conversion Hints," \$1.00. Catalog only, 50c. Marine Mart, Buffalo 7-B, N. Y.

STEERING Wheels, windshield brackets, from \$6.95. Modern fittings at lowest prices. Complete pre-cut plywood boats. Bargains galore. Folder 10c. Marine, Box 681, Mendota, Minnesota.

BUILD Your boat from our accurate paper patterns or materials, thirty designs, 7-54 feet. Forty years careful designing. Send 10c for folders. Illustrated book, small boat construction, \$1.50 postpaid. Germain Boat Company, W. Saginaw, Michigan.

SAVE $\frac{2}{3}$ Cost. Build your own boat with our ready cut parts by the Welch system. No experience necessary. Rowboats to cruisers. Illustrated catalog 25c. Midwest Boat Company, Menomonee Falls, Wisconsin.

OUTBOARD Motors—Used bargains, \$45 up, free list. Used parts, most models, save money! Boat and motor equipment and accessories. Big catalog, send dime. Crandall-Hicks, 911 Commonwealth, Boston, Mass.

NEW. Used, rebuilt marine motors. Marine conversions, fittings. Free catalog. Stokes Marine Supply, Dept. 24, Coldwater, Michigan.

MARINE Conversions for Ford and Jeep engines. Catalog 10c. Lehman Manufacturing Company, Department D, Newark 2, New Jersey.

BOATS And all about them. How to select, build, repair and operate. For 40 years the leading practical boating magazine. Half price trial subscription, 12 issues for \$1.00. Motor Boat, 62 Gold Street, New York 7.

ENGINES, MOTORS, DYNAMOS

WELDER 150 Ampere \$47.50. Water pumps, 400 gallon, \$12.75. Fans, 32 volt, 2 speeds, \$3.75. Butler, 1885 Milwaukee, Chicago.

MOTORS— $\frac{1}{6}$ hp., 32 volt, D.C., 1750 speed, new, \$15. Empire Electric, 89 Jay, Brooklyn 1, N. Y.

MOTORS $\frac{1}{2}$ h.p. 1750 r.p.m. \$18.50. $\frac{1}{2}$ h.p. 3450 r.p.m. \$16. $\frac{3}{4}$ h.p. 3450 r.p.m. \$26. Roberts, 7232 Madison, Forest Park 3, Illinois.

WATER Motors—All sizes. For any purpose. Rotary and semi rotary. Duplex Motors, Burlington, Iowa.

WINDING Data, listing 225 motors, single and three phase, \$1.00. Motor Data Co., Box 7631, Kansas City 3, Mo.

ATHLETIC EQUIPMENT, BODY BUILDING COURSES

BECOME A big strong muscleman. Instructions only \$2.00. News and pictures 10c. Barbell equipment. Personal supervision, etc. Write Sid's System, PM12, 8421 $\frac{1}{2}$ Evergreen, Southgate, California.

BARBELLS—Finest quality \$8.98 up. Free catalog. Lurie Barbell Co., 1729-M6 Rockaway Parkway, Brooklyn, New York.

BARBELLS, Dumbbells. Inquiries invited. York Barbells (Canada), Scarborough Bluffs, Ontario, Canada

WEIGHTLIFTERS—New invention which develops terrific hand strength; uses barbell weights. Free folder. Johnson, 259 S. E. Ave., Bridgeton, N. J.

BARBELLS! Muscular physique, strength. Send stamp. Jackson Barbells, Springfield, N. J.

BARBELLS, Exercise equipment. Courses. Free booklet. Good Barbell Co., Reading, Penna.

DEADLY Judo—Fiercest fighting technique. Trick knockouts. (200 photographs; plus illustrations.) Expert instructions, three volumes. Complete \$2.25. Variety House, Box 46-B, Wall Station, New York 5.

SPORTING GOODS, GUNS, FISHING TACKLE, ARCHERY, TRAPPING

MOLDS—For fishermen's sinkers. Ocean City Mold Co., 649 Wilcox Ave., New York 61, N. Y.

190 **PROFUSELY** illustrated pages antique and modern pistol, sword, etc. values. 50c. Robert Abels, A860 Lexington Ave., New York 21.

USED Guns—Close-out bargains. List 10c. Rywell, Harriman, Tenn.

PISTOLS, Firearms, ammunition. Complete list 25c. Frank Farish, Vicksburg, Miss.

WE Swap guns, scopes, binoculars. Catalog 10c. Livingston Shooters Supply, East Corinth 87, Maine.

SEND 10c For list 100 used guns. Prayseth's, Willmar, Minn.

TENTS, War surplus, all sizes; cots, hammocks, camping equipment, canvas covers, fishing and sporting goods, rope. Morsan, 10-19E 50th Avenue, Long Island City 1, N. Y.

MOLDS For fishermen's sinkers, squids, and jigs. Sweet's Molds, Tonawanda, N. Y.

BOWS, Arrows. Quality archery equipment. Popular prices. Catalog 10c. Illustrated archery instruction book 50c. Archery, 617-K So. State, Chicago 5.

5000 **BARGAINS,** Firearms, binoculars, war relics. Catalog 40c. Smith Firearms, Runnemed, New Jersey.

SHOTGUNS, Rifles, revolvers, over 500 modern, obsolete. Also cartridges, list 10c coin. Ed Howe, 52 Main, Coopers Mills, Maine.

TAXIDERMY

"MODERN Taxidermist Magazine," Greenfield Center, N. Y. Devoted exclusively to taxidermy. Two sample copies 25c.

BINOCULARS, TELESCOPES, MICROSCOPES, MAGNIFIERS

"HOW To Select Binoculars"—Free booklet. Write today! Bushnell Importers, 676-8 South Lafayette, Los Angeles 5.

BINOCULARS, Telescopes, watches, guns. Buy, sell, trade. Schweer's, Donnellson, Iowa.

POWERFUL Astronomical telescope, equatorial mounting, two eyepieces, \$16.50. Blum Optical Lab., 4213 Gifford Ave., Cleveland 9, Ohio.

GIANT Astronomical telescope 100 diameters magnification, with tripod. Full power, clear vision. \$15.00. Suffolk Science Service, Manorsville, N. Y.

"TERRIFIC" Bargains — Government surplus telescopes, binoculars. Send \$1.00 for 10 piece hobbyist lens set. Contains magnifying and reducing lenses. Send stamp for "bargain" list. P. Jaegers, 93-08 95th Ave., Ozone Park 16, N. Y.

WAR Surplus bargains. Binoculars, telescopes, sextants, millions of lenses, prisms, reticles, eyepieces, objectives, etc. Request free Catalog CH. Edmund Salvage Co., Audubon, N. J.

REFLECTING Telescopes, 60X, completely assembled \$25.00. Guaranteed observatory clearness. Free information. Skyscope, 475 Fifth Avenue, New York 17.

POWERFUL Astronomical telescopes easily made. Perfect lenses and instructions: 100X \$3.00, 100X and 200X \$4.00, 100X, 200X and 400X \$6.00. Clear vision, full power guaranteed. Instructions alone 10c. Suffolk Science Service, Manorsville, N. Y.

ASTRONOMICAL Telescopes, binoculars, microscopes; bought, sold, repaired. Books. Lists 10c. Rasmussen-Reece, Amsterdam, N. Y.

TELESCOPES, Binoculars, microscopes, big bargain catalog free. Brownscope Company, 24 West 45th Street, New York.

DOGS, PETS, BIRDS, RABBITS

BEAUTIFUL Pure white pedigreed police dogs. Ansonia Kennels, Mose, N. Dak.

HAMSTERS: Finest pedigreed breeding stock, reasonably priced. Mount Clemens Hamstery, 94 Church, Mount Clemens, Michigan.

RAISE Guinea pigs. Make money at home. Booklet free. Taylor, Box 426A, Hapeville, Georgia.

RAISE Chinchilla rabbits. Year-round money-makers from furs, meat, breeders. Experience unnecessary. Write today. Willow Farm, Sellersville 15, Penna.

FERRETS \$10. Mink kits \$15 up. Van Garp Ranch, Pella, Iowa.

RAISE Rabbits. Four pound fryers in eight weeks. Ready market for meat, fur, wool. Illustrated book, describing leading breeds, housing, breeding, feeding, marketing. By America's largest rabbit association. 10 cents. American Association 12, AR & CBA Building, Pittsburgh 17, Pennsylvania.

SPORTSMEN: 200 Pointers, setters, straight cooners, combination hunters, rabbit and fox hounds. Reasonable. List free. Ramsey Creek Kennels, Ramsey, Ill.

SEE Gulf Hamstery ad on page 33. Shows picture of Hamster.

ANGORA Rabbits for pleasure and profit. Fred Wellen, Elkhart, Iowa.

\$400 MONTHLY. Raising Angora rabbits. Good wool markets. Details free. White's Rabbitry, Newark, Ohio.

HOHL'S Hamsters. Clean, quiet, odorless pets. Photo, literature free. Lab. Stock, 317-M Mt. Vernon Rd., Newark, Ohio.

HAMSTERS—Guaranteed virgin breeders. \$5.00 pair. Order direct. Wholesale business solicited. Pyle Hamstery, Okmulgee, Oklahoma.

\$300 MONTHLY Raising Angoras for our market. Particulars free. Wilson, Stanton, Calif.

ENGLISH Shepherds, puppies, spayed females. Healers livestock, companion children. Best watchers. Barnes, Collyer, Kans.

RAISING Hamsters is profitable. Information. Pem's Hamstery, 3010-10th Ave., No., St. Petersburg 6, Fla.

MAKE Extra cash. Raise Giant Chinchilla rabbits. Waters Rabbit Farm, Glennville, Ga.

MINK Raising information free. Complete. Lake Superior Mink Farm, Superior, EE1, Wisconsin.

INCREASE Your income by raising domestic rabbits. Small space needed. Ready market for delicious meat, fur and wool. Largest magazine in the industry tells you how. \$1.50 per year. Sample 15 cents. No stamps. Small Stock Magazine, Lamoni 20, Iowa.

\$3000 YEARLY Raising Angora rabbits. We buy your output. Contract particulars free. Kise's Enterprises, St. Paul 8, Minn.

FARMS, FARM LANDS, REAL ESTATE

OZARK Mts. \$25 will buy a tract of land. Hunt, fish, farm, invest in timber or mineral land. Brasel, Jasper, Ark.

FREE Fall catalog of farm bargains, many states, some equipped, many illustrated! United Farm Agency, 1408-PM Consumers Bldg., Chicago 4, Ill.

SPECIAL Ozark land buys. Free descriptions. Write Armstrong, Shook, Mo.

WEST'S New time and money saving catalogue, over 1000 farm and business bargains. Free. West's Farm Agency, CK-2, Pittsburgh 17, Penna.

CHEAP Homes in beautiful, pleasant, healthful Ozarks. Free stock range. Free literature. Free modern cabins for customers. Write. Barnsley, Ozone, Ark.

FLORIDA Campsites near Ocala National Forest and many nice fishable lakes. World's best bass fishing. Wonderful hunting. 2½ high dry acres \$275 at \$10 monthly. Folder free. Howard Vernor, DeLand, Florida.

ALASKA Farms. Free homestead 160 acre. Tracts suitable farming, ranching. Unlimited opportunities. Complete details \$2.00. Edward Wade, 6220 Woodlawn, Chicago 37, Illinois.

STROUT'S Farm catalog! Time and money-saver—Free! Describes 2790 bargain properties. 35 states coast-to-coast. Write today for your free copy! Strout Realty, 255-P 4th Ave., New York 10, N. Y. 20 W. 9th St., Kansas City 6, Mo. 453 S. Spring, Los Angeles 13, Calif.

\$5.00 MONTHLY Buys 40 acres near town; price \$200.00. Free list. Box 425-P, Carthage, Mo.

GOVERNMENT Lands \$2.00 acre up. Information all states twenty-five cents. National Tax Service, 901-A Majestic Bldg., Detroit.

GOOD Farms—Ranches. Washington, Minnesota, Montana, Idaho, Oregon, North Dakota. Dependable crops, favorable climate. Write for literature, lists describing typical farm opportunities. Specify which state. J. W. Haw, 119 Northern Pacific Railway, St. Paul 1, Minn.

SOLD For taxes. Calif., Oregon, Washington timber, grazing, ranch and mining lands. 25c to \$3 acre min. bid. 10c (coin) brings circulars, photos, maps. Pacific Lands, Box 2350-PM, Hollywood, Calif.

OZARK Magazine. Eureka Springs 11, Arkansas. For homeseekers, tourists. Year. \$1.50.

LOTS \$300—Convenient payments. California's finest garden section. On Morro Bay's scenic shores. Wonderful fishing, hunting, boating, bathing. Fertile soil, softest water, temperate climate, congenial community. Free literature. Richard Otto, Department M, San Luis Obispo, California.

POULTRY, FARM SUPPLIES

GROW Chicken of tomorrow today with chicks from Pilch's Famous Old Hen Breeders. You too will like Pilch's chicks because so many other people do. 14,000 Pullorum Clean Breeders. Reds, Rocks, Crosses, Sex-Links, White Rocks, Hamps, Started Pullets, Started Chicks, Capons. Write for valuable '49 calendar. Pilch's Chicks, Box M, Thompsonville, Conn.

KNOW How to raise poultry for profit. Read Northeastern Poultryman. Every issue packed with helpful hints and practical suggestions. Latest articles on breeding, feeding and management. Subscribe now. 1 year 65c. 2 years one dollar. foreign subscriptions \$1.00 a year. Northeastern Poultryman, Dept. P.M., 376 Boylston St., Boston 16, Mass.

EARN \$4 To \$12 hourly. Chick sexing, culling and caponizing. G.I. approved. Pilch's School, Box PM, Thompsonville, Connecticut.

PROFITABLE OCCUPATIONS

LIFETIME Repeat orders! Sell our business cards by mail, your territory. Small "starter" plan. Lynn Art Products, 5710-A Bankfield, Culver City, California.

STENOTYPE Machine. course, pads, \$150.00. Field, Box 112, Brooklyn 12, N.Y.

LOCKSMITHING Secrets! Key fitting. Lock repairing, opening; prices, sources. Illustrated book \$1.00. Wexler, 7 West 36, New York City.

"FROG-RAISING"—New book explains everything! Marlboro-A, Box 7002, New Orleans 19, Louisiana.

FREE Details. Successful local or mail order plans. Postway copyrighted. Odell's, Box 86B, Meeker, Okla.

MUSHROOMS Grown. Boxes, barrels. Instructions 50c, spawn \$1.00. Manureless process \$2.50. Gordons, 553 William, Winnipeg, Manitoba.

FREE Book "372 Unusual Worldwide Businesses!" South America, New Zealand! Work delightful, "different" plans home (U.S.A.). Publishers-F5, Carlsbad, Calif.

LEARN Photo offset printing. Uncrowded field. Write John L. Moon, Box 1775, Spokane, Washington.

INTERESTED In Latin American and foreign employment? \$1.00 brings copyrighted "Foreign Service Directory" with complete listing of firms in oil, mining, aviation, construction, steamship, manufacturers, importers and exporters with hot tips for immediate application. Published since 1944. Global Reports, P.O. Box 883-P, Hollywood 28, Calif.

FOREIGN Employment? Latest bulletin, overseas directory and application forms: \$1.00. (C.O.D. \$1.32.) Foreign Service Institute, P.O.B. 3934, Miami, Fla.

\$46 FROM Square foot plywood; jigsaw necessary. Write, Woodarts, P-38, Bridgewater, Mass.

SENSATIONAL! It's easy to earn big money with your own profitable business. Earn \$10.00 to \$50.00 a day. Make lamps at home. General illustrated course teaches you quickly. Course and wholesale supply catalog only \$2.00. Gearon Company, Dept. 200-B8, 27 South Desplains, Chicago, Illinois.

FOREIGN Construction work. Construction men, building trades mechanics, helpers, office men. Good workers needed for oil projects, mining, pipe lines, dams, power plants, roadways, shipping, etc. Transportation and quarters furnished; high wages. Listings of firms actively working and hiring on projects in South America, Arabia, Asia, Africa, Alaska, Central America, etc. Send \$1.00 for foreign construction compendium and application form. Foreign Service Bureau, Dept. P.M.8 (Employment), P.O. Box 295, Metuchen, New Jersey.

WEAVE At home for pleasure and profit! Easy to learn. Fun to do. Make scarves, luncheon sets, table runners, drapes, neckties, etc. for own use, for gifts, or for profitable sale to friends, neighbors, local merchants. Details free. Lucto Products, 400 W. Madison St., Dept. 32, Chicago, Illinois.

OWN And operate mirror shop! Supplies for resilvering mirrors, making chipped glass nameplates and electroplating. John Sprinkle, V50, Marion, Indiana.

"173 Ways To Make Money at Home"—Big book yours as gift! Tells how to play for pay. Given with special trial subscription to Profitable Hobbies—read by 100,000 ambitious folks. Four big monthly issues only \$1.00. Money back guarantee. Write Profitable Hobbies, 4040 Hobbies Building, Kansas City 16, Missouri.

NO Job? Raise chickens for sale quickly. Instructions one dollar. Joseph Feldstein, 224 Upson, San Antonio 1, Texas.

LEARN To hang wallpaper like professional. Easy, profitable. Complete illustrated instructions \$1.00. Practical Decorator, Box 582, Lewistown, Penna.

RAISE Fishworms. Easy, profitable. Send 25c in coin for complete instructions. Huffman Worm Ranch, Rives Junction, Mich.

\$400 MONTHLY. Raising Angora rabbits. Good wool markets. Details free. White's Rabbitry, Newark, Ohio.

TYPISTS, Profitable business at home. Complete copyrighted information 50c. Rosdahl Industries, 72-A W. Washington St., Chicago 2, Ill.

MAKE Greaseless doughnuts at home. New amazing electric machine. You'll coin money selling to grocers, drug stores, cafes, hamburger stands. Low cost will surprise you. Experience unnecessary. Send for free recipes and plans. Morgan Ray Co., 3605 South 15th Ave., Minneapolis 7, Minn.

WOULD You pay 3¢—First \$350 made? Illustrated book "505 Odd, Successful Enterprises" free! Work home. Expect something odd! Pacific, Oceanside, Calif.

NO Work or cost. Make fabulous money growing dwarf trees in your room. Free details for stamp. American, 385 La Tijera Station, Los Angeles 43, California.

OUTDOOR Work for extra income. Information free. Morris, 328-A Parkway NE, Atlanta 5, Georgia.

WANTED—Purchasing agents. No money or experience required. Write Dept. C, Purchasing Manager, 2719 Lawrence, Chicago, Ill.

YOU Can make real money raising Golden Hamsters. New tiny animal. Easily raised at home. Write for details. Hudson Hamstery, Newfoundland 1, N. J.

CONSTRUCTION Report—Send \$1.00 for world wide job project listings. Up-to-minute-facts for construction men. Global Reports, P.O. Box 883-DX, Hollywood 28, Calif.

EXCELLENT Profits. Make, sell holiday flowers, novelties. Literature free. Velve Artcrafts, 324-M East 14, New York 3, N. Y.

BE The Popular Mechanics representative in your neighborhood and earn big profits in your spare time. Write Popular Mechanics Magazine, Room 408M, 200 E. Ontario St., Chicago, Ill.

\$40.00 WEEKLY Made growing mushrooms, fresh, dried. Dominion patent 331583. Free spawn. North American, 169P Yonge, Toronto, Canada.

ALASKA—The Last Frontier offers unlimited opportunities, \$1 brings government map and directory listing firms in fishing, construction, mining, aviation, fish and game rules, homestead data. Alaska Opportunist, Box 883-M, Hollywood 28, Calif.

BOOKS, PERIODICALS, PICTURES, POSTCARDS

QUICK Profits taking magazine subscriptions, handling greeting cards. Caswell Publishers Service, Westfield, N. J.

LIST Free book selections by and about Negroes. Mailway Success Book Distributors, 534 15th Street, Oakland 12, Calif.

TRADE Books. Send books plus 10c each. We return different books of same type. Satisfaction guaranteed. Dept. B, 411 Crawford St., Middletown, Ohio.

BACK Number magazines reasonable. Reedmore, 240 East 9th, New York, N. Y.

BOOKFINDERS! (Scarce, out-of-print, unusual books). Quickly supplied. Send wants. Clifton, Box 1377-PM, Beverly Hills, Calif.

NATIONAL Geographic Magazines 1888-1949. Any issue, Box 327-PM, Periodical Service, Swarthmore, Penna.

SELF-EXPLAINING Bible: Illustrated circular free. Box 446-P, Minneapolis, Minn.

BOOKHUNTERS! All subjects. Send wants: Jaher Book Service, 620-P East 178 Street, New York 57.

MOVIE Stars photographs 8x10, westerns, over 1000 to choose from. 25 cents each, 6 for \$1.00. Illustrated catalogue with order. Mortensen Studios, Box 1055-P, Burbank, California.

GAMES, ENTERTAINMENT

WORLD'S Largest kite. Only \$20. Lifts light person. War surplus. Free literature. Great-Northern Mart, No. Adams, Mass.

MAGIC TRICKS, PUZZLES, JOKER NOVELTIES

LARGE 160 Page catalog, just published, 35c. We have supplied the best tricks to beginners and professionals for 38 years. Chicago Magic Company, 2300-Y No. Mason Avenue, Chicago 39.

500 TRICKS You can do! Send 10c for Douglas famous catalog, best in magic at lowest prices. Unequaled service to magicians for 30 years. Douglas Magicland, Dept. 1, Dallas, Texas.

VENTRILOQUISM—Free information. State age. Maher, Box 36-M89, Kensington Station, Detroit 24, Mich.

500 TRICKS Catalog and book "84 Card Tricks," both only 50c. Robbins Co., 152-P West 42nd Street, New York.

AMAZING Ghost quarter trick free if 25c is sent for big illustrated catalog listing 500 wonderful magic tricks. Rush 25c now. The Magician, 2463-P Kensington Ave., Philadelphia 25, Penna.

JOKER Novelties. Laugh, have fun. List, catalogue 10c, refund first order. Novelty Sales, 112 Moore, Sanford, N. C.

SQUARE Hole filled with round peg? Can be done, wonderful money maker. Send \$1.00, Olson's, Battle Creek, Mich.

MAGIC Tricks, puzzles, books, cards, punch boards. Catalog 10c. Specialty, Box 671, St. Louis 1, Mo.

LEARN 50 Card secrets for a penny apiece. Our book #502 is yours for only 50c. Whoopee cushions, 35c. Tricky dogs, 25c. Itch, sneeze powders, each 10c. Many more items in our list of magic tricks, joker novelties, etc., one dime or free with order. Behnke Sales, 5721 Leland, Chicago 30, Illinois.

MAGIC Books, magazines, bought, sold, exchanged. Russell Duck, Philipsburg, Penna.

BE A magician. Large professional magic catalog of latest tricks, 35c. Ireland, C-109 North Dearborn, Chicago 2.

PROFESSIONAL Catalog. 124 pages, 25c. Williams, 900 Plymouth, Ellwood City, Penna.

VENTRILOQUISM Taught, 3c stamp bring particulars. Smith, 801 Bigelow, Peoria 5, Ill.

WORLD'S Largest professional magic shop, keeps you in touch with latest tricks. To receive mailings, send 50c for new catalog. Holden's, M220 West 42nd St., New York.

LEARN Magic, ventriloquism, mind-reading. Write for particulars. Quackenbus, Big Flats, N. Y.

16 CARD Tricks and catalog 25c. Sterling Magic, Royal Oak, Mich.

400-PAGE Catalogue of 2000 tricks, pocket, parlor, stage. World's finest magic. Send \$1.00 for catalogue (refund first \$5.00 order). Kanter's, M-1311 Walnut, Philadelphia 7.

STAMP COLLECTING

FINE Approvals. Fast, personal service. What countries do you prefer? I'll send their stamps. Skinner, 438 Locust, Long Beach 12, Calif.

POSTMARKS. Meters, slogans, trademarks. 300 package 50c, catalog. Safford, 25 Union, Worcester, Mass.

100 DIFFERENT Denmark. Fascinating collection. Write your address, inclose 50 cents postage. Knud Hansen, Oesterbrogade 88, Copenhagen, Denmark.

UNUSUAL! Honduras first issue plus 100 other fine stamps 10c. Approvals. Haney, Box 145M, Batavia, Ohio.

10 ASSORTED U. S. Commemorative stamps 15c. Five U. S. Air Mail 15c. Both 25c. Ideal Stamp, Box 179H, Park Ridge, Illinois.

PENNY Approval bargains! Write Department PM, 1267 Tutwiler, Memphis 7, Tennessee.

FREE! Complete Balkan aviation set with approvals. Beaman, Leeds, Alabama.

FAMOUS Approvals. Free premiums your choice. Berthal, 2219 H, Bellingham, Washington.

1862 PRINCE Edward Islands—Just 3c with approvals, Viking, 130-Z Clinton St., Brooklyn, N. Y.

FREE. Military govt. set. Approvals. Raymax, 123-Z William St., New York 7.

FREE! Six large mint pictorials! Request approvals. Phipps, 910 20th, Santa Monica, Calif.

PACKETS! Free list. King Stamp Co., 2310 Vista Gordo Dr., Los Angeles 26, Calif.

FREE—Bulgaria, Congo, Algeria, Sudan. Foreign approvals. Colonial, Box 326A, Passaic, N. J.

FREE! Tiny Chinese "midget" war set. Approvals. Seminole, Leeds, Alabama.

10 TRIANGLES 10c With approvals. Valley Stamp Co., Harrisonburg, Virginia.

66 DIFFERENT Stamps, including U. S. battleships 6c. Worldwide approvals. Telic-Arts, Devon, Conn.

MOZAMBIQUE Triangulars, unused set, 10c with approvals. Vargo Stamps, 6044 South Fairfield, Chicago 29, Illinois.

200 FOREIGN, 25 U. S. commemoratives, 10c. Approvals. Weckerling, 516½ So. Adams, Tucumcarl, N. M.

APPROVALS. 60% Discount from Scott's catalog. Trader Terry, Wilmington, Ill.

GIPT. Three U. S. centenary San Marino to approval applicants. Deane Stamps, Box 87, Miami 35, Florida.

TRAINS! Trains! Trains! 12 train stamps and packet of 100 different stamps for 10c with approvals. Reich Stamp Company, 4647 Kenmore, Dept. M20, Chicago 40, Illinois.

FREE "Stamp Finder." Tells instantly country to which any stamp belongs. 32 pages profusely illustrated. Approvals. Garcelon, Calais 17, Maine.

FREE! Mint United States block, Russia airmails packet, approvals. Greenwood, 263 Meridian, Miami Beach, Fla.

BARGAIN! Assortment triangles, assortment Africa, \$2,000,000.00 stamp, \$5.00 U. S. stamp, 10 different Bohemia, Rubies, Iceland, etc. Eckerman, 7830 Paso Robles, Van Nuys, Calif.

FREE With approvals. British, Spanish, French Colonies, Vatican, Hitler heads, and airmail packet. Pan-American Stamp Co., Box 145, New York 33, N. Y.

250 DIFFERENT U. S., \$2.00. Contains 110 commemoratives. Approvals on request. Harman Stamp Co., Dept. P, Box 515, Port Jervis, N. Y.

FREE! Powerful magnifying glass—To approval buyers; also big bargain lists. Jamestown Stamp Co., Dept. 207, Jamestown, New York.

FREE—Famous Americans set, Flag set, National Parks set, and Presidential set to \$5.00. A total of 90 stamps free to customers for our unsurpassed U.S. and foreign selections. Send 3c for 15 of the above stamps and full particulars. Triboro Stamp Co., 145 Nassau St., Dept. 108, New York.

307 ALL Different 10c. Commemoratives, triangles, bicolored beauties, high values. Strange countries. New varieties galore. Only 10c with approvals. Garcelon, Box 400, Calais, Maine.

750 FRANCE And colonies stamps only 10c with approvals. Littleton Stamp Co., Littleton 25, N. H.

VICTORY Packet free—Includes stamps from Tanganyika, British Cayman Islands, animal, scarce babyhead, Coronation, early Victorian, airmail, map stamps. Including big illustrated catalogue. Send 5c for postage. Gray Stamp Company, Dept. PM, Toronto, Ontario.

MILLION Members wanted, \$1.00 yearly. Rhodesian Stamp Exchange Club, Kitwe, Northern Rhodesia.

BEAUTIFUL New Zealand life insurance, healths, Otago centenaries. Send \$1.00 bill for three complete sets. Approvals on request. Kwongchong, Don Street, Invercargill, New Zealand.

TOPS! Our booklet "How To Collect Stamps." Send for your free copy today! Littleton Stamp Co., Littleton 37, N. H.

1c EACH And less! Thousands of bargains! Cole, 43-A Rinewalt, Buffalo 21, New York.

FREE 500 Hinges and 25 different Hungary with approvals. Jaydee, 218 W. Dickinson, Grand Rapids 7, Mich.

COLLECTION Of French Colonies, 50 different pictorials, 10c with approvals. Fields, 1939 E. 85, Cleveland 6, Ohio.

\$1-\$2-\$5 UNITED States, commemoratives, airmail, high values in large collection United States stamps only 5c to applicants United States approvals. Metropolitan, 140B Nassau, New York 7.

UNITED States stamps nearly 100 years old, Roosevelt set, others, 40c value—only 5c to applicants United States approvals. Wakonda, 140G Nassau, New York 7.

FINE, Foreign approvals. French colonies. Stamps for International album, 1 and 2. Frank Moret, 1001A Sidney, St. Louis 4, Mo.

LEADING Stamp paper—Sample copy free. Western Stamp, Albany, Oregon.

INTERESTING Stamp weekly. Next ten issues 10c. Southern Philatelist, Miami 42, Florida.

50 INDIA 10c plus big packet price list. Chase, 1026 Walker Avenue, Oakland 10, California.

FREE Asia, Africa, Europe packet. Approvals. Desk C. Standard Stamp Co., Barneveld, N. Y.

YOU Need these! All six for 10c! To introduce our exceptional approval service, we'll send you: 1. Pocket stock book. 2. Watermark detector. 3. Stamp tongs. 4. Perforation gauge. 5. Book for duplicates. 6. Package of stamp hinges. All only 10c to approval applicants. Free! Big list other bargains. Jamestown Stamp Co., Dept. K, Jamestown, New York.

COLD-Blooded murder! 200 British Empire stamps: Contains new colonies of Norfolk and Tokelau Islands; Grahamland (Britain's only colony at the South Pole); Pakistan; Nepal; big stamp commemorating murdered Mahatma Gandhi; many other fascinating varieties, including stamps cataloging up to 20c each! Amazingly low price (with approvals) only 10c! Kenmore Stamp Co., Section 15, Arlington 74, Mass.

FREE! United States commemorative price list. Historical Stamp Co., 1280 Ocean Ave., Brooklyn 30, N. Y.

50 DIFFERENT U. S. 10c. No approvals. Pricelist free. Seidenberg, Cassopolis, Mich.

PENNY Approvals by country. M. H. Hoerning, 15, Farmington, Ark.

FREE—Illustrated catalog. Kenmore Stamp Co., Dept. 37, Arlington 74, Mass.

AIRMAIL Packet—Worldwide. Big bargain. With approvals 5c. A. Wirth, Norwichtown, Conn.

CASH For your duplicates! Particulars free. Goliath, Bethlehem 7, N. H.

128-PAGE United States catalog—1000 illustrations. 25c. Harris & Co., 202 Transit Bldg., Boston.

EXOTIC Pictorial collection; Sakalava Chief, Fezzan Ghadames, Djibouti, Togoland, Reunion, Andorra, Algeria, Miquelon, Tunisia, Monaco, Guadeloupe, Martinique, Many others. Everything 5c. Imperial Stamps, Tampa, Florida.

FREE! Illustrated United States catalog. Low prices! Americo, Bristol, Conn.

1/2c UP U. S. or foreign approvals by countries. Hurt & Fosse, Blue Ridge, Virginia.

\$5.00 CATALOG Price for 10c! (1) Big collection 112 all different stamps from Africa, South America, South Sea Islands. (2) Four desirable unused U. S. cataloging 40c. (3) Fine packet 25 British Colonies; Burma, Solomon Islands, etc. (4) U. S. \$5.00 high value. Everything (all four items) only 10c with approvals. Crystal, Littleton 41, New Hampshire.

WOW! \$10.00 Worth of fun 10c! What a treasure hunt! Big package 500 foreign stamps, including airmails, pictorials and others from the world over; stamps worth up to 25c each. This offer sent for 10c to approval applicants only. Jamestown Stamp Co., Dept. 22, Jamestown, New York.

UNITED States approvals complete coverage, fine quality, attractive prices. Seminole Stamps, Box 1138-P, Coral Gables, Florida.

\$1.00, \$2.00, \$5.00 U. S. Free. Approval applicants. Flamingo, Box 4038, Miami 38, Florida.

"MAN Size" United States approvals! Illustrated catalog! Sullivan, Endicott Arcade, St. Paul 1, Minn.

FLAG Stamp free with U. S. approvals. Wegman, 1933 Patterson, Chicago.

50,000 STAMP Grabbags 25c each. Anderson, 630 Bingaman 1, Reading, Penna.

WORLDWIDE Different. 200, 25c; 500, 50c; 1000, \$1.25; 2000, \$3.00; 5000, \$15.00. Beacon Sales, Maynard 2, Mass.

U. S. Price list. Send postage. State Stamp Service, 1225 Park Building, Pittsburgh 22, Penna.

200 DIFFERENT Including Roosevelt triangle, 5c to approval applicants. M. Avalon Stamp Company, Springfield, Mass.

FREE! Crystal-mount samples! Har-risco, 202 Transit Bldg., Boston.

BINGO! Jackpot collection! Triangles, maps, animals, midgets. All for 5c to approval applicants only. Southwest Stamps, Box 117, Long Beach 1, California.

FREE U. S. price list, postage 3c. Mark Hanna, 335 5th Ave., Pittsburgh 22, Penna.

WORLD—500 Diff. 50c, 1000 \$1.25, 75 Canada 25c, approvals, lists. Victoria Stamp Co., London 4, Canada.

WORLD'S Largest stamp (7 1/2 x 14 inches). A real curiosity! Retail for 50c, only 3c to approval applicants. Tatham Stamp Co., Springfield 30, Mass.

FREE! 100 Worldwide different stamps to approval buyers. Big U.S. and illustrated bargain lists sent with approvals. Bookman, Maplewood, N. J.

STAMP Collections wanted. Complete collections, duplicate lots, surplus stock, mint and used. Prefer trade for printing or other items, buy outright if priced right. What have you, what's wanted? Vanroy Shirk, Lebanon, Penna.

DEALERS—Wholesale list. Postage 3c. Frank, 5031 Queensberry, Baltimore 15, Md.

OLD Scarce U. S. seconds on approval. Slightly defective, bargain prices. Her-nfield, Clintonhill Station, Newark 8, N. J.

25 ALL Different stamps 10c. Tunis, Wakeman Ave., Newark 4, New Jersey.

POUND Stamps containing thousands \$1.00. Longacre Shop, 108 West 42nd, New York 18.

ZOWIE-E! A barrel of fun for only a dime. 500 United States stamps—absolutely unpicked and unsorted—just as received from church missions. Many varieties, including large commemoratives, airmails, high denominations up to \$5.00! Stamp-dom's biggest package of fun—and you might find something really valuable! Price only 10c to serious approval service applicants. Money back if not delighted. Illustrated bargain lists with each order. Mystic Stamp Company, Dept. 80, Camden, New York.

UNITED—States commemorative collection. Thirty-three different unused. Columbian to 1943 issues only. Price \$1. Request approvals. "Stamps," Albany 4, New York.

NICARAGUA "Tin Pan Alley" diamond. Ecuador showing George Washington, and American flag in natural colors. Fezzan, Trieste, "American Army" stamp, first U. S. commemorative, \$100.00 Shanghai, Corsica, Anzac, Antique, others. All 5c. Approvals. Capital Stamp Co., Dept. 2, Little Rock, Ark.

COINS, TOKENS, CURRENCY

3-LEGGED Buffalo nickel \$1.25. 20 different Indian cents \$1.00. 1932-D quarter \$1.00. 1932-S quarter \$1.00. 255 page guidebook \$1.50, handbook 75c; giant bargain catalogue 15c. Bebee Coin Company, 1180 East 63rd, Chicago 37, Illinois.

20 DIFFERENT African coins \$3.00. 200 different African stamps \$3.00. Send dues in dollar bills registered. Burnman, Kitwe, Rhodesia, Africa.

FOREIGN Coins. 10 different. 25c. Lists. Oliver Arnold, Macon, Mo.

100 COINS And bills, \$1.00. Oddehon, Box 482, St. Louis, Mo.

43 MIXED Indian pennies \$1.00. 33 different foreign coins \$1.00. Chelsea, 40 West 18, New York City 11.

OLD Money wanted. Do you know that coin collectors pay up to \$100.00 for certain U. S. cents? And high premiums for all rare coins? We buy all kinds. Send 4c for large coin folder. May mean much profit to you. Numismatic Co., Dept. 20, Fort Worth, Texas.

100 DIFFERENT Oriental currencies \$1.00. South China Overseas Corp., Box 2112, Hong Kong, China.

MAGNIFICENT Stock of U. S. coins. All series. Catalogue listing 2500 coins 15c. \$50,000.00 stock of gold coins. Worldwide selection. Catalogue 15c. James Randall, 116 South Michigan Avenue, Chicago 3, Illinois.

FREE: Mexican ten peso bill and coin list. Send self-addressed stamped envelope. Ben's Coin Company, 31 North Clark, Chicago 2, Illinois.

GET Profit and pleasure in collecting old coins. Send 10c for 56 page illustrated coin catalog. You'll be delighted with it. Send for it now. B. Max Mehl, 370 Mehl Bldg., Fort Worth, Texas. Largest rare coin establishment in U. S. Established 49 years.

FREE! Foreign coin, banknote and coin collectors illustrated catalog to approval service applicants. Send 3c postage. Tatham Coinco, Springfield 30, Mass.

COINS Wanted, will pay up to \$2000 for certain coins, send 25c for catalogue. Burton's, 111 So. Third, Columbus, Ohio.

COMMEMORATIVE 1/2, Oregon, Texas, Kentucky, Cleveland, Long Island. \$2.00 ea. Illustrated catalogue 25c. Norman Shultz, Salt Lake 9, Utah.

ANTIQUES, RELICS, INDIAN GOODS, CURIOS

10 ANCIENT Indian arrowheads \$1.00. Tomahawk \$1.00. List free. Lear's, Kirby, Arkansas.

PRECIOUS STONES, MINERALS

ZIRCONS, Diamond-like white, blue, or golden, 1 1/2 carat size plus 2 crystal clear sparkling zircon side stones \$5.00. Others. Catalog 10c. Imhusex, Box 232, White Plains, N. Y.

GEMS—Save money buy direct. Zircons, and other semi-precious stones. Catalog free. J. Lavinger, 1140 Adams, Redwood City, California.

URANIUM. Locate deposit. Cash in on government bonus \$10,000. Generous sample \$1.00. Wendt, Troy, New Hampshire.

"GENUINE" Deep red Arizona rubies (Garnets). Send quarter for packet. Bitner's, Box 2651, Phoenix, Arizona.

GEMSTONES, Mineral specimens. Every variety. Lowest prices. Postcard brings free list. Plummer's, 217C Bacon, San Diego 7, California.

GEMS, Precious and semi-precious, all genuine, from world wide sources. Deal direct, no overhead, save money. Catalog 10c. Hill Co., Route 7, Salem, Oregon.

METAL Detectors. The very latest circuit. Send 25c for literature. Hedden Metal Detectors, 3329 Liberty Ave., Pittsburgh 1, Penna.

HOBBIES AND COLLECTIONS

WANTED. Old cigarette cards. Write Charles Bray, East Bangor, Penna.

THREE Military emblems and price list 10c. Hobbyguild, 57B Sumner Ave., Brooklyn, N. Y.

50 DIFFERENT Army embroidered patches \$1. Other bargains. Insignia Mart, 703A Broadway, New York 3, N. Y.

UNPAINTED Plaster ornaments, Loxite for moulds. Free literature. Midwest Novelty Manufacturers, Box 788-A, Anaconda, Montana.

UNUSED Matchbook covers—100 different \$1.00. Catalog 10c. Charles Edelman, 1311C East 84, Cleveland 3, Ohio.

INVENTING Can be an interesting and profitable hobby. Write for complete particulars. Institute of American Inventors, Dept. 40-E, 1926-Eye St. N. W., Washington 6, D. C.

CAMERAS, PHOTO SUPPLIES

NEW Low priced camera, develops and prints pictures. Speed Camera, 7 Bicknell Street, Norwood, New York.

ELECTRONIC Photoflash outfit. Eliminates flashbulbs. \$49.50 complete. Very limited quantity. Precise, 942 Kings Highway, Brooklyn 23, N. Y.

PRISMS. Government surplus. Ideal for experimenters. Silvered for making photo-stats on enlargers. Unsilvered for showing spectrum, reflecting telescopes, etc. 1 1/4" size \$1.00. 1 1/2", \$1.50. Wolf, 1261 Union Street, Brooklyn 25, N. Y.

PHOTOGRAPHY For pleasure or profit. Learn at home. Practical basic training. Long established school. Write for free booklet. American School of Photography, 1315 Michigan, Dept. 343C, Chicago 5.

MINIATURE Camera, \$7.95, imported "Mighty," half size of cigarette package. 4.5 lens, excellent enlargements. Camera and leather case, \$7.95. Roll film, 10 exposures, 20c. Fotosonic, 132 W. 43 St., New York City.

CAMERA-50c Camera-50c camera-50c camera-50c. Rent new Argoflex camera, for indoors and outdoors, 50c for 10 day period. Write for free application blank. Fotosonic, 132 W. 43 St., New York City.

BASS Says: Bargaingram 257 ready and waiting for you. The book which tells all. The finest in new and used camera equipment. A veritable encyclopedia. Write, phone or call the sign of the old "Horse Trader." 39th year of satisfaction or your money back dealing. Bass buys, sells and trades. Bass Camera Company, Dept. AG, 179 W. Madison St., Chicago 2.

PHOTOCOPY Anything, papers, books. No darkroom. 8 1/2 x 11" complete, \$6.95. Fotoflek, 4801 Yarmouth, Cincinnati 29, Ohio.

PHOTO FINISHING

AUTOMATIC Photo-electric finishing. 8-25c; 12-40c; 16-55c. Oversize, add 10c. Mississippi Finishing, 2212 East 12th, Davenport 4, Iowa.

SENSATIONAL! 8"x10" Enlargement, beautifully oil-colored, 50c. Surgals, 3300 Beach, Chicago 51.

GUARANTEED Film—Four rolls \$1.00, 116, 616, 120, 620, 127; eight exposure roll developed and printed 25c. Sun Photo, Box 202, Pittsburg, Kansas.

GREAT News! Price reduction on our famous Century jumbo oversize finishing. Our new Chicago plant makes these reductions possible, and new improved equipment, exclusive with Century, produces sensationally magnificent quality work. Any 8-exposure roll finished deluxe style only 30c. 12 exp. 45c. 16 exp. 55c. 36 exp. \$1.25. All oversize reprints 4c each. Free mailers. Send us your next order, you will be delighted with results. Century Photo Service, Box 5208, Chicago 80, Ill.

FILMS Developed. Quality work. Enlarged Fanfold prints. 35c 8 exposures, 45c 12 exposures. Pittsburgh Photo Lab., Box 9665, Pittsburgh 26, Penna.

PHOTOGRAPHY For pleasure or profit. Learn at home. Practical basic training. Long established school. Write for free booklet. American School of Photography, 1315 Michigan, Dept. 343C, Chicago 5.

FREE To camera owners! Amazing new sky-filter. Fits any camera. Given free to introduce our Supa Film finishing service. Film finished and 8 double size prints only 35c in coin. 12 to 16 exposures only 60c in coin. Fast dependable service. Quality work and low prices plus the amazing \$1.00 sky-filter free. Satisfaction guaranteed. Keep sky-filter regardless. Send exposed film and coin today. Supa-Film Service, Box 6398, Chicago 80, Ill.

FREE Price list on quality developing, printing, enlarging. Write for it today. Bryan's Photo Shop, Dept. M, Panama City, Florida.

8 HOUR Service, Box 468, San Francisco. Your 8 exposure roll printed jumbo or regular size 30c; 12 exposures 35c; 16 exposures 50c; 36 exposures \$1.00. Reprints, jumbo or regular 3c. Regular prints deckled. Fine grain developing. Send for free mailers. Quality Photo Service, Box 468, San Francisco 1, Calif.

TOP Quality and immediate service. Your 8 exposure rolls developed with jumbo prints 35c. Write for free mailers, price list and gift enlargement offer. Send to "Mail To-day," Box 1112-C, Altoona, Penna.

FREE Snapshot magazine, photofinishing list, mailers. Henry Houghton's, Athol, Massachusetts.

8 PRINTS From your roll or negatives 30c; 12-40c; 16-55c. Or 8 double size enlargements 35c; 12-45c; 16-65c. Highest quality. Overnight service. Young Photo Service, 405-E, Albany 2, N. Y.

16 ENLARGED, Jumbo, oversize deckled prints from any 6-8-12-16-20 or 36 exposure roll film developed only 35c and this ad. Electronically exposed. Enlargement coupon free. Skrudland, 6444-R Diversey, Chicago.

8 BEAUTIFUL Double size pictures and roll developed 30c. 8 hour service. Free mailers. Pacific Photo Service, Box 666, San Francisco, Calif.

EXPERT Finishing. Roll developed and 8 prints 30c. Rancho Photo, Dept. P, Ontario, Calif.

2 BEAUTIFUL Hi-Gloss prints each good negative and enlarging coupon with each 8 exposure roll developed 28c. Free mailers. Owlphoto Co., Weatherford, Oklahoma.

8 PRINTS All enlarged to nearly postcard size from your roll or negatives 25c; 16-50c. (Trial offer). Willard Studios, Box 3535A, Cleveland, Ohio.

MOTION PICTURES AND SOUND EQUIPMENT

UNIQUE Movies, equipment. Free catalog. Home Pix, 1674 Broadway, New York 19.

16MM. Films. Lists. Dime. Sam's Electric Shop, Passaic, New Jersey.

8MM. 16MM. Magazines B & W. \$3. Includes processing. Dephoto, 648 Helen, Detroit 7, Mich.

MOTION Picture technique at home. Big money. Special registration for veterans. Free catalog. Motion Picture Institute, Birmingham 4, Mich.

397 FREE Rental film sources. Latest compilation \$1.00. Waverlynn Company, Dept. 3, 436 W. 42nd St., New York 18, New York.

FILM—Large discounts. 16 s.o.f., silent, 8mm. 100' 16mm. sound subjects, slightly used. \$1.75, 3 for \$5.00. Refund if dissatisfied. Free catalogs. Imperial Enterprise, Inc., Dept. P.M., 551 Surf Avenue, Brooklyn 24, N. Y.

SEND Ten cents for lists 8mm. and 16mm. motion pictures plus old time comedy star photographs. Film Classic Exchange, Fredonia, N. Y.

FREE Movies. Thousands of subjects. Interesting. Entertaining. Fascinating. New directory—only 50c. International Cine Society, Dept. 102-M, 1300 Taylor N. W., Washington 11, D. C.

8-2 1/4 x 3 1/4 NEGATIVES And prints from 16mm. movies, \$2.00; tie thread to wanted frames, cutting unnecessary. Benson's Studio, 232 N. Harvey, Oak Park, Ill.

DYNACOLOR. New. 8mm. At last you can afford color film. Send \$3.00 cash, check or m.o. or inquire today. Guaranteed. Dynacolor, Dept. M2, Rochester 3, New York.

SEND 10c for 1949 photographic catalogue. Bargain list included. Sterling's, 679 Northampton, Easton, Pennsylvania.

GUARANTEED Fresh 25' spools double 8 mm full color film! Processing free! \$3.80 each. 3 spools \$11.00. Catalog. Filmcraft, 47th Holly, Kansas City 2, Mo.

GUARANTEED Fresh anti-halo outdoor movie film! Weston 12! Daylight loading! Processing free! Three spools double 8 mm. \$3.45! Six single 8 mm. for Univex, \$4.60! Postpaid! Catalog. Filmcraft, 47th Holly, Kansas City 2, Missouri.

BASS Says: 39 years of leadership guarantees satisfaction. Finest cine equipment, 8mm., 16mm., and 35mm., silent and sound. Write the old "Horse Trader." Satisfaction or your money back always! Bass Camera Company, Dept. A, 179 W. Madison St., Chicago 2.

TITLE Making, free booklet. Westwood Company, 635 Victoria Street, San Francisco, California.

LEARN Movie projection, management. Free catalog. Theatre Institute, Elmira, N. Y.

I BUY, Exchange, swap movies. What have you? What do you want? Lowest exchange rates in world. Catalogue \$1.00. Refundable. Harvey Iris, Box 539, Brockton, Mass.

MUSIC AND MUSICAL INSTRUMENTS

FRASER Violins lead all! Folder. Fraser, 2025 Stark, Saginaw, Mich.

FREE Catalog. Latest records 39c. Jude Specialties, P.O. Box 1084, Altoona, Penna.

YOUR Poems set to music, recorded. Free booklet, attractive offer. Write. Songland, 331-C West 46th, New York.

SONGWRITERS Investigate new offer, submit poems. Honest criticism. Copies furnished. Nat Gardner, 1650T Broadway, New York.

STREAMLINE Accordions below wholesale. Circular. Metro, 44 North Albany, Chicago.

REED Organ internal electric blower plans, patterns. Finch, 266 Sweeney, North Tonawanda, New York.

SONGWRITERS Attention! The amazing demand for phonograph records, accelerated by countless juke-boxes, warrants your immediate investigation. We are offering new writers the rare opportunity of having celebrated "hit" composer furnish music on reduced percentage basis for any likely poems received this month. Phonograph records are outselling piano copies 5 to 1. Recola Records, Hollywood 28, Calif.

POEMS Wanted. Percentage basis collaboration. Terry Tune Master, 709 1/2 PM North Broadway, Oklahoma City 2.

1949 ACCORDIONS. Wholesale, free catalog. American Accordion Center, 5329 Belmont, Chicago.

POEMS Wanted for musical setting. Send poems for free examination. Five Star Music Masters, 630 Beacon Bldg., Boston, Mass.

ACCORDIONS, Mikes, amplifiers. Save up to 50%, cash or terms. Buy direct, save middle man's profits. Del Principe, 307 South Wabash, Chicago.

SONGWRITERS! Outstanding, ethical offer. Hibbler, C5, 2157 N. Avers, Chicago.

SONGWRITERS—Publication collaboration. Newport Publishers, G.P.O. Box 1226, Syracuse, N. Y.

POEMS Wanted to be set to music. Free examination. Send poems. McNeil, Master of Music, 510-PM S. Alexandria, Los Angeles, California.

WRITE Songs. Big money and reputation. Write for information. J. Gordon Pub. Co., 201 N. Hoyne Ave., Chicago.

RADIOS, SUPPLIES, INSTRUCTION

SERVICE Your own radio. Simple easy-to-follow instructions. Save money, make money. Free information. Ridgeway Radio, Ridgeway, S. C.

TELEVISION Bargains, 10" \$174.50; 16" \$324.50. Mahogany cabinets. Richards, 33 Phillips, Andover, Mass.

FIX Any radio. Amazing new instrument locates radio troubles double quick. Simple instructions show you how. Thousands now in use. Free—write today for 28-page illustrated technical manual, "The Inside Story." Feiler Engineering Company, Dept. 8PM9, 945 George St., Chicago, Illinois.

HEADPHONES. Guaranteed U. S. Signal Corps used headsets with adjustable leather headbands and black Bakelite earphones. Special now \$1.99. Allen Radio, Dept. HPM, Clinton, Missouri.

BE A television announcer, director, actor or writer. Learn in Hollywood. Complete courses in school established 20 years. Radio Television Arts Academy, 3819 Wilshire, Hollywood 5, California. Approved for veterans.

COAXIAL Cable:—100 feet \$3.00; sample 10c. Harry H. Van Dick, Little Falls, New Jersey.

MAKE Simple, tubeless, batteryless, distance-getting crystal radios. Crystal and illustrated instructions 25c postpaid. Allen, 427-P, Clinton, Missouri.

FREE—Money saving bargain bulletins in radio and television sets, record changer, tubes, parts, amplifiers, speakers, etc. Write today. Radionic Equip't Co., Dept. 2006, 170 Nassau St., New York 7, N. Y.

BUSINESS OPPORTUNITIES

TRADE Magazines help you get ahead. Latest single copies. Over 1000 covering every trade, business and interest. List with prices, free. Commercial Engraving Publishing Co., 34C North Ritter, Indianapolis 19, Indiana.

START Home manufacturing business making Cleaning Compounds, Soaps, Insecticides, Cosmetics, Polishes, Food Flavors. No machinery. Literature free. Kemix, Park Ridge, Ill.

RESURFACE Butchers' chopping blocks with easy fast working portable electric machine. Unique service in wide demand with little competition. Large steady profits from full or part time work. Hill Machine Co., Box 677B, Rockford, Ill.

IF You do gold stamping or imprinting of initials or names write quick for free information that will help you open up big, brand-new market for your work. William E. Moore, Costume Button Jewelry, Box 546-M, Winnemucca, Nevada.

EVERYBODY Likes candy—Learn to make professionally. (Our 39th year.) Ragsdale Candies, D5, East Orange, New Jersey.

EARN \$50.00 Or more weekly operating vending machine route in your spare time. As small investment as \$13.95 will get you started. Details free. Danco Coin Machine Co., Dept. PM, 1302 E. Baltimore St., Baltimore 31, Md.

BE Independent—Own and operate routes of automatic popcorn and chewing gum machines. Will accept foreign coins. Also hand operated photo machines, peanut roasters, hotdog machines, snow ball machines, candy floss machines. Also supplies. Immediate delivery. Reference—Dun-Bradstreet. Prices—Factory to you. Coastal Photo Supply Co., Export Dept., Wallace, N. C.

"HOW To Get The Job You Want." Amazing plan. Works wonders. Secrets revealed. Write. Parker, Box 576-B, Cleveland, Tenn.

FOR An extremely profitable lifetime business, operate a collection agency-credit bureau. Easily learned. Free folder. Cole & Associates, Syracuse 2, New York.

ELECTROPLATING Instructions and formulas for brass, copper, cadmium, chromium, nickel, gold and silver plating. Instructions for baby shoe bronzing and gun blueing. All for \$1.00. M. Hyde, Box 2099-Station V, Los Angeles 3, California.

WHERE To buy 500,000 wholesale articles. Details free. Krueger, 3418 Wolcott, Chicago 13.

MAKE Money by mail. Particulars free. Dawson, 1308F, The Dalles, Oregon.

MAKE Strange plastic—1c pound. Makes attractive walls, floors, built-ins, roofs. Build charming home yourself, \$150.00 room. Bays Laboratory, Oklahoma City 9.

MAKE Perfume. Profitable mailorder business. Information free. "International," 6347 Parnell, PM-8, Chicago 21, Illinois.

METALLIZE Baby shoes. Excellent profits. New system assures success. Free details. Treasures Forever, 89-B Henry Ave., Lynn, Mass.

"WATERLESS Hand cleaner." Make, sell. No machinery. Build profitable business. Formula \$1.00. "Wax-o-Glass" cleans glass; polishes metals. Formula \$1.00. "Wipe-on auto paint" formula \$1.00. Metallizing baby shoes, complete process \$1.00. All four formulas only \$2.00. Satisfaction guaranteed. Ideal Formula Service, Park Ridge 7, Illinois.

PROFITABLE Mailorder business, selling to women everywhere. I received 200 orders from first small ad, operating from home. Folio, 25c, explains. Grant Lovell, 2166 South Shore, Erie 9, Penna.

MAIL Order offers increased income, independence, unlimited possibilities. Free literature. Manhattan House, 126 Lexington, New York 16.

DELIGHTFUL Plans from Australia, South America! Free book "372 Unusual Worldwide Businesses." \$800 month reported (exceptional). Work home (U.S.A.)! Prepare for surprise! Publishers-F6, Carlsbad, Calif.

ANNOUNCING Home study course in commercial baking. Practical basic training. Good field for those with aptitude. Nearly depression proof. Send for free booklet, "Opportunities in Baking Industry." National Baking School, 1315 Michigan Ave., Dept. 343B, Chicago 5, Ill.

IF You are looking for profitable mail order business that brings in the dollars, write today for details. Sullivan, Box 1563-M, Phoenix, Arizona.

START A Christmas card imprinting business. Write Dunbar, Middlebush, N. J.

MANUFACTURE And sell soap that removes grease. Formula \$1.00. R. Sickels, Metamora, Michigan.

MAIL Order News (55th year) brings you the mail order ideas you're looking for. Copy 25c. Clarence Woodfall, Publ., Route 3, Charleston, Ill.

RESILVER Mirrors at home. Formula 25c. Ideal Service, Park Ridge 8, Illinois.

BABY Shoe mountings. St. Albans Plating and Casting, So. Ozone Park 20, New York.

SELL \$2. Fire extinguishers. Locally, mailorder. Free starting offer. Lorrac Products, Albany 1, N. Y.

EARN At home, casting novelties. Free instructions using latex molds. Major Chemical Company, 164 Portland St., Cambridge, Mass.

WOULD You pay 3¢—first \$350 made? Illustrated book "505 Odd, Successful Enterprises" free! Work home. Expect something odd! Pacific, Oceanside, Calif.

MAKE Money spare or full time, casting metal toys and novelties. Big wholesale and chain store demand for cast metal autos, soldiers, ashtrays, banks, etc. keeps manufacturers busy. Production moulds furnished for up to 100 and more castings per hour. No experience or special place necessary. "Cash-in" on holiday orders now being placed. Write for full information and illustrations of patterns needed. Metal Cast Products Co., Dept. A, 1696 Boston Road, New York 60, N. Y.

UNPAINTED Figurines. Free list. Progress Company, 4033-P Chowen, Minneapolis 10, Minnesota.

EASY, Profitable and enjoyable business of your own—raising Chinchillas. Write for prices (wholesale and retail) of our Lanigera Chinchillas. The Chinchilla Ranch, Inc., PM-1, 259 E. Wells St., Milwaukee 2, Wis.

10,000 FORMULAS And trade secrets. Free literature. Stillman Co., 555 Kings-ton Ave., Brooklyn 3, N. Y.

SENSATIONAL Hand cleaner! (Not ammonia—kerosene.) 400% profit! Free manufacturing-distributing methods. Rythmo-C-Ex, Kingsport, Tennessee.

A Profitable business of your own. Particulars free. Redusoll Co., 356 S. Broadway, Los Angeles, Calif.

BRONZING Shows profits. Literature concerning equipment and process free. L. G. Jones, Box 7283, Ft. Worth, Texas.

SELL By mail! Ideas galore! Join Mail Selling Opportunities Club! Details free! R. Wehner, Box 142-A, Roxbury 19, Mass.

BABY Shoe metallizing. Everything you need to know. Schoettle, Friendship, Ohio.

COIN Machine that dispenses America's most popular and fastest moving candy bar. Terrific profit returns on investment as low as \$37.50. Unlimited opportunities. Saratoga-National Enterprises, 101, 2317 Fruitvale Avenue, Oakland 1, California.

START Your own business on credit. Always your own boss. 1554 dealers, sold \$5,000 to \$26,500 in 1948; their average \$6,742. We supply stocks, equipment on credit. 200 home necessities. Sales experience not needed to start. Wonderful opportunity to own pleasant, profitable business backed by world-wide industry. Write Raleigh Co., Dept. H-U-PPM, Freeport, Ill.

SPARE Minutes bring dollars selling this new burn ointment. Free details. Clover Products, 11860 Mississippi Ave., Los Angeles 25.

HOW To set up and run a mirror shop! Resilver mirrors. Make chipped glass nameplates. Electroplating salts and rectifiers. John Sprinkle, V60, Marion, Indiana.

FIX Typewriters, full or part time. Inexpensive copyrighted home study course quickly trains you for high earnings. Factory methods cover all phases with drawings and illustrations. No curiosity seekers. Typewriter Repair, 8915 Corbet, Tarentum, Pennsylvania.

BABY Shoe business for sale with or without manufacturing equipment, bookends, ash trays, photopanel, 400 satisfied retail distributors with samples, 25,000 advertising folders. A going business that will stand closest investigation. Priced for quick cash sale. Provo Statuized Shoes, Escanaba, Mich.

EARTHWORM Breeding. Valuable bulletins on successful methods mailed free. Earthmaster Publications, Dept. 14, Sun Valley, Calif.

BE Independent—Operate America's lowest price penny vending machine. Big profits. Immediate shipments. Write for bulletin and prices. Fielding Mfg. Co., Desk 89, Jackson, Mich.

"ELECTROPLATING-Know-How" includes baby shoe metallizing and other lucrative fields for you. Write for my free illustrated booklet! Joseph B. Kushner, Electroplating Consultant, Stroudsburg 19, Penna.

POSTCARDS: Bring orders galore. 75c, \$1.25, \$1.50 profit per order. New, no stock to buy or carry. Nothing like it elsewhere. Stamped addressed envelope. Agents wanted now. Fiant's, Duenweg, Mo.

LEARN Piano tuning at home in thirty days. Unlimited income. Sound recordings, electric record player, tools and instructions furnished. Write Capitol City Tuning School, Department PM, 211 East Michigan, Lansing, Michigan.

MAILPROFIT Making! Five all different propositions selling to women! New, "different" ideas. Profits good. Merchandise finest. Complete five ideas, order filling instructions, service sales outline, sample "Leader" ads, for just 25c. No postals answered. Mail Marketing Services, Rt. 1, Box 522 1-B, Dayton 5, Ohio.

HOW To look ahead and make money. No one ever made money if he did not know how to look ahead. Our books teach you how. Send your name and address for free moneymaking literature. Book manuscripts of all types wanted for publication. Send yours. Immediate report. Granite House, Book Publishers, 675 Congress Street, Portland, Maine.

MAKE New auto product at home. Sells on sight. Box 552, Memphis 1, Tenn.

NEED Money? Make and sell glamorous, sparkling costume jewelry. Complete kits with full instructions. Free literature. Jewel-Craft, Vanceburg, Ky.

"1000 ITEMS Free." A book you can sell. Write—Round The World Press, Dept. PMM, Buckeye Lake, Ohio.

OPPORTUNITIES Course on manufacturing, mail order, formulas, supply source. Free information. Roberts Publications, 433-A East Galena Street, Butte, Montana.

LEARN Piano tuning, repairing at home. Tremendous field! Piano parts, tools furnished. Established 1935. Empire School of Piano Tuning, 606-B East University Ave., Champaign, Illinois.

CARNIVAL Concessionaires earn tremendous salaries. We want men to operate concessions in your territory. Write for details. Lawrence Concessions, 464C Walnut Avenue, Elgin, Illinois.

BE A manufacturer. Flock Christmas trees and decorations for florists and retail trade. Big profits, no house-to-house selling. Send \$1.00 for complete instructions showing how to do the work—how to get the business. Carpenters, 4534 Woodlawn, Chicago.

HOME Business opportunities. Mail, local. Details free. Etterman, 1991-B8 Lake, Muskegon, Mich.

SELL Merchandise by mail. Big profit business! Everything furnished—orders filled for you! Easy, pleasant. Write: National, Box 88-Y, Dorchester 22, Mass.

MAKE Big money in home mail business! Few dollars starts you; interesting, profitable! Write: Smith, Box 2592-A, Hines, Illinois.

100 BUSINESS Ideas—Formulas. Also 200 plans for heavy duty machines for shop, home, farm. Flasco Sales, 2505VC 150 Street, Flushing, New York.

AMAZING Marble-glazed cement pottery, Hollywood style, without moulds. Benches, fountains, stucco-rock walls, garden ornaments; chemically colored. Dime brings sample, pictures. Hollywood Cementcraft, 8527-R Wonderland, Hollywood 46, California.

SELL By mail. Unusual opportunities. 10c brings 60 page informative trade magazine. Isbell, Suite 619-PM, 216 West Jackson, Chicago 6, Ill.

BIG Money. Spare or full time in your home. No selling! Spray new miracle finishes, plush and suede, on signs, radios, automobiles, figurines, lamps, toys, etc. Our business is booming. Help us fill huge demand. New easy Flok-Kraft methods. Material costs few pennies. You get dollars. Free samples, complete powerful money making plan free. Write now! Coast, 1010 S. Los Angeles St., Los Angeles 15.

FIGURINES And all supplies for Dresden painting. Gift ornaments. Unpainted, many to choose from. Start a profitable business; hobby. Send 25c for catalog. Will refund on first order. Suiter Art Industries, 314 Westport, Kansas City, Mo.

PROFITABLE Business making and building with easy-laying interlocking building blocks. Rex Products, Dept. 10, Piqua, Ohio.

FREE Particulars of money making plans. Pierce, Box 235, St. Louis 3, Mo.

RAISE Earthworms. Easy, profitable. Send for free literature or send dollar bill for illustrated book. Money back guarantee. Earthworm Culturists, Dept. P, Box 83, Station C, Atlanta 5, Ga.

PART-TIME. All ages. \$2.00 hour up. Sell creme shampoo. Every home uses. Free sample, details. Twice, 5672-A Fernwood, Hollywood 28, Calif.

LEARN Sewing machine repairing at home. Install our wholesale motor kits. Make \$125 to \$300 in a week. Free particulars. Taylor Service Co., Hamilton PM, Ohio.

FORTUNE For you in formulas. Eye-opening details free. Write today. Allen, Box 132, Ganges, Michigan.

NEW Industrial hand cleaner. Free manufacturing-distributing plans. Unusual money-making proposition. "Acro-Sol-Ex," 623 West 14th Ave., Denver 4, Colorado.

DOLLARS In personalized baby record books. Sell by mail. Use same literature we do. No-Co-Ro, Oakland 6, California.

UNPAINTED Figurines—Wholesale, retail. Illustrated list free! Oman, 642L Broadway, St. Paul 1, Minnesota.

SELL Big money-maker to men and women. Easy handwork makes fast-selling useful articles. Sunmade Company, Brockton 64, Mass.

CO-PUBLISH And advertise in The Central Mail Advertiser. Sample copy 10c. Low rates. Large circulation. Bagby Printing Co., Georgetown, Ohio.

DEPRESSION Insurance! Own money-making business. Information free. Pru-AM, Kingsport, Tennessee.

BIG Money! Made in lettershop operation! Easy pleasant work. Free details! Woods Letter Service, Bedford, Penna.

GET Free literature. Wholesale supply sources. Money making items. Formulas. Allen Service, 245 Main, Ganges, Mich.

MAKE Rubber stamps, metalize baby shoes, repair dolls, silver mirrors, make plaster novelties. Catalogue of "30 ideas" free! Universal, Box 1076-A, Peoria, Ill.

NATURAL Molding Latex. Extra thick. Free sample. W. Wooley, 115-A Donald, Peoria, Ill.

SPECIAL Rubber for making molds. Literature and sample free. Universal, Box 1076-A, Peoria, Ill.

SELL Jewelry by mail. Everything furnished ready to go. Orders filled; small capital. Tremendous possibilities! Jomay, Box 1224-A, Toledo 3, Ohio.

CASH For your idea. 280 manufacturers need inventions, patented or unpatented. List free. Invention Bureau, 208M Clinton, Oak Park, Illinois.

MAKE Money making new greaseload doughnuts at home on electric machine. Wholesale to grocers, drug stores, cafes, hamburger shops. Send for free recipes and plans. M. Ray Company, 3605 South 15 Ave., Minneapolis 7, Minnesota.

LIQUID Rubber, make flexible molds. Free sample. Chaney, 1130 E. 16th St., Jacksonville 6, Fla.

RECAST Old batteries into new. Latest achievements. Battery Laboratories, Minneapolis.

"SPECIALTY Manufacturing." Big money business. Start on small capital with dependable formulas. Send for free interesting booklet. Howard Robinson, Ph. G., 1300-A South Ohio Street, Sedalia, Mo.

MAILING Postcards selling repeat merchandise is profitable. Everything supplied. Details free. Gordon Publishers, Box 23, Pawtucket, R. I.

"HOW To start a successful mail order business." The guide to sound, profitable mail merchandising. 25c. Manhattan House, 126-B Lexington, New York 16, N.Y.

ENVELOPES Addressed accurately, reasonably. Fast service. We have capable addressers in your city. Glenway System, 5713-Y Euclid, Cleveland 3, Ohio.

HOME Business making statuettes, plaques, artificial marble, rubber molds. Metallizing baby shoes. Silvering mirrors. Formulas. Folder free. Creative, 236-I, Winnetka, Illinois.

VENDING Machines earn big money! An investment as low as \$10.50 will start you in this fascinating, profitable business that can lead you to the road of success and independence. Routes can be established and operated in either full or spare time with no experience needed. Write for full details and our free catalog illustrating our nut, candy, gum and stamp vendors; also pin ball machines, music boxes, etc. Write immediately to Parkway Machine Corporation, Dept. 7, 623 W. North Avenue, Baltimore 17, Maryland.

YOUR Own profitable home business. Preserve live flowers to last forever. New simple discovery. Enormous demand all year 'round. Tremendous profits! Light fascinating work. Send \$2.00 for working equipment, instructions, and valuable sales plans. Satisfaction guaranteed or money promptly refunded. Alfred Hermansen, 210 Fifth Ave., Suite 1102A, New York 10, N. Y.

NO Selling, operate vendors, amazing profits, details free. Silver-King, Suite B, 622 Diversey, Chicago 14, Ill.

I MAKE Big money in the mail-order business. You can do the same at home with copyrighted system. Write me. I'll tell you how. F. Little, R.D. #1, Glenshaw, Penna.

POPCORN Equipment, potato chip outfits. Long Eakins Company, 4960 Hi Street, Springfield 99, Ohio.

READ "Advance"—The voice of mail order. Offers money-making opportunities, sources of supply, personal guidance, etc. Issued monthly. Sample copy 25c. Yearly subscription \$2.00. Advance Publishing Company, 313 East 21st Street, Suite 450, New York 10, N. Y.

A BUSINESS In your own home! Our chemicals, plus free water and cheap "grocery store" materials can bring you over \$500 monthly earnings. Plans and formulas free. Chemica Division, 1269 S. Norton, Los Angeles 6.

A FACTORY In your home garage! Mfg. and sales rights, mechanics' waterless hand cleaner, \$500-\$800 monthly. No special equipment necessary. Formula free. Western Aircraft Mfg., Dept. D, Los Angeles 6, Calif.

OPERATE Profitable mail order business. Write Walter Service, 4159-A East 112th, Cleveland 5, Ohio.

COLORGLAZED Concrete pottery made without molds. Patented method. Cemetery products, novelties, tiles. Basement leak-sealing. Money-making projects. Booklet, details free. Men only. National Potteries Company, Grand Rapids, Minnesota.

START Mailorder bookshop—Everything furnished. 25c brings booklet, samples, exciting ideas. General Publications, Ossining, N. Y.

\$25 WEEKLY Working two hours daily. No canvassing. No manufacturing. Lycke, Box 2471, Cleveland 12, Ohio.

137 WAYS To make money, in home or office, business of your own. Full particulars free. Elite Co., 220 Grand St., New York 13.

BRUSH Plating outfits connect to a battery. No tanks necessary. Good paying business at home plating autoparts, bathroom fixtures, bicycles, reflectors, silvering mirrors. No shop or experience required. Outfits furnished. Free booklet, Gunmetal Co., Ave. H, Decatur, Ill.

COPUBLISH Leading m.o. paper. Latest copy Mail Sale Advertiser and proposition, dime. Vanroy W. Shirk, Lebanon, Penna.

MONEYMAKING OPPORTUNITIES

TREMENDOUS Demand for Creme Shampoo brings terrific profits. Formula, directions, \$2.00. Ruiz, 3933 Greenview, Chicago.

ASSEMBLE Swiss musical church. Complete kit \$3.50. Sells on sight. Piltzecker Swiss Imports, Wood-Ridge, N. J.

MAKE Money sharpening and gumming cross cut circular saws. Build machine yourself at small cost. Plans, illustrations, instructions \$1.00. Satisfaction guaranteed. Charles Lashley, Wellington 1, Ohio.

START A home business in spare time. Experience not essential. Literature free. Fairfax, 4262 Centenary Station, Shreveport, La.

ADDRESS, Mail circulars for advertisers. Full information and list of firms—25c. Write for other offers. Imperial, Dept. PM8, 902 South 9th, Wilmington, North Carolina.

HOME Mfg. enterprises. 70 projects, large variety, 500% profit. 100 illustrations. 56 pages, \$1.00. Home Industries, Omaha 5, Nebr.

THOUSANDS Articles wholesale. "Supply Source Directory" 10c. Ideal Service, Park Ridge 30, Illinois.

200 SELECTED Money making plans 50c. Special offer. New York Publishing Co., 86-44 121 St., Richmond Hill 18, N. Y.

BECOME An expert mail order specialist. Information free. J. W. Stenger, 500-20th St., Rock Island, Ill.

FREE Book "372 Unusual Worldwide Businesses." Successful! Australia, South America! Not hokum! Work home (U.S.A.). "Different" plans. Prepare for surprise! Publishers-F7, Carlsbad, Calif.

MAKE Money selling Christmas decorations. Details from Wales Xmas Co., Cold Spring, N. Y.

WOULD You pay 3%—first \$350 made? Illustrated book "505 Odd Successful Enterprises" free! Work home. Expect something odd! Pacific, Oceanside, Calif.

SAWDUST. Turn it into cash. Six methods. Instructions 25c. Charles, 12-APP, Norwood, Ohio.

FISHWORMS. Easy raise, sell, hundreds, millions. Surface without digging. Instructions 50c. Charles, 12-APG, Norwood, Ohio.

EARN Money evenings, copying and duplicating comic cartoons for advertisers. Adservice, Argyle 1, Wisconsin.

15 MINUTES Masters advertising and sign lettering, complete system; sign painters' secrets; cartooning book; all three \$1. Free circular. Abenterprises, Box 875-M, Peoria, Illinois.

MAKE Extra money sparetime. Work at home. Literature free. Liebig Industries, Box 400M, Beaver Dam, Wisconsin.

UNPAINTED Bookends, plaques, statues, figurines. List. Haverty Products, 1219 8th Ave., Altoona, Penna.

CHURCHES. Organizations, earn \$100.00 plus 24 card tables. Free delivery. Box 392, Clementon, New Jersey.

MONEY-Making opportunities galore including magazines, 10c. Wilbur Erickson, Englishtown 12, New Jersey.

DOLLARFUL Ideas for you every month in advance—"Voice of Mail Order." Leads the field in exclusive supply sources. Plans for mail order operation; new products, etc. Details free. Advance Publishing Company, Suite 350, 313 East 21st Street, New York 10.

POPCORN Poppers, vendors, peanut roasters, copper kettles, bottled gas, gasoline burners; new, used. Northside Sales, Indianola, Iowa.

DEPRESSION Insurance! Own profitable business. Information free. Pru-Ex, Kingsport, Tennessee.

UNUSUAL Back yard money-making opportunities! Fully outlined! Write: Pickett's, 62-A Sanders, Florence, Kentucky.

START Profitable home business in spare time. Make extra money raising Golden Hamsters. Small, clean, odorless. New. Unlimited market. Literature free. Golden Gate Hamstery, 631-H Richmond Street, El Cerrito, California.

READ Progressive Mailtrade, the magazine that tells how to make money by mail. Dime brings sample and special offer. Progressive Mailtrade, Box 357, Sheboygan, Wisconsin.

PROFIT With Larson Leathercraft. Belts, purses, 100 other ideas. Largest supply in U. S. Catalog 10c. Larson, Dept. C, 824 S. Tripp, Chicago 24.

WIN Contest money. General Contest Bulletin gives hundreds of tips. Lists current contests and rules. Sample 25c. General Contests, 1609½ East 5th, Duluth, Minn.

PUBLISH Your own magazine. Hand-some 52 page format, well edited, illustrated. Cost low as \$1.00 month. Brings you prestige, profits. 25c brings sample, details. National, Ord. Nebr.

PRIZE Contest bulletin gives various contests now operating, and valuable hints. 3c stamp. National Contest Bulletin, Box 2685P, Miami, Florida.

RUSH Card—Five profitable small capital mail sales propositions free. Schenck, 717-P W. Penn, Butler, Penna.

FORMULAS, PLANS, ETC.

PRODUCTS Analyzed. Duplicated. Improved. Formulas. Consulting Scientific Company, Swarthmore, Pennsylvania.

MAKE—Sell cleaners, soaps, polishes, flavors, cosmetics. No machinery. Formula literature free. Kemico, Park Ridge 16, Illinois.

FORMULAS. Processes, analysis. Free literature. Pricopoulos, 761 Worthington, Springfield 5, Massachusetts.

10,000 FORMULAS And trade secrets. Free literature. Stillman, 555 Kingston Ave., Brooklyn 3, N. Y.

24 MONEYMAKERS—Tested formulas for home manufacturing, 25c. Satisfaction guaranteed. Details free. Nelson, Howel, Kentucky.

11,146 FORMULAS. Postal brings literature. Formulab, 1707 Maryfield, Ann Arbor, Michigan.

FORMULAS For nearly everything. Catalog free. Write Creative, Winnetka, Ill.

TESTED Formulas. Interesting descriptive booklet free. Pont, Box 635-PM, Terre Haute, Indiana.

REAL Manufacturing formulas. Lists free. Cummings, Chemist, Gordon Ave., Syracuse 4, N. Y.

PLASTICS

FLEXIBLE Mold makers handbook. Be an expert. Send only \$1.00 for your postpaid copy today. Multi-Mold Products, 265 West 30 Street, New York 1.

LUCITE, Plexiglas. Any size sheets, masked. Square foot (12 x 12) cost, 1/16" 95c; 1/8", \$1.25; 3/16", \$1.50; 1/4", \$1.80. Colors add 10%. Include 10% postage. Almac Plastics, 230 Fifth Avenue, New York 1, N. Y.

NEW Liquid plastic. Clear, colors. Cast without heat. Embed flowers, insects, coins. Saw, drill, carve. Complete kit only \$3.95 postpaid, or send 25c for exciting new home project manual showing how to get started. Castolite, Dept. J-101, Woodstock, Ill.

PLEXIGLAS. Clear, colored, masked sheets, 76c per sq. ft., 1/16; 99c, 1/8; \$1.21, 3/16; \$1.43, 1/4; \$1.86, 3/8. Internal carving blocks \$1.00 lb. Write Hub, 356P Congress, Boston, Mass.

"CASTING Plastics"—Latest edition of famous manual, \$1 per copy. Plastics Research, Box 346, Alhambra, Calif.

WHOLESALE Plastics supply catalog. 10c. Lucite, clear, colored. Metallic Acetate. Complete Castolite line. Phosphorescent, pearling pigments, dyes. Metal findings. Tools. Ideas and bargains galore. Fast delivery from stock. Gem-O'-Lite, Box 686E, North Hollywood, Calif.

PLASTIC, Sheets, rods, tubes, etc. Free list. Plastic Supply Co., 2901 N. Grand Blvd., St. Louis 7, Mo.

CHEMISTRY

MAKE Chemistry your hobby. Fascinating, educational, recreational, vocational. Large general catalogue. Chemicals and apparatus 15c. Microscopic stain catalogue 20c. Both for 25c. National Scientific Company, (Est. 1916), 2204 W. North Ave., Chicago 47, Ill.

HANDBOOK For chemical experimenters, illustrated, hundreds of experiments, 50c. Experiment booklet, 15c. Reading Scientific Company, Reading, Penna.

NEW Idea chemical and apparatus outfits for home experimenting. Photo-scales, microscopes, chemicals, biological and laboratory supplies in small quantities. Catalog 15c. Established 1931. John H. Winn, 124A West 23rd Street, New York, N. Y.

NEW Catalog: Chemistry, mineralogy, biology. 10c. Tracey Laboratories, Evanston, Illinois.

CHEMICALS And apparatus for industrial, analytical, and private laboratories. Catalog 15c. Dept. M-50, Biological Supply Co., 1176 Mt. Hope Ave., Rochester, 7, N. Y.

HELP WANTED

APPLIANCE Designer. Well established company in mid-west has permanent salary position for a man 35 years of age or under to design, develop and follow through on mechanical and electrical household applying and dispensing equipment. Write fully stating experience, salary requirements, and give references. All replies will be held confidential. M. Leve, Room 1158, Merchandise Mart, Chicago 54, Ill.

BOYS Wanted. Over \$2.00 hour! Sell name plates for front doors. Free sample. Write Dept. 51, National Engravers, 214 Summer, Boston, Mass.

HIGH School students—Earn big money selling our custom club emblems, "T" shirts, novelties, pins, decals and trophies at your school. Write for free literature. Jest-Art, Dept. M, Culver City, California.

AGENTS WANTED

AT Last! Something new and sensational in Christmas cards. Show gorgeous satins, velours and plastics never before offered. Gets easy orders fast! Pays big profits. Free samples of Christmas cards with name 50 for \$1, imprinted stationery, floral charmettes, napkins, 50 other assortments 60c to \$1.25. Samples on approval. Write, Puro Co., 2801 Locust, Dept. 940-K, St. Louis, Mo.

EXTRA Money yours—easy! Profits to 100%. Sell thrilling value plastic Christmas cards, 50 for \$1.00 personals, everyday, religious, children's, gift wrap assortments. Request deluxe 21-card \$1.00 Christmas assortment, name imprinted Christmas cards. Stationery samples on approval. Holiday Card Co., 463 Congress St., Dept. C, Portland, Maine.

EARN Extra money easily, sell new Christmas cards and gifts—'n-things. 21 folder ass't, sells for \$1.00, sent on approval; no investment. Get \$50 or more selling only 100 boxes. Amazing sample offers. Headquarters for new 3-dimensional Christmas cards. Plastics, genuine engraved etchings. We send free samples of easy-to-sell personal Christmas cards and stationery. Pen 'n Brush Studios, Dept. PM-9, 139 Duane St., New York 13, N. Y.

EXTRA Money! Sell friends Christmas cards—including fascinating plastics. 100% profit. Request free samples exclusive name-imprinted Christmas cards, stationery unobtainable elsewhere with Christmas and everyday assortments on approval. Regal Greetings, Dept. PM-8, Hazel Park, Mich.

QUICK, Easy, cash for you! Sell amazing variety new Christmas cards. Profits to 100%. Novel plastic, 3-dimension "Stage set," metallic, Christmas carol cards, gift wraps, animated books, table settings, 8 special offers. Bonus. Write for feature samples on approval and free samples 4 different name imprinted Christmas card lines, floral and personal stationery. Elmira Greeting Card Co., MB-109, Elmira, N. Y.

MAKE \$50 Selling only 100 boxes America's leading 21 card Christmas assortments. Samples on approval. Complete line plastics, wrappings. Free samples. 50 for \$1.00 name imprinted Christmas cards. Write Lorain Art Studios, Dept. AO, Vermillion, Ohio.

AMAZING Spare time earnings. Sell Christmas cards, stationery, napkins; 50 with name \$1.00. Complete line Christmas, everyday boxes. Profits to 100%. Write for samples. Empire Card, 135 Fox, Elmira, N. Y.

AMAZING Offer—\$40 is yours for selling only 50 boxes Christmas cards. Also 50 and 25 for \$1.00 with or without name. Free samples. Other boxes on approval, including entirely new, different deluxe assortment with feature television card. Cute plastic assortments. Write today. It costs nothing to try. Cheerful Card Co., 843, White Plains, N. Y.

SHINE Shoes without "polish." New invention. Lightning seller. Shoes gleam like mirror. Samples sent on trial. Kristee, 132, Akron, Ohio.

\$1.00 STARTS You in business. Sell men's neckwear full or part-time. Low investment, big profits. Send \$1.00, receive two sample ties, plus free catalogue, color pictures, selling plan. Radio City Neckwear, Dept. M1, 112 W. 50th, New York City.

SELL Fluorescent plastic signs. Iwano Plastic Products, 9108 Olivet Avenue, Detroit 9, Michigan.

EXTRA Money quick! Take easy orders low cost; high profit Christmas cards. Wonderful new type plastic, metallic assortments. Send at once for free 48-page catalog, feature samples on approval and free name imprinted Christmas card sample portfolios. Special offers. New England Art Publishers, North Abington 51, Mass.

EARN Extra money! Make up to 100% profit selling personalized Christmas cards, stationery, napkins, matches, playing cards, coasters and other personalized items. All items sell on sight. Request free catalogue. Lynne Novelty, 739 Riverside Ave., Elmira, N. Y.

FREE! Win television set and big cash prizes! Sensational offer. Make more money selling plastic Christmas cards, 50 and 25 for \$1.00, imprinted. Fast selling line, bonus. Free contest entry and portfolios. Richar's, 16AT East 18th, New York 3.

CHRISTMAS Cards. Earn \$5.00 with every ten 21 card \$1.00 boxes you sell. Also new \$1.00 plastic cards, personalized cards and stationery, note paper and wrappings. Send for samples today. Howard P. Ellis, Dept. PM-8, Pitman, N. J.

SELL Direct to homes, merchants, hundreds of items. Free catalogue. Champion Specialty, 816 Central, Kansas City 6, Missouri.

MUSIC Greeting cards. All occasions. Dorby Music Cards, P.O. Box 738, Morristown, New Jersey.

MAKE Money easily. New spare time plan. Up to 100% profit. No experience. Show unusual Christmas, everyday card assortments, plastics, gleam and glo, kiddies cards, wrappings. Attractive gift items. Bonus. Special offers. Send today for free samples 30 different Christmas cards with name. 50 for \$1.00 up, stationery, coasters. Thomas Terry Studios, 100 Union Ave., Westfield, Mass.

UP To 442% profits selling "Quick Determing Atomic Metal Plates." Instantly cleans silverware, jewelry, metals. Wholesale, retail, sideline. Manufacturers, 508-PM9 New York St., Aurora, Illinois.

MEN, Women—Sell character building gift items. Send for samples on approval offer. Al Hawkins Company, Sioux City 7, Iowa.

YOU Can make big money selling Mayer stainless steel aluminum handle cutlery. Write now for particulars. Mayer Company, Waterloo, Iowa.

SELL Dress fabrics to friends, neighbors. Stylish, beautiful materials. Year round profits. No experience needed. Free details. National, 640 Broadway, Dept. M, New York 12.

BIG Bargains for big profits. Over 100 sensational values. Men's used suits \$2, pants 35c, topcoats \$1.25, overcoats \$2, shoes 20c. Experience unnecessary. Free wholesale catalog. Superior, 1250-A Jefferson, Chicago 7.

EARN Big money plus sensational bonus. Be a one person department store. Sell men's, women's, children's apparel and accessories, etc. Free sales equipment. Corporate Merchandisers, Dept. PM-16, 547 Broadway, New York City.

SELL Newest and fastest selling item in plastic. Patented cover for old style bath tubs. Beautiful pastel colors. Cost \$42.00 per dozen, sell for \$72.00 and up. All orders f.o.b. Chicago, cash or c.o.d. Minimum orders 7 dozen. Marlin Sales Co., 2060 Milwaukee Ave., Chicago, Ill.

SELL Amazing non-electric fluorescent signs. Extraordinary brilliance. Huge profits. Patented process. Send \$1.00 for fast-selling samples. Hatt Industries, 1412-A Great Northern Bldg., Chicago 4.

PROFITS. Big demand and repeat orders selling rubber mats for home or auto. Free sales plan. Mitchell, Dept. PM8, 2140 San Fernando Road, Los Angeles 41.

PLASTIC Tablecloth covers, curtains, drapes, baby pants, bowl covers and other plastic articles selling like wildfire! Make big money now! Free details. Write L & M Co., Dept. 58-H, 510 St. Charles, St. Louis, Mo.

A SURE Way to make money. No exp. needed; Christmas cards sell fast! From 50 for \$1.00 with name! Big line box assts; profit up to 100%. Write for samples on approval. Mendler Art Company, 37A Pearl Street, Boston, Mass.

CALL On friends with sensational Christmas cards in handy assortments. Sell for \$1.00. Profit up to 50c. Also popular-priced personal Christmas cards, everyday assortments, stationery, imported napkins. Samples on approval. Wallace Brown, Dept. B-4, New York 10, N. Y.

FREE Nylons given if Kendex hosiery runs or snags! World's only women's hosiery sold with written guarantee amazing everybody. Mere words could not express unbelievable money-making opportunity. Fantastic earnings become reality. Armstrong earned \$202 in 9 days. Watkins sent 92 orders in one day. Imagine replacing hosiery free regardless of cause—whether use or abuse! Truly sales dynamite for terrific profits. Even if you never sold before, three magic words: "Guaranteed Against Everything" will open doors for you—make women listen and pour money in your pocket. Complete line from sneerest to service (15-20-30-40-60 denier) all lengths 28 to 35 inches—latest colors—seamed full fashioned and seamless. No competition because Kendex guaranteed nylons not sold in stores. Also complete line men's hosiery actually guaranteed for one full year! Nothing like this anywhere. Includes rayon, nylon, lisle, wool, cotton, mixtures, etc. All styles, patterns, colors, prices to please everybody. Thousands shipped daily. 100,000 pairs constantly in stock for fast delivery. Over 30 years in business. You need no money or experience. Nothing to pay now or later. Show free outfits. Write orders. We deliver and collect. Big advance cash plus huge bonus. Earn money spare or full time—exclusively or side line. No restrictions. Become manager—appoint others to sell for you—earn steady income on their sales. Complete money-making outfits including salesbooks in color, samples of hosiery materials, etc. furnished free and prepaid. Simply mail name and address to: Kendex Company, Babylon 83, N. Y.

A Dress yours with every 3 you order for yourself and family. Amazing new bonus plan. Everything free. Harford Frocks, Dept. A-335, Cincinnati, Ohio.

DON'T Sell junk! The Frawley chair-side coin rack is in America's finest hotels. Proven and accepted! Your local hotels, courts, hospitals, resorts, coin operators, investors, radio men, etc. are all prospects. Splendid commissions! Time payment plan and complete sales helps for easy selling. Write today! Hotel Radio Corporation, 3000 E. Jefferson Ave., Detroit 7, Michigan.

POWER Mower—\$59.50. Home agents. Sensation. Earn yours; free. Smith Agency, S-2008, Excelsior Springs, Mo.

PAINTS—Enamels. Roofing 65c gal. up. Your name on label. Certified Products, 812E 38th, Louisville, Ky.

EARN Spare time cash. Sell Xmas, everyday cards, stationery, specialties. Profits to 100%. Bonus. Box sent on approval. Birchard, 27C Lester St., Springfield, Mass.

BRAND New! Amazingly different and smart Christmas cards bring you big money! Take easy orders for sensational new Christmas cards. Amazing values. Pays up to 100% cash profit. Big line of Christmas, everyday assortments from 60c up. Christmas cards with name 50 for \$1, up. Imprinted stationery, floral charmettes, napkins. Get samples on approval, imprints free. Write North Star, 31 Glenwood, Dept. A-18, Minneapolis, Minn.

BIG Profits. Every auto owner buys at \$1.50. Unusual but proven product. Guaranteed. Jackson, 728 W. Peachtree, Atlanta, Georgia.

MONEY Quick. Take easy orders sensational men's cushion shoe line. Build steady, repeat business your neighborhood. Free outfit. Concordian Shoes, 5-A, West Concord, Mass.

1949 CHRISTMAS Card catalog now ready! Earn more money! Be a wholesale jobber! A large selection of box assortments. Imprint lines, religious, personalized cards and Christmas novelties. Three sample boxes, retailing for \$2.60, only \$1.00 postpaid. Catalog free! Elfko, 440 North Wells, Chicago 10.

INCREASE Your income. Sell for manufacturer. Nylon uniforms to waitresses, beauticians, doctors, dentists, nurses. Sales outfit and extra catalogs with your name and address furnished free. Terrific cash commissions. Medikote, Rockville Centre 2, N. Y.

BIG Profits—Taking orders from friends, neighbors. 50 super value Christmas folders \$1.25 with name. America's leading \$1 box 21 French folders. Christmas Holly box—lined envelopes. Also: gift wrappings, plastics, religious, kiddies, napkins, stationery, etc. Samples on approval. No investment. Sunshine Art Studios, Dept. PM-8, 115 Fulton St., New York 8, N. Y.

NYLON Uniforms. Immediate delivery, immediate profits. Sell to doctors, dentists, nurses, waitresses, beauticians, housewives. Free sales kit. Superior Fabrics, Dept. P8, 3936 Market, Philadelphia 4, Penna.

NEW Notion millions need. Sensational profits. Tyform, 5829 Napoleon, Chicago.

LOOK Here! Wanted—Men and women to start in business on credit. Sell some 200 farm-home products. Thousands our dealers now make quick sales, big profits. For particulars write Rawleigh's, Dept. H-192-PPM, Freeport, Ill.

AMAZING Ketchup dispenser! Pumps ketchup out of bottle. Sells fast to housewives, restaurants, stores. King, 55-P Oleander, West Springfield, Mass.

BLIND Workers need your support. Make more money taking orders for floor brushes, rugs, towels, many other items made by the blind people and also help create work for them. Free catalogue. Pacific Blind Products, 1024-M Santee, Los Angeles 15, Calif.

NEW Sensational money maker. "2-in-1" scissors and knife sharpener. Nothing like it before. Proven success. 100% profit. 30 second demonstration gets order. Special trial offer. Barberdier, 918 Eleventh, Sacramento, Calif.

HOTTEST 39c item on the market. Write National Sales & Service, Greenville, Penna.

SELL Big profit 5x6 1/2 inch stock signs. Write for jobbers introductory offer. Al Hawkins Sign Co., Sioux City 7, Iowa.

FREE Samples. Big profits showing amazing Glow-in-the-Dark specialties. House numbers, pictures, plastic novelties, religious and nursery objects, etc. Large manufacturer. Madison Plastics, 303 Fourth Ave., New York 10, N. Y.

BE First! Clean up selling brilliant new, metal Christmas cards featured in America's greatest box assortment line. Special metal, plastic, foil and novelty assortments. Five portfolios of personal cards. Fast imprint service. Free samples. Elmcraft Chicago, 5930 South Western, Chicago 36, Ill.

BOYS! Earn big money easy, spare time, selling brass name plates for neighbor's doors. Write Hubstamp, 359-C Congress, Boston, Mass.

ABSOLUTELY Free! Big package actual sample fabrics and style presentation of dresses, lingerie, hostery, etc. Take orders. Commissions big. Send no money. Melville Co., Dept. 5103, Cincinnati 3, Ohio.

BE Renewal headquarters for all magazines. Handle everything at home. Big profits. No experience. No capital needed. Free catalog tells how. Write McGregor Magazine Agency, Dept. 129, Mount Morris, Ill.

LOOK! Make money all year round selling personal initialed individualized belts, buckles, cap badges, western buckles, tie holders, name plates, 2000 emblems to choose. Big profits, whole or part time. Please write today special outfit offer. Hook-Fast Specialties, Box 1425, Dept. 6, Providence, R. I. Established 1926.

SEWING Machine electrification kit. Nationally advertised. Has Good Housekeeping Guaranty Seal. Can be demonstrated and sold in 5 minutes. Make at least \$5 per sale. For complete details write today to Brownell Distributors, Inc., Dept. PM, 308 Canal St., New York 13, N. Y.

FREE Water and our concentrates, make flavors, lotions, shampoos, 125 products, labels, bottles supplied. Qualco, E20030 Russell, Detroit.

MEXICAN Feather pictures. Unusual novelty. \$1.00 (stamps) brings \$2.00 worth samples, details. Refunded if unsatisfied. Aztec Art-P, Apartado 762, Mexico City.

MAGIC Cleaner—Laundry soap deal. Hotter than a firecracker. Big profits. Sample free. Bestco, 4642 No. Central, Chicago.

AGENTS: Stamping names on pocket-key protectors. Sample check with your name, address, 25c. Stamping outfits. Emblem checks, check-fobs, name plates. Hart Mfg. Co., 303 Degraw St., Brooklyn, N. Y.

PHOTO-Salesmen-agents. Sell beautiful hand-colored plastic enlargements. Collect deposit, we deliver. Profitable sideline. Send card, for free sample kit. Novel Portrait Co., 3343 North Ave., Chicago, Ill.

GOLD Lacquered window sign letters. Large sizes penny each. New foils. Absolutely beautiful. Free samples. Atlas, 544 W. 79th, Chicago 20.

AGENTS—300% Profit selling genuine gold window letters: stores and offices. Free samples. Metallic Letter Co., 438-B North Clark, Chicago.

EXCELLENT Sideline for printing and advertising salesmen. Decalcomania name plates in small quantities. Great demand. Also, make money with our line of automobile initials and sign letters. Free samples. "Ralco" XL-Roxbury, Boston 19, Mass.

HIGH-GRADE SALESMEN

SALESMAN! Make over \$30.00 a day! Sell nationally advertised adding machine for only \$12.95 complete. A desk model portable, precision built, fully guaranteed, every inch a business machine. Easy to operate, easy to sell, easy for you to make big money at 49% profit! For life-size color photo and full details, write today to Lightning Adding Machine Co., Inc., Dept. ZD-9, 543 So. Spring Street, Los Angeles 13, California.

PATENTED Screw-holding screw drivers! Remove, insert screws difficult places; fast sales stores, factories, mechanics; low prices. Toolco, 301 Wentworth Bldg., Boston, Mass.

SALESMEN—Sideline. Earn \$3,000 next 5 months selling calendars, advertising specialties. Buyers everywhere. Big comm. advanced. Samples free. Continental Calendar, 542-A South Dearborn, Chicago.

15 COLOR Sport shirts. Cuban jackets. Terrific commissions, free outfit. Nylons, houseaddresses. Jarod Manufacturing, Rockville Centre 71, New York.

SELL Ultra-blue stock signs to stores. 1000 slogans, comedy, general, religious. "7x11" cost 6c, sells 35c. Make money. 15 samples ultra-blue signs "7x11" \$1.00 postpaid. Lowy, 8 West Broadway, Dept. 482, New York City 70.

MARINE And hardware salesmen. Fast moving, non-conflicting, sideline. Packaged in cellophane. Free sample. Wilson Products Company, 740 E. 106th St., Chicago 28, Ill.

ADVERTISING Book matches—Cash in on big demand; sell union label matches. Cuts for all businesses and political parties. Free powerhouse selling kit, low prices, protection guaranteed on repeat orders. Cash commissions. Superior Match Co., Dept. M-89, 7530 Greenwood, Chicago.

UP TO \$50.00 in a week and tailored suit for yourself without paying one cent. Write for plan. Progress Tailoring Co., Dept. V-217, Congress and Throop, Chicago 7, Ill.

MAKE \$100.00 A week selling subscriptions for "Jr." The magazine for boys and girls. Every parent a prospect. See the possibilities? Write Dept. B-4, "Jr." Magazine, 812 North Dearborn, Chicago 10, Illinois.

DEMONSTRATE, Sell to taverns, amazing, original glass rinse "Clear Glass." No water spots guaranteed, no toweling. Sell thru jobbers, override, all you can sell free, less jobber commission. Riesen Chemical, 419 Vliet Street, Milwaukee 12.

FIRE—The big "Chief" automatic plus highest profits is the reason fire control men are writing to Red Ball, Inc., Box 1552, Salt Lake City, Utah.

NEW Jobs open in selling! Send name, address for five free issues of Opportunity Magazine's money-making guide, listing hundreds of companies who'll pay you well, full or part-time. No experience needed. Opportunity, 28 E. Jackson, Dept. 17, Chicago 4, Ill.

STOP! Want to make money all year round selling a complete line, wool uniforms, shirts, caps, ties, badges, 2000 emblems, personal initialed buckles, belts, and hundreds of other easy-to-sell items? Sales kit furnished. Please write today. Hook-Fast Company, Box 480PM, Roanoke, Va.

BIG Money taking orders. Shirts, ties, Sox, pants, jackets, sweaters, shoes, uniforms, etc. Sales equipment free. Experience unnecessary. Nimrod, 4922-AN Lincoln, Chicago.

EDUCATIONAL AND INSTRUCTION

SPANISH The easy way—With Speed-O-Way phonograph records. Complete course \$7.95. Free folder. Speed-O-Way, Dept. 116, Box 2301, Houston 1, Texas.

GET A dependable U. S. gov't. job! Start high as \$3,351.00 year. Qualify now. Many openings expected. Free 40-page book, details. Write: Franklin Institute, Dept. T24, Rochester, N. Y.

FALL Classes in air conditioning, refrigeration, heating and heat pump engineering are forming now. Write for free information. Detroit Air Conditioning Institute, Dept. B, 4125 Grand River, Detroit, Michigan.

DON'T Cheat yourself! Ignorance of the progressive steps to life-success is poor excuse for failure and discouragement. You can win life's game if you know the rules. Avoid mistakes, overcome obstacles, save time, money with this proved, practical method. Send \$1.00 for amazing sixteen-page, self-help plan. Satisfaction or refund. Success, 135 W. Union, Dept. 1-B, Pasadena 1, California.

3800 LATEST Used correspondence courses. Catalog 50c. EG, Elmsford, N. Y.

CAN A man my age become a hotel executive even though he has no previous hotel experience? Would you like to step into a well-paid position as hotel or club manager, purchasing agent, social director or assistant manager, etc.? The success of Lewis graduates from 18 to 50 proves you can—though you never had a minute's experience in hotel work. C. P. Hearne says: "Shortly after receiving my diploma from the Lewis School, I gave up my job in a power plant and accepted a position obtained for me by the Lewis Placement Bureau as Assistant to the Manager of a famous country club. Now manager and have had three raises in salary." Our free book, "Your Big Opportunity" explains how you can qualify for a well-paid position in leisure time, how you are registered free of extra cost in Lewis National Placement Service: shows how you can be a Lewis Certified Employee—certified to "make good" when placed. Write for it today. Course approved for veterans' training. Lewis Hotel Training School, Desk PM-324, Washington 7, D. C.

USED Correspondence courses and educational books bought, sold, rented. Free catalog. Educational Exchange, Summer-ville, Ga.

MAKE Up to \$35-\$45 week as a trained practical nurse! Learn quickly at home. Booklet free. Chicago School of Nursing, Dept. M-8, Chicago.

EXPORT! Learn at home from established world trader. Big paying positions. Your own profitable world-wide business by mail order without capital; or travel abroad. Experience unnecessary. Free booklet. Mellinger, 108W, Los Angeles 24, Calif.

BE A real estate broker through home study or classroom instruction. Write for free book. Approved for veterans. Weaver School of Real Estate, 15 E. Pershing Rd., Box CP-8, Kansas City 8, Mo.

VOCATIONAL High school trains catholic boys for religious brotherhood. St. Michael's, Conesus, N. Y.

PHOTOGRAPHIC Mind with Super-memory. Write Thor Books, P-8, Box 1210, Chicago.

PARENTS—Help your child to be outstanding when he goes to school. Let them learn while they play. Interesting, constructive activities which prepare them for school work. Pre-school kit \$4.95. Money refunded if not satisfied. Educational Supplies, Holly Ave., Ingleside, Norfolk 2A, Va.

LEARN Auctioneering at home! Col. Nelson, nationally known auctioneering teacher can teach you to become a successful auctioneer, by his spare time home study course. Sample lesson free. Guaranteed. Copyrighted. Nelson Auction School 184, Renville, Minnesota.

PIANO Tuning pays. Learn this profitable profession at home. Our Tonometer and mechanical aids make learning easy. No knowledge music necessary. Diploma granted. Largest and oldest school—51st year. G.I. approved. Write for booklet. Niles Bryant School, 78 Bryant Bldg., Washington 16, D. C.

"HOW To Break and Train Horses"—A book every farmer and horseman should have. It is free; no obligation. Simply address Beery School of Horsemanship, Dept. 1107, Pleasant Hill, Ohio.

VOICE—Strengthen, train your voice this tested, scientific way. Self-instruction course; no music or piano required. Silent exercises develop your voice power. Results guaranteed! Sensational details free. State age. Perfect Voice Institute, 1141 Wabash, Dept. 2G-2, Chicago 5.

BUILD a writing career in trade journalism. The best field for the beginning writer. Good pay, huge markets, little competition. Send for details. John F. Bristol, 23 Wayne Road, Bridgeton, New Jersey.

HOME Study course, drugless therapy. Free literature. Institute of Drugless Therapy, Tama, Iowa.

EARN Extra money, working with figures. Write Jimmy Sherrod, Pavo 1, Ga.

INVESTIGATOR Training. Phillips Secret Service System, 1917B North Kenneth, Chicago 39, Illinois.

MEDICAL Laboratory technicians in great demand. We train you in your own home. Catalogue free. Imperial Technical Institute, Box 973-J, Austin, Texas.

DENTAL Technician's practice kit. Artificial teeth, plastic, etc. Instructions included. Grant Laboratory, S-219 W. 7th, Los Angeles, Calif.

BOOKKEEPERS! Increase your earnings! Operate your own simplified "Dollar-A-Week" bookkeeping and tax service. Full or spare time. Details free. No obligation. Ellis, Box 200, Cedar Grove, North Carolina.

LINGUAPHONE Makes languages easy. At home learn to speak Spanish, Portuguese, Italian, French, German, Russian, by quick, easy Linguaphone Conversational Method. Save time, work, money. Linguaphone correspondence courses are available to veterans under G.I. bill of rights. Send for free book. State if G.I. Linguaphone Institute, 83 RCA Bldg., New York 20, N. Y.

USED Correspondence courses and books bought, sold, rented and exchanged. Catalog free. Lee Mountain, Pisgah, Alabama.

SECRET Investigation. Experience unnecessary. Investigators particulars free. George Wagner, M 125 West 86th, New York.

PLAYS, STORIES, MANUSCRIPTS

I WANT New writers to cash checks of \$1 to \$100 offered daily. The easiest way to write for pay. No previous experience necessary. Free details. Saunders M. Cummings, 468-11 Independence Bldg., Colorado Springs, Colo.

BUSINESS SERVICE

CHOICE Mailing lists. Many classifications. Write W. Nothern, Lake City, Arkansas.

WE Receive, remail letters; \$3.00 monthly or 25c each. "Hawkins," (Est. 1917), 1300 Taylora, Washington 11, D. C.

INCORPORATE Your business, free details. Tax Research Bureau, Inc., Delaware Trust Building, Wilmington, Delaware.

SPECIAL SERVICES

LETTERS Retailed, forwarded, from Miami. For information write Box 604, Coral Gables 34, Florida.

LETTERS Received, retailed; 25c each. Halley, 11037 Estepa, Oakland 3, Calif.

CARTOONING, COMMERCIAL ART, SHOWCARD WRITING, SIGN PAINTING

"HOW To Make Money With Simple Cartoons"—A book everyone who likes to draw should have. It is free; no obligation. Simply address Cartoonists' Exchange, Dept. 98-C, Pleasant Hill, Ohio.

CARTOONING And life figure drawing. Learn our modern system and make money doing advertising art. Amazing set of 5 easy lessons. Send only \$2. Waller Art Studios, Dept. 2, 1000 N. Charles Street, Baltimore 1, Md.

9 ALPHABET 3 Numeral pattern sets and catalog, \$1.00. Sign Letter Distributors, P.O. Box 101, Mineola, N. Y.

SIGN Painting taught at home. Test lesson free. Ben Kerns, Box 812-T, Greenville, S. C.

CHALK Talks. Laugh producing program, \$1.00. Catalog 10c. Balda The Cartoonist, Oshkosh, Wisconsin.

ADVERTISING AGENCIES, LETTER WRITERS, FOR ADVERTISERS

ADVERTISEMENTS, Mailorder letters, literature, campaigns, worded to sell anything worthwhile. Finkle-Advertising, 257M- South Spring, Los Angeles 12.

100 FRESH Names weekly of our mail order customers 25c. Mostly rural families seeking bargains and opportunities. Can supply 7 weeks back. Deitrich Nursery, Box 5020, Miami 29, Fla.

ADVERTISE: 24 Words, 40 newspapers \$3.50. Lists free. Advertising Bureau, 10511-C Springfield, Chicago 43.

AVOID Costly advertising mistakes. Get enlightening Ad-Guide and Ratebook leading newspapers, magazines, mailing lists, 10c. Chicago Advertising Agency, (Established 1900), Chicago 4.

INCREASE Your mail order sales. Sell to the farm market. Let us show you what others are doing. Free information. Farm Journal, 601 Farm Journal Building, Philadelphia 5, Penna.

DOUBLE The results from your advertising after reading Successful Advertising. Only \$2.00, postpaid. Satisfaction guaranteed. William Bennett, 114-35D 116th Street, Ozone Park 16, New York.

ADVERTISERS! Reach nearly 18,000,000 readers. 25 Sunday national key newspapers, 18 words, \$51.50. "Terrific pullers." 20 popular newspapers, \$10.00. "Free booklet." Special—One inch display 2-821,198 circulation, \$48.30. Newmark's Advertising Agency, (Established 1893), 217-7th Ave., New York 11.

24 WORDS In 50 weeklies, \$4.96. J. Darnell, 730 Hays, Jackson, Tennessee.

ADS Placed in out of town newspapers and magazines. Low rates. Catalogue free. Ideas that pay. Baker Advertising Agency, Successors Ankrum Agency, 189 W. Madison, Chicago 2.

MAILING Lists, certified, productive, inexpensive, \$5.00 1000. Homeworkers, agents, buyers, etc. Write Dixie Service, King, N. C.

TYPEWRITERS, DUPLICATORS, OFFICE DEVICES

ADDRESSING Machine plus supplies postpaid \$32.50. Folder free. Elcraft, Box 8184-D, Portland 7, Ore.

ADVERTISE Increase business. "Printomatic" selffeeding "mimeograph" post card duplicator prints, reproduces, thousands anything typewritten, handwritten, \$13.50. Literature. Pittsburgh Typewriter Company, 336-3 Fourth Avenue, Pittsburgh 22, Penna.

AMAZING New portable addressing machine only \$24.50! Complete details free. Addresso, 1008A Northeast Gould, Minneapolis 21.

RECONDITIONED Typewriters, mimeograph, multigraph printing devices, appliances, supplies. Catalog. Dixiegraph Service, King, N. Carolina.

RUBBER STAMPS AND OFFICE SUPPLIES

3 LINES 45c. Cushioned, indexed, 55c. Pads 35c. Stampright, Wauwatosa, Wis.

MIMEOGRAPH Paper, 8 1/2 x 11, 16 lb., 68c ream, 12 reams to carton. Remit \$8.16 minimum order, f.o.b. warehouse. Brookman Paper Co., 56 West 24th St., New York, N. Y.

PRINTING, MULTIGRAPHING, MIMEOGRAPHING, GUMMED LABELS

125 HAMMERMILL Letterheads 8 1/2 x 11 \$1.00 postpaid. Envelopes same. Odum, Box 9345, Tampa, Florida.

LETTERHEADS, Envelopes, statements, billheads. Mango, 555-A South 20th, Newark 3, N. J.

100 LETTERHEADS, 100 Envelopes \$1.40. Samples. L. Norman, Sterling, Virginia.

5,000 6x9 CIRCULARS, \$14.50 postpaid. Journal Printing Co., Newark, Ark.

100 8 1/2 x 11 MIMEOGRAPHED 90c. Free price list. Gregg, 5030M South Workman Mill, Whittier, Calif.

SEND For samples of better printing. Har-Vis, 1011A Parkwood, Richmond, Va.

2000 BUSINESS Cards, \$3.00 postpaid. News-Messenger, South Lancaster 10, Massachusetts.

STATIONERY, Business, Personal, 200 sheets 5 1/2 x 8 1/2. 100 envelopes \$2.00. Samoset Press, Plymouth, Mass.

2000 BUSINESS Cards \$3.45 postpaid. Samples, list, gratis. Zenith Print, 5114P Beeman, Dallas, Tex.

100 ENVELOPES Printed, 2-colors \$1.00. Box 523, Rochester 2, N. Y.

"TELEPHONE Memos," 4x4 3/4, 1000 \$1.50 postpaid. Siemens, 3723 Wisconsin, St. Louis, Mo.

100 8 1/2 x 11 HAMMERMILL Letterheads and 100 envelopes \$1.85. Herbert Hudson, Centredale, R. I.

MIMEOGRAPHING, Anything, lowest prices, quality work. Rapid Service, 317 W. 26 St., New York.

1000 BUSINESS Cards, \$2.50 prepaid. Samples free. Reliable Print Shop, 905 East Jefferson, Louisville 6, Ky.

QUALITY Printing—5,000 6x9 circulars \$21.50; 4-page folders \$38.50. Fast service. Bagby Printing Company, Georgetown, Ohio.

QUALITY Printing! Send copy for estimate. Nationwide Printing Company, Dept. PM, 2337 Bath Avenue, Brooklyn 14, N. Y.

SEND 10c Now, for our 48 page 1949 price list—refunded first order. McCall Press, 1326 South 27th, Omaha, Nebraska.

500 3/4 x 2 1/4 FOUR Line gummed stickers 35c; red border 50c. Moritz Printery, Saginaw, Mich.

MIMEOGRAPHING—Letters, pricelists, formulas, instructions. Lowest prices. Lem's Letter Shop, 5710 Stanton, Detroit 8.

EMBOSSED Business cards, 1,000 \$3.45 postpaid. Samples. Spada Enterprises, 10C Lexington, Wethersfield 9, Conn.

PRINTING OUTFITS AND SUPPLIES

GOLD Imprinter \$3.25. Samples 10c. Garza, 98 Pleasant, Cambridge 39, Mass.

MAKE Your own rubber printing cuts. Self-molding process. Plexirubber, Argyle 1, Wisconsin.

BARGAINS—Hand presses, supplies. Catalog 10c. Customprint, 211-W, Springfield, Missouri.

PRINT Your own cards, stationery, circulars, advertising. Save money. Simple rules. Print for others, nice profit. Raised printing like engraving too. Have home shop. Details free. Kelsey Presses, L-11, Meriden, Conn.

PRESSES, Type, cabinets, supplies. List for stamp. Lincoln Press Company, 220B Hartwell, Fall River, Mass.

USED Type, printing presses, type cabinets, etc. cheap. Visit our store. Edward Van Dillen, Inc., 74 Beekman St., New York 7, N. Y.

PRINTING Presses, type, supplies. Lists 3c. Turnbaugh Service, Loysville, Penna.

INEXPENSIVE Home-made printing press. Details free. Novelty Shop, Downsville, Louisiana.

PATENT ATTORNEYS

IF An inventor believes he has an invention, a search of the most pertinent prior U. S. Patents should be made and a report obtained relative to its patentability. Write for further particulars as to patent protection and procedure and "Invention Record" form at once. No obligation. Mc Morrow, Berman & Davidson, Registered Patent Attorneys, 134-D Victor Building, Washington 1, D. C.

PATENT Protection—This well-known organization will supply inventors, promptly upon request and without obligation, a booklet containing detailed information concerning steps to take to protect their inventions by a U. S. Patent. Victor J. Evans & Co., Merlin M. Evans, Registered Patent Attorney, 431-J Merlin Building, Washington 6, D. C.

PATENTS. "Proof of Invention" folder mailed without obligation. E. E. Vrooman, Registered Patent Attorney, 507 McKim Building, Washington 5, D. C.

PATENTS, Trade marks. Sanders, 6430 Evans, Chicago. (Registered U. S. Patent Office.)

PATENTS—Trade marks. Gustave Miller, Registered Patent Attorney, 69-A Warner Building, Washington 4, D. C. Patent Lawyer.

CANADA—Ramsay Company Registered, 273 Bank Street, Ottawa, Canada.

INVENTORS: Learn how to protect your invention. Unless the inventor is familiar with patent matters, he should engage a competent registered patent attorney or agent to represent him. We are registered to practise before the U.S. Patent Office and prepared to serve you in handling your patent matters. "Patent Guide for the Inventor" containing detailed information concerning patent protection and procedure with "Record of Invention" form will be forwarded to you upon request—without obligation. Clarence A. O'Brien & Harvey Jacobson, Registered Patent Attorneys, 91B-G District National Building, Washington, D. C.

PATENTS—Trade marks. Irving L. McCathran, 315 McLachlen Bldg., Washington 1, D. C. Registered Patent Attorney.

C. A. SNOW & Co.—M-427, Snow Building, Washington 1, D. C. Registered Patent Attorneys. Write for information.

INVENTORS: When you are satisfied that you have invented something of value write me, without obligation, for information as to what steps you should take to secure a patent. Write Patrick D. Beavers (Formerly Randolph & Beavers) Registered Patent Atty., 935 Columbian Bldg., Washington 1, D. C.

INVENTORS: Without obligation, write for information explaining the steps you should take to secure a patent. John N. Randolph, Registered Patent Attorney, 203 Columbian Bldg., Washington 1, D. C.

"INVENTOR'S Guide" free on request. Frank Ledermann; Registered Patent Attorney, 154 Nassau St., New York 7, N. Y.

INVENTORS: Write for free brochure "Evidence of Invention." Labiner, World Building, New York 7.

PATENT—Practice before U. S. Patent Office. Validity and infringement investigations and opinions. Booklet and form "Evidence of Conception" forwarded upon request. Lancaster, Allwine & Rommel, Registered Patent Attorneys, Suite 411, 815-15th Street, N.W., Washington 5, D. C.

INVENTORS: For "Record of Invention" form, contact Carl Miller, Registered Patent Attorney, Woolworth Building, New York.

FOR INVENTORS

INVENTORS—This firm is registered to practice before the U. S. Patent Office and is available to assist inventors in the preparation and prosecution of their cases. "Patent Protection for Inventors" booklet containing detailed information and steps to take toward patent protection will be sent upon request. No obligation. Victor J. Evans & Co., 432-J Merline Building, Washington 6, D. C.

IF An inventor believes he has an invention, a search of the most pertinent prior U. S. Patents should be made and a report obtained relative to its patentability. Write for further particulars as to patent protection and procedure and "Invention Record" form at once. No obligation. McMorro, Berman & Davidson, Registered Patent Attorneys, 134-C Victor Building, Washington 1, D. C.

PATENT Office search, analysis your invention, \$5.00. Drawings. Designing. Inventions, patents marketed. Protection forms free. Industrial Patent Reports, Box 1081, Massachusetts Avenue and North Capitol, Washington 13, D. C.

INVENTORS! Have you good, patentable ideas? Write Patent Agent Metzler, 11 West 42nd, New York.

CONFUSED? "Conception to Marketing" reveals our experiences. Our mistakes guaranteed to save you time, money and headaches! \$1 copy, Turner Mail-Teller Company, Lima, Ohio.

INVENTORS—What have you, patented, patent pending to offer manufacturers? Request free copyrighted booklet. Market Contacts, 11106-A2 Longwood, Chicago 43.

PATENTED. Unpatented inventions promoted. M. Joyce Humphries, 1424 Landtitle, Philadelphia 10, Penna.

PATENT Searches \$5.00. Includes nearest patent copies. 48 hour service. Free protection forms. Patent Research Engineering, 318 Evans Building, Washington 5, D. C.

PATENT Searches \$5.00. Reports airmailed within 4 days. Invention protection forms free. Write Raymond L. Smith, Patent Searcher, 410 Bond Building, Washington 5, D. C.

PATENT Searches \$5.00. Reports airmailed within 4 days. Invention protection forms free. Write Miss Ann Hastings, Patent Searcher, P.O. Box 176, Washington 4, D. C.

INVENTORS: Learn how to protect your invention. Unless the inventor is familiar with patent matters, he should engage a competent registered patent attorney or agent to represent him. We are registered to practise before the U.S. Patent Office and prepared to serve you in handling your patent matters. "Patent Guide for the Inventor" containing detailed information concerning patent protection and procedure with "Record of Invention" form will be forwarded to you upon request—without obligation. Clarence A. O'Brien & Harvey Jacobson, Registered Patent Attorneys, 91A-G District National Building, Washington, D. C.

SEE Our ad under "Models" in which we tell you the story of our activities for many years. The Gent Machine Co., 443 Green Rd., South Euclid 21, Ohio.

LIST Your invention with qualified brokers. Write Elo Development Co., Long Island City 1, New York.

INVENTIONS Promoted—Book "Dollars and Sense in Inventions" tells how. \$2.00 postpaid. Adam Fisher Co., 61 Enright, St. Louis 8, Mo.

INVENTORS: Without obligation, write for information explaining the steps you should take to secure a patent on your invention. John N. Randolph, Registered Patent Attorney, 203 Columbian Bldg., Washington 1, D. C.

CASH For your idea. 280 manufacturers need inventions, patented or unpatented. List free. Invention Bureau, 208M Clinton, Oak Park, Illinois.

INVENTORS: If you have an invention for sale, patented or unpatented, write Institute of American Inventors, Dept. 40A, 1926 Eye St. N.W., Washington 6, D. C.

"INVENTOR'S Guide" free on request. Frank Ledermann, Registered Patent Attorney, 154 Nassau St., New York 7, N. Y.

INVENTORS. For "Record of Invention" form, contact Carl Miller, Registered Patent Attorney, Woolworth Building, New York.

INVENTORS—Possibly I can help you. Many years experience. Charles A. Scott, 773PM Garson Avenue, Rochester 9, N. Y.

INVENTORS: The usual first step is to have a search of the U. S. Patents conducted, so I can report on patentability. Write, without obligation, Patrick D. Beavers (Formerly Randolph & Beavers), Registered Patent Atty., 936 Columbian Bldg., Washington 1, D. C.

INVENTIONS WANTED

INVENTORS: Inventions, ideas wanted. Write description. We may accept for sales listing. Invention Exchange, 393 Smith St., Perth Amboy, N. J.

INVENTORS — Charges from royalties only. Inventors Manufacturers Associates, 5 Beekman Street, New York.

SMALL Inventions wanted by manufacturers. I'll help you sell your invention. Write for circular. Stanley Hull, 7829 Euclid, Cleveland 3, Ohio.

CASH For your idea. 280 manufacturers need inventions, patented or unpatented. List free. Invention Bureau, 208M Clinton, Oak Park, Illinois.

HIGHEST Royalties — Cash. Official U. S. I. R. C. certification. Request free Booklet "M". Universal Marketing Co., 354 South Spring St., Los Angeles 13, Calif.

INVENTORS: Hundreds of manufacturers have requested our assistance in locating marketable new products. Complete information, free. Institute of American Inventors, Dept. 40-D, 1926-Eye St. N.W., Washington 6, D. C.

INVENTIONS Wanted. Patented or pending only. Inventors' Exchange-B, Hartford 1, Conn.

PATENTS FOR SALE

PATENT Right for sale. Combination fish scaler and dorsal fin remover. Write for model. A. E. Klawitter, Hutchinson, Minnesota.

INVENTORS: Test the commercial value of your patented or unpatented inventions, quickly and inexpensively. Write for free information. Institute of American Inventors, Dept. 40-B, 1926-Eye St. N.W., Washington 6, D. C.

MANUFACTURING

CONTRACT Machine work: welding, light stampings; finished castings, steel, grey iron, brass and aluminum. Gaston Tool & Machine Co., 1505 College, Springfield, Missouri.

MODELS Of inventions; development; designing; manufacturing. Henry, 2815 Hudson Blvd., Jersey City 6, N. J.

PARTS; Manufacturing; booklet. Arizona Tool & Die Co., 33 Rillito St., Tucson, Arizona.

WANT Something made? We'll make it. Consultation free. Write Jayemm Company, Burlington, Kentucky.

MODELS — Small lot manufacturing. Metals, plastics, etc. Milburn, Burlington, Kentucky.

MODELS, Tools, dies, experimental work; large and small lot manufacturing. Van-Ess Specialties Company, 212 W. 14th Street, Covington, Ky.

COMPLETE Constructional details on seventeen low-cost boats—power, sail, row. Designed for home builder with limited tools, no experience and little money to spend \$1.50. Popular Mechanics Press, (C-43), 200 E. Ontario, Chicago.

MODELS, MODEL SUPPLIES

STEAM Marine engines, boilers, casting kits. Box 326, Evanston, Illinois.

SHIP And yacht model fittings; blueprints. Send 25c for illustrated catalog No. 24—listing hundreds of items. A. J. Fisher, 1002-1 Etowah Ave., Royal Oak, Mich.

NEW Midget steam engines. Single or V-type. Literature free. R. Looker, Box 105, Michigan City, Indiana.

BUILD And operate your own trolley and interurban cars. Complete information, all gauges, all manufacturers, in Model Traction Catalog, P.O. Box 104, Cincinnati 15, Ohio. Send 25c coin.

BUILD Historic ship models, complete kits, 39c to \$9.00. Catalog 10c. Ideal Models, 19 West 18th, New York 11, N. Y.

INVENTIONS Developed: The specialists are at your service who can develop auto accessories, gasoline engines, automatic cigarette-making machines; weighing, vending and automatic photograph machines; electric scales; turbines; air, electric and steam motors and other intricate devices. We can handle your development drawings, experimental work, patterns, models, special tools, dies, stampings, castings, plating, forging and spinning. Can make any metal novelty. Complete organization for developing, manufacturing and selling. Advice backed by 50 year's experience. Send drawings or samples. The Gent Machine Company, 445 Green Rd., South Euclid 21, Ohio.

KEEP In touch with the activities of the British modelmaking fraternity. Send a dollar bill for year's subscription (4 issues) Modelcraft Magazine and list. 77 Grosvenor Road, London, S. W. 1.

LANDLOCKED Sailors! Here's a beautiful, richly illustrated, fully descriptive catalogue of famous model ships—whalers, slovers, corvettes, etc., authentic in every detail. Send for it today. Only 25c. Halesite Yacht Service, Inc., Department B.L., Halesite, Huntington, N. Y.

RAILROADERS—50c Gets 1949 catalog reference manual. State O or HO gauge. Walthers, 247 Erie, Milwaukee 2, Wis.

MINIATURE Steam locomotives, 1/4", 1/2", 3/4" scales. Castings, parts, rail, steam fittings! Thorough drawings with instructions. Catalog 25c. Little Engines, Wilmington, Calif.

SHIP Models and yacht supplies complete. Large 64 page catalogue 30c. Bill Wild's, 510 East 11 St., New York City 9.

HOME CRAFTSMEN

OZARK Wood samples. Eleven varieties, each identified, including sassafras, persimmon, cherry, walnut. Can be made into ash trays, paper weights, etc. Shipped prepaid in U. S. for \$1.25. Send cash or check to C. E. Davis Lumber Co., Cabool, Mo.

16 NEW Lawn chairs, 22 tables, benches, trellises, etc. All 38 plans, with full size patterns, \$1.00. Mastercraft 8M3, 7041 Olcott, Chicago 31, Illinois.

PLASTIC Sheets, Formica, Panelyte, Textolite 67c sq. ft., 1/16 thick, for counter, sink, table tops. Write Hub, 356T Congress, Boston, Mass.

STAINLESS Steel. Pound assortment with plans for making rings, bracelets, clasps, brooches, etc. \$2.00 postpaid. Harper's Machine Shop, 218 22nd St., Dunbar, W. Va.

BUILD Printing press. Profitable hobby. Literature free. Otaneoh, Box 114E, Akron 5, Ohio.

90 ALL New, full size lawn ornament and novelty patterns up to 20" high. Only \$1.00. Mastercraft 8M2, 7041 Olcott, Chicago 31, Illinois.

SWISS Musical movements, \$1.25 up. Assorted tunes. Martin Plastics Co., 32 Arcade Bldg., Providence 3, Rhode Island.

METALLIZING Service. Plastics, non-metallics professionally plated. Philip Stein, Oswego, Illinois.

JEWELRY Supplies. Illustrated catalog 10c. George Sassen, 154 Nassau St., New York 7, N. Y.

GLASY-Cast, the liquid plastic that works the quick and easy way. Cold-set. 15 to 30 minutes for finished product. Free samples and instructions. Make embeddings, novelties, plastic frames, machine parts, etc. for real profits. Two lbs. for \$2.95. Elasto-Mold: Flexible production molds made in 20 minutes. Also finest quality rubber latex. Wholesale prices. Plastic Service, 294 Washington St., Dept. K-1, Boston 3, Mass.

\$46 FROM Square foot plywood. Jigsaw necessary. Write, Woodarts, C-38, Bridgewater, Mass.

ALUMINUM—Bulletin A P M free, rounds, squares, sheets, etc. Kale Crafts, 2250 Milwaukee, Chicago 47, Illinois.

ALUMINUM Tubing, sheets, etc. Lists free. Willard Radcliff, Fostoria, Ohio.

LEATHERCRAFT. Monthly price list guarantees best prices. Catalog free upon request. Tandy Leather Company, Dept. PM-89, P.O. Box 397, Tulsa 1, Oklahoma.

KNOCKDOWN Cedar chests. Lumber and veneers. Free price list. Giles & Kendall Company, Huntsville, Ala.

EXPERT Clay modeling set, professional model, 5 piece introductory offer, 10 inch square plate, 10 lbs. clay, finishing steel, trimming wire and carving tool for only \$2.95 plus freight. Byrd Studio, Dept. B, Box 64, Rt. 7, Tyler, Texas.

TOOLING Leather—Trade your calfskins for tooling leather. Write for information. Bay-River Trading Co., 1688 Pomona Ave., San Jose, Calif.

INTERNAL Carving blanks at lowest prices. Plastic Designs, 1113 E. Condit, Decatur, Ill.

PROFIT With Larson Leathercraft. Belts, purses, 100 other ideas. Largest supply in U. S. Catalog 10c. Larson, Dept. C, 824 S. Tripp, Chicago 24.

WHOLESALE Shellcraft Book 15c. Large shellcraft kit \$1.69 postpaid. Shell-Art Novelty, Dept. PM, 5th and Moore, Philadelphia 48, Penna.

8 BEAUTIFUL Full-size whatnot patterns only 25c. Joanness, P.O. Box 141-M, Omaha 7, Nebr.

SHELLS, Plastics, findings. Lowest prices. Free catalog. Frances Jones, Box 251, Sarasota, Fla.

LAWN Ornaments. Ready cut patterns, full size, 20 assorted \$1.00 postpaid. Lincoln Craft Studio, Farmington, Conn.

LEATHERCRAFTERS! Complete stocks of leathers, tools, supplies. Metal tooling supplies. Immediate shipment. Free catalog. Kit Kraft, 7377 Melrose Ave., Los Angeles 46, Calif.

CRAFT Catalog free "Artcraft's Little Giant," 6500 items covering several crafts. "Tops in our field." Artcraft Leather, Oakland 7, Calif.

SHELLCRAFT. Make beautiful seashell jewelry! (Buy direct). Pace's, Box 279 P.M., Bradenton, Fla.

LEATHERCRAFTERS: Belt kits, projects, leather, supplies. Free catalog. Art Leather, 411 Joseph Ave., Rochester 5, N.Y.

JEWELRY Findings, rhinestones, pearls, sequins, cameos. J & M Novelties, Box 464P, Griffith, Ind.

TURN Your workshop into cash. Send postcard for catalog of modern saleable projects. Craftplans, 7241-P Madison, Kansas City 5, Mo.

MAKE Your own jewelry! All types of findings, metal and plastic; cameos, beads, shell kits, illustrated catalog, 20c. Hobby Art, P.O.B. 276, Dept. 7, New York 18, N. Y.

LEATHER. Retail, mail orders, catalog, tools, lacing, supplies. National Handicraft Co., 30 Frankfort St., New York City 7.

WORKERS In metal, leather, wood, beads, paint, fabric. "Bear-Step's Album of Indian Symbols, Designs and their Meanings." 180 pictures. Send 25c. Shatka Bear-Step, 17041 Wilkie, Torrance, Calif.

LUMBER For home craftsmen. Cut to order. Write Forest Products Company, Box 341, Binghamton, New York.

MAKE IT YOURSELF

BUILDING Construction. All kinds. 100 ways to save. 100 illustrations. 52 page book, \$1.00. Home Industries, Omaha 5, Nebraska.

BUILD A tractor. Easy plans, instructions. Light, heavy, walking, riding. Send postcard. Free information. Ellsworth Tractor Co., D-I, Camptonville, California.

GRANDFATHER Clock easily built. Big savings. See ad on page 249.

LATEST Model quilt chest. Displays all quilts when door opens. Remove or replace either without touching others. Think how convenient, useful. Needed in all homes. Inexpensive, easily built. Start home business small capital. Complete plan \$1.00 this month. Refunded if dissatisfied. Jennings, 5319 Beeman, Dallas 10, Texas.

OPERATE Overhead Hollywood garage doors from car. Kit of parts \$12.50. Circular stamp. Dooromatic, 7116½ Ave. E, Houston 11, Texas.

BE Independent. Big profits in leather work. Leathers, tools, supplies, bargains. Catalogue 20c. Govan Craft, 3908 Grove Street, Oakland 9, California.

HOME Freezer and cool room plans and price list \$1.00. Farm Freezer Equipment Company, Route 7, Box 1038, Vancouver, Washington.

EASY Simple way to build your own modern furniture. Write for free details. Fabbrola Products, 110 West 84th St., New York, N. Y.

AUTOMATIC Electric clothes dryer. Easily built. Plans \$1.00. List 200 plans, stamp. Modern Design, East Rockaway 35, N. Y.

"CONCRETE Block Homes," 32 page booklet on how to build. \$1.00. H. C. Lightfoot, Civil Engineer, Richboro 1, Penna.

WATCHES, OLD GOLD, JEWELRY

WATCHMAKERS' Tools, supplies, parts. Write for price list. Dean Co., 116-K Nassau St., New York 7, N. Y.

WATCHMAKERS' Tools, supplies. Sold—bought. Catalogue! Bengal Company, Culver City, California.

HIGHEST Cash for old, broken jewelry, gold teeth, watches, silverware, diamonds, spectacles. Free information. Satisfaction guaranteed. Government licensed. Rose Smelting Company, 29-A East Madison, Chicago.

GOLD \$35.00 Ounce—Mail old gold teeth, jewelry, watches, diamonds—receive cash by return mail. Satisfaction guaranteed. Free information. Dr. Weisberg's Gold Refining Company, 1500R Hennepin, Minneapolis, Minn.

TOBACCO, SMOKERS' SUPPLIES

BEAUTIFUL Gift—Baseball player figure hand finished metal ashtray. Value many times special introductory price of \$1.00. Park City Crafts, P.O. Box 132, Bridgeport 1, Conn.

CIGARETTES—Popular brands \$1.51 per carton postpaid. West of Mississippi add 7c per carton. Min. order 3 cartons. Send check or money order. King Co., Box 1713-D, Baltimore, Maryland.

DON Q. "he smokes his own," mentholated cigarettes. Offered for the first time at \$1.60 per carton. 2 cartons \$3.10. 5 cartons or more, \$1.50 each. Ancient blend fine pipe tobacco \$1.50, 8 oz. can. Cash with order, postpaid. Quotations furnished on any cigarette. Geegee Co., Box 229, Blackstone, Va.

SURVEYING INSTRUMENTS

GUARANTEED Factory rebuilt transits and levels, sale, or rent, with purchase option. We will repair, trade or buy old instruments. Write for list M-49. Warren-Knight Co. (Manufacturers of Surveying Instruments), 136 North 12th St., Philadelphia 7, Penna.

RAZORS, BLADES, SHARPENING

SAFETY Razor Co., Box 14, New York City 14. Guarantees 200 regular or 100 single-edge or 50 stainless steel blades \$1. Clip this ad now.

FOR THE HOME

KITCHEN Cabinets, modern streamlined construction described in illustrated manual. Includes individual designing service and factory prices on knock-down parts. All for \$1.00. Thombert Company, Newton 8, Iowa.

FOR SALE—MISCELLANEOUS

HOSIERY (Firsts, imperfects), handkerchiefs, shirts! Wholesalers, distributors, write for prices. Spartan Hosiery Company, Spartanburg, South Carolina.

SAVE Money—Buy everything wholesale. Free information. Orysen, 1147 Sunkist, Waukesha, Wisc.

FREE Catalog! War surplus clothing. Men's, women's. Amazing bargains! N. Y. Clothing Co., 2079A Second Ave., New York 29.

USED Vending machines, all types. Satisfaction guaranteed. Vassar, Cleveland 5, Ohio.

COTTON Sewing thread—Bulk close-out quantities; (samples). Rainbow, Decherd, Tenn.

FOR Sale—Auto parts store, Town of 4000, cleared \$7000.00 in 1948. Write Harold D. Thomas, 429 Choctaw, Bartlesville, Oklahoma.

BARGAINS Galore—Power lawn mowers, shop equipment, machinery, hand tools, million other surplus items. Atlas Equipment, 229B Southwest Blvd., Kansas City, Mo.

HOTTEST Surplus list in the country. Electronics, hydraulics, aircraft, gadgets. Dick Rose, Everett, Wash.

WANTED—MISCELLANEOUS

SWAP It. Free listing. You furnish what have you. We furnish swapper. Postal brings details. U-Swap-It, 209 Cleveland, Amarillo, Texas.

CORRESPONDENCE Solicited, in Spanish, with export firms, preferably of merchandise that can be shipped by parcel post. Interested in any kind of novelties. Samples paid for upon receipt. Staff of experts. Representations, exclusive distribution, sales on commission. J. A. Ferraro, Apdo. Postal 1323, Caracas, Venezuela, S. A.

QUICKSILVER (Mercury) urgently needed! Immediate payment. Wholesale Terminal, Norwood, Massachusetts.

PERSONAL

HOTEL, Railroad, steamer stickers African, 10c ea. Mail cards, letters from Cape Town, 6 cards \$1.00, letters 25c. Farad, P.O. Box 1882, Cape Town, South Africa.

"INTERESTING Mails" with useful free gift. One month listing 25c; Three months 50c; Six months \$1.00. Bentz, Jr., Chatawa 87, Mississippi.

STOP Foot aches instantly! Sensational plastic innersole gives new joy and blessed comfort. \$1.79 pair. Give shoe size. Literature free. Richards, P.O. Box 139, New York 32, N. Y.

ARGENTINE Postmark! Letters re-mailed 25c (stamps). Charter, Vera 1440, Capital, Buenos Aires.

"HOW Can I find out?" You can! Information discreetly developed. Any matter, person, problem, anywhere. Worldwide. Officially licensed, bonded service. Established 1922. Reasonable. Confidential. William Herman, 170 Broadway, New York.

GIANT Mails for four months, info how to get latest edition "1,000 Items Free," 25c, plus dealership offers. Wright Publications, 2370 Hubbard, Memphis 8, Tenn.

CHICAGO Forwarding receiving service. 25c each letter, postcards 10c. Gilbert, PM3519 Reta, Chicago 13, Illinois.

MEXICAN Law. General Practice Attorney, 1203 Arizona Street, El Paso, Texas.

MISCELLANEOUS

AIRFOAM Rubber, 1"x16"x18", \$1.95; 4"x21"x22", \$3.95; 6"x21"x22", \$5.95; 4"x22"x37", \$5.95; 1"x24"x62", \$7.95; 6"x24"x38", \$9.95. Other sizes cut or fabricated to order. Write for prices. All shipments prepaid. In Calif. add 2½% sales tax. United Foam Rubber, Dept. C, 233 Broadway, Oakland, Calif.

NO Parking tickets, with crystal horse-shoe nickel holder. Neat, useful, different key charm. Sample 25c prepaid. Retailers wanted. Moores, 1205 Pershing Road, Zanesville, Ohio.

CERAMIC Hobbyist. "Novelglazes." Just paint it on, no firing needed. Gives china-like effect without firing. Send \$1.25 for postpaid sample kit of 1 oz. ea. clear, color, brush cleaner, instructions. Novel, Inc., Sparta, Wisconsin.

HANDWRITING Reveals character—For free information bulletin on this most interesting science send name and address to: Analyst, Box 6124, Station B, Albuquerque, New Mexico.

HAWAIIAN Framed floral prints. Six assorted 14"x18" \$27.00. Sample: \$4.95. Andrade, 178 Grand, Oakland, California.

"RECEIVE Mail." Moneymaking offers, opportunities, catalogs. Name listed 10c. Ideal Service, Park Ridge 10, Ill.

SURPLUS Special. Mixed airplane bolts and nuts. Hundreds of sizes, handy for any shop. Four pound assortment one dollar. Oland Boat Co., Rt. 5, Puyallup, Washington.

GEIGER Counters. Uranium quickly located with new, super-sensitive, 5 lb. detector. Sensational low price. The Detector Company, 5637 Cahuenga, North Hollywood, California.

TREASURE Locators. New electronic lightweight M-Scope mineral and metal finders are now available for immediate shipment. Built for arctic-tropic use. Revolutionizes locating of minerals, gold, silver, metal objects. Unsurpassed efficiency, factory guaranteed. Low prices, time payment plan available. Send for free 16-page illustrated booklet. Fisher Research Laboratory, Inc., Palo Alto, California.

"WERE The Fossils Contemporary?" 25c. Christian Evidence League, Malverne, New York.

\$25,000 A Ton is paid for high-grade uranium ore. Send \$1.00 for official manuscript "The Search for Uranium" and literature on latest type Geiger-Mueller Counters. Complete details for hikers, campers, prospectors, etc. Box 486, Main P.O., Detroit 31, Michigan.

WRITE For our catalog of complete Chinchilla supplies and equipment. The Chinchilla Ranch, Inc., PM-2, 259 E. Wells St., Milwaukee 2, Wis.

"WATERLESS Hand Cleaner." Make, sell. No machinery. Build profitable business. Complete formula \$1.00. Ideal Service, Park Ridge 2, Illinois.

RECEIVE Mails, magazines, samples. Your name in numerous mailing lists 10c. Wallace Greenwood, 273 Broadway, New York 7.

FRESH California dates. All varieties, wholesale and retail. Gift packs our specialty. Sedwell's, 2802 South La Cienega Blvd., Los Angeles 34, California.

SEND \$1 and 20 comic books. Receive 20 different ones. c/o Ace Novelty Co., Box 706, Alliance, Ohio.

NECKTIES Exchanged! Mail us six you're tired of. Pronto you receive six different cleaned ties. Pay postman \$1. Tie Exchange, 3, Watertown, S. D.

URANIUM Prospector's Handbook \$1. Craft Publications, 601 S. Vermont, Dept. G, Los Angeles 5, California.

GEIGER Counter, miniature. Under one pound. \$48.50 complete with phones, directions, and radioactive sample. Guaranteed. Western Radiation Laboratory, 1107 West 24th Street, Los Angeles 7, Calif.

STOP. Look. Read. You may win a fortune! Learn the groundwork of winning prize contests. Send for our book today. Only 50c or write. Nanna Specialty Service, 1944 Union Street, San Diego 1, California.

RUST Remover for cloth; metal. One dollar, prepaid. Rust Scat, Box 194, Austin, Texas.

WORLD'S Uranium deposits tabulated! Detection and exploration methods explained. Details free. Woodwid Industries, 5217-A Hollywood Blvd., Hollywood 27, California.

70 BIBLE Lessons, 25c. Bulletin, Box 87, Cathedral Station, New York 25.

TATTOOING Outfits, supplies. Illustrated list free. Zeis, 728 Lesley, Rockford, Illinois.

SQUARE Dance instructions. Calls, 25 sets, \$1.00. Rayburne, Eureka Springs, Arkansas.

SAVE Electricity; install own rubber refrigerator door gaskets. Replacements; ice cube and glass defrosting trays. Free catalog, Rues Trading, 6017D 13th, Brooklyn 19, N. Y.

GEIGER Counters for finding uranium ores. Simple operation. Low prices. Interesting literature free. Fisher Research Laboratory, Inc., Palo Alto, California.

TATTOOING Machines, outfits. Free catalogue. Jensen, 120 West 83rd Street, Los Angeles 3.

PANNING Gold—Free instruction booklet. Catalogue mining books; supplies. Old Prospector, B-255 Dutch Flat, Calif.

PLASTIC-O—Clear book covering paint. Send 25c sample, starts your own firm. By Olympic Trainer Co., Inc., P.O. Box 707, Tacoma, Washington.

SAFETY! "Screenlox" with screens window your lock. 12 locks \$1.00 postpaid. Safetee Homes Company, Box 601, Glendale, Calif.

GRAVITY—If you are interested in gravity, write us. No expense to you. Gravity Research Foundation, New Boston, N. H.

GEIGER Counters. Make your own and cash in on \$10,000 Uranium bonus or re-sell profitably. Send \$1.00 for detailed plans for simple, sensitive unit any home mechanic can build. We can supply any or all parts. Box 486 Main P.O., Detroit 31, Michigan.

PROTECT Photos—Frequently used data. Any size enclosed in edge-welded transparent plastic. Can't discolor insert. Wallet size 25c. Free circular. Sample 15c. Seal-View, R2, Lancaster, Penna.

BOOKS—All Kinds—Homecraft. Radio, Plastics, Boat Building, Photography, Model Building. Catalog free. Popular Mechanics Press, 200 E. Ontario St., Chicago 11, Ill.

EARN \$10,000 A YEAR

Many excellent opportunities for over 100 occupations including clerks, mechanics, engineers, electricians, apprentices, laborers, etc. You can earn \$2700 to start — quarters and subsistence furnished. **TRAVEL, ADVENTURE, FUN, PROFIT, EDUCATION** are yours with a career in the American Merchant Marine—Absolutely Non-Military. Write for your Free booklet today.

INTERNATIONAL MARITIME INSTITUTE
79 WALL STREET NEW YORK 5, N. Y.

LOCKSMITHING & Key Making

PRACTICAL UP-TO-DATE COURSE—ONLY \$3.95
Easy-to-learn modern information for self-instruction. How to work on locks, de-code, make master-keys, repair, install, service, etc. For every handyman, home owner, carpenter, mechanic, service station operator, fix-it shop, hardware dealer, gunsmith. 53 plain illustrated lessons. **FULL PRICE ONLY \$3.95. SEND NO MONEY.** Just pay postman plus C.O.D. postage. Or send \$3.95 with order, we'll ship postpaid. Satisfaction guaranteed or refund.
NELSON-HALL CO., 1139 S. Wabash Ave., Dept. H-2, Chicago 5, Ill.

WORLD TRAVEL — ADVENTURE!

and a profitable career in civilian-manned **MERCHANT MARINE SHIPS.** First year salary to \$4,000 plus excellent food, quarters, and many other attractive benefits — **ALL FREE!** Copy-righted book, "JOB OPPORTUNITIES IN THE MERCHANT MARINE," gives complete and detailed information on how to ship out; required documents; examination questions; steamship companies; unions. **HOW TO OBTAIN FREE TRAINING WITH PAY, etc. \$1.00 Postpaid.** Address:
MARINE BOOK SALES, Box 322, Orange, N. J.

PAINT YOUR CAR WITH WYPE for \$2.95!

There's no brushing, no masking or spraying. Thousands of car owners are delighted with the results. See your local dealer, department store or order direct.
WYPE CORPORATION
DEPARTMENT 16-H 2214 DOLMAN ST. ST. LOUIS 4, MO.

SAY YOU SAW IT IN POPULAR MECHANICS

LEARN DIESEL AT HOME the famous HEMPHILL WAY

Get big, **FREE, Illustrated catalog** Shows opportunities in growing Diesel Industry—
Trains, trucks, construction equipment, ships, drilling rigs, logging equipment, etc., all use Diesels. Get the training to enter the field of your choice.
HEMPHILL DIESEL AND AUTOMOTIVE SCHOOLS
Department of West Coast University
1601 S. Western Ave., Dept. PM-89, Los Angeles 6, Calif.

BUILD YOUR OWN 5-ROOM HOUSE \$2500



Price includes lumber, millwork, doors, windows, glass, hardware, roofing, etc. Immediate shipment anywhere. Build it yourself and save up to \$3000 or more. **PAY AS YOU BUILD.** Simple step-by-step building instructions furnished. **SEND 50c TODAY** for Plan Book 149 showing 21 MODERN HOMES—38 FLOOR PLANS with estimates for pre-cut or custom-assembled materials.

SUPERIOR HOMES COMPANY
295 GLASS BLOCK MARION, IND.

A BIG MONEY MAKER...JUST WHAT ALL DIAL PHONE USERS QUICK-EASY-SALES ARE LOOKING FOR..

A MIRACLE FOR HOUSEWIVES, STORES AND OFFICES

HERE is positively the **EASIEST** and **QUICKEST** selling item you ever saw! **APPEALS INSTANTLY.** In a **BIG DEMAND MARKET** it **SELLS RAPIDLY.** You can step along from Office to Office, House to House and Store to Store. They all buy. **PREVENTS WRONG NUMBERS**

for All Square Model Phones



THEY ALL BUY WHEN THEY SEE IT

Phone Operators readily see the necessity of using the Stesco. Housewives say — "Just what they need and have been looking for." They buy extra ones for **GIFTS.** The **STESCO** is not a gadget. It is practical and useful.
NEEDED ON EVERY DIAL PHONE
Why grope along with some slow selling item when you can join a fast stepping organization of Real Go-Getters. With Millions of prospects and Millions of Dial Phones. Offices buy 2, 4, 6, 8, 10 and more. Some firms need 25, 50, and more.



DISTRIBUTORS ENTHUSIASTIC
No wonder... Even Spare Time **PAYS BIG.** It is possible to **MAKE** from \$57.60 to \$100. and over a week. Sounds big? yes Sir! This is **BIG BUSINESS.** Better **HURRY!**

No Tools Needed
WRITE TODAY for FREE PARTICULARS

Reuben Dight Inc.
652-654 Diversey Parkway, Dept. P-8, CHICAGO 14, ILLINOIS

Make Use of
**POPULAR
MECHANICS
BOOKS**

STREAMLINED HELP



**BETTER JOBS
HOBBIES
AND PASTIMES
HOME AND FARM
WORK SHOPS
HOME REPAIRS-
IMPROVEMENTS**

THE INEXPENSIVE PRACTICAL BOOKS WITH A MILLION READERS!

Want help on your job—extra knowledge that brings extra pay? Want to save money on home repairs? Want practical information to better enjoy hobbies and home and farm workshop projects? Then get a Popular Mechanics Book. These easy-to-use books, written in plain, everyday how-to-do-it English, and extravagant with pictures, plans, diagrams, etc., will give you the practical help you need. Full library size, cloth bound book unless otherwise described. Rush order on coupon today. Money back if not satisfied.



FORTY POWER TOOLS YOU CAN MAKE

Have your own powered workshop at low cost. Tells how to make forty different machines such as lathes, drill press, jig saw, band saw, circular saw, sanders, from pipe fittings, old auto parts, wood, etc. New 1948 edition. \$1.50

POPULAR MECHANICS PHOTO HANDBOOK

An entirely new and different book from our popular Photo Guide. It's a complete guide to better pictures and darkroom technique, and features dozens of handy gadgets you can make yourself. \$2.00

BUILD A BOAT FOR PLEASURE OR PROFIT

How to build 17 low-cost boats at home—power, sail or row boat. Prepared especially for the home builder with limited tools, no experience and little money to spend. Plans, diagrams and illustrations. \$1.50

WHAT TO MAKE FOR CHILDREN

A Popular Mechanics book for Dad, Mother and the whole family. Shows how to make toys, dolls, doll houses, slides, see-saws, rocking horses, furniture. 175 projects to make from discarded or inexpensive materials. \$2.00

THE GARDEN BOOK

How to build your own trellises, fences, lawn furniture, outdoor fireplace, attractive ornaments and other things for your yard and garden. Beautify your grounds—enjoy attractive equipment—at low cost. \$1.25

OUTDOOR SPORTS MANUAL

220 helpful articles and hints for fishermen, hunters, campers, trappers, archers and boatmen. If you love the outdoors, double your enjoyment with the help of this new book. Contains 334 illustrations. \$2.00

WHAT TO MAKE. 10 Volumes



The famous annual craftsman's guide. Shows what to make and how to make hundreds of things in spare time for fun or profit. Novelties, gifts, toys, games, furniture, etc. Cloth bound and filled with instructive pictures. Single volumes, each \$1.75. Save money on 10 volume set, complete, only \$15.00.

POPULAR MECHANICS SHOP NOTES

New 1949 volume. Latest in series of practical and helpful year books for every man who uses tools. Contains 240 pages and 750 illustrations. This book will make money for you and make your job easier. Soil-proof paper cover. \$1.00

POPULAR MECHANICS MOTORIST'S HANDBOOK

For every man who drives a car and wants to do his own servicing and simple repairs. A money-maker for the professional auto repairman. Hundreds of ideas, helps, and kinks you can use every day. \$2.00.

CONCRETE HANDBOOK

How to do all types of concrete work and make ornamental things of cement—walks, driveways, foundations, steps, vases, benches, etc. Ideal book for home owner, handyman and construction men. \$1.50

WELDING, BRAZING AND SOLDERING

How to construct welding equipment and use it effectively—small arc welder, spot welder, arc torch. Best approved methods, tricks and kinks to use in soldering, brazing, heat treating iron and steel. \$1.25



YOUR HOME and HOW TO BUILD IT YOURSELF

Step by step instruction by which anyone with ordinary knowledge of use of hand tools can build a five-room house complete. Every detail is shown in pictures with amazing clarity. Will save hundreds of dollars building any house. Spiral bound. \$3.00. Complete set regular builders plans \$12.50. Book and plans \$14.00.

FARM MANUAL

Hundreds of articles on making farm implements and equipment, maintaining the home, farm workshop, live stock and poultry, many farm hints and kinks. A book for every member of every farm family. 284 pages. Hundreds of illustrations. \$3.00



THE BOY MECHANIC

One of the most popular and best known Popular Mechanics publications. Describes hundreds of things for boys to do and make. Develops natural talents and industry. Crammed with how-to-do-it illustrations. The perfect gift for every boy. \$2.00

PAINTING, FURNITURE FINISHING AND REPAIRING

A book for craftsmen, home owners, shop workers and furniture repairmen and finishers. Covers repairs and finishing, restoring antiques, spray and brush painting of all kinds. An all 'round book for everyone. \$1.50

USE THIS HANDY COUPON • Mail Today

POPULAR MECHANICS PRESS, Dept. 128, 200 E. Ontario St., Chicago 11

Send Popular Mechanics books checked. I will pay postman, plus charges (U.S.A. only). Remittance enclosed—send fully prepaid. I will return books in five days for return of money if not satisfactory. Outside U.S.A. please add 15% for postage and wrapping.

Forty Power Tools . . . \$1.50	What to Make (Children) . . . \$ 2.00	Boy Mechanic . . . \$ 2.00
Painting, Finishing, etc. 1.50	Garden Book . . . 1.25	Concrete Handbook . . 1.50
Motorist's Handbook . . 2.00	What to Make (1 Vol.) 1.75	Welding, Brazing . . . 1.25
Photo Handbook . . . 2.00	10 Volumes . . . 15.00	Your Home 3.00
Build a Boat 1.50	Shop Notes 1.00	Book with Plans . . 14.00
Sports Manual 2.00		Farm Manual 3.00

Name _____

Address _____

City _____ State _____

Check for
**FREE
Cata-
log**

Be A MASTER PLUMBER

Earn \$15 To \$50 A Day

DON'T ENVY THE PLUMBER - BE ONE

Every skilled workman will tell you that Plumbers have the best of it. WINTER and SUMMER the Plumber is busy at top wages. No skilled Plumber is ever out of a job—compare his opportunities with any trade, plus the opportunities of having your own shop.

We teach you Plumbing with TOOLS (not books) under Licensed Master PLUMBERS in one of the finest equipped schools in America. We make you a Plumber, every branch is taught thoroughly—Lead Work—Blueprint for plan reading—all other tricks.

LEARN IN 30 WEEKS WITHOUT PREVIOUS EXPERIENCE

If you like to work with tools you owe it to yourself to investigate. No need to ever work as an apprentice. Get free bulletin. Write now! G.I. APPROVED. Our 24th year.

UNIVERSAL PLUMBING SCHOOL

877 HOLMES STREET

KANSAS CITY, MO.



BUILD a BOAT

- Row Boat—12 Foot
- Dinghy—8 Foot
- Training Ship—6 Foot
- Sea Sled—5 Foot
- Outboard—12 Foot
- Cruiser—18 Foot
- Bicycle Boat—Sectional
- Row Boat—Sectional
- Dinghy—Sailing
- Canoe—16 Foot
- Sailing—12 Foot
- Outboard—Runabout
- Pontoons Ice Yacht

FOR PLEASURE OR PROFIT DESCRIBES 17 LOW COST BOATS Get this outstanding book and build a boat at home for your own use or to sell at a profit. You can do it. Just the boat you've always wanted—power, sail or row boat—17 different kinds and sizes.

Order **BUILD A BOAT** on postal card and pay only \$1.50 plus postage on delivery. Return in 5 days if not pleased and get money back. Or send \$1.50 with order and we'll pay postage. (Outside U. S. \$1.70 with order.) Order today.

POPULAR MECHANICS PRESS
Dept. 598, 200 E. Ontario, Chicago 11

THEY MAKE JOBS EASIER
-HELP ME EARN MORE!



SAVE MONEY ON Popular Mechanics SHOP NOTES for a limited time!

3 Latest Volumes Only \$1.98 Postpaid

Now you can get three of Popular Mechanics famous, practical and helpful year books for the price of two. Every man who uses tools needs Shop Notes—packed with hundreds of ideas and kinks for machinists, auto workers, sheet metal men, painters, carpenters, plumbers, electricians, home repairers, home craftsmen and others. Every page of every volume is filled with money-saving and money-making facts for both professional and amateur mechanics, that you can use every day.

Start your Shop Notes Library now while our limited supply of the three latest volumes lasts. Rush coupon today with \$1.98 for 1948 and 1949 volumes and we will include 1947 FREE. Send only \$1.98 for all three volumes.

688 PAGES OVER 2000 Illustrations

Written in Popular Mechanics' famous style—Easy to Read—Easy to Understand—Easy to Use.

POPULAR MECHANICS PRESS, Dept. 400, 200 E. Ontario St., Chicago 11
Rush Shop Notes volumes as checked. Remittance enclosed for

- \$ _____
- Special Offer: 1949-1948 and 1947 volumes—\$1.98
 - 1949 Volume—\$1.00
 - 1948 Volume—\$1.00
 - 1947 Volume—60c

Name _____
Address _____
City _____ Zone _____ State _____

\$100.00 A DAY

Yes! \$100⁰⁰ a day!

Sensational "walk-in, walk-out" 10-second demonstration makes possible 30 to 50 calls a day. Sell 1 out of 3 for a daily profit of \$100.00 or more.

Spectacular Invention

You write on glass in 5 colors with "Magic Crayon." Then watch letters "catch fire" and burn like brilliant Neon! Merchants amazed—snatch crayon out of your hand—start writing themselves! Nothing before like Litewriter profits ever thrilled salesmen.

Write with Light

Rush Coupon for FREE OFFER on the most Breath-taking Money Maker of the Day!

Salesmen, Distributors, Crew Managers try out Litewriter for one day—then drop everything for this astounding money-maker. It's patented—hence exclusive with Maxilume men. No competition. Quick sales come easy. Many merchants buy three or four. Many salesmen close 1 out of 3 demonstrations. **Don't waste time.** Wire, phone or airmail name for facts. **ALL FREE.** If you have a crew, ask for Exclusive Territory information. This is the biggest thing of the year. Don't miss it. Address L. B. Patterson, MAXILUME COMPANY, 125 W. Hubbard St., Dept. L-88, Chicago 10, Ill.

L. B. Patterson, MAXILUME CO., Dept. L-88
125 W. Hubbard St., Chicago 10, Illinois

Rush complete information on Litewriter, Free Selling Kit, Free offer of Demonstrator and instructions for making "walk-in, walk-out" demonstration. No charge now or at any other time.

Name _____
Address _____
City _____ Zone _____ State _____
 I have a crew and can handle a territory. I am attaching separate letter telling of my qualifications and giving details of territory wanted.

TRAVEL for "UNCLE SAM"



START as high as \$3,351 Year

Prepare NOW For Next Examinations

VETERANS GET SPECIAL PREFERENCE
Many examinations expected soon
City Mail Carriers
City Postoffice Clerks
Stenographers-Typists
Messengers,
Liquor Inspectors—and many others.
40-Page Book on Civil Service FREE

20,000 appointments each month

FRANKLIN INSTITUTE

(Not Government Controlled)

Dept. 584

Rochester 4, N. Y.

Mail Coupon today—SURE Name _____
Address _____
City _____ Zone _____ State _____ Vet? _____



**A MUST FOR EVERY FARM FAMILY!
 SAVES MONEY FOR HOME OWNERS
 A PRICELESS GIFT TO SEND TO
 A FAMILY ON THE FARM!**

**Farm Help That Works
 Every Day in the
 Year For
 Only \$3**



**POPULAR MECHANICS
 FARM
 MANUAL**

*A Thousand and
 One Ideas You Can
 Use on the Farm!*

**Use This Book to Step up Farm Efficiency—
 Increase Farm Production—Improve Farm
 Appearance—Save Time, Labor, Money!**

Popular Mechanics Farm Manual is packed with practical ideas and usable information that can easily be worth hundreds of dollars to every farm family and to home owners everywhere. Here are a few of the things it covers:

Farm Machinery and Implements

How to make tractors, scoops, scrapers, cordwood saws, buckrake, power driven elevator, "Farmette" — odd job tractor, hoists, dump trucks, spreaders, seed-grain duster, posthole auger, etc.

Farm Workshop Equipment and Repairs

Welding on the farm, soldering, workshop power saws, home built air compressor, small shop forge, workbenches, curing gas engine troubles, hydraulic rams, drive your own wells, etc.

Poultry and Livestock

How to build poultry houses, incubators, brooders, at low cost, feeding, stock care hints, hog care gadgets, etc.

Vegetable Storage — Processing

All-winter vegetable storage, preparing food for home-freezer storage, how to make your own home freezer, charts, guides.

Farm Home Improvement

Fencing, repairing electrical appliances, plumbing, electrical wiring, saving coal, painting, curing leaky basements, hanging wall paper, making garden tools, garages, working with concrete, painting, etc.

Farm Hints and Kinks

Forty pages of illustrated practical ideas, short cuts, etc., that will save time, labor and money around every farm and city home.

This is the book that thousands of farmers and home owners have waited for. It is the experience of hundreds of successful operators brought together in one handy, easy-to-read, easy-to-use, working handbook by the editors of Popular Mechanics. It is brimful of short cuts, labor-saving ideas, ingenious apparatus and methods that will simplify the day's work and lighten some of the more tedious chores, make money and save money for you.

**284 FACT
 PACKED PAGES
 •
 HUNDREDS OF
 ILLUSTRATIONS
 •
 FULL SIZE
 Library Binding**

HELPS IN THE FIELD — IN THE BARN — IN THE HOME

Every department of the farm is covered in the Farm Manual. Every member of the family will find in it something that he or she can use to tremendous advantage in farm operation, maintenance and improvement, from the building and care of equipment to painting the farm home and fast freezing fruits and vegetables. It covers all farm buildings, the farmhouse and other homes and is of interest equally to the woman looking for home improvement, beauty and convenience and the man striving for easier and more profitable operation.

ORDER TODAY — FOR YOURSELF — FOR A GIFT

Use the coupon below. Mail it today. Book will be sent at once, post-paid if you include payment with your order. If you don't think the Farm Manual is worth even more than you paid for it after five days' use, send it back by mail and your money will be refunded. This may be the best investment you ever made. Rush coupon today.



MAIL COUPON • Money Back if Not Satisfied

Popular Mechanics Press, Dept. 49C
 200 East Ontario St., Chicago 11, Ill.

Send _____ copies of the Farm Manual at once.
 Remittance (\$3.00 each) enclosed. Send postpaid. Add 15% if outside U.S.A.
 Send C.O.D. (\$3.00 each) plus delivery charges. U.S.A. only.
 (If sent as a gift to another, send name and address on separate sheet.)

Name _____
 Address _____
 City _____ Zone or Route _____ State _____

WAR SURPLUS ALL STAR LINEUP

CANDIDATES WERE CHOSEN FOR THEIR LOW PRICE AND HIGH VALUE

TWO STAR BARGAIN CARRIERS . . .

STAINLESS STEEL TABLE TOPS

Polished top, dull bottom, hardwood veneer center $\frac{3}{4}$ " thick. Ideal for work table, laundry tubs, shelves, back bar work board, etc.

22x19 $\frac{1}{2}$ "	11 lb.	\$1.95
22x21 $\frac{1}{2}$ "	12 lb.	\$1.95
23 $\frac{1}{2}$ x27"	15 lb.	\$2.45
22x29 $\frac{1}{2}$ "	16 lb.	\$2.95
22x34"	20 lb.	\$3.45
22x37"	22 lb.	\$3.95

Stock No. 411



CLUTCH

For Motor-scooters, Motor-bikes, Lawn Mowers, etc.

Mercury centrifugal clutch for use with any small gas engine.

"A" belt pulley, $\frac{3}{8}$ " bore. Brand new only. Stock #400. \$9.95 IN LOTS OF 12. \$8.00 EACH.

GENERATORS & AC ARMY Light Plants

ALL NEW UNLESS SPECIFIED. ALL 110 VOLT 60 CYCLE UNLESS SPECIFIED.

Light Plants

300 watt, 110-220 volt AC, 60 cycle light plant powered by 1 HP gas engine, direct drive. Mounted on base weighs 40 lbs. Stock #409. \$99.50

500 watt. Onan direct connect. ed. Stock #414. NEW. \$149.50

NEW 1000 watt Briggs & Stratton Leland generator. \$189.50

Stock #351. NEW 1500 watt with Briggs & Stratton belt driven Leland generator. \$209.50

Stock #352. 2500 watt. Briggs & Stratton Model Z and Leland generator. Stock #317. \$225.00

Used but like new. \$295.00

NEW. Tools and spare parts included. 5000 watt, automatic remote control. Powered by 4 cyl. Jeep gas engine. Used like new. Stock #318. \$575.00

7500 watt, powered by a VE 4 Wisconsin 4 cyl. gas engine. Continental or Hollingsworth generator. Remote control starting. Complete with switchboard. Used but like new. Stock #347. \$675.00

Add \$65.00 for transformer to make this plant 3 phase 220 volt. \$900.00

10,000 watt, 110-220 volt AC, 60 cycle. Remote control. Powered by a Jeep 4 cyl. gas engine. Used like new. Stock #319. \$1100.00

NEW job, original crate, only. 25,000 watt 220 volt AC, 3 phase. Spare parts. NEW packed for export. Stock #415. \$1995.00



MARINE FLOAT

Heavy rubberized fabric, $\frac{1}{2}$ " rope encircles raft passing through dee rings as handles. Can be used as wading pool, dock, raft, etc. Will support 4 ton and cannot tip. Used but like new.

6' W x 20' L	6' W x 25' L
\$49.50	\$59.50

50% deposit to handle shipping.



All Bronze GEAR PUMP

All bronze corrosion resistant gear pump. Lifts water 25'. Delivers 1020 gal. per min. at 1200 RPM. Develops 110 lbs. pressure at 250' head. Self locking packing nuts, drain cock, reversible head. Will pump brine, salt water, oil, vinegar, gasoline, etc. Dimensions: 10"L x 7"H x 5 $\frac{1}{2}$ "W. Base holes 1 $\frac{3}{4}$ " x 3". Shaft 1 $\frac{1}{16}$ ", 1" x 1" inlet & outlet. Wt., 24 lbs. Mfg. by Sherwood Brass Works. All pumps belt driven. All bronze gear pump with 8" V pulley. PUMP ONLY. Stock #314. \$24.00

\$80 value. Same pump as above, with motors, (electric). Stock #549. \$67.00

1/2 HP. \$74.00

3/4 HP. \$74.00

1 1/2 HP. \$89.50

2 1/2 HP. \$135.00

3 1/2 HP. \$165.00

6 HP. \$195.00

The MORE HP the more PRESSURE.



HALES FIRE PUMP

For fire depts., factories, forest fire prevention, etc. 600 gal. per min. Can be operated with a four or six cylinder gas engine. 4 1/2" intake. . . 2-2" outlets. . . 265' head at 120 lbs. pressure. Passed by national board of fire underwriters. NEW. Stock #407. Price. \$149.50

BALL BEARING ARBORS



Grinding and saw arbor, has 1/2" double end shaft, 1 1/4" long with 2" center pulley. New Departure double roll ball bearings. Right and left hand thread. Self aligning Dodge pillow block. 10,000 RPM. Bearings alone list at \$10. Complete arbor new. Stock #305. \$4.95

HI-SPEED GRINDER (not pictured) has 2 step pulley driven thru rear or base. Stock #328. \$10.95

PLASTIC TUBING

Good for water, oil, air, electrical installations & radio work. Available in 100 ft. lengths. Min. order 50'.

1/4"	3/16"	1/4"	1/2"	7/16"	4c
per ft.	2c	per ft.	1"	3 ft.	lengths
5/16"	3/8"	per ft.	only.	3 ft.	lengths
per ft.	3c	per ft.	only.	3 ft.	lengths
per ft.	13/8"	per ft.	only.	3 ft.	lengths
per ft.	8c				

★ HALF TON WAGON



Half ton wagon with plate aluminum body 24" x 42". 5/8" steel axle. Stock #332. Write for details.

SWIMMING OR BATHING POOL



Made of heavy glass cloth with rubber impregnated on both sides. 12' diameter, 5' high. 3000 gal. cap. Ideal for: small irrigation project, swimming pool, animal watering. Complete with cover & guide lines. Gov. price approx. \$350. Our price. \$69.50

Due to handling remit full amount.

WESTINGHOUSE

3 phase motors. All models 1/2 HP to 1 1/2 HP. 220 volts. Motors totally enclosed—ball bearing. Stock #541. 40% off list prices.

AIR COMPRESSORS

All ratings from 1/2 HP to 10 HP—new and rebuilt. Write for free details.

HOSE 20' LENGTHS

Gas, oil or water resistant. Neoprene treated 1 1/4". Male & female brass connectors. Standard filling station size. Value \$7.50 \$20.00. Stock #528. Our price. FOOT VALVE. \$3.00

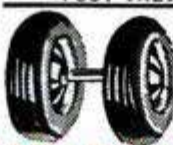

RUBBER WHEELS

Good for boats, scooters, wheelbarrows, etc. Stock #536

2.75 x 10 1/2"	1/2" bore	\$4.50
4.00 x 8 1/2"	1/2" bore	\$10.95
10 1/2" x 4	6 ply 5/8"	\$8.95
14 1/2" x 5	6 ply 1"	\$10.95

New airplane tires, tubes and wheels with high speed Timken Hyatt ball bearings. Stock #544. 800 x 5-6 ply 1". \$14.50

1700x20" 12 ply TUBES. Stock #545. \$44.50

for earthmovers, trucks, \$300 value. 56" 16 ply Bomber TIRES and TUBES only \$600 value, for tractors, etc. Stock #546. Our price. \$59.50

AIRPLANE TIRES with landing gear hydraulic strut. Firestone & Goodyear standard tires, 8 ply 27", 29" high. Hydraulic strut is 44" long. 3 1/2" dia. Can be made into heavy duty trailer. Stock #551. \$22.50 each.

BRIGGS-STRATTON GAS ENGINES

SAVE \$25 ON LIST PRICE

All are NEW in original crate. Rope start. 1700 RPM all brand new and guaranteed. 1 3/4 to 2 1/2 HP Model AP List price \$102.10. Stock #307. Our price \$77.00

3 1/2 HP Model BP. List price \$111.50. Stock #308. Our price \$86.00

5 to 7 HP Model ZPP. List price \$137.00. Stock #309. Our price \$102.00



CHIMES OR CALL SYSTEM

Navy type. Good for schools, hospitals, office, homes, etc. 110 Volt AC or DC. Weather proof. LIST PRICE \$15.00. Stock #552. Super value at only. \$1.95

A REAL BUY

BULL BUFFER

Fits any 1/4" drill. Polishes, sands & grinds. Sheepskin. 4 3/4" rubber disc. COMPLETE. Stock #553. \$1.95

Imagine it's only. Extra sanding discs \$1.20 a Doz.

GENERATORS

300 watt, 12 volt DC. 2000 RPM. Heavy duty with current cut out relay. High and low switch. 30 amp. meter. Can be bought less shaft and base to be used directly mounted to a Briggs & Stratton 1 HP engine. Stock #323. NEW only. \$7.00

Complete with shaft base and bearing. Stock #324. \$15.95

300 watt, 110-220 volt AC generator. Mfg. by Electric Specialties Co. Weighs 20 lbs. Stock #416. NEW only. \$34.50

1000 watt, 110 volt AC, 60 cycle generator with built in radio filter. Leland ball bearing 1800 RPM. Stock #526. \$89.50

1500 watt. Same as above. Stock #527. \$99.50

2500 to 3000 watt, Leland generator 110 volt 60 cycle. Self excitor, radio filter, junction box for plug in. Stock #525. \$145.00

NEW. 3000 watt, Delco. 110 volt DC. Plug-in, ball bearing 2800 RPM. List price \$343.00. Used but like new. \$99.50

HEAVY DUTY ELECTRIC CABLE

3 wire #10 Super cable. Stock #351. 65' with leads. Value \$26.00. Our price. \$13.00

3 wire #10 government submarine type. Use underground, underwater, overhead. Cost U. S. 90c ft. Stock #542.

OUR PRICE

100 ft.	\$24.00	500 ft.	\$100.00
250 ft.	\$55.00	2900 ft. reel	\$530.00

2 conductor rubber cable #4—stranded—7 1/2 ft. length with connectors. Stock #543. List price \$177.00. Our price \$90.00

4 wire #6 stranded heavy duty. List price \$2.36 per ft. Stock #547.

50 ft.	\$30.00
100 ft.	\$55.00
250 ft.	\$125.00
500 ft.	\$225.00
1000 ft. reel	\$400.00

3 wire 10# rubber cable, two male connectors. Value \$109.50. Stock #554. Price. \$35.00

WESTINGHOUSE Transformers

Dry type-insulated-440 volt, 220 volt to 110 volt—single phase.

75 K.V.A. List price \$1009.00. Our price \$504.00

37 1/2 K.V.A. List price \$ 717.00. Our price \$358.00

20 K.V.A. List price \$ 626.00. Our price \$310.00

25 K.V.A. List price \$ 558.00. Our price \$279.00

20 K.V.A. List price \$ 460.00. Our price \$230.00

All like new and guaranteed.

ALL ITEMS GUARANTEED AS REPRESENTED C & H ELECTRIC CO.

434 W. JUNEAU AVE. MILWAUKEE 3, WISCONSIN

All prices F.O.B. Milwaukee. 25% deposit required on all C.O.D. orders. No C.O.D.'s under \$10.00. Use stock number when ordering. Many other bargain items not listed—write for our free circulars.

He'll have a happy trip ... he's got P.A.*



New HUMIDOR TOP
— locks out air —
locks in freshness
and flavor

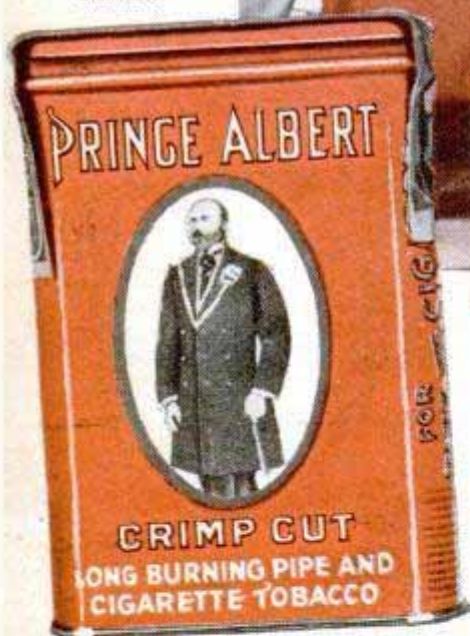

● Of course he'll be popular with the ladies! He has Pipe Appeal, the ultra-masculine charm of the pipe-smoking man! And with Prince Albert tobacco in his pipe, he's headed for smoking joy and comfort. P. A. is rich-tasting, mild, and easy on the tongue!

P.A.* means **P**ipe **A**ppeal
P.A.* means **P**rince **A**lbert

The
National
Joy Smoke

Did you know that Prince Albert is choice crimp cut tobacco that's *specially treated to insure against tongue bite?* That's right! And that's just *one* reason why more men smoke Prince Albert than any other tobacco! Try P. A. today!

"NO WONDER P.A. IS SO
POPULAR FOR CIGARETTE
'MAKING'! ROLLS UP FAST
... TASTES GRAND"



R. J. Reynolds Tob. Co., Winston-Salem, N. C.

Lynn A. Williams, Jr., Vice-President of the University of Chicago, points out that there is more to the atom than war and destruction



POPULAR MECHANICS

AUGUST 1949

WRITTEN SO YOU CAN UNDERSTAND IT
VOL. 92 NO. 2

How the atom is working for you

By Lynn A. Williams, Jr.,
Vice-President of the University of Chicago

IN 1887 an American scientist was engaged in a very strange and useless pursuit. He was measuring the speed of light. His name was Albert Michelson. If anyone had asked him what use his researches would have, he would have said, "None." It wasn't necessary to know the speed of light to drive a carriage or light a candle. The knowledge Michelson sought could not be put in a box and sold for a profit. But his work had some surprising consequences.

You all know that he found that light travels 186,000 miles a second. This was not surprising in itself. But he found that all light seemed to travel at the same speed.

Now if you are in a car traveling 50 miles

an hour against a 20-mile wind, you will feel a 70-mile wind on your face. If you go 50 miles per hour with a 20-mile-per-hour wind, you will feel a 30-mile-per-hour wind on your face.

So you would suppose that if you were moving toward a light source (as the earth moves toward a star or as it revolves toward the sun and away from it on the other side) then you would expect to find that the light speed would be measured at 186,000 miles per second plus the speed at which you moved toward the light. If you went away from the light, you would expect its measured speed to be less.

Michelson and Morley found this not to

Artist's conception of an atom-powered submarine which could remain submerged indefinitely if necessary

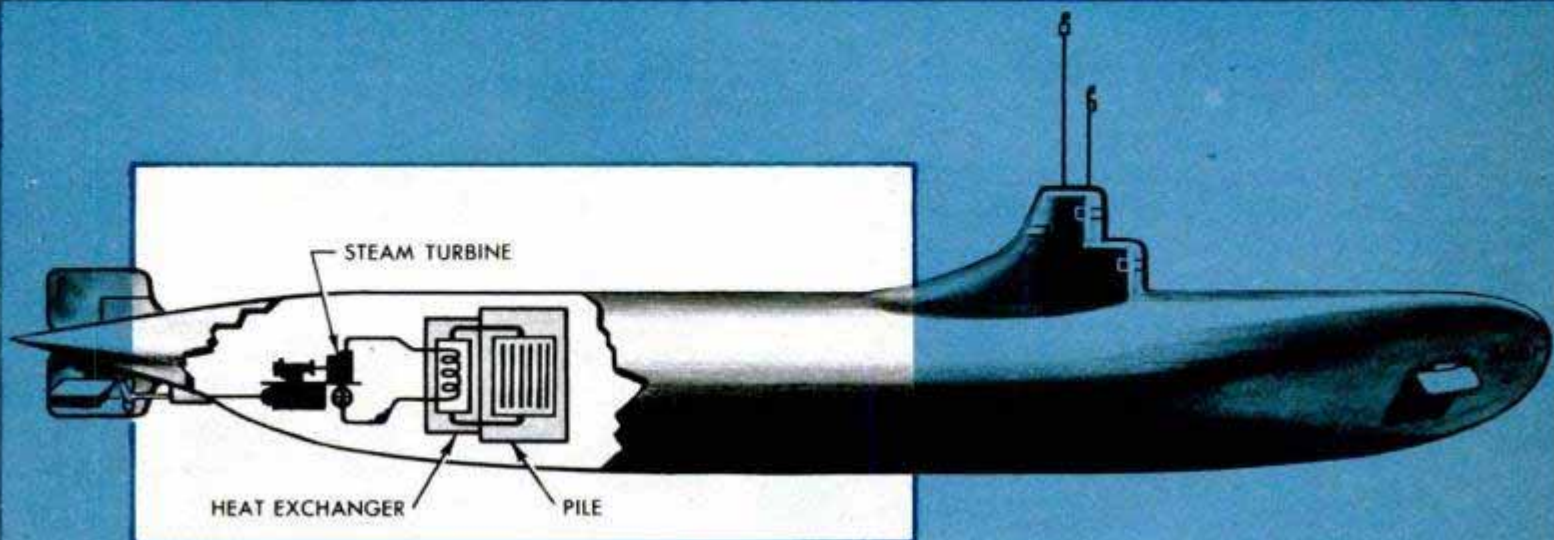



Top, radioactive algae, grown in these jars at Argonne National Laboratory, are fed to animals in research on food

Above, radioactive carbon dioxide is forced into sealed jar where lettuce thrives in the radioactive atmosphere

Right, Chicago scientist puts specimen of digitoxin made from radioactive fox-glove plant in slide of Geiger counter

be true. All light, no matter what its source, has the same speed. How could this be?

In Germany in 1905, Albert Einstein proposed an answer. The speed of light does change, he said, but as matter moves in space it lengthens or shortens relative to its motion. And time also changes relative to motion. In developing the formulae to express the theory of relativity, Einstein noticed that one factor, Mc^2 , kept cropping up. He explained this factor in a dramatic flash of genius and insight. This factor, Mc^2 , he said, was the energy inherent in matter. Thus the famous formula, $E=Mc^2$ was born. "E" is energy, "M" is mass or weight and "c" is the speed of light. Einstein said that the energy of matter was stupendous because c^2 is such a tremendous number: $186,000 \times 186,000$.

On December 2, 1942, a group of scientists gathered

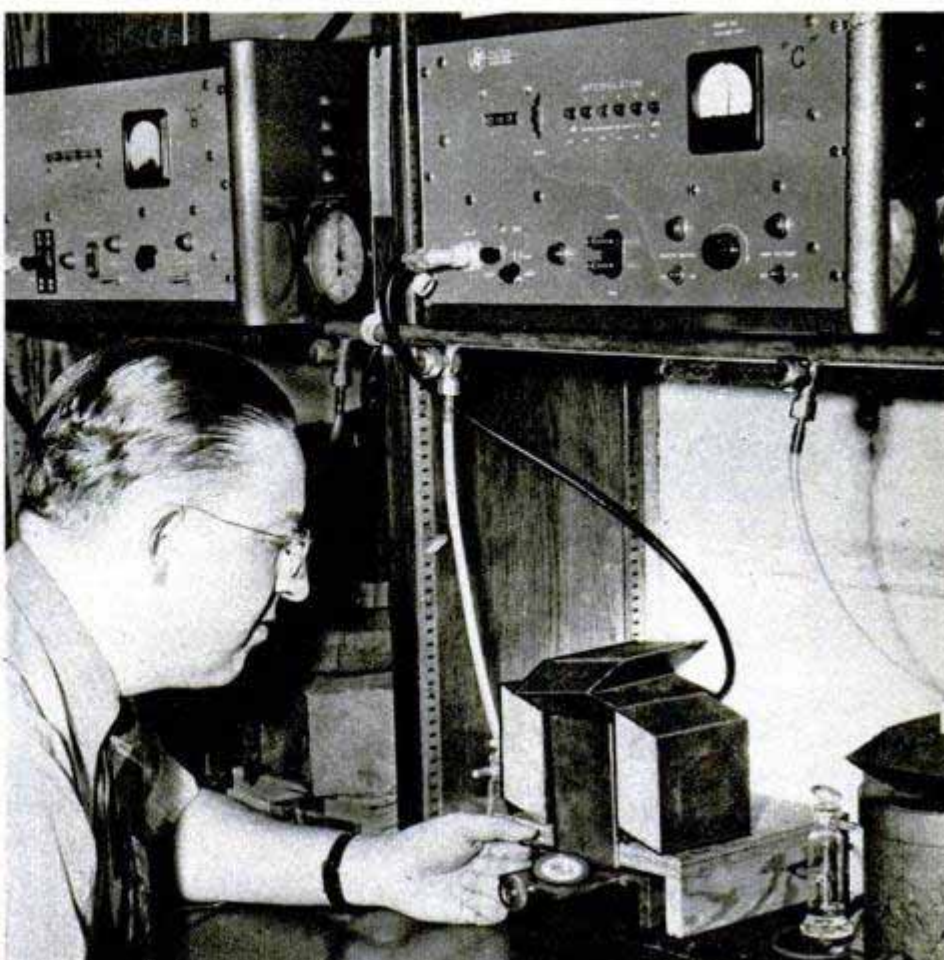

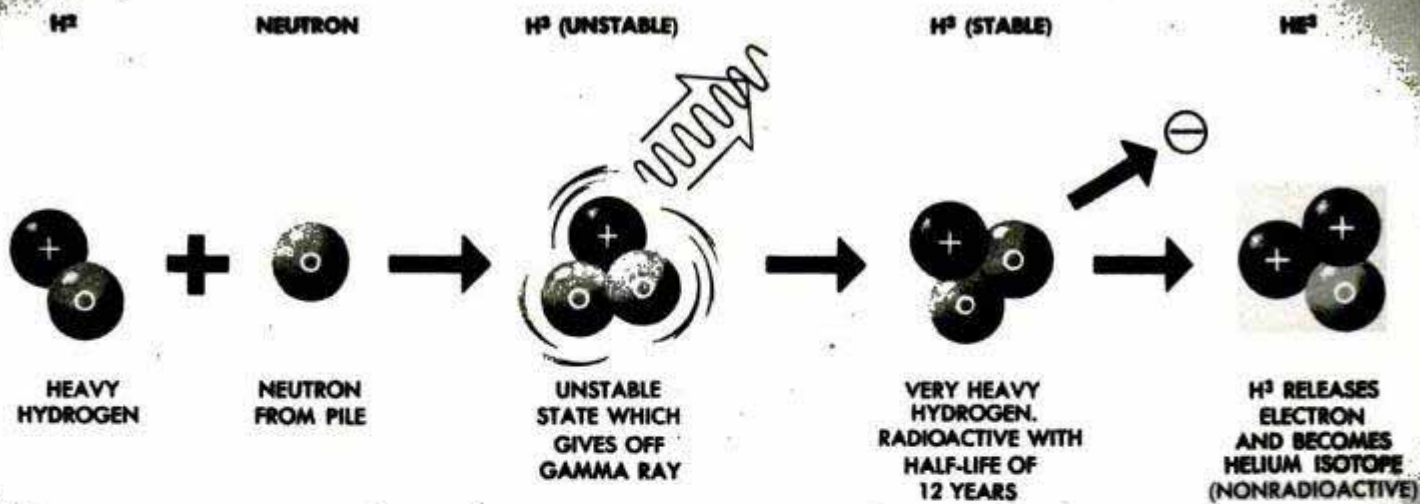

Drawing shows how an isotope is made radioactive and how its radioactivity stops with release of electron

at the University of Chicago and initiated uranium chain reaction which transforms matter into energy. They had calculated the output of energy from Einstein's equation and the enormous value which was predicted spurred them on to their goal. They opened the way to the greatest military weapon of all time. They created the greatest economic fact of our era. They opened new and endless vistas of scientific inquiry and knowledge.

Of course, many ideas intervened between Michelson and Einstein and Fermi and the "pile" in 1942. For nuclear energy was no accidental discovery. Science does not proceed by aimless experiment and observation leading to a theory. The theory comes first, the experiment follows. The pile under the grandstand at the University of Chicago, where the first self-sustaining chain reaction was achieved, was constructed with the greatest of care according to

precise calculations by nuclear scientists.

Before atomic research could even be considered, a number of ideas had to exist. The idea that there is an atom had to be established. Although the ancients, Lucretius, for example, postulated that

matter might be composed of tiny particles, it was not really until this century that the evidence began to pile up sufficiently to permit the formulation of a theory which includes the atom as a basic building block of everything—the chair you are sitting on, the air you breathe and even your own body.

Then it was necessary to get the idea that the atom itself had an internal structure. Obviously, there could be no splitting of atoms unless the atom was composed of parts which could be split. Also, there is Einstein's important idea that energy and matter are different forms of the same thing.

The formula, $E=Mc^2$, means that energy and matter can be

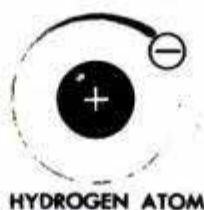

Ordinary hydrogen atom has one proton and electron. Add neutron and it changes to heavy hydrogen

When four hydrogen atoms combine into a helium atom in the sun, there is a loss of mass, called mass defect



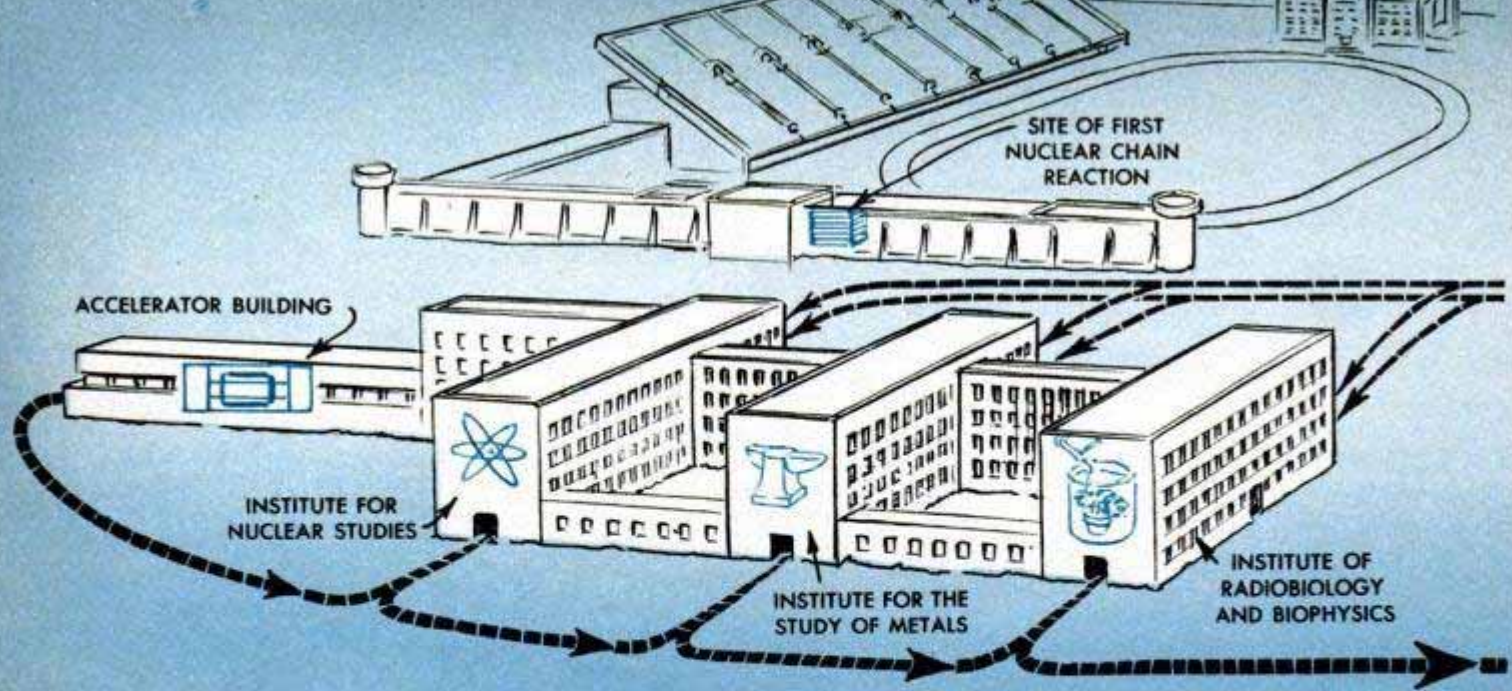

At the University of Chicago, the atom is a great research tool. Dotted lines show importance of free exchange of ideas among various branches of science



Ancient wood, above, is placed in center tube of a supersensitive Geiger counter, below, to have its age determined by measuring residual radioactivity



equated, and that the energy existent in matter is tremendous. If we were able to get from matter all of the energy which is in it, we could get from two pounds of matter 25 billion kilowatt hours—enough energy to supply all the power needs in this country for two months. Twelve pounds of matter, therefore, would last this country for a whole year. This, of course, is theoretical only. We don't yet know how to get this much energy out of matter. In fact, in the atom bombs which were dropped on Japan, we got only about $\frac{1}{10}$ of one percent of the potential. This would mean that instead of 12 pounds, we would need 12,000 pounds or 6 tons, an amount you could easily store in your basement.

Now I should like to discuss some of the particles which make up the atom. Let us start with the simplest atom, hydrogen. The hydrogen atom is thought to be composed of a nucleus of a very dense or heavy proton which has one positive charge and an electron having almost no weight but having one negative charge.

There is one other very important particle to be considered: the neutron. Like the proton, it has great mass, but does not have any electric charge.

The nucleus of every element except ordinary hydrogen is made up of protons and neutrons. It is possible, for example, to have heavy hydrogen which is like ordinary hydrogen, except that in addition to the one proton in the nucleus there may be also a neutron, thus making this hydrogen twice as heavy as ordinary hydrogen.

Helium consists, in its nucleus, of two protons and two neutrons so that its mass is four times that of ordinary hydrogen. One kind of atomic energy exists in the sun through a cycle in which hydrogen atoms eventually are combined to form helium. When this happens, there is somewhat less

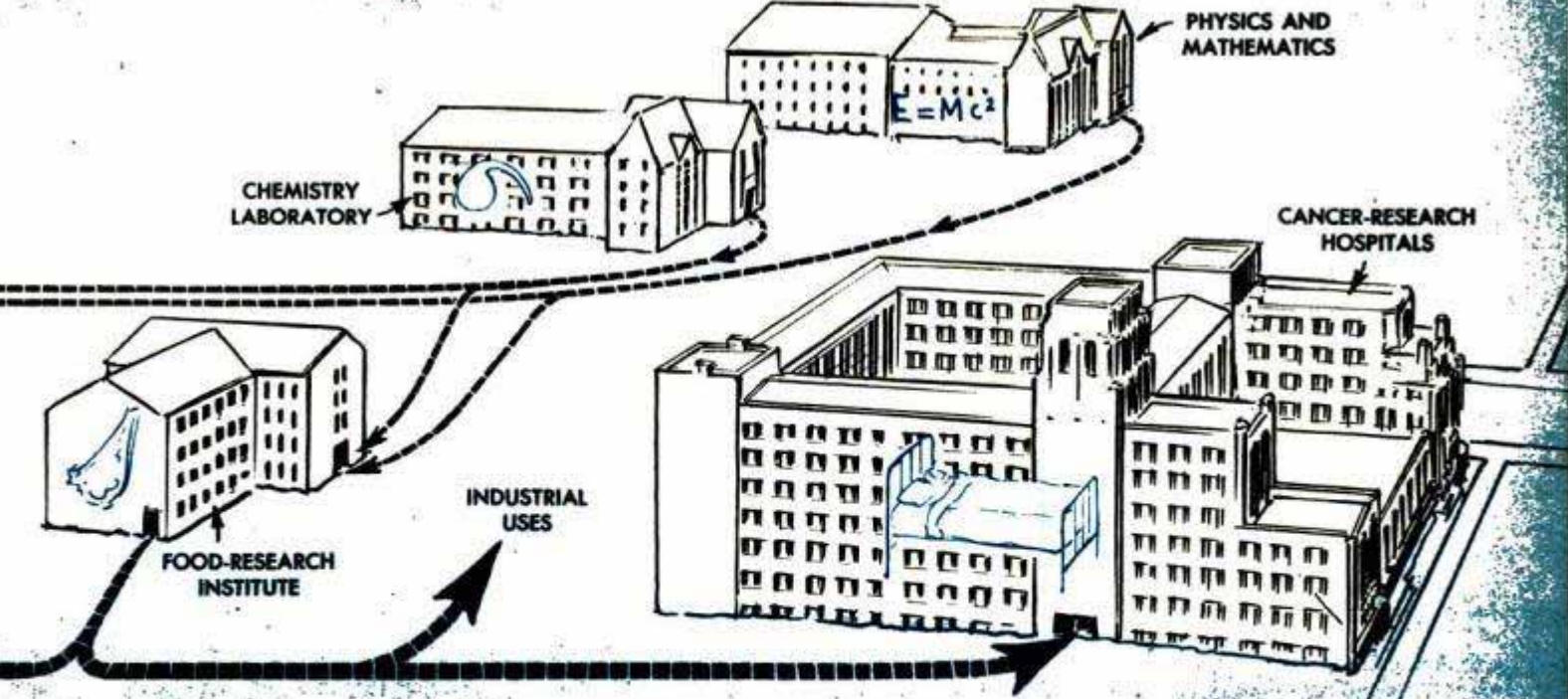

mass in the helium than there was in everything which went into it and this loss of mass has had to come out as energy. It is this which is thought to account for the energy from the sun. The man-made atomic energy, thus far, does not come from these very simple elements like hydrogen, but it comes rather from the very complex elements like uranium. Uranium, instead of having a mass of about one, has a mass of 238. It is composed of 92 protons and 146 neutrons. But this form or isotope of uranium is too stable to be the source of a chain reaction. There is, however, another form or isotope of uranium, called U-235 (92 protons and 143 neutrons), which occurs in the ratio of about one part in 140 in ordinary uranium and is the basic element in atomic energy as now conceived. If the nucleus of U-235 is hit by a neutron, it breaks apart into other elements, barium, krypton, strontium and xenon and, in the course of doing this, releases energy. In the course of releasing energy, it releases a number of free neutrons. These neutrons can, under proper circumstances, hit the nucleus of another uranium atom which will split and produce more neutrons. It is this which is called the chain reaction.

This is the kind of reaction
(Continued to page 242)

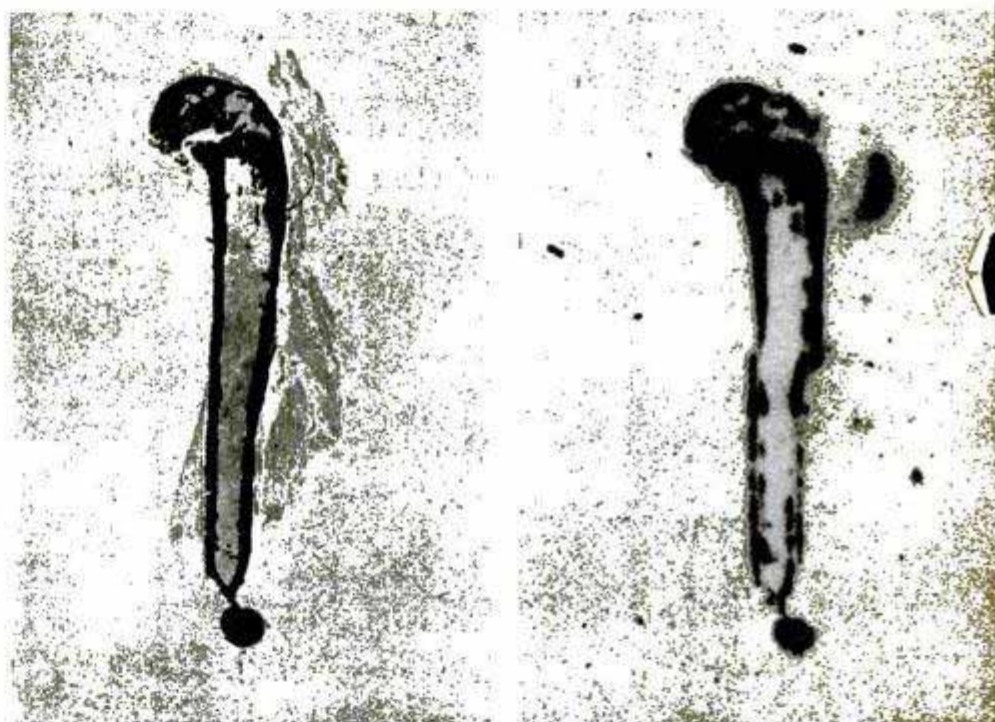

Above, right, radioautograph of chicken bone was made by rays from radioactive strontium injected in the bird to learn where it goes in the bone structure. At left is an ordinary photograph of the same bone section. Below, film, taped to casting, will pick up rays from the isotope being pulled inside, thus detecting any flaws in metal

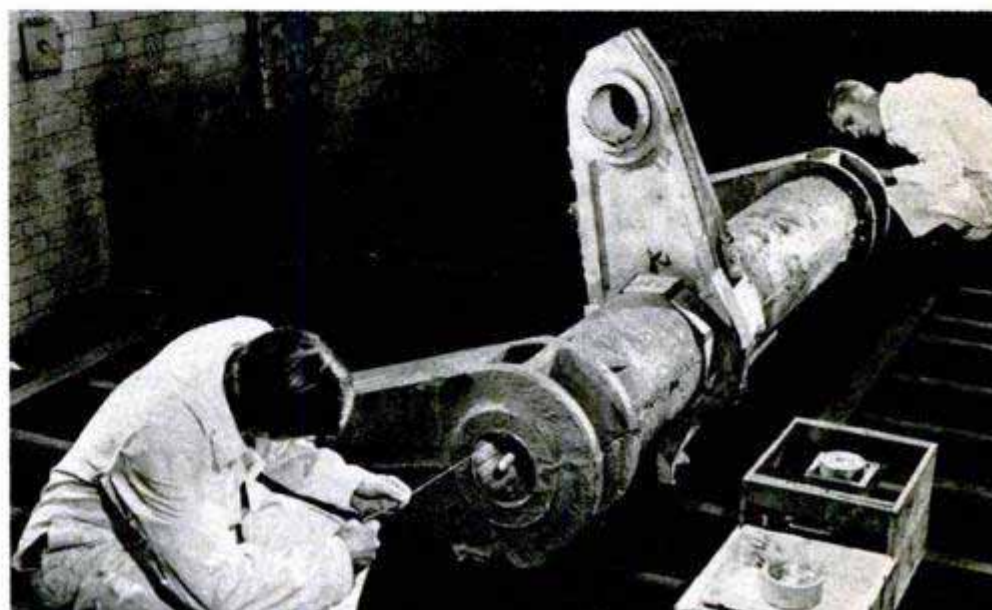

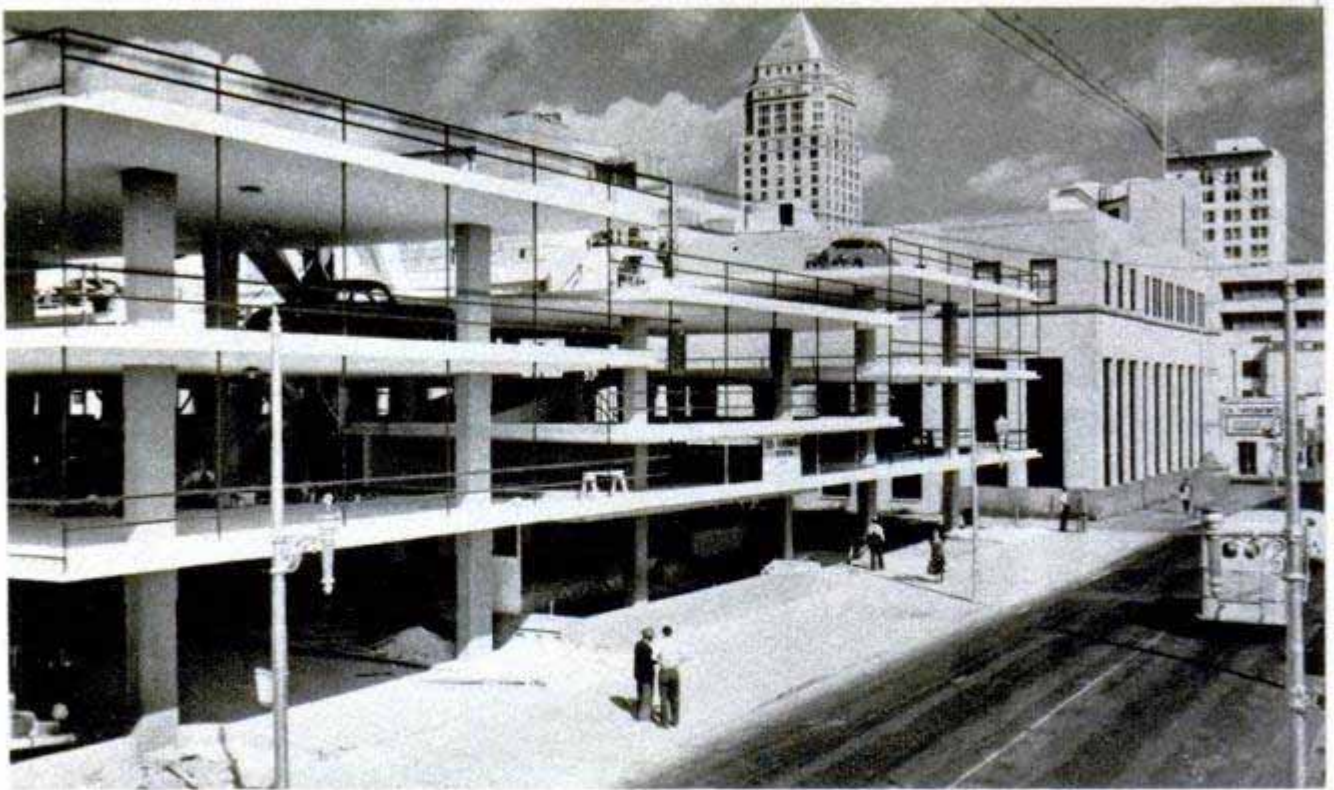

Concrete Building Without Walls Holds 360 Cars

Tourists might think one of Miami's new buildings is unfinished. Actually, it's a building without walls. Made of poured

reinforced concrete, the structure is used as a parking garage. Its three "decks" hold a total of 360 automobiles.

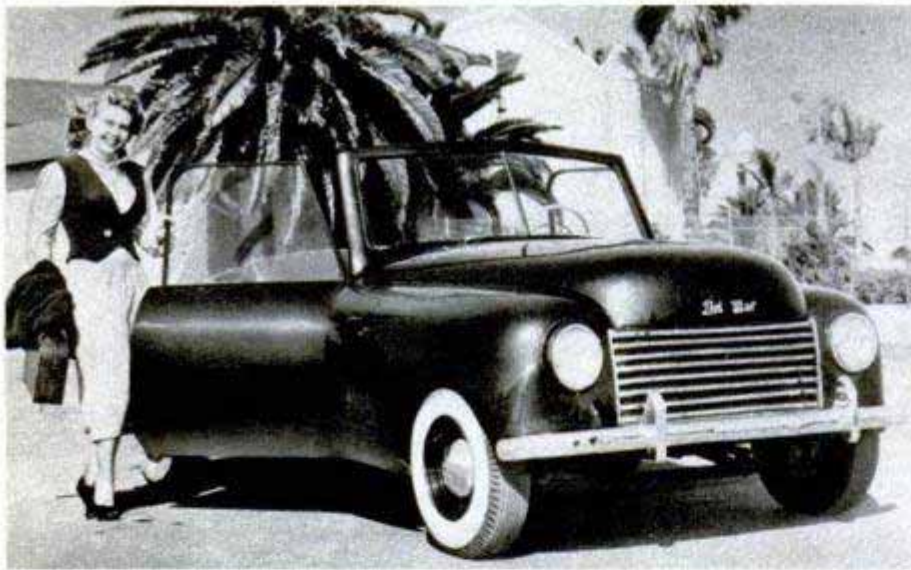

Economy Automobile Uses Standard Parts

Constructed of nationally known standard parts, a new small car, being produced in California, will sell for less than \$1200. It has a 63-horsepower engine and will go 80 miles an hour. It's economical to operate, getting 30 miles to the gallon. Because it is assembled with standard automobile parts, the car can be serviced any place in the country.

Phosphorescent Material "Previews" Photo Prints

Photo hobbyists can "preview" prints without using paper or chemicals by exposing their negatives against a phosphorescent material. The negative is slipped between a sheet of the material and a yellow filter. After a three-second exposure to a photoflood bulb, the phosphorescent material provides a clear positive image that lasts for about one minute, enabling the photographer to see how a print made from the negative would look. The viewer has to be used in a dark room.



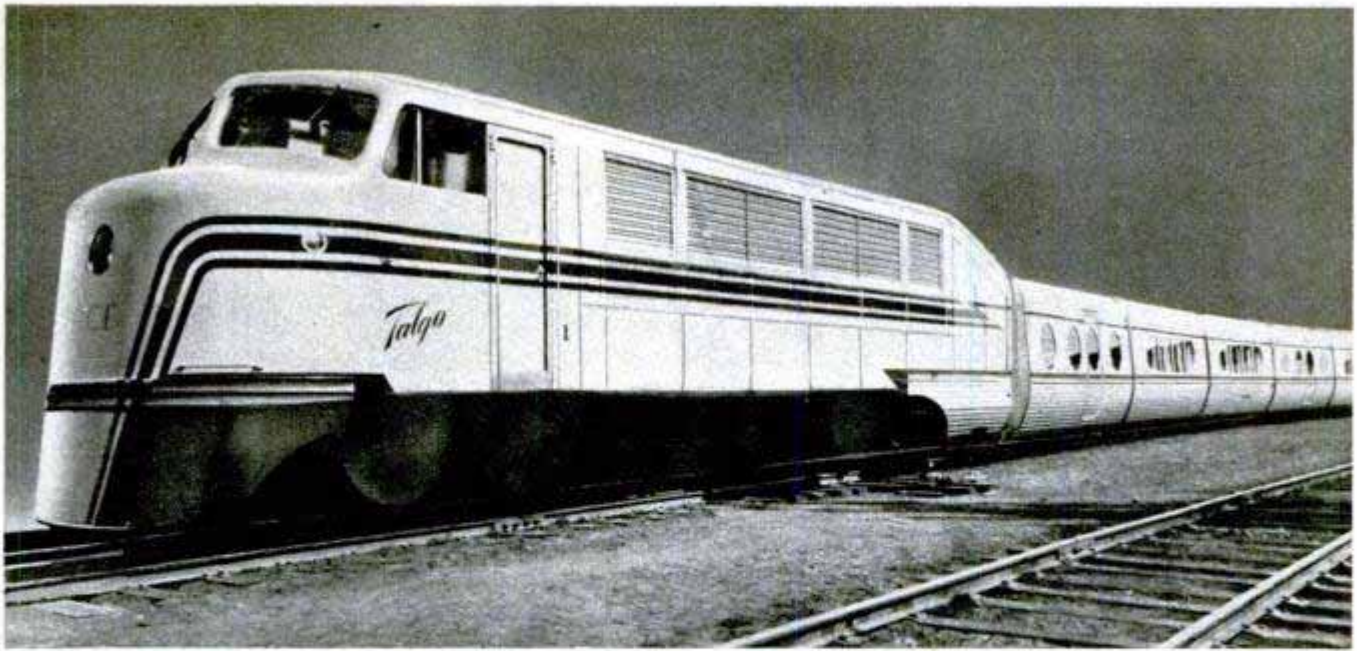

Low-Slung Spanish Train Is "Zippered" Together

Built in the United States for a Spanish railroad, a new streamlined passenger train is so low that people standing on the station platform have to look down at seated passengers. Because of its all-aluminum construction, the train is almost 75 percent lighter than a conventional streamliner. Each coach of the train is actually five articulated units, their joints closed by zippered rubber diaphragms. One of the five units of each coach houses the equipment that would be mounted beneath the floor of a conventional coach. Each unit has only one pair of wheels and the front portion of the unit is supported by the wheels of the preceding section. Designed by Spanish engineers, the train will go into



service between Madrid and the French border, a distance of about 500 miles. Expected to reduce present running times, the train has a cruising speed of 120 miles an hour on straightaways and will take curves at 80 miles an hour.

Quick-Change License Holder

You can change plates on your car without tools if you have a license-plate holder and frame combination that holds the plate securely by spring action. The base of the holder is bolted permanently to the bracket on the car. Then the plate, framed by four interlocking metal pieces, is slipped into a top groove and pushed upward, stretching two strong springs that are part of the base. The lower edge of the plate then slips into another groove in the bottom of the base where it is held securely by the downward pull of the springs.



• Listen to the fax

NEWSPAPERS have broadened their services until the printed page does just about everything except speak aloud to the reader. Now a new kind of newspaper is doing exactly that. It's a newspaper that talks to the reader as he scans the headlines.

The University of Missouri's School of Journalism is the scene of intense experimental work to develop audio-facsimile, whereby a page of news and pictures is reproduced by radio while a commentator discusses the information.

Since October, 1948, Missouri FAX, one of two daily facsimile newspapers now in operation, has produced a unique audio-visual printed page. Facsimile equipment for the experiment is provided by the St. Louis Star-Times and radio station KXOK.

Audio-fax, as the system is called, is made possible by a development called multiplexing, which allows broadcasting of sound and facsimile over a single FM radio channel. Because Columbia, Mo., has no FM station, FAX uses direct wire rather than radio transmission, but operates exactly as it would over the air waves.

The facsimile laboratory now is experimenting with 15-minute, four-page audio-

fax broadcasts. Here's the way it works:

An audio newsmen and a photographer are sent to the scene of any news event. The newsmen prepares an on-the-spot tape recording while pictures are being taken.

At the laboratory the pictures are developed immediately and worked into a page layout. Meanwhile other staff members prepare news stories and headlines for the visual page and blend the tape recordings into a smooth commentary.

Special advertisements are designed for this type of newspaper. As the ad appears on the viewer, the announcer points up the printed message by drawing attention to the pictures.

Although facsimile has been under development for years, the synchronization of a radio voice with the printed page is new. Authorities at Missouri's School of Journalism, who are deep into facsimile by now, say that mass production could bring the price of AM-FM-Fax sets down to about \$100 or \$150. However, only those persons within the range of a facsimile broadcasting station could use the sets.

Missouri FAX now pipes the printed page and commentary to five receivers in campus buildings, a bank and a theater.

Staff member starts the drum on the transmitter rolling while the announcer stands by to start his commentary
University of Missouri photos

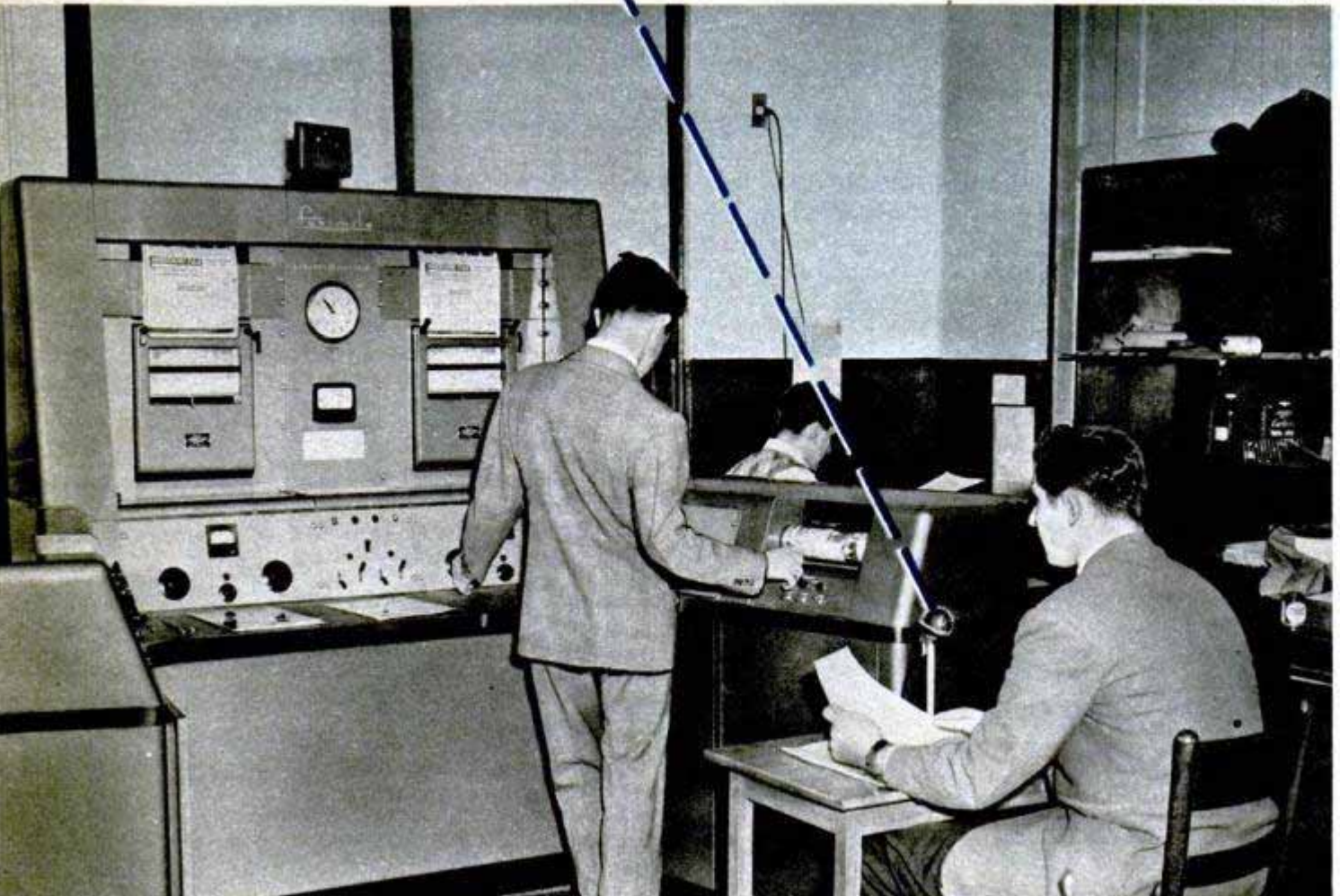

After the page has been prepared for transmission, it is wrapped around a cylindrical whirling drum and an electric eye scans it from top to bottom. Shades of black and gray in the original copy provide the varying signals that go out to the receivers. There these signals are converted back to a printed page by an electrolytic printing process. Particles of iron are transferred from a printer blade to a chemically treated sheet of paper. The particles combine with the chemicals to produce black and gray patterns that are identical with the original page. The paper, which is moist, is dried by a heating bar as it comes from the receiver. Only about 3½ minutes pass between the time the page is placed on the drum and the time the facsimile page rolls from the receiver.

Audio-facsimile is expected to make possible many new uses for radio. Music and foreign language lessons can be conducted by voice while printed examples appear before the student. Housewives listening to cooking-school programs would hear oral instructions and have a permanent printed record. Police could speed the pursuit of criminals by sending fingerprints by facsimile while describing the criminal by voice.



Prepared copy, headlines and photos are pasted to a backing sheet. Finishing touches are added to the page with black ink

Student FAX staff members edit and rewrite stories and make the broadcasts. The paper is unique because it speaks aloud to the reader, combining a facsimile page with a commentary

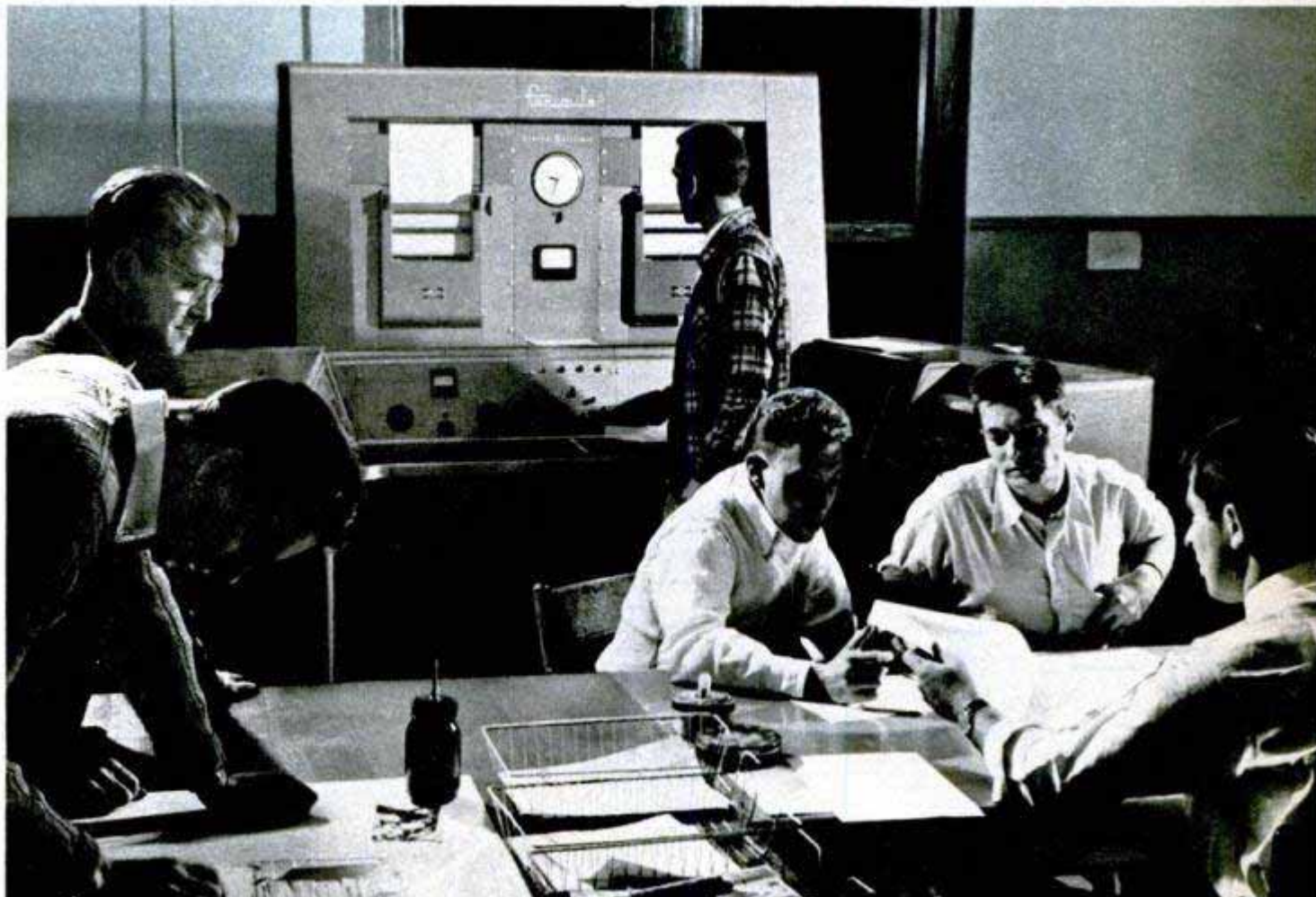



American Helicopter Co. photos

Lightweight, compact jet-engine system of the Top Sergeant, above, permits added space for cargo and passenger. Right, fuel is pumped through rotary seal and carried to rotor-tip engines by flexible lines

Jets on Tips of Rotor Blades Fly Top Sergeant 75 M.P.H.

One or both pulsejet engines on the rotor-blade tips can safely operate a new helicopter known as the XA-5 Top Sergeant. The first helicopter specifically designed for pulsejets, it is built to carry a pilot and observer 140 miles at a top speed of 75 miles an hour. After compressed air starts one engine, the rotor starts whirling and air ramming into its intake starts the second engine. The only moving part of the power plant is a reed valve system that takes only five minutes to replace. The entire helicopter can be assembled in 30 minutes.

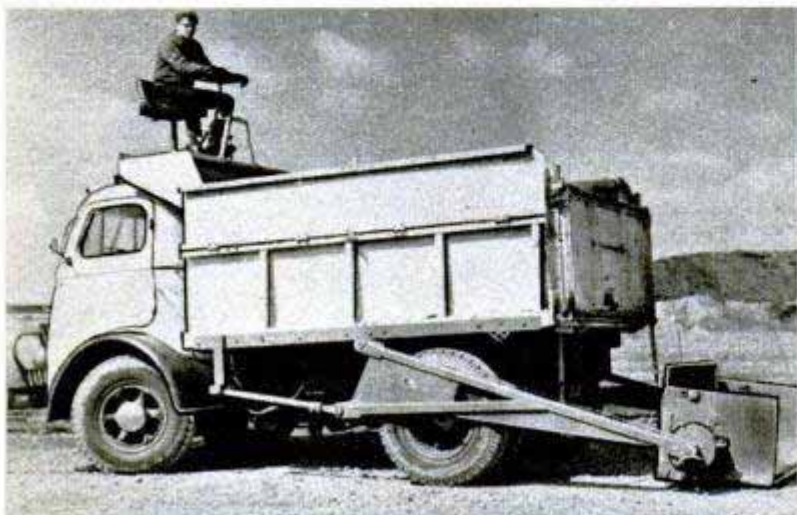

Hydraulic Truck Loader

One man can load a truck in 10 minutes with a hydraulic loader operated from a platform atop the cab. From this platform, the operator can drive the truck as well as operate the loading apparatus. The loader has a variety of uses: It scoops loose material into the truck from the ground; it serves as a lift for raising heavy crates; and the scoop pivots for use as a loading cup, such as used on garbage-collection trucks. The loader can lift 2000 pounds.

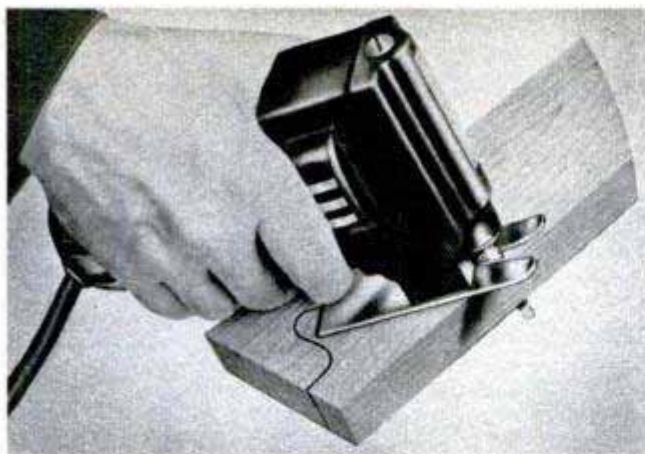

Power Keyhole Saw

With an electric keyhole saw that uses a saber-toothed blade, you don't have to drill a starting hole to cut out an opening in the center of a board. The blade has a special point that cuts directly through material up to one inch thick. It also cuts around a $\frac{1}{4}$ -inch radius. The fractional-horsepower motor delivers 3250 cutting strokes a minute. A stand is available for mounting the saw upside down on a workbench, converting it into a table saw.

Front-Vision Mirror

Driving an automobile is made safer by a front-vision mirror device that enables the driver to "see around" a car or truck in front of him before he swings out to overtake it. Consisting of two mirrors, mounted so that the image is reflected back toward the driver, the device clamps on top of the door. By watching the reflected image in the mirror facing him, the driver can see approaching vehicles without swinging out of his traffic lane.



Bad-Weather Football

More than 100 grooves along its length make a new bad-weather football easier to handle in rain, sleet, snow and extreme cold. It was designed by a leading sporting goods company in keeping with official size and weight requirements to make ball handling and passing easier and to minimize fumbles.

Flint-Type Lighter for Lanterns

Gasoline lanterns can be lighted even in a high wind or hard rain if they are equipped with a new flint-type lighter. Fastened directly to the bottom of the lantern, the lighter throws up sparks to light the mantle or wick. The lighter fits all models of gasoline lanterns, lamps, stoves and heaters.

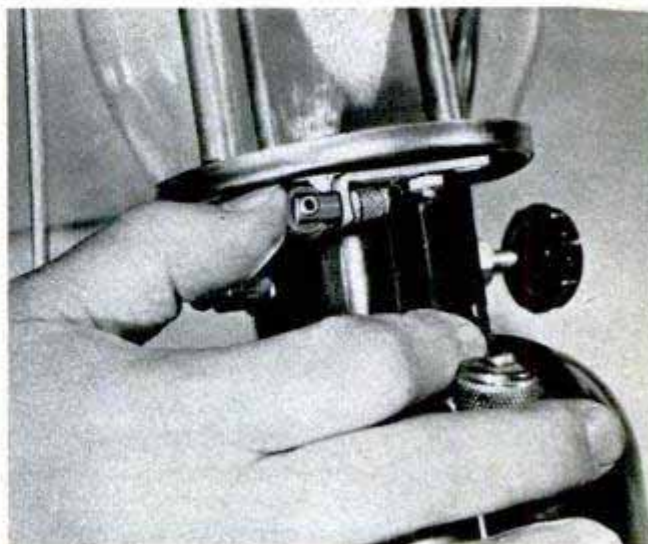

High School Assignment:

Homework for the high-school boys at Chester, Ill., is house-building. They earn their diplomas, their classwork helps solve housing shortage

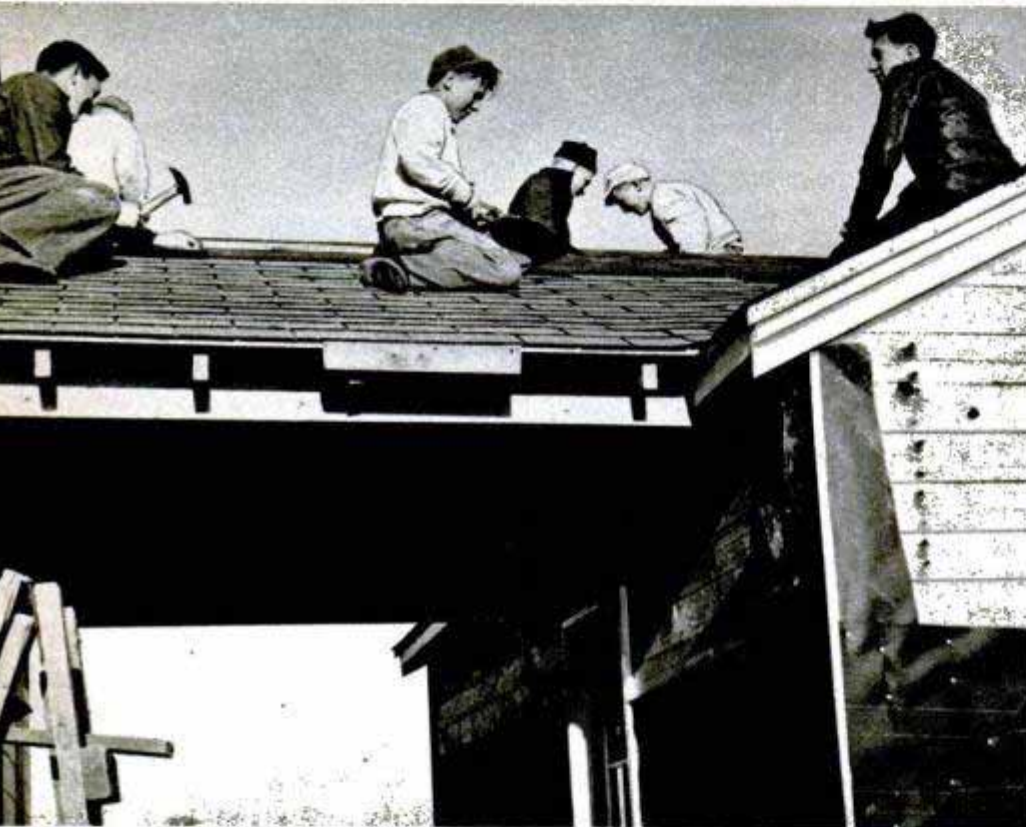

Above, roofing goes on fast with a half-dozen hammers pounding. Here, the high-school students nail down the shingles on the breezeway roof. Below, as the crew puts up siding, a helper cuts the shingles to size

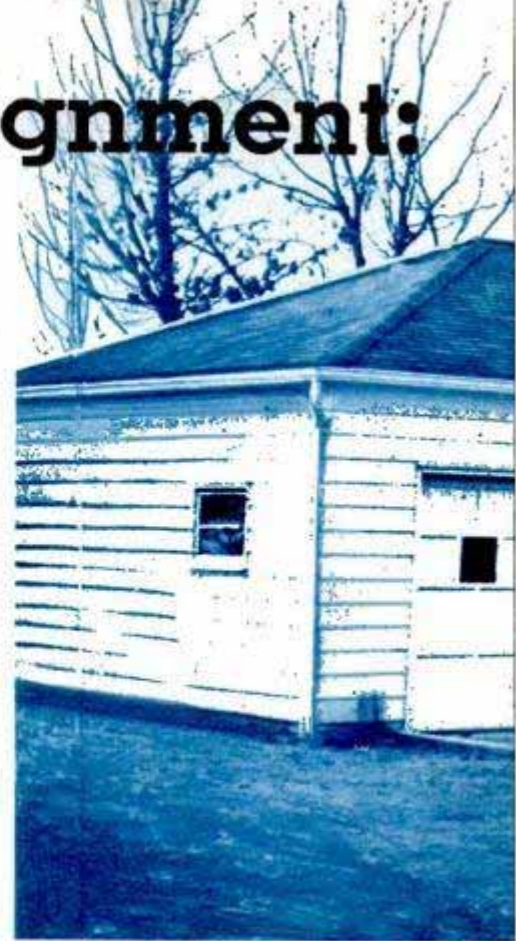

By Dorothy O. Moore

BOYS SCRAMBLED Over the rafters, dangled from scaffolds and dashed busily about a ranch house being built in a new subdivision of a midwestern American town. They were there to earn high-school diplomas and were building the house without experienced help other than that of their instructor.

Chester, Ill., is a town where most of the wage earners are craftsmen. It has a flour mill, a shoe factory and a building boom. Because building trades appeal most to boys of the community, Chester was chosen two years ago as one of the spots where educators would experiment with a new approach to "shop" education.

Seventeen top-ranking high-school students, ages 16 to 18, were selected from a long list. They passed an aptitude test and qualified for the experimental class by working 100 spare-time hours at a building trade. There

POPULAR MECHANICS

build a house



This neat home was built by the Class of 1948 and sold to the highest bidder at the end of the school year

was a wave of amateur home repair work in the southern Illinois town during the next summer vacation. Boys who had never used a razor picked up planes and deftly smoothed doors that stuck, cleaned refuse from sink goosenecks, repaired faulty toggle switches and converted attics to pine-paneled playrooms.

Money to finance the class project of building a family-size residence was borrowed by the school board from local banks. Tools, materials and a plot of ground were purchased. Chester's first boy-built house was in the making.

In September 1947, Maurice McElhiney, vocational building trades instructor of Chester High School, started the term by handing his class of 17 a "home" work assignment: five rooms with bath, garage and utility room. In the classroom, the kids drew plans and specifications. Then they hiked or hitch-hiked to the home site, took shovels and dug the excavation for footings.

The house grew in spite of football practice, Christmas and Easter holidays and an epidemic of

romances. There was some trouble with plaster but finally the finish coat was smooth. The furnace and plumbing functioned perfectly, light switches worked like Aladdin's lamp. By the end of the term in June 1948, the house was ready for some house-hungry family.

The kids rolled the lawn to smoothness, planted evergreens, packed up their tools and held out their hands for diplomas. Educators beamed, for the house the kids built was as solid as any in the block. The Class

Big enough to cover an entire wall without unsightly seams, this wall-board had to be bowed and tied before it would pass through the doorway

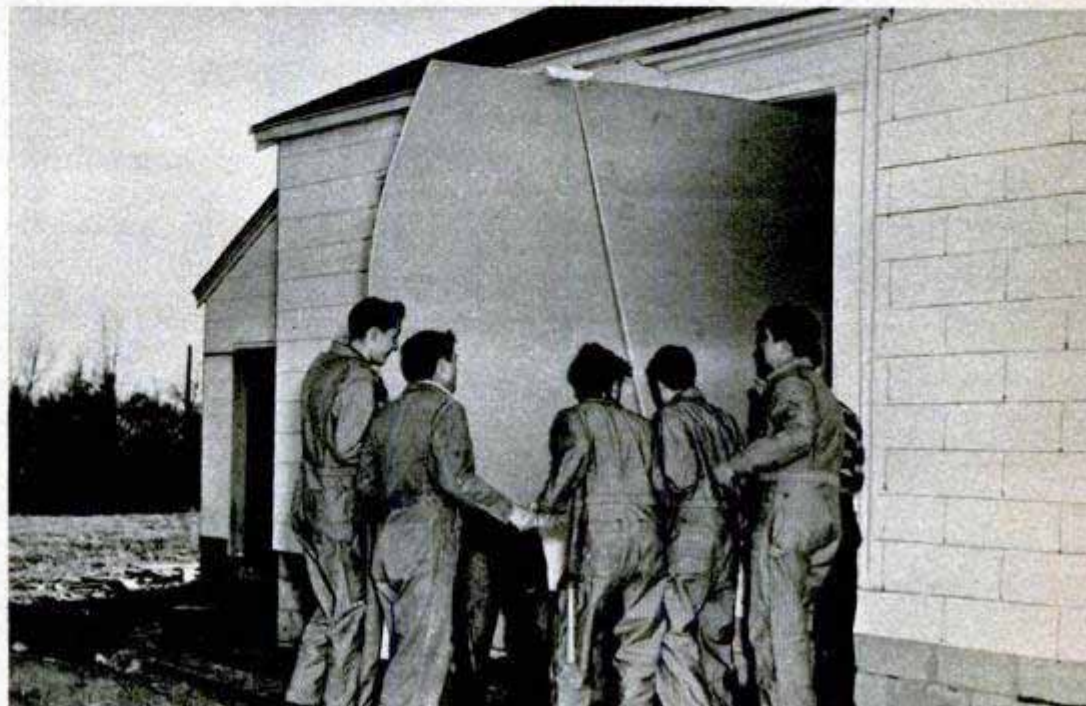



Above, two of the high-school home builders set the first ceiling square in the bedroom. Below, the boys' instructor, Maurice McElhiney, demonstrates the way to measure the wallboard sheet to assure an exact fit



of '48 had pounded home lessons never to be forgotten.

There was an "open house" reception on the Sunday after Commencement Day. Prospective buyers thronged through the rooms, over the lawn and gazed down the slope with a view to the Mississippi.

An auctioneer swung into his chant and the visitors topped each other's bids until the trim, white frame house was sold with a profit of \$2000.

The 1949 vocational building trades class began a new term last September with an order for a four-room house, a nest-egg of \$2000 and the conviction that there's nothing like building a lesson from the ground up. Bankers agreed and lent more money.

This term's house was slightly different from the first. It was smaller, there was a breezeway to catch the zephyrs from the Mississippi and walls were not of plaster.

On a 60 by 120-foot lot which they selected, three blocks from the first "school" house, the boys dug for footings. Some had argued for a basement, but digging with hand shovels in the Illinois clay is slow work and the house had to be weatherproof before winter. The kids settled for a ground-floor utility room.

When foundation trenches were ready, the class was divided into working groups. Some shoveled sand, gravel and cement for a 2-4-10 mixture and dumped it into the hopper of a concrete mixer. Others turned the mixer by hand until the "fudge" was ready to be poured for footings. Another group set the concrete blocks for the foundation and troweled the mortar between them. It was mixing mortar for mortarboards, but lessons never were more fun.

Floor joists were toe-nailed down, studding erected and the skeleton of the roof took shape. Enthusiastic carpenters sawed pine two-by-fours to meet specifications. They learned that a "bird's mouth" is a notch sawed near the end of each rafter and they learned how to fit the bird's mouth to plate. They sawed "tail cuts" where the rafters project beyond the wall.

Under McElhiney's watchful eye, they centered rafters on 16-inch centers, using a carpenter's square to determine the lengths of the jack rafters. They had to keep bevel and plumb cuts accurate. Over the roof boards went green composition shingles and the project was snugly under roof before winter deadline.

Student plumbers dug a trench for sewage pipe, installed a septic tank and fitted inside plumbing. Electrical wiring was laced along studding and outlet boxes were set into the walls. Exam time found school board and union officials inspecting and approving the work while the kids nailed white asbestos shingles to wall sheathing.



Left, an inside view of the kitchen built by the Class of 1948. Right, installing a heating duct in the attic

The floor plan, carefully worked out by the boys, includes a 15 by 15½-foot living room with fireplace, two bedrooms with ample closets, a kitchen-dinette with a breakfast bar, a wall of built-in cabinets and outlets for all the electrical appliances used by today's homekeeper. The bath is tiled, the utility room houses a forced-air, oil-burning furnace, a shower and stationary laundry tubs. Across the breezeway is the garage, large enough for a family car, the lawn mower and fishing tackle.

No one showed up at a high-school prom last term with plaster in his pompadour. The Class of '49 ordered pre-cut room-size

slabs of building board for interior walls and ceilings. By bending the flexible sheets, the boys were able to take them in through the front door. Not a nailhead or corner joint can be seen on the finished walls.

The kids won their diplomas by completing the ranch house before Commencement Day. Educators who sponsored the idea are predicting a new curriculum for the nation's teenage vocational students. Master craftsman, at first reluctant to approve the plan, admit the youngsters have done a workman's job. The house the kids built is straight as a plumb line. The boys have passed the test of good craftsmanship.

This family is happy in its student-built home. Photograph shows the professional quality of the construction





Camera Checks on a Champ DIVER



Seagoing birds, such as the brown pelican shown here, don't often pose for the camera, especially when diving for food. However, Hugo Schroder, a Florida photographer, happened by with his camera as this pelican put on a display of diving just off a long wharf. He shot this group, the only pelican-diving series he's been able to get in 20 years. He used a Graflex camera for the shots. Exposure: 1/490 at f:8

Top, left, this dive will be no prize winner. Bird is too far over on back as he nears the surface

Left, with a loud whack, the bird hits the water back first. This is his poorest dive of the day

Top, right, this dive is perfect! Legs and wings are elevated to streamline the bird as it falls

Center, right, the end of a perfect dive! Note the small splash. Wings and legs have been extended

Left, pelican brings its powerful wings forward as it comes up from dive. Its legs push it forward

Right, leaving the water, the pelican spreads its broad wings and tail to get into the air quickly





Furnace door opens automatically like a blinking eye when bundle of stainless-steel rod is properly annealed

They Spin Wire by the Mile

By Clifford B. Hicks

SUPPOSE you could zoom around the earth 18 times every 24 hours, unreeling a strand of wire as you made the circuit. You would be laying wire just about as fast as American mills are spooling it up. Every time our globe whirls once around its axis, our mills spin out about 450,000 miles of wire.

Still an infant in this brisk industry is the making of wire from stainless steel.

The baby has begun to walk by himself but can't yet keep up with the older kids. For several years we've had stainless-steel wire, but not in the quantity we can use; and even the top wire engineers aren't yet sure they have found the fastest way to turn out this shining yarn.

Industry converts stainless-steel wire into refrigerator trays and springs, into welding wire and plane rivets. Recording

COATING TIRE-BEAD WIRE WITH BRASS



COIL OF WIRE TO BE COATED

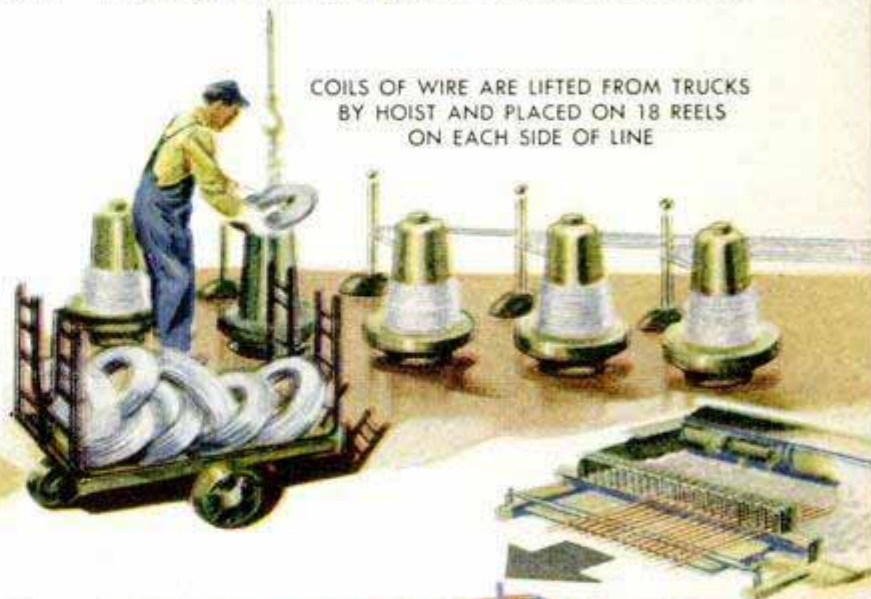

COILS OF WIRE ARE LIFTED FROM TRUCKS BY HOIST AND PLACED ON 18 REELS ON EACH SIDE OF LINE





Gleaming stainless-steel wire piles up on drums after passing through dies

wire also is stainless steel, as fine as a hair from your head. If you live along a sea-coast and admire your neighbor's gleaming rustproof fence, the chances are it is made of stainless steel.

Because the so-called stainless steels resist corrosion, they are invaluable in making certain products. But when man developed these special steels during World War I, he developed a material much harder than the proverbial nails. Stainless steel is just about the toughest infant in the neighborhood and consequently poses a good many problems in behavior.

A bright new plant at Waukegan, Ill., began turning out stainless-steel wire a

couple of months ago and may well become a full-scale laboratory for solving some of those problems. Jim Fenner, a top authority on wire drawing and superintendent of this new American Steel and Wire Company plant, says the difficulties encountered in drawing stainless-steel wire are not much different from those in drawing ordinary wire. Stainless steel is just more so.

A few hundred feet from the mill where Fenner's crews are patiently drawing stainless-steel wire, other crews are spooling up ordinary wire. They are using techniques as old as wire itself to turn out the shiny stuff.

Any kind of wire is made by grabbing a metal rod and jerking it through a hole smaller than its own diameter. This squeezes and stretches the grains of the metal, cutting down the size of the rod but making it longer. Actually, it's just a method of stretching metal, like stretching a rubber band. Then if you pull it through another, smaller die you produce even finer wire. Probably the wire in your window screens came from Waukegan after being drawn through 20 dies.

Wire first was produced by hammering, but in the Middle Ages some bright metallurgist invented the modern system of

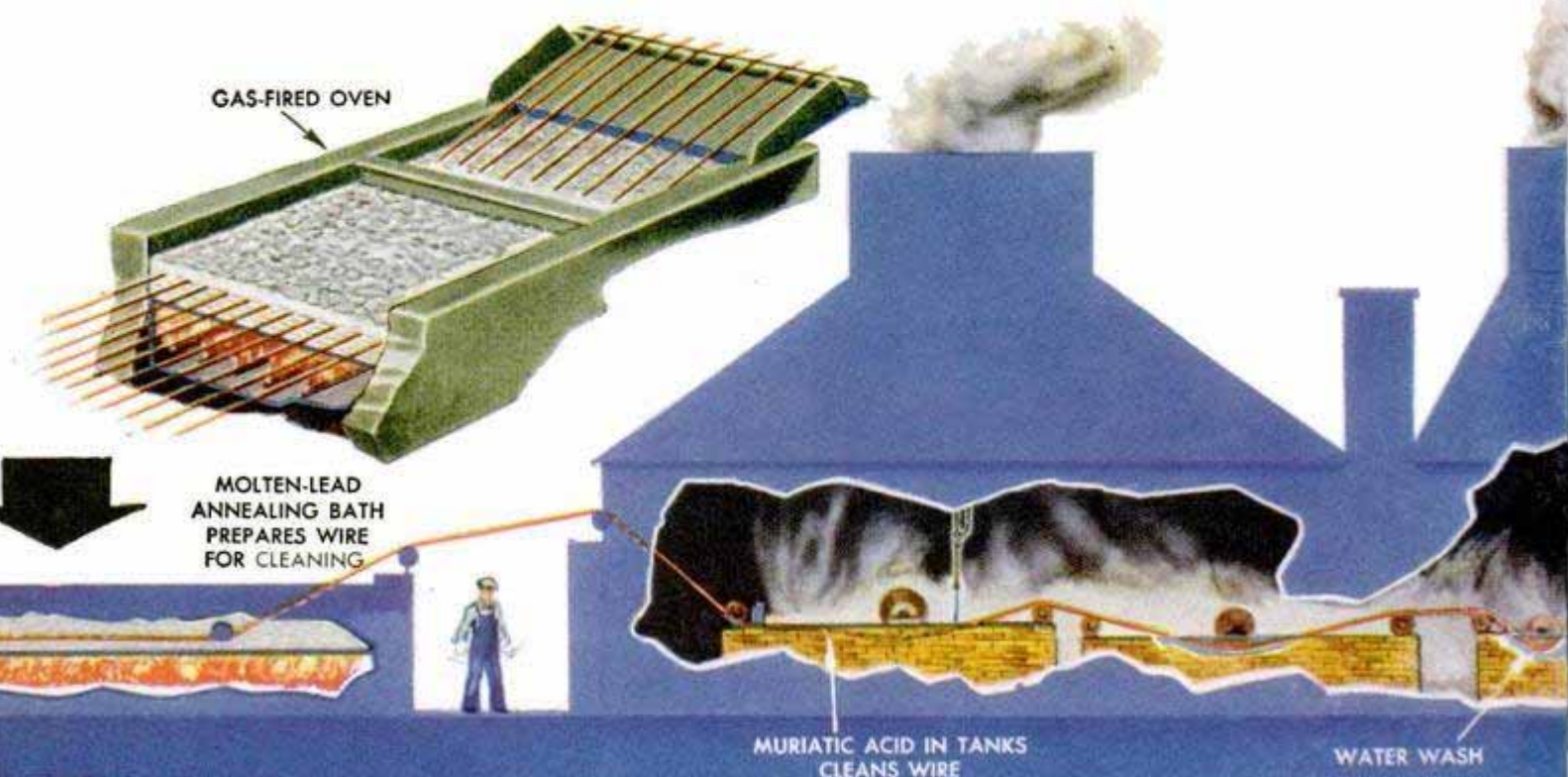

drawing. By 1430 iron wire was made essentially as it is today—but not with the same equipment. In those early days a wiremaker's best tool was a strong back. He'd pierce an iron block with several holes and drive it into a tree stump. After filing a point on a metal rod he'd stick it through the proper hole. Then he'd sit down on a swing in front of this wire mill, seize the pointed rod with a pair of pliers, lean back and push on the stump with his toes. If the swing, iron block, stump or his back didn't snap, he'd pull through a few feet of wire.

Today, whirling power drums pull wire through the dies at high speed. At the Waukegan plant, more than 75,000 miles of wire pile up on the drums each day. Most of it is round, but for special purposes it can be drawn in flat, square, triangular, oval and other shapes.

Raw material comes into the mill in 4500-foot coils of hot-rolled steel rod, normally about the diameter of a lead pencil. Days later this same rod may be shipped out as a tiny thread of steel no larger than a human hair but about 180,000 feet long. The rod goes through the first draft at a speed of about 350 feet per minute, but in the final draft piles up at 1000 to 3000 feet per minute. It takes about 12 drafts through 12



"Rod ripper" tugs rod through first die as worker stirs up soap lubricant

successively smaller dies to stretch the rod to this length.

When a coil of rod first comes into the mill, scale and dirt are removed by dunking it in a sulphuric-acid bath. Later, it is washed and soaked in a solution of lime. The lime neutralizes the acid and also acts as a lubricant when the rod passes through the die. The coil is baked in an oven to about 300 or 400 degrees to solidify this lime coating and remove brittleness from the metal. It then is flash-welded to other coils. A workman shoves one end of the entire bundle into a machine that points or "swedges" it, and at last the rod is ready to be yanked through the first die.

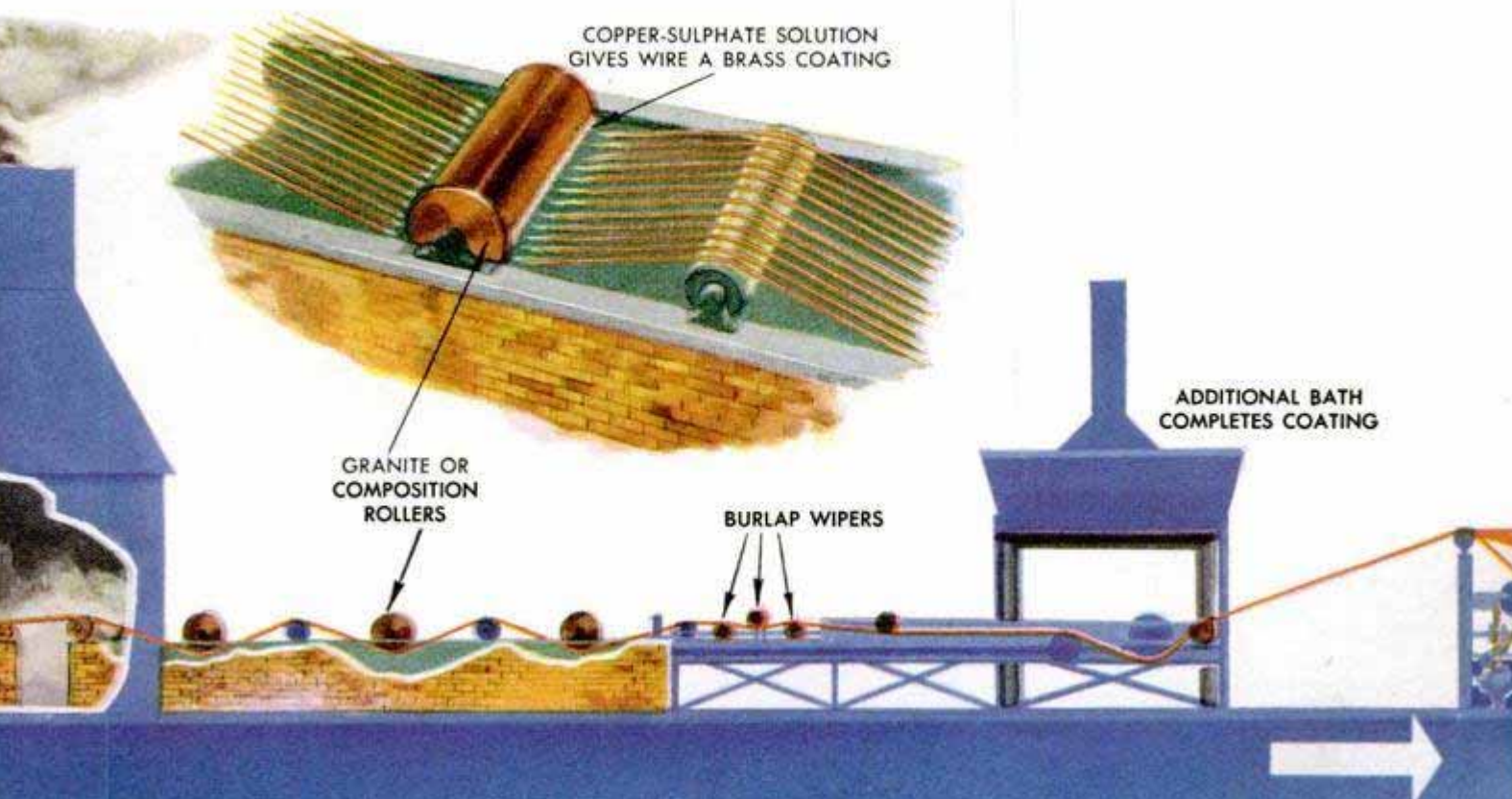

You can hold this die—the heart of the sprawling wire industry—in the palm of your hand. Dies are divided into four zones; the entering angle, the doorway through which the wire and lubricant pass; the approach angle where the wire is squeezed into shape; the bearing angle which determines the final shape and size; and the back relief angle, which prevents edges of the hole from breaking away.

Dies are made of tungsten carbide, almost as hard as a diamond. But they are pitted against an enemy that always wins—the terrific strain and heat that wear them down, so that they must be reamed out to the next larger size before they can be used again.

A vise holds the die securely in position. The pointed end of the rod is pushed through the die and grabbed by pincers that tug the rod through the hole and wrap it around the power block. As the block whirls, it drags the rod through the hole to transform it into wire. After the rod has passed through one die it is called wire; successive drafts make the diameter smaller and the wire longer. The diameter of the wire is reduced an average of 30 percent each draft.

The lime coating plays its part almost instantaneously as the wire grinds through

the die, acting as a lubricant to reduce the terrific friction. And just in front of the die the rod passes through another lubricant, usually soap or grease, which performs the same task.

At the instant the wire squeezes through the hole, the friction is so great the heat would ruin the wire if it weren't controlled. In some cases water is circulated through the die casing to dissipate this heat, and in every case air is blown on the block to cool the hot wire.

Ordinary wire machinery pulls the rod or wire through a single die and coils it on a drum. Then it is stripped off this drum, swedged again and passed through the next die. This laborious process is repeated until the wire is drawn to the desired size. However, the ingenious modern continuous-drawing machines pull the wire through as many as 14 successive dies without removing it from the block. The wire travels a looping path through the first die, around a block, through the second die, around the second block and continues until it is drawn to the proper size in a single operation. Because each block must rotate faster than the preceding one in order to accommodate the lengthening wire, this process is as intricate as the movement of traffic on the Indianapolis Speedway.

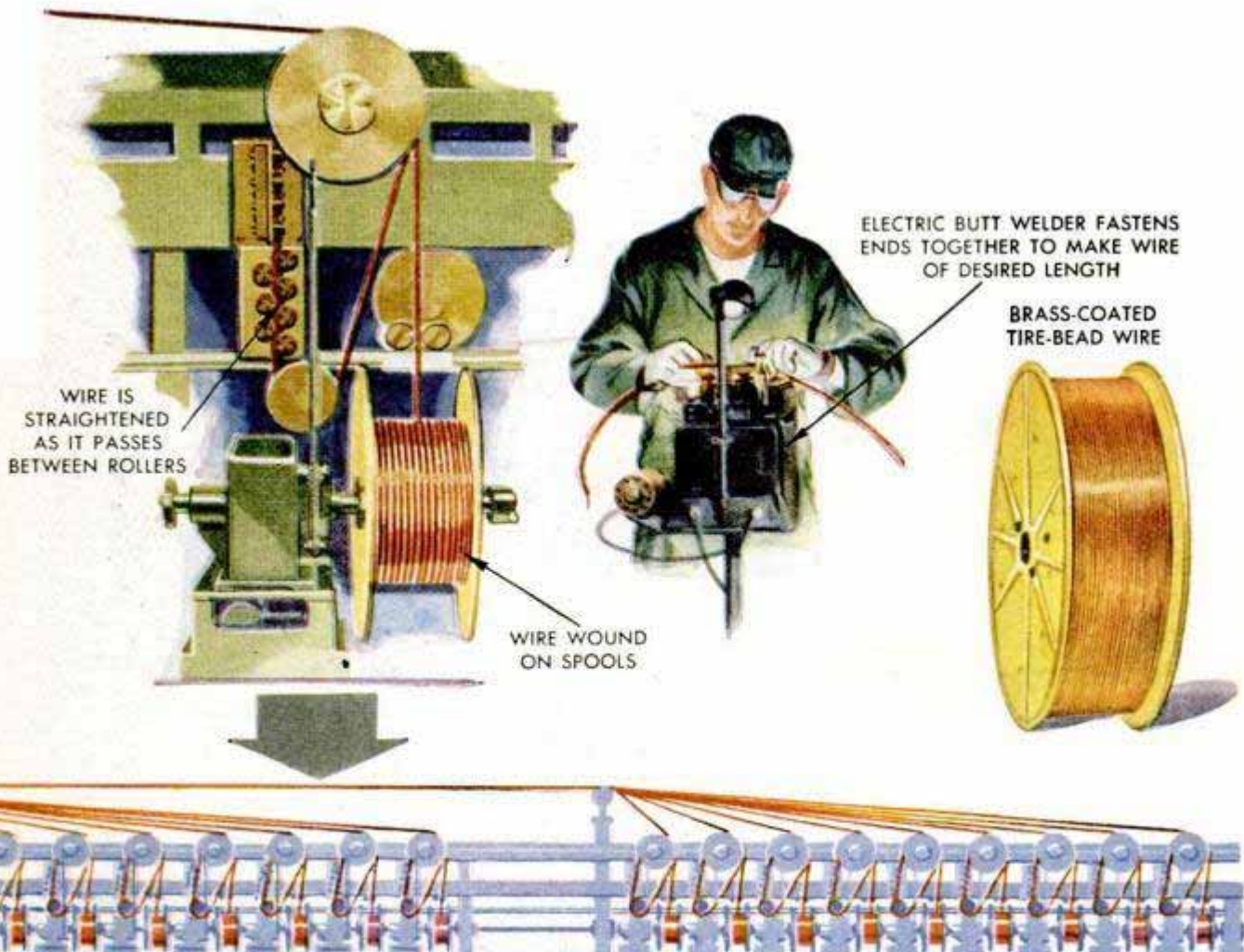

In addition to stretching the filament, each die also smashes the small grains of steel together, hardening the wire. Eventually, it becomes so brittle it would break if left untreated. To counteract this, the wiremaker heats or anneals it in a furnace, which permits the distorted grains to relax, relieving all internal strain and leaving the wire soft and ductile.

When he has drawn the wire to the desired size, the wiremaker gives it any kind of coating ordered by the fabricator. For example, wire for the beads of your automobile tires must be brass-coated to provide a surface to which rubber will cling. The wire travels along a 300-foot coating line, dipping in and out of a bewildering number of heat treatments and baths. Near the end of this line it runs through a solution which coats it with a thin film of brass. The steps in this fascinating process are shown in the diagrams on pages 89 through 92.

Wire to be used outdoors for fences or guy wires must be galvanized. Such strands pass through a hot-lead bath which softens them, then through a cleaning bath and finally through molten zinc which adheres to the clean surface. Or the wire may be galvanized by an electrolytic process. In either case, the result is a wire that won't rust. Tin or copper coatings are vital to still other types of wire.

All wire at Waukegan is "cold drawn"—unheated when it is tugged through the die—although most of the coatings are applied by hot baths.

What happens to the wire after it is drawn and spooled depends upon the use for which it has been designed. A great deal is shipped out for use as is. About 20 percent of all steel wire runs through nail-making machines, which clip it to the desired length, point each section on one end and hammer out a head on the other. Still more of it goes to a staple-making machine

Top, sparks fly as bundles of rod are welded together to make drawing continuous. Center, as strands pass through a heat-treating furnace, a metallurgist checks the temperature by noting color of rods in optical pyrometer. Right, white-hot stainless-steel rod is dropped on the quenching platform which will lower it into the water

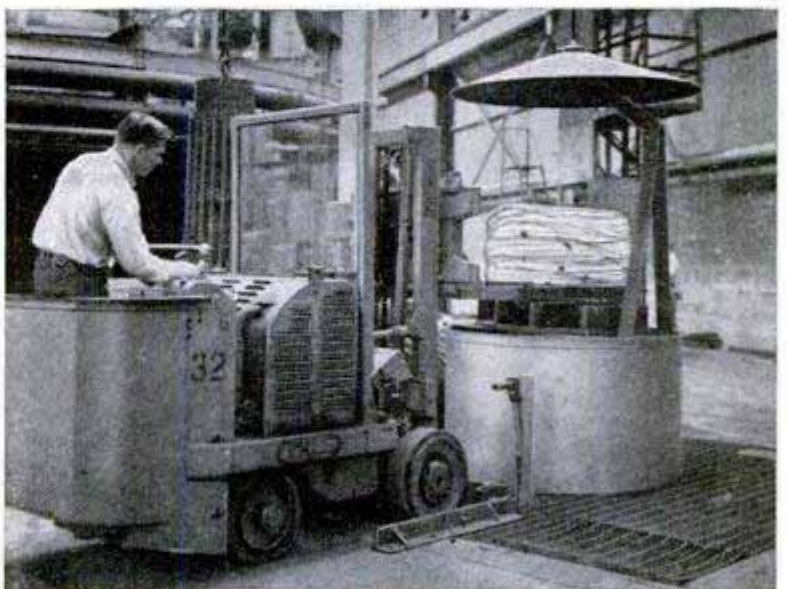
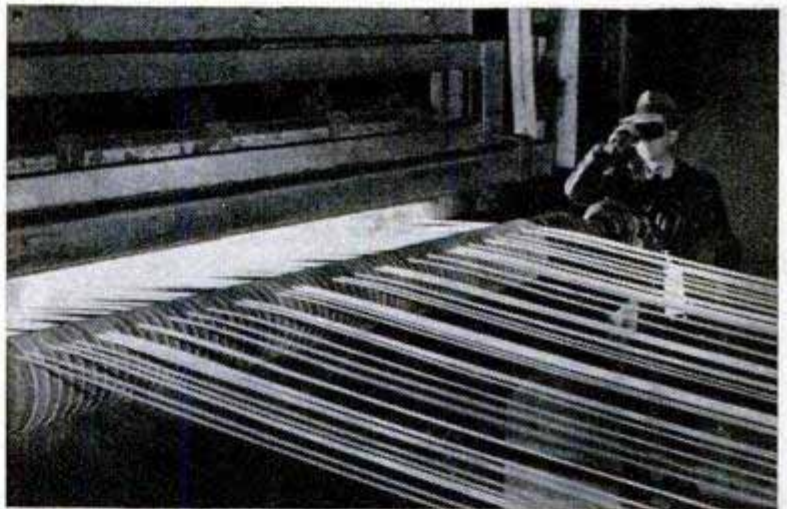
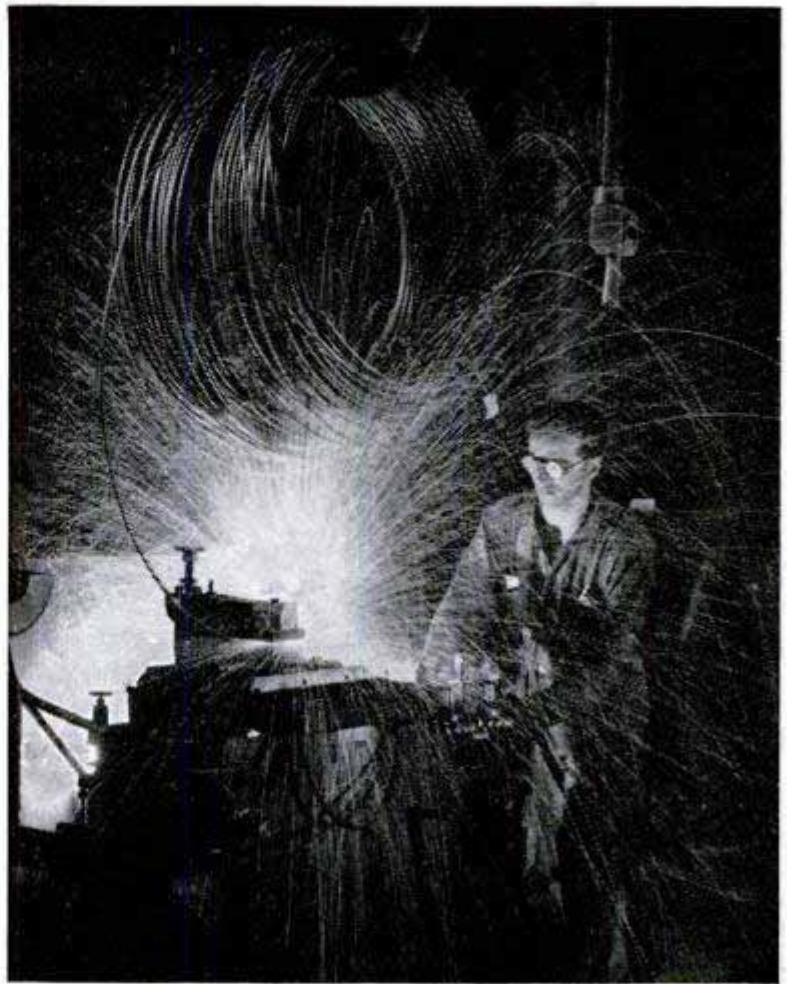

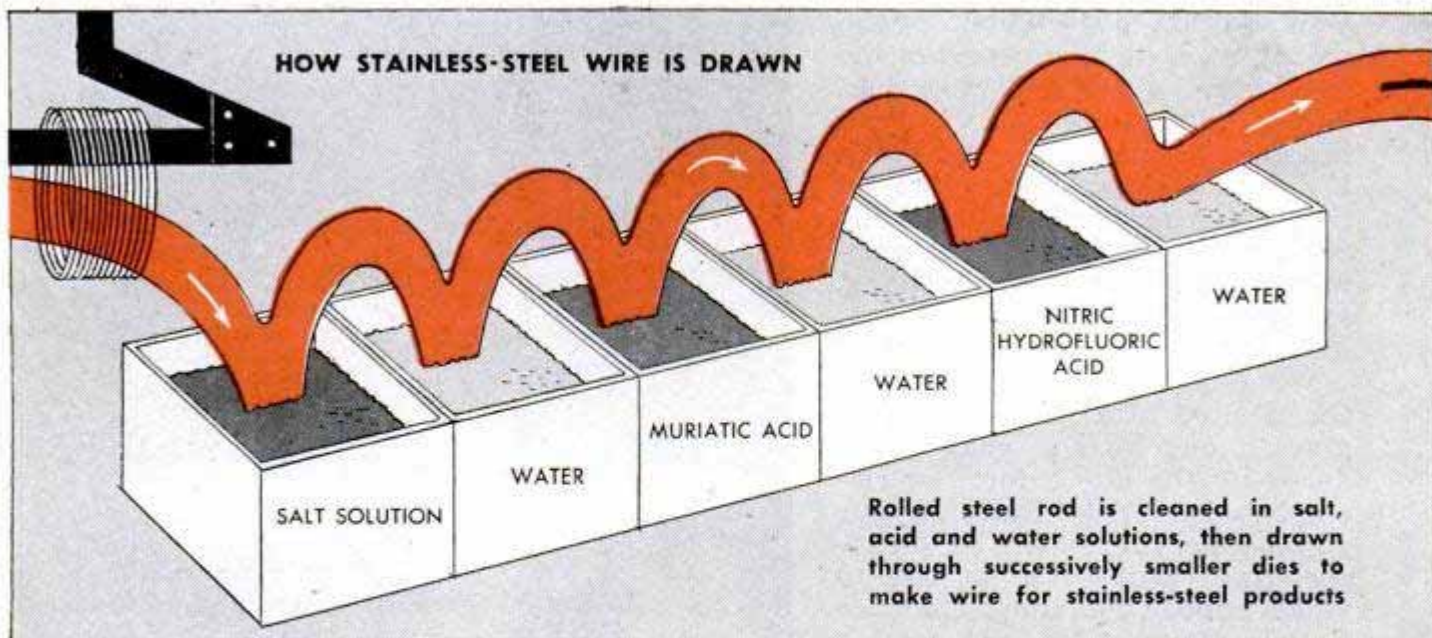

where it is sharpened on both ends and bent into the shape of a horseshoe.

The Waukegan plant also turns out a good many wire springs ranging from mammoth 200-pounders to springs so small it takes 1000 of them to weigh $\frac{1}{10}$ pound. This wire first is straightened as it is taken from the coil, heat-treated, then turned in spring-making machines to produce the desired spring size.

Plunk the new "E" string on a violin or a mandolin and you are vibrating the strongest wire ever made. This same wire, only recently developed, makes it possible for a banjoist to hit an octave above middle

Power hoist lifts a coil of carbon-steel wire off end block. In foreground is the vise which holds the die



"C," which apparently has been the goal of the banjoist since the days of the minstrel show. The wire in cross-section area is twice as strong as the strands fabricated into the cables that support the suspension bridge across San Francisco Bay.

Wire, like wine, improves with age up to a certain point. After it passes through the die for the last time, the small grains of metal are distorted and stretched, a posture that won't let them relax. This strain can weaken wire and must be eliminated in wires that require exceptional strength. Spools of such wire are set aside for long periods of time before they are used. Gradually the inner tensions are relieved and the entire wire relaxes. This process is called age-hardening.

Obviously, drawing ordinary wire is a ticklish process that can produce a good many worries. But to find the men who really are persecuted by a lifeless bundle of steel, step now into the new section of the Waukegan plant where wire made of stainless steel piles up on the spools.

Stainless steels are divided into groups depending upon the amount of alloying metals stirred into the recipe. Some are quite ductile, others are stronger and tougher than almost any metal made. Each type of stainless-steel rod requires individual treatment. The new Waukegan plant actually is an in-between stage in the development of stainless-steel wire—all the problems of mass production haven't been worked out but all the facilities are available when answers to the questions are found.

Cleaning stainless-steel rod is much more difficult than cleaning ordinary steels. A difficult group of chrome and nickel oxides are on the surface when the rod reaches Waukegan, and are cleaned off by dips in four acid and salt solutions.

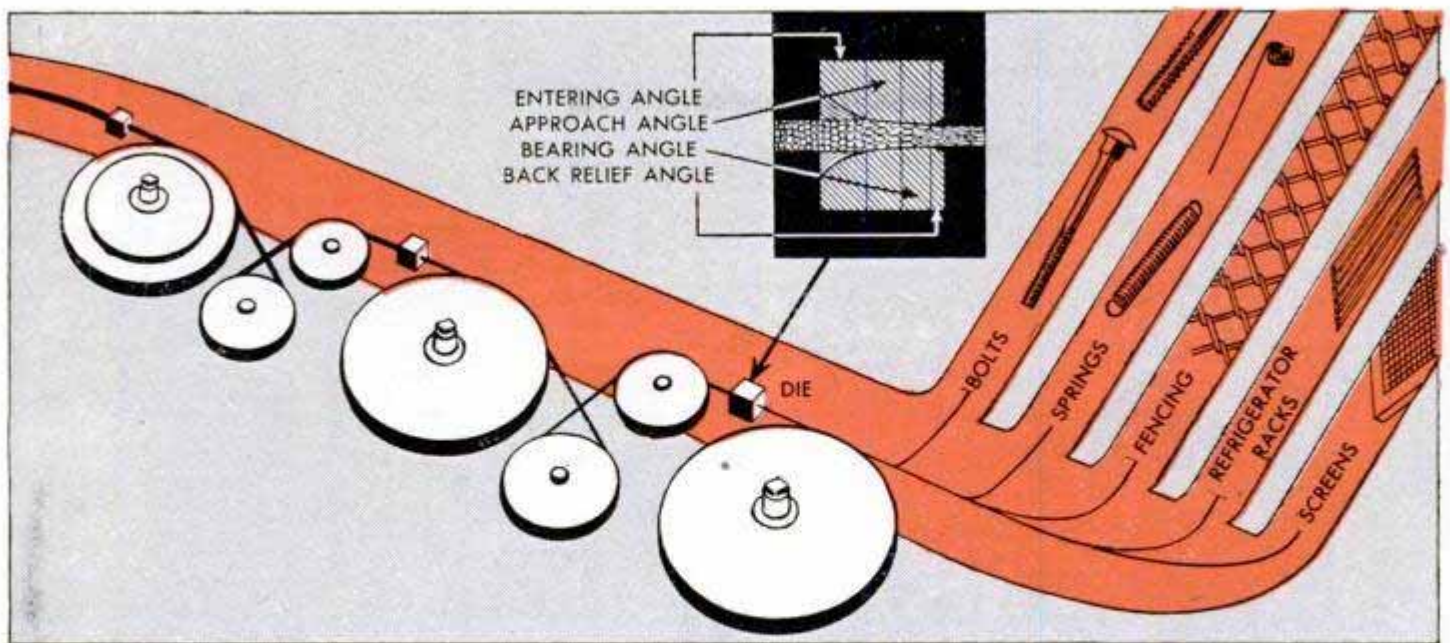

Most important treatment of all is the annealing of stainless steel before it is drawn. Other types of steel are heated to moderate temperatures and then permitted to cool. But certain grades of stainless must be heated to temperatures ranging from 1300 to 2100 degrees F. and then cooled immediately. A workman on a lift truck scoops up a bundle of stainless-steel rod and wheels toward the door of a huge revolving furnace. An electric eye opens the door automatically and he dumps the rod on a platform in the white-hot interior. As soon as the bundle has been heated to the right temperature for a specific period of time, a signal flashes and the correct bundle appears automatically at the doorway of the furnace. Two such furnaces at Waukegan have a capacity of 4000 pounds per hour each.

The workman drives the fork of his truck into the furnace, plucks out the bundle and wheels it immediately to a cylindrical platform. The platform—really an elevator—sinks out of sight and a moment later the metal hisses as it is quenched in a cold-water bath. After a timed interval, the elevator automatically rises with the coil.

Drawing stainless steel through a die requires slow production and close attention. For example, it can't be drawn nearly as far between annealings. Therefore, it must be heated and cooled frequently. It is drafted at much slower speeds than the carbon steels. For multiple drafting, a heavy coating must be applied to protect the wire surface, which scratches easily. Each grade of steel requires a different practice because of its inherent characteristics. All the equipment for coarse wire-drawing is variable speed because the optimum speed for drawing stainless steel is not yet known.

Nature herself coats stainless steel. The

metal is believed to resist rust and other forms of corrosion because of a very thin, continuous, transparent film that forms naturally on the clean surface when it is exposed to air. This stain-resistance is increased by adding more chrome to the alloy.

Stainless-steel wire often is coated but not to protect it from corrosion. A copper coating sometimes is applied to wire designed for bolts and nuts. This coating acts as a lubricant when the metal passes through the machine which cuts threads and applies a head. Or the wire may be lead-coated if it is to be made into stainless-steel springs. Like copper, the lead

Galvanized wire piles up on blocks after zinc coating is applied. Waukegan produces 750,000 miles annually

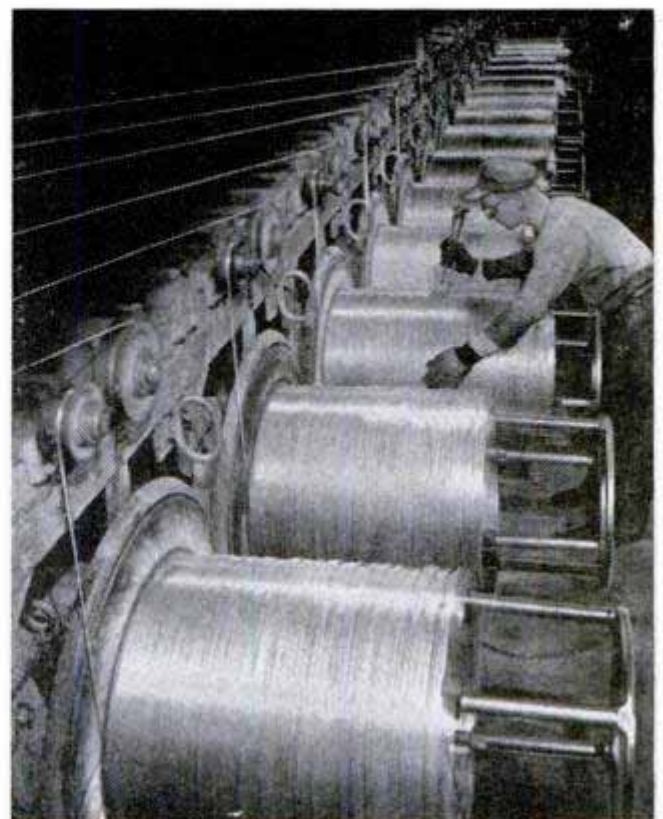



This high-speed machine turns out a real staple commodity. It stamps wire into 1000 staples each minute

acts as a lubricant in coiling the springs. Both copper and lead coatings usually are removed after they serve their purpose.

In cases where the wire is to be used in armature binding for motors, it is coated with tin. This makes it possible to solder the stainless steel satisfactorily.

If a bright finish is required, the wire may be "pickled," a process in which all lubrication is removed from the surface. Or it may be drawn through oil to give the wire an ornamental finish. A final draft

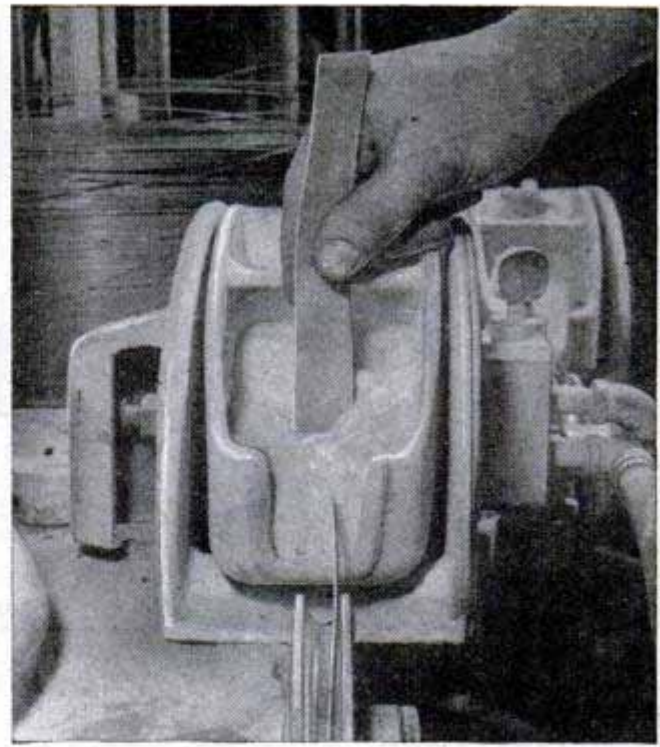

Powdered soap coats wire just before it enters the die, lubricating the strand against enormous friction

through a diamond die gives the wire its most attractive finish, smooth and bright. Drawn through soap, it acquires a finish with a minimum of luster.

The Waukegan plant has a rated capacity of 500 tons of stainless-steel wire per month. Whether it can attain this capacity depends upon whether Superintendent Fenner and his assistants can work out new techniques for mass production. Fenner says that stainless-steel wire is in its infancy—no telling how fast it will grow.

Waukegan plant makes the wire, then fabricates it into 50,000 types of springs. Big one weighs 200 pounds





Neon Sign Has Plug-In Letters To Permit Change of Wording

You do your own neon signwriting with a kit consisting of a display base and interchangeable neon letters that plug into the base to spell out your message. A wide variety of letters, figures and designs enables you to change your display at frequent intervals without buying a new sign. All symbols and letters have identical two-pronged bases that plug into sockets on two levels of the display. The replaceable letters also speed repair jobs.



Mask Protects Against Heat Without Obstructing Vision

Providing full face and head protection without obstructing vision, a heat mask made of steel screen protects workers on furnaces, cupolas and other areas of intense heat. The 30-mesh steel screen deflects heat rays and prevents infrared burns. The mask weighs only 18 ounces and has a fiber chin rest and adjustable headband. For additional protection, a woolen bib and snood can be added to the mask by means of convenient snap fasteners.

Compost Processor Shreds and Mixes in One Operation

Compost is produced quickly by an electric shredder-mixer that shoots out a continuous stream of pulverized compost as fast as the hopper is filled. Shredding, aerating and mixing with lime dust and fertilizers are carried out by an endless

belt covered with steel teeth or sprigs that comb the materials into small particles and discharge the compost by centrifugal force. Waste materials and trash discharge at the lower end of the belt, which is mounted on a 45-degree slant inside the machine.

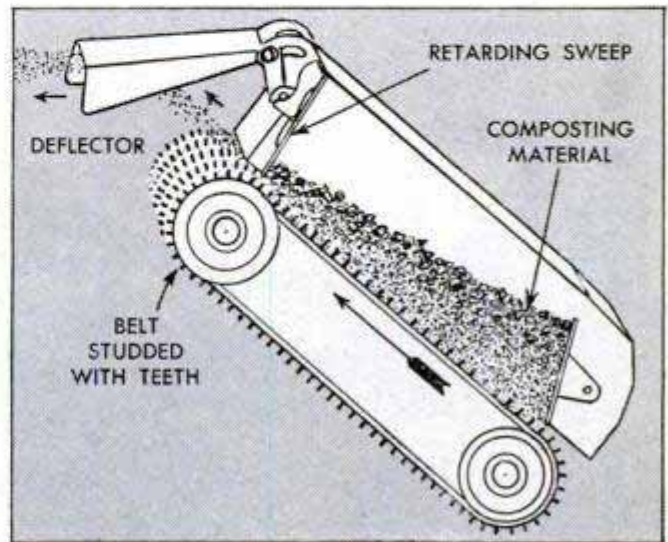



This is the Navy Corsair in which Cook Cleland set the present Thompson speed record of 396.131 m.p.h.

War Horses Still Fight Out

TREMENDOUS CHANGES have taken place in racing airplanes since the days of Jimmy Doolittle and Roscoe Turner. The present-day pylon polishers are no more like the ships flown by those famous pilots than are the modern Indianapolis racers similar to cars driven by Barney Oldfield.

Most of the changes have been due to the accelerated advancement made in high-speed aircraft and engine design during the war years. The backbone of modern high-speed air racers consists of a group of the world's fastest propeller-driven fighter planes stripped of their armament and other military accouterments with wings clipped and engines souped up.

Although the type of airplane which an individual could build in his garage no longer fits into this class of competition, this does not mean that individual ingenuity has had to take a back seat. On the contrary, the good old American backyard mechanic has found a challenge in the war planes. Since these craft were not designed specifically for pylon flying, or even for cross-country racing, there has been plenty of room for genius in adapting them to these purposes. Consequently, the types with the best war records have not necessarily dominated peacetime racing.

Most of our Army service types used during the war, and a few Navy aircraft

Endurance rather than speed helped Anson Johnson win the Thompson Trophy with this Mustang P-51-H in 1948





Clipped wings aren't permitted in the Women's Trophy Race, where the reliable AT-6s spread-eagle the field

the Air Derby

By John L. MacKenzie

as well, have found their way into the races. Both the Thompson Trophy Race, the world's premier closed-course competition, and the equally great Bendix Transcontinental Derby, have benefited by the participation of these planes. So let's take a look at the records and see how each has fitted into its new postwar role. At the same time we shall establish a basis of comparison for the 1949 National Air Races, which are to be held at Cleveland over the Labor Day week end.

The North American Mustang or P-51 was the fastest fighter plane produced by this country during the past conflict. Powered by a single Packard-built Rolls-

Royce engine of some 1700 horsepower, it was a favorite with Americans and their allies. In view of their speed characteristics, more P-51s than any other single type have been acquired for closed-course racing. However, they have not done as well as might be expected in the Thompson.

Anson Johnson, who won the big race last year, flew a Mustang. But he won by outlasting his competitors rather than by outspeeding them. In fact, his winning speed of 384.469 miles per hour was considerably below the Thompson record. Yet his was the best showing yet made by a P-51 in the pylon races.

In cross-country work, however, the

Lockheed P-38 was souped up by clipping a few feet off wings and stabilizer tips and adding 4400-hp. engines





Cook Cleland revs up one of his two Corsairs (F-2-G) in preparation for the Thompson Trophy take-off in '48. The plane has a 3500-hp. radial engine



Charlie Tucker clipped eight feet off each wing of his P-63 Kingcobra and qualified for the Thompson at 392 m.p.h. He is expected to race the plane again this year. Below, P-39 owned by Chuck Brown is towed to start line

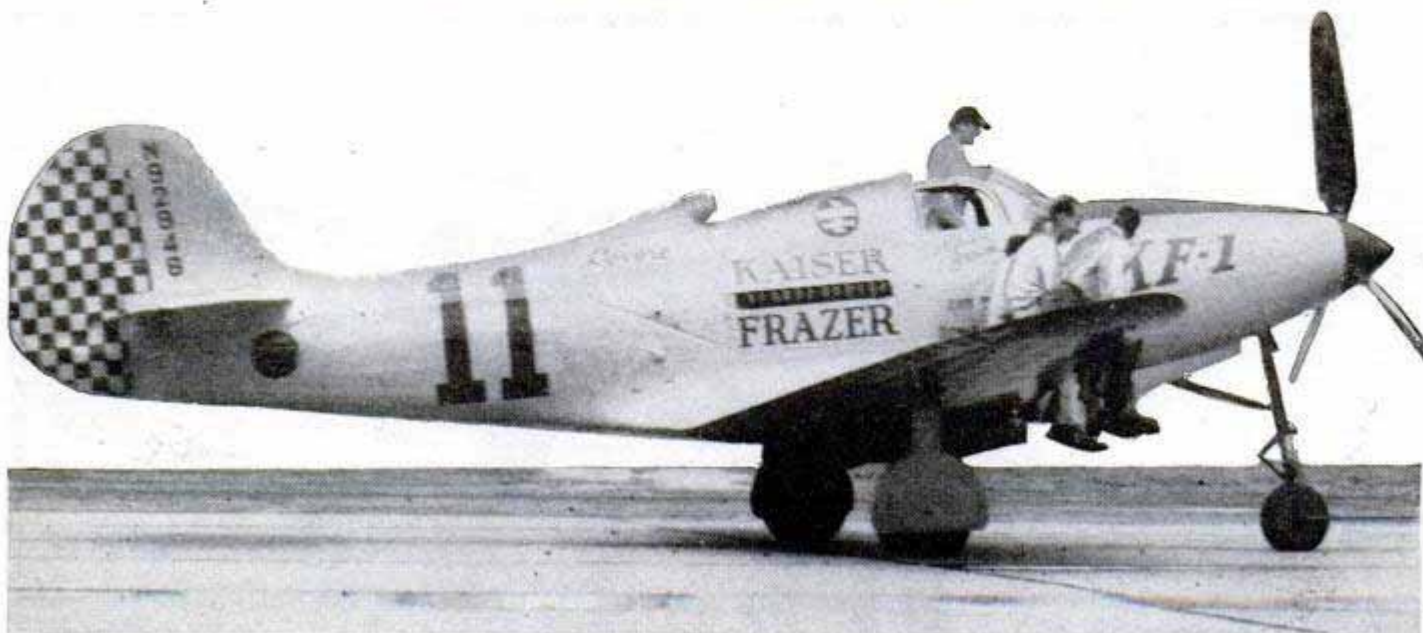

P-51 has written a different story. The Bendix Derby in all three postwar years has been Mustang all the way. Each year all of the top positions have gone to this great ship. Not only has the well-known Paul Mantz scored three successive victories in this classic, but he has also cracked transcontinental records in his early model P-51. Jacqueline Cochran, ace ladybird, with a similar ship has given Mantz serious competition in (Continued to page 248)

Circular Gas Torch Is Plumber's Helper

Because it heats the entire circumference of a pipe at one time, a circular gas torch saves a plumber's time in sweating on pipe joints and fittings in hard-to-reach places. There are six jets on the torch, three on each curved section. It will heat pipes up to two inches in diameter. The torch will also thaw frozen pipes.

Whole Eggs Frozen

Whole eggs have been preserved by freezing at Louisiana State University by Dr. Socrates A. Kaloyereas. Vacuum and dehydrating agents were used to extract a sufficient amount of the eggs' water content to permit the expansion of yolk and white that occurs upon freezing. This eliminated the rupturing of eggs that had previously made the process impossible.

Lightweight Sinks of Plastic

Household sinks and washbasins made of plastics are now coming on the market. Extremely light in weight, the heaviest model manufactured is a deluxe bathroom fixture weighing only 7¼ pounds. The material is Lucite acrylic resin, which can be made transparent, translucent or opaque and in a variety of pastel shades.

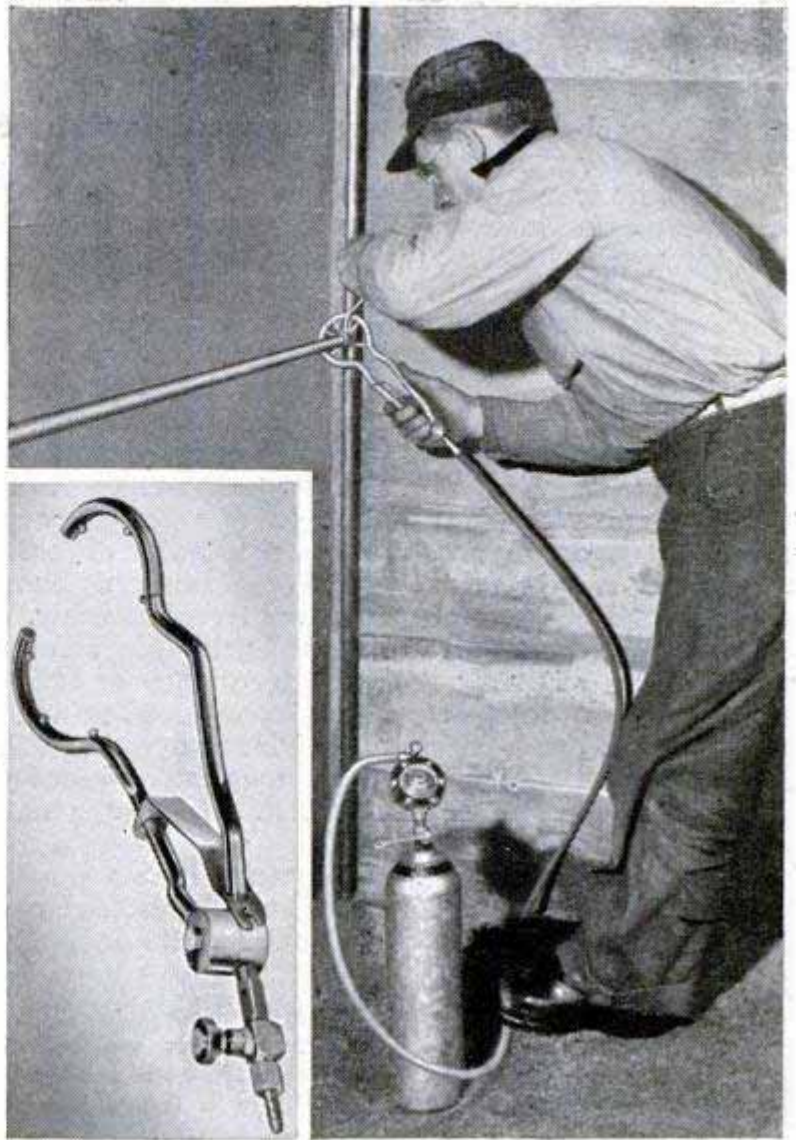

The fixtures are formed by a combination of blowing, pressing and vacuum drawing; special models are being made for use on aircraft, trains and trailers.



Recorder Checks Eggs To Eliminate Lazy Hens

Lazy hens that don't lay the required number of eggs are soon found out at a breeding farm near Kirkland, Wash. Art Heisdorf, one of the owners, records the egg-laying activities of 10,000 chickens by talking into a wire recorder. Four days a week he visits each nest with the recorder, lifting each hen and then speaking her number and production into the microphone. An office girl transfers these records to individual cards. The owners then can check the egg production of any particular hen.

❑ Flat tires are the most frequent cause of automobile breakdowns with battery failures running a close second.

Pocket SOS

RESCUE probabilities for airmen forced down over water, jungle, desert or arctic terrain are increased by a new midget radio transmitter developed by the U. S. Air Force.

It is superior in everything but range to the wartime counterpart, AN/CRT-3, popularly known as the Gibson Girl because of its hourglass shape. The CRT-3 is too bulky and heavy for anything but large aircraft, where it will continue to be used along with the new equipment.

Radio beacon AN/CRN-16 weighs only two and a half pounds, in contrast to its forerunner's 40 pounds, and is small enough to be tucked into the pocket of a life vest or a parachute harness. The Gibson Girl has to be shifted to a life raft during ditching, or dropped by separate parachute, both ways risking the possibility of loss. With the new sets, every flyer will always have his own SOS sending facilities, even if separated from his crew.

It operates on the "line of sight" principle, sending out a continuous distress signal at a frequency of 140.58 mc., modulated by a tone varying with the speed at which the generator hand crank is turned. Planes flying at 2000 feet can pick up the signal 50 miles away. The older model can be heard several thousand miles away when used under ideal conditions.

For an antenna, the CRN-16 uses either a short, telescoping rod or a folded loop. The Gibson Girl requires 306 feet of antenna wire, payed out by kite or by balloon.

Air Materiel Command photo



Right, individual SOS signal transmitters are built in two sections, both small enough to fit in a flyer's jacket pocket



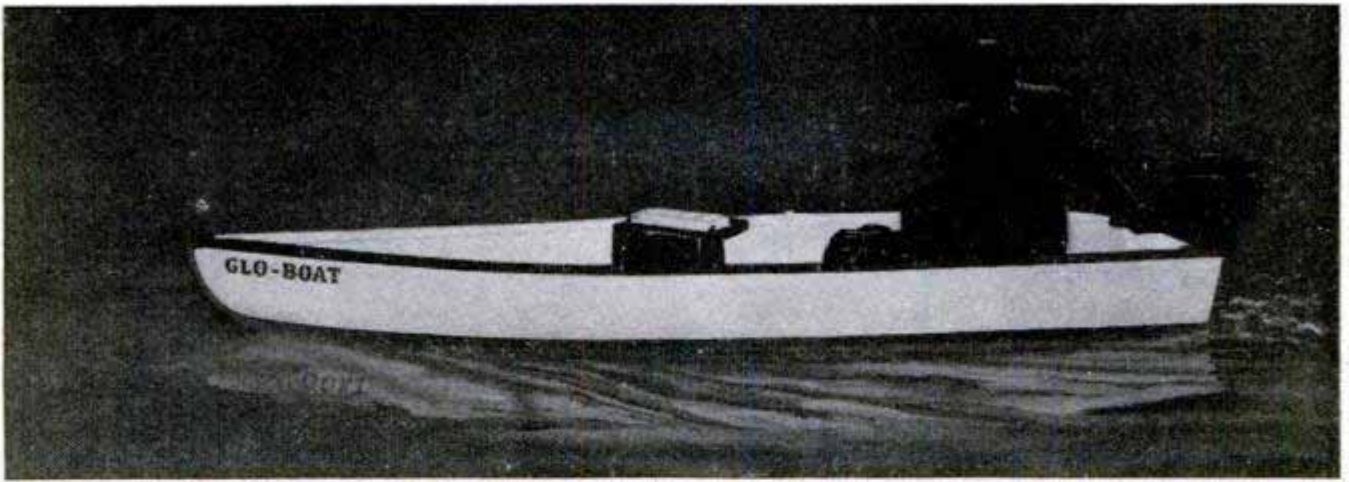

Boat Glows at Night

Because he was almost run down by speedboats as he fished from his boat at night, an Illinois fisherman painted his rowboat with luminous paint both inside and out. The outside paint makes the boat

clearly visible at night, thus offering protection from collisions. The inside paint throws off enough light so that he can see to bait his hooks. He used two coats of lead-free undercoat, then two coats of the luminous paint and, finally, a coat of clear spar varnish for weatherproofing.

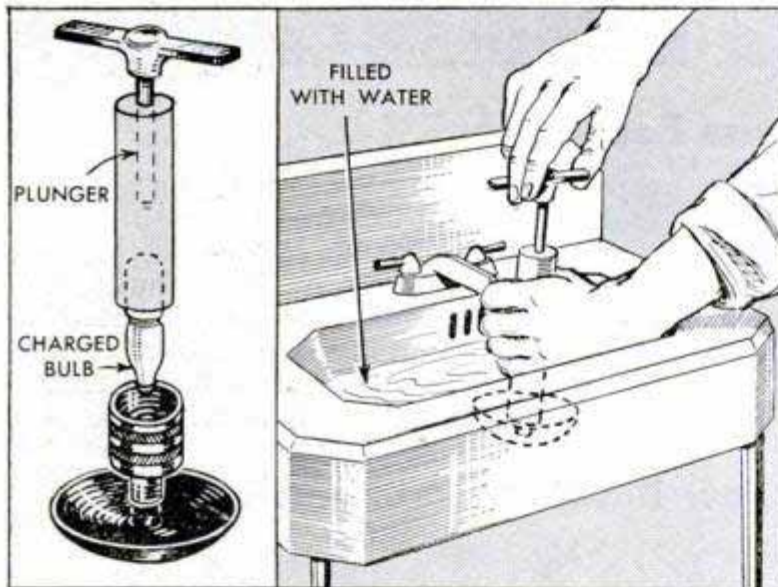

Jet Drain Opener

With a sudden surge of gas, a home plumbing tool opens clogged drains. Carbon-dioxide cartridges—the kind used in seltzer bottles—provide the discharge of gas. A cartridge is placed in the tool and a rubber seal is held over the drain opening. After the receptacle is filled with water the tool's handle is twisted, puncturing one end of the carbon-dioxide cartridge to release a jet of gas down the plugged drain. Pressure exerted at the drain opening is carried by the water column to the point of obstruction.

Pins Drop in Oar Sockets To Moor Small Boat

By simply dropping the pins of a new boat hitch into the oar sockets you can moor a small craft to a pier or boathouse. The hitch "anchors" the boat 6 to 14 inches away from the pier to prevent damage, yet leaves it free to ride up and down or rock with the waves. The hitching pins are pulled out of the sockets to release the boat.

☐ Satellite rockets whirling around the earth at an altitude of 4000 miles may some day broadcast televised images of cloud movements to help forecasters predict weather.

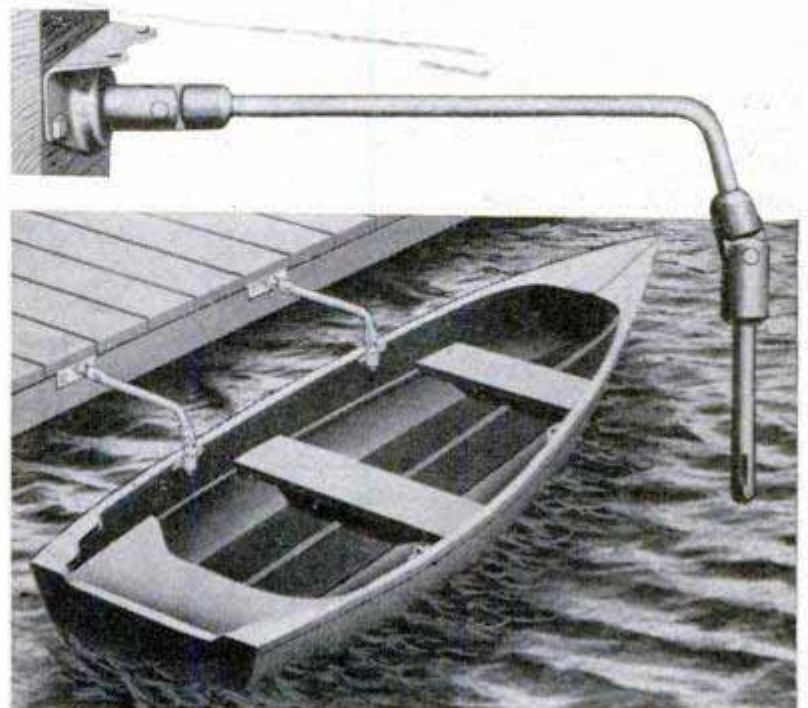



Copyright "Mechanics"

Camera Goes to Sea to Televisе Boat Race

Television rode the waves of the Thames in a British experiment to transmit this year's historic boat race between Oxford and Cambridge. The British Broadcasting Company cooperated with equipment manufacturers and the General Post Office in transmitting close-up pictures of the crews as they pulled at their oars. The

camera was mounted in the bow of a 60-foot launch that followed the boats during the race. Transmitting and control equipment were housed in four "suitcases" amidships. Receiving stations located at high points along the shore picked up the video signals from the launch and transmitted them to receiving sets.

Single Drafting Aid Combines Four Drawing Instruments

Combined in a single pocket-size drafting instrument are a compass, protractor, ruler and square. Stamped into the transparent plastic are circles graduated from $\frac{1}{8}$ to $\frac{1}{2}$ inch. Circles from $\frac{5}{8}$ to 6 inches can be drawn by centering a pivot, placing the pencil point through the proper hole and using the instrument as a compass. The rounded end is marked for use as a protractor and one side is scaled for use as a ruler. The transparent pivot also serves as a magnifying lens.

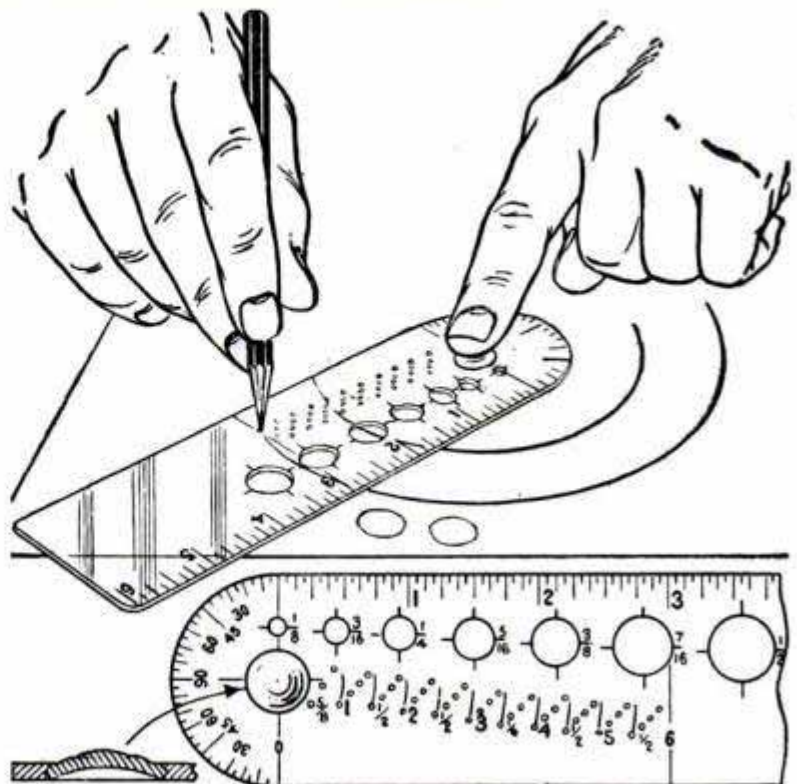

Information not listed on articles in the index, starting on page 10, frequently is listed in the WHERE-TO-FIND-IT INDEX, which is available to readers without charge from Bureau of Information, Popular Mechanics Magazine, 200 E. Ontario St., Chicago 11

Pontoon-Type Sailboat

Capable of speeds up to 15 miles an hour, a pontoon-type sailboat weighs only 98 pounds complete with sail, yet is seaworthy enough to take the rough waters of oceans and large lakes. A dagger-type centerboard is easily raised and lowered through a watertight slot in the hull. Guard rails and a non-slip deck provide secure seating for the helmsman and passenger despite the lack of a cockpit. With a length of only 11 feet 7 inches and a beam of 2 feet 7 inches, the craft is easily carried on the roof of a car. The lightweight boat is extremely buoyant and, if overturned, can be righted without lowering the sail.

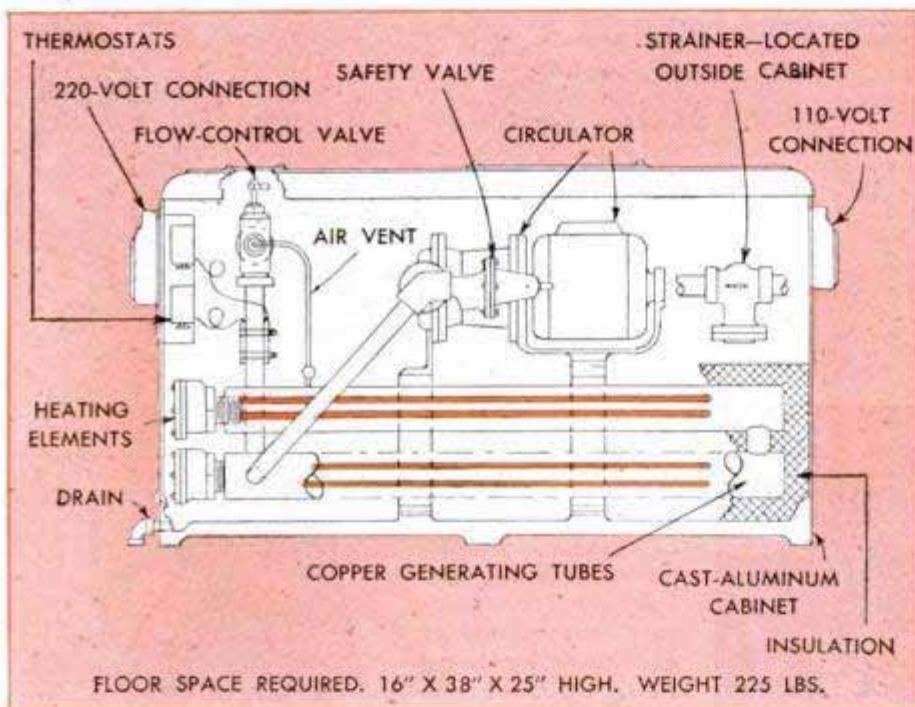

Electric Generator For Hot-Water Heat

All types of hot-water heating systems can be operated by an electric generator that has automatically controlled heating units. It is built in models from 10,000 to 48,000 watts, supplying from 228 to 1094 square feet of radiation.

☞ To prevent infections from mercury dust released by broken fluorescent tubes containing beryllium phosphor, manufacturers are producing tubes with non-poisonous phosphor.

Toy "Prefab" Building Kit

Made of plywood, a toy "prefabricated" building kit contains various sections cut on a scale of $\frac{1}{2}$ inch to the foot. Metal clips connect the parts to form buildings of various shapes and styles. With the toy, boys can build small homes, garages and other structures for their model railroads while their parents can see what a new home they plan to build will look like.

☞ Agricultural engineers at Madison, Wis., are experimenting with electric heaters for beehives to prevent the heavy losses of bees by winterkilling.

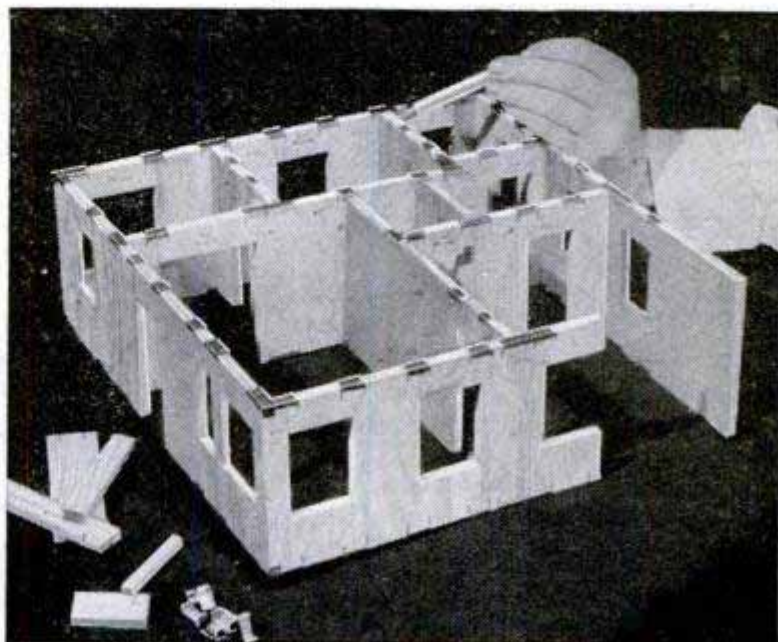

Old-Timers Come to the Fair

At the 1949 Chicago Railroad Fair, yesterday and today join hands to present a panorama of U. S. history. Colorful new exhibits, not in the 1948 Fair, are helping make this repeat performance another big hit.



Above, portraying the way one '49er made a gold-ore crusher from parts of his covered wagon, Cactus Cal is giving Fair goers an accurate look at one of our most exciting times, the Gold Rush



Left, Cal looks over ore crushed by anvil that is operated with mule-power through crude system of gears

Right, a little of San Francisco at the 1949 Railroad Fair is this cable car, transplanted along the shores of Lake Michigan. The car operates continuously, providing free rides for the Fair customers

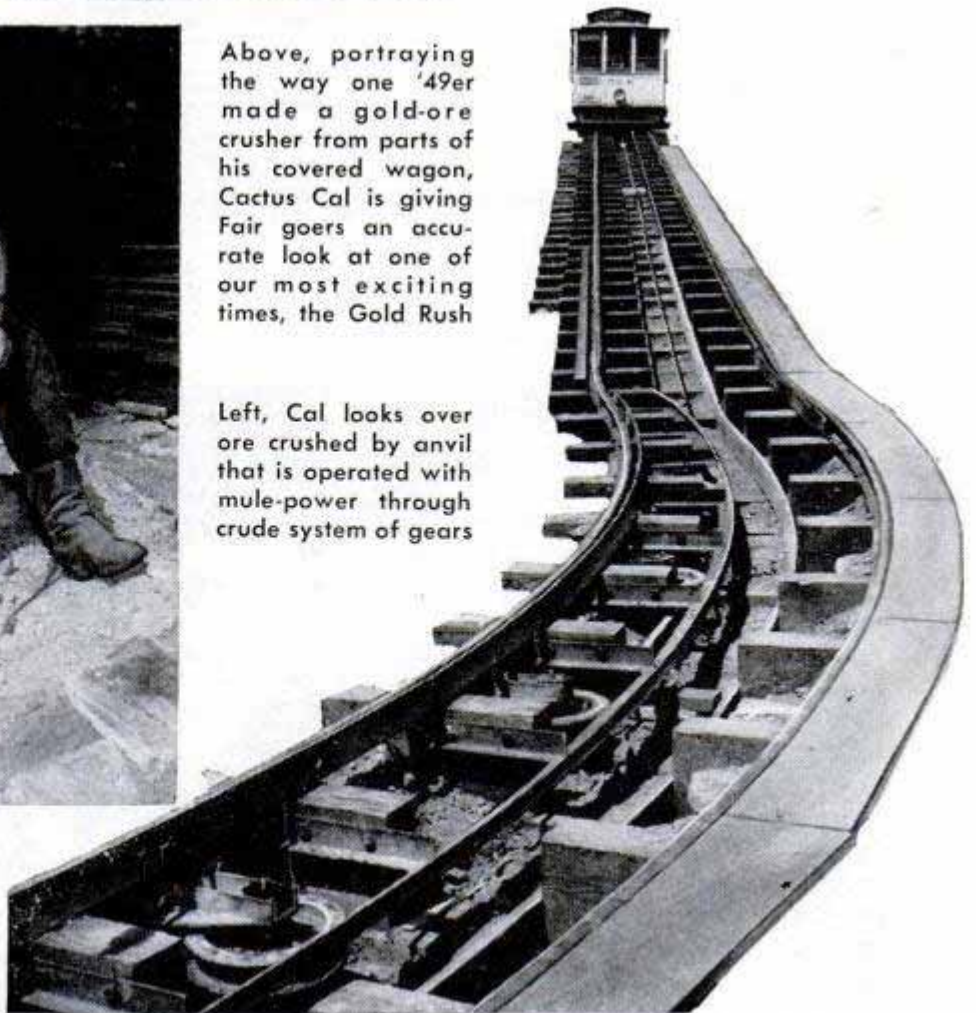



Above, controls of the cable car are simple. Lever in the center raises and lowers the grip that grabs the cable to move the car. Other levers are brakes



Above, right, head-on view of the transplanted cable car. Gripman is yanking the bell cord. San Francisco natives are proud of the "music" played on these bells

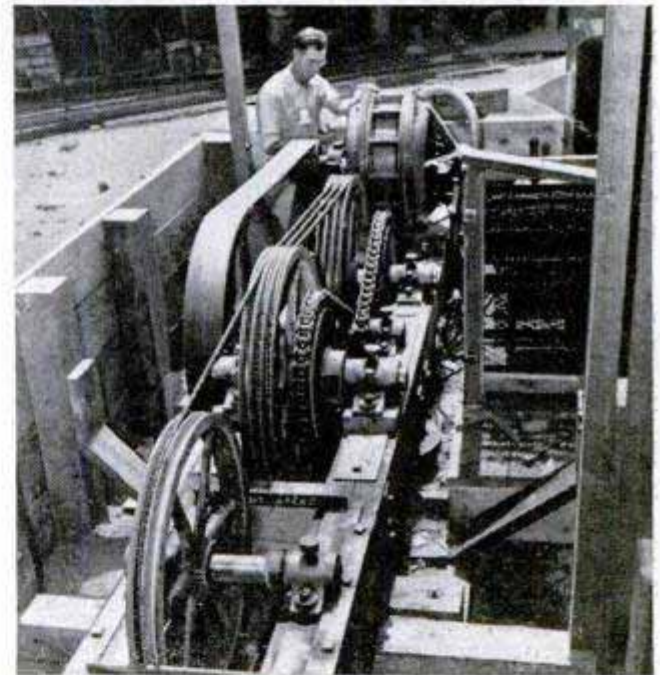

Right, the cable-winding mechanism at Chicago is just a pint-size version of the machinery at San Francisco. Most of these parts had to be custom-made for the job

Below, there's even a turntable at the end of the run and customers are expected to help swing the car as they do in the coast city. This is a test operation

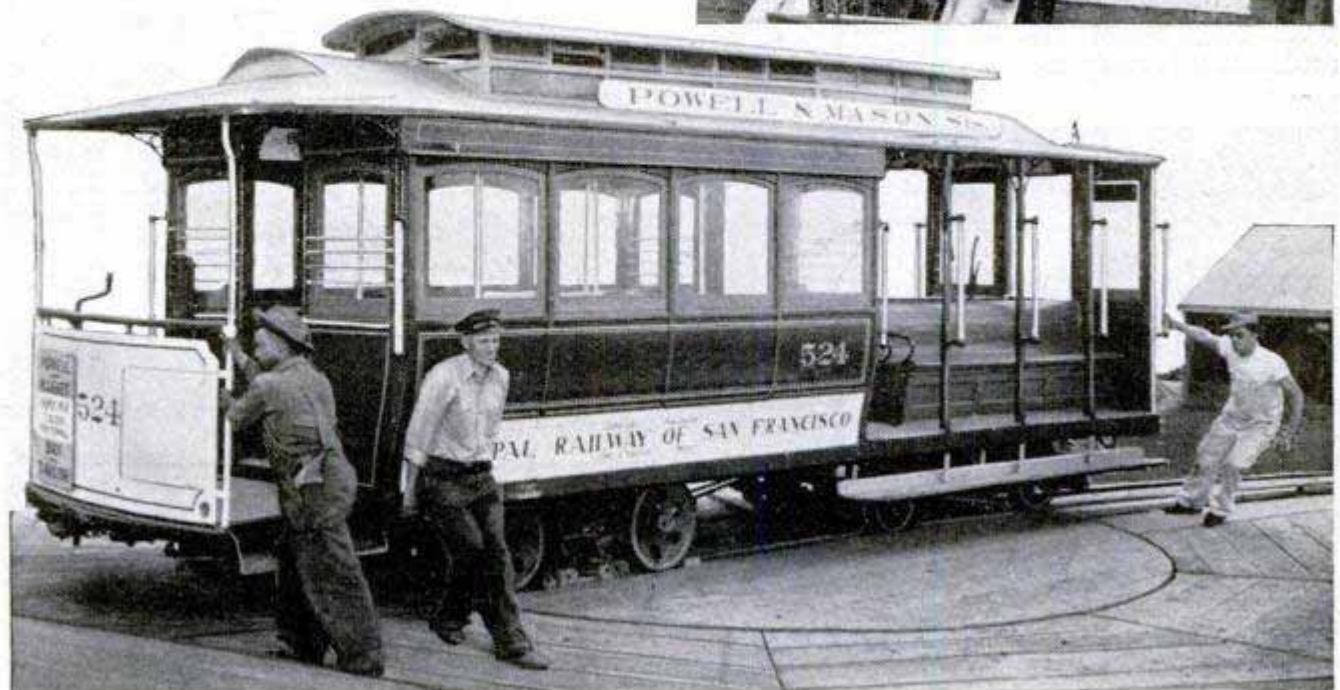



Container Blows Seed Over Lawn

Grass seed is blown across a lawn by a new container that operates as an air pump. The user holds the top section of the cylindrical container with one hand, grasps the bottom section with the other, and pumps. With the container pointed at an angle of 45 degrees, the seed is blown out in an even spray.

Multi-Bladed Scraper

Scraping operations are speeded by a flexible scraping tool that has 11 blades loosely mounted in V-slots in the rubber holder. Pivoting from the top of the V-slots, the blades always present a sharp edge to the surface. Because the blades are almost glass-hard, the tool can be used on steel, wood, plastics, iron, plaster and other materials. It will smooth down everything from rough welds to fine woodwork without gouging. The blades are reversible and can be sharpened in the flexible holder.

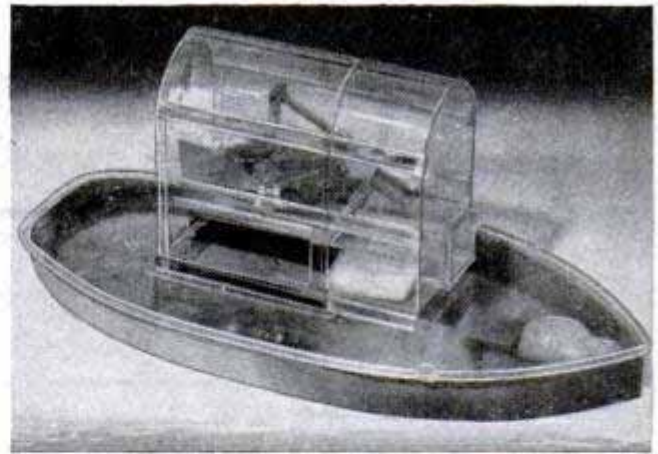
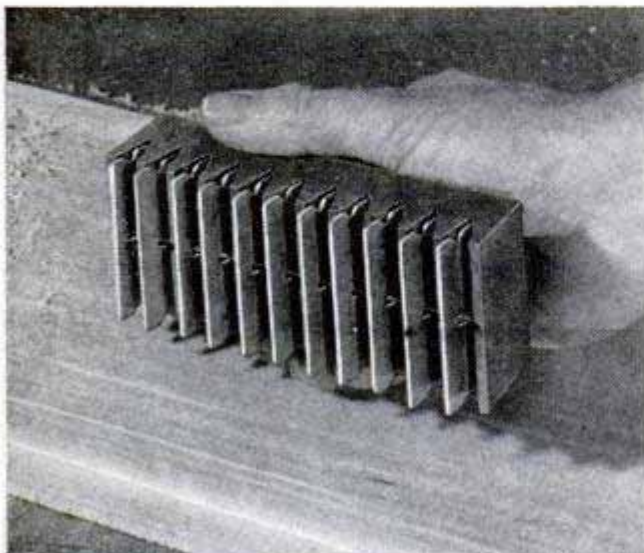

"Tugboat" Catches Mice

As many as 10 mice can be caught at one setting with an automatic mousetrap that looks like a miniature tugboat. The trap has a superstructure made of transparent plastic built-in sections to catch mice without sacrificing the bait. The mouse, approaching the bait from any direction, steps on a spring platform. This drops him down a hatch, and his only exit is through a trap door that leads to a perforated aluminum container from which there is no escape. Next, the boat is set afloat, thereby drowning the mouse or mice.

Metal Plate Burglarproofs Door

Apartment dwellers can make their entrance doors burglarproof with a small metal plate that clamps to the doorknob and prevents the latch thumbpiece from turning. A narrow slot in the plate fits over the thumbpiece, making it impossible to release the bolt either by force or key. It can be left on the knob when not being used.

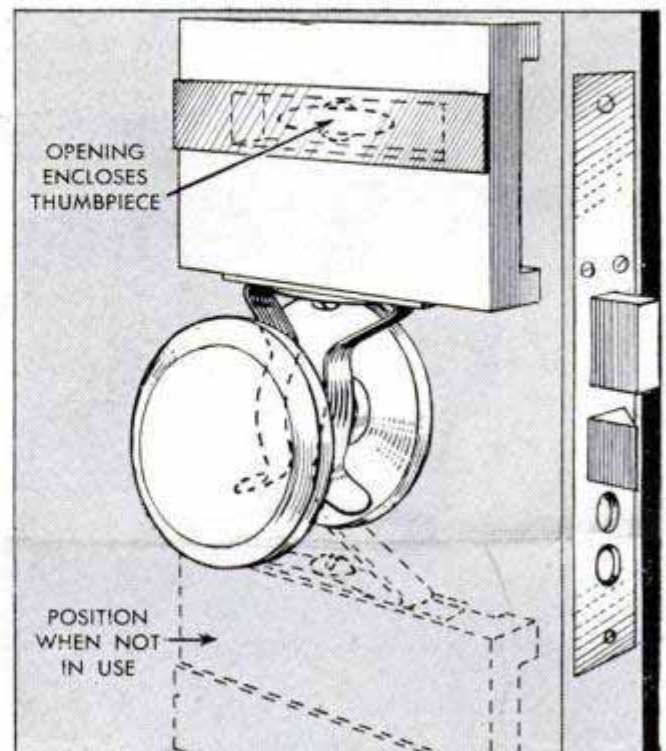



Auto Clothes Rack Can Be Carried Into Hotel

Quickly detached from its window-frame bracket, an automobile clothes rack makes it possible to carry the garments from the car into the hotel and hang them up in a closet without removing them from the rack. Six to twelve garments can be

hung on the rack, which is supported by the window frame and does not interfere with the operation of the window. An elastic strap is fastened around the clothes and prevents them from swinging when the car door is opened.

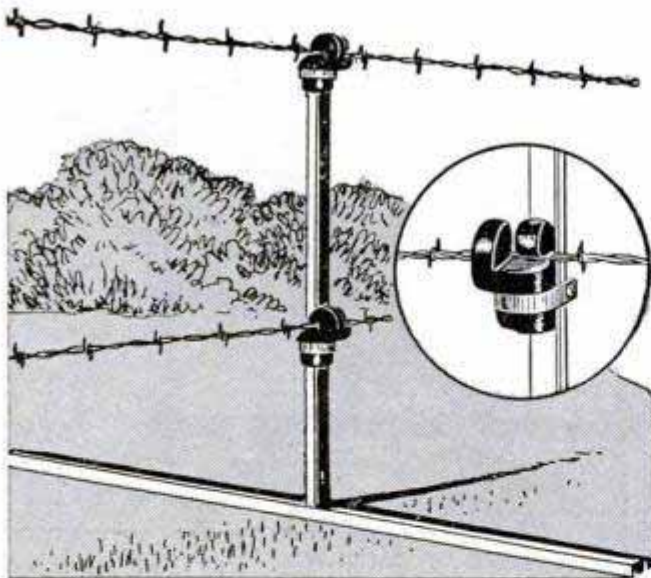

Portable Electric Fence Post

Farmers can build electric fences within a few minutes by using portable posts that stand on top of the ground. Each post has a right-angle bar on the base which gives it firm support. The wire, smooth or barbed, is placed in a plastic insulator. When the post is turned 90 degrees, the insulator grips the wire. The posts permit the farmer to eliminate much permanent fencing.

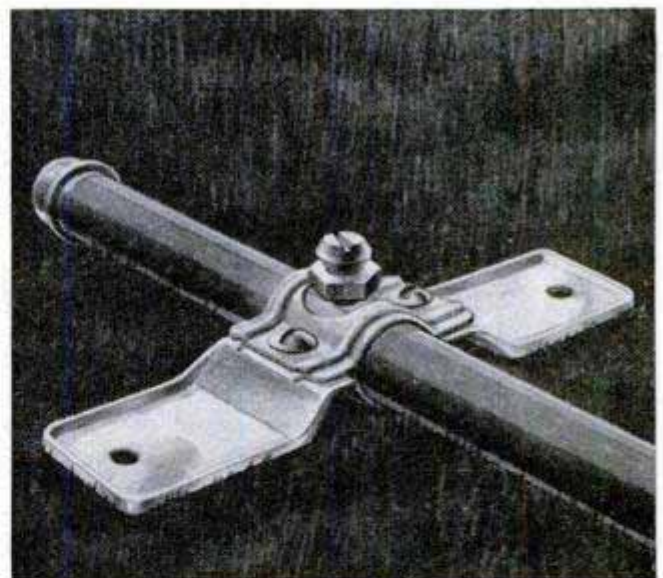

Old Hose Made Into Sprayer

Worn-out garden hose can be used with new adjustable spray units to water an area as large as 600 square feet. There are five units in a kit, five hose holders, a small hand punch and a hose end cap. Holes are punched along the hose at approximately 10-foot intervals and the sprays screwed into the hose body. One or more units can be closed off.

HUGE ROCKET MOTORS that are contemplated for the future—up to 10 times more powerful than the motors of V-2s—are to be studied in a new test stand built into the face of a cliff in the Organ Mountains, overlooking the White Sands Proving Grounds in New Mexico.

Resembling a massive Mayan temple from a distance, the test installation consists of a pair of fuel houses—each of which can hold 15,000 gallons of fuel, two adjacent pump houses and the motor test frame itself. An 80-foot sheer rock wall below the test frame provides space for the flame from the power plant. When mounted in firing position, the motor is pointed downward at an angle of 60 degrees from the horizontal to avoid spoiling of the natural rock sluiceway.

Each of the large fuel tanks is surfaced inside with virtually pure aluminum, necessary to withstand the "malignant" acid fuels that are being developed for possible rocket use. The fuel houses have lightweight roofs that would offer little resistance in case of explosion and the tanks have quick-opening, large-orifice dump valves and long concrete spillway troughs so that the fuel could be rapidly removed

in case of emergency. In addition the contents of a 100,000-gallon tank of water can be dumped through the fuel tanks and on into the open desert to hasten removal of the fuel.

Around one shoulder of the cliff an entrance door leads to a tunnel that has been cut through the solid rock to a control room in the face of the cliff about 100 feet to one side of the motor firing position. Here technicians will be able to observe the jet flame by peering through armored glass ports at diagonal polished stainless-steel mirrors placed at a 45-degree angle outside the control room.

The tunnel inside the mountain has numerous baffles to prevent the spread of possible fire. It also provides access to a 100-foot-tall escape hatch up which the technicians can climb to a safe elevation if something goes wrong. An armored pillbox at the top of the escape hatch leads out onto the surface of the mountain.

An additional armored observation post from which the jet flame can be observed is located ½ mile away on the desert floor.

Rocket motors that are to be tested will be transported to a position under the test frame on special railroad cars. Then they

ROCKET TEST STAND

By Thomas E. Stimson, Jr.

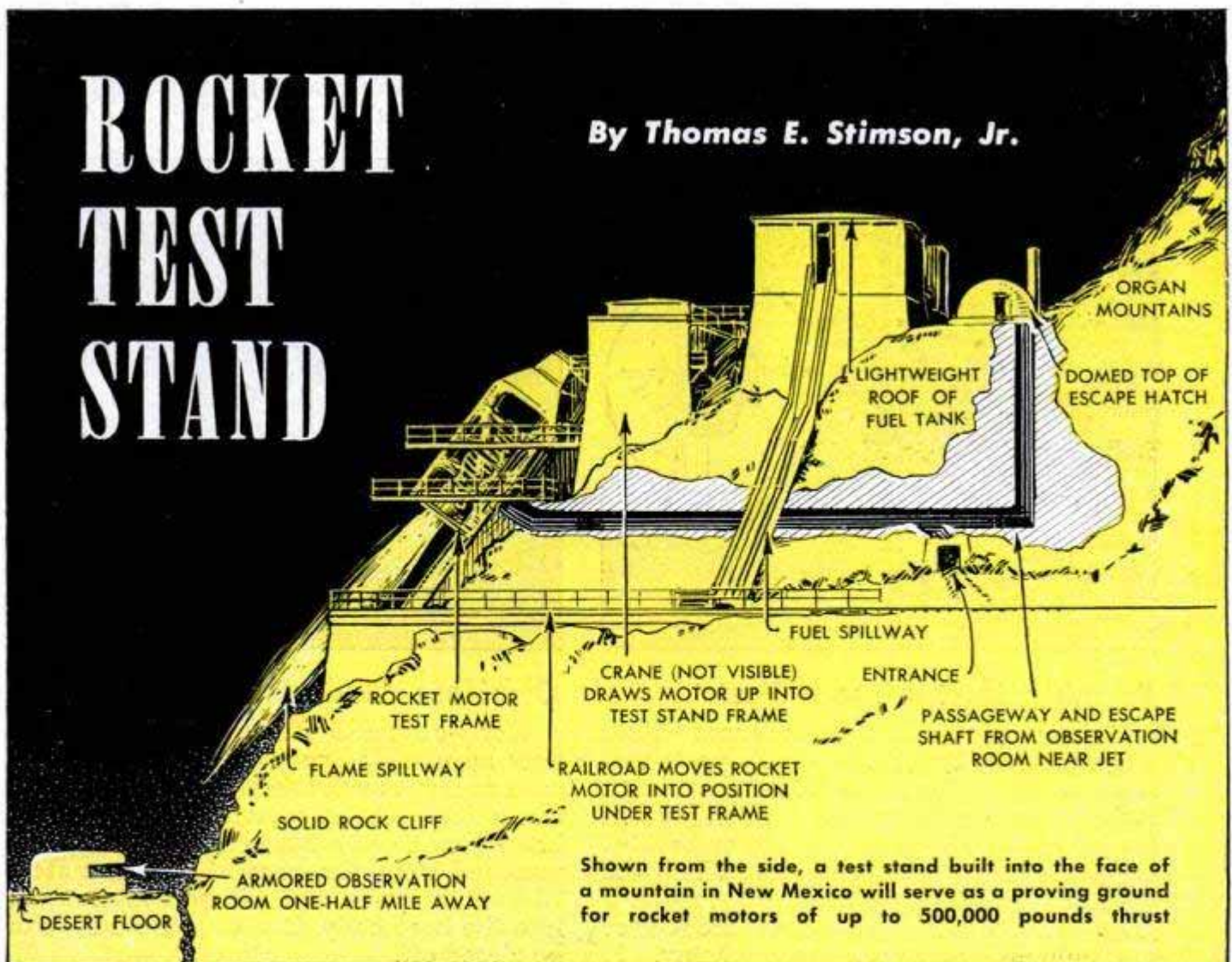

Shown from the side, a test stand built into the face of a mountain in New Mexico will serve as a proving ground for rocket motors of up to 500,000 pounds thrust

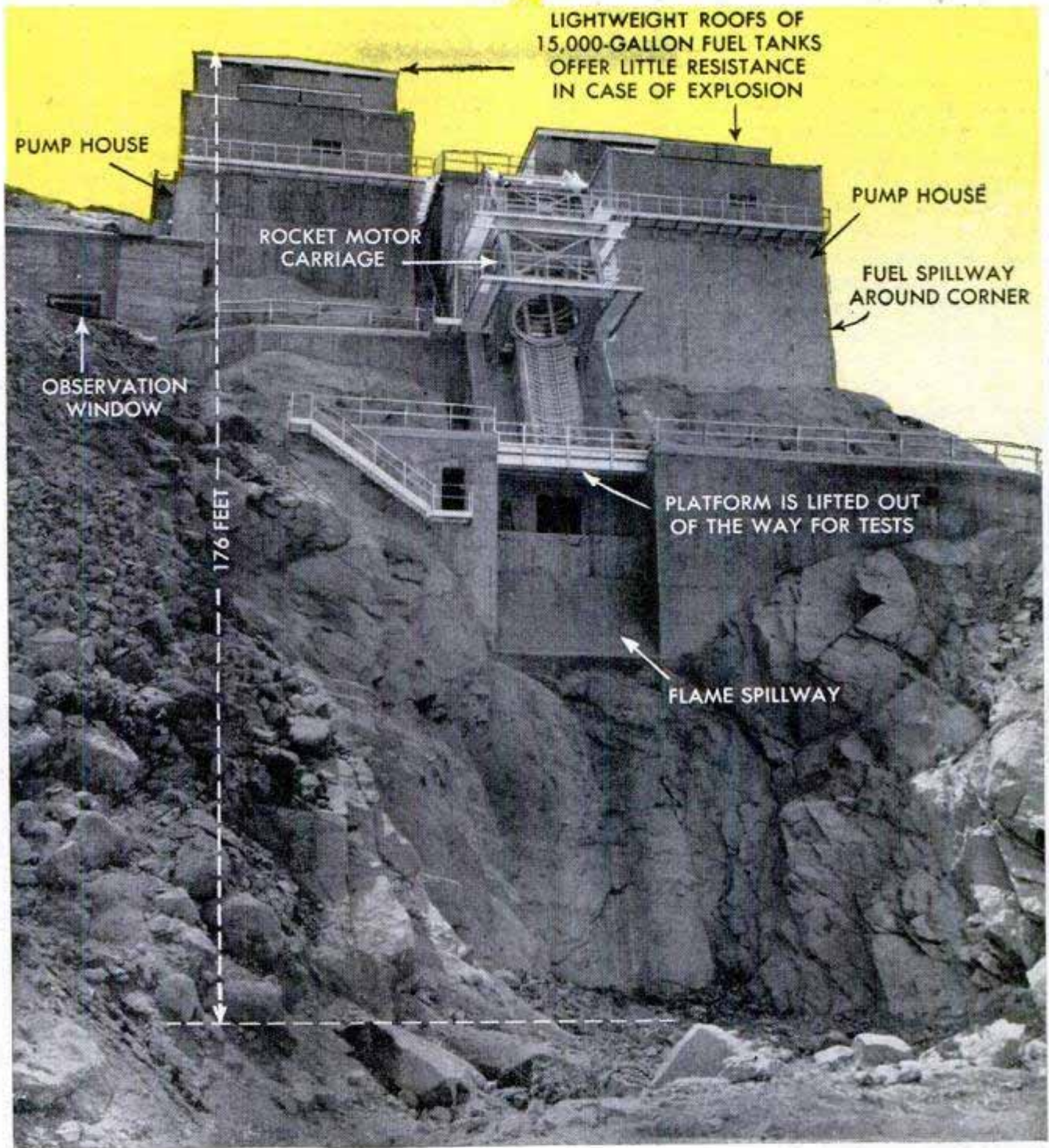

will be hauled up into position in the frame by a mobile Lorraine-type crane, which will also be used to remove the rail trackage below the test stand before a motor is tested. Another purpose of the crane is to aid in the exchange of pumps so that pumps of varying characteristics can be used to provide the correct mixture ratio of fuels for the particular motor under test.

The Organ installation is capable of testing rocket motors of up to 500,000 pounds

Test stand from front, showing 80-foot-high spillway for flames from motors. Below, concrete observation post, 1/2 mile away on desert





Looking up into the test frame. Rocket motors are drawn up on rollers in foreground by a mobile crane

thrust, of either solid or liquid type, for as long as two minutes. Due to refinements in design, motors of 500,000 pounds thrust would be only approximately twice the size of a V-2 motor.

To be put in use this winter, the motor test stand will allow measurement of motor vibration in three planes during burning, measurement of the velocity and temperature of the jet stream, measurement of temperatures and pressures inside the



Frame holds motor pointing downward at angle of 60 degrees to avoid damaging a natural-rock sluiceway

combustion chamber, and measurement of the amount of static electricity and ionization that is generated by the jet stream. The amount of absorption of radar waves by the jet stream also will be studied.

Eventually an identical test facility is to be built alongside the present one so that the present control room can be utilized for a larger number of tests simply by turning the exterior mirrors toward the rocket motor that is to be tested.



Left, in case of fire, fuel can be dumped down spillway and pushed out onto the desert by 100,000 gallons of water. Below, reinforced pillbox at the top of a 100-foot-tall escape hatch leads out onto mountain



Code Taught in Hour By "Sight" Method

Morse International Code is learned in a fraction of the usual time with a visual method of associating the code symbols with the shape of the letter. The letter "I", which consists of two dots in code, is shown as two bull's-eyes with the key word "eyes" printed underneath. The "T"—a dash in code—is printed with the crossline or dash emphasized. Different visual aids, one for each letter of the alphabet, are printed on colored cards. The inventor, a commercial artist, says it is possible to learn the complete code in less than an hour with his method.

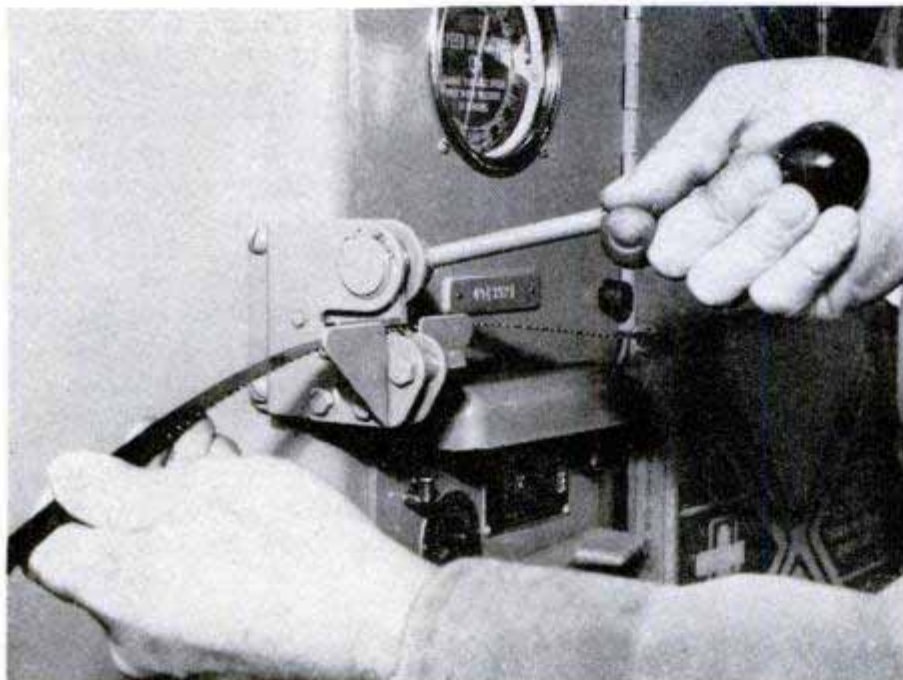
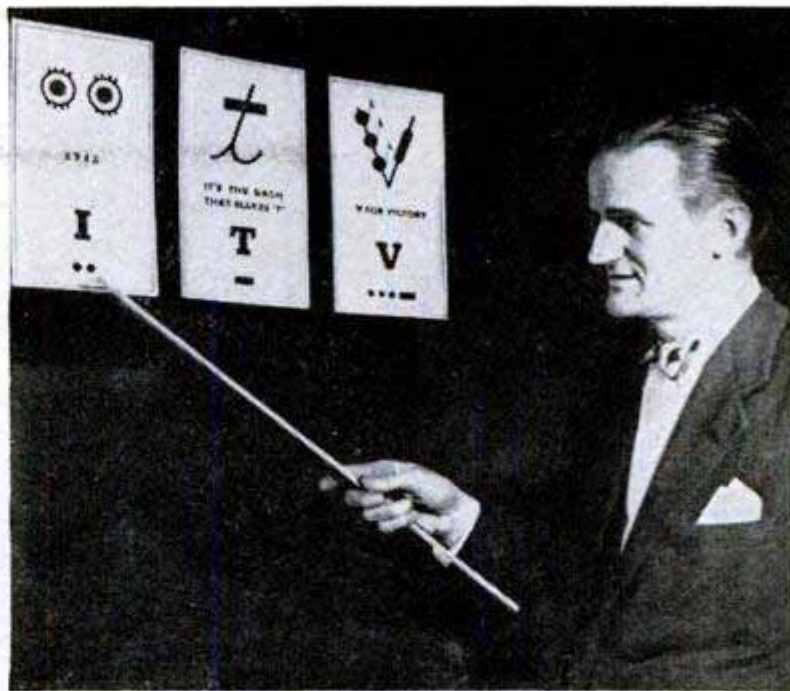

Saw-Blade Shear Makes Square Cut

Mounted on the side of the bandsaw, a three-blade shear cuts bandsaw blades square and flat to assure a perfectly matched weld. It speeds the welding operation because no preparatory grinding of the ends is necessary. A squaring plate accurately positions the blade as the pivoted shear comes down between two knife-edge blades. The shear removes a narrow section of the blade, thus cutting out the old weld.

"Insect Gun" Swats Flies Between Two Paddles

Latest weapon in the war against flies is an "insect gun" invented by Peter Jacobsen of Denmark. When the trigger handle of the gun is squeezed, two arms swing forward suddenly to trap the insect between two transparent swatters. A "sight" on the gun is touched to the wall above the fly so the user can gauge the proper distance to the insect.

☐ In 1947—the last year for which figures are available—the total population of the world was 2,320,000,000 according to a report by the statistical office of the United Nations.

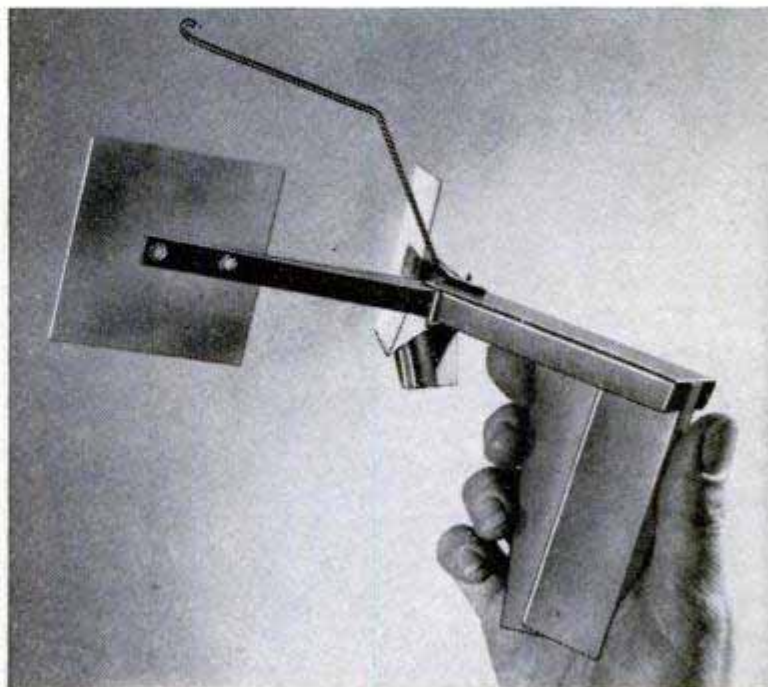

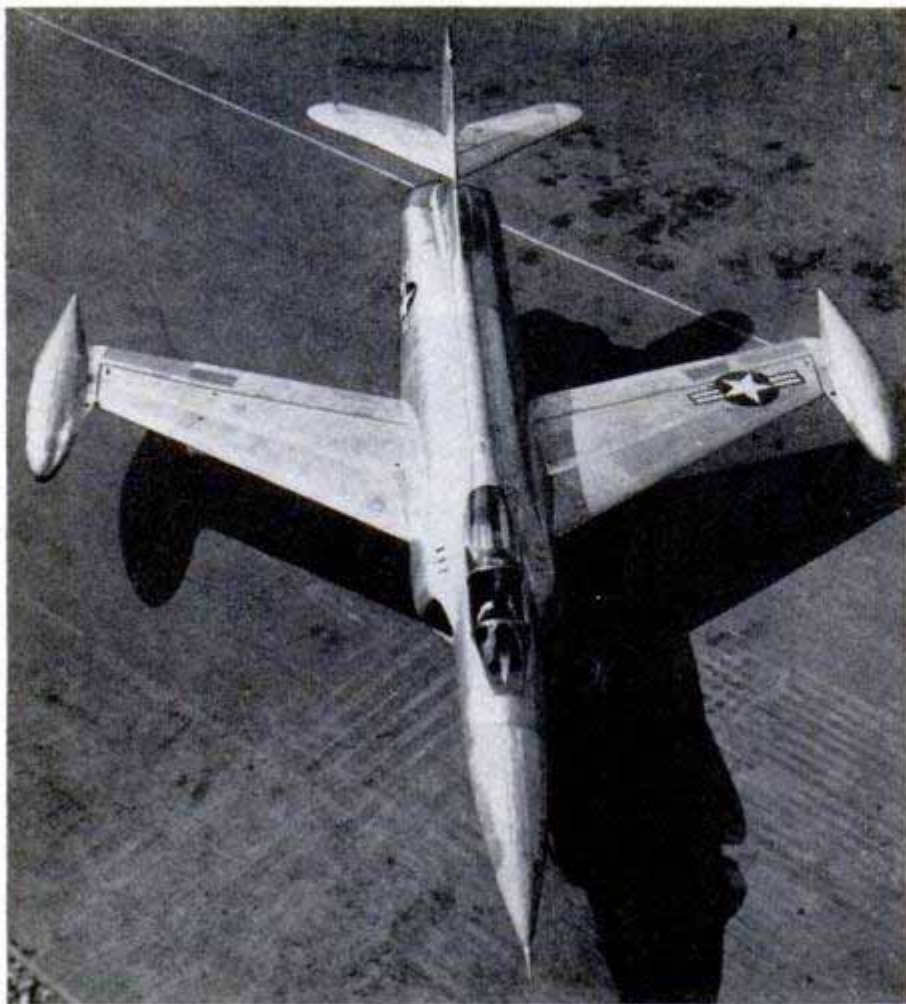

Wings of the new Air Force long-range fighter sweep back at 35-deg. angle

HEAVYWEIGHT FOR LONG-RANGE BLOWS

From the tip of its needlelike nose to its tail, the hard-hitting XF-90 is 55 feet long. The cockpit is pressurized and has a pilot-ejection seat

Lockheed Aircraft photos

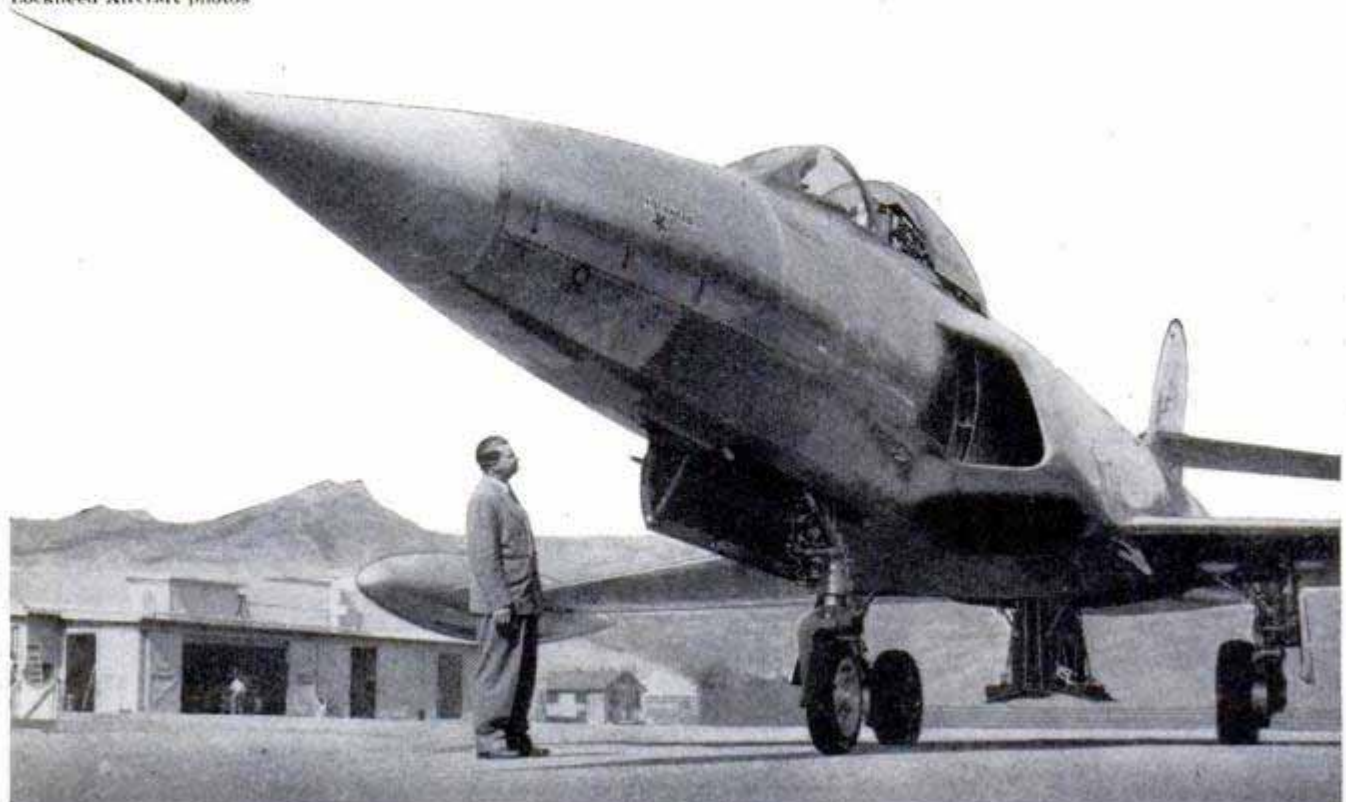

With the test pilot's appraisal—"she likes to fly"—initial air runs were completed for one of the largest fighter planes ever built. The U. S. Air Force's XF-90 is 55 feet long, has swept-back wings spanning 40 feet and weighs 26,000 pounds. Though a single seater, it is almost as heavy as the familiar 21-passenger DC-3 airline transport. The crest of the tail is approximately 15 feet above the ground. The Lockheed-built plane is designed to fly and fight deep within enemy territory, relying on speed and maneuverability to avoid trouble while seeking out such military targets as trains, tank and truck convoys and ammunition dumps. Every precaution was taken to make it as invulnerable as possible to battle damage. No performance figures were announced, but the plane is powered by two Westinghouse J-34 jet engines, each rated at 3000 pounds thrust. The plane's fuel supply alone weighs nearly as much as an F-80 Shooting Star.

Electronic Detector Finds Football Leaks

Football leaks as slow as $\frac{1}{100}$ ounce a year are detected by electronic inspection. A small quantity of Freon gas is put into the balls during inflation. Samples of air surrounding the ball are then sucked into the detector, and if there is any trace of the gas, a "peeping" sounds in headphones connected to the detector. The former system of allowing inflated balls to stand 10 days did not reveal very slow leaks and slowed production. The General Electric developed instrument is so sensitive that entire cases of footballs can be checked by passing the pistol-shaped detector over them.



General Electric photo

Fresh Orange Juice Holds Flavor for Weeks

Fresh, unpasteurized orange juice, prepared by a process developed by the Department of Agriculture, can be shipped to distant markets without noticeable loss of flavor or vitamin-C content. The juice is kept cold in sealed cans. Because the oil of the peel causes off-flavor development, the new process involves careful reaming so none of this oil gets into the

juice. The prepared juice, after straining, is quickly chilled to 30 degrees and is held at this temperature until used. Even after more than two weeks, no noticeable loss in flavor or vitamin content has taken place.

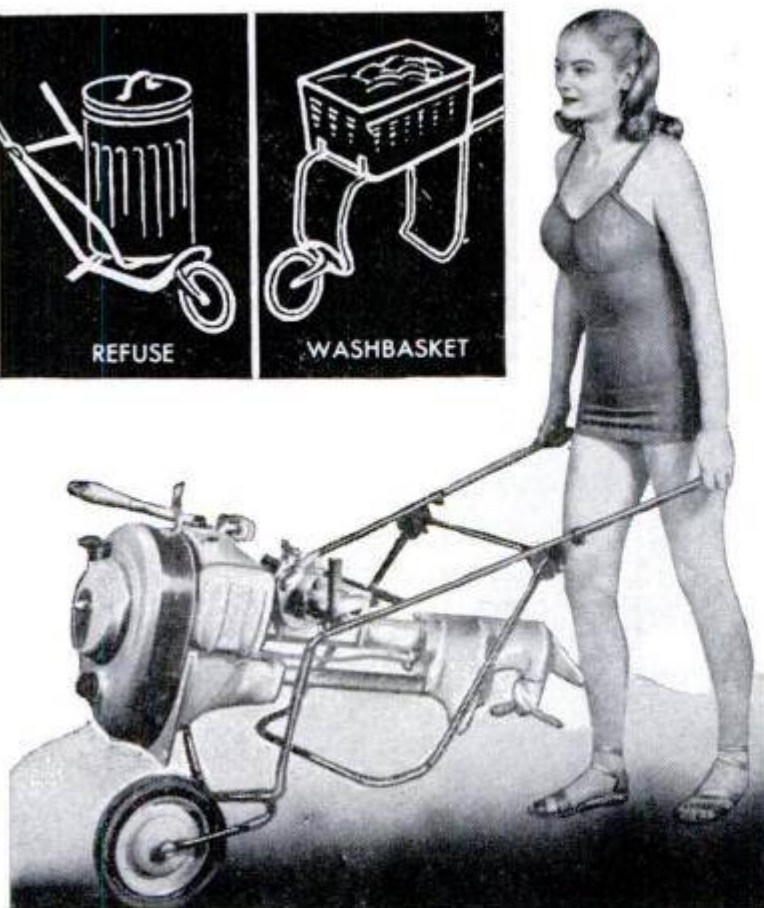

Outboard-Motor Pushcart

Although primarily designed for hauling outboard motors, a one-wheel carrier doubles as a wheelbarrow for moving boxes, ice, wood and other bulky items. It will stand vertically on its handles and kick-stand, holding the motor upright for storage. Made of tubular steel, the carrier weighs only 15 pounds, yet will carry 100 pounds. With the motor in position, it will fit in a car trunk when the wheel is removed.

Marked Trolling Line

Fishermen can tell at a glance just how much line they have out with a new nylon trolling filament marked clearly every 100 feet. The marks are a series of bands two inches wide, dyed a highly visible blue. One band means 100 feet have been payed out; two bands represent 200 feet. The dye will not fade in fresh or salt water.



You

STEP RIGHT UP and get the scare of your lives!"

Americans respond to this call to the tune of \$100,000,000 which they spend every year on roller coasters, whips, "thunderbolts" and other devices calculated to make the rider think he is endangering his life. Actually, the whole thing is a happy fraud; these rides are safer than riding in an automobile.

It is a tribute to the ingenuity and careful planning of the designers of amusement-park rides that they can make you think you've had a sniff of death, yet only leave you mentally ruffled at the end of the ride.

Even in the roller coaster, famed for the terror it produces, the danger is not nearly so great as imagined. The roller coaster rarely beats 60 miles per hour, which is par for some motorists and peanuts for pilots. This speed is maintained only for short periods, and the average speed is considerably lower.

Hang on for your lives! That's just a gag for statistics show you are actually safer in the "death car" than in your home

can Scream in Safety

By Morris Chaklai and Allan Rechtschaffen

The trick is not in the speed but in the sudden change in acceleration. If you were driving along at 60 miles per hour in a car, you might feel entirely comfortable. But if you were driving at five miles per hour and one second later the speed were suddenly picked up to 60, you would feel the same way that you do in a roller coaster, except for the addition of sudden drops, sharp turns and breathtaking lifts.

It is the myriad of combinations of these dips, turns and lifts which makes each of the more than 200 roller coasters in the United States different.

For the most part, the coaster runs simply on gravity. The only part of the ride that is motor driven is a drag chain that pulls the cars to the top of the first incline. This is the highest point in the entire structure. Here the train is automatically disengaged from the drag chain and is on its own until the end of the ride, pro-

ceeding by momentum and gravity over humps which gradually decrease in size.

The first drop, which is usually in the neighborhood of 90 feet, is the one that sends your stomach up to clog your windpipe. Although the drops are rarely steeper than 45 degrees, the suddenness of changing direction makes people swear they have experienced perpendicular plunges.

Where drops are not so steep and along towards the end of the ride, excitement is maintained by various combinations of sharp banks and turns.

Much of the terror experienced on a coaster is caused by the groaning and shaking of the wooden structure while the cars are speeding over the tracks. This groaning and shaking is in itself a safety measure, because if the structure were built entirely rigid, the wood would have no "give" and would tend to crack under extreme tension.

A three-wheel construction of the car's

Safety devices under roller-coaster car include the two hooklike gears in center of photo below. Left gear engages drag chain to pull car and the other prevents car from slipping backward. Right, three-wheel construction holds the coaster to the track
Photos by Wallace C. Robbins

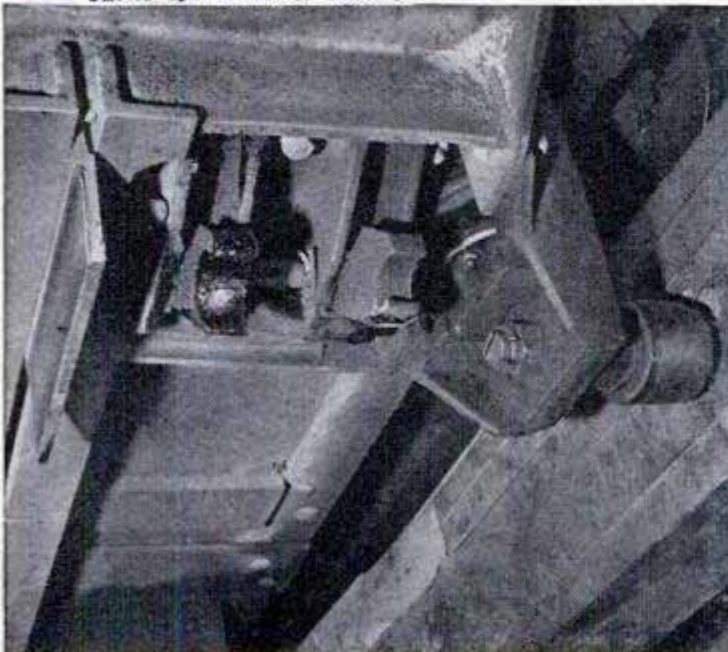

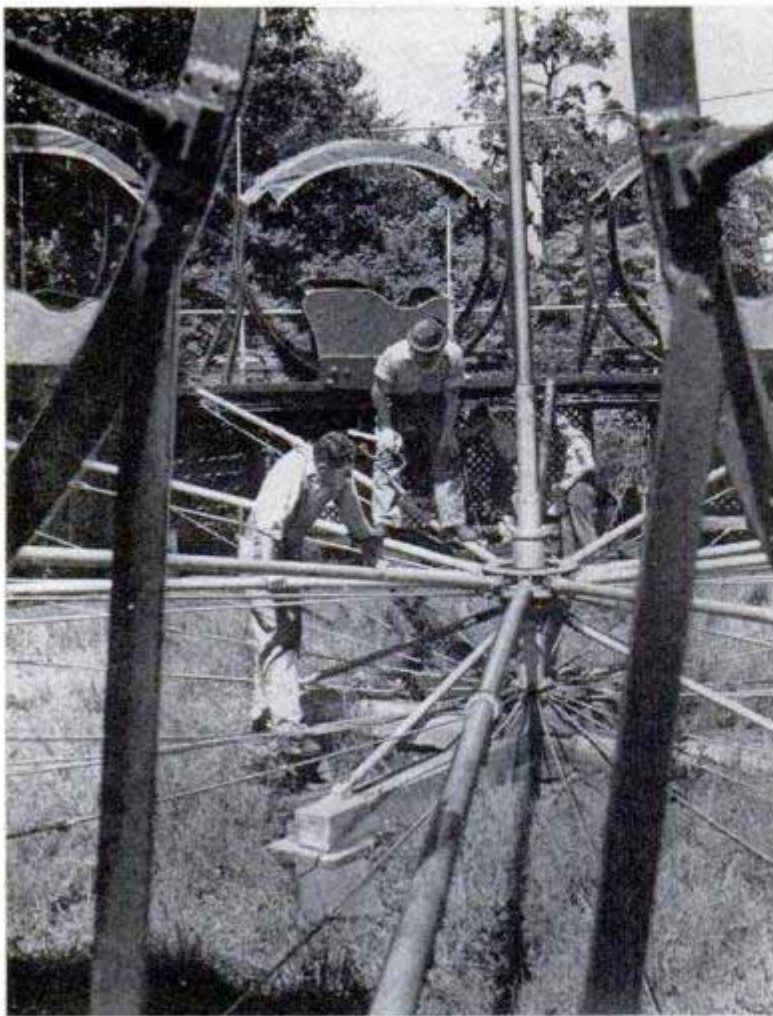

underpinning insures against the car flying off the track. Beside the conventional wheel, which rolls along the top of the wooden rail, a side friction wheel rolls along the side of the track, and a bottom friction wheel spins against the bottom of the track so the car cannot go anyplace but straight ahead.

Under each car, too, is the brake shoe, a keel-like steel shaft that slides between the plates of a squeeze brake on the track. Once a car has started dropping from the first peak, it cannot be stopped, except by one of these squeeze brakes located about the center of the ride, and another at the end of the ride. Very few coaster operators have ever seen the mid-brake used for emergency purposes.

The roller coaster, whether it is called the Cyclone, Tornado, Shooting Star or any other name, is the biggest money-maker in an amusement park. This is due not

Left, before the customers arrive, crews of mechanics make their daily rounds testing rides. Below, on the Wonder Wheel at New York's famed Coney Island the cars slide back and forth on tracks as wheel turns



only to its popularity, but to its capacity. The latter is a factor the layman usually does not consider, but which is of vital concern to the designer.

Two classic rides, often talked about but now practically extinct, are the Loop-the-Loop and the Bobsled. Tremendously popular, both of these lost money because they could not send more than one car on the track at one time. A roller coaster can put three cars on the track and have no "dead time" at all. Two trains will always be in motion while one is loading.

The Loop-the-Loop, built at a cost of \$400,000, was a brilliant feat of engineering. The car sped down an incline, sped up a hill which never straightened out but kept curving until the car was inverted and its occupants hanging upside down, and then on around the circle. So perfectly was this job accomplished that in an experiment, a glass of water placed in the car did not spill.

Testimony to the difficulty of combining apparent danger with actual safety in a ride is the fact that there are only five designers of roller coasters left in the U. S.

The achievements of these men seems even more amazing when it is considered that none of them is a graduate engineer. Each of them, in Horatio Alger fashion, has risen from nailing boards and running pipes to being an expert designer. It is through experience and rule-of-thumb methods that these men do their work. Though recognized engineers could probably figure out the mathematics and physics of a roller coaster, it is doubtful that they could integrate this technical knowledge with

(Continued to page 238)

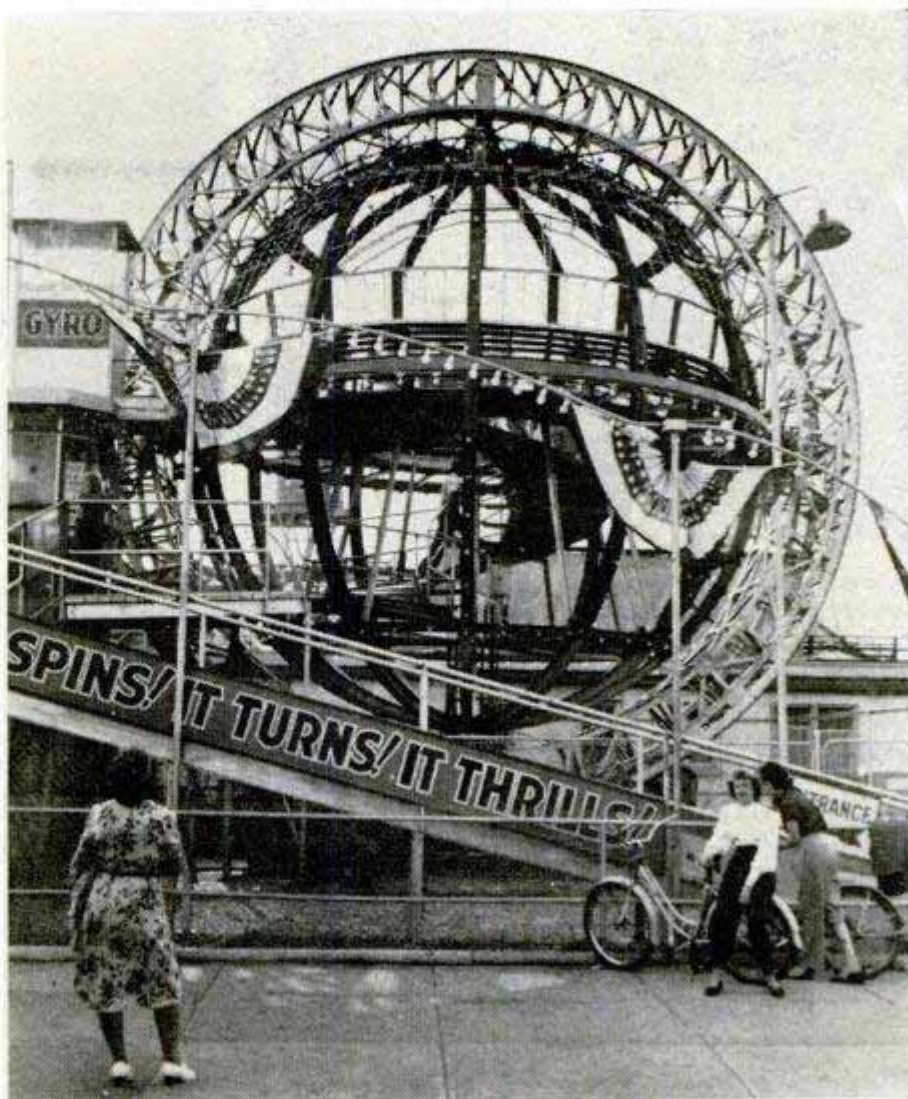

This dizzy delight is the Gyro, one of the newest rides at Coney Island. The Gyro not only rotates on its axis but also turns through an angle of 60 degrees in both directions. Below, happy youngsters are protected by a safety cable running through the eyebolts on the steel arm of every car. If the main cable should snap, passengers would get harmless jolt

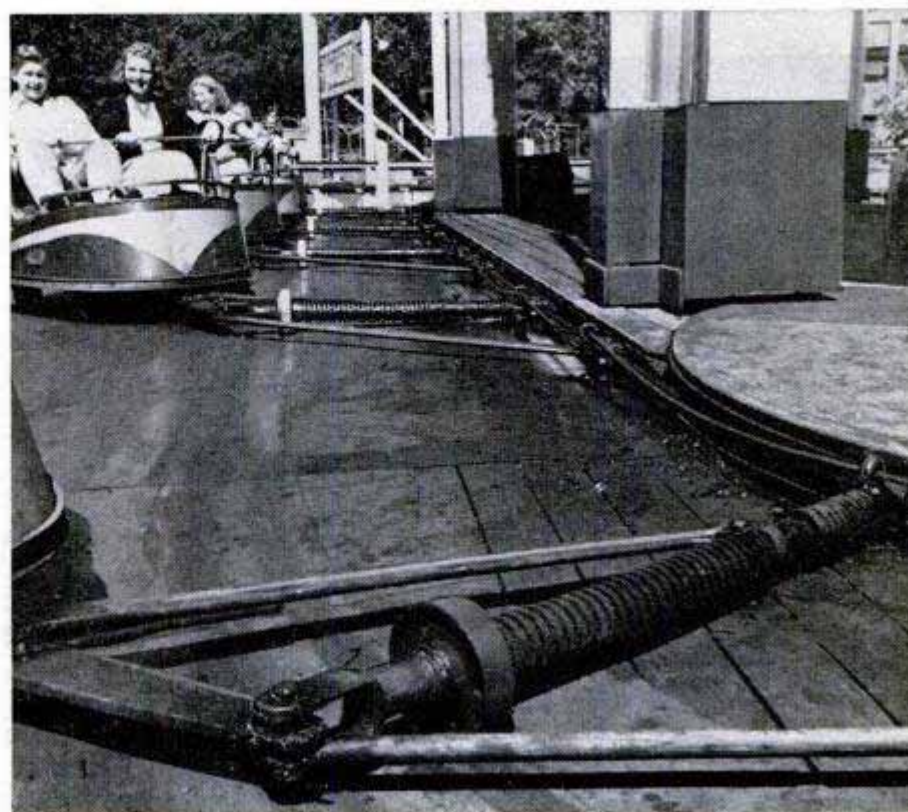



Above, concrete is sprayed on mesh to form lower half of pipe. Above, right, when lower half has set, wooden forms are built to support steel plates. Right, the completed pipe before inner forms have been removed

Concrete Sprayed in Trench Makes Irrigation Pipe

Concrete irrigation pipe is made as it is laid by spraying the concrete over curved forms right in the trench. The slow, laborious work of hauling and lifting heavy, precast concrete pipe is eliminated and savings of 50 percent are possible. The trench is excavated in a semicircular shape and lined with wire mesh. Concrete is sprayed on the mesh to a thickness of three inches. When this hardens, bracing timbers are placed three feet apart along the half pipe and curved steel plates mounted on them. Wire reinforcing mesh is added and



spraying is completed. Braces and steel plates are removed when the concrete hardens, leaving a smooth, jointless pipe. A crew of eight men can make 150 feet of pipe in a day by this method.

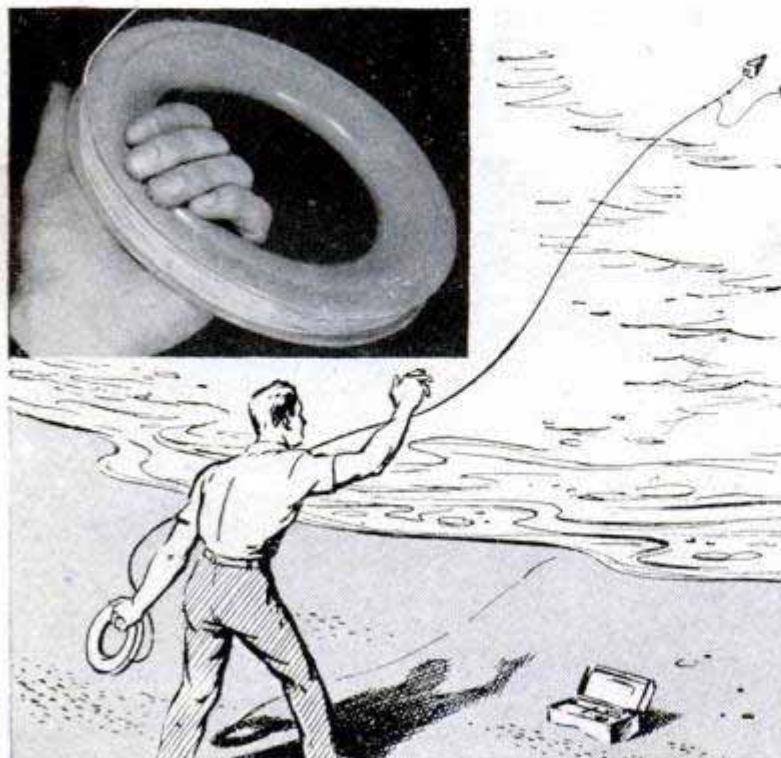

Fishline Unwinds off Reel For Casting Without Rod

Casting a line a long distance without a fishing rod is possible with a plastic ring that allows the cord to unwind smoothly. The weighted line is wound on the ring and then hurled across the water with the ring held at right angles to the direction of the throw. This permits the line to spin off the ring freely. Casts of 150 to 200 feet are made easily with a two-ounce weight on the end of the fishline. The six-ounce ring is hollow and will float if accidentally dropped in the water.

University of Illinois faculty members flew 300,000 passenger miles in school-owned planes last year in their assignments.

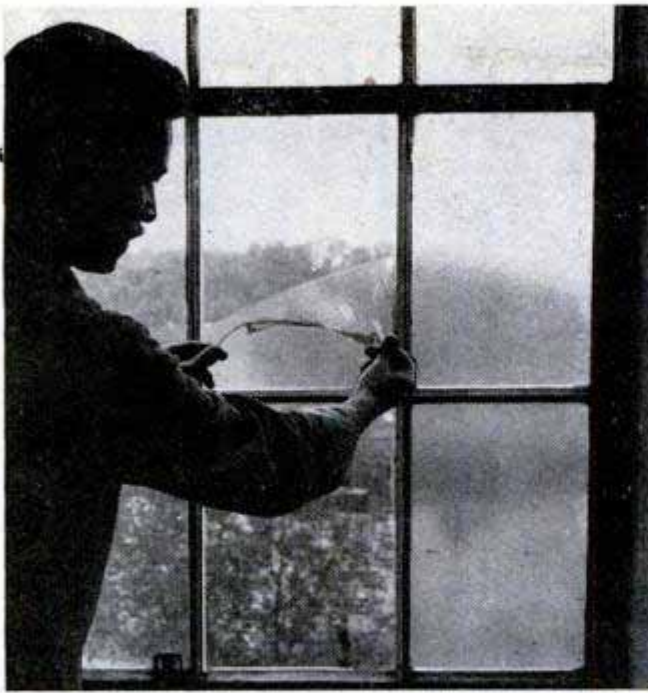

Sprayed Coating Reduces Glare

In summer when the heat and glare of the sun make work in bright factories difficult, the windows can be sprayed with a translucent green film. Then in late autumn the film can be peeled off by hand to permit more of the sun's rays to enter the windows. The coating, which can be applied with brush or spray, is a resin film which withstands water, soap and most window-cleaning compounds. If desired, it can be left on the glass indefinitely.



Chest-Pod for Reflex Camera

Photographers using reflex cameras can shoot off-the-camera flash shots without danger of dropping the camera when they wear a support that straps around the chest. The camera is attached to the chest plate by a universal joint that enables the photographer to tilt the camera in any direction. A web strap holds the breastplate in position. The complete support weighs only eight ounces and was invented by a Cincinnati newspaper photographer.

British Fire Fighters Ride Special Train to Blaze

Within five minutes after receiving an alarm, special fire-fighting trains maintained by the British Railways can be speeding to the blaze at 60 miles an hour. Organized to provide defense against fires that start along the right-of-way, the spe-

cial trains carry 8500 gallons of water, a supply of foam extinguishers, miles of fire hose and rations for the crew. The trains, manned by specially trained crews, are painted a bright red and are stationed at strategic spots along the lines.



Transparent Navy

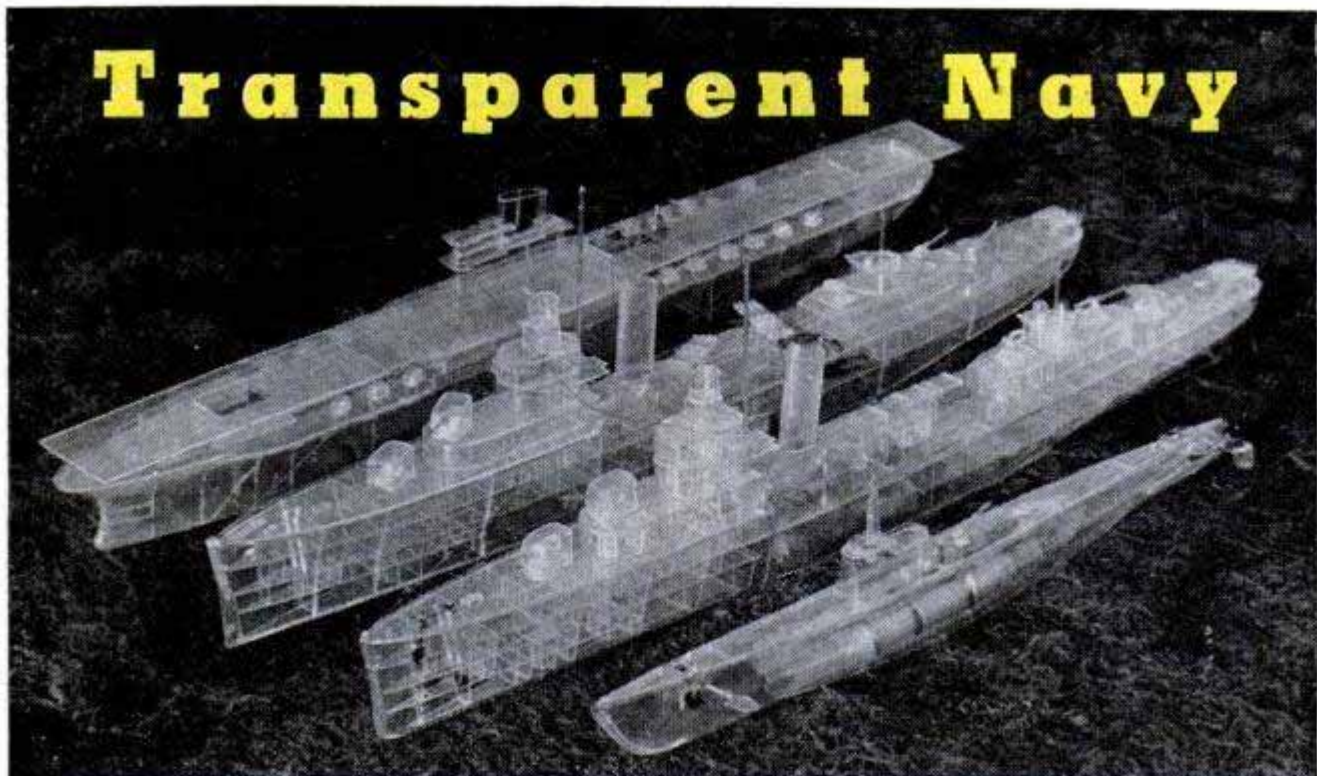

Part of the transparent navy is shown here in "dry dock." Notice the bulkheads and other interior parts. The fleet is not built to the same scale throughout

Left, the model builder poses beside a 40-inch model of a Star sloop which he built for his "civilian" fleet. Even the sail of the plastic boat is transparent

Below, the wooden hull patterns in foreground were used to make the two molds in the rear. Richards is holding a submarine hull he formed with these molds

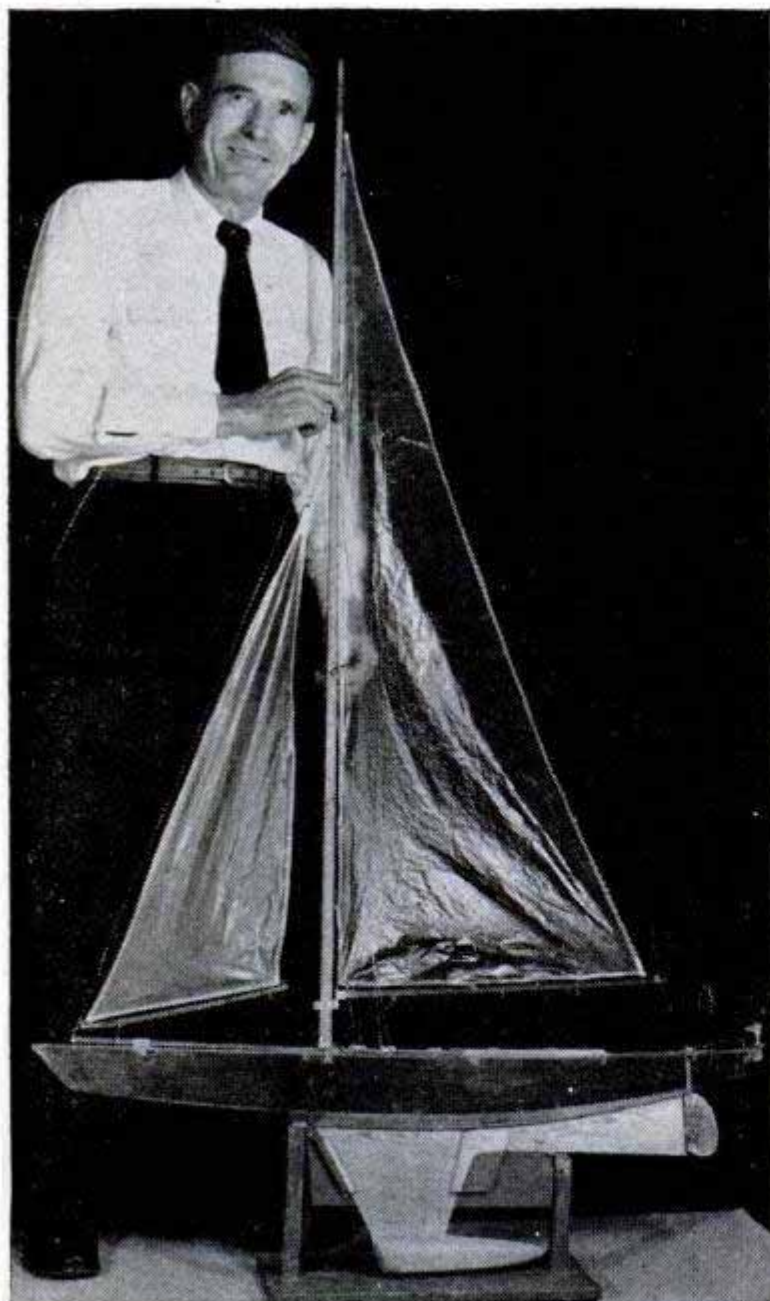

MODERN warships are complex, with a maze of bulkheads and passageways, but transparent scale models make the ships' construction as clear as the Plexiglas of which they are formed. John Richards of Long Beach, Calif., a former Navy man, makes these models to clarify the internal structure of ships to student designers and sailors.

From his back-yard workshop has come a score of craft built to scale and specifications. The fleet includes destroyers, submarines, an aircraft carrier and sailing yachts. The yachts will actually sail and the men-of-war cut through the water, powered by tiny electric motors. Davits and gun mounts swing, lights flash on port and starboard. The anchors can be hoisted and lowered.

Richards first makes a wooden model of the hull, then with this pattern he molds a plaster cast from which he makes interior and exterior molds of metal. The plastic is heated until pliant. It is then placed in the outer mold and the inner mold is forced into it with a jack-screw. He uses the same procedure for such small parts as lifeboats and gun turrets, except that a drill press provides pressure.



The model submarine gets under way powered by six flashlight batteries. Below, left, smaller pieces, such as this lifeboat, are pressed into a form with this drill press. Below, even the anchors move up and down

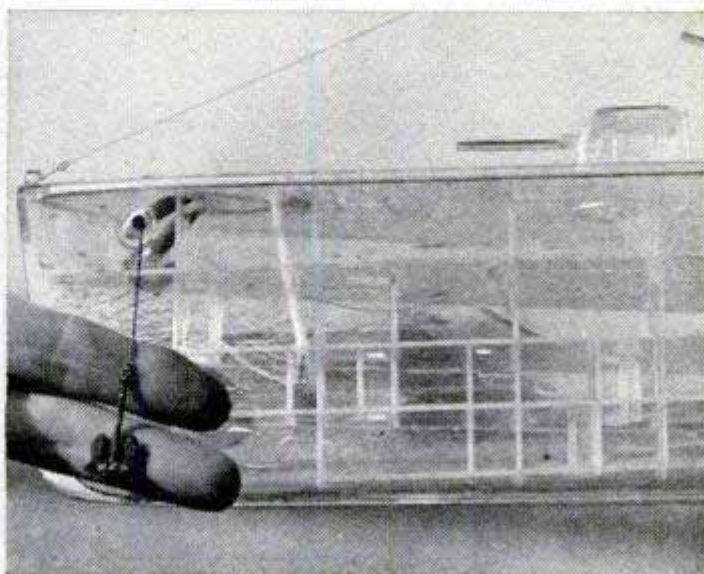
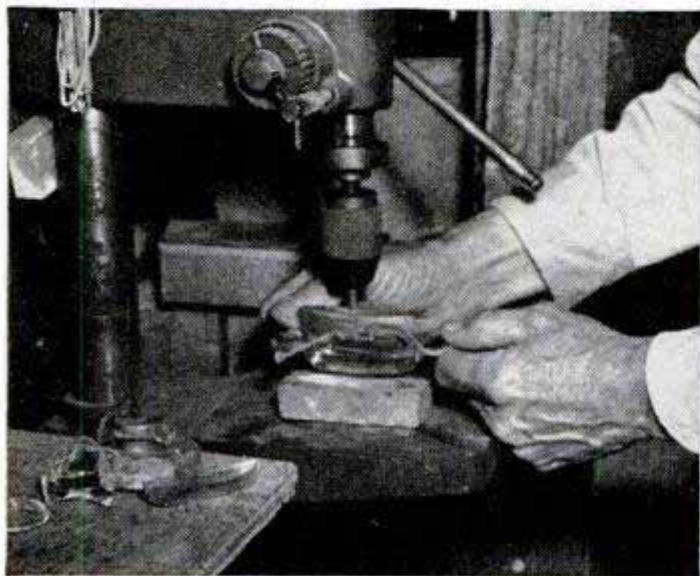



Airfield at Rock of Gibraltar Heads Out to Sea

When the British forces on the Rock of Gibraltar needed an airfield during the war, there was only one way they could go to build it—out to sea. The Rock is much too small to hold a regulation airport. Instead, a 5400-foot air strip was built out

into the water at right angles to the causeway connecting the Rock to the Spanish mainland. Rock excavated during tunnel construction for Gibraltar's defenses provided the fill. The air strip is now used by British airlines.

Automat for Hens Shoves Mash Along Trough

Chickens now can eat at a cafeteria—an automatic poultry feeder that shoves the mash along a trough. Developed at Pennsylvania State College, the feeder can accommodate up to 200 hens. Feed hoppers of varying capacities hold from 300 to 500 pounds of mash. A time clock connected

with the electric lights in the pen regulates the feeder, turning it on for a few minutes every half hour. A conveyor chain carries feed down one side of the trough and back the other side. Building plans are available from the School of Agriculture, Pennsylvania State College, State College, Pa.

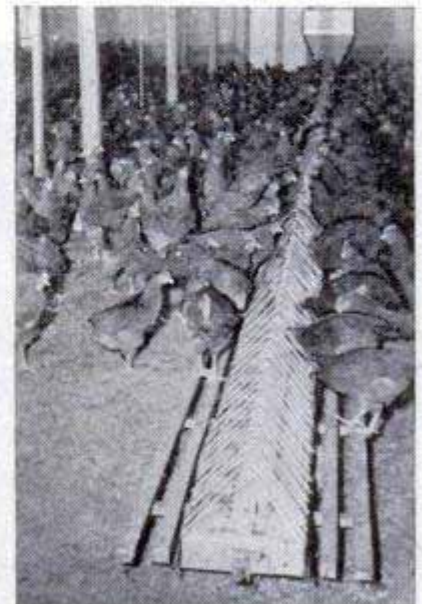
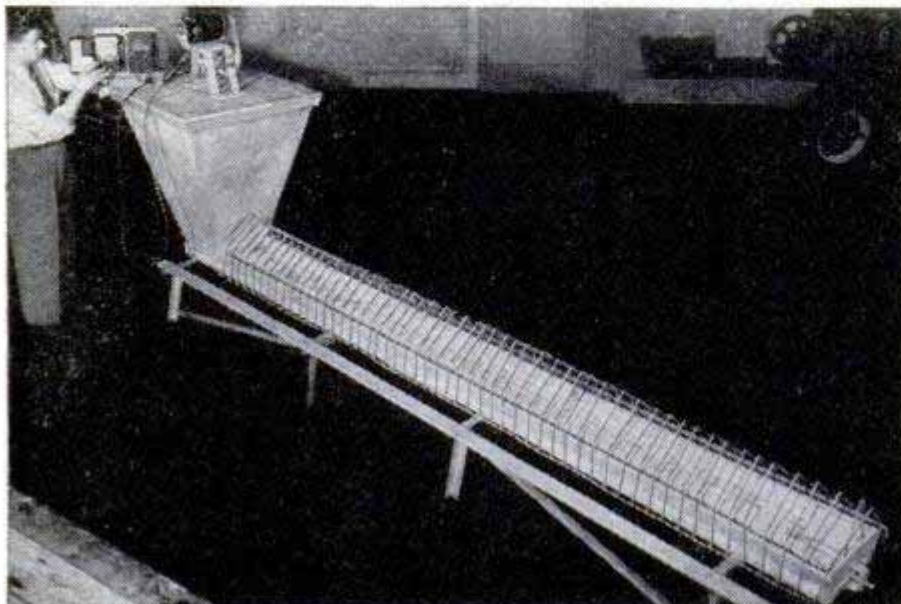

Arctic Adventure With a Camera

By C. J. Albrecht



Dressed for field work in the Arctic, the author wears woolen clothes and underclothes and caribou outer garments. Turret-head camera has three lenses

from his sensitive nose to the tips of his claws—you aren't likely to shoot with a camera. A rifle is a better weapon. I've shot with camera and rifle both to bring home bear steaks, photographs and my own shaking knees.

My business is lecturing on wildlife and procuring animal specimens to be mounted for museum displays. Currently I'm commissioned to design and mount displays for the Chicago Museum of Natural History. My "water hole" group there, more than 50 feet long, is the largest group ever mounted, containing numerous animals including five giraffes, five zebras, eight gazelles, two elands (large antelope), two rhinoceroses and one oryx.

In addition to my museum work, I present lectures on wildlife and travel, illustrating them with motion pictures and, in some cases, with stills. It is in preparing

PHOTOGRAPHY for thrills—that's one aspect of my business. In my six trips to the Arctic I've had some of the biggest thrills of my life, and brought back action photographs of those thrills.

When you see a giant Kodiak bear charging at you like a runaway freight train—an animal that measures almost nine feet

Photo shot at 50 yards shows Barren Land caribou on winter migration from Hudson Bay south to timberland

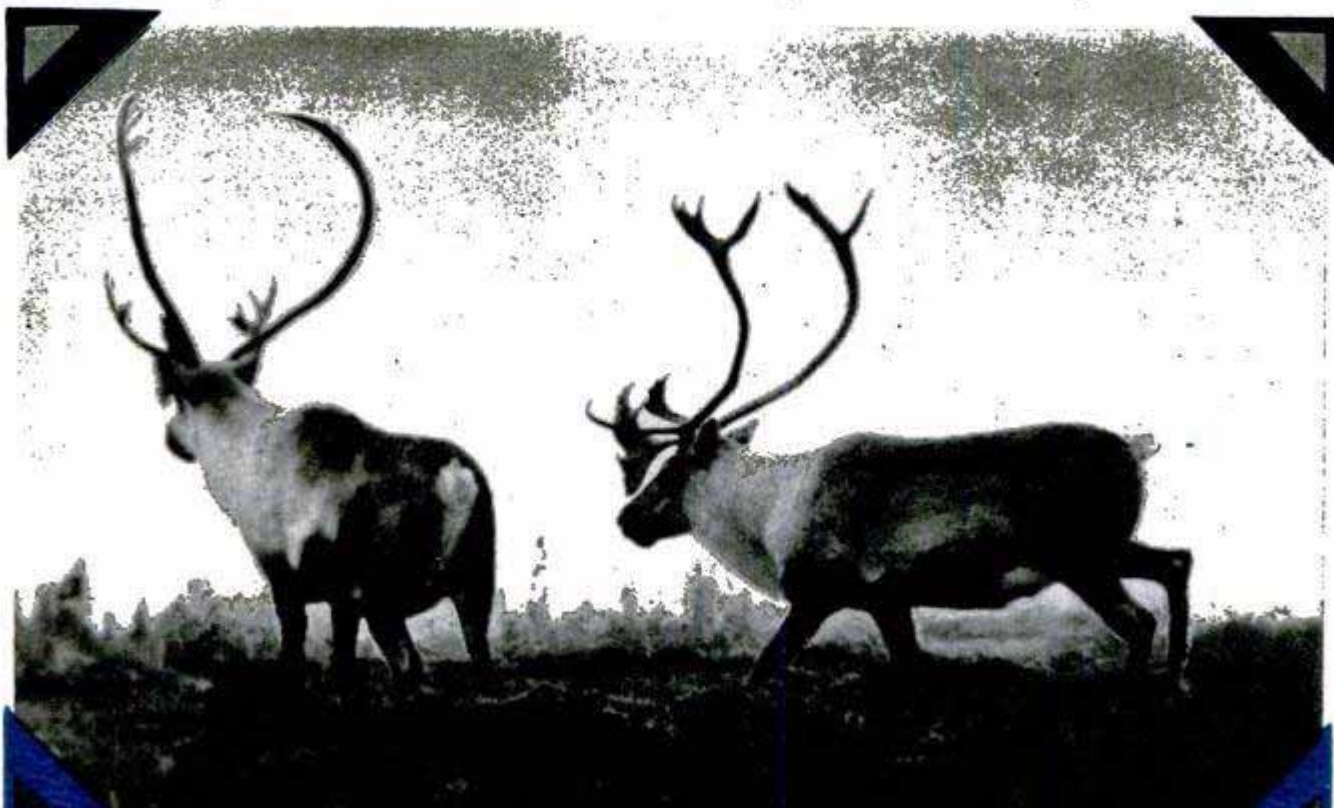

these pictures that I've had my biggest thrills, and a good many of them have come in the Arctic.

There's a mystery to the Arctic that brings a man back time and time again, despite 50-below temperatures and 35-mile-per-hour winds that whip your breath out of your lungs and leave an icicle inside your chest.

Arctic photography is an art in itself and requires a great deal more preparation than ordinary photography. I take both color and black and white, stills and motion pictures. That accounts for my excess baggage. For lecture material, I use 16-mm. motion in color with plenty of telephoto lens work on wildlife. Packing tripods through the Arctic is no fun, but is essential in making professionally smooth motion pictures.

The Arctic has as many types of weather as any area in the world, varying from rainy summers to blasts of 60 below in the winter. I winterize my equipment by removing all heavy lubricants and applying a special light oil. A hand-cranked motion camera is essential in case the motor fails to turn. When I'm ready for a winter expedition, I subject all my equipment to tests inside a freezer.

When I see a subject in the field that strikes me as new, interesting or different, I take it with plenty of footage. If the subject is put off until later, it's likely to become commonplace and I can't recapture my enthusiasm.

Take the case of the charging brown bear. I would have missed some of my



Top, giant Kodiak bear charges Albrecht. Moment later cameraman snatched up rifle and shot animal 12 feet away. Above, bear's footprint compared with rifle. Below, bear of similar size measures eight feet six inches





Author photographs wildlife from a distance, using a tripod-mounted Leica with cable release and 12-inch lens

most priceless shots if I had decided to wait for a better opportunity.

I spotted seven brown bears of different sizes across a stream and immediately set up with my telephoto lens. I was hard at work when suddenly out of the corner of my eye I noticed that the largest had crossed upstream and was coming toward me at a dead run. I turned toward him and snapped pictures as he bore down on my camera. He was mad clean through. At the last minute I dropped my camera, snatched up my rifle and fired a shot that struck him in the chest. He didn't even swerve. When he was 12 feet away, he reared up and I pumped a shot into the base of his skull. The slug went through his brain and he toppled over so close to

me that I could see every hair on his body.

Right here I'd like to clear up some misconceptions about the brown, or Kodiak, bear. It really is a huge animal, as some of my photographs show. The bear I described above left tracks in the sand, each about 17 inches long and 9 inches wide. By measuring the distance between them I found that his normal running stride was about six feet. He wasn't the record bear killed, but it was in this vicinity that a friend of mine did bring down the champion. This playful little monster, by actual measurement, was 9 feet high, 60 inches around the neck, almost 7 feet around the chest, 36 inches around the upper arm and weighed 1200 pounds. I mounted him in my new group at the museum.

Albrecht took this photo of the northern lights over a trapper's cabin when the temperature was 30 below. The picture was taken at midnight with a 30-second exposure on Super XX film with a lens opening of f:4.5

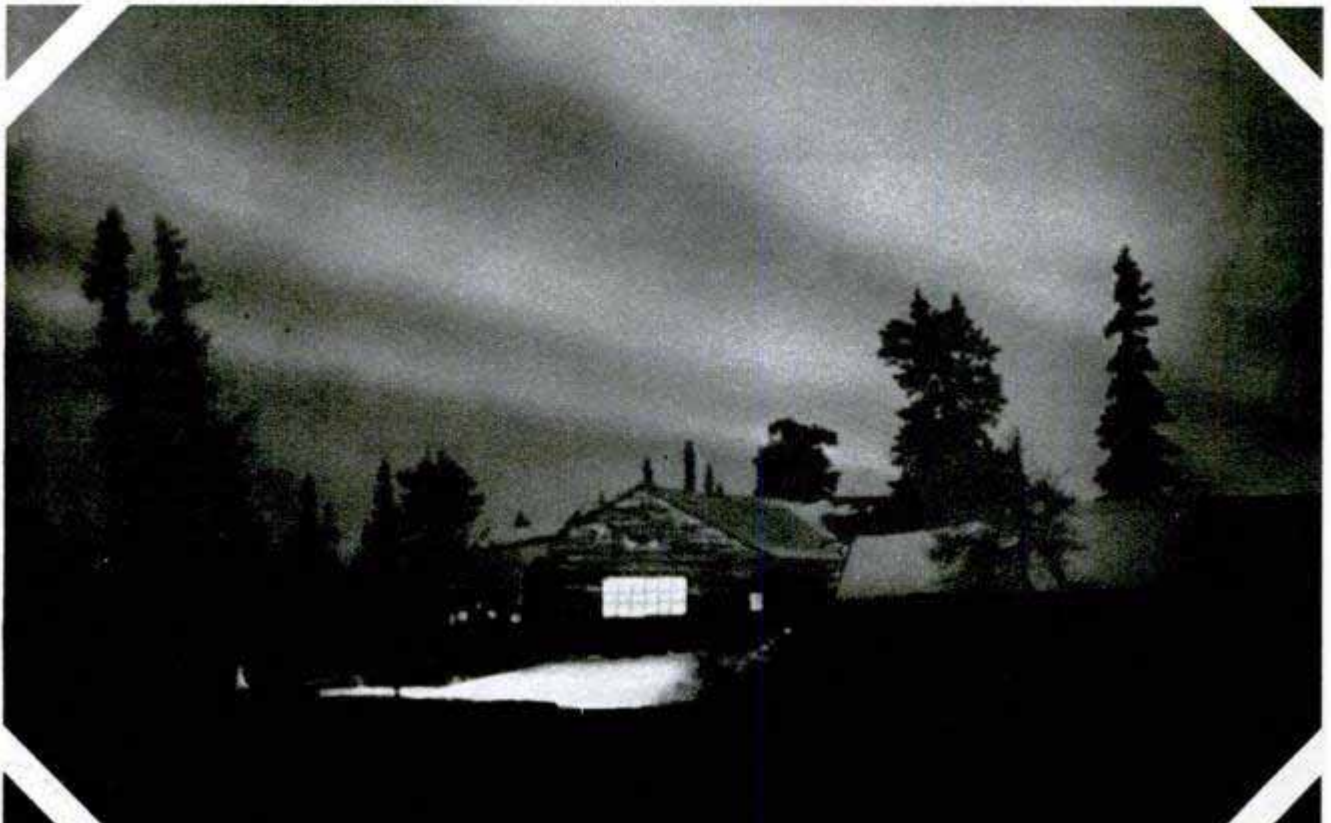

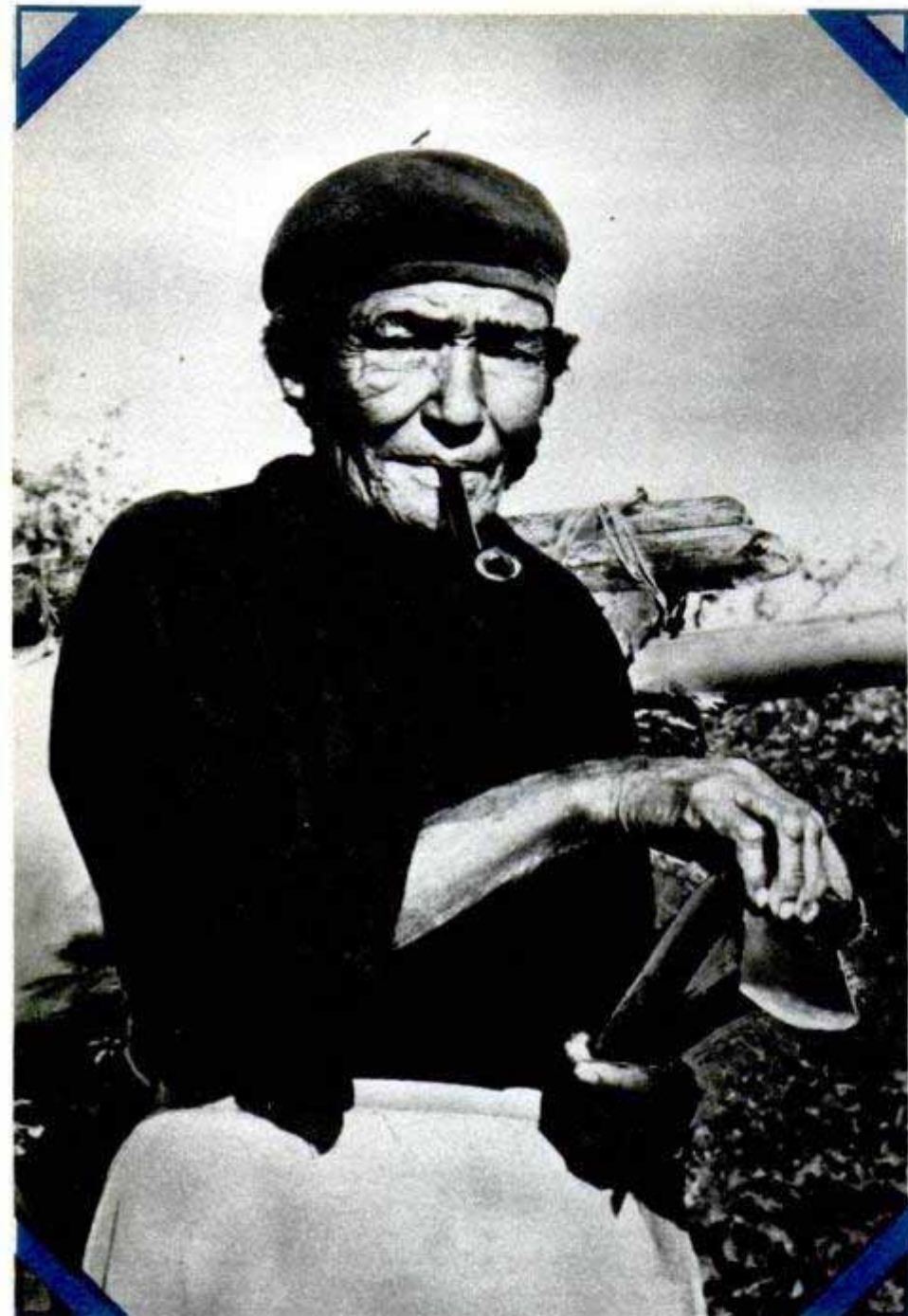

An 80-year-old buckskin maker poses for Albrecht's camera with the ax blade she uses as a scraper on the bull-moose hide behind her. Below, author explained his exposure meter to these timid Eskimos to gain their confidence, then asked them to pose for this picture



In the field I either stalk my subject or work from a blind. While stalking I frequently carry the camera mounted on the tripod, ready for anything that may turn up. I go the limit on telephoto lenses—the larger the better. My choices are 7, 12 and 20-inch jobs. Heavy? Yes, but they bring in the pictures.

Blinds of branches and grass are constructed to prevent animals from detecting motion. They may be open on top and back but must block out actions in silhouette. In addition, the photographer's movements must be slow and deliberate.

Clothing depends upon the season, varying from hip boots and head nets to wool underwear, eider-down jackets, parkas and snowshoes. Proper clothing played a big part in saving my life during a storm in the Arctic.

We were aboard a 117-foot, two-masted schooner and that particular day we crossed and recrossed the Arctic Circle six times. Without warning, a heavy wind broke off our rudder and its four-inch iron support. We were adrift in heavy Arctic seas.

Our first thought was to find some means of navigating our boat, so we rigged up a jury rudder that helped a little. We toppled through the waves for hours. After dark that night we crashed between two of the Diomed Islands, damaging the boat even further. Eventually we made our way to Teller, Alaska, just before the wind changed, or we would have been blown back out to face the sea again. Fortunately, I was dressed warm enough to survive the hardships of this trip.

On my field expeditions today I carry much more equipment than I did on my first trip to Alaska-Siberia in 1913, but it weighs much less. In those days I used a heavy Pathe 35-mm. camera with tripod, a combination



that tipped the scales at 100 pounds. The smallest automatic, a French Aeroscope, was a heavy job with four air-compression tanks that were filled with a bicycle pump and controlled with a throttle like a steam engine. This came in handy when I was chasing walrus and polar bear.

If I were limited to one motion camera for any and all field work my choice would be a Victor 16-mm. Model 5. In my opinion, it is the most versatile and adaptable camera I have handled. It has a fast-sighting view finder for snapshooting, such as birds in flight or fleet animals, and still has a critical parallax compensation for close work. It is adaptable to anything from $\frac{1}{2}$ inch to a 20-inch lens and it has a button release, operated like a trumpet key, that can be used even if the photographer's hands are covered with a pair of the heaviest Arctic mittens.

I have found the American .50-caliber ammunition boxes to be most useful for packing and carrying film and cameras. With balsa wood, velvet and a little ingenuity anyone can build a good camera case out of one of these boxes. One container will hold two dozen 100-foot rolls of 16-mm. film or an assortment of rolls and cut film. In the field the cases can be used for seats on the damp ground.

One piece of equipment that is vital when trying for photographs of large game is a high-powered rifle. You

(Continued to page 232)

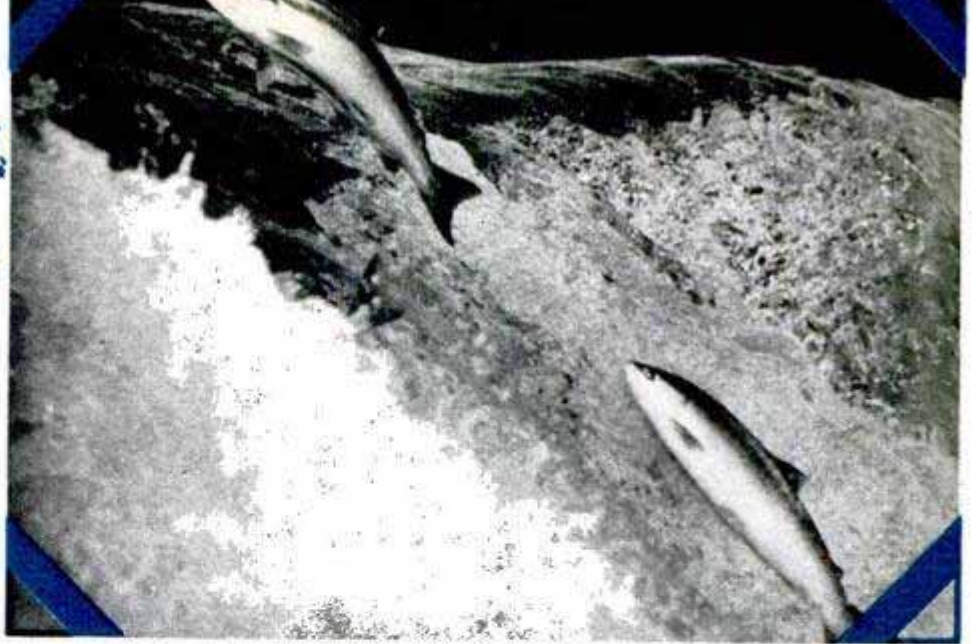

Exposure of only 1/1000 second yielded print of salmon leaping falls



By playing a mouth organ to this cautious willow ptarmigan, Albrecht stalked close enough to snap a portrait. Below, trappers log in wood supply for winter. Arctic is rich ground for interesting camera shots





Model Engine Scoots Scooter

Riding a sidewalk scooter powered by a model-airplane engine, a Los Angeles hobbyist breezes past pedestrians. Between model meets the amateur mechanic mounts the little $1\frac{1}{2}$ -horsepower engine on the front of the scooter. The inventor uses a standard model-airplane propeller to provide the pulling power. The little vehicle has a one-pint fuel tank.

Modern Tokyo Office Building

With its lower floors occupied by an American-style department store, a proposed nine-story office building in Tokyo will have a total of 3,600,000 square feet of floor space. The building will be constructed by the International Club of that city. The top floor will be used as a church.



Tubes Made Punctureproof By Sealing Compound

Regular automobile tubes are made punctureproof by a sealing compound that is pumped into the tube through the valve stem. Produced in England, the compound, forced in by air pressure, coats the inner walls of the tube, making it self-sealing when punctured by nails or sharp objects.

Clamp Holds Drills for Sharpening

Small drills are sharpened accurately in a hand-held clamp that guides an oilstone as it is stroked against the point. The drill is inserted in a bushing of the correct size and held in a chuck with the point protruding through an angled surface. The oilstone then is rubbed against one lip of the drill until it is flush with the surface. To sharpen the other lip, the drill is rotated one half turn. The sharpening kit includes the holder, 20 bushings to accommodate drill sizes from 41 to 60 inclusive and an oilstone.

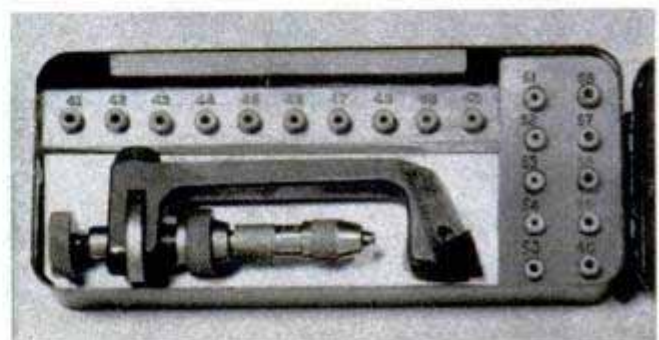

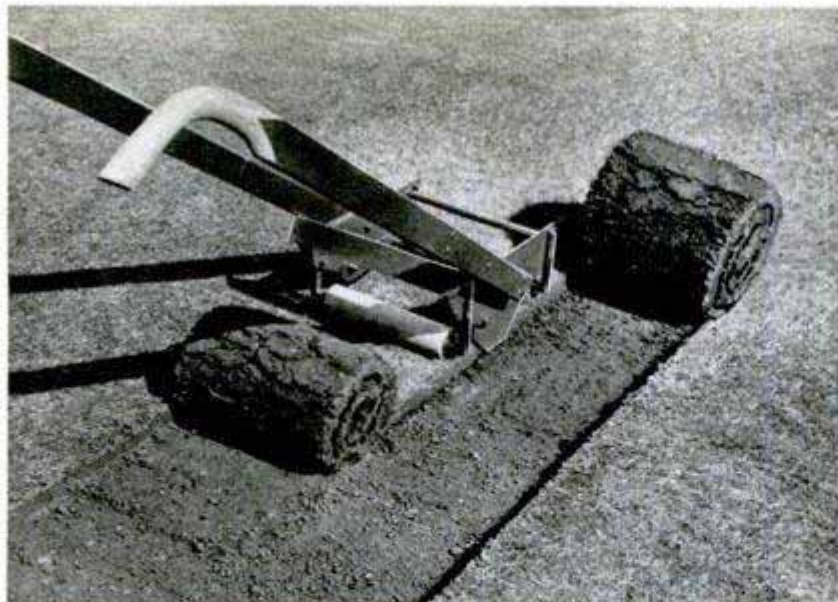

Sod Cutter Slices Turf Into Even Strips

Sod is removed from lawns so evenly with a new sod cutter that when it is replaced there is almost no sign that the lawn was disturbed. Consisting of a double-edge cutting blade that can be adjusted to depths from 1 to 3½ inches, the cutter is pushed

along on two rollers. To start cutting, the operator presses down on the rear of the cutter with his foot until the blade is forced into the sod. Then, by pushing on the handles, he slices the turf into even strips of sod that can be rolled up without damage.

Truck Tracks

Crawler-type tracks for trucks help pull the heaviest loads through deep snow, mud or sand. The tracks, which have been used by the armed forces and approved by U. S. Army Engineers, will fit single or tandem-axle trucks equipped with standard dual tires. It only takes about 10 minutes to mount the tracks. The pads are made of drop-forged steel alloy and connected by a cadmium-plated steel chain.

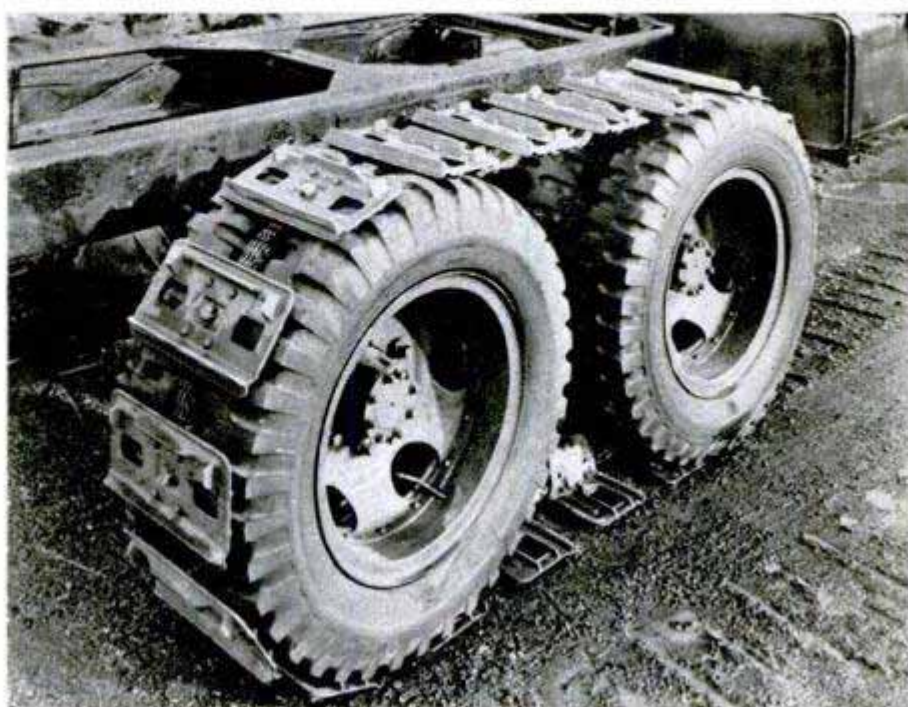
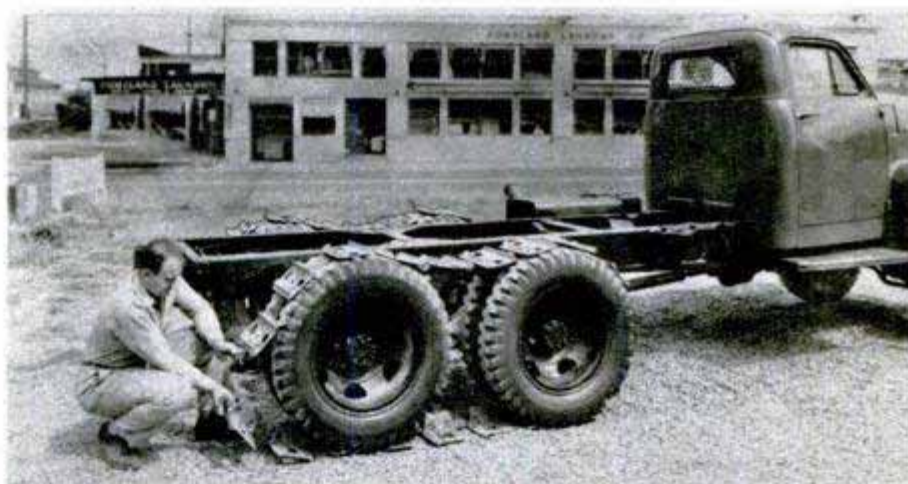

Drive-In Theaters To Get Heaters

Drive-in theaters will soon provide their customers with heat as well as sight and sound. A heater-speaker unit, designed to hang inside the car window, has an enclosed heating coil that keeps the car temperature at a comfortable level. With these heaters, drive-in operators expect to add at least two months to their seasons.

Mountain-Top Lighthouse



By Harriet McIntosh

DAWN WAS BREAKING over the Arizona desert as C.A.A. maintenance technician A. H. Lee killed his third rattler. Atop Picacho Peak, which jutted 1800 feet from the desert floor, the airways flasher beacon winked off for the day. Lee noticed it with satisfaction, nudged the snake from the path and continued up the cactus-spiked trail toward the big light.

From coast to coast, lights on mountain peaks are the road maps of night-darkened skyways for pilots. They must be as failure-proof as precision equipment can make

C.A.A. maintenance technician A. H. Lee must polish and inspect the beacon's lamp housing each month

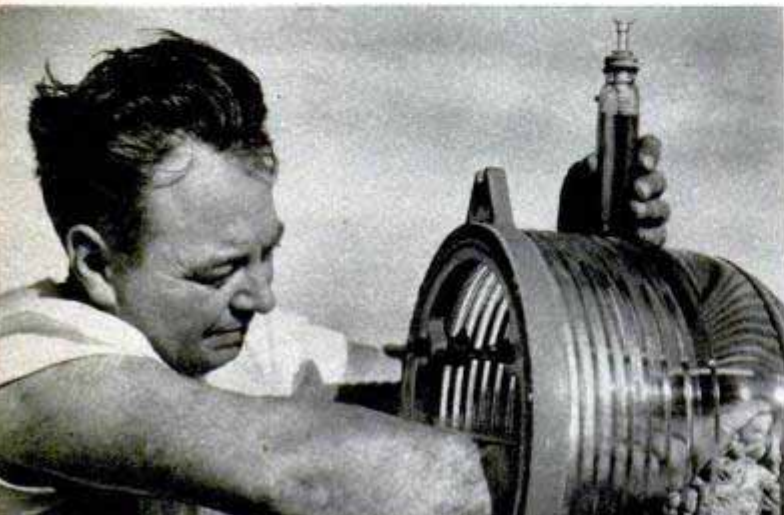

them. Once installed they become subject to the vigilance of the maintenance men in C.A.A.'s Airways Communications.

Like Lee, these men are in their thirties. After passing rigid tests for a civil-service rating, they are assigned an area within one of the country's seven air communications regions, where they watch and maintain up to 25 beacons. They acquire a panel truck, repair tools and the technique of a mountain goat. Each light is checked once a month; some more frequently.

Though assignments may include checking airport lighting and some power substations, most time is spent on the giant flight route lamps, spaced in remote areas some 20 miles apart. Close-up, the lamps resemble big eggs with one end dyed red or green. Most common are "obstruction blinkers," red or white warning lights that wink atop towers or sharp peaks near landing areas. Least understood is the "code light," a flasher beacon which blinks the number of miles from the last point of departure. Many beacons, like Picacho, sit on isolated pinnacles miles from any road. Lying between Phoenix and Tucson, Picacho is a focal point for night pilots who first spot its code 40 miles away. It tells them they are 60 miles out of Phoenix, thrumming east from Los Angeles.

Lee knows when he leaves his truck at

Tender

On the highest pinnacle of Picacho Peak, left, sits one of C.A.A.'s many beacons marking the airways for night pilots. Servicing them is a tough, full-time job for men who must be agile as well as able

Picacho's code blinker rests on a fixed mount on the platform of a 40-foot tower. Spikes on the tower rail discourage buzzards from nesting in the beacon's light path, saving technician Lee extra work

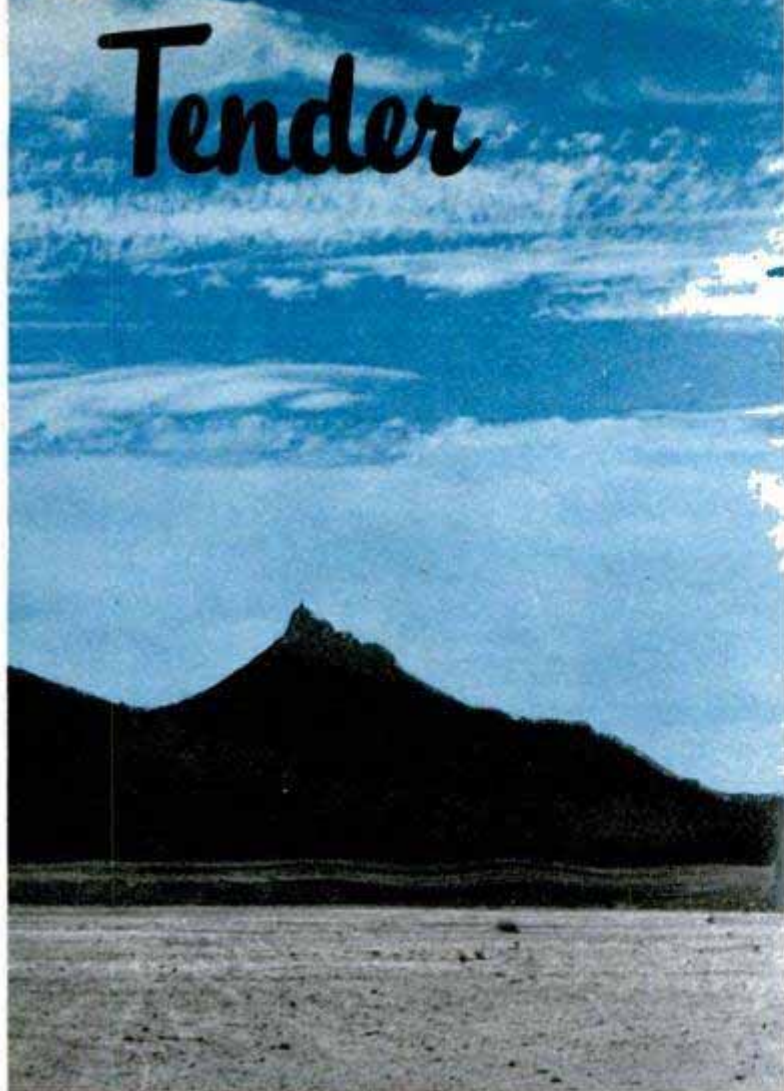

the base of the peak that six hours will elapse before he returns from the rugged trek.

Picacho's beacon is a Code Type 'E,' consisting of a 40-foot tower topped by a stationary fixture holding a 500-watt bulb. Like most beacons it has an emergency bulb fixed at right angles to the one in use. In case of failure, a small motor swings the used bulb aside and snaps the emergency bulb in place. Picacho's biggest asset is power-line electricity. Many isolated beacons have gasoline generators, involving portage of fuel—no cherished task.

No rule says Lee must work an odd shift, but he prefers predawn rattlesnakes to blistering heat, so his day begins at 3:30 a.m., when he drives his truck out of Phoenix toward





Rugged trail to the beacon is three miles and almost vertical. C.C.C. boys built it and strung the guide ropes

the foot of Picacho Peak, climbs to the summit and goes to work.

The light is controlled by a clock which sets it winking code at sunset and snaps it off at dawn. After checking the clock at the tower base, Lee climbs to the light, which he cleans and inspects.

During summer, the tower is a magnet for lightning. Maintenance men are used to midnight calls which send them rocketing through lashing rain to trace a beacon failure. On such a mission, Lee once brushed a mountain lion that was sleeping under a ledge, and raised a mean snarl from the beast. "I quaked for three days," he recalls.

Beacons like Picacho, by their very iso-

lation, seem a challenge to vandals who may drive 50 miles and hike 3 just to shoot rifle bullets at the power line insulators or destroy water supplies. Maintenance men look for such damage, and also for birds who love to nest near the bright beam, blocking its path. One man had to climb an 80-foot tower, wedge himself into a railing and blitz a nest while battling at the outraged crows he was displacing.

No airways maintenance technician considers his job worth chest-thumping. But few men love their work as well, despite the modest salary. "I can't explain it," says Lee. "I just know that when I'm driving home and pass a couple of beacons flashing in good order, I feel good."

Torque-type clock turns beacon on at sunset, off at dawn, automatically adjusting to seasonal variation. Lee adjusts it, left, then oils the code cam, right. As cam turns, it makes contact for a long flash, two shorts

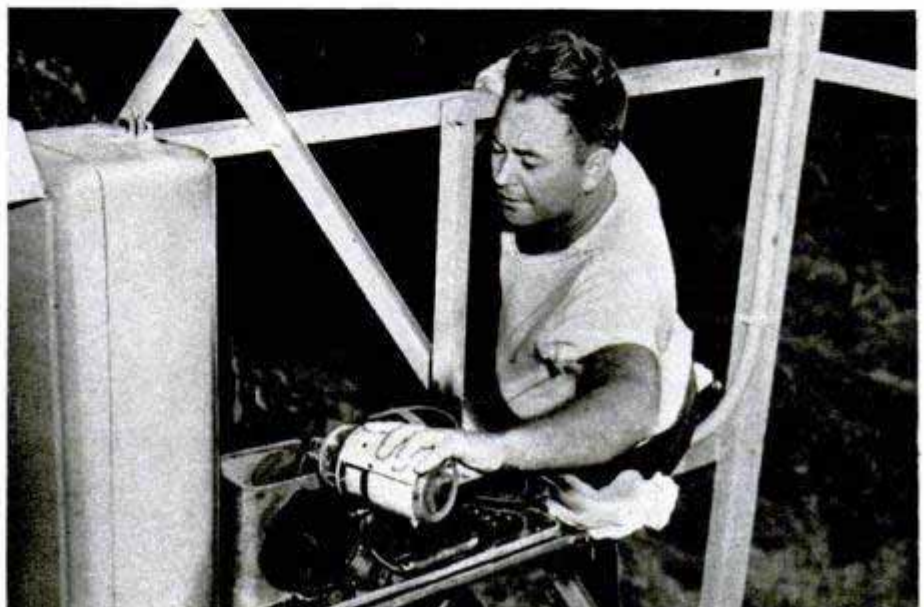

Plastic Insulation Is Lightest Solid

Twenty times lighter than the fluffy meringue on a lemon pie, a plastic foam insulating material is believed to be the world's lightest solid. Developed by a Westinghouse chemist, the new material is being tested as insulation for refrigerators. It is produced by baking a molasseslike synthetic resin at about 350 degrees, causing it to expand to 100 times its original volume. Thousands of gas bubbles are trapped in the foam when it solidifies. The material can be shipped in its liquid



form and expanded at the place where it is to be used, easing the problem of shipping and storage.

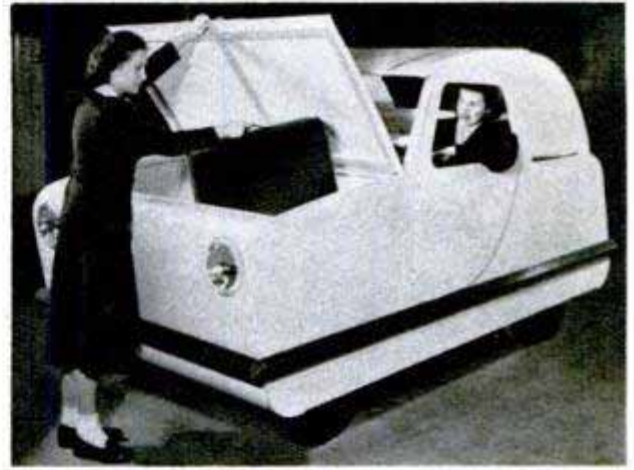

Car for Errands Carries Three

Cheap transportation is provided by a small coupe designed to serve as the extra car in the family. Just right for the trip to the shopping district, school or neighborhood theater, the car has a top speed of 35 miles an hour and averages from 45 to 60 miles to the gallon. It has an automatic

clutch and transmission. A 7½-horsepower air-cooled engine is mounted in the rear. The front end includes a large luggage compartment. The body is formed of pressed wood and three adults can ride comfortably in the single seat. Standard equipment includes hydraulic brakes, electric starter, automatic choke, safety-glass windshield and coil springs.

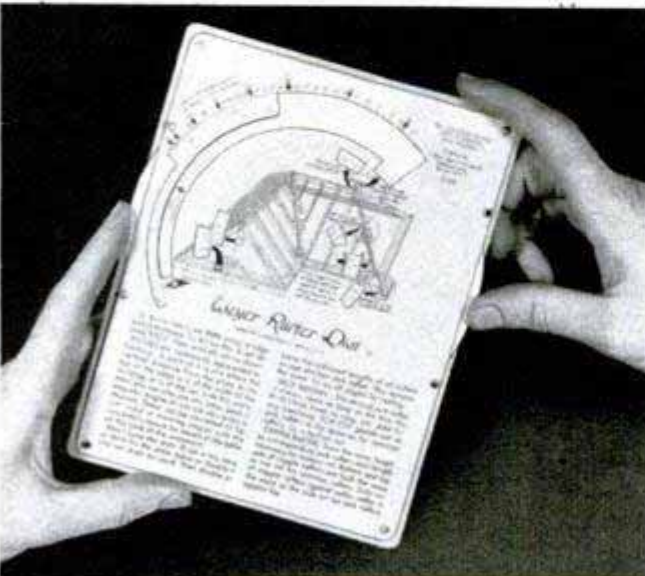

Roof Calculator

By merely setting two dials on a new calculating instrument a carpenter can determine the lengths and cuts of all roof rafters. The Vinylite-plastic instrument shows a picture of a roof. With the dials properly set, arrows on the picture point out the exact readings for the lengths and angles of the various rafters. The calculator is small enough to fit into a coat pocket, brief case or toolbox.

¶ An estimated 250,000 model-railroad fans in the United States operate enough miniature trackage to reach eight times across the country, and spend \$5,000,000 annually on their hobby.



Daniel Boones on the Rifle Range



Modern frontiersmen line up for a volley with their muzzle-loaders. Above are match rifle and hunting rifle with equipment for each





Two recognized firing positions during the matches are the offhand or standing and the bench rest or sitting

By Andrew Hamilton

ON LABOR DAY week end, approximately 600 "gunbugs" from all parts of the United States will gather in Friendship, Ind., (55 miles southwest of Cincinnati) for one of America's unique sporting events—the national matches of the National Muzzle Loading Rifle Association.

Peeking over their shoulders for five days will be more than 3000 pop-eyed spectators. They'll see shooters ranging in age from 12 to 80 years. They'll smack their lips over delicious, home-cooked food prepared by ladies of a nearby church.

And next year—maybe—some of the on-lookers themselves will be up on the firing line banging away.

Chances are it won't be the food that will make converts for this all-American sport. It will be the muzzle-loading rifle—a slim, straight-shooting beauty as rich in tradi-

tion and history as it is in grace and charm.

Defined by the Official Range Rules and Regulations of the National Muzzle Loading Rifle Association, a muzzle-loader is "any gun that repellent charge and patched ball or patched bullet is loaded in the muzzle of the gun and ignition at the breech is by cap or flint."

"Muzzle-loaders?" someone is bound to wisecrack. "I thought those things went out of style with Daniel Boone."

Actually, the muzzle-loading rifle has never been abandoned here in the United States. In some of the remoter regions of Kentucky, Tennessee, Ohio and Indiana, the muzzle-loader still provides meat for the table and guards the home against intruders. And within the past 16 years, the match shooting of muzzle-loaders has developed into a national sport.

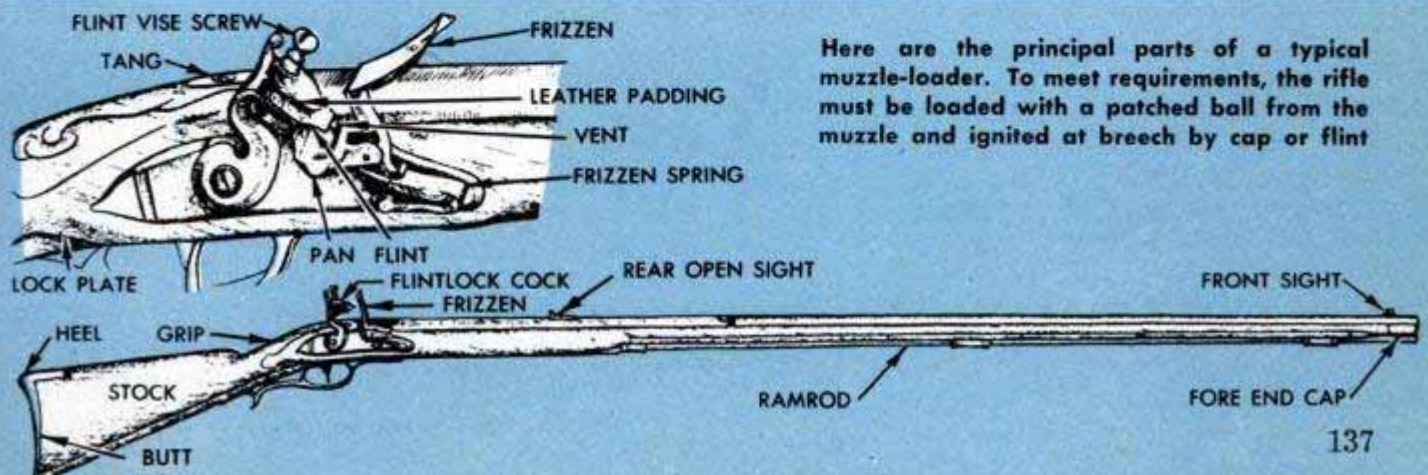

Here are the principal parts of a typical muzzle-loader. To meet requirements, the rifle must be loaded with a patched ball from the muzzle and ignited at breech by cap or flint

Ever heft a muzzle-loading rifle—a Kentucky for example?

They're long—up to 60 inches—but light and well-balanced. At the breech is an old-style flintlock or percussion-cap mechanism. The stock is almost always made of light brown, curly maple wood, inlaid with brass or silver. The octagonal barrel, up to fifty inches long, has from five to eight grooves in the bore.

Put it to your shoulder. The stock angles sharply down and the butt fits into your upper arm instead of your shoulder. Sight down the barrel and slowly squeeze the trigger. There's a blinding, sizzling flash of black powder and the kick and roar of the explosion.

A few muzzle-loading pistols and shotguns exist in the United States today. But the typical representative of all muzzle-loading weapons is the Kentucky rifle.

It was this rifle which was originated in the United States and brought to its highest perfection here. Around 1720, a group of German, Dutch and Swiss craftsmen settled in Lancaster County, Pa., and began to make the gun we know today as the Kentucky rifle.

These early artisans didn't copy European guns—heavy, clumsy, short-barrel, large-caliber weapons. They made an entirely new gun, adapted to the woods and mountains of North America. To give greater accuracy, they lengthened the barrel. To save on powder and lead, they reduced the inside diameter of the barrel from a European caliber average of .50 to one inch to the Kentucky rifle's .40 to .50. As a matter of fact, the Kentucky rifle was 125 years ahead of its time. The United States Army didn't reduce the caliber of its rifles to .45 until 1873, subsequently reducing it even further to .30.

It's been said that the Kentucky rifle "cleared a wilderness and made a new nation." Lewis and Clark's men carried these rifles when they explored the Oregon Trail. One of the first groups to volunteer for George Washington's ragged army in 1775 was a regiment from York, Pa., armed with muzzle-loaders. Andrew Jackson's 2000 frontiersmen at the Battle of New Orleans held off 12,000 British redcoats and helped to win the War of 1812.

Although there never was a time in the last 200 years when you couldn't get up an impromptu match somewhere in the Middle West, muzzle-loading rifle shooting wasn't formally organized as a sport until George Washington's birthday, appropriately enough, in 1933.

It was a cold, blustery day in Portsmouth, Ohio, but 67 gunbugs brought their Kentucky rifles and gathered for a muzzle-loading rifle match. That evening some of

1



the sportsmen sat around a fire and talked.

By the time the snapping logs turned to embers, they had hammered into shape the outlines of the National Muzzle Loading Rifle Association. Today there are 6000 regular, paid-up members of the organization in the United States, Canada, Mexico, the Canal Zone, the Hawaiian Islands, Alaska and Europe.

The association is nonprofit and exists solely to perpetuate the craftsmanship of fine gunmaking and to preserve the American heritage of skilled marksmanship.

If shooting a muzzle-loading rifle appeals to you as an interesting hobby and sport, here are the steps you may take to become a "muzzler":

1. Join the National Muzzle Loading Rifle Association. (Address: P. O. Box 1150, Portsmouth, Ohio.) It will cost you \$2 for an annual membership or \$25 for a life membership. You'll receive a subscription to the organization's monthly magazine, "Muzzle Blasts." It contains 24 to 32 pages of fascinating shoptalk about all types of muzzle-loading guns.

2. Acquire a gun. This will require some initiative on your part. First, rummage through the family heirlooms. There may be a muzzle-loader stored away in an attic trunk, out in the smokehouse or down in the cellar. Second, try the secondhand stores in your community. Guns are getting harder to find, but sometimes you will run across one and can buy it cheap. Third, read the advertisements in "Muzzle Blasts" and other gun magazines. A number of dealers throughout the country offer muzzle-loaders for sale. For a gun in fair condition, an average price is \$35 to \$50.

Some muzzlers who are also expert

2



3

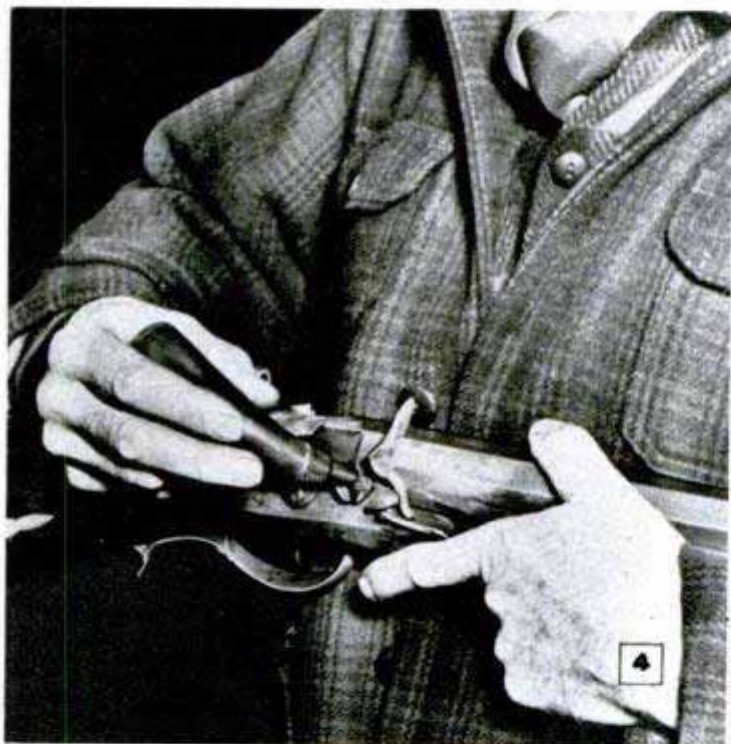

4



5

1. First step in loading is to measure a charge of black powder out of the leather flask or powder horn

2. Cloth is wet with the tongue and wrapped around ball. Load is tamped into muzzle and cloth trimmed

3. Next the wrapped ball is driven very carefully down the length of the barrel with a hickory ramrod

4. Muzzleer primes the flintlock with a few grains of black powder which will ignite the main charge

5. Pulling the trigger produces sizzling flash and then roar of explosion. Cloth around ball cleans bore



craftsmen follow a hobby of making duplicates of famous old-time rifles—lock, stock and barrel. Others build muzzle-loaders with emphasis on getting highest accuracy out of them—heavy-barreled jobs that weigh nearly 50 pounds. Still others are bitten by the collecting bug and own up to 60 or 70 muzzle-loading weapons.

3. Have the gun carefully checked by a competent gunsmith. This is especially important with rifles that have been stored away for a number of years. A cracked barrel or a defective breech could mean serious injury or death.

4. If a gun needs repairs or alterations, you have a choice of working on it yourself or having a good gunsmith fix it. You can't do much about a new barrel unless you are an expert machinist. You'd better count on buying that part for \$20 to \$35, depending on weight. But if you fancy yourself an amateur mechanic, you may be able to fix the breech, lock and trigger mechanism. Sometimes all you'll need is a new, sharp flint or a squirt of oil.

5. When the gun has been repaired or remodeled, be sure that it is test-fired before putting it to your shoulder. To test-fire a gun, mount it securely in clamps or tie it to a tree. Then place a string around the trigger, stand some distance away and pull. Test it several times before shooting it from the shoulder.

6. In addition to the gun, you'll need some other equipment. For example, a bullet mold, some soft lead for making bullets, a supply of black powder, extra flints or percussion caps, a hickory ramrod and some linen cloth. The black powder is carried in a powder horn or flask. Some of the other equipment is carried in a leather "possible bag." Many muzzleers prefer to make the last two items themselves.

7. When you're ready to shoot, you'll want to review the
(Continued to page 234)

Some muzzleers add modern ingenuity to the shooting of old-time rifles. This marksman designed a crank-handled device for measuring an accurate amount of black powder into the rifle muzzle for each charge

Off or on the firing line muzzleers are a friendly, talkative group. These modern Daniel Boones discuss their hobby as they prepare rifles for their turn on the line. Note elaborate equipment some have made



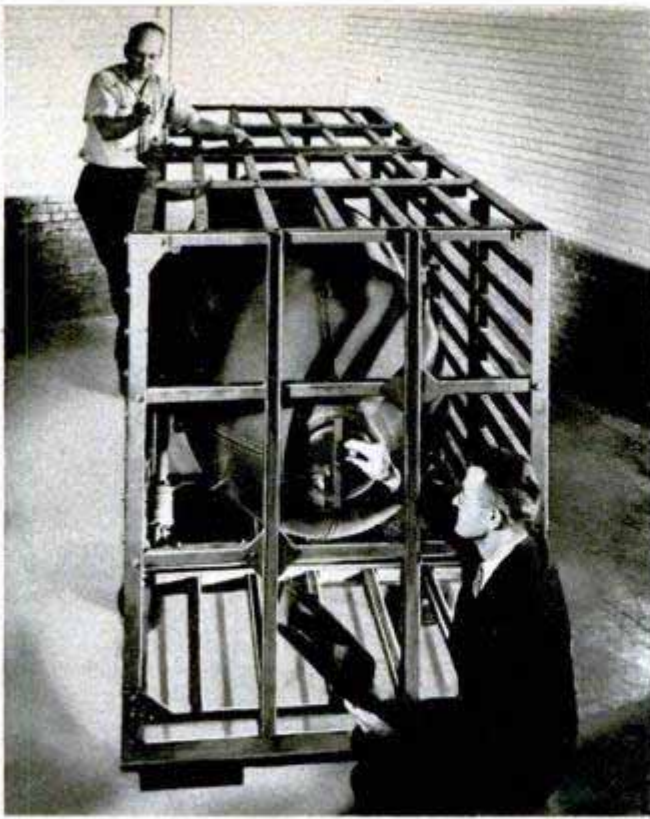

Pressurized Crate Protects Jets From Damage During Shipment

Jet engines, completed for delivery, now are packaged in torpedolike cylinders that are pressurized to protect the jets from humid air. The cylinder is mounted on rubber shock absorbers inside a mobile aluminum crate. The crate rides on a four-wheel dolly which also is mounted on rubber to prevent damage in shipment and storage. The engines are packaged by the Firestone Tire and Rubber Company. The Navy has placed a large production order for the pressurized package.

Quick-Acting C-Clamp

Eliminating the slow and tedious process of spinning the C-clamp closed, a new push-pull clamp is quickly set to position by sliding the pressure shaft to any position. When the handle is turned, an eccentric spline arrangement instantly locks the pressure bar and pressure screw as one unit for applying pressure to the foot. To release the clamp, you unscrew the handle slightly and the locking device releases, allowing the pressure bar to be pulled back without additional turning.

Popular Mechanics provides two sources of further information concerning articles published in each issue: the WHERE-TO-BUY-IT INDEX, starting on page 10, and the WHERE-TO-FIND-IT INDEX, which is available without charge from Bureau of Information, Popular Mechanics Magazine, 200 East Ontario Street, Chicago 11, Illinois.



Life Preserver Built Into Jacket

Fishermen and boating enthusiasts need no life preserver when they wear a new sports jacket. Built into the jacket is a Vinylite air tube that can be quickly inflated by mouth. Uninflated, the garment looks like an ordinary jacket. If the wearer finds himself in the water, he turns a valve cap on the left side of the collar and blows into the valve. The preserver extends from either side of the chest around the neck. Air is retained by turning the valve cap clockwise. The jacket is available in sizes for men, women and children.

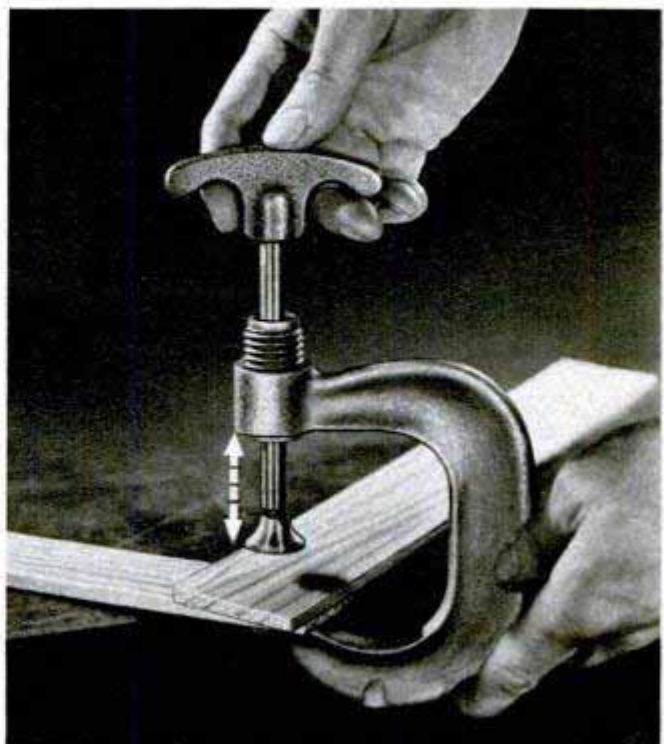



Days before the twisting, hazardous race, the drivers gather for practice spins

WHICH automobile race in the United States pays the highest cash prize per mile?

The answer is the annual Pikes Peak Hill Climb, held each Labor Day on the slopes of the famous mountain near Colorado Springs, Colo. Probably of more interest than prizes is the fact that the Peak race is one of the most grueling tests of man and machine to be found.

The highway to the summit of Pikes Peak is a beautiful gravel boulevard offering safety for the sightseeing motorist, but presenting a challenge of the top order to the racing driver. More than 165 turns,

curves and hairpin corners line the course, and in many places a bit of careless driving would send the participant plunging over an embankment or spinning off into the thick underbrush.

Old Man Weather occasionally attends the event along with the thousands of spectators who line the 12 miles of roadway, and on these days the driver may have the odd experience of starting the race in the warm autumn sunshine of the Labor Day morning and finishing in a storm of rain, hail or snow that can envelop the summit so suddenly at the 14,110-foot elevation.

Mechanics who groom the cars for this

Contestant brakes around a curve below the timber line, then guns on up the slope in his race against time



Auto Race to the Clouds

By
O. L. WOOLLEY

Thousands of sight-seers have driven this twisting course but not at high speed. There are over 165 turns

contest have far more than a fast machine to produce. The variation of over 5000 feet in elevation between the start and finish constitutes an extremely tough problem in carburetion and cooling systems. Obviously, a carburetor adjustment that provides the proper fuel-to-air ratio at the lower altitudes will not be satisfactory in the rarefied atmosphere near the top. The lowered boiling point of liquids at high altitudes demands that cooling and lubricating systems operate efficiently.

The car must also handle perfectly to

Spectators line roadway at 13,000-foot level, watching Al Rogers, 1948 winner, throw his car into controlled skid to negotiate a turn

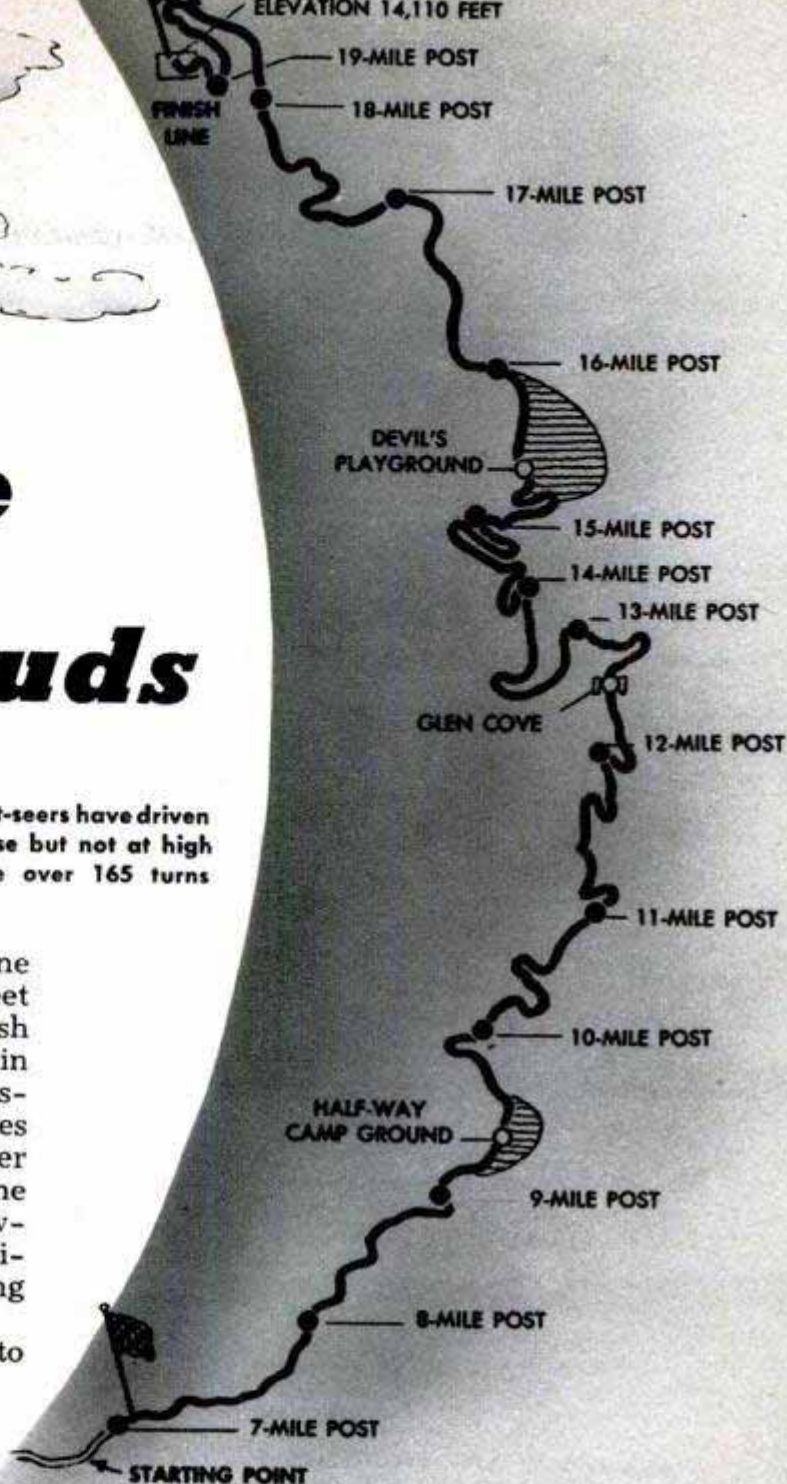



Louis Unser, who holds the course record, thunders around a corner just below the 13-mile post. Below, driver heads into a switchback high on the slopes of the Peak. Note the twisting roadway far below



Racing turns at Indianapolis are a snap compared to these. The course snakes more than 12 miles to summit

permit the driver to maintain complete command as he throws the machine into one controlled skid after another. In dozens of places the driver must shift to a lower gear for rapid acceleration out of a climbing hairpin corner, and clutch and transmission assemblies must absorb a brutal pounding. The power plants follow conventional racing practices with multiple carburetion, overhead camshafts and, in some instances, dual ignition. The majority of the drivers favor the special racing engines, such as the Offenhauser and Miller, while a few have gone in for the complete custom-built car as exemplified by the Alfa-Romeo or Maserati.

Strangely enough, the tires used for this race are stock tires of the type that may be purchased for a passenger car. For many years, tire manufacturers have worked closely with the drivers and the result has been a distinct improvement in conventional tire design and construction. Engineers report that the abuse and wear given a tire in the Peak race exceeds the wear that would occur from many thousands of miles of passenger-car service. The tires are altered only in one respect—deep grooves are cut across the tread surface to provide a more positive gripping action.

The Pikes Peak Hill Climb was first held in 1916 and has been run annually since, except for the war years. Through the years the race has consistently attracted thousands of racing enthusiasts. From many points the fan may look down from a lofty seat and follow the progress of the racers as they thunder over the course, climbing from the pine-covered hills of the starting point to the timber line where vegetation can no longer exist, and then upward to the top of the peak that Lt.





Driver roars past the finish line atop Pikes Peak. Box among rocks holds light for photoelectric timer

Zebulon Pike vowed in 1806, "No human being can ascend its pinnacle."

Many of the famous names of racing have appeared on the hill-climb entry sheets, including "Cannonball" Baker, Red Shafer, Joel Thorne and Russ Snowberger of Indianapolis fame. However, the majority of winners have been men familiar with the course. Familiarity with the twisting road is a great asset to high-speed driving.

For many years a driving duel has been waged between Louis Unser, eight-time winner, and Al Rogers, winner of the 1940 and 1948 events. Both are long-time residents of Colorado and are familiar with every rock and tree along the course.

Unser drives an eight-cylinder Maserati, which is brought from the eastern tracks each year for this event. Rogers' car is a special hill-climb job, the result of many years of work and experimentation by Joe Coniff, the owner. It has an Offenhauser racing engine of 225 horsepower. The car resembles a typical track racer in outward appearance, although designed solely for the Peak race.

An entry that aroused interest in the last race was that of William Milliken of Williamsville, N. Y. This car was originally designed for the Indianapolis track and features a four-wheel drive powered with a Miller racing engine. Due to mechanical difficulties the car was forced from the 1948 race, but some fans feel that the four-wheel drive may give a better account of itself in future events by utilizing the added traction for quick getaway in sharp corners.

Another Indianapolis car was the Alfa-Romeo driven by John Mauro of Denver.

(Continued to page 226)

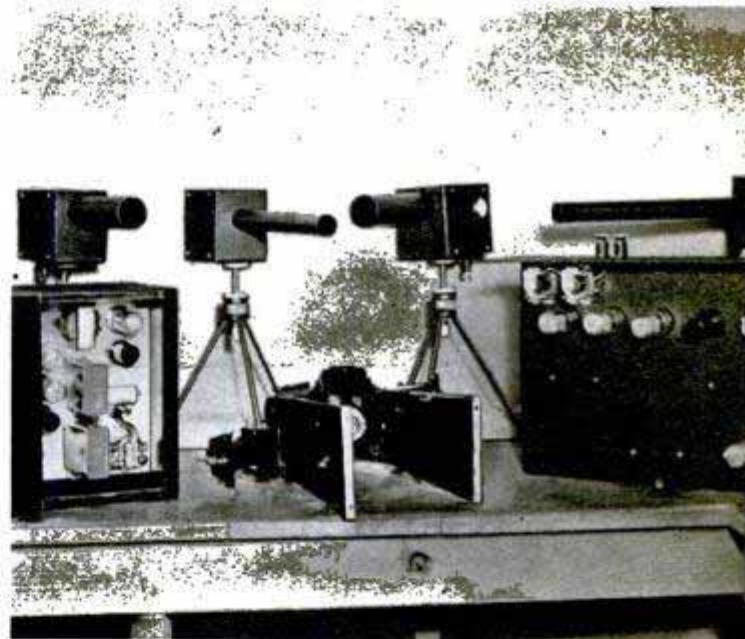

Here's just part of the split-second timing equipment used in judging the race. Photo cells perch atop tripods. Cameras photograph the clock when it is tripped. Below, equipment is installed in a bus, complete with facilities for developing the films

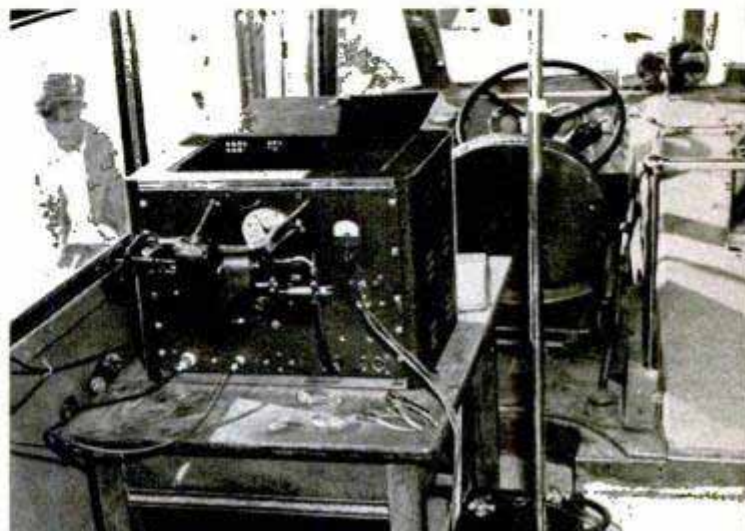



Left, a helper holds the aquarium submerged as the photographer snaps the picture, right, through the glass

Aquarium Keeps Camera Dry for Underwater Shot

When he was called upon on short notice to photograph a diver underwater, one resourceful photographer kept his camera dry and got the picture he wanted by using a small fish aquarium. By placing his reflex camera inside the aquarium, he was able to shoot below water level through the glass walls of the aquarium. Two flash

bulbs illuminated the underwater subject, Nick Reinhardt, one of the winners of the Westinghouse Science Talent Search. The photograph shows Reinhardt using a diving outfit he made with a face mask, garden hose and an old paint sprayer. He uses the outfit to experiment with an underwater loudspeaker system of his own design.



Sign Reminds Driver To Dim Headlights

Motorists who drive with their up-beam are automatically reminded to dim their lights when the approaching car has a highly reflective sign mounted on its front bumper. The letters of the "dim" sign are three inches high and can be seen at 300 feet when lighted by a headlight beam. At that distance, the sign reflects 235 times more light than white enamel and 70 times more than a plastic-reflector unit.



Air-Driven Hand Tool Has Variable Speeds

Driven by air pressure, a small hand tool can be adjusted to run at speeds from 500 to 14,000 revolutions a minute merely by turning a convenient thumbscrew, permitting slow finishing operations or high-speed grinding. Less than five inches long, the air tool is used for grinding, sanding, polishing, drilling and many other operations. A fingertip lever controls the flow of air from the compressor.

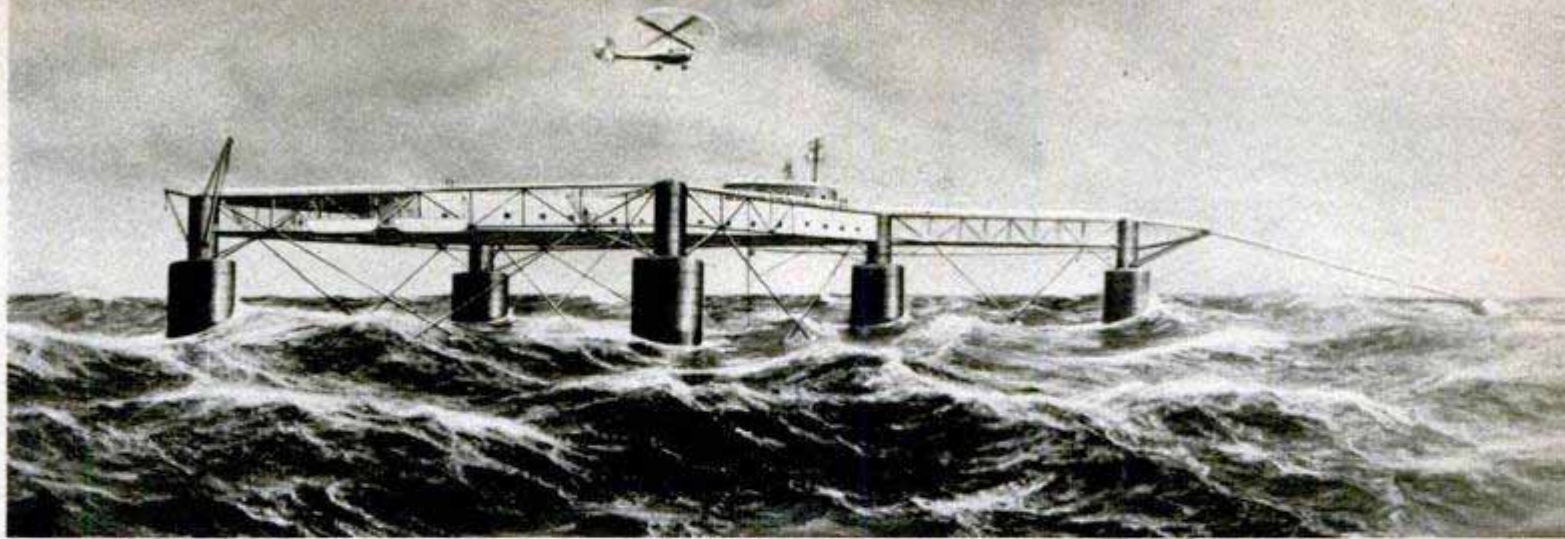

Mid-Ocean Weatherdrome

WEATHER observations spanning the Atlantic may someday be made from floating weatherdromes anchored in the high seas. The Coast Guard has asked Congress for authority to proceed with plans for the floating islands. Invented by Edward R. Armstrong, the weatherdrome would have quarters for crew members who would report weather conditions to the mainland. The inventor's plans also call for a helicopter landing deck, although the Coast

Guard says that the weatherdrome will not be specifically designed as a landing field for planes. Weighing 2000 tons, the weatherdrome would have five supporting pylons extending 175 feet down into the water. Plans call for a girderlike extension 150 feet long to project out from the 300-foot main part of the station. This would give the unit a length of 450 feet, which is longer than any wave that might strike the structure. The station would be held in place by a dome-type anchor that would grip the ocean floor firmly through friction.

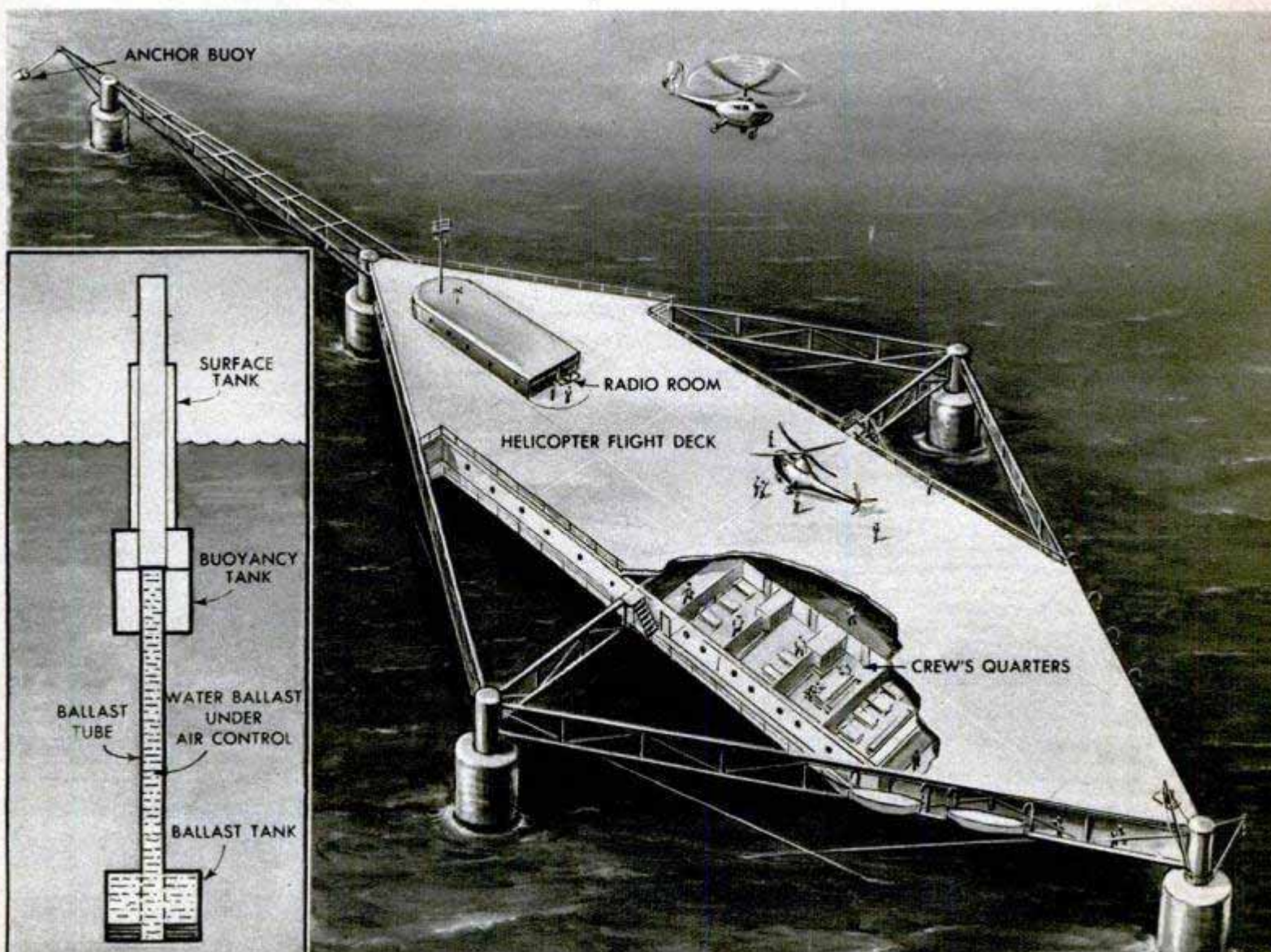



Stop Lights Change to Green When They "Hear" Fire Trucks

Emergency vehicles, such as fire trucks, ambulances and police cars, are given the green light at intersections automatically by an electric "ear" that picks up the sound of the sirens and changes the traffic signal. Directional microphones pick up the siren's wail and an amplifier converts the sound into electrical energy for changing the lights. The microphones are placed so that they are sensitive only to sirens coming from one direction. The equipment, mounted on the signal control box, switches the signals back to normal operation after a time delay long enough to allow the emergency vehicle to pass the intersection.

Electrical Tube in Water Tank Prevents Scale From Forming

Scale is prevented from forming in boilers and water tanks by a control tube that subjects the water to an electrical field. As the water passes through the field, the particles and salts act as a conducting medium, picking up an electrical charge. Because of this charge, they no longer are attracted to tubes, castings and other metal surfaces with which they come in contact. The control tube is made of a plastic which is a nonconductor and noncorrosible.

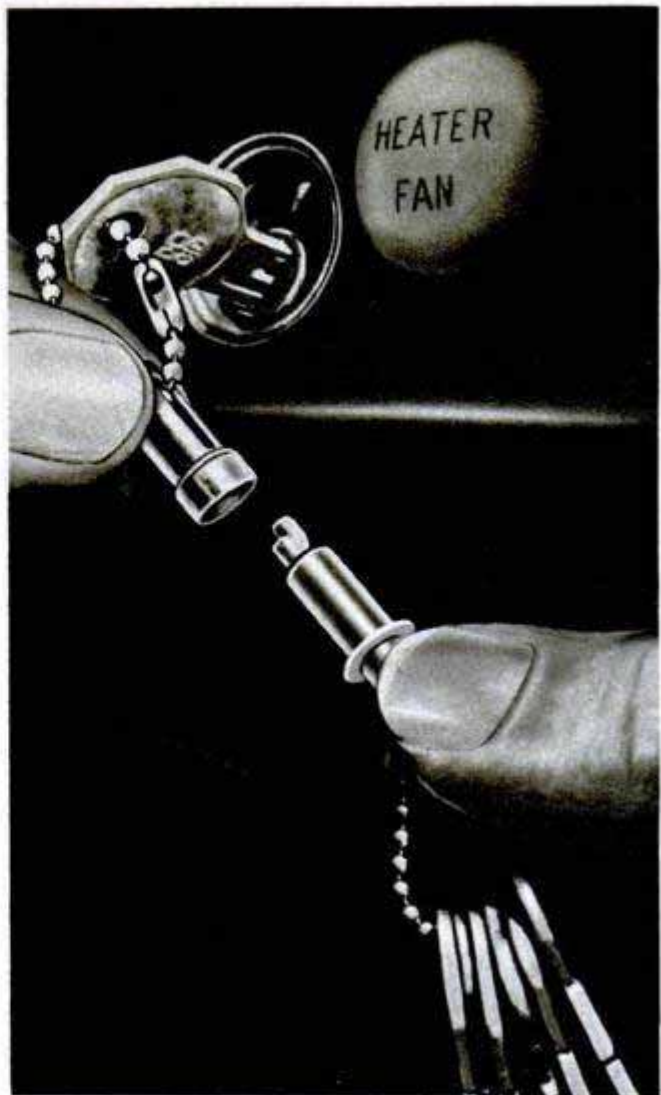

Key Chain Comes Apart With Finger-Tip Pressure

With a coupler-type key carrier, you can leave the ignition key in your car and, with one hand, remove the other keys to open the glove compartment, luggage compartment or garage doors. The two halves of the coupler are separated by a slight tug on the locking collar. To connect the two sections, the motorist merely pushes the projecting cylinder at the base of the coupler and the two parts become one again. It's especially handy when leaving your car in a garage or parking lot.

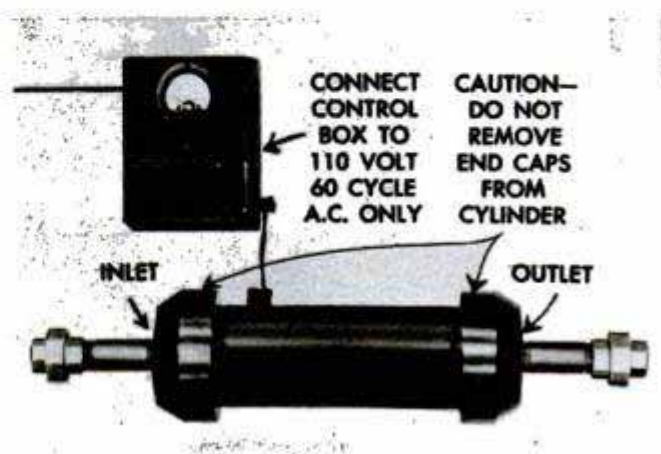

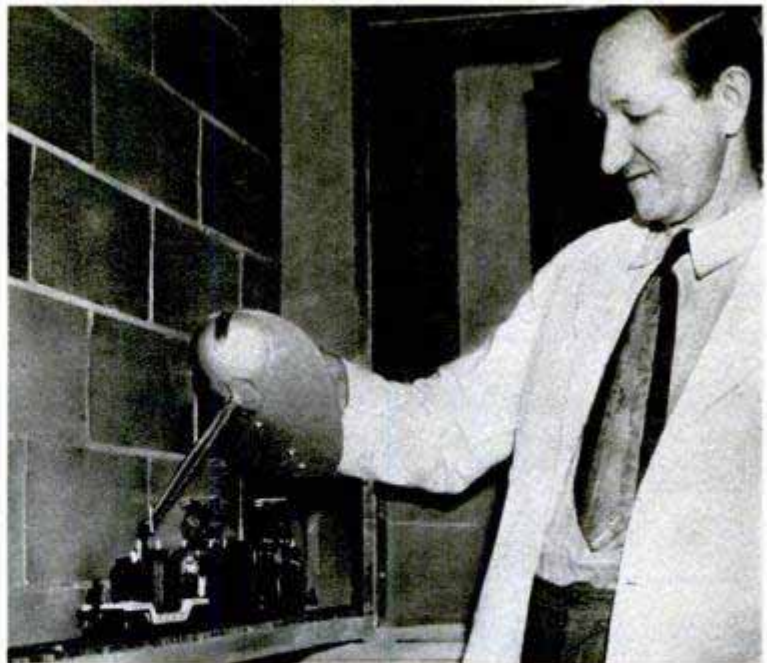
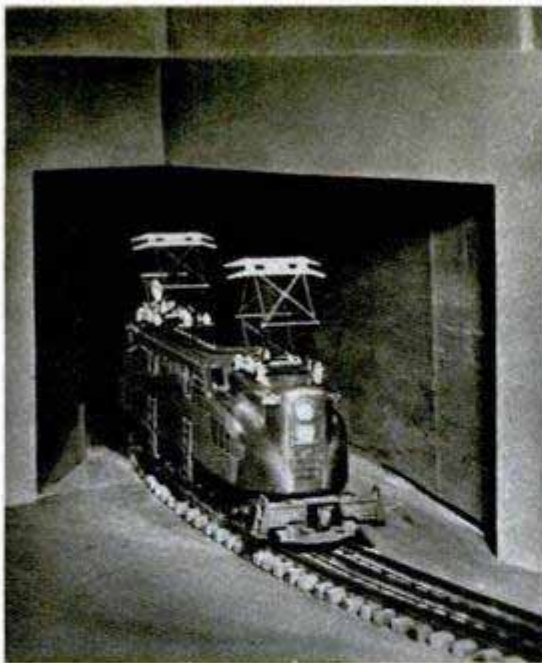

"Radium" Train

Highballing "hot cargo" from one station to another, the "Radium Limited" is the only train in the world to carry exclusively radioactive materials. It's a model train installed in the radiation laboratory of Cleveland Clinic. Dr. Otto Glasser, medical physicist, conceived the idea of using a model railroad to carry radon, a radioactive gas produced by radium, from one part of the laboratory to another. The gas, which is dangerous because of its radioactivity, is used in treating cancer and in research work. Until the railway was installed, the clinic technicians carried the gas by hand in lead-lined containers. The railroad includes only a locomotive and a flatcar carrying a lead-lined container, and is operated by remote control. Eventually

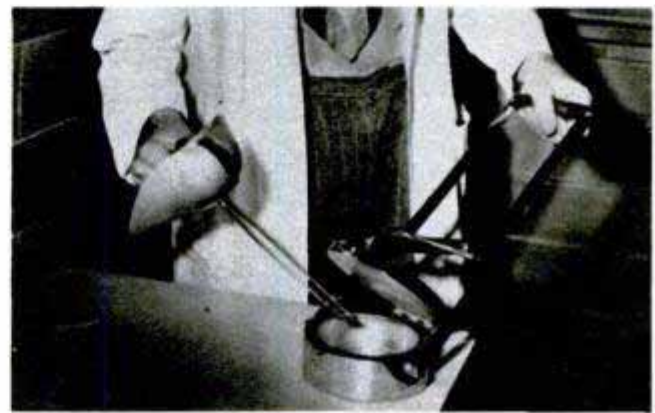

Top, left, train backs into supply room. Top, radon "seed" is placed on the flatcar. Above, pellets were carried by hand before installation of the railroad

Dr. Glasser wants to load and unload the flatcar with automatic devices, providing further protection for the workers.

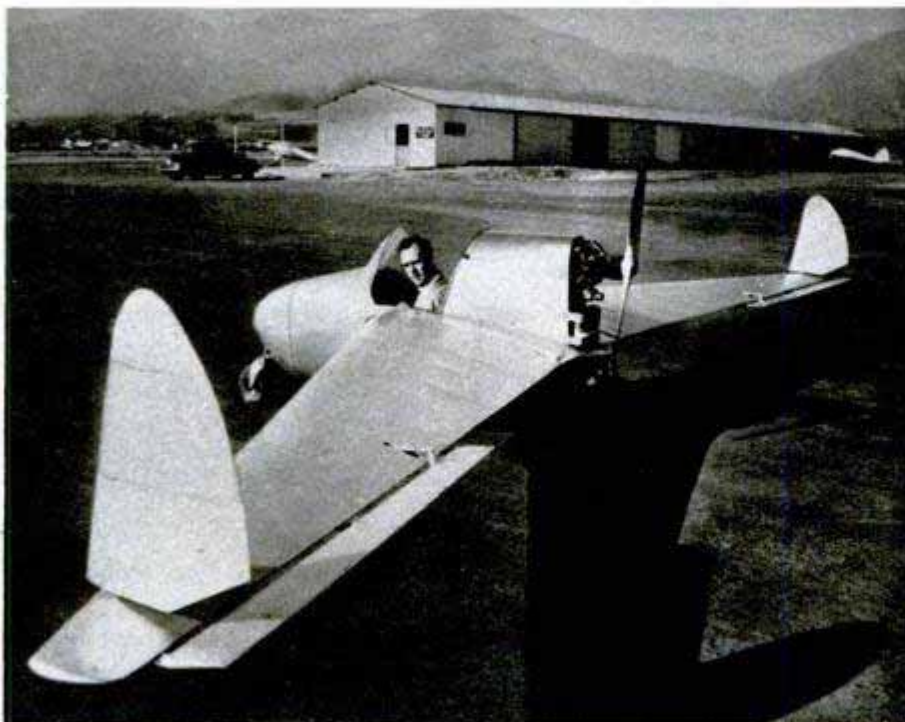

Tiny Plastic "Wing"

Nose and windshield of a 150-pound plane built by Robert M. Sebring of San Fernando, Calif., are clear plastic and the swept-back wings are plastic plywood. Building it took less than \$100 for materials and all of his spare time for three years. Ground tests indicate the craft should cruise at 65 miles an hour.

⌚ Moving stairways being installed on three Navy aircraft carriers will carry fully equipped pilots up to their flight deck in one minute.

CARVING in CRYSTAL



With a grease pencil, Franciska Patsalie draws an original design on this glass goblet to guide the grinder who will carve it skillfully in the crystal

By Lyn Harrington

BEAUTIFUL crystal, carved to order, has promoted a hobby into a successful business in Victoria, B. C. Started as a hobby by Mrs. Franciska Patsalie, the glass-carving company now keeps six persons busy full time, producing mirrors, glass tops for tables, stemware, tumblers, bowls and plates.

Designs vary with the customer. A singer chose the novel effect of bars of music on her glassware. One retired grain farmer preferred a graceful wheat design. A Western cattleman had his steins engraved with his cattle brand.

Mrs. Patsalie learned the carving art in her uncle's shop in Vienna. Both she and her husband are creative artists, sketching the designs freehand on the glass with a grease pencil. The glass is ornamented with patterns made by abrasive wheels of aluminum oxide. Each wheel edge is shaped to an exact curvature so that it produces a specific result.

When the glass touches the wheel, it is roughened and dulled. This frosted appearance produces interesting variations, depending upon the play of light. A delicate line is made by a stone brought to a peak

Photographs by Richard Harrington

in the center of its grinding face. The same peak makes the oval petals of a flower when the glass is held obliquely. Pressure is an important part of the art—an inexperienced worker can rasp a hole in fine glass in no time. A stone with a convex edge is used to grind circles and oblongs.

For picture frames and mirrors with beveled edges, the bevel is made first on a large iron wheel, revolving horizontally, on which Carborundum drips slowly. Then the glass goes to the smoothing stone, a circular natural stone about four inches thick. The final polishing is by buffer, a felt belt impregnated with jeweler's rouge, to bring back the sparkle to the cut surfaces.

Buffing also eliminates the inevitable fine scratches which appear greatly magnified once a piece of plate glass is silvered. If the scratch is too deep to be buffed away, the piece must be discarded or the design changed to incorporate the scratch. A new and beautiful design may owe its existence to just such a slip of the cutter's wrist.

Using creative imagination, native talent and an occasional accidental flaw, the Patsalies have carved their artistic reputations in crystal.



Above, a sheet of plate glass is laid over a drawing and the design traced on the glass with a grease pencil. The tracings are not followed exactly, but serve to assure the desired proportion and effect. Right, the delicate lines of this musical design are cut in the glass by a wheel with a beveled edge

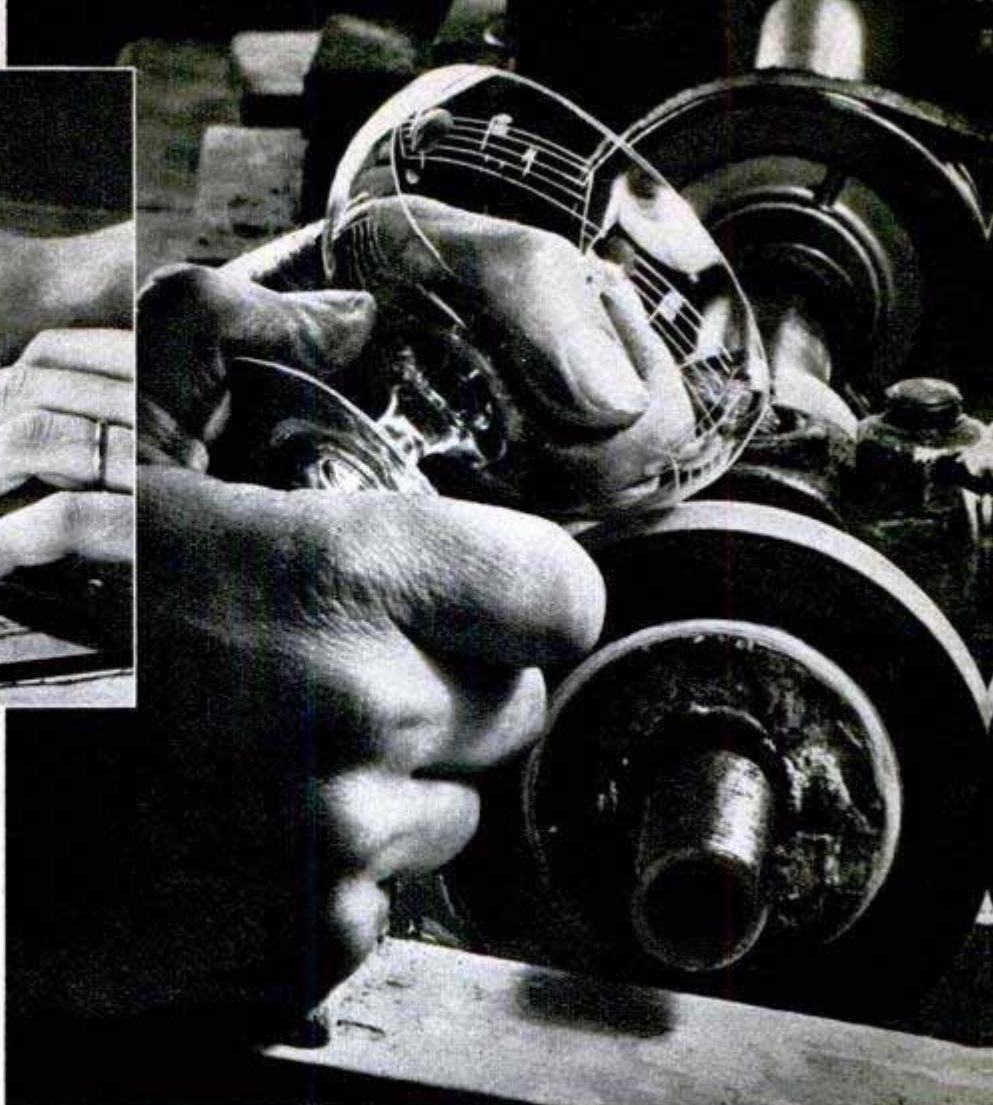

Right, after the crystal has been cut, the roughened parts are polished with this felt buffer. The glass shown in this picture will be a mirrored frame. Below, the beveled grinding wheel is being used here to carve an attractive design on a plate-glass coaster. The stream of water keeps the wheel cool

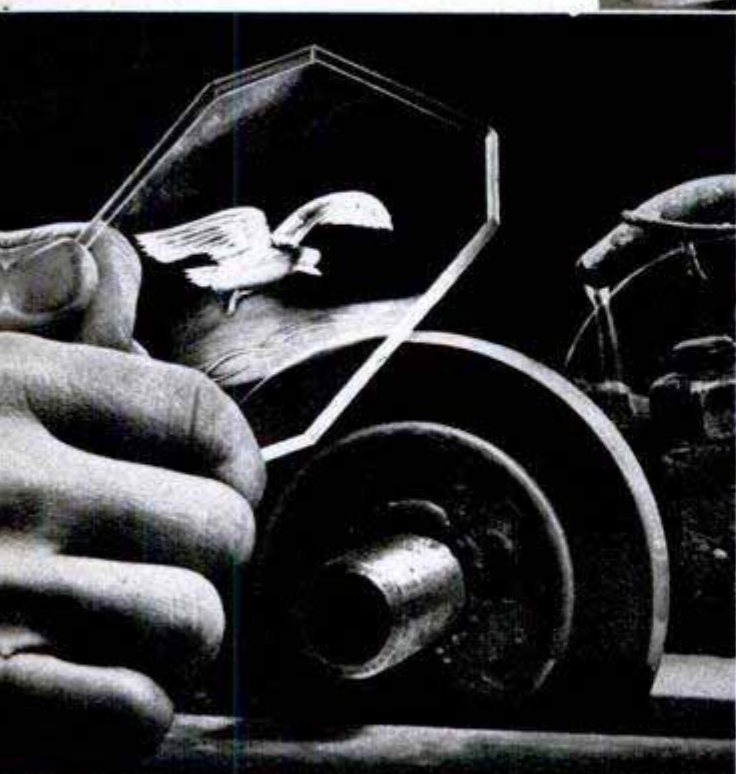



Motorized Window

Just flip a switch and a new motorized window disappears into the wall as a screen moves into place. The screen is supported by a roller in the wall above the window. Its bottom edge is fastened to the double-glazed panel. When the switch is turned, the motor rolls up or lowers the screen, moving the window to the desired position. Because the window is double-glazed, no storm sashes are required. The window is made in all standard sizes.

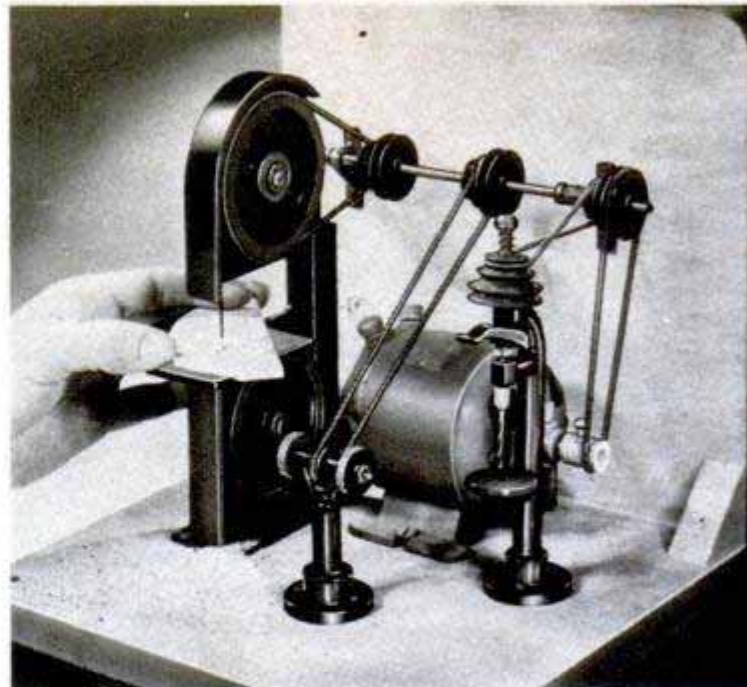

Midget Woodworking Shop

Modelmakers can turn out intricate work on the power tools of a midget woodworking shop that can be carried from room to room like a portable radio. Consisting of a bandsaw, drill press and grinder, the power-tool kit is driven by a $\frac{1}{20}$ -horsepower motor. The largest tool, the bandsaw, stands only 10 inches high and the tiny grinder is less than 4 inches high. All tools are made of plastic and come complete with pulley and belt system.

Automobiles Turned on "Spit" for Rustproofing

Automobiles are being completely rust-proofed at a Birmingham, England, factory where the bodies are impaled on a "spit" and revolved through a series of six tank

British Information Services photo

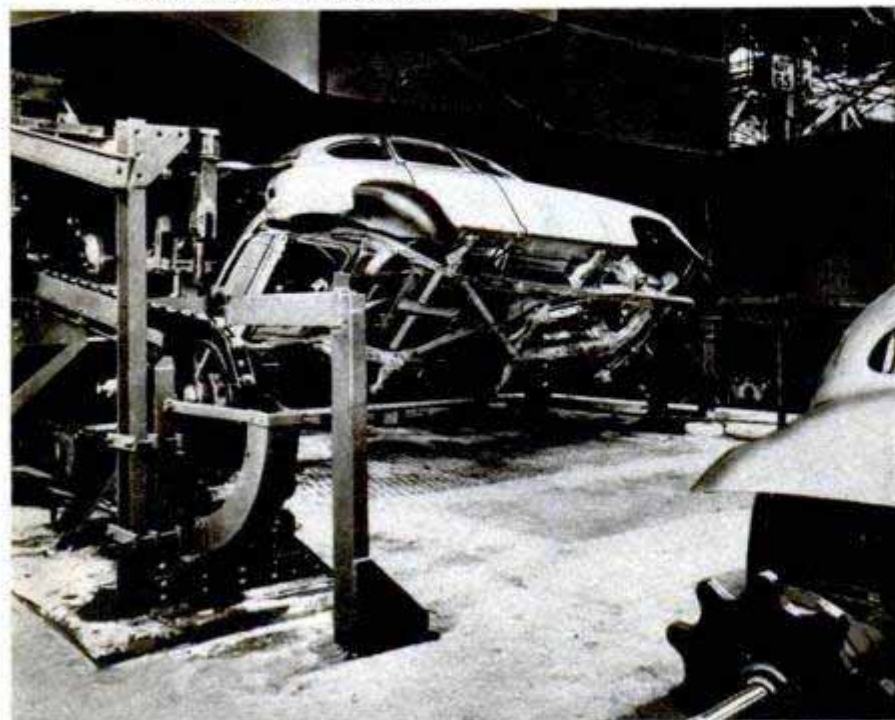

baths. During the process they are cleaned, rinsed twice, covered with a rust-resisting compound, rinsed again, dipped in a 5000-gallon vat of paint and baked. Similar treatment is given the chassis. The whole process takes 107 minutes per car and the plant handles 18 an hour. Cars treated can be left indefinitely in the open in any climate without rusting. Even if the protective coating is broken, rust will attack only the exposed metal and will not spread.

Farm Accidents Costly

Over half the average U. S. wheat crop could be produced in the time lost annually through farm accidents. They cost the nation \$1,000,000,000 yearly, according to the National Safety Council. With falls, burns and firearms as the main causes, one third of the 19,000 annual farm deaths occur in homes. Nonfatal accidents total 1,500,000 each year.

A WINDOW demonstration and a minor accident started Mrs. William Harshbarger on a hobby that has grown to nationwide proportions—the making of life-like roses, carnations, orchids and other flowers from wood fiber.

The window demonstration was staged in a downtown Akron, Ohio, store by a man who was selling flower-making materials. Mrs. Harshbarger, happening by, became so fascinated that she went inside to talk to the demonstrator. She asked him so many questions that he decided the easiest way out would be to organize a class in flower making. Of course, Mrs. Harshbarger was one of the first enrollees.

It was while she was practicing with flower-making materials on the dining-room table that a friend of her husband accidentally spoiled some of them. Desiring to make amends, he asked her to fashion some roses he could give to a lady friend. That started the sales ball rolling; and in the 10 years since the dining-room accident, she has delivered corsages, wreaths, bouquets, individual blossoms and special floral arrangements to virtually every part of the United States and several points

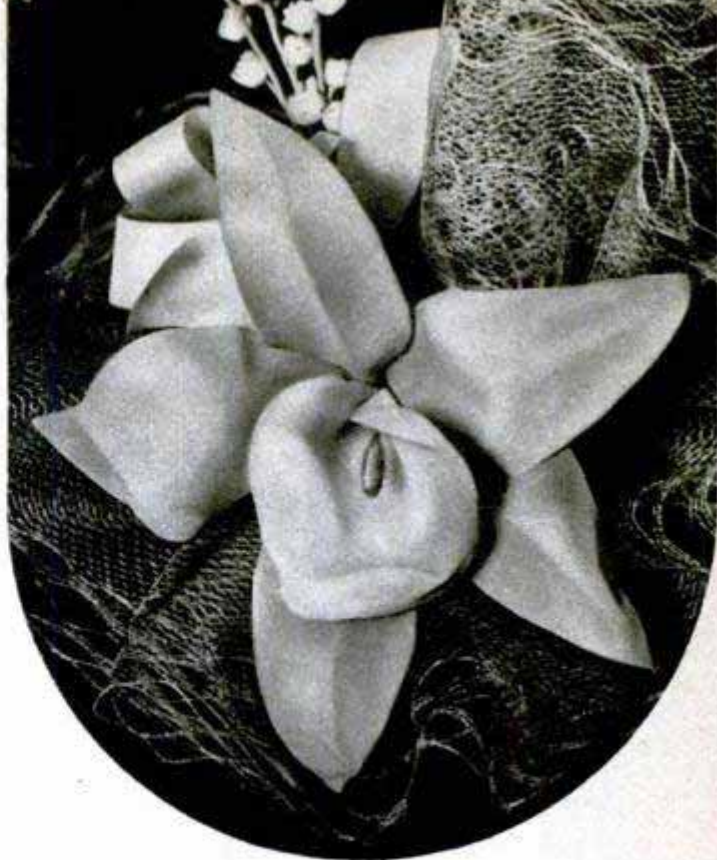

This corsage can't wilt! The realistic orchid and lilies of the valley are expertly formed of a wood fiber that is imported from the island of Formosa

By *Walter E. Burton*

FLOWERS THAT NEVER FADE



Even the most exacting bride wouldn't mind holding a rose spray like this one when her wedding picture is taken. Mrs. Harshbarger's flowers will not wilt under the intense heat of floodlights in a photo studio



Left, the first step in the flower-making process is cutting the wood fiber into petal shapes. The petals being trimmed here are for a rose. Right, gum-arabic cement is applied to the petals to hold them in place

beyond and has drawn upon worldwide sources of raw materials.

The wood fiber that Mrs. Harshbarger uses for flower petals, buds and other parts comes only from Formosa. It is made from the pith of a species of a bamboo plant which grows in swampland forests and which is sometimes grown in the United States for decoration. Formosan natives slice the pith into thin sheets of somewhat varying thickness, much as wood veneer is cut. In America, these sheets are available from importers in various colors and have a soft, petal-like feel. Wood fiber is easily cut and cemented, is durable and retains its resilience. A carnation or other blossom made of it can be crushed flat in the fingers, yet will spring back to its natural shape upon release.

Mrs. Harshbarger purchases the wood fiber and other supplies through regular supply houses. Flower making is a widespread activity in this country and there are a number of dealers to supply the raw materials. The large number of artificial-flower makers does not worry Mrs. Harshbarger because she has had little difficulty in selling her products. She attributes the superior appearance and lasting qualities of her flowers to skill, patience, one or two minor trade secrets and her desire to make the flowers as much like the real blossoms as possible instead of being satisfied with approximations.

The production of scores of different flowers has made it necessary for her to develop about 140 different patterns for petals and other parts. She is able to produce the astonishing total of 428 different blossoms. Most of the wood fiber she uses is purchased already colored, so her first step is to cut out petals, sepals and other parts according to pattern. Several layers of the fiber can be cut at once with ordinary scissors. Such parts as leaves, the

complete calyx, stamens and pistils are obtainable ready-made, although when a rare type of flower is to be reproduced, the flower maker usually has to form all of the parts. Mrs. Harshbarger uses a spray gun to apply a thin coating of shellac to the leaves to give them a natural appearance and to help preserve them.

In assembling the parts, she uses a gum-arabic cement. To the gum, which she obtains in unrefined form, she adds glycerin, perfume and other ingredients. The brewing of this cement is a ticklish process she has worked out patiently by trial and error. She applies the hot adhesive with a brush to such parts as rose petals, which are made by gluing together two or three thicknesses of the wood fiber and then curling the edges around a pin or needle before the gum arabic sets. In some cases, she applies artists' colors of India ink to produce a natural-looking tint or vein pattern.

The wood-fiber flowers have proved to be extremely durable, which accounts for much of the demand for them. Usually, accumulated dirt can be removed by brushing or with a vacuum cleaner. If that doesn't work, corn meal can be used. It is applied liberally to the flowers, worked well into all parts, then shaken out, much as a furrier might clean a fine pelt. Some people have washed their wood-fiber flowers with water and soap.

Mrs. Harshbarger's flowers are used by numerous portrait and commercial photographers. In fact, she has made a special effort to produce bouquets, corsages and other arrangements that will help lighten the photographer's problems. Artificial flowers often are preferred to the natural variety for use in bridal pictures, for table decorations involving blossoms, and wherever single blossoms or arrangements are to appear in a picture. In making white roses or other white flowers for photographic



Left, before the cement has set, the edges of the petals are curled around a pin. Right, the center bud of the rose is formed by wrapping scraps of wood fiber in a sheet of the same material and tying it with wire

purposes, Mrs. Harshbarger uses a special white that does not appear too light in a picture. The intense heat of studio lights will wilt natural flowers in a few minutes, but it has no effect on the wood-fiber variety. For this reason, the Akron flower maker is attempting to interest motion-picture studios in her work. Her products are also used in funeral parlors, in store-window and
(Continued to page 226)

Right, wire of the bud is threaded through the petals. Later, the calyx, leaves and stem covering are added. In the display below are white carnations, calla lilies and Oriental poppies

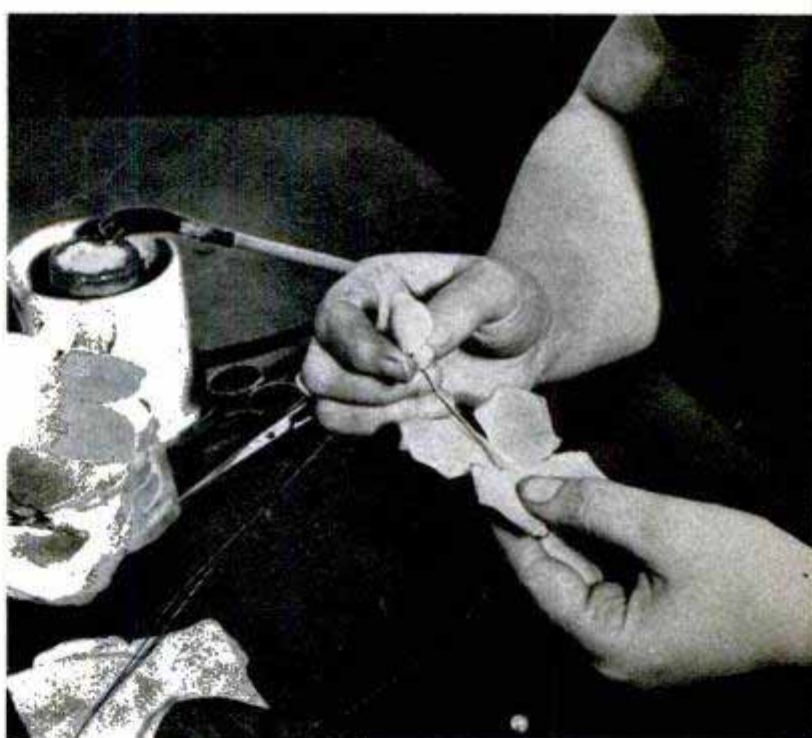

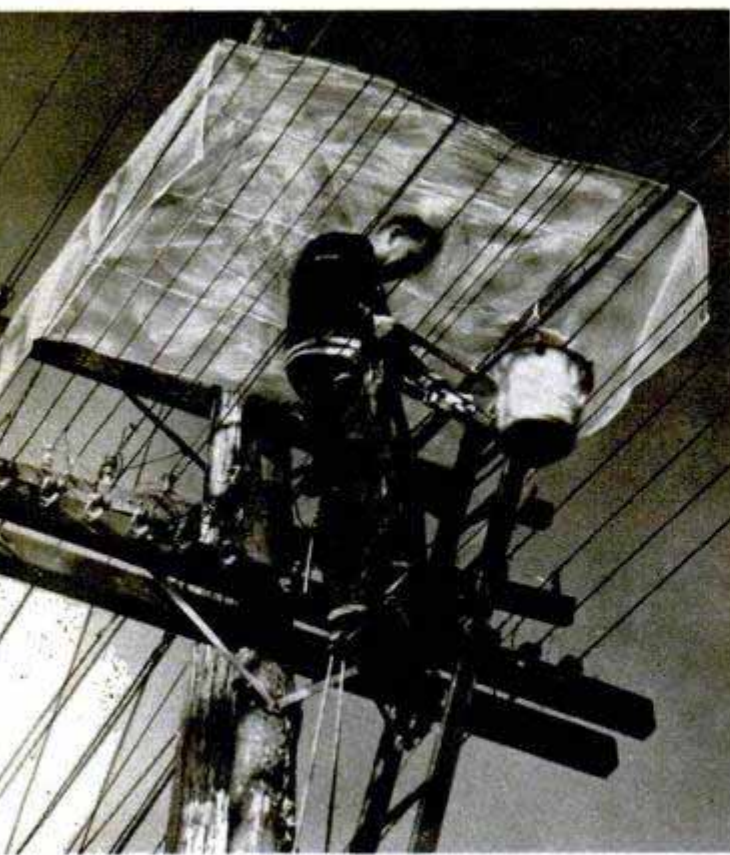

Plastic "Tarpaulin" Protects Linemen

Telephone linemen are protected from wind and rain by a Vinylite plastic "tarp" that can be draped over wires without shorting, because of the insulating quality of the material. Hot solder spilled on the sheeting will not burn through and, being transparent, the cover does not shut out light. The plastic can be folded when wet without danger of rotting.



Iron Out the Wrinkles With This Suitcase Handle

Living out of a suitcase is no excuse for wearing wrinkled clothing when the suitcase has a handle that detaches to become an electric iron. The base plate of the handle fits snugly into a recess in the top of the suitcase and can't jar loose. The cord is permanently attached to the iron, which has an automatic heat control. If you have to leave the suitcase unwatched, you can remove the handle, making it difficult for petty thieves to walk off with your property. The suitcases are available in a variety of colors.

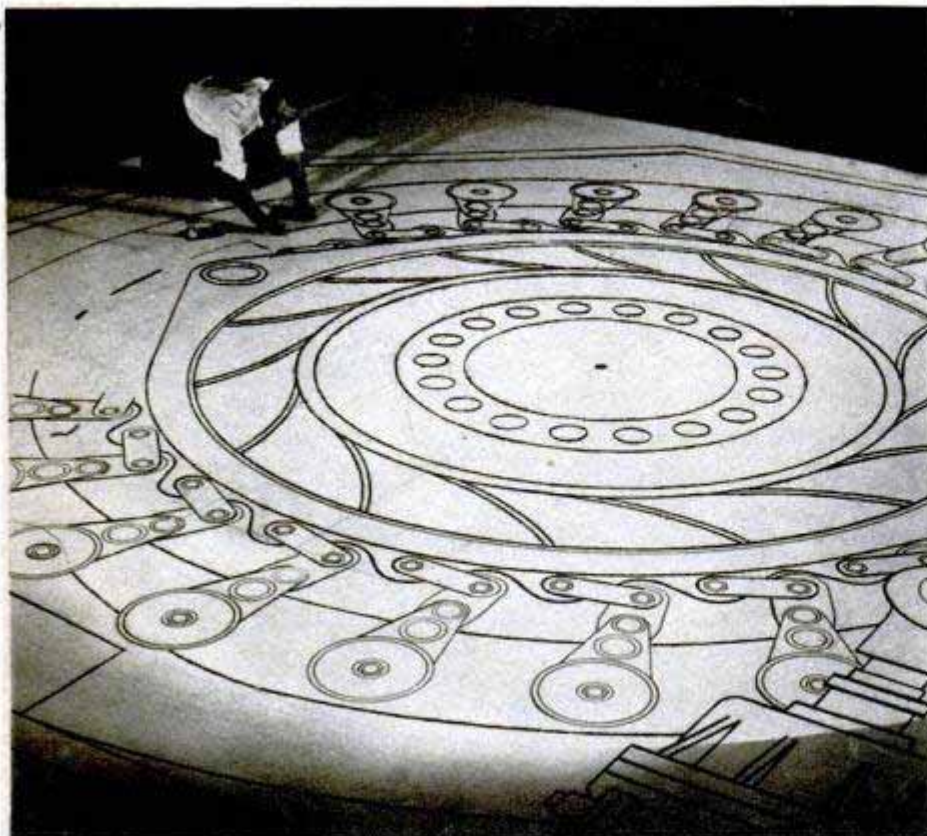

Huge Drawing Guides Mosaic

Measuring 21 feet 8 inches in diameter, a giant ink drawing will serve as a guide in making a government mosaic. The U. S. Bureau of Reclamation drawing shows an inverted outline of man's mightiest hydroelectric generator at Grand Coulee Dam in Washington. It will be outlined in permanent terrazzo in the west powerhouse at the dam. Travelers, who visit the dam by the thousands, will walk across the mosaic. Heavy lines on the drawing represent zinc strips which will separate the various colors of mosaic.

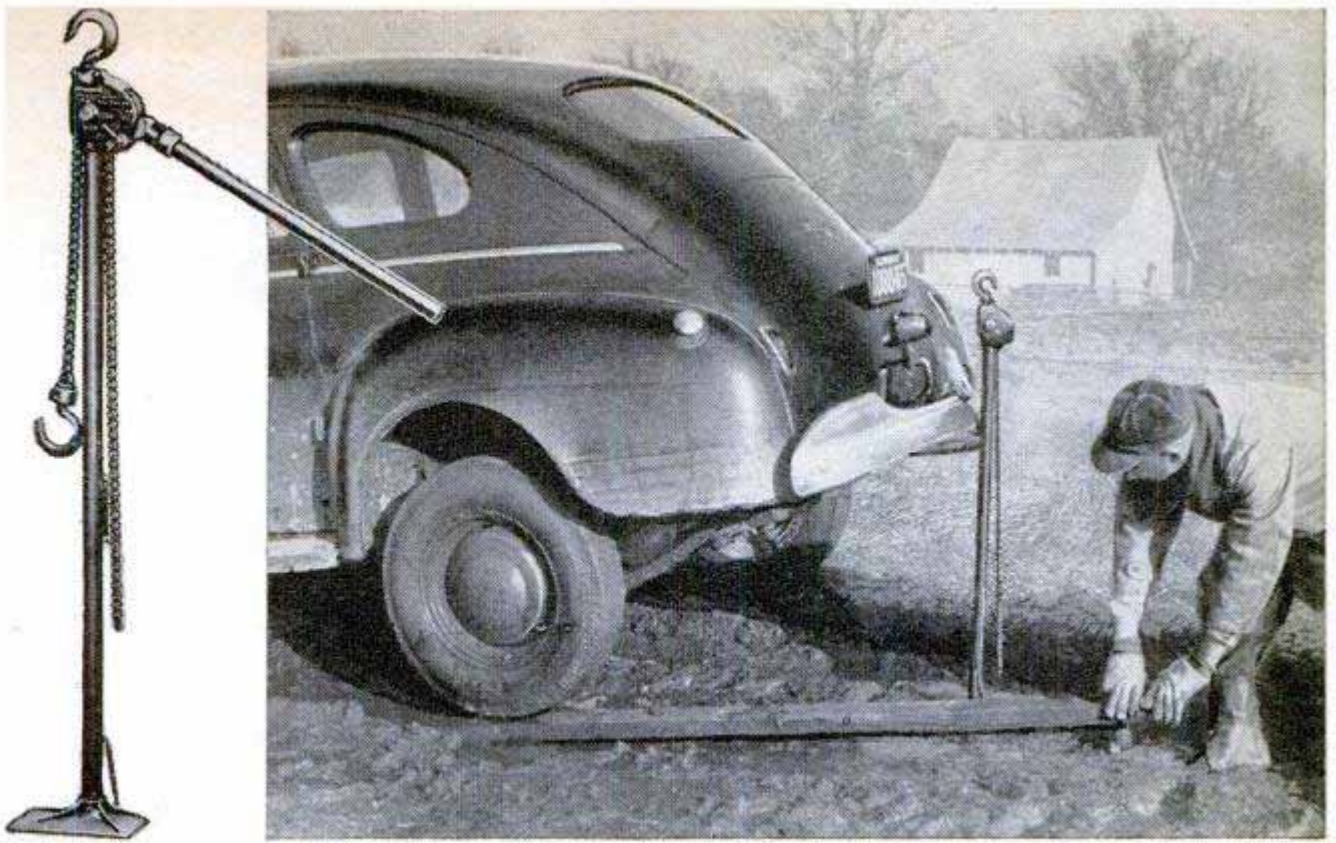

Hoist-Jack Lifts 2000 Pounds

With a rated capacity of 2000 pounds, a portable tool can be used either as a hoist or a jack. It is designed for factory, shop and farm use and has a ratchet-and-pawl construction. The tool consists of a two-piece pipe stand with a base, the hoist unit and a safety handle that will bend before the hoist is overloaded. When the handle is pumped up and down, the top of the stroke is just even with the top of the frame, making it possible to operate the hoist in very little headroom. The tool can be used as a tractor-wheel puller, car jack, fence stretcher, post puller, load binder and utility hoist. It weighs 23 pounds and can be packed in a space 23 inches long.

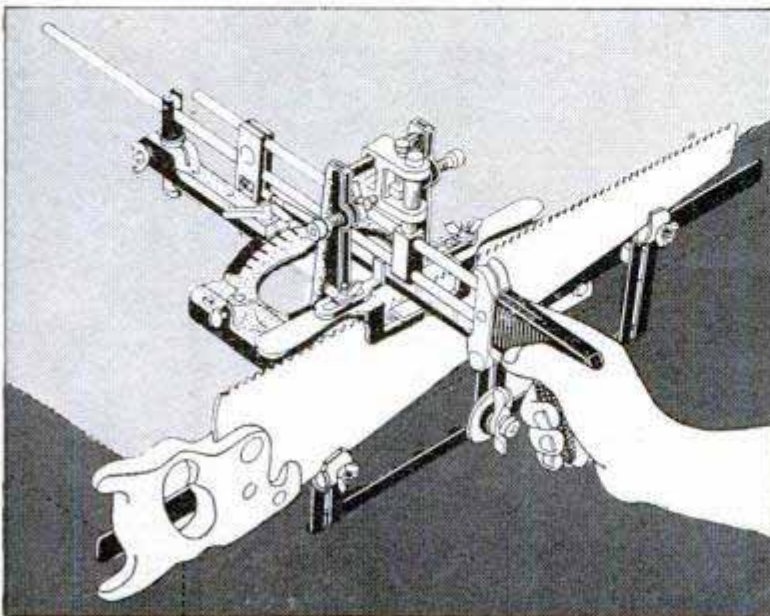
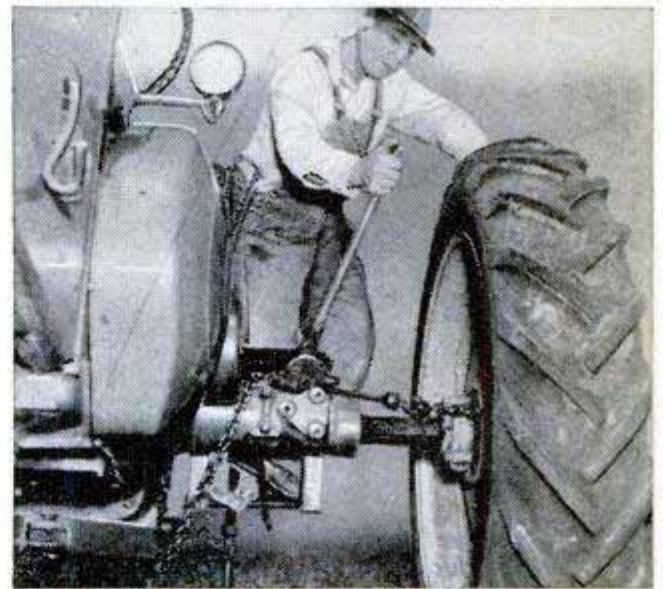

Guide for Sharpening Saws Adjusts to Any Tooth Size

Accurate filing of a saw is possible with a new guide that controls the depth, hook, bevel and the feed of the next tooth. One adjustment prepares the filer for saw teeth of any size. The file is clamped in the guide and pushed with a handle. After a tooth is sharpened, the file is raised up and over, coming to rest against another tooth. The filing guide is made of bronze and aluminum, with steel guide rods. One model files hand, band or circular saws while another is made for hand-saws only.

No longer in phone directory

Car-Top Boat Carrier Swings Craft Into Position



Sportsmen can carry their boats atop their cars, yet have them ready to launch within three or four minutes, with a new carrier that operates on swinging arms. The aluminum arms are clamped to the right side of both front and back bumpers. While they are resting on the ground, the boat is fastened in place. Then as the boat is lifted, the arms swing it over and deposit it on top of the car. Suction cups hold it securely in position. The boat can be mounted or detached by one person. Boats weighing up to 125 pounds can be handled by the swinging carrier.

Mailbox "Hangs" Atop Chain

Motorists driving past the mailbox of Frank Miller, La Crosse, Ind., turn around for a second look. They see a mailbox standing atop a length of chain that apparently has no support. Miller welded the links of the big log chain together, set the base in concrete and then used the rigid chain as a unique post for the mailbox.

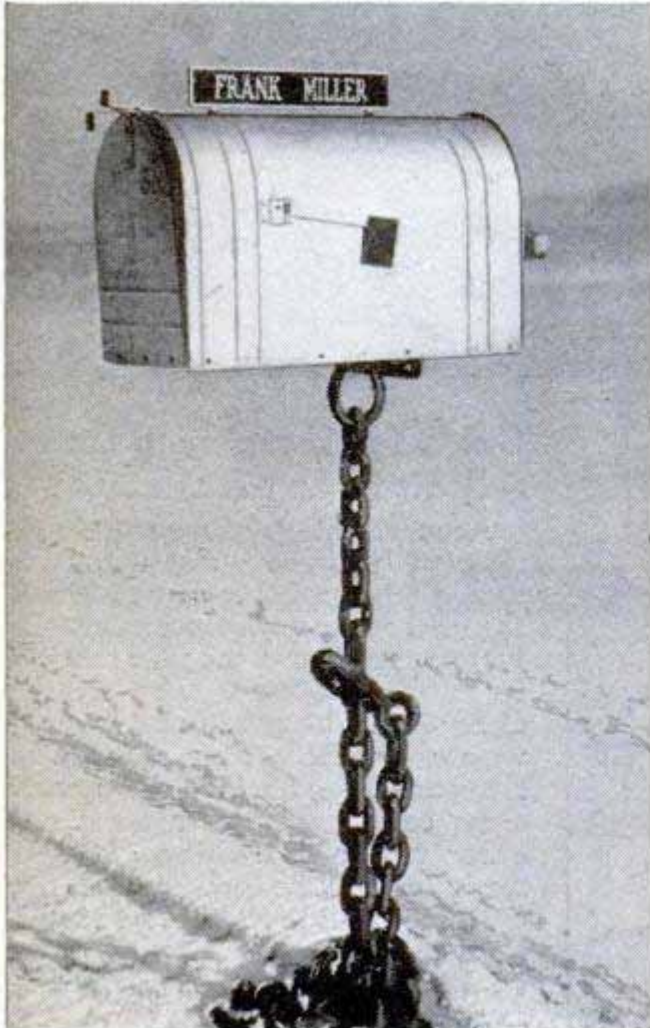

Cleanup Brush Inside Golf Ball

Twist a new golf ball apart and inside you'll find a bristle brush and a metal spike. Actually the product is a replica of a golf ball made of Tenite plastic. One half contains the nylon brush, useful for removing dust and dirt from golf clubs, clothing, hats and shoes. The metal spike in the other half serves two purposes—it holds the two halves of the ball together and is a handy tool for scraping mud from shoe cleats or clubs. To avoid the possibility that a golfer might accidentally drive the ball-brush down the fairway, the ball is available in bright red, green and yellow as well as conventional white.



Belly-Tank Auto Travels 45 M.P.H.

Streamlined like a torpedo, a miniature automobile, built by Emory Stanfield of Los Angeles, Calif., is made from a P-38 belly tank. The vehicle is 13 feet long, weighs about 500 pounds and cruises at 45 miles an hour. The state licensed it in the motorcycle classification. Mounted behind the seat, the one-cylinder, 5½-horsepower engine is geared to provide two forward speeds and one reverse. The motor uses a motorcycle battery. A chain drive delivers the power to the rear wheel. A full gas tank — two gallons of fuel — carries Stan-



field 114 miles. Airplane tires are used on the three wheels. Cost of building the car was \$400.

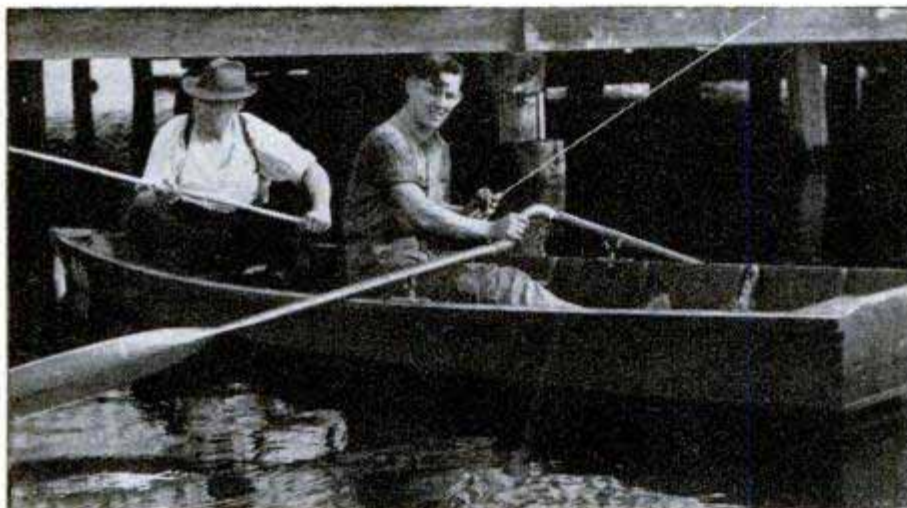

One Hand Rows Boat With Oar Joiner

Fishermen can row their boat with one hand while casting with the other with the aid of a spring that fastens the oars together. Each end of the spring is locked to one oar, thus both oars can be moved with one hand. By twisting the hand, the rower can lift one of the oars out of the water to turn the boat.



Top, left, fisherman twists hand, lifting one oar out of the water to guide the boat. Left, the spring fastens over handles of the oars, locking them together

Old-Time Pumpers Built From Kits

Models of old-time fire engines, complete to pump and piston, flywheel and valve, can be built from kits that contain all the materials. The models are replicas of several horse-drawn fire-fighting vehicles. The parts are semifinished. The pumpers are enameled in bright red and gold. Fire departments as well as hobbyists are exhibiting the models.



WHAT'S NEW *For Your Home*



PRESSURE COOKER can be opened as food cooks. It ends shrinkage and pre-searing of meats. Steam is locked in jacket—see inset



FOOD STAYS HOT on a serving tray with a glass top that is heated by electricity. Plug in the cord and a thermostat keeps the glass at a constant 200 degrees

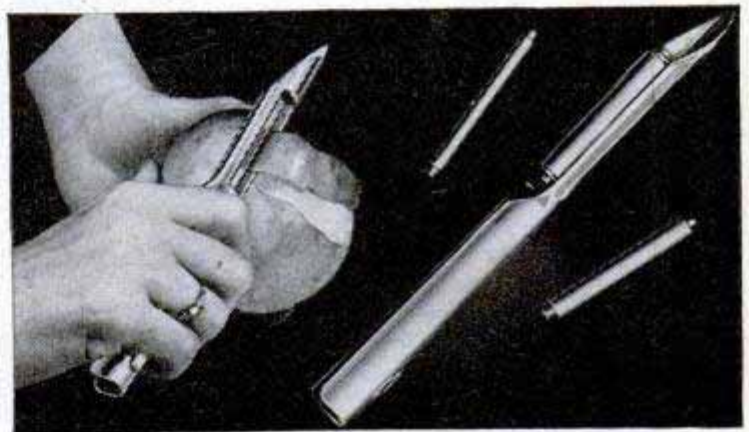

ROLLER ACTION of paring knife lets you adjust the depth of cut by using any of three rollers. It peels, slices or shreds, depending on size of the roller used

QUICK JUICER takes the whole orange. There is no need to slice the fruit in half. Just put the orange in the machine, pull down the handle and the juicer cuts and squeezes the fruit

FLORAL ARRANGEMENTS are easy to set up and change when you use a transparent-plastic stand that is held securely to the bowl by a rubber suction cup

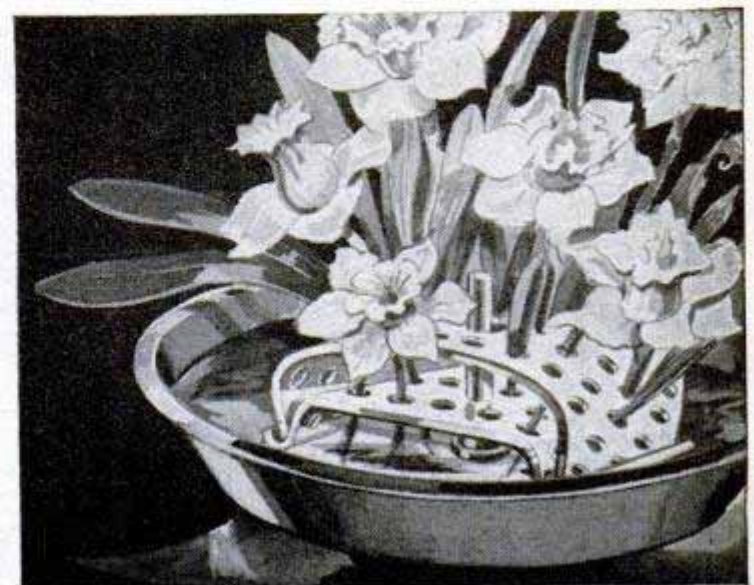

POP-DOWN TOASTER slides the toast down and out when done so you can do small pieces without having to spear them with a fork for removal. Has two racks for toasting filled sandwiches

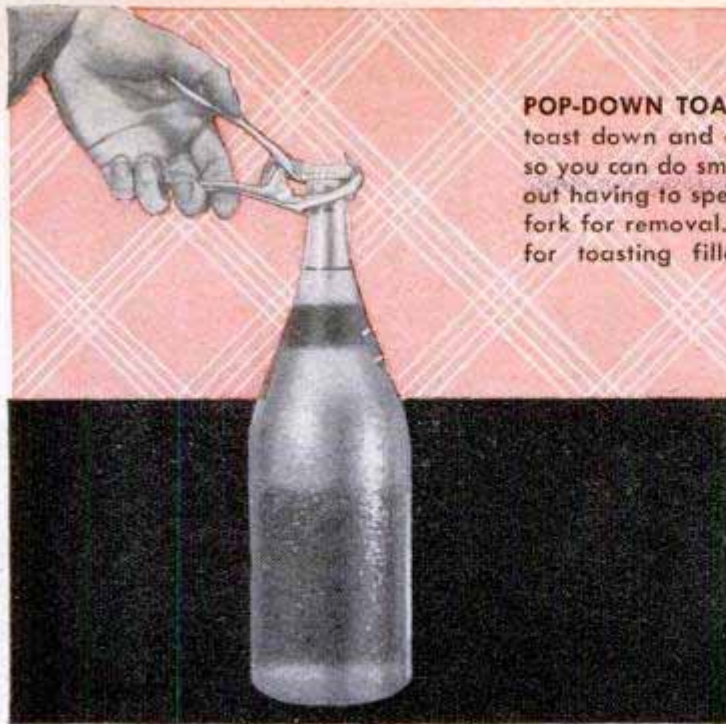

ONE-HAND OPENER holds the bottle and removes the cap with one easy squeeze of handles. The cap is undamaged and can be used to reseal the bottle



AUTOMATIC PORCH LIGHT goes on when bell button is pushed. It turns itself off in about five minutes

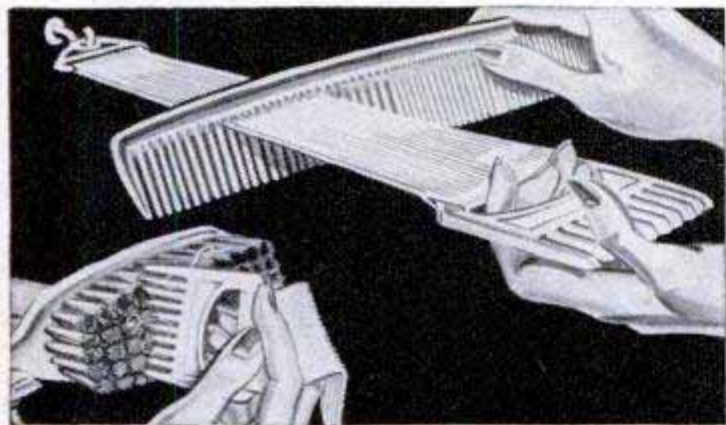

COMB-BRUSH CLEANER combines two functions in one piece of equipment. The stranded section is for cleaning combs and the toothed end for brushes

SCALLOPER for the home sewer comes in several sizes. Made of Vinylite, it will not warp or curl. It can also be used as a ruler and a button spacer

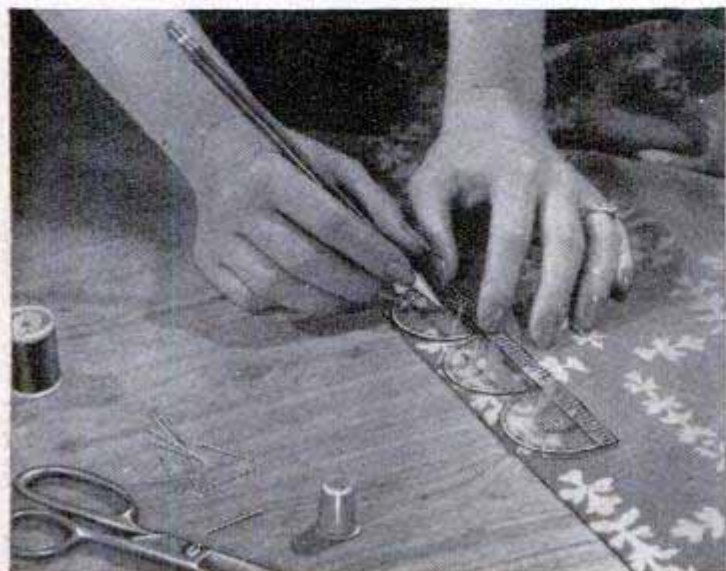



Crash Radio for Aircraft Transmits Automatically

Helping rescue parties locate crashed aircraft, a compact radio starts transmitting automatically when the plane crashes. The transmitter weighs only 10 pounds and is powered by two crashproof batteries. Its range is about 18 miles. The antenna is mounted on a pivot and is pulled into a vertical position automatically by a weighted base. The set will float if dropped in water. It is mounted in the tail of the plane, since this is the section that is least likely to be destroyed in a crash.

Slide Makers "Freeze" Bugs With Synchronized Flash

Photographers who use the Leica for making slides of live insects can now stop action by illuminating the subject with synchronized flash. With the synchronizer, the full range of shutter speeds up to $\frac{1}{1000}$ second can be used. As many as three lights can be fired by the unit when working at small apertures.

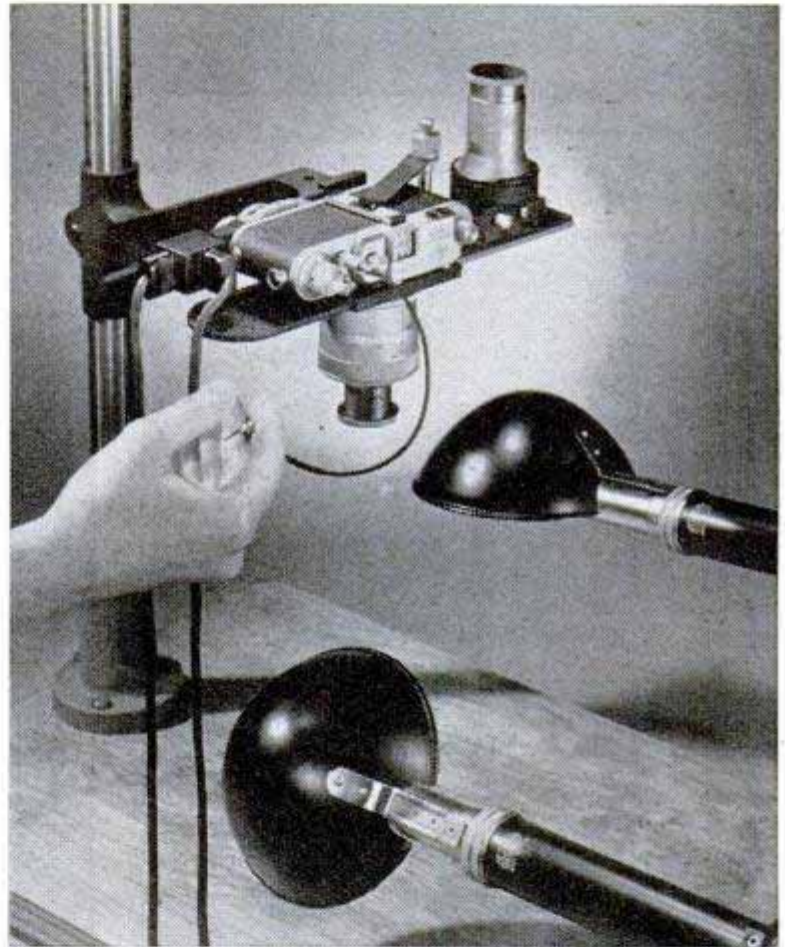

Pliers That Pulverize Can't Damage Machinery

Because they pulverize under pressure, safety pliers used for feeding material into a punch press cannot damage the machinery if accidentally caught in the die. In addition, the aluminum alloy pliers are safer for the machine operator since there is no danger of flying fragments. Despite the pulverizing characteristic, the pliers are sufficiently strong to handle sheet material.

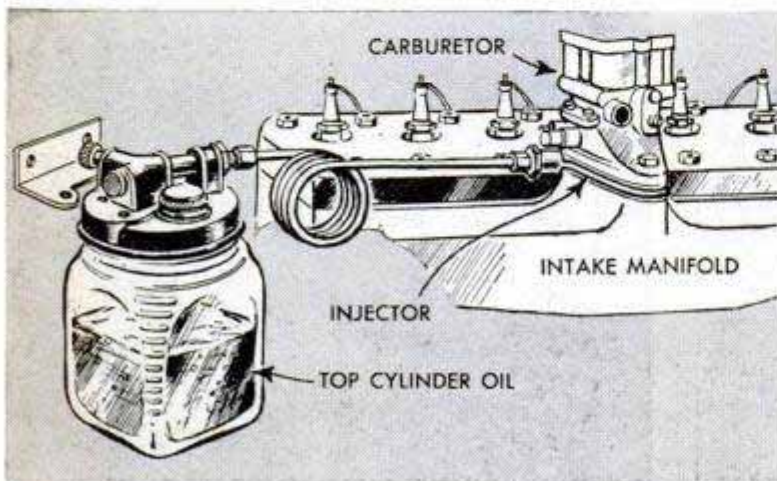

Upper-Cylinder Lubricator

Top cylinder oil is introduced into the intake manifold of a gasoline engine by a metering device that assures lubrication and reduces carbon formation in the upper cylinder section. A fine spray of the oil mixes with the gasoline as it passes from the carburetor to the combustion chamber. The lubricator is connected by a tube to an injector plate sandwiched between the carburetor and manifold.

Nonelectric Light Bulb Glowes When It Is Shaken

As if by magic, a new fluorescent light bulb that uses no electric current lights up when you shake it. Inside the sealed bulb are a small drop of mercury, some fluorescent powder and a small quantity of rare gas. When the bulb is shaken, these materials combine to produce light. With no filament to burn out, the bulbs should last indefinitely. They can be manufactured in a variety of shapes and sizes. Various colors are produced by using different fluorescent powders inside the bulbs. Plans are being made to use the bulbs as fish lures, which would glow brightly when agitated by the action of the water. Other possible uses of the bulbs are as auto taillights, distress-signal lights and novelty lights for bicycles.

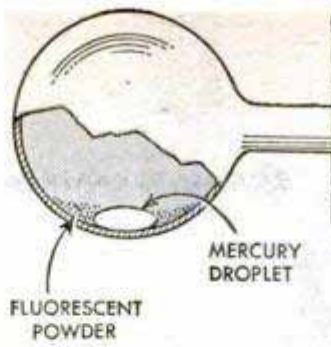

Plow on Fire-Fighters' Jeep Cuts a Four-Foot Furrow

Forest fire fighters now can stop the spread of flames across a forest floor with a jeep plow that cuts a double furrow about four feet wide. The V-shape plow is made of two pieces of steel pipe cut into the proper shape and welded together. A five-inch I-beam supports the plow and a rolling coulter cuts roots and lifts the blade over obstructions. A hand winch raises and lowers the plow. To balance the jeep and provide traction for the front wheels, a 250-pound counterweight is mounted on the front bumper.

Above, the V-shape plow turns a double furrow in the forest floor to stop spreading flames. Below, left, when not in use, the plow is pulled over on its back inside the jeep. Below, right, winch lowers the plow

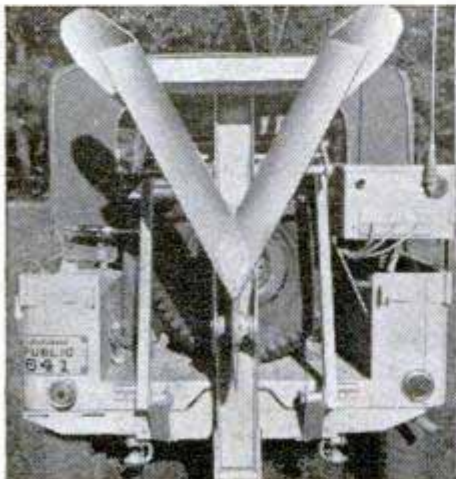

Solid Sides of Auto Transport Protect New Cars From Road Dust

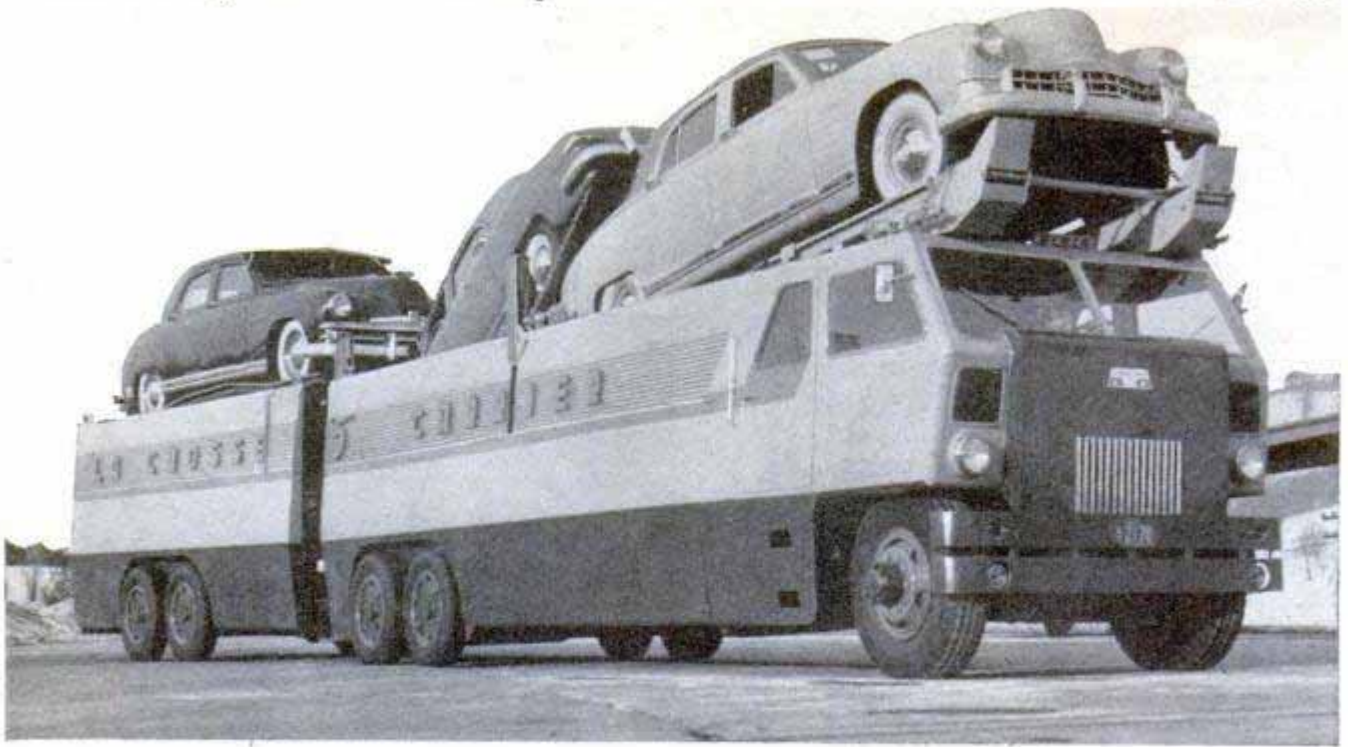

With its lower portion completely enclosed to protect the load from dirt and damage, a new automobile transport carries five cars instead of the four-car load of conventional carriers. Three cars are loaded in the main unit and the trailer car-

ries two more. All ramps for loading and unloading are hydraulically operated from a power take-off, enabling one man to do the complete operation. The transport has a front-wheel drive with the engine being located under the cab.

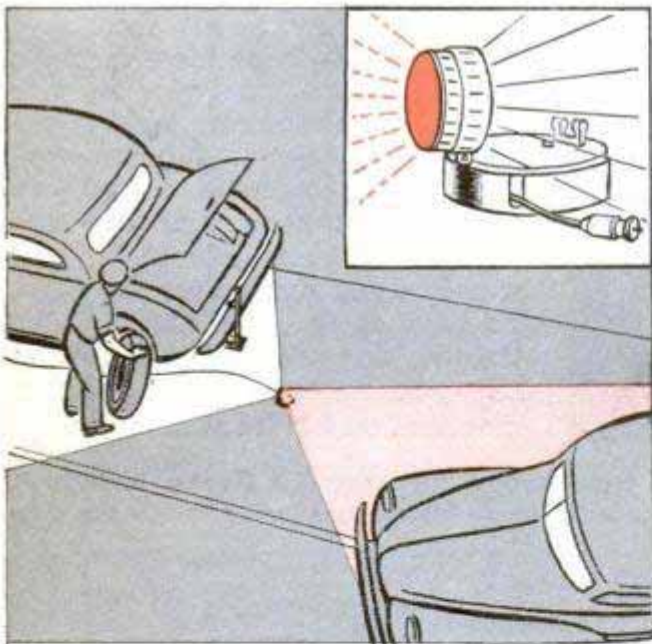

Tire-Changing Light

Changing a tire after dark is easier and safer with a combination warning and work light that plugs into the car's cigarette lighter. The 17-foot electric cord un-reels from the base of the light. A white, continuous light shines on the working area and a red signal blinks to warn other motorists. The cord is rewound by holding the base and turning the light.

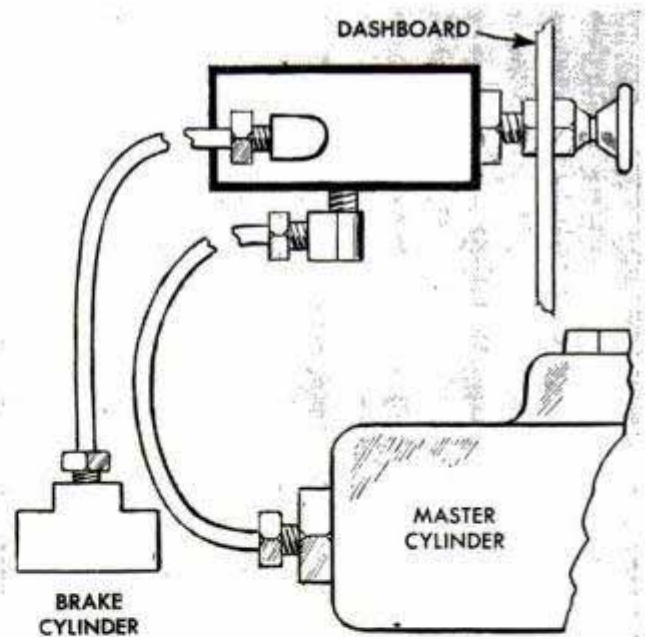

Dashboard Hill Holder

Your brakes are held on by a finger-operated dash button that allows you to take your foot off the brake pedal when starting up on a hill without causing the car to roll back. Nonelectric, the switch is installed between the master cylinder and the hydraulic line to the brake drums. It can also be used to lock all four wheels while you are changing tires.

ROLL THIS PHOTO LAB to your kitchen sink and you have a complete apartment darkroom at your fingertips. Turn to page 201 for construction details

the CRAFTSMAN section

WEAVING A REED CHAIR SEAT is easy. Just bring that old ladder-back chair down from the attic, spend a couple of hours reeding the seat and there you are, good as new. Start-to-finish instructions, page 174

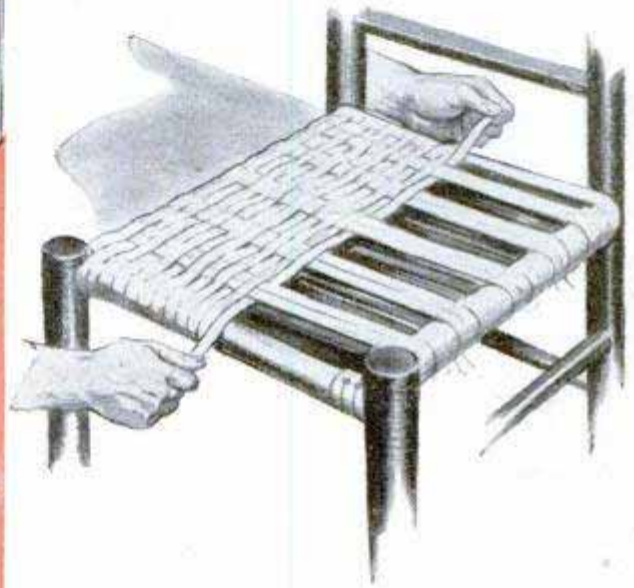

A PORTABLE BOWLING ALLEY for your rumpus room is described on page 187. Keglers of all ages match their skill by rolling a golf ball at pint-size tenpins. Looks like a cinch, doesn't it? Maybe, but just try it!

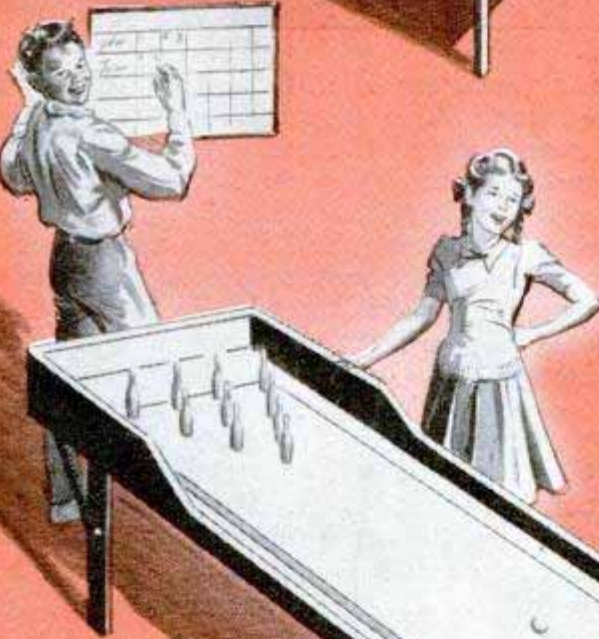

WAVE-POWERED MOTOR drives 3-ft. model at rowboat speed. Page 182 tells how to make it and how it works



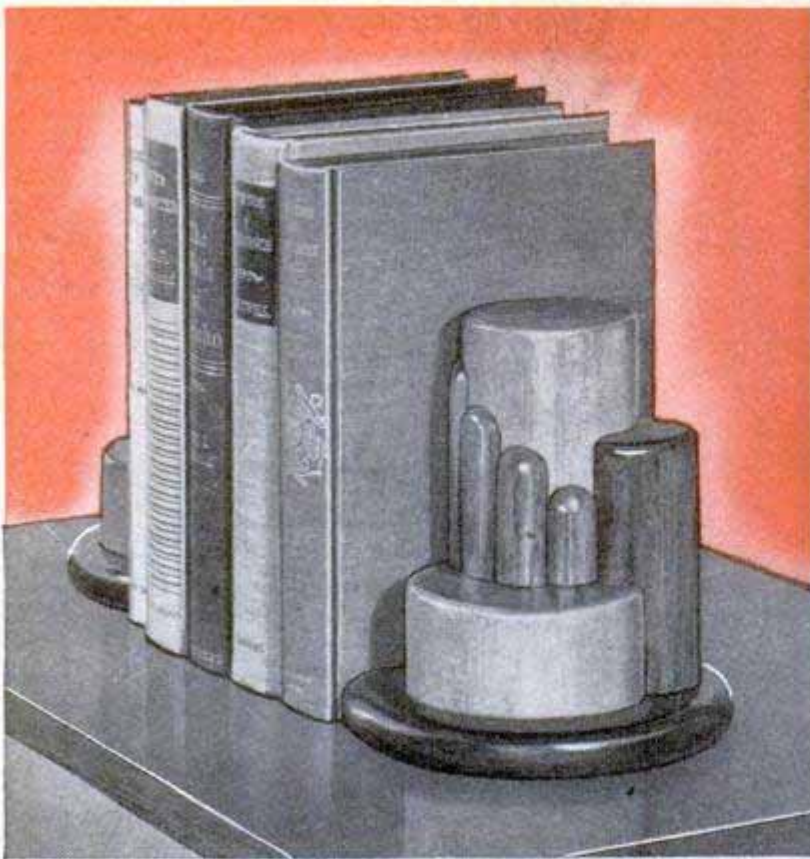

MODERN BOOK ENDS

By
Milt Evans

INTERLOCKING cylinders of contrasting woods, such as maple and walnut, are assembled in pyramidal fashion to form this striking pair of modernistic book ends. Largely a simple lathe project, the various parts are turned in pairs, after which they are cut apart with a parting tool, Fig. 3, and shaped to nest together. Figs. 1 and 2 give the diameters and lengths of the three cylinders, A, B and C and also the dimensions of the beading and the base.

Before starting to turn the parts of the book ends, it is best to lay out a full-size pattern of the base as in Fig. 2, using a compass to mark the positions of the three cylinders. Begin the project by turning a pair of the tall, center cylinders, part A,

making them $2\frac{9}{16}$ in. in diameter and $5\frac{1}{4}$ in. long. The upper ends are faced-off smoothly and the edges rounded slightly. In the same way, parts B and C are turned to the sizes given in Fig. 2, their top edges also being rounded. While part A of the original set of book ends was hollowed out to receive part B as shown in Fig. 4, this part can be left intact and part B cut out instead. The latter procedure is somewhat easier, especially for the inexperienced craftsman. To do this, place the paper pattern over the end of part B and mark the contour of part A. Then, roughcut the piece a little to the right of the contour line so that enough waste stock will remain to permit sanding. If a bandsaw is available,

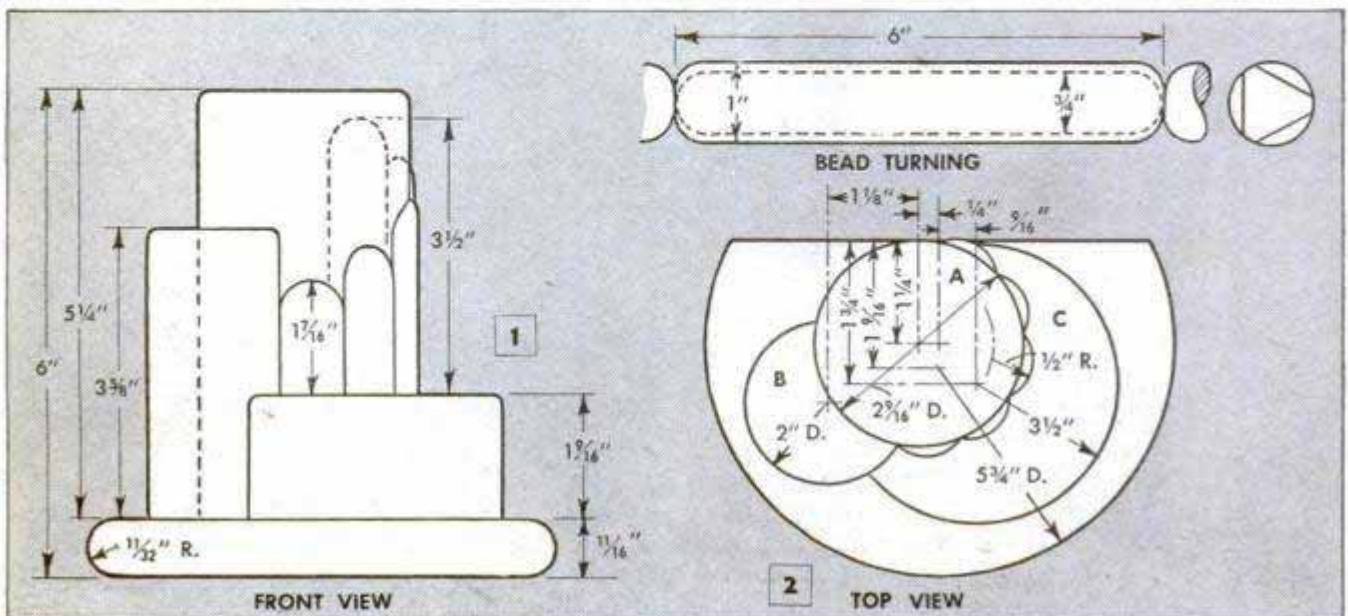

you can make this cut with the piece standing vertically. Otherwise, a gouge can be used to work the stock down to the line. Then, with fine sandpaper wrapped around part A, use the latter as a sanding block to smooth part B to a perfect fit. Part C is cut out in the same way, marking it from the paper pattern and fitting it to the contours of both parts A and B.

The bases of the book ends are 5 $\frac{3}{4}$ -in. disks, $\frac{1}{16}$ in. thick, and their edges are rounded to an $\frac{1}{32}$ -in. radius. The portion of each base which will be at the back of the book end is cut off flat $1\frac{5}{16}$ in. in from the edge, and the top of the base is marked to match the paper pattern, Fig. 5. Three countersunk holes are drilled up through the bottom of the base. These are for screws which fasten the vertical members in place. The screw holes should be located near the outside edges of the scribed circles so the center of the base can be recessed and filled with lead to weight the book ends.

To add decoration, lengths of beading can be applied vertically around the center cylinder, part A. These are cut in five different lengths graduated from $1\frac{1}{16}$ in. to $3\frac{1}{2}$ in. and are arranged to form a spiral design. The beads for both book ends are cut from two sausage-shaped turnings as shown in the upper detail of Fig. 2. Sections $\frac{3}{16}$ in. thick and $\frac{3}{4}$ in. wide are ripped from the turnings as in Fig. 6. These are cut to length and suitable flats are filed on the sides of part A to allow the beading to set flush. The top portions of the flats will have to be rounded to match the ends of the decorative beading.

To assemble the book ends, glue parts A, B and C together, clamping them by wrapping round and round with cord. Then, glue and screw these parts to the bases and glue the beading to part A. After the glue is dry, weight the book ends and glue felt to the bottoms. The units can be finished simply by waxing and polishing after final assembly.

Half-round strips of molding are formed by slicing sections from the sides of sausage-shaped turnings

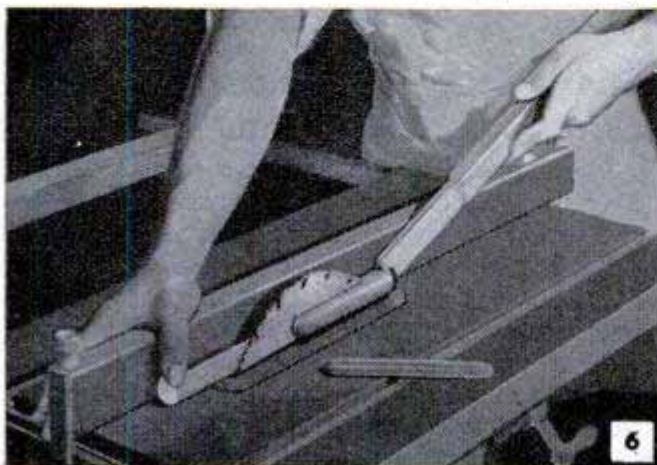

6

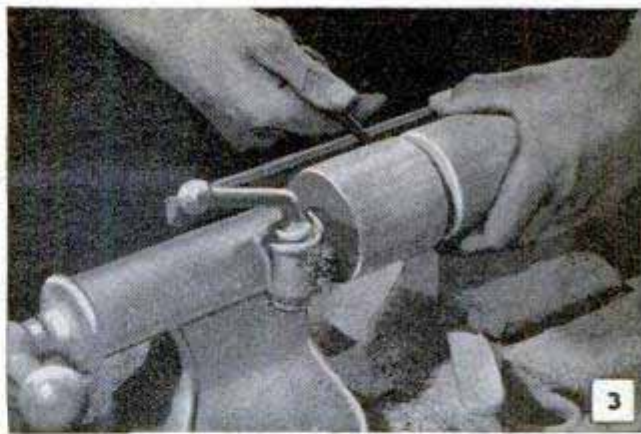

3

Different sizes of cylinders for the book ends are turned in pairs and separated with a parting tool



4

Above, center cylinder is hollowed out with a gouge to receive smaller cylinder, part B. Below, after one side of base is cut off flat, compass is used to transfer positions of cylinders from paper pattern

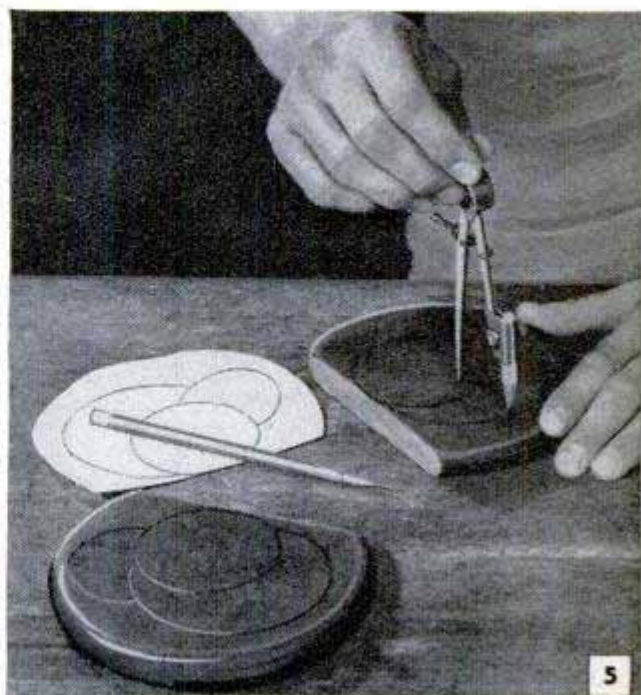

5

Flashing Compound Applied Neatly With Kerosene-Dipped Paddle

Home Repairs

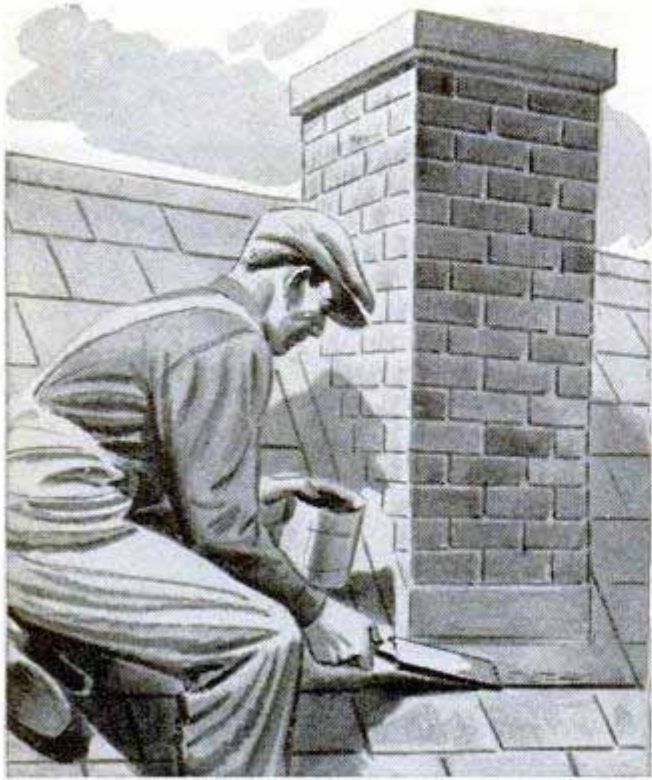

Because of the stickiness of flashing compound, it is somewhat difficult to apply it neatly around chimney flashing. However, a neat job can be done quickly if a wooden paddle dipped in kerosene is used to smooth the compound. If the paddle is dipped in the kerosene frequently, the compound will not adhere to it.

Ralph McClung, Hitchins, Ky.

Brush Jungles in Cool Water Improve Midsummer Fishing

During the hot summer months when the shallow water near shore gets warm, game fish, pan fish and catfish prefer to stay in the cooler deep water during the day. How-

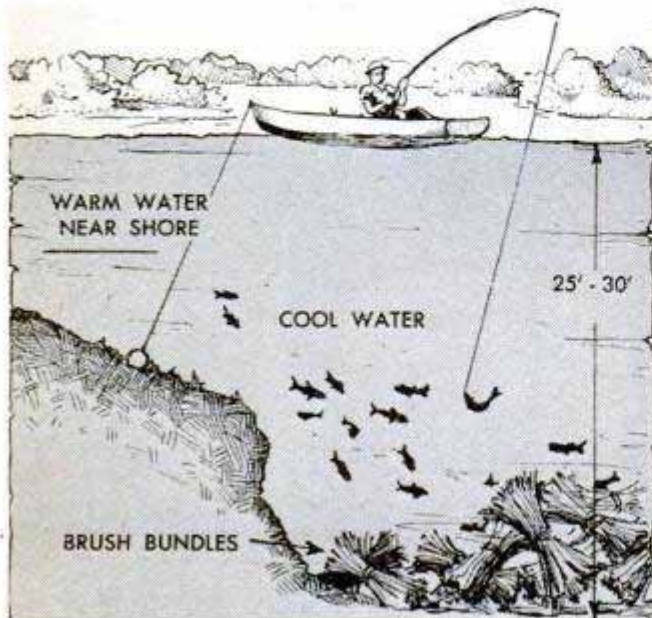

ever, good midday fishing can be had if brush jungles are sunk at strategic locations to attract the fish. The jungles consist of bundles of tall brush, 6 to 10 ft. high, which are towed into the lake, weighted with heavy stones and sunk some time prior to the fishing season. A dozen or two large bundles will form a satisfactory jungle. This will be successful if built in any of three places which are easy to find in most lakes. The first location is in 25 to 30 ft. of water just below the drop-off. The second is in 20 to 30 ft. of water out from the point where a stream flows into the lake, and is excellent because fish lie in such places waiting for food carried into the lake by the stream. The third location is a spot where cold water bubbles up from a spring hole on the lake bottom. The jungles can be located by aligning them with trees or landmarks on the shore or, if desired, the spots can be marked with buoys. The latter need only be corked bottles anchored with stones. Occasionally baiting the jungles with ground rough fish, such as carp, is an added attraction for all kinds of fish, but especially catfish and bullheads.

R. A. Jenkins, St. Louis, Mo.

Wall Bracket Holds Flowerpot

Just the thing to brighten a drab corner on the front or rear porch, this wooden flowerpot bracket is screwed to a wall or post. The bracket is sawed approximately to the shape shown in the drawing, its size being determined by the size of the flowerpot. The rim of the flowerpot fits into a slot in the edge of the bracket, and a short dowel holds the bottom of the pot to the base of the bracket.

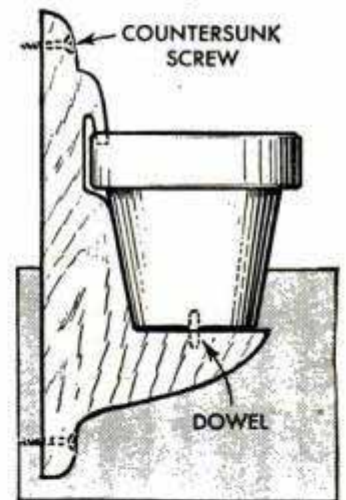

A. V. Malone, Los Angeles, Calif.

Sturdy Louvers for Barn or Garage Have Sheet-Metal Slats

Combining economy with quick assembly, sturdy louvers for a barn or garage are made by fitting slats of galvanized sheet metal into wooden endpieces. After the slats are cut to size, their ends are pressed into angular saw cuts made halfway through the width of the wooden uprights. Then facing strips are nailed over the edges of the uprights to hold the slats in place.

Werner Kraatz, Santa Cruz, Calif.

Durable Aluminum Canopy Resembles Awning

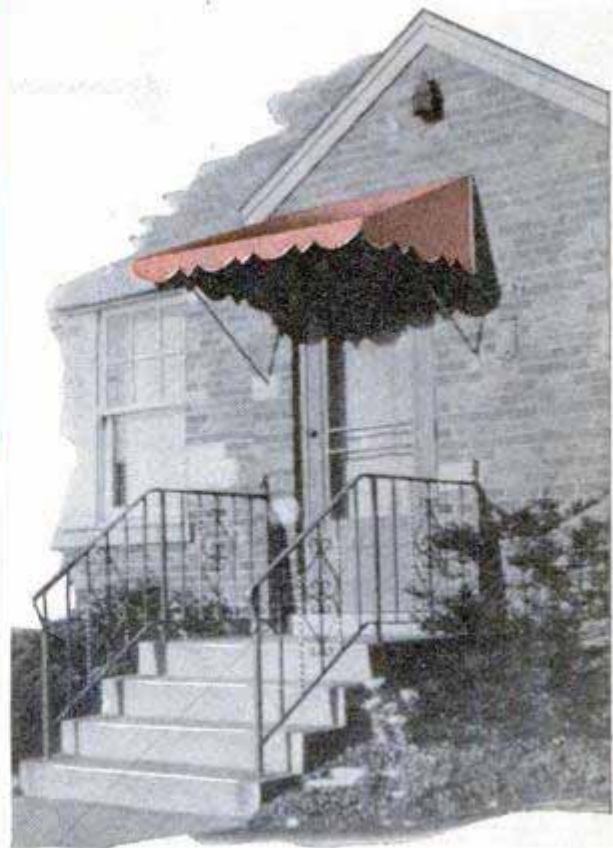
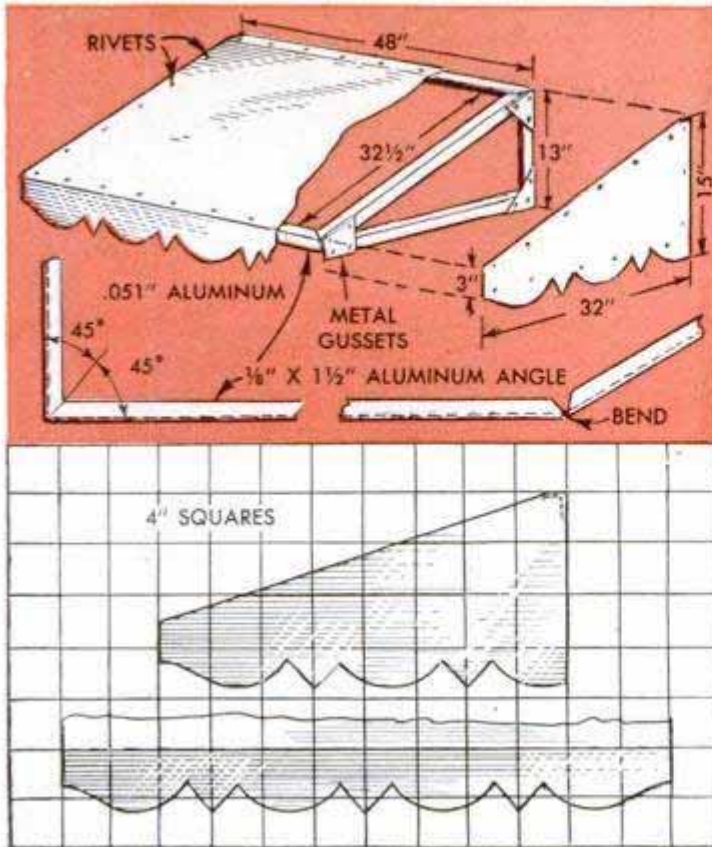

This door canopy is supported by a rigid aluminum-angle frame to resist high winds and to prevent sagging. The slanting, or top, section of the frame is bent U-shaped from a single length of aluminum angle notched at the corners. This part is fastened to a second U-shaped section which forms the back. Lower members of the sides are separate lengths of angle, and the parts are held together with metal gussets riveted at the corners. The top covering is cut from sheet aluminum according to the squared pattern and is riveted to the top

and back frame members. The covering for the ends is also cut from the pattern and riveted in place, using filler strips of aluminum between the gussets to give a smooth joint. The strips should be the same thickness as the gussets. Attach the canopy to a masonry wall with lag screws turned into expanding sleeves seated in holes drilled into the wall with a star drill. Use lag screws alone when attaching the canopy to a frame house. If desired, metal braces can be added as in the photo.

Edmund Jezuit, Chicago.

Adapter on Photo-Light Stand Holds Home-Recording Microphone

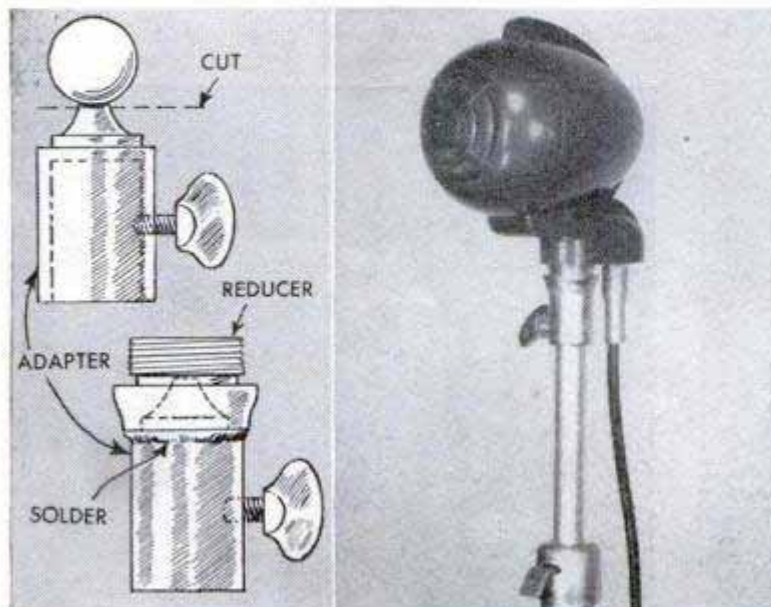

An inexpensive floor stand for a home-recording microphone can be made by mounting a special fitting on an ordinary photo-light stand. The fitting consists of a threaded reducer and a ball-type adapter used for attaching a clamp-on photo reflector to the stand. The ball tip of the adapter is cut off as shown in the upper detail and the reducer is soldered to the adapter as in the lower detail. The threads of the reducer should, of course, fit the microphone. After the fitting is turned into the base of the microphone, it is slipped over the tip of the light stand and tightened securely in place with the thumbscrew on the adapter.

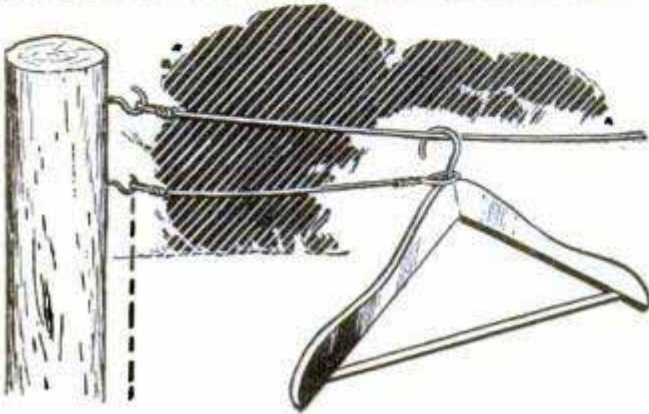
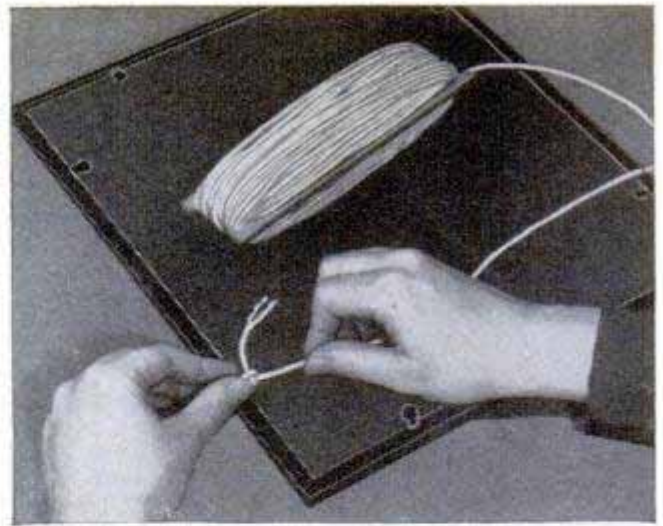
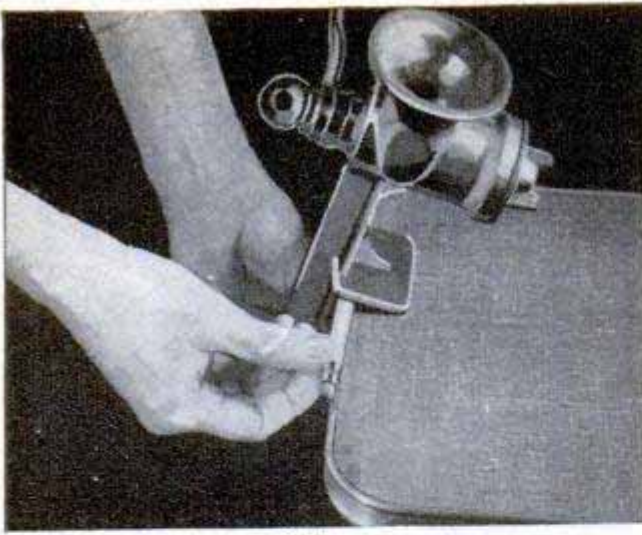

TILTING A FOOD GRINDER toward the bowl causes juices from the food to run into the container instead of dripping to the floor. A pencil placed between the grinder and the table top does the trick

HANGING PICTURES with fishline is better than using ordinary cord when regular picture wire is not at hand, as fishline is the stronger of the two

GARMENT HANGER STAYS PUT on clothesline when tied with wire "leash." A loop is formed at each end of the wire, one being slipped over a screw hook turned in post and the other over the hanger hook

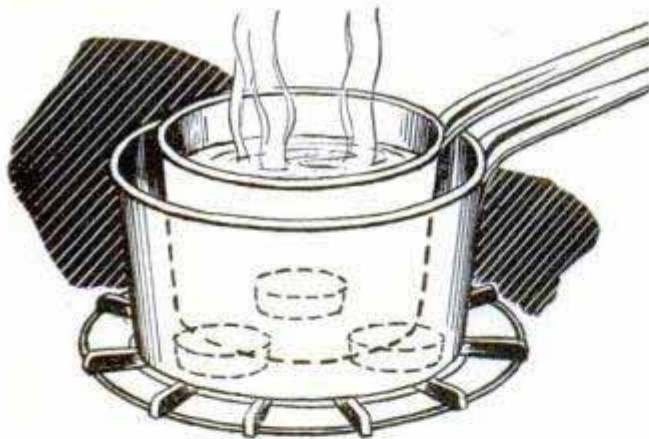

AN IMPROVED DOUBLE BOILER consists of a small saucepan supported on bottom of a larger pan with three fruit-jar lids. Large pan is filled with water

ELIMINATE SHINY AREAS ON CLOTHING by rubbing them with potato before pressing. Cut a piece from the potato and rub fabric with the sliced surface

OILCLOTH ROLLED FOR STORAGE won't stick together and damage the design if a sheet of tissue or wax paper is laid on the cloth and rolled up with it



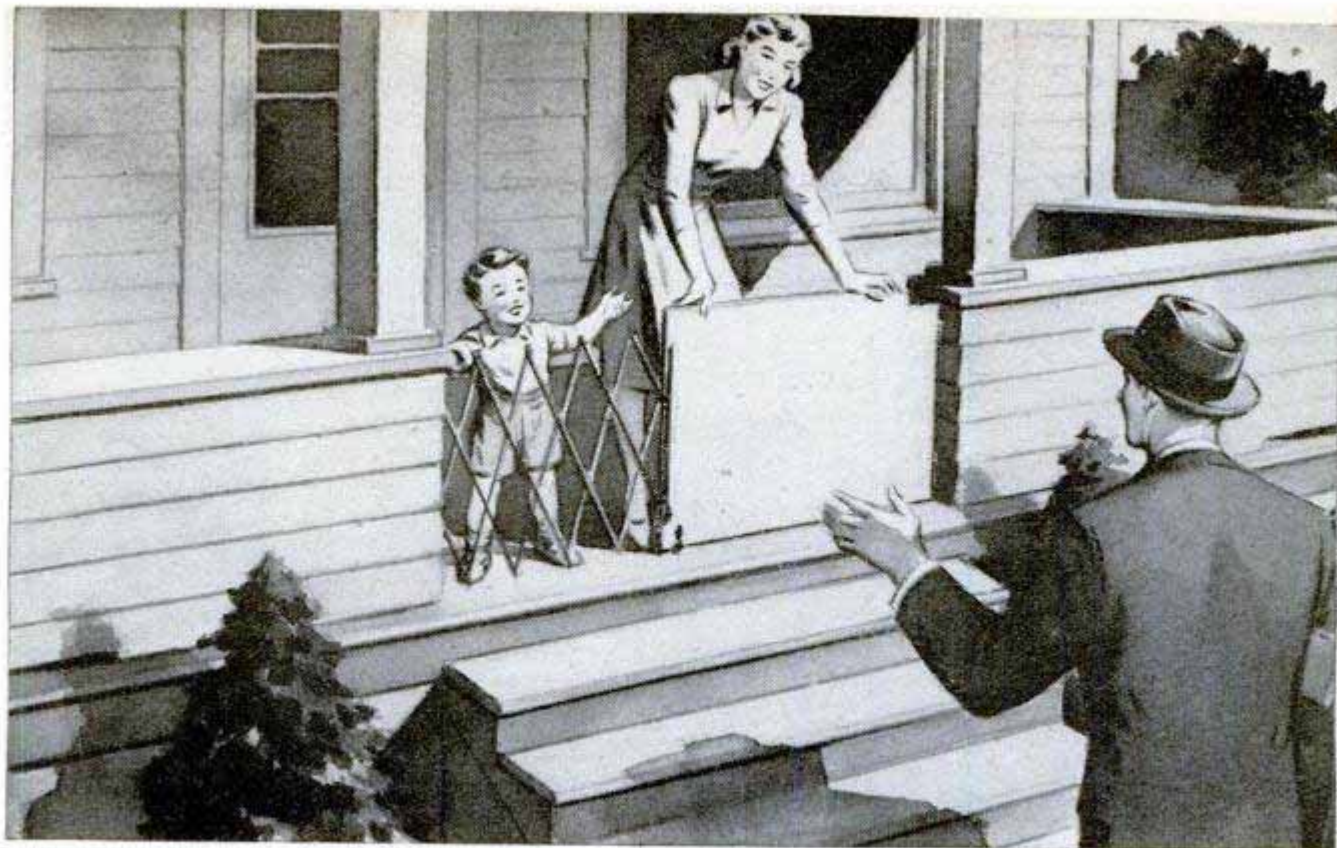

HOME PROBLEMS

SAFETY EXTENSION on folding gate closes large porch opening. Extension is a sheet of hardboard or plywood hinged to post. The gate is screwed to extension which is held to floor with screen-door hook

DRY PAINT SPOTS are removed from window glass by rubbing with a cloth moistened with hot vinegar. Use the vinegar full strength and heat it by setting the uncapped bottle in a saucepan filled with water

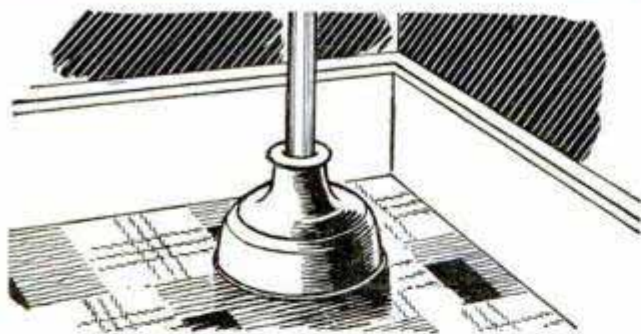

LAYING LINOLEUM is an easier job if a large suction cup, such as a drain plunger, is used to lift the corners. For a tight grip, rub soap on the cup edges

TO STRAIGHTEN PLASTIC KNITTING NEEDLES, dip in hot water and roll on a table top. Then insert them in a piece of corrugated cardboard and allow to cool



Segments Cut From Flanged Disk Provide Modern Drawer Pulls

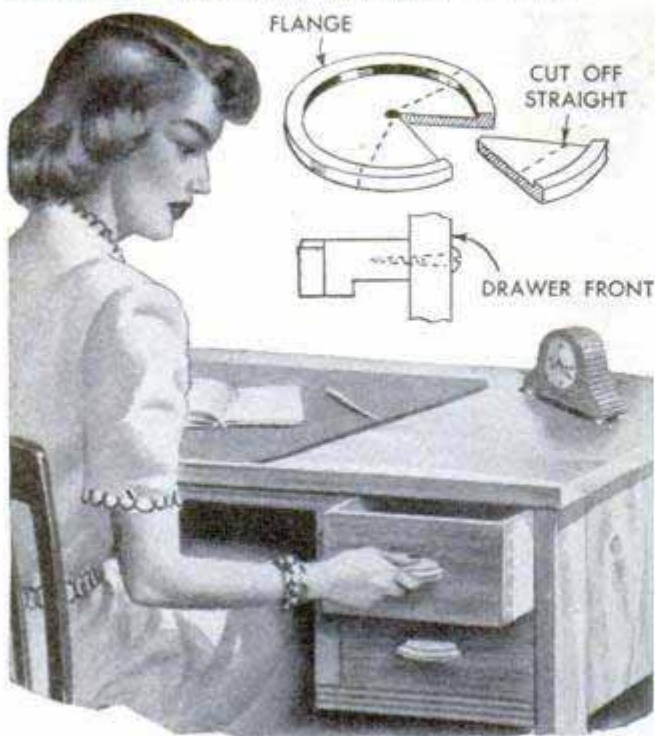

Turning a flanged hardwood disk on a lathe is a quick way to shape a number of modern drawer pulls. After the disk has been turned, it is cut into pie-shaped segments to form the individual pulls. The disk is recessed to produce a flange deep enough for a comfortable finger grip, and the radius of the curved faces of the pulls is, of course, determined by the radius of the disk. The edge of the disk can be grooved, chamfered or rounded while in the lathe to form a decorative effect. The pulls are attached with screws driven from the inside of the drawer fronts.

M. B. Birge, Hinsdale, Ill.

Trailer Held Against Garage Wall Requires Little Storage Space

Having to store my small trailer in a one-car garage presented a problem until I tried standing it on end against the rear wall. A

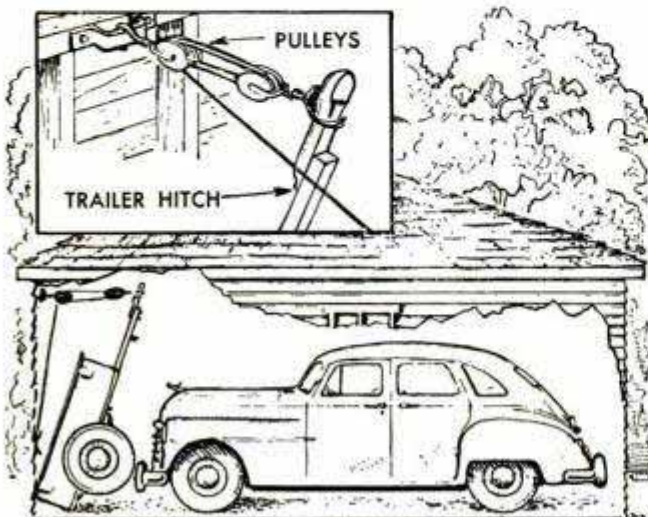

set of pulleys is used to raise the trailer into position and lower it when needed. Both the car and trailer fit nicely into the garage in this way. However, if the trailer is used infrequently, its wheels can be removed to afford more space for the car.

Fred Premo, Utica, N. Y.

Staples Form Temporary Hinge

Where a hinge is only temporary and the parts do not have to fit flush, a "continuous hinge" can be made quickly by driving rows of staples in the wooden members. First, one row of staples is driven into the edge of the fixed member. Then another row

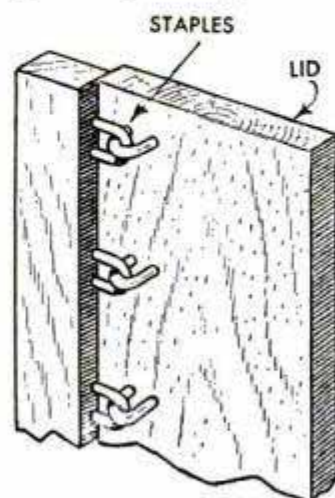

is driven into the face of the lid, or swinging member, so that a prong of each of the staples passes through one of the staples in the fixed member.—W. F. Schaphorst, Newark, N. J.

Film Cartridge Dispenses Stamps

The metal cartridge from a roll of 35-mm. film provides a handy postage-stamp dispenser which keeps the stamps both clean and dry. A roll of stamps is wound loosely around the core of the cartridge and the last one is pushed through the slot. Then the stamps are simply pulled from the dispenser and torn off just beyond the slot as they are needed.

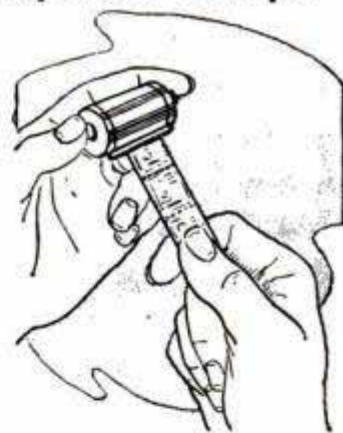

Harry Radzinsky, Great Neck, L. I., N. Y.

Eraser Clamps Furnish Propellers For Solid Model Airplanes

A small two or four-bladed propeller for a solid model airplane can be improvised from a metal eraser clamp of the type used on automatic pencils. The sides of the clamp are spread flat and trimmed to shape with a scissors or tinner's snips. Most of the clamps have a hole in the bottom, but some may have to be drilled for the propeller hub. A slight twist of the blades will provide the desired pitch.

Charles F. Dayton, Akron, Ohio.

Dashboard Tray Increases Comfort on Long Trips

When driving your car on long vacation trips no doubt you have often wished for a flat, steady surface in the front seat—someplace where you could pour a cup of coffee from a Thermos bottle without doing a juggling act. If so, this little tray is just the thing. Hooked under the glove-compartment door, the tray provides an ideal place for setting cups and sandwiches plus a handy writing surface for jotting down notes or writing postcards while traveling. In addition, there is plenty of space between the top and bottom of the tray for road maps, guides and stationery. As the tray does not take up much room, it can be carried in the rear seat of the car when not in use. It also can be hung from the underside of the dashboard, if the design of the car permits. The tray is simply constructed of solid stock and plywood and can be painted to match the interior trim of the car. Ordinary metal corners are bolted to the back of the tray to form mounting hooks and brackets, as shown in the detail. Pieces cut from the corners that are used to form the hooks provide spacers for the lower ends of the brackets. The tray hooks over the front edge of the glove compartment

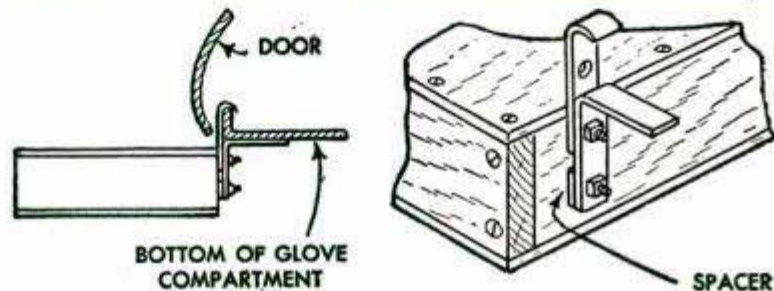

and is held in the horizontal position by the brackets. In most cases, there will be enough space at the bottom of the glove-compartment door to permit hanging the tray. However, if there is not enough room, small slots can be filed in the bottom edge of the door to permit inserting the hooks. If done carefully, the slots in the glove-compartment door will not be noticeable.

Garden Hose Reinforced by Wrapping With Tape to Prevent Kinking

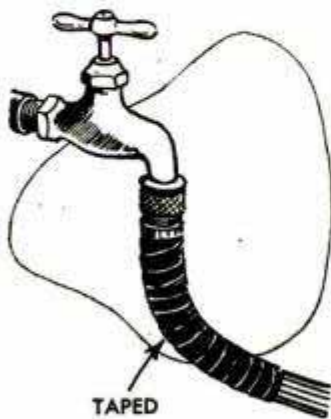

Repeated kinking of a garden hose near the faucet connection eventually breaks the hose and causes a leak. To prevent this, apply a tight spiral wrapping of friction tape around the hose so it extends a foot or so from the connection. Be sure

the tape wrapping is long enough to cover the place where the hose usually kinks when it is pulled. Another way to accom-

plish this is to slip a short length of larger diameter hose over the end of the garden hose. This also will reinforce it sufficiently to prevent kinking.

Bobby Pin Holds Brads For Easy Starting

Tiny brads and tacks which are difficult to hold with the fingers can be started easily if they are held in position with a bobby pin. Place the brad between the arms of the pin and, after it has been started, simply pull the pin loose.

☛ To renew the appearance of artificial flies, shake them in a sack of hot salt.



By W. Allphin

TO REPLACE an average-size reed chair seat, you'll need about one pound of oval-split reed, which can be purchased from a dealer in seating materials. The reeds must be soaked in water for at least a half hour before using. Tack two strips to the front rail as shown in Figs. 1 and 3. Go under the front rail, over the adjacent side rail,

Warp is begun by tacking two reeds to front rail

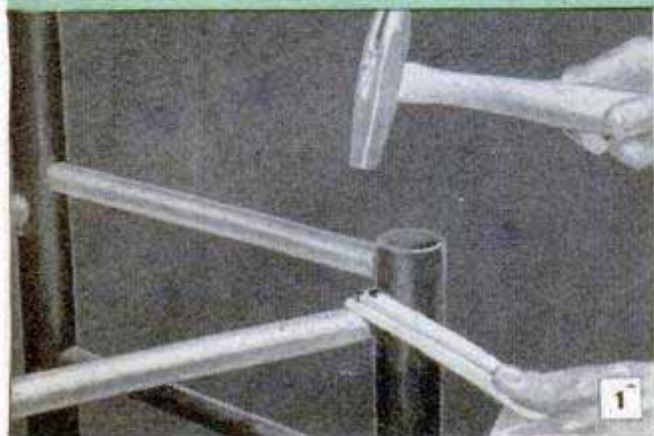

1



The completed seat is singed with the flame of a tightly rolled newspaper to remove the reed fibers

and then across to the opposite side rail. Wrap both strips around this rail and make an extra turn around it before returning the warp underneath to the first side rail. Make an extra turn here and go across the top again, as in Fig. 4. Each time you come to a rail, wrap an extra turn of the warp around it firmly before returning to the other side of the seat.

When near the end of a warp strip, shorten it if necessary so that it will end on the underside of the chair. Notch the edges of the old and new strips as in Figs. 2 and 5, and tie with string. A temporary tie is

Detail below at left shows how reed splice is made

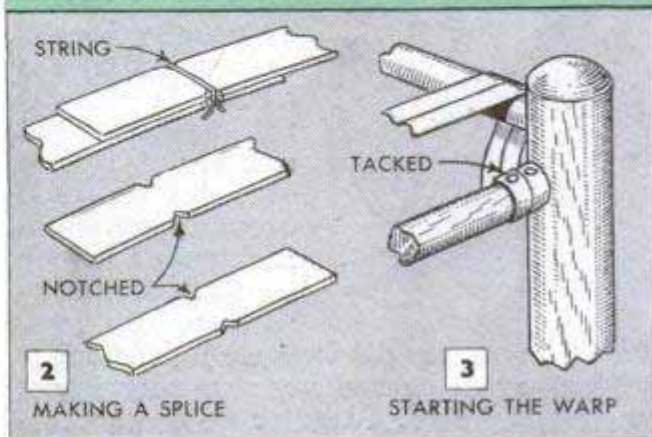

A REED-BOTTOM CHAIR

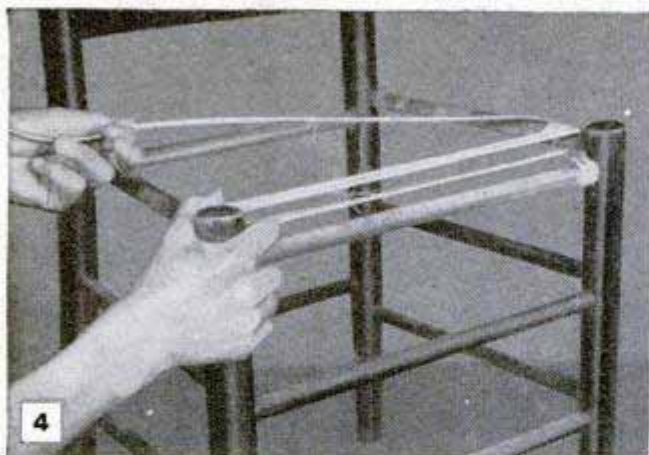

Warp strands are given one turn around side rails

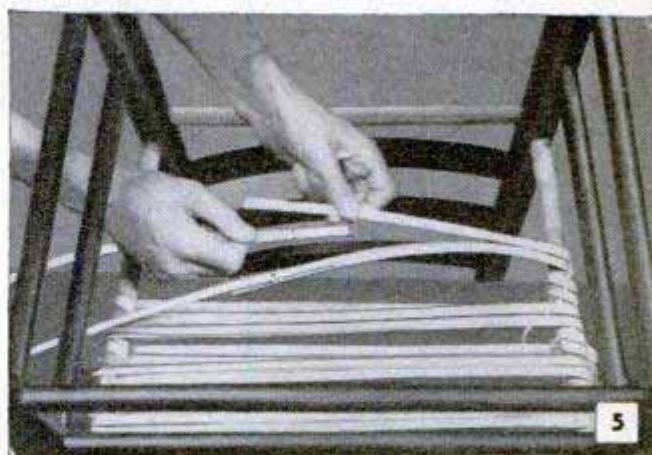

Splicing warp strands is done on underside of seat

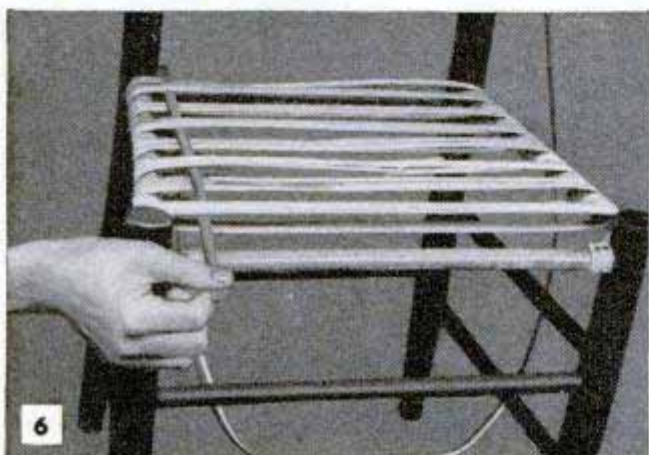

Woof strands are passed over and under warp strands

made around the rail at the last turn, as shown, to hold the strips while they are being spliced. Crowd the turns a bit wherever necessary so that the last warp on the upper side is back as far as possible. Start the woof across as a single strip at right angles to the front rail. This will leave a triangular space at the side. Weave under two, over two and around the rail, as in Fig. 6. Tuck the new piece in on top of the old one for a distance equal to two pairs of warp strips, as in Figs. 7 and 8.

Weaving woof is fun, just over two and under two



Woof is spliced by tucking end under warp strands

When you have completed the square area, fill in remaining areas along the side rail as in Fig. 9. Start a short piece by pushing it into the smallest opening through which it will pass, and weave it around to the bottom, finishing by cutting off the strip and tucking in the end. Repeat with a shorter strip until the area is filled. Let the reeds dry overnight and then singe off the loose fibers. Be careful not to scorch the reeds. Singeing can be done with a newspaper torch.

Fill-in areas at sides are woven with short strands



These Special Baits Are Sure To Tempt Carp

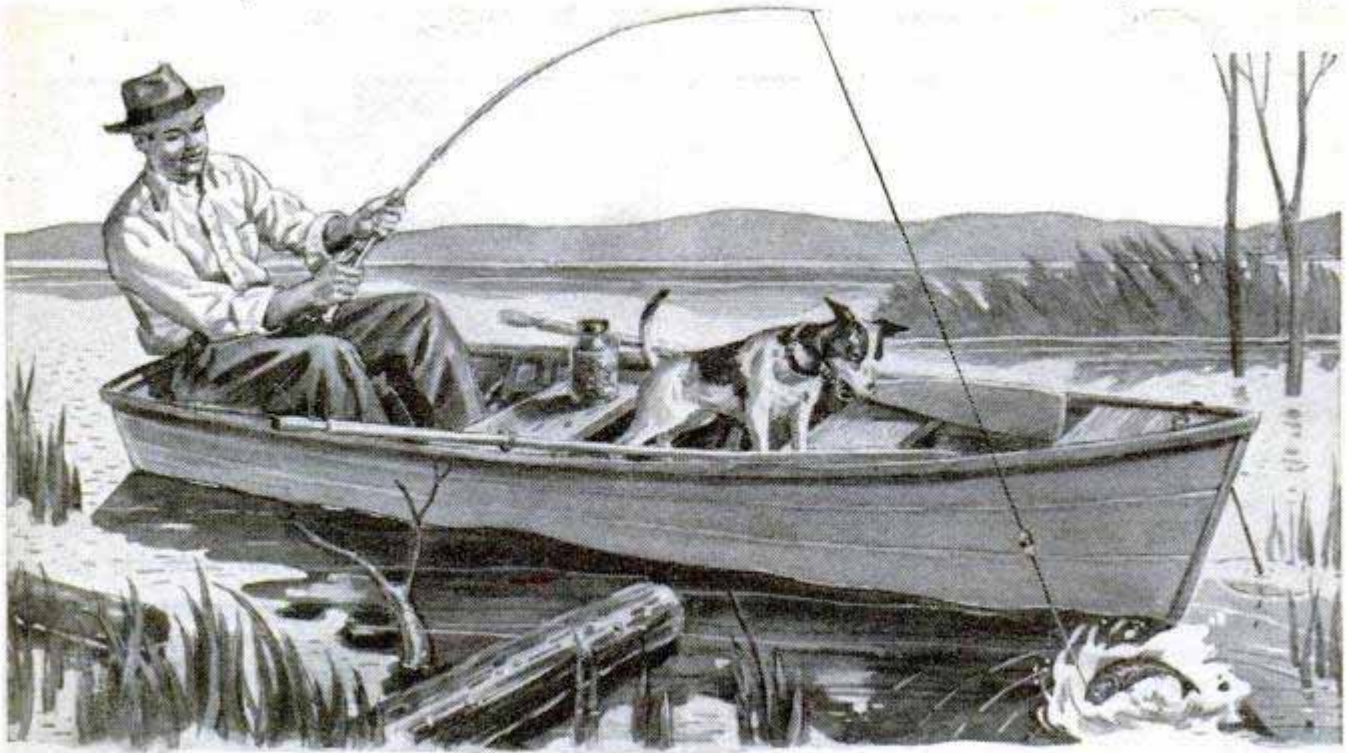

TAKING carp on light tackle with specially prepared baits is a novel fishing experience, particularly when you remember that the food preferences of the carp are unlike those of any other fresh-water fish. Carp are what fishermen call bottom feeders. They frequent the still backwaters of ponds, small lakes and sluggish streams where they regularly forage for food on the mud bottoms of these silt-laden waters. Thus, any baits offered must be fished deep in the stream or pond. This means that the first tackle requirement is a small hook tied close to a fairly heavy sinker so that the baited hook will go straight down from the surface of the water and will remain more or less stationary. Most carp fishermen use an adjustable float to hold the baited hook at a constant level, but others prefer to fish with a taut line. One of the baits rated highest among experienced carp fishermen is an ordinary marshmallow cut three ways with a sharp knife. If this is done carefully, you get eight pieces of just the right size. These should be kept in a closed container to prevent drying out. Another good bait is made by boiling licorice root, 2 oz., and aniseed, $\frac{1}{2}$ oz., in water, 1 qt. Continue boiling the liquid solution until it is reduced to about 1 pint, then strain and stir in sugar, $\frac{1}{2}$ cup, and enough flour to make a stiff, rubbery dough. Mold the dough into small baits and drop these into boiling water. When they rise to the top, remove and store in a tight container. Another long-lasting bait is prepared by first wadding small bait-sized balls of cotton. Melt grated cheese,

$\frac{1}{2}$ cup, in a shallow container and immediately drop in the wads of cotton. When the cotton wads have absorbed all they will of the melted cheese, remove and place them on a piece of board or in a shallow pan to harden. As soon as the baits have hardened, store in a tight container. Two other baits the carp fisherman keeps on his list are corn hominy and small squares cut from a ripe tomato and, if he should run out of bait entirely on a day when the fish are biting especially well, he remembers to search the edge of the stream or along the shore of the pond or lake until he finds a moss-coated log or stone. A small wad of the wet moss is excellent carp bait.

R. A. Jenkins, St. Louis, Mo.

Box 42

Armload of Books Carried Easily

When carrying an armload of books back and forth to school or to the library, they can be held without tying by interlocking the covers. Stacking the books one on top of the other and slipping the cover of one of them under the cover of the next, forms a neat "package."

John E. Sullivan, Springfield, Mass.



☐ Windows glisten if washed with a solution of witch hazel, $\frac{1}{2}$ cup, in warm water, 1 qt., polishing with a lint-free cloth.

Loading and unloading a small boat from a rack on top of a car becomes a one-man job when this roller-type carrier is used. The carrier consists of two wooden frames. One of them is strapped permanently to the car in the usual way and the other is detachable. The boat is strapped to the second, detachable, frame which is fastened to the top of the first frame with bolts and wing nuts. A metal roller is mounted on one side of the bottom frame and extends its full length.

To remove the boat from the carrier, the top frame is pulled over the roller and swung downward along the side of the car. Flat-iron hooks attached to the far side of this frame engage the roller and keep the boat and frame from falling to the ground. Both frames are made of hardwood to the

Car-Top Carrier Fitted With Roller Permits Easy Handling of Light Boat

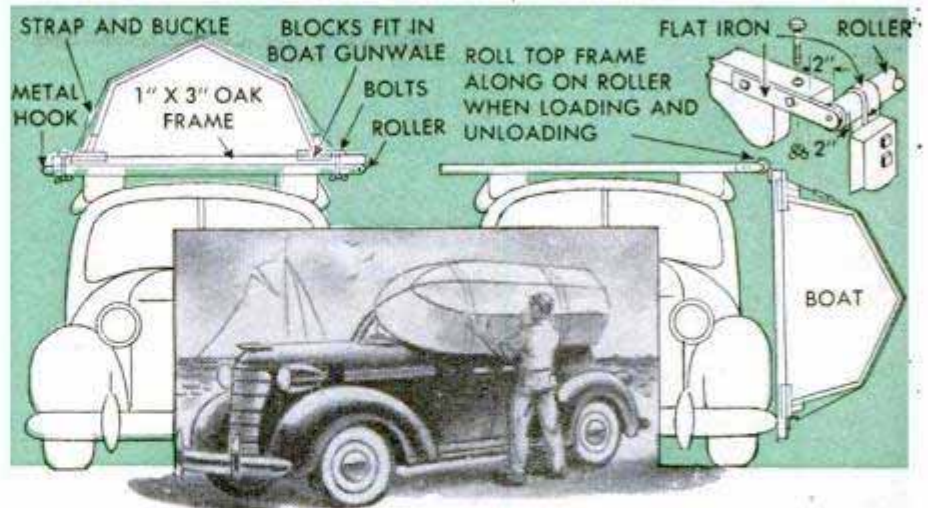

same size, and the roller can be merely a length of pipe rotating on an iron rod. The ends of the rod, which should extend through the endpieces of the frame, are threaded and the rod is tightened in place by drawing up nuts at the ends.

Ray C. Edwards, Wauwatosa, Wis.

Pocket Kit for Young Fishermen Carries Necessary Equipment

Small boys who like to keep fishing equipment handy won't tear their trouser pockets with loose fishhooks if the hooks are stored in a hollow bamboo float. Winding a line, with a sinker attached, around the float provides a compact pocket kit that contains all necessary items except bait. The bamboo is cut through the joint so the bottom end of the float is solid, and the top end is capped with a wooden plug. Pointed wooden stems are pressed tightly into holes drilled in the bottom of the float and in the plug. The line is passed through a brass ring, wired to the bottom stem.

C. L. Meehan, Lakeview, Ont., Can.

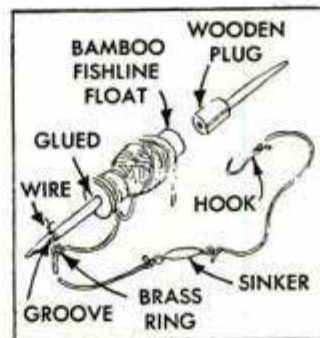

Portable Small-Parts Tray Utilizes Milk Cartons



This simple wooden box having eight or more individual containers is just the thing for carrying nails, screws or other small parts. The box is made from scrap lumber and a length of

dowel or broomstick provides a handle. The containers are formed by cutting the tops from milk cartons and standing the lower portions in the box.

Driving Tent Stakes to Hold in Wind

Tent stakes will be less likely to pull loose from the ground on a windy day if two of them are driven together to form an X. In this way, the pull of each rope is evenly divided between two stakes, affording double the usual amount of holding power. — Edward Stevens, Michigan City, Ind.

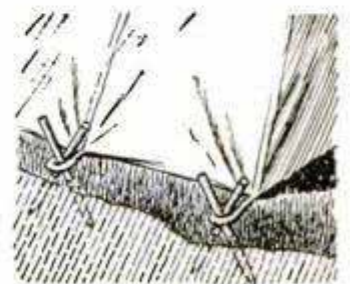

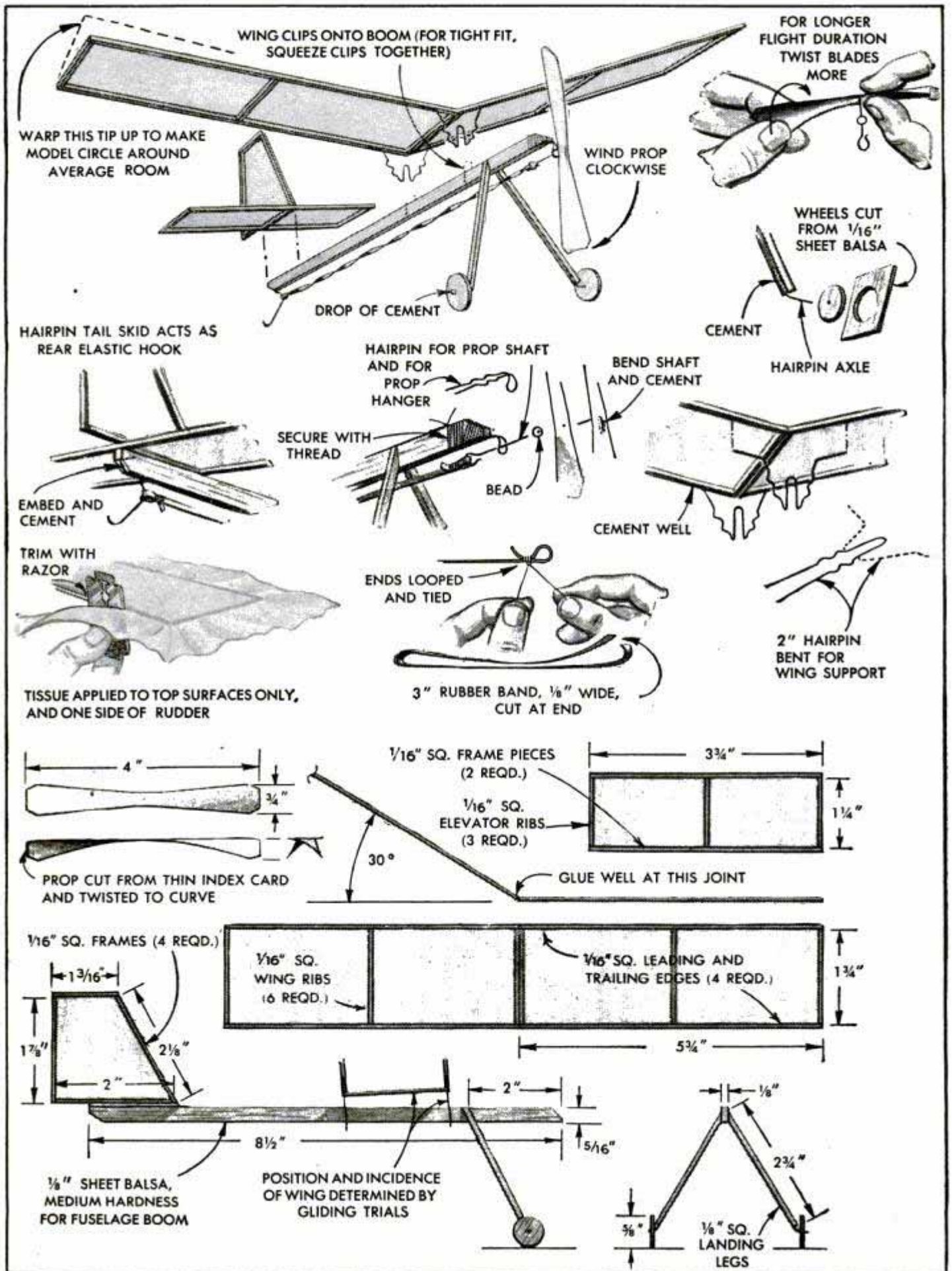

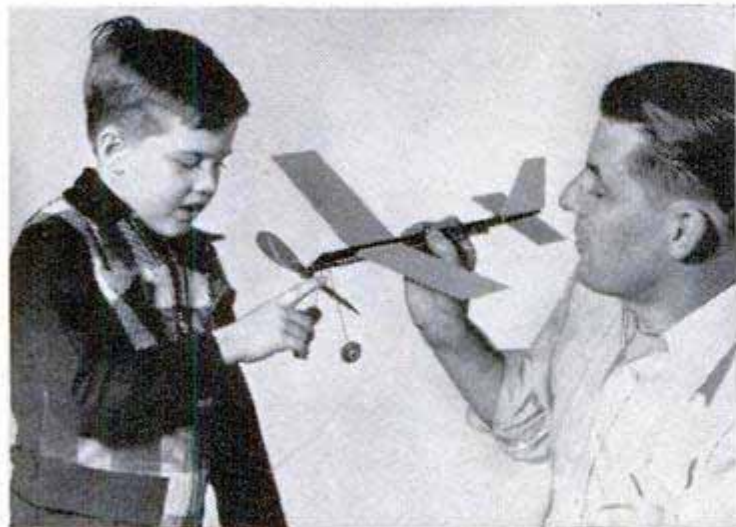

By Henry Clark

BRIGHTEN up those dull evenings and rainy Sunday afternoons by flying Giggle-Getter for your little boy or girl. Too light to do any damage, the tiny plane is ideal for staging an impromptu air show right in the living room, and its ridiculous antics are sure to bring peals of laughter from the whole family. You can build Giggle-Getter in an evening—its construction is that simple. Only materials needed are several balsa strips, a piece of sheet balsa, an index card, some tissue paper and cement. The tissue is attached to the frames with flour-and-water paste and the edges are trimmed with a razor blade. Use hairpins for the fittings and a rubber band to power the plane. With the prop fully wound, the plane will make as many as three circuits around a large living room. Before winding the motor, check the flight characteristics with a few glides, moving the wing forward or backward and adjusting its angle to obtain the best flight path.



Magazine Pages Removed Neatly

Using a razor blade or a knife to remove a page from a magazine often results in mutilating the text or details on the page being removed and also cutting into the adjoining page. However, this can be done neatly and without damage to adjoining pages by passing a loop of thread over the page and pulling it as shown.



Andrew Vena, Philadelphia, Pa.

Washing Machine Churns Butter

A washing-machine agitator comes in handy to churn a small amount of butter. The cream is poured into a glass jar which is tightly capped and then wired to the top of the agitator. The wires can be fastened so the jar will not slip out when the machine is in motion by looping one wire around the neck of the jar and another around the jar near the bottom. A third length of wire is secured across the bottom of the jar. Finally, a wire bail, which is slipped over the top of the agitator, is attached between the two loops.

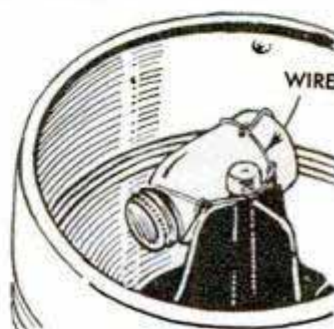

Wayne A. Ward, Watertown, N. Y.

Tab Fastened to Car-Door Switch Keeps Interior Lights Off

When the interior lights of a car are operated by automatic door switches, they, of course, will stay on as long as the door is open. If the door is left open for an extended period of time, the lights are likely to run down the battery. To avoid this when working on the car or sending it to a garage for repairs, simply attach a sheet-metal tab to the switch plate, fastening it with the lower screw so it is loose enough to be moved. The tab is swung over the switch button to keep it depressed when the door is open and moved out of the way when not needed.

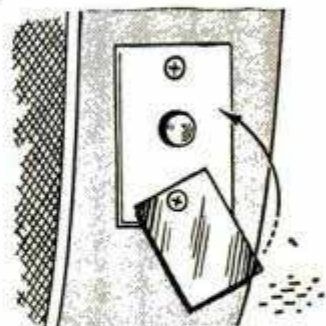
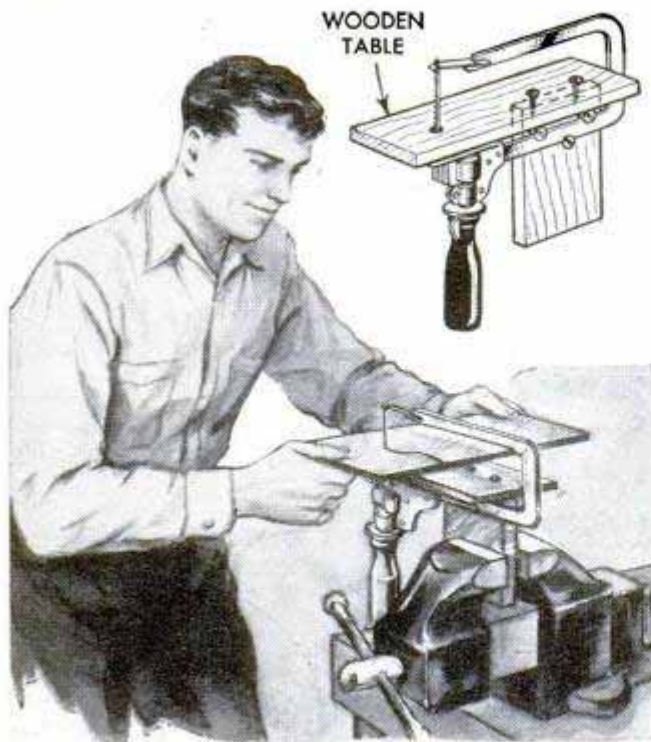

Table on Electric Coping Saw Permits Mounting in Vise



To increase the usefulness of an electric coping saw and insure a right-angle cut, one craftsman fitted a plywood table to the saw and clamped it in his workbench vise. Thus, he can use the tool as a table-model jigsaw and guide the work with both hands. A hole for the saw blade is drilled through the table and the latter is screwed to a block of wood which is clamped in the vise. Three roundheaded screws driven into the side of the block hold the saw frame in place. A piece of sheet metal screwed loosely to the saw handle holds the trigger-type switch closed, and is swung out of the way to release the switch.

Steven Morenoc, Fall River, Mass.

Food Bag Keeps Flashlight Dry

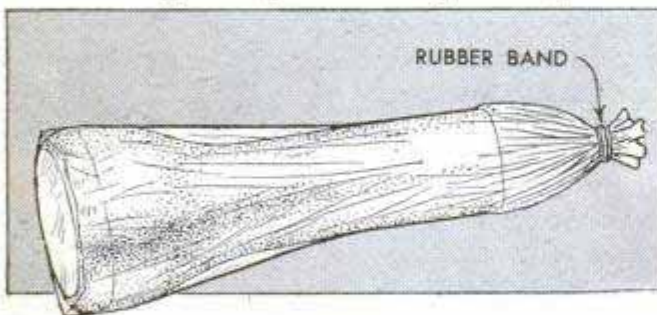

Before going on a fishing or camping trip, enclose your flashlight in a Cellophane food-freezing wrapper or a transparent plastic food bag. This will keep the flashlight watertight for use in the rain and, even if it is dropped from a pier or boat into shallow water, it can be retrieved in perfect condition. Wrap the bag or sheet

of Cellophane around the flashlight and secure the end tightly with a rubber band. The switch can be operated through the covering without damaging it.

Bird Feeder From Gallon Can

Dry feed in all kinds of weather is a distinct feature of this bird feeder made from a gallon can. Opposite sides of the can are cut in half lengthwise, and the upper halves are bent outward to form awnings. Sharp edges of the can should be folded over or filed smooth. The feeder is mounted on the top of a post.



Victor H. Lamoy, Upper Jay, N. Y.

Lasting Filler for Wood Cracks

For filling cracks or holes in wood, I use a mixture of sawdust and resin glue. This provides a lasting repair which can be painted successfully. Use fine sawdust, preferably from a sander, and stir it into the glue until the mixture is the consistency of putty. Then work the filler into the crack, leaving it raised slightly above the surface, as it tends to shrink.

S. H. Winchester, St. Petersburg, Fla.

Balancing Rubber Fan Blades

Vibration of a rubber-bladed ventilating fan in a car can be reduced or completely eliminated by balancing the blades. To do this, temporarily attach an inner-tube patch to first one blade and then another, checking the balance of the fan until an improvement is noticeable. After the "light" blade has been determined, try placing the patch at various distances from the fan hub. When the patch is located in a position at which the fan runs most smoothly, permanently fasten the patch to the blade with rubber cement.—Ed Packer, Chicago.

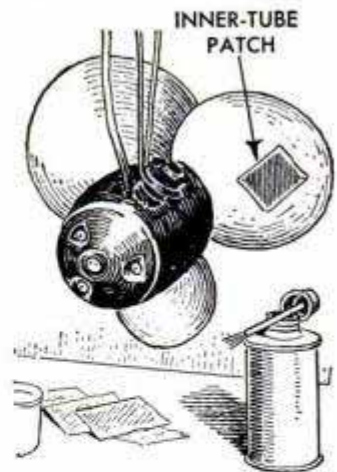

House plants can be prevented from growing lopsidedly by turning them frequently to expose opposite sides to the sun.

Well Pump Modeled in Walnut Forms Lamp Base

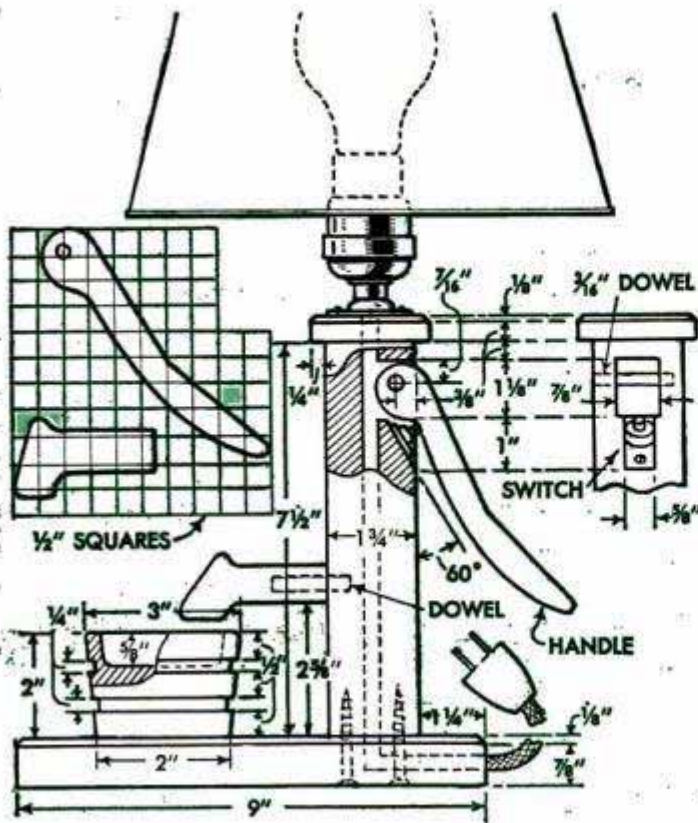

A scale replica of an old, wooden well pump forms the attractive base of this reading lamp. As will be seen from the construction details, pressing the handle turns the lamp on and off. Select a grainy square of walnut for the column, and center a $\frac{5}{16}$ -in. hole through it lengthwise to permit passage of the lamp cord. Jigsaw the handle and spout from $\frac{1}{2}$ -in. walnut stock, using the squared pattern as a guide. Then mortise the column for the handle and run a chisel cut into the bottom of the mortise at a 60-deg. slant to form a mounting pad for the switch. Make the base from 1-in. walnut 5 in. wide and 9 in. long. Chamfer the top edges and drill two $\frac{5}{16}$ -in. holes at right angles for the lamp cord as indicated

by the dotted lines. Make the weather cap for the top of the pump column from $\frac{3}{8}$ -in. stock and drill holes in the cap for the cord and screws holding the flange-mounted socket. Before assembling the parts, pass the lamp cord through the base and column and wire the switch and socket. Then dowel the spout to the column and screw the column to the base. Pivot the pump handle on a small dowel and, finally, turn the water tub from walnut to the dimensions indicated. If desired, the tub can be scored to simulate staves. Fill the wood with a walnut-colored filler. Follow this with a coat of white shellac, and then finish with paste wax polished to a soft sheen.

I. M. Fenn, Chicago.

Hook Bent From Wire Coat Hanger Eliminates Flush-Tank Leak

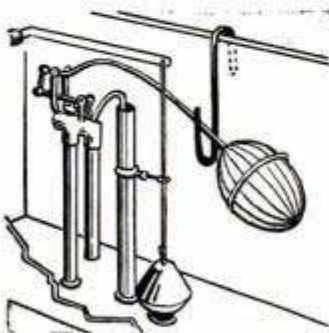

If a flush tank leaks persistently even though the parts and working action seem to be in good condition, the trouble may be caused by the float interfering with the seating of the ball valve at the bottom of the tank. When this is the case, it can be corrected by means of an S-hook bent from a wire coat hanger. The hook, which is hung over the side of the

tank, is bent so that it stops the float when the latter has dropped far enough to open the inlet. However, the hook keeps the float sufficiently high to prevent interference with the movement of the ball valve.

Aluminum Foil Speeds Ironing

Spreading a sheet of aluminum foil over the ironing-board pad before tying down the cover speeds ironing considerably. The metal keeps the moisture in sprinkled clothes, reflects heat from the iron and thus helps to produce steam.

D. M. Gwinn, Anderson, Ind.

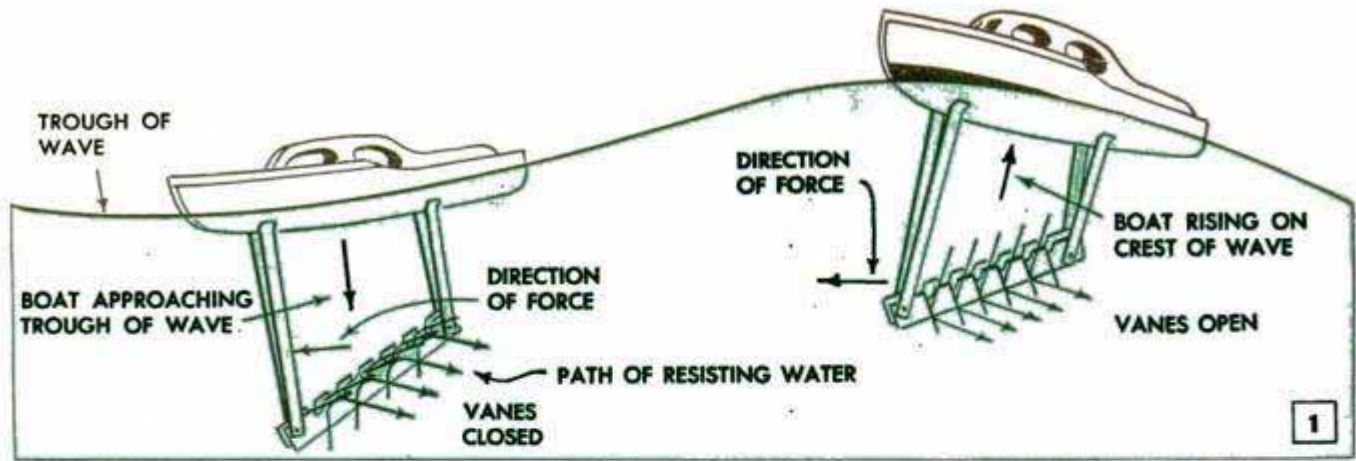

This "wave motor" drives a 3-ft. model boat at rowboat speeds in a light fresh-water chop. There are no springs to wind, no sails to trim and no need for a keel or rudder



WAVE-POWERED

By Austin H. Phelps

YOUNGSTERS and grownups alike will get a thrill out of the performance of this model-size wave-powered boat. The hull is made from balsa wood and is scaled down to about 36 in. in length using as a prototype almost any design that strikes your fancy, from a submarine to an ocean liner. However, models with a comparatively low, streamlined superstructure give the best performance as this type offers less wind resistance. Fig. 1 shows how the "motor" works. Wave movement diminishes a short distance below the surface and, if an inclined plane is suspended in this comparatively still water, it will be drawn upward as the boat crests a wave. The inclination of the plane surface (in this case, the metal vanes), acting against water resistance, propels the boat forward as in the right-hand detail in Fig. 1. As the boat passes the crest and approaches the trough, the vanes close or, in effect, reverse, and the propelling forces act on the opposite surface of the vanes. As the boat reaches the trough, the vanes automatically reset to the open position and the cycle repeats. Thus, the wave motor, Fig. 2, is simply a series of inclined vanes, B, supported by the struts C and D, which are attached to the bottom of the boat. The parts A, B, C, D and E in Fig. 2 are detailed in Fig. 3. Cut the vanes, part B, from half-hard sheet aluminum, .0159 in.

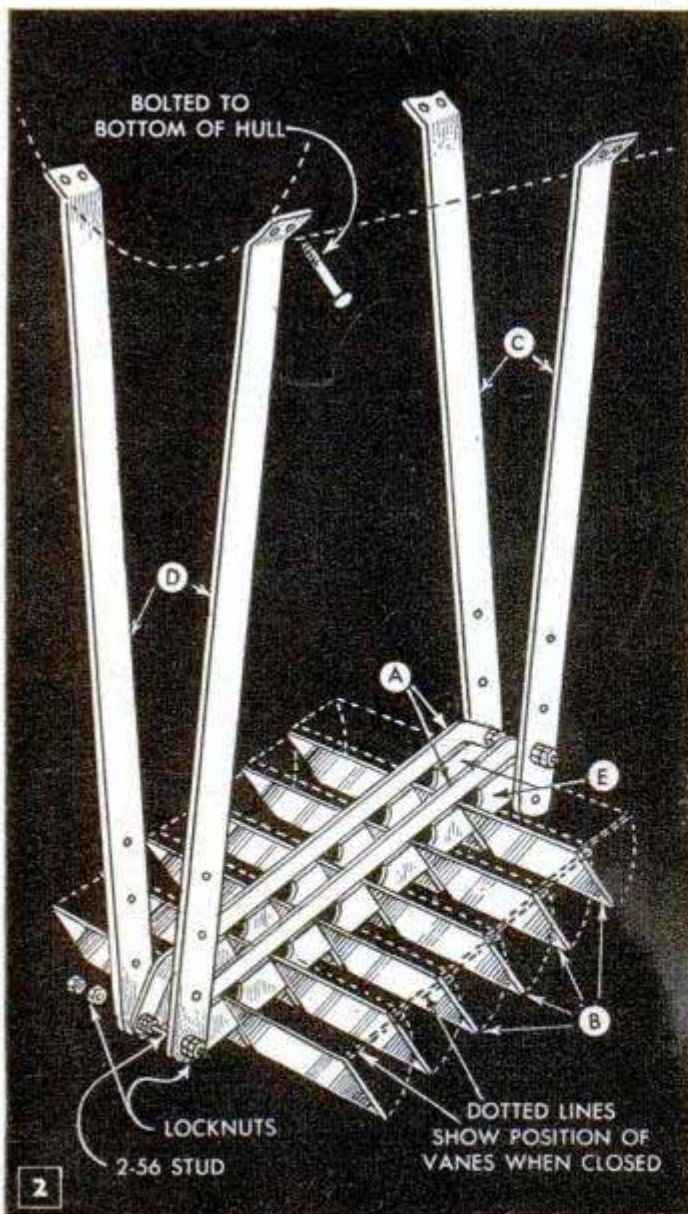



MOTOR PROPELS MODEL BOAT

thick (26 B & S gauge). Care should be taken to cut the vanes to exact size, particularly the width, so that they will overlap slightly when in the closed position. Remove all burrs from the cut edges. If the vanes are bent slightly in the cutting operation, hammer them flat with a soft mallet. The same care should be taken in cutting the notched parts E to duplicate dimensions. Use half-hard aluminum .0640 in. thick (14 B & S gauge) for these parts. The notches can best be cut with a hand scroll-saw or coping saw fitted with a fine-toothed blade. File out the saw marks and smooth the curved edges of the notches with fine emery cloth. Parts A can be cut from the same material as parts E, or they can be cut from $\frac{1}{8}$ -in. aluminum as are the front and rear struts, parts C and D. Bend the ends of the parts A to a 45-deg. angle as shown, hammer the bends flat if necessary, and drill all holes indicated on parts C, D, A and E. Now the motor is ready for a trial

assembly. Make studs by cutting 2-56 threads on each end of a 2-in. length of $\frac{3}{32}$ -in. brass rod. Assemble the parts as in Fig. 2, using eight brass locknuts on each stud. The important thing is to make sure by trial assembly that all vanes open and close fully, and that each one moves freely without binding at any point. Unless, the error in hand cutting has been considerable, the vanes can be adjusted for free movement merely by changing the position of the locknuts. Shifting the locknuts slightly either way along the threaded ends of the studs will vary the distance between the parts E. After it is correctly adjusted, attach the assembly to the hull with 2-56 brass bolts which pass through the bottom of the hull and are held with nuts turned down on large washers to prevent cutting into the soft wood. The vane assembly should center under the hull at a point just aft of midship. Experiment a little to find the correct position of the vanes.

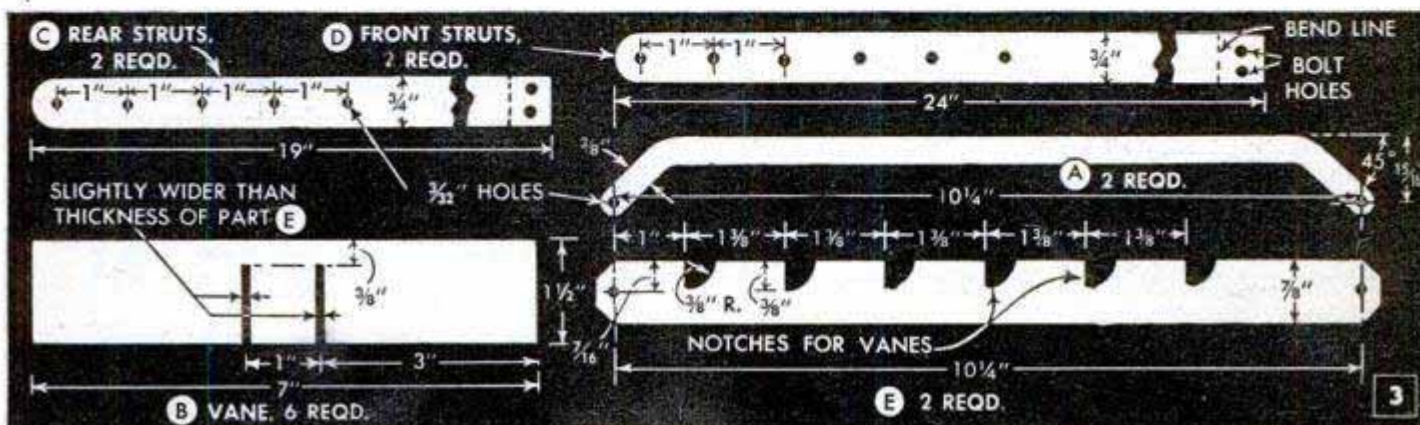

More Room on Indoor Clothesline Provided by Wooden Slats

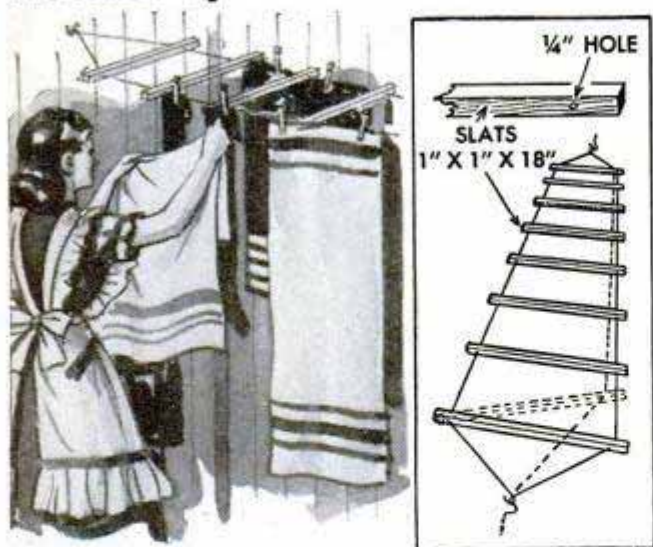

Where washing must be hung on an indoor clothesline in a limited amount of space, more clothes can be hung in the same area by using wooden slats to separate a double line. In this way, additional clothes may be hung over the slats and the two lines can be supported by one hook at each end. Holes should be drilled about 1 in. from the ends of the slats so the clothesline can be threaded through them. To balance the clothesline, adjust one of the end slats as indicated by the dotted lines.

John P. Gillese, Edmonton, Alta, Can.

Insulated Toggle-Switch Extension Improvised From Fuller Ball



An ordinary fuller ball pressed over the end of a toggle switch provides an extension which makes the switch easier to operate. This is especially handy on power tools, as the switch can be snapped off quickly in case of an emergency. In addition, the ball forms an insulated finger grip to eliminate the danger of shock.

Richard Hanscom, Elmhurst, Ill.

Refinishing Plastic Novelties

If plastic book ends, picture frames and trinkets have become scratched and dull, their original luster can be restored by sanding and polishing. Using wet-or-dry sandpaper, begin with a coarse grade (for deep scratches) and progress through two or three intermediate grades to the finest one. If the object merely looks dull be-

cause of minute scratches, the finest grade alone will be satisfactory. Rinse the object with water between the sandings. After sanding, polish the surface with a commercial buffing or polishing compound, pumice or tooth powder, using a moistened pad of soft cloth for an applicator and rubbing vigorously with a circular motion. Finally, wash away all traces of the polishing compound and apply a wax polish with a clean, soft cloth. This fills in any remaining scratches and is a protective coating.

Robert Hoppough, Waukegan, Ill.

Swordfish Paper Knife in Hardwood Forms Attractive Desk Accessory

This little swordfish opens your mail with its beak. Carved from hardwood, its body forms a novel handle. After sawing a rough blank from a piece of walnut, maple or other fine wood, carve the fish with a sharp jackknife, smoothing with sandpaper and steel wool. The gills and mouth can be cut with a veining tool and the eye can be made in two ways. One is to form a $\frac{1}{16}$ -in.-deep socket with a $\frac{1}{8}$ -in. drill, using the head of a straight pin as the pupil. The shaft of the pin is first cut off so it is only about $\frac{1}{4}$ in. long and this is driven into the eye socket. The other way is simply to drill the eye socket deep enough to receive a white bead which is cemented in place. Before installing the eye, however, wax and buff the paper knife, being careful not to break the fins and tail.—Hi Sibley, Nuevo, Calif.

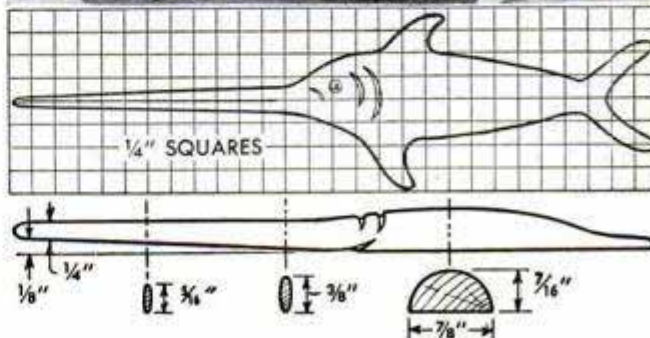

Two-Way CANDLESTICKS



By *Benj. Nielson*

BY A SIMPLE half turn of the ball, which is mounted on a concealed pivot pin, these novel candlesticks are adapted for use either on a table or a wall. Turning them is an interesting job for the craftsman who likes to work at the wood lathe. Use a fine cabinet wood such as maple, walnut or mahogany. Turn the ball candle sockets first, using a special template made from heavy cardboard or thin hardwood. Work slowly, checking the work frequently to assure that the balls are turned to true

spheres. Drill each ball as indicated in the sectional view. The tapered hole forming the candle socket is drilled while the ball is still in the lathe. To finish the ball, apply a thin coat of shellac. Then immediately moisten a pad with alcohol and polish the work with the lathe running. Proceed in a similar manner when making and finishing the base, using a special template to bring the concave cut to exactly the same radius as that of the ball. Drill meeting holes from the bottom of the base to provide space for an L-hook, and counterbore for the pivot pin. Then glue felt to the base.

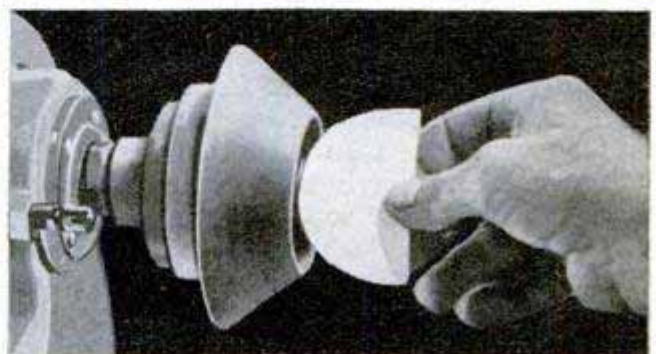
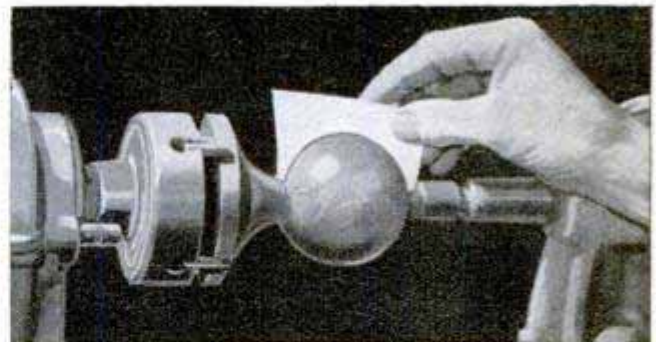
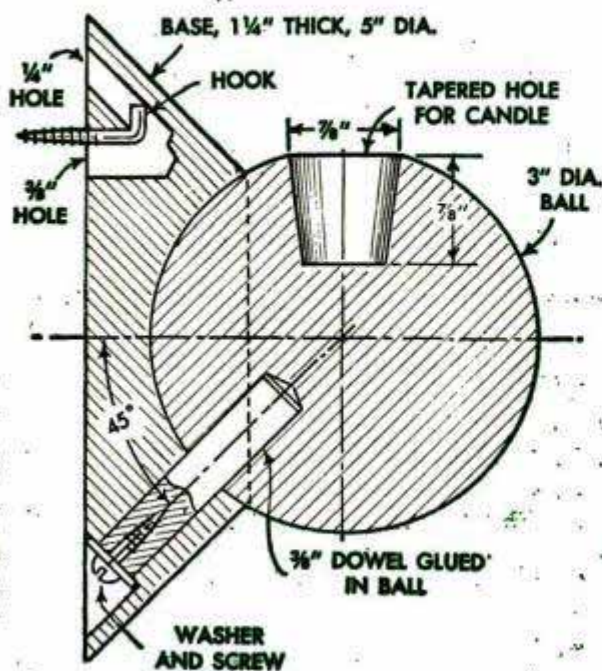

Dowel Chucked in Drill Press Serves as Spindle Sander

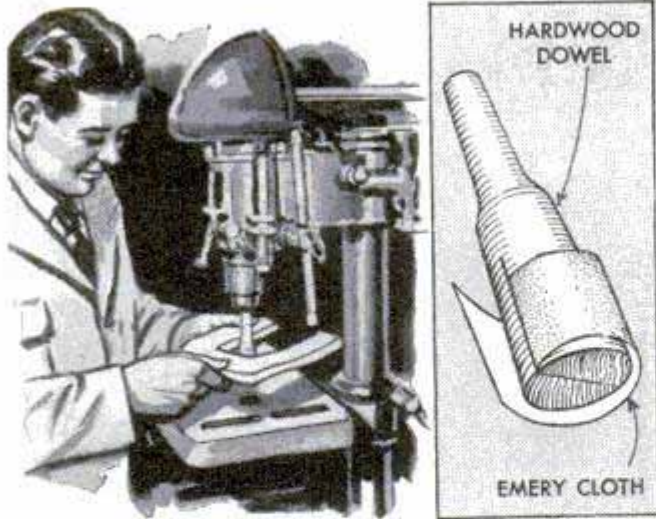

Chucked in a drill press, a hardwood dowel forms a spindle sander which is ideal for quickly smoothing the edges of intricate scrollwork. One end of the dowel is tapered to fit the drill-press chuck and the other end is slotted. Then a 1-in.-wide strip of emery cloth is inserted in the slot and torn off so that it completely encircles the dowel. If the cloth is mounted as shown in the detail, it is not necessary to glue it, as the clockwise rotation of the drill press will hold it in place.

Dick Hutchinson, El Monte, Calif.

Inside Measurements Taken Quickly By Means of Folding Rule

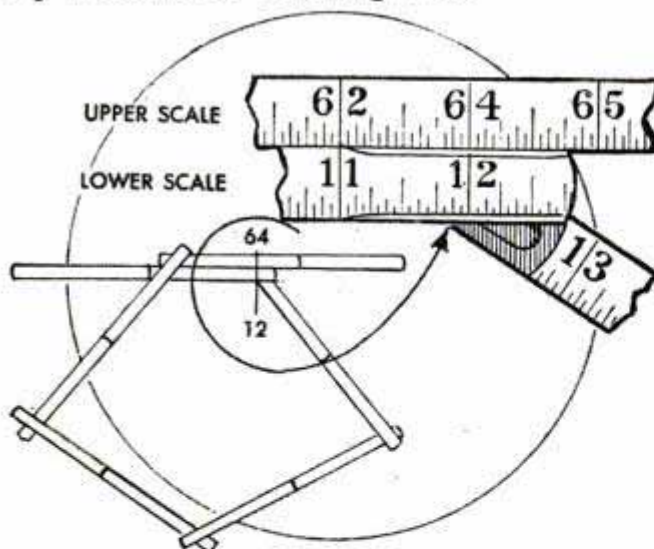

Using an ordinary 6-ft. folding rule, inside measurements can be taken quickly and accurately. This is especially handy when installing shelves in cabinets, measuring windows for screens or storm sash, etc. Simply fold the rule to form a circle, as shown, placing the ends against the sides of the cabinet or window frame. Then, using a reading on the lower scale as a refer-

ence mark, add this dimension to the difference between the dimension directly above it and 72 in. Thus, in the example, 72 in. minus 64 in. equals 8 in., and 8 in. added to 12 in. is 20 in., which is the distance between the ends of the rule.

Robert M. Barry, Chincoteague, Va.

Trapping Frogs With Oilcan

Fitted with a wooden handle, a 5-gal. oilcan provides an excellent "net" for catching frogs. The top and bottom of the can are cut away and the handle is nailed between two sides at the top. When a frog has been sighted, the can is quickly slapped over it. The frog cannot jump out of the can because of the vertical sides and it is a simple matter to reach down into the can and remove the frog.

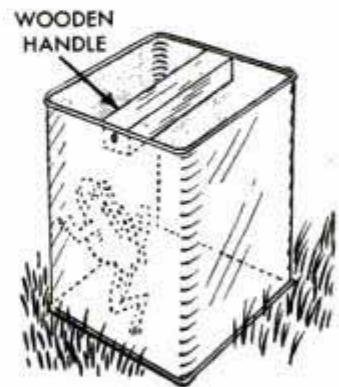

Renewing Screw-Hole Threads

When threads formed by a screw driven in a piece of wood have been stripped so that the screw no longer holds fast, they can be renewed by the use of wood putty. First, drill the hole slightly oversize and fill it with putty. While the latter is still soft, carefully turn the screw about half-way into the hole to make a perfect thread and remove it. Then, allow the putty to harden thoroughly and drive the screw into the hole, using the previously formed threads as a guide.



Stopping Outboard Motors Properly

Do not shut off your outboard motor while it is running at high speed as this results in fouled spark plugs and hard re-starting. Instead, slow the motor down to trolling speed for half a minute or so before stopping. This will burn out excess oil from the combustion chambers.

Raymond B. Lee, Daly City, Calif.

☐ Removing cigarette burns and stains from silver can be simplified by rubbing the juice of an onion over the stained portions of the surface with a soft cloth.

STRIKES AND SPARES in miniature

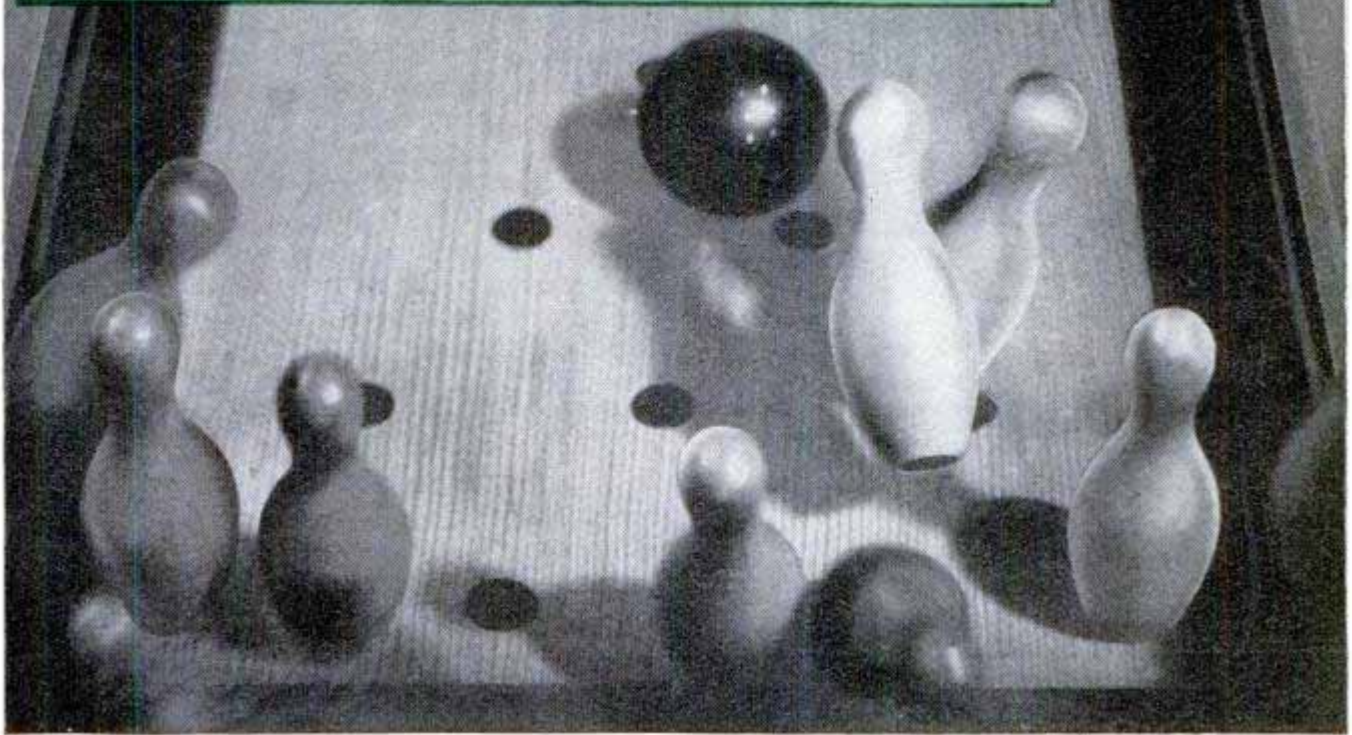

By R. DeWitt Miller

HERE'S regulation bowling scaled down to pint size. All items of the equipment, except the length of the alleys, are reduced to approximately one-fifth size, making the unit ideal for use in home playrooms. This reduction scale makes a golf ball just about the right size and weight for the miniature bowling ball, Fig. 3, and brings the pins down to a height of 3 in. and a maximum diameter of $1\frac{1}{8}$ in. To be in the same scale with the standard 80-ft. alley, the miniature alley would be 16 ft. long. However, the details in Fig. 4 dimension an 8-ft. alley which was found to be just as effective as the longer one in duplicating the conditions of play and is, of course, a more convenient length for the recreation room. Miniature bowling is scored in the same way as the regulation game, small score sheets being ruled on ordinary typewriter paper.

The alley bed is built up from two or more pieces of $\frac{3}{4}$ -in. stock, edge-glued, doweled and cleated across the bottom. The gutters are formed by $\frac{1}{2}$ x $1\frac{3}{4}$ -in. strips assembled with an edging strip of $\frac{3}{4}$ -in. stock as shown in section B-B, Fig. 4. Note that these edging strips are 8 ft., $7\frac{1}{4}$ in. long, the $7\frac{1}{4}$ -in. extension on each side forming the frame for the pit. The sides of the pit are 5 in. wide and have both front and rear ends cut at angles as shown in

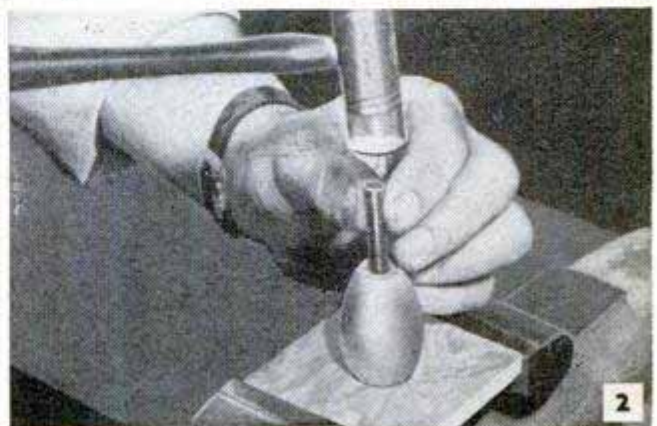
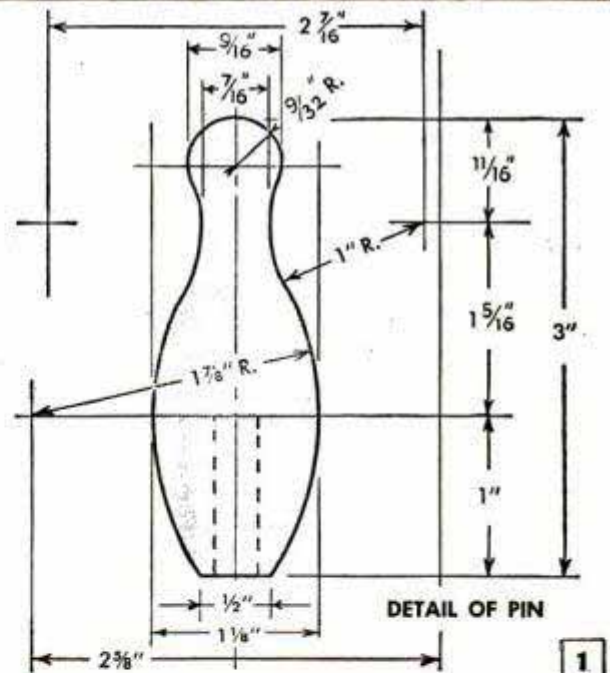

Boy-Scout Lantern Made From Tin Cans Uses Candle to Provide Light Source

Taking one of these candle-burning lanterns on your next overnight camping trip will furnish extra light without wasting flashlight batteries. In addition to costing practically nothing, the lightweight lantern is easily carried and the candle is well protected from wind and rain. The lantern is made from two tin cans, one of them providing a base and the other, which is mounted horizontally, serving as a reflector to give a spotlight effect. The can forming the base is cut away so the other will fit neatly within its sides and the two cans are soldered together. The candle is held upright in the reflector by impaling it on a short nail which is driven through the side of the can and soldered in place. A wire handle is fastened to the top of the lantern by means

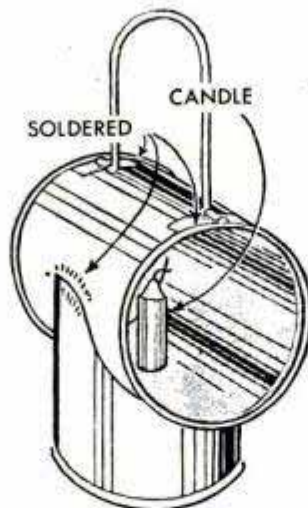

No. 10 CANS



of a metal tab soldered near each end of the can. If an opening is cut in the side of the base can, spare candles and dry matches can be carried inside the lantern. This opening can be fitted with a metal cover.

Elmer A. Anderson, Prairie du Sac, Wis.

Cardboard Inserted Under Hinge Corrects Binding Door Without Planing

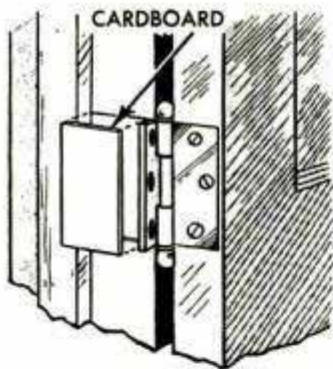

Doors that drag on the threshold or bind at the top, in many cases, can be corrected by merely inserting a cardboard shim under one of the hinges. If the door binds at the bottom, remove the

lower hinge from the jamb, fit a piece of cardboard in the mortise and replace the hinge. The shim will lift the bottom of the door off the threshold. To correct a door that binds at the top, the upper hinge can be shimmed in the same way. Although a door that binds at the top can be planed easily, this stunt is particularly helpful when the door binds at the bottom, as it makes removal of the door unnecessary.

W. H. McClay, Pasadena, Calif.

Modern Picture Frame in Transparent Plastic Supported by Wire Stand

Combining clear plastic with a stand bent from $\frac{3}{16}$ -in. aluminum-alloy wire results in an attractive picture frame which can be made in a few minutes. Bend the wire to form the base of the stand and a double loop above it, joining the ends of the wire with cellulose tape. Then, cut the picture and cardboard backing to fit between the wire loops, and make the frame by cutting a thin sheet of clear plastic to slide over the front of the picture. The plastic not only frames the picture, but protects it and keeps it free from dust.

Frank Shore, New York City.

Keep a small bag in every room for a dustcloth. These bags may be secreted in hidden, yet easily accessible, places. This will save time and steps and assure a cloth being at hand for a last-minute dusting.

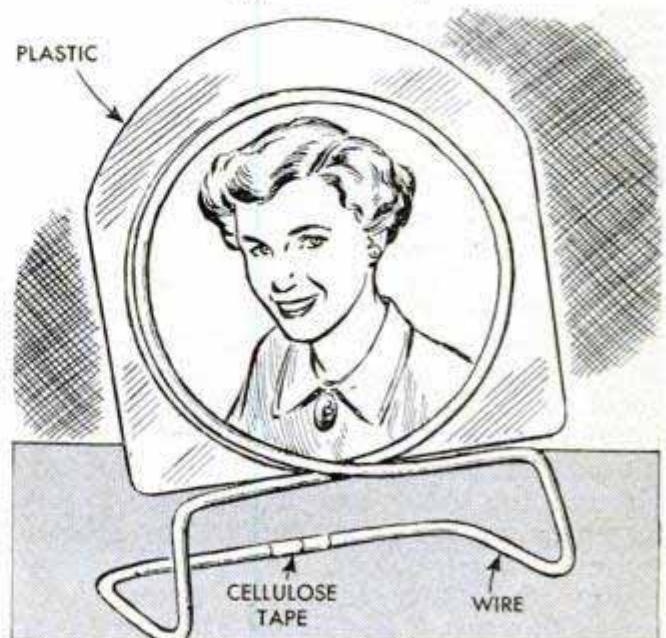

PERIODIC CHECKS

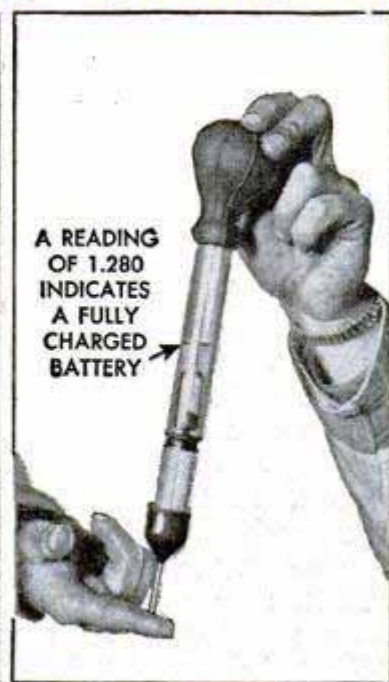
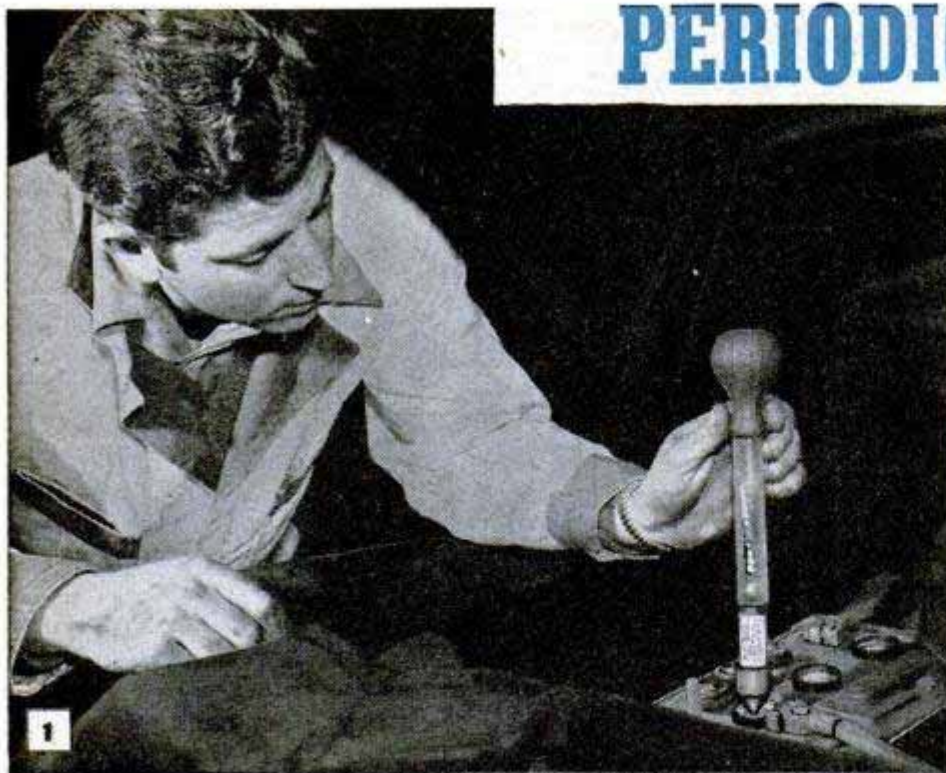

By Phil Ruskin

YOUR CAR will not stall on the highway or give trouble starting in cold weather if the starting and ignition systems are kept in top-notch condition by periodic inspection and repair. Most parts of both systems are inexpensive to repair or to replace entirely when no longer serviceable or reliable. As a rule, the battery will require periodic checks more frequently than other parts. During the hot summer months the liquid level should be checked at least once every 10 days to make sure that the level is kept above the plates in all three cells. Periodic checks with a hydrometer, Fig. 1, should show a reading of 1.280 or slightly higher. This not only indicates that the battery is fully charged, but that it is holding the charge without any appreciable loss over a period of time. Keep the battery and terminals clean and tight. On older cars it's a good idea to remove both the ground and starter leads and clean the terminals thoroughly. If the starter fails to turn the engine over steadily and strongly at any time, look for loose connections, worn or corroded leads and, of course, check the battery. Sometimes failure of the starter is due to a faulty switch, especially in later model cars having push-button starter switches on the dash. To check for a faulty switch, hold one end of a jumper wire on the relay terminal to which the lead from the switch is connected. Ground the other end of the wire to the frame or engine as in Fig. 2. The starter switch also can be checked as in Fig. 3, by simply placing the blade of a screwdriver across the switch and battery terminals. If

the starter motor turns over when either of these tests is made, the starter switch or its wiring is defective. If the starter motor does not operate, then the trouble may be in the relay or in the relay ground circuit. To check for a defective relay or relay circuit, have someone depress the starter switch and hold it in the "on" position. Hold a jumper from the ground terminal of the relay to the car frame, Fig. 4. If the starter motor turns over, the relay ground circuit is defective. If the motor remains inoperative when grounded in this way, the relay is defective and should be replaced.

A periodic inspection of the starting circuit and the starter motor should be made every 5000 miles even though the system may be operating satisfactorily. This precaution is quite likely to catch certain defects while they are in the development stage, long before a failure occurs. One important step in this inspection is to remove the dust shield from the commutator end of the starter motor and check the condition of the brushes and commutator. If the commutator is in good condition, it is easily cleaned with fine sandpaper as in Fig. 5. Do not use emery cloth for this purpose, as some of the fine abrasive grains are certain to be loosened from the cloth in this operation and may find their way into the armature bearing. If, on the other hand, the commutator brush track is badly worn or grooved, then the armature should be removed and the commutator reconditioned or the starter motor replaced. Worn brushes should always be replaced. In checking the brushes, be sure that the follower springs bear on each one with a uniform tension, and that none of the brushes

PREVENT IGNITION BREAKDOWN

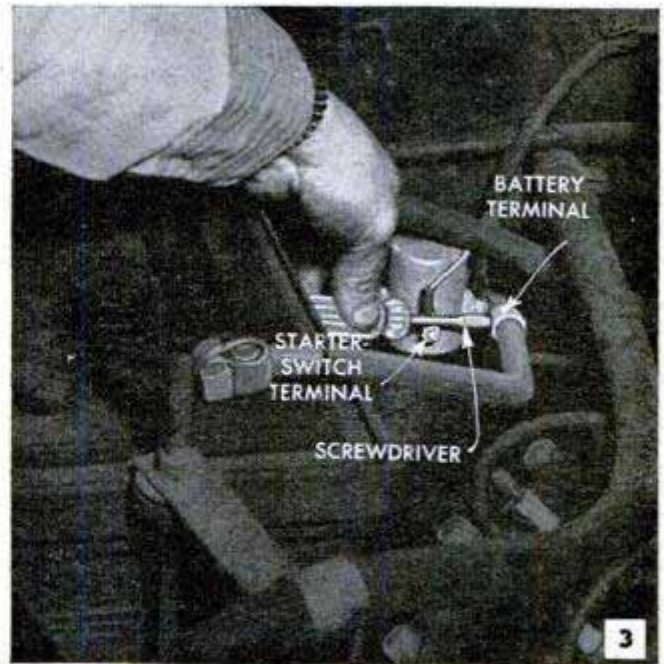
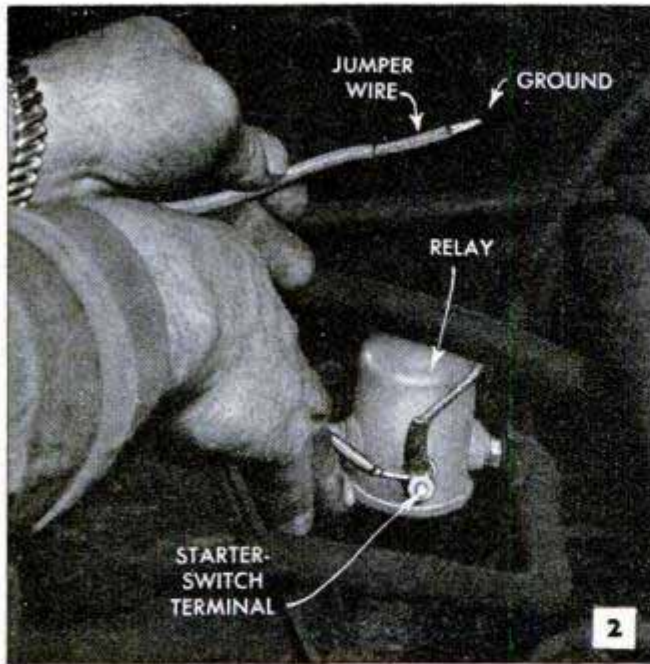

is stuck in the holders. If the starter-motor bearings are fitted with oil cups, place a few drops of light oil in the cups at each inspection or after each 5000 miles.

The generator supplies current for ignition, lights, radio, heater and lighter at all engine speeds slightly above idling speed. It also supplies current for replenishing the battery. Fig. 6 shows wiring diagrams of the two types of generator controls in common use. In the third-brush type, the electrical output is controlled by shifting the third brush in the direction of armature rotation to increase output and in the opposite direction to decrease it. However, in some generators of this type the third brush is fixed, the output being controlled by a special regulator. A circuit breaker, or cutout, is provided with all common types of generators now in use to prevent discharge of the battery through the generator when generator voltage is lower than battery voltage, and also when the generator is not running. On the shunt-type generator, the output is automatically adjusted to the requirements of the electrical circuit at all times when the car is in operation. In this system there is no manual adjustment, as the automatic voltage regulator "meters" current to the battery, ignition system and accessories as needed. Trouble in the generator circuit is indicated when the battery either loses its charge rapidly or shows a constant condition of overcharge. A simple test for faulty charging is first to note the charging rate on the ammeter at a medium engine speed. Then shut off the engine and operate the starter for about 10 seconds continuously. Again start the engine and run at medium

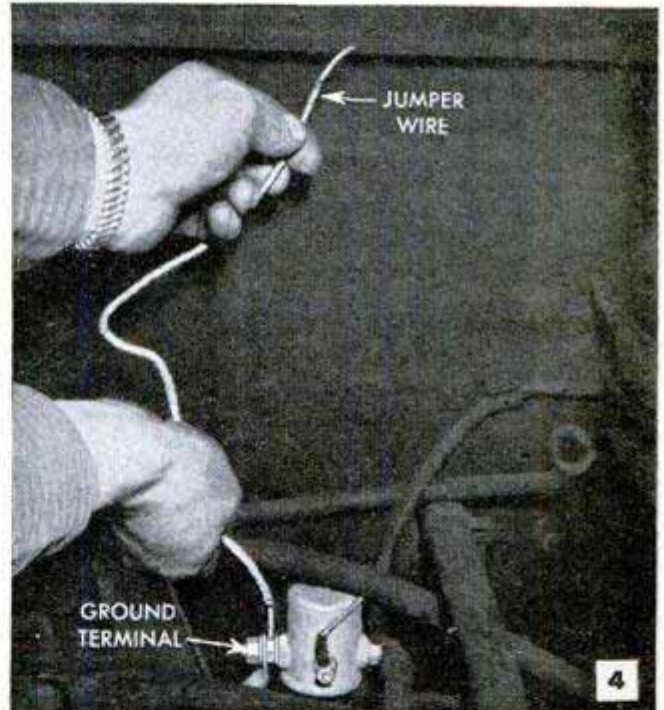

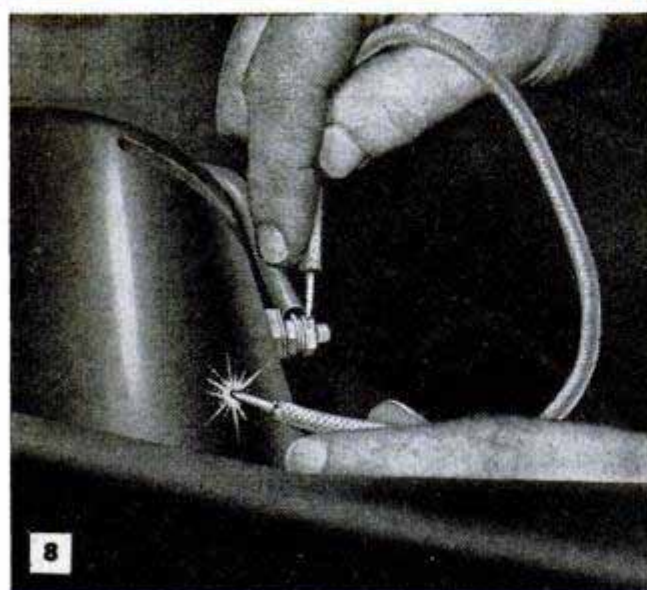
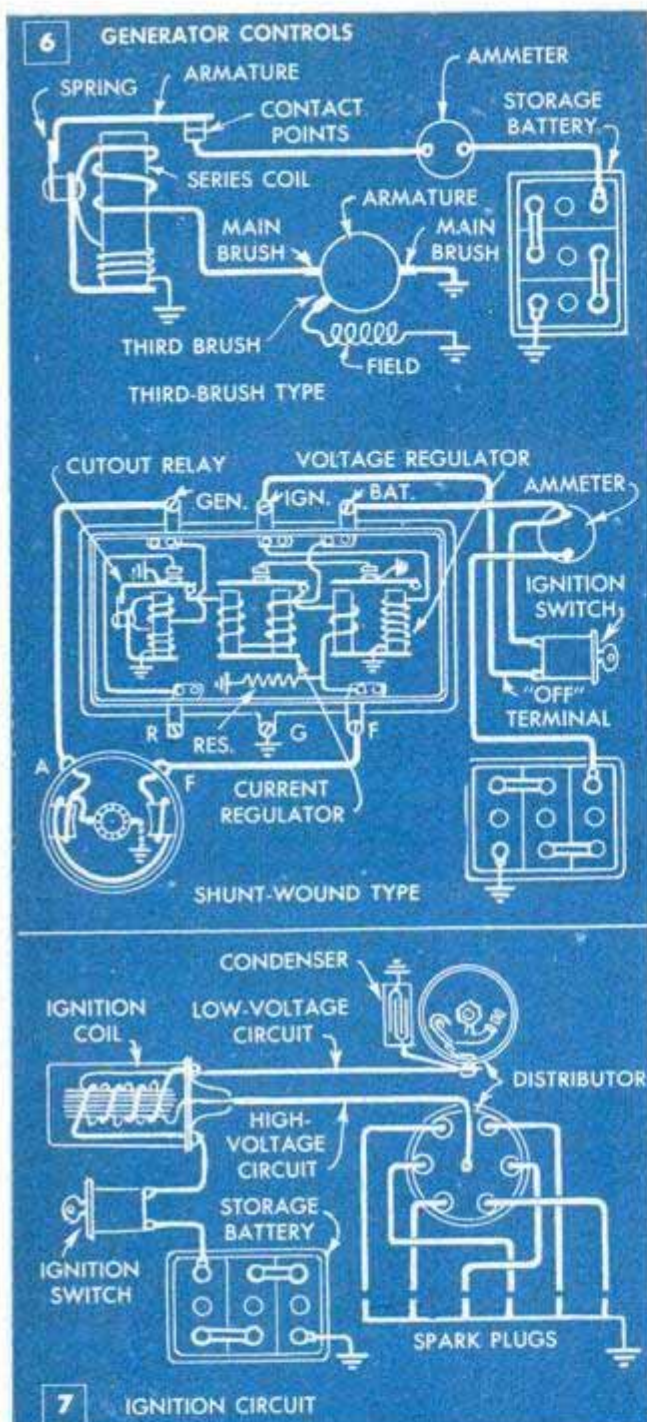

8 Checking the generator with a jumper wire. A bright hot spark indicates that the generator is charging

throttle. The ammeter should show a somewhat higher reading than before. After a few minutes of engine operation at the same throttle setting, the charging rate should taper off to about the same rate as first noted. If it does not, the voltage regulator probably needs adjusting. One thing to keep in mind in connection with this test is that high resistance in the charging circuit causes the regulator to operate as though the battery were fully charged. High resistance in the circuit can be caused by loose or corroded connections, worn generator brushes and frayed or damaged wiring. Generally it is a good idea to check for these defects before adjusting the regulator. If the ammeter shows discharge when all equipment and the ignition are off, it is likely that the cutout contacts are sticking in the closed position. If the ammeter shows no charge rate with the engine running at medium throttle, the cutout points are probably stuck in the open position. This trouble can be prevented by keeping the cutout contacts clean and adjusted to the manufacturer's specification. To check the generator itself for faulty operation, hold one end of a jumper wire on the field-wire terminal and, with the engine running, touch the other end of the wire to the ground, which may be the engine or the generator housing, Fig. 8. You should get a bright spark when the jumper makes and breaks contact with the ground. No spark indicates that the generator is not charging, and immediate repair or replacement is necessary. In servicing the generator periodically, follow the same procedure as in servicing the starter motor.

With the starter and generator circuits in good working order, any trouble with the ignition system, Fig. 7, usually is traceable to the distributor, coil, plugs or to the wiring that joins these units. A simple precautionary check is made by going over all the wiring, including that under the dash, at regular intervals. A slight twist on each rigid terminal will detect a faulty connection before it can cause trouble. Keep a careful check on the high-tension wire at the coil, Fig. 9. Often vibration alone will cause this wire to loosen sufficiently to break the ignition circuit. It will help in making even the simplest checks of the ignition system if one thinks of this as consisting of two separate electrical circuits, the primary (low voltage) and secondary (high voltage), Fig. 7. Primary current passes from the battery to the primary coil winding, then through the breaker points to the ground thus completing the circuit back to the battery, which also is grounded at one terminal. The secondary circuit originates in the secondary winding of the coil, from which it passes to the center

terminal of the distributor, then to the spark plugs and back to the ground. The high-voltage current is induced in the secondary winding of the coil when the breaker points open to interrupt the primary current. To check the coil, remove the secondary lead from the center of the distributor cap and hold it about $\frac{1}{4}$ in. from the cylinder block, or some other engine part as in Fig. 10. When the engine is turned over with the starter, you should get a bright, hot spark. If there is no spark, either the primary or secondary coil winding may be burned out. To determine which winding, remove the distributor cap and turn the ignition on. If primary current is flowing through the breaker points, it will show as a slight spark when the breaker points are opened with a screwdriver as in Fig. 11. This means that the primary winding is okay and that the secondary winding probably is burned out. Replace the defective coil. A weak spark from the secondary wire, using the above test, usually indicates a weak condenser. If the breaker points are pitted and burned, this proves it. In some cases, it will be necessary to replace both the condenser and breaker points. When replacing these parts, be sure that all connections are tight, and that the breaker points are adjusted to the recommended setting.

Any condition that builds up undue resistance in the path of the secondary circuit will result in a weak and irregular spark at the plugs. Carbon and oil or grease deposits in the distributor cap, loose connections at the plugs or in the distributor cap, frayed or broken insulation on the high-tension leads and a cracked rotor are causes of hard starting, sluggish pickup and high fuel consumption. If there are indications of burning and arcing in the distributor cap, replace both the cap and the rotor. If the high-tension wires to the plugs are worn, oil soaked, or have frayed or cracked insulation, it will pay to replace these also. Make it a rule to examine the rotor each time the distributor cap is removed. Be sure that it seats properly on the shaft and that it makes good contact with the secondary lead and the spark-plug lead inserts. Any time the ignition system is serviced, remove and clean the spark plugs and check the electrode gap on each plug. It is important to set the spark-plug gap to the exact specification of the manufacturer of the car. It will be worth-while to install new spark plugs at the end of each 10,000 miles of service.

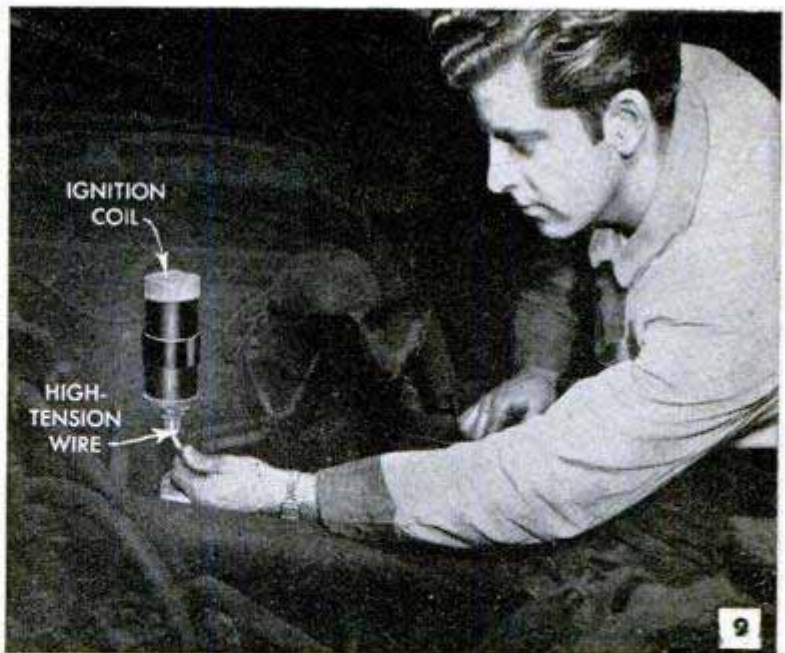

Keep a regular check on the high-tension lead at the coil



Above, a simple check will show up a faulty coil. Below, if primary current is flowing from the coil, a spark will show when the breaker points are opened

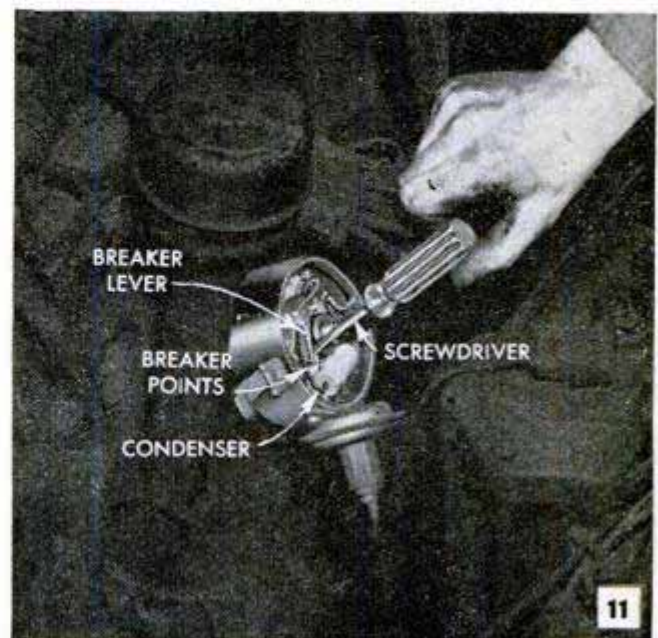

Cigarette Case in Laminated Paper Is Tooled to Simulate Fine Leather

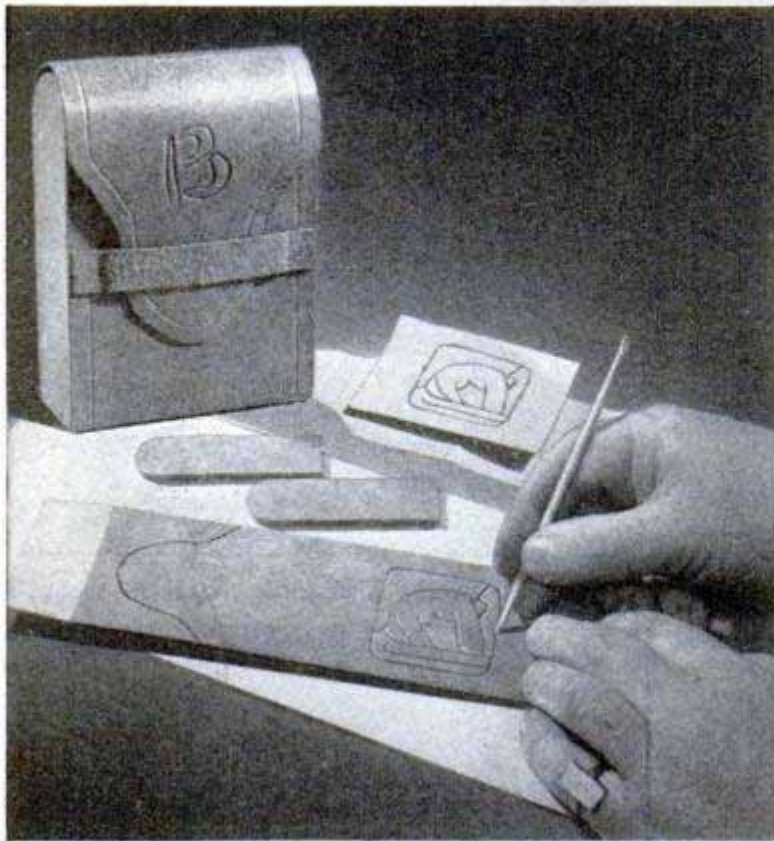

By laminating paper with resin-type glue, it is easy to make an attractive cigarette case that simulates tooled leather. First, form the sides of the case by gluing together two thicknesses of heavy cardboard. Make the front, bottom, back and cover of the case in one piece, using sheets of medium-weight paper laminated with glue. Then cover the inside of each of the parts with colored paper and the outside with leather-textured cover stock. When mounting the latter, apply the glue liberally so it will penetrate the paper and permit tooling. Trace the design and, before the glue dries, tool with an orangewood manicure stick. Lubricate the point with paraffin, and apply the stick with sufficient pressure to tool the paper deeply. Bend the bottom and cover to shape before the glue sets and glue the three parts together. Glue a strip of laminated paper across the front of the case to serve as a hold-down for the cover.

Wooden Drill Jig Facilitates Locating Centers of Dowels and Round Stock

Centers of dowels and round stock are located and marked in one operation with the aid of this wooden drill jig. The latter is a 2½-in. hardwood cylinder about 3 or 4 in. long. This is drilled exactly through the center with a ¼ to ½-in. bit and tapered inward 45 deg. from the edges to the center hole. In use, the jig is slipped over a bit of

the same diameter as the center hole, upper photo, so the end of the bit is inside the hole. Then, the work is pressed firmly into the jig and against the rotating bit, as in the lower photo. The angular sides of the jig guide the work so the bit can mark the exact center. Be sure to oil the hole in the center of the jig to prevent the bit from cutting into the wood and enlarging the hole. This method can be used either on a drill press or a lathe with a drill-chuck attachment.

W. G. Waggoner, Sacramento, Calif.

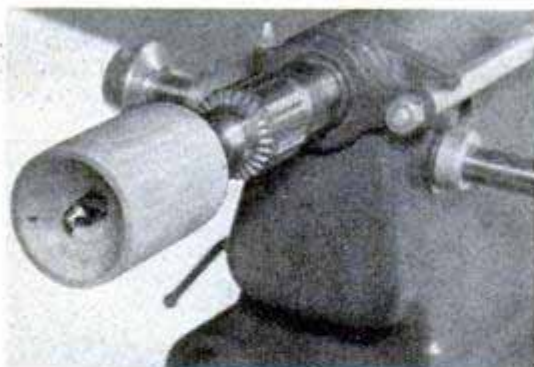

Cloth Placed Over Putty Knife Removes Excess Paint

When painting woodwork, excess paint is bound to flow from the quarter round onto the varnished floor or from the trim to the wall. This can be wiped off quickly without smearing the newly painted surface by using a single thickness of cloth wrapped around the blade of a putty knife.

The cloth is rubbed lightly over the wet paint to absorb and erase it.

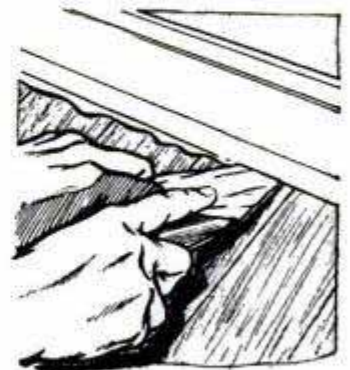

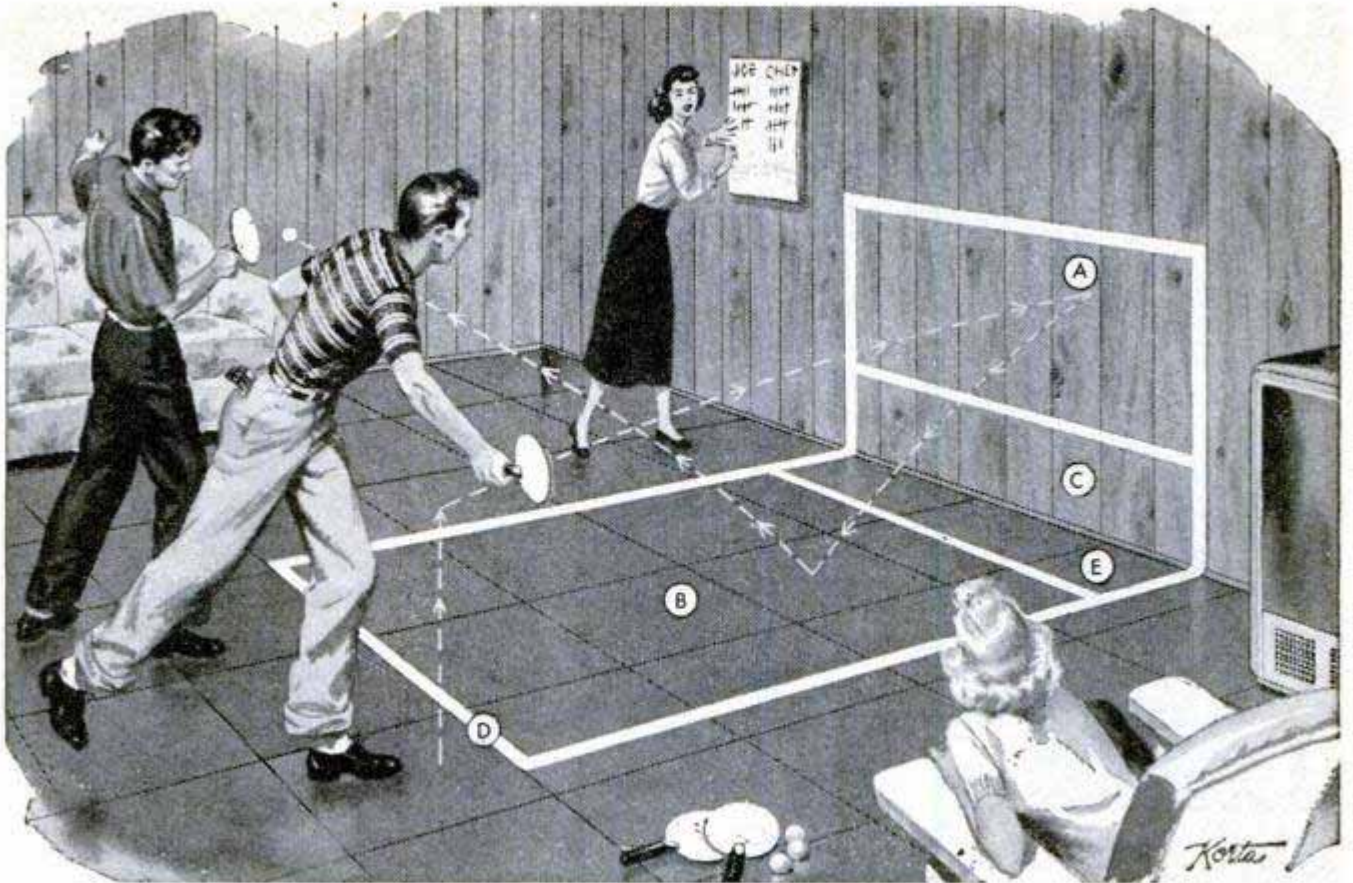

"21" Game Combines Squash and Table Tennis

If you like plenty of fast action in the rumpus room, then here's your game. It's similar to table tennis, the scoring being the same, and is played with the same type of balls and paddles. The court boundaries are lines painted on the floor and wall of the room, or strips of masking tape can be used for this purpose. The lines enclose two courts on the floor and two on the wall as shown. The over-all floor space required is 5 ft. wide and 10 ft. long and the wall space is 4 ft. high and 5 ft. wide. Spaces C and E are each 16 in. wide and 5 ft. long. Spaces A and B are called the wall court and the floor court respectively. If desired, the wall and floor courts can be made larger. In starting the play, the first player serves the ball by bouncing it on the floor behind the base line D. On the first bounce, the ball is batted against the wall court A, from which it must bounce back into court B to remain in play. As the ball rebounds from court B, the second player hits it back against court A, thus putting the ball in play alternately between the players. Points are scored by a player when his opponent faults, or fails to return the ball. Each player serves for five points alternately, and the winner is the first player scoring 21 points. Should the game be tied at 20-all, the winner must take two consecutive points, as in table tennis. Faults are: bouncing the ball on serve inside the base line D, ball hitting the wall outside of

court A, ball bouncing back onto the floor outside of court B. If the ball strikes within spaces C or E in the course of play, this also is counted a fault. A player must move quickly out of the way after making a shot, as it is counted as a fault if the ball strikes his body on the rebound, thus preventing his opponent from returning it. Except on the serve, players may step within the boundaries of court B whenever necessary. The rules given are merely suggested ones which can be varied to suit conditions.

Anchors for Cemetery Vases Cut From Coat Hangers

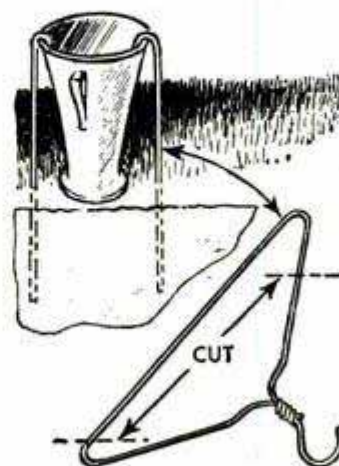

Pottery vases and jars which are used to hold cut flowers on a grave are likely to be blown over by the wind unless they are anchored. Excellent anchors can be cut from wire coat hangers as shown in the detail. Make two of these for each vase and press them firmly into the ground with their hooked ends engaging the rim of the vase.

Mrs. Michael Fey, New York City.

Child-Size Mirror and Towel Rack in Bathroom Encourages Habits of Personal Cleanliness

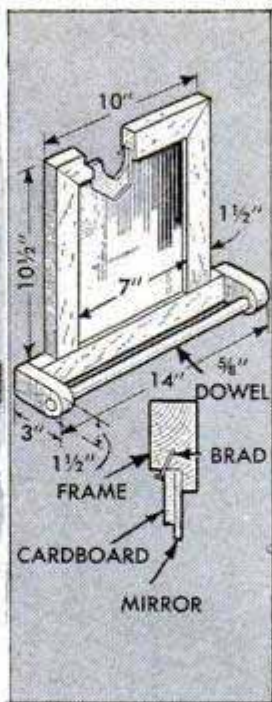

With a special bathroom mirror all her own—just like the big one over the washstand—your child won't have to be coaxed to brush her teeth or comb her hair. This miniature mirror-and-towel-rack combination is hung from the bathroom wall at a convenient height for the child. The mirror frame and rack are made from 1 x 2 and the towel bar is a length of $\frac{5}{8}$ -in. dowel. The frame is rabbeted to receive the mirror in picture-frame fashion. After the parts are glued together, the wood can be painted a color that harmonizes with the bathroom finish.

Self-Locking Garden Reel Mounted on Flat-Iron Frame Aids Row Marking

When it comes to planting straight rows, laying out neat flower borders and grading or filling-in the garden, this self-locking reel is a useful item to have at hand. The spool and shaft are mounted in a flat-iron frame which is clamped to a length of iron rod by means of a wing nut. The rod is driven into the ground to serve as an anchor. A spring-action pawl engages a ratchet on the reel shaft to hold the line taut.—W. H. Eyerly, South Norwalk, Conn.

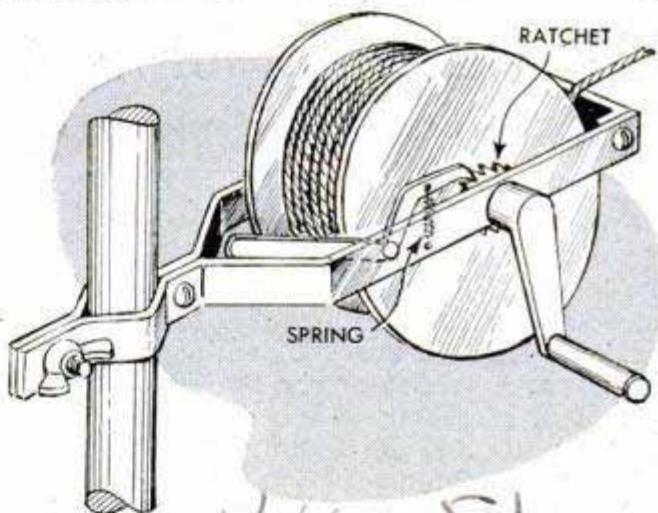

Metal Funnel Locates Keyhole

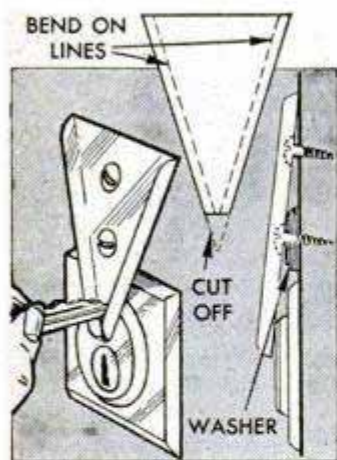

If it is difficult to locate the keyhole to your apartment in a darkened hallway, fasten a sheet-metal "funnel" above the lock to serve as a guide for the key. After cutting the metal to the shape of a triangle, bend the edges at right angles to form the sides of the funnel.

Then, screw it to the door, positioning it so that when the end of a key is slid downward against the metal, the sides of the funnel will guide it into the keyhole. If the lock protrudes from the door, place a washer over the lower screw to support the center section of the funnel.

N. V. Davidson, San Diego, Calif.

Doorstops Raise Youngster's Table

A child's table which has been outgrown will still serve as a useful play table if a couple of inches are added to its height. This can be done by attaching a wooden doorstop to the bottom of each leg. Thus, besides increasing the height, the stops, which are screwed in place, look like a turned part of the leg.

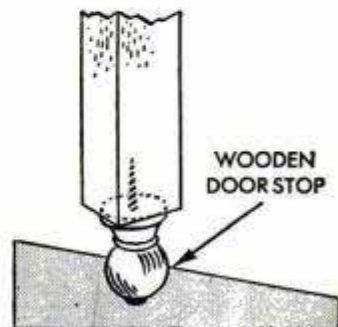

To remove burs from a dog's hair, work gun oil into the tangle with your fingers and the burs can be removed easily.

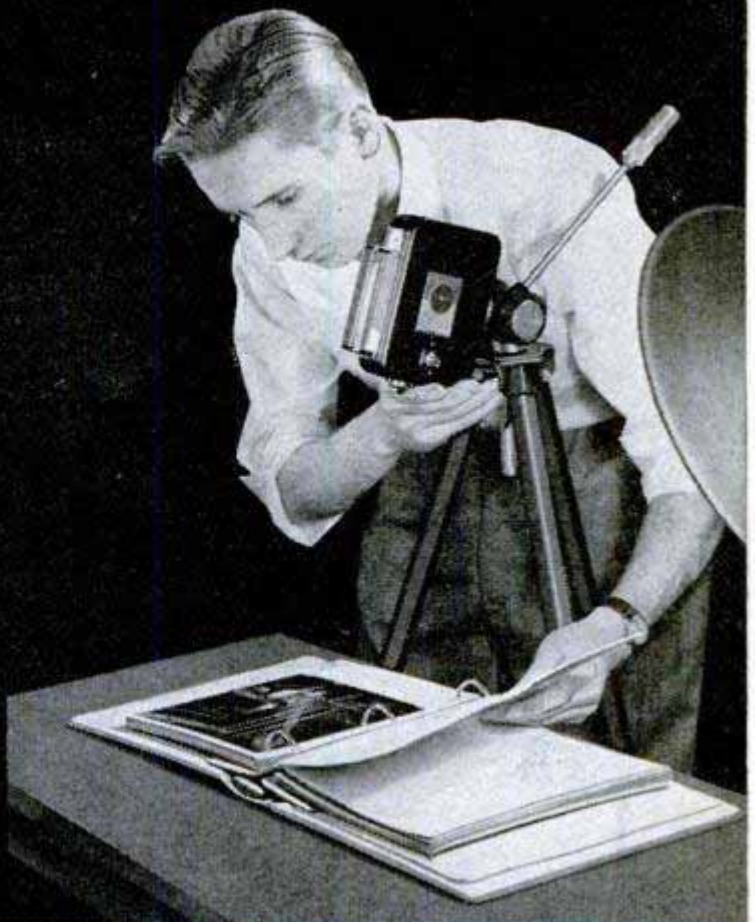
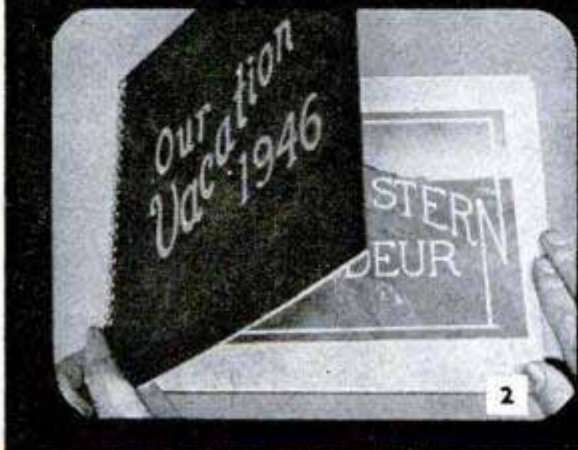

MOVIE TITLES *from your* **VACATION ALBUM**

By M. G. Winterton

THAT PHOTO album made up of choice shots taken on your vacation trip can be utilized effectively for titling vacation movie film. By carefully arranging a sequence and introducing eye-directing motion, it is easy to maintain an interesting continuity throughout the entire film. Figs. 1 to 4 inclusive suggest an opening sequence. The first, Fig. 1, introduces the album, the hand reaching for it lending just the proper amount of animation to catch and hold the interest of your audience. The next frame, Fig. 2, shows the hand turning the cover of the album in a natural manner and gives a hint of the locale where the scenes to follow were filmed. The third frame, Fig. 3, fixes the attention of the audience, titles the picture story and indicates the location. Then the page is turned, revealing the first subtitle. If you wish, other introductory shots, perhaps of the camera man, can be worked into the sequence. If your vacation movies are in color, colored postcards or publicity pictures make fine title and subtitle backgrounds over which the title can be lettered. Gummed paper letters, available at most all stationery stores, can be arranged over a colored title background

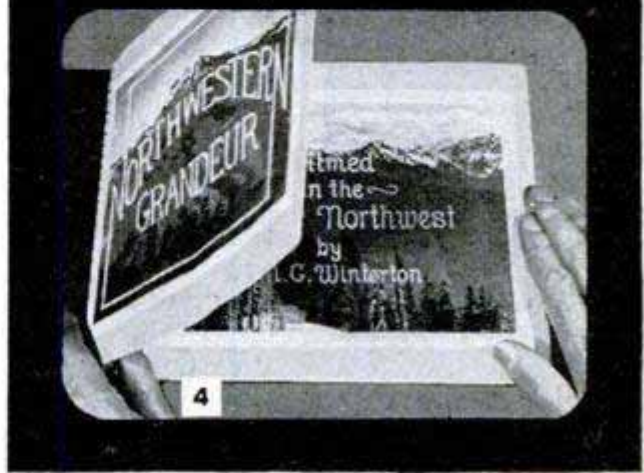
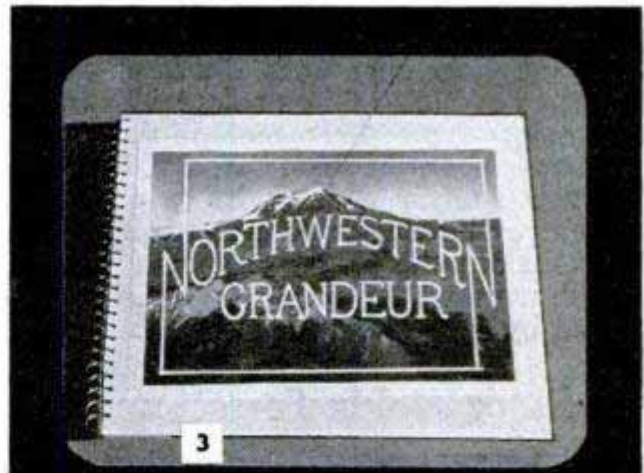

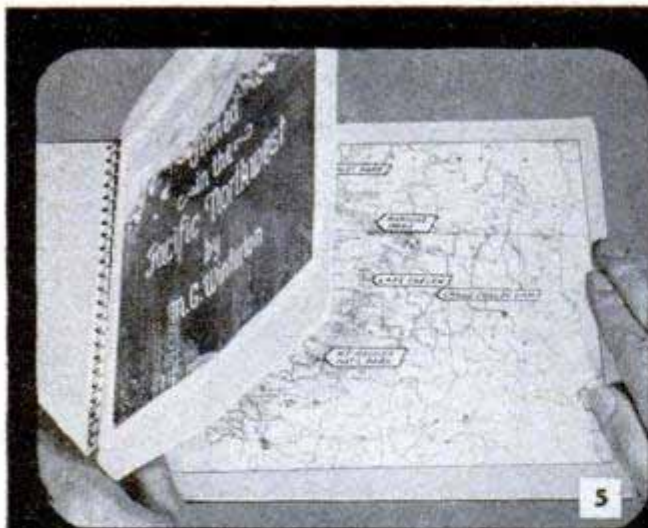

5



6

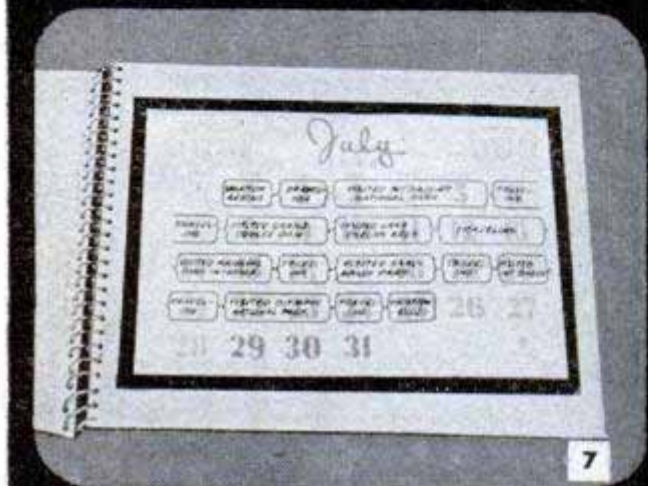

7



8

as in Figs. 6 and 8. These can be tinted to contrast pleasingly with the background by using ordinary water colors. The introductory scene also can include the special features shown in Figs. 5 and 7. In Fig. 5 the first subtitle is followed by a map on which you have lettered arrows and names to point out the places of special interest which were visited on the trip. This is followed by a shot of the calendar month in

which the trip was taken. On this you bracket the number of days on the road, the places of interest visited and the time on the road between stops. The suggestions for subtitles in Figs. 6 and 8 are especially appropriate in introducing special features of the film. After the album has been filmed, the vacation movie is edited and the title and subtitle frames are stripped-in in the regular manner.

Radiator Holds Ferrotypes Tins to Serve as Improved Print Drier

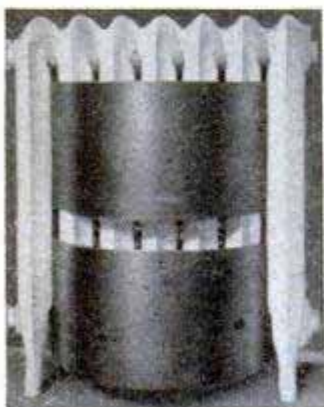

Curving ferrotypes tins so their ends fit between the sections of a room radiator produces a convenient and efficient print drier. Apply glossy prints to the ferrotypes tins emulsion side downward and curve the tins so the prints face the radiator while drying. This counteracts the natural curl of the prints. For matte-finish prints, place the emulsion side of the

paper upward and reverse the curve of the tins so the prints face the room. Cover the matte prints with cheesecloth or porous toweling for more even drying and to keep them from falling off the tins.

Pat Richardson, Minneapolis, Minn.

Emergency Ground Glass

If the ground glass on a camera is broken and there is not time to obtain a new one, the Cellophane wrapping from a cigarette package will serve as a substitute. Cut the Cellophane to fit the ground-glass frame and dull one side with sandpaper or by rubbing it over a concrete surface.

Anthony Cararie, Lawton, Okla.

Made primarily of pipe fittings, this sturdy photo-light stand, which is mounted on casters, can be moved into position easily and is quickly taken apart for carrying. The base of the stand consists of a $\frac{3}{4}$ -in. cross with $\frac{3}{4}$ -in. side outlets, four reducing bushings, four lengths of $\frac{3}{8}$ -in. pipe and four awning eyes which are turned on the ends of the pipe. The casters are bolted to the awning eyes. If a $\frac{3}{8}$ -in. cross with a $\frac{3}{4}$ -in. side outlet is available, the reducing bushings will not be necessary. The lower section of the stand is a length of $\frac{3}{4}$ -in. pipe, and a tee, having a $\frac{1}{4}$ -in. outlet, is turned on the end of the pipe. The outlet is plugged and then drilled and tapped for a thumbscrew. A $\frac{3}{8} \times \frac{3}{4}$ -in. reducing bushing is turned into the end of the tee. The $\frac{3}{8}$ -in. threads are reamed out to permit the next section, which is a length of $\frac{3}{8}$ -in. pipe,

to slide through. A second tee, also fitted with a thumbscrew, is mounted on the end of the $\frac{3}{8}$ -in. pipe. However, a short length of $\frac{3}{8}$ -in. pipe instead of a reducing bushing is turned into the top end of this tee. Then

Adjustable Photo-Light Stand of Pipe Fittings Rolls on Casters and Is Disassembled Easily

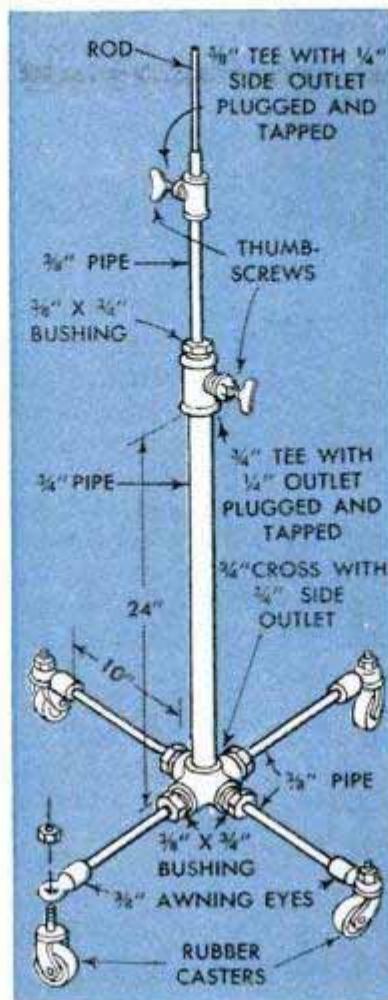

a length of $\frac{3}{8}$ or $\frac{7}{16}$ -in. cold-rolled rod is inserted in the pipe and clamped with the thumbscrew. The lights are mounted on the end of the rod in the usual way.

Norman Fallon, Sedona, Ariz.

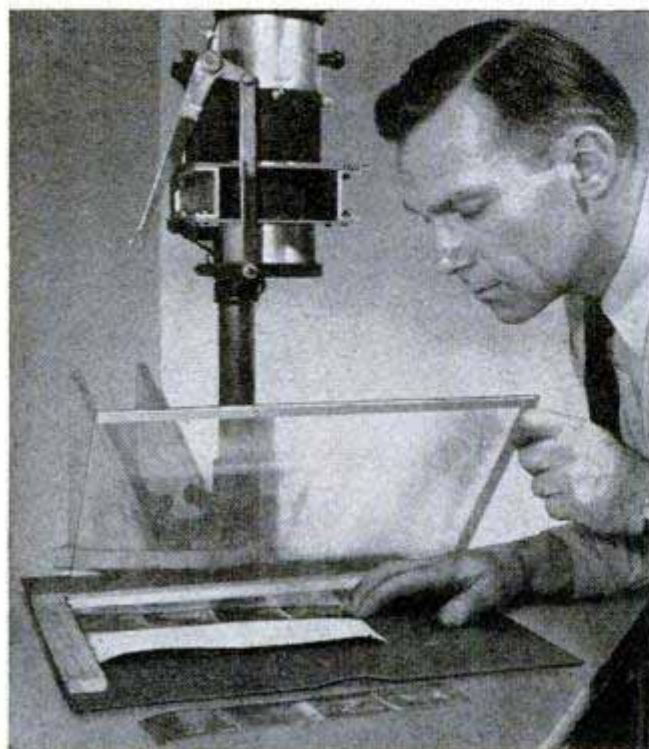

Hardboard Easel for Enlarger Permits Contact Printing

By utilizing light from an enlarger, contact prints from several negatives of cut or strip film can be made simultaneously with this hardboard easel. The easel is assembled in a few minutes and the only expense is that of a sheet of hardboard and a piece of plate glass. To permit aligning the paper and negatives, two wooden cleats are tacked at right angles to each other on the smooth side of the hardboard. The glass, which holds the negatives flat against the paper, covers the entire surface of the easel from the inside edges of the cleats to the edges of the board. The latter is notched at one side to aid lifting the glass with the fingers and the edges of the glass are covered with masking tape. The size of the easel depends upon the area covered by the light from the enlarger.

Ande Photography Studio, Chicago.

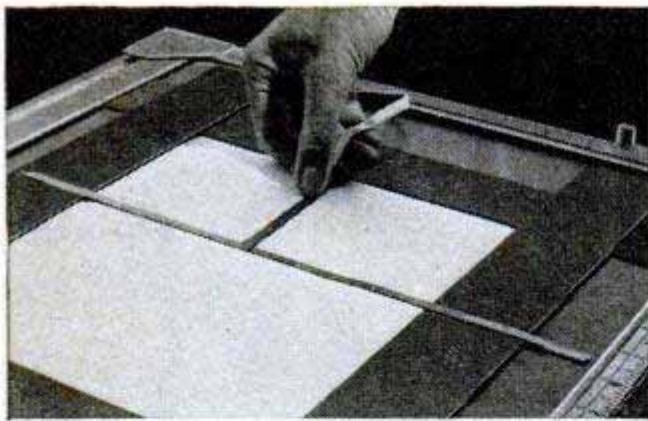

Cellulose Tape Masks Paper For Multiple Printing

When two or more pictures are printed on one sheet of photo paper, an even white margin between the prints is insured by masking the margins with colored cellulose tape. To prevent fogging, be sure to cover the areas not being printed during each exposure. Do not press the tape in place too firmly or it may mar the emulsion when pulled off. Remember to remove the tape before developing the print.

Virginia Hanson, Santa Monica, Calif.

Cardboard Clamped to Reflector Shields Lens From Direct Light



When a clamp-on reflector having a light-stand adapter is mounted on a stand, the unused clamp makes an excellent holder for a cardboard shield. As the clamp is attached with a

swivel joint, the cardboard can be moved to any position to shield the camera lens.

Arthur Trauffer, Council Bluffs, Iowa.

Enlarger Vibration Reduced By Felt Pads Under Base

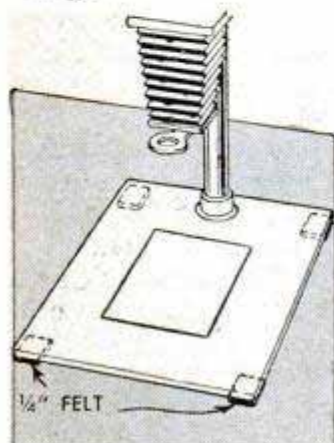

To reduce enlarger vibration to a minimum, cement a felt pad, approximately $\frac{1}{4}$ in. thick, to the underside of the base at each corner. In addition to absorbing vibration, the pads provide a stable base. — Henry Zave, Chicago.

Scale on Camera Focusing Knob Indicates Flash Exposure

If your camera is a reflex type having a focusing knob which makes only one complete turn, you can equip it with a scale that will indicate automatically the correct aperture setting for the distance focused when taking a flash shot. To make the scale,



wrap a strip of paper around the focusing knob and, while holding it there, calibrate it by marking the various distances on it. Then type corresponding shutter settings for flash shots at $\frac{1}{100}$ sec. on the paper and fasten it to the knob with cellulose tape. With both the speed and distance marked on the scale, the correct aperture for the distance focused is indicated automatically by merely turning the knob. The same film speed and the same size flash bulb must be used each time to obtain consistent results.—Kenneth Murray, Colon, Mich.

Cotton Serves as Tissue To Clean Lenses

Surgical cotton forms an excellent substitute for lens-cleaning tissue. It is lintless and so soft it cannot damage the lens. Fresh cotton should be used each time and then discarded, as dust on the cotton is liable to scratch the lens surface. When not in use, the package of cotton should be kept tightly closed for the same reason.

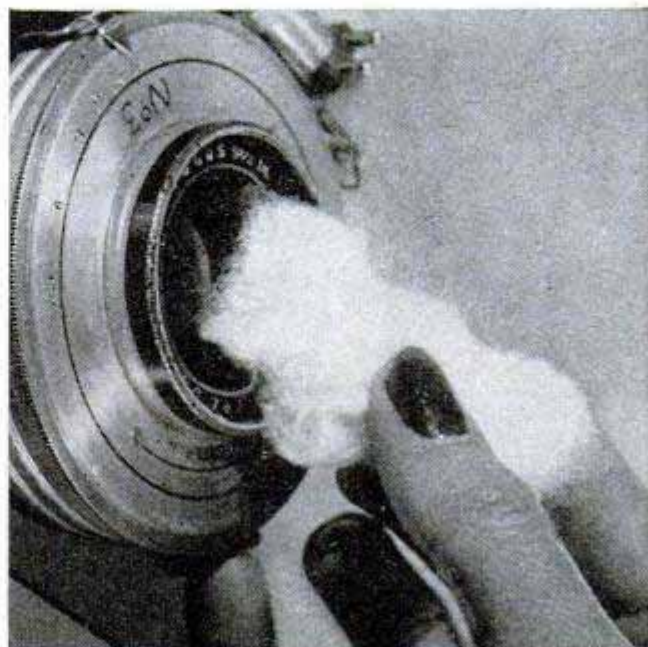

APARTMENT PHOTO LAB

By W. C. Horst

Occupying only 2 sq. ft. of floor space, this compact photo lab is the answer to the problems of the amateur photographer who lives in a small apartment. It consists of a roll-away cabinet mounted on an angle-iron base, a knock-down table, a contact printer, and a safelight. The printer and the table legs are stored in the bottom of the cabinet with the table set upright in front of them. Shelves in the upper part of the cabinet provide room for paper, chemicals, etc. The construction combines solid stock and plywood and the table top is covered with linoleum. Pins and brackets are used to hold the table in the open position and the removable legs are held with long pins. The printer is controlled independently from the safelight which remains on when the unit is plugged into the line as shown in wiring diagram

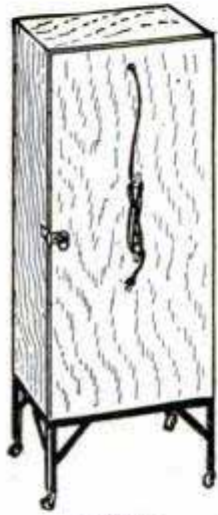

CLOSED

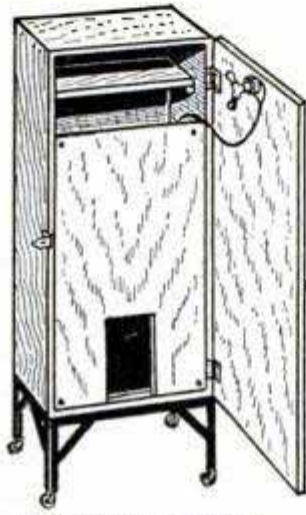

HOW TABLE IS STORED

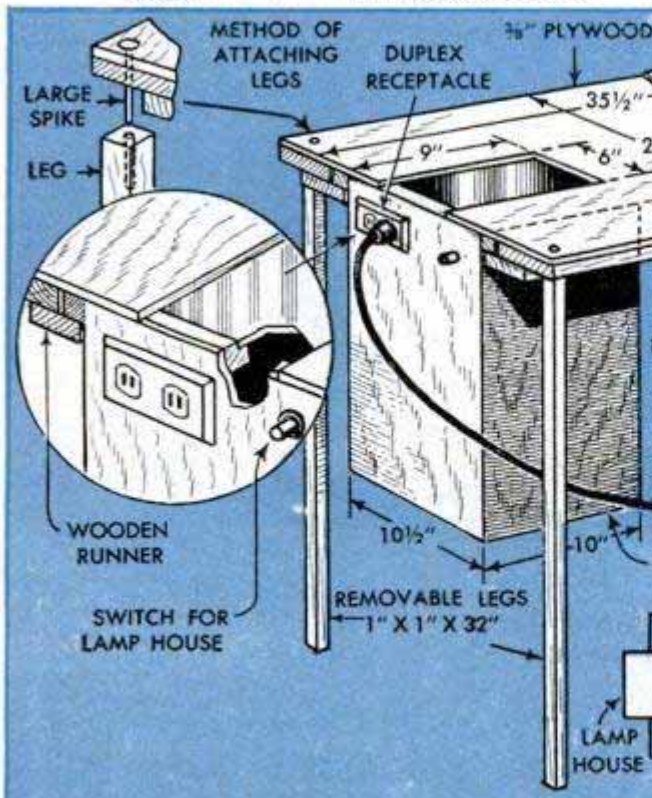
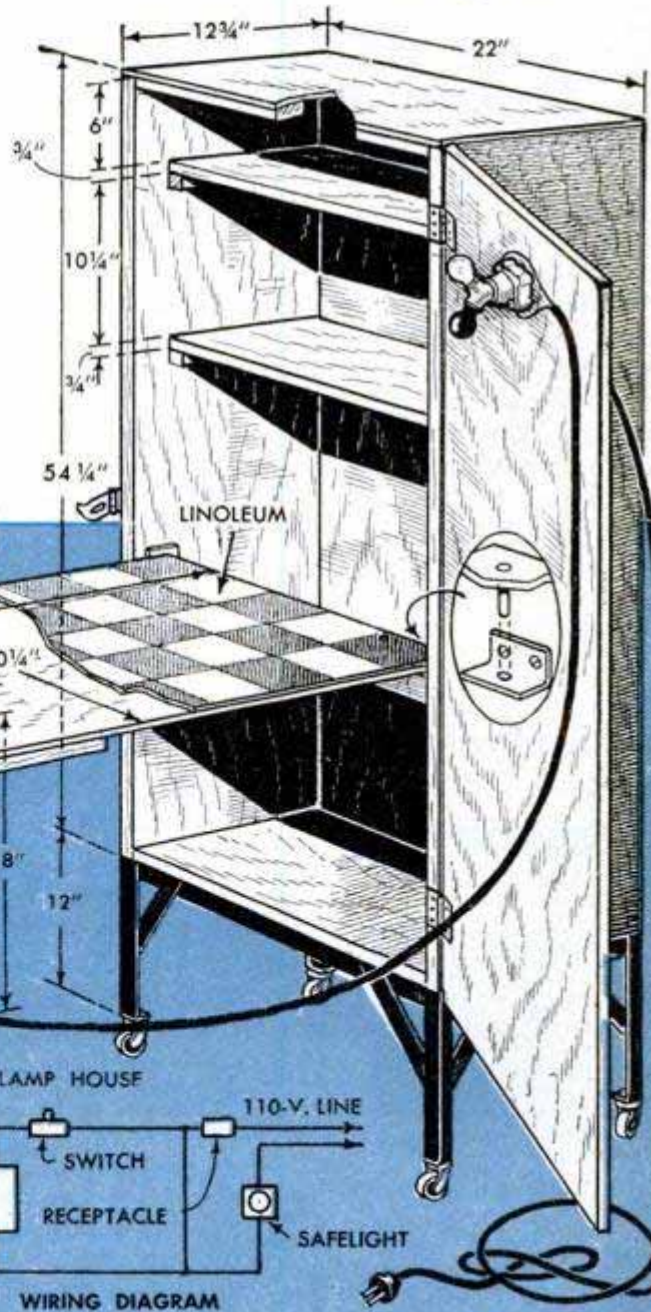

Camera Fitted With Hand Mirror Used for Direct Copying

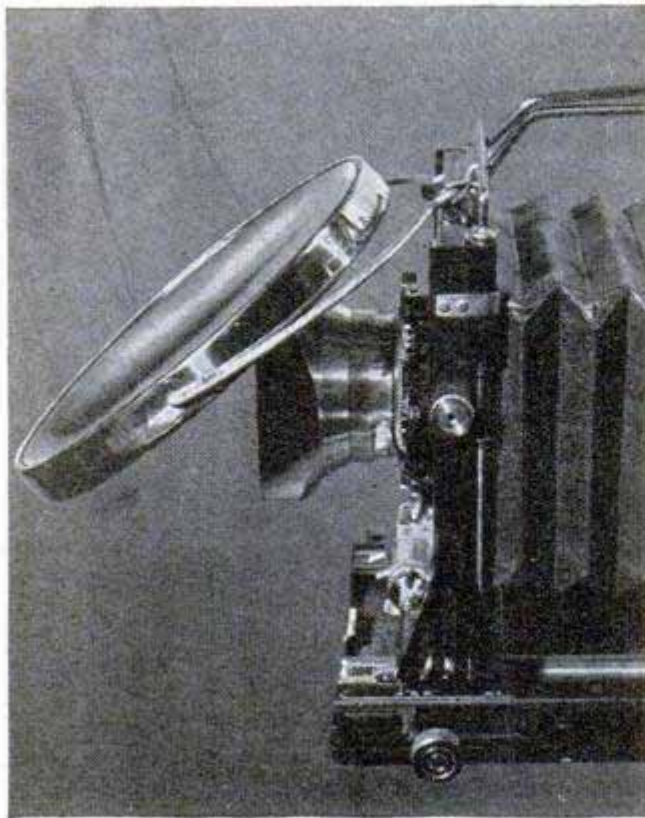

Direct copies of photo releases and other legal documents can be made with any camera that will handle cut film. Just load fast enlarging paper into the film holder, mount a hand mirror on the front of the camera, as shown, and take the photo. The camera is set up horizontally with the lens directly above the material to be copied. The mirror, which is positioned to reflect the image into the camera lens, makes the copy read properly instead of in reverse as it would in a negative. The correct exposure can be determined in a short time by trial and error and the paper is developed in the same way as an ordinary print.

Sensitive Switch on Contact Printer Operates Light Automatically

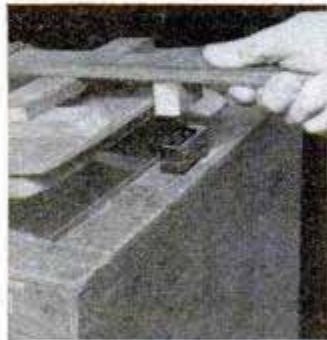

If you use a homemade contact printer or one without an automatic switch, the light can be operated by mounting a sensitive switch directly under the handle of the printer. Use

a switch that is normally in the open position so that pressure from the handle when the cover is closed will turn on the light, and release of the pressure by opening the cover will turn off the light. A wooden

block or a flat-headed screw driven in the underside of the handle will depress the switch button. With a little experimenting, the switch can be adjusted to turn on the light only when the printer is closed.

U.I. '51 Plastic Bag Protects Camera

When taking a camera on a vacation where it is likely to be damaged by sand or moisture, protect the mechanism by placing the camera in a plastic food bag. Use the type of bag which is fitted with a drawstring closure. When not in use, the bag can be carried in your pocket.



Photo-Paper Box Made Lightproof By Adding Second Cover

To keep photo paper conveniently at hand in the darkroom, one photographer unwraps the paper and stores it in a special box fitted with an extra cover. This cover, which makes the box lightproof, is made from the bottom of a spare box. After one end is cut away, as shown by the dotted lines, the box bottom is cut in half, $\frac{1}{8}$ in. being removed from the center. The two parts are taped together to form the second cover, their sides fitting in the space ordinarily taken up by the wrapping. Rounding the sides at the back and adding a tab at the front aid opening the box. A suitable tab can be formed by sticking a strip of paper tape to the front and top of the cover.

Michael Ligocki, Gary, Ind.

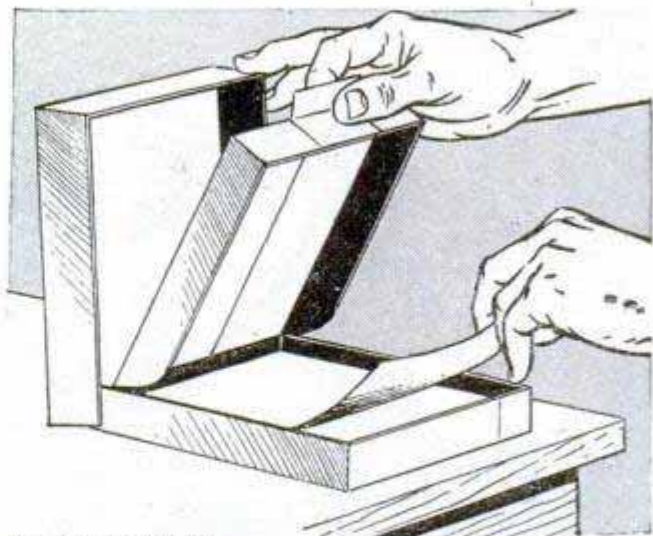

REMOVE $\frac{1}{8}$ " FROM
CENTER OF BOTTOM

CUT ON
DOTTED LINES



HI-POWER ATTACHMENT FOR BINOCULARS

IF MORE power is desired from those 6X Army or 7X Navy binoculars, you can convert them to 8, 10 or 11 power, or even more, simply by adding a negative lens to each optical system. These lenses are inexpensive and can be obtained from war-surplus dealers specializing in optical equipment. The performance of the altered glasses is excellent, the only fault being an increase in the field curvature which causes objects at the edge of the field to be less sharp than those at the center of the field.

The general arrangement of the optical system, which is shown in the full-size detail, Fig. 5, is that of a modified telephoto lens. A negative lens combined with the positive objective serves to increase the equivalent focal length of the objective without greatly affecting its forward position. The internal shoulder of the objective-lens cell should be run out on the lathe to permit maximum forward position of the objective, and it will be necessary to add a $\frac{3}{32}$ -in. spacer below the objective adapter. This size of spacer is for the 6X-to-8X conversion only, other sizes being given in the table, Fig. 3. The negative lens itself is fitted in a cell which is screwed into the prism shelf, Fig. 1. Threads for the cell are already cut in the left-hand prism shelf (these were originally intended for a reticle cell), but the right-hand cell is blank and must be threaded to suit. This job is done easily by screwing the shelf to a wooden block which is chucked in the lathe. This block has a guide boss turned at the center as shown in Fig. 2.

Note in the table, Fig. 3, that the stronger the negative lens (short focal length) or the shorter the spacing from prism to lens, the higher the power of the binocular will be. Therefore, it is important to keep both sides of the binocular at exactly the same spacing. An easy check of the magnification of each



Above, assembly of negative-lens parts. Right-hand prism shelf must be threaded

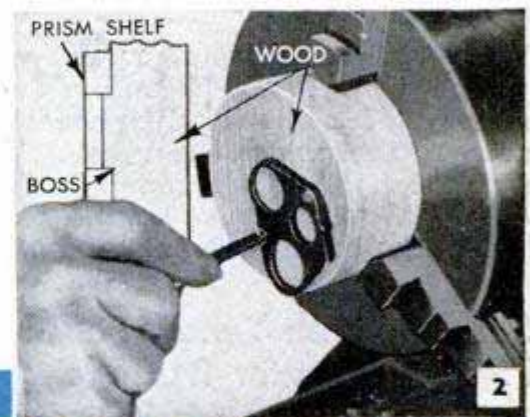

3 CONVERSION DATA

	Power	Negative Lens	Space "S"	Field	Objective Advance	Percent Light		Power	Negative Lens	Space "S"	Field	Objective Advance	Percent Light
USING ARMY 6X BINOCULAR	6X	—	—	150 yds.	—	100	USING NAVY 7X BINOCULAR	7X	—	—	125 yds.	—	200
	8X*	17.5 x 52	$\frac{3}{16}$ "	90 yds.	$\frac{3}{32}$ "	56		8X	23 x 152	0"	90 yds.	$\frac{3}{32}$ "	156
	10X	19 x 28	$\frac{3}{16}$ "	70 yds.	$\frac{3}{16}$ "	36		10X	25 x 48	$\frac{1}{4}$ "	70 yds.	$\frac{3}{8}$ "	100
	11X	19 x 28	0"	62 yds.	$\frac{3}{8}$ "	30		11X	25 x 48	0"	62 yds.	$\frac{1}{2}$ "	83

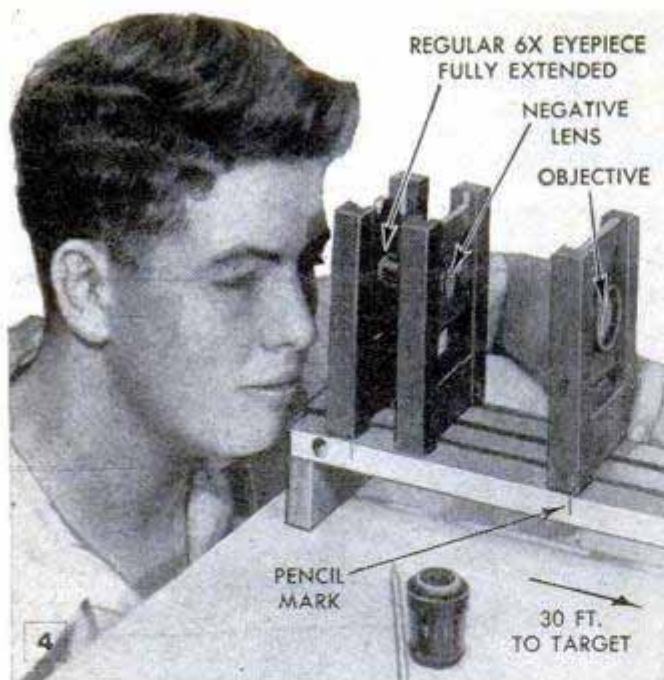

optical system is made by swinging the binocular housings outward. Then, viewing a sheet of paper at about 30 ft. away, you will see two images of the paper and can note which one is the larger. Adjust by unscrewing the negative-lens cell on the strong side of the binocular until a balance is reached. Check the amount of turn-out necessary and transfer this to the weak side by turning off the same amount from the end of the weak-side cell.

Various powers can be tested on the optical bench, Fig. 4, using a target at 30 ft. and with the eyepiece fully extended. Use the objective and eyepiece only and mark the bench to show the normal location of the objective. Then, add the negative lens without disturbing the eyepiece.

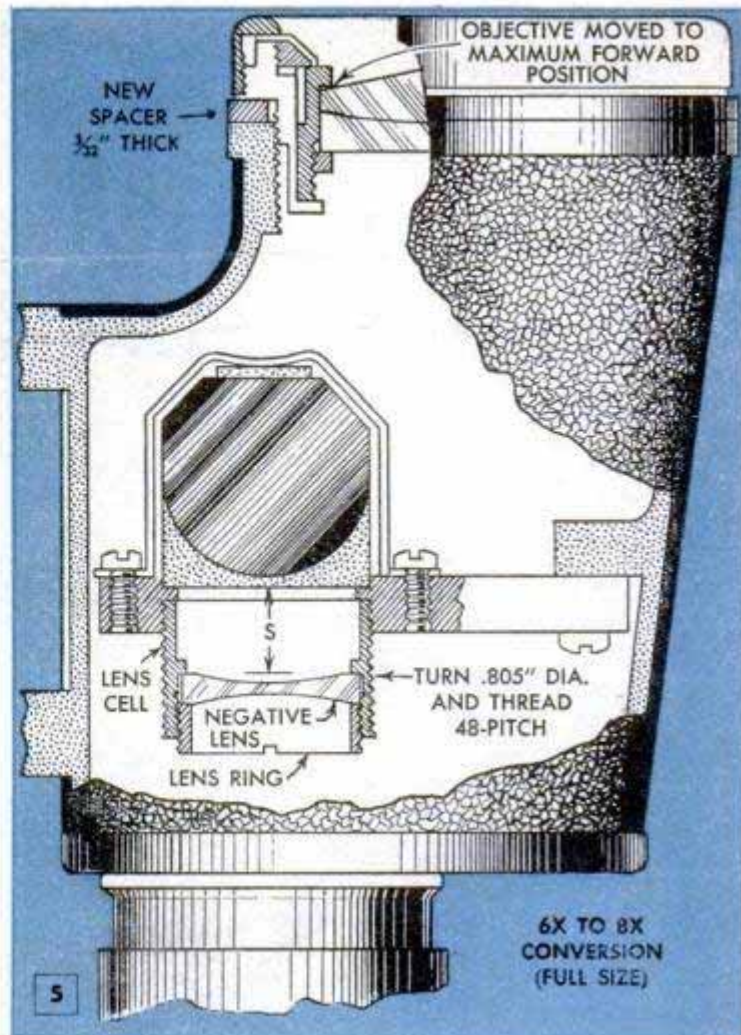

Gradually move the negative lens forward and readjust to sharp focus by moving the objective. In this way, you can see the magnification increase and the amount of extension needed. For extensions over $\frac{1}{8}$ in., it is necessary to make a front extension for the objective.

Display Sign for Garage or Filling Station Made From Old Auto Tire

An old auto tire suspended from a post provides a novel frame for a garage or filling-station display sign. The tire is attached to an upright and a horizontal member with long bolts, the heads of which are reinforced with sheet metal. A sheet-metal sign, slightly larger than the diameter of the tire rim, is held in place with bolts. The tire can be painted black.

Shading With Yellow Pencil Produces Neater Tracings

When it is necessary to indicate solid areas on tracings, such as carbide-tipped tools or shaded details, one draftsman uses a yellow pencil instead of a black one. He finds that the yellow-shaded areas stand out more sharply than the black and that the yellow does not smear or rub off.

Stanley R. Welling, Racine, Wis.

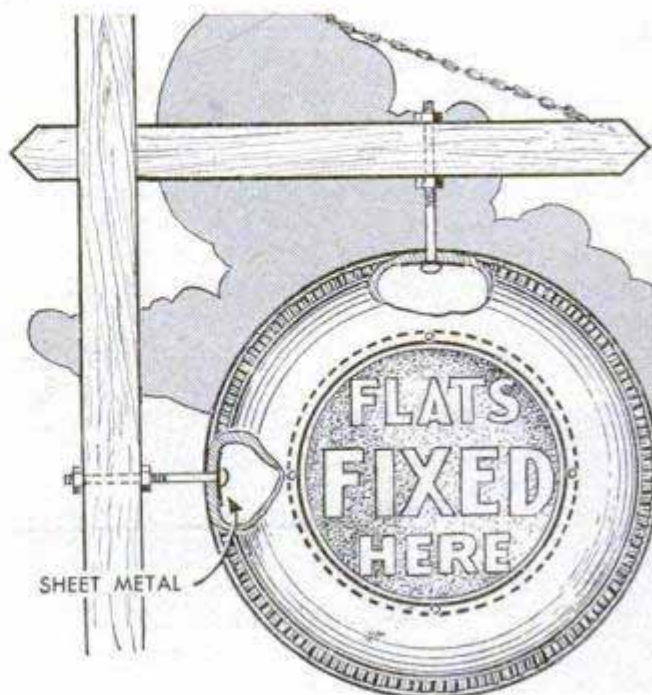

There is no trick at all in obtaining neat-fitting corners and seams in linoleum if you use this simple scribing tool. It is especially useful when covering counters and sink tops which are fitted with metal edging. You can make the tool for only a few cents from a carpenter's hardwood marking gauge and a strip of metal, preferably brass or aluminum. Cut the strip to the dimensions shown in the detail and form a slot about $\frac{3}{16}$ in. wide and $2\frac{1}{2}$ in. long in the center of the strip. This is done by drilling holes at the ends of the slot and cutting out the metal. The scribing point of the gauge is placed through the slot when the tool is used to transfer a wall offset as pictured in the upper left-hand detail. Round the front end of the slotted strip and drill the holes as indicated. Turn or grind a $\frac{1}{8}$ -in. tenon on a brass guide pin, insert tenon through front hole in the strip and peen over the end to hold it in place. Finally, screw the metal strip to the sliding member of the marking gauge.

Eldon Schiel, Chicago.

Handy Scriber for Fitting Linoleum Improved From Marking Gauge

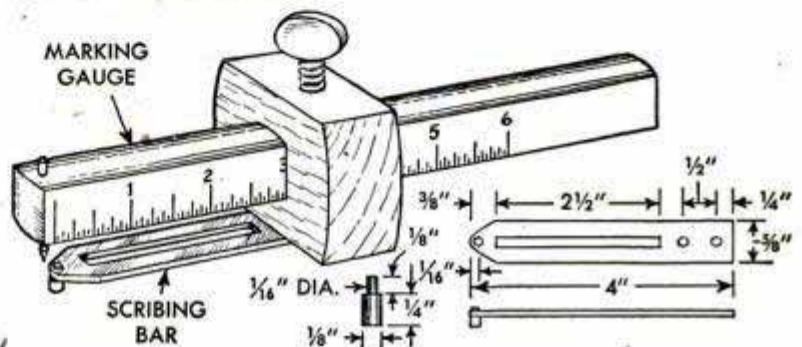
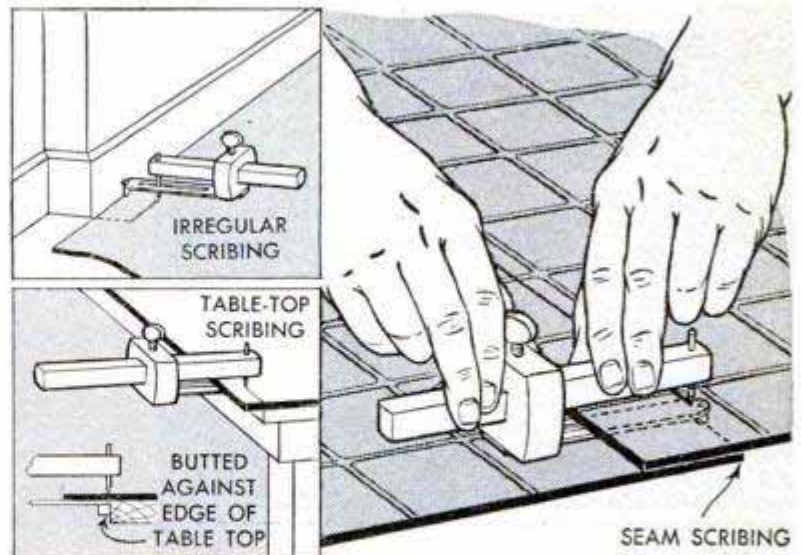

Sulphur Fumes Piped to Dens Kill Ground Hogs or Ferret Other Animals

By piping sulphur fumes into ground-hog dens, I managed to rid my farm of these animals. Not only will this method destroy ground hogs or gophers, but it is also an excellent way to ferret skunks, squirrels and other fur-bearing animals. First, a length of pipe is pushed through the entrance to the den, the end being allowed to project a few inches above the ground. The opening around the pipe is packed with

cloth or small stones and filled with dirt. Then, one or two spoonfuls of motor oil are poured into the pipe. This is followed with a few spoonfuls of sulphur, which is held to the sides of the pipe by the oil. To burn the sulphur, the flame of a blowtorch is directed into the pipe. This also forces the sulphur fumes throughout the den. When the den is filled with fumes, the pipe is pulled out and the hole covered with dirt. If the den has more than one entrance, cover the other holes before burning the sulphur, leaving enough opening in these holes to allow a little smoke to seep through. In this way, you can tell when the den is filled with the sulphur fumes. It is a good idea to drill a hole near the upper end of the pipe and attach a length of wire to it, as this will permit pulling the pipe from the hole and carrying it even though it is too hot to hold in the hand.

Luther Strosnider, Havensville, Kans.



Estimating Tonnage in Coal Piles

The tonnage in a conical pile of coal can be estimated quickly. First, measure the diameter of the pile at its base. Then, multiply the cube of the diameter (in feet) by .00248 for bituminous coal or .00172 for anthracite coal.

CUT YOUR OWN MOLDING

By Sam Brown

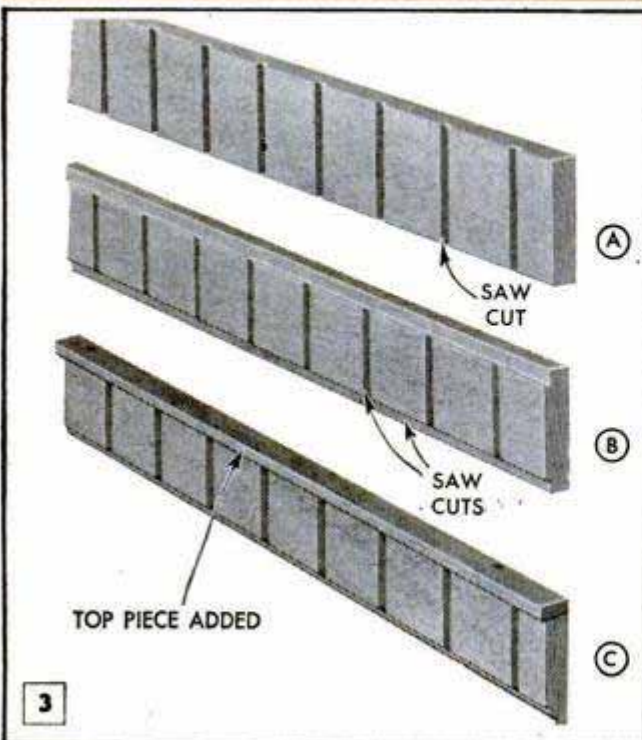
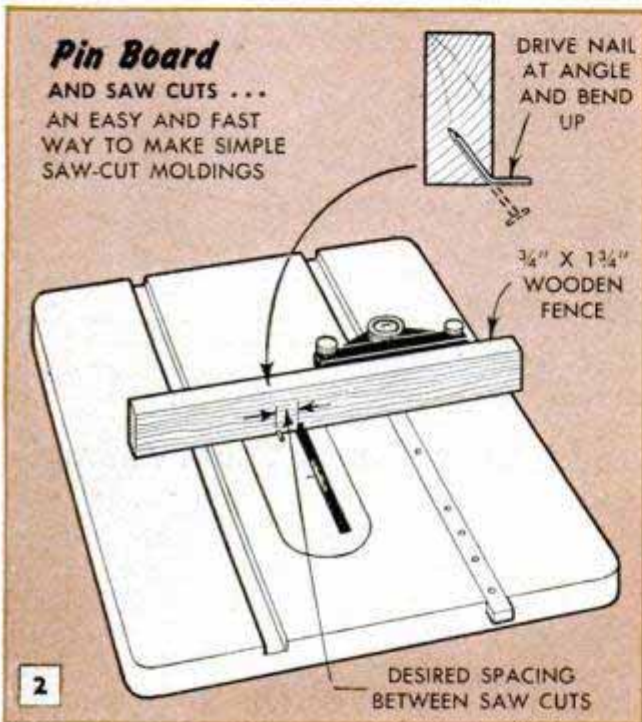

ORNAMENTAL moldings feature a pattern which repeats at regular intervals along the length of the molding. The pattern effect usually is simple, consisting merely of straight cuts, beads or coves. However, the work may be further ornamented by intersecting the crosscut patterns with a running mold cut on the edges of the piece. The details A to Z and AA to AD show 30 different styles, all utilizing simple cuts, yet offering a wide variety of attractive shapes suitable for almost any kind of trim work.

Saw cuts: Patterns worked out with plain saw cuts, or grooves, are the simplest to make. The blade used for this work preferably should be hollow-ground to assure smooth cutting. Fig. 2 shows the pin-board setup commonly used as a spacing device. As each cut is made, it is fitted over the pin, thus accurately spacing the next cut. It is easiest to work the spaced cuts on a board 3 to 6 in. wide as in Fig. 1. The piece is later ripped or sliced to the desired molding size, Fig. 4. Details B and C in Fig. 3 show how rabbets can be run on the edges of the molding to add to the appearance. Another trick is to add a second molding at the top of the original strip as shown by mold-type C in Fig. 3. By making the saw cuts different widths and varying the spacing, a variety of moldings may be formed in this manner. A wobble saw speeds this work considerably.

Dentil molding: This molding, details D, E and F in Fig. 4, is the most popular of the saw-cut shapes. It is worked out with the aid of a pin board by alternating cuts on both faces of the stock, Fig. 6. Then the grooved strip is sliced along the length with the setup shown in Fig. 5. To prevent the thin slices falling through the saw slot, set the ripping fence the proper distance from the blade, lower the blade below the surface of the table and clamp a board to the table with one edge against the ripping fence, Fig. 7. Then start the machine and raise the blade slowly until it projects above the board a distance equal to the thickness of the mold stock, plus about $\frac{1}{16}$ in. Then proceed as in Fig. 5, using a narrow push stick. The slices are then glued to a backing strip as in Fig. 4.

Using molding head: A molding head designed for use on a circular saw permits cutting beads, vees and coves, Fig. 12, which are the basis for certain types of ornamental moldings. The spacing setup for running these molded shapes consists

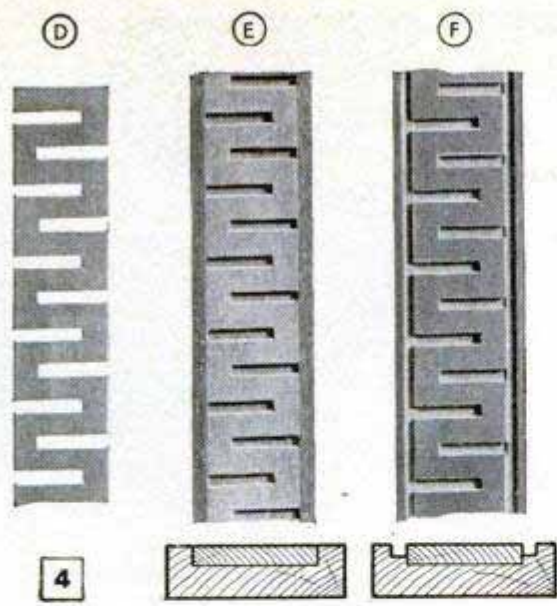

Dentil Molding
 IS ATTRACTIVE AND WORKS UP FAST IN BLOCK FORM CUT WITH SAW OR DADO HEAD

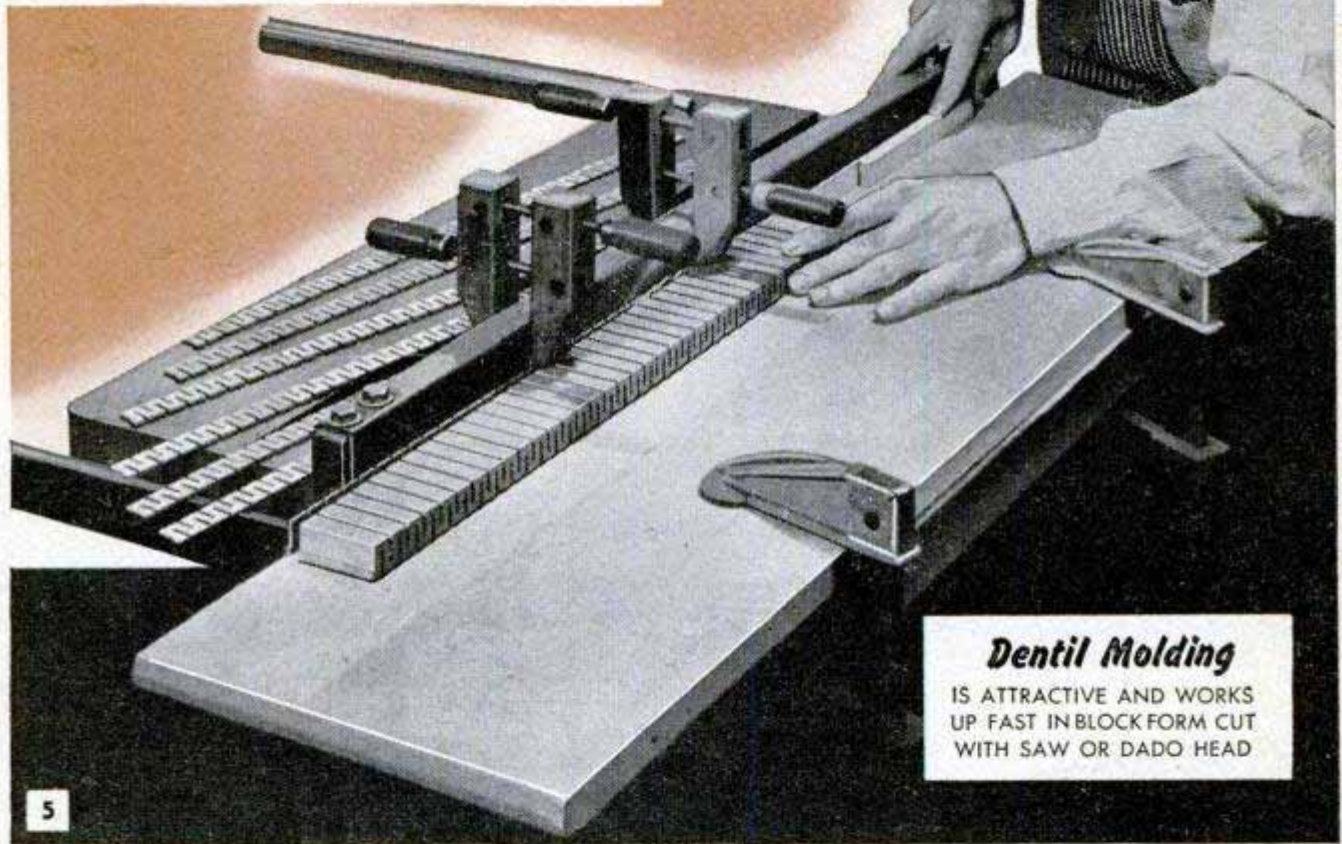

Pictured above and below is the common procedure in working out the basic dentil-mold strip on a circular saw. A block grooved alternately on both faces is sliced into strips which are glued to a base piece

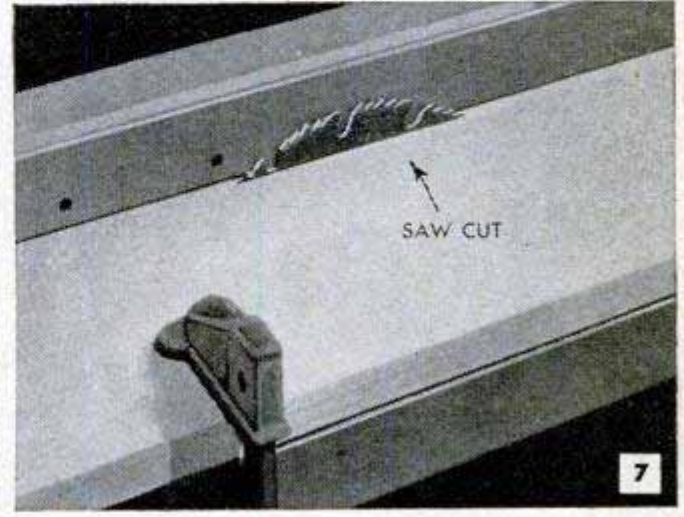
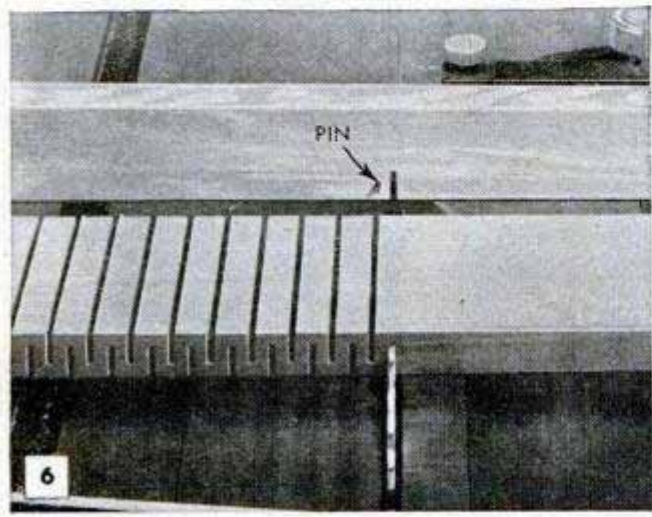

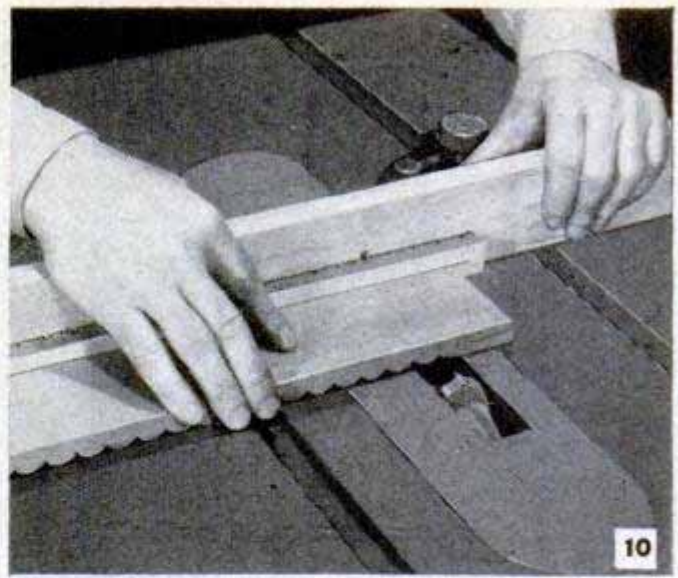
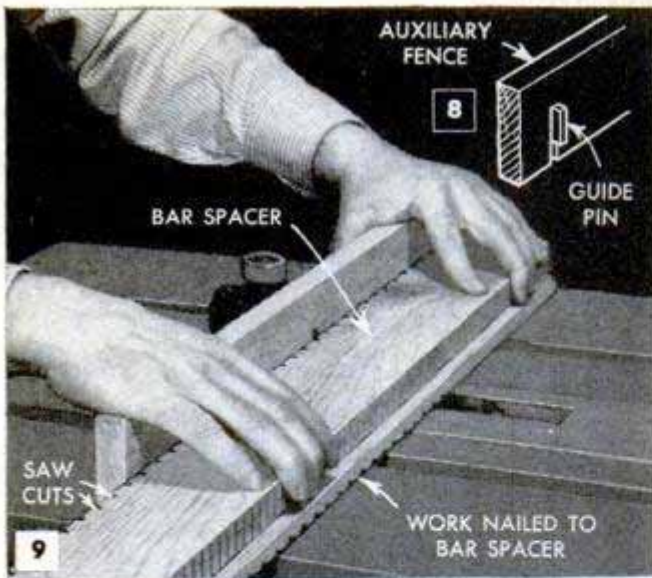

Molding Head

... USED ON THE MANDREL OF A BENCH SAW PERMITS CUTTING A WIDE VARIETY OF BEAD, VEE AND COVE SHAPES BY FEEDING THE WORK SIMILARLY TO RIPPING A BOARD

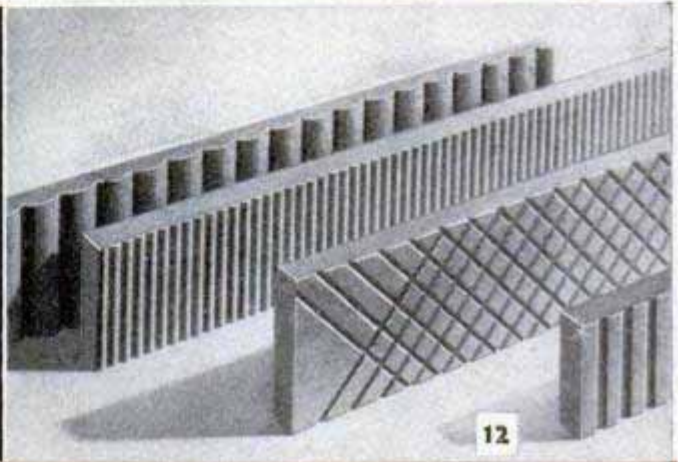

EDGE SHAPES CAN BE WORKED ON SAW WITH MOLDING HEAD, OR ON SHAPER OR DRILL PRESS

G **H** **I** **J** **K** **L** **M** **N** **O** **P** **Q** **R**

VEE AND COVE MOLDINGS **BEAD MOLDINGS**

of a separate spacer bar having notches cut along its edges as in Fig. 9. The spacer bar itself is cut by using the pin board. These spacers are permanent equipment and should be retained for future use. It's a good idea to have at least two of them, each $\frac{3}{4} \times 3 \times 36$ in., having saw cuts of $\frac{1}{4}$, $\frac{5}{16}$, $\frac{3}{8}$ and $\frac{5}{8}$ -in. spacings center to center. In use, the work is nailed to the bar at each end and the spacer is then worked over a wooden guide pin mortised into the face of an auxiliary fence screwed to the miter gauge, Fig. 8. The bar spacer also can be nailed to the edge of the work, Fig. 10. Details G to R inclusive show basic cuts worked in block form. These can be ripped and then edge-molded to provide a variety of shapes, Fig. 11. Moldings K and R show how side-by-side beading cuts work out. Mold K is simply a slice off a large workpiece. L is a similar slice off a piece molded with the miter gauge set at 45 deg. Mold M is a thin slice excellent for a scalloped effect. N and O picture the scallop with standard molds run on the edges. P and Q have the shaping cuts run on the face. Style Q works up into a diamond pattern when run in narrow widths as at R. Molds G and H are made with the V-cut. Most of these cuts are run with the miter gauge set at 45 deg. Edge moldings added to the basic shape are shown at I and J. An applied molding at the top edge of the piece is often used with these styles.

Wave moldings: These moldings are interesting to work out as they offer a practical work setup which is followed through by running the mold on the edge of the workpiece and then ripping it off. The spacer bar again is used, but this time it is set by means of a small pin made especially to fit in the starter-pin hole on the shaper table. The basic cut is made with a straight shaper cutter, as in Fig. 13, and results in the shape S pictured below Fig. 13. A $\frac{5}{8}$ -in. spacing with a cutter $1\frac{7}{8}$ in. in diameter

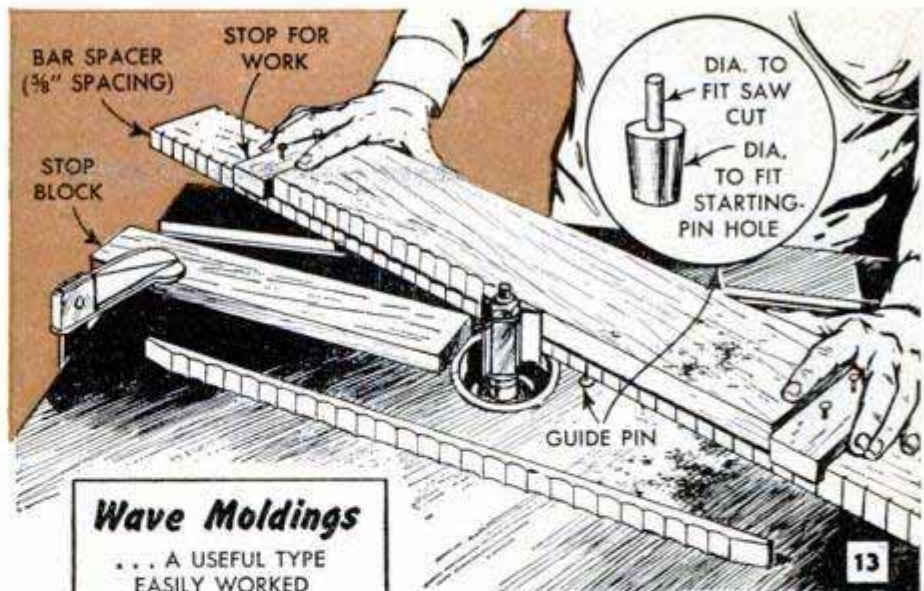

Wave Moldings

... A USEFUL TYPE
EASILY WORKED
ON SHAPER OR DRILL
PRESS WITH BAR SPACER

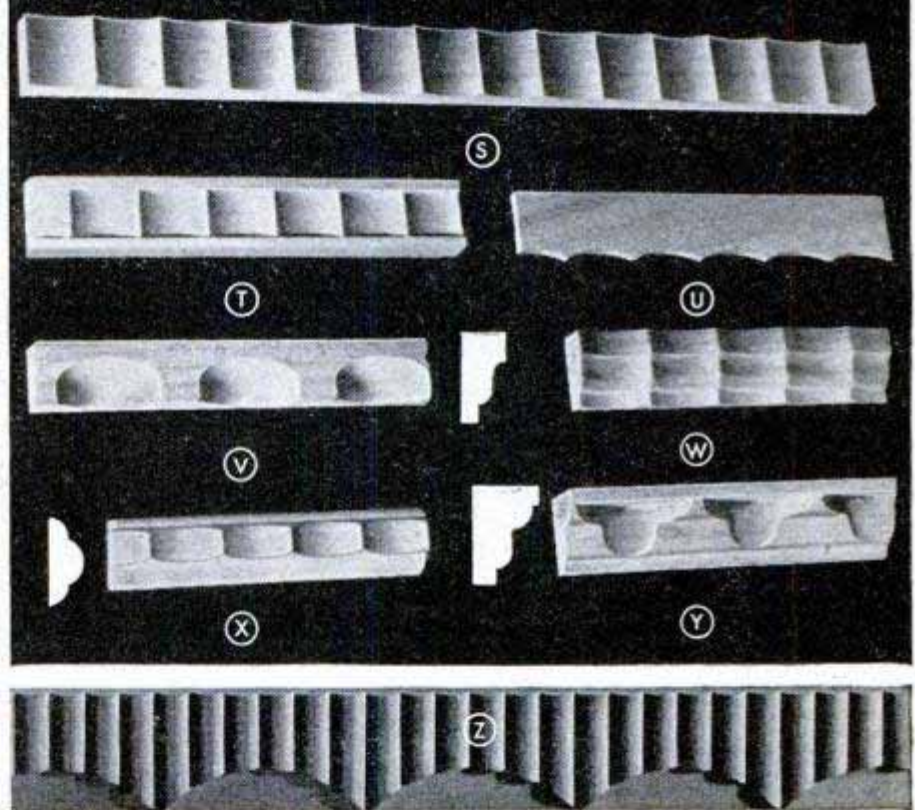

gives about the right form. Molds T to Z show variations which are pictured about one half full size. Mold T is the wave form run in with a cutter $\frac{1}{2}$ in. wide, and mold U is a slice from the basic mold. Extra curves, run with the conventional shaper guide collars, produce the shape shown at W. Mold V is the basic shape but the cuts are double-spaced. Molds X and Y show what happens when the wave cuts are run on regular molding shapes. Mold Z is a novel application of the wave form. The setup for running this mold requires that the work be located on the spacer bar in the same approximate position as shown in Fig. 13, except that the work must be shifted slightly to center the cut. No depth stop is used, the work being advanced into the

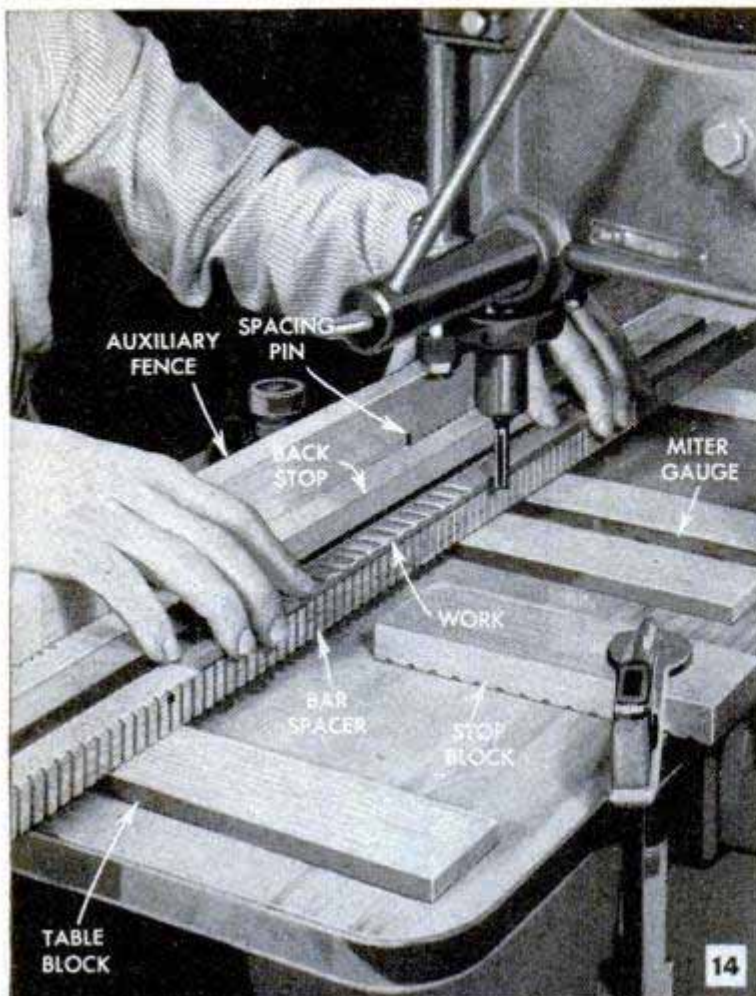

**On the
Drill Press**

... YOU CAN DO ALL SHAPER WORK, ALSO SPECIAL END-CUTTING OPERATIONS SUCH AS ROUTING AND SPOTTING



cutter until the individual cuts point up on the bead lines.

Use of drill press: Where a wood shaper is not available the drill press can be pressed into service to run most of the molding and shaper cuts commonly used in making up ornamental molds. In addition, certain end-cutting operations can be done on a drill press which are not possible with any other type of power tool. One basic mold cut made on the drill press is a stopped recess run in from one edge of the stock with a router bit. Molding AA is an example of this work. A typical setup is pictured in Fig. 14. Here you see the bar spacer used in much the same fashion as on the circular saw. The drill press is provided with a special auxiliary table large enough to support the work with additional space available for clamping stops in various positions. Only one stop is required for mold AA. Two stops will be required when running the stopped router cuts on mold AB. A conventional miter gauge sliding between strips attached to the auxiliary table guides the work into the router bit. Instead of using the straight-in miter-gauge feed, the guide pin can be fitted directly to the drill table, Fig. 15. Here the cut will be curved as on the mold AC, the radius of

curvature depending on the distance of the pin from the cutting tool. The pin, of course, acts as a pivot. If the pivot is some distance from the cutting bit, the cut will be almost as straight as when run with the straight spacer bar. Spot decorations, arranged singly or in a pattern, can be added to moldings by using various shapes of carving burrs. A common shape is the round indentation shown in mold AD. The spot is made as in Fig. 16, with the drill-press depth stop adjusted to give a uniform depth of cut. Usually it is not necessary to use the spacer bar for this job, as the spots can be located either by eye or by pencil marks at measured distances along the length of the mold strip. The cuts may be spaced by means of a pencil witness mark in line with cuts previously made.

Woods to use: The best wood for ornamental moldings is red gum in select grade. The next best selection is yellow poplar. Woods with a heavy open grain are not generally suitable. Clear white pine will do very well for most work if the molding is to be painted. Birch is a good selection for the molds formed by routing operations and for the dentil mold. Maple is too hard and dense for molding work. The wave forms work up nicely in yellow poplar.

Timely Suggestions for Better Farming



To protect poults from drafts on cool mornings, one turkey rancher tacked heavy feed sacks to the sides of the sun porches. The sacks, split at the seams, are folded upward as the day becomes warmer

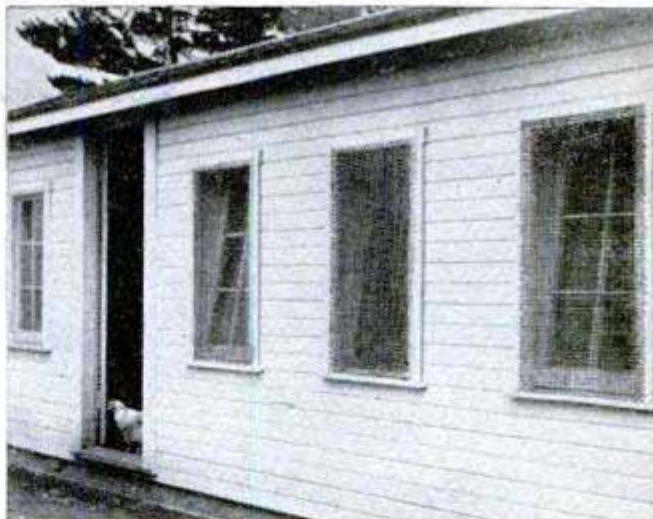

Poultry-house windows can be opened wide without fear of vermin or birds if they are covered with $\frac{1}{2}$ -in.-mesh hardware cloth. Tacked to the window frames, the cloth also discourages poultry thieves

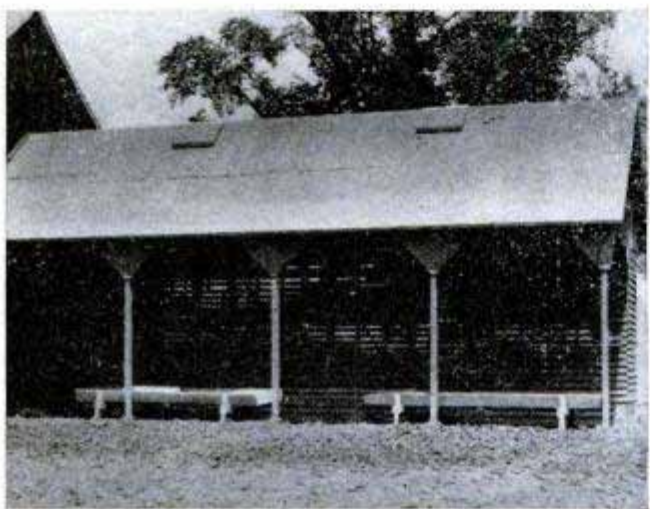

This combination crib-and-feeding shed is a work-saving addition to the farm. Feed bunks for cattle are built alongside the crib and are filled directly from several doors conveniently located in the crib

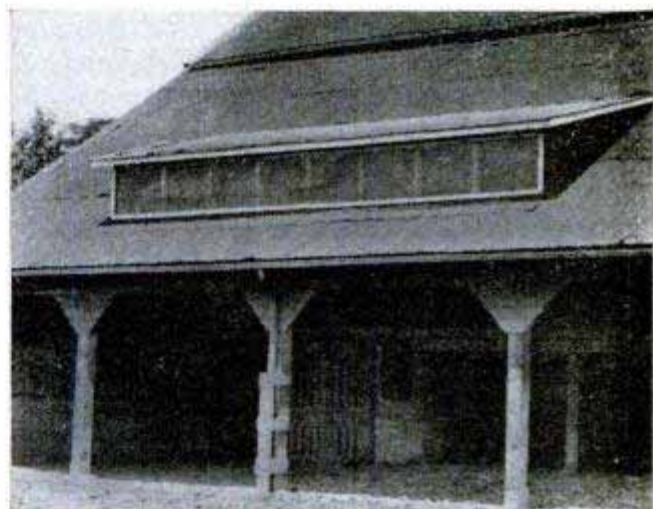

Well-lighted barn is had by adding a long dormer to roof. The dormer is covered with cellulose glass and protected with wire netting, providing a weatherproof window which admits an abundance of light

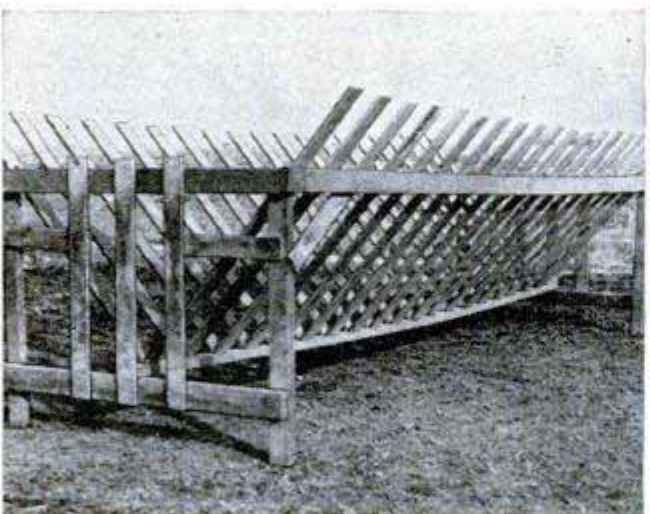

Lightweight feed rack for sheep is used in barn or pasture, depending on the season, and can be moved on a hayrack or carried by hand. It is approximately 5 ft. wide, 16 ft. long, and 4 ft. high

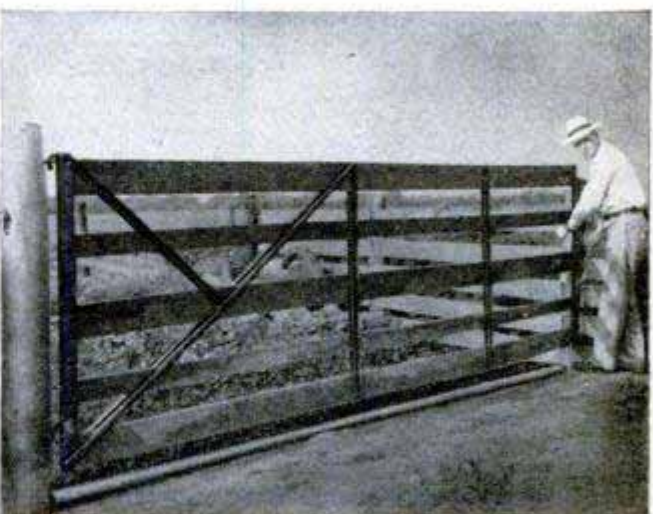

Length of heavy iron pipe anchored at ground level underneath a wide road gate helps prevent soil erosion due to flow of water and passage of cattle. The pipe also keeps hogs from rooting under gate

Oil Drums Form Diverting Gates At Irrigation-Ditch Branch



Inexpensive and serviceable, two oil drums with the bottoms removed provide excellent diverting gates at a Y-branch of an irrigation ditch. The gates are sheet-metal or board covers which completely cover the upstream ends of the drums. These are held in place by water pressure and are lifted out of the way to allow water to flow through the drums. The latter are anchored with rock and dirt, and flat rocks placed in the main ditch at the end of each drum prevent water from undercutting.

E. V. Reyner, Townsend, Mont.

Removing Cap From Paint Tube



If the cap of a tube of artists' paint cannot be removed with the fingers, it can be loosened by heating slightly. Hold the cap in the flame of a match for a few seconds.

Heat-Hardening Polished Steel Without Damaging Finish

Articles of polished tool steel can be heat-hardened without damaging or scalding the finish by coating them with a mixture consisting of equal parts of table salt and fine corn meal. When exposed to extreme heat, the coating melts and forms a flux which prevents oxidation and subsequent pitting of the surface of the metal. First, dip the article in water and then in the mixture. Heat until the coating becomes glazed and dip again into the mixture. Continue the heating process and, if

any portion of the coating appears dry, spread the mixture over that point. The coating is removed by soaking in oil or water.—Leonti Thompson, New York City.

Magnet Aids Filling Cistern Pail

When using a pail to dip water from a cistern, it usually is necessary to pull the rope back and forth to make the pail sink and fill. This annoyance can be eliminated by tying a horse-shoe magnet to the rope, as shown, to

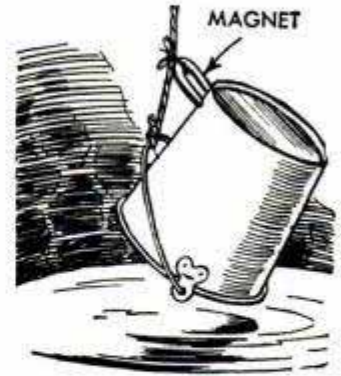

hold the pail in an inverted position. In this way, the pail will sink immediately and a sharp tug on the rope will release the magnet, allowing the pail to right itself.

Angle Setting of Worn Knurling Tool Prevents Overlapping Pattern

Setting a worn knurling tool at an angle of 5 deg. to the axis of the work will help to prevent the troublesome overlapping which occurs when the knurling wheels "climb" suddenly and spoil the knurl pattern. Feeding into the work at an angle alters the knurl pattern somewhat as the leading edge of each wheel cuts slightly deeper. In this position, the wheels cut a well-defined pattern in the first pass over the work. This results in accurate tracking and produces a clean, sharp knurl even though the wheels are worn from long use.

Glenn Lawler, West Lafayette, Ind.

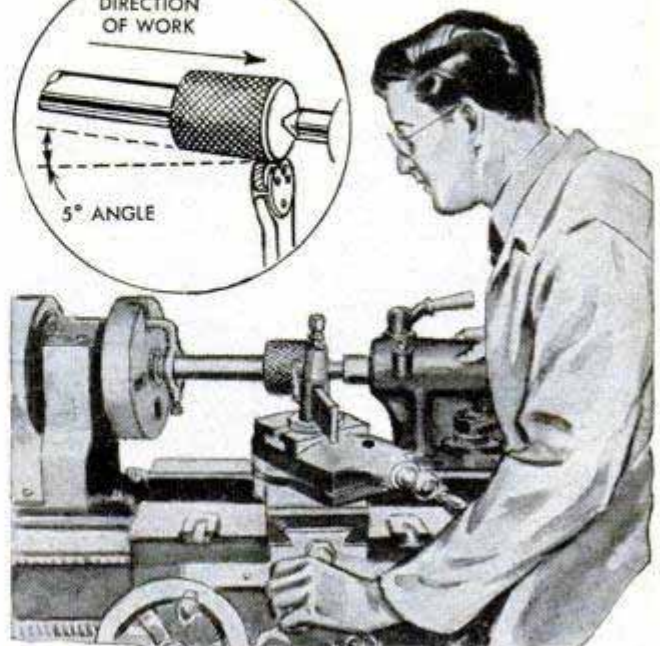
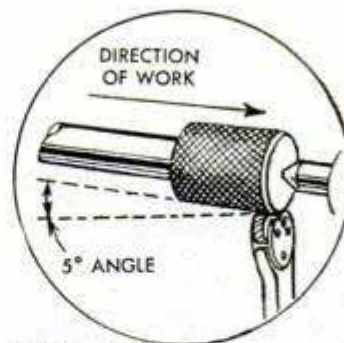

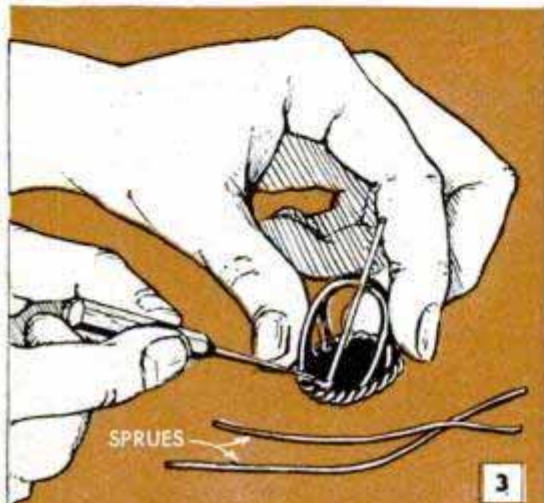
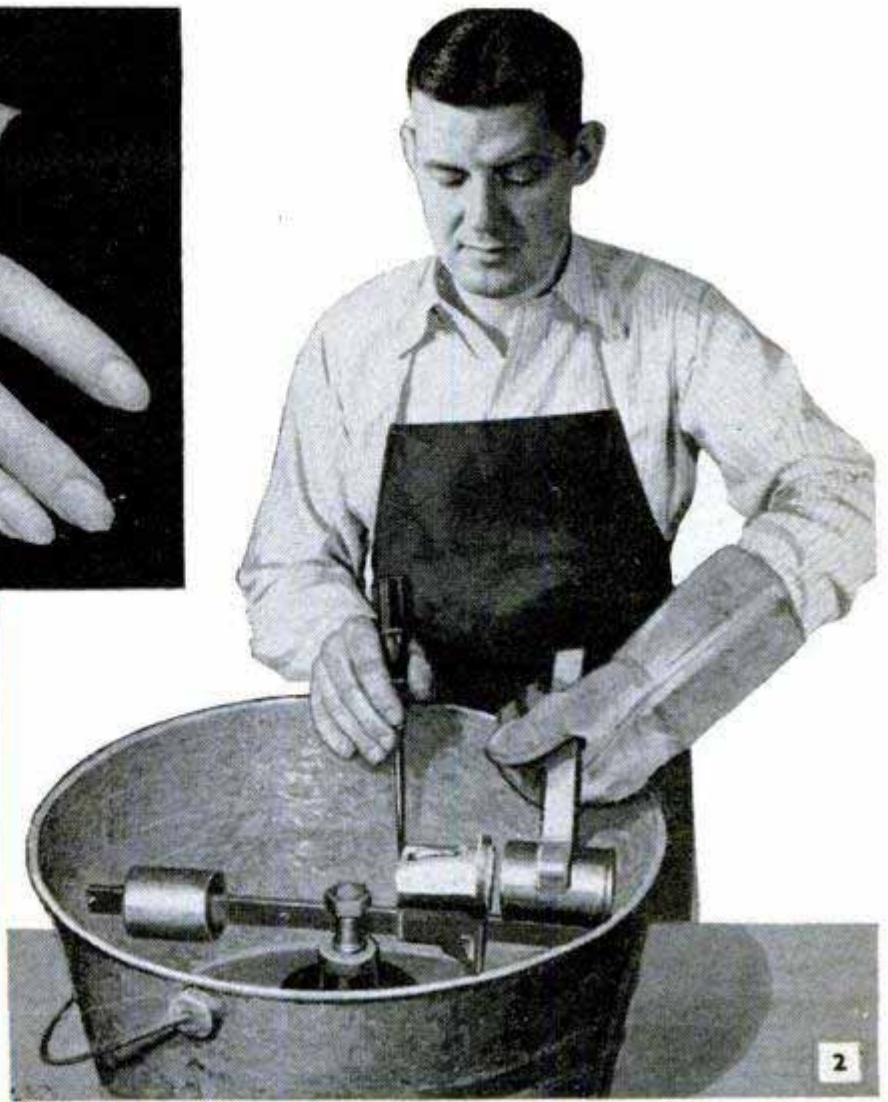

THE SPRUES ARE "WELDED" TO THE WAX PATTERN WITH A HOT NEEDLE

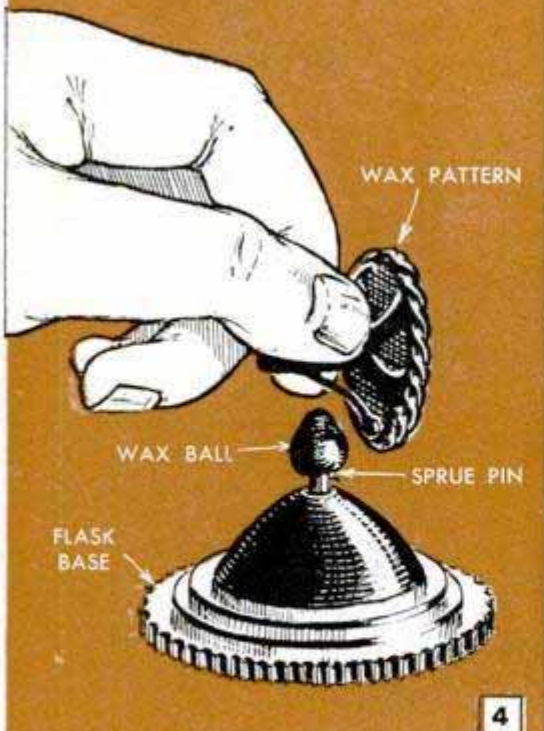

PLACING WAX PATTERN IN POSITION ON THE WAX BALL OF FLASK BASE

PRECISION CASTING

By the Lost-Wax Process

By Herbert C. McKay

LOST-WAX casting makes it possible for the home craftsman to reproduce in metal any form he can model in wax. Unlike sand casting, which demands experience and unwieldy equipment, the technique of this method can be learned in a single day with a minimum of special equipment. It is particularly adaptable to making small metal parts for model work and jewelry, such as the ring shown in Fig. 1. Regardless of how delicate or intricate the design may be or how high the relief or depth of undercutting on the pattern, the final casting will be an exact duplicate. In professional work, ferrous alloys are often used, but these are difficult for the home craftsmen to melt because of the high temperatures required. However, bronze, brass, gold, silver, aluminum, zinc and the white-metal alloys are easily cast.

Briefly, the lost-wax process consists of making a pattern from wax, as in Fig. 3, placing it in a flask and filling the flask with plaster to form a mold, or investment, around the pattern, Fig. 9. After the plaster hardens, it is heated until the wax pattern melts and flows from the

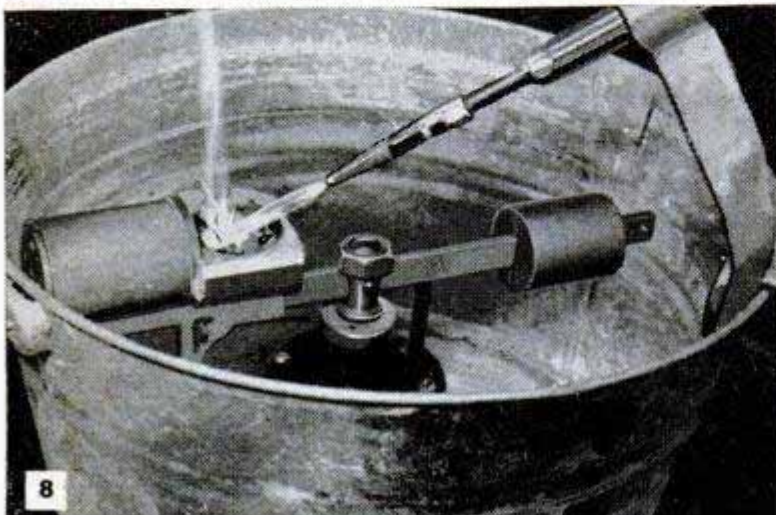
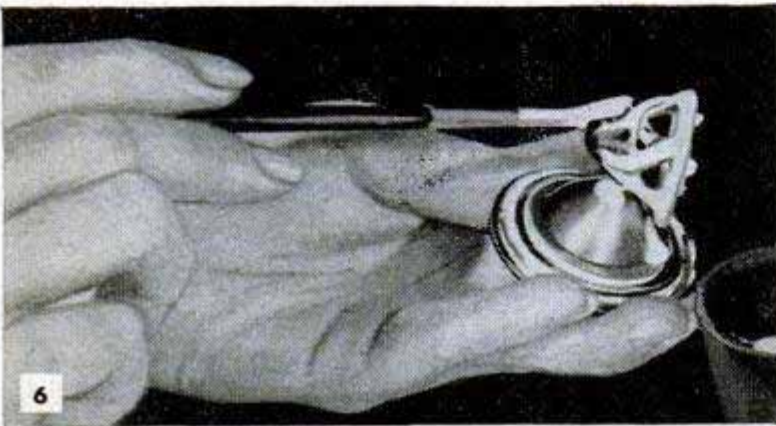
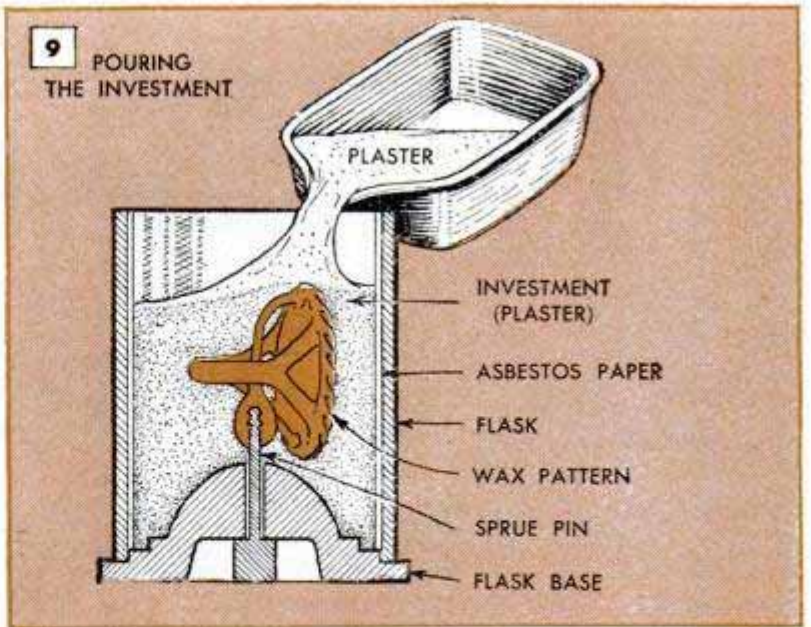
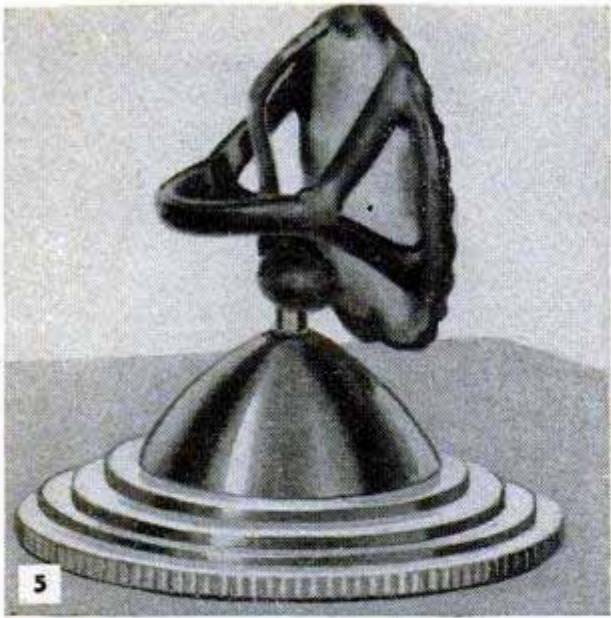

mold, leaving a cavity shaped exactly like the pattern, Fig. 10. The mold, together with a crucible full of molten metal, is then placed in a centrifugal casting machine which forces the metal into the cavity, Fig. 11. After the metal has solidified, the casting is obtained by removing the mold from the flask and breaking it apart as in Fig. 12.

The wax, as well as the special mold plaster, can be compounded by the user. However, the centrifugal casting machine should be purchased, as the details of its design make it expensive and impractical to build. The cost of a commercial casting machine is comparable to the price of a small drill press or circular saw.

The simplest soft wax for patterns is made by mixing equal parts of beeswax and paraffin. Since paraffin is available in several different melting temperatures, it is possible to vary the hardness of the wax mixture. If the wax pattern is to be formed by cutting or carving, a still harder mixture can be made by adding ceresin and carnauba wax to the beeswax and paraffin. One mixture suitable for carving consists of equal parts of the four ingredients. Another is made from four parts each of beeswax and paraffin, two of ceresin and one of carnauba. The best method is to vary the quantities of each ingredient until you obtain a wax with the degree of hardness best suited to your needs. Regardless of the mixture, the wax must melt

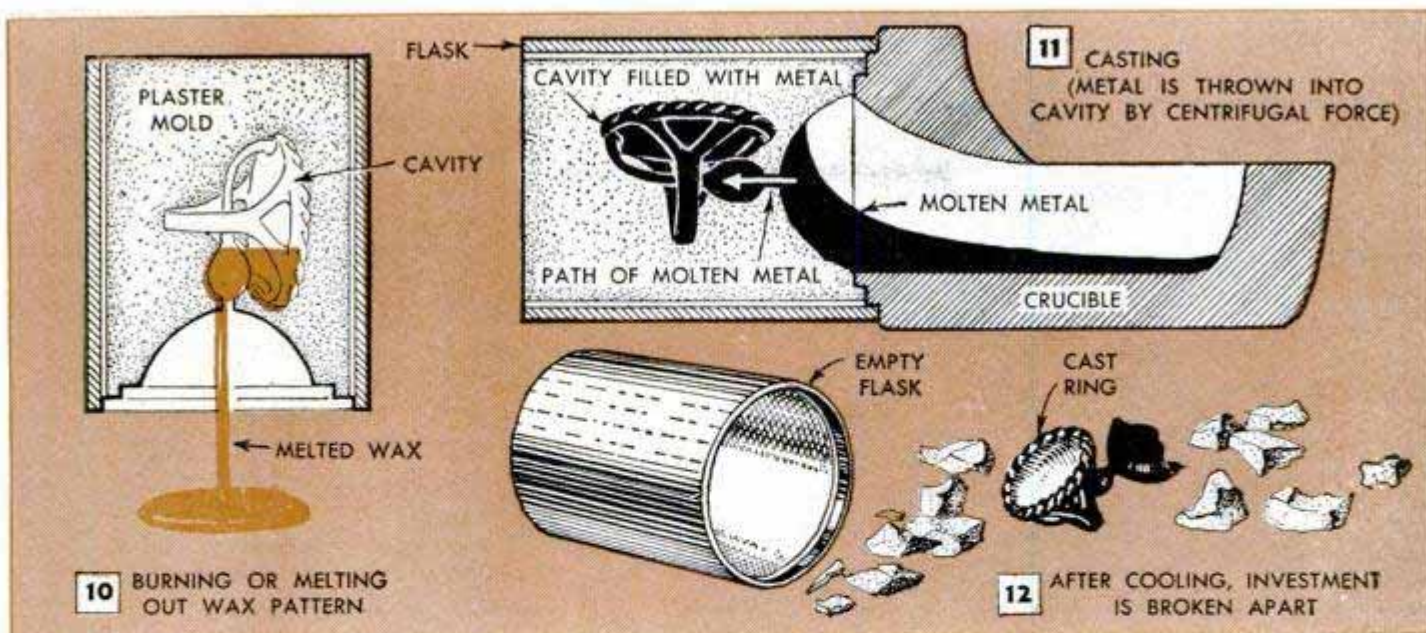

and burn away completely when it is heated so that no ash or residue remains in the plaster mold.

The plaster must withstand high temperatures without breaking down, and yet must crumble easily when wet. This is usually made by mixing plaster with soapstone, asbestos lint or calcined diatomaceous earth. The best mixture for fine detail is the commercial material having a cristobalite base. A mixture containing plaster of paris, five parts, powdered coal ash, three parts, and powdered talc, one part, may be used successfully. A mixture of eight parts plaster, six parts asbestos powder and one part powdered talc also is good. The aggregates are mixed with water to the desired consistency.

A miniature gas or electric furnace or a torch can be used to burn out the wax pattern and melt the casting metal. For castings that can be enclosed within a $\frac{3}{8}$ -in. cube, a mouth blowpipe and Bunsen burner will do. For larger castings, an ordinary gasoline blowtorch, an oxyacetylene welding torch or any gas-burning torch having a forced-air supply may be used.

To make a piece of jewelry, for instance, the design is first drawn on paper to exact size. Then, using this as a guide, thin sheets of the transparent wax are laid over the design and the various shapes cut out with a sharp needle set in a wooden handle. The wax pieces are formed and then assembled by holding their edges together and touching the junction with a hot needle to weld the pieces together. When the assembly is completed, the rough places are scraped smooth with a small scraper, made from a piece of metal $\frac{3}{32}$ in. wide fitted with a handle. Small pieces of wax may be added and carved as desired. Every extra minute spent in shaping the wax pattern will save 10 or 15 minutes in dressing down the final

metal casting. Every defect in the wax pattern will be reproduced. In fact, with a little experience in patternmaking, you can reproduce minute detail visible only on the most careful inspection.

No vents are used in this type of casting. However, it is necessary to provide channels, known as sprues, to allow molten metal to reach all parts of the mold before it starts to solidify. These are made of pieces of wax, rolled into rods of about $\frac{1}{8}$ in. dia., and are fastened to the pattern by the hot-needle method as shown in Fig. 3. After the sprues are attached, the pattern is ready to mount in the flask of the casting machine. The flask is simply a length of brass pipe and a tightly fitting base which is shaped to form a funnel-like depression at one end of the plaster mold. A hole through the center of the base is fitted with a large-headed pin, the tip of which is wrapped with a length of sprue wax carefully shaped and melted into a ball, Fig. 4. The sprues of the pattern are then fastened to the wax ball with a hot needle. This holds the pattern firmly to the base in the desired casting position.

The success of the casting depends upon the care used in making the plaster mold, or investment, Fig. 9. A small amount of the investment is mixed to a creamy consistency and brushed on the pattern as in Fig. 6. The brush is used to work the investment into every detail of the pattern and also to remove small air bubbles. After covering, the investment is allowed to set until half hard but not dry. Meanwhile, the flask is lined with thin asbestos paper, wetted so it will adhere to the inner walls. The flask is then placed over the invested pattern, Fig. 7, and fitted to the base. Another batch of investment, mixed thick enough just to flow smoothly in a sluggish stream, is poured into the flask until a slight

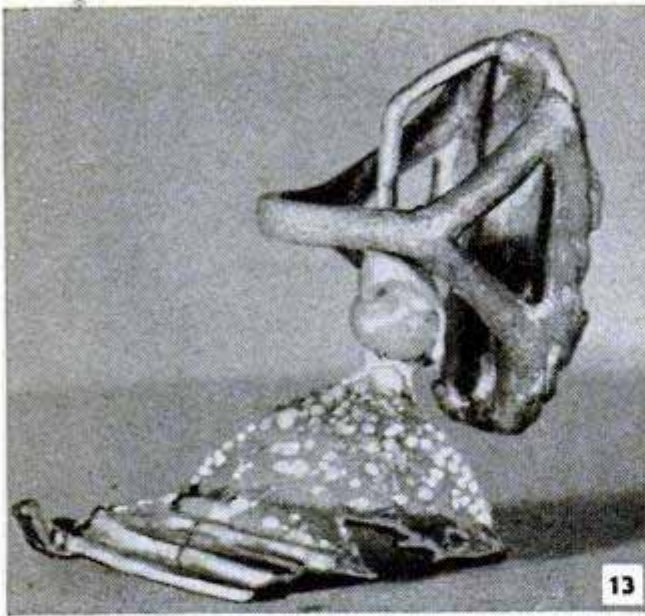

Above, appearance of casting with sprue and sprue base after removing from flask. Tiny white spots are bits of investment. Below, sprues are cut off leaving stumps which are ground flush with casting

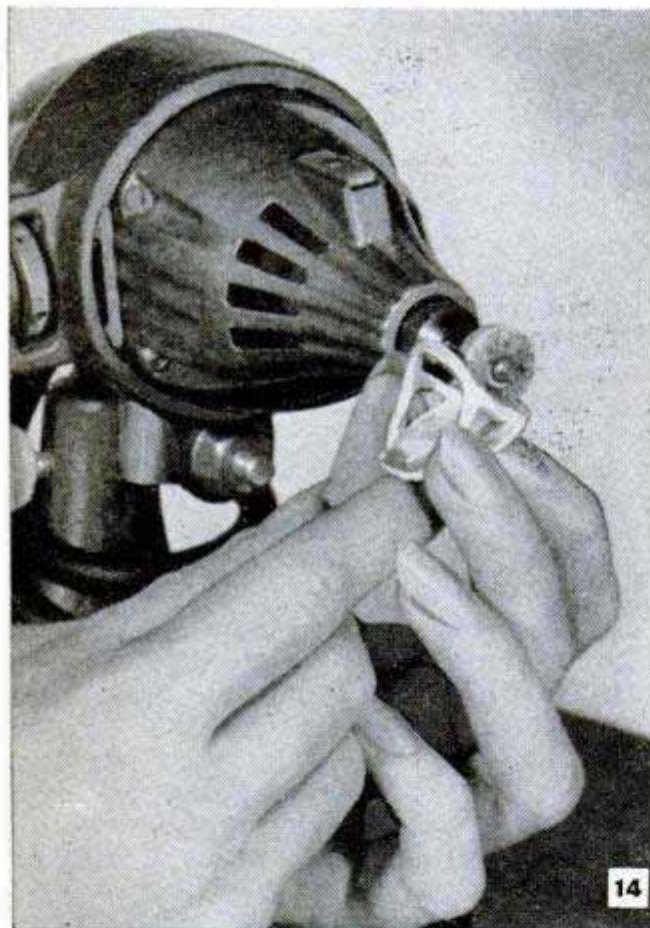

crown is formed above the top. After the investment is semisolid, the crown is scraped level with the top of the flask. The investment is then allowed to set until hard, after which the sprue pin is removed and the base separated from the flask. The mold, which is still surrounded by the flask, can be dried in two hours by placing it in an oven heated to about 100 deg. F., but it is advisable to let it stand overnight.

The next step is removing the wax from

the mold. This is done by the application of heat, about 500 deg. F., for a half hour. The wax melts and runs out as in Fig. 10. But, as it usually ignites and burns when it reaches the air, no wax is recovered. Hence, it becomes the "lost wax." This may be done in a furnace or by supporting the flask over a medium flame of a gas burner. After the bulk of the wax is removed, the residue must be removed by a thorough burning out. In the furnace, this is done by increasing the heat to 1200 deg. F. for one hour. If a gas burner is used, a tin can turned upside down over the flask will act as an oven chamber. At the end of the burning-out period, the flask and mold, shown held with tongs by the gloved hand in Fig. 2, is securely clamped between the crucible and thrust plate located at one end of the rotating arm of the casting machine. The other end of the arm has an adjustable weight to counterbalance the flask, crucible and metal to be cast. It is essential that this balancing be done before the cast is made. The arm is fastened to a shaft projecting above the center of a metal base inclosing a strong spiral spring which rotates the arm. In use, the arm is turned against the spring about three turns and a gravity stop pin raised to hold it in place. The flame from a gas torch is then directed on the metal in the crucible, Fig. 8, until the metal is melted. When the metal is completely melted, a pinch of borax is dropped on it, and as soon as the metal surface shows bright and clean it is ready for casting. The counterweighted end of the arm is then pulled back about $\frac{1}{4}$ in. against the spring, thus allowing the gravity pin to fall clear, to release the arm. Centrifugal force causes the molten metal to flow into the mold cavity as in Fig. 11. After four or five minutes, the flask is removed from the machine and cooled slowly by quickly dipping it 10 or 12 times in a pan of water until it is cool enough to handle. Usually, the mold and its asbestos wrapping will slide out of the flask when cooled with water. If not, the investment, which has the consistency of thick sludge, will come out easily if dug into with a screwdriver. The casting will come out covered with a film of investment, which can be removed by scrubbing with a stiff brush. The casting, Fig. 13, now duplicates the original wax pattern and part of the base, Fig. 5. The base is removed by cutting or sawing the sprues as close to the casting as possible, and the remaining stumps of the sprues are ground off flush with the surface of the casting with a small abrasive wheel as indicated in Fig. 14. In most cases, any surface discoloration on the casting will disappear when buffed with a cloth or felt wheel loaded with polishing compound.

High-Speed Communication

AN ELECTRONIC ultra-high-speed unit for use in the transmission and reception of messages and data has reached the development stage. It is claimed that equipment can be designed to produce messages in printed form at the rate of one million words per minute. The chief component in this Electrontype unit is a Charactron, a new type of cathode-ray tube. J. T. McNaney, who invented the tube, is shown examining one of the experimental types in photo A.

The operating principles of one type of Charactron can be understood by referring to Fig. 1. The tube represented is basically similar to the conventional cathode-ray tube, but it is equipped with means by which an electron beam can be converted into shapes of predetermined characters. At a midpoint location in the tube there is a character shadowing disk. The cross section of the electron beam is made to conform to the shapes of aperture configurations in the disk when directed through the individual openings. Electron shadows of predetermined characters can then be selectively focused on the viewing screen. A complete Electrontype recorder is illustrated diagrammatically in Fig. 2. Photo B is a close-up of the Charactron used for numerical displays. Photo C shows messages on a Charactron in response to a high-speed code transmitter.

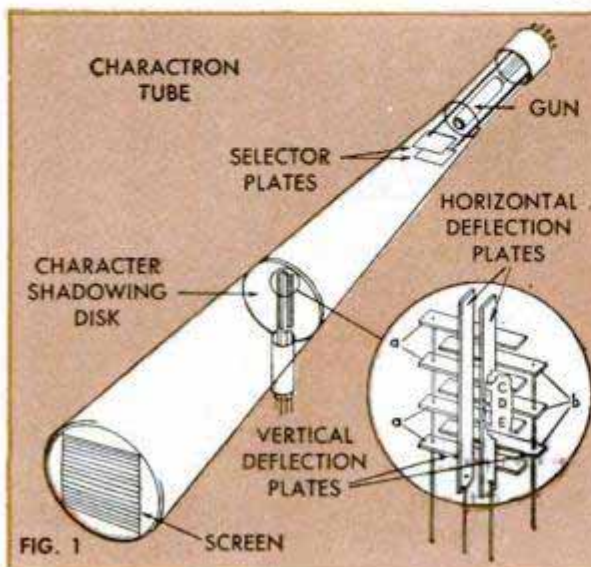
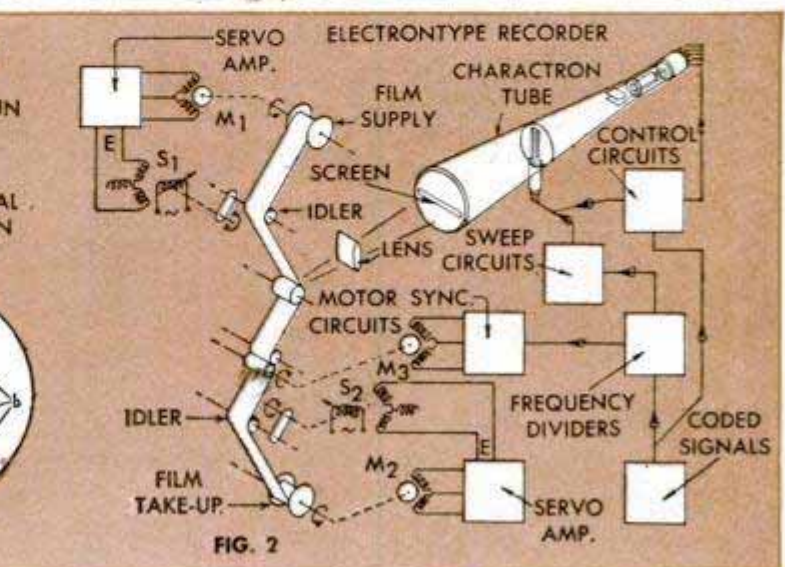

HOW TO BUILD AN INEXPENSIVE

By L. M. Dezettel

SIGNAL tracing means to sample or examine the signal at any specified point on its journey through the various stages in a receiver to the loudspeaker. It is a modern method of servicing radio sets; when you pass from a point of normal signal to the point at which this "electronic bloodhound" verifies or confirms the complaint, you have just passed into or through the defective stage. In other words, this signal tracer will quickly enable you to locate the defective stage and, in many cases, the defective part itself. It also enables you to listen to the actual signal as it is traced through the set and provides a means for checking the quality of the signal at each sampling point.

It is easy to build and simple to use as it is merely an audio amplifier with a built-in power supply and a nonlinear detector in the form of a probe. The unit illustrated consists of two amplifying stages employing one 6SH7 tube and one type 6K6-GT tube. The nonlinear detector probe, which is housed in a short length of Bakelite tubing, is connected to a 6-ft. length of 3-conductor cable, in which one lead is shielded. It employs a 6C4 tube; the cable terminates in a type P-303-CCT Jones plug. Since this is a grid-leak type of detector, it also adds considerably to the signal amplification. A 5Y3-GT/G tube is used in the conventional built-in power supply, with the additional condensers C11 and C12 employed to take

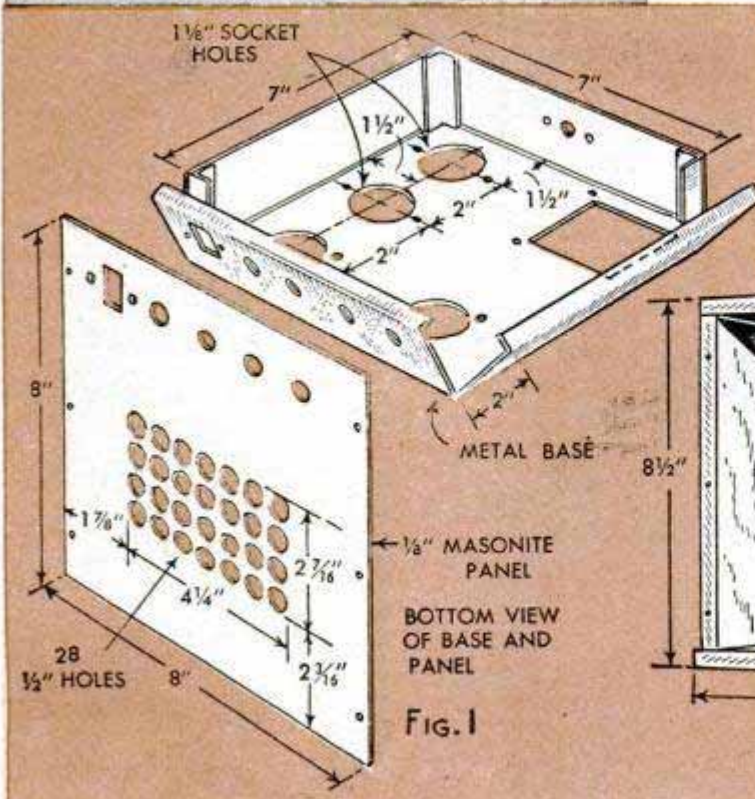
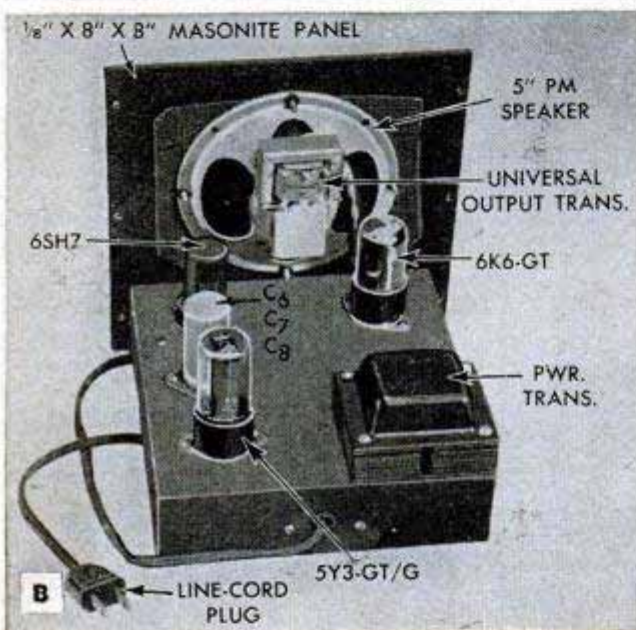

RESISTORS	
1-10-megohm, 1/2-watt carbon, R1	
1-510,000-ohm, 1/2-watt carbon, R2	
1-4.7-megohm, 1/2-watt carbon, R3	
1-510,000-ohm, 1/2-watt carbon, R4	
2-1-megohm, 1/2-watt carbon, R5 and R6	
1-680-ohm, 1-watt carbon, R7	
1-10,000-ohm, 1/2-watt carbon, R8	
1-100,000-ohm, 1/2-watt carbon, R9	
1-3.3-megohm, 2-watt carbon, R10	
1-500,000-ohm, audio taper volume control R11, with s.p.s.t. switch. (Mallory-type MR 48 with Mallory M26 switch used in model)	

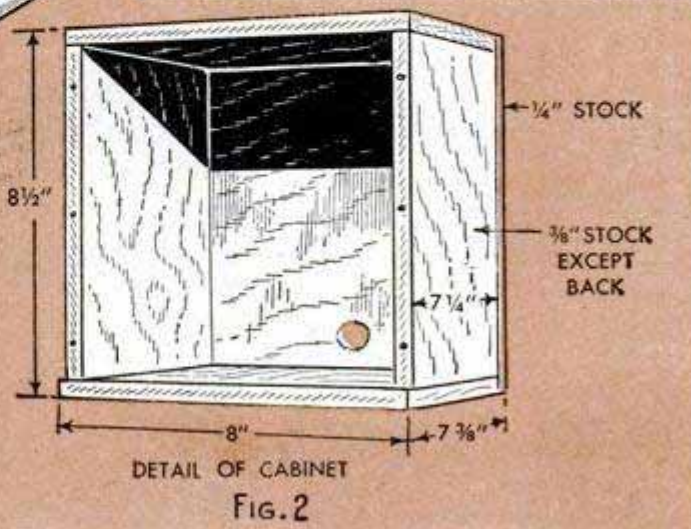

SIGNAL TRACER FOR RADIO SERVICING

out line noises which might appear in the signal tracer, because of its high amplification. Photos A, B, F, G and H show various views of the completed instrument. The metal chassis base, Masonite panel, and cabinet are all carefully detailed in Figs. 1 and 2. A complete schematic circuit diagram is given in Fig. 3. Pictorial wiring diagrams of the 6C4 tube socket, probe, and cable connections are shown in Figs. 3-A and 3-B. Condenser C1, resistor R1 and the 6C4 miniature tube are all contained within a 1½-in.-dia. piece of Bakelite tubing which is closed at each end with a disk of ¼-in. polystyrene. This is a clear plastic insulating material that is available from all radio-parts houses. Condenser C1 consists of two pieces of insulated hookup wire 1¼ in. long twisted together to provide a necessary small capacity; note that only one end of each wire is connected, as indicated in Fig. 3-B. Photos D and E show the completed probe and cable. The banana plug is the actual probe which is used to contact the various parts of the receiver. It picks off either an R.F., I.F., or audio

(Continued to page 222)

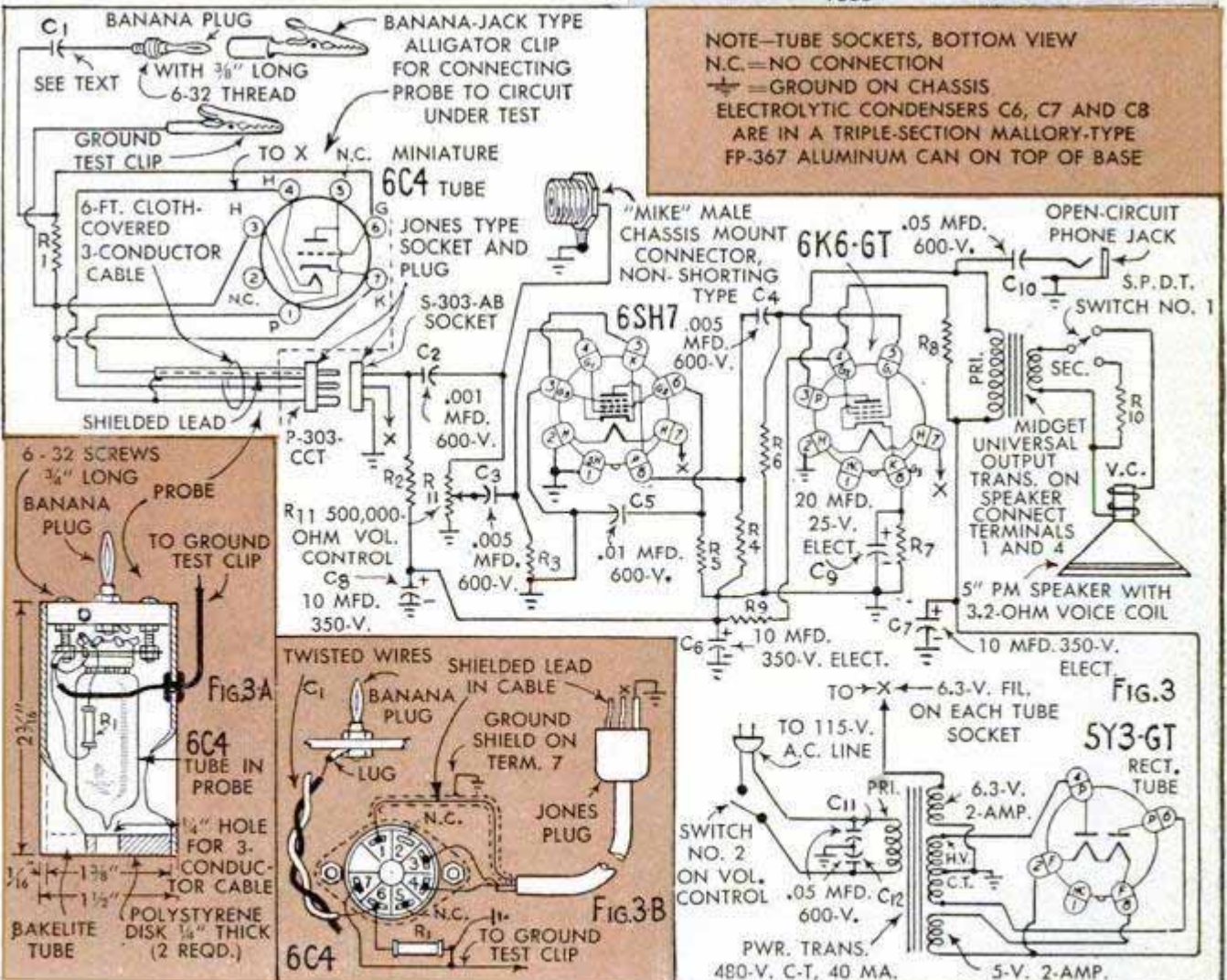
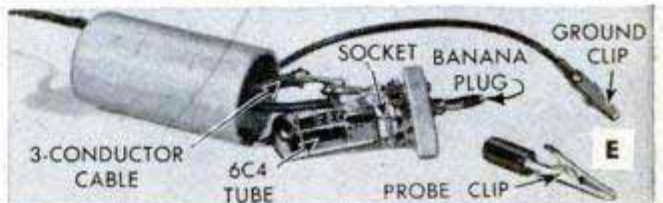
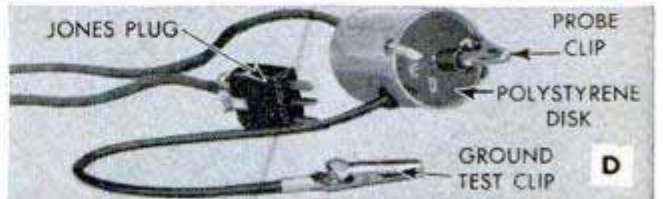
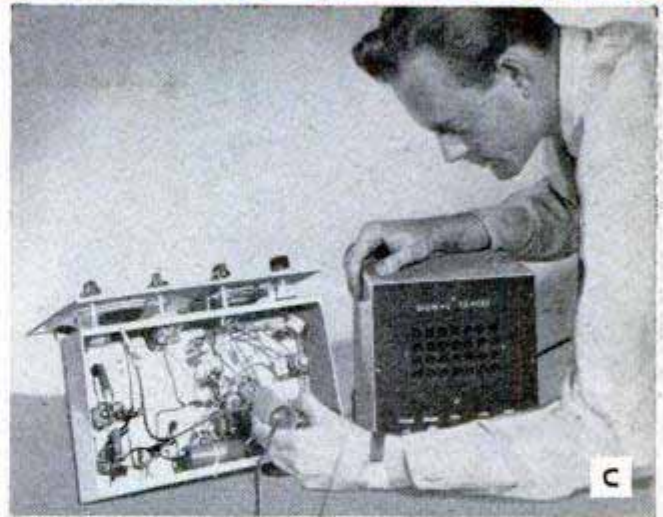

DEMONSTRATION PANELS For Teaching TV and Electronics

DEMONSTRATION panels, or "operating blueprints" have proved to be valuable aids in teaching radio and electronics to large groups. Recently announced as commercially available by the educational section of General Electric's Apparatus Department, the demonstration panel illustrated in photos A, B and C, aids in teaching the principles of industrial electronic motor-control circuits. It is similar to the standard Thy-mo-trol drive which provides adjustable speed from an a.c. source. A type GL-5545 thyatron tube supplies the armature current and a type-83 rectifier tube supplies the field current.

The equipment, in kit form, to be wired by the students, includes the panel, tubes, push-button station, a fractional-horse-power motor, wire and all components. All control parts except the tubes are to be mounted on the back of the 22 x 31-in. unit. The circuit diagrammed in white on the black self-supporting panel, has been laid out with emphasis on its educational value to simplify the teaching of phase shift, d.c. bias effect, thyatron grid control, etc. More than 20 sets of jacks provide for the measurement of current or voltage at all important points in the circuit, while additional contactors and jacks make possible the control of auxiliary equipment. The d.c. motor may be started, stopped, reversed, and its speed varied from 50 to 1725 r.p.m. from the remote-control push-button station.

The introduction of a new Television Dynamic Demonstrator, at the recent national convention of the Institute of Radio Engineers, brought the demonstration-panel idea into the television field. Developed by the RCA Tube Department and shown in photo D, this panel is a complete operating, 30-tube television receiver spread flat on an upright panel for the study of TV service conditions and the training of servicemen. Resembling a giant operating blueprint, the demonstrator panel is 3½ ft. high by 5½ ft. wide. Tubes, resistors, capacitors and other components are plugged into outlets connected by wiring on the back of the panel, while their relationship is shown by a circuit diagram on the panel's face. Parts may be removed individually, or in various combinations to simulate difficulties encountered in servicing television receivers. The signal is picked up with a conventional television antenna and high-quality images are presented on a standard 10-in. picture tube mounted on the panel.

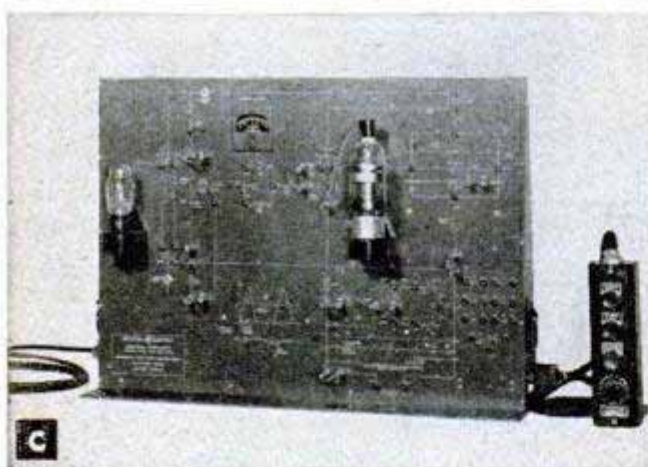
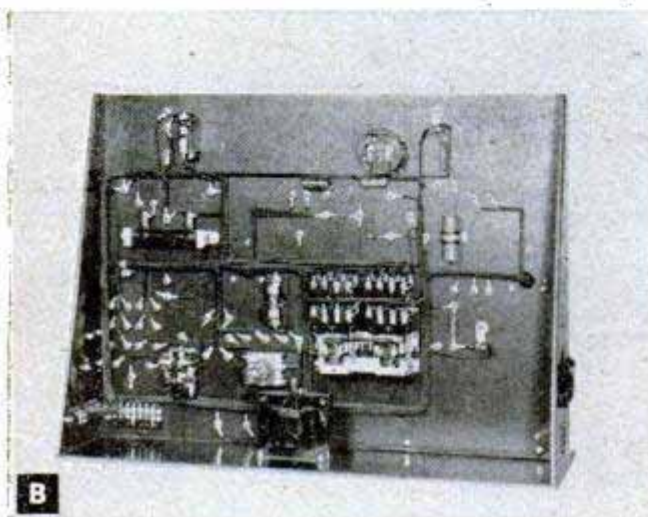

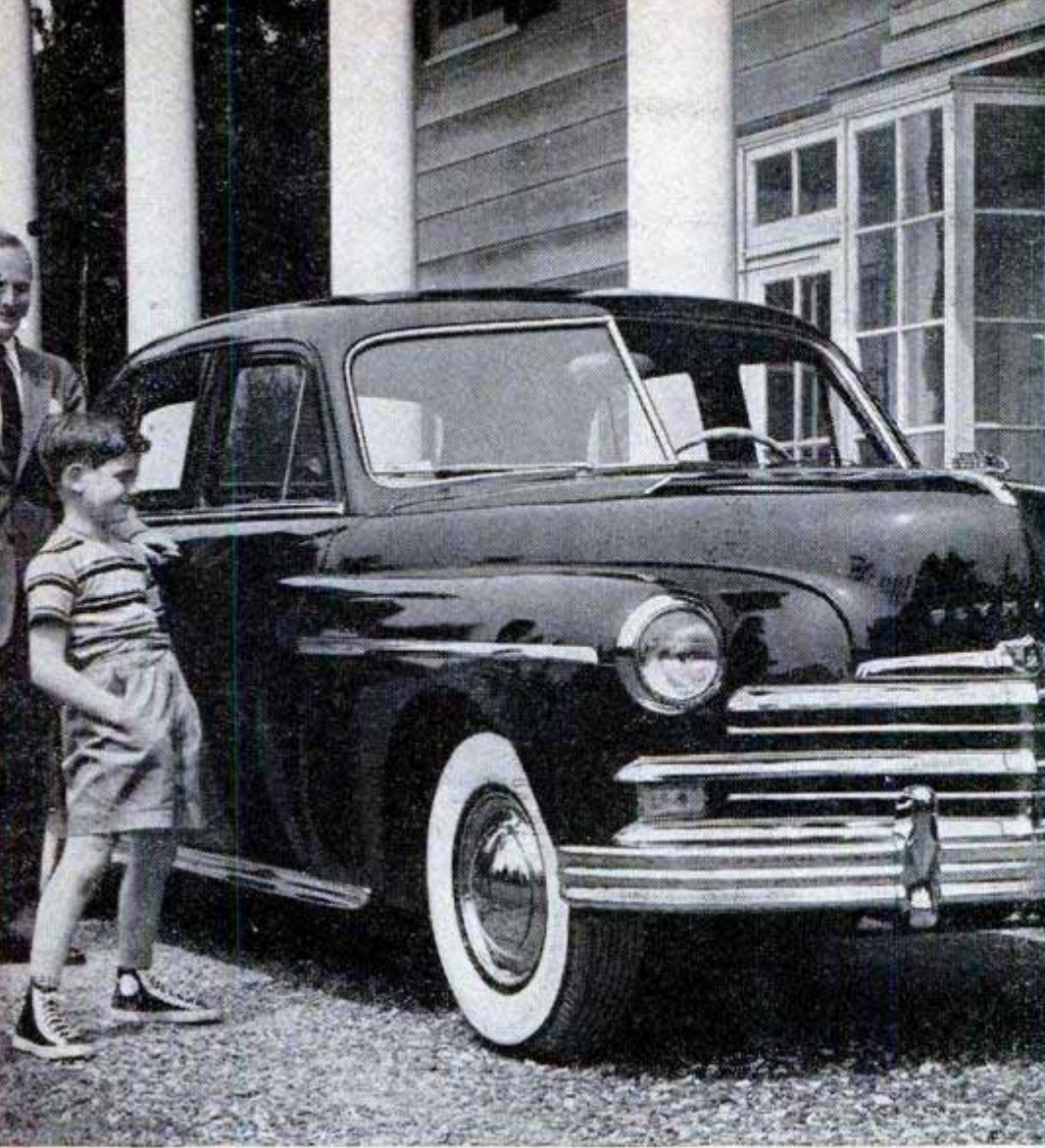

White sidewall tires and chrome wheel covers optional at extra cost.

The car that
likes to be
compared

NEW

PLYMOUTH

Yes, it likes to be
compared for SAFETY, too!

Hear the soft click, solid-sounding as a bank vault, when you slam a door. Box-type construction of important steel members, and many other engineering improvements give the body and frame 23% greater rigidity.

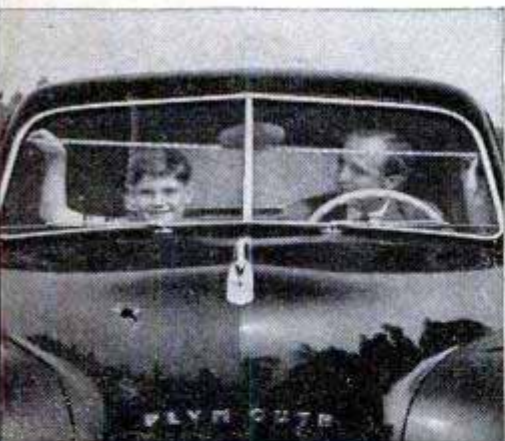

See ahead through a windshield now 37% larger. See back through a 35% bigger rear window. See the road with clear, control-tower visibility.



Hold the road easily in case of tire failure. Safety-Rim Wheel keeps the tire straight on the rim — and, as always, Safe-Guard Hydraulic Brakes slow you to a safe, sure stop.

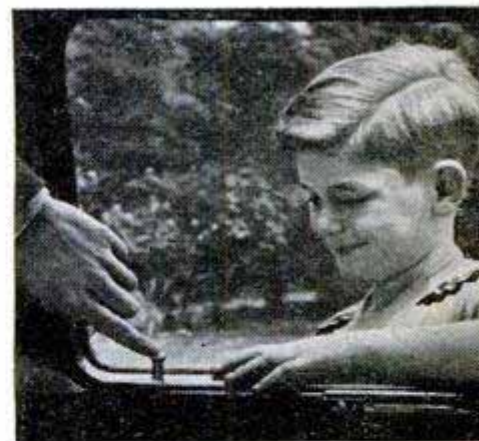

Press the safety lock and rear doors can't be opened from the outside or accidentally from the inside. And all doors are hinged in front.

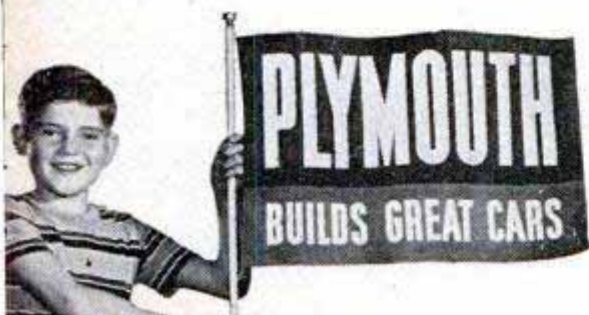

Check the new Quality Chart at your nearby Plymouth dealer's. Of 22 Quality Features found in most high-priced cars, you'll see that low-priced Plymouth has 21, low-priced car "A" has 13, and low-priced car "B" has 4. Then as a final clincher, take the wheel. Drive the Plymouth—let the ride decide!

PLYMOUTH Division of CHRYSLER CORPORATION, Detroit 31, Michigan

SELF-CONTROL STARTS HERE



and to restore
CAR PERFORMANCE

OIL-CONTROL STARTS HERE

TO STOP OIL-PUMPING, REPLACE WORN
ENGINE CONNECTING ROD BEARINGS

On the fairway or on the highway, lost control means poor performance. Like a topped tee shot, worn engine bearings lead to trouble.

Connecting rod and main bearings control oil flow for internal lubrication. When worn, they let excess oil reach combustion chambers. It burns to power-stealing carbon on pistons, rings, valves and spark plugs . . . *performance goes up in smoke!* Give the new rings a chance to do their own job—ask your mechanic! To restore power and pep, he will recommend Genuine Federal-Mogul Oil-Control Bearings.

FEDERAL-MOGUL SERVICE
(Division of Federal-Mogul Corporation)
DETROIT 13, MICHIGAN



CONTROL OIL-PUMPING
WHERE IT STARTS—WITH

FEDERAL-MOGUL

OIL CONTROL BEARINGS

1899 • FIFTY YEARS OF CONTINUOUS BEARING EXPERIENCE • 1949

How to Build an Inexpensive Signal Tracer for Radio Servicing

(Continued from page 219)

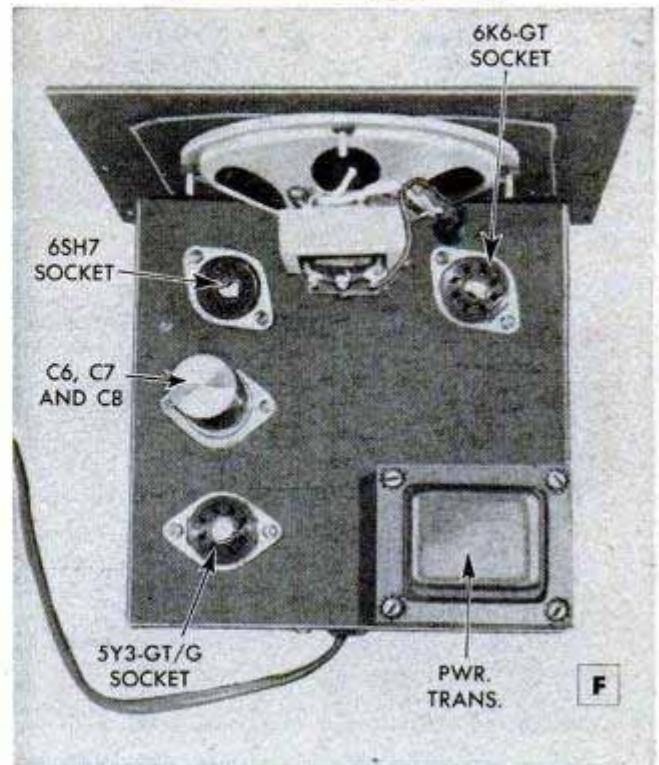

signal. For R.F. or I.F., the signal is detected in the 6C4 tube and converted to audio where it is further amplified in the other two tubes for operating either a loudspeaker or a set of headphones. Switch No. 1 cuts in a dummy load when phones are used. With the microphone connector you have a 2-stage public-address amplifier should the emergency ever arise.

When arranging the parts on the chassis base, mount them so as to make all connections between the various terminals as short as possible. All "hot" wires associated with the output circuit, such as the plate side of the 6K6-GT, must be well separated from any wires associated with the input or grid side of the 6SH7 tube. Leads and components connected to grids or plates of either tube should have the shortest possible length; clip the pigtailed of resistors and condensers where necessary to keep these leads short. In common practice, the signal tracing procedure is to work backwards from the loudspeaker towards the antenna circuit. Always guard against possible shock by disconnecting the receiver from the power line and use the alligator clips to make the necessary circuit connections each time the probe is moved. Assuming that you have a "dead" receiver but your meter indicates plate and filament voltage to the tubes, you begin with your signal tracer by connecting the ground clip to the chassis of the set and check at the

(Continued to page 224)

Built for Professional Mechanics . . . GENUINE **Snap-on** WRENCH SETS

Give YOU a lot MORE for YOUR Money!

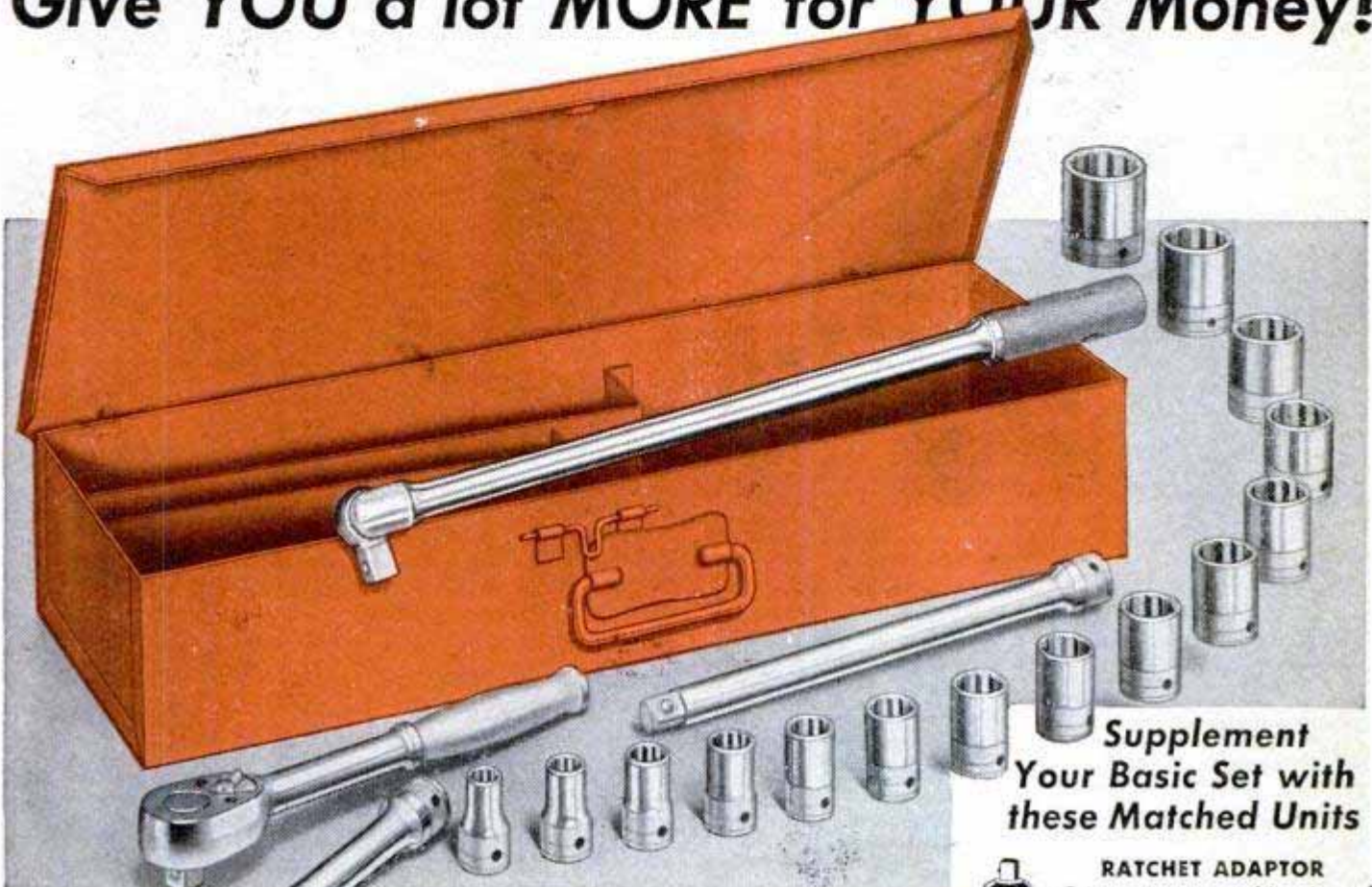

BASIC SET 319-M-B — 1/2" SQUARE DRIVE UNITS

Here's the ideal starter set for the alert mechanic. It has a basic selection of 1/2" square drive Snap-on "Matched Unit" wrenches of the exact quality used by professional mechanics. They're precision engineered for absolute accuracy . . . machined from fine alloy steels, and heat treated for toughness and hardness. The set includes 19 tools; an 18" nut spinner, ratchet wrench, 5" and 10" extension bars, and 15 popular sizes of sockets from 7/16" to 1 1/4". Complete in a red enameled heavy-gauge metal box with plenty of room for additional tools.

319-M-B Basic Master Set.....

\$29⁹⁰

Add local sales tax

Mail This Coupon Today!

Supplement Your Basic Set with these Matched Units

RATCHET ADAPTOR
Converts any combination of handle extension and socket into a ratcheting tool.

HEXAGON FLEXOCKETS
Sockets with built-in universal joints—reach around obstructions to turn nuts. Sizes range from 9/16" to 7/8"

DEEP HEXAGON SOCKETS
Give you additional clearance to service spark plugs, spring "U" bolts and nuts set deep over bolts. Sizes 1/2" to 1-1/8"

SPEEDER HANDLE
Spins nuts on or off in a hurry! Both handle grips swivel for easy operation. Overall length 18-3/4"

SNAP-ON-TOOLS CORPORATION, 8062-H 28th Ave., Kenosha, Wis.

Enclosed find check money order, or Company Purchase Order for the \$29.90 Master Basic Set.
 Please send illustrated brochure describing 105 Snap-on Master Series Wrenches and Sets.

Name.....
Address.....
City..... State.....



GENUINE Snap-on Tools

can be bought only from Snap-on branch sales offices and field representatives or Direct-by-Mail.

NEW EDITION

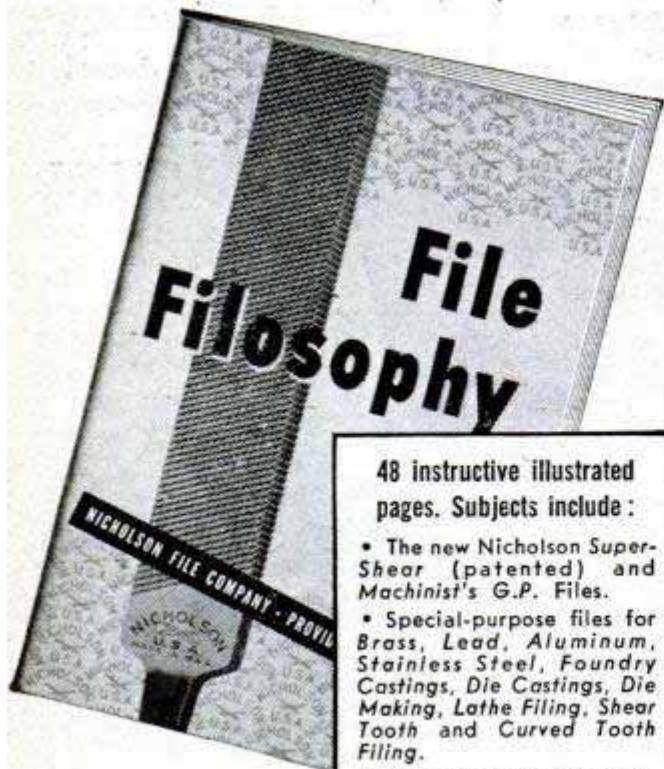

48 instructive illustrated pages. Subjects include:

- The new Nicholson Super-Shear (patented) and Machinist's G.P. Files.
- Special-purpose files for Brass, Lead, Aluminum, Stainless Steel, Foundry Castings, Die Castings, Die Making, Lathe Filing, Shear Tooth and Curved Tooth Filing.
- All representative regular-purpose files and rasps.
- Swiss Pattern files.
- History and manufacture of files.
- File terminology.
- Filing methods and how to get the most out of files.
- Saw files and filing.
- Precision filing.
- Sharpening tools and implements.

FREE to home craftsmen, inventors, model builders, die makers, industrial and machine-shop mechanics.

USE COUPON (or letter or post card) to request a copy.

"FILE PHILOSOPHY," a practical guide in the art of filing, has become universally accepted as an authority in its field. Mechanical and technical experts have used it as a foundation for articles in the mechanics and industrial press. It is a recognized "textbook" in hundreds of mechanical training schools.

This latest edition comes to you in up-to-the-minute form and reflects the leadership Nicholson holds as the largest and one of the oldest and most progressive file manufacturers in the world.



NICHOLSON FILE COMPANY
Providence 1, R. I.
(In Canada, Port Hope, Ont.)



NICHOLSON FILES FOR EVERY PURPOSE

NICHOLSON FILE CO., 22 Acorn St.
Providence 1, R. I.

(In Canada, Port Hope, Ont.)

Send copy of the new 1949 edition of "File Philosophy."

Name _____

Address _____

I am a _____

(State if home craftsman, regular mechanic, or other file user.)

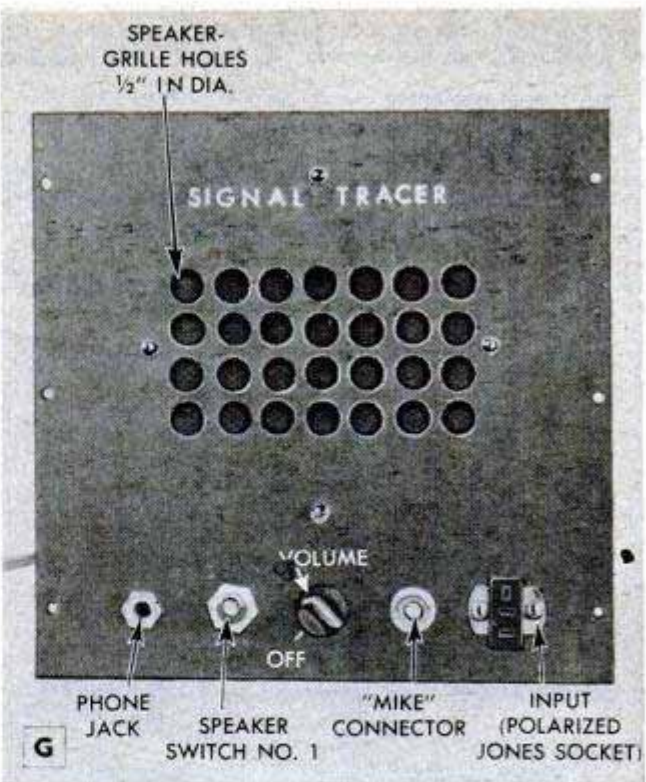

speaker voice-coil leads. Then go to the plate terminal of the output stage and next to the grid terminal of the output stage, etc., until something is heard in the loudspeaker of the signal tracer. The best points of contact are usually the grids or plates of each of the tubes (except the power-supply rectifier tube), checking every tube all the way back down the line until the signal is heard. When the signal is heard, this is your indication that immediately following this point, there is a failure in the receiver itself. Thus, by process of elimination, you are able to find the cause of the trouble. Detailed student material list R-380 is available from Popular Mechanics Radio and Electronics department upon receipt of ordinary letter postage.

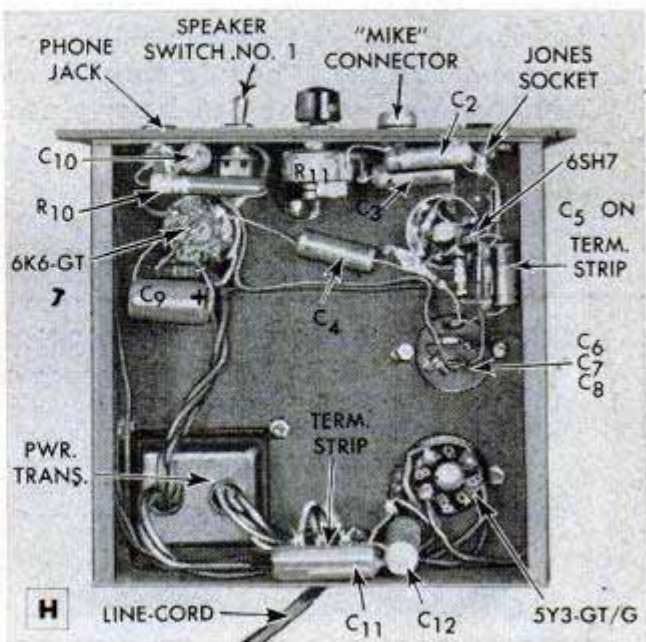

DEPENDABLE

CHAMPION

SPARK PLUGS

← America's Favorite!



The modern farmer will tell you that car, truck, tractor, stationary engines and other power farming equipment are the key to increased farm production. That's why *dependable* spark plugs are of paramount importance to him—why he uses *dependable* Champion Spark Plugs in vast majority. This preference is unquestionably based upon better performance in every type of engine, so whether you are farm, town or city folk, insist on Champion Spark Plugs—the leader in public preference for more than a quarter century.

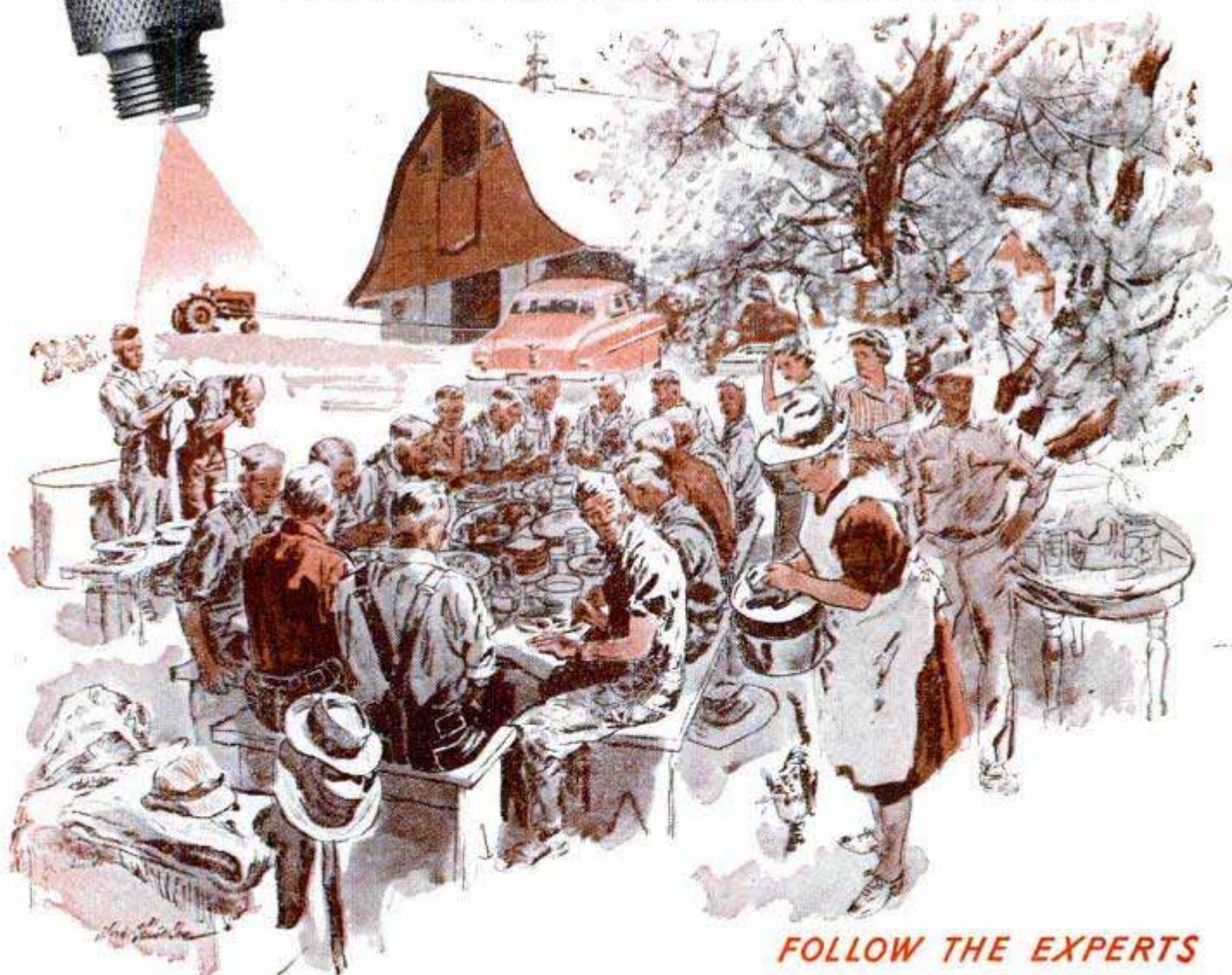

FOLLOW THE EXPERTS

USE THE SPARK PLUGS CHAMPIONS USE!

Listen to the CHAMPION ROLL CALL . . . Harry Wisner's fast sportscast every Friday night, over the ABC network

when you
think of pliers...

think of
CHANNELLOCK

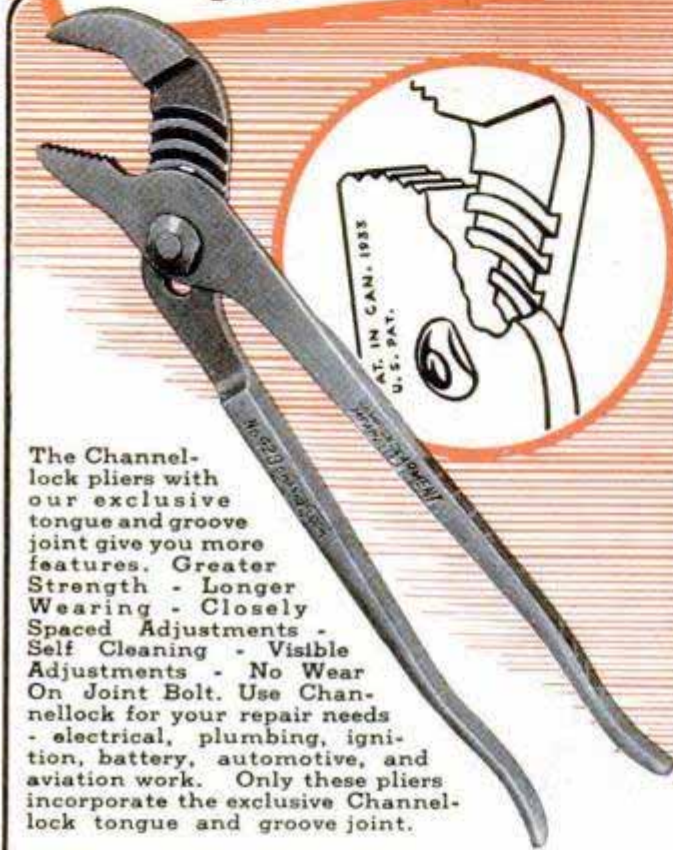

The Channellock pliers with our exclusive tongue and groove joint give you more features. Greater Strength - Longer Wearing - Closely Spaced Adjustments - Self Cleaning - Visible Adjustments - No Wear On Joint Bolt. Use Channellock for your repair needs - electrical, plumbing, ignition, battery, automotive, and aviation work. Only these pliers incorporate the exclusive Channellock tongue and groove joint.



There is a line of standard pattern pliers, too, with Channellock quality construction . . . including diagonal cutters, needlenose pliers, linemen's and electricians' pliers, battery and standard slip-joint pliers.

Choose the pliers that fit your needs . . . Choose Channellock.

Send for Free Catalog, A-10

CHAMPION DEARMENT TOOL CO.
MEADVILLE, PA.

Only Champion DeArment makes

CHANNEL LOCK

Flowers That Never Fade

(Continued from page 155)

showcase displays, as bouquets in the home and for party-going corsages.

Someone once asked Mrs. Harshbarger to make some stephanotis. She thought at first that this must be a kind of disease, but discovered that it really is a small, white flower that is popular for bridal wreaths and bouquets. A search of available flower-making literature and manufacturers' catalogues failed to reveal a word about this blossom. Finally, she was able to obtain some actual blossoms which are very small and composed of extremely delicate and tiny parts. But she managed to make acceptable reproductions, although she had to create all of the parts herself.

In an attempt to keep up with new developments, Mrs. Harshbarger collects specimens of flower-making work from Europe, South America and other parts of the world. Some of these examples are excellent, some inferior. She believes that many flower craftsmen do not take the pains necessary to reproduce all the essential details. She is a perfectionist and tries to make every petal, every sepal and leaf and every other part resemble as closely as possible the model Mother Nature built.

Mrs. Harshbarger has won several prizes with her flowers in hobby competitions. The first was a highly-prized "Oscar" she won in a free-for-all contest against such veteran hobbyists as coppersmiths and model builders. She has exhibited her flowers in various Midwestern cities and plans to show them on the West Coast soon.

Auto Race to the Clouds

(Continued from page 145)

This type car is well suited for road racing and turns in a good performance on the Peak highway, the motor developing in excess of 300 horsepower.

Fans were treated to an unexpected surprise last year when Herb Bryers of Colorado Springs, a newcomer to the hill climb, kicked over the "dope bucket" by taking second place in the race, beating out such drivers as Unser, Mauro and Snowberger.

The race is a dash against time, which adds a psychological obstacle for the drivers inasmuch as the official times are not released until the last car has finished its run. Each driver, therefore, must run at maximum speed even though he might have a comfortable lead. The clocking of the event is a problem because three to four cars may be on the course at one time.

(Continued to page 232)

BANISH

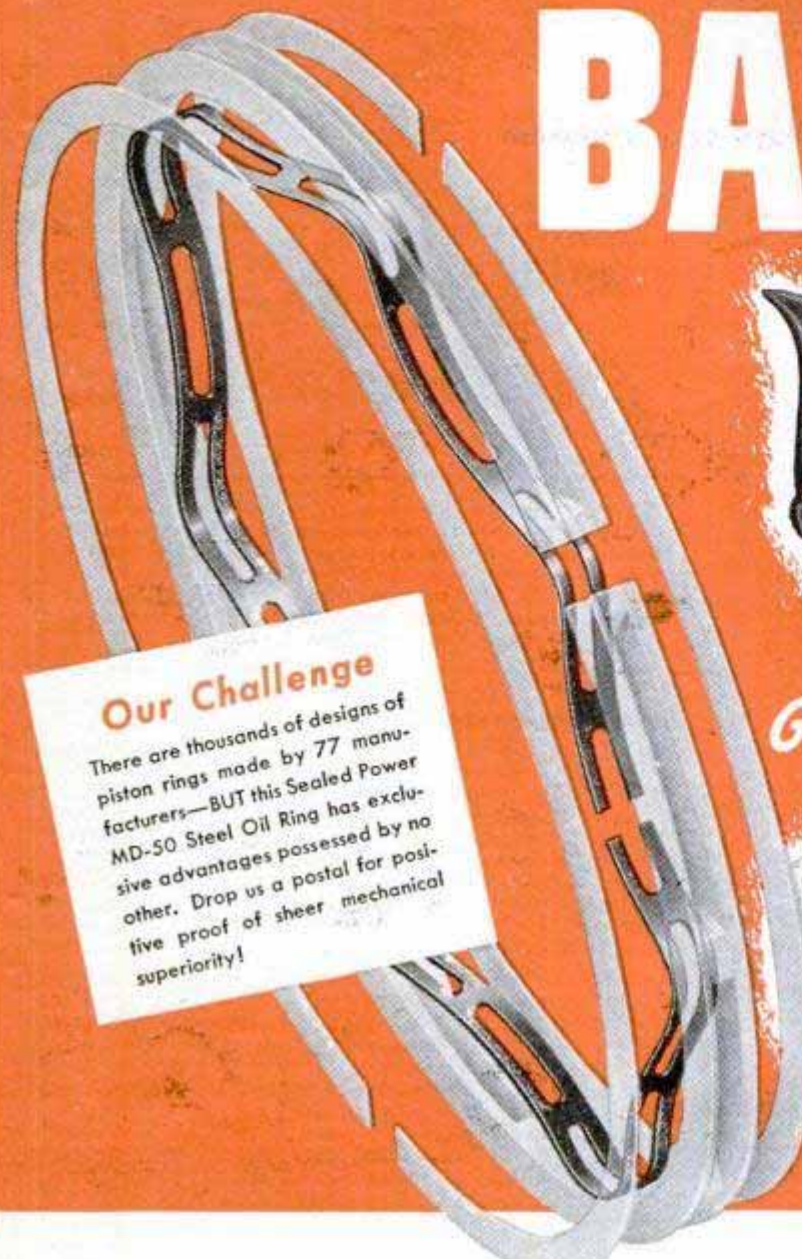

Oil Waste



Gas Waste



and Failing Power



Our Challenge

There are thousands of designs of piston rings made by 77 manufacturers—BUT this Sealed Power MD-50 Steel Oil Ring has exclusive advantages possessed by no other. Drop us a postal for positive proof of sheer mechanical superiority!

SEALED POWER PISTON RINGS

Save Oil—Save Gas—Seal Power!

Enjoy 1949 power and 1949 economy in your car, truck or tractor, no matter what year it was built! This great Sealed Power Piston Ring ends oil and gas waste, gives you back the thrilling power you used to enjoy. It is the only ring with the Sealed Power Full-Flow Spring, praised by mechanics and car owners all over America! Ask your Sealed Power Dealer to tell you the whole story!

Mail coupon today for proof to back up our challenge! At the same time we'll send you our new illustrated booklet on 7 ways to save oil. It's free and may save you real money. Ask for Sealed Power Pistons, Cylinder Sleeves, Valves, Water Pumps and Chassis Parts.

There is a Sealed Power Set specifically engineered for your car, truck or tractor—whatever the make, model or engine condition.

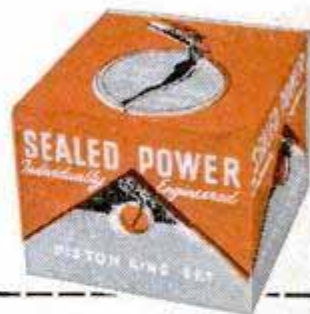

Sealed Power
PISTON RINGS
BEST IN NEW CARS! BEST IN OLD CARS!



Mail coupon for
FREE BOOKS!

SEALED POWER CORPORATION,
Dept. G8, Muskegon, Michigan
Please send me your two FREE books, "Proof!"
and "Seven Ways to Save Oil."

Name _____

Address _____
(Paste coupon on penny postal card)

DEMAND GENUINE

Chromtrim

TRADE MARK
A PRODUCT OF R. D. WERNER CO., INC.

"Trim-it-Yourself"

METAL MOULDINGS
trade mark-wrapped

FOR YOUR
PROTECTION

Join the thousands who have beautified their homes, from cellar to attic... yes, TRIM IT YOURSELF with high-lustre CHROMTRIM and erase years from rooms in a matter of minutes! Insist on CHROMTRIM — the only line that was specially developed for home applications. The name CHROMTRIM is on every, ready-wrapped, 6-foot length... don't accept substitutes!



EASY TO CUT



EASY TO BEND



EASY TO APPLY

Serve yourself from this colorful Chromtrim floor display at your favorite store... choose from the 12 popular Chromtrim shapes that help modernize your home in hundreds of ways!



SEND FOR YOUR "TRIM IDEAS" BOOK!

R. D. WERNER CO., INC., 295 Fifth Avenue, N.Y. 16
Enclosed is 10c. Please send me a copy of your 16 page full color booklet "Trim Ideas", telling me how to decorate with Chromtrim metal mouldings.

Name

Address

City State PM-8

Clinic



for Homemakers

As a service to our readers in solving the hundreds of problems pertaining to a home—inside or out—the editors of *Popular Mechanics* invite you to present your problems to The Clinic Editor for help and advice. Address your questions to The Clinic Editor, *Popular Mechanics Magazine*, 200 East Ontario Street, Chicago 11, Ill.

Preventing Household Tools From Rusting

Q—I have a number of household tools, hand drills, saws, hammers, chisels, brace and bits, files and the like, which I keep in a metal toolbox in the basement. It seems almost impossible to keep these tools from rusting, especially during the summer months. I keep the tools coated with a light machine oil but even so, when I take a tool out of the box, there usually will be a spot of rust somewhere on the bright metal parts. What can I do to prevent this?
C.D.—Sioux City, Iowa.

A—In the basement where the humidity usually is high during the summer months, moisture tends to collect in any closed box or other container. This is due chiefly to a lack of air circulation and, of course, inadequate ventilation. When the tools coated with oil or grease are placed in the toolbox, some of the oil may be rubbed off or, if one tool touches another, the oil coating will be absorbed or displaced at the point of contact, leaving the metal without a protective film at this point. Several rust-preventing liquids now are available which can be applied to metal surfaces with a brush. These set lightly after application and form a thin film which is impervious to moisture, does not rub off easily and is not readily absorbed by contact with other materials. This product is available at any well-stocked hardware store.

Smoke-Pipe Corrodes



Q—The long smoke pipe leading from my furnace to the chimney gathers drops of moisture during the summer months and corrodes badly. In fact, the pipe is in such poor condition that it must be completely renewed every two heating seasons. What causes this corrosion and is there any sure remedy?
A.W.—Freeport, Ill.

A—Residues of combustion which collect in the pipe during the heating season combine with moisture to form certain corrosive acids. There really is no complete protective procedure against this corrosion which is practical to carry out, except to remove the pipe at the end of the heating season, clean each section as thoroughly as possible and then store the parts in a dry place. This procedure probably will add at least another year to the serviceable life of the pipe. Cast-iron smoke pipe, although comparatively expensive, has a serviceable life of 10 years or more.

(Continued to page 230)

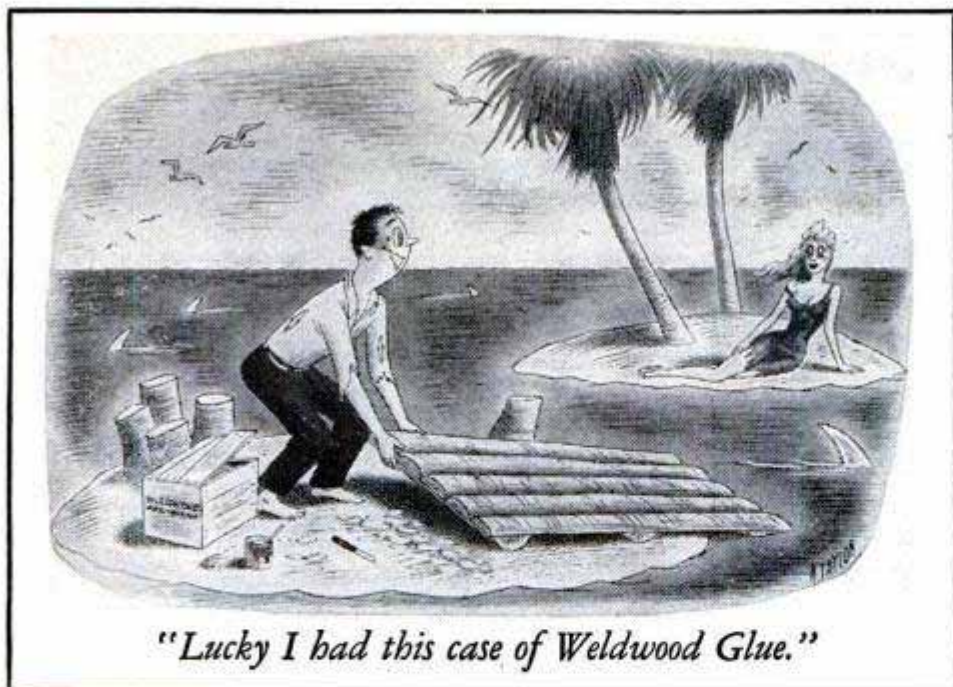

"Lucky I had this case of Weldwood Glue."



Remember Weldwood Glue when you need dependable wood-to-wood bonds. Quick and easy to mix with cold water... tremendously strong... stain-free... rot-proof... and permanent. At paint, hardware, variety stores and lumber yards. 15¢, 35¢, 65¢, 95¢ and larger sizes.

WELDWOOD PLASTIC RESIN GLUE

United States Plywood Corporation, New York 18, N. Y.

ALSO HANDY FOR WOOD HOBBYISTS!



Firzite

— to give you smooth finishes on fir plywood and other soft woods.

A pre-finishing material that seals the wood pores... tames the wild grain... virtually eliminates checking and grain raising. An excellent base for stain, paint or enamel. White or clear. White Firzite provides an easy, low-cost way to achieve "blond," "bleached" or "wiped" finishes.



Satinlac

— to preserve the beauty of all woods.

An inexpensive coating for the proper finishing of Weldwood Hardwood Plywood and similar woods. Clear. No brush marks. Brings out all the natural beauty of wood. Does not yellow or darken with age.

FIRZITE and SATINLAC are available from paint, hardware and lumber dealers.

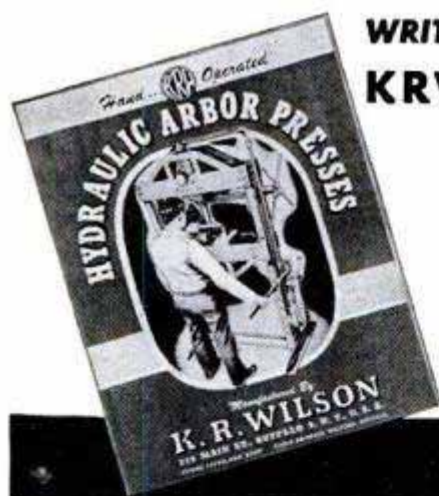

WRITE FOR YOUR FREE COPY OF THE NEW KRW HYDRAULIC PRESS BOOK

Describes all manner of Production and Shop Work on KRW Hydraulic and Bench Type Presses. Illustrates the new KRW Hand-operated, Electric-operated and Air-operated Hydraulic Presses. 25 to 100-ton capacities.

Write for your copy today.

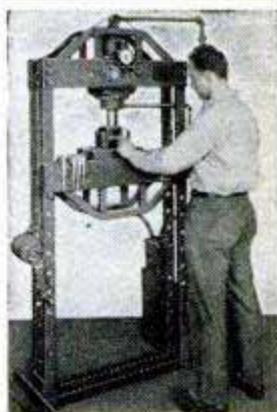

K. R. WILSON, DEPT. 17, 215 MAIN ST., BUFFALO 3, N. Y.



Free Sample!

Big profits showing amazing GLOW-IN-THE-DARK SPECIALTIES. House numbers, pictures, plastic novelties, religious and nursery objects, etc. Large manufacturer. Enormous demand. Sell on sight. Write at once for FREE SAMPLES.

MADISON MILLS, Dept. X-4
303 Fourth Ave. NEW YORK 10, N. Y.



Helps you s-t-r-e-t-c-h your dollars on TV, electronics, radio and tools.

Write today for the 1949 Lafayette-Concord catalog. A penny postcard will do the trick. You'll find pages and pages of the finest equipment at new low prices. Use the catalog to order everything you need and save. It's free. Write to Lafayette-Concord, Dept. LH-9, 100 Sixth Ave., New York 13. 901 West Jackson Blvd., Chicago 7.

M-SCOPE TREASURE -MINERAL LOCATORS

WRITE FOR FREE, ILLUSTRATED 16-PAGE BOOKLET

M-SCOPE TREASURE-MINERAL LOCATORS. Low priced, unsurpassed efficiency, lightweight models. Factory guaranteed. Immediate shipment. Credit plan available. Write for free 16-page booklet.

GEIGER COUNTERS for finding Uranium ores. Several models. Simple operation. Low priced. Immediate shipment. Interesting free literature.

URANIUM

FISHER RESEARCH LAB., INC., PALO ALTO, CALIF.

GOLD

NEW! 2-INCH WRIST CAMERA

Makes BIG 4"x5" PICTURES in COLOR!

Pixie

A fine precision Camera

Wear Pixie on your wrist, or tuck in pocket. America's smallest precision camera gives you BIG candid shots in color or black-and-white — at amazingly low price.



The ONLY Camera That Takes COLOR at 10c a "Shot"!

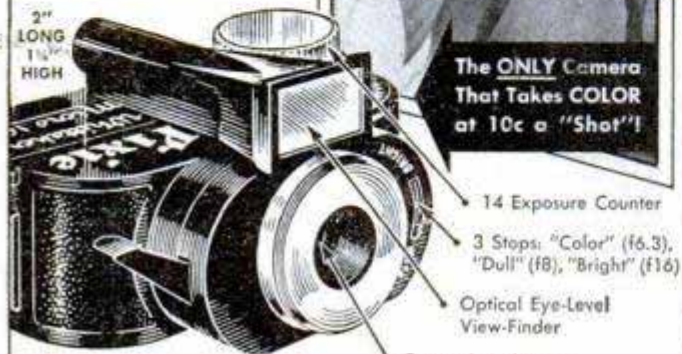

- 14 Exposure Counter
- 3 Stops: "Color" (f6.3), "Dull" (f8), "Bright" (f16)
- Optical Eye-Level View-Finder
- Fastest Lens in any fixed-focus camera, (f6.3 doublet)

Takes 14 Beautiful Pictures!

The ONLY Still Camera With MAGAZINE LOAD!



Magazine loading is automatic, fool-proof. Film is encased in light-tight magazine which snaps into camera instantly. No threading. No damaged film. Pixie is the only still camera in which you can alternate color and black & white shots.

Film Available Everywhere

Pixie uses Ansco Color Film or DuPont Black & White. If your dealer cannot supply film, write direct.

• Case of non-shattering high-finish Polystyrene

INCLUDED AT NO EXTRA COST
\$1.29 Color Film — 14 Exposures!

SENSATIONAL INTRODUCTORY OFFER!

Send NOW for your Pixie Camera and get, at NO EXTRA COST, a \$1.29 magazine loaded with Ansco Color Film, enough for 14 color shots. Return film for FREE processing. MONEY-BACK GUARANTEE if not fully satisfied. Can you ask for more? (Offer good for limited time only.)

SEND NO MONEY

Mail coupon today. When your Pixie and Color Film arrive, pay postman \$6.25 plus few cents postage. Or send cash with order and we will pay postage.

PIXIE plus COLOR FILM \$6.25 Incl. Fed. Tax

MONEY-BACK GUARANTEE

HELM-CRAFT, Inc. Dept. PM 89
Box No. 1145, Hollywood 28, California

Please send me Pixie Camera (plus Color Film) on 10-day trial.

- Send C.O.D. plus postage. I will pay postman. I enclose \$6.25. Send postpaid.
 Send also Pixie Wrist Strap. (I enclose 69c) (Send C.O.D.)

NAME _____ AGE _____
STREET _____
CITY _____ ZONE _____ STATE _____

Best Time To Paint

Q—What is the best time to paint a 20-year-old house that already has been painted a number of times? The painted siding seems to be in good condition and the paint coat unbroken but when the fingers are rubbed over the surface they come away coated with a chalky substance which I suppose is some ingredient of the paint. Can I apply paint over this surface and when during the year is the best time to do it? W.S.—Malden, Mass.

A—Judging from your description of the condition of the painted surfaces you are fortunate, as it should require only a light dusting to prepare the building for repainting. Just when to paint depends on local weather conditions, of course, but in general paint can be applied any time when the surface is dry and the temperature is fairly certain to remain above 60 deg. F. until the paint is dry. Do not apply house paint on hot, humid days or any time when a high wind is blowing as the surface may become coated with dust. The best time to paint a house is during a prolonged period of clear, cool weather, as the humidity usually is quite low and drying conditions ideal.

Circular-Saw Speeds

Q—How does one calculate the proper size pulleys to use when setting up a small circular saw for use in the home shop? I want to drive a 6-in. diameter blade at the proper speed and I don't know how to figure the pulley sizes required.

R.T.—Little Rock, Ark.



A—Manufacturer's specifications for the operating speed of a 6-in. saw blade vary somewhat, but around 5000 r.p.m. is a fair average. To find the diameter of the driving pulley where the speed of the motor and the diameter and speed of the arbor pulley are known, use this rule: Multiply the diameter of the driven (arbor) pulley by the required arbor speed (r.p.m.) and divide by the speed (r.p.m.) of the driving pulley. For example, the speed of the motor is 1725 r.p.m., the required speed of the arbor is 5000 r.p.m., and the diameter of the arbor pulley is 2½ in. Then,

$$\frac{2.50 \times 5000}{1725} = 7.246 \text{ in. or } 7\frac{1}{4} \text{ in.,}$$

the required diameter of the driving pulley. However, for intermittent work such as that in the home shop it is not necessary to drive a 6-in. blade at 5000 r.p.m., as it will do satisfactory light work at much lower speeds. A fair rule of thumb is merely to double the diameter of the arbor pulley—that is, if the arbor pulley is 2½ in. in diameter use a 5 or 5½-in. pulley on the motor.

Removing Calcimine

Q—Recently I tried washing off calcimine in two rooms of my home. It washes off quite easily on some fairly large areas but no amount of rubbing will remove all the coating in some spots on both walls and ceilings. Is this oil paint, or what? What can I use to remove it? G.A.—Portland, Ore.



A—Probably oil paint as you suggest, but there also is a possibility that it is some other type of wall coating, such as washable calcimine or perhaps a water-emulsion paint. In washing, you obviously are removing only the last application of calcimine from these areas. It is suggested that you first try a paste-type paint remover on the spots where the coating resists removal. Apply the paste remover with a putty knife and allow to stand for an hour or more. Then, if the coating in question is an oil paint, it should scrape off easily. Manufacturers of water-emulsion paints supply special removers for use on these wall coatings.

You Can Be the Local Manufacturer

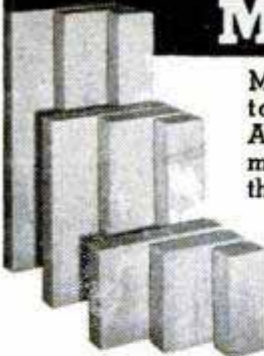

More local plants are badly needed to make Dunbrik-Dunstone—America's finest masonry. Smart—modern—colorful. Yet costs less than lumber. Millions used annually for homes, stores, factories, public buildings, etc.

Write for portfolio "Blueprints for Profit"



With Dunbrik-Dunstone you can ride the tide of the biggest building cycle in history. Local plant—local materials—local labor. Equipment costs moderate. Liberal sponsor co-operation. 100%—150% mark-up on basic costs. Write at once.

W. E. DUNN MFG. CO.
600 W. 24th St., Holland, Michigan

DUNBRIK DUNSTONE

FORMING WITHOUT DIES

with DI-ACRO BENDER

Many small parts can be rapidly formed without dies, to accuracy of .001" with DI-ACRO "Die-Less Duplicating" Machines—Benders, Brakes, Shears, Rod Parters, Notchers, Punches. Save die expense and time delay. For experimental work, samples, models, etc., as well as regular production runs. Write for "Die-Less Duplicating" circular.

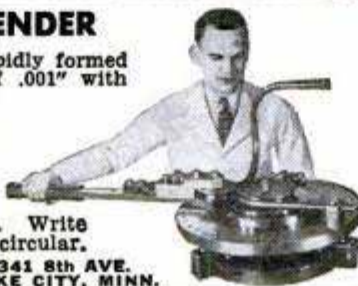

O'NEIL-IRWIN MFG. CO. LAKE CITY, MINN.
341 8th AVE.

KODACHROME PRINTS and ENLARGEMENTS

up to 11x14...from your color transparencies

Order through your Kodak dealer

EASTMAN KODAK CO., Rochester 4, N. Y.

AUTOMATIC RETOOTHER

MAKES NEW PROFITS

Cuts new teeth in 50 seconds—any size 4 to 16 points. Old teeth fall off as chips. Easy to operate. A perfect job.

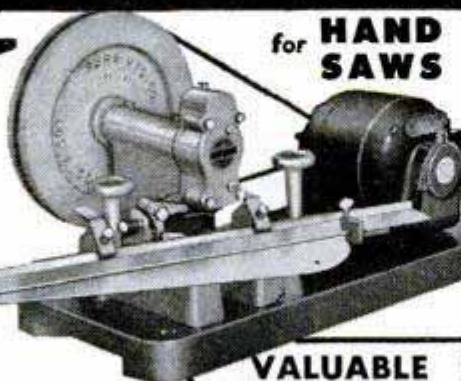

for **HAND SAWS**

IMMEDIATE DELIVERY

BURR MFG. CO.
8933 VENICE BLVD.
LOS ANGELES 34, CALIFORNIA

VALUABLE BOOK

Order Burr's Blue Book of Coast to Coast prices for saw shop services.

25c

SPIEGEL SINCE 1865

NEW



GET YOUR COPY NOW

Shop from the Spiegel Catalog and enjoy the advantages of shopping in a big department store.

712 PAGES packed with thousands of items for home and family. Every item accurately pictured and described and priced low to save you money. SHOP WITH CONFIDENCE! Every purchase is backed by our pledge of SATISFACTION GUARANTEED Or Your Money Back.

PIN A DOLLAR TO THE COUPON! We'll send your copy of the Catalog and a Dollar Merchandise Certificate good on any Spiegel Mail Order of \$10 or more.

PIN A DOLLAR TO THE COUPON

Get Your Catalog and \$1 Certificate

Spiegel, Inc., Chicago 9, Ill.—I am enclosing a DOLLAR DEPOSIT for the new Spiegel Catalog and my Dollar Certificate.

Name

Address

Town, State

R-20-46



EASY PROFIT IN PAINT SPRAYING

Paints walls, ceilings, screens, furniture and machinery faster, better. All complete as shown less motor. Carry anywhere. Fully guaranteed. Could be used with 1/4 H.P. motor or less. Price \$35.00 less motor F.O.B. Chicago. \$5.00 deposit balance C.O.D. or see your dealer. With motor \$55.00.

IDEAL AUTOMATIC PUMP CO., Dept. P.M. 8
801 W. Washington Blvd. Chicago 7, Ill.

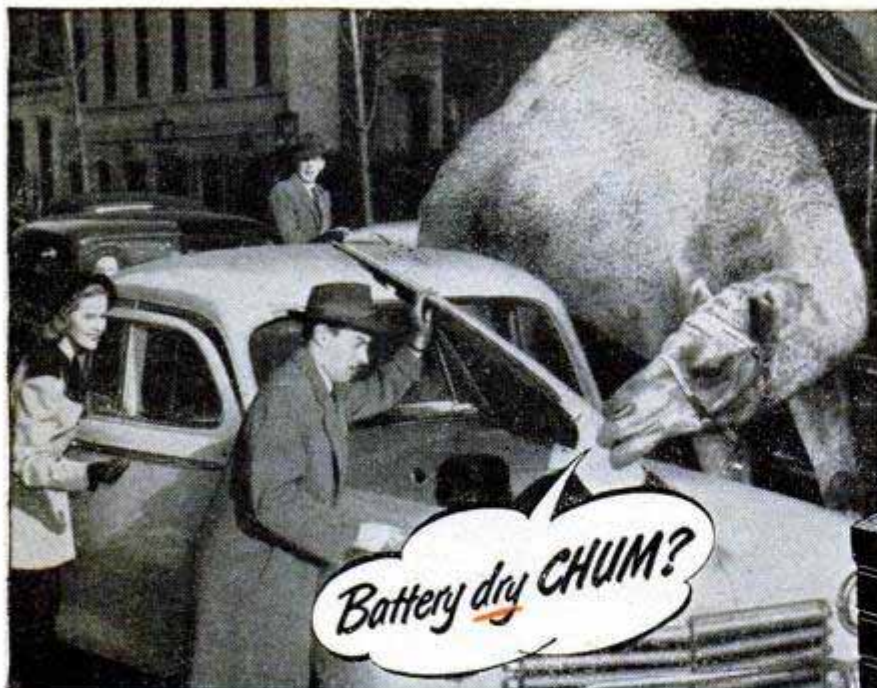

Avoid battery troubles—buy a Prest-O-Lite Hi-Level Battery. Gives up to 70% longer average life as shown in tests conducted in accordance with S.A.E. life cycle standards. See your Prest-O-Lite Hi-Level dealer today.

Toledo 1

PREST-O-LITE BATTERY COMPANY, INC.

Ohio

BUY
Prest-o-lite
 hi-level batteries...need
 water only 3 times a year*

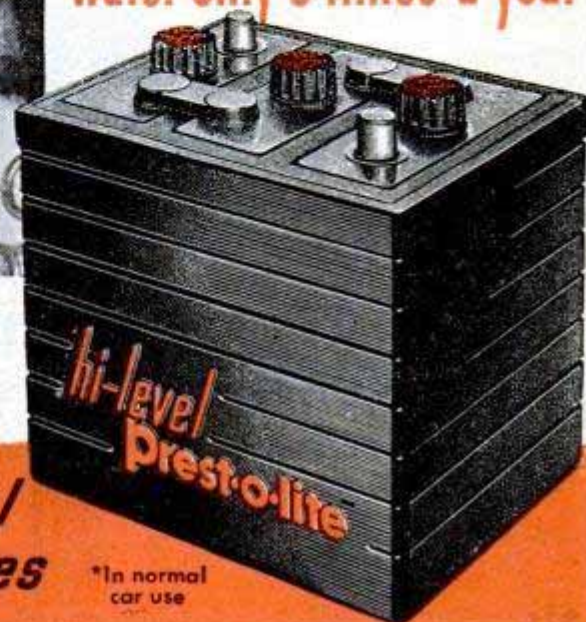

prest-o-lite *hi-level batteries*

*In normal car use

The racers start at five-minute intervals. To achieve absolute accuracy, a complex system of timing has been developed, using electric-eye beams, radio transmitters, cameras and highly accurate chronometers.

The race is run under the full sanction of the American Automobile Association and points are awarded toward AAA championships on the basis of 200 points for first place, scaling down to 10 points for the twelfth-place winner. The race is run regardless of weather conditions. The rules do not impose weight restriction and allow free selection of fuel.

The winner of the 12-mile-plus-2000-foot dash is awarded cash prizes that total over \$5000 and a massive sterling silver and 14-karat-gold belt buckle, handmade and engraved. The second-place winner receives over \$3000 in cash, and prizes are paid down to the twelfth-place contestant who pockets \$210.

The course record is held by Unser for his 1946 run of 15 minutes, 28.7 seconds.

The sportsmanship of the competitors in the Peak race is high, and it is not unusual to find the owners and drivers loaning parts and equipment to their closest rivals.

At the conclusion of the 1948 race Al Rogers was asked if any particular corners gave him trouble. "Yes," the congenial driver replied, "about 165 of them."

Arctic Adventure With a Camera

(Continued from page 129)

can predict how some animals will act, but others are as changeable as a woman. Most animals will turn and run when confronted by man. Just don't count on it. One of them might fool you sometime.

My closest brush with eternity came in Africa and it was my rifle that saved me. I was photographing lions at 20 feet, but it wasn't a big cat that almost got me. Unless a lion is excited, he'll go the other way. It was a Cape buffalo that came charging through the bush, having picked up our scent. Now in my estimation a Cape buffalo is the meanest thing alive. He's not satisfied with bowling a man over. He actually rubs out his enemy with his head. He'll take all day to rub out a man, keeping at his work until there's nothing left except a spot on the ground.

When this particular bull came snorting through the bush, I shot him through the shoulders. It was a mistake I later regretted, for he didn't drop but turned and ran. We crept into the bush after him, determined to finish him off. Finally, we found him and I pumped a second shot into his body; but this too failed to kill him and he disappeared again. We thought we had

(Continued to page 234)

AMAZING MAGNETIC DRAIN PLUGS

Replace the ordinary drain plugs in the crankcase, transmission and rear axle of your car with MAGNETIC plugs. Phantom view shows how magnet is set in each plug. The powerful magnet pulls abrasive metal particles and chips out of the lubricant. Cuts down wear; cuts repair bills. Proved in war equipment. Millions in use. SPECIAL—set of three plugs to fit your car, postpaid, only \$2. No C.O.D. Be sure to give make and year of car.



LISLE CORPORATION CLARINDA, IOWA



Just dial
ANY WIDTH CUT
ON YOUR PRESENT
CIRCULAR SAW BLADE!

Guaranteed to cut clean grooves—12 widths—no sanding. No fuss—no trick assembly. 5 sizes— $\frac{1}{8}$ ", $\frac{3}{16}$ ", $\frac{1}{4}$ ", 1", $1\frac{1}{4}$ ". SEE WARREN DADO SAWING WASHERS AT YOUR DEALERS, OR WRITE. **\$4.95** 4 Set

WARREN WASHERS CO., 70 MEDBURY—DETROIT

HUNDREDS OF ITEMS AND IDEAS FOR THE WOODWORKER

Big New 144 Page Catalog No. 16 OF HARD TO FIND WOODWORK ITEMS, HARDWARE AND SUPPLIES, the finest craftsman catalog Harold Hunt ever published—32 rare and fancy woods in natural colors—also in color, 43 matched veneer designs, multi-colored bandings, inlays, overlays, scroll patterns, etc. Only 15c, rebated on first order.

CRAFTSMAN WOOD SERVICE CO.
2729 S. Mary St. Dept. A-8 Chicago 8, Ill.

HARD TO FIND LUMBER

Top Grade Kiln Dried A Board or a Carload

UNEQUALED BARGAINS

WALNUT, MAHOG., CHERRY, MAPLE, WM. HARD AND SOFT, POPLAR, PL-QTR. OAK, AROMATIC RED CEDAR

PREPARE NOW for Next Winter

Call Air SnowCars are now being built on special order for fall delivery or we furnish detailed plans and parts for home builders. Plans \$10.00. Complete machines from \$1550.00 up. Wheel equipped jobs available. Two, three and four place jobs with engines from 65 to 125 h.p.

CALLAIR, Afton, Wyoming

BUILD YOUR OWN POWER LAWN MOWER

WHY BREAK YOUR BACK MOWING FIELD OR LAWN?

WRITE FOR FREE Building Instructions The Rite-Way Mower Attachment Ball Bearing

SAVE MONEY SAVE TIME

Now anyone can save time and effort mowing field or lawn by building their own whirl type power mower. Build according to your own ideas and needs at small cost. Cut close to fences, walks, buildings, etc. Build in short time with parts and instructions we furnish. Save hours of time and back breaking labor. Write today for FREE information.



IT'S FUN TO BUILD

T & H MFG. CO., Dept. MP22
811 E. 31, Kan. City 3, Mo.

Flex-O-Shaft

HANDLES LIKE A PEN*

\$35.00



FLEX-O-SHAFT is an improved all-purpose machine for homes, schools, shops, or factories. The slender, light-weight aluminum hand piece is ideal for grinding, drilling, sawing, buffing, scoring, etching, polishing, and scores of other uses. There is no bulky, throbbing, pulling motor in your hand. The light-weight motor can hang on the wall, or can be set down on working table. Speed is controlled by foot-operated rheostat, leaving hands free. This precision ball-bearing tool is as easily guided as a pen, speeding up operation because of ease in handling. It is a wonderful, compact, power house for making all kinds of objects. This unit consisting of Flex-O-Shaft with 6-ft. cord, 1/16 H.P. Motor, Rheostat with cord and plug, all for \$35.00. Write today!

FLEX-O-SHAFT and complete Tool Kit with 66 accessories ONLY

\$50.00

F. W. STEWART MFG. CORP.
Dept. A, 4311 Ravenswood Ave.
Chicago 13, Ill.

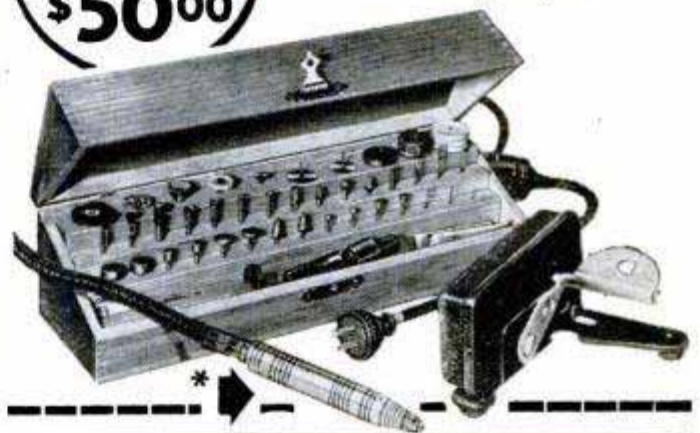

Big Values in small diesels

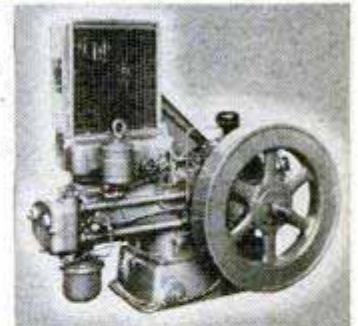

Witte Diesel Power Unit Model BDR

Dollar for dollar, Witte Diesels are the best power investments you can make. They'll deliver reliable power for a few cents an hour . . . year in and year out.

Witte Diesels start at the touch of a button, operate on low-cost diesel fuel, and require only a minimum of maintenance. You don't have to be a diesel expert to operate and service them.

Witte Diesel Power Units are offered from 4 to 12 H.P. And Witte Dieselelectric Plants . . . a package unit consisting of a Witte Diesel and a direct-connected or belted constant voltage generator . . . range from 3 to 10 KVA-AC; 2.5 to 8 KW-DC.

Specify the type of unit and the horsepower or KVA you need. We'll send you specifications, prices and the name of your Witte dealer.



WITTE ENGINE WORKS

Dept. C-8, Kansas City 3, Mo., U. S. A.
Division of Oil Well Supply Company
Witte Dieselelectric Plants and Diesel Power Units

UNITED STATES STEEL

46% MORE POWER

SERVI-CYCLE New Model

**LOWEST-PRICED
COMPLETE POWERCYCLE**

Delivered Fully-Equipped

\$248

U. S. Tax Paid



Write for

FREE Folder

• **Safe**

• **Dependable**

• **Economical**

SIMPLEX MANUFACTURING CORPORATION

538 N. CARROLLTON AVE.
NEW ORLEANS 19, U.S.A.

him cornered, so my companions went one way and I went the other to make sure he wouldn't elude us. I was crawling through the bush on my hands and knees when suddenly I heard him snort. He was no more than 50 feet away and came charging down on me like a locomotive. I jumped to my feet and fired once, hitting him just below the eye, but it failed to drop him. By then he was right on top of me, so close that I could only leap to one side, lift my rifle and fire straight down on top of his neck. That final shot did it. He was an old bull weighing 1800 pounds, each pound packed with muscle and meanness.

In my 30 different expeditions to study wildlife, photograph it, or bring back specimens I've never had such a close call.

I'd like to make one final point. Perhaps you'll think I'm joking when I say that both the Arctic and the jungle are safer than the Chicago Loop during business hours. It's true, though. I'd rather face a family of brown bears than a horde of pedestrians, and a Cape buffalo isn't as dangerous as a "Windy City" taxicab.

Daniel Boones on the Rifle Range

(Continued from page 140)

fundamentals of loading. First, measure out a charge of black powder and pour it

into the muzzle. Then take a piece of linen cloth, wet it with your tongue and place a newly molded lead ball in one corner. Using the short end of a wooden "starter," press the linen-wrapped ball inside the muzzle of the rifle. Cut off the surplus with a sharp knife. Drive the ball well down into the barrel with the long end of the starter. Push it carefully all the rest of the way down with your hickory ramrod. Don't "wham" it and deform the ball.

8. Learn and observe the rules of safety. They're the same as those that apply to any weapon: never point a gun at another person, don't load except while on the firing line and don't drink or smoke when you're handling a gun. In the case of a muzzle-loader, there's an added precaution: don't hurry to reload, because a lingering spark can cause accidents when a fresh charge of powder is put in too soon.

When you've gotten this far, you'll begin to look around for some other muzzleers and a place to shoot some matches. Chapters of the National Muzzle Loading Rifle Association are located in more than 30 American cities.

Regulation small-bore rifle targets are used on all ranges. There is only one radical change from the rules of small-bore

(Continued to page 236)

BACK ACHE?

SORE MUSCLES?



When muscles are stiff and sore from unusual exercise or strain, use HEET®, the liniment that's *strong* yet does not burn the skin. Wonderful relief from muscular soreness comes as comforting HEET quickly starts to *penetrate*. Just brush it on with the applicator. HEET starts at once to ease muscular pain and *keeps on working* for hours, warms and soothes the painful area.

NOW! More Shooting Fun



with Crosman's New \$14.95 "Town & Country Jr." RIFLE

Expert or beginner—you'll like this rifle for year 'round shooting indoors and out. Accurate, hard hitting, yet safe to use anywhere thanks to Crosman's "controllable power" feature. Has rifled barrel; standard sights. Weighs only 4 lbs. 7 ozs. Available in .177 and .22 cal. single shot models at your dealer. Write for literature.

Crosman Arms Co., Inc. 3 HENRIETTA STREET
ROCHESTER 7, N. Y.

AIR AND LIQUID TANKS

Compare Our Price! \$3.59



Non-rusting stainless steel; 10 gallons liquid capacity; 12" diameter, 24" length. Holds up to 400 pounds safe air pressure. No operating cost; fill free at any gas station. Complete tire filling outfit including filler valve, air chuck, 2 ft. hose and tank—only \$5.21. Price list of separate accessories (air hose, gauge, fittings) on request. Also get catalog of thousands of other \$\$-saving bargains. Write

The Original MIDWEST BUY-ANYTHING CO.

America's Most Varied Merchandise Store
Dept. M, 1520 Locust Street Kansas City, Mo.

FULLSIZE, CUT-TO-SHAPE BOAT PATTERNS

and specifications. Designed by Naval Architect. Cruisers, runabouts,



Blueprint Co., Dept. 666, Cleveland 13, Ohio

Save Time and Money with this Press

Ten-ton press, ideal for all kinds of pressing, separating, straightening, and bending jobs. Ample capacity for home shops. Easily adjustable table takes work up to 18 inches wide and 11½ inches high. Roller-bearing ram for long life. Send for free bulletin showing press and wide variety of accessories.

UT-10A Press f.o.b. factory \$36.00

DAKE ENGINE COMPANY
624 Seventh Street, Grand Haven, Michigan



"Just bought
my third
CROSLEY"



"I am over six feet tall. I bought the second Crosley ever sold in Baltimore by the Freedom Motor Company," writes Mr. George Kachaylo of Baltimore, Md. "I have since purchased another Crosley for myself and also one for my mother. I have previously owned seven cars but from now on it's Crosley for me!"

Take a tip from over 60,000 Crosley owners. Get a Crosley, the smart, new American car everyone can afford. Hundreds of improvements including amazing Hydradisc brakes, ultra-modern hydraulic brakes of the type used on the biggest planes. New CIBA (Cast Iron Block) engine—larger, longer body lines—luxury interior appointments! Real economy! Up to 50 miles a gallon, and prices that range downward from the Station Wagon at \$929 F.O.B. Marion, Ind. Free—New Catalog of all 5 new passenger and commercial models. Write name and address in margin of this ad, tear off and mail to Crosley Motors, Inc., 2530-HH Spring Grove Ave., Cincinnati 14, Ohio.

CROSLEY



a FINE car

HINDIZE

ENDS RUST and DETERIORATION!

Unlike anything ever offered before, HINDIZE is a natural liquid product specially treated to provide a transparent, penetrating, non-slippery, waterproof, pliable and durable finish on metal, wood, leather, canvas, or other surfaces. It is not a lubricant or plastic. Prevents rust, rot, and corrosion; will not crack, peel, or blister. HINDIZE tools, instruments, scale models, etc. for long-lasting usefulness. Endless uses around the house: for linoleum, window sills, chrome car fittings; outdoor furniture, etc. Easily applied with brush or swab; by dipping or spraying.



5 oz. can.....\$1.00
(brush in screw-top)
1 qt. can..... 2.95
1 gal. can..... 7.25
Postpaid in U. S. A.

Write for free folder: "How To Make Things Last Longer."

THOMAS J. HIND COMPANY
139 MAGAZINE STREET BOSTON 19, MASS.
— 65 Years in Business in Boston —

Last Year's Profit \$3,000!

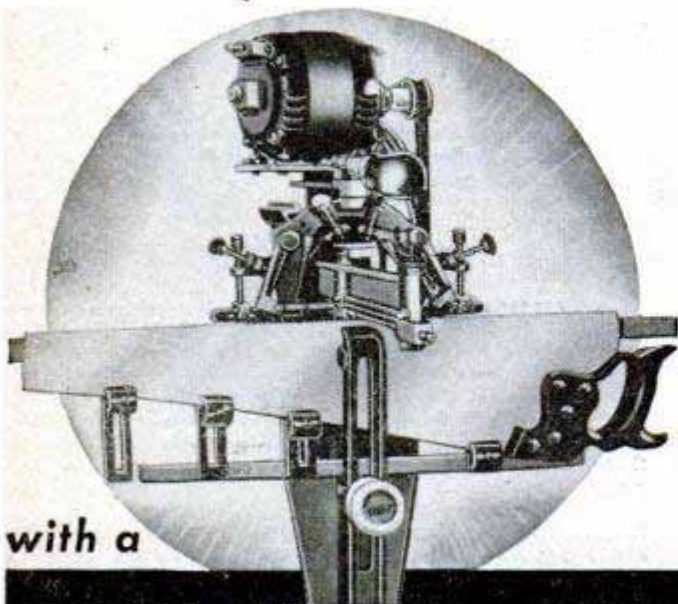

with a

FOLEY *automatic* SAW FILER

"Last year's profit amounted to \$3000. Not so bad for a one-man outfit" — from Charles C. Hough. From Ohio James B. Williams wrote us—"I made \$765 last year filing saws, and it sure comes in handy. I do this work in my spare time." Men in communities of all sizes make up to \$2 or \$3 an hour with the Foley Saw Filer working full time or part time. That extra money comes in mighty handy in these days of rising prices.

It's no trick to take care of the saw filing for your neighborhood hardware or lumber dealer — plus looking after the saws for farmers, townspeople, manual training departments and factories. The Foley files all hand saws, also band and cross-cut circular saws. It's a cash business, no canvassing, no eyestrain and no experience needed.

FREE BOOK

Shows How to Start

INDEPENDENCE AFTER 40 shows just how you can start at home in your spare time — work in your basement or garage. It's an immediate cash business that can develop into a full-time repair shop.



Send For **FREE BOOK**

FOLEY MFG. CO., 816-9 Foley Bldg.
Minneapolis 18, Minn.

Send me free book "INDEPENDENCE AFTER 40."

Name _____

Address _____

rifle-match shooting: the value of the shot is scored from the center of the bullet hole instead of the edge nearest the bull's eye. This gives no advantage to the chap who is shooting a .48 rifle over one who is using a .30 caliber.

Outdoor ranges of regulation matches are 25, 50, 100 and 200 yards. Two positions are recognized: the offhand (standing) and the bench rest. In the latter position you are allowed to rest your rifle on anything you wish. Theory behind this is that the old-time frontiersmen lay down behind a log and picked off any Indian or redcoat who came into range. As a general rule, the lighter guns are shot from the offhand position, heavier guns from the bench rest.

Interest in muzzle-loading guns builds up all year long toward the national matches in Friendship, Ind. Here the National Muzzle Loading Rifle Association has built the 55-acre Walter Cline Memorial Range as a tribute to one of the founders of the organization. The range includes a fine clubhouse and a 20-acre camping ground which is dotted with the tents and trailers of the shooting brethren during the Labor Day matches.

Shooting a muzzle-loader, however, isn't confined to the target range alone. Many sportsmen use such weapons for game hunting. Deer are the favorite targets, but rabbits, squirrels, woodchucks, opossums, grouse, pheasant and even mountain lions, buffaloes and bears have been bagged.

The special appeal of muzzle-loading guns is the same urge that makes men want to shoot bows and arrows or to seek a 100-pound sailfish on a 6-ounce rod and 9-thread line. With a muzzle-loader, you get one shot at your game—no more.

As one muzzleeer put it: "The modern, high-powered rifle, built with the finest skill and precision, is too coldly scientific. The Kentucky rifle is more of a challenge and more of a sporting proposition."

Another gunbug stated the lure of the muzzle-loader on the range in these terms: "When you're up there on the firing line with a modern rifle, nobody dares talk above a whisper. Everything is grim as death. But those muzzle-loading boys—they chatter like a stump full of chipmunks. You take about 10 minutes between shots, you ask your neighbor how his crops are doing, you laugh at the latest political joke. There's a lot of kidding going on all the time. The guys act human, not like a group of machines."

Muzzle-loading weapons offer two sports and two hobbies — target shooting and hunting, gunsmithing and collecting. Chances are, if you really become interested, you'll be doing a little of all four.

One Swipe of NEW PLASTIC Makes these LEATHER and LEATHERETTE Items LIKE NEW

Get Into A Money Making Business

Make like new, worn, scuffed or faded leather and artificial leather equipment. Either your own to renew, recolor and beautify, or cafe, restaurant and hotel equipment as a business. Single stroke with a brush renews. Does not crack, peel or scuff. Resists acid, alcohol, caustics and weather. All colors. Mail coupon for free sample.

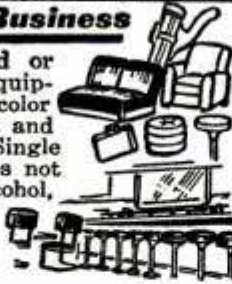

FREE Sample SHOWS EFFECT

**\$50 to \$500 Profit
On One Job Possible**

Let me show you how, as I have shown others. Get your own exclusive territory while available. Mail coupon today, I'll do the rest. — Jack Edwards, Sales Mgr.

LEATHER-NEW PRODUCTS,
6082 Sunneslope, Kansas City, Mo.
Send me without obligation a sample of Leather-New coated material so I can inspect it.

Name

Address

City State

"Fleas Don't
Bother Me
I'm Dusted with
PULVEX DDT"



PULVEX ... KILLS FLEAS
FLEA POWDER ... KEEPS 'EM OFF

make your own **Gems** 29.50
F.O.B.

All necessary lapidary equipment is furnished, including a super-charged diamond blade for sawing, and all wheels for grinding, shaping and polishing; also complete instructions. The complete equipment as shown, less motor and belt, for only \$29.50, f.o.b., Burlington, Wisconsin. Write today for information and literature.

B&I MANUFACTURING CO.
Dept. S Burlington, Wis.

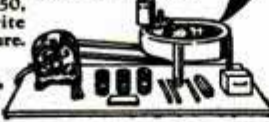

ELECTRIC HOME-UTILITY TOOLS for HOMES • FARMS WORKSHOPS
Products of:
The Black & Decker Mfg. Co.



PLOW



CULTIVATE



SHAW MFG. CO.

SAVE TIME, WORK, MONEY!

SHAW DU-ALL

and "PEPPY PAL" TRACTORS

These rugged walking or riding tractors are ideal for farm, truck garden, orchard, poultry farm. Operate on a few cents an hour. A child can handle them.

DO DOZENS OF JOBS Both riding and walking tractors quickly and easily plow, cultivate, harrow, disk, bulldoze, spray, haul, grind, saw wood, etc. **LOW FACTORY PRICES** Buy direct or through your dealer. Year's guarantee!

RIDING TRACTORS 4 models from 5 to 12½ H.P., 58 in. wheelbase, 36 to 52 in. wide, 24 in. plant clearance. Hand or electric starter. Walking Tractors 1½ to 5 H.P.

FREE Illustrated folders giving complete details and price lists—write today!

4508 FRONT ST., GALESBURG, KANS.
668G NORTH 4TH ST., COLUMBUS, O.

Biggest buy in Hobby history!

"FORTY-NINER"

Complete set of X-acto Hobby Knives \$25
and Tools in portable wooden chest

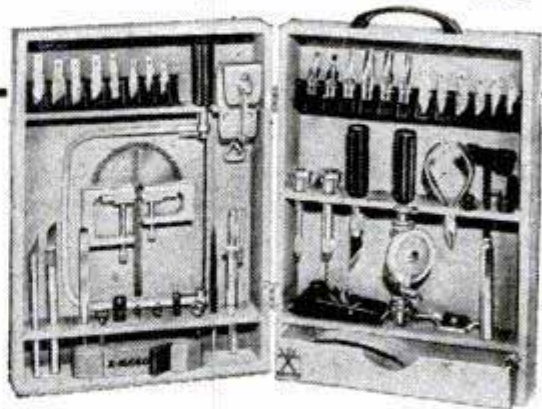

Every knife, tool and blade in the famous X-acto line. Precision made, easy to handle, joy of amateur and expert hobbycrafters in every field. X-acto knives and tools sell singly and in sets, 50¢ to \$50 at hobby, gift, hardware and department stores. (Prices slightly higher in Canada.)

X-acto 

X-acto Crescent Prod. Co., Inc., 440—4th Ave., N.Y. 16
In Canada: Handicraft Tools, Ltd., Hermant Bldg., Toronto

PRESSURE QUEEN

Outperforms them all!



THE only portable air compressor having 4 cylinders in space usually required for one—absolutely no pulsation. Does more painting in an hour than hand brushing in a day. Lubricates machinery, inflates tires. Ideal for home,

farm, service station, machine shop and contracting painter. Powered by gas engine or electric motor.

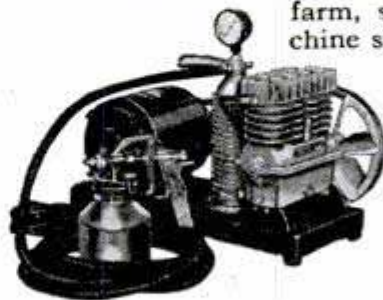

Write for Literature and Prices

THE CAMPBELL-HAUSFELD CO.

1046 RAILROAD AVENUE HARRISON, OHIO

PROFITS AND SPEED

THE MODERN LAWN MOWER SHARPENER

PRICE
\$241.50
LESS
MOTOR

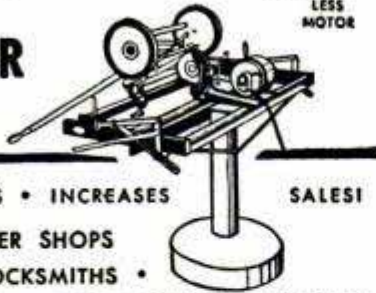

INCREASES PROFITS • INCREASES SALES!
FOR LAWN MOWER SHOPS
FIXIT SHOPS • LOCKSMITHS •
HARDWARE STORES • GOLF COURSES • SCHOOLS
PARKS • PLAYGROUNDS • INSTITUTIONS •
CEMETERIES • AND ALERT INDIVIDUALS!

*Sharpens All Reel Type Mowers • Hand, Power or
Gang • 10 to 20 Minutes • No Dismantling
No Extra Attachments Needed*

All reel type mowers, from 5-inch edgers to 36-inch power mowers, are quickly sharpened to extreme ends of both left and right twist reel blades. Handle, wheels, roller and motor remain in place when sharpening is in process. Bed knife is sharpened in same brackets that hold mower in grinding position. No extra attachments required. One lever puts mower or bed knife in grinding position. 100% steel construction. Grinding head rides on five ball bearing races. Small, compact, easy to operate. Sharpens wood chisels, joiner knives and planer blades without extra attachments.

**ORDER
NOW**
Immediate
Delivery

*Skate Sharpener Attachment Available
Send For Free Bulletin No. 10B*

MODERN MFG. CO. 160 N. FAIR OAKS AVE.
PASADENA, CALIFORNIA

FREE ALLIED'S LATEST RADIO CATALOG!

Radio's Biggest Values
SEND FOR IT TODAY

Everything in Radio At Lowest Prices!

See the latest ALLIED Catalog for greatest values in Television receivers, latest radios and radio-phonos, high-fidelity custom sound components, recorders, sound systems, Amateur receivers and station equipment. Everything for Builders and Experimenters—thousands of parts, tubes, test instruments, tools, books, diagrams and kits. World's largest stocks—all at really low-money-saving prices. Get your Free ALLIED Catalog now!



The **DEPENDABLE**
Radio Buying Guide

**FREE
CATALOG**
Send for it

ALLIED RADIO

833 W. Jackson Blvd., Chicago 7, Ill. Dept. 5-H-9
Rush FREE ALLIED Catalog.

Name.....
Address.....
City.....State.....

You Can Scream in Safety

(Continued from page 119)

the understanding of how potential customers would react to their dips and curves.

One of these five men is 61-year-old John McKee, superintendent of Palisades Amusement Park in New Jersey, one of the largest in the country. Some 2,000,000 electric light bulbs flashing across the Hudson light the way for thousands of New Yorkers who visit the park every summer. It is the job of John McKee to keep his rides safe. The adverse publicity resulting from one accident can ruin a season's business.

After 43 years of building coasters throughout the United States, in Canada, Italy, France, Germany and England, Mr. McKee has never seen an accident due to mechanical or structural defect. He says quietly, simply, but with emphasis, "If you just sit there, the ride'll take you home." He doesn't hesitate to explain that nearly all the accidents which occur are due to the foolish antics of show-off customers.

There are two main factors besides the various safety devices themselves by which safety on amusement rides is insured: by severe testing and constant inspection. In the same manner that every new jet plane is given a test flight, so is each new amusement-park ride given its test run. In the case of the roller coaster, each car is loaded down to more than three times its normal operating capacity during the trial run.

An ordinary roller coaster represents an investment of \$75,000 to \$150,000, while an entire large park costs millions. The owners are astute businessmen who, in order to protect their investments, employ large crews of welders, carpenters, electricians and mechanics who can be found scurrying over the park inspecting every ride each morning. In the off season, major rebuilding and repairs are undertaken.

Amusement parks, besides constituting a great American holiday pastime, are excellent matchmakers. McKee claims that Palisades Park is responsible for about a dozen marriages each year. One couple, a few years ago, was so indebted to the coaster on which they met that they decided to get married on it. So round and round they went as the preacher, getting paler and paler, pronounced them man and wife.

Probably next to the coaster in popularity of appeal to our masochistic natures is the whip, a suspense-filled little torture device that carries its passengers in a car at a relatively slow speed until it comes to the end of its oval orbit. There it whips the car around the semicircular bend with tremendous speed and jarring suddenness. A

(Continued to page 240)

STOP TAPPET NOISE!

Install ADJUSTABLE TAPPETS

for FORD and MERCURY V-8's (85-100 HP)



Johnson Adjustable Tappets guarantee better engine performance! Nothing complicated... no extra labor involved. Simple and easy to install during valve grinding jobs.

NEW PRICE ONLY 85¢ each

ASK YOUR SERVICE MAN OR NEAREST AUTOMOTIVE JOBBER TODAY

JOHNSON PRODUCTS INC. Muskegon, Michigan

DRAINS CELLARS, WASH TRAYS CIRCULATES OIL



Pumps 1800 GPH 300 gal. 30' high, use 1/8 to 1/2 HP **\$6.50** motor. Will not clog.

Postpaid if cash with order. (Add 50c for west of the Mississippi.)

Thousands in use since 1936

LABAWCO PUMPS, BELLE MEAD 7, N. J.

MARCOT KEY MACHINE



Immediate Delivery

MARCOT No. 8 KEY MACHINE, mounted on Cabinet, less motor. \$95.00
Auto Code Book and Depth Wlys. 12.50
100 Dz. Popular Key Blanks. 60.00
Set — Key File, Follow-Through Rods, Lock Picks, Bit Key Gauge, Thimble, Pins, Springs. 10.50
"Locksmith Trade Books": 6.75
How to Open Locks without Keys or Picks; Secret of Locksmithing; How to Make Keys by the Impression Method; Master Key Systems.
TOTAL COST \$184.75

A. J. MARCOTTE CO., 1200 N. Kedzie Ave., Dept. PM, Chicago 51, Ill.

10 P. PORTABLE POWER PLANT from any CAR or TRUCK

Line up with rear wheel, drive on to unit—that's all! Unfailing power where you want it—when you want it! No demounting, no jacking-up! Suitable for any belt-driven, power operation. NEW, LOW PRICE! ACCESSORIES AVAILABLE: Generator, Grinder, Centrifugal pump. Illustrated circular on request.

FREE Illustrated Circular

ASPEGREN MFG. CO.
1612-M Webster Ave., N. Y. C. 57



NEW ROCKET 25,000 M. P. H.

JET PROPULSION. FOR FUN OR EXPERIMENT. Zooms over 200 feet high.

Speed a rocket must attain to escape from the earth. Many other facts supplied with full instructions. Special launching stand. Can be used repeatedly. Send \$2.95 we pay postage. Sent C.O.D. for \$3.50.

\$2.95

WALSH PRODUCTS INC.
209-M8 N. Maple Ave., East Orange, N. J.

FASTEST PLANER in the WORLD at this Low Price... \$195.00

BELSAW Multi-Duty Planer

Speed up production! Increase your profits! BELSAW power self-feeds at 24 feet per minute...



The lowest-priced surfacer that will handle 12x6 in. stock. Planes green or dry sawed lumber into smooth, worked forms. Three high-speed steel knives make 42 cuts per inch. Multi-duty BELSAW takes inexpensive attachments for all planing mill operations—Jointing, Rabbling, Grooving, Matching. BELSAW is the only 12 in. planer providing attachments for jointing and grindings its own knives. Start planning NOW for BIGGER VALUE and BETTER PERFORMANCE, with BELSAW. Write for FREE specifications, illustrations and low prices.

● LARGER CAPACITY ● FASTER OUTPUT ● KNIFE SHARPENING ATTACHMENT

BELSAW MACHINERY CO B-1019 Field Bldg., 315 Westport Rd., Kansas City, Mo.



LOW PRICED Mall Saw DOES EVERYTHING

MODEL 60

ONLY \$61.95

6" BLADE—2" CAPACITY

Complete with Bevel-Depth Attachment

SAW ONLY \$54.95

ATTACHMENT \$7.00

All Prices F. O. B. Chicago. Ask Your Hardware or Power Tool Dealer. FREE Booklet "Mall Portable Power Tools" mailed upon request.

It bevel cuts to 45-degrees, rips, crosscuts, angle cuts, rough or dressed lumber. It grooves mortar joints, cuts metals, cuts and scores tile, concrete and other aggregate compositions. Depth is easily adjusted on straight cuts from 5/16" to 1-31/32"; and from 1/4" to 1-11/32" on 45-degree bevel cuts. When set in a Mall Saw Table, various available attachments equip it as a table saw, face and drum sander, wire brush and shaper. Light-weight rugged construction. Operates from 115-volt AC:DC or 230-volt AC:DC. For 32-volt battery lighting systems without Bevel-Depth attachment \$58.95.

MALL TOOL COMPANY

7805 SOUTH CHICAGO AVE., CHICAGO 19, ILL.

Cracked Water Jacket SEALED TIGHT

Use Smooth-On No. 1 Iron Cement to seal cracks in cast metal parts such as water jackets, crank cases, gear cases, etc. This quick-hardening cement stops leaks and holds tight—for it expands slightly as it sets. Use it, too, to stop leaks in radiators, gas tanks, heating, cooling and exhaust systems. Keep Smooth-On No. 1 handy for many auto and household repairs. Buy it in 1-, 5- or 20-lb. size at your hardware store. If they haven't it, write us.



FREE 40-Page Repair Handbook

Shows, besides above repairs, many time-saving, money-saving household uses. Heating and plumbing system leaks stopped. Loose hinges, handles, parts tightened. 170 illustrations. Write for your free copy TODAY.

SMOOTH-ON MFG. CO., Dept. 37H
570 Communipaw Ave., Jersey City 4, N. J.

Do it with

SMOOTH-ON

THE IRON CEMENT OF 1 000 USES

SAY YOU SAW IT IN POPULAR MECHANICS



Smooth Going



After a...



CASITE TREATMENT

- A Pint through the Air Intake
- A Pint in the Crankcase



Tune up your engine with a Casite Treatment. A pint through the air intake quickly frees sticky valves and rings, gives old-time zip and power.

A pint in the crankcase *keeps* your engine clean and free running—speeds up lubrication—retards engine wear and cuts repair bills. That's the Casite Treatment. That's the way to smoother, happier miles.

Get a Casite Treatment today—from any garage, service station or car dealer.

THE CASITE CORPORATION, HASTINGS, MICH.
Casite Division, Hastings Ltd., Toronto

BETTER AND SMOOTHER PERFORMANCE
or Double-Your-Money-Back

one-inch steel cable, which runs around the central platform dragging the cars around also keeps them from yielding to centrifugal force and flying off on a tangent.

The thought of what would happen were this cable to snap is a standard American nightmare which has replaced the bogeyman for sheer terror. One ride on the whip leaves most people with images of their car hurtling through the rail, into crowds, and splashing its occupants like eggs against a wall two miles away.

What most people fail to note in their excitement, however, is that there is another cable, a slack cable, which is passed through an eyebolt on the steel arm leading to each car. This cable is never strained while the ride is in operation and is ready to sustain a load of five tons, more than is necessary to hold the cars in check should the main cable break. All that the occupants would feel would be a slight jolt. This safety cable was first used by John McKee and has since been universally adopted by manufacturers.

The principle of a slack safety cable has been applied to many other rides including the Scooter. Here, cable-supported cars are swung around a circular path several yards above the ground. Besides the supporting cables, several slack cables are strung around each car so that they would support the car only in the event that the main cables broke.

Amusements have come a long way since the days of the tiny Roman merry-go-round to the 200-ton, 150-foot-high Wonder Wheel at New York City's Coney Island. This overgrown Ferris wheel, which would cost \$300,000 to build today, has the novel feature of cars which roll on tracks back and forth from the center to the edge of the wheel as it turns.

New rides come into existence every year. Latest among these are the Gyro and the Hurricane. An idea of how the Gyro works can be obtained by imagining a huge steel gyroscope with people seated along the edge of the spinning wheel, while the outside sphere rolls from side to side through an angle of 60 degrees in each direction as it rotates.

The Hurricane is an octopuslike horror machine which spins around, while the "tentacles" with the cars at their ends move up and down.

Whatever the contraption, no matter how terrifying it is, you can bet your bottom dollar on the fact that it is safe and that it has been tested and is tested daily. For, as one Coney Island amusement-ride operator put it, "the reason they spend money to ride is that they know in their hearts the ride is safe. That's just the gimmick."



... Quick Easy Way to BIG PROFITS

Read What Others Are DOING!

"Enclosed you will find 56 orders representing 9½ hours' work on Monday and Tuesday."
 "Enclosed are twelve orders secured after supper this p.m."

Housewives are Enthusiastic

Everyone that sees this outstanding Cell-U-Mop immediately wants one . . . That's the reason why our distributors are so successful . . . You also have the advantage of our other QUICK SELLING PRODUCTS that step up your Volume Sales and Profits.

Hands Never Touch the Water—Can be put in Boiling Water. Housewives Like It.

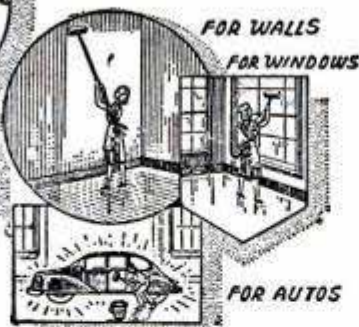

48" Long Handle

Sales QUICK, EASY Every Locality

SALES ARE EVERYWHERE . . . Sells quick to Taverns, Clubs, Hotels, Hospitals, Stores, Restaurants, Large and Small Buildings and the Homes . . . Scores can be sold on a single street . . . Note the Drain Bracket in the illustration . . . This squeezes out the water so thoroughly that HANDS NEVER TOUCH THE WATER . . . Makes no difference what you ever sold, you will like this proposition . . . Your name on a Post Card will bring you FREE PARTICULARS.

CELL-U-MOP CO., Dept. P-8, FREEPORT, ILL.

• We Teach You How •

Gets down under and around for MOPPING, DUSTING or WASHING

DOES THE WORK OF 6 TOOLS IN 1

Get Choice Territory NOW!

Holds 20 times its weight in water.



REAL DIESEL ENGINE

\$2.95

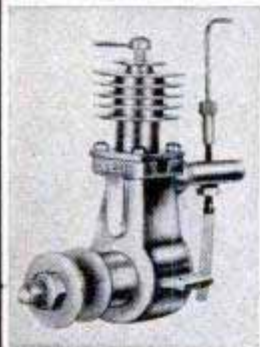

WE'RE CRAZY, they tell us, giving away a real diesel engine, complete with cylinder and piston, carburetor, crankshaft and connecting rod. All parts completely machined, ready for easy assembly. ONLY \$2.95. How do we do it? We're selling thousands of DEEZILS. So production's up; costs tumble down. DEEZIL is a precision engine. Actually runs at 7500 RPM. Produces 1/7 HP. Ideal for planes, boats, midget cars. Send \$2.95 plus 25c postage today.

GOTHAM HOBBY CORP.

107 East 126th Street New York 35, N. Y. Dept. "P"

AUTO CURB WARNINGS

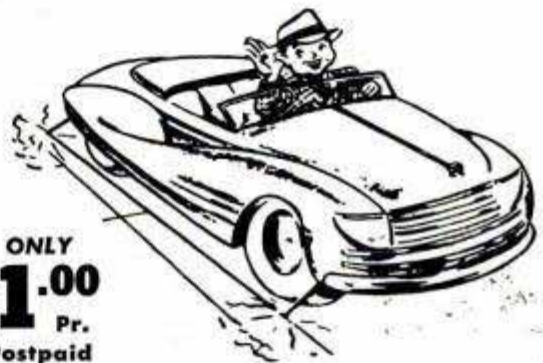

ONLY \$1.00 Pr. Postpaid

Easily installed on lower edge of right fenders. Will Warn You Before Damage to Fenders, Tires or Hub Caps. Will Save Many Times Their Cost.

FERCO MFG. CO.
VINELAND, N. J.

Some dealer territories available.

Spray away Starting Troubles



SEND \$1 FOR SPECIAL INTRODUCTORY CAN (REGULAR \$2.35 VALUE)

SHORTSTOP IGNITION SPRAY
ELIMINATES SHORT CIRCUITS IN MOTORS
ZACO LABS • 1360 W. 9th • Cleveland, O.

ORDER DIRECT TODAY!

SAY YOU SAW IT IN POPULAR MECHANICS

ELECTRO BAND SAW BRAZER



FOR RESISTANCE BRAZING OF BAND SAW BLADES

Repairs broken saw blades without delay. Permits savings by making new blades from coil stock. Simplifies inside sawing. Welds up to ½" blade in one operation and up to 1" blade in two operations. Portable. Uses 50 C-60 C, 110 V. Fully guaranteed.

only \$19.75 COMPLETE WITH SERVICE KIT OF FLUX AND SOLDER
See your dealer or write

The ERWOOD Company
CRYSTAL LAKE, ILLINOIS

Dept. PM

THOUSANDS BUILD AT ½ THE PRICE



START NOW!

EASY TO ASSEMBLE KITS

NO EXPERIENCE NECESSARY Everything Complete in Kit. Quality Material. Simple as ABC instructions. Immediate Delivery. Save Money, Big Value. Sturdy

ROWBOATS, KAYAKS, DINGHIES, INBOARDS, OUTBOARDS, RUNABOUTS, CABIN CRUISERS

SEND 25¢ (COIN) FOR CATALOGS Colorful Illustrations show all '49 Models. 8 to 23 Ft., and Construction Details.

U-MAK-IT PRODUCTS MARINE DIVISION
Formerly Kayak Boat Co. 703P WHITTIER ST., N.Y. 59, N.Y.

MEASURE PROFIT 4 WAYS

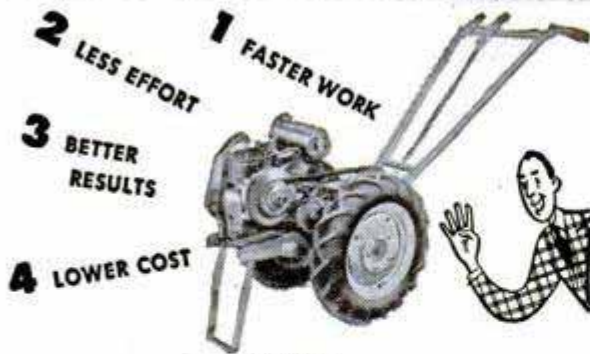

WITH BOLENS HUSKI POWER-HO

It's always ready to do a big job for you . . . any day of any season. Use it to plow, seed, cultivate, weed, mow lawns, spray, compress air or plow snow in winter. For really efficient work at low cost, you can't make a better buy than the 1½ h.p., variable speed BOLENS HUSKI Power-Ho. See your Bolens dealer or write direct for complete information.

BOLENS HUSKI TRACTORS — the Complete Line
From 1 h.p. to 5 h.p.—1 wheel,
2 wheel and 3 wheel models.



BOLENS PRODUCTS DIVISION
Food Machinery and Chemical Corp.

Better performance, better price...your best buy is BOLENS
265-8 Park Street • Port Washington, Wis.

How the Atom Is Working for You

(Continued from page 77)

which occurred in the atom bomb. It is the kind of reaction which occurs in a pile. It is from this that energy may be obtained.

In an atomic pile, uranium pieces are arranged in a material known as a moderator. Any pile generates some heat or energy. The big piles at Hanford, Wash., are cooled by water from the Columbia River. As a result, the water is raised in temperature. Several piles are now under construction, however, in which the temperature at which they operate will be high enough to



After severe irradiation, tulip bulbs are checked for radioactivity by Argonne scientist in experiment to learn effect of neutron bombardment on tulip heredity

produce steam; this steam can be used to run a turbine and generate electricity.

A ship powered by atomic energy would become obsolete through normal deterioration long before the amount of uranium consumed exceeded that which could be stored in the captain's cabin, shielded, of course, by thick lead walls. The energy available from a pound of uranium is equal to that of three million pounds of coal.

There is one interesting prospect now under investigation. The part of uranium which is fissionable is U-235, but, when neutrons hit U-238, which is much more common, the result is to change some of the U-238 into plutonium. Plutonium acts like U-235; that is, it is easily fissionable. This means, therefore, that as the U-235 is being used up, it is producing plutonium. It is

(Continued to page 244)

WHOLESALE SLIGHTLY USED TIRES DIRECT TO YOU

(10% discount on 4 or more tires if you send this ad with order)

TUBE DELIVERED WITH TIRE AT NO EXTRA COST

Safe — Our tires used on school buses and ambulances
All good tires with a

GOLD BOND GUARANTEE FOR 12 MONTHS

550-16\$3.54	30-5\$ 7.98	1200-20\$18.78
600-16 3.59	650-20 7.69	750-24 (36-6) 12.21
650-16 3.89	700-20 (8) .. 9.29	38-7 (825-24) 13.75
700-16 4.59	700-20 (10) 12.48	1000-22 17.70
550-15 3.79	750-20 (8) .. 8.19	1100-22 16.89
650-15 3.89	750-20 (10) 9.19	900-24 (40-8) 21.60
700-15 3.98	825-20 11.19	900-16 8.98
550-17 5.69	900-20 11.89	825-15 14.10
750-16 8.40	1000-20 12.89	(14 ply) .. 14.10
600-20 7.98	1100-20 13.89	750-15 11.30
		(12 ply) .. 11.30

Exceptionally good tread — No recaps — With a GOLD BOND GUARANTEE FOR 24 MONTHS

550-16\$5.19	525-18\$ 6.69	700-15\$ 5.29
600-16 5.29	550-17 7.99	600-20 9.75
650-16 5.29	650-15 4.98	650-20 9.75
700-16 6.29	825-20 15.98	700-20 10.98
550-15 4.81	900-20 15.98	32-6 (8) .. 10.49
450-21 6.25	1000-20 16.89	32-6 (10) .. 13.75
475-19 6.35		

GOLD BOND SPECIAL — 750-20 MILITARY TIRES

Will fit 650 x 20 700 x 20 (8 & 10 ply) 34 x 7 (8 & 10 ply)

Special\$10.49	Guaranteed 12 months
Superior Quality .. 12.98	Guaranteed 18 months
Gold Bond Finest.. 14.98	Guaranteed 24 months
900 x 16 Special.... 9.03	900 x 16 extra .. 11.19

Send check or money order with this ad

GOLD BOND TIRE CO., Dept. PM 24

512 NORTH 1ST ST., RICHMOND, VA.

"A gold bond written guarantee with every tire"

PRINT YOUR OWN POST CARDS

COMPLETE OUTFIT
only
\$7.50

Amazing results in sales, inquiries and contacts . . . saves time and money . . . very easy to use **GEM STENCIL DUPLICATOR** is ideal for Advertising, Announcements, Notices, Labels, Forms, Price Lists—hundreds of uses for every type of business and organization. Comes complete with all supplies, instructions and 60-page Book of Ideas.

FREE TRIAL OFFER: Try it before you buy it! Write and a GEM OUTFIT will be sent you postpaid. After 10 days, send only \$7.50 or return the GEM, no questions asked. The GEM must sell itself; you be the judge.

BOND EQUIPMENT CO. • Dept. 135
6633 Enright • St. Louis 5, Mo.

SEND NO MONEY • FREE TRIAL OFFER

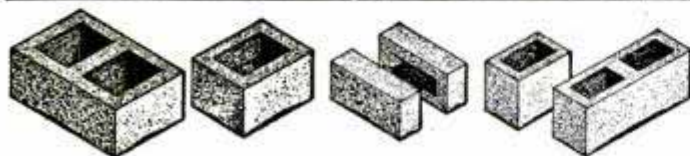

Make Concrete Blocks and Bricks

New superior method makes square, true, easy-to-lay units which will pass any building code. Small investment, high production, big profits. One \$30.00 machine will make four 5"x8"x12" blocks per minute—1000 per day. Pays for itself in a few days. Sell blocks or save 2/3 building cost by making and laying your own.

POST CARD BRINGS FREE FOLDER

Economy Manufacturing Company
Dept. P Stone Mountain, Georgia

WAR SURPLUS BARGAINS

Substantial Savings on WAR SURPLUS and other MERCHANDISE OVER 200 TIMELY ITEMS

FREE CIRCULAR FOR **SIoux FALLS SURPLUS STORE** SIoux FALLS S.D.

Order your NEW DEFLECTO

The only Deflector that Really Deflects BEAUTIFY YOUR CAR. PROTECT ITS FINISH

The most beautiful chrome dome deflector ever produced. Actually deflects gases to roadbed away from car. Guaranteed free of back pressure. Brilliant polished chrome finish on 18 ga. steel. Send year and make of car with order. Price \$2.25 each. Postage Free on Prepaid Orders. 25% deposit on C.O.D.

AUTOMOTIVE MILLINERY OF HOLLYWOOD
P.O. Box 2452 Terminal Annex Los Angeles 54, California



ONLY **\$2.25**

SURPLUS HIGH SPEED DRILLS MICROMETERS

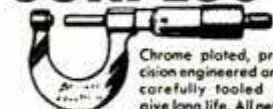

Chrome plated, precision engineered and carefully toolled to give long life. All new.

0-1" capacity . . . each **\$2.25**
1-2" capacity . . . each **3.50**
2-3" capacity . . . each **5.50**
3-4" capacity . . . each **6.50**



All New Drillist Fractional and numbered. Original value \$15.00. Thirty assorted sizes and lengths . . . **\$3.50**

EXPANSION REAMERS



Spiral Flute. Mfd. by Alvord Polk Tool Co. All New, original pack. 1/4", 3/8", 7/16" Recommended expansion limit, .006". Original value \$12. Set of 3 . . . **\$4.95**

SEND 10c FOR ILLUSTRATED CATALOG

Send check, money order or cash. 25% deposit required on C.O.D. orders. All prices F.O.B. Culver City, Calif.

AIRBORNE SALES CO., INC. DEPT. PM
CULVER CITY, CALIF.

FAMOUS BRAND PORTABLE POWER TOOLS FOR THE HOME SHOP, FARM, BUILDER AND FACTORY

We are moving these tools out at below established factory prices so we cannot mention brand name. All tools have amazing perpetual lifetime guarantee.

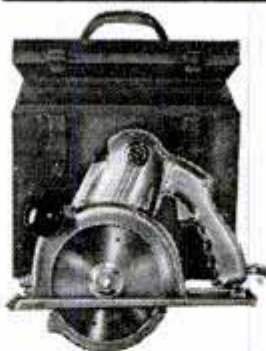

6" PORTABLE HAND SAW

A perfectly balanced saw with positive visibility. See where you are cutting! An internal blower clears the sawdust from the work. The 11 lbs. weight of the saw is balanced over the work so that sawing is easy without undue strain on the wrist. Ideal for cutting, ripping lumber and 2 x 4's.

CHECK THESE FEATURES

- 6" combination blade, 1 3/8" depth cut
- Alloy steel worm, Navy bronze gear
- Base adjustable for depth of cut
- Internal blower clears sawdust & cools motor
- Automatic safety guard
- Anti-friction ball & roller bearings
- Heavy gauge steel carrying case
- Lifetime factory guarantee
- 110-115 volt AC-DC motor

Shpg. wt. 20 lbs. **\$58.50**
Complete price



1/4" DRILL

A rugged shop drill with a full handle grip. The RPM regulates to the load preventing the drill from stalling.

CHECK THESE FEATURES

- Rugged cast aluminum
- Motor will not stall
- 1/2" 3 jaw "Jacobs" geared chuck with key
- Sealed & lubricated reduction gears & thrust bearing
- Built in cooling fan
- 2200 RPM at no load. 115 volt AC-DC
- Lifetime guarantee

Shpg. wt. 6 lbs. **\$17.95**
Complete Price

1/4" DRILL STAND converts drill into handy drill press. Complete as shown . . . **\$9.85**

Prepaid orders sent postpaid. 10% deposit req. on C.O.D. orders.

HARDWARE SURPLUS SALES CO.
300 W. 51 St., N.Y.C., N.Y. DEPT. PM

1/2" HEAVY DUTY DRILL

A precision drill constructed for rugged, heavy duty work.



CHECK THESE FEATURES

- Sturdy cast aluminum housing
- 1/2" 3 jaw "Jacobs" geared chuck with key
- Specially heat treated reduction gears & thrust bearing
- Sealed gear case fully lubricated for years of trouble free service
- Built in cooling fan
- Anti-friction ball, roller and "Oilite" bearings
- 550 RPM, 115 volt AC-DC motor
- Lifetime guarantee

Shpg. wt. 11 lbs. **\$34.25**
COMPLETE PRICE

1/2" DRILL STAND converts into handy drill press. Complete stand as shown. Shpg. wt. 26 lbs. . . . **\$15.50**

Say You Saw It in POPULAR MECHANICS



Mufflers—All Ford, Chev., Ply. . . . \$4.45
All Buick, Pont., Olds., Chrys., Dodge, Hudson, K.F., Pack., etc. . . \$5.45
V-8 and Merc. Duals (32-49 incl.) **\$15.95**



DURABILITY

SPORTONE MUFFLERS
(Pat. Pend.)

DEALERS WANTED

Beautiful SANDIE Fender Skirts **\$16.95**

A SANDIE Sportone will outlast two ordinary mufflers and give More Power! More Speed! More Mileage!—plus a tone quality unsurpassed.

Please ship (item): _____ Price _____
Car and Year _____ Name _____
Address _____

SANDEE MUFFLER CO. 5643 Corryne Pl. Culver City, Calif.

WE FURNISH ALL MACHINED METAL PARTS, EVERY SCREW,
NUT, BOLT, WASHER, AND COMPLETE PLANS FOR THIS...

BIG 10" POWER SAW



\$9.95
LESS GUARD
AND WOOD

POST PAID
ANYWHERE
IN U.S.A.

FULL \$9.95
REFUND IF
NOT SATISFIED
WITHIN 10 DAYS

QUALITY
ASSEMBLE IT YOURSELF WITH
SIMPLE HOUSEHOLD TOOLS!

TABLE 24" x 20" • TILTS TO 45°
CUTS 0" TO 3/4" DEEP • TAKES 10" BLADE

COMPLETE PLANS (WITHOUT PARTS) 10c

MARCUS • POLLAK DEPT. 44
ROYERSFORD, PA.

she's some **SMOOTHIE!**
(YOUR CAR, THAT IS)

when equipped with

ADVANCE "ULTRA DEEP-TONE" MUFFLERS
DUAL OR SINGLE STRAIGHT-THRU

Rich, low, mellow tone. Also greater power, speed, and economy result from reduced back pressure. Rugged steel tube, blow-out proof. Simple to install. No welding. Dual set comes complete with rubber mounted clamps, fittings.

ADVANCE FENDER SKIRTS

These heavy duty steel skirts will beautify and streamline your car. Tight fit, no rattle, easy to install, prime painted. Real top quality, not to be confused with cheaper, light weight makes.

ADVANCE KI-YI AND RAZZ HORNS

Get these novelty horns for laughs.

MAIL COUPON BELOW DEALER INQUIRIES INVITED

ADVANCE MUFFLER CO. Dept. PM 89
1458 E. COMPTON BLVD., COMPTON 3, CALIF.

Send check, money order, or we will mail C.O.D. You pay postage upon receipt.

<input type="checkbox"/> Dual Muffler Set (Ford, Mercury only) . . . \$20.00	<input type="checkbox"/> Single Muffler (other makes) \$5.50	<input type="checkbox"/> Fender skirts, pr. \$16.95
<input type="checkbox"/> Single Muffler (Ford, Chev., Plym.) 4.86	<input type="checkbox"/> 2 1/2" Chrome tail pipe lips . ea. . . . 1.75	<input type="checkbox"/> Ki-Yi Horn, each 3.25
<input type="checkbox"/> Send free catalog showing complete line.		<input type="checkbox"/> Razz Horn, each 3.25

Car make _____ Year _____ Model _____
Name _____
Address _____ City _____ State _____

almost as though the coal we burn produced ashes which themselves were as good as coal. This is known as the breeder principle because the uranium can be made to breed plutonium which is, in itself, good fissionable material.

The energy possibilities are very great and very dramatic. It is because of the tremendous energy, that the atom bomb is in an entirely different class from ordinary chemical explosives like T.N.T. It is because the energy of matter is so great that it becomes possible to think of running airplanes, ships, automobiles and railroads with fuel that would be built in and would never have to be replenished. But I would not want anyone to think this is just around the corner. There are many serious problems in putting this energy to work on an economical basis.

I should like now to tell of another application of atomic research. You have heard about isotopes. Two isotopes are forms of the same element differing in the number of neutrons in the nucleus. For example, heavy hydrogen is an isotope of ordinary hydrogen. The two isotopes behave chemically in exactly the same way. Therefore, wherever ordinary hydrogen is used it would be possible to use heavy hydrogen. Some isotopes are radioactive; that is, they are giving off radiant energy because the nucleus is unstable. These isotopes provide a means of tracing chemical reactions.

For example, it is possible to put a radioactive isotope of sulphur into the coal and coke used in a blast furnace. This can be done in such a way that when the iron comes out, with a certain amount of sulphur in it, you can tell whether the sulphur came from the coal or from the iron ore, simply by finding out whether the iron is radioactive. This knowledge is very important for blast-furnace operation.

For medical work, the tracers are also important. It is possible, for example, to put a pinch of radioactive metal into the diet and to find out where the metal goes in the body. One tenth of a gram can be spread over the diet of one million rats and every one of them will be radioactive. A little bit goes a long way.

You have heard of digitalis. It is a wonderful drug for stimulating the heart. Many people have been kept alive with it for long periods. It is made from the root of the foxglove. But, while doctors have been using it for many years, they haven't known just how it worked—whether it went into heart muscles, heart nerves or into blood vessels. But now it is possible to grow the foxglove plant in an atmosphere in which the carbon dioxide, necessary to plant growth, is made

(Continued to page 246)



**NOW AVAILABLE
AT NEW LOW PRICE
FREE RUNNING
WHEELS**

**ONLY
\$1.95
ea.
SIZE
10x1.75
Minimum
Order
2 Wheels**

**MADE OF
FINEST GRADE
16 GAUGE
ALUMINUM**

These sturdy and attractive aluminum rust-proof wheels come complete with semi-pneumatic puncture-proof tires. 7/16" ball-bearing — for 7/16" axle. No painting. Perfect for building and repair of many house and garden devices, toys, etc. Run smoothly! Easily! **HUGE SAVING** to you because . . .

These Wheels Are Standard Equipment on World Famous K-KART GOLF BAG CARRIER

ORDER TODAY — Send cash, check or M.O. — Add 10% for prepaid shipment in U.S.A.

KUNKLE INDUSTRIES
2358 Clybourn Ave., Chicago 14, Ill.

NEW QUICK-CLAMP 30" BRAKE

Forms angles, channels, vees, flanges, locks, etc. Handles 24 gage sheet steel, heavier gages of aluminum. Cam hold-down. No unscrewing. Held in vise, bolted down, or clamped to truck. All steel. Wt. 45 lbs. Shipped **\$24.50** express collect.



12" BRAKE. Fits in vise to form difficult and compound bends, up to 20 gage steel, **\$12.50 PP.**

SHEAR. Cuts 16 gage steel any length and width, **\$12.50 PP.**
SHEET METAL PLIERS. 2 1/2" wide, **\$2.00**; 5", **\$3.00.**

NEW SHAPING MACHINE. Does work of metal and wood cut-off, planer, lathe, etc. Notching and grooving up to 30", **\$36.50.**

IRON BENDER. Forms hooks, braces, eyelets. Bends 1/4x2, **\$10.00.**
Immediate delivery. Order direct, cash or C.O.D., or send for folder.

1116 So. 27th St. **WISE BRAKE MFG. CO.** Omaha 5, Nebr.

"EVEREADY"

THE FLASHLIGHT BATTERY WITH "NINE LIVES"

**Recovers Power Between Uses—
Bounces Back for Extra Life!**

SAW SHARPENER



Table model, adjustable for any degree of bevel. Takes saws up to 20" and can be used to face off inserted point teeth and other type saws. 3/4 h.p. motor, total weight only 60 lbs.

\$64 F.O.B. Portland

P. T. HOBBS Machinery

8375 N. Interstate Ave., Portland 3, Ore.



WELDS • BRAZES • SOLDERS • CUTS

ANYONE CAN OPERATE the newly invented Four-Way Portable Electric Welder—does brazing, soldering, welding, cutting on iron, steel, brass and other metals. **WORKS INSTANTLY** off any properly wired **110 VOLT AC or DC line.** The time and money you save on auto, home appliance, farm and shop repairs will quickly pay for this machine. Comes **COMPLETE** with Power Unit and **ALL SUPPLIES** ready-to-operate, including simplified instructions. Write for **Free particulars** or order one today for **10 Day Trial.**

FOUR-WAY WELDER CO., Dept. PMF-89
2326 SO. MICHIGAN AVE., CHICAGO 16, ILLINOIS

NOW YOU TOO CAN BUILD 15 RADIOS

**Absolutely No Knowledge
of Radio Necessary**

You Need NO Additional Parts

The PROGRESSIVE RADIO KIT

is **THE ONLY COMPLETE KIT.** Contains everything you need. Instruction Book, Metal Chassis, Tubes, Condensers, Resistors and all Radio parts.

The **36-Page Book** written by Expert Radio Instructors teaches you to build radios in a Professional Manner. You start with a 1-tube receiver. Before you are done with this kit, you will have built 11 Receivers, 1 Public Address System and 3 Transmitters. **SPECIAL FREE OFFER!**

Electrical and Radio Tester sent absolutely **FREE** with each Progressive Radio Kit. **PLUS FREE** membership in Progressive Radio Club. Entitles you to free expert advice and consultation service with licensed radio technicians.

Write for further information, or **ORDER your KIT \$14.75**

NOW! ONLY
Postage prepaid with check or money order
(Postage not prepaid with C.O.D. orders)

PROGRESSIVE ELECTRONICS CO., Dept. PM-27
497 Union Avenue Brooklyn 11, N. Y.



Build Your Own TOW TRUCK

**The Easy
"Jack Heil"
Way**

**A Rugged, Heavy Duty, Lifetime
Unit by the manufacturers of the
"World's Finest Towing Equipment"**

All parts cut and shaped to fit, exact duplicates of parts used in our production line. Only a welding machine needed to complete this power winch, universal model. Capable of handling trucks, cars, tractors and trailers. Includes complete operator's manual showing proper step by step procedure of doing heavy hi-way wrecking, and towing, diagrams, technical information, etc. Solve your own problems. Complete units also available at great savings.



Also available: A complete line of bodies, cranes, winches, spacer bars, cable, other towing equipment. Operator's manual free with each order. Otherwise, send \$2.50.

JACK HEIL "Builds Truck Bodies"

Dept. PM, 2112 N. Clybourne, Chicago 14, Illinois
Experienced Salesmen now calling on automotive trade,
write for territories!



If you like fine tools

. . . then you'll certainly like to work with the new **GREENLEE** Socket Chisels. Perfectly balanced . . . handsome, transparent green plastic handles . . . fine bevel-edged **GREENLEE** blades, so long the choice of true craftsmen. Ask your hardware dealer about them.



**SPECIAL OFFER . . . WOODWORKING
CALCULATOR . . . 10¢.** Quick solutions to countless problems . . . converting linear to board feet, nail and bit sizes, etc. Send 10c to Greenlee Tool Co., 2108 Columbia Ave., Rockford, Ill.

Can You Equal This Home for **2475**

Shipped Direct from Our Mill



Save 30% to 40% on Your New Home..

Act Now!

Don't pay several hundred dollars more than necessary when you build a home! Buy it direct from our mill at our low factory price. We ship you the materials—lumber cut-to-fit, ready to erect. Paint, glass, hardware, nails, etc., all included in the price—no extra charges. Plans furnished—also complete building instructions. No wonder our customers write us that we saved them 30% to 40%. Prices subject to change without notice.

BIG BOOK of House Plans in Colors 25¢

Handsome Big CATALOGUE

Pictures wonderful homes in colors at money-saving prices. Designs to suit everyone. Send 25c for catalogue today.

LEWIS MANUFACTURING CO.

1298 Lafayette Ave., Bay City, Michigan

FUN for YOUR FAMILY



5-in-1 WORKSHOP

Only 6¢ per Hour **\$39⁹⁵** CASH OR ON TIME

Inexpensive. Wholesome Recreation for entire family. EMRICK Power Workshop includes heavy-duty Lathe, Drill Press, Saw Arbor, Grinder and Sander—all operating from ONE motor. Equals in performance equipment costing up to 8 TIMES MORE. Make professional looking articles of wood, metals and plastic... save plenty on household repairs... keep children interested in home projects. MONEY-BACK GUARANTEE. Write for FREE Catalog.

EMRICK, INC., 1692 Clinton, Kalamazoo, Mich.

Clean-up Time

...for car cooling systems, too!

Avoid engine overheating on hot summer days

with Warner care



WARNER RADIATOR CLEANER—Thoroughly cleans cooling system of rust, oil-muck and grease. Harmless to metals, hose and car finish.

WARNER COOLING SYSTEM PROTECTOR—Prevents rust and corrosion—keeps cooling system clean for maximum efficiency.

"Just Shake . . . Pour . . . and Fret No More" See your service man or do it yourself.

Warner-Patterson Company, 920 S. Michigan Ave., Chicago 5

of radioactive carbon. The plant then carries the radioactive carbon into the root and when the digitalis is extracted it has radioactive carbon in it. When this digitalis is fed to the patient, it becomes possible to trace the course of it through the body and find out what parts of the heart system are affected by it.

At the University of Chicago, we have a little farm where we are growing many kinds of plants—foxglove for digitalis, poppies for morphine, etc.—in radioactive carbon dioxide. By this method we are beginning to find out how many important drugs really work.

One interesting result of this isotope research was found when some radioactive table salt was fed to people. All of us had supposed that salt went through the body fairly slowly but, as a matter of fact, within one minute after radioactive salt was eaten, the perspiration coming out of the pores was found to be radioactive.

Isotopes are being used in over 1000 research projects. They are helping us learn how fertilizer makes things grow. It has been known for a long while that only a small part of the fertilizer actually goes into the plant. Now we are beginning to find out why this is so by using isotopes of nitrogen, phosphorus, sulphur, calcium, iron and many other elements in order to learn just what part of the fertilizer is really doing the work. The effect that this may have ultimately on farming may be most dramatic. It is of particular interest, of course, in view of the reports we hear that the population of the world is out-stripping its ability to produce food.

But, one of the most interesting ideas that comes from atomic research is in the effect that radiation has on living things. When you stop to reflect, you have to recognize that all energy on earth has been coming from the nuclear reaction taking place on the sun. Every plant that has ever grown, including those which have gone into the making of petroleum and coal, derived its growth from energy from the sun.

The new availability of radiation from man-made nuclear reactions may open up new patterns of growth. For example, we know that radiation has an effect on living cells. By shooting radiations at seeds, it is possible to produce a great variety of weird and unusual sports or freaks. Most of them are useless, but some may be very useful. I have been told, for example, that by this means a pineapple plant has been produced which yields pineapples many times the volume of ordinary pineapples.

Much work is going on to learn how the different kinds of radiations may affect

(Continued to page 248)

5 YEAR WRITTEN GUARANTEE
17 JEWEL CHRONOGRAPH
 2 PUSH BUTTON

ORIGINALLY \$71.50

- WRISTWATCH
- STOPWATCH
- TELEMETER
- TACHOMETER

Precision 4 in 1 Timepiece. Incublock shock resistant feature. Sweep Second hand. Anti-magnetic. Radium Dial. Stainless steel back. Unbreakable crystal. Perfect for physicians, scientists, technicians, engineers, aviators, photographers, broadcasters, navigators, sportsmen, servicemen, etc. Thousands sold at \$71.50. Order now while they last at this record breaking low price. Send only \$1 down payment with order. Pay balance to postman on arrival plus postage. Or we pay postage if you include full payment plus tax with your order.

Our Price
 Now Only
\$21.95
 Plus
\$2.20
 Tax



FREE! HANDSOME EXPANSION BAND INCLUDED. Money back in 5 days if not delighted. Order now!
MARYLAND DISTRIBUTORS, Dept. 70, 501 E. Baltimore St., Baltimore 2, Md.

SPEED AND POWER HANDBOOK



Build fast Stock Cars! California Roadsters! 150 MPH Rods! Covers Fords to Cadillacs—all makes! Breathtaking methods—Authentic—Direct from California!

SAVE MANY DOLLARS

Build your own Dual Manifolds! Superchargers! Hot Cams! Water Injectors! Hi-Compression Heads! Mileage Devices! Get racing speed, lightning acceleration, dynamic power increases from any make passenger automobile! Get construction drawings! Tuning techniques! Speed tricks! Picture catalogues! Ingenious formulas! Economy secrets! Including—"Racing Frames"—"Reciprocating Masses"—"Jet Engines"—"Braking Characteristics"—"Dynamometers"—Dual Pipes, Gears, Fuels, Manifolds, Porting, Relieving, Balancing, Lowering!

Includes—"CALIFORNIA AUTOMOBILE CUSTOMIZING"—Glossy photographs! Diagrams! Newest ideas! Conversions! Re-Styling! all makes! Streamlining! Chopping! Channeling! Customizing!

50 CHAPTER LIBRARY EDITION—complete—\$1.98 Postpaid.

NEWHOUSE AUTOMOTIVE INDUSTRIES

5805-B4 EAST BEVERLY LOS ANGELES 22, CALIF.

BRONZE FOUNDRY Schools and Home Workshops

Make your own castings of aluminum, copper, bronze, silver. Foundry sets are available in three sizes including 2400 Deg. F. blast Furnaces. \$22.50; \$29.50; and \$42.00, f.o.b. Kansas City. Free Circular.

KANSAS CITY SPECIALTIES CO.

P. O. Box 6022, Dept. P-7 Kansas City, Mo.

NU-WAY HEAVY DUTY CUTTING UNIT
 with Timken Roller Bearings

PRICE
\$16.50
 WHY PAY MORE



Build your own rotary type lawn or weed cutter. Take the hard work out of weed cutting. Build yourself an up-to-date weed and lawn mower with the Nu-Way heavy duty unit.

Write for Free Circular—We Supply Cutting Unit Complete
TRACTOR-LITE MFG. CO., Spirit Lake, Iowa

\$\$ SAVE MONEY \$\$

REPLACE YOUR VOLTAGE REGULATOR WITH
AMAZING NEW WATTAGE REGULATOR

A complete new principle in current and voltage control. Scientifically engineered and designed, to give you the utmost of performance for the life of your car. USERS report . . . increased or doubled life of battery, generator and ignition points. Brighter lights . . . better radio reception . . . reduced water consumption . . . easier starting in cold or hot weather and batteries in top capacity at all times.

The WATTAGE REGULATOR has QUICK CHARGE characteristics, for short-hop driving . . . stick- and burn-proof, self-cleaning contacts to last for the life of the car. In an emergency, you can drive hundreds of miles with a dead battery or without a battery and prevent costly tow and service charges. . . Install a WATTAGE REGULATOR now and prevent costly generator, ignition and battery replacement in the future. The WATTAGE REGULATOR is Guaranteed 100,000 miles or 1 year. With full instructions, easy to install. No mechanic required. Price only \$9.50—C.O.D. plus postage. State make and model of car . . .

SEND FOR FREE BULLETIN

SCIENTIFIC ELECTRIC COMPANY,

P.O. Box 2162 P.M., Station H Cleveland, Ohio

BUILD YOUR OWN DARKROOM



—gameroom, laundry, or any extra room You can do it easily, quickly and at low cost with Gold Bond Gypsum Wallboard. Big lightweight panels are fire-proof, moisture resistant and easy to nail. Then paint with Gold Bond Sunflex, the low cost wallpaint . . . dries in one hour. Get both at your local Gold Bond Lumber and Building Material Dealer's.

Free Book of suggestions



NATIONAL GYPSUM COMPANY,
 Dept. E-2, Buffalo 2, N. Y.

Gentlemen: Send free copy of new Booklet, "Modernizing Magic" showing remodeling ideas and methods:

Name.....
 Street.....
 City..... State.....
 (Please print name and address.)

32 PROFESSIONAL TOOLS

for ONLY \$9.95

All Compactly Fitted
 in a Sturdy 2-Pc.
 Steel Tool Box!



For the Hobbyist and Home Mechanic

- | | | |
|--|--|--|
| Slip Joint Plier 6" | Forged Ball Peen Hammer | 1 Try Square 6" |
| Heavy Plier | Forged Hatchet | 1 Block Plane 7" |
| 4-pc. Wrench Set | 1 Awl | 1 Wood Chisel 1/2" |
| Screw Driver 6" | 1 1/2 Round File 6" | 1 Wood Chisel 3/4" |
| Blade | 1 Four-sided File 6" | 1 Set of 3 saws with adjustable handle |
| Hand Drill | 1 Four-sided File 10" | 1 Wood level 6" |
| 1 Set of Carbon Drills - 1/8", 3/16", 1/4" | 1 6-Ft. Steel Tape, Push Button Return | 1 Coping Saw |
| Forged Nail Hammer, 16-oz. | 19" Steel tool box with lock, heavy hinges and partitioned liftout tray. | 1 Utility Knife |
| | | 1 Pkg. Sand Paper |
| | | 1 Sheet Emery Cloth |

ALSO AVAILABLE—kit #2—the Utility—\$14.95
 kit #3—the DeLux Professional—\$36.95
 POSTAGE PREPAID ON ALL CASH ADVANCE ORDERS

Here is value that's hard to top. A full set of man-sized top quality Tools (NOT TOYS), which item for item could not be replaced for twice the cost.

Charles Weiland Inc.
 Established 1882
 149 Chambers St.
 N.Y.C. 7, N. Y.

Charles Weiland Inc., Dept. PM
 149 Chambers St., N.Y.C. 7, N. Y.
 Send me.....tool kits.
 \$ 9.95 Kit
 14.95 Kit
 36.95 Kit
 Enclosed find check or M.O.
 Ship C.O.D. I will pay post.
 Name.....
 Address.....
 City..... State.....

King Midget



- HOME ASSEMBLED
- MASS PRODUCED
- LOW-COST AUTOMOBILE

Drive this car for as low as 50c per week. Up to 90 miles per gallon, 45 to 50 m.p.h. Large enough for a husky six footer. A pleasure to assemble. Just bolt together our precision built parts. Get the facts. Send 25c for detailed circular with large photo, 4 view drawings, price of all parts. Better still, send \$1 (refunded first order) for this plus actual assembly book with 42 photos, drawings; blueprints of snow and ice conversions, etc.

WORLD'S LOWEST PRICED CAR

MIDGET MOTORS MFG. CO., Athens 1, Ohio

A TOOL... NOT A BRUSH

\$1.00 POST PAID

PAINTERS' STRIPING TOOL

NOW! PAINT STRIPING MADE EASY!

Easy to use as a pencil! Draws parallel lines, straights, curves, circles with paint, enamel, lacquer, etc. Do your own striping on autos, furniture, toys, bikes, model planes, signs, linoleum... make wall board look like tile. Painters - craftsmen, order today! Type "M" Master Painters' Striping Tool complete with tip for 1/16" stripe, \$1.00. Tool with choice of 1/64", 1/32", 3/64", 5/64", 3/32", 1/8" tip—\$1.50... all tips 75c ea. Tool with complete set of 7 tips \$5.00. (COD's postage collect.) Dealers write!

WENDELL MFG. CO.
4234-B Lincoln Ave., Chicago 18, Illinois

EARN BIG MONEY AND BE YOUR OWN BOSS Sharpening Lawn Mowers

Build a Business of Your Own With A UNIVERSAL GRINDER

In your own garage or basement, and earn \$25.00 a day or more. Mr. Hardy writes, "I am using a fine business with the UNIVERSAL GRINDER. One customer sends another. I spent 40c for a newspaper ad and have done nearly \$500.00 worth of business." Mr. Helmeck of Canada writes, "We sharpened 750 mowers last year and are 1056 on this year run. The Universal surely makes customers." Mr. Barton of California says, "The mower business, with the Universal Grinder, has been a gold mine these last two years."



Only on the UNIVERSAL GRINDER can the inside face and edge of the stationary blade, as well as the reel blades, be ground to proper clearance ALL IN ONE SET-UP without removing any blade from the mower.

WRITE FOR FREE FOLDER TODAY!
ROGERS MFG. CO., Dept. M-89, Lindsey, Ohio

cancerous growths. It has even been suggested that the aging processes, the reason why plants and animals and people grow old, may be found in the free radiation of cosmic rays. There is even the dim possibility that we may open up the shocking problem of letting people live without growing old. Imagine how you'd feel if you could stay at the age of 22 forever—subject only to the avoidance of automobile accidents or war—and imagine what a mess the world would be in!

There is no question that atomic research is opening up the greatest economic facts since the discovery of fire—and all of them are based upon a chain of ideas which is still being forged.

Ideas beget ideas. Michelson inspired Einstein. Einstein suggested something to Rutherford and Rutherford to Fermi. Back and forth in an endless criss-cross the ideas bound. Thus the chain reaction of knowledge proceeds.

To have ideas, we must have freedom. It is for this reason that freedom in universities, the so-called academic freedom, is important. It is not because it is important to the universities—it is not because it is important to the students, professors or scientists—it is because it is important for you and me.

Freedom of ideas produced the atom bomb. But the atom bomb is not our greatest weapon. Our greatest weapon is freedom itself.

War Horses Still Fight Out the Air Derby

(Continued from page 100)

the Bendix on two occasions and has established an international record of 469.349 miles per hour for the 100-kilometer closed course. (This flight was performed at high altitude and is not to be compared with the Thompson type of closed-course flying.) Another P-51, owned by movie-actor Jimmy Stewart and flown by Joe DeBona, has figured in recent transcontinental records.

To date the P-51 has been unbeatable in long-range, high-altitude flying and we may expect it to remain at the top in the Bendix. But, although these ships will probably be numerous in the Thompson again this year, their likelihood of winning is apt to depend upon the failure of several other ships that are better suited to the pylons circuit.

The Lockheed Lightning had been expected to show real class in the cross-country contests, but it has sadly disappointed its proponents in the Bendix. On the other

(Continued to page 252)

ARC WELDING

FOR PROFIT OR PLEASURE

60 LBS. OF READY MADE PARTS

Only \$24.95

BUILD YOUR OWN HEAVY DUTY WELDER

SAVE Buy Only NECESSARY PARTS

All parts Ready-Made and easy to assemble. You can do all around welding on steel, cast iron and other metals after only a few hours practice. Illustrated instruction manual included. Sold on 30-Day Money-Back Guarantee!

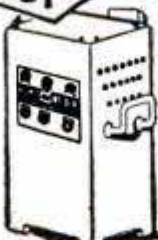

Gives 100% penetration. Welds are stronger than original metal. Operates on 110 or 220 AC.

FREE: Write today for fully illustrated Pamphlet P-8

ATOMIC ARC WELDER CO.
1037 So. 19th St. OMAHA, NEBR.

RUPTURED?

Get Relief This Proven Way

Why try to worry along with trusses that gouge your flesh—press heavily on hips and spine—enlarge opening—fail to hold rupture? You need the Cluthe. No leg-straps or cutting belts. Automatic adjustable pad holds at real opening—follows every body movement with instant increased support in case of strain. Cannot slip whether at work or play. Light. Waterproof. Can be worn in bath. Send for amazing FREE book, "Advice To Ruptured," and details of liberal truthful 60-day trial offer. Also endorsements from grateful users in your neighborhood. Write:

CLUTHE SONS, Dept. 31, Bloomfield, New Jersey

PISTONS

ALUMINUM ALLOY. For Auto, Truck, Tractor, Motorcycle, Scooter, Outboard, Marine, Compressor, Industrial Engines. **EVERY MAKE, ANY YEAR,** odd or foreign. Send sample or specifications.
JUDSON MFG. CO., 4527 Hedge St., Phila. 24, Pa.

\$10,000 REWARD

Earn the government bonus by locating Radio-Active Ores with the

P.R.I. GEIGER COUNTER

Weight about 2 lbs. Price only \$75.00 complete. The most sensitive portable Geiger counter made.

PRECISION RADIATION INSTRUMENTS, INC.
1101-P N. Paulina St. Chicago 22, Ill.
Dealer Inquiries Invited

SAY YOU SAW IT IN POPULAR MECHANICS

LAWNMOWER SHARPENER OPERATORS

Increase your output... Year 'round business!

NEW BED KNIFE GRINDER

sharpens all STRAIGHT EDGE TOOLS

Model 50 Ideal Bench Grinder doubles your output of sharpening jobs, speedily grinds straight blade knives. Sharpens all kinds of straight edge tools and ice skates. Write for FREE, fact-filled folder.

THE FATE-ROOT-HEATH COMPANY
Dept. D-3, Plymouth, Ohio

AMAZINGLY LOW PRICED CASCO Power Tool KITS

With a Casco Power Tool Kit, every job is a better job! For the finest equipment at any price is right at your fingertips. And the cost is so very low, it quickly pays for itself. A "must" for every craftsman, hobbyist, builder and repairman!



for WOOD, METAL, PLASTICS, FIBRE, GLASS, LEATHER...

It drills! It polishes!
It saws! It etches!
It carves! It grinds!
It sands! It buffs!
It sharpens! It cuts!

CASCO ELECTROMATIC
(What a Gift!) ONLY \$19.95
50-pc. set

CASCO TOOL 'N' RAK
hangs up where you work! \$17.95
40 pieces, ONLY



GET YOURS NOW at Department, Hardware, Auto Supply, Appliance and Jewelry stores.

CASCO CASCO Products Corp.
Bridgeport 2, Conn.

BUILD FINE GRANDFATHER CLOCK NOW

The simple sensible Red-i-Kut way as thousands have—SAVE HALF. SHOP TESTED PLANS "SPIRIT OF THE CENTURY" Narrow waist 23" tall or stately "SPIRIT OF AMERICA" straight side model with pictures. EASY-TO-FOLLOW PLANS tell all—plus BROCHURE of heavy brass weight Westminster, tube chime, movements, dials, solid mahogany case kits. Send \$1.00 today—Both Plans \$1.50 NOW. **KUEMPEL CHIME CLOCK CO., #4 Kuempel Bldg., Minneapolis 16, Minn.**

Why Pay More?

TUBE GIVEN WITH EVERY TIRE

EVERYONE TAKE 10% DISCOUNT ON ALL TIRES

OUR TIRES must make good or WE WILL If You Want SAFE TIRES

Be Wise—See Us Before You Buy Our Experience Insures Your Safety

You get what we advertise Highest Quality Lowest Prices

HIGH ORIGINAL TREADS Slightly Used BUY IN CONFIDENCE safe dependable selected POPULAR BRANDS—Guaranteed to give A-1 SERVICE. These tires are absolutely NOT Re-caps or Re-molds.

NEEDLESS TO PAY MORE RISKY TO PAY LESS

SELECTED for TOUGHEST JOBS Not just good... THE BEST These are genuine Values! One Trial will CONVINCE YOU

TOPS IN VALUE		TOPS IN SAFETY	
600-16	\$5.02	650-16	\$4.72
650-15	4.72	700-15	5.02
700-16	\$6.02	750-16	7.62

World's Best Truck Tire Values Top Service Minimum Prices

6.00-20(6)	\$9.22	7.50-20(10)	\$13.92	11.00-20(12)	\$16.42
6.50-20(6)	9.22	8.25-20(10)	15.52	11.00-22(12)	18.42
7.00-20(8)	10.52	9.00-20(10)	15.52	32x6 (8)	10.02
7.50-20(8)	10.52	10.00-20(12)	16.22	32x6 (10)	12.82

750-20 MILITARY 8 PLY REGULAR \$9.62—SUPER \$12.92
900-16 MILITARY 8 PLY REGULAR \$8.72—SUPER \$10.92
ONE QUALITY THE BEST AVAILABLE

HERE'S MAXIMUM QUALITY IN THESE O.K. SAFE TIRES

600-16	\$3.42	650-16	\$3.62	700-16	\$4.42
650-15	3.62	700-15	3.72	750-16	5.62
6.00-20(6)	\$7.72	7.50-20(10)	\$ 9.02	11.00-20(12)	\$13.42
6.50-20(6)	7.52	8.25-20(10)	11.02	11.00-22(12)	15.92
7.00-20(8)	9.02	9.00-20(10)	11.62	32x6 (8)	9.02
7.50-20(8)	8.02	10.00-20(12)	12.22	32x6 (10)	10.92

OUR SPECIALTY—TIRES FOR SCHOOL BUSES AND AMBULANCES

Thousands of Tires Shipped to Satisfied Customers Throughout United States and Many Distant Points. Please Note: We've made Thousands of Friends by giving a Tube with Passenger and Truck Tires. MAIL ORDERS given Personal Attention—Send This Ad with Check or Money Order. Dept. 2

STANDARD 834 N. Broad St., Philadelphia 30, Pa.

2 Pages of GROBAN'S WAR SURPLUS Specials!

MINIATURE High Speed ELECTRIC MOTOR

IDEAL FOR MODEL BUILDERS, MODEL RAILROADERS, EXPERIMENTERS, HOBBYISTS, AC or DC. Reversible, speed may be regulated by varying voltage. Has miniature Klaxon thermostatic switch. All connections are external and accessible. Has 3 mounting feet for easy installation. Double-end ball bearing supported shaft with small gear on one end. Die-cast housing with laminated field. Overall Dimen.: 3 1/4" long x 2 3/8" wide x 1 3/8" high. Net wt. 12 oz. A \$22.00 value. (ITEM #5)



Brand New

\$2.95 post-paid

SPECIAL! HANNA AIR CYLINDER

Brand New Used for heavy duty industrial applications on shop air lines or with low pressure systems. With 100 lbs. of air pressure, will deliver 1900 lbs. pressure at the ram shaft. All steel construction. Adjustable cushions at both ends of cylinder. Shaft dia. 1 1/2". Foot mounting with clevis on ram shaft. 26 1/2" double-acting stroke; 5" bore, 40 1/2" overall length closed, 7" overall width. 89 1/2 lbs. net wt. Gov't. acq. cost \$101.85.

AN EXCELLENT VALUE for **\$39.50**

(ITEM #61) F.O.B. Chicago



Brand New PNEUMATIC COMPRESSION RIVETER

MODEL CP 625-T8112

Made by Chicago Pneumatic Tool Co. Equipped with built-in control valves for use with cable operated remote control. Has 6" dia. actuating cylinder with right angle head. Base is 27 1/2" x 4". Height 40". Ram assembly adjustable for height. Approx. wt. 1300 lbs. A \$1200.00 value. (ITEM #62) Now

\$169.50

F.O.B. Chicago



ROSS 4-Way Foot Operated AIR VALVE Model 398

BRAND NEW. For double-acting pneumatic devices. Fine for operating presses, air vises, air machinery of many types. Heavy duty cast construction. No neutral position. Maintains pressure against the piston when the foot control is in the "Up" position. Threaded for 1/2" pipe. Dimensions of valve body: 7 3/4" L x 4 1/4" W x 7 1/2" H. Net wt. 28 lbs. A \$64.00 value for only. . . . (ITEM #60) F.O.B. Chicago

\$19.50



LOGAN 4-Way Foot Operated AIR VALVE—Model 6520

BRAND NEW. For double acting pneumatic devices. Fine for operating air vises, presses, air machinery of many types. Heavy cast construction. Threaded for 1/2" pipe. Dimensions of valve body: 8 1/2" L x 5 3/4" W x 7 1/2" H. Net Wt. 28 lbs. Gov't acquisition cost \$42.00. AN OUTSTANDING BUY AT. . . . (ITEM #59) F.O.B. Chicago

\$15.00



CENTRIFUGAL PUMP BELT DRIVEN

Ready for use on any Liquid Pumping Need

- Use it for DRAINING BASEMENTS
- HOME WATER SYSTEMS
- IRRIGATION
- STOCK WATERING
- FIRE PROTECTION
- DRAINING PONDS TANKS, etc.
- INDUSTRIAL PUMPING

A super value for all types of intermittent service in pumping large volumes of liquid in home, farm and industrial service. Ideal for home water systems, draining basements, fire protection, etc. On the farm for watering stock, draining ponds, sprinkling, etc. In shops and factories for all types of pumping service.

MOVE LARGE VOLUME QUICKLY When operated at 1750 RPM, will pump 42 gallons per minute on a 23 foot head; at 3600 RPM on 52 foot head will pump 88 gallons per minute. May be run with electric motor, gas engine or power take-off on tractor.

COMPLETE ENGINEERING REPORTS AND OPERATING INSTRUCTIONS FREE WITH PUMP

Pump has cast aluminum housing—accurately machined bronze impeller vanes. Complete with mounting bracket and 3/4" V belt pulley. Shaft rotates on sealed ball bearings with grease gun fitting. Has 1 1/2" threaded intake flange, two 1 inch outlets. Use one or both, as necessary. Made for Packard Motor Car Co. for use in Rolls-Royce Merlin Aircraft engines.

GREATEST PUMP VALUE IN YEARS Shipping weight 23 lbs. You can't beat this value at anywhere near this price. Satisfaction guaranteed. Original Cost Approx. \$147.00. (ITEM #64)



Brand New

\$29.75 F.O.B. Chicago

SPECIAL AUGUST BUYS!

BRAND NEW 3-IN-ONE GEAR PUMP

Three independent gear pump sections running off of one shaft; for single or multiple pumping. Has pipe thread connections. Shipping wt. 10 lbs. (ITEM #14) F.O.B. Chicago **\$9.95**

AIR FORCE WOOD PROPELLER

BRAND NEW—Made of polished laminated hard wood, 90 inches long, shpg. wt. 75 lbs. (ITEM #30) F.O.B. Chicago **\$9.75**

BRAND NEW GENERAL ELECTRIC 8" SEALED BEAM FLOODLIGHTS 300 Watts, 110 Volts, A.C. - D.C.

Has countless uses for: • Homes • Garages • Workshops • Driveways • Outdoor advertising • Displays • Beach lighting • Private air ports • Photography Wherever you need flood-lighting! Bought by the U. S. Army for signal use. This is the greatest surplus bargain ever offered. Lens, reflector and electrode vacuum sealed in one dustproof, air tight unit. 300 Watts, 110 Volts. Weighs only 2 1/2 lbs. List price \$10.50. A TREMENDOUS VALUE for. . . . (ITEM #8) 12 or more \$2.50 ea. postpaid **\$2.75** EA. POSTPAID



BRAND NEW Hale Fire and Irrigation High Volume CENTRIFUGAL PUMP

For Fire Protection, Irrigation, De-Watering, Industrial Uses, Farm Uses, Etc. **Pumps Rated 500 Gallons Per Minute at 275 Ft. Head Pressure**

Equipped with 1 1/2" diameter straight splined shaft for direct coupling drive; 4 1/2" threaded suction intake; two—2 1/2" threaded discharge outlets; Hale Pump Co. Model CF volute type; use any 4 or 6 cylinder gas engine or couple directly to front of truck or auto; or use 25 H.P. electric motor; dimensions 21" x 24" x 28". Complete with full accessory kit including suction and pressure gauges, priming equipment, and instruction book. Ship. wt. 415 lbs. **GOV'T ACQUISITION COST \$425.00 (ITEM #48) F.O.B. Chicago**



NOW \$149.50

SCREW JACK

Ideal for raising, lowering, leveling and adjusting. Use on tables, machine tools, toys, etc. Overall length closed 9 inches, open 14 inches. Worm gear box with 54 to 1 reduction, with double end drive shaft. Use either end or both. Extension screw shaft 30 to 1 reduction. \$35.00 value. AN OUTSTANDING BUY. (ITEM #45)

Brand New **\$3.95** postpaid

SHOCK ABSORBER

Use them to spring suspend vehicles, hoists, pumps, heavy and light machinery, compressors, etc. 1 1/2" x 2" dia. Welded steel construction for extra strength—U. S. Air Force bought them for bomber gas tank shock absorbers. Rated 2500 lb. Ship. wt. of 4—11 lbs. Each . . . \$1.50 FOB CHICAGO. **4 for \$5.00** (ITEM #21) F.O.B. Chicago

Self-Priming ELECTRIC PUMP

APPLICATIONS: oil burners, aquariums, fluid metering, fuel pump, tool post grinder, coolant pump, pressure lubricating pump, general industrial, etc. **BRAND NEW MOTOR MFD. BY BLACK & DECKER:** double ball bearing series wound, continuous duty, 1/30 H.P. electric motor, rated 12,000 R.P.M. Transformer included for use on 110 V AC current. Also applicable for 24-32 V DC. **PUMP MFD. BY WELDON TOOL CO.** with standard 1/4" tubing ports; rated 2 G.P.H.; remove pump and use motor as high speed grinder. **OVERALL DIMENSIONS:** 7 3/4" long x 3 1/4" wide x 3 1/4" high. Approx. wt. 5 lbs. \$51.00 value. (ITEM #1) **\$12.95** postpaid



Brand New Gear Type INSECTICIDE PUMP

All Manganese Bronze for spraying D.D.T., 2-4D, Sulphur Compounds, Etc. Pressures up to 150 lbs. to 14 gallons per minute—1500 RPM. Will not rust, pit, foul or freeze up. Use rubber hose inlet, pipe or tubing outlet. Equipped with 1/2" standard pipe thread port. Wt. 10 lbs. Dimen.: 8" x 5" x 6 1/2". Standard 1" manganese bronze shaft with keyway. U.S. Gov't. Acquisition Cost \$62.00 NOW ONLY (ITEM #50) F.O.B. Chicago **\$15.00**



GENERAL ELECTRIC DC GENERATOR

For Farm—Home—Factory Welding—Light Plants Delivers 30 volts, 267 amps. at 4000 RPM. Rated 8 Kilowatts, ball-bearing supported. Fan cooled armature. Drive it off of farm tractor, gas engine of 10 H.P. or more. Ship. wt. 65 lbs. U. S. Government acquisition cost—\$277.00. **\$28.50** F.O.B. Chicago Now Only (ITEM #51)



ORDER DIRECT FROM AD Send payment or purchase order today **SATISFACTION GUARANTEED**

Brand New Air or Oil HYDRAULICS



Use hydraulics on arbor presses, hydraulic presses, hay lifts, manure loaders, lift trucks—push or pull, tilt or turn, press or squeeze, open or close, lift or lower—and other hydraulic and industrial applications. Use with either air or oil . . . of finest precision workmanship.

ITEM #4—Double action, 1" bore, 3" stroke, will lift 770 lbs. in 1/10 of a second using Logan Pump. All steel barrel. Ideal for controls, door openers, positioning, etc. **\$4.95**

An \$18.00 value postpaid
ITEM #33—Double action, 1 1/2" bore, 5" stroke, will lift 1760 lbs. in one second with Logan Pump. **\$8.95**

Wt. 3 lbs. A \$35.00 value postpaid
ITEM #32—Double action, 1 1/2" bore, 9" stroke, will lift 1760 lbs. in one second with Logan Pump. **\$10.95**

Wt. 4 lbs. A \$45.00 value postpaid
ITEM #16—Use these cylinders on farm trucks, bulldozers, hay lifts, manure loaders, etc. Double action, 1 1/2" bore, 2 1/2" stroke. (Will lift 1760 lbs. in 2 seconds with Logan Pump). Wt. 8 lbs. A \$55.00 hydraulic cylinder value for **\$12.95**

only postpaid
ITEM #17—Double action, 2 3/8" bore, 8" stroke. (Will lift 4400 lbs. in one second with Logan Pump). Will withstand 1500 P.S.I. against wall. Wt. 7 lbs. **\$14.50**

A \$65.00 value postpaid
ITEM #20—Double action 2 3/8" bore, 4" stroke, two-way solid 5/8" alloy steel shaft (will lift 4400 lbs. in one second with Logan Pump). A \$73.00 value postpaid **\$16.50**

ITEM #15—Double action, 3" bore, 8 1/2" stroke. All steel hydraulic cylinder, will lift up to 12,000 lbs. (7000 lbs. in 3 seconds with Logan Pump). Complete with fittings. Wt. 12 lbs. **\$19.50**

A \$78.00 value postpaid
ITEM #31—Double action, 3 1/2" bore, 1 1/2" stroke. (Will lift 9600 lbs. in 7 seconds using Logan Pump.) Complete with fittings. Wt. 15 lbs. A \$92.00 value postpaid **\$22.50**

ITEM #6—Double action, 3" bore, 2 3/4" stroke, hydraulic cylinder will lift 7070 lbs. in 5 1/2 seconds using Logan Hydraulic Pump. Especially suited for farm and construction machinery. Clevis mounting for easy use. Wt. 22 lbs. A \$145.00 value. **\$27.50**

F.O.B. Chicago
HI-PRESSURE FITTINGS for cylinders and valves available at 35c ea. for 3/8" pipe and 50c ea. for 1/2" pipe.

Hydraulic Control Valves Brand New



ITEM #24—Four way control valve for use with double action hydraulic cylinder, may be used with 1500 P.S.I. hydraulic system to open and close hydraulic cylinders. Brand new. Ship. **\$7.95**

Wt. 4 lbs. A \$38.00 value postpaid
ITEM #26—Four-way control valve for use with two hydraulic double action cylinders. Each cylinder may be operated independently of the other or in conjunction with the other. Oil may be locked in any of the cylinders to hold the piston at any required position. Brand New. Ship. Wt. 6 lbs. A \$60.00 Value postpaid **\$10.95**

ITEM #28—A two cylinder double action valve with a unique arrangement, allowing the operator to raise both cylinders simultaneously, to lower them simultaneously or to raise one and lower the other at any predetermined rate and speed. Brand New. Ship. Wt. 8 lbs. **\$14.95**

A \$75.00 value postpaid

BRAND NEW Logan Double-Action Pneumatic — Hydraulic PRESS

\$300.00 value offered at a fraction of original cost

Using air or oil, this device is ideal as a punch press, vise, arbor press, etc. An excellent tool for industrial and shop use. Use 150 lbs. of air pressure or 250 lbs. of oil pressure. Cushioned double action "Logan" Model AC ram, 6" bore and 8" stroke. Capable of up to 4200 lbs. of pressure using air. Has 3" throat. Lubricated gibs provide perfect alignment. Has adjustable work space. Hardened alloy steel piston rod 1" diameter. Frame constructed of cast steel with 3/4" base plate. Manufactured by Sipp-Eastwood Co. Unit is 49" high. Base is 9 1/2" wide by 18" deep. Wt. approx. 300 lbs. AN **\$79.50**



F.O.B. Chicago

Brand New 18" Wire Spoke WHEEL



For use on motorcycle or adaptable for midget cars, trailers, small trucks, any wheeled vehicle. With bearing races and gear. Takes 18" tire. Wt. 19 lbs. A REAL VALUE at **\$3.95**

(ITEM #57) F.O.B. Chicago

BRAND NEW FIN-COOLED HIGH PRESSURE AIR COMPRESSOR

For pneumatic tools, filling hi-pressure vessels, paint spraying, insecticide vaporizing and other uses. Rated 450 P.S.I. at 1200 R.P.M. Used on Packard Merlin Engine, this aluminum air pump with air filter intake weighs only 4 1/2 lbs. 9" x 5" x 3 1/4". Gov't. Acq. Cost \$185.00. **\$15.00**



NOW ONLY postpaid (ITEM #56)

SHOP BY MAIL and SAVE at GROBAN'S Buy direct from ad!

Logan Heavy Duty Oil HYDRAULIC PUMP

BRAND NEW . . . for operating hydraulic cylinders and hydraulic motors on tractors, bulldozers, construction machinery, lift trucks, industrial applications, etc. Delivers 8 GPM at 1200 RPM at 1000 P.S.I. using 5 H.P. Has 1 1/2" pipe thread inlet, 3/8" pipe thread outlet, 3/4" shaft with flat and key-way for direct or pulley drive. Has flange with 4 bolt holes for convenient mounting. Ship. wt. 22 lbs. Overall dimen.: 7" L x 5 1/2" H x 5 1/2" W. A \$105.00 value. FOR ONLY **\$22.50**



F.O.B. Chicago (ITEM #29)

LOGAN Heavy Duty Oil HYDRAULIC CONTROL VALVE



BRAND NEW control valve with built-in adjustable relief valve, will operate one double-acting hydraulic cylinder or two cylinders as one or a reversible hydraulic motor. Valve handle latches in neutral position. Made of rugged cast aluminum alloy. Open center unloads the pump in neutral position. Throttling control allows operator to regulate the speed of movement of the hydraulic cylinder or motor. Has removable mounting brackets with 4 bolt holes, 3/8" pipe thread connections. Overall dimen.: 12 1/2" H x 8 1/2" D x 8" W. Ship. Wt. 17 lbs. Gov't. Acquisition Cost over \$100.00. **\$21.95**

(ITEM #37) AN EXCELLENT BUY FOR F.O.B. Chicago

G-1 STAINLESS TANK

Use these tanks on compressors, for tire inflators, pulsation chambers, floats, buoys, hydraulic reservoirs, fluid and milk containers, fuel containers, etc.



Tough, light, 450 lbs. P.S.I. Aviators Breathing OXYGEN bottles, type G1. 2100 cu. in. (approx. 9 gallons) int. vol. 24" x 12". 1/4" threaded openings at ea. end. Wt. 19 lbs. .051" thick. (ITEM #63) Price: F.O.B. Chicago **\$4.95**

Hydraulic Pressure Gauge



BRAND NEW Ideal for high pressure hydraulic systems, adjusting pressure, relief valves, etc. Range 0 to 2000 P.S.I. Black plastic case 2 3/8" square, 1 3/4" deep. Black instrument face with white pointer and numerals. Worth many times this low price of postpaid **\$2.95**

(ITEM #36)

HAND HYDRAULIC PUMP Brand New

Used for hydraulic jacks, presses, hoists and other hydraulic applications. For operating hydraulic cylinders to pump oil or hydraulic fluid under pressure. Hand pump has built-in check valve and is capable of delivering 1000 lbs. of pressure. Has alloy aluminum housing. Dimen.: 8" long x 3 1/2" high x 2 3/4" wide. Ship. wt. 3 lbs. A \$45.00 value. (Item #11) Now **\$8.95**



postpaid

Vickers MF9 Hydraulic PUMP or MOTOR



complete with mounting kit ready to install

\$19.90

\$75.00 value

Pump is compact, powerful, rated 1,000 P.S.I., .507 cu. in. per revolution, 8 gal. per min. at 3750 RPM. Change rotation by reversing flow. Delivers up to 6 H.P. Requires 1/3 to 6 H.P. to drive directly or by pulley. BRAND NEW. Mounting kit has been especially designed to provide maximum utility and ease of mounting MF Series Vickers Pumps. Brackets are constructed of heavy steel plate; shaft is made of 1/2" steel with one end splined to fit pump; other end of shaft has machined flat for mounting a standard pulley with 1/2" hole. Shaft runs in oilite bronze bearings. PUMP ONLY (ITEM #18) \$14.95 postpaid MOUNTING KIT ONLY (ITEM #38) \$ 4.95 postpaid BOTH AS COMPLETE UNIT (ITEM #39) \$19.90 postpaid

ADJUSTABLE RELIEF VALVE (ITEM #34) \$2.95 post paid

HYDRAULIC FLUID (ITEM #53) per gallon F.O.B. Chicago \$1.75

10 FT. LENGTH OF HI-PRESSURE HYDRAULIC HOSE with 1/4" female pipe thread fittings (Item #27) F.O.B. Chicago \$3.95

BRAND NEW HYDRAULIC TANK 3 GALLON CAPACITY with oil-indicator cap, 4"x12"x13 1/2". Ship. wt. 13 lbs. \$4.95 (ITEM #58). NOW AT THIS LOWEST PRICE. F.O.B. Chicago

FREE: Write for free copy of our 40 page catalog including Hydraulic Manual featuring diagrams, photographs and instructions. Catalog lists excellent war surplus values: pumps, valves, hydraulics, lights, motors, etc.

GROBAN SUPPLY CO.

1507 SOUTH MICHIGAN AVE.
Chicago 5, Ill. Dept. PM-8



"YANKEE" VISES

*hold work through every step
without a misstep*

Any job locked in a "Yankee" Vise, is correctly positioned for every operation . . . hand or machine. Lifts on and off swivel base at bench. Machined accurately . . . top, bottom, sides and front end . . . V-grooved block for rounds. Four sizes, with and without swivel base . . . 1½", 2", 2¾" and 4" jaw widths. At your dealer's.



Write for
"Yankee"
Tool Book

NORTH BROS. MFG. CO.
Philadelphia 33, Pa.

YANKEE TOOLS NOW A PART OF
STANLEY
THE TOOL BOX OF THE WORLD

Do a Better Job WITH ONE OF THESE EMPIRE LEVELS

EMPIRE TORPEDO LEVEL
Smallest, most handy and accurate Level made. "Cigar-shaped"—no sharp corners to tear pocket. Aluminum stock. Only 3 oz. wgt. 9" long. Has Level, Plumb, 45° Vials.
No. 26 \$2.00



ALUMINUM LEVEL — No. 151
Cast and Machined, a Beautiful Tool, with Patented, Removable Level and Vial.
With 2 Plumb, 2 Levels, 2 — 45° Vials. 18" \$6.40
24" \$6.80 28" \$7.80
Order **EMPIRE LEVELS** from your local dealer.
Write direct for literature.



EMPIRE LEVEL MFG. CO.
BOX 97, DEPT. P-253 MILWAUKEE 13, WISCONSIN

MAKE YOUR OWN! WITH



Griffin READCUT LEATHER PROJECTS

Over 100 KITS in every kind of Tooling and Carving Leather, accurately cut, all parts included. Only Top Grade Leathers used You do the choosing. You do the tooling, carving, stamping, the punching and assembling

SEND FOR
COMPLETE CATALOG
Please send
10c to cover
mailing.

SINCE 1924
OUT OF THE WEST, THE HOME OF LEATHER CARVING
Griffin Craft Supplies
5515-A GROVE STREET
OAKLAND 9, CALIFORNIA

**EVERYTHING FOR THE
LEATHER WORKER**
Largest, most complete stock
of *Leathercraft Tools and Acces-*
ories in U.S.A.
**HIDES AND
SKINS** of Craft
Leathers of every
kind if you prefer
to cut your own.



hand, this big twin-engine P-38 could hardly be expected to do well in closed-course racing. Yet Tony LeVier made an excellent showing in such a ship in both the '46 and '47 Thompson Trophy Races. LeVier, however, evidently has gotten the ultimate in speed out of the Lightning and he has been the only pilot to make a good showing in the twin-tail airplane.

It is an air-cooled shipboard fighter that has been the hottest thing to date in pylon racing. The present Thompson record of 396.131 miles per hour was established in 1947 by Cook Cleland flying a Goodyear Corsair. Known to the Navy as the F-2-G, the big Corsair was designed and built by Goodyear Aircraft in the closing days of the war along the same general lines as the famous Vought-Sikorsky design. It embodies the 3500-horsepower Wasp Major 4360, a 28-cylinder, four-row, radial engine such as is used in the B-36 bomber. No previous single-engine plane ever carried as much power.

The F-2-G was never put into mass production, so only a few were made. Of these only three are in civilian hands. Cook Cleland owns two of them, both specially prepared for racing. The other is the property of Ron Puckett of Washington, D. C. This particular ship does not have the refinements of Cleland's planes, but it is still a promising contender for Thompson honors. Although the Cleland planes experienced engine trouble due to an experimental fuel last year, they are still the world's best closed-course racers. They are particularly well suited to the tight pylon turns and low-altitude flying found in the Thompson Trophy Race.

Another surprising performer is the much-maligned Airacobra. Although the P-39 became obsolete as a fighter some years back, it had enough oomph to win the first postwar Thompson. Furthermore, it was the fastest qualifying plane last year. Using alcohol-triptane fuel, young Chuck Brown of Indianapolis burned up the course at 418.300 miles per hour. He also led the big race for 18 laps with a new record almost in his grasp before engine trouble forced him down.

Originally, two of these ships were prepared for the races by Bell test pilots Jack Woolams and Alvin Johnston. Christened Cobra I and Cobra II, the planes were identical, having Allison 1500-horsepower engines substituted for the original 1000-horsepower type. Both showed terrific speed, but unfortunately the Cobra I crashed in Lake Ontario with Woolams at the controls during prerace tests in 1946.

(Continued to page 254)

Hydraulic SPEED REDUCER of many uses

Variable Speeds and INSTANT REVERSE

FROM ZERO TO 700 R.P.M.

For LATHES, REAMERS, TRANSMISSION, MIDGET CARS, MILLING MACHINE TABLE, SHAPER, THREAD MILLING FIXTURES, HOME MADE WOOD WORKING LATHES, EXHAUST FAN, PUMP, HOIST, GENERATOR, OVERHEAD TROLLEY, PRODUCTION BELT, OPENING and CLOSING DOORS, and MANY OTHER USES. Industrial or Home Use. Cost Government \$300.00. High Quality Precision Workmanship. Case measures 7 1/2" Long, 7" High, 6 1/2" Wide. Input and Output Shafts 3/8" diameter. Beautiful Red Crackle Finish Case.

OUTPUT TORQUE ADJUSTMENT ZERO TO 100 INCH POUNDS

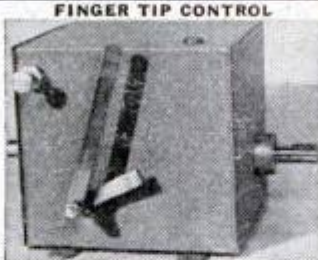

FINGER TIP CONTROL
Shipping Wght. 25 pounds

Only \$54.50

PREPAID 2 quarts oil included FREE

If C.O.D. is requested a 10% Deposit must accompany order and we ship F.O.B. Chicago.

1 1/2"-8 thread Lathe Chuck Adapter, \$3 extra

DIRZIUS MACHINE SHOP K, 1423-25 So. 52nd Ave., CICERO 50, ILL.

Make Ur-Own Rotary Type POWER MOWER KEEN MOWER

Model 49M—Just add electric motor or gas engine, concealed blade for safety, 3 cutting heights, 1 1/2" to 3 1/2". Ball bearing rubber tired rear wheels. 18" cut. Cuts to within 1/2" of sidewalk. Wght. 48 lbs. America's Greatest Power Mower value. Order Now!



Price FOB, K.C. Send chk. or M.O.—No COD's.
ATLAS EQUIPMENT CO.
229 S.W. Blvd. Dept. MP8 Kansas City, Mo.

NONE BETTER! SUPER DRILL GRINDER



Sharpens round shank drills from 3/32" to 1/2" in diameter, up to 6" long. Grinds old drills like new in 4 different point angles, using hand or power grinding wheels. Money-back guarantee.

Price only \$2.95 At Dealers or Postpaid

CRANDALL MFG. CO. 1512 W. Slauson, Dept. FA-43, Los Angeles 44, Calif.

NOW - AMAZING NEW LOW PRICE

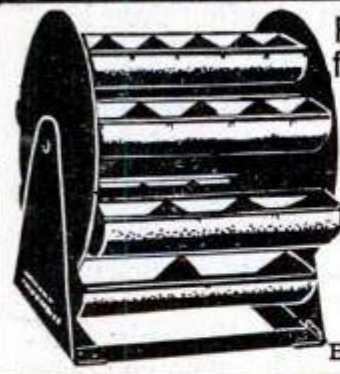

REVOLVING GADGET TRAY for Carpenters, Machinist, Mechanics, Cobblers and Hobbyist.

FOR BOLTS, SCREWS, NAILS AND SMALL PARTS

\$5.88 K.D.

BUILT OF STRONG DURABLE STEEL FOR A LIFETIME USE
HOMERY INDUSTRIES
BOX 981 WARREN, OHIO

WORLD'S LOWEST PRICED ADDING MACHINE



IDEAL FOR BUSINESS AND PERSONAL USE - GUARANTEED ACCURATE. Not a toy. Operates with only a finger flick. Adds, subtracts, multiplies, divides. Counts up to one billion. Pays for itself over and over. Ideal Gift - for Business, Income Tax and School use. MONEY BACK GUARANTEE. Send name and address. Pay postman only \$2.95 plus postage. (Send full cash if outside U.S.) Beautiful rich-looking Leatherette Case included at no extra cost. Money back in 10 days if not delighted. AGENTS WANTED.
CALCULATOR MACHINE CO., (Mfrs.)
Dept. 217, P.O. Box 248 Glenview, Illinois

60 Cycle
110-120
Volt AC



NEW

BETTER WAY TO HONESHARP Almost ANYTHING!

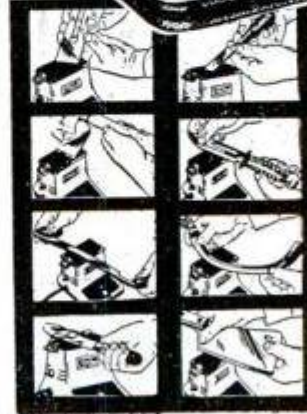

Pictures SHOW YOU how brand-new SYNCRO Electric HONE SHARPENER STARTS sharpening where ordinary electric sharpeners STOP! The ONLY Electric HONE with 14,400 strokes a minute! Invaluable for workshops, homes, kitchens, cafes, industry! A novel Gift. No belts, gears, wheels. HONING is best, safest way. SYNCRO comes with 3 Honing Stones, \$10.50 cord, plug, switch...

NEW and BETTER Electric SANDER-POLISHER Ready!



SYNCRO presents a new, superior electric sander-polisher! For light sanding, refinishing, finishing, etc. Polishes furniture, autos, shoes. 14,400 "POWER" MOTION strokes a minute sand or polish better, faster! With 9 sheets Aluminum Oxide sandpaper, felt and virgin lambs-wool pads, 8 ft. cord, plug \$14.50.



WORLD'S SAFEST ELECTRIC JIG SAW!

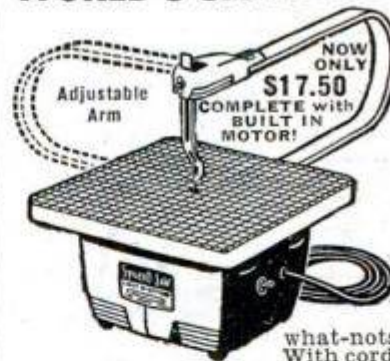

Safe for children, powerful enough for any workshop! Portable. THOUSANDS OF SAFE SYNCROS SOLD! Arm adjusts to permit cutting ANY length material. For delicate work on cardboard, wood, plywood, thin metal, plastic. No belts, no gears. NO OILING. Self-contained motor included. Just plug in any 60 cycle, 110-120 volt AC - and saw SAFELY. Fun and profit making scroll-work, what-nots, photo silhouettes, etc. With cord, plug, 3 blades, only \$17.50.

YOU CAN DO IT BETTER WITH

SYNCRO

QUALITY PRODUCTS FOR HOMES • WORKSHOPS • COMMERCE • INDUSTRY

HOW TO GET YOUR SYNCRO:

At your dealers. If dealer hasn't the brand new Sharpener, new Sander-Polisher or Saw, order direct from factory. Send full amount, we'll ship PREPAID.

DEALERS! Write for SYNCRO'S "BIG 3" Profit Facts.

SYNCRO CORP., Dept. H-89, Rochester, Michigan

SAY YOU SAW IT IN POPULAR MECHANICS

BULL BUFFER

announces a sensational new

HOME KIT

FOR THE FIRST TIME, YOU CAN POLISH,
SAND AND DRILL "THE RIGHT-ANGLE WAY"
—AND PICK THE RIGHT SPEED FOR THE JOB!

all for only \$29.95!



KIT INCLUDES

- BULL DRILL — new stream-lined, power packed, 1600 r.p.m. electric drill, with JACOBS GEARED CHUCK.
- BULL BUFFER — right-angle polisher-sander with gear reduction.
- ADAPTER SET — for sanding at twice drill speed.
- Sheepskin bonnet and 2 sanding discs.

You Asked for It— Here It Is!

A stream-lined, powerful electric drill . . . PLUS one of the finest geared chucks money can buy . . . PLUS the famous Bull Buffer, now in use in more than 100,000 homes . . . PLUS an adapter that enables you to sand at twice drill speed . . . a kit that comes to you complete, ready-to-use with no "extras" to buy . . . a kit you'll use day in, day out, for drilling, waxing, removing paint, and polishing and sanding your car, boat, floors, woodwork, furniture . . . all these quality tools of a thousand uses at one low price—and your Bull Buffer Kit carries a 90-day guarantee! Order today, at your dealer, or send cash, check or money order.

IF YOU ALREADY HAVE A DRILL

order your Bull Buffer today! It's the only right-angle polisher-sander with gear reduction, and it fits any drill. Comes complete, including 5-inch rubber disc, sheepskin bonnet and 2 sanding discs, only **\$9.95**



POLISH at 800 r.p.m.



SAND at 3200 r.p.m.



DRILL at 1600 r.p.m.

ORDER THESE KIT ITEMS SEPARATELY, IF YOU WISH

Bull Drill—new stream-lined, power-packed 1600 r.p.m. electric drill with Jacobs geared chuck.....	\$19.95
Adapter B set (for sanding at twice drill speed—can ONLY be used with Bull Buffer).....	2.00
Extra sheepskin bonnets, each.....	1.25
Extra sanding discs, (000-00-0-1-2 1/2-3-4), each.....	.10

AT YOUR DEALER OR ORDER DIRECT TODAY — WE PAY POSTAGE

BERTRAM S. ENGINEERING CO.

3121 MAIN ST.

KANSAS CITY, MO.

Tex Johnson, however, went on to win the Thompson Trophy in the Cobra II. Jay Deming, another Bell test pilot, flew the Cobra II to a third place behind Cleland's two Corsairs in 1947. Chuck Brown flew this same airplane with a new propeller, a further souped-up engine and rechristened KF-1. His amazing performance puts this P-39 in the same class as the F-2-Gs for future races.

Another airplane that has appeared in great abundance on the racing fields is the Bell Kingcobra. To that rugged ship goes the ignominious honor of nailing down last place in all three of the postwar Thompson races. Probably no other plane has undergone as much surgical work at the hands of hopeful contestants as has the P-63. Charlie Tucker, an ex-Flying Tiger, started it all when he trimmed his Kingcobra down to a 25-foot span. Other pilots followed suit, but still these ships have made a poor showing in competition with the previous mentioned types. The best racing record among the P-63s is held by the Spirit of Tick, flown last year by Bob Tucker and owned by Russ Hosler of Cleveland. Hosler has recently acquired Tucker's plane also. This ship is a real "hot rod," having shown greater speeds than any other of its class. Both of these Kingcobras are of Thompson caliber.

Another well-known plane to be seen at the air races is the AT-6. Having served as an advanced trainer, this airplane would seemingly be a far cry from the racing type. But it fits admirably into the special contest that has been created for it. The only pylon race which has been open to women pilots since the war has required that the North American AT-6 be used.

The ladies have not been outdone by their flying brethren in adapting their lowly trainers to the sport. Typical of that class is the ship flown last year by Mrs. Grace Harris of Kansas City. A stream-lined fairing completely covers the rear cockpit. The three-blade propeller with reduction drive also is an innovation over the standard model. Mrs. Harris won the Kendall Trophy at an average speed of 239.962 miles per hour in her AT.

These fighter planes are the only contenders in the unlimited horsepower class of racing at the present time. Experimental and foreign types may appear at the forthcoming races, but they will be hard put to better the performance of these ships. The best of the fighter craft developed during World War II, they have become the fastest racers the world has ever seen. Today the Corsairs, Mustangs, Lightnings and Cobras are the cream of powerhouse planes.

SURPLUS BRAND NEW AIR COMPRESSORS

for Garage - Shop - Factory - Farm or Home. Height 9" - Weight 7 1/2 lbs. Uses 1/4 HP Motor



\$4.90

Syphon Type Spray Gun

A sturdy, well built air compressor of steel and die cast metal constructed to give satisfactory and lasting service. 20-30 lbs. continuous pressure. Higher pressure for intermittent service. Formerly sold for \$14.50. Synthetic rubber hose with fitting, 12 1/2 feet \$1.70, 23 1/2 feet \$3.00.

COMPRESSOR CORPORATION OF AMERICA
ST. JOSEPH, MICH.

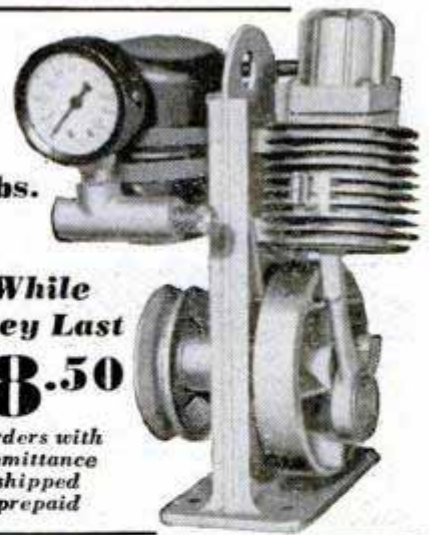

While They Last
\$8.50

Orders with remittance shipped prepaid

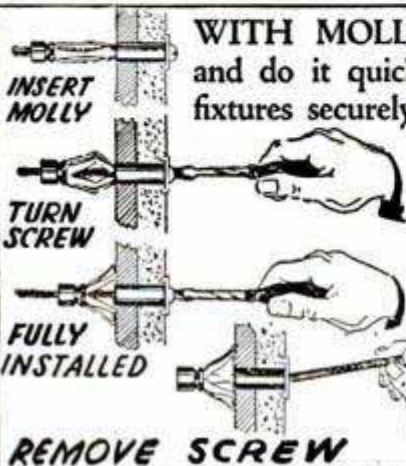

WITH MOLLY YOU CAN FASTEN ANYTHING and do it quickly, neatly and safely. MOLLY will hold fixtures securely to floors, ceilings or any hollow wall construction... Simple to install, all you need is a screw driver. Sold by leading hardware stores everywhere.

Write for Free Descriptive Folder

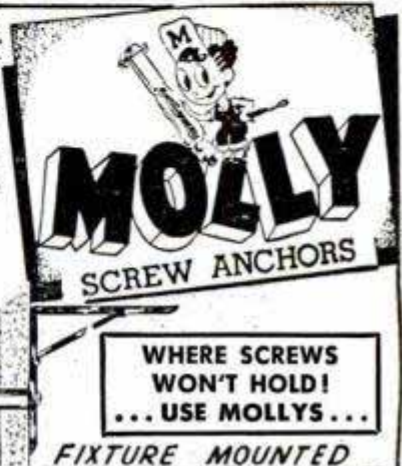

WHERE SCREWS WON'T HOLD! ... USE MOLLYS ...

MOLLY CORPORATION

522 COURT ST.

READING, PA.

Sensational Bargains: LOWEST PRICES! All Items Guaranteed As Represented



HOME WORKSHOP MOTORS
1/4 H.P. 1725 RPM. Fob. **\$11.95**
1/2 H.P. 1725 RPM. Fob. **\$13.75**

BARGAIN WORKSHOP MOTORS
Westinghouse . . . Leland . . . G.E. & Sunbeam, etc. 1/2-110V. A.C. 60 cy., 1 phase, 1750 RPM. Capacitor & Repulsion Induction Types. Like New. Fully Guaranteed. Fob. Only **\$19.75**

General Electric . . . Delco . . . Leland & Others . . . 1/2 H.P. A.C. 110 V 60 cy., 1 phase 3450 RPM. Capacitor & Repulsion Induction Types. Fully Guaranteed. Fob. Only **\$22.50**

Write for our BARGAIN FAN & MOTOR Circular and SAVE MONEY **RUSH ORDER TODAY**
C. MARSHALL SALES, 3546 W. Fullerton Ave., Dept. P-8, CHICAGO 47, ILL.

BARGAIN GASOLINE ENGINES

Jacobsen 2 cycle 3/4-1 H.P. Ball Bearing. Less Gas Tank, Shop-worn but never used. Fob. each **\$22.50.**

BRAND NEW BROWN & BROCKMEYER MOTORS

3/4 H.P. A.C. 110-220 V. 60 cy. 1 phase 1750 R.P.M. Ball Bearing Repulsion Induction Type. Fob. Only **\$34.50**

Clearance of Late SUMMER BREEZE BARGAINS

BUILD YOUR OWN Window Fan, Attic Fan or Night Air Cooler . . . All parts Torrington: Deep Pitch Blade, Shaft Bearings, Pulleys, Belt, etc. #F-20. **\$12.50**
FAN KIT. 5000 C.F.M. only . . . Fob. **\$15.00**
#F-24. FAN KIT. 6200 C.F.M. only . . . Fob.

Completely Assembled Ball Bearing Belt Driven Fans
F-C #24 . . . 24" . . . 6200 C.F.M. Only **\$32.50** Fob.
F-C #30 . . . 30" . . . 8500 C.F.M. Only **\$36.00** Fob.
F-C #36 . . . 36" . . . 9600 C.F.M. Only **\$39.75** Fob.
Add \$11.75 if Motor is desired on Above Fans.

16" 3 Speed Oscillating Fans . . . Gen'l Electric, Robbins & Myers Makes: Like New . . . List Price \$45.00. #BF-16 . . . 110 V. A.C. . . . Only . . . \$22.50 Fob. Same As Above. 1 Speed 16" Non-Oscillating. 110 V. A.C. Only **\$15.00** Fob. 16" Westinghouse Exhaust Fans #388 W. 110 V. A.C. Only **\$18.00** Fob.



DUST-O-VAC FOR ALL MACHINES
For Home Workshops & Industry. DUST-O-VAC collects & bags wood & plastic chips, wood & metal dust, wood shavings. Free Bag. Attaches to circular saw, planer, band saw, grinder, belt or disc sander, shaper, drill press with shaper or sander attachment, spindle shaper, wood lathe, jig saw. 110 A.C., D.C. Send for mounting instr. for all machines.

Free Ship. east of Miss. West of Miss., add \$1. Check, M.O.

HEAVY CAST ALUMINUM BLOWER — ONLY \$10
110V, AC 50-60 cycles, cont. duty motor, deliver app. 100 C.F.M. For workshop, lab, kitchen, cellar, etc. Install yourself. Send for circular.

UNIVERSAL YONKERS CORP., 137 Alexander St., M8, Yonkers 2, N. Y.

MONEY BACK GUAR.



7x50 PRISM BINOCULARS
PRECISION OPTICS — BRAND NEW
\$36*

6x50 ACHROMATIC FIELD GLASSES
\$16*

*20% Federal Tax

Send for Free Catalog of Binoculars, Telescopes and Microscopes

BROWNSCOPE CO.

Dept. 8M, 24 W. 45th St., New York 19, N. Y.

Build Your Own Portable Welder
save up to \$300

Pay for it out of profits . . . Easy Terms

\$300 to \$500 extra profit monthly

Write for this booklet on how to build your own Arc Welder

FREE

BUILD YOUR OWN portable ARC WELDER and have a profitable business of your own. It's easy. No experience required. Go after big pay welding jobs.

Send catalog on Arc Welders.

HOBART Bros. Co., Box M-89, Troy, O.

"One of the world's largest builders of arc welders"



Send for this FREE
DIESEL BOOKLET



See how the economy and long life of a

Sheppard DIESEL

reduces power costs
by at least 75%!

Send for this new Sheppard Diesel booklet. It tells the complete Sheppard story of simplified fuel injection . . . full diesel operation on any 1 of 15 different fuels . . . 3 to 5 times longer engine life. Send for your free copy today.

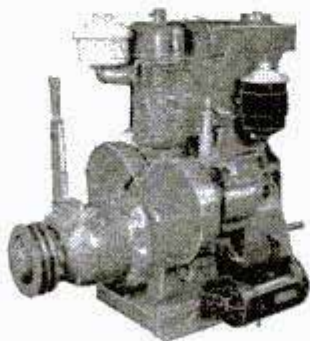

5.4 H.P. AIRCOOLED single cylinder power unit. Others up to 100 H.P. Generating sets from 2 to 36 K.W.

Sheppard Diesels
Hanover 4, Pa.

DEALERS—Send for details on profitable Sheppard franchise.

STATIONARY • AUTOMOTIVE • MARINE

DIESEL'S THE POWER... *Sheppard's* THE DIESEL

SO HANDY FOR
SO MANY USES

AT HOME
OFFICE AND SHOP

32 DRAWER
MODEL PICTURED
ONLY
\$5.95
POST PAID.



THE
JIFFY
METAL
CABINET

Now you can keep nuts, bolts, screws, nails, parts, washers, stamps, hobbyist needs, etc., at your fingertips.

Just think, 32 or 64 drawer cabinet to keep those small items that usually get mislaid. Spot welded steel cabinet, enamel finish, metal drawer guides. Looks good anywhere. Send check or money order please—no C.O.D.'s. Prices below. Your money refunded if not satisfied.

SPECIFICATIONS

32 Drawer Unit

6" Deep
12 3/4" Wide
15 1/4" High

64 Drawer Unit

6" Deep
25 1/2" Wide
15 1/4" High

Drawer Size

1 1/4" Deep
2 3/4" Wide
6" Long

WITH ALUMINUM DRAWERS

One piece rustproof aluminum drawers for heavy service—good for work bench and industry use.

32 drw. \$8.95

64 drw. \$15.95

POSTAGE PAID

WITH CARDBOARD DRAWERS

Suitable for most home uses. Heavy board kraft covered. Metal drawer pulls.

32 drw. \$5.95

64 drw. \$9.95

POSTAGE PAID

KAYTEE PRODUCTS DEPT. M. BOX 588 CANTON O.

Sensational New MOTOR Offering John Oster Heavy Duty Fractional H.P.



1/40 HP Induction Type, single phase, 110 V. AC, 60 cycle, bronze bushings, 5/16" shaft, 1725 RPM, Standard Base. Ideal for Hobbyists for many uses. Window and regular fans, grinders, etc. Shpg. wgt. 6 lbs. **\$4.95**

Add 35c handling and mailing

Make Your Own POWER LAWN MOWER

with this DRIVE CUTTER ASSEMBLY
Constructed for those who desire to build their own mower or to replace your old cutter assembly. Complete with 18" blade and double ball bearing drive, only **\$11.95**



Add 50c to cover handling & shipping. No COD's

ATLAS EQUIPMENT CO., Dept. P.M.8A
229 SW BLVD. KANSAS CITY, MO.



CAPE COD CHAIRS TRELLISES • ARBORS DUTCH WINDMILLS

Chairs style B-C-A PLANS 50c Ea., all 3 only \$1.00. 12 different trellis designs PLAN of all 12 only 50c. Authentic 40" high Dutch Windmill Detailed PLAN only 75c. Unique 40" high Light-house having copper lantern, ideal for garden or on lake shore of summer home. Large detailed PLAN 75c.

SPECIAL ALL PLANS ABOVE \$3.00 VALUE ONLY \$2.50
SEND 10c for catalogue of many S&C projects.
CRAFTSMAN'S MODEL CO. Dept. P7, 2030 No. 41st Street Milwaukee 8, Wis.

SHARPEN CIRCULAR SAWS LIKE AN EXPERT



No experience needed. Two simple adjustments. Gets hollow-ground, cross-cut or combination saw blades true and sharp. Fits 6" to 12" blades with 1/2" to 1 1/4" centers. Includes file and complete instructions. \$6.95 postpaid. (Check or money order) C.O.D.s postage extra. Guaranteed—Money back if not satisfied after 10 day trial. A money maker for fix-it shops. Soon pays for itself. Order today.

\$6.95
SURE SHARP MFG. CO., Dept. M-89, P. O. Box 24, Santa Ana, Calif.

\$\$Flocks, Sandblasts, Smalts, Beads\$\$

Spray Gun does Everything. Uses only 25 lbs. air pressure. 5000 profitable uses in Shop, Industry, Farm, Home. Get the facts FREE.

BLASTO SPRAY GUN MFG., Div. 24, 7007 Haas Ave., Los Angeles 44, Calif.

Only
\$498



OTTAWA Mule Team Tractor

Finest of all low cost tractors. Costs too little to do without. Has the toughness and strength of a team of mules. Over 4,000 in use. With ease and low operating cost, it plows, discs, harrows, mows, plants, cultivates, etc. Weighs nearly 1,000 lbs. and has Bull-Dog traction. Sold only direct to user. Write quick for FREE details.

OTTAWA MFG. CO., 2-927 Garden St., Ottawa, Kansas

← YOUR MOTOR

Foredom PRESTO-FLEX

with PENCIL-SIZE Handpiece **\$5.95**

WITH MARVELOUS EASE, you can grind, polish, drill, rout, mill, saw, sharpen, clean, carve, engrave, etch, etc. — on metal, wood, glass, plastic or linoleum. Simply attach to your electric drill, drill press or motor. Presto—a flexible shaft machine! Off again in a jiffy! Pencil-sized handpiece gives finger-tip control. Gets into tight places. Handy 35" overall length. And—only \$5.95 complete! ORDER NOW. If you order Presto-Flex for use on motor, specify motor shaft diameter. Add 50c for motor coupling. (Available for 1/4", 3/16", 3/8" and 1/2" shafts.) No. 50 Accessory Set available \$1.50 extra.

Foredom also makes a complete line of motor driven models at low prices. Write for Catalog E-1120 and see the many Foredoms now available.

FINGER-TIP CONTROL

FOREDOM ELECTRIC CO., Dept. E-1120
27 PARK PLACE NEW YORK 7, N. Y.

BUILD YOUR OWN TILTING ARBOR SAW!



- 27x28 in. table stays level. Blade tilts full 45 degrees
- 10 in. blade cuts 3 1/4 in. deep, jack-screw depth adjustment
- Floor model, 34 in. table height
- New Departure ball bearing arbor, 3/4 in. precision shaft, ready to run, 5/8 in. bore blades
- Quick-positioning, self-aligning rip fence guide
- Sturdy wood, steel and aluminum construction
- No machining—Build easily with hand tools only
- Capacity and performance of floor saws selling for \$150.00 and up!!

SAVE \$50 OR MORE

GIL-BILT Step-by-Step pictorial plans (No blueprint reading required), full scale patterns, 11 actual photographs.....\$1.00

GIL-BILT Metal Parts Kit—includes Plans, ball-bearing arbor, cast aluminum miter gauge and bar, rip fence guide, machined lock knobs, jackscrew mechanism with 4 1/2 in. handwheel, and all other metal parts including every screw, bolt, nut and washer (less blade). \$20.95
 Same Kit with 10" combination blade.....\$25.90
 Same Kit with 8" combination blade.....\$24.90

Return in 10 days for full refund if not satisfied. (Prices include postage up to 600 miles.)

Also available—Plans and Metal Parts Kits for 8" Tilt/Table Saw and 12" Band Saw. Order Plans at \$1.00 each—sent postpaid anywhere in the world, or write for FREE descriptive Catalog.

GILLIOM POWER TOOLS P.O. BOX 1-PH. LAMBERT FIELD ST. LOUIS 21, MISSOURI

OVER 50,000 SATISFIED USERS! DYNAMIC HEAVY DUTY WELDER

MAKE OR SAVE TIME & MONEY!

Now You Can Repair Auto, Home Appliance, Farm & Shop Equipment for yourself & others with this Genuine Transformer Type Welder—75 Amp. Capacity. Does Welding, Brazing, Soldering and Cutting on iron, steel, brass and other metals. Portable. Easy to operate from any properly wired 110 Volt Line (other voltages at slight extra cost). Has 8 metallic and carbon arc welding heat stages. Comes COMPLETE ready-to-weld with helmet, rods, cable, etc. and Simplified Instructions which are actually a short course in welding. A few repair jobs will more than pay for it. **SPECIAL GIFT \$6.80 ARC TORCH** yours at **NO EXTRA COST.** Write today for FREE details and 10-DAY TRIAL OFFER.
DYNAMIC WELDER CO., 15 E. 23rd St., Dept. TD-89, Chicago 16, Ill.



ONLY \$28.50 COMPLETE

MANUFACTURE BUILDING BLOCKS

Easy to start your own profitable business. General high speed, low cost Concrete Vibrator Block Machine produces 1000 blocks in 8-hour day. All sizes and shapes. Complete details FREE. Mail \$1 for wonderful book, "How to Build Your Own Concrete Block Home."

Only \$199



GENERAL ENGINES CO.
 (EASTERN DIVISION) DEPT. F - DREXEL BLDG., PHILA. 6, PA.

NEW SAW EASY HANDLING BIG POWER



New American Portable Electric Saw saves time, labor and money in production work. Not a hobby tool. One hand operation. Cuts any angle. 8" blade. Write... give occupation.

AMERICAN

FLOOR SURFACING MACHINE COMPANY
 535 So. St. Clair St. Toledo 3, Ohio



Plans... Projects...
 How-To-Do-It Information for woodworking hobby fun
 Yours — in every issue of **THE DELTAGRAM®**

A whole year's supply of easy-to-work drawings and step-by-step project instructions. New ideas on beautifying your home. Inspiration for projects that win admiration. Tips on using tools efficiently and safely. Leaves nothing to guesswork. Everything detailed and specific. Read by thousands. Get your subscription in now for The DeltaGram. Send name and address today—with coin, U. S. postal note, or money order.

6 Big Issues 75c

DELTA MANUFACTURING DIV.
 Rockwell Manufacturing Company

HM-75 680H E. Vienna Ave., Milwaukee 1, Wis.

2 DRILLS IN 1



This attachment gives you two drills in one.

It converts any 1/4 inch electric drill to 1/2 inch capacity. Reduction gears reduce the drill speed 5 to 1, the average speed of a 1/2 inch drill, and thereby increases the power. Absolutely indispensable for all shop work and home craftsmen. Satisfaction guaranteed. Order yours now.....

\$11.95 post paid

Send check or Money Order with order. Jobbers write for special information.

G. M. CO. MANUFACTURING, INC.
 1308 43rd Ave.
 Long Island City 1, New York

LATHE CUTTER BIT GRINDING GAUGE
 For checking clearance and rake angles.
50c postpaid
 SOUTH BEND LATHE WORKS
 455H E. MADISON ST., SOUTH BEND 22, IND.



New LABOR SAVER for the HOME



Patented
Electric

"MOTO-SANDER-POLISHER" ONLY \$14.85 POSTPAID

Say "Good-bye" To Hand Sanding & Polishing! Let speedy "Moto-Sander" do the work while you just guide it. Use for light sanding jobs—finishing, refinishing, redecorating. Moto-Sander quickly and smoothly sands furniture, walls, woodwork, wall board, plaster joints; boats, workshop projects, etc. Straight-line action (non-rotary) will not burn or scratch surface. Also ideal for fast, effortless polishing of furniture, refrigerator cabinets, automobiles, other waxed surfaces. There are dozens of time and money-saving uses in every shop and home for this inexpensive machine. Moto-Sander is the lightest, most practical electric sander & polisher. Gets into tight corners... 7,200 strokes a minute... weighs only 2 1/2 lbs. Furnished complete with 6 sheets assorted grade Garnet Paper for sanding, plus felt pad and sheepskin for wax polishing. Operates on 110-120 V., 60 cycle A.C. Thousands of satisfied users.

WHERE TO BUY IT: Buy Moto-Sander at your dealer's. If he cannot supply you, send only \$14.85 (check or M.O.) and we will ship postpaid. Or, send only \$2 now, and pay postman balance plus postage. **MONEY BACK** if not delighted after 5 days' trial.
DREMEL MFG. CO., Dept. SP119-H, Racine, Wis.



AMERICA'S LARGEST STOCKS OF JEEP PARTS

FREE BIG Catalog
... with **THOUSANDS OF OTHER JEEP PARTS**
AND **ACCESSORIES**
YOURS FOR **THE ASKING**
Write for Your Copy Today!

We Guarantee All Merchandise to be as Represented. You Must Be Satisfied or Your Money Will Be Promptly Returned.

Let us know your special requirements
If Berg doesn't have it ... no one has.
Export Inquiries Invited

TERMS: Net cash with order. C.O.D. Shipments should have 25% deposit with order. Open Account to rated firms only. All prices are F.O.B. our yards, Chicago, Illinois. Be sure to include sufficient postage on Parcel Post Orders. Any overage will be promptly returned.



CYLINDER HEAD New \$8.40
A1534-GPW6050 (Reprocessed) \$6.95

CRANKSHAFT BEARING SERVICE KIT—Standard
A6798-GPW18347 \$4.50
CRANKSHAFT BEARING SERVICE KIT—.010
A6746-GPW18348 \$4.75
CRANKSHAFT BEARING SERVICE KIT—.020
A6747-GPW18349 \$5.50
CRANKSHAFT BEARING SERVICE KIT—.030
A6748-GPW18350 \$5.50



OIL PAN GASKET 12c
639980-GPW6710
VALVE REGRIND GASKET SET
A1537-GPW18387 \$.75

EXHAUST VALVES
637183-GPW6505 \$.69
INLET VALVES
637182-GPW6507 \$.39



CLUTCH PRESSURE PLATE ASSEMBLY
638992-GPW7563
(Outright) (Exchange)
\$7.60 \$6.50

CLUTCH RELEASE BEARING CARRIER
639654-GPW7561 \$.95
CLUTCH DISK (Exchange)
636755-GPW7550 \$4.75
Outright \$5.50
CLUTCH RELEASE BEARING
635529-GPW7580 \$2.10



STARTER
Auto Lite No. MZ4113 \$26.50

A1245-GPW11001—NEW
(Replacement Type) \$18.50
VALVE SPRING RETAINER LOWER LOCK
375994-GPW6546 \$.04
CONNECTING ROD BEARINGS—Std. .002, .010, .020, .030
A7233-34-35-36-GPW18330ABC \$.55
TIE ROD END
A838-GP3291 \$1.25



SPEEDOMETER HEADS
A8180-GPW17255A
\$7.50

INNER SPEEDOMETER SHAFT
1344-GPW17262 \$.90
OUTER SPEEDOMETER SHAFT
1343-GPW17261 \$1.20
PISTONS AND PINS, Any Size
637041-GPW6105A \$3.50
PISTON RINGS SET—Any Size, Re-ring Type
116110-GPW6149 \$3.75



RADIATOR ASSEMBLY \$27.50
HEAVY DUTY—NEW
A1214-GPW8005A
Rebuilt \$22.50
Also interchangeable with Civilian Jeep #640145-640146

BRAKE CYLINDER REPAIR KIT
6133-GPW18368 \$.42
PULLEY ENGINE CRANKSHAFT
645623-GPW6312 \$1.35
CLUTCH DISK—Civilian Jeep
642918 \$6.50



WATER PUMPS
639992-GPW8501
Reprocessed New
Outright . . \$5.50 \$6.75
Exchange . \$4.50 \$5.75

FULCRUM CLUTCH RELEASE LEVER
630068-GPW7516 \$.12
HUB OIL SEAL ASSEMBLY
A864-GP1177 \$.48

WHEEL BEARING CONE
52942-GPW1201 \$2.10



CARBURETOR REPAIR KIT
A6840-GPW18357B \$4.35

WHEEL CUPS
52943-GPW1202 \$1.35
SOCKET-TIE ROD ASSEMBLY FOR CIVILIAN JEEP
640178 \$2.52

HYPOID BEVEL RING GEAR AND PINION SET
A789-GPW4209 \$16.50



COMPLETE TRANSFER CASE
A1195-GPW7700
REBUILT (Outright) \$120.00
(Exchange) \$95.00

REAR AXLE SHAFT—Short—New
A901-GP4234 \$6.95
REPROCESSED \$4.75

REAR AXLE SHAFT—Long—New
A902-GP4235 \$7.25
REPROCESSED \$5.00

DISTRIBUTOR CAP
A1655-GPW12106 \$1.25



UNIVERSAL JOINT JOURNAL SERVICE PACKAGE
A1433-GPW18397 \$3.50

ROTARS
A1658-GPW12200 \$.27

CONDENSERS
A1631-GPW12300 \$.50

BERG TRUCK & PARTS COMPANY, INC. 1608 SOUTH WABASH AVENUE
CHICAGO 16, ILLINOIS
CABLE ADDRESS . . . JEEP KING



LOWEST PRICES • BRAND NEW • GUARANTEED

HUB AND DRUM ASSEMBLY
A1690-GP1102
New **\$9.35**
Reprocessed \$6.50



MASTER CYLINDER COMPLETE
A556-GPW2140 **\$5.95**



SEAL BEAM UNITS
A1033-GPW13007
\$1.65



COMPLETE DIFFERENTIAL ASSBY.
A788-GPW4207
Complete with pinion **\$22.50**



SEAT CUSHIONS
A2986-GPW1162900B
NEW **\$3.50** USED **\$2.50**



8 PIECE BRAKE LINING SET
116600-GPW18367 **\$3.50**



Trailer LIGHTING CABLES WITH ONE SOCKET
A6019-GPW14407 **\$4.00**



FRONT AXLE SHAFT—LONG
A6030-GPW3207 **\$27.00**
Interchangeable with Civilian Jeep CJ2A



FRONT AXLE SHAFT (Short)
A6031-GPW3206A **\$27.00**

REAR POWER TAKE OFF (AMPHIBIOUS TYPE)
GPW7275 **\$34.50**
Mounts directly behind transmission. Provides a quick and ready means for auxiliary power use of the Jeep engine.



BELL CRANK
A1211-GPW3131 **\$4.65**



BELL CRANK SHAFT
A855-GPW3165 **\$.80**

BELL CRANK BEARING
A857-GPW3171 **\$.40**

TRANSMISSION PARTS

Large stocks of parts for complete transmission assemblies. Also available are Transmission Parts for CJ2A Willys. Write for prices and special needs.



COMPLETE TRANSMISSIONS

A1145-GPW7000

	Rebuilt	New
Exchange . . .	\$49.50	\$60.00
Outright . . .	\$55.50	\$67.50

TRANSMISSION CASE ASSEMBLY
A1148-GPW7005 **\$9.50**

TRANSMISSION MAIN DRIVE GEAR
A5554-GPW7017 **\$5.35**

TRANSMISSION BEARING RETAINER
640017-GPW7050 **\$1.40**

TRANSMISSION MAIN SHAFT
A519-GPW7061 **\$6.00**

MAIN SHAFT SECOND SPEED GEAR
638798-GPW7102 **\$5.25**

SYNCHRONIZING UNIT COMPLETE
A6318-GPW7124 **\$6.25**

COUNTERSHAFT
638948-GPW7111 **\$6.60**

CLUSTER GEAR
A739-GPW7113 **\$9.25**

TRANSMISSION REVERSE IDLER GEAR SHAFT
638952-GPW7140 **\$4.45**

HIGH AND INTERMEDIATE CLUTCH HUB
637830-GPW7105 **\$2.65**

SECOND AND DIRECT SPEED CLUTCH SLEEVE
637833-GPW7106 **\$2.27**

TRANSMISSION CONTROL LEVER ASSEMBLY
A1380-GPW7210 **\$2.30**

SHIFTER PLATE
A7260-GPW7211B **\$1.15**

LOW AND REVERSE GEAR
636879-GPW7100 **\$3.20**

SYNCHRONIZER BLOCKING RING
637834-GPW7107 **\$.72**

BRAKE SHIELDS AND SHOE
A1496 **\$6.95**



TAIL AND STOP LIGHT—Complete
A1064-GP13405 **\$2.25**

When You Buy It From Berg the "KING of JEEPS" You Know the Price Is Right

SHOP BY MAIL and SAVE at BERG'S
ORDER DIRECT FROM THIS AD
Send Payment or Purchase Order Today
SATISFACTION GUARANTEED

All Items Subject to Prior Sale. All Prices Subject to Change Without Notice. We sell exclusively wholesale and operate on a small margin of profit—the savings are passed right on to you. All exchanges must be shipped to us prepaid.

Remember . . .
We have thousands of other parts not listed here. Write for your copy of our FREE Catalog . . . or send us your special requirements today!

Sharpens 1,000 MOWERS per Season

"I have sharpened over 10,000 mowers in my FOLEY LAWN MOWER SHARPENER in the last 10 years."
—Charles H. Smith.



The Foley sharpens all sizes and types of mowers in 15 or 20 minutes (with handles on). Prices run from \$1.50 to \$2.00 for hand mowers, and \$5.00 to \$8.00 for power mowers.

Low Prices, Less than \$50 Starts You with new 1949 model on payment plan. 99c out of each dollar you take in is profit. FREE PLAN shows how to start — write now!

FOLEY MFG. CO., 807-9 Foley Bldg., Minneapolis 18, Minn.

EXTRA PROFITS FOR SAW SHOPS WITH BEMACO RAPID SAW SET

IT'S AUTOMATIC

Sets hand saw teeth in 60 seconds—Approx. 400 band saw teeth, 4½ to 12 points with one adjustment. Hammer and anvil action does precision job. Every tooth alike—no breakage.



NEW LOW PRICE

WRITE TODAY

HAND SAWS
BAND SAWS
HAND SAWS
BAND SAWS
HAND SAWS
BAND SAWS

802-F South Isis Avenue, Inglewood, California

BEAVER MFG. CO.

SAVE UP TO 25% ON QUALITY BALL-BEARING WHEELS!

Bilt-Rite wheels roll smoothly and easily, are semi-pneumatic, ball-bearing, painted red; guaranteed top quality—and you save up to 25%! Compare Bilt-Rite's quality and price—then get your order in today! Dealer inquiries invited.

BILT-RITE BARGAINS on BALL-BEARING WHEELS

(For 1/2-inch Axles)	
6 x 1.00.....	\$1.30
8 x 1.25.....	1.65
8 x 1.75.....	1.80
(For 5/8-inch axle)	
6 x 1.50.....	\$1.50
6 x 2.00.....	\$3.95
8 x 2.50.....	\$4.45
10 x 2.75.....	Only \$4.65!



Bilt-Rite Guarantee
No better wheels are made regardless of price; 10 day return privilege.

If size you need isn't listed, write for Folio A ORDER TODAY—Send cash, check, or M.O.—Pay postage on arrival.

BILT-RITE WHEEL COMPANY
520 EAST MISSOURI AVE. KANSAS CITY 6, MISSOURI

STEADY PROFITS

YOUR OWN BUSINESS WITH CORADIO

The Coin Operated Radio

Place these specially built radios that play 1 or 2 hours for 25c in the thousands of available hotel rooms, tourists courts, etc. They yield immediate profits and steady income. Install Coradio, the finest made. Limited capital required. Send for further information. Write today.

CORADIO Coin Operated Radio
DEPT. C

212 Broadway, Phone: BEekman 3-0038-9
NEW YORK 7, N. Y.



FULLY GUARANTEED TIRES COST LESS!

Nationally famous FIRESTONE, GOODRICH, U. S. ROYAL, GOODYEAR, and other makes. Trucking Fleets, Busses, Hospitals and Schools buy from PYRAMID with confidence. Every tire selected and inspected for your safety!

MID with confidence. Every tire selected and inspected for your safety!

Tube Given Free With Every Tire — 10% Discount to Veterans			
550x16 3.25	700x15 3.70	700x20 8.65	34x7 9.45
600x16 3.45	700x16 4.95	32x6 (8) 8.65	825x20 11.45
650x16 3.45	750x16 6.45	32x6 (10) 9.45	900x20 11.60
650x15 3.45	600x20 7.15	750x20 (8) 8.20	1000x20 12.60

AAA Premium Grade — Guaranteed to Give Longer Service			
600x16 5.45	700x16 6.95	700x20 10.95	34x7 12.95
650x16 5.45	750x16 7.95	32x6 (8) 11.90	825x20 14.95
650x15 5.35	600x16 (6) 6.95	32x6 (10) 12.45	900x20 14.95
700x15 5.45	600x20 9.95	750x20 (8) 10.95	1000x20 15.95

MILITARY "ALL-PURPOSE" TREADS			
900x16 8.65	750x20 8.95	1100x20 16.95	
900x20 13.95	1000x20 14.95	1400x20 22.95	
600x16 MILITARY "NEW TREAD" TIRES 7.95			

Largest stock of used tires in the East. Thousands of satisfied customers. Tires shipped to all parts of the world. Mail orders given personal attention. Send Money Order or check with order.

PYRAMID TIRE CO.
1333-35 North 5th St.
Dept. M, Phila. 22, Pa.

EASY WAY TO REMOVE PAINT

Wonder-Paste Remover quickly softens up the toughest paint, varnish, enamel, etc. Apply with brush; allow time for penetration—then remove with a putty knife. At paint and hardware stores.

WILSON-IMPERIAL CO., 119 Chestnut Street, Newark 5, N.J.

SPECIAL OFFER!

LOCK-STITCH SEWING AWL

\$1.
Postpaid

Famous, patented lock-stitch sewing awl complete with needles, waxed thread and direction folder. Hundred uses — sewing, repairing leather goods, canvas, belting, harness, saddles, gun cases, awnings, golf bags. Extra needles and thread available. Satisfaction guaranteed or money back. Send currency, check or money order. Yates Mfg. Co., 611-H Main St., Lake Geneva, Wisconsin

OWN A Printing Business
Cards, Tickets, Stationery, etc. Good profit in spare time. PRINT YOUR OWN greeting cards, movie titles, church work, etc. Save money. Easy rules supplied. Raised printing like engraving too. Have home shop. Sold direct from factory only. Pays for itself in short time. Write for free catalog of outfits, and all details. KELSEY PRESSES, G-37, MERIDEN, CONNECTICUT

Write today for Complete details

GEIGER COUNTERS

FOR PROSPECTING RADIOACTIVE MINERALS

OMAHA SCIENTIFIC SUPPLY CO.
Dept. R, 3601 N. 24th St., Omaha 10, Nebr.

BUILD OR BUY A LAWN SWEEPER

No tiresome raking. The quick and easy way for cleaning your lawn. Picks up leaves, grass, acorns, sticks, and combs the grass. Easily built from available parts. Mail 35c for complete plan telling you how. Catalog listing parts and factory-built sweeper, sent free with plan.

147 LeJay Bldg.
LeJAY MFG. CO. Minneapolis 8, Minn.

SAY YOU SAW IT IN POPULAR MECHANICS

Navy SURPLUS BARGAINS

NAVY DIVING EQUIPMENT



TREMENDOUS SAVINGS... the most complete selection of the Navy's finest diving gear is now available at unheard of prices. Mark V Mod. 1 diving helmets, dresses and a large stock of accessories mfg. by Schrader, Miller-Dunn and Morse Diving Equipment Companies. "Guided Radio" telephone amplifier units and other diving communications equipment.

WRITE FOR DIVING EQUIPMENT CATALOG!

C & H SALES COMPANY

1850-M-8 EAST COLORADO ST., PASADENA 8, CALIF.

SPEED & MILEAGE MANUAL

125 ILLUSTRATIONS

EASILY OBTAIN GREATER SPEED, MILEAGE, RACING PERFORMANCE FROM ANY AUTOMOBILE!

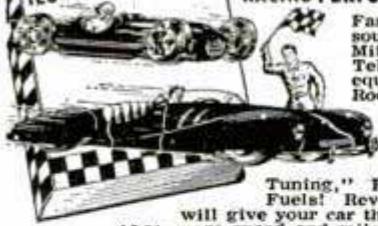

Famous new book shows simplified soup up methods—Speed Tuning—Mileage Secrets—Economy Tips! Tells how to build your own speed equipment! Fast Conversions! "Hot Rods"! Sports Cars! Complete instructions on building inexpensive superchargers, Hi-Speed Heads, Dual Mufflers, Manifolds, "Water Injectors!"

All about engines, "Economy Tuning," Restyling, "Racing Tricks"—Fuels! Reveals Track Proven Methods that will give your car thrilling new getaway—with up to 40% more speed and mileage!

Also shows latest "Hollywood Custom Styling" methods! Streamlining! Sport Changes! Money-Saving Speed Conversions! California Roadsters Plans! Racer Diagrams! Working Drawings! Speed Catalogues! Photographs! Complete Data—Plus "Beautiful Custom Car and Hot Rod Pictorial Supplement!"

SATISFACTION GUARANTEED—ONLY COMPLETE \$1.98 Post-book of its kind.....ONLY paid

Almquist Engineering Milford 6, Pennsylvania

MORE NEW CARS AND TRUCKS ARE EQUIPPED WITH

AC SPARK PLUGS

THAN WITH ANY OTHER MAKE

BRUSH PLATING OUTFITS

for re-plating articles in the home and shop. No tanks necessary. Free particulars.

GUNMETAL CO., AVE. M, DECATUR, ILLINOIS

STOP FOOT PAINS



OR NO COST!—Try Dr. Barron's GENUINE Foot Cushions for quick foot relief! They take painful pressure off callouses, corns, sore heels, aching arches—absorb foot shocks, help support weak arches. Light, ventilated, spongy. LIKE WALKING ON A PILLOW! Wear in any shoes. Dr. Barron says: "Relieves tired, aching feet from heel to toes." Send only \$1.98 for A PAIR, or C.O.D. plus postage. State shoe size and if man or woman. 30-DAY TRIAL GUARANTEE. Money back if no blessed relief.

ORTHO, Inc., 2700 BROADWAY, Dept. 49J, N.Y.C. 25

BUILD YOUR OWN FAN



One-piece cast aluminum propellers for cooling and ventilating.

Size	Polished	Unpolished	Bore
Inches 2 Blade 3 Blade 3 Blade	12, 58, 34	12, 58, 34	1/2, 5/8, 3/4
15	\$3.00	\$4.00	\$2.50 \$3.00
18	3.75	4.50	3.00 3.50
20	4.00	5.00	3.25 4.00
24	4.50	5.50	4.00 4.50

Let us give you our prices on your aluminum castings.

Write for pamphlet on larger fan blades, wire guards, fan bases, shutters, pillow blocks, exhaust fan frames, etc., shipped prepaid if money accompanies order. Dealers write for discount.

KLOPPENBORG ALUMINUM FDY., Dept. PM89, Davenport, Iowa

SAY YOU SAW IT IN POPULAR MECHANICS

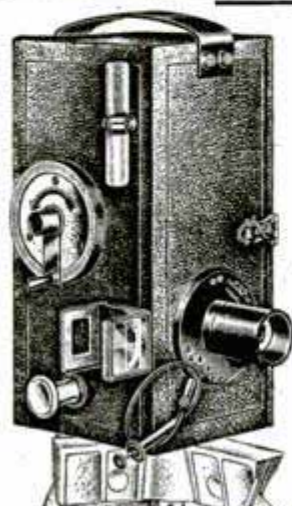

Finished Photos in 2 Minutes!
Great Quick Photo Invention
P D Q CHAMPION PHOTOMASTER

Takes and finishes 30 to 40 everlasting, black and white or sepia photos an hour. No dark room. Guaranteed not to fade. Photos taken on "SUPER-SPEED" direct positive paper. Picture size 2 1/2 x 3 1/2 in. Complete, easy-to-operate portable photo studio. 700% PROFIT. Write quick, get details about the great PHOTOMASTER.

P D Q CAMERA CO.
1161 N. Cleveland Ave., Dept. PM-8
Chicago 10, Ill.

Thousands of Parts For Military TRUCKS

PURCHASED FROM U. S. GOVT. OUR PRICES CAN'T BE BEAT.

We have for immediate delivery genuine parts for all makes and models, 4x2-4x4-6x4 and 6x6. All models from 1/4 ton to 20 tons. All makes: Auto-car, Biederman, Brockway, Chevrolet, Diamond T, Dodge, Federal, Ford, GMC, International, Mack, Oshkosh, Reo, Studebaker, White, Willys and Jeeps. We have parts lists available on most models. Write stating model of Truck.



JEEP TOPS and CURTAINS

(Weatherizing Kit), complete top with back curtain and side curtains with zip-in-doors. 5 windows. Waterproof O.D. color, shipping weight 40 lbs. Wonderful \$39.50 value. F.O.B. K.C.

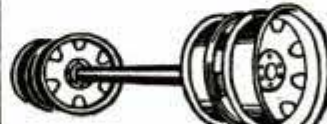

TRAILER AXLE

Heavy duty trailer axle suitable for many types of trailer construction. Also excellent for building of heavy farm trailers and wagons. It is a 12,000 lb. capacity square type straight trailer axle complete with Timken roller bearings, hubs, and 6 hole 750 x 20 Budd Wheels. Without brakes. Axle is 2 inches square and 69 inches between wheel mounting flanges. Std. width. AN EXCELLENT BUY.

With Single Wheels \$59.50 With Dual Wheels \$69.50

Save \$30.00 On JEEP Spare Parts KIT

Originally packed for Amphibious Jeeps. Also adaptable for all military and some civilian jeeps. Offered \$8.95 at our low price of.....

- KIT CONSISTS OF THE FOLLOWING PARTS:
- 4-#1177 Retainer Wheel Grease. 1-#2078 Hose Assy.—Rear Brake
 - 1-#2079 Hose Assy.—Fl. Brake. 1-#2197B Hose Assy.—Axle—Vent
 - 2-#3135 Seal—Frt.—Axle—Pivot. 1-#4022B Plug Assy.—Axle Vent
 - 1-#5666 Belt Capstan. 1-#8620 Belt—Fan. 1-#12405 Spark Plug
 - 1-#13466 Bulb (Black-Out Marker Lamp).
 - 1-#15480 Belt—Biige—Pump
 - 1-#13485 Unit Assy. (Rear Lamp Stop). 1-#1752960 Strap Assy.
 - 1-#13491 Unit Assy. (Rear Lamp Lower)
 - 1-#18318 Kit—Cotter Pin (asst)
 - 1-#13494 Unit Assy. (Rear Lamp Service)
 - 1-#17008 Container Assy. Spare Parts (Water'roof)
 - 1-#17058 Tape—Friction (3/4"—8 oz.—Roll)
 - 1-#17060 Wire—Annealed (No. 22—Ga—1/4 No. Roll)
 - 1-#18320 Kit Tire Valve Core (5-B-1725)
 - 1-#18322 Kit Tire Valve Cap (5-GPW-1720)
 - 1-#1711340B Seal Transfer Case Output Shaft Collar
 - 1-#1711344 Seal—Drive Shaft Housing Gear
 - 1-#1711346 Seal—Drive Shaft Housing Front
 - 1-#1711356 Seal—Front Floor Tunnel Drag Link

BRAND NEW HYDRAULIC JACKS

Walker, 3 ton. Complete, limited supply. \$9.95 Each.....

UTILITY GAS TANK 6 quarts — New Surplus. Cylindrical 5 1/2" x 15 1/2". Brackets for mounting. Complete with Filler cap, drain plug and pet-cock. Ideal for small gas engines, stoves, etc. \$1.50

SURPLUS POWER WINCHES All are brand new and suitable for front or rear mounting. GARWOOD OR HEIL—15,000 lb. capacity. \$150.00

Surplus WINCH CABLE

200 ft. length	250 ft. length	300 ft. length	WHILE THEY LAST
1/2" \$25.00	1/2" \$30.00	1/2" \$35.00	
3/4" \$30.00	3/4" \$40.00	3/4" \$40.00	

HUNDREDS OF OTHER TRUCK PARTS AND SUPPLIES

All prices quoted good 30 days FOB, Kansas City. 25% deposit required on COD orders.

American AUTO PARTS CO.
1830 LOCUST — DEPT. PM
KANSAS CITY, MISSOURI.



Carve for Fun and Profit!
No skill needed with Dumore Carvit
Anyone can make woodcarvings with a Carvit! It copies low-cost models you can buy in any dime store. The result—beautiful ornaments, unusual gifts, fine carvings that sell.
Write for Free folder with full details
The Dumore Company
Dept. H-51 Racine, Wisconsin

WESTINGHOUSE Air Compressor

WITH 20 FT. AIR HOSE
AND
DETACHABLE TIRE CHUCK

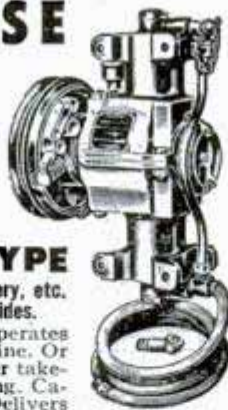

2-CYLINDER PISTON TYPE
Spray paint your buildings, cars, trucks, machinery, etc.
Inflate tires, grease machinery, spray insecticides.

Built to sell for 3 times our low price. Operates from 1/2 h.p. motor or equivalent gas engine. Or may be run from truck, tractor, jeep power take-off or fan belt; designed for easy mounting. Capacity up to 6 1/2 cu. ft. 100 lb. pressure. Delivers filtered "Oil free air". Air output double that of similar compressors. Rugged, super-efficient, portable.

Special \$22.95 price F.O.B. Chicago area includes compressor, 20 ft. double braid heavy duty air hose, Schrader Air Chuck. You save over 1/2. Act now! Money back guarantee. Send check or money order to:

— MAIL COUPON TODAY —

A & K Equipment & Supply Co., Dept. 26, Burlington, Wis.
Enclosed find remittance for \$22.95. Send brand new Westinghouse Compressor, 20 ft. of heavy duty air hose and tire chuck.

Name.....
Address.....
City..... State.....

WAR SURPLUS BARGAINS!

STARK'S

WAR SURPLUS BARGAINS

\$500,000.00 INVENTORY for QUICK LIQUIDATION

Surplus items—hundreds of them for home, shop, factory, farm and outdoor use. New items, used items, reconditioned items—all at tremendous savings—all priced for quick sale.

Page After Page of Values

This big catalog shows page after page of amazing money saving values. Write for your copy today. Send 10c to cover postage, mailing, etc. Write today!

10c

STARK'S Dept. PM8 509 So. STATE STREET CHICAGO 5, ILLINOIS

TRAILER-LITE WITH PLUG IN CONNECTOR

COMPLETE KIT 15 FT. LENGTH

NEEDED BY EVERY TRAILER OWNER. Fully Guaranteed.

- CONNECT OR DISCONNECT YOUR LIGHT IN A SECOND
- DIRECT GROUND EVEN ON A WOOD FRAME
- ELIMINATES BLINKING AND CONSTANT ATTENTION

Furnished with 2 wire flexible black rubber weatherproof cord. The connector has brass inserts with positive connection.

Please rush.....Trailer-Lites @ 2.95 set.
Enclosed Check—Money Order—Cash— We pay postage. C.O.D. You pay postage—Send no money.

Name..... Address.....
SALESMEN AND DISTRIBUTORS PLEASE WRITE
ACE MFG. CO., INC., 939 N. Arnolda St., Indianapolis 22, Indiana

FENDER SKIRTS.....\$16.95 PER PAIR

FOR FORD, CHEV., MERC., PLYM., DeSOTO, CHRY., DODGE, KAISER-FRAZER AND BUICK

Beautifully your car—bring out the flowing lines inherently designed there. Sparkling beauty you'll like. Constructed of heavy gauge body steel, finished in prime. Perfect fit.

SANDEE MUFFLER CO. Box 296, La Tijera Sta. Los Angeles 43, Calif.
Gentlemen: Please send me one set of Sandee Fender Skirts to fit my..... (year and make of car)
 Check for \$16.95 enclosed
 Ship C.O.D.

WEED SPRAY PUMPS

Build your own power sprayer. Bronze gear type. 0-150 lb. pressure, \$12.35 up. 3/4" Flexrotor, \$16.95. Complete Power take-off combinations, \$26.90 up. Other sizes and types available. Valuable pamphlet on construction and operation of Boom sprayers with parts lists and prices of Nozzles, hose, fittings, gauges, valves, etc. Free with pump order. Send 10c for new 1949 52-page illustrated Catalog with hundreds of bargain items for home, workshop, industry and farms.

MIDWEST SALES CO.
2533 Indiana Dept. PM8 Kansas City, Mo.

BUILD "EXTRA" SPARE TIME PROFITS!

Genuine Poly ball bearing arbor C4 (shown) with 1/2 x 12 1/2 spindle only \$7.95 postpaid. Order today! Free literature available on request.

POLY PRODUCTS • 2032-C E. Walnut • Pasadena 8, Calif.

INSTANT NICKEL

NO CURRENT OR BATTERIES USED

COMPLETE \$2.50 POST PAID 1948 PATENT AGENTS WANTED

JUST PATENTED—Now everybody can NICKEL PLATE. No equipment or electricity needed. Just rub, a BLESSING to Doctors, hobbyists, Auto, Machinery and home owners and practically everybody. NO POISONOUS CYANIDES OR QUICKSILVER. It will heavily plate INSTANTLY. Steel, Iron, Copper, Brass, etc. It's NEW, DIFFERENT, PRACTICAL, ECONOMICAL—Just rub with a cloth to any thickness. Fascinating hobby—Plate for neighbors and friends. MONEY BACK GUARANTEE. C.O.D.'s few cents extra. INSTANT PLATING PRODUCTS, DEPT. M-7, 3439 So. Michigan, Chicago 16, Ill.

AGENTS 300% Profit SIGN LETTERS

For Store Fronts and Office Windows. Anyone can put them on. Free Samples. Liberal Offer to General Agents.

METALLIC LETTER CO., 430 N. Clark, Chicago 10

Pioneers

Leaders

AIR RIFLES BENJAMIN AIR PISTOLS

WITH SAFETY LOCK

SEND FOR FREE FOLDER OF LATEST MODELS TODAY

If you want a REAL GUN for PRACTICAL USE inside or outdoors, get a SAFE—CLEAN—ECONOMICAL—BENJAMIN with Adjustable Power and Amazing Accuracy. Use BENJAMIN H-C PELLETS for BEST RESULTS in all rifled models. WRITE AT ONCE.

BENJAMIN AIR RIFLE CO., 812 MARION ST., ST. LOUIS 4, MO.

GERSTNER Tool Chests

are unmatched for dependable, long service in protecting tools of Machinists and Toolmakers. Free catalog.

GERSTNER TOOL CHESTS
449 Columbia St. Dayton 7, Ohio

VALVE CAP with built-in TIRE GAUGE

New, improved AIRVUE tire gauge replaces regular valve cap—shows your tire pressure at all times—saves your time and your tires! Weighs only 1/5 oz.! Available for low pres. and reg. NOW ONLY tires. Thousands sold direct over past year. Single gauges 60c each. We pay \$2.95 postage on prepaid orders. Money-back guarantee. Set of five Postpaid

Pat. **CAP-GAUGE CO.** 1506 Wabasso Way
Pend. Glendale 8, Calif.
BE SAFE! CHECK YOUR TIRES AT A GLANCE!

SAY YOU SAW IT IN POPULAR MECHANICS

New War Surplus HOIST and WINCH

Originally made to be used on B-29s for lifting bombs. Mounted on welded steel base, can be attached to truck body or any solid base. Ideal for lifting or moving loads onto trailers, trucks or tractors or for machine shops, garages or warehouses. Capacity 2,000 lbs. Equipped with ratchet for holding load and 18 ft. 3/8" steel cable. Shipping weight 50 lbs. FOB, Kansas City, Mo. **\$29.95**

Send check or M.O. for immediate delivery. No COD's

AMERICAN AUTO PARTS CO., INC.
1830 LOCUST DEPT. PM8 KANSAS CITY, MO.

NEW D.C. ARC WELDER

Introductory Offer **\$97.50** A \$300 Value at Less Than 1/3rd

200 AMPERES CONTINUOUS DUTY
Up to 250 amperes intermittent duty. Easily mounted on tractor or elsewhere. Welding range by dial-type control from 0-up. Guaranteed one year with money-back 10-day trial period. Write for free literature or save time and order direct from **35c** this ad. Or, send for PLAN "Build Your Own Welder from Surplus Aircraft Generator" and we'll include free literature and catalog.



LEJAY MFG. CO.
847 LeJay Bldg., Minneapolis 8, Minn.

- ELECTRIC TOOL KIT,** Casco hand, new, complete with 15 accessories tools **\$14.95**
With metal case and 35 tools..... **\$19.95**
- ELECTRIC CLIPPER,** Wahl, brand new, size 000, special..... **\$9.75**
- DUPLIX SLIDE RULE,** 10 inch, value \$10, special..... **\$5.95**
- WEATHER BAROMETER** S. & A. Anchor Style, all brass precision instrument..... **\$12.50**
- LENSATIC COMPASSES,** U. S. Govt., like new, cost \$12.50, special **\$2.95**

PUBLIC SPORTS SHOPS

11 South 16th St., Phila. 2, Pa. (No COD's)



KILRAY AUTO BLIND

Keeps Sun Out!

The smart-looking KILRAY keeps cars degrees cooler, protects passengers and upholstery from sun. Installed in a jiffy!

FITS ALL CARS! Polished aluminum brackets and bonderized steel slats give full rear vision; cannot rattle. **\$9.95** postpaid—check or M.O. C.O.D.s plus postage. Specify make, year, body style of car.

SANDERS & CO. • 140 PEACHTREE • ATLANTA, GA.

BUILD HEAVY DUTY MACHINES

SAVE UP TO 90%— You can build, using our practical, easy-to-read plans, all kinds of machines, for home, farm or shop—scooters, portable sawmills, metal working machines, concrete machinery of all kinds, printing equipment, woodworking machines, midget autos, dish washers, farm equipment, freezers, tractors.

FREE

CATALOG HANDBOOK
183 SETS OF PLANS
VALUABLE INFORMATION

NICHOLS EQUIPMENT COMPANY
D-2510 PURVIS, MISS.



Drive by HULL

AUTOMOBILE COMPASS

Avoid Direction Worries
on Strange Vacation Roads

Beaconlite Illuminated **\$5.95**
Streamline Standard **\$3.95**

At your dealer's. Write for literature.

HULL MANUFACTURING CO. P. O. Box 246-DB
Warren, Ohio

FIBRE ARMS AND LEGS!

Light, correctly fitted, strong and comfortable. Natural appearance. Braces for all deformities. Scientific design. Fair Terms.

BUCHSTEIN-MEDCALF 223 S. 6th St., Minneapolis, Minn.

SAY YOU SAW IT IN POPULAR MECHANICS



SO-EASY CAR WASHER
SOAPS
WASHES
\$3.75 RINSES
P.Pd.

Saves you time and money. 45" tube reaches all parts. Extra Features: Thru-flu replaceable mop. Best too for palm use. Rubber grips protect hands. Coil spring protects hose. H.L.D. Friendship, N. Y. writes, "Yours is best of any we have used." Guaranteed.

KEELCRAFT, W. ENGLEWOOD 5, N. J.

THIS IS IT!

THE LOWEST-PRICED

BALL BEARING, TILT/ARBOR

SAW IN AMERICA!



\$39.50 F.O.B.

Kalamazoo, Mich.
Price includes motor rail, belt, pulley, mitre gauge, fence, splitter, guard—less motor. Extensions \$3.50 each.

THE NEW Atlas

POWER KING 3001

Yes, this is it! The saw thousands of shop owners have been asking for. The new 3001 ball bearing tilt/arbor Power King. A big-capacity saw with big saw features, yet priced so low it pays for itself quickly with the money you save on a few projects alone.

Compare these features and we think you'll agree the new 3001 is today's outstanding circular saw value!

BIG SAW FEATURES!

- ★ **TILT/ARBOR CONSTRUCTION**—table and work are always flat for safe angle sawing.
- ★ **BALL BEARINGS**—sealed from dirt and dust, assure smooth running and lasting accuracy.
- ★ **BIG CAPACITY.** With a 2 1/4" depth of cut, and a 12" x 16" table that has 7 1/8" area ahead of blade, the 3001 handles a broad range of work.
- ★ **PRECISION-GROUND GREY-IRON TABLE.** Heavy cast iron table is rib-braced and reinforced for absolute rigidity. Precision ground top assures smooth easy sliding surface.
- ★ **RIGID RIP FENCE**—full table width, locks at both ends, releases instantly.
- ★ **TABLE EXTENSIONS AVAILABLE.** Exclusive, grey-iron grill type extensions, measuring 6 3/4" x 16"; can be added to the 3001 at low cost. Add one to right side and you can rip to the center of a 24" panel. Add one to each side, and table area is increased to 25 1/2" x 16". Tops are precision ground.

Please send circular on the new Power King 3001 tilt/arbor saw.

Name _____
Address _____
City, State _____

ATLAS PRESS CO.

843 N. Pitcher St., Kalamazoo, Mich.



MATCHED PRECISION TOOLS FOR
WOODWORKING AND METALWORKING

LITTLE THINGS HARD TO FIND?
GET YOURSELF A
HANDI-CHEST
FOR AS LITTLE AS
\$3.95
POSTPAID

32
DRAWERS
ALL METAL
\$8.95
POSTPAID



DRAWERS
Uniform in all chests
... are 1 1/4" deep, 2 1/4"
wide, 5 1/4" long. 1-piece
aluminum units have
removable dividers to
make 3 bins; index
cards on front. Kraft-
board drawers have
metal pull tabs.

YOUR MONEY BACK if you are
not satisfied with your **HANDI-CHEST**

NOW with three times the "bins," **HANDI-CHEST** is a must for home, office, shop. Ideal kit for small parts, hobby needs, sewing, fishing, etc. Steel spot-welded cabinets, metal drawer guides, pleasing grey finish, rubber feet that won't mar any surface. Aluminum or Kraft-board drawers. Manufacturer ships promptly, direct, postpaid. Send check or money order. No C.O.D., please. Ohio orders add 3% sales tax. Ask about quantity discounts.

16 drawers Steel Cabinet is 6" deep, 8 1/4" high, 12 1/4" wide. 48 compartments in aluminum drawers Model 16A **HANDI-CHEST** complete **4.95**

Model 16K **HANDI-CHEST**, same size as above, with heavy Kraft-board drawers, metal pull tabs, complete **3.95**

32 drawers Steel Cabinet is 6" deep, 15 1/4" high, 12 1/4" wide. 96 compartments in aluminum drawers Model 32A **HANDI-CHEST** complete **8.95**

Model 32K **HANDI-CHEST**, identical in size, with heavy Kraft-board drawers, metal pull tabs, complete..... **5.95**

64 drawers Steel Cabinet is 6" deep, 15 1/4" high, 24 1/4" wide. 192 compartments, aluminum drawers Model 64A **HANDI-CHEST** complete **15.95**

Model 64K **HANDI-CHEST**, same dimensions as 64A, sturdy Kraft-board drawers, metal pull tabs, complete **9.95**

ALL HANDI-CHESTS ARE SHIPPED POSTPAID IN U. S. A.
TIBBITS MFG. CO., Dept. 8E, Alliance, O.

Now CHEAP OIL BURNER
FOR HEATING AND COOKING STOVES-FURNACES
HEAT YOUR HOME, COOK YOUR MEALS
WITH CHEAP FURNACE OIL

NO MORE SHOVELING COAL OR ASHES. Sensational Fuelizer Starter Vaporizing System turns Cheap No. 1 Furnace Oil, also Range, Heater, Tractor Distillate, Kerosene and like oils into oil heat—one of the quickest, hottest fires known. **LIFETIME GUARANTEE.** \$1.00 Bonus Offer for Testing.

We will let you try it in your own stove or furnace for one month. Get yours for introducing. Big profits **QUICK.** Be first. Send in your name today for details and cash in on the tremendous demand for this Amazing Invention.

NORTHWEST MFG. CO., 634-K, Mitchell, S. Dak.

NOW! FILE YOUR OWN SAWS

Do expert saw filing at home. Precision filing easy without experience. Two simple adjustments. Keeps any hand saw extra sharp and true-cutting. Complete with file. Money back guarantee. Cash with order, prepaid. (COD postage extra.) Order today. **\$2.95**

THE SPEED CORP., Dept. PM
512 N.E. 73 Ave., Portland 16, Oregon

\$4.95 REAL ENGINE VALUE

A miniature gas engine that really operates. Thousands of Buzz "B" gasoline engines have been sold at twice the price. Now is your chance to buy a real 1/6 H.P. gas engine for only **\$4.95**. Turns up over 8,000 r.p.m. For Boats, planes, midget cars, etc. Guaranteed and ready to run. Includes Champion spark plug and tank. Send only \$1.00, engine shipped collect for balance, same day.

WRITE FOR FREE CATALOG OR SEND 10c FOR NEW MAMMOTH ILLUSTRATED CATALOG OF THOUSANDS OF HOBBY ITEMS.

America's Hobby Center, Inc., Dept. B-89, 156 West 22nd St., N. Y. 11

SAVE MONEY on TRAILER BUILDERS' SUPPLIES! BUILD, REPAIR or MODERNIZE! We are the largest and most complete trailer supply house in the States. Get our New Large 1949 Catalog 10c; blue prints and building instructions 25c.

National Trailer Equipment Co., 1007 N. Water St., Milwaukee 2, Wisc.

Why not get the tools you **REALLY NEED?** SEARS famous **CRAFTSMAN** **HAND and POWER TOOLS**

are preferred by professional craftsmen for fine quality . . . precision performance . . . and money-saving low prices! Buy them **NOW** . . . at SEARS convenient Retail Stores . . . in principal cities throughout the United States.

SEARS, ROEBUCK and CO.

MAGNETS OF ALL TYPES—10c UP
AMAZINGLY POWERFUL!!

4 oz. Alnico Magnet, lifts 10 lbs. \$1.10. Our Leader, 15 oz. Magnet, lifts 40 lbs. \$2.50. New alloy—will not weaken! Useful for lifting valuables from tanks, lakes, or rivers easily! 7 small magnets \$1.10 with list of many shop and home uses. Satisfaction guaranteed.

R. EYRICH, 2566 N. 49TH ST., MILWAUKEE 10, WIS.

CENTRIFUGAL PUMP—SERIES 130

WILL PUMP UP TO 180 GPM All Purpose, ALL 2" Brand New ONLY **\$19.90**

At a fraction of original cost. With Adjustable Pulley. Remit with order. We Prepay Freight. Free Literature.

While They Last—RUSH ORDER the freight

ARGO-SUMMIT SUPPLY CO., 7418 W. Archer Ave., Dept. P-8, Summit, Ill.

LAW **STUDY AT HOME** for Business Success and **LARGER PERSONAL EARNINGS.** 40 years expert instruction—over 114,000 students enrolled. LL.B. Degree awarded. All text material furnished. Easy payment plan. Send for **FREE BOOK—"Law and Executive guidance," NOW!** (G.I. Approved.)

AMERICAN EXTENSION SCHOOL OF LAW
Dept. 17-PM 646 N. Michigan Ave. Chicago 11, Ill.

ONAN Portable ELECTRIC PLANTS

FOR CABINS, TRAILERS, CONTRACTORS, BOATS

Light weight, compact, air-cooled engine-driven. Furnish regular city-type A.C. electricity for lights, appliances, radios, etc. Can be carried by hand. Fit trunk of car. Plug-in receptacles on plant. Larger models for farms, homes, businesses beyond highlines. Catalog shows over hundred models. 350 to 55,000 watts.

Gasoline or Diesel Powered

WRITE FOR CATALOG
D. W. ONAN & SONS INC.
5824 Royalston Ave., Minneapolis 5, Minn.

NEWEST OTTAWA LOG SAW

SELF-PROPELLED — MOVES ANYWHERE on OWN POWER

World's fastest Log Saw. Powerful 6 H-P air-cooled motor. Attachments for sawing down trees, buzzing limbs, post hole digging and pulley for belt jobs. Big demand for wood, pulp, posts. Make big money sawing wood this easy way. Low factory-to-user prices. Nothing like it. **FREE** details.

OTTAWA MFG. CO., 7-927 Pine St., Ottawa, Kansas

BRONZE-CRAFT
BABY SHOE MOUNTS

Beautiful Designs — Classic Lines
Book-End Sets — Picture Frames — Ash Tray Desk Sets

SPECIAL PRICE — \$12.00 Doz. Sets
Send \$1.00 for sample set prepaid.

BRONZE-CRAFT, 774 Newark Ave., Jersey City, N. J.



SURPRISE VALUE
 100 Pieces for **\$1.00**
 Electric Grinders
 A Bagful of Bargains at
 Grinding Wheels, Cut-off Wheels,
 Sanding Discs, Mounted Stones,
 Sharpening and Honing Stones,
 Rotary Cutting Burs, Abrasive
 Cartridges, and many other items. Rush check or Money Order.

High Speed Steel PLASTIC DRILLS 3 for \$2.25
 for Internal Carving 3/32" shank Post Paid in U.S.A.

2 CIRCULAR SAWS
 AT A RECORD BREAKING PRICE—BOTH AT ONLY **\$1.50**
 1" diameter saws on 1/4" Mandrels. For cutting wood, plastic, or soft metals. Order at once! Send Check or Money Order for this bargain. (No C.O.D.'s.) U.S.A.

SCHUPACK SUPPLY CO., 7331 Cottage Grove, Dept. M7, Chicago 19, Ill.

15 ESSENTIAL WORKSHOP OPERATIONS ON YOUR DRILL PRESS

Barron Precision Drill Press Tools and Accessories—Planers, Rotary and Drum Sanders, Auxiliary Tables, Hi-Speed Router Bits, Shaper Fences, Molding Cutters, Dovetail Cutters—a host of other useful drill press items give complete workshop facilities at 1/4 the cost. Over 200,000 Barron owners. Get the facts on these popular, versatile drill press tools today. Sold on 10 day money back guarantee.

BARRON TOOL CO. Inc.
 669 ARCHITECTS BLDG. DETROIT 1, MICHIGAN

FREE Workshop Guide & Catalog

FREE PLANS POWER MOWER KITS FREE PLANS

Have one of the finest mowers money can buy. Write for **FREE PLANS** and **PARTS LIST** showing you how to **SAVE** up to 75% by assembling Triangle's **POWER MOWERS**.

SPECIAL FACTORY PRICES
 Kits, Parts, Engines, Wheels, Etc. Also complete TRIANGLE MOWERS ready to mow, at Low Factory Prices. 3 and 4 wheel models.

SAVE your back. Assemble or build your own 3 or 4 wheel power mower with our precision made kits and parts. Write today for full facts. Free Plans, Parts List, Low Factory Prices. DEALERS INVITED. TRIANGLE MANUFACTURING CO., Dept. M-6, Box 185, Fort Scott, Kans.

TWIN-USE POCKET WATCH & ALARM CLOCK
LOWEST PRICE EVER at \$9.95
 Dependable time-keeper & appointment reminder for pocket, table & office use. Loud ring; Luminous hands, numerals & second indicator. Chromed case. Easy to set. Reg. price \$17.50. **BUY DIRECT**, only \$9.95. We pay tax & del. chgs., or sent C.O.D. **10 DAY RETURN PRIVILEGE.**
 IMPEXTRA, (Dept. M), 551 Fifth Ave., New York 17, N. Y.

HOW TO CUT RAFTERS

New vest pocket book gives lengths, side cuts, plumb cuts, deductions. For all rafters for any building from one inch to forty feet wide. Gives numbers to cut on square. Also degrees for same cuts for Radial Saws. All standard pitches from 1/4 to 5/8. Just open book to pitch page and there are your lengths, side cuts, etc. Anyone who knows what a jack rafter is can frame a roof if he has this great book. Price \$1.50 prepaid. Builders' Topics, Dept. M, Lock Box 828, Seattle, Washington. CARPENTERS, PLUMBERS, PLASTERERS, ELECTRICIANS, ETC., subscribe for Builders' Topics, the monthly magazine for HE-MAN CONSTRUCTION WORKERS. Only \$2.00 per year. Sample copies 25c.

RUPTURE-EASER

A strong, form fitting, washable support. Back lacing adjustable. Snaps up in front. Adjustable leg strap. Soft, flat groin pad. No steel or leather bands. Unexcelled for comfort. Also used as after operation support. For men or women. Mail orders give measure around the lowest part of the abdomen. Specify right or left side or double. Save postage—send money with order—or sent C.O.D.



PIPER BRACE CO.
 308 East 12th Dept. PM-8 Kansas City 6, Mo.

THE SPORTSEAT



MAKES EVERY SEAT A "BOX" SEAT!

- IDEAL FOR:**
- FISHING
 - BOATING
 - PICNICKING
 - AT THE BEACH
 - BOXING MATCHES
 - BASEBALL
 - FOOTBALL
 - BASKETBALL GAMES



IT'S PORTABLE FOLDS FLAT

Relax in comfort with this convenient, portable seat. Constructed for hard usage and long wear. Back and felt-filled cushion covered with sturdy, bright canvas duck. Steel frame, finished in Walnut baked-on enamel. See Your Dealer or Send Check or Money Order.

\$3.95 POSTPAID

*Add 30¢ to above price for SEAT GRIP

McENTIRE BROTHERS, INC.
 239 QUINCY ST. TOPEKA, KANS.

HIGH POWER TELESCOPE
60 POWER - ALUMINUM TUBES - OPENS TO 33"

Variable Power Eyepiece Adjustable to 15X, 30X and 60X.
\$4.50
 Leather Case Included

5 Sections. 4 Ground & Polished Lenses. Also used as 50X Microscope. Ready to use, only \$4.50 POSTPAID.
BROWNSCOPE CO. Dept. 8M, 24 W. 45th St., NEW YORK 19, N. Y.

ELECTRIC SIREN **Fender Skirts for All Cars**

6 volt. Complete with push button... **\$10.95**

Give year, make & model of car when ordering. All Metal. Prime finish. Rubber beading prevents rattle. Easy to install. **\$12.95 PAIR.**

1935-48 FORD V8 & 1939-48 MERCURY
DUAL MUFFLERS
 Increases power. Reduces back pressure. Saves gas. MD20N-208—Complete Set... **\$14.95**
DUALS FOR 1949 FORDS, Set... \$19.95

GUTTED MUFFLERS FOR ALL CARS
 Gives that Motorboat Tone. Universal type to fit all cars, ea... **\$4.95**

We Can Supply **NEW CONVERTIBLE TOPS & REBUILT MOTORS** for all Cars. Write for Prices.
 Send 25% Cash With All Orders, Balance C.O.D.
J. C. WHITNEY & CO.
 1917 ARCHER AVE. CHICAGO 16, ILL.

**2 Sensational
Bargain Values!**



BRAND NEW CLARK 1/4 H.P. ELECTRIC MOTORS Quiet, laboratory-tested. Ball bearing; heavy duty, split phase; 110 volts, 60 cycles AC; standard 3/8" shaft; adaptable for cord or conduit connection; fully enclosed. Packed weight, 28 1/2 lbs. \$16.95 value, while they last only **\$8.50**

OVAL PAINT & VARNISH BRUSH
Rubber set in one-piece steel ferrule; 2 1/4" diameter, 3 1/4" bristles; 6 1/2" comfort-grip tapered handle; 55% bristle, 45% horse-hair. Ideal for painting, varnishing, sash tool, marine use, dusting, flat work. Weight 5 1/2 lbs. per dozen. \$4.25 value, now only \$16.00 per dozen, 3 for \$4.25. **\$1.47** Each



LIMITED STOCK — ORDER TODAY
All prices F.O.B. Chicago
COBB, WHYTE & LAEMMER
309 W. Madison St., Dept. P, Chicago 6, Ill.



**INTERNAL
Pipe WRENCH**

It Really Works!

Cam Action Gives Non-Slip Grip On INSIDE of Nipples & Pipes

Easy to use—insert into pipe and turn. Removes or inserts pipe in hard to reach places. Saves pipe, time, money Pays for itself. Made of best grade tool steel for long life. If your dealer can't supply, write direct.

Latherette kit of 4 wrenches—3/8", 1/2", 3/4", 1"
\$8.86 postpaid. Send \$1 with COD orders.
MONEY-BACK GUARANTEE.
RODDICK TOOL CO., Costa Mesa 1, Calif.



NEWEST B-M POWER MOWER

For Modern Lawn Care

Low
Factory
Price
•
Fully
Guaranteed
•
Some
Dealerships
Available



Newest addition to our family of fine power lawn mowers. Light, 3-wheel, rotary blade mower. Lifetime construction. Powerful 1 1/2 h.p. 4-cycle engine. Self-propelled and other models available, including 3 h.p. 22 inch mower.

Model D-3
B-M MOWER CO., Box 66-PM, Blue Mound, Kans.

Write for FREE Literature

MICRO-VOX
THE WIRELESS "MIKE"

Broadcasts Over Any
Radio Within 75 Feet!

Here's a fascinating complete miniature transmitting system that will delight everyone! Round table discussions . . . Baby listener . . . Practical jokes and dozens of other uses that will astonish one and all! Complete with tube, batteries, tuner and built-in high-fidelity microphone. Clear, life-like tone. Easy to operate!

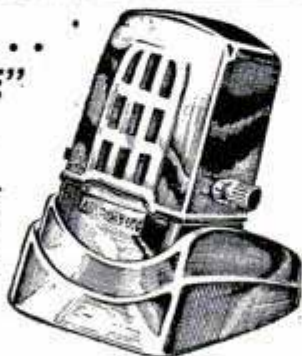

SAVE MONEY!
Send check or M.O. We Pay Postage, C.O.D. Plus Postage. **\$6.95** COMPLETE

TRUSOUND, INC. (Dept. PM-8) 630 W. Randolph St. Chicago 6, Ill.

MACHINE SHOP EQUIPMENT

The 1949 edition of the famous Center Tool Co. Catalog is now ready! Every workshop owner should have a copy! 240 pages full of illustrations, descriptions, and prices of the latest tools made by best known manufacturers in U. S. You pay the cost of printing—50c. We refund your 50c with your first order of \$10.00 or more. Prompt delivery on most tools. Send check or money order today!



CENTER TOOL CO.
153 Centre Street, Dept. C, New York 13

**Start a NEW BUSINESS
Or Add to Your Present
Repair Business**
**Sharpen Dull Pipe Wrenches
Pipe Taps & Dies
"Gum" Circular Saws**
Write for information.



Pat. applied for
J. C. MOORE INDUSTRIES P. O. Drawer 276
FREDONIA, PA.

LIQUID MARBLE COMPOSITION FLOORS
FLEXIBLE MOLDS
MOLD Novelties, Statuary, Art Goups in Flexible Plastic Molds; 5c material makes \$1 seller. Make Marbleized floors, Tile Walls. Colorful, glossy, amazing! Easily learned; start in garage or basement. Particulars free.
MARBLEIZING SERVICE, Dept. 10-F, Edwardsville, Ill.

**MAKE MONEY
AT HOME**
MAKE Greaseless Doughnuts at home. New amazing electric machine. You'll coin money selling to grocers, drug stores, cafes, hamburger stands. Low cost will surprise you. Experience unnecessary. Send for free recipes and plans.

MORTON RAY CO.
3605 SO. 15th AVE. MINNEAPOLIS 7, MINN.

SURPLUS HYDRAULIC PUMP

Genuine Vickers constant displacement high pressure pump. Use it for any type of liquid pumping job. Will pump 600 gal. per hour at 3750 R.P.M. Precision piston type design provides 1000 lbs. per square inch pressure. Self priming. Standard thread 3/4 inch intake and discharge ports. With 3/8 inch splined shaft—just add pulley and power and you're ready to go. These pumps are brand new. Original acquisition cost approx. \$100.00. Can also be used as hydraulic motor; for rams, opening doors, hydraulic lifts, etc. also for any liquid transporting job. War surplus, but brand new. Shp. \$9.95 wgt. 7 lbs.
F.O.B. HOUSTON. SEND CHECK OR MONEY ORDER
SOUTHWEST AERO SUPPLY Dept. PM8, Drawer 488
South Houston, Texas

"How to Work with Tools and Wood"

Book for amateur woodworkers. 188 pages, cloth bound. A workshop "must"—only \$1.00, postpaid. Stanley Tools, 189 Elm St., New Britain, Connecticut.

DUAL CROSS and ROTARY FEED

PALMGREN ROTARY, INDEX, MILLING TABLE No. 83

Has 8" table, 360° movement and 4" cross feed travel. Adjusting wheels and dials graduated in degrees and thousands. Slotted for bolting to table. No. 83 Priced \$49.50. No. 82 without rotary feed \$39.75.
Write for Circular No. 10
CHICAGO TOOL AND ENGINEERING CO.
8365 South Chicago Ave., Chicago 17, Ill.

WE'LL PAY YOU for 3 gallons of "WORN OUT" motor oil from your own auto, truck or tractor engine. Details, page 30 in our FREE BOOK—"Oil Facts."
\$1000.
RECLAIMO MFG. CO., 5083 Elston Ave., Dept. 97, Chicago 30, Ill.

LAWN ORNAMENT-NOVELTY PATTERNS

28 Lawn Ornament Patterns, 25c. Other patterns; 15-20" high; Dutch Girl, Dutch Boy, Pirate, Bull Terrier, Mexican Girl, Mexican Boy, Dwarf, Penguin, Flower Girl, 10c each. 25 Novelty Patterns, 30c. All 62 Full Size Patterns, \$1.00 Postpaid. Strother Pattern Service, Dept. BE-8, Box 128, Belington, W. Va.

Say You Saw It in Popular Mechanics

Build your own JET ENGINE!

Order these plans today
1. JET PROPELLED BICYCLE. Assemble your own. Photo and instructions \$1.00.
2. HOW TO MAKE EXPERIMENTAL JET ENGINES. Seven sheets drawings with information and instructions \$2.95.
3. BOTH OF ABOVE in one order \$3.75. SEND NO MONEY. Order both at once \$3.75 C.O.D. in USA plus c.o.d. postage. Send check or Money Order and we pay postage. Get other information too. Rush Order.
J. HOUSTON MAUPIN, Dept. 55, Tipp City, Ohio

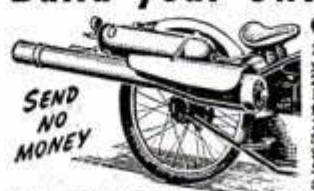

SEND NO MONEY

"Wellworth" Sensational Offer! Reg. \$60.50 WESTINGHOUSE AIR COMPRESSOR

Model T-1
Brand
New!

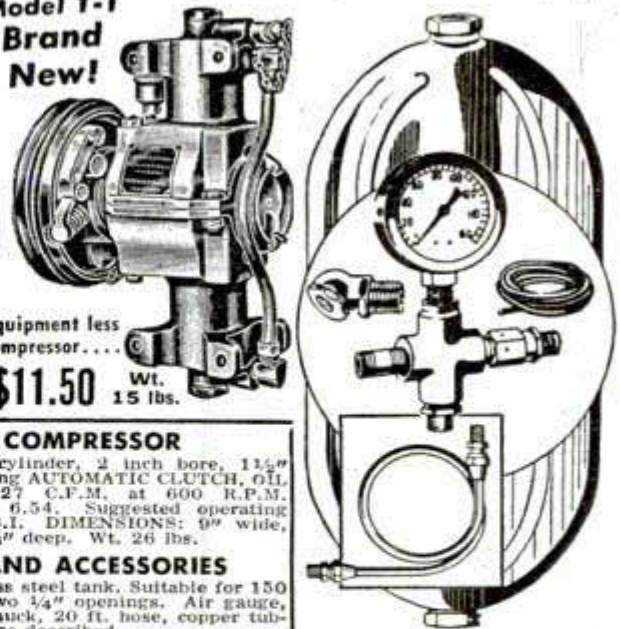

2-CYLINDER PISTON TYPE
Operates with 1/2 H.P. motor
or equivalent gas engine

Automatic clutch makes it suitable for mounting and operating from truck, tractor, etc. Instructions furnished. Replacement parts available. Wt. 26 lbs. Price of compressor only.....

\$21.50

Complete outfit consisting of compressor, pressure tank, air gauge, air chuck, 20-ft. hose, pop valve, copper tubing with 4 brass flared fittings for connecting compressor to tank, 4-way cross and 3 nipples—Complete Outfit only Wt. 40 lbs.

\$31.25

Equipment less compressor....
Wt. 15 lbs.

IDEAL for HOME • FARM • FACTORY
Wherever Compressed Air is Needed

A fortunate purchase from the Government enables us to offer you this amazing buy. This low price is but a fraction of the price of manufacturer and of leading mail order houses. All Brand New equipment. **ORDER NOW!**

THE COMPRESSOR
Piston Type, 2-cylinder, 2 inch bore, 1 1/2" stroke Ball Bearing AUTOMATIC CLUTCH, OIL FREE AIR. 3.27 C.F.M. at 600 R.P.M. Capacity up to 6.54. Suggested operating pressure 75 P.S.I. DIMENSIONS: 9" wide, 11 1/8" high, 6 5/8" deep. Wt. 26 lbs.

TANK AND ACCESSORIES
6" x 24" stainless steel tank. Suitable for 150 lb. pressure. Two 1/4" openings. Air gauge, pop valve, air chuck, 20 ft. hose, copper tubing and fittings as described.

PORTABLE SPRAY OUTFIT

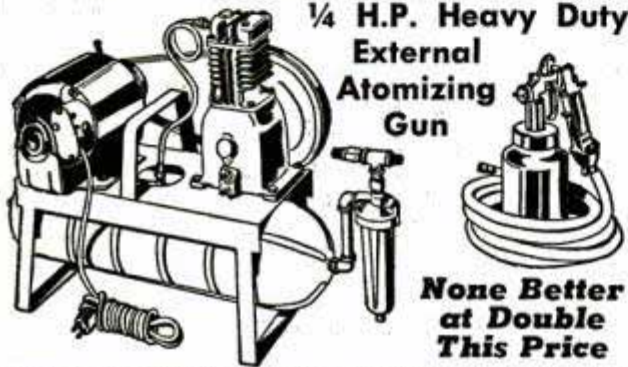

1/4 H.P. Heavy Duty
External
Atomizing
Gun

None Better
at Double
This Price

Paint Sprayer mounted on 6 x 24 inch tank, 1/4 H.P. 110 V. 60 cy. Heavy duty motor with overload relay, 10 ft. cord and plug, V Belt drive. Piston type Compressor with 2 Compression rings, 1 oil ring, 2 inch Bore, 1 3/4 inch stroke, displacement 2.86 C.F.M. at 60 lbs. pressure. Safety Valve. Gun external atomizing. Flat and round spray, quart cup; maintains 35 to 40 lbs. working pressure. Oil and water extractor, 1 air gauge, 20 ft. heavy duty 2-braid air hose with leak proof fittings, complete with carrying handle. Net weight 54 lbs., ship. wt. 60 lbs.....

\$57.50

Outfit less motor.....\$47.50
Compressor only.....17.50
Spray gun and 20 ft. hose 12.95

140 CFM "WELLWORTH" BLOWER



Single-inlet blower that gives top performance on heating, ventilating, exhausting, cooling, drying and similar applications. 5 1/4 x 4" mounting flange with 2 1/2" square discharge. 3 1/2" dia. blower wheel powered by direct-connected 1/15 H.P., 110V., 60C., A.C. motor with conduit box and 20" leads. 7 1/2" wide less flange by 7 1/4" H. x 6 3/4" D. Suited for hundreds of new and replacement uses. Shpg. wt. 6 lbs.....

\$16.50

PNEUMATIC AIR TOOLS

USED, GUARANTEED LIKE NEW.



CHICAGO PNEUMATIC RIVETER & CHIPPING HAMMER

CP#4 Pistol grip handle. Takes up to 3/16" rivet. Weight 6 lbs. List price \$73.00.

SPECIAL PRICE.....\$14.50
Same as above, brand new.....\$22.50
Size CP3. Takes 5/32" Rivet.....\$10.95

Chicago Pneumatic Lever Type AIR DRILL

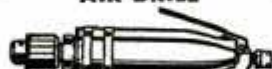

With 1/4" Jacob Chuck. Wt. 2 lbs. List price \$17.50 \$55.00. Only.....



Ingersoll Rand AIR DRILL

With 1/4" Jacob Chuck. Wt. 2 lbs. List price \$17.50 \$55.00. Only.....

AUTOMATIC COMPRESSOR UNIT

1/3 H.P. heavy duty capacitor motor AC 110/220 volt 60 cycle, 2 x 1 3/4 inch piston type compressor, splash feed lubrication, 12 x 24 inch tank, automatic pressure switch, pressure range 100 to 125 lbs., CFM 2.2, check valve, safety valve, air regulator with gauge and filter, 20 ft. air hose with air chuck for inflating tires. V. belt drive. Shipping wt. 90 lbs.

Special **\$79.50**
Price

Same unit as above with 1/2 H.P. motor, furnished with 13" x 24" tank. CFM 2.8 at 125 lb. pressure. Shipping wt. \$98.50 125 lbs.....

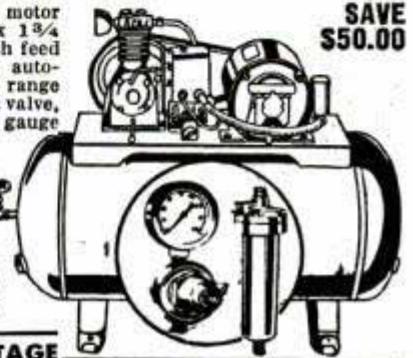

SAVE \$50.00

"WELLWORTH" TWO STAGE COMPRESSOR UNIT

Ideal for paint spraying and general use

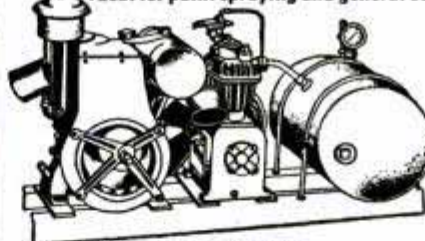

Compressor with unloader, wt. 160 lbs.\$128.00
Engine only, wt. 90 lbs.87.50
Tank and accessories, wt. 110 lbs.62.50

Compressor: Size 3 1/2 x 2 x 2 1/2 with unloader for continuous pressure service; displacement 10 C.F.M. at 200 lbs. pressure. Unloader set at 150 to 165 lbs. Compressor idles when 165 lbs. is reached, starts pumping again when pressure is down to 150 lbs. Wisconsin Gasoline air cooled, easy starting engine. 3 1/2 H.P. at 1800 R.P.M. 4.1 H.P. at 2400.

Air Tank: A.S.M.E. 200 lbs. working pressure; size 16" x 20" with safety valve, drain, two 3/8" globe valves and pressure gauge. 2 "V" belts and pulley. 40 ft. air hose and fittings.

Reg. **\$225** less mounting base \$400
Shipping wt. 350 lbs.

AUTOMATIC PRESSURE SWITCH WITH UNLOADER

Double pole, with 2 way release valve. Set at 125 to 150 lbs. pressure. \$10.25 Wt. 4 lbs. Only.....



"Wellworth" Check Valves

Dash pot type Quiet operating
1/4" valve \$2.75
1/2" valve \$4.50



"Wellworth" 1/4" REDUCING VALVE & GAUGE

Oil resistant, pressure 0-to-200 lb. Reduced pressure 0-to-75 lb.; 3 outlets 1/4"; Wt. 2 lbs. \$5.75



6 FT. STOW FLEXIBLE SHAFT

Heavy Duty, 3/8" Core. Best piano wire. Ball bearing handle and arbor, rubber covered housing; for 1/2" motor shaft; for 1/2" bore wheels. Operates on 1/4 H.P. Motor at 1725 or 3450 R.P.M. \$29.00 Value, \$14.50. Wt. 8 lbs.



Prices f.o.b. Chicago. Immediate delivery. All items sold on money back guarantee. Send check or money order today.

WRITE FOR FREE CATALOG

WELLWORTH TRADING CO.

Merged with C & M Equipment Co.

1831 S. STATE ST. DEPT. D-8 CHICAGO 16, ILL.

SAVE UP TO 85% in WAR SURPLUS & BANKRUPT STOCKS at 'GADGETEER'S HEAVEN' IN MANY ITEMS WE HAVE THE WORLD'S LARGEST SUPPLY

NEW 1949 CATALOG 92 PAGES-ILLUSTRATED SEND 25c TODAY!

New Hydraulic Cylinders, Valves, Pumps, Fittings, Hose and Tanks
51 SIZES AND TYPES.
WORLD'S LARGEST SUPPLY
1001 Labor Saving Adaptations for Pulling, Pushing, Lifting Operations. Finest Precision workmanship and materials. Liquid and/or Air Operation, developing terrific power. 20,000 Available. Write for Catalogue Priced to sell at 15% Gvt. Cost

New Electric Motors
#500 new RHP-27 Volt DC-24 Volt AC. This motor can be readily adapted to deliver up to 1/2 HP on 110 Volts AC by the simple method of rearranging armature brushes. We furnish free diagram of instructions with each order. A Sensational Value \$5.95
#500A Converted to 110 Volts-AC. Equipped with plug and 3/16" Heavy Duty Cord \$8.49
#501 - 1/8 HP - 24 Volt DC. Motor. Series wound. NEW - \$3.95 ea
#502 - 2 HP - 24 V. DC. used \$8.95

GADGET MIX
Especially prepared for the HOMEYEST, Nuts, Spacers, Bolts, Screws, Nails, Geom. etc. A gold mine. \$1.19
#106

BEARING MIX
Needle, Ball & Roller Bearings in excellent assortment. Sizes from 1/8" to 2". One of our "BEST SELLERS" 15 BEARINGS #170 for ONLY \$2.95

HINGE MIX
12 pairs of strap and butt hinges. Sizes 1" x 1 1/2" to 4" x 6" in length to 8" strap. #170H. A \$3.09 Value FOR ONLY \$1.09

ABRASIVE AND GRINDING WHEEL MIX
16 pieces including bearing stones, pencil rolls, wheels. Abrasive sheets, etc. A really sharp value. #170AG. 99c

SPRING MIX
Tension, Compression & Test also Springs, coiled. \$2.06
#206

COMBO-MIX
2 LBS. for ONLY 89c
Comb. of all above. All in one pkg. Ideal. An special introductory price \$5.79

SWITCH MIX
12 assorted types of Aircraft Switches. Including double & single throw, double & triple poles & multiples. Voltage ratings from 5 to 20 amps. 125 Volts A. C., 35 amps. 24 Volts D. C. 1001 uses in Auto, Truck, Tractor, Jeep, Shop, Radio. \$2.95

FILE MIX
Ten Assorted Files of 6", 8", 10", 12", includes 3 Vixena, half rounds, bastards, mills, etc. in seconds and used but in good condition. 1 Vixena alone worth our price for the entire mix 99c

PULLEY MIX
You'll want this one around. 10 micarta and metal pulleys ranging from 1" to 5" with ball and one piece bearings. These are aircraft pulleys, the best made with hundreds of uses. A WONDERFUL BUY @ \$2.95

COUNTERSINK MIX
#168A - Countersink Assortment. Excellent condition - High Speed Steel. Assortment of ten 100" and 110" with pilot sizes ranging from 3/32" to 3/16". \$2.69

WINCH HOISTS
Thousands of satisfied users. Hundreds have written, the most wonderful tool in the world.
No. 100 WINCH HOIST
Cap. 2500 lbs. with 24:1 ratio controlled bronze worm gear. 19" 1/4" alloyed steel cable with hook. Two speed handle. Ideal for Boat Garage, etc. \$100 Val \$15.99

DC GENERATORS
Suitable for adaptation to home welding units, portable & rural lighting, power plant on boats, etc.
TYPE AMPS VOLTS
New G1 140 27 \$17.95
New G1 25 12 \$13.95
Used But Guaranteed Condition
P1 200 27 1/2 \$22.50
R1 300 30 \$29.75
ESA 50 12 \$17.95

D. C. METERS
VOLTMETERS
AMMETERS 0 - 150 0-30 \$3.95
30 - 0 - 30 + 0 - 300 \$3.95
40 - 0 - 40 + 0 - 250 \$3.95
All 2" face except 0 - 300 which is 3" face.
Combination Voltmeter-Ammeter
30V - 30 AMP \$4.95
30V - 60 AMP \$4.95
SHUNTS Required for use with D.C. Ammeters 30 - 60 - 120 - 240 - 300 - 350 SOLD ONLY WITH METERS \$1.00 ea

POWER UNIT
The Complete Model GE3 12-24-100 Consists of a Single Cylinder, Air-Cooled, Four-Cycle Briggs Stratton Gasoline Engine, Type-Stroke Cylinder, Air Cooled, L-Head, Four-Cycle, 4 H. P. Bore 3", Stroke, 3/4". Governed for Speed Between 1500 - 3200 R. P. M.
Directly Connected to a Direct Current Generator of 2800 Watts. Rating 28.5 Volts. 100 Amps. to form an Integral Unit. Fuel Container 1 1/2 Gallons.
The Engine and Generator are Mounted on Four Shock Absorbing Rubber Motor Mounts Attached to a Channel Iron Base. 4 Wheeled for Mobility can be used as Lighting Plant or Power Supply. A TERRIFIC VALUE!
RECONDITION GUARANTEED ONLY \$109.89

NEW PRESSURE TANKS
Stainless steel - Shatter proof. Rustless. 18,000 available in 8 different sizes. 1001 uses. G-1 1 1/2" x 24 inches - 2190 Cu. In. capacity 28 cu. ft. \$4.75
D-2 8 1/2" x 24 in. 500 Cu. In. capacity \$2.49
D-2 Stainless Steel \$3.49
F-2 2 x 45 in. - 1000 Cu. In. capacity 14 cu. ft. \$3.95
A-4 5" x 8" 104 cu. In. Capacity \$1.35
Ideal for painting, cooking, spraying, ocean buoys, underwater fishing, or diving. #OR-1 Oxygen Regulator with 500 lb. gauge, will fit all tanks \$1.39

OXYGEN & ACETYLENE REGULATORS
Oxygen Regulator Bottle Pressure Gauge 0-3000 PSI
Regulating Press. Gauge 0-400 PSI
ACETYLENE REGULATOR Bottle Pressure Gauge 0-500 PSI
Regulating Pressure Gauge 0-50 PSI
AIRCO & Other Popular Makes to fit ALL Standard Bottles
ALL NEW! A Real Buy at \$12.95 or Both for \$25.00
#155 VICTOR CUTTING TORCH \$15.75
Type #400SS. Used but in gd. cond.

High Pressure Oxygen Bottle
New. Will hold up to 3,000 lbs. P.S.I. with Co2 used as tire inflator or fire extinguisher, with oxygen for sick room or deep-water diving, etc. Completely equipped with brass valve, 36" hose, Dial gauge, & canvas bag. \$2.29

FIRE EXTINGUISHER
Kidde Lux Co2 Type. Built Gov't spec. waterproof Heavy Case. Fully recharged. 4 lb. 18"x5"
Wheel control with horn 47B type. \$25 Value #601B \$13.25
7 1/2 lb. Co2 type \$35 Value #602A 14.75
10 lb. Charged with horn Co2 \$45 Value #603 \$25.75
5 lb. Break Disc type New \$75 Value #603A \$29.75
15 lb. Wheel Control #605B \$32.95
15 lb. Squeeze strip. New #605C \$85 Value \$39.95
All above Co2 type. Fully charged and with horn.

ELECTRIC SOLDERING IRON
110 Volt A. C. Vulcan \$8.50 Value #198A 100 Watt \$2.95
ESSICO 75 Watt \$1.69

Continental Gas Engine
Genuine Red Seal 4 Cycle Air Cooled L head standard equipment inc. Mesh type air cleaner, flywheel, magneto, float type carburetor, blower housing, muffler, fuel tank, fuel filter with shut off valve, starter pulley, etc. The ideal power package for light tractors, lighting plants, compressors, boats, lawn mowers, etc. And cost your eyes at this price
A \$75.00 VALUE NEW For ONLY \$47.95
New BRIGGS & STRATTON MODEL "A" GAS ENGINE Rating 2.10 H. P. 4 cycle, single cylinder. Complete in original Factory Crates. A \$102 Value for Only \$64.95

AIR COMPRESSOR
Thousands now in use for spraying, inflating, tractors, trucks, garage, laboratory, air tools, industrial use, etc. Lightweight but powerful, can be run by 1/4 H. P. Motor or Gas Engine. Operates in either Direction or rotation. Gives approximately 3.27 CFM at 800 R.P.M. 6.54 CFM displacement at 1200 R.P.M. Has 2 inch bore, 1 1/2 inch stroke. Suggested pressure 75 P.S.I. Size 9" x 12" x 18 1/2" Weight approximately 23 pounds. AT THIS NEW LOW PRICE \$23.95
Motors, Tanks, Fittings to Adapt this Unit also Avble.

MECHANIC'S MONKEY WRENCH
Adjustable 4" jaw opening. Black 79c
Drop long Auto. type. Plated 89c

Electronic Transmission Gear Train
GT-1 Containing approx. 50 Bronze Spur & Pinion Gears ranging from 1/8" to 4" dia., 5 sets of 7 cluster gears, 2 complete worm & worm gear drive sets, 40 N. D. ball bearings from 1/8" to 1 1/2" dia. watch springs, bushings, posts, face plates, housings, Micro Switches, 2 miniature, controlled clutches, etc. 19 lb. of Pleasure and profit. A Tremendous Gadget Mine. Only Gears in above train are all in multiple size and sequence with identical teeth ratio giving hundreds of ideal gear reduction combinations. \$8.49

Black & Decker ELECT. DRILL KIT
INCLUDES...
5 1/2" ELECTRIC DRILL with JACOBS HEX KEY TYPE CHUCK & ACCESSORIES...
Everything you need for Drilling, Grinding, Cleaning, Buffing & Polishing is contained in this handy kit. A REAL ASSET TO HOME WORKSHOP OR BUSINESS. Drill has 110V. AC-DC "Universal" motor. Heavy duty cord. Weighs only 3 1/2 lbs. \$39.95
Complete Home Utility Set
DRILL ONLY - Including 1/4" JACOBS HEX-KEY type CHUCK \$18.95

PIANO HINGE
Overall Width Length Price
1 1/4" (3/8" side) 72" alum. \$1.00 ea.
1 1/2" (3/8" side) 72" alum. \$1.19 ea.
1 1/2" (3/8" side) 53" cad. steel .75 ea.
3 1/2" (1 1/2" side) 33" steel \$1.00 ea.

RAWHIDE MALLETS
For working light metals, wood or plastic. Leaves no marks. Leather head bound in metal collar. Head dia. 1 1/4" x 4" ONLY 99c

PNEUMATIC AND AIR TOOLS
10,000 in various popular makes, sizes, types. Cleco, Aro, Ingersoll Rand, Chicago Pneumatic, Buckeyes, etc.

RIVET GUNS
Pistol & Gosseneck Type
#181 PISTOL - 10" Usec. Chipping, Riveting, Hammering, Breaking cement. Auto body work. Chicago Pneumatic, Cleco, Ingersoll Rand Makes. E3. E2. 3X. 2X. OY.
\$55 VALUE #180 Gosseneck \$8.95
#186 Squeezee PNEUMATIC ALLIGATOR SQUEEZER \$80 Value \$15.95

AIR DRILLS OR MOTOR SPECIAL
with 1/4" Jacobs Chuck \$15.00
THOR #210R Model 4526 REVERSIBLE AIR DRILL 2300 R.P.M. \$19.95
Xint. for Tapping PNEUMATIC ANGLE DRILL \$12.50
With Terry Adapter ea.
Send for Catalogue and List of Other Sizes, Types of Pneumatic Tools.

Vickers Hydric Transmission
VT-1 Sell - contained. 2 H. P. constant torque at all speeds with variable volume reversible piston pump (controlled by outside lever) supplying piston hydraulic motor. Automatic pressure, dash pot for smooth control. Power output R. P. M. - O to 1/2 input R. P. M. 1800 continuous 4000 intermittent. Dash pot can be removed for greater R. P. M. Ideal for Lathes, Duplicator Setup on Mills, Conveyors, Small Cars, Drives, Gearing, Etc. COST GOVERNMENT APP. \$400.00 You'll Chortle when you get it for ONLY \$19.50

GEAR BOXES
VTG-1-30" 1 1/2" to 1 bevel gear reduction. 1/2" dia. with lever control for engaging & disengaging positive clutch, dust proof bearings, planetary control, bronze size 7" x 9". A lifetime value \$3.95
VTG-2-Inline spur gear reduction 16 to 1. thru 4 gears. Fluct take-off 4" dia. 28 tooth. W" Alum. spur gear with lever control for engaging and disengaging positive clutch, dust proof housing, polished bearings, size 1 1/2" x 8". Only \$6.49
Both above gear boxes can be used with above Transmission.

RUBBER GOODS
NEOPRENE SHEET RUBBER
Thickness Price per
#325 .020" 1/64 36" 75
#328 .032 1/32 22" \$1.39
#329 .125" 1/8" 46" \$4.75
Item #325 is laminated rubber sheet with cloth center. Flexible but very fine for heavy wear. Rubberized Hoop. or Bed Shis. \$2.29
54"x72". \$10.00 Value Only

AIRCRAFT CABLE
Alloyed steel, rust resistant, 3/16" dia. 18 ft. long with turnbuckle ends. 99c ea.
Reformed 7 x 19 strand-on reels in any length...
1/16" 3c ft. 5/32 5c ft.
3/32 4c ft. 3/16 6c ft.
1/8 4 1/2c ft. 9/32 8c ft.

CASTER UNIT 4" hard rubber wheels on steel frame and mounting plate. \$2.25
Full ball bearing swivel \$5.95
Like above with 2" wheel. \$9.95

PALLEY SUPPLY CO. 6321 SAN FERNANDO RD, DEPT. P.M. 8 GLENDALE 1, CALIF.
Order from this Ad. All sales final. All Prices F. O. B. Los Angeles. Pay by M. O. or Check. P. O. Acctd. from D & B firms. 1/2 deposit with C.O.D's.

SAVE MONEY WITH SHOPMASTER TOOLS

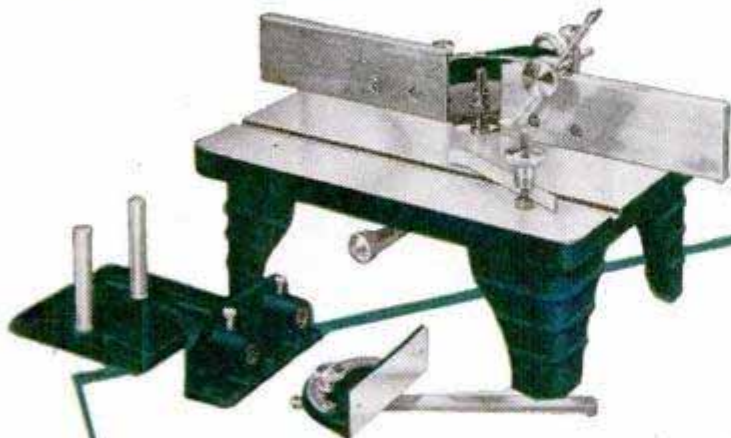

The Tool of a Thousand Uses

The Shopmaster Shaper will make moldings, edge table tops, finish off odd shaped pieces, add fluting, and do many other jobs that give a professional touch to your work.



"Dad, I'm really proud of this table!"

Less than \$16.00 starts your Shopmaster Shop with the Shopmaster Saber Saw. The Shopmaster Saber Saw crosscuts, rips, cuts circles, bevels, and is ideal for making internal cuts on large stock. It cuts material up to 1 1/2 inch thick.

Each Shopmaster Tool, with accessories that are available, will do many tasks. Only a few are required for a complete shop, and the total cost is surprisingly low.

It's easy to do skilled work with Shopmaster Tools. They will return their cost many times in what you save when you build it yourself.



WRITE FOR THIS FREE CATALOG, DESCRIBING THE COMPLETE LINE OF SHOPMASTER TOOLS.



SHOPMASTER, INC.
1214 THIRD ST. S.
MINNEAPOLIS 15, MINN.

Millions of Americans find fun and profit with power tools.

Send me your free catalog.

Name _____

Address _____

City _____ State _____

Easiest pen in the world to fill

See

SHEAFFER'S

TOUCH DOWN

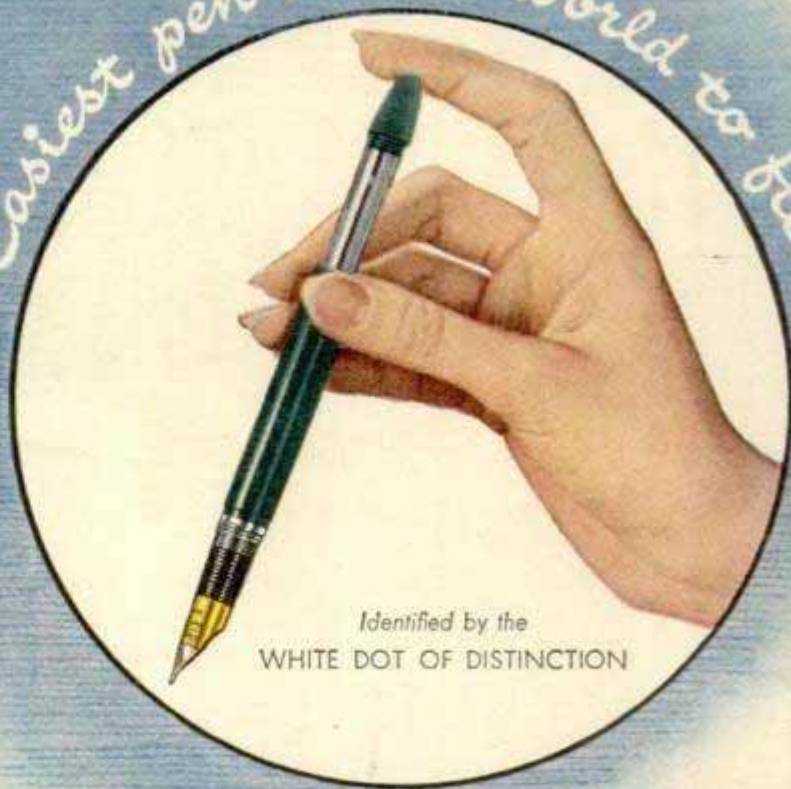

Identified by the
WHITE DOT OF DISTINCTION

Exclusive Pneumatic Down-stroke Filler



SENTINEL DELUXE THREESOME
Pen, \$15.00—Pencil, \$5.00
Stratowriter Ballpoint, \$10.00
Complete Set, \$30.00; no fed. tax
Available in Green, Blue, Brown, Black



STATESMAN THREESOME
Pen, \$10.00—Pencil, \$4.00
Stratowriter Ballpoint, \$7.00
Complete Set, \$21.00; no fed. tax
Available in Green, Blue, Brown, Black



Skrip makes any pen write better,
last longer. Permanent or Washable.
Exclusive top-well bottle makes pen
filling quick, clean, easy!

No other pen can offer so much... no pen in the world can match it! Truly new—excitingly different—outstandingly better. Sheaffer's amazing Touchdown with its new, exclusive *pneumatic* filler is the first pen—the only pen that empties, cleans, refills completely at a single, light, finger-stroke! Touchdown is the only pen that provides the giant, hand-ground 14K gold point that gives you the ultimate in smooth-writing performance. And only Sheaffer's gives you the perfect balance of beauty and design that makes Touchdown the easiest pen to write with—the most beautiful pen to own! See Touchdown today at your Sheaffer dealer's.

W. A. Sheaffer Pen Company
Fort Madison, Iowa and Malton, Ontario, Can.

SHEAFFER'S

WHITE DOT OF DISTINCTION

AMERICA'S First CHOICE!



STUDENTS! Go back to school with the very best. In the complete Sheaffer line of quality writing instruments, you'll find the exact equipment for every purpose—priced to fit every purse. Sheaffer pens begin at only \$3.75.