

ANC



POPULAR MECHANICS

MAGAZINE

WRITTEN SO YOU CAN UNDERSTAND IT

REG'D. TRADE MARK, G.E.

REG. U.S. PAT. OFF.



See Page 73

"Hey Jack, put a *Whizzer*^{*} on it!"

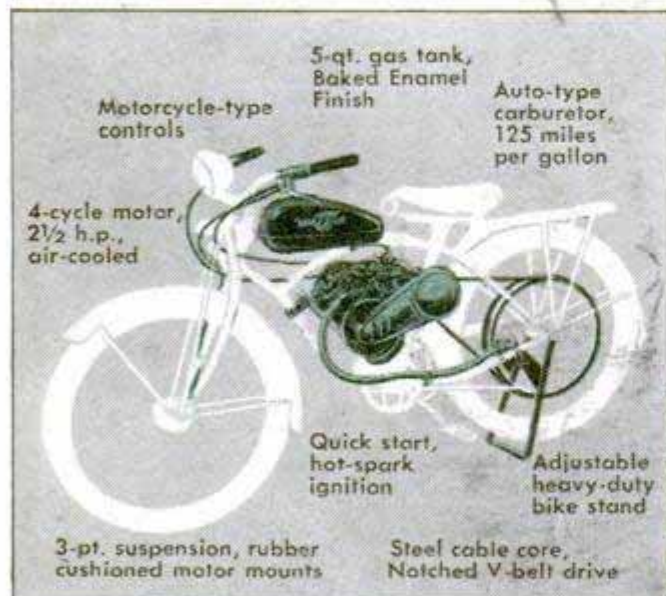

***THE WHIZZER MOTOR** — a compact, lightweight power unit — fits any man's balloon-tire bike. Precision-engineered, 5/10,000" cylinder-tolerance, finest in the field. Also available — the Pacemaker — a complete motor bike, ready to run. Over 4,000 Whizzer dealers, coast to coast. For fun, work, thrift, it's wise to go Whizzer.

FOR QUICK GUIDE TO YOUR NEAREST WHIZZER DEALER — call Western Union, ask for Operator 25 for dealer's address. No charge of any kind to you.

FREE "FULL-DETAIL" CATALOG. Close-ups of Whizzer motor. Describes parts. Explains installation. Shows complete line of motor bike accessories. Also pictures the Pacemaker, a complete motor bike. Write "WHIZZER," Pontiac, Michigan.

I'd like the full Whizzer story. Please send catalog.

Name _____
 Street _____
 City _____ Zone _____ State _____

COMPLETE MOTOR WITH ALL NECESSARY ATTACHMENTS... \$109⁹⁷ Fed. Tax Included. F.O.B. Pontiac, Mich.

“I'm proud the name Kaiser is on the first really new idea since the self-starter...it's 2 cars in 1...I'd like you to see it!”

Henry J. Kaiser

Kaiser Traveler only \$2088*... world's most useful car!



Henry J. Kaiser
Chairman of the Board
Kaiser-Frazer Corporation

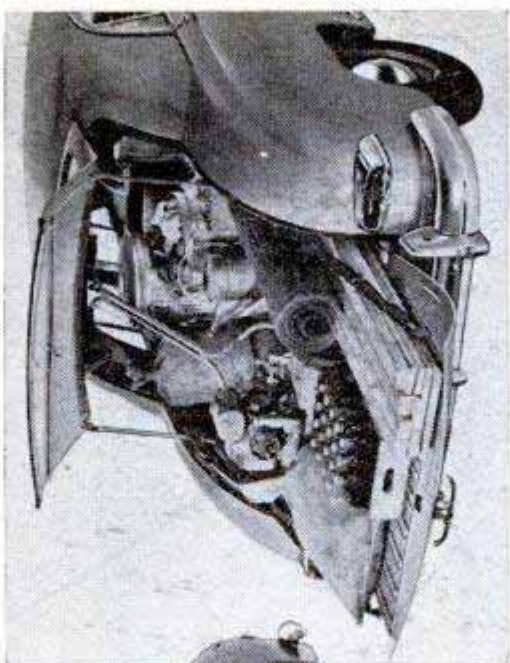
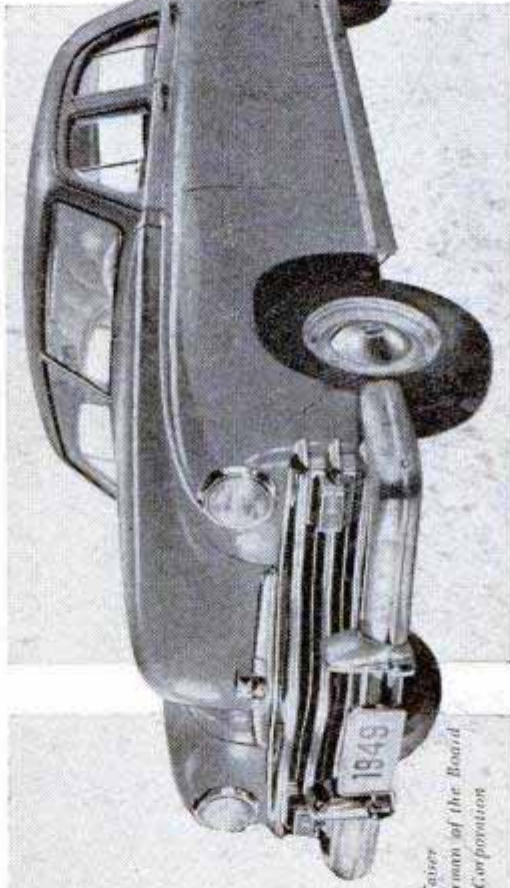

1 “For a long time, I’ve thought that many Americans want and need a practical kind of automobile that can do double duty as a passenger car for pleasure and a cargo carrier for work. So I talked to the boys of our engineering-production team, and the result was the all-new Kaiser Traveler. One minute it’s a big, beautiful 6-passenger sedan any family would be proud to own. Ten seconds later it’s a roomy, steel-shod cargo carrier. I believe the Kaiser Traveler is the practical answer to the problem of thousands who need two kinds of cars but can afford only one.”

2 “The Kaiser Traveler is a luxurious 6-passenger sedan, with a wheelbase of 123½ inches. It is also a sturdy cargo-carrier with a ten-foot-long, steel-shod hold. It’s powered by the mighty Kaiser engine, with its high compression ratio of 7.3-to-1. Just fold down the rear seat, flip open the cargo-hatch and let down the tailgate. Springs and shock absorbers have extra muscles to carry a big load, and give a grand ride. The upholstery is long-wearing and easy to wash. With three people in the front seat there is over 190 cubic feet of storage space in the cargo hold...with six, 78 cu. ft.

3 “Price of the Kaiser Traveler is only \$2088.* Merchants and salesmen, traveling men, housewives, sportsmen...almost everybody can put this Kaiser Traveler to practical use. It’s the one car that gives you everything you want... comfort, safety, the prestige of big car ownership, plus the extra advantages of owning a fine-performing cargo carrier that costs several hundred dollars less than the cheapest station wagon, and is much more practical. Write me what you think of the Kaiser Traveler. Address me at Willow Run, Michigan. I’d really like to hear from you.”

★ f.o.b. factory, including Fed. tax, factory equipment. Nothing more to buy. Only transportation, State, local taxes (if any) extra. © KAISER-FRAZER SALES CORP., WILLOW RUN, MICH.

This One





YOUR telephone receiver should treat each tone in the voice alike; that is important to you, because proper balance makes pleasant listening and easy understanding. Naturalness in receiver performance is pictured in a matter of seconds by the apparatus shown at left.

The receiver is clamped in place and an oscillator feeds into it frequencies representing all talking tones. Then a bright spot darts across an oscilloscope screen leaving behind it a luminous line which shows instantly

**It listens so
YOU
can hear better**

the receiver's response at each frequency. It is precise; and it is many times faster than the old method of measuring receiver performance point-by-point and then plotting a curve.

At Bell Laboratories, development of techniques to save *time* parallels the search for better *methods*. For each time an operation is made faster, men are freed to turn to other phases of the Laboratories' continuing job — making your telephone system better and easier for you to use each year.



BELL TELEPHONE LABORATORIES

EXPLORING AND INVENTING, DEVISING AND PERFECTING, FOR CONTINUED IMPROVEMENTS AND ECONOMIES IN TELEPHONE SERVICE.

Popular Mechanics Magazine

Registered in U. S. Patent Office and Canada

H. H. WINDSOR, Founder

H. H. WINDSOR, JR., Editor and Publisher



this month's cover

WHEN our young friend, Stanley Hiller, Jr., of Hillercopter fame first told us about the passenger rocket he had designed to carry a two-man crew we turned on our skepticism. We are not interested in airplanes that don't fly and we are shy about publicizing inventions that have not progressed beyond the model stage. But Hiller contends that his model and plan are worth national attention even before test flights are made, and after reading Thomas E. Stimson's article (page 73) we think you will agree. As a captive model the rocket did perform as the engineers planned, taking off vertically and then flying horizontally. The cover painting by Bruce Bomberger depicts the rocket being prepared for a take-off in the early dawn, with a sister ship in horizontal flight in the distance. We are personally not interested in being aboard for the first flight, but we'll accept an invitation to be on the sidelines.

Published monthly by Popular Mechanics Company, 200 E. Ontario St., Chicago 11, Ill. H. H. Windsor, Jr., president; Paul H. Dunakin, vice president and general manager; D. F. Windsor, vice president and secretary-treasurer; William Harrison Petridge, vice president and assistant to the publisher; Clover L. Perkins, advertising manager; Alan M. Deyoe, circulation manager. Single copy in the United States and Canada, 35 cents; subscription rates in United States and possessions, Canada, Philippines and countries of the Pan-American Postal Union, 1 year, \$3.50; 2 years, \$6.00; 3 years \$8.00. To all other countries add \$1.00 a year over United States prices for overseas postage. If you plan to move, notify us at least 30 days in advance so you will not miss an issue. Give both old and new addresses. Entered as Second Class Matter, September 15, 1903, at the Post Office at Chicago, Illinois, under Act of March 3, 1879. Entered as Second Class Matter at Post Office Dept., Canada. Copyright 1949 by Popular Mechanics Company, Copyright under International Copyright Union. Copyright in France. All rights reserved under Pan-American Copyright Union. Printed in the United States of America.

Volume 92 JULY 1949 Number 1

Managing Editor.....Roderick M. Grant
 Assistant Managing Editor.....Wayne Whittaker
 Shop Notes and Crafts Editor.....James R. Ward
 Radio-Television, Electronics Editor.....Frank L. Brittin
 Associate Editor, Aviation.....Aubrey O. Cookman, Jr.
 Associate Editor.....Clifford B. Hicks
 Eastern Editor.....Richard F. Dempewolf
 Western Editor.....Thomas E. Stimson, Jr.
 Art Director.....Frank Beatty

Assistant Editors

Donald R. Brooks Dorothy E. Hoffmann Arthur R. Railton

Assistant Editors, Shop Notes and Crafts

W.ClydeLamney WayneC.Lecky FrankN.Stephany A.E.Youngquist

IN THIS ISSUE

Blueprint for a Passenger Rocket	73
Railroad Under a Lake	80
The Floor Show That Grew in a Workshop	84
Golden Harvest Feeds the World	89
Forecasters for the Air Waves	101
Underwater Speedway	114
"Poly"—the All-Star Plastic	125
Animals Enact Aesop's Fables	132
Pack Into the Wilderness	136
Venezuela's Magnetic Mountain	142
Putting a River in Its Place	152
Eggs on the Production Line	162

For the Craftsman

Desk Accessory Has Secret Compartments	166
Planning and Building Outdoor Fireplaces	174
High-Speed Boat Trailer	182
Knots and Ties	188
How to Mend Torn Sails	196
File Cabinet Holds 2000 Slides	201
Heavy-Duty Boring Bar	205
Compound Cuts Are Tricky	210
Radio-Television, Electronics	221
Clinic for Homemakers	232

Other items, and manufacturers of available products described, are listed on pages 10, 12 and 14

How to Fix a Flat BEFORE it Happens!

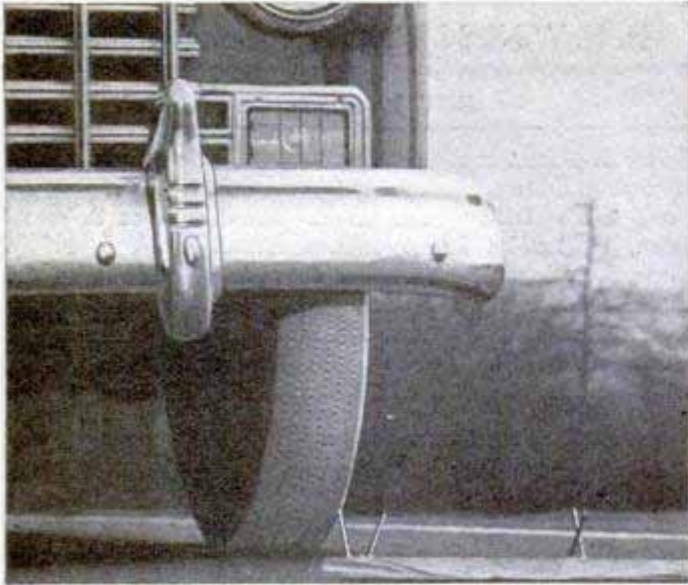

1. Running nails, glass, or other sharp objects into tires can (and does) happen to almost everyone who drives. But punctures need *not* mean flat tires, thanks to Bulkheading—a revolutionary principle of tube construction perfected and patented by Seiberling.

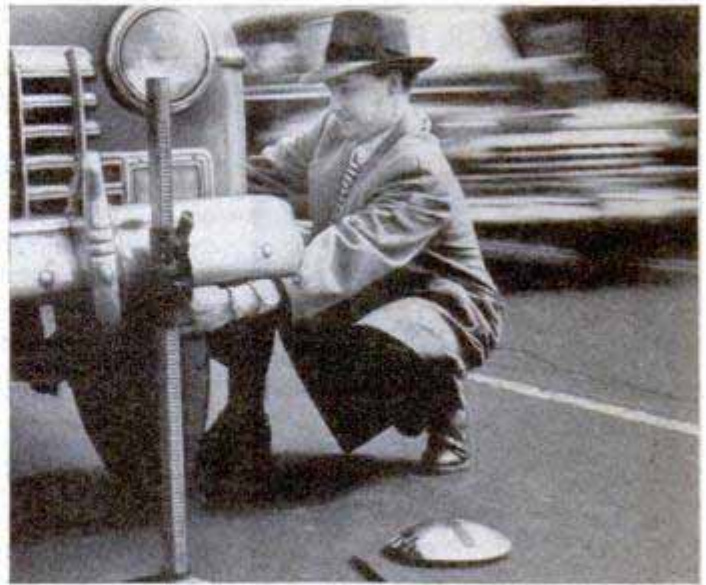

2. A dangerous tire change, lost time, dirty clothes, repair bills—and maybe a ruined casing if you've rolled too far on the flat—they are the usual results of a puncture. But *not* if you're driving on the *only* tubes with patented Bulkheads!



3. Best way to fix a flat is *before* it happens, by equipping your car with Seiberling Sealed-Air Tubes, the *only* tubes with patented Bulkheads. Sealed-Air Tubes repair themselves, *seal punctures permanently while you ride*. Nearest you ever come to "repairing" a Sealed-Air Tube is pulling out a nail whenever you happen to see one.

HOW TO END THE DANGER AND NUISANCE OF FLAT TIRES . . . AND SAVE MONEY AT THE SAME TIME!

If you drive a car or truck, *find out more about the world's safest tubes*. How can Seiberling Sealed-Air Tubes, the *only* tubes with patented Bulkheads, enable you to drive year after year *without a single flat tire*? How can they protect you against blow-outs, too, and outlast set after set of tires? How can they do all this—and *save you money at the same time*? Get the answers in a fascinating new book which we'll be glad to send you. Mail the coupon *now*.

SEIBERLING

Sealed-Air TUBES

WITH PATENTED BULKHEADS

FREE! "10,189 Punctures and not ONE flat!"—the inside story of Seiberling Sealed-Air, the world's safest tube, the *only* tube that gives you the extra puncture and blow-out protection of patented Bulkheads. Mail this coupon now, *before you have another dangerous flat!* Send it to Seiberling Rubber Company, Dept. P-4, Akron 9, Ohio.

Name _____

Address _____

City _____ State _____

NEW!

a different name
for your old friends

PROTO TOOLS

- formerly - **PLOMB
TOOLS**



LONG LIFE

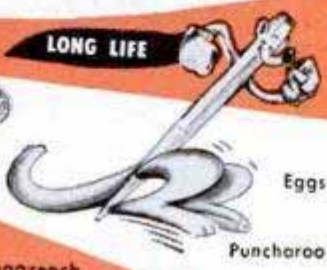

Puncharoo



Eggstractor

GUARANTEED

TOP QUALITY

Sockurl

SOCKURL



Plion

B'ar

B'ar



Sockorse

EXTRA STRENGTH

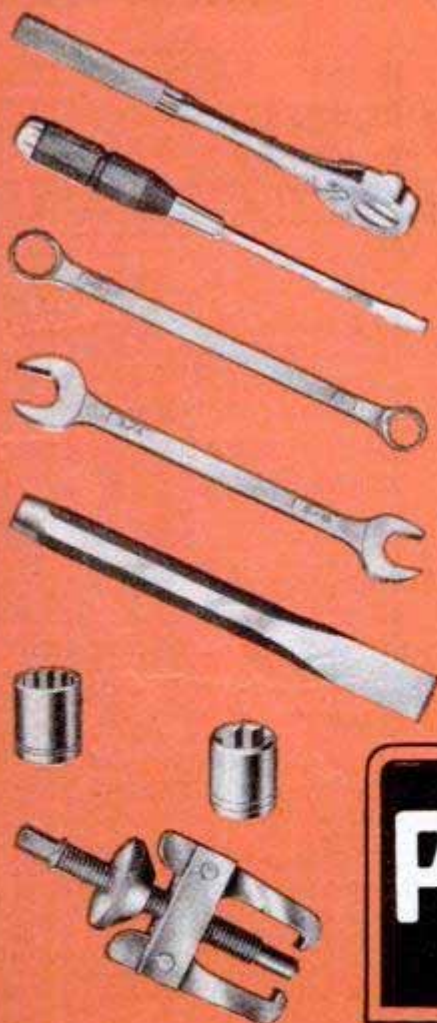

Remember—the new name for the leading brand of mechanics hand service tools is PROTO—formerly Plomb Tools. When you buy PROTO from your dealer, you are getting tools designed and built for professional users. They have the same high quality, long life and superior designs that have made them the choice of professionals for over 40 years under the old brand name.

Write for catalog to

PLOMB TOOL COMPANY

2255J Santa Fe Avenue, Los Angeles 54, California

PROTO TOOLS

REG. U. S. PAT. OFF. LOS ANGELES MADE IN U. S. A.

4982

in this corner.....

THE EDITORS



Joe's Medicine Works

After "putting to bed" his three colorful articles on "How to Tempt a Fish" in our April, May and June issues, Joe Godfrey, Jr., headed for Florida to try out his own medicine. It worked.

In a report to the editor on the efficacy of his fly strategy the sportsman-writer enclosed photographic proof. The bonefish (fastest fish that swims, writes Joe) that he brought in from the flats of Key Largo weighed 9 pounds, 15 ounces, just 10 ounces under the world record bonefish taken on a fly.

* * *

Letter to the Editor:

My 14-year-old son, Michael, devised the enclosed gadget last summer when wearied of my complaints in the series of mishaps that befell my driving glasses. He started with a leather glass case attached to tin strips, riveted together to fit on the sun visor of the car. The device did the job so well that my friends induced him to make a number of replicas. It was then that Mike suddenly realized that his allowance was much too small and he therefore decided that no one should be denied the usefulness of his "invention."

He bought some sheet plastic, and ex-

(Continued to page 8)



Ever Fly a bike?*

*Translation: Ever know the thrill of New Departure 2-speed biking? It turns cycling into soaring. Works like the gear shift on a car—**LOW SPEED** for quicker getaway, easier pedaling on hills, better control in traffic; **HIGH SPEED** for making time on the level runs. The "Speed Changer" fits right into your New Departure Coaster Brake. Ask your bicycle dealer about it today!

This unit does the trick



On your new bike insist on America's favorite

New Departure COASTER BRAKES



1864

FREE! Have fun mystifying your friends! Guess their ages, read their minds! Send a post-card for Magic Packet P4. Address:

NEW DEPARTURE • DIVISION OF GENERAL MOTORS
BRISTOL, CONNECTICUT

MORE MONEY \$\$\$ a BETTER JOB



YOU'RE in the biggest competition—yes, the biggest battle in the world—that of making a living. You have to work for a living—so does everyone else. Competition for

promotion is keen—people all around you are looking for more money—a better job—and so are you.

You can get a head start. Other men have—and in a short time you should be able to out-distance those who have no progress plan, make more money—have a better job—a more certain future.

Few people prepare themselves for that promotion—that better job and more money. Not many are making any special effort to learn outside of the time they put in each day on their work. They're taking the long, hard road to success. *How about you?* Are you, too, taking that same old, winding road—with its many disappointments and heartbreaks?

Here at LaSalle we have been training ambitious men and women for success for more than 40 years—enrolled hundreds of thousands of students—and our files overflow with grateful letters from students who have attained success and earnings far beyond their fondest dreams.

Perhaps we can help you—at any rate it will be well worth a three cent stamp to mail the coupon below. **DO IT NOW!** Just check the field of your choice and we'll send you full information on that field without obligation—plus "Ten Years' Promotion in One"—a book which has helped many men. It may be the turning point in your life to a successful career, and more money.

Your Competition is Keen



LASALLE EXTENSION UNIVERSITY

A Correspondence Institution
417 So. Dearborn St.

DEPT. 764-R

CHICAGO 5, ILL.

I am interested in preparing myself for a better job and more money. Please send me your free 48-page booklet on the training course I have checked below—plus "Ten Years' Promotion in One."



- | | |
|----------------------------------------------|----------------------------------------------|
| <input type="checkbox"/> Higher Accountancy | <input type="checkbox"/> Traffic Management |
| <input type="checkbox"/> C.P.A. Coaching | <input type="checkbox"/> Foremanship |
| <input type="checkbox"/> Bookkeeping | <input type="checkbox"/> Industrial Mgt. |
| <input type="checkbox"/> Law: LL.B. Degree | <input type="checkbox"/> Stenotypy |
| <input type="checkbox"/> Business Management | <input type="checkbox"/> (Machine Shorthand) |
| <input type="checkbox"/> Salesmanship | |

Name _____ Age _____

Street Address _____

City, Zone and State _____

LASALLE EXTENSION UNIVERSITY
A Correspondence Institution
Dept. 764-R Chicago 5, Ill.

**CLIP AND MAIL
THIS COUPON TODAY!**

a little PYROIL means a lot of extra miles for your car...

This is the season when you hit the road and pile up miles of added driving. That's why Summertime is wear-and-tear time on your car. To make sure your summer driving will be really care-free, try the simple Pyroil formula—

**3 ounces of Pyroil in your gas tank
1 pint of Pyroil in your crankcase**

Pyroil improves lubrication because it has the property of clinging to cylinder walls—eliminating the wearing friction of dry metal parts, preventing rust and corrosion. Pyroil removes harmful gums and sludges—and keeps your motor clean.

Pyroil goes a longer way—and assures your car a longer life. Ask your gas station man to add Pyroil—he knows the simple Pyroil formula—he knows it will add miles to your car.

Pyroil for Aircraft Engines

Use Aircraft Pyroil B for lubricating oil, Aircraft Pyroil A for gasoline.

GIVEN! An attractive Pyroil metal savings bank—takes coins up to 50c pieces. **MOTORISTS**, it's yours for the asking—sent postage paid.

Manufactured and Guaranteed by Pyroil Company, 93 Pyroil Bldg., La Crosse, Wisconsin.

Canadian Distributors: Central Purchasing Agencies, Ltd. Toronto, Ontario



PYROIL COMPANY

93 Pyroil Bldg., La Crosse, Wisconsin

I want my car to last and run properly. Please tell me more about Pyroil and how it can accomplish this for me.

Name _____

Address _____

City or Town _____ State _____



perimented with it tirelessly in his small workshop. On my best electric iron he heated the plastic and formed it over his wooden molds. He designed the clip to hold a glass case of any size and fabric, developed a shape for the extremity of the bands that would grip a visor of any thickness, and made the bands adjustable in length to lock in place on a visor of any width. He thus made the original models which were turned over to a patent attorney, as well as the models which were sent to the plastic factory now producing them in quantities by extrusion.

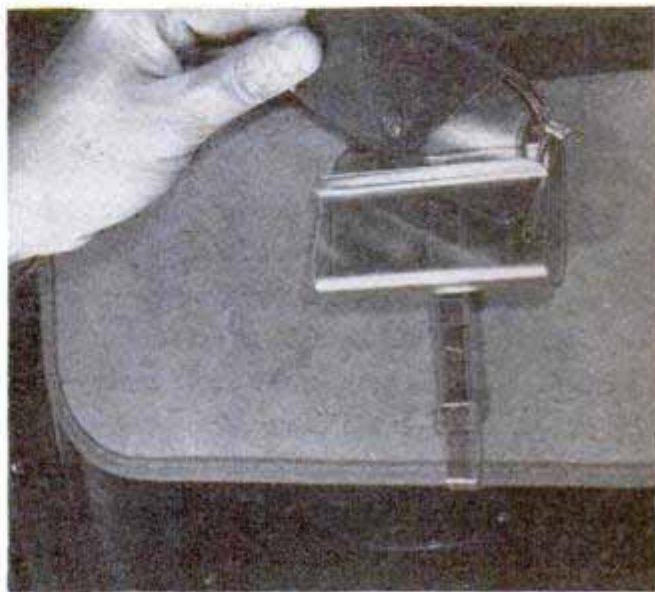

Since this time, Michael has persuaded most of my adult friends who have never worn glasses that they really should. He demonstrates with gestures, to all who will listen, that the nuisance of forgetting driving glasses on the table and the calamity of sitting or stepping on bifocals in the car—both belong to a day that is gone forever.

Very truly yours,
Elaine J. Ackerman, (Mrs. Wm. G.)
893 Oakdale Road,
Atlanta, Ga.

* * *

Next Month

"How the Atom is Working for You" is the title of an eye-opening feature which leads off the August issue. Vice-president Lynn A. Williams, Jr., of the University of Chicago, fits together the pieces of the atomic jigsaw puzzle and comes up with a clear picture of how the atom already is affecting our daily health and wealth. An article in the Craftsman section shows how to use vacation snapshots to dress up titles for travel movies. Another feature shows how easy it is to cut ornamental moldings for your home projects on a circular saw.

THERE'S BIG MONEY IN DRAFTING



JOIN the career-minded men who are *drafting* successful futures for themselves. Design your own program for self-improvement. International Correspondence Schools can show you how.

I. C. S. Courses in Mechanical or Architectural Drafting have helped many hundreds of ambitious young men get started in this rewarding field—have helped pave the way for promotions and salary increases.

Each of the 400 I. C. S. Courses (covering business and technical subjects) is prepared by outstanding authorities with *practical* knowledge of their subject. Each is revised to meet up-to-the-minute developments.

You want to be counted among tomorrow's leaders. You want the rewards that come with *training*. Then get started by clipping and mailing the coupon *today!* It's your application for a share in the future.

INTERNATIONAL CORRESPONDENCE SCHOOLS



BOX 5655-K, SCRANTON 9, PENNA.

Without cost or obligation, please send me full particulars about the course BEFORE which I have marked X:

- | | | | |
|------------------------------------------------------------------------------------------------------------------------------------------------------------------------------------------------------------------------------------------------------------------------------------------------------------------------------------------------------------------------------------------------------------------------------------------------------------------------------------------------------------------------------------------------------------------------------------------------------------------------------------------------------------------------------------------------------------------------------------------------------------------------------------------------------------------------------------------------------------------------------------------------------------------------------------------------------------------------------------------------------------------------------------------------------------------------------------------------------------------------------------------------------------------------------------------------------------------------------------------------------------------------------------------------------------------------------------------------------------------------------------------------------------------------------------------------------------------|------------------------------------------------------------------------------------------------------------------------------------------------------------------------------------------------------------------------------------------------------------------------------------------------------------------------------------------------------------------------------------------------------------------------------------------------------------------------------------------------------------------------------------------------------------------------------------------------------------------------------------------------------------------------------------------------------------------------------------------------------------------------------------------------------------------------------------------------------------------------------------------------------------------------------------------------------------------------------------------------------------------------------------------------------------------------------------------------------------------------------------------------------------------------------------------------------------------------------------------------------------------------------------------------------------------------------------------------------------------------------------------------------------------------------------------------------------------------------------------------------------------------------------------------------------------------------------------------------------------------------------------------------------|--------------------------------------------------------------------------------------------------------------------------------------------------------------------------------------------------------------------------------------------------------------------------------------------------------------------------------------------------------------------------------------------------------------------------------------------------------------------------------------------------------------------------------------------------------------------------------------------------------------------------------------------------------------------------------------------------------------------------------------------------------------------------------------------------------------------------------------------------------------------------------------------------------------------------------------------------------------------------------------------------------------------------------------------------------------------------------------------------------------------------------------------------------------------------------------------------------------------------------------------------------------------------------------------------------------------------------------------------------------------------------------------------------------------------------------------------------------------------------------------------------------------------|--------------------------------------------------------------------------------------------------------------------------------------------------------------------------------------------------------------------------------------------------------------------------------------------------------------------------------------------------------------------------------------------------------------------------------------------------------------------------------------------------------------------------------------------------------------------------------------------------------------------------------------------------------------------------------------------------------------------------------------------------------------------------------------------------------------------------------------------------------------------------------------------------------------------------------------------------------------------------------------------------------------------------------------------------------------------------------------------------------------------------------------------------------------------------------------------------------------------------------------------------------------------------------------------------------------------------------------------------------------------------------------------------------------------------------------------------------------------------------------------------------------------------------------------------------------------------------------------------------------------------------------------------------------------------------------------------------------------------------------------------------------------------------------------------------------------------------------------|
| <p>Air Conditioning and Plumbing Courses</p> <ul style="list-style-type: none"> <input type="checkbox"/> Air Conditioning <input type="checkbox"/> Heating <input type="checkbox"/> Refrigeration <p>Chemistry Courses</p> <ul style="list-style-type: none"> <input type="checkbox"/> Chemical Engineering <input type="checkbox"/> Chemistry, Analytical <input type="checkbox"/> Chemistry, Industrial <input type="checkbox"/> Chemistry, Mfg. Iron & Steel <input type="checkbox"/> Petroleum Refining <input type="checkbox"/> Pulp and Paper Making <p>Civil Engineering, Architectural and Mining Courses</p> <ul style="list-style-type: none"> <input type="checkbox"/> Architecture <input type="checkbox"/> Architectural Drafting <input type="checkbox"/> Bridge and Building Foreman <input type="checkbox"/> Building Estimating <input type="checkbox"/> Civil Engineering <input type="checkbox"/> Coal Mining <input type="checkbox"/> Contracting and Building <input type="checkbox"/> Highway Engineering <input type="checkbox"/> Lumber Dealer <input type="checkbox"/> Reading Structural Blueprints <input type="checkbox"/> Sanitary Engineering <input type="checkbox"/> Structural Drafting | <ul style="list-style-type: none"> <input type="checkbox"/> Plumbing <input type="checkbox"/> Steam Fitting <p>Structural Engineering</p> <ul style="list-style-type: none"> <input type="checkbox"/> Surveying and Mapping <p>Communications Courses</p> <ul style="list-style-type: none"> <input type="checkbox"/> Electronics <input type="checkbox"/> Practical Telephony <input type="checkbox"/> Radio, General <input type="checkbox"/> Radio Operating <input type="checkbox"/> Radio Servicing <input type="checkbox"/> Telegraph Engineering <p>Electrical Courses</p> <ul style="list-style-type: none"> <input type="checkbox"/> Electrical Drafting <input type="checkbox"/> Electrical Engineering <input type="checkbox"/> Electric Light and Power <input type="checkbox"/> Lighting Technician <input type="checkbox"/> Practical Electrician <p>Internal Combustion Engines Courses</p> <ul style="list-style-type: none"> <input type="checkbox"/> Auto Technician <input type="checkbox"/> Diesel-Electric <input type="checkbox"/> Diesel Engines <p>Mechanical Courses, Jr.</p> <ul style="list-style-type: none"> <input type="checkbox"/> Aeronautical Engineer's, Jr. <input type="checkbox"/> Aircraft Drafting <input type="checkbox"/> Forging <input type="checkbox"/> Heat Treatment of Metals <input type="checkbox"/> Industrial Engineering | <ul style="list-style-type: none"> <input type="checkbox"/> Industrial Metallurgy <input type="checkbox"/> Machine Shop <input type="checkbox"/> Mechanical Drafting <input type="checkbox"/> Mechanical Engineering <input type="checkbox"/> Mold-Loft Work <input type="checkbox"/> Patternmaking—Wood, Metal <input type="checkbox"/> Reading Shop Blueprints <input type="checkbox"/> Sheet-Metal Drafting <input type="checkbox"/> Sheet-Metal Worker <input type="checkbox"/> Ship Drafting <input type="checkbox"/> Tool Designing <input type="checkbox"/> Welding Engineering <input type="checkbox"/> Welding—Gas and Electric <p>Railroad Courses</p> <ul style="list-style-type: none"> <input type="checkbox"/> Air Brake <input type="checkbox"/> Diesel Locomotive <input type="checkbox"/> Locomotive Engineer <input type="checkbox"/> Locomotive Fireman <input type="checkbox"/> Locomotive Machinist <input type="checkbox"/> Railroad Section Foreman <p>Steam Engineering Courses</p> <ul style="list-style-type: none"> <input type="checkbox"/> Boilermaking <input type="checkbox"/> Combustion Engineering <input type="checkbox"/> Engine Running <input type="checkbox"/> Marine Engineering <input type="checkbox"/> Steam Electric | <ul style="list-style-type: none"> <input type="checkbox"/> Ship Fitting <input type="checkbox"/> Toolmaking <p>Textile Courses</p> <ul style="list-style-type: none"> <input type="checkbox"/> Cotton Manufacturing <input type="checkbox"/> Loom Fixing <input type="checkbox"/> Textile Designing <input type="checkbox"/> Woolen Manufacturing <input type="checkbox"/> Rayon Weaving <p>Business and Academic Courses</p> <ul style="list-style-type: none"> <input type="checkbox"/> Accounting <input type="checkbox"/> Bookkeeping <input type="checkbox"/> Business Administration <input type="checkbox"/> Business Correspondence <input type="checkbox"/> Certified Public Accounting <input type="checkbox"/> Commercial <input type="checkbox"/> Cost Accounting <input type="checkbox"/> Federal Tax <input type="checkbox"/> Foremanship <input type="checkbox"/> Good English <input type="checkbox"/> Higher Mathematics <input type="checkbox"/> Motor Traffic <input type="checkbox"/> Retailing <input type="checkbox"/> Retail Store Management <input type="checkbox"/> Salesmanship <input type="checkbox"/> Sign Lettering <input type="checkbox"/> Spanish <input type="checkbox"/> Advertising <input type="checkbox"/> Commercial Art <input type="checkbox"/> French <input type="checkbox"/> High School <input type="checkbox"/> Postal Civil Service <input type="checkbox"/> Secretarial <input type="checkbox"/> Stenography <input type="checkbox"/> Traffic Management |
|------------------------------------------------------------------------------------------------------------------------------------------------------------------------------------------------------------------------------------------------------------------------------------------------------------------------------------------------------------------------------------------------------------------------------------------------------------------------------------------------------------------------------------------------------------------------------------------------------------------------------------------------------------------------------------------------------------------------------------------------------------------------------------------------------------------------------------------------------------------------------------------------------------------------------------------------------------------------------------------------------------------------------------------------------------------------------------------------------------------------------------------------------------------------------------------------------------------------------------------------------------------------------------------------------------------------------------------------------------------------------------------------------------------------------------------------------------------|------------------------------------------------------------------------------------------------------------------------------------------------------------------------------------------------------------------------------------------------------------------------------------------------------------------------------------------------------------------------------------------------------------------------------------------------------------------------------------------------------------------------------------------------------------------------------------------------------------------------------------------------------------------------------------------------------------------------------------------------------------------------------------------------------------------------------------------------------------------------------------------------------------------------------------------------------------------------------------------------------------------------------------------------------------------------------------------------------------------------------------------------------------------------------------------------------------------------------------------------------------------------------------------------------------------------------------------------------------------------------------------------------------------------------------------------------------------------------------------------------------------------------------------------------------------------------------------------------------------------------------------------------------|--------------------------------------------------------------------------------------------------------------------------------------------------------------------------------------------------------------------------------------------------------------------------------------------------------------------------------------------------------------------------------------------------------------------------------------------------------------------------------------------------------------------------------------------------------------------------------------------------------------------------------------------------------------------------------------------------------------------------------------------------------------------------------------------------------------------------------------------------------------------------------------------------------------------------------------------------------------------------------------------------------------------------------------------------------------------------------------------------------------------------------------------------------------------------------------------------------------------------------------------------------------------------------------------------------------------------------------------------------------------------------------------------------------------------------------------------------------------------------------------------------------------------|--------------------------------------------------------------------------------------------------------------------------------------------------------------------------------------------------------------------------------------------------------------------------------------------------------------------------------------------------------------------------------------------------------------------------------------------------------------------------------------------------------------------------------------------------------------------------------------------------------------------------------------------------------------------------------------------------------------------------------------------------------------------------------------------------------------------------------------------------------------------------------------------------------------------------------------------------------------------------------------------------------------------------------------------------------------------------------------------------------------------------------------------------------------------------------------------------------------------------------------------------------------------------------------------------------------------------------------------------------------------------------------------------------------------------------------------------------------------------------------------------------------------------------------------------------------------------------------------------------------------------------------------------------------------------------------------------------------------------------------------------------------------------------------------------------------------------------------------|

Name _____ Age _____ Home Address _____

City _____ State _____ Working Hours _____ A.M. to _____ P.M.

Present Position _____ Employed by _____

Length of Service in World War II _____ Enrollment under G.I. Bill and P.L. 16 approved for World War II Veterans. Special tuition rates to members of the Armed Forces. Canadian residents send coupon to International Correspondence Schools Canadian, Ltd., Montreal, Canada.

WHERE-TO-BUY-IT INDEX

Source of supply appears after items commercially available

AUTOMOTIVE

Fabric-metal patch repairs rusted car bodies (Swiss Laboratory, 1533 Hamilton Ave., Cleveland 14, Ohio).....	79
Lever tool eases wheel on car (Lutz Tire Lift Co., 2168 Juliet Ave., St. Paul 5, Minn.).....	96
Seat "toppers" of rubber (United States Rubber Co., Rockefeller Center, New York City 20).....	100
Dodge roadster has hand-operated top (Dodge Motor Corp., Detroit, Mich.).....	105
Combination car—catchall (Plymouth Motor Corp., Detroit 26, Mich.).....	105
Snap-on tow cable (Grove Sales and Engineering, 104 Grove, Detroit 3, Mich.).....	110
Dash-controlled shock absorbers.....	113
Auto curb light.....	123
Garage repair rack holds any auto part (Blackhawk Manufacturing Co., Milwaukee 1, Wis.).....	123
Car's lift-trailer serves as wrecker (Sparton Automotive Division, The Sparks-Withington Co., Jackson, Mich.).....	131

AVIATION

Hydraulic fluid is fire resistant (Monsanto Chemical Co., 1700 South Second St., St. Louis 4, Mo.).....	83
Folding plane seats provide cargo space.....	83
Aircraft gas tank withstands flame.....	88
B-36 adds four jet engines.....	124
Twin-boom plane seats two (Anderson Greenwood & Co., Sam Houston Airport, Houston, Tex.).....	157
Electronic shakers find "flutter" bugs.....	160
Radio-radar domes.....	164
Liquid-oxygen converter for high-altitude planes.....	238

FARM

Potato harvester (Lion Stamping Co., Marshgate Lane, Stratford, London E. 15, England).....	77
2,4-D on vegetables keeps them fresh.....	78
Insert for tractor cylinders boosts pulling power (Hi-Com-products Co., Washington, Iowa).....	108
Dual wheels on tractor aid traction in wet soil.....	110
Rotary rake spreads mulch (Superior Separator Co., Hopkins, Minn.).....	141
Midget tractor pulls big loads (Mayrath Machinery Co., East Trail St., Dodge City, Kans.).....	141
Cotton duster.....	151

FISH AND FISHING

Joe's medicine works (Mr. Joe Godfrey, 6243 N. Sauganash, Chicago 30).....	6
Clamp holds fish rod for baiting (Rod and Sinkers Holder Co., Box 15, Kingsbridge Station, New York City 63).....	100
Fish Skinner (Townsend Engineering Co., 315 East Second St., Des Moines 9, Iowa).....	109
Bubbling bait (F. S. Burroughs & Co., Dover, N. J.).....	113
Twin-minnow lure (Staley-Johnson Manufacturing Co., Inc., 430 Florence Ave., Fort Wayne, Ind.).....	113
Cage protects outboard propellers (Luxeguard Manufacturing Co., 16 Spruce St., Lockport, N. Y.).....	113

HOUSE AND HOME

Thermostat "breathes" air sample (McLarty Systems, 205 W. Michigan Ave., Battle Creek, Mich.).....	108
Cement and wood shavings form building slabs.....	134
Chicken-pie mold (H. H. Eilers, 3135 Meramec, Box 1912, St. Louis, Mo.).....	135
Tubular furniture for children fits into suitcase (The WoodDick Corp., Box 181, Madison 1, Wis.).....	147
"Foam concrete" houses built by Messerschmitt.....	148
Wind-up barbecue (Cheftan Corp., 20 Cross St., Woburn, Mass.).....	151
Crank-broiler (Supermatic Products Co., Burbank, Calif.).....	158
Disappearing wringer (Automatic Washer Co., Newton, Iowa).....	158
Hanging rack (Cary Products Co., 934 N. Lancaster Ave., Dallas, Tex.).....	158
Pot wrapper aids plant care (Mary Donlan Ver Mett, 604 S. Adelaide, Fenton, Mich.).....	158
Electric fan packs for traveling (Fresh'nd Aire Co., Div. of Cory Corp., 221 N. LaSalle St., Chicago 1).....	159
Cream remover (J. A. Danielson Co., 224 Sixth St., Richmond, Calif.).....	159
Deodorizer for refrigerators (Roclair of Hollywood, Box 2, Culver City, Calif.).....	159
Fat drainer built into skillet (Hollis Co., 11 Commerce St., Newark, N. J.).....	159
Space-saving dinette (Modern Woodcraft Corp., Cambridge, Mass.).....	159

INDUSTRY

Supersensitive vacuum gauge.....	83
Gas-turbine locomotive.....	106
Mobile lifts for steel handle 20,000-pound rolls.....	111
"Cold steam" spray cleans metal parts (D. & M. Products, Inc., 4655 Kingswell, Los Angeles 27, Calif.).....	112
Atom test for engine wear.....	119
Infrared "oven" dries wood (Chicago Streamlite Corp., 306 West 37th St., Chicago).....	124
"Waste" coffee made into soap.....	134
Track-laying hand truck rolls up or down stairs (American Machine Works, Inc., 1320 Clark St., Racine, Wis.).....	146
Coal-mine car hugs ground.....	147
Giant synchrotron joins attack on the atom.....	148
Paper-pulp process uses wheat straw.....	151
Enamels for aluminum (E. I. du Pont de Nemours & Co., Inc., Wilmington 98, Del.).....	161

LAWN AND GARDEN

Sower spreads grass seed evenly (Shopmaster, Inc., 1214 S. Third St., Minneapolis 15, Minn.).....	97
Clothesline works every day (Nileway Products Co., 7324 Crenshaw Blvd., Los Angeles 43, Calif.).....	109
Flower stakes of heavy wire (T. Sheridan, Hamiota, Man., Can.).....	110

MEDICAL

Dogs go "on the air" to help scientists.....	78
----------------------------------------------	----

(Continued to page 12)

Embry-Riddle begins Your Aviation Career



Your Success in Aviation begins with thorough, practical Embry-Riddle training. Engineering and mechanic students work on live aircraft in airline size hangars... study design in spacious, well-lighted classrooms. Flight students train in the most modern aircraft...fly year-round in Miami's perfect flying weather. And at world-famous Embry-Riddle you live amidst the international hustle and bustle of the world's greatest air center.

Never has there been such opportunity for you in Aviation. The demand for trained men far exceeds the supply. Embry-Riddle prepares you in a few short months for all fundamental flight, engineering and mechanic positions, including the new, wide field for combination ability (pilot plus mechanic certification). Take advantage of the magnificent training facilities at vast Opa-locka Airport, operated entirely by Embry-Riddle. Study under the best instructors...backed by Embry-Riddle's quarter-century of aviation training experience. Live directly on the Airport. Enjoy Florida's matchless climate year-round, its wealth of sport and recreational facilities. Start your Aviation Career NOW at Embry-Riddle.

Send coupon today for new catalog and proof of career opportunities for Embry-Riddle graduates.

AUTHORIZED G. I. TRAINING

Dean of Enrollments - Dept. 99
Embry-Riddle School of Aviation
Miami 30, Florida

Please Print

NAME _____

ADDRESS _____

City _____

State _____

Age _____

I am interested in...

- A.&E. Mechanic
- Commercial Pilot
- Engineering
- A.&E. Combined with Commercial Pilot
- Flying Mechanic
- Drafting & Design

Check One Veteran Non-Veteran



TRAIN IN MIAMI -- AIR CAPITAL OF THE WORLD

WHAT Every AUTO MECHANIC Wants to Know

A motor vehicle is a machine of many parts, each part designed and constructed for its own special function. All good mechanics, like good doctors, should know the working theory and operation of each part and understand what causes trouble and how to remedy it.

LET AUDELS AUTO GUIDE SOLVE YOUR PROBLEMS

Every auto mechanic, helper, serviceman and operator can use AUDELS AUTO GUIDE. The information it gives saves time, money and worry. Highly endorsed by all users. It presents the whole subject of auto mechanics from A to Z in plain language and simple terms.

This Big Practical Book gives full information with working diagrams covering the principles, construction, ignition, service and repair of modern cars, trucks and buses.

A complete Guide of 1800 pages, with over 1500 illustrations showing inside views of the working parts, with instructions for service jobs. Diesel engines, Fluid and Hydra-matic drives fully explained.

IT PAYS TO KNOW HOW TO

How to fit pistons—How to locate engine knocks—How to fit connecting rod bearings—How to service main bearings—How to recondition valves—How to time valves—How to adjust fan belts—How to adjust carburetors & chokes—How to rebuild a clutch—How to service automatic transmissions—How to service brakes—How to adjust steering gear—How to cope with ignition troubles—How to service distributors—How to time ignition—How to "tune up" an engine.

INFORMATION IN A HANDY FORM

73 INTERESTING CHAPTERS—Read this partial list of subjects on which practical information is fully given for quick reference under the headings as shown below. Ready Reference Index.

All Parts of an Automobile—Automotive Physics—The Gas Engine—Gas Engine Principles—Multi-Cylinder Engines—Horse Power—Automobile Engines—Stationary Parts—Moving Parts—Pistons—Piston Rings—Connecting Rods—Crank Shafts—Valves—Valve Gear—Cams and Cam Action—Valve Timing—Cooling Systems—Fuel Feed Systems—Dual Fuel Feed—Mixture—Carburetors—Carburetor Service—Automatic Choke—Super-Chargers—Transmissions—Special Transmissions—Fluid and Hydra-matic Drives—Clutches—Universals and Propeller Shafts

A Ready Reference

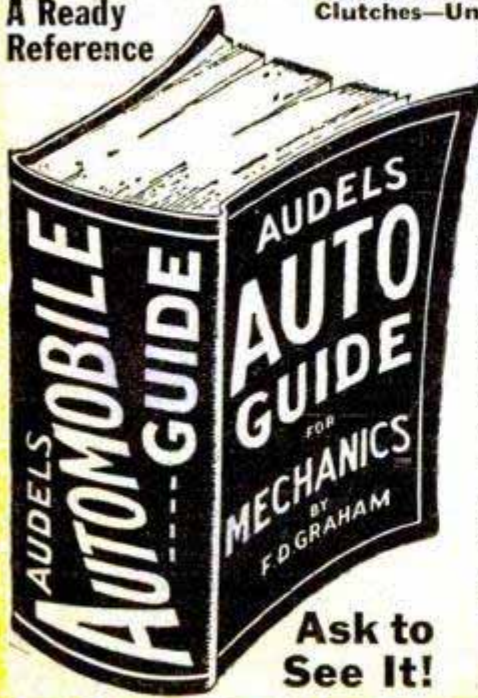

—The Differential—Rear Axles—Rear and Front Suspension—Running Gear—Brakes—Wheel Alignment—Knee Action—Steering Gear—Tires—Lubricants and Lubrication—Automotive Electricity—Ignition Systems—Magneto Ignition—Spark Plugs—Ignition Coils—Distributors—Automatic Spark Control—Ignition Timing—Generators—Starters—Generator and Starter Testing—Lighting Systems—Storage Batteries—Charging and Testing—Diesel Engines and Trouble Shooting.

7 DAYS' FREE TRIAL
TO GET THIS ASSISTANCE FOR YOURSELF SIMPLY FILL IN AND MAIL COUPON TODAY.

\$ 4 COMPLETE PAY \$1 A ONLY 1 MO.



Sent on 7 Days Approval

Step up your own skill with the facts and figures of your trade. Audels Mechanics Guides contain Practical Inside Trade Information in a handy form. Fully Illustrated and Easy to Understand. Highly Endorsed. Check the book you want for 7 DAYS FREE EXAMINATION. Send No Money. Nothing to pay postman.

---CUT HERE--- MAIL ORDER

AUDEL, Publishers, 49 W. 23 St., NEW YORK 10, N. Y.

Please send me postpaid for FREE EXAMINATION books marked (x) below. If I decide to keep them I agree to mail \$1 in 7 Days on each book or set ordered and further mail \$1 monthly on each book or set until I have paid price, otherwise I will return them.

- AUTO GUIDE**, 1800 Pages . . . \$4
- DIESEL ENGINE MANUAL, 400 Pages . . . 2
- WELDERS GUIDE, 400 Pages . . . 1
- MACHINISTS Handy Book, 1600 Pages . . . 4
- POWER PLANT ENGINEERS Guide, 1500 Pages. 4
- ENGINEERS & FIREMANS EXAMS, 528 Pages. 4
- PUMPS, Hydraulics & Air Compressors, 1658 Pgs. 1
- MARINE ENGINEERS Handy Book, 1280 Pages 4
- ENGINEERS & Mechanics Guides (8 Book Set). 12
- Answers on Practical ENGINEERING, 254 Pages 1
- ELECTRIC WIRING DIAGRAMS, 210 Pages . . . 1
- ELECTRICIANS EXAMINATIONS, 250 Pages. 1
- ELECTRICAL DICTIONARY, 9000 Terms . . . 2
- ELECTRIC MOTOR GUIDE, 1000 Pages . . . 4
- HANDY BOOK OF ELECTRICITY, 1440 Pages 4
- ELECTRICAL POWER CALCULATIONS, 425 Pgs. 2
- RADIOMANS GUIDE, 914 Pages . . . 4
- ELECTRONIC DEVICES, 216 Pages . . . 2
- ELECTRIC LIBRARY, 7000 Pages (12 Book Set). 18
- Vols. I, II, III, IV, V, VI, VII, VIII, IX, X, XI, XII \$1.50 Ea.
- OIL BURNER GUIDE, 384 Pages . . . 1
- HOUSE HEATING GUIDE, 1000 Pages . . . 4
- CARPENTERS & Builders Guides (4 Book Set). 6
- PLUMBERS & Steamfitters Guides (4 Book Set). 6
- MASONS & Builders Guides (4 Book Set) . . . 6
- BLUE PRINT READING, 416 Pages . . . 2
- PAINTERS & DECORATORS MANUAL, 450 Pgs. 2
- GARDENERS & GROWERS Guides (4 Book Set). 6
- REFRIGERATION & Air Conditioning, 1280 Pgs. 4
- SHEET METAL WORKERS Handy Book, 388 Pgs. 1
- SHEET METAL PATTERN LAYOUTS, 1100 Pgs. 4
- AIRCRAFT WORKER, 240 Pages . . . 1
- MECHANICAL DRAWING GUIDE, 160 Pages. 1
- MECHANICAL DRAWING & DESIGN, 480 Pgs. 2
- MATHEMATICS & CALCULATIONS, 700 Pgs. . 2
- MECHANICAL Dictionary, 968 Pages . . . 4
- MILLWRIGHTS & Mechanics Guide, 1200 Pgs. 4

Name _____
 Address _____
 Occupation _____
 Employed by _____

AUDEL, Publishers, 49 W. 23 St., New York 10, N. Y.

Get into BUSINESS for Yourself!



METALIZE BABY SHOES At Home—In Spare Time

Get the facts about amazing **MONEY-MAKING Warner Success Plan** that shows you every easy step in completely charted path to personal independence — with home as your headquarters. And, this **PROVED and TESTED** plan is working like magic. Backed by an old, reliable company. We send it to you on **No-Risk Trial Money Back Guarantee**.

FREE

OFFER OF
COMPLETE
MONEY-
MAKING
PLAN
SEND NO
MONEY
JUST MAIL
COUPON

QUICK CASH WAITING!

Demand for **METALIZED BABY SHOES** and **OTHER KEEPSAKES** is growing bigger daily. Our Tested Plan Shows How to Do the Work, How to Bring In the Business ... How to Make as Much as \$5.00 an Hour. Spare or full time, **BIG STEADY PROFITS ARE WAITING FOR YOU**. Send a penny postcard or Mail Coupon for **FREE Facts**. Act now! Time is precious.

Ray Brandell, Mgr., WARNER ELECTRIC CO.
1512 Jarvis Ave. Dept. 37 Chicago 26, Ill.

Ray Brandell, Mgr., Warner Electric Co.,
1512 Jarvis Ave., Dept. 37, Chicago 26, Ill.

Please rush complete details about your **No-Risk Trial Money Back Plan for Metalizing Baby Shoes**. Everything you send now is **FREE** and costs me nothing — now or ever.

Name _____

Address _____

City _____ Zone _____ State _____

(Continued from page 10)

Drug protects African cattle against fly-carried disease.....	109
Parachute aid kit supplies 10 victims.....	130
Drug for allergies cures seasickness.....	145
"Cat test" at customs fights spread of disease.....	146
Gallstone "detector".....	161
Aids for amputees.....	164

OUTDOOR RECREATION

Boat serves as extra roof on sportsman's trailer.....	88
Miniature paddle-wheeler made of inner tubes.....	131
Fish stringer serves as carrier (Han-Dee Products Co., 795 Richmond Rd., Cleveland 21, Ohio).....	135
Pendulum golf putter (Mr. Jules Sternberg, Mull Avenue, R.D.1, Sinking Spring, Pa.).....	157

PHOTOGRAPHY

Power pack built into reflector of electronic photoflash unit (Photographic Products, Inc., 955 N. Mansfield, Hollywood, Calif.).....	96
Wrist camera is quick-loading (William R. Whittaker Co., Ltd., 915 N. Citrus Ave., Hollywood 38, Calif.).....	97
Fine-grain developer in one-use package (Eastman Kodak Co., Rochester 4, N. Y.).....	131
Camerman gets his pictures three at a time.....	156
Photoflash reflector softens shadows (Provident Camera Co., 720 Vine St., Cincinnati 2, Ohio).....	156

TOOLS

Three-wheel bandsaw mounted on lathe (The Steiner Band Saw, 1014 Washington St., Hoboken, N. J.).....	78
Marimbas tuned with a bandsaw.....	82
Thimble wrench for tight spots (G. M. Basford Co., 2020 Lincoln Bldg., New York City 17).....	82
Hand gun sprays metal powders (Schori Process Division, Ferro-Co. Corp., 8-11 Forty-Third Road, Long Island City 1, N. Y.).....	96
Power tool deglazes cylinders (Burd Piston Ring Co., Rockford, Ill.).....	96
Compressor converts drill into paint spray gun (F. R. Williams Co., 5311 N. Kenmore Ave., Chicago 40).....	111
Tool drives angle screws without damaging threads (Greenlee Tool Co., Division of Greenlee Bros. & Co., 1703 Mason Ave., Rockford, Ill.).....	122
Turntable unit marks keys with identifying names (Metro Manufacturing Co., Palmolive Bldg., Chicago 11).....	130
Metal bandsaw pivots at base (Rother Products, 2134 N. 15th St., Milwaukee 5, Wis.).....	135
Gun stapler has toothed claw for stretching wire screen.....	135
Bow saw cuts logs without binding (McCulloch Motors Corp., 6101 W. Century Blvd., Los Angeles 45, Calif.).....	141
Welder thaws pipes with electricity.....	145
"Coffee pot" melting furnace (The Jelrus Co., Inc., 136 W. 52nd St., New York City 19).....	149
Adapter transfers motion around 90-degree turn.....	156
Electric-mixer motor becomes power tool (Electric Mixer Adapter Co., 852 South West 21st Ave., Portland, Ore.).....	157

TOYS AND NOVELTIES

Architect in sugar.....	98
Bridge made of toothpicks supports 10-pound load.....	112
Pneumatic "crew" brings model boat back to port.....	122
Glass orchestra.....	145

MISCELLANEOUS

Prefabricated boat dock (Michigan Dock Co., 1451 East Michigan Ave., Battle Creek, Mich.).....	71
Thin concrete forced into pavement prevents highway damage	79
Bent-stem pipe rests on chin (Kaywoodie Co., 7400 Broadway, West New York, N. J.).....	82
Single rinse cleans paint brush (Elgin Plastic Products Co., 4011 W. Harrison St., Chicago 24).....	97
Plug repairs worn sockets (Flexsaw Co., Port Austin, Mich.).....	97
Shoe-repair bar (Auto-Soler Co., 267 Marietta St., Atlanta 3, Ga.).....	100
Fort Worth policemen speak in a loud voice.....	108
Pentoon houseboat.....	111
"Blackboard" sign (Litewriter Corp., 351 W. 52nd St., New York City).....	119
Cutout model shows action of electrical charge.....	119
Troubleshooter on the scent.....	120
Shotgun cleaner protects barrel (W. & W. Manufacturing Co., Grandview, Mo.).....	123
Two people travel 400 miles on 2½ gallons of gas.....	134
Florist's "robot" wraps wire around flower stem (T. E. Reynolds, Lodi, Calif.).....	146
"Pistol" dispenses tape (Ferris Products, Inc., Cleveland 3, Ohio).....	149
Dry lubricant applied as paint (Huron Industries, Box 557-Q, Port Huron, Mich.).....	149
Miniature scaffold for all ladders (Juniata Co., Park Bldg., Pittsburgh 22, Pa.).....	149
Card-size library books (Northern Engraving and Manufacturing Co., La Crosse, Wis.).....	150
Moving light beams pace swimmers.....	160
There are air tides, too.....	161
Adhesive stencils stick to surface while paint is applied.....	161

Craftsman and Shop Notes Index

AUTOMOTIVE

Reflecting letters on car door warn approaching drivers.....	180
Rope provides convenient grip for wiping top of car.....	195
Illuminating dashboard ash tray.....	200
Squeezing-in that new car.....	217
Screws replace fender bolt.....	220

FARM

Caterpillar tent on tree removed with long-handled brush.....	207
Vibration of power-take-off shields silenced by inner-tube patches.....	207
Eaves-trough sections provide molds for pouring concrete fence posts.....	209
Tongue for tractor is hinged and fitted with clevis.....	215
Posts of electric fence anchored with mower sections.....	216
Poultry held for weighing by trouser-leg funnel.....	220

(Continued to page 14)



I Will Show You How to
LEARN RADIO
 Servicing or Communications
by Practicing in Spare Time

*I Send You
 Many Kits of
 Radio Parts*



YOU PRACTICE RADIO SERVICING

You build the modern Radio shown below as part of my Servicing Course. I send you the speaker, tubes, chassis, transformer, loop antenna, EVERYTHING you need to build this modern Radio Receiver. Use it to make many tests, get practical experience.



YOU PRACTICE RADIO COMMUNICATIONS

I send you parts to build the Transmitter shown below as part of my new Communications Course. Conduct actual procedure of Broadcast Station Operators, practice interesting experiments, learn how to put a transmitter on the air.



NEW

YOU BUILD THIS TESTER



as part of my Servicing Course. It soon helps you **EARN EXTRA MONEY** fixing neighbors' Radios in spare time.

BUILD THIS WAVEMETER

as part of my **NEW Communications Course**. Use it with Oscillator you also build that furnishes basic power to transmitter and determines transmitter frequency.



I TRAINED THESE MEN

HAS GOOD JOB IN RADIO STATION
 "Am Chief Engineer of Radio Station **WORD** in charge of 4 men. Owe all I know about Radio to NRI."
 —CLYDE J. BURDETTE, Spartanburg, South Carolina.

HAS HIS OWN RADIO BUSINESS
 "Now have two Radio shops servicing about 200 sets a month. Have largest service establishment in South-eastern Missouri."
 —ARLEY STUDYVIN, DeSoto, Missouri.

KNOW RADIO · Win Success
I Will Train You at Home · SAMPLE LESSON FREE

Want a good-pay job in the fast-growing Radio and Television Industries, or your own money-making Radio-Television shop? I've trained hundreds of men **WITH NO PREVIOUS TRAINING** to be Radio technicians. I can do the same for you. Or now you can enroll in my **NEW practical course in Radio-Television COMMUNICATIONS**—learn to be a Broadcasting and Communications technician. You get practical Radio experience with **MANY KITS OF PARTS** I send you in my train-at-home method. All equipment yours to keep.

Make Extra Money In Spare Time

As part of my Radio Servicing Course, I send **EXTRA MONEY** booklets starting the day you enroll. Make extra money fixing Radios in spare time while training. Then start your own Radio sales and service shop

or get a good-pay job in Government, Police, Aviation or Marine Radio, Broadcasting, Public Address work, etc. Or think of amazing Television opportunities. Already manufacturers are producing over 100,000 sets a month. New stations going on the air everywhere! Television is America's fastest-growing industry and men who know it will be in demand.

Get Actual Lesson And Book Free

My **DOUBLE FREE OFFER** entitles you to actual **SAMPLE LESSON** and my 64-page book, "HOW TO BE A SUCCESS IN RADIO-TELEVISION-ELECTRONICS," both **FREE**. Mail coupon now. See how quickly, easily you can start. **J. E. SMITH, President,** Dept. 9GP, National Radio Institute, Pioneer Home Study Radio School, Washington 9, D. C.

VETERANS

Get This Training Without
 Cost Under G. I. Bill

Good for Both - FREE

MR. J. E. SMITH, Pres., Dept. 9GP
 National Radio Institute, Washington 9, D. C.
 Mail me **FREE Lesson** and 64-page book. (No salesman will call. Please write plainly.)

NAME.....AGE.....

ADDRESS.....

CITY.....ZONE.....STATE.....

Check if Veteran

APPROVED FOR TRAINING UNDER G. I. BILL



MY COURSE INCLUDES **TELEVISION**

MEN-IF YOU VALUE Your Future- read this FREE BOOK

SEND
FOR IT
Today!

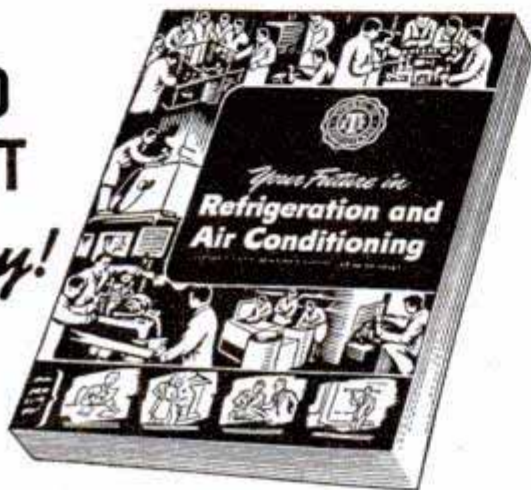

**Tells You How to Win
Bigger Pay and Real Security**

This book is yours without a penny of cost. "Your Future in Refrigeration and Air Conditioning" tells you what's in store for you in this fast moving, big pay field. No obligation. We want you to have this big, fascinating book. We want you to have the opportunity to read it—and to decide for yourself whether this is the field for you. You'll see pages of interesting pictures showing men on-the-job in Refrigeration and Air Conditioning. You'll read all about the fine opportunities in this amazing industry. This can easily be the most important book you'll ever receive and read—because it concerns your own future! Refrigeration and Air Conditioning has plenty of room for trained men—to handle good paying jobs in the many branches of this great industry. Almost unlimited future for men who know this work. Now you may learn Refrigeration and Air Conditioning at home in spare time. No need to give up present job or income while preparing to step into a better job. Act now! Simply write your name and address on the coupon below and mail today. Get your free copy at once . . .

INDUSTRIAL TRAINING INSTITUTE

2150 Lawrence Avenue, Dept. W-1, Chicago 25, Ill.

MAIL COUPON NOW No Cost
No Obligation

Mr. C. H. Smith, President,
Industrial Training Institute, Dept. W-1
2150 Lawrence Avenue, Chicago 25, Illinois

Please send me a FREE COPY of "Your Opportunity in Refrigeration and Air Conditioning" by return mail.

Name _____
Address _____
City and Zone _____ State _____

(Continued from page 12)

FISH AND FISHING

Portable seat for fisherman utilizes old garden hose.....	172
Spare fishing tackle carried in hollow end of cane pole.....	180
Inexpensive live box made from hardware cloth.....	181
White fishing floats retouched with golf-ball lacquer.....	186
Take-apart fishline drier stored in small space.....	194
Modeling clay holds fishhooks on inside of tackle-box lid.....	200
Tallow-filled shotgun shell dries and waxes fishline.....	203

HOUSE AND HOME

Solving home problems.....	170
Extensions adapt washing machine for use at kitchen sink.....	185
Memo pad hung from kitchen wall is ideal for shopping lists.....	186
Breakfast set folds into wall.....	187
Nonslip grip for shampoo bottle made from rubber glove.....	192

NOVELTIES

Say "Come and get it" with this tiny dinner bell.....	169
Identify your home.....	173
Wheelbarrow flower box utilizes old nail keg and fence pickets.....	192
Vanity lamps turn on automatically.....	193
Picture molding frames wallpaper to form bed headboard.....	199

OFFICE, SHOP AND STORE

Paper is perforated quickly if scored on hardboard.....	168
Labels typed on cloth tape are handled easily.....	195
Sponge rubber cushions door when fastened to stop.....	195
Copper pipe and steel flange joined with novel silver-soldering method.....	208
Labels held in typewriter.....	208
Kinks quickly removed from baling wire.....	209
Spring-loaded bumper cushions impact of heavy shop door.....	209
Making cloth gloves last longer.....	209
Plastic strip provides naval-architect's spline.....	215
V-sander collects pencil dust.....	216
Metal stand holds watch in convenient position on desk.....	220

PAINT AND PAINTING

Shellac prevents stain bleeding.....	168
Paint sample carried safely in empty match book.....	168
Paint can carried up ladder should not be full.....	195

PHOTOGRAPHY

Reinforcing corners of backing protects photos for mailing.....	168
Notations in photograph album made with white shoe polish.....	185
Aluminum hood over view finder provides sunshade.....	204
Plastic "ice cubes" cool developer.....	204
Wafer-thin foot switch for photo enlarger.....	204

TOOLS

Saw doubles as disk sander.....	180
Auxiliary motor replaces countershaft.....	193
Rubber guard protects surface if screwdriver slips.....	199
Countersunk dead center for lathe tailstock aligns armature shaft to turn commutator.....	208
Moving of hollow grinder base facilitated by dumping out sand ballast.....	208
Carrying case from lunch box holds electric drill.....	216
Micrometer stop facilitates precision machining.....	219
Depth stop for lathe chuck adjusted while in spindle.....	220

TOYS AND OUTDOOR RECREATION

Sunglasses kept from dropping by ribbon tied to frames.....	168
Smooth-running scooter wheels.....	168
Effective insect repellent.....	172
Picnic cloth held to ground with clothespin anchors.....	180
Recipe for modeling clay.....	180
"Skip scotch" provides an entertaining beach pastime.....	181
Loss of outboard motor prevented by safety block on transom.....	186
Garden hose covers slide rails to protect children's hands.....	186
Reflectors soldered to wheels make scooter visible at night.....	194
Bicycle identification tag hidden inside handle bar.....	194

MISCELLANEOUS

Sealing leaks in rubber boots.....	172
Floating foundation bolts permit slight error.....	172
Copper strip prevents seepage between wall and footing.....	172
Box on bicycle luggage carrier handles parcels.....	192
Floor jack assembled from length of pipe and scrap parts.....	193
Nail polish colors spectacle frame.....	195
Mortar box made from oil drum ideal for small jobs.....	200
Small animals caught easily with rough wooden trap.....	200
Photo corners hold coins for mailing with letter.....	203
Paper around steampipes prevents cracks in plaster.....	203
Wooden tees facilitate grading small lot evenly.....	215
Dry storage for grass seed.....	216
Wedge locks nut on bolt.....	216
Electric-fan trouble shooting.....	218
Warning flag attached to ladder with rubber-hose sections.....	220

Radio-Television, Electronics

Newspapers through the air (Facsimile table-model receiver-recorder, Radio Inventions Inc., New York City 4; facsimile-transmitter console, General Electric Co., Syracuse, N. Y.; home-console facsimile receiver, General Electric Co., Syracuse, N. Y.; display facsimile receiver, Stewart-Warner Corp., 1826 Diversey Pkwy., Chicago 14).....	221
Personal headphone receiver and reading lamp.....	222
Radio and electronic hints for today (Console-type toy record player, General Electric Co., Syracuse, N. Y.; hearing-aid B-battery, Olin Industries Inc., New Haven, Conn.; miniature microphone, Altec Service Corp., 161 Sixth Ave., New York City 13; tool kit for radio servicemen, Vaco Products Co., 317 E. Ontario St., Chicago 11; electronic narrator, General Electric Co., Syracuse, N. Y.; teen-ager's radio hat, American Merri-Lei Corp., 918 Halsey St., Brooklyn 3, N. Y.; radio-phono combination that plays four types of records, Stewart-Warner Co., 1826 Diversey Pkwy., Chicago 14).....	224

IMPORTANT NOTICE—It is the intention of this magazine to provide its readers with information regarding the latest developments in the mechanical arts. We take no responsibility as to whether the disclosures contained in our articles are covered by patents and advise readers to investigate this subject before making, using, or selling any of the products, machines, or processes described in order to avoid possible liability for patent infringements.



INVENTORS



Learn how to protect your invention. The U. S. Patent Laws provide that any new and useful art, machine, article of manufacture, or composition of matter, or any new and useful improvement thereof, may be patented if the act of invention is involved. Therefore, every inventor with a valuable invention should take advantage of the Patent Laws and proceed for patent protection in order to safeguard his rights.

A patent gives the inventor the exclusive right to prevent others from making, using, or selling the invention claimed in the patent for a period of seventeen years.

The Patent Laws were enacted for the benefit of the inventor to give him protection for the features of his invention which are patentable. These features must be properly and concisely set forth and claimed in a formal application for patent, in order to comply with the requirements of the Patent Laws. For that reason, unless the inventor is familiar with patent matters, he should engage a competent registered patent attorney or agent to represent him. We are registered to practice before the U. S. Patent Office and are prepared to serve you in the handling of your patent matters.

A specially prepared booklet entitled "Patent Guide for the Inventor", containing detailed information with respect to patent protection and procedure, together with a "Record of Invention" form will be promptly forwarded to you without obligation upon request.

CLARENCE A. O'BRIEN & HARVEY JACOBSON

Registered Patent Attorneys

91-G DISTRICT NATIONAL BUILDING • WASHINGTON 5, D. C.

Patents
Trademarks
Copyrights

CLARENCE A. O'BRIEN & HARVEY JACOBSON
Registered Patent Attorneys

91-G District National Bldg., Washington 5, D.C.

Please send me copy of "Patent Guide for the Inventor" and also "Record of Invention" form. This request does not obligate me.

Name _____

Address _____

City _____ State _____

(Please write or print plainly.)

In Your Mind's Eye

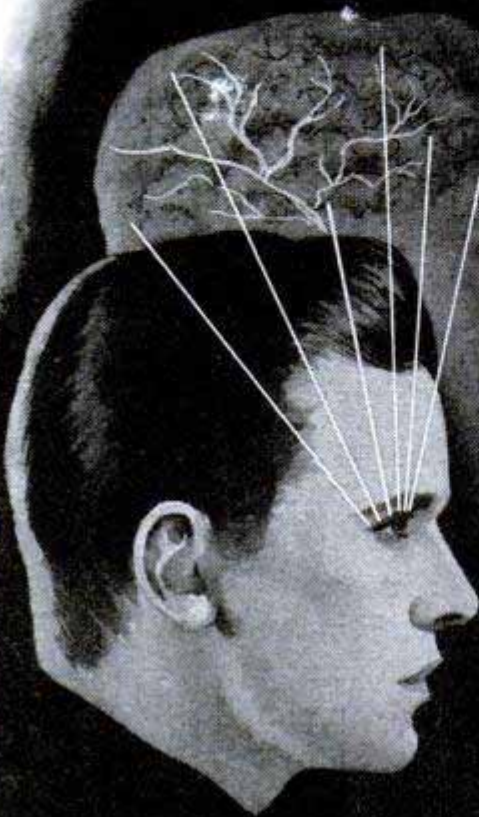

The Secret of MENTAL CREATING

IF you just like to dream, read no further. There comes a time when your fancies *must be* brought into light—and stand the test of every-day, hard realities. Are you one of the thousands—perhaps millions—whose thoughts never get beyond the stage of *wistful wishing*? Do you often come to from a daydream with the sigh, “If only I could bring it about—*make it real*?”

All things begin with thought—it is what follows that may take your life out of the class of those who hope and dream. Thought energy, like anything else, can be dissipated—or it can be made to produce actual effects. *If you know how to place your thoughts* you can stimulate the creative processes within your mind—through them you can assemble things and conditions of your world into a happy life of accomplishment. *Mental creating* does not depend upon a magical process. It consists of *knowing how* to marshal your thoughts into a power that draws, compels and organizes your experiences into a worth-while design of living.

ACCEPT THIS *Free* BOOK

Let the Rosicrucians tell you how you may accomplish these things. The Rosicrucians (not a religious organization), a world-wide philosophical fraternity, have preserved for centuries the ancients' masterful knowledge of the functioning of the inner mind of man. They have taught men and women how to use this knowledge to *recreate their lives*. They offer you a free copy of the fascinating book, “The Mastery of Life.” It tells how you may receive this information for study and use. Use coupon opposite.

The ROSICRUCIANS
(AMORC)

SAN JOSE

CALIFORNIA

SCRIBE: K. J. Z.
The Rosicrucians (AMORC),
San Jose, California.

Please send free copy of “The Mastery of Life,”
and I shall read it as directed.

Name.....

Address.....

City.....

INVENTORS

Patent laws encourage the development of inventions.

We recommend that an inventor employ a registered Patent Attorney or agent, if the inventor is not familiar with patent matters. This is because the value of a patent depends largely upon the skillful preparation of the specification and claims in the patent application.

The firm of McMorrow, Berman and Davidson is registered to practice before the United States Patent Office. Additionally it engages patent attorneys able to readily understand inventors' disclosures, to advise concerning patentability, and to prepare appropriate specifications and claims.

If an inventor believes he has an invention, a search of the most pertinent prior U. S. patents should be made and a report obtained relative to its patentability. Where such report indicates that the invention appears patentable, in order to secure protection, diligence should be exercised in making application for a patent.

Send for a copy of Patent Booklet entitled "How To Protect Your Invention." This booklet contains information on patent protection and procedure. You will also receive an "Invention Record" blank. This will be promptly forwarded to you upon request—no obligation.

McMORROW, BERMAN & DAVIDSON

Registered Patent Attorneys

PATENTS • TRADE MARKS • COPYRIGHTS

1352 VICTOR BUILDING, WASHINGTON 1, D. C.

McMORROW, BERMAN & DAVIDSON

Registered Patent Attorneys

1352 Victor Building, Washington 1, D. C.

Send me your Patent Booklet, "How To Protect Your Invention", and also "Invention Record" form at once. I understand this request does not obligate me.

Name.....

Address.....

City.....

(WRITE OR PRINT NAME CLEARLY)

HE Mailed This Coupon



CHARLES ATLAS
115 East 23rd St., New York 10, N. Y.
I want the proof that your system of "Dynamic Tension" will help make a "New Man" of me—gives me a healthy, husky body and big muscle development. Send me your free book, "Everlasting Health and Strength."
Name **THOMAS MANFRE**.....
(Please print plainly)
Address **875 E. 45 St.**.....
City **BROOKLYN**..... State **N.Y.**.....

...and Here's the Handsome Prize-Winning Body I Gave Him!

Thomas Manfre of New York mailed my coupon. Got my free book. Won my Atlas-Champion, Sterling Silver Cup. He says: "Look at me NOW! 'Dynamic Tension' WORKS! I'm proud of the natural, easy way you made me an 'Atlas Champion!'"

Let Me Prove I Can Make You a New Man!

Would you like greater development—a muscular body? Then listen: I was once a 97 lb. weakling. Afraid to fight, ashamed to be seen in a swimming suit. Then I discovered the secret that changed me into "World's Most Perfectly Developed Man." My secret is "Dynamic Tension." Its purpose is to give you powerful rippling muscles you like to see in your mirror. And for those with systems sluggish from lack of exercise—to help them tone up their entire body, inside and out.

Only 15 Minutes a Day

My method—"Dynamic Tension"—will turn the trick for you. No theory—every exercise is practical. And man, so easy! Spend only 15 minutes a day in your own home. From the very start, you'll be using my method of "Dynamic Tension" almost unconsciously every minute of the day—walking, bending over, etc.—to BUILD MUSCLE and VITALITY.

FREE BOOK "Everlasting Health and Strength"

In it I talk to you in straight-from-the-shoulder language. Packed with inspirational pictures of myself and pupils—fellows who became NEW MEN in strength, my way. Let me show you what I helped THEM do. See what I can do for YOU! For a real thrill, send for this book today. AT ONCE.

CHARLES ATLAS,
Dept. 8V, 115 E. 23rd St.,
New York City.

CHARLES ATLAS
Dept. 8V, 115 East 23rd St., New York, N. Y.

I want proof "Dynamic Tension" will help make me a New Man—with healthy, husky body, big muscle development. Send FREE book, "Everlasting Health and Strength" and details about Trial Offer.

Name _____ Age _____
(Please print or write plainly)

Address _____

City _____ State _____

SAY YOU SAW IT IN POPULAR MECHANICS

CHARLES ATLAS

An untouched photo of Charles Atlas, twice winner and holder of the title "The World's Most Perfectly Developed Man."

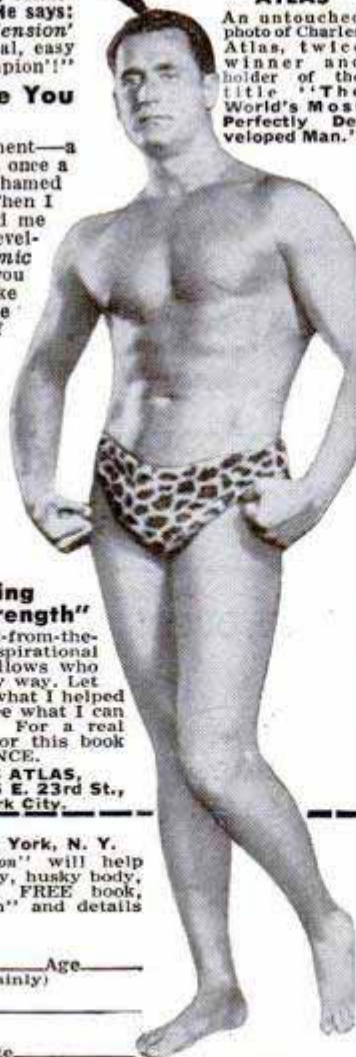

PRINT YOUR OWN POST CARDS

COMPLETE OUTFIT only \$7.50



Amazing results in sales, inquiries and contacts... saves time and money... very easy to use GEM STENCIL DUPLICATOR is ideal for Advertising, Announcements, Notices, Labels, Forms, Price Lists—hundreds of uses for every type of business and organization. Comes complete with all supplies, instructions and 60-page Book of Ideas.

FREE TRIAL OFFER: Try it before you buy it! Write and a GEM OUTFIT will be sent you postpaid. After 10 days, send only \$7.50 or return the GEM, no questions asked. The GEM must sell itself; you be the judge.

BOND EQUIPMENT CO. • Dept. 135
6633 Enright • St. Louis 5, Mo.

SEND NO MONEY • FREE TRIAL OFFER

WATCHMAKING

JEWELRY ENGRAVING AND REPAIR

Enter this high-paying, time-honored profession, or prepare for a business of your own. Watchmakers in great demand. More jobs than qualified workers. Study under expert instructors in a long-established, nationally recognized school. Receive recognized diploma and certificate. Placement service. Approved under G. I. Bill. Write for FREE booklet.



The Baronian School, Inc.

2116 WALNUT ST. (DEPT. C) PHILA. 3, PA.



COMPLETE COURSE IN AUTO BODY REPAIR

Do your own auto body and fender repairs, or learn high profit body repair business. Fully illustrated step by step procedure from damage analysis to metal finishing. For beginners or experts. Send for "The Key to Metal Bumping."

ONLY \$1

MANZEL, INC., 315 Babcock St., Buffalo 10, N. Y.

REAL ESTATE BE A BROKER

PAYS BIG! SEND FOR FREE, BIG, ILLUSTRATED CATALOG NOW! No obligation. Graduates report making substantial incomes. Start and run your own business quickly. Men, women of all ages, learn easily. Course covers Sales, Property Management, Appraising, Loans, Mortgages, and related subjects. **STUDY AT HOME** or in our classrooms in big cities. Diploma awarded. G.I. approved. Nationally known.

WEAVER SCHOOL OF REAL ESTATE (Est. 1936)
15 E. Pershing Road Dept. PM-7 Kansas City, Mo.

FREE BOOK TELLS HOW



LEARN Photo-Engraving

You can get into this big demand, high profit, high wage field. Learn at home or in our modern, friendly, approved school in Aurora where training costs you less than \$1.00 per hour with everything furnished.

Famous Tasope' photo-engraving plants are again available. You can start your own full or part time photo-engraving business right in your own home. With the Tasope' plant there is profit and fun for the whole family. Be independent, be your own boss or pave the way to a high pay job with experience gained in your own shop. Write to-day for details. No obligation.

The Aurora School of Photo-Engraving
Dept. P9M, Tasope' Bldg. Aurora, Missouri

VETERAN'S CHOICE

More than 400 I. C. S. Courses are available to Veterans entitled to benefits under the G. I. Bill of Rights.

Here's your chance to start a program of Personal Advancement—through training. You select your own course, study in your spare time, progress as fast as your ability and ambition permit.

Each I. C. S. Course is a gateway to a profitable, exciting field. Each is practical, easy to understand.

The time for action is **now**. Remember, Veteran Training is a limited offer. For most Veterans, July 25, 1951, is the deadline. The time to get started is now! Mark and mail the coupon today! It brings full details on how to enroll.

INTERNATIONAL CORRESPONDENCE SCHOOLS



BOX 5656-K, SCRANTON 9, PENNA.

Without cost or obligation, please send me full particulars about the course BEFORE which I have marked X:

- | | | | |
|----------------------------------------------------------------------------------------------------------------------------------------------------------------------------------------------------------------------------------------------------------------------------------------------------------------------------------------------------------------------------------------------------------------------------------------------------------------------------------------------------------------------------------------------------------------------------------------------------------------------------------------------------------------------------------------------------------------------------------------------------------------------------------------------------------------------------------------------------------------------------------------------------------------------------------------------------------------------------------------------------------------------------------------------------------------------------------------------------------------------------------------------------------------------------------------------------------------|----------------------------------------------------------------------------------------------------------------------------------------------------------------------------------------------------------------------------------------------------------------------------------------------------------------------------------------------------------------------------------------------------------------------------------------------------------------------------------------------------------------------------------------------------------------------------------------------------------------------------------------------------------------------------------------------------------------------------------------------------------------------------------------------------------------------------------------------------------------------------------------------------------------------------------------------------------------------------------------------------------------------------------------------------------------------------------------------------------------------------------------------------------------------------------------------------------------------------------------------------------------------------------------------------------------------------------------------------------------------------------------------------------------------------------------------------------------------------------------------------------------------------------------------------------------------------------------------------------------------------------------------------------------------------------------------------------------------------------------------------------------------------------------------------------------------------------------------------------------------------------------------------------------------------------------------------------------------------------------------------------------------------------------------------------------------------------------|-----------------------------------------------------------------------------------------------------------------------------------------------------------------------------------------------------------------------------------------------------------------------------------------------------------------------------------------------------------------------------------------------------------------------------------------------------------------------------------------------------------------------------------------------------------------------------------------------------------------------------------------------------------------------------------------------------------------------------------------------------------------------------------------------------------------------------------------------------------------------------------------------------------------------------------------------------------------------------------------------------------------------------------------------------------------------------------------------------------------------------------------------------------------------------------------------------------------------------------------------------------------------------------------------------------------------------------------------------------------------------------------------------------------------------------------------------------------------------------------------------------------------|-----------------------------------------------------------------------------------------------------------------------------------------------------------------------------------------------------------------------------------------------------------------------------------------------------------------------------------------------------------------------------------------------------------------------------------------------------------------------------------------------------------------------------------------------------------------------------------------------------------------------------------------------------------------------------------------------------------------------------------------------------------------------------------------------------------------------------------------------------------------------------------------------------------------------------------------------------------------------------------------------------------------------------------------------------------------------------------------------------------------------------------------------------------------------------------------------------------------------------------------------------------------------------------------------------------------------------------------------------------------------------------------------------------------------------------------------------------------------------------------------------------------------------------------------------------------------------------------------------------------------------------------------------------------------------------------------------------------------------------------------------------------------|
| <p>Business and Academic Courses</p> <ul style="list-style-type: none"> <input type="checkbox"/> Accounting <input type="checkbox"/> Bookkeeping <input type="checkbox"/> Business Administration <input type="checkbox"/> Business Correspondence <input type="checkbox"/> Certified Public Accounting <input type="checkbox"/> Commercial <input type="checkbox"/> Commercial Art <input type="checkbox"/> Cost Accounting <input type="checkbox"/> Federal Tax <input type="checkbox"/> First Year College <input type="checkbox"/> Foremanship <input type="checkbox"/> Good English <input type="checkbox"/> Higher Mathematics <input type="checkbox"/> Motor Traffic <input type="checkbox"/> Retailing <input type="checkbox"/> Salesmanship <input type="checkbox"/> Sign Lettering <input type="checkbox"/> Spanish <input type="checkbox"/> Traffic Management <input type="checkbox"/> Air Conditioning <input type="checkbox"/> Heating <input type="checkbox"/> Refrigeration | <p><input type="checkbox"/> Advertising</p> <p><input type="checkbox"/> French</p> <p><input type="checkbox"/> High School</p> <p><input type="checkbox"/> Postal Civil Service</p> <p><input type="checkbox"/> Retail Store Management</p> <p><input type="checkbox"/> Secretarial</p> <p><input type="checkbox"/> Stenography</p> <p><input type="checkbox"/> Plumbing</p> <p><input type="checkbox"/> Steam Fitting</p> <p>Chemistry Courses</p> <ul style="list-style-type: none"> <input type="checkbox"/> Chemical Engineering <input type="checkbox"/> Chemistry, Analytical <input type="checkbox"/> Chemistry, Industrial <input type="checkbox"/> Chemistry, Mfg. Iron & Steel <input type="checkbox"/> Petroleum Refining <input type="checkbox"/> Plastics <input type="checkbox"/> Pulp and Paper Making <p>Civil Engineering, Architectural and Mining Courses</p> <ul style="list-style-type: none"> <input type="checkbox"/> Architecture <input type="checkbox"/> Architectural Drafting <input type="checkbox"/> Building Estimating <input type="checkbox"/> Civil Engineering <input type="checkbox"/> Coal Mining <input type="checkbox"/> Contracting and Building <input type="checkbox"/> Highway Engineering <input type="checkbox"/> Lumber Dealer <input type="checkbox"/> Reading Structural Blueprints <input type="checkbox"/> Sanitary Engineering <input type="checkbox"/> Structural Drafting <input type="checkbox"/> Structural Engineering <input type="checkbox"/> Surveying and Mapping <p>Communications Courses</p> <ul style="list-style-type: none"> <input type="checkbox"/> Electronics <input type="checkbox"/> Practical Telephony <input type="checkbox"/> Radio, General <input type="checkbox"/> Radio Operating <input type="checkbox"/> Radio Servicing | <p><input type="checkbox"/> Telegraph Engineering</p> <p>Electrical Courses</p> <ul style="list-style-type: none"> <input type="checkbox"/> Electrical Drafting <input type="checkbox"/> Electrical Engineering <input type="checkbox"/> Electric Light and Power <input type="checkbox"/> Lighting Technician <input type="checkbox"/> Practical Electrician <input type="checkbox"/> Power House Electric <input type="checkbox"/> Ship Electrician <p>Internal Combustion Engines Courses</p> <ul style="list-style-type: none"> <input type="checkbox"/> Auto Technician <input type="checkbox"/> Diesel-Electric <input type="checkbox"/> Diesel Engines <input type="checkbox"/> Aviation <input type="checkbox"/> Gas Engines <p>Mechanical Courses</p> <ul style="list-style-type: none"> <input type="checkbox"/> Aeronautical Engineer's, Jr. <input type="checkbox"/> Aircraft Drafting <input type="checkbox"/> Forging <input type="checkbox"/> Heat Treatment of Metals <input type="checkbox"/> Industrial Engineering <input type="checkbox"/> Industrial Metallurgy <input type="checkbox"/> Machine Shop <input type="checkbox"/> Machine Shop Inspection <input type="checkbox"/> Mechanical Drafting <input type="checkbox"/> Mechanical Engineering | <p><input type="checkbox"/> Mold-Loft Work</p> <p><input type="checkbox"/> Patternmaking—Wood, Metal</p> <p><input type="checkbox"/> Reading Shop Blueprints</p> <p><input type="checkbox"/> Sheet-Metal Drafting</p> <p><input type="checkbox"/> Sheet-Metal Worker</p> <p><input type="checkbox"/> Ship Drafting</p> <p><input type="checkbox"/> Tool Designing</p> <p><input type="checkbox"/> Welding Engineering</p> <p><input type="checkbox"/> Welding—Gas and Electric</p> <p>Railroad Courses</p> <ul style="list-style-type: none"> <input type="checkbox"/> Air Brake <input type="checkbox"/> Diesel Locomotive <input type="checkbox"/> Locomotive Engineer <input type="checkbox"/> Locomotive Fireman <input type="checkbox"/> Locomotive Machinist <input type="checkbox"/> Railroad Section Foreman <p>Steam Engineering Courses</p> <ul style="list-style-type: none"> <input type="checkbox"/> Boilermaking <input type="checkbox"/> Combustion Engineering <input type="checkbox"/> Engine Running <input type="checkbox"/> Marine Engineering <input type="checkbox"/> Steam Electric <input type="checkbox"/> Steam Engineer <p>Textile Courses</p> <ul style="list-style-type: none"> <input type="checkbox"/> Cotton Manufacturing <input type="checkbox"/> Loom Fixing <input type="checkbox"/> Rayon Weaving <input type="checkbox"/> Textile Designing <input type="checkbox"/> Woolen Manufacturing <p><input type="checkbox"/> Ship Fitting</p> <p><input type="checkbox"/> Toolmaking</p> <p><input type="checkbox"/> Car Inspector</p> |
|----------------------------------------------------------------------------------------------------------------------------------------------------------------------------------------------------------------------------------------------------------------------------------------------------------------------------------------------------------------------------------------------------------------------------------------------------------------------------------------------------------------------------------------------------------------------------------------------------------------------------------------------------------------------------------------------------------------------------------------------------------------------------------------------------------------------------------------------------------------------------------------------------------------------------------------------------------------------------------------------------------------------------------------------------------------------------------------------------------------------------------------------------------------------------------------------------------------|----------------------------------------------------------------------------------------------------------------------------------------------------------------------------------------------------------------------------------------------------------------------------------------------------------------------------------------------------------------------------------------------------------------------------------------------------------------------------------------------------------------------------------------------------------------------------------------------------------------------------------------------------------------------------------------------------------------------------------------------------------------------------------------------------------------------------------------------------------------------------------------------------------------------------------------------------------------------------------------------------------------------------------------------------------------------------------------------------------------------------------------------------------------------------------------------------------------------------------------------------------------------------------------------------------------------------------------------------------------------------------------------------------------------------------------------------------------------------------------------------------------------------------------------------------------------------------------------------------------------------------------------------------------------------------------------------------------------------------------------------------------------------------------------------------------------------------------------------------------------------------------------------------------------------------------------------------------------------------------------------------------------------------------------------------------------------------------|-----------------------------------------------------------------------------------------------------------------------------------------------------------------------------------------------------------------------------------------------------------------------------------------------------------------------------------------------------------------------------------------------------------------------------------------------------------------------------------------------------------------------------------------------------------------------------------------------------------------------------------------------------------------------------------------------------------------------------------------------------------------------------------------------------------------------------------------------------------------------------------------------------------------------------------------------------------------------------------------------------------------------------------------------------------------------------------------------------------------------------------------------------------------------------------------------------------------------------------------------------------------------------------------------------------------------------------------------------------------------------------------------------------------------------------------------------------------------------------------------------------------------|-----------------------------------------------------------------------------------------------------------------------------------------------------------------------------------------------------------------------------------------------------------------------------------------------------------------------------------------------------------------------------------------------------------------------------------------------------------------------------------------------------------------------------------------------------------------------------------------------------------------------------------------------------------------------------------------------------------------------------------------------------------------------------------------------------------------------------------------------------------------------------------------------------------------------------------------------------------------------------------------------------------------------------------------------------------------------------------------------------------------------------------------------------------------------------------------------------------------------------------------------------------------------------------------------------------------------------------------------------------------------------------------------------------------------------------------------------------------------------------------------------------------------------------------------------------------------------------------------------------------------------------------------------------------------------------------------------------------------------------------------------------------------|

Name _____ Age _____ Home Address _____

City _____ State _____ Working Hours _____ A.M. to _____ P.M.

Present Position _____ Employed by _____

Length of Service in World War II _____ Enrollment under G.I. Bill and P.L. 16 approved for World War II Veterans. Special tuition rates to members of the Armed Forces. Canadian residents send coupon to International Correspondence Schools Canadian, Ltd., Montreal, Canada.

INVENTORS

A patent is a valuable right. On the basis of a provision in the Constitution of the United States, Congress has established a system under which inventors may secure the exclusive right to prevent the unauthorized use, manufacture and sale of their inventions for periods of seventeen years. The inventor secures this protection for his invention by obtaining a patent.

This firm is registered to practice before the U. S. Patent Office and is available to assist inventors in the preparation and prosecution of their cases. Detailed information and the steps to take to obtain patent protection will be furnished upon request.

Form below for mailing convenience

VICTOR J. EVANS & Co. *Merlin M. Evans*
REGISTERED PATENT ATTORNEY
430-H MERLIN BUILDING, WASHINGTON 6, D. C.

• • • • •

VICTOR J. EVANS & CO.
430-H Merlin Building, Washington 6, D. C.

Please send me without obligation a copy of your booklet "Patent Protection For Inventors" together with your convenient "Evidence of Invention" form.

Name.....

Address.....

City and State.....

• • • • •

PATENTS TRADEMARKS COPYRIGHTS
SAY YOU SAW IT IN POPULAR MECHANICS

STUDY AT HOME

With An Educational Institution

Men with specialized training win higher positions, insure larger earnings, and are bigger successes in business and public life. Opportunities NOW greater than ever before. Send for our Catalog.

ARTS and SCIENCES

Courses in Philosophy; Education; Letters; Public Health; Medical Jurisprudence; Psychology; Sociology; Physics; Chemistry; Plastics; Geology; Political Science; Theology; Business and Commerce; Accounting; Mathematics; Statistics; Agriculture.

ENGINEERING

Courses in Electrical, Civil Mechanical, Drafting, Architectural, Steam, Aeronautical, Radio, Structural, Mining, Industrial, Petroleum, Marine, Chemical, Diesel, Automobile, Refrigeration, and Air Conditioning Engineering.

LAW

Complete Professional Law Course includes 18 Hornbook Series college grade textbooks. Courses also in Commercial Law, Patent Law and Medical Jurisprudence.

McKinley-Roosevelt Incorporated, 4610-K, Sheridan Rd., Chicago 40, Ill.

TRI-STATE COLLEGE

B. S. DEGREE IN 27 MONTHS

66th Year.

Students from all over the world.

ENGINEERING—Courses in Civil, Electrical, Mechanical, Chemical, Aeronautical and Radio (including Television). Also Bus. Admin., Acc't. and Sec. Science. Low living costs. Modern cafeteria on campus. Graduates in demand. Enter Sept., Jan., March, June. Write for Catalog, 479 College Avenue, Angola, Indiana.

READ Job-O-Grams BEFORE

you spend time and money on a training program

JOB-O-GRAMS will tell you

- What you will have to do
- What the qualifications are
- How much you can earn
- About training
- About getting a job
- About the future of the job

DO YOU WANT TO BE A

- ___ Mechanical Engineer
- ___ Restaurant Owner or Manager
- ___ Public Relations Director
- ___ Executive
- ___ Medical Secretary
- ___ Radio-Electronics Technician
- ___ Accountant
- ___ Building Superintendent
- ___ Casualty & Surety Insurance Agent

Send for your Job-O-Grams today. 25c each (No stamps).

JOB-O-GRAMS, Dept. B

287 EAST GUNHILL ROAD NEW YORK 67, N. Y.

STRENGTHEN Your VOICE!

YES—you can now build yourself a powerful speaking and singing voice with this amazing new scientifically sound tested method. Self-training... no music or piano required. Results GUARANTEED. Just send your name for the sensational details. FREE chart of your vocal mechanism included! PERFECT VOICE STUDIOS, Studio G-2, 1141 S. Wabash Ave., Chicago 5, Ill.

COMMERCIAL TRADES'

GRADUATES GET THE BETTER JOBS

PRACTICAL SHOP TRAINING IN
AIR CONDITIONING — REFRIGERATION
ELECTRICITY MAJOR APPLIANCES
SERVICE, MAINTENANCE & INSTALLATION

Write for Catalog PM4

COMMERCIAL TRADES INSTITUTE

200 SOUTH 20TH ST. BIRMINGHAM, ALA.

Member: Southern Association of Private Trade Schools
An approved school to TRAIN Veterans & Non-Veterans

SAVE UP TO 50% AND MORE—GENUINE DIAMONDS

Send today for

All diamonds reset in new mountings

FREE



CATALOG

Reference: Your Own Bank or Any Mercantile Agency

BERMAN'S DIAMOND LOAN BANK

Dept. P
Berman Bldg., Balto. 1, Md.

OUT OF PAWN

GENUINE DIAMONDS \$10 to \$10,000

BERMAN'S
Illustrated Catalog

Diamonds from estates, banks, unredeemed pledges offered at substantial savings
Sold with iron clad money-back guarantee

Choose one of these **2 GREAT FIELDS**
 — Get Ready **QUICK** at **COYNE!**

ELECTRICITY OR **RADIO TELEVISION**



This big fire-proof building is occupied entirely by Coyne.

Prepare for Success Quickly... in the

GREAT SHOPS OF COYNE

Conditions today are different. Many "one-operation" jobs that pay well will not last. Plan for steady pay and advancement by training NOW. Come to the great shops of COYNE in Chicago, for "all-around" training in Electricity or Radio-Television—the 2 great opportunity fields.

NOT "HOME-STUDY" COURSES

Our famous "Learn-by-Doing" method gives you practical experience on a massive outlay of equipment. Not by correspondence, but actual shop work plus necessary theory. You are trained right here in the great Coyne shops that has been training men and young men for over 50 years.

ELECTRICITY RADIO-TELEVISION SERVICE

INCLUDING INDUSTRIAL ELECTRONICS

Big future in Power Plant Work, Motors, Armature Winding, Home and Factory Wiring, Appliances, Refrigeration, Maintenance, Illumination, etc. Electricians are in demand everywhere—lifetime job service to Coyne graduates. Send for **BIG FREE BOOK**.

A great field now, even greater growth ahead. Here at COYNE you're trained for Construction, Testing, Troubleshooting on Radio, Public Address, Sound Picture Units. Training includes FM, Television Servicing, etc. Our training is quick, easy, practical. Many Coyne trained men own well-paying radio businesses of their own.

LARGEST, OLDEST, BEST EQUIPPED SCHOOL OF ITS KIND IN THE U.S.

Pick Field You Like

—Mail Coupon for **Big FREE Book**



Whether you prefer Electricity, or Radio, train on actual equipment, at Coyne. We have a big, fully illustrated book on each course, and we'll send you the one you want, without obligation. Mail coupon — TODAY.



ELECTRIC REFRIGERATION COYNE

Added training in Electrical Refrigeration can now be included.

G. I. APPROVED

NON-VETERANS who are short of cash can finance most of their tuition and pay in easy monthly payments after graduation. Many earn while learning.

B. W. COOKE, President



COYNE ELECTRICAL AND RADIO SCHOOL

500 South Paulina Street, Dept. B9-72H, CHICAGO 12, ILLINOIS

B. W. COOKE, President
 COYNE ELECTRICAL AND RADIO SCHOOL
 500 S. Paulina St., Dept. B9-72H, Chicago 12, Ill.

Send me your **BIG FREE BOOK**—for the course checked below. This does not obligate me and no salesman will call.

ELECTRICITY RADIO—TELEVISION

NAME.....

ADDRESS.....

CITY.....STATE.....

BE A **WINNER** AT ANYTHING YOU TACKLE WITH **PROGRESSIVE POWER**

Now **ALL 5 FAMOUS JOWETT COURSES** in 1 Volume for only **25¢**

DARLING, THAT BULLY WON'T PICK ON YOU AGAIN.

WHAM!

JOE YOUR NEW ENERGY AND APPEARANCE SURE DO A GOOD JOB! YOU EARNED YOUR PROMOTION.



George F. Jowett
Whom experts call "Champion of Champions"

- World's wrestling and weight lifting champ at 17 and 19.
- World's Strongest Arms.
- 4 times World's Perfect Body — plus other records.

10 DAY TRIAL!
Think of it—all five of these famous courses now in one picture-packed muscle-building volume for only 25¢. If you don't actually FEEL results within ONE WEEK, send it back and your money will be promptly refunded! Photo Book Of Famous Strong Men!

FREE!



Photos that inspire you to might and muscle. Free with order.

Let's Go, Pal! I'll prove I can make YOU an "ALL-AROUND" HE-MAN

FAST — OR NO COST!
says George F. Jowett
World's Greatest Body Builder

Enjoy My "Progressive Power" Strength Secrets! Give Me 10 Easy Minutes a Day — Without Strain! I'll teach you the "Progressive Power Method" through which I rebuilt myself from a physical wreck the doctors condemned to die at 15, to the holder of more strength records than any other living athlete or teacher! "Progressive Power" has proven its ability to build the strongest, handsomest men in the world. And I stand ready to show you on a money back basis—that no matter how flabby or puny you are I can do the same for you right in your own home. Let me prove I can add inches to your arms, broaden your shoulders, give you a man-sized chest, powerful legs and a Rock-like back—in fact, power pack your whole body so quickly it will amaze you! Yes, I'll join you with power and confidence to master any situation—to win popularity—and to get ahead on the job! Through my proven secrets I bring to life new power in you inside and out, until YOU are fully satisfied you are the man you want to be.

PROVE IT TO YOURSELF IN ONE NIGHT.
Send only 25¢ for my 5 easy-to-follow, picture-packed courses now in 1 complete volume "How to Become a Muscular He-Man." Try it for one night! Experience the thrilling strength that surges through your muscles.

I am making a drive for thousands of new friends fast—REGARDLESS OF COST!

SO GET NOW MY 5 Muscle Building COURSES
(Valued at 55¢ each)
All in 1 Great Complete Volume Packed With How-To-Do-It Pictures!

Now, this "get-acquainted," extremely low price of only 25¢ is your chance to build a body you'll be proud of! Follow Jowett's easy method of muscle building NOW!

For only 25¢



FREE GIFT COUPON!

Jowett Institute of Physical Culture DEPT. PM-97
230 Fifth Avenue, New York 1, N. Y.

Dear George: — Please send by return mail, pre-paid, **FREE** Jowett's Photo Book of Strong Men, along with all 5 Muscle Building Courses. 1. Molding a Mighty Chest. 2. Molding a Mighty Arm. 3. Molding a Mighty Grip. 4. Molding a Mighty Back. 5. Molding Mighty Legs—Now all in One Volume "How to Become a Muscular He-Man." Enclosed find 25¢. NO C.O.D.'S.

NAME _____ AGE _____
(Please Print Plainly, Include Zone Number)

ADDRESS _____

AVIATION

Aeronautical University Approved Training meets exacting standards of aviation industry, prepares for key positions, big opportunities.

Courses in:
AERONAUTICAL ENGINEERING, B.S. degree.
AERONAUTICAL ENGINEERING DRAFTING
CERTIFIED AIRPLANE AND ENGINE MECHANICS ADMINISTRATION—including sales.
PRE-ENGINEERING: Special course for high school graduates and veterans needing math and science.
 Also refresher courses for Gov't Airplane and Engine Mechanics Licenses for those with aviation experience.
 Oldest fully approved aviation school. Outstanding faculty, modern equipment, outside employment, placement service. Day, evening. Approved for Veterans. Send for **FREE** catalog Opportunities in Aviation. 20th anniversary.

AERONAUTICAL UNIVERSITY
 Dept. 79, 116 S. Michigan Ave., Chicago 3, Ill.



SUCCEED IN THE POULTRY BUSINESS!



Poultry is providing many trained men and women with a good, comfortable living, either part or full time. For 28 years our Home Study Course has been helping thousands obtain training and "know how" that means extra income from the start. Don't delay — Write today for prospectus describing courses, methods, service, opportunities.

NATIONAL POULTRY INSTITUTE
 DEPT. 50 ADAMS CENTER, N. Y.

DIESEL TRAINING

Get set NOW for steady, big-pay jobs in Diesel, Tractor and Heavy Equipment. Interstate's practical home training gives you the "know-how" for success and security. Investigate!

SEND POST CARD FOR FREE INFORMATION

INTERSTATE TRAINING SERVICE
 Dept. 3-G 4035 N.E. SANDY BLVD., PORTLAND 13, OREGON

Learn PHOTOGRAPHY

Win success in photography by spare time Home Study or at our famous Resident School in the heart of New York. Commercial, Advertising, Portrait, Color, etc. 39th year. Write today!

NEW YORK INSTITUTE OF PHOTOGRAPHY
 Dept. "49", 10 W. 33 St., New York 1, N. Y.

CARTOONING

HAVE FUN! MAKE MONEY! Cash in on your sense of humor AT HOME—BY MAIL. No experience needed to start. Write today for **FREE TRIAL LESSON** and full particulars.

MOON Gag Cartoon School, Dept. D, Fall Creek, Wis.

FIND OUT FREE—HAVE YOU GOT WHAT IT TAKES...

to be a **FINGER PRINT EXPERT** or **TRAINED INVESTIGATOR?**

Send for **free** IAS Qualification Questionnaire. If in our opinion your answers indicate that you "have what it takes," then you will receive **absolutely free** the famous "Blue Book of Crime" . . . plus full details on how to train at home in Crime Detection and Finger Printing! IAS graduates are key men in over 800 Police Bureaus. See if YOU can train for this exciting, steady, "good pay" work! No obligation. No salesman will call. Write today, stating age.

INSTITUTE OF APPLIED SCIENCE
 1920 Sunnyside Ave., Dept. 135-B, Chicago 40, Ill.



WHICH OF THESE *Opportunities* INTERESTS *You* MOST?

● Today, choose the job you want—and prepare for it. Or if you are already engaged in the work you like best, start training now for quicker promotion. Acquire the knowledge that will help you to get ahead faster, make more money and have greater security.

American School, founded in 1897 as an educational institution not for profit, can help you to reach your goal just as it has helped others during the past fifty-two years. Check the coupon at right, add your name and address and mail it at once. The school will send you details on its training plan and outline of study prepared by specialists. There is no charge, no obligation, so send the coupon immediately.

CHECK, CLIP AND MAIL COUPON NOW

AMERICAN SCHOOL, Dept. GB45, Drexel at 58th, Chicago 37, Ill.

Without obligation, Please send FREE and postpaid, bulletin and details of the Subjects checked:

- | | | |
|----------------------------------------------------|-------------------------------------------------------|----------------------------------------------------------------|
| <input type="checkbox"/> PLASTICS ENGR | <input type="checkbox"/> Accounting | <input type="checkbox"/> Drafting and Design for Men and Women |
| <input type="checkbox"/> Refrigeration | <input type="checkbox"/> Electrical Engr. | <input type="checkbox"/> Radio |
| <input type="checkbox"/> Architecture and Building | <input type="checkbox"/> Electricity-Pract. | <input type="checkbox"/> High School |
| <input type="checkbox"/> Contracting | <input type="checkbox"/> Electronics, Industrial | <input type="checkbox"/> Air Conditioning |
| <input type="checkbox"/> Practical Plumbing | <input type="checkbox"/> Bookkeeping | <input type="checkbox"/> Mechanical Eng. |
| <input type="checkbox"/> Automotive Engr. | <input type="checkbox"/> Private Secretary | <input type="checkbox"/> Shop Management |
| <input type="checkbox"/> Aviation Drafting | <input type="checkbox"/> Diesel Engineering | <input type="checkbox"/> Tool Making |
| <input type="checkbox"/> Aviation | <input type="checkbox"/> Sheet Metal Pattern Drafting | <input type="checkbox"/> Better Foremanship |
| <input type="checkbox"/> Business Management | <input type="checkbox"/> Railway Training | <input type="checkbox"/> Machine Shop Operations |

Name _____ Occupation _____

Address _____ Age _____

City _____ State _____

AMERICAN SCHOOL

Dept. GB45, Drexel at 58th Street, Chicago 37



Earn Big PROFITS with ARC WELDING

Your Own Shop can earn \$350.00, \$500.00 monthly

It's easy. Let Hobart help you build a profitable business quickly. Experience not required as welding skill is built in the machine.

New Booklet, "How to Start a Welding Business," tells full story. Send 10c for postage.

HOBART Brothers Co., Box M-79, Troy, Ohio

HOBART "One of the world's largest builders of arc welders"

Build Your Own arc welder with this generator and Save \$300.00 to \$500.00



BLISS Electrical Training

Intensive 32 weeks' residence course in fundamentals of industrial electrical engineering, including radio and electronics. Extensive laboratory, shop work, drafting. Prepares for electrical technician and engineering aides

in communications, power, manufacturing, business machines, sales, service. G.I. approved. 56th year. Enter Sept. 6, Jan. 9. Catalog. 7636 TAKOMA AVENUE, WASHINGTON 12, D. C. 

DRAW for MONEY... Be an ARTIST!

Trained Artists are Capable of Earning \$65, \$80 and MORE a WEEK!

YOU CAN learn to draw at home in your spare time the well-known WSA way, COMMERCIAL ART, DESIGNING, CARTOONING all in ONE complete course. No previous Art experience necessary—we teach you step-by-step. Prepare for a fascinating hobby or profitable career. For 35 years WSA graduates have been making good—WHY NOT YOU?



VETERANS! WSA Approved for Training Under G. I. Bill. Write for FREE BOOK, "Art for Pleasure and Profit," fully describes course, our method of instruction and commercial opportunities for you. TWO ART OUTFITS included with training.

MAIL COUPON TODAY FOR DETAILS.

Washington School of Art, Studio #127R
1115—15th St., N.W., Washington 5, D. C.

Please send me full information and your Free Book, "Art for Pleasure and Profit."

Name _____ Age _____

Street _____

City _____ Zone _____ State _____

I am entitled to training under "G.I." Bill

Learn JEWELRY MAKING WATCHMAKING ENGRAVING

TRADES WITH
GREATER SECURITY—
HIGHER EARNINGS



Earn MORE All of Your Life

Increasing Demand for Trained Men and Women. No Age Limit. Learn Thoroughly—Quickly by KCSW's Special Application Method. Day and Evening Classes. Write for free Catalog. Approved for Veteran Training.

KANSAS CITY SCHOOL OF WATCHMAKING

1218 Admiral Blvd.

Kansas City 6, Mo.

Learn A Trade NOW! PRACTICAL SHOP TRAINING!

In Our Chicago Shops

- | | |
|-------------------------------------------|----------------------------------------------|
| <input type="checkbox"/> AUTO MECHANICS | <input type="checkbox"/> WELDING—ARC and GAS |
| <input type="checkbox"/> DIESEL MECHANICS | <input type="checkbox"/> MACHINIST |
| <input type="checkbox"/> REFRIGERATION | <input type="checkbox"/> PIANO TUNING |
| <input type="checkbox"/> BODY-FENDER | |

Above Approved For G. I.'s and Civilians
One of America's Leading Practical Schools
7 Floors of Fully Equipped Shops
Over 48,000 Successful Graduates
Expert Individual Instruction
Learn by Doing—Low Living Expense
Established 1902—Day and Evening Classes

Also the following Home Study Courses

- | | | |
|----------------------------------|----------------------------------------|---------------------------------|
| <input type="checkbox"/> PLASTIC | <input type="checkbox"/> REFRIGERATION | <input type="checkbox"/> DIESEL |
|----------------------------------|----------------------------------------|---------------------------------|

—CALL IN PERSON OR MAIL THIS AD TO—

GREER SHOP TRAINING

(Desk 10) 460 South State St., Chicago 5, Ill.

Please send without obligation free information regarding trade checked above. (Specify whether you are a Veteran or Civilian)

Name _____ Age _____
Address _____
City _____ State _____

Famous BAILEY TECHNICAL SCHOOLS

OFFER THE FOLLOWING COURSES:

- COMMERCIAL ELECTRICITY
- PRACTICAL DIESEL ENGINEERING

Your future success depends largely on the reputation of the school you attend. Don't take chances! Train at America's foremost school of mechanical specialization. Bailey is recognized and approved by industry. Bailey graduates get the top pay jobs! Send for FREE Catalog. State name of course in which you are interested. G. I. Approved.

BAILEY TECHNICAL SCHOOLS

1655 So. Grand Blvd., St. Louis, Mo.

SHORTHAND in 6 Weeks at Home

Famous Speedwriting system. No signs; no symbols; no machines; uses ABC's. Easy to learn; easy to write and transcribe. Low cost. 100,000 taught by mail. For business and Civil Service. Also typing. 26th year. Write for free booklet to:

Speedwriting
Dept. 1507-9, 55 W. 42 St., New York 18

LEARN TO WRITE

a Good Hand!

FOR BUSINESS AND SOCIAL SUCCESS!

Easy to improve your handwriting at home quickly with my new instruction books just off the press. Master all the secrets of better penmanship. Simple and easy, fully illustrated, highly endorsed. Begin today. Write for: New Free Book, "How to Become a Good Penman," or check books wanted, \$1.00 each. Business Writing Artistic Writing Card Writing Engrossing Alphabets Bird and Design Flourishing Complete Set \$4.50 Enclose 10c for your name beautifully written and special penpoint for shaded writing.
S. A. Ziller, President, TAMBLYN SCHOOL OF PENMANSHIP
441 Ridge Bldg. In Business Over 52 Years Kansas City, Mo., U.S.A.



RAISE HAMSTERS

The new wonder animals from Syria. Often called Toy Bears. Delightful pets. Everyone wants them. Laboratories need thousands. Clean, odorless. Raise anywhere. A profitable and interesting hobby or business. We furnish breeding stock with manual of instructions.

Write today for free illustrated literature.

GULFHAMSTERY, 1536 BASIL, MOBILE, ALA.

APTITUDE TESTS

discover the kind of work or studies best for your success! You get a personal report—a guide for life—more happiness—more prosperity. For men, women, boys and girls. Write for complete facts.
VOCATIONAL COUNSELING INSTITUTE
956 Maccabees Bldg., Detroit 2, Michigan

Be an INVESTIGATOR

JAMES S. BOLAN, FORMER POLICE COMMISSIONER OF NEW YORK CITY offers MEN & WOMEN an attractive opportunity to prepare for a future in Investigation & Criminology by comprehensive Home Study Course. Free placement service assists graduates to obtain jobs. APPROVED UNDER G. I. BILL OF RIGHTS.

Write for Free Booklet PM.

THE **BOLAN ACADEMY**, INC.
EMPIRE STATE BLDG., NEW YORK 1, N. Y.



TELEVISION WILL BE THERE..WILL YOU?

TELEVISION

RADIO • ELECTRONICS
OUR GREATEST OFFER IN 17 YEARS
• BULLETIN!

Fires, Sporting Events, Major happenings and other news events are being covered by Television Camera Crews in a growing number of areas. Let us show you how to prepare to enter the profitable and exciting technical phases of Television, Radio, Electronics. Mail coupon. Get Free information about our greatest offer in 17 years.

Send for FREE Information

See HOW—in your own home—DeForest's Training, Inc., now brings you one of today's most complete combinations of major home training aids. You (1) Learn-by-Seeing from D.T.I.'s exclusive instructive Home Movies.

You (2) Learn-by-Reading from well-illustrated lessons. And (3), you set up your own HOME LABORATORY where you Learn-by-Doing from 16 shipments of Radio-Electronic parts which you use and KEEP to work over 300 instructive...fascinating projects.

This includes building the valuable 6 tube "Superhet" RADIO and commercial-type OSCILLO-SCOPE, R-F SIGNAL GENERATOR, and Jewel-Bearing MULTIMETER, pictured at right. You may use this test equipment to help you earn real money—both in your spare time and later when working full time in the field either in a good job or your own business. Get complete facts. Mail coupon today!



EMPLOYMENT SERVICE

When you complete your training, our effective Employment Service is available to you without extra cost—a valuable aid to help you get started.

MODERN CHICAGO LABORATORIES

If you prefer, you can get ALL your preparation in our new Chicago training laboratories—among the finest of their kind. Train quickly, using a wide variety of commercial equipment... ample instructors... every major training advantage. Write for details. (The Chicago Laboratory Program is available to qualified veterans under the G.I. Law.)

You also use HOME MOVIES!

..a D. T. I. Exclusive!... D. T. I., alone, includes the use of one of today's most effective training aids...MOVIES...to help you learn important fundamentals faster, easier at home. See electrons on the march, and other fascinating "hidden action"—a remarkable home training advantage that speeds your progress.



6-TUBE RECEIVER

YOU BUILD AND KEEP THIS EQUIPMENT TO WORK OVER 300 HOME EXPERIMENTS.

MAIL THIS OPPORTUNITY COUPON NOW!

DeForest's Training, Inc.
 2533 N. Ashland Ave., Dept. PM-F7
 Chicago 14, Illinois

Please give me complete facts showing how I may prepare to make my start in Television-Radio-Electronics.

Name _____ Age _____
 Street _____ Apt. _____
 City _____ Zone _____ State _____

DeFOREST'S TRAINING, INC.
 CHICAGO 14, ILLINOIS

Affiliated with the DeVry Corporation. Builders of Electronic and Movie Equipment

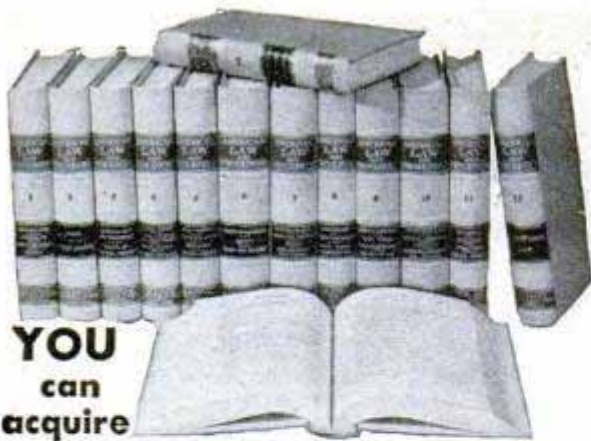

YOU
can
acquire

LAW NIGHTS AT HOME! L. B. DEGREE

LaSalle's famous Law Library—used as reference in many Law libraries and Law offices—has enabled thousands to master Law surprisingly fast, in spare hours at home, for business and professional advancement.

These 14 remarkable volumes, compiled by leading professors and lawyers, cover the whole basic field of Law in condensed, orderly, simplified manner.

You advance rapidly with this great library, plus special lectures furnished. We guide you step-by-step with personalized Problem Method of instruction . . . you learn by doing—handling legal problems—not by memorizing rules.

Send for two FREE 48-page booklets, "Law Training for Leadership," and "Evidence," answering questions about Law and its value to you, and telling how LaSalle Law graduates are winning rapid advancement in business and public life. Mail coupon below. No obligation.

LA SALLE EXTENSION UNIVERSITY

A Correspondence Institution

417 S. Dearborn St. Dept. 764-L Chicago 5, ILL.

Send me your two FREE booklets described above, without obligation.

Name.....Age.....

Street.....

City, Zone & State.....

ENGINEERING DEGREE IN 27 MONTHS

Big Demand for Graduates

Aeronautical, Chemical, Civil, Electrical, Mechanical and Radio Engineering (including Television)

Hundreds of young men are earning engineering degrees in this recognized institution each year—continuous operation. New terms start quarterly. Many students earn a major part of their college expenses in this large industrial center.

Low tuition. Competent instruction. Thorough intense practical program. Modern laboratory facilities including new physics lab. and modernized wind tunnel. Individualized instruction emphasized.

Approved for Veterans. Engineering preparatory courses. Students from 48 states and 21 foreign countries. Enter September, December, March or June. Send coupon for free catalog and full information. Enroll now.

INDIANA TECHNICAL COLLEGE

579 E. Washington Boulevard
Fort Wayne 2, Indiana

Please send me free information on B.S. Engineering Degree in 27 months as checked.

Aeronautical, Chemical, Civil, Electrical,
 Mechanical, Radio-Television.

Name.....

Address.....

Career Training in a Minimum of Time RADIO—ELECTRONICS TELEVISION ENGINEERING

GRADUATES of CREI residence school are preferred by industry because of their training and ability. CREI prepares the young man for a good job in industry in a minimum of time. 22 years practical experience. CREI offers an outstanding faculty, modern laboratories, shops and equipment. New students accepted twice monthly and each may advance as rapidly as he is capable. Basic course with one specialized course requires an average of 20 months to complete.

Approved for Veteran's Training.

• Write for Details and Free Catalog

CAPITOL RADIO

ENGINEERING INSTITUTE

Dept. 177A, 15th & Park Rd. N.W.
Washington 10, D.C.



Look-BIG MONEY is Yours!



Take this easy step to extra cash. Everybody who sees our smart Personal Yuletide Greetings at 50¢ for \$1 buys. Big profit on every sale! Other Name-Imprinted items including Personal Stationery, Decorated Napkins, Floral Notes. Money-making samples sent FREE. Also show LEADER Christmas Assortment. 21 lovely Greeting Cards sell for \$1. Up to 50¢ CASH on every box is yours! 28 other Christmas and Everyday Assortments retail at 60¢ to \$1.25. LEADER Assortment on approval plus FREE Imprinted Samples. Write NOW! FRIENDSHIP STUDIOS, INC. 566 ADAMS STREET, ELMIRA, N. Y.

LEARN WATCH REPAIRING



AT HOME. By our modern and original system of instruction you can learn every part of the **WATCH REPAIRING TRADE AT HOME.** Prepare yourself for a well-paying position or start in business after completing our course of instruction. Good watch repairers are in demand and generally earn very good salaries. For particulars apply to the Wisconsin School of Watch Repairing 759 North Milwaukee St., Milwaukee 2, Wis.



BARGAIN BAR BELLS! 895

BUILD your chest, arms, neck, shoulders, thighs as Nature intended! Have a magnificent new body in Less Than 3 Months.—Only 5 Minutes a Day! 4 Million Men, Coast to Coast, 8 to 80, are doing this—YOU CAN, TOO! Get details about Paramount Bar Bells and System—finest on the market—at Factory-Price Savings up to 30%. Send NOW for your "Power-Thru-Paramount" Self-Check Health Chart. Just say—"Send Chart." It's FREE! Write TODAY!! INDEPENDENT IRON WORKS, Dept. B 2416 E. 23rd St. Los Angeles 11, Calif.

BE A NOTARY PUBLIC

Old legal-supply house, 22 cities, guarantees your appointment by governor if you qualify, equips you fully. Pay after appointment (2 payments \$12.50 each). Respected public office. You certify legal papers, use official seal made with your name, collect your fees. Easy, Inquire—

STATIONERS EXCHANGE

BOERNE 37, TEXAS

WOULD \$400 PER MONTH



INTEREST YOU?

It is easily possible to earn \$400 to \$500 a month raising ANGORA RABBITS. No experience required. Wool brings \$9 lb. Plenty markets. WRITE TODAY for FREE INFORMATION, PRICES & WHERE to SELL.

WHITE'S RABBITRY
NEWARK 10, OHIO

Learn BAKING At Home

Baking is one of America's high industries in wages. Nearly depression-proof. Thorough basic home course lays sound foundation. If you have aptitude, write for FREE BOOKLET, "Opportunities in Commercial Baking." National Baking School, 1315 Mich. Ave., Dept. 1358, Chicago 5





FREE
7-DAY TRIAL!
 Return and Pay Nothing
 If Not Completely Satisfied

**MOTOR'S
 AUTO
 REPAIR
 MANUAL**

**Now Any
 AUTO REPAIR JOB**

Can Be "Duck Soup" For You!



See How to Repair—Quickly and Easily—Any Car Built Since 1935! Over 200,000 Service and Repair Facts—More than 2100 "How-to-Do-It" Photos, Drawings, Diagrams! Over 200 "Quick-Check" Tables! 800 Pages of Easy, Step-by-Step Instructions!

HERE'S the huge, illustrated "How-to-Do-It" volume you NEED to "whiz through" any service or repair job on any make or model car built from 1935 thru 1949! Save work on those "ornery" jobs that can be such a "headache!" Make MORE money by doing more jobs in LESS time!

Whether you're a trained specialist or a beginner mechanic, you'll quickly get the "know-how" from MoToR's Auto Repair Manual. Just look up the make, model and job in the Instant-Reference Index. Then go to it! Easy step-by-step pictures make every operation "duck soup" for you!

LIKE 150 SHOP REPAIR MANUALS IN ONE!

Here, in detailed "Quick-Reference" tables and concise "How-to-Do-It" words and

pictures, are the official facts and instructions you MUST HAVE to tune up, service or repair any car! Priceless help that saves you "guess-work"—eliminates trial and error!

Factory engineers from every automobile plant in America worked out these time-saving standard procedures for their own motor car line. Now the editors of MoToR have gathered together this wealth of "Know-How" from over 150 Official Factory Shop Manuals, "boiled it down" into clear, readable terms in one handy, indexed book!

EVERYTHING YOU'LL NEED TO KNOW

MoToR's Manual takes nothing for granted. Starts at the very beginning; tells you how to identify all 697 car models. More than 2100 easy-to-follow Photos, Drawings, and Diagrams guide you step-by-step right through each operation. 800 big, readable pages are crammed with Factory Specifications and Adjustment Tables, Tune-Up Charts, Tables of Measurements and Clearances, Overhauling and Replacement facts, and Much MORE!

SEND NO MONEY

Just mail coupon! When the postman brings book, pay him nothing. First, make it show you what it's got! Unless you agree this is the greatest time-saver and work-saver you've ever seen—return book in 7 days and pay nothing. Mail coupon today! Address: MoToR Book Dept. Desk 17, 250 West 55th Street, New York 19, N. Y.

Used By
 U. S. Army
 and Navy

**COVERS ANY
 CAR BUILT
 SINCE 1935!**

- American
- Bantam
- Auburn
- Austin
- Chrysler
- Cord
- Cadillac
- De Soto
- Kaiser
- Lafayette
- La Salle
- Lincoln
- Lincoln Zephyr
- Mercury
- Oldsmobile
- Nash
- Packard
- Pierce Arrow
- Plymouth
- Pontiac
- Reo
- Studebaker
- Terraplane
- Willlys
- Buick
- Crosley
- Dodge
- Ford
- Frazier
- Graham
- Chevrolet
- Hudson
- Hupmobile



ABOVE: Showing operation of Buick Dyna-Flow — and, BELOW: How to adjust Ford Clutch. Every moving part is covered in simple words and BIG, CLEAR 8 1/2" x 11" Pictures.

Just 2 of the Many Letters of Praise



"MoToR's Manual paid for itself on the first 2 jobs, and saved me valuable time by eliminating guesswork." — **W. SCHROP, Ohio**



"Instructions so clear have no trouble learning anything about any car. Now working as mechanic in big plant." — **SAM ORDONEZ, Cal.**

Same FREE Offer on MoToR's TRUCK MANUAL

Covers EVERY job on EVERY truck made from 1936 thru 1946. 1400 pictures, 952 pages, 300,000 facts. Gasoline Engines, Truck Diesels, Hesselmanns, Fuel Systems, Governors, Lubrication, Ignition, Starters, Clutches, Axles, Brakes, etc.

ALSO covers many buses, tractors, contractor and road building equipment, stationary power machinery. Check box in coupon.



Published by MoToR, The Leading Automotive Business Magazine.

MAIL COUPON NOW FOR 7-DAY FREE TRIAL

MoToR BOOK DEPARTMENT
 Desk 17, 250 West 55th Street, New York 19, N. Y.

Rush to me at once: (Check box opposite book you want)
 MoToR's **AUTO REPAIR MANUAL**. If O.K. I will remit \$1 in 7 days, (plus 35c delivery charge), then \$2 monthly for 2 months, and a final payment of 95c a month later. Otherwise I will return book postpaid in 7 days. (Foreign price, remit \$8 cash with order.)
 MoToR's **TRUCK REPAIR MANUAL**. (Described at left.) If O.K. I will remit \$2 in 7 days, and \$2 monthly for 3 months, plus 35c delivery charge with final payment. Otherwise I will return book promptly. (Foreign price, remit \$10 cash with order.)

Print Name.....Age.....

Print Address.....

City & Zone No.....State.....

SAVE 35c delivery charge by enclosing WITH COUPON check or money order for full payment of \$5.95 for Auto Manual (or \$8.00 for Truck Manual). Same return-refund privilege applies.

KNOW ELECTRICITY AS THE EXPERTS KNOW IT... and get an expert's pay

EVERYWHERE the Croft Library is acknowledged as the standard—the leader—the last word in practical electrical education. It is more than a set of books. It is a complete Home-Study Course, capable of equipping any ambitious man for success in the electrical field. Thousands have used the Croft books to step up to better positions. The books are capable of solving easily and quickly problems which rise up to puzzle you in the day's work. They are accurate—thorough—fascinating—practical.



The Croft Library of Practical Electricity

The Croft Library is a complete electrical educator. It is founded on practice—on 20 years of shirt-sleeve experience—on work as it is actually done. It is jammed from cover to cover with the kind of hard-headed facts you want. Written so that the beginner can easily understand it, yet so sound, so thorough, that it is the daily guide of 50,000 highly paid electrical workers and engineers. Croft tells you the things you need to know about motors, generators, armatures, commutators, transformers, circuits, switchboards, distribution systems—electrical machinery of every type—wiring for light and power—wiring of finished buildings—underwriters and municipal requirements—illumination in its every phase—the most improved methods of lighting lamps—and lamp effects, etc.—how to do a complete job, from planning it, to completion.

No money down — easy payments

Fill in and mail the coupon attached and we will send you the entire set of seven volumes for ten days' examination on approval. We take all the risk—you assume no obligation. If you decide to keep the books, send \$3.50 in 10 days and the balance at the rate of \$4.00 a month. Send the coupon NOW and see the books for yourself.

McGRAW-HILL BOOK CO., 330 W. 42nd St., New York 18, N. Y.
Send me for ten days' examination on approval the Croft Library of Practical Electricity, 7 vols. If satisfactory I will send you \$3.50 in 10 days and \$4.00 monthly until the price of \$19.50 is paid. If not wanted, I will return the books.

Name _____
Home Address _____
City and State _____
Company _____
Position _____ PM-7-49

AUDELS REFRIGERATION and AIR CONDITIONING GUIDE



4 Books in One! Covering:
Basic principles, Servicing, Operation, Repair of
1—Household Refrigeration
2—Special Refrigeration Units
3—Commercial & Industrial Refrigeration
4—Air Conditioning Systems
A gold mine of essential important facts for ENGINEERS, SERVICEMEN & USERS.

A Good Book is a Good Friend! Here you have at your fingers' ends a Complete Library in ONE VOLUME, the necessary data you have been looking for on: MODERN UNITS, SYSTEMS & MACHINES, REFRIGERANTS, including Freon, Lockers, Water Coolers, Quick Freezing & Air Conditioning Systems. 1280 Pages, 46 chapters all Fully Illustrated & Indexed for Ready Reference.

ANSWERS YOUR QUESTIONS Get This Information for Yourself. Mail Coupon Today. No Obligation Unless Satisfied. ASK TO SEE IT.

\$4 COMPLETE • PAY ONLY \$1. A MONTH ←

AUDELS, Publishers, 49 W. 23rd St., New York 10, N. Y.
MAIL AUDELS NEW REFRIGERATION GUIDE for free examination. If O. K. I will send you \$1 in 7 days; then remit \$1 monthly until price of \$4 is paid. Otherwise I will return it.

Name _____
Address _____
Occupation _____
Employed by _____ PM

SAY YOU SAW IT IN POPULAR MECHANICS

Learn to MOUNT BIRDS

Tan SKINS, make up FURS
Be a Taxidermist. Double your hunting fun. We teach you at Home. Mount Birds, Animals, Fish, Heads, common specimens. Fun and profits. Decorate home and den MAKE MONEY. Mount game, tan for others. Big profits in spare time. WRITE TODAY. 100 game pictures in FREE BOOK. Hunters, get your copy. It's Now Free. Send post card. State your AGE. NORTHWESTERN SCHOOL OF TAXIDERMISTRY Dept. 2507 Omaha, Nebraska

LAW

STUDY AT HOME for Business Success and LARGER PERSONAL EARNINGS. 40 years expert instruction—over 114,000 students enrolled. LL.B. Degree awarded. All text material furnished. Easy payment plan. Send for FREE BOOK—
"Law and Executive Guidance," NOW!
AMERICAN EXTENSION SCHOOL OF LAW
Dept. 16-PM 646 N. Michigan Ave. Chicago 11, Ill.

Learn to Write at Home in spare time

Regardless of how you Now write, you can become an Expert Penman at home in spare moments by my Simplified Method, as hundreds of others have done, who never before thought they could learn. Good penmanship pays big dividends and helps you win success. Write for Full Details and my FREE BOOK, "How to Become an Expert Penman," which contains specimens of penmanship and shows what others have accomplished by taking my Courses at home in spare moments. If you wish, enclose 10c for Special Penpoint and your name with a flourished bird written on a card. Write TODAY.
Box 25K, CHILLICOTHE, MO.

LEARN MEAT CUTTING

through actual practice. Profitable Meat Cutting and Successful Meat Merchandising taught easily, quickly. LEARN BY DOING at Toledo in just six short weeks under actual market conditions. For beginners or men with experience. All subjects taught thoroughly and completely. Diploma. Job help. Get store of own. People must eat. School in operation over 25 years. Approved for GI training. Send today for FREE illustrated catalog. No obligation. NATIONAL SCHOOL OF MEAT CUTTING, Dept. 50P, Toledo 4, Ohio

'How to Make Money with Simple Cartoons'

A book everyone who likes to draw should have. It is free; no obligation. Simply address
FREE BOOK
CARTOONISTS' EXCHANGE
Dept. 97-D Pleasant Hill, Ohio

TRAINED MEN GET THE BETTER JOBS PRACTICAL SHOP TRAINING in AUTOMOTIVE MECHANICS BODY and FENDER REBUILDING

If interested write for catalog or wire
ATLANTA MOTIVE TRADES INSTITUTE
Dept. P, 254 IVY St., N.E., Atlanta, Georgia
Member of the Southern Association of Private Trade Schools
Veterans ask about G I Training

Midget Camera 99c

TAKE SECRET PICTURES
Midget camera only 2x3 inches! Actually conceal in palm of hand! Easy to carry, easy to use. Black & white or color pictures. Standard Eastman 828 film. Bakelite case, good quality lens and shutter. 8 pictures 1 3/4 x 1 1/2-in. on each roll. Beautiful enlargements. **99c**
SPECIAL CASH PRICE
Carrying Case, 50c; Black & White Film 35c Roll, 3 for \$1.00
JOHNSON SMITH & CO. Dept. 132 Detroit 7, Michigan

**The Dramatic Test
That Amazed the
25,000,000 Readers of
LIFE Magazine**



RECENTLY Life Magazine startled its readers with the story and photographs of a remarkable demonstration. Charles Roman, manufacturer of a new product called Phenoplast, coated one half of a table top with it, the other half with varnish. Then, as Life's photographer snapped away, Roman attacked both halves of the table top with burning cigarettes and newspapers, spilled ink and liquor, paint remover, screwdrivers. The varnished half of the table was completely ruined—but the surface protected with PHENOPLAST came through unharmed! Phenoplast is now available to the public—read below.

**NOW—Lifetime Protection for
ALL WOOD and METAL SURFACES!***



**"PHENOPLAST" — Beautiful New Super-Hard Plastic Finish
Recently Described in Life Magazine — Permanently
"Seals Pores" of Raw Wood; Also Brick, Concrete, Plaster**



BOATS treated with PHENOPLAST need no annual re-varnishing; are protected against salt water, marine growths, etc.



FURNITURE is protected against stains, scratches; needs no waxing.



GARDEN FURNITURE can be left outdoors during all weather; no re-finishing needed.



OUTDOOR WOODWORK is sealed against moisture changes; prevents warping, cracking, etc.



FLOORS last years longer, gleam like glass.



PLASTER CASTS acquire strong ceramic-like finish.

IMAGINE brushing or spraying-on a clear liquid finish which hardens to an almost damage-proof glossy finish! Right in your own home or workshop, cover raw wood, brick, plaster, metal, or concrete with one of the hardest plastics known to modern science! "Sets" to form indestructible brilliant-polish baked-like finish usually obtainable only through use of huge ovens or gigantic molding-presses.

It's PHENOPLAST—the new 100% pure phenolic resin which recently created such a sensation when Life Magazine photographed, and devoted an entire article to its amazing resistance to gruelling tests!

Now ready at last for YOU to use. Apply it as quickly and easily as varnish. Keeps boat hulls strong and waterproof for years without refinishing. Gives a glossy, baked-like, scratch-resistant finish to furniture, handicraft, woodwork, floors, sporting equipment. Not affected by boiling water, rough weather, acid, alcohol. Needs no waxing—just wipe with wet cloth! Use as beautiful natural finish or as waterproof fire-retardant base for paint. If object is already painted,

simply use paint-remover or "Underpheno" first (see below).

TRY It — Money Back If Not Delighted

PHENOPLAST will protect dozens of your most valuable investments in home and hobby materials. You'll discover **NEW USES** for it every day! Try it and see. If you are not delighted, return trial can within 10 days for **FULL REFUND**. If your hardware, marine supply, or department store cannot supply you, order directly from manufacturer; just mail this coupon. For 1 pint, enclose \$2.50 plus 20c shipping cost. Quart, \$3.75 plus 25c shipping. Gallon, \$12.50 plus 50c shipping. PHENOPLAST CORPORATION, Dept. 47, 115 E. 23rd St., New York 10, N. Y.



**Acts as
Powerful Glue**

Glue 2 blocks together with Phenoplast as shown—then defy your friends to break them apart!

*** For use on metal, paint, or other non-porous surfaces, first apply "UNDERPHENO," special base coat.**

If you plan to coat metal, already-varnished surfaces with Phenoplast, you **MUST** first apply the special base coat made for this purpose: "Underpheno." If you use coupon to order "Underpheno," enclose \$1.95 per pint plus 20c shipping. Quart, \$2.95 plus 25c shipping. Gallon, \$8.95 plus 50c shipping.

PHENOPLAST
(PATENT APPLIED FOR)

**Has These
Amazing
Properties:**

- Waterproof
- Acid-Proof
- Fire-Retardant
- Gasoline-Proof
- Alcohol-Proof
- Stain-Proof
- Scratch-Resistant
- Weather-Proof
- Beautiful Crystal-Clear Finish
- Never Needs Waxing
- Use for "Cold Lamination"
- A Powerful Glue

**PHENOPLAST CORP.
Dept. 47, 115 East 23rd St., New York 10, N. Y.**

Please send me PHENOPLAST: Pint Quart Gallon
Please send me UNDERPHENO: Pint Quart Gallon

Enclosed is \$_____, full price plus shipping costs. If I am not delighted, I may return can within 10 days and my money will be promptly refunded.

Name _____
Address _____
City _____ Zone No. _____ State _____
(if any)

I buy my paint and hardware at _____
(name of local store)

Do you want

- ..to go to College?
- ..or to enter a Profession?
- ..or get an Office Position?

(Such as Accounting, Architecture, Nursing, Dentistry, Teaching, Social Work, Osteopathy, Beauty Culture, Optometry, Embalming, Chiropody, Law, Medicine, etc.)

To get anywhere, you practically MUST finish High School FIRST. You can complete our simplified High School Course in SPARE time at home, as FAST as your time and abilities permit. Equivalent to resident school work—prepares you for college, pre-professional examinations, business, industry. Standard texts furnished. Diploma. Credit for H. S. subjects already completed. Single subjects if desired. Low tuition, easy terms. American School, Chicago, est. 1897—endorsed by educators. Finish your high school education NOW. Write TODAY!

High School Course at Home

Many Finish in 2 Years

American School, Dept. HB45, Draxel Ave. at 58th St., Chicago 37, Ill. Gentlemen: Send me FREE information covering special training in subjects checked below. No obligation on my part.

- | | |
|------------------------------------------------------|--------------------------------------------------------------|
| <input type="checkbox"/> High School Course | <input type="checkbox"/> Diesel Engineering |
| <input type="checkbox"/> Architecture and Building | <input type="checkbox"/> Drafting and Design for Men & Women |
| <input type="checkbox"/> Automotive Engineering | <input type="checkbox"/> Plastics |
| <input type="checkbox"/> Business Management | <input type="checkbox"/> Private Secretary |
| <input type="checkbox"/> Electrical Engineering | <input type="checkbox"/> Mechanical Engineering |
| <input type="checkbox"/> Elec. and Gas Refrigeration | <input type="checkbox"/> Aviation |
| <input type="checkbox"/> Air Conditioning | <input type="checkbox"/> Salesmanship |
| <input type="checkbox"/> Railway Training | <input type="checkbox"/> Radio |
| <input type="checkbox"/> Electronics, Industrial | |

Name.....

Address.....

Learn this Profitable Profession



IN 90 DAYS AT HOME

Money-Making Career Open to Men and Women, 18 to 50

Hundreds of men and women between 18 and 50 make \$10 to \$20 in a single day giving scientific Swedish Massage and Hydro-Therapy treatments. There is big demand from doctors, hospitals, sanatoriums and clubs. Graduates earn large full time incomes from these or in private practice in their own offices. Others make good money from home treatments given in spare time. Learn this interesting, money-making profession in your own home, through our home study course. Same instructors as in our nationally known resident school. You can win independence and prepare for future security by qualifying for your Diploma. Course can be completed in 3 to 4 months. Many earn while they learn. Begin your training at once.



Anatomy Charts & Booklet FREE

Enroll now and we will include, at no extra cost, many needed supplies. Fit yourself to help meet growing demand for Scientific Swedish Massage. Send the coupon at once for complete details. Anatomy Charts and 32-Page Illustrated Booklet, FREE, postpaid.

THE COLLEGE OF SWEDISH MASSAGE

Dept. 964H, 41 E. Pearson, Chicago 11, Illinois

Please send me FREE and postpaid, Anatomy Charts, 32-page Booklet and complete details on Home Training.

Name..... Age.....

Address.....

City..... State.....

Plastic Coasters and Tiles

EMBED REAL FLOWERS in NEW Magic PLASTIC



Now create many lovely and unusual things like the distinctive pansy coaster shown—made by embedding real pansies in Castolite—the "magic" liquid casting plastic. Comes crystal clear, or may be dyed to produce gorgeous color effects. Make really different jewelry, book ends, picture frames, candle sticks, figurines. Embed butterflies, coins,

medals, photos, for novel plaques, paper weights, tiles, other art objects. Use only home utensils. Follow simple step by step method. New pleasure, fine profits are possible. Send 25c for exciting new Home Project Manual showing how to get started. Write today! The Castolite Company, Dept. H-1, Woodstock, Ill.

MANUAL 25c

LEARN MEAT CUTTING At Home—In Spare Time



Get into the vital meat industry. Concise, practical Home Training based on 25 years proven instruction methods used at National's famous resident school. Prepares you for bigger pay as Meat Cutter, Supervisor, market manager or more money in your own store. Go as rapidly as your spare time permits. Diploma. Start NOW to turn your spare hours into money. Send for FREE bulletin today. No obligation.

NATIONAL SCHOOL OF MEAT CUTTING, INC., Div. U-107, Toledo 4, Ohio

OWN a Business



Clean and Mothproof rugs and upholstery "in the home." Patented equipment. No shop needed. Duraclean dealer's gross profits up to \$20 a day on EACH serviceman. These Nationally Advertised services create repeat customers. Easy to learn. Quickly established. Easy terms. Send today for FREE Booklet—Full details. DURACLEAN CO., 9-167 DURACLEAN BLDG. DEERFIELD, ILL.

ARTISTS MAKE MONEY

Do you like to draw? Send name, address, age and occupation for FREE ART TEST, to find out your ability.

ART INSTRUCTION, Inc.

7139 ART INSTRUCTION BLDG., MINNEAPOLIS 15, MINN.

ELECTRICIANS' SCHOOL

HOUSE AND COMMERCIAL WIRING • MOTOR REPAIR AND REWINDING • ELECTRIC REFRIGERATION

Approved for Veterans Training

PENNSYLVANIA INSTITUTE SCHOOL OF ELECTRICITY

42nd and SPRUCE STS.

PHILADELPHIA 4, PENNA.

TOOL AND DIE DESIGN



FREE COPY of our catalog explains comprehensive 12 month course in tool or die design. Expertly planned curriculum. Highly individualized instruction. Housing, employment problems aided. Write today for complete information.

TECHNICAL EDUCATION, INC. (Acme School)

Dept. PM, 2804 Belmont

Chicago

LOTS \$300 LOW TERMS

In California's loveliest Garden Spot, on scenic shores of beautiful Morro Bay. Enjoy future independence with excellent soil, soft water, wonderful fishing, hunting, boating, bathing, etc. Grow fruits, vegetables, poultry. Perfect temperate climate. Congenial community. Finest investment. Free literature.

RICHARD S. OTTO

DEPT. M

SAN LUIS OBISPO, CALIFORNIA

WHY DON'T YOU WRITE?

Writing short stories, articles on business, homemaking, travel, gardening, hobbies, shop crafts, local and club activities, etc., will enable you to earn extra money. In your own home, on your own time, the New York Copy Desk Method teaches you how to write the way newspaper men learn—by writing. Our unique "Writing Aptitude Test" tells whether you possess the fundamental qualities essential to successful writing. You'll enjoy this test. Write for it, without cost or obligation.

Veterans: This course approved for Veterans' Training.

NEWSPAPER INSTITUTE OF AMERICA

SUITE 5599-L, ONE PARK AVENUE, NEW YORK 16, N. Y.

BUILDERS

TRADE GUIDES

AUDELS CARPENTERS AND BUILDERS GUIDES—4 VOLS. \$6



4 Vols. \$6



Inside Information for Carpenters, Builders, Joiners, Building Mechanics—all Woodworkers. 1600 pages; 3700 diagrams; flexible; pocket size. Short-cut instructions, new methods, ideas, solutions, plans, systems—money saving suggestions. An easy progressive course for the apprentice. A practical daily helper and Quick Reference for the master worker. A Helping Hand to Easier and Better Work and Better Pay. To get this aid for yourself, simply fill in and mail the FREE COUPON below.

INSIDE TRADE INFORMATION ON:

How to use steel square; How to file and set saws; How to build furniture; How to use mitre box; How to use chalk line; How to use rules; How to make joints; Carpenters' arithmetic; Mensuration problems; Estimating

strength of timbers; How to set girders and sills; How to frame houses and roofs; How to estimate costs; How to build houses, barns, garages, bungalows, etc.; How to read and draw plans; Drawing up specifications; How

to excavate; How to use settings 12, 13 and 17 on the steel square; How to build hoists and scaffolds—skylights; How to build stairs; How to put on interior trim; How to hang doors; How to lath—lay floors; How to paint.

"Audels Guides worth four times their price—handy too as I carry them in pocket for reference." W. J. Bates, Knoxville, Va.



AUDELS PLUMBERS AND STEAMFITTERS GUIDES—4 VOLS. \$6



4 Vols. \$6



A new edition—just out! A practical, illustrated, Reference Library and Study-Course for Master Plumbers, Journeymen and Apprentice Steamfitters, Gas Fitters and Helpers, Sheet Metal Workers, Draughtsmen, Master Builders, Engineers and all Building Trade Students. 1670 pages; 3642 diagrams; flexible; pocket size. Guides explain all the principles, advances and short cuts of the Plumbing and Heating trade. Contains instructions on how to figure and estimate jobs. Use FREE COUPON below to examine, without obligation, this valuable work.

INSIDE TRADE INFORMATION ON:

Air Conditioning. Soldering, tinning. Joint wiping, bending, heating. Pipe—iron—steel, threading. Mathematics, tables, physics. Materials—iron, steel, copper, brass, lead, tin, antimony. Sheet metal—galvanized—plate. Sanita-

tion, syphonage, tanks. Drainage, sewage, purification. Fixtures—bath—kitchen. Pipe fittings, soil pipe, tools. Laying out work. Roughing. Screwed fittings, flanges, joints. Pipe bending, examples. Elbows. Heating, ven-

tilation, refrigeration. Water supply, mains, wells, tanks. Gas-fittings. Underwriters. Sheet metal work, problems, methods, Brazing, heating, lead burning. Welding, various welds, methods. Blacksmithing, forges, tools.

"Audels Guides are practical, easy to understand, reliable. Cover the field in plain language." W. F. Arminger, Annapolis, Md.



AUDELS MASONS AND BUILDERS GUIDES—4 VOLS. \$6



4 Vols. \$6



A complete, illustrated trade reference library, for Bricklayers, Cement Workers, Plasterers, Tile Setters and Stone Masons, including a practical outline of Steel Construction. 1100 pages; 2067 diagrams; flexible; pocket size. A practical Trade Assistant explaining modern methods of masonry construction. Easy to understand and apply. A reliable and authentic reference work and study-course for Master Journeyman and Young Mechanic. Use FREE COUPON below and find out for yourself, without obligation, whether this set will benefit you.

INSIDE TRADE INFORMATION ON:

Bricklaying, tools, materials; Brick designs, patterns, bonds; Setting frames and foundations; Mortars, scaffolds, estimating; Mortars and mortar mixing; Tile setting, mosaic, hollow tile; Straight edge test, trow-

eling; How to figure brick work; Safe loads, piers, chimneys; Boiler settings, anchors, fire stops; Labor tables; Concrete, forms; How to figure concrete work; Stucco—on old and new buildings; Plastering—wood lath—metal;

Plasterers agreement; Plastering on various surfaces; Stone masonry; Cutting, finishing, estimating stone; Derricks, rigging; Steel construction; Fire proof; How to read blue prints.

"Audels Masons Guides are the best books on the subject. Have laid brick 12 years and am able to judge." H. A. Sognnett, Corliss, Pa.



PRACTICAL ELECTRICITY—1 VOL. \$4

Audels Handy Book of Practical Electricity is a simplified Ready Reference and Study Course in one pocket size volume—for Engineers, Professional Electricians and Students. 1040 pages; 2600 diagrams; flexible bound. A reliable authority and handy helper for every electrical worker. Contains important and valuable wiring diagrams, calculations, machine sketches, helps on maintenance and repair. Use this FREE COUPON today and find out, without obligation, how this handy book will help you in your daily work.



Complete in one handy, red leather bound volume

1040 Pages 2600 Diagrams

INSIDE TRADE INFORMATION ON:

Electro-Therapeutics, X-Rays, Shocks, Welding, Brazing, Radio Hook-ups, Motion Pictures, Telephone, Telegraph, Cranes, Bells, Elevators, Pumps, Tools, Ship Drive, Railways, Vehicles, Automobile Electric Systems, Ignition, Generation, Lighting, Plant Management, Power Plans, Armature Winding, Repairing, A. C. Motors and Apparatus, D. C. Motors and Apparatus, Alternator Construction, Dynamos, Wiring, Diagrams, Sign Flashers, Cable Splicing, Power Wiring, Outside Wiring, Switches, Lighting, Rectifiers, Converters, Transformers, Fuses, Circuit Breakers, Rheostats, Electro Plating, Electrolysis, Storage Batteries, Magnetism, Electrical Energy, Conductors, Insulators, Static, Dynamic, Radio Electricity, Applications, Ready Reference and Index Covering the entire field of Modern Electricity.

Learn More and You Will Earn More!

Know your job and you'll never be without one. The skilled man is always in demand. Knowledge is power. Learn your trade thoroughly by easy reading. This coupon is your opportunity for advancement and better pay. You risk nothing in sending for Audels Guides for free examination. Send it NOW!

FREE EXAMINATION COUPON

THEO. AUDEL & CO.

49 W. 23 ST., NEW YORK CITY

Please mail me for free examination the books marked (x) below. If I find them satisfactory, I agree to mail \$1 in 7 days, on each set ordered, and to further mail \$1 monthly on each set until I have paid the purchase price.

- 4 CARPENTERS GUIDES \$6 4 PLUMBERS GUIDES \$6
- 4 MASONS GUIDES \$6 1 ELECTRICIANS HANDY BOOK \$4

NAME.....

ADDRESS.....

OCCUPATION.....

EMPLOYED BY..... PM



AUTO BOOKS ON APPROVAL



SEND NO MONEY. Just mail the coupon for a complete set of 4 Big, Thick Auto Books, 20th Edition. Over 2700 Pages! Whether you are a mechanic or helper, expert or apprentice, auto owner or driver, take immediate advantage of this **FREE EXAMINATION OFFER.**

MAKE GOOD MONEY NOW HOLD A PERMANENT JOB

America wants its automobiles kept in good repair. Men with "know how" are in demand, at big pay. These books will help you get and hold an important job, or give you a chance to go into business for yourself now or later. Any man who half tries to improve himself can learn auto servicing and repairing by this quick reference method. Use the **JIFFY INDEX** to find easily understood answer to any auto problem. These wonder books prepared by eleven of America's great automobile engineers. Many hundreds of valuable illustrations. Send the coupon **TODAY.**

A year's consulting privileges with our engineers now given with these books without extra charge.

Publishers Since 1898

CAN YOU FIX IT?

These wonder books tell step by step **HOW** to make difficult repairs and adjustments, how to keep a car at maximum efficiency, including latest improvements in car design and operation. Engine troubles and how to correct them well covered.

4 BIG, THICK VOLUMES

Over 2700 pages, 2000 illustrations, wiring diagrams, etc. Beautiful modernistic, washable cloth binding.

AMERICAN TECHNICAL SOCIETY, Dept. AB19
Drexel Ave. at 58th St., Chicago 37, Ill.

I would like to examine your 4-Volume Set of Auto Books. I will pay the delivery charges only, but if I choose I may return them express collect. If after 10 days' use I prefer to keep them, I will send you \$2 and pay the balance at the rate of only \$3 a month until \$24.80 has been paid. Include consulting service as offered above.

Name _____

Address _____

City _____ State _____

Please attach letter stating age, occupation, employer's name and address and name and address of at least one business man as reference. Men in service, also please give home address.



HIGH PAY • SECURITY When You LEARN A TRADE



Get ready for a well-paid, lifetime job or a business of your own in one of these **FIVE ESSENTIAL TRADES.** Complete training under expert instructors with practical experience prepares you to step into a good paying job with a future and security.



ELECTRICITY: Basic electricity, Residential and Industrial Wiring and Appliance Repair.



PLUMBING: Every phase — pipe cutting and threading to complete installations, blue print reading.



AUTOMOTIVE & TRACTOR: Engine overhaul, Transmissions, Carburetion, Generator-Ignition Systems, Tune Up.

DRAFTING: College level training in general Machine and Architectural Drafting

SHOE REPAIRING: Complete practical training includes reconditioning and rebuilding.

Approved For Veteran's Training

NATIONAL TRADE SCHOOL

2610 Grand • Kansas City 8, Mo.

Without obligation to me please send full information on the course checked.

.....Automotive and Tractor Technician Drafting

.....PlumbingElectricityShoe Repairing

Name _____ Age _____

Address _____

City _____ State _____

Veteran? _____

SAY YOU SAW IT IN POPULAR MECHANICS



SUCCESS • SECURITY • RESPECT
as a Master Watchmaker!

APPROVED FOR VETERAN TRAINING

Learn today's top mechanical profession at the world's largest, best-equipped school of its kind. Individual instruction, day or evening classes. You graduate with complete watchmakers' tools, ready to start your own business or work for established jewelers.

SEND FOR FREE 116-PAGE INFORMATION PACKET

WESTERN PENNSYLVANIA HOROLOGICAL INSTITUTE

WORLD'S LARGEST WATCHMAKING SCHOOL



DESK 40, 808 RIDGE AVE., PITTSBURGH, PA.



Helps you **s-t-r-e-t-c-h** your dollars on TV, electronics, radio and tools.

Write today for the 1949 Lafayette-Concord catalog. A penny postcard will do the trick. You'll find pages and pages of the finest equipment at new low prices. Use the catalog to order everything you need and save. It's free. Write to Lafayette-Concord, Dept. LG-9, 100 Sixth Ave., New York 13, 901 West Jackson Blvd., Chicago 7.

LAW FREE BOOK



Your **FREE** copy of "The Law-Trained Man" shows how to gain prestige and greater earnings through Blackstone home law study. All instruction material furnished including 18-volume Law Library written by 65 well-known law authorities. Lawyers, judges among our graduates. LL.B. degree. Low cost; easy terms. Write today.

BLACKSTONE COLLEGE OF LAW Dept. 50-B, Chicago 1, Ill.
A Correspondence Institution Founded in 1890

GREAT PROFITS

MAKE YOUR OWN RUBBER MOLDS

X.L. RUBBER MOLDS

will realize you great profits quickly!
WRITE FOR NEW FREE CATALOG

YOU can **EASILY** learn to cast thousands of perfect plaques, book ends, figurines, ash trays, etc. IT'S **EASY, FUN, PROFITABLE!**

X.L. Rubber, Pts. \$2.00;
Qts. \$3.50; Gallons \$8.95;
Models and enough rubber for 3 molds \$1.30 postpaid.

SEND FOR FREE FACTS

PLASTIC ARTS STUDIO • Route 5 • Dept. 2 | Muncie, Ind.

HYDROPONICS

Grow **out-of-season** vegetables, rare flowers or house plants by hydroponics—**WITHOUT SOIL**— Start a fascinating hobby or a profitable business in your own home. No experience needed for top results. Only small space gets big returns. Easy, clean, pleasant way to grow any plant indoors or out every day in the year. Fast growth, increased yields, unlimited profit opportunities. Send today for **FREE** 16 page picture book showing how others from every state are succeeding in this wide open field. Send postcard for complete facts.

CHAPMAN-GILBERT, 824 W. IVY, SAN DIEGO, CALIF.

NATION'S LARGEST EXCLUSIVE ELECTRICAL SCHOOL

"LEARN-BY-DOING"

ELECTRICITY

PRACTICAL TRAINING NOT "HOME STUDY"

G.I. APPROVED Get actual experience in great shops of M.T.I. Learn all phases Practical Electricity; Housewiring, Motors, Const., Maintenance, etc. Living arrangements, Part-time jobs, etc.

--- Send coupon TODAY. ---

MICHIGAN TECHNICAL INSTITUTE Veteran

2281 W. Fort St., Detroit, Mich., Dept. PM-7

Name _____

Street _____

City _____ State _____

"Learn to draw in 'teens!"

says famous illustrator



Arnold Friberg

Lawrence Photo

"I was only 14 when I enrolled in your home study course," writes Arnold Friberg, successful western artist. (Letter of April 15, 1948) "Waiting to study drawing until you have completed High School keeps you still wrestling with fundamentals at an age when you should be free to plunge into creative work while you still have the fire of youth. For a number of years I have

been making illustrations for national advertising . . . and paintings for calendar subjects. The training which I received from your school was very beneficial. I count your home study course the very best in its field."

Arnold Friberg

ART INSTRUCTION, INC., Dept. 7139-C

500 So. 4th Street, Minneapolis 15, Minnesota

Please send me your FREE TALENT TEST.

Name _____

Address _____ Zone _____

City _____ County _____ State _____

Occupation _____ Age _____

YOU ARE IN DEMAND IF YOU CAN DRAW!

Make money in art! If you like to draw, sketch or paint, send coupon for FREE TALENT TEST.

100 GAMES ON HORSEBACK!

Games from MEXICO • ARABIA • INDIA • • Cowboy Sports
Learn to play—scoring—Fields and Courses
Exhibitions—Over 100 Games and Contests described
ANIMAL LOVERS BOOK STORE • Box KA 111, TARZANA, CALIF.

ONLY \$1.50

STAMMER ?

This new 128-page book, "Stammering, Its Cause and Correction," describes the Bogue Unit Method for scientific correction of stammering and stuttering—successful for 48 years. Benj. N. Bogue, Dept. 4914, Circle Tower, Indianapolis 4, Ind.

GET THIS FREE BOOK!



NOT A SEASONAL JOB—
A LIFETIME OPPORTUNITY

G. I. APPROVED

EARN \$3800.00 A YEAR! ADVANCE TO \$7000.00

A CRITICAL SHORTAGE OF STATION AGENTS and TELEGRAPHERS EXISTS!
ATTEND THE WORLD'S LARGEST RAILROAD SCHOOL

VETERANS! NON-VETERANS! THIS IS IT! Thousands of trained men are needed by all U.S. Railroads because of new 40 hour week provision, and men reaching retirement age. Assure yourself of immediate employment after graduation . . . attend the school endorsed by the ORDER OF RAILROAD TELEGRAPHERS. Gale Institute has placed over 1,000 men in the past 18 months. YOU MUST ACT NOW—CLASSES ARE LIMITED. WRITE TODAY!

- IN RAILROAD WORK YOU GET:
- Free travel passes
 - Vacation with pay
 - Low cost insurance
 - Advancement opportunity
 - Retirement fund

GALE INSTITUTE, 1400 West Lake St., Minneapolis 8, Minn.

New Advertising Machine



PRINTS and ILLUSTRATES

1¢ Post Cards

FREE Learn how thousands of business men, in every line, are boosting sales in spite of conditions—with 1¢ messages—printed and illustrated in a few minutes on gov't post cards—with amazing new patented **CARDMASTER**. Your "today's" ideas, read by your prospects next morning. Not a toy, but a sturdy advertising machine, built to last for years. Low price, sold direct. Guaranteed for five years. Send name today. **SEND NAME** We'll send **FREE** illustrated book of money-making **IDEAS** for your business and complete, unique advertising plans. **RUSH YOUR NAME TODAY.**

CARDMASTER COMPANY
1920 SUNNYSIDE AVE., Dept. 137, CHICAGO 40, ILL.

OPPORTUNITIES AHEAD!
TRAIN FOR A FUTURE IN
DIESEL

• Prepare for the big earning power of **Diesel Trained Men**. Start learning at home, in spare time. UEI's easy, practical training covers all phases of **DIESEL** engine operation, fuel systems, auxiliary equipment, repairs and maintenance. When home course is completed, you come to Chicago for actual shop practice on **DIESEL MOTORS** under expert instructors, at UEI's fine, modern school. **BEGIN AT ONCE—GET ALL THE FACTS FREE. WRITE TODAY!**

DIESEL DIVISION UTILITIES ENGINEERING INSTITUTE
2521 Sheffield Avenue • Dept. DC-3 • Chicago 14, Illinois

BIG MONEY PRINT PHOTOS
on PAPER
CLOTH, LEATHER or WOOD
Simple—Takes 2 Minutes

AMAZING EARNINGS by quickly printing cherished photos on ties, handkerchiefs, purses, stationery, keepsakes, etc. in your own home for extra money or independence. Reports of \$6.00 per hour not unusual! Demand grows bigger daily. Complete Photo Outfit to make 100 prints includes "Magic Liquid," vignettes, easy-to-follow directions, how to bring in business for big steady profits, just \$1.95 postpaid. C.O.D.'s plus postage.

TIFFANY'S, 2128 Montrose JE, Chicago 18, Ill.

SAY YOU SAW IT IN POPULAR MECHANICS

SHOE REPAIR OFFERS BIG INCOME

LEARN IN 12 WEEKS TIME



You can own your own shop or earn big income as skilled shoe repairman. Growing demand everywhere at top wages for men who know how. We teach you quickly by actually working on shoes and modern machines. School open to all from 18 to 60 years of age. **FREE BIG 20 PAGE BOOK** explains everything. Send for your copy today. Chicago & Los Angeles schools only approved for Vets.

MODERN SHOE REBUILDING SCHOOL
Established 1927 Dept. PM
2937 Belmont Ave., Chicago. 361-12th St., Oakland, Calif.
806 So. Figueroa St., Los Angeles 14, Calif.

WATCH REPAIRING

Be a Master Watchmaker! Graduates earn big money—many in business for themselves. The famous Sweazey System of Instruction teaches you quickly and easily. Our 42nd year.

Write today for free information.

CHICAGO SCHOOL OF WATCHMAKING
Dept. 179, 1608 Milwaukee Ave. Chicago 47, Ill.

"RUPTURED"

WRITE for free information on our
"SCIENTIFIC VACUUM PAD TRUSS"

It is something different. No leg straps. Its pad is a **NOVELTY**. It is a vacuum cushion that stays on its right place. You can bathe with it on, as it is made of plastics, rubber and metal. Invented by a physician who has dedicated his whole life in the treatment of ruptures without surgery.

Write to: **"SCIENTIFIC TRUSS"**
829 So. Dr. Coss Street Monterrey, Old Mexico

MAKE EXTRA MONEY

Selling Christmas Card Box Assortments, also 25 and 50 cards for \$1.00 with name imprinted. Personalized stationery. Rush name. Samples on approval.

GENERAL ART CO., 225 - 4th Ave., N. Y. 3, N. Y.

IF I Send YOU THIS FINE SUIT—

Will You Wear It and Show It to Friends?
I need a reliable man in your town to get a fine, made-to-measure, all-wool suit without paying cash, but by taking a few orders from friends. Wear it—show it—to help you take more orders with my line of nearly 100 guaranteed quality fabrics. You can make up to \$12 in a day without experience or investment. I supply everything required **FREE**. Write for **FREE** outfit. **John Grant.**
STONE-FIELD Corp., 5325 Throop St., Dept. U-816, Chicago 7, Ill.

BE A TILE SETTER

LEARN TILE SETTING AT HOME. Ever increasing demand for tile setters. Easy to learn! Big money! Even as a sideline you can make \$75 and up each week. Write today for details.

INTERNATIONAL TILE INSTITUTE
P. O. BOX 6961 LOS ANGELES 22, CALIFORNIA

SPEED AND POWER HANDBOOK

Build fast Stock Cars! California Roadsters! 150 MPH Rods! Covers Fords to Cadillacs—all makes! Breathtaking methods—Authentic—Direct from California!

SAVE MANY DOLLARS
Build your own Dual Manifolds! Superchargers! Hot Cams! Water Injectors! Hi-Compression Heads! Mileage Devices! Get racing speed, lightning acceleration, dynamic power increases from any make passenger automobile! Get construction drawings! Tuning techniques! Speed tricks! Picture catalogues! Ingenious formulas! Economy secrets! Including—"Racing Frames"—"Reciprocating Masses"—"Jet Engines"—"Braking Characteristics"—"Dynamometers." Also—Dual Pipes, Gears, Fuels, Manifolds, Porting, Relieving, Balancing, Lowering!

Includes **"CALIFORNIA AUTOMOBILE CUSTOMIZING"**—Glossy photographs! Diagrams! Very newest ideas! Conversions! Re-Styling all makes! Streamlining! Chopping! Channeling! Customizing! 50 CHAPTER LIBRARY EDITION—complete—\$1.98 Postpaid.
Newhouse Automotive Industries, 5805-84 East Beverly, Los Angeles 22, Calif.

The Success Story of Bill Smith... OR YOU!



Mails coupon to National Schools in Los Angeles, and receives Free Lesson and book of information about Radio, Television and Electronics training.



Enrolls... studies in spare time. Finds personal attention from instructors, interesting material and practical equipment, all increase his interest.



Builds actual units as part of Course. Earns money doing spare time repair and installation work.



Completes Course and receives Diploma... is now a qualified Radio, Television and Electronics Technician.



Applies for—and GETS—a good pay, full time job in industry. Finds that employers know National Schools and like to hire their graduates.



Or he opens own profitable Service Shop, with valuable counsel and aid from National Schools. Now for real happiness and success!



You Build This Superheterodyne Receiver With Parts We Send

You receive complete standard equipment, including latest type High-Mu Tubes, for building various experimental and test units. You progress step by step until you build a complete Superheterodyne Receiver. It is yours to use and keep.

Professional Multitester Included!

This portable instrument (see right) enables you to perform many practical tests, make delicate adjustments and do service work. Complete with test leads.

You receive a series of special laboratory experiment lessons to guide your practical exercises with your equipment. These lessons have been prepared with a special technique of illustrating radio principles by numerous easy-to-understand examples.

Both Resident and Home Study Courses Offered

Send Coupon Today for These Two Valuable Free Books



GET INTO RADIO, TELEVISION and ELECTRONICS by NATIONAL SCHOOLS SHOP METHOD HOME TRAINING

THIS PRACTICAL, TECHNICAL RESIDENT TRADE SCHOOL TRAINS YOU AT HOME FOR BIG RADIO OPPORTUNITIES!

Never in history has such rapid progress been made as in the great Radio, Television and Electronics Industry today! This exciting, fast-moving development means new and greater opportunities for the trained, skilled man—for you—in Television and Radio Broadcasting, Installing, Servicing; in Frequency Modulation; in Applied Electronics in many industries; in a business of your own!

National Home Training is Practical
Your National Schools Course fully covers basic, advanced and specialized instruction in all phases, including basic radio principles, receivers, am-

plifier systems, transmitters, television, aviation radio, electronics. You get complete instruction material, including shop manual, tube manual, job sheets, radio dictionary, special laboratory experiment lessons, experimental equipment. You receive complete, modern television lesson texts.

Your Home Study is supervised by our staff of highly trained instructors who daily teach our resident students here. Let the Free Books shown below tell you more about National Home Training. Use coupon today!

APPROVED FOR VETERANS

NATIONAL SCHOOLS

LOS ANGELES 37, CALIF. • EST. 1905



FIND OUT NOW... MAIL COUPON TODAY

National Schools, Dept. 7-PM (Mail in envelope 4000 South Figueroa Street or paste on postcard) Los Angeles 37, California

Mail me FREE the book, "Your Future in Radio," and a sample lesson of your course.

NAME.....AGE.....

ADDRESS.....

CITY.....ZONE.....STATE.....

Check here if veteran of World War II

INVENTORS

When you are satisfied that you have invented a matter of value—write me, without obligation, for full information as to what steps you should take to secure a Patent.

The usual first step is to have a search of the prior U. S. Patents conducted, so that I can report to you on the question of Patentability.

PATRICK D. BEAVERS

(Formerly RANDOLPH & BEAVERS)

Registered Patent Attorney

934 Columbian Building Washington 1, D. C.

PATRICK D. BEAVERS, Registered Patent Atty.
934 Columbian Bldg., Washington 1, D. C.

Please send me full information on how to secure Patent Protection and Trademark Registration.

Name _____
Street _____
City _____ State _____

INVENTING

—FOR PROFIT! If you have an inventive turn of mind, write for free 28-page booklet explaining how the Institute of American Inventors is helping inventors pre-test the profit possibilities of proposed devices to fill today's unprecedented demand for useful new inventions.

INSTITUTE of AMERICAN INVENTORS

Dept. 4, 1926 Eye St., NW, Washington 6, D. C.

PATENTS

AND TRADE MARKS

C. A. SNOW & CO.

REGISTERED PATENT ATTORNEYS

WRITE FOR INFORMATION TO

428 SNOW BUILDING, WASHINGTON 1, D. C.

TRAIN NOW FOR AN

AVIATION CAREER

IN SUNNY SOUTHERN CALIFORNIA

MAXIMUM TRAINING IN MINIMUM TIME
Specializing in AERONAUTICAL ENGINEERING and MASTER AVIATION MECHANICS since 1929 America's Finest Aeronautical Institute . . . 7000 successful graduates . . . MAKE MORE MONEY . . . MAIL COUPON TODAY APPROVED FOR VETERANS.
Board and Room now available.
Without obligation, send free catalogue with full information.

NAME _____ AGE _____ PM-7

ADDRESS _____

CITY _____ ZONE _____ STATE _____

CAL-AERO TECHNICAL INSTITUTE
GRAND CENTRAL AIR TERMINAL • GLENDALE 1, CALIFORNIA

MONEY MEN ALL FREE

DATA

THE PLASTEX Industry needs manufacturers on small scale and for big production of Lamp and Clock Stands, Art Goods and Novelties in Plastex and Marble imitation. Experience unnecessary. 1/2c material makes regular 10c store sellers. Rubber moulds furnished for speed production. Small investment brings good returns. Big chain store orders now being placed. Ambitious men have chance for real prosperity. Our Free booklet will interest and benefit you.

PLASTEX INDUSTRIES, Dept. A
3400 Third Ave. New York 56, N. Y.

TRADE MARKS •
COPYRIGHTS •

PATENTS

The Time to Contact
a Patent Attorney is Promptly
After You Have Finished Your Invention

Write for FREE "INVENTOR'S GUIDE" & "Record of Invention"

FRANK LEDERMANN Registered Patent Attorney
154 Nassau St. • 20th Floor • New York 7, N. Y.

INVENTORS

HIGHEST

ROYALTIES and CASH

FOR YOUR INVENTIONS
Write for FREE booklet without obligation

UNIVERSAL MARKETING CO.
354 South Spring St. (Suite M) Los Angeles 13, Calif.

PATENTS PATENT LAWYER

TRADE MARKS
GUSTAVE MILLER
79-PM WARNER BLDG.
WASHINGTON 4, D. C.

ASSOCIATE EXAMINER
U. S. PATENT OFFICE 1922-1929
REGISTERED PATENT ATTORNEY
Send for Form
"INVENTOR'S RECORD"

PATENTS

"Proof of Invention"
Folder mailed without
obligation.

E. E. VROOMAN, Registered Patent Atty.
505 McKim Building, Washington 5, D. C.

INVENTORS

Whether an invention is patentable can be substantially determined by a search of the U. S. Patent records. Without obligation, write for information explaining the steps you should take to secure a patent.

JOHN N. RANDOLPH
Registered Patent Attorney
201 Columbian Building, Washington 1, D. C.

BE A DETECTIVE

WORK HOME or TRAVEL. Experience unnecessary.

DETECTIVE Particulars FREE. Write to
GEO. P. M. WAGNER, 125 W. 86th St., N. Y.

INVENTORS

IF YOU WISH TO PROTECT YOUR INVENTION,
You should take steps to protect it by a U. S. Patent.
Write me for "Record of Invention" form.

CARL MILLER
REGISTERED PATENT ATTORNEY

Woolworth Bldg., 35th Floor, Dept. 79-A, New York City
Please send me "Record of Invention" form.

NAME _____

ADDRESS _____

**FREE... New 48-Page
PICTORIAL BULLETIN**



- TELEVISION
- RADIO
- ELECTRONICS
- ELECTRICAL POWER
- ELECTRICAL ENGINEERING
- AIR CONDITIONING
- REFRIGERATION
- HEATING
- WELDING
- METAL FABRICATION

SEND COUPON TODAY!

Get the Facts on How You Can Train for FIELDS OF GREAT OPPORTUNITY

Since its founding in 1903 over 35,000 students have received practical technical training at the Milwaukee School of Engineering. Our time-tested concentric curriculum enables you to build your career step by step in 6 to 36 months at service, technical and professional level. Each course unit is complete in itself. It prepares you for specific occupational objectives or advanced training. You select the course in which you are most interested. More than 1,500 students now enrolled from 48 states and 18 overseas countries. Faculty of 85 specialists. Alumni counselors everywhere.

Industry Needs Technically TRAINED MEN!

Select the course that
Interests you most!

SERVICE — 6 to 12 months

- Practical Electricity
- Practical Welding
- Refrigeration Service
- Heating Service

TECHNICIAN — 1 to 2 years

- Electrotechnics (Power)
- Radio and Television Technician
- Electronics Technician
- Refrigeration, Heating and Air Conditioning Technician
- Welding, Metal Fabrication

PROFESSIONAL — 3 years

- Electrical Engineering
- Bachelor of Science Degree
- Major in Electronics or Power



SEND COUPON TODAY

MILWAUKEE SCHOOL OF ENGINEERING

Dept. PM-749, N. Broadway and E. State, Milwaukee, Wis.

Without obligation send me free bulletin "Your Career" and more details on course in

Name _____ Age _____

Address _____

City _____ State _____

Check here if World War II Veteran

MILWAUKEE SCHOOL OF ENGINEERING

FOUNDED 1903 BY
OSCAR WERWATH



Terms start
September,
January,
April, July



YOU'RE EARNING REAL MONEY, JIM— WHERE DID YOU LEARN YOUR TRADE?

AT HOME - C.T.I. TAUGHT ME ALL I NEEDED TO KNOW!



Begin Your Training Now—with C.T.I.

Industry offers wonderful opportunities for success to trained men. It selects personnel who have a good trade for such jobs as foremen and superintendents—and pays them well for their knowledge! You can prepare yourself for advancement at home in spare time by C.T.I.'s Shop-Proved Home Training Methods. Or, in our big, modern Chicago shops. The coupon below lists many trades in expanding fields. Each offers success and security. G. I. approved. Finance plan for non-vets. Guard your future—mail coupon today!

COMMERCIAL TRADES INSTITUTE, Dept. E2-7
1490 W. Greenleaf, Chicago 26, Ill.

Send free illustrated Brochures and other information about the field I have checked below:

- | | |
|---------------------------------------------------------|---------------------------------------------------|
| <input type="checkbox"/> Refrigeration-Air Conditioning | <input type="checkbox"/> Automotive Mechanics |
| <input type="checkbox"/> Electricity | <input type="checkbox"/> Body & Fender Rebuilding |
| <input type="checkbox"/> Radio Servicing-Television | <input type="checkbox"/> Building Construction |
| <input type="checkbox"/> Diesel Mechanics | <input type="checkbox"/> Drafting |

Name _____

Address _____

City _____

State _____

9 BIG BUILDING BOOKS

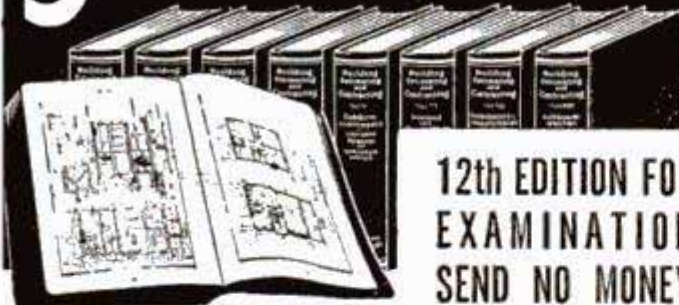

12th EDITION FOR EXAMINATION SEND NO MONEY

Learn to draw plans, estimate, be a live-wire builder, do remodeling, contracting. These 9 practical, profusely illustrated books cover subjects that will help you to get more work and make more money. Masonry, concrete forms, carpentry, steel square, roof framing, construction, plumbing, heating, painting, decorating and many other subjects. More than 4000 pages—2750 illustrations.

BETTER JOBS — BETTER PAY

A nationwide building boom is in full swing and trained men are needed. Big opportunities are always for MEN WHO KNOW HOW. These books supply quick, easily understood training and handy, permanent reference information that helps solve building problems.

UP-TO-DATE EDITION

These books are the most up-to-date and complete we have ever published on these many subjects.

Coupon Brings Nine Big Books for Examination

AMERICAN TECHNICAL SOCIETY—Publishers since 1898
Dept. GB19 Drexel at 58th Street Chicago 37, Ill.

"You may ship me the Up-to-Date edition of your nine big books, "Building, Estimating and Contracting," without any obligation to buy. I will pay the delivery charges only, and if fully satisfied in ten days, I will send you \$2.00, and after that only \$3.00 a month, until the total price of only \$34.80 is paid. I am not obligated in any way unless I keep the books."

Name _____

Address _____

City _____

State _____

Please attach a letter stating your age, occupation, employer's name and address, and name and address of at least one business man as a reference. Men in service, also please give home address.

LEATHER TOOLING MADE EASY



Now, a new method that simplifies Leathercraft. Send today for our amazing offer: 16 beautiful hand-tool billfold designs, with 16 actual size patterns, reproduction showing correct tool to use, and tracing paper, all for only 50c postpaid to you. FREE new 28 page illustrated Leathercraft catalog. ORDER TODAY!

Since 1919

HINCKLEY-TANDY LEATHER CO.
PO BOX 791-D FT. WORTH 1, TEXAS



WHAM-O SPORTSMAN* \$1.00 Postpaid
Powerful—New—Accurate
Kills Rabbits, Squirrels, Etc.
Routs Pests

Rivals Archery!
Fast Becoming a Major Sport.
Handy Silent - Inexpensive. Easy to use.

Complete with 40 pellets and extra rubber straps.
WHAM-O MFG. CO., Box G 92, South Pasadena, Calif.
*Professional model used by members Nat'l Slingshot Assoc.

GIGANTIC WAR EQUIPMENT MAIL SALE

AMAZING VALUES, FRACTION OF ORIGINAL COST
(WE PAY FREIGHT AND PARCEL POST CHARGES IN THE U.S.)

● A-C Power Plants.....\$345.00	● Utility Clutches\$13.95
● Compressor Sprayers .. 99.50	● Briggs (3.5) Engines ... 75.50
● Capstan Winches 29.90	● Briggs (6.5) Engines ... 86.90
● Multi-Speed A-C Motors 8.75	● Power Shaft and Stone. 1.29
● Rotary Pump 3.95	● D-C Welding Generator. 89.00

ALSO HUNDREDS ELECTRICAL AND RADIO BARGAINS
Send Card for Complete Sales Catalog
LECO ENGINEERING CO., Box 908-PM-20, Lincoln, Nebr.

Learn to Service and Repair ELECTRICAL APPLIANCES

Open your own electrical appliance service shop. Complete illustrated course covering washing machines, vacuum cleaners, elec. ranges, motors, house wiring and REFRIGERATION. Appliance tools included. Send today for FREE BOOKLET without obligation.

PACIFIC TRAINING SCHOOL

7217 So. Broadway, Dept. P-97, Los Angeles 3, Calif.

PILOT type  Only \$2.95
SUNGLASSES
LENS WIPER
and CASE

Send NO money—Mail a 1¢ post card, with your name, and your address. Pay postman \$2.95 plus small government charges. If you send money order we pay postage.

MITCHELL OPTICAL CO., DEPT 2A BOX 28, FEDERAL SQ. NEWARK, NEW JERSEY

RUPTURE RELIEF

Advanced method. No leg straps, no elastic, no steel. Entirely different. Guaranteed. Write:
SMITH MANUFACTURING COMPANY
DEPT. PM PRESTON, ONT., CAN.

PAY YOUR BILLS with CHRISTMAS CARDS

Are you burdened down with bills? Let Artistic Christmas Cards bring you the extra Money you need! These Greetings sell on sight! You make big profits taking easy orders for Name-Imprinted Folders at 50¢ for \$1, up to 100%. Your profit up to 100%. Other fast-sellers include exquisite Plastic Greetings, Gift Cards, Handi-Notes, Religious, Everyday, Gift Wraps. Also Name-Imprinted Floral Notes, Decorated Napkins, Personalized Stationery. FREE Samples of Imprints and FEATURE Ass'ts, on approval.
ARTISTIC CARD CO., INC.
228 WAY STREET ELMIRA, N. Y. **WRITE FOR SAMPLES NOW**

GET INTO

DIESEL-AUTO MECHANICS

Master All Phases

JOBS LIKE THESE ARE AVAILABLE TO TRAINED MECHANICS. CHOOSE THE FIELD YOU LIKE BEST

Get Complete Training

Diesel Fuel Injection
Automotive Motor Tune-up
Diesel Engine Rebuilding
General Garage Mechanic
Agricultural Implements
Auto Engine Rebuilding
Auto Elec. Service
Public Utilities
Parts Dealers
Bus & Truck Lines
Industrial Maintenance
Contracting & Excavating
Business of Your Own
AND MANY other similar openings.

As a National Schools graduate, you are trained for ALL opportunities in the Diesel & Auto Industries

EARN WHILE YOU LEARN

With our practical Master Shop-Method Home Training, you study at home in your spare time. You receive Spare Time Work Lessons, which show you how to earn while you Learn . . . for extra money and experience. You Learn by DOING.

TOOLS AND EQUIPMENT

To make your training complete, we give you selected mechanic's tools and equipment, illustrated below, including all-metal toolbox — as a regular part of your instruction.

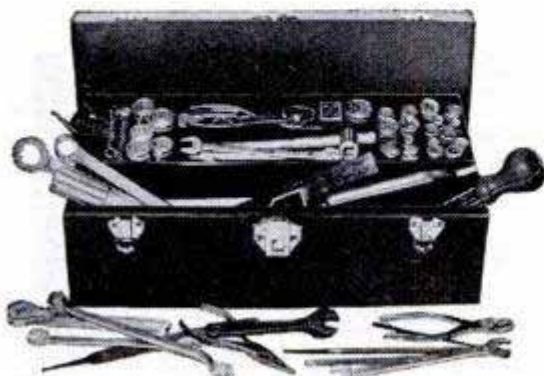

WE GIVE YOU TOOLS OF YOUR TRADE

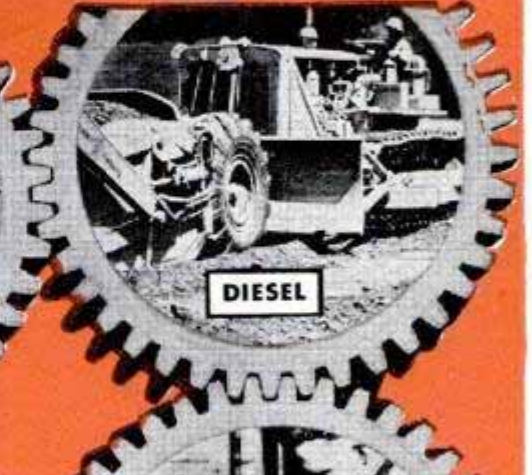

Shop-Method Home Training by an Established Resident School Prepares you for Many Good Jobs

Opportunity is everywhere for the trained Diesel-Auto Mechanic. Highways throng with cars, busses, trucks, tractors. Garages and Service Stations are kept busy. Factories, ships, farms, railroads, general industry, are dependent upon engine power. Here's a dynamic, fast-growing field that needs trained men who know ALL phases: installation, operation, maintenance and repair. Now—National Schools offers you a practical, all-embracing Diesel-Auto Mechanic's Course, including all of these advantages:

Complete training, covering—Diesels, High Speed and Heavy Duty; Semi-Diesels, Gasoline and Special Fuel Engines AND Allied Mechanics.

- Basic Lesson Texts
- Diesel Installation
- Operation - Maintenance
- Diesel Chart Manual
- Spare Time Lessons
- Engine Service Manuals
- Engine Repair
- Drive Systems
- Diesel Electric Power
- Thermodynamics

TOOLS AND EQUIPMENT

INVESTIGATE
Secure Full Information

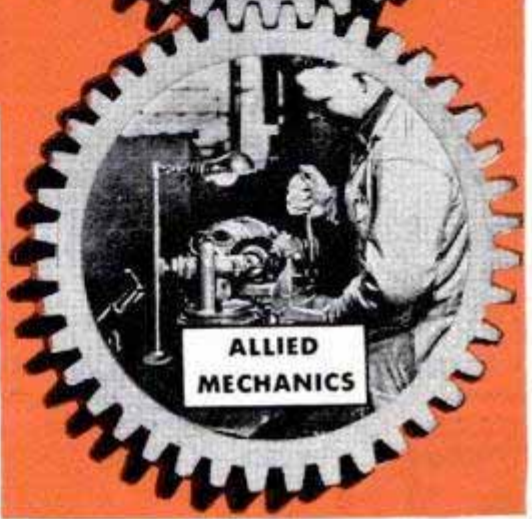

NEW, ILLUSTRATED BOOK & SAMPLE LESSON SHOW HOW WE TRAIN YOU . . . SEND FOR THEM TODAY!

NO COST
NO OBLIGATION



APPROVED FOR VETERANS

Check coupon below

NATIONAL SCHOOLS

LOS ANGELES 37, CALIF. • EST. 1905



FIND OUT NOW... MAIL COUPON TODAY

NATIONAL SCHOOLS, DEPT. 7-PMO
4000 South Figueroa Street
Los Angeles 37, California

(Mail in envelope or paste on penny postcard)

Mail me FREE the book, YOUR FUTURE IN DIESEL-AUTO MECHANICS, together with the Sample Lesson. I understand I may keep and use the information with no obligation.

Name _____ Age _____

Address _____

City _____ Zone _____ State _____

Check here if Veteran of World War II

**"TOOK IN \$217
FIRST 10 DAYS"**

**Some Make More,
Some Less... We Help
You to Start Your
Own All-Year
Business, Make
Big Money!**

With our easily operated, highly efficient wall washer, Chas. Stelle took in \$217 gross in first ten days. E. L. Goss took in more than \$10,000 in one year. E. C. Taber wrote, "I made \$400 gross in two weeks." And no wonder — this machine washes walls 6 times faster and better than by hand.



Your Money-Making Opportunity

We want more men to go into this profitable business for themselves and enjoy independence. There are customers everywhere—homes, offices, schools, churches, hotels, stores, etc. What you take in is mostly profit, for material costs are low. And there's no need to rent a shop or office. Operate your business from your home.

Lose no time. Get all facts without obligation. **WRITE FOR FREE INFORMATION.** Ask for Wall Washer Details at once.

VON SCHRADER MFG. CO., CB91, RACINE, WIS.

**FAST, SMART & SNAPPY
FOLBOT
FOLDS IN TWO LIGHT BAGS**

Paddles • Outboards • Sails
17½ ft. of stately, streamlined craft; wide beam, large decks, low center of gravity for sturdy performance with greatest safety record. Weighs only 65 lbs.—loads 750 lbs.—3 people and gear. One person can handle it. Easily packed and stored, fits inside car trunk. Wonderful for cruising, hunting, fishing in open seas, surf, rapids, or rocky waters. Rock resistant and leakproof. No upkeep or fees.



Set up in a jiffy. No tools required.

**BIG
\$250 CRAFT
NOW ONLY**

\$129

Special off season price
Small deposit holds
Since 1933, thousands of enthusiastic Folbot owners, including guides, experts, champions, scout-leaders, explorers, Navies, royalty.

FREE giant illustrated catalogue. Write today: FOLBOT 42-09 PM Hunter St. Long Island City 1, N. Y.

**SNOW WHITE HOUSE
PAINT**

Won't peel, rub
or wash off.
Won't turn
yellow.

**\$3⁹⁵
gal.**

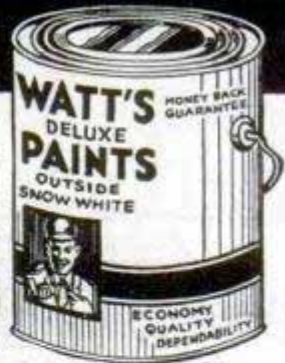

in 5-gal. Cans
Freight Prepaid

SOLD ON MONEY-BACK GUARANTEE
WATTS de Luxe OUTSIDE Snow-White Paint of proven quality unusually low price. Formula contains lead, zinc, titanium pigments, oils, dryers, mineral spirits and a MILDEW PREVENTIVE. Sample can, 50c, postpaid.

WATTS PAINT CO.

416 Woodland Ave., Toledo 2, O.
18 Gansevoort St. New York, N. Y.
158 N. Central St., Chicago, Ill.
3007 Kirkman St., Lake Charles, La.

1845 LITTLE BLUE BOOKS

Send postcard for our FREE CATALOGUE. Thousands of bargains. Address: HALDEMAN-JULIUS CO., Catalogue Dept., Desk M-2470, GIRARD, KANSAS

**BIG MONEY! SECURE FUTURE!
LEARN WATCH REPAIRING AT HOME**

EARN \$50 UP A WEEK WITH OUR NEW 13 ITEM SELF TRAINING KIT

ENLARGED KIT Contains: WATCH MOVEMENT for practicing (newest added feature)—PROFESSIONAL TOOLS: Loupe; 6 Screw Drivers; Tweezer; Material Tray; Case Opener & Knife; Movement Gauge and COMPLETE ILLUSTRATED BOOK ON WATCH REPAIRING. Only \$9.35 Post (C.O.D. plus charges) MONEY BACK GUARANTEE Tool Catalog FREE with KIT or send \$.50 credited to 1st order

MODERN TECHNICAL SUPPLY CO.
Dept. 7MMC, 55 W. 42nd St. New York 18, N. Y.

RADIO ENGINEERING. Broadcasting, Television, FM, Servicing, Electronics, Aviation, Marine & Police Radio taught thoroughly. Engineering course equivalent to 3 years' college radio work. Approved Veteran Training. Catalog free.

VALPARAISO TECHNICAL INSTITUTE, Dept. D, Valparaiso, Ind.

**MAKE MONEY IN
LANDSCAPING**

Thorough training by Internationally known Landscape Architect to start your own business, improve your home or advance in this well paid field. Many Opportunities. Approved for Veterans. Send for FREE BOOK.



NATIONAL LANDSCAPE INSTITUTE
Dept. P-7, 310 So. Robertson Los Angeles 36, Calif

**LEARN MOVIE
PROJECTION
THEATRE MANAGEMENT**



The Motion Picture Theatre Business offers big opportunities for trained men. Get into a fascinating field with a promising future. Train at home in spare time. Free Catalog. Established 20 years.

THEATRE SCHOOL, 370 Washington St., Elmira, New York

Learn PHOTOGRAPHY at Home

Splendid opportunities. Prepare in spare time. Practical basic training. Long-established school. Send for free book, "Opportunities in Photography." No obligation.

AMERICAN SCHOOL OF PHOTOGRAPHY
1315 S. Michigan Ave. Dept. 1358 Chicago 5, Ill.

A Good Business Of Your Own...

AND NOT A PENNY TO INVEST!

Start Now In Spare Time — You Don't Need Experience

WE WANT a reliable man in your community to take care of local greeting card needs. No "high pressure" selling. You just show friends and neighbors the famous Doehla box assortments of All-Occasion and Christmas Greeting Cards. Everybody needs and buys greeting cards throughout the year. They'll be happy to get these finer cards from you . . . save the trouble of shopping . . . and actually *pay less!* (Only \$1 for a really large assortment of top-quality cards.)

You make up to 50c profit on each \$1 box; more on bonus orders. The 30 fast-selling Doehla assortments also include stationery, gift wrappings, and "NAME-IMPRINTED" CHRISTMAS CARDS —25 for \$1.

Start now—without giving up your job. Soon you can have a good-paying business of your own. Some of our men who started in spare time now employ others. A few earn between \$15,000 and \$25,000 a year.

Free!
BOOK



FREE 2-WEEK TRIAL
Send No Money

Why not try it for a week or two? Mail coupon now—without money. We'll send you everything you need to start earning immediately—sample boxes on approval, FREE stationery samples, and our FREE BOOK showing how *even beginners* make good money right from the start. If friends don't "snap up" these samples, return them at our expense! *Harry Doehla Co., Studio P47, Fitchburg, Mass. (or if you live west of Rockies—mail coupon to Palo Alto, Calif.).*

**HARRY DOEHLA CO., Studio P47,
Fitchburg, Mass. (or Palo Alto, Calif.)**

Send me—for FREE TRIAL—sample assortments on approval and money-making plan. Also Free Stationery Samples and Free Book, "How to Make Money and Friends."

Name _____

Address _____

City & State _____

Please state Zone No. (if any)

Buys New Sedan



Geo. Adler

"In the past two years, I have made enough profit from selling your cards to buy a new 4-door, deluxe sedan. I don't owe anybody a cent, and I have a nice bank account." *George N. Adler, Indiana.*

Sales Increase Each Year

"I have been showing Doehla greeting cards for over 8 years, and each season the sales have increased. I order 100 boxes at one time and think nothing about it." *L. D. Kenworthy, Calif.*



L. D. Kenworthy

\$1,000 for Home Improvements

"My time is quite fully taken up with other work but I made almost \$1,000 last year selling Doehla cards and used it for improvements on my home."—*Miles Rolfe, No. Dakota.*

Lives Well — Takes 3 Month Vacations

"I have supported a family of 6. I have paid for a modern 9-room house, also enjoy a vacation from December to March — 3 months." *J. F. Johnson, Ill.*



WOULDN'T TAKE \$1000 FOR COURSE

"The lessons are so simple that anyone can understand them. I have learned to play by note in a little more than a month. I wouldn't take a thousand dollars for my course." **S. E. A., Kansas City, Mo.*



PLAYS ON RADIO

"I can't keep from telling you that I have a good position playing from KTHS, Hot Springs, Ark., every morning." **J. S., Okla.*



PLAYS AT DANCES

"The Piano course I'm taking is the 3rd course with your school. Previously I took Saxophone and Clarinet. Since then I've played a lot of dance jobs." **E. A., Lake View, Iowa*

THOUSANDS NOW PLAY who never thought they could!

You, too, can play any instrument by this **EASY A-B-C METHOD**

YOU think it's difficult to learn music? That's what thousands of others have thought! Just like you, they longed to play some instrument. But they denied themselves the pleasure—because they thought it took months and years of tedious study to learn.

And then they made an amazing discovery! They learned about a wonderful way to learn music at home—without a private teacher—without tedious study—and in a surprisingly short time. They wrote to the U. S. School of Music about this remarkable short cut method. A free print and picture sample actually showed them how easy it was to learn.

The result? Over 850,000 people have studied music at home this simple, A-B-C way. They have found the key to good times, popularity and profit.

And that's what you can do right now. Simply mail the coupon. Get the proof that you, too, can learn to play your favorite instrument—quickly, easily, in spare time at home. Just read the fascinating illustrated booklet—examine the print and picture sample. Tear out

the coupon now, before you turn the page. Instruments supplied when needed, cash or credit. U. S. School of Music, 77 Brunswick Bldg., New York 10, N. Y. 51st year. (Established 1898.)

**Actual names on request. Pictures by professional models.*

FREE! Print and Picture Sample

U. S. School of Music, 77 Brunswick Bldg., New York 10, N. Y. I am interested in music study, particularly in the instrument indicated below. Please send me your free booklet, "How to Learn Music at Home" and your Print and Picture Sample. (Do you have instrument?)

Piano	Piano Accordion	Reed Organ	Clarinet
Guitar	Saxophone	Tenor Banjo	Trombone
Violin	Trumpet, Cornet	Ukulele	Other Instrument

Name _____ (PLEASE PRINT)

Street _____

City _____ State _____

Check here if under 16 years of age.

SAVE 2c—Stick coupon on penny postcard

**DON'T START
YOUR CAR
WITH
BRAKES ON
GET THE FAMOUS
Signal-Stat
EMERGENCY
BRAKE LITE**

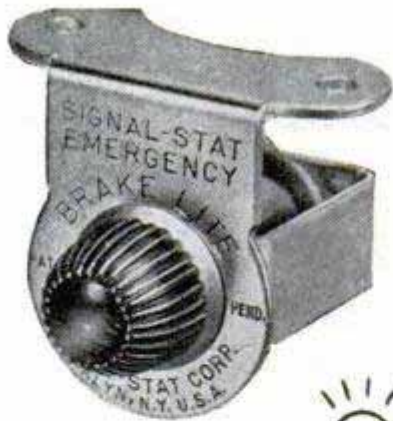

\$1.50
POSTPAID



This fool-proof signal device warns against starting with brakes on . . . lights up RED when emergency brake is on. It's too late when you smell the brakes! . . . Saves burned-out lining trouble, repair bills. No drain on battery. Used only on cars with brake lever mounted from dash. Anyone can install it. \$1.50 postpaid anywhere in U. S.

. . . TEAR OUT THIS AD AND MAIL . . .

- BRAKE LITE \$1.50
- STOPLITE PILOT \$1.50
(Tells whether or not stop light functions properly)
- Both BRAKELITE and STOPLITE PILOT \$2.75

CHECK WHICH YOU WANT. Send cash, check or M.O. (money-back guarantee)

NATIONAL SAFETY SALES CO. • P. O. BOX 581, BROOKLYN, N. Y.

**NEW
Edition**

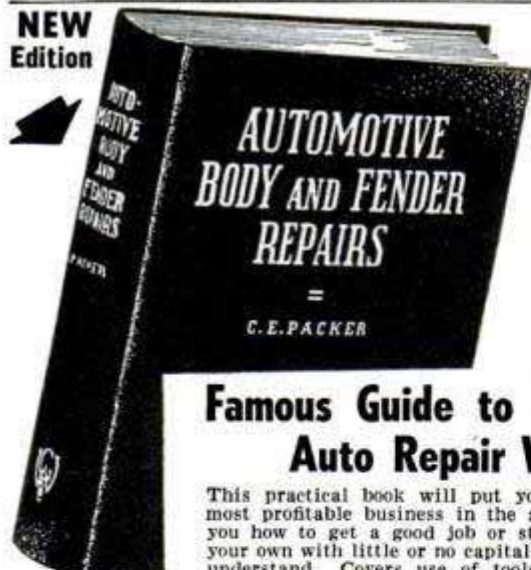

**NOW
HAS
325
PAGES
232
ILLUS.
\$3.50
Total Cost**

**Famous Guide to Best Pay
Auto Repair Work**

This practical book will put you right into the most profitable business in the auto field. Shows you how to get a good job or start a business of your own with little or no capital. Easy to use and understand. Covers use of tools and equipment, gives approved methods, describes materials and shows you how to actually do a professional job, operate a shop, etc. The very latest information and pictures on all interior and exterior body work and fender repairs—the kind of work people everywhere want and will pay big for when you can do it. Mail coupon now. Use book 5 days and if not O.K. return it and we will refund your money.

**Most
Complete
Information
Ever
Published**

GOODHEART-WILLCOX CO., Dept. 1-B
1321 S. Michigan Avenue, Chicago 5

**MAIL ORDER
COUPON**

Send Auto Body and Fender Repairs C.O.D., I will pay postman plus charges. (C.O.D. in U.S. only.) Remittance for \$3.50 enclosed, send postage paid. If not O.K. I will return in 5 days and you will refund purchase price.

Name _____

Address _____

City _____ State _____

E-Z CAR WASHER SOAPS, WASHES and RINSES

Can also be used to wash **in one operation**
Windows, Walls, Boats, Porches, Cellars, Garage Floors and many other uses.

Order Now!
Send \$3.50 check or money order. We deliver postpaid. Money back if not entirely satisfied.

Easily attached to garden hose —45" aluminum handle
Insert teaspoonful of any household soap powder or detergent in built-in soap pouch.
Replaceable mop
Cars can be washed easily without getting yourself wet



E-Z CAR WASHER

401 West 48th St., Dept. PM1, New York 19

CLIPS . . . Hold Everything
IN YOUR POCKET AT ANY POSITION OF YOUR BODY



Used on work, sport and dress clothing; by mechanics, shop and office workers. Saves miles of aggravating retraced steps hunting for articles lost from your pockets. Attractive gleaming finish. Sample 25c. Five assorted designs postpaid \$1.00.

STATE LINE SERVICE, INC., UNIONVILLE, N. Y.

PISTONS 

ALUMINUM ALLOY. For Auto, Truck, Tractor, Motorcycle, Scooter, Outboard, Marine, Compressor, Industrial Engines. EVERY MAKE, ANY YEAR, odd or foreign. Send sample or specifications.
JUDSON MFG. CO., 4527 Hedge St., Phila. 24, Pa.

SWISS MUSIC MOVEMENTS 

Put them in toys, stuffed animals, novelties, cigarette box, cake plate. Or, use your imagination to create something new and original. Hundreds of uses. For pleasure or profit.
CHOICE OF MANY DELIGHTFUL TUNES
Latest, most popular songs, waltzes, nursery, folk songs, operatic, birthday, Christmas, wedding, anniversary.
SPECIAL OFFER — 2 TUNE MOVEMENT (PLAYS 5 MINUTES) ONLY \$3.95
Money back guarantee. Pay postman C.O.D. plus postage, or send money and we pay postage. One Tune \$2.95
GREAT AMERICAN CO., 2433 S. Indiana Ave., Dept. 588, Chicago 16, Ill.

LEATHERCRAFT FOR FUN FOR PROFIT

Make your own Leather Novelties, Belts, Bags, etc., in spare time. A hobby you will love. Complete kits and equipment for tooling, carving and embossing at very low cost. Send 10c for catalog describing tools, leather and instructions. Your 10c refunded on 1st order.
JONAS HANDICRAFT CO. (Dept. M-7), 32 Frankfort St., New York 7, N. Y.

RUBINA opens NEW TRENDS . . .
16mm "Still" Photography!



A superb TINY precision camera that takes thrilling low-cost Salon pictures in Color or Black-and-White!
16mm rubix-RUBINA color photography rivals results of finest 35mm cameras! Negatives enlarge to 8x10 without ANY loss of definition. Slides can be used in 16mm or 35mm standard projectors.

SEND \$29.50 tax incl.

- Color corrected f/3.5 anastigmat lens.
- Shutter speeds, 1/25th, 1/50th, 1/100th & B.
- Ratchet Film Counter. • FREE — Leather Case.
- Anso Color Film, 20 exp. (incl. proc.)..... \$2.00
- B. & W. Film, 30 exp..... \$1.00

ORDER rubix-RUBINA NOW by MAIL
10-DAY MONEY-BACK GUARANTEE! Money Order or Check, Please.
Write for MYCRO CAMERA CO., INC. Dept. R-1 Literature! 527 FIFTH AVENUE, NEW YORK CITY

HELPFUL WOODWORKING HANDBOOK



and catalog of famous
HOMECRAFT® POWER TOOLS

Gives you information you want on tools made especially for folks who like to "tinker" in the home shop — low-cost, big-capacity tools, made by Delta, that are fun to run and easy to own. Includes how-to-do-it facts like how to plan your shop . . . how to build a woodworking bench . . . how to enlarge plans and drawings . . . other things worth knowing. Send 10 cents in coin, money order, or United States postal note with your name and address today.

10¢

**DELTA MANUFACTURING DIVISION
ROCKWELL MANUFACTURING COMPANY**

680G E. Vienna Ave., Milwaukee 1, Wis.

FIRES SNUFFED OUT AUTOMATICALLY!

with Famous

RED COMET FIRE EXTINGUISHERS!

When fire starts Red Comets go into action release powerful spray, create a blanket of fog which smothers fire—without human aid! Can be mounted in homes, shops, autos, boats—in any enclosed space! Write for FREE LITERATURE today!



RED COMET, INCORPORATED

159 Red Comet Building • Littleton, Colorado

SALESMEN! Operate your own business—sell Red Comets! Every home, farm, store a prospect. Territories open! Write!

**MONEY
BACK
GUAR.**

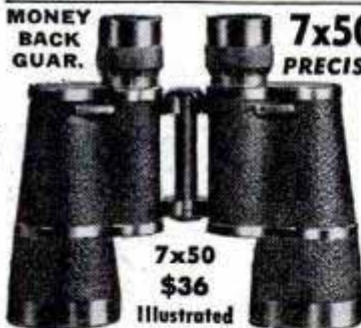

7x50 PRISM BINOCULARS
PRECISION OPTICS—BRAND NEW

\$36*

**6x50 ACHROMATIC
FIELD GLASSES**
\$22.50*

*20% Federal Tax

Send for Free
Catalog of Binoculars,
Telescopes and Microscopes

BROWSCOPE CO.

Dept. 7M, 24 W. 45th St.,
New York 19, N. Y.

ELECTRIC LOCK for FUEL-DOOR



Concealed Tamper-
Proof Lock.
Great Money Maker.



NO KEYS
Press Button



Opens
Automatically

Write for sales plan
STEELE MFG. CO.

445 WINCHESTER AVE.

ASHLAND, KY.

FENDER SKIRTS \$16.95 PER PAIR

FOR FORD, CHEV., MERC., PLYM., DeSOTO, CHRY., DODGE, KAISER-FRAZER AND BUICK

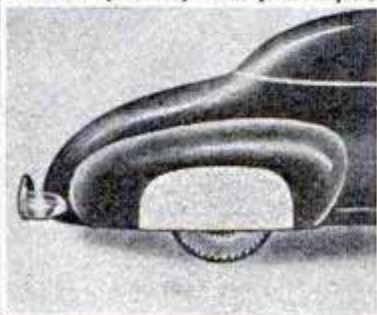

Beautify your car—bring out the flowing lines inherently designed there. Sparkling beauty you'll like. Constructed of heavy gauge body steel, finished in prime. Perfect fit.

SANDEE MUFFLER CO.
Box 296, La Tijera Sta.,
Los Angeles 43, Calif.
Gentlemen: Please send me one set of Sandee Fender Skirts to fit my . . . (year and

make of car)
 Check for \$16.95 enclosed
 Ship C.O.D.

EARN MORE IN DRAFTING



Steady
Employment

•
More
Opportunities
for Promotion

"Here I am at work making good money as a draftsman. I'm glad I sent the coupon to Chicago Tech for that Free Trial Lesson and found out how easy it is to learn Drafting in spare time at home. Today I feel secure in my job because the draftsman's work comes first on any new project. And, in addition, draftsmen can't be replaced with machines. What's more, I feel I'm slated for promotion and more pay, because I see so many draftsmen advancing to high-pay jobs."

LEARN IN SPARE TIME—AT HOME! (or at the College in Chicago)

A few hours of pleasant home study every week—that's all. No interference with your present job. All the tools you need; drawing outfit included. With Chicago Tech's help, you train yourself step by step. This tested method—developed over 45 years of C.T.C. progress—prepares men quickly for good position in industry.



FREE INFORMATION—SEND COUPON

To prove to you how easy it is to learn Drafting at home by the Chicago Tech method, we will send you this FREE TRIAL LESSON. No charge for this lesson, now or later. Fill out and mail coupon, or send post card today.

CHICAGO TECHNICAL COLLEGE

H-212 Tech Bldg., 2000 So. Michigan Ave., Chicago 16, Illinois

Mail me FREE Lesson with information about big opportunities in DRAFTING.

Name _____ Age _____

Address _____

City _____ Zone _____ State _____

STEP OUT FOR EASIER WINDOW WORK WITH

WINDOSTEP



Makes all outside window work easy & enjoyable!

**SAVES TIME • SAVES MONEY
SAVES LADDER-LIFTING!**

HELPS YOU Wash windows . . . Hang screens, storm windows & awnings . . . Paint, putty & repair.

IT'S STRONG . . . Supports 1000 lbs.
IT'S STURDY . . . Has steel rail & wood platform.

IT'S PORTABLE . . . Easy to carry
-Weights 11 lbs.

**IT'S AUTOMATICALLY
GRAVITY LOCKED** to window sill from inside. (It's installed from inside.)

IT'S GUARANTEED

Or Your Money Back!
Low priced, only **\$9.85**
Plus C.O.D. & P.P. or \$10.50
Prepaid. Add 50c west of Rockies. Dealer Inquiries Invited. Patent Pending

MORRISON CRAFTERS INC.

711 Miami St., Toledo 5, Ohio

ORDER TODAY!

For Better Housekeeping, Your Home needs a WINDOSTEP!

Don't Envy The PLUMBER-Be One

Make \$15 to \$50 a Day

Every skilled workman will tell you Plumbers have the best of it. WINTER and SUMMER the Plumber is busy at top wages. No skilled Plumber is ever out of a job. Compare his opportunities with any trade. To the man with know how, Plumbing means profit. Investigate Universal Plumbing School. Not a "war born School," but a plumbing school developed and operated by plumbers since 1923.



Own Your Own BUSINESS

Have your own business and big profits with little other than training and a kit of tools.

JOURNEYMAN Gets Good Salary

Master Plumbers own their own shop. A Journeyman works for a Master. With this training journeymen can depend on high wages.

BE A PLUMBER IN JUST 32 WEEKS

Learn With Tools—Not Books

No need ever serve an apprenticeship. Don't envy the plumbers big profits—enjoy them. Learn every trick of the trade—Leadwork—Blueprint for plan reading, etc. under Licensed Master Plumbers.

Over 7,000 Successful Plumbers Recommend This School

This system has made more than 7,000 plumbers. Investigate our past performance. If you like to work with tools this is your opportunity. Become a Plumber in America's largest and only school devoted exclusively to plumbing. Write today for FREE information.

G. I. Approved. Established 1923

UNIVERSAL PLUMBING SCHOOL

877 Holmes Street

Kansas City, Mo.

BEFORE BUYING "ANY" TIRE, REMEMBER THESE 3 THINGS:

1. Consider Your Family's Safety, — Not Just "Price."
2. You See OUR Reliable Ad, Month After Month.



➔ TAKE 10% DISCOUNT IF YOU ORDER DURING JULY.

GOODRICH FIRESTONE GOODYEAR U. S. ROYAL & OTHERS
Original Tread TIRES Worn Slightly

GOLDEN RULE 15 MONTH GUAR. BOND with ALL These Fine FREE BUTYL TUBE Grade 'A' Tires

475-19	\$5.70	600-16	\$3.54	600-20	\$7.42	32x6(8)	\$ 8.92
525-18	5.85	650-16	3.72	650-20	7.70	32x6(10)	11.12
550-19	6.50	650-15	3.72	700-20	8.95	825-20	11.50
550-17	5.75	700-15	3.92	34x7	9.62	900-20	11.65
750-16	6.75	700-16	5.15	1100-20	13.12	1000-20	11.62

HURRY. SAVE \$4 to \$14 ON THESE DIFFERENT FACTORY ADJUSTED "ALL-PURPOSE" AAA GRADE TIRES

25 Month Golden Rule Guar. Bond with Every Tire							
600-16	\$5.55	700-15	\$6.66	550-17	\$7.77	650-16 (6)	\$6.66
650-16	5.55	700-16	7.50	525-18	6.66	710-15	6.66
650-15	5.55	750-16	8.50	600-16(6)	6.66	820-15	7.77

WE ARE TRUCK-TIRE SPECIALISTS! Truck-owners the world over depend on us to keep their trucks rolling ON TIME "at lowest cost"

Factory Adjusted "All-Purpose" AAA Grade Tires GOLDEN RULE 25 MONTH REPLACEMENT GUARANTEE BOND

The Tire for Your Job. (Matched Height & Width)							
Delivery Schoolbus	Off-the-Road Ambulance	Highway Trailer	Farm Dump				
Help us to help you. Tell us speeds, weights, loads, single or duals.							
600-16(6)	\$7.77	700-17	\$9.99	32x6(8)	\$11.50	825-20	\$15.55
650-16(6)	7.77	750-17	11.10	700-20(8)	11.95	900-20	16.66
700-15(6)	7.77	600-20	9.99	32x6(10)	13.50	1000-20	17.77
750-15(10)	15.95	30 x 5	9.99	750-20(8)	10.55	1100-20	18.88
750-16	8.80	650-20	10.50	34x7(10)	13.33	1200-20	22.22

I personally select "extra special" instant shipments to far-west, down south, & the world-over. Don't gamble—depend on us

PREMIUM GUAR. 26 MOS. MILITARY SUPER GUAR. 14 MOS.		
900-16 SUPER \$7.77 PREMIUM \$10.75	750-20 SUPER \$8.95 PREMIUM \$13.00	750-16 SUPER \$9.50 PREMIUM \$12.85

Send check or money order for a rush shipment. Save this ad. We won't ship a tire that we wouldn't use ourselves. We have personally inspected every tire. Please depend on us.

BLATT GIRARD & LANCASTER AVE., DEPT. PM
BLATT BUILDING, PHILADELPHIA 31, PA.
THE NAME YOU CAN TRUST IN TIRES

Get in the BIG MONEY CLASS

USE YOUR SPARE TIME—AT HOME

If you find it difficult to come to our large school classes. Then we offer you the full advantage of the ALLIED PLAN of HOME TRAINING. Under the ALLIED PLAN we give you the same high quality training as we give in our residence school. Therefore, you can take our HOME TRAINING with complete confidence that you are getting the best. You will be amazed at the unique simplicity of this course. No tedious textbook reading is necessary. Your study is reached with practice material in an easy-to-read, simple, direct manner. WRITE for FREE Descriptive Literature NOW. A POST CARD WILL DO.

NEW—RAPID, EASY WAY TO LEARN DRAFTING AT HOME

ALLIED SCHOOL 1338-40-42 So. Michigan Ave. of MECHANICAL TRADES, Inc. 427-H Allied Bldg., CHICAGO 5

LOCKSMITHING & Key Making

PRACTICAL UP-TO-DATE COURSE—ONLY \$3.95

Easy-to-learn modern information for self-instruction. How to work on locks, de-code, make master-keys, repair, install, service, etc. For every handyman, home owner, carpenter, mechanic, service station operator, fix-it shop, hardware dealer, gunsmith. 53 plain illustrated lessons. FULL PRICE ONLY \$3.95. SEND NO MONEY. Just pay postman plus C.O.D. postage. Or send \$3.95 with order, we'll ship postpaid. Satisfaction guaranteed or refund. NELSON-HALL CO., 1139 S. Wabash Ave., Dept. G-2, Chicago 5, Ill.



REPLACE Old wood or metal venetian blind slats with LIFE TIME FLEXIBLE STEEL

24 beautiful baked enamel colors to choose from in all sizes. Write for color book and full information and a free 12 inch ruler.

LIFE TIME PRODUCTS CORP. P.O. Box 2742 Haselton Sta. Youngstown 8, Ohio OR 631 E. Florence Ave. Los Angeles 1, California

IMPORTED ZEISS TYPE BINOCULARS

BRAND NEW 7x50 Leather Case included. Add 20% Fed. Tax. Selection of other sizes equally low priced. SUPER QUALITY—LIFE TIME CONSTRUCTION—MONEY BACK GUARANTEE. (REG. 878) DEAL DIRECT WITH THE IMPORTER AND SAVE UP TO 50%! Know the EXTRA PLEASURE OF OWNING a pair of FINE BINOCULARS. Enjoy the thrill and satisfaction of clear, vivid close-ups at sporting events, dramatic, week-end trips, vacations, cruises, etc. Send NOW for Booklet "How to Select Binoculars for Your Personal Needs." It's FREE! Write for it TODAY! Bushnell Importers, 672-M7 South Lafayette, Los Angeles 5, Cal.

Wildercraft INDIAN-TYPE MOCCASINS

Beautiful soft leather tops, stitched to sturdy soles with tongue and lacing ready to assemble. Solid foot comfort for home, campus or cabin, indoors or outdoors. MONEY BACK GUARANTEE. Send \$3.50 for Ladies or Children. Men's Outfit \$3.75. Add 15c per pair postage. If not delighted, return in 10 days for refund. Ladies—colors White, Brown, Red, Black & White and Brown & White. Sizes 3 to 8. Boys—Brown only. Sizes 1 to 5. Men's—Brown only. Sizes 6 to 11. Order NOW—TODAY! Catalog FREE. WILDER & COMPANY Dept. A-7 Chicago 10, Ill.

THERE'S MONEY IN CARTOONS!

RAYE BURNS will teach you HOW to CREATE ORIGINAL CARTOONS at home that you may SELL! Course contains 26 lessons and over 600 illustrations. All for Only... \$2.85 Send name and address for free details. RAYE BURNS SCHOOL, Dept. M, Box 3583, Cleveland, Ohio

EXPORT PAYS BIG

World Trade firm offers men and women quick preparation for big pay positions or unlimited-profit businesses of their own. Mail order World-wide without capital, from home; or travel abroad. Represent manufacturers. Past experience not needed. Write today for FREE BOOK. State if veteran. Airmail reaches us over night. Mellinger Co., 1422-GR Westwood Blvd., Los Angeles 24, California



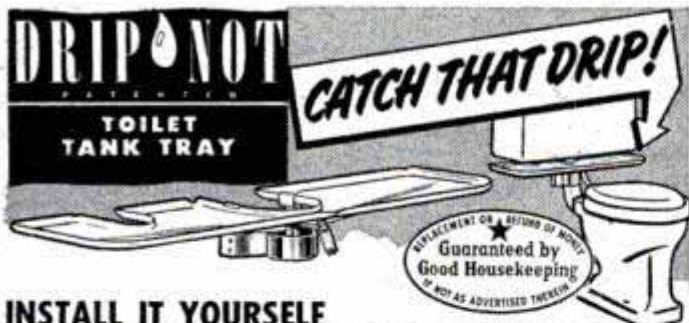

**INSTALL IT YOURSELF
IN A JIFFY!... PREVENT LOOSENING, ROTTING,
DISCOLORING OF BATHROOM FLOORS**

Stop messiness and damage caused by toilet tanks that sweat and drip. Install DRIPNOT under tank. Small hose pipes moisture into bowl. Gleaming, white enamel finish. Won't warp. Won't rust.

PRICE **\$3.95**

DRIPNOT Sold By Department, Plumbing, Hardware Stores. If Your Dealer Does Not Carry, WRITE DIRECT.

DEALER INQUIRIES INVITED

LAUFENBERG INC., Dept. P-7

2229 So. Kinnickinnic Ave. Milwaukee 7, Wis.

YOUR HOME MAY BE NEXT...

be safe with **PRESTO!**



**SURE FIRE-PROTECTION FOR
YOUR HOME, CAR, OR BOAT!**

PRESTO packs more fire-killing power than extinguishers many times its size, yet it fits in the palm of your hand. So small, so light that a child can operate it. Effective against all types of fire: gas and oil, electrical, brush and rubbish.

ONLY **\$3.98**
incl.
BRACKET

Presto has saved countless lives (testimonials on request) and thousands of valuable properties. Ready for instant use. Does not deteriorate. Useable over and over again.

Every car, boat, or property owner is a prospect. Send postcard for details and low wholesale prices, now.

MERLITE INDUSTRIES, INC., 201 E. 16th St., New York 3

PAINT YOUR CAR WITH WYPE for \$2.95!

There's no brushing, no masking or spraying. Thousands of car owners are delighted with the results. See your local dealer, department store or order direct.

WYPE CORPORATION

DEPARTMENT 16-G 2214 DOLMAN ST. ST. LOUIS 4, MO.

Chronograph Wrist Watch

LOWEST MARKET PRICE \$7.25



Sweep Second Hand; Precision Workmanship; Rugged Shock-resistant case; Radium hands and numerals; Leather strap. It measures distance, speed of cars, planes, horses and other moving objects. It's a time keeper, stop watch, telemeter, tachometer. **ONE YEAR WRITTEN GUARANTEE** and full operating instructions enclosed with each watch. **SEND NO MONEY.** Mail your order today. Pay postman \$7.25 plus 10% Federal tax. Total \$8.00 plus postage. Or send cash (money order or check) with your order and save postage charge.

MARDO SALES CO., Dept. P.M.
480 Lexington Ave., Rm. 1115, N.Y. 17, N.Y.

THE GREATEST
THING

IN
PLASTICS!

PLASTICAST



A NEW HOME INDUSTRY AND HOBBY!

PLASTICAST is a transparent liquid plastic; can be poured into ANY kind of mold or container. Hardens in a few minutes into a transparent solid, clear-as-glass, tough as steel plastic! No tools, machinery or skill required. IDEAL for imbedding pretty flowers, butterflies, photos, medals, souvenirs, biological specimens, etc. Makes a **PERMANENT** and **ATTRACTIVE** display. Make attractive jewelry, gems, lenses, knick-knacks, novelties. Easily cast into sheets, rods, blocks, ANY color, ANY shape! **EVERYTHING** furnished, including molds, for making about \$50.00 worth of unusual novelties! **PLASTICAST OUTFIT, Complete \$3.50** with 3 molds. Illustrated Instruction Manual included.

Our Casting Plastics are as easy to use as pouring water out of a glass!
PLASTIDUR . . . (LIQUID IVORY). Ideal for casting all OPAQUE articles. Hardens in a few minutes into an extremely hard IVORY-like plastic! May be dyed any color or cast into any shape. Works in **EVERY** type of mold! Non-inflammable, waterproof, DURABLE. Ideal for statuary, novelties, figurines, toys, gadgets, tools, knobs, bases . . . a million useful applications! Outfit comes complete with molds, dyes, accessories, instructions, etc. for making about \$100.00 worth of attractive jewelry, etc! **\$5.00**

PLASTIDUR OUTFIT, Complete with 3 molds \$5.00

TERMS: We pay the postage (U.S.A.) if full cash accompanies your order. C.O.D. accepted (U.S.A. only) if \$1.00 deposit is included for each item ordered. C.O.D. orders not postpaid.

FREE A very attractive novelty made with one of above plastics FREE with our BIG catalog! Catalog lists largest selection of MOLD MAKING and CASTING materials in the WORLD! Liquid Plastics, Liquid Ivory, Liquid Porcelain, Moulage, Latex, Multiplex, Etc. Also Shellcraft, Internal Carving, Plastics, Glazes, Jewelry Accessories, etc. Price of catalog only 10c U.S.A. (25c Canada).

DEALERS: WRITE FOR ATTRACTIVE WHOLESALE PRICE LISTS

PLASTICAST CO. (Dept. C)
4637 N. Kedzie Ave. Chicago 25, Illinois
Nearest Address: P. O. Box 987 Palo Alto, Calif.
CANADIAN CUSTOMERS, please order directly from: Canadian Industrial Plastics, Ltd., 1056 1/2 Pender St. West, Vancouver, B. C.

ENGINEERING

Building, Drafting, Etc.

**Chicago
TECH
College**

Degree in 27 mos. Approved for G.I. Training. Prepare in Chicago, the Industrial Hub. Earn part living expenses. 45th year. Other shorter courses in Air Conditioning, Refrigeration, Radio, Electricity. Enter Jan., March, July, Sept.

Write for catalog

H-83 TECH BLDG., 2000 SO. MICHIGAN AVE., CHICAGO 16

No Waiting to LEARN
START NOW TO EARN!
This BIG BOOK SHOWS HOW



PRACTICAL IDEAS—
GIVE QUICK RESULTS

Never before such a book of helps for you who wish your own business. In this book are formulas, recipes, secrets that have amazed the world. Use these tips to make many needed money-making products.

Experts wrote this book in simple terms, with supply sources for materials, short-cuts and methods for profitable results.

START NOW—Become Independent

Lots of profitable businesses have started with a single recipe. Choose from the 162,000 facts and 10,000 formulas such as: — Adhesives, Cosmetics, Beverages, Candy, Ceramics, Cheese, Cleaners, Concrete, Dentifrices, Dyes, Depilatories, Enamels, Gum, Home formulas, Inks, Insecticides, Lacquers, Linoleums, Lubricants, Metals, Mirrors, Oils, Ointments, Paints, Perfumes, Polishes, Remedies for Man, Beast & Fowl, Soaps, Solders, Varnishes, etc. 1000's of others to make all sorts of profitable items.

BE READY, IF YOUR JOB FOLDS

This big book tells what to do and how. No experience needed. You work from the money-making facts and ideas that are explained in words easily understood. Many fortunes have been made with a single formula. Mail in your order and start right NOW!

POSTPAID
\$3.98
ANYWHERE IN THE WORLD

\$3.98 postpaid throughout the world. (C.O.D. plus postage in U. S. only.) Shipped at once.

ADAMS BROWN COMPANY, BOSTON 67, MASS. U.S.A.

ROLL YOUR OWN TRAFFIC LINES

with the new, easy-to-use, economical and lightweight

LITTLE GIANT HANDI-LINER*

THE SPEEDY HAND-OPERATED LINE PAINTER



Parking lots, factories, drive-ins, service stations, airports, etc.—save time and money with the new "Little Giant" Handi-Liner. Paints perfect traffic lines almost as fast as operator can walk. Long-lasting, sturdy. No moving parts to get out of order. Uses any good traffic paint. Used and endorsed by leading firms, municipalities and government agencies.

only \$24.50 complete
Highest quality Line-marking Paint: white, \$2.70 gal. Yellow, \$2.85 gal.

ORDER TODAY! 2-year guarantee
RELIABLE DEALERS & AGENTS
a few exclusive territories are open. Write for information.

LASTING PRODUCTS CO., paint manufacturers
Franklinton Road Plant Baltimore 23, Md.

MAKE MONEY AT HOME
MAKE Greaseless Doughnuts at home. New amazing electric machine. You'll coin money selling to grocers, drug stores, cafes, hamburger stands. Low cost will surprise you. Experience unnecessary. Send for free recipes and plans.
MORTON RAY CO.
3605 SO. 15th AVE. MINNEAPOLIS 7, MINN.

DARK ROOM VENTILATORS



VENTILATE YOUR DARK ROOM
\$25 VALUE—Price \$7.50 Set, \$4.00 Each
— New Government Surplus —

Air flows through these louvers freely. Due to arrangement of baffle plates, light does not show through ventilators. Hundreds of these vents have been installed in dark rooms. You will need two for your dark room. Install one in or near ceiling and one near floor.
\$7.50 Set of two, or \$4 each. Pay by money order or check. 25% with order on C.O.Ds. Prices FOB Fresno, Calif. Shipping weight 29 lbs. per set of two.

ARMY SURPLUS SALES
OF FRESNO
1820 TULARE ST. FRESNO, CALIF.

TUBE GIVEN WITH EVERY TIRE
EVERYONE TAKE 10% DISCOUNT ON ALL TIRES
OUR GUARANTEE OUR TIRES must make good or WE WILL NEEDLESS TO PAY MORE RISKY TO PAY LESS OUR LONG EXPERIENCE INSURES YOUR SAFETY You get what we advertise Highest Quality Lowest Prices

HIGH ORIGINAL TREADS Slightly Used
BUY IN CONFIDENCE safe dependable selected POPULAR BRANDS—Guaranteed to give A-1 SERVICE. These tires are absolutely NOT Re-caps or Re-molds.

SELECTED FOR TOUGHEST JOBS Not just good... THE BEST These are genuine Values! One Trial will CONVINCE YOU

TOPS IN VALUE		TOPS IN SAFETY	
600-16	...\$5.32	650-16	...5.32
650-15	...5.02	700-16	...6.32
		750-16	...7.92

World's Best Truck Tire Values Top Service Minimum Prices

6.00-20(6)	\$9.92	7.50-20(10)	\$13.92	11.00-20(12)	\$17.42
6.50-20(6)	11.22	8.25-20(10)	15.92	11.00-22(12)	19.92
7.00-20(8)	11.72	9.00-20(10)	16.42	32x6 (8)	11.42
7.50-20(8)	11.02	10.00-20(12)	17.02	32x6 (10)	13.42

750-20 MILITARY 8 PLY REGULAR \$9.62—SUPER \$12.92
900-16 MILITARY 8 PLY REGULAR \$8.72—SUPER \$10.72
ONE QUALITY THE BEST AVAILABLE

HERE'S MAXIMUM QUALITY IN THESE O. K. SAFE TIRES

600-16	...\$3.62	650-16	...\$3.92	700-16	...\$4.62
650-15	...3.92	700-15	...4.02	750-16	...5.92
6.00-20 (6)	\$8.42	7.50-20(10)	\$10.92	11.00-20(12)	\$13.92
6.50-20 (6)	8.72	8.25-20(10)	11.22	11.00-22(12)	16.92
7.00-20 (8)	9.32	9.00-20(10)	11.92	32x6 (8)	9.42
7.50-20 (8)	9.52	10.00-20(12)	12.22	32x6 (10)	11.22

OUR SPECIALTY—TIRES FOR SCHOOL BUSES AND AMBULANCES

Thousands of Tires Shipped to Satisfied Customers Throughout United States and Many Distant Points. Please Note: We've made Thousands of Friends by giving a Tube with Passenger and Truck Tires. MAIL ORDERS given Personal Attention—Send This Ad with Check or Money Order, Dep't. 2

STANDARD 834 N. Broad St., Philadelphia 30, Pa.

FREE 1949 SEA-HORSE HANDY CHART

Illustrates and charts in detail the new QD Gear Shift outboard motor and the 4 other great Johnsons for '49. Sent free. Write for your copy today.

JOHNSON MOTORS
400 Pershing Road, Waukegan, Ill.
Johnson Motors of Canada, Peterboro, Can.



IS YOUR MIND ASLEEP?

"THINKING-ALPHABET" helps you FIND YOURSELF; develop your Rich, Creative Ability; improve Speech, Self Confidence and Personality; uncover Hidden Opportunities and Earning Power. **FREE FOLDER.** Write Frank Tibolt, 6258A N. 4th St., Phila.

Powerful
Amazingly Accurate
INDOOR OR OUT, THE BIG, NEW
Boone AIR TARGET PISTOL
INCLUDING 150 RDS. BBS

Rustless steel and aluminum 9 3/4" long. \$3.95 postpaid (or \$1. with \$2.95 and postage C.O.D.)
\$3.95
PRECISION SPORTS PRODUCTS POSTPAID
Parma 2, Michigan

SAY YOU SAW IT IN POPULAR MECHANICS

WAR SURPLUS BARGAINS

WAR SURPLUS BARGAINS
\$500,000.00 INVENTORY for QUICK LIQUIDATION
Surplus items—hundreds of them for home, shop, factory, farm and outdoor use. New items, used items, reconditioned items—all at tremendous savings—all priced for quick sale.
Page After Page of Values
This big catalog shows page after page of amazing money saving values. Write for your copy today. Send 10c to cover postage, mailing, etc. Write today!

SEND TODAY FOR YOUR COPY **10c**

STARK'S Dept. PM7 509 So. STATE STREET CHICAGO 5, ILLINOIS

NEW
Indian
LIGHTWEIGHT
MOTORCYCLES
 revolutionize
 the sport of
 motorcycling

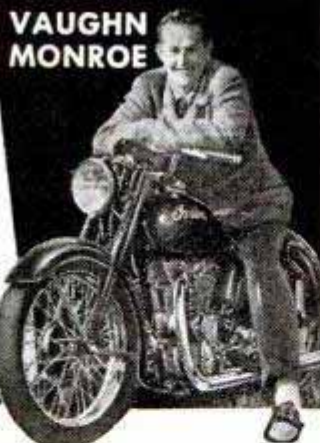

VAUGHN
 MONROE

You can learn to ride in 5 minutes

More and more people are taking up motorcycling—for fun, relaxation, and economy. For the new Indian Lightweights are so easy to ride you can learn in 5 minutes. They're the "World's Most Modern Motorcycles." Send for free book, "How to Ride a Motorcycle," by Bill Stern of NBC.

INDIAN MOTORCYCLE CO., Dept. PM79, Springfield, Mass.
DEALER INQUIRIES INVITED

DISCOVER URANIUM
 and Other Valuable Radioactive Ores!



The TX-8 GEIGER COUNTER—a superior instrument for locating deposits of radioactive ores. Compact, light weight, simple to operate, rugged. Extra sensitive—locates the ores and estimates the quantity and quality—right in the field. Made by world's largest exclusive manufacturers of Geiger Counters for prospectors.

Advance orders being taken for "URANIUM PROSPECTING" by Victor Shaw. A prospector's manual—tells where and how to look, what to look for, etc., \$2.00 per copy.

Write for details and prices

OMAHA SCIENTIFIC SUPPLY CO.
 DEPT Q, 3601 N. 24th St., OMAHA 10, NEBR.



Earn BIG PAY while learning

Veterans Can Earn Up To \$290.00 per month while training

Learn By Doing in Our **BIG ALLIED SHOPS**

Accredited by The American Society of Tool Engineers. Endorsed by Leaders of Industry throughout U.S.A.

- MACHINIST TRADE.
- TOOL, DIE MAKING & DESIGNING.
- TOOL ENGINEERING.
- DRAFTING—ALL BRANCHES.
- PRODUCT ILLUSTRATION & DESIGN.

● **BIG DEMAND FOR TRAINED MEN**

FREE Employment Service After Graduation

ALLIED SCHOOL OF MECHANICAL TRADES, Inc.
 1338-1340-1342 So. Michigan Avenue
 427 Allied Building, Chicago 5, Ill.

Write for **FREE Catalog**
A 1c Postcard will do.

New Easy Way
TO MAKE
BIG MONEY!

AT HOME

FULL OR SPARE TIME

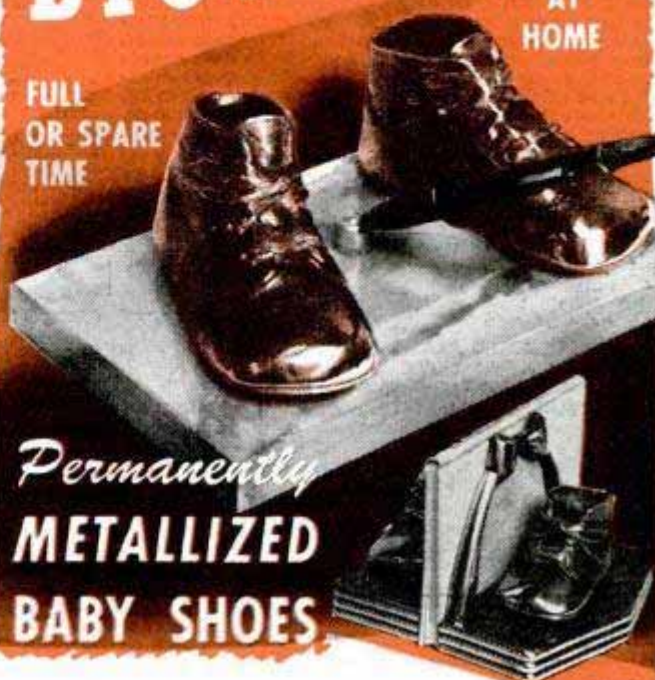

Permanently
METALLIZED
BABY SHOES

MAKE MONEY AT ONCE! Need extra money? I show you how to start earning extra money immediately. Just like O. Hayden, Maine, who writes, "I did like you suggested and showed the model shoe samples to a few and picked up 12 orders the first day." And Mrs. H. Powell, Colo., "I am more than pleased with your course. In one afternoon I took enough orders to almost pay for my course and equipment."

\$5 PER HOUR I show you how to make more money in just a few spare time hours than many workers earn in an entire week. Think how this can grow when the whole family pitches in!

METALIZING BABY SHOES IS BIG BUSINESS Get the BEST! I teach you ALL these processes—Genuine Metal, GOLD, SILVER, and BRONZE—PLUS Simulated BRONZE, GOLD, SILVER—AND beautiful colored PEARL FINISHES.

START YOUR OWN BUSINESS IN 2 WEEKS You get my Complete Course—with illustrated step-by-step instructions—and 2 beautifully processed metallized shoes—PLUS tested and proved methods which show you how to quickly start and operate your own successful spare or full time permanent metallizing business.

NO HUNTING FOR SUPPLIES We have the World's Largest variety of baby shoe mountings and other supplies at low prices.

MILLIONS OF NEW PROSPECTS YEARLY!

Over 15,000,000 Babies born in last five years. **BIG PROFITS** waiting for you in the Baby Shoe Metallizing Business the year round. Get **FREE** facts **NOW!**

SEND NO MONEY
 USE THIS COUPON

John Kiktavi KIKTAVI CO.

Department PM-7
 2111 W. Manchester
 Los Angeles 44, California

Rush me **FREE** full particulars at once.

Name _____
 Address _____
 City _____ Zone _____ State _____

Want **BIG PROFITS**
IN YOUR OWN BUSINESS?
NEW "MIRACLE FINISH"
MAKES IT EASY



SPARE TIME — FULL TIME

HELP FILL HUGE DEMAND—Rich profits are waiting to be tapped in this NEW field. New MIRACLE FINISH gives velvety, luxurious surface to radios, lamps, toys, signs, store displays, figurines, auto dash boards and hundreds of other items. Make old objects beautiful and salable—make new things worth much more. This soft rich covering can be applied to any surface.

START RIGHT AWAY—You can learn in a few days to START MAKING MONEY! Everything you need included. Fully illustrated instructions that are EASY to understand show you how to start on the road to BIG MONEY, spare or full time in your own home.



BE A MODERN ALADDIN—FLOK-KRAFT makes old things NEW! COVERS: Wood, Plastic, Fabric, Metal, Glass, Plaster—any surface.

EVERYTHING COMPLETE—Included with full instructions is complete set of materials that enable you to start at once. A FEW CENTS worth of materials can BRING YOU DOLLARS. Up to \$5.00 per hour is easy—add to your income from regular job or start your own business.

ACT NOW!—Grasp this opportunity TODAY—SEND NO MONEY—Mail coupon for full details and FREE SAMPLE of FLOK-KRAFT material also hundreds of profitable ideas. DO IT NOW!—be first!

GET THE
FACTS
FREE!

MAIL
COUPON
TODAY



COAST INDUSTRIES Dept. 27
1006 S. Los Angeles St., Los Angeles 15, Calif.
Gentlemen: Please rush me details.

NAME _____
STREET _____
CITY _____ STATE _____

SO HANDY FOR
SO MANY USES

AT HOME
OFFICE AND SHOP

THE
JIFFY
METAL
CABINET

Now you can keep
nuts, bolts, screws,
nails, parts, wash-
ers, stamps, hobby-
ist needs, etc., at your fingertips.



32 DRAWER
MODEL PICTURED
ONLY
\$5.95
POST PAID

Just think, 32 or 64 drawer cabinet to keep those small items that usually get mislaid. Spot welded steel cabinet, enamel finish, metal drawer guides. Looks good anywhere. Send check or money order please—no C.O.D.'s. Prices below. Your money refunded if not satisfied.

SPECIFICATIONS	WITH ALUMINUM DRAWERS	WITH CARDBOARD DRAWERS
32 Drawer Unit 6" Deep 12 3/4" Wide 15 1/4" High	One piece rustproof aluminum drawers for heavy service—good for work bench and industry use.	Suitable for most home uses. Heavy board kraft covered. Metal drawer pulls.
64 Drawer Unit 6" Deep 25 1/2" Wide 15 1/4" High	32 drw. \$8.95	32 drw. \$5.95
Drawer Size 1 1/4" Deep 2 3/4" Wide 6" Long	64 drw. \$15.95	64 drw. \$9.95
	POSTAGE PAID	POSTAGE PAID

KAYTEE PRODUCTS DEPT. M., BOX 588, CANTON, O.

"I'm buying my
second **CROSLLEY**"



"I'm buying another Crosley because it's the easiest way to save money," says Mr. Albert E. Wallace, Covington, Kentucky. "My Crosley took me over 20,000 miles without a repair bill. And 40 miles on a gallon of gasoline means money in the bank".

See the new Crosley. Prices range downward from the Station Wagon at \$929 F.O.B. Marion, Ind. Free—New Catalog of all 5 new models. Write name and address in margin of this ad, tear off, and mail to Crosley Motors, Inc., 2530-HG Spring Grove Ave., Cincinnati 14, Ohio.



—\$10,000 REWARD
Earn the government bonus by locating
Radio-Active Ores with the
P.R.I. GEIGER COUNTER
Weight about 2 lbs. Price only \$75.00 complete.
The most sensitive portable Geiger counter made.
PRECISION RADIATION INSTRUMENTS, INC.
1101-P N. Paulina St. Chicago 22, Ill.

ATTENTION LEATHERCRAFTERS

LOOK WEST, the home of Leather Carving and Stamping. More than 100 LEATHERCRAFT KITS in finest Tooling and Carving Leathers. Best assortment of tools and accessories in U.S.A. Other handcraft materials also. Send 10c for 80 page illustrated catalog.

GRIFFIN CRAFT SUPPLIES (since 1924)
5515-A GROVE STREET OAKLAND 9, CALIFORNIA

BUILD YOUR OWN ENLARGER
Enjoy Photography's most fascinating hobby at a fraction of usual cost. With simple step-by-step instructions and diagrams plus a screwdriver and pliers you assemble your own Enlarger and Save! Get all features of more expensive Enlargers: precision machined aluminum alloy castings, 90° tilt for wall projection of prints, spherical aluminum lamphouse, helical rack and pinion focusing with extra large knobs, unconditional guarantee. For 35mm to 2 1/4 x 3 1/4 negatives. Time payment plan.
Write Today for Free Illustrated Folder
CALIFORNIA TECHNICAL PRODUCTS CO.
448 S. Hill, Dept. M-7, Los Angeles 13, Calif.

Learn **TELEVISION-ELECTRONICS**
2 Big Books **FREE**
Train at Home—Get Big Kits of Radio Parts!
Prepare now in spare time. Practical instruction. Approved for Veterans. Write for details and 2 Radio Books—ALL FREE! Rush name today!
SPRAYBERRY ACADEMY OF RADIO
Dept. 10-T 20 N. Wacker Drive, Chicago 6, Illinois

ATTIC WINDOW FANS
PARTS—Build Your Own—SAVE MONEY
QUIET, deep-pitched, TORRINGTON, painted fan blades. Precision-bored, rubber-mounted bronze bearings, shaft, "V" belt and pulleys for 1725 RPM motors, and all nuts, bolts, set screws, collars, etc. required for assembly. Motors are 115 volt, 60 cycle, 1725 RPM, rubber-mounted. You make the mounting best suited for your job. Instructions included. Write for further information.
FAN DIA. CU. FT. per MIN. Kit Less Motor Kit With Motor
20" 3,200 \$17.00 1/6 hp \$30.00
22" 4,000 18.00 1/6 hp 31.00
24" 5,000 19.00 1/6 hp 32.00
30" 7,000 24.00 1/4 hp 38.00
36" 10,000 27.00 1/4 hp 41.00
42" 12,500 30.00 1/3 hp 45.00
F.O.B. Trenton, N. J.
Specify fan diameter wanted. Send check or Money Order (No C.O.D.)
ENGINEERING SALES CO. 124 NORTH MONTGOMERY ST. TRENTON 8, N. J.

Say You Saw It in
POPULAR MECHANICS



Aeronautical Engineering offers a wide choice of interesting duties. Here two engineers install a guided missile model in the Northrop Aircraft, Inc. wind tunnel.



Wing-top classroom—an example of how engineering instruction at Northrop comes vividly to life in the midst of this famous aircraft research and production center.

APPROVED FOR VETERANS



Northrop Aeronautical Institute

Division of Northrop Aircraft, Inc. ★ James L. McKinley, Managing Director
1527 EAST BROADWAY, HAWTHORNE, LOS ANGELES COUNTY, CALIF.

There's a BIG Future for YOU in AERONAUTICAL ENGINEERING — with NORTHROP Training

You can ride to success on wings of the great *Air Age*. Aviation is progressing at "super-sonic" speed. Things to come defy your imagination. Stretching ahead of you can be a lifetime career of fascinating work and rich rewards—in *Aeronautical Engineering*. Many types of creative duties call for men with *imagination* and *originality*. Many practical kinds of work call for men who like *action* and the *use of skill*.

Northrop training in *Aeronautical Engineering* has won choice jobs for graduates. Many of even the more recent Northrop graduates are in such important work as design, research, testing, stress analysis, aerodynamics and power plant engineering. They have drawn top pay brackets for starting jobs...have moved up fast to even better jobs.

Learn all about your big opportunities in Aviation. Get full details on Northrop's 2-year *Aeronautical Engineering Course*. You can begin your training soon—classes start every 8 weeks.

SEND COUPON FOR CATALOG NOW

NORTHROP AERONAUTICAL INSTITUTE
1527 East Broadway, Hawthorne, Los Angeles County, Calif.

Please send information on opportunities in Aeronautical Engineering, your catalog, and starting dates of classes. I am interested in:

Aeronautical Engineering Aircraft & Engine Mechanics

Name _____ Age _____

Address _____

City _____ Zone _____ State _____

Check one: Veteran Non-Veteran



Sensational New Electric ① WELDER ② CUTTER!

FOR 110-115 AC or DC • WELD—BRAZE—CUT—SOLDER—HEAT TREAT
INSTRUCTIONS INCLUDED • LOWEST PRICE IN HISTORY!

The **WELDRITE** Combination—tested and proved by countless commercial and amateur users, is now offered direct to you at the amazingly low price of only **\$12.00**. No Gas—No Gauges—No Spark Lighter needed. Always ready for immediate use—Just plug **WELDRITE** into 110-115 AC or DC outlet. Uses standard welding and brazing materials. **WELDRITE** furnished complete with Converter Unit, #1 Single Holder for welding metal to $\frac{3}{16}$ " thickness, using up to $\frac{3}{32}$ " rod, and #2 Double Holder with Copper Coated Carbon Electrodes for Brazing, Cutting, Heat Treating, etc. Starting welding

materials and instructions included.

Ideal for home workshop. Invaluable for garages, repair shops, farms, etc.

SEND NO MONEY! 10 DAY TRIAL. Order your **WELDRITE Electric WELDER-BRAZER-CUTTER C.O.D.** today. Pay postman **\$12** plus postage charges (wt. 4 lbs.) or send **\$12** and we pay postage. Either way, if not satisfied, return **WELDRITE** in 10 days for refund, less postage charges. **WELDER HOOD**—Approved Arc Welding lens—only **\$3.95**. Calif. orders add 2½% tax.

BOTH only \$12

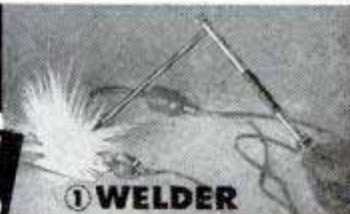

CALIFORNIA TECHNICAL PRODUCTS CO.

Dept. A-7, 448 So. Hill St., Los Angeles 13, Calif.

WANT A GOVERNMENT JOB?

START AS HIGH AS \$3,351

Many Permanent Appointments Being Made

VETERANS GET SPECIAL PREFERENCE

Many Government Jobs.
City and Rural Carriers—
Postoffice Clerks—Liquor
Inspectors—Meat Inspectors
— Accountants — Ste-
nographers — Typists
—etc. Prepare now for
next Examinations.

FRANKLIN INSTITUTE,
Dept. 583, Rochester 4, N. Y.
(Not Government Controlled)

Sirs: Rush to me, without charge, copy of 40-page book, "How to Get a U. S. Government Job," list of positions, and full particulars telling how to qualify for them.

NAME _____

ADDRESS _____ VET? _____



The LAWNHAVER

SELF-PROPELLED

MAKES MOWING AS EASY AS WALKING EMPTY-HANDED



The **SECRET** is in the 3rd wheel drive

3/4 HP—\$125
1 1/2 HP—\$139.50

Yes, the 3rd wheel drive does away with all controls. Start the LAWN-SHAVER, cut your lawn—to stop or turn around lift 3rd wheel from ground by raising the handle with fingertip ease (its perfect balance makes this simple). Trims flush with obstacles, can be operated in spots where no other power mower can go. Vertical height adjustment 1/2" to 3/4". Chain driven wheel and reel. Heavy duty solid steel construction. 4 cycle gas engine.

See Your Local Dealer or Order Today on Coupon Below

SEND FOR FREE BOOKLET

Enclosed find check _____ money order _____ in the amount of \$ _____ for _____ LAWNHAVER. Please send to . . .
NAME _____
ADDRESS _____

SOUTHERN METAL STAMPING CO., Inc.
1111 S. Liberty St.,
New Orleans, La.

RUBBER HOSE SALE LESS THAN 1/2 Price



TERRIFIC VALUES!

(Inside Diam.) 1 1/4 in. 1 1/2 in. 1 3/4 in.
Length 25 ft. 40 ft. 30 ft.
Price \$8.75 13.75 13.75

Brand new genuine Neoprene Hose—outlasts ordinary rubber 3 to 1. Reinforced with super tough cotton cord plies. Flexible, easy to handle. Easy Flo brass couplings with standard pipe threads for quick connections, included.

Pump water for irrigation, stock, tanks, home, barn, fire fighting, etc.

If specified we will send special hose for gas or oil at same prices. All prices f.o.b. Chicago area. Satisfaction guaranteed. Send check or money order in full, or \$3.00 deposit and balance c.o.d. Master Mechanic Co., Dept. 16, Burlington, Wisconsin

PLYWOOD BOAT KITS



\$67.50
(Freight Included)

Build the 12 ft. V-Bottom "Sportsman" as shown. Ready-cut kits include all hardware, paint, etc. Send for free folder on all models as low as \$29.95, freight included.

TAFT MARINE WOODCRAFT

Dept. "R," 636 39th Ave. N.E. Minneapolis 21, Minn.

PLASTICATED "GI" CLOTHS

WATERPROOF, LIGHTWEIGHT, 8 X 8 foot, 1001 uses as painter's dropcloth, lawn, furniture, machinery, merchandise cover, beach blanket, or shelter. Many uses camping, fishing, or picnic trips. Send \$1.25, and we will ship one cloth prepaid. (\$2.50 for 9 X 12 size.) C.O.D.'s accepted. Money Back Guarantee.

SAX-ON • Dept. 452 • 3840 Fullerton • Chicago 47, Ill.

WHEELS - WHEELS

5" disc wheel, 5/8" tire, 5/16 or 3/8" sleeve	\$0.30
6" disc wheel, 5/8" tire, 5/16 or 3/8" sleeve	\$0.35
7" disc wheel, molded tire, 3/4" sleeve	\$0.45
8" disc wheel, 1 1/8" tire, 1/2" sleeve	\$0.70
7" disc wheel, 1" tire, 1/2" ball bearing	\$0.80
8" disc wheel, 1 1/4" tire, 1/2" ball bearing	\$1.00
10" disc wheel, 1.75 semi-pneumatic tire, 1/2" B.B.	\$1.50
Above wheels painted red	
10" cast alum. wheel, 2 3/4" semi-pneumatic tire, 5/8" ball bearing	\$4.50
Hub caps for 5", 6", 7" wheels	3c each Plus postage

UNITED WHEEL STAMPING CO., Dept. PM-7

2756 W. 115th St. Chicago 43, Ill.

Plastics Supplies Catalog

Just off press. Get details on Plexiglas, Lucite, rods, sheets, tubes, Acetates, cements, dyes, buffs, molding sets, tools, carving kits, everything in plastics. Lowest prices. Price 10c, stamps or coin, with ad for catalog.

Plastics Mfg. & Supply Corp., Dept. PM-7, 4707 Euclid Ave., Cleveland, Ohio

Ball-Bearing SPEED WHEELS



JUVENILE WHEELS

(No bearing, solid tires)

5".....45c 6".....65c
7".....75c

(Semi-pneumatic tire, ball bearing)

8x1.25	1.85	10x1.25	2.20
8x1.75	1.95	10x1.75	2.30
8x2	2.20	12x1.75	3.45

INDUSTRIAL WHEELS FOR HEAVY LOADS

5x1.75 Bolted	3.65	10x2.75 HC.	5.70
6x2 Welded	3.45	10x2.75 Pnc.	7.60
6x2 Bolted	4.35	12x2.00	6.90
8x1	5.25	12x3.00	10.60
8x2.00	5.20	4.00x8-2	14.70
8x2.50	5.40	4.00x8-4	15.85
10x2.00	6.10	16x4.00	15.15

DEALERS, JOBBERS AND MANUFACTURERS: OUR NEW PRICES WILL INTEREST YOU.

WRITE US NOW FOR COMPLETE NEW CATALOG

Send check with order. No C.O.D.

JIM BROWN TOY COMPANY

1097 Home Ave.

Akron 10, Ohio

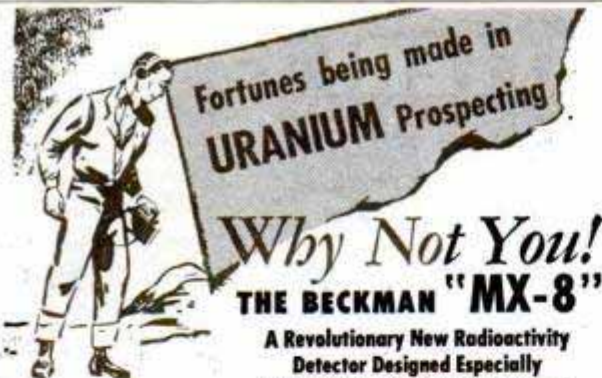

Why Not You!
THE BECKMAN "MX-8"

A Revolutionary New Radioactivity Detector Designed Especially For Amateur Uranium Prospecting!

Developed by one of the nation's leaders in building scientific instruments, the Beckman "MX-8" enables amateurs to join the new "Gold Rush" for uranium deposits. Take it on hunting, fishing, vacation trips—prospect as you go. You may discover valuable uranium deposits as others have. Fortunes are being made in this fascinating new hobby-science.

- ◆ The "MX-8" is compact, portable, weighs only 3 1/4 lbs. complete.
- ◆ Simple one-hand operation.
- ◆ Ruggedly built for rough field service.
- ◆ Highly sensitive—detects Beta, Gamma and X-Rays in both low and high intensities.
- ◆ Inexpensive to buy and maintain.

Many other unique features make the "MX-8" ideal for prospecting, health protection, other radioactive detection. Write for literature!

Free Helpful data (reprint of feature article from leading national magazine) on profitable new hobby-science of amateur uranium prospecting. Tells how, where. Send for your copy today.



ONLY \$97.50 COMPLETE! F.O.B. South Pasadena

Beckman Instruments
NATIONAL TECHNICAL LABORATORIES
South Pasadena 59, California

GET IN ON THE GROUND FLOOR!

YOUR OWN PROFITABLE BUSINESS with the **BEELERIZER**

The Original Food Liquefier

The Beelerizer is America's newest kitchen appliance—a necessity in every home. Although it has widespread acceptance this is the first time it has been offered for direct-to-consumer sales!

It transforms ordinary foods into a gold mine of health and vitality for the entire family—is a MUST for homes with babies and growing children. A 44 page book, a "passport to better living" with hundreds of recipes for vitamin and mineral rich foods is furnished with each Beelerizer. It provides you with a "step by step" visual sales manual. You can recruit large numbers of men, women and housewives to sell the Beelerizer on full or part time basis in cities and small towns. The Beelerizer, built by a 40 year old company renowned for the inherent quality of its products, means health to the family—economy and convenience.

Its exclusive features will enable you to build a substantial, year round, highly profitable business free of competition.

Write for full particulars today!

BEELER CORPORATION
105 West Adams St. Chicago 6, Illinois



BRASS NAME PLATES OR KEY TAGS

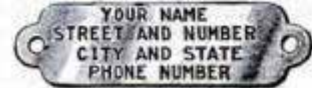

(INDIVIDUAL STAMPING)
40c each—3 for \$1.00

Half actual size
QUANTITY PRICE - SAME STAMPING
8 for \$2. - 15 for \$3. - 25 for \$4. - 50 for \$6.
LARGER QUANTITIES ON REQUEST
TAGCO, BOX 38X, WINGDALE, N. Y. STAMPING EQUIPMENT



BARBELLS

Save Money—Buy the finest barbell equipment direct from our foundry—No other company can match our low price or value!

Send to-day for our FREE Barbell Catalog
BUR BARBELL CO.
Lyndhurst 19, New Jersey

95 lb. SET
\$10.80
Extra plates 10c lb.

Low FACTORY-TO-YOU Prices New! MIDWEST TELEVISION

with **BIG 75 Square Inch SCREEN**



- 12 1/2" PICTURE TUBE
- 12 TELEVISION CHANNELS
- PICTURE-HOLD CONTROL

30 DAYS TRIAL - EASY TERMS

Other Models Include:
SYMPHONY GRAND AM-FM RADIO-TELEVISION-PHONOGRAPH with DUAL-SPEED RECORD PLAYER

Also complete CHASSIS for Custom Installation—and Adapter Chassis and Console for use with 1947, 1948, 1949 Midwest Radio Models.

Factory Authorized Service in all Television Areas



Also—Sensational **NEW MIDWEST RADIOS with DUAL-SPEED Phonograph**

Send for TELEVISION Folder Prices and **NEW 1949 MIDWEST RADIO Catalog**

MIDWEST RADIO & TELEVISION CORP.
Dept. T-25B, 909 Broadway, Cincinnati, Ohio

Name _____
Address _____
City _____ Zone _____ State _____

AAF Type SUN GLASSES

Finest Army Air Corps type sun glasses. Lifetime Guaranteed! 4 base ground and processed lenses. Optically correct. Gold-plated frames, mother-of-pearl sweat bar. Complete with smart belt case. **\$2.00***



FREE CATALOG
16 PAGES OF DOWN-TO-EARTH VALUES!



SURPLUS HUNTING KNIVES

7" Blade! U. S. Marine Issue
Excellent hunting knives with extra heavy reinforced sheath. For hunters, fishermen, every outdoor use. Made by Kabar & Camillus. Parkerized Blade. Very slightly used. Guaranteed. In excellent condition. Postpaid, only **\$1.00**
Same knife, brand new with sheath....\$1.50

MOSQUITO HEADNETS

Cover head and neck. Wear over hat. Fish in solid comfort this summer. Strong, green mesh. Postpaid. **2 for \$1.00**

Satisfaction guaranteed on all orders or money back.
SURPLUS MARTS Dept. M-7, 6225 Santa Monica Blvd. Hollywood 38, California

SURPLUS BRAND NEW AIR COMPRESSORS

for Garage - Shop - Factory - Farm or Home. Height 9" - Weight 7 1/2 lbs. Uses 1/4 HP Motor

A sturdy, well built air compressor of steel and die cast metal constructed to give satisfactory and lasting service. 20-30 lbs. continuous pressure. Higher pressure for intermittent service. Formerly sold for \$14.50. Synthetic rubber hose with fitting, 12 1/2 feet \$1.70, 23 1/2 feet \$3.00.

COMPRESSOR CORPORATION OF AMERICA
ST. JOSEPH, MICH.

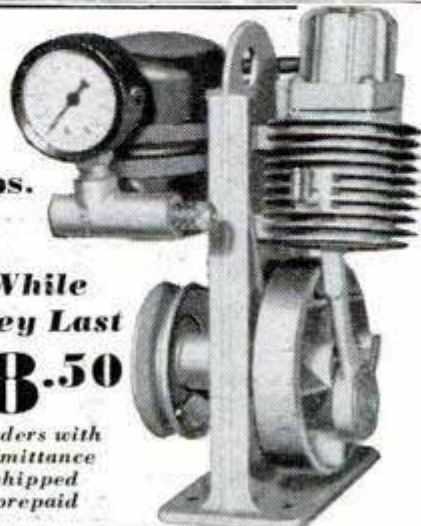

While They Last
\$8.50

Orders with remittance shipped prepaid



\$4.90

Syphon Type Spray Gun

Announcing...

a special offer to

**POPULAR
MECHANICS** *Readers*



The Octagane Water Injector is designed to give you premium performance — and better — from regular gasoline. It will eliminate "ping" or "knock," and your engine will last longer because it is kept absolutely clean. You will have the use of all your engine's horsepower. The Octagane is designed to last for the life of your car. It is constructed to rigid engineering specifications of finest quality bronze, copper, and stainless steel. It comes ready for its simple installation down to the last nut and bolt. And, of course, a one year guarantee comes with it. Send for the Octagane today and give your car a new lease on life!

We believe that you, as a reader of Popular Mechanics, are a leader in taking up new developments in science and technology, such as the Octagane Water Injector. We also believe that your friends listen to your advice on technological developments. Therefore, we make the following offer, which we believe has never before been made by anyone else in any national advertisement:

1. We will send you the new Octagane Water Injector, complete with stainless steel tank and all fittings for your car, at the nationally advertised price of \$24.95.
2. We will send you absolutely free a Gane Airflow Idling Needle Kit for your car. (These needles will give you 1 to 4 added miles per gallon. The Gane and the Octagane work together—the Gane improves performance and mileage below 20 m.p.h. and the Octagane does the job above that speed.) The regular price of the Gane Airflow Needle is \$3.00 per pair.
3. We will send your order C. O. D. and we will pay the postage. You need send no money.
4. **AND FINALLY:** If you promise to send us the names of five friends who own cars, **WE WILL SEND YOU \$5.00 IN PAYMENT FOR THESE NAMES ALONG WITH YOUR ORDER!**

We make this unprecedented offer only because we think that Popular Mechanics readers are leaders in adopting new devices and we believe that others are confident in their judgment. We need your help to get information about water injection to drivers who need to know about the Octagane. We ask you to help us, to help your friends, and to help yourself.

This offer is being made now for the first and only time. It expires at midnight, September 30, 1949, and all orders must be postmarked before that date.

Fill out the coupon below today!

COMMONWEALTH CARBURETOR CORPORATION
DIV. 19-B, 1478 UNIVERSITY AVENUE, BERKELEY 2, CALIFORNIA

GENTLEMEN: I WANT TO TAKE ADVANTAGE OF YOUR OFFER RIGHT AWAY. PLEASE SEND MY OCTAGANE C. O. D. AT ONCE. I UNDERSTAND THAT YOU WILL INCLUDE A GANE KIT ABSOLUTELY FREE, AND THAT YOU WILL PAY POSTAGE. SEND ME \$5.00 ALONG WITH MY ORDER AND IN RETURN I WILL SEND YOU THE NAMES OF FIVE FRIENDS WHO OWN CARS, AND WHO SHOULD BE INTERESTED IN WATER INJECTION.

NAME _____
STREET _____
CITY _____ STATE _____
MAKE & YEAR CAR _____ NO. CYLINDERS _____ MAKE CARBURETOR _____

BURN WATER IN YOUR CAR!

**WORLD'S
BEST
WANT AD
MEDIUM**

CLASSIFIED Advertisements



Advertisements in this section 75 cents per word, each insertion, minimum 10 words, payable in advance
To be inserted under proper classification, copy must be in our office the 22nd of the
second month preceding date of issue

F. W. Johnson, Manager, Classified Advertising
Popular Mechanics Magazine, 200 East Ontario Street, Chicago 11, Illinois

YOU'LL PROFIT

By reading and answering the classified ads in this section. Hundreds of opportunities for you to make and save money

AUTOMOBILES. MIDGET CARS

DUAL Muffler sets for Ford and Mercury. Famous Power-Tone only \$16.95 per set. Power dual intake manifolds for Ford and Mercury (up to 1949 only) \$24.85. Fender skirts \$12.95. Immediate delivery. Certified Welding Co., Dept. 10-G, Taylor and Delmar, at. Louis 8, Mo.

STEAM Automobile Books. Clymer's Steam Scrapbook, 224 pages, 100 steam cars illustrated, described, \$2.00. Modern Steam Car Book \$2.00. Original catalog reprints Stanley, White, Doble \$1.00 each postpaid. Specify title wanted. Clymer, Dept. A-SS, 1268 So. Alvarado, Los Angeles 6, Calif.

"VAPO-STEAMATIC" Water injector. Easily built! Finest automatic "Moist-Humidity" system! Engineering triumph—Gets up to ten extra miles per gallon! Tremendously increases horsepower! Eliminates ping, carbon, overheating! Reduces wear—Lengthens engine life! Copyrighted "Water Injection Handbook"—with working drawings covering automobiles, motorcycles, airplanes, tractors! Includes plans, catalogues, diagrams, instructions—\$1.00 complete. Newhouse Automotive Industries, 5805-B1 East Beverly, Los Angeles 22.

POWER-TONE Mufflers for all cars. Gives that power plus tone. Singles and dual sets for Ford and Mercury. Also the new Power dual intake manifold for Ford and Mercury cars. Many other items. Dealer inquiries invited. Power Engineering Company, Dept. PM-7, 4506R Delmar, St. Louis 8, Mo.

OUTBOARD Book. Complete servicing information all makes. 252 pages. Postpaid \$3.50. Clymer, Dept. A-OM, 1268 So. Alvarado, Los Angeles 6, Calif.

CALIFORNIA Custom accessory headquarters. Buy direct from original designers and save. Solid hood sides, grille panels, lowering kits, fender skirts, dual pipes, chrome motor accessories, speed equipment. 1949 illustrated catalogue—32 pages. 200 California accessories—25c. Eastern Auto Supply, 3319-A South Grand, Los Angeles 7, Calif.

TED Horn Number 1. A new book on life, racing experiences late American Automobile Racing Champion. 224 pages with 95 photographs Horn and famous cars. Fascinating, colorful record entire career. Beautifully bound Fabrikoid Memorial Edition with gold leaf lettering \$3.50. Paper edition \$2.00. Postpaid. Clymer, Dept. A-TH, 1268 Alvarado, Los Angeles 6, Calif.

TOOL Pouch, heavy waterproof canvas duck, wide zippered opening. Keeps tools safe, convenient, dry, in home, car, garage. 4½x9, \$1.00; 5½x12, \$1.25; 7½x17, \$1.60. Lafayette Supply Co., West Lafayette, Ohio.

FORD Model "A" complete service manual \$1.00. Model T manual \$1.50. Fordson Tractor \$1.00 postpaid. Clymer, Dept. A-AT, 1268 So. Alvarado, Los Angeles 6, Calif.

JUST Published! Big speed equipment guide book—secrets of lightning acceleration, horsepower, economy. All cars. 25c (refundable). SSA, 5747 Waveland, Chicago 34.

NEW Ignition tester—Tests weak, fouled or shorted spark plugs. Locates electrical leaks. Handy pocket size—\$1.00. Tyson's, Box 118-A, Northport, Ala.

"SPEED & Power" Handbook—50 chapter library edition! Breathtaking methods—authentic—direct from California! Covers Fords to Cadillacs—all makes! Build your own dual manifolds! Superchargers! Hot Cams! Water injectors! Hi-compression heads! Mileage devices! Save many dollars! Get racing speed, lightning acceleration, dynamic power increases from any make automobile! Build fast stock cars! California roadsters! 150 MPH rods! Get construction drawings! Tuning techniques! Speed tricks! Picture catalogues! Ingenious formulas. Economy secrets! Including—"Racing Frames"—"Reciprocating Masses"—"Jet Engines"—"Braking Characteristics"—"Dynamometers." Also—dual pipes, gears, fuels, porting, relieving, lowering, balancing! Includes "California Automobile Customizing," glossy photographs! Diagrams! Very newest ideas! Conversions! Re-styling all makes! Streamlining! Chopping! Channeling! Customizing! Complete \$1.98 postpaid. Newhouse Automotive Industries, 5805-B2 East Beverly, Los Angeles 22.

HANDBOOK All Ford cars 1932 to 1949 inclusive. Complete detailed information, service operations, 100 illustrations. A must for every Ford owner. Includes V-8 and 6. Entirely new, just out. \$1.50 postpaid. Clymer, Dept. A-WL, 1268 So. Alvarado, Los Angeles 6, Calif.

CALIFORNIA Hot Rod Handbook—Shows how to hop up your Ford or Mercury. Speeds up to 140 MPH. \$1.00 postpaid. Hotrod Specialties, Box 639, Inglewood, Calif.

RADIATORS—Ford, Chevrolet factory outlet. All new in original cartons. Write for price list. Buy direct, save dollars. Guaranteed Radiators, 8815 De Haviland, Los Angeles 45, California.

CLYMER'S New catalog illustrates, describes all 1949 American cars. Complete detailed specifications all makes, including Tucker, Playboy, Del Mar, Davis, Keller, all G-M, Ford, Chrysler lines and independents. Compare all cars in one book. Sensational. 115 photographs. \$2.00 postpaid. Clymer, Dept. A-49, 1268 So. Alvarado, Los Angeles 6, Calif.

SEE Our ad under motorscooters for midget car bargains. Midget Motors Directory, Athens, Ohio.

NEW Ford Hotrod Manual. 128 pages chock full of cutaway construction drawings, photos, and valuable easy to read and understandable technical data. Neatly bound with colorful eye-catching cover. Includes complete data on installing V-8 motor in model A chassis, hydraulic brakes for any Ford, roadster and fast road car info. How to rework these engines for speed: V-8, Merc., Ford 6, Zephyr, model A. Guaranteed the finest manual of its type published to date. Sent postpaid for \$2.00. California Bill, Box L-1, Eaglerock, Los Angeles 41, Calif.

CLYMER'S New Steam Traction Engine Album. 160 large pages. 470 photographs, charts, drawings, early advertisements 105 makes steam engines, threshing equipment. See Case, Advance, Reeves, Rumley, Avery, Westinghouse, others, from 1855 to 1929. Postpaid \$2.50. DeLux Edition Fabrikoid bound \$3.50. Clymer, Dept. A-ST, 1268 So. Alvarado, Los Angeles 6, Calif.

NEW Hot Rod Book. Revised, 1946, 1947, 1948 speed record cars, photos, descriptions. \$1.50 postpaid. Clymer, Dept. A-7NV, 1268 So. Alvarado, Los Angeles 6, Calif.

HOT ROD—The only monthly magazine about building roadsters, streamliners, etc. Sample copy 25c, \$3.00 yearly. Hot Rod, 7164 Melrose, Hollywood, Calif. Dept. PM.

INTERESTED In automobiles? Send for free sample copy. Franson's Weekly Motor News, Box 254, Eugene, Oregon.

AUTOMOBILE Racing, Sixth Edition. 100 illustrations. Working drawings with building instructions for Ford-60 midget, California roadster, Offenhauser racer. Details on racer parts. Sample entrance blank. World's record 158.5 m.p.h. rear engine four-wheel drive car. Interesting information for fans, drivers, mechanics, \$2.00 postpaid; \$2.40 c.o.d. Ray Kuns, Department 63, Cincinnati 27, Ohio.

CHEVROLET Hotrod Manual gives full details and photos on how to obtain terrific speed, acceleration and hotrod performance from your 1937 thru 1949 Chevrolet. 54 pages, expertly written. Packed with accurate data you can use! Sent postpaid for \$2.00. California Bill, Box L-1, Eaglerock, Los Angeles 41, Calif.

DUALTONE Crystalline packed California mufflers and dual sets. California chromed accessories, lowering blocks all automobiles. Speed and doll-up equipment. Catalogue 20c, streamlining manual \$2.00. Dealers request dealership information. Dualtone Mufflers, 2636C India Street, San Diego 1, California.

AUTOMOBILE Racing book, fifth edition, well illustrated. Instructions on building bodies, frames, engines. Ford A and B conversions. Plans, AAA rules, specifications. Roadster racing, Indianapolis cars. \$1.00 postpaid, \$1.40 C.O.D. Ray Kuns, Dept. 47, Madisonville, Cincinnati 27, Ohio.

INTERCHANGEABILITY Bearing book. Saves dollars for garagemen, dealers, fleets, mechanics, owners. Many bearings are of same identical specifications 100 percent interchangeable, but their identity is hidden because of wide spread in different car manufacturer's prices. \$5.00 per copy. Covers cones, cups, pins, roller, ball; for (wheels, transmissions, differentials, axles, generators, steering, etc.) Order now at special price. Send only \$2. Automotive Research Publications Inc., PM59, Islip, New York.

RACING Car equipment for all cars, engines, racing heads, manifolds, carburetors, mufflers, etc. Speed instructions and literature \$1.00—refunded first order. Lee Motorcraft Co., 1412-D Great Northern Bldg., Chicago 4, Ill.

NEW Sensational seat cover. Mono, 6545 Santa Monica Blvd., Hollywood, California.

WE Sell direct to customers over 200 speed equipment parts manufactured by us. Ford A-B-V8-6-4-(Ferguson), Studebaker Champion, Chevrolets and Willys. Cylinder heads, dual intake manifolds, lynite flywheels, oversize valves, compound springs, camshafts and other supplies. Complete engines ready for race for cars, boats and midgets. \$1.00 to cover illustrated literature and price sheet. R & R Mfg. Co., Robert M. Roof, Box 546, Anderson, Indiana.

IT'S Here. The last thing in customizing. Front fender skirts. Unbelievable beauty. Easily made at home. Full plans only 50c. Customcraft Auto Works, Box 1002, Springfield, Mass.

FROM Speedway to roadway! Track-proved hi-speed heads and manifolds now available for your passenger car! No special tools needed! Increase horsepower 25%! Astounding getaway! Free illustrated catalog. Speedsport, 6215AA Diversey, Chicago 39.

AUTO SUPPLIES AND EQUIPMENT

FORD Parts—Genuine. Complete stock of Model T, A, B, and all later models. We ship anywhere. Established 1920. De Perty's Ford Parts, 161 Fifth Street, Newark 7, N. J.

WELD Cast iron, AC, DC. Easy with free instructions sent with generous trial package. Send \$1.00 to Hobartweld, Box M-793, Troy, Ohio.

SAVE Your finish. Hawk Gas Channel stops gasoline blow-back caused by rapid filling. \$2.00. Hawk Development Co., 118 Campus, Ames, Iowa.

WELDING Bodies, blocks—Repairing fenders, adds profits. Easy with low cost Hobart Welders. Terms. Free catalog. Write Hobartweld, Box M-792, Troy, Ohio.

PARTS, New, used, for all cars. Auto Parts Service, 111 Sunset Ave., Fairfield, Conn.

"LEKTRON" Atomic coil booster saves gas! Instant starting. Only \$2.00. Money-back guarantee. Easily installed. Specify car. Electronic Industries, Cleveland 11, Ohio.

FUEL Pumps—A.C. Carry a spare for summer driving. Ford, Chevrolet, Plymouth, Dodge, DeSoto. Guaranteed. Full price \$1.75 postpaid. Custom Bilt Carburetor Co., Del Vallee Sta., P.O. Box 7862, Los Angeles 15, California.

BATTERY Master. Light mounted on automobile dash indicates low water level and less than full battery charge. Easily installed. \$4.00 prepaid. Electrical Indicator Company, 542 S. Dearborn Street, Chicago 5, Illinois.

SHINE Your car with Plasticote. A scientific combination cleaner and polish. Contains liquid plastic. Circular 10c. Sample 25c. Year supply \$1.25. Lenvor Distributing Co., Geary, Oklahoma.

INCREASED Power—Lower fuel cost. Economy converter converts motor to burn kerosene or distillate. Easily built at slight cost. Complete plans and instructions for Model A or B Ford \$5.00. Adaptable for any engine except V type. Arnold Shuler Machine Works, Rt. 3, De Funiak Springs, Fla.

GANES Aero jets save gas! \$1.50 each. Sent postpaid for free trial for your car. Pay postman nothing! If not delighted after 10 days return them and you owe nothing. Send make of car and carburetor today. Advanced Automotive Products Co., 563 Lake Road, Webster 2, N. Y.

INITIALS For your car. Send 50c for 6. Stilwell, Empress Bldg., Decatur 64, Ill.

PISTONS—American, foreign, and racing. Any model. Merryman Co., Lawndale PM6, California.

NEW And used guaranteed parts for civilian and army cars and trucks. Largest stock in America. Mail orders. Pioneer Auto Wrecking Co., 734 W. 13th Ave., Denver, Colorado.

"SMITHYS Mufflers" for all cars. Free list. Buck's Auto Parts, 1296H, Merced 9, California.

BUICK Parts—Enjoy new-car pep and power in your old Buick. Same day service from world's largest stock of new (not rebuilt) Buick parts and engines. Ship anywhere. Write today. Robertson Buick Co., 1001 S. Wabash Ave., Chicago 5, Ill.

"AIRFLOW Needles." Save gasoline. Free trial! Send make car and carburetor. Neher Industries, La Verne, Calif.

HYDRAULIC Jack repair kits. Repair your own. Send for prices. Beerman Machine Works, 2000 So. Claiborne, New Orleans 13, La.

"WATER Injection." Free descriptive, illustrated, information. Neher Industries, La Verne, Calif.

NEW Patent. Lachapelles motor and motor fuel treatment stops ping, gives more power, more miles per gallon, more miles per motor, enough for 100,000 miles. \$3.00 postpaid. Ferns Products, 8120 Walnut Dr., Los Angeles 1, Calif.

AUTO Parts. Buy direct. Get dealers' prices. Represent us in your territory. Write requirements. Specify car make. Mechanics Auto Parts, Factory Warehouse, 3807-PM N. Ashland, Chicago 13.

AUTOMOTIVE Surplus tool specials! Pullers, wrenches, socket sets, reamers, other bargains. Nationally advertised merchandise. Free catalogue. Glenco Supply, 7519 Myrtle Avenue, Glendale 27, N. Y.

GOVERNMENT Surplus. Low voltage circuit tester in steel box. Cost \$202.00. Our price \$27.50. Will test batteries, starters, generators, voltage regulators, grounds, short circuits. Wilt Electrical Company, 7829 S. Racine Ave., Chicago 20, Ill.

FIBRE Seat covers \$9.98, plastic \$17.98. State make, model. Arnold, 382 Livonia, Brooklyn 12, New York.

RUSTED—Out bodies, doors, fenders repaired without welding, soldering. Professional results. Instructions \$1. Gibes, 2134 Haddon, Chicago 22.

GASOLINE Saver. \$1.00. Stromberg carburetors EE1-AAV16. Walert Co., 3429 No. 10th St., Milwaukee 6, Wis.

MECHANICS—Be independent. Smooth all cranks/casts. \$15.00. Free literature. D. McGee, 719A Cascade, Wenatchee, Wash.

AUTO Parts for all cars, transmissions, motors, differentials, fenders, carburetors. Security Auto Parts, 1923-PM Grace, Chicago 13.

CHEVROLET Parts. Scarce motor, body, sheet metal parts. Grossman Chevrolet, Minneapolis, Minnesota.

HARD-TO-GET Auto body parts. We supply. Miller Auto Parts Service, 192 N. Clark Street, Chicago.

BRUSH Plating outfits connect to a battery. No tanks or shop required. Free particulars. Gunmetal Co., Avenue J, Decatur, Illinois.

AUTO TRAILERS

BUILD Your own trailer! Save money! Have every feature you want! Plans for house, sport, camp and utility trailers. Catalog describing 9 models 10c. 15c in Canada and overseas. Jim Dandy, Box 125-A, Wausau, Wisconsin.

MOTORCYCLES, BICYCLES, MOTORSCOOTERS AND SUPPLIES

USED Motorscooter \$4.50, motorbike \$5, midget racer \$10, new Regal motorscooter \$37.50, less motors. Super-Cycles, Cushman, Salsburys. Briggs motor \$8, others \$3 up. New motorbike conversions \$5. Plenty of brand new motorscooters, midget cars, homebuilders parts, automatic clutches, transmissions, engines, tires, etc. at factory prices. Special sale: Four balloon tires for \$3. Over 4500 tires in stock. Mailorder only. Send 25c for big war-bargain catalogue number 31, just out, listing these and hundreds of other bargains. (35c by first class mail). Midget Motors Directory, Athens, Ohio.

HARLEY-DAVIDSON Parts, accessories, oil, expert service. Tires all sizes. Send \$2.25 for Army 45 motorcycle manual. 25c for accessory catalog and bulletins. Knuth's (Harley-Davidson Dealers), 2491 Fondulac, Milwaukee, Wis.

MOTORCYCLE Monthly—Worldwide News. Generously illustrated. Year's subscription \$1.00. Sample 15c. Motorcycle News, 5424-A Sawyer, Chicago 25.

NEW 1949 Indian and Harley parts and accessory handbook, 25c. Motor parts, chains, batteries, chrome accessories. Motor rebuilding. Bootz, 1700 East University, Des Moines 16, Iowa.

HARLEY-DAVIDSON 125—America's outstanding lightweight powercycle. Floor models and demonstrators at a saving. Send 10c for bulletin. Knuth's, 1753 Muskego, Milwaukee, Wis.

BICYCLE Supplies wholesale, retail. List 10c. Universal, 4713 Virginia, St. Louis, Missouri.

ACCESSORIES, Apparel. American, English. Send 20c for biggest illustrated catalog ever printed for motorcyclists. Limex, Dept. M, Bellerose, N. Y.

COMPLETE Parts for all American motorscooters from 1940. Also automatic clutches, generators, tires, chain. Motor parts. Lauson and Briggs and Stratton engines available. Moto-Scout, Inc., 1323 W. Carroll Ave., Chicago, Ill.

CUSHMAN Motorscooter (4 H.P. motor) \$19.98 complete; Midget car (leather seat) \$25.00; Motorscoot \$15.00; 1946 Whizzer \$35.00; Motorbike outfit \$5.00; Indian motorcycle \$30.00. Other motorscooters \$8.00 up, motors \$3.00 up. Send 25c for new summer catalog listing many other sensational bargains in used motors, motorscooters, motorcycles, parts, etc. Associated, Box 1764-CS, Toledo, Ohio.

MOTOR Scooters, bicycle engines. 120 miles gallon. Dime for catalog. Clymer, Desk A-75, 1268 So. Alvarado, Los Angeles 6, Calif.

MOTORCYCLE Pistons and parts, new, used. Harley, Indian, Henderson, Super-X. List 10c. Ballak, 811 N. 9th, St. Louis 1, Missouri.

\$12 **SPRING** Pillion seat only \$8. Free illustrated catalogue. Cycle Products Ltd., 1120 So. Los Angeles, Los Angeles 15, Calif.

WHIZZER Bike-motor \$25.00; Cushman motorscooter \$15.00; midget racer \$40.00; Shaw bicycle-motor \$15.00; Harley-Davidson motorcycle \$15.00; Smith motor-wheel \$25.00; Good motorscooter (twist grip) \$22.50. Rush 25c for new catalog #14 listing many other amazing bargains in motorscooters, used motors, midget cars, parts, wheels, etc. Gail, 538 Erie, Toledo, Ohio.

COMPLETE One stop Harley Davidson sales service. Comprehensive accessory catalogue 25c. 813 Ohio St., Wichita Falls, Texas.

HARLEY-DAVIDSON Parts, accessories, batteries, and tires. 24 hour service. Authorized factory dealer. Philadelphia Harley-Davidson Company, 857 North Broad Street, Philadelphia 23, Penna.

MOTORSCOOTERS, New design, 6 big features. Literature 10c. Rollaway Motors, Lancaster, N. H.

RECONDITIONED Motorcycles and motors. Chromium accessories. Complete stock Indian parts. Expert rebuilding. Fast service. Indian Motorcycle Sales, Kansas City 1, Mo.

WHEELS! Build wagons, scooters, mowers, trailers, wheelbarrows, grocery carts, baby carts; play pens, baby carriages. 4" to 16". Free list. Trulsen Mfg. Co., 811 E. 31, Kansas City, Mo.

TIRES And industrial wheels, suitable for scooters, wheelbarrows, farm equipment, etc. All sizes. Bicycles and accessories. Largest assortment in America. Send dime for list. Cycle Transport Company, 1241 So. Michigan Ave., Chicago 5, Illinois.

AVIATION

RAM JETS—Complete theory and design data \$2.00. W. T. Decker, Plasterco, Va.

LIGHTPLANE Manuals, blueprints. Circular illustrating designs, motors 20c. Craftsmann Books, Box 1153, Milwaukee 1, Wis.

USED Airplane bargains. Read Flying Reporter, 10c copy, \$2.00 year. Hibbing, Minnesota.

AAF Pilot's breathing oxygen set-up! Flyers, outdoorsmen, mountain climbers. Consists 6"x24" light-weight steel bottle, regulator, gage, mask; new surplus! Non-technical, merely breathe. \$7.95; filled w/oxygen, \$9.95. (Cost over \$100.) Aero Parts, Dept. T, Municipal Airport, Houston.

JET Engine \$3.00; plans \$1.00; literature 10c. M.E.W., 387 University, St. Paul, Minn.

PROPELLERS, Plans, skis, engines, for ice-snow sleighs, air boats. Literature 10c. Banks-Maxwell, R.F.D. 12, Ft. Worth.

PROPELLERS—2-3 Blade for sleds, air-drive boats. Catalog. Standard Aero Craft, Box 387, Ft. Worth, Texas.

BATTERIES, GENERATORS

EDISON Non-acid lifetime storage batteries for home lighting, motors, industrial uses, radios, etc. Free interesting literature. Hawley Smith Co., Croton Falls 1, N. Y.

ELECTRICAL SUPPLIES

ELECTRONIC Door lock. Sensational. Invisible. Positive protection. Inexpensive. Ends losing keys. Send only \$2 for thoroughly engineered drawings and complete simplified instructions. Satisfaction guaranteed. Aynsworth, 17544 Raymer, Northridge, California.

SILICON Transformer lamination cut to order. Magnet wire, supplies. Send for bulletin 42949M. Morton Electrical Service, Maywood, Ill.

BUY Lamp parts wholesale. Parts you need for building, repairing, or assembling. Save money on large or small orders. New catalog for 10c. Gearon Company, Dept. 300-B7, 27 South Desplaines, Chicago, Illinois.

"ELECTRICAL Contractors Estimating Handbook." Takes guess-work out of estimating. Write, The Estimator, 1805-A Sixtieth Street, Kenosha, Wisconsin.

ELECTRIC Pencil: Engraves all metals \$1.25. Beyer Mfg., 10511-H Springfield, Chicago 43.

INFINITELY Variable voltage transformer operates from home lighting current. Steps voltage up or down. Vary the speed of motors, dim lights, do radio test work. Copyright data \$1.00. PeJay Engineering, P.O. Box 1172, Oakland 4, Calif.

NEW G.E. motors 1/3 H.P. \$12.50, others in stock. Free literature. Plenge, 114 Elliot Place, Bronx 52, New York.

LAMPS—If you build or repair and had trouble getting parts—your search is ended! 24 hour service from the most complete stock in country. Illustrated catalog 10c. Dealers, send business card for quantity discount. Gyro Lamps, 5402P Clark, Chicago 40.

FRACTIONAL Horse-power replacement motors; blowers. Send for folder. Box 292, Binghamton, N. Y.

WELDING, SOLDERING, PLATING

"BUILD-UR-OWN" Welder plus AC power plant. Weld, run tools, lights, motors, anywhere. Use for stand-by power. Save \$350. Terms. Send 10c for valuable instruction book. Hobartweld, Box M-794, Troy, Ohio.

ACETYLENE Welding outfits new \$45.00, Arcwelders \$46.50. Eagle Welding, Dept. PM, 5085 Broadway, Chicago 40, Ill.

VALUABLE Book. "How to Operate a Profitable Welding Business." Regular 75c value. Send just 10c to Hobartweld, Box M-795, Troy, Ohio.

ELECTROPLATING Units—Complete. \$2.00 and up. Free literature. Regency Sales, Dept. M, 5316 So. Justine, Chicago 9, Ill.

RADIATOR Repairing, cleaning, recoring. How to equip small shop at low cost. Supply sources, trade secrets, instructions. Now only \$3.50 postpaid. Radiator Service, McBain, Mich.

WELDING. Best equipped school in U.S. Demand for trained men. G.I. approved. Free catalog. Write Hobartweld, Box M-796, Troy, Ohio.

AUTO Radiator repairing supplies, equipment, books, gasoline torch. Write, Curfman Co., Maryville, Mo.

WELDERS 110v. Welds 1/2" steel \$32.50. Morris Welding Service, 1850A State, Schenectady 4, N. Y.

BUY Direct from factory. Welding outfit, \$48.36. Soldering outfits \$7.76 to \$10.16 complete prepaid. Box 331, Hamilton, Ohio.

OWN Mirror shop. Resilver mirrors. Glass sign making. Electroplating. Supply prices. John Sprinkle, V55, Marion, Indiana.

MACHINERY, TOOLS, SUPPLIES

14 INCH Bandsaw \$75.00. Heavy cast iron construction. Precision ball bearings. Large 13 inch tilting table, ball bearing saw guides. Write for descriptive circular. Maxwell Mfg. Co., 10750 Nassau, Sunland, Calif.

1/4" ELECTRIC Drill \$8.95. 1/2" electric drill \$22.95, 1/4 hp. bench grinder \$22.95. New and guaranteed, catalog 10c. Box 1161, Oklahoma City, Oklahoma.

CONVERT Your bench lathe to vertical milling. Montgomery, 53 Park Place, New York City 7.

DRILL To 1/2" with 1/4" electric drills. One hand. \$7.50. Literature. Palmer, 12 East Holly, Pasadena 1, Calif.

THE Acme sharpener will produce a smooth, fast cutting edge on any kind of circular saw. Send for free literature. Max Mfg. Co., 138 Stockton Ave., San Jose 11, California.

CHUCKS (Genuine Westcott), top quality independent, universal, threaded 1"-8, 1"-10, 1"-12, 1 1/2"-8 for Delta, Walker-Turner, Atlas, South Bend, Logan, Craftsman and other leading lathes. Other chucks to 16". To receive definite quotation and free literature advise size and type chuck required, also make of your lathe and spindle specifications. No obligation. Westcott Chuck Co., 3600 Walnut, Onida, N. Y.

SURPLUS Bargains. \$14.00 value, 2" 3 jaw universal chucks, now \$2.95 ea. \$12.00 value 6 volt DC motors for auto heaters, fans, toy trains, etc. now 3 for \$2.50, sample \$1.00. Send money order or check. Har-Mur, 2349 W. Devon Ave., Chicago 45, Ill.

POCKETOOL With quick-change bits does many jobs for craftsmen, electricians, mechanics. Free folder. Rodor Tools, Metropolitan Building, Chicago 2.

PRECISION Tools, used: Micrometers, verniers, etc. H. Riley, 150 East 19th St., Brooklyn 26, N. Y.

"TIRES"—Save 1/3. New, rugged all purpose airplane tires. 10 inches to 56 inches high. Complete wheel assemblies attach easily to your axles. Free details. Write card today. Airplane Tire Co., Box 1201A, Tulare 5, California.

B-29 FUEL Pumps 3/4". Ideal for pumping water, etc. Pumps 400 gals. per hr. only \$9.95. Satisfaction guaranteed. Imm. delivery. Send check or money order. Airplane Surplus Co., 3055 N. Broadway, Wichita, Kansas.

14"x6" HENDEY Engine lathe \$625.00. 18"x8" American GH screw cutting lathe \$350.00. #1 1/2 Valley universal milling machine \$425.00. 15" Potter Johnston metal shaper \$490.00. 20" Barnes drill press \$55.00. Cincinnati Machinery Co., Dept. B, 217 2nd St., Cincinnati, Ohio.

DRILL Press attachment instantly converts to wood shaper. Complete, for 1/2" chuck, with 5 different blades \$3.98 postpaid. Extra blank blades, 3 for \$1.00. Free circular. Thayercraft, Box 182, Culver City, Calif.

CONCRETE Block machines. Standard sizes, economical, dependable, low prices. \$39.50. Free catalog. Concrete Machine Co., 5129 S. Compton, St. Louis, Mo.

BENCHES, Cabinets, drawer cases and complete line of workshop equipment. Free catalog. Burkel Equipment, 1627 W. Fort, Detroit 16, Michigan.

BOATS, OUTBOARD MOTORS

CONVERSION Parts for all engines, marine manifolds, transmissions changed to high-speed reverse, propellers, shafts, couplings, etc. Money back guarantee. Conversion Parts Co., 278 Adams Street, Boston 22, Mass.

STEERING Wheels, windshield brackets, from \$6.95. Modern fittings at lowest prices. Complete pre-cut plywood boats. Bargains galore. Folder 10c. Marine, Box 681, Mendota, Minnesota.

BOAT Plans, kits—Hardware, conversions, plywood. See Marine Mart display ad page 237.

BUILD Your boat from our accurate paper patterns or materials, thirty designs, 7-54 feet. Forty years careful designing. Send 10c for folders. Illustrated book, small boat construction, \$1.50 postpaid. Germain Boat Company, W. Saginaw, Michigan.

KNOCK-DOWN Boat kits. Outboards, inboards, sail, hydroplanes. Easy to assemble, minimum cost. Catalog with specifications, prices 25c. Brooks Boat Company, Carrollton P6, Michigan.

TWENTY Plywood boat plans \$1.00. The Rudder, 15 Murray Street, New York 7.

GEM Oil measuring disc for outboard motors. Right mixture always. Oil measured directly from round standard quart can. Acts as cover. Keeps oil clean. Send 25c. W. L. Rives Company, 87 Riverside Viaduct, Jacksonville, Florida.

SAVE 2/3 Cost. Build your own boat with our ready cut parts by the Welch system. No experience necessary. Rowboats to cruisers. Illustrated catalog 25c. Midwest Boat Company, Menomonee Falls, Wisconsin.

OUTBOARD Motors—Used bargains. \$45 up, free list. Used parts, most models, save money! Boat and motor equipment and accessories. Big catalog, send dime. Crandall-Hicks, 911 Commonwealth, Boston, Mass.

BOAT Plans: Over 300 designs easy-to-build outboards, sailboats, runabouts, cruisers, etc. Get free catalog now. Motor Boating, 572C Madison Avenue, New York 22, N. Y.

BOAT Plans: Wood; steel. Book, "Modern Designs for Boats and Yachts." \$1.00. John B. Clark, Yacht Designer, 329 Kenmore Drive, Bay Village, Ohio.

BOATS And all about them. How to select, build, repair and operate. For 40 years the leading practical boating magazine. Half price trial subscription, 12 issues for \$1.00. Motor Boat, 62 Gold Street, New York 7.

P38 BELLY Tank boat plans, complete instructions \$1.00. Details free. Anzio Boat Company, 1635 T. Merced, California.

NEW, Used, rebuilt marine motors. Marine conversions, fittings. Free catalog. Stokes Marine Supply, Dept. 24, Coldwater, Michigan.

MARINE Conversions for Ford and Jeep engines. Catalog 10c. Lehman Manufacturing Company, Department D, Newark 2, New Jersey.

ENGINES, MOTORS, DYNAMOS

MOTORS! 1/2 H.P. D.C. converted to A.C. All new. High speed 110 volt, 25 or 60 cycle, ball bearing motors. Actual value about \$75.00. Now \$15.00 each or 3 for \$40.00. With forward and reverse switch \$19.50, 3 for \$50.00. Countless uses for home mechanics. Can be used in any position. Order today! Immediate delivery! No c.o.d. orders. "Amazing Bachman's" 27 Herman Street, Rochester 5, New York.

WELDER 150 Ampere \$47.50. Water pumps 300 G.P.H. \$12.75. Fans 32 volt 2 speeds \$3.75. Butler, 1885 Milwaukee, Chicago.

ARMATURE Winders, write for winding and testing bulletins. Motor Industries, Quincy, Illinois.

MOTORS—1/2 Horse B.B. 1750 R.P.M. \$18.50, 3/4 horse \$28.00, 1 horse \$35.00. Roberts, 7232 Madison, Forest Park, Ill.

WINDING Data, listing 225 motors, single and three phase, \$1.00. Motor Data Co., Box 7631, Kansas City 3, Mo.

ATHLETIC EQUIPMENT, BODY BUILDING COURSES

BARBELLS! Muscular physique, strength. Send stamp. Jackson Barbells, Springfield, N. J.

BARBELLS. Exercise equipment. Courses. Free booklet. Good Barbell Co., Reading, Penna.

DEADLY Judo—Fiercest fighting technique. Trick knockouts. (200 photographs, plus illustrations.) Expert instructions, three volumes. Complete \$2.25. Variety House, Box 46-B, Wall Station, New York 5.

SPORTING GOODS, GUNS, FISHING TACKLE, ARCHERY, TRAPPING

FLYTYING Materials. Beginner's kit \$5.00. Free catalog. Cunningham, Sunnyside P.O., Long Island City 4, N. Y.

SKET—The shotgun sport for year-round shooting pleasure. For descriptive literature and sample copy of Skeet magazine write National Skeet Shooting Association, 3911 1/2 Oak Lawn, Dallas, Texas.

FISHERMEN! Save money on bait. Raise your own. This book "Raising Worms For Pleasure or Profit" tells how. \$1.00 postpaid. Very liberal starting offer. Tennessee Worm Hatchery, Box 265PM, Nashville 2, Tennessee.

180 PAGES Antique and modern pistol, sword, etc. values. 50c. Robert Abels, A860 Lexington Ave., New York 21.

PISTOLS, Firearms, ammunition. Complete list 25c. Frank Farish, Vicksburg, Miss.

AAF Pilot's breathing oxygen set-up! Flyers, outdoorsmen, mountain climbers. Consists 6"x24" light-weight steel bottle, regulator, gage, mask; new surplus! Non-technical, merely breathe. \$7.95; filled w/ oxygen, \$9.95. (Cost over \$100.) Aero Parts, Dept. T, Municipal Airport, Houston.

AMMUNITION—Norma Europe's finest. Available all Mannlicher's, Mauser's. Japanese rifles rechambered. Reloaders attention! Bullets, powder, primers. Write needs. Expert gunsmithing. Free catalog. Ashton Company, 1511 Gardner, Hollywood 47, California.

TENNIS Players—A tennis counter on the butt of your racket makes score keeping automatic. Weighs approximately 3/4 ounce. Does not affect balance or grip. Installed in a minute. \$1.00 postpaid. Tennisore Co., Box 352, Youngstown, Ohio.

GUNS, blue-plated. Bluing salts for gunsmiths. Gunreblu, Biltmore 11, N. C.

MOLDS—For fishermen's sinkers. Ocean City Sinker Mold Co., 649 Wilcox Ave., New York 61, N. Y.

WE Swap guns, scopes, binoculars. Catalog 10c. Livingston Shooters Supply, East Corinth 87, Maine.

SEND 10c For list 100 used guns. Frayseth's, Willmar, Minn.

BARGAINS In popular and unusual fishing specialties. Write for free catalogue. Hobby Specialty Company, 415 Francis Palms, Detroit 1, Michigan.

TENTS, War surplus, all sizes; cots, hammocks, camping equipment, canvas covers, fishing and sporting goods, rope. Morsan, 10-19E 50th Avenue, Long Island City 1, N. Y.

MOLDS For fishermen's sinkers, squids, and jigs. Sweet's Molds, Tonawanda, N. Y.

BOWS, Arrows. Quality archery equipment. Popular prices. Catalog 10c. Illustrated archery instruction book 50c. Archery. 617-K So. State, Chicago 5.

5000 BARGAINS. Firearms, binoculars, war relics. Catalog 40c. Smith Firearms, Rummeneide, New Jersey.

SHOTGUNS. Rifles, revolvers, over 500 modern, obsolete. Also cartridges, list 10c coin. Ed Howe, 52 Main, Coopers Mills, Maine.

TAXIDERMY

"MODERN Taxidermist Magazine," Greenfield Center, N. Y. Devoted exclusively to taxidermy. Two sample copies 25c.

BINOCULARS, TELESCOPES, MICROSCOPES, MAGNIFIERS

BINOCULARS, Telescopes, watches, guns. Buy, sell, trade. Schweer's, Donnellson, Iowa.

BINOCULARS. Buy direct from importer. (7X50 \$40.) Free catalog. Write today. Bushnell Importers, 676-7 South Lafayette, Los Angeles 5.

POWERFUL Astronomical telescope. Equatorial mounting, two eyepieces, \$16.50. Blum Optical Laboratories, 4213 Gifford Ave., Cleveland 9, Ohio.

GIANT Astronomical telescope 100 diameters magnification, with tripod. Full power, clear vision. \$15.00. Suffolk Science Service, Manorville, N. Y.

TELESCOPES—17 Power; extends 36 inches, precision ground lenses. Ideal for studying stars, plane spotting, etc. Satisfaction guaranteed or money refunded. \$2.95 postpaid. Dept. PMC2, Criterion Co., 438 Asylum St., Hartford 3, Conn.

"TERRIFIC" Bargains — Government surplus telescopes, binoculars. Send \$1.00 for 10 piece hobbyist lens set. Contains magnifying and reducing lenses. Send stamp for "bargain" list. P. Jaegers, 93-08 95th Ave., Ozone Park 16, N. Y.

POCKET Size 40X microscope \$15.00. 6X telescope \$10.00. Both items are precision instruments of fountain pen size and have pocket clips. Shipped prepaid, satisfaction guaranteed. Free literature. Thayercraft, Box 182, Culver City, Calif.

WAR Surplus bargains. Binoculars, telescopes, sextants, millions of lenses, prisms, reticles, eyepieces, objectives, etc. Request free Catalog CH. Edmund Salvage Co., Audubon, N. J.

REFLECTING Telescopes, 60X, completely assembled \$25.00. Guaranteed observatory clearness. Free information. Skyscope, 475 Fifth Avenue, New York 17.

POWERFUL Astronomical telescopes easily made. Perfect lenses and instructions; 100X \$3.00. 100X and 200X \$4.00. 100X, 200X and 400X \$6.00. Clear vision, full power guaranteed. Instructions alone 10c. Suffolk Science Service, Manorville, N. Y.

ASTRONOMICAL Telescopes, binoculars, microscopes; bought, sold, repaired. Books. Lists 10c. Rasmussen-Reece, Amsterdam, N. Y.

TELESCOPES. Binoculars, microscopes, big bargain catalog free. Brownscope Company, 24 West 45th Street, New York.

DOGS, PETS, BIRDS, RABBITS

ST. BERNARD Pups! Reg'd! Complete details, including prices and fifteen charming pictures, free upon request. Manitou Kennels, Watrous, Sask., Canada.

BEAUTIFUL Registered collie puppies reasonable. Norbert Gonnering, Kaukauna, RI, Wisconsin.

ST. BERNARD Puppies perfectly marked. Dolomounts, 2619 E. Tremont Ave., New York 61, N. Y.

ANGORA Rabbits for pleasure and profit. Fred Wellen, Elkhart, Iowa.

SAINT Bernard and Boxer puppies. AKC registered. Schwarzwald Hof Kennels, 5136 Cascade Road S.E., Grend Rapids 6, Mich.

RAISE Guinea pigs. Make money at home. Booklet free. Taylor, Box 426A, Hapeville, Georgia.

\$400 MONTHLY. Raising Angora rabbits. Good wool markets. Details free. White's Rabbitry, Newark, Ohio.

HOHL'S Hamsters. Clean, quiet, odorless pets. Photo, literature free. Lab. Stock, 317-M Mt. Vernon Rd., Newark, Ohio.

HAMSTERS, Fine breeding stock. \$5.50 per pedigreed pair. Book \$1.00. Literature free. Prompt service. Mount Clemens Hamstery, 94 Church, Mount Clemens, Mich.

BEAUTIFUL Pure white pedigreed police puppies. Ansonia Kennels, Mose, N. Dak.

HAMSTERS—Guaranteed virgin breeders. \$5.00 pair. Order direct. Wholesale business solicited. Pyle Hamstery, Okmulgee, Oklahoma.

SEE Gulf Hamstery ad on page 24. Shows picture of Hamster.

\$300 MONTHLY Raising Angoras for our market. Particulars free. Wilson, Stanton, Calif.

ENGLISH Shepherds, puppies, spayed females. Heelers livestock, companion children. Best watchers. Barnes, Colyer, Kans.

RAISING Hamsters is profitable. Information. Pem's Hamstery, 3010-10th Ave., No., St. Petersburg 6, Fla.

MAKE Extra cash. Raise Giant Chinchilla rabbits. Waters Rabbit Farm, Glennville, Ga.

GRINSTEAD'S Famous Angoras! Giant Chinchillas! World's most profitable rabbits. Finest pedigreed, heavy-producing, prize-winners. Literature free. Grinsteads, Edwardsville, Illinois.

MINK Raising information free. Complete. Lake Superior Mink Farm, Superior, EEL, Wisconsin.

INCREASE Your income by raising domestic rabbits. Small space needed. Ready market for delicious meat, fur and wool. Largest magazine in the industry tells you how. \$1.50 per year. Sample 15 cents. No stamps. Small Stock Magazine, Lamoni 20, Iowa.

\$3000 YEARLY Raising Angora rabbits. We buy your output. Contract particulars free. Kise's Enterprises, St. Paul 8, Minn.

PLANTS, SEEDS, NURSERY AND GARDEN SUPPLIES

CACTUS (Thornless!) Miniatures! 25—\$1.10 postpaid. Gifthouse, Box 4550-CC, Coral Gables, Florida.

FARMS, FARM LANDS, REAL ESTATE

IMPROVED Ozark farm complete only \$25 monthly. Get details. Armstrong, Shook, Missouri.

BIG Free summer catalog of farm bargains, many states, some equipped, many illustrated! United Farm Agency, 1408-PM Consumers Bldg., Chicago 4, Ill.

FLORIDA Garden farms in famous Panama City, pleasure resort area. Marvelous beaches. Wonderful fishing. Glorious climate. Grow vegetables, fruits, berries, nuts, poultry. 10 acres, high and dry, beautifully wooded. Price \$595, payable \$15 month. Larger farms at low prices. Write today. Owen Alden Wood, Box 873, Houston, Texas.

STROUT'S Farm catalog! Time and money-saver—Free! Describes 2790 bargain properties, 35 states coast-to-coast. Write today for your free copy! Strout Realty, 255-P 4th Ave., New York 10, N. Y. 20 W. 9th St., Kansas City 6, Mo. 453 S. Spring, Los Angeles 13, Calif.

\$5.00 MONTHLY Buys 40 acres near town; price \$200.00. Free list. Box 425-P, Carthage, Mo.

GOVERNMENT Lands \$2.00 acre up. Information all states twenty-five cents. National Tax Service, 901-A Majestic Bldg., Detroit.

GOOD Farms—Ranches. Washington, Minnesota, Montana, Idaho, Oregon, North Dakota. Dependable crops, favorable climate. Write for literature, lists describing typical farm opportunities. Specify which state. J. W. Haw, 119 Northern Pacific Railway, St. Paul 1, Minn.

SOLD For taxes. Calif., Oregon, Washington timber, grazing, ranch and mining lands. 25c to \$3 acre min. bid. 10c (coin) brings circulars, photos, maps. Pacific Lands, Box 2350-PM, Hollywood, Calif.

OZARK Magazine. Eureka Springs 11, Arkansas. For homeseekers, tourists. Year. \$1.50.

OZARK Lands for all purposes. Actual river frontages. 5+ acres \$90.00 and upwards. Free list and literature. Hubbard, 424-I Minnesota Ave., Kansas City 4, Kansas.

LOTS \$300—Convenient payments. California's finest garden section. On Morro Bay's scenic shores. Wonderful fishing, hunting, boating, bathing. Fertile soil, softest water, temperate climate, congenial community. Free literature. Richard Otto, Department M, San Luis Obispo, California.

80 ACRES Unincumbered. So. Missouri. Sacrifice \$37 acre cash. National Petrol Co., 6126 S. Michigan Ave., Chicago 37, Ill.

POULTRY, FARM SUPPLIES

GROW Chicken of tomorrow today with chicks from Pilch's Famous Old Hen Breeders. You too will like Pilch's chicks because so many other people do. 14,000 Pullorum Clean Breeders. Reds, Rocks, Crosses, Sex-Links, White Rocks, Hamps, Started Pullets, Started Chicks, Capons. Write for valuable '49 calendar. Pilch's Chicks, Box M, Thompsonville, Conn.

KNOW How to raise poultry for profit. Read Northeastern Poultryman. Every issue packed with helpful hints and practical suggestions. Latest articles on breeding, feeding and management. Subscribe now. 1 year 65c. 2 years one dollar. Foreign subscriptions \$1.00 a year. Northeastern Poultryman, Dept. P.M., 376 Boylston St., Boston 16, Mass.

EARN \$4 To \$12 hourly. Chick sexing, culling and caponizing. G.I. approved. Pilch's School, Box PM, Thompsonville, Connecticut.

PROFITABLE OCCUPATIONS

SENSATIONAL! It's easy to earn big money with your own profitable business. Earn \$10.00 to \$50.00 a day. Make lamps at home. General illustrated course teaches you quickly. Course and wholesale supply catalog only \$2.00. Gearon Company, Dept. 200-B7, 27 South Desplains, Chicago, Illinois.

RAISE Fishworms. Easy, profitable. Send 25c in coin for complete instructions. Huffman Worm Ranch, Rives Junction, Mich.

FREE Details. Successful local or mail order plans, complete. Copyrighted. Odell's, Box 86B, Meeker, Okla.

\$400 MONTHLY. Raising Angora rabbits. Good wool markets. Details free. White's Rabbitry, Newark, Ohio.

RESILVER Mirrors at home. Formula 25c. Ideal Service, Park Ridge 7, Illinois.

TYPISTS, Profitable business at home. Complete copyrighted information 50c. Rosdahl Industries, 72-A W. Washington St., Chicago 2, Ill.

FOREIGN Employment? Bulletin 43 with overseas directory and application forms: \$1.00 (C.O.D.) \$1.33. Foreign Service Institute, P.O.B. 3934, Miami, Fla.

HAVE Your own portable 16mm. movie theatre. Big profits. Also sell 16mm. sound projector. Write G. Jessen, 5 S. Wabash, Chicago 2, Illinois.

NEW Home-moneymaker business! With latest discovery bases and concentrates make finest perfumes, start selling locally, by mail, through agents. No experience required. 25c brings exciting "How-to-do-it" plan, details. H. Bonheim, 610 W. 204th, New York 34, N. Y.

LOCKSMITHING Secrets! Key fitting. Lock repairing, opening; prices, sources. Illustrated book \$1.00. Wexler, 7 West 36, New York City.

STUFF And mount fish. Make big money. Instruction sheet \$2.00. Address Fezler Co., Patchogue, N. Y.

MAKE Greaseless doughnuts at home. New amazing electric machine. You'll coin money selling to grocers, drug stores, cafes, hamburger stands. Low cost will surprise you. Experience unnecessary. Send for free recipes and plans. Morgan Ray Co., 3605 South 15th Ave., Minneapolis 7, Minn.

FREE Book "372 Unusual Worldwide Businesses!" South America, New Zealand! Work delightful, "different" plans home. Publishers-F2, Carlsbad, Calif.

WOULD You pay 3%—First \$350 made? Illustrated book "505 Odd, Successful Enterprises" free! Work home. Expect something odd! Pacific, Oceanside, Calif.

NO Work or cost. Make fabulous money growing dwarf trees in your room. Free details for stamp. American, 385 La Tijera Station, Los Angeles 43, California.

THRILLING Home business. Make pictures from gorgeous natural colored jungle bird feathers. No experience. Profits tremendous. Whirlwind seller. Starting outfit \$1 (refundable). Carlos Liebhaber, Volcan, Costa Rica.

FOREIGN Construction work. Construction men, building trades mechanics, helpers, office men. Good workers needed for oil projects, mining, pipe lines, dams, power plants, roadways, shipping, etc. Transportation and quarters furnished; high wages. Listings of firms actively working and hiring on projects in South America, Arabia, Asia, Africa, Alaska, Central America, etc. Send \$1.00 for foreign construction compendium and application form. Foreign Service Bureau, Dept. P.M.7 (Employment), P.O. Box 295, Metuchen, New Jersey.

MUSHROOMS Grow boxes, Barrels. Instructions 50c. Spawn \$1.00. Manureless process \$2.00. Gordons, 553 William, Winnipeg, Manitoba.

"EVERYBODY Likes candy." Learn to make professionally. Our 39th year. Ragsdale Candies, D6, East Orange, New Jersey.

OUTDOOR Work for extra income. Information free. Morris, 328-A Parkway NE, Atlanta 5, Georgia.

WANTED—Purchasing agents. No money or experience required. Write Dept. C, Purchasing Manager, 2719 Lawrence, Chicago, Ill.

YOU Can make real money raising Golden Hamsters. New tiny animal. Easily raised at home. Write for details. Hudson Hamstery, Newfoundland 1, N. J.

CONSTRUCTION Report—Send \$1.00 for world wide job project listings. Up-to-minute-facts for construction men. Global Reports, P.O. Box 883-DX, Hollywood 28, Calif.

EXCELLENT Profits. Make, sell holiday flowers, novelties. Literature free. Velva Artercrafts, 324-M East 14, New York 3, N. Y.

"FROG-RAISING"—New book explains everything! Marlboro, 1035 Marlborough, Detroit 15, Michigan.

BE The Popular Mechanics representative in your neighborhood and earn big profits in your spare time. Write Popular Mechanics Magazine, Room 408M, 200 E. Ontario St., Chicago, Ill.

\$46 FROM Square foot plywood; jigsaw necessary. Write, Woodarts, P-38, Bridgewater, Mass.

OWN Mirror shop. Resilver mirrors. Glass sign making. Electroplating. Supply prices. John Sprinkle, V50, Marion, Ind.

\$40.00 WEEKLY Made growing mushrooms, fresh, dried. Dominion patent 331583. Free spawn. North American, 169P Yonge, Toronto, Canada.

INTERESTED in Latin American and foreign employment? \$1.00 brings Foreign Service Directory listing exporters and importers, oil, construction, mining, aviation companies. Hot tips for applications. Global Reports, Box 883-M, Hollywood 28, Calif.

ALASKA—The Last Frontier offers unlimited opportunities, \$1 brings government map and directory listing firms in fishing, construction, mining, aviation, fish and game rules, homestead data. Alaska Opportunist, Box 883-M, Hollywood 28, Calif.

BOOKS, PERIODICALS, PICTURES, POSTCARDS

QUICK Profits taking magazine subscriptions, handling greeting cards. Casell Publishers Service, Westfield, New Jersey.

BOOKFINDERS! (Scarce, out-of-print, unusual books). Quickly supplied. Send wants. Clifton, Box 1377-PM, Beverly Hills, Calif.

BOOKS—Government surplus. Textbooks, including International Correspondence School's Home Study Pamphlets. One half million volumes. Bargain prices. Free catalog. Long's College Book Co., Dept. PM, Columbus 1, Ohio.

BOOKHUNTERS! Any subject, any language. Send wants! Atlantic Book Service, Charlestown 29, Massachusetts.

NATIONAL Geographic Magazines 1888-1949. Any issue, Box 327-PM, Periodical Service, Swarthmore, Penna.

SELF-EXPLAINING Bible: Illustrated circular free. Box 446-P, Minneapolis, Minn.

BOOKHUNTERS! All subjects. Send wants! Jaher Book Service, 620-P East 178 Street, New York 57.

GAMES, ENTERTAINMENT

MICHIGAN Rummy—With fascinating new twist. Fun for young, old, expert or inexperienced at cards. You get durable leathertext layout 25" x 32" and instructions, \$1.00 postpaid. Gamlin, 411 East 8th, Kansas City, Mo.

BUILD Zippo and his act for hours of fun. Complete data and design charts in book form, \$1.00. Send to Louis Dentrux, 217 Center St., Princeton, West Virginia.

MAGIC TRICKS, PUZZLES, JOKER NOVELTIES

LARGE 160 Page catalog, just published, 35c. We have supplied the best tricks to beginners and professionals for 38 years. Chicago Magic Company, 2300-V No. Mason Avenue, Chicago 39.

NEW, Sensational, wonder puzzle. 35 puzzles in one. Test your wits, only \$1. Wonder Puzzle, 222 East 104th Street, New York City 29, N. Y.

LEARN Ventriloquism. Free information. State age. Maher, Box 36-M79, Kensington Station, Detroit 24, Michigan.

FREE Lists. Magic tricks, novelties. "Marean" Magic Shop, Hopewell, Va.

MAGIC Tricks, puzzles, books, cards, punch boards. Catalog 10c. Specialty, Box 671, St. Louis 1, Mo.

NOVELTIES, Tricks, jokes. Illustrated catalog 10c. Mann, Box 6521, Los Angeles 55, Calif.

SEND Only 50c for book "84 Card Tricks" and catalog of 500 amazing tricks. Robbins Co., 152-P W. 42nd St., New York.

MAGIC Books, magazines, bought, sold, exchanged. Russell Duck, Philipsburg, Penna.

500 TRICKS New 1949 edition. Send 10c for Douglas famous catalog showing best in good magic, lowest prices, fastest same-day service. 30 years in business. Douglas Magicland, Dept. 1, Dallas, Texas.

AMAZING Trick disappearing watch. Vanishes mysteriously from open hand, given with great magic catalog. Over 400 tricks that astonish, amuse and confuse, only 25c. The Magician, 2463 P Kensington Ave., Philadelphia 25, Penna.

BE A magician. Large professional magic catalog of latest tricks, 35c. Ireland, C-109 North Dearborn, Chicago 2.

SNEEZING, Itching, powders. Eighteen other tricks free with Joker's catalog 25c. 2404-N Fifteenth, Philadelphia.

PROFESSIONAL Catalog. 124 pages, 25c. Williams, 900 Plymouth, Ellwood City, Penna.

VENTRILLOQUISM Taught. 3c stamp bring particulars. Smith, 801 Bigelow, Peoria 5, Ill.

WORLD'S Largest professional magic shop, keeps you in touch with latest tricks. To receive mailings, send 50c for new catalog. Holden's, M220 West 42nd St., New York.

LEARN Magic, ventriloquism, mind-reading. Write for particulars. Quackenbus, Big Plats, N. Y.

"VENTRILLO," Professional voice throwing instrument and "unusual" catalog 25c. POB-971, Philadelphia.

LARGE Catalogue of the best magic for professionals and amateurs. Send 35c. Mazda Magic Co., 1135 Westgate Ave., Oak Park, Ill.

16 CARD Tricks and catalog 25c. Sterling Magic, Royal Oak, Mich.

400-PAGE Catalogue of 2000 tricks, pocket, parlor, stage. World's finest magic. Send \$1.00 for catalogue (refunded first \$5.00 order). Kanter's, M-1311 Walnut, Philadelphia 7.

DOLLAR Magic set free with mammoth catalog 25c. "Mysto," 4462-PM Germantown, Philadelphia.

STAMP COLLECTING

\$1-\$2-\$5 UNITED States, commemoratives, airmail, high values in large collection United States stamps only 5c to applicants United States approvals. Metropolitan, 140B Nassau, New York 7.

UNITED States stamps nearly 100 years old. Roosevelt set, others, 40c value—only 5c to applicants United States approvals. Wakonda, 140G Nassau, New York 7.

ABSOLUTELY Free—Gilbert Ellice, Cook Islands, Tonga, Seychelles, Ascensions—free to approval applicants. Viking, 130-Z Clinton St., Brooklyn, N. Y.

STAMP Bargain! Over 100 different with Samoa, Cooks, Nyasaland, Somali, Togo, St. Pierre, etc. Everything 10c with approvals. James Long, Dept. 5G, Box 1866, San Francisco 1, California.

GIGANTIC Pricelist plus 100 different Switzerland 30c. Martin Band, 4143E 39th Place, Sunnyside, N. Y.

GIBRALTAR Packet free—Nice collection Gibraltar, New Zealand Centennial, British Uganda, French Colonials, early British Colonial, West Indies, South American, war stamps plus Philatopic Monthly Magazine. All for 5c postage. Empire Stamp Company, Dept. PM, Toronto 5, Canada.

4 TRIANGLES And 20 French Colonials free! Approvals. Gordon Davison, Box 1019H, Manchester, N. H.

10 ASSORTED U. S. Commemorative stamps 15c. Five U. S. Air Mail 15c. Both 25c. Ideal Stamp, Box 179, Park Ridge, Ill.

BOY, Oh boy! 500 France and Colonies—unpicked as received from French missions including stamps from France and her colonies, such as Camerouns, Guadeloupe, Inini, Niger, etc. Only 10c to approval applicants! Methuen Stamp Service, Inc., Dept. 40, Methuen, Mass.

200 MIXED Stamps 10c. Pictorials, commemoratives included. Sibley, Mendon, Mass.

MEXICO—15 Different 10c. Ezquerro 10, La Paz, Baja California, Mexico.

66 DIFFERENT Stamps, including U. S. battleships 6c. Worldwide approvals. Telic-Arts, Devon, Conn.

FINE Approvals. Fast, personal service. What countries do you prefer? I'll send their stamps. Skinner, 438 Locust, Long Beach 12, Calif.

FINE, Foreign approvals. French colonies. Stamps for International album, 1 and 2. Frank Moret, 1001A Sidney, St. Louis 4, Mo.

FREE—Montenegro, Syria, Togo, Silesia. Foreign approvals. National, Box 326A, Passaic, New Jersey.

100 DIFFERENT U. S. 35c. Roush Stamps, 51 Chestnut, Mansfield, Ohio.

FREE! Canadian sets, royal visit. George VI, George V, coronation, jubilee, others, to approval applicants. Ensign, Box 118-M, South Orange, N. J.

EXCHANGE Stamps universe. Particulars free. "Exchangers," Bry 126, Seine, France.

FREE! Nicaragua colorful triangles plus another beautiful set. Approvals. "PG," 195 Park, Lewiston, Maine.

QUALITY Approvals. U. S. price list free. Lash, 196 Morris Avenue, Denville, New Jersey.

LEADING Stamp paper—Sample copy free. Western Stamp, Albany, Oregon.

TRADE Your duplicates. Join World Wide Exchange Club, 4701-13 Sheridan, Chicago 40.

307 ALL Different 10c. Commemoratives, triangles, bicolored beauties, high values. Strange countries. New varieties galore. Only 10c with approvals. Garcelon, Box 400, Calais, Maine.

INTERESTING Stamp weekly. Next ten issues 10c. Southern Philatelist, Miami 42, Florida.

GIFT Six Roosevelts San Marino to approval applicants. Deane Stamps, Box 87, Miami 35, Florida.

SUPERB Approvals, net prices. Stamps $\frac{1}{2}$ to $\frac{1}{8}$ catalog. P. G. Beals, 170A Tremont St., Boston, Mass.

LIBERIAN Triangulars, 10c with approvals. Vargo Stamps, 6044 South Fairfield, Chicago 29, Illinois.

500 MIXED Plus mint set, 5c to approval applicants. Fred's, 15 Stegman Court, Jersey City 5, N. J.

SCARCE Nova Scotia. Ninety year old stamp. Only 10c with approvals. Garcelon, Box 700, Calais, Maine.

STAMPS—150 Different Australian \$2. Walker Eastern Market, Melbourne, Australia.

POPULAR Stamp selections! Worldwide! Illustrated bulletin free. C. Donner, Box 643, Ann Arbor, Michigan.

50 INDIA 10c plus big packet pricelist. Chase, 1026 Walker Avenue, Oakland 10, California.

GERMANY, "War packet," assaultboats, warplanes, Hitlers, Nazi emblems; free to approval customers. William Deems, Ravenswood, West Virginia.

U. S. price catalogue free. S. Stone, 618 Washington, Dorchester 24, Mass.

SELL Stamps, no investment. William Waugh, 2140 N. N.W., Washington 7, D. C.

GENUINE "Goya Nude" set (Catalogs 55c) 15c. Approvals. Royal Stamp Company, Tamaqua, Penna.

FREE "Stamp Finder." Tells instantly country to which any stamp belongs. 32 pages profusely illustrated. Approvals. Garcelon, Calais 17, Maine.

ALL Free Roosevelt Monaco stamps incl. Roosevelt triangle. Also Tasmania, Victoria, Ukraine, Cilicie, Persia to approval applicants. Exotic Stamp Corner, Box 867, Miami 5, Florida.

FREE Asia, Africa, Europe packet. Approvals. Desk C, Standard Stamp Co., Barneveld, N. Y.

UNITED States approvals on request. Heath, Box 4018, Pittsburgh 1, Penna.

200 DIFFERENT Stamps 3c to approval buyers. Littleton Stamp Co., Littleton 91, New Hampshire.

SALE! Foreign packets—All different. 500, 75c; 1000, \$1.50; 2000, \$4.50; 3000, \$7.50; 4000, \$11.50; 5000, \$16.50. U.S. 200, \$1.50. Postpaid. Ewing - Stamps, 109 N. Dearborn, Chicago 2.

YOU Need these! All six for 10c! To introduce our exceptional approval service, we'll send you: 1. Pocket stock book. 2. Watermark detector. 3. Stamp tongs. 4. Perforation gauge. 5. Book for duplicates. 6. Package of stamp hinges. All only 10c to approval applicants. Free! Big list other bargains. Jamestown Stamp Co., Dept. K, Jamestown, New York.

30,000 STAMP Grabbags 25c each. Fredericks, Box 11, Clifton, N. J.

EXCHANGE 100 different and dime for 100 different. J. Service, Prospect Park, Penna.

COLD-Blooded murder! 200 British Empire stamps: Contains new colonies of Norfolk and Tokelau Islands; Grahamland (Britain's only colony at the South Pole); Pakistan; Nepal; big stamp commemorating murdered Mahatma Gandhi; many other fascinating varieties, including stamps cataloging up to 20c each! Amazingly low price (with approvals) only 10c! Kenmore Stamp Co., Section 15, Arlington 74, Mass.

DIRECT From war-torn China! 100 airmails, pictorials, war issues, high values, etc. Just 5c if you request approvals. Star Stamp Company, Jamestown, New York.

50 DIFFERENT U. S. 10c. No approvals. Pricelist free. Seidenberg, Cassopolis, Mich.

GERMANY—300 different 50c with approvals. Jewells "Stamps," Tamaqua, Penna.

FREE—Famous Americans set, Flag set, National Parks set, and Presidential set to \$5.00. A total of 90 stamps free to customers for our unsurpassed U.S. and foreign selections. Send 3c for 15 of the above stamps and full particulars. Triboro Stamp Co., 145 Nassau St., Dept. 107, N. Y.

FREE Set Egypt catalog 50c with fascinating "Hidden Treasure" approvals. Stratton Snow, Box 1898, Delray Beach, Florida.

312 MIXED U. S.—Including airmails! Commemoratives! Revenues! Possessions! High-values! Only 10c to "Gold Nugget approval" applicants. Kessel's, Folsom, California.

115 DIFFERENT. Hitlers, Roosevelt, Vatican, Liberia, etc., 25c. Buckley, 208 Ludlow Bldg., Dayton 2, Ohio.

FREE! United States commemorative price list. Historical Stamp Co., 1280 Ocean Ave., Brooklyn 30, N. Y.

PENNY Approvals by country. M. H. Hoerning, 15, Farmington, Ark.

FREE. Irish commemoratives with approvals. Raymax, 123-Z William St., New York City 7.

U. S. Bargain List free. Slikes, 1831 E. Allegheny, Philadelphia 34, Penna.

FREE—Illustrated catalog. Kenmore Stamp Co., Dept. 37, Arlington 74, Mass.

AIRMAIL Packet—Worldwide. Big bargain. With approvals 5c. A. Wirth, Norwichtown, Conn.

1/18th CATALOGUE. Beautiful Bulgaria parcel post complete. Catalogue \$1.87, dime. Approvals accompany. Corley, A285 Carlton, E. Rutherford, New Jersey.

\$2.00 CAT. Free. Approval applicants. 50,000 1c up. Everglades, 279 Northwest 57th St., Miami, Fla.

FREE. Fifteen different Switzerlands with approvals. Stampchest, Box 164-M, Teaneck, New Jersey.

ZEPPELIN—Columbian, Roosevelt, Hitler; airmail etc., only 10c to applicants requesting our approvals. Thirdco, 101 Third Ave., Newark 4, N. J.

CASH For your duplicates! Particulars free. Goliath, Bethlehem 7, N. H.

128-PAGE United States catalog—1000 illustrations, 25c. Harris & Co., 202 Transit Bldg., Boston.

EXOTIC Pictorial collection! Sakalava Chieftain, Fezzan Ghadames, Djibouti, Togoland, Reunion, Andorra, Algeria, Miquelon, Tunisia, Monaco, Guadeloupe, Martinique. Many others. Everything 5c. Imperial Stamps, Tampa, Florida.

FREE! Illustrated United States catalog. Low prices! Americo, Bristol, Conn.

1/2c UP U. S. or foreign approvals by countries. Hurt & Fosse, Blue Ridge, Virginia.

\$5.00 CATALOG Price for 10c! (1) Big collection 112 all different stamps from Africa, South America, South Sea Islands. (2) Four desirable unused U. S. cataloging 40c. (3) Fine packet 25 British Colonies: Burma, Solomon Islands, etc. (4) U. S. \$5.00 high value. Everything (all four items) only 10c with approvals. Crystal, Littleton 41, New Hampshire.

FREE! Unusual illustrated lists. Littleton Stamp Co., Box 65, Littleton, New Hampshire.

55 DIFFERENT U. S. stamps 10c. with approvals. Robert Anderson, Route #1, Madrid, Iowa.

PENNY Approvals that satisfy. Neil Gronberg, Box 5441-P, Philadelphia 43, Penna.

WOW! \$10.00 Worth of fun 10c! What a treasure hunt! Big package 500 foreign stamps, including airmails, pictorials and others from the world over; stamps worth up to 25c each. This offer sent for 10c to approval applicants only. Jamestown Stamp Co., Dept. 22, Jamestown, New York.

UNITED States approvals complete coverage, fine quality, attractive prices. Seminole Stamps, Box 1138-P, Coral Gables, Florida.

ILLUSTRATED Stamp magazine, 26 weeks 25c. Stamp Journal, Kalamazoo, Michigan.

FREE! U. S. monthly lists, fine stamps! Cole, 43-A Rinevalt, Buffalo 21, N. Y.

\$1.00, \$2.00, \$5.00 U. S. Free. Approval applicants. Flamingo, Box 4038, Miami 38, Florida.

"MAN Size" United States approvals! Illustrated catalog! Sullivan, Endicott Arcade, St. Paul 1, Minn.

FRENCH Colonies, 50 colorful, large pictorials, 10c only with approvals. Fields, 1939 E. 85, Cleveland 6, Ohio.

FLAG Stamp free with U. S. approvals. Wenigman, 1933 Patterson, Chicago.

50,000 STAMP Grabbags 25c each. Anderson, 630 Bingaman 1, Reading, Penna.

WORLDWIDE Different. 200, 25c; 500, 50c; 1000, \$1.25; 2000, \$3.00, 5000, \$15.00. Beacon Sales, Maynard 2, Mass.

U. S. Price list. Send postage. State Stamp Service, 1225 Park Building, Pittsburgh 22, Penna.

200 DIFFERENT Including Roosevelt triangle, 5c to approval applicants. M. Avalon Stamp Company, Springfield, Mass.

FREE! Crystal-mount samples! Har-risco, 202 Transit Bldg., Boston.

BINGO! Jackpot collection! Triangles, maps, animals, midgets. All for 5c to approval applicants only. Southwest Stamps, Box 117, Long Beach 1, California.

FREE U. S. price list, postage 3c. Mark Hanna, 335 5th Ave., Pittsburgh 22, Penna.

WORLD—500 Diff. 50c, 1000 \$1.25, 75 Canada 25c, approvals, lists. Victoria Stamp Co., London 4, Canada.

WORLD'S Largest stamp (7 1/2 x 14 inches). A real curiosity! Retail for 50c, only 3c to approval applicants. Tatham Stamp Co., Springfield 30, Mass.

FREE! 100 Worldwide different stamps to approval buyers. Big U.S. and illustrated bargain lists sent with approvals. Bookman, Maplewood, N. J.

STAMP Collections wanted. Complete collections, duplicate lots, surplus stock, mint and used. Prefer trade for printing or other items, buy outright if priced right. What have you, what's wanted? Vanroy Shirk, Lebanon, Penna.

DEALERS—Wholesale list. Postage 3c. Frank, 5031 Queensberry, Baltimore 15, Md.

OLD Scarce U. S. seconds on approval. Slightly defective, bargain prices. Her-nfield, Clintonhill Station, Newark 8, N. J.

25 ALL Different stamps 10c. Tunis, Wakeman Ave., Newark 4, New Jersey.

POUND Stamps containing thousands \$1.00. Longacre Shop, 108 West 42nd, New York 18.

BERLIN Bears, complete set of eight and 100 different stamps only 10c to approval applicants. Reich Stamp Co., 4647 Kenmore, Chicago 40, Ill., Dept. M11.

NICARAGUA "Tin Pan Alley" diamond. Ecuador showing George Washington, and American flag in natural colors. Fezzan, Trieste, "American Army" stamp, first U. S. commemorative, \$100.00 Shanghai, Corsica, Anzac, Antique, others. All 5c. Approvals. Capital Stamp Co., Dept. 2, Little Rock, Ark.

ZOWIE-E! A barrel of fun for only a dime. 500 United States stamps—absolutely unopened and unsorted—just as received from church missions. Many varieties, including large commemoratives, airmails, high denominations up to \$5.00! Stamp-dom's biggest package of fun—and you might find something really valuable! Price only 10c to serious approval service applicants. Money back if not delighted, illustrated bargain lists with each order. Mystic Stamp Company, Dept. 80, Camden, New York.

UNITED-States commemorative collection Thirty-three different unused. Columbians to 1943 issues only. Price \$1. Request approvals. "Stamps," Albany 4, New York.

COINS, TOKENS, CURRENCY

OLD Money wanted. Will pay fifty dollars per nickel of 1913 with Liberty head (no buffalo). We pay cash premiums for all rare coins. Send 4c for large coin folder. May mean much profit to you. Numismatic Co., Dept. 20, Fort Worth, Texas.

UNCIRCULATED Foreign coin and banknote with huge price list 10c. Toussaint Coins, 109 Mathilda Avenue, Sunnyvale, Calif.

AMERICAN Coins wanted. Give full details first letter. Von, 1319 Teneighth Way, Sacramento 14, Calif.

60 COINS And bills, \$1.00, 100 bills, \$1.00, 35 coins \$1.00, Oddehon, Box 482, St. Louis, Mo.

MAGNIFICENT Stock of U. S. coins. All series. Catalogue listing 2500 coins 15c. \$50,000.00 stock of gold coins. Worldwide selection. Catalogue 15c. James Randall, 116 South Michigan Avenue, Chicago 3, Illinois.

FREE: Mexican ten peso bill and coin list. Send self-addressed stamped envelope. Ben's Coin Company, 31 North Clark, Chicago 2, Illinois.

\$1,000.00 WE Will pay for 1913 Liberty Head nickel. 1894-S, dime \$500.00. And hundreds of others. Know the true value of old money. Send 25c for our complete buying and selling catalogue. Worthy Coin Corporation, 294 Washington (D-116), Boston, Mass.

COIN Collector's Magazine. Sample copy 25c. 100 pages. Scrapbook, 5444 Clark, Chicago 40.

FOREIGN Bills—10 different, 15c. Bills and coins, lists. Oliver Arnold, Macon, Mo.

LARGE \$1.00 Bill \$1.60; Large \$2.00 Bill \$3.40. 10 Wooden Nickels \$1.00, 255 Page Guidebook \$1.50, Handbook 75c. Giant Catalogue 15c. Bebee Coin Company, 1180 East 63rd, Chicago 37, Ill.

35 WORLD Coins \$1.00. Harry Elsholz, Box 9014, Pittsburgh 24, Penna.

GET Profit and pleasure in collecting old coins. Send 10c for 56 page illustrated coin catalog. You'll be delighted with it. Send for it now. B. Max Mehl, 370 Mehl Bldg., Fort Worth, Texas. Largest rare coin establishment in U. S. Established 49 years.

FREE! Foreign coin, banknote and coin collectors illustrated catalog to approval service applicants. Send 3c postage. Tatham Coinco, Springfield 30, Mass.

COINS Wanted, will pay up to \$2000 for certain coins, send 25c for catalogue. Burton's, 111 So. Third, Columbus, Ohio.

COMMEMORATIVE 1/2, Oregon, Texas, Kentucky, Cleveland, Long Island, \$2.00 ea. Illustrated catalogue 25c. Norman Shultz, Salt Lake 9, Utah.

PRECIOUS STONES, MINERALS

GEMSTONES. Mineral specimens. Every variety. Lowest prices. Postcard brings free list. Plummer's, 2177C Bacon, San Diego 7, California.

URANIUM Bearing torbernite, fluoresces bright green, specimen 50c, pound \$1.25. Bixbyite 50c, Cassiterite 25c, 50c, 110 volt mineral light and ten fluorescent specimens \$13.50. Prospector, Winston, New Mexico.

GEMS. Precious and semi-precious, all genuine, from world wide sources. Deal direct, no overhead, save money. Catalog 10c. Hill Co., Route 7, Salem, Oregon.

GEMS—Save money buy direct. Zircons, rubies, and other semi-precious stones. Catalog free. J. Lavinger, 1140 Adams, Redwood City, California.

CALIFORNIA Jade 50c, three shades \$1.00. "Burnight," Rt. 2, Box 199, Chico, California.

ZIRCONS. Diamond-like white, blue, or golden-brown, 1 1/4 carat size plus 2 crystal clear sparkling side stones \$5.00. Others. Catalog 10c. Imhusex, Box 232, White Plains, N. Y.

METAL Detectors. The very latest circuit. Send 25c for literature. Hedden Metal Detectors, 3329 Liberty Ave., Pittsburgh 1, Penna.

ZIRCONS. Loose. Genuine Siam imports. Pure white. Special: 3 genuine zircons, from 1/2 kts. to 1 1/2 kts., \$6.00 tax included. We can supply zircons in all sizes and mountings of all types. Send order or write for details today. B. Lowe, Holland Bldg., Dept. PM, St. Louis, Mo.

HOBBIES AND COLLECTIONS

SILK Screen process men! The "Film Line Cutter" cuts lines, line drawings, etc., on stencil film. Save up to 80% cutting time. Cuts the lines, peels out the film in one stroke. Sold by most suppliers. Set of three \$5.00. For information write The Ramsey Company, 1101 Iowa Ave., Dallas, Texas.

LEATHERCRAFT Supplies, leathers and tools, low prices. Send 10c for catalogue. Refunded first order. Jonas Handicraft, 32 Frankfort St., New York 7.

UNPAINTED. Finished figurines, molds. Send 10c for catalogue. M. Brown, Keene, Texas.

GET Your share of mail and samples. Name listed 10c, three times 25c. John Lenner, 174 Ocean Ave., Jersey City, N. J.

UNPAINTED Figures and novelties, new original designs. Illustrated folder free. Creekturn Pottery, Hainesport, N. J.

CERAMIC—Sgraffito tools. Four different tools, each having many uses—including finest detail work; artful etching, cutting, smoothing, etc. (Not scratching tools.) Fine steel, precision sharpened; set in beautiful plastic handles. Sure to please the most fastidious. Complete set \$5.95. Postage paid in U. S. A. The Ramsey Company, 1101 Iowa Ave., Dallas, Texas.

UNPAINTED Plaster ornaments, Loxite for moulds. Free literature. Midwest Novelty Manufacturers, Box 788-A, Anaconda, Montana.

WANTED Old cigarette cards. Write Charles Bray, East Bangor, Penna.

30 DIFFERENT American, foreign military insignia, complete catalog 50c. Five different metal emblems 25c. Japanese surrender document 25c. Hobbyguld, 57-B Sumner, Brooklyn, N. Y.

UNUSED Matchbook covers—100 different \$1.00. Catalog 10c. Charles Edelman, 1311C East 84, Cleveland 3, Ohio.

INVENTING Can be an interesting and profitable hobby. Write for complete particulars. Institute of American Inventors, Dept. 40-E, 1926-Eye St. N. W., Washington 6, D. C.

CAMERAS, PHOTO SUPPLIES

NEW Camera. Take, develop and print pictures on the spot. Amazing offer! Speed Camera, 7 Bicknell Street, Norwood, New York.

COLORSLIDES Mexico, Guatemala, Hawaii. Intro offer; 3 for \$1.00. Free lists. Jaycee Colorslides, 3961 Sacramento, San Francisco 18, Calif.

MASTERPIECE Art slides in beautiful natural colors. Sample order 3 for \$1.00. Send for free catalog and volume price list. Buckingham, 241 Lafayette St., Dept. 24, New York 12.

MINIATURE Camera, \$7.95, imported "Mighty," half size of cigarette package. 4.5 lens, excellent enlargements. Camera and leather case, \$7.95. Roll film, 10 exposures, 20c. Fotosonic, 132 W. 43 St., New York City.

ROLL Film special! Sizes 127, 120, 820, 116, 616. Tested, perfect. Not outdated or surplus. Purchased from trustees of Kryptar Film Co. \$1.50 dozen rolls; 3 dozen, \$4.25; 6 dozen, \$8.00. Fully panchromatic, sensitive, all colors. 50 Weston daylight. Delta Photo, 690 Third Ave., New York City 17, Dept. PM-7.

CAMERA "Specials" for P.M. readers. Argus, Revere, Kodak. Buy, sell, write or wire. Carl Wolfe, 167 Canal Street, New York 13, New York.

AIR Corp gun cameras 16mm 24 volt Bell & Howell or Fairchild only \$22.50. Satisfaction guaranteed, immediate delivery. Send check or money order to Airplane Surplus Co., 3055 N. Broadway, Wichita, Kansas.

FREE To camera owners! Amazing new sky-filter. Fits any camera. Given free to introduce our Supa Film finishing service. Film finished and 8 double size prints only 35c in coin. 12 to 16 exposures only 60c in coin. Fast dependable service. Quality work and low prices plus the amazing \$1.00 sky-filter free. Satisfaction guaranteed. Keep sky-filter regardless. Send exposed film and coin today. Supa-Film Service, Box 6398, Chicago 80, Ill.

CAMERA-50c Camera-50c camera-50c camera-50c. Rent new Argoflex camera, for indoors and outdoors, 50c for 10 day period. Write for free application blank. Fotosonic, 132 W. 43 St., New York City.

1949 PHOTO Catalog, 124 pages, 700 illustrations. Send 10c stamp. Bloom's Camera Center, 1657-PM Main, Springfield, Mass.

BASS Says: Bargaingram 257 ready and waiting for you. The book which tells all. The finest in new and used camera equipment, a veritable encyclopedia. Write, phone or call the sign of the old "Horse Trader." 39th year of satisfaction or your money back dealing. Bass buys, sells and trades. Bass Camera Company, Dept. AG, 179 W. Madison St., Chicago 2.

PHOTOCOPI Anything, papers, books. No darkroom. 8 1/2 x 11" complete, \$6.95. Fotoflek, 4801 Yarmouth, Cincinnati 29, Ohio.

PHOTO FINISHING

8 HOUR Service, Box 468, San Francisco. Your 8 exposure roll printed jumbo or regular size 30c; 12 exposures 35c; 16 exposures 50c; 36 exposures \$1.00. Reprints, jumbo or regular 3c. Regular prints deckled. Fine grain developing. Send for free mailers. Quality Photo Service, Box 468, San Francisco 1, Calif.

MOVIE Star photos with 8 exposure roll developed, 16 prints—35c. Exotic premiums. Hollytints, P-1350, Hollywood 28, California.

ENLARGEMENTS! Quality 5"x7", 15c; 8"x10", 25c. Oil coloring, 50c. New negatives, 50c. Brandt Photo, Box 222 H, Kenilworth, Illinois.

TOP Quality and immediate service. Your 8 exposure rolls developed with jumbo prints 35c. Write for free mailers, price list and gift enlargement offer. Send to "Mail To-day," Box 1112-C, Altoona, Penna.

JUMBO Or photo pack prints, 8 exp. roll 35c. 16 exp. roll 65c. NuTone Fotos, Box 228, Pottstown, Penna.

8" x 10" QUALITY Enlargements 30c, four \$1.00. Surgals, 3300 Beach, Chicago 51.

PORTRAIT Quality 5x7 enlargements 15c, 2 for 25c. NuTone Fotos, Box 228, Pottstown, Penna.

FILMS Developed and printed by new electronic process. Enlarged. High quality. 35c 8 exposures, 45c 12 exposures. Pittsburgh Photo Lab., Box 9665, Pittsburgh 26, Penna.

FREE Snapshot magazine, photofinishing list, mailers. Henry Houghton's, Athol, Massachusetts.

8 PRINTS From your roll or negatives 30c; 12-40c; 16-55c. Or 8 double size enlargements 35c; 12-45c; 16-65c. Highest quality. Overnight service. Young Photo Service, 405-E, Albany 2, N. Y.

FILMS Developed and enlarged double size, 8 exposures 35c; 12 exposures 50c; 16 exposures 65c. Prompt service. Mailing envelopes on request. Real Fotos, P.O. Box 172 M, Station B, Brooklyn, N. Y.

ROLL Films developed and 8 super (oversize) prints 35c. Free mailing envelopes. Finest quality. O. Henry Photo Service, Box 2458, Greensboro, North Carolina.

16 ENLARGED. Jumbo, oversize deckled prints from any 6-8-12-16-20 or 36 exposure roll film developed only 35c and this ad. Electronically exposed. Enlargement coupon free. Skrudland, 6444-R Diversey, Chicago.

8 BEAUTIFUL Double size pictures and roll developed 30c. 8 hour service. Free mailers. Pacific Photo Service, Box 866, San Francisco, Calif.

EXPERT Finishing. Roll developed and 8 prints 30c. Rancho Photo, Dept. P, Ontario, Calif.

2 BEAUTIFUL Hi-Gloss prints each good negative and enlarging coupon with each 8 exposure roll developed 28c. Free mailers. Owlphoto Co., Weatherford, Oklahoma.

8 PRINTS All enlarged to nearly post-card size from your roll or negatives 25c; 16-50c. (Trial offer). Willard Studios, Box 3535A, Cleveland, Ohio.

MOTION PICTURES AND SOUND EQUIPMENT

SUMMER Sale of 16mm. features. Want a real buy in 16mm. sound films? Take advantage of the I.C.S. 1949 summer sale of 16mm. sound features—comedies, cartoons, novelties, musicals—new, used. Specify. Send for our giant list "A" today stating machine you own (make and model). Institutional Cinema Service, Inc., 1560-PM Broadway, New York 10, N. Y.

BARGAINS! Guaranteed, reconditioned 16mm. sound projectors. Robert Salmon, 3558 So. 11th, East Salt Lake City, Utah.

RECEIVE Cheaply 6 reel 16mm. sound features regularly. Free details. Jaydee, 218 W. Dickinson, Grand Rapids 7, Mich.

NEW 16MM sound projectors, film. Rental list. Cine Service, Box 582, Ithaca, N. Y.

100 FREE 16mm S.O.F. libraries. Names, addresses, \$2.00. Jan Associates, 476 Anita, Millbrae, Calif.

35MM Ansco color reloads—Fresh stock guaranteed! 20 exposures \$2.00 includes color processing, unmounted. 3 for \$5.50. Indoor, outdoor—specify type. Photo Surplus Sales, Box D, 12 Duane Street, N.Y.C.

SEND 10c for 1949 photographic catalogue. Bargain list included. Sterling's, 679 Northampton, Easton, Pennsylvania.

GUARANTEED Fresh 25' spools double 8 mm full color film! Processing free! \$3.80 each, 3 spools \$11.00. Catalog, Filmcraft, 47th Holly, Kansas City 2, Mo.

UNIQUE Movies equipment. Free catalog. Home Pix, 1674 Broadway, New York 19.

BETTER 8MM. and 16mm. movie camera film. Lower prices. Better Films, 742 New Lots, Brooklyn 7, N. Y.

GUARANTEED Fresh anti-halo outdoor movie film! Weston 12! Daylight loading! Processing free! Three spools double 8 mm. \$3.45! Six single 8 mm. for Univex, \$4.60! Postpaid! Catalog, Filmcraft, 47th Holly, Kansas City 2, Missouri.

BASS Says: 39 years of leadership guarantees satisfaction. Finest cine equipment, 8mm., 16mm., and 35mm., silent and sound. Write the old "Horse Trader." Satisfaction or your money back always! Bass Camera Company, Dept. A, 179 W. Madison St., Chicago 2.

8-16MM. Silent-sound films. Complete rental library. All latest subjects. Free catalogue. (sample film 10c). Garden Film, 317 West 50th, New York 19.

TITLE Making, free booklet. Westwood Company, 635 Victoria Street, San Francisco, California.

LEARN Professional motion picture technique at home. Approved for veteran training under G.I. Bill. Free catalog. Motion Picture Institute, Birmingham 4, Mich.

LEARN Movie projection, management. Free catalog. Theatre Institute, Elmira, N. Y.

I BUY. Exchange, swap movies. What have you? What do you want? Lowest exchange rates in world. Catalogue \$1.00. Refundable. Harvey Iris, Box 539, Brockton, Mass.

DYNACOLOR—New, 8mm. At last you can afford color film. Send \$3.00 cash, check or MO or inquire today. Guaranteed. Dynacolor, Dept. S1, Rochester 3, N. Y.

MUSIC AND MUSICAL INSTRUMENTS

POEMS Wanted. Percentage basis collaboration. Terry Tune Master, 709 1/2 PM North Broadway, Oklahoma City 2.

1949 ACCORDIONS. Wholesale, free catalog. American Accordion Center, 5329 Belmont, Chicago.

SWISS Musical units \$2.75. Music Boxes, 131 West 42nd, New York 18.

SONG-POEMS Wanted. Outstanding proposition for suitable material. Special Service, 210 Fifth Avenue, Suite 1102, New York 10.

MUSICAL Instruments 10 day trial. 10c for catalog. Meyer's, 454-A Michigan, Detroit 26, Michigan.

POEMS Set to music and recordings by radio singing star and teacher. Free examination. Prize for best poem submitted. Prof. C. E. Riddell, Newport, Delaware.

SONGWRITERS! Words or music. Amazing offer. 7760 Santa Monica, Hollywood 46, Calif.

RECORDS, Slightly used. Popular hits, only 5 for \$1.00. Limited quantity. Juke Records, Box 6332, Cleveland, Ohio.

POEMS Wanted for musical setting. Send poems for free examination. Five Star Music Masters, 630 Beacon Bldg., Boston, Mass.

PLAY Most popular piano! Send 20c for home study folder and novel breaks for hit-tunes. Christensen Studio C, P.O. Box 185, Wheaton, Ill.

ACCORDIONS, Mikes, amplifiers. Save up to 50%, cash or terms. Buy direct, save middle man's profits. Del Principe, 307 South Wabash, Chicago.

YOUR Poems set to music, recorded by professional artists. Send poems or write. Free booklet, attractive offer. Song Service, 331-C West 46th, New York.

SONGWRITERS! Outstanding, ethical offer. Hibbler, C5, 2157 N. Avers, Chicago.

SONGWRITERS-Publication collaboration. Newark Publishers, G.P.O. Box 1226, Syracuse, N. Y.

POEMS Wanted to be set to music. Free examination. Send poems. McNeil, Master of Music, 510-PM S. Alexandria, Los Angeles, California.

WRITE Songs. Big money and reputation. Write for information. J. Gordon Pub. Co., 201 N. Hoyne Ave., Chicago.

RADIOS, SUPPLIES, INSTRUCTION

FIX Any radio. Amazing new instrument locates radio troubles double quick. Simple instructions show you how. Thousands now in use. Free—write today for 28-page illustrated technical manual, "The Inside Story," Feller Engineering Company, Dept. 7PM9, 945 George St., Chicago, Illinois.

BARGAIN Kits! Builds electric eye, volt-meter, oscillator. Only \$2.95. Snooper-scope supplies. Infra red filters 15c. Precise, 942 Kings Highway, Brooklyn 23, N. Y.

LEARN Morse code new easy picture way. Complete course, alphabet and numbers. Only \$1. Otto Luther, Dept. M, New Preston, Conn.

MAKE Loudest crystal radio. Instructions, loudest crystal, catalog: 25c. Amorse, Route Four, Richmond, Virginia.

"RADIOBUILDER," 3 issues 25c. Sample free. Laboratories, 578-C, San Carlos, California.

TELEVISION Wiring diagrams—Set of ten, only \$1.00 postpaid. Melpro Co., P.O. Box 40, Bay Ridge Station, Brooklyn 20, N. Y.

FREE—Send postcard for free plans 3-tube portable. Loud speaker volume. No obligation. Build your own. Save 50%. Clyde Smith, 771 Walton Ave., St. Louis 8, Mo.

WIRE Recorders. Surplus new mechanisms complete with recording-playback head and motor. Combine with your amplifier and oscillator for complete unit. \$42.50 fob Detroit. Free literature. Box 486, Main PO, Detroit 31, Michigan.

BE A television announcer, director, actor or writer. Learn in Hollywood. Complete courses in school established 20 years. Radio Television Arts Academy, 3819 Wilshire, Hollywood 5, California. Approved for veterans.

MAKE Simple, tubeless, batteryless, distance-getting crystal radios. Crystal and illustrated instructions 25c postpaid. Allen, 427-P, Clinton, Missouri.

FREE—Money saving bargain bulletins in radio and television sets, record changer, tubes, parts, amplifiers, speakers, etc. Write today. Radionic Equip't Co., Dept. 2006, 170 Nassau St., New York 7, N. Y.

TELEVISION, Radio, tubes, parts. Send for free bargain list. Hallmark, 592B Communipaw, Jersey City, New Jersey.

BOOKS—All Kinds—Homecraft, Radio, Plastics, Boat Building, Photography, Model Building. Catalog free. Popular Mechanics Press, 200 E. Ontario St., Chicago 11, Ill.

BUSINESS OPPORTUNITIES

LIQUID Silver polish that plates with genuine silver. Manufacture at home with no special equipment. Non-poisonous. Laboratory approved. Enormous profits. Wonderful demonstrator. Buy ingredients locally. Complete formula and full instructions \$5.00. Leco Company, 18667 Waltham, Detroit 5, Michigan.

AMAZING. Marble-glazed cement pottery. Hollywood style, without moulds. Benches, fountains, stucco-rock walls, garden ornaments: chemically colored. Dime brings sample, pictures. Hollywood Cementcraft, 8527-R Wonderland, Hollywood 46, California.

SELL Handi-Grip to homes, stores, theaters, etc. Unique forceps eliminate stooping. Fogarty Engineering Co., Baldwin, N. Y.

TRADE Magazines. Profit by keeping posted on conditions, developments and opportunities. Choose current copies from our list of 1093 periodicals covering every business, vocation or interest. Ask for free price list. Commercial Engraving Publishing Co., 34C North Ritter, Indianapolis 19, Indiana.

IS Your line of merchandise complete? Nice profits selling costume jewelry. Home of "Nadine" pearls, rosaries. Free information. Master Makers, P.O. Box 207, DuBois, Penna.

"COLLECT And Grow Rich" is a free booklet that's yours for the asking. Learn of this opportunity of a lifetime, spare or full time office business of your own, where you can make a profit on the work of hundreds of others. T. J. Surface, Pres., Roanoke 4, Va.

RAISE Fishworms commercially; illustrations. Breeding outfits furnished, Stoners, Chattanooga 4, Tennessee.

PROFITABLE Business making and building with easy-laying interlocking building blocks. Rex Products, Dept. 10, Piqua, Ohio.

"WATERLESS Hand cleaner." Make, sell. No machinery. Build profitable business. Formula \$1.00. "Wax-o-Glass" cleans glass; polishes metals. Formula \$1.00. "Wipe-on auto paint" formula \$1.00. Metallizing baby shoes, complete process \$1.00. All four formulas only \$2.00. Satisfaction guaranteed. Ideal Formula Service, Park Ridge 6, Illinois.

SELL Power mowers. Rotary Mower Company, Securities Building, Omaha, Nebraska.

ANNOUNCING Home study course in commercial baking. Practical basic training. Good field for those with aptitude. Nearly depression proof. Send for free booklet, "Opportunities in the Baking Industry," National Baking School, 1315 Michigan Ave., Dept. 343B, Chicago 5, Ill.

BE Independent—Operate America's lowest price penny vending machine. Big profits. Immediate shipments. Write for bulletin and prices. Fielding Mfg. Co., Desk 79, Jackson, Mich.

BIG Money. Spare or full time in your home. No selling! Spray new miracle finishes, plush and suede on signs, radios, automobiles, figurines, lamps, toys, etc. Our business is booming—new easy Flok-Kraft methods—material costs few pennies, you get dollars. Free samples, complete powerful money making plan free. Write now! Coast, 1010 F S. Los Angeles, Los Angeles 15.

EXCEPTIONAL Money making opportunity for live-wire distributor. Dealer's county franchise now available for fast selling low-priced fire extinguisher and alarm. Made of glass, modern as tomorrow. Tremendous market. Big profit. Write for full information. Autofirstop Co., Dept. E-7, 2035 Washington Avenue, Philadelphia 46, Penna.

FIRE Control men selling automatic extinguishers handle Red Ball for dependability, beauty and extra profits. Box 1552, Salt Lake City, Utah.

FOR An extremely profitable lifetime business operate a collection agency-credit bureau. Easily learned. Free folder. Cole & Associates, Syracuse 2, New York.

START Your own business on credit. Always your own boss. 1554 dealers, sold \$5,000 to \$26,500 in 1948; their average \$6,742. We supply stocks, equipment on credit. 200 home necessities. Sales experience not needed to start. Wonderful opportunity to own pleasant, profitable business backed by world-wide industry. Write Rawleigh Co., Dept. G-U-PPM, Freeport, Ill.

FREE Particulars of money making plans. Pierce, Box 235, St. Louis 3, Mo.

RAISE Earthworms. Easy, profitable. Send for free literature or send dollar bill for illustrated book. Money back guarantee. Earthworm Culturists, Dept. P, Box 83, Station C, Atlanta 5, Ga.

THE Excel electric pop corn machine will put you in business. We can now sell you machine with complete supplies for \$110.90. Indiana Pop Corn Co., Muncie, Indiana.

LIFETIME Repeat orders! Sell our business cards by mail, your territory. Small "starter" plan. Lynn Art Products, 5711 Bankfield, Culver City, California.

PART-TIME. All ages. \$2.00 hour up. Sell creme shampoo. Every home uses. Free sample, details. Twice, 5672-A Fernwood, Hollywood 28, Calif.

FREE! "How to Sell by Mail." 39 page booklet on mail selling sent free with latest copy of Opportunities Preferred magazine 25c. Culver Enterprises, 16102W Via Descanso, San Lorenzo, California.

START Home manufacturing business making Cleaning Compounds, Soaps, Insecticides, Cosmetics, Polishes, Food Flavors. No machinery. Literature free. Kemix, Park Ridge, Ill.

SELL By mail. Write today. Gladson, Box 62A, Packer's Station, Kansas City, Kansas.

PROFITS In mail order business. Spare or full time. Details free. Mail Order Service, Box 3923, Portland 8, Ore.

BABY-Shoe mountings, ash trays, frames, etc. St. Alban's Plating & Casting, 135-17-135 Ave., So. Ozone 20, New York.

X-RAY Mirrors. You can see through them from the back—you can't be seen. Used by stores, offices, banks, police departments. Material and instructions for making \$80 worth of X-Ray mirrors, \$4 postpaid. Satisfaction guaranteed. Gateway System, Waynesville 2, Mo.

MAIL Order News (55th year) brings you the mail order ideas you're looking for. Copy 25c. Clarence Woodfall, Route 3, Charleston, Ill.

SELL By mail! Ideas galore! Join mail selling opportunities club! Details free! P. Wehner, Box 142-A, Roxbury 19, Mass.

START Profitable mail order business. Amazing profits—literature free. United Mail Service, Box 355, Roselle, Ill.

LEARN Sewing machine repairing at home. Install our wholesale motor kits. Make \$125 to \$300 in a week. Free particulars. Taylor Service Co., Hamilton PM, Ohio.

"ELECTROPLATING-Know-How" includes baby shoe metallizing and other lucrative fields for you. Write for my free illustrated booklet! Joseph B. Kushner, Electroplating Consultant, Stroudsburg 18, Penna.

I Received 200 orders from first small ad. Operate at home this profitable mail-order business, selling to women everywhere. Folio, 25c, explains. Grant Lovell, 2166 South Shore, Erie 9, Penna.

FREE Literature. Start a home business in spare time. Experience not essential. E. Teator, 6206 Hedge Ave., Cincinnati 13, Ohio.

FORTUNE For you in formulas. Eye-opening details free. Write today. Allen, Box 132, Ganges, Michigan.

\$15.00 - \$50.00 WEEKLY. Sparetime. Anxious customers everywhere. Lifetime opportunity. Puraclean, 17-E East 42nd, New York 17.

OWN Your mail order business. No investment. Omaha Envelope Service, 4721-B California, Omaha 3, Nebr.

OPERATE Profitable mail order business. Splendid opportunity. Standard Supply Co., P.O. Box 360, Donelson, Tennessee.

NEW Industrial hand cleaner. Free manufacturing-distributing plans. Unusual money-making proposition. "Acro-Sol-Ex," 623 West 14th Ave., Denver 4, Colorado.

BRONZED Baby shoe mountings. Reasonable prices. Write for price list. Standard Bronze Co., 311 N. Desplaines, Chicago 6, Ill.

MAKE Perfume—Profitable mailorder business. Information free. International, 6347 Parnell, PM-7, Chicago 21, Illinois.

SHARE In million dollar industry manufacturing new deodorizer solution used in homes, institutions, factories, theaters. Easy to mix. No machinery. Operate from home. \$2.00 will start you in business. We furnish ingredients, labels, instructions for packaging and selling. Franchise basis. Don't wait. Send check or money order. Kalom, 5027 N. Francisco, Chicago 25, Ill.

BE Your own boss. Earn \$6000.00 or more a year. For only \$2.85 you will receive this copyrighted book, "How to Successfully Operate an Employment Agency." This book gives you the know-how on opening and operating an agency, samples of all forms you will need, addresses of the state offices in your state controlling agencies, and free consultation-service. We will send c.o.d. or send check and save postage. Business Enterprises Company, P.O. Box 1472, Longview, Texas.

MAKE Money at home by mail! Thousands do! Fascinating details free! Write: Morris, 356 South Spring Street, Concord, North Carolina.

300% PROFIT Manufacturing an amazing product. No special equipment. Samples and information \$1.00. Box 924-Z, Fort Wayne, Indiana.

YOUR Own exceedingly profitable year around business. 20 to 50 dollars a day. Manufacture potato salad, macaroni olive salad. Wholesale, retail. Fresh, canned. Every grocery, meat counter handles. Complete details, business procedure, factory plans, recipes, consultation service—\$2.75 postpaid. Fryette's, Box 1832, Sta. A, Brentmont, Wash.

FREE Book "372 Unusual Worldwide Business Adventures!" Australia, South America, New Zealand! \$800 month reported (exceptional). Work delightful enterprises home. Prepare for surprise! Publishers-F3, Carlsbad, Calif.

MAIL Business magazines two different 10c, five different 20c. Lincoln, Box 449, Irwin, Penna.

ANNOUNCING: Complete simplified shoe repair course, big demand, in depression proof trade. \$7.95 complete, information free. Shoe Service System, Oonway, New Hampshire.

100 BUSINESS Ideas-formulas. Mail order-farm-workshop. Particulars free. Flasco Sales, 2505VB 150 Street, Flushing, New York.

MAKE Big money in home mail business! Few dollars starts you—interesting, profitable! Write: Smith, Box 2592-A, Hines, Illinois.

GLASY-Cast, the liquid plastic that works the quick and easy way. Cold-set. 15 to 30 minutes for finished product. Free samples and instructions. Make embeddings, novelties, plastic frames, machine parts, etc. for real profits. Two lbs. for \$2.95. Elasto-Mold: Flexible production molds made in 20 minutes. Also finest quality rubber latex. Wholesale prices. Plastic Service, 294 Washington St., Dept. H-1C, Boston 8, Mass.

SELL By mail. Unusual opportunities. 10c brings 60 page informative trade magazine. Isbell, Suite 619-PM, 216 West Jackson, Chicago 6, Ill.

AMAZING New hobby or profitable business. Make rubber molds, cast stone-like merchandise for resale. No experience, heat or pressure needed. Complete information and catalog 10c. Hobby Rubber Craft, Lake Villa, Illinois.

HOME Business! Learn how to fix cracked batteries! Money-maker! Instructions \$1.00. Batteryman, Grand Junction, Colorado.

DOLLARS in personalized baby record books. Sell by mail. Use same literature we do. No-Co-Ro, Oakland 6, California.

SAWDUST. Turn it into cash. Six methods. Instructions 25c. Charles, 12-APD, Norwood, Ohio.

UNPAINTED Figurines—Wholesale, retail. Illustrated list free! Oman, 642L Broadway, St. Paul 1, Minnesota.

WOULD You pay 3¢—first \$350 made? Color-illustrated book "505 Odd, Successful Enterprises" free! Work home. Expect something odd! Pacific, Oceanside, Calif.

CARPENTERS—Own profitable business installing kitchen cabinets. Write Thombert Company, Box 447C, Newton, Iowa.

FIGURINES, Gift ornaments. Unpainted, many to choose from. Start a profitable business—hobby. Write for free circular and information. Suiter Art Industries, 314 Westport, Kansas City, Mo.

SELL Big money-maker to men and women. Easy handwork makes fast-selling useful articles. Sunmade Company, Brockton 64, Mass.

CO-PUBLISH And advertise in The Central Mail Advertiser. Sample copy 10c. Low rates. Large circulation. Bagby Printing Co., Georgetown, Ohio.

10,000 FORMULAS And trade secrets. Free literature. Stillman Co., 555 Kingston Ave., Brooklyn 3, N. Y.

DEPRESSION Insurance! Own money-making business. Information free. Pru-Ax, Kingsport, Tennessee.

TESTED Money-makers: 68 page book, 25 cents, postpaid. Ideas, plans, formulas, supply sources. Money back if dissatisfied. L. Clay, Box 1063, Wichita, Kansas.

BABY Shoe metallizing. Secrets never before revealed. Schoettle, Friendship, Ohio.

"HOW To get the job you want." Amazing plan. Works wonders. Secrets revealed. Write: Parker, Box 576, Cleveland, Tenn.

BIG Money! Made in lettershop operation! Easy pleasant work. Free details! Woods Letter Service, Bedford, Penna.

BRONZING Baby shoes is big business, start your own business for \$4.95 includes materials and instructions. No equipment required. Particulars free. Metaloids, Box 2095, Wichita, Kansas.

HOW And where to obtain capital. Small and large loans. Free particulars. Star Service, Wapakoneta, Ohio.

GET Free literature. Wholesale supply sources. Money making items. Formulas. Allen Service, 245 Main, Ganges, Mich.

BRONZED Baby shoes mountings; metals, onyx, plastics. Hardening solution. Wholesale, Box 2095, Wichita, Kansas.

LEARN Piano tuning, repairing at home. Tremendous field! Piano parts, tools furnished. Established 1935. Empire School of Piano Tuning, Dept. 16-A, 1753 S.W. 23rd Terrace, Miami 33, Florida.

START Mail order business. Postal brings helpful hint. Shaw, Box 438, Coconut Grove, Fla.

STEADY Cash income by mail. Details 10c. Suproco, Ogema, Wisconsin.

MAKE Rubber stamps, metalize baby shoes, repair dolls, silver mirrors, make plaster novelties. Catalogue of "30 ideas" free! Universal, Box 1076-A, Peoria, Ill.

NATURAL Molding Latex. Extra thick. Free sample. W. Wooley, 115-A Donald, Peoria, Ill.

HALF Million articles wholesale. Directory 25c. Krueger, 3418 Wolcott, Chicago 13.

MAIL Order offers increased income, independence, unlimited possibilities; free literature. Manhattan House, 126 Lexington, New York 16.

SPECIAL Rubber for making molds. Literature and sample free. Universal, Box 1076-A, Peoria, Ill.

SELL Jewelry by mail. Everything furnished ready to go. Orders filled; small capital. Tremendous possibilities! Jomay, Box 1224-A, Toledo 3, Ohio.

CASH For your idea, 280 manufacturers need inventions, patented or unpatented. List free. Invention Bureau, 208M Clinton, Oak Park, Illinois.

MAKE Money making new greaseless doughnuts at home on electric machine. Wholesale to grocers, drug stores, cafes, hamburger shops. Send for free recipes and plans. M. Ray Company, 3605 South 15 Ave., Minneapolis 7, Minnesota.

LIQUID Marble—Colorful, glossy! Molded, brushed, sprayed! Cast novelties, statuary, colored tiles. Flexible molds. Composition floors. Particulars free. Marbleizing Service, Edwardsville, Illinois.

LIQUID Rubber, make flexible molds. Free sample. Chaney, 1130 E. 16th St., Jacksonville 6, Fla.

RECAST Old batteries into new. Latest achievements. Battery Laboratories, Minneapolis.

"SPECIALTY Manufacturing." Big money business. Start on small capital with dependable formulas. Send for free interesting booklet. Howard Robinson, Ph. G., 1300-A South Ohio Street, Sedalia, Mo.

MAILING Postcards selling repeat merchandise is profitable. Everything supplied. Details free. Gordan Publishers, Box 23, Pawtucket, R. I.

"HOW To start a successful mail order business." The guide to sound, profitable mail merchandising. 25c. Manhattan House, 126-B Lexington, New York 16, N. Y.

PLASTERCRAFT Supplies. Rubber molds, natural liquid rubber, rayon and cellophane flock finishes, etc. Illustrated catalog and "Plastercraft" course free on request. Blue Rapids Supply, Blue Rapids, Kansas.

ENVELOPES Addressed accurately, reasonably. Fast service. We have capable addressers in your city. Glenway System, 5713-Y Euclid, Cleveland 3, Ohio.

HOME Business making statuettes, plaques, artificial marble, rubber molds. Metallizing baby shoes. Silvering mirrors. Formulas. Folder free. Creative, 236-I, Winnetka, Illinois.

MAKE Money spare or full time, casting metal toys and novelties. Latest scale model autos, original ashtrays, savings banks, water pistols, etc. Enormous wholesale and chain store demand keeps manufacturers busy. No experience or special place necessary. Write for details and illustrations of patterns needed. Metal Cast Products Co., Dept. A, 1696 Boston Road, New York 60, N. Y.

VENDING Machines earn big money! An investment as low as \$10.50 will start you in this fascinating, profitable business that can lead you to the road of success and independence. Routes can be established and operated in either full or spare time with no experience needed. Write for full details and our free catalog illustrating our nut, candy, gum and stamp vendors; also pin ball machines, music boxes, etc. Write immediately to Parkway Machine Corporation, Dept. 7, 623 W. North Avenue, Baltimore 17, Maryland.

YOUR Own profitable home business. Preserve live flowers to last forever. New simple discovery. Enormous demand all year 'round. Tremendous profits! Light fascinating work. Send \$2.00 for working equipment, instructions, and valuable sales plans. Satisfaction guaranteed or money promptly refunded. Alfred Hermansen, 210 Fifth Ave., Suite 1102A, New York 10, N. Y.

NO Selling, operate vendors, amazing profits, details free. Silver-King, Suite B, 622 Diversey, Chicago 14, Ill.

MAKE Money addressing envelopes. Our instructions reveal how. Glen Glenway, 5713 Euclid, Cleveland 3, Ohio.

I MAKE Big money in the mail-order business. You can do the same at home with copyrighted system. Write me. I'll tell you how. F. Little, R.D. #1, Glenshaw, Penna.

POPCORN Equipment, potato chip outfits. Long Eakins Company, 4960 Hi Street, Springfield 9, Ohio.

OWN Mirror shop. Resilver mirrors. Glass sign making. Electroplating. Supply prices. John Sprinkle, V60, Marion, Indiana.

READ "Advance"—The voice of mail order. Offers money-making opportunities, sources of supply, personal guidance, etc. Issued monthly. Sample copy 25c. Yearly subscription \$2.00. Advance Publishing Company, 313 East 21st Street, Suite 450, New York 10, N. Y.

A BUSINESS in your own home! Our chemicals, plus free water and cheap "grocery store" materials can bring you over \$500 monthly earnings. Plans and formulas free. Chemica Division, 1269 S. Norton, Los Angeles 6.

A FACTORY in your home garage! Mfg. and sales rights, mechanics' waterless hand cleaner. \$500-\$800 monthly. No special equipment necessary. Formula free. Western Aircraft Mfg., Dept. D, Los Angeles 6, Calif.

OPERATE Profitable mail order business. Write Walter Service, 4159-A East 112th, Cleveland 5, Ohio.

COLORGLAZED Concrete pottery made without molds. Patented method. Cemetery products, novelties, tiles. Basement leak-sealing. Money-making projects. Booklet, details free. Men only. National Potteries Company, Grand Rapids, Minnesota.

START Mailorder bookshop—Everything furnished. 25c brings booklet, samples, exciting ideas. General Publications, Ossining, N. Y.

\$25 WEEKLY Working two hours daily. No canvassing. No manufacturing. Lycke, Box 2471, Cleveland 12, Ohio.

137 WAYS To make money, in home or office, business of your own. Full particulars free. Elite Co., 220 Grand St., New York 13.

BRUSH Plating outfits connect to a battery. No tanks necessary. Good paying business at home plating autoparts, bathroom fixtures, bicycles, reflectors, silvering mirrors. No shop or experience required. Outfits furnished. Free booklet. Gunmetal Co., Ave. H, Decatur, Ill.

COPUBLISH Leading m.o. paper. Latest copy Mail Sale Advertiser and proposition, dime. Vanroy W. Shirk, Lebanon, Penna.

250 ENTERPRISES. Local, mail order, foreign. Atlantis, Box 2085, Station V, Los Angeles 3, Calif.

START Plating business at home. Amazing profits. Make own outfit. Inexpensive. Illustrated instruction booklet 25c. Popular Mechanics Press, (C-43), 200 E. Ontario, Chicago.

MONEYMAKING OPPORTUNITIES

RESURFACE Butcher blocks with portable machine. Butchers pay well for this service. You can easily make \$50 to \$100 per week for part time work. Write for details, Hill Machine Co., Box 677, Rockford, Illinois.

THOUSANDS Articles wholesale. "Supply Source Directory" 10c. Ideal Service, Park Ridge 40, Illinois.

"**WESTERN Advertiser**" offers many worthwhile mail order opportunities. 6 months subscription, 10c. H. Edlund, 577 Kensington, Los Angeles 26, Calif.

UNPAINTED Bookends, plaques, statues, figurines. List. Haverty Products, 1219 8th Ave., Altoona, Penna.

MAIL Order success even for beginners. Join profitable opportunities club. Details free. Perrin Co., 428-D Pine St., Nevada City, Calif.

EARN Money evenings, copying and duplicating comic cartoons for advertisers. Adservice, Argyle 1, Wisconsin.

WOULD You pay 3%—first \$350 made? Color-illustrated book "505 Odd Successful Enterprises" free! Work home. Expect something odd! Pacific, Oceanside, Calif.

NECKTIE Clean 'n' press form 50c postpaid. Get ready for business! Ryane's, 61 Freeman St., Buffalo 15-M, New York.

CHURCHES, Organizations, earn \$100.00 plus 24 card tables. Free delivery. Box 392, Clementon, New Jersey.

MONEY-Making opportunities galore including magazines, 10c. Wilbur Erickson, Englishtown 12, New Jersey.

DOLLARFUL Ideas for you every month in advance—"Voice of Mail Order." Leads the field in exclusive supply sources. Plans for mail order operation; new products, etc. Details free. Advance Publishing Company, Suite 350, 313 East 21st Street, New York 10.

HOW To design posters that sell! Other big pay projects. Folder free. Ryane's, 61 Freeman St., Buffalo 15, New York.

FREE Book "372 Unusual Worldwide Business Adventures!" Successful! Australia, South America, New Zealand! Not hokum! Work home. "Different" plans. Prepare for surprise! Publishers-F4, Carlsbad, Calif.

POPCORN Poppers, vendors, peanut roasters, copper kettles, bottled gas, gasoline burners; new, used. Northside Sales, Indianola, Iowa.

"**EVERYBODY** Likes candy." Learn to make professionally. Our 39th year. Ragdale Candies, D4, East Orange, New Jersey.

DEPRESSION Insurance! Own profitable business. Information free. Pru-Ex, Kingsport, Tennessee.

15 MINUTES Masters advertising and sign lettering. \$1; free circular. Abenterprizes, Box 875-M, Peoria, Illinois.

UNUSUAL Back yard money-making opportunities! Fully outlined! Write: Pickett's, 62-A Sanders, Florence, Kentucky.

START Profitable home business in spare time. Make extra money raising Golden Hamsters. Small, clean, odorless. New. Unlimited market. Literature free. Golden Gate Hamstery, 631-H Richmond Street, El Cerrito, California.

ANALYZE Handwriting for profit! Complete outfit \$1.00. Graphologists, POB-971, Philadelphia.

READ Progressive Mailtrade, the magazine that tells how to make money by mail. Dime brings sample and special offer. Progressive Mailtrade, Box 357, Sheboygan, Wisconsin.

PROFIT With Larson Leathercraft. Belts, purses, 100 other ideas. Largest supply in U. S. Catalog 10c. Larson, Dept. C, 824 S. Tripp, Chicago 24.

WIN Contest money. General Contest Bulletin gives hundreds of tips. Lists current contests and rules. Sample 25c. General Contests, 1609½ East 5th, Duluth, Minn.

PRIZE Contest bulletin gives various contests now operating, and valuable hints. 3c stamp. National Contest Bulletin, Box 2685P, Miami, Florida.

PUBLISH Your own magazine. Handsome 52 page format, well edited, illustrated. Cost low as \$1.00 month. Brings you prestige, profits. 25c brings sample, details. National. Ord. Nebr.

FORMULAS, PLANS, ETC.

24 MONEYMAKERS—Tested formulas for home manufacturing, 25c. Satisfaction guaranteed. Details free. Nelson, Howel, Kentucky.

MAKE—Sell cleaners, soaps, polishes, flavors, cosmetics. No machinery. Formula literature free. Kemico, Park Ridge 16, Illinois.

10,000 FORMULAS And trade secrets. Free literature. Stillman, 555 Kingston Ave., Brooklyn 3, N. Y.

11,146 FORMULAS. Postal brings literature. Formulard, 1707 Maryfield, Ann Arbor, Michigan.

\$1.00 GETS You 21 money-making popcorn, candy apple formulas. We supply equipment. Concession Supply Company, Dept. A, Station B, Toledo, Ohio.

HOT Tamale. Making for profit. Particulars. Box 384, Altus, Okla.

FORMULAS For nearly everything. Catalog free. Write Creative, Winnetka, Ill.

TESTED Formulas. Interesting descriptive booklet free. Pont, Box 635-PM, Terre Haute, Indiana.

REAL Manufacturing formulas. Lists free. Cummings, Chemist, Gordon Ave., Syracuse 4, N. Y.

PLASTICS

WHOLESALE Plastics supply catalog, 10c. Lucite, clear, colored. Metallic Acetate. Complete Castolite line. Phosphorescent, pearling pigments, dyes. Metal findings. Tools. Ideas and bargains galore. Fast delivery from stock. Gem-O'-Lite, Box 686E, North Hollywood, Calif.

FLEXIBLE Mold makers—"Instruction Manual" explains new type plastic mold materials. Cost: Only \$1.00 postpaid. Multi-Mold Prod., 265 W. 30 St., New York 1, N. Y.

LUCITE, Plexiglas. Any size sheets, masked. Square foot (12x12) cost, 1/16" 95c; 1/8", \$1.25; 3/16" \$1.50; 1/4", \$1.80. Colors add 10%. Include 10% postage. Almac Plastics, 230 Fifth Avenue, New York 1, N. Y.

METALLIZING Service. Plastic articles, wood, plaster, etc., beautifully plated. Philip Stein, Oswego, Illinois.

AMAZING Liquid plastic. Sets in half hour. Beautiful results. Embed photographs, coins, keepsakes. Make solid objects. Clear, colors. Needs no expensive equipment. Machines as easily as wood. Complete kit \$3.25. Send for price list. Kristal Plastics, Box 29, Dept. P-8, Wilmette, Illinois.

SPECIAL Prime masked 6" x 12" plexiglas sheets 1/16". 3 for \$1.45 postpaid. 1/8" 3 for \$1.75 postpaid. Free catalogue. Craft Plastics, Somerville, New Jersey.

PLASTIC, Sheets, rods, tubes, etc. Free list. Plastic Supply Co., 2901 N. Grand Blvd., St. Louis 7, Mo.

INTERNAL Carved roses, orchids, swans, goldfish, butterflies, etc. Jewelry and gifts. Crystal Floral Novelty Co., Bound Brook, New Jersey.

CHEMISTRY

HANDBOOK For chemical experimenters, illustrated, hundreds of experiments, 50c. Experiment booklet, 15c. Reading Scientific Company, Reading, Penna.

NEW Idea chemical and apparatus outfits for home experimenting. Photo-scales, microscopes, chemicals, biological and laboratory supplies in small quantities. Catalog 15c. Established 1931. John H. Winn, 124A West 23rd Street, New York, N. Y.

NEW Catalog: Chemistry, mineralogy, biology. 10c. Tracey Laboratories, Evanston, Illinois.

NEW Laboratory supply catalog of chemicals and apparatus. Contains many thousands of items with illustrations. Send 25c. Standard Science Supply Company, 1232 N. Paulina St., Chicago 23, Ill.

CHEMICALS And apparatus for industrial, analytical, and private laboratories. Catalog 15c. Dept. M-50, Biological Supply Co., 1176 Mt. Hope Ave., Rochester, 7, N. Y.

HELP WANTED

BOYS Wanted. Over \$2.00 hour! Sell name plates for front doors. Free sample. Write Dept. 50, National Engravers, 214 Summer, Boston, Mass.

SELL "Secret Envelopes"—Stuffed with curiosities. Sample 10c. Stampico, Detroit 4, Mich.

AGENTS WANTED

BIG Profits—Taking orders from friends, neighbors. 50 super value Christmas folders \$1.25, with name. America's leading \$1 box 21 French folders. Christmas Holly box—lined envelopes. Also: gift wrappings, plastics, religious, kiddies, napkins, stationery, etc. Samples on approval. No investment. Sunshine Art Studios, Dept. PM-7, 115 Pulton St., New York 8, N. Y.

EXTRA Cash! Sell plastic Christmas card—everyday assortments. New, different personalized money-makers. Profits to 100%. Free samples name imprinted 25 and 50 for \$1.00 Christmas cards, stationery, napkins, guest towels, matches, keepsake notes. Senrab Co., 129 N. Warren St., Syracuse, N. Y.

AT Last! Something new and sensational in Christmas cards. Show gorgeous satins, velours and plastics never before offered. Gets easy orders fast! Pays big profits. Free samples of Christmas cards with name 50 for \$1, imprinted stationery, floral charmettes, napkins. 50 other assortments 60c to \$1.25. Samples on approval. Write: Puro Co., 2801 Locust, Dept. 940-J, St. Louis, Mo.

YOUR Own business! Steady, permanent income. Amazing profits. America's fastest selling household and industrial article for 29 years. Tremendous market. Sells quickly. Constant repeats. Exclusive territory. Write now for special no-risk offer. Dominant Products, 359 Pearl Street, Dept. P-1, New York.

NEED Money? Get it easy! Sell friends glamorous plastic Christmas cards, other novel assortments. Profits to 100%. Bonus, 50 and 25 for \$1.00, 25 for \$1.95 name imprinted Christmas cards—free sample portfolios. Feature assortments on approval. Special offers. Write Pilgrim Greetings, 111 Summer, Dept. AN-2, Boston, Mass.

NEW Sensational money maker. "2-in-1" knife and scissors sharpener. Nothing like it before. Proven success, 100% profit. 30 second demonstration gets order. Special trial offer. Barberdier, 918 Eleventh, Sacramento, Calif.

CHRISTMAS Cards. Earn \$5.00 with every ten 21 card \$1.00 boxes you sell. Also new plastic cards, personalized cards and stationery, note paper and wrappings. Send for samples today. Howard P. Ellis, Dept. PM-7, Pitman, N. J.

BETTER Earnings possible with over 200 household products. You own the business. Send for free samples. Miles Household Products Corp., East Orange 4, New Jersey.

FRIENDLY Social visits bring you big Christmas card profits. Take easy orders wonderful new type plastic, metallic assortments. Send at once for free 48-page catalog. Feature samples on approval and free name imprinted Christmas card sample portfolios. Special offers. New England Art Publishers, North Abington 51, Mass.

HOTTEST Item today. Combination ball pen; cigarette lighter. All gold finish. Year around seller. Suitable men or women. Retail for only \$1.00. Fertig Products, Dept. N-7, Bronx 60, N. Y.

EARN Extra money easily, sell new Christmas cards and Gifts-'n-Things. 24 folder asst. sells for \$1.00, sent on approval; no investment. Get \$50 or more selling only 10¢ boxes. Amazing sample offers. Headquarters for new 3-dimension Christmas cards. Plastics, genuine engraved etchings. We send free samples of easy-to-sell personal Christmas cards and stationery. Pen 'n Brush Studios, Dept. PM, 139 Duane St., New York 13, N. Y.

EARN Big money plus sensational bonus. Be a one person department store. Sell men's, women's, children's apparel and accessories, etc. Free sales equipment. Corporate Merchandisers, Dept. PM-14, 54½ Broadway, New York City.

EXTRA Money! Sell friends Christmas cards—including fascinating plastics. 100% profit. Request free samples exclusive name-imprinted Christmas cards, stationery unobtainable elsewhere with Christmas and everyday assortments on approval. Regal Greetings, Dept. PM-7, Hazel Park, Mich.

4 BRAND New products. Needed by millions everywhere. Samples 50c. information free. Liebig Industries, Beaver Dam, Wisconsin.

HOTTEST 39c Item on the market. Write National Sales & Service, Greenville, Penna.

SHINE Shoes without "polish." New invention. Lighting seller. Shoes gleam like mirror. Samples sent on trial. Kristee 131, Akron, Ohio.

MAKE Extra money fast! Sell Christmas and everyday cards to friends, neighbors, club members, others. Amazing profits. 100 sell-on-sight items. 6 plastic assortments — "Little Stars," "Jack Frost," "Little Ones." Glamorous "Gleam 'n' Glo" metallic cards. "Mild Animals," "Smile Please," stationery, wrappings, juveniles, Christmas trees, gifts. Write today for feature box on approval. Hedenkamp, 343 Broadway, Dept. PM-2, New York.

A Dress yours with every 3 you order for yourself and family. Amazing new bonus plan. Everything free. Harford Frocks, Dept. A-235, Cincinnati, Ohio.

ELECTRIC Lawn mower. Sample \$59.50 (delivered), or sales kit—Free. Satisfaction guaranteed. Smith Agency, S-2007, Excelsior Springs, Mo.

LOOK Here! Wanted—Men and women to start in business on credit. Sell some 200 farm-home products. Thousands our dealers now make quick sales, big profits. For particulars write Rawleigh's, Dept. G-192-PPM, Freeport, Ill.

QUICK, Easy cash for you! Sell amazing variety new Christmas cards. Profits to 100%. Novel plastic, 3-dimension "Stage Set," metallic, Christmas carol cards. Gift wraps, animated books, table settings. 14 special offers. Bonus. Write for feature samples on approval and free samples 4 different name imprinted Christmas card lines, floral and personal stationery. Elmira Greeting Card Co., MA-109, Elmira, N. Y.

PLASTIC Tablecloth covers, curtains, drapes, baby pants, bowl covers and other plastic articles selling like wildfire! Make big money now! Free details. Write L & M Co., Dept. 58-G, 510 St. Charles, St. Louis, Mo.

AMAZING Offer—\$40 is yours for selling only 50 boxes Christmas cards. Also 50 and 25 for \$1.00 with or without name. Free samples. Other boxes on approval, including entirely new, different deluxe assortment with feature television card. Cute plastic assortments. Write today. It costs nothing to try. Cheerful Card Co., 774, White Plains, New York.

CALL On friends with sensational Christmas cards in handy assortments. Sell for \$1.00. Profit up to 50c. Also popular-priced personal Christmas cards, everyday assortments, stationery, imported napkins. Samples on approval. Wallace Brown, Dept. A-4, New York 10, N. Y.

SELL Big profit 5x6 1/2 inch stock signs. Write for jobbers introductory offer. Al Hawkins Sign Co., Sioux City 7, Iowa.

PROFITS. Big demand and repeat orders selling rubber mats for home or auto. Free sales plan. Mitchell, Dept. PM7, 2140 San Fernando Road, Los Angeles 41.

STOP The music. Original titles mystery melodies \$1.00 year. Mitchell, Box 175, Huntington, W. Va.

MOVIE Projector 16mm sound. Sell churches, schools, industry. Big profits. Write N. Jessen, 5 S. Wabash, Chicago 2, Illinois.

PAINTS - Enamels, roofing 65c gal. up. Your name on label. Certified Products, 812E 38th, Louisville, Ky.

GREETING Card bargains. Gift wrappings, stationery, notes, novelties, plastic cards. Personalized Paper Products, Raum, 4154g Fifth Street, Philadelphia 40.

BEAUTIFUL Bright red extinguisher. "Fire Doctor." Fifteen inches tall, hangs on wall. Dry chemical forms carbon dioxide gas. Fastest \$2.00 seller. Will send postpaid two "Fire Doctors" and literature anywhere U.S. only \$2.00. Agents averaging four sales per hour. Marvel Chemical Products Co., Cortland, New York.

NEW, All chrome, metal shower. Attaches permanently any bath faucet; in few minutes take bath or shower; ball socket head large enclosure; no leaks, no plumbers, big profits. Send for information. Hava Shower, 5 East 9th Street, New York 3, N. Y.

WAGE Earners records. Business cards. Samples free. Goerke, 524 E. Seventh, Long Beach, Calif.

FREE Samples. Big profits showing amazing Glow-in-the-Dark specialties. House numbers, pictures, plastic novelties, religious and nursery objects, etc. Large manufacturer. Madison Plastics, 303 Fourth Ave., New York 10, N. Y.

BUY Thousands of nationally advertised products direct from manufacturers and distributors. Write for "Buy Direct and Save." Service Publishing, 218-A Investment Bldg., Pittsburgh 22, Penna.

MUSIC Greeting cards. All occasions. Dorby Music Cards, P.O. Box 738, Morristown, New Jersey.

FREE! Big cash contest. Sensational offer. Make more money selling plastic Christmas cards. 50 and 25 for \$1.00, imprinted. Fast selling line. Bonus. Free contest entry and portfolios. Richar, 16A East 18th, New York 3.

BIG Commissions—Fast sales. Sell popular line of chenille spreads, rugs, etc., direct to homes. No investment in stock, your commissions at once. Our agents make up to \$25.00 daily. Write today for full details of tested selling plan and free sales kit. Stafford-Smith Chenille Co., Dept. PM, P.O. Box 481, Dalton, Georgia.

SENSATIONAL Non-electrical burglar alarm for doors or windows. Untouched market. Retails \$2.95. Millions of prospects. Earl Denton Co., 221 N. LaSalle, Chicago.

FIRE Extinguishers, pressurized liquid. Sells \$2.00. Costs \$1.00. Free details. Firecom, Southport, Connecticut.

SELL Printing in your spare time on commission basis. Send for free sample outfit and details. Baynas Press, 3752 N. Cicero Ave., Chicago 41, Ill.

NYLON Uniforms. Immediate delivery, immediate profits. Sell to doctors, dentists, nurses, waitresses, beauticians, housewives. Free sales kit. Superior Fabrics, Dept. P7, 3936 Market, Philadelphia 4, Penna.

RIBBONS—Sell 10c hanks everyday and Xmas ribbons with your line greeting cards. Price 3c each gross lots. Samples 10c. Wotring Co., Catasauqua, Penna.

UP To \$100 daily selling "Quick De-Tarnishing Atomic Metal Plates." Instantly cleans silverware, jewelry, metals. Sensational demonstrator. Wholesale, retail, sideline, spare, full time. Mfgs., 508 New York Street, Aurora, Ill.

SCISSORS Sharpeners. Fast 25c seller. Mar. 74 Park, Webster, New York.

BIG Money selling "Ear-Buds" the perfume earrings. Sample pair \$1.00. Particulars free. Minot, Box 77, Dorchester 22, Massachusetts.

BE First! Clean up selling brilliant new, metal Christmas cards featured in America's greatest box assortment line. Special metal, plastic, foil and novelty assortments. Five portfolios of personal cards. Fast imprint service. Free samples. Elmcraft Chicago, 5930 South Western, Chicago 36, Ill.

BOYS! Earn big money easy, spare time, selling brass name plates for neighbor's doors. Write Hubstamp, 359-C Congress, Boston, Mass.

LARGE Profits, selling leading American colored granite memorials. Mihelich Monument Co., St. Cloud, Minn.

150¢ SELLING EZC needle threaders 10c. Remit \$1.00 for 25 on card. 6 cards \$5.00. Money back guarantee. EZC Co., 196 Chestnut Street, Springfield, Mass.

ABSOLUTELY Free! Big package actual sample fabrics and style presentation of dresses, lingerie, hosiery, etc. Take orders. Commissions big. Send no money. Melville Co., Dept. 5103, Cincinnati 3, Ohio.

BE Renewal headquarters for all magazines. Handle everything at home. Big profits. No experience. No capital needed. Free catalog tells how. Write McGregor Magazine Agency, Dept. 129, Mount Morris, Ill.

LOOK! Make money all year round selling personal initialed individualized belts, buckles, cap badges, western buckles, tie holders, name plates. 2000 emblems to choose. Big profits, whole or part time. Please write today special outfit offer. Hook-Fast Specialties, Box 1425, Dept. 6, Providence, R. I. Established 1926.

SEWING Machine electrification kit. Nationally advertised. Has Good House-keeping Quarranty Seal. Can be demonstrated and sold in 5 minutes. Make at least \$5 per sale. For complete details write today to Brownell Distributors, Inc., Dept. PM, 308 Canal St., New York 13, N. Y.

FREE Water and our concentrates, make flavors, lotions, shampoos, 125 products, labels, bottles supplied. Qualco, E20030 Russell, Detroit.

MEXICAN Feather pictures. Unusual novelty. \$1.00 (stamps) brings \$2.00 worth samples, details. Refunded if unsatisfied. Aztec Art-P, Apartado 762, Mexico City.

BIG Money—Fast! Sell quality plastic tablecloths (from \$4.00 dozen), curtains, aprons, etc. Factory prices. Free samples! Durever, 282-C Albany Ave., Brooklyn 13, N. Y.

FREE Nylons given if Kendex hosiery runs or snags! World's only women's hosiery sold with written guarantee amazing everybody. Mere words could not express unbelievable money-making opportunity. Fantastic earnings become reality. Armstrong earned \$202 in 9 days. Watkins sent 92 orders in one day. Imagine replacing hosiery free regardless of cause—whether use or abuse! Truly sales dynamite for terrific profits. Even if you never sold before, three magic words: "Guaranteed Against Everything" will open doors for you—make women listen and pour money in your pocket. Complete line from sheerest to service (15-20-30-40-60 denier) all lengths 28 to 35 inches—latest colors—seamed full fashioned and seamless. No competition because Kendex guaranteed nylons not sold in stores. Also complete line men's hosiery actually guaranteed for one full year! Nothing like this anywhere. Includes rayon, nylon, lisle, wool, cotton, mixtures, etc. All styles, patterns, colors, prices to please everybody. Thousands shipped daily. 100,000 pairs constantly in stock for fast delivery. Over 30 years in business. You need no money or experience. Nothing to pay now or later. Show free outfits. Write orders. We deliver and collect. Big advance cash plus huge bonus. Earn money spare or full time—exclusively or side line. No restrictions. Become manager—appoint others to sell for you—earn steady income on their sales. Complete money-making outfits including salesbooks in color, samples of hosiery materials, etc. furnished free and prepaid. Simply mail name and address to: Kendex Company, Babylon 73, N. Y.

SELL By mail books, novelties, bargains! Ready made circular service! Large profits! Catalog free! Elifco, 432 North Wells, Chicago 10.

BIG Money selling cast iron and aluminum cooking utensils direct to consumer, exclusive designs. Free illustrations. Jones Machine & Foundry Co., Chattanooga 2, Tenn.

MAGIC Cleaner—Laundry soap deal. Hotter than a firecracker. Big profits. Sample free. Bestco, 4642 No. Central, Chicago.

AGENTS: Stamping names on pocket-key protectors. Sample check with your name, address, 25c. Stamping outfits. Emblem checks, check-fobs, name plates. Hart Mfg. Co., 303 Degraw St., Brooklyn, N. Y.

PHOTO-Salesmen-agents. Sell beautiful hand-colored plastic enlargements. Collect deposit, we deliver. Profitable sideline. Send card, for free sample kit. Novel Portrait Co., 3343 North Ave., Chicago, Ill.

GOLD Lacquered window sign letters. Large sizes penny each. New foils. Absolutely beautiful. Free samples. Atlas, 544 W. 79th, Chicago 20.

EXCELLENT Sideline for printing and advertising salesmen. Decalcomania name plates in small quantities. Great demand. Also, make money with our line of automobile initials and sign letters. Free samples. "Ralco" XL-Roxbury, Boston 19, Mass.

AGENTS—300% Profit selling genuine gold window letters; stores and offices. Free samples. Metallic Letter Co., 438-B North Clark, Chicago.

HIGH-GRADE SALESMEN

SALESMAN! Make over \$30.00 a day! Sell nationally advertised adding machine for only \$12.95 complete. A desk model portable, precision built, fully guaranteed, every inch a business machine. Easy to operate, easy to sell, easy for you to make big money at 49% profit! For life-size color photo and full details, write today to Lightning Adding Machine Co., Inc., Dept. ZD-8, 543 So. Spring Street, Los Angeles 13, California.

SENSATIONAL Hermetically sealed automobile safety flares sell three for \$1.00. Producers territory protected. Send dollar for six samples. Hurry. Anga Enterprises, Inc., Box 67, Minneapolis, Minn.

UP To \$50.00 in a week and tailored suit for yourself without paying one cent. Write for plan. Progress Tailoring Co., Dept. U-217, Congress & Throop, Chicago 7, Ill.

ADVERTISING Book matches—Cash in on big demand; sell union label matches. Cuts for all businesses and political parties. Free powerhouse selling kit, low prices, protection guaranteed on repeat orders. Cash commissions. Superior Match Co., Dept. M-79, 7530 Greenwood, Chicago.

SELL Calendars now. Be the first in your district. Good sideline or full time. Every business wants them. Few calendar salesmen are on the road now which means more sales for you. Fleming Calendar Co., 6539 Cottage Grove, Chicago 37.

SELL Ultra-blue stock signs to stores. 1000 slogans, comedy, general, religious. "7x11" cost 6c, sells 35c. Make money. 15 samples ultra-blue signs "7x11" \$1.00 postpaid. Lowy, 8 West Broadway, Dept. 476, New York City 70.

SENSATIONAL Commissions selling 15 color sport shirts, pajamas, pinafores, boleros. Free portfolio. Jarod Manufacturing, Rockville Centre 55, New York.

DON'T Leave town without our specialties to sell. Currier Manufacturing, St. Paul 8, Minn.

ADVERTISING Gummed tape salesmen wanted. Best line in country. Jobbers profits—all yours. Repeats. Every merchant, factory is a prospect. Free sales kit. Telco, Dept. B, 17540 Freeland, Detroit 21, Michigan.

NEW Jobs open in selling! Send name, address for five free issues of Opportunity Magazine's money-making guide, listing hundreds of companies who'll pay you well, full or part-time. No experience needed. Opportunity, 28 E. Jackson, Dept. 17, Chicago 4, Ill.

STOP! Want to make money all year round selling a complete line, wool uniforms, shirts, caps, ties, badges, 2000 emblems, personal initialed buckles, belts, and hundreds of other easy-to-sell items? Sales kit furnished. Please write today. Hook-Fast Company, Box 480PM, Roanoke, Va.

BIG Money taking orders. Shirts, ties, Sox, pants, jackets, sweaters, shoes, uniforms, etc. Sales equipment free. Experience unnecessary. Nimrod, 4922-AN Lincoln, Chicago.

FISH Poles, coping saws, screw drivers, bathroom fixtures etc., wholesale. Humphrey Specialty Company, Box 898, Santa Monica, California.

EDUCATIONAL AND INSTRUCTION

LEARN Auctioneering at home! Col. Nelson, nationally known auctioneering teacher can teach you to become a successful auctioneer, by his spare time home study course. Sample lesson free. Guaranteed. Copyrighted. Nelson Auction School 184, Renville, Minnesota.

SPEED And skill in radio code to qualify for amateur or commercial radiotelegraph license. Learn at home with the famous Candler System used to train radiotelegraph experts and champions. Good pay or fascinating and profitable hobby. Free book. Candler, Dept. 5-H, Box 928, Denver, Colo.

PIANO Tuning pays. Learn this profitable profession at home. Our Tunometer and mechanical aids make learning easy. No knowledge music necessary. Diploma granted. Largest and oldest school—51st year. G.I. approved. Write for booklet. Niles Bryant School, 78 Bryant Bldg., Washington 16, D.C.

"HOW To Break and Train Horses"—A book every farmer and horseman should have. It is free; no obligation. Simply address Beery School of Horsemanship, Dept. 1107, Pleasant Hill, Ohio.

EXPORT! Learn at home from established world trader. Big paying positions. Your own profitable world-wide business by mail order without capital; or travel abroad. Experience unnecessary. Free booklet, Mellinger, 107W, Los Angeles 24, Calif.

U. S. Gov't jobs! Start high as \$3,351.00. Men-women. Qualify now for secure positions. Free 40-page book, sample tests. Write today: Franklin Institute, Dept. S-24, Rochester, N. Y.

SPANISH Quickly, with records. \$7.95 complete. Free folder. Speed-O-Way 113, Box 2301, Houston 1, Texas.

STUDY For game warden, fish, park, forestry, patrol and wildlife conservation service. Details free. Write Delmar Institute, D11, Denver, Colo.

AMBITIOUS? Then don't cheat yourself into failure and discouragement. Don't be ignorant of the sixteen progressive steps to success. You can't win life's game unless you know the rules. Avoid mistakes, overcome obstacles with this proved, practical method. Send \$1.00 for guaranteed success plan. Satisfaction or refund. Success, 135 W. Union, Dept. 1-A, Pasadena 1, Calif.

WIN A well-paid job in travel—Step into a new world of glamorous opportunity! Today more Americans are "going places" than ever before in history. As a result—the hotel and institutional field is surging ahead to new prosperity. Successful Lewis graduates are "making good" everywhere in luxurious hotels, fashionable resorts, smart restaurants, and clubs. Free book explains how to qualify at home for a well-paid position in this ever-growing business where you are not dropped because you are over 40—shows how you are registered free of extra cost in the Lewis National Placement Service. Approved for veteran's training. Write today. Room PL-395, Lewis Hotel Training School, Washington 7, D.C. (Now in its 33rd year.)

BE A real estate broker through home study or classroom instruction. Write for free book. Approved for veterans. Weaver School of Real Estate, 15 E. Pershing Rd., Box CP-7, Kansas City 8, Mo.

BECOME A Doctor of Psychology or Metaphysics. Teach secret of contentment, happiness. Win degree of Ps.D. or MsD. Solve mental worries. Free book. College of Universal Truth, 5153-C North Clark, Chicago.

MOTION And time study correspondence course. Time Analyst, 407 S. Bedford, Evansville, Indiana.

LEARN Optics—Be an optician. Good income! Free details on "How to Become an Optician." Write Dr. Mason, 4003 West Madison, Chicago.

MAKE Up to \$35-\$45 week as a trained practical nurse! Learn quickly at home. Booklet free. Chicago School of Nursing, Dept. M-7, Chicago.

VOICE—Strengthen, train your voice this tested, scientific way. Self-instruction course; no music or piano required. Silent exercises develop your voice power. Results guaranteed! Sensational details free. State age. Perfect Voice Institute, 1141 Wabash, Dept. 2G-2, Chicago 5.

PHOTOGRAPHIC Mind! Amaze, earn, learn! Facts, figures, names stick like burrs with Supermemory. Thor Books P-7, Box 1210, Chicago.

REFRIGERATION Servicing means financial independence. Ordinary mechanical ability plus proven home study are all you need. Free booklet. Dept. RS, Penn-Weston Training Institute, Box 189, Concord, N. H.

BUILD a writing career in trade journalism. The best field for the beginning writer. Good pay, huge markets, little competition. Send for details. John F. Bristol, 23 Wayne Road, Bridgeton, New Jersey.

HOME Study course, drugless therapy. Free literature. Institute of Drugless Therapy, Tama, Iowa.

EARN Extra money, working with figures. Write Jimmy Sherrod, Pavo 1, Ga.

INVESTIGATOR Training. Phillips Secret Service System, 1917B North Kenneth, Chicago 39, Illinois.

MEDICAL Laboratory technicians in great demand. We train you in your own home. Catalogue free. Imperial Technical Institute, Box 973-J, Austin, Texas.

DENTAL Technician's practice kit. Artificial teeth, plastic, etc. Instructions included. Grant Laboratory, S-219 W. 7th, Los Angeles, Calif.

BOOKKEEPERS! Increase your earnings! Operate your own simplified "Dollar-A-Week" bookkeeping and tax service. Full or spare time. Details free. No obligation. Ellis, Box 200, Cedar Grove, North Carolina.

LINGUAPHONE Makes languages easy. At home learn to speak Spanish, Portuguese, Italian, French, German, Russian, by quick, easy Linguaphone Conversational Method. Save time, work, money. Linguaphone correspondence courses are available to veterans under G.I. bill of rights. Send for free book. State if G.I. Linguaphone Institute, 83 RCA Bldg., New York, 20, N. Y.

USED Correspondence courses and books bought, sold, rented and exchanged. Catalog free. Lee Mountain, Pisgah, Alabama.

SECRET Investigation. Experience unnecessary. Investigators particulars free. George Wagner, M 125 West 86th, New York.

PLAYS, STORIES, MANUSCRIPTS

I WANT New writers to cash checks of \$1 to \$100 offered daily. The easiest way to write for pay. No previous experience necessary. Free details. Saunders M. Cummings, 468-11 Independence Bldg., Colorado Springs, Colo.

BUSINESS SERVICE

WHERE—To-buy-it information; most products, material or equipment. State wants. Donald Kelly, AT-9544 Whitcomb, Detroit 27, Michigan.

WASHINGTON, D.C. New York City, Philadelphia, remailing service 25¢ each, 3 for 50¢. Richards, 6709 Elmwood Ave., Philadelphia 42, Penna.

INCORPORATE Your business, free details. Tax Research Bureau, Inc., Delaware Trust Building, Wilmington, Delaware.

SPECIAL SERVICES

WE Receive, remail letters; \$3.00 monthly or 25¢ each. "Hawkins," (Est. 1917), 1300 Taylora, Washington 11, D. C.

INFORMATION

FOREIGN Employment for you. Excellent permanent job opportunities for U. S. citizens. Wages at least 20% higher, less taxation, lower living costs. Improved social position. Transportation and housing furnished. Choice of climate and location. South and Central America, Far East, China, Alaska, Australia, New Zealand, Africa. Send \$1.00 for copyrighted digest showing oil, shipping, construction, mining, etc., companies working and hiring. Includes sample application letter, advice on wages, tips, etc. World Wide Company, Dept. PM-7, Madison 1, Wisconsin.

SKILLED Workers—Subscribe now for monthly news-letter listing \$400,000,000 in newly awarded worldwide construction contracts. Send \$1.00 single copy, \$3.00 six months, \$5.00 year. Letters, Box 232, Knoxville, Tenn.

CARTOONING, COMMERCIAL ART, SHOWCARD WRITING, SIGN PAINTING

"HOW To Make Money With Simple Cartoons"—A book everyone who likes to draw should have. It is free; no obligation. Simply address Cartoonists' Exchange, Dept. 97-C, Pleasant Hill, Ohio.

PROFESSIONAL Photographic silk-screen formula, \$1.00. Edgar Formulas, 576 Alma, Oakland, Calif.

ART Books for pleasure and profit. Five books covering all art subjects. 100 pictures. Postpaid. Satisfaction guaranteed. Send \$1.00. Hollywood Artists, 3606 Amesbury, Los Angeles, Calif.

ARTISTIC Back dated art magazines. Six, \$1; 36, \$3.50 postpaid. Art bargains, Catalogue 10c. Art Book Shop, Arnold 6-0, Mo.

9 ALPHABET 3 Numeral pattern sets and catalog, \$1.00. Sign Letter Distributors, P.O. Box 101, Mineola, N. Y.

PROFESSIONAL Showcard letter patterns. Samples dime. Demonstrators, 1743P Harrison, Chicago.

SIGN Painting taught at home. Test lesson free. Ben Kerns, Box 812-T, Greenville, S. C.

CHALK Talks. Laugh producing program, \$1.00. Catalog 10c. Balda The Cartoonist, Oshkosh, Wisconsin.

ADVERTISING AGENCIES, LETTER WRITERS, FOR ADVERTISERS

DOUBLE The results from your advertising after reading Successful Advertising. Only \$2.00, postpaid; Satisfaction guaranteed. William Bennett, 114-35C 116th Street, Ozone Park 16, New York.

ADVERTISE: 24 Words, 40 newspapers \$3.50. Lists free. Advertising Bureau, 10511-C Springfield, Chicago 43.

GET More mail order profits! "Big time" specialist who developed many small sparetime enterprises to Big Daily Mail sales, gives you plan and complete instructions in his booklet "How To Build Your Own Mail Order Business." and make it pay. "Must" for beginners. Test-plan-guide for established operators. 25¢ brings this revealing, exciting booklet. Edition limited. Order yours now. Newberrys, 524 PM Williams, Citronelle, Alabama.

ADVERTISERS! Reach nearly 16,000,000 readers. 25 Sunday national key newspapers, 18 words, \$51.50. "Terrific pullers." 20 popular newspapers, \$10.00. "Free booklet." Special—One inch display 2,-821,198 circulation, \$48.30. Newmark's Advertising Agency, (Established 1893), 217-7th Ave., New York 11.

24 WORDS In 50 weeklies, \$4.96. J. Darnell, 730 Hays, Jackson, Tennessee.

ADS Placed in out of town newspapers and magazines. Low rates. Catalogue free. Ideas that pay. Baker Advertising Agency, Successors Ankrum Agency, 189 W. Madison, Chicago 2.

MAILING Lists, certified, productive, inexpensive, \$5.00 1000. Homeworkers, agents, buyers, etc. Write Dixie Service, King, N. C.

TYPEWRITERS, DUPLICATORS, OFFICE DEVICES

POCKET Seal for notary public, corporation, professional engineer, \$4.50. America's best value. Information free. Campbell Products, Urbana 2, Ill.

SAVE On printing, addressing! Mimeographs—Letter to postcard size \$13.50 up. Amazing addresser, no plates, \$24.50. Free folders. Atomic Sales, 345 South Pulaski, Chicago 24, Illinois.

AMAZING New portable addressing machine only \$24.50! Complete details free. Addresso, 1008A Northeast Gould, Minneapolis 21.

STANDARD Typewriters \$17.50; duplicators \$12.50; adders \$12.50. Nationwide service. Typewriters, 118 Spruce, Wichita, Kansas.

PRINT-O-MATIC Selffeeding post card stencil printing duplicator \$13.50. All office machines. Supplies. Bargains. Type-write for free literature. Pittsburgh Typewriter Supply, 336-7 Fourth Avenue, Pittsburgh 22, Penna.

RECONDITIONED Typewriters, mimeograph, multigraph printing devices, appliances, supplies. Catalog. Dixigraph Service, King, N. Carolina.

STEEL Safes, filing cabinets—wholesale. Modern Safe Company, Beloit, Wisconsin.

RUBBER STAMPS AND OFFICE SUPPLIES

INTRODUCTORY Offer. New two-color rubber stamp. Prints blue air mail inside red arrow. One impression. Mailed anywhere. \$1.00. Year's ink supply. Satisfaction guaranteed. Multi-color Stamp Company, Keene 3, Texas.

PRINTING, MULTIGRAPHING, MIMEOGRAPHING, GUMMED LABELS

100 ENVELOPES Printed, 2-colors \$1.00. Box 523, Rochester 2, N. Y.

"TELEPHONE Memos," 4x4 1/4, 1000 \$1.50 postpaid. Siemens, 3723 Wisconsin, St. Louis, Mo.

100 8 1/2 x 11 HAMMERMILL Letterheads and 100 envelopes \$1.85. Herbert Hudson, Centredale, R. I.

MIMEOGRAPHING'S Best. Samples free. Martin Mimeographing, 3212 Harper, Saint Louis 7, Missouri.

MIMEOGRAPHING—Excellent quality, reasonable prices. Free samples, price list. Russell Mimeographing, Homewood, Alabama.

PERSONAL, Business stationery, cards. Free catalog. Spenn, 1728 Mardell, San Antonio, Texas.

COMMERCIAL, Personal, invitations printing. Letterart. Jeka, Box 140, Jersey City 3, N. J.

MIMEOGRAPHING, Anything, lowest prices, quality work. Rapid Service, 317 W. 26 St., New York.

1000 BUSINESS Cards, \$2.50 prepaid. Samples free. Reliable Print Shop, 905 East Jefferson, Louisville 6, Ky.

QUALITY Printing—5,000 6x9 circulars \$21.50; 4-page folders \$38.50. Fast service. Bagby Printing Company, Georgetown, Ohio.

200 5 1/2 x 8 1/2 HAMMERMILL Letterheads; 200 envelopes \$2.98 postpaid. Odom, Box 9345, Tampa, Florida.

1000 NAME-ADDRESS Labels \$1.00. Kay Press, 1560 South Fifth, Milwaukee 4, Wis.

QUALITY Printing! Send copy for estimate. Nationwide Printing Company, Dept. PM, 2337 Bath Avenue, Brooklyn 14, N.Y.

BLACK-ON-WHITE Photostat prints from drawings, tracings, etc. 25c per copy up to 8 1/2 x 11", 50c per copy up to 14" x 17", plus postage. United Industries, Dept. A, Box 449, Madison 1, Wisconsin.

SAVE Money on printing. Tell us what you need. Journal Printing Co., Newark, Ark.

400 8 1/2 x 5 1/2 LETTERHEADS \$1.35. Mango, 555-A South 20th, Newark 3, N.J.

SEND 10c Now, for our 48 page 1949 price list—refunded first order. McCall Press, 1326 South 27th, Omaha, Nebraska.

500 3/4 x 2 1/4 FOUR Line gummed stickers 35c; red border 50c. Moritz Printery, Saginaw, Mich.

MIMEOGRAPHING—Letters, pricelists, formulas, instructions. Lowest prices. Lem's Letter Shop, 5710 Stanton, Detroit 8.

EMBOSSER Business cards, 1,000 \$3.45 postpaid. Samples. Spada Enterprises, 10C Lexington, Wethersfield 9, Conn.

PRINTING OUTFITS AND SUPPLIES

PRINTING Outfits. New and different. Complete with type, leads, slugs, ornaments, "raised letter" heater, powder, and carrying case. Print names on greeting cards, personal stationery, etc., at home or traveling. Price \$15. Write Keena, 1312 Jefferson Ave., D-6, Grand Rapids 7, Mich.

COMPLETE 9x12 Silkscreen printing outfit \$5.00. Details free. Castellano, 530 East 134 St., Bronx, N. Y.

MAKE Your own rubber printing cuts. Self-molding process. Plexirubber, Argyle 1, Wisconsin.

6x10 EXCELSIOR, 9x13 Pearl. Complete shop. Nicholas, Rt. 1, Box 360A-A, Toledo 5, Ohio.

PRESSES, Type, cabinets, supplies. List for stamp. Lincoln Press Company, 220B Hartwell, Fall River, Mass.

PRINTING Presses, type, supplies. Details free. Kelsey Presses, K-11, Meriden, Conn.

BARGAINS—Hand presses, supplies. Catalog 10c. Customprint, 211-R, Springfield, Missouri.

USED Type, printing presses, type cabinets, etc. cheap. Visit our store. Edward Van Dillen, Inc., 74 Beekman St., New York 7, N. Y.

PRINTING Presses, type, supplies. Lists 3c. Turnbaugh Service, Loysville, Penna.

INEXPENSIVE Home-made printing press. Details free. Novelty Shop, Downs-ville, Louisiana.

PATENT ATTORNEYS

IF An inventor believes he has an invention, a search of the most pertinent prior U. S. Patents should be made and a report obtained relative to its patentability. Write for further particulars as to patent protection and procedure and "Invention Record" form at once. No obligation. McMorrow, Berman & Davidson, Registered Patent Attorneys, 134-A Victor Building, Washington 1, D. C.

PATENTS, Trade marks, Sanders, 6430 Evans, Chicago. (Registered U. S. Patent Office.)

PATENTS—Trade marks. Gustave Miller, Registered Patent Attorney, 69-A Warner Building, Washington 4, D. C. Patent Lawyer.

CANADA—Ramsay Company Registered, 273 Bank Street, Ottawa, Canada.

INVENTORS: Learn how to protect your invention. Unless the inventor is familiar with patent matters, he should engage a competent registered patent attorney or agent to represent him. We are registered to practise before the U.S. Patent Office and prepared to serve you in handling your patent matters. "Patent Guide for the Inventor" containing detailed information concerning patent protection and procedure with "Record of Invention" form will be forwarded to you upon request—without obligation. Clarence A. O'Brien & Harvey Jacobson, Registered Patent Attorneys, 91B-G District National Building, Washington, D. C.

PATENT Protection—This well-known organization will supply inventors, promptly upon request and without obligation, a booklet containing detailed information concerning steps to take to protect their inventions by a U. S. Patent. Victor J. Evans & Co., Merlin M. Evans, Registered Patent Attorney, 431-H Merlin Building, Washington 6, D. C.

PATENTS, "Proof of Invention" folder mailed without obligation. E. E. Vrooman, Registered Patent Attorney, 505 McKim Building, Washington 5, D. C.

PATENTS—Trade marks. Irving L. McCathran, 315 McLachlen Bldg., Washington 1, D.C. Registered Patent Attorney.

INVENTORS: When you are satisfied that you have invented something of value write me, without obligation, for information as to what steps you should take to secure a patent. Write Patrick D. Beavers (Formerly Randolph & Beavers) Registered Patent Atty., 935 Columbian Bldg., Washington 1, D. C.

C. A. SNOW & Co.—M-427, Snow Building, Washington 1, D. C. Registered Patent Attorneys. Write for information.

INVENTORS: Without obligation, write for information explaining the steps you should take to secure a patent. John N. Randolph, Registered Patent Attorney, 203 Columbian Bldg., Washington 1, D. C.

"INVENTOR'S Guide" free on request. Frank Ledermann, Registered Patent Attorney, 154 Nassau St., New York 7, N. Y.

INVENTORS: Write for free brochure "Evidence of Invention." Labiner, World Building, New York 7.

PATENT Practice before U. S. Patent Office. Validity and infringement investigations and opinions. Booklet and form "Evidence of Conception" forwarded upon request. Lancaster, Allwine & Rommel, Registered Patent Attorneys, Suite 411, 815-15th Street, N.W., Washington 5, D. C.

INVENTORS. For "Record of Invention" form, contact Carl Miller, Registered Patent Attorney, Woolworth Building, New York.

FOR INVENTORS

INVENTORS: Learn how to protect your invention. Unless the inventor is familiar with patent matters, he should engage a competent registered patent attorney or agent to represent him. We are registered to practise before the U.S. Patent Office and prepared to serve you in handling your patent matters. "Patent Guide for the Inventor" containing detailed information concerning patent protection and procedure with "Record of Invention" form will be forwarded to you upon request—without obligation. Clarence A. O'Brien & Harvey Jacobson, Registered Patent Attorneys, 91A-G District National Building, Washington, D. C.

INVENTORS—This firm is registered to practise before the U. S. Patent Office and is available to assist inventors in the preparation and prosecution of their cases. "Patent Protection for Inventors" booklet containing detailed information and steps to take toward patent protection will be sent upon request. No obligation. Victor J. Evans & Co., 432-H Merlin Building, Washington 6, D. C.

IF An inventor believes he has an invention, a search of the most pertinent prior U. S. Patents should be made and a report obtained relative to its patentability. Write for further particulars as to patent protection and procedure and "Invention Record" form at once. No obligation. McMorrow, Berman & Davidson, Registered Patent Attorneys, 134-B Victor Building, Washington 1, D. C.

SEE Our ad under "Models" in which we tell you the story of our activities for many years. The Gent Machine Co., 443 Green Rd., South Euclid 21, Ohio.

PATENT Office search. Analysis your invention for technical, commercial merit. Both \$5.00. Protection forms free. Industrial Patent Reports, Box 1081, Massachusetts Avenue and North Capitol, Washington 13, D. C.

PATENT Searches \$5.00. Includes nearest patent copies. 48 hour service. Free protection forms. Patent Research Engineering, 318 Evans Building, Washington 5, D. C.

IDEAS Are worth money. Shop drawings, patent drawings, models made by progressive shop and engineering organization. Excellent work guaranteed. Confidential. Write TAB Engineers Incorporated, National Security Bank Bldg., Chicago 22, Illinois.

PATENT Searches \$5.00. Reports air-mailed within 4 days. Invention protection forms free. Write Raymond L. Smith, Patent Searcher, 410 Bond Building, Washington 5, D. C.

PATENT Searches \$5.00. Reports air-mailed within 4 days. Invention protection forms free. Write Miss Ann Hastings, Patent Searcher, P.O. Box 176, Washington 4, D. C.

LIST Your invention with qualified brokers. Write Elo Development Co., Long Island City 1, New York.

INVENTORS! Have you good, patentable ideas? Write Patent Agent Metzler, 11 West 42nd, New York.

INVENTORS: Without obligation, write for information explaining the steps you should take to secure a patent on your invention. John N. Randolph, Registered Patent Attorney, 202 Columbian Bldg., Washington 1, D. C.

INVENTIONS Promoted—Book "Dollars and Sense in Inventions" tells how. \$2.00 postpaid. Adam Fisher Co., 61 Enright, St. Louis 8, Mo.

PATENT Searches \$5.00. Includes nearest patent copies. 48 hour service. Free protection forms. Patent Research Engineering, 318 Evans Building, Washington 5, D. C.

CASH For your idea. 280 manufacturers need inventions, patented or unpatented. List free. Invention Bureau, 208M Clinton, Oak Park, Illinois.

INVENTORS: If you have an invention for sale, patented or unpatented, write Institute of American Inventors, Dept. 40A, 1926 Eye St. N.W., Washington 6, D. C.

"INVENTOR'S Guide" free on request. Frank Ledermann, Registered Patent Attorney, 154 Nassau St., New York 7, N. Y.

INVENTORS. For "Record of Invention" form, contact Carl Miller, Registered Patent Attorney, Woolworth Building, New York.

INVENTORS—Possibly I can help you. Many years experience. Charles A. Scott, 773PM Garson Avenue, Rochester 9, N. Y.

INVENTORS: The usual first step is to have a search of the U. S. Patents conducted, so I can report on patentability. Write, without obligation, Patrick D. Beavers (Formerly Randolph & Beavers), Registered Patent Atty., 936 Columbian Bldg., Washington 1, D. C.

INVENTIONS WANTED

INVENTORS—Charges from royalties only. Inventors Manufacturers Associates, 5 Beekman Street, New York.

SMALL Inventions wanted by manufacturers. I'll help you sell your invention. Write for circular. Stanley Hull, 7829 Euclid, Cleveland 3, Ohio.

CASH For your idea. 280 manufacturers need inventions, patented or unpatented. List free. Invention Bureau, 208M Clinton, Oak Park, Illinois.

HIGHEST Royalties—Cash. Official U. S. I. R. C. certification. Request free Booklet "M". Universal Marketing Co., 354 South Spring St., Los Angeles 13, Calif.

INVENTORS: Hundreds of manufacturers have requested our assistance in locating marketable new products. Complete information, free. Institute of American Inventors, Dept. 40-D, 1926-Eye St. N.W., Washington 6, D. C.

INVENTIONS Wanted. Patented or pending only. Inventors' Exchange-B, Hartford 1, Conn.

PATENTS FOR SALE

PLASTIC Dairy products order board, "The Silent Milkman." Nelson Novelty, Mankato, Minn.

NEED Aid to finance and develop ideas. C. Holzinger, 601 Ridgewood, Minneapolis 3, Minn.

PATENT—Therapeutic powder for treatment fungus infection. (Athletes foot.) Dr. W. Keil, Iowa City, Iowa.

INVENTORS: Test the commercial value of your patented or unpatented inventions, quickly and inexpensively. Write for free information. Institute of American Inventors, Dept. 40-B, 1926-Eye St. N.W., Washington 6, D. C.

MANUFACTURING

PARTS; Manufacturing; booklet. Arizona Tool & Die Co., 33 Rillito St., Tucson, Arizona.

WANT Something made? We'll make it. Consultation free. Write Jayemm Company, Burlington, Kentucky.

MODELS—Small lot manufacturing. Metals, plastics, etc. Milburn, Burlington, Kentucky.

MODELS. Tools, dies, experimental work; large and small lot manufacturing. Van-Ess Specialties Company, 213 W. 14th Street, Covington, Ky.

MODELS, MODEL SUPPLIES

CASTINGS, Flywheels and steam engine models. Illustrated list 10c. Century Models, 340 Guaranty Building, West Palm Beach, Florida.

BUILD Historic ship models, complete kits, 39c to \$9.00. Catalog 10c. Ideal Models, 19 West 18th, New York 11, N. Y.

INVENTIONS Developed; The specialists are at your service who can develop auto accessories, gasoline engines, automatic cigarette-making machines; weighing, vending and automatic photograph machines; electric scales; turbines; air, electric and steam motors and other intricate devices. We can handle your development drawings, experimental work, patterns, models, special tools, dies, stampings, castings, plating, forging and spinning. Can make any metal novelty. Complete organization for developing, manufacturing and selling. Advice backed by 50 year's experience. Send drawings or samples. The Gent Machine Company, 445 Green Rd., South Euclid 21, Ohio.

KEEP In touch with the activities of the British modelmaking fraternity. Send a dollar bill for year's subscription (4 issues) Modelcraft Magazine and list. 77 Grosvenor Road, London, S. W. 1.

LANDLOCKED Sailors! Here's a beautiful, richly illustrated, fully descriptive catalogue of famous model ships—whalers, slavers, corvettes, etc., authentic in every detail. Send it for today. Only 25c. Halesite Yacht Service, Inc., Department B.L., Halesite, Huntington, N. Y.

RAILROADERS—50c Gets 1949 catalog reference manual. State O or HO gauge. Walthers, 247 Erie, Milwaukee 2, Wis.

SHIP and yacht model fittings; blueprints. Send 25c for illustrated catalog No. 21—listing hundreds of items. A. J. Fisher, 1002-1 Etowah Ave., Royal Oak, Mich.

MINIATURE Steam locomotives, 1/4", 1/2", 3/4" scales. Castings, parts, rail, steam fittings! Thorough drawings with instructions. Catalog 25c. Little Engines, Wilmington, Calif.

SHIP Models and yacht supplies complete. Large 64 page catalogue 30c. Bill Wild's, 510 East 11 St., New York City 9.

HOME CRAFTSMEN

16 NEW Lawn chairs, 22 tables, benches, trellises, etc. All 38 plans, with full size patterns, \$1.00. Mastercraft 7M3, 7041 Olcott, Chicago 31, Illinois.

WHOLESALE Shellcraft Book 15c. Large shellcraft kit \$1.69 postpaid. Shell-Art Novelty, Dept. PM, 5th and Moore, Philadelphia 48, Penna.

LEATHERCRAFT. Monthly price list guarantees best prices. Catalog free upon request. Tandy Leather Company, Dept. PM-79, P.O. Box 397, Tulsa 1, Oklahoma.

90 ALL New, full size lawn ornament and novelty patterns up to 20" high. Only \$1.00. Mastercraft 7M2, 7041 Olcott, Chicago 31, Illinois.

8 BEAUTIFUL Full-size whatnot patterns only 25c. Joanness, P. O. Box 141-M, Omaha 7, Nebr.

SHELLS, Plastics, findings, Lowest prices. Free catalog. Frances Jones, Box 251, Sarasota, Fla.

SWISS Music movements, assorted tunes, \$1.90. Direct from manufacturers agent. Helax Company, 233 West 72 Street, New York.

CRAFT Supplies. Send for illustrated catalog. Sola Sales, 1142 1/2 El Centro, Los Angeles 38, California.

BURGLAR Protection. "Screenlox" locks your window screens tight. Keeps children in and burglars out. Jiffy installation. Set of 12 complete "Screenlox" only \$1.00 p.p. Send now to Safetee Homes Company, Box 601, Glendale, California.

JEWELRY Supplies. Illustrated catalog 10c. George Sassen, 154 Nassau Street, New York 7.

OZARK Wood samples. Eleven varieties, each identified, including sassafras, persimmon, cherry, walnut. Can be made into ash trays, paper weights, etc. Shipped prepaid in U. S. for \$1.25. Send cash or check to C. E. Davis Lumber Co., Cabool, Mo.

LAWN Ornaments. Ready cut patterns, full size, 20 assorted \$1.00 postpaid. Lincoln Craft Studio, Farmington, Conn.

LEATHERCRAFTERS! Complete stocks of leathers, tools, supplies. Metal tooling supplies. Immediate shipment. Free catalog. Kit Kraft, 7377 Melrose Ave., Los Angeles 46, Calif.

\$46 FROM Square foot plywood. Jigsaw necessary. Write, Woodarts, C-38, Bridgewater, Mass.

MAKE Your own "Hercules" belts! Complete kit includes finest calfskin links, tongue and metal buckle. Simple instructions enclosed. Send \$1.00, we ship prepaid. Arokraft, Dept. M, 32 W. Randolph, Chicago 1.

AT Last! Precious Hawaiian hardwoods. The most beautifully grained woods in the world. Monkey Pod, Opuma, Mango. We can furnish any size piece or pieces desired up to 24"x36"x8" at 3c per cu. inch. Samples sent postpaid any place in U. S. for \$1.00. Mainland Branch, Hawaiian Mould Limited, 418 Corbett Building, Portland 4, Oregon.

COMPLETE Line of leathercraft supplies, quality leather, tools and accessories. Write for latest catalog. Department 79-PM, Wilder-Craft, 1038 Crosby Street, Chicago 10, Illinois.

SAVE Thousands building your own home. Practical 47-lesson home-study course explains home-building A to Z. Includes plans and specifications for 6-room house. Others using with great success. Big 22-page book sent free. Commercial Trades Institute, Dept. DC2-7, 1400 Greenleaf Ave., Chicago 26, Ill.

CRAFT Catalog free "Artcraft's Little Giant," 6500 items covering several crafts. "Tops in our field." Artcraft Leather, Oakland 7, Calif.

FREE Catalog. Complete line of supplies. Lucite, plexiglas, shells, jewelry findings. Plastic Land, 1210 Spruce Street, Philadelphia, Pennsylvania.

SHELLCRAFT. Make beautiful seashell jewelry! (Buy direct). Pace's, Box 279 P.M., Bradenton, Fla.

BARBECUE Fireplaces. Necessary finished castings, parts to build. Bulletin upon request. Smith-Matthews Foundry, 6036 Charlevoix, Detroit 7, Michigan.

LEATHERCRAFTERS: Belt kits, projects, leather, supplies. Free catalog. Art Leather, 411 Joseph Ave., Rochester 5, N. Y.

THE Electric Red Pek Versa-Tool with twelve bits used for engraving, carving, leather tooling comes complete \$5.95. Canterbury Sales, 1121 Fourth Avenue, Rockford, Illinois.

ALUMINUM—Rounds, squares, sheets, etc. Bulletin APM free. Kale Crafts, 2250 Milwaukee, Chicago 47, Illinois.

JEWELRY Findings, rhinestones, pearls, sequins, cameos, J & M Novelties, Box 464P, Griffith, Ind.

TURN Your workshop into cash. Send postcard for catalog of modern saleable projects. Craftplans, 7241-P Madison, Kansas City 5, Mo.

MAKE Your own jewelry! All types of findings, metal and plastic; cameos, beads, shell kits, illustrated catalog. 20c. Hobby Art, P.O.B. 276, Dept. 7, New York 18, N. Y.

LEATHER. Retail, mail orders, catalog, tools, lacing, supplies. National Handicraft Co., 30 Frankfort St., New York City 7.

COPPER And brass materials. Complete line for craftsmen and workshops. Catalog A free. Groundmaster Company, Boulder, Colorado.

LEATHER Carving. Fascinating, highly-paid art; age-old secrets now taught for first time in home study course. For hobby, profession or profitable business, write: Baird School of Leather Carving, Box 1367-A, Manitou Springs, Colo.

UNPAINTED Figurines. Free list. Progress Company, 4033-P Chowen, Minneapolis 10, Minnesota.

MAKE IT YOURSELF

BUILD A "tractor." Easy plans, instructions. Light, heavy, walking, riding. Portable power unit. FlexDbar, tools, power take-off any tractor. Rush postcard. Free information. Ellsworth Tractor Co., D-I, Camptonville, California.

OPERATE Hollywood overhead garage doors from car. Kit of parts \$12.50. Circular stamp. Dooromatic, 7116 1/2 Ave. E. Houston 11, Texas.

YOU Swap it. Free listing. Tell us what you have. Also what you want. Youswapit Service, 209 Cleveland, Amarillo, Texas.

AUTOMATIC Electric clothes dryer. Easily built. Plans \$1.00. List 200 plans, stamp. Modern Design, East Rockaway 35, N. Y.

GRANDFATHER Clock easily built. Big savings. See ad on page 257.

BUILD Your own trailer for boats, general utility. New axle and wheel assemblies, with Timken bearings. \$26.35 without tires or tubes. Write Standard Equipment Co., Dept. PM, Cedar Rapids, Iowa.

"CONCRETE Block Homes." 32 page booklet on how to build. \$1.00. H. C. Lightfoot, Civil Engineer, Richboro 1, Penna.

PERSONAL

SAVE Thousands building your own home. Practical 47-lesson home-study course explains home-building A to Z. Includes plans and specifications for 6-room house. Others using with great success. Big 22-page book sent free. Commercial Trades Institute, Dept. DC2-7A, 1400 Greenleaf Ave., Chicago 26, Ill.

WATCHES, OLD GOLD, JEWELRY

POCKET Alarm watch, chrome, imported, guaranteed time keeper, clear bell alarm \$10.95 including tax. Richards, P. O. Box 139, New York 32, N. Y.

MEN'S Reconditioned wristwatches: Bulova 17-J, \$12.95. Waterproof, shock-proof, 17-J, \$8.95. Tax included. New gold stretchbands guaranteed, \$2.95. Sydney Eisenberg, 1009 Stockton, Jacksonville 4, Florida.

WATCHMAKERS' Tools, supplies, sold—bought. Catalogue! Bengal Company, Culver City, California.

HIGHEST Cash for old, broken jewelry. Mail gold teeth, watches, rings, silverware, diamonds, spectacles. Satisfaction guaranteed. Free information. Rose Smelting Co., 29-A East Madison, Chicago.

TOBACCO, SMOKERS' SUPPLIES

CIGARETTES—Popular brands \$1.51 per carton postpaid. West of Mississippi add 7c per carton. Min. order 3 cartons. Send check or money order. King Co., Box 569D, Dover, Del.

DON Q. "he smokes his own," mentholated cigarettes. Offered for the first time at \$1.60 per carton. 2 cartons \$3.10. 5 cartons or more, \$1.50 each. Ancient blend fine pipe tobacco \$1.50, 8 oz. can. Cash with order, postpaid. Quotations furnished on any cigarette. Geegee Co., Box 229, Blackstone, Va.

FREE Literature—Pipe carving kits \$1.00. Pipe "seconds," 2 for \$1.00. CarvPIPE, 2829-G Dixie, Hamilton, Ohio.

FOR THE HOME

KITCHEN Cabinets, modern streamlined construction described in illustrated manual. Includes individual designing service and factory prices on knock-down parts. All for \$1.00. Thombert Company, Newton 8, Iowa.

YOUR Heating problems solved. Results guaranteed, including a surprising fuel saving idea. Send one dollar. Heating Expert, 177 Hill, Detroit 3, Michigan.

FURNITURE Bottoms sagging? Save money—new furniture bottom home repair kit. Send for free circular. Stylecraft Upholstery Co., 260 Main Street, East Orange, New Jersey.

YOUR Name, beautifully engraved, on a heavy polished brass doorplate, 13 1/4" x 9". Postpaid \$2.00. H. V. Ackerman, Maiden on Hudson N. Y.

FOR SALE—MISCELLANEOUS

PAINT—House and barn paint for wagon jobbers, auctioneers and house to house men. White, gray, red, \$1.25 gallon; extra bright aluminum paint, \$1.45 gallon, all in 5-gallon cans. Gallon cans 10c higher. Will repeat. Chance to make big money. Mail check or money order for immediate shipment. Trading Post, 2014 Burlington, North Kansas City 16, Mo.

ALASKA Gold in natural state. Forty-three dollars ounce. The Goldminer, Box 362, Fairbanks, Alaska.

BARGAINS Galore—Power lawn mowers, shop equipment, machinery, hand tools, million other surplus items. Atlas Equipment, 229B Southwest Blvd., Kansas City, Mo.

RECORDS—New 1948-1949. 20 different records \$4.95. Universal Music Sales, 54 West Randolph, Chicago.

WANTED—MISCELLANEOUS

MAILING Lists wanted. Of persons suffering from tuberculosis. Or who have had this disease. Institutional, or home addresses. Premium payment on good coverage. Review Service, Box 119, Dorchester, Ontario, Canada.

USED Overshot water wheel, give dimensions. John Harris, Welles St., Forty Fort, Penna.

QUICK SILVER (Mercury) urgently needed! Immediate payment. Wholesale Terminal, Norwood, Massachusetts.

MIAMI Postmark! Letters 25c each. McDowell, 504 Pacific Building, Miami, Florida.

RECEIVE Mail, free samples, for six months, 25c. Farbee Associates, 44 Court Street, Brooklyn 2, New York.

CONFUSE Your friends. Letters postmarked Seattle, Wash. Souvenir sent. Send 50c. D-31 Cedar Park, Renton, Wash.

RECEIVE Magazines, mail. Free samples. Your name listed 10c. Sibley, Melton, Mass.

PROSPECTS In Argentina: Amongst sunniest, cheapest living places with immense future, 5000 word up-to-minute report airmailed: finance, farming, industries, pioneering, housing, land values, 50c money order. Migrators, Casilla Correo Central, 4342, Buenos Aires.

CHICAGO Forwarding receiving service 25c each letter or three cards. Gilbert, PM3519 Reta, Chicago 13, Illinois.

WRITER Prepares letters, essays, speeches. Any subject \$1. McDowell, 1530-B South Lumpkin, Athens, Georgia.

HAIR Falling? Dandruff? Write. Elson, 137 Lewis St., Phillipsburg, N. J.

MEXICAN Law. General Practice Attorney, 1203 Arizona Street, El Paso, Texas.

HOW You can find out! Information discreetly developed, any matter, person, problem, anywhere. Personal-business assignments, representations undertaken. Nation-wide. Officially licensed, bonded service established 1922. Reasonable. Confidential. William Herman, 170 Broadway, New York.

MISCELLANEOUS

FOUNTAIN Oiler, Pen-sized with clip. Useful around home, office, workshop. \$1.25 postpaid. Sunshine Sales, Dept. PM-O, Loudonville, Ohio.

FRESH California dates. All varieties, wholesale and retail. Gift packs our specialty. Sedwell's, 2802 South La Cienega Blvd., Los Angeles 34, California.

NECKTIES Exchanged! Mail us six you're tired of. Pronto you receive six different cleaned ties. Pay postman \$1. Tie Exchange, 3, Watertown, S. D.

EVERLAST Ball pen 35c. 3 for dollar. Capener, 849 Almaden, San Jose, Calif.

"RECEIVE Mail." Mon ymaking offers, opportunities, catalogs. Name listed 10c. Ideal Service, Park Ridge 10, Ill.

\$25,000 A Ton is paid for high-grade uranium ore. Send 35c for official manuscript "The Search for Uranium" and literature on latest type Geiger-Mueller Counters. Complete details for hikers, campers, prospectors, etc. Box 486, Main P.O., Detroit 31, Michigan.

SQUARE Dance instructions. 40 dances, \$1.00. Wesley Rader, 1922 Grant, Denver, Colorado.

SEND \$1 and 20 comic books. Receive 20 different ones. c/o Ace Novelty Co., Box 706, Alliance, Ohio.

"INTERESTING Mails"—One month listing 25c; three months 50c; six months \$1.00. Bentz, Jr., Chatawa 71, Mississippi.

URANIUM Prospector's Handbook \$1. Craft Publications, 601 S. Vermont, Dept. G, Los Angeles 5, California.

PANNING Gold—Free instruction booklet. Catalogue mining books; supplies. Old Prospector, B-255 Dutch Flat, Calif.

"INTERESTING Mails." Free gift, 25c. Scott, 521 North Memorial, Rockford, Illinois.

PERSONAL: The razor blade problem is solved; numerous undreamed of additional and better shaves per blade can be had with Blade-Saver; no honing or stropping, easy and quick to use, works with all blades, lasts a lifetime. Saves up to 85% of blade bill. Blade-Saver means blade-saver. Send for yours now. Price only \$1.00 with order; we pay parcel post. The Blade-Saver Co., 5038 Harper Ave., Chicago 15, Ill.

HEY! What will you swap? Write details. National Swapper's Bureau, 162 Forbes Rd., Bedford, Ohio.

GROW Lovely flowers, invest in earthworms, nature's fertilizer. Write for folder. J. W. Porter, 3004 Springer, Cincinnati 8, Ohio.

NEW Amazing burglar alarm. Nonelectrical. Attach windows, doors. Loud alarm. Descriptive details free. Haviland, 11-A So. Oxford, Brooklyn 17, N. Y.

STOP. Look. Read. You may win a fortune! Learn the groundwork of winning prize contests. Send for our book today. Only 50c or write. Nanna Specialty Service, 1944 Union Street, San Diego 1, California.

FREE. Pair work pants with purchase of genuine rayon gabardine trousers. Crease resistance. Blue, gray, brown. Send \$7.95. Waist measurement. Save 50%. Satisfaction guaranteed. Established 1925. Yale Clothing, Meriden, Conn.

RUST Remover for cloth; metal. One dollar, prepaid. Rust Scat, Box 194, Austin, Texas.

OUT Of print books found quickly. Send wants, no obligation. Coast Bookfinders, Box 8686, Los Angeles 46, California.

CARTOONS. The kinds you'll like. Samples 25c. Verret, Raceland, Louisiana.

END Your travel worries and cares—"Home of a Thousand Addresses." Build it yourself. It features complete house-keeping facilities and will sleep four comfortably. Inside dimensions are 7' 6" x 17' x 6' 4". Any car will tow it. All-steel chassis and rugged framework permit it to roll along safely on the roughest roads. Send \$1.50 for complete set of blueprints and material lists. Popular Mechanics, Room 604, 200 E. Ontario St., Chicago 11, Ill.

INSTRUCTIONS For building Radio Treasure Finder, \$1.00. Wyss, 104 1/2 Francis, St. Joseph, Mo.

"BOOK On "Building Geiger Counters" 50c. Geiger tube and book \$10. Butler Co., Box 1242, Grand Central Station, New York.

GEIGER Counters. Uranium quickly located with new, super-sensitive, 5 lb. detector. Sensational low price. The Detection Company, 5637 Cahuenga, No. Hollywood, Calif.

WORLD'S Uranium deposits tabulated! Detection and exploration methods explained. Details free. Woodwid Industries, 5217-A Hollywood Blvd., Hollywood 27, California.

70 BIBLE Lessons, 25c. Bulletin, Box 87, Cathedral Station, New York 25.

TATTOOING Outfits, supplies. Illustrated list free. Zeis, 728 Lesley, Rockford, Illinois.

SQUARE Dance instructions. Calls, 25 sets, \$1.00. Rayburne, Eureka Springs, Arkansas.

COMPLETE Constructional details on seventeen low-cost boats—power, sail, row. Designed for home builder with limited tools, no experience and little money to spend \$1.50. Popular Mechanics Press, (C-43), 200 E. Ontario, Chicago.

GEIGER Counter, miniature. Under one pound. \$48.50 complete with phones, directions, and radioactive sample. Guaranteed. Western Radiation Laboratory, 1107 West 24th Street, Los Angeles 7, Calif.

TREASURE Locators. New electronic lightweight M-Scope mineral and metal finders are now available for immediate shipment. Built for arctic-tropic use. Revolutionizes locating of minerals, gold, silver, metal objects. Unsurpassed efficiency, factory guaranteed. Low prices, time payment plan available. Send for free 16-page illustrated booklet. Fisher Research Laboratory, Inc., Palo Alto, California.

GEIGER Counters for finding uranium ores. Simple operation. Low prices. Interesting literature free. Fisher Research Laboratory, Inc., Palo Alto, California.

TATTOOING Machines, outfits. Free catalogue. Jensen, 120 West 83rd Street, Los Angeles 3.

NOW Ready: New, amazing Classified Advertising Record Book—prepared especially for classified advertisers. Here is a book that tells you instantly whether or not your advertising in any publication is paying you real results. You can tell immediately how many inquiries each publication produced—how much cash received from every ad. Spaces are provided for the name and address of the publication, date of issue, space used, rate, cost of ad, key number, etc. You have a complete record of each publication right before your eyes. Plenty of space to keep accurate record of 28 separate publications. You can have a copy by sending only 10c to cover postage and handling. Send for your copy now. W. F. Johnson, Classified Adv. Mgr., Popular Mechanics Magazine, 200 E. Ontario Street, Chicago 11, Illinois.

WORLD'S MOST FAMOUS AUTO BOOK!



Leader
for 32
Years.
Now
New 21st
Edition.
1483
Pages.
4600
Illus.
Weighs 6 lbs.

For Repairmen, Students, Owners!
Sold on Money Back Guarantee!

"Dyke's" is more than a book on automobiles. It is a complete course of instruction in automotive mechanics, with special emphasis on trouble shooting, testing, adjusting and repairing with every operation explained in detail for quick and easy understanding. It tells HOW to do things, along with the WHY—combining practical instruction with detailed basic principles that give the user a broad practical knowledge of all cars, no matter when and where made. Over a half-million copies of 20 editions of Dyke's have been sold. New edition includes 1947 passenger car specification, 1948 trucks, buses, tractors and diesels, Buick Dynaflo, farm and outboard motors, new electrical systems, etc. World's biggest book value. Only \$7.50. Send remittance with coupon or we will send C.O.D. Use for 5 days, then if not O.K. return and we will refund money.

MAIL ORDER COUPON

for \$7.50 enclosed, send postage paid. If not O.K. I will return in 5 days and you will refund purchase price.

Name _____

Address _____

City _____ State _____

GOODHEART-WILLCOX CO., Dept. 51-B
1321 S. Michigan Avenue, Chicago 5

Send Dyke's Automobile and Gasoline Engine Encyclopedia C.O.D. I will pay postman plus charges. (C.O.D. in U.S. only.) Remittance



EASY PROFIT IN PAINT SPRAYING

Paints walls, ceilings, screens, furniture and machinery faster, better. All complete as shown less motor. Carry anywhere. Fully guaranteed. Could be used with 1/4 H.P. motor or less. Price \$35.00 less motor F.O.B. Chicago. \$5.00 deposit balance C.O.D. or see your dealer. With motor \$55.00.

IDEAL AUTOMATIC PUMP CO., Dept. P.M. 8
801 W. Washington Blvd. Chicago 7, Ill.

SANDEE

SPORTONE MUFFLERS
(Pats. Pend.)

DURABILITY

Beautiful
SANDEE
Fender Skirts
\$16.95

Mufflers—All Ford, Chev., Ply. \$4.45
All Buick, Pont., Olds., Chrys.,
Dodge, Hudson, K.F., Pack., etc. \$5.45
V-8 and Merc. Duals
(32-49 incl.)
\$15.95

DEALERS WANTED

A SANDEE Sportone will outlast two ordinary mufflers and give More Power! More Speed! More Mileage!—plus a tone quality unsurpassed.

Please ship (item): _____ Price _____

Car and Year _____ Name _____

Address _____

SANDEE MUFFLER CO. 5643 Corryne Pl. Culver City, Calif.

BUILD THIS HOUSE Yourself



Designed by Popular Mechanics and Famous Architects. Every Detail Simplified and Explained. No Previous Experience Needed!

Can you use everyday tools as well as the average Popular Mechanics reader? Then you, too, can easily build this modern house in any of its five designs, doing every part of the job yourself. The new Popular Mechanics Book, "Your Home—How to Build It Yourself" will show you how.

Space for Living and Family Growth

This beautiful, modern house is 1 1/2 stories, with basement, living room, kitchen, dining nook, two bedrooms, bath, plenty of closets and space for two additional bedrooms on second floor. The house itself is 35' 9"x28' 11"; breezeway 20' 10"x8'; garage 20' 10"x12'.

The House That Has Everything

Designed for easy construction and the most living space for the least cost, the Build-It-Yourself House is also most attractive and suitable for any community and most income groups. The basic plan is adaptable to four other exterior designs.

Get Book and Plans Now—Build When You Can

You may never have thought about actually building a house yourself, but now that building restrictions have been lifted, it is easier than you think. So order book and plans today. Even if you engage a contractor to build for you, you will need the plans. And you certainly will want the book which can easily save you hundreds of dollars, whether you build this or any other house.

MAIL COUPON FOR BOOK AND PLANS

POPULAR MECHANICS PRESS

200 E. Ontario St., Chicago 11

I enclose \$_____ Send me the items checked at once.

- Your Home and How to Build It Yourself..... \$ 3.00
 Complete set of plans for Popular Mechanics Home... 12.50
 Book and plans at reduced price..... 14.00
 Duplicate sets of plans..... 5.00

Name _____

Address _____

City _____ Zone _____ State _____

The Famous Popular Mechanics House

The picture below is from an actual photograph of the Build-It-Yourself House with breezeway and garage, as built by Jack Brownson, 23-year-old veteran, in Aurora, Illinois.

Mail Coupon for New Book and Plans!

Build It Yourself or Have It Built—Save Hundreds of Dollars!

PLANS YOU CAN READ AND FOLLOW

Plans consist of ten working-size blueprints—floor plans, elevations, construction notes, framing, joints, lumber and mill list, specifications, plumbing and wiring diagrams. Every measurement is marked—every detail made clear as ABC. Book has 100 pages—three-fifths are photographs and drawings. Some sections in colors, showing just how your house will look when finished.

BIG BOOK
8 1/2 x 11 inches



Sensational NEW INVENTION

U. S. PATENT #2,469,797

BIG MONEY MAKER

ROLIT KNIFE GRINDER is, without a doubt, the greatest advance toward perfection in knife sharpeners. Designed and Manufactured by our craftsmen... A DEMAND product in a tremendous market. Practical and Useful.

Cannot Harm the Finest

Hollow Ground Knife Edge
Do not confuse the ROLIT with the common line of metal cutters, referred to as sharpeners. The ROLIT is different: GRINDS A PERFECT EDGE, QUICK AND EASY. As its name implies: YOU ROLL IT. Uniform sharpening.

Housewives Enthusiastic

ROLIT sharpens knives FASTER, EASIER, SHARPER. Never strips off curls or flakes of metal. Housewives want extra ROLIT'S for friends, neighbors and relatives. Here is big volume business.

Distributors Wanted Everywhere

ROLIT sells quick in Homes, Restaurants, Hotels, etc. For Housewives, Hunters, Fishermen, Boy Scouts, etc., in fact, wherever knives are used. Of course you can sell a product like this. This is a REAL OPPORTUNITY... Get choice territory NOW.

Grinds a Perfect Cutting Edge QUICK AND EASY



A TWIST AND IT'S OPEN

A TWIST AND IT'S CLOSED



THE ALDEN SPEARS'S SONS CO., Est. 1851
133 Sixth St. CAMBRIDGE 42, MASS.

LUMINESCENT PRODUCTS

• LIGHT REFLECTING CRYSTALS
• COLORED GLASS CRYSTALS
• LUMINOUS POWDERED PIGMENTS

COMBINATION TRIAL ORDER & LISTING \$1.00 POSTPAID ORDER TODAY

GLOWELL COMPANY
475 FIFTH AVE. • DEPT. 317 • NEW YORK 17, N. Y.

\$\$\$Extra Profits! Flocks and Sandblasts!\$\$\$

Blasto Dual Purpose Spray Gun uses only 25 lbs. air pressure. Thousands of profitable uses in Home, Shop, Industry. SEND FOR FREE INFORMATION

BLASTO SPRAY GUN MFG., Div. 23, 7007 Haas Ave., Los Angeles 4, Calif.

MAKE BIG MONEY LEARN TO REBUILD SEALED REFRIGERATION UNITS
LEARN NOW—WE TEACH YOU HOW REFRIGERATION UNITS
MILLIONS of Sealed Units will need rebuilding. Factories usual charge is \$80 to \$100 per unit. We offer a Post-Graduate Course (10 weeks) to graduates of schools or those with few years service experience. START YOUR OWN BUSINESS.
PRACTICAL TRADES INSTITUTE, Inc. WRITE TODAY
25 University Ave., S.E., Dept. P-7, Minneapolis 14, Minn.

Say You Saw It in POPULAR MECHANICS

A Manufacturing Opportunity Open to YOU!

Your big years are right ahead! You can tie in with the great building industry, yet develop your own business manufacturing concrete block, drain tile, brick, roof tile, etc. We'll start you right in the



Modern Masonry Products

business and help you put it over. We supply complete equipment, built and developed through forty years of dealing with men like you. Helps you build for local market, using local materials and labor. High income potentials. Our line of modern machinery enables you to start small and grow big.

Write for catalog. Gives prices and full information.

CONCRETE EQUIPMENT CO.

512 Ottawa Ave., Holland, Mich.

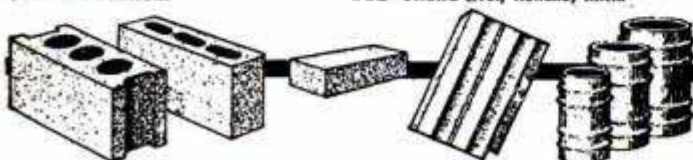

SURPLUS BARGAINS ASSEMBLE YOUR OWN BINOCULARS!

Complete Optics! Complete Metal Parts!
Save More Than 1/2 Regular Cost

GOVERNMENT'S 7X 50 BINOCULARS

We supply full instructions

METAL PARTS—Set includes all Metal Parts—completely finished—for assembly of 7 X 50 Binoculars. No machining required. A sturdy Binocular carrying Case is optional with each set of Metal Parts.

Stock # 842-H \$39.40
Postpaid, plus \$4.80 for Case—Total \$44.20

OPTICS—Set includes all Lenses and Prisms you need for assembling in excellent condition—perfect or near-perfect—and have new low reflection coating.

7 X 50 Binoculars. These are

Stock # 5102-H \$25.00 Postpaid
(These are standard American made parts not Jap, French or German.)
NOTICE! If you buy both Binocular Optics and Binocular Metal Parts, add 20% Federal Excise Tax to above prices.

ARMY'S 6 X 30 BINOCULARS—We have complete Optics and Metal Parts. Write for Catalog H.

SLIDE PROJECTOR SETS—Consist of all unmounted lenses you need to make the following size projectors:

Stock # 4038-H—2 1/4"x2 1/4" \$3.35 Postpaid

Stock # 4039-H—2 1/2"x3 1/2" \$3.35 Postpaid

Stock # 4029-H—35 mm. \$2.85 Postpaid

SIMPLE LENS KITS!—THE LENS CRAFTERS DELIGHT!

Fun for adults! Fun for children! Kits include plainly written, illustrated booklet showing how you can build lots of optical items. Use these lenses in photography for copying, ULTRA CLOSE-UP SHOTS, Microphotography, for "Dummy Camera," Kodachrome Viewer, Detachable Reflex View Finder for 35 mm. cameras, Stereoscopic Viewer, ground glass and enlarging focusing aids. And for dozens of other uses in experimental optics, building TELESCOPES, low power Microscopes, etc.

Stock # 2-H—10 lenses \$1.00 Postpaid

Stock # 5-H—45 lenses \$5.00 Postpaid

Stock # 10-H—80 lenses \$10.00 Postpaid

We have literally millions of war surplus lenses and prisms for sale at 10c and up. Write for Catalog "H"—Sent Free!

Satisfaction Guaranteed Order by Stock No.

EDMUND SALVAGE COMPANY

P. O. AUDUBON, NEW JERSEY

SALESMEN!

10-Second
Demonstration
Nets You
\$9.95



Yes—Storekeepers now "Write with Light"—wipe off and write new sign—all in 10 seconds. Fastest seller in years. 10-second demonstration pays you \$9.95 cash in advance. Orders pour in HAND-OVER-FIST. Get started in your territory while "LITEWRITER" is brand new and hot as a pistol.

Litewriter "MAGIC CRAYON" MAKES SIGNS THAT GLOW LIKE BRILLIANT NEON!

Merchants everywhere—in small town and big city—all stare with amazement at this newest of all Fluorescent Sensations! They write on glass with "MAGIC CRAYON"—and Presto!—before their very eyes—there's a 5-color Advertising Message that glows like a brilliant Neon Sign!

FREE! Complete Sales Kit. Send name on penny postcard NOW for Big FREE Sales Kit and Free offer of Sample Demonstrator. No cost now or ever. Rush postcard now.

MAXILUME CO., 125 W. Hubbard St. DEPT. L-87 CHICAGO 10, ILLINOIS

OVERDRIVE for YOUR CHEVROLET!

For '41, '42, '46, '47,
'48, '49 models

SAVE... SAVE
SAVE
EVERY
MILE
YOU
GO!

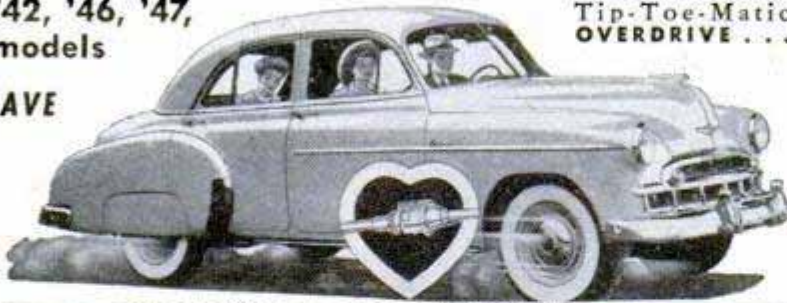

Saves up to 28% on gas... cuts engine wear up to 50%
THRILL to driving 50 or 60 mph... relaxed, free from fatigue... while your engine glides along at a smooth, quiet 35 or 40. **SAVE** up to 28% on gas... 50% on engine maintenance costs. Thousands of Chevrolet owners are doing this with **TRUCKSTELL Tip-Toe-Matic OVERDRIVE...**

the all-mechanical, fully automatic overdrive! Operates in all forward speeds. No free-wheeling means positive control at all times. Has "hill holder" safety feature. Mail coupon today for free 12-page booklet and name of nearest dealer for a demonstration ride.

Mail Coupon
Today

TRUCKSTELL MFG. CO.
2016 Union Commerce Bldg., Cleveland 14, Ohio
Please rush free booklet and dealer's name.

Name _____
Address _____
City _____ State _____



HOLLYWOOD CHROME TRIM

RAILS to doll up each side after running boards removed. SHIELDS for inside fender ends. '35-'40 Fords, '39 & '40 Mercury, '39 & '40 Chev., also most cars with slight adaptation. Complete sets \$26.00.

Nails only \$12.50 pr. Shields only \$6.95 pr. Front or rear. SOLID HOOD PANELS—Ford '28-'36 \$9.95 pr.

FORD HYDRAULIC BRAKE KITS

A-B & thru '38. Install Hydraulic Brake system now—Be SAFE. Complete kit includes everything needed—Cylinders, backer plates, lines, brackets, hoses, easy to follow instruction. Easy to install in 8 hours. Satisfactory operation guaranteed. Order Direct! Complete kits only \$75.00. Los Angeles. \$25 deposit on C.O.D. Return old backer plates collect for \$10.00 refund.

STREAMLINE MODERNIZE YOUR CAR

Lower body with our special shackles. Gives car Fast, Low, Racy look—Smoother Ride. No welding or cutting. Set of 4, \$1.50 (Fords) (Specify 4" or 6" shackles and year of car. Lowering kits for other cars \$8.00 set. FREE History of Hot Rod & Midget Racing. We supply everything you need to build your own Track Cars—Hot Rods and Boats—the ideas, technical data and equipment. RACING HISTORY and CATALOG 25c without order. ANSEN, 3805 W. Jefferson, Dept. PM-7, Los Angeles, Calif.

LEARN PLASTICS AT HOME

GET 7 BIG KITS WITH COURSE—MAKE USEFUL ATTRACTIVE ARTICLES.
Write for free catalog. Approved for Vets—Non-Vets.
PLASTICS INDUSTRIES TECHNICAL INSTITUTE
1601 South Western Avenue, Dept. PM-79, Los Angeles 6, California

NATIONALLY RENOWNED SCHOOL

OFFERS YOU THIS FREE BOOK

A WEALTH OF INFORMATION THAT HAS GUIDED THOUSANDS toward Successful Futures

Start toward your success by the same steps thousands have already proved! Hills' is fully accredited and nationally recognized. Free placement service to graduates throughout the nation. Where ever you live, Hills' can train you through our Extension or Residence School. Check your subject below, fill in coupon and send this ad today.

- Accounting Salesmanship Stenographic
 Bookkeeping Secretarial Penmanship
 Accounting & Business Administration

Hills BUSINESS UNIVERSITY & EXTENSION SCHOOL

Hills Business University & Extension School
Dept. PM-79, 619 W. Main St., Oklahoma City 2, Okla.
Please send your Free book that fully describes & illustrates the story "Thru Hills to Success".

NAME _____ AGE _____
ADDRESS _____
CITY _____ STATE _____
 G. I. BILL RESIDENT HOME STUDY

EASY-TO-USE COUPON TODAY

SAFE DEPOSIT BOX LOCKS LIKE A SAFE

PROTECT VALUABLE PAPERS, CASH, JEWELS, ETC.

Opens only by private combination which you select. Very strong steel box. Five lid locks with plastic dials prevent tampering. Simple and easy to operate by owner. Beautiful jewel case finish in Blue, Gold-Bronze, Hammertone Grey. Smooth rounded corners and knobs. Every home, office and store needs at least one. Built to last a lifetime. Shipped postpaid. Sold on MONEY BACK GUARANTEE.

Only \$3.95
E. P. JOHNSON, Manufacturers
2934 S. San Gabriel Blvd., San Gabriel, Calif.

Capacity 19.5 cu. in.
10" x 6" x 3"
DEALERS WANTED

DEPRESSION INSURANCE!!

Earn well even in hardest times by saving other people money! People pay up to \$5.00 or more per hour to have their vacuum cleaners, irons, refrigerators fixed, houses wired, etc. When money is tight, millions of appliances will be repaired rather than replaced. Make Money Now in your spare time with new system. Learn Electrical Appliance Repairing by making actual repairs! Pay us later for kits, illustrated lessons, etc., from earnings while learning. Write for FREE Book. CHRISTY TRADES SCHOOL, 2835 N. Central Ave., Dept. D-7103, Chicago 34.

RAISE Money Making CHINCHILLAS

Several females and a male start a large herd which will furnish you an income for years. Just a few feet of space are required. No experience needed. We furnish all instructions. Write world's largest breeder today for free details.

WILLOW BROOK FARM, R-36, Sellersville, Pa.

Happy Highways Ahead!

With Popular Mechanics new **MOTORIST'S HANDBOOK**. 160 pages of authoritative advice to keep your car rolling smartly—longer. Brakes, body, spark plugs, battery, starter—every automotive part is covered in this up-to-the-minute manual of year 'round driving pleasure.

Your news dealer has the 60c paper edition. Order the clothbound \$2.00 volume from

POPULAR MECHANICS PRESS
200 E. ONTARIO ST. CHICAGO 11

Build Your Own Motorized Workshop

Easy-to-Make 40 Different Power Machines

Make them yourself—lathes, drill presses, sanding machines, shaper, circular, band and scroll saws and other power tools— from wood, pipe, and discarded parts that cost little or nothing. Get the new edition of "Forty Power Tools You Can Make" even though you have the older edition. This new book has 20 new tools. Make yourself up-to-date, efficient power machines that will save you hundreds of dollars. Send \$1.50 with order and save high C. O. D. charges. Your money back if not satisfied.

POPULAR MECHANICS PRESS, 200 E. Ontario St., Chicago 11, Ill.

40 Power Tools YOU CAN MAKE

NEW EDITION

EXTRA SURPLUS STAR BARGAIN EXTRA

CLARK-HENKE, PUBLISHERS - C & H ELEC. CO.

BARGAIN ISSUE, JULY 1, 1949

STAINLESS STEEL TABLE TOPS

Polished top, dull bottom, hardwood veneer center 3/4" thick. Ideal for: work table, laundry tubs, shelves, back bar work board, etc.

22x19 1/2"	11 lb.	\$1.95
22x21 1/2"	12 lb.	\$1.95
23 1/2x27"	15 lb.	\$2.45
22x29 1/2"	16 lb.	\$2.95
22x34"	20 lb.	\$3.45
22x37"	22 lb.	\$3.95

BALL BEARING ARBORS



Grinding and saw arbor, has 1/2" double end shaft, 1 1/2" long with 2" center pulley. New departure double roll ball bearings. Right and left hand thread. Self-aligning Dodge pillow block. 10,000 RPM. Bearings alone list at \$10. Complete arbor new.....

Stock #305 only **\$4.95**
HI-SPEED GRINDER (not pictured) has 2 step pulley driven thru rear or base
 Stock #328 only **\$10.95**

PLASTIC TUBING

Good for water, oil, air, electrical installations & radio work. Available in 100 ft. lengths. Min. order 50'.

1/4", 3/16", 1/4"	9/16" per ft.	4c
(your choice)	3/4", 1", (your choice) per ft.	6c
5/16"	1 1/4" per ft.	8c



MARINE FLOAT

Heavy rubberized fabric. 1/2" rope encircles raft passing through deep rings as handles. Can be used as wading pool, dock, raft, etc. Will support 4 ton and cannot tip. Used but like new.

6' W x 20' L	6' W x 25' L
\$59.50	\$69.50

50% deposit to handle shipping.

HORNS and HOWLERS



Motor driven (not a vibrator). Heavy duty with great power and long life. Adjustable for high, medium or low tone. 100 volt AC current. Weather proof. For alarm or signal horn on boats, school yards, factories, etc. List price \$47.00. New Stock #302 **\$9.45**
 Our price.....

HALF TON WAGON



Half ton wagon with plate aluminum body 24" x 42". 3/8" steel axle. Stock #332. Write for details.

HOSE 20' LENGTHS

Gas, oil or water resistant. Neoprene treated 1 1/4". Male & female brass connectors. Standard filling station size. Value **\$7.50**
 \$20.00. Stock #528. Our price.....
FOOT VALVE **\$3.00**

SWIMMING OR BATHING POOL



Made of heavy glass cloth with rubber impregnated on both sides. 12' diameter, 5' high. 3000 gal. cap. Ideal for: small irrigation project, swimming pool, animal watering. Complete with cover & guide lines. Gov. price approx. \$350. **\$79.50**
 Our price.....
 Due to handling remit full amount.

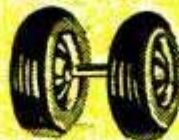

RUBBER WHEELS

Good for boats, scooters, wheelbarrows, etc. Stock #536

2.75 x 105/8" & 1/2" bore	\$ 4.50
4.00 x 85/8"	\$10.95
10 1/2" x 4, 6 ply 3/8"	\$ 8.95
14 1/2" x 5, 6 ply 1"	\$10.95

New airplane tires, tubes and wheels with high speed Timken Hyatt ball bearings.
 Stock #544. 800 x 5-6 ply 1"..... **\$14.50**
 1700 x 20" 12 ply TUBES. Stock #545. **\$44.50**
 for earthmovers, trucks, \$300 value.
 56" 16 ply Bomber TIRES and TUBES only \$600 value, for tractors, etc. Stock #546. Our price..... **\$59.50**



HALES FIRE PUMP

For fire depts., factories, forest fire prevention, etc. 600 gal. per min. Can be operated with a four or six cylinder gas engine. 4 1/2" intake. 2-2" outlets. 265" head at 120 lbs. pressure. Passed by national board of fire underwriters. NEW.
 Stock #407. Price..... **\$139.50**

BRIGGS-STRATTON GAS ENGINES

SAVE \$25 ON LIST PRICE. All are NEW in original crate. Rope start. 1700 RPM all brand new and guaranteed. 1 1/4 to 2 1/2 HP Model AP List price \$102.10. Stock **\$77.00**
 #307. Our price
 3 1/2 HP Model BP. List price \$111.50. Stock **\$86.00**
 #308. Our price
 5 to 7 HP Model ZEP. List price \$137.00. Stock #309. Our price **\$102.00**



GAS ENGINE

1 HP—two cycle—NATIONALLY KNOWN—gas engines—3400 RPM—shaft 5/8" lightweight—12 lbs. List price \$72.00. Stock **\$44.50**
 #537. Our price.....

CENTRIFUGAL PUMP

1" intake and outlet. Drip proof motor. (Master). 4 1/2 gal. per min. at a 20' head. Ideal for condensate, sprinkling, circulating water in cooling systems and for air conditioning units. Stock #532. AC-110 volt. Mfg. price 1 1/2 HP unit—\$110.00. **\$75.00**
 Our price.....
 AC-110 volt, Mfg. price 1/2 HP unit—\$120.00. Our price **\$80.00**
BELT DRIVEN pumps 1" intake, 3/4" discharge. With release valve. 1 1/2 hp capacity. 110 volt motor. Stock #538. **\$49.50**
 Our price.....
BELT DRIVEN pumps. Same as above, 1/2 HP. Stock #539. **\$64.50**
 Our price.....

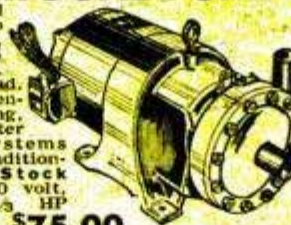

JACK and HEINZ Electric Motors
 New. 1/3 HP—110 volt AC. Capacitor type. Sleeve bearing—3/8" shaft. List price \$29.50. Stock #540. A real **\$16.50**
 buy at.....

WESTINGHOUSE

3 phase motors. All models 1/2 HP to 1 1/2 HP. 220 volts. Motors totally enclosed—ball bearing. Stock #541. 40% off list price.



CLUTCH

For Motor-scooters, Motor-bikes, Lawn Mowers, etc.

Mercury centrifugal clutch for use with any small gas engine. "A" belt pulley, 3/8" bore. Brand new only. Stock #400. **\$9.95**

AIR COMPRESSORS

All ratings from 1/2 HP to 10 HP—new and rebuilt. Write for free details.

GENERATORS & AC ARMY Light Plants

ALL NEW UNLESS SPECIFIED. ALL 110 VOLT 60 CYCLE UNLESS SPECIFIED.

Light Plants

300 watt, 110-220 volt AC, 60 cycle light plant powered by 1 HP gas engine, direct drive. Mounted on base weighs **\$99.50**
 40 lbs. Stock #409
 500 watt. Onan direct connect—**\$149.50**
 ed. Stock #414. NEW
 NEW 1000 watt Briggs & Stratton belt driven Leland generator. **\$189.50**
 Stock #351
 NEW 1500 watt with Briggs & Stratton belt driven Leland generator. **\$209.50**
 Stock #352
 2500 watt. Briggs & Stratton Model Z and Leland generator. Stock #317. **\$225.00**
 Used but like new.....
 NEW **\$295.00**
 Tools and spare parts included.
 5000 watt, automatic remote control. Powered by 3 cyl. Jeep gas engine. Used **\$575.00**
 like new. Stock #318.....
 7500 watt, powered by a VE 4 Wisconsin 4 cyl. gas engine. Continental or Hollingsworth generator. Remote control starting. Complete with switchboard. Used but **\$675.00**
 like new. Stock #347.....
 Add \$65.00 for transformer to make this plant 3 phase 220 volt.
 10,000 watt, 110-220 volt AC, 60 cycle. Remote control. Powered by a Jeep 4 cyl. gas engine. Used like new. **\$900.00**
 Stock #319
 NEW job, original crate. **\$1100.00**
 only
 25,000 watt 220 volt AC, 3 phase. Spare parts. NEW packed for export. **\$1995.00**
 Stock #415

GENERATORS

300 watt, 12 volt DC, 2000 RPM. Heavy duty with current cut out relay. High and low switch. 30 amp. motor. Can be bought less shaft and base to be used directly mounted to a Briggs & Stratton 1 HP on **\$7.00**
 gine. Stock #323. NEW only.....
 Complete with shaft base and **\$15.95**
 bearings. Stock #324.
 300 watt, 110-220 volt AC, generator. Mfg. by Electric Specialties Co. Weighs **\$34.50**
 20 lbs. Stock #416. NEW only.....
 1000 watt, 110 volt AC, 60 cycle generator with built in radio filter. Leland **\$89.50**
 ball bearing 1800 RPM. Stock #526
 1500 watt. Same as above. **\$99.50**
 Stock #527
 2500 to 3000 watt, Leland generator 110 volt 60 cycle. Self excitor, radio filter, junction box for plug in. Stock #525. **\$145.00**
 NEW
 3000 watt, Delco, 110 volt DC. Plug in, ball bearing 2800 RPM. List price \$343.00. Used but like new. **\$99.50**
 Stock #321

WESTINGHOUSE Transformers

Dry type—insulated—440 volt, 220 volt to 110 volt—single phase.
 75 K.V.A. List price **\$1000.00**
 Our price **\$504.00**
 37 1/2 K.V.A. List price **\$717.00**
 Our price **\$358.00**
 30 K.V.A. List price **\$626.00**
 Our price **\$310.00**
 25 K.V.A. List price **\$558.00**
 Our price **\$279.00**
 20 K.V.A. List price **\$460.00**
 Our price **\$230.00**
 All like new and guaranteed.

HEAVY DUTY ELECTRIC CABLE

3 wire #10 Super cable. Stock #351. 65' with lugs. Value **\$26.00**.
 Our price **\$13.00**
 3 wire #10 government submarine type. Use underground, underwater, overhead. Cost U. S. 90c ft. Stock #542.
 OUR PRICE
 100 ft. **\$24.00** 500 ft. **\$100.00**
 250 ft. **\$55.00** 2900 ft. reel **\$530.00**
 2 conductor rubber cable #4—stranded—75 ft. length with connectors. Stock #543. List price **\$177.00**.
 Our price **\$90.00**
 4 wire #6 stranded heavy duty. List price **\$2.36 per ft.** Stock #547.
 OUR PRICE
 50 ft. **\$ 5.00**
 100 ft. **\$ 9.00**
 250 ft. **\$25.00**
 500 ft. **\$225.00**
 1000 ft. reel. **\$400.00**

ALL ITEMS GUARANTEED AS REPRESENTED C & H ELECTRIC Co. 434 W. JUNEAU AVE. MILWAUKEE 3, WISCONSIN

All prices F.O.B. Milwaukee. 25% deposit required on all C.O.D. orders. No C.O.D.'s under \$10.00. Use stock number when ordering. Many other bargain items not listed—write for our free circulars.

Perfect Circle

The Most Honored Name in Piston Rings

Honored by America's foremost automotive engineers, who recently acclaimed Perfect Circle Piston Rings as best engineered 4 to 1.*

Honored by Doctors of Motors, America's expert mechanics, who actively express their piston ring preference by installing millions of Perfect Circles every year.

Honored by motor-wise car owners all over America, who in survey after survey have invariably named Perfect Circle their first choice by a wide margin.

*In an independent survey recently completed among automotive engineers—maintenance men, fleet operators and designers of new equipment—Perfect Circle was first choice as the best engineered piston ring—first by more than 4 to 1 and received more votes than ALL other brands combined!

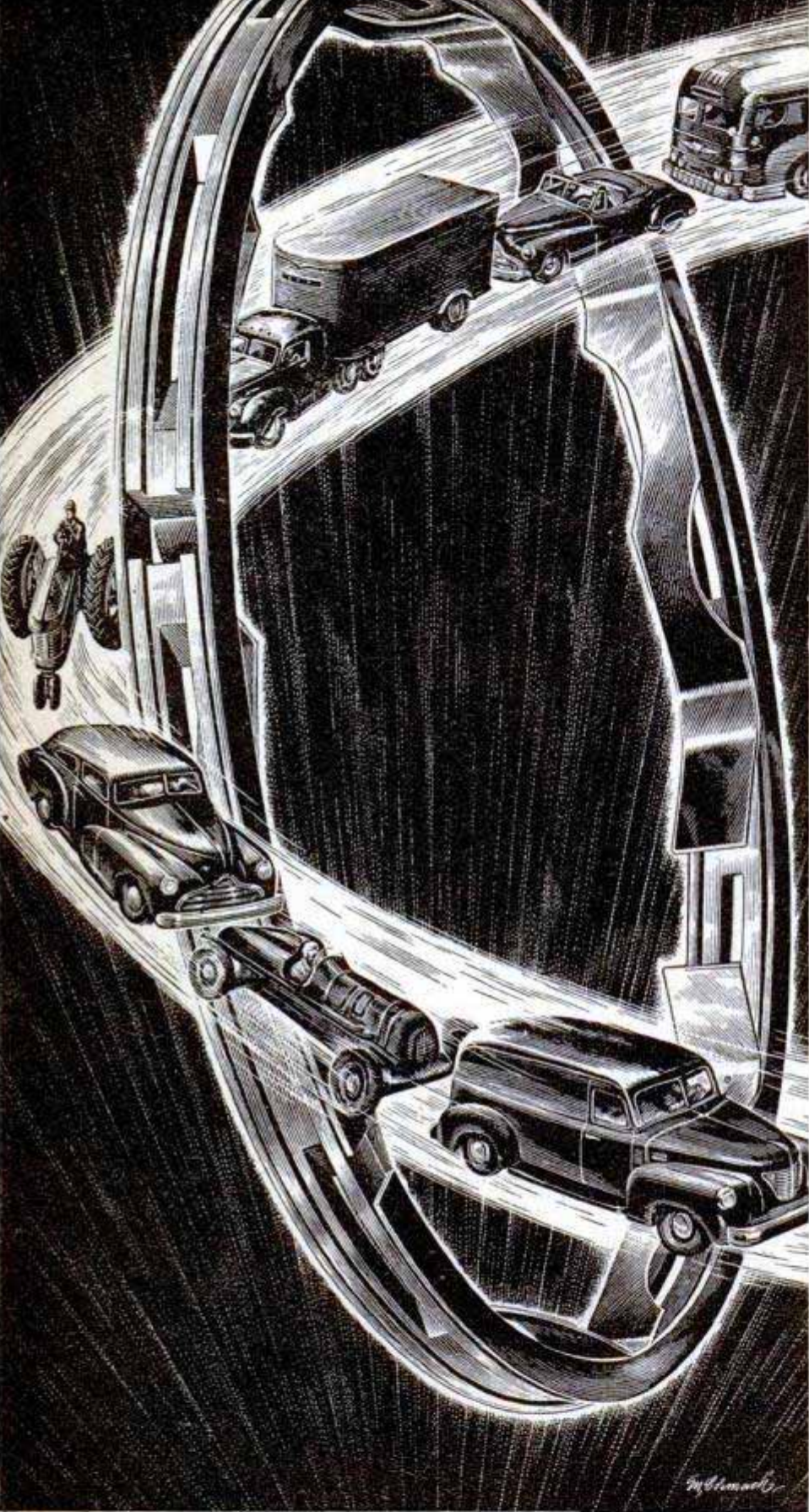

Illustrated—GX steel oil ring, one of 61 types of Perfect Circle Piston Rings for Custom Made Sets

Look for this sign (right) It identifies a place where your car will receive expert attention. Your local Doctor of Motors knows your car, knows the value of honest workmanship and reliable parts. He will install a set of Perfect Circle Piston Rings *Custom Made* for your car to restore power, save gas, stop oil burning.

Perfect Circle Corporation, Hagerstown, Indiana, U. S. A. and The Perfect Circle Company, Ltd., Toronto, Ontario, Canada. Export Division: Utility Building, Fort Wayne, Indiana, U. S. A.



Blueprint for a

POPULAR MECHANICS

JULY
1949

WRITTEN SO YOU CAN UNDERSTAND IT
VOL. 92 NO. 1

Passenger Rocket

By Thomas E. Stimson, Jr.

A WINGED ROCKET that carries a crew of two in its transparent nose has passed its initial tests in model form and can be built at any time. That's the assertion of Stanley Hiller, Jr., West Coast helicopter manufacturer, after months of research in which the rocket and its control system were developed.

The man-carrying rocket would rise straight up from the ground, lie over on its side to fly and maneuver like an airplane at speeds up to 600 miles per hour, and would "back down" against its motor thrust to land gently on a three-point landing gear attached to its tail.

The proposed full-size vehicle would be 30 feet tall. It would resemble a V-2 rocket with a pair of small vanelike wings and a fixed landing gear attached. Two exterior streamlined drop tanks would carry sufficient fuel for one hour of flight and could be detached from the rocket in flight when emptied. Additional fuel would be carried inside the rocket's body.

The VJ-100 would be powered with a 6000-pound-thrust Rolls-Royce

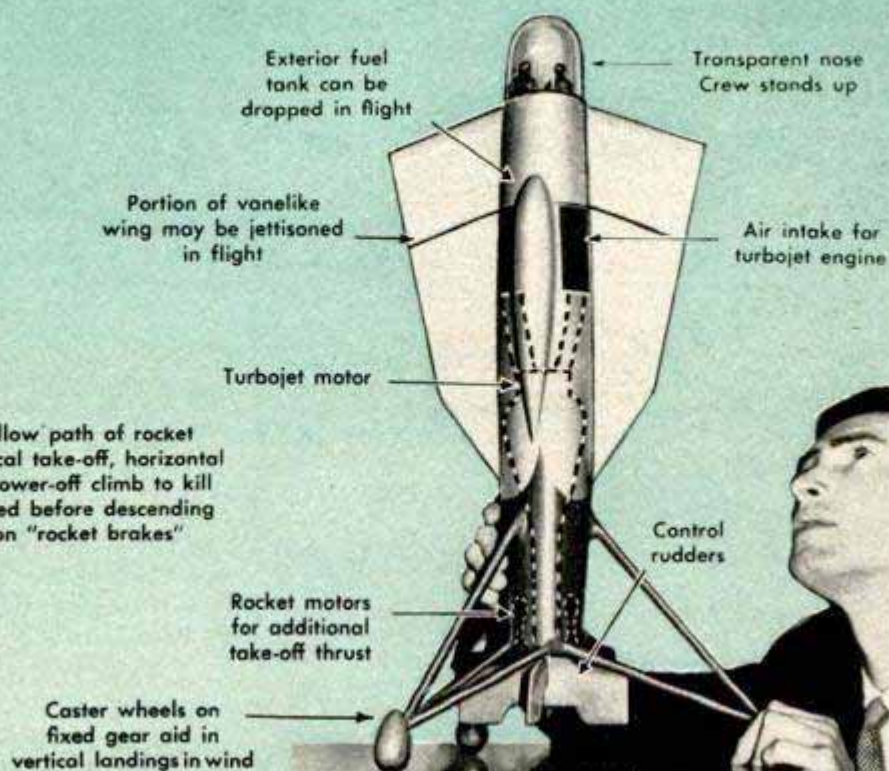

Arrows follow path of rocket through vertical take-off, horizontal flight and power-off climb to kill forward speed before descending to earth on "rocket brakes"

Stanley Hiller, Jr.

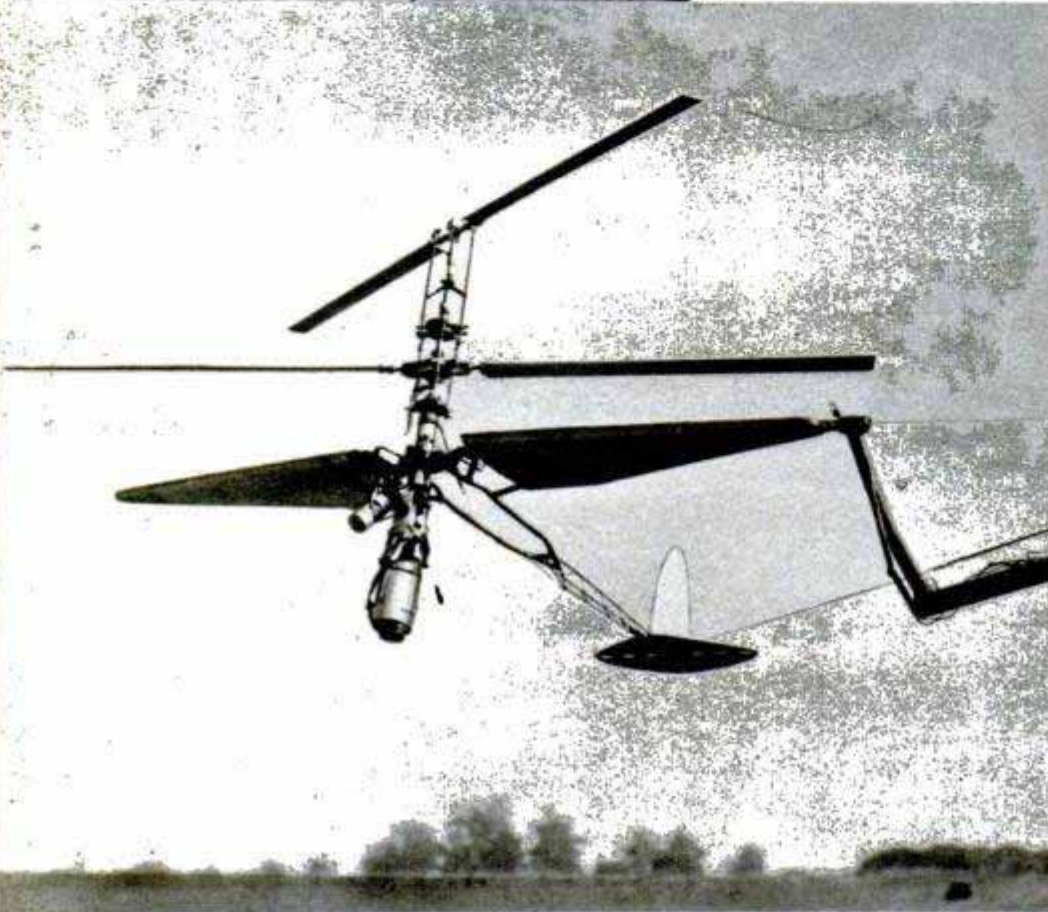

Hiller's man-carrying rocket stemmed from research with craft above. It resembled conventional plane but had overhead rotor blades for both upward and forward flight. Below, blades tilted for forward motion. Craft's motor was swung back into fuselage to maintain proper center of gravity

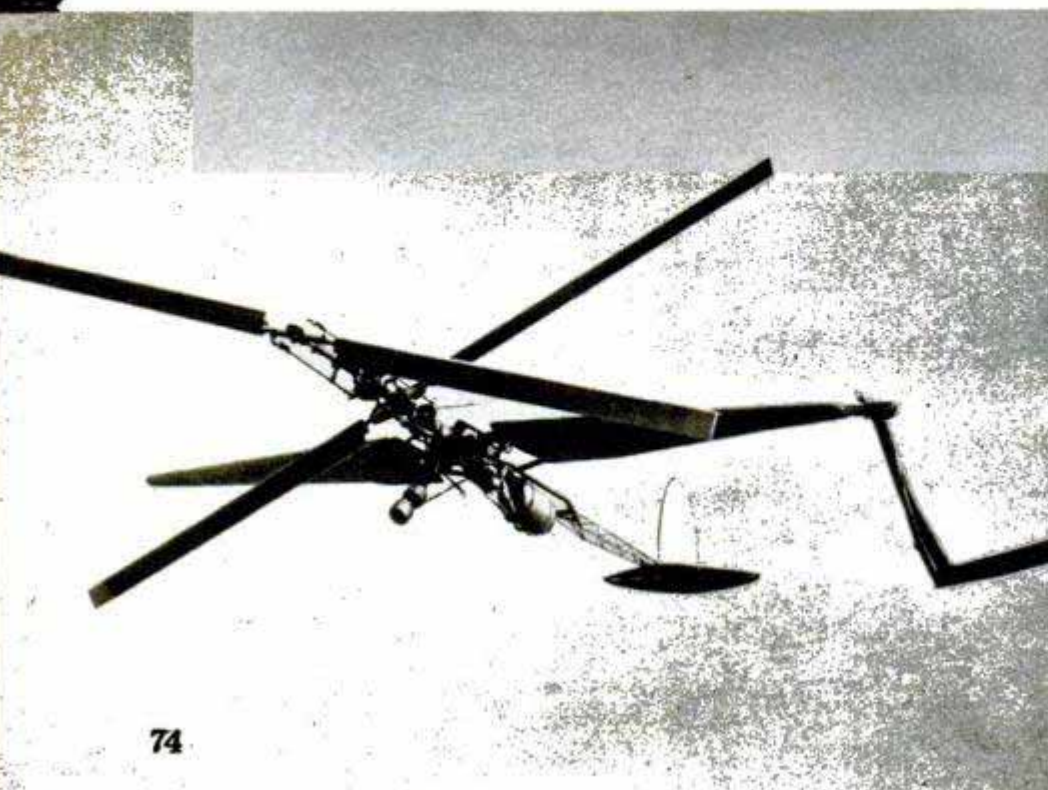

"Nene" turbojet engine and four liquid-fueled rocket motors. The latter, firing through the tail, would provide 5000 pounds of additional thrust for lifting the 11,000-pound craft vertically from the ground. The rocket could accelerate vertically at speeds up to 4.8 feet per second. Since air is required for operating its power plant, the craft would not be a space ship that could leave the earth's atmosphere.

After attaining altitude and speed, the booster rockets are shut off and the craft is laid over on its side for cruising on its turbojet. The vestigial wings have enough surface to provide full lift for horizontal flight at speeds above 200 miles per hour. They also serve as stabilizers when the craft is being backed down to a landing.

Both the pilot and passenger are strapped side by side in a standing position in the nose for the ascent, and lie prone when the craft is in level flight. Cockpit controls similar to those of a conventional helicopter are used for all maneuvering.

To prepare for a landing, the pilot reduces the power and points the rocket's nose upward in a climb that kills his forward speed. He then backs down to the ground at a controlled rate of descent, using blasts of the turbojet or the rocket motors to almost equalize the pull of gravity.

Tests have shown that there are no difficult control problems in holding the rocket balanced in a vertical position during the descent. Provision is made for jettisoning the cockpit capsule and the forward part of the wing during flight, after which the crew would descend by parachute. This emer-

gency measure is common to most aircraft in the 600-mile-per-hour speed range.

Design of the rocket is the outcome of research by Hiller's company, United Helicopters, Inc., of Palo Alto, Calif., to create an air vehicle that has an exceedingly high ratio between top speed and landing speed. This ratio is only five or six to one for the fastest conventional aircraft.

The first attempts to improve this ratio were embodied in a "convert-a-plane," a craft resembling a conventional airplane and equipped with a pair of overhead coaxial helicopter rotor blades. These blades would lift the craft up from the ground to a desired altitude and would then be tilted forward to operate like ordinary airplane propellers for producing forward flight.

Models of the convert-a-plane were put through exhaustive runs on dynamic test stands. Though the idea proved feasible, it was dropped because of several complications, including the mechanism required for changing from helicopter to fixed-wing operation.

Jet propulsion seemed to be a simpler idea because the same jet can be used to provide vertical lifting force and the thrust required for forward flight. Jet-powered models were studied both on test stands and in free flight, with results indicating that the basic design of the rocket, its power plants and control system are practical.

Hiller foresees one potential use of the VJ-100 as a high-speed military photo-reconnaissance aircraft that could be towed on a trailer to any desired operating point. An elevator on the trailer would

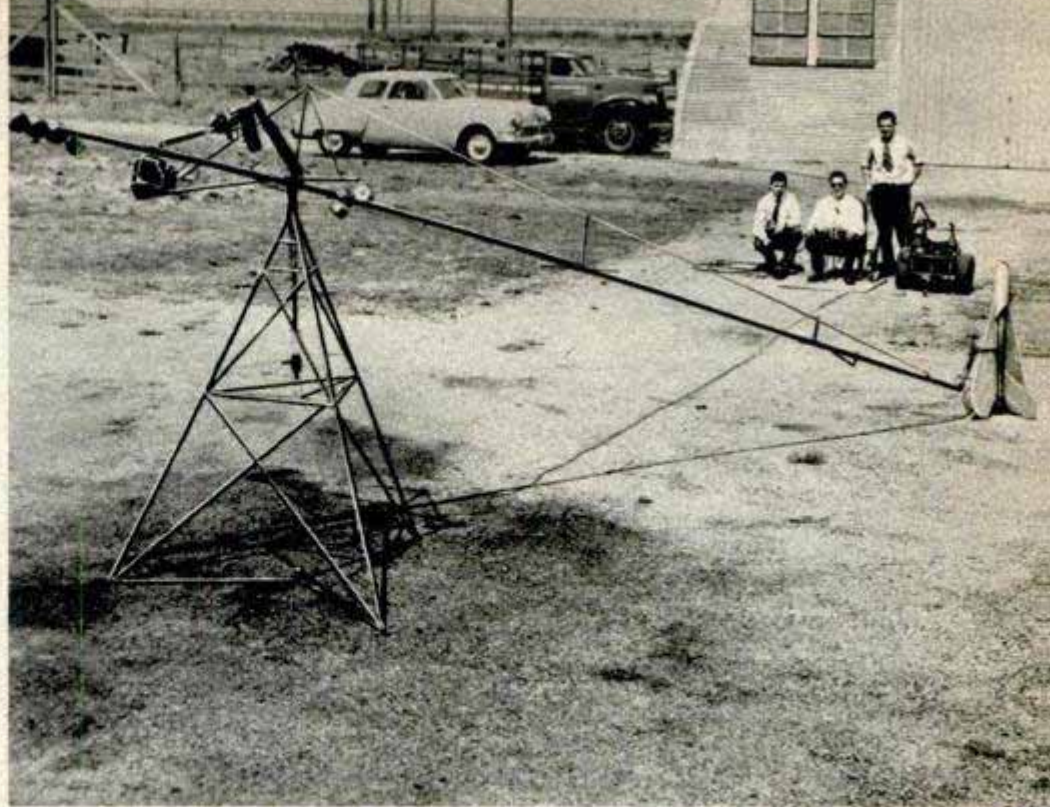

Operated by middle man in background, test stand forerunner of VJ-100 tilts over on its side and flies in circles. Experiments indicated ship had enough stability to back safely down to earth, at low speed, against the jet thrust. Below, the model whirling around stand in level flight



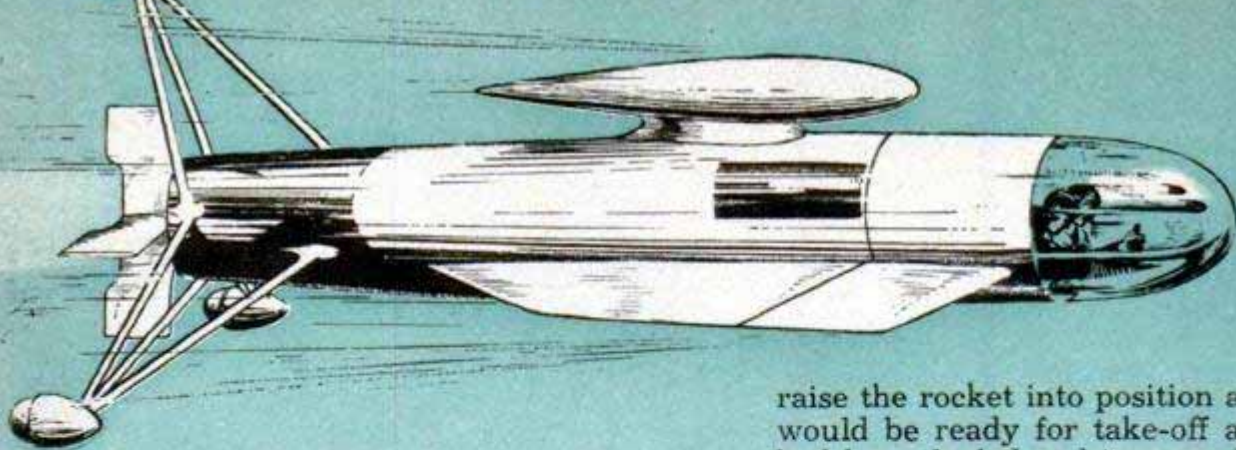

Above, after vertical take-off, with crew standing upright, craft is put over on its side for level flight on single turbojet engine. Landing gear would stay in fixed position

Below, man-carrying rocket could be unloaded in this fashion for photo-reconnaissance assignment. Any flat field with radius of 25 feet could be used as temporary operating base

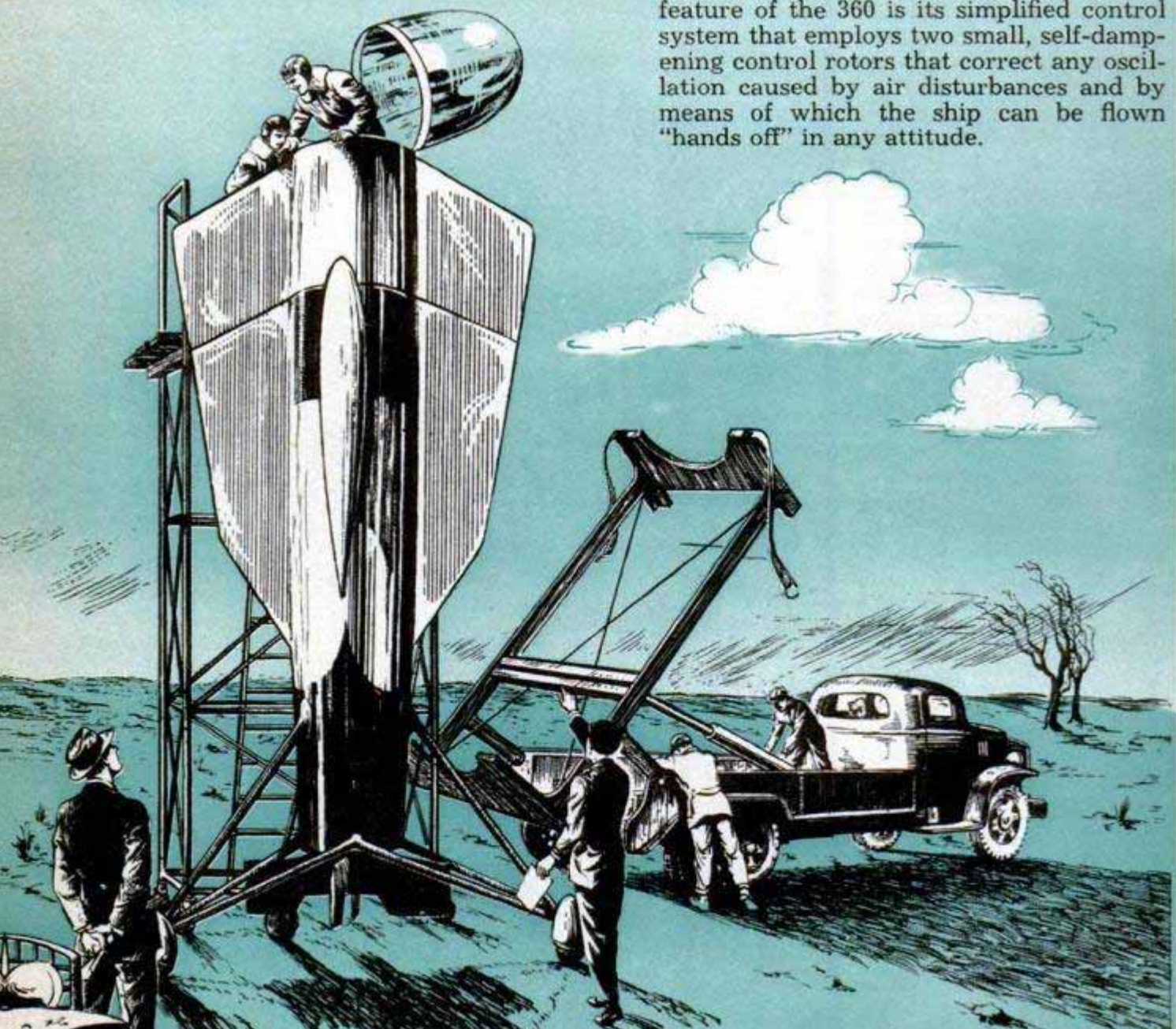

raise the rocket into position and the craft would be ready for take-off as soon as it had been fueled and its crew had climbed on board. Any flat piece of ground with a radius of 25 feet would be suitable as a launching and landing platform.

In addition to conducting an intensive research program, United Helicopters is in production of the Hiller 360 helicopter at the rate of one ship every other day. Carrying 3 people, the 360 has a top cruising speed of 84 miles per hour, a ceiling of 9900 feet and can cruise for 2½ hours.

As a duster or other cargo-carrying vehicle the 360 can carry a pay load of 551 pounds in addition to the pilot plus sufficient fuel for an hour of flight. One unique feature of the 360 is its simplified control system that employs two small, self-dampening control rotors that correct any oscillation caused by air disturbances and by means of which the ship can be flown "hands off" in any attitude.

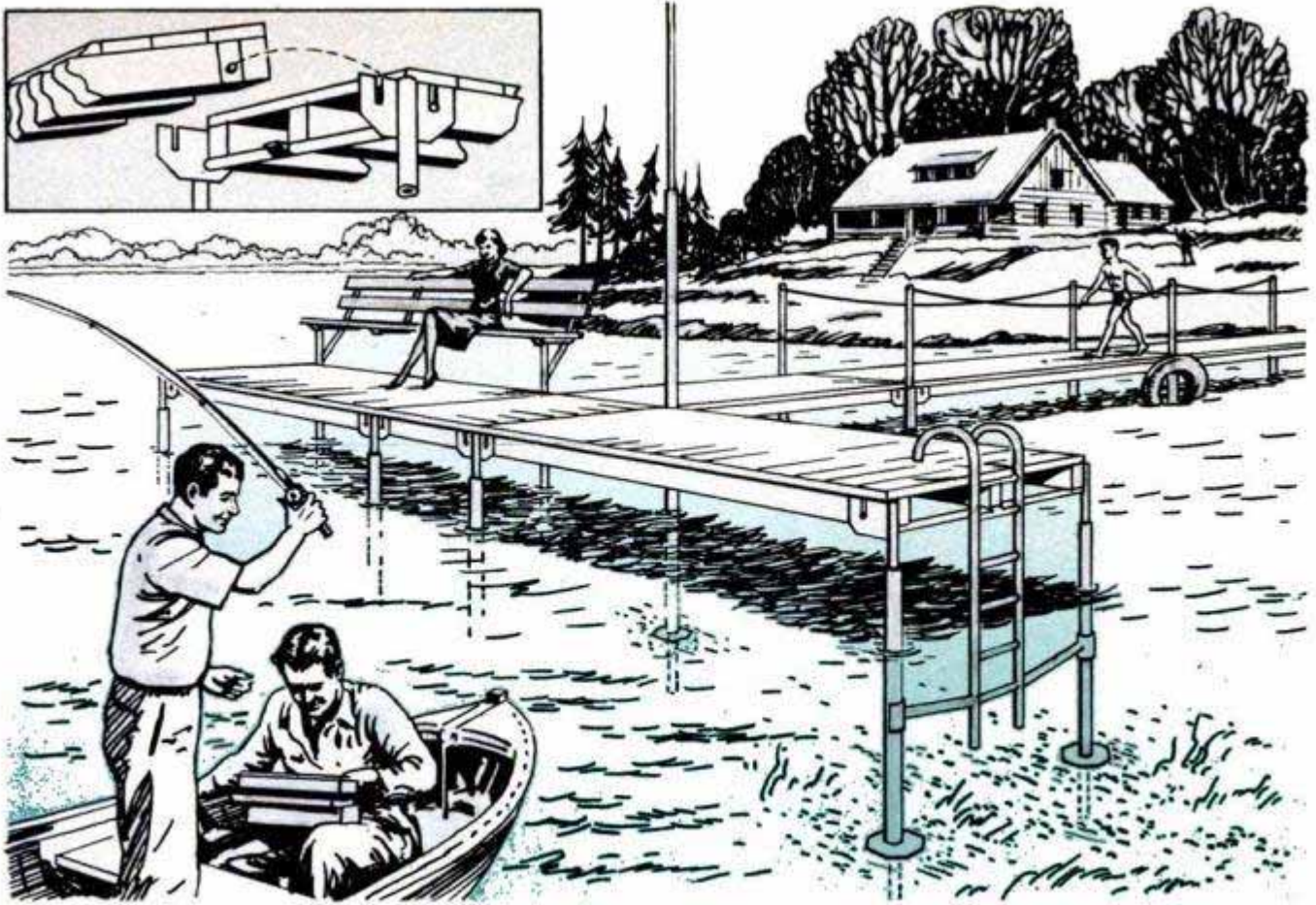

Prefabricated Dock Is Assembled Without Bolts

Portable and demountable, a prefabricated dock is made in sections which are assembled without bolts, producing a sturdy, self-aligning boat dock. A variety of designs can be worked out with the sections which come in 9 and 11-foot lengths. Supports for the dock are two-piece, galvanized-steel pipes that telescope for adjustment. A shiftproof base plate and pin hold the dock supports in position.

Also available is a variety of accessories such as flagpoles, benches and ladders for use when the dock is built as a lake-front swimming enclosure. The wood decking comes in completely assembled sections or, if you prefer, you can buy the metal framework and install the deck yourself. Dock designs ranging from a one-boat landing to a U-shaped boat well can be formed with the prefabricated sections.

POTATO HARVESTER made in England can be operated by one man. Potatoes are scooped into the machine and lifted into a rotating drum which knocks off most of the dirt. Machine will harvest four acres of potatoes in a day. Needed in a hurry to harvest a crop, it was finished five weeks after plans were received from Sweden

British Information Services photo





Dogs Go "On the Air" To Help Scientists

Dogs are on the radio at Bar Harbor, Me., but for science rather than for entertainment. At the Roscoe B. Jackson Memorial Laboratory, scientists are carrying out research in animal behavior with the help of battery-operated transmitters that broadcast the dogs' heart beats and respiratory rates while the animals run free. A shoulder "holster" is strapped on the dog to carry the portable transmitter. Broadcasts are picked up by a receiver and recorded on a paper tape. Formerly, the animals were held on a table while their reactions were studied. With the new recording system, the emotional responses of dogs are more natural.

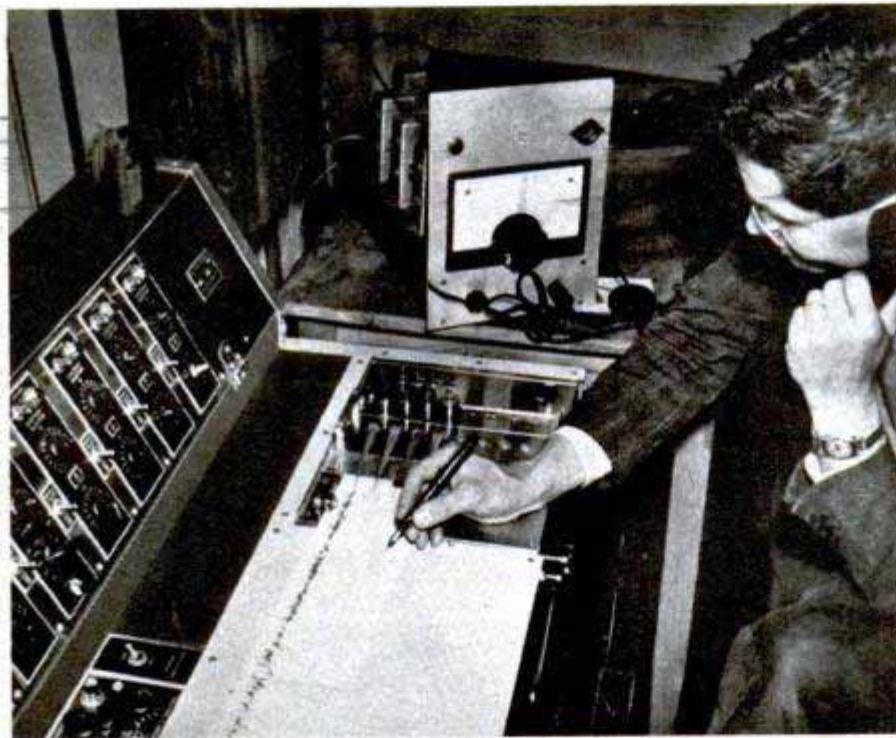

2,4-D on Vegetables Keeps Them Fresh

Cauliflower sprayed with 2,4-D, a growth-regulating hormone, retains its freshness in storage for a longer period, according to the Department of Agriculture. A preharvest treatment of cauliflower has reduced leaf dropping from 80 to 10 percent. The vegetables were stored for six weeks at 33 degrees Fahrenheit.

Three-Wheel Bandsaw Mounted on Lathe

Attached to the tool post of a lathe, a bandsaw takes advantage of the lathe's back-gear system to provide various speeds for cutting different materials. The saw will cut to the center of a 36-inch circle and will take stock up to six inches thick. One of the band wheels is chucked in the lathe and used as a driver. The lathe's cross-feed carriage tightens the blade.

☐ Insects destroy over five percent of all cereal foods in storage.

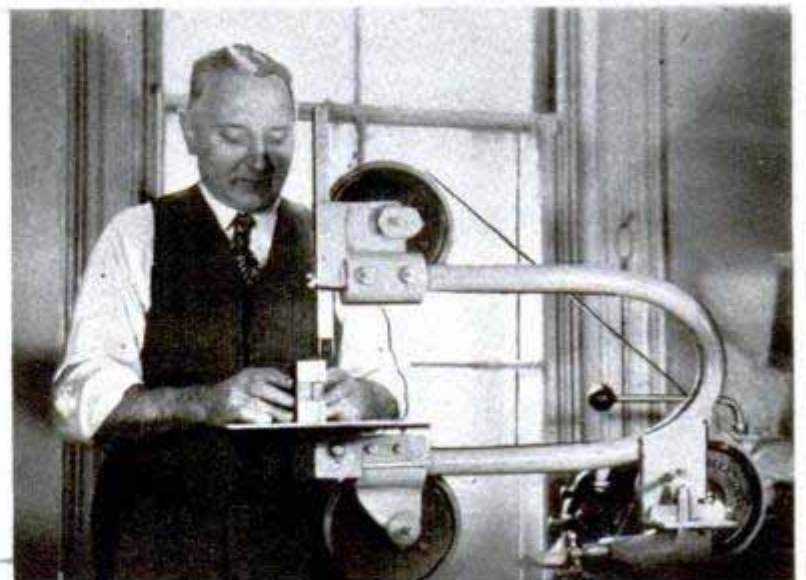



Rusted out and weakened area on top of a rear fender first is sanded to provide a clean surface for patch

Coating of cold solder is applied over the patch. When hard, it is sanded smooth by hand or machine

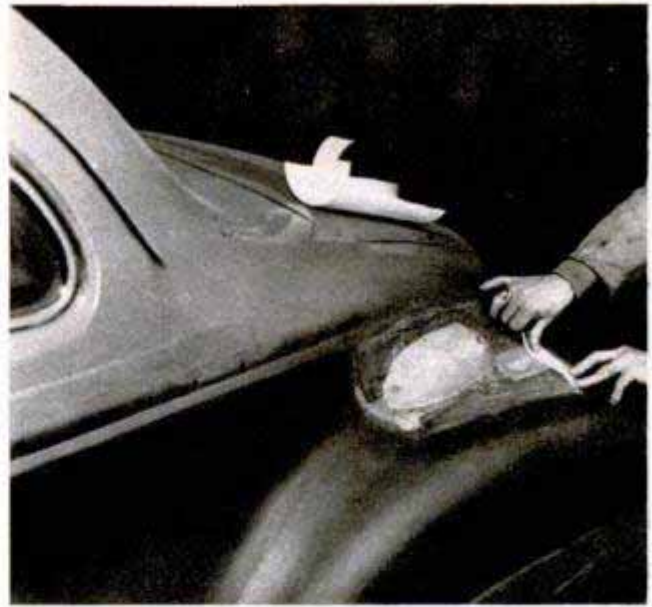

Patch fabric is dipped into a solvent, which softens it, and then smoothed neatly over area to be patched

Fender is painted with brush or spray enamel and shows no trace of the neat fabric and metal patch

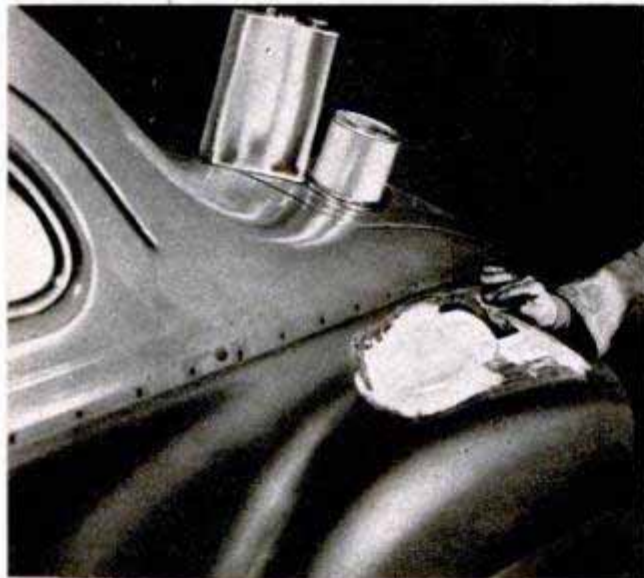

Fabric-Metal Patch Repairs Rusted Car Bodies

Areas on car bodies that are rusted out can be filled in and repainted to look like new with a fabric and metal patch kit. The damaged section of the car is sanded smooth and clean. Then the patch material is dipped into a special solvent and applied over the hole, where it dries into a hard

surface. A cold solder is spread across the patched area and allowed to harden. Then the patch is sanded smooth and painted. The patching kit also can be used to repair wood, plaster or concrete around the home, dented refrigerators, stoves and leaky water tanks.

Thin Concrete Forced Into Pavement Prevents Highway Damage

Pavement breakdowns that disfigure many miles of American highways are prevented by a new cement slurry developed at Purdue University. The principal cause of damage to highways is "pumping," a name given to the process where soil and fill are forced up through the pavement between cracks. The resulting void beneath the highway causes the pavement

slabs to break down. The new cement, a combination of portland cement and calcium aluminate cement, is mixed to a consistency almost as thin as water and forced through pavement holes. It hardens quickly, and is practically impervious to water.

☐ Your chances of being injured while in an elevator are less than one in 100 million.

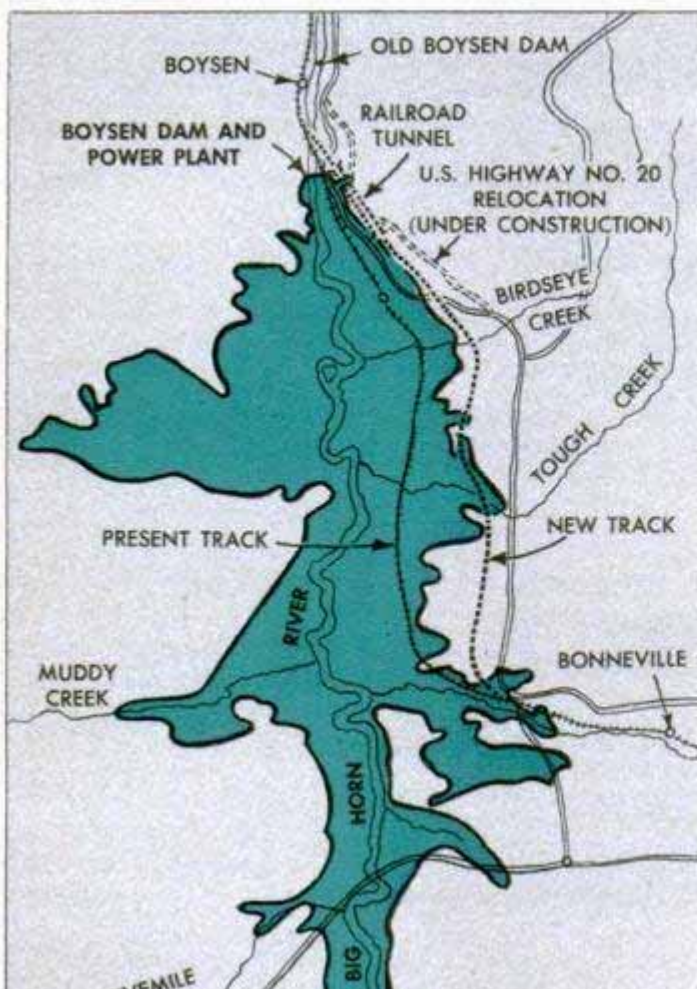
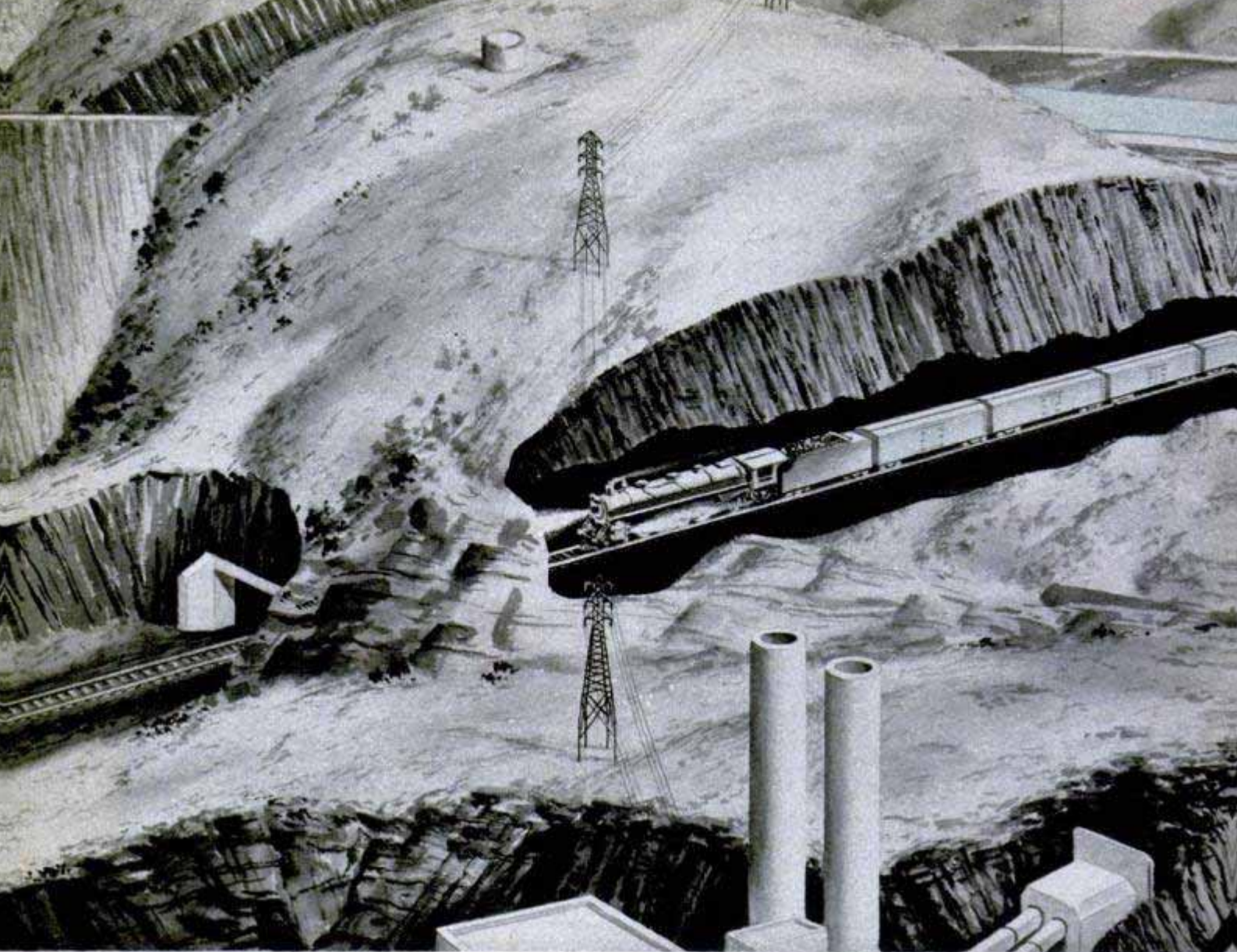

Railroad Under a Lake

TRAINS between Billings, Mont., and Casper, Wyo., soon will plunge through a tunnel $1\frac{1}{3}$ miles long, passing beneath the reservoir to be created by Boysen Dam.

The dam is being erected by the U. S. Bureau of Reclamation. The existing tracks of the Chicago, Burlington & Quincy Railroad must be relocated because the reservoir will inundate part of the present right-of-way. The new track will pass directly under one bay of the big reservoir.

Trains will duck into the tunnel where the Big Horn River enters Wind River Canyon and will emerge below the dam. The 12 miles of new track bed and the tunnel will cost an estimated \$1,000,000 per mile, with the total railroad relocation project costing about \$13,000,000. This is nearly half of the estimated \$28,000,000 cost of the entire project including the dam.

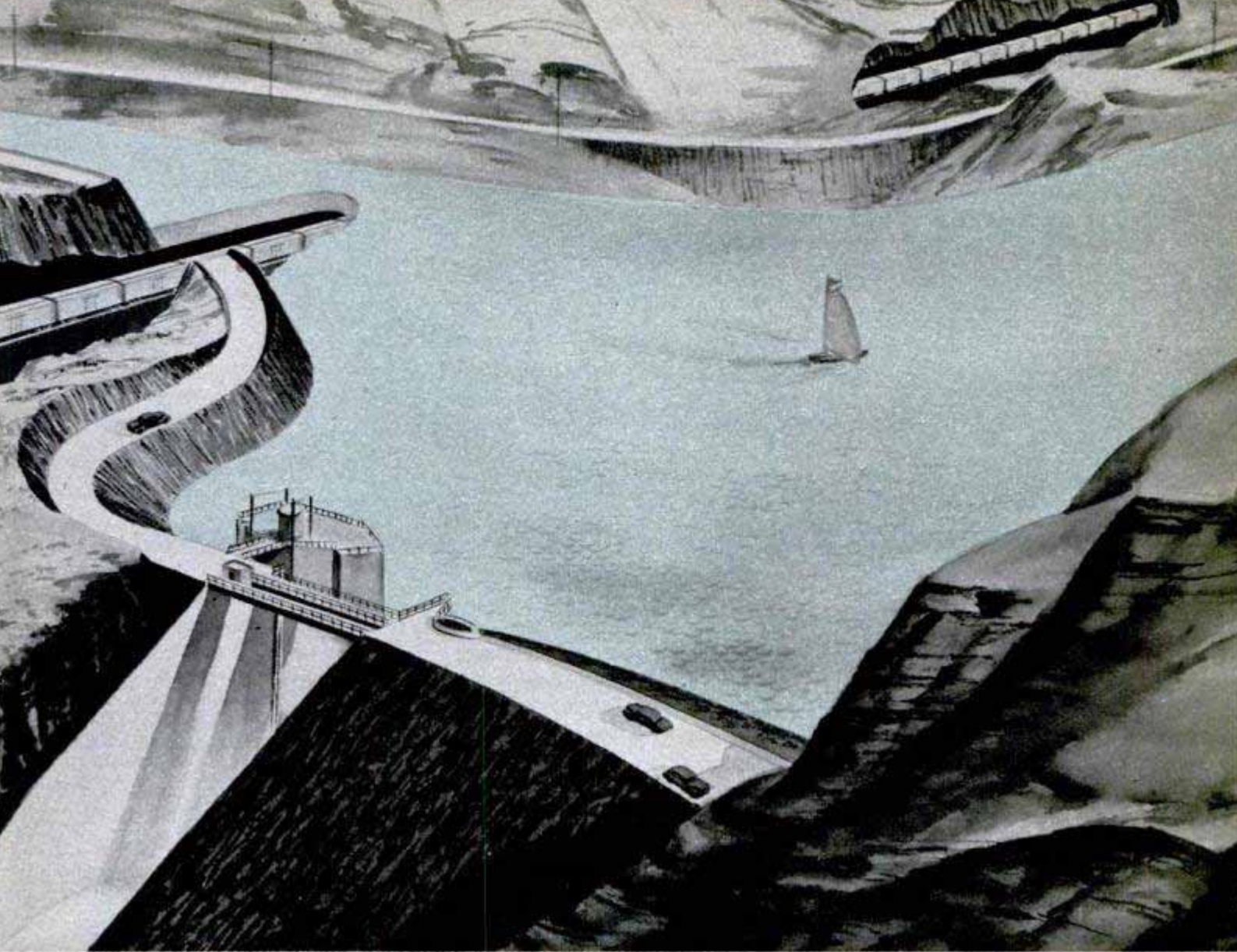

Puffing through the new tunnel, trains will pass beneath one arm of the lake created by the new Boysen Dam

Present plans call for the tunnel to be completed about the end of 1949, with trains using the new track early in 1950.

Engineers who are building the new tunnel have encountered difficulties they didn't anticipate. A quantity of "silt rock" lies directly in the tunnel path. This is an earth material that appears hard and flinty but flakes off when exposed to the air and turns into slime when soaked with water. The original plans for the tunnel called for eight-inch beams four feet apart to support the roof and sides, but now the engineers are placing the beams only a foot apart in the weaker sections.

Despite this precaution there are places where the rock formation has slipped down on the beams, twisting and bulging them. Reinforcements in the form of steel and concrete bars are being set in place to overcome these weak areas.

Boysen Dam will be a multiple-purpose structure 150 feet high. It will be an earth-and-rock-fill dam about 1000 feet long at the crest, containing 1,400,000 cubic yards of fill. The dam will build up a reservoir

covering 31,300 acres of land, most of which now is used for grazing.

Primarily, the dam will be used to generate power. Engineers are installing two generators with a combined capacity of 15,000 kilowatts. About 6500 kilowatts of this total will be "firm"—available the year round. The remainder will be available depending upon the water flow through the river, and will be used whenever there is sufficient water to turn both generators. Enough water will pass through the two turbines to keep up the normal river flow.

The capacity of the reservoir will be about 1,493,000 acre-feet of water. Reclamation officials say the regulation of the stream by the new dam will benefit irrigation projects both up and downstream. The top 27 feet of storage space in the reservoir will be set aside for flood control.

In one way, previous railroad facilities will aid in the new project. A tunnel bored years ago for the railroad will be used as the penstock or tunnel through which water will drop from the dam to the hydroelectric plant.



Bent-Stem Pipe Rests on Chin

There's no strain on your teeth or jaw when you use a bent-stem pipe that rests comfortably on your chin. A gentle curve in the stem fits against the chin, permitting the pipe to be held in the mouth with very little pressure.

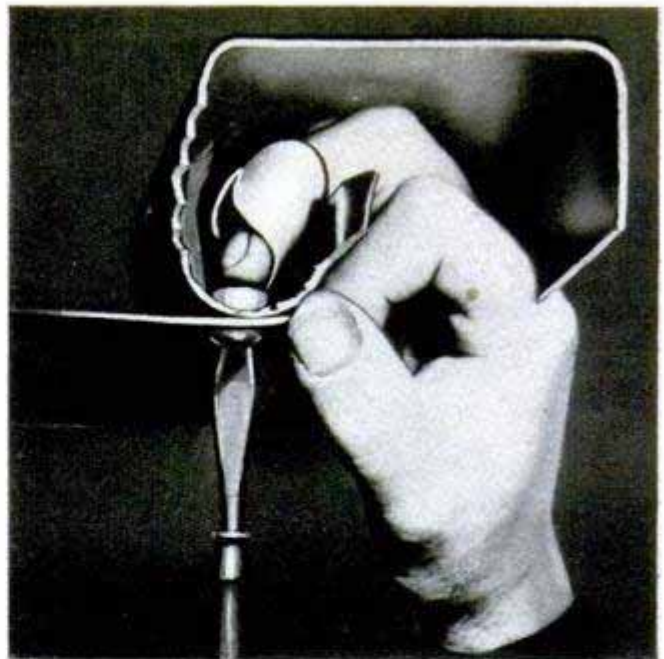

Thimble Wrench for Tight Spots

Worn like a thimble, a finger tool solves the problem of getting at a nut in those hard-to-reach places found in ranges, automobile bodies and other sheet-metal products. The flanges fit snugly around the finger and the wrench-size opening at the tip of the tool grips the nut.



Musician tests tone of rosewood bar after cutting it on bandsaw. Right, finished bars are exactly in tune

Marimbas Tuned With a Bandsaw

Marimbas now are tuned with a bandsaw. The exacting process of tuning the rosewood bars was accomplished in the past by shaving away the underside until an arch was produced. Then the bar was cut and scraped until it resonated at the proper pitch. Recently, an enterprising Chicago manufacturer tried a bandsaw as a means of bringing the bars to pitch in the hope that this would speed manufacture. Now, an accomplished musician feeds

the bars into the bandsaw, following a jig template. At one pass the bar is arched. It then is struck with a hammer and the tone compared with a standard note. Two or three passes usually are necessary. With the bandsaw, a bar can be tuned in less than one minute, compared to seven minutes with the best previous process.

☐ Electronics experts have discovered that the mysterious radar reflections or "blips," which have baffled them for years, are caused by insects flying in the beam.

Folding Plane Seats Provide Cargo Space

Folding airplane seats have been introduced to accommodate varying loads on cargo-passenger runs to Alaska. They are collapsed by pushing the backs down and turning the armrests inward. Each two-seat unit is folded against the cabin wall. The steel framework of the seats forms posts for cargo lashing to supplement the tie-down rings inserted in the floor.

Supersensitive Vacuum Gauge

By means of the ionization gauge it is possible to measure a vacuum so high that all but about a trillionth of an atmosphere has been removed, General Electric researchers announce. During the war, when advances in electronics brought increased activity in the field of vacuum production, high-speed pumps were developed for use at the low pressure of one millionth of an atmosphere. In the



Northwest Airlines photo

laboratory it is possible to produce vacuums that would have to be increased at least 10 trillion times to raise them to normal atmospheric pressure.

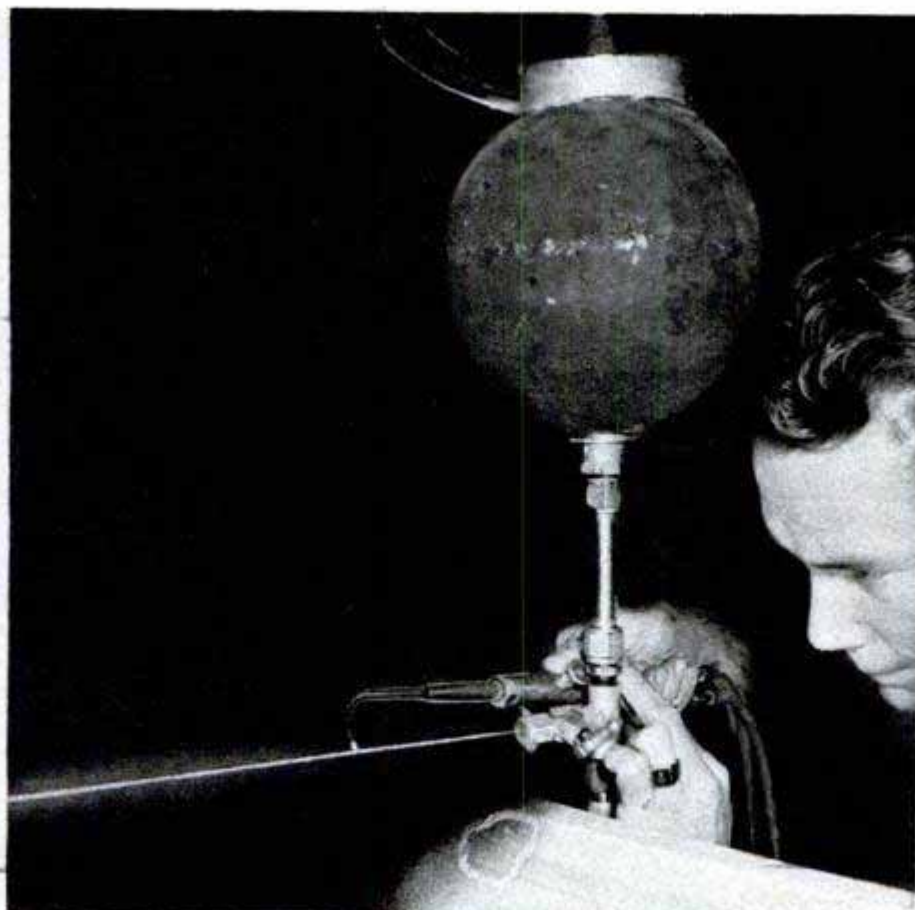

Hydraulic Fluid Is Fire-Resistant

Airplane hydraulic fluid, essential to modern planes, has been made fire-resistant, reducing fire hazard. Hydraulic fluid is used to operate such devices as retractable landing gear, brakes, wing flaps and even windshield wipers. In one test, a thin stream was passed through the flame of an oxyacetylene torch. It failed to ignite until the torch was held at some distance from the sprayer orifice and even then it flashed only momentarily. When introduced into an existing fire under the proper conditions, the fluid will burn, but it does not support combustion, going out when the existing fire is removed.

***the floor show
that grew in
a workshop***

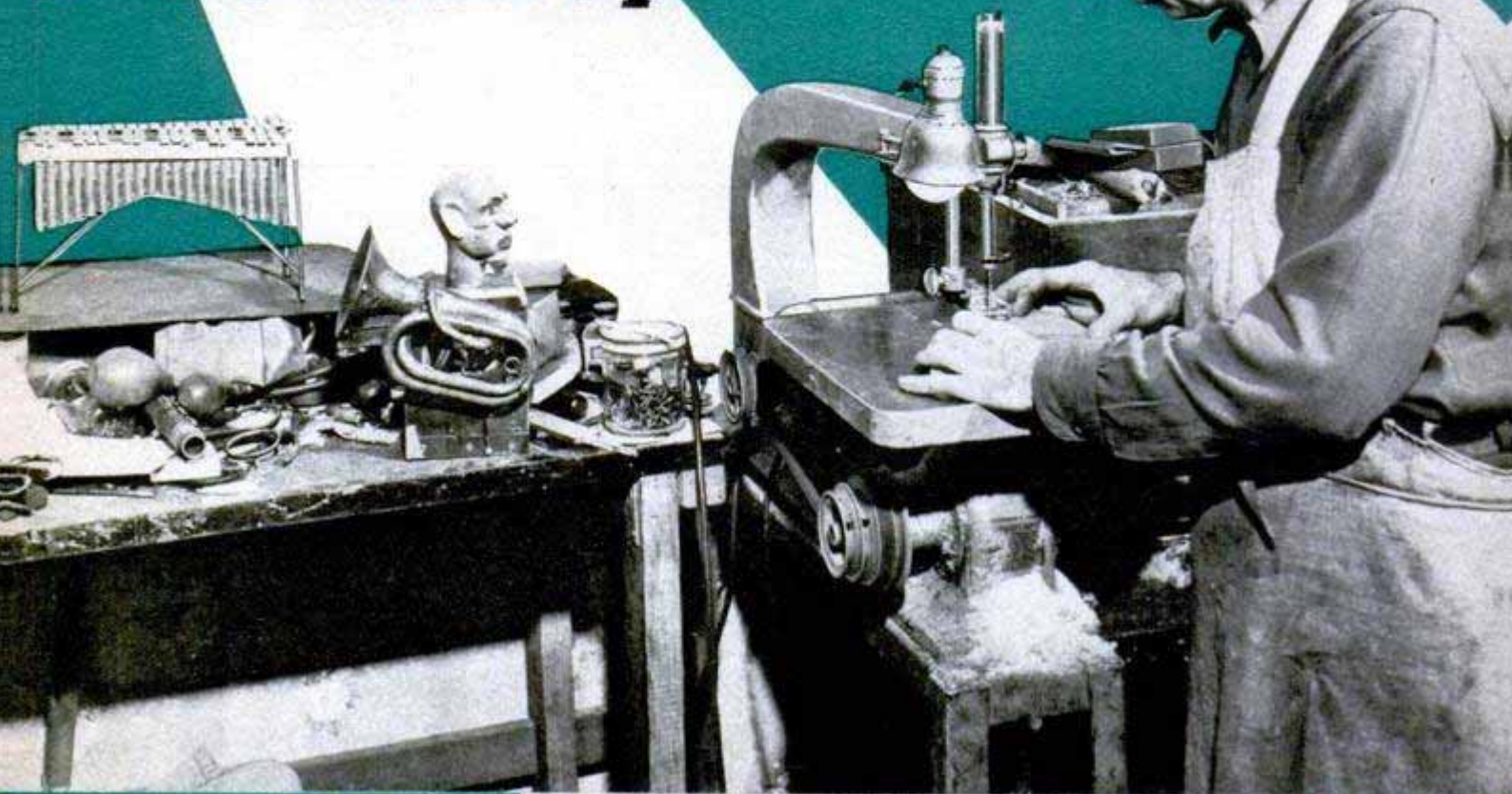

Pete Evans develops a hilarious new gag in his workshop. Who knows what that small bald head will be? Probably not even the entertainer himself at this stage in the development. Below, left, Evans and his pals perform their gags on a crowded little stage. Some of their instruments are real, altered for their purposes, and some are homemade. Below, when Evans sits down, a stool built into his coat falls into place



Photos by
Grant and Marjorie Heilman

A FLOOR SHOW so zany that the patrons are flocking to a Pittsburgh night club was born and reared in a cluttered workshop.

Before the war, Pete Evans was just a happy night-club entertainer who happened to have an amateur interest in puttering around a workshop. But after he spent his war years as a welding instructor, a mechanical revolt took place in Evans' night-club act, for he suddenly discovered he could mix his hobby with his floor show. The result is a screwball act so funny that it tickles the patrons into tear-streaked laughter.

Evans turns out the absurd mechanical devices for his show in a crowded workshop above the night club. During his off hours you'll likely find him in the shop, tinkering with everyday items to convert them into new and still funnier gimmicks.

Most of the props used in the act are perfectly sane, respectable items which Evans has rebuilt into entirely unpredictable props. For example, all of the musical instruments play real music, but they also are likely to explode, spray water on the customers or even smoke cigarettes.

Evans and his three partners, Jack Peck, Tiny Miller and Walter Camarada crowd onto a stage only five feet square and put

Scroll of cello suddenly opens to reveal a mouth. Then it calmly puffs cigarette supplied by Evans



Comedians play Oriental music and a snake weaves wearily out of a kettle

these countless hilarious props through their paces to entertain the patrons.

Tiny Miller's eyeglasses seem innocent, but suddenly come alive to act out some of the songs. When Tiny sings "I Cried for You," the glasses spout tears. When he changes to "Smoke Gets in Your Eyes," a cloud of smoke pours from the frames.

The glasses have standard frames, but along the frames is a piece of copper tubing drilled with small holes. A rubber hose runs behind Tiny's ear and down beneath his coat to Pete Evans, who is armed with a glass of water and a cigarette to produce the spray of tears and cloud of smoke.

During the hilarious act Evans becomes the victim of his own cleverness. The bass horn he plays suddenly shoots a stinging spray of water into his face. The secret is an extra valve he has installed in the horn, a valve made from an old soda siphon. The valve is attached through tubing to a small tank partially filled with water and then pressurized with a tire pump. Press the valve and the water shoots out of the horn.

During one act, the performers play Oriental music on strange homemade instruments while clustered around a kettle. Suddenly a snake rears up out of the kettle and wearily dances to the tune. The audience, naturally, can't see the string that holds up the snake.

Jack Peck interrupts his violin playing when his violin suddenly breaks in half, revealing a row of white teeth and a red tongue that leaps out to try to snare a bug which is bothering Peck.

As the customers watch, some of the instruments actually seem to come to life. While Evans calmly plays his bass fiddle,



When orchestra plays "Smoke Gets in Your Eyes," a cloud of smoke pours from Miller's glasses

Below, "I Cried for You" sings Miller, and tears spray forth to prove the singer's words

Secret of gag is tube that runs behind the bulky singer to Evans who provides water and smoke



an eyelid built into the sound box slowly opens and a huge glass eye follows Evans' fingers as he plays. When the eyelid closes again, a cuckoo suddenly pops out of the other side of the instrument and shakes its head in pity.

When Evans gets tired of standing during the act he just sits down, apparently on thin air. In the tails of his coat is a built-in stool that automatically falls into place beneath him when he bends his knees.

Always good for a big laugh is Evans' cello, which springs to life as he plays it. Suddenly the cello opens up to reveal a set of white teeth. When the entertainer puts a cigarette into this comical mouth, the scroll of the cello immediately begins to puff smoke. Secret of the gag is a tiny hole drilled through the scroll and connected by tube to a rubber bulb that Evans holds in his hand. When the screwball entertainer squeezes the bulb, the scroll calmly inhales and exhales the smoke.

Evans also has built an extra valve into a tuba. When he presses the valve the horn sprays white powder over the customers—who laugh uproariously as they brush themselves off.

Probably the greatest miracle of the entire floor show is that all the props are stored either around the tiny stage or in the dressing room, which is just about the size of a small closet. Meanwhile Pete Evans is in his workshop above the stage, working out new gags for an act that constantly changes.



Above, bass horn suddenly spouts a geyser of water into the entertainer's face. He seems to bear the instrument's revolt patiently. The spray is controlled by an extra valve made from an old soda siphon



Above, right, the valve is attached through tubing with a small tank partially filled with water. The tank is pressurized with a tire pump. When the entertainer presses valve, water is forced out spout

Right, eyelid on bass fiddle suddenly opens to reveal a glass eye which follows Evans' hands as he plays. Later a cuckoo pops out of the instrument, listens for a moment, then shakes its head



Below, Jack Peck's violin breaks open suddenly to become a huge mouth. Tongue pops out to snare an insect which has been bothering the entertainer. Spring-and-cord mechanism operates the instrument

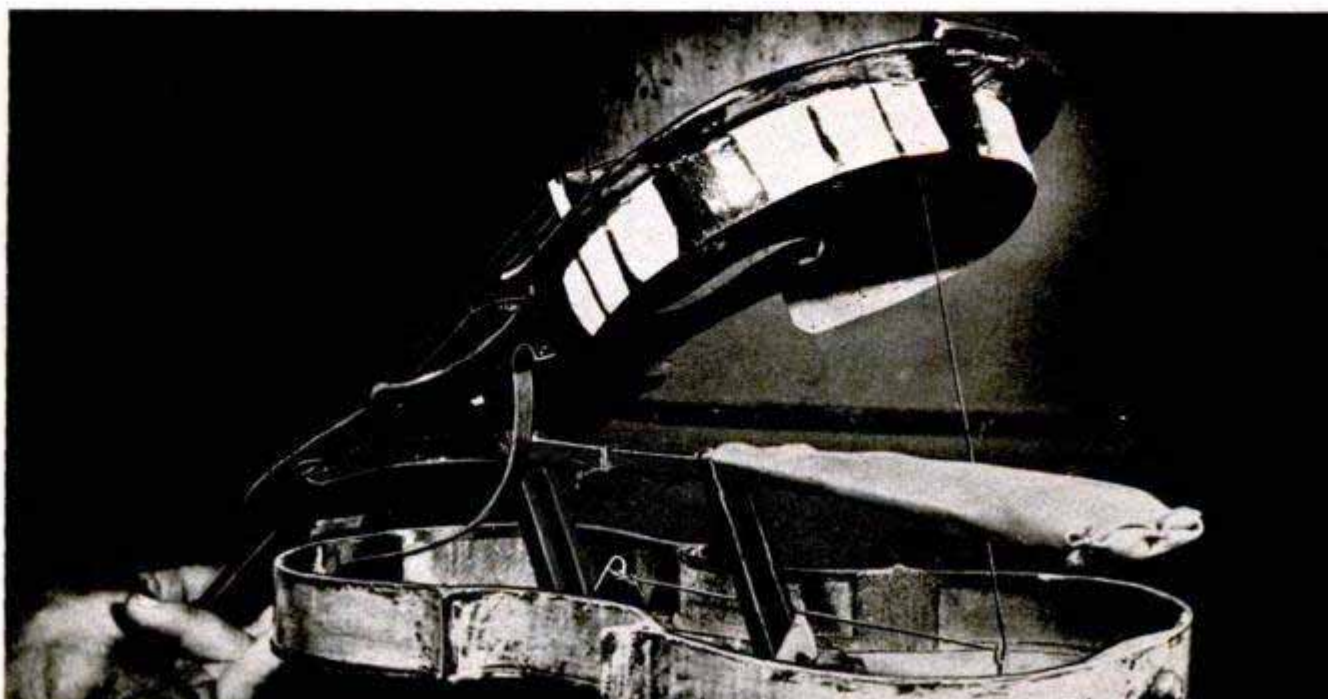



Boat Serves as Extra Roof on Sportsman's Trailer

Three persons can sleep in a sportsman's trailer built by a San Pedro, Calif., draftsman and his wife. A 90-pound boat, secured from inside the trailer by pins, forms a double top. A roller on the boat's bow simplifies unloading. Fishing rods, guns and other items are carried in the double floor of the trailer. The outfit includes a cooking stove and 50-pound ice-box. The hinged rear bumper comes down to serve as a brace for keeping the floor level when the trailer is parked.

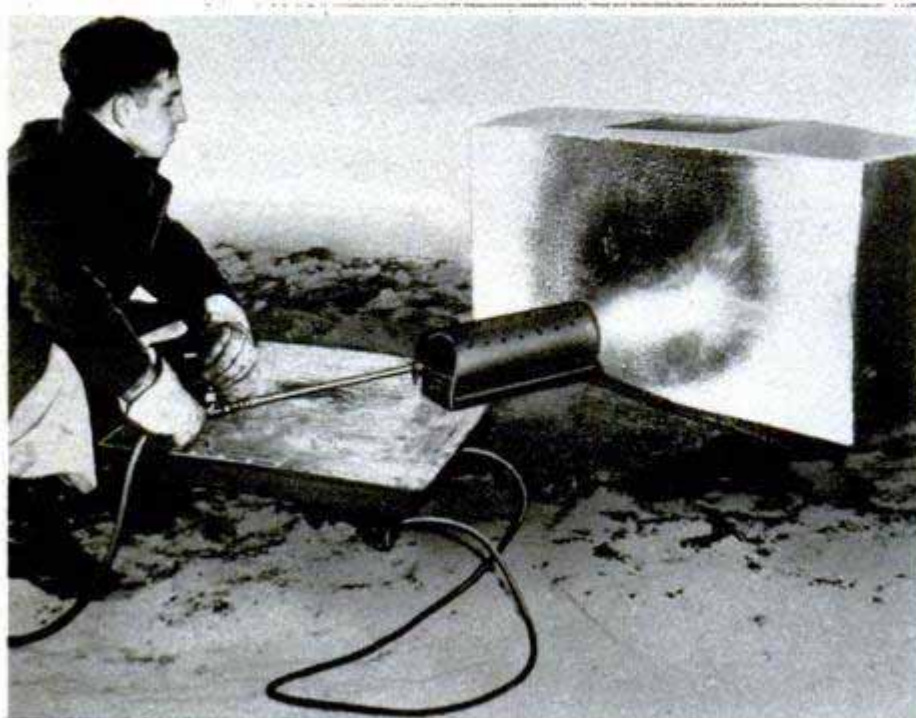
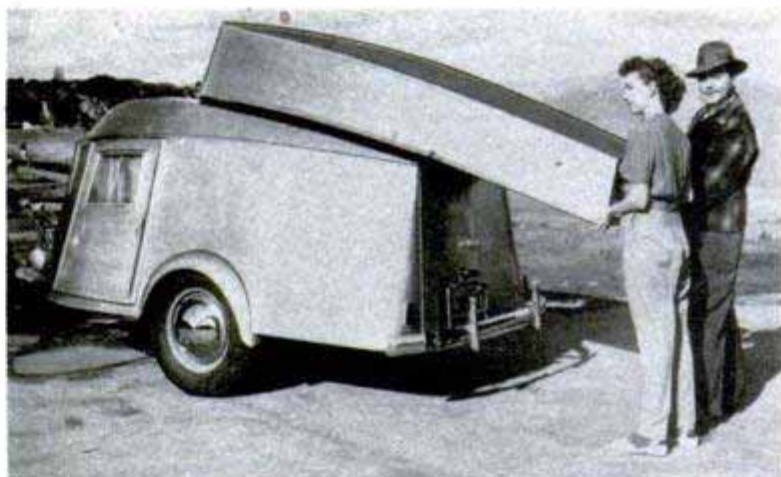

Aircraft Gas Tank Withstands Flame

Capable of withstanding fire and temperatures of 2000 degrees, a lightweight fuel tank has an outer coating of rubber and other materials that increases the safety factor when it is installed in airplanes. Designed by Goodrich for the Navy, the tank was not damaged by prolonged exposure to a blowtorch flame which disintegrated an ordinary aluminum tank in less than 60 seconds. The tank, also bullet-sealing, is the first of its kind to withstand direct flame.



When grain elevators overflow, the golden wheat is stored on the ground. There are 75,000 bushels in this pile

Golden Harvest *Feeds the World*

By Thomas E. Stimson, Jr.

JUST AT THE TIME when a hungry world direly needs any surplus we can spare, American farmers are producing the greatest wheat crops in history. The United States grows a fifth of all the wheat that is produced by the world and ships more of it abroad than do all the other wheat-producing nations combined.

Last year's bumper crop in the United States amounted to some 1¼ billion bushels, which is equal in volume to 18 dams the size of Hoover Dam or enough to hide all of New York City under a golden blanket two inches deep. The crop could provide the flour to bake 72 billion standard one-pound loaves of bread.

This immense production has been possible because of favorable weather, strong prices that provided an incentive to the growers and because vastly improved strains of wheat and better mechanical farm equipment were developed just as the

need for more wheat became imperative.

Growing wheat and handling it is a special major industry all across the country from New England to the Northwest and down into the deep South. Two thirds of the total output, however, is produced on the Great Plains between the Mississippi and the Rockies. Harvesting begins in central Texas in May just as the hard winter wheat that was planted the previous autumn becomes mature. Up in the Dakotas and Montana, at about the same time, spring wheats that will mature in the late summer are being planted.

The harvest crews, who start the season in Texas, slowly move north as the summer advances, reaping the grain from millions of acres and reaching the states on the Canadian border just as these northern fields are ready for harvesting. Some 3000 custom combines make the trip from Texas to the northern border every year and this

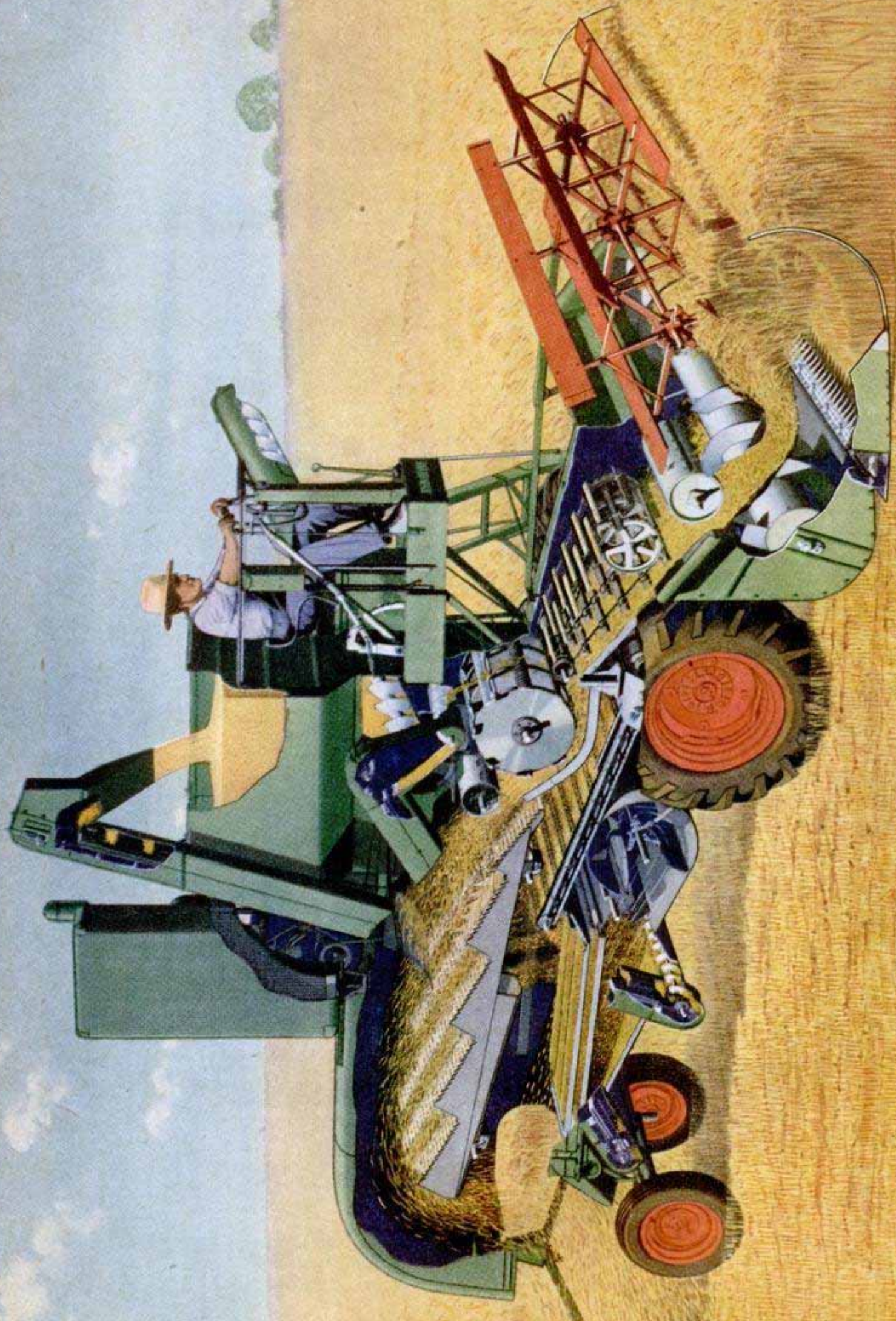

traveling equipment is augmented by thousands of other units that operate within small local areas. Twenty bushels of wheat, on the average, are taken from every acre. Some rich fields produce 40 or 50 bushels per acre or more.

Wheat is an entirely mechanized crop these days. Seeding is done by tractor-drawn drill-type seeders, some of which also fertilize the ground at the same time. Harvesting is performed by combines, the combination reaping and threshing machines that cut the heads from the wheat stalks, shake out the grains of wheat and discharge the chaff and straw back onto the fields. Most of the combines in use are tractor-drawn and require a two-man crew, but this equipment is being replaced by the new self-propelled combine machines that can be handled by a single operator.

One man on a self-propelled combine and one man in a truck to pick up the wheat and haul it to storage comprise a harvest crew that handles as many acres today as 12 to 15 men could handle in the '20s. Two or three man-hours of labor per acre of wheat, from tillage to market, are all that are required today and the result is that one farmer often can handle his own fields, amounting to 500 or more acres, all by himself. Operators who farm two or three times that acreage require only small amounts of help.

Harvest time is the final critical period in making a crop and each grainland owner wants to see his wheat safely under cover the moment it is ripe enough to thresh. The Great Plains in particular have a tricky climate and a few days of delay may bring on a high wind or a rain or hailstorm that shatters the heads and lays the stalks down on the ground, decimating the crop.

Because of this danger, harvesting is always a rush operation and the crews work all day long and far into the night, every day of the season. The emergency isn't over until the last acres along the northern border have been reaped.

Meanwhile the storage elevators

← Cutaway drawing of the John Deere self-propelled combine. With its one-man crew, this machine reaps and threshes grain



Above, research worker cuts down one row of experimental wheat at a time with this small reaper to avoid mixing the variety with adjacent growths. Below, another miniature machine for test stations is this thresher being used here on a pea crop



JULY 1949
Ag. Exper. Station



Tractor-drawn combine harvesting wheat in Washington. Pipe projecting at right unloads grain into trucks

and the railroads fight their annual battles to get the precious grain under a roof or on its way to the big central storage houses and the mills. New concrete elevators have been built every 10 miles or so alongside the railroads that cross the wheat country

and even their capacities are taxed by bumper crops. Some farmers have had to store their wheat temporarily on the ground. At some of the elevators, huge wooden cribs have been built alongside the bins to take care of the overflow.

Flour sample is placed in an electric furnace to test its mineral content



The railroads are in a similar fix at harvest time. There are never enough cars to meet the demand even though plans are started six months ahead of time to divert every available boxcar to the prairies. Extra locomotives are brought in from as far away as the West Coast. Additional crews of engineers, firemen, conductors, brakemen and switchmen are recruited from other divisions. The freight departments of the Santa Fe, Southern Pacific, Union Pacific and the other lines in the wheat territory

reschedule many of their operations to give priority to the wheat specials.

Most of the grain that moves by rail goes to the huge terminal elevators, some of which have capacities of more than 10 million bushels, located at Kansas City, Chicago, Wichita and other points. Suction hoses sweep the cars clean of their loads and the cars are then made up into long strings of empties to go back for another load. Several of the largest elevators have automatic car dumps that can pick up an entire boxcar and tilt it so that all of its grain spills out into a receiving hopper in seven minutes.

Wheat used to be a scrawny plant subject to many ills. Sudden frosts would kill it, prolonged droughts would dry it up, smuts or rots or such insects as the Hessian fly would destroy whole crops. These calamities still threaten but modern improved wheats have much more resistance to disease and weather than the older varieties.

Along with the other improvements in the "re-modeled" wheats have come tremendous increases in yield, up to 50 percent in some cases over the best varieties that were available in the past. Kansas harvests 30 million bushels more from the same acreage simply because of the success of the prolonged plant-breeding program. Over a period of 40 years the original hard red Turkey pioneer wheat of the Plains has been given built-in disease and insect resistance, higher yield and has even been redesigned for machine handling. The newest Pawnee strain bears little resemblance to its Turkey ancestor and almost guarantees a good crop in

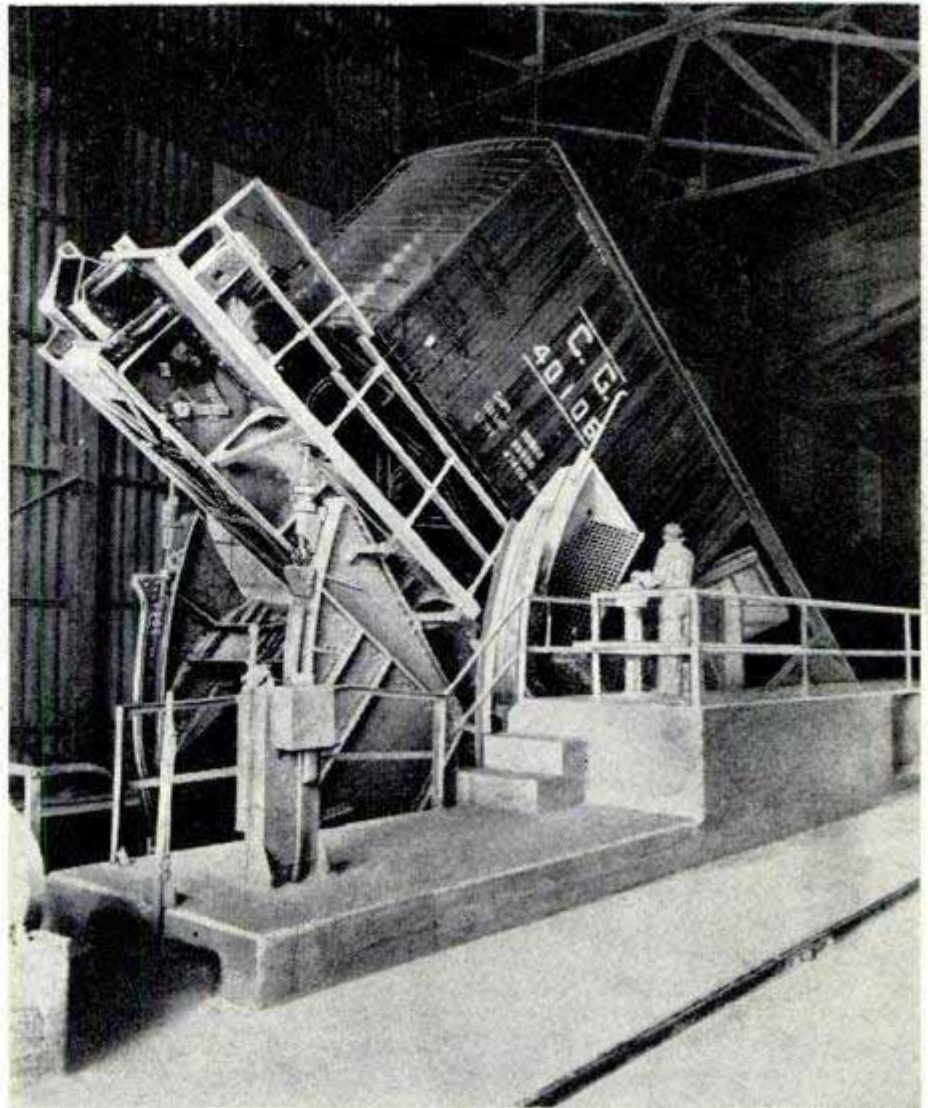

Link-Belt Co. photo

Freight cars loaded with grain are picked up and dumped by this unloader that will handle as many as 10 cars an hour. A large steel hopper below the tracks catches the grain as it spills through the door. Below, four steel rollers support the cradle on which the car is placed for dumping

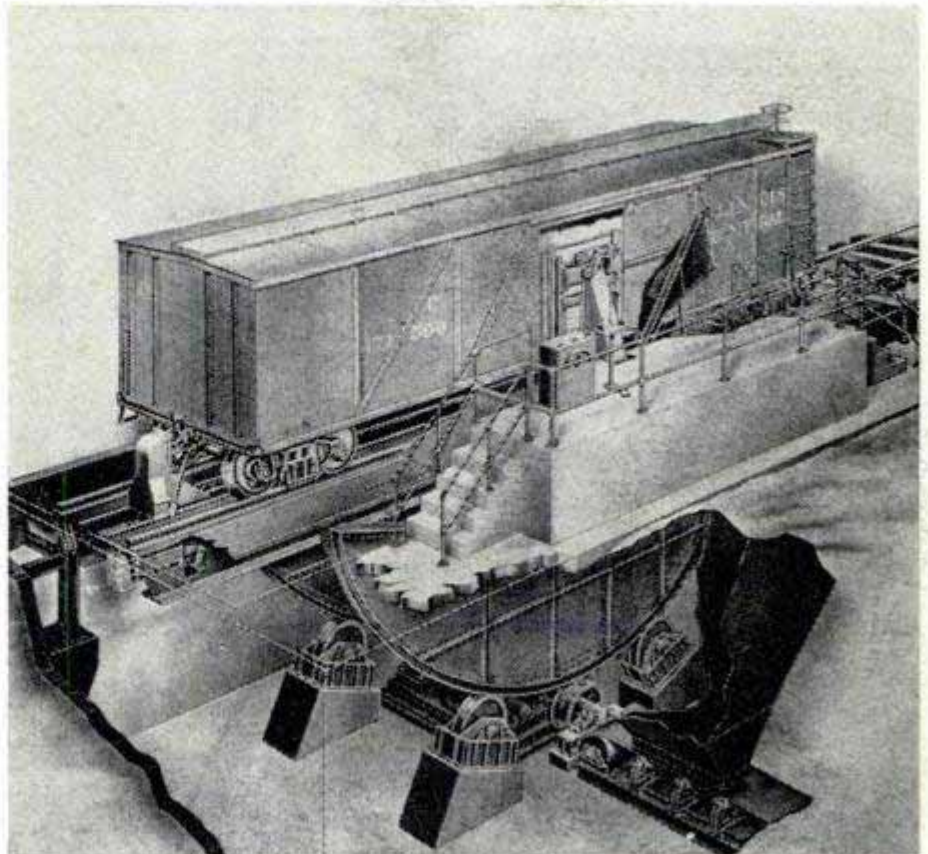

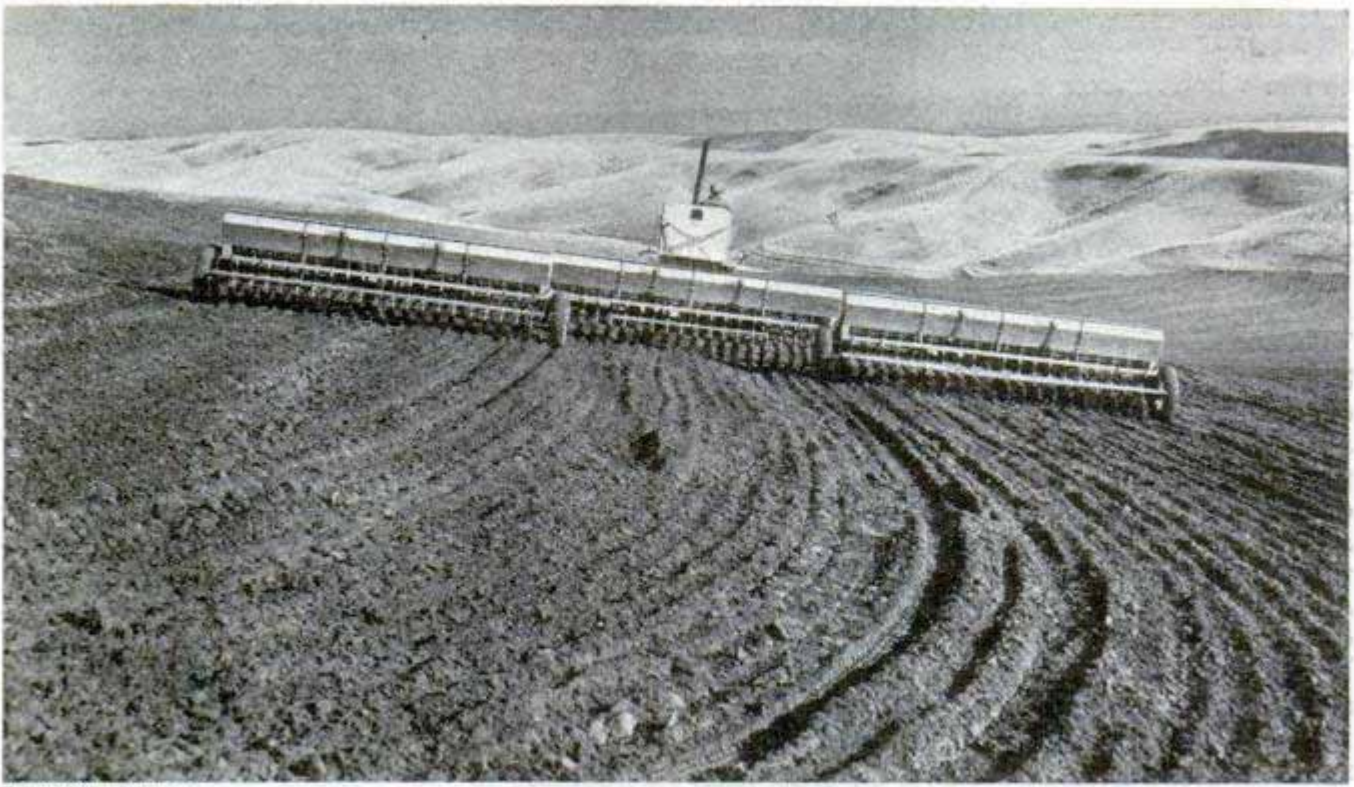

Deere & Co. photo

This gang drill, drawn by a tractor, plants a 30-foot strip with seed wheat at a speed of six miles an hour

the particular region to which it is adapted.

In all, more than 200 distinct varieties of wheat are grown in the United States because a type that is ideal in one region often is not a good producer elsewhere. The plant-breeding program is intended to create an ideal variety for each region. Agronomists and geneticists of the United

States Department of Agriculture, the various state colleges and private plant breeders are all cooperating in the program. The work is exacting and complicated because the geneticist must constantly keep in mind that he is seeking a variety that, among other things, has a high yield and a high weight per bushel, a short

Not all wheat is grown on the plains, and in hilly land like this a double-jointed hillside combine is used

International Harvester photo



stiff straw and resistance to winter-kill as well as to drought. The same wheat must also resist insects and diseases and must resist shattering in the field.

Even when a cross is produced that fulfills all these specifications, the plant breeder moves cautiously. The grain must pass several other tests before a seed crop can be grown and released for use. The breeder remembers one instance in the past when an extremely good new wheat was created and 350,000 acres were sown with it at once. Farmers got a bumper crop and then they learned that the mills couldn't handle it. The new wheat produced a fluffy meal that floated in the air and just wouldn't pass through the mill.

Today, the geneticists use small specially built mills that duplicate in miniature all the grinding and sifting processes through which wheat must pass in a huge commercial mill. Each of the big regional laboratories, too, has its own baking department. A wheat that looks good in the experimental growing fields is taken into the lab and, if it passes all the tests for milling qualities, it takes a final examination on its baking qualities. Its flour

(Continued to page 230)

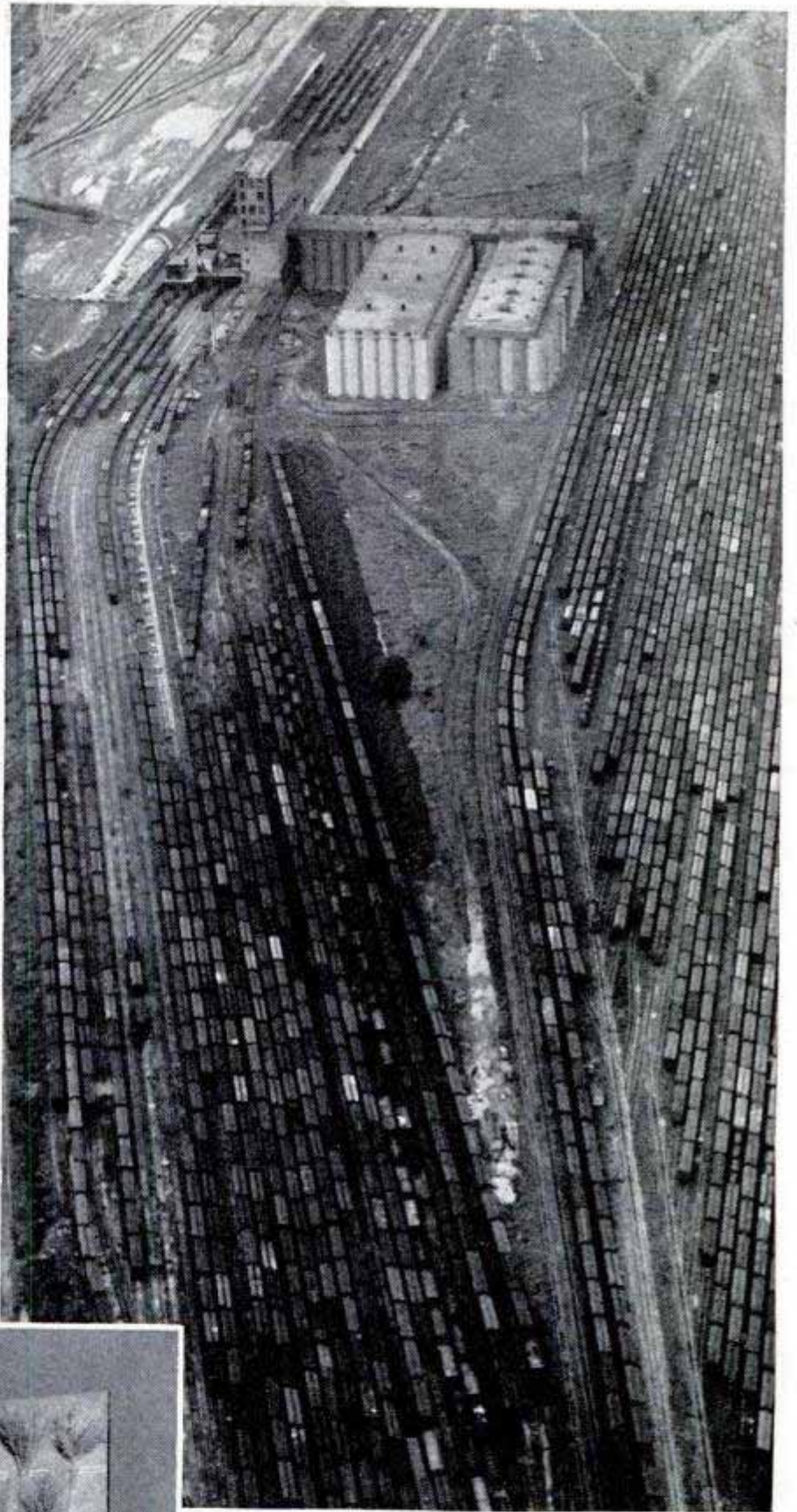

Hundreds of wheat-laden freight cars fill sidings at the 10-million-bushel Santa Fe elevator in Kansas City as the golden harvest rolls to the market



Left, there are about 200 different varieties of wheat raised in the United States. Samples shown here are types that have proved best in Northwest



Power Pack Built Into Reflector Of Electronic Photoflash Unit

Eliminating the separate power pack and bothersome connecting cables, a new electronic photoflash unit has its power supply built into the reflector. The unit uses a hollow-type flash tube that fits over a built-in modeling lamp. The flash is the equivalent of a No. 5 bulb. A photoelectric cell on the reflector sets off the flash when it is used as a slave light.

Lever Tool Eases Wheel on Car

Almost every phase of tire changing is made easier by a handy lever tool. First it pries off the hub cap; then, acting as a lever, it lowers the wheel off the car; finally, it provides leverage to ease the spare tire onto the hub. In addition, the aluminum tool can be used to remove the casing from the wheel.

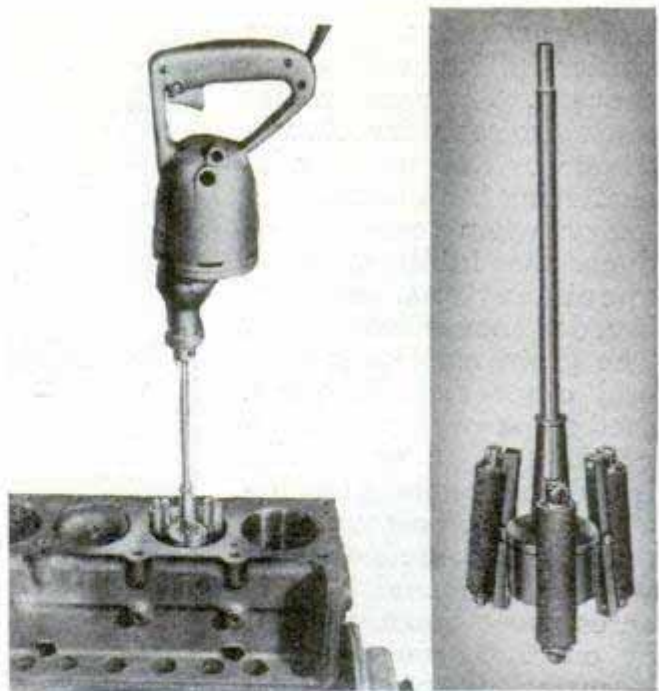

Power Tool Deglazes Cylinders

Cylinder walls are deglazed safely and quickly by a self-adjusting tool that has no springs or gears to wear out. It will not grab or bind and it adjusts itself to the bore automatically. Cloth abrasive material is used on the blades. The deglazer can be used with any clockwise electric drill.

Hand Gun Sprays Metal Powders

Metallic or plastic powders are heated to a liquidizing temperature and sprayed in a continuous film by a laboratory-size spray pistol. A controlled flame provides the necessary heat. When it has cooled, the film adheres tightly to the surface. Nonporous films of plastic can be sprayed with the pistol to prevent corrosion. It can also be used to heat, solder or braze.

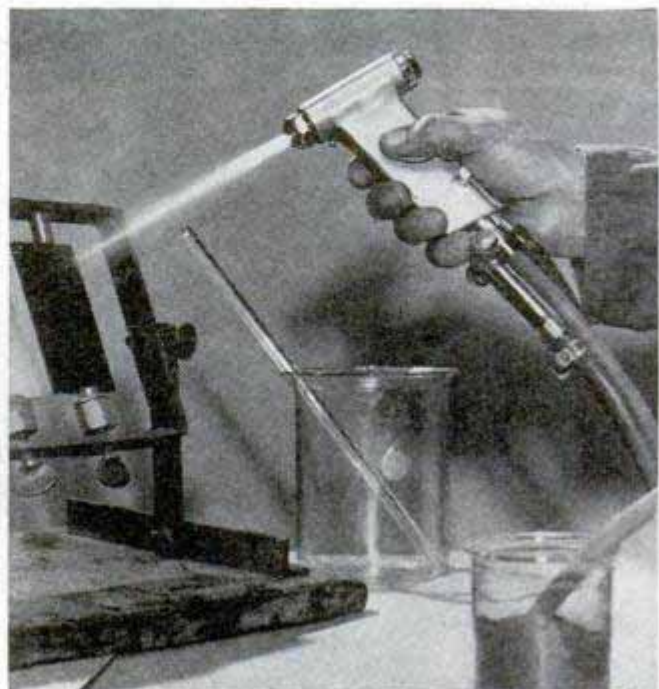



Sower Spreads Grass Seed Evenly

Squeezing the handle of a new lawn seeder sprays grass seed across the ground in a uniform pattern. The hopper of the tool holds about a pound of seed. The user holds the tool in front of him and squeezes the handle as each foot touches the ground. Seed passes through a hole in the bottom of the hopper and is ejected by small whirling rods. The tool leaves a swath of seed about three feet wide.

Plug Repairs Worn Sockets →

Anyone can repair a worn electric socket without tampering with the wires by pushing a new plug-type connector into place. The device locks permanently inside the socket and provides a tight fit for all standard electric plugs. It then replaces the worn outlet and eliminates the bothersome loose connection.

Single Rinse Cleans Paintbrush

Cleaning brushes after you finish painting is a quick operation with a new liquid cleaner that is so effective you can switch from black to white paint without streaking. You merely immerse the brush in the liquid, agitate it for a few seconds and wipe off the excess. The brush is completely clean and ready for new paint or to be put away. Safe for use with brushes having either hair or nylon bristles, the cleaner keeps the bristles soft and pliant.



Wrist Camera Is Quick-Loading

Small enough to be worn like a wrist watch, a new miniature camera is magazine-loaded to enable you to switch quickly from black and white to color film in the middle of a roll without wasting a picture. The rotary shutter has only one speed, $\frac{1}{50}$ second, and there are three aperture settings, f: 6.3, f: 8 and f: 16. The 16-mm. film is bought in a 14-exposure magazine and the purchase price includes the cost of factory processing for either black and white or color film. The camera has an eye-level view finder fitted with a ground lens.



Architect in Sugar

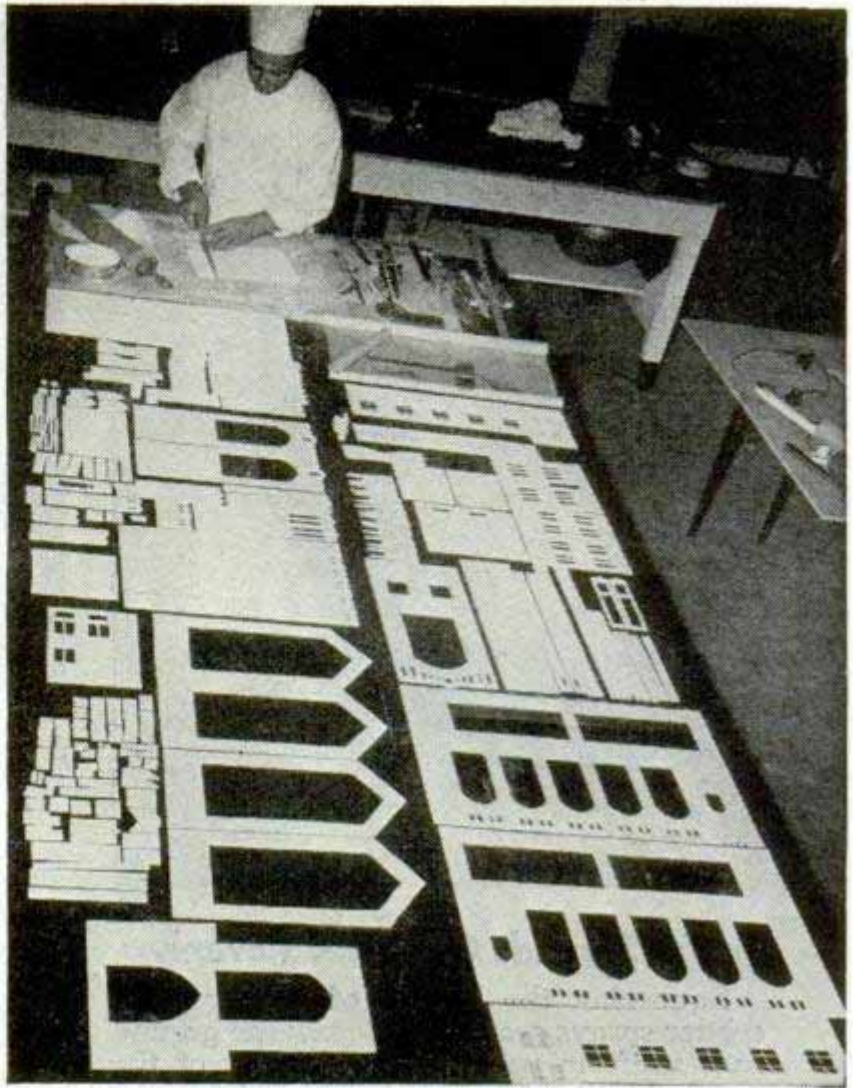
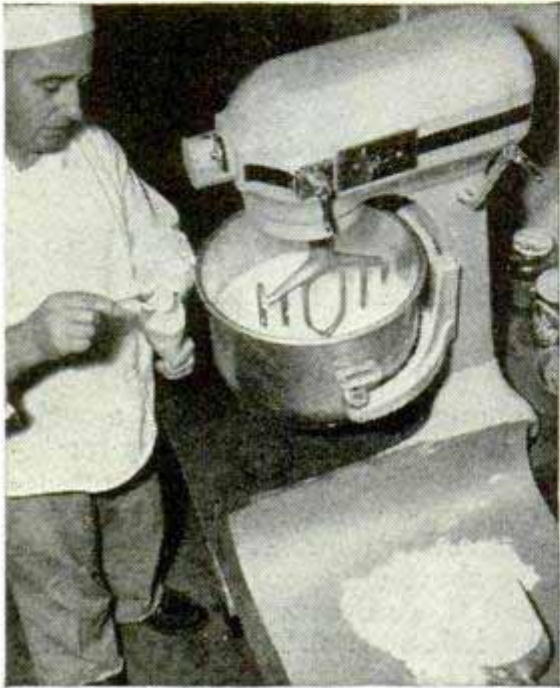

SUGAR and egg whites are the building materials used by a Chicago baker who specializes in scale models you can eat if you wish. He recently "built" a four-foot model of a Chicago church, complete with "stained glass" windows. More than 300 pieces were used in the construction, a task that took 184 hours. The model is self-supporting, there being no internal braces or frames. Four electric lights within the church illuminate the interior and bring out the colors of the many translucent windows. For amateur builders who are tempted to try their skill, here's the recipe: 25 egg whites, 10 pounds of sugar, the juice of two lemons and peppermint flavoring. Five times this amount was needed for the church. John J. Zenker, who teaches cake decorating in his own school, was the "contractor" in charge of design and construction. The church is only one of many sugar models Zenker has produced. Others include the Eiffel Tower, the Lin Yutang Fountain and a model of Chicago's State Street, complete from department stores to lampposts.

Left, mixing the recipe would be a tiring job by hand, but this power mixer does it thoroughly and quickly. Mixture is then kneaded, rolled flat and cut to shape. Right, the 324 separate pieces for the church are laid out on table to dry

Below, the model windows, stained with vegetable coloring, are decorated by hand to resemble those in the real church

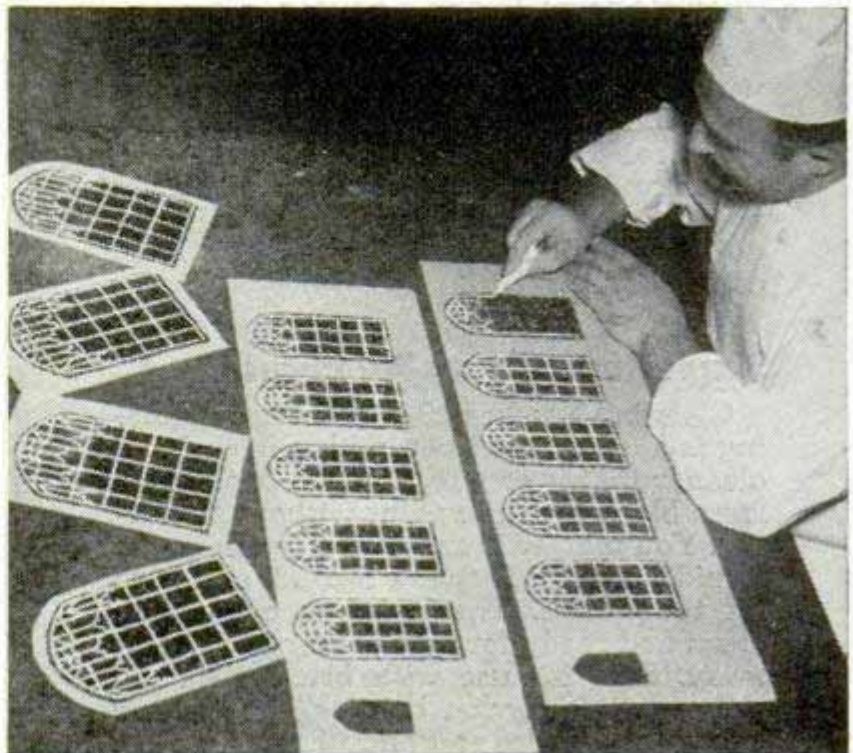

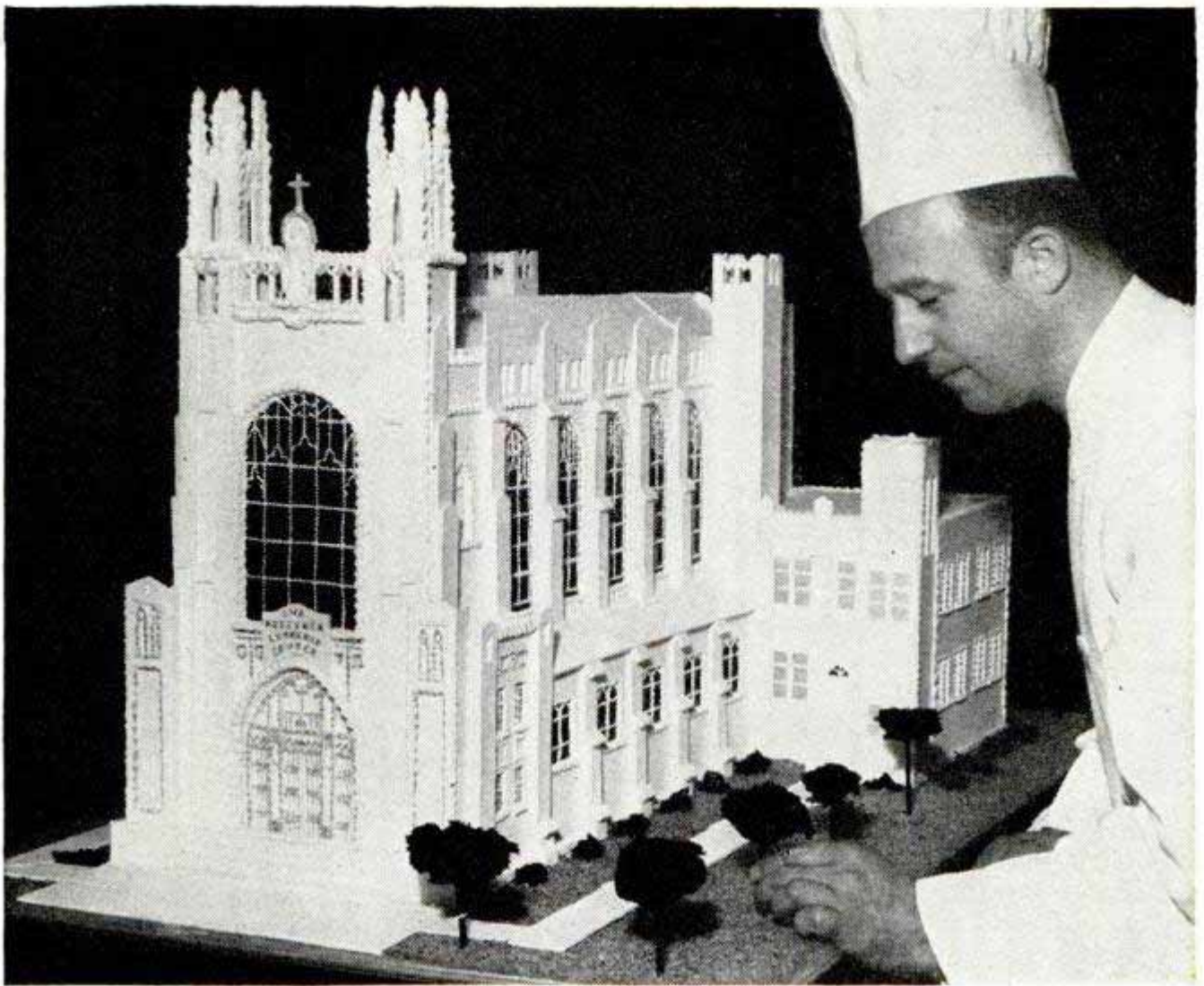

Zenker places the artificial shrubbery in place around the completed sugar church. Below, a wall section is moved into place. Royal icing is used as the glue. String around top of model is removed when icing hardens

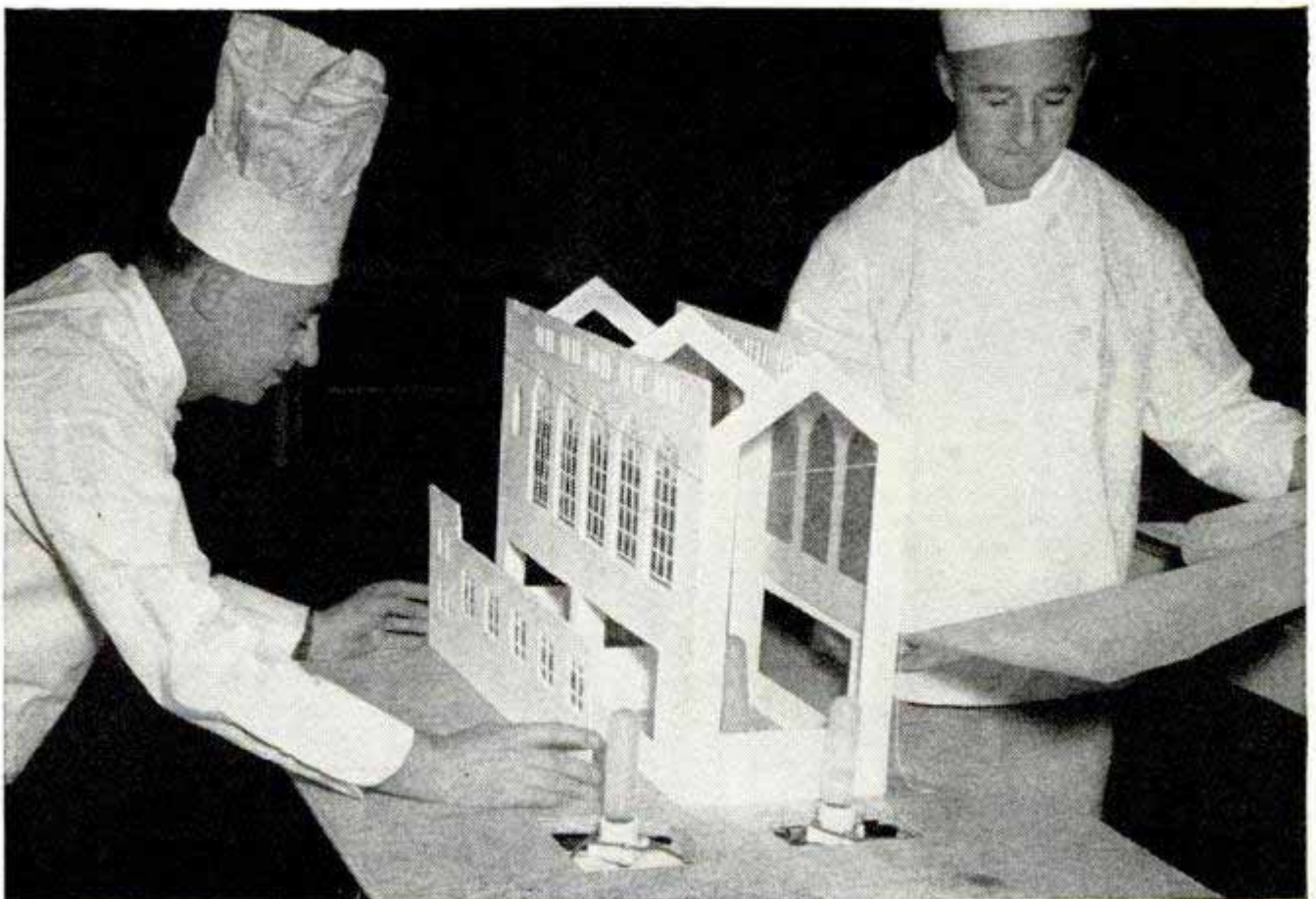



Seat "Toppers" of Rubber

For more comfortable riding, a foam-rubber cushion now can be installed on the car seat by the motorist himself. The seat "toppers" are one inch thick and are available in two sizes, 20 by 52 inches and 20 by 56 inches, to fit seats of any car model from 1915 to 1949. They are installed quickly by removing the outer seat cover, placing the foam cushion on the seat and then replacing the cover.

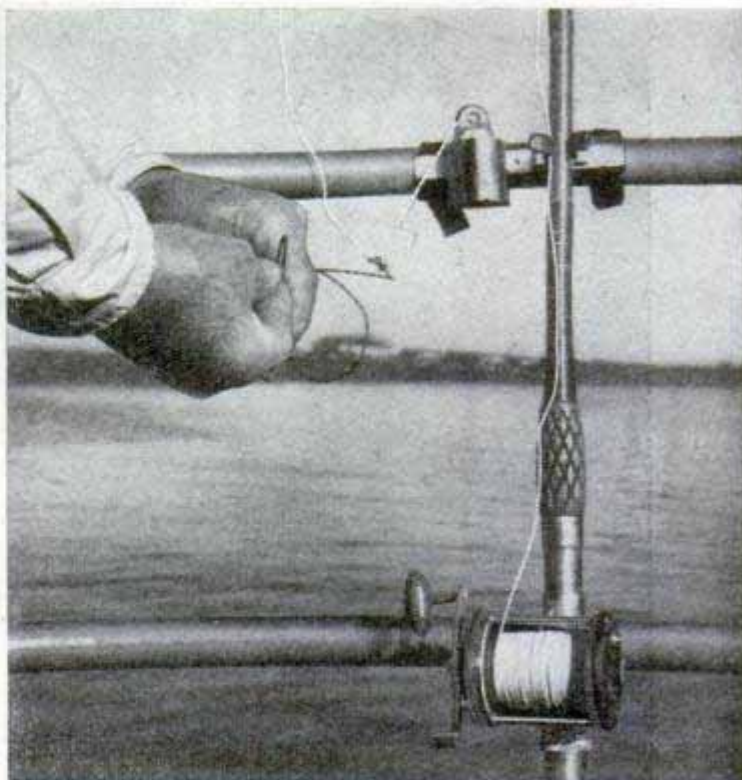

Clamp Holds Fish Rod for Baiting

Fishing rods are held securely in an upright position by a clamp that fastens to the gunwale or rail of a boat. The holder is designed to keep rods out from underfoot while they are not in use or while the line is being baited. It consists of a spring clip to grip the rod and a cup which holds the sinker, preventing the line from being tangled. The holder, made of stainless steel, is available in two models, one with a spring clip for fastening it to a gunwale and the other with straps which hold it on a rail.



Shoe-Repair Bar

Customers needing minor shoe repairs now can wait for on-the-spot work while seated at a bar similar to a lunch counter. Openings in the base of the bar permit the repairman to remove the customer's shoes and replace them after new heels have been installed or minor repairs made. The shoe-repair work is done on a compact machine unit at the rear of the bar.

Popular Mechanics provides two sources of further information concerning the articles published in each issue: the WHERE-TO-BUY-IT INDEX, starting on page 10, and the WHERE-TO-FIND-IT INDEX, which may be obtained without charge by writing Bureau of Information, Popular Mechanics Magazine, 200 E. Ontario St., Chicago, 11

Forecasters for the air waves

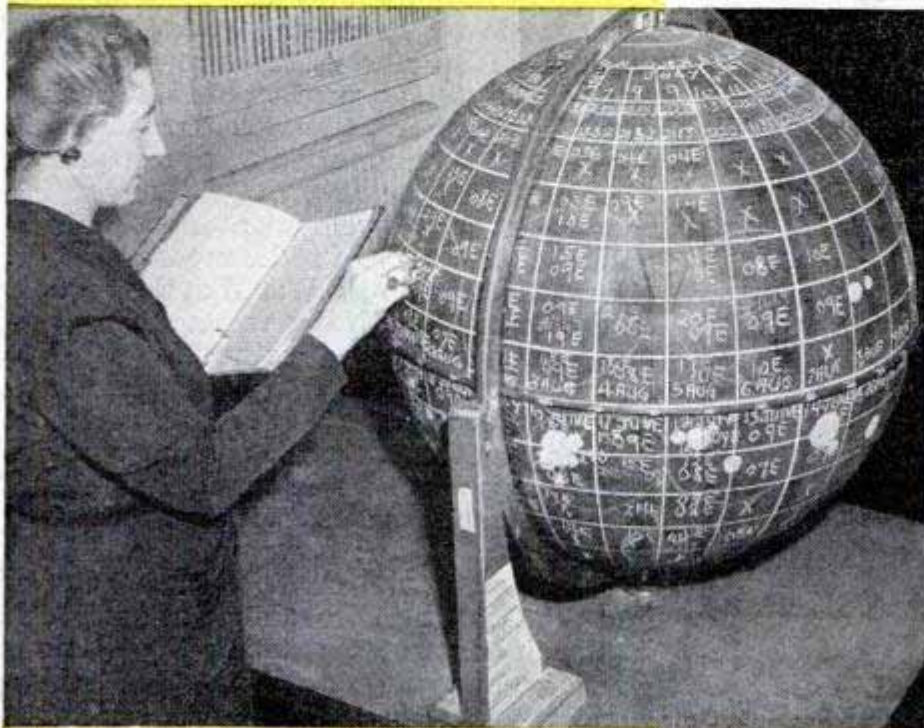

National Bureau of Standards photos

Code marks, plotted on this globe, permit forecasters to see the pattern of radio reception everywhere in world three months in advance. Below, ionospheric stations can be found from the Harvard campus to Pacific atolls. This one is on the island of Maui in the Hawaiians

THE ANNOUNCER

on the radio program beamed at Russia said: "This is the 'Voice of America,' speaking to you from New York and bringing you a news program. Meanwhile, may we remind you that this station is on the 11-13-16-meter band. Our next regular program to your area will be on the 19-21-23-meter band. . . ."

Why the change in frequency? Why require the farmers around Stalingrad or the factory workers in Moscow, tuned to the American news program, to change the setting of their radio dials? Wouldn't some of the listeners be lost in the process? Wouldn't this be a blow to our efforts to bring the truth to the Russian people?

Well—better to lose a few listeners than to have no listeners at all.

And therein lies the story of the Radio Propagation Laboratory, maintained by the National Bureau of Standards in



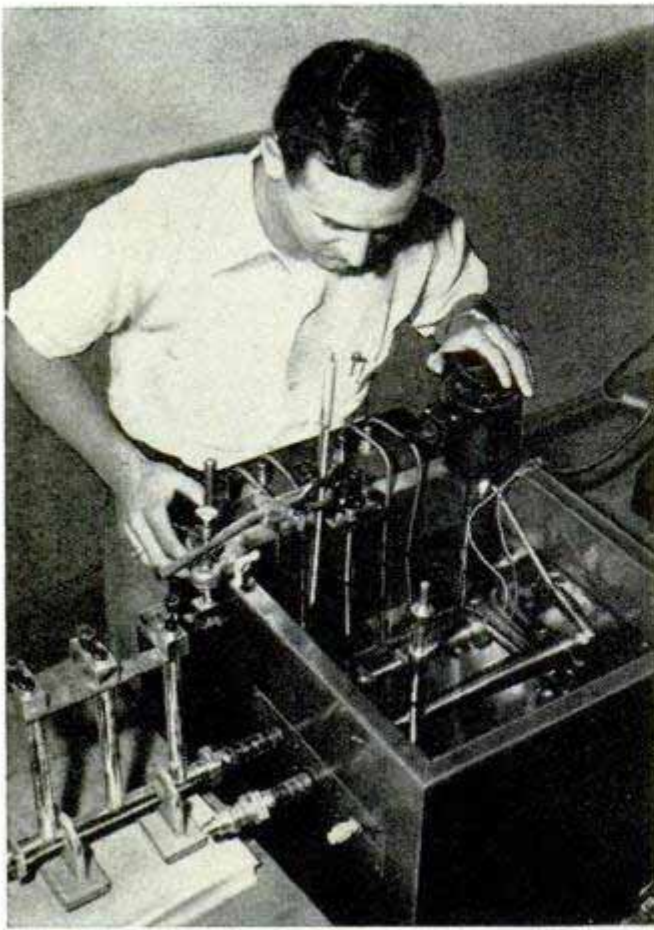

Instrument for measuring microwave frequencies is kept in constant-temperature oil bath. Below, ionospheric recorder notes radio-wave characteristics

Washington, D. C., which is making possible better short-wave radio communication with all parts of the world.

This unusual laboratory can predict three months in advance what the short-wave radio communications over any 2500-mile path anywhere in the world will be like any hour of the day. Its 300-man staff on the Bureau of Standard's campuslike setting at the nation's capital also does much basic research—theoretical and experimental studies of maximum usable frequencies, the absorption of radio signals in the atmosphere, the variations of radio propagation characteristics, the effects of the sun, weather and magnetism of the earth and the development and maintenance of standards of radio measurements.

Organized in World War II at the request of the Army and Navy when radio communication had to be maintained all over the globe, the Radio Propagation Laboratory now is making its services available to such peacetime agencies as the Weather Bureau, the State Department, the Federal Communications Commission, the Civil Aeronautics Administration, the Forest Service Radio Laboratory, the Coast Guard and the Coast and Geodetic Survey.

Also, it has proven valuable to such non-government groups as airlines, steamship companies, television and radio schools,

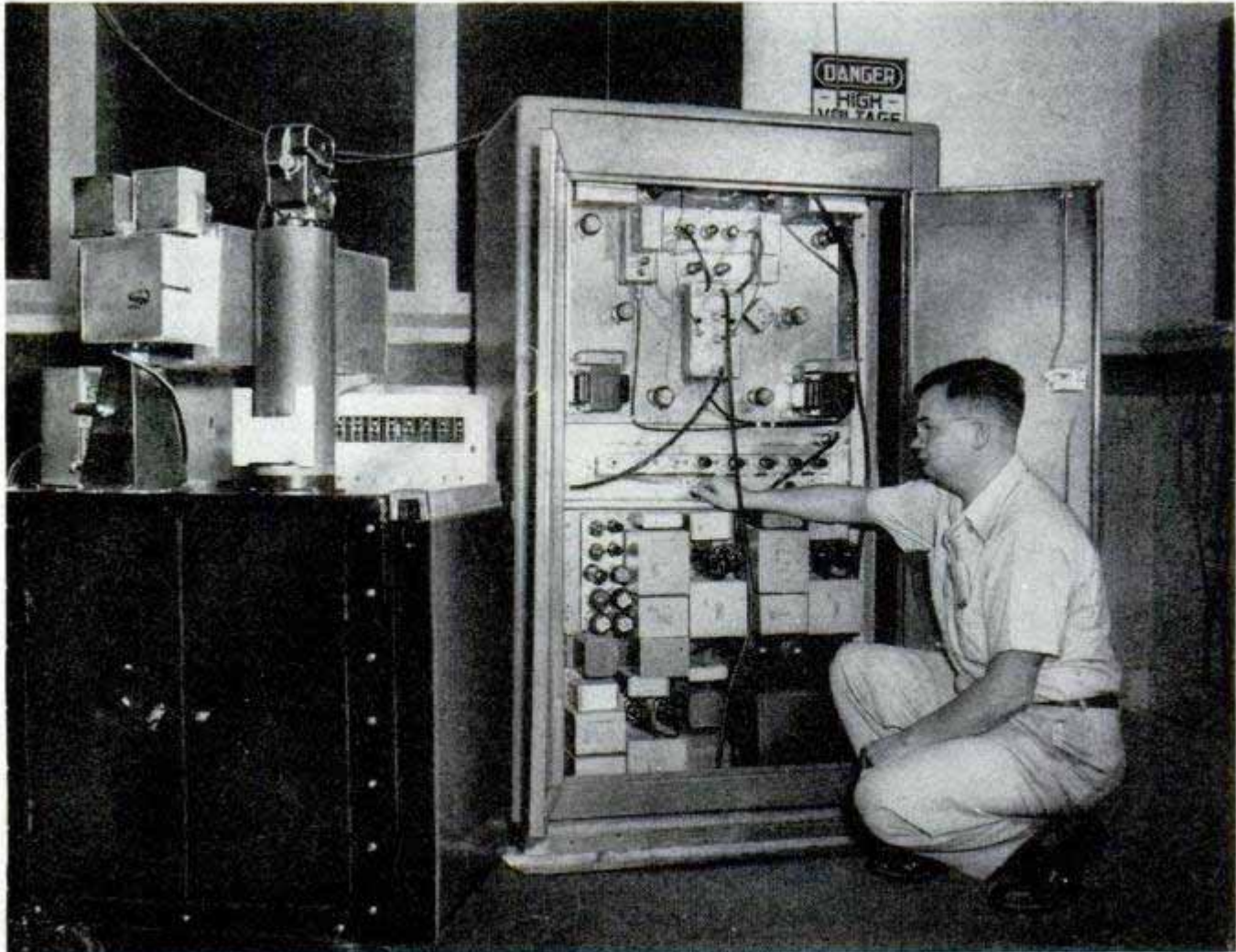

college and university research laboratories, radio and telegraph companies, navigation-instrument manufacturers and geographical exploration outfits.

And last, but not least, the Radio Propagation Laboratory is enabling a number of the more enthusiastic radio "hams" to increase their distribution of "CQ" cards.

As far back as 1902, scientists began to realize that long-distance radio transmission is made possible by the ionosphere. This consists of a series of layers in the atmosphere 50 to 250 miles above the earth. Radio waves are reflected from these layers back to earth again like light flashing between a series of mirrors or a rubber ball bouncing back and forth between the floor and ceiling of a long, low tunnel. The ionosphere is electrically conducting because its gas molecules have been "ionized" (given an electric charge) by ultra-violet light from the sun.

The more they studied the ionosphere, the more scientists found it to be a complicated phenomenon. During daylight hours, for example, it is separated into three layers. These are the E layer, the F1 layer and the F2 layer—existing at heights of 60, 120 and 180 miles above the earth. Below the E layer is a D layer which absorbs low-frequency radio waves. At night the picture isn't quite so involved. The entire ionosphere merges into a single F1 layer.

Furthermore, the ionosphere is about as unstable as the weather. Its characteristics change with geographical location. They are affected by seasons of the year. They are altered when sunspots flare up. Sometimes changes occur suddenly and mysteriously for no apparent reason.

Although some preliminary work was done in the 1930s, scientists didn't really buckle down and apply this ionospheric knowledge to practical short-wave radio problems until World War II. They

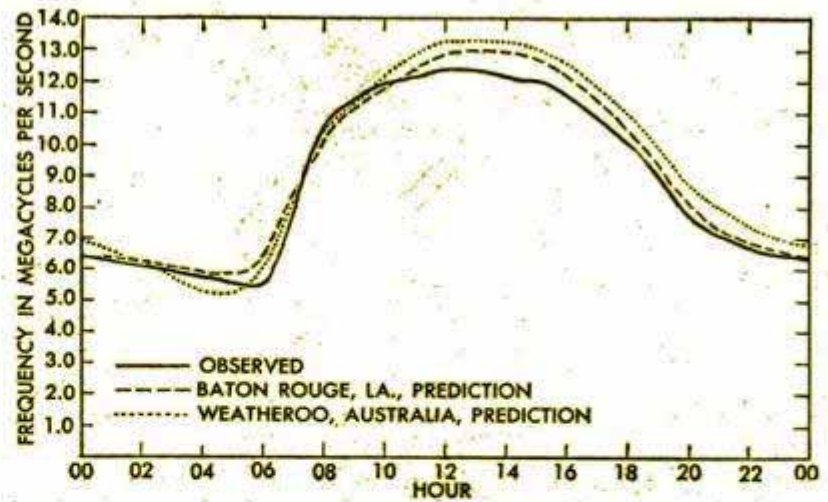

Graph shows curious fact that radio waves behave about the same at Weatheroo, Australia, and Baton Rouge, La. Note how close the predictions were to observed behavior of waves on this particular day

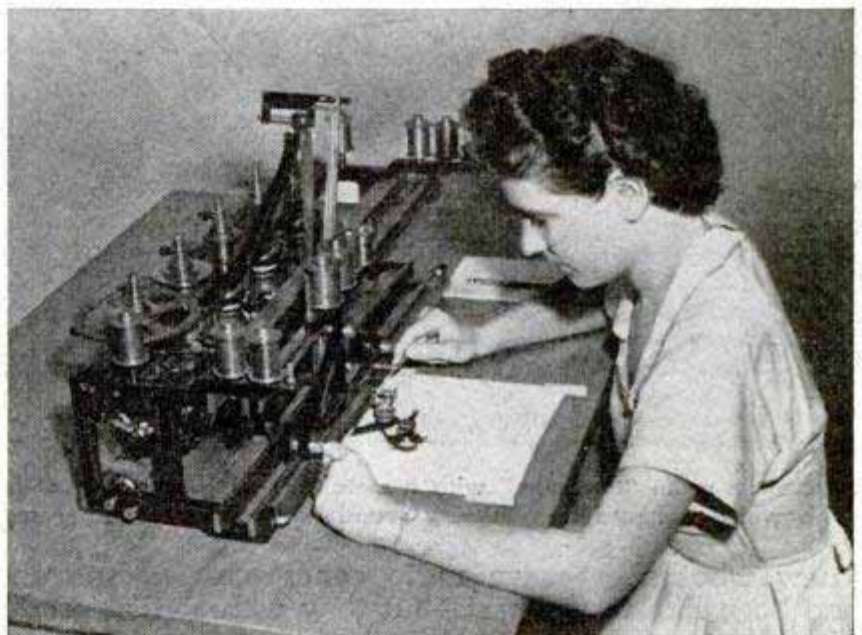

Instrument plots in curves the seasonal and daily variations in the reflection of radio waves from the ionosphere. Such information shows radio engineers how well their broadcasts will be received. Below, here are the locations of the ionospheric stations around the world

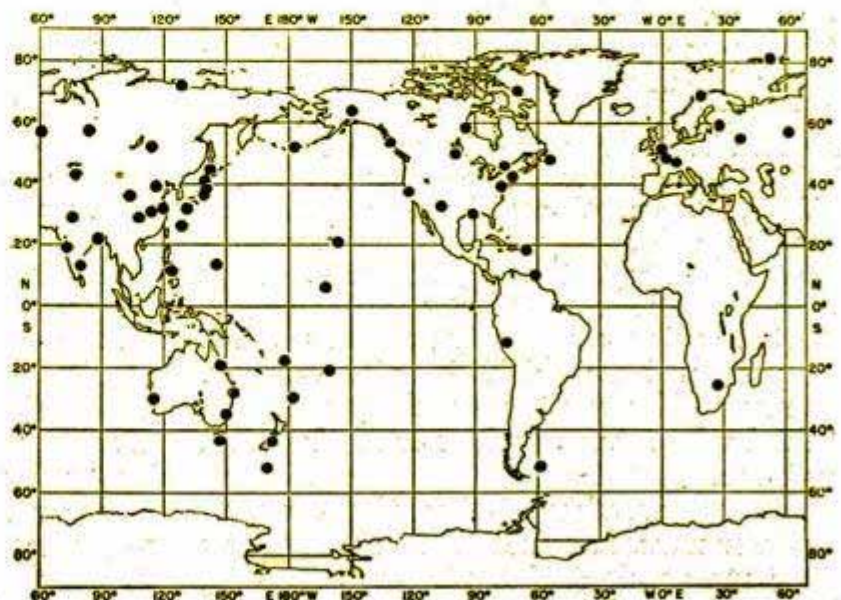

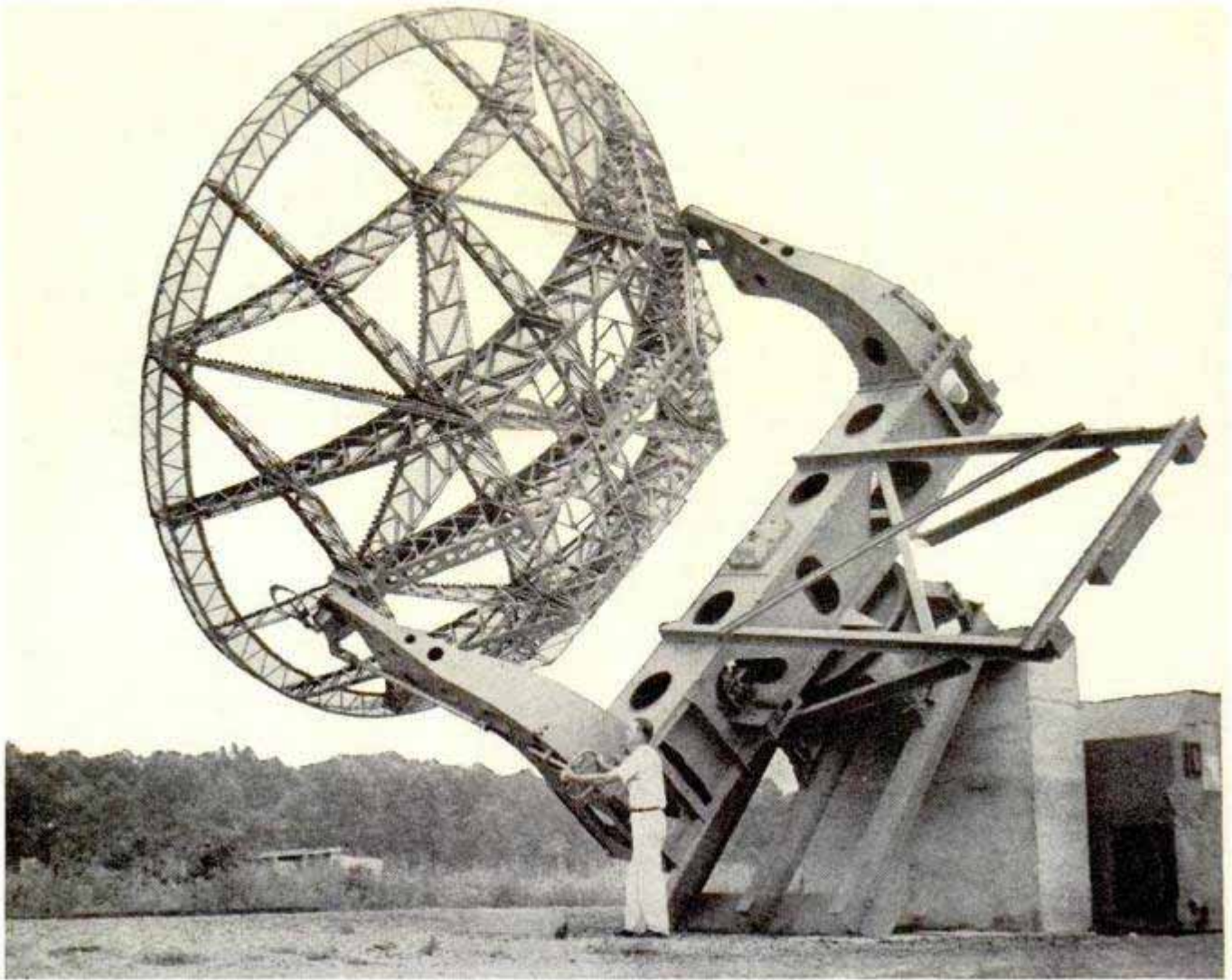

Twelve-ton radio "telescope" with a metal-mesh reflector 25 feet in diameter intercepts and records solar noise which is heard as a hissing sound and interferes with reception. This reflector is at Sterling, Va.

knew what short-wave radio conditions had been like in the past—but they were woefully weak in their ability to forecast the future.

Today, the Radio Propagation Laboratory in Washington, D. C., is the center of a worldwide network of 60 ionospheric stations which feed in valuable information each day. Sixteen domestic and overseas stations are operated directly or under contract with the Bureau of Standards. The others are maintained by foreign governments, universities or private concerns.

What is an ionospheric station?

Well, it's something like a weather station. It may be located on a coral beach at Palmyra Island in the South Pacific, it may be buried under snowdrifts at Fairbanks, Alaska, or it may be situated on a quiet part of the Harvard University campus. It's manned by two to six technicians, with a chief who is usually a trained electrical engineer.

Unlike a weather station, there are no thermometers, barometers, rain gauges or other meteorological equipment. Instead, the principal equipment is a high-powered

radio transmitter and a radarlike receiver that produces a "pip" on the screen of an oscilloscope.

The transmitter is a "pulse" machine that automatically sends a series of high-frequency radio signals into the air. They travel upward until they reach the ionosphere layers and then are reflected downward to be recorded by the receiving part of the equipment. This can be done visually by the operator or recorded by 35-mm. motion-picture cameras. The two critical factors to be measured are the time of the bounce-back, which determines height, and the frequency of the waves which are reflected. If the frequency is too high, they will go right on through like minnows escaping a tuna net.

It's a curious fact, but somewhat similar results have been found for areas on opposite sides of the world. Two stations, Weatheroo, Australia, and Baton Rouge, La., for example, will show almost identical communications conditions for corresponding seasons of the year. This proves helpful in filling in some of the "blind spots" of the

(Continued to page 248)



Plymouth Combination Station Wagon and Utility Vehicle

With a sort of resigned defeat, suburbanites for years have made the family buggy double as a combination limousine, pickup truck, station wagon and traveling nursery. The resultant tears, gouges and stains from garden tools, oilcans and grocery baskets haven't helped make the "doubling in brass" too successful. Now Plymouth has brought out its Suburban to help solve the forgotten Main Streeter's car problem. The sporty looking utility vehicle of all-metal construction is a slick five-passenger family car on a 111-inch wheelbase—designed to get by at the swankiest country club. But when it's time to go marketing, the rear seat pivots into a foot well in the floor. Folded forward, the seat forms a bulkhead at the head of a huge cargo-carrying space about 5½ feet deep. The back of the seat becomes part of

the floor. By opening the tailgate, the area is increased to seven feet, five inches. Seat and upholstery face away from the compartment, and thus are protected from gouging or chafing. The ever-annoying spare tire is out of the way in a floor well, so stowage space is clear. The Suburban features rear side pockets for small parcels, strong, washable vinyl fabric for upholstery, 18-inch wheels (optional) for greater clearance in backwoods driving. It has the same 97-horsepower engine featured in the deluxe line. Plymouth expects a long, eager look from salesmen with cartons of samples to lug around; surveyors, construction workers and photographers laden with gear; hunters, fishermen and skiers; not to mention the long overwhelmed commuters with their multiple problems.

Dodge Roadster Has Canvas Hand-Operated Top

Dodge's new "economy" roadster has a canvas top which is put up by hand and plastic side windows framed in aluminum which are stored behind the seat when not in use. The top can be put up by the driver

without leaving his seat; all he has to do is reach back with one hand and pull the top into position. The roadster is powered by the same engine used in other models and has Fluid Drive and Super-Cushion tires. This three-passenger open car recalls the many roadsters built in the 1920s. Roadster production dropped from 322,502 in 1920 to 1134 in 1937. Dodge built its last roadster in 1932. The Wayfarer roadster is designed as a car for young people or as a second car in two-car families. Width of the single seat is 58 inches. The special axle gear ratio is 3.73 to 1.



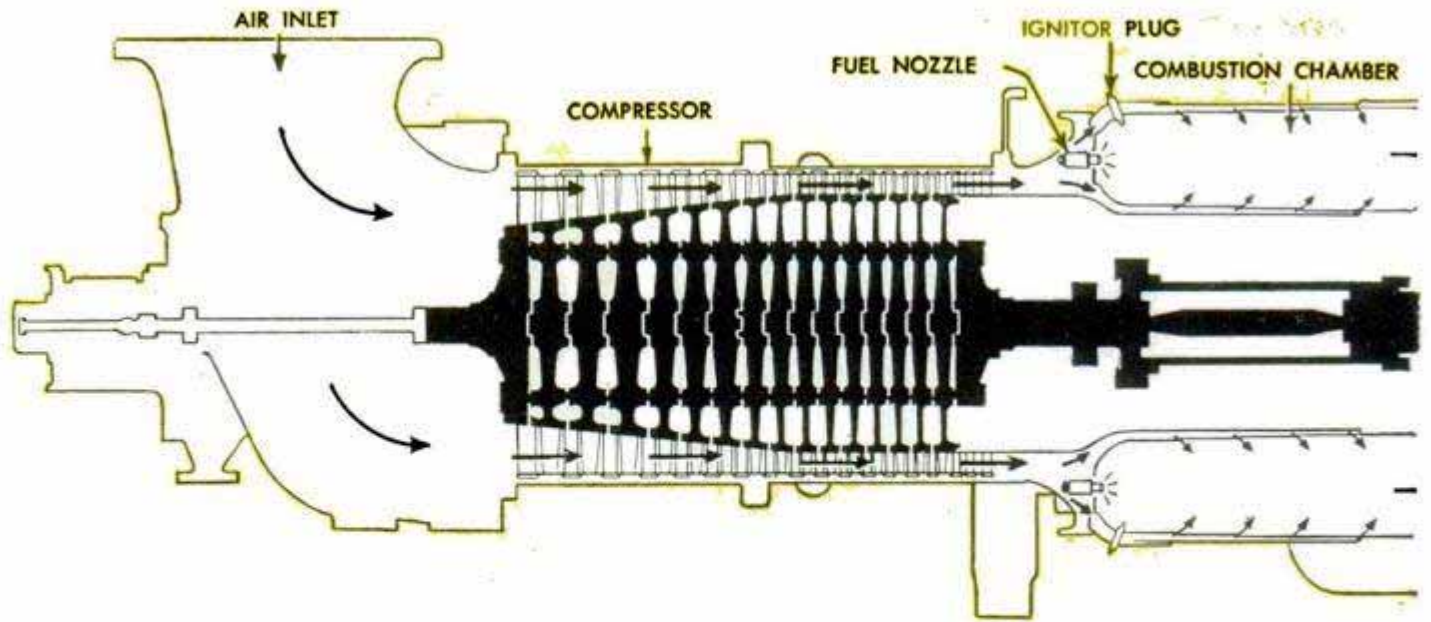

AFTER years of research and months of road tests, a 4500-horsepower gas turbine-electric locomotive is making its bow this month on a freight run. The locomotive, developed by the American Locomotive Company and General Electric, is being put into service by the Union Pacific Railroad. The locomotive gas turbine differs from the aircraft jet engine in that the gases it produces are harnessed within the power plant and the resultant power is transmitted electrically to drive the wheels. The aircraft engine provides forward thrust from the exhaust stream. The new locomotive's compressor, combustion chamber and turbine are of in-line construction. Air is drawn through a compressor into several combustion chambers. Fuel is injected and the mixture burns, raising the temperature of the compressed air. The gases expand and move at great velocity against the turbine blades, turning the shaft. The shaft drives both the power-plant compressor and the generator. Power from the genera-

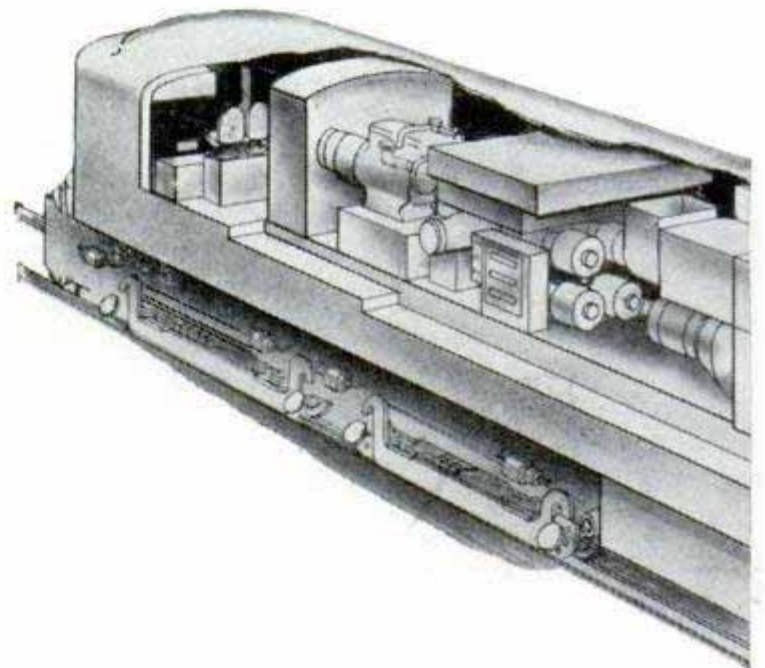

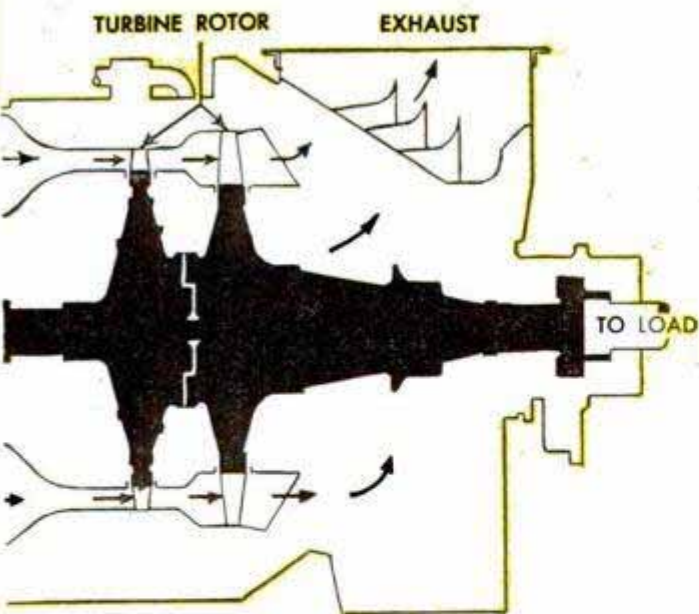

GAS-TURBINE LOCOMOTIVE

**A new trail in railroading
is being blazed by Union
Pacific's revolutionary
4500-hp. 'gas' locomotive**

tor is supplied to eight traction motors, each of which drives an axle. The locomotive is of single-cab construction with an operating station at each end. It develops 53 horsepower per foot of length, weighs 500,000 pounds and is 83 feet 7½ inches

long, 14 feet 3½ inches high and 10 feet 7 inches wide. Geared for 79 miles per hour, the locomotive carries enough fuel for 12 hours. It is fired with oil. Research is continuing on the possibility of burning coal in an engine of this type.

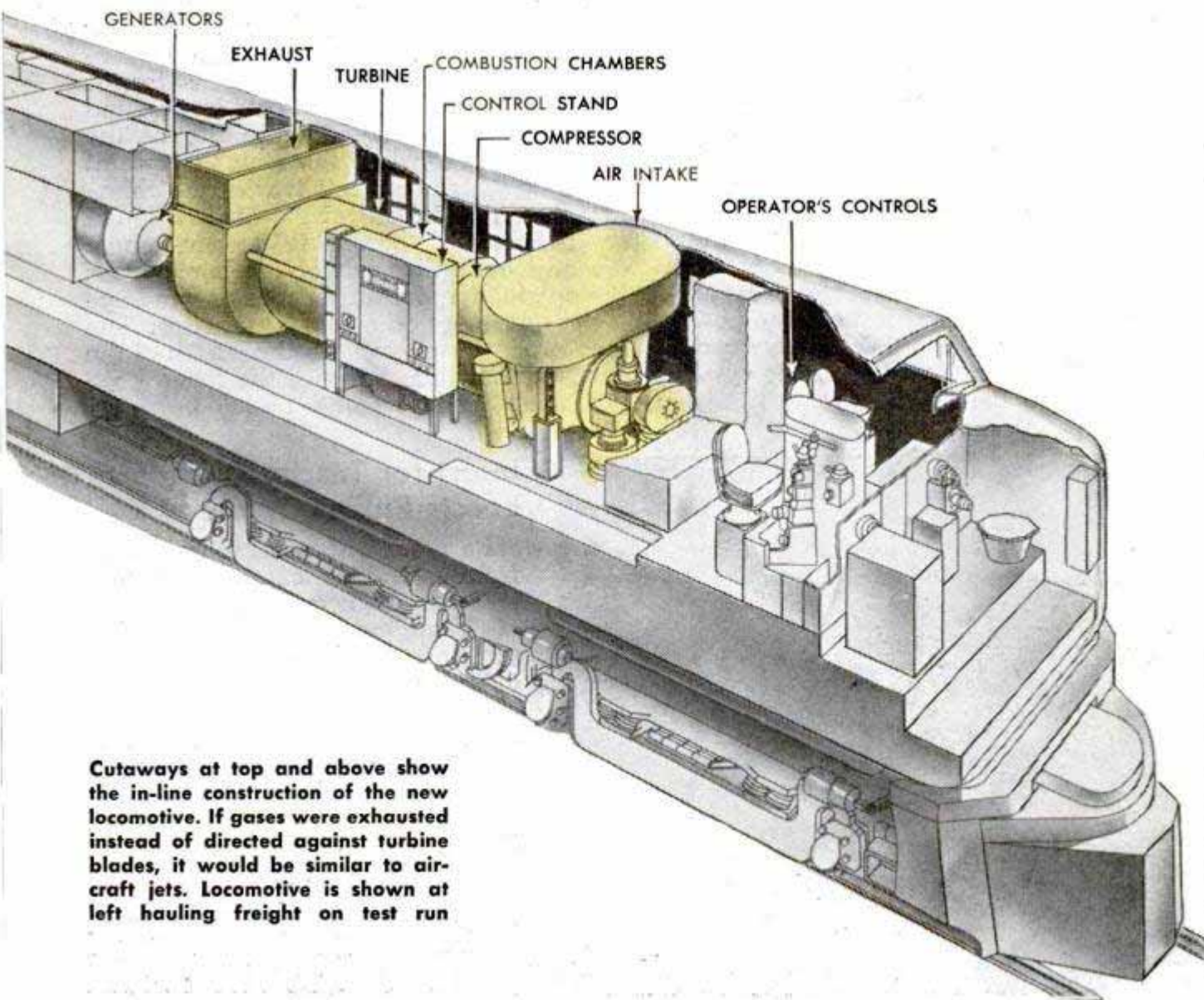

Cutaways at top and above show the in-line construction of the new locomotive. If gases were exhausted instead of directed against turbine blades, it would be similar to aircraft jets. Locomotive is shown at left hauling freight on test run



Fort Worth Policemen Speak in a Loud Voice

Motorcycle policemen in Fort Worth, Tex., don't have to shout to make themselves heard over the noise of traffic. Instead, they talk into a hand microphone and a 15-watt public-address system, operated from the motorcycle's battery, booms their words out clearly. The amplifier, a two-tube circuit, uses the power supply of the motorcycle's two-way radio. The directional loudspeaker of the system is mounted on the handlebars.

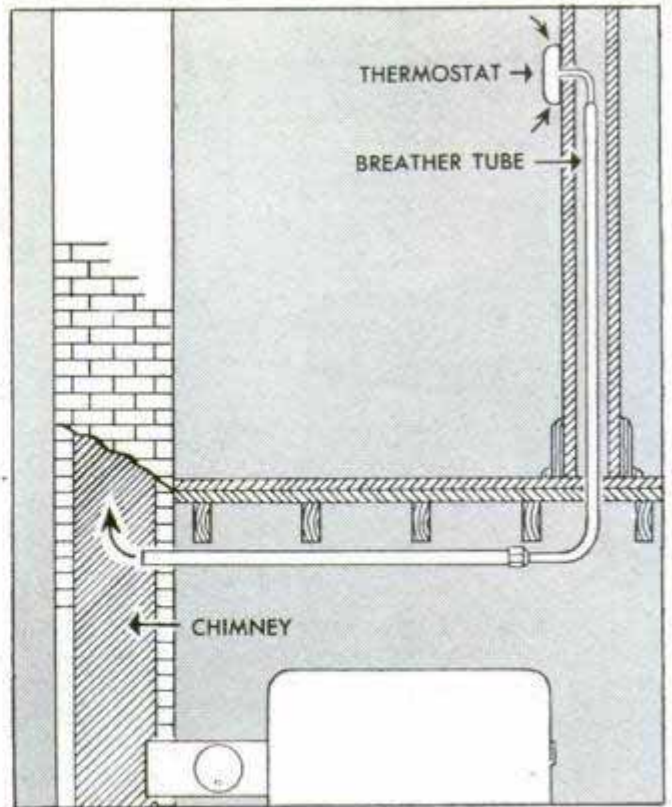

Thermostat "Breathes" Air Sample Through Draft in Chimney

Greater fuel economy for oil, stoker or gas furnaces is promised with a new thermostat that automatically compensates for warm, cold or windy weather. Fewer and larger fuel runs add to the life of the burner. The heart of the new thermostat is a tube which connects it with the chimney flue. The tube draws a draft through the thermostat, "breathing" an air sample directly over the control mechanism. As the outside temperature drops or wind velocity increases, the draft increases. The amount of draft regulates the length of the "on" period, thus keeping the firing proportionate to the weather demand.

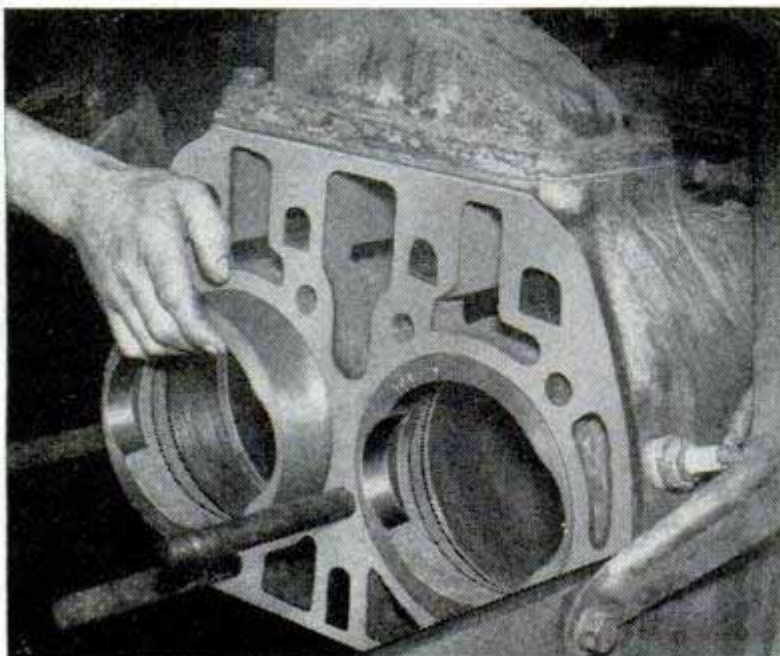

Insert for Tractor Cylinders Boosts Pulling Power

Farmers who want more power from a tractor can convert the motor to high compression without changing any of the parts. Inserts are placed in the top of the cylinder, cutting down the space in the combustion chamber to produce the higher compression. The inserts increase the pulling power of the tractor about a gear. They are available for several models of John Deere, Allis Chalmers and Farmall tractors.

☐ In 1948, a record-breaking 15½-billion dollars' worth of minerals was mined in the United States.

This Clothesline Works Every Day

Your clothesline will become a beautiful addition to your back-yard pleasure if you install a combination sunshade-clothes drier that is useful seven days a week. On wash days, you have 200 feet of plastic-coated line to hold the laundry. The rest of the week, the line supports a canvas awning that provides 125 square feet of shade for outdoor eating and lounging. The end supports can be raised, lowered and tilted to give maximum shade or, if desired, can be turned vertically to support a badminton or volley-ball net. Hanging clothes is a no-stretch operation because you can crank the line down to a convenient height and then raise it to a height of seven feet for fast drying.

Top, six days a week you relax beneath this huge awning which, come Monday, right, slips back to uncover a roomy clothesline

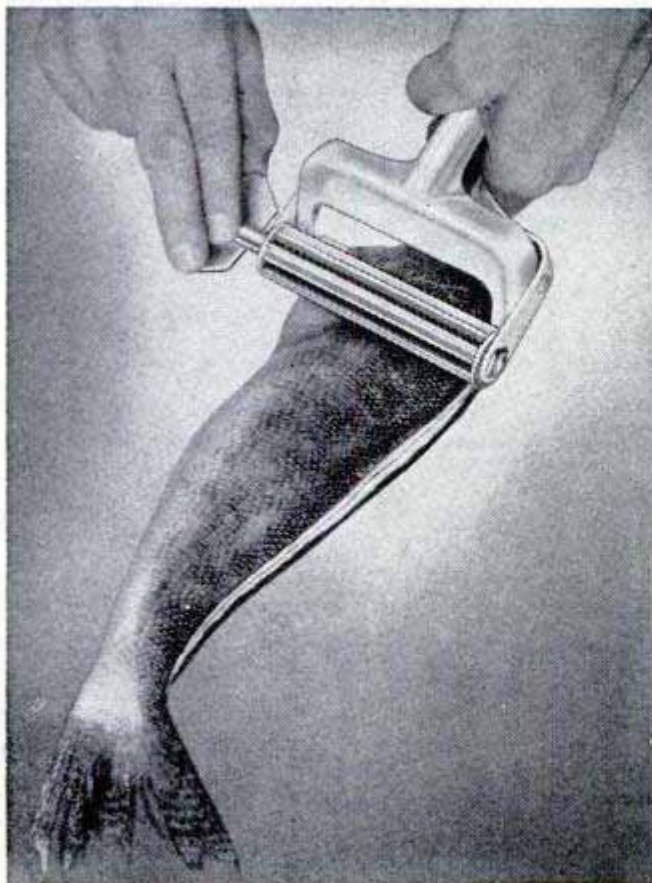

Fish Skinner

By simply turning the handle of a new kitchen aid the fisherman can skin his catch, peeling off the scales at the same time. The device is patterned after commercial meat skinners. It operates without throwing scales or tearing the flesh. The fisherman prepares the fish by cutting the skin down the belly and the back and removing the fins and head. Then the edge of the skin is pinched into the skinner. Turning the handle separates the skin from the flesh and feeds it back through an opening with the scales still attached.

Drug Protects African Cattle Against Fly-Carried Disease

Use of a new drug that cures and protects cattle against all forms of a tsetse-fly-carried disease is expected to open 4,500,000 square miles of tropical Africa to stock raising. Named Antrycide by its British discoverers, the white crystalline powder will cure the two worst forms of the disease in one treatment.



Dual Wheels on Tractor Aid Traction in Wet Soil

Tractors often bog down in the soggy, rice-growing land in Texas, but one farmer, near Port Arthur, solved the problem by mounting a pair of steel-lug wheels on the outside of his tractor's regular wheels. The rubber tires keep the tractor from sinking into the soft soil and the long lugs of the steel wheels provide traction even when rolling through water. To remove the oversize steel wheels, the farmer drives his tractor next to the edge of a furrow in the field before loosening the four bolts that hold the wheels in place.

Flower Stakes Of Heavy Wire

Flower gardeners can improve the appearance of their plots and also protect the slender stems of large blossoms with an inconspicuous plant stake that holds the flower upright, yet allows it to turn with the sun. One model has a telescoping feature which adjusts to the height of the growing plant. Made of heavy woven wire, the stakes are flexible enough to sway gently with the wind. The wire loop that is pushed into the earth does not interfere with root growth. A support for peony plants has four stakes which hold a horizontal wire grille. All models of the stakes have an ingenious wire lock that can

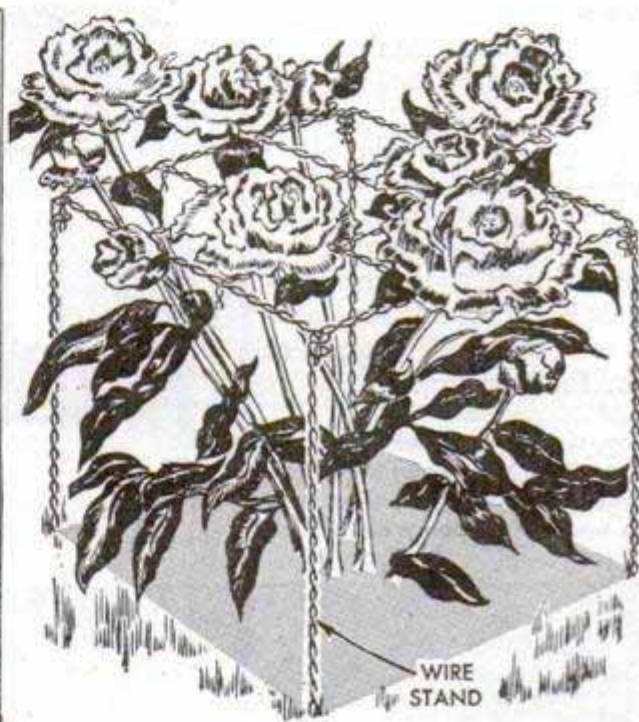
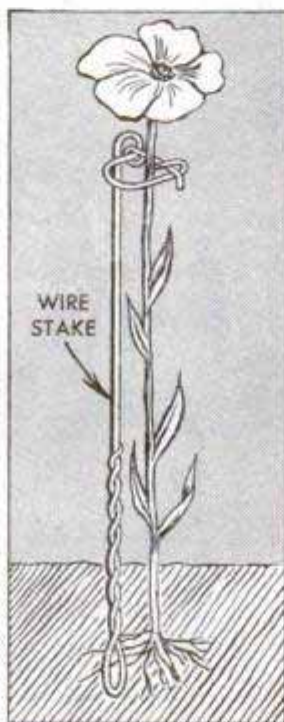

be removed at any time without damaging the plant. For use with house plants, there is a model only one foot long.

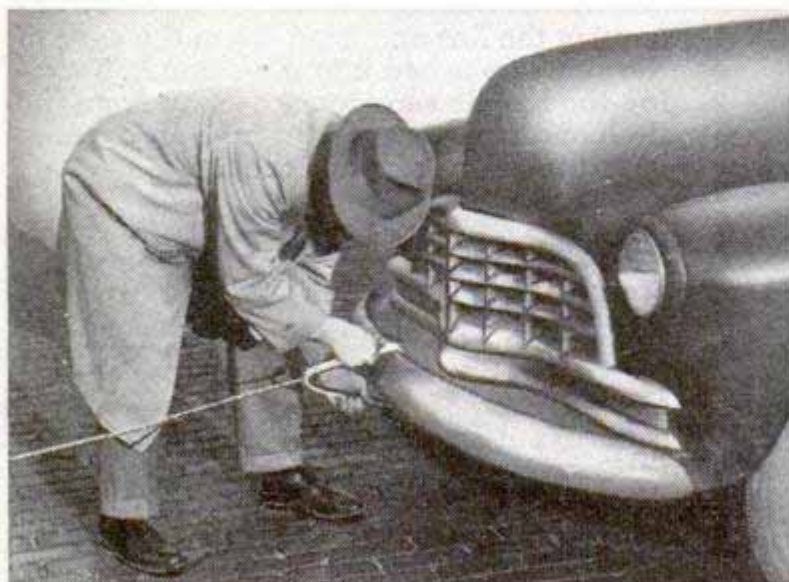

Snap-On Tow Cable

You won't have to crawl under the car to hook on a heavy chain when you need a tow if you have a spring-clamp-equipped cable with you. Steel clamps on the ends of the flexible steel cable snap over the bumpers quickly and securely. The complete assembly can be rolled into a small coil and carried conveniently in a corner of the luggage compartment.

☐ Crop experiments in Oklahoma show that burning off a pasture reduces its yield about 50 percent by killing soil organisms.



Pontoon Houseboat

Built with an Army bridge pontoon for a hull, a houseboat constructed by a Daventry, Iowa, grocer accommodates 10 persons. The builder, Richard Buergel, fitted a cabin to the aluminum pontoon, equipped it with a marine engine and operates his

unusual craft on the Mississippi River. The work was done almost entirely by hand, an electric drill being the only power tool used. The houseboat is 32 feet 11 inches long, has a beam of 8 feet 8 inches and draws only 6 inches of water. One feature is a top-deck steering apparatus. This was Buergel's first boatbuilding project.

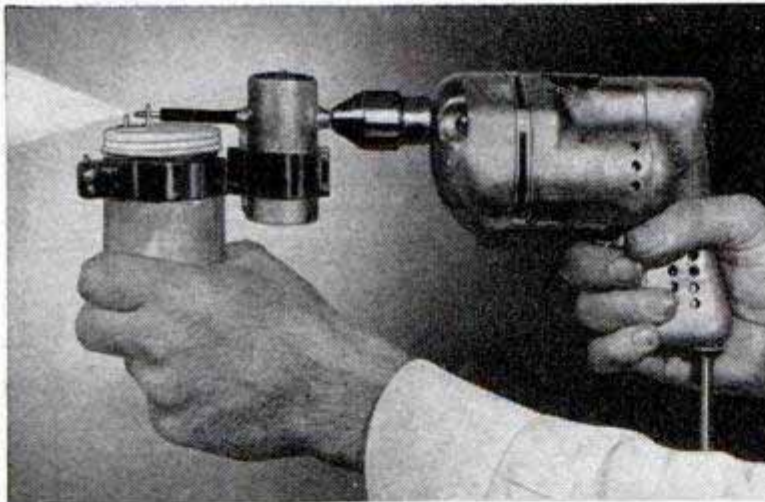

Compressor Converts Drill Into Paint Spray Gun

Any 1/4-inch electric hand drill can be converted into a spray gun with an attachment that includes a miniature air compressor. The attachment provides a small sprayer for touch-up paint jobs around the shop and for hobby use. Weighing only eight ounces, the unit is made of an aluminum-alloy casting fitted with bronze bearings. The container-gun is held in place by a chrome strap.

Mail returned. No longer listed in phone book.

Mobile Lifts for Steel Handle 20,000-Pound Rolls

Steel rolls weighing 20,000 pounds are handled with ease by mobile lifts at the Ford Motor Company's River Rouge plant. They have taken over work formerly done by cranes.

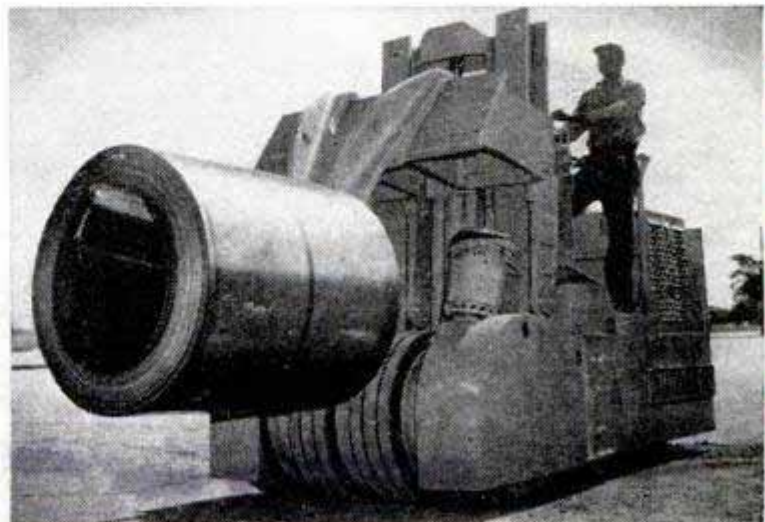

Information not listed on articles in the index, starting on page 10, frequently is listed in the WHERE-TO-FIND-IT INDEX which is available without charge from our Bureau of Information, 200 East Ontario Street, Chicago 11

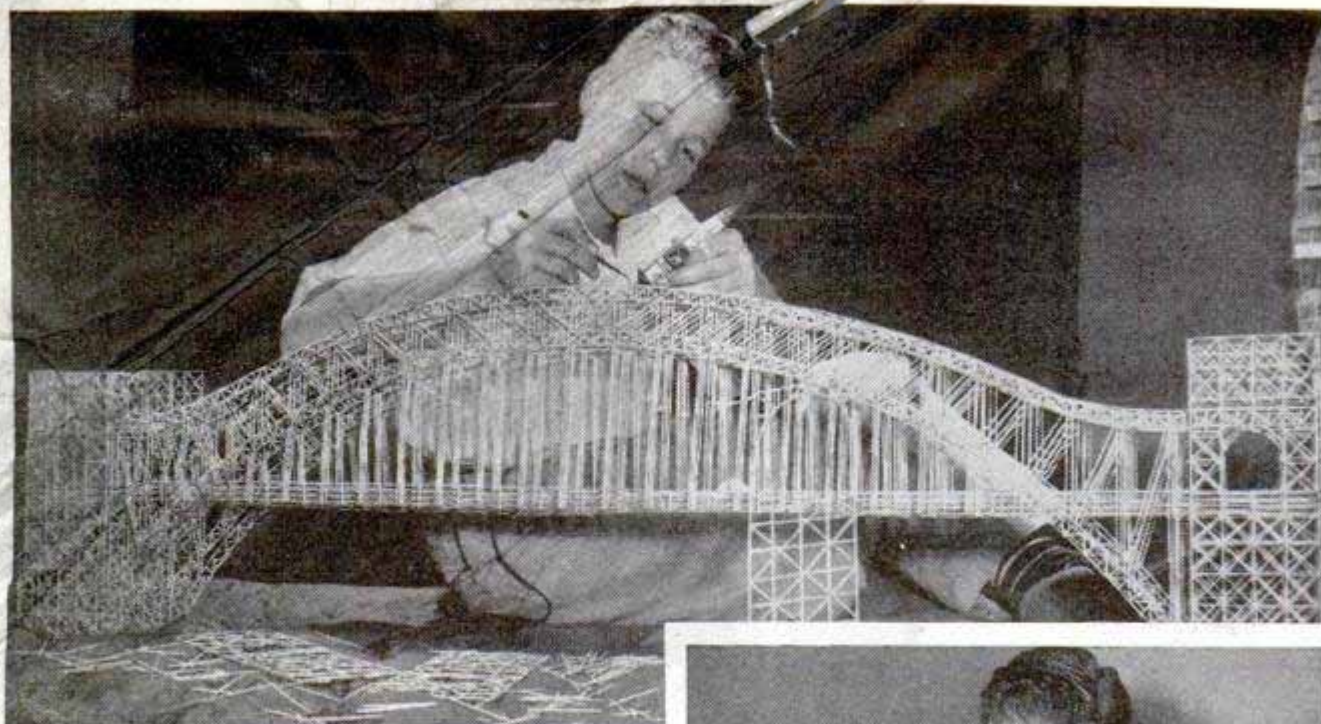

Bridge Made of Toothpicks Supports 10-Pound Load

Toothpicks are the building blocks of youthful Barry Pariser of New York, whose hobby is constructing bridges. The youth built one arch bridge of 2500 toothpicks which weighs only a few ounces, yet it will support more than 10 pounds. His next project was a 4½-foot railway bridge that required 35,000 toothpicks. The young engineer figures it takes about five months' work to complete such a project. Construction tools include liquid cement, tweezers to handle the toothpicks, nippers to cut them—and a great deal of patience.

Top, one of the young engineer's projects is this 4½-foot railway arch bridge requiring about 35,000 toothpicks. Right, smaller bridge easily holds 10 pounds of books. Cement holds the toothpicks together

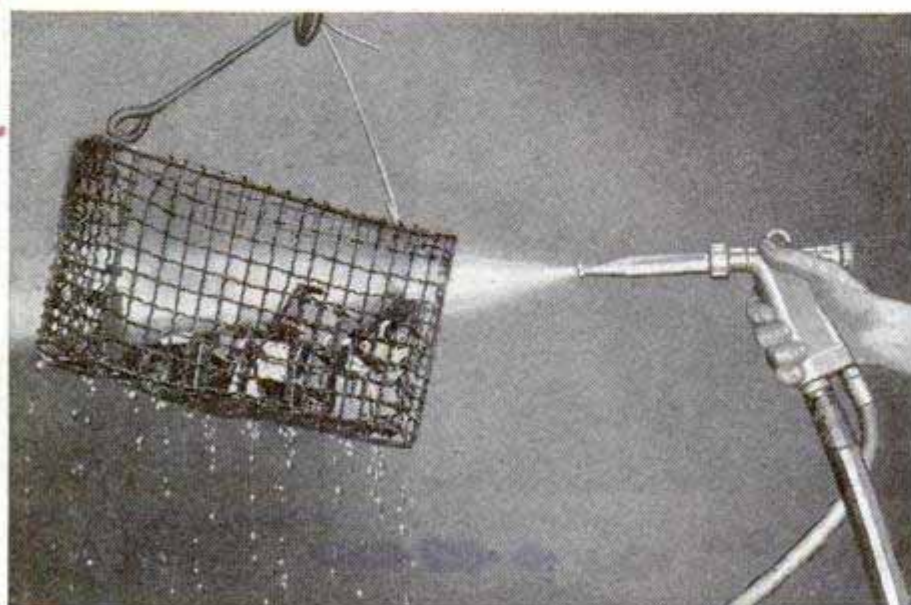
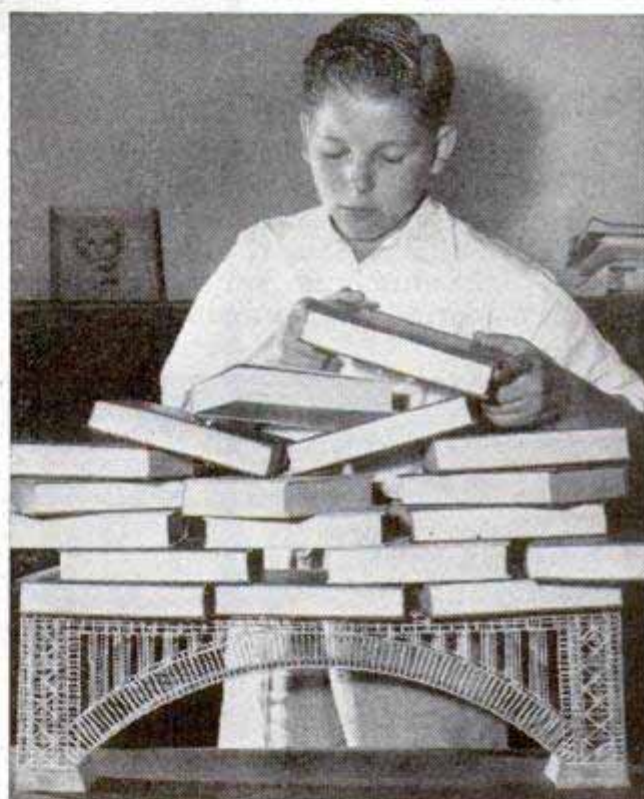

"Cold Steam" Spray Cleans Metal Parts

Pressure rinsing with "cold steam" from a hand gun that combines water and air into a high-pressure stream of tiny droplets blasts heavy dirt and grease from machines and small parts. There is no back splash and the spray won't harm the finest finish. The material to be cleaned is dipped or sprayed with a pre-soaking solution before the pressure rinsing operation is started.

Cage Protects Outboard Propellers

Outboard motors are protected by a new guard cage made of stainless steel. The guard is spherical and completely encloses the propeller, eliminating damage to the blades and shear pin. Being stainless steel, the guard will not corrode in salt water. A trolling plate fits the contour of the cage for fast motor operation at low speed.

Dash-Controlled Shock Absorbers

Because shock absorbers can be made adjustable by the use of a fluid having a magnetic-controlled viscosity, the motorist of tomorrow may be able to adjust the smoothness of the ride from the dashboard. Recommended at a meeting of the Society of Automotive Engineers, the dash-controlled shock absorbers would use fluid consisting of finely powdered iron dispersed in a liquid. When a magnetic field passes through the fluid, the iron particles tend to flux and thus viscosity is increased. This would enable the driver to adjust the riding comfort of his car or truck to road and load conditions.

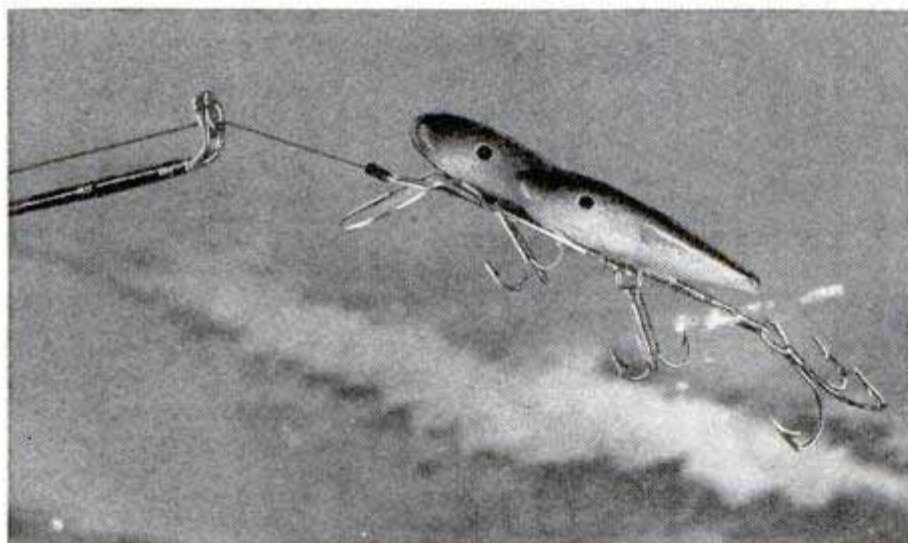
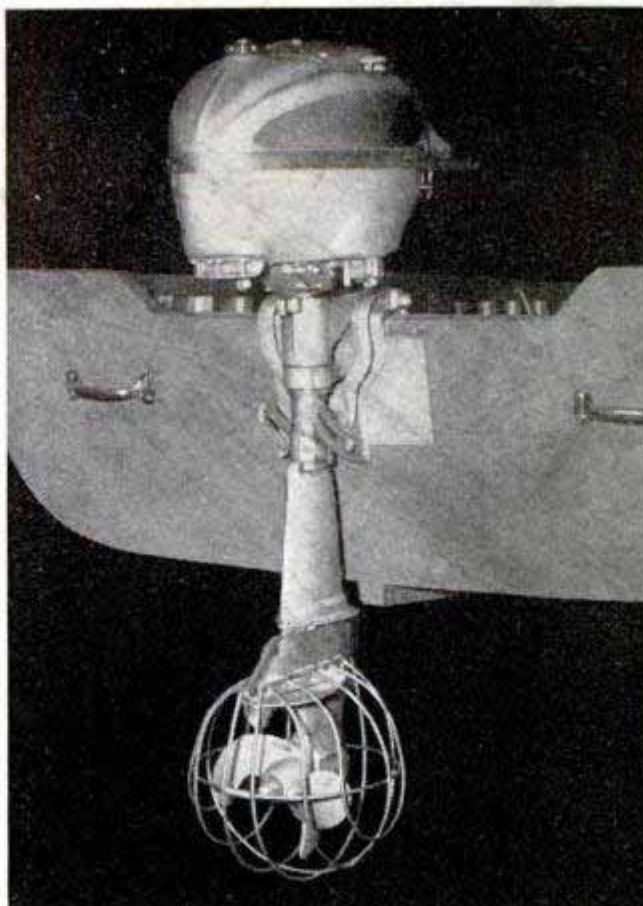

Twin-Minnow Lure

Combined in a single angling lure are two artificial minnows, simulating the action of small fish that travel in schools. The minnows are mounted on a metal chassis, one staggered to the rear of the other. Three sets of hooks project well away from the chassis, making it difficult for the fish to strike the twin lure without first coming in contact with one of the hooks.

Bubbling Bait

Bobbing and weaving like a real fish, a new lure made of Celanese plastic emits bubbles to coax the big ones to the surface. A special pill is clipped beneath the lure's snout to give off the bubbles which provide the lifelike action. No rod-tip manipulation is required with the lively lure, which also can be used without the pill as an underwater bait.

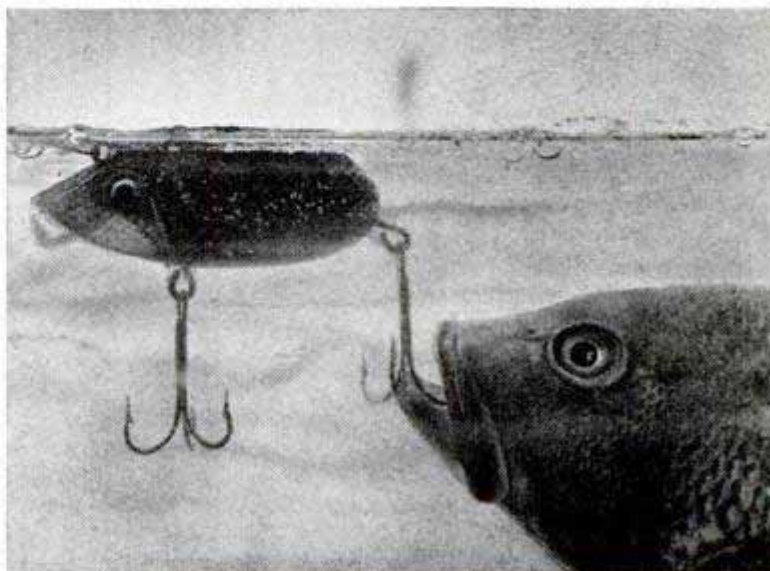

☐ Antarctica, with an average height of 6000 feet above sea level, is the highest continent.

Underwater Speedway

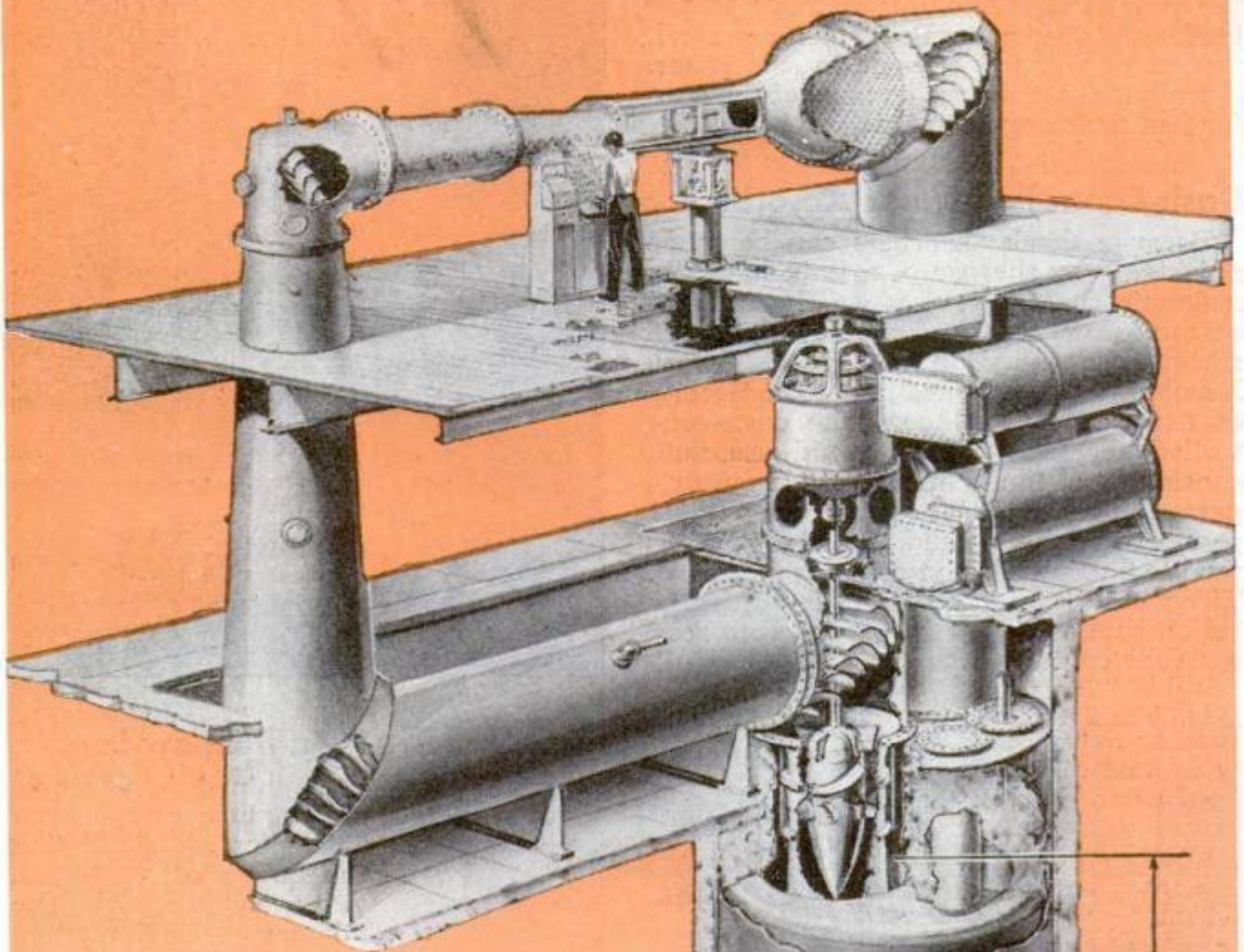

Water flows at speed of 100 feet per second past the test section (to right of observer in drawing) of huge research water tunnel. Below, torpedo model is attached to balance mechanism prior to test

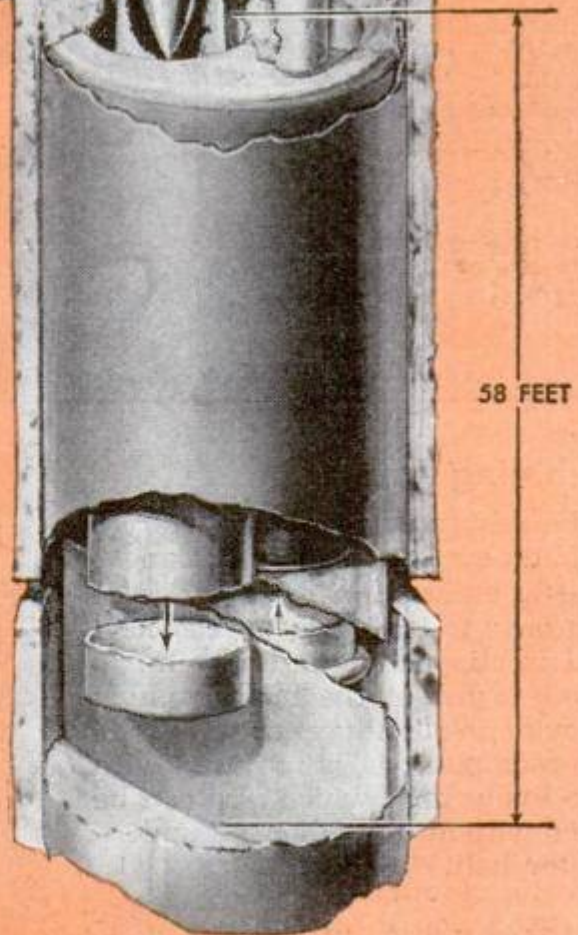

58 FEET

WHEN AN OBJECT moves underwater at high speed a mysterious force is brought into play that has baffled scientists for years. The speeding object may be one of the new underwater missiles propelled by the furious action that occurs when sodium or some other substance is allowed to unite with water. Or, it may be a speedboat, a torpedo, or a pump for a dam like Grand Coulee.

The mysterious force which acts as a brake on any speeding underwater object is known as cavitation. This bugaboo of hydrodynamics is something like the drag that limits the efficiency of airfoils in the atmosphere. A swiftly moving body creates a cavity in the water in the form of a blanket of low-pressure bubbles that appear, grow and collapse. The hammering of the water as the bubbles collapse creates vibrations, limits speeds and actually erodes metal. Fast ocean liners must sometimes go into dry dock for repairs to propellers that have been eaten away by cavitation.

Engineers know what causes cavitation and they know its harmful effects but they don't know for certain how it works. To find out, the hydrodynamics laboratory of the California Institute of Technology is making studies in water tunnels that are comparable to the wind tunnels used in aerodynamics.

Among those keenly interested in this research are the many designers in remote fields who are plagued by the vagaries of cavitation. Naval architects who design fast sailing cutters find that each boat has an arbitrary "hull speed" beyond which it hardly can be driven. The boat shakes and trembles when the hull speed is attained. The underwater disturbance creates a rumble that one racing skipper compares to the sound of sailing the boat across a gravel bar.

Cavitation is also a costly factor in the design of

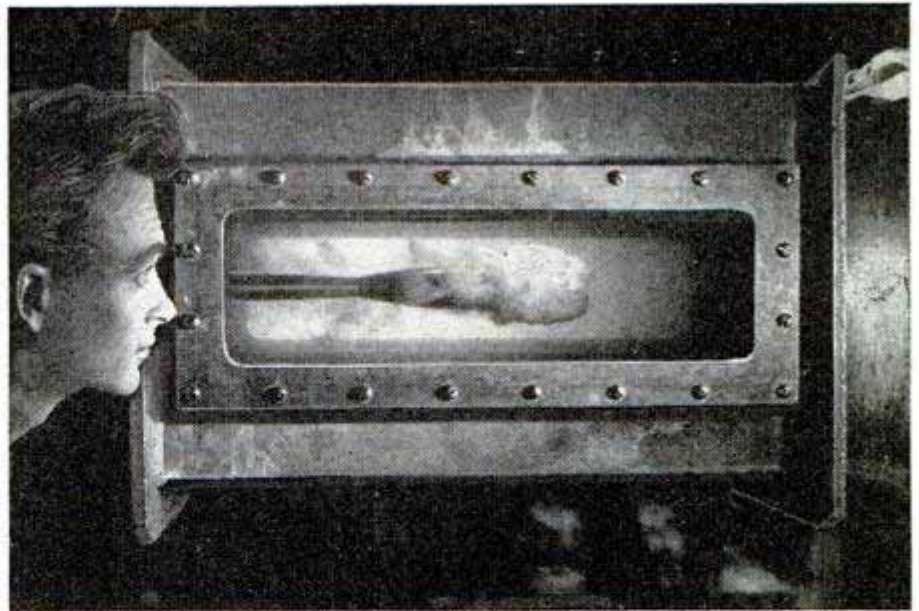

Models in high-speed water tunnel are viewed through heavy glass plate. Cloudy area over nose of model is result of cavitation—tiny bubbles

the pumps that will lift part of the Columbia River up the side of a 300-foot cliff at Grand Coulee Dam for irrigation purposes. This job will be done by 12 giant pumps. Each has an impeller wheel 14 feet in diameter and a shaft that weighs 30 tons. Each will be driven by a 65,000-horsepower electric motor. Smaller, faster pumps could do the job at less cost if it were not for cavitation.

The mystery of cavitation may be solved in C.I.T.'s water tunnels. Streams of water are made to flow past models at speeds up to 100 feet per second. A balance system

Laboratory equipment includes camera that takes 20,000 pictures in one second. Photographer trips button that operates camera and flash lamps

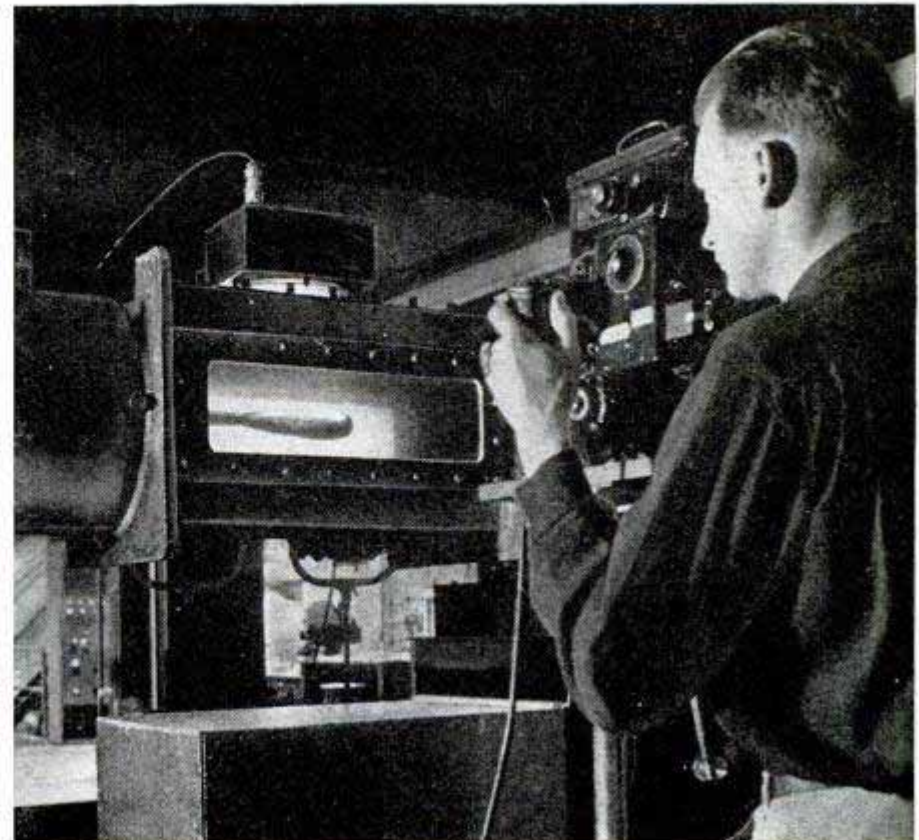

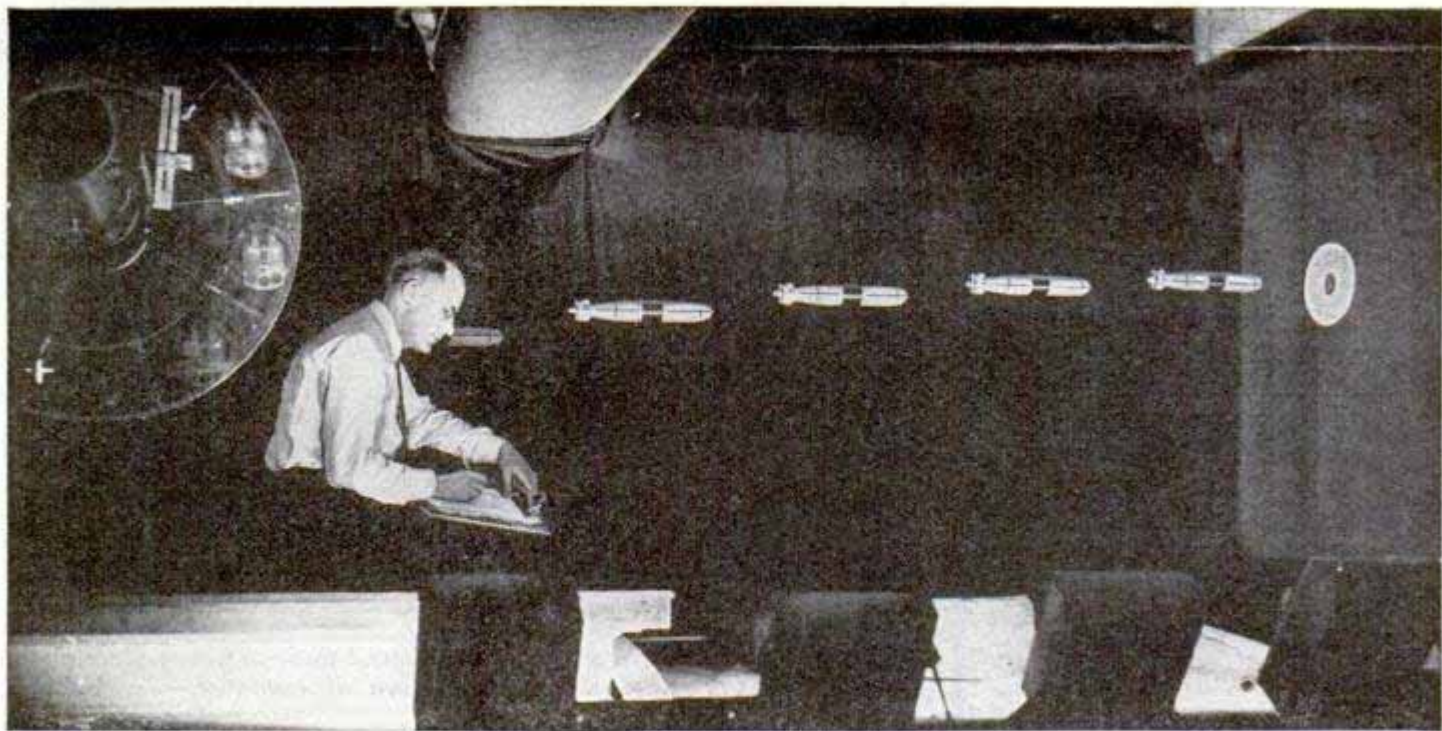

Torpedo launcher is tested by firing at target 12 feet away. Opening in curtain is $\frac{1}{2}$ inch in diameter larger than torpedo. Left, close-up of torpedo on wheel-launching device. Below, magazines of five high-speed underwater cameras in the launching tank

that is attached to the model is used to control its attitude in the water and to measure the hydrodynamic forces that act on it. High-speed cameras take pictures of the cavitation that the model induces.

Looking through the thick glass wall of the water tunnel, no evidence of cavitation can be seen while the water moves at low speed past the model. But when the velocity is increased, the water behind the model becomes disturbed and finally begins to



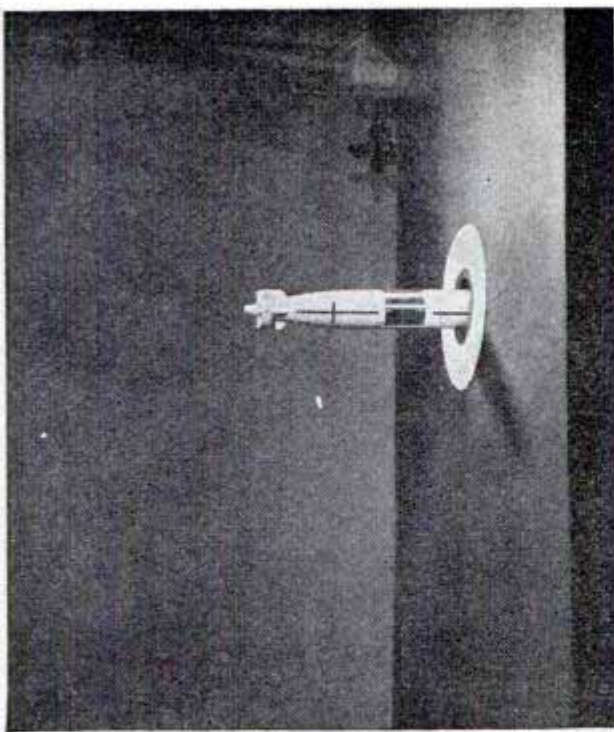

froth. At top water speed, the whole model may be coated with minute white bubbles.

This is evidence that the shape of the model is forcing the water away from it, leaving a partial vacuum in which gases and water vapor bubble and boil.

"Cavitation limits the speed of underwater bodies and creates problems in controlling them," says Dr. Robert T. Knapp, director of the laboratory. "It limits the size and speeds of turbines and causes loss of efficiency in pumps. It is a limiting factor to all types of hydraulic machinery.

"The research that is being done with water tunnels may ultimately improve every type of machine that moves in a fluid, for when we understand how cavitation works it may be that we can control or reduce it."

The high-speed water tunnel is one of the chief tools for cavitation studies. Water is forced through the tunnel circuit by a 350-horsepower electric pump, is cooled by refrigeration to remove the heat that is created by the pumping action, and is forced down and up an 85-foot-deep steel well twice to cause it to reabsorb any bubbles that it may contain. Entering the working section of the tunnel, the water is forced through the small end of a huge nozzle that helps build the water speed up to a maximum of about 70 miles per hour.

Most cavitation phenomena are studied by means of high-speed photography. Special cameras are used to magnify time, to

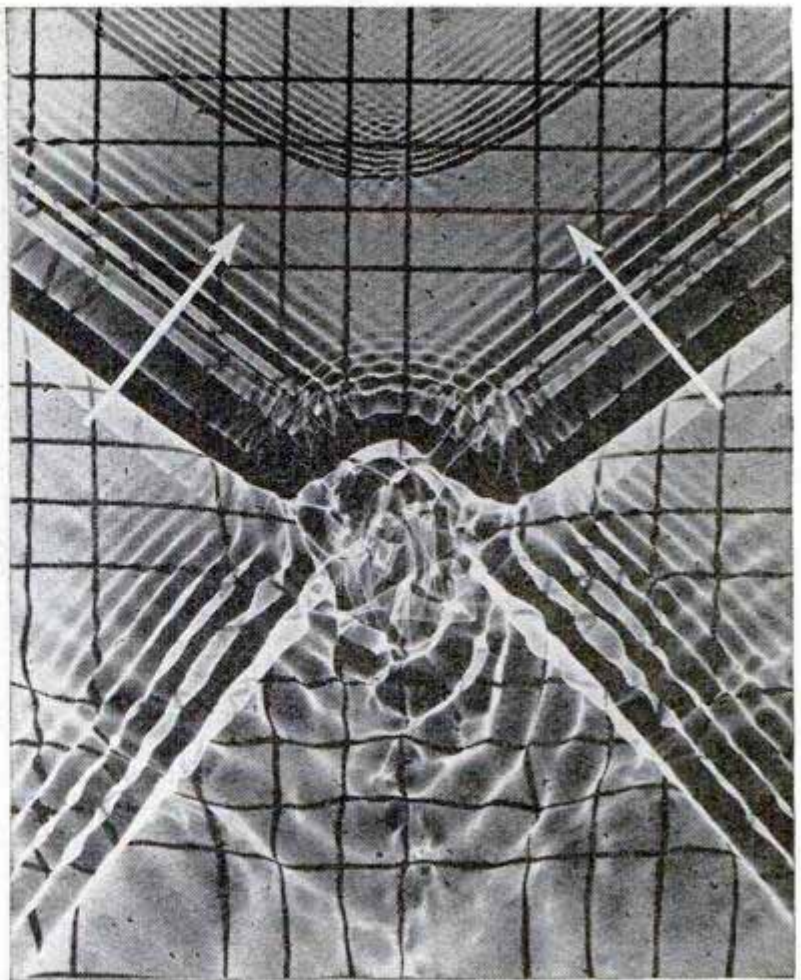

Ripple pattern is produced when two shock waves collide in a shallow water tank. Below, transparent table top is used to study ripples and wave motions. Plastic instruments being placed on the table measure heights and lows of waves

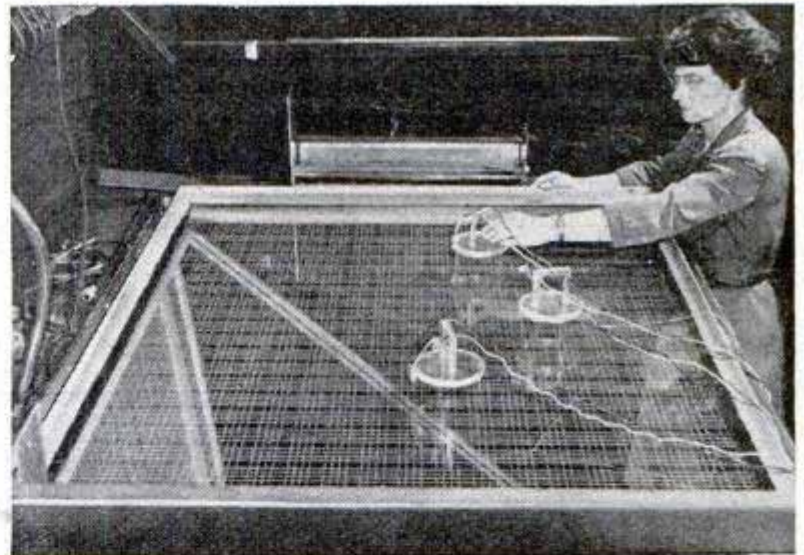

stretch one second into as long a period of time as 20 minutes. This allows examination, step by step, of the mechanics of the formation and collapse of cavitation bubbles that live and die in tiny fractions of seconds. Cameras are used as precision measuring instruments.

One 16-mm. camera used with the high-speed water tunnel exposes a 100-foot roll of film in one second. Instead of the ordinary camera aperture, a special slit $\frac{1}{16}$ inch wide is used, permitting 20,000 individual

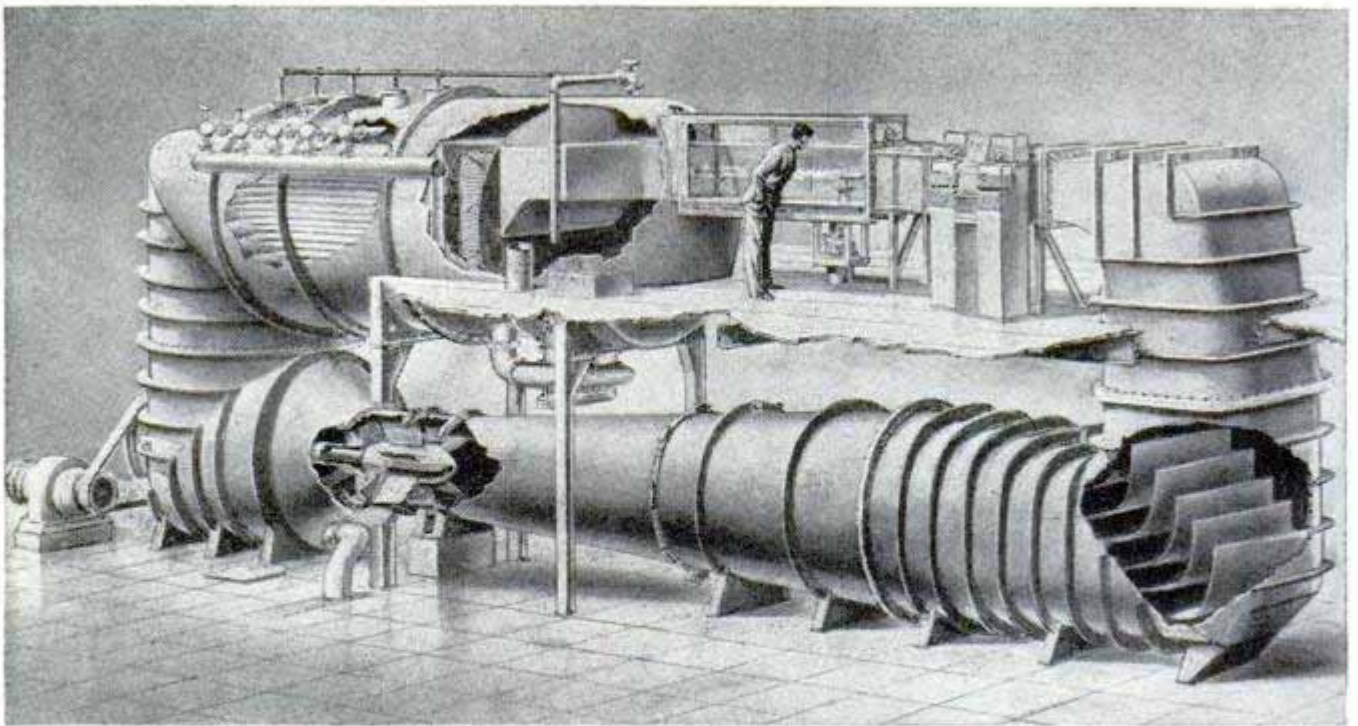

Caltech's "free surface" water tunnel is used in laboratory study of submerged bodies close to the surface

pictures to be made on a single roll of film.

Hydrodynamicists have no expectation that they will double or triple the efficiency of water machinery. Many pumps are 90 percent efficient already and ships' propellers are 70 or 80 percent efficient. These figures apply to the "designed speed" at which the blades will be operated most of the time. What the scientists do hope for is to learn how to design smaller blades that will perform the same amount of work by operating at higher speeds, without harmful cavitation, and that will be more efficient over wide speed ranges.

During the war Caltech's hydrodynamics laboratory specialized in studying the behavior of underwater rockets, depth bombs and torpedoes.

To learn what happens to torpedoes that

are released from aircraft, the laboratory built an enormous launching tank in the form of a closed cylinder 29 feet long and 13 feet in diameter. Thirty thousand gallons of distilled water, necessary for good underwater photography, partly fill the tank. The air in the space above the water can be pressurized to the extent of 40 pounds per square inch.

Built into the roof of the tank is a hinged hatch that supports a heavy flywheel on its lower side. Attached to the flywheel is a mechanical hand that holds a model of a torpedo and releases the torpedo at some predetermined angle after the flywheel has been brought up to speed. The path of the torpedo through the atmosphere and into the water is then recorded

(Continued to page 242)

This photo was made in test section of tunnel above. It shows a torpedo just after it has entered the water

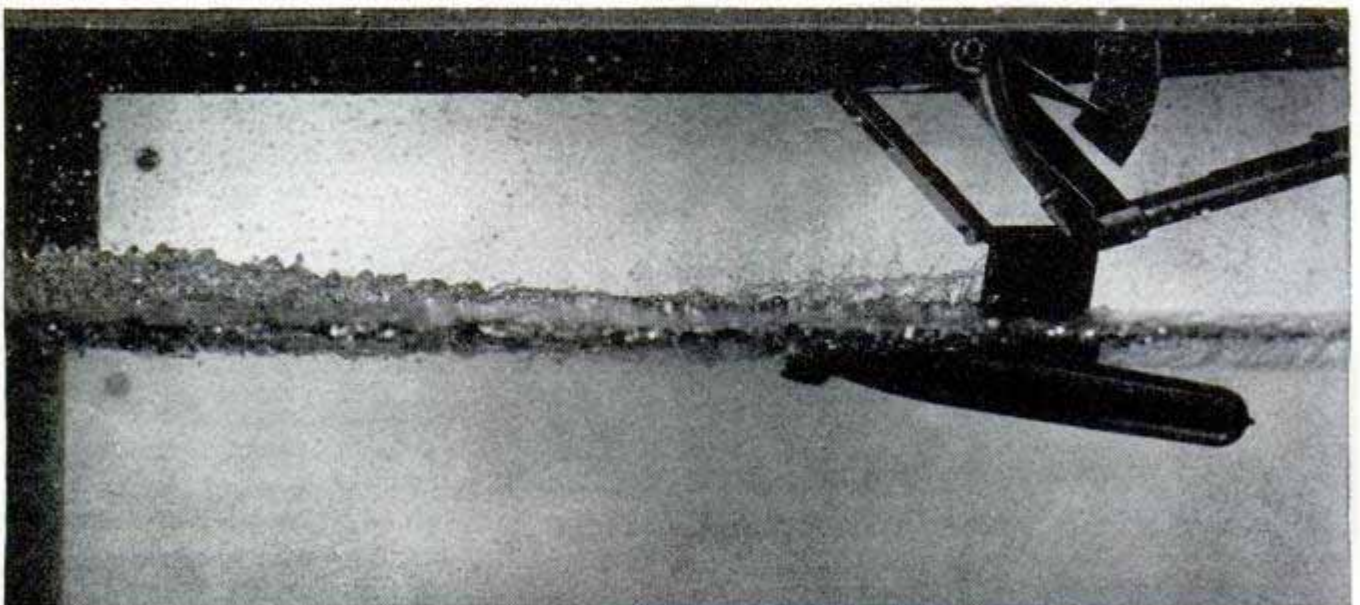



"Blackboard" Sign

Advertising messages can be wiped off a new glowing sign and other words written on the surface. The sign, which glows like a neon tube, is edge-lighted with a 15-watt fluorescent tube. The message is written on the surface with special crayons or painted on with water colors. The writing captures the light from the tube.

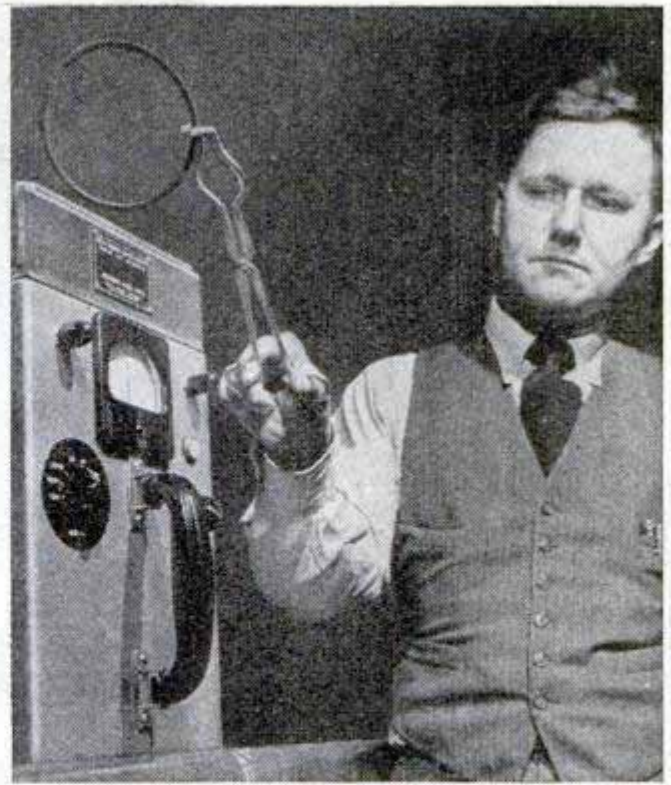

Atom Test for Engine Wear

Atomic energy has been put to work to improve fuels and lubricants for your car. The California Research Corporation is conducting tests with radioactive piston rings. A ring is exposed to an atomic pile and then placed in a test engine. After three or four hours of operation, technicians remove a sample of oil from the engine's crankcase and expose it to a Geiger counter. The instrument measures radioactivity in the oil and thus indicates the amount of metal worn from the ring.

Cutout Model Shows Action of Electrical Charge

Nobody knows what electricity looks like, but a cutout fiberboard model produced at General Electric shows graphically how electrical peaks are built up as a simulated lightning stroke, lasting 250 millionths of a second, travels through a coil. Patterned from photographs of oscillograph readings, the model shows voltage peaks and valleys that resulted from the current. Height of the model indicates voltage variations, width represents time and the length traces the location of the impulse in the winding.

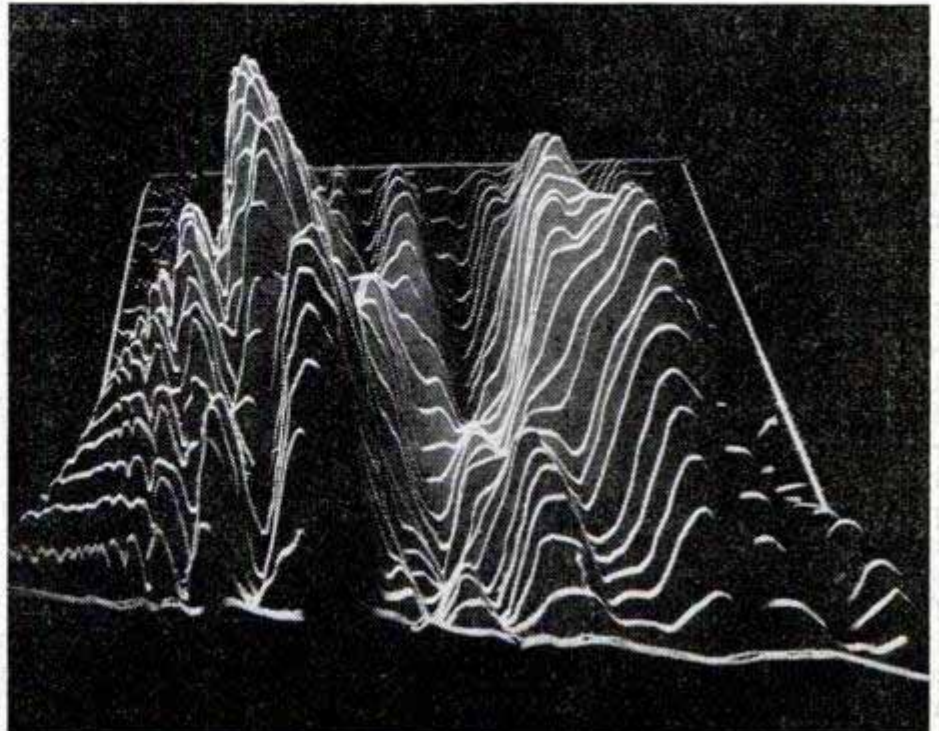



Trouble Shooter on the Scent

By Alfred Eris

AT LEAST one nose in America can appreciate the more full-bodied odors like those made by a skunk or a civet cat, yet is sufficiently delicate to lead its owner to create exotic perfumes for America's most discriminating women.

That most sensitive nose belongs to Albert J. Dillinger, whose job is to concoct scents for U. S. nasal organs. To industrialists, Dillinger is a "trouble shooter" for their smell problems. Take the candy manufacturer who recently called for help because sales were dropping and complaints were pouring in. One customer after another was irate because the firm's candy smelled like cardboard. The trail Dillinger followed led to the paper mill where he introduced a "neutralizer" so that the old and odorous papers and rags used in the manufacture of cardboard would not per-

Up to the sensitive nose goes a prepared scent. After sniffing a few times, Dillinger will pronounce judgment on the odor

meate the products sold therein.

The requests Dillinger gets are as varied as human imagination can create. Some screwball ideas he must, regretfully, turn down. Others, seemingly impossible, he fills quite easily. For an insurance firm he produced an ink that smelled like a fire-gutted house. Used on a direct-mail pamphlet, it startled many prospects into signing on the dotted line. He has been asked to make plastic bones smell like beef (for dogs), sponge rubber to smell like cheese (for mouse-traps) — and a thousand and one items for humans, too. One of his current problems is impregnating waxed paper, in which bread is wrapped, with a "bread smell."

Dillinger makes artificial leather smell like the real thing; he makes the letterheads of mountain resorts smell of fresh pine woods; he gives greeting cards a distinctive odor; he permeates the paper in which bacon is wrapped with a "baconish" odor and he has even filled a request for starch to smell

"extra clean—like fresh sunlight."

Sitting in his aromatic hideaway among hundreds of bottles, his task is one which demands extreme concentration. All day long, strips of blotting paper soaked in some aromatic chemical compound are waved in front of one of America's most sensitive noses. The incorporation of odors with commercial products started some 12 years ago with simple assignments like perfuming printers' inks, insecticides, stationery or impregnating artificial flowers with a "real" odor.

Today, there's no limit to Dillinger's field—cheese, stockings or ink, it's all in the day's grind. From a prodigious memory he will quickly make a mental analysis of a formula which is close, if not fully accurate. From hundreds of bottles at his fingertips, he will select a few, draw a drop

from this, a touch from that and—presto!—beef, leather or whatever scent the manufacturer wants is produced.

There's far more to concocting scents than the average perfume-user realizes. Apart from the fact that basic ingredients such as oils, balms and resins must come from burning wastes, a mountain of Tibet or the depths of the Atlantic, a skilled aromatic chemist must know his anatomy if he is to be efficient.

Dillinger's highly respected and specialized ability is such that he is sometimes called upon to confirm—they hope—the expectations of landlubbers or seafaring men who think they have ambergris. This valuable (\$8.00 an ounce) product of the sperm whale is often confused with other animal products generally considered useless. Ambergris is formed by the digestive fluids of the whale and the squid meat it has swallowed.

Not very long ago Dillinger had to break the bad news to a sea captain who had already put a ton of his "ambergris" into drums, piled the drums on a pier and sat in his cabin making mental computations of how he'd spend his loot. Instead of the cheery news he expected, it was the distressing duty of Dillinger to advise the seafaring gent that the stuff was completely useless.

Dillinger also keeps tabs on the Chinese equivalent of Western horse thieves. The Tibetan thieves have acquired the dodge of buying musk pods from hunters and adulterating them with such sundries as powdered broiled liver, roasted powdered beans, dried blood and iron rust, and

(Continued to page 240)

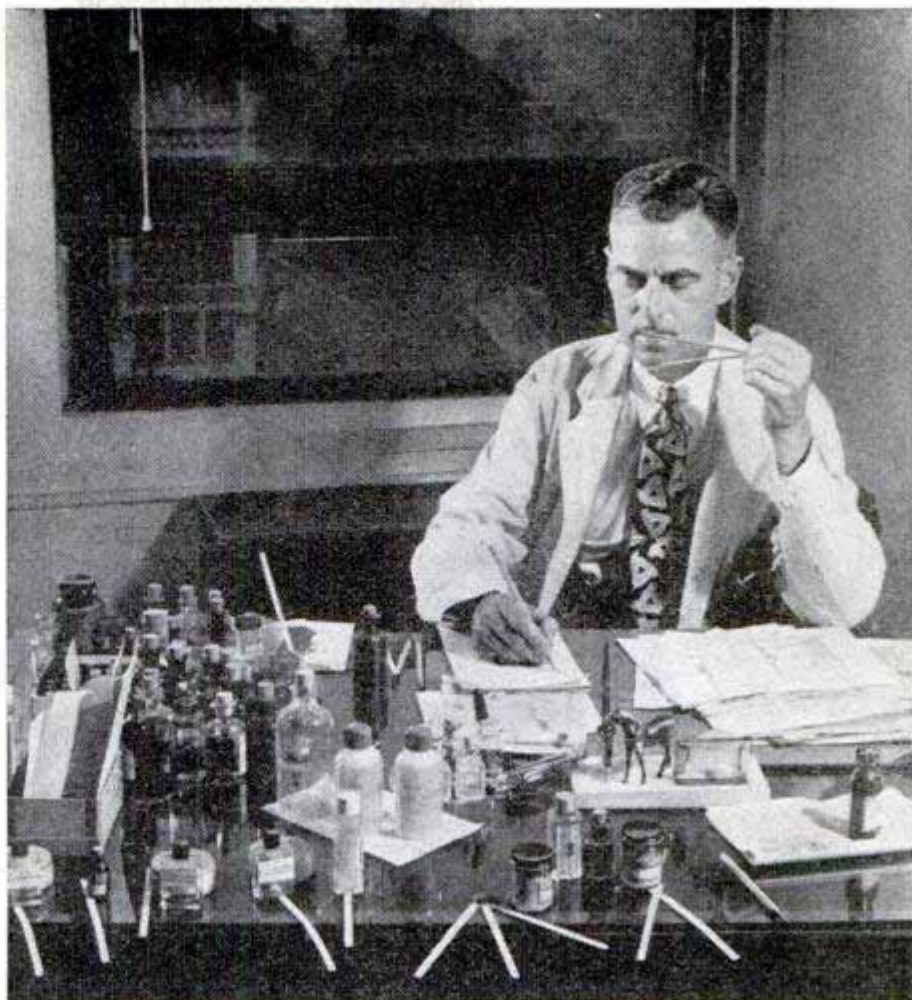

Through his prodigious memory the sniff sleuth can smell a new mixture and list up to 30 ingredients used in making the odor. Below, his aromatic laboratory is lined with hundreds of bottles containing essences



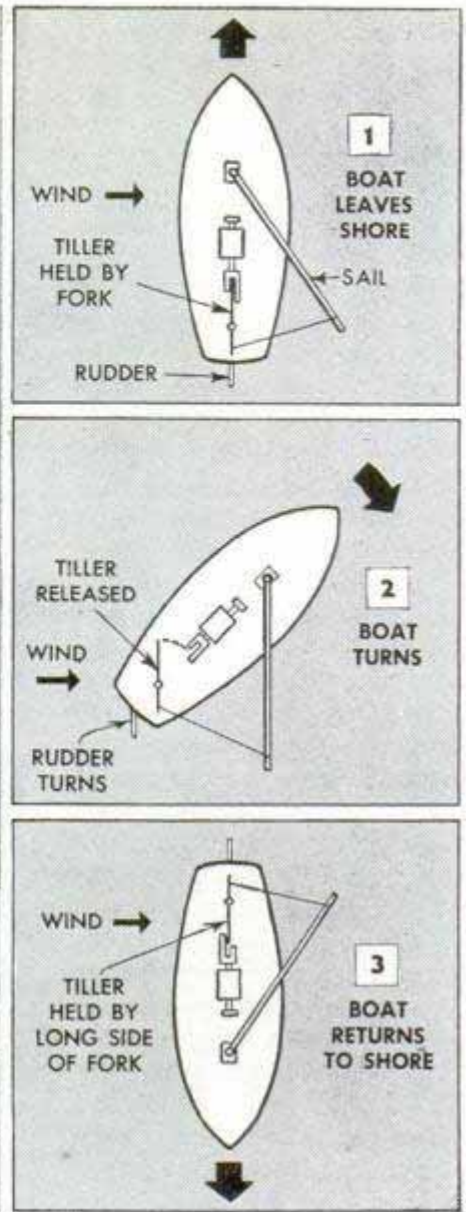
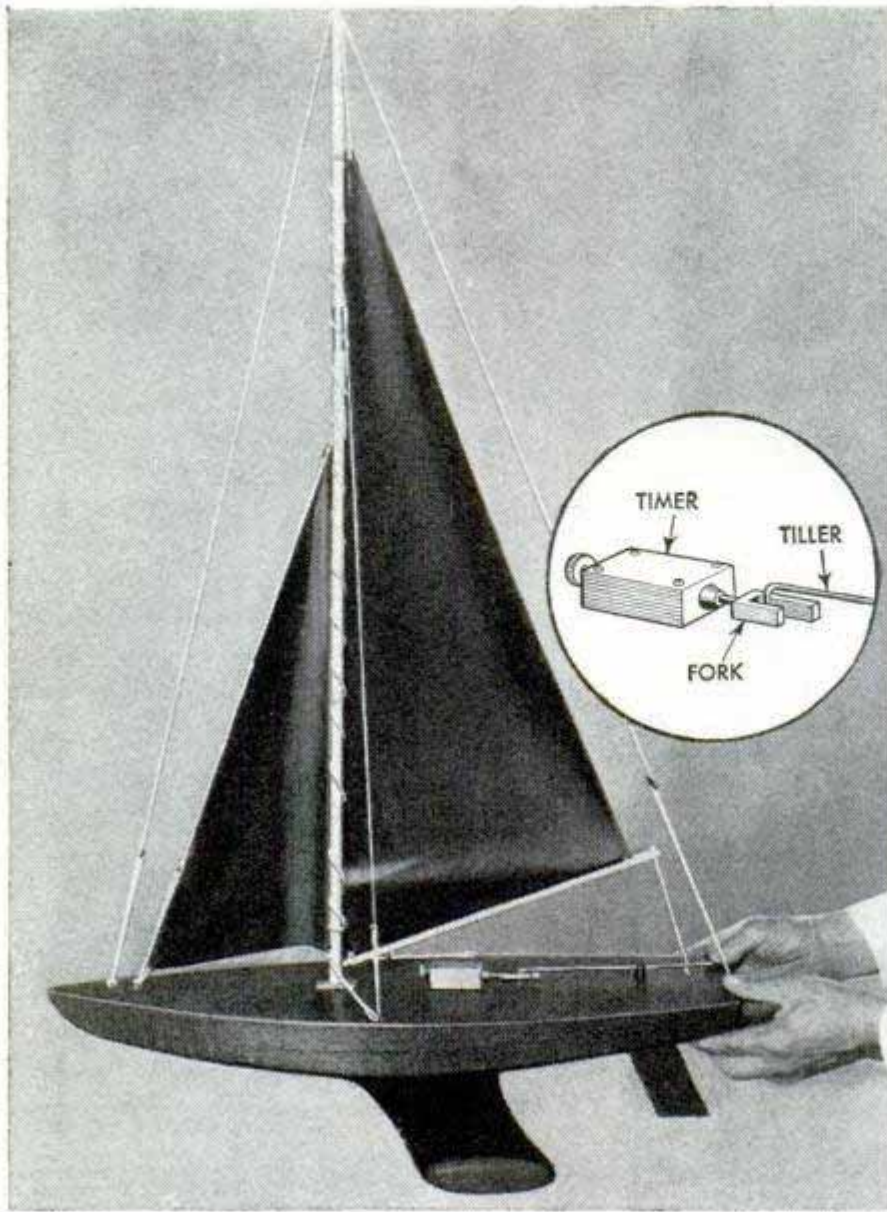

Pneumatic "Crew" Brings Model Boat Back to Port

Model sailboats are brought back to port by a "crew" that swings the rudder over after a definite length of time. The crew is a pneumatic timer with a slotted shaft protruding from the after end. At the start of the cruise, the forward end of the tiller, a long rod pivoted on the rudder post, is held securely in the fork and the main sheet is tied to the after end of the tiller. As the time expires, the timer shaft moves into

the case. Since the leeward side of the fork is shorter than the other side, the boom pulls the tiller hard over as soon as it can clear the short arm of the fork, swinging the boat around. When the boat has come about, wind pressure on the opposite side of the sail forces the tiller against the still-protruding long arm of the fork and the rudder is held on a straight course for the homeward leg.

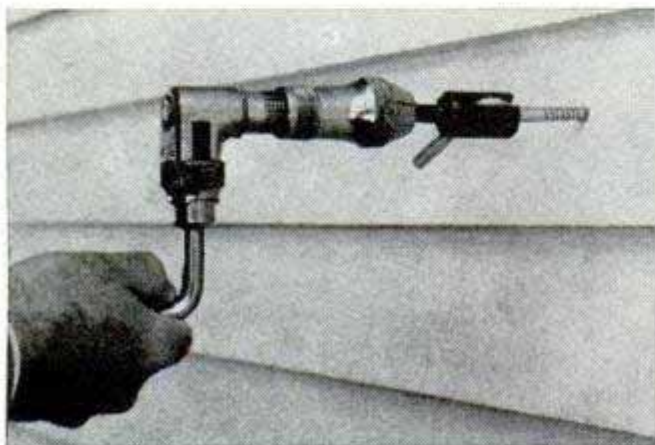

Tool Drives Angle Screws Without Damaging Threads

Angle screws used in wiring installation are driven into wood without preboring by a special screwdriver that fits into the chuck of a brace. The angle screw is inserted in a hole in the tool which holds it firmly. A few quick turns of the brace drives the screw into the wood without damaging the threads.

☛ Car trouble forced the average U. S. motorist to call a garageman 1.2 times in 1948.

Garage Repair Rack Holds Any Auto Part

Any part of an automobile, regardless of shape or size, can be clamped in a rack where it is held securely for repairs. The rack's four vertical arms can be adjusted to a convenient height. Horizontal arms slide in and out, providing an infinite variety of holds. Within 90 seconds any job can be set up on the rack. Weighing 150 pounds, the rack is adjustable in height from about 31 to 42 inches. The brackets are lined with fabric.

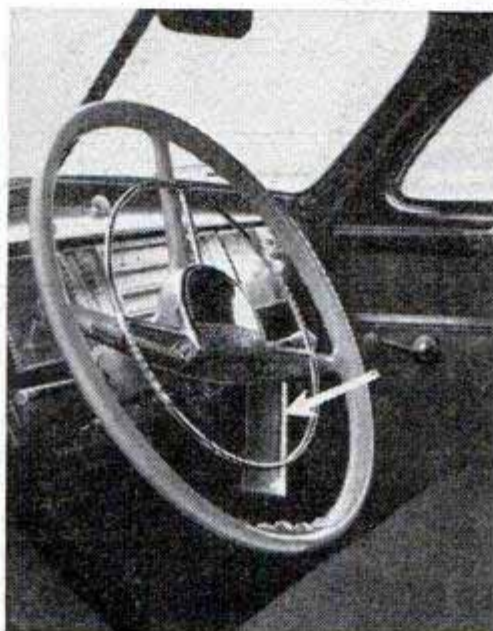
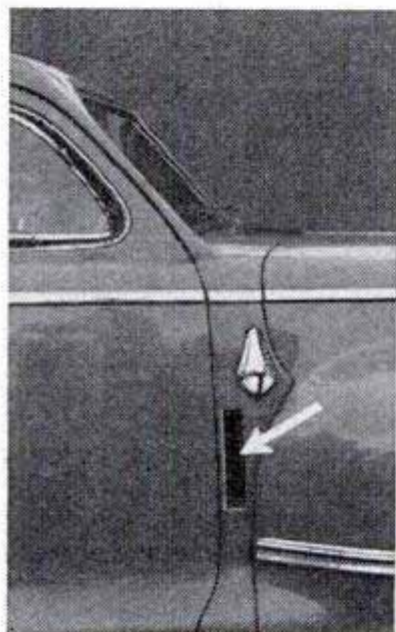
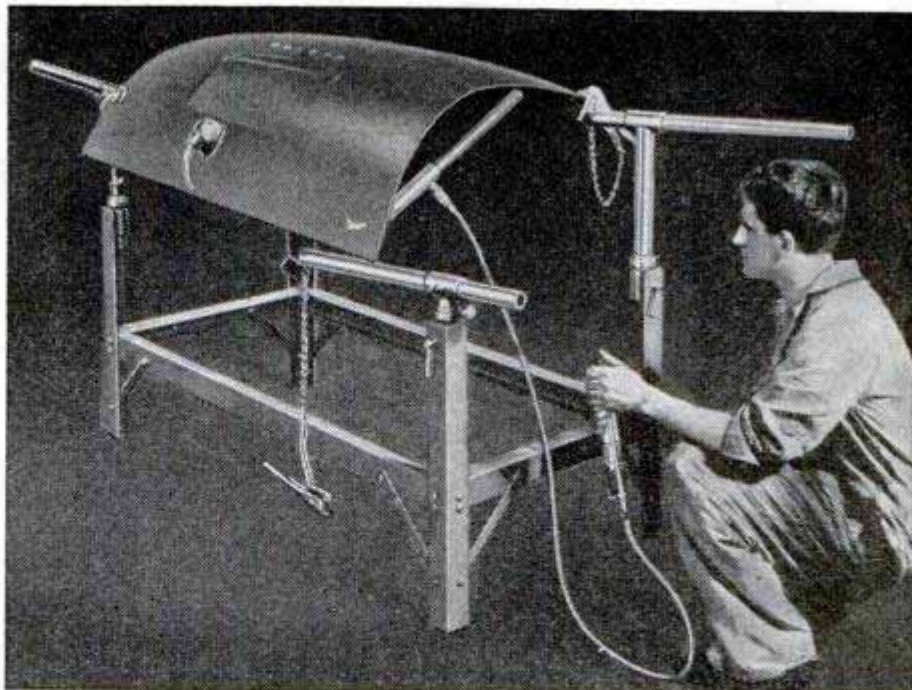

Curb Light

One automobile driver solved a parking problem with a side light and plastic-window combination. This enables him to see the curb by day or night when parking. The driver, K. A. Staley of Madison, Ohio, cut a slot two inches wide and eight inches high in the side of his car, about 28 inches above the ground. The inner opening is flared to five inches in width and is 11 inches high. For illumination he used a small parking light.

Shotgun Cleaner Protects Barrel

Cleaning and oiling your favorite shotgun is a one-minute operation when you use a combination device that can't damage the barrel. Consisting of a 34-inch wood rod covered with two inches of lamb's wool, the cleaner is pushed into the barrel from the chamber end. The wool is compressed tightly as it is forced into the barrel and it scrapes grime loose and pushes it out the muzzle.

An oil-soaked bob, also made of wool, is then hooked to the projecting end of the rod and drawn back through the barrel,



leaving a thin film of oil. A carrying case is furnished with the kit. The cleaner is available for the standard shotgun gauges.

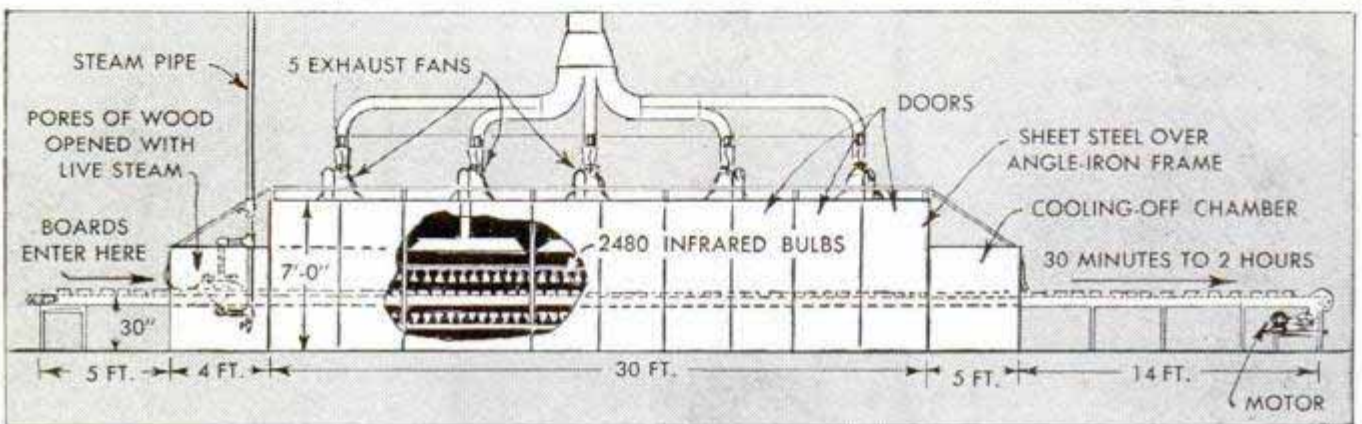
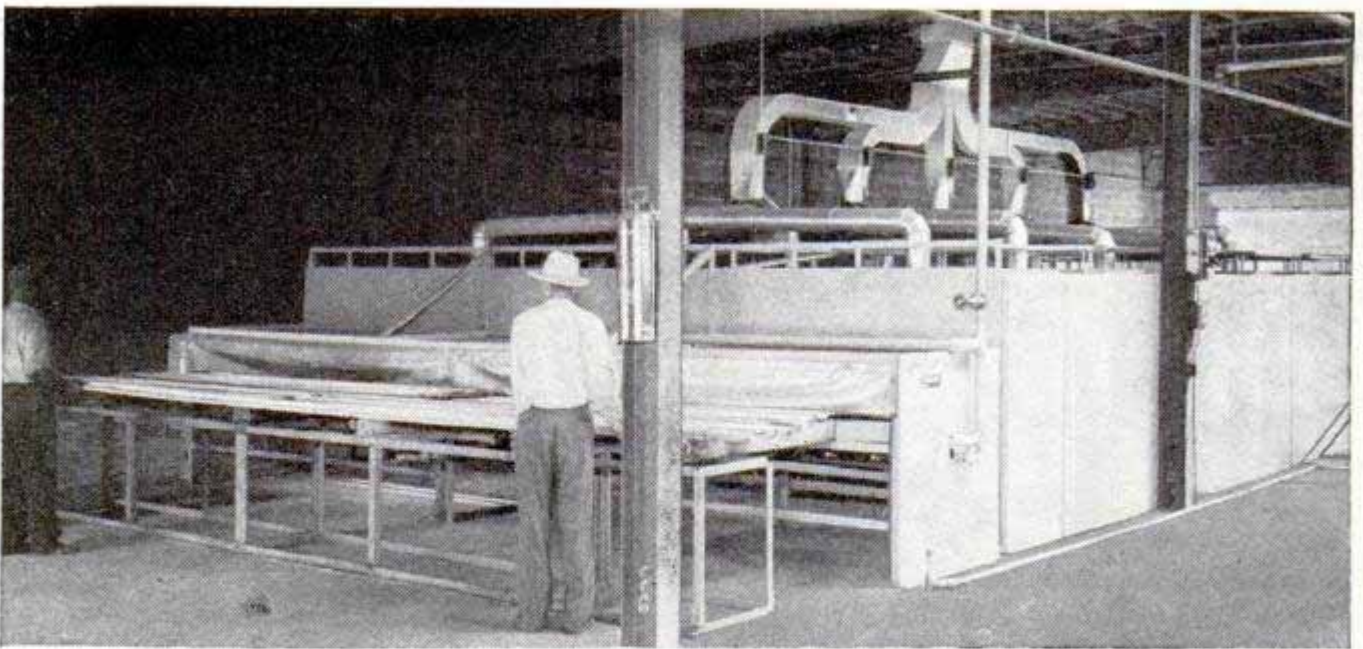

Infrared "Oven" Dries Wood

Lumber is thoroughly dried in 45 minutes—instead of 14 days and nights—in an infrared light kiln perfected by the Chicago Streamlite Corporation. Conveyors take

boards through a live-steam bath before exposing them to temperatures of approximately 250 degrees Fahrenheit from 2480 infrared bulbs. It lowers the moisture content of the wood from approximately 28 percent to 9 percent.



Consolidated-Vultee Aircraft photo

B-36 Adds Four Jet Engines

Adding pairs of jets in a "pod" beneath each outer wing panel of the B-36 gives the world's largest bomber a record total of 40,000 horsepower. They supplement six

3500-horsepower piston engines for added power on take-off and extra speed over the target area. Using them the giant plane has taken off at a gross weight of 280,000 pounds in 3500 feet of runway and reached a 40,000-foot altitude.

The All-Star Plastic

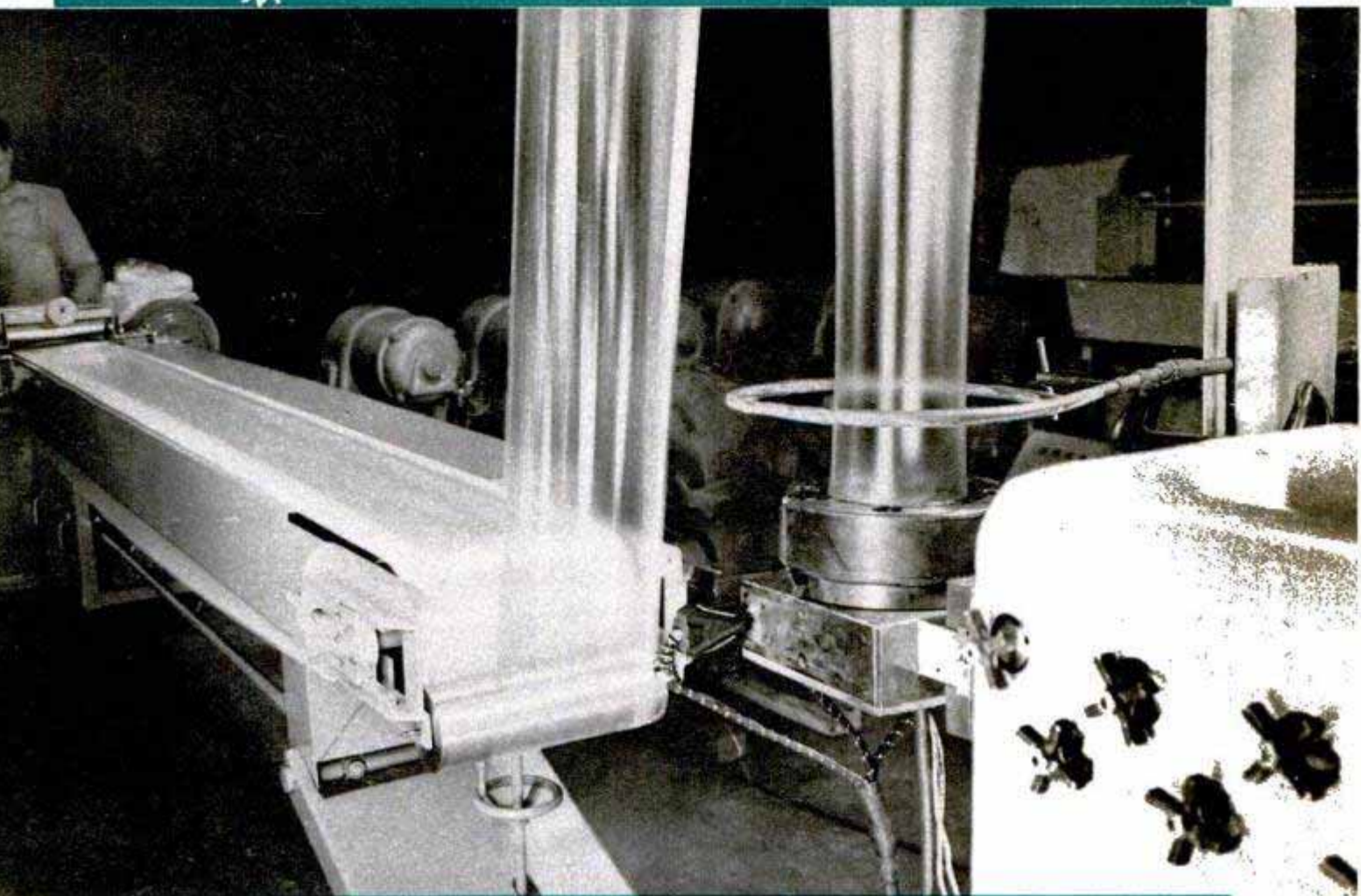

Modern Plastics Machinery Co. photo

This machine extrudes polyethylene vertically in the form of lay-flat tubing, widely used in packaging

By Bill Reiche

HIGH ON THE all-too-short list of postwar "dream products" must be placed a versatile young member of the plastics family, polyethylene, a material which has been aptly called "the precocious plastic."

Considerably less than 10 years old as a commercial product, this plastic—known as polythene to one of its major producers—is challenging Cellophane as a packaging material; is replacing lead in a major application of that not-too-abundant metal; has proved extremely valuable as a structural material in surgery; and has a list of other current and potential applications as long as your arm.

Polyethylene has so many good qualities that it is hard to know where to begin enumerating them. It is one of the lightest plastics known to man and a pound of it,

costing about 44 cents, goes a long way. Having low-loss electrical properties, it makes excellent insulation and in this application its characteristics of toughness, flexibility, low water-vapor transmission and ability to withstand a wide range of temperatures prove most valuable. The material has high shock-resistance, can withstand acids and other chemicals better than glass, can be made either opaque or almost clear and takes color beautifully.

Like many other scientific developments, polyethylene goes back almost half a century and, at the same time, is just about as new as radar.

Around the turn of the century a polymerized ethylene was achieved, using diazomethane, but because of its low molecular weight it varied in consistency between a light oil and a waxy solid and had no

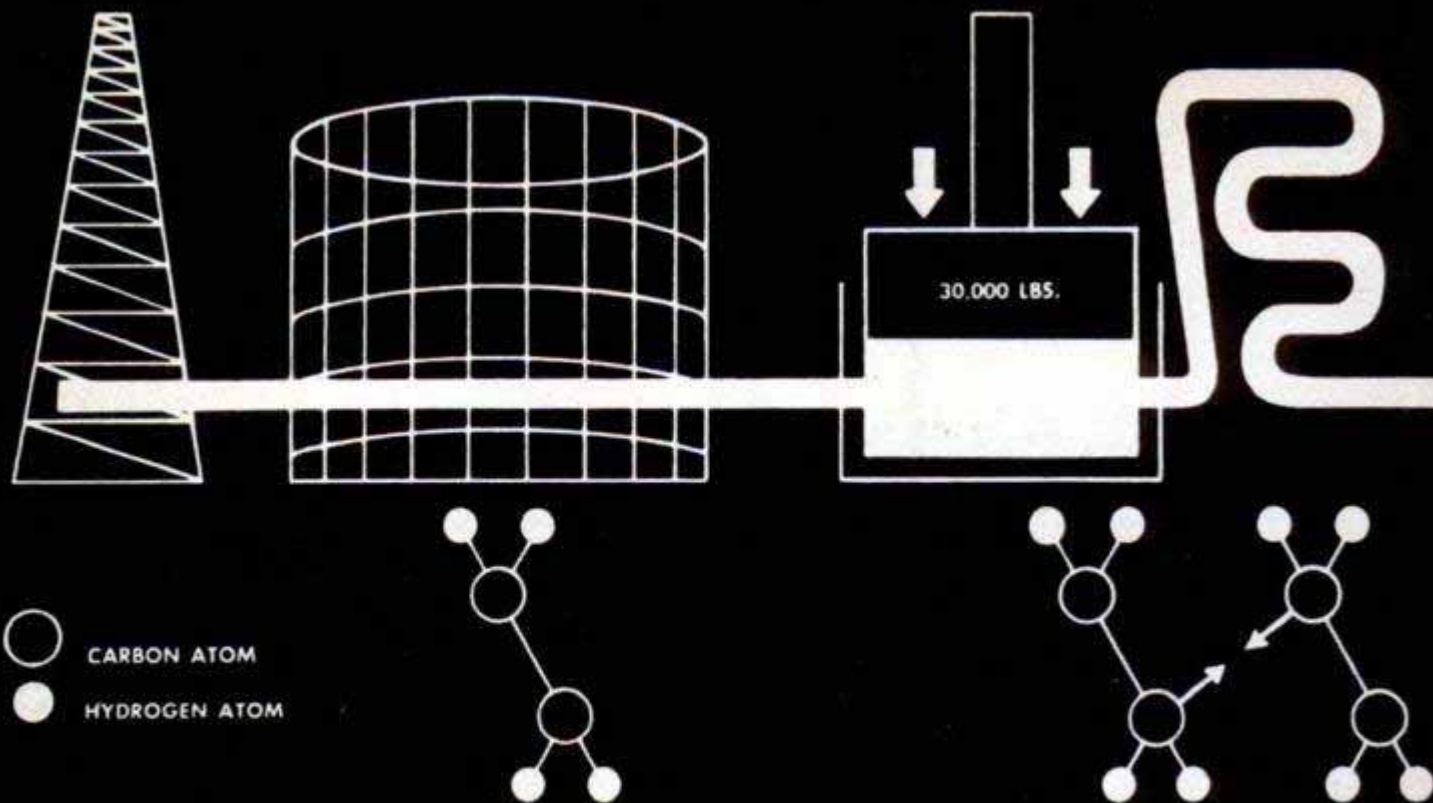

Schematic diagram of the life story of polyethylene from its natural-gas origin to a completed product. Lower section shows the resultant molecular changes

plastic properties. In the '30s research chemists of Imperial Chemical Industries Ltd., in England, turned to the problem and found that ethylene gas could be polymerized into a crystalline solid that was flexible and tough and composed of straight chain molecules.

However, this process was performed under pressures up to 1500 atmospheres, or 22,500 pounds to the square inch, and at temperatures up to 480 degrees Fahrenheit.

Large-scale production was delayed, therefore, until equipment was devised which would safely withstand the pressure and dissipate the heat.

World War II prevented what might have been a glamorous commercial debut for polyethylene; instead, under a cloak of military security, it sneaked out the back way and joined the armed forces as insulation for wire and cable in radar sets. All types of radar devices use vast quantities of wire and cable, which had been traditionally insulated with lead, a relatively scarce material in wartime. The new plastic stepped into the breach and did an outstanding job.

During the war, research was conducted into other uses for the new material and in 1944 the Bakelite Corporation and Du Pont went into commercial production under licensing agreements with Imperial Chemical Industries.

Last year the two companies produced about 15 million pounds of the plastic; this year all indications point to an output of about 50 million pounds and it is believed that this production will not be enough to keep ahead of demand. Both organizations have big new plants to produce the material: Du Pont (which calls it polythene) at Sabine River, Tex., and Bakelite at South Charleston, W. Va.

As diverse as the uses of polyethylene have become, the first application—for sheathing wire and cable—still leads the way in quantity consumed. It was estimated recently that 80 percent of the total

Television cable insulated with polyethylene comes through the extrusion head and is wound on the reel

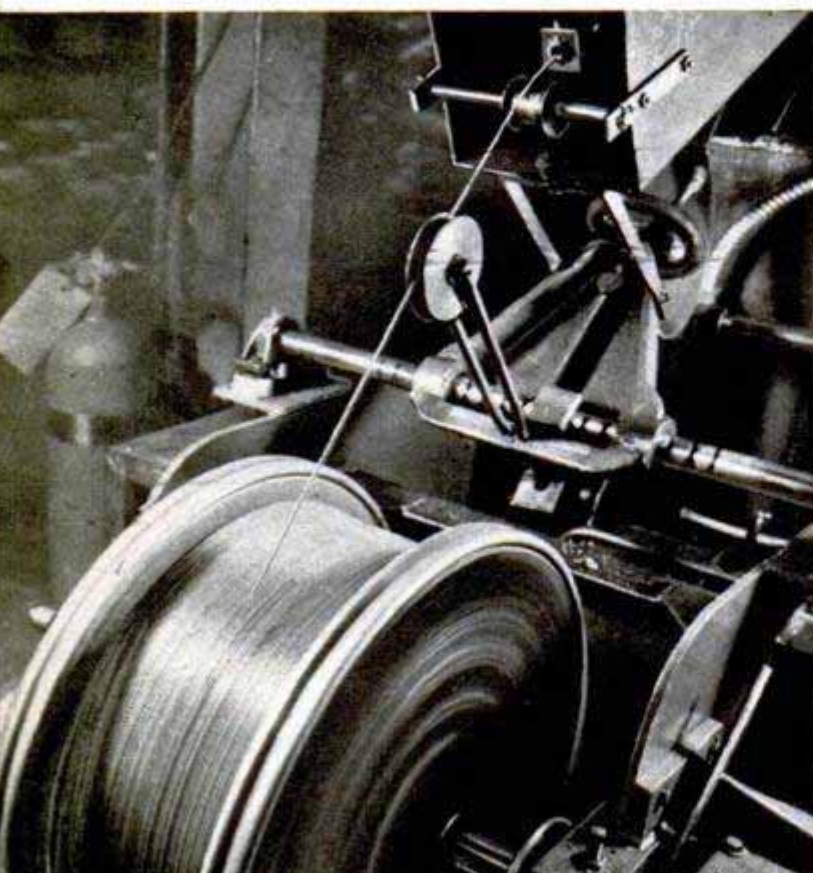

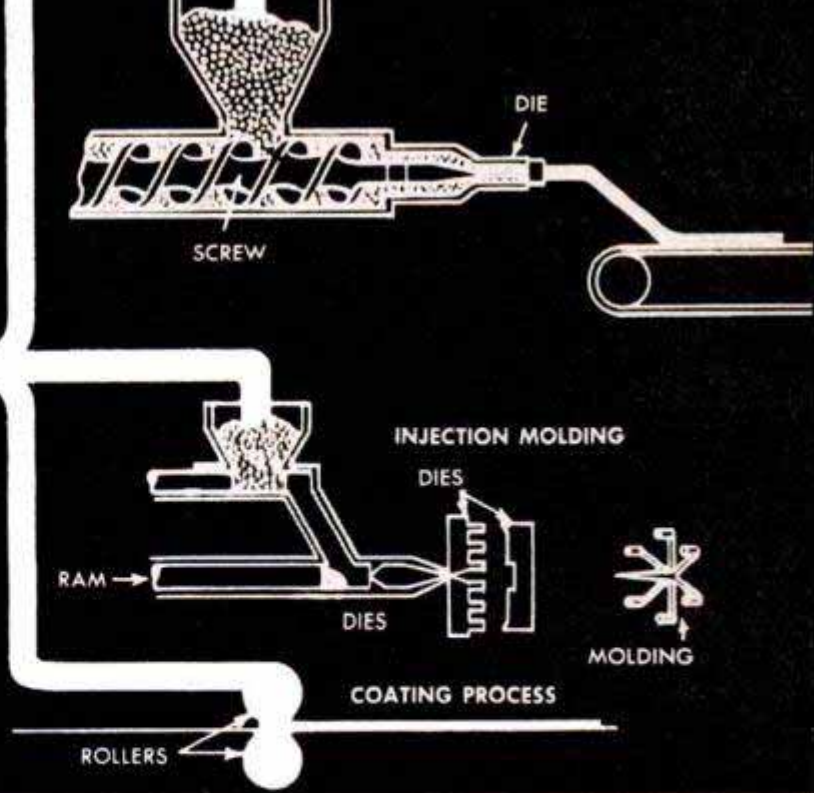
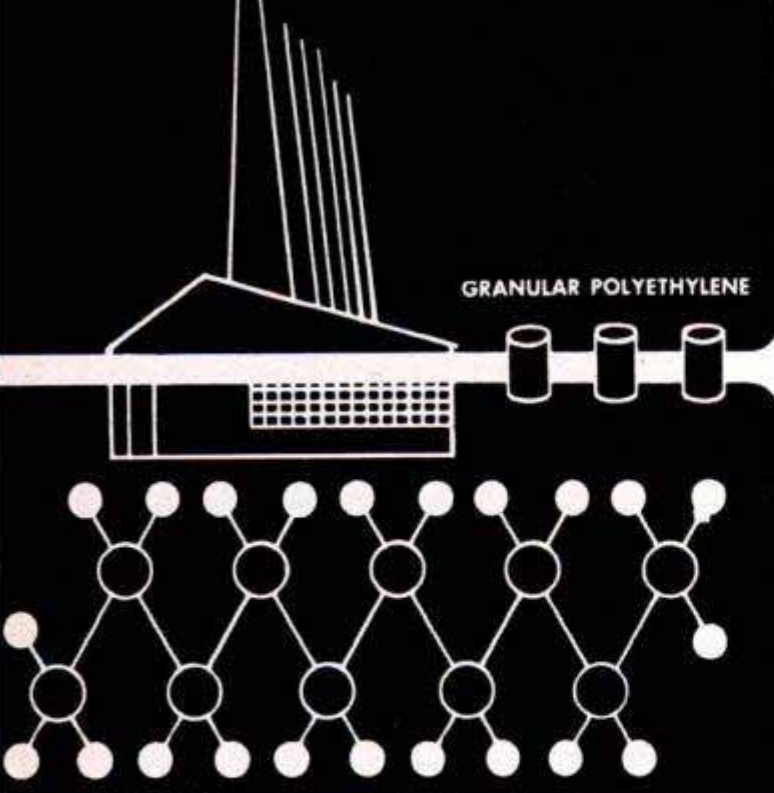

output went into such uses and the forecast is that the wire-and-cable industry will double its consumption by next year and treble it by 1953.

The spring after the war ended the Bell Telephone System estimated that it would have to have 60 billion feet of cable to meet the pent-up demand for new telephone service and for replacement—enough to carry 24 pairs of wires from the earth to the moon and double the amount produced in 1929, the prewar peak year.

Lead in sufficient quantity for sheathing was out of the question. A substitute existed but it had never been field-laboratory tested or used in a service installation, although it had been subjected to accelerated aging. This sheathing is called Alpeh, from the key letters of its components' names, ALuminum and PolyETHylene. From the center out, an Alpeh-coated cable consists of the pulp-wrapped telephone wires, a paper wrapping, a corrugated aluminum covering and, finally, a sheath of polyethylene compounded with carbon black and an antioxidant to protect it from exposure to sunlight and atmosphere. Western Electric produced 60 billion conductor feet of this cable in a year. Compared with lead-coated cable, the new type carries three times as many pairs of wires, pound for pound; it is cheaper to make, to ship and to string in aerial installations; it is smoother, therefore longer lengths can be pulled through conduits, reducing splices; and it is not susceptible to corrosion.

Polyethylene is serving in the East-Mid-

west coaxial television cable. In each of the coaxial lines the plastic serves as spacers between the center and outer conductors, as many as 506,000 spacers per mile, replacing the hard rubber formerly used. Not only is there less high-frequency loss with the plastic disks, but a saving in cost.

A Brooklyn schoolboy who lost an ear now mingles with his playmates, freed of the childhood curse of being "different." Plastic surgeons at Kings County Hospital, New York, gave him a polyethylene ear which is not only natural in appearance but extremely efficient in function.

Polyethylene is widely used for insulating cables, such as the one being pulled through a conduit here



The material has been found by surgeons to have unique qualities which make it particularly adaptable to reconstruction work on the human body, both internally and externally.

It has been described in a report carried by *The Journal of Plastics and Reconstructive Surgery* as "the most satisfactory substitute" for human cartilage and bone in plastic surgery. Describing chemically pure polyethylene, the report states that it is "chemically inert and resistant to most common solvents. It has no adverse effect on body tissues, nor is it in turn affected by them or by normal temperature ranges. Its natural flexibility and pliability remain unchanged, yet it forms a secure scaffolding on which surgeons can build the final shapes needed to repair accidental and natural deformities."

Perhaps its most dramatic application in surgery was to provide "blowout patches" on the aorta, the main artery carrying blood from the heart to the entire body. Six persons, the *American Heart Journal* reports, whose aortas bulged—as a weakened inner tube might—as the result of disease, had them either patched or completely wrapped with polythene. After more than two years all had survived this delicate operation, whereas a "blowout" of the artery would have been instantly fatal.

Ethylene gas, the source of this material, is found in natural gas and petroleum and exists in great, if undetermined, quantities. It is polymerized, a process which combines small molecules to make large ones, and the resulting molding powder is waxy-looking and translucent. By strict control of manufacturing, particle size can be varied, thus changing such characteristics as tensile strength, elongation at break, brittleness temperature, tear resistance and plasticity.

Television images and control circuits are carried from cameras to control rooms and transmitters over polyethylene-insulated cable. Larger coaxials, for network telecasts, also use this versatile plastic

Smooth, odorless, tasteless, nontoxic and nonabsorbent, polyethylene is a natural as a packaging material and this is expected to be the field of greatest consumption, with the possible exception of electrical insulation and sheathing. The obvious question is, "How does it stack up as compared to Cellophane?"

Some persons in the plastic industry believe it will outstrip that glistening material, claiming that it is tougher and that its low water-vapor transmission gives it a decided edge in packaging frozen foods. Goods wrapped in Cellophane, which passes moisture more readily, sometimes are "scorched" and become discolored at the time of freezing. Polyethylene is not subject to this undesirable reaction. But, on the other hand, it cannot be made as transparent as Cellophane, which means that it lacks the sparkle and "showcase" characteristics of the older material. Du Pont people see no slackening in the demand for Cellophane ahead, feeling that there is room for both in the field.

Applications of the plastic in consumer goods are almost without number and new ones seem to appear daily. The same material which imprisons highly corrosive hydrofluoric acid, which chemists call a "glass eater," makes an excellent, pre-sterilized, nursing "bottle" that cuts down baby's burping. Tubular sections are cut off, fitted with a plastic top, filled with formula and closed with the nipple. The tube collapses as it is emptied, cannot feed the baby air and give him indigestion. The disposable bottles cost a cent apiece.

It makes fish lures so much like eel skins and pieces of squid that the canny striped bass is fooled. It will keep a head of lettuce fresh at room temperature for a week because the thin plastic sheet "breathes." Toilet preparations can be squeezed from a flexible polyethylene container and ice cubes pop out of a polyethylene freezing tray with a twist of the wrist.

"Poly" keeps food odors sealed in when used to cover leftovers in your refrigerator. It is not brittle and won't crack, yet it wipes clean with a damp cloth. You can make attractive covers for appliances with it in any color you choose. In rubber production, carbon black is packed in polyethylene bags which are tossed into the mix without being opened, the plastic having been included in the formula.

Made into tubing, it handles sulphuric acid or fresh milk. Polyethylene bags hold peat humus without rotting, a tremendous advantage over paper and cardboard, which are soon decomposed by the organic material. The precocious plastic is useful, decorative and inexpensive. It has earned a place on the all-star plastic team.

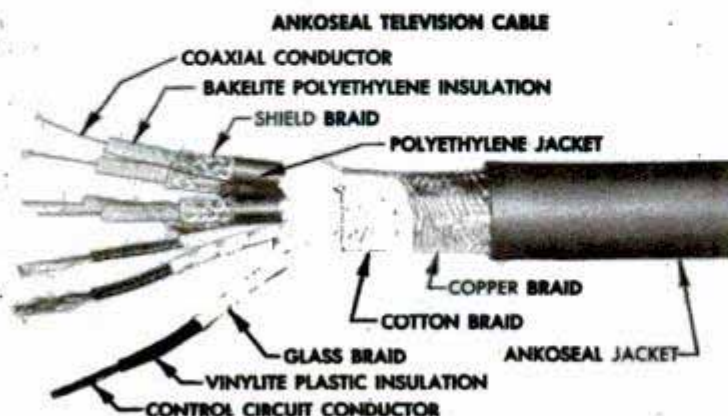



Ice cubes pop out of this polyethylene tray with a twist of the wrist. It's virtually unbreakable, too



Polyethylene, the all-star plastic, forms the neat shield that protects the twin lenses of this camera

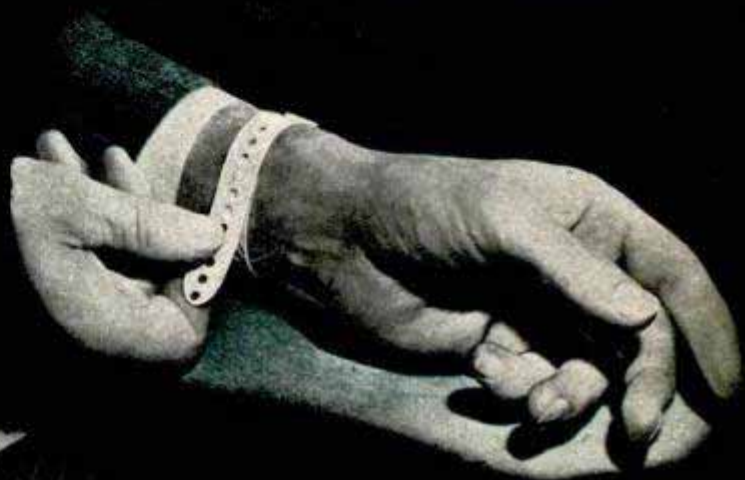

This watch band is also a "poly" product. Button-like snaps keep it tight



Humus bags are made of "poly" because it won't decompose as paper does

Food stored in plastic bags, below, retains original flavor much longer

Fishermen use the all-star plastic, too, as these lures, below, testify

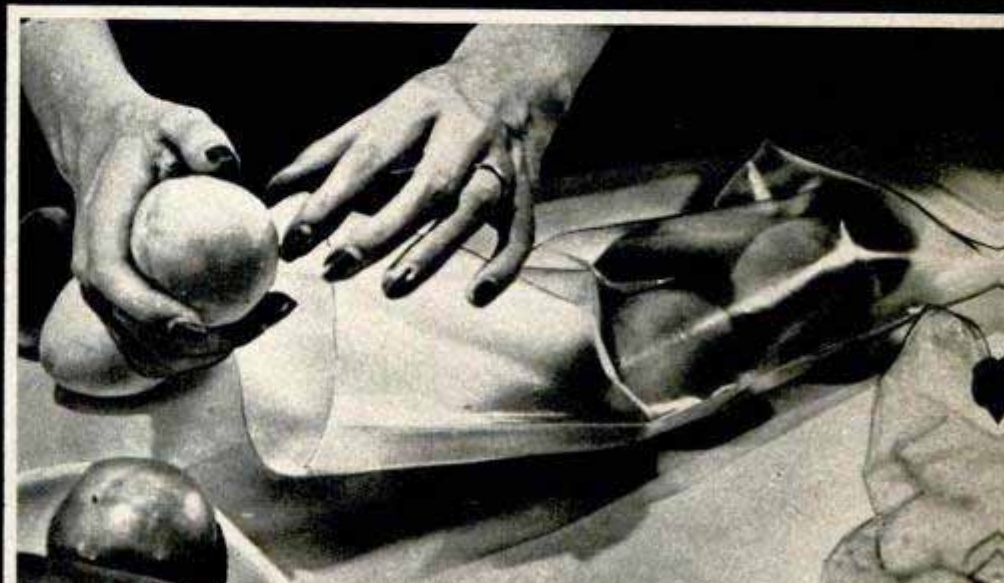
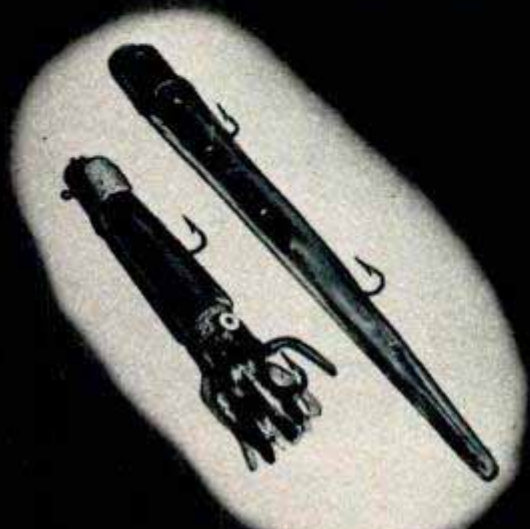

Parachute Aid Kit Supplies 10 Victims

Fragile medical supplies parachute to earth safely in a new droppable kit adopted by the Royal Canadian Air Force. Containing supplies sufficient for 10 persons, it will be standard equipment for "mercy flights" over the Arctic and the bush country. Each item will be individually packaged to withstand the landing shock. The kit was developed by the Institute of Aviation Medicine of Toronto. In addition to medicine, instruments, plasma and splints, it will include hollow poles that can be used with the kit's covering to make a stretcher. Tubes of drugs and lubricating jelly will be placed inside the poles and the top of the kit will be packed with hot-water bottles, folded in half, and tourniquets.

Crown Copyright photos.

Top, all medical supplies shown can be parachuted in a single shockproof kit. Center, canvas kit covering and poles form a stretcher. Left, the sectioned poles are also used in splints

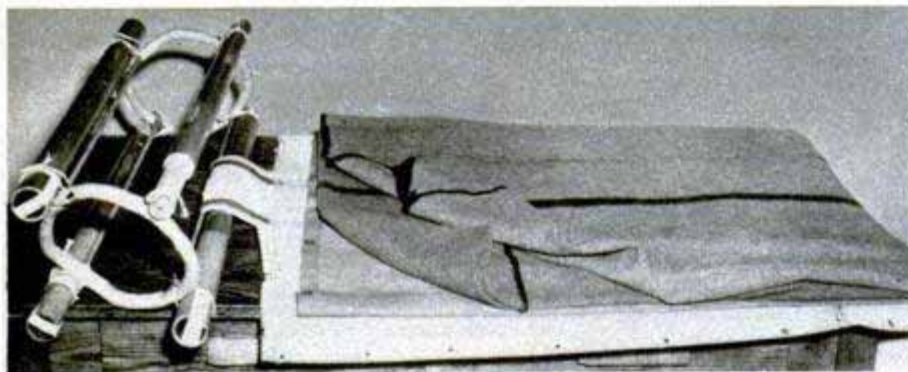
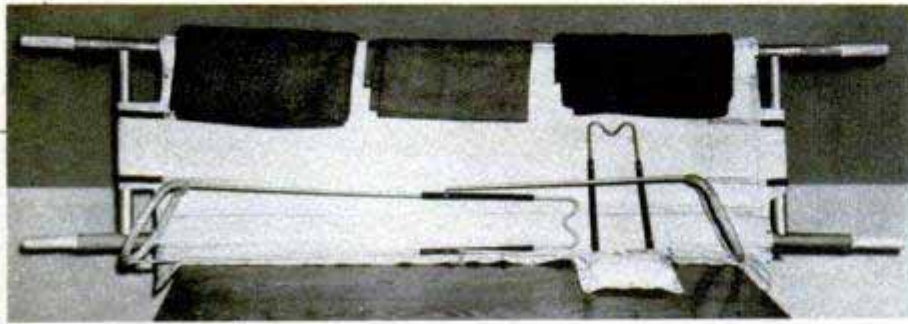

Turntable Unit Marks Keys With Identifying Names

You'll always be able to find the right keys when you have them marked with an identification name on the key head. This is done with a turntable die unit and a wide variety of dies is available for the machine, designed for use in factories, warehouses and key shops. The key head is placed beneath the die tip and one sharp blow with a hammer makes the impression. To make the letters more legible, paint is rubbed into the impression.

☐ Now in its 20th year without a fatality or serious injury to passenger or crew member, Colonial Airlines has flown over 250,000,000 passenger miles while establishing a world's safety record for scheduled airline operation.

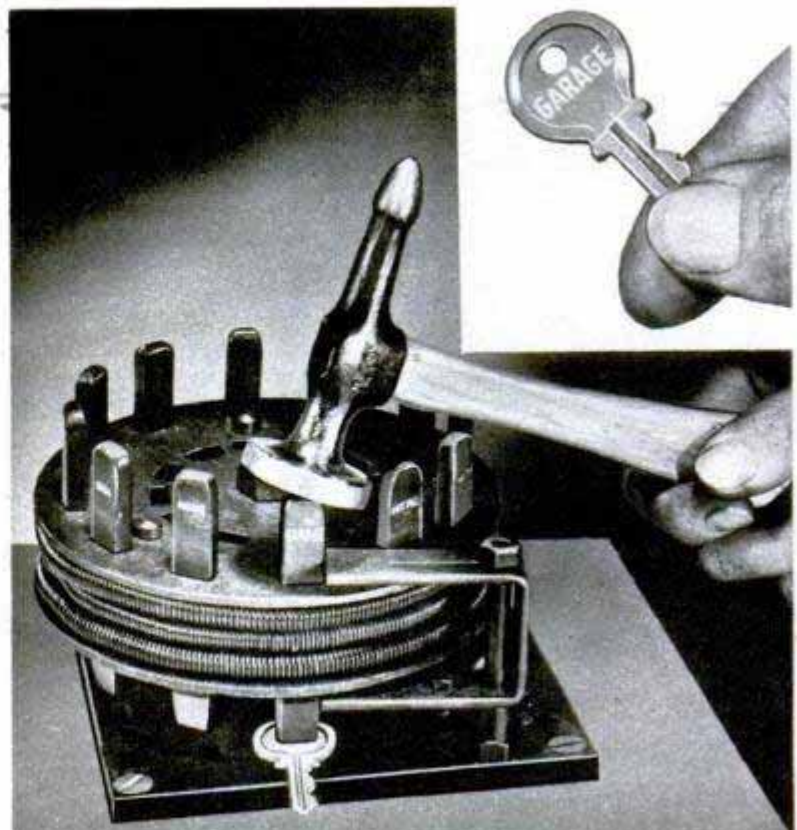

Car's Lift-Trailer Serves as Wrecker

Any car can be converted into a wrecker with a trailer that lifts and supports a damaged auto while it is towed to the garage. It connects to any car or light truck with an ordinary trailer hitch. Adjustable jaws are extended from the two-wheel trailer and slipped under either end of the damaged car. A hydraulic jack lifts the car off the ground. When the tow car is backed up, the trailer frame telescopes until the load is directly over the two trailer wheels.

Fine-Grain Developer In One-Use Packages

Photo hobbyists who develop small quantities of film only occasionally can now get fine-grain developer packaged in aluminum-foil packets, which contain chemicals for eight ounces of solution. Since the developer is discarded after one use, there is no liquid storage problem. By mixing the chemicals each time film is to be developed, the hobbyist always has a fresh batch of developer and that means better negatives.

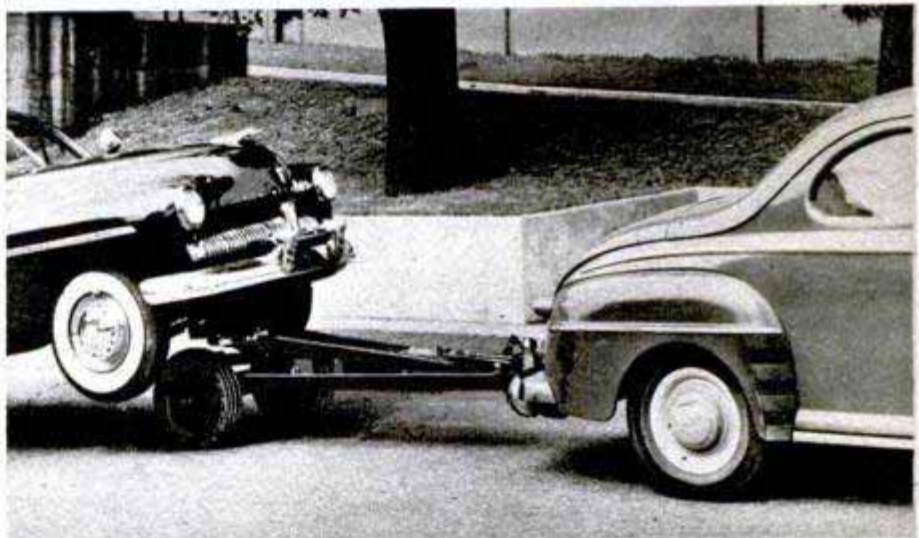

Miniature Paddle-Wheeler Made of Inner Tubes

Four can ride without danger of tipping or sinking in a craft made of inner tubes and canvas. Howard Karst of Los Angeles, builder of the Gazook, believes it is just the thing for families living near a lake or pool. It is hand-powered by metal paddle wheels.

☞Horses will become extinct in perhaps 15 or 20 million years according to Professor Laurence L. Sloss, Northwestern University geologist, who bases his prediction on the known history of horses and horselike animals.



The Fox is acting out the fable, *The Fox and the Grapes*, for the movie camera. Actually, he's jumping after a piece of beef liver behind the grapes

Below, right, in a scene from the familiar fable, the plodding Tortoise passes the Hare, who is so sure of winning the race that he stops for a little nap

Below, as Chace looks over the script, the playful Raccoon sneaks up behind him and bites at his hair. This is a part of the getting-acquainted procedure



ANIMALS ENACT AESOP'S FABLES

Photographed by Lynwood M. Chace for
Encyclopedia Britannica Films

HOLLYWOOD directors who think their movie stars are difficult to handle should be thankful they don't have Lynwood M. Chace's assignment. The stars in his films are more temperamental than the flightiest prima donna. They are all animals and the script they follow is Aesop's Fables. Included in the cast are such well-known Aesop characters as the Hare, Tortoise, Fox, Stork, Owl and Raccoon.

Before filming starts, Chace turns each new animal loose in the brightly lighted studio and lets it romp around, getting accustomed to the lights and equipment. He sits quietly in a corner taking notes on the animal's behavior, noting which actions can be worked into the script. He experiments with various foods to discover those with the most appeal to the animal. Later, he uses these foods to tempt the animal into following the script.

The movies are filmed for Encyclopedia Britannica Films, Inc., and, when completed, consist of 400 feet of 16-mm. sound film for use in teaching the fables to school children. Standard movie equipment is used and Chace usually takes about 1200 feet of film for each movie. By careful editing and splicing, he gets a movie short that is filled with 400 feet of action.



The Great Horned Owl, who plays the role of judge in the race between the Hare and the Tortoise, is completely at ease as he poses for a close-up shot

Right, in Aesop's fable of the Hare and the Tortoise, the Hare, bragging about how fast he can run, tells how he outraced a dog, as shown in this movie scene

Below, the Fox, a sly creature, invites the Stork to dine with him and serves soup in a shallow dish so the bird can't get any. But the Stork is no fool and he returns the invitation, placing the food in a long-necked jar, center, much to the disgust of the Fox who goes hungry as the Stork eats at right



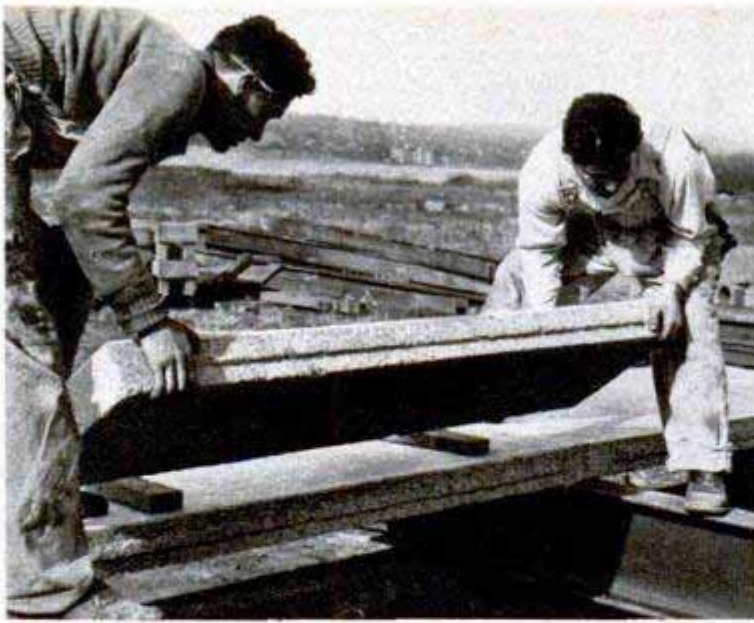

Left, two men can handle a roof plank of wood-aggregate concrete. Right, an aluminum batten seals wall joint

Cement and Wood Shavings Form Building Slabs

Fireproof and soundproof, a lightweight building material is made of chemically treated wood shavings mixed with cement and molded under pressure into planks, slabs and blocks. The material has a high insulating value and resists attacks by insects and vermin. Reinforced planks, eight

feet long, are used for roof decks and are light enough to be handled by two men. For exterior walls, aluminum battens seal the joints between the slabs. The material is used as a plaster base for interior walls where its soundproofing quality deadens bothersome noises in the home.



"Waste" Coffee Made Into Soap

"Waste" coffee, about one third of the world's production that is unsuited for beverage and was formerly dumped or burned, is being made into soap products. The soaps remove dirt, grease, stains, ink and paint. A new process separates the natural oils from roasted coffee beans after they are ground. The oils are treated with alkali to produce soap. The caffeine extracted is used for medicinal purposes. Odorless, "coffee soap" eliminates foreign smells and has proved nonallergic in hospital tests.

Travels 400 Miles On 2½ Gallons

Two can travel almost as cheaply as one and when they go by motorbike-trailer combination that's real economy. A German couple recently traveled over 400 miles on 2½ gallons of gasoline on a lightweight motorbike and homemade trailer. A padded chair on the pneumatic-tired trailer provided a comfortable ride for the passenger.

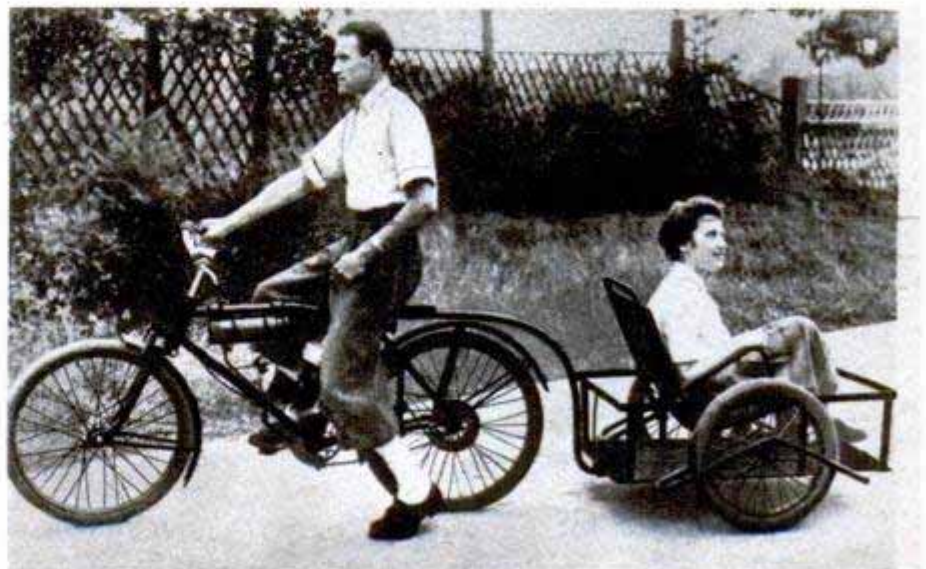

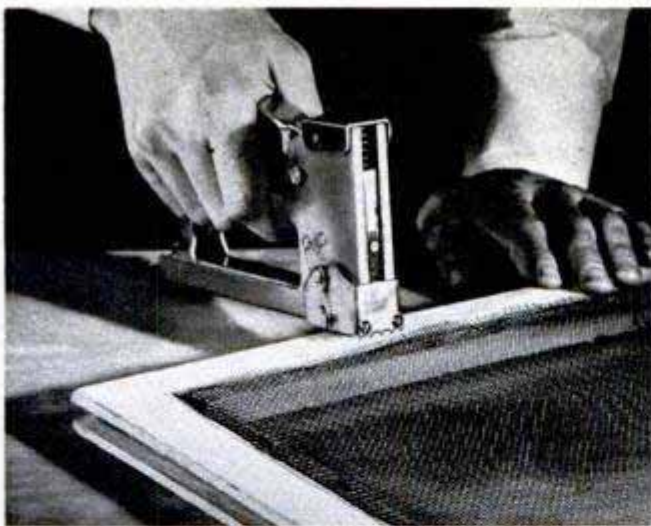

Gun Stapler Has Toothed Claw For Stretching Wire Screen

Wire screen is stretched and tacked in one quick operation by a gun-type stapler that has a toothed claw attached to its front end. The teeth are hooked into the screen to pull back on the wire and make it taut. Then the trigger is squeezed and the gun fires a staple between the wire strands, tacking the screen in place. When not needed, the claw is reversed so that the teeth face upward.

Fish Stringer Serves as Carrier

Fishermen can hold their catch in the water with a new stringer that also serves as a carrier. The lock on the stringer holds 100 pounds securely and can be opened with one hand. The leader chain has an eye on the end for fastening the catch to a boat or pier. The stringer is made of rustproof, tempered steel.

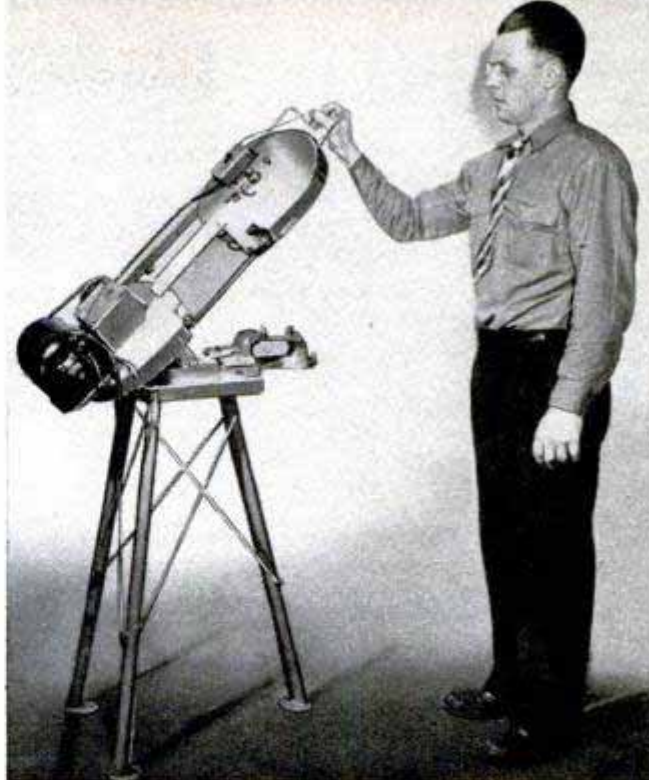

Metal Bandsaw Pivots at Base

Small metal parts can be held in a vise while they are cut by a bandsaw that pivots down against the work. The saw also is designed to handle pieces too unwieldy to move during the cutting operation. It is hinged at the base and can be swung down to bring the blade in line with the desired cut. The capacity is 3½ by 3½ inches.

Chicken-Pie Mold

Chicken pie is shaped to resemble a baked chicken when prepared in a new cast-aluminum mold. Weighing one pound, the mold can be used in baking other meats and fish, or for forming Jello or ice cream.

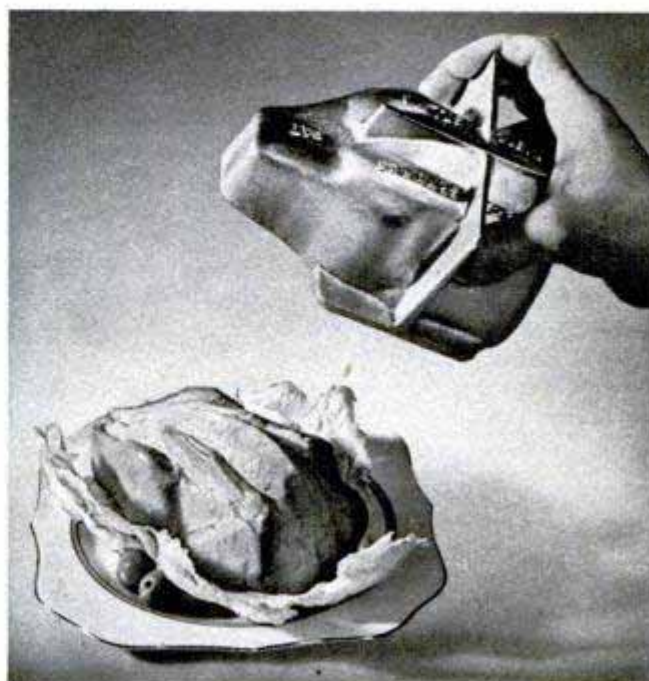

Pack Into the Wilderness

By Andrew Hamilton

When you head into the rugged forests of the West with rod or rifle, you'll find no modern substitute for those old-fashioned beasts of burden, the pack horses





These pack horses haul supplies in Montana's Flathead National Forest for sportsmen who will ride in later

WANT TO BAG a spread of horns to grace your den? Want to stuff a creel with fish big enough to boast about for months? If you do, then you'd better plan to go on a pack trip.

The pack trip is an institution as Western as the lariat, the cayuse or the sombrero. In Maine or Canada you paddle a canoe to get "where the big ones are." In Florida you charter a power launch. But in the Far West you hire a packer.

A pack trip is an expedition on horseback into some part of America's 30,000 square miles of wilderness—the "happy hunting ground" of hunters and fishermen.

Every summer and autumn, scores of pack trips are organized and conducted into remote corners of national parks and national forests in Idaho, Montana, Wyoming, Colorado, Utah, Washington, Oregon, California, Arizona and New Mexico. Much of the remaining wilderness area is almost as primitive as when Lewis and Clark or Kit Carson tramped through it. Deer, bear, moose, bighorn sheep, mountain goat and elk prowl up its canyons. Ducks, geese, dove and pheasant whirr across its marshes and meadows. Trout and salmon riffle its lakes and streams.

A pack trip requires time, effort and money. But it's worth it. As one old-time guide says, "You can't sit in your automobile, and expect to shoot an eight-point buck or hook a 30-pound salmon."

In the Western states a number of packers make a profession out of taking hunting and fishing parties into wilderness areas. Three requisites of a good packer are: (1) a string of dependable horses, (2) first-rate equipment, and (3) a palm-of-the-

hand knowledge of the area to be covered.

Some states license their packers; others are currently planning to do so. This is an effort to eliminate the "tin horns"—fly-by-night fellows with poor equipment and little experience. Not only is the reputation of established packers damaged, but a miserable time and little or no game result for the sportsman.

A pack trip may be made by a single individual—or by as many as 10 or 12 persons. The ideal number, packers say, is three. Rates vary from place to place and according to the equipment required. The price of a big-game hunting trip may run as high as \$50 per day per person. An overnight fishing trip with a group of 8 or 10 may cost as little as \$5 per person.

Women sometimes go on hunting and fishing pack trips. But the rigors and uncivilized character of a pack trip should always be carefully explained to any woman who fancies herself a 20th-century Diana. A pack trip is a lot more primitive than a Sunday picnic.

Most pack trips into fishing areas are made during the months of June, July, August and September. Pack trips to hunting areas are made during September, October and November.

Horses used for pack trips are regular Western cow ponies—smaller than some other breeds of American horses, but sure-footed and possessed of tough endurance. Those that carry hunters or fishermen are saddled with the familiar Western saddle; those that tote provisions and equipment carry the sawbuck pack saddle. The traditional diamond hitch is used for lashing gear on any animal. Each packer usually

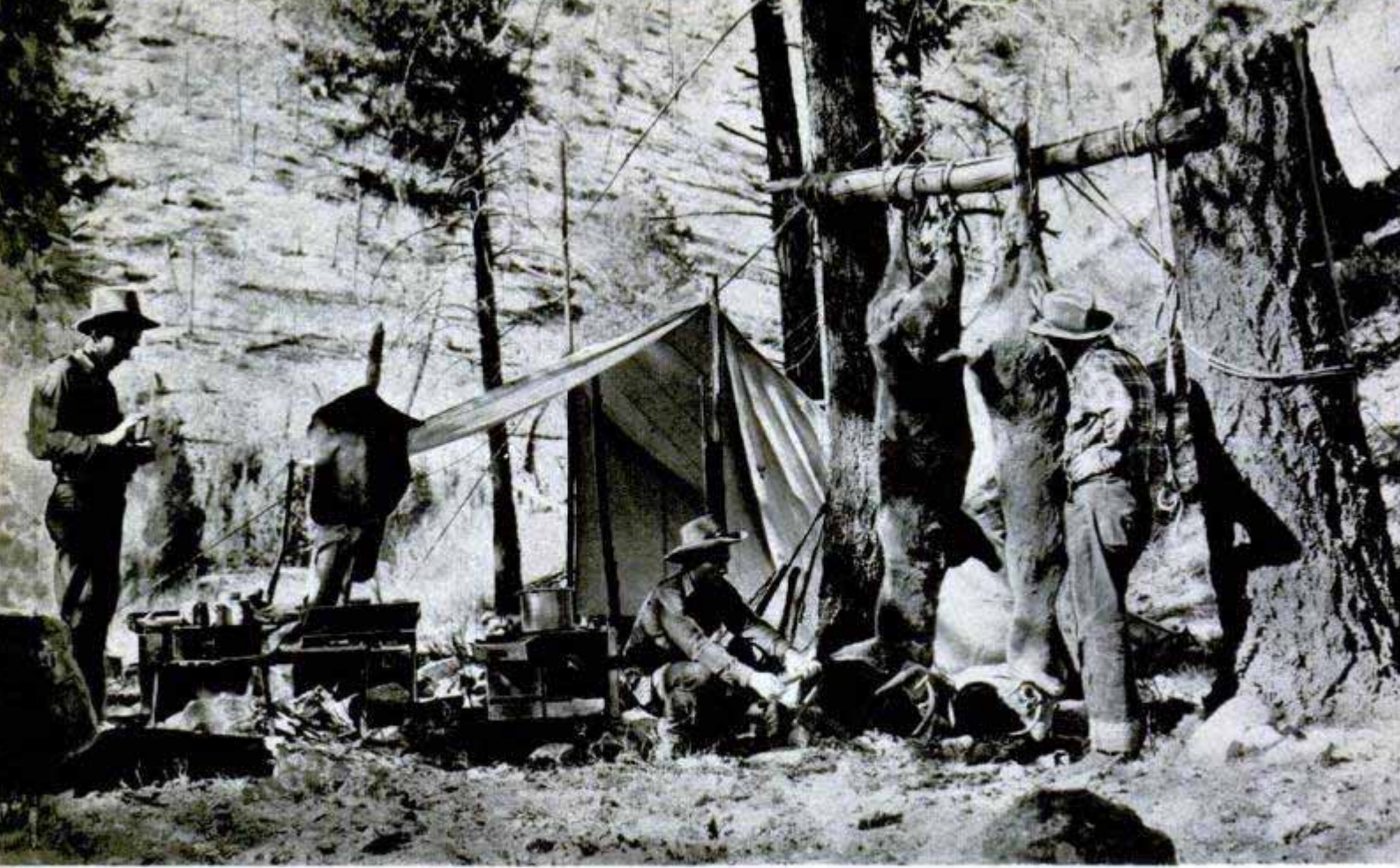

There is double proof here of the good hunting you'll get by packing into the wilderness around Sun Valley

develops his own variation, however, of this famous rope hitch.

More and more persons are packing into wilderness areas not to fish or hunt, but simply to enjoy the rugged grandeur of the mountains. One of these groups is the Trail Riders of the Wilderness, a nonprofit organization. Begun in 1933 by the American Forestry Association, Trail Riders has conducted over 65 expeditions into 10 Western states over trails totaling 8000 miles.

Last summer for example, the Trail Riders sponsored nine expeditions into wilderness areas in Idaho, Colorado, Montana, California and Washington. They range in

length from 7 to 16 days, and in price from \$129 to \$228. The size of each party varies from 20 to 30 riders.

Does a pack trip interest you? If so, put on a flannel shirt and blue jeans and we'll take a trip into the Middle Fork of the Salmon River in central Idaho.

We've made headquarters at Sun Valley, Idaho. The famous winter ski resort becomes "home base" for hunters and fishermen during summer and fall. A tall, wiry chap by the name of Joe Burgy is our guide. A graduate of Georgetown University, Joe studied for the foreign service and for seven years was secretary to Senator Borah. Because he loved the blue skies and towering peaks of Idaho, he returned to his native state. Now he is director of outdoor activities for Sun Valley.

This is to be a big-game trip, so Joe suggests that we go over to the shooting range to sight-in our guns. Good advice for any kind of a hunting trip.

"Guns get knocked about and the sights become crooked," he says. "On a hunting trip you may get only one good shot. If your gun is firing three feet high, you'll miss your one chance."

Joe also advises us on the subject of equipment (weight should not exceed 50 pounds) and helps select the food we'll need.

Drawings on these two pages are from the book, *Wildwood Wisdom* by Ellsworth Jaeger, copyright 1945 by The Macmillan Company and used with their permission.

Almost every packer has his own variation of the famous diamond hitch. This is the basic pattern

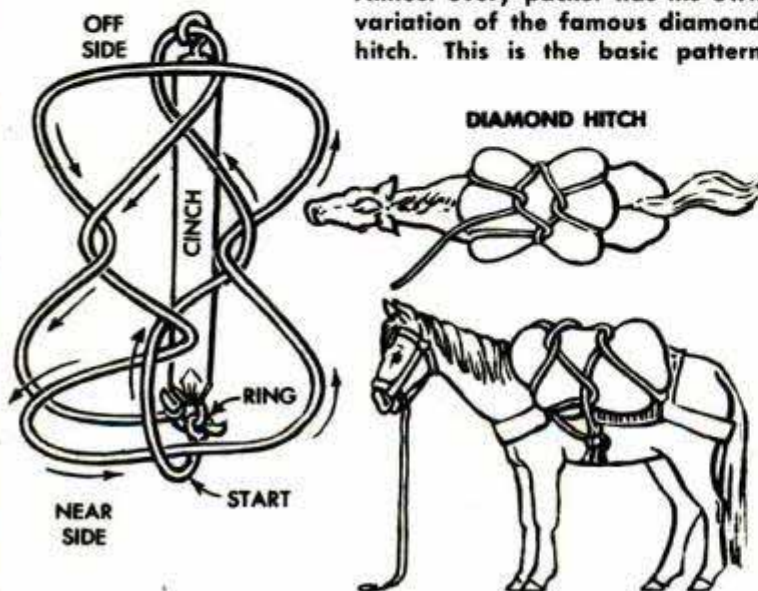



Packing into the wilderness is not exclusively stag. A man and wife try their luck in Lolo National Forest

The matter of equipment is important. Waterproof sleeping bags and air mattresses are recommended. A slicker or raincoat comes in handy to ward off quick summer thundershowers. Trousers should be loose at the knees. Most experienced guides recommend blue jeans or khaki pants. A broad-brimmed felt hat will keep off the sun's rays, which burn deep and quickly at high altitudes. Toilet articles should be compact. Cameras, binoculars, a sharp jackknife and a small folding drinking cup are found useful.

Preparations completed, we climb into a station wagon and drive 100 miles north of Sun Valley to the tiny outpost of Challis. Here "Andy" Anderson, a veteran packer, maintains a string of horses and equipment.

"Howdy," Anderson says, "I'm all set to go—soon as you gentlemen say the word."

The pack animals are waiting. One saddle horse for each sportsman, guide and packer. Three pack horses to carry the tents, cooking equipment and food. Since we are going hunting, there are additional animals to carry the mountain goat, deer or elk that we might shoot. One horse can carry a 250-pound deer. It takes two horses to haul back larger game.

As important as the packers who take you into hunting and fishing areas are guides like Joe Burgy, Taylor Williams, Dutch Gunderson, Jim Saviers and others in the Sun Valley country. They're essential because as a stranger in the primitive Middle Fork area, you could easily become lost, and you've got to have someone along who knows the habits of big game and fish, where they are found and how the weather affects them.

That's why most guides are older men—or men who have lived in the area since childhood. It requires a lifetime study to outwit a fish like a salmon that has sneaked

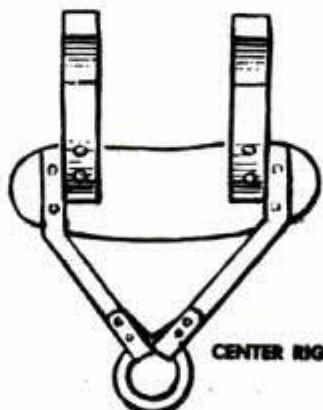

CENTER RIG



Two types of sawbuck pack saddles, the center rig and the double rig, that are standard for pack horses

SAWBUCK PACK SADDLE

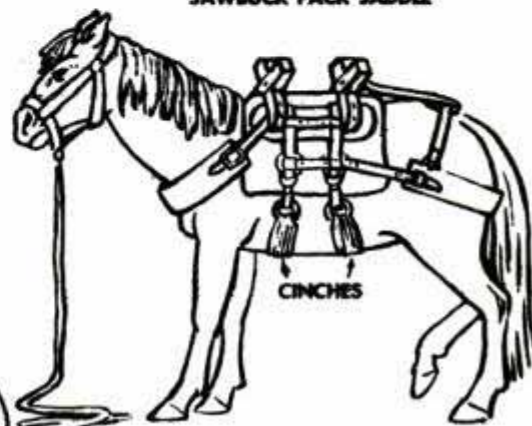

DOUBLE RIG

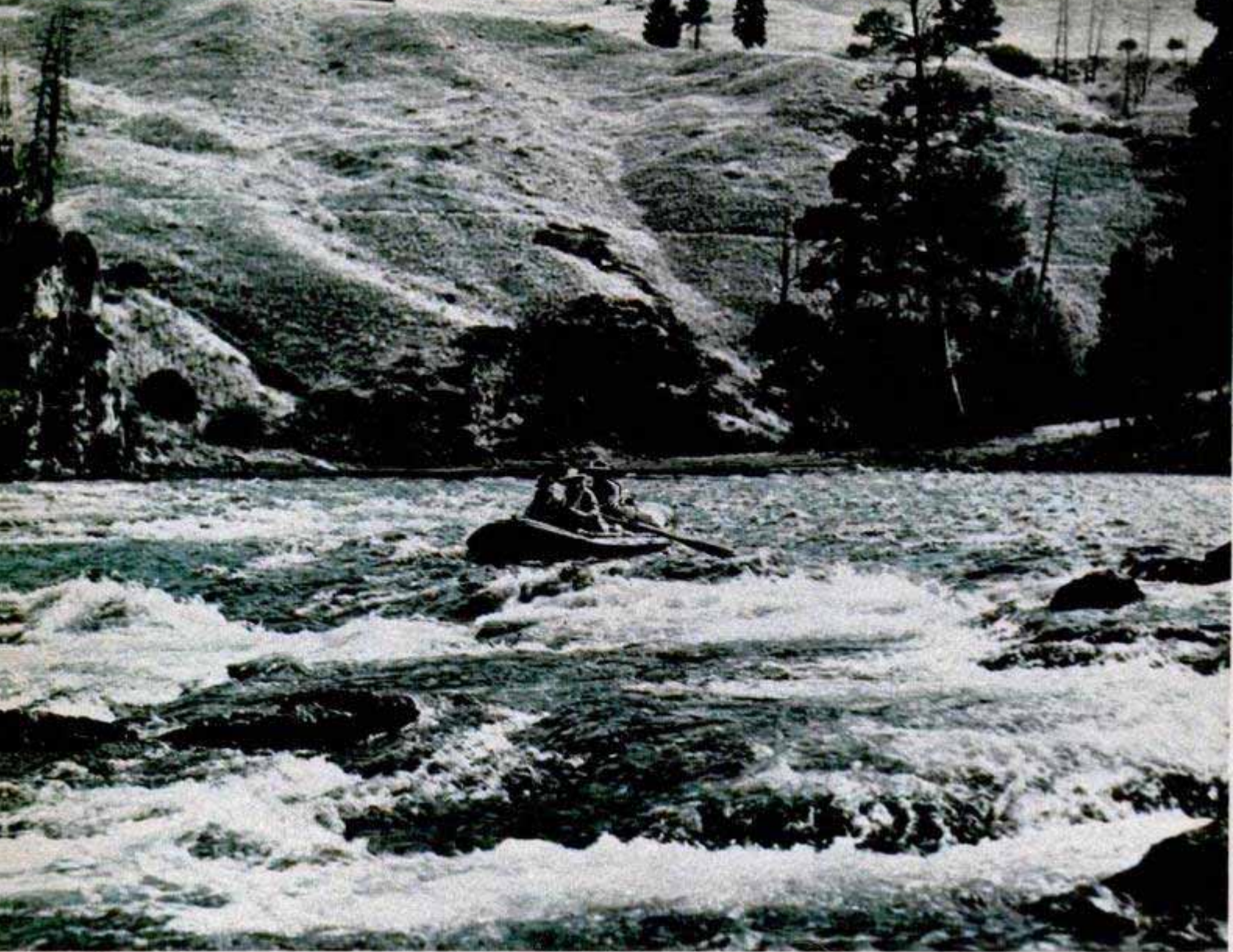

It's a rough ride down the rapids of Salmon River which drops 1700 feet in 60 miles, but it takes more than white water to stop the enthusiast

Deflated, this double-bottom rubber boat is hauled in by pack horse. Pumped full of air, it is sturdy enough to shoot the turbulent rapids



past the rapids and nets of the Columbia River—or a bull elk that has escaped the natural and man-made perils of the forest for a score of years.

The first day's journey on a pack trip may be an easy 8 to 10 miles. The following days will be more rugged—15 or 20 miles.

Man-made improvements in this part of Idaho's wilderness area—and in all national forests—are maintained by the U. S. Forest Service. Its green-uniformed Rangers supervise the maintenance of trails, inspect camp sites and protect the areas from fires. At the same time they strive to maintain the primitive environment of the wilderness that is so

(Continued to page 236)

Bow Saw Cuts Logs Without Binding

Timber can be cut in any position without pinching by a powered bow saw that has a 20-inch curved blade. Driven by a five-horsepower gasoline motor, the saw cuts rapidly through any type of wood, whether it is on the ground, propped at one or both ends or swinging. The curved blade allows cuts to be made without difficulty all the way through a log that is flat on the ground.

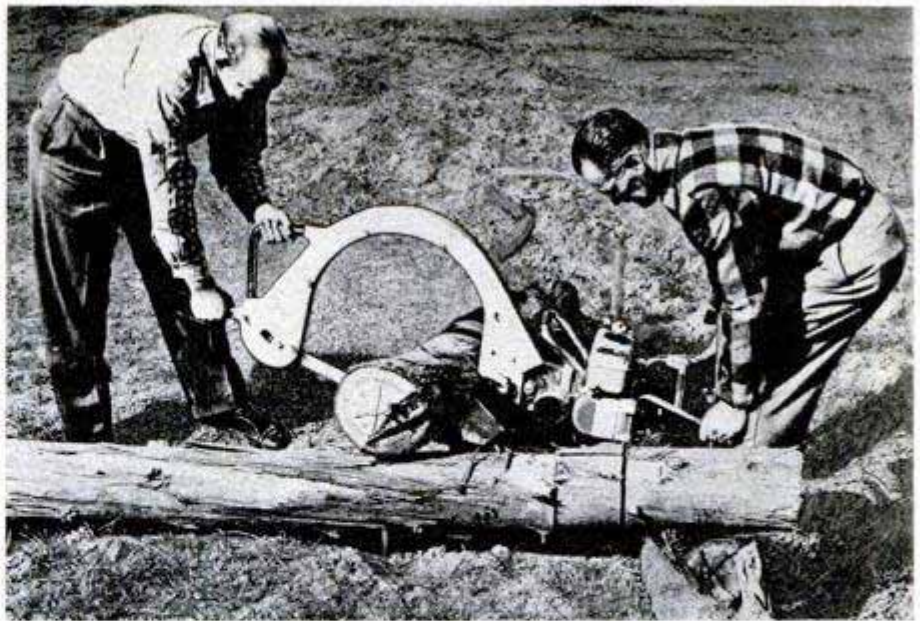

Midget Tractor Pulls Big Loads

Weighing only 525 pounds, a small tractor is powered by an air-cooled engine that drives it up to 30 miles an hour and goes 60 miles on a gallon of gasoline. Capable of pulling a 12-inch-bottom plow, 6 inches deep, at 4 miles an hour, the tractor is also useful for delivery work and odd jobs around town. It has a standard transmission and differential with three forward speeds and one reverse. Maintenance costs are low because of its simple construction. Attachments include a mower, rake, seeder, snowplow, cultivator and bulldozer.



Huge Rotary Rake Spreads Mulch

Loose straw and stubble are spread over plowed fields by a big rotary rake, preventing erosion and providing a mulch. The rake can be pulled behind almost any kind of a plow. It revolves to spread loose stubble from unplowed land across freshly plowed land. The mulcher rides on rubber tires and is adjustable in height for all kinds of straw, stubble, sweet clover and other vegetation. The teeth are made of high-carbon steel and can be replaced if they wear out.

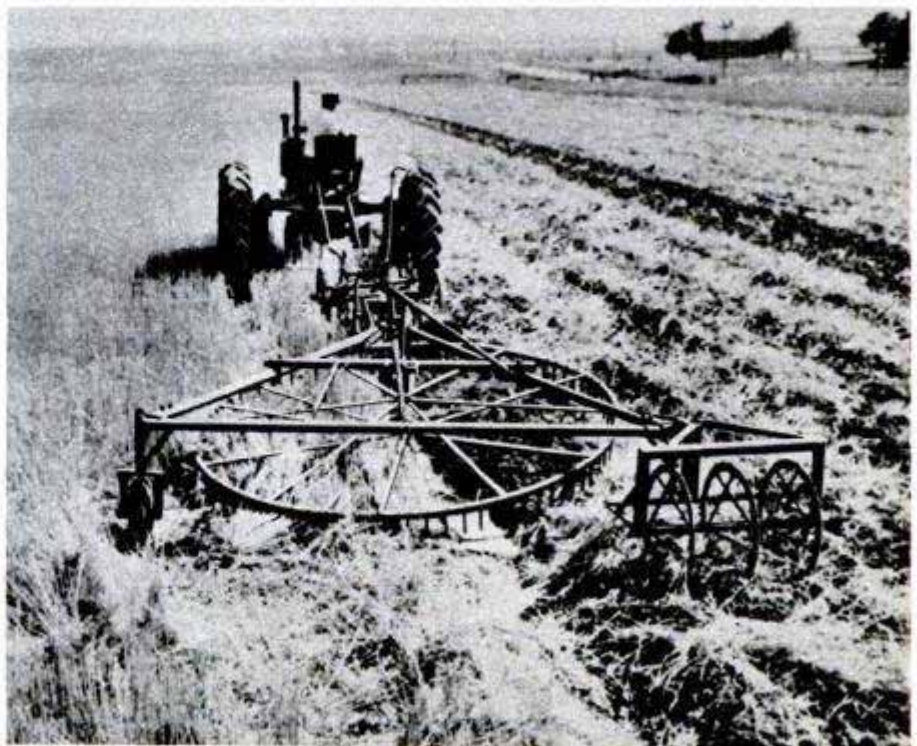



Creole Petroleum Corporation photo

Venezuela's Magnetic Mountain

By Harry Chapin Plummer

WHEN THE CONQUISTADORES of old Spain explored the jungle country of eastern Venezuela four centuries ago, the native Indians told them tales of a strange mountain which attracted lightning. Later the Spaniards saw for themselves this magic mound which, when struck by a lightning bolt, gave forth a spray of flashes. The Spaniards dubbed the mountain "El Florero"—the Flower Pot—because the lightning flashes looked like flowers growing from the peak.

Today that mound has been found to hold one of the world's richest iron-ore deposits.

Credit for that discovery goes to an alert Venezuelan mining inspector, Eduardo Boccardo. In 1926 he determined to penetrate beyond the superstitions of the natives and to find out why the mountain was one of the spots most frequently struck by lightning on the South American continent. What he discovered was a fabulously rich lode of iron ore which, by magnetic at-

traction, drew lightning to the mountain. The Spaniards, intent upon their quest for gold and silver, had passed up a deposit so valuable that even now its riches can be only estimated.

traction, drew lightning to the mountain. The Spaniards, intent upon their quest for gold and silver, had passed up a deposit so valuable that even now its riches can be only estimated.

Surveys of that part of the mountain granted to Boccardo show that about 35,000,000 tons of mineral rich in iron underlay his concession. Assays have proved that this ore actually is 55 to 68 percent iron. Absolutely pure iron ore is made up of 72 percent iron and 28 percent oxygen. The iron content of Minnesota's famous Mesabi range is about 57 to 63 percent. On this basis, the Flower Pot represents one of the most important discoveries of the century in the field of metallurgy.

Naturally, it didn't take industry long to jump into this whopping mountain of ore. Today the Iron Mines Company of Venezuela, organized as a subsidiary of the Bethlehem Steel Company of the United States, already has a small army of employees in the jungles near the Orinoco. Their task is to form a modern mining industry in the heart of the forests. They are at work between El Pao, the ore site, and Palua, the loading point on the Orinoco.

The task of these workers is staggering. They must build the mines and the port, highway and railway—even their own homes in the wilderness. Already they have



Workers are carving modern road and railroad out of this jungle. That's a labor camp on side of mountain

completed a highway more than 14 miles long which eventually will serve as the right-of-way for a standard-gauge railway, the vital artery from the mines to the river. This railroad will have a steep grade from sea level to the mines.

When the harbor and dock installations, the roads and railways finally are completed, the ore will move by truck and train from the mines to the ships on the Orinoco. It then will travel aboard a fleet of ore carriers, especially built for the purpose, to the blast furnaces at Baltimore, Md.

It is estimated that production will rise to 3,000,000 tons of ore annually from ore reserves that will last a quarter of a century.

Already rolling along the uncompleted rail line is a 1500-horsepower diesel locomotive. When the track is completed, the railroad will have four locomotives, 100 ore cars with a capacity of 70 tons each, eight boxcars, four tank cars and a crane.

Before the end of this year the ore will begin to flow from the mines atop the magnetic mountain. There crews especially trained for the job will perforate and excavate the rock and earth, which will be picked up by four gigantic electric shovels each capable of taking a huge bite out of the ground. The shovels will load the ore into trailer-trucks hauled by tractors. From

there it will be taken to big ore crushers—one of them said to be the largest in the world. The fragments of crushed ore will be carried by an aerial cable arrangement to the waiting ore cars on the railway.

It is estimated that about 10,000 tons of the rich earth will be hauled down the mountainside every working day.

When the ore reaches the harbor, it will be dumped into a huge storage area. An ingenious series of chutes at the base of the area will drop each load into an underground conveyor installed in a tunnel. After passing through the earth, it will climb up a huge loading bridge which extends



Map shows location of the iron-mining area. Ore will be shipped down Orinoco from a point near San Felix



Diesel locomotive pulls ore cars along the top of the dumping structure. Chutes at the base drop ore into a conveyor tunnel

As efficient as a section of the New York subway, the underground conveyor system carries ore to the river loading bridge



like a pointing finger over the waters of the Orinoco. The load will slide by toboggan into 4000-ton lighters. Tugs then will pick up six of the lighters, form them into a train and haul them downriver to the Gulf of Paria. From there the new 24,000-ton ore carriers will take the ore by ocean to Baltimore.

This modern industrial system in the heart of the jungle is within the orbit of Ciudad Bolivar, the principal river port of the Orinoco and the administrative and financial center of the region watered by the river.

Almost due south of Ciudad Bolivar the United States Steel Corporation has been conducting explorations of another area that appears to have huge ore deposits. It seems likely that the same vein which crops out atop the magnetic mountain also appears in this new area.

Reports state that the mineral deposits found in this second area are of a high quality, satisfactory for smelting in open-hearth furnaces.

These two ore strikes are the second great boon to Venezuelan national economy within the past half-century. The first was the discovery of petroleum around Lake Maracaibo. Huge investments in drilling and pumping equipment, pipe lines, railways, bridges, community settlements, hospitals and schools have been made by the participating oil companies.

Venezuela has enacted a law which requires the oil companies, both foreign and national, to refine within the country a percentage of the crude oil that is recovered. The purpose, of course, is to have a supply of domestic oil. It is anticipated that similar legislation will apply to recoveries of iron ore, and that eventually there will be smelting operations within Venezuela.

Such a development would place Venezuela in the forefront of South American nations which at the turn of the century were dependent upon agriculture—cattle, coffee, sugar, cacao, tobacco and rubber growing. Thus the magic mountain that attracts lightning may revolutionize the economy of a nation.

Glass Orchestra

Imagination coupled with craftsmanship has produced a tiny orchestra with the instruments and figurines made entirely of glass. Harry G. Nunamaker, who fashions glass research equipment for the University of Iowa, made the figurines by bending and spinning $\frac{3}{8}$ -inch glass tubing in an oxygen and acetylene blast burner. With the glass at its softening point, Nunamaker gives his imagination complete freedom in guiding his hands. Dabs of softened glass are added here and there to complete the figurines.

Drug for Allergies Cures Seasickness

Seasickness may be eliminated by a synthetic chemical originally made to relieve hayfever, hives, and other allergies. The ability of the drug to prevent and cure all types of motion sickness was discovered by a fortunate accident. It was given to a woman to cure her hives, but unexpectedly relieved the car sickness which she had suffered all her life. Subsequent tests by the Army in the rough waters of the Atlantic showed that less than



two percent of several hundred men who took the drug became seasick. The drug, called Dramamine, also gives complete relief from airsickness, according to Johns Hopkins scientists who first discovered its new use.



Welder Thaws Pipes With Electricity

During extremely cold weather in Portland, Ore., last winter, W. C. Peters came to the rescue of the city by thawing frozen water mains with electricity. Rapid thawing of the mains was essential to provide water for fighting fires. Peters showed city fathers how to warm the pipes with a heavy-duty electric welder. He attached the positive and negative cables of the welder to accessible sections of the pipe on opposite ends of the part to be thawed, eliminating the need to dig ditches.

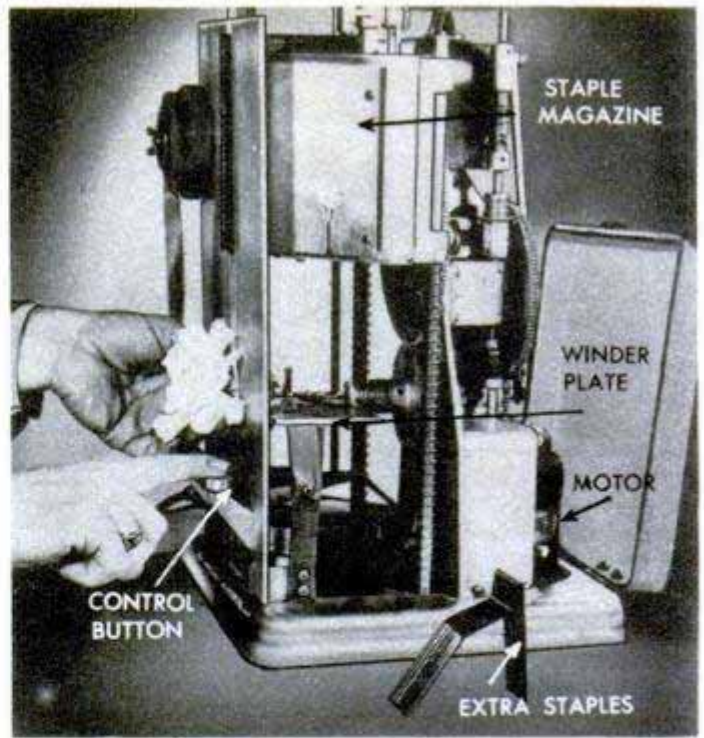
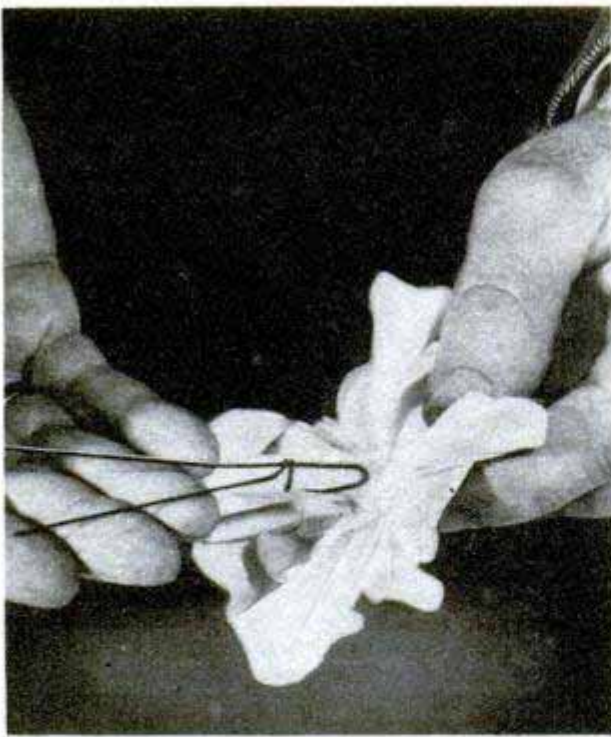

Florist's "Robot" Wraps Wire Around Flower Stem

Stemming — wrapping wire around the stems of cut flowers for wreaths and corsages—is done automatically by a machine invented by a California florist. Previously, stemming has been a tedious hand operation. The labor-saving machine handles the blossoms so delicately that it can stem

Gladiolus blooms, ferns and greens without damage, something that hand-stemming has never done successfully. The stem of the flower is placed in an opening in the face of the machine and, when the control button is pressed, a winder plate wraps the wire around the stem.



Track-Laying Hand Truck Rolls Up or Down Stairs

Refrigerators and other heavy items roll up and down stairs smoothly on a track-laying hand truck that makes the moving operation a one-man job. For rolling along the level, the carriage is swung up against the refrigerator allowing the truck to roll on the two front wheels, thus increasing its maneuverability. The truck is equipped with brakes.

"Cat Test" at Customs Fights Spread of Disease

Tourists entering the United States from Mexico at Zapata, Tex., undergo a "cat test" as customs inspectors try to prevent the northward spread of foot-and-mouth disease. Fresh meat and rare game are frequent carriers of the disease and tourists who try to smuggle these items into this country are caught by a cat named Solomon which picks up the scent when allowed to explore vehicles.

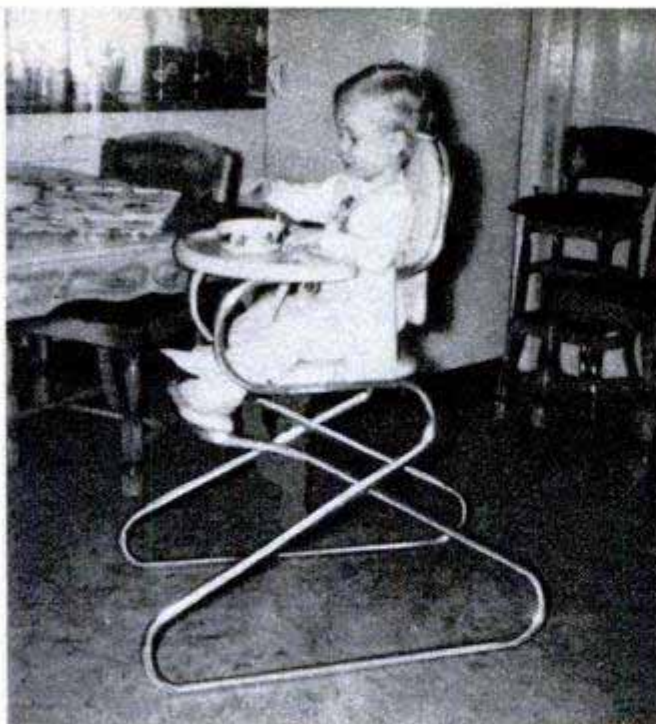

Tubular Furniture for Children Fits Into Suitcase

Supported by a frame of aluminum-alloy tubing, a lightweight baby's high chair weighs only 10 pounds. The bent tubing forms a broad, stable base that makes the chair nontippable even for active babies. The easily cleaned tray is made of plastic. Both the seat and footrest are upholstered in washable plastic. The chair is quickly disassembled for travel and all parts except the tubular frame fit neatly into a small suitcase. Of similar construction is a desk-and-chair set suitable for home and school use. This set also comes apart and the seat and back can be packed into the boxlike desk top.

Top, right, chair-and-desk set of tubular aluminum. Top, left, lightweight high chair has a broad base that makes it virtually nontippable. At left, the seat and tray fit into a small suitcase for travel

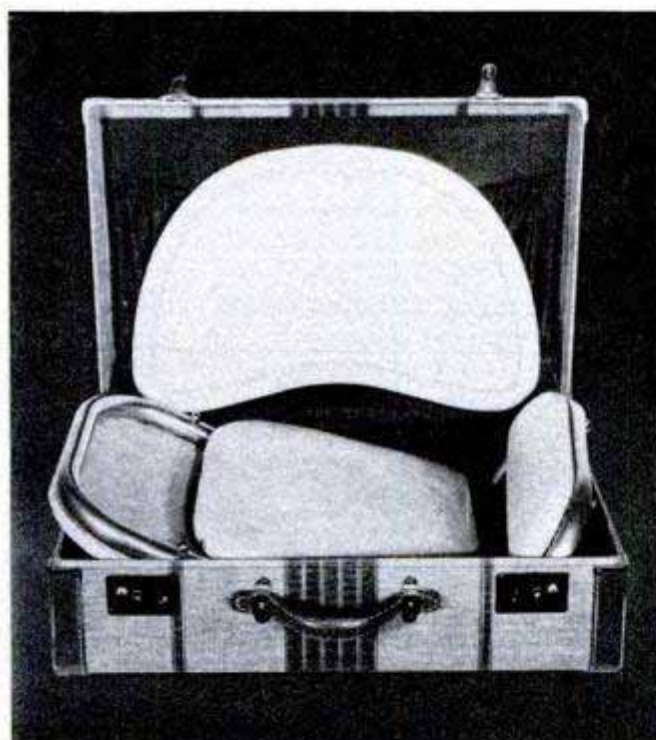

Coal-Mine Car Hugs Ground

Riding prone, a supervisor or engineer in a coal mine can drive safely in tunnels no more than two feet in height on an underslung three-wheel vehicle. The flat car is only 22 inches high with driver. Powered by a 20-volt battery, the car maneuvers easily and moves at five miles an hour. The single rear wheel steers the car which can turn around in a nine-foot circle.

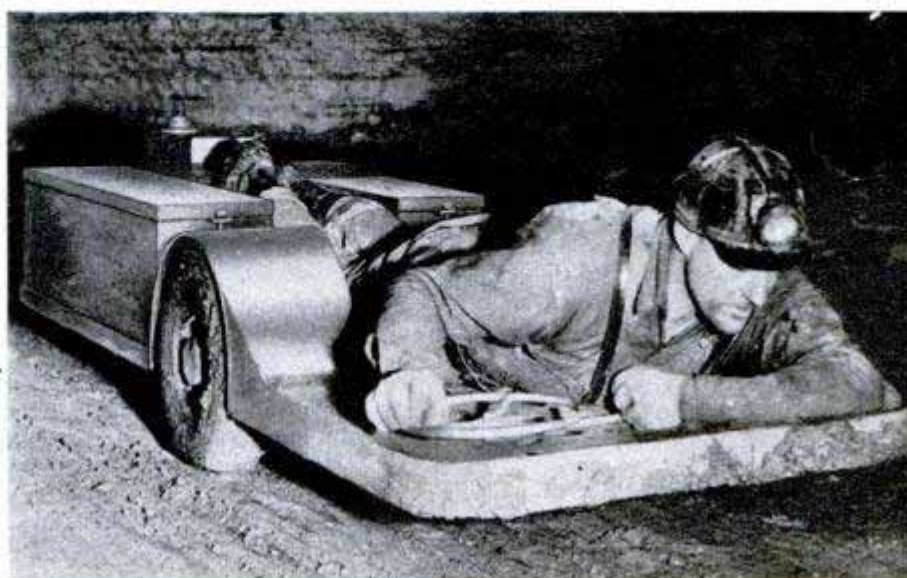

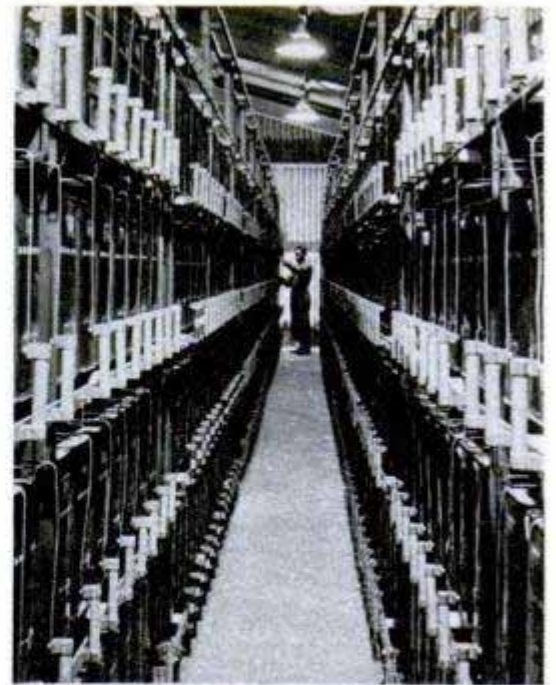
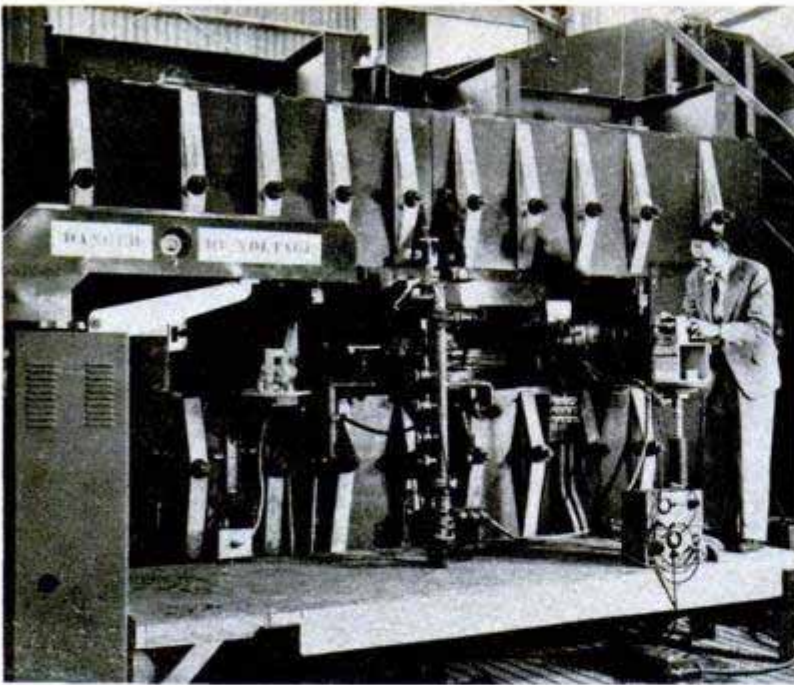

Left, Dr. Edwin McMillan adjusts target in preparation for X-ray bombardment. Right, part of condenser bank

Giant Synchrotron Joins Attack on the Atom

Three times as powerful as the largest betatron, the new synchrotron at the University of California fires a stream of electrons which, upon impact with a heavy metal target, liberates X-rays of 300 million electron volts. The fine, highly penetrating X-ray beam, the most powerful in the world, is used for bombarding atoms. Power for the 135-ton synchrotron magnet is stored in the largest condenser bank in the world. A total of 3328 condensers is

used in the bank which serves as a storage tank for electric power. During the $\frac{1}{50}$ second periods in which the synchrotron actually operates, this tremendous power is thrown into the magnet and back into storage again. In operation, the synchrotron sounds something like a high-powered diesel engine. It begins with a low thumping when the magnet is turned on, then builds up to a loud, regularly spaced hammering when it is working at full power.

"Foam Concrete" Houses Built by Messerschmitt

One of Germany's greatest wartime airplane manufacturers, Willi Messerschmitt, is now producing prefabricated houses of steel and concrete slabs in Munich. All supporting parts are of corrosionproof

steel. The concrete slabs are made in one standard size and are formed of "foam concrete" made with carbon dioxide gas to decrease weight. Pipes for gas, water and electricity are enclosed in the slabs.

Left, wheeling a concrete slab into place. Right, welded-steel rafters support roof of three-story house

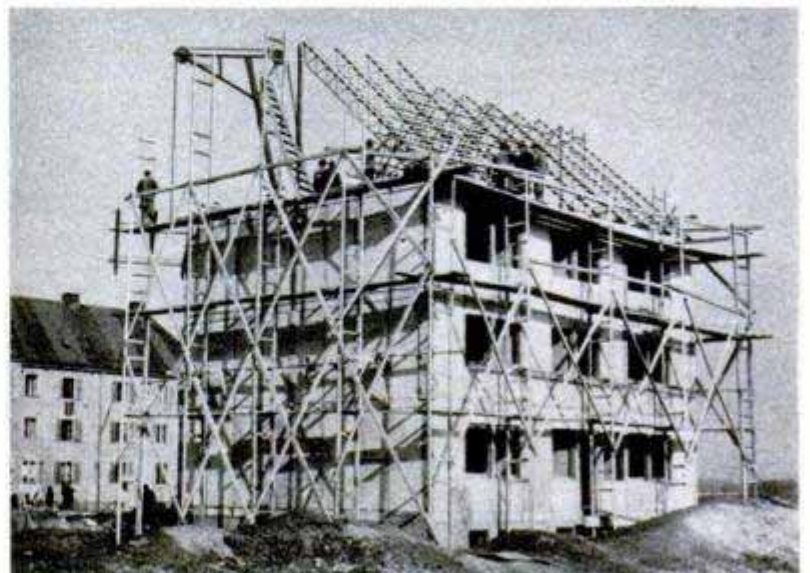



"Pistol" Dispenses Tape

Speedier application of cellulose tape is possible with a pistol-type dispenser. Pulling the trigger ejects the tape and setting a thumb button cuts it at any length up to 1½ inches. When set at a noncut position, as much tape as needed can be unreeled. Only one hand is used to operate the unit, leaving the other free to hold the material being taped.

"Coffee Pot" Melting Furnace

Nonferrous metals are melted quickly in an electric furnace that weighs only five pounds and has an insulated pouring handle like a coffee pot. A pyrometer indicates metal temperatures, assuring consistent results in successive melts. The furnace has a temperature range to 2000 degrees Fahrenheit and operates on 110 volts either a.c. or d.c. It will melt 15 ounces of silver in 10 minutes.

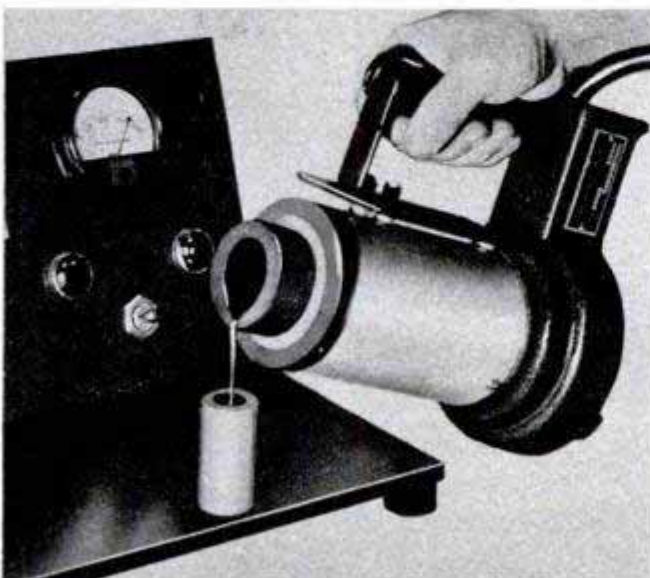

Miniature Scaffold for All Ladders

Any ladder can be quickly converted into a miniature scaffold by adding a stage. Measuring 24 by 26 inches, the stage provides safe footing from which a repairman or painter can work. Made of aluminum alloy with wooden footboards, the portable unit weighs only nine pounds. The footboards are slotted and can be adjusted for width.

Dry Lubricant Applied as Paint

Applied by brush or dipping, a new lubricant produces a dry graphite surface that won't come off. The liquid is composed of graphite particles suspended in alcohol. Painted on any surface, it dries rapidly to a lustrous lubricating film. The lubricant can be used on guns and ammunition, drawers and windows that stick, bicycle chains, door locks, model-railroad cars and knife-switch contacts.

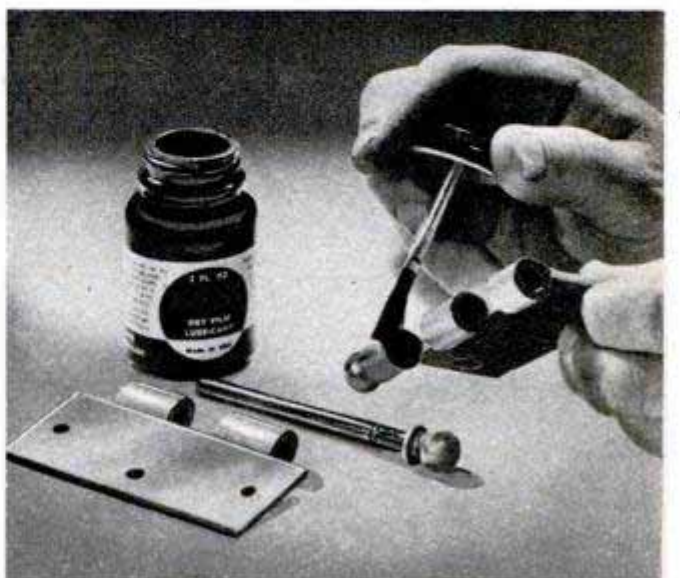



Magnified 24 times, the microtext is as easy to read as the original. Right, inserting a card in the reader

CARD-SIZE LIBRARY BOOKS

Libraries of the future may have their book shelves replaced by neat filing cabinets containing small microcards on which are reproduced in microtext as many as 200 book pages per card. The cards, of standard card-catalogue size, are made of

special fine-grain photographic paper and are placed in a projection reader that magnifies the text 24 times, making it easily legible on a translucent screen. A convenient control knob "turns" the pages. At the top of the cards are printed in regular size type the usual catalogue entries, eliminating need for separate catalogue cards.

Type and page size determine number of pages a card can carry. Below, in actual size, is a 64-page card

<p>0 2 5 Microcards</p> <p>Rider, Fremont, 1885-</p> <p>The scholar and the future of the research library, a problem and its solution . . . New York city, Hadham press, 1944. (xiii p., 1 l. 236 p. 2 facsim., diagr. 24 cm.) Proposes microcards as the solution for research library growth.</p>	<p style="text-align: right;">Z 6 6 5</p> <p style="text-align: right;">(Card 1—p. i-xiii, p. 1-64)</p>	

Cotton Duster

Riding high on "stilt wheels," a homemade machine dusts cotton plants without damaging them. The vehicle, built by two veterans near Fresno, Calif., can cover 25 to 35 acres an hour, dusting 15 to 20 rows at a time. Equipped with lights, the machine can be used after dark to take advantage of the moisture on the cotton plants. It is powered by a V-8 engine which operates the rear wheels by chain drive. The gear ratio produces a road speed of 35 miles an hour. A single wheel supports the front end and all three wheels are housed in streamlined guards.

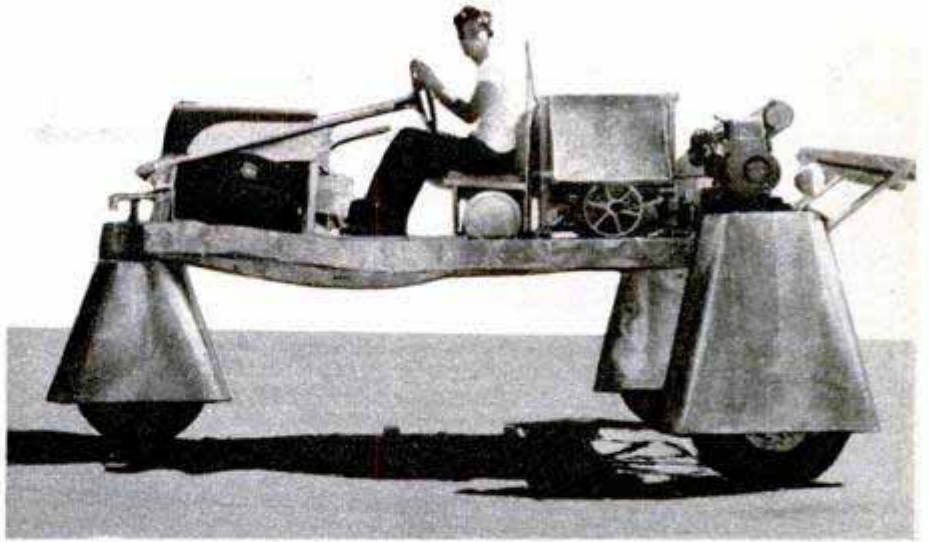

Paper-Pulp Process Uses Wheat Straw

New uses for straw promise to turn into an economic asset the 40 million tons of wheat straw burned or wasted annually on U. S. farms. Experiments at the Department of Agriculture have resulted in processes which permit the use of wheat straw in the production of paper pulp and building board. The paper-pulp process not only makes fine paper from straw, but also improves the present process used in making strawboard for boxes so



that a better product is created at lower cost. The new building board is a blend of ordinary straw pulp, such as used in strawboard, a new pulp that is cheaper to produce and which adds strength to the finished product.

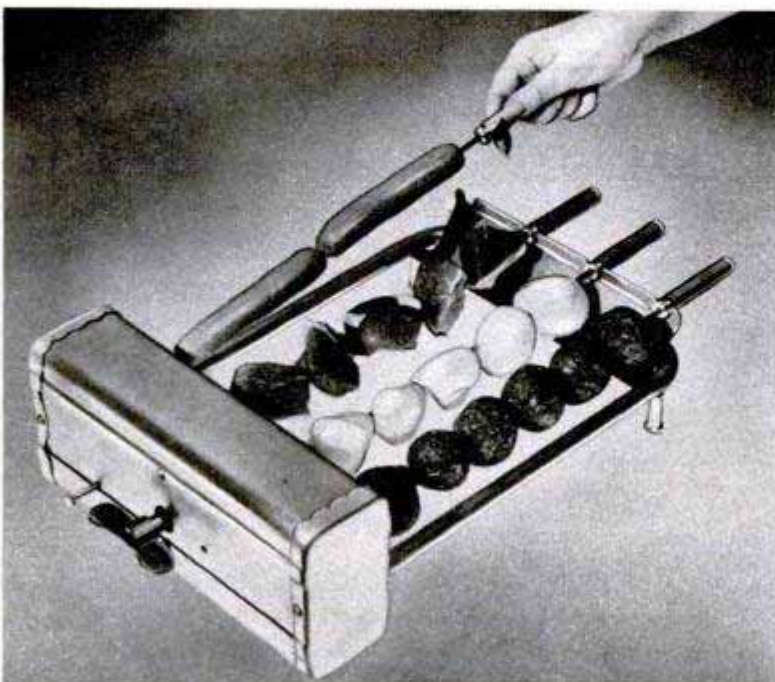

Wind-Up Barbecue

Foods skewered on a new barbecue grill are turned slowly and automatically over the flames by a spring-driven motor. The grill can be used over a fireplace, a gas or electric range or inside an oven. One winding of the motor will turn the four skewers for 20 minutes, sufficient time to cook most foods that are cut into small pieces. An asbestos shield prevents damage to the motor.

Many of the products described in this issue are already commercially available. For the names and addresses of manufacturers, turn to the WHERE-TO-BUY-IT INDEX, starting on page 10

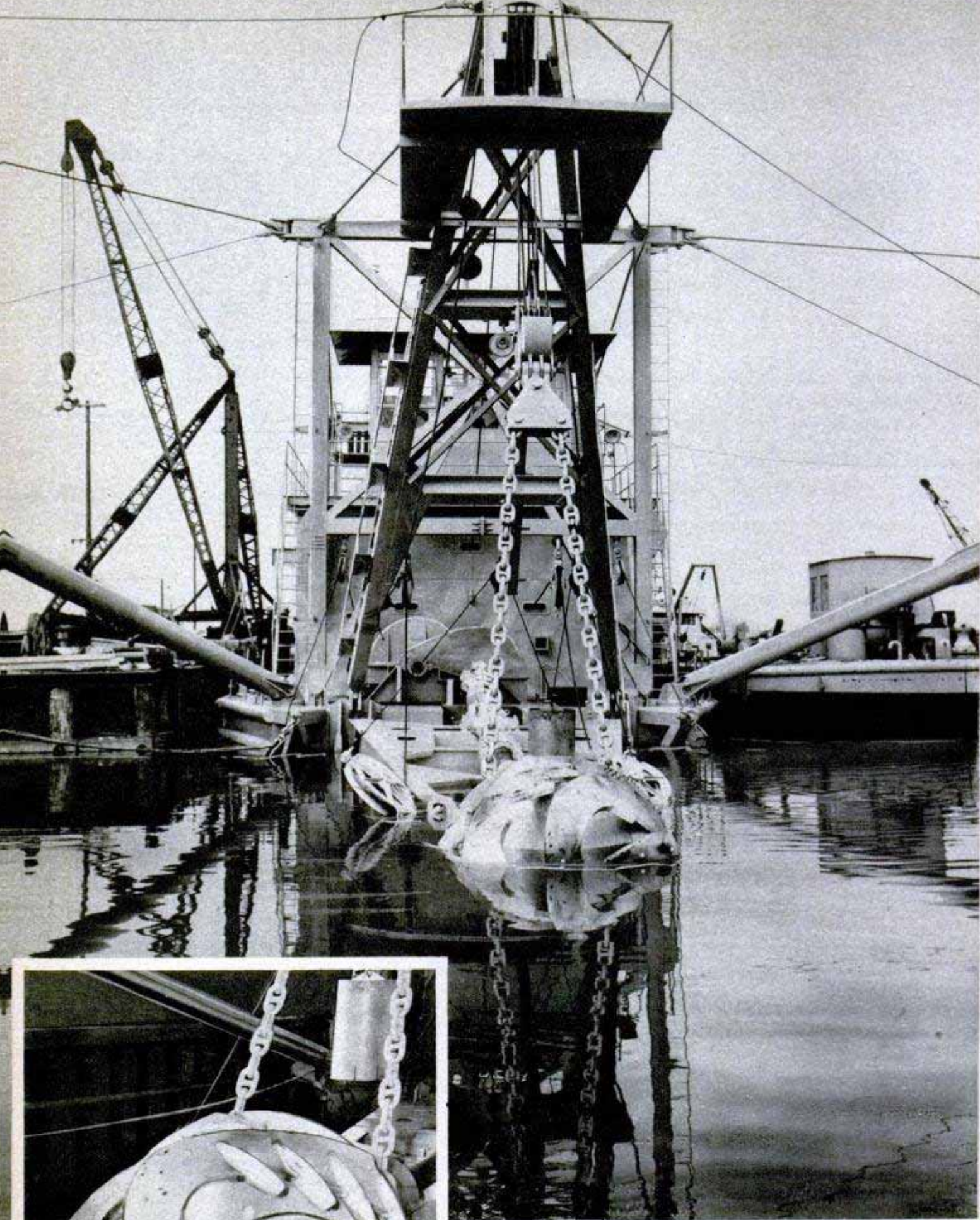

Bureau of Reclamation photos

Giant dredge now is slashing its way through roots and rocks to open a new channel for the mighty Colorado in man's unceasing battle to control the turbulent river

Dredge's 20-inch cutterhead has teeth that bite into the earth. Material is sucked into a pipe and carried away

POPULAR MECHANICS

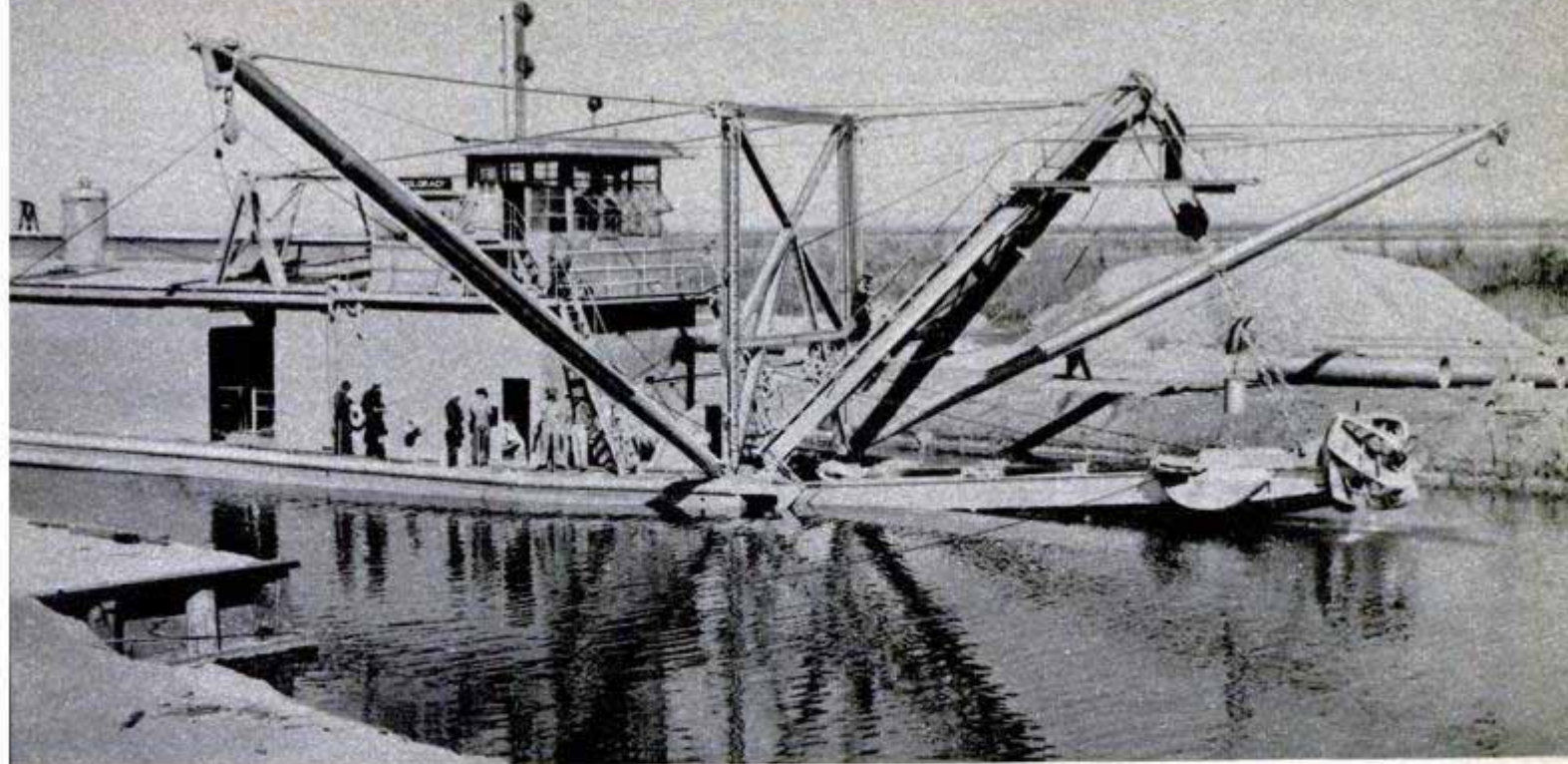

Demountable dredge, assembled in a man-made basin, now must cut its own way out to site of the new channel

Putting a River in Its Place

By Laura Bell

THE BUREAU OF RECLAMATION is winning another round in the endless struggle to keep the mighty Colorado River in its place.

The successful weapon this time is not a dam but a newly designed dredge—largest of its type ever constructed—which was built at Alameda, Calif., and transported in sections by rail to Needles, Calif., where it was assembled and put to work this year.

Its job there is to carve a new river 300 feet wide and 15 to 17 feet deep through

dense tules, willows and silt, to Topock, 12 miles downstream. There are other jobs in view when this one is completed after about 1½ years of work.

The machine, designed by Bureau of Reclamation engineers to take on this mammoth task, is a 20-inch pipe-line cutterhead dredge, 130 feet long, 30 feet wide, 500 tons in weight and with a draft, loaded, of about 5 feet. Because dams on the river preclude navigation, the dredge is built in sections weighing not more than 35 tons each so that

Map shows location of the dredge cut in vicinity of Needles, Calif. Channel will extend 12 miles to Topock

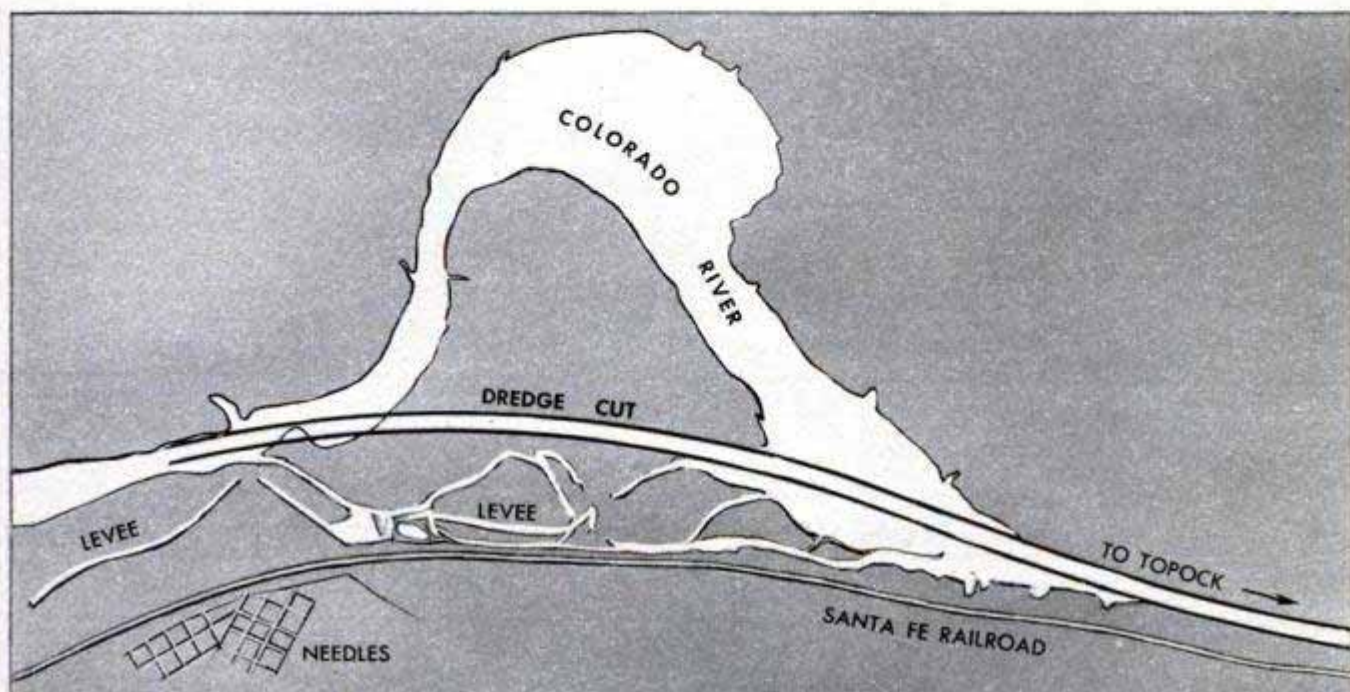

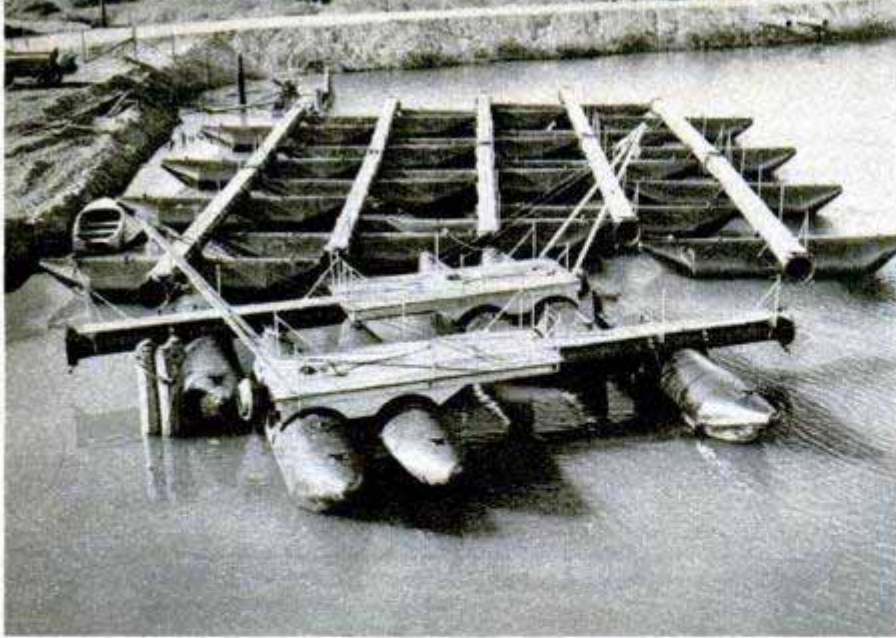

Cutter ladder, shown while it was being assembled, extends far in front of the dredge to support the big cutterhead. The machine was built in transportable sections, then assembled on site

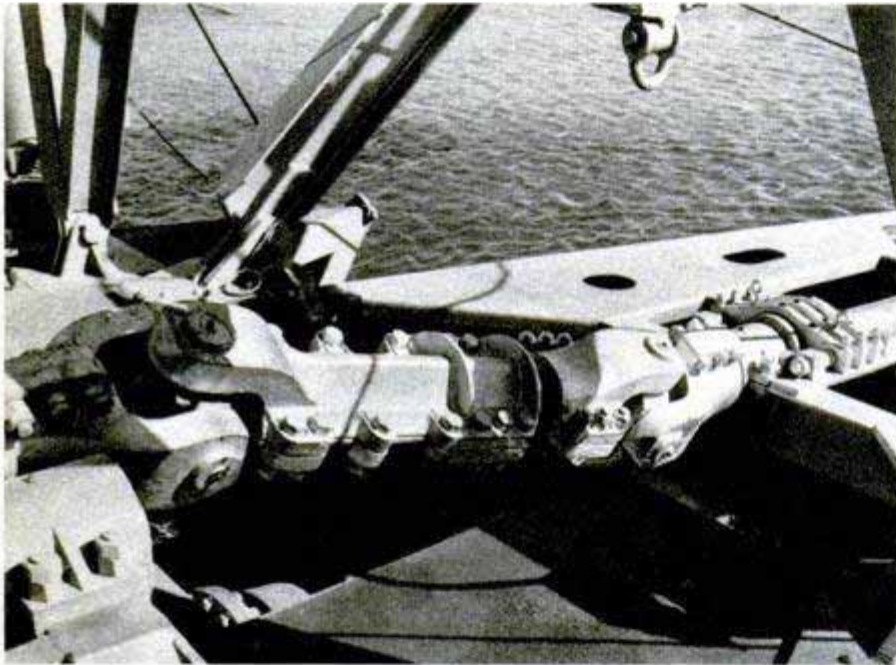

Universal joint on the drive shaft transmits power from the diesel engines to the cutterhead. Below, floating pipe line carries earth and root material away for discharge. Small derricks help the crew in coupling sections of the pipe together

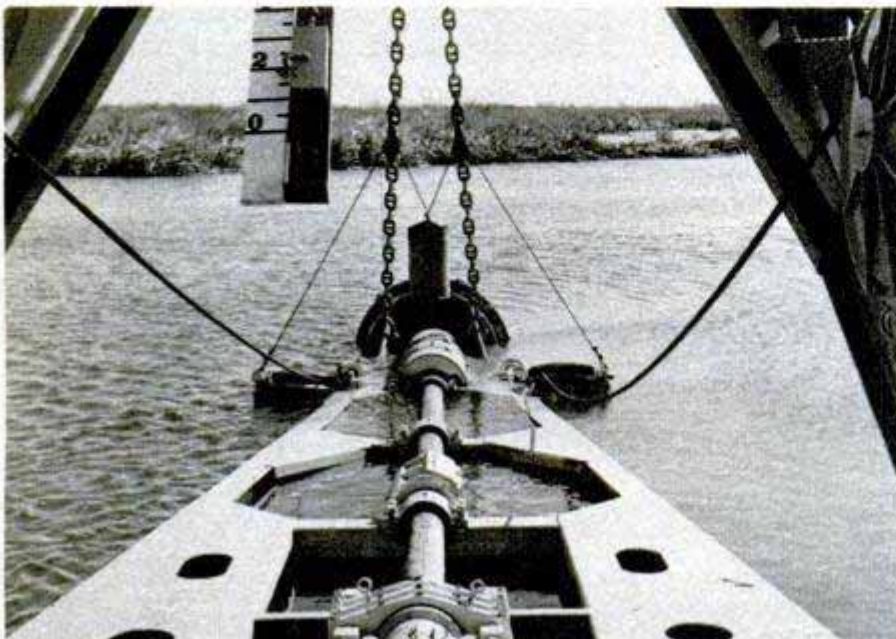

it can be dismantled and transported on railroad cars. It is made up of nine pontoons fastened together with 880 steel bolts. It is not self-propelling, but is moved by two stiltlike spuds and swing lines, or is pushed by the accompanying powerboat.

Two diesel engines of 525 and 1350 horsepower supply power for the dredge which moves 500 to 1800 yards of channel silt and roots an hour, depending on the type of material and length of the pipe line. It is capable of digging out gravel, clay, willow roots and swamp material to a depth of 25 feet below water level. It passes the material through a pipe line 1900 feet long and discharges it 10 feet above water level at the rate of not less than 500 cubic yards of solid material each hour, when the solid material constitutes 10 percent by volume of the discharge.

The mighty Colorado was not tamed when the gates of Hoover Dam closed on it in Black Canyon 14 years ago. The river only changed its strategy, using silt instead of seasonal floods to undo the works of man. After the tallest dam in the world began controlling the flow of the once turbulent and muddy river, the gradient changed and silt plugs raised the river bed several feet at various points below the dam. At Needles this caused the water to spread over a wide area to form swamps and endanger the low-lying portions of the city as well as the Santa Fe Railroad tracks. The railroad crosses the river at Topock and runs parallel with the west bank up to Needles.

Although an investigation was made in 1941, little was done until 1944 when the water surface reached the railroad tracks. The Santa Fe was hauling war materials, and Uncle Sam soon made available emergency funds to throw up a levee and pump the water out.

C. P. Vetter, who has worked with the Bureau of Reclamation for many years, was called back from an engineering job in Cuba to work out methods of controlling the recalcitrant Colorado. In August 1944, the Office of River Control was established with Vetter as its chief. Congress has

Rear view shows the stiltlike spuds, one in a raised position. They act as anchors and also as pivots as the digger lurches forward with the help of a boom-operated anchor on front. A powerboat also is used to push the mighty dredge as it opens the new channel



since been appropriating a million dollars a year for its use.

When Vetter recommended in the early report that levees be thrown up at Needles, he also urged that the river channel be dredged.

"It was obvious," he says, "that we could not keep on raising the levees and pumping the seepage water higher and higher."

In August 1947 the contract was awarded to the Pacific Coast Engineering Company of Alameda on a low bid of \$871,700. The contract called not only for furnishing and assembling the dredge, but also for providing its attendant fuel barge, work barge, pipe barge and power plant. A year later the construction was completed in the Alameda yard.

After completing the job between Needles and Topock, the dredge will be dismantled and shipped 100 miles down the Colorado to the Cibola Valley above Blythe, where the perverse "Old Lady," as Vetter calls the river, keeps building up the water table and

drowning out more and more of the rich agricultural land along her banks. Two years or more will be spent in correcting the course of the river in that area, according to estimates; then the dredge will be brought back to Needles to work up the river toward Davis Dam, which will be completed some time next year.

When that stretch of river channel is straightened and deepened, the Old Lady undoubtedly will have thought up some other mischief which will have to be undone by this new weapon in the nip-and-tuck battle of river control.

The new million-dollar dredge is only one spearhead in the carefully planned long-range campaign to keep the great Southwest's only source of water and power from dissipating her forces in riotous living.

Another attack on the silt problem is the sedimentation survey on Lake Mead behind Hoover Dam and the river above as

(Continued to page 242)

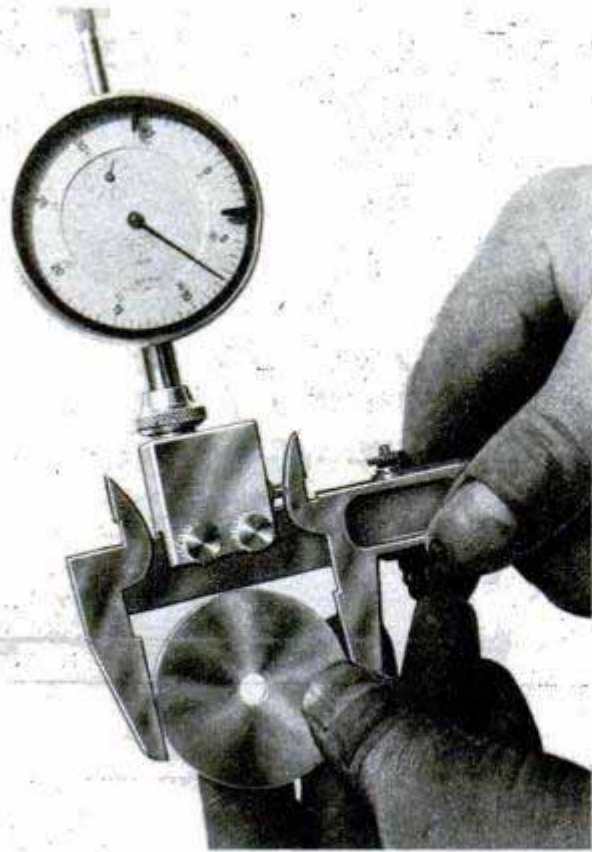

Adapter Transfers Motion Around 90-Degree Turn

Motion is transferred at right angles to operate a dial-indicator shaft by a small clamp-on adapter that has only two moving parts. Used with a dial indicator, the adapter converts a slide caliper for measuring motion at right angles to the indicator shaft, whereas normally motion has to be parallel with the shaft for measurement. Accurate to within .0025 inch, the adapter will make a crude measuring tool micro-matic in accuracy.

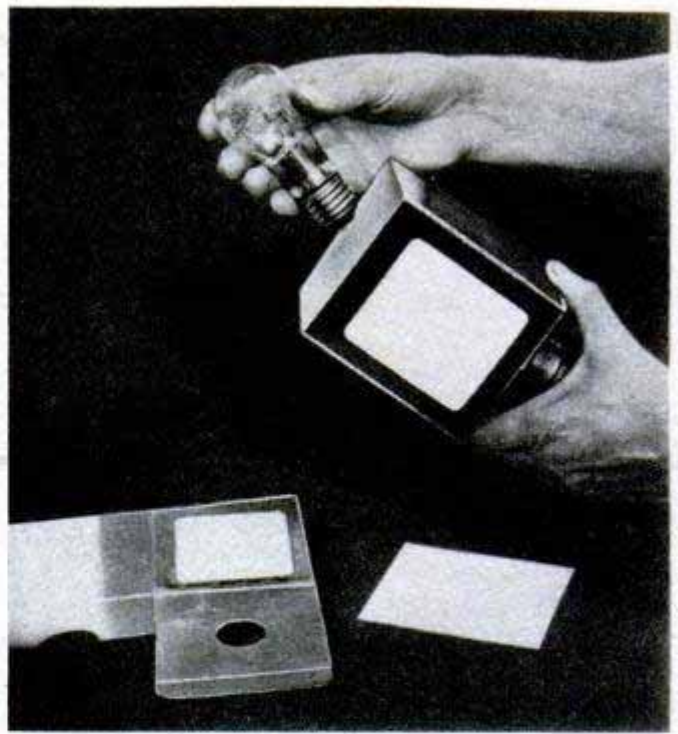

Photoflash Reflector Softens Shadows

Harsh, black shadows that characterize photographs taken with a single flash bulb are eliminated by a cardboard reflector shaped like a box with an open top. The front side of the box consists of a translucent window which passes enough light to produce faint shadows. When shadows are to be reduced even more, a piece of translucent paper is placed over the window. The open top permits light to escape and be reflected from the ceiling, filling in shadows around the subject. The reflector reduces the effective output of the flash bulb, making it necessary to use larger lens apertures and slower shutter speeds.

Newsreel Cameraman Gets His Pictures Three at a Time



Three at a time is the way Parris Emery, newsreel cameraman, gets pictures of exciting news events. He mounts two movie cameras, one 35 mm. and the other 16 mm., and a press camera on a long bracket that attaches to the tripod head. As he follows the scene in the 35-mm. viewfinder, the other cameras automatically cover the same action. With the two movie cameras he films the action for newsreel release and home-movie release simultaneously, and with the press camera he shoots spot news photos for newspapers when the action reaches a climax.

☞ There are about 1500 drive-in theaters in the United States, enough to handle 300,000 cars.

Twin-Boom Plane Seats Two

Twin booms connect the tail with the wing section of a new personal plane, permitting the use of a shorter body with resulting reduction in drag. The engine is located behind the two-place seat and is connected directly with a pusher propeller. The tricycle-type landing gear permits the plane to be steered like an automobile. Baggage is carried in a compartment aft of the seat, with fuel carried in the leading edge of the wing. With this weight near the center of gravity, load has little effect on the flying trim. Passengers

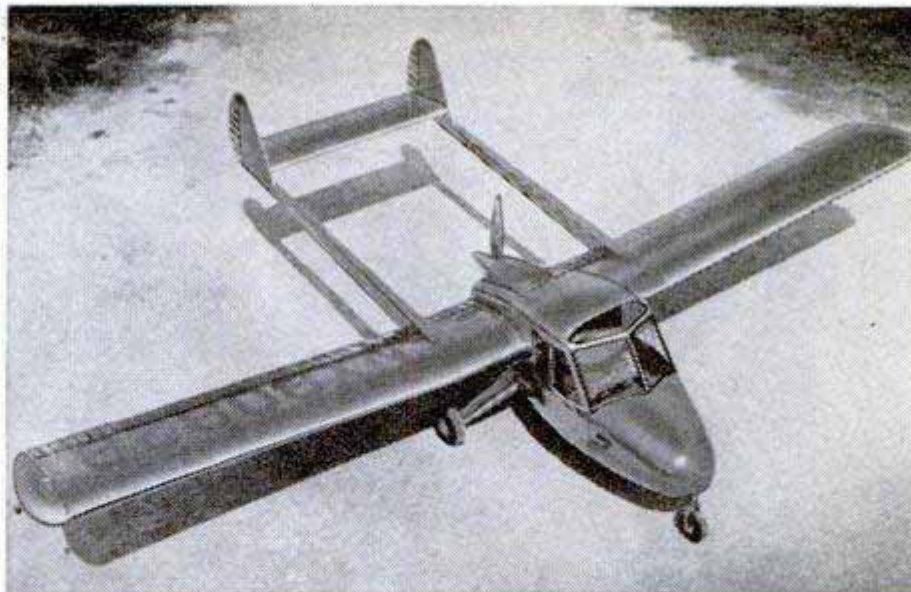

have unrestricted vision and the cabin of the plane remains free of engine oil and exhaust vapors.

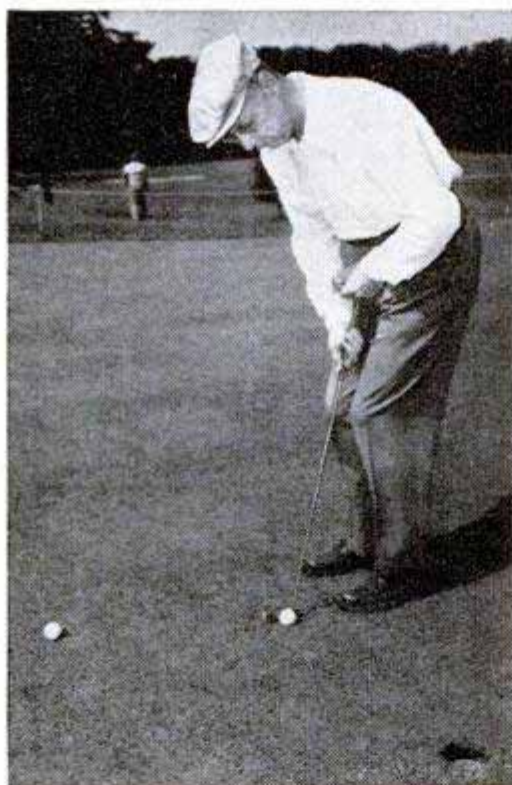

Pendulum Golf Putter

Golfers who have trouble on the green may find that a pendulum-type putter will bring down their scores. The putter has a crossbar handle at the top, parallel with the head. The player's left hand grips the handle rigidly, simulating the pivot point of a pendulum. The right hand, placed near the top of the shaft, swings the club down and into the ball. According to the inventor, Jules Sternberg of Reading, Pa., the club's action minimizes pushing or pulling off line and produces a natural follow through. A pair of runners at the base of the club head reduces grass friction.

☐ Minnesota law now requires that all new cars sold in the state be equipped with turn signals.

Electric-Mixer Motor Becomes Power Tool

That electric mixer your wife has in the kitchen becomes a handy, light-duty power tool for polishing, drilling, sanding and buffing when you install a simple adapter kit. The mixer beater is replaced by a conversion shaft mounting a 1/4-inch chuck. Grinding stones and other accessories are attached to the shaft.

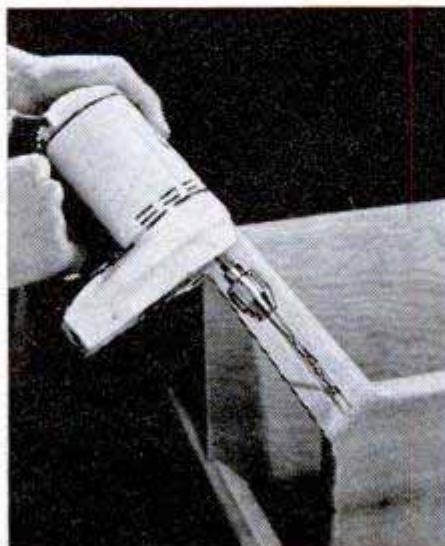

WHAT'S NEW *For Your Home*

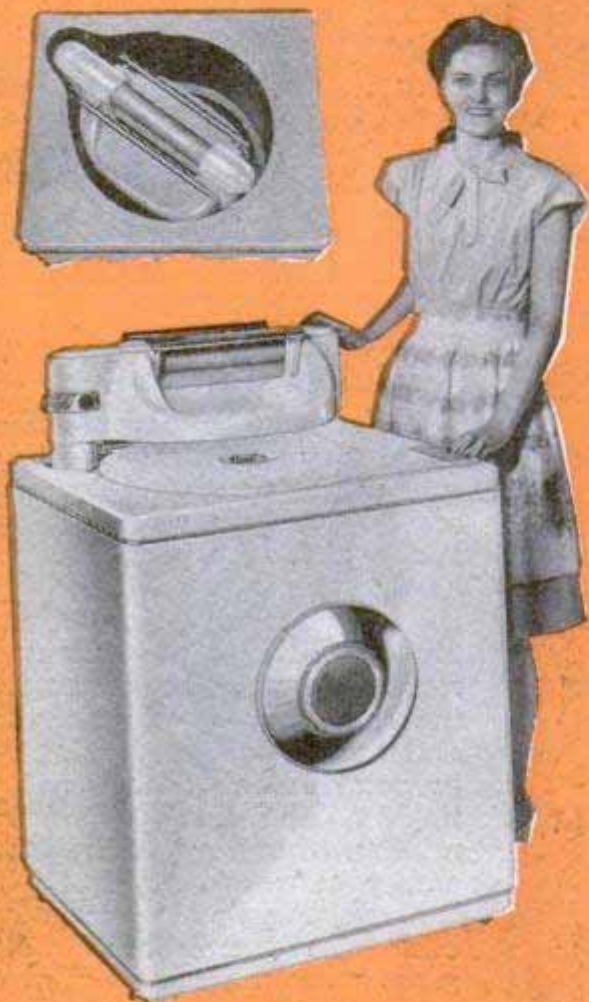

CRANK-UP BROILER can be raised or lowered with the door closed. A crank handle at the base of the broiler door operates the lift mechanism

DISAPPEARING WRINGER on washing machine, left, slips down inside cabinet when not in use, giving the washer a flat top at counter height.

HANGING RACK, below left, is handy to use and attractive to look at. Crystal plastic clips can be adjusted to any position on aluminum rods

POT WRAPPER, below, makes plant care easier. You pour water into the Vinylite-plastic wrapper and the roots keep moist by gradual absorption

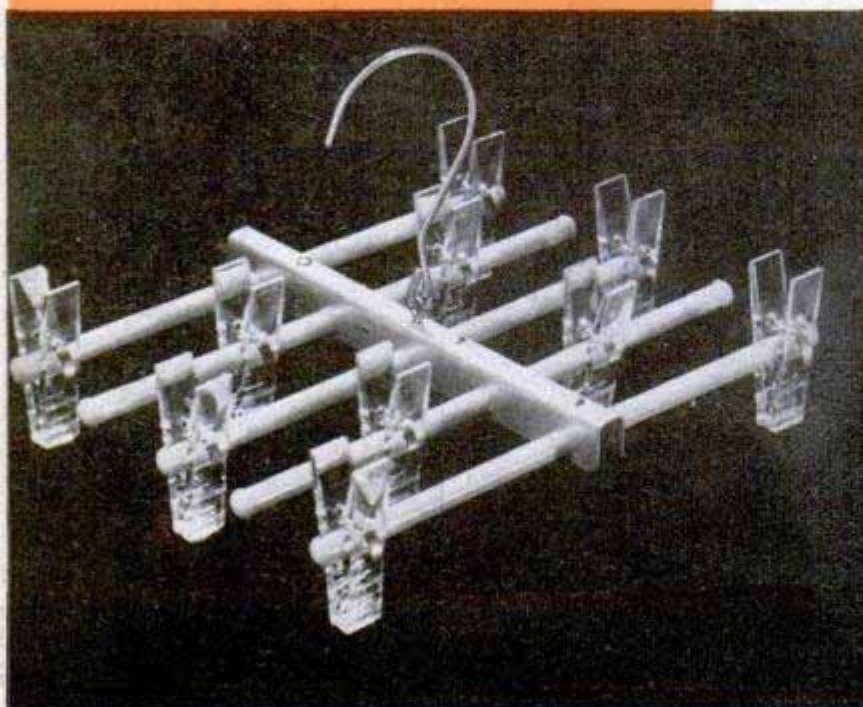



SPACE-SAVING DINETTE has shelves concealed when closed. At mealtime, the front swings down to form a comfortable dining set for six persons



PORTABLE BREEZES go right along with you when you travel in the hot weather if you pack this light electric fan in your traveling bag

CREAM REMOVER, below left, for paper milk carton works like a spile in a maple tree. You push it into the carton and the cream pours out

FOOD ODORS in refrigerator are eliminated by a deodorizer, below center, enclosed in a plastic case that clips to the underside of shelf

FAT DRAINER built into frying pan, below right, makes tipping the skillet unnecessary. You press the lever and the grease drains off



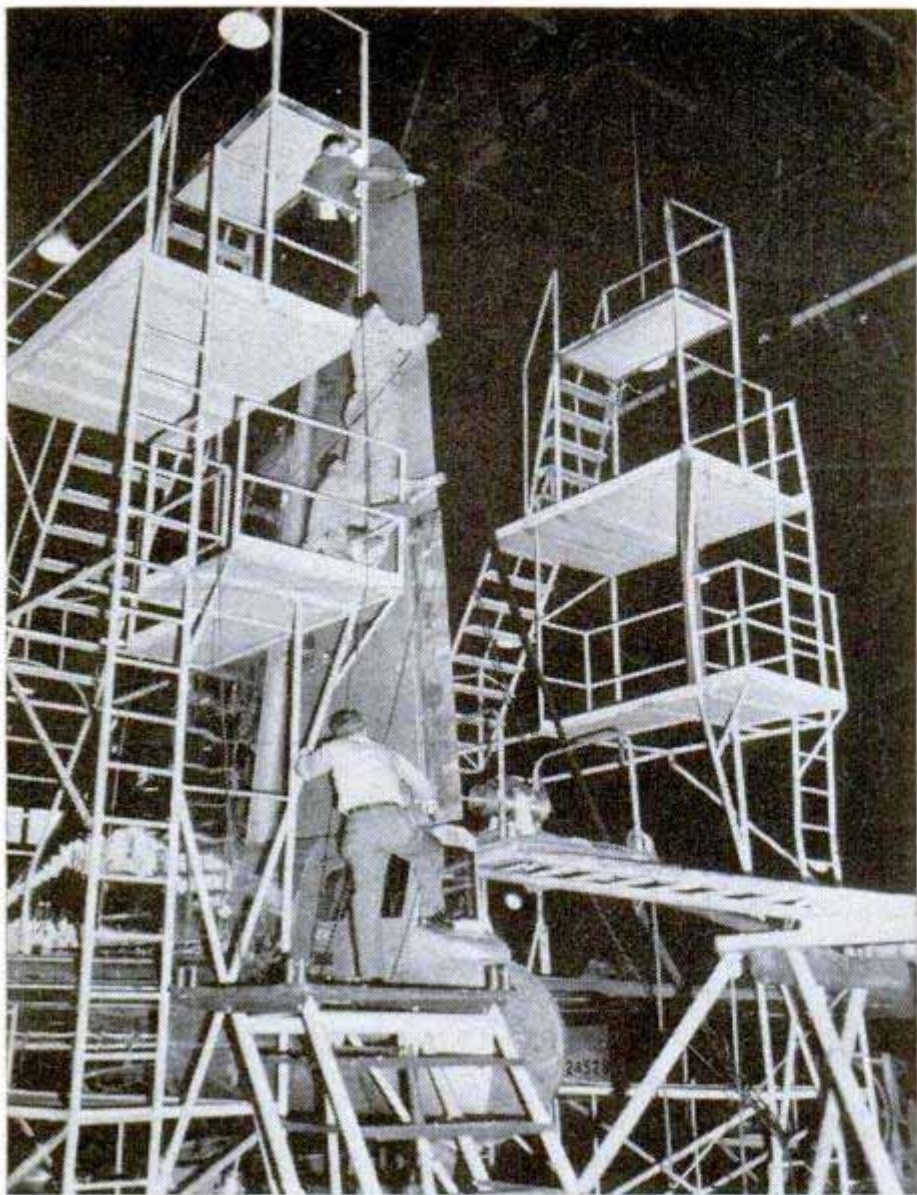

Electronic Shakers Find "Flutter" Bugs

Electronically run exciters now make sure the "flutter" bugs are out of planes before the craft ever flies. They're doing the job so well that not a drop of water spills from a full glass placed on a Boeing Stratocruiser armrest in flight. Along with dangers created for the plane's structure, steady vibrations of as little as .002 inch have been found to annoy passengers. The new exciters, driven by electrical currents, can duplicate movement precisely over a wide range of frequencies. In addition to hand-held deflection indicators, small magnet-and-coil pickups, sometimes distributed over as many as 100 places on the plane, help register the amount of vibrations.

←Boeing Aircraft photo

Working on four-story perch, engineers at different levels use deflection indicators as vibrator at right shakes the rudder of Boeing B-50 bomber

Moving Light Beams Pace Swimmers

Swimmers can time themselves during practice with a light beam that moves along the gutter of the pool at any preset speed. The pacing machine is designed to develop swimming teams. In some pools, two of the lights are used to cast a moving spot on each gutter. The beams travel in unison at a constant speed so that the swimmer can see one of the lights no matter which direction he is moving. The instrument enables a swimmer to set his pace for a certain distance and know at all times just how hard he must swim in order to make his goal. The speed of the lights may be varied from 13 to 26 seconds per length of a 25-yard pool, so that each

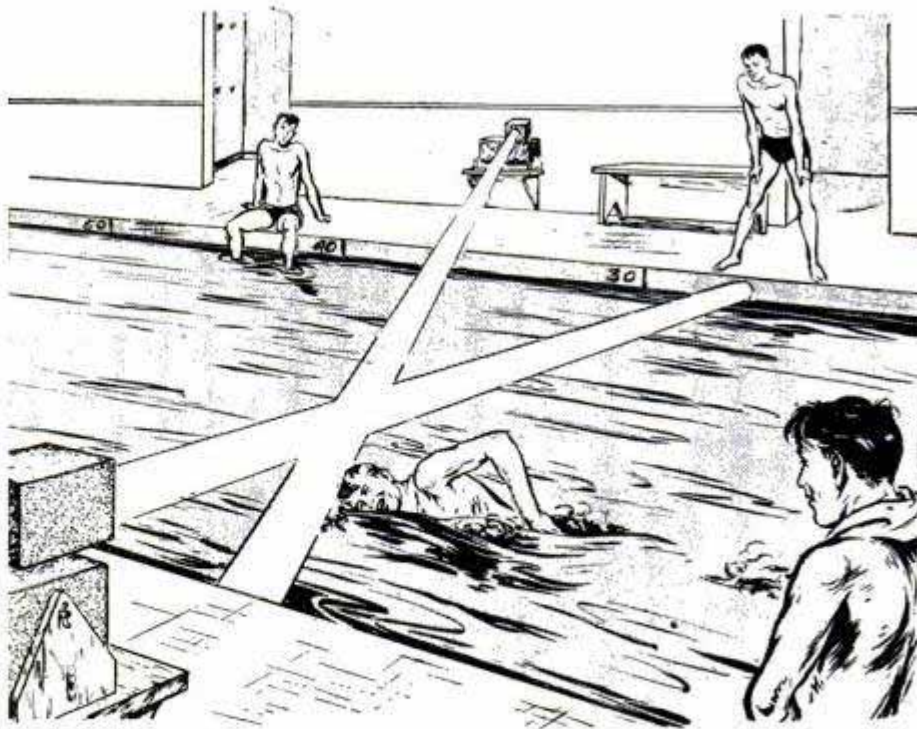

day the swimmer can increase the speed of the lights by a few tenths of a second. In one test, a swimmer cut 16 seconds from his time for 440 yards.

Gallstone "Detector"

Pennsylvania surgeons and engineers cooperated in the development of a gallstone "detector," an electro-acoustical instrument that transmits a metallic sound whenever a crystal on its probing wire touches a stone in the human body during a surgical operation. The detector was first used successfully at the University of Pennsylvania Medical School Hospital in Philadelphia. It was said to make known the presence of tiny stones which might otherwise go undetected by the surgeon.

Enamels for Aluminum

Enamels have been developed for two alloys of aluminum to make them more durable and widen their decorative use. Enameled aluminum, used on storefront panels and in many other ways, is fired on strips at a temperature several hundred degrees below that required in enameling steel. Other uses for



the Du Pont Company discovery may include washing machine tubs and agitators, architectural tile and outdoor furniture.

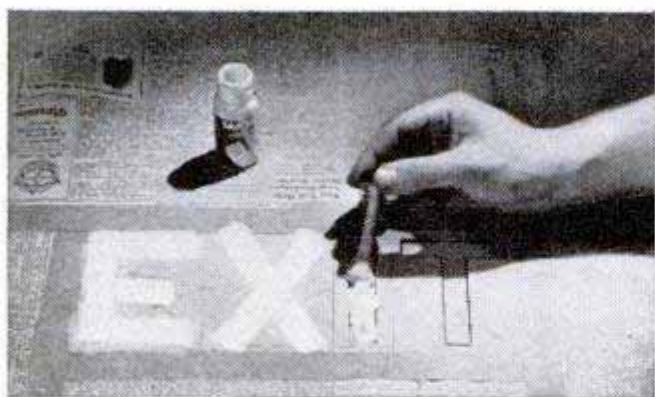

Adhesive Stencils Stick to Surface While Paint Is Applied

Amateurs can paint signs that have a professional appearance with the aid of stencils that stick to the surface to be lettered. The sign painter draws a center line across the surface which serves as a guide for corresponding lines on the stencils. A backing is peeled off each letter or figure chosen, exposing an adhesive coating which sticks to the surface. After the stencils have been fastened in place, paint is applied with a brush or a spray gun. If a "pin stripe" is desired around each letter, certain parts of the stencil are replaced and a contrasting paint applied. The stencil cards themselves can be used as temporary signs. A quick-drying or luminous paint is recommended for use with the cards. The stencils originally were designed for marking insignia and other information on aircraft.

There Are Air Tides, Too

Tides are not limited to water, according to a Norwegian meteorologist who states that every day two tide crests sweep through the ocean of air at the bottom of which we live. One tide is a response to the moon's pull, the other to the sun's, with the solar air tide being much higher. At sea level, the crests come at 10 a.m. and 10 p.m., Dr. J. Berknes told a recent meeting of the National Academy of Sciences.



Eggs on the production

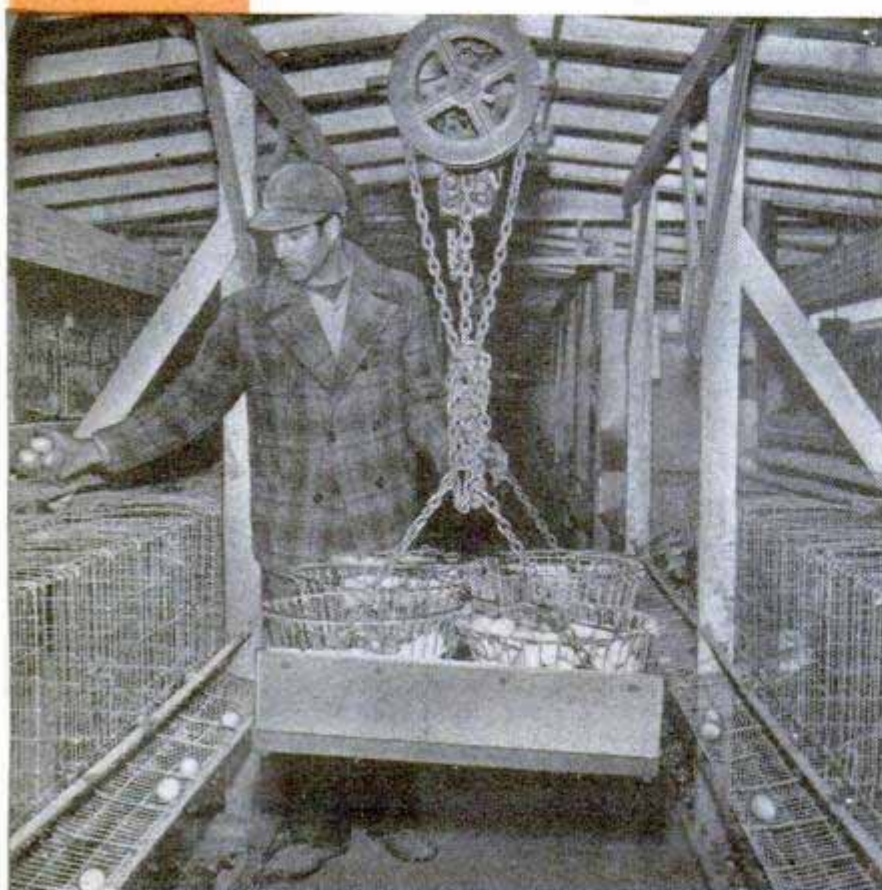

THE 7000 laying hens on a California egg ranch eat their meals in reverse-cafeteria style. Instead of moving past rows of food as people do in cafeterias, the hens merely stand in their individual cages and eat their meals as the food moves past them on endless belts. Once a full-time job for three men, feeding can now be done by one man. He dumps dry mash into hoppers from which it is picked up in chain-driven buckets and dropped on the moving belts. The cages are arranged in two tiers and the food, after passing in front of the top hens, is dropped to a lower belt which carries it past the lower tier of hens and then

Eggs are collected from troughs into which they roll as soon as laid

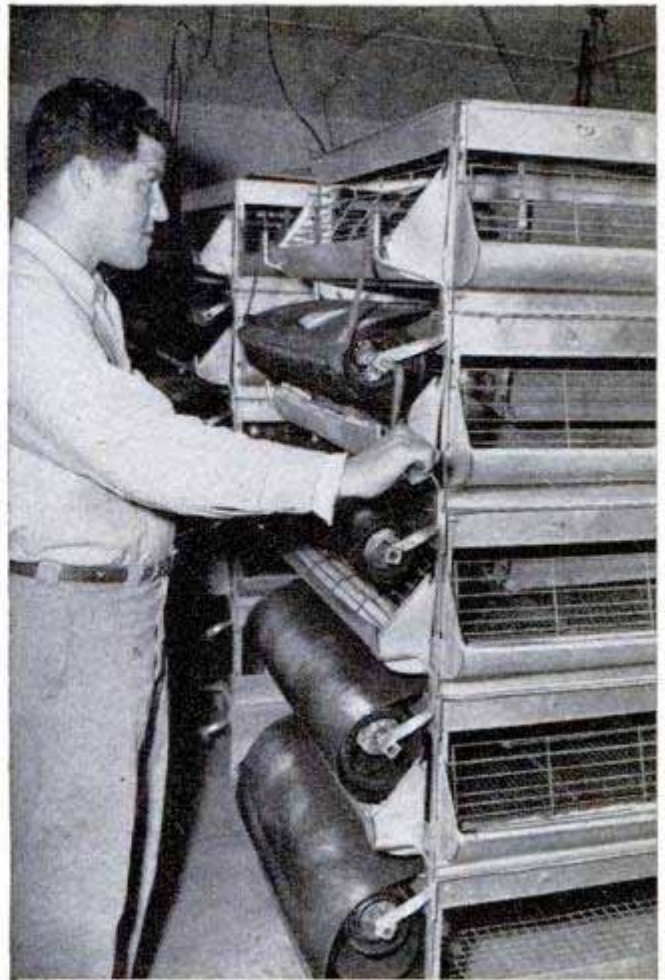

Left, resistance wire around water pipes prevents freeze-ups. Above, the paper floors of brooders are scraped clean when they are cranked around rollers

line

returns the uneaten food to the hopper.

Built by two California egg raisers, the production-line egg farm has 12,000 chickens, including baby chicks and young hens being raised to maturity. The weekly grocery bill is pretty big. The hens eat 3000 pounds of feed every day.

Everything on the ranch is as mechanical as possible. An overhead monorail trolley carries feed to the hoppers. The same trolley rail is used to move baskets along the tiered cages during egg collection. The floors of the wire cages slant and when an egg is laid, it rolls toward the aisle where it is easy to collect. Production charts above each cage show how each hen is doing. The cages have individual drinking cups, filled automatically. The hens are housed in open-sided sheds that are cooled in summer by a water-spray system on the roofs. Eggs are sorted according to their weight by a mechanical sorter that weighs the eggs and segregates them in the standard weight ranges.

Eggs are graded automatically by this machine that rolls them into compartments according to weights

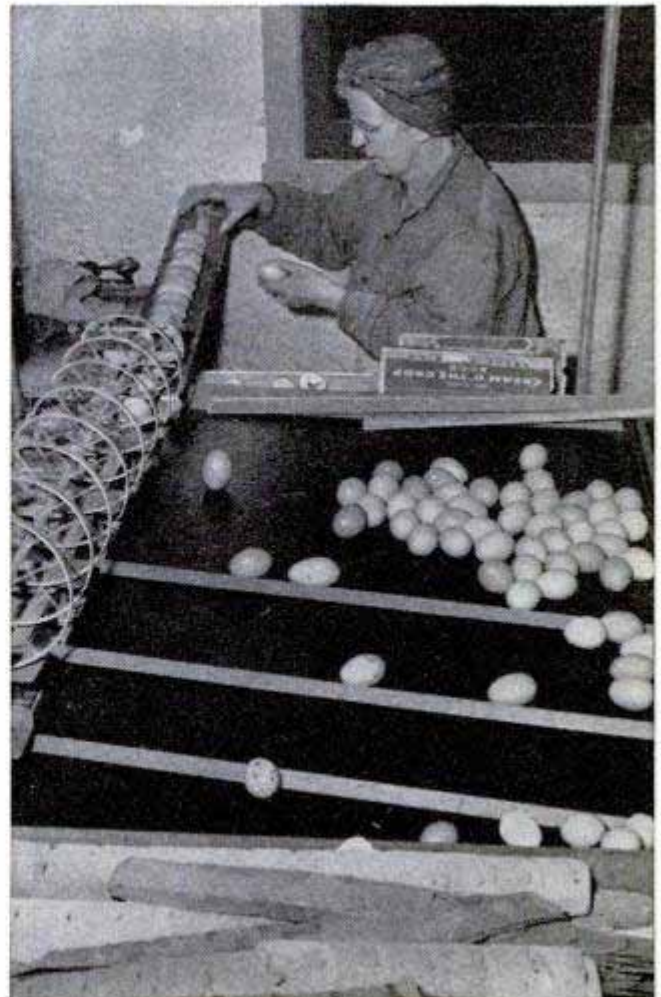



↑ Student grips steering wheel with one of the attachments for his artificial arm. Above, right, aluminum wrench fits socket for changing a tire. Right, here are some of fittings that make 15 different tools

Aids for Amputees

Fifteen different tools fit into the socket of an artificial forearm, making it possible for an amputee to write, shave, drive an automobile and make car repairs. The arm was designed by Waldo Rook of Berlin, who lost a hand in World War II. It operates on the principle of a socket wrench to hold the aluminum tools. One tool slips into the socket to aid in changing a tire. Another connects with a car's steering wheel. Aluminum for the fittings is donated from scrap in the American and British sectors of Germany. Rook operates a school sponsored by the city. About 400 students have already learned to use the artificial arm and attachments in a class that lasts four weeks. The city gives an arm and fittings free to any student who enrolls in the school and completes the course.



Radio-Radar Domes

Shifting radio and radar equipment to experimental wing-tip domes has increased cargo space in the Fairchild Packet. The plastic "radomes" resemble the droppable fuel tanks used on fighter aircraft. About 200 pounds of radar, formerly in the hold, are now at the left wing tip. A like amount of radio equipment has been moved to the right wing tip to balance the ship aerodynamically.



The CRAFTSMAN

★ Why just dream about having an outdoor fireplace when it's so easy to build one yourself? The full-color story starting on page 174 gives all the pointers one should know before starting to build—how to lay bricks, how to mix mortar, importance of location, etc.

★ Shooting transparencies is a fascinating hobby, but filing the slides in order—that's work, unless you have a cabinet similar to the one on page 201. It holds 2000 slides.

★ A damaged sail can lay up your boat over several week ends unless you know how to mend sail. Beginning on page 196, professional sailmakers tell the tricks of the trade.

★ A shop story on sawing compound angles, page 210, contains invaluable data for your reference file.

COLOR-SLIDE
FILE CABINET



DESK ACCESSORY

has secret compartments

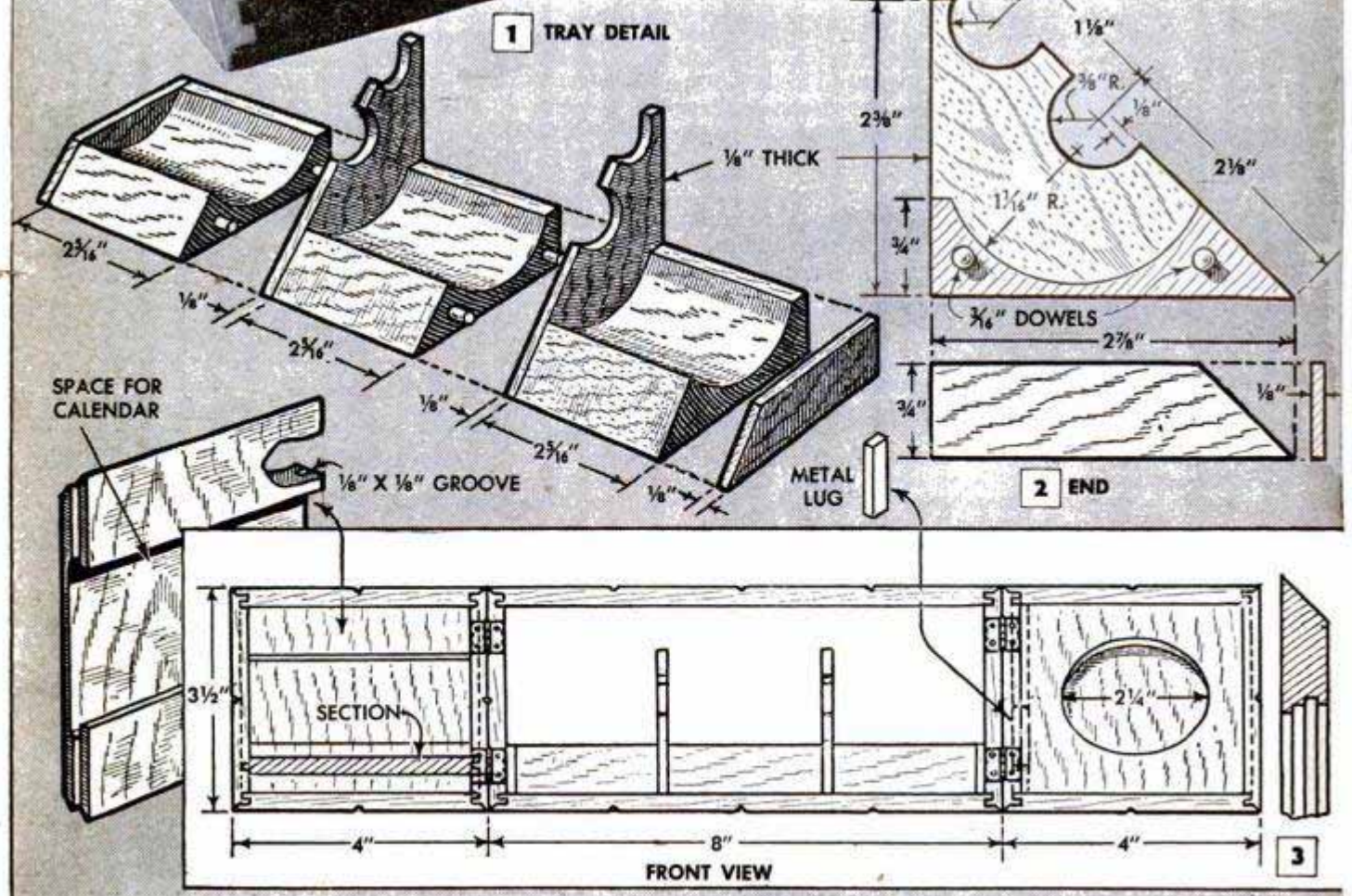



By Benj. Nielsen

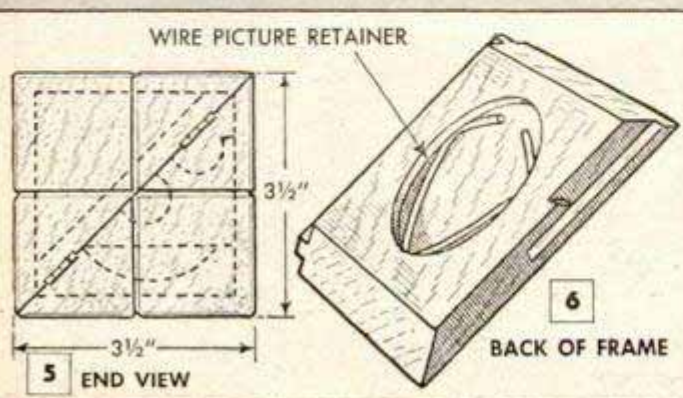
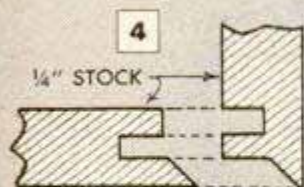
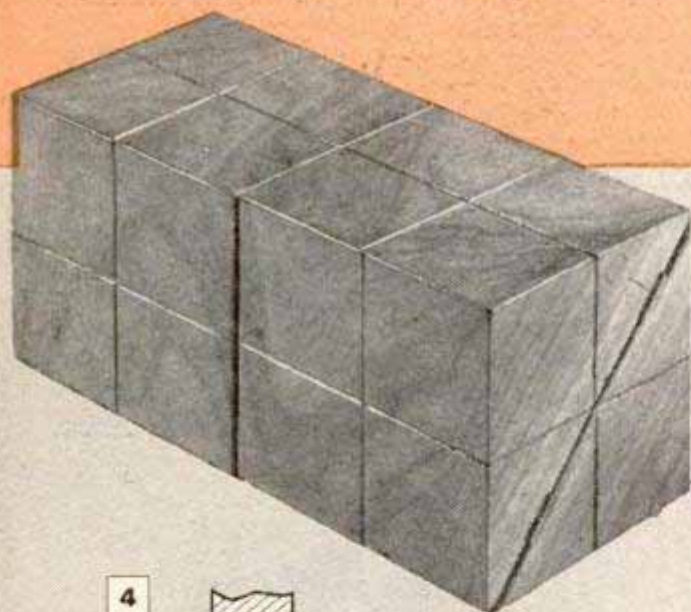

HOW DOES it open? That's what your puzzled friends will ask when they examine this intriguing desk accessory. The tendency is to try to raise the lid like any box, but that's when it fools you. For, instead of opening from the front, the box opens outward from the center and becomes a triangular-shaped unit, containing a calendar, photo frame and a removable tray for pencils, stamps, paper clips, etc. In addition to these features, the spaces behind the photo and calendar can be used to hide small items of value. To the casual observer it appears that the covers to the compartments are fixed, but actually they are removable—that is, if you know the trick. A small metal lug, concealed in a blind groove run in the edge of each cover, serves as a lock which is released by turning the box upside down and tapping it. This causes the lug to slide down to the open end of the groove, thereby unlocking the cover. By taping the valued item to the inside of the compartment so it will not rattle, it will be safe from the unsuspecting petty thief.

While appearing to be assembled in a single unit and then sawed apart diagonally, the box is made in three separate sections. Except for the parts of the tray, Figs. 1 and 2, $\frac{1}{4}$ -in.-thick solid stock is used throughout. Fig. 3 shows a direct front view of the box, opened, while Fig. 5, an end view, shows it closed. Mitered tongue-and-grooved joints, detailed in Fig. 4, are used at all corners. The triangular-shaped ends of the hinged sections must be grooved on the inside before assembling to take the covers and the locking lugs. Fig. 6 shows the combination rabbet and groove for the lug and how a tongue is formed on the opposite edge. The section through the calendar cover, Fig. 3, shows this clearly. The grooving is the same on both covers, except that one is made left hand and the other right hand. The hole for the photo is lathe-turned and rabbeted for a wire ring as detailed in the sectional drawing above Fig. 3. All surfaces of the box are scored lightly in a squared pattern so that the grooving aligns when the hinged sections are closed. Tiny brass hinges mortised flush are used to hinge the sections. Meeting edges of the folding sections may have to be trimmed slightly to permit closing.

Paper Is Perforated Quickly If Scored on Hardboard



Placing a sheet of paper on the back side of a piece of tempered hardboard and scoring it with a single stroke of a sharp knife results in perforations that permit easy tearing of the paper. The rough surface of the hardboard allows cutting through the paper at the high spots, but the material is soft enough so it will not dull the knife blade. A single sheet of gummed paper can be perforated to form labels by typing it prior to tearing along the perforations.—Michael Ligocki, Gary, Ind.

Shellac Prevents Stain Bleeding

Before applying a light-colored paint to varnished woodwork or furniture, first sand the surface and paint a small test spot in an unnoticeable place to see if the stain will bleed through. Wait a few days and inspect the spot for discoloration. If present, the entire surface should be sealed with two coats of shellac before the painting is continued.

Reinforcing Corners of Backing Protects Photos for Mailing

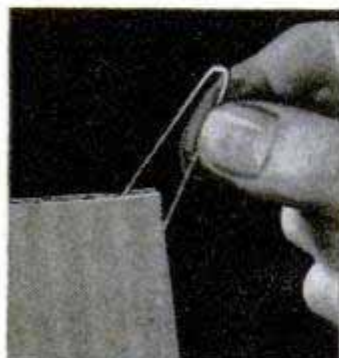

Even though photographs are protected by corrugated-cardboard inserts when mailing, the corners frequently are bent and the appearance spoiled. To reduce this possibility, re-

inforce the inserts by pressing a hairpin diagonally through the corrugations at each corner. This will add strength and rigidity without materially increasing the weight.

William Swallow, Brooklyn, N. Y.

Paint Sample Carried Safely In Empty Match Book

Recently when decorating my kitchen, I found that I was not going to have quite enough paint to finish the job. I had mixed the paint myself and, not wishing to re-mix the small additional amount required, I decid-

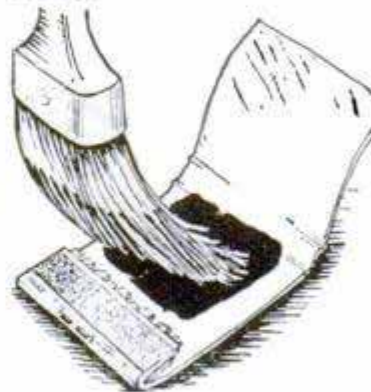

ed to try to match it with ready-mixed paint. The problem of how to carry a fresh sample of the color safely to a store was solved by using an empty match book. I daubed a bit of the paint on the inside of the cover and closed the flap over it. Thus I was able to carry it in my pocket.

George Henry, Argyle, Wis.

Sunglasses Kept From Dropping By Ribbon Tied to Frames

To make sure that your sunglasses do not fall and break during summer sports, tie a ribbon to the frame so it will hold the glasses around your neck. This is also a convenient way to carry the glasses when they are not needed.

Arthur Trauffer, Council Bluffs, Iowa.



Say "Come and Get It" With This Tiny Dinner Bell

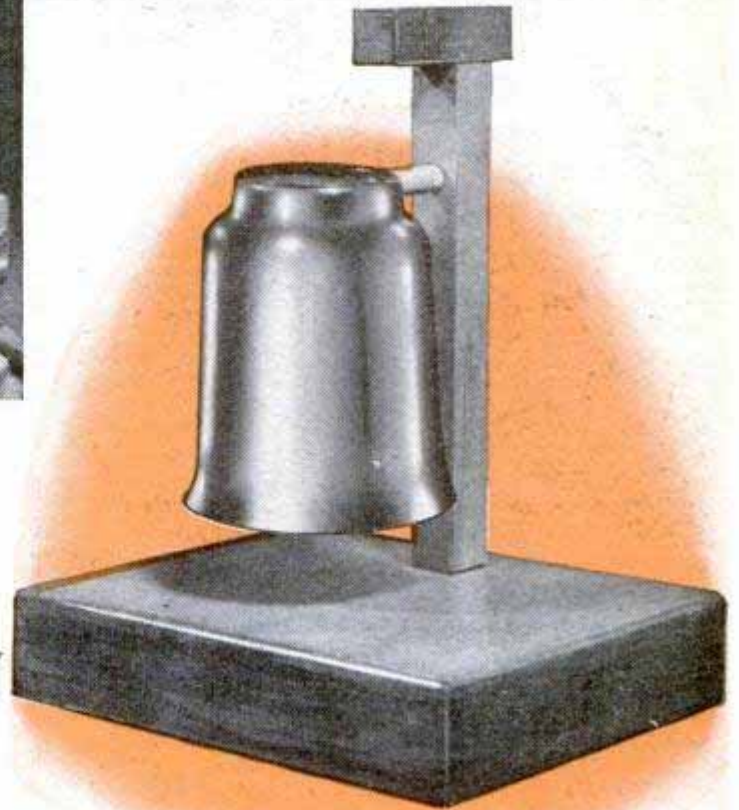
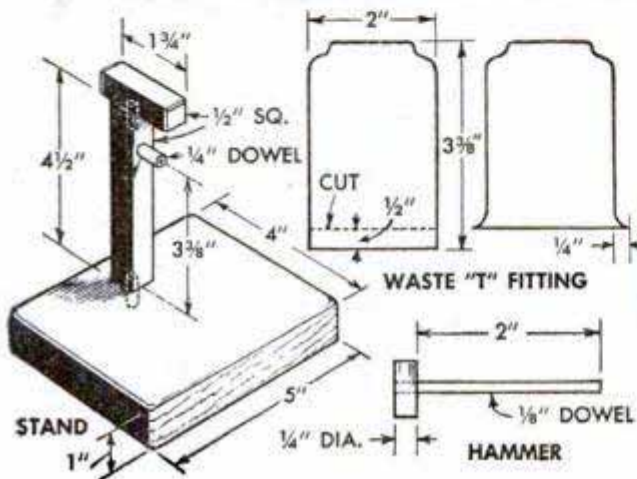

At dinnertime the soft tone of this tiny bell calls all hands at a single stroke. The bell is obtained ready-made from your plumber for it's simply a chrome-plated escutcheon, or cover, used in conjunction with a pop-up waste "T" fitting of a built-in drain plug on a lavatory. The straight end of the fitting is drawn and flared about $\frac{1}{4}$ in. by hammering it on a stake, which, in this case, is simply a 6-in. length of $1\frac{1}{2}$ -in., round cold-rolled steel. Use a soft hammer to avoid denting the metal. The stand is a good one-evening project. Use a cab-

inet wood that matches the dining table or sideboard for the base and upright. The bell is mounted by inserting a wood screw through the setscrew hole already in one side of the bell at the top and driving the screw into a hole drilled in the end of a short length of $\frac{1}{4}$ -in. dowel, as indicated in the left-hand detail. The head of the striking hammer is made from $\frac{1}{4}$ -in. steel rod and fitted with a wooden handle turned from the same wood as that used in the stand. Finish the stand with varnish or wax.—R. J. DeCristoforo, New York City.

Smooth-Running Scooter Wheels Provided by Auto-Axle Bearings

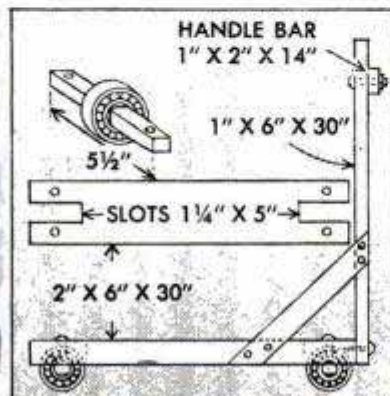

Worn rear-axle bearings from an automobile provide smooth-running wheels for a comparatively silent scooter which can be made in a short time. The base of the scooter is cut out, as shown, for the wheels which rotate on hardwood axles. The latter are simply lengths of square stock tapered at one end and driven through the center hole of the bearing. The ends of the axles are drilled and screwed to the underside of the scooter base.

C. E. Wilkinson, Golden, Ohio.

☐ Fish that have been out of the water for some time will scale more easily if they are dipped in boiling water for a minute.

Solving HOME PROBLEMS



It isn't necessary to keep your eye on a double boiler to see that it doesn't boil dry. Just place a fruit-jar lid in the bottom vessel and when the water gets low the jar lid will rattle loud enough to give warning that it's time to add more water

Novel shade pulls, especially appropriate for a game room or den, can be made from large-size colored dice. To attach them to the shade, drill a hole through the center and counterbore the bottom as indicated to take knotted end of the cord

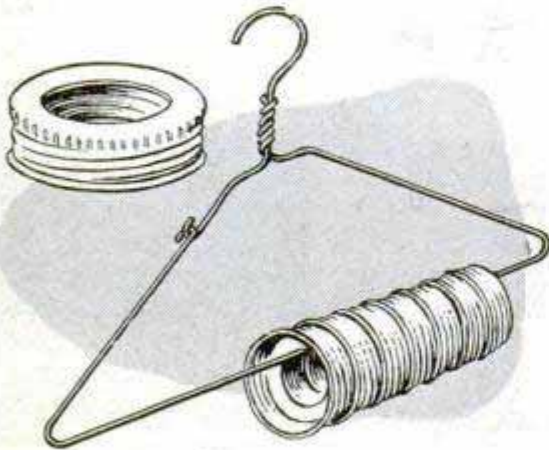
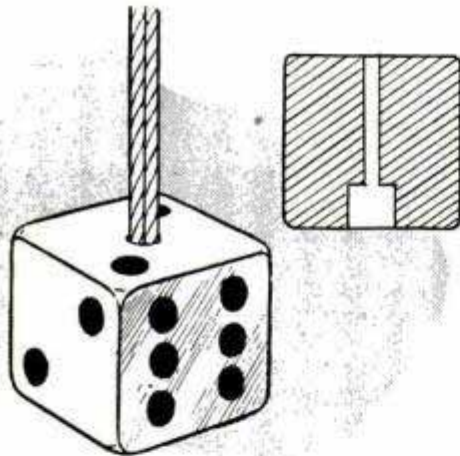

Keeping track of fruit-jar covers from one canning season to the next is no problem if a practice is made of threading them on a coat hanger when they are removed. The hanger is cut near the twisted end and severed ends are bent into hooks

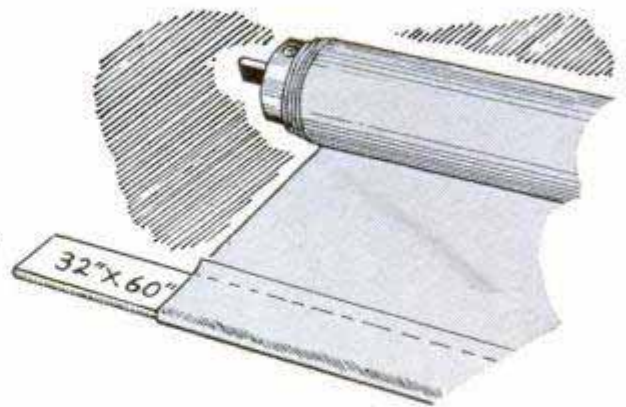

When shades are fitted to windows of a new home, future replacement of them is simplified if the length and width are marked on the shade. A good place to write this is on the end of the wooden slat. Thus the note is handy for quick reference

If the screw hole in a wooden turn button becomes so enlarged that the screw will no longer hold it in a set position, a section of clock spring, placed under the screwhead, will provide enough pressure to keep the turn button in a horizontal position

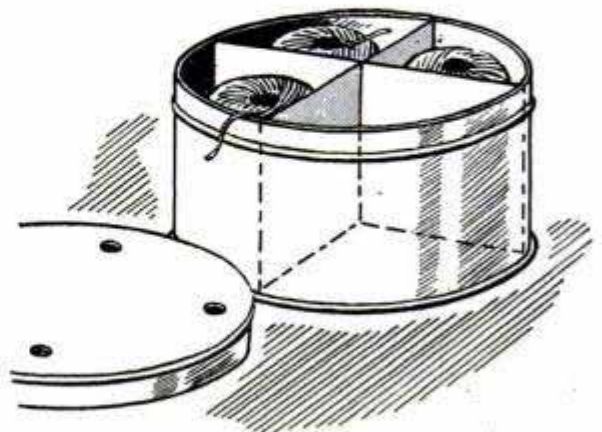
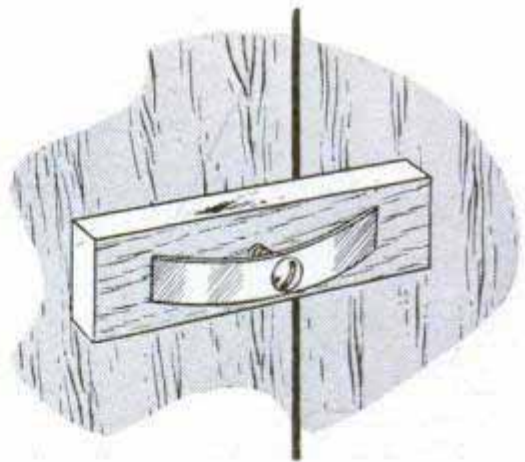

A large canister or metal candy box fitted with compartments makes an excellent dispenser for balls of string or yarn. Two pieces of cardboard, slit and half-lapped, divide the box into four compartments. Holes are drilled or punched in the lid

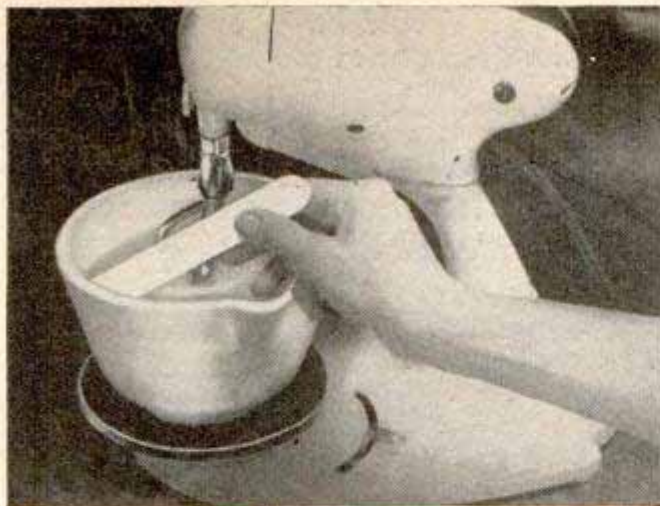

Possible damage to the beaters of a food mixer is prevented by using wooden tongue depressors instead of a spoon to scrape mixture from sides of the bowl. Thus, if the depressors accidentally catch in the beaters, they will not damage the latter.



The job of breaking ice cubes into small pieces to fill a Thermos bottle is avoided if "icicles" are used. These are frozen in a mold formed by folding a strip of wax paper in pleats. The mold is placed in a freezer tray and covered with water.

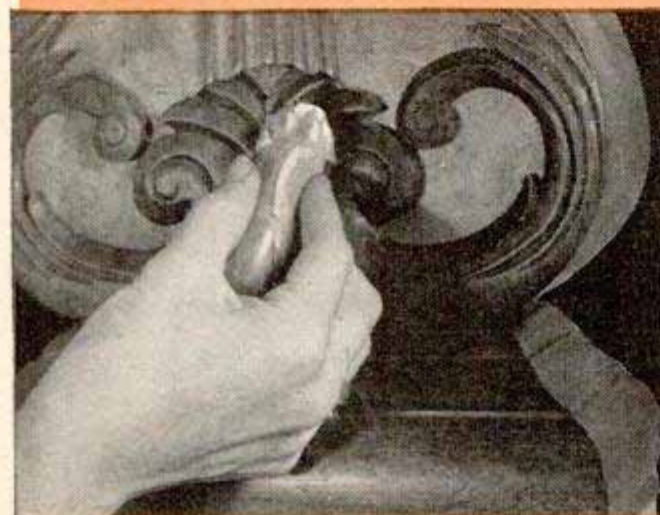

Wallpaper cleaner is put to new use in removing the film which collects on fancy carved furniture. Being pliable, the cleaner can be shaped to get into tiny crevices and other hard-to-reach places encountered in cleaning intricate overlay carvings.



Nothing is more annoying than pricking the fingers when applying curtains to a stretcher. Next time, try placing a common thimble on each thumb. Used in manner shown, thimbles serve as guards to bring the edge of the curtain over the barbs.



Eggs will fit nicely in round bun sandwiches if they are fried inside a tin can placed in the skillet. Top and bottom of the can are removed and resulting band serves as a cup to retain the egg as it is fried. Select a shallow can for the purpose.

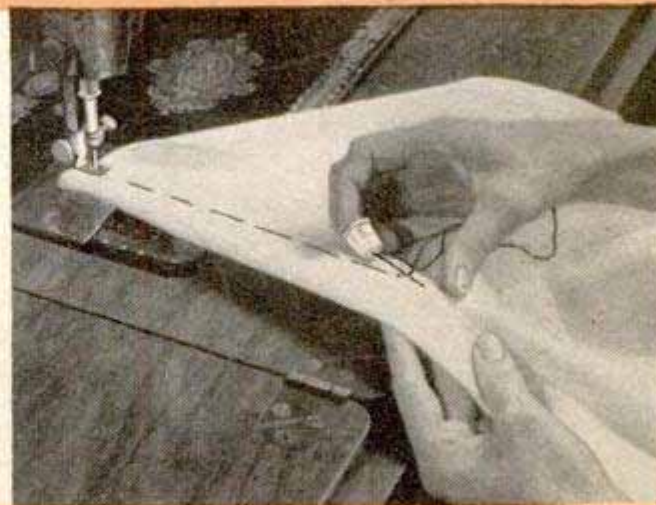

Basting hems is considerably less tedious when the presser foot of a sewing machine is used as a hold-down. With both hands free, the material can be held taut as it is being basted which not only speeds work but produces a straight running hem.

Portable Seat for Fisherman Utilizes Old Garden Hose

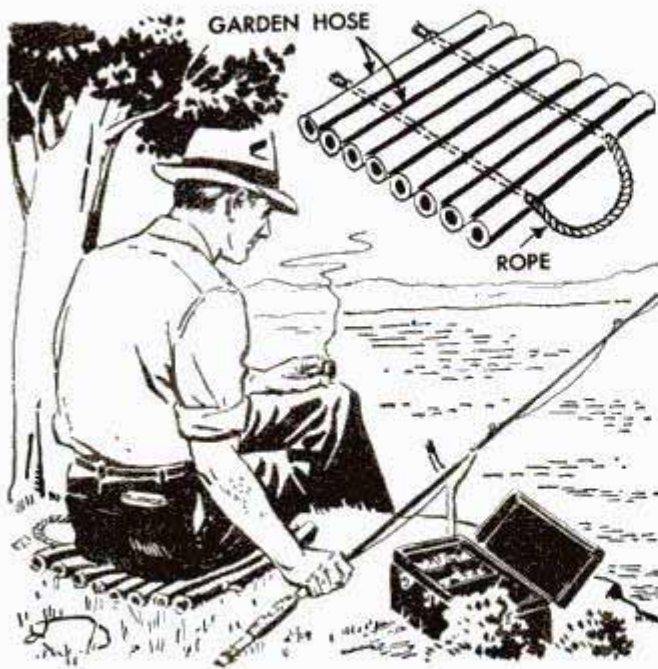

Several sections of discarded garden hose strung on a length of clothesline provide a portable seat which is just the thing when fishing from the bank of a river or lake. Such a seat is quickly made and, if there is a sufficient amount of old garden hose available, a number of them also will come in handy for picnics. They will be welcome in the early part of the day when the ground is still damp. To make the seats, cut the hose sections to size and drill two holes through each of them. Then, string the clothesline through the holes and knot the ends to form a handle for the seat.

Floating Foundation Bolts Permit Slight Error

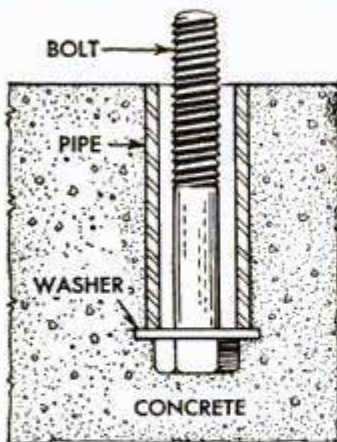

To allow for small errors in center-to-center distances when drilling holes in the plates of a frame house, one home builder embeds "floating" bolts in the concrete foundation walls. This is done by placing a washer and a short length of pipe over

the bolt and then setting the assembly in the wet concrete so the top of the pipe is flush with the surface. The pipe keeps the concrete away from the shank of the bolt, permitting the threaded end to be moved slightly in either direction to pass through the hole in the plate. The inside diameter

of the pipe should be $\frac{1}{4}$ to $\frac{3}{8}$ in. larger than the diameter of the bolt to provide a maximum amount of float.

Roger Isetts, Kenosha, Wis.

W.T.M. Concrete Copper Strip Prevents Seepage Between Wall and Footing

When pouring the foundation for his new home, one man sealed the joint between the footing and wall with a copper strip, 4 in. wide, to prevent seepage into the basement. About half the width of the strip was embedded in the wet concrete of the footing all the way around the house. After the wall was poured, this formed a watertight joint.

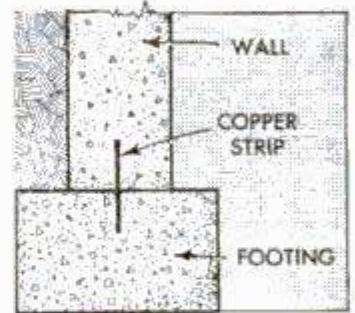

Sealing Leaks in Rubber Boots

Small leaks in rubber boots or waders can be sealed without using unsightly patches by cementing pieces of rubber band in the holes. First, locate the leak by shining a flashlight inside the boot.

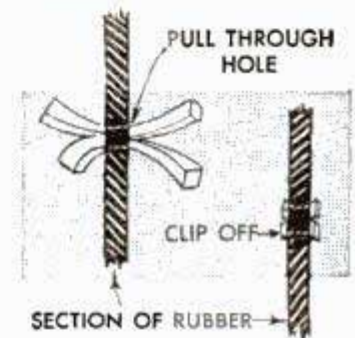

Then, work some rubber cement into the hole with a needle or toothpick, and pull one or more short lengths of rubber band through the hole so it is filled completely. Set the boot aside until the cement has dried thoroughly and clip off the ends of the rubber bands flush with the sides of the boot. The resulting mend will be long lasting and practically invisible.

Effective Insect Repellent

Applied to the socks, shoes and trouser legs every two or three hours, this chigger repellent will see you safely through badly infested brush and grass. The repellent consists of a mixture of oil of spearmint, 1 oz., and oil of pennyroyal, $\frac{1}{2}$ oz. For a mosquito repellent, add $\frac{1}{2}$ oz. glycerin to the above formula and apply to the hat, shirt and socks. In addition to being effective, the repellent is long lasting and has a pleasant odor.

☐ A simple and inexpensive clothes sprinkler is made by punching holes in the metal cap of a catchup bottle or one similar to it. The cap should be of the screw-on type.

IDENTIFY YOUR HOME

Friends who are unfamiliar with the location of your home will appreciate an attractive plaque or sign listing your name and house number where it is easily seen day or night from the street. If the sign is illuminated by a post lantern, it can be located so it lights the way to your door. The designs sketched below show what can be done with such materials as outdoor plywood, sheet metal and bent iron. The ironwork should be finished in flat-black lacquer and the wood painted

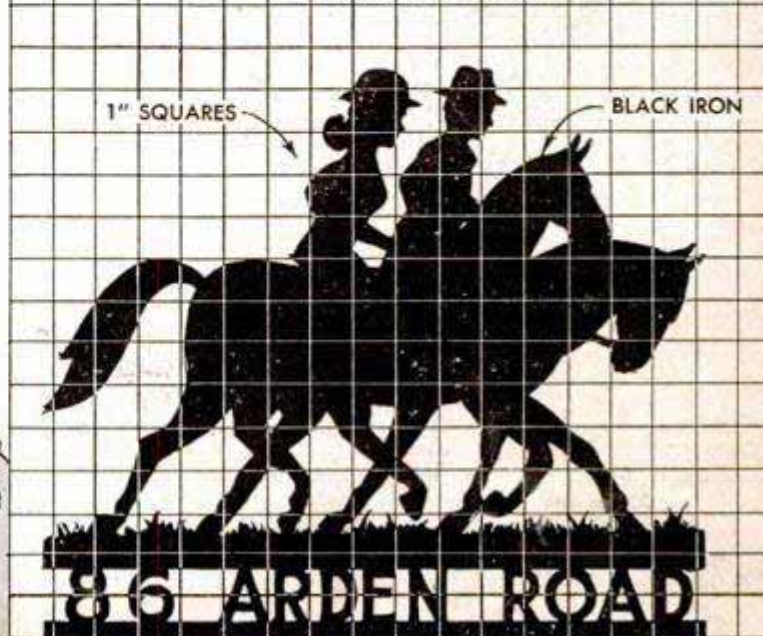
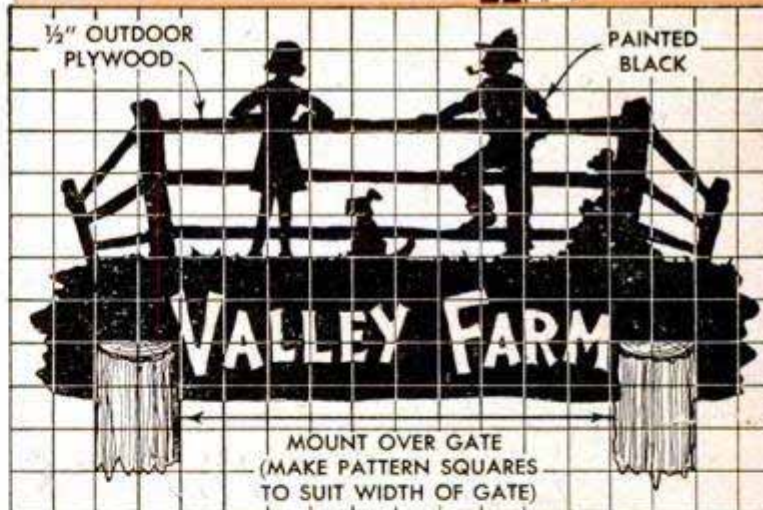
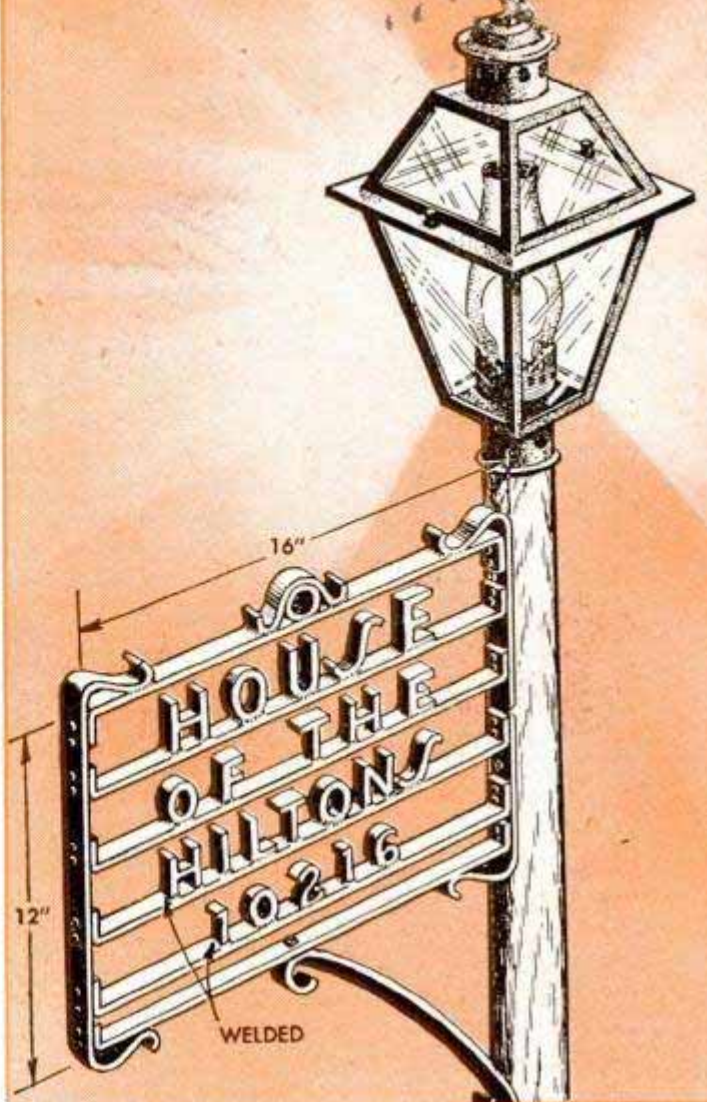
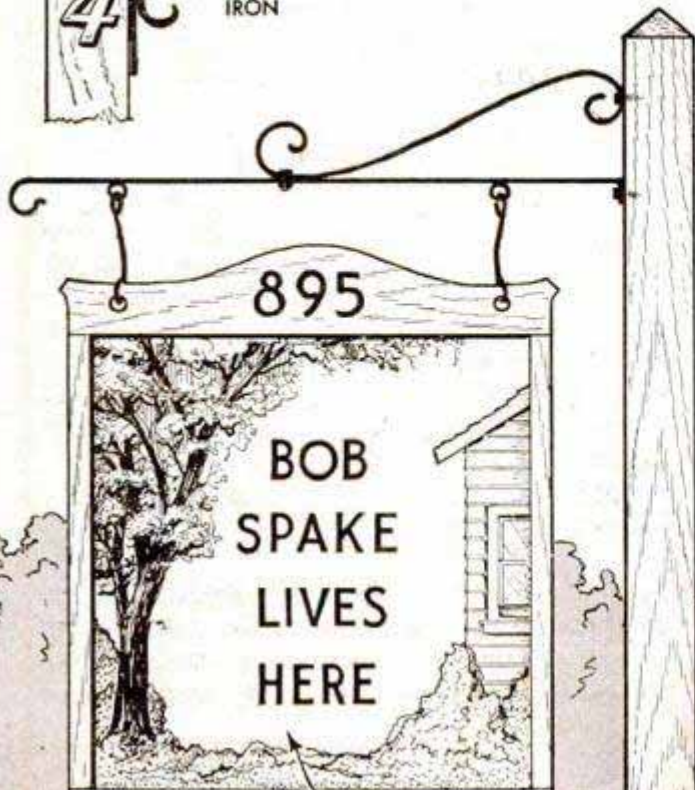



By E. R. Haan

HAVE YOU been anticipating the pleasures of an outdoor fireplace but have not done anything about it, either because the cost of having the work done is prohibitive, or because it seems that the job is too forbidding to tackle yourself? Building one isn't so difficult if you arm yourself with guiding facts on just how to proceed—information such as is contained in this article.

What type of fireplace do you want? You may prefer a fireplace of the simplest type like the one shown in Fig. 2, which is low and consists of bricks laid without mortar. This type is serviceable if used only occasionally. In the more permanent structure shown in Fig. 3, a concrete foundation slab supports three sides and

Planning and Building Outdoor Fireplaces

X285
Also X253

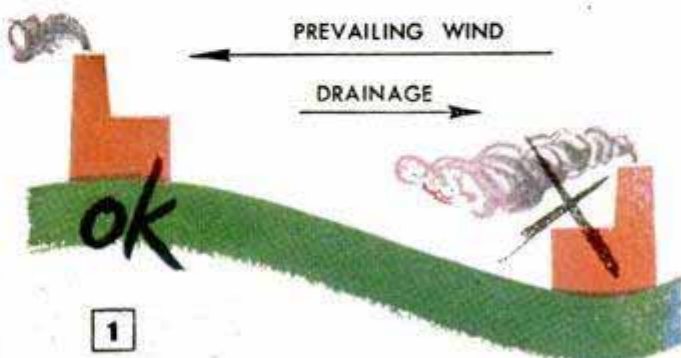

Pointers on location and arrangement—importance of good design—how to mix and use mortar — how to lay brick, etc.

a chimney. Grates can be formed by setting iron bars in the masonry, but greater cooking efficiency is possible by using a steel firebox and ashpit around which the fireplace is built as in Fig. 4. Then, there are more elaborate fireplaces. One combining a cooking grill and Dutch oven with an open hearth that gives warmth on cool evenings is shown in Fig. 5. Storage space for cooking utensils and fuel can be included. You also can incorporate a trash burner or a garbage incinerator, concealed from the cooking end of the fireplace and operating independently.

Important facts about location: After deciding just which type of fireplace you want, determine its location. Select a dry spot having good drainage, where water does not collect and where heaving frost will do the least amount of damage to units that do not have deep foundation walls. Prevailing wind direction can make your fireplace either a pleasure or a tribulation. The fireplace should face prevailing winds, Fig. 1, so that full advantage is taken of the draft and so the smoke will blow away from the crowd. Also, in order

2

Simplest fireplace setup consists of brick laid without mortar to form three sides for the grate. The chimney is omitted



3

For permanence, fireplace is built on concrete slab with brick laid in mortar. Chimney is low for better draft





Photo courtesy Mangel Florist, Chicago

to avoid interference with the draft, a fireplace should not be located under a tree, Fig. 6, or under a high wall. Other important considerations when selecting the location are appearance and utility. The fireplace should enhance your yard or garden, and it must not be too large in proportion to the lot. It should neither block the view from house windows nor be close to a doorway. Equally important, it should not be situated where the wind tends to carry the smoke into the house. The appearance also can be improved by using a type and color of brick or stone for the fireplace which harmonize with the house.

A firm foundation: The fireplace must have adequate support to prevent it from settling unevenly in soft earth, or from being damaged by frost. Where frost is negligible, a concrete slab 6 or 8 in. thick and reinforced with iron rods and pipes, Fig. 7, will be adequate. The top of the slab should extend a couple of inches above the ground level so that water will not collect in the ashpit. For the same reason, the floor of an ashpit should always slope to drain out water. If the soil does not have good drainage, the slab should be poured over an 8-in. layer of crushed stone or cinders, which has been well tamped.

In northern climate, a small, lightweight structure may be built on a slab foundation as described above, but a heavy structure requires a concrete foundation wall extending below the frost line and having a footing as in Fig. 8. For concrete foundations in sandy or loose earth, a double form should be used as in Fig. 9. To avoid buying lumber for making forms, you may be able to rent or borrow ready-made forms from a cement contractor. On large jobs, it is often advisable to have the concrete work done by a contractor. It is possible to pour the footing and wall at one time by nailing 1-in. wooden strips to the lower edges of the forms and bracing them with stakes, Fig. 9. In heavy soil, such as clay, the soil itself often will serve as one side of the form, Fig. 10, or it may be possible to dispense with wooden forms entirely, Fig. 11. It is best to pour all the concrete for the foundation at one time. After the forms are removed, the floor of the fireplace can be poured. Concrete foundation walls consist of ingredients in the proportion as given in the table, Fig. 12. To determine quickly the quantity of ingredients required for your fireplace, figure its volume in cubic feet. If, for example, the volume is 54 cu. ft., or twice as much as 27 cu. ft.

By using a steel firebox and ashpit, greater cooking efficiency is possible because of advantage of the better draft control



Warmth and cheer of an open fireplace on cool evenings is an added advantage of a more elaborate one



6 CLEARANCE ABOVE ABOVE

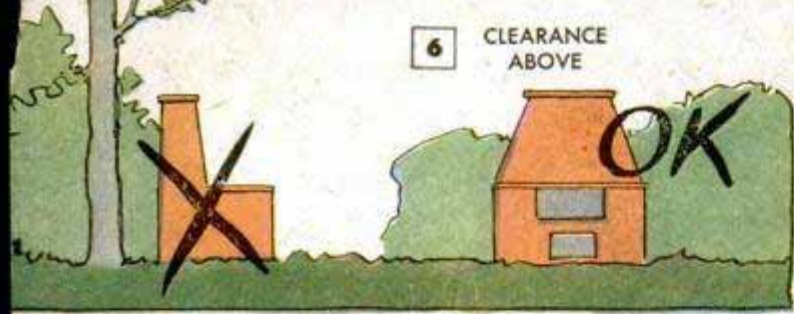

on which the quantities in Fig. 12 are based, you will need just twice as much of each ingredient. Or, if you require only 9 cu. ft., you will need only one third of the quantities given in the table. Only enough water is added to form a mushy, but not a soupy, mixture. The ingredients are first mixed thoroughly while dry, on a level platform or in a shallow box. When mixed, the pile is shoveled outward to build up the edge and form a depression into which water is poured, Fig. 14. Then the material is pushed from the edges into the water slowly.

Facts about good design: Outdoor fireplaces frequently are made too large and massive, even though small ones are less expensive and easier to build. For the sake of convenience, the area of a grate should not be less than 2½ sq. ft. Cast-iron grates are available in many sizes from manufacturers of fireplace equipment. These or homemade grates shown in Fig. 17, can be held in place with pins or bars set in the mortar. Dimensions of grates to be purchased should be known prior to building so that the fire-chamber dimensions can be determined. A built-in grate, consisting of iron rods or lengths of pipe, can be installed in the masonry as in Fig. 18. The rods should extend 2 or 3 in. into the wall, and they should be spaced not to exceed 1¼ in. A little extra care taken to make the grate surface perfectly level will be appreciated when the fireplace is being used. Do not permit the ends of the rods to butt tightly against any part of the masonry but provide a little space to compensate for expansion of the metal when hot. In some cases where this precaution was neglected, fireplaces have been wrecked by expanding metal.

Best results are obtained in building a fire if the fuel rests on a grate through which air passes to the fire. This type of bottom grate is located over an ashpit and is heavier than the top grate on which cooking is done. For greatest efficiency, the distance between the two grates should not exceed 8 in. Other recommended dimensions for efficient fire chambers are given in Fig. 13. There also is a definite

Photo courtesy Portland Cement Assn.

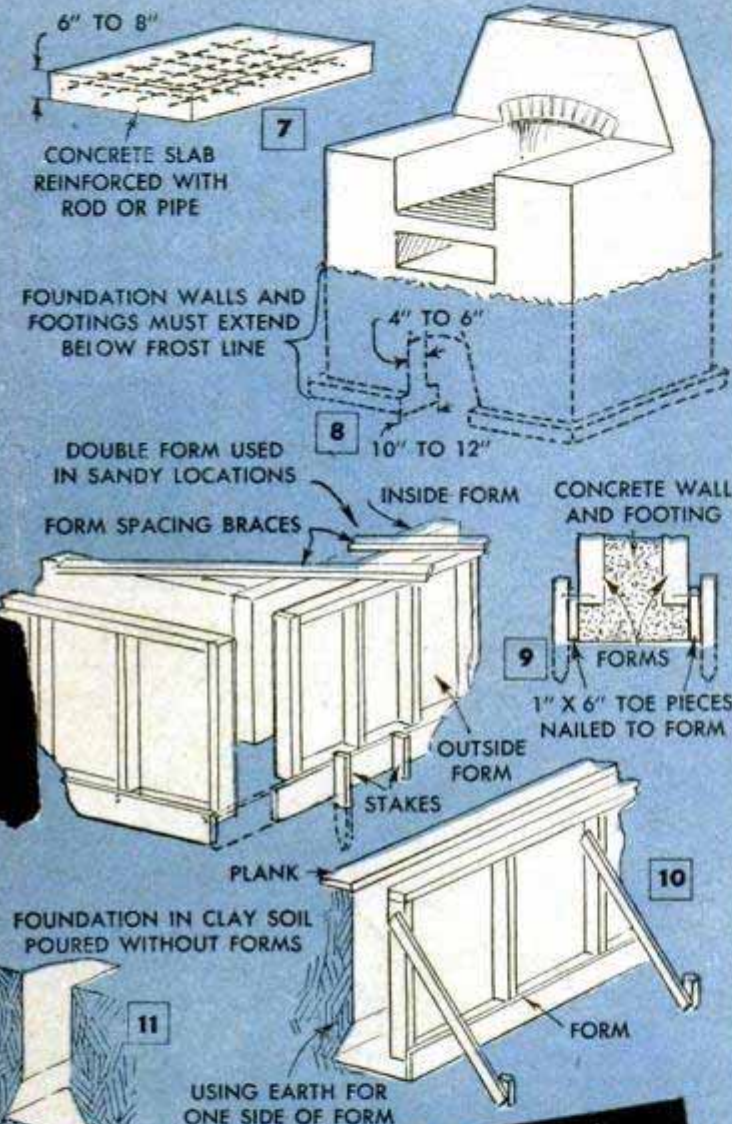

12

ONE CU. YD. (27 CU. FT.) OF CONCRETE FOR OUTDOOR FIREPLACE FOUNDATIONS CONTAINS

3 parts	Cement (1 bag=1 cu. ft.)	4.3 cu. ft.
3.75 parts	Sand	16.1 cu. ft.
5 parts	Crushed stone or gravel	21.5 cu. ft.
Minimum amount until "mushy"	Water	27.6 gals.

RECOMMENDED SIZES FOR FIRE CHAMBERS

- A—DEPTH—6 TO 8"
- B—WIDTH—12 TO 18"
- C—LENGTH—16 TO 30"
- GRATE AREA NOT LESS THAN 2½ SQ. FT.

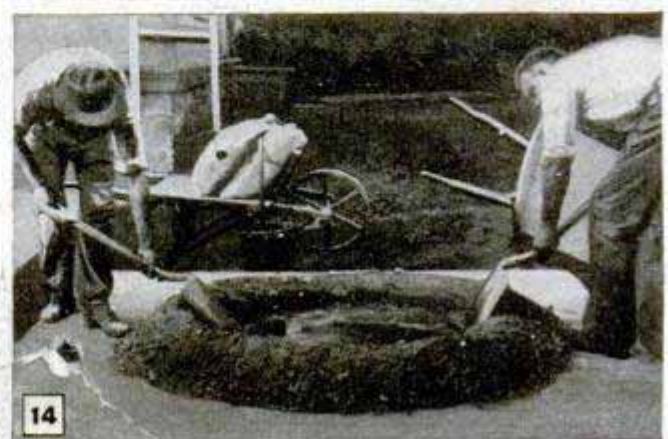

Photos courtesy
Donley Brothers Co.
Cleveland, Ohio



15



16

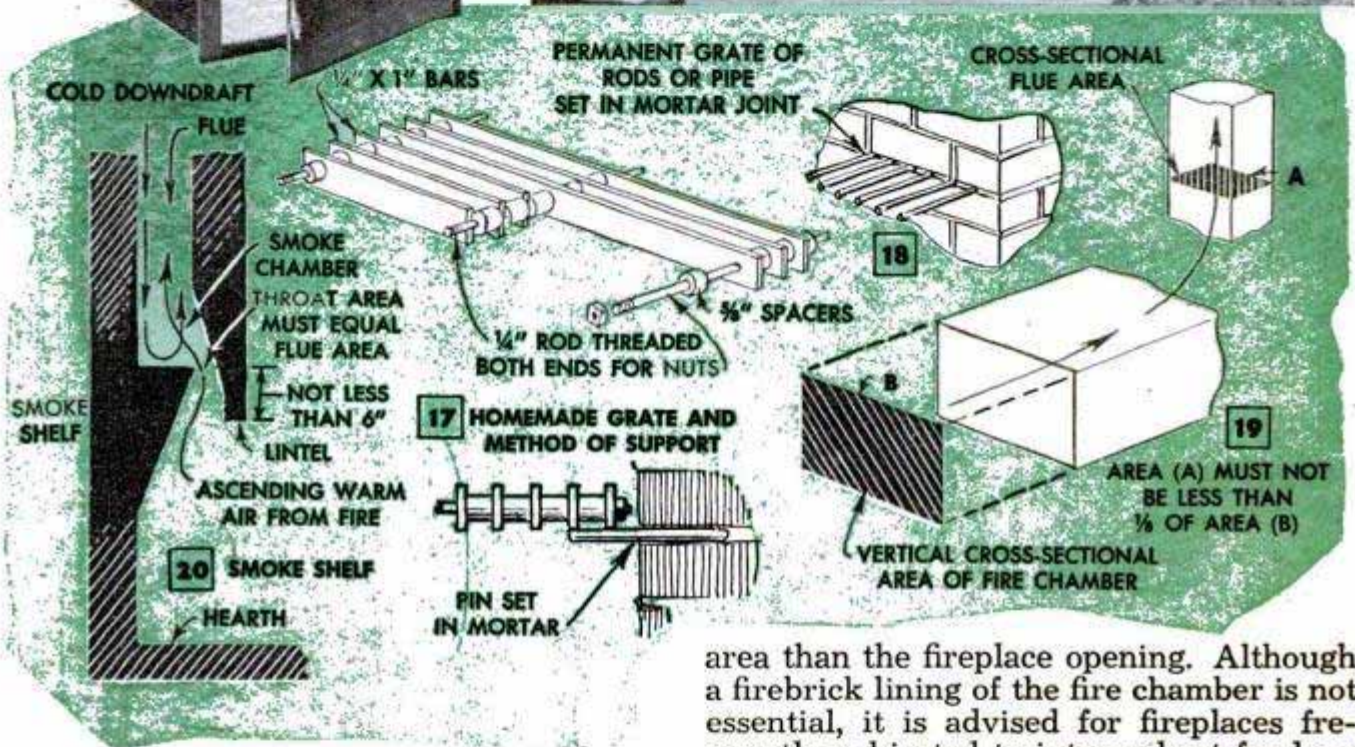

relationship in size between the fire chamber and the chimney flue. The cross-sectional area of the chimney flue should not be less than one eighth of the vertical cross-sectional area of the fire chamber, Fig. 19. Many builders of outdoor fireplaces use ready-made fire chambers as shown in Figs. 15 and 16.

A smoke shelf is an important feature to prevent descending cold air in the chimney from interfering with the upward movement of smoke. The shelf turns the descending cold air into the ascending column of hot, smoke-filled air with which it mixes and returns up the chimney, as in Fig. 20. The width of the smoke shelf is about equal to that of the chimney flue. The smoke chamber flares out at an angle of approximately 30 deg. past the front of the smoke shelf which is supported by brickwork built out at an angle from the rear wall of the fireplace. The space from lintel to smoke shelf must not be less than 6 in., and the opening or "throat" located just in front of the smoke shelf should not be less in

area than the fireplace opening. Although a firebrick lining of the fire chamber is not essential, it is advised for fireplaces frequently subjected to intense heat for long periods, especially when the brick or stone used is porous like sandstone, which absorbs water readily and chips when exposed to high temperatures.

Brick and stonework: Like determining the amount of concrete needed, it is easy to figure the quantity of bricks required, Fig. 22. Fireplace walls should not be less than 8 in. thick. Standard building bricks are 8 in. long, 3¾ in. wide and 2¼ in. thick. Standard firebricks are 9 in. long, 4½ in. wide and 2½ in. thick. A strong mortar consists of portland cement, 1 part, and sand, 3 parts. If a more "buttery" mortar is desired, replace from 10 to 15 percent of the portland cement of the above mix with hydrated lime. About ⅓ cu. ft. of mortar is used for each cubic foot of brickwork having ½-in. joints. Firebricks are laid in fire clay. To start with the brickwork, lay the entire outside row of bricks in place as shown in Fig. 23, allowing about ½-in. space between the bricks. Generally the spacing can be increased or decreased uniformly so that the course of bricks will



21

Photo courtesy Louisville Cement Co.

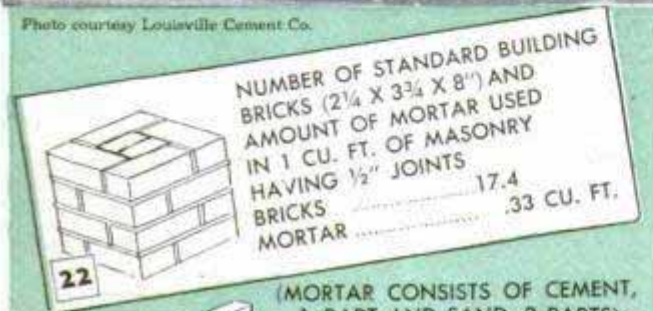

22

(MORTAR CONSISTS OF CEMENT, 1 PART AND SAND, 3 PARTS)

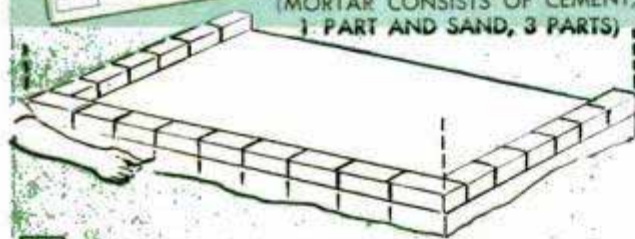

23 SPACING BRICKS TO FIT FOUNDATION

FIRST COURSE LAID TEMPORARILY WITHOUT MORTAR AND THEN POSITION OF JOINTS MARKED ON FOUNDATION

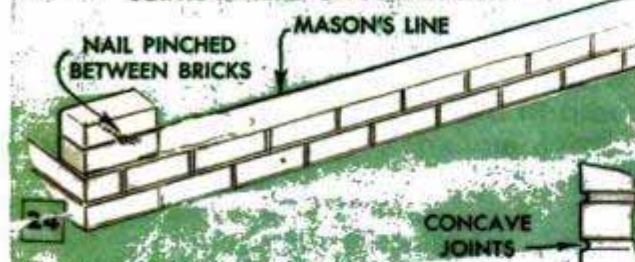

24

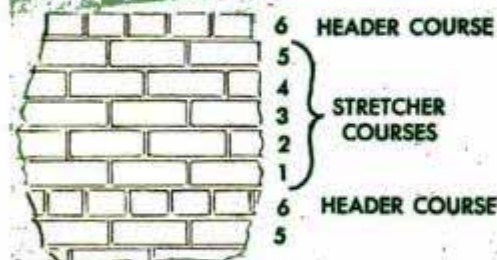

25 ARRANGEMENT OF BRICK COURSES FOR FIREPLACES

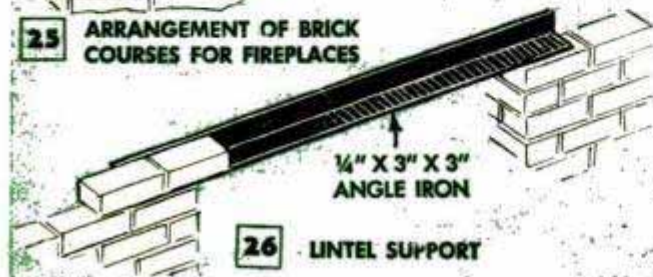

26 LINTEL SUPPORT

fit exactly from corner to corner on the slab. If not, a half brick is set between the last two bricks, or the last brick is laid at right angles, starting the course on the adjacent side. The position of each joint is marked carefully on the foundation. Then the bricks are removed, and mortar is applied so that when the bricks are pressed down firmly they will be raised about 1/2 in. Bricks to be laid must be kept thoroughly soaked so that moisture will not be absorbed from the mortar. A straight line of bricks is assured by using a mason's line stretched taut from two nails pinched between bricks, Fig. 24.

Corners of the brickwork must be kept plumb, which can be checked with a level. The inner

bricks of an 8-in. wall are staggered half-way between outer bricks, like those in successive courses. You can use the "common" bond consisting of five courses laid lengthwise and a sixth course laid crosswise to bind inner and outer layers together, Fig. 25. After placing the mortar, the brick is pressed down and also against the mortar on the end of the last brick laid. Simultaneous with these two movements is a third, forcing the brick outward to align its upper edge with the line—not touching it, however. This movement squeezes some mortar out beyond the face of the brick as in Fig. 21. The trowel is used to remove this surplus mortar and to wipe it on the end of the brick just laid. After a course is laid, the mortar joint is raked to a concave shape with the aid of a raking tool or metal rod. This type of joint, shown in Fig. 25, is best for brickwork exposed to weather.

When working with bricks, remember that they are slightly wedge shaped. The top is wider than the bottom, which has a depression or is marked with a trade name, and one face of common brick is square but the opposite face has a slight bevel. Bricks are laid so the face having the depression or trade name is at the bottom and the true face is exposed on the outside of the wall. The first course of brick or stone over a fireplace lintel is given adequate support with a length of 1/4 x 3 x 3-in. angle iron as in Fig. 26. When using stone for outdoor fireplaces, keep it wet when laying it in mortar, as is done with brick. Limestone, which is relatively soft, is a favorite material, but harder and denser stone will last longer under all kinds of weathering conditions and intense fire heat. Select only pieces of stone that are solid and have no cracks. A stone wall, like one built of bricks, must have bonding stones here and there to keep the separate layers together.

27 PIVOTED FIREPLACE CRANE

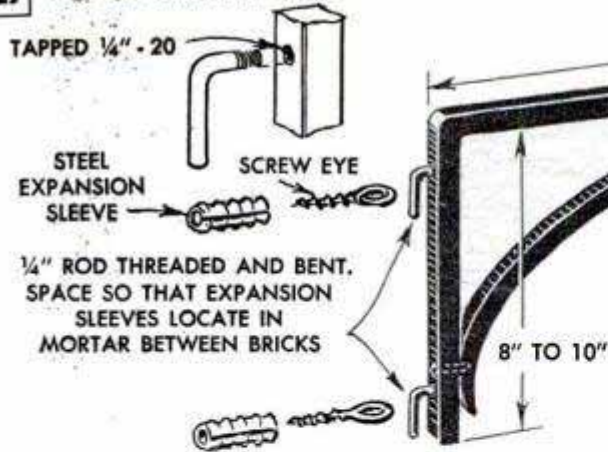

Stones can be chipped to shape and size by using a cold chisel and sledge hammer.

Added conveniences: A solid plate over the grate is often desired to avoid getting utensils coated with soot and getting fly ash in the food. Such a plate should be 1/4 in. thick. It may be loose or hinged to swing back against the chimney. Food can be prepared in an iron kettle hung on a crane, Fig. 27, and another convenience is a shallow frying pan, Fig. 28. Two charcoal baskets, hanging vertically in a fireplace from two 1/2-in. iron rods resting on the fireplace sides, are ideal for broiling steaks. You can purchase these or improvise a pair as shown in Fig. 29.

Three methods of installing a Dutch oven are shown in Fig. 31. To avoid starting a fire on your neighbor's shingle roof or in a patch of dry grass, install a wire-mesh guard on top of the chimney flue as shown in Fig. 30. It's a good idea to provide space for fuel so that it can be kept dry and always ready for use. Such space can be had by incorporating a fuel compartment in the fireplace when designing it. Dishes and utensils can be kept in a Dutch oven although separate storage space can be provided if desired. Scrupulous cleanliness is of utmost importance because scraps of food attract insects and rodents.

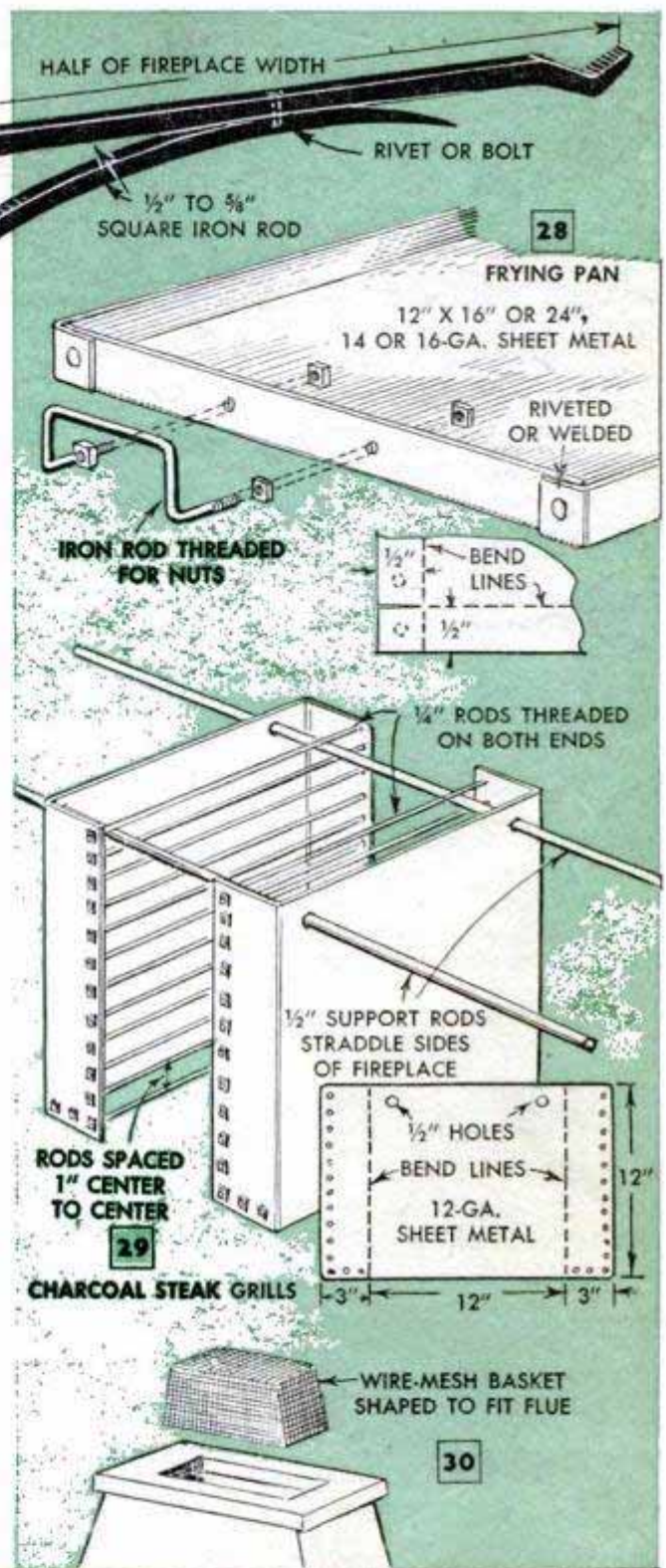

31 METHODS OF INSTALLING DUTCH OVENS

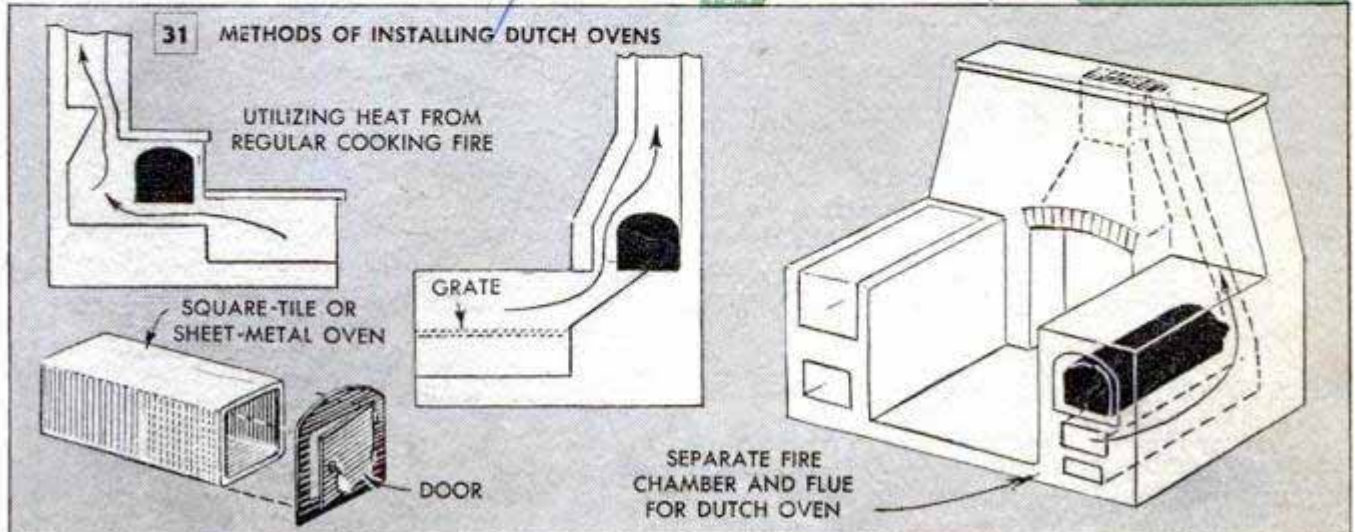

Picnic Cloth Held to Ground With Clothespin Anchors

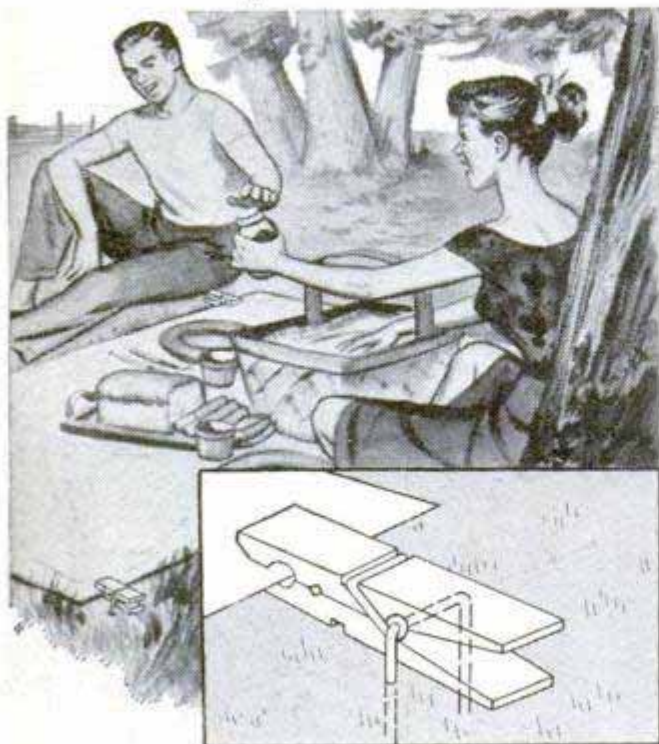

Spring-type clothespins fitted with long wire staples provide excellent anchors for holding the corners of a picnic cloth securely to the ground. A piece of stiff wire is pushed through the spring of each clothespin and the ends are bent downward. In use, the staple is pressed into the ground and the corner of the cloth is gripped by the jaws of the clothespin.

Spare Fishing Tackle Carried In Hollow End of Cane Pole

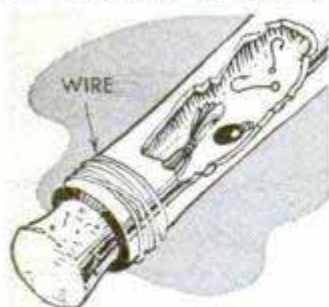

One of the advantages of cane-pole fishing is not being burdened with a large amount of tackle, but it's a good idea to carry a few extra hooks, leaders and sinkers and a spare line, just in case. Even these can be carried compactly inside the hollow pole. Simply cut off the handle end of the pole above the first joint, insert the tackle in the hollow and cap the opening with a tight-fitting cork. To keep the pole from splitting, wrap tape or wire around the end.

Harold Rolseth, Pewaukee, Wis.

Recipe for Modeling Clay

Most children enjoy playing with modeling clay, and some can be made in a jiffy by mixing the following ingredients with enough water to bind them together: flour,

1 cup, salt, $\frac{1}{2}$ cup, and alum vegetable coloring, 3 teaspoonfuls. To keep the clay moist, store it in a can or jar or roll it into a ball and cover with a damp cloth.

Saw Doubles as Disk Sander

Having only occasional need for a disk sander, I temporarily convert my circular saw into a sander and find it does the job satisfactorily. I merely slip a heavy abrasive disk over the saw shaft and tighten it against the blade. The blade provides a solid backing for the disk. As the guard must be removed, be exceptionally careful when sanding.

Robert B. Leslie, Kansas City, Mo.



Reflecting Letters on Car Door Warn Approaching Drivers

As it is necessary for one driver to make a left turn off a dark, heavily traveled highway in order to reach his home, he cemented reflecting sign material to the frame of the car door to form the word "left." Now, when he slows down for the turn, he opens the door, and the warning, gleaming in the bright lights of cars approaching from the rear, cautions drivers who otherwise would attempt to pass him on the left. The thick door frames of the newer cars provide plenty of space to cement large, clearly visible letters.

F. Edward Litty, Denver, Colo.



Requiring only a floating court and two sets of wooden disks, all of which can be made in a few hours, "skip scotch" is an action-packed game that provides real fun at the beach. After the court has been anchored in the water 60 ft. from the shore line, each player attempts to skip four disks into the highest-scoring section of the court. The first player to score 18 points is the winner of the game. The court sections are numbered as shown in the detail, the front, or triangular, section having the highest number of points. One point is subtracted from the player's score for each disk that misses the court, and disks that come to rest on the framework are not counted. These rules, of course, are merely suggested ones and they can be altered as desired. The wooden framework

"Skip Scotch"—Played With Wooden Disks Provides an Entertaining Beach Pastime

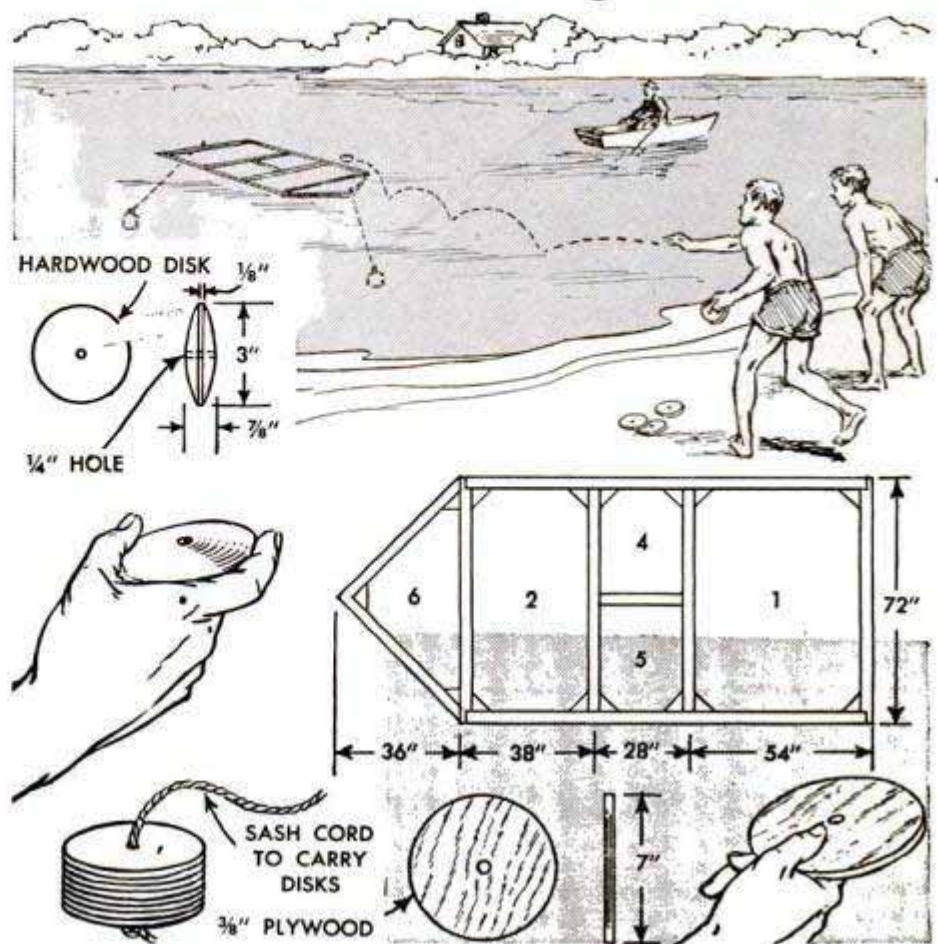

is made as shown and, after the top has been painted white so it can be seen easily, the entire court is given a coat of spar varnish. Small, convex disks can be made of hardwood, or larger, flat disks of waterproof plywood can be used. One set of disks is painted yellow and the other set red, all of them being given a final coat of spar varnish. Before painting, the centers of the disks are drilled so they can be strung on a length of sash cord or clothesline for

carrying. Anchors attached to the front and rear of the court hold it in position, and their lines should be as short as possible to keep the court from swinging. Cans filled with concrete will provide anchors. If the game is to be carried in a car, the court can be hinged to fold compactly or made in two or more separate sections which can be quickly hooked or screwed together at the beach and later taken apart in a few minutes for carrying.—Hi Sibley, Nuevo, Calif.

Inexpensive Live Box Made From Hardware Cloth Hangs Over Side of Boat

Made of 1/2-in. hardware cloth stapled to top and bottom pieces of solid stock, this inexpensive live box is just the thing to hold a day's catch. A door, sawed in the

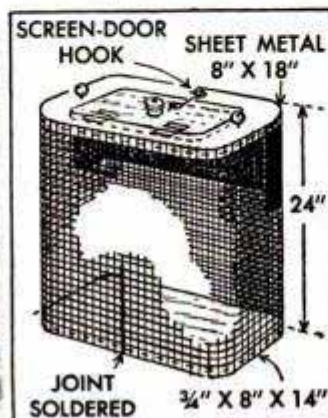

toppiece, is hinged to open away from the boat. This makes it easier to transfer the fish from the boat to the box. A small knob is fastened to the upper side of the door, which is held closed with a screen-door hook. A cleat can be nailed to the underside of the toppiece to form a rabbet in which the edge of the door rests. The box is secured to the boat with a length of rope tied to two screw eyes turned into the toppiece. Note that the joint of the hardware cloth is soldered and that a sheet-metal bumper protects the mesh from being damaged against the side of the boat.

M. B. Birge, Hinsdale, Ill.

☐ A coat of white shoe polish will make white Venetian blind tapes look like new.

FROM PALMS

With This High-

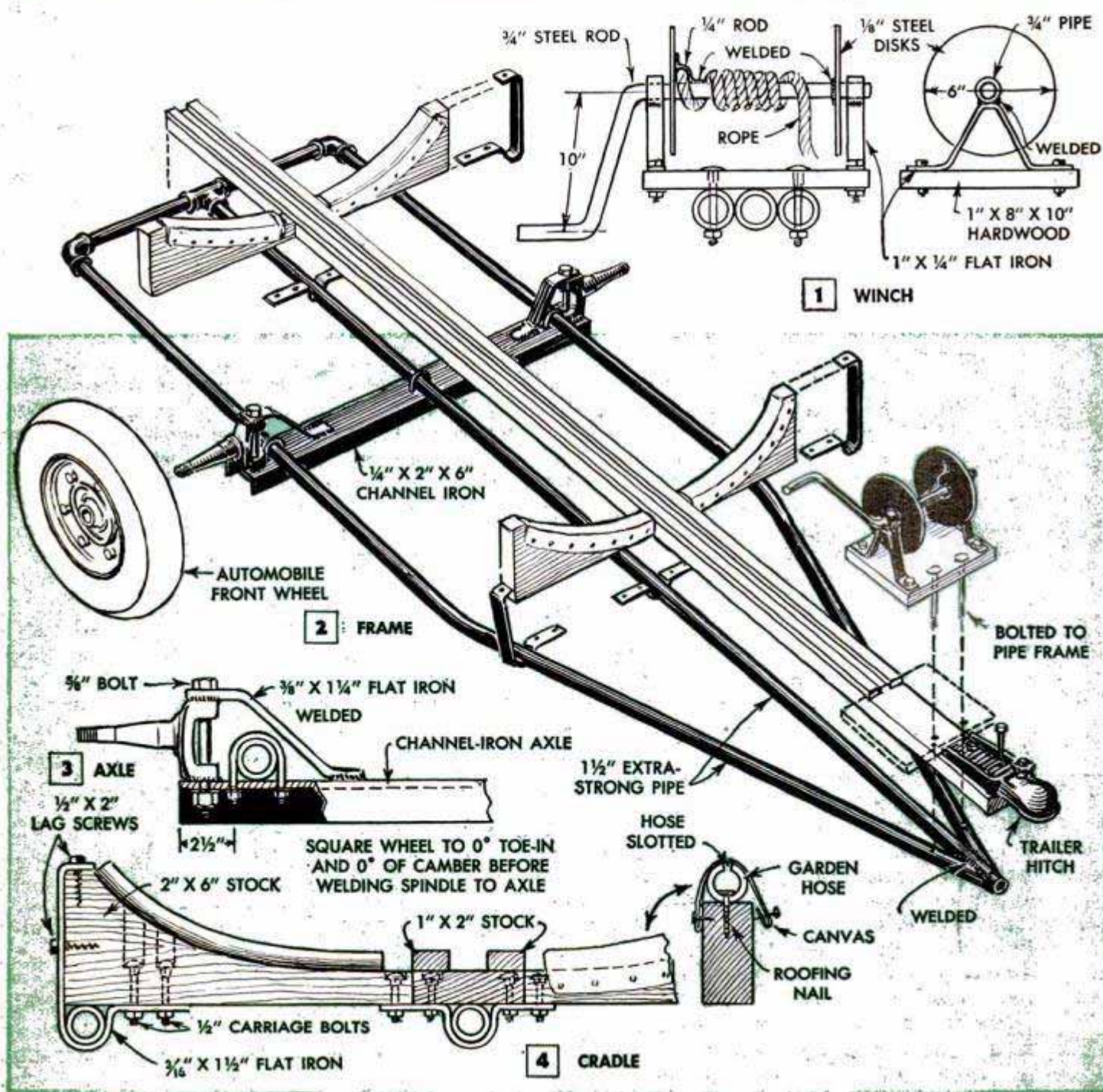
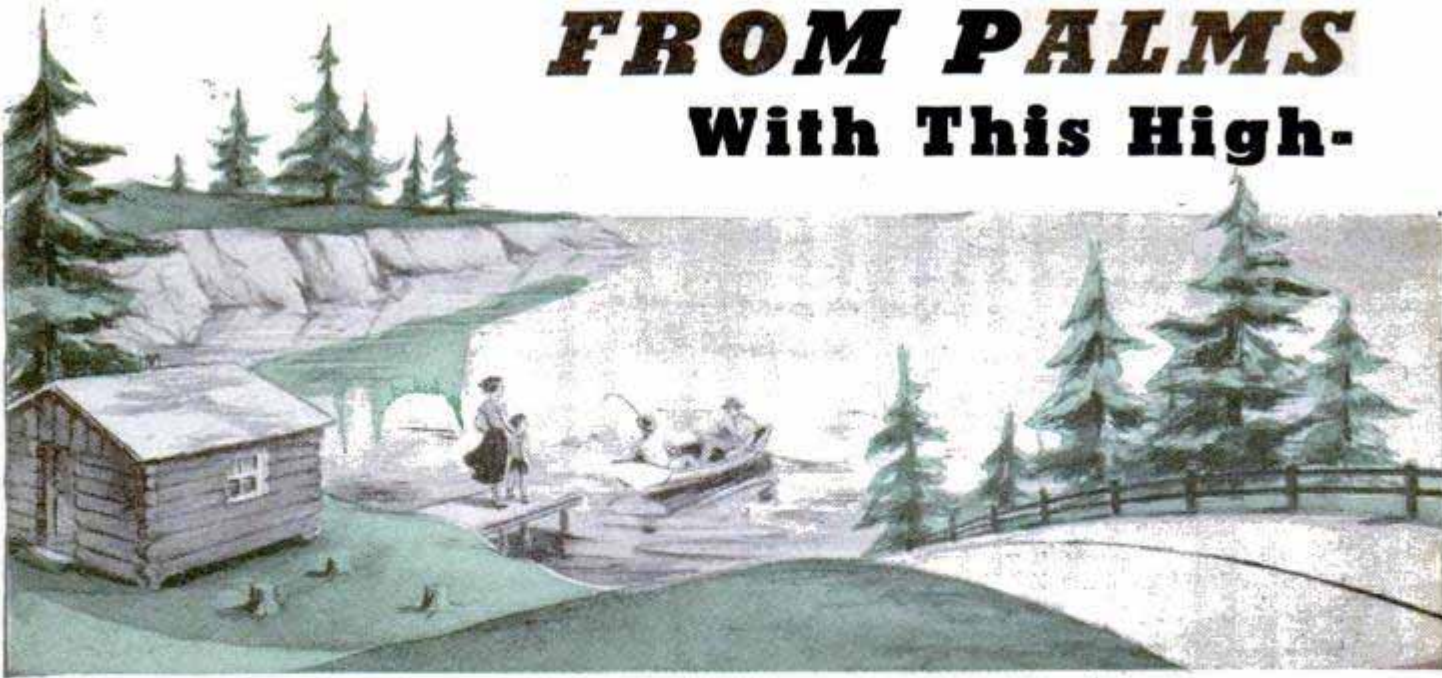

TO PINES

Speed Boat Trailer

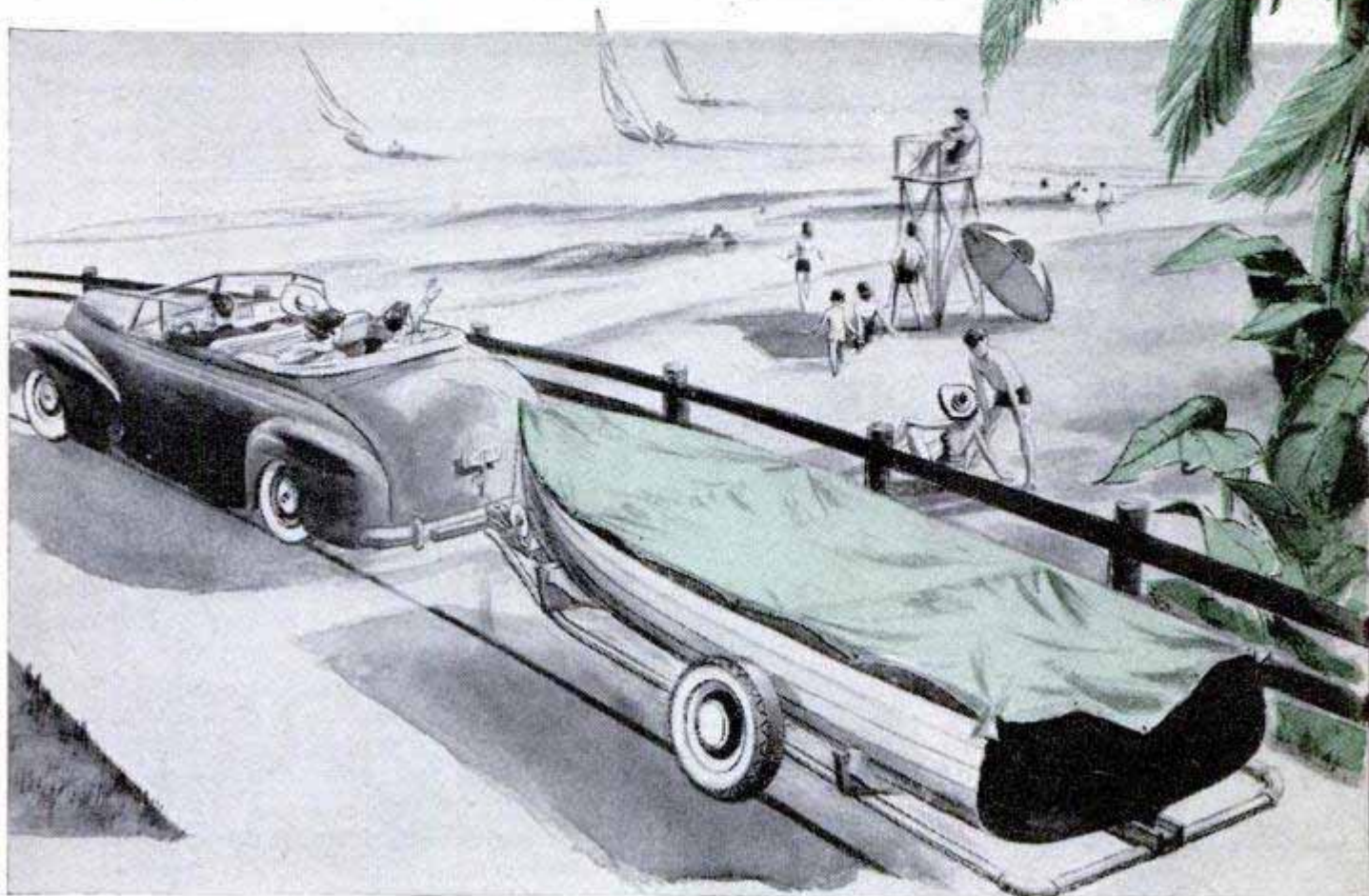

WITH THIS trailer you're all set to take your boat anywhere a car will go. Although it's built especially for fast highway cruising speeds, the trailer also has the built-in strength and stamina to take the rough going on those back trails that usually lead to the best fishing waters. As you will see from the details in Figs. 1 and 2, the trailer frame is designed for both lightness and rigidity and is fitted with padded cradles which support the boat at two points, a powerful loading winch and a full-length hardwood keel track. For boats up to 16 ft. in length, use 1½-in. "extra strong" pipe for the side frames and the center member. For a longer hull or a heavier inboard-motor job, use 1½-in. pipe of the grade called "double extra strong."

Full dimensions are not given as it is necessary to build the trailer frame to suit your boat. The essential measurements are easily determined directly from the boat itself. As a fair rule, the frame should be from 8 to 12 in. longer than the boat when assembled. This means that the side members will have to be at least 18 ft. long to allow for the bend when the trailer is designed for a 16-ft. boat. Assemble the frame by first screwing the T-fitting on the

threaded end of the center frame member. Screw the long nipples into the T-fitting and turn the 90-deg. elbows on the ends of the nipples. Then bend the side members at approximately the points indicated in Fig. 2. Check the accuracy of the bends by laying the members in position. Then mark and saw the forward ends at an angle to fit against the center member. Finish up with a half-round file to get a good fit before welding. Support the frame on leveled sawhorses while welding the side members to the center member. Both rigidity and strength of the frame depend to a large extent on the care with which this joint is fitted and welded. The weld should be continuous, not intermittent.

Construction of the axle will be clearly understood from Figs. 2 and 3. First obtain two second-hand auto front wheels with 6.00 x 16 tires and spindles. Check to see that the bearings and spindles are in perfect condition. Remove the spindles and bolt them to a length of channel. When wheels and axle are assembled, the tread should be 60 in. so it is necessary to locate the spindles and true them carefully before welding to the channel. After the spindles are bolted to the channel, replace the



Boat loaded, battened down and all ready for a long, fast trip

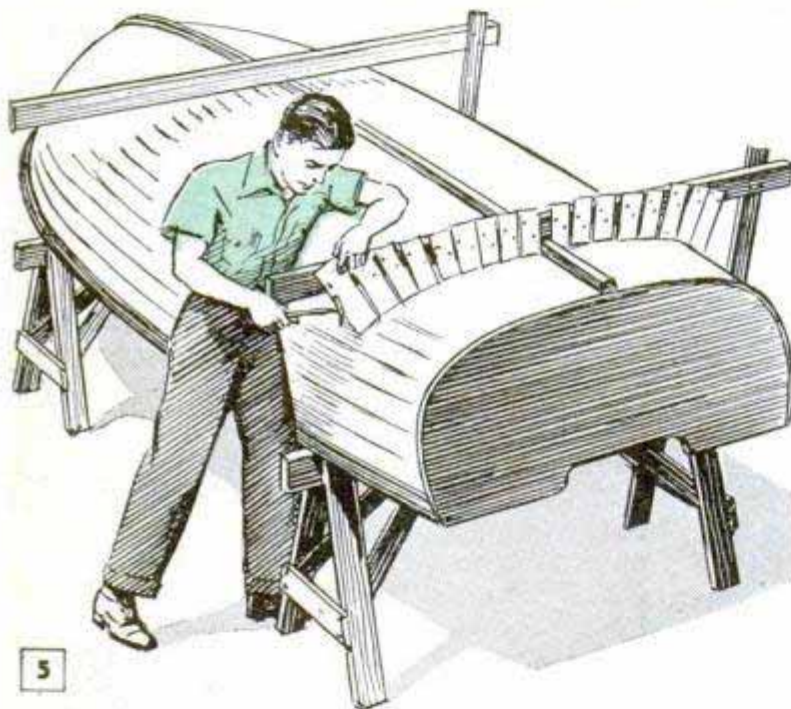

5

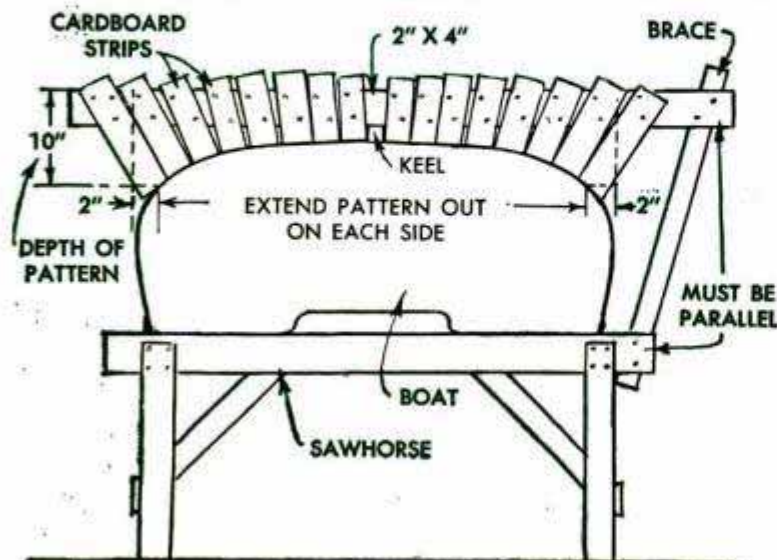

6

METHOD OF MAKING PATTERN FOR BOAT CRADLE

wheels and true each one to 0-deg. toe-in and 0-deg. camber before welding the spindles in place. Do not weld on the spindle brace, Fig. 3, at this time. Position the axle temporarily on the frame and drill the channel for the U-bolts. A straight-grained 2 x 6-in. piece of oak or yellow pine makes the keel track. Two 1 x 2-in. strips nailed to the top face serve as guides for the keel. The trailer hitch is bolted to the forward end of the track as in Fig. 2.

Figs. 5 and 6 detail a method of quickly finding the curve of the hull at two points along the length. Use the templates thus improvised to lay out the curve of each cradle member. On a 15-ft. boat, for example, the rear cradle should be located about 40 in. from the transom and the front cradle approximately 60 in. from the bow. These measurements are, of course, only for boats of conventional round-bottom construction. Now, saw out the curved cradle members and pad the curved edges with lengths of garden hose and canvas as detailed in Fig. 4. The flat-iron brackets used to fasten the keel track and cradles in place can be made by a local blacksmith shop or ornamental-iron works at a very nominal cost. It is difficult to bend these parts cold to the 90-deg. angles and short-radius bends required. Drill these members and then bolt and lag-screw the parts in position on the frame.

Make the winch detailed in Fig. 1, bolt it to a hardwood base and then bolt the unit to the keel track as in Fig. 2. Bolt the axle in an approximate position on the frame and load the boat with the winch. Now you have everything in place and it's an easy matter to balance the trailer just as you like it. Ordinarily, it should balance with about 25 to 35 lbs. weight on the hitch when the trailer is in the running position. Some drivers will want more weight on the hitch, perhaps as much as 75 lbs. That's a matter of choice. Jack up the loaded trailer and shift the axle until you get just the degree of weight on the hitch that you want. When this has been determined, bolt the axle permanently in place on the frame. Then unload the boat and

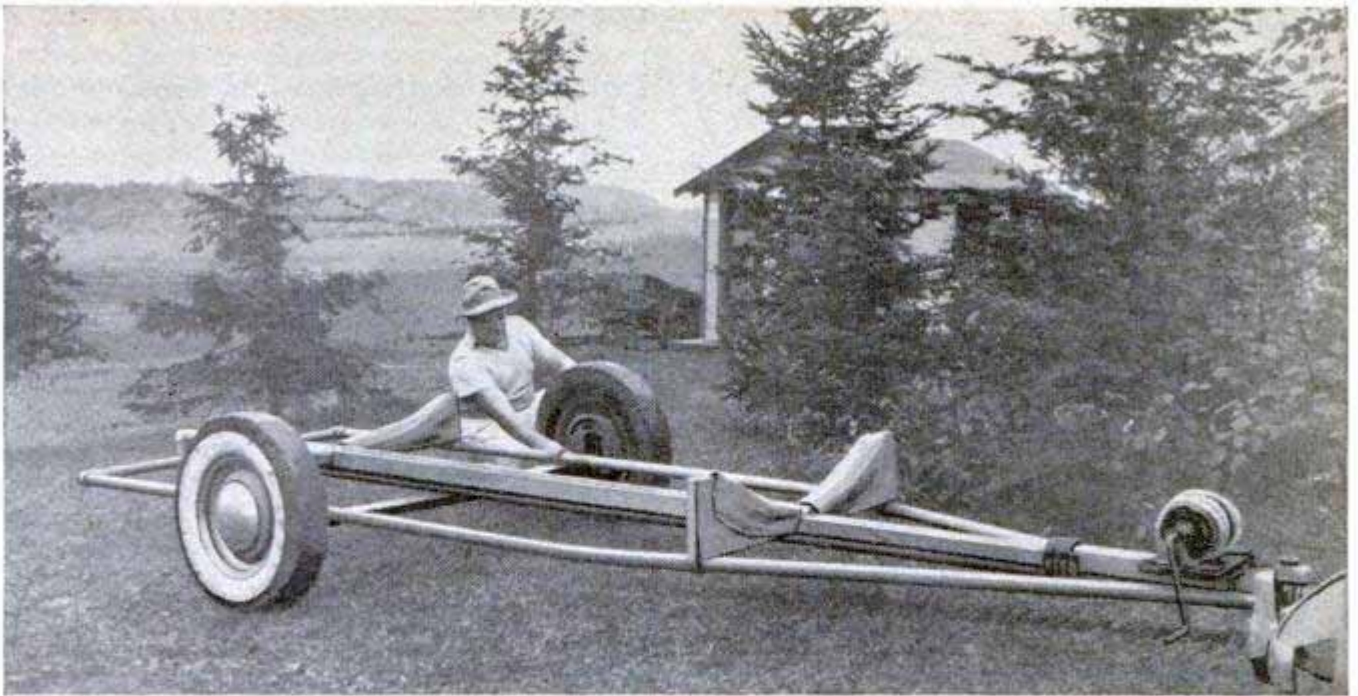

Here's what you have when the job is finished, ready for use. Note underslung frame, low center of gravity

weld on the axle braces as shown in Fig. 3.

Use lock washers on all bolts to prevent the nuts from working loose. Sand all the wooden parts and finish with two coats of spar varnish or with two coats of outdoor enamel in the desired color. Go over the metal parts with fine emery cloth to remove rust and other loose material. Then apply an undercoater specially mixed for use on metal. Follow with two coats of chassis enamel or an auto enamel of the color desired. In use, the trailer may be backed

into the water to launch the boat. For this reason it's a good idea to use plumber's pipe compound in all the threaded joints of the frame when it is being assembled. This will prevent water from entering the frame through the threaded joints. Weld a cap over the open end of the center member of the frame. Be sure to clean and lubricate the wheel bearings before putting the trailer in service. Provide safety chains in addition to the hitch. Check the hitch at times to guard against excessive wear.

Caster Extensions Adapt Washing Machine for Use at Kitchen Sink

When a standard washing machine must be used at the kitchen sink of an apartment or small house, it often is necessary to raise the machine to permit the wringer to pass over the rim of the sink. This can be done by fitting each leg of the machine with an extension made from a pipe nipple and coupling. A wooden plug which is drilled to take a caster socket is driven in the coupling as shown in the detail. The length of the pipe coupling determines the distance the washer is raised.

W. Mack Angas, Brooklyn, N. Y.

Notations in Photograph Album Made With White Shoe Polish

Liquid white shoe polish provides an excellent substitute for white ink when printing identifying labels or commentaries on the black pages of a photo album. The polish is applied with a pen or small brush.

Glue a strip of emery cloth inside your hatband or coat and you'll always have a dry place to scratch a match.



Garden Hose Covers Slide Rails To Protect Children's Hands



Children's hands will be protected from splinters if the wooden rails of a playground slide are covered with lengths of garden hose. Split the hose lengthwise with a sharp knife, press it over the top edges of the rails and carefully tack in place. The hose also will prevent clothing from becoming snagged on the rails.

R. M. Woodbury, Haverhill, Mass.

Memo Pad Hung From Kitchen Wall Is Ideal for Shopping Lists

There will be no more hunting through the house for a scrap of paper to make up a shopping list or jot down a recipe, when this memo pad hangs from a convenient spot on the kitchen wall. A roll of adding-machine tape supplies enough paper for



hundreds of memos and, if the holder is made carefully and painted or stained to harmonize with the kitchen appointments, it is as attractive as it is useful. The wooden base and brackets are cut from $\frac{1}{2}$ -in. stock, the brackets being fastened with flat-headed screws driven from the underside of the base. The paper roll revolves on a dowel axle which rests in slots cut in the brackets. The bottoms of the slots must be at least 2 in. above the base to allow for the thickness of the roll. Two strips of copper, one mounted under the roll and the other at the lower end of the base, guide the paper, the lower strip also serving as a straightedge for tearing the paper. The brackets are notched to provide clearance for the upper strip and both strips should be shimmed with washers or pieces of copper to permit the paper to pass under them. Note that the lower ends of the brackets are shaped to form a pencil rest and the top of the base is drilled for a screw.

Ken Sellers, Columbia, Mo.

White Fishing Floats Retouched With Golf-Ball Lacquer

The white portions of fishing floats and bobbers will remain clearly visible if they are retouched occasionally with golf-ball lacquer. As this lacquer is quick-drying and applied like nail polish, a bottle of it can be carried in the tackle box and used to renew the finish of the floats while on a fishing trip.

H. Leeper, Canton, Ohio.



Loss of Outboard Motor Prevented By Safety Block on Transom

Fastened to the transom of a rowboat just above the locking screws of an outboard motor, a safety block prevents loss of the motor if the screws work loose. The block, which is 1 in. square and about 8 in. long, keeps the ends of the locking screws from slipping upward and allowing the motor to drop off the transom.

Sol Tepfer, Brooklyn, N. Y.



Breakfast Set Folds into Wall

By William H. Freeman

THIS FOLD-AWAY breakfast set has been designed especially to solve the problem of space in small kitchens. It seats four persons comfortably and when not in use the whole unit folds into the wall behind doors that close flush, leaving the wall and floor space clear. Note in the details below that the width of the table is given as 25 in. and the width of the wall recess as 30 in. The latter dimension is the approximate width of the wall opening before installing the header, false studs and jambs. Locating the breakfast set on an outside wall provides maximum depth for the opening and, if the unit must be installed in exceptionally limited space, some changes in dimensions may be necessary. Finish the wall opening and hang the doors first, then make the table and benches from $\frac{3}{4}$ -in. plywood. Assemble the hinged parts with the special hinge fittings shown in the details. In the original design, the rear end of the table is guided by steel pins sliding in stopped grooves cut at an angle in the jambs. This construction can be simplified by using two hardwood strips nailed to each jamb and spaced to allow the pins to slide freely. Provide stop blocks at the lower ends of the guides.



When not in use, benches and table fold into wall behind doors that close flush, leaving wall space clear

Furniture you can build yourself

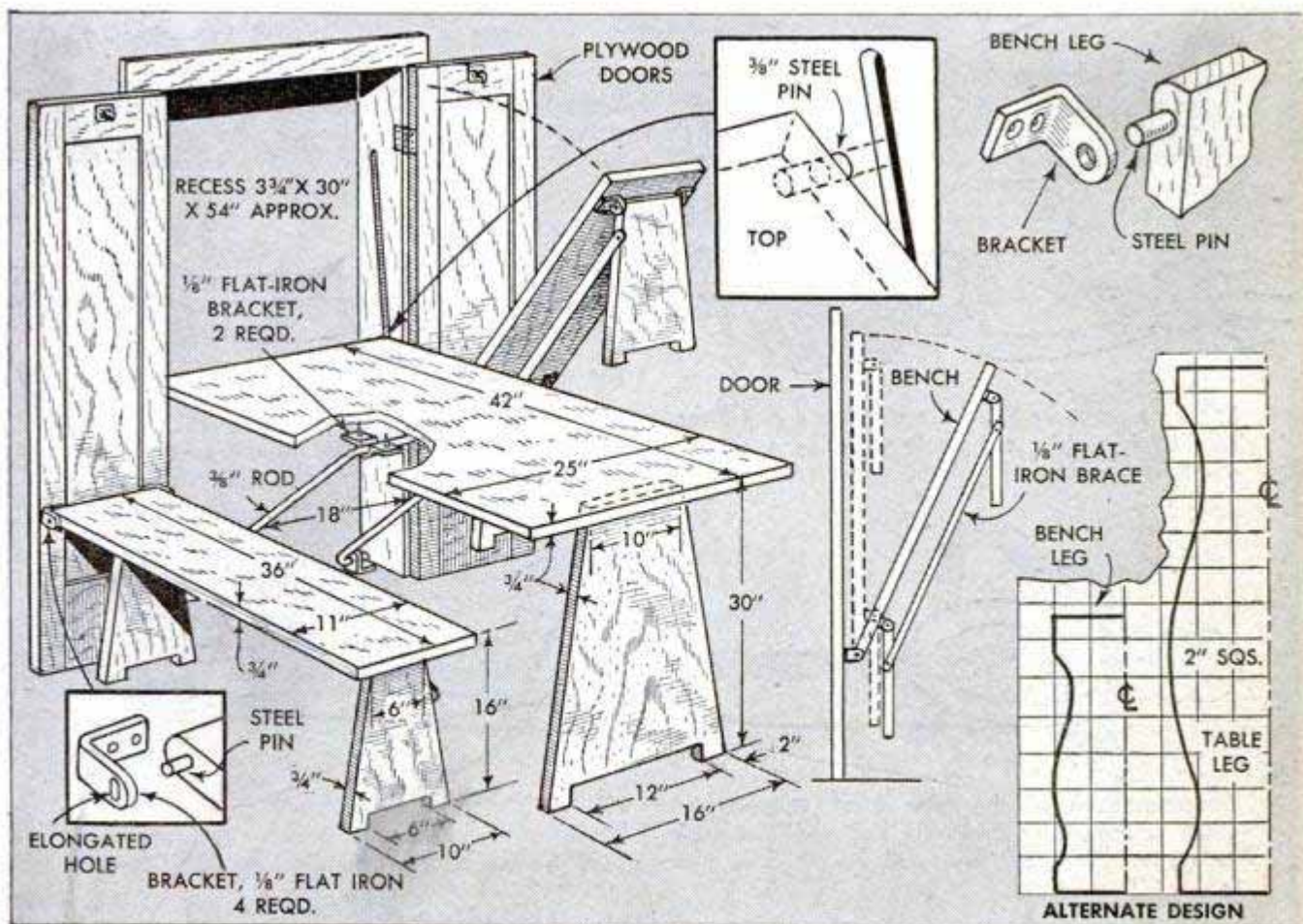

TYING LINES TO LEADERS

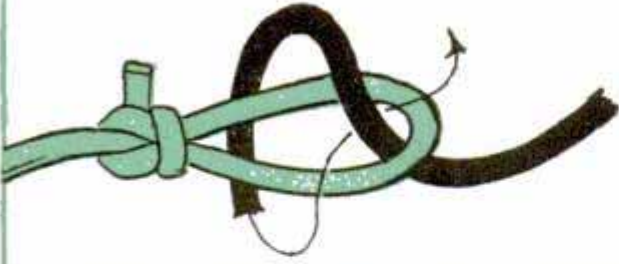

This knot is known quite generally to fishermen as the single tie or single sheet bend. Detail above shows a common way of starting the tie

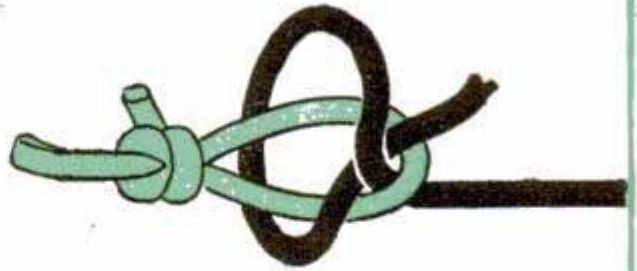

Here's the same tie with the formation of the knot completed by passing the line under the standing part before drawing the knot tight



Drawn up, the single tie looks something like this. It cinches up tightly under a moderate strain and is easy to untie after slacking off

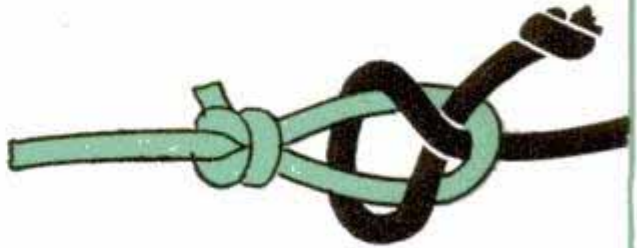

Here again is the single sheet bend with an overhand knot on the end of the line. In drawing up, overhand knot is worked down to the bend



Somewhat simpler than the sheet bend, the reef knot cinches tightly and holds fast but when tension is released the loop can be slacked off

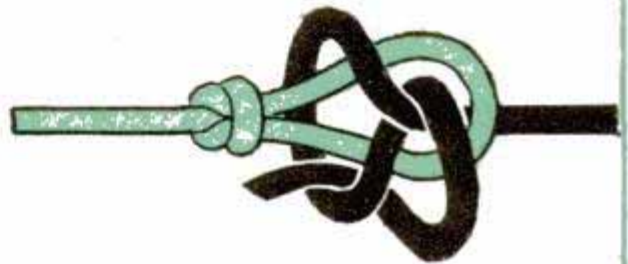

The popular figure-of-eight knot can be used to attach the fly to the leader or the leader to the line. A simple, reliable fly-fisherman's tie



The first stage in tying the overhand jam knot. Here it is simply a slipknot with the overhand knot tied around the standing part of the line



The slipknot becomes a sheet bend when worked down over the end of the leader loop and tightened. Many fly fishermen prefer this neat tie



Sometimes called the tiller knot, the slipped hitch is especially desirable because it is easy to untie. Slack off and pull on the free end



The reef knot again, but with the end of the line seized to the standing part. Smoother even than the jam knot as there are no dangling ends

KNOTS and TIES

By W. Clyde Lamme

LIGHT-TACKLE fishermen who wet lines in sweet water from the time of the first hatch of flies in early spring to the close of the season need to have almost as good a working knowledge of knot tying as did the old-time sailors. Although history of the development of knot tying is in many instances not definitely known, it is fairly certain that many of the knots now used by fly fishermen were developed in an early day by good marlinespike seamen and also by fishing sailormen.

Experienced fresh-water fishermen usually choose only types of knots which seem best suited to their purpose and use these regularly for everyday fishing needs. Anyone can learn to tie any knot from the simplest to the most complicated, but some knots require much more practice than others before the process of tying them can be clearly established in mind. As a rule, fishermen do not use involved knots as these usually are bulky even when cinched up tightly. Such knots offer considerable resistance to movement through the water, leave a trail of bubbles underwater and form a wake when on the surface. These features are objectionable to most fishermen. Among the knots approved by nearly all fly fishermen for joining lines to leaders are the single sheet bend, the reef and figure-of-eight knots, the overhand jam knot, and the tiller or slipped hitch. All these knots are detailed on the opposite page. Some anglers do not approve the overhand jam knot (the fourth knot from the top in the left-hand column), but it will be noted that when the tie is properly finished it makes a neat, reliable knot which is no larger than the leader loop. It can be whipped through a quiet pool with practically no disturbance of the water. The

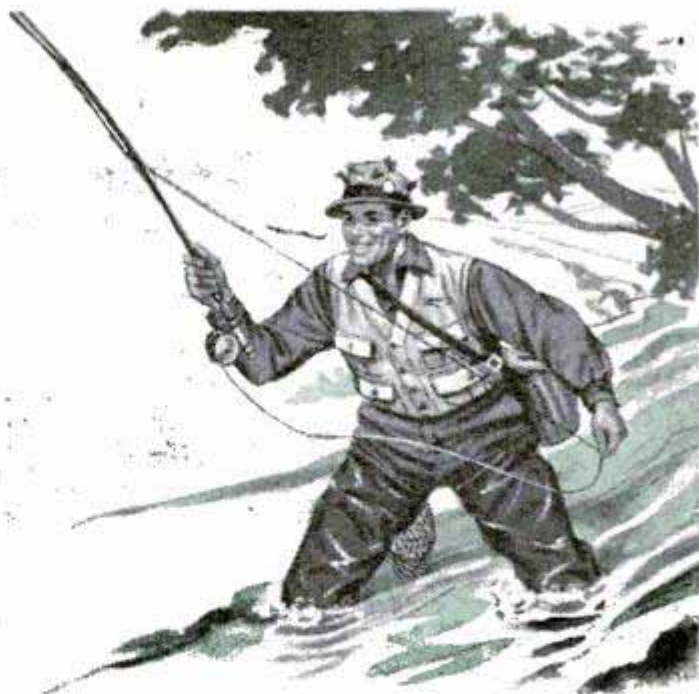

Joining Leaders

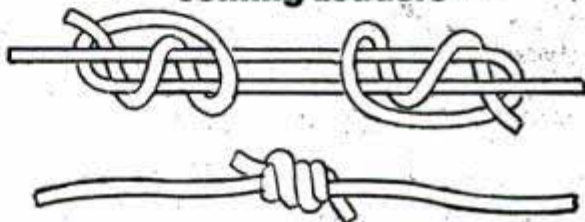

For joining the ends of leaders, the fishermen's bend is perhaps the simplest of barrel-knot ties

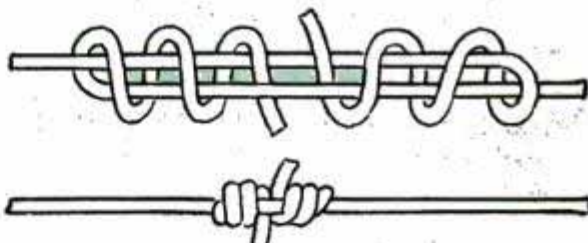

Another variation of the fishermen's bend which is preferred by some anglers for artificial leaders

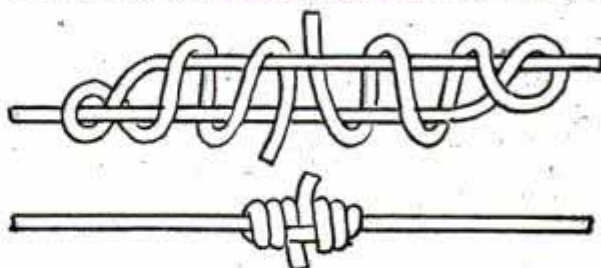

A third variation with turns made in the opposite direction. Work out the slack gradually

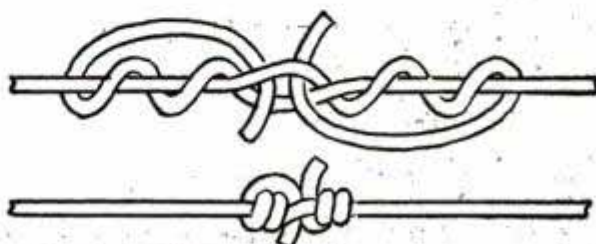

The Blood-knot bend builds up a neat, smooth tie

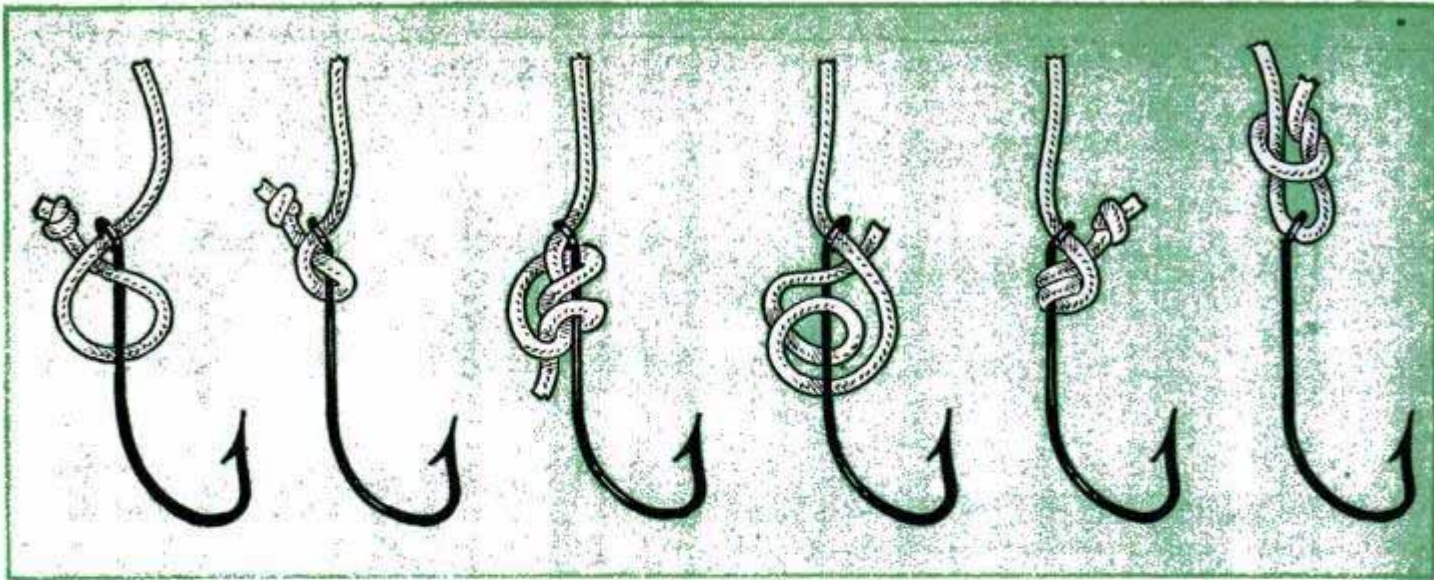

Of the four fishhook ties left to right above, the first two are the familiar single sheet bend with an overhand knot in the end of the line. The next is the round-turn fishhook tie before drawing up. Following this comes the double sheet bend shown loose and drawn up, and finally an application of the overhand knot

simplest and quickest, perhaps, of all these knots to tie and untie is the single sheet bend and, of course, the neatest and smoothest one of all is the reef knot with the free end seized to the standing part.

For joining the ends of leaders when building up a long, single leader, the details at the right on the preceding page show several variations of the barrel-knot bend, or double fisherman's bend, as it is often called. The knot in the lower detail is perhaps more properly called the Blood-knot bend. The trick in tying these bends is not in the formation of the knot, which is comparatively simple, but in working out the slack and drawing up the turns to make a smooth tie. This is especially true of the fishhook ties shown above and on the following page. All of these are either detailed loose or partly drawn up. None are shown cinched up tight as they would be when in use. One of the most popular knots for attaching lines to hooks is the familiar single

sheet bend. An overhand knot tied in the end of the line prevents slipping or pulling out. Some fishermen prefer the double-sheet bend for attaching fine lines to small hooks. Other knots in the series shown are used extensively by fishermen when building up heavy tackle. Although not shown in all details above, many fishermen tie an overhand knot in the end of the line as a regular practice when tying either lines or leaders to hooks. It should be noted, of course, that most of the fishhook ties are used by fishermen for tying both lines and leaders to hooks or eyed flies.

The turtle knot, shown in the first three details below, is considered by many anglers to be the best ever developed for tying either lines or leaders to hooks and also leaders to flies. As you can see by study of the knot formation, it is simply a sliding overhand knot, the overhand knot being tied on the standing part after the line has been passed through the eye of

Left to right below, the first two details show how the turtle-knot tie is used to attach the line to the hook. Third detail shows application of this knot when joining eyed flies to line or leader. Fourth detail is a twisted tie which is especially suitable for attaching eyed flies to artificial leaders. Work the turns tight

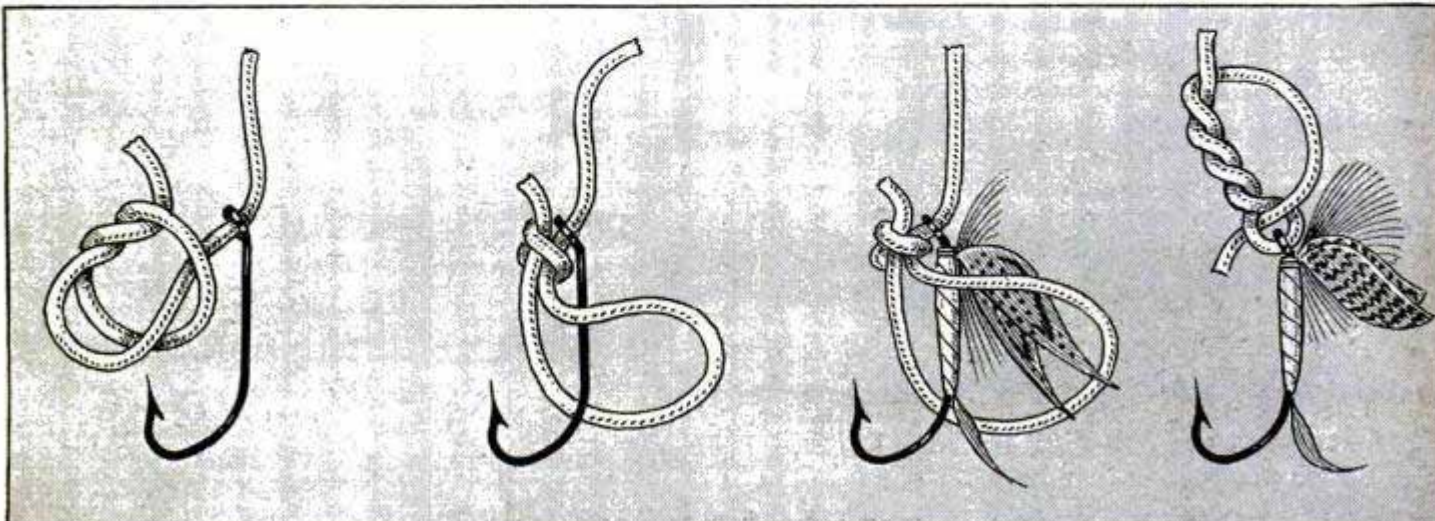

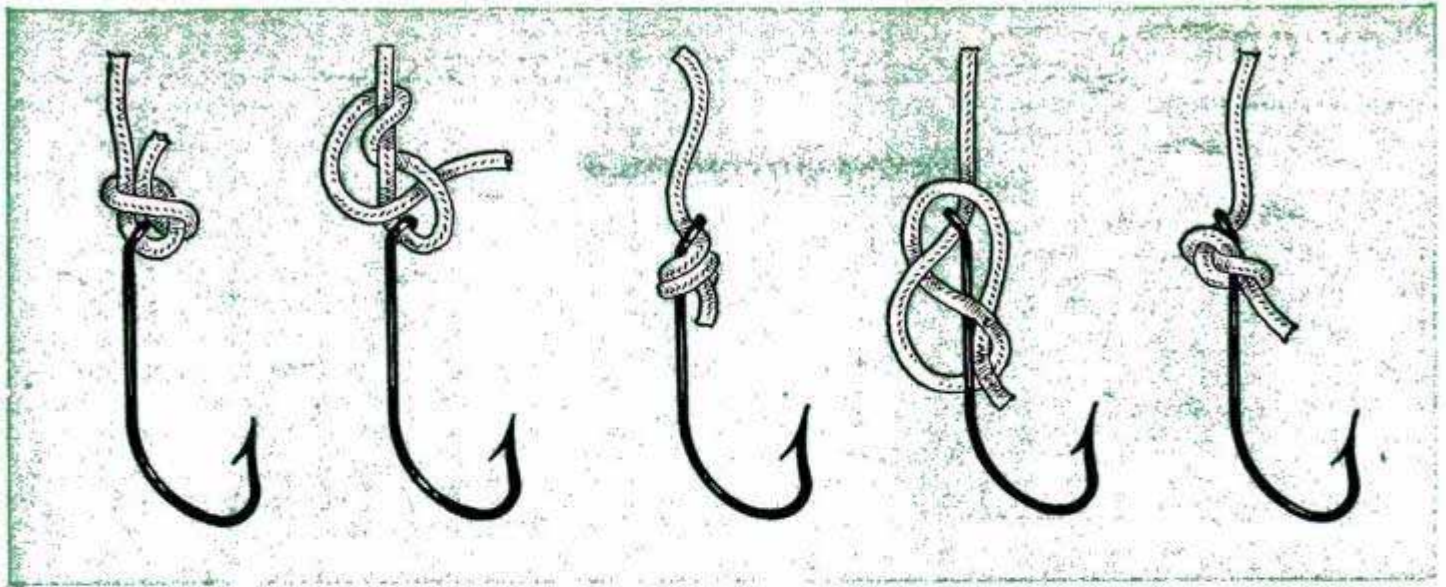

Left to right, the first detail shows the sliding overhand knot pulled up to eye of hook. Next two details show the wedge tie loose and drawn up, the knot being slipped over the turned-down eye of hook. Last two details show a figure-of-eight knot, in common use among fishermen. Note that knot is drawn up below the eye

the hook. The loop is then passed over the hook or fly and snugged up against the eye. Hold the overhand knot tightly between the thumb and forefinger when pulling up the loop. Simplicity is the feature of the twisted tie shown in the fourth, or right-hand, detail below on the preceding page. It is quite similar to the timber hitch and holds securely when the turns are carefully worked down to the eye of the hook or fly. The three details at the bottom of this page show two methods of attaching a dropper fly. Two overhand knots are tied side by side. Then the knotted end of the dropper is inserted between the standing parts as shown. The overhand knots are then worked up against the dropper and drawn tight. In the center detail below, the knots are not shown fully drawn up. In the right-hand detail below, a barrel knot is tied on the line to prevent slipping and the dropper is attached by means of an angler's loop. In certain applications, the name of



the knot is determined to some extent by variations in common use. An example is the ordinary slipknot. It is also referred to as the jam knot and the sliding overhand knot but, of course, it consists of essentially the same formation. The same is true of certain other knots in various applications.

Left to right below are two methods of attaching a dropper fly. In the first detail, overhand knots are tied side by side, or back to back, as shown. Then the knots are drawn up over the knotted end of the dropper as in the center detail. Right-hand illustration shows barrel knot combined with angler's loop

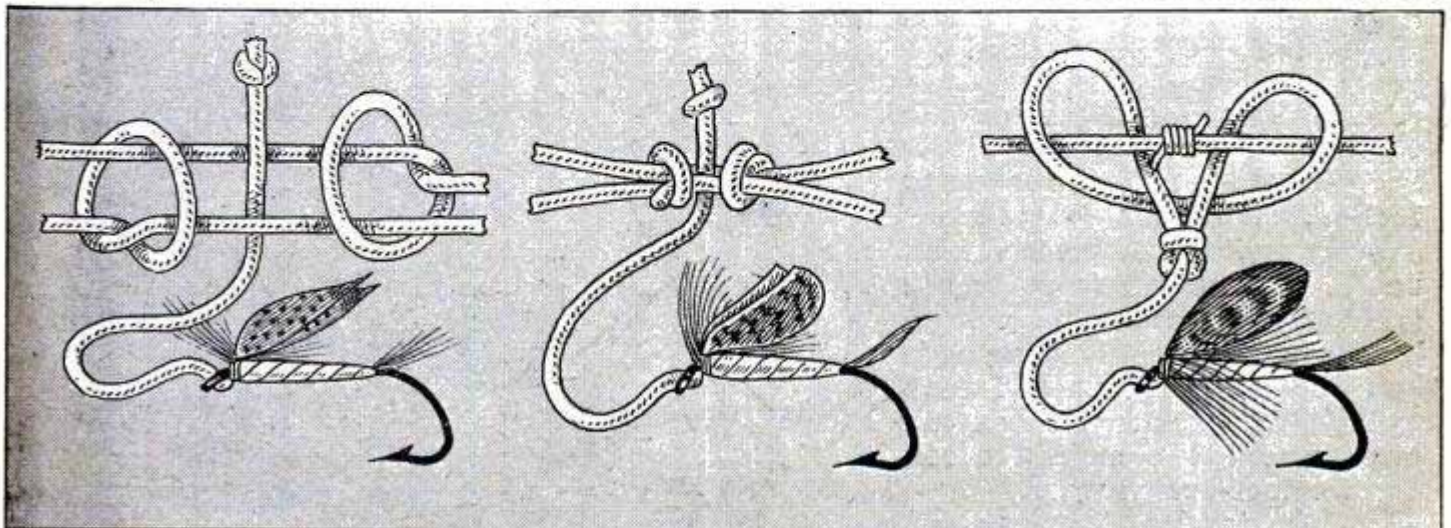

Box on Bicycle Luggage Carrier Handles Parcels

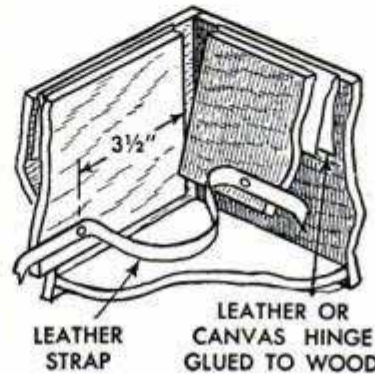
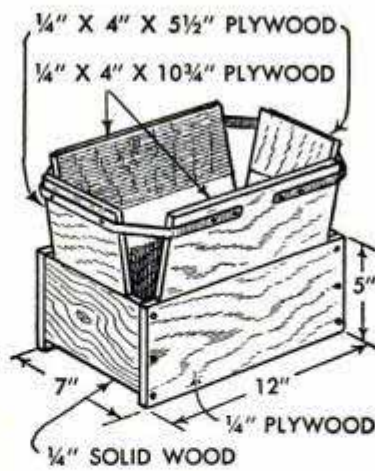
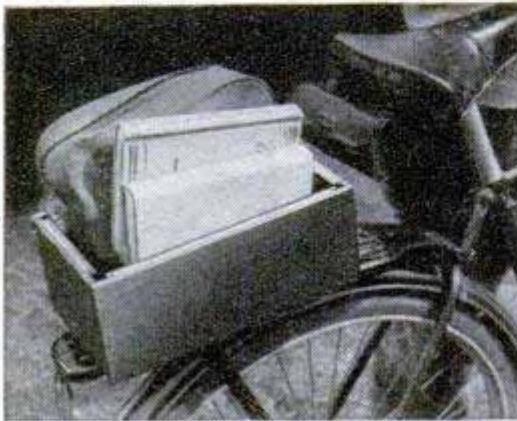
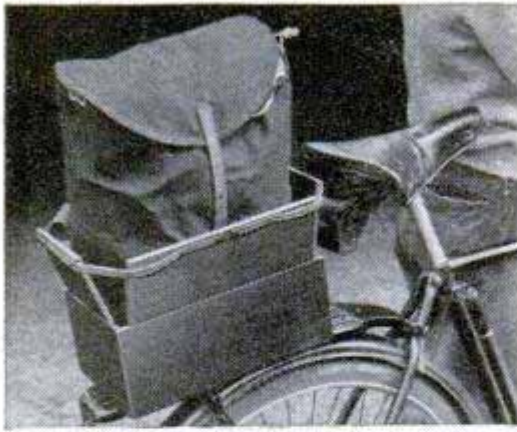

This adjustable wooden box fastened to the luggage carrier of a bicycle is just the thing for carrying books, lunches and parcels. To handle more bulky items and replace saddle bags, the hinged sides of the box can be opened to almost double its depth. The bottom of the box is of $\frac{3}{4}$ -in. solid stock and is bolted to the luggage carrier. Plywood sides are screwed to solid endpieces and folding sides and endpieces are hinged to them with leather or canvas. The hinges, which should be the full length of the joints, are glued to the wood. Leather straps, riveted to the folding members, support them in the opened position.

Nonslip Grip for Shampoo Bottle Made From Wrist of Rubber Glove

Cut the wrist portion from an old rubber glove and place it over a bottle of shampoo. This will keep the bottle from slipping out of wet hands and possibly breaking. If a

rubber glove is not available, several rubber bands slipped around the bottle will serve the same purpose.

Mrs. Burnice Bourquin, Palo Alto, Calif.

Rustic Wheelbarrow Flower Box Utilizes Old Nail Keg and Fence Pickets

Made by mounting a discarded nail keg on a wheelbarrow-type framework, this unusual flower box adds a pleasing rustic touch to the back yard or terrace. On the original flower box, fence pickets were used to provide arms for the wheelbarrow frame, but any boards of suitable length can be employed. One end of each arm is shaped to form a handle, and the two arms are fastened together with cleats, the front one being curved to fit the round side of the keg. The legs and braces can be of 1 x 2-in. stock and the wheel band-sawed to suit from a piece of 1-in. board. The upper side of the keg is cut away and the wire hoops are bent inward. Then the opening is boxed-in by nailing strips of wood to its edges. The flower box can be painted white or stained to look like weather-beaten wood.

Eda Johnston, Los Angeles, Calif.

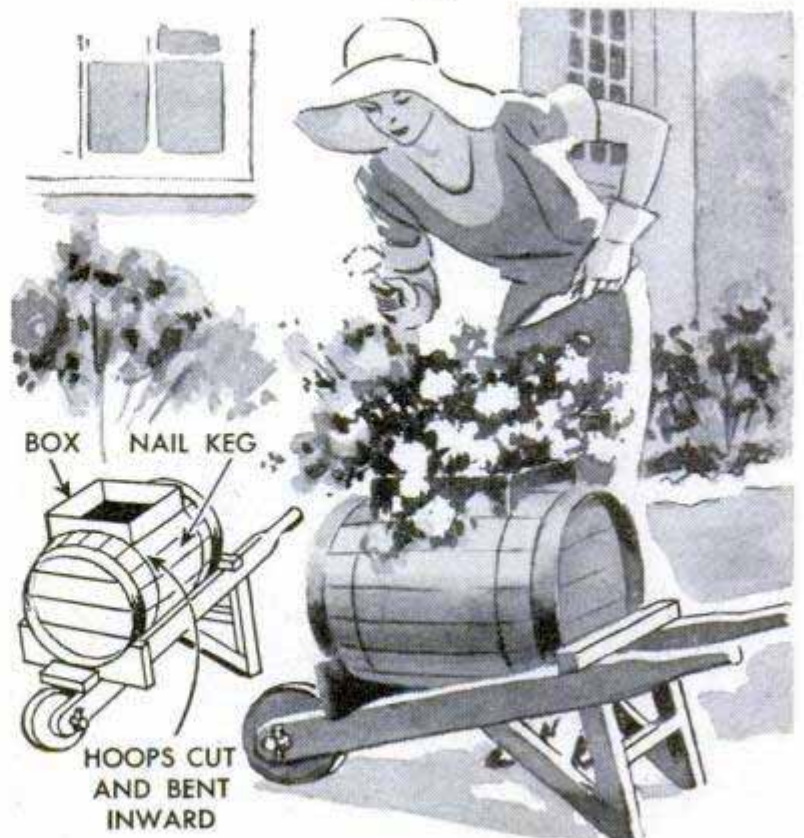

Controlled by a sensitive switch, a set of vanity lamps can be wired to turn on automatically when the center drawer of the vanity is pulled open. A sensitive switch or a switch of the type used on refrigerator and car doors is installed at the back of the drawer, so that opening the drawer releases pressure on the button and closes the circuit. The type of switch and its location depends, of course, on the amount of space available in back of the drawer. The lamps are wired in parallel and the switch is wired into the circuit as shown in the diagram. When wiring the switch, be sure that the wires are placed so the insulation will not be worn.—John R. Handley, Cuyahoga Falls, Ohio.

Vanity Lamps Turn on Automatically When Center Drawer Is Pulled Open

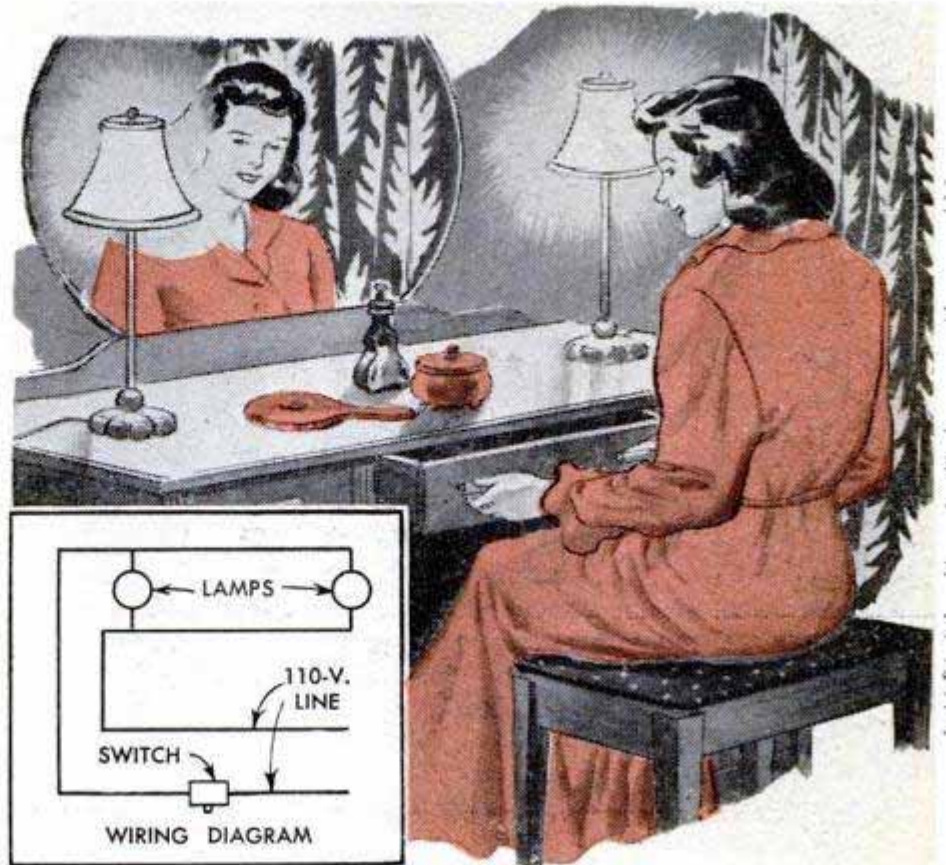

Inexpensive Floor Jack Assembled From Length of Pipe and Scrap Parts

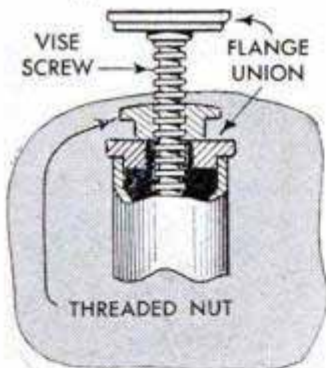

Assembled from scrap parts, this sturdy floor jack will do the job at a minimum cost. The post is a length of pipe, preferably 3 in. in diameter. Two flange unions are used, one to provide a cap for the post and the other a cap for the jackscrew. The latter can be a vise screw, and a hub plate from an old-fashioned wooden car wheel. A floor

flange will serve as an excellent base. To assemble the jack, the base is welded to the post. Then, one of the flanges is turned down so it rests on the top end of the post, its lower portion fitting inside the pipe. The hole in the flange is enlarged to permit the jackscrew to slide through it. The other flange is pressed onto the unthreaded portion of the screw, and a threaded nut, which also can be taken from a vise, is turned on the screw so it rests on top of the post cap. With the jack in position under a beam, the nut is turned with a wrench to raise the screw and tighten the jack.

D. C. Marshall, Manhattan, Kans.

Auxiliary Motor Replaces Countershaft to Permit Low Drill-Press Speeds

One craftsman who uses his drill press for low-speed work finds that he can make speed changes more quickly with an auxiliary motor than with a countershaft. He mounted the motor to one side of the drill press and, when a low speed is desired, he uses the auxiliary motor to drive the drill-press motor, which serves as a jackshaft. This takes advantage of the speed reduction afforded by the extra set of pulleys. Wm. F. Macomber, Palo Alto, Calif.

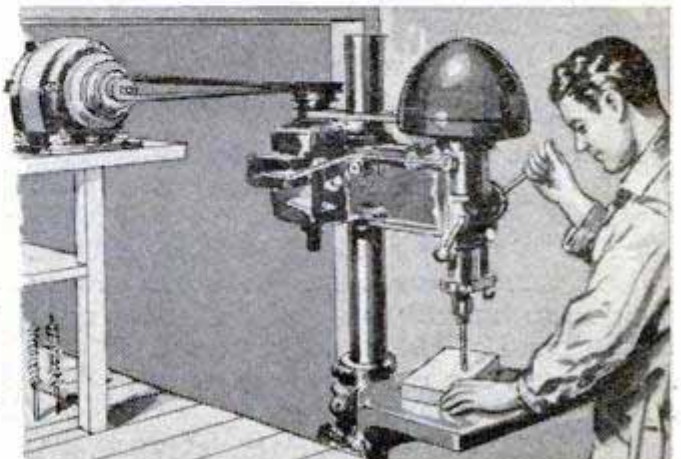

☞ When dusting, use a cloth in each hand and you will save considerable time.

Take-Apart Fishline Drier Stored in Small Space

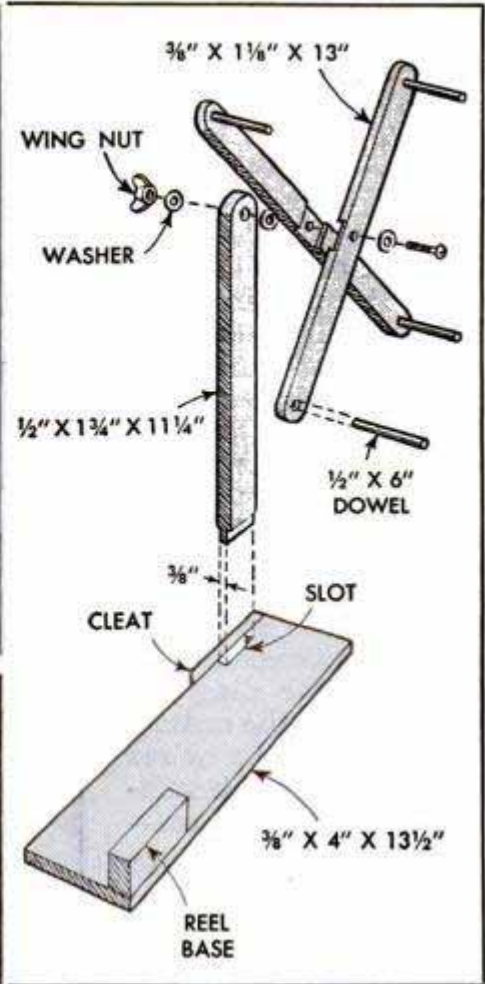
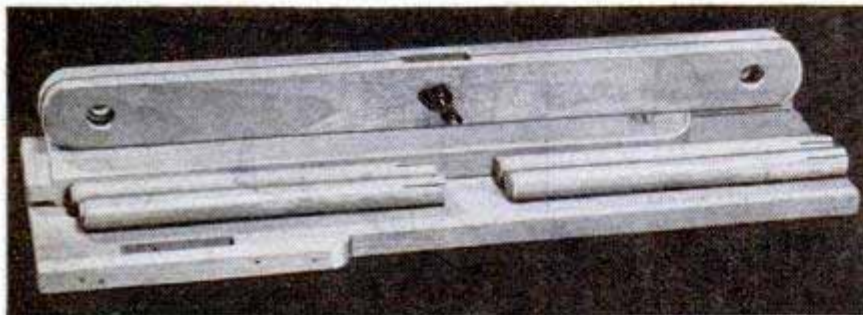
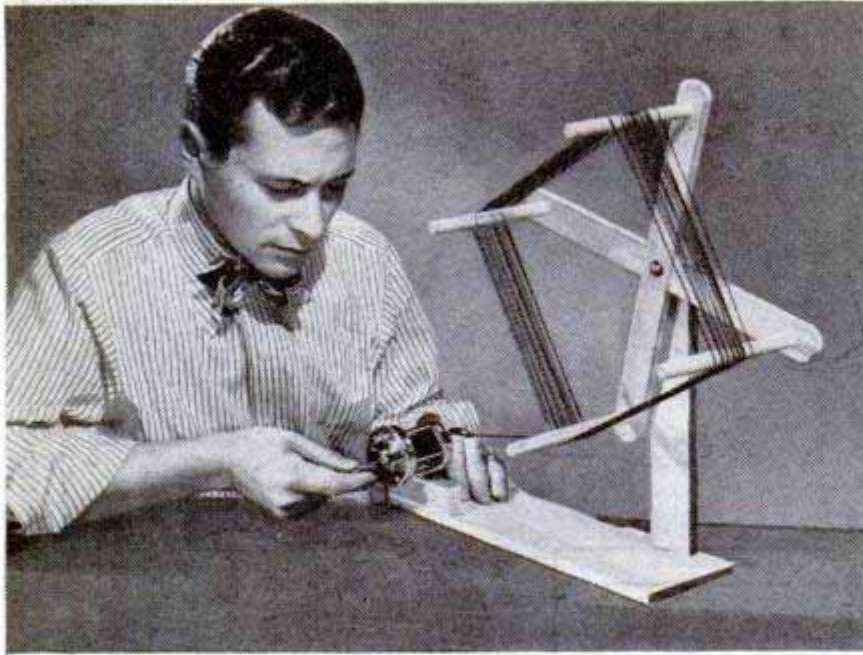

To fishermen who take special pride in having tackle always in perfect condition, a line drier is a "must" item of equipment. This one is made entirely of hardwood and the take-apart design permits it to be stored in a small space when not in use. It can be set up in a jiffy. The reel spider turns on a simple bearing on which tension is adjustable by means of a wing nut, permitting just the right drag on the line when rewinding to the reel. Reel arms can be lengthened to 8 in. if desired. Finish the parts with spar varnish.

Reflectors Soldered to Wheels Make Scooter Visible at Night

If scooters, coaster wagons or tricycles are likely to be used after dark, ruby reflectors soldered to the wheels will make crossing streets with them considerably safer. The reflectors should be soldered near the rims of the wheels so they will look like pin wheels in the dark, thus attracting the attention of approaching motorists.—Opie Read, Jr., Chicago.



Bicycle Identification Tag Hidden Inside Handle Bar

Hidden within the handle bar of a bicycle, an aluminum name plate is a sure means of proving ownership of a stolen bicycle. Just stamp your name on a 2 x 3-in. piece of sheet aluminum, roll it to fit snugly inside the handle bar, and push it almost to the bend of the bar. When needed, the name plate can be pulled out with a piece of wire bent to form a hook.

Donald Kolesar, Terrace, Pa.

Rope Provides Convenient Grip For Wiping Top of Car

Owners of older cars know what a trying job it is to wipe the top of the car while standing on the running board. There's just nothing to grasp to maintain balance. A simple solution to the problem is had by using a short length of clothesline for a handhold, hooking it over the door handle on the opposite side of the car, as shown in the photo. Use a piece of cotton rope so that it will not scratch the finish.

Paint Can Carried Up Ladder Should Not Be Full

Whether painting a ceiling from the top of a stepladder or the outside of a house from an extension ladder, it is a good idea to keep only a small amount of paint in the can. The partially filled paint can is considerably easier to handle than a full one and, if it is dropped, less paint is spilled. In addition, if the brush must be put aside for a moment, it may be stood in the can of paint. Especially helpful when it is difficult to look downward, the brush can be dipped in the paint until it touches the bottom of the can.

Sponge Rubber Cushions Door When Fastened to Stop

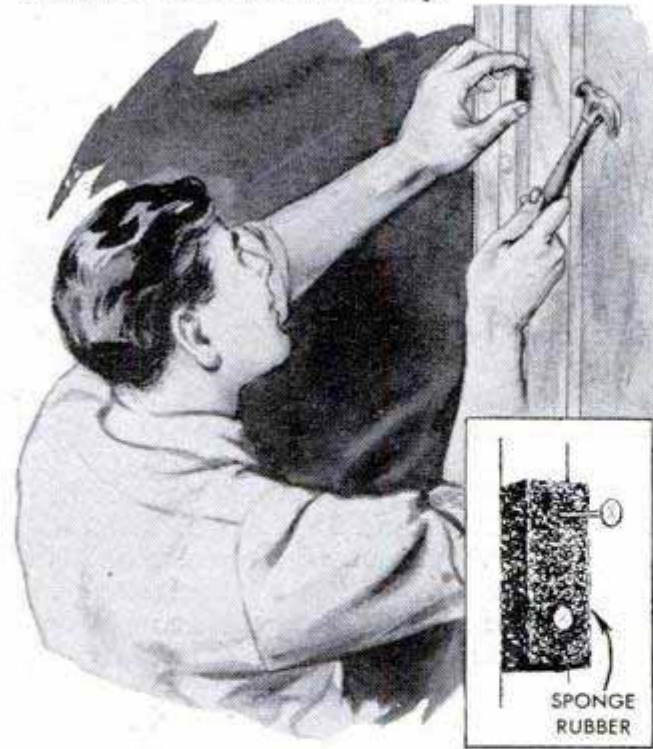

Rattling of loose-fitting doors can be prevented and the doors cushioned against slamming by fastening pieces of sponge rubber to the doorstop. One piece of rubber tacked or glued near the top of the door and another piece similarly attached near the bottom will serve the purpose.



Nail Polish Colors Spectacle Frame

If the color of your plastic spectacle frame is no longer desirable, you can change it to any one of a wide variety of colors by applying a coat of nail polish. The polish dries smoothly and makes the frame look like new. If you do not wish to change the color permanently, be sure that the frame is not made of a plastic that will be affected by the nail-polish remover.

Ellis Roberts, Decatur, Ill.



Labels Typed on Cloth Tape Are Handled Easily

Gummed labels that stay in place but can be removed simply by pulling them loose are had by typing the information on gummed-cloth binding tape. This is the kind of tape used for bookbinding and should not be confused with ordinary adhesive tape.

Mount the tape directly on the typewriter platen and merely pull it off when finished. As the gummed surface does not dry out, the label is easily removed from its position at any time.

☞ Wine stains may be removed by holding the stained portion of cloth in boiling milk.





Photo courtesy Los Angeles County Chamber of Commerce

HOW TO MEND TORN SAILS

EXPERIENCED sailors avoid the risk of being caught with a torn sail aloft by keeping sailcloth always in good repair. A short tear takes the drive out of a sail and a bad tear, which usually starts with a small rip in the canvas, may leave your boat wild a long way from help or the home port. Mending sail will come easy to the amateur yachtsman after he learns the tricks of handling a sailmaker's needle and how and where to use the flat and herringbone stitches employed by the professional sailmaker. Inventory of a sailmaker's "ditty bag" will show that it contains one or more sailmaker's needles, a "palm thimble" or palm, as it is called, a sharp knife, a ball of twine (it is never called thread) and a lump of sailmaker's wax. In the sailmaker's loft, the wax is referred to as "composition." All these items are available from marine-supply dealers at a nominal cost. The palm is made from soft leather and fits in the palm of the right hand as in Fig. 1.

An indented metal plate sewed into the leather palm serves as a "thimble" for forcing the heavy needle through the cloth. The procedure pictured in Figs. 1, 2 and 3 shows how to apply a patch to a straight-line tear, using the flat stitch, also called the round stitch. Note the position of the left hand in Fig. 1. The cloth is grasped between the thumb and the left fore and middle fingers. As the needle passes through the cloth in making the stitch, it touches the middle finger and simultaneously the thumb presses the cloth down, causing the point of the needle to emerge or "break." This finger action produces stitches of a uniform length and, although the procedure requires considerable skill, it can be mastered with practice. Fig. 2 shows a patch sewed over a short straight-line tear like that shown at the left in the photo. First, the patch is sewed to the sail with the edges tucked under, Fig. 2. Then the sail is sewed to the patch, Fig. 3. Diagonal



By Ed Lundburg

A torn sail can spoil your week-end yachting trip — unless you know how to mend it. Here, professional sailmakers tell you how

cuts are made at each end of the tear and the edges of the sailcloth are tucked under as the sewing proceeds. A straight-line tear may extend the full span of the sail and yet it can be mended with a patch applied as shown.

In all photos showing the stitches, black twine was used for purposes of clarity. In actual practice white twine is used almost exclusively. Figs. 1, 2 and 3 do not show all the movements in completing a stitch, nor do they show the natural position of the hands in actual practice. As an example, the fingers of the right hand, Fig. 1, are shown much higher than they would be in normal procedure. This has been done in order to show clearly the position of the needle. After the needle has been pushed through by the palm, it is grasped firmly by the thumb and forefinger of the right hand and pulled through to tighten the twine. In mending sail, the twine is never tugged at the completion of the series of stitches. It is merely pulled taut and to a light tension. The twine is never knotted, at either the beginning or finish ends. In all patching, the edges of the patch, as well as the torn edges of the sail covered

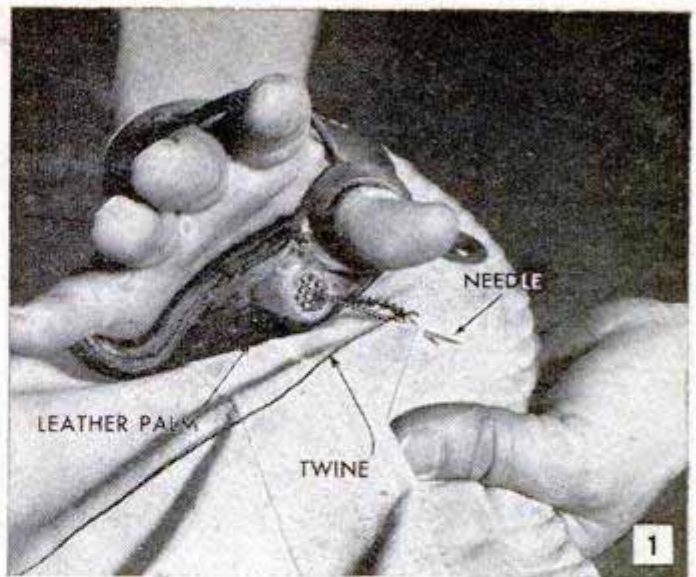

Leather palm with metal thimble protects sailmaker's hand as needle is driven through sail and patch. Pressure with left thumb "breaks" needle into the clear

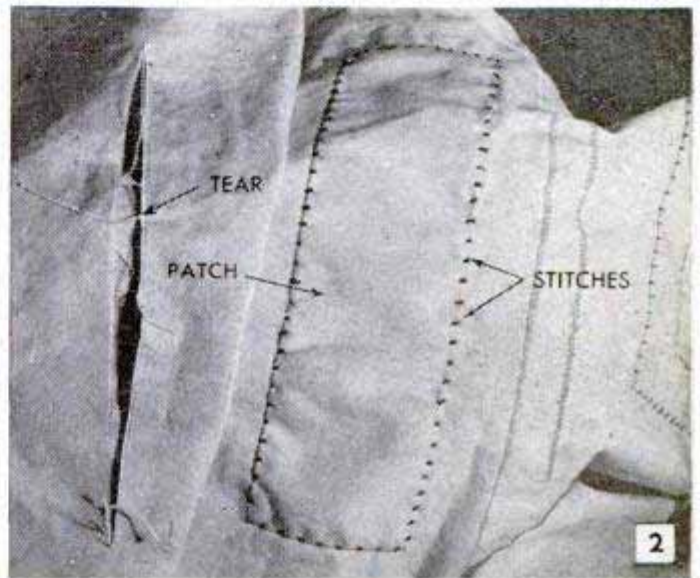

How a patch is sewed over a straight-line tear similar to one at left. Sewing the patch to the canvas is the first step in making the repair. Edges are tucked under

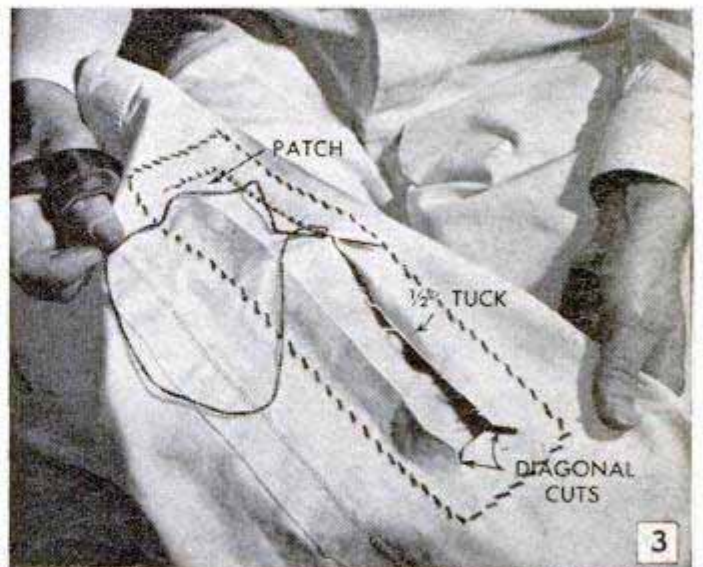

Photos by Jasper Nutter

With the patch in place, the canvas is reversed and the sail is sewed to the patch. At ends of the tear, cloth is cut diagonally and tucked under to prevent fraying



4 Patch at the right repairs an L-shaped rip similar to one shown at the left. Procedure is the same as that employed in repairing the straight-line tear

The completed herringbone stitch with the finish end about to be cut off. Some sailmakers return the twine through several loops before cutting the end

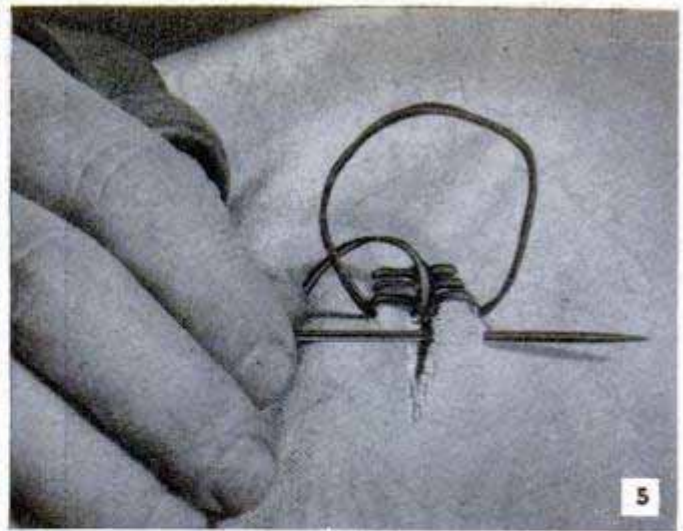

5 Minor tears, both straight and L-shaped, are mended with herringbone stitch like that shown above. No patch is used. Herringbone stitch is self-locking

The herringbone stitch also is used to repair tears around grommets. In making the repair, one loop of each stitch passes around the grommet ring as shown

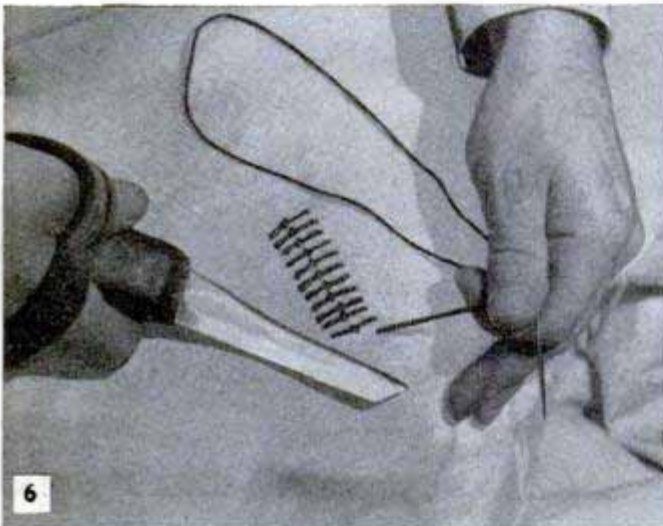

by the canvas patch, are tucked under to prevent fraying of the cloth. Ordinarily, the patch is cut from material of the same weight as that of the sail and it is cut to a width that will extend it at least 3 in. on each side of the tear before tucking. Sailmakers use several methods of locating the patch correctly over the tear. A short tear offers little difficulty but a long rent or one that is L-shaped requires more care, Fig. 4. It's important to make sure that the patch extends an equal distance beyond the limits of the tear at both ends. About 3 to 4 in. is a good average. Long patches can be tacked temporarily to the sail with several stitches at intervals along the length. Old sailmakers frowned on this practice, however, as they found there is a possibility of a patch applied in this way causing unequal tensions in a large sail. Perhaps the best practice in applying fairly large patches is to spread the sail on a flat surface, smooth all the wrinkles out of



the canvas, then mark the location of the patch on the cloth. The marks on the sail make it easy to locate the patch as the sewing proceeds. Sailmakers usually start the first stitch about halfway along the length of the patch. The initial stitch goes down through the sail and patch and back up and the twine is pulled through until only about 3 or 4 in. of the end remain. This free end is then folded under the tuck where it is locked in place by subsequent stitches. At the finish end of the stitch, the twine is carried back under several loops and cut off.

The herringbone stitch, Figs. 5 to 8 inclusive, is used in repairing snags, small rips and tears both straight-line and L-shaped, and also for mending the tears that develop around grommets, Fig. 7. It is self-locking and exceptionally flat and, when carefully made by a skilled workman, it results in a neat and permanent repair. Figs. 5 and 6 show the start and end of the

stitch and Fig. 8 details the procedure quite clearly. Note in Fig. 8 that the dark-shaded portions of the twine are on top of the cloth while the lighter portions are underneath. With this in mind, it is easy to follow the course of the needle and twine above and below the cloth. The stitch is started as in Fig. 8 by forcing the needle through the cloth, then back up and through to the underside again. Next, the twine is carried to a point just about opposite the end of the tear and about $\frac{3}{8}$ in. to one side of it. Then the twine is brought up through and across to an equal distance on the opposite side of the tear where it is passed again through the cloth and brought up through the tear. From here it is taken over the first loop and down through the tear. This completes the first individual stitch. The trick in making a smooth, neat repair without bulges or wrinkles is simply to maintain an even tension on the twine as the individual stitches are made. A common method of ending the stitch is to cut the twine as in Fig. 6 about $\frac{1}{2}$ in. above the cloth. Another acceptable method is to pass the needle through several loops and then cut the twine just back of the last loop. In repair-

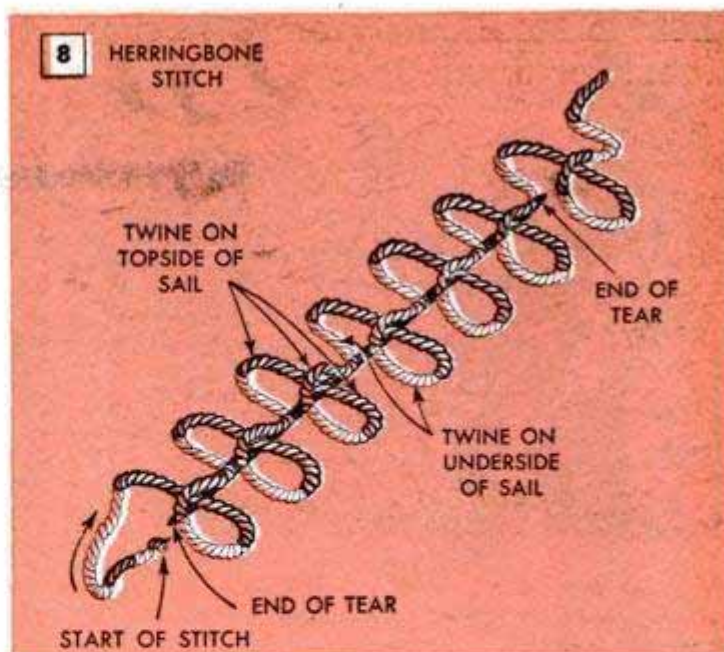

ing the cloth around grommets, one loop of the stitch passes around the grommet ring, Fig. 7. This type of grommet repair cannot be considered permanent, although it will last throughout a full season unless the sail is old and the cloth weakened by age and weathering. In making any repair, experienced sailmakers usually hold the sail on the lap as this position permits free movement of the left hand.

Picture Molding Frames Wallpaper to Form Novel Bed Headboard

An attractive and inexpensive headboard for a Hollywood-type bed is had by applying wallpaper to the wall in back of the bed and framing it with picture molding. Against solid-colored walls, paper having

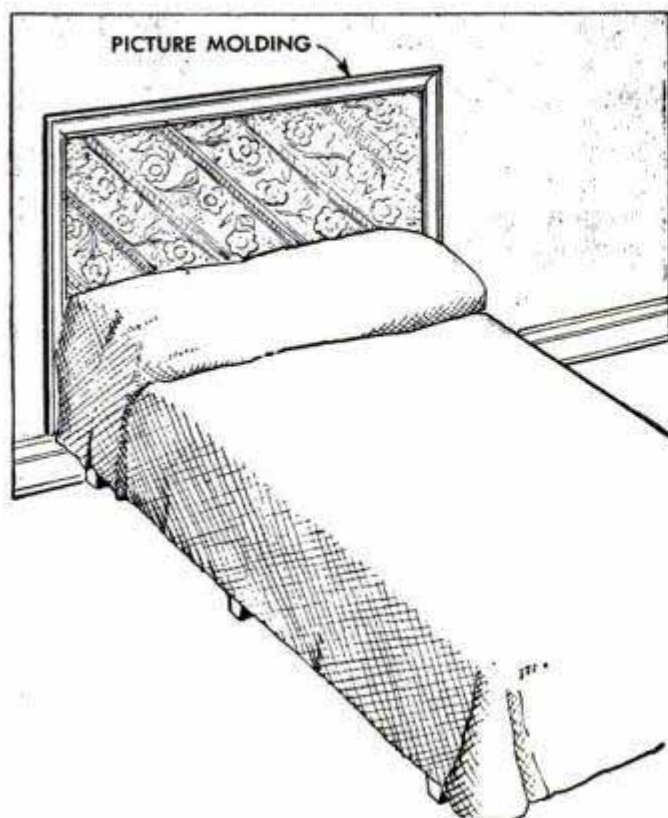

a prominent design or a contrasting color looks well. On papered walls which have a colored design, solid-colored paper or water-soluble paint makes a neat appearing headboard. The picture molding is attached to the wall with finishing nails, the heads of which are set and then puttied over. The molding can be painted to match the woodwork or finished to resemble the bedroom furniture.—A. E. Fenn, Chicago.

Rubber Guard Protects Surface If Screwdriver Slips

Where it is particularly important to avoid marring the work by having a screwdriver slip from the head of a screw, a large rubber disk cut from a piece of inner tube will protect the surface. The screw is driven into the work through a hole punched in the center of the disk. It's an easy matter to remove the disk by lifting it up over the head of the screw just before driving it home.

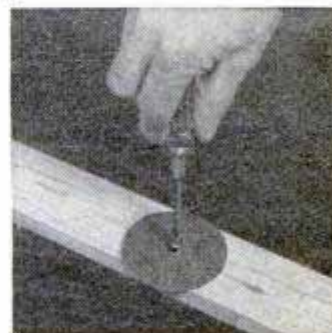

Mortar Box Made From Oil Drum Ideal for Small Jobs



Made from half an oil drum, this steel mortar box is more durable than the wooden type, cannot leak or splinter and is just the thing for small jobs. In addition, its rounded bottom facilitates mixing the mortar and shoveling it from the box. The drum is cut in half, lengthwise, with a torch, and should be steam-cleaned before cutting to remove any fumes which might cause an explosion. Flat-iron legs are welded to the drum to keep it from tipping.

Victor H. Lamoy, Upper Jay, N. Y.

Illuminating Dashboard Ash Tray

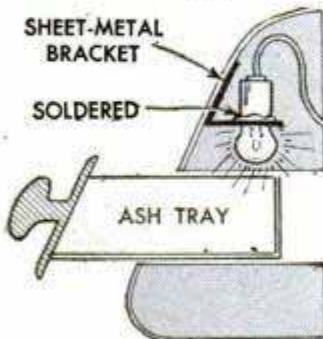

Cigarette ashes frequently are dropped on the car floor when driving at night because the dashboard ash tray cannot be seen plainly. This can be avoided by illuminating the inside of the ash tray with a small light

installed behind the dashboard. The bulb is located directly above the ash tray and is not visible when the latter is closed. This method, of course, is effective only on ash trays which pull straight out from the dashboard. The bulb is inserted in a standard socket which is mounted on a sheet-metal bracket soldered to the inside of the dash-

board. The lead from the bulb is wired into the circuit of the instrument-panel lights and the bracket serves as a ground.

W. M. Dierks, Chicago.

Modeling Clay Holds Fishhooks On Inside of Tackle-Box Lid

To eliminate searching through the tackle box and thus to save time when changing hooks or flies, one fisherman selects in advance those lures that will be needed and presses them into a wad of modeling clay.

MODELING CLAY



Then he sticks the clay to the inside of the tackle-box lid so the hooks are handy when needed.—G. E. Hendrickson, Argyle, Wis.

Small Animals Caught Easily With Rough Wooden Trap

Properly baited, this live trap will easily catch rabbits, skunks and other small animals. As most animals are suspicious of new lumber, the trap should be built from old, weathered boards. A loose-fitting door slides vertically in channels made by nailing two cleats to each side, and is held open with a length of picture wire run through a hole in the roof. The free end of the wire is baited and the bait pushed under a staple driven into the floor of the trap directly beneath the hole. When an animal pulls the bait from under the staple, the trap door is released and drops. Timid animals will enter the trap more readily if the back is covered with chicken wire or hardware cloth instead of boards.

R. A. Jenkins, St. Louis, Mo.

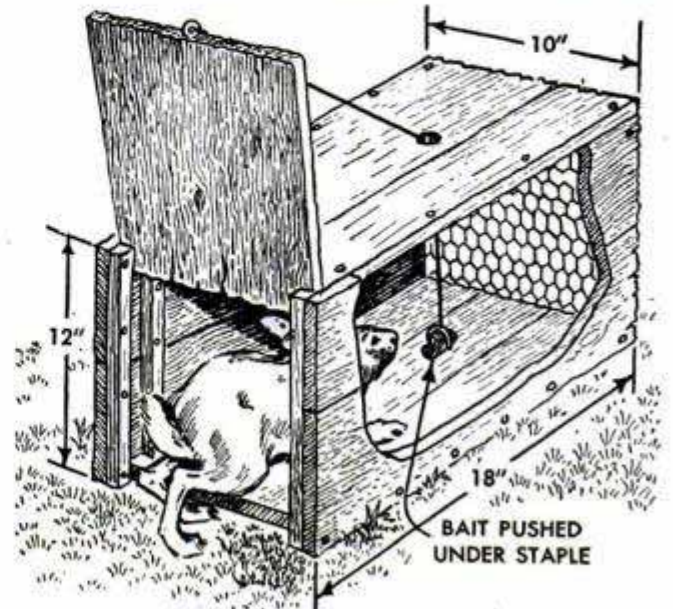

FILE CABINET

holds 2000 slides

By Alexander Maxwell

SHOOTING transparencies soon becomes such a fascinating hobby that the job of cataloguing and filing the many slides quickly outgrows the capacity of the small, individual file box generally used. That was my problem, and rather than bother with a number of file boxes, I designed and built this 10-drawer cabinet. Holding up to 2000 slides, it will fill the needs of the most avid color enthusiast.

You'll notice that the drawers or trays of the original cabinet are housed in an open framework. This was done purposely to reduce its weight but, if desired, the cabinet can be enclosed and even fitted with a door to protect the slides from dust. Except for the four corner posts and the top and bottom assemblies, the drawers and their frames are all made from 1/4-in. material. As the parts of all drawers are alike, duplicate pieces can be mass-produced by using stop blocks and special setups to assure identical units. An example is given in Fig. 2, which shows how a simple wooden jig attached to the crosscut guide (miter gauge) can be used to

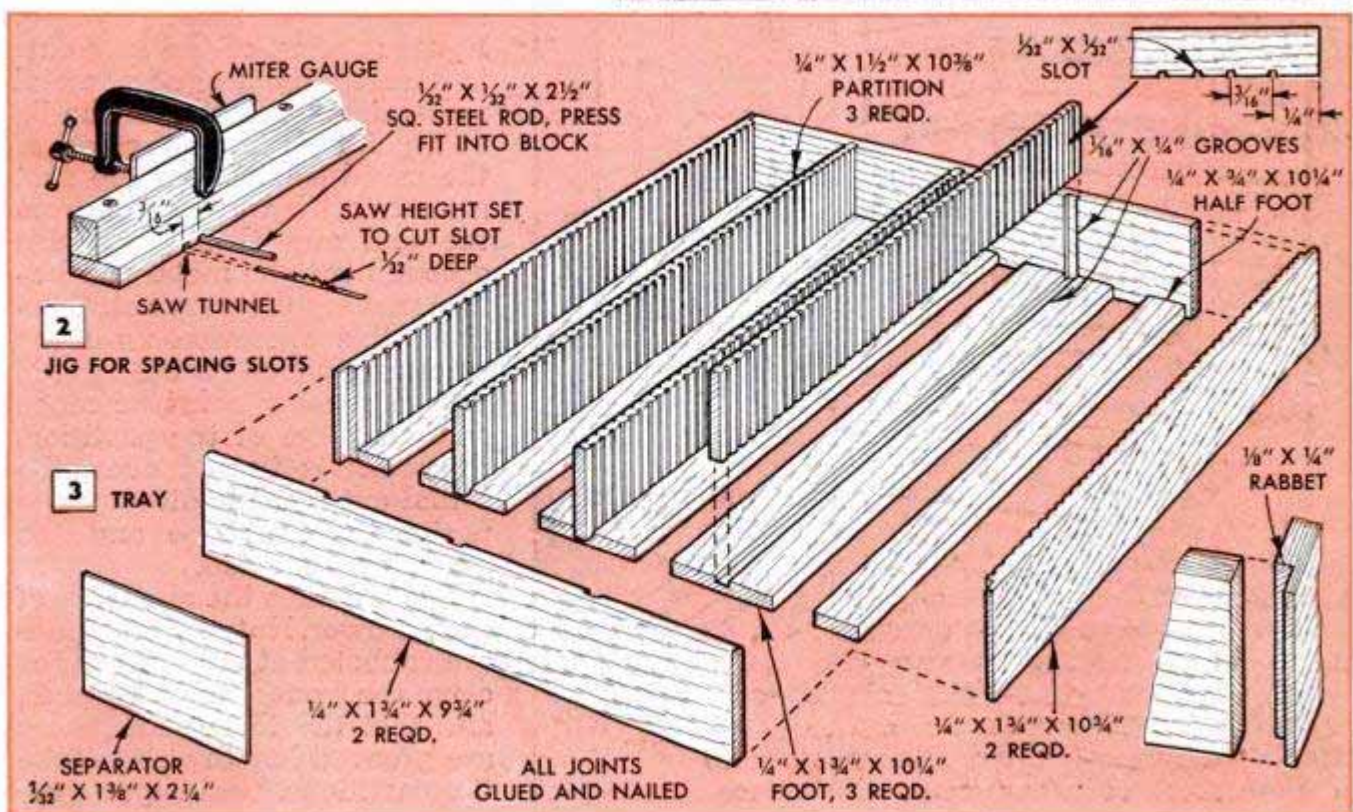
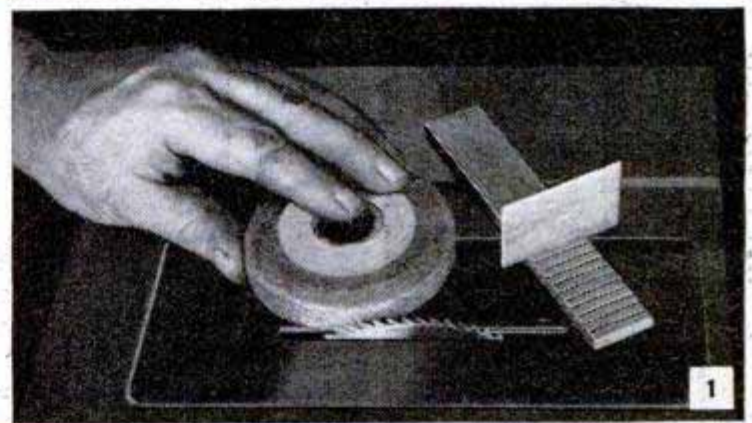
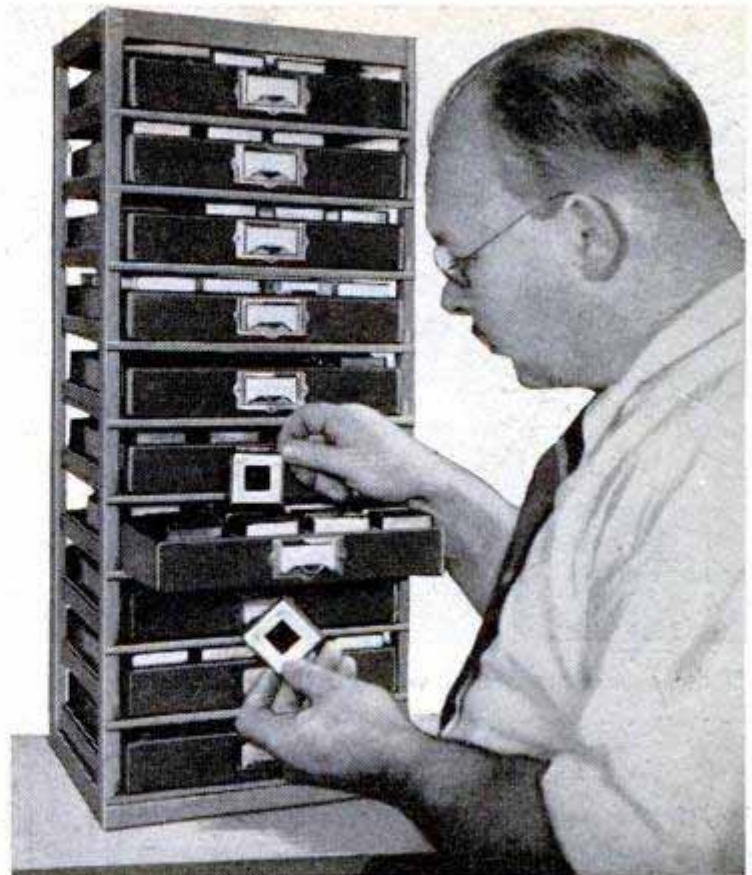

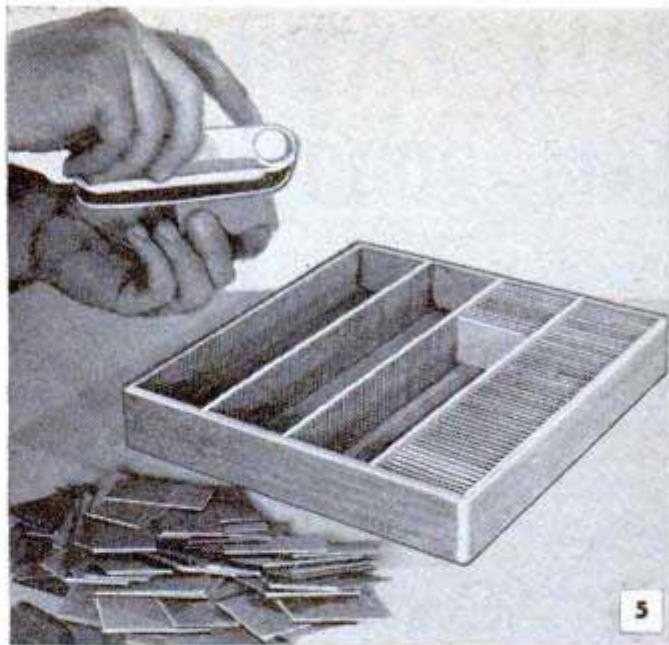
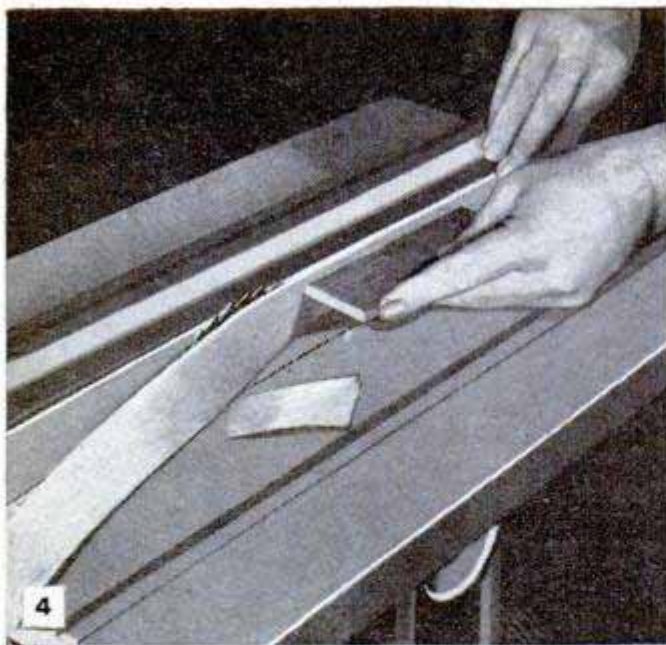

If the separators are of wood, a thin shaving cut is taken from 1 $\frac{3}{8}$ -in. stock, cut into pieces and sanded

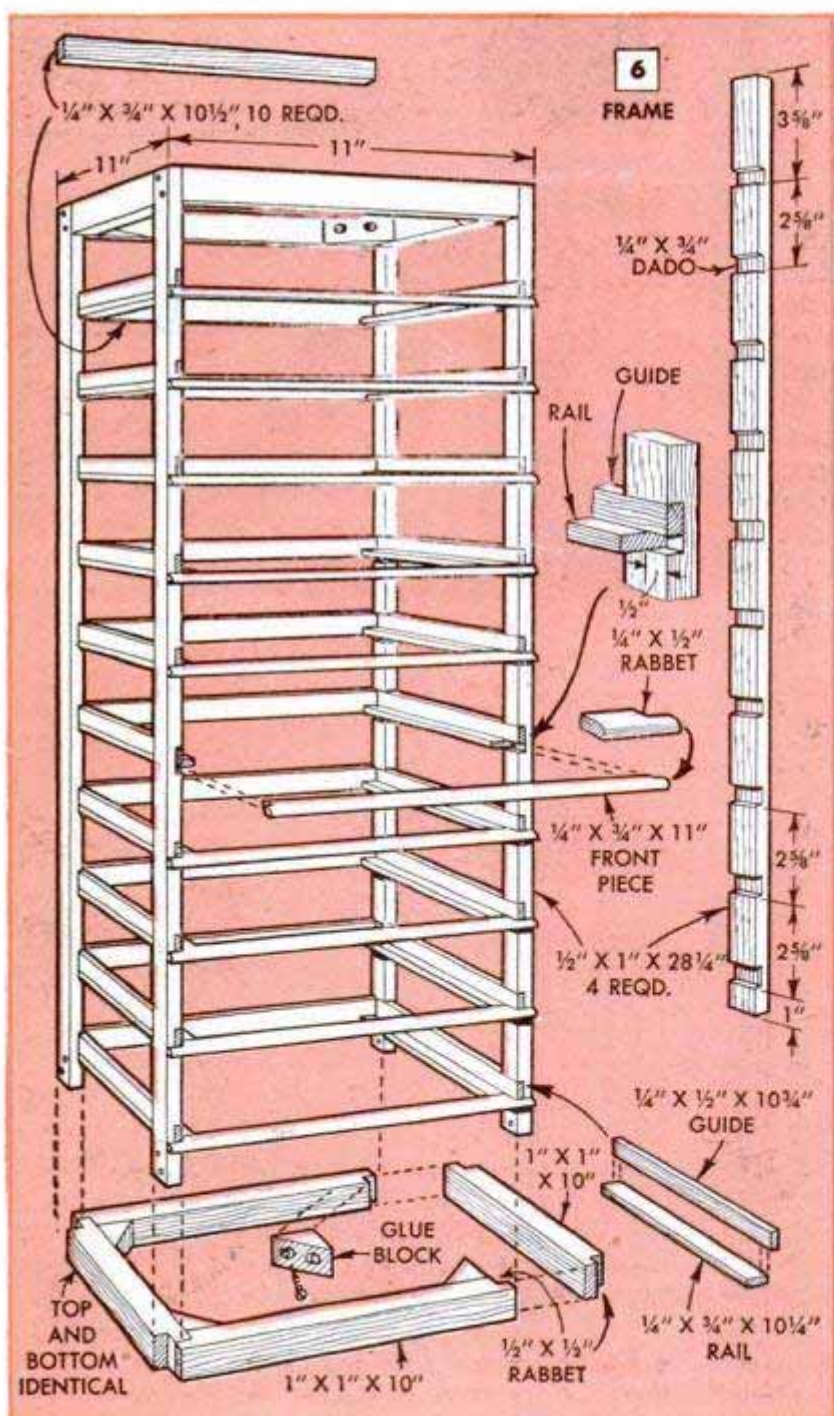

produce identically spaced saw cuts in the partition members of the drawers. The grooves are for thin separators which can be cut from plastic, metal or wood. I made them of wood, slicing them to paper-thinness as shown in Fig. 4. As the average saw blade produces a saw cut much too wide to provide a close fit for the separators, I took an old blade and dressed it down to the required thickness, using a grinding wheel as in Fig. 1. The blade is resharpened afterwards and is used without set. The latter is not necessary when making such shallow cuts as those required. Equal spacing of the saw cuts is assured by a square metal rod which is inserted in the jig at a point $\frac{3}{16}$ in. to the left of the saw blade. Make the first groove in the work $\frac{1}{4}$ in. from the end and then place this groove over the metal rod before making the next cut. Continue this operation until the piece is grooved its full length. Where grooves must be made on both sides of the partition, the work is turned over, the initial cut is made directly opposite the first one and the process is repeated.

Fig. 3 details the assembly of each drawer. Note that the sides are rabbeted at the ends to receive the front and back pieces, and that the three foot pieces are grooved lengthwise to take the partitions. Resin-type glue

and small brads are used in assembling the pieces. The top edge of each separator is rounded slightly with a sanding block, Fig. 5, before inserting it in place. No glue is required in holding the separators in the grooves. A coating of clear varnish or lacquer sprayed on the finished drawer will seal the separators in the grooves.

Fig. 6 details the assembly of the framework of the cabinet, which can also be mass-produced as it consists of many duplicate parts. Dadoes are equally spaced in the four corner posts of the framework to receive the guide and rail members. These are installed after the top and bottom assemblies are attached to the posts. Final sanding completes construction, Fig. 7, which is followed by varnishing or painting all parts except the drawer guides. Each drawer is fitted with a standard label-holder pull.

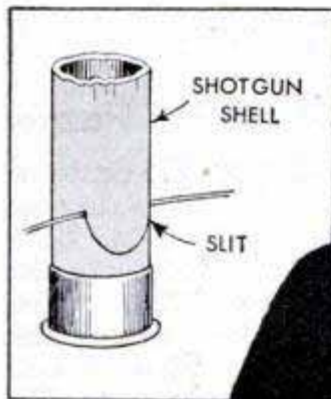
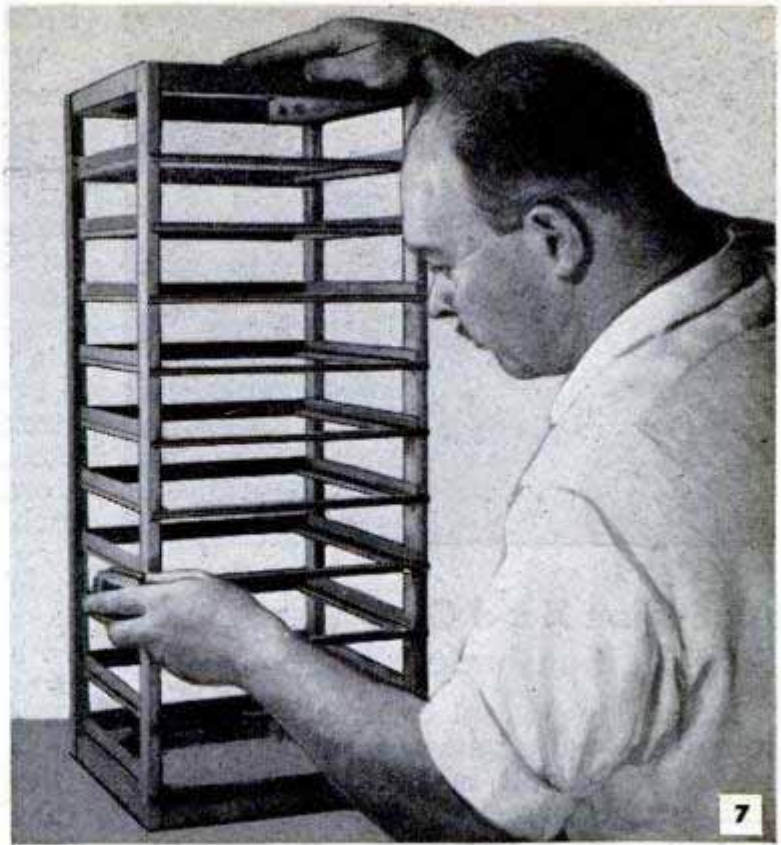

Tallow-Filled Shotgun Shell Dries and Waxes Fishline

To wipe a fishline dry and wax it in a single operation, one fisherman uses a fired shotgun shell filled with melted tallow. A slit is cut through the side of the shell and into the wax, as shown, and the line is inserted in the slit. Then, as the line is reeled in, the water is squeezed out and wax applied at the same time. The wax should be warmed occasionally to close the slit for efficient operation.

Paper Around Steampipes Prevents Cracks in Plaster

When steam or hot-water lines pass through a plastered wall, the plaster around the pipes frequently cracks because of the expansion of the pipes. This can be prevented by wrapping several thicknesses of wrapping paper around each pipe before plastering. Then, after the plaster dries, the paper is removed, leaving clearance between the pipes and the plaster to allow for expansion.—Arthur N. Nelson, Kansas City, Mo.

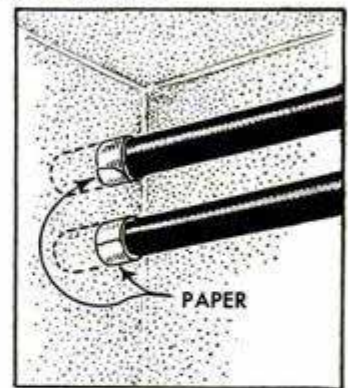
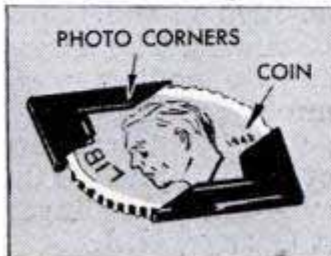
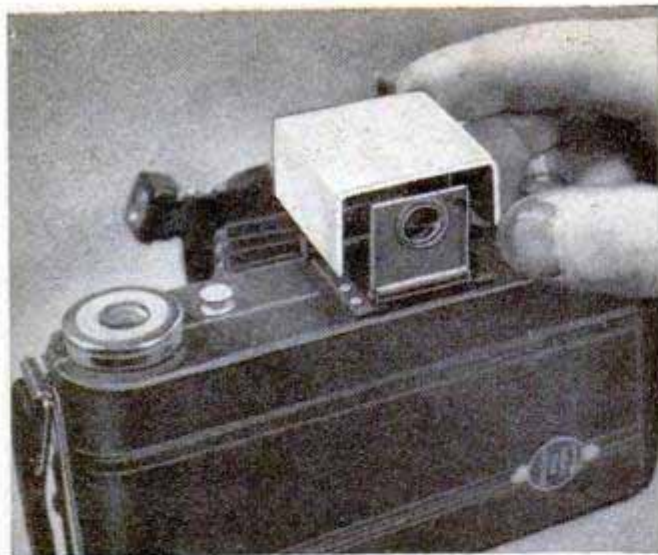

Photo Corners Hold Coins For Mailing With Letter

Coins enclosed with a letter or order blank will not slide around in the envelope if they are fastened to the sheet of paper with gummed photo corners. Just slip two corners over the edge of the coin, one opposite the other, moisten the backs and stick them to the paper. —P. Criton, Kayville, Sask., Can.



☞ For a better job, warm furniture polish thoroughly in hot water before applying.



Aluminum Hood Over View Finder Provides Sunshade

In using the two-piece direct view finder found on many cameras, sunlight often makes it difficult to obtain clear vision. This can be corrected by fitting an aluminum sunshade over the finder. Cut the metal to size and bend it to clip over the front and rear parts of the finder like a hood.

Plastic "Ice Cubes" Cool Developer

When warm weather makes it a problem to maintain photo solutions at the proper temperature in a small darkroom, here's a way you can cool the liquid without diluting its strength. Simply place a couple of frozen plastic "ice cubes" in each tray until the tem-

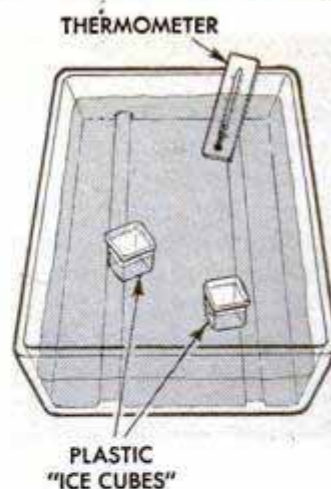

perature of the solution is lowered the required amount. Designed to cool drinks without diluting, the cubes are of transparent plastic and have water sealed inside which is retained upon melting. The cubes can be used over and over again by simply refreezing. As some cubes are identified by color, it is easy to prevent contaminating a solution by accidentally placing a cube in hypo that has been in developer.—Will Stoll, Elmhurst, Ill.

Wafer-Thin Foot Switch for Photo Enlarger Eliminates Stumbling Hazard

If the foot switch on your enlarger is a bulky affair or if you do not have a foot switch, make this compact, wafer-thin switch. It is easily assembled in layers of fiber, rubber, copper and brass. First, cut the bottom and intermediate disks from $\frac{1}{4}$ -in. fiber, making them 4 in. in diameter. Then drill a $\frac{3}{4}$ -in. hole in the center of the intermediate disk and rout a slot in the underside of the disk for the wires which run to the terminals. The latter are brass screws located on each side of the center hole. After this, cut a disk of sheet rubber and a disk of brass to the same diame-

ter as the fiber disks. Cut out the center of the brass disk to form both the top ring and the top plate. Then drill $\frac{1}{8}$ -in. holes through the centers of the top plate and rubber disk. Now, cut a disk from sheet copper to form the contact plate. This should be large enough to fit over both terminals, and a $\frac{1}{4}$ -in. hole is drilled through its center. Next, drill four registering holes through the edges of the ring and disks to permit fastening the assembly together with machine screws. Bolt the top plate, rubber disk and contact plate together, using a fiber insulating washer

between the contact plate and the bolt and a larger fiber washer between the plate and the nut to keep the current from flowing through to the brass top plate. Then, attach the wires to the contact terminals and assemble the switch, inserting a stiff compression spring in the $\frac{3}{4}$ -in. hole in the intermediate disk. The spring holds the contact-plate assembly off the terminals when foot pressure is not being applied to the switch.—Jack Mellinger, West Orange, N. J.

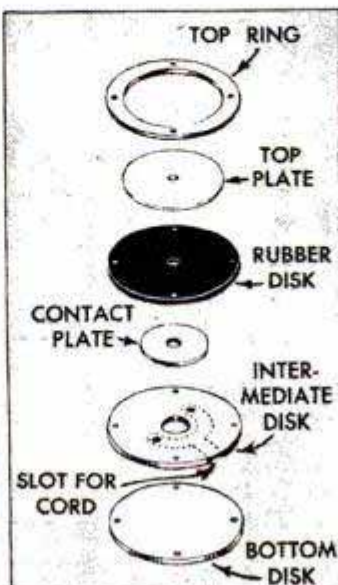

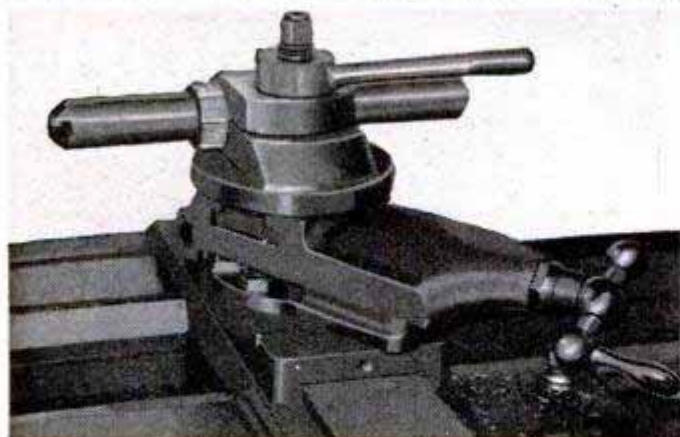

heavy-duty BORING BAR

By Everett W. Holt

THIS VERSATILE boring bar is especially designed to provide maximum rigidity for turning and boring operations on diameters up to the full capacity of the average lathe, Fig. 1. A novel eccentric bushing permits accurate adjustment of the cutter height and top rake in relation to the axis of the work. Made to the dimensions given, the unit is suitable for use on lathes having up to 13-in. swing.

Begin work on the body, Fig. 2. Dimension "H" should be carefully determined before facing and finishing the stock. Start with a 4-in. disk of cold-rolled steel having a thickness slightly greater than dimension H plus $\frac{3}{4}$ in. The excess over the sum of these two dimensions is the allowance for facing both sides. After facing to the correct dimension, scribe intersecting center lines and prick-punch the true center of the disk. Then scribe offset center lines, one $\frac{3}{16}$ in. and the other $\frac{5}{8}$ in. Prick-punch the centers and mark the $\frac{5}{8}$ -in. offset "X" as in Fig. 2. Then set up the work in the four-jaw chuck and adjust to bring the $\frac{3}{16}$ -in. offset true with the tail center. Drill $\frac{15}{32}$ in., ream $\frac{1}{2}$ in. and counterbore $\frac{13}{16}$ in. Next, insert a $\frac{1}{8}$ -in. spacer between the back of the work and the chuck jaw at the center point, X, and finish an angular cut to clean up at exactly $\frac{17}{16}$ -in. diameter. The angularity of this cut assures that the hub of the clamping lever will bear on the outer portion of the lug when the lever is tightened. Re-chuck and true the $\frac{5}{8}$ -in. offset center with the tail center, using spacers, if necessary, to limit the depth of the work



This tool will handle either inside or outside work

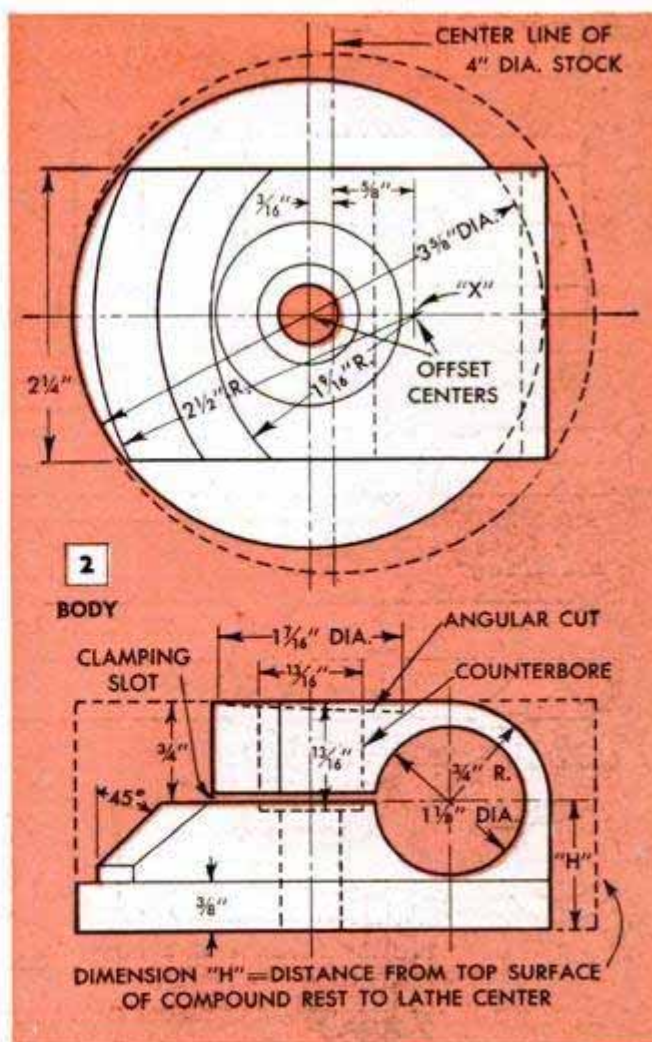

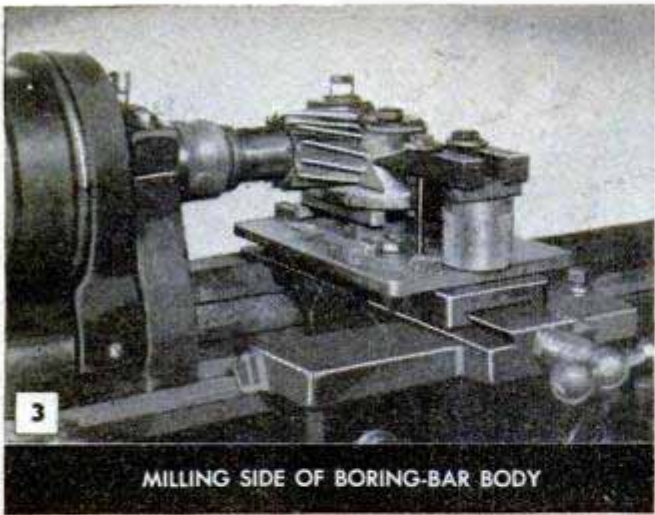

MILLING SIDE OF BORING-BAR BODY

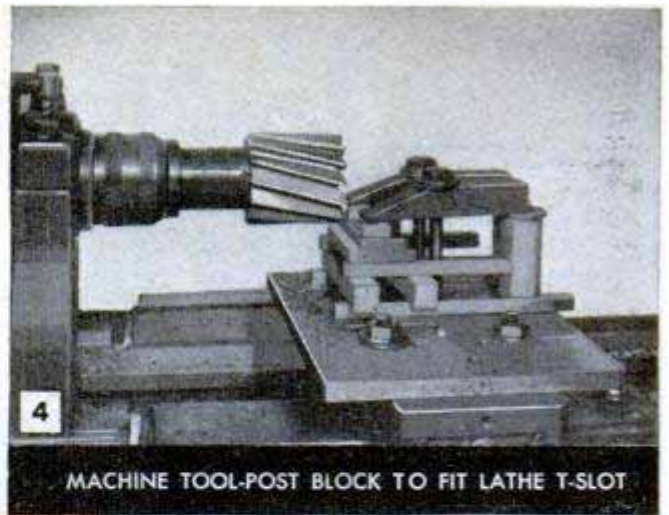

MACHINE TOOL-POST BLOCK TO FIT LATHE T-SLOT

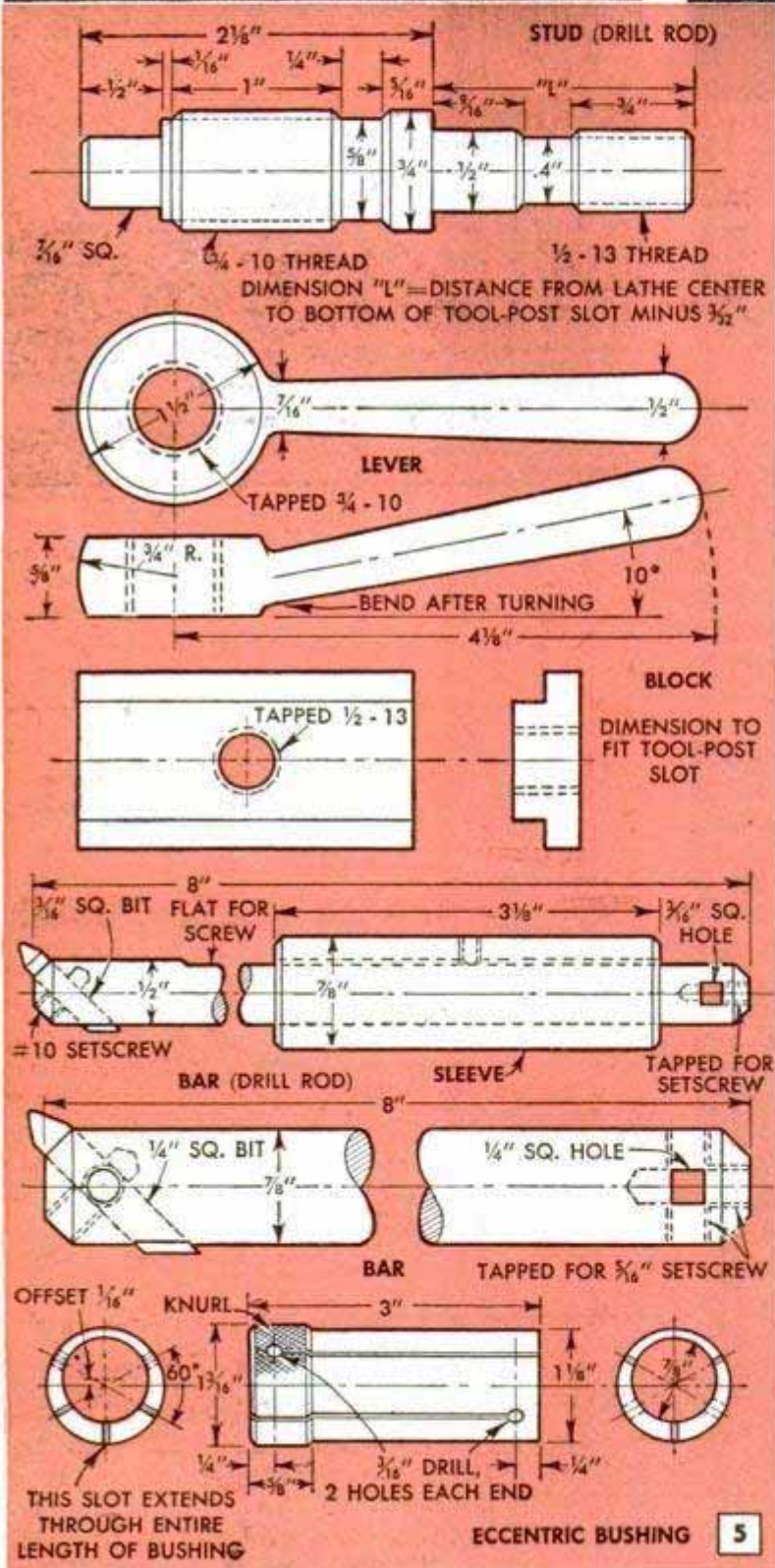

in the chuck jaws to $\frac{3}{8}$ in. Turn the $2\frac{1}{2}$ -in. radius, Fig. 2, back to the chuck jaws, then turn the $1\frac{1}{16}$ -in. radius to $\frac{3}{4}$ -in. length and finish the 45-deg. chamfer.

Mount the stock for the stud, Fig. 5, between centers, then finish and thread that portion of it which is $\frac{1}{2}$ in. in diameter. Clamp the partly finished body block to this improvised mandrel with a $\frac{1}{2}$ -in. nut and turn the $3\frac{5}{8}$ -in. diameter on the body, Fig. 2. Take a light cut on the bottom of the body up to the nut if runout is noticeable.

The sides and front of the body block are milled as in Fig. 3. Drill and tap a $5 \times 7\frac{1}{2}$ -in. steel plate for hold-down bolts. Then bolt the plate to the cross slide. Mount the work on the plate and clamp it securely in place with hold-down bolts. Use a right-hand shell mill mounted on a stub arbor. Next, shoulders are milled on the special tool-post clamping block as in Fig. 4. No dimensions are given on this part in Fig. 5 as it must be dimensioned to fit the tool-post T-slot on your lathe. The setup for milling flats on the locking stud is shown in Fig. 6. After milling one flat, the next cut is indexed by bringing the finished flat square with the base plate. In finishing the stud, break all corners where indicated.

Now the body block can be mounted in working position on the cross slide and bored for the eccentric bushing as in Fig. 7. Use either an offset boring head, as shown, or a boring bar with fly cutter. The eccentric bushing, Fig. 5, is machined and ground to a slip fit in the hole bored in the block. Then bore the bushing off-



SETUP FOR MILLING FLATS ON STUD

center and ream or grind to a slip fit over the bar sleeve, Fig. 5. Knurl the bushing and drill stop holes $\frac{1}{4}$ in. from each end. Then saw the slot through the heavy side, using either the slitting saw on the milling machine or a hacksaw blade stoned to remove some of the set so that you get a smooth cut. Saw or mill slots from each end of the bushing to the stop holes and remove burrs on the inside and outside. Now the body can be finished by milling or sawing the clamping slot, Fig. 2. If you must use a hacksaw, two blades used side by side will give a slot of the correct width.

Squared holes at the ends of the boring bars are readily formed by first drilling $\frac{3}{16}$ -in. holes in the smaller bar and $\frac{1}{4}$ -in. holes in the larger bar. The holes are then cornered with a square file to very nearly the finished size, and are broached by driving through $\frac{1}{4}$ and $\frac{3}{16}$ -in. cutter bits, the ends of which have been ground square across. The clamping lever, Fig. 5, is made from $\frac{5}{8}$ x $1\frac{1}{2}$ -in. stock. The handle is turned between centers and the work is

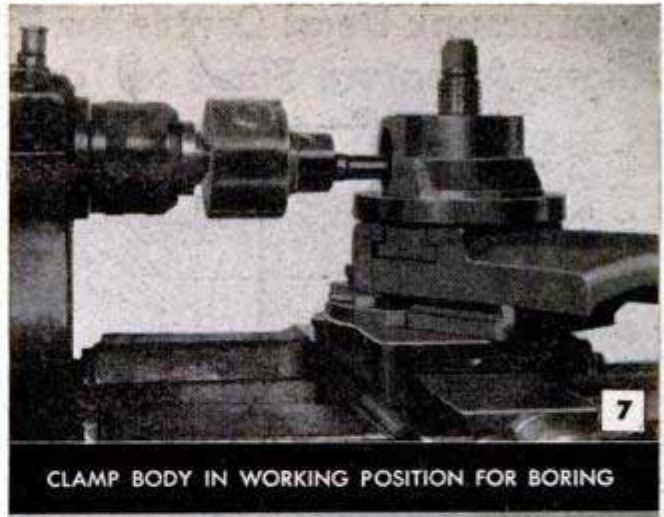

CLAMP BODY IN WORKING POSITION FOR BORING

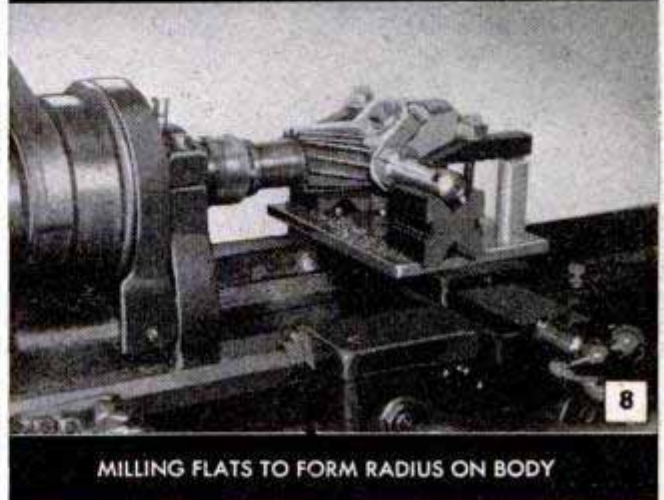

MILLING FLATS TO FORM RADIUS ON BODY

chucked for facing, boring and threading the hub. This done, the hub is formed by sawing away the waste and filing to a smooth contour. As the final operation, the handle is heated and bent to a 10-deg. angle. Now the body can be finished by milling a series of flats, Fig. 8, across the front to rough in the $\frac{3}{4}$ -in. radius shown in Fig. 2. After milling, the surface is finished to a smooth curve by filing.

Caterpillar Tent on Fruit Tree Removed With Long-Handled Brush

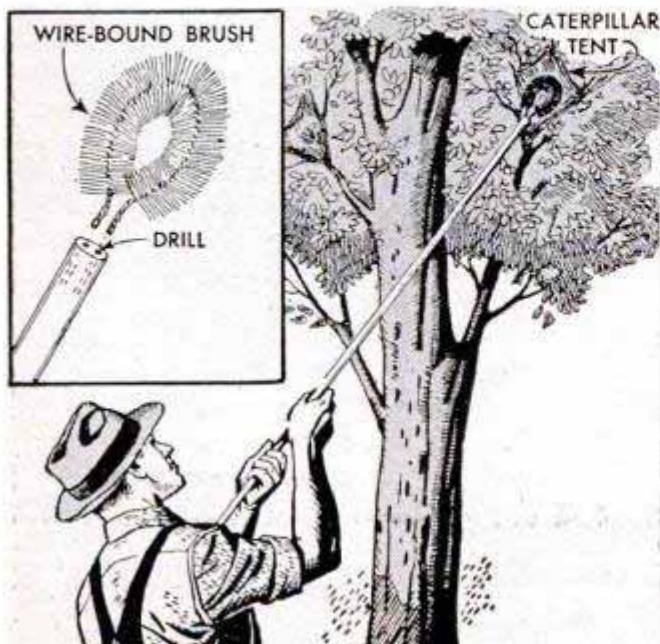

Instead of endangering fruit or shade trees by burning caterpillar tents with a torch, just pull them off with a long-handled brush and drop them into a can filled with kerosene. A wire-bound brush having fairly stiff bristles is suitable for this purpose. The prongs of the brush can be pressed into holes drilled in the end of a broom or rake handle.

J. Modroch, Danbury, Conn.

Vibration of Power-Take-Off Shields Silenced by Inner-Tube Patches

The noisy vibration of power-take-off shields at certain tractor speeds can be muffled with inner-tube patches. Simply vulcanize a patch to one of the shields wherever another one vibrates against it.

P. R. Wilson, Brooklin, Ont., Can.

Countersunk Dead Center for Lathe Tailstock Aligns Armature Shaft to Turn Commutator

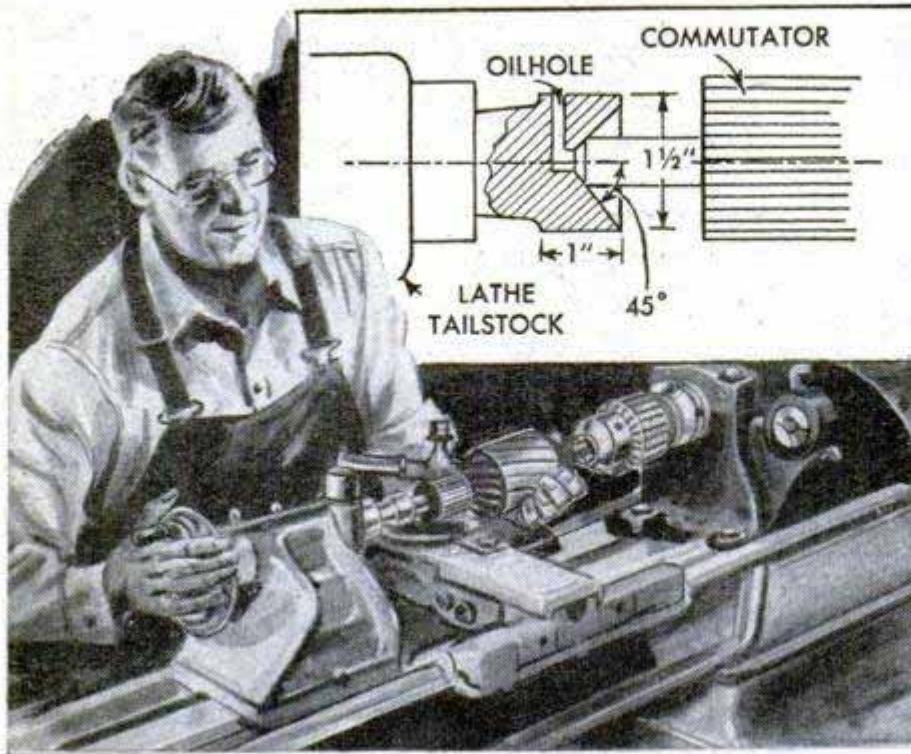

When turning the commutator on an armature shaft which does not have a center hole, one machinist uses a countersunk tailstock center to mount the work in the lathe. The center is countersunk as shown in the detail, and the shank of the center is turned to a standard taper to fit the tailstock spindle. The edges of the armature shaft are beveled by touching lightly with a file. Then, the work is chucked in the lathe, the tailstock center is brought in contact with the end of the shaft, and the sloping sides automatically center the work. Note that an oilhole for lubricating the bearing surface is drilled through the shoulder of the center.

Copper Pipe and Steel Flange Joined With Novel Silver-Soldering Method

Having to weld a copper pipe to a steel flange, I first tried to do the job with the conventional technique for silver-soldering, using a rod having a high copper content and a melting point of about 1190 deg. F. This rod was selected because it produces a strong joint at a low temperature. As copper is a better heat conductor than

steel, it was extremely difficult to heat both of the materials to a uniform temperature. However, I found a solution to this problem simply by tinning the surface of the steel flange with silver solder and then silver-soldering the copper pipe to the tinned surface of the steel flange.

Cleon A. Wing, Mechanic Falls, Me.

Moving of Hollow Grinder Base Facilitated by Dumping Out Sand Ballast

Extremely free from vibration, this hollow grinder base is made of welded steel and weighted with sand. A steel bottom is welded inside the base slightly above the floor level, so that all weight rests on the edges of the base. The unit is then filled with sand which is dumped out when the base is to be moved any appreciable distance.—L. H. Houck, Jefferson City, Mo.

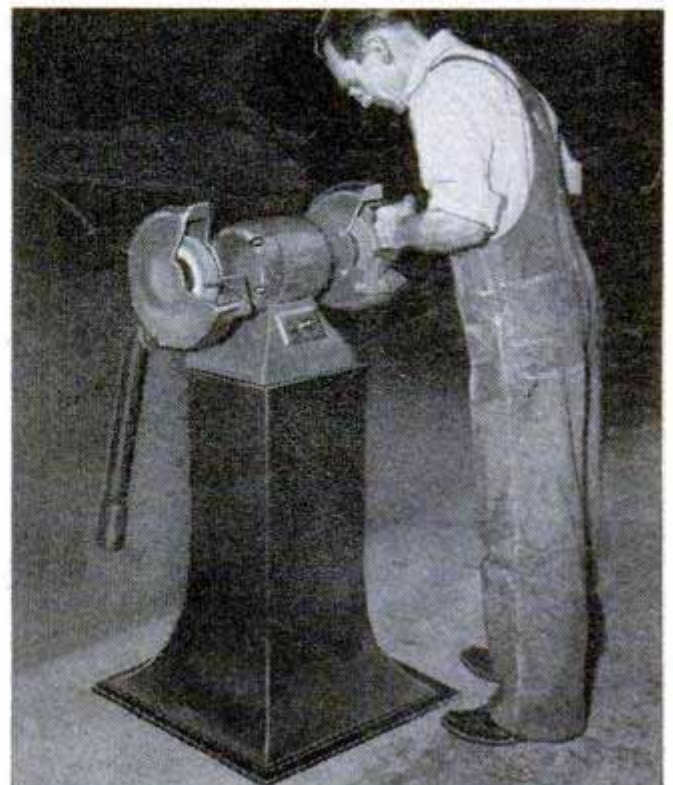

Labels Held in Typewriter

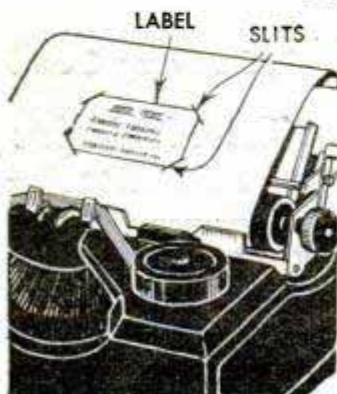

Labels won't slip in the typewriter platen if their corners are inserted in four diagonal slits cut in a sheet of paper. This will hold the labels securely and allow typing along their bottom edges without slipping.

When salvaging baling wire for reuse, one farmer straightens the lengths quickly with the aid of a bench vise and wrecking bar. First, a wooden cleat is nailed to the bench top, being positioned so that its distance from the vise is slightly less than the length of the baling wire. Then, the looped end of a length of wire is slipped over the claw of the bar and the other end is clamped tightly in the vise jaws. With the cleat serving as a fulcrum, the wire is drawn taut simply by applying pressure with the wrecking bar.

Kinks Quickly Removed From Baling Wire By Using Bench Vise and Wrecking Bar

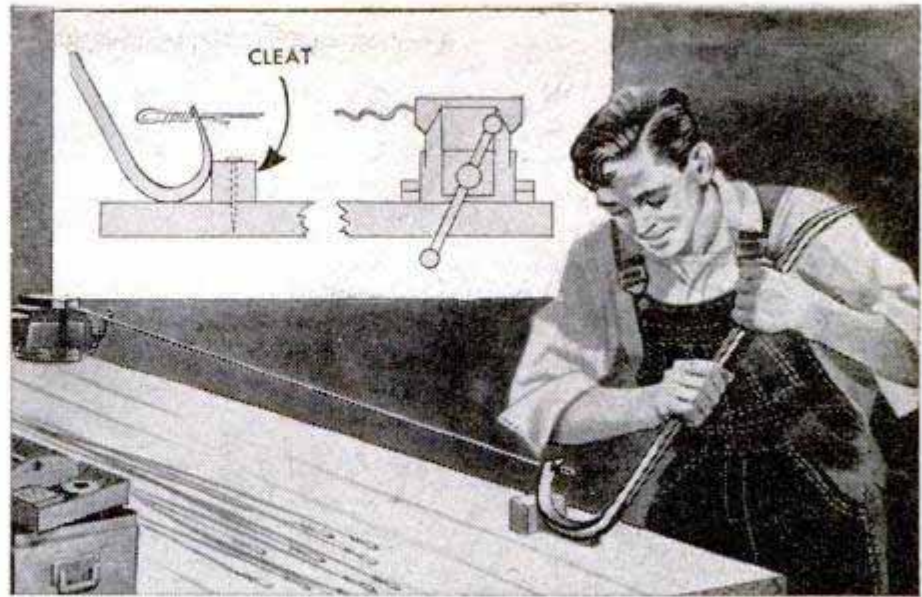

Spring-Loaded Bumper Compresses to Cushion Impact of Heavy Shop Door

In addition to being rubber tipped, this heavy-duty door bumper compresses to absorb and cushion the impact of a heavy door. It consists of five parts—a floor flange,

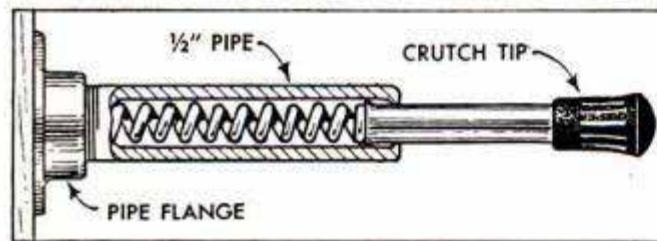

a pipe nipple, a light compression spring, a crutch tip and a short length of iron rod. One end of both the pipe and the rod is peened over slightly to form a lip. The peening must allow the rod to slide freely inside the pipe, and yet keep it from coming out. The opposite end of the pipe nipple is threaded for a floor flange and the outer end of the rod is capped with a crutch tip. The length of the spring should be sufficient to exert a slight pressure on the rod when the bumper is mounted.

W.T.M. Concrete

Eaves-Trough Sections Provide Molds for Pouring Concrete Fence Posts

Sections of discarded eaves trough supply inexpensive molds for pouring reinforced-concrete fence posts. The eaves trough is cut into 6-ft. lengths and the ends are blocked with pieces of wood shaped to fit, the blocks being fastened with nails driven through the sides of the trough. After the molds are oiled to keep the concrete from sticking, the concrete is poured and the reinforcing rods added. The posts should be allowed to cure for several days before they are used.

Charles E. Mason, California, Mo.

Making Cloth Gloves Last Longer

My work as a sheet-metal mechanic requires using soft cloth gloves which usually wear out within a few days. However, I make them last three times as long by dipping the thumbs and first two fingers in waterproof glue and rubbing sawdust in the glue. The glue must be thoroughly dry before the gloves can be used.

A. P. Washlake, Detroit, Mich.





1 PICTURE FRAME IS 4-SIDE MITER AT 45°



2 TRAY TABLE TOP LEANS OUTWARD AT 25° ANGLE

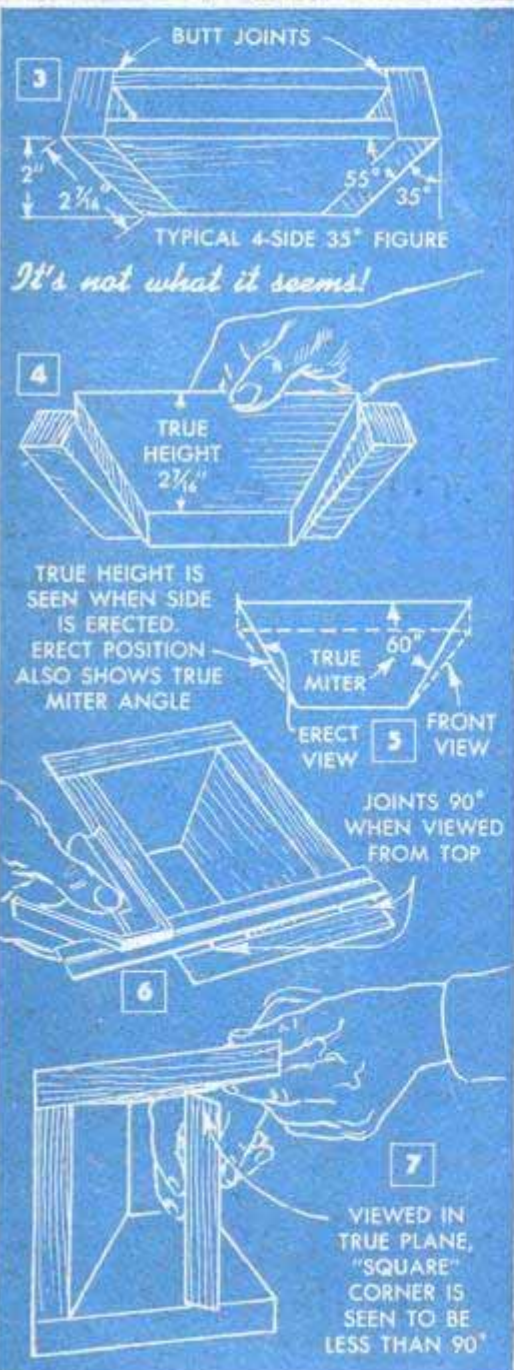

COMPOUND CUTS

By Sam Brown

IN MAKING a compound cut with a circular saw, a miter and a bevel are cut in the same operation. The compound-angle cut is required when sawing the parts of any box or open framework having sloping sides. Typical examples of this type of joinery are shown in Figs. 1, 2 and 8. The angles do not show on an ordinary plan drawing and, even when you examine a finished job, the angles are not what they seem.

Laying out: As viewed from the front, the simple box in Fig. 3 is 2 in. high and the sides seem to be 35 deg. from vertical. Joints appear to be cut at a 90-deg. angle, but a study of Figs. 4 to 7 will show that you could not cut a compound corner joint, or "hopper" joint as it is sometimes called, by following these measurements. The true height of the box sides is 2 7/16 in. and not 2 in. The miter angle is 60 deg. instead of 55 deg. What appears to be a square butt joint is cut at 70 1/2 deg. instead of 90 deg. These angles are determined simply by consulting a table, Fig. 23, which gives the required tilt of the saw table and the swing of the miter gauge in degrees for sawing a number of common compound angles. The example, Fig. 3, is a butt-joint job with the sides slanting at 35 deg. The table, Fig. 23, shows that the saw table must be tilted 19 1/2 deg. and the miter gauge set to 60 1/4 deg. to produce the joint.

Sawing the parts: The parts for a box or frame can be cut from several individual pieces or continuously from one board. Strip cutting is nearly always preferred as it is simple and saves material. Fig. 9 shows the lower course of a birdhouse roof being cut from a single strip, the board being simply turned over for alternate cuts. All parts of such a structure as the birdhouse roof, Fig. 10, must be cut



8

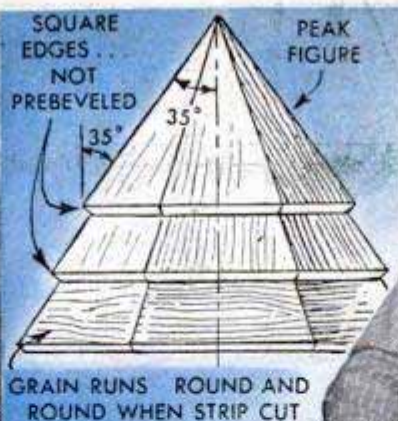

GRAIN RUNS ROUND AND ROUND WHEN STRIP CUT

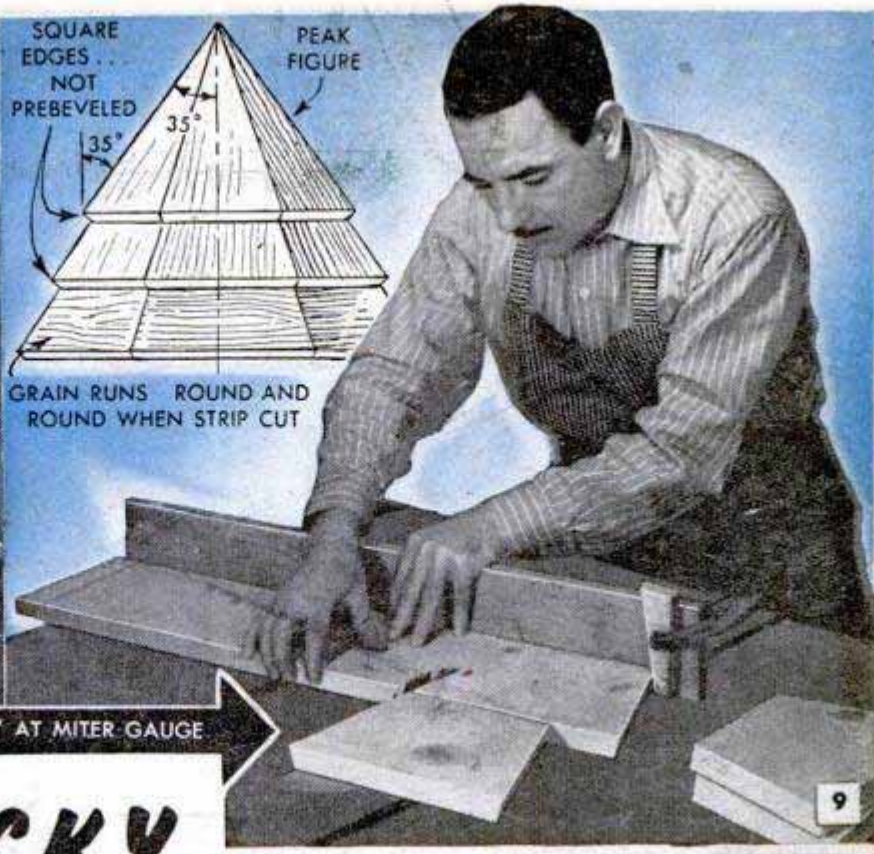

9

8-SIDES, 35° MITER TAKES 18 1/4° TILT AND 76 1/2° AT MITER GAUGE

ARE TRICKY

at the same setting. Figs. 11 and 12 show how the miter gauge is used when the pieces are individually cut. Note that the gauge remains at the same setting but is reversed, that is, turned around and used backwards, for the second cut in order to support the wide side of the work against the miter-gauge facing. In this case, the saw is a tilting-arbor type, the blade tilting to the right. To clarify this alternate use of the miter gauge, two sets of details are given in Fig. 13.

Miter-gauge positions: The right-hand details in Fig. 13 are for a tilting-arbor saw with the blade tilting to the right. The left-hand diagrams are for tilting-table saws or tilting-arbor saws on which the blade tilts to the left. Although the details are identical, they are lettered differently to correspond to instructions in the notes. The four standard positions are common to all miter cuts and the two sets of positions, A and B, and C and D, are pairs worked by shifting the miter gauge from one table groove to the other. Use any of the four positions shown for strip work or large individual pieces. In some instances, it will be necessary to use definite miter-gauge positions instead of using any of the four regular positions at will. A common limitation of this kind is caused by the use of pre-beveled boards. The boards are beveled, of course, to make the bottom and top edges of the box flat. As an example, the box sides shown in Fig. 3 are beveled at 35 deg., which is the same as that specified for the inclination of the sides. The details in Fig.

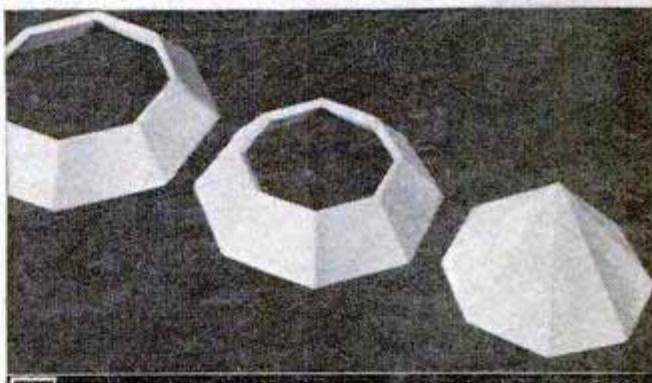

10

ALL PARTS ARE CUT AT SAME SETTING

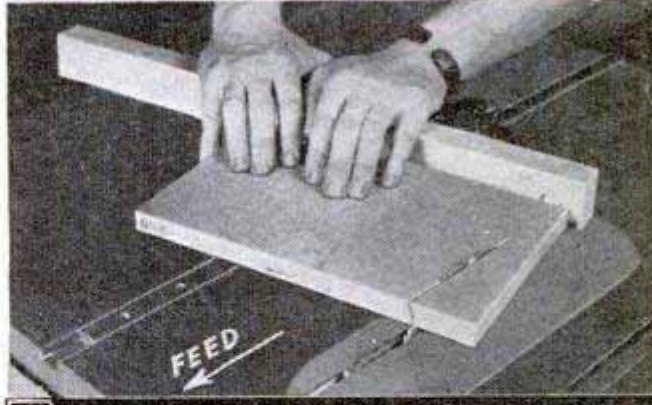

11

FIRST POSITION FOR PEAK OR SHORT BASE WORK

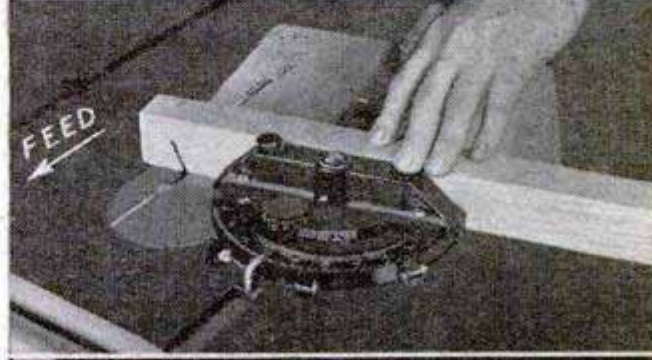

12

SECOND POSITION—WIDE END IS SUPPORTED

13 MITER-GAUGE POSITIONS FOR COMPOUND CUTS

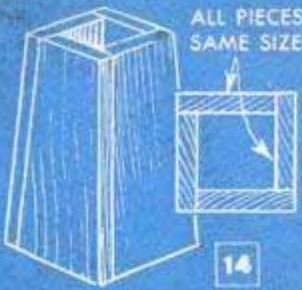

14

OVERLAPPING ASSEMBLY OF BUTT JOINTS MAKES A SQUARE FIGURE WITH SAME SIZE PIECES



15

FENCE-POST TOPS COME TO A PERFECT PEAK IF JOINTS ARE MITERED. ANGLE IS 35° OR 40°

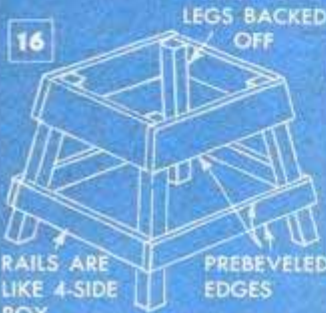

16

PEDESTAL STANDS AND SAWHORSES INVOLVE SAME ANGLES AS A 4-SIDE BOX

POSITIONS FOR TILTING TABLE SAWS OR LEFT-TILTING ARBOR

POSITIONS FOR TILTING-ARBOR SAW WITH RIGHT-HAND TILT

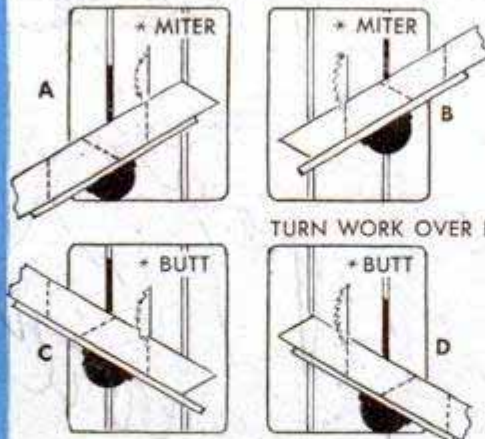

TURN WORK OVER FOR ALTERNATE CUTS

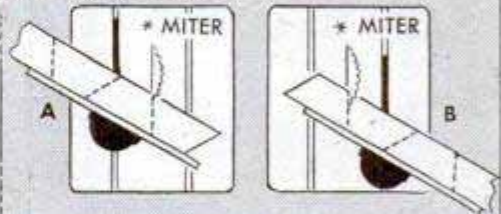

Four Standard Positions... USE ANY POSITION FOR STRIP WORK OR LARGE INDIVIDUAL PIECES NOT PREBEVELED. IF EDGES ARE PREBEVELED, USE POSITION A OR B FOR MITER JOINT AND C OR D FOR BUTT JOINT ... THIS KEEPS BEVELED EDGE UP

MAKE SECOND CUT WITH C POSITION

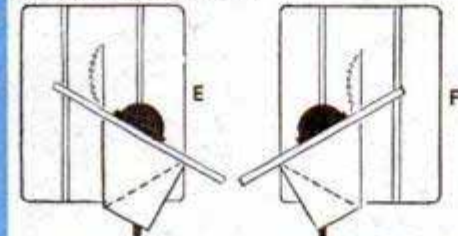

(COMBINE WITH C) (COMBINE WITH B)

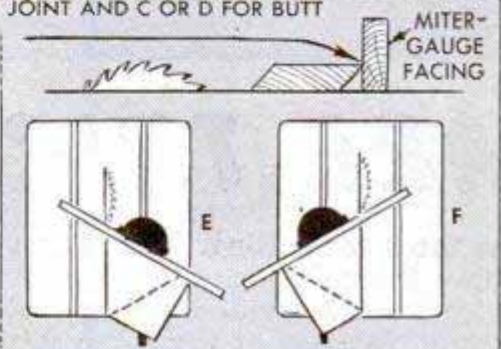

(COMBINE WITH A) (COMBINE WITH D)

Two Special Positions... ARE USED FOR PEAK OR SHORT BASE WORK. EITHER OF THESE POSITIONS WILL KEEP WIDE SIDE OF WORK AGAINST MITER GAUGE. IF WORK IS PREBEVELED, THE BEVEL WILL BE UP FOR ONE CUT BUT DOWN FOR THE OTHER



17 TILTED TABLE LEGS UP TO 10° ANGLE ARE USUALLY WORKED "IN THE SQUARE" AND WITH TOPS AND BOTTOMS CUT AT TILT AND MITER GAUGE SETTINGS EQUAL TO SAME ANGLE AS WORK. JOBS REQUIRING OVER 10° TILT SHOULD BE BACKED OFF AND OTHERWISE TREATED THE SAME AS A CORNER BLOCK. (SEE OPPOSITE PAGE)

13 show that only two of the four positions can be used for prebeveled work, that is, if the corner of the bevel is to bear against the miter gauge with the sharp corner up. Another limitation will turn up when cutting parts from individual boards to form a peak. In this instance, the work has only one base and this must be held against the miter-gauge facing for both cuts. In this case, either the E or F position, Fig. 13, may be used. When a peak is to be cut from individual prebeveled boards, the long side of the work must be held against the miter-gauge facing for both cuts, and the bevel must be up for both cuts. On a tilting-table saw, use positions B and E, Fig. 13, if the joints are mitered, or C and F if the joints are butted. On a right-hand tilting-arbor saw the positions are A and F for a miter joint and D and E for a butt joint. These combinations permit the gauge to be used on the same table groove but require a swing of the gauge from one side to the other as the alternate cuts are made. Although the instructions may seem complicated, they actually are quite simple if you just forget those which do not apply to your type of saw and refer only to the six positions in Fig. 13 which apply to your particular type of machine.

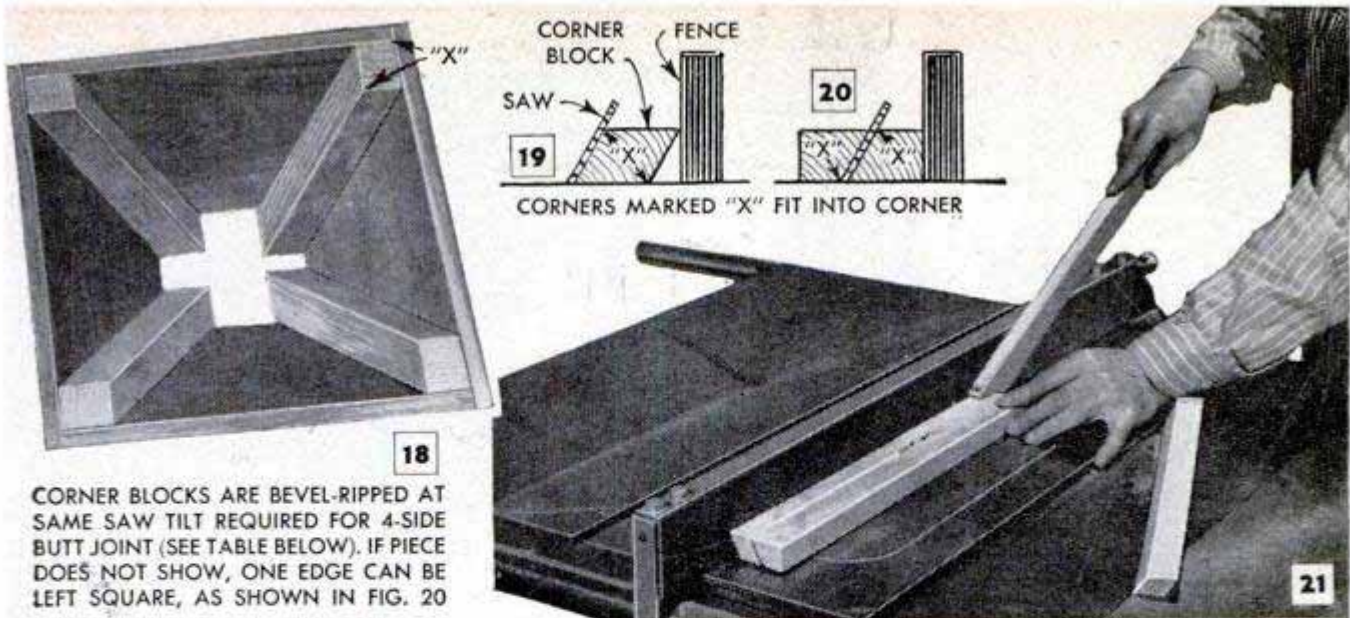

18

CORNER BLOCKS ARE BEVEL-RIPPED AT SAME SAW TILT REQUIRED FOR 4-SIDE BUTT JOINT (SEE TABLE BELOW). IF PIECE DOES NOT SHOW, ONE EDGE CAN BE LEFT SQUARE, AS SHOWN IN FIG. 20

CORNER BLOCK FENCE SAW 19 CORNERS MARKED "X" FIT INTO CORNER 20

21

Corner blocks: Corner blocks are often required to stiffen the joints of a box such as that shown in Figs. 14 and 18. Simply bevel-rip the material with the blade tilted to the same angle as that required for a four-sided butt-joined box, Fig. 23. Fig. 21 shows the operation. The second bevel cut is run as in Fig. 19. If the blocks do not show in the finished work, a single ripping cut will make two corner blocks, Fig. 20. Top and bottom ends of the blocks are cut as in Fig. 22. The miter-gauge setting is taken from the table but the tilt of the saw table remains the same as when making the ripping cuts.



22

Pedestal stand: Any structure with splayed legs such as a pedestal stand, lamp table or

TOPS AND BOTTOMS OF CORNER BLOCKS ARE CUT WITH MITER-GAUGE SETTING FROM TABLE. SAW TILT IS SAME AS WORK ANGLE. (NOT TAKEN FROM TABLE)

23 TILT AND MITER-GAUGE SETTINGS FOR COMPOUND ANGLES

Work Angle	4 Sides Butt Joint		4 Sides Miter Joint		6 Sides Miter Joint		8 Sides Miter Joint	
	Tilt Table	Miter Gauge	Tilt Table	Miter Gauge	Tilt Table	Miter Gauge	Tilt Table	Miter Gauge
5°	½	85	44¾	85	29¾	87½	22¼	88
10°	1½	80¼	44¾	80¼	29½	84½	22	86
15°	3¼	75½	43¾	75½	29	81¾	21½	84
20°	6¼	71	42	71	28¼	79	21	82
25°	10	67	40	67	27¼	76½	20¼	80
30°	14½	63½	37¾	63½	26	74	19¼	78¼
35°	19½	60¼	35¾	60¼	24½	71¾	18¼	76¾
40°	24½	57¼	32¾	57¼	22¾	69¾	17	75
45°	30	54¾	30	54¾	21	67¾	15¾	73¾
50°	36	52½	27	52½	19	66¼	14¼	72½
55°	42	50¾	24	50¾	16¾	64¾	12¾	71¼
60°	48	49	21	49	14½	63½	11	70¼

FIGURES ARE IN DEGREES AND ARE FOR DIRECT SETTING TO TILT SCALE AND MITER GAUGE. SCALE PROVIDING TILT STARTS AT 0° AND MITER GAUGE AT 90° IN NORMAL POSITION.

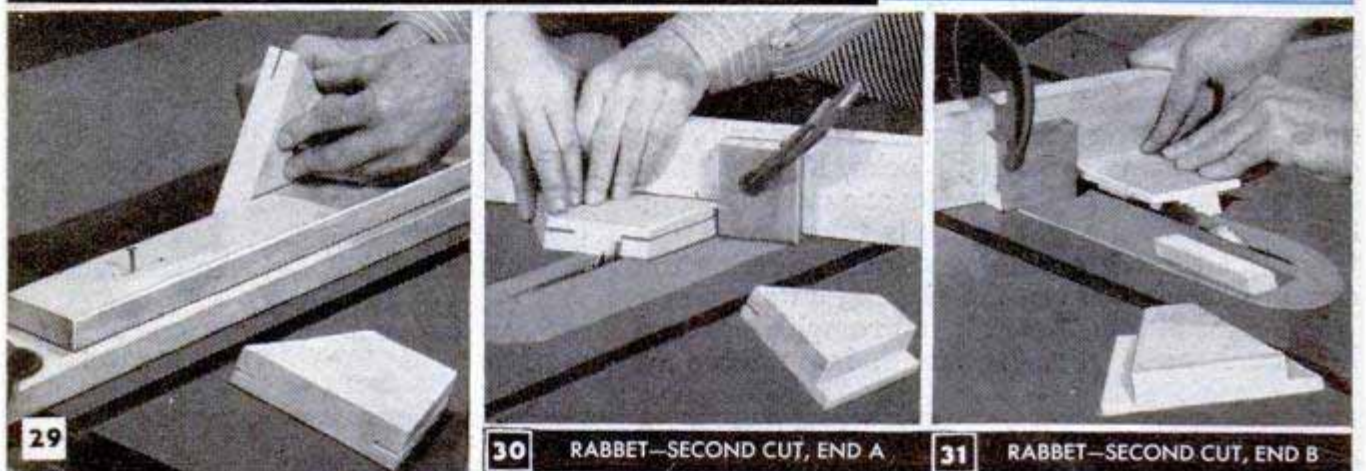
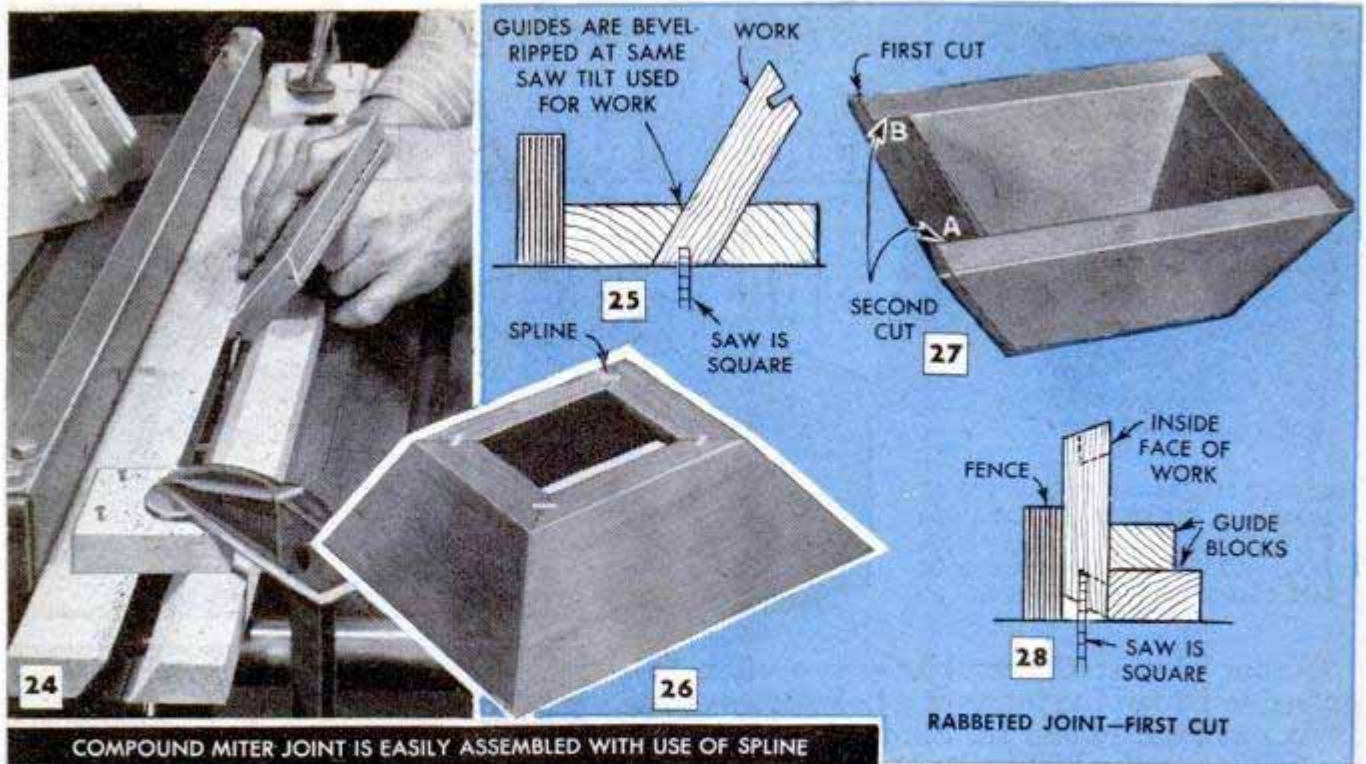

sawhorse, is worked out at the same angles as a box figure of the same general dimensions. Figs. 16 and 17 are typical examples of this type of work. A common procedure in making a pedestal like that in Fig. 16 is to make the rails first and assemble them. Then back off the legs on two opposite sides and make the angle cuts at the top and bottom ends of the legs. On the simple pedestal shown in Fig. 16, an average slope of the legs would be 15 deg. Taking this as the basic angle, you will see by referring to Fig. 23 and to the work itself that the rails are prebeveled 15 deg. The compound setting for the rails would be made by tilting the saw table $3\frac{3}{4}$ deg. and the miter gauge $75\frac{1}{2}$ deg. The legs would be backed-off $3\frac{3}{4}$ deg., and the top and bottom ends cut with a $75\frac{1}{2}$ -deg. miter-gauge setting and a 15-deg. saw-table tilt.

Types of joints: Rough work assembled with compound joints usually is simply butted and nailed. Screws and glue can be used where greater strength is required, but the finer work, such as the picture frame in Fig. 1, the birdhouse roof in Fig. 8,

and jobs like those in Figs. 15 and 26, require a plain mitered joint or a mitered joint fitted with a spline. Run the spline grooves as in Figs. 24 and 25, using the simple fixture in the manner pictured. Rabbeted joints are cut in two passes, the first cut being from the end of the work as in Figs. 28 and 29. The second cut parallels the end surface and is made at the same tilt and miter-gauge settings as were used in cutting the joint. Limitations are that the inside surface of the work must be down and the wide end of the work must bear against the miter-gauge facing. If the piece is small, the gauge must be swung to the opposite side and it must be used backward when making one of the cuts. Fig. 30 shows the end A, Fig. 27, being cut in the conventional position. Fig. 31 shows the same cut on end B being made with the gauge reversed. Always use a sharp saw blade with a medium set for all bevel cuts.

Ⓞ Instead of scrubbing hearth tiles, rub them with furniture polish. They will look much cleaner and take on a splendid polish.

Wooden Tees Facilitate Grading Small Lot Evenly

Having to fill in my back yard for a lawn and garden, I obtained an evenly graded lot in a comparatively short time by using three wooden tees to level the tops of stakes driven into the ground. The tees were made by nailing 8-in. crosspieces to boards 4 ft. long, special care being taken to make all three of them exactly the same length. First, I drove a stake at each corner of the area to be filled and left the stakes extending above ground a distance equal to the desired depth of fill. With two friends helping me, I set a tee upright on one corner stake and another tee on the stake at the opposite corner. Next, we drove a stake at the center of the area and stood a tee on it. By sighting over one of the corner tees and across the top of the center tee to the tee at the opposite corner, we drove in the

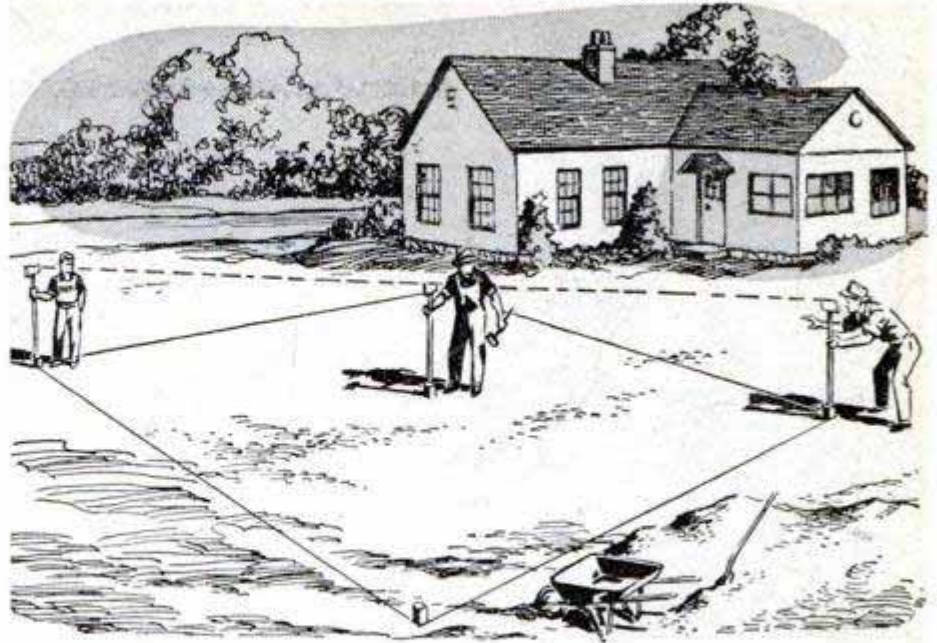

center stake until the top of the center tee was exactly level with the tops of the other tees. The tops of the stakes, in turn, were also level. Proceeding in the same way, we drove stakes about 6 ft. apart throughout the area. Then it was simply a matter of filling in with dirt to the tops of the stakes.

Harry Ingole, Kingsford Heights, Ind.

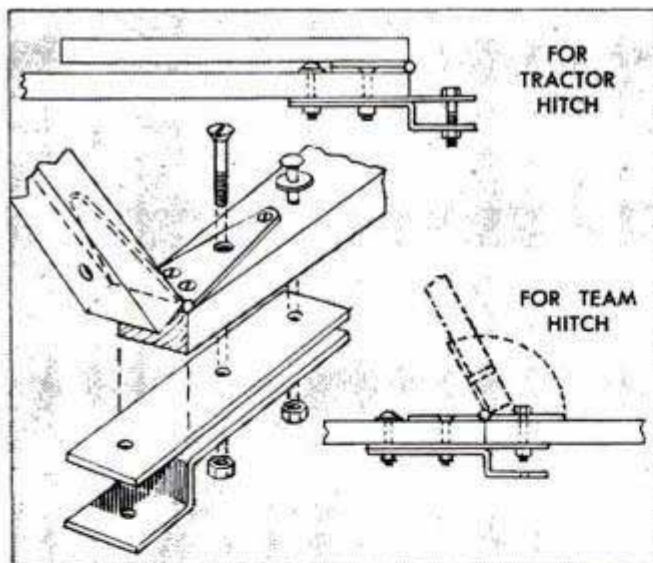

Tongue for Tractor or Team Hitch Is Hinged and Fitted With Clevis

Hinged and fitted with a flat-iron clevis, this dual-purpose wagon tongue is quickly adapted for use with either a tractor or team. To expose the clevis for hitching to a tractor, a bolt, which secures the front section of the tongue to the upper member of the clevis, is removed and the tongue is folded back. The same bolt serves as a pin for the hitch. The strap hinge is fastened with flat-headed screws and the bolt, which is flat-headed also, passes through the hinge leaf to attach the clevis to the underside of the tongue. This allows the front section of the tongue to fold back flatly.

Plastic Strip Secured by Masking Tape Provides Naval-Architect's Spline

When fairing lines on a boat drawing, an inexpensive substitute for a naval-architect's spline and ducks can be improvised from a strip of plastic which is held in place on the drawing with tabs of masking tape. The plastic strip should be approximately $\frac{1}{16} \times \frac{3}{8} \times 30$ in. and the tabs are spaced 2 in. apart along the full length of the strip as shown in the photo. A pin pressed into the drawing board at each end of the strip helps hold the shape of the curve.

Eldon Schiel, Chicago.

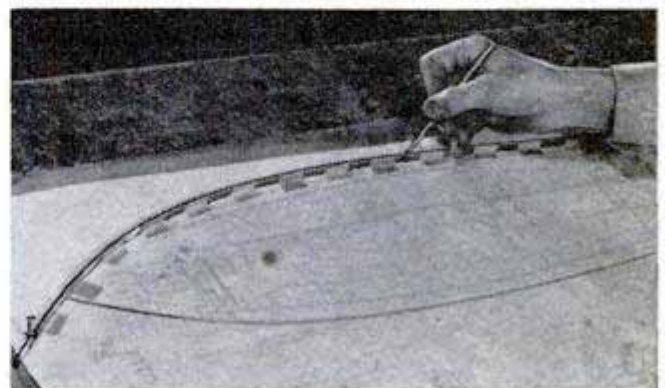

Posts of Electric Fence Anchored With Mower Sections



Inexpensive posts for an electric fence are made by welding discarded mower sections to 4 or 5-ft. lengths of angle iron. One section is welded near the lower end of each post to anchor it in the ground and another section is welded to the upper part of the post for each run of fence wire. Porcelain insulators are attached by bolting them through the rivet holes in the mower sections.—Asa F. Miller, Sabetha, Kans.

Carrying Case From Lunch Box Holds Electric Drill

A metal lunch box forms a compact carrying case for a portable electric drill and its accessories, or, if the drill is kept in the shop, the box provides a handy storage



container. The Thermos bottle in the cover of the box is replaced with a tennis-ball container to hold drill bits and accessories.

Wedge Locks Nut on Bolt

Here is a simple way to lock a nut permanently on a bolt when a lock washer is not available. First cut a deep slot across the end of the bolt and three shallow slots across the top of the nut, forming six castellations.

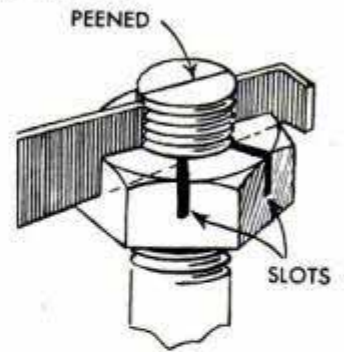

The slot in the bolt should be closed by peening over the edges. With the nut tightened, drive a tapered sheet-metal wedge in one of the slots in the nut and through the slot in the bolt. Then bend over the narrow end of the wedge to keep it from slipping out of the slots.

V-Sander Collects Pencil Dust

To sharpen pencils without getting dust on fingers and drawing board, one artist uses this novel V-sander. It consists of two wooden blocks screwed together. The adjoining faces of the blocks are beveled to suit the taper of the pencil and covered with sandpaper glued in place. To sharpen the pencil, the point is inserted in the vee and the pencil rotated with the fingers.

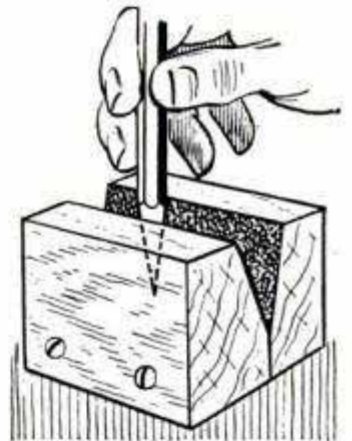

Dry Storage for Grass Seed

If grass seed is stored for any length of time, it must be protected from the moisture in the air to prevent spoiling. This is done by placing the sack of seed in a barrel and filling the barrel with ground feed. A layer of feed should be poured over the bottom of the barrel before the sack is inserted and the top of the sack should be completely covered.

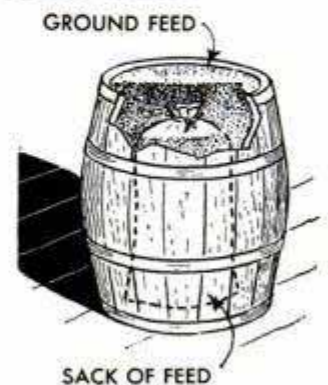

SQUEEZING-IN THAT NEW CAR

By Richard Hanscom

NEW CARS and old garages just don't go together. Whether the rear bumper extends an inch or a foot beyond the wall line, the problem is essentially the same—how to gain the extra space needed to close the doors. In some cases, the doors will close but the short length of the building leaves no room for walking around the car to the side door. Easing into such a restricted space without knocking out the rear wall of the building is an added inconvenience, especially when the car is used every day.

There are several ways of stretching an old garage so that new car will fit in it with room to spare. The method used will depend on the construction of the building, the type of doors used, and the amount of room needed. If, for example, the doors swing outward and it happens that the car bumper extends only 3 or 4 in., building out the door jambs, as in Fig. 1, will give the required space. To do this, the doors are removed and two 2 x 4s are spiked or bolted to the sides and across the top of the doorframe directly over the trim boards, as shown in the detail. This arrangement gives the maximum space. Provide a wide sheet-metal drip cap across the top to prevent leakage. Then paint all the new woodwork and rehang the doors. It may be necessary or desirable to build out the ramp



to close an open space under the doors. When an overhead door has been installed or where the doors are of the folding type that rolls on an overhead track along the inside of one wall, about the same amount of space can be gained at the rear wall of the building by using the methods shown in Figs. 2 and 4. Where still more room is required, the lean-to structure detailed in Fig. 3 is the most practical solution. This is built high enough to clear the car hood. Use of waterproof plywood sheathing and flooring simplifies and speeds up this job.

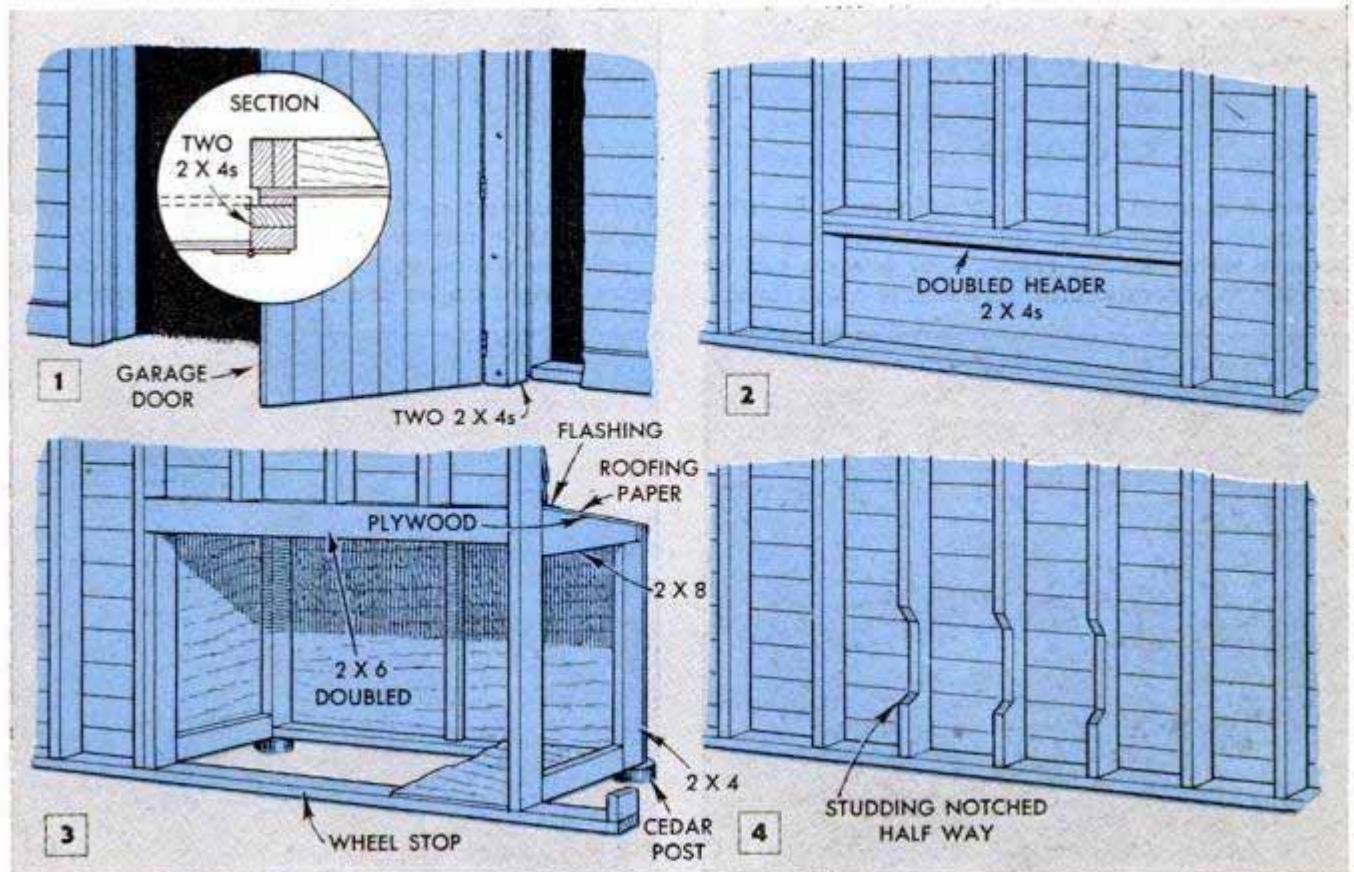



Electric-Fan

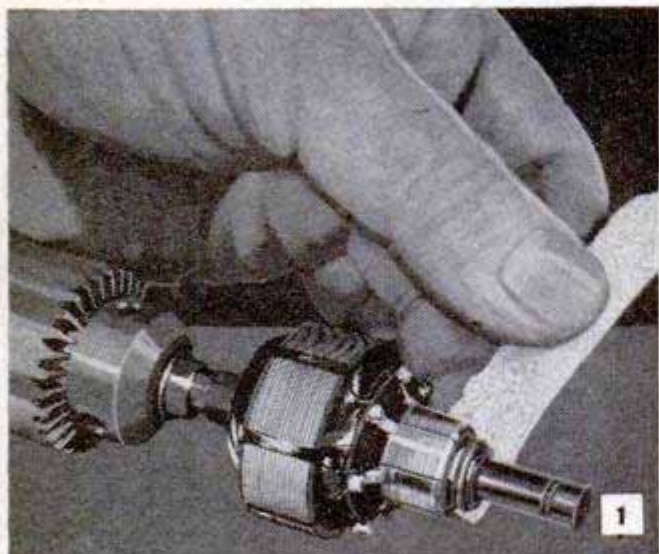

If the brush track on the commutator is badly carboned, it can be cleaned with ordinary fine sandpaper. Do not use any other abrasive for this work

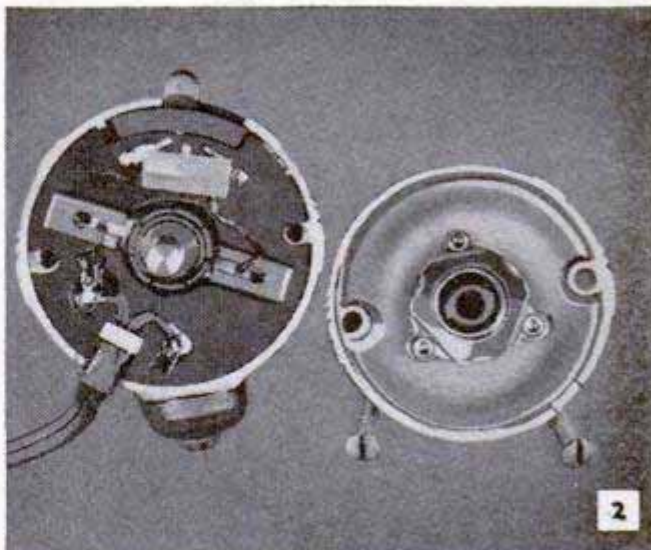

This is what you'll find inside a typical electric-fan motor when the end shield is removed. On some motors, wires are unsoldered to free the brush plate

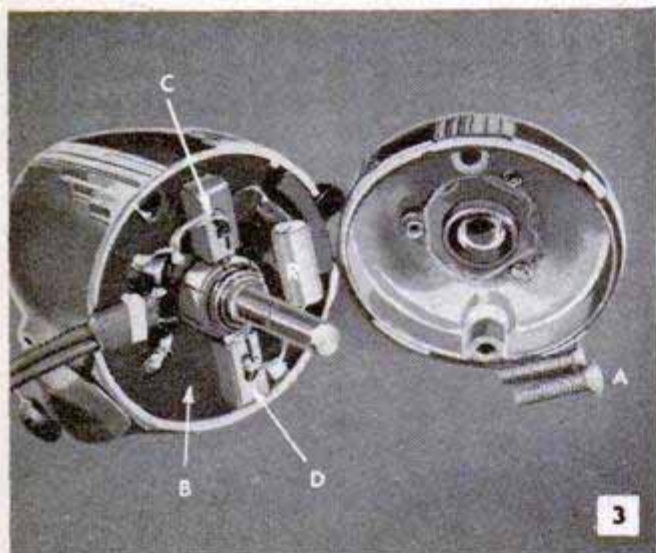

Above, a common cause of motor failure is jamming of the brush pigtails in the holders when brushes become worn. Below, replacement brushes can be made from generator brushes. Measure brush for size

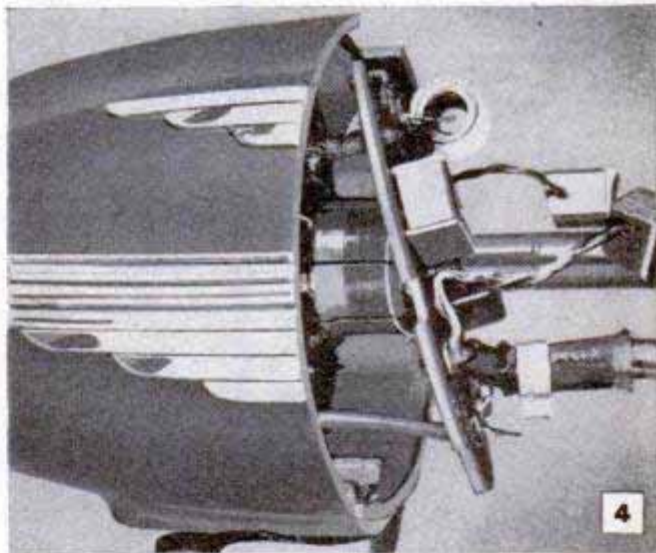

Above, in most small fan motors, the brush-holder plate must be removed to free the armature. Below, attach the pigtail to replacement brush by drilling holes at right angles and then anchoring with solder

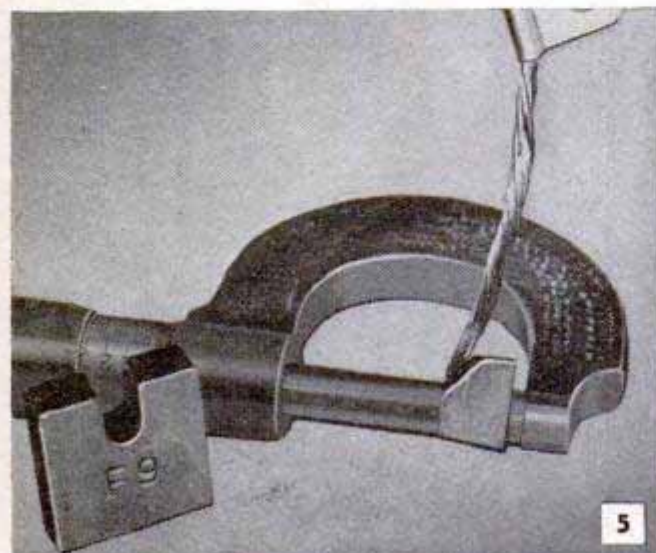

Trouble Shooting

By C. E. Packer

FAILURE of small electric-fan motors usually is due to four common causes—lubricant hardened or dried, bearings clogged with dust, brushes worn short and a loose connection. Any one of these can put the motor temporarily out of service. Most small fan motors can be dismantled quite easily by first removing the wire guard, the fan unit and the motor end shield. On some fan motors, it will be necessary to unsolder wire leads before the brush-holder plate can be removed. On others, this is not necessary. Fig. 2 shows a common arrangement of parts on the brush-holder plate. After removing the two screws, A in Fig. 3, work carefully in removing the end shield or damage may result. Removing the end shield generally exposes the brush-holder plate, B, the brush holders, C and D, and the resistance unit, R. Excessive wear of the brushes frequently causes the brush pigtails to jam in the holders, thus interfering with proper brush contact on the commutator. If the brushes are so badly worn that the pigtails jam or the follower springs no longer bear on the top ends, then they should be replaced. If new brushes are not readily available, replacements can be made from



common generator brushes. Make the old brush as in Fig. 5 to get the exact size. Then cut the generator brush to these dimensions and drill for the pigtail as in Fig. 6. Drill another hole at right angles through the first one and anchor the pigtail with solder. If the commutator brush track is badly carboned, it must be cleaned. Remove the holder plate, Fig. 4, and also the armature. Then mount the armature in a drill chuck, and clean and true the commutator with a piece of fine sandpaper as in Fig. 1. Clean the armature bearings with a solvent, such as kerosene, and apply new lubricant before reassembling the motor.

Micrometer Stop for Lathe Carriage Facilitates Precision Machining

When doing precision facing, depth boring and duplicate shouldering in the metal lathe, a micrometer carriage stop is essen-

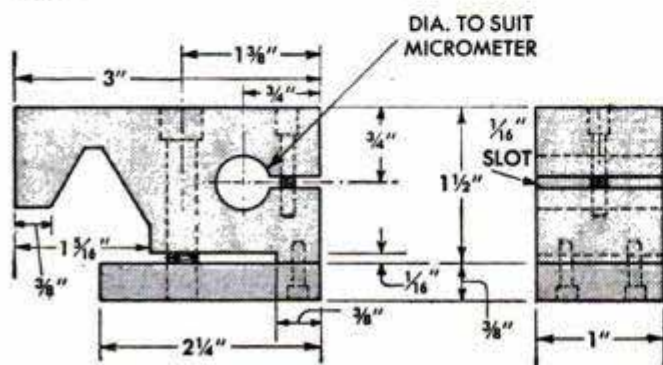
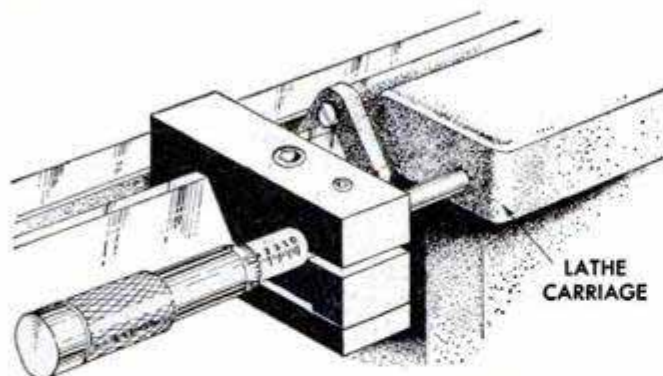

tial. It's easy to make one by using a micrometer-caliper head, a head with a ram travel of 0 to 1 in. being sufficiently large for average use. The mike head is supported in a clamp-type holder made from tool steel. One end of the holder is profiled to fit over the outer V-way of the lathe bed. It is held in place by a clamp lug which is drawn against the bottom of the V-way by a socket-headed binding screw inserted from the top through a counterbored clearance hole drilled in the holder body. The screw turns into a tapped hole in the lug. A 1/16-in. offset milled, or filed, across the bottom of the holder permits sufficient movement of the lug. Next, a hole is drilled transversely through the body of the holder to take the graduated barrel of the mike head. The holder body is then slotted through the center line of this hole and a socket-headed binding screw is provided for locking the mike in place. For a neat job, the body of the holder is finished over its entire surface and all screw-holes are counterbored.

Edward S. Barrows. Philadelphia, Pa.

Metal Stand Holds Pocket Watch In Convenient Position on Desk

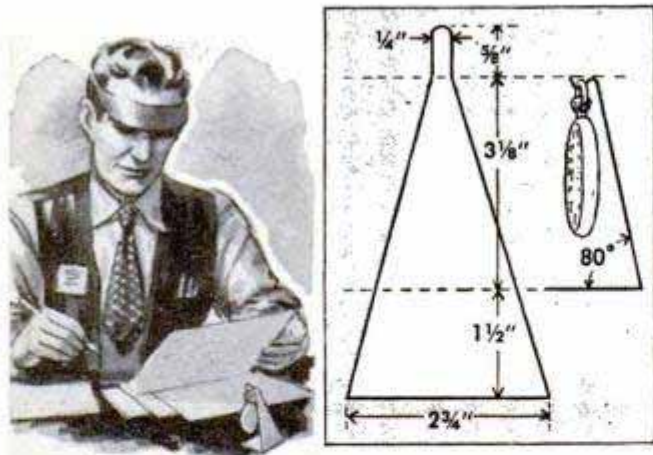

Particularly useful for transportation dispatchers, this little desk stand holds a pocket watch so that the time can be checked frequently without glancing up at a wall clock. The stand is made in a few minutes by cutting it from a tin can or sheet aluminum and bending as shown in the detail, forming a hook at the top.

Robert V. Dee, Chillicothe, Ohio.

Depth Stop for Lathe Chuck Adjusted While in Spindle

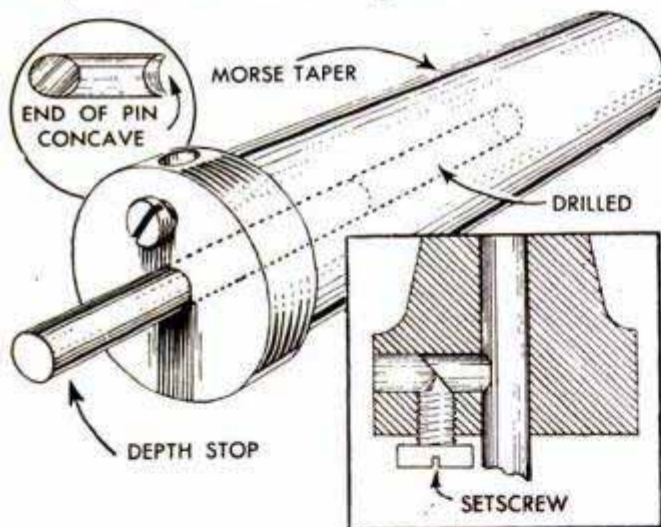

This depth stop for an engine lathe does not have to be removed from the spindle for adjustment. A setscrew on the face of the taper is loosened, the stop is pushed in or pulled out of the taper as required and the setscrew is tightened to clamp the stop in place. The stop itself is simply a length of rod which is a sliding fit in a hole drilled in a Morse taper. A pin inserted in a transverse hole drilled through the edge of the taper flange locks the stop. One end of the pin is ground concave to provide maximum gripping surface on the side of the rod, and the other end is ground at an angle of approximately 45 deg. A setscrew having a pointed tip enters from the face of the taper and exerts pressure on the angular end of

the pin. This, in turn, forces the concave end of the pin against the depth stop.

Borge Hansen, Copenhagen, Denmark.

Warning Flag Attached to Ladder With Rubber-Hose Sections

When carrying a ladder on a truck or trailer, a red warning flag can be quickly attached to the end rung of the ladder and just as easily removed if two rubber-hose sections are used to hold it in place. One or two turns of the flag are first wrapped around the rung, and then short hose sections, slit lengthwise, are forced over the flag and rung.

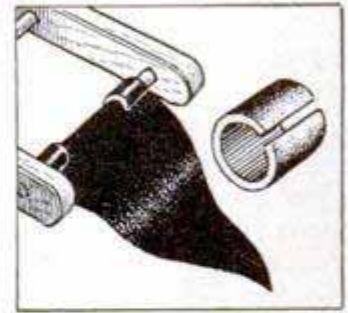

Screws Replace Fender Bolt

Where it is impractical to drill out and replace a broken fender bolt, a quick and efficient repair can be made by driving two sheet-metal screws through the fender and body, one on each side of the bolt as shown. These screws, which are self-tapping, should be driven about 1 or 1 1/2 in. from the broken bolt. Short, heavy screws are recommended for this job.—Ed Packer, Chicago.

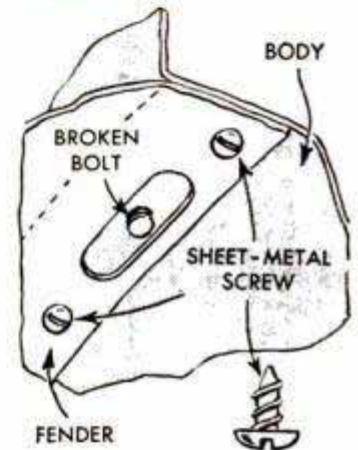

Poultry Held for Weighing By Trouser-Leg Funnel

One poultryman improvised an emergency weighing funnel from one leg of a discarded pair of trousers. He cut a section from the leg and fitted one end with a button and buttonhole to keep the fowl from slipping through. Then he made a hole in the other end for the scale hook. The fowl is held securely by the sides of the trouser leg and is released by unfastening the button.

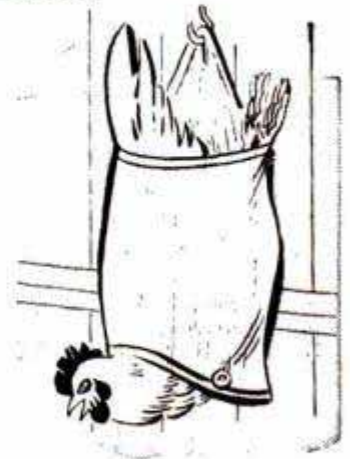

Newspapers Through the Air

FACSIMILE, the electronic newspaper that is delivered through the air by means of transmitted words and pictures on FM radio waves, prints these items on paper coming from receivers installed in your home or office. Although still in the experimental stage, this service may be available in your area soon.

Original, experimental facsimile transmissions were made just before the late war by broadcasting stations located in Chicago, Newark, N. J., Cincinnati, Ohio and other cities. New activity in this field is now evidenced by the equipment shown in photo A, which was recently installed by General Electric at the Miami Florida Herald. This facsimile-transmitter console is used for programming experiments which include broadcasting stock-market reports, news and other items of importance to business firms and executives. It is claimed that other newspapers and broadcasting stations in this country and Canada will soon install similar equipment.

Collaborating with General Electric in the design and production of facsimile equipment, Radio Inventions Inc., of New York City shows the table-model, display receiver-recorder combination illustrated in photo B. The home-console facsimile-receiver combination shown in photo C is made by General Electric.

The initial showing of the new Stewart-Warner "display" facsimile receiver, for use in

(Continued to page 226)

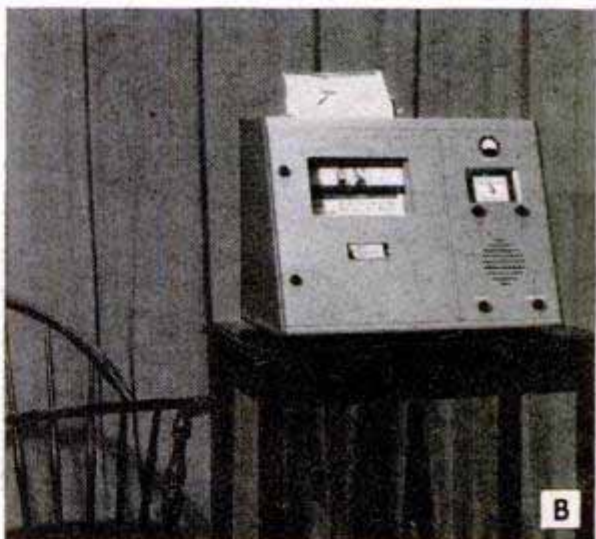

PERSONAL HEADPHONE RECEIVER

By S. A. Johnson

HERE IS an easy-to-build radio for that member of the family who frequently wants to listen to radio programs which are not particularly popular with the rest of the group. Since it uses headphones, it is completely "personal." Furthermore, it is built into a useful 60-watt homemade reading lamp in which a cookie jar does double duty in providing the lamp base and also the housing for the receiver.

Despite its simplicity, this compact set will pull in all of the "local" stations with only a short length of wire tossed on the floor to serve as an antenna. With a good outside antenna, this highly efficient little "one-tuber" really brings in distant stations with surprising volume and clarity. The cookie jar and lamp shade cost one dollar each at a "ten-to-a-dollar" store. These two units, plus a short length of hollow curtain rod, or piece of brass tubing, and a

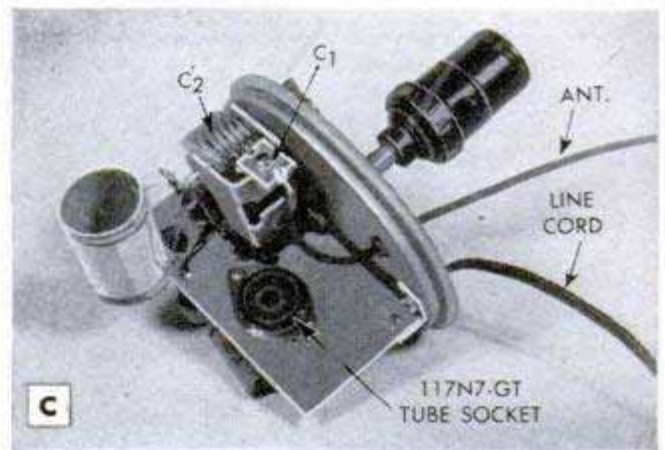
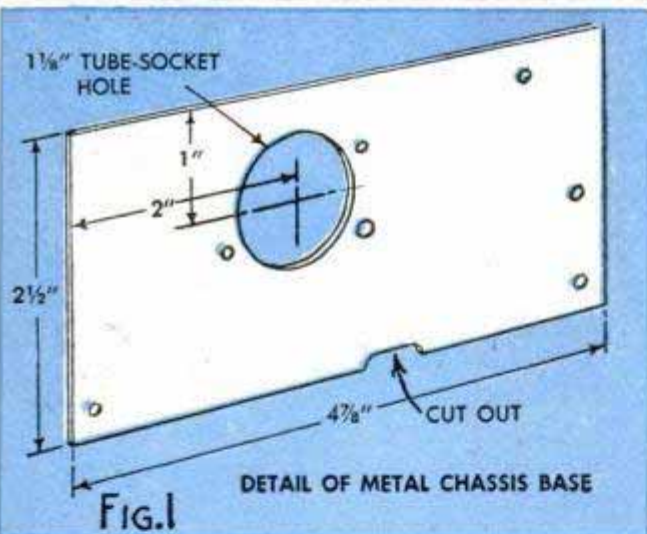
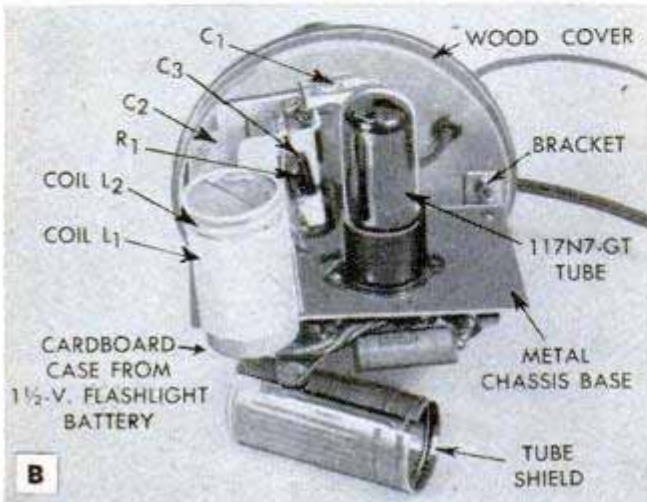
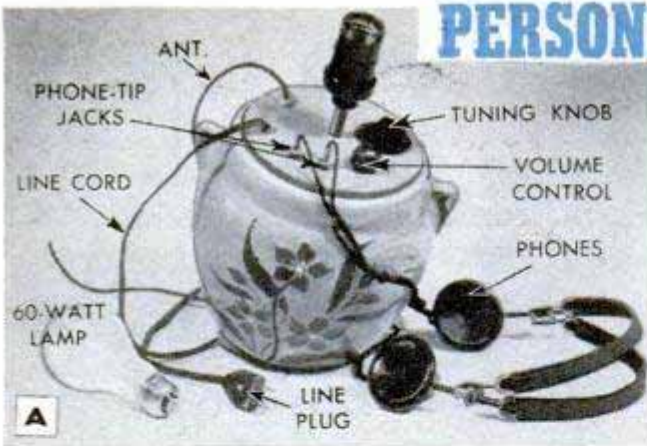

RESISTORS

- R1 2-megohm, 1/2-watt carbon
- R2 0-10,000-ohm, audio-taper volume control with s.p.s.t. switch
- R3 4,000-ohm, 1-watt carbon
- R4 25,000-ohm, 1-watt carbon

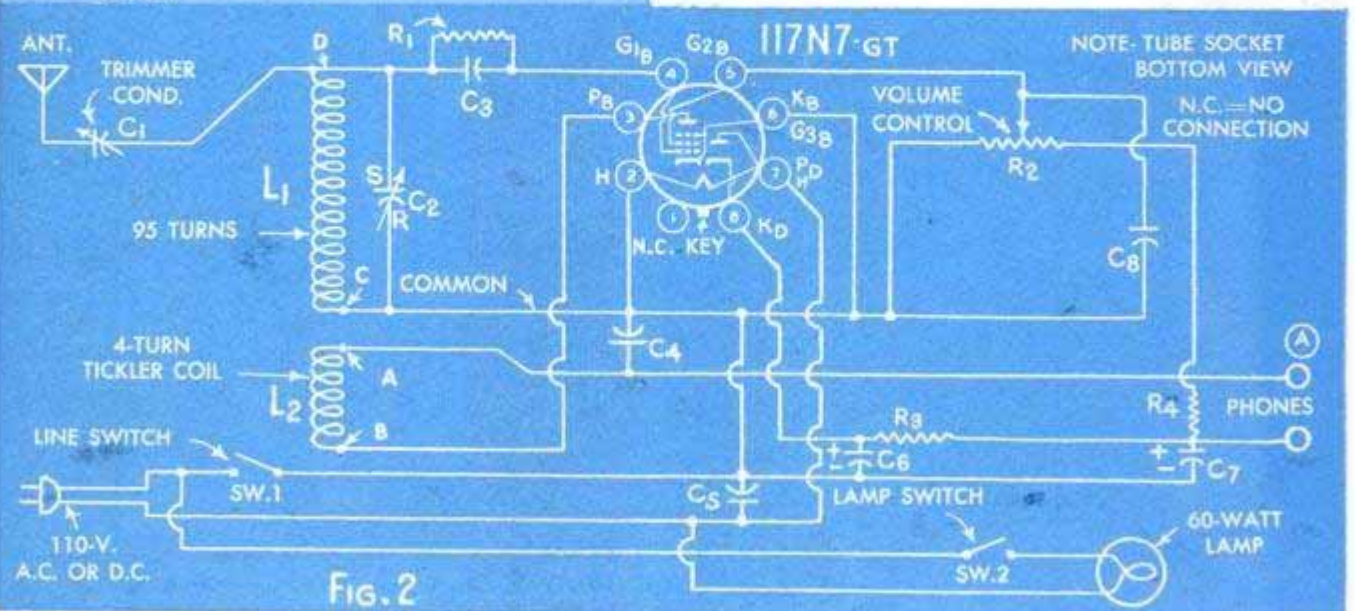

AND READING LAMP

standard socket with a built-in switch, are all the parts needed for the lamp with the exception of a wooden top. The brass tubing supporting the socket is force-fitted in a hole in the lid. This lid was made up of two layers of $\frac{1}{4}$ -in. plywood cut to form a snug-fitting lid for the jar. All of the component parts for the receiver are assembled on the underside of this lid. The jar used in the model is $6\frac{1}{4}$ in. deep, and the top opening is $5\frac{1}{4}$ in. in diameter.

The simple metal chassis base is detailed in Fig. 1; this is mounted on the underside of the wooden lid by means of two, $\frac{1}{2}$ x $\frac{1}{2}$ -in. angle brackets, as will be noted in photos B, C and F. Use plastic-top screws for mounting this metal chassis (or countersink the screwheads and plug the holes with wood putty) to prevent possible shock. The coil is hand-wound on a cardboard case removed from an old standard-size flashlight battery cell. This coil consists of two windings wound clockwise as detailed in Fig. 3, and is mounted on the rear of the metal chassis in an upright position by means of a small angle bracket. The schematic circuit diagram is given in Fig. 2; a pictorial wiring diagram showing all

(Continued to page 226)

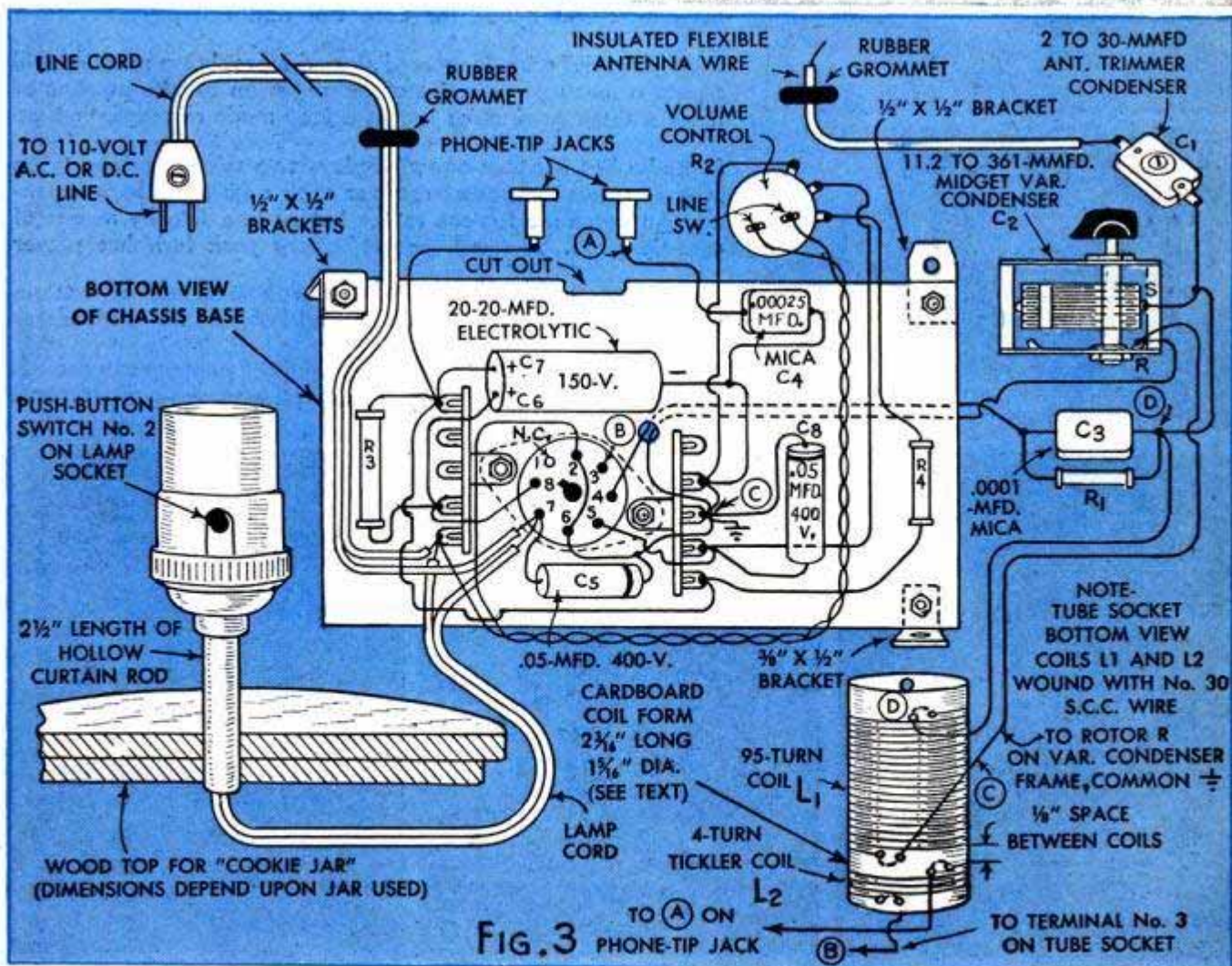
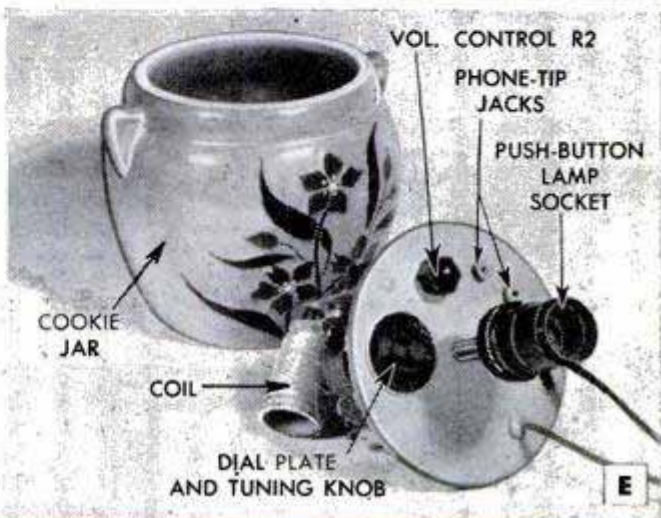

FIG. 3

Radio and Electronic Hints for Today



A



B



C

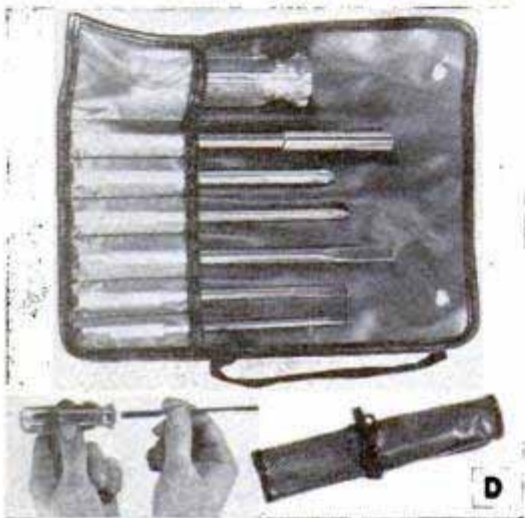

D



E

A—Console-model toy record player employs two-tube amplifier and a 5-in. permanent-magnet speaker which is protected by a multiweave metal grille. Plays regular 10 and 12-in. records

B—Hearing-aid B-battery is made up of small plastic cells which interlock to make all internal electrical connections

C—Tiny microphone weighing less than ¼ ounce is small enough to be carried in a walnut shell as indicated in the photo. It has a miniature diaphragm no larger than the human eardrum

D—Screwdriver kit includes a handle and five different interchangeable shanks, thus enabling the user to service most of his screwdriver needs for both slot and Phillips-type screws

E—"Electronic" narrator recording and reproducing machine will repeat a message or series of messages an infinite number of times without rewinding; it uses a loop made of magnetic tape

F—Radio hat for teen-agers employs two miniature-type tubes in a complete broadcast receiver with adjustable loop antenna. An earphone fastens to the hat on one side by means of cord-tip jacks. A small, pocket-battery-pack furnishes power

G—Phono-radio combination housed in kitchen cabinet. Shelves were removed in the end section and hole cut for loudspeaker

H—All the four present sizes and speeds of phonograph records can be played automatically in this phonograph-radio console



F

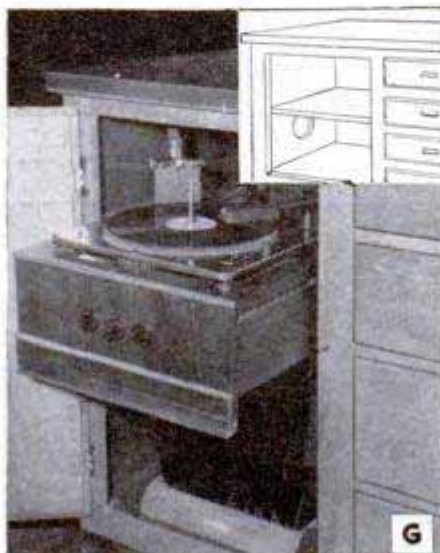

G



H

Meet the NEW Kodak Duaflex Camera with Kodak f/8 Lens



Here's the De Luxe Model of the popular Kodak Duaflex Camera. Lens sets in a jiffy to $f/8$, $f/11$, or $f/16$. You don't have to wait for the sun to shine before taking pictures. Open the lens wide to $f/8$...turn the focusing lens mount to correct distance setting...look through the brilliant reflex finder, and shoot. The two other settings "get the picture" in varying degrees of daylight. Lens can be focused from $3\frac{1}{2}$ feet to infinity.

Automatic Shutter-Lock prevents double exposures. Ingenious new control

"remembers" for you—makes sure you can't spoil a good picture by tripping the shutter twice on the same negative. After each shot, the shutter-release locks until you advance film. You get 12 negatives, $2\frac{1}{4} \times 2\frac{1}{4}$, on black-and-white Kodak 620 Film, or 9 full-color pictures on Kodacolor Film.

Prices include Federal Tax
(Prices subject to change without notice)

\$19.85
including
neck strap and
lens shield

See it at your Kodak dealer's. Also ask to see the Kodak Duaflex Camera with Kodak lens...everything's adjusted at the factory; all you have to do is aim and press the trigger. \$13.50.

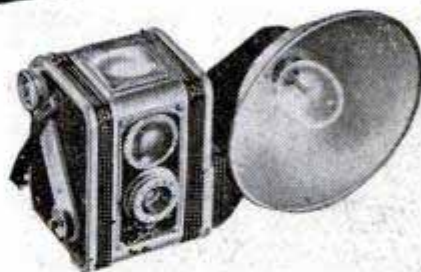

Flashholder for both
Duaflex models—\$3.33

EASTMAN KODAK COMPANY, ROCHESTER 4, N. Y.

"Kodak" is a trade-mark

Kodak

Flavor Packed!

There is no name more famous for flavor than Beech-Nut...



There is no chewing gum more dependable for fine flavor and uniform high quality than...

Beech-Nut GUM

It's "Always Refreshing"

Beech-Nut **BEECHIES**, the Candy Coated Chewing Gum in three varieties:

PEPPERMINT, PEPSIN and SPEARMINT

Newspapers Through the Air

(Continued from page 221)

banks, department stores, hotel lobbies and other public places, was made in the equipment exhibition at the recent convention of the National Association of Broadcasters. This large, upright instrument is illustrated in photo D. It is claimed to include all of the features required for programming news features and advertising. The unit is to be sold or leased by the facsimile-transmitting station or publisher. Receiving sound and facsimile programs simultaneously, it provides completely unattended service, and all components are housed in a tamperproof cabinet. It will operate approximately three weeks (with four 15-minute 4-page "editions" every day) on one "loading" of facsimile paper. Actual facsimile "printing" starts whenever an edition transmittal begins, and stops when a broadcast is terminated by the station.

Personal Headphone Receiver

(Continued from page 223)

circuit connections appears in Fig. 3. The midget, variable-tuning condenser C2 is mounted directly on the underside of the wooden lid just above the metal chassis base by means of a countersunk, flat-head, 6-32 machine screw. A hex nut is used as a spacing bushing. The dial plate on top of the lid is a 0-1 midget type, and a pointer-knob is used. The volume control R2 (actually a regeneration control) is also mounted directly on the underside of the wooden lid.

A single, 117N7-GT tube is used in the a.c.-d.c.-type circuit; this dual-purpose tube was chosen because it combines a rectifier section, which supplies the required B-voltage, and a pentode section which acts as a regenerative detector.

When winding the coil, leave sufficient wire at the beginning and end of each winding for making the circuit connections. Anchor the start and finish ends in holes punched as indicated in the sketch. Both coils are close-wound with No. 30, single-cotton-covered magnet wire, and they are spaced $\frac{1}{8}$ in. apart.

When mounting the coil on the chassis base, make sure that it will clear the jar when the set is installed. To test the set, first recheck the wiring, then insert the tube in its socket and assemble the set. Now plug in the line cord and a pair of 2000-ohm headphones; turn the volume control so that the switch snaps to the "on" position. Advance the volume control

(Continued to page 228)

What's **NEW**
in Batteries?

AUTO-LITE **Sta-ful** BATTERY...needs water only 3 times a year*

A revolutionary new development, the Auto-Lite "Sta-ful" Battery, protects you against a major cause of battery failure . . . damage to plates due to liquid loss. This new "Sta-ful" Battery design permits a liquid reservoir with 3 times the capacity of ordinary batteries . . . keeps plates fully covered and active months longer in normal car use.

In addition, "Sta-ful" has extra plates for greater electrical capacity . . . Fibre-glass mats to hold the power-producing material in those plates for longer battery life. To get more for your battery dollars, replace with an Auto-Lite "Sta-ful". Money cannot buy a better battery.

AUTO-LITE BATTERY CORPORATION
Toledo 1 Ohio

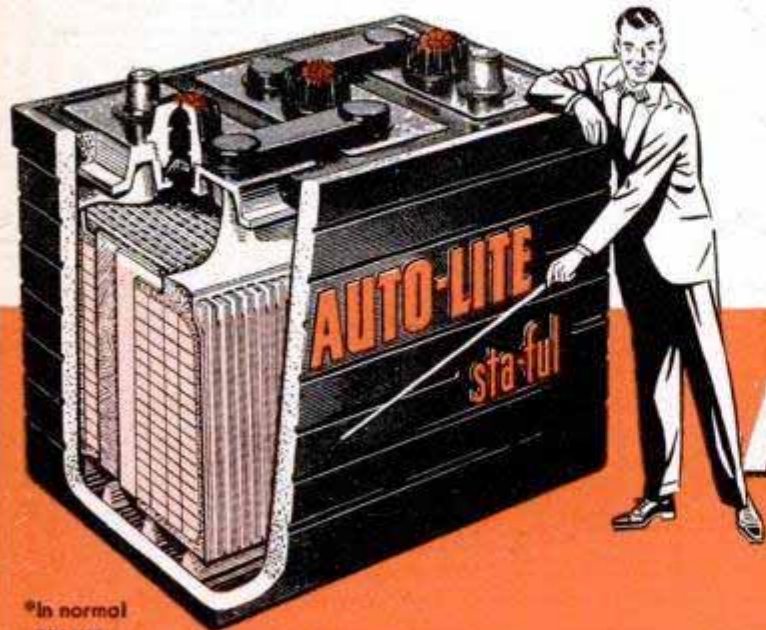

*In normal car use

Because of a unique construction, the new Auto-Lite "Sta-ful" Battery holds more than 3 times the liquid reserve of ordinary batteries.

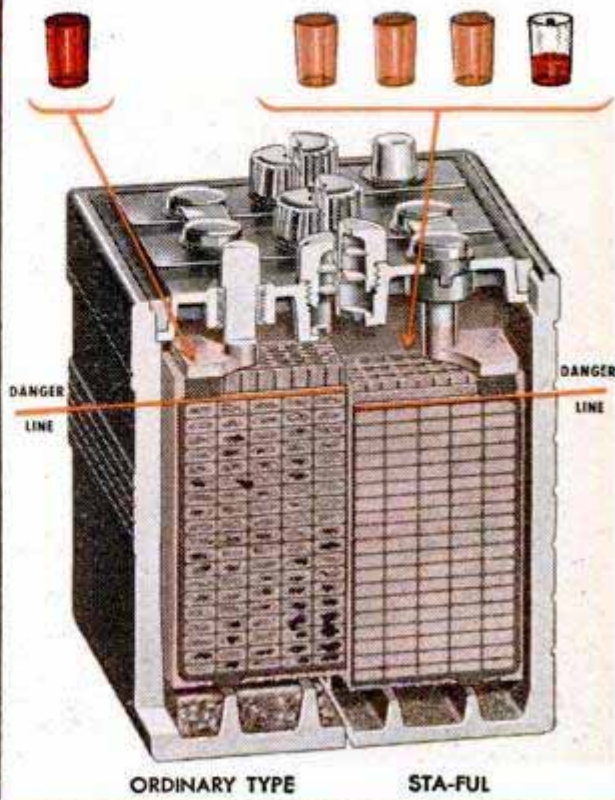

Note how the protective Fibre-glass mat retains the power-producing material in the positive plate while ordinary battery plates shed the active material until it fills the sediment well.

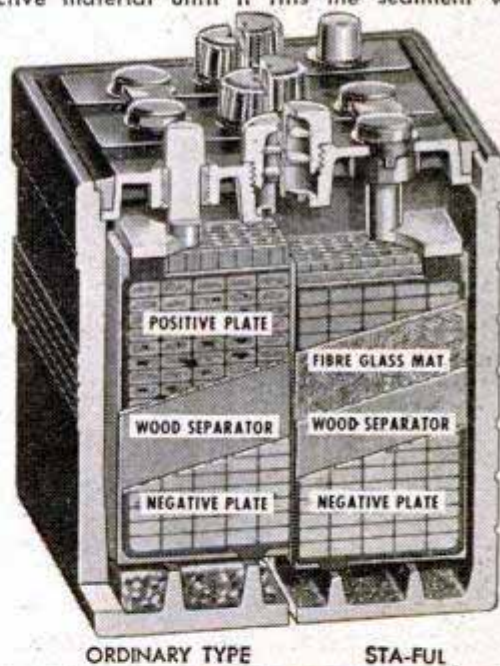

AUTO-LITE Sta-ful BATTERIES

EXTRA COMFORT

EXTRA WEAR

2-PLY GLOVES



Riegel's 50-50

2-ply palm, thumb and index finger.

Knit wrist or gauntlet

Twin plies of soft but sturdy fabric make Riegel's 50-50 Work Gloves a big value in comfort, safety and long wear.

OTHER STYLES FOR EVERY NEED

Canvas, jersey, leather . . . knit wrist, band top, gauntlet . . . double palm, reversible, quilted. Ask for the Riegel brand wherever work gloves are sold. Free catalog if requested on business letterhead.

Riegel Textile Corp.
342 Madison Avenue
New York 17, N. Y.



THIS TRADE MARK IS YOUR GUARANTEE OF VALUE

slowly and tune in a station with the tuning condenser. The presence of a station will be indicated by hearing a whistle in the headphones. Now back off the volume control until the program becomes clear. Finally, tip up the lid carefully and adjust the antenna trimmer condenser C1 with a small screwdriver for maximum volume. This does not have to be done again unless you change the length of your antenna.

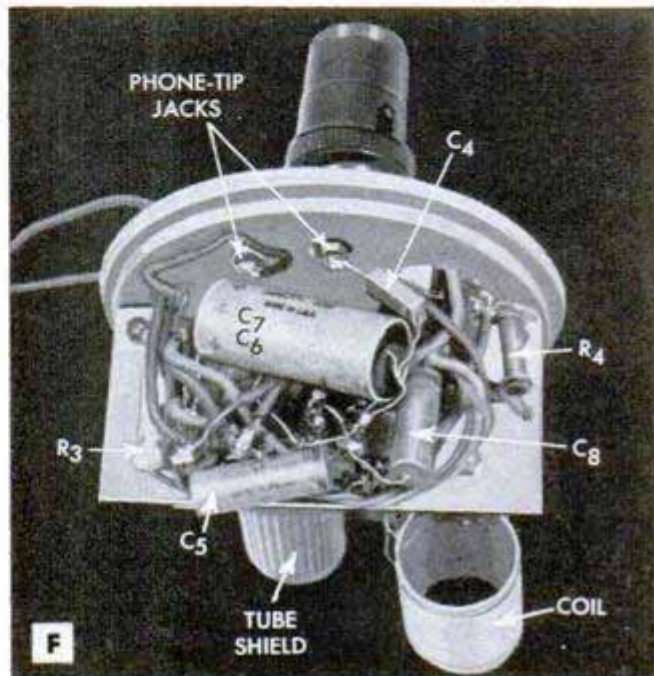

Since tubes differ slightly, in extreme cases it may be necessary to add a turn or two to tickler coil L2 to make the set "oscillate." However, before doing this, try reversing the A and B leads on the tickler coil, Fig. 3. Detailed student material list R-379 is available from Popular Mechanics Radio and Electronics department without charge upon receipt of ordinary letter postage.

Handbook for Uranium Prospectors

A pocket-size handbook entitled "Prospecting for Uranium" has been published jointly by the U. S. Atomic Energy Commission and the U. S. Geological Survey. This 123-page handbook is designed to answer 5000 inquiries which have been received by government agencies as a result of the Atomic Energy Commission's domestic uranium program announced in 1948. Under the program, the AEC established guaranteed minimum prices for various types and grades of uranium ore, and offered a \$10,000 bonus for the discovery of a high-grade deposit and the production of 20 short tons of ore or concentrates. The handbook is available from the Superintendent of Documents, U. S. Government Printing Office, Washington, D. C., for 30 cents. An article on the progress of the AEC program, and a detailed construction article on how to build a Geiger-Mueller uranium survey meter, appeared in the February 1949 issue of Popular Mechanics Magazine

*Piston Rings
need
replacing, too!*

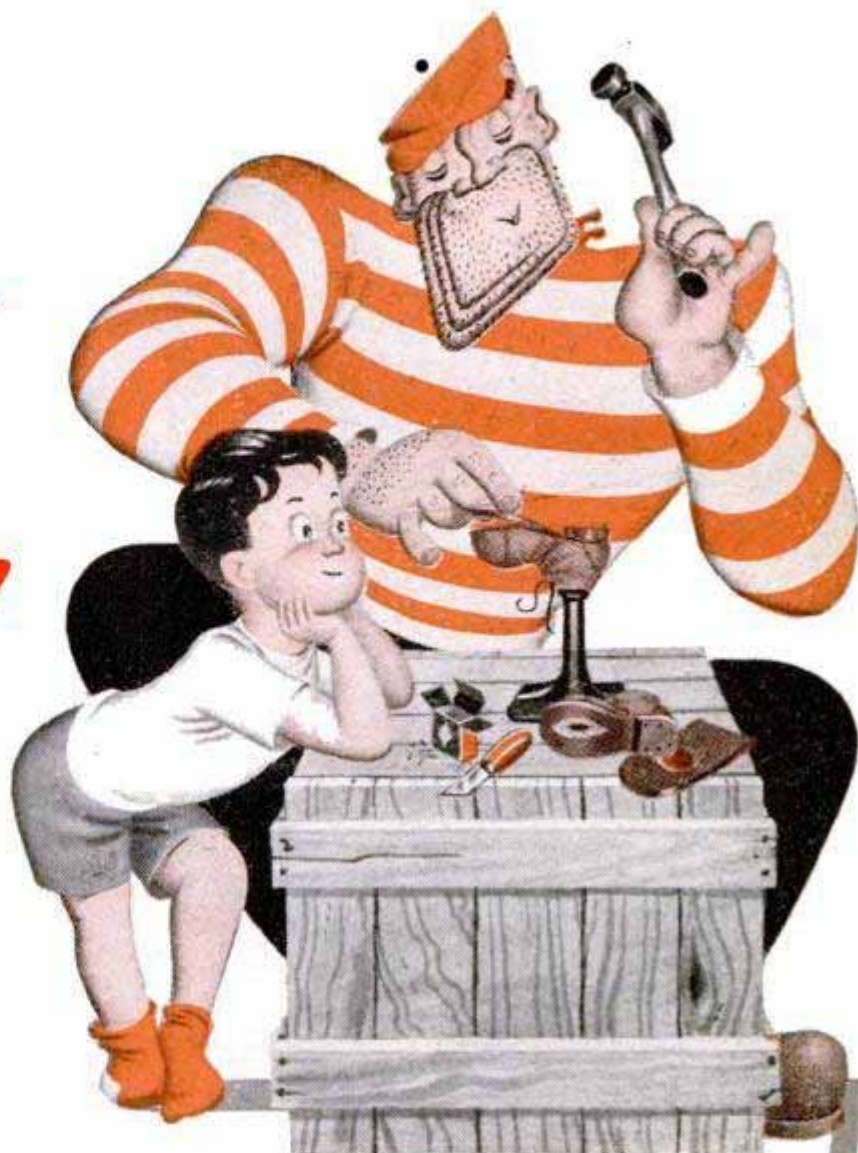

WHEN OIL-PUMPING flashes its warning that your piston rings are worn out, don't delay. The sooner you replace worn-out piston rings the longer your engine will last.

Fortunately, rings are *easily replaced*. And when you replace

with Hastings piston rings, you *stop* oil-pumping, *check* cylinder wear and *restore* performance. It's the best money you can spend on your car.

HASTINGS MANUFACTURING COMPANY
HASTINGS, MICHIGAN
Hastings Ltd., Toronto

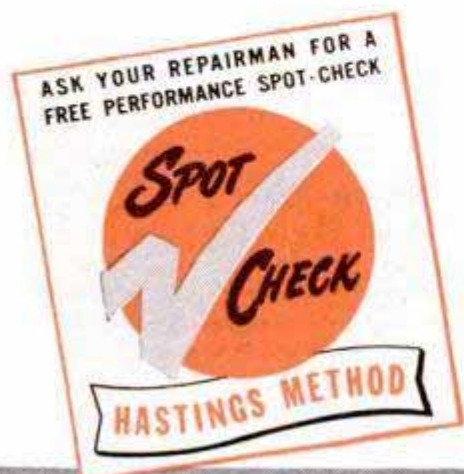

HASTINGS
Steel-Vent Piston Rings

"TOUGH... BUT OH SO GENTLE"

TOUGH on oil-pumping — GENTLE on cylinder walls

"I'll take the **WHITE** one every time!"



WYTEFACE Steel Tapes, with their jet black markings on a white background, are easier to read in any light. They are rust-resisting, hard to kink and easy to clean.

Protected by U. S. Patent 2,089,209

WYTEFACE

TRADE MARK

STEEL TAPES

KEUFFEL & ESSER CO.

PROFITS AND SPEED

**THE MODERN
LAWN MOWER
SHARPENER**

PRICE
\$241⁵⁰
LESS
MOTOR

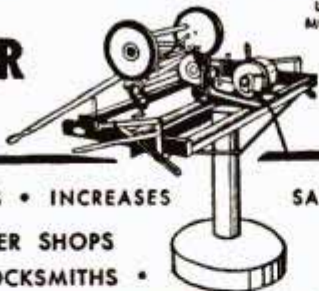

INCREASES PROFITS • INCREASES SALES!
FOR LAWN MOWER SHOPS
FIXIT SHOPS • LOCKSMITHS •
HARDWARE STORES • GOLF COURSES • SCHOOLS
PARKS • PLAYGROUNDS • INSTITUTIONS •
CEMETERIES • AND ALERT INDIVIDUALS!

Sharpens All Reel Type Mowers • Hand, Power or Gang • 10 to 20 Minutes • No Dismantling • No Extra Attachments Needed

All reel type mowers, from 5-inch edgers to 36-inch power mowers, are quickly sharpened to extreme ends of both left and right twist reel blades. Handle, wheels, roller and motor remain in place when sharpening is in process. Bed knife is sharpened in same brackets that hold mower in grinding position. No extra attachments required. One lever puts mower or bed knife in grinding position. 100% steel construction. Grinding head rides on five ball bearing races. Small, compact, easy to operate. Sharpens wood chisels, joiner knives and planer blades without extra attachments.

ORDER NOW

Immediate Delivery

Skate Sharpener Attachment Available

Send For Free Bulletin No. 10B

MODERN MFG. CO. 160 N. FAIR OAKS AVE. PASADENA, CALIFORNIA

Golden Harvest Feeds the World

(Continued from page 95)

is kneaded into bread dough or into biscuits and cakes and it goes into the oven. It must produce a good breadstuff of fine texture and good taste, among other qualities, before it is ready for release.

Up in the Northwest there is one good soft wheat that might be grown on millions of acres except for one objectionable characteristic. Ideal in almost all other respects, its chaff works into the skins of the harvest crews and produces an extremely irritating itch. The harvesters don't like to handle it and the result is that not much of it is grown. When the plant breeders eliminate this one objection, they will have a good, popular variety.

It takes moisture to get a crop and the Great Plains in particular have been enjoying several years of above-average rainfall. When the weather cycle swings around to the dry side again, it may be that the Dust Bowl troubles of 15 years ago will return, but some soil-conservation experts think not. They point out that most grain growers have learned the value of stubble-mulch farming in which straw and stubble are broken up and left on the surface to keep the soil from blowing and washing away and at the same time to reduce rain runoff and evaporation. Strip-cropping is also widely practiced. Legume crops are grown between strips of wheat lined up across the direction of the prevailing wind and summer fallow has come into its own. That is, when a farmer decides that the ground holds too little moisture to produce a good crop he lets the land lie fallow for a year, storing up two years' moisture to produce one good crop instead of taking a chance of losing two crops in a row. All these practices conserve the soil and if they work as well as expected the dust storms of the early '30s will never return.

The world is always hungry for wheat and it is such a precious commodity that it figures in many political treaties and international contracts. As much as they can, American farmers are doing their part to provide bread for the world.

Corncocks Form Abrasive In Mechanics' Hand Soap

Waste agricultural products, such as corncocks and nutshells, can be used instead of corn meal in abrasive hand soaps. The current world food shortages led Department of Agriculture chemists to substituting waste products for corn meal in the mixture. The cobs are ground and sieved before being mixed with the soap.

NOW! Special 30-Day Offer on these 2 CRAFTSMAN SUPER-BARGAINS!



CRAFTSMAN 1/4-in. ELECTRIC DRILL Handy! Precision-built! Low Priced!

Look at these superior features!



Comfortable saw-grip handle.



Built-in non-locking trigger switch.



1/4-in. chuck holds bits true and tight.



Powerful; drives 1/4-in. bits into steel!



Precision-cut triple reduction gears.



Formex insulated; resists burn-outs.

1/4-in. ELECTRIC DRILL
SEARS REGULAR PRICE ~~\$14.50~~
Special 30-Day Offer
NOW ONLY \$12.50

CRAFTSMAN 10-pc. high speed steel drill set for CRAFTSMAN 1/4-in. Electric Drill. For use in wood or metal. 1/16 to 1/4-in. sizes in handy drill stand. Price now only **\$3.50**



CRAFTSMAN fine quality, light-duty electric drill . . . NOW at an amazing saving during this special 30-day offer! Strong, compact! Ideal for light, intermittent use in home or workshop. Powerful 110-120-volt, 25-60 cycle, A.C. or D.C. universal motor; sturdy die-cast aluminum frame, balanced for fast, easy, accurate drilling! No-load chuck speed, 1500 R.P.M. 1/4-in. capacity Jacobs "Handtite" chuck; finest bronze bearings. 12-in. long. 6-ft. rubber-covered cord, unbreakable plug. Underwriters' Labs. approved.

CRAFTSMAN DISC SANDER-POLISHER Does the job 10 times faster than by hand!



A real work saver polishing cars, removing rust, etc.



Resurfaces and polishes furniture, woodwork, floors.



Sands irregular surfaces. Works in any position.

A sensational work saver . . . NOW bargain-priced! Ideal for polishing, sanding, buffing . . . for autos, boats, furniture, floors, wood or metal. Easy to use! Light (only 6 lbs.), yet sturdily built! Heavy duty 110-120-volt, 25-60 cycle, A.C. or D.C., G.E. universal motor; Formex-insulated. Non-locking trigger switch; precision ball bearings; helical spur gears. No-load speed, 1600 R.P.M. 10-ft., 3-wire rubber-covered cord, unbreakable plug. 7-in. high. Underwriters' Labs. approved. With 6-in. flexible rubber sanding disc, 7-in. lamb's wool buff, 6 assorted sanding discs and wrench, in steel case.

Take advantage of these special 30-day offers NOW! Get these 2 CRAFTSMAN super-values at your nearest SEARS Retail Store TODAY!

Sears Easy Terms make it easy to pay for the CRAFTSMAN tools you need . . . while you use them. (This special 30-day offer is good only at Sears Retail Stores in the United States.)



Outfit complete with steel carrying case.

SANDER-POLISHER OUTFIT

SEARS REGULAR PRICE ~~\$39.50~~

Special 30-Day Offer

NOW \$35.95 Cash

ONLY \$4.00 DOWN

On Easy Terms



Adaptor makes Sander-Polisher even more useful! Permits using a chuck, for drilling; grinding wheels, etc. . . . **49c**

CRAFTSMAN Hand and Power Tools by SEARS, ROEBUCK AND CO.
Famous for fine quality . . . precision performance . . . low price!

PROTECT SCREEN DOORS

... beautify them too!

FITS-ALL Adjustable Screen Door Grille

This handsome grille dresses up your door and braces it, too! Strong and sturdy; silvery satin finish will not rust or tarnish. Completely adjustable for windows or doors. Comes complete with screws. Can be installed by anyone in minutes. Also makes perfect window guard.



**NO CUTTING OR FITTING
Easily Installed**

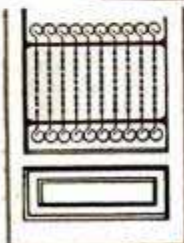

Nu-WAY Screen Door Grille

This equally sturdy, attractive style comes in black, flexible enamel finish. Adjustable to nearly all doors and windows. Makes perfect window guard, too! Furnished fully assembled, ready to install.

**MACKLANBURG-DUNCAN CO.
OKLAHOMA CITY 1, OKLA.**

**BUY AT YOUR LOCAL HARD-
WARE STORE, BUILDING SUPPLY
DEALER OR LUMBER YARD.**



Be Your Own Boss



There's a great feeling to being in something for yourself, where all the profits go into your own pocket. American floor sanders make it possible for you to realize this ambition without special schooling or a big investment. Begin small and work up to as large an enterprise as you desire... It all depends on your ambition to get ahead.

Ask for "tell-all" booklet entitled "Opportunities in Floor Surfacing". Use coupon and enclose 25 cents in coin or stamps to cover handling.

AMERICAN FLOOR SURFACING MACHINE CO.

535 So. St. Clair St. • Toledo 3, Ohio
Gentlemen:

Enclosed find 25c in stamps or coin for booklet "Opportunities in Floor Surfacing," telling me how I can start my own floor sanding business.

Name _____

Street _____

City _____ State _____



Clinic



for Homemakers

As a service to our readers in solving the hundreds of problems pertaining to a home—inside or out—the editors of *Popular Mechanics* invite you to present your problems to The Clinic Editor for help and advice. Address your questions to The Clinic Editor, *Popular Mechanics Magazine*, 200 East Ontario Street, Chicago 11, Ill.

Watering Lawn

Q—What is the correct way to water a lawn—how does one tell when to water, how much water to apply, etc?

M.W.—Madison, Wis.

A—A well-established lawn does not need watering except during prolonged dry weather and then only at fairly long intervals. When the lawn is watered it should be given a thorough soaking. Sprinkling is not approved, especially during a dry season. Light sprinkling may actually do more harm than good at such a time. One practical way of watering is to remove the nozzle from the hose and lay a board about 2 ft. long under the open end of the hose to spread the stream. Then turn the water on at about half pressure and let it run until an area of 20 to 30 sq. ft. is thoroughly soaked, that is, until water stands on the surface. Then move the hose a few feet and repeat the process in the same way until the whole lawn has been gone over. This procedure takes a lot of water but it is the only practical way of assuring a thorough job. Some homeowners prefer to use a canvas waterer. The device consists of a canvas tube about twice the diameter of the hose and 6 to 10 ft. long. It is closed at one end, the other end being fitted with a coupling for attaching to the hose. When the water is turned on, it fills the canvas tube and seeps slowly through the fabric.

Finishing Knotty Pine

Q—How can I finish knotty pine in the natural color? The boards are in random widths with one beaded edge. Some of the knots are light-colored and many are checked or cracked. I would like to have knots all of a fairly uniform dark color.
G.M.—Spokane, Wash.



A—The first step is to sand the wood smooth, paying special attention to areas about the knots where the angle of the grain may have been the cause of slight chipping at the time the boards were planed. After the first sanding, fill the cracks in the knots with stick shellac of a color to match the knots as closely as possible. Stick shellac can be melted and worked into the cracks with a clean, hot soldering iron. Allow the shellac to set, then sand again to smooth it flush with the surface. Darken light-colored knots with a penetrating stain (not oil stain) of a color approximating that of the darker knots. Apply the stain with a small, round brush. Sand the stained knots lightly to

(Continued to page 234)

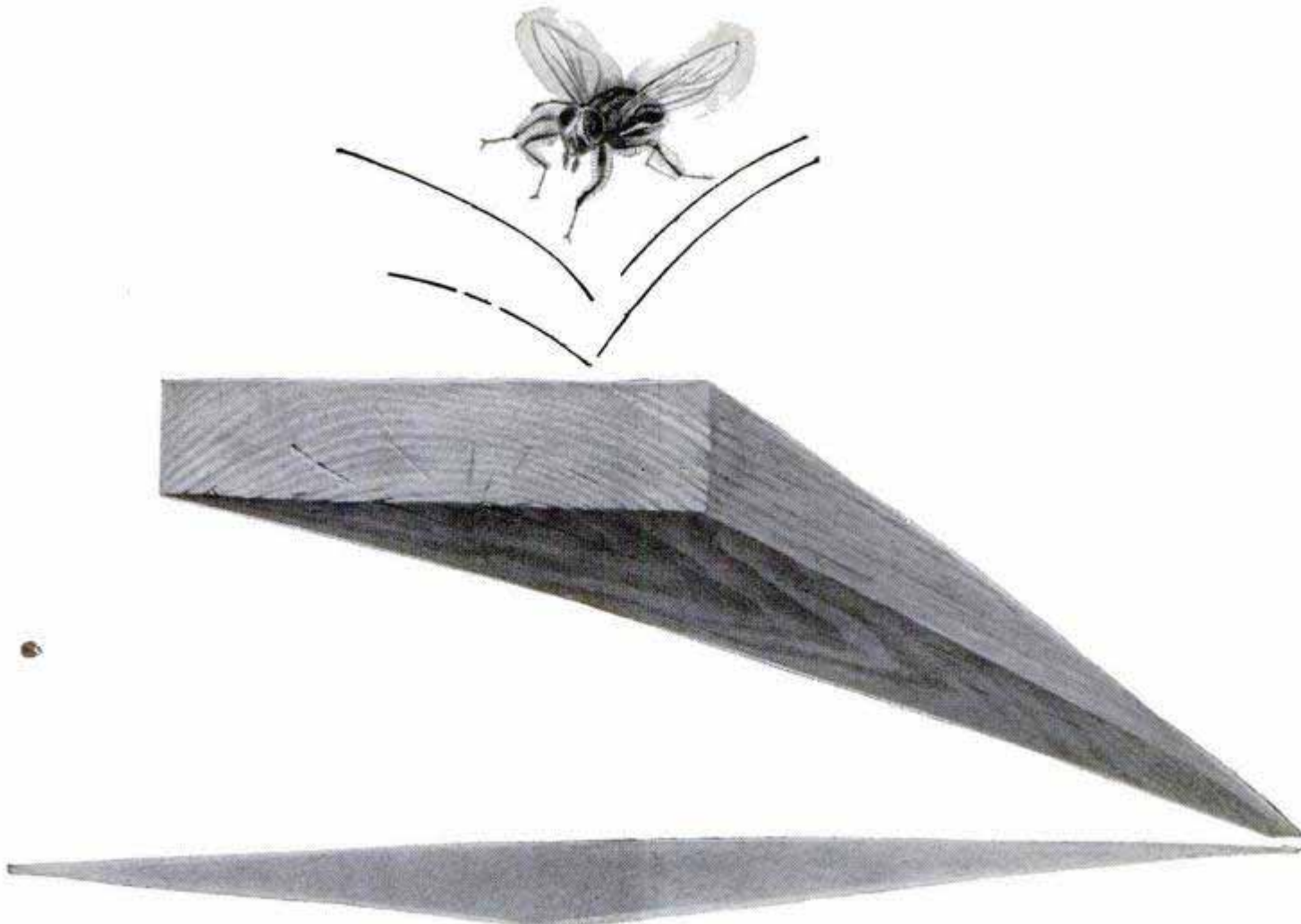

Supersensitive electron tube, developed by RCA, makes possible more accurate measurement of minute vibrations.

Can a housefly make a board bounce?

Surprising though it seems, a fly—when it lands on a board—causes distinct vibrations. They can actually be detected by a remarkable, and supersensitive, new RCA electron tube.

Slimmer than a cigarette, and only half as long, RCA's tube picks up vibrations with a pin-sized shaft—and these vibrations may then be converted to visible or audible signals. More important, the new RCA electron tube can be used to measure the degree of vibration.

Scientists predict many practical uses for this *electronic transducer*. Airplane designers can hitch it to engines or whirling propellers and locate vibrations which might lead to trouble. Oil men can use it to measure the sound waves from explosions with which they scout for oil.

And your smooth-running automobile of the future may be an even better car when the facts gathered by RCA's new tube are put to work.

Another RCA "first":

The electronic transducer, first of its kind, is one of many research achievements pioneered at RCA Laboratories. Such leadership in science and engineering adds *value beyond price* to any product or service of RCA and RCA Victor.

* * *

Examples of the newest developments in radio, television and electronics can be seen in action at RCA Exhibition Hall, 36 West 49th St., N. Y. Admission is free. Radio Corporation of America, Radio City, New York 20.



RADIO CORPORATION of AMERICA

World Leader in Radio — First in Television

MOTORISTS WISE SIMONIZ

U. S. PAT. OFF.

MAKES CARS STAY BEAUTIFUL

Better than 10
'Here-Today...
Gone-Tomorrow'
Polishings!



Simonizing saves you time as
it saves the finish!

Don't waste your time with 'temporary polishings'! Simonizing gives long lasting beauty... protects the finish and keeps colors from fading. Do as millions of motorists... Simoniz your car. It's easy to do yourself.

THE SIMONIZ COMPANY, CHICAGO 16, ILL.



Use Simoniz Kleener (liquid or paste) to clean finish.
Then Simoniz for lasting beauty. Sold everywhere!

restore natural appearance at the edges. After the stain is dry, reduce orange shellac about 30 percent with alcohol or prepared thinner and apply to the boards with a clean varnish brush. Two or more light coats may be necessary. Smooth the surface lightly between coats with fine steel wool. Orange shellac brings out the characteristic grain of the wood and darkens it only slightly. The finished wood will darken with age. After the shellac is thoroughly dry, apply paste wax and polish to whatever degree of gloss is desired.

Cleaning Tile Floor

Q—How can I clean a tiled bathroom floor to restore the original white? None of the tile seems to be loose, nor is the floor uneven, but some of the tile are discolored. No washing-powder solution I have tried will remove the embedded grime or the discolorations. C.G. — Rochester, N. Y.



A—It is doubtful if you can restore the original color of the tile, especially if the surface is pretty well worn. A strong solution of trisodium phosphate should remove the embedded grime and dirt in both the tile and the joints, but it probably would not affect the discoloration. A medium solution of oxalic acid would be more likely to bleach out the discolorations so that they at least would be less noticeable. We would not recommend a strong solution as it might damage the tile, particularly on the worn spots. If the acid solution is used, apply it to the floor with a cloth swab and immediately wash or mop the floor with clear water to remove all traces of the acid. (Caution: In a closed room, provide a fan or other means of ventilation to carry away fumes from the acid solution. Do not place your hands in the solution or handle any cloth or swab soaked in it. Wear rubber gloves.)

Home-Shop Layout

Q—I have only a small space in one corner of my basement for a workshop. I have planned to install several power tools—jointer, circular saw, bandsaw, drill press and lathe. How do I figure the minimum working space required around each machine in such limited floor space? B.A. —Akron, Ohio.



A—One simple method of arriving at a fairly accurate and convenient placement of small machines in limited space is to sketch a rough floor plan of the shop on a scale of $\frac{1}{2}$ in. equals 1 ft. Then determine the approximate floor space required for each machine and locate these areas on the floor plan in the position you want the machines. Sketch the locations as squares or rectangles and be sure to allow wall clearance for motors and other projections. Then from the approximate center of the work area of such machines as the bandsaw and drill press, strike a semicircular arc about the front of the machine on a 30-in. radius. On the plan, these arcs must clear other similar arcs around the working areas of machines nearby. In the case of a bandsaw, drill press and jointer, the 30-in. radius will give you a place to stand and also clearance to work anywhere along the length of a piece of stock 30 in. long. The lathe may require a little more working space than will be enclosed by the semicircle. The circular saw should have about the same space at the rear as is allowed at the front so that stock will clear when ripping. These measurements represent just about the minimum working-space requirements for small machines. A working radius of 36 to 48 in. will allow much more efficient use of the machines, of course.

MAKE THE WHOLE COUNTRY

Your Vacation Land!

HARLEY-DAVIDSON
WITH THE NEW
HYDRA-GLIDE FORK



See America the scenic, fun-packed way — on a Harley-Davidson Hydra-Glide Motorcycle. You'll enjoy a new kind of vacation — a thrill-packed tour with picturesque back-country roads, breath-taking mountain trails, hidden lakes and quaint towns ever beckoning to new adventures and good times. You'll ride smoothly and comfortably, too — float along like a breeze! Even on longest trips, you'll hardly know you've been traveling — you're fresh as a daisy and ready for more fun! One ride will convince you. See your dealer. Mail coupon today.



HARLEY-DAVIDSON MOTOR CO.
Dept. P, Milwaukee 1, Wisconsin

Send free copy of ENTHUSIAST Magazine filled with motorcycle action pictures and stories; also literature on latest models.

Name.....

Street or R.F.D.....

City.....Zone..... State.....

EVINRUDES with Fisherman Drive

The *only* motors that let you go *anywhere* ...over snags, rocks, shoals, thru thick weeds ANYWHERE there's water to float your boat!



SPORTSMAN—The only light "Single" with FISHERMAN DRIVE. Top choice for small fishing craft, canoes, auto-top and rental boats. Simplex starter, Co-Pilot, Full Pivot Reverse. 1.5 O.B.C. certified brake H.P. at 4000 R.P.M.

SPORTWIN —

The only alternate firing "Twin" with FISHERMAN DRIVE... the only motor with fuel gauge. Years ahead in engineering and advanced features. Full Pivot Reverse . . . 3.3 O.B.C. certified brake H.P. at 4000 R.P.M.



ZEPHYR—The only "Four" with FISHERMAN DRIVE... the only motor that offers four-cylinder performance with freedom to power *anywhere* there's water to float your boat. 5.4 O.B.C. certified brake H.P. at 4000 R.P.M.



See Your Evinrude Dealer... look for his name under "Outboard Motors" in the yellow pages of your phone book. For free catalog of the complete

line of 40th Anniversary Evinrude Models—1.5 to 50 certified H.P. —write EVINRUDE MOTORS, 4359 N. 27 St., Milwaukee 9, Wis.

In Canada — Evinrude Motors, Peterboro, Ontario



EVINRUDE

FIRST IN OUTBOARDS... 40th YEAR

Pack Into the Wilderness

(Continued from page 140)

appealing to a dyed-in-the-wool sportsman.

Settling down for the night is a major undertaking. A suitable camp site that will provide water, wood and feed for the horses must be found. The animals are unpacked and watered. Firewood is gathered. Provisions are broken out and supper is started. Everyone pitches in and does his share. On a pack trip such as this, democracy in its purest form is the accepted custom. A millionaire sportsman may find he can be most helpful by peeling the spuds.

If the area is one where water and grass are plentiful, the pack horses will feed themselves. If not, they are fed from the sack of oats brought along for the purpose. Horses are hobbled to prevent their straying or heading back toward the stables.

"Many is the time—especially early in the season—when I've chased horses a couple of miles down a canyon," says Joe Burgy. "Some of them can hop like grasshoppers, even when hobbled."

The Middle Fork of the Salmon River begins where it is joined by Beaver Creek and Marsh Creek. Here is the "big hole," a fishing mecca which has produced trout ranging from one to five pounds, salmon from 10 to 40 pounds.

Beyond the "big hole," the Middle Fork begins a rough, rocky descent. Riding down the trail that hugs the river, you are constantly aware of the mountains rising on either side. The descent narrows until it forms the 1500-foot-wide "Impassable Canyon." Along some parts of the river no trail exists. A collapsible boat is taken off one of the horses and you shoot the rapids.

The Salmon River is nicknamed the "River of No Return." Legend has it that gold was found in this wild canyon many years ago. The prospectors hired a crew of Chinese to mine it on the theory that, being unable to speak English, they would not reveal the mine's presence. But gold does things to men and one day the crew took \$300,000 in nuggets and dust, stole a boat and attempted to shoot the rapids of Impassable Canyon. They were never seen nor heard from again. Somewhere in the canyon must lie the waterlogged bones and a fortune in gold.

This is wilderness country where Gary Cooper and Ernest Hemingway come to hunt. The country is so rugged that few hunters venture in so far. But it's a sporting proposition. Any hunter who gets a chance to draw a bead on an elk after riding a rough trail, shooting the rapids and clam-

(Continued to page 238)



THE GLORY of the WEST LIVES AGAIN in the NEW

H & R "PLAINSMAN" .22 Caliber Bolt Action Repeater

Fastest reloading bolt action repeater you ever handled! Actual reloading time tests prove that the H & R PLAINSMAN with positive magazine ejector is faster than any comparable bolt action repeater model on the market. Fire 5 shots . . . press magazine ejector . . . magazine is pushed out . . . slap in another . . . fire away! Check and compare! See this new PLAINSMAN at your dealer's. It's a sensation at...

\$23.95



NEW
Magazine Ejector

FEATURES YOU'LL ENJOY

- A. Magazine Ejector. Speedier, easier reloading.
- "Bull's-Eye" Broach Rifling. All six barrel grooves cut in one operation. No variances. Absolute shooting accuracy.
- Chambered for short, long, and long rifle ammunition, regular or high speed.
- Easy action, side thumb safety.
- Crisp, smooth action. Magazine fed repeater.
- Five-shot magazine — flush to stock.
- Natural balance for easy, steady sighting.
- Hand-rubbed oil finish American Walnut stock.

For FREE catalog and specifications on the PLAINSMAN and other H & R sporting arms, write today!

HARRINGTON & RICHARDSON ARMS CO., 371 PARK AVENUE, WORCESTER 2, MASS.
CANADIAN SUBSIDIARY: H & R ARMS CO., LTD. • LONG BRANCH, ONTARIO, CANADA

World Famous PACKAGED BOAT KITS

\$34.50 UP



1949 LINE—18 MODELS—8 TO 18 FT.

New models offer increased performance! Simplified building instructions! Low prices! 8 ft. dinghy \$34.50, 16 ft. Runabout \$159. Dinghies, skiffs, fishing and speed boats. All parts pre-cut, frames pre-assembled. SEND 25c (coin) FOR LITERATURE or send \$1.00 for literature plus booklet "Plywood Boats."



MARINE MART—DEPT. 24—BUFFALO 7, N. Y.

BOAT PATTERNS

100 designs by Deed, Lord, Crandall etc., Plank, steel, and plywood. All types, 6-35 ft. Detailed blueprints, full-size paper patterns. Catalog 35c (coin). Catalog and booklet "Boat Building" \$1.00.

PLYWOOD CONVERSIONS HARDWARE

—and Marine lumber. Stock list 10c. List and handbook "Plywood Hints" 50c (coin).

Drives, gears, engines, kits. Catalog 50c (coin). With booklet "Conversion Hints" \$1.00.

Send \$1.00 for 250-page Builders Guide. 15,000 items pictured, priced.

M-SCOPE TREASURE-MINERAL LOCATORS

WRITE FOR FREE, ILLUSTRATED 16-PAGE BOOKLET

M-SCOPE TREASURE-MINERAL LOCATORS. Low priced, unsurpassed efficiency, lightweight models. Factory guaranteed. Immediate shipment. Credit plan available. Write for free 16-page booklet.

GEIGER COUNTERS for finding Uranium ores. Several models, Simple operation. Low priced. Immediate shipment. Interesting free literature.



URANIUM

FISHER RESEARCH LAB., INC., PALO ALTO, CALIF.

GOLD

NEW Stanley "Handyman" Electric Drills

Make your work a lot easier with these two drills built for mechanics by Stanley. They'll pay for themselves over and over again.



No. 04

No. 04 — ¼" capacity in steel, ½" in wood. Weighs only 3¼ lbs. \$26.00.



No. 012

No. 012 — ½" capacity in steel, 1⅜" in wood. Offset spindle permits close quarter drilling without removing pipe or spade handle. Weighs 9¾ lbs. \$42.50.

Bench stands available to convert these drills into economical drill presses.

The greatest name in tools

STANLEY
HANDYMAN

HARDWARE • HAND TOOLS • ELECTRIC TOOLS • STEEL STRAPPING

Order from your hardware, electrical or implement dealer. Illustrated folder E9 on request. Stanley Electric Tools, 488 Myrtle St., New Britain, Conn.

FOR YOUR SHOP... The DU-FAST[®] OSCILLATING SANDER and POLISHER... tool of a thousand uses!



Especially designed as a versatile attachment for the well-known HOME UTILITY, ¼" Electric Drill, and HOME UTILITY 5" Disc Sander-Polisher (products of Black & Decker). It brings quick, easy, fine finishes within the reach of every craftsman!

Regardless of what your specialty . . . if you work with wood, metal, plaster, wallboard, plastics or other project materials . . . DU-FAST saves you money, time and work on every job . . . in your home, in your shop, in your hobby and wherever you want professional type finishing and polishing. Working surface a full 3½" x 7".

IDEAL FOR . . . SHOP PROJECTS • FURNITURE • AUTO BODY WORK • MARINE USE • FLOORS • AROUND MOLDINGS • IN CORNERS • WOOD, PLASTIC, METAL FINISHING • and hundreds of other applications!

SAFE, QUICK, EASY, FOOL-PROOF AND ECONOMICAL TO USE . . . DU-FAST IS PERFECT FOR YOUR SHOP . . . *Pat. Applied For ASK YOUR HARDWARE DEALER TODAY!

\$14⁹⁵

DU-FAST ATTACHMENT ONLY

MANUFACTURED BY

DU-FAST, inc.

32 EAST FOURTH STREET, NEW YORK 3, N. Y.

Available only at hardware dealers carrying Black & Decker Home Utility Tools. Stop at one today!

bering up the rocky sides of the canyon fully deserves his trophy.

After a day of hunting you head back toward camp. As the afternoon shadows lengthen and the higher peaks begin to turn gold and scarlet, blue wood smoke drifts up among the trees. And as you get closer you smell the golden odor of frying trout, sheepherder's spuds and coffee. It's enough to make a man believe in heaven on earth.

In the evening, you sit around a glowing campfire and sing songs or spin yarns. One of the wranglers tells how a railroad vice-president was taught how to cast a fly.

"He kept flinging his elbow out until Dutch Gunderson asked him for his wallet. Dutch placed it under his arm and told him to go ahead and cast. He looked at the stream below and then at the fat wallet under his elbow. He didn't give Dutch any more trouble from then on."

The days go by with startling swiftness and almost before you know it you're back at Sun Valley. You begin to think about icing up some of the elk you've shot and expressing it home, giving the rest to the folks at Ketchum. You also begin to wonder about a good taxidermist to mount the head and horns.

The pack trip is over, but you'll remember it for a long time to come. Perhaps you'll think of it in the words of one of the veteran packers:

"I've seen a lot of men pack into these mountains—some of them rich, some of them famous. They think they're coming in to hunt and fish. But it's more than that. Perhaps it's a chance to get close to the mountains and trees and stars. Whatever it is, they keep coming back for more."

Liquid-Oxygen Converter For High-Altitude Planes

Development of a new converter system may make liquid oxygen feasible for high-flying U. S. Air Force planes. Lack of a satisfactory method of storing and handling the liquid in planes has previously prevented its use. Fully charged, gaseous-type oxygen tanks for a B-17 weigh 400 pounds, while the liquid weighs 130 pounds and takes 80 percent less space. The converter consists of a vacuum-walled metal container, a vaporizing coil and safety and operating valves. On vaporization, the oxygen is forced through the distribution system by pressure formed by the change from liquid to gas. A mobile plant that can be parked beside runways produces 80 pounds of liquid oxygen an hour. For use at remote bases, 1700-gallon storage tanks have been designed for transport in C-74s.

SORE MUSCLES?

BODY ACHES?



When muscles are stiff and sore from unusual exercise or strain, use HEET®, the liniment that's *strong* yet does not burn the skin. Wonderful relief from muscular soreness comes as comforting HEET quickly starts to *penetrate*. Just brush it on with the applicator. HEET starts at once to ease muscular pain and *keeps on* working for hours, warms and soothes the painful area.

"Fleas Don't Bother Me I'm Dusted with PULVEX DDT"



PULVEX ... KILLS FLEAS
FLEA POWDER ... KEEPS 'EM OFF

SURPLUS HIGH SPEED DRILLS MICROMETERS

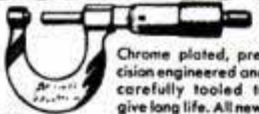

Chrome plated, precision engineered and carefully tooled to give long life. All new.

0-1" capacity . . . each \$2.25
1-2" capacity . . . each 3.50
2-3" capacity . . . each 5.50
3-4" capacity . . . each 6.50

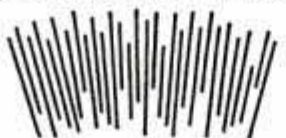

All New Drills! Orig. value \$15.
30 assorted sizes and lengths \$3.50

SEND FOR FREE DESCRIPTIVE CATALOG

Send check, money order or cash. 25% deposit required on C.O.D. orders. All prices F.O.B. Culver City, Calif.

AIRBORNE SALES CO., INC. DEPT. PM CULVER CITY, CALIF.

MARCOT KEY MACHINE

Immediate Delivery



MARCOT No. 8 KEY MACHINE, mounted on Cabinet, less motor \$ 95.00
Auto Code Book and Depth Keys . . . 12.50
100 Dz. Popular Key Blanks . . . 60.00
Set - Key File, Follow-Through Rods, Lock Picks, Bit Key Gauge, Thimble, Pins, Springs . . . 10.50
"Locksmith Trade Books": . . . 6.75
How to Open Locks without Keys or Picks; Secret of Locksmithing; How to Make Keys by the Impression Method; Master Key Systems.
TOTAL COST . . . \$184.75

A. J. MARCOTTE CO., 1200 N. Kedzie Ave., Dept. PM, Chicago 51, Ill.

Mower Builder's Kit

M.B.K. KIT CONSISTS OF

1-TIMKEN BEARING EQUIPPED HI-SPEED SPINDLE
1-HI-CARBON STEEL 20" BLADE
2-10"x1.75" PUNCTURE-PROOF SEMI-PNEUMATIC, RUBBER TIRES, BALL BEARING WHEELS
1-5" SWIVEL CASTER WHEEL

SPINDLE & BLADE ALONE . . . \$18.75

FAMOUS **MOZALL** POWER MOWERS NOW AVAILABLE . . . FREE FOLDER
SEND CHECK OR M.O. TO

Dept. M-7

WIND-KING ELECTRIC MFG. CO. MERRILL, IOWA



UNCONDITIONALLY GUARANTEED

\$28.50 COMPLETE



What makes the difference?

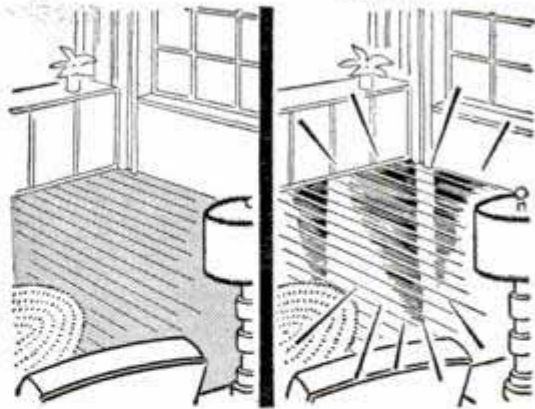

LIN-X CLEAR-GLOSS VARNISH

Yes, and what a difference! That clear, tough, long-lasting coat of Lin-x Clear-Gloss Varnish protects and beautifies floors, woodwork, furniture, printed linoleum, boats, countless other surfaces—resists boiling water, sizzling cooking greases, alcoholic beverages. And so EASY to use—just brush it on!



At your paint, hardware and department store!



Distributed by

Acme White Lead & Color Works, Detroit • The Lowe Brothers Co., Dayton • John Lucas & Co., Inc., Philadelphia • The Martin-Senour Co., Chicago
Rogers Paint Products, Inc., Detroit • The Sherwin-Williams Co., Cleveland

SAY YOU SAW IT IN POPULAR MECHANICS

King Midget

- HOME ASSEMBLED
- MASS PRODUCED
- LOW-COST AUTOMOBILE



Drive this car for as low as 50c per week. Up to 90 miles per gallon. 45 to 50 m.p.h. Large enough

for a husky six footer. A pleasure to assemble. Just bolt together our precision built parts. Get the facts. Send 25c for detailed circling with large photo, 4 view drawings, price of all parts. Better still, send \$1 (refunded first order) for this plus actual assembly book with 42 photos, drawings; blueprints of snow and ice conversions, etc.

MIDGET MOTORS MFG. CO., Athens 1, Ohio

WORLD'S LOWEST PRICED CAR

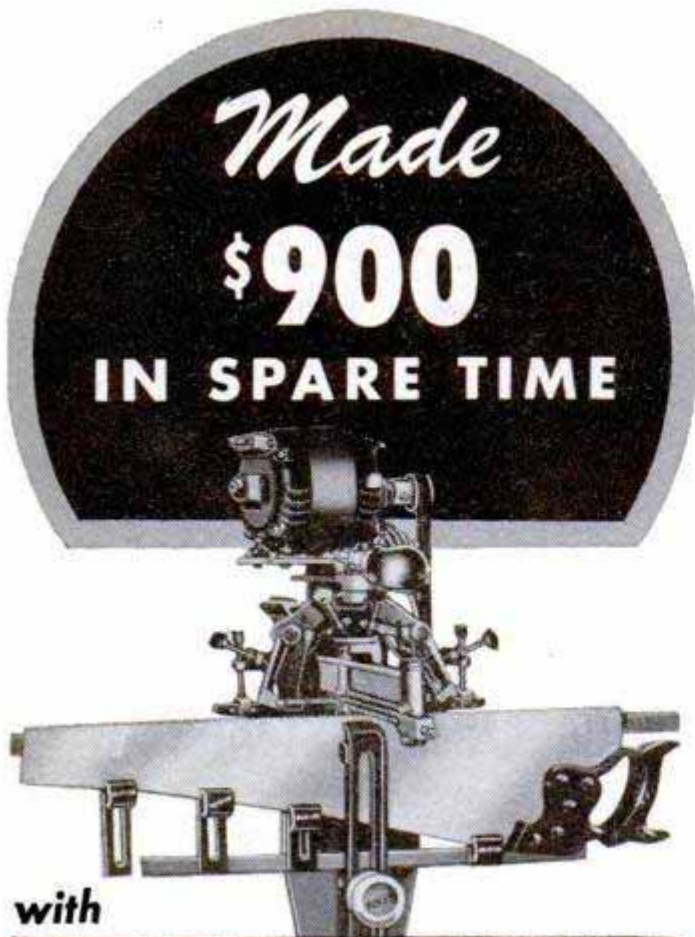

Made
\$900
IN SPARE TIME

with

FOLEY* automatic SAW FILER

*Trade Mark Reg. U. S. Pat. Off.

"I did very well last year with my Foley equipment, about 950 saws and 240 lawn mowers, in my spare time. About \$900 for me." Leo H. Mix. Len Crego says: "I have done 4 or 5 thousand saws in my spare time in the 4½ years since I got the outfit, and they are all coming back."

Make up to \$2 or \$3 an hour in Spare Time. With the high prices of food, clothing and everything else, just think what you could do with extra money every week! With a Foley Automatic Saw Filer you can file hand, band and circular saws better than the most expert hand filer. "The first saw I sharpened with my Foley Filer came out 100%"—writes Clarence E. Parsons. Every saw you sharpen with the machine accuracy of the Foley Saw Filer is an ad that brings you more customers. Cash business, no canvassing. No eyestrain, no experience needed.

FREE BOOK INDEPENDENCE AFTER 40!

Shows just how you can start at home in spare time in your basement or garage. Just think—with a small investment, no overhead, no stock of goods to carry, you can get right into a cash business—and later on develop into a full-time repair shop. Send coupon today for this practical plan.



Send Coupon for FREE BOOK

FOLEY MFG. CO., 716-9 Foley Bldg., Minneapolis 18, Minn.
Send FREE BOOK—"Independence After 40."

Name _____

Address _____

Trouble Shooter on the Scent

(Continued from page 121)

then reselling them as genuine pure musk. Musk is, of course, a very highly rated scent, held in esteem by perfumers and considered by many to have definite medicinal value.

Dillinger has no elaborate regulations to keep his nose in perfect operating condition other than trying to avoid colds. A cold has never put him out of condition, Dillinger says, "but it's bothered me at times and slowed me down."

Dillinger's facility for tracking down elusive odors can be bothersome, even to himself. If he detects a strange whiff in his own home, he is apt to follow the odor to its source and neglect other matters until the irksome problem is solved. The sight of him trailing an odor in the best Sherlock Holmes fashion is a familiar spectacle to his family.

A civet cat has an intolerable stench to most people, but to an aromatic chemist like Dillinger the odor is "intriguing." "By an intriguing odor," he explains, "I mean a rich, full-bodied one—to be studied, of course."

Whereas the average person can distinguish some two dozen or so odors, Dillinger stocks about one thousand in his mind. His favorite scent is that of lilac, and he grows this flower in his own garden. Then, in the laboratory, he duplicates its odor, a process requiring some 30 ingredients. To do this scientifically, a knowledge of the make-up of a flower is essential including the scent of each component such as petals and stamen. Since the blend of each of these scents provides the ultimate lilac smell, he follows the same course in his lab.

The use of odors for a variety of purposes has been long recognized, Dillinger points out. Lavender has the same effect as catnip on lions and tigers, wild birds can be tamed by rubbing oil of bergamot on their nostrils, mosquitoes will shun anything that smells like citronella and Japanese beetles will travel miles to be near geraniol.

Recently Dillinger introduced the use of perfume for crippled children in a Texas hospital. Such scents as magnolia have been used for stimulating the appetites of child patients, and pine is good for sinus trouble. Cape jasmine and lilac, on the other hand, tend to soothe the nerves.

Dillinger's sensitive sniffer may someday explore the field of medical treatment.

☐ In 1948 American air carriers flew over eight billion passenger miles with a passenger fatality rate of only 1.3 per 100 million passenger miles flown.

REAL DIESEL ENGINE

\$2.95

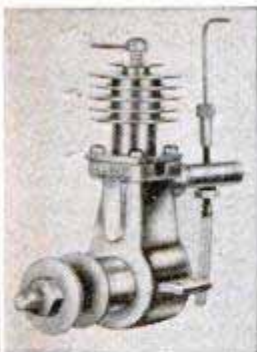

WE'RE CRAZY, they tell us, giving away a real diesel engine, complete with cylinder and piston, carburetor, crankshaft and connecting rod. All parts completely machined, ready for easy assembly. **ONLY \$2.95.** How do we do it? We're selling thousands of **DEEZILS.** So production's up; costs tumble down. **DEEZIL** is a precision engine. Actually runs at 7500 RPM. Produces 1/7 HP.

Ideal for planes, boats, midget cars. Send \$2.95 plus 25c postage today.

GOTHAM HOBBY CORP.

107 East 126th Street New York 35, N. Y. Dept. "P"

MUCH MORE SPEED FOR OUTBOARDS!



All tests conclusively prove that **MICHIGAN'S** newly developed "AQUA-JET" propellers provide much more speed for motors of 7½ HP to 50 HP on racing runabouts and step-bottom hydroplanes. No rebuilding of lower unit is necessary. Write for prices. Other propellers for superior performance for practically every outboard in every application. Write for catalog with recommendation charts. **MICHIGAN WHEEL CO.,** Grand Rapids 3, Mich.—World's largest manufacturers of motor boat propellers. Dealers everywhere.

SHINE WITHOUT 'POLISH'

New Invention! • Sells Like Wild



Replaces messy pastes, liquids. Simply glide over shoes—and **PRESTO!**—you have a lustrous, long-lasting shine. No mess. No muss. No soiled hands. Clean. Handy. **WORKS LIKE MAGIC!** For Men's, Women's and Children's Shoes. Low priced. Lightning seller!

SAMPLES FOR AGENTS Sample offer sent immediately to all who send name at once. A penny postal will do. **SEND NO MONEY—just your name.** **KRISTEE CO.,** 680 Bar Street, AKRON, OHIO

SPECIAL OFFER!

LOCK-STITCH SEWING AWL

\$1.

Postpaid

Famous, patented lock-stitch sewing awl complete with needles, waxed thread and direction folder. Hundred uses—sewing, repairing leather goods, canvas, belting, harness, saddles, gun cases, awnings, golf bags. Extra needles and thread available. Satisfaction guaranteed or money back. Send currency, check or money order. **Yates Mfg. Co.,** 611-H Main St., Lake Geneva, Wisconsin

SAVE TIME, WORK, MONEY!

SHAW DU-ALL

and "PEPPY PAL" TRACTORS

Easy and Cheap to Operate

PLOW

CULTIVATE

TRACTORS

SHAW MFG. CO.

These rugged walking or riding tractors are ideal for farm, truck garden, orchard, poultry farm. Operate on a few cents an hour. A child can handle them.

DO DOZENS OF JOBS Both riding and walking tractors quickly and easily plow, cultivate, harrow, disk, bulldoze, spray, haul, grind, saw wood, etc. **LOW FACTORY PRICES** Buy direct or through your dealer. Year's guarantee!

RIDING TRACTORS 4 models from 5 to 12½ H.P., 58 in. wheelbase, 36 to 62 in. wide, 24 in. plant clearance. Hand or electric starter. Walking Tractors 1½ to 5 H.P.

FREE Illustrated folders giving complete details and price lists—write today!

4507 FRONT ST., GALESBURG, KANS.
668G NORTH 4TH ST., COLUMBUS, O.

RISLONE with your oil gives your car smooth new power in 10 miles

You can feel the *guaranteed* improvement as it dissolves the gum and sludge in your car



You get your money back if you don't feel an actual difference in 10 miles after adding Rislone to your oil: instant starting... power-surge pick-up...

smooth, quiet power at all speeds.

Rislone is a super oil-alloy that keeps your car at peak performance as you drive. It dissolves gum and sludge to keep your motor clean and protected, to free sticking valves, to eliminate sluggish power and low-gear jerkiness.

Rislone is a full time lubricant with no harmful ingredients. For all cars—of any age; it actually permits normal driving speeds immediately in new and reconditioned cars.

Prove Rislone's "motor magic" to yourself. Try it today. Available at car dealers, better garages, and service stations everywhere.

The Shaler Company, Waupun, Wis.



Whenever you change your oil ..put in a quart of **SHALER**

Rislone

(2 quarts for larger cars). As you add oil, make every fourth quart **RISLONE.**

SAY YOU SAW IT IN POPULAR MECHANICS

REMOVE PAINT

WITH WONDER-PASTE



In refinishing furniture, woodwork, etc. all cracked or peeling portions of the old finish should be removed. It's easy with **WONDER-PASTE REMOVER.** Applied with an ordinary paint brush, this remarkable paste quickly softens up the toughest finish, whether paint, varnish, enamel, lacquer or shellac. Will not run, even on an upright surface. Turns the finish into a soft sludge that comes off easily at every stroke of the scraper. A long-time favorite of painters.

Get Wonder-Paste at your paint or hardware store. Write for Wonder-Paste leaflet, and for advice on your particular removing problem.

Wilson-Imperial Co., 119 Chestnut Street, Newark 5, N. J.



ELECTRICIANS! Use This Amazing New Insulating Tape For All Electrical Jobs

NEW "SCOTCH" No. 33 Electrical Tape, with plastic backing and pressure sensitive adhesive, has been called "The most important tool in the electrician's kit." Here are some of the reasons why:

- Does the work of both rubber and friction tape.
- Thin caliper—takes up minimum room in junction boxes.
- Dielectric strength, over 7,000 volts.
- Resists moisture, oils, acids, alkalis, alcohol, aliphatic hydrocarbons.
- Excellent aging properties prevent checking, cracking—reduce maintenance.
- Tough, stretchy plastic backing moulds snugly to irregular surfaces.

ORDER YOUR ROLL now—from your local electrical jobber, or with the handy order form below. Roll is $\frac{3}{4}$ inch wide, 66 feet long.



Made in U. S. A. by

MINNESOTA MINING & MFG. CO. SAINT PAUL 6, MINN.

also makers of other "SCOTCH" pressure-sensitive tapes, "Underseal", "Scotchlite", "3M" Abrasives, "3M" Adhesives.

GENERAL EXPORT: DUREX ABRASIVES CORP., 240 NORTH AVE., NEW ROCHELLE, N. Y.
IN CANADA: CANADIAN DUREX ABRASIVES LTD., BRANTFORD, ONTARIO

Minnesota Mining & Manufacturing Co.
Saint Paul 6, Minnesota
Dept. PM-7

Please send me by parcel post _____ rolls of
"SCOTCH" No. 33 Electrical Tape.

I enclose \$1.50 for each roll.

Name _____

Address _____

City _____ Zone _____ State _____

Putting a River in Its Place

(Continued from page 155)

far as Bridge Canyon. The U. S. Navy was put to work in the middle of the desert on this problem, and lake-bottom surveys were made from a special barge by men in diving suits. The actual survey has been completed and reports will be out in a few months, Vetter says.

The bureau's long-range vision for the future includes several other projects which eventually will metamorphose the once tumultuous, destructive river into a series of reservoirs for the storage of irrigation water and the generation of power to fill the increasing needs of the Southwest area.

Hoover Dam won't even continue to hold its proud title of highest dam in the world when the proposed Bridge Canyon project is completed. This barrier will rise 740 feet from bedrock, thus overtopping Hoover Dam by 13 feet. River barriers are envisioned also for Glen Canyon and Cocolino, among others.

Bureau of Reclamation engineers are unimpressed by pessimists who theorize that reclamation projects are doomed by the inevitable action of natural forces. They believe that man can cope with the Old Lady on her own terms.

Underwater Speedway

(Continued from page 118)

by high-speed photographic equipment.

To test the accuracy of the device, the hatch is raised and the model is released in the open air. A curtain 15 feet away, with a hole in it that is slightly larger than the diameter of the model torpedo, serves as the target. If the controls have been properly set, the model is released by the spinning wheel and flies straight through the air, passing through the target hole without disturbing the curtain.

The big launching tank has three camera ports placed above water surface for recording the air trajectory of the models, and five ports below water level for the cameras that record the underwater runs of the models. Each of the underwater ports is an optically ground spherical window that serves as an auxiliary wide-angle lens for its camera. Each camera magazine contains 32 feet of 35-mm. film spliced to form a continuous loop. The film loop is rotated at high speed when exposures are made.

The interior of the tank is illuminated, for pictures, by 30 high-speed flash lamps, some inside of aluminized Lucite reflectors.

(Continued to page 244)

IF YOUR ARCHERY TURNS
OUT LIKE THIS...IT'S TIME
FOR NEW ARROWS...

and

IF YOUR CAR FEELS LIKE THIS
IT'S TIME FOR MARFAK
CHASSIS LUBRICATION

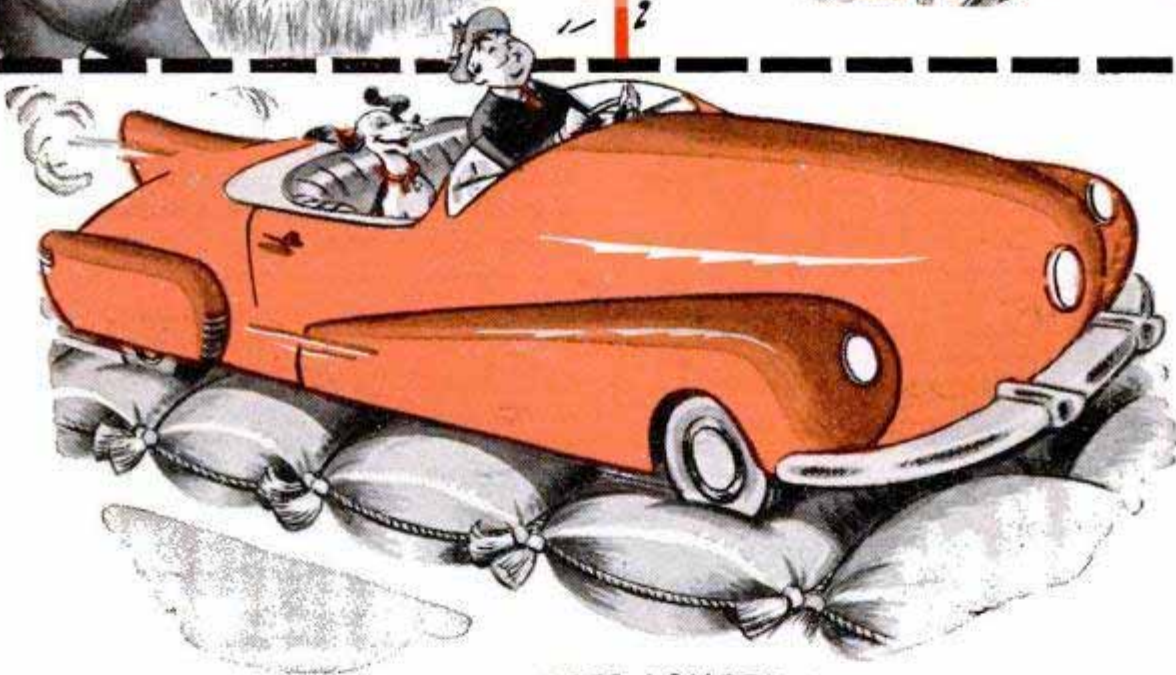

THAT CUSHIONY FEELING LASTS LONGER WITH MARFAK!

You can't beat *Marfak* lubrication for *longer-lasting* chassis protection. *Marfak* is specially compounded for extra toughness. Protects bearings and wear points against costly friction for 1,000 miles and *more*. *Marfak* resists wash-out, squeeze-out, shock. That's why you get that grand "cushiony" driving that lasts. Get *Marfak* lubrication today at your friendly neighborhood Texaco Dealer, *the best friend your car ever had*.



THE TEXAS COMPANY
TEXACO DEALERS IN ALL 48 STATES

Texaco Products are also distributed in Canada

For CRACKS in Concrete

Don't let cracks, widened seams, shallow holes in your concrete basement or garage floor cause you trouble! Fill them with Smooth-On No. 7B Quick Floor Patch Cement. Finish level with surrounding surface. The repair hardens in a few hours and is then ready for use. Ask for Smooth-On No. 7B Quick Floor Patch by name and number, in 1-, 5-, 20- or 100-lb. sizes. If your hardware store hasn't it, write us.



FREE 7B LEAFLET and SMOOTH-ON HANDBOOK

Leaflet shows how to use No. 7B. Handbook shows time-saving, money-saving home repairs you can make with other Smooth-On Cements—leaks stopped, cracks sealed, loose parts made tight. 40 pages, 170 pictures. Write us for both—FREE—today.

SMOOTH-ON MFG. CO., Dept. 37C
570 Communipaw Ave., Jersey City 4, N. J.



Do it with **SMOOTH-ON**
QUICK FLOOR PATCH CEMENT

GLASS BLOCK PARTITION

It's easy to install!

Insulux Set-in-Wood—needs no mortar



1. Insulux Set-in-Wood is easy to install. Nail wedges first.



2. Glass Blocks fit into framing, using prefabricated wood strips.



3. Wedges anchor each row firmly. Simple tools are all you need.



4. Horizontal strips cover rows. Send coupon for full details.

American Structural Products Co.
Subsidiary of Owens-Illinois Glass Company
Dept. F201, P. O. Box 1035 • Toledo 1, Ohio

Please send full details on Insulux Glass Block Set-in-Wood partitions.

Name _____

Address _____

City _____ Zone _____ State _____

MAIL COUPON NOW

All the lamps are flashed simultaneously at up to 3000 flashes per second, about 1/10,000 of the exposure time normally used in motion-picture photography.

No human operator could synchronize all this equipment manually. After the launcher and the eight strips of film in the cameras have come up to speed, the operator holds down a launching button. A series of interlocks waits until the film splices have passed through the camera, then immediately trips the model and launches it, and turns on the high-speed lamps. Three thousand separate exposures are made during the one second that the model is in motion.

Later the pictures are analyzed by projecting two frames at a time, from overlapping cameras, onto a movable "exploring" screen to which is attached a half-model of the torpedo. When the two film images of the model coincide with the half-model projecting from the screen, the research technicians know exactly the position that the projectile occupied in the tank at that particular stage of its run.

Other equipment in the laboratory includes a polarized-light flume that uses a dilute suspension of bentonite, with double refractive powers, as a fluid. When a body is placed in the flowing material and is illuminated by polarized light, the flow pattern around and past it becomes visible.

To study surface waves on enclosed bodies of water and, by inference, supersonic shock waves in the atmosphere, the laboratory uses a shallow glass-bottom tank. Small wave machines produce ripples in the water surface. The heights and frequencies of these ripples are then recorded by electric pickups.

Recently the laboratory installed a "free surface" water tunnel for studying the forces that act on a body that is at or near the surface of the water. The working section of the tunnel has transparent Lucite

(Continued to page 246)

CHAMPION V-GLOW PLUGS

for model engines only

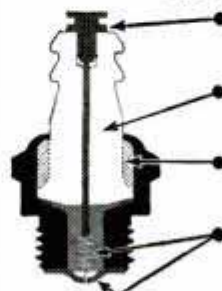

• **CHAMPION TERMINAL**—assures better center electrode seal and provides sturdier electrical connection.

• **CHAMPION-CERAMIC INSULATORS**—proved dependable in millions of Champion Spark Plugs.

• **CHAMPION SILLMENT SEAL**—prevents excessive compression leakage between insulator and shell.

• **CHAMPION "THERM-O-FLEX" CONSTRUCTION**—longer element life, more dependable performance.

Follow recommendations of plug types and fuels approved by engine manufacturer.

CHAMPION SPARK PLUG COMPANY, TOLEDO 1, O.

DEPENDABLE

CHAMPION

SPARK PLUGS

America's Favorite!

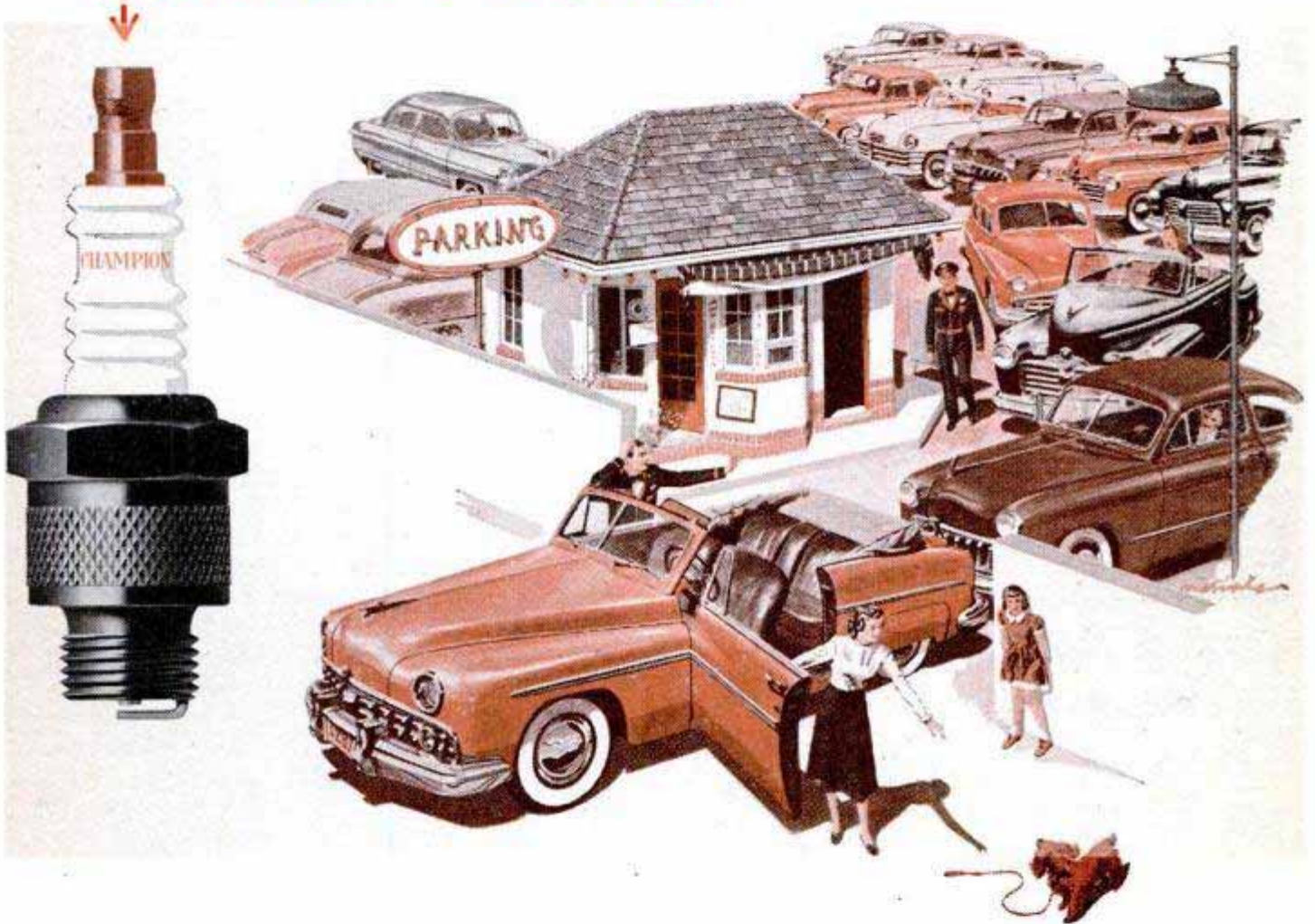

In parking lots anywhere, you'll find cars of practically every make and vintage. If you were to lift the hoods of all of them, you'd find the majority—regardless of make—equipped with dependable Champion Spark Plugs. We've made this test over and

over again, definitely proving that Champion is America's favorite spark plug—obviously the result of better performance. This leadership in public acceptance has continued for over a quarter century! Champion Spark Plug Company, Toledo 1, Ohio.

FOLLOW THE EXPERTS
USE THE SPARK PLUGS CHAMPIONS USE!

Listen to the CHAMPION ROLL CALL . . . Harry Wismer's fast sportscast every Friday night, over the ABC network

Get these new
FLEETWING TRIM TABS
 DRESS UP ANY CAR

from the **ACCESSORY CLUB**

only \$3⁹⁵ Set of 8

ACCESSORY CLUB
 AUTOMOBILE



For the look of luxury that makes every car look like the most expensive on the street . . . to streamline and modernize . . . dress up with Fleetwings. Easy to install. Brass with copper, nickel and chrome plated—they won't rust. Money back guarantee if not satisfied.

Complete set of 8 only \$3⁹⁵

Order C. O. D. or send check or money order and save C. O. D. charges.

WITH YOUR FLEETWING TRIM TABS
 You get YOUR MEMBERSHIP CARD

Yes, you'll be the first in your community to belong to the Accessory Club, which gives you month after month the sportiest equipment for your car. You'll always be a pace-setter—you'll always save money.



SAVE MONEY WITH YOUR MEMBERSHIP CARD Now! Get your TURBO-TUBES



Give your car that luxury appearance. 6 chrome on brass rings with welted rubber edges. Will not scratch—noiseless. Order C.O.D. or rush check or money order. Yours at sensational price of only \$2.95 once you order your Fleetwings.

Complete set of 6 only \$2⁹⁵

Order C. O. D. or send check or money order and save C. O. D. charges.

Watch for our new Hollywood Tone Mufflers.

RAJO MOTORS, 624 S. Michigan Ave., Chicago 5, Ill.

Gentlemen: Enclosed find \$3.95 for Fleetwings. Send me my membership card. As a member, I want to save on Turbo-Tubes. Send a set now at \$2.95.

Enclosed find \$3.95 for TRIM TABS Enclosed find \$6.90 for BOTH

NAME _____

ADDRESS _____

CITY _____

ZONE _____

STATE _____

sides and an open top that allows free wave action. The water travels past a stationary model at speeds up to 20 miles per hour and, since this is above the velocity of surface waves, the tunnel has many points of similarity with supersonic wind tunnels. The air pressure above the water in the working section can be reduced to about one point per square inch, permitting cavitation effects to be exaggerated and thus making it possible to determine the effects that cavitation has on the forces that act on a model.

Working in a new field, the laboratory has had to invent its own unique apparatus and techniques. Most of the studies are made to develop basic information rather than solving particular problems but, as Dr. Knapp points out, the information that is acquired in the water tunnels can be used in many applications, including better fluid drives for automobiles and even the prevention of hammering and vibration in water pipes.

Portable Pipe Bender
 Uses Automobile Jack

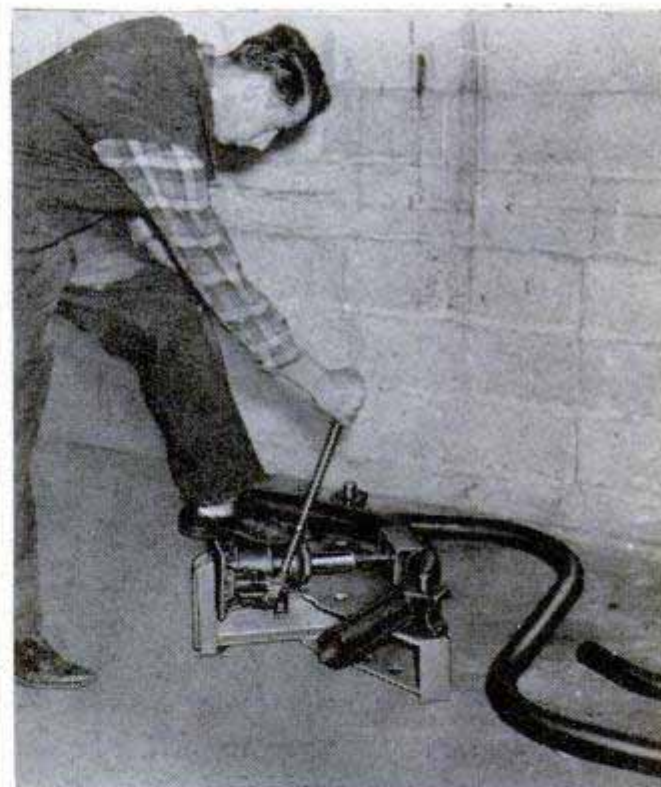

Plumbers and electricians can bend pipes, thus eliminating the need for elbows and other fittings, with a portable pipe bender that uses a hydraulic automobile jack. The jack can be removed from the bending frame for other uses. Pipes are bent without wrinkles or fractures and no heating or filling is required. Dies furnished with the tool handle pipes from 3/4 to 2 1/2 inches in diameter.



TIME-SAVING TOOLS for SHOP and HOME

OWN A FAMOUS MOTO-TOOL

The "Pocket-Size Machine Shop" HIGH-SPEED STEEL CUTTERS - AT NO EXTRA COST

No shop or home is completely equipped without MOTO-TOOL . . . the correctly balanced motor-in-hand tool. It grinds, drills, carves, polishes—without vibration. 27,000 r.p.m. (approx.) does work better, faster, in wood, metal, glass, plastic. MOTO-TOOL Kit No. 2 includes high-speed steel cutters for longer life. MOTO-TOOL is backed by over 12 years of industrial use . . . packs years of pleasure. Due to wide popularity and increased production, Dremel's pre-war prices still prevail!



APPROX. 27,000 R. P. M.

MOTO-TOOL KIT NO. 2 with 23 accessories including high-speed steel cutters and Model 2 Moto-Tool in hard-wood case . . . \$23.50
MOTO-TOOL NO. 2 with one emery point . . . \$16.50
MOTO-TOOL KIT NO. 1 with 34 accessories and Model 1 Moto-Tool in wood case . . . \$17.50
MODEL 1 MOTO-TOOL with one emery wheel . . . \$9.85



NEW DRILL PRESS
This 12" high, precision drill press is ideal for model making, wood carving, routing, etc. Utilizes No. 2 Moto-Tool. Only \$9.95 (Less Moto-Tool).



Look For These Moto-Tool Features

Dynamically balanced armature for vibrationless finger-tip control • Oilless (oil-sealed) bearings • Patented automatic chuck lock pin • Over-size armature shaft—hardened, ground, polished • 110 Volt AC-DC motor • Snap-type sliding switch • Cord protector • Shockproof bakelite housing • Dust-filtered air-cooling system • Weighs 13 oz.

NEW ELECTRIC "MOTO-SANDER" AND POLISHER

MAKES FUN of HARD WORK



Only \$14.85 POSTPAID

Patented

Say "Good-bye" To Hand Sanding & Polishing!

Let speedy "Moto-Sander" do the work while you just guide it. Ideal for light sanding jobs. Use Moto-Sander for finishing, refinishing, redecorating. Quickly and smoothly sands furniture, walls, wood-work, wall board, plaster joints; boats, workshop projects, etc. Straight-line action (non-rotary) will not burn or scratch surface. Use Moto-Sander also for fast, effortless polishing of furniture, refrigerator cabinets, automobiles, other waxed surfaces. This versatile machine works on flat or curved surfaces—gets into tight corners. Moto-Sander is the lightest, most practical electric sander on the market. Delivers 7,200 strokes a minute . . . weighs only 2½ lbs. Furnished complete with 6 sheets assorted grade Garnet Paper for sanding, plus felt pad and sheepskin for wax polishing. Operates on 110-120 V., 60 cycle A. C. Thousands of users.



GETS INTO TIGHT CORNERS



GREAT FOR AUTO POLISHING

MOTO-SAW AN ELECTRIC SCROLL SAW SAFER THAN A HAND SAW

A high-speed power saw for boys from 8 to 80! Moto-Saw's 7,200 strokes a minute easily cuts intricate scroll designs—no limit to length of cut—averages 1 foot per minute through medium hardwood up to 3/4" thick. Four-way blade holder permits sawing in any direction . . . at any angle. Moto-Saw has only 2 moving parts—never needs oiling. Operates on 110-120 V., 60 cycle A. C. Thousands of satisfied users.



Only \$5.85 POSTPAID (WITH 3 BLADES)

JUST GUIDE IT!

The versatile Moto-Saw is as safe as a hand saw. A touch of the trigger switch sets it going . . . releasing stops it instantly.

WHERE TO BUY: Buy Dremel Tools from your dealer. If he cannot supply you, send full purchase price (check or money order) and we will ship postpaid. Or, send only \$2.00 now, and pay postman balance plus postage upon delivery. Your Money Back if not delighted after 5 days' trial.

DREMEL MFG. CO.
DEPT. 119-G RACINE, WIS.

RUPTURED?

Get Relief This Proven Way

Why try to worry along with trusses that gouge your flesh—press heavily on hips and spine—enlarge opening—fall to hold rupture? You need the Cluthe. No leg-straps or cutting belts. Automatic adjustable pad holds at real opening—follows every body movement with instant increased support in case of strain. Cannot slip whether at work or play. Light. Waterproof. Can be worn in bath. Send for amazing FREE book, "Advice To Ruptured," and details of liberal truthful 60-day trial offer. Also endorsements from grateful users in your neighborhood. Write:

CLUTHE SONS, Dept. 31, Bloomfield, New Jersey

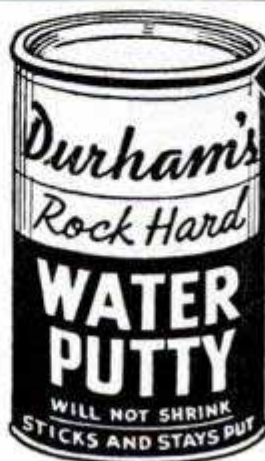

The Modern PLASTIC for lasting Home Repairs

PERMANENTLY mends cracks or holes in wood, tile, stone or plaster. Sticks and stays put—Does not chip, shrink or fall out. Easy to use. Economical. Mold it, chisel it, polish or paint it. If unobtainable from your lumber, paint or hardware dealer, the big 4-lb. can will be sent you postpaid (in U.S.) for only \$1. Full money-back guarantee, order now.

DONALD DURHAM CO.
Box 804-S, Des Moines, Ia.

MECHANICS!

Take 1½" to 40" I. D.'s easily and accurately with

LUFKIN INSIDE MICROMETERS



Tubular, light-weight measuring rods can be added to both ends of the micrometer head, thus keeping the head central and in balance, assuring precise readings—more sensitive "feel."



Ground threads on micrometer heads assure smooth operation and great accuracy. Rods and caps ground to extremely close limits to permit interchangeability. Heads have "Rapid Reading" (each thousandth numbered) to eliminate errors in

reading. Lock nut holds measurement firmly.

Flat surface on knurled collar opposite reading line makes it easy to instantly find reading line even in poor light.



Write Dept. M for fascinating booklet, "The Amazing Story of Measurement." Enclose 10c (no stamps) to cover handling and mailing.

Buy **LUFKIN**



Precision Tools • Tapes • Rules • FROM YOUR DEALER
The Lufkin Rule Company • Saginaw, Michigan

Forecasters for the Air Waves

(Continued from page 104)

globe (such as South Africa and the southern part of South America) where ionospheric stations are spread rather thin.

Once the Radio Propagation Laboratory has gathered data, facts and figures from all parts of the world, it subjects them to statistical analysis. And from such analysis it prepares a monthly publication called "Basic Radio Propagation Predictions." This publication is printed by the U. S. Government Printing Office and mailed three months in advance to anyone who wants it. The price: 10 cents per copy or \$1 per year.

The laboratory has also prepared a manual called "Ionospheric Radio Propagation," selling for \$1, which explains in somewhat more detail the mystery of the ionosphere and how it affects short-wave radio communication.

It's easy enough, for example, to be the engineer of a powerful radio station where all you have to do to increase the strength of your signal is to turn on more power. But this is not always economical and it plays hob with other stations on the same frequency.

But, suppose you are a Navy communications officer aboard a ship operating in Arctic waters. You have to get an important message back to the Navy Department in Washington, D. C. There isn't enough power to blast a message through. What do you do?

First you consult your copy of "Basic Radio Predictions" and choose a frequency and time best suited to short-wave transmission. The frequency must be low enough so that it will be reflected from the upper layers of the ionosphere to its ultimate destination. If the frequency is too high, it will penetrate the ionosphere; if too low it will be subject to great absorption in the lower part of the ionosphere. Under certain conditions, the selection of the correct frequency is easily done. Under others, no communication whatsoever can be established.

Scientists at the Radio Propagation Laboratory say that enough data has been collected already so that predictions as far ahead as 1955 or 1956 could be made with a fair degree of accuracy. But like weathermen, the closer they are to a critical date, the better their forecasting.

It is the somewhat unexpected factors that plague the ionospheric forecasters—such as atmospheric radio noise, cosmic noise and solar noise.

(Continued to page 250)



New HOME-UTILITY 6" Electric SAW

ONLY
\$59.95

SPEEDS UP

- General Carpentry
- Home Construction, Alterations
- Farm Building, Maintenance

BEATS HAND SAWING 10 to 1

- CUTS UP TO TWO-INCH DEPTH
- Rips TEN feet of lumber in time Hand Saw takes to rip ONE!

EASY TO HANDLE: Perfectly balanced, close-coupled construction, light weight (only 9½ lbs.), eliminates fatigue. Comfortable handle, close to blade, for easy, one-hand control.

EASY TO FOLLOW: Cutting guide line is always visible. Sawdust blown clear of cutting action.

SAFE TO USE: Telescoping guard automatically covers blade except when sawing. Instant-release trigger switch. Ground wire prevents shock if tool shorts.

UNMATCHED QUALITY: Powerful new Home-Utility universal motor, built by Black & Decker specifically for power sawing. Full-sized ball bearings throughout. Sturdy aluminum housings. Tough gears for years of service. Typical of Black & Decker's 38 years of outstanding electric tool building!

LOOK it over today at your hardware, electrical or implement dealer!

<p>Trims stock size windows, doors, screens to fit.</p>	<p>Makes pocket cuts in walls for built-in cabinets.</p>
<p>Saws stair stringers in fraction of hand sawing time.</p>	<p>Cuts transite, tile, slate, etc., with abrasive discs.</p>

HUNDREDS OF OTHER USES: Sawing lumber to construction length. Fitting interior trim and moulding. Cutting out plywood and wallboard panels. Preparing concrete forms, etc.

ELECTRIC HOME-UTILITY TOOLS

Products of The BLACK & DECKER Mfg. Co.
Dept. H7M, Towson 4, Md.

- ELECTRIC DRILLS • SANDER-POLISHERS • BENCH STANDS • DRILL KITS



Save \$300.00 to \$500.00. Build your own arc welder !!

It's easy to Build your Own Arc Welder. Be prepared to go after the profitable outside repair and construction jobs. Pay for your welder out of increased earnings that start immediately.

Go after those BIG PAY jobs. No need waiting to own a complete factory built outfit. Let Hobart help you get started now. It's easy. Write for full details. Tell us your plans.

Send for Book **How to Build Your Own Welder** 15c postage and handling.

HOBART

HOBART BROTHERS COMPANY, Box M-791, Troy, Ohio

"One of the world's largest builders of arc welders"



SET THE PACE WITH THE

- Cruises at 45 MPH—with faster pickup than car
- 39" high, 71" long over-all, wt., 190 lbs.
- 8 HP motorcycle engine
- 50 miles to the gallon
- Automatic clutch
- Internal expanding brakes — handle-grip throttle controls

POWELL MANUFACTURING COMPANY
DEPT. PM749 • COMPTON, CALIF.

Powell
P-81!

ONLY **\$247³⁴**
AT COMPTON, CALIF.
EXCISE TAX INC.

Write for FREE folder and name of nearest dealer

Dealer Inquiries Invited



Build Your Own

TOW TRUCK

The Easy
"Jack Heil"
Way

A Rugged, Heavy Duty, Lifetime Unit by the manufacturers of the "World's Finest Towing Equipment"

All parts cut and shaped to fit, exact duplicates of parts used in our production line. Only a welding machine needed to complete this power winch, universal model. Capable of handling trucks, cars, tractors and trailers. Includes complete operator's manual showing proper step by step procedure of doing heavy hi-way wrecking, and towing, diagrams, technical information, etc. Solve your own problems. Complete units also available at great savings.



Also available: A complete line of bodies, cranes, winches, spacer bars, cable, other towing equipment. Operator's manual free with each order. Otherwise, send \$2.50.

JACK HEIL "Builds Truck Bodies"

Dept. PM, 2112 N. Clybourne, Chicago 14, Illinois
Experienced Salesmen now calling on automotive trade, write for territories!

"MOWER POWER"



Requires
No Welding

PRECISION
BUILT
To Last a
Lifetime

COMPLETE ATTACHMENT. For Either Electric Motor or Gasoline Engine. Fits Any Make or Size of Lawn Mower. POSITIVE CHAIN DRIVE and FREE WHEELING. Easy to Install, in Less Than an Hour. IMMEDIATE DELIVERY. Sold Direct to you at Factory Price, ATTACHMENT **\$27.80**

ENGINE

Powerful 2 H.P. 4 cycle air cooled gasoline engine. Weight 30 lbs. Precision made for years of dependable service. Designed for rugged work. Smooth running and quick starting at any temperature. No vibration. Sold direct to you at Factory Price **\$55.50**

"ROYAL" ROTARY MOWER

New "Royal Rotary Mower" for either gasoline or electric motor is the most economical and practical mower ever made. Cuts with a smooth finish through any Lawn, Spike grass, dandelions and high weeds. Clippings are scattered evenly. No need for racking or after turning. 20 inch cut. Easy to adjust cutting height. Weighs only 34 lbs. Sold direct at factory prices. Without motor,



\$50.00

ABSOLUTE MONEY-BACK GUARANTEE
WRITE FOR FREE FOLDER TODAY

ROYAL OAK LAWN MOWER SHOP
P.O. Box 48 Royal Oak 1, Michigan

You've probably heard some of these disturbing factors on your own radio or television set. Atmospheric noise is commonly called "static" and is generated by electrical discharges from thunderstorms. Cosmic noise seems to come strongest from the vicinity of the constellation Sagittarius in the Milky Way and is heard as a slow, steady hiss. Solar noise is also a hissing sound, interrupted by "puffs" and "swishes" which are the result of sunspot activity.

With the use of higher and higher frequencies in communication and radar equipment, both solar and cosmic noise have come to be recognized as increasingly important. Recent advances in the design of very-high and ultra-high frequency receivers, which practically eliminate internal set noise, indicate that the limiting factor in the use of such equipment will be the "out of this world" noises from the sun and stars.

Radio Propagation Laboratory scientists, therefore, are much concerned with the study of solar and cosmic noises—and their effect on short-wave, long-range transmission. The researchers want to know the range of frequencies broadcast by the sun, received intensities and the correlation of the various kinds of noise in the atmosphere.

Two giant radar mirrors set up by the Radio Propagation Laboratory at Sterling, Va. (one built, the other under construction) will intercept and record solar noises reaching the earth. These devices are particularly suitable for this type of research because of their size. Their 25-foot reflectors will be aimed at the sun all day to pick up, initially, signals in the 480 to 500-megacycle band. Other ranges will be investigated later.

In addition to sending out printed material, the Radio Propagation Laboratory also broadcasts a vast amount of information over its radio station WWV. Located in Washington, D. C., WWV broadcasts on eight frequencies (2.5, 5, 10, 15, 20, 25, 30 and 35 megacycles). Seven or more transmitters are on the air at all times, day and night. This insures blanket coverage of the U. S. and much of the rest of the world.

Here is the information made available:

1. *Standard radio frequency*—The accuracy of any one of the radio carrier frequencies transmitted by the Bureau of Standards is one part in 50,000,000. Such gnat's eyelash measurements are of value to radio, electronic and acoustic research. Any desired radio frequency, including microwave, may be measured in terms of standard frequencies.

(Continued to page 252)

grand slam...

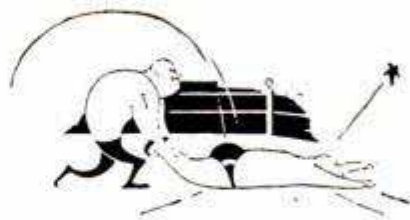

● **Grand slam in performance.**

Because of AC's patented CORALOX Insulator,* AC Spark Plugs perform better than spark plugs ever did before.

They start better . . . idle better . . . fire better under all conditions.

They offer more resistance to oxide coating.

They give you a grand slam in spark plug performance.

That's a big order . . . but it's true. A set will prove it.

AC SPARK PLUG DIVISION • GENERAL MOTORS CORPORATION



SPARK PLUGS

BUY WHERE YOU SEE THIS SIGN



**MORE NEW CARS AND TRUCKS
ARE EQUIPPED WITH AC SPARK PLUGS
THAN WITH ANY OTHER MAKE**

* AC's patented processes make Coralox the finest insulator in spark plug history. Improved electrical insulation, no matter how high the temperature. Better heat conduction. Maximum resistance to heat shock. Less fouling. Stronger, longer-lived.

NEVER BEFORE!

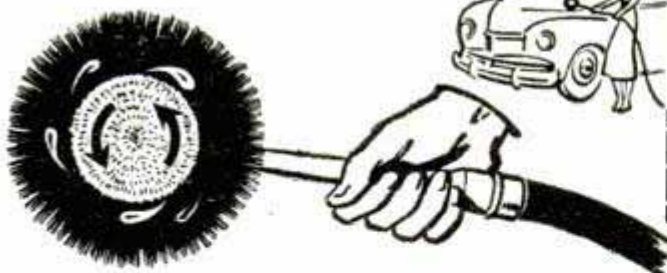

such an easy way to wash your car!

Just hold the **SWIRL-O-MATIC**
The Revolving Brush Does the Work!

SIMPLY attach Swirl-O-Matic to any garden hose . . . the amazing, whirling turbine action automatically cleans, gives car a gleaming jewel finish. Outer brush prevents splashing, gets into corners.

"DOES SO MUCH FOR SO LITTLE"

- Rinses as it cleans! No streaking!
- No rubbing, scrubbing, wiping!
- Washes windows, siding, etc.
- Easy to use . . . weighs less than 1 lb.
- Guaranteed! Economical! Pays for itself in 5 or 6 washings. Brushes are replaceable.

ONLY
\$6.95
PREPAID

Try the Swirl-O-Matic—see how amazingly fast it washes. If car not too dirty, or is simonized or porcelainized, just plain water will do the job beautifully. For really dirty jobs, FREE "Magic" detergent included. For washing windows, siding, etc., order 3 ft. extension, ideal for this purpose. \$2.50 extra (Prepaid).

West of Mississippi: add 25c each item. AGENTS WANTED.

MELAIRE DISTRIBUTING CO.

Dept. 1PM, 420 Lexington Ave., New York 17, N. Y.

Learn A Trade NOW! PRACTICAL SHOP TRAINING!

In Our Chicago Shops

- | | |
|-------------------------------------------|----------------------------------------------|
| <input type="checkbox"/> AUTO MECHANICS | <input type="checkbox"/> WELDING—ARC and GAS |
| <input type="checkbox"/> DIESEL MECHANICS | <input type="checkbox"/> MACHINIST |
| <input type="checkbox"/> REFRIGERATION | <input type="checkbox"/> PIANO TUNING |
| <input type="checkbox"/> BODY-FENDER | |

Above Approved For G. I.'s and Civilians
One of America's Leading Practical Schools
7 Floors of Fully Equipped Shops
Over 48,000 Successful Graduates
Expert Individual Instruction
Learn by Doing—Low Living Expense
Established 1902—Day and Evening Classes

Also the following Home Study Courses

- | | | |
|----------------------------------|----------------------------------------|---------------------------------|
| <input type="checkbox"/> PLASTIC | <input type="checkbox"/> REFRIGERATION | <input type="checkbox"/> DIESEL |
|----------------------------------|----------------------------------------|---------------------------------|

—CALL IN PERSON OR MAIL THIS AD TO—

GREER SHOP TRAINING

(Desk 16) 460 South State St., Chicago 5, Ill.

Please send without obligation free information regarding trade checked above. (Specify whether you are a Veteran or Civilian)

Name _____ Age _____

Address _____

City _____ State _____

2. *Time announcements*—Eastern Standard Time is announced in telegraphic code every five minutes. At the hour and half hour, announcements are followed by station announcements in voice.

3. *Standard time interval*—A pulse of .005-second duration is broadcast at intervals of one second. These are heard as a faint click. On the 59th second of each minute, this signal is omitted.

4. *Standard audio frequencies*—Two standard audio frequencies, 440 and 4000 cycles per second, are broadcast. They are useful for accurate measurement or calibration of sensitive instruments in the supersonic range.

5. *Standard musical pitch*—The 440 cycles per second is the standard musical pitch—"A" above "Middle C." It is broadcast for four minutes and then interrupted for one minute. This service is useful to musicians and manufacturers of musical instruments.

6. *Radio propagation disturbance warning notice*—In spite of carefully drawn, scientific broadcasts, sudden ionospheric disturbances arise now and then. The Radio Propagation Laboratory provides a warning in code at 20 and 50 minutes past each hour. A series of "Ws" signifies that disturbed conditions are to be expected within 12 hours; a series of "Ns" means that none are expected.

Taking the guess out of radio "bounce" is important now that domestic broadcasting is moving into the higher-frequency ranges and FM and television are coming to the foreground. It means better communications with the whole world and higher standards of accuracy for researchers and manufacturers.

Softwoods Become Hardwoods Under Pressure and Heat

Almost any softwood of low resin content can be made into a hardwood substitute by a mechanical process in which a board is compressed to one third its original thickness. White fir, an inexpensive and plentiful product in the Western states, makes a superior hardwood substitute that feels as hard and heavy as a smooth piece of slate. The board is subjected to a pressure of 1500 pounds per square inch at 325 degrees. The natural lignin in the wood flows under the heat and acts as the cementing agent to hold the board to its compressed thickness.

☛ Just one of the large rubber companies makes rubber bands in 29 standard sizes, as well as other sizes for specialized uses.

THE BULL BUFFER

PAT. PEND.



You polish and sand faster, easier — do beautiful, professional work—with this amazing new attachment for your hand drill. And it more than pays for itself the very first time you polish and sand your car, floors, woodwork, furniture.

(or flexible shaft). It's the only buffer you can turn in a complete circle while you hold your hand drill stationary. Reaches all curved and flat surfaces. It's packed with power, built of lifetime materials and guaranteed.

The Bull Buffer fits any chuck on an electric drill

Order today—at your dealer, or send cash, check, or

ORDER THESE ACCESSORIES FOR YOUR BULL BUFFER:



Cup wire brush attachment for removing paint, rust, scale, etc. \$1.75



Jacobs key chuck; when attached to Bull Buffer, increases 1/4" drill to 1/2" capacity — reduces speed, increases power. \$5.00

- Bull Buffer car cleaner \$.50
- Bull Buffer car polish 1.00
- Extra sheepskin bonnet 1.25
- Extra sanding discs (0000-000-00-0-1-2 1/2-3) each10
- 1/2" Jacobs No. 6425 key chuck (see photo) .. 5.00
- 2 1/2" cup wire brush (see photo) 1.75
- Adapter B set for sanding at twice drill speed ... 2.00

money order for your Bull Buffer, complete as pictured below, each.....

\$9.95

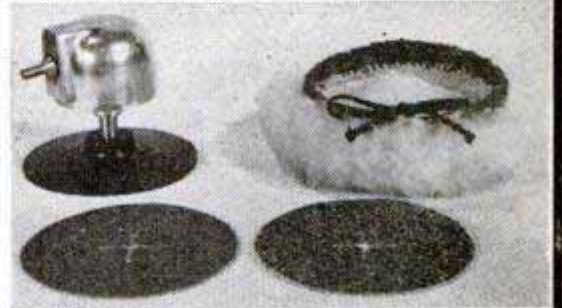

Bull Buffer comes complete with 5-inch rubber disc, sheepskin bonnet, and 2 sanding discs, only \$9.95.

BERTRAM R. ENGINEERING COMPANY
 3121 MAIN ST. Dealers, Write for name of nearest wholesaler KANSAS CITY, MO.

LOWEST PRICED COMPLETE POWERCYCLE

The New Model "L" Servi-Cycle, which gives you 30% more power and is acclaimed "The World's Best Powercycle," sets new standards for safety, dependability, operating economy; and, for low initial cost. The New Model "L" Servi-Cycle, fully-equipped, sells for \$100 less than other complete lightweight machines.



Model "L"



U. S. Tax Paid

\$248.00
 DELIVERED
 Fully-Equipped

FEATURES

- 30% More Power
- Three-Speed Foot Shift
- Balanced "V" Drive
- Twist-Grip Controls
- Double-Action Fork Springs
- Aluminum Cylinder
- "Kwick-Klean" Air Cleaner
- Dependable Kick Starter
- Quiet, Efficient Muffler
- Super-Safe Brakes
- Full-Grained Leather Saddle
- Sturdy Safety Guards
- Safety Parking Stand
- Low Center of Gravity
- 100 Miles Per Gallon

Write for FREE Folder

SIMPLEX MANUFACTURING CORPORATION 540 N. CARROLLTON AVENUE
 NEW ORLEANS 19, U.S.A.

WRITE FOR YOUR FREE COPY OF THE NEW KRW HYDRAULIC PRESS BOOK

Describes all manner of Production and Shop Work on KRW Hydraulic and Bench Type Presses. 32 pages illustrating the new KRW Hand-operated, Electric-operated and Air-operated Hydraulic Presses. 25 to 100-ton capacities.

Write for your copy today.

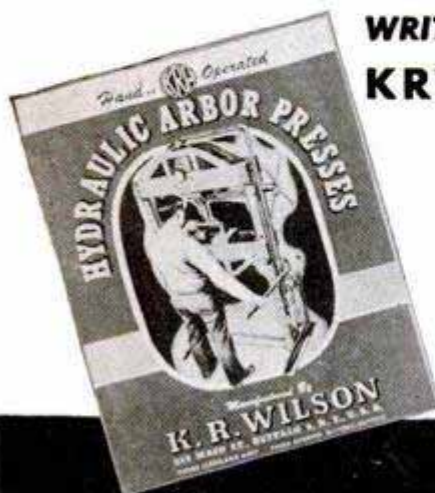

K. R. WILSON, DEPT. 17, 215 MAIN ST., BUFFALO 3, N. Y.

THOUSANDS BUILD



U-MAK-IT BOATS

EASY TO

ASSEMBLE KITS

NO EXPERIENCE NECESSARY

Everything Complete in Kit. Quality Material. Simple as ABC instructions. Immediate Delivery. Save Money, Big Value, Sturdy

ROWBOATS, KAYAKS, DINGHIES, INBOARDS, OUTBOARDS, RUNABOUTS, CABIN CRUISERS

SEND 25¢ (COIN) FOR CATALOGS

Colorful Illustrations show all '49 Models, 8 to 23 Ft., and Construction Details.

U-MAK-IT PRODUCTS

MARINE DIVISION
Formerly Kayak Boat Co.
703P- WHITTIER ST., N. Y. 59, N. Y.



3 NEW
ATOMIC
RACERS
NOW READY

Crosman TARGET PISTOLS

.177 or .22 Cal.

NOW you can shoot indoors as well as outdoors, for Crosman adjustable "power without powder" is safe, and there's no noise or powder reek. Fine balance, rifled barrel, push-type safety, adjustable rear sight; grip fits either hand. Only \$14.95! At your dealer's; write for literature.



Crosman Arms Co., Inc. 3 HENRIETTA STREET ROCHESTER 7, N. Y.

This Modern Masonry Has High Earning Power

An Outstanding Manufacturing Opportunity for Right Man



Tie in with today's demand for smart, colorful, low-cost masonry for homes and other buildings. Dunbrik-Dunstone has beauty, strength, modernity. Easily America's finest masonry, with tremendous appeal to building owners. Yet costs less than lumber because locally manufactured from local materials by local labor for local consumption.

More local plants are needed. You can be one of a national chain. Simple, compact equipment. Moderate in investment. 100%—150% mark-up on basic costs. Broad protection and liberal cooperation. Write for "Blueprints for Profit."

W. E. Dunn Mfg. Co.
600 W. 24th St., Holland, Mich.

DUNBRIK DUNSTONE



Shaving Brush Has Cream Inside Its Handle

Shaving cream is always handy when you use a shaving brush that holds a supply of cream right inside the handle. You twist the knurled base of the handle and the cream is forced into the bristles ready to go to work on your beard. The hollow handle is large enough to take the contents of a tube of your favorite cream. A cover keeps wet bristles from soiling clothes when the brush is packed in a suitcase.

Sliding Disk Holds Fishhook

There's no need to worry about dangling fishhooks when you carry your rod from place to place if you use a new line holder. The holder, 11 inches long, has a loop at one end which slips over one handle of the reel. The other end is hooked around the rod. The hook is inserted into a hole in a sliding disk.

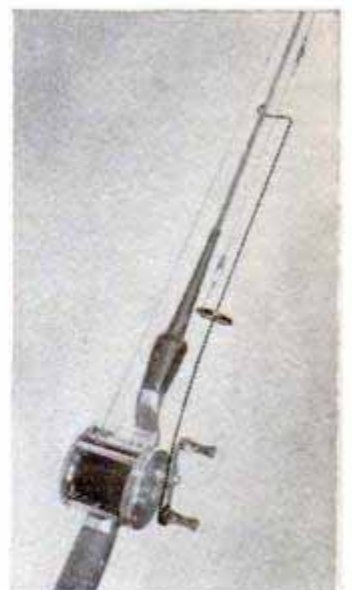

According to a General Electric engineer, a man-carrying rocket big enough to go to the moon and back would have to be about 500 feet long and weigh approximately 2000 tons.

FREE parts catalog



Build Better Trailers
with Safety-Engineered

- ★ Torq-less Axles
- ★ Bull Dog Hitches
- ★ Parking Jacks

... Send for your copy TODAY!



HAMMER BLOW TOOL CO.

Dept. 133, Wausau, Wisconsin



Finished Photos in 2 Minutes! Great Quick Photo Invention P D Q CHAMPION PHOTOMASTER

Takes and finishes 30 to 40 everlasting, black and white or sepia photos an hour. No dark room. Guaranteed not to fade. Photos taken on "SUPER-SPEED" direct positive paper. Picture size 2 1/2 x 3 1/2 in. Complete, easy-to-operate portable photo studio. 700% PROFIT. Write quick, get details about the great PHOTOMASTER.

P D Q CAMERA CO.
1161 N. Cleveland Ave., Dept. PM-7
Chicago 10, Ill.

It's so Easy... **CLEAN'em up** *SHINE'em up*

THE QUICK ZECOL WAY

**Rub on -
let dry -
wipe off!**

ZECOL WAX
QUICKER EASIER LASTS LONGER
60 MINUTE WAY TO AUTOMOBILE BRILLIANCE

ZECOL SUPER SCUM REMOVER
The Quick and Effective Way to Remove Grease, Oil, Wax, and All Other Stubborn Deposits from Your Automobile

AT GARAGES AND SERVICE STATIONS
ZECOL INC., Milwaukee 1, Wisconsin

GOLD BOND
BUY AT WHOLESALE

WHOLESALE SLIGHTLY USED TIRES DIRECT TO YOU

(10% discount on 2 or more tires if you send this ad with order)

**TUBE DELIVERED WITH
TIRE AT NO EXTRA COST**

Safe—Our tires used on school buses and ambulances—All good tires—No recaps—With a

GOLD BOND GUARANTEE FOR 12 MONTHS

550-16 ... \$3.54	550-15 ... \$3.79	450-21 ... \$5.14
600-16 ... 3.59	650-15 ... 3.89	475-19 ... 5.42
650-16 ... 3.89	700-15 ... 3.98	525-18 ... 5.69
700-16 ... 4.59		550-17 ... 5.69

Exceptionally good original tread—No recaps—With a

GOLD BOND GUARANTEE FOR 24 MONTHS

550-16 ... \$5.19	550-15 ... \$4.81	450-21 ... \$6.25
600-16 ... 5.29	650-15 ... 4.98	475-19 ... 6.35
650-16 ... 5.29	700-15 ... 5.29	525-18 ... 6.69
700-16 ... 6.29		550-17 ... 7.99

Truck Tires—Just what you wanted to order—With a

GOLD BOND GUARANTEE FOR 24 MONTHS

600-20 .. \$7.98	825-20 .. \$11.19	1100-22 .. \$16.89
30-5 ... 7.98	900-20 .. 11.89	900-24
650-20 ... 7.69	1000-20 .. 12.89	(40-8) 21.60
700-20 (8) 9.29	1100-20 .. 13.89	750-16 .. 8.40
700-20 (10) 12.48	1200-20 .. 18.78	900-16 .. 8.98
750-20 (8) 8.19	750-24	825-15
750-20 (10) 9.19	(36-6) 12.21	(14 ply) 14.10
	38-7	750-15
	(825-24) 13.75	(12 ply) 11.30
	1000-22 .. 17.70	

Gold Bond Special — 900-16 Military, \$6.98 • 750-20 Military, \$8.49

Send check or money order with this ad

GOLD BOND TIRE CO., Dept. PM 24

512 NORTH 1ST ST., RICHMOND, VA.
"A gold bond written guarantee with every tire"

HOLD-E-ZEE

The Original
**AUTOMATIC GRIP
SCREWDRIVERS**

Hold, start and set up screws in unhandy places. Gripper instantly released by SPRING ACTION, sliding up out of way when not in use. Highest quality throughout.

New Models FOR RECESSED HEAD SCREWS

UPSON BROS., INC., ROCHESTER 4, N. Y. *At Leading Dealers Everywhere*

TRY THIS AMAZING WELDER at your local Lincoln Weldealer

See how easy it is to—

- REPAIR BROKEN PARTS
- RECLAIM WORN PARTS
- BUILD EQUIPMENT

with the "LINCWELDER 180 AC"

Get full details in Bulletin 370. Consult your telephone directory for nearest Lincoln Weldealer or write The Lincoln Electric Company, Dept. 192, Cleveland 1, Ohio.

PRICE
\$150.00
FREIGHT
PREPAID

Has the amazing Self-starting Arc for World's Easiest Welding.

Built for 220-volt line only.
Accessories as shown, \$19.00.

BASEMENT DAMP?

NEW! IMPROVED! SOLVAY AIR-DRYETTE JR.

with
SOLVAY CALCIUM CHLORIDE

absorbs moisture—the cause of rust, warping, mildew in workshops, darkrooms, closets, playrooms, storage rooms, vaults. New, improved design gives 50% greater capacity, simplifies filling and emptying. Compact, inexpensive, clean, safe, odorless, thousands in use. Write for booklet and name of your nearest dealer. Dept. 89-7, Solvay Sales Division, Allied Chemical & Dye Corporation, 40 Rector St., New York 6, N. Y.



New STEEL ADJUSTABLE BRACKETS & STANDARDS For HEAVY DUTY SHELVING



LOCKS IN PLACE
—EASY TO ADJUST
UP OR DOWN

Standards are bolted or screwed into wall vertically. Brackets readily slide into place and are safely locked by patented principle, and HELD SECURELY BY WEIGHT OF THE LOAD. Can be raised or lowered 1½" variation. Re-arrangement of shelving requires very few minutes.

HUNDREDS OF USES — QUICKLY INSTALLED

Ideal for stores, garages, filling stations, store-rooms; widely used in homes, workshops, barns, tool-houses; railroad shops and maintenance departments; in hotels, restaurants, etc. Lasts a life-time. No special tools required to install. Costs little more than make-shift wood brackets. You can make good, steady income installing JIFFY BRACKETS in thousands of business plants, offices, warehouses, etc. WRITE for FREE CIRCULARS and CONSTRUCTION PLANS.

JACKSON MFG. CO. Dept. PM5, 622 East Third St. Kansas City 6, Mo.

Mows and Trims Lawns



In One Simple
Easy Operation
8¼ Lbs.



Save Time
and Labor with a

MONTAMOWER

New model. New type metal handle has special device to adjust cutting height. Drive shaft now mounted on free rolling, factory lubricated, sealed ball bearings. No tired backs or aching arms. 8¼ lbs. live precision made mechanism that first gathers, then cuts smoothly a clean 16" swath through grass, dandelions, spike grass, lawn weeds. No noise or clatter. As modern and efficient as your electric razor. Cuts right up to walls, fences, trees or posts; leaves no fringes to be trimmed by hand. Cutters self-sharpening. Built to last many years. Many thousands in use. Sold direct from factory for 26 years. Costs little. Write at once for trial on your own lawn "approval offer," guarantee information and literature.

MONTAMOWER DISTRIBUTING CO.

97 Keeler Bldg.

GRAND RAPIDS 2, MICHIGAN



Aluminum Liner for Fish Crates

Easily removed for washing, an aluminum liner for fish crates provides a hygienic method of handling fish at ports. Made of a light gauge, the liner slips easily into the wood crate. Produced in England, it has been recommended by a United Nations committee for use by all countries.

Clamp Holds Brush on Paint Can

Paint brushes are held securely on the rim of a can or pail by a clamp device that slips over the brush handle. Made of steel, the clamp is attached to the brush by two screws. Springs on the screws allow the clamp to be opened for slipping it over the rim of the can.

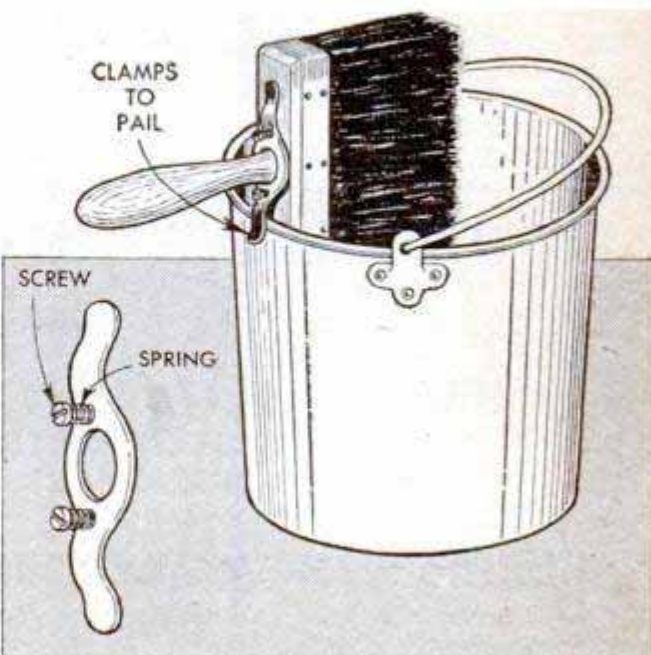

Make Money *Manufacturing* Ornamental Masonry



Eye Appeal Makes for Cash-and-Carry Sales

Millions of homes can use these Ornamental products—urns, vases, flower boxes, bird baths, lawn seats, flagstones, etc. Easily made of sand and cement. Permanently glazed in a range of smart colors. Distinctive—attractive—quick selling. Selling prices allow 200% to 300% mark up on basic costs. Only a small investment needed for supply of molds. Easily set up in shed or garage. Write immediately for catalogue OM and price list.

Colorcrete Industries, Inc.
710 Ottawa Ave. Holland, Mich.

A Profitable Whole-Time or Part-Time Opportunity

AMAZING NEW SAFE JIG SAW READY!

At last — a revolutionary, new electric jig saw small children may use, yet powerful enough to be the basic tool in Dad's workshop. Make "Standing Photo Silhouettes" of favorite snap shots . . . fancy what-nots, toys, for fun and profit! Just plug in! No motor to buy—no oiling. Thousands sold. Use in livingroom, apartments, etc. Patented. Nothing else like it. Mail postal NOW for illustrated, Free Circular, low price!

Dealers Write!

READY!

FREE
Circular!

SYNCRQ

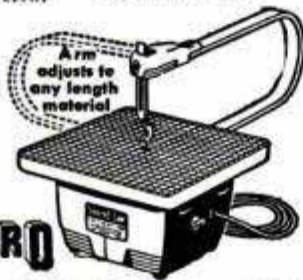

SYNCRQ CORPORATION, Dept. H-79, Rochester, Mich.



BUILD FINE GRANDFATHER CLOCK NOW

The simple sensible Red-i-Kut way as thousands have—SAVE HALF. SHOP TESTED PLANS "SPIRIT OF THE CENTURY" Narrow waist 83" tall or stately "SPIRIT OF AMERICA" straight side model with pictures. EASY-to-FOLLOW PLANS tell all—plus BROCHURE of heavy brass weight Westminster, tube chime, movements, dials, solid mahogany case kits. Send \$1.00 today—Both Plans \$1.50 NOW. KUEMPFL CHIME CLOCK CO., #4 Kuempel Bldg., Minneapolis 16, Minn.

BRONZE FOUNDRY Schools and Home Workshops

Make your own castings of aluminum, copper, bronze, silver. Foundry sets are available in three sizes including 2400 Deg. F. blast Furnaces. \$22.50; \$29.50; and \$42.00, f.o.b. Kansas City. Free Circular.

KANSAS CITY SPECIALTIES CO.

P. O. Box 6022, Dept. P-6

Kansas City, Mo.

HUDSON Miniatures' "Old Timer" AUTO KITS

The Famous 1911 Maxwell. Exactly as illustrated \$2.50

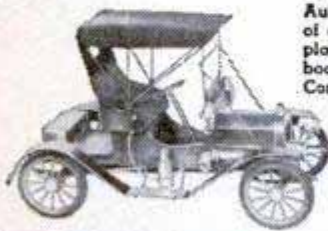

Authentic, easily-assembled scale models of early autos. 1/4" scale; all parts cast plastic, die-cut wood or special process board. No carving or cutting required. Complete instructions with all kits. Other models: 1904 Oldsmobile, \$1.95; 1903 and 1910 Fords, each \$2.50; 1909 Ford, \$2.95; 1909 Stanley Steamer, \$2.95. Finished models 6" to 8" long. Perfectly detailed models make outstanding collector's items. Send for free folder. No C.O.D.'s. Add 25c for postage and packing.

Scranton Hobby Center

315 Adams Avenue, Dept. 14, Scranton 10, Pa.

RECOGNIZED BY THEIR STRIPES



BURGESS

To millions of portable radio users, the distinctive Burgess stripes mean power—dependable, vital, fresh!

And no wonder! Today, as always, Burgess quality speaks for itself. Burgess is the only dry battery that uses chrome protection to give you fresh power, longer. Burgess paces the field in dry battery manufacture, using finest raw materials and thoroughly testing each cell in every battery before it leaves the factory. Yes, and *all* Burgess Batteries are plainly dated for your assurance of freshness!

Whatever your battery need, you can be sure there's a power-packed black and white striped Burgess Battery for you! Ask for Burgess Batteries at your radio or hardware dealer. Remember, when you buy Burgess, you buy the best!

BATTERIES



REMEMBERED BY THEIR SERVICE

NEW! 2-INCH WRIST CAMERA
Makes BIG 4"x5" PICTURES
in COLOR!

Pixie

A fine precision Camera
 Wear Pixie on your wrist,
 or tuck in pocket. America's
 smallest precision camera
 gives you BIG candid shots
 in color or black-and-white
 — at amazingly low price.



Pixie fits on wrist

The ONLY Camera
 That Takes COLOR
 at 10c a "Shot"!

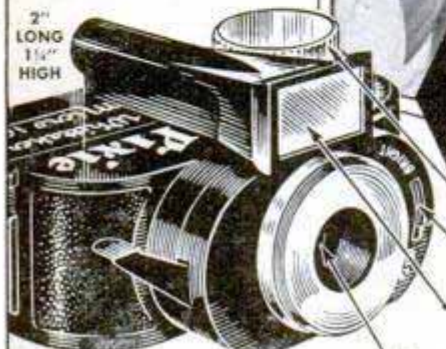

- 14 Exposure Counter
- 3 Stops: "Color" (f6.3), "Dull" (f8), "Bright" (f16)
- Optical Eye-Level View-Finder
- Fastest Lens in any fixed-focus camera, (f6.3 doublet)

Takes 14 Beautiful Pictures!

The ONLY Still Camera
 With MAGAZINE LOAD!



Magazine loading is automatic, fool-proof. Film is encased in light-tight magazine which snaps into camera instantly. No threading. No damaged film. Pixie is the only still camera in which you can alternate color and black & white shots.

Film Available Everywhere

Pixie uses Ansco Color Film or DuPont Black & White. If your dealer cannot supply film, write direct.

Case of non-shattering high-finish Polystyrene

INCLUDED AT NO EXTRA COST
\$1.29 Color Film - 14 Exposures!

SENSATIONAL INTRODUCTORY OFFER!

Send NOW for your Pixie Camera and get, at NO EXTRA COST, a \$1.29 magazine loaded with Ansco Color Film, enough for 14 color shots. Return film for FREE processing. MONEY-BACK GUARANTEE if not fully satisfied. Can you ask for more? (Offer good for limited time only.)

SEND NO MONEY Mail coupon today. When your Pixie and Color Film arrive, pay postman \$6.25 plus few cents postage. Or send cash with order and we will pay postage.

PIXIE plus COLOR FILM
\$6.25 Incl. Fed. Tax

MONEY-BACK GUARANTEE

HELM-CRAFT, Inc. Dept. PM 79
 Box No. 1145, Hollywood 28, California

Please send me Pixie Camera (plus Color Film) on 10-day trial.

Send C.O.D. plus postage. I will pay postman. I enclose \$6.25. Send postpaid.
 Send also Pixie Wrist Strap. (I enclose 69c) (Send C.O.D.)

NAME _____ AGE _____
 STREET _____
 CITY _____ ZONE _____ STATE _____

Send NOW for your PIXIE and Color Film

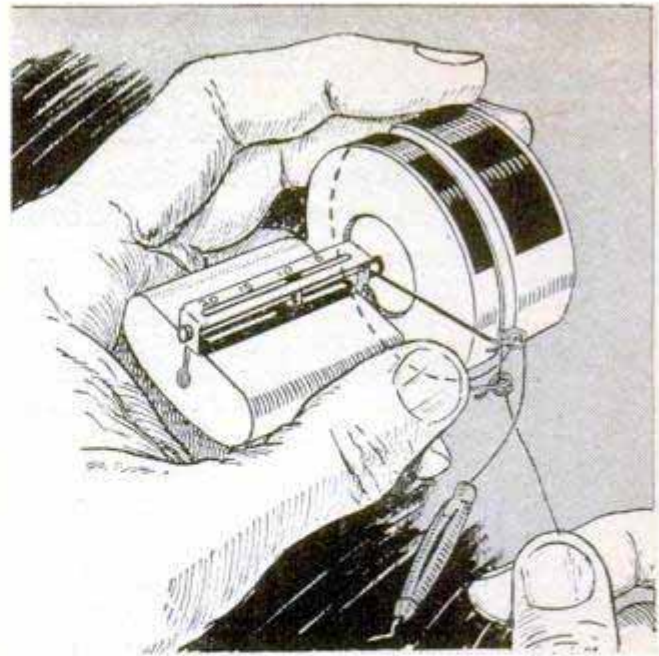

Casting Bobber

When a fisherman casts a new bobber, the hook automatically descends to the desired depth for still fishing. The angler sets an indicator to lower the line as deep as 20 feet. When a fish strikes and the fisherman reels in the line, the bobber automatically returns to its original position against the sinker, thus taking up slack in the line. The bobber is made of plastic, bronze and stainless steel to resist corrosion.

Machine Applies Tape To Edges of Blueprints

Blueprints, maps and other papers that receive rough handling are given a protective edging of an adhesive paper tape by a crank-operated machine. The tape is folded automatically so that it sticks to both sides of the paper, giving a tearproof edge. The device can also be used to bind single sheets together to form a folder and to reinforce the fold in sheet music.

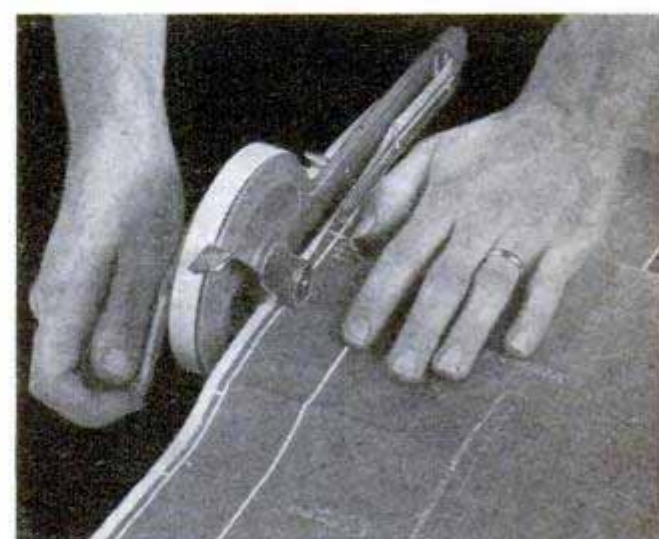



DUST-O-VAC FOR ALL MACHINES

For Home Workshops & Industry. DUST-O-VAC collects & bags wood & plastic chips, wood & metal dust, wood shavings. **Free Bag.** Attaches to circular saw, planer, band saw, grinder, belt or disc sander, shaper, drill press with shaper or sander attachment, spindle shaper, wood lathe, jig saw. 110 A.C., D.C. Send for mounting instr. for all machines.

\$19.95

Free Ship. cost of Miss. West of Miss., add \$1. Check, M.O.

HEAVY CAST ALUMINUM BLOWER — ONLY \$10
110V, AC 50-60 cycles, cont. duty motor, deliver app. 100 C.F.M. For workshop, lab, kitchen, cellar, etc. Install yourself. Send for circular.

UNIVERSAL YONKERS CORP., 137 Alexander St., M7, Yonkers 2, N. Y.

HIGH POWER TELESCOPE

60 POWER - ALUMINUM TUBES - OPENS TO 33"

Variable Power Eyepiece Adjustable to 15X, 30X and 60X.

\$4.50



Leather Case Included

5 Sections. 4 Ground & Polished Lenses. Also used as 50X Microscope. Ready to use, only \$4.50 POSTPAID. **BROWNSCOPE CO.** Dept. 7M, 24 W. 45th St., NEW YORK 19, N. Y.

30" SHEET METAL BRAKE

Forms angles, channels, voes, flanges, locks, zees. Handles 26 gage sheet steel, heavier gages of aluminum. Quick locking levers. No screwing down. Can be held in a bench vise, or bolted down. All steel. Wt. 40 lbs. Shipped exp. collect.

\$24.50



12" BRAKE. Fits in vise to form difficult and compound bends, up to 20 gage steel 12" wide, \$12.50 PP.
SHEAR. Cuts 16 gage steel any length and width, \$12.50 P.P.
SHEET METAL PLIERS. 2 1/2" wide, \$2.00; 5", \$3.50. Immediate delivery. Order direct, cash or C.O.D., or send for folder.

WISE BRAKE MFG. CO.

1116 SO. 27th ST. DEPT. P-7 OMAHA 5, NERR.

CASH IN ON THE BUILDING BOOM



Only \$199

Amazing, General High-Speed low cost Concrete Vibrator Block Machine. Will produce 1000 blocks in an 8 hour day. All sizes. Easy to start your own profitable business. Complete details sent FREE. Mail \$1 for WONDERFUL BOOK "How To Build Your Own Concrete Block Home."

GENERAL ENGINES CO.
(EASTERN DIVISION) DEPT. F • DREXEL BLDG., PHILA. 6, PA.

BUILD HEAVY DUTY MACHINES



SAVE UP TO 90% — You can build, using our practical, easy-to-read plans, all kinds of machines, for home, farm or shop — scooters, portable sawmills, metal working machines, concrete machinery of all kinds, printing equipment, woodworking machines, midget autos, dish washers, farm equipment, freezers, tractors.

FREE

CATALOG HANDBOOK
183 SETS OF PLANS
VALUABLE INFORMATION

NICHOLS EQUIPMENT COMPANY
D-2410 PURVIS, MISS.

THE Eager Beaver

A man-size ball-bearing bench saw for only **\$10.95** PLUS TAX

IMMEDIATE DELIVERY

LOOK AT THESE FEATURES:
1. All metal construction
2. Smooth-rolling ball bearings
3. Light and portable
4. Adjustable rip fence

5. Indexed mitre gauge
6. 1 1/2" arbor pulley
7. Full two inch cut
8. Designed for safety
9. Table size 12 1/2" x 13 1/2"
10. 6 in. combination blade

If your dealer cannot supply you send check or money order with dealers name. We'll ship prepaid. Price does not include motor. No C.O.D.'s please.

SIERRA TOOL CO., INC., 1618-B NORTH VERMONT AVE. LOS ANGELES 27, CALIFORNIA

AMAZING FORREST METAL CUTTER

Fits Any Circular Saw Arbor. No teeth to wear out, break or sharpen; lasts a lifetime. Made of high test stainless steel. Cuts any metal up to 1/16-in. thick without curling or bending. Also cuts plastic. Money back guarantee. Specify arbor size when ordering.

\$3.00 POST PAID. SEND CASH, CHECK OR M.O. TODAY!

FORREST SALES CO. 643 Russ Bldg. San Francisco 4, Calif.

Time to "Summer-Proof" your Oil filter

SUMMER'S HARD ON OIL FILTERS. Long trips pile up mileage, speed the formation of sludge. Dusty roads load your oil with engine-wrecking abrasives and dirt.

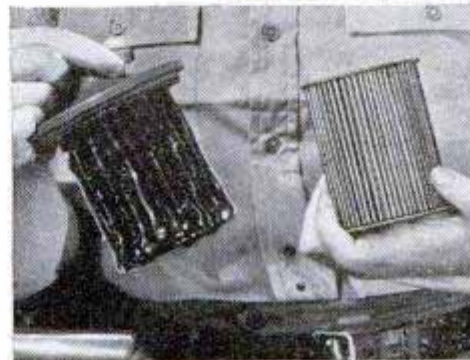

MICRONIC REFILL A MONEY-SAVER. No other oil filter compares in dirt-absorbing capacity. No other filter keeps your oil so clean, repair bills so low.

OUT WITH THAT CLOGGED-UP CARTRIDGE. Insert a Purolator Micronic Refill... to help check engine wear, forestall an untimely overhaul or repairs.



Make your next oil change complete . . . new oil and a new filter refill. Insert a Purolator Micronic Refill. Traps *all* the engine-wrecking sludge and abrasives. Fits almost all filters. \$1.38 to \$2.50, depending on make of car; inserted in a few minutes.

If your car is *not* equipped with an oil filter, install a Purolator, \$6.50, or a bit more, also depending on make of car. Purolator Products, Inc., Newark 2, N. J., and Windsor, Ontario, Canada.



WE FURNISH ALL MACHINED METAL PARTS, EVERY SCREW, NUT, BOLT, WASHER, AND COMPLETE PLANS FOR THIS...

BIG 10" POWER SAW



\$9.95
LESS GUARD AND WOOD

POST PAID ANYWHERE IN U.S.A.

FULL \$9.95 REFUND IF NOT SATISFIED WITHIN 10 DAYS

ASSEMBLE IT YOURSELF WITH SIMPLE HOUSEHOLD TOOLS!

TABLE 24" x 20" • TILTS TO 45°
CUTS 0" TO 3/4" DEEP • TAKES 10" BLADE

COMPLETE PLANS (WITHOUT PARTS) 10c

MARCUS • POLLAK DEPT. 44 ROYERSFORD, PA.

FREE ALLIED'S LATEST RADIO CATALOG!

Radio's Biggest Values
SEND FOR IT TODAY



Everything in Radio At Lowest Prices!

See the latest ALLIED Catalog for greatest values in Television receivers, latest radios and radio-phonos, high-fidelity custom sound components, recorders, sound systems, Amateur receivers and station equipment. Everything for Builders and Experimenters—thousands of parts, tubes, test instruments, tools, books, diagrams and kits. World's largest stocks—all at really low-money-saving prices. Get your Free ALLIED Catalog now!

The DEPENDABLE Radio Buying Guide

FREE CATALOG Send for it

ALLIED RADIO

833 W. Jackson Blvd., Chicago 7, Ill. Dept. 5-G-9

Rush FREE ALLIED Catalog.

Name.....

Address.....

City.....State.....

SAVE \$55.00 ON THE PRICE OF

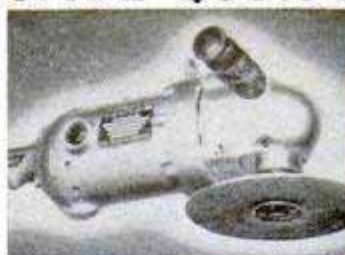

3/4 H. P.
115 v.
AC-DC motor
4200
R. P. M.

THIS VERSATILE HEAVY DUTY TOOL!

ONLY \$42.50 Direct from mfr.

Get this bargain now! Limited offer from surplus stock. No "catch." Brand new A-1 Spinner. Send check or M.O. today. (No C.O.D.)

HOLT MFG. CO., 272 BADGER AVE., NEWARK 8, N. J. 651 20th STREET, OAKLAND 12, CALIF.

COOLING...

Suitable for stores, homes, offices and shops. All types. Blowers and blower parts. Motors. Lowest prices. Wholesale and retail. Free literature.

PEERLESS SALES & SUPPLY
4318 Sheridan Lincoln 6, Nebr.



WELDS • BRAZES • SOLDERS • CUTS

ANYONE CAN OPERATE the newly invented Four-Way Portable Electric Welder—does brazing, soldering, welding, cutting on iron, steel, brass and other metals. WORKS INSTANTLY off any properly wired 110 VOLT AC or DC line. The time and money you save on auto, home appliance, farm and shop repairs will quickly pay for this machine. Comes COMPLETE with Power Unit and ALL SUPPLIES ready-to-operate, including simplified instructions. Write for Free particulars or order one today for 10 Day Trial. FOUR-WAY WELDER CO., Dept. PMF-79 3180 N. CLARK STREET, CHICAGO 14, ILLINOIS



STUDY AT HOME for Business Success and LARGER PERSONAL EARNINGS. 40 years expert instruction—over 114,000 students enrolled. LL.B. Degree awarded. All text material furnished. Easy payment plan. Send for FREE BOOK—"Law and Executive Guidance," NOW!

AMERICAN EXTENSION SCHOOL OF LAW
Dept. 16-PM 646 N. Michigan Ave. Chicago 11, Ill.

10 HP PORTABLE POWER PLANT from any CAR or TRUCK

Line up with rear wheel, drive on to unit—that's all! Unfailing power where you want it—when you want it! No demounting, no jacking-up! Suitable for any belt-driven, power operation. NEW, LOW PRICE! ACCESSORIES AVAILABLE: Generator, Grinder, Centrifugal pump. Illustrated circular on request.

FREE Illustrated Circular

ASPEGREN MFG. CO.
1612-M Webster Ave., N. Y. C. 57



An Outstanding METAL HAND PUNCH with unusual performance

Needed by every Mechanic in every Shop.....

No. 5 Jr. HAND PUNCH

CAPACITY—1/4" THRU 16 Ga. Mild Steel. 3/32" — 1/8" — 5/32" — 3/16" — 7/32" — 1/4" — 9/32" — Punches and Dies Furnished.

THROAT DEPTH 2 inches

Weights 2 3/4 lbs.

only \$8.75

ORDER YOURS TODAY!

Write for FREE Catalog on other tools.

Postpaid in U.S.A.

WHITNEY METAL TOOL CO., Dept. P-7. Rockford, Ill.



WAR SURPLUS SPECIALS!

Logan Heavy Duty HYDRAULIC PUMP

BRAND NEW . . . for operating hydraulic cylinders and hydraulic motors on tractors, bulldozers, construction machinery, lift trucks, industrial applications, etc. Delivers 8 GPM at 1200 RPM at 1000 P.S.I. using 5 H.P. Has 1 1/2" pipe thread inlet, 3/4" pipe thread outlet, 3/4" shaft with flat and keyway for direct or pulley drive. Has flange with 4 bolt holes for convenient mounting. Ship. wt. 22 lbs. Overall dimen.: 7" L x 5 1/4" H x 5 1/4" W. A \$105.00 value. FOR ONLY



\$22.50

F.O.B. Chicago

LOGAN Heavy Duty HYDRAULIC CONTROL VALVE

BRAND NEW control valve with built-in adjustable relief valve, will operate one double-acting hydraulic cylinder or two cylinders as one or a reversible hydraulic motor. Valve handle latches in neutral position. Made of rugged cast aluminum alloy. Open center unloads the pump in neutral position. Throttling control allows operator to regulate the speed of movement of the hydraulic cylinder or motor. Has removable mounting brackets with 4 bolt holes, 3/8" pipe thread connections. Overall dimen.: 12 1/2" H x 8 1/2" D x 8" W. Ship. Wt. 17 lbs. Gov't. Acquisition Cost over \$100.00. AN EXCELLENT BUY FOR . . .



\$21.95

F.O.B. Chicago

BRAND NEW GENERAL ELECTRIC 8" SEALED BEAM FLOODLIGHTS

300 Watts, 110 Volts, A.C. - D.C. Has countless uses for: • Homes • Garages • Workshops • Driveways • Outdoor advertising • Displays • Beach lighting • Private air ports • Photography Wherever you need flood-lighting! Bought by the U. S. Army for signal use. This is the greatest surplus bargain ever offered. Lens, reflector and electrode vacuum sealed in one dustproof, air tight unit. 300 Watts, 110 Volts. Weights only 2 1/2 lbs. List price \$10.50. A TREMENDOUS VALUE for . . .



\$2.75

12 or more \$2.50 ea. postpaid

BRAND NEW Hale Fire and Irrigation HIGH VOLUME CENTRIFUGAL PUMP

FOR FIRE PROTECTION, IRRIGATION, DE-WATERING, INDUSTRIAL USES, FARM USES, ETC. PUMPS RATED 500 GALLONS PER MINUTE AT 275 FT. HEAD PRESSURE

Equipped with 1 1/2" diameter straight splined shaft for direct coupling drive; 4 1/2" threaded suction intake; two—2 1/2" threaded discharge outlets; Hale Pump Co. Model CF volute type; use any 4 or 6 cylinder gas engine or couple directly to front of truck or auto; or use 25 H.P. electric motor; dimensions 21" x 24" x 28". Complete with full accessory kit including suction and pressure gauges, priming equipment, and instruction book. Ship. wt. 415 lbs. . . .

\$149.50

Gov't. acquisition cost \$425.00

NOW

F.O.B. Chicago

Brand New Self-Priming BRONZE PUMP

Perfect for draining basements, irrigation, fire fighting, sprinkling, pressure booster, insecticide and other spraying, fuel transfer, stock watering, industrial pumping, deep well jet pumping and home water systems. Rated 25 ft. suction and 150 ft. head pressure at 80 gallons. Use from 1/2 to 5 H.P. motor. COMPLETE ENGINEERING REPORT AND INSTRUCTIONS FREE WITH PUMP



Mfd. by the Pump Division Eaton Mfg. Co.

\$32.50

Supplied with mounting brackets and 5" V belt pulley, ready for instant use. Standard 1 1/2" pipe thread inlet and outlet. Dimensions: 9 1/2" x 7 1/4" x 4 1/4". Ship. wt. 18 lbs. A \$142.00 value. . . .

F.O.B. Chicago

SCREW JACK

Ideal for raising, lowering, leveling and adjusting. Use on tables, machine tools, toys, etc. Overall length closed 9 inches, open 14 inches. Worm gear box with 54 to 1 reduction, with double end drive shaft. Use either end or both. Extension screw shaft 30 to 1 reduction. \$35.00 value. AN OUTSTANDING BUY . . .



Brand New **\$3.95** postpaid

SHOCK ABSORBER

Use them to spring suspend vehicles, hoists, pumps, heavy and light machinery, compressors, etc. 1 1/2" x 2" dia. Welded steel construction for extra strength—U. S. Air Force bought them for bomber gas tank shock absorbers. Rated 2500 lb. Ship. wt. of 4—11 lbs. . . .

\$5.00

Each . . . \$1.50 FOB CHICAGO. 4 for . . .

F.O.B. Chicago

SHOP BY MAIL and SAVE at GROBAN'S Buy direct from ad!

Brand New Air or Oil HYDRAULICS

Use hydraulics on arbor presses, hydraulic presses, hay lifts, manure loaders, lift trucks—push or pull, tilt or turn, press or squeeze, open or close, lift or lower—and other hydraulic and industrial applications. Use with either air or oil . . . of finest precision workmanship.



- Double action, 1" bore, 3" stroke, will lift 770 lbs. in 1/10 of a second using Logan Pump. All steel barrel. Ideal for controls, door openers, positioning, etc. **\$4.95**
An \$18.00 value postpaid
- Double action, 1 1/2" bore, 5" stroke, will lift 1760 lbs. in one second with Logan Pump. **\$8.95**
Wt. 3 lbs. A \$35.00 value postpaid
- Double action, 1 1/2" bore, 9" stroke, will lift 1760 lbs. in one second with Logan Pump. **\$10.95**
Wt. 4 lbs. A \$45.00 value postpaid
- Use these cylinders on farm trucks, bulldozers, hay lifts, manure loaders, etc. Double action, 1 1/2" bore, 27" stroke. Will lift 1760 lbs. in 2 seconds with Logan Pump. Wt. 8 lbs. A \$55.00 hydraulic cylinder value for only **\$12.95**
5. Double action, 2 3/4" bore, 8" stroke. (Will lift 4400 lbs. in one second with Logan Pump). Will withstand 1500 P.S.I. against wall. Wt. 7 lbs. **\$14.50**
A \$63.00 value postpaid
- Double action 2 3/4" bore, 4" stroke, two-way solid 5/8" alloy steel shaft (will lift 4400 lbs. in one second with Logan Pump). A \$73.00 value postpaid **\$16.50**
- Double action, 3" bore, 8 1/2" stroke. All steel hydraulic cylinder. Will lift up to 12,000 lbs. (7000 lbs. in 3 seconds with Logan Pump). Complete with fittings. Wt. 12 lbs. A \$78.00 value postpaid **\$19.50**
- Double action, 3 1/2" bore, 11" stroke. (Will lift 9600 lbs. in 7 seconds using Logan Pump.) Complete with fittings. Wt. 15 lbs. A \$92.00 value postpaid **\$22.50**
- Double action, 3" bore, 23" stroke, hydraulic cylinder will lift 7070 lbs. in 5 1/2 seconds using Logan Hydraulic Pump. Especially suited for farm and construction machinery. Clevis mounting for easy use. Wt. 22 lbs. A \$145.00 value. **\$27.50**
F.O.B. Chicago

HI-PRESSURE FITTINGS for cylinders and valves available at 35c ea. for 3/8" pipe and 50c ea. for 1/2" pipe.

Hydraulic Control Valves Brand New



- Four-way control valve for use with double 1" action hydraulic cylinder, may be used with 1500 P.S.I. hydraulic system to open and close hydraulic cylinders. Brand new. Ship. **\$7.95**
Wt. 4 lbs. A \$38.00 value postpaid
- Four-way control valve for use with two hydraulic double action cylinders. Each cylinder may be operated independently of the other or in conjunction with the other. Oil may be locked in any of the cylinders to hold the piston at any required position. Brand New. Ship. Wt. 6 lbs. A \$60.00 value. postpaid **\$10.95**
- A two cylinder double action valve with a unique arrangement, allowing the operator to raise both cylinders simultaneously, to lower them simultaneously or to raise one and lower the other at any predetermined rate and speed. Brand New. Ship. Wt. 8 lbs. **\$14.95**
A \$75.00 value postpaid

Brand New Double-Action Pneumatic — Hydraulic PRESS

\$300.00 value offered at a fraction of original cost

Using air or oil, this device is ideal as a punch press, vise, arbor press, etc. An excellent tool for industrial and shop use. Use 150 lbs. of air pressure or 250 lbs. of oil pressure. Cushioned double action "Logan" Model AC ram, 6" bore and 6" stroke. Capable of up to 4200 lbs. of pressure using air. Has 3" throat. Lubricated gibs provide perfect alignment. Has adjustable work space. Hardened alloy steel piston rod 1" diameter. Frame constructed of cast steel with 3/4" base plate. Manufactured by Sipp-Eastwood Co. Unit is 49" high. Base is 9 1/2" wide by 18" deep. Wt. approx. 300 lbs. AN OUTSTANDING BUY at . . .

\$79.50

F.O.B. Chicago



Brand New Gear Type INSECTICIDE PUMP



All Manganese Bronze for spraying D.D.T., 2-4D, Sulphur Compounds, Etc. Pressures up to 150 lbs. to 14 gallons per minute—1500 RPM. Will not rust, pit, foul or freeze up. Use rubber hose inlet, pipe or tubing outlet. Equipped with 1/2" standard pipe thread port. Wt. 10 lbs. Dimen.: 8" x 5" x 6 1/2". Standard 1" manganese bronze shaft with keyway. U.S. Gov't. Acquisition Cost \$62.00 NOW ONLY **\$15.00**

F.O.B. Chicago

ADJUSTABLE RELIEF VALVE \$2.95 postpaid

FREE: New, 36-page illustrated Hydraulic Manual featuring diagrams, photographs, and instructions—FREE with each hydraulic order.

Write for our new 40-page catalog. It's Free!

GROBAN SUPPLY CO.

1507 SOUTH MICHIGAN AVE.

Chicago 5, Ill. Dept. PM-7

HIGH PRESSURE HYDRAULIC PUMP FOR HOME, SHOP AND FARM USE

Genuine Vickers constant displacement high pressure pump. Use it for any type of liquid pumping job. Will pump 400 gal. per hour at 3750 R.P.M. Precision piston type design provides 1000 lbs. per square inch pressure. Self priming. Standard thread 3/4 inch intake and discharge ports. With 3/8 inch splined shaft — just add pulley and power and you're ready to go.

HAS HUNDREDS OF USES

These pumps are brand new. Original acquisition cost approx. \$100.00. Can also be used as hydraulic motor; for rams, opening doors, hydraulic lifts, etc.—also for any liquid transporting job. War surplus, but brand new. Shp. wgt. 7 lbs. Will include at no extra charge an hydraulic control valve and ship postpaid when remittance accompanies order. (Control valve, only \$1.95.) F.O.B. Houston. Satisfaction guaranteed. Rush your order today.

\$9.95



HYDRAULIC PRESSURE GAUGE

Made by U. S. Gauge Co., type AN5771; 0-2000 PSI with luminous dial. Measures 2 3/8 x 2 3/8 inches. New, in original factory cartons. Complete with all mounting screws, nuts, etc., including instructions. A real value at this low price. **\$2.95** EACH, ONLY



PNEUDRAULIC POWER RIVETING MACHINE

BRAND NEW WAR SURPLUS

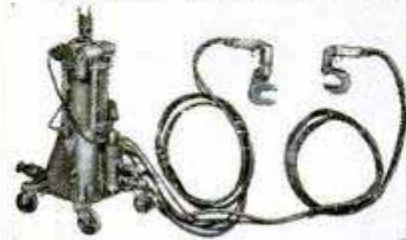

Made by Chicago Pneumatic. This fine machine is a complete hydraulic action riveter. (The hydraulic unit is operated by regular air compressor pressure.) Complete as a unit, it utilizes the automatic power actuator and dual light weight hydraulic yoke riveters for fast, light and heavy riveting work with ease, economy and efficiency. Machines are complete in crates, with instruction booklet, many extra heads, adapters, sets, etc. New war surplus, priced to close out at hardly 10% of original cost. **\$195.00** EACH

\$195.00

SURPLUS AIRCRAFT COMBUSTION HEATER

Fuel vapor type, 15,000 BTU. Brand new, in orig. factory boxes. Shp. wgt. 30 lbs. **\$9.95** EACH

We pay shipping charges on all PREPAID orders. Send check or money order.

SOUTHWEST AERO SUPPLY Dept. PM7, DRAWER 488 SOUTH HOUSTON, TEXAS

PRICE CORRECTION!

Price for Speedy Sprayer Outfit in last month's issue of this magazine should have read **\$29.95**, less motor.

W. R. BROWN CORP., 5718 Armitage Ave. • Chicago 39, Ill.

Say You Saw It in POPULAR MECHANICS

AMERICA'S MOST-WANTED SMALL TRACTOR!



SEE THE POWERFUL
5-H. P. GRAVELY—

the world's finest, yet most moderately priced Garden Tractor. Complete line of exclusively designed power tools for every Garden, Lawn and Field job.

ONE
TRACTOR
DOES
17 JOBS!

GRAVELY TRACTOR

FIELD-TESTED FOR 27 YEARS

MAIL NOW! FOR NEW FREE BOOKLET!

GRAVELY MOTOR PLOW & CULTIVATOR CO
BOX 763 DUNBAR, W. VA.

NAME _____
ADDRESS _____
TOWN _____ STATE _____

SOLVING YOUR LAWN & GARDEN PROBLEMS

Sensational One Unit Portable Power Driven Tool POLISH • SAND • DRILL



Put a professional finish on your AUTO, BOAT, FURNITURE in 1/2 the usual back-breaking time.

1/4-INCH AC-DC DRILL

Drills steel, wood, bone, plastic; sturdy and lightweight; with 6 ft. line cord.

**SATISFACTION
GUARANTEED**

Send check or money order, we pay postage
The ORDER MART, Dept. PM, 62 Warren St., N.Y.C.7

\$12.50
COMPLETE WITH A POLISHER-SANDER UNIT

POLISHER-SANDER UNIT, ALONE

High-pile lambs wool bonnet on heavy duty flexible rubber disc, with sandpaper. **\$2.25**

NEW ROCKET

JET PROPULSION. FOR FUN OR EXPERIMENT. Zooms over 200 feet high.

25,000 M. P. H.

Speed a rocket must attain to escape from the earth. Many other facts supplied with full instructions. Special launching stand. Can be used repeatedly. Send \$2.95 we pay postage. Sent C.O.D. for \$3.50.

WALSH PRODUCTS INC.

209-M7 N. Maple Ave., East Orange, N. J.

\$2.95

REYNOLDS CIRCULAR SAW GRINDER

For jointing, gumming, tooth forming and reshaping.



Saws 5"-30"

Cuts saw maintenance costs, increases saw sharpening profits. Any hook or pitch of tooth and depth of cut is quickly adjusted. Both hands are free to control position of saw while grinding. Ball bearing action sealed against grit and dust.

PROVIDENCE SAW & KNIFE COMPANY

REYNOLDS MACHINERY CO. BLDG. 303 EDDY STREET, PROVIDENCE 3, R. I.



\$2.95 EACH

NOW! FILE YOUR OWN SAWS

Do expert saw filing at home. Precision filing easy without experience. Two simple adjustments. Keeps any hand saw extra sharp and true-cutting. Complete with file. Money back guarantee. Cash with order, prepaid, (COD postage extra.) Order today, \$2.95.

THE SPEED CORP., Dept. PM
512 N.E. 73 Ave., Portland 16, Oregon

Build your own JET ENGINE!



SEND NO MONEY

Order these plans today

1. JET PROPELLED BICYCLE. Assemble your own. Photo and instructions \$1.00.
2. HOW TO MAKE EXPERIMENTAL JET ENGINES. Seven sheets drawings with information and instructions \$2.95.
3. BOTH OF ABOVE in one order \$3.75. SEND NO MONEY. Order both at once \$3.75 C.O.D. in USA plus c.o.d. postage. Send check or Money Order and we pay postage. Get other information too. Rush Order.

J. HOUSTON MAUPIN, Dept. 55, Tipp City, Ohio

CRESCENT TOOLS

Give Wings to Work

ASK YOUR
HARDWARE
DEALER

MOTOR SPRINGS for General Use—

BLUE TEMPERED Wherever Heavy Springs Are Needed
Length 9 feet 3 inches. Width 3/4 inch. Thickness .026. Wound when shipped. One Spring ONLY 65c Postpaid. 12 or more less 10%.
FRANKLIN PHOTOGRAPHIC INDUSTRIES
223 West Erie St., CHICAGO 10, ILL. Sorry No C.O.D.'s RUSH YOUR ORDER

6" CIRCULAR SAW

\$12.95

MONEY BACK

GUARANTEE

Best Quality—Lowest Price!

Floor Stand \$12.95
Floating Motor Rail \$1.50



Table Size: 9" x 11" Table Sizes: 7"x8" & 4 1/2"x5 1/2"

BLADES DO NOT TILT — BRONZE BEARINGS

CHILDS & CO., P.O. Box 457, CONNEAUT, OHIO

POPULAR MECHANICS

SURPLUS BARGAINS



DELCO CARBON PILE GENERATOR VOLTAGE REGULATOR (24 Volt)
While they last . . . this hard to get item is being offered at a give-away price. No. 94-32276-A. Up to 200 amps.
SLIGHTLY USED **ONLY \$3.95**

LEAR REVERSIBLE MOTOR

This 24 volt 7.6 amp, series wound reversible motor, with overload clutch has dozens of uses in the workshop. Motor turns 11,000 rpm. Approx. 4" x 7". Like new.



ONLY \$5.95



DUMORE 1/2 H.P. MOTOR
A real bargain! Power packed! 24 volt, 20 amp ac/dc series wound. With worm gear head. 3" long. Used, like new
ONLY \$3.95

C & H WAR SURPLUS CATALOG

—that is jam-packed with values galore for the factory, home, workshop, farm and outdoors! Now, used and reconditioned items priced amazingly low!

Send 25% with Order, Balance C.O.D. All Equipment F.O.B.

C & H SALES CO.

1850-M-7 East Colorado St. Pasadena 8, Calif.



LATHE CUTTER BIT GRINDING GAUGE

For checking clearance and rake angles.

50¢ postpaid

SOUTH BEND LATHE WORKS
455H E. MADISON ST., SOUTH BEND 22, IND.

RESIZE YOUR OWN PISTONS!



Save real money

Sealed Power Piston Resizer equals work of machines costing hundreds of dollars. Simple to operate. Results permanent. Thousands now in use. Uses swaging action inside piston skirt, compressing action outside. Resizes steel, cast iron, aluminum pistons. Wood vice included. Satisfaction guaranteed. Send \$8.50, check or M. O. to Sealed Power Corporation, Muskegon, Mich.

"EVEREADY"

THE FLASHLIGHT BATTERY WITH "NINE LIVES"

Recovers Power Between Uses—
Bounces Back for Extra Life!



Ask Your Hardware Store for
FULLER'S
Unbreakable Amber Handle
SCREW DRIVERS

America's most popular line of moderately-priced screw drivers! Wide range of sizes.
FULLER TOOL COMPANY, Inc.
911 Faile St. New York 59
World's largest makers of Amber-Handle Tools

Print Your Own

Cards, stationery, circulars, tags, labels, photo and movie titles, advertising, etc. Save money. **Print for Others, Good Profit!** easy rules sent. Raised Printing like Engraving, too. Sold direct from factory only. Write for free catalog of outfits and all details. **KELSEY PRESSES, M-37, Meriden, Conn.**

Say You Saw It in Popular Mechanics



Carve for Fun and Profit!
No skill needed
with Dumore Carvit

Anyone can make woodcarvings with a Carvit! It copies low-cost models you can buy in any dime store. The result—beautiful ornaments, unusual gifts, fine carvings that sell. Write for Free folder with full details
The Dumore Company
Dept. G-51 Racine, Wisconsin

THIS IS NEW!

Enjoy the ease and speed of spray-gun painting!

Give your projects that professional touch!

You spray one quart perfectly in only 3 minutes with the sensational **PAYSWELL ALL-PURPOSE Sprayer**



Take the gun to the job, not the job to the gun! Plug into any 110-volt outlet

GUN, MOTOR, COMPRESSOR self-contained in a single compact, portable unit!

Weights less than 5 pounds including shatter-proof one-quart heavy aluminum canister.

Air pressure of 50 pounds atomizes all sprayable liquids, including water paint, oil paint, lacquer, enamel, stain, varnish, airplane dope, disinfectants.

ONLY \$39.95 complete including the three interchangeable nozzles. **NO EXTRAS TO BUY.**

See your paint or hardware dealer, or write for the name of your **PAYSWELL SPRAYER dealer.**

PAYSWELL ALL-PURPOSE Sprayer



SELLCO CORP. Dept. PM

801 Andrus Bldg., Minneapolis 2, Minn.

NEW! POWER KING CATALOG AND SHOP HINTS!



Just off the press! Send today for this unusual new Power King catalog. Gives you complete information about Atlas-built low-cost Power King tools for your shop plus helpful hints on types of joints for furniture and other projects. Gives facts about various woods, lists and describes Atlas Easi-Bild patterns. Write today.

SEND THIS COUPON FOR YOUR COPY

NAME _____
ADDRESS _____
CITY _____
STATE _____

ATLAS PRESS CO.
735 N. Pitcher St., Kalamazoo, Mich.



MATCHED PRECISION TOOLS FOR WOODWORKING AND METALWORKING

The HEART

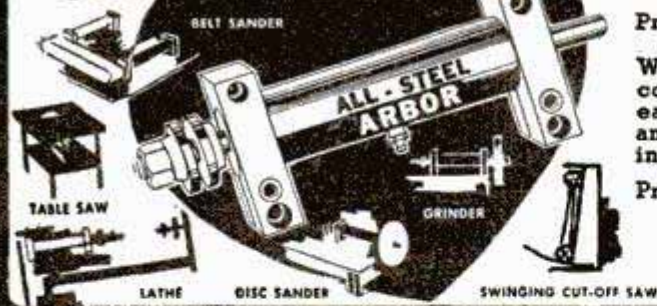

of every HOME SHOP TOOL

Precision machined ball bearing arbor — *Guaranteed Accuracy*

With the Trebor ALL-STEEL ARBOR you're well on the way to constructing any power tool for your home shop — the rest is easy! Flanges ground after assembly, grease-sealed ball bearings and adjustable 1" steel bearing blocks. No castings — no welding. $\frac{5}{8}$ " shaft accommodates 12" saw blade. Overall lg. 11 $\frac{1}{4}$ ".

Price \$8.95 prepaid in U. S. A. . . . Send check or Money Order.

Dealer inquiries invited.

TREBOR MACHINERY CO.

759 N. Milwaukee Street • Milwaukee 2, Wisconsin

AUTOMATIC RETOOTHER

MAKES NEW PROFITS

Cuts new teeth in 50 seconds — any size 4 to 16 points. Old teeth fall off as chips. Easy to operate. A perfect job.

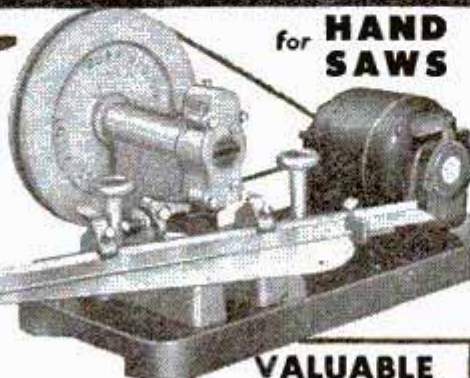

for HAND SAWS

IMMEDIATE DELIVERY

BURR MFG. CO.
8933 VENICE BLVD.
LOS ANGELES 34, CALIFORNIA

VALUABLE BOOK

Order Burr's Blue Book of Coast to Coast prices for saw shop services. **25c**

Build it — Fix it with AMBROID



The Universal Liquid Waterproof Cement
"It Stays Stuck"

At your dealers — or send 25c for generous 2 oz. tube. Postpaid.

AMBROID CO., 303 Franklin Street, Boston 10, Mass.

WHAT! NO LIGHTS!

Katolight Plants furnish the same kind of A.C. current as the High-lines. Sizes 500 Watt to 300 Kilowatt. Also manufacturers of Rotary Converters, Frequency Changers, D.C. Motors 1/4, 1/3, and 1/2 H.P., A.C. Motors, single phase in 2, 3, and 5 H.P., high frequency Generators.

KATO ENGINEERING COMPANY
1402 FIRST AVENUE
MANKATO, MINNESOTA

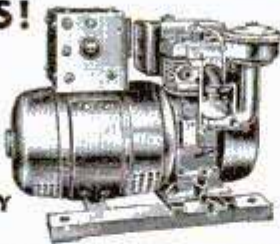

SAVE UP TO 25% ON QUALITY BALL-BEARING WHEELS!

Bilt-Rite wheels roll smoothly and easily, are semi-pneumatic, ball-bearing, painted red; guaranteed top quality — and you save up to 25%! Compare Bilt-Rite's quality and price — then get your order in today! Dealer inquiries invited.

BILT-RITE BARGAINS on BALL-BEARING WHEELS

(For 1/2-inch Axles)	
6 x 1.00	\$1.30
8 x 1.25	1.65
8 x 1.75	1.80
6 x 1.50	\$1.50
(For 3/8-inch axle)	
6 x 2.00	\$3.95
8 x 2.50	\$4.45
10 x 2.75	Only \$4.65!



Bilt-Rite Guarantee
No better wheels are made regardless of price; 10 day return privilege.

If size you need isn't listed, write for Folio A ORDER TODAY — Send cash, check, or M.O. — Pay postage on arrival.

BILT-RITE WHEEL COMPANY
520 EAST MISSOURI AVE. KANSAS CITY 6, MISSOURI

Who Ever Heard of Only \$8.00 Each? POWER TOOLS

Own a power workshop. Have fun. Make money. Get heavy-duty Emrick Lathe, Drill Press, Saw Arbor, Grinder, Sander — all in ONE machine. Use $\frac{1}{4}$ to $\frac{1}{2}$ H.P. motor. Equals in performance equipment costing \$200 or more. Direct factory price \$39.95 cash, or on Easy Payment Plan. 10-day FREE TRIAL. Money-Back Guarantee. Write for FREE Catalog.



EMRICK, INC., 1684 Clinton, Kalamazoo, Mich.

Drive a FORD and Feel the DIFFERENCE!

PREPARE NOW for Next Winter

Call Air SnowCars are now being built on special order for fall delivery or we furnish detailed plans and parts for home builders. Plans \$10.00. Complete machines from \$1550.00 up. Wheel equipped jobs available. Two, three and four place jobs with engines from 65 to 125 h.p.

CALLAIR, Afton, Wyoming

LIQUID MARBLE COMPOSITION FLOORS FLEXIBLE MOLDS MOLD Novelties, Statuary, Art Goods in Flexible Plastic Molds; 5c material makes \$1 seller. Make Marbleized floors, Tile Walls. Colorful, glossy, amazing! Easily learned; start in garage or basement. Particulars free. MARBLEIZING SERVICE, Dept. 10-F, Edwardsville, Ill.

Rebuilt Transmissions PLYMOUTH — DODGE \$25.95 Exch. 35-39 only. F.O.B. Chicago Guaranteed. Also Transmissions for all other cars. **REBUILT GENERATORS** Chevrolet — Ford — Plymouth Exch. Price \$6.95 F.O.B. Chicago. Guaranteed. We carry a full line of automotive parts, starters, transmissions, rear-ends, and generators at tremendous savings. Rebuilt by factory trained experts. **LOWEST PRICES IN MIDWEST**

WORLD AUTO PARTS CO. 2200 N. Ashland Chicago 14, Ill. ORDER from one of the nation's largest replacement dealers

LAWN ORNAMENT-NOVELTY PATTERNS

28 Lawn Ornament Patterns, 25c. Other patterns; 15-20" high; Dutch Girl, Dutch Boy, Pirate, Bull Terrier, Mexican Girl, Mexican Boy, Dwarf, Penguin, Flower Girl, 10c each. 25 Novelty Patterns, 30c. All 62 Full Size Patterns, \$1.00 Postpaid. Strother Pattern Service, Dept. BD-8, Box 128, Belington, W. Va.

For Finest Performance Use **SHOPMASTER TOOLS** **SHOPMASTER INC.** 1214 THIRD ST. S., MINNEAPOLIS 15, MINN.

SAY YOU SAW IT IN POPULAR MECHANICS

WOOD SHAPER \$34.95 SWING SAW \$69.50

LESS MOTOR

Write for Other New Bargains

DEALER INQUIRIES INVITED

J-M MACHINE WORKS, Inc.
SYLACAUGA 1, ALA.



... Quick Easy Way to BIG PROFITS

Read What Others Are DOING!

"Enclosed you will find 56 orders representing 9½ hours work on Monday and Tuesday."
 "Enclosed are twelve orders secured after supper this p.m."

Housewives are Enthusiastic

Everyone that sees this outstanding Cell-U-Mop immediately wants one . . . That's the reason why our distributors are so successful . . . You also have the advantage of our other QUICK SELLING PRODUCTS that step up your Volume Sales and Profits.

• We Teach You How •

Gets down under and around for MOPPING, DUSTING or WASHING

DOES THE WORK OF 6 TOOLS IN 1

Get Choice Territory NOW!

Holds 20 times its weight in water.



Hands Never Touch the Water—Can be put in Boiling Water. Housewives Like It.

48" Long Handle

Sales QUICK, EASY Every Locality

SALES ARE EVERYWHERE . . . Sells quick to Taverns, Clubs, Hotels, Hospitals, Stores, Restaurants, Large and Small Buildings and the Homes . . . Scores can be sold on a single street . . . Note the Drain Bracket in the illustration . . . This squeezes out the water so thoroughly that HANDS NEVER TOUCH THE WATER . . . Makes no difference what you ever sold, you will like this proposition . . . Your name on a Post Card will bring you FREE PARTICULARS.

CELL-U-MOP CO., Dept. P-7, FREEPORT, ILL.

EVERY BATHROOM NEEDS ONE!



NOW—no one can see in your bathroom when window is open for fresh air ventilation. NO-PEEK Venetian-type blind gives you absolute privacy from neighbors, Peeping-Toms, etc. Keeps out dirt, dust, rain, snow. Our exclusive patent, NO-PEEK BLINDS fit any window up to 42 inches wide—standard or casement. Shipped complete. Postage paid on case orders. C.O.D.'s accepted. Money Back Guarantee. ORDER TODAY.

Easily installed in 2 minutes. Attaches permanently in place. No adjusting. No rattles. Beautifies any home and made to last a lifetime. Off-white enameled steel slats, all metal, rust proof. Ideal for bathrooms, bedrooms, dressing rooms, any room. ORDER DIRECT TODAY—only \$2.49 each (sold by mail only). Shipped complete. Postage paid on case orders. C.O.D.'s accepted. Money Back Guarantee. ORDER TODAY.

NO-PEEK VENTILATING BLINDS, 703-815 S. Date Ave., Alhambra, Calif.

GENTLEMEN: Please send me _____ NO-PEEK BLINDS. I enclose \$_____.
 (Print name and address plainly on the page margin below.)



U-BUILD IT

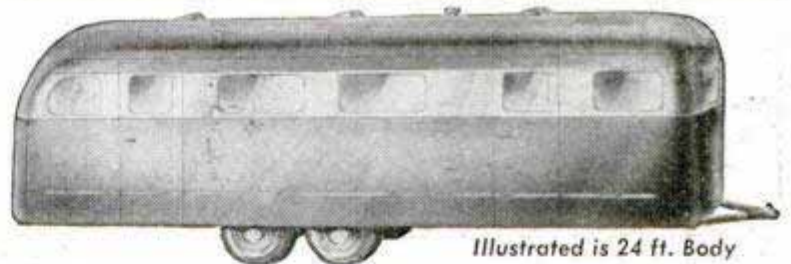

Illustrated is 24 ft. Body

12 ft. Trailer Shell **\$299.00**; 16 ft. \$529.00; 20 ft. \$699.00; 24 ft. \$799.00; 28 ft. \$899.00; 32 ft. \$999.00
 All prices F.O.B. Elkhart, Ind.

Easily Erected! This Modern Metal Trailer comes to you knocked down, complete with all parts for quick assembly. Windows, doors, exterior panels, complete chassis and axle assembly with tires, roof caps, bows, corners, roof ends. No expensive tools required — no experience necessary. **EXPORT-TERRITORIES AVAILABLE**

Write for working plans showing detailed construction and location of parts. **\$1** Each size

U-BUILD-IT Trailer Co. \$1.00 enclosed.
 Dept. B, 917 Fremont St., Elkhart, Ind.

Send working plans for 12 ft., 16 ft., 20 ft., 24 ft., 28 ft., 32 ft., Custom Built.

Name _____ (print)

Address _____

City _____

Sensational Bargains: LOWEST PRICES! All Items Guaranteed As Represented



BACKGEAR MOTOR

90 RPM 110V, 60 cycle, A.C. slow speed motor. All brass construction. Sturdy gears & bearings. Drives

window displays, toys & useful experimental work. 6" x 2 1/2", 5/32" shaft. Pulley FREE. \$3.50 ea. Postpaid. In lots of 6 ONLY \$2.95 each.

ELECTRIC MOTORS . . . Brand New General Electric 110 V—60 cy. 1 ph. A.C.



TWO SPEED FAN MOTORS
 1/6 H.P. 1725 & \$23.50
 1140 RPM. Fob.
 1/8 H.P. 1140 & \$26.50
 860 RPM. Fob.
HOME WORKSHOP MOTORS
 1/4 H.P. 1725 \$11.95
 RPM. Fob.
 1/3 H.P. 1725 \$13.75
 RPM. Fob.

Bargain Workshop 1/2 H.P. Motors

Westinghouse . . . Leland . . . G. E. & Sunbeam, etc. 1/2-110 V. A.C. 60 cy. 1 phase, 1750 RPM. Capacitor & Repulsion Induction types. Like New . . . Fully Guaranteed . . . Only \$19.75 Fob.
 General Electric . . . Delco . . . Leland & Others . . . 1/2 H.P. A.C. 110 V. 60 cy. 1 ph. 3450 RPM. Capacitor & Repulsion Induction Types. Fully Guaranteed . . . Only \$22.50 Fob.

Write for our BARGAIN FAN & MOTOR Circular and SAVE MONEY

New C-Breeze Powerful Electric Window Ventilator Two Fans in One



Fits Any Window or Transom. Quiet Operation. 12 Inch Blades. Moves 1500 CFM. Beautiful Cream Streamlined Design. Puts comfort in your home at the finger touch . . . Reversible to draw out odors or draw in fresh air. Any Window 24 to 34 inches. Height 16". Wgt. 27 lbs. CW-1-110 V.-60 cy. AC-1ph. **\$29.75** ONLY. Fob.

New C-Breeze Floor Circulator

COOL COMFORT AND HEALTHFUL LIVING Completely enclosed motor, quiet in operation. Cools with a maximum air delivery in a 360° area. 12 inch blades deliver 1500 CFM. 3 Speeds. 15 inches in Diameter. 16 inches Overall Height. Immediate Delivery from Chicago's Largest Fan and Motor Stock. Shipping Wgt. 20 lbs. CF-2-110 V.-60 cy. A.C. 1 ph. . . . ONLY **\$29.75** Fob.



C. MARSHALL SALES, 3546 W. Fullerton Ave., Dept. P-7, CHICAGO 47, ILL. • RUSH ORDER TODAY

Mow 'Em Down with PRONTO POWER LAWN MOWER

Give your lawn the new
look with Pronto

After 4 years production a proven, well engineered, original, safe, lifetime, quick action, easy handling, economical, most simple and practical of all power lawn mowers.

Pronto first with quiet enclosed spiral gear 4 ball bearing drive. No troublesome belts, pulleys, chains, sprockets, friction wheels or inefficient cutter revolving at engine speed.

Four 10 inch ball bearing (sealed) rubber tired wheels.

Pronto design 20 inch blade whirling type with removable safety type manganese steel cutter tips (new set postpaid \$1.00).

Cutter arm readily adjustable any height from ground to suit operator, and will cut grass as close as any mower. Pronto cutter assembly has highest cutter torque for horse power of any mower known, and up to three times more cutting power at blade than other mowers.

Pronto base is cast of light strong Aircraft metal. Axles extend entirely through base for strength. Steel handles are adjustable for height and position.

Our long experience and know how in the whirling blade mower field qualifies us to offer the Pronto as a satisfactory mower, proved by hundreds of satisfied users for every type and condition of grass as well as weeds, long and short, light and heavy, also uneven, rough and terraced lawns. Cutter blade trims to within 1/2 inch of any desired object, therefore ideal for cutting around trees, shrubbery, walks, fences, etc.

Briggs and Stratton or Clinton 4 cycle gasoline Engines are used on the Pronto mower as both Engines are well known for their reliability and easy starting, as well as nation wide service facilities.

COMPLETE MOWER \$89.50

MOWER LESS ENGINE, OTHERWISE COMPLETE..... **\$54.50**

GEAR DRIVE CUTTER ASSEMBLY

For those who desire to construct their own mower, or want a replacement cutter assembly, we furnish the complete gear driven cutter assembly as used on Pronto mowers, with flexible connection to Engine shaft, (give diameter of Engine shaft when ordering) and 20 inch blade with safety cutter tips complete as shown for..... **\$22.50**

All prices FOB factory, check or money order in full with order, no COD's, all orders filled in rotation as received by us. We have one price to all, and no dealers or agents.

PRONTO MOWERS
OLDSMAR, FLORIDA

WESTINGHOUSE

Air Compressor
WITH 20 FT. AIR HOSE
AND
DETACHABLE TIRE CHUCK **\$22.95**

2-CYLINDER PISTON TYPE

Spray paint your buildings, cars, trucks, machinery, etc. Inflate tires, grease machinery, spray insecticides.

Built to sell for 3 times our low price. Operates from 1/2 h.p. motor or equivalent gas engine. Or may be run from truck, tractor, jeep power take-off or fan belt; designed for easy mounting. Capacity up to 6 1/2 cu. ft. 100 lb. pressure. Delivers filtered "Oil free air". Air output double that of similar compressors. Rugged, super-efficient, portable.

Special \$22.95 price F.O.B. Chicago area includes compressor, 20 ft. double braid heavy duty air hose, Schrader Air Chuck. You save over 1/2. Act now! Money back guarantee. Send check or money order to:

— MAIL COUPON TODAY —
A & K Equipment & Supply Co., Dept. 15, Burlington, Wis.

Enclosed find remittance for \$22.95. Send brand new Westinghouse Compressor, 20 ft. of heavy duty air hose and tire chuck.

Name.....
Address.....
City..... State.....

SAY YOU SAW IT IN POPULAR MECHANICS

UTICA TOOLS

For More Tool Mileage



TOOL No. 50
Electricians' Standard
Side Cutting Pliers
5", 6", 7", 8"

SEE
YOUR
DEALER

UTICA DROP FORGE & TOOL CORP.
UTICA 4, NEW YORK

ELECTRICITY Anywhere

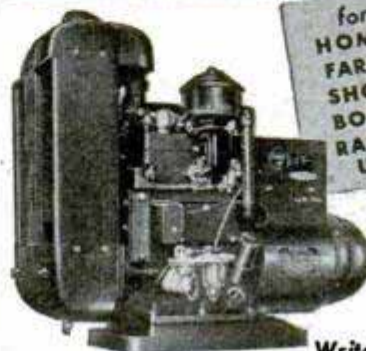

for
HOMES
SHOPS
BOATS
RADIO
USE

Onan gasoline-engine-driven Electric Plants supply reliable, economical electric service for any use Portable, stationary or stand-by models. Water or air-cooled, compact and rugged.

A.C.: 350 to 35,000 watts in all standard voltages and frequencies. D.C.: 600 to 10,000 watts. 115 and 230 volts. BATTERY CHARGERS: 500 to 3,500 watts; 6, 12, 24, 32 volts.

Write for folder

D. W. ONAN & SONS INC.

5823 Royalston Ave., Minneapolis 5, Minn.



OTTAWA Tiller & Mower

Patents Pending

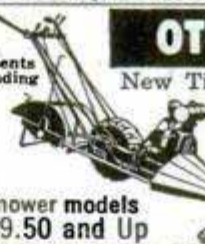

New Tiller and Mower with 2 H-P Red Seal Continental Motor. 2-speeds and free wheeling. MOWS 40 in. SWATH. Cuts close to trees and fences. Furnished with or without tiller. Thousands in use. Sold only direct to user. Now in our 45th year of dealing direct. FREE details.

3-mower models
\$89.50 and Up

OTTAWA MFG. CO., 4-927 Lawn Ave., Ottawa, Kansas

A
HULL
AUTOMOBILE
COMPASS

Pays for Itself

One wrong turn costs actual dollars in wasted mileage, lost time, business and personal inconvenience. Invest in a Hull Automobile Compass to save, over and over. BEACONLIGHT illuminated. \$5.95. STREAMLINE standard, \$3.95.

At your dealer's. Write for literature.



HULL MFG. CO., P. O. Box 246-D7, Warren, Ohio

TENTS

WAR SURPLUS
ALL TYPES AND SIZES



A Few of our Low Prices:

NEW WALL TENTS: 5x7 \$10.95; 7x7 \$14.85; 10x12 \$37.50; 17x33 dbl. sqd. \$91.50. 7x7 umbrella \$12.50.

USED RECONDITIONED TENTS: 9x9 wall \$24.45; 16x16 \$29.75; GI pup tents \$2.95; 18x50 hospital \$125.

2-man nylon mountain tent with sewed-in floor. New \$12.50 Used reconditioned \$9.50

All above tents complete with poles, stakes & ropes. Send check or money order or 25% deposit for C.O.D. 5-day money back guarantee.

Also camping equipment, sporting & fishing supplies, rope, cots, blankets, sleeping bags, hammocks, tarpaulins, camp stoves, lanterns, grills, haversacks, picnic equipment, work clothes, paints, etc.

LOW PRICES!

FREE 24-PAGE CATALOG ON REQUEST

MOR-SAN SALES

10-17E 50th Avenue
Long Island City 1, N. Y.

RECORD SMASHING VALUES IN "WANTED" SURPLUS GOODS ★ ★ ★ QUICK IMMEDIATE CLOSE-OUT

101 WAR SURPLUS BARGAINS ORDER BY NUMBER ALL SALES FINAL AT THESE LOW PRICES Offer Will Not Be Repeated — ORDER NOW

- #100 — GOGGLES, AAF type AN6550. New, clear, precision ground, polished, shatterproof lenses. Metal frame, rubber facing, elastic band, adj. nose-piece. Orig. cost \$16.00, only **\$1.95**
- #101 — AAF HELMETS — New! Of tan cloth with strap, ear muffs, etc. Each **75c**
- #102 — SUN GOGGLES — NEW! Pilot-type, green lenses, gold plated frame. Carrying case. Orig. cost \$7.50. Each **\$1.95**
- #103 — FLYING SUITS — AAF K-1 for pilots. Lightweight type Byrd cloth khaki, plenty zippers, pockets, etc. Sizes 38 to 40 (incl. long) only. Orig. cost \$18.00. Only **\$6.95**
- #104 — HEAD PHONES — For radio use. AAF type with cord and PL54 plug. Each **\$1.10**
- #105 — HAND MIKE — AAF type with cord and PL68 plug. Each **\$1.50**
- #106 — COMPASS — NEW, magnetic, airplane compensating type. AAF. Panel mounting. PIONEER. For planes, boats, autos, etc. Orig. cost \$78.00. Each **\$5.95**
- #107 — As above, but used **\$3.95**
- #108 — RADIO DIRECTION finder, automatic Bendix SCR2686G type. Just tune in marine beacons, aircraft or commercial stations to "follow the needle home"; complete inc. plugs, 24-28V dynamo-inverter, receiver, loop, indicator, flex. cables and lines (hook-up wire not included). With complete wiring-up instructions. Beach checked before shipment. Weight approx. 85 lbs. Good used cond. Orig. cost over \$200.00. **\$12.50**
- #109 — CARBURETORS — Holly #410 type, for aircraft engines around 150 HP. Reconditioned. Each **\$9.95**
- #110 — BATTERIES — Aircraft, wet cell type. Unused surplus.
12V — 8 1/2 x 5 1/2" Each **\$6.95**
6V — 4 1/2 x 4 3/4" Each **\$5.95**
2V — Small, wet cell. Ea. **\$1.95**
- #111 — ROTARY INVERTER* for converting DC to AC at 400 cycles. Self-cooled (2 fans), radio filter, etc. Input 24V, two outputs (250 VA and 20V 500 VA and 115V). Size 12x7x8". Wgt. 21 lbs. Each **\$24.50**
- #112 — RADIO DYNAMOTOR — type PS225, 14V input, 375V output. NEW. Each **\$4.75**
- #113 — RADIO DYNAMOTOR — type PE80-J, 28V input, 250V output DC. NEW. Each **\$2.75**
- #114 — COMPLETE GENERATOR SET. Includes Aviation type generator (type L3, 28V, 25 Amp, rotation CW, 2500 RPM). Measures 12x5 inches, weighs 24 lbs. Output also includes famous Carbon File type voltage regulator (Ar 3080-1) with mounting base for same. Holds voltage within given operating range at varied generator speeds. Complete set, generator, regulator and base (all like new) offered at approx. 10% of AAF acquisition cost. Complete set only **\$24.50**. Generator only (shp. wgt. approx. 35 lbs.) only **\$17.50**
- #115 — STRUT GAUGE — Hydraulic. For air or oil strut. Inflates, deflates and shows gauge pressure at same time. Includes gauge, valve, air chuck, hose. Nearly new. Each **\$9.95**
- #116 — HAND FUEL PUMP — AAF, primer type. Parker. For two engines. Approx. 1/2 oz. per stroke. Use for priming gas engines, feeding outboard motors, etc. Orig. cost approx. \$40. New. Ea. **\$3.95**
- #117 — CAMP AXE — full 3 1/2 in. bit, wgt. 1 1/4 lbs., 14 in. handle. NEW. Each **\$1.29**
- #118 — HUNTING KNIFE — NEW! with leather handle, sheath. NEW. Each **\$1.19**
- #120 — FOLDING RULE — Aluminum zig-zag, 6 ft. New! Each **\$1.29**
- #121 — 4 IN 1 TOOL — For shearing, riveting, punching and forming (light narrow work only) instr. inc. NEW. Each **\$9.95**
- #122 — WIRE PLIERS — NEW! Side cutting type with wire strippers. Each **99c**

- #124 — PINKING SHEARS — Cuts ravel-proof edge on cloth, etc. 7 inches overall. New! Each **\$3.95**
- #125 — FLOOD LIGHT — Airplane landing type with streamlined metal case, clamp-on, adjustable mount, 12 volt, 250 watt. Ideal for boats, planes, mobile vehicles, etc. New surplus. Each **\$4.95**
- #126 — SWITCHES, airplane, off-on toggle type with luminous tip. Each 35c. Four for **\$1.00**
- #127 — HARDWARE ASST. Aviation assortment of mixed rivets, screws, bolts, washers, few nuts. All new, 10 lbs. **\$1.95**
20 lbs. **\$3.50**
- #128 — WRIST WATCH — Pilot's type, no jewels. Has full sweep second hand, leather band. Accurate. New! Each **\$6.95**
- #129 — PELORIS*, AAF type, model A3A. Can be used on boats, etc. Good used condition. Each **\$3.95**
- #130 — SEXTANTS* — Navigators, with case, etc. All used but checked before shipment. Standard Fairchild A10-A with automatic averaging. **\$14.95**
Link model A12 only **\$14.95**
- #131 — AIRPLANE PAINT PRODUCTS. Fine pigmented airplane dope (Insignia Red, Cessna Red, International Orange, Lt. Blue, Insignia Blue, Travelair Blue, Vermillion, Stinson Green, Ivory and Grey. Cost approx. \$6.00 gallon, now in 5 Gal. cans only, Val-Aero (Valspar). Gallon **\$2.00**
- #132 — MEGAPHONE, portable electric. Complete including amplifier, battery case with new batteries, shoulder strap and megaphone type speaker with pistol grip handle and trigger switch. Weight approx. 12 lbs. Approx. cost \$160.00. Now only **\$39.50**
- #133 — THROAT MIKE — Complete with cord, switch and plug. For radio use. Each **\$1.29**
- #134 — WIRE ROPE, Aviation 7x19 strand, extra flexible with high break test. Random lengths and sizes, our selection. Approx. 500 ft. **\$9.95**; 200 ft. **\$4.95**
- AIRPLANE TIRES. All new. Have many uses. Tubes not needed on light loads.
#135 — 12 1/2" high, 3 1/2" hubsize. Each **\$2.95**
#136 — 14 1/2" high, 4 1/2" hubsize. Each **\$3.95**
#137 — 17" high, 5 1/2" hubsize. Each **\$3.95**
#138 — 24" high, 12 1/2" hub or wheel. Ea. **\$6.95**
#139 — 27" high, 13 1/2" hub or wheel. Ea. **\$11.95**. Tube **\$2.50**
#140 — 18" high, 10" hub or wheel. Ea. **\$6.95**. Tube **\$2.00**
- #141 — INNER TUBES, Airplane type. Use for swim floats, etc. Size 6.50x10, approx. 15 ins. Each **\$1.29**
- #142 — PILOT'S OXYGEN. Consists of D-2 tank 6x24 inches, regulator gauge, hose, oxygen face mask, etc. Used by airmen, mountaineers, health purposes, etc. New. Each **\$7.95**; Same, but oxygen filled. Each **\$9.95**
- #143 — STEEL BOTTLES, 6x24", 500 PSI. Wgt. 3 lbs. Each **\$2.95**
As above but Stainless Steel. Each **\$3.95**
- #144 — STEEL BOTTLE, 12x24 in., 2100 Cu. in. capacity, 500 PSI. Holds approx. 9 gal. Each **\$5.95**
- #145 — AIRPLANE TAPE, Grade "A" cloth, 3 1/2" wide with pinked edge. 100 yards. **\$1.95**
- #146 — SAFETY BELTS, Rusco airplane type with quick detaching buckle — for planes, boats, hot rods, etc. New! Each **\$1.29**
- #147 — SLIDE VIEWER with 50 2x2" slides of war planes or warships (state which or will mix) including slide file case for 120 slides. Each **\$2.95**
As above but with 120 slides. Each **\$4.95**
- #149 — GENERATOR — Airplane high Amp. type P-1 from Bombers. Soun glass wound, 24-28 Volt, 200 Amp. Wgt. approx. 40 lbs. Good for welders, DC light plants, etc. Each **\$19.95**
- #150 — CONTROL BOX — Usable for parts. Type RL, has two toggle switches, 2 volume control switches, etc. Each **69c**
Two for **\$1.00**

- #151 — DC MOTOR, Emerson Turbent, with two sprockets, 24 volt; 100 RPM, torque 160 oz. fl. New surplus. Each **\$5.95**
- #152 — CIRCUIT BREAKER toggle switch, 15 Amp, 1x2 1/2 x 3 1/2" 95c
3 Amp. circuit breaker toggle switch. Each **39c**
- #153 — STEEL CLAMPS, Thumb screw tightening, 2" size. Use for hose, etc. Dozen **99c**
- #154 — FOOT SWITCH, Regular \$3.95 value. Foot operated for starting machines, darkroom use, etc. Each **99c**
- #155 — RESPIRATOR — M1 type, protects lungs from dust, etc. New. Each **79c**. Two for **\$1.00**
- #156 — MICRO SWITCHES, Asst. of 4 types. New. Only **\$1.95**
- #157 — SWITCH BOX, Control box 3x3x2". Has 3 toggle switches, 1 Micro, 1 indicator light assembly, etc. New **\$1.10**
- #158 — LEATHER CASE, Genuine leather 4x7x2". Snap flap. Use for policies, valuables, etc. Each **\$1.00**
- #159 — TOGGLE SWITCH, Type B18, heavy duty OFF-ON, 80 Amps. Each **75c**. Three for **\$1.95**
- #160 — RELAYS, B2A, 24V, 25 amp. New. Each **95c**. Six for **\$3.95**
- #161 — SOLENOID, Starting Solenoid Relay, Eclipse C-1-24V. Each **\$1.29**
- #162 — LIGHT PLANT, Homelite 14V, 1000 Watts, with 3 HP gas engine attached. Mounted on pneumatic wheeled dolly. Perfect condition. Wgt. 100 lbs. Ea. **\$74.50**
- #163 — REVOLVER, H & R #2922, .22 caliber, 6 inch barrel, holds 9 short or long per load. Gold front sight. Brand new! Only **\$24.95**
- #164 — AIRGIDE, Instrument that tells temperature and humidity, 3 1/2 x 3 1/2 inches. New! Each **\$2.95**
- #165 — FLUORESCENT Ultra Violet light assembly complete with 24 volt bulb, starter and rheostat switch, for small area in airplane cockpit. New! Each **\$2.95**
- #166 — PLASTIC TUBING, Phenolic non-rigid type in 100 ft. rolls. Inside diameter given: 5/32", **\$1.95**; 1/4", **\$2.65**; 1/2", **\$4.45**
- #167 — HUGE INNER TUBES, Bomber type 1600x16 — nearly 4 ft. high when inflated. New. Fine for rafts, swim floats, etc. Each **\$4.95**
- #168 — FIRE EXTINGUISHERS*, CO2 type, 22" long, horn type valve. Wgt. 9 lbs., empty. Each **\$6.95**
- #169 — CABLE SPLICER*, Complete splicing tool kit in case with adapters. Each **\$4.95**
- #170 — DYNAMOTOR, Triple output, 28V input. With voltage regulator, etc. Stored outside — shows use. Wgt. approx. 40 lbs. Only **\$4.95**
- #171 — FREE AIR TEMP. GAUGE. Reads -40 to 50 degrees C. Elec. operated, 24V, DC. Has 3 1/4 inch dial face. New! Only **\$2.95**
- #172 — DIRECTIONAL GYRO, Sperry "gyro compass" airplane instrument, 0-360 degrees with ball-bank attachment; suction driven, reconditioned by AAF — like new. Each **\$4.95**
- #173 — DRIFT METER*, AAF B-3. Has electric gyroscope, lenses, prisms, etc. 47 in. long. Used for navigating bombers. Wgt. 40 lbs. Each **\$9.95**
- #174 — SERVO UNIT, Sperry A5 from Auto-Pilot. Has 1/10 HP, 24V, DC motor. Wgt. 25 lbs. Each **\$5.00**
- #175 — CONTROL UNIT and panel for Sperry Auto-Pilot, 7 1/2 x 8 x 4 ins. Has 6 toggle switches, two 3-way switches, 3 dial indicators, plugs, etc. NEW! Each **\$5.00**
- #176 — BALL BEARINGS, Assortment of 20 bearings, all under 1 in. OD. Our choice **\$1.95**
- #177 — NAF INTERPHONE UNIT* 28V type with tubes. Use for parts only. Each **\$5.00**

- #178 — RADIO OUTFITS, Transmitter and receiver. Used for "friend or foe" identification during war. Includes dynamotor, valuable tubes, etc. Used — suitable for rebuilding or parts salvage. Wgt. 40 lbs. Each **\$7.95**
- #179 — ANGLE GEAR DRIVE, Has 2" with bearing drive on each side. With 5/8 and 1 1/16 in. shafts, aluminum housing 7 x 5 inches. Ideal for converting lawn mower for power as round flange is easily mounted with shaft for blades — other shaft at 90 degree angle for pulley. New. Each **\$6.95**
- #180 — HYDRAULIC GAUGE, AAF type for pressure readings, 0-2000 PSI, 2x2 inches. New! Ea. **\$2.95**
- #181 — TURN AND BANK instrument, AAF, with suction gyro. For blind flying. Each **\$5.00**
- #182 — OIL PRESSURE GAUGE*, 0-200 PSI, 2x2 inches. Ea. **\$1.95**
- #183 — WINDIKATOR, anemometer. Hand type. Tells speed of wind up to 60 MPH. NEW! Each **\$7.95**
- #184 — TACHOMETER, AAF type. Chrometric type, 0-3500 RPM or 0-4500 RPM. New. Each **\$5.95**
- #185 — AMP-METERS*, 0-150A, 2 1/2" size or 0-300A, 3 3/4" size. Shunt not furnished. Each **\$1.95**
- #186 — AIR SPEED METER*, 0-300 MPH, 0-500 MPH, 0-700 MPH. AAF type. Each **\$2.95**
- #187 — NOISE FILTER, Mallory NF-1 type. Eliminates noise between motor and battery. Size 3 1/2 x 3 1/2". NEW! Each **\$1.00**
- #188 — ANTENNA PHANTOM*, Radio noise eliminator for use in antenna circuit. Each **49c**
- #189 — ELECTRIC VALVE, 24V, 1 inch ports, AAF, handled fuel. NEW. Each **\$1.29**
- #190 — HAND FILE ASST. All used but good. Twenty assorted sizes, our choice **\$1.45**
- #191 — AVIATION BOOKS, Aeronautical library of 20 unused books. Orig. cost over \$40.00. Our choice of titles. Only **\$7.95**
- #192 — MACHINIST GOGGLES, Metal frames, shatterless lenses, made by AO and B&L. With case. Reg. \$6.50 value. Each **\$1.10**
- #193 — HAND LANTERN, Includes stainless steel case. Stenciled 2 bulbs and toggle switch. Uses 6 volt dry lantern battery (not furnished). Each **\$2.95**
- #194 — CANVAS BAGS, For general utility. With straps. Orig. held gas masks. Four for **\$1.00**
- #195 — WHITE HOUSE PAINT, Good quality. Gallon Cans **\$2.49**
- #196 — ELASTIC STOP NUTS, Need no washers. AAF, 6/32, 8/32, 10/32 sizes. Per 100 **99c**
- #197 — GREASE KITS, Consists of 4 grease guns, 4 cans different grease, loading stick, tool, etc. in fine metal case. New. Each **\$8.95**
- #198 — AIRPLANE GAS ENGINES — various types from 175 HP up. Priced from \$100.00 up. Write for details.
- #199 — HYDRAULIC PRESSURE Assembly. Complete, ready-to-use unit with hydraulic reservoir, puralator filter, pressure accumulator, relief valves, pressure control valves, solenoids, valves, Pasco 1000 lb. gear pump, 24V powerful DC motor, connectors, tubing, etc. Measures 24x18x9" overall. Wgt. 60 lbs. Reduced to close out **\$44.95**
- #200 — FOOD WARMER KIT, AAF, for warming foods, liquids, etc. and keeping them warm. Measures 11x17x17 ins. overall. Operates on 110V AC or 28V DC. Includes six 4 1/2 inch stainless steel cups with lids, four stainless steel food trays with lids, six each knives, forks, spoons, one water container, plugs, etc. Fine for home use, cafes, trailers, planes, boats, etc. Wgt. 35 lbs. Ea. **\$19.95**
- #201 — FREE AVIATION BOOK. Text book on aviation given FREE with every purchase of \$5.00 or more. Our selection of titles. Will not be sent unless requested. Orig. value \$2.50.

* Asterisk where shown indicates that item is in used condition. Low prices require that all sales are final. Accuracy of descriptions, etc. guaranteed.

All offerings subject to prior sale. Send check or money order. We can ship transit charges collect. Please order by number.

AERO PARTS SUPPLY

MUNICIPAL AIRPORT
HOUSTON 17, TEXAS

Thousands of Parts **TRUCKS** For Military

PURCHASED FROM U. S. GOVT.
OUR PRICES CAN'T BE BEAT.

We have for immediate delivery genuine parts for all makes and models, 4x2-4x4-6x4 and 6x6. All models from 1/4 ton to 20 tons. All makes: Autocar, Biederman, Brockway, Chevrolet, Diamond T, Dodge, Federal, Ford, GMC, International, Mack, Oshkosh, Reo, Studebaker, White, Willys and Jeeps. We have parts lists available on some models. Write stating model of Truck.

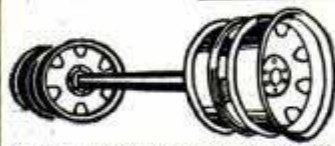

TRAILER AXLE

Heavy duty trailer axle suitable for many types of trailer construction. Also excellent for building of heavy farm trailers and wagons. It is a 12,000 lb. capacity square type straight trailer axle complete with Timken roller bearings, hubs, and 6 hole 750 x 20 Budd Wheels. Without brakes. Axle is 2 inches square and 69 inches between wheel mounting flanges. Std. width. AN EXCELLENT BUY.

With Single Wheels. \$59.50 With Dual Wheels. \$69.50

DIAMOND T 4 Ton WRECKER



With 3 power axle. Equipped with Hercules RXC engine. Complete with Twin Booms, Holmes Wrecker Crane, 9:00 x 20 tires. Complete with closed steel cab and Holmes Wrecker from \$4250 to... **\$3750.00**

With Open Cab.....\$3250.00
Chassis and Closed Steel Cab without Holmes Wrecker.....\$2950.00
Open Cab.....\$2750.00

These trucks are commercially unused but have been slightly used by Army. Are in A-1 condition. Write for detailed information. Subject to prior sale.

UTILITY GAS TANK 6 quarts - New Surplus. Cylindrical 5 1/2" x 15 1/2". Brackets for mounting. Complete with Filler cap, drain plug and pet-cock. Ideal for small gas engines, stoves, etc. \$1.50

SURPLUS POWER WINCHES All are brand new and suitable for front or rear mounting. GARWOOD OR HEIL-15,000 lb. capacity.....\$150.00

WINCH CABLE

200 ft. length 1/2" cable Chain and Hook. \$25.00
300 ft. length 5/8" cable with hooks. \$37.50

HUNDREDS OF OTHER TRUCK PARTS AND SUPPLIES

All prices quoted good 30 days FOB, Kansas City. 25% deposit required on COD orders.

American AUTO PARTS CO
1830 LOCUST - DEPT. PM
KANSAS CITY, MISSOURI.



STRIPE WITH PAINT EASY AS USING A PENCIL

PAINTERS' STRIPING TOOL

NOW you can do your own expert striping on furniture, bikes, model planes, bulletins, autos, toys, signs, linoleum, wall board... make plain walls look like tile! It's easy to paint straight, curved, circular, even parallel lines with any color. Handiest paint tool in your workshop! Type "M" Master Painters' Striping Tool complete with tip for 1/16" stripe, \$1.00. Tool with choice of 1/64", 1/32", 3/64", 5/64", 3/32", 1/8" tip-\$1.50... all tips 75c ea. Tool with complete set of 7 tips \$5.00. (COD's postage collect.) WENDELL MFG. CO., 4234-B Lincoln Ave., Chicago 18, Ill.

A TOOL... NOT A BRUSH



\$1.00 POST PAID

Dealers Write Today!



Just dial

ANY WIDTH CUT ON YOUR PRESENT CIRCULAR SAW BLADE!

Guaranteed to cut clean grooves—12 widths—no sanding. No fuss—no trick assembly. 5 sizes—1/2", 3/8", 3/4", 1", 1 1/4". SEE WARREN DADO SAWING WASHERS AT YOUR DEALERS, OR WRITE. **\$4.95** 4 Set

WARREN WASHERS CO., 70 MEDBURY—DETROIT

SAVE GAS • get 1 to 4 EXTRA miles per gal.



Give make of CAR and CARBURETOR. 6 cyl. cars use one needle—8 cyl. cars use two.

New GANE AIRFLOW NEEDLES replace present idle adjustment screw on your carburetor. SAVES GAS. SMOOTHER IDLING. EASIER STARTING. Users report up to 4 more miles per gallon. Thousands in use. 10-day money-back guarantee! Easily installed in few minutes. ORDER YOURS TODAY—\$1.50 each postpaid—Complete with instructions.

NEHER INDUSTRIES, Box 177, La Verne 4, California

A \$50 A DAY BUSINESS IN YOUR SPARE TIME

FREE BOOK

Take BELSAW Portable Sawmill right to the trees—turn out valuable lumber for local yards—do "custom sawing" for neighbors. BELSAW lasts a lifetime. No crew needed. Power with old auto engine or tractor. Beginners get excellent results. \$62.50 down Send postcard for FREE BOOK, "How To Make Lumber." **BELSAW MACHINERY CO** 811-T Field Bldg, 315 Westport Rd, Kansas City 2, Mo

FULLSIZE, CUT-TO-SHAPE BOAT PATTERNS

and specifications. Designed by Naval Architect. Cruisers, runabouts, sloops, outboards, sailing canoe, etc. Low prices. Send 10c (coin) for illustrated catalog. SPECIAL: Send \$1.00 for "HOW TO BUILD BOATS" book, postpaid. PolyWog Houseboat Plans, \$10. Cleveland Boat Blueprint Co. Dept. 666, Cleveland 13, Ohio



BURIED TREASURE, MINERALS AMAZING NEW GOLDAK LOCATORS

SENSATIONAL NEW MODEL! ONLY 11 pounds weight! One hand operation! Money-Back Guarantee of Superiority. Write for full details.

THE GOLDAK CO.
1542 WEST GLENOAKS BLVD.
GLENDALE 1, CALIFORNIA

World's largest maker of fine locators.



POWERMAX MIDGET AIR TOOL

- ★ Variable speeds 500 to 14,000 r.p.m.
- ★ Finger tip control
- ★ Only 4 1/2" long — 1" diameter
- ★ Powerful, cool running vane motor
- ★ 1/8" collet chuck
- ★ Requires only 3 c.f.m. air at 50 lbs.
- ★ Complete with 6' hose

Never before so much useful power in so small a package.

For Grinding • Sanding • Polishing • Drilling • Milling • Routing • Carving

FERRIOT BROS., INC.

2680 Mogadore Rd. AKRON 5, OHIO

Send check or money order—no C.O.D.'s please.

EARN BIG MONEY AND BE YOUR OWN BOSS

Sharpening Lawn Mowers

Build a Business of Your Own With A UNIVERSAL GRINDER

In your own garage or basement, and earn \$25.00 a day or more. Mr. Hardy writes, "I am doing a fine business with the UNIVERSAL GRINDER. One customer sends another. I spent 40c for a newspaper ad and have done nearly \$500.00 worth of business." Mr. Helmeck of Canada writes, "We sharpened 750 mowers last year and are 1056 on this year's run. The Universal surely makes customers." Mr. Barton of California says, "The mower business, with the Universal Grinder, has been a gold mine these last two years."

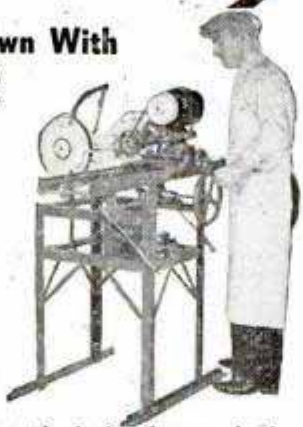

Only on the UNIVERSAL GRINDER can the inside face and edge of the stationary blade, as well as the reel blades, be ground to proper clearance ALL IN ONE SET-UP without removing any blade from the mower.

WRITE FOR FREE FOLDER TODAY!
ROGERS MFG. CO., Dept. M-79, Lindsey, Ohio

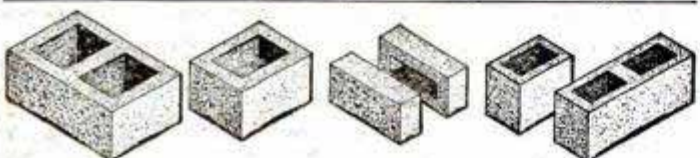

Make Concrete Blocks and Bricks

New superior method makes square, true, easy-to-lay units which will pass any building code. Small investment, high production, big profits. One \$30.00 machine will make four 5"x8"x12" blocks per minute—1000 per day. Pays for itself in a few days. Sell blocks or save 2/3 building cost by making and laying your own.

POST CARD BRINGS FREE FOLDER

Economy Manufacturing Company
 Dept. P Stone Mountain, Georgia

HUNDREDS OF ITEMS AND IDEAS FOR THE WOODWORKER

Big New 144 Page Catalog No. 16 OF HARD TO FIND WOODWORK ITEMS, HARDWARE AND SUPPLIES, the finest craftsman catalog Harold Hunt ever published—32 rare and fancy woods in natural colors—also in color, 43 matched veneer designs, multi-colored bandings, inlays, overlays, scroll patterns, etc. Only 15c, rebated on first order.

CRAFTSMAN WOOD SERVICE CO.
 2729 S. Mary St. Dept. A-7 Chicago 8, Ill.

HARD TO FIND LUMBER

Top Grade Kiln Dried A Board or a Carload

UNEQUALED BARGAINS

WALNUT, MAHOG., CHERRY, MAPLE, WH. HARD AND SOFT, POPLAR, PL-QTR, OAK, AROMATIC, RED CEDAR

HOME IDEA BOOK!

How to Build and Enjoy an OUTDOOR FIREPLACE

52 pages of ideas, recipes, tips — plus 11 easy-to-build plans.

Send for Your Copy Now to cover handling costs send only 25c



It's fun and economical to fit any masonry design around this rugged unit. Uses wood or charcoal. Cast iron grates and door. Size: 21"x26"x13 1/2". Price \$17.95. Larger sizes available. See your dealer or write.

The Majestic Company
 198 Erie St., Huntington, Indiana

MODEL OF-28

ASSEMBLE YOUR OWN TRAILER



CUB SPORTSTER

SAVE UP TO 50%



CUB SENIOR

Enjoy the luxury of owning one of these sturdy, streamlined trailers. Save up to half the normal cost by assembling it yourself. For practically material costs alone, you can buy the full-size CUB SPORTSTER or CUB SR. trailer in construction kit form.

In only a few hours, using a screwdriver, hammer and wrench, either trailer can be easily assembled. Precision cut, factory-finished panels and sub-assemblies are guaranteed to fit. Both trailers have sleeping room for two adults and two children, thus they can pay for themselves during one vacation. Many Cub trailer owners make extra money by renting their trailers for week-end and vacation trips!

The CUB SPORTSTER has a rugged all metal body and all steel frame that weighs only 450 lbs. It is 12' 7" long, 6' wide, 5' in height and it adds only 75 lbs. tongue weight to your car. The CUB SPORTSTER kit includes a galley, ice box, wheels, fenders and all parts except tires and tubes.

Only **279.50** plus tax

The CUB SENIOR can't be matched in either price or quality. A walk-in trailer, it has plenty of room for everything in pre-assembled cupboards, drawers and a spacious closet. Built-in dinette bed, sink, ice box and two fold-away tables give you all the comforts of home. The CUB SENIOR is 10' long (8' body length), 6' 4" wide and 6' 9" in height. It has an all steel frame and all parts are included except tires and tubes.

Only **395.00** plus tax

(C.O.D. shipment will be made on either trailer if at least \$50.00 deposit accompanies order.)

Write today for FREE illustrated folder. Dealer inquiries are invited
National Trailer Stores

BOX 2353, DEPT. M-79, TERMINAL ANNEX
 LOS ANGELES, CALIFORNIA

D.C. ARC WELDER

200 AMPERES CONTINUOUS DUTY ONLY \$97.50

Easily mounted on tractor or elsewhere. Welding range 0-250 amperes by dial type control. Includes proper pulley for your application. 12 months guarantee, with money-back 10-day trial period, (A \$300 value) at less than half. Write today for free literature or catalogue. Or, send **35c** for PLAN "Build Your Own Welder from Surplus Aircraft Generator" and we'll include free literature and catalogue.



LEJAY MFG. CO.
 847 LeJay Bldg., Minneapolis 8, Minn.

Say You Saw It in Popular Mechanics

THE BIGGEST SURPLUS BARGAINS IN YEARS

ELECTRIC MOTOR 1/2 H. P. 27 V.D.C. R. P. M. 4000 No. 750. For Intermittent or Continuous Duty 5/8" SHAFT. VARIABLE SPEED MOTOR CAN BE ADAPTED, TO 110V.A.C. or R.E.A. line by simple arranging armature brush leads. UNUSED. Instructions \$5.50 incl.
ELECTRIC MOTOR 1/2 H. P. 24 Volt D.C. R.P.M. 2500 \$3.50
 Amp. 22. BRAND NEW. Ea.

WEAVERS HYDRAULIC HAND PUMP — BRAND NEW. For hydraulic Jacks, presses, hoist, etc. For operating hydraulic cylinders, to pump oil or hydraulic fluid under pressure. Has built in check valve, and is capable of delivering 1000 lbs. pressure. Wt. 10 1/2 lbs. A \$50.00 value. Instructions incl. **\$8.50**

VICKERS CONSTANT DISPLACEMENT HIGH PRESSURE PUMP. Use it for any type liquid pumping job 375 gal. per hr. at 3750 R.P.M. 1000 pounds pressure per sq. in. Can be used as hydraulic motor O. Acq. \$100.00. **\$8.95** postpaid Brand new directions incl. Wt. 7 lbs.

VICKERS UNLOADING VALVE. Brand New—By passes full amount output of the pump while the cylinder is not in operation. Takes starting load off of electric motor driving the pump. Price **\$4.95** postpaid

BRAND NEW HYDRAULIC CONTROL VALVE. This is a TWO CYLINDER DOUBLE ACTION VALVE with unique arrangement allowing the operator to raise both cylinders simultaneously, to lower them simultaneously or to raise one and lower the other at any predetermined rate and speed. A \$75.00 value. **\$8.95** Postpaid

BRAND NEW HYDRAULIC CONTROL VALVE. Four Way control for use with two hydraulic double action cylinders. \$60.00 value. Price **\$7.95** Postpaid

AIRFORCE GUN SIGHT #165. Contains triple lens non-glare variable density lens plus other lens. Reflector sight for photo works, etc. Wt. approx. 4 lbs. **\$3.50** plus postage

THOMPSON BOOSTER PUMP. Use them for Homes, Farms, Ranch, and Shop. Motor driven centrifugal pump will empty 50 gal. drum of water in approx. 20 min. Runs on 24V. D.C. A.C. **\$7.50** New.

LUBE PUMP. BRAND NEW. Precision Gear Impeller Pump. Pumps liquids up to 3 gal. per minute. Pressure up to 200 lbs. per sq. in. 3/4" 1/2" Threaded and keyed shaft. Instructions incl. Wt. 4 lbs. Price. **\$3.95** plus postage

SENSATIONAL FASCINATING MYSTERIOUS SELSYN. Two or more connected together, work perfectly on 110 V.A.C. For weather vanes rotating directional antennas or controlling distance operations. Complete with diagram and instructions. Wt. 3 1/2 lbs. **\$3.50** PER PAIR plus postage

VALUABLE GEARS BARGAINS SPEED REDUCER 10-1 or 5-1 ratio, 90 degree angle. Shaft Driven 1/2" spline Shaft with 3 mounting holes 5/16". Gears held in forged and machined aluminum housing with two needle bearings, one bronze bearing, and three high speed shielded bearings. Sealed self lubricating chamber. **\$3.50** Price

BRAND NEW DYNAMOTOR. Model DY-22/ARC. Input 28 V.D.C. Output 210 V.D.C. Cont. Duty. Base mounting. Wt. 5 1/2 lbs. Ea. **\$1.65** plus postage

DYN. New Model #23350. Input 27V.D.C. Output 285 V.D.C. Wt. 3 1/2 lbs. **\$1.35** plus postage

NEW PUROLATOR GASOLINE FILTER. Aircraft type. Today's advanced gasoline Re-refining filter for all cars, Trucks, Tractors and all Motor Boats. Cleans and refines gasoline as you drive. Removes solids, water and prevents sludge formation. Install at home in a few minutes. STOP GASOLINE WASTE AND EXPENSE. Instructions incl. Permanent, needs no replacements. Ea. **\$4.95**

NEW CUNO OIL FILTER, aircraft type. Filters oil without cartridge replacements. For Autos, Trucks, etc. Install at home in a few minutes. STOP CHANGING MOTOR OIL. Instructions incl. Ea. **\$4.95**

WRITE FOR HYDRAULIC LISTING
 Send check or Money order. No c.o.d.'s. Prices f.o.b. K.C. except when marked postpaid.

GENERAL SALVAGE COMPANY
 Dept. 17, 2920 E. 27th St. Kansas City, Mo.

15 ESSENTIAL WORKSHOP OPERATIONS ON YOUR DRILL PRESS

Barron Precision Drill Press Tools and Accessories—Planers, Rotary and Drum Sanders, Auxiliary Tables, Hi-Speed Router Bits, Shaper Fences, Molding Cutters, Dovetail Cutters—a host of other useful drill press items give complete workshop facilities at 1/4 the cost. Over 200,000 Barron owners. Get the facts on these popular, versatile drill press tools today. Sold on 10 day money back guarantee.

BARRON TOOL CO. Inc.
 669 ARCHITECTS BLDG.
 DETROIT 1, MICHIGAN

FREE Workshop Guide & Catalog

ARC WELDING FOR PROFIT OR PLEASURE

60 LBS. OF READY MADE PARTS **Only \$24.95**

BUILD YOUR OWN HEAVY DUTY WELDER

SAVE Buy Only NECESSARY PARTS
 All parts Ready-Made and easy to assemble. You can do all around welding on steel, cast iron and other metals after only a few hours practice. Illustrated instruction manual included. Sold on 30-Day Money-Back Guarantee!

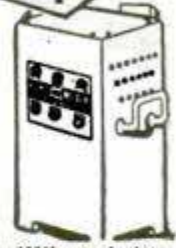

FREE: Write today for fully illustrated Pamphlet P-7

ATOMIC ARC WELDER CO.
 1037 So. 19th St. OMAHA, NEBR.

Gives 100% penetration. Welds are stronger than original metal. Operates on 110 or 220 AC.

- Army 16 Jewel waterproof wristwatch, Elgin or Bulova. \$42.50 value. **\$19.50**
 - New Canvas Roll Carry-All for sportsmen and general use. Gov. surplus. \$12.50 value. **2.50**
 - Binocular Cases, all leather, 6 x 30, \$5.00 and 7.50. 7 x 50. **7.50**
 - Leather Rifle Slings. Gov. Surplus, used, good condition. **75c**
 - TELESCOPES, U. S. Navy, 16 power, wood cabinet, length 31 in., focusing eyepiece, 2 3/4 in. objective lens. Plain **29.50** Coated **35.00**
- PUBLIC SPORTS SHOPS**
 11 SOUTH 16th ST., PHILA. 2, PA. (No COD's)

MAKE! FOLD-A-WAY
FOLDING TABLES - BENCHES - HORSES - IN A JIFFY
 CHANNEL STEEL LEGS
 Shipped complete, ready to fasten to your top in a minute. Rubber tipped. Used on the job, in homes, workshops, ping pong tables, trailers, camps, boats, churches, lodges, banquet halls. Send for free circular.

\$4.98 Pr. 24" Legs
 \$5.98 Pr. 30" Legs
 Postpaid in U.S.A.

THE DIAMOND MFG. COMPANY
 1190 ALTMONT AVENUE SCHENECTADY 7, N. Y.

MACHINE SHOP EQUIPMENT

• The 1949 edition of the famous Center Tool Co. Catalog is now ready! Every workshop owner should have a copy. 240 pages full of illustrations, descriptions, and prices of the latest tools made by best known manufacturers in U. S. You pay the cost of printing—50c. We refund your 50c with your first order of \$10.00 or more. Prompt delivery on most tools. Send check or money order today!

CENTER TOOL CO.
 153 Centre Street, Dept. C, New York 13

METALS FOR HOME WORKSHOPS

Aluminum, Brass, Copper, Monel, Steel and Cast Iron. In Bars, Angles, Channels, Sheets and Tubes. Sold in Small Quantities. Write for Free Price List.

CASHMETALS CO.
 2720 CALIFORNIA AVE. PITTSBURGH 12, PA.

BUILD YOUR OWN TRAILER with NATIONAL'S Easy-to-Read PLANS

Here it is! Your own full size house on wheels . . . or if you prefer, a sleek sports trailer that will add new thrills to your vacation. Easy to read, easy to follow instructions and a complete "cost of materials" with every plan.

THREE Smart MODELS

- ORDER ALL THREE GET ONE FREE!**
 - Model 27 27-foot Luxury Liner, 35' 100 rooms, toilet. Sleeps 6.
 - Model 20 20-foot Cabin Trailer, 5' 100 tops for looks. Sleeps 4.
 - Model 10 Sports Trailer for hunting, fishing. Sleeps 2. **50c**
- Big illustrated parts Catalog with Any Order!

NATIONAL TRAILER STORES
 Dept. PM-Box 2353 Terminal Annex - Los Angeles 54, Calif.

OVER 250 SURPLUS BARGAINS



GENUINE M-6 COMPASS \$5.95

A real precision instrument made to rigid Govt. specifications. Universal bracket easily mounts on cars, trucks, boats, planes, etc. Nite lite, instruction book and calculator included.

GENUINE G. E. 2 H.P. 4-CYCLE GASOLINE ENGINES

Brand new! In original factory cartons. Complete with oil air filter, dustproof magneto, gas tank, shaft pulley, throttle control, etc. Excellent for mowers, boats, saws, etc. Ship. wt., 37 lbs. Shipped express collect, \$69.50 value.



- Water Bag—2 1/2 gal. U. S. Desert type. New..... \$1.98
- Officers' Tents . . . 9 x 9 ft. Wt. 60 lbs. New..... \$29.50
- Sun Glasses—Air Force Type. Lifetime guarantee..... \$1.98
- New Sprayer—4-gal. cap. Complete with pump and hose. Wt. 15 lbs. \$3.95

Mail orders add sufficient postage unless otherwise noted

Write for Big FREE CATALOG Today!

FISLER SALES CO. 723 Walnut St. Kansas City 6, Mo.

New War Surplus HOIST and WINCH

Originally made to be used on B-29s for lifting bombs. Mounted on welded steel base, can be attached to truck body or any solid base. Ideal for lifting or moving loads onto trailers, trucks or tractors or for machine shops, garages or warehouses. Capacity 2,000 lbs. Equipped with ratchet for holding load and 18 ft. 3/8" steel cable. Shipping weight 50 lbs. FOB, Kansas City, Mo. **\$29.95**

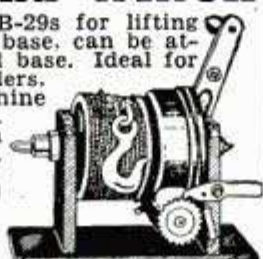

Send check or M.O. for immediate delivery. No COD's
AMERICAN AUTO PARTS CO., INC.
 1830 LOCUST DEPT. PM6 KANSAS CITY, MO.

NU-WAY HEAVY DUTY CUTTING UNIT with Timken Roller Bearings

PRICE \$16.50
 WHY PAY MORE

Build your own rotary type lawn or weed cutter. Take the hard work out of weed cutting. Build yourself an up-to-date weed and lawn mower with the Nu-Way heavy duty unit.



Write for Free Circular—We Supply Cutting Unit Complete
TRACTOR-LITE MFG. CO., Spirit Lake, Iowa

Thompson BEATS the World on BOATS

Safe Boats With Full Length Spray Rails
 Keep passengers perfectly dry—even at high speeds. Catalog also shows two new models of "Take-Along" Boats. Two big factories—save you freight.
CATALOG FREE
 Write for your copy. State kind of boat in which you are interested.
THOMPSON BROS. BOAT MFG. CO. (151)
 213 Ann St. PESHTIGO, WIS. (Write to either place) Light Boat for Auto 213 Elm St. CORTLAND, N.Y.



ONLY \$61.95
6" BLADE—2" CAPACITY

Complete with Bevel-Depth Attachment

• **SAW ONLY \$54.95**

• **ATTACHMENT \$700**

• It bevel cuts to 45-degrees, rips, crosscuts, angle cuts, rough or dressed lumber. It grooves mortar joints, cuts metals, cuts and scores tile, concrete and other aggregate compositions. Depth is easily adjusted on straight cuts from 5/16" to 1-31/32"; and from 1/4" to 1-11/32" on 45-degree bevel cuts. When set in a Mall Saw Table, various available attachments equip it as a table saw, face and drum sander, wire brush and shaper. Light-weight rugged construction. Operates from 115-volt AC:DC or 230-volt AC:DC. For 32-volt battery lighting systems without Bevel-Depth attachment \$58.95.

All Prices F. O. B. Chicago. Ask Your Hardware or Power Tool Dealer. FREE Booklet "Mall Portable Power Tools" mailed upon request.

MALL TOOL COMPANY 7805 SOUTH CHICAGO AVE., CHICAGO 19, ILL.

IT CUTS TOUGH WEEDS WITH GREATEST EASE!



Sickle Bars in 30", 32", 36" widths.

4 Tractor Models starting at \$159.50 f.o.b. factory

For speed and efficiency in mowing the toughest weeds get a Garden-All Sickle Bar. Three sizes to choose from, depending on the tractor model you buy. For lawns see the Garden-All reel-type lawn mowers—available in 24", 26" and 30" widths. You can use all Garden-All lawn and garden attachments with only one power unit. See Garden-All before buying any power equipment. You'll be glad you did!

GARDEN-ALL TRACTOR, INC. Dept. P, 110 W. UNION STREET, LIBERTY, INDIANA

Make UR-OWN Rotary Type POWER MOWER

Just add electric motor or gas engine, concealed blade for safety, 3 cutting heights, 1 1/2" to 3 1/2". Ball bearing rubber tired rear wheels, 18" cut. Cuts to within 1/2" of sidewalk, weight 48 pounds.



Available with McCullough 2 1/2 hp gas engine, as shown. **\$119.50**

With 1/2 hp elec. motor and 75 ft. cord, complete. **\$69.50**

Send Check or M.O. No COD's. FOB, K. C.



ATLAS EQUIPMENT CO. Dept. B1
229 S.W. BLVD. KANSAS CITY, MO.



Free Sample!

Big profits showing amazing GLOW-IN-THE-DARK SPECIALTIES. House numbers, pictures, plastic novelties, religious and nursery objects, etc. Large manufacturer. Enormous demand. Sell on sight. Write at once for FREE SAMPLES.

MADISON MILLS, Dept. W-4
303 Fourth Ave. NEW YORK 10, N. Y.

Only \$498



OTTAWA Mule Team Tractor

Finest of all low cost tractors. Costs too little to do without. Has the toughness and strength of a team of mules. Over 4,000 in use. With ease and low operating cost, it plows, discs, harrows, mows, plants, cultivates, etc. Weighs nearly 1,000 lbs. and has Bull-Dog traction. Sold only direct to user. Write quick for FREE details.

OTTAWA MFG. CO., 2-927 Garden St., Ottawa, Kansas

FIRING • FORGING • MELTING

Ideal for small batches. Build your own furnaces.



UTILITY BURNER
Only \$72.50

Do your own HEAT TREATING, ASSAYING, BRAZING, BENDING, DRYING, HEATING, BAKING. Fires in open and into furnaces with clean hot flame. Controllable atmosphere. Temperatures up to 3000° F. Ready to operate. Starts quickly. Portable. Neat, compact, assembled unit.

Specifications: 35,000-130,000 Btu/hr.; 110V, 60 Cycle; 28" long, 10" high, 8" wide; fuel—kerosene, #1 and #2 oil; fuel gravity feed; manual operation; weight 22 lbs. Instructions included for building inexpensive furnaces, ovens, kilns, pots.

Send Check or Money Order. We pay postage. 25% deposit on C.O.D. Satisfaction or money back.

STODDARD PRODUCTS CO., INC., Box A3042, Westville, New Haven, Conn.

Build YOUR OWN BOAT



Build a better boat than you can buy for the money! Save 35-55%. Exclusive laminated ribbed construction, prefabricated for easy assembly. All popular types from simple car-top models to mahogany-decked runabouts, priced from \$39.50 to \$199.50. Send 10 cents for literature.

\$39.50 and up

OZARKA

679 BORDEN LANE
WOODSTOCK, ILL.

One Swipe of NEW PLASTIC Makes these LEATHER and LEATHERETTE Items LIKE NEW

Get Into A Money Making Business

Make like new, worn, scuffed or faded leather and artificial leather equipment. Either your own to renew, recolor and beautify, or cafe, restaurant and hotel equipment as a business. Single stroke with a brush renews. Does not crack, peel or scuff. Resists acid, alcohol, caustics and weather. All colors. Mail coupon for free sample.



FREE Sample SHOWS EFFECT

\$50 to \$500 Profit
On One Job Possible

Let me show you how, as I have shown others. Get your own exclusive territory while available. Mail coupon today, I'll do the rest. — Jack Edwards, Sales Mgr.

LEATHER-NEW PRODUCTS,
6082 Sunneslope, Kansas City, Mo.
Send me without obligation a sample of Leather-New coated material so I can inspect it.

Name _____
Address _____
City _____ State _____



BARGAINS FROM WORLD WAR II

Thousands of Bargains in Military, Outdoor and Sport Goods for Hunter, Farmer, Scout. Write for FREE 32-page CATALOG OF BARGAINS.

A and N SUPPLY CO., 4720 Lester St. Richmond 15, Va.



RCD

Write for FREE FOLDER

DRILL BILLY says: "Drill holes in concrete faster and better with THE ORIGINAL

ROTARY CONCRETE DRILL BIT"

Revolutionary design. Quiet, pulverizing action. No pounding or chipping. For use in electric or air rotary drills.

ROTARY CONCRETE DRILL COMPANY

650 S. Arroyo Parkway, Pasadena 1, Cal.

\$ AGENTS 300% Profit SIGN LETTERS

For Store Fronts and Office Windows. Anyone can put them on. Free Samples. Liberal Offer to General Agents.

METALLIC LETTER CO., 430 N. Clark, Chicago 16

WE'LL PAY YOU \$1000. for 3 gallons of "WORN OUT" motor oil from your own auto, truck or tractor engine. Details, page 30 in our FREE BOOK—"Oil Facts."

RECLAIMO MFG. CO., 5083 Elston Ave., Dept. 95, Chicago 30, Ill.

WOODWORKERS ... Get this

CONSTANTINE MASTER MANUAL

Get the Most Fun From Your Hobby Indispensable to woodworkers. Newest, biggest edition, more pages, more color, helpful how-to-do-it articles, pre-war and new items, more bargains. Send 25c today and we will include **FREE! FULL YRS. SUBSCRIPTION** to Chips and Chats, published bi-monthly. Keeps you up-to-date on everything in woodworking, offers big money-saving bargains. Send now.

ALBERT CONSTANTINE & SON, Inc.
791-C East 135th Street, New York 54, N. Y.



MOTORISTS! SAVE MORE at J.C. WHITNEY & CO.



CHROME PLATED! Rear Fender Pebble Deflectors

- No Extra Holes to Drill
- Easy to Install

Ford, Mercury 42, 46-48
Chevrolet 42, 46-48
Plymouth 46-48, also
All Chrys. Corp. cars

\$4.95
PER PAIR

GUTTED MUFFLERS



FOR
ALL
CARS

Gives that Motorboat
Tone, Universal type to
fit all cars, ea.

\$4.95

1935-48 FORD V8 &
1939-48 MERCURY

DUAL MUFFLERS

Increases power. Reduces back
pressure. Saves gas.
MD20N-208—
Complete Set.

\$14.95

DUALS FOR 1949 **\$19.95**
FORDS, Set

1949 NEW TRIM RINGS



Chrome Plated. Universal Fits
All Cars. Theftproof — Easy to
Install — Fastens with
small bolt on both
sides of fenders or
hood. Set of 6, only

\$1.95

\$35.00 Transparent Plexiglas

SUN VISORS

Believes eye strain and
glare. Permits full vision
of stop lights. Green Plexi-
glas panels, chrome plated
center strip and
wings. Univer-
sal — fits all
cars. EA.

\$22.95

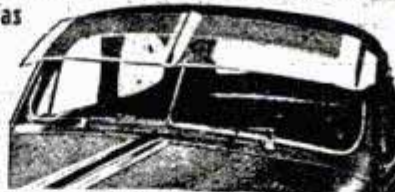

ALL METAL SUN VISORS Air Flow Style. Fits ALL CARS. **\$8.95**
Stainless steel center strip. Complete with fittings.

NEW CONVERTIBLE TOPS

100% Waterproof,
Weatherized Mate-
rial. Not Affect-
ed by Snow or
Rain. Choice of
Black or Tan.

AS LOW AS
\$24.95

"ZIPPER type" Rear Curtain

Consists of main top proper, rear curtain
and all needed binding and fittings. (Glass
is not supplied.) All metal parts are of
heavy bright chrome plated rust resistant.
Tops are heavily stitched with treated
thread and sewed for durability.

- | | |
|--------------------------------------------------------------|---------|
| 2 Pass. Ford A 28-31 Roadster & Coupes | \$24.95 |
| 2 Pass. Ford 33-39 Roadster & Coupes | 29.50 |
| 5 & 6 Pass. Ford 36-49 & Mercury 39-49 Coupes | 33.75 |
| 2 & 4 Pass. Ply., Chry., De Soto & Dodge 35-39 Cpes. | 29.50 |
| 4 & 6 Pass. Ply., Chry., De Soto & Dodge 40-48 Cpes. | 35.45 |
| 2 & 4 Pass. Chev., Buick, Olds., Pont. & Cad. 36-38 Cpes. | 37.50 |
| 4, 5 & 6 Pass. Chev., Buick, Olds., Pont. & Cad. 39-48 Cpes. | 34.50 |
| 5 & 6 Pass. Nash 37-41; Packard 36-48; Stude. 1948 Cpes. | 43.75 |
- NOTE: SPECIFY COLOR WANTED ALSO MODEL OR SERIES, BODY STYLES, YEAR AND MAKE WHEN ORDERING.



Easy to
Install

3 PLY RUBBER AND FABRIC MATERIAL

- A. Treated, weather-
proofed cotton fabric.
B. Absolutely WATER-
PROOF heavy, live rub-
ber ply bonded to both
cotton sheets.
C. Tightly loomed, spe-
cially treated cotton, fin-
ished for utmost beauty.

FENDER SKIRTS



Made of all metal, prime finish,
with Rubber beading
to prevent rattle. Easy to
install. MC31N-9. Per Pair. **\$12.95**
Be sure to specify year, make
and model of car.

FLYING SWAN

CHROME PLATED!
2 stud one piece
mounting easily
installed. EA.

\$3.95



BUFFALO HEAD for KAISER-FRAZER

Massive design 18 1/2 in., long.
Gleaming triple
chrome plate. Nuts,
bolts and template
supplied. EA.

\$6.95

CHROME or WHITE WALLS



15" & 16"
Wheel
sizes

Dressy wheel walls snap on in-
stantly under regular hub caps.
Set of 4 — **\$9.95**
Chrome
Set of 4 — **\$5.95**
White
(Specify Year, Make & Size)

FOG HORN

Complete with
variable tone and
volume control.

List **\$12.50**
Now **\$9.95**

Deep penetrating
tone. Roars like
lion, bellows like
a bull. Note vol-
ume control.



Our Finest Precision REBUILT MOTOR BLOCK ASSEMBLIES

Sold Outright or Exchange

Rebuilt by skilled mechanics.
Assembly has Reborn Block
with New Pistons, Pins, Rings,
Reground Crankshaft, all New
Bearings. Guaranteed 90 Days.
Allowance on Old Motor
We ship at outright price.
Send your motor prepaid, must
be suitable for rebuilding.
Send in notarized bill of sale
showing title number if any.
We refund difference when we
receive your motor.

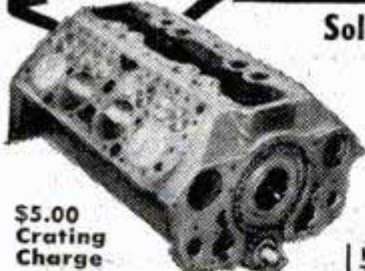

\$5.00
Crating
Charge

BUICK	Outrt.	Exch.
34-47 8 cyl.	\$209.00	\$165.00
CHEVROLET	Outrt.	Exch.
29-47 6 cyl.	115.00	95.00
CHRYSLER	Outrt.	Exch.
34-47 6 cyl.	157.00	132.00
35-47 8 cyl.	209.00	165.00
DE SOTO	Outrt.	Exch.
34-47 6 cyl.	157.00	132.00
DODGE—3 1/4" bore	Outrt.	Exch.
33-47 6 cyl.	150.00	120.00
3 3/8" bore	Outrt.	Exch.
34-47 6 cyl.	157.00	132.00
FORD	Outrt.	Exch.
28-31 4 cyl.	107.00	87.00
32-34 V8	129.00	109.00
35-47 V8	149.00	109.00
37-39 60 HP.	154.00	109.00
MERCURY	Outrt.	Exch.
39-47 V8	149.00	109.00

HUDSON-TERRA.	Outrt.	Exch.
35-36 6 cyl.	\$181.00	\$137.50
37-42 6 cyl.	199.50	149.50
LINCOLN-ZEPHYR	Outrt.	Exch.
36-37 also	232.00	192.00
fits 38-39	232.00	192.00
39-40	299.50	234.00
Oldsmobile	Outrt.	Exch.
37-47 6 cyl.	177.50	137.50
35-47 8 cyl.	209.00	165.00
PACKARD	Outrt.	Exch.
37-42 6 cyl.	199.50	149.50
35-42 8, 120.	212.50	172.50
PLYMOUTH	Outrt.	Exch.
33-47 6 cyl.	145.00	120.00
PONTIAC	Outrt.	Exch.
37-47 6 cyl.	177.50	137.50
35-47 8 cyl.	209.00	165.00
Studebaker	Outrt.	Exch.
35-47 Comm.	181.50	137.50
39-46 Cham.	159.50	126.50
35-47 8 cyl.	209.00	165.00



CHROME PLATED
FRONT & REAR

TUBE GUARDS

Chrome finish, extra heavy gauge
steel tubing, 1 1/4 in. diameter.
Installed easily in 5 minutes
with original equipment bumper
guards.

- | | | |
|-------------------|---------------|---------------|
| CHEVROLET 46-49 | FRONT OR REAR | \$3.95 |
| FORDS | | |
| PLYMOUTH 46-49 | | |
| DODGE | | |
| DE SOTO | | |

65 KW. 225 Volt D. C. DIESEL ELECTRIC GENERATING UNIT RECONDITIONED



RADIATOR
for above **\$100.00**
Unit.

Equipped with 6 cyl. DRXB
Hercules DIESEL engine,
4 3/8" bore, 5 1/4" stroke,
120 H.P. at 2000 R.P.M.
Complete with injector,
pump, nozzles and electri-
cal equipment. Generator
attached to engine. Com-
plete as shown.

PG60R-193 **\$1250.00**
Each

GAS ELECTRIC D. C. UNIT

Same unit as above except with 6 cyl., RXLCT
HERCULES Gasoline Engine, 4 5/8" bore, 5 1/4" stroke.
PG60R-191—Each. **\$695.00**

Hi-Speed ELECTRIC SIREN



6 Volt. Used by
hundreds of
Fire and police
departments,
buses, ambu-
lances, etc.
Complete with
bracket screws, and
push button. Ea.

\$10.95

Send 25% Cash With All Orders, Balance C.O.D.

J.C. WHITNEY & Co.
1919 Archer Ave. Chicago 16, Ill.

Dual Tail Pipe Extension



\$2.95
Each

Universal for all cars. Deep Tone
produced by double 2 1/2" outlets.

LAWNMOWER SHARPENER OPERATORS

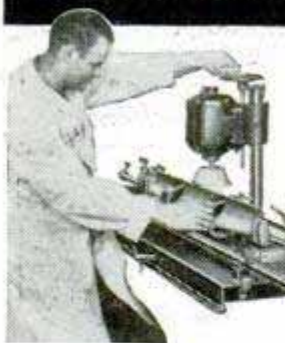

Increase your output...
Year 'round business!

SHARPEN ALL STRAIGHT EDGE TOOLS

Model 50 Ideal Bench Grinder doubles your output of sharpening jobs, speedily grinds straight blade knives. Sharpens all kinds of straight edge tools and ice skates. Write for FREE, fact-filled folder.

THE FATE-ROOT-HEATH COMPANY
Dept. D-3, Plymouth, Ohio

Build your own SMITH Compressor

Operates spray guns, rock drills, tampers, paving breakers, sandblasting . . . Uses only 1 gallon of gas an hour!



Save Money—build your own Smith Air Compressor! Famous the world over! Capacity 60 cu. ft.; pressure up to 100 lbs. per sq. inch. Just order the Smith Compressor Head and Accessories with complete instructions for assembling. All you need is a Ford Motor and shop facilities. Head equipped with high speed compressor valves; automatic unloading and idling.

Write for complete information!

GORDON SMITH & COMPANY, Inc.
410 College Street • Bowling Green, Ky.

Hydraulic SPEED REDUCER of many uses

Variable Speeds and INSTANT REVERSE

FROM ZERO TO 700 R.P.M.

For LATHES, REAMERS, TRANSMISSION, MIDDLET CARS, MILLING MACHINE TABLE, SHAPER, THREAD MILLING FIXTURES, HOME MADE WOOD WORKING LATHE, EXHAUST FAN, PUMP, HOIST, GENERATOR, OVERHEAD TROLLEY, PRODUCTION BELT, OPENING and CLOSING DOORS, and MANY OTHER USES. Industrial or Home Use. Cost Government \$300.00. High Quality Precision Workmanship. Case measures 7 1/2" Long, 7" High, 6 1/2" Wide. Input and Output Shafts 1/2" diameter. Beautiful Red Crackle Finish Case.

If C.O.D. is requested a 10% Deposit must accompany order and we ship F.O.B. Chicago.

OUTPUT TORQUE ADJUSTMENT ZERO TO 100 INCH POUNDS

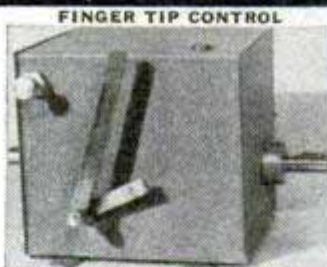

Shipping Wght. 25 pounds
Only \$54.50 PREPAID
2 quarts oil included FREE
1 1/2"-8 thread Lathe Chuck Adapter, \$3 extra

DIRZIUS MACHINE SHOP H, 1423-25 So. 52nd Ave., CICERO 50, ILL.

NOW YOU TOO CAN BUILD 15 RADIOS

Absolutely No Knowledge of Radio Necessary

You Need NO Additional Parts

The PROGRESSIVE RADIO KIT

is THE ONLY COMPLETE KIT. Contains everything you need. Instruction Book, Metal Chassis, Tubes, Condensers, Resistors and all Radio parts. The 36-Page Book written by Expert Radio Instructors teaches you to build radios in a Professional Manner. You start with a 1-tube receiver. Before you are done with this kit, you will have built 11 Receivers, 1 Public Address System and 3 Transmitters. **SPECIAL FREE OFFER!**

Electrical and Radio Tester sent absolutely FREE with each Progressive Radio Kit. PLUS FREE membership in Progressive Radio Club. Entitles you to free expert advice and consultation service with licensed radio technicians.

Write for further information, or ORDER your KIT **\$14.75** NOW! ONLY

Postage prepaid with check or money order (Postage not prepaid with C.O.D. orders)

PROGRESSIVE ELECTRONICS CO., Dept. PM-26
497 Union Avenue Brooklyn 11, N. Y.



CAPE COD CHAIRS TRELLISES • ARBORS DUTCH WINDMILLS

Chairs style B-C-A PLANS 50c Ea., all 3 only \$1.00. 12 different trellis designs PLAN of all 12 only 50c. Authentic 40" high Dutch Windmill Detailed PLAN only 75c. Unique 40" high Light-house having copper lantern, ideal for garden or on lake shore of summer home. Large detailed PLAN 75c.

SPECIAL ALL PLANS ABOVE \$3.00 VALUE ONLY \$2.50

SEND for catalogue of many fine projects.

CRAFTSMAN'S MODEL CO. Dept. P6, 2030 No. 41st Street Milwaukee 8, Wis.

MAGNETS OF ALL TYPES—10c UP

AMAZINGLY POWERFUL!
4 oz. Alnico Magnet, lifts 10 lbs. lifts \$1.10. Our Leader, 15 oz. Magnet, lifts 40 lbs. \$2.50. New alloy—will not weaken! Useful for lifting valves from tanks, inks, or rivers easily! 7 small magnets \$1.10 with list of many shop and home uses. Satisfaction guaranteed. R. EYRICH, 2566 N. 49TH ST., MILWAUKEE 10, WIS.

SHARPEN CIRCULAR SAWS LIKE AN EXPERT



Precision file circular saws in your own workshop. No experience necessary. Two simple adjustments. Gets hollow-ground, cross-cut or combination saw blades true and sharp. Fits 6" to 12" blades with 1/2" to 13/16" centers. Complete with file and complete instructions. \$6.95 postpaid (check or money order) or C.O.D. plus small delivery and handling charge. Money-back guarantee. Order today or write for free illustrated folder. Money-maker for fix-it shops.

SURE-SHARP MFG. CO., Dept. M-79, P.O. Box 24, Santa Ana, Calif.

make your own Gems 29.50 F.O.B.

All necessary lapidary equipment is furnished, including a super-charged diamond blade for sawing, and all wheels for grinding, shaping and polishing; also complete instructions. The complete equipment as shown, less motor and belt, for only \$29.50. f.o.b., Burlington, Wisconsin. Write today for information and literature.

B&I MANUFACTURING CO.
Dept. S Burlington, Wis.

FIBRE ARMS AND LEGS!

Light, correctly fitted, strong and comfortable. Natural appearance. Braces for all deformities. Scientific design. Fair Terms.

BUCHSTEIN-MEDCALF 223 S. 6th St., Minneapolis, Minn.

NOW AVAILABLE!

The Gas Powered Scale Model Racing Car that Broke the World's Record is now in Full Production

WRITE FOR FREE INFORMATION—TODAY!
MODEL INDUSTRIES, INC., DEPT. 97-P
63 FOREST VIEW DRIVE, SAN FRANCISCO 16, CALIF.
DEALER'S INQUIRIES INVITED

BUILD "EXTRA" SPARE TIME PROFITS!

Genuine Poly ball bearing arbor C4 (shown) with 1/2 x 12 1/2 spindle only \$7.95 postpaid. Order today! Free literature available on request.

POLY PRODUCTS • 2032-C E. Walnut • Pasadena 8, Calif.

MICROSCOPES SUPPLIES-ACCESSORIES & SCIENTIFIC INSTRUMENTS

B&L SPENCER NEW & USED LEITZ ZEISS MEDICAL INDUSTRIAL AMATEUR BOUGHT-SOLD-EXCHANGED-REPAIRED Send for FREE LIST NATIONAL SCIENTIFIC INSTRUMENT CO. 119 CHAMBERS ST. NY 7

FREE PLANS POWER MOWER KITS PLANS

Have one of the finest mowers money can buy. Write for FREE PLANS and PARTS LIST showing you how to SAVE up to 75% by assembling Triangle's POWER MOWERS.



SAVE your back. Assemble or build your own 3 or 4 wheel power mower with our precision made kits and parts. Write today for full facts. Free Plans, Parts List, Low Factory Prices. DEALERS INVITED.

TRIANGLE MANUFACTURING CO., Dept. M-5, Box 185, Fort Scott, Kans.

O. D. WOOL SHIRTS
13 to 15
244

PANTS
28 to 32
266

Used, reg. re-issue, perfect condition, 100% wool serge. Cleaned & pressed by Q.M. Corp. Add 12c ea. post.

BRAND NEW KHAKI SHIRTS-PANTS
14 to 17
299

Genuine 8.2 chino khaki sultan material. Pants with cuffs. Add 11c post. per garment.

GEN. NYLON 50 FT
39¢

PARACHUTE CORD
3/16" dia. White or khaki. 550 lb. strength. For clotheslines, venetian blind and drapery cords and other uses. Add 4c post.

50% WOOL HOSE
Med. light wt. Khaki & natural. Add 3c post.

CUSHION SOLES
63% wool, heavy cushion sole. Khaki & white. Add 3c post.

NAVY T-SHIRTS
WHITE
59¢

Full cut. Combed yarn. Small, large. Add 3c post.

WAR SURPLUS
AND OTHER **ORDER FROM THIS AD PLEASE**

BARGAINS

MAIL ORDERS
Please send remittance with order. Include postage. Guaranteed satisfaction or your money back.

New O.D. Wool BLANKETS
Size 66"x82". Over 3 1/2 lbs. All wool. O.D. color. Add 477 20c post.477

PUP TENTS
335
Used, like new. Complete tent (2 halves) incl. stakes and poles. Add 25c post.

PARATROOPER BOOTS
Brown, elk uppers, oak bend soles with composition tap sole, 10" high. Add 27c post.
888

NAVY STYLE FIELD SHOES
Add 22c postage
488

SIZZLING SPECIALS

POPLIN SPORT COAT **388**

Full zipper front, neatly tailored. Made of water repellent poplin, sultan color. Best sport coat value in the USA. Add 15c post.

DUST MASKS
33¢

Reg. \$1.50 value

For farmers, millers, and all types of spraying, etc. Add 6c post.

ARMY STYLE COMBAT BOOTS
10" high. Reversed uppers. Full oak sole with comp. outer sole. Add 27c post.
655

GREATEST WATCH VALUE IN U.S.A.

17 JEWEL Military Style WRIST WATCH

BRAND NEW GEN. INCABLOC WATERPROOF SHOCKPROOF

Non-magnetic, radium dial, sweep second hand. St. steel case. Complete with leather strap. Guaranteed Swiss 17-Jewel movement. A truly remarkable value. Add 15c post.

19.95 PLUS 10% FED. TAX

DOWN AND FEATHER FILLED SLEEPING BAGS **1499**

Down & chicken feather mixture filled. Waterproof poplin outside. Full size, mummy style. Add 35c post.

NAVY SUN GLASSES **66¢**

Navy issue. Ground & polished lenses, plastic frame, wire center. \$4.00 value. Add 6c post.

WAR SURPLUS CIRCULAR

SEND FOR FREE

Over 200 War Surplus and other outstanding bargains.

SIoux FALLS SURPLUS STORE
113 NO. PHILLIPS SIoux FALLS, S. DAK.

AVIATORS **24K Style GOLD PLATED RIMS** **1.55**

Large size. 52mm lenses. Shuts out max. violet & infra red ray. 4-base curve. Pearl sweatband. Comp. with handsome case. Add 7c post.

OUR BETTER QUALITY.....2.55

FOR ALL MAKES AND MODELS

DOUGLASS Steel-Pack MUFFLERS

Performance that excels • Stamina that endures

Rugged construction. Steel tubing. Straight-thru-design. Solid tube with steel packing. "Throbbing Deep Tone." Complete for Easy Installation Satisfaction Guaranteed

32-40 FORD V-8	\$5.96	29-48 CHEVROLET	\$5.96
41-49 FORD V-8	6.85	31-41 PLYMOUTH	5.96
39-49 MERCURY	6.85	42-48 PLYMOUTH	6.85
35-49 FORD & MERCURY DUAL SETS			\$23.00
49 FORD & MERCURY DUAL SETS			25.00

ORDER NOW! Specify Year and model • Enclose Money Order or Check with Order. Dept. #M-7

DOUGLASS MUFFLER MANUFACTURING COMPANY - 1916 W. VALLEY BLVD. - ALHAMBRA, CALIF.

DRAINS CELLARS, WASH TRAYS CIRCULATES OIL

Pumps 1800 GPH 300 gal. 30' high, use 1/8 to 1/2 HP **\$6.50** motor. Will not clog.

Postpaid if cash with order. (Add 50c for west of the Mississippi.)

Thousands in use since 1936

LABAWCO PUMPS, BELLE MEAD 7, N. J.

SAY YOU SAW IT IN POPULAR MECHANICS

BUILD YOUR OWN TILTING ARBOR SAW!

SAVE \$50 OR MORE

- 27x28 in. table stays level. Blade tilts full 45 degrees
- 10 in. blade cuts 3 1/4 in. deep, jack-screw depth adjustment
- Floor model, 34 in. table height
- New Departure ball bearing arbor, 3/4 in. precision shaft, ready to run, 5/8 in. bore blades
- Quick-positioning, self-aligning rip fence guide
- Sturdy wood, steel and aluminum construction
- No machining—Build easily with hand tools only
- Capacity and performance of floor saws selling for \$150.00 and up!

GIL-BILT Step-by-Step pictorial plans (No blueprint reading required), full scale patterns, 11 actual photographs.....\$1.00

GIL-BILT Metal Parts Kit—includes Plans, ball-bearing arbor, cast aluminum mitre gauge and bar, rip fence guide, machined lock knobs, jackscrew mechanism with 4 1/2 in. handwheel, and all other metal parts including every screw, bolt, nut and washer (less blade). \$20.95

Same Kit with 10" combination blade.....\$25.95

Same Kit with 8" combination blade.....\$24.95

Return in 10 days for full refund if not satisfied. (Prices include postage up to 600 miles.)

Also available—Plans and Metal Parts Kits for 8" Tilt/Table Saw and 12" Band Saw. Order Plans at \$1.00 each—sent postpaid anywhere in the world, or write for FREE descriptive Catalog.

GILLIOM POWER TOOLS P.O. BOX 1-PG, LAMBERT FIELD ST. LOUIS 21, MISSOURI

BRIGGS-STRATTON ENGINES

1 1/2 HP MODEL N—GOVT. SURPLUS

In good operating condition with 30 day written guarantee **\$39.50**

PRICE FOB, K. C. NO COD'S

Write for new 1949—52 page illustrated catalog filled with thousands of new items and War Surplus Bargains. Send 10c to Cover Handling and Mailing Costs.

MIDWEST SALES CO.
2533 I Indiana Kansas City, Mo.

MAKE OLD CHAIRS LIKE NEW!

Don't throw away broken furniture, mirrors, glassware, etc. Repair them like new with Rogers "Gorilla Grip" Glue. FREE — FULL SIZE SAMPLE. See how Rogers Glue bonds permanently, sets fast, holds 3885 lbs. per square inch. Get your full-size jar PLUS free "How-to-do-it" woodworking plans for making end tables, sewing cabinets, etc.

Take advantage of this special offer . . . send 10c today to Rogers Isinglass & Glue Co., Gloucester, Mass.



ROGERS

the best LIQUID FISH GLUE
GLOUCESTER, MASS.

HOW TO CUT RAFTERS

New vest pocket book gives lengths, side cuts, plumb cuts, deductions. For all rafters for any building from one inch to forty feet wide. Gives numbers to cut on square. Also degrees for same cuts for radial saws. All standard pitches from 1/4 to 5/8. Just open book to pitch page and there are your lengths, side cuts, etc. Anyone who knows what a jack rafter is can frame a roof if he has this great book. Price \$1.50 prepaid. Builders' Topics, Dept. M, Lock Box 828, Seattle, Washington. CARPENTERS, PLUMBERS, PLASTERERS, ELECTRICIANS, ETC., subscribe for Builders' Topics, the monthly magazine for HE-MAN CONSTRUCTION WORKERS. Only \$2.00 per year. Sample copies 25c.

SAVE MONEY

REPLACE YOUR VOLTAGE REGULATOR WITH

AMAZING NEW WATTAGE REGULATOR

A complete new principle in current and voltage control. Scientifically engineered and designed, to give you the utmost of performance for the life of your car. USERS report . . . increased or doubled life of battery, generator and ignition points. Brighter lights . . . better radio reception . . . reduced water consumption . . . easier starting in cold or hot weather and batteries in top capacity at all times.

The WATTAGE REGULATOR has QUICK CHARGE characteristics, for short-hop driving . . . stick- and burn-proof, self-cleaning contacts to last for the life of the car. In an emergency, you can drive hundreds of miles with a dead battery or without a battery and prevent costly tow and service charges. . . . Install a WATTAGE REGULATOR now and prevent costly generator, ignition and battery replacement in the future. The WATTAGE REGULATOR is Guaranteed 100,000 miles or 1 year. With full instructions, easy to install. No mechanic required. Price only \$9.50 — C.O.D. plus postage. State make and model of car . . .

SEND FOR FREE BULLETIN

SCIENTIFIC ELECTRIC COMPANY,

P. O. Box 2162 P.M., Station H Cleveland, Ohio

HYDRAULIC-PNEUMATIC

ACTUATING CYLINDER

WITH ATTACHED HIGH PRESSURE SWIVEL CONNECTOR. DOUBLE ACTION Raise, lower machinery, garage doors, dump trucks, bulldozer blades, shovels, other uses. Brand new, war surplus, genuine Bendix Aviation part #402685; 4" bore, 18" stroke, 317 long; solid impeller shaft, 1 1/2" diam.; mounting holes 3/8" I.D., 186-2000 p.s.i.; ship wt. 50 lbs.; fitting 3/4"-16 thread. Only \$24.50 P.O.B. Chicago area. Gov. cost \$300; a top value; a powerful worker. Don't delay. Order today! Send check or money order, 25% with C.O.D.'s. Satisfaction guaranteed.

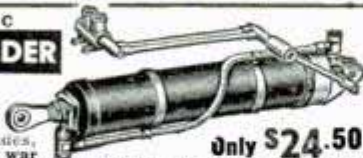

Only \$24.50

Quantity Buyers, Dealers, write for special discount. STAHLER DISTRIBUTORS — PM7 — 810 Michigan, Evanston, Ill.

WORLD'S LOWEST PRICED ADDING MACHINE

Vest Pocket Size FREE TRIAL

IDEAL FOR BUSINESS AND PERSONAL USE — GUARANTEED ACCURATE. Not a toy. Operates with only a finger flick. Adds, subtracts, multiplies, divides. Counts up to one billion. Pays for itself over and over. Ideal Gift — for Business, Income Tax and School use. MONEY BACK GUARANTEE. Send name and address. Pay postman only \$2.95 plus postage. (Send full cash if outside U.S.) Beautiful rich-looking Leatherette Case included at no extra cost. Money back in 10 days if not delighted. AGENTS WANTED. CALCULATOR MACHINE CO., (Mrs.) Dept. 216, P.O. Box 248 Glenview, Illinois



18 ROTARY CUTTERS
\$5.85
\$13.50 Value
Post Paid in U.S.A.
Assorted sizes cutter on 1/8" or 3/32" shank. Will fit all hand grinders. Ideal for cutting wood, metal, or plastic. Brand new.
Schupack Supply Co., 7331 Cottage Grove Ave., Dept. M6, Chicago 19, Ill.

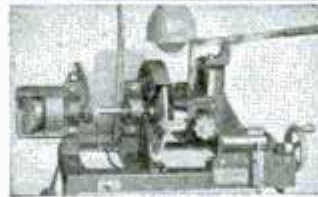

Pat. applied for

Start a NEW BUSINESS
Or Add to Your Present Repair Business
Sharpen Dull Pipe Wrenches
Pipe Taps & Dies
"Gum" Circular Saws

Write for information.

J. C. MOORE INDUSTRIES P. O. Drawer 276 FREDONIA, PA.

Make Money SELLING Multi-Mowers AND DOING Garden Work

PLOWS CULTIVATES HARROWS HAULS SPRAYS MOWS

FOR BETTER LAWNS and GARDENS also POWER MOWERS and RIDING TRACTORS Women can operate it.

Change TOOLS in 2 Minutes

Write to Dept. 43 Eshelman Co. 1-2-3 H.P.119 Light St., Balto. 2, Md.

GERSTNER Tool Chests are top favorites with good machinists and tool-makers. They provide proper care for good tools. Free catalog.

GERSTNER TOOL CHESTS 449 Columbia St. Dayton 7, Ohio

OTTAWA Buzz Master

3 MODELS — \$99.00 up

Greatest offer ever made by oldest and largest firm in the business. Made by men with the know-how. A model to fit your needs and your pocketbook. Endorsed by Conservation experts. Send for FREE details. Now in our 46th year.

OTTAWA MFG. CO., 1-927 Brush Ave., Ottawa, Kan.

BRUSH PLATING OUTFITS

for re-plating articles in the home and shop. No tanks necessary. Free particulars.

GUNMETAL CO., AVE. M, DECATUR, ILLINOIS

BUILD YOUR OWN FAN

One-piece cast aluminum propellers for cooling and ventilating.

Size	Polished Blade	Unpolished Blade	Bore			
Inches	2 Blade	2 Blade	Inches			
15	\$3.00	\$4.00	\$2.50	1 1/2	3/8	3/4
18	3.75	4.50	3.00	1 3/4	3/8	3/4
20	4.00	5.00	3.25	4.00	1 1/2	3/4
24	4.50	5.50	4.00	4.50	1 1/2	3/4

Let us give you our prices on your aluminum castings.

Write for pamphlet on larger fan blades, wire guards, fan bases, shutters, pillow blocks, exhaust fan frames, etc., shipped prepaid if money accompanies order. Dealers write for discount.

KLOPPENBORG ALUMINUM FDY., Dept. PM79, Davenport, Iowa

Free Booklet on FLEX-O-SHAFT

illustrating this all-purpose power machine with hand-piece that handles as easily as a pen. Motor with switch, foot-operated rheostat, and 66 accessories at special low price. Write

FLEX-O-SHAFT SALES CO. Dept. C Prairieview, Illinois.

Say You Saw It in Popular Mechanics

\$4.95 REAL ENGINE VALUE

A miniature gas engine that really operates.

Thousands of Buzz "B" gasoline engines have been sold at twice the price. Now is your chance to buy a real 1/6 H.P. gas engine for only \$4.95. Turns up over 8,000 r.p.m. For boats, planes, midget cars, etc. Guaranteed and ready to run. Includes Champion spark plug and tank. Send only \$1.00, engine shipped collect for balance, same day.

WRITE FOR FREE CATALOG OR SEND 10c FOR NEW MAMMOTH ILLUSTRATED CATALOG OF THOUSANDS OF HOBBY ITEMS.

America's Hobby Center, Inc., Dept. B-79, 156 West 22nd St., N. Y. 11

**!!SPECIAL ANNOUNCEMENT!!
FCC AUTHORIZES RADIO FOR
PRIVATE SERVICE!!!!**

(The FCC announced that effective June 1, any American over 17 years of age is eligible for a 5 year station permit. In the "Citizens" band, no code test or technical knowledge are necessary.)

GENERAL ELECTRIC 15 TUBE TRANSMITTER-RECEIVER SET. This brand new 15 tube transmitter-receiver was designed for mobile storage battery powered service. It will operate in the "Citizens" band where no amateur license to transmit is necessary. It's a cinch for any experimenter to connect this unit for 110 VAC operation by following the instructions and diagrams supplied, which cover numerous applications, including television. For those intending to use on car or boat, a new dynamotor, exactly as originally supplied, costs only \$15.00. Don't fail to write for FREE descriptive bulletin. Order our RT-1248 for only \$29.95, or two for \$53.90.

Our PE-109 DIRECT CURRENT Power Plant

This power plant consists of a gasoline engine that is coupled to a 2000 watt 32 volt DC generator. This unit is ideal for use in locations that are not serviced by commercial power or to run any of the surplus items that require 24-32v-DC for operation. The price of this power plant tested and in good condition is only \$79.95 F.O.B. Buffalo, or we can supply in strictly "as is" condition for \$58.95 F.O.B. our New York City warehouse. These latter are exactly as received, in heavy steel-strapped gov't cases, and we are unable to determine if the individual units are new, or what the condition is if used, while the \$79.95 are some of the same that we have brought to Buffalo for testing and repair if necessary. We do not recommend gambling on the "as is" condition, except for quantity purchasers. We can also supply a converter that will supply 110v AC from the above unit or from any 32v DC source for \$12.95.

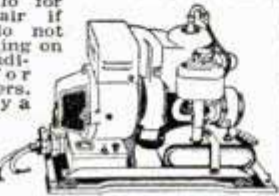

"SO" RADAR RECEIVER complete with 9 tubes including picture tube. This Plan-Position-Indicator Oscilloscope has a self-contained pack designed to run from the 110V. power supply on LST or PT boats. It provides a 5" diameter picture adjustable at will to an 80, 40, 4 or 2 mile circle with the boat at the center, showing location of land, other ships or any obstruction, so that navigation can be carried out in pitch darkness or pea-soup fog with as much safety as in brightest sunlight. Also a natural for adaptation as a television set. Your cost \$39.95.

\$12.95 TAKES ALL THREE BIG BARGAINS

1. SENSATIONAL, FASCINATING, MYSTERIOUS SELSYNS. Brand new Selsyns made by G.E. Company. Two or more connected together work perfectly on 110V AC. Any rotation of the shaft of one Selsyn and all others connected to it will rotate exactly as many degrees in the same direction, following unerringly as if the units were connected together by shafting instead of wire. This is true whether you twist the shaft of the master unit a fraction of a revolution or many revolutions. Useful for indicating direction of weather vane, rotating directional antennas, or controlling innumerable operations from a distance. Complete with diagram and instructions. Per Matched pair \$4.95.



2. ALUMINUM GEAR BOX 18x8x7 that contains two powerful electric motors and two matched gear trains, 62 gears in all varying in size from 1/2 to 4 inches in diameter. This unit is readily converted to rotate a beam antenna or for any other similar use. . . . \$5.00

3. HOME WORKSHOP AT BARGAIN PRICE. Accurate and precise 2 speed guaranteed hobby lathe, the essential machine for the home workshop. Sturdy enough for light production work or factory standby service. Supplied with 58" of belting for connecting to any available electric motor or power take-off, such as on a jeep or tractor. Also included in this unbelievable offer are such accessories as a 1/2" drill chuck with specially hardened tool steel jaws, a 4" electric furnace high speed grinding wheel, a cotton buffing wheel with a large supply of buffing compound, and a 4" steel wire scratch brush. Your cost \$6.00. Sole export agent. Distributor inquiries invited.

PORTABLE ELECTRIC DRILL

TERRIFIC VALUE ONLY \$20.95

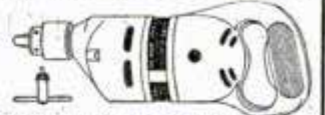

Equipped with 1/4" Jacobs Geared Chuck and Key. Not an intermittent duty drill, but a full size rugged tool. Most convenient type switch, natural grip handle, and balance like a six-shooter. Precision cut gears—turbine type cooling under heaviest pressure because of powerful 110 Volt AC or DC motor and multiple ball thrust bearing. Other bearings self-aligning lifetime-lubricated Oilite type. Made for toughest year-in and year-out service in plant or on construction jobs. Amazing perpetual factory guarantee assures you of a lifetime of trouble-free use. Full refund (you pay transportation) if not pleased with drill after trial.

COMPRESSED AIR

INSTANTLY ANYWHERE

Portable Air Compressor and storage tank. Ruggedly built of best materials using lifetime lubricated ball-bearing on connecting rod and oil impregnated main bearing on shaft. Unusual design forever eliminates valve trouble, the most common fault in air compressors.

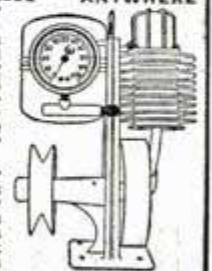

PATENTED unique air intake system increases efficiency tremendously over other compressors so that air output is much greater than that from larger compressors powered by heavier motors. Will deliver approximately 3500 cu. inches of air per minute at maintained pressure of 30 lbs., or will inflate a 90 lb. truck tire in less than one minute. Comes complete with 100 lb. gauge, although finger-tip adjustment allows setting of output pressure of any value, which will automatically be maintained. Works from any 1/4 H.P. motor. Useful for spraying paints or lacquers, disinfectants, insecticides, annealing or brazing with natural gas, inflating tires, etc. Price \$14.50 with postage prepaid anywhere in the U. S. Efficient, completely adjustable syphon type spray gun complete with 12 ft. of 100 lb. tested hose available for only \$7.75 with pint container, also prepaid. 25% required on all C.O.D. orders.

BUFFALO RADIO SUPPLY, 219-221 Genesee St., Dept. PM, BUFFALO 3, N. Y.

BUY DIRECT FROM THE LEADING MANUFACTURER OF PRECISION ALL-PURPOSE WHEELS



SAVE FROM \$2 to \$7 each ALL TYPES AND SIZES from 3" to 23" Diameter

Mail Money Order or Check for \$30.00 and we will send you TWO 4.00 x 8 x 16" Diameter Wheels . . . High Tensile Steel . . . Grease Sealed Timken High Speed Taper Roller Bearings for 1" Diameter Straight Axle . . . Four Ply Grade "A" High Speed Goodrich Heavy Duty Tires (700 lb. Load per wheel) And Inner Tube. The Finest Quality Money Can Buy . . . VALUE \$22.00 Each. Add 10% if you wish shipment sent Prepaid in U.S.A.

DESCRIPTIVE CIRCULARS AND LISTS OF OUR PRODUCTS WILL BE MAILED PROMPTLY IF YOU ENCLOSE 10c IN YOUR LETTER.

Ride Around in Your Own Car

Everyone can afford to own a car at OUR LOW PRICE. Look at this chassis: Has Self-Aligning Ball Bearing Pillow Blocks on 3/4" Dia. Rear Axle. Drive Sprocket for No. 40 Chain Attached To Axle.

ORDER NOW

NEW 14" Steering Wheel

TWO PASSENGER Model "E" Chassis ONLY \$99.50

plus \$6.50 crating charge.



Dual Tire Brakes

Model "E" Chassis 76" LONG 36" WIDE TAKES UP TO 4 H.P. SAME AS SHOWN WITH 10"x2.50" WHEELS \$10 LESS.

OSBORN WHEEL CO., 115 So. Main St., Dept. P-7, Doylestown, Penn.

2 TERRIFIC BUYS FOR YOUR CAR



ORDER BY MAIL TODAY \$17.50

ALL STEEL Deluxe Model

ACE AUTO VISOR makes driving safer, more restful. Keeps rain, sun, and snow off of windshield. Streamlined design and heavy chrome trim beautifies your car. Adjustable to any angle. Tested at 100 miles per hour for no rattles. INSTALL WITH ONLY A SCREWDRIVER—NO HOLES TO DRILL. Specify: Prime finish for painting. Hi-Polish finish requires no paint.

ACE FENDER PANTS give your car that "NEW LOOK!" Hooks on in a jiffy to any 1935 to 1949 model car. All makes. Made of heavy gauge body steel, prime finished, with rubber stripping to prevent rattles and scratching. Specify car make, year and model. Order by mail now!



Enclose check or money order . . . or \$5.00 deposit, pay balance on delivery

*** ACE AUTO PRODUCTS • DEPT. PM79 • Box 366, Huntington Park, California**



ONLY \$9.75

POST PAID

Pat. No. 2,188,175

SAVE UP TO 25%

VAPJET gives your car super aircraft power and performance. VAPJET users report 25% more mileage from regular gas. A double saving! Eliminates carbon, vaporlock and overheating. Complete kit permits easy installation—fits all cars. Order today—\$9.75 complete. Postage prepaid. \$1.00 deposit on C.O.D.—your check or money order in full saves postage. You take no chances—satisfaction guaranteed or money back! Specify car, year, number of cylinders. MAIL COUPON NOW!

VAPJET MANUFACTURING COMPANY
11424 BIONA DRIVE, DEPT. M-79, LOS ANGELES 34, CALIF.

MORE GAS MILEAGE with VAPOR INJECTION

—ORDER TODAY—

Gentlemen: Please rush me _____ Vapojet units, complete with necessary linkage, instructions, etc. Enclosed is my check (or money order) in amount of \$ _____

Car _____ No. of cyl. _____ Year _____

NAME _____

STREET _____

CITY _____ STATE _____



she's some **SMOOTHIE!**
(YOUR CAR, THAT IS)

when equipped with
ADVANCE "ULTRA DEEP-TONE" MUFFLERS
DUAL OR SINGLE STRAIGHT-THRU

Rich, low, mellow tone. Also greater power, speed, and economy result from reduced back pressure. Rugged steel tube, blow-out proof. Simple to install. No welding. Dual set comes complete with rubber mounted clamps, fittings.

ADVANCE FENDER SKIRTS
These heavy duty steel skirts will beautify and streamline your car. Tight fit, no rattle, easy to install, prime painted. Real top quality, not to be confused with cheaper, light weight makes.

ADVANCE KI-YI AND RAZZ HORNS
Get these novelty horns for laughs.



MAIL COUPON BELOW DEALER INQUIRIES INVITED

ADVANCE MUFFLER CO. Dept. PM 79
6800 S. VERMONT AVE., LOS ANGELES 44, CALIF.

- Send check, money order, or we will mail C.O.D. You pay postage upon receipt.
- | | | |
|---------------------------------------------------------------------------|--------------------------------------------------------------------|-----------------------------------------------------|
| <input type="checkbox"/> Dual Muffler Set (Ford, Mercury only) .. \$20.00 | <input type="checkbox"/> Single Muffler (other makes) \$5.50 | <input type="checkbox"/> Fender skirts, pr. \$16.95 |
| <input type="checkbox"/> Single Muffler (Ford, Chev., Plym.)... 4.86 | <input type="checkbox"/> 2 1/2" Chrome tail pipe tips, ea.... 1.75 | <input type="checkbox"/> Ki-Yi Horn, each 3.25 |
| <input type="checkbox"/> Send free catalog showing complete line. | | |

Car make _____ Year _____ Model _____
Name _____
Address _____ City _____ State _____

← YOUR MOTOR

Foredom PRESTO-FLEX

with PENCIL-SIZE Handpiece \$5.95

WITH MARVELOUS EASE, you can grind, polish, drill, rout, mill, saw, sharpen, clean, carve, engrave, etch, etc. — on metal, wood, glass, plastic or linoleum. Simply attach to your electric drill, drill press or motor. Presto—a flexible shaft machine! Off again in a jiffy. Pencil-sized handpiece gives finger-tip control. Gets into tight places. Handy 35" overall length. And—only \$5.95 complete! ORDER NOW. If you order Presto-Flex for use on motor, specify motor shaft diameter. Add 50c for motor coupling. (Available for 1/4", 5/16", 3/8" and 1/2" shafts.) No. 50 Accessory Set available \$1.50 extra. Or, order the Foredom Model 99, ONLY \$15.95 complete with universal motor, flexible shaft and pencil-sized handpiece. Write for Catalog E-1119 and see the many Foredoms now available.

FINGER-TIP CONTROL
FOREDOM ELECTRIC CO., Dept. E-1119
27 PARK PLACE NEW YORK 7, N. Y.

OVER 50,000 SATISFIED USERS!

DYNAMIC HEAVY DUTY WELDER

MAKE OR SAVE TIME & MONEY! ONLY \$28.50 COMPLETE

Now You Can Repair Auto, Home Appliance, Farm & Shop Equipment for yourself & others with this Genuine Transformer Type Welder—75 Amp. Capacity. Does Welding, Brazing, Soldering and Cutting on iron, steel, brass and other metals. Portable. Easy to operate from any properly wired 110 Volt Line (other voltages at slight extra cost). Has 8 metallic and carbon arc welding heat stages. Comes COMPLETE ready-to-weld with helmet, rods, cable, etc. and Simplified Instructions which are actually a short course in welding. A few repair jobs will more than pay for it. SPECIAL GIFT \$6.80 ARC TORCH yours at NO EXTRA COST. Write today for FREE details and 10-DAY TRIAL OFFER.

DYNAMIC WELDER CO., 15 E. 23rd St., Dept. TD-79, Chicago 16, Ill.

Now **CHEAP OIL BURNER**
FOR HEATING AND COOKING STOVES—FURNACES

HEAT YOUR HOME, COOK YOUR MEALS WITH CHEAP FURNACE OIL

NO MORE SHOVELING COAL OR ASHES. Sensational Fuelizer Starter Vaporizing System turns Cheap No. 1 Furnace Oil, also Rango, Heater, Tractor Distillate, Kerosene and like oils into oil heat—one of the quickest, hottest fires known. LIFETIME GUARANTEE. \$1.00 Bonus Offer for Testing. We will let you try it in your own store or furnace for one month. Get yours for introducing. Big profits QUICK. Be first. Send in your name today for details and cash in on the tremendous demand for this Amazing Invention.

NORTHWEST MFG. CO., 634-J, Mitchell, S. Dak.

2 DRILLS IN 1

This attachment gives you two drills in one. It converts any 1/4 inch electric drill to 1/2 inch capacity. Reduction gears reduce the drill speed 5 to 1, the average speed of a 1/2 inch drill, and thereby increases the power. Absolutely indispensable for all shop work and home craftsmen. Satisfaction guaranteed. Order yours now.....

\$11.95 post paid

Send check or Money Order with order. Jobbers write for special information.

G. M. CO. MANUFACTURING, INC.
1308 43rd Ave.
Long Island City 1, New York
SAY YOU SAW IT IN POPULAR MECHANICS

NEWEST OTTAWA LOG SAW

SELF-PROPELLED — MOVES ANYWHERE on OWN POWER

World's fastest Log Saw. Powerful 6 H-P air-cooled motor. Attachments for sawing down trees, buzzing limbs, post hole digging and pulley for belt jobs. Big demand for wood, pulp, posts. Make big money sawing wood this easy way. Low factory-to-user prices. Nothing like it. FREE details.

OTTAWA MFG. CO., 7-927 Pine St., Ottawa, Kansas

BUILD YOUR OWN POWER LAWN MOWER

WHY BREAK YOUR BACK MOWING FIELD OR LAWN?

WRITE FOR FREE Building Instructions The Rite-Way Mower Attachment Ball Bearing

SAVE MONEY SAVE TIME Now anyone can save time and effort mowing field or lawn by building their own whirl type power mower. Build according to your own ideas and needs at small cost. Cut close to fences, walks, buildings, etc. Build in short time with parts and instructions we furnish. Save hours of time and back breaking labor. Write today for FREE information.

IT'S FUN TO BUILD

T & H MFG. CO., Dept. PM21
811 E. 31, Kan. City 3, Mo.

SAVE UP TO 85% in WAR SURPLUS SENSATIONAL VALUES
 at "GADGETEER'S HEAVEN"
 IN MANY ITEMS WE HAVE THE WORLD'S LARGEST SUPPLY

NEW 1949 CATALOG
 92 PAGES—ILLUSTRATED
 SEND 25c TODAY!

Sportsman's Tent
 Sturdy, lightweight, easy to erect. Will pack into a 12" roll 36" long. Made of 8 oz. forest green, WATERPROOF DRILL. Full floor cover, with mosquito netting on window & door. Reinforced throughout—Hardwood jointed center pole & 12 stakes included. A LIFETIME VALUE
 9' x 9' size \$34.50
 11' x 9' size \$39.50

FOLDING STEEL With Tubular Headlands and sturdy double heavy wire SC \$2.95 Ea.
COTS twine springs. A life time buy.
NAVY BUNK BED With steel angle headlands, steel frame spring made of twisted heavy gauge wire reinforced with lateral stringers. Can be used as single bed or joined two-high to serve as double bunk bed. Specially suited to hard wear, active children, dormitory rooms, etc. Single \$8.10. Ea. \$3.95
 In sets of two Ea. \$7.75
FILLOWS Curled Chicken Feathers 99c Each
 20 x 17 Blue & white ticking
 The coils of bed each weigh approximately 12 lbs. Consult your local motorist for shipping cost due to 100lb. min. mattress shown below can be included at no extra charge cost.
MATRESS for above cot or bed, cotton filled 3 1/2" thick spec. built not to flatten out. Tuffed edges, quilt top, blue & white heavy ticking. MT-1 \$6.95 Each

FOOT LOCKER Pine wood. Store clothes, bed covers, books, tools, and handy in moving. Removable tray 3" deep, rounded metal corners, screw hinge, length 30", width 17 1/2", height 13". Used, but in good condition. Sturdy & well built. Limited number. ONLY \$4.95

Aviation Emergency Vests
 Sturdy, Yet Light Weight. Satin Lined with Tie Straps. 14 Outside Pockets. Plus Knife, Gun, or Tool Leather Holder. 2 large 11" x 8" Pockets Inside. Wonderful Hunting, Fishing, or Mechanic Cost the Government \$30. A Steal at \$3.49

CLAMP-ON ANYWHERE LAMP With adjustable ball and socket swivel head, long rubber covered cord and wall plug.
 The All Purpose Lamp. Wonderful for Indoor Photography, Floodlights, Baby Spot or Large Spot, Personal Bed Reading, Workbench, Garage, etc. Lamp Alone 99c
 Highly Polished 9" diameter Parabolic Reflector or 5" diameter Spot Reflector at Only 85c ea.

Sperry Aircraft Directional GYRO COMPASS
 Precision made for Positive direction. 360° swing calibrated in 1/10 degree (six min.) luminous dial. Built-in bank indicator and instrument light. Case is 4 1/2" square with 3" dia. face. Operates on vacuum. Ideal for autos, light planes and boats. Can be used in autos and boats by attaching one tube to intake manifold. Complete with caging and reset knob. Re-issue—good condition. ONLY \$449

HUNTING KNIFE #367
 6" chrome vanadium blade, handle, leather grip. In leather sheath. \$5.95 Value for ONLY \$1.89
 (Like Above) 5 in. polished blade \$1.69
 With Parkerized black finish \$1.49
BOLO KNIFE
 10" x 2" Parkerized blade. 5" Gripped Handle. Weight 1 1/4 lbs. Ideal for Hunting, Clearing Brush or Trails. With Case \$1.19 ea.

PROTECT YOUR EYES!!
Genuine ARMY AIR FORCES SUNGLASSES
 HERE'S THE REAL McCoy!
 ARMY AIR FORCE & base. Precision Polished and Ground. Clear-Flex lens with leather case that can be attached to belt. Gold plated adjustable frame. Pearloid sweat bar and pads. \$3.95
 A real Policy \$17.50 Value for Only \$3.95
ARMY AIR FORCE TYPE SUNGLASSES
 4 base, polished and ground lens. 3 1/2" Ultra Violet Ray lens, gold plated frame, pearloid bar & pads, leatherette case. Our price \$2.39 ea.

New Navigators Magnetic Compass
 #111 Type D-12 size 7" dia x 4 1/2" deep. Rubber lined, rotating verge range rings calibrated in 1 degree from 0-360° with 2 parallel grid wires for alignment with U.S. line. Best. \$14.95

FOAM RUBBER CUSHIONS
GOODYEAR AIRFOAM
 Molded and pre-shaped. Cement or cut to fit. Variety of sizes and shapes. For chair pads, auto & truck seats, trailer & boat seats outdoor furniture and nooks.
 18" x 18" x 6" \$4.89 ea.
 17" x 22" x 4" \$4.89 ea.
 36" x 18" x 4" \$5.39 ea.
 42" x 18" x 3 1/2" \$6.89 ea.
 52" x 24" x 6" \$10.95 ea.

WRIST WATCHES
 7 jewel—sweep sec. hand, metal face, Radium Dial & Numbers \$7.95
 15 jewel—Waterproof, Radium dial & hands, sweep sec. hand, stainless steel screw back. A terrific Buy at \$13.95
 17 jewel—AUTOMATIC WINDING-SWISS SHOCKPROOF-WATERPROOF-SWISS WATCH. Sweep sec. hand, stainless steel screw back, radium dial & hands. Body movements keep it properly wound. \$23.95
Chronograph
 17 jewel—One of the finest made anywhere. Cased in Switzerland. Sweep sec. hand, stop & re-set buttons. Measures distance, airspeed, groundspeed, races. Ideal for the sportsman. We've got a Special on these at \$23.95

COMPASSES #151 Marching, lensless, with luminous dial \$1.59
 #152 Matchbox, both jewel & liquid floating dial 39c
 #154 Wrist Strap Compass 69c
 NEW 1 1/2" Jewel Watch Pocket Compass #153 \$1.59

LEATHERETTE
 Genuine Leatherette to cover Chairs, Patio Furniture, Nooks, Auto Seats, etc. 10 colors at a BARGAIN PRICE.

BUCKET SEATS
 Tough, durable construction of water and weatherproof plywood... lightweight and easy to mount. Real luxury for the pleasure or fishing boat. Seat 18" x 18", back 26" high. ONLY \$449

Hand Mike Highly Sensitive with thumb control button on handle. Ideal for home recorders, public address systems, etc. Comp. with 2 ft. rub. cd. ONLY \$1.19

WIDITH COLORS PRICE (per run, yd.)
 36" Grey, Brown, Black \$1.19
 36" Lt. Green, Dark Green, Blue 1.65
 54" Red, Grey, Lt. Blue, Ivory, Yellow 1.89

NEW CUSHIONS
 Finest imitation leather. Filled with kapok to float. Yellow color for great visibility in water. Just the thing for your boat, truck auto tractor.
 SEAT, New, 17" x 16" x 3" thick \$3.49
 New Back Rest, 22" x 16" x 1 1/2" thick \$2.95

HS 33 NEW LOW IMPEDANCE RADIO HEADSET
 The latest and most improved style, currently in use in aircraft. New! Packed in original box. Leather head band, sponge rubber ear pads, includes JORD and JACK \$3.25
 High to Low Impedance Adapter 35c ea.
HEADSET HS-30-U Two Magnetic Type receivers in watertight brass case. Soft rubber inserts in each receiver to fit into wearers' ears. Flange steel head band. Ideal for communications, divers, workers in noisy compartments, etc. NEW! \$1.59

MESS TRAY 6 compartments, rustless, stainless steel. Barbecue, outdoor cooking, save dish-washing. Hospital, Restaurant, Home, or roughing. #311 New 83c ea.
 #311A Used but in Fine Serviceable Condition 59c ea.

GENUINE GOGGLES
 Aviators (AN-6530) Windproof & Dustproof
 Sponges and leather protected frame with ground lens in clear, amber or green. Clear set in replaceable metal frame with hinged nose bar. Ideal for Motorcycling, etc. Co-55 \$1.69 ea.

Radio ANTENNA Reel
 Just the thing for tuning beam antenna. Powered by 1/4 h. p. 24v G. E. Motor. Removable 4" Rev. Limit Switch - Cam Worm gears. Rev. gear. Solenoid clutch. Motor engaged to gear reduction only when electrical contact made. Operates in either direction. Ideal for auxiliary power take-off, opening and closing doors, etc. A TREMENDOUS VALUE \$4.29

SLEEPING BAG
 NEW! 100% wool. Mummy type. Heavy duty 30" zipper. 4000 Goo-Loc cost \$22.00. \$3.95
 Used water repellent cover \$1.95 extra. Sold only with Sleeping Bag.

HERE ARE PLASTIC KITS
 UNSURPASSED VALUES for ARTISTICALLY INCLINED HOME HOBBYIST!
 Start Planning Model Kits GIVE NOW!
 Kit #1 contains 2 lbs. plasticine & 4 plastic sheets in various shades. 1 ea. bottle of clearset cement, and 5 bottles of colors in 1 ea. bottle of clearset cement, and the Plastic Handbook. A \$5.50 Value for ONLY 99c
 Plexiglass & Nacalite clear plastic sheets. At Tremendous Savings to You!
 MASCOLITE—Full sheet up to 37" x 45" up to 18" thick. Per Sheet \$12.50
 PLEXIGLASS—Full Sheet 5/16" x 36" x 24" Per Sheet \$13.00
 9/16" x 36" x 48" Per Sheet \$25.00
 Fabricators write in for our special quantity prices. All above are new & marked. Also inquire about our other large stocks of Plexiglas.

NYLON FISHLINE Special
 Strong—Lightweight—2 ply NYLON FISHING LINE. ROT-PROOF and WATERPROOF... Especially treated for strength and long life. ON SPOOLS.
 a. 10 LB. TEST. \$1.69
 b. 15 LB. TEST. 150 FT. \$3.19
 c. 20 LB. TEST. 400 FT. \$1.19
 d. 25 LB. TEST. BRAIDED BLACK and GREY 100 FT. \$3.49
 e. 100 LB. TEST. 100 FT. WHITE \$3.79

FEATHER & DOWN BAG
 Water repellent Poplin cover... Heavy duty 3/4 length zipper... Weighs only 5 1/2 lb. Prepare for that vacation NOW... We made a TERRIFIC BUY... Yours while they last for ONLY \$13.95
KAPOC BAG with air mattress compartment and wind-breaker hood... Just the thing for the outdoor man. ONLY \$15.95
AIR MATTRESSES 25" x 72" \$11.95

Clear Plexiglass Window
 12 1/2" x 9" — 3/8" thick with aluminum piano hinge for attachment. Fine for boats, trailers, etc. \$1.69
NAVY BATTLE LANTERN
 This powerful battle tested lantern complete with 2 standard 1 1/2 volt dry cell batteries. Size 6" x 7" x 4" with a 4" dia. reflector. Comp. Only \$3.29
THE Air Forces' BEST Loose Leaf BINDER
 3 metal post cylindrical locking heavy duty 3/16" fabric and lined cover. End identification window. Ideal for price books, salesman catalogues, photo albums, students, publications, reference books, artist sketch books, etc. Will hold 500 sheets. 8" x 11". A \$5.00 Value for Only 59c
PLASTIC PARALLEL STRAIGHT EDGE
 with knobs and rubber pads for non-slip on each section. A must for navigators, mechanics, draftsmen, and engineers... You've never seen 'em at 97c ea.

PALLEY THE LARGEST FIRM OF ITS TYPE SUPPLY CO. IN THE WORLD DEPT. PM 7 6321 SAN FERNANDO RD GLENDALE 1, CALIF.
 Order from this Ad. All sales final. All Prices F. O. B. Los Angeles. Pay by M. O. or Check. P. O. A. Acctd. from D & B firms. 1/3 deposit with C.O.D.s

"Wellworth" Sensational Offer! Reg. \$60.50 WESTINGHOUSE AIR COMPRESSOR

Model T-1
Brand
New!

plus pressure tank, air gauge, air chuck, 20 ft. hose, pop valve, and fittings as shown.

COMPLETE OUTFIT OF 6 ITEMS ONLY....

IDEAL for HOME • FARM • FACTORY
Wherever Compressed Air Is Needed

A fortunate purchase from the Government enables us to offer you this amazing buy at a small fraction of the price of the manufacturer and of leading mail order houses. All brand new. You get the WESTINGHOUSE COMPRESSOR and all of the accessories shown for Only \$31.50. Shipping wt. 50 lbs. Designed for automotive truck or tractor mounting. Can be run off fan belt or power take-off, or mounted horizontally. Comes with automatic clutch. Can be installed for use on farm trucks, jeeps, tractors, tire or garage service trucks, contractor or road building machinery, pneumatic devices, etc. Can be operated with 1/2 H.P. or more electric motor or equivalent portable gas engine. Replacement parts available.

This low price is but a fraction of the price of manufacturer and of leading mail order houses.

\$31.50

COMPRESSOR SEPARATELY
\$21.50

Equipment less
Compressor..... **\$12.50**

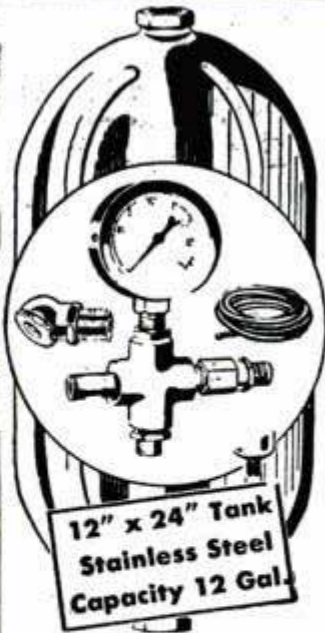

12" x 24" Tank
Stainless Steel
Capacity 12 Gal.

THE COMPRESSOR

Piston Type, 2-cylinder, 2 inch bore, 1 1/2" Stroke Ball Bearing AUTOMATIC CLUTCH. OIL FREE AIR 3.27 C.F.M. at 600 R.P.M. 8.54 at 1200. Suggested operating pressure 75 P.S.I. DIMENSIONS: 9" wide, 11 7/8" high, 6 3/8" deep. Wt. 26 lbs.

TANK AND ACCESSORIES

12" x 24" stainless steel tank suitable for 150 lb. pressure. Two 1/4" openings. Air gauge, pop valve, air chuck, 20 ft. hose and fittings as shown.

PORTABLE SPRAY OUTFIT

1/4 H.P. Heavy Duty
External
Atomizing
Gun

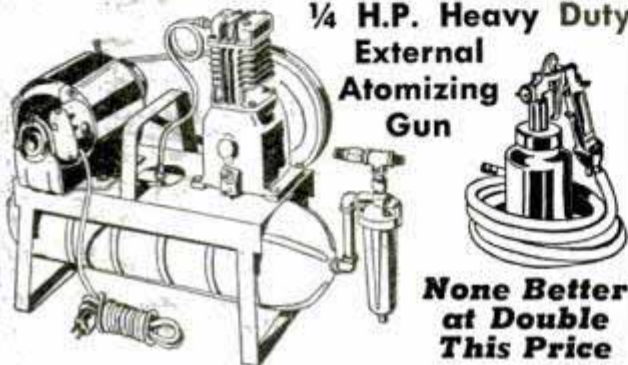

None Better
at Double
This Price

Paint Sprayer mounted on 6 x 24 inch tank, 1/4 H.P. 110 V. 60 cy. Heavy duty motor with overload relay, 10 ft. cord and plug, V belt drive. Piston type Compressor with 2 Compression rings, 1 oil ring, 2 inch bore, 1 3/4 inch stroke, displacement 2.86 C.F.M. at 60 lbs. pressure, Safety Valve. Gun external atomizing. Flat and round spray, quart cup; maintains 35 to 40 lbs. working pressure. Oil and water extractor, 1 air gauge, 20 ft. heavy duty 2-braid air hose with leak proof fittings, complete with carrying handle. Net weight 54 lbs., ship. wt. 60 lbs.....

\$57.50

Outfit less motor..... **\$47.50**
Compressor only..... **17.50**
Spray gun and 20 ft. hose **12.95**

300 GAL. COOLANT PUMP A HEAVY-DUTY PUMP AT 40% LESS

You pay less and get a larger, higher pressure, higher capacity, heavy duty coolant-type, recirculating pump. Also extensively used on evaporative coolers. Will deliver 60 gal. per hr. at 8 ft. head and 300 GPH at no head. Heavy duty 1/30 H.P. totally enclosed, 110V., 60C., motor with long life oiling. Noncorrosive shaft and pump. 10 1/2" high, 3/8" I.P.T. Shpg. wt. 12 lbs.

\$19.50



PNEUMATIC AIR TOOLS

Used. Guaranteed like new.



CHICAGO PNEUMATIC RIVETER
& CHIPPING HAMMER

CP4X Pistol grip handle. Takes up to 3/16" rivet. Weight 6 lbs. List price \$73.00.

SPECIAL PRICE..... **\$14.50**

Same as above, brand new..... **\$22.50**

Size CP3. Takes 5/32" Rivet..... **\$10.95**

A.V.C. 11 INGERSOLL RAND



Push button, takes 5/32" rivet. Wt. 3 lbs. List price \$65.00. Only **\$10.95**



Ingersoll Rand
AIR DRILL

With 1/4" Jacob Chuck. Wt. 2 lbs. List price \$55.00. Only **\$17.50**

AUTOMATIC COMPRESSOR UNIT

1/3 H.P. heavy duty capacitor motor AC 110/220 volt 60 cycle, 2 x 1 3/4 inch piston type compressor, splash feed lubrication, 12 x 24 inch tank, automatic pressure switch, pressure range 100 to 125 lbs., CFM 2.2, check valve, safety valve, air regulator with gauge and filter, 20 ft. air hose with air chuck for inflating tires. V. belt drive. Shipping wt. 90 lbs.

Special Price **\$79.50**

Same unit as above with 1/2 H.P. motor, furnished with 13" x 24" tank. CFM 2.8 at 125 lb. pressure. Shipping wt. **\$98.50**
125 lbs.....

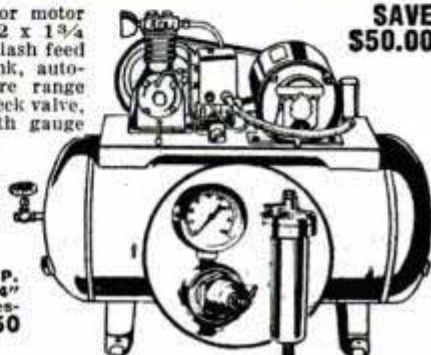

SAVE
\$50.00

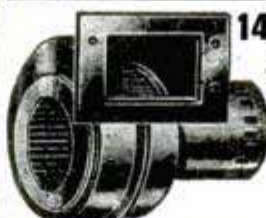

140 CFM "WELLWORTH" BLOWER

Single-inlet blower that gives top performance on heating, ventilating, exhausting, cooling, drying and similar applications. 5 1/8 x 4" mounting flange with 2 1/2" square discharge, 3 1/2" dia. blower wheel powered by direct-motor with conduit box and 20" leads. 7 1/2" wide less flange by 7 1/4" H. x 6 3/4" D. Suited for hundreds of new and replacement uses. Shpg. wt. 6 lbs.....

\$16.50

"Wellworth" CHECK VALVES



1/4" valve **\$2.75** 1/2" valve **\$4.50**

6 FT. STOW FLEXIBLE SHAFT

Heavy Duty, 3/8" Core. Best piano wire. Ball bearing handle and arbor, rubber covered housing; for 1/2" motor shaft; for 1/2" bore wheels. Operates on 1/4 H.P. Motor at 1725 or 3450 R.P.M. \$20.00 Value, **\$14.50**. Wt. 8 lbs.



Reduced Price
Only **\$14.50**

Chicago Pneumatic Lever Type AIR DRILL



With 1/4" Jacob Chuck. Wt. 2 lbs. List price \$55.00. Only **\$17.50**

AUTOMATIC PRESSURE SWITCH WITH UNLOADER

Double pole, with 2 way release valve. Set at 125 to 150 lbs. pressure. **\$10.25** Wt. 4 lbs. Only..



Prices f.o.b. Chicago. Immediate delivery.
All items sold on money back guarantee.
Send check or money order today.

WRITE FOR FREE CATALOG

WELLWORTH TRADING CO.

Merged with C & M Equipment Co.

1831 S. STATE ST. DEPT. D-7 CHICAGO 16, ILL.



**NOW... LIGHT
WHEN YOU NEED IT!**

Ray-O-Vac LEAK PROOF batteries
stay fresh for years!
(because they're sealed in steel!)



© 1949 BY RAY-O-VAC COMPANY, MADISON, WIS. RAY-O-VAC, CANADA LTD., WINNIPEG, MAN.

See how much more you get

in these truly modern batteries. Each Ray-O-Vac Leak Proof starts with a powerful, well made battery. Then...

1. Steel bottom is added. 2. And a steel top.
3. Next—multiple insulation. Nine layers of protection against corrosion.
4. Last—a steel jacket. This completes an air-tight seal, to stop corrosion and keep the battery fresh and powerful. Only Ray-O-Vac builds batteries with all four of these safeguards.

GUARANTEE on every Ray-O-Vac Leak Proof: "If your flashlight is damaged by corrosion, leakage or swelling of this battery, send it to us with the batteries and we will give you FREE a new, comparable flashlight with batteries."

Ask for Ray-O-Vac Leak Proofs

Buy Spares

they stay fresh

Lew
Worsham

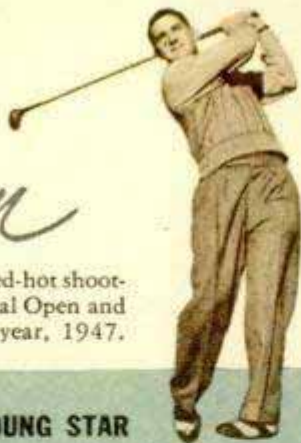

"Powerhouse" Lew, whose red-hot shooting captured both the National Open and the Denver Open the same year, 1947.

Gene
Sarazen



The ever-amazing shot-maker of pro golf... U.S. Open and P.G.A. champion back in '22, and collector of a long list of titles ever since.

THE BRILLIANT YOUNG STAR

AND THE GREAT VETERAN OF GOLF AGREE:

Camels for Mildness!

In a recent test of hundreds of people who smoked only Camels for 30 days, noted throat specialists, making weekly examinations, reported

NOT ONE SINGLE CASE OF THROAT IRRITATION due to smoking CAMELS

Every day...every week...all over the nation...smokers are making this simple "prove-it-yourself" test—*smoking Camels, and only Camels, for 30 days!*

There's change in the air and this change is to Camels... for *mildness, for flavor!* Make your 30-Day Test in your "T-Zone". See if you, too, don't change to Camels!

H. J. Reynolds
Tobacco Co.,
Winston-Salem,
N. C.



YES, GENE, I LEARNED SOMETHING IN THE 30-DAY TEST! — CAMELS ARE REALLY MILD... TASTE GREAT, TOO!

RIGHT, LEW! THAT'S WHY I'VE SMOKED CAMELS FOR ALL THESE YEARS!

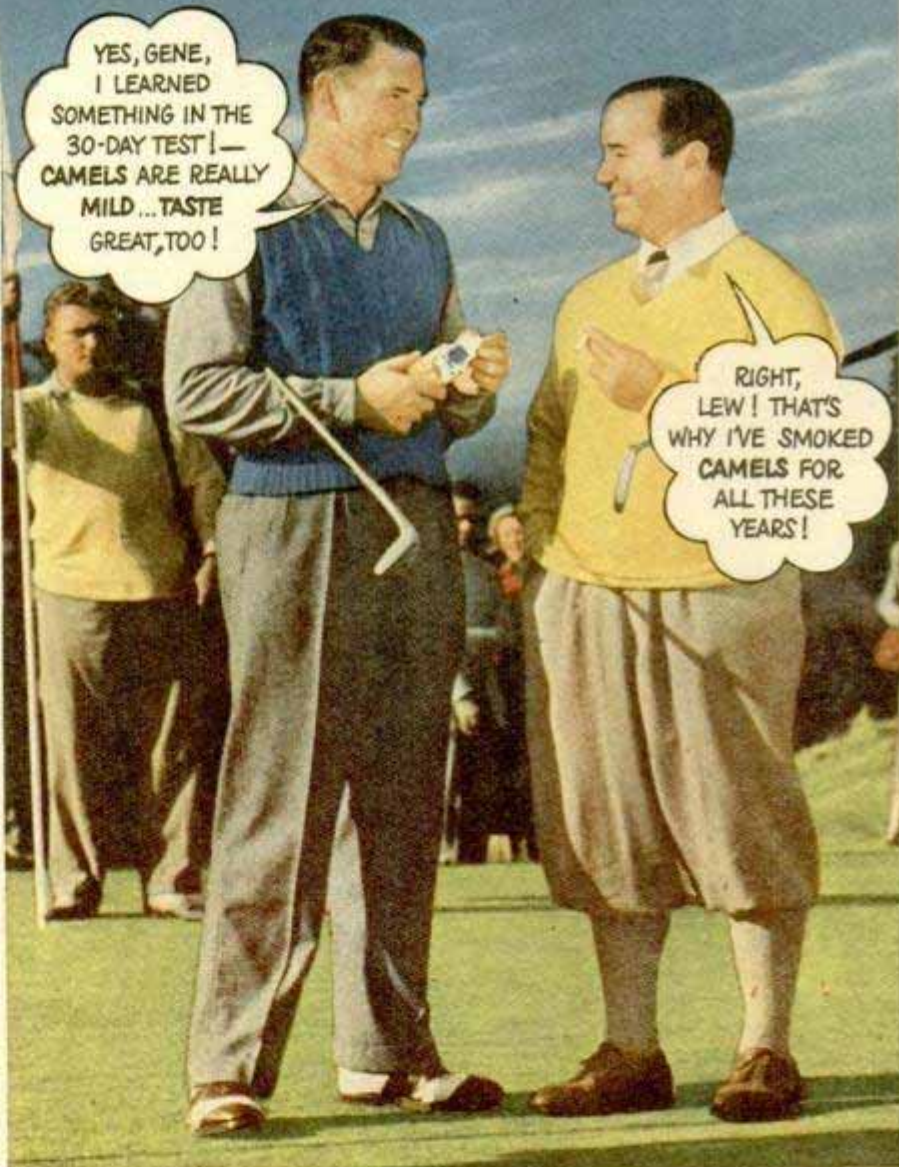

According to a Nationwide survey:
MORE DOCTORS SMOKE CAMELS THAN ANY OTHER CIGARETTE

When three leading independent research organizations asked 113,597 doctors what cigarette they smoked, the brand named most was Camel!