

ANC



POPULAR MECHANICS

MAGAZINE

WRITTEN SO YOU CAN UNDERSTAND IT

REG'D. TRADE MARK, GREAT BRITAIN, No. 1 0426

REG. U.S. PAT. OFF.

35 CENTS



"SPIDER" CARRIES A HUMAN FLY

7-122

Take it Easy - RIDE A WHIZZER!

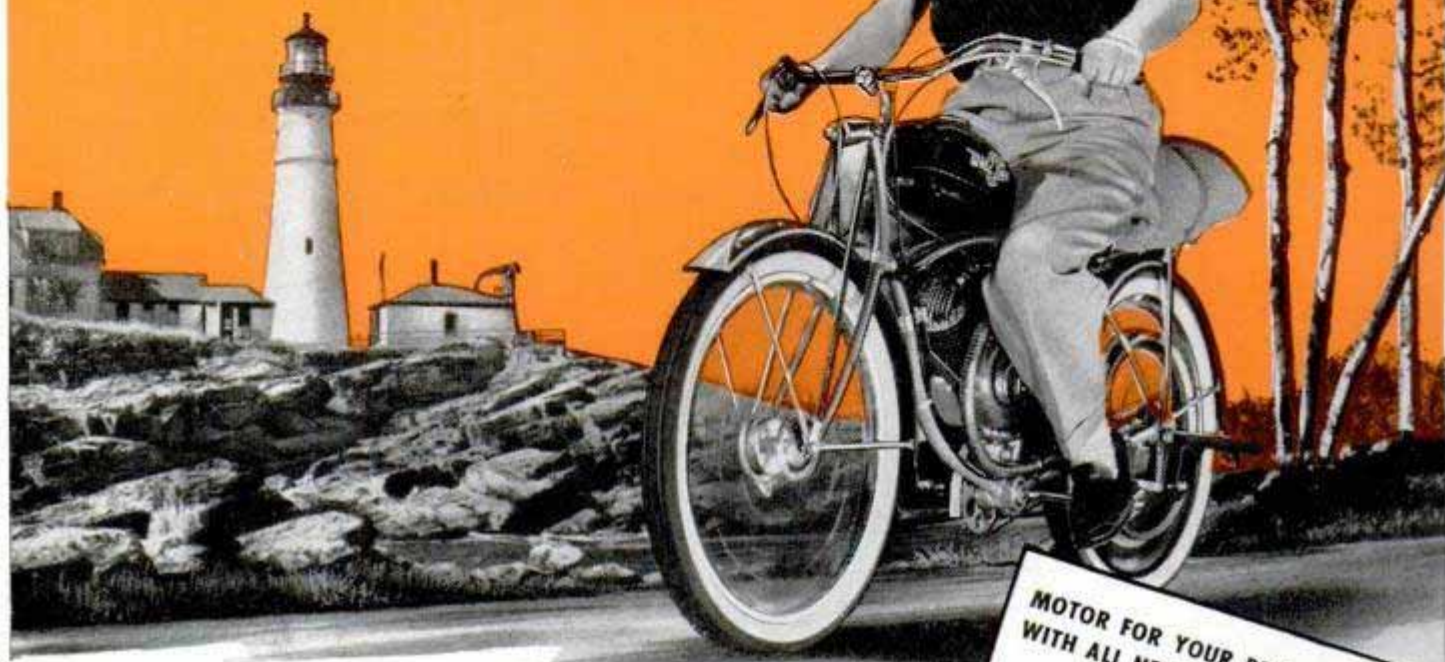

Yes, getting there's easy, with a Whizzer motor on your bike. Go wherever and whenever you want, for pennies a day. It's the smart, thrifty answer for personal transportation—to school . . . work . . . shopping . . . week-end adventures . . . thrilling, carefree vacations you'll remember.

FITS ANY MAN'S BALLOON TIRE BIKE

America's Leading Bike Motor - Whizzer!

AIR COOLED MOTOR -
4-cycle . . . 2½ h.p.

ECONOMY PLUS - 125 miles per
gallon . . . speeds to 35 m.p.h.

RUBBER MOTOR MOUNTS - three-point
suspension soaks up vibration.

STEEL CABLE BELT DRIVE - notched V-belts rein-
forced with 5 high-flex steel cables.



EASY TO RIDE - lightweight,
balanced power.

TWIST-GRIP CONTROLS - positive,
safe under all conditions.

ALL-CHROME TRIM - including mounts,
belt guard, exhaust pipe.

PRECISION ENGINEERED - cylinder micro-
honed to 5/10,000" tolerance.

**MOTOR FOR YOUR BIKE - COMPLETE
WITH ALL NECESSARY ATTACHMENTS**

\$109⁹⁷

Federal Tax Included
F.O.B. Pontiac, Mich.

For nearest Whizzer Dealer, call
Western Union, ask for Operator 25

See the COMPLETE line - Whizzer Bike Motors, Motor Bikes and the many new Whizzer accessories. For free literature, write:
WHIZZER MOTOR COMPANY • PONTIAC, MICHIGAN

Solid Facts about the NEW FORD "FEEL"

There's a new "feel" in driving and only Ford has it!

One of the most important parts of this new Ford "Feel" is the sense of solidity and strength that comes from the new Ford frame and body. Side rails of the new frame are box-section, and there are five sturdy cross members for even greater strength. (Convertibles and Station Wagons have even heavier frames.) What's more, the famous "Lifeguard" Body is made of heavy-gauge steel and, combined with the frame, gives 59% more rigidity than ever!

No wonder drivers everywhere are so genuinely enthusiastic about the '49 Ford's remarkable feeling of solid safety and reassuring roadability.

For the new Ford "Feel" is really a brand new *kind* of driving—with new ease of control, new performance, new security, new fine car comfort. Try it, and then enjoy the greatest feeling of all—the prideful thrill of owning the "Fashion Car of the Year"...the '49 Ford!

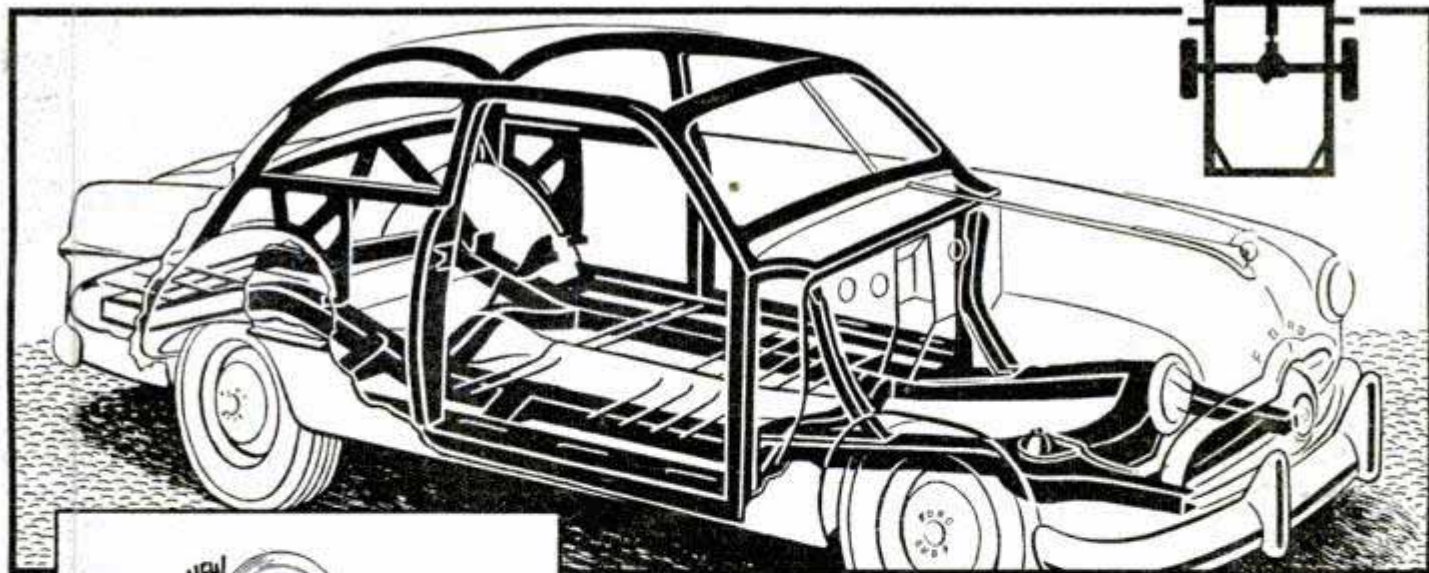

There's a ^{NEW} Ford in your future

"DRIVE A FORD AND FEEL THE DIFFERENCE"



This One



GET A JOB IN AVIATION

No Experience Needed . . .

Good Pay While Learning

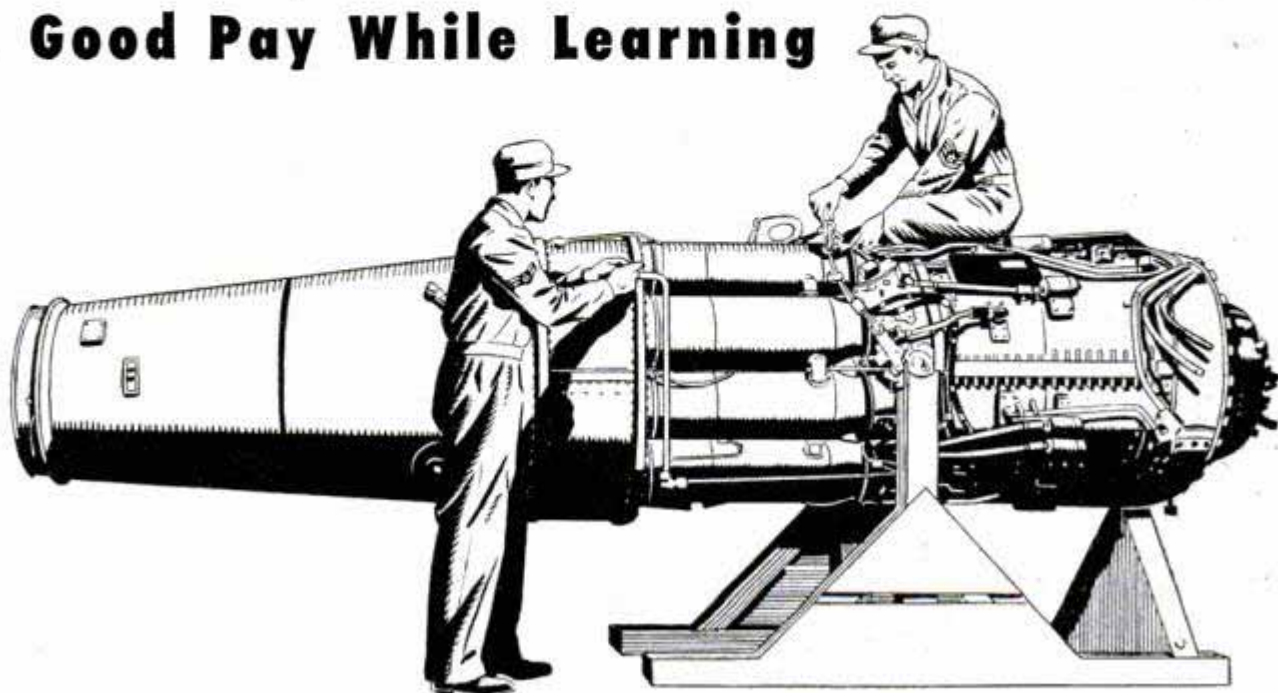

If you are looking for a job with a *real* future, get into aviation . . . NOW. Today's *best* deal for the aviation beginner is in the United States Air Force. Look into the opportunities it offers and see for yourself.

EARN WHILE LEARNING. You get good pay *right from the start* in the Air Force . . . \$75 a month in cash . . . *free* room and board . . . *free* clothing and equipment . . . *free* medical and dental care . . . *free* retirement plan. Air Force beginner's pay is equal to at least \$3,000 a year in civilian life. Where can you match that?

BEST OF TRAINING. Two kinds of training are open to men in the Air Force. You can learn on the job, under the world's most skilled experts. Or, if you qualify, you can go to the finest

Air Force technical schools while vacancies exist. It would cost hundreds of dollars to get such training elsewhere.

PROMOTIONS. Advancement in the Air Force is based on merit. Better jobs . . . non-commissioned ratings . . . go to the qualified men next in line. Right now skilled men are needed.

This is your *big* opportunity. Look into it *today*. You can get full details, without obligation, at your nearest Recruiting Station, Air Force Base, or by writing: Chief of Staff, U. S. Air Force, Att.: PMP-3A, Washington 25, D. C.

VOLUNTEER TODAY



FOR THE
U.S. AIR FORCE

U. S. ARMY and U. S. AIR FORCE RECRUITING SERVICE

Popular Mechanics Magazine

Registered in U. S. Patent Office and Canada

H. H. WINDSOR, Founder

H. H. WINDSOR, JR., Editor and Publisher



this month's cover

THAT HUMAN FLY dangling beneath the huge suspension bridge can crawl just about anywhere he wants to go. He can scale the top of the bridge, creep along beneath it or swing far below for a long look at the span's over-all condition. He can move any direction without any topside help. Secret of his mobility is that ingenious little stage he's standing on. Suppose the man wants to move sideways beneath the bridge. He presses a button and zooms up the cable. Reaching out a spare chain, he hooks it around one of the supports and detaches the hook that was supporting him. In this way he crawls anywhere beneath the bridge. For a close-up of this agile little platform, turn to page 122. And just opposite, you'll learn how engineers plan to span San Francisco Bay with a twin of the longest bridge in the world, and lay still a third "bridge" beneath the Bay's blue waters.

Published monthly by Popular Mechanics Company, 200 E. Ontario St., Chicago 11, Ill. H. H. Windsor, Jr., president; Paul H. Dunakin, vice president and general manager; D. F. Windsor, vice president and secretary-treasurer; William Harrison Petridge, vice president and assistant to the publisher; Clover L. Perkins, advertising manager; Alan M. Deyou, circulation manager. Single copy in the United States and Canada, 35 cents; subscription rates in United States and possessions, Canada, Philippines and countries of the Pan-American Postal Union, 1 year, \$3.50; 2 years, \$6.00; 3 years \$8.00. To all other countries add \$1.00 a year over United States prices for overseas postage. If you plan to move, notify us at least 30 days in advance so you will not miss an issue. Give both old and new addresses. Entered as Second Class Matter, September 15, 1903, at the Post Office at Chicago, Illinois, under Act of March 3, 1879. Entered as Second Class Matter at Post Office Dept., Canada. Copyright 1949 by Popular Mechanics Company. Copyright under International Copyright Union. Copyright in France. All rights reserved under Pan-American Copyright Union. Printed in the United States of America.

Volume 91 JUNE 1949 Number 6

Managing Editor.....Roderick M. Grant
 Assistant Managing Editor.....Wayne Whittaker
 Shop Notes and Crafts Editor.....James R. Ward
 Radio-Television, Electronics Editor.....Frank L. Brittin
 Associate Editor, Aviation.....Aubrey O. Cookman, Jr.
 Associate Editor.....Clifford B. Hicks
 Western Editor.....Thomas E. Stimson, Jr.
 Art Director.....Frank Beatty

Assistant Editors
 Donald R. Brooks Dorothy E. Hoffmann Arthur R. Railton

Assistant Editors, Shop Notes and Crafts
 W. Clyde Lammey Wayne C. Leckey Frank N. Stephany A. E. Youngquist

IN THIS ISSUE

Voice of the Prowl Car	- - - - -	81
Phantom Photos With 20 Million Volts	- - - - -	92
How to Tempt a Fish—Part III	- - - - -	97
Take a Lesson From Champion Pitchers	- - - - -	108
Canned Fresh Milk Is Coming	- - - - -	114
Revolution in Steelmaking	- - - - -	118
The Bay Bridge is to Have a Twin	- - - - -	123
Helicopter on the Newsfront	- - - - -	136
Cranberry Special	- - - - -	144
\$100,000 Speedboat to Challenge the World	- - - - -	150
He Built His Own Dream	- - - - -	156
Fortune Hunt in a Cave	- - - - -	160
Twist, Stretch and Smash, Inc.	- - - - -	166

For the Craftsman

All Aboard for Fun!	- - - - -	182
Build This Concrete-Block House—Part II	- - - - -	190
Chessmen in Plastic	- - - - -	195
Car Noises Have Meaning	- - - - -	201
Choose the Right Paper for Photo Printing	- - - - -	209
Never Trust a Circular Saw	- - - - -	218
Insulated Milk-Cooling Tanks	- - - - -	226
Radio-Television, Electronics	- - - - -	229
Clinic for Homemakers	- - - - -	240

Other items, and manufacturers of available products described, are listed on pages 10, 12 and 14

**CRAFTSMEN
RECOGNIZE
QUALITY**

By these fine features in

SIDE-CUTTING PLIERS

MADE OF CRESTOLOY STEEL
especially formulated for the manufacture of high quality tools.

HANDLES
Shaped for comfortable grip, tempered for spring and toughness.

HAND HONED CUTTING EDGES
Will cut heavy wire easily and fine-strand and silk insulated wire, cleanly.

BALANCED
perfectly for easy manipulation.

SURER GRIP
with teeth that are milled-in (not pressed or molded).

PRECISION MACHINED
joint prevents strain ... insures perfect jaw alignment. Factory lubricated for easy action.

INDIVIDUALLY TESTED
for strength and cutting ability. Watch for the Crestoloy tag. This PLIER is No. 1950, made in 6, 7, and 8 inch sizes. Other CRESTOLOY CUTTING PLIERS available in Diagonal, End and Light Side-Cutting patterns.

This Plier is made of CRESTOLOY STEEL and has tested 100% satisfactorily

**EVERYBODY
RECOGNIZES
QUALITY**

By this Trade-mark

CRESCENT TOOLS



*Sign of the Artisan
Symbol of Excellence*

"Crescent" is our trade-mark, registered in the United States and abroad, for wrenches and other tools. Sold by leading distributors and retailers everywhere and made only by **CRESCENT TOOL COMPANY, JAMESTOWN, NEW YORK**

THE TUBE NO ONE CAN IMITATE!

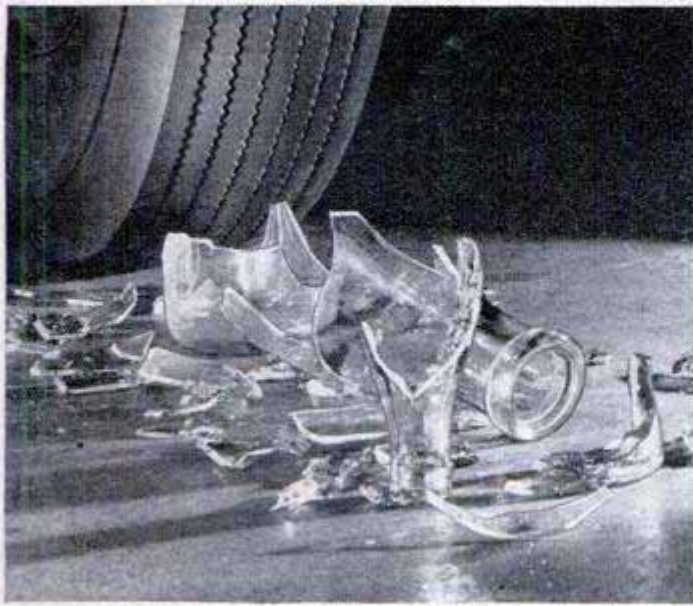

1. EVEN JAGGED, razor-sharp glass won't make *this* tire go flat—it's equipped with a Seiberling Sealed-Air Tube, *the tube no one can imitate!* Because the Seiberling Sealed-Air Tube is *different from any other in the world,* it gives you puncture and blow-out protection you can get in no other way!

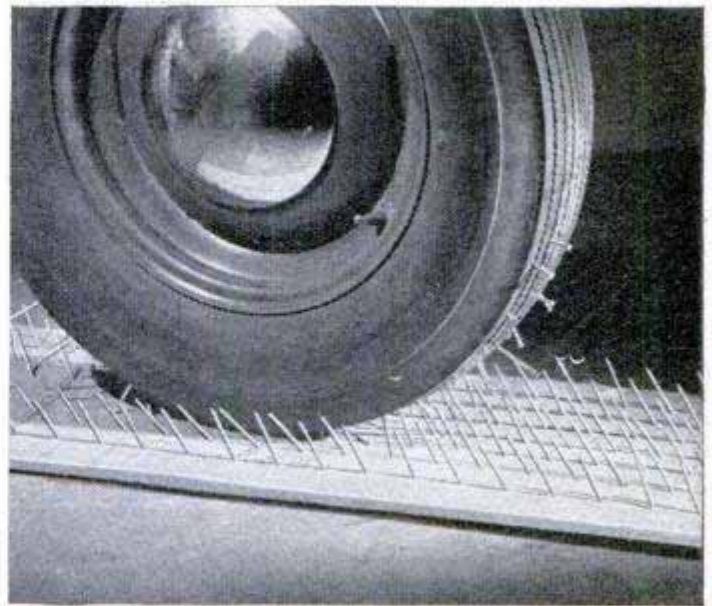

2. HERE YOU SEE the same tire being punctured *hundreds* of times, picking up more nails than you'll pick up in a lifetime of driving. And what happens? Nothing . . . each puncture is sealed *permanently* while you ride—no tire changing, no delays, no repair bills or ruined casings!

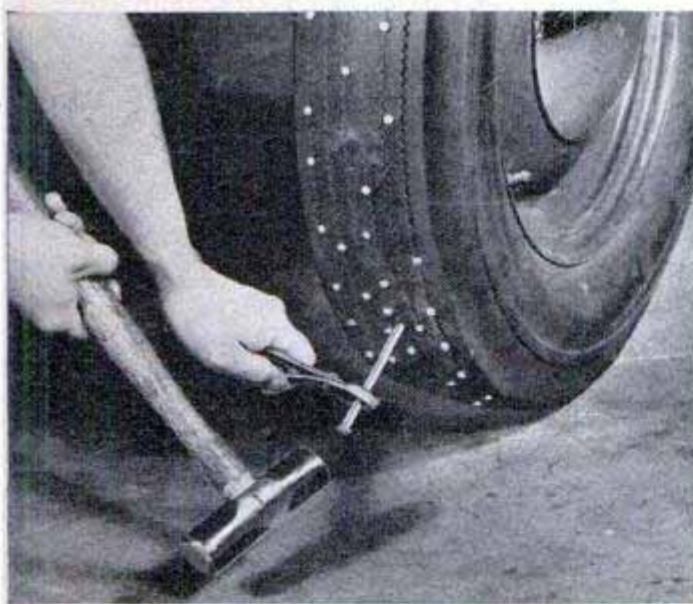

3. CHANCES ARE you'll never pound spikes into *your* tires. But Seiberling Sealed-Air Tubes can take even *this* extreme punishment because they're built around a revolutionary principle of tube design perfected and patented by Seiberling . . . built to give you *many years* of amazingly economical puncture and blow-out protection *in set after set of tires!*

HOW CAN THIS TUBE

- go 475,000 miles
- take 10,189 punctures
- ... **WITHOUT GOING FLAT?**

What is the secret behind the amazing performance of the Seiberling Sealed-Air Tube, *the tube no one can imitate?* How could one set of these tubes (as our files prove) go more than 475,000 miles, take thousands of punctures, outlast set after set of tires for over ten years—and not once go flat? What is the revolutionary principle of tube design, perfected and patented by Seiberling, that makes Sealed-Air Tubes not only the world's *safest* but also the most *economical* you can buy? The whole story, important to *everyone* who drives is told in a new book which we'll be glad to send you free. Mail the coupon below, now!

SEIBERLING

Sealed-Air TUBES

WITH PATENTED BULKHEADS

FREE: to everyone who drives a car or truck!

Today, before you have another dangerous flat tire or blow-out, send for the new book, "10,189 punctures . . . and not one flat!" Fill in and mail this coupon now! Address Seiberling Rubber Company, Dept. P-3, Akron 9, Ohio.

Name _____

Address _____

City _____ State _____

"WHAT YOU NEED IS 2-SPEED!"



This unit does the trick

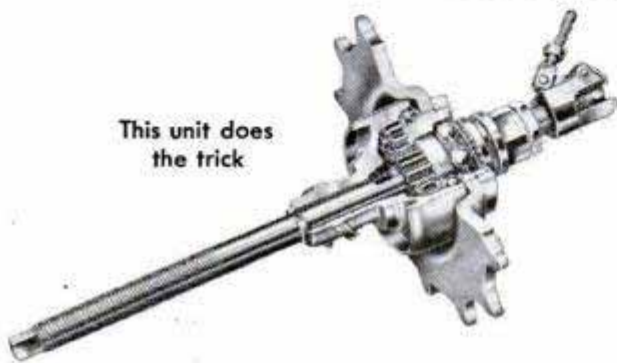

Yes, it's back! Once again a genuine New Departure "Speed Changer" for your bike. Works like the gear shift on a car—LOW SPEED for quicker getaway, easier pedaling on hills, better control in traffic; HIGH SPEED for making time on level stretches. The "Speed Changer" fits right into your New Departure Coaster Brake. Ask your bicycle dealer about it today!

On your new bike insist on America's favorite

New Departure COASTER BRAKES



1863

FREE! Have fun mystifying your friends! Guess their ages, read their minds! Send a post-card for Magic Packet P3. Address:

NEW DEPARTURE • DIVISION OF GENERAL MOTORS
BRISTOL, CONNECTICUT

in this corner.....

THE EDITORS



ASSOCIATE EDITOR Aubrey Cookman had no idea he was about to become a "Fogundsmogger" when we dispatched him to Germany last winter to fly the air lift into Berlin and tell its story. But he is one, and here's how, as 1st Lt. Hal L. Eustace of the 1807th AACS Wing informed him in a letter from Germany:

"Sir:

"The purpose of this epistle is to tell you flat to your secretary's face that you are a Fogundsmogger. Wait, don't swing yet—hear the rest of the story.

"Enclosed herewith is your ticket as an honorary member of a creme-de-la-creme flying clan, the Vittles Fog & Smog Club. These token mementos are being awarded to Vittles pilots who are forced to make radar blind landings in sub-minimum weather, after runs through the Rheinisch sky puree.



"Several hundred pilots have been awarded Fogundsmogger cards so far, and some of the boys have as many as four sub-minimum Ground - Controlled - Approach runs to their credit. GCA is getting a saturation test over here, and more than 25,000 GCA runs have been logged so far in Vittles. American units are snaking the air-lift planes in out of the fog at Celle, Fassberg, Tegel (Berlin), Tempelhof (Berlin), Rhein/Main and Wiesbaden. RAF units do the same at Gatow (Berlin) and Wunstorf.

"Those GIs who are handling the GCAs are something extra-special. Most of them are former officer-pilots with a lot of flying time behind them. Often the GI on the ground in GCA has more flying time than the officer-pilot he is talking down.

(Continued to page 8)

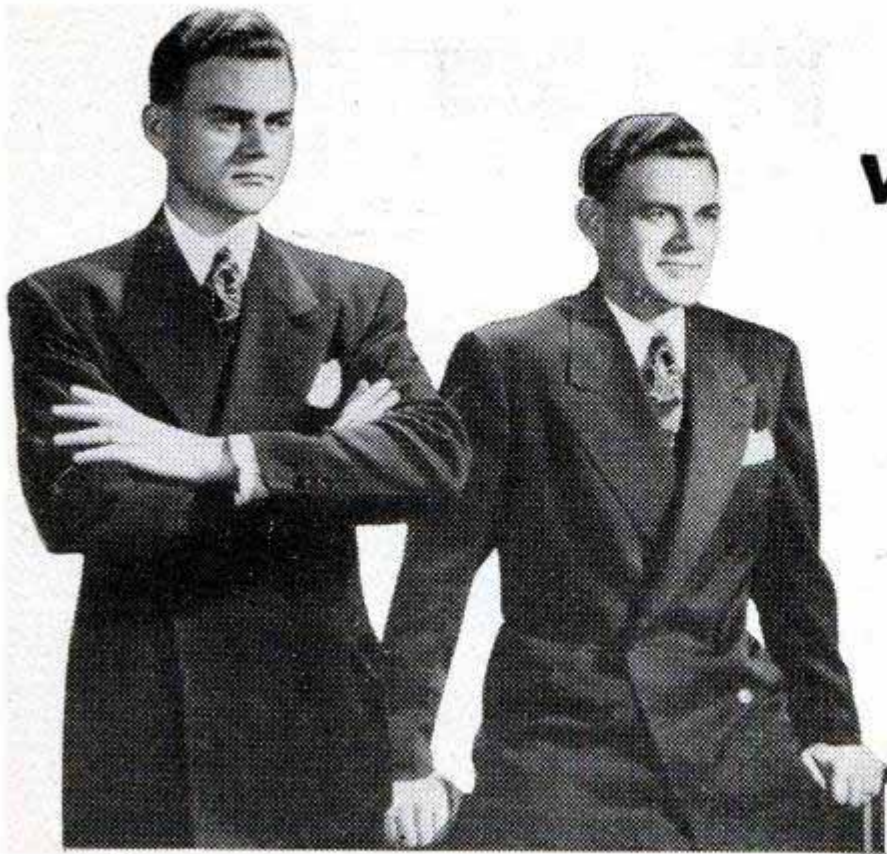

If YOU were Boss would YOU promote "YOU"?

Business is always willing to pay the man who knows—and pay him well. The man who is ready and will-

ing to take responsibilities—and capable of directing the efforts of other men is a valuable asset to any business organization. He never wants for a good job and above average earnings. He gets ahead.

We have helped thousands of men achieve promotion and more money—success sometimes beyond their dreams—a success that was started by a coupon similar to the one below.

Get out of that rut—don't be satisfied with a mediocre job at small pay—be a success in business—this coupon may be your first step.

Mail the coupon and we'll include "Ten Years' Promotion in One"—a book which has helped many men. Do it today—tomorrow never comes for the man who consistently puts things off.

Be honest now—

suppose that a better job had opened up in your company—carrying with it promotion and more money—could you qualify?

If you were boss, would you select "YOU" for that better job?

Consider before you answer.

First of all, could you *fill* the job? Has your experience fitted you for the step forward—have you been preparing for promotion apart from experience gained on the job?

Or have you just been filling a niche, doing daily tasks well but making no real and intelligent effort to learn and qualify for the job ahead so that if an opening should occur you would be ready to fill it?

The man who gets real promotion is the one who makes his own breaks—the man who slaves in the ordinary job at low pay just wishes and dreams of promotion and more money. Which are you?

LASALLE EXTENSION UNIVERSITY A Correspondence Institution

Dept. 664-R, 417 S. Dearborn, Chicago 5, Ill.

Please send me your free 48-page booklet telling how I can succeed in the field I have checked below—plus "Ten Years' Promotion in One" without obligation.

- | | |
|--|--|
| <input type="checkbox"/> Higher Accountancy | <input type="checkbox"/> Traffic Management |
| <input type="checkbox"/> C.P.A. Coaching | <input type="checkbox"/> Foremanship |
| <input type="checkbox"/> Bookkeeping | <input type="checkbox"/> Industrial Management |
| <input type="checkbox"/> Law: LL.B. Degree | <input type="checkbox"/> Stenotypy |
| <input type="checkbox"/> Business Management | <input type="checkbox"/> (Machine Shorthand) |
| <input type="checkbox"/> Salesmanship | |

Name..... Age.....
Address.....
City, Zone, State.....

LASALLE EXTENSION UNIVERSITY
A Correspondence Institution
Dept. 664-R Chicago 5, Illinois

From Old Timers to new 49'ers **PYROIL** makes **YOUR** car run finer

because:

Pyroil prevents battery drain

Pyroil clings to cylinder walls

Pyroil makes starting easier

Pyroil prevents sludge and carbon formation

Whether you're driving an old-timer or a new 49'er—ADD PYROIL—add miles to your car.

PYROIL FOR AIRCRAFT ENGINES — Use Aircraft Pyroil B for lubricating oil, Aircraft Pyroil A for gasoline.

GIVEN! An attractive Pyroil metal savings bank—takes coins up to 50c pieces—is yours for the asking—sent postage paid.

Manufactured and Guaranteed by Pyroil Company, 92 Pyroil Bldg., La Crosse, Wisconsin.

Canadian Distributors:
Central Purchasing Agencies, Ltd.
• Toronto, Ontario



PYROIL COMPANY

92 Pyroil Bldg., La Crosse, Wisconsin

I want my car to last and run properly. Please tell me more about Pyroil and how it can accomplish this for me.

Name _____

Address _____

City or Town _____ State _____



"After the war, ex-officers were given the opportunity of enlisting in the grade of Master Sergeant. Quite a few pilots accepted the offer. Where could their flying ability best be used on the ground? GCA, of course. They are members of Airways & Air Communications Service, which is to the Air Force approximately what CAA is to civil aviation in the States. I thought you might like a Fogundsmogger as a souvenir of the second great air lift.

"Regards,
"Hal Eustace,
"1st Lt. USAF."

* * *



ONE OF the newest innovations in home heating is General Electric's wall-duct system, described on page 159. We are glad to note that one of the first installations is in good hands. Mr. and Mrs. Emil Piel of Caldwell, N. J., General Electric tells us, are building it into their new home . . . and among GE's packet of pictures we find the young couple studying *Popular Mechanics'* very popular book, "Your Home and How to Build It Yourself." Mr. Piel, a veteran of action over the Pacific as fighter pilot with the U. S. Marine Corps, is now a teacher of physics at Caldwell High School.

How do you rate?

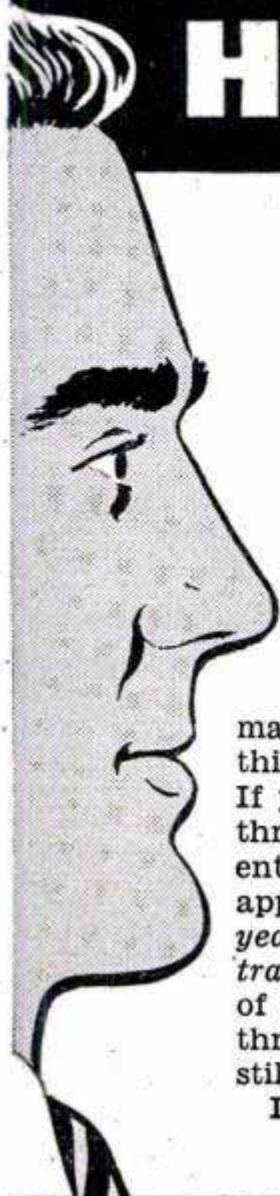

LENGTH OF SERVICE IN WORLD WAR II

- 3 MONTHS
- 6 MONTHS
- 9 MONTHS
- 12 MONTHS
- 15 MONTHS
- 18 MONTHS
- 21 MONTHS
- (or more)

EDUCATION BENEFITS UNDER THE G.I. BILL

- 12 MONTHS
- 15 MONTHS
- 18 MONTHS
- 21 MONTHS
- 24 MONTHS
- 27 MONTHS
- 30 MONTHS (plus
one month for each
additional month of
service)

I. C. S. TRAINING TO WHICH YOU'RE ENTITLED

- 48 MONTHS
- 60 MONTHS
- 72 MONTHS
- 84 MONTHS
- 96 MONTHS
- 108 MONTHS
(Training benefits
expire at the end
of nine years)

YOUR veteran training benefits may be worth more to you than you think. Figure it out for yourself. If you are a qualified veteran with three months of service, you are entitled to a year's education in an approved resident school—or *four years of approved correspondence training*. If you have used up most of your entitlement and have only three months remaining, you can still study with I.C.S. for a *full year*. I. C. S. Courses do not interfere

with your job. You study in your spare time. Furthermore, you progress as rapidly as you wish with no limit to the amount of material you cover during your period of entitlement. And you have 400 practical, success-proved courses from which to choose.

IMPORTANT: You must enroll within four years after your discharge or before July 25, 1951—whichever is later. The time for action is *now!* Mark and mail the coupon TODAY!

INTERNATIONAL CORRESPONDENCE SCHOOLS



BOX 5653-K, SCRANTON 9, PENNA.

Without cost or obligation, please send me full particulars about the course BEFORE which I have marked X:

- | | | | |
|--|---|---|---|
| <p>Air Conditioning and Plumbing Courses</p> <ul style="list-style-type: none"> <input type="checkbox"/> Air Conditioning <input type="checkbox"/> Heating <input type="checkbox"/> Refrigeration <input type="checkbox"/> Plumbing <input type="checkbox"/> Steam Fitting <p>Chemistry Courses</p> <ul style="list-style-type: none"> <input type="checkbox"/> Chemical Engineering <input type="checkbox"/> Chemistry, Analytical <input type="checkbox"/> Chemistry, Industrial <input type="checkbox"/> Chemistry, Mfg. Iron & Steel <input type="checkbox"/> Petroleum Refining <input type="checkbox"/> Pulp and Paper Making <input type="checkbox"/> Plastics <p>Civil Engineering, Architectural and Mining Courses</p> <ul style="list-style-type: none"> <input type="checkbox"/> Architecture <input type="checkbox"/> Architectural Drafting <input type="checkbox"/> Bridge and Building Foreman <input type="checkbox"/> Building Estimating <input type="checkbox"/> Civil Engineering <input type="checkbox"/> Coal Mining <input type="checkbox"/> Contracting and Building <input type="checkbox"/> Highway Engineering <input type="checkbox"/> Lumber Dealer <input type="checkbox"/> Reading Structural Blueprints <input type="checkbox"/> Sanitary Engineering <input type="checkbox"/> Structural Drafting | <p><input type="checkbox"/> Structural Engineering</p> <p><input type="checkbox"/> Surveying and Mapping</p> <p>Communications Courses</p> <ul style="list-style-type: none"> <input type="checkbox"/> Electronics <input type="checkbox"/> Practical Telephony <input type="checkbox"/> Radio, General <input type="checkbox"/> Radio Operating <input type="checkbox"/> Radio Servicing <input type="checkbox"/> Telegraph Engineering <p>Electrical Courses</p> <ul style="list-style-type: none"> <input type="checkbox"/> Electrical Drafting <input type="checkbox"/> Electrical Engineering <input type="checkbox"/> Electric Light and Power <input type="checkbox"/> Lighting Technician <input type="checkbox"/> Practical Electrician <p>Internal Combustion Engines Courses</p> <ul style="list-style-type: none"> <input type="checkbox"/> Auto Technician <input type="checkbox"/> Diesel-Electric <input type="checkbox"/> Diesel Engines <input type="checkbox"/> Gas Engines <p>Mechanical Courses</p> <ul style="list-style-type: none"> <input type="checkbox"/> Aeronautical Engineer's, Jr. <input type="checkbox"/> Aircraft Drafting <input type="checkbox"/> Forging <input type="checkbox"/> Heat Treatment of Metals <input type="checkbox"/> Industrial Engineering <input type="checkbox"/> Flight Engineer <input type="checkbox"/> Foundry Work | <p><input type="checkbox"/> Industrial Metallurgy</p> <p><input type="checkbox"/> Machine Shop</p> <p><input type="checkbox"/> Mechanical Drafting</p> <p><input type="checkbox"/> Mechanical Engineering</p> <p><input type="checkbox"/> Mold-Loft Work</p> <p><input type="checkbox"/> Patternmaking—Wood, Metal</p> <p><input type="checkbox"/> Reading Shop Blueprints</p> <p><input type="checkbox"/> Sheet-Metal Drafting</p> <p><input type="checkbox"/> Sheet-Metal Worker</p> <p><input type="checkbox"/> Ship Drafting</p> <p><input type="checkbox"/> Tool Designing</p> <p><input type="checkbox"/> Welding Engineering</p> <p><input type="checkbox"/> Welding—Gas and Electric</p> <p>Railroad Courses</p> <ul style="list-style-type: none"> <input type="checkbox"/> Air Brake <input type="checkbox"/> Diesel Locomotive <input type="checkbox"/> Locomotive Engineer <input type="checkbox"/> Locomotive Fireman <input type="checkbox"/> Locomotive Machinist <input type="checkbox"/> Railroad Section Foreman <input type="checkbox"/> Car Inspector <p>Steam Engineering Courses</p> <ul style="list-style-type: none"> <input type="checkbox"/> Boilermaking <input type="checkbox"/> Combustion Engineering <input type="checkbox"/> Engine Running <input type="checkbox"/> Marine Engineering <input type="checkbox"/> Steam Electric | <p>Textile Courses</p> <ul style="list-style-type: none"> <input type="checkbox"/> Cotton Manufacturing <input type="checkbox"/> Loom Fixing <input type="checkbox"/> Textile Designing <input type="checkbox"/> Woolen Manufacturing <input type="checkbox"/> Rayon Weaving <p>Business and Academic Courses</p> <ul style="list-style-type: none"> <input type="checkbox"/> Accounting <input type="checkbox"/> Bookkeeping <input type="checkbox"/> Business Administration <input type="checkbox"/> Business Correspondence <input type="checkbox"/> Certified Public Accounting <input type="checkbox"/> Commercial <input type="checkbox"/> Cost Accounting <input type="checkbox"/> Federal Tax <input type="checkbox"/> Foremanship <input type="checkbox"/> Good English <input type="checkbox"/> Higher Mathematics <input type="checkbox"/> Motor Traffic <input type="checkbox"/> Retailing <input type="checkbox"/> Retail Store Management <input type="checkbox"/> Salesmanship <input type="checkbox"/> Sign Lettering <input type="checkbox"/> Spanish <input type="checkbox"/> Advertising <input type="checkbox"/> Commercial Art <input type="checkbox"/> French <input type="checkbox"/> High School <input type="checkbox"/> Postal Civil Service <input type="checkbox"/> Secretarial <input type="checkbox"/> Stenography <input type="checkbox"/> Traffic Management |
|--|---|---|---|

Name _____ Age _____ Home Address _____

City _____ State _____ Working Hours _____ A.M. to _____ P.M.

Present Position _____ Employed by _____

Length of Service in World War II _____ Enrollment under G.I. Bill and P.L. 16 approved for World War II Veterans. Special tuition rates to members of the Armed Forces. Canadian residents send coupon to International Correspondence Schools Canadian, Ltd., Montreal, Canada.

WHERE-TO-BUY-IT INDEX

Source of supply appears after items commercially available

AUTOMOTIVE

Car bunk for children (Koneta Products, Box 21, Wapakoneta, Ohio)	87
Coin holder on gearshift lever (Robert Y. Grant Corp., Fitchburg, Mass.)	116
Driving light inside grille turns with front wheels (Safe-T-Scope Co., Division of Sherman Industries, Inc., Ferndale 20, Mich.)	117
Hot-dog stand in car trunk	129
Midget makes bow	155
Italian sports coupe (Alfa Romeo, Via M.U. Traiano 33, Milano, Italy)	165
Plastic deflectors clip to ventilating windows (Peters & Russell, Inc., Springfield, Ohio)	170
Rear-view mirror fastens to top of door (Ford Motor Co., Dearborn, Mich.)	170
Plastic auto cover (W. H. Temme & Co., 827-31 Madison St., Oak Park, Ill.)	171
"Educated" nut for wheel bearings (Advance Display Service Co., 233 S. Broadway, Los Angeles, Calif.)	258

AVIATION

Engine "trouble shooter"	91
"Hospital" helicopter evacuates wounded	96
First four-engine personal-type plane (Monsted-Vincent Aeronautical, Inc., 325 N. Hennessey St., New Orleans 19, La.)	142
Repair your own plane	143
Retractable rocket mounts for fighter planes	153
Pronged "scarecrow" keeps pigeons away	153
Metal crate delivers jeep by parachute	154
Shock absorber for light planes (Air-N-Oil Shock Absorbing System, Box 133, Vandalia, Ohio)	158
Cloud-height indicator	171
Flying boxcar	172

FARM

House-number post holds produce signs (Nu-Way Signs, Rockwood, Mich.)	96
Gas-powered sprayer (R. E. Chapin Manufacturing Works, Inc., Batavia, N. Y.)	133
Exhaust-gas "fertilizer" increases soil yield	148
Soil-heating cables save birds	149
Fence with a bounce	158
Double-row stalk cutter (Lone Star Trailer Co., 206 E. 36th St., Amarillo, Tex.)	252

HOUSE AND HOME

One-legged table (Joseph E. Lewis & Co., Inc., 1303 Carroll St., Baltimore 50, Md.)	90
Plastic-surfaced paper plates (Bowes Industries, Inc., 5537 N. Clark St., Chicago)	106
Aluminum nails won't streak siding (Nichols Wire & Aluminum Co., 1725 Rockingham Road, Davenport, Iowa)	112
Bathroom for home shipped as a unit (Builders Manufacturing Co., Bremen, Ind.)	117
Edge-lighted frame shows color pictures (S.E. Overton Co., South Haven, Mich.)	121
Versatile blower has twin fans (Queen Stove Works, Inc., Albert Lea, Minn.)	132
Multiple fuse plug (H-R Electric Co., 6401 Miller Road, Dearborn, Mich.)	133
Safety bib also serves as restraining harness (Carner & McKewen, 305 W. Redwood St., Baltimore 1, Md.)	134
Air circulator is built in coffee table (Howard Industries, Inc., 209 W. Jackson Blvd., Chicago 6)	134
Revolving brush is driven by water pressure (Melaire Distributing Co., 420 Lexington Ave., New York City 17)	134
Steam vaporizer shuts off automatically (Electric Steam Radiator Corp., Paris, Ky.)	135
Patterned floors from rubber tile (Danbury Rubber Co., Danbury, Conn.)	135
Bread dispensed one slice at a time (Ward Philips Co., Box 3451 Merchandise Mart, Chicago 54)	135
Pop-up meat toaster (Graphic Arts Research Foundation, 18 E. Kinzie St., Chicago 11)	135
Basket cart has folding stand (B-W Manufacturers, Inc., 721 N. Webster St., Kokomo, Ind.)	135
Combination range and refrigerator (General Air Conditioning Corp., 4542 E. Dunham St., Los Angeles 23, Calif.)	135
Transparent knitting bag (Everett Transparent Container Corp., 251 3rd Ave., New York City)	148
Stovepipe heating system cuts installation costs	159
Lightweight baby carriage (Carry-Cab Corp., 60 East 42nd St., New York City)	164
Slip-resistant paint (Benjamin Foster Co., 4635 West Girard Ave., Philadelphia 31, Pa.)	246

INDUSTRY

Bayou oil hunt	86
Vacuum harvests oysters	96
Paint conducts "lightning" across glider elevator	107
Plastic-coated work glove (Belle City Glove Co., 112 East Chestnut St., Chicago 11)	107
Nail-driving machine (Food Machinery Corp., Nailing Machine Division, Riverside, Calif.)	129
Better light diffusion	142
"Light pipe"	158
Paper tape used as strapping (Minnesota Mining and Manufacturing Co., 900 Paquiere Ave., St. Paul 6, Minn.)	164
Paper-plastic skin for plywood (Kimberly-Clark Corp., Neshann, Wis.)	254
Underground radio broadcasting may aid mine rescuers	258
Meter tests painted surface to determine when to repaint (Henry A. Gardner Laboratory, Inc., 4723 Elm St., Bethesda 14, Md.)	260
Papermaking technique ends river pollution	262
Swedish "smoke drinkers"	264

(Continued to page 12)

Embry-Riddle begins Your Aviation Career



Your Success in Aviation begins with thorough, practical Embry-Riddle training. Engineering and mechanic students work on live aircraft in airline size hangars... study design in spacious, well-lighted classrooms. Flight students train in the most modern aircraft...fly year-round in Miami's perfect flying weather. And at world-famous Embry-Riddle you live amidst the international hustle and bustle of the world's greatest air center.

Never has there been such opportunity for you in Aviation. The demand for trained men far exceeds the supply. Embry-Riddle prepares you in a few short months for all fundamental flight, engineering and mechanic positions, including the new, wide field for combination ability (pilot plus mechanic certification). Take advantage of the magnificent training facilities at vast Opa-locka Airport, operated entirely by Embry-Riddle. Study under the best instructors...backed by Embry-Riddle's quarter-century of aviation training experience. Live directly on the Airport. Enjoy Florida's matchless climate year-round, its wealth of sport and recreational facilities. Start your Aviation Career NOW at Embry-Riddle.



Send coupon today for new catalog and proof of career opportunities for Embry-Riddle graduates.

AUTHORIZED G. I. TRAINING

Dean of Enrollments - Dept. 99
Embry-Riddle School of Aviation
Miami 30, Florida

Please Print

NAME _____

ADDRESS _____

City _____

State _____ Age _____

I am interested in...

- A.&E. Mechanic
- Commercial Pilot
- Engineering
- A.&E. Combined with Commercial Pilot
- Flying Mechanic
- Drafting & Design

Check One Veteran Non-Veteran

TRAIN IN MIAMI -- AIR CAPITAL OF THE WORLD

AUDELS CARPENTERS & BUILDERS GUIDES—(4 Book Set).....\$6

A practical illustrated trade assistant on modern construction for carpenters, joiners, builders, mechanics and all woodworkers. 4 vols., 1600 pages, 3700 illustrations. Fully indexed, flexible covers. Each volume sold separately \$1.50 a vol.

AUDELS PLUMBERS & STEAMFITTERS GUIDES—(4 Book Set).....\$6

A Practical Trade Assistant & Ready Reference. Explains in plain language & by clear illustrations, diagrams, charts, graphs, pictures principles of modern plumbing practice including Marine Pipe Fitting and Air Conditioning. 4 Vols.—1670 Pages—3642 Diagrams & Illustrations. Each Vol. Sold Separately \$1.50 a Vol.

AUDELS OIL BURNER GUIDE.....\$1

384 Pages Covering Installation, Servicing & Repairs All Types Domestic & Industrial Burners. Illustrated. Highly Endorsed.

AUDELS HOUSE HEATING GUIDE.....\$4

1000 Pages Covering Working Principles, Installation, Service of All Modern House Heating, Ventilating & Air Conditioning Systems. Explains New Radiant Heating. Fully Illustrated & Indexed.

AUDELS REFRIGERATION & AIR CONDITIONING GUIDE.....\$4

New from Cover to Cover—1280 Pages, Fully Illus. Covering basic principles, servicing, operation & repair of household, commercial & industrial refrigeration & air conditioning. A gold mine of essential important facts for engineers, servicemen, users.

AUDELS SHEETMETAL WORKERS HANDY BOOK.....\$1

Practical inside information. Fundamentals of Sheet Metal Work. 388 pages. Illustrated. 11 sections. Clearly written. Essential & important facts, figures, pointers in everyday language. Ref. Index.

AUDELS SHEETMETAL PATTERN LAYOUTS.....\$4

Developed by Experts for Sheet Metal Workers. Layout Men & Mechanics. A Practical Encyclopedia in 10 Sections, size 7 x 10 x 2—1125 Pages—350 Layouts—1600 Illustrations. 1001 Key Facts. Fully indexed for ready reference in answering your layout problems. Covers all phases of sheet metal work including Pattern Cutting, Pattern Development & Shop Procedure.

AUDELS BLUE PRINT READING.....\$2

For Mechanics & Builders. Covers all types of blue print reading including ship & airplanes. 416 pages, fully illustrated.

AUDELS MATHEMATICS & CALCULATIONS FOR MECHANICS \$2

Mathematics for home study or reference. 700 pages, 550 illus. Practical mathematics from beginning. How to figure correctly. Easy, correct methods covering complete review. Illus. & Indexed.

AUDELS AUTOMOBILE GUIDE.....\$4

A practical quick ready reference book for auto mechanics, service men, operators & owners. Explains theory, construction & servicing of modern motor cars, trucks, buses & auto type Diesel engines. 1700 pages, fully illustrated. 55 chapters. Indexed. A standard book for mechanics. New Hydraulic drive covered.

AUDELS DIESEL ENGINE MANUAL...\$2

A practical, concise treatise with questions and answers on the theory, operation and maintenance of modern diesel engines. Over 400 pages, fully illus. All details plainly brought out, this book is of extreme value to engineers, operators & students.

AUDELS WELDERS GUIDE.....\$1

A concise, practical text on operation & maintenance of all welding machines for all mechanics. Over 400 pages, illustrated. Covers all methods of electric and acetylene welding including airplane work.

AUDELS MACHINIST & TOOLMAKERS HANDY BOOK.....\$4

Covers modern machine shop practice in all its branches. Tells how to set up & operate lathes, screw and milling machines, shapers, drill presses & all other machine & hand tools. 1600 pages, fully illustrated. Indexed. 5 sections. 1—Modern Machine Shop Practice. 2—Blue Print Reading & How to Draw. 3—Calculations & Mathematics for Machinists. 4—Shop Physics. 5—How to Use the Slide Rule. 60 chapters. Easy to read and understand. A shop companion that answers your questions.

AUDELS ELECTRIC MOTOR GUIDE \$4

Practical Information Covering Construction, Control, Maintenance & Wiring Hookups of All Types Electric Motors also Armature Winding. 1000 Pages Fully Illustrated & Indexed.

AUDELS ELEC. WIRING DIAGRAMS \$1

210 Pages. Illustrated. Gives practical facts on wiring of electrical apparatus. It shows clearly how to wire apparatus for practically all fields of electricity. Each diagram is complete & self-explanatory. Highly Endorsed Pocket Companion.

AUDELS PRACTICAL ELECTRICITY \$4

A key to a practical understanding of Electricity. For maintenance engineers, electricians & all electrical workers. 1440 Pages, 2600 illus. Covers important electrical information in handy form—including wiring for Light & Power. Indexed.

AUDELS RADIOMANS GUIDE.....\$4

A key to the practical understanding of radio including Frequency Modulation, Television, etc., Aircraft & Marine Radio. For radio engineers, servicemen, amateurs, 914 Pages, 633 Illustrations & Diagrams. Photos. Review Questions & Answers, Reference Index.

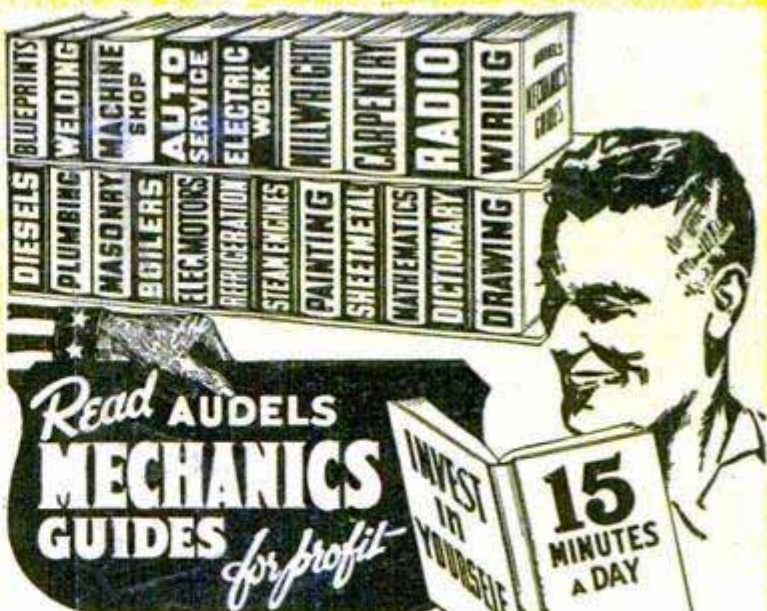

AN AUDEL GUIDE IS A GOOD FRIEND!
Step Up Your Own Skill with the Practical Facts and Figures of Your Trade. Save time and money with right methods, short cuts, labor saving ideas. CHECK NOW! You can look over any Audel Guide in your home. Start the Easy Payments if satisfied.

CUT HERE MAIL ORDER

AUDEL, Publishers, 49 W. 23 St., New York 10, N. Y.

Please mail me for 7 days' free examination the books marked (X) below. I agree to mail \$1 in 7 days on each book or set ordered, and to further mail \$1 a month on each book or set ordered until I have paid the purchase price.

If I am not satisfied with Guides I will return them.

- AUTOMOBILE GUIDE, 1700 Pages \$ 4
- DIESEL ENGINE MANUAL, 400 Pages 2
- WELDERS GUIDE, 400 Pages 1
- CARPENTERS & Builders Guides (4 Book Set) 6
- PLUMBERS & Steamfitters Guides (4 Book Set) 6
- MASONS and Builders Guides (4 Book Set) 6
- BLUE PRINT READING, 416 Pages 2
- MASTER PAINTER & Decorator, 320 Pages 2
- GARDENERS & GROWERS GUIDES (4 Book Set) 6
- OIL BURNER GUIDE, 384 Pages 1
- HOUSE HEATING GUIDE, 1000 Pages 4
- REFRIGERATION & Air Conditioning Guide, 1280 Pages 4
- SHEET METAL WORKERS Handy Book, 388 Pages 1
- SHEET METAL PATTERN LAYOUTS, 1100 Pages 4
- AIRCRAFT WORKER, 240 Pages 1
- MECHANICAL DRAWING GUIDE, 160 Pages 1
- MECHANICAL DRAWING & DESIGN, 480 Pages 2
- MATHEMATICS and CALCULATIONS, 700 Pages 2
- MECHANICAL DICTIONARY, 968 Pages 4
- MACHINISTS & Toolmakers Handy Book, 1600 Pages 4
- MILLWRIGHTS & Mechanics Guide, 1200 Pages 4
- POWER PLANT ENGINEERS GUIDE, 1500 Pages 4
- ENGINEERS & FIREMANS EXAMINATIONS, 528 Pages 1
- PUMPS, HYDRAULICS & Air Compressors, 1658 Pages 4
- MARINE ENGINEERS Handy Book, 1280 Pages 4
- ENGINEERS and Mechanics Guides (8 Book Set) 12
- Answers on Practical ENGINEERING, 254 Pages 1
- ELECTRIC WIRING DIAGRAMS, 210 Pages 1
- ELECTRICIANS EXAMINATIONS, 250 Pages 1
- ELECTRIC DICTIONARY, 9000 Terms 2
- ELECTRIC MOTOR GUIDE, 1000 Pages 4
- PRACTICAL ELECTRICITY Handy Book, 1440 Pages 4
- ELECTRICAL POWER CALCULATIONS, 425 Pages 2
- RADIOMANS GUIDE, 914 Pages 4
- ELECTRONIC DEVICES, 216 Pages 2
- NEW ELECTRIC LIBRARY, 7000 Pages (12 Book Set) 18

Vols. I, II, III, IV, V, VI, VII, VIII, IX, X, XI, XII—\$1.50 Each

Name _____

Address _____

Occupation _____

Employed by _____

AUDEL, Publishers, 49 W. 23 St., N. Y. 10

YOUR OWN

BUSINESS WITH A FUTURE!

Get the facts FREE!

a few cents worth of materials BRINGS YOU DOLLARS!!

Rich profits are waiting to be tapped in this new field. New MIRACLE finish gives a velvety, luxurious surface to radios, lamps, toys, signs, store displays, figurines, auto dashboards, and hundreds of other items. Make old objects beautiful and saleable — make new things worth much more with this soft, rich covering that can be applied to any surface, even if old and worn.



Have
Your Own Lasting, Successful Business—Be Your Own Boss—Help Fill Huge Demand ... No Experience Is Necessary

Yes, you can learn in a few days to start **MAKING MONEY!** Everything you need is furnished, including fully detailed, illustrated instructions that are complete and easy to understand. Every point is explained, to show you how to start on the road to big money, full or spare time, right in your own home.

EVERYTHING COMPLETE

In addition to full instructions, you get a complete set of materials that enables you to start at once. A few cents worth of materials can mean many dollars in return to you — you can earn up to \$500 or more per month full time; up to \$75 per week spare time.

ACT NOW

Grasp this opportunity **TODAY** — start your own business. It's too good to miss! **SEND NO MONEY** — fill out the coupon and stick it on a post card or in an envelope and mail today for full details, **FREE** sample of FLOK-KRAFT covered material, and hundreds of useful and profitable IDEAS. Do it **NOW** — be first!

USE THIS COUPON

SEND NO MONEY

COAST INDUSTRIES

Dept. 26, 1006 So. Los Angeles St., Los Angeles 15, Calif.

Please rush me all the details!

NAME _____
STREET _____
CITY _____
STATE _____

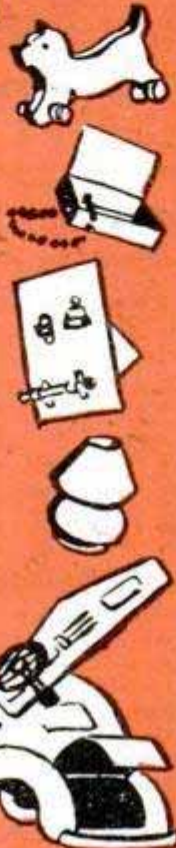

- TOYS
- JEWELRY BOXES
- DISPLAY PIECES
- LAMPS
- CAR DASHBOARDS
- CAR TRUNKS
- Covers Wood, Fabric, Metal, Plaster, Plastic, Glass, or any Surface

(Continued from page 10)

LAWN AND GARDEN

- Hand sprayer pumps from bucket (Armstrong Products Corp., Huntington, W. Va.)..... 87
- Soilless-garden kit for city "farmers" (Magic Gardens, Inc., Box 4635, Jacksonville, Fla.)..... 107
- Lawn edger turns furrow (F. C. Smith Development Co., 16596 Pinehurst Ave., Detroit 21, Mich.)..... 112

OFFICE AND STORE

- Cabinet files unfolded blueprints (Empire Development Corp., 209 Union Trust Bldg., Washington, D. C.)..... 106
- Ribbon-eradicator combination makes perfect typing simple (Aetna Products Co., 202 East 44th St., New York City)..... 142
- "Window shopper"..... 159

OUTDOOR RECREATION

- Winder takes snarls out of fishing line (C-B Tool Co., Lancaster, Pa.)..... 105
- Fish-pole holder clamps to car (Rodkarloc, 527 35th St., Richmond, Calif.)..... 112
- Book gives golfers coaching on links (The Sports Center, 561 Fifth Ave., New York City)..... 113
- Mechanical pitchers (Foster-Porter Enterprises, Inc., 1241 N. Broadway, Baltimore 13, Md.)..... 116
- Rifle features automatic safety (Winchester Repeating Arms Co., Division of Olin Industries, Inc., New Haven, Conn.)..... 133
- Twist of wrist opens reel for cleaning or oiling (James Heddon's Sons, Dowagiac, Mich.)..... 154
- Starting gate for sprinters..... 165

RADIO AND TELEVISION

- Video multiscope shows time, news..... 90
- Floating arm for microphone (Dazor Manufacturing Corp., 4481-87 Duncan Ave., St. Louis 10, Mo.)..... 105
- Radio-frequency checker..... 107
- Video camera lens "sees" in dim light..... 149
- Lift truck forms broadcast tower (Clark Equipment Co., Battle Creek, Mich.)..... 256

TOOLS

- Multi-purpose tool holder (Elk Tools, Inc., 71 West Broadway, New York City 7)..... 106
- Portable vise has telescoping screw (Parent Brothers, 3341 Union Pacific Ave., Los Angeles, Calif.)..... 112
- Power sander has "edger" adapter (O. E. Hadwiger, 715 West Abriendo Ave., Pueblo, Colo.)..... 113
- Spring-action screwdriver holds screw firmly (Eslick Products, Inc., 1312 Hawthorne Ave., Grosse Pointe Woods 30, Mich.)..... 154
- Circular-saw sharpener (Treyco Products, 264 Hartford Ave., Buffalo 17, N. Y.)..... 164
- Clamp for drill press holds work securely (Dodd Products, 405 Atkins Ave., Lancaster, Pa.)..... 262
- Suspension-spring tool balancer (Keller Tool Co., Grand Haven, Mich.)..... 264

TOYS AND NOVELTIES

- Frontier days in balsa..... 88
- Duck delivers cigarettes (Gustafson Brothers Manufacturing Co., 517 West Superior St., Chicago 10)..... 106
- Palm stems make eerie masks..... 121

MISCELLANEOUS

- Focusing magnifier for reflex cameras (Stroba Manufacturing Co., 2-4 Howard St., New York City)..... 87
- Accidents take biggest toll of man's productive years..... 90
- Aluminum trailer supports are nested for storage (Reese Products, 2111 South Main St., Elkhart, Ind.)..... 105
- Sidewalk automat..... 117
- "Spider" carries a human fly (Spider Staging, Inc., 8th Ave., North, Renton, Wash.)..... 122
- Highway yacht with a sun deck (Mid-States Trailer Sales, Inc., 831 South Wabash Ave., Dept. M-12, Chicago 5)..... 130
- Push-button subway controls..... 132
- Automatic transparency projector (LaBelle Industries, Inc., Oconomowoc, Wis.)..... 133
- Robot weather stations..... 148
- Mattress massages patient by air-pressure action (The Firestone Plastics Co., Pottstown, Pa.)..... 149
- Talking traffic lights..... 158
- "Amphib" trailer sleeps four (Sterling Marine Co., Box 54, Baxter Station, Louisville 4, Ky.)..... 170
- Weather forecaster..... 172
- Inhaler-vaporizer uses no steam (Progressive Enterprises, 1001 N. Vermont Ave., Los Angeles 27, Calif.)..... 254
- Ship-steering recorder..... 254
- Science shivers to a new low..... 256
- Planes sow DDT on Arctic snow to kill mosquito larvae..... 260
- Fly killer surpasses DDT..... 262
- Lemon-peel chemical cuts radiation injuries..... 264

Craftsman and Shop Notes Index

AUTOMOTIVE

- Cylinder-head guide pins made from bolts..... 216
- Side carrier for ladder protects car finish..... 225
- Aligning drooping door handles by twisting shank..... 228

FARM

- Hot-water tanks buried under farm lane form culvert..... 214
- Chute blinders aid loading cattle..... 214
- Bumper jack serves as stretcher to draw barbed wire taut..... 224
- Milk can provides funnel for filling grain sacks..... 224
- Poultry fountain kept sanitary by setting on platform..... 225
- Hook mounted at front of tractor aids pulling hay rope..... 225
- Prolonging life of fence posts with chemical treatment..... 228
- Seat cushion for tractor made from inner tube..... 228

FISH AND FISHING

- Bait-shy trout lured successfully with camouflaged worms..... 175
- Utility bag becomes fishing creel..... 180
- Winding fishing rods..... 194

(Continued to page 14)



BE A SUCCESS AS A RADIO-TELEVISION TECHNICIAN

TWO FREE BOOKS SHOW HOW MAIL COUPON

America's Fastest Growing Industry Offers You...

I TRAINED THESE MEN AT HOME



"Today I am considered an expert Radio-Television Technician. Have four employees. Business has doubled." — PAUL MILLER, Toledo, Ohio.

"Am Broadcast Engineer for Station KROP. Fundamentals of Radio learned in N. R. I. invaluable." — JERRY COLLETT, Brawley, California.



"For the past five years, I have been averaging \$15 and up a week repairing Radios in my spare time." — STANLEY GENTON, Cincinnati, Ohio.

"Since I finished your course, have been busy repairing Radios, installing Television. It's the coming business." — V. MARCHE-SANI, Philadelphia, Pa.



"After finishing course, opened my own repair shop. Can't praise your training too high." — ERNEST T. SLATE, Corsicana, Texas.

1. EXTRA MONEY IN SPARE TIME

As part of my servicing course, I send you SPECIAL BOOKLETS starting the day you enroll that show how you can make \$5, \$10 or more a week EXTRA fixing neighbors' Radios in spare time while learning. Tester you build with parts I send helps.

2. GOOD PAY JOB

Your next step is a good job installing and servicing Radio-Television sets, or becoming boss of your own Radio-Television Sales and Service Shop, or getting a good job in a Broadcasting Station. In 1945, there were 943 Radio Stations. Today, about 2,700 are on the air! Result—thousands of qualified men stepped into good jobs. Then add developments in FM, Two-Way Radio, Police, Aviation, Marine, Micro-wave Relay Radio. Think what this means! New jobs, more jobs, good pay for qualified men.

3. BRIGHT FUTURE

And think of the opportunities in Television. Only 19 Stations were on the air in 1947. Today, more than fifty. And the experts say there will be over 1,000 within three years. Manufacturers are producing over 100,000 Television sets a month. Be a successful Radio-Television Operator or Technician... get in line for success and a bright future in America's fastest growing industry!



I Will Train You at Home You Practice Servicing or Communications with MANY KITS

I've trained hundreds of men with no previous experience to be successful TECHNICIANS. I will train you, too. Or now you can enroll for my NEW practical course in Radio-Television Communications. Train for your FCC operator's or technician's license. You learn Radio-Television theory from clear, illustrated lessons in my tested home study courses.

As part of both my Servicing and Communications course, I send you MANY KITS of modern equipment that "bring to life" theory you learn.



You Build This MODERN RADIO

As part of my Servicing course, I send you speaker, tubes, chassis, loop antenna, transformer, EVERYTHING you need to build this modern Radio. Use it to conduct many valuable tests and practice servicing. It's yours to keep.

You Build This TRANSMITTER

As part of my New Communications course, I send parts to build this low-power broadcasting Transmitter that shows how to put a station "on the air." Perform procedures demanded of Broadcast Station operators, conduct many tests, experiments. It's yours to keep.



Building circuits, conducting experiments with them, introducing and repairing defects, gives you valuable, practical experience. (Some of the equipment you get is shown below.) Everything I send is yours to keep.

Mail Coupon for Books FREE

Coupon entitles you to ACTUAL LESSON on Radio Servicing with many pictures and diagrams plus my 64-page book, "HOW TO BE A SUCCESS IN RADIO-TELEVISION" both FREE. See what my graduates are doing and earning. Send coupon today, J. E. SMITH, President, Dept. 9FP, National Radio Institute, Pioneer Home Study Radio School, Washington 9, D. C.

VETERANS

GET THIS TRAINING WITHOUT COST UNDER G. I. BILL. MAIL COUPON NOW.

Good for Both—FREE

MR. J. E. SMITH, President, Dept. 9FP National Radio Institute, Washington 9, D. C.

Mail me Sample Lesson and 64-page Book about How to Win Success in Radio-Television—both FREE. (No salesman will call. Please write plainly.)

Name..... Age.....

Address.....

City..... Zone..... State.....

Check if Veteran Approved Under G. I. Bill



Everything in Radio at Lowest Prices!

FREE

Send for
ALLIED'S
180 Page
Catalog



**BUILDER'S KITS
TELEVISION SETS
HI-FIDELITY SOUND
AMATEUR GEAR
THOUSANDS OF PARTS
TUBES, TOOLS, TESTERS
BOOKS & DIAGRAMS**

Everything for
*Servicemen, Engineers,
Experimenters, Builders,
Soundmen, Amateurs*



Radio's Leading Buying Guide

Get ALLIED'S 1949 Catalog —biggest and most complete in Radio. Get *everything* you need from the world's largest stocks of top-quality equipment—at down-to-earth money-saving prices. Have the advantages of speedy reliable shipment, expert personal help, and complete satisfaction on every purchase. Get more for your money at ALLIED—Radio's Largest Supply House. Send today for your **FREE ALLIED Catalog**—the preferred Buying Guide to *everything* in radio and electronic equipment.

ALLIED RADIO

ALLIED RADIO CORP.,
833 W. Jackson Blvd., Dept. 5-F-9
Chicago 7, Illinois

FREE

Send FREE 1949 ALLIED Catalog.

Name.....

Address.....

City..... Zone..... State.....

(Continued from page 12)

Window for head net allows unobstructed vision.....	198
Spectacle case sheathes lure.....	200
Magnets hold fishhooks on hatband.....	205
Coat hanger forms minnow dipper.....	208

HOUSE AND HOME

Dine in the open.....	177
Rubber pads aid in removing ice cubes.....	178
Preventing holes in towels.....	178
Keeping ball fringe from matting.....	178
Identifying bottles of poison.....	178
Securing screen-door hook.....	178
Garden hose kept from kinking.....	179
Drawer stop improvised from cupboard latch.....	179
Door key held in place.....	179
Can covers provide ant traps.....	179
On-a-door wastebaskets.....	179
Flameproofing curtains and drapes.....	188
Recipe file.....	189
Incinerator for back yard reinforced with iron rod.....	194
Orange crates covered with fabric provide bookcase.....	197
Attractive rack from plastic permits quick selection of ties.....	198
Trouser hanger mounted on closet wall saves much time.....	204

OFFICE, SHOP AND STORE

Debris catcher under workbench keeps shop floor clean.....	176
Paper perforated for ring binder without using punch.....	176
Manila envelope tacked to wall stores sheets of sandpaper.....	194
Pencil holder and string dispenser.....	200
Cellophane improves stencils.....	215
Circle stamp for shipping tag emphasizes important data.....	216
Wrapping packages facilitated by corrugated platform.....	216
Labels smoothed on cartons with blackboard eraser.....	224
Fluorescent-bulb rack on ladder speeds electrician's work.....	228

OUTDOOR RECREATION

Colorful beach sun hood.....	181
Compact portable picnic table folds for carrying in car.....	205
Take it easy in this garden lounge.....	206
Bring the beach to your back yard with this lawn shower.....	208

PHOTOGRAPHY

Extra socket on photo reflector adds built-in focusing spot.....	212
Reclaiming silver from hypo.....	212
Rubber band around holder indicates unexposed film.....	212
Ice-filled test tube cools developer solution.....	212

TOOLS

Friction tape holds oilstone.....	180
Notched jig spots electric drill on vertical surfaces.....	194
Jig for disk-sanding thin stock insures even thickness.....	200
Tape backing on sandpaper aids sanding lathe turnings.....	208
Sliding marker improves rule.....	208
Power tools for miniature work.....	213
Curved segments pattern-cut with bench saw.....	215
Metal lathe forms keyways in bronze bushings.....	215
Handy spacer blocks of bar stock save time in layout work.....	216
File tang used to make box-end wrenches.....	217
Production jig setup speeded with clamp screw.....	217
Taping transformer coils speeded with wooden shuttle.....	224

TOYS AND NOVELTIES

Corncob handles on jumping rope.....	176
Pecan shells ballasted with BB shot provide hulls for tiny ship models.....	188
Paper-knife-and-bookmark in hammered metal.....	198
Lemon juice provides invisible ink.....	198
Bucking bronco simulated by oil drum suspended with rope between posts.....	205

WOODWORKING

Designed for smokers.....	174
Novel coasters turned from hardwood pinch-hit as decorative wall plaques.....	188
Matched lumber provides stock to build cupboard doors.....	200
Roughing out pitch of blades with handsaw simplifies carving model-airplane propeller.....	204

MISCELLANEOUS

Bicycle seat protected from rain.....	176
Necktie serves as shoehorn to slide foot into boot.....	176
Use of string as gluing clamp improved by dampening.....	180
Retrieving debris from cistern.....	180
Padlock secured to boat chain.....	180
Mirror frame provides shoehorn.....	194
Tidewater pier.....	199
Tape on edges of book pages facilitates turning them.....	200
Rubber tip for cane handle.....	204
Inverted mixing bowl forms sturdy base to prevent tipping varnish can.....	204
Novel paint can is dirtproof.....	208
Brush torch has corn cob wick.....	224

Radio-Television, Electronics

Improved picture tubes (RCA Manufacturing Corp., Camden, N. J.).....	229
Two-tube super battery pack set for vacations.....	230
Signal-shifter kit for radio "hams" (Allied Radio Corp., 822 W. Jackson Blvd., Chicago).....	232

IMPORTANT NOTICE—It is the intention of this magazine to provide its readers with information regarding the latest developments in the mechanical arts. We take no responsibility as to whether the disclosures contained in our articles are covered by patents and advise readers to investigate this subject before making, using, or selling any of the products, machines, or processes described in order to avoid possible liability for patent infringements.



INVENTORS



Learn how to protect your invention. The U. S. Patent Laws provide that any new and useful art, machine, article of manufacture, or composition of matter, or any new and useful improvement thereof, may be patented if the act of invention is involved. Therefore, every inventor with a valuable invention should take advantage of the Patent Laws and proceed for patent protection in order to safeguard his rights.

A patent gives the inventor the exclusive right to prevent others from making, using, or selling the invention claimed in the patent for a period of seventeen years.

The Patent Laws were enacted for the benefit of the inventor to give him protection for the features of his invention which are patentable. These features must be properly and concisely set forth and claimed in a formal application for patent, in order to comply with the requirements of the Patent Laws. For that reason, unless the inventor is familiar with patent matters, he should engage a competent registered patent attorney or agent to represent him. We are registered to practice before the U. S. Patent Office and are prepared to serve you in the handling of your patent matters.

A specially prepared booklet entitled "Patent Guide for the Inventor", containing detailed information with respect to patent protection and procedure, together with a "Record of Invention" form will be promptly forwarded to you without obligation upon request.

CLARENCE A. O'BRIEN & HARVEY JACOBSON

Registered Patent Attorneys

91-F DISTRICT NATIONAL BUILDING • WASHINGTON 5, D. C.

Patents
Trademarks
Copyrights

CLARENCE A. O'BRIEN & HARVEY JACOBSON
Registered Patent Attorneys
91-F District National Bldg., Washington 5, D. C.
Please send me copy of "Patent Guide for the Inventor" and also
"Record of Invention" form. This request does not obligate me.

Name _____

Address _____

City _____ State _____

(Please write or print plainly.)

THE GREATEST
POWER ON
EARTH!

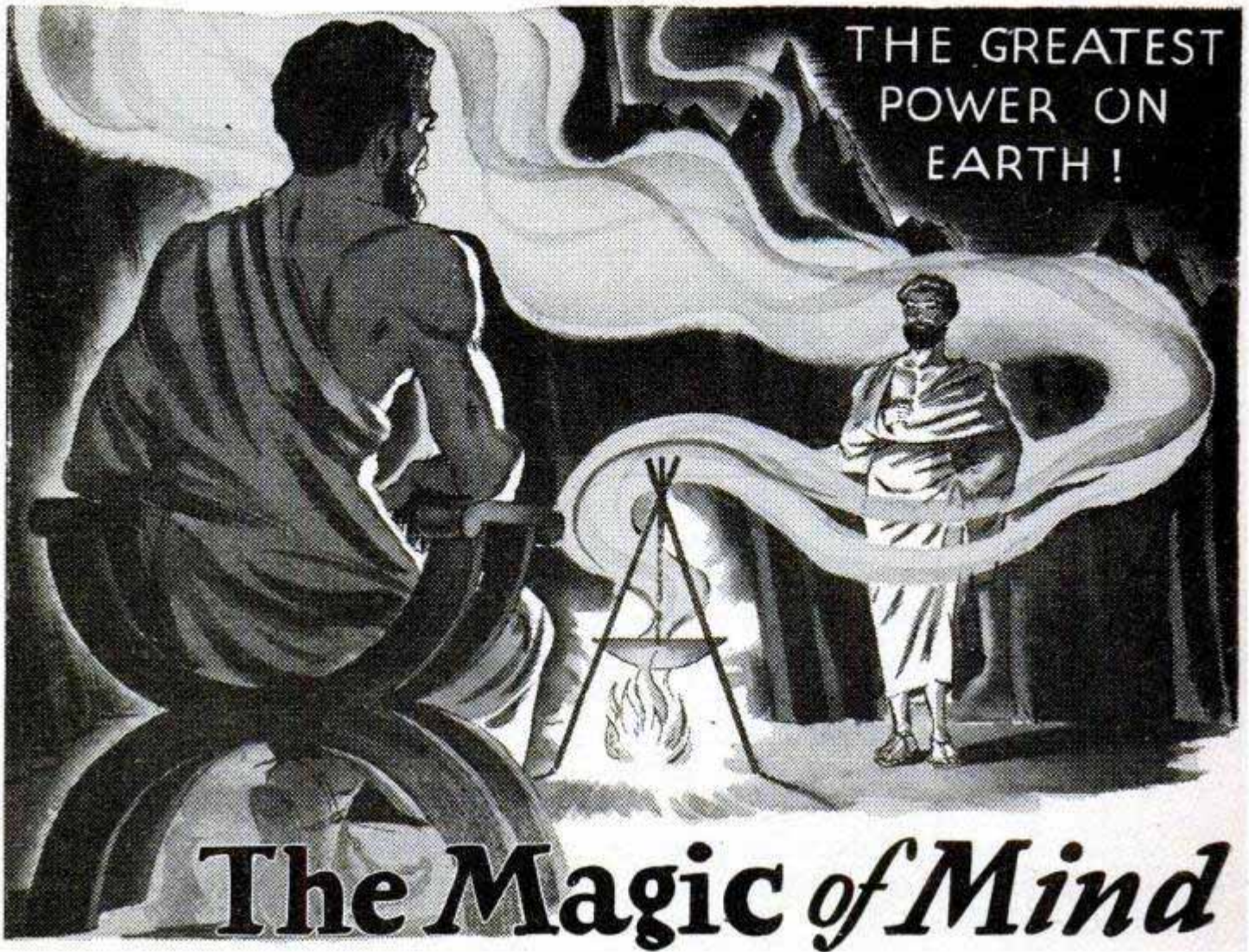

The Magic of Mind

WERE the great personages of the past victims of a stupendous hoax? Could such eminent men of the ancient world as Socrates, Pericles, and Alexander the Great have been deluded and cast under the spell of witchcraft—or did the oracles whom they consulted actually possess a *mysterious faculty of foresight*? That *the human mind can truly exert an influence over things and conditions* was not a credulous belief of the ancients, but a known and demonstrable fact to them. That there exists a wealth of infinite knowledge just beyond the border of our daily thoughts, which can be aroused and commanded at will, was not a fantasy of these sages of antiquity, but a dependable aid to which they turned in time of need.

It is time you realized that the rites, rituals and practices of the ancients were not superstitions, but subterfuges to conceal the marvelous workings of natural law from those who would have misused them. Telepathy, projection of thought, the materializing of ideas into helpful realities, are no longer thought by intelligent persons to be impossible practices, but instead, *demonstrable sciences*, by which a greater life of happiness may be had.

One of America's foremost psychologists and university instructors, says of his experiments with thought transference and the powers of mind—"The successes were much too numerous to be merely

lucky hits and one can see no way for guessing to have accounted for the results." *Have you* that open-minded attitude of today which warrants a clear, positive revelation of the facts of mind which intolerance and bigotry have suppressed for years? *Advance with the times*; learn the truth about your inherited powers.

Let this free book explain

The Rosicrucians (NOT a religious organization) have been leaders in introducing the ancient wisdom of mental phenomena. Established throughout the world for centuries, they have for ages expounded these truths to those thinking men and women who sought to make the utmost of their natural faculties. Use the coupon below—avail yourself of a pleasing book of interesting information which explains how you may acquire this most *unusual* and *helpful* knowledge.

The ROSICRUCIANS (AMORC)

USE THIS COUPON

Scribe J. F. F.
The Rosicrucians, AMORC,
San Jose, California.

I am sincerely interested in knowing more about this unseen, vital power which can be used in acquiring the fullness and happiness of life. Please send me, without cost, the book, "THE MASTERY OF LIFE," which tells me how to receive this information.

Name _____

Address _____

State _____

INVENTORS

Patent laws encourage the development of inventions.

We recommend that an inventor employ a registered Patent Attorney or agent, if the inventor is not familiar with patent matters. This is because the value of a patent depends largely upon the skillful preparation of the specification and claims in the patent application.

The firm of McMorrow, Berman and Davidson is registered to practice before the United States Patent Office. Additionally it engages patent attorneys able to readily understand inventors' disclosures, to advise concerning patentability, and to prepare appropriate specifications and claims.

If an inventor believes he has an invention, a search of the most pertinent prior U. S. patents should be made and a report obtained relative to its patentability. Where such report indicates that the invention appears patentable, in order to secure protection, diligence should be exercised in making application for a patent.

Send for a copy of Patent Booklet entitled "How To Protect Your Invention." This booklet contains information on patent protection and procedure. You will also receive an "Invention Record" blank. This will be promptly forwarded to you upon request—no obligation.

McMORROW, BERMAN & DAVIDSON

Registered Patent Attorneys

PATENTS • TRADE MARKS • COPYRIGHTS

1351 VICTOR BUILDING, WASHINGTON 1, D. C.

McMORROW, BERMAN & DAVIDSON

Registered Patent Attorneys

1351 Victor Building, Washington 1, D. C.

Send me your Patent Booklet, "How To Protect Your Invention", and also "Invention Record" form at once. I understand this request does not obligate me.

Name.....

Address.....

City.....

(WRITE OR PRINT NAME CLEARLY)

HOW JOE'S BODY BROUGHT HIM

FAME INSTEAD OF SHAME



I Can Make YOU A New Man, Too in Only 15 Minutes A DAY!

If YOU, like Joe, have a body others can "push around"—if you're ashamed to strip for sports or a swim—give me just 15 minutes a day! I'll PROVE you can have a body you'll be proud of!

"Dynamic Tension" Does It!

Using "Dynamic Tension" 15 minutes a day, in your own room, you quickly begin to put on muscle, broaden your chest and back, fill out your arms and legs. Before you know it, this easy method will make you a New Man!

FREE BOOK

Send NOW for my FREE BOOK. It shows actual photos of men I've turned from weaklings into Atlas Champions; tells how I can do the same for YOU. Charles Atlas, Dept. 8T, 115 East 23rd St., New York 10, N. Y.

**CHARLES ATLAS, Dept. 8T,
115 East 23rd St., New York 10, N. Y.**

I want proof that "Dynamic Tension" will help make a New Man of me—with a healthy, husky body, big muscular development. Send me free book, "Everlasting Health and Strength."

Name _____ Age _____
 (Please print or write plainly)
 Address _____
 City _____ State _____



FIND OUT FREE—HAVE YOU GOT WHAT IT TAKES...

to be a FINGER PRINT EXPERT or TRAINED INVESTIGATOR?

Send for free IAS Qualification Questionnaire. If in our opinion your answers indicate that you "have what it takes," then you will receive absolutely free the famous "Blue Book of Crime" . . . plus full details on how to train at home in Crime Detection and Finger Printing! IAS graduates are key men in over 800 Police Bureaus. See if YOU can train for this exciting, steady, "good pay" work! No obligation. No salesman will call. Write today, stating age.

WRITE TODAY

INSTITUTE OF APPLIED SCIENCE

1920 Sunnyside Ave., Dept. 135-A, Chicago 40, Ill.

WATCHMAKING

JEWELRY ENGRAVING AND REPAIR

Enter this high-paying, time-honored profession, or prepare for a business of your own. Watchmakers in great demand. More jobs than qualified workers. Study under expert instructors in a long-established, nationally recognized school. Receive recognized diploma and certificate. Placement service. Approved under G. I. Bill. Write for FREE booklet.



The Baronian School, Inc.

2116 WALNUT ST. (DEPT. C) PHILA. 3, PA.

MONEY for MEN ALL DATA FREE

THE PLASTEX Industry needs manufacturers on small scale and for big production of Lamp and Clock Stands, Art Goods and Novelties in Plastex and Marble imitation. Experience unnecessary. Lac material makes regular 10c store sellers. Rubber moulds furnished for speed production. Small investment brings good returns. Big chain store orders now being placed. Ambitious men have chance for real prosperity. Our Free booklet will interest and benefit you.

PLASTEX INDUSTRIES, Dept. A
3400 Third Ave. New York 56, N. Y.

REAL ESTATE BE A BROKER

PAYS BIG! SEND FOR FREE, BIG, ILLUSTRATED CATALOG NOW! No obligation. Graduates report making substantial incomes. Start and run your own business quickly. Men, women of all ages, learn easily. Course covers Sales, Property Management, Appraising, Loans, Mortgages, and related subjects. STUDY AT HOME or in our classrooms in big cities. Diploma awarded. G.I. approved. Nationally known.

WEAVER SCHOOL OF REAL ESTATE (Est. 1936)
15 E. Pershing Road Dept. PM-6, Kansas City, Mo.

FREE BOOK TELLS HOW

"LEARN-BY-DOING"

ELECTRICITY

NATION'S LARGEST EXCLUSIVE ELECTRICAL SCHOOL

PRACTICAL TRAINING NOT "HOME STUDY"

G.I. APPROVED Get actual experience in great shops of M.T.I. Learn all phases Practical Electricity; Housewiring, Motors, Const., Maintenance, etc. Living arrangements, Part-time jobs, etc.

Send coupon TODAY.

MICHIGAN TECHNICAL INSTITUTE Veteran

2281 W. Fort St., Detroit, Mich., Dept. PM-6

Name _____
 Street _____
 City _____ State _____

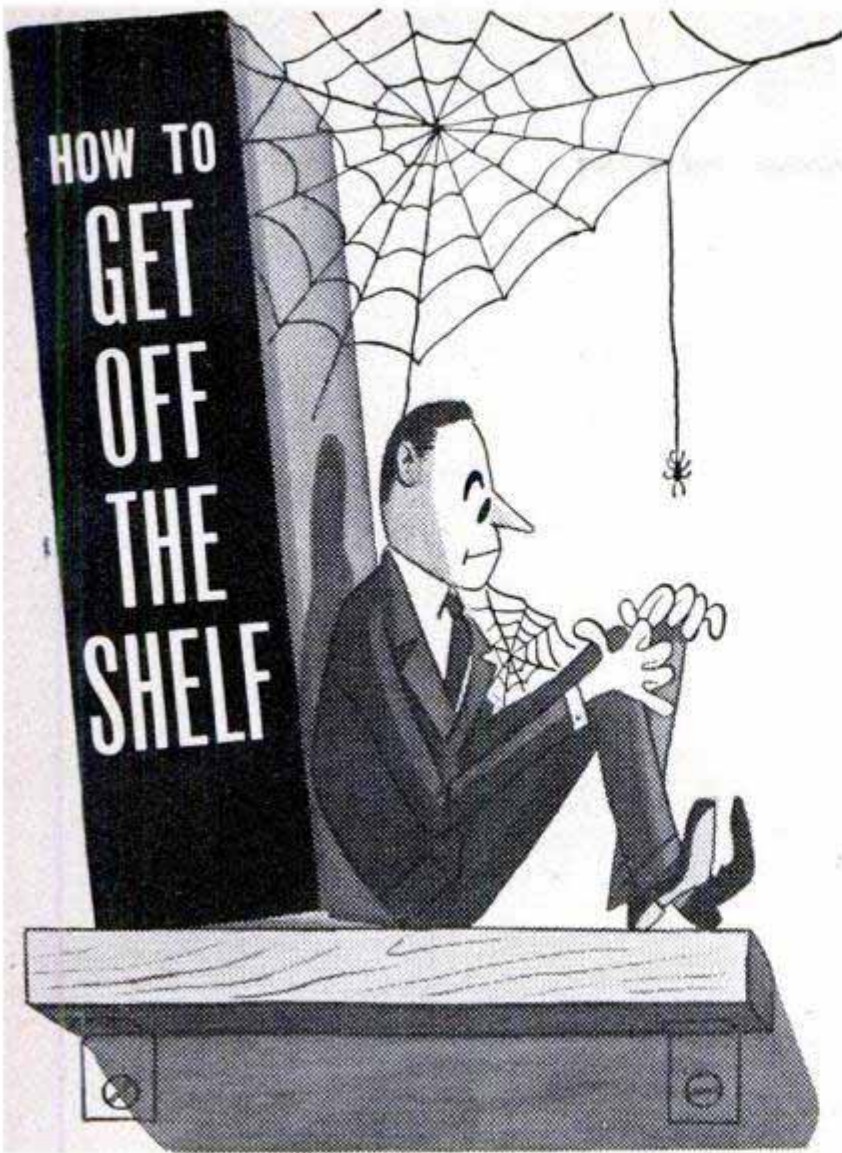

ONE or two promotions . . . several pay raises . . . and then that long, long stretch "on the shelf." You want to keep on climbing. You want to feel that you are getting somewhere. But how?

I. C. S. can show you. A little more training could be all you need to get back in the *upswing*. An advanced course or a "refresher"—studied in your spare time—will help prepare you for the next step, will show that you are ready to handle more responsibility, a better job.

Trained men get the "breaks"! That's a fact proved over and over again by the records of former I. C. S. students.

You don't want to bog down in your job. You don't want to remain "on the shelf" with the untrained. Mail the coupon today for complete information on how you can join the steady climbers.

INTERNATIONAL CORRESPONDENCE SCHOOLS



BOX 5654-K, SCRANTON 9, PENNA.

Without cost or obligation, please send me full particulars about the course BEFORE which I have marked X:

- | | | | |
|---|--|--|---|
| <p>Business and Academic Courses</p> <input type="checkbox"/> Accounting <input type="checkbox"/> Advertising
<input type="checkbox"/> Bookkeeping
<input type="checkbox"/> Business Administration
<input type="checkbox"/> Business Correspondence
<input type="checkbox"/> Certified Public Accounting
<input type="checkbox"/> Commercial
<input type="checkbox"/> Commercial Art
<input type="checkbox"/> Cost Accounting
<input type="checkbox"/> Federal Tax
<input type="checkbox"/> First Year College
<input type="checkbox"/> Foremanship
<input type="checkbox"/> Good English
<input type="checkbox"/> Higher Mathematics
<input type="checkbox"/> Motor Traffic <input type="checkbox"/> Postal Civil Service
<input type="checkbox"/> Retailing <input type="checkbox"/> Retail Store Management
<input type="checkbox"/> Salesmanship <input type="checkbox"/> Secretarial
<input type="checkbox"/> Sign Lettering
<input type="checkbox"/> Spanish <input type="checkbox"/> Stenography
<input type="checkbox"/> Traffic Management
Air Conditioning and Plumbing Courses
<input type="checkbox"/> Air Conditioning
<input type="checkbox"/> Heating
<input type="checkbox"/> Refrigeration
<input type="checkbox"/> Plumbing
<input type="checkbox"/> Steam Fitting | <p>Chemistry Courses</p> <input type="checkbox"/> Chemical Engineering
<input type="checkbox"/> Chemistry, Analytical
<input type="checkbox"/> Chemistry, Industrial
<input type="checkbox"/> Chemistry, Mfg. Iron & Steel
<input type="checkbox"/> Petroleum Refining <input type="checkbox"/> Plastics
<input type="checkbox"/> Pulp and Paper Making
Civil Engineering, Architectural and Mining Courses
<input type="checkbox"/> Architecture
<input type="checkbox"/> Architectural Drafting
<input type="checkbox"/> Building Estimating
<input type="checkbox"/> Civil Engineering <input type="checkbox"/> Coal Mining
<input type="checkbox"/> Contracting and Building
<input type="checkbox"/> Highway Engineering
<input type="checkbox"/> Lumber Dealer
<input type="checkbox"/> Reading Structural Blueprints
<input type="checkbox"/> Sanitary Engineering
<input type="checkbox"/> Structural Drafting
<input type="checkbox"/> Structural Engineering
<input type="checkbox"/> Surveying and Mapping
Communications Courses
<input type="checkbox"/> Electronics
<input type="checkbox"/> Practical Telephony
<input type="checkbox"/> Radio, General <input type="checkbox"/> Radio Operating
<input type="checkbox"/> Radio Servicing | <p><input type="checkbox"/> Telegraph Engineering
 Electrical Courses
 <input type="checkbox"/> Electrical Drafting
 <input type="checkbox"/> Electrical Engineering
 <input type="checkbox"/> Electric Light and Power
 <input type="checkbox"/> Lighting Technician
 <input type="checkbox"/> Practical Electrician
 <input type="checkbox"/> Power House Electric
 <input type="checkbox"/> Ship Electrician
 Internal Combustion Engines Courses
 <input type="checkbox"/> Auto Technician <input type="checkbox"/> Aviation
 <input type="checkbox"/> Diesel-Electric
 <input type="checkbox"/> Diesel Engines <input type="checkbox"/> Gas Engines
 Mechanical Courses
 <input type="checkbox"/> Aeronautical Engineer's, Jr.
 <input type="checkbox"/> Aircraft Drafting <input type="checkbox"/> Flight Engineer
 <input type="checkbox"/> Forging <input type="checkbox"/> Foundry Work
 <input type="checkbox"/> Heat Treatment of Metals
 <input type="checkbox"/> Industrial Engineering
 <input type="checkbox"/> Industrial Metallurgy
 <input type="checkbox"/> Machine Shop
 <input type="checkbox"/> Machine Shop Inspection
 <input type="checkbox"/> Mechanical Drafting
 <input type="checkbox"/> Mechanical Engineering </p> | <p><input type="checkbox"/> Mold-Loft Work
 <input type="checkbox"/> Patternmaking—Wood, Metal
 <input type="checkbox"/> Reading Shop Blueprints
 <input type="checkbox"/> Sheet-Metal Drafting
 <input type="checkbox"/> Sheet-Metal Worker
 <input type="checkbox"/> Ship Drafting <input type="checkbox"/> Ship Fitting
 <input type="checkbox"/> Tool Designing <input type="checkbox"/> Toolmaking
 <input type="checkbox"/> Welding Engineering
 <input type="checkbox"/> Welding—Gas and Electric
 Railroad Courses
 <input type="checkbox"/> Air Brake <input type="checkbox"/> Car Inspector
 <input type="checkbox"/> Diesel Locomotive
 <input type="checkbox"/> Locomotive Engineer
 <input type="checkbox"/> Locomotive Fireman
 <input type="checkbox"/> Locomotive Machinist
 <input type="checkbox"/> Railroad Section Foreman
 Steam Engineering Courses
 <input type="checkbox"/> Boilermaking
 <input type="checkbox"/> Combustion Engineering
 <input type="checkbox"/> Engine Running
 <input type="checkbox"/> Marine Engineering
 <input type="checkbox"/> Steam Electric <input type="checkbox"/> Steam Engineer
 Textile Courses
 <input type="checkbox"/> Cotton Manufacturing <input type="checkbox"/> Loom Fixing
 <input type="checkbox"/> Rayon Weaving <input type="checkbox"/> Textile Designing
 <input type="checkbox"/> Woolen Manufacturing </p> |
|---|--|--|---|

Name _____ Age _____ Home Address _____
 City _____ State _____ Working Hours _____ A.M. to _____ P.M.
 Present Position _____ Employed by _____
 Length of Service in World War II _____ Enrollment under G.I. Bill and P.L. 16 approved for World War II Veterans. Special tuition rates to members of the Armed Forces.
 Canadian residents send coupon to International Correspondence Schools Canadian, Ltd., Montreal, Canada.

I N V E N T O R S

A Patent is a Valuable Right. On the basis of a provision in the Constitution of the United States, Congress has established a system under which inventors may secure the exclusive right to prevent the unauthorized use, manufacture and sale of their inventions for periods of seventeen years. The inventor secures this protection for his invention by obtaining a United States Patent.

*T*his firm is registered to practice before the U. S. Patent Office and is available to assist inventors in the preparation and prosecution of their cases. Detailed information and the steps to be taken in obtaining patent protection will be furnished upon request.

Form below for mailing convenience

VICTOR J. EVANS & CO. • *Merlin M. Evans*
REGISTERED PATENT ATTORNEY
430-G MERLIN BUILDING, WASHINGTON 6, D. C.

VICTOR J. EVANS & CO. • Merlin M. Evans
Registered Patent Attorney

430-G Merlin Building, Washington 6, D. C.

Please send me without obligation a copy of your booklet "Patent Protection For Inventors" together with your convenient "Evidence of Invention" form.

Name.....

Address.....

City and State.....

PATENTS TRADEMARKS COPYRIGHTS

LEARN

ELECTRICITY

ON REAL EQUIPMENT

IN THE GREAT SHOPS OF **COYNE**



RADIO-TELEVISION

NEW OPPORTUNITY FIELD

The fast-growing field of Television—the new development in the Radio field offers unlimited opportunities today. Coyne offers a separate course in Radio-Television, Radio-Construction, Installation, Testing, Trouble-Shooting on Radio, F.M., and Television equipment. Get big free book today.

LEARN THE COYNE PRACTICAL WAY

Year by year for 50 years we have learned how to make Coyne Training quicker, more practical. Coyne is the only school of its kind offering you all the advantages of 50 years of training experience.

Coyne Trained Men in Good Jobs

Thousands of Coyne trained men in good jobs or in a business of their own, make real money while others putter along. Yes, you can get ready for Good Pay—a Big Future—by training at COYNE here in Chicago. Here you work on real motors, armatures, switchboards—do actual wiring and trouble-shooting—get the practical training you need.

Not "Home-Study"

We do not teach by mail. For 50 years all training has been given in our Great Shops, plus necessary theory. Expert instructors guide you. No advanced education or previous experience needed.

GI Approved — Finance Plan for Non-Vets

COYNE is authorized to train men under the G.I. Bill! Non-veterans may enroll now, pay most of tuition after graduation. If you need part-time work to help out with living expenses while at Coyne, we'll help you get it.

Mail Coupon for Big FREE BOOK

Whether you prefer Electricity, or Radio-Television, train on actual equipment, at Coyne. We have a big, fully illustrated book on each course, and we'll send you the one you want, or both, without obligation. Mail coupon—TODAY.

B. W. COOKE, President, COYNE ELECTRICAL & RADIO SCHOOL, 500 S. Paulina St., Chicago 12, Ill. Dept. A9-72H



B. W. COOKE, President COYNE ELECTRICAL & RADIO SCHOOL, Dept. A9-72H 500 S. Paulina St., Chicago 12

Send FREE, the book or books checked below, and details of your training offer. This does not obligate me and no salesman will call.

ELECTRICITY RADIO-TELEVISION

NAME.....

ADDRESS.....

CITY.....STATE.....



1 You are TOLD the how and why of each job.



2 You're shown how to do typical jobs by trained instructors.



3 You DO practical job YOURSELF on equipment.

MEN-IF YOU VALUE Your Future- read this FREE BOOK

SEND
FOR IT
Today!



**Tells You How to Win
Bigger Pay and Real Security**

This book is yours without a penny of cost. "Your Future in Refrigeration and Air Conditioning" tells you what's in store for you in this fast moving, big pay field. No obligation. We want you to have this big, fascinating book. We want you to have the opportunity to read it—and to decide for yourself whether this is the field for you. You'll see pages of interesting pictures showing men on-the-job in Refrigeration and Air Conditioning. You'll read all about the fine opportunities in this amazing industry. This can easily be the most important book you'll ever receive and read—because it concerns your own future! Refrigeration and Air Conditioning has plenty of room for trained men—to handle good paying jobs in the many branches of this great industry. Almost unlimited future for men who know this work. Now you may learn Refrigeration and Air Conditioning at home in spare time. No need to give up present job or income while preparing to step into a better job. Act now! Simply write your name and address on the coupon below and mail today. Get your free copy at once . . .

INDUSTRIAL TRAINING INSTITUTE
2150 Lawrence Avenue, Dept. U-1, Chicago 25, Ill.

MAIL COUPON NOW No Cost
No Obligation

Mr. C. H. Smith, President,
Industrial Training Institute, Dept. U-1
2150 Lawrence Avenue, Chicago 25, Illinois

Please send me a FREE COPY of "Your Opportunity in Refrigeration and Air Conditioning" by return mail.

Name _____
Address _____
City and Zone _____ State _____

PRINT YOUR OWN POST CARDS

COMPLETE
OUTFIT
only
\$7.50



Amazing results in sales, inquiries and contacts . . . saves time and money . . . very easy to use GEM STENCIL DUPLICATOR is ideal for Advertising, Announcements, Notices, Labels, Forms, Price Lists—hundreds of uses for every type of business and organization. Comes complete with all supplies, instructions and 60-page Book of Ideas.

FREE TRIAL OFFER: Try it before you buy it! Write and a GEM OUTFIT will be sent you postpaid. After 10 days, send only \$7.50 or return the GEM, no questions asked. The GEM must sell itself; you be the judge.

BOND EQUIPMENT CO. • Dept. 135
6633 Enright • St. Louis 5, Mo.

SEND NO MONEY • FREE TRIAL OFFER

'How to Make Money with Simple Cartoons'



A book everyone who likes to draw should have. It is free; no obligation.

Simply address

FREE
BOOK

CARTOONISTS' EXCHANGE
Dept. 96-D Pleasant Hill, Ohio

Learn PHOTOGRAPHY at Home

Splendid opportunities. Prepare in spare time. Practical basic training. Long-established school. Send for free book, "Opportunities in Photography." No obligation.

AMERICAN SCHOOL OF PHOTOGRAPHY
1315 S. Michigan Ave. Dept. 135A Chicago 5, Ill.

\$10,000 REWARD

Earn the government bonus by locating
Radio-Active Ores with the

P.R.I. GEIGER COUNTER

Weight about 2 lbs. Price only \$75.00 complete.
Enclose check to save C.O.D. charges.

PRECISION RADIATION INSTRUMENTS, INC.
1101-P N. Paulina St. Chicago 22, Ill.

STAMMER ?

This new 128-page book, "Stammering, Its Cause and Correction," describes the Bogue Unit Method for scientific correction of stammering and stuttering—successful for 48 years. Benj. N. Bogue, Dept. 4914, Circle Tower, Indianapolis 4, Ind.

GET THIS
FREE
BOOK!



VETERANS
training is FREE
under G. I. BILL.

Learn WOOD PRODUCTION ENGINEERING

GET THIS FREE BOOK
Today

It tells you how you can learn to become a successful WOOD PRODUCTION ENGINEER . . . by the Klok Home Study Correspondence Method . . . or by studying here in Grand Rapids in our Resident School . . . Training in WOOD PRODUCTION ENGINEERING offers you great opportunities . . . either to get a top position or to operate your own plant successfully.

The Klok Course teaches you SKETCHING, ROD-MAKING, DETAILING, STOCK BILLING, TIME STUDY, COST and MANAGEMENT.

WRITE FOR FREE BOOK TODAY! State preference whether Home Study or Resident course, with name, age, occupation and if veteran.

KLOK INSTITUTE
LOUIS ST., N.W.
GRAND RAPIDS, MICHIGAN



WHICH OF THESE *Opportunities* INTERESTS *You* MOST?

● Today, choose the job you want—and prepare for it. Or if you are already engaged in the work you like best, start training now for quicker promotion. Acquire the knowledge that will help you to get ahead faster, make more money and have greater security.

American School, founded in 1897 as an educational institution not for profit, can help you to reach your goal just as it has helped others during the past fifty-two years. Check the coupon at right, add your name and address and mail it at once. The school will send you details on its training plan and outline of study prepared by specialists. There is no charge, no obligation, so send the coupon immediately.

CHECK, CLIP AND MAIL COUPON NOW

AMERICAN SCHOOL, Dept. GA45, Drexel at 58th, Chicago 37, Ill.

Without obligation. Please send FREE and postpaid, bulletin and details of the Subjects checked:

- | | | |
|--|--|--|
| <input type="checkbox"/> PLASTICS ENGR | <input type="checkbox"/> Accounting | <input type="checkbox"/> Drafting and Design for Men and Women |
| <input type="checkbox"/> Refrigeration | <input type="checkbox"/> Electrical Engr. | <input type="checkbox"/> Radio |
| <input type="checkbox"/> Architecture and Building | <input type="checkbox"/> Electricity-Pract. | <input type="checkbox"/> High School |
| <input type="checkbox"/> Contracting | <input type="checkbox"/> Electronics, Industrial | <input type="checkbox"/> Air Conditioning |
| <input type="checkbox"/> Practical Plumbing | <input type="checkbox"/> Bookkeeping | <input type="checkbox"/> Mechanical Eng. |
| <input type="checkbox"/> Automotive Engr. | <input type="checkbox"/> Private Secretary | <input type="checkbox"/> Shop Management |
| <input type="checkbox"/> Aviation Drafting | <input type="checkbox"/> Diesel Engineering | <input type="checkbox"/> Tool Making |
| <input type="checkbox"/> Aviation | <input type="checkbox"/> Sheet Metal Pattern | <input type="checkbox"/> Better Foremanship |
| <input type="checkbox"/> Business Management | <input type="checkbox"/> Drafting | <input type="checkbox"/> Machine Shop Operations |
| | <input type="checkbox"/> Railway Training | |

Name _____ Occupation _____

Address _____ Age _____

City _____ State _____

AMERICAN SCHOOL

Dept. GA45, Drexel at 58th Street, Chicago 37

Be an INVESTIGATOR

JAMES S. BOLAN, FORMER POLICE COMMISSIONER OF NEW YORK CITY offers MEN & WOMEN an attractive opportunity to prepare for a future in *Investigation & Criminology* by comprehensive Home Study Course. Free placement service assists graduates to obtain jobs. APPROVED UNDER G. I. BILL OF RIGHTS.

Write for Free Booklet PM.

THE BOLAN ACADEMY, INC.
EMPIRE STATE BLDG., NEW YORK 1, N. Y.

STOP FOOT PAINS



OR NO COST!—Try Dr. Barron's GENUINE Foot Cushions for quick foot relief! They take painful pressure off callouses, corns, sore heels, aching arches—absorb foot shocks, help support weak arches. Light, ventilated, spongy. LIKE WALKING ON A PILLOW! Wear in any shoes. Dr. Barron says: "Relieves tired, aching feet from heel to toes." Send only \$1.98 for A PAIR, or C.O.D. plus postage. State shoe size and if man or woman. 30-DAY TRIAL GUARANTEE. Money back if no blessed relief!

ORTHO, Inc., 2700 BROADWAY, Dept. 49F, N.Y.C. 25

SAY YOU SAW IT IN POPULAR MECHANICS

SUCCEED IN THE POULTRY BUSINESS!



Poultry is providing many trained men and women with a good, comfortable living, either part or full time. For 28 years our Home Study Course has been helping thousands obtain training and "know how" that means extra income from the start. Don't delay—Write today for prospectus describing courses, methods, service, opportunities.

NATIONAL POULTRY INSTITUTE

DEPT. 50

ADAMS CENTER, N. Y.

STUDY AVIATION

BUILD YOUR FUTURE

IN THE *Fastest Growing* INDUSTRY...

SUCCESS IS *Speedier*, TOO...



Increase your earnings. Train for a successful career at this internationally-famous aeronautical school. Government Approved and industry recognized. You learn on "live" aircraft—the same type you will work on after graduation.

Complete, thorough courses in Engineering, Flight, Mechanics, Radio and Electronics, Meteorology, Airport Management and Operations, Instruments, Link Trainer and Parachutes.

Spartan's 21 years of experience is your assurance of getting the greatest amount of training in the shortest possible time.

Investigate the many opportunities and the training required.

SPARTAN
SCHOOL OF AERONAUTICS
TULSA, OKLAHOMA

MAIL COUPON TODAY

Spartan School of Aeronautics
Tulsa, Oklahoma Dept. PM-69
Please send me complete information on: Course _____

Name _____ Age _____

Street _____

City _____ State _____

YOUR CAREER IN AVIATION

SPARTAN

FREE Catalog and Aviation Career Studies.

Learn A Trade NOW! PRACTICAL SHOP TRAINING!

In Our Chicago Shops

- | | |
|---|--|
| <input type="checkbox"/> AUTO MECHANICS | <input type="checkbox"/> WELDING—ARC and GAS |
| <input type="checkbox"/> DIESEL MECHANICS | <input type="checkbox"/> MACHINIST |
| <input type="checkbox"/> REFRIGERATION | <input type="checkbox"/> PIANO TUNING |
| <input type="checkbox"/> BODY-FENDER | |

Above Approved For G. I.'s and Civilians
One of America's Leading Practical Schools
7 Floors of Fully Equipped Shops
Over 48,000 Successful Graduates
Expert Individual Instruction
Learn by Doing—Low Living Expense
Established 1902—Day and Evening Classes

Also the following Home Study Courses

- | | | |
|----------------------------------|--|---------------------------------|
| <input type="checkbox"/> PLASTIC | <input type="checkbox"/> REFRIGERATION | <input type="checkbox"/> DIESEL |
|----------------------------------|--|---------------------------------|

—CALL IN PERSON OR MAIL THIS AD TO—

GREER SHOP TRAINING

(Desk 10) 460 South State St., Chicago 5, Ill.

Please send without obligation free information regarding trade checked above. (Specify whether you are a Veteran or Civilian)

Name _____ Age _____

Address _____

City _____ State _____

9 BIG BUILDING BOOKS

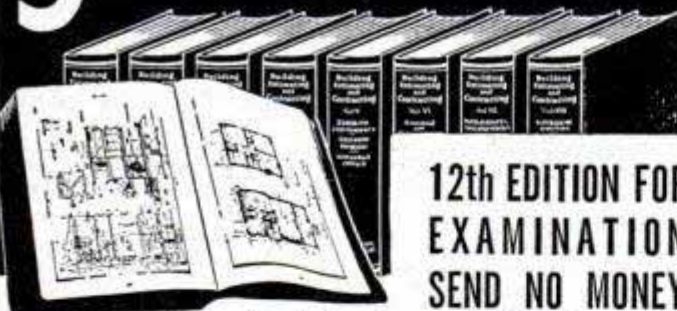

12th EDITION FOR
EXAMINATION
SEND NO MONEY

Learn to draw plans, estimate, be a live-wire builder, do remodeling, contracting. These 9 practical, profusely illustrated books cover subjects that will help you to get more work and make more money. Masonry, concrete forms, carpentry, steel square, roof framing, construction, plumbing, heating, painting, decorating and many other subjects. More than 4000 pages—2750 illustrations.

BETTER JOBS — BETTER PAY

A nationwide building boom is in full swing and trained men are needed. Big opportunities are always for MEN WHO KNOW HOW. These books supply quick, easily understood training and handy, permanent reference information that helps solve building problems.

UP-TO-DATE EDITION

These books are the most up-to-date and complete we have ever published on these many subjects.

Coupon Brings Nine Big Books for Examination

AMERICAN TECHNICAL SOCIETY—Publishers since 1898
Dept. GA19 Drexel at 58th Street Chicago 37, Ill.

You may ship me the Up-to-Date edition of your nine big books, "Building, Estimating and Contracting," without any obligation to buy. I will pay the delivery charges only, and if fully satisfied in ten days, I will send you \$2.00, and after that only \$3.00 a month, until the total price of only \$34.80 is paid. I am not obligated in any way unless I keep the books.

Name _____

Address _____

City _____ State _____

Please attach a letter stating your age, occupation, employer's name and address, and name and address of at least one business man as a reference. Men in service, also please give home address.

BE A SUPERVISOR



FRANKLIN TECHNICAL INSTITUTE
HELPS YOUNG PEOPLE GET AHEAD

Specialized technical training opens wide the door to well-paid supervisory jobs in industry. 50,000 young men and women have graduated from this Boston school and found good jobs in engineering and technical fields.

Practical two-year day courses in industrial electricity and electronics, industrial chemistry, mechanical and machine design, structural design and architectural drafting, automotive service and management, electric wiring and maintenance. One-year course in professional photography. Also preparatory and evening classes. Approved for veterans. 41st year. Write for catalog.

FRANKLIN TECHNICAL INSTITUTE
43 BERKELEY STREET, BOSTON 16, MASS.

RAISE REAL CHINCHILLAS

(not rabbits)

Matched breeding stock — Little space needed
PROFITABLE — GENTLE — HARDY

Write for free information . . . or
History and Handbook \$2.50

ALLIED DISTRIBUTORS, Dept. A, Gardena, Calif.

WATCH REPAIRING

Be a Master Watchmaker! Graduates earn big money — many in business for themselves. The famous Sweazey System of Instruction teaches you quickly and easily. Our 42nd year.

Write today for free information.

CHICAGO SCHOOL OF WATCHMAKING
Dept. 169, 1608 Milwaukee Ave. Chicago 47, Ill.

LEARN TO WRITE a Good Hand!

FOR BUSINESS AND SOCIAL SUCCESS!

Easy to improve your handwriting at home quickly with my new instruction books just off the press. Master all the secrets of better penmanship. Simple and easy, fully illustrated, highly endorsed. Begin today. Write for: New Free Book, "How to Become a Good Penman," or check books wanted, \$1.00 each. Business Writing Artistic Writing Card Writing Engraving Alphabets Bird and Design Flourishing Complete Set \$4.50 Enclose 10c for your name beautifully written and special penpoint for shaded writing. S. A. Ziller, President, TAMBLYN SCHOOL OF PENMANSHIP 441 Ridge Bldg. In Business Over 52 Years Kansas City, Mo., U.S.A.

CORRESPONDENCE COURSES IN RADIO and ELECTRICAL ENGINEERING

ELECTRICAL ENGINEERING. Get good grasp of wide electrical field. Modern. Very understandable. Theory made easy. RADIO ENGINEERING. Extra fine course in radio, public address, photo-electric work. Trains you to be super service man, real vacuum tube technician. Tuition ONLY \$25, either course. Deferred payment plan. Servicemen needed badly. FREE Electronic Kit given to students enrolling by June 1st. Write for free copies of school catalogs, student magazines, etc. LINCOLN ENGINEERING SCHOOL, Box 931-PM-6, Lincoln, Nebr.

Tuition
\$25

LEARN Photo-Engraving

You can get into this big demand, high profit, high wage field. Learn at home or in our modern, friendly, approved school in Aurora where training costs you less than \$1.00 per hour with everything furnished.

Famous Tasope' photo-engraving plants are again available. You can start your own full or part time photo-engraving business right in your own home. With the Tasope' plant there is profit and fun for the whole family. Be independent, be your own boss or pave the way to a high pay job with experience gained in your own shop. Write to-day for details. No obligation.

The Aurora School of Photo-Engraving
Dept. P9M, Tasope' Bldg. Aurora, Missouri

See how YOU may get started toward an Exciting Future in

TELEVISION! RADIO·ELECTRONICS!



OUR GREATEST OFFER IN 17 YEARS!

Here is your big opportunity to get started toward FASCINATING WORK... GOOD MONEY... a THRILLING FUTURE! Mail the coupon today. See how YOU may prepare to tie in your future with a field that includes one of America's fastest-growing new industries—Television. You'll find out, too, about the many other thrilling opportunities in FM Radio... Aviation and Broadcast Radio... 2-Way Taxi, Truck and Police Radio... Industrial Electronics... even the chance to start your own profitable Television-Radio Sales and Service business. And to top it all, you'll see that you don't need to know a thing about this subject at present—that NOW you can get the very training and starting help you need by means of our GREATEST OFFER IN 17 YEARS.

**YOU BUILD and KEEP
THIS EQUIPMENT TO
WORK OVER 300
HOME EXPERIMENTS**

MODERN CHICAGO LABORATORIES

Train quickly, using a wide variety of commercial equipment. D. T. I.'s new laboratories are among the finest of their kind. Ample instructors... every major training advantage. Write for details!

EMPLOYMENT SERVICE

When you complete your training, our effective Employment Service is available to you without extra cost—a grand aid to help you get started.

YOU ALSO USE HOME MOVIES a D.T.I. Exclusive!



D. T. I., alone, includes the use of one of today's most effective training aids... MOVIES... to help you learn important fundamentals faster, easier, at home. What an advantage to see electrons on the march, and other fascinating "hidden action"—a remarkable home training advantage that speeds your progress.

Send for FREE Information

See HOW—in your own home—DeForest's Training, Inc., now brings you one of today's most complete combinations of major home training aids. You (1) Learn-by-Reading from well-illustrated lessons. (2) You Learn-by-Seeing from D.T.I.'s exclusive instructive Home Movies. And (3), you set up your own HOME LABORATORY where you Learn-by-Doing from 16 shipments of Radio-Electronic parts which you use and KEEP to work over 300 instructive... fascinating projects. This includes building the valuable 6 tube "Superhet" RADIO and the commercial-type OSCILLOSCOPE, R-F SIGNAL GENERATOR, and Jewel-Bearing MULTIMETER, pictured at the right.

You may use this test equipment to help you earn real money—both in your spare time and later when working full time in the field. Get complete facts. Mail coupon today!

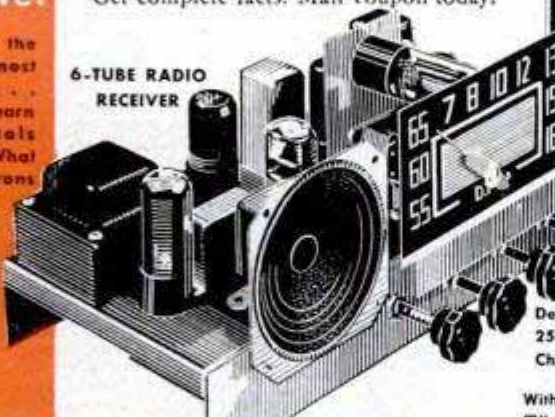
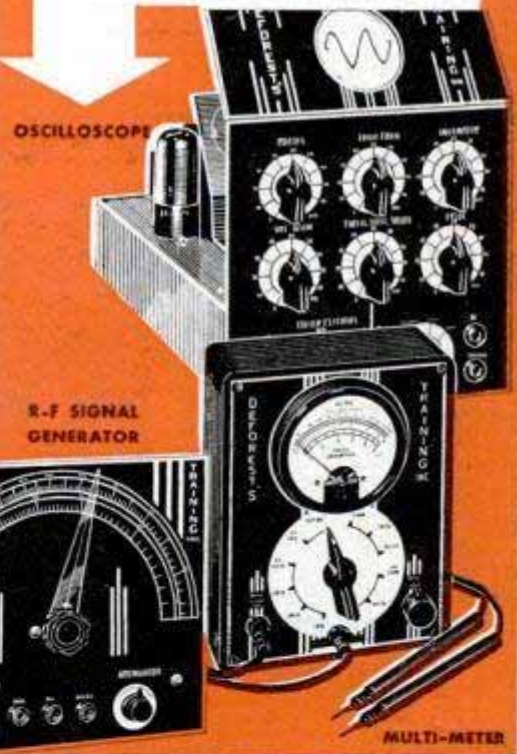

OPPORTUNITY COUPON!

DeForest's Training, Inc.
2533 N. Ashland Ave., Dept. PM-FG
Chicago 14, Illinois

MAIL TODAY

Without obligation, send me complete facts showing how I may make my start in Television-Radio-Electronics.

Name Age

Street Apt.

City Zone State

DeFOREST'S TRAINING, INC.

CHICAGO 14, ILLINOIS

Affiliated with the DeVry Corporation,
Builders of Electronic and Movie Equipment.

LEARN AVIATION

AN ESSENTIAL INDUSTRY IN PEACE OR WAR
MAXIMUM TRAINING IN MINIMUM TIME

for 19 years Cal-Aero Technical Institute has specialized in....

✓ AERONAUTICAL ENGINEERING

2 year course - kept abreast of new research and scientific development.

✓ MASTER AVIATION MECHANICS

1 year course - C. A. A. approved for Airplane and Engine License.

Modern "live" training equipment, including helicopters, jets, rockets, wind tunnel... Classes start monthly - Room and board available on our airport... Cal-Aero Tech Training is carefully designed for just one thing - **TO MAKE MORE MONEY FOR YOU.** More than 7000 successful graduates in addition to 26,000 pilots and 7500 mechanics trained for Army & Navy Air Forces, prove that our career training is unsurpassed. **APPROVED FOR VETERANS**



**GRAND CENTRAL AIR TERMINAL
 GLENDALE 1, CALIFORNIA
 LOS ANGELES COUNTY**

MAIL THIS COUPON TODAY!

Please send full information on Aviation Training FREE - without obligation.

Name _____ Birth Date _____

Street _____ Zone _____

City _____ State _____

CHECK ONE VETERAN NON-VETERAN PM-6

Helps you solve today's toughest CONSTRUCTION PROBLEMS



6 vols., 3763 pp., illus.
10 DAYS' FREE TRIAL

Here are the facts you need on every problem concerned with the design and construction of civil engineering structures. These books give you the most complete compilation of structural engineering data ever published—bring you genuinely professional information from records of actual practice. Written by 63 recognized engineering specialists, these six volumes are a complete reference on each aspect of structural engineering.

STRUCTURAL ENGINEERS' HANDBOOK LIBRARY

Covers the how and why of foundation and substructure design and construction, general theory of structural members and detailed design of such members—explains the principles of statics, reactions, moments and shears in beams and trusses, influence lines, methods of computing stresses in lateral trusses—gives details of design and construction of steel, timber and concrete structures, etc., etc.

See coupon for Special Price and Terms

McGraw-Hill Book Co., 330 W. 42 St., New York 18, N. Y.

Send me for ten days' free examination the Structural Engineers' Handbook Library. If satisfactory I will send you \$4.75 in 10 days and \$5.00 monthly until the price of \$29.75 is paid. If not wanted I will return books.

Name _____

Home Address _____

City _____ Zone _____ State _____

Company _____

Position _____ PM-6-49

SAY YOU SAW IT IN POPULAR MECHANICS

MAKE YOUR OWN!

WITH **Griffin READYCUT LEATHER PROJECTS**

Over 100 KITS in every kind of Tooling and Carving Leather, accurately cut, all parts included. Only Top Grade Leathers used. You do the choosing. You do the tooling, carving, stamping, the punching and assembling

SEND FOR COMPLETE CATALOG Please send 10c to cover mailing.

EVERYTHING FOR THE LEATHER WORKER
 Largest, most complete stock of Leathercraft Tools and Accessories in U.S.A.

HIDES AND SKINS of Craft Leathers of every kind if you prefer to cut your own.

SINCE 1924
OUT OF THE WEST, THE HOME OF LEATHER CARVING
Griffin Craft Supplies
 5515-A GROVE STREET
 OAKLAND 9, CALIFORNIA

OWN a Business

Clean and Mothproof rugs and upholstery "in the home." Patented equipment. No shop needed. Duraclean dealer's gross profits up to \$20 a day on EACH serviceman. These Nationally Advertised services create repeat customers. Easy to learn. Quickly established. Easy terms. Send today for FREE Booklet—Full details.

DURACLEAN CO., 16-6 Pl., Deerfield, Ill.

BE A NOTARY PUBLIC

Old legal-supply house, 22 cities, guarantees your appointment by governor if you qualify, equips you fully. Pay after appointment (2 payments \$12.50 each). Respected public office. You certify legal papers, use official seal made with your name, collect your fees. Easy. Inquire—

STATIONERS EXCHANGE BOERNE 36, TEXAS

WOULD \$400 PER MONTH INTEREST YOU?

IT is easily possible to earn \$400 to \$500 a month raising ANGORA RABBITS. No experience required. Wool brings \$9 lb. Plenty markets. WRITE TODAY for FREE INFORMATION, PRICES & WHERE to SELL.

WHITE'S RABBITRY
 NEWARK 10, OHIO

LAW FREE BOOK

Your FREE copy of "The Law-Trained Man" shows how to gain prestige and greater earnings through Blackstone home law study. All instruction material furnished including 18-volume Law Library written by 65 well-known law authorities. Lawyers, judges among our graduates. LL.B. degree. Low cost; easy terms. Write today.

BLACKSTONE COLLEGE OF LAW 225 N. Michigan Ave. Dept. 50-A, Chicago 1, Ill.
 A Correspondence Institution Founded in 1890

WOULD YOU SPEND 50c TO LEARN DAN LURIE MUSCLE BUILDING SECRETS

Dan Lurie, "America's Most Muscular Man" tells all in one complete easy-to-follow book — **75 HOW-TO-DO-IT PICTURES**—Plus 4—11"x22" illustrated wall charts only 50c postpaid. (No stamps please.) This is the same guaranteed method that champions throughout the world use. Dan Lurie says—"Either I show you (without the bunk and baloney) how to turn your flesh into power-packed, useful muscles or back goes your 50c." Can you afford NOT to start today? Send to Dan Lurie, Personal, Dept. 159-F, 1729 Rockaway Parkway, Brooklyn 12, N. Y.

DAN LURIE
 4 time winner

"America's most muscular man"

POPULAR MECHANICS

NOW ANY Auto Repair Job is a "Cinch" for YOU!

MoToR's AUTO REPAIR MANUAL is Showing Thousands of Men How To Handle ANY Job on ANY Car—Faster and Easier! Now Let It Go to Work For YOU!

Actual Size
A Big 8 1/2 x 11 Inches

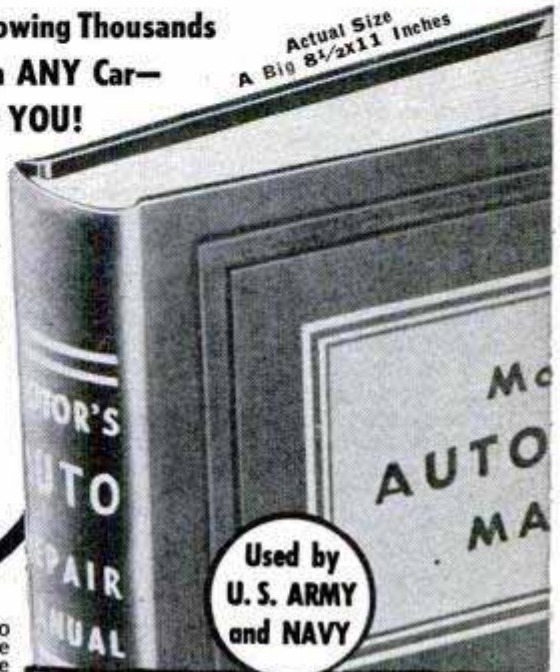

Free
7-DAY
OFFER



"A boy can easily follow its instructions."—Curtis Auberry, Murfreesboro, Tenn.

WITH MoToR's amazing AUTO REPAIR MANUAL you can whiz through ANY job—in LESS time, and with LESS work! Just look up make, model, and job—and go to it! With this easy-to-follow book, any job—from radiator to rear end—becomes a pushover for you!

"EVERYTHING You Need to Know about EVERY Make and Model Car Since 1935!"



"MoToR's Manual paid for itself on the first two jobs and saved me valuable time by eliminating 'guess work.'"—Wilson J. Schrop, Akron, Ohio.

Nothing like MoToR's AUTO REPAIR MANUAL has ever been published! It's just as if plain-talking engineers from every auto plant in America got together to show you everything you need to know about the cars they themselves had designed. It brings you the complete "dope" from over 150 Official Factory Shop Manuals, boiled down in simple easy-to-read and easy-to-understand language.

Here, right at your fingertips—are over 200,000 service, repair, adjustment, replacement, tune-up facts on all standard makes and models built from 1935 thru 1949! More than 1900 cut-away photos, diagrams, and drawings SHOW you exactly what the clear text TELLS you! Used by the U. S. Army and Navy and technical schools! No wonder thousands of auto repairmen call it their auto "Bible"!



"I have done jobs with this Manual that I would not attempt without it."—C. L. Vanerstrom, Hazel Park, Mich.

Why Thousands Rave About It
Thousands of men have already discovered what a

WORTH BIG MONEY TO:
Mechanics Repair Men
Handymen Service Station
Garagemen Operators
Farmers Taxi Owners

timesaver MoToR's Auto Repair Manual is. (At the left are just a few who have told us they just "wouldn't be without it.")

This is a BIG 800-page book, measuring 8 1/2 x 11 inches. Simple to use, too, because it opens flat for "working while you read." All you have to do is look up the quick index—and it leads you to the right page in a jiffy. Then you just follow the simple instructions, step by step. Everything is set forth so clearly you simply CAN'T go wrong!

SEND NO MONEY

Find out for yourself—without risking a cent—how this book pays for itself the first few times you use it. Mail the coupon, without money. Try it out—FREE—for 7 days. Then,

if not convinced it's the greatest time-saver and work-saver you ever saw, return the book and pay nothing. MoToR Book Dept., Desk 16, 250 W. 55 Street, New York 19, N. Y.

Covers Every Job on Every Car Built from 1935 thru 1949!

Over 200,000 service and repair facts on all these makes:

- | | | |
|-----------|----------------|------------|
| American | Ford | Nash |
| Bantam | Frazer | Oldsmobile |
| Auburn | Graham | Packard |
| Austin | Hudson | Pierce |
| Buick | Hupmobile | Arrow |
| Cadillac | Kaiser | Plymouth |
| Chevrolet | Lafayette | Pontiac |
| Chrysler | La Salle | Reo |
| Cord | Lincoln | Studebaker |
| Crosley | Lincoln Zephyr | Terraplane |
| De Soto | Mercury | Willys |
| Dodge | | |

MAIL COUPON NOW FOR 7-DAY FREE TRIAL

MoToR Book Dept., Desk 16, 250 W. 55 Street., New York 19, N. Y. Rush to me at once (check box opposite book you want):

- MoToR's AUTO REPAIR MANUAL. If O.K., I will remit \$1 in 7 days (plus 35c delivery charges), \$2 monthly for 2 months and a final payment of 95c one month after that. Otherwise I will return book postpaid in 7 days. (Foreign price, remit \$8 cash with order.)
- MoToR's TRUCK REPAIR MANUAL. (Described at left.) If O.K., I will remit \$2 in 7 days, and \$2 monthly for 3 months, plus 35c delivery charges with final payment. Otherwise I will return book postpaid in 7 days. (Foreign price, remit \$10 cash with order.)

Print Name _____ Age _____

Print Address _____

City _____ State _____

Check box and save 35c delivery charge by enclosing WITH coupon entire payment of \$5.95 for Auto Repair Manual (or \$8 for Truck Repair Manual). Same 7-day return-refund privilege applies.

Same FREE 7-DAY Offer Applies On MoToR's TRUCK REPAIR MANUAL

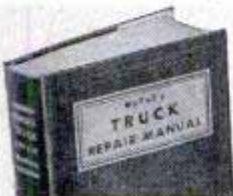

Covers EVERY job on EVERY truck from 1936 thru 1946! 1400 pictures, 952 pages, 300,000 facts. Warranted to contain every essential fact you need.

Covers all types Gasoline Engines; Diesels and Hesselmans. Fuel Systems, Governors, Lubrication Systems, Ignition Systems, Starters, Generators, Clutches, Transmissions, Axles, Torque Dividers, Transfer Cases, Brakes, Steering, etc. Offered on same FREE 7-day examination as, Auto Repair Manual. Check box in coupon.

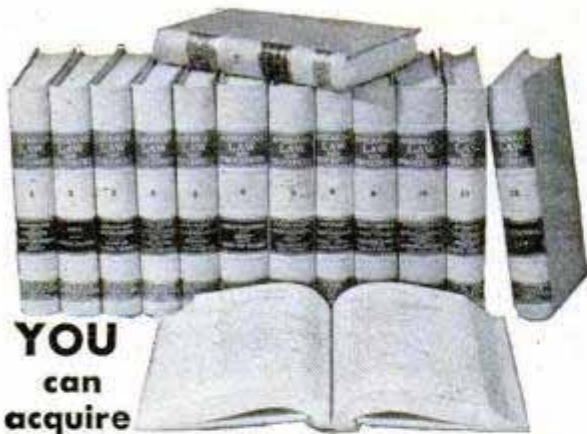

YOU
can
acquire

LAW NIGHTS AT HOME! L. B. DEGREE

LaSalle's famous Law Library—used as reference in many Law libraries and Law offices—has enabled thousands to master Law surprisingly fast, in spare hours at home, for business and professional advancement.

These 14 remarkable volumes, compiled by leading professors and lawyers, cover the whole basic field of Law in condensed, orderly, simplified manner.

You advance rapidly with this great library, plus special lectures furnished. We guide you step-by-step with personalized Problem Method of instruction . . . you *learn by doing*—handling legal problems—not by memorizing rules.

Send for two FREE 48-page booklets, "Law Training for Leadership," and "Evidence," answering questions about Law and its value to you, and telling how LaSalle Law graduates are winning rapid advancement in business and public life. Mail coupon below. No obligation.

LA SALLE EXTENSION UNIVERSITY

A Correspondence Institution

417 S. Dearborn St. Dept. 664-L Chicago 5, ILL.

Send me your two FREE booklets described above, without obligation.

Name..... Age.....

Street.....

City, Zone & State.....

ENGINEERING DEGREE IN 27 MONTHS

Big Demand for Graduates

Aeronautical, Chemical, Civil, Electrical, Mechanical and Radio Engineering (including Television)

Hundreds of young men are earning engineering degrees in this recognized institution each year—continuous operation. New terms start quarterly. Many students earn a major part of their college expenses in this large industrial center.

Low tuition. Competent instruction. Thorough intense practical program. Modern laboratory facilities including new physics lab. and modernized wind tunnel. Individualized instruction emphasized.

Approved for Veterans. Engineering preparatory courses. Students from 48 states and 21 foreign countries. Enter June, September, December or March. Send coupon for free catalog and full information. Enroll now.

INDIANA TECHNICAL COLLEGE

569 E. Washington Boulevard
Fort Wayne 2, Indiana

Please send me free information on B.S. Engineering Degree in 27 months as checked.

Aeronautical, Chemical, Civil, Electrical,
 Mechanical, Radio-Television.

Name.....

Address.....

Tells How You Can Learn to

FREE BOOK MOUNT BIRDS!

Learn At Home

Men, Boys, Hunters, Fishermen, mount and save your lovely wild-game trophies. Be a Taxidermist, Mount Birds, Animals, Heads, Fish, Tan skins. YOU learn easily, quickly in spare time. Have a grand home-museum. The finest and the greatest hobby known, for sportsmen. Fun, real profits.

FREE BOOK Yes, FREE. Beautiful strange, valuable Book, telling all about Taxidermy. Contains over 100 beautiful game-pictures. And it's yours FREE, if you rush your request. You can mount

all kinds of wild-game, and common specimens too. We can positively TEACH YOU. So GRASP this opportunity. RUSH letter or postal for this amazing FREE BOOK. Don't delay. State your AGE. N. W. SCHOOL OF TAXIDERMY, 2506 Elwood Bldg., Omaha 2, Neb.

THERE'S MONEY IN CARTOONS!

RAYE BURNS will teach you HOW to CREATE ORIGINAL CARTOONS at home that you may SELL! Course contains 26 lessons and over 600 illustrations. All for Only... **\$2.85**

Send name and address for free details.

RAYE BURNS SCHOOL, Dept. M, Box 3583, Cleveland, Ohio

LEARN MEAT CUTTING At Home — In Spare Time

Get into the vital meat industry. Concise, practical Home Training based on 25 years proven instruction methods used at National's famous resident school. Prepares you for bigger pay as Meat Cutter, Supervisor, market manager or more money in your own store. Go as rapidly as your spare time permits. Diploma. Start NOW to turn your spare hours into money. Send for FREE bulletin today. No obligation.

NATIONAL SCHOOL OF MEAT CUTTING, INC., Div. U-106, Toledo 4, Ohio

APTITUDE TESTS

discover the kind of work or studies best for your success! You get a personal report—a guide for life—more happiness—more prosperity. For men, women, boys and girls. Write for complete facts.

VOCATIONAL COUNSELING INSTITUTE
956 Maccabees Bldg., Detroit 2, Michigan

TRAINED MEN GET THE BETTER JOBS

PRACTICAL SHOP TRAINING

in AUTOMOTIVE MECHANICS
BODY and FENDER REBUILDING

If interested write for catalog or wire

ATLANTA MOTIVE TRADES INSTITUTE

Dept. P, 254 IVY St., N.E., Atlanta, Georgia

Member of the Southern Association of Private Trade Schools

Veterans ask about G I Training

WANTED JEWELRY

We buy old or broken jewelry. Highest cash prices paid immediately. Mail us gold teeth, watches, rings, diamonds, silverware, eyeglasses, old gold, silver, platinum, etc. Satisfaction guaranteed or your merchandise returned. Write for free information. ROSE SMELTING CO., 29-AA East Madison St., Chicago 2, Ill.

AVIATION

Aeronautical University Approved Training meets exacting standards of aviation industry, prepares for key positions, big opportunities.

Courses in:

AERONAUTICAL ENGINEERING, B.S. degree.
AERONAUTICAL ENGINEERING DRAFTING
CERTIFIED AIRPLANE AND ENGINE MECHANICS
ADMINISTRATION—including sales.

PRE-ENGINEERING: Special course for high school graduates and veterans needing math and science.

Also refresher courses for Gov't Airplane and Engine Mechanics Licenses for those with aviation experience.

Oldest fully approved aviation school. Outstanding faculty, modern equipment, outside employment, placement service. Day, evening. Approved for Veterans. Send for FREE catalog Opportunities in Aviation. 20th anniversary.

AERONAUTICAL UNIVERSITY

Dept. 79, 116 S. Michigan Ave., Chicago 3, Ill.

FOUNDED
BY
CURTISS-
WRIGHT

BUILDERS

TRADE GUIDES



4 Vols. \$6

AUDELS CARPENTERS AND BUILDERS GUIDES—4 VOLS. \$6

\$1 PER MO.

Inside Information for Carpenters, Builders, Joiners, Building Mechanics—all Woodworkers. 1600 pages; 3700 diagrams; flexible; pocket size. Short-cut instructions, new methods, ideas, solutions, plans, systems—money saving suggestions. An easy progressive course for the apprentice. A practical daily helper and Quick Reference for the master worker. A Helping Hand to Easier and Better Work and Better Pay. To get this aid for yourself, simply fill in and mail the FREE COUPON below.

INSIDE TRADE INFORMATION ON:

How to use steel square; How to file and set saws; How to build furniture; How to use mitre box; How to use chalk line; How to use rules; How to make joints; Carpenters' arithmetic; Mensuration problems; Estimating strength of timbers; How to set girders and sills; How to frame houses and roofs; How to estimate costs; How to build houses, barns, garages, bungalows, etc.; How to read and draw plans; Drawing up specifications; How to excavate; How to use settings 12, 13 and 17 on the steel square; How to build hoists and scaffolds—skylights; How to build stairs; How to put on interior trim; How to hang doors; How to lath—lay floors; How to paint.

"Audels Guides worth four times their price—handy too as I carry them in pocket for reference." W. J. Bates, Knoxville, Pa.



4 Vols. \$6

AUDELS PLUMBERS AND STEAMFITTERS GUIDES—4 VOLS. \$6

\$1 PER MO.

A new edition—just out! A practical, illustrated, Reference Library and Study-Course for Master Plumbers, Journeymen and Apprentice Steamfitters, Gas Fitters and Helpers, Sheet Metal Workers, Draughtsmen, Master Builders, Engineers and all Building Trade Students. 1670 pages; 3642 diagrams; flexible; pocket size. Guides explain all the principles, advances and short cuts of the Plumbing and Heating trade. Contains instructions on how to figure and estimate jobs. Use FREE COUPON below to examine, without obligation, this valuable work.

INSIDE TRADE INFORMATION ON:

Air Conditioning. Soldering, tinning. Joint wiping, bending, beating. Pipe—iron—steel, threading. Mathematics, tables, physics. Materials—iron, steel, copper, brass, lead, tin, antimony. Sheet metal—galvanized—plate. Sanitation, syphonage, tanks. Drainage, sewage, purification. Fixtures—bath—kitchen. Pipe fittings, soil pipe, tools. Laying out work. Roughing. Screwed fittings, flanges, joints. Pipe bending, examples. Elbows. Heating, ventilation, refrigeration. Water supply, mains, wells, tanks. Gas-fittings. Underwriters. Sheet metal work, problems, methods, Brazing, heating, lead burning. Welding, various welds, methods. Blacksmithing, forges, tools.

"Audels Guides are practical, easy to understand, reliable. Cover the field in plain language." W. F. Arminger, Annapolis, Md.

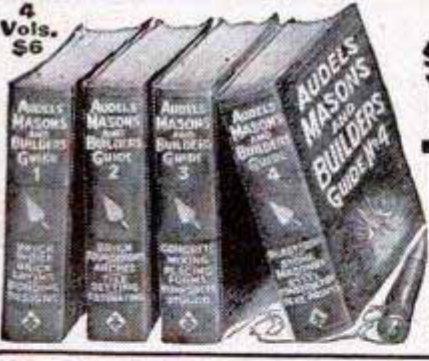

4 Vols. \$6

AUDELS MASONS AND BUILDERS GUIDES—4 VOLS. \$6

\$1 PER MO.

A complete, illustrated trade reference library, for Bricklayers, Cement Workers, Plasterers, Tile Setters and Stone Masons, including a practical outline of Steel Construction. 1100 pages; 2067 diagrams; flexible; pocket size. A practical Trade Assistant explaining modern methods of masonry construction. Easy to understand and apply. A reliable and authentic reference work and study-course for Master Journeyman and Young Mechanic. Use FREE COUPON below and find out for yourself, without obligation, whether this set will benefit you.

INSIDE TRADE INFORMATION ON:

Bricklaying, tools, materials; Brick designs, patterns, bonds; Setting frames and foundations; Mortars, scaffolds, estimating; Mortars and mortar mixing; Tile setting, mosaic, hollow tile; Straight edge test, troweling; How to figure brick work; Safe loads, piers, chimneys; Boiler settings, anchors, fire stops; Labor tables; Concrete, forms; How to figure concrete work; Stucco—on old and new buildings; Plastering—wood lath—metal; Plasterers agreement; Plastering on various surfaces; Stone masonry; Cutting, finishing, estimating stone; Derricks, rigging; Steel construction; Fire proof; How to read blue prints.

"Audels Masons Guides are the best books on the subject. Have laid brick 12 years and am able to judge." H. A. Sonnett, Corliss, Pa.



PRACTICAL ELECTRICITY—1 VOL. \$4

\$1 PER MO.

Audels Handy Book of Practical Electricity is a simplified Ready Reference and Study Course in one pocket size volume—for Engineers, Professional Electricians and Students. 1040 pages; 2600 diagrams; flexible bound. A reliable authority and handy helper for every electrical worker. Contains important and valuable wiring diagrams, calculations, machine sketches, helps on maintenance and repair. Use this FREE COUPON today and find out, without obligation, how this handy book will help you in your daily work.

Complete in one handy, red leather bound volume



INSIDE TRADE INFORMATION ON:

Electro-Therapeutics, X-Rays, Shocks, Welding, Brazing, Radio Hook-ups, Motion Pictures, Telephone, Telegraph, Cranes, Bells, Elevators, Pumps, Tools, Ship Drive, Railways, Vehicles, Automobile Electric Systems, Ignition, Generation, Lighting, Plant Management, Power Plans, Armature Winding, Repairing, A. C. Motors and Apparatus, D. C. Motors and Apparatus, Alternator Construction, Dynamos, Wiring, Diagrams, Sign Flashers, Cable Splicing, Power Wiring, Outside Wiring, Switches, Lighting, Rectifiers, Converters, Transformers, Fuses, Circuit Breakers, Rheostats, Electro Plating, Electrolysis, Storage Batteries, Magnetism, Electrical Energy, Conductors, Insulators, Static, Dynamic, Radio Electricity, Applications, Ready Reference and Index Covering the entire field of Modern Electricity.

Learn More and You Will Earn More!

Know your job and you'll never be without one. The skilled man is always in demand. Knowledge is power. Learn your trade thoroughly by easy reading. This coupon is your opportunity for advancement and better pay. You risk nothing in sending for Audels Guides for free examination. Send it NOW!

FREE EXAMINATION COUPON

THEO. AUDEL & CO.
49 W. 23 ST., NEW YORK CITY

Please mail me for free examination the books marked (x) below. If I find them satisfactory, I agree to mail \$1 in 7 days, on each set ordered, and to further mail \$1 monthly on each set until I have paid the purchase price.

4 CARPENTERS GUIDES \$6 4 PLUMBERS GUIDES \$6

4 MASONS GUIDES \$6 1 ELECTRICIANS HANDY BOOK \$4

NAME.....

ADDRESS.....

OCCUPATION.....

EMPLOYED BY.....

"TOOK IN \$217 FIRST 10 DAYS"

Some Make More,
Some Less... We Help
You to Start Your
Own All-Year
Business, Make
Big Money!



With our easily operated, highly efficient wall washer, Chas. Stelle took in \$217 gross in first ten days. E. L. Goss took in more than \$10,000 in one year. E. C. Taber wrote, "I made \$400 gross in two weeks." And no wonder — this machine washes walls 6 times faster and better than by hand.

Your Money-Making Opportunity

We want more men to go into this profitable business for themselves and enjoy independence. There are customers everywhere—homes, offices, schools, churches, hotels, stores, etc. What you take in is mostly profit, for material costs are low. And there's no need to rent a shop or office. Operate your business from your home.

Lose no time. Get all facts without obligation. **WRITE FOR FREE INFORMATION.** Ask for Wall Washer Details at once.

VON SCHRADER MFG. CO., CA91, RACINE, WIS.

Say You Saw It in Popular Mechanics



HIGH PAY • SECURITY When You LEARN A TRADE

Get ready for a well-paid, lifetime job or a business of your own in one of these **FIVE ESSENTIAL TRADES**. Complete training under expert instructors with practical experience prepares you to step into a good paying job with a future and security.

ELECTRICITY: Basic electricity, Residential and Industrial Wiring and Appliance Repair.

PLUMBING: Every phase — pipe cutting and threading to complete installations, blue print reading.

AUTOMOTIVE & TRACTOR: Engine overhaul, Transmissions, Carburetion, Generator-Ignition Systems, Tune Up.

DRAFTING: College level training in general Machine and Architectural Drafting

SHOE REPAIRING: Complete practical training includes reconditioning and rebuilding.

Approved For Veteran's Training

NATIONAL TRADE SCHOOL 2610 Grand • Kansas City 8, Mo.

Without obligation to me please send full information on the course checked.

.....Automotive and Tractor Technician .. Drafting
.....PlumbingElectricityShoe Repairing

Name.....Age.....

Address.....

City.....State.....

Veteran?.....

STEP OUT FOR EASIER WINDOW WORK WITH

WINDOSTEP



Makes all outside window work easy & enjoyable!

**SAVES TIME • SAVES MONEY
SAVES LADDER-LIFTING!**

HELPS YOU Wash windows . . .
Hang screens, storm windows & awnings . . . Paint, putty & repair.
IT'S STRONG . . . Supports 1000 lbs.
IT'S STURDY . . . Has steel rail & wood platform.

IT'S PORTABLE . . . Easy to carry
Weights 11 lbs.

**IT'S AUTOMATICALLY
GRAVITY LOCKED** to window
sill from inside. (It's installed
from inside.)

IT'S GUARANTEED

Or Your Money Back!
Low priced, only **\$9.85**
Plus C.O.D. & P.P. or \$10.50
Prepaid. Add 50c west of
Rockies. Dealer Inquiries
Invited. Patent Pending

MORRISON CRAFTERS INC.

709 Miami St., Toledo 5, Ohio

ORDER TODAY!

For Better Housekeeping, Your Home needs a WINDOSTEP!

LEARN WATCH REPAIRING



AT HOME. By our modern and original system of instruction you can learn every part of the **WATCH REPAIRING TRADE AT HOME.** Prepare yourself for a well-paying position or start in business after completing our course of instruction. Good watch repairers are in demand and generally earn very good salaries. For particulars apply to the **Wisconsin School of Watch Repairing** 759 North Milwaukee St., Milwaukee 2, Wis.



DIESEL TRAINING

Get set **NOW** for steady, big-pay jobs in Diesel, Tractor and Heavy Equipment. Interstate's practical home training gives you the "know-how" for success and security. Investigate!

SEND POST CARD FOR FREE INFORMATION

INTERSTATE TRAINING SERVICE

Dept. 3F 4035 N.E. SANDY BLVD., PORTLAND 13, OREGON



RAISE HAMSTERS

The new wonder animals from Syria. Often called Toy Bears. Delightful pets. Everyone wants them. Laboratories need thousands. Clean, odorless. Raise anywhere. A profitable and interesting hobby or business. We furnish breeding stock with manual of instructions.

Write today for free illustrated literature.
GULFHAMSTERY, 1536 BASIL, MOBILE, ALA.



**YOU
can
draw!**

AMAZING NEW HOLLYWOOD PLAN

Yes, YOU can draw **GIRLS, CARS, FRIENDS** and even **MAGAZINE COVERS**. It's so simple, no matter what your age. Many artists make more than \$150.00 per week in advertising and cartoons. Be your own boss, draw for money anywhere. Our Commercial Artists will teach you the secrets from **HOLLYWOOD**. Drawing materials furnished. Be a success. Write **NOW** for free details

HOLLYWOOD SCHOOL OF ART

6533 Hollywood Blvd. Hollywood 28, Calif. Age.....

Name.....

Address.....

City..... Zone State.....

The Success Story of Bill Smith... OR YOU!



Mails coupon to National Schools in Los Angeles, and receives Free Lesson and book of information about Radio, Television and Electronics training.



Enrolls... studies in spare time. Finds personal attention from instructors, interesting material and practical equipment, all increase his interest.



Builds actual units as part of Course. Earns money doing spare time repair and installation work.



Completes Course and receives Diploma... is now a qualified Radio, Television and Electronics Technician.



Applies for—and GETS—a good pay, full time job in industry. Finds that employers know National Schools and like to hire their graduates.



Or he opens own profitable Service Shop, with valuable counsel and aid from National Schools. Now for real happiness and success!



You Build This Superheterodyne Receiver With Parts We Send

You receive complete standard equipment, including latest type High-Mu Tubes, for building various experimental and test units. You progress step by step until you build a complete Superheterodyne Receiver. It is yours to use and keep.

Professional Multitester Included!

This portable instrument (see right) enables you to perform many practical tests, make delicate adjustments and do service work. Complete with test leads.



You receive a series of special laboratory experiment lessons to guide your practical exercises with your equipment. These lessons have been prepared with a special technique of illustrating radio principles by numerous easy-to-understand examples.

Both Resident and Home Study Courses Offered

Send Coupon Today for These Two Valuable Free Books

GET INTO RADIO, TELEVISION and ELECTRONICS by NATIONAL SCHOOLS SHOP METHOD HOME TRAINING

THIS PRACTICAL, TECHNICAL RESIDENT TRADE SCHOOL TRAINS YOU AT HOME FOR BIG RADIO OPPORTUNITIES!

Never in history has such rapid progress been made as in the great Radio, Television and Electronics Industry today! This exciting, fast-moving development means new and greater opportunities for the trained, skilled man—for you—in Television and Radio Broadcasting, Installing, Servicing; in Frequency Modulation; in Applied Electronics in many industries; in a business of your own!

National Home Training is Practical

Your National Schools Course fully covers basic, advanced and specialized instruction in all phases, including basic radio principles, receivers, am-

plifier systems, transmitters, television, aviation radio, electronics. You get complete instruction material, including shop manual, tube manual, job sheets, radio dictionary, special laboratory experiment lessons, experimental equipment. You receive complete, modern television lesson texts.

Your Home Study is supervised by our staff of highly trained instructors who daily teach our resident students here. Let the Free Books shown below tell you more about National Home Training. Use coupon today!

APPROVED FOR VETERANS

NATIONAL SCHOOLS

LOS ANGELES 37, CALIF. • EST. 1905



FIND OUT NOW...MAIL COUPON TODAY

National Schools, Dept. 6-PM (Mail in envelope 4000 South Figueroa Street or paste on Los Angeles 37, California postcard)

Mail me FREE the book, "Your Future in Radio," and a sample lesson of your course.

NAME..... AGE.....

ADDRESS.....

CITY..... ZONE..... STATE.....

Check here if veteran of World War II

Complete blueprints of this RICHardson refreshment stand available for construction.



Go in Business

WITH THIS REAL MONEY MAKER

Open your own roadside stand! It's a profitable enterprise requiring little investment. And your investment is protected by the exclusive RICHardson Root Beer franchise. Many veterans and other progressive business men are making hundreds of dollars a week with the RICHardson refreshment stand... and they are having fun, too.

SEND FOR FREE BOOKLET



Free booklet shows layout drawings and gives full details on basic stand and plans for later expansion into a larger stand. Write for your copy today.

RICHardson Corporation
Dept. P-6, Rochester 3, N. Y.

Learn this Profitable Profession

IN 90 DAYS AT HOME

Money-Making Career Open to Men and Women, 18 to 50

Hundreds of men and women between 18 and 50 make \$10 to \$20 in a single day giving scientific Swedish Massage and Hydro-Therapy treatments. There is big demand from doctors, hospitals, sanatoriums and clubs. Graduates earn large full time incomes from these or in private practice in their own offices. Others make good money from home treatments given in spare time. Learn this interesting, money-making profession in your own home, through our home study course. Same instructors as in our nationally known resident school. You can win independence and prepare for future security by qualifying for your Diploma. Course can be completed in 3 to 4 months. Many earn while they learn. Begin your training at once.



Anatomy Charts & Booklet FREE

Enroll now and we will include, at no extra cost, many needed supplies. Fit yourself to help meet growing demand for Scientific Swedish Massage. Send the coupon at once for complete details. Anatomy Charts and 32-Page Illustrated Booklet, FREE, postpaid.

THE COLLEGE OF SWEDISH MASSAGE
Dept. 964G, 41 E. Pearson, Chicago 11, Illinois

Please send me FREE and postpaid, Anatomy Charts, 32-page Booklet and complete details on Home Training.

Name _____ Age _____

Address _____

City _____ State _____

Say You Saw It in Popular Mechanics

Famous BAILEY TECHNICAL SCHOOLS

OFFER THE FOLLOWING COURSES:

PRACTICAL DIESEL ENGINEERING
COMMERCIAL ELECTRICITY

Your future success depends largely on the reputation of the school you attend. Don't take chances! Train at America's foremost school of mechanical specialization. Bailey is recognized and approved by industry. Bailey graduates get the top pay jobs! G. I. Approved. Send for FREE Catalog. State name of course in which you are interested.

BAILEY TECHNICAL SCHOOLS

1656 So. Grand Blvd., St. Louis, Mo.



IF I Send YOU THIS FINE SUIT—

Will You Wear It and Show It to Friends? I need a reliable man in your town to get a fine, made-to-measure, all-wool suit without paying cash, but by taking a few orders from friends. Wear it—show it—to help you take more orders with my line of nearly 100 guaranteed quality fabrics. You can make up to \$12 in a day without experience or investment. I supply everything required FREE. Write for FREE outfit. John Grant, STONE-FIELD Corp., 5325. Throop St., Dept. T-816, Chicago 7, Ill.

ELECTRICAL TRAINING

Intensive 32 weeks' residence course in fundamentals of industrial electrical engineering, including radio, electronics. Prepares for technician, engineering aides. Approved for veteran training. 56th year. Enter September 6, January 9. Catalog.

BLISS ELECTRICAL SCHOOL

7834 TAKOMA AVENUE
WASHINGTON 12, D. C.

HYDROPONICS

Grow out-of-season vegetables, rare flowers or house plants by hydroponics—WITHOUT SOIL— Start a fascinating hobby or a profitable business in your own home. No experience needed for top results. Only small space gets big returns. Easy, clean, pleasant way to grow any plant indoors or out every day in the year. Fast growth, increased yields, unlimited profit opportunities. Send today for FREE 16 page picture book showing how others from every state are succeeding in this wide open field. Send postcard for complete facts. CHAPMAN-GILBERT, 824 W. IVY, SAN DIEGO, CALIF.

LEARN PLASTICS AT HOME

GET 7 BIG KITS WITH COURSE—MAKE USEFUL ATTRACTIVE ARTICLES.

Write for free catalog. Approved for Vets—Non-Vets.
PLASTICS INDUSTRIES TECHNICAL INSTITUTE
1601 South Western Avenue, Dept. PM-69, Los Angeles 6, California

MORE PERSONAL ATTENTION

WHEN YOU LEARN

WATCHMAKING JEWELRY REPAIR ENGRAVING

...THE THACKER WAY!

Students learn FAST when Instructors offer personal attention. Our Master Course prepares you for all



branches of the Jewelry Trade. High percentage of graduates placed. Housing available. (Schools in Warren, O., and Pittsburgh, Pa.) G.I. Approved. Catalog FREE.

A. W. THACKER ACADEMY FOR JEWELERS

Dept. P • 423 Federal St. • Pittsburgh 12, Penna.

Build This 5-Room Concrete Block House Yourself - Complete for less than \$3650

Popular Mechanics Home of the Year

Has All These Features

- ★ Five Finished Rooms plus Bath and Three Closets
- ★ Concrete Block Walls—Poured Concrete Floors—Vapor-Sealed
- ★ Walls Stuccoed Outside—Fully Plastered Inside
- ★ Complete Heating and Plumbing Equipment and Electric Wiring
- ★ Modern Cabinet Kitchen
- ★ Insulated Ceiling

Build-It-Yourself Book and Set of Building Plans, Only \$12.50

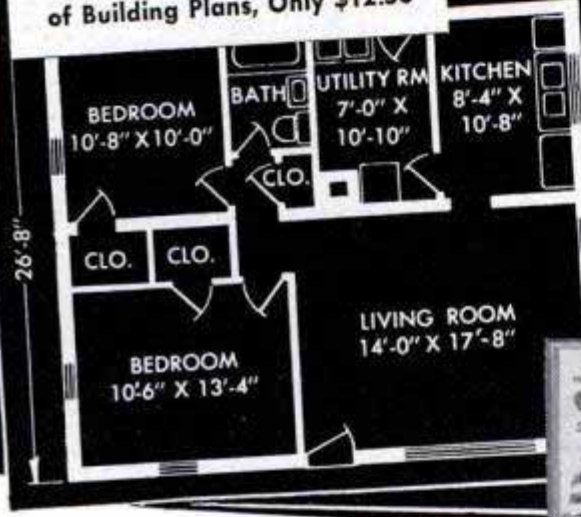

Beat the High Cost of Home Owning! No Experience Needed! Follow Book and Plans! Save Thousands of Dollars!

If you can mix a batch of concrete following simple instructions, and saw a board straight you can build this new Popular Mechanics concrete block house yourself. Yes Sir! In a few months of spare time you can laugh at the housing shortage and save several thousand dollars while acquiring a home you will be proud to own.

Like Popular Mechanics' famous Build-It-Yourself frame house introduced in 1947, a new BUILD-IT-YOURSELF BOOK for this five room Concrete Block House is now ready, along with a full size set of building blueprint plans. The book covers every construction detail and the plans are so simplified, so easy to follow, that you need have no experience to do a fine workman-like job. On the other hand, if you want to hire a contractor or an ordinary builder, have him follow these plans and still enjoy a tremendous saving. Read further about this fine permanent type house. See how easy you can build it and own it yourself. Order book and plans on coupon below.



Start Planning Now!

It's Easier Than You Think to Own Your Home

IDEAL FOR FAMILY OF FOUR

Popular Mechanics Build-It-Yourself Concrete Block House is 26'-8" deep by 32'-8" wide. It has 675 square feet of comfortable living space — living room, two bed rooms, cabinet kitchen, utility room, bath and three closets. Built in a Chicago suburb, a relatively high price region, in a high price year, its total cost was less than \$3650.00 including all material, heating, plumbing and electrical equipment and outside labor for installing the equipment and plastering all rooms. In many localities it can be built for even less and additional savings can be made by using less expensive bath and kitchen equipment.

LONG LIFE MATERIALS — EASY UPKEEP

Construction is concrete throughout — poured concrete floors and concrete block walls — both vapor sealed for insulation — construction that requires no special skill. Walls are furred-out and plastered inside, stuccoed outside. Ceiling is insulated. Only a very minimum of carpentry is required —

simple shingled hip roof, door frames and trim, which almost anyone can do. Interior doors are new flush type. Hot air heating plant may be gas, oil or coal-fired. Hot air ducts terminate in ceiling, cold air ducts are tile laid under the floor.

EASY TO BUILD — EASY TO OWN

Every part of the construction is simplified and thoroughly explained in the BUILD-IT-YOURSELF Book, from the turning of the first shovel full of earth to the last flick of the paint brush. It is written in plain, understandable terms and packed with pictures and diagrams that make every construction detail simple as ABC. The book also tells how to make your own concrete blocks, how to select and buy a lot and how to build a house of bricks. Book and set of ten working blueprint plans are all you need to get started and enjoy the thrills of home owning, doing the job yourself and saving money too. Book, \$2.00. Set of plans, \$12.00. See coupon for special money-saving offer when both are ordered together.

USE THIS COUPON TO GET BUILD-IT-YOURSELF BOOK AND PLANS

Popular Mechanics Press, Dept. 600
200 East Ontario Street, Chicago 11

Send postpaid, the items checked. Remittance for

- \$ _____ enclosed.
- Build-It-Yourself Concrete Block House Book \$ 2.00
 - Set of 10 Builders Blueprint Plans 12.00
 - Book and Plans ordered together (Save \$1.50) 12.50
 - Extra sets of plans—each 5.00

Name _____

Address _____

City _____ Zone _____ State _____

Learn JEWELRY MAKING WATCHMAKING ENGRAVING

TRADES WITH
GREATER SECURITY—
HIGHER EARNINGS



Earn MORE All of Your Life

Increasing Demand for Trained Men and Women. No Age Limit. Learn Thoroughly—Quickly by KCSW's Special Application Method. Day and Evening Classes. Write for free Catalog. Approved for Veteran Training.

KANSAS CITY SCHOOL OF WATCHMAKING

1218 Admiral Blvd. Kansas City 6, Mo.

Here's How CREI Prepares You for a Professional Career with Industry-Recognized Training in a Minimum of Time

RADIO - ELECTRONICS TELEVISION ENGINEERING

GRADUATES of CREI residence school are preferred by industry because of their training and ability. This recognition is the reason that CREI men quickly find good jobs. With 22 years of practical teaching experience in these highly technical fields, CREI offers an outstanding faculty, modern and complete laboratories, shops and equipment. New students are accepted twice monthly and each may advance as rapidly as he is capable. The basic course with one specialized course requires an average of 20 months to complete.

CREI is recognized as one of the country's leading technical institutes. Its work is of college level. It prepares the young man for a good job in industry in a minimum of time.

Approved for Veterans' Training

CAPITOL RADIO ENGINEERING INSTITUTE

An Accredited Technical Institute Founded in 1927

Mail coupon for Free Catalog

Capitol Radio Engineering Institute, Dept. 176A
16th & Park Road, N.W., Washington 10, D. C.
Please send me your illustrated catalog and complete details.

Name _____ Age _____

Street _____

City _____ Zone _____ State _____

I am entitled to training under G.I. Bill.

10,000 HELPS TO BE YOUR OWN BOSS, IN THIS BIG BOOK!



PRACTICAL IDEAS— GIVE QUICK RESULTS

Never before such a book of helps for you who wish your own business. In this book are formulas, recipes, secrets that have amazed the world. Use these ideas and make many needed money-making products.

Experts wrote this book in simple terms, with supply sources for materials, shortcuts and methods for profitable results.

START NOW—Become Independent

Lots of profitable businesses have started with a single recipe. Choose from the 162,000 facts and 10,000 formulas such as:

— Adhesives, Cosmetics, Beverages, Candy, Ceramics, Cheese, Cleaners, Concrete, Dentifrices, Dyes, Depilatories, Enamels, Gum, Home formulas, Inks, Insecticides, Lacquers, Linoleums, Lubricants, Metals, Mirrors, Oils, Ointments, Paints, Perfumes, Polishes, Remedies for Man, Beast, & Fowl, Soaps, Solders, Varnishes, etc. 1000's of others to make all sorts of profitable items.

BE READY, IF YOUR JOB FOLDS

This big book tells what to do and how. No experience needed. You work from the money-making facts and ideas that are explained in words easily understood. Many fortunes have been made with a single formula. Mail in your order and get started right NOW!

POSTPAID
\$3.98
ANYWHERE IN
THE WORLD

\$3.98 postpaid throughout the world. (C.O.D. plus postage in U. S. only.) Shipped at once.

ADAMS BROWN COMPANY, Dept. P69, Boston 67, Mass., U.S.A.



BARGAIN BAR BELLS! 895 UP

BUILD your chest, arms, neck, shoulders, thighs as Nature intended! Have a magnificent new body in Less Than 3 Months.—Only 5 Minutes a Day! 4 Million Men, Coast to Coast, 8 to 80, are doing this—YOU CAN, TOO! Get details about Paramount Bar Bells and System—finest on the market—at Factory-Price Savings up to 30%. Send NOW for your "Power-Thru-Paramount" Self-Check Health Chart. Just say—"Send Chart." It's FREE! Write TODAY!!

INDEPENDENT IRON WORKS, Dept. B
2416 E. 23rd St. Los Angeles 11, Calif.

SHORTHAND in 6 Weeks at Home

Famous Speedwriting system. No signs; no symbols; no machines; uses ABC's. Easy to learn; easy to write and transcribe. Fast preparation for a job. Surprisingly low cost. 100,000 taught by mail. Used in leading offices and Civil Service. Write for free booklet to: SPEEDWRITING, Dept. 1506-9, 55 W. 42 St., N. Y. 18

Can You Sell?

SALESMEN had average earnings of \$6,000 last year. Can you sell? New test, proved 80% accurate, rates your chances of success at 4 kinds of profitable selling careers. Send \$1; fill out and return test; receive confidential, scientific rating of your sales ability.

THE GLENDON CO.

4333 N. TRIPP AVE. CHICAGO 41, ILL.



NEW

IMPROVED...AMERICANIZED

JUDO

TWO BIG BOOKS FULLY ILLUSTRATED
1220 SHOW-NOW PHOTOS. 71 LESSONS
MANY NEW HOLDS

Protect yourself and others. Size and strength mean nothing. Knowledge and skill enable you to master any situation even against biggest bullies or armed thugs. Written and illustrated by one of the world's great Judo experts. Volume 1, basic and advanced holds, Volume 2, very advanced. . . each volume \$1.50.

Big Combination Offer!
SAVE...

BOTH BOOKS \$2.50 POSTPAID
OR C.O.D. PLUS POSTAGE
5-day Money Back Offer. ACT NOW!

DEPT. M-6
IMPROVED JUDO, INC. P. O. Box 7355, Sta. I, Los Angeles, Calif.

GET INTO DIESEL-AUTO MECHANICS

Master All Phases

JOB LIKE THESE ARE AVAILABLE TO TRAINED MECHANICS. CHOOSE THE FIELD YOU LIKE BEST

Get Complete Training

Diesel Fuel Injection
Automotive Motor Tune-up
Diesel Engine Rebuilding
General Garage Mechanic
Agricultural Implements
Auto Engine Rebuilding
Auto Elec. Service
Public Utilities
Parts Dealers
Bus & Truck Lines
Industrial Maintenance
Contracting & Excavating
Business of Your Own
AND MANY other similar openings.

As a National Schools graduate, you are trained for ALL opportunities in the Diesel & Auto Industries

EARN WHILE YOU LEARN

With our practical Master Shop-Method Home Training, you study at home in your spare time. You receive Spare Time Work Lessons, which show you how to earn while you Learn . . . for extra money and experience. You Learn by DOING.

TOOLS AND EQUIPMENT

To make your training complete, we give you selected mechanic's tools and equipment, illustrated below, including all-metal toolbox — as a regular part of your instruction.

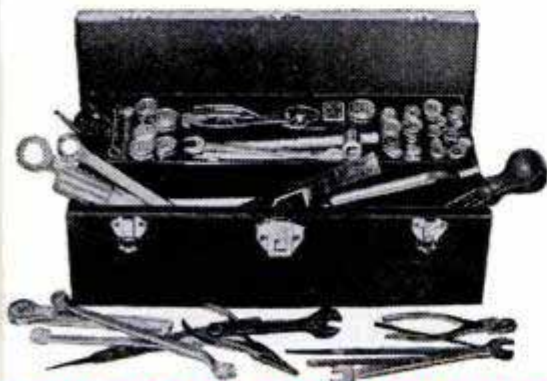

WE GIVE YOU TOOLS OF YOUR TRADE



Shop-Method Home Training by an Established Resident School Prepares you for Many Good Jobs

Opportunity is everywhere for the trained Diesel-Auto Mechanic. Highways throng with cars, busses, trucks, tractors. Garages and Service Stations are kept busy. Factories, ships, farms, railroads, general industry, are dependent upon engine power. Here's a dynamic, fast-growing field that needs trained men who know ALL phases: installation, operation, maintenance and repair. Now—National Schools offers you a practical, all-embracing Diesel-Auto Mechanic's Course, including all of these advantages:

Complete training, covering—Diesels, High Speed and Heavy Duty; Semi-Diesels, Gasoline and Special Fuel Engines AND Allied Mechanics.

- Basic Lesson Texts
- Diesel Installation
- Operation - Maintenance
- Diesel Chart Manual
- Spare Time Lessons
- Engine Service Manuals
- Engine Repair
- Drive Systems
- Diesel Electric Power
- Thermodynamics

TOOLS AND EQUIPMENT

INVESTIGATE
Secure Full Information

NEW, ILLUSTRATED BOOK & SAMPLE LESSON SHOW HOW WE TRAIN YOU . . . SEND FOR THEM TODAY!

**NO COST
NO OBLIGATION**



APPROVED FOR VETERANS

Check coupon below

NATIONAL SCHOOLS

LOS ANGELES 37, CALIF. • EST. 1905



FIND OUT NOW...MAIL COUPON TODAY

NATIONAL SCHOOLS, DEPT. 6-PMD
4000 South Figueroa Street
Los Angeles 37, California

(Mail in envelope or paste on penny postcard)

Mail me FREE the book, YOUR FUTURE IN DIESEL-AUTO MECHANICS, together with the Sample Lesson. I understand I may keep and use the information with no obligation.

Name _____ Age _____

Address _____

City _____ Zone _____ State _____

Check here if Veteran of World War II

INVENTORS

When you are satisfied that you have invented a matter of value—write me, without obligation, for full information as to what steps you should take to secure a Patent.

The usual first step is to have a search of the prior U. S. Patents conducted, so that I can report to you on the question of Patentability.

PATRICK D. BEAVERS

(Formerly RANDOLPH & BEAVERS)

Registered Patent Attorney

934 Columbian Building Washington 1, D. C.

PATRICK D. BEAVERS, Registered Patent Atty.
934 Columbian Bldg., Washington 1, D. C.

Please send me full information on how to secure Patent Protection and Trademark Registration.

Name _____

Street _____

City _____ State _____



PATENTS

AND TRADE MARKS

C. A. SNOW & CO.

REGISTERED PATENT ATTORNEYS

WRITE FOR INFORMATION TO

428 SNOW BUILDING, WASHINGTON 1, D. C.



FREE BOOK

TELLS HOW TO BE AN . . .

Accountant

Salesman

Secretary

Stenographer

SECURED FUTURE . . . FREE EMPLOYMENT SERVICE

Enter one of the "substantial earnings" fields through Hill's "Success Plan" training. A lifetime opportunity to join thousands of successful graduates in positions secured through our nation-wide employment service. No matter where you live, what you are doing now, Hill's can train you by study at home or in the resident school. Big Free book shows you the way to substantial earnings and an assured future. G. I. Approved.

Hill's Extension School & Business University
Dept. PM-69, 619 W. Main St., Oklahoma City 2, OKLA.
Please send your free book, "Through Hill's to Success."

NAME _____
ADDRESS _____
CITY _____ STATE _____

Check here if eligible under G.I. Bill.

Please check course and training plan preferred.

Course _____ Resident Home Study

MAIL THIS

EASY-TO-USE COUPON TODAY

TRADE MARKS •
COPYRIGHTS •

PATENTS

The Time to Contact
a Patent Attorney is Promptly
After You Have Finished Your Invention

Write for FREE "INVENTOR'S GUIDE" & "Record of Invention"

FRANK LEDERMANN Registered Patent Attorney

154 Nassau St. • 20th Floor • New York 7, N. Y.

INVENTORS

Whether an invention is patentable can be substantially determined by a search of the U. S. Patent records. Without obligation, write for information explaining the steps you should take to secure a patent.

JOHN N. RANDOLPH

Registered Patent Attorney

201 Columbian Building, Washington 1, D. C.

INVENTORS

HIGHEST

ROYALTIES and CASH

FOR YOUR INVENTIONS

Write for FREE booklet without obligation

UNIVERSAL MARKETING CO.

354 South Spring St. (Suite M)

Los Angeles 13, Calif.

PATENTS PATENT LAWYER

TRADE MARKS

GUSTAVE MILLER

69-PM WARNER BLDG.

WASHINGTON 4, D. C.

ASSOCIATE EXAMINER

U. S. PATENT OFFICE 1922-1929

REGISTERED PATENT ATTORNEY

Send for Form
"INVENTOR'S RECORD"

PATENTS "Proof of Invention"

Folder mailed without obligation.

E. E. VROOMAN, Registered Patent Atty.

505 McKim Building, Washington 5, D. C.

INVENTING

—FOR PROFIT! If you have an inventive turn of mind, write for free 28-page booklet explaining how the Institute of American Inventors is helping inventors pre-test the profit possibilities of proposed devices to fill today's unprecedented demand for useful new inventions.

INSTITUTE OF AMERICAN INVENTORS

Dept. 4, 1926 Eye St., NW, Washington 6, D. C.

BE A DETECTIVE

WORK HOME or TRAVEL. Experience unnecessary.
DETECTIVE Particulars FREE. Write to
GEO. P. M. WAGNER, 125 W. 86th St., N. Y.

INVENTORS

IF YOU WISH TO PROTECT YOUR INVENTION,
You should take steps to protect it by a U. S. Patent.
Write me for "Record of Invention" form.

CARL MILLER
REGISTERED PATENT ATTORNEY

Woolworth Bldg., 35th Floor, Dept. 69-A, New York City
Please send me "Record of Invention" form.

NAME _____

ADDRESS _____

IT'S EVEN EASIER THAN IT LOOKS



to learn to play your favorite instrument in your own home without a private teacher

Look at the diagram at the right. The first note on the music is "D."

Following the dotted line to the keyboard, "D" is the white key between the two black keys near the middle of the keyboard. From that you can find the other notes. As you strike them on the piano you'll be playing the melody of the famous "Merry Widow" Waltz. Easy, isn't it?

SIMPLE AS A-B-C

the famous "Merry Widow" Waltz



AND IT COSTS ONLY A FEW CENTS A DAY!



LEARNED QUICKLY AT HOME

"I didn't dream I could actually learn music without a teacher. People hardly believe I learned to play so well so quickly."

*H. C. S. California

*Actual pupil's name on request. Picture by professional model.

YOU'LL get a big surprise when you start your U. S. School of Music lessons. You'll see how easy it is to learn to play this simple Print and Picture way. It's even easier than it looks!

Here is the secret! You learn to play by playing. No long-winded explanations. No boring exercises. You play real tunes by note with the first lesson. Simple melodies at first, but you gradually go on to more advanced pieces. And sooner than you ever expected you should be playing popular numbers by note.

If you really want to learn music quickly and easily, send today for our FREE 36-page Booklet and Print and Picture Sample. They'll tell you the whole story. Instruments supplied when needed, cash or credit. U. S. School of Music, 76 Brunswick Bldg., N. Y. 10, N. Y. (51st Successful Year.)

FREE PRINT AND PICTURE SAMPLE

U. S. School of Music, 76 Brunswick Bldg., New York 10, N. Y.

Please send me free booklet and Print and Picture Sample. I would like to play instrument checked below.

Piano	Saxophone	Modern Elementary
Guitar	Trumpet, Cornet	Harmony
Violin	Reed Organ	Clarinet
Piano Accordion	Tenor Banjo	Other Instrument

Name _____ (PLEASE PRINT)

Street _____

City _____ State _____

Note: If you are under 16 yrs. of age, parent must sign coupon.

— SAVE 2c — Stick coupon on penny postcard.



Learn ENGINEERING DRAFTING... BUILDING in Chicago, Industrial Hub

Approved for G.I. Training

Time-Saving Courses

Day & Evening Classes

Get your training at Chicago Tech in the Nation's industrial center. Chicago provides unequalled opportunities for part-time employment while training and for permanent positions upon graduation. Many other cultural and recreational advantages described in Catalog—sent Free!

Chicago Tech, founded 45 years ago, has trained thousands of men now occupying important places in industry the world over. Training combines theory and practice in 1 year, 2 year, and 3 year (Degree) courses. Saving in time means earlier graduation — and consequently earlier employment.

Terms start January, April, July and October. Get information now to arrange for early admission and accommodations.

CHICAGO TECHNICAL COLLEGE
G-83 Tech Bldg.
2000 So. Michigan Ave.
Chicago 16, Ill.

1 YEAR • 2 YEAR
3 YEAR COURSES

BUILDING
DRAFTING
ENGINEERING
AIR CONDITIONING
REFRIGERATION
ELECTRICITY
RADIO



MAIL COUPON TODAY

CHICAGO TECHNICAL COLLEGE
G-83 Tech Bldg., 2000 So. Michigan Ave.
Chicago 16, Ill.

Please send me without obligation free booklet on Time-Saving Technical Training.

Name _____ Age _____

Address _____

City _____ Zone _____ State _____

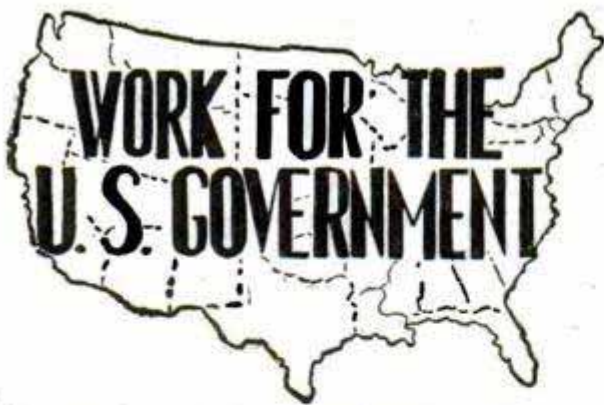

**Start As High As
\$3,351 YEAR**

MEN - WOMEN

Postoffice Clerks-Carriers
Railway Postal Clerks
Stenographers
Accountants
Statistical Clerks
Typists
Liquor Inspectors
Many Other Jobs.

Veterans Get Preference

MAIL COUPON TODAY SURE

Name _____

Address _____ Vet? _____

FRANKLIN INSTITUTE
(Not Government Controlled)

Dept. R86

Rochester 4, N. Y.

Gentlemen: Rush to me, FREE of charge, list of U. S. Government big pay jobs. Send FREE 40-page book describing salaries, vacations, hours, work, etc. Tell me how to qualify for one of these jobs.

ELECTRICIANS' SCHOOL

HOUSE AND COMMERCIAL WIRING • MOTOR REPAIR AND REWINDING • ELECTRIC REFRIGERATION

Approved for Veterans Training

PENNSYLVANIA INSTITUTE SCHOOL OF ELECTRICITY

42nd and SPRUCE STS.

PHILADELPHIA 4, PENNA.

Learn PHOTOGRAPHY

Win success in photography by spare time Home Study or at our famous Resident School in the heart of New York. Commercial, Advertising, Portrait, Color, etc. 39th year. Write today!

NEW YORK INSTITUTE OF PHOTOGRAPHY

Dept. "49", 10 W. 33 St., New York 1, N. Y.

High School at Home

Many Finish in 2 Years

No classes. No time wasted going to and from school. Progress as fast as your time and abilities permit. Standard H. S. texts supplied. Thousands enroll each year in this 52-year-old school. Send for FREE descriptive booklet.

AMERICAN SCHOOL, Dept. HA45
Drexel at 58th St., Chicago 37, Ill.

Without obligation, please send FREE descriptive booklet.

Name _____

Address _____

K-R-O KILLS RATS

• K-R-O BIS-KITS are ready-made, easy to use; containing *fortified red squill*, they're safer around livestock, pets, and poultry. K-R-O POWDER is 100% *fortified red squill*; economical to use in badly infested areas when mixed with natural baits. BIS-KITS, 35c and \$1.00; POWDER, 75c at drug, seed, and feed stores. Money-back guarantee. *The K-R-O Company, Springfield, Ohio.*

LEARN MEAT CUTTING



through actual practice. Profitable Meat Cutting and Successful Meat Merchandising taught easily, quickly. LEARN BY DOING at Toledo in just six short weeks under actual market conditions. For beginners or men with experience. All subjects taught thoroughly and completely. Diploma. Job help. Get store of own. People must eat. School in operation over 25 years. Approved for GI training. Send today for FREE illustrated catalog. No obligation.

NATIONAL SCHOOL OF MEAT CUTTING, Dept. 50N, Toledo 4, Ohio

WHY DON'T YOU WRITE?

Writing short stories, articles on business, homemaking, travel, sports, gardening, shop crafts, local and club activities, etc., will enable you to earn extra money. In your own home, on your own time, the New York Copy Desk Method teaches you how to write the way newspaper men learn—by writing. Our unique "Writing Aptitude Test" tells whether you possess the fundamental qualities essential to successful writing. You'll enjoy this test. Write for it, without cost or obligation.

Veterans: This course approved for Veterans' Training.
NEWSPAPER INSTITUTE OF AMERICA

SUITE 5599-H, ONE PARK AVENUE

NEW YORK 16, N. Y.

LEARN MONEY-MAKING CARTOONING

IN SPARE TIME — by Easy Picture Chart Method

Same Simplified Method that has helped train creators of "Terry & Pirates," "Freckles," "Our Own Way," "Winnie Winkle," "Raglar Fellers," "Strange As It Seems," "The Neighbors," and many others. Earn while learning. Send 10c for Picture Chart (to test your ability), and full details. (State age.)

THE LONDON SCHOOL, 4906 Cleve. Transit Bldg., Cleveland, O.



EASY TO LEARN CODE

Learn or increase speed with an Instructograph—the Radio-Telegraph Code Teacher that takes the place of an operator-instructor and enables anyone to master code without further assistance. Available tapes from beginners alphabet to typical messages on all subjects. Speed range 5 to 40 WPM. Always ready—no QRM. Thousands have "acquired the code" with the Instructograph System. Write today for convenient rental and purchase plans.

INSTRUCTOGRAPH COMPANY

4701-V Sheridan Road, Chicago 40, Illinois



SAY YOU SAW IT IN POPULAR MECHANICS

Learn NEON

AMERICA'S TOP-PAY TRADE!

BE A NEON EXPERT! Earn \$16 to \$24 a day or start local business. Learn how to make, repair and service NEON SIGNS. Easy, illustrated lessons (15) show how. ONLY COURSE OF ITS KIND! Send \$1 or order C.O.D. Positive Money-back guarantee.

MODERN PUBLISHING CO.

Dept. 769, 333 Molino Ave., Long Beach 14, Calif.



Start Your Career in 6 to 36 Months With Our Unique Step by Step Training

Each course unit at the Milwaukee School of Engineering is complete in itself. All courses begin with practical training in the school's complete laboratories — and prepare you for specific occupational objectives or advanced training. More than 1,500 students now enrolled from 48 states and 18 overseas countries. Faculty of 85 specialists, 35,000 former students in industry all over the world.

MILWAUKEE SCHOOL OF ENGINEERING



A Technical Institute
Founded in 1903
by Oscar Werwath

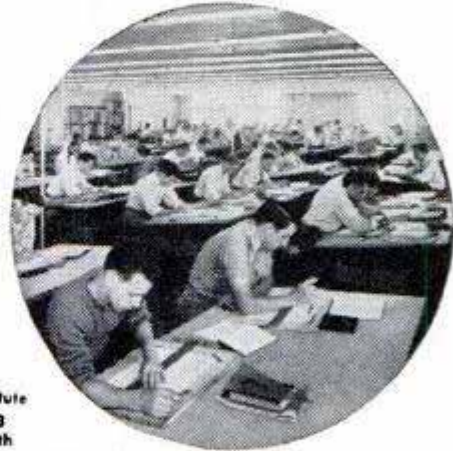

Courses Available at Vocational, Technical and Professional Level SERVICE	TECHNICIAN	PROFESSIONAL
6 to 12 Months	1 to 2 Years	3 Years
<ul style="list-style-type: none"> Electricity Welding Refrigeration Heating 	<ul style="list-style-type: none"> Electrotechnics (Power) Radio and Television Electronics Refrigeration, Heating and Air Conditioning 	<ul style="list-style-type: none"> Electrical Engineering Bachelor of Science Degree Major in Electronics or Power

MILWAUKEE SCHOOL OF ENGINEERING
Dept. PM-649, N. Broadway and E. State, Milwaukee, Wis.

Without obligation send me free booklet "Career Building" and more details on course in.....

Name..... Age.....

Address.....

City..... State.....

Terms Start July, September, January, April . . . SEND COUPON TODAY

SAVE UP TO 50% AND MORE OUT OF PAWN GENUINE DIAMONDS \$10 to \$10,000

Send today for **FREE CATALOG**

Iron-clad money back guarantee
All Diamonds Reset in new Mountings

BERMAN'S
Illustrated Catalog

Diamonds from estates, banks, unredeemed pledges offered at substantial savings
Sold with iron clad money-back guarantee

BERMAN DIAMOND CO.
America's Great Diamond Values
DEPT. P—BERMAN BLDG., BALTO. 1, MD.

TYPICAL BERMAN VALUE: Approx. 1/2 Ct. \$95 incl. tax \$200 Value

100 GAMES ON HORSEBACK

Games from MEXICO • ARABIA • INDIA • • Cowboy Sports
Learn to play — scoring — Fields and Courses
Exhibitions — Over 100 Games and Contests described

ANIMAL LOVERS BOOK STORE • Box KA 111, TARZANA, CALIF.

ONLY \$1.50

Plastic Coasters and Tiles

EMBED REAL FLOWERS in NEW Magic PLASTIC

Now create many lovely and unusual things like the distinctive pansy coaster shown—made by embedding real pansies in Castolite—the "magic" liquid casting plastic. Comes crystal clear, or may be dyed to produce gorgeous color effects. Make really different jewelry, book ends, picture frames, candle sticks, figurines. Embed butterflies, coins, medals, photos, for novel plaques, paper weights, tiles, other art objects. Use only home utensils. Follow simple step by step method. New pleasure, fine profits are possible. Send 25c for exciting new Home Project Manual showing how to get started. Write today! The Castolite Company, Dept. G-1, Woodstock, Ill.

MANUAL 25c

ONLY 2 SHINES A YEAR AND SHE GLEAMS LIKE NEW!

LACQUERWAX
MODERN PROTECTION FOR MODERN CARS
Shine in the Sun! Stay Glossy! Stay Cool! Stay Clean!

BEFORE YOU BEGIN READ INSTRUCTIONS ON BACK OF CAN

Yes, sir — give your car the glow that rests your elbow! Use LACQUERWAX — the peerless auto finish protector. It's 5 times faster and easier to apply than ordinary paste waxes — and one treatment lasts 4 to 6 months!

LACQUERWAX contains no lacquer, but this hard, liquid wax is CLIMATE-PROOF! Its brilliant luster shines right through hot sun and driving rain. You can't wash it off... it won't spot! It brings out and preserves the full beauty of your car's finish. Only \$1.00 for a pint can. Mail coupon NOW!

LACQUERWAX CO.
HARTFORD 3, CONN.

Gentlemen: My check, cash or money order for \$..... is enclosed, covering cost of..... can(s) of LACQUERWAX. Please send my order to:

Name.....

Address.....

City..... Zone..... State.....

LACQUERWAX
LACQUERWAX CO. HARTFORD 3, CONN.

SAY YOU SAW IT IN POPULAR MECHANICS

3-Step Plan to Get into Building!

Don't let the other fellows grab off the best opportunities in building. Instead use our three-step method to cash in. With our direct, practical plan you can do one of three things, or do all three of them: (1) Build your own home at a savings of thousands of dollars; (2) Go into business as a Building Contractor; (3) Get a well paid job with an established building firm.

STEP ONE—Get Big FREE Book

First of all get FREE 22-page book that gives you latest building facts and shows the splendid opportunities now open to you. Book also tells what others, including many beginners, are doing by using our proved methods. Book explains how, through the famous C. T. I. Home-Building Course, you learn about modern home construction methods from A to Z—methods and principles others took years to learn. Act now to get your FREE copy without delay.



STEP TWO—

Build Your Own Home

Along with the C. T. I. Course, we ALSO SEND complete plans and Specifications for a modern six-room house. Two stories, double-garage, full size basement. Plans and "Specs" alone worth far more than low cost of complete course. We show you how to build this house or any other house. Or how to remodel any existing structure. Often C. T. I. Students start making money in just a few weeks doing remodeling jobs.



Get Plans for This House

Complete Plans and Specifications for this fine six-room house come with the very first lesson of your C. T. I. Home-Building Course. You learn how to build this house or other fine houses. Easy plain-as-day lessons show you exactly what to do—everything from ordering correct materials to supervising every detail of construction. No need to lose time. Get the facts by sending for interesting free book. Mail coupon today. Or if you prefer, get information on any of the other fine C. T. I. courses listed in the coupon.

STEP THREE—

Get Job - Go into Business

We quickly show you how to put your C. T. I. training to work. Today with liberal financial help through F.H.A. and the V.A. it is often possible to build for less than paying rent. We show you how to be your own contractor; how to finance and buy materials; how to let sub-contracts; how to do cost estimating; how to supervise construction from basement to roof. No experience needed. Hundreds of charts and diagrams make things clear. Big FREE book explains fully. RUSH request for your copy TODAY.

FREE BOOK COUPON

Commercial Trades Institute C. T. I. Courses
Dept. D2-6, 1400 Greenleaf Avenue G.I. approved
Chicago 26, Ill.

Send complete facts about the course checked below.

- | | |
|---|--|
| <input type="checkbox"/> Home Building | <input type="checkbox"/> Electricity |
| <input type="checkbox"/> Diesel Mechanics | <input type="checkbox"/> Radio and Television |
| <input type="checkbox"/> Auto Mechanics | <input type="checkbox"/> Refrig. and Air Cond. |
| <input type="checkbox"/> Body and Fender Rebuilding | <input type="checkbox"/> Drafting |

Name _____

Address _____

City _____ State _____

Vet. Non-Vet.

SAY YOU SAW IT IN POPULAR MECHANICS

WHAM-O SPORTSMAN® \$1.00 Postpaid
Powerful—New—Accurate
Kills Rabbits, Squirrels, Etc.
Routs Pests



Rivals Archery!
Fast Becoming a Major Sport.
Handy • Silent • Inexpensive. Easy to use.
Complete with 40 pellets and extra rubber straps,
WHAM-O MFG. CO., Box G 92, South Pasadena, Calif.
*Professional model used by members Nat'l Slingshot Assoc.

Learn to Service and Repair ELECTRICAL APPLIANCES

Open your own electrical appliance service shop. Complete illustrated course covering washing machines, vacuum cleaners, elec. ranges, motors, house wiring and REFRIGERATION. Appliance tools included. Send today for FREE BOOKLET without obligation.

PACIFIC TRAINING SCHOOL

7217 So. Broadway, Dept. P-96, Los Angeles 3, Calif.



Regardless of how you Now write, you can become an Expert Penman at home in spare moments by my Simplified Method, as hundreds of others have done, who never before thought they could learn. Good penmanship pays big dividends and helps you win success. Write for Full Details and my FREE BOOK, "How to Become an Expert Penman," which contains specimens of penmanship and shows what others have accomplished by taking my Courses at home in spare moments. If you wish, enclose 10c for Special Penpoint and your name with a flourished bird written on a card. Write TODAY.

D. J. Davis Box 25K, CHILLICOTHE, Mo.

NEW AUTO WASHER



Your car sparkling clean—in a jiffy—magic "sponge" cleaning-cloth. Simply glide over car. PRESTO! Dust, grease, dirt, and grime disappear in a jiffy. Leaves finish clear, lustrous. Autos gleam like a mirror. **SAMPLES for AGENTS** Sample offer sent immediately to all who send name at once. Penny postal will do. Send no money—JUST YOUR NAME. KRISTEE CO., 679 BarSt., Akron, Ohio



"THE KEY TO METAL BUMPING"

Complete course in famous Fairmount method of body and fender repair. Step by step procedure from damage analysis to metal finishing. Over 100 illustrations. Send \$1.00 to

MANZEL, INC., 315 Babcock St., Buffalo 10, N. Y.

make MONEY CASTING AT HOME



Make your own rubber molds quickly, cheaply with X.L. RUBBER. Cast thousands of perfect figurines, book ends, plaques, ornaments, ash trays, etc. GREAT PROFITS! Write for NEW Catalog. X.L. Rubber, Pts. \$2.00; Qts. \$3.50; Gallons \$8.95; Models and enough rubber for 3 molds \$1.30 postpaid.

PLASTIC ARTS STUDIO Route 2 • Dept. 2 • Muncie Ind.

Become a Doctor of PSYCHOLOGY

Win the degree of Ps.D. Teach the secret of contentment, happiness. Solve mental worries. Experience the revelation of truth. Chartered college. Individual help. Write for FREE book. COLLEGE OF UNIVERSAL TRUTH, 5153-B North Clark St., Chicago.

MAKE MONEY IN LANDSCAPING

Thorough training by Internationally known Landscape Architect to start your own business, improve your home or advance in this well paid field. Many Opportunities. Approved for Veterans. Send for FREE BOOK.



NATIONAL LANDSCAPE INSTITUTE Dept. P-6, 310 So. Robertson Los Angeles 36, Calif.

STUDY AT HOME

With An Educational Institution

Men with specialized training win higher positions, insure larger earnings, and are bigger successes in business and public life. Opportunities NOW greater than ever before. Send for our Catalog.

ARTS and SCIENCES

Courses in Philosophy; Education; Letters; Public Health; Medical Jurisprudence; Psychology; Sociology; Physics; Chemistry; Plastics; Geology; Political Science; Theology; Business and Commerce; Accounting; Mathematics; Statistics; Agriculture.

ENGINEERING

Courses in Electrical, Civil Mechanical, Drafting, Architectural, Steam, Aeronautical, Radio, Structural, Mining, Industrial, Petroleum, Marine, Chemical, Diesel, Automobile, Refrigeration, and Air Conditioning Engineering.

LAW

Complete Professional Law Course includes 18 Hornbook Series college grade textbooks. Courses also in Commercial Law, Patent Law and Medical Jurisprudence.

McKinley-Roosevelt Incorporated, 4610-K, Sheridan Rd., Chicago 40, Ill.



LEARN AERONAUTICAL ENGINEERING

Aircraft and Engine Mechanics (A & E)

Train at the Flying Wing school—New classes starting soon. Write for illustrated catalog.

Northrop Aeronautical Institute

APPROVED FOR VETERANS DIVISION OF NORTHROP AIRCRAFT, INC.
1527 E. Broadway, Hawthorne, Los Angeles County, California



LEARN MOVIE PROJECTION THEATRE MANAGEMENT

The Motion Picture Theatre Business offers big opportunities for trained men. Get into a fascinating field with a promising future. Train at home in spare time. Free Catalog. Established 20 years.

THEATRE SCHOOL, 370 Washington St., Elmira, New York

ELECTRICAL CONTACTS

TUNGSTEN-SILVER-PLATINUM Assorted sizes for repair jobs on motors, switches, appliances, controls, etc. With this assortment of points on hand you save time; give quick service, prevent tie-ups of equipment. 15 varieties, 20 of each. All in transparent plastic "See-Thru" boxes. Each box nests securely in a sturdy metal hinged-cover dust-proof KIT only 7"x7"x3/4". Highest quality contacts backed by 20 years of specialized manufacturing experience. Let us tell you how KIT users are cutting most repair bills in half and making more money. Write at once for full details.

In Handy KIT

RICH ENGINEERING CO., 1729 N. Cicero Ave., Dept. 16, Chicago 39, Ill.

Learn CARTOONING

HAVE FUN! MAKE MONEY! Cash in on your sense of humor at HOME—BY MAIL. No experience needed to start. Write today for FREE TRIAL LESSON and full particulars.

Moe N Gag Cartoon School, Dept. C, Fall Creek, Wis.



SHOE REPAIR OFFERS BIG INCOME

LEARN IN 12 WEEKS TIME



You can own your own shop or earn big income as skilled shoe repairman. Growing demand everywhere at top wages for men who know how. We teach you quickly by actually working on shoes and modern machines. School open to all from 18 to 60 years of age. FREE BIG 20 PAGE BOOK explains everything. Send for your copy today.

MODERN SHOE REBUILDING SCHOOL
Approved for Vets Established 1927 Dept. PM
2937 Belmont Ave., Chicago. 361-12th St., Oakland, Calif.
806 So. Figueroa St., Los Angeles 14, Calif.

Get into BUSINESS for Yourself!

METALIZING BABY SHOES AT HOME IN SPARE TIME



Get facts about amazing money-making Warner Success Plan that shows you every easy step in completely charted path to personal independence—with your home as your headquarters... This proved and tested Plan is working like magic. It's backed by an old, reliable company... And we send it to you on a No-Risk Trial Money Back Guarantee.

QUICK CASH WAITING
Demand for METALIZED Baby Shoes and other keepsakes is growing bigger daily. Our Tested Plan Shows How to Do the Work, How to Bring in the Business, How to Make as much as \$5 an Hour. Spare or full time, big steady profits are waiting for you. Send penny postcard or mail coupon for FREE Facts. Act! Time is precious.

FREE
offer of
COMPLETE MONEY MAKING PLAN
•
SEND NO MONEY
Just Mail COUPON

Ray Brandell, Mgr., Warner Electric Co.,
1512 JARVIS AVE., DEPT. 36, CHICAGO 26, ILL.

Please rush complete details about your No-Risk Trial Money Back Plan for Metalizing Baby Shoes. Everything you send is FREE and costs me nothing—now or ever.

NAME _____

ADDRESS _____

CITY _____ ZONE _____ STATE _____



THE NEW MONARK Super Deluxe

—with features not found on any other bicycle!

One Year's Fire and Theft Insurance Included in Purchase Price

MONARK leads the field in "49" with its new "Silver-Wing" fender crest and "Air-Wing" headshield.

OTHER FEATURES

- New "Rubber-Cushioned" double spring shock absorbing fork.
- New "Safety-Gard" saddle rail.
- New, glistening, "Super-Tone" color combinations.

To find your nearest Monark dealer call Western Union by number—ask for

OPENED 25

Monark Silver King, Inc.
8501 W. Grand Avenue
Chicago 35, Ill., Dept. C-150
Please send me a "King on Wheels" Badge and folder of new Monark bikes—FREE!

NAME _____

ADDRESS _____

CITY _____ STATE _____

Don't Envy The PLUMBER-Be One

Make \$15 to \$50 a Day

Every skilled workman will tell you Plumbers have the best of it. WINTER and SUMMER the Plumber is busy at top wages. No skilled Plumber is ever out of a job. Compare his opportunities with any trade. To the man with know how. Plumbing means profit. Investigate Universal Plumbing School. Not a "war born School," but a plumbing school developed and operated by plumbers since 1923.



The Plumber Protects The Health of the Nation

Own Your Own BUSINESS

Have your own business and big profits with little other than training and a kit of tools.

JOURNEYMAN Gets Good Salary

Master Plumbers own their own shop. A Journeyman works for a Master. With this training journeymen can depend on high wages.

G. I. Approved. Established 1923

UNIVERSAL PLUMBING SCHOOL

877 Holmes Street

Kansas City, Mo.

BE A PLUMBER IN JUST 32 WEEKS

Learn With Tools—Not Books

No need ever serve an apprenticeship. Don't envy the plumbers big profits—enjoy them. Learn every trick of the trade—Leadwork—Blueprint for plan reading, etc. under Licensed Master Plumbers.

Over 7,000 Successful Plumbers Recommend This School

This system has made more than 7,000 plumbers. Investigate our past performance. If you like to work with tools this is your opportunity. Become a Plumber in America's largest and only school devoted exclusively to plumbing. Write today for FREE information.

SAY YOU SAW IT IN POPULAR MECHANICS

WORLD'S MOST FAMOUS AUTO BOOK!

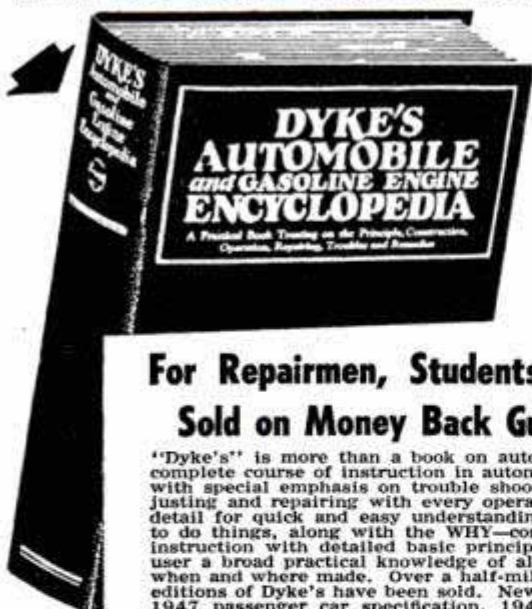

Leader for 32 Years. Now New 21st Edition. 1483 Pages. 4600 illus.

Weights 6 lbs.

For Repairmen, Students, Owners!
Sold on Money Back Guarantee!

"Dyke's" is more than a book on automobiles. It is a complete course of instruction in automotive mechanics, with special emphasis on trouble shooting, testing, adjusting and repairing with every operation explained in detail for quick and easy understanding. It tells HOW to do things, along with the WHY—combining practical instruction with detailed basic principles that give the user a broad practical knowledge of all cars, no matter when and where made. Over a half-million copies of 20 editions of Dyke's have been sold. New edition includes 1947 passenger car specification, 1948 trucks, buses, tractors and diesels, Buick Dynaflo, farm and outboard motors, new electrical systems, etc. World's biggest book value. Only \$7.50. Send remittance with coupon or we will send C.O.D. Use for 5 days, then if not O.K. return and we will refund money.

MAIL ORDER COUPON

GOODHEART-WILLCOX CO., Dept. 51A
1321 S. Michigan Avenue, Chicago 5

Send Dyke's Automobile and Gasoline Engine Encyclopedia C.O.D. I will pay postman plus charges. (C.O.D. in U.S. only.) Remittance

for \$7.50 enclosed, send postage paid. If not O.K. I will return in 5 days and you will refund purchase price.

Name _____

Address _____

City _____ State _____

42

\$10,000 REWARD for URANIUM! Build Your Own Detector \$59.95 in ONE HOUR at HOME!

COMPLETE

It's easy and fun to build your own Geiger-Mueller Uranium detector. And it may earn you a fortune! The Atomic Energy Commission pays \$10,000 cash and a good price per ton for new uranium deposit discoveries. Build your own detector at home in one hour with this complete kit. Includes plans, Geiger-Mueller tube, earphones, 3 brand-new batteries, all necessary condensers, plugs, tubings, wiring, etc. Everything brand-new! Instrument so sensitive it detects radium on watch dial! Add fun, excitement, adventure to vacations, outings, picnics. Rush your order now! Send \$3.00 with order, complete kit (less housing) sent C.O.D. for balance plus postage. Or send \$59.95 with order and kit shipped postpaid. Satisfaction guaranteed!

SUPERTONE, 733 N. Michigan Ave., Chicago, Illinois

45 x 3.5 POWER BINOCULAR

With COATED LENSES

and INTERPUPILLARY ADJUSTMENT

Sensation of the Year!

Many features of high priced binoculars. Heavy duty, all-purpose; precision. Carrying case, shoulder straps. SEND NO MONEY, pay postman plus charges. Send remittance with order and we send postpaid. Ideal gift. Money back if not satisfied.

GOERTZ CO., Dept. G-15, 1148 W. Chicago Ave., Chicago 22, Ill.



\$10.00 VALUE

\$4.98

PLUS 20% FED. TAX

TOTAL \$5.98

TRI-STATE COLLEGE

B. S. DEGREE IN 27 MONTHS

66th Year. Students from all over the world.

ENGINEERING—Courses in Civil, Electrical, Mechanical, Chemical, Aeronautical and Radio (including Television). Also Bus. Admin., Acc't. and Sec. Science. Low living costs. Modern cafeteria on campus. Graduates in demand. Enter June, Sept., Jan., March. Write for Catalog. 469 College Avenue, Angola, Indiana.

"RUPTURED"

WRITE for free information on our "SCIENTIFIC VACUUM PAD TRUSS"

It is something different. No leg straps. Its pad is a NOVELTY. It is a vacuum cushion that stays on its right place. You can bath with it, as it is made of plastics, rubber and metal. Invented by a physician who has dedicated his whole life in the treatment of ruptures without surgery.

Write "SCIENTIFIC TRUSS" to:

829 So. Dr. Cass Street

Monterrey, Old Mexico

LOCKSMITHING & Key Making



PRACTICAL UP-TO-DATE COURSE—ONLY \$3.95

Easy-to-learn modern information for self-instruction. How to work on locks, de-code, make master-keys, repair, install, service, etc. For every handyman, home owner, carpenter, mechanic, service station operator, fix-it shop, hardware dealer, gunsmith. 53 plain illustrated lessons. FULL PRICE ONLY \$3.95. SEND NO MONEY.

Just pay postman plus C.O.D. postage. Or send \$3.95 with order, we'll ship postpaid. Satisfaction guaranteed or refund. NELSON-HALL CO., 1139 S. Wabash Ave., Dept. F-2, Chicago 5, Ill.

Need a Chimney?

for your home or cabin

YOU YOURSELF CAN INSTALL IT

Van-Packer Prefabricated Chimney shipped complete, all parts ready for immediate installation. • Needs no foundation. SAFE... Underwriters and FHA approved. • Any fuel in any home. Safer than brick. • Half the cost. Immediate delivery.



WRITE FOR FREE BOOKLET

Van-Packer Corp. Dept. PM Field Building, Chicago 3

POPULAR MECHANICS



GET INTO DRAFTING

The Draftsman Plays a most Important Part in INDUSTRY

DRAWING OUTFIT INCLUDED with Drafting courses

All the tools you need including folding drawing table. With them you can put your ideas on paper quickly and with accuracy. With training you are all set to master Drafting in months, — not years — at home.

Learn in Spare Time—At Home! (or at the College in Chicago)

A few hours of pleasant home study every week — that's all. With Chicago Tech's help, you train yourself step by step. This tested method — developed over 45 years of C.T.C. progress — prepares men for good positions in industry.



Practically everything that's built or manufactured these days is constructed from blue print drawings prepared by the draftsman. He is the KEY man in industry. No new machines can be built, no bridges erected, no buildings constructed until the draftsman has completed his work.

Drafting is clean, interesting, professional-type work. The draftsman is paid well to start. And he has real opportunities for advancement to high-pay jobs in Engineering. The tremendous production programs ahead in industry will require more draftsmen than ever before.

Send today for free information. See what this training has done for others, what it can do for you. Simply MAIL COUPON TODAY in an envelope or use a penny postcard.

**CHICAGO
TECHNICAL COLLEGE**
G-212 Tech Building, 2000 South Michigan Ave.
Chicago 16, Illinois

MAIL COUPON NOW

Chicago Technical College
G-212 Tech Bldg., 2000 So. Michigan Ave.
Chicago 16, Illinois

Mail me FREE Drafting Lesson with information about big opportunities in DRAFTING and how I can train at home.

- Architectural Drafting Electrical Drafting
 Machine Drafting Structural Drafting
 Builders' Course

Name _____ Age _____

Address _____

City _____ Zone _____ State _____

EXPORT PAYS BIG

Large World Trade firm offers men and women quick preparation for big pay positions or unlimited-profit businesses of their own. Mail order World-wide without capital, from home; or travel abroad. Represent manufacturers. Past experience not needed. Write today for FREE BOOK. State if veteran. Airmail reaches us over night. Wellinger Co., 1422-GA Westwood Blvd., Los Angeles 24, California

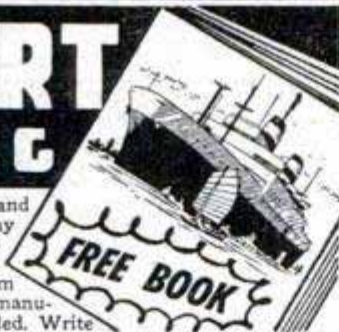

LAW STUDY AT HOME for Business Success and LARGER PERSONAL EARNINGS. 40 years expert instruction — over 114,000 students enrolled. LL.B. Degree awarded. All text material furnished. Easy payment plan. Send for FREE BOOK — "Law and Executive Guidance," NOW!

AMERICAN EXTENSION SCHOOL OF LAW
Dept. 15-PM 646 N. Michigan Ave. Chicago 11, Ill.

STRENGTHEN Your VOICE!
YES—you can now build yourself a powerful speaking and singing voice with this amazing new scientifically sound tested method. Self-training . . . no music or piano required. Results GUARANTEED. Just send your name for the sensational details. FREE chart of your vocal mechanism included!
PERFECT VOICE STUDIOS, Studio F-2, Kimball Hall Building, Chicago 4, Ill.



Free Sample!
Big profits showing amazing GLOW-IN-THE-DARK SPECIALTIES. House numbers, pictures, plastic novelties, religious and nursery objects, etc. Large manufacturer. Enormous demand. Sell on sight. Write at once for FREE SAMPLES.
MADISON MILLS, Dept. U-4
303 Fourth Ave. NEW YORK 10, N. Y.

SALESMEN!

10-Second
Demonstration
Nets You
\$9.95



Yes — Storekeepers now "Write with Light" — wipe off and write new sign — all in 10 seconds. Fastest seller in years. 10-second demonstration pays you \$9.95 cash in advance. Orders pour in HAND-OVER-FIST. Get started in your territory while "LITE WRITER" is brand new and hot as a pistol.

Litewriter "MAGIC CRAYON"
MAKES SIGNS THAT
GLOW LIKE BRILLIANT NEON!

Merchants everywhere — in small town and big city — all stare with amazement at this newest of all Fluorescent Sensations! They write on glass with "MAGIC CRAYON" — and Presto! — before their very eyes — there's a 5-color Advertising Message that glows like a brilliant Neon Sign!

FREE! Complete Sales Kit. Send name on penny postcard NOW for Big FREE Sales Kit and Free offer of Sample Demonstrator. No cost now or ever. Rush postcard now.
MAXILUME CO., 125 W. Hubbard St.
DEPT. L-86 CHICAGO 10, ILLINOIS

SAY YOU SAW IT IN POPULAR MECHANICS

HATE WORKING FOR OTHERS?

THEN LEARN A GOOD TRADE

JOHN SMITH COMPANY

- AND BE YOUR OWN BOSS!

TRAIN AT HOME WITH C.T.I.!

Yes, it's usually the man with a trade who enjoys both high income and independence! You, too, can learn a trade at home—by C.T.I.'s Shop-Proved Home Training Methods. Or, train in our Chicago shops. The coupon below lists fields which offer you splendid opportunities for success. Let nothing stop your determination to be somebody! G. I. approved. Mail coupon today!

COMMERCIAL TRADES INSTITUTE, Dept. E2-6
1400 W. Greenleaf, Chicago 26, Ill.

Send free illustrated Brochures and other information about the field I have checked below:

Refrigeration-Air Conditioning Automotive Mechanics
 Electricity Body & Fender Rebuilding
 Radio Servicing-Television Building Construction
 Diesel Mechanics Drafting

Name _____
 Address _____
 City _____ State _____

GOLD BOND

WHOLESALE SLIGHTLY USED TIRES DIRECT TO YOU

(10% discount on 2 or more tires if you send this ad with order)

TUBE DELIVERED WITH TIRE AT NO EXTRA COST

Safe—Our tires used on school buses and ambulances—All good tires—No recaps—With a **GOLD BOND GUARANTEE FOR 12 MONTHS**

550-16 ... \$3.54	550-15 ... \$3.79	450-21 ... \$5.14
600-16 ... 3.59	650-15 ... 3.89	475-19 ... 5.42
650-16 ... 3.89	700-15 ... 3.98	525-18 ... 5.69
700-16 ... 4.59		550-17 ... 5.69

Exceptionally good original tread—No recaps—With a **GOLD BOND GUARANTEE FOR 24 MONTHS**

550-16 ... \$5.19	550-15 ... \$4.81	450-21 ... \$6.25
600-16 ... 5.29	650-15 ... 4.98	475-19 ... 6.35
650-16 ... 5.29	700-15 ... 5.29	525-18 ... 6.69
700-16 ... 6.29		550-17 ... 7.99

Truck Tires—Just what you wanted to order—With a **GOLD BOND GUARANTEE FOR 24 MONTHS**

600-20 ... \$7.98	825-20 ... \$11.19	1100-22 ... \$16.89
30-5 ... 7.98	900-20 ... 11.89	900-24
650-20 ... 7.69	1000-20 ... 12.89	(40-8) 21.60
700-20(8) 9.29	1100-20 ... 13.89	750-16 ... 8.40
700-20	1200-20 ... 18.78	900-16 ... 8.98
(10) ... 12.48	750-24	825-15
750-20(8) 8.19	(36-6) 12.21	(14 ply) 14.10
750-20	38-7	750-15
(10) ... 9.19	(825-24) 13.75	(12 ply) 11.30
	1000-22 ... 17.70	

Gold Bond Special—900-16 Military, \$6.98 • 750-20 Military, \$8.49

Send check or money order with this ad

GOLD BOND TIRE CO., Dept. PM 24
512 NORTH 1ST ST., RICHMOND, VA.
 "A gold bond written guarantee with every tire"

BIG MONEY! SECURE FUTURE!
LEARN WATCH REPAIRING AT HOME

WITH OUR 12 ITEM SELF-TRAINING KIT
START NOW in this uncrowded field! **EASY** to learn! Earn while you learn! Even as a sideline you can make \$50 and up each week. — KIT contains: **PROFESSIONAL TOOLS** (Loupe, 3-4 power; 6 Special assorted Screw Drivers; Tweezers; AA; Plastic Material Tray; Case Opener & Knife, & **MOVEMENT GAUGE**) and **COMPLETE BOOK** on Modern Watch Repairing. Fully illustrated, easy to understand, shows every step in repair, and use of tools. Only **\$7.45** Post Paid (if C.O.D., plus charges.) Money Back Guarantee.

MODERN TECHNICAL SUPPLY CO.
SPECIAL WATCH REPAIR DEPT. for jobs you can't handle. **LOW PRICES.** Send watch for **FREE** estimate.
 Dept. 6MMC, 55 W. 42nd Street, New York 18, N. Y.

New Complete Catalog on all Modern Precision Tools, Materials & Books with Descriptions & over 600 Illustrations for Watch-Clockmaking, Jewelry, Tool-Instrument Making. Useful for years because catalog entitles you to future **FREE** supplements.
 Catalog **FREE** with KIT or 50c credited to 1st order

THEY'RE SUPER SCOPES!

36" 17 POWER

Extends to 36 inches, Precision and Polished Lenses. Ideal for Studying Stars, Plane Spotting, etc. Satisfaction Guaranteed or Money Refunded. Send Check or Money Order to.....

\$2.95 Post Paid

CRITERION CO., Dept. PM5
 438 Asylum St. Hartford 3, Conn.

FIND THE JOB YOU WANT! IT'S STARTING
IF YOU LOOK THE MODERN WAY . . . START TODAY

Whether you are unemployed or stuck in a rut . . . you KNOW old fashioned slipshod methods don't work. Our booklet explains simply the efficient way to success in any field. Send only \$1 (cash or M.O.). Why wait . . . start NOW! Write

A-D PUBLICATIONS, Dept. P, 743 N. 4th St., Milwaukee 3, Wis.

BARBELLS

Save Money—Buy the finest barbell equipment direct from our foundry—No other company can match our low price or value!

Send to-day for our **FREE** Barbell Catalog

BUR BARBELL CO.
 Lyndhurst 18, New Jersey

95 lb. SET \$10.80
 Extra plates 10c lb.

Wildcraft INDIAN-TYPE MOCASINS

Beautiful soft leather tops, stitched to sturdy soles with tongue and lacing ready to assemble. Solid foot comfort for home, campus or cabin, indoors or outdoors.

\$3.50 **GENUINE LEATHER**

MONEY BACK GUARANTEE

Send \$3.50 for Ladies or Children. Men's Outfit \$3.75. Add 15c per pair postage. If not delighted, return in 10 days for refund.

Ladies—colors White, Brown, Red, Black & White and Brown & White. Sizes 3 to 8.
Boys—Brown only. Sizes 1 to 6.
Mens—Brown only. Sizes 6 to 11.

Order NOW—TODAY! Catalog **FREE.**
WILDER & COMPANY, Dept. A-6 Chicago 10, Ill.

SAY YOU SAW IT IN POPULAR MECHANICS

NEW ADVERTISING MACHINE FREE!

PRINTS and ILLUSTRATES 1c POST CARDS

Boost sales with **CARDMASTER** like thousands are doing. Not a toy . . . but a sturdy advertising machine . . . guaranteed for 5 years. Get money-making facts TODAY. SEND YOUR NAME to

CARDMASTER, 4546 Ravenswood, Dept. 136, Chicago 40, Ill.

Illustrated Book of Plans and Ideas for Your Own Business.

FLATFISH! **WORLD'S LARGEST SELLING PLUG!**

Noted for its lifelike action. The only lure with offset hooking. That's why it catches 'em for keeps. World's largest selling plug. Made in 21 colors. Underwater, surface and trolling models. \$1.35 each. Musky, \$1.45. Flyrod size, \$1.10. Write for **FREE** circular—or send 20c for 48-page booklet with plug-fishing secrets of famous anglers.

Send 20c for **CATALOG!**

HELIN TACKLE CO.
 6342 PULFORD, DETROIT 7, MICH.

SURPLUS BARGAINS

2 in one Mat Raft

For Water or Beach



Easily inflated by mouth or cartridge. Separate air cells for safety. Folds compact when deflated. 2 sizes—6 cell, 55"x24"; 8 cell, 55"x30". Complete. Save.

Extra Dual Tubes \$1.19 ea.
Inflating Cartridges, 10 for.....79c

U. S. Army Folding Cots, new (Frt. coll.) \$4.98
Jungle Hammocks, nylon netting, new \$4.98
Rafts, AAF, 5 man, oars, pump, etc. . \$29.50

Mail orders add 10% Write for FREE Catalog today

FISLER SALES CO. 723 Walnut St. Kansas City 6, Mo.

CARBURETOR TOO RICH MAKES MOTORIST TOO POOR



Car owners who are wasting money and not getting proper gas mileage due to over-rich mixtures will be pleased to learn how to save gasoline by VACU-MATING over-rich mixtures. VACU-MATIC fits all cars, trucks and tractors. It is automatic and operates on the supercharge principle. Easily installed in a few minutes.

SALESMEN WANTED! Big Profits! Send name, address on penny postcard for free particulars and how to get yours for introducing.

VACU-MATIC CO., 7617-1531 W. State St., WAUWATOSA, WIS.

BRUSHES ONLY 4c EACH

This assortment of brushes can be used for paint, enamel, lacquer, glue, paste, oil, chemicals, etc. It is a terrific value and sold to you below manufacturers cost. Ideal for hobbyists, workshop, factory and household uses.

100 for \$4.00 — 50 for \$3.00 — 25 for \$2.00

ALL PRICES POSTPAID
A. ELGENE MFG. CO.

9015 — 5th Avenue

Brooklyn, N. Y.



ELECTRIC APPLIANCES REPAIRED
YOUR NAME

Start YOUR OWN BUSINESS!

Repair electrical appliances of friends and neighbors. Service electrical equipment in factories, stores, etc. Work full or part time!

New Shop Method home-training system. Rush name today for **FREE BOOK** and special form for getting Electronic Kit, Special Service Kits, Armature Growler, Illustrated Instructions on new easy-payment plan. Pay us later with your **EARNINGS WHILE LEARNING.** Rush name.

CHRISTY TRADES SCHOOL

2835 N. Central Ave., Dept. D-7003, Chicago 34

THE GREATEST THING

IN PLASTICS!

PLASTICAST



A NEW HOME INDUSTRY AND HOBBY!

PLASTICAST is a transparent liquid plastic; can be poured into ANY kind of mold or container. Hardens in a few minutes into a transparent solid, clear-as-glass, tough as steel plastic! No tools, machinery or skill required. **IDEAL** for imbedding pretty flowers, butterflies, photos, medals, souvenirs, biological specimens, etc. Makes a **PERMANENT** and **ATTRACTIVE** display. Make attractive jewelry, gems, lenses, knick-knacks, novelties. Easily cast into sheets, rods, blocks, ANY color, ANY shape! **EVERYTHING** furnished, including molds, for making about \$50.00 worth of unusual novelties! **PLASTICAST OUTFIT, Complete \$3.50** with 3 molds. Illustrated Instruction Manual included.

Our Casting Plastics are as easy to use as pouring water out of a glass!
PLASTIDUR . . . (LIQUID IVORY). Ideal for casting all OPAQUE articles. Hardens in a few minutes into an extremely hard IVORY-like plastic! May be dyed any color or cast into any shape. Works in **EVERY** type of mold! Non-inflammable, waterproof. **DURABLE.** Ideal for statuary, novelties, figurines, toys, gadgets, tools, knobs, bases . . . a million useful applications! Outfit comes complete with molds, dyes, accessories, instructions, etc. for making about \$100.00 worth of attractive jewelry, etc! **\$5.00**
PLASTIDUR OUTFIT, Complete with 3 molds. \$5.00

TERMS: We pay the postage (U.S.A.) if full cash accompanies your order. C.O.D. accepted (U.S.A. only) if \$1.00 deposit is included for each item ordered. C.O.D. orders not postpaid.

FREE A very attractive novelty made with one of above plastics **FREE** with our **BIG** catalog! Catalog lists largest selection of **MOLD MAKING** and **CASTING** materials in the **WORLD!** Liquid Plastics, Liquid Ivory, Liquid Marble, Liquid Glass, Ceramics, Liquid Porcelain, Moulage, Latex, Multiplex, Etc. Also Shellcraft, Internal Carving, Plastics, Glazes, Jewelry Accessories, etc. Price of catalog only 10¢ U.S.A. (25¢ Canada).

DEALERS: WRITE FOR ATTRACTIVE WHOLESALE PRICE LISTS
PLASTICAST CO. (Dept. C)

4637 N. Kedzie Ave. Write to P. O. Box 987
Chicago 25, Illinois Nearest Address Palo Alto, Calif.
CANADIAN CUSTOMERS, please order directly from: Canadian Industrial Plastics, Ltd., 1056 1/2 Pender St., West, Vancouver, B. C.



"SAFE MOTORCYCLING is what I want," says pretty Joan Burns. "That's why I chose a JAWA." Her instructor shows Joan the foot gear shift and automatic clutch. These two JAWA features plus spring frame, telescopic fork, adjustable steering control and non-sway brakes make for sporty, safe transportation.

See the JAWA models—CZ "125," JAWA "250" and OGAR "Twin" at your dealer . . . at new low prices. Write for **FREE** booklet 10. JAWA MOTOR-CYCLE CO., 2432 Grand Concourse, N. Y. 57, N. Y.

SAY YOU SAW IT IN POPULAR MECHANICS

NEW
Edition

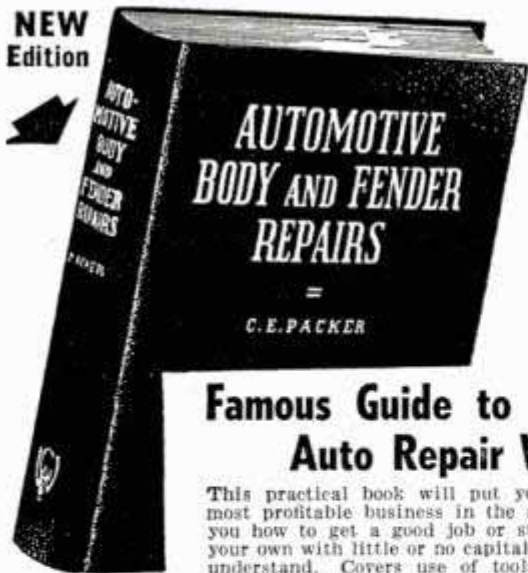

NOW HAS 325 PAGES 232 ILLUS. \$3.50 Total Cost

Famous Guide to Best Pay Auto Repair Work

This practical book will put you right into the most profitable business in the auto field. Shows you how to get a good job or start a business of your own with little or no capital. Easy to use and understand. Covers use of tools and equipment, gives approved methods, describes materials and shows you how to actually do a professional job, operate a shop, etc. The very latest information and pictures on all interior and exterior body work and fender repairs—the kind of work people everywhere want and will pay big for when you can do it. Mail coupon now. Use book 5 days and if not O.K. return it and we will refund your money.

Most Complete Information Ever Published

GOODHEART-WILCOX CO., Dept. 1A
1321 S. Michigan Avenue, Chicago 5

MAIL ORDER COUPON

Send Auto Body and Fender Repairs C.O.D., I will pay postman plus charges. (C.O.D. in U.S. only.) Remittance for \$3.50 enclosed, send postage paid. If not O.K. I will return in 5 days and you will refund purchase price.

Name _____

Address _____

City _____ State _____

she's some SMOOTHIE!
(YOUR CAR, THAT IS)

when equipped with

ADVANCE "ULTRA DEEP-TONE" MUFFLERS
DUAL OR SINGLE STRAIGHT-THRU

Rich, low, mellow tone. Also greater power, speed, and economy result from reduced back pressure. Rugged steel tube, blow-out proof. Simple to install. No welding. Dual set comes complete with rubber mounted clamps, fittings.

ADVANCE FENDER SKIRTS

These heavy duty steel skirts will beautify and streamline your car. Tight fit, no rattle, easy to install, prime painted. Real top quality, not to be confused with cheaper, light weight makes.

ADVANCE KI-YI AND RAZZ HORNS
Get these novelty horns for laughs.

MAIL COUPON BELOW DEALER INQUIRIES INVITED

ADVANCE MUFFLER CO. Dept. PM 69
6800 S. VERMONT AVE., LOS ANGELES 44, CALIF.

- Send check, money order, or we will mail C.O.D. You pay postage upon receipt.
- | | | |
|---|---|---|
| <input type="checkbox"/> Dual Muffler Set (Ford, Mercury only) .. \$20.00 | <input type="checkbox"/> Single Muffler (other makes) .. \$5.50 | <input type="checkbox"/> Fender skirts, pr. \$16.95 |
| <input type="checkbox"/> Single Muffler (Ford, Chev., Plym.)... 4.86 | <input type="checkbox"/> 2 1/2" Chrome tail pipe tips, ea. ... 1.75 | <input type="checkbox"/> Ki-Yi Horn, each 3.25 |
| <input type="checkbox"/> Send free catalog showing complete line. | | <input type="checkbox"/> Razz Horn, each 3.25 |

Car make _____ Year _____ Model _____
Name _____
Address _____ City _____ State _____

MADE \$582.00 in One Month

"My lowest month sharpening lawn mowers was \$80.00 and highest \$582.00. My best months are in Summer." — W. W. Loud.

WORK AT HOME — PART OR FULL TIME
Build a steady repeat CASH business with the Foley Lawn Mower Sharpener—uses same system as lawn mower factories. Sharpens all sizes and types in 15 or 20 minutes—no experience needed.
FREE PLAN tells how to start—no canvassing necessary. 99c out of every dollar you take in is clear profit. Write today for Free Plan.
FOLEY MF6. CO., 607-9 Foley Bldg., Minneapolis 18, Minnesota

LEATHERCRAFT FOR FUN FOR PROFIT

Make your own Leather Novelties, Belts, Bags, etc., in spare time. A hobby you will love. Complete kits and equipment for tooling, carving and embossing at very low cost. Send 10c for catalog describing tools, leather and instructions. Your 10c refunded on 1st order.
JONAS HANDICRAFT CO. (Dept. M-6), 32 Frankfort St., New York 7, N. Y.

HOW'S YOUR GASOLINE MILEAGE?
GET UP TO 50 MILES MORE PER 10-GAL.
WE'VE GOT SOMETHING HERE!!
30-DAY UNCONDITIONAL GUARANTEE
To prove how much you can save on your car or truck
IT'S A POSTWAR DEVELOPMENT
Easily Installed
PATENT APPLIED FOR **\$2.95** FOR MAIL ORDERS STATE CAR MAKE AND YEAR
ZIP FUEL SAVER CO., 2147 Ferry Park, Detroit 8, Mich.

Learn TELEVISION-ELECTRONICS RADIO

2 Big Books **FREE**

Train at Home—Get Big Kits of Radio Parts! Prepare now in spare time. Practical instruction. Approved for Veterans. Write for details and 2 Radio Books—ALL FREE! Rush name today!
SPRAYBERRY ACADEMY OF RADIO
Dept. 10-5 20 N. Wacker Drive, Chicago 6, Illinois

INSTANT NICKEL
NO CURRENT OR BATTERIES USED

COMPLETE \$2.50 POST PAID 1948 PATENT AGENTS WANTED

JUST PATENTED—Now everybody can NICKEL PLATE. No equipment or electricity needed. Just rub. A BLESSING to Doctors, hobbyists, Auto, Machinery and home owners and practically everybody. NO POISONOUS CYANIDES OR QUICKSILVER. It will heavily plate, INSTANTLY. Steel, Iron, Copper, Brass, etc. It's NEW, DIFFERENT, PRACTICAL, ECONOMICAL—Just rub with a cloth to any thickness. Fascinating hobby—Plate for neighbors and friends. **MONEY BACK GUARANTEE.** C.O.D.'s few cents extra. **INSTANT PLATING PRODUCTS, DEPT. M-6, 3439 So. Michigan, Chicago 16, Ill.**

BARGAINS! Surplus Items

WELDING GOGGLES
Regular welding lens. Ventilated side shield. New. Pr. \$1.25
Industrial chipping or grinding goggle. New. Pr. \$1.15
Add 15c to either item for handling and mailing.

REPLACEMENT LENSES
50 MM. heavy duty chipping lenses 49c pr.
50 MM. welding goggle lens. shade 5 59c pr.

WORK TABLE LAMPS
Adjustable to 100's positions for localized lighting. 60 to 100 watt. 110 volt lamp. Overall length of 53 in. Like new. Has cord, socket, shade, plug. **\$3.95**
Add 35c for mailing. NOT SATISFACTORY!

WARRANTY
MONEY REFUNDED IF NOT SATISFACTORY!

VAN BRUNT SUPPLY CO.
3018 Van Brunt Blvd. Kansas City 3, Mo.

INSURE YOUR FUTURE

• toolmaking
• drafting
• design

KEY POSITIONS OPEN

INDUSTRY

APPROVED BY AMERICAN SOCIETY OF TOOL ENGINEERS

MACHINIST TRADE
 TOOL & DIE MAKING & DESIGNING
 DRAFTING TOOL ENGINEERING
 PRODUCT ILLUSTRATION & DESIGN
 HOME STUDY—DRAFTING

**ENDORSED BY INDUSTRY
APPROVED FOR VETERANS**

Write for FREE Catalog
A 1¢ Postcard will do.

**ALLIED SCHOOL
OF MECHANICAL TRADES, INC.**

1338-1340-1342 So. Michigan Avenue
426 Allied Building • Chicago 5, Illinois

YOU CAN TRAIN AT ALLIED'S BIG SHOPS OR STUDY AT HOME UNDER ALLIED'S SUPER-VISED HOME PLAN

BE A GOVERNMENT LICENSED AIRPLANE AND ENGINE MECHANIC

Train Now at LINCOLN

EARN BIG PAY IN AVIATION

Our new enlarged school now offers these courses:
MASTER AVIATION MECHANICS, CAA Approved 1 Yr. Airplane & Engine Mechanics Course, **REFRESHER AIRPLANE & ENGINE MECHANICS**. Designed for veterans with aviation mechanics experience. Either course is available to veterans under the G. I. Bill of Rights. Write today for complete information.

LINCOLN AVIATION INSTITUTE

UNION AIR TERMINAL DEPT. P-6 LINCOLN, NEBRASKA

Low **FACTORY-TO-YOU** Prices

New! MIDWEST TELEVISION

with **BIG 75 Square Inch SCREEN**

• 12½" PICTURE TUBE
• 12 TELEVISION CHANNELS
• PICTURE-HOLD CONTROL

30 DAYS TRIAL - EASY TERMS

Other Models Include:
SYMPHONY GRAND AM-FM RADIO-TELEVISION-PHONOGRAPH with DUAL-SPEED RECORD PLAYER

Also complete CHASSIS for Custom Installation—and Adapter Chassis and Console for use with 1947, 1948, 1949 Midwest Radio Models.

Factory Authorized Service in all Television Areas

Also—Sensational **NEW MIDWEST RADIOS with DUAL-SPEED Phonograph**

Send for TELEVISION Folder Prices and **NEW 1949 MIDWEST RADIO Catalog**

MIDWEST RADIO & TELEVISION CORP.
Dept. T-25A, 909 Broadway, Cincinnati, Ohio

Name _____
Address _____
City _____ Zone _____ State _____

THE WORLD'S LARGEST WATCHMAKING SCHOOL GIVES YOU:

• G.I. APPROVED, NATIONALLY ACCREDITED COURSES • MOST ABUNDANT WORKING AND TRAINING FACILITIES • INDIVIDUAL INSTRUCTION BY EXPERIENCED FACULTY • FREE PLACEMENT SERVICE FOR PART-TIME WORK AND HOUSING DURING TRAINING

• FREE EMPLOYMENT SERVICE UPON GRADUATION • COMPLETE SET OF WATCHMAKER'S TOOLS TO VETERANS • \$100 BONDED GUARANTEE OF PROFICIENCY TO PROSPECTIVE EMPLOYERS.

SEND FOR FREE 116-PAGE INFORMATION PACKET

WESTERN PENNSYLVANIA HOROLOGICAL INSTITUTE, INC.
DESK 40, 808 RIDGE AVENUE PITTSBURGH 12, PA.

DRAW for MONEY... Be an ARTIST!

Trained Artists are Capable of Earning **\$65, \$80 OR MORE A WEEK!**

You can learn to draw at home in your spare time the well-known WSA way. **COMMERCIAL ART, DESIGNING, CARTOONING**—all in ONE complete course. No previous art experience necessary—we teach you step-by-step. Prepare now for a fascinating hobby or profitable career. For 35 years WSA graduates have been making good—**WHY NOT YOU?**

VETERANS!
WSA is approved for training under the G. I. Bill

Write today for **FREE BOOK, "Art for Pleasure & Profit."** It fully describes our correspondence course, instruction service, and commercial opportunities for you. Two **ART OUTFITS** and other features included with training.

WASHINGTON SCHOOL OF ART, Studio 126R
1115—15th St., N.W., Washington 5, D. C.

Please send me full information and your Free Book, "Art for Pleasure and Profit."

Name _____ AGE _____
Street _____
City _____ Zone _____ State _____
 I am entitled to training under the G. I. Bill.

You have seen our reliable Adv. month after month so
BEFORE YOU BUY "ANY" TIRE

Consider Your Family's Safety — Not Just Price!



Vets take 10%. You certainly deserve it.

Goodrich
Firestone
Original
High Tread
GOODYEAR
TIRES
United States
& Others
Worn Just
Slightly

GOLDEN RULE 14 MONTH GUAR. BOND
FREE BUTYL TUBES With ALL OUR A-1
TIRES
WHY PAY MORE? RISKY TO PAY LESS!
You Get What We Advertise. Selected For
Toughest Jobs. Not just Good.
BEST, SAFE & O.K.

**TOPS IN WORLD'S BEST LO-PRICE
VALUE, MILEAGE, SAFETY & SERVICE**

600-16 \$3.57	650-15 \$3.87	32 x 6 (8) \$ 9.17	JUST
650-16 3.87	700-15 4.00	32 x 6 (10) 11.17	COMPARE
700-16 4.57	600-20 7.95	825-20 11.17	OUR
750-16 6.00	650-20 7.70	900-20 11.87	PRICES
525-18 5.90	700-20 9.27	1000-20 12.87	ORDER
550-17 5.90	34x7 9.17	1100-20 13.87	TODAY!

SPECIAL OFFER "ALL-PURPOSE" TIRES "PREMIUM"
LIMITED TIME "TOP GRADE"

Genuine Factory Adjusted Tires — Stock Limited!
WHAT A DIFFERENCE A FEW CENTS MAKE

GOLDEN-RULE GUAR. 24 MOS. AGAINST ANYTHING!

600-16 \$5.50	525-18 \$7.00	600-20 \$ 9.50	32 x 6 (10) \$13.25
650-16 5.50	550-17 7.00	650-20 9.50	825-20 15.75
650-15 5.50	700-16 6.50	700-20 10.85	900-20 15.75
700-15 6.00	750-16 8.00	32 x 6 (8) 10.25	1000-20 16.75

We've shipped Tires to Canada, Italy, Puerto Rico, Alaska
OUR TIRES USED ON SCHOOL BUSES AND AMBULANCES



750-20 MILITARY FITS 32 x 6 700-20

SUPER GRADE \$10.57. Guar. 8 Mos.
"TRIPLE A" Grade \$13. Guar. 18 Mos.
PREMIUM GRADE \$15.00. Guar. 30 Mos.
900-16 Super \$9.17 900-16 Premium \$11.17

Send check or money order and this ad for rush shipment. We won't
ship a tire that WE wouldn't use. BLATTS have personally Machine-
point-inspected 1/2 million tires. Please depend on us.

NOTE: Butyl Tube Given With "EVERY" A-1 Pass. & Truck Tire

**BLATT GIRARD AVE. TO LANCASTER AVE., DEPT. PM
BLATT BLDG., PHILADELPHIA 31, PA.
THE NAME YOU CAN TRUST IN RUBBER**

Midget Camera 99c

TAKE SECRET PICTURES



Midget camera only 2x3 inches!
Actually conceal in palm of hand!
Easy to carry, easy to use. Black &
white or color pictures. Standard
Eastman 828 film. Bakelite case,
good quality lens and shutter. 8
pictures 1 3/4 x 1 1/2 in. on each roll.
Beautiful enlargements. **99c**

SPECIAL CASH PRICE
Carrying Case, 50c; Black & White
Film 35c Roll, 3 for \$1.00
Dept. 131 Detroit 7, Michigan

JOHNSON SMITH & CO.

SANDEE

Mufflers—All Ford, Chev., Ply.....\$4.45

All Buick, Pont., Olds., Chrys.,

Dodge, Hudson, K.F., Pack., etc.....\$5.45

V-8 and Merc. Duals
(32-49 incl.)

\$15.95



DEALERS
WANTED

Beautiful
SANDEE
Fender Skirts
\$16.95

A SANDEE Sportone will outlast two ordinary mufflers and
give More Power! More Speed! More Mileage!—plus a tone
quality unsurpassed.

Please ship (item): _____ Price _____
Car and Year _____ Name _____
Address _____

SANDEE MUFFLER CO. 5643 Corryne Pl. Culver City, Calif.

RUBBER HOSE SALE LESS THAN 1/2 PRICE



TERRIFIC VALUES!

Brand new genuine Neo-
prene Hose—outlasts or-
dinary rubber 3 to 1. Re-
inforced with super tough
cotton cord plies. Flexible,
easy to handle. Easy Flo
brass couplings with stand-
ard pipe threads for quick
connections, included.

(Inside Diam.)	1 1/4 in.	1 1/2 in.	1 3/4 in.	Pump water for irrigation, stock, tanks, home, barn, fire fighting, etc.
Length	25 ft.	40 ft.	30 ft.	
Price	\$8.75	13.75	13.75	

If specified we will send special hose for gas or oil at same prices.
All prices f.o.b. Chicago area. Satisfaction guaranteed. Send
check or money order in full, or \$3.00 deposit and balance c.o.d.
Master Mechanic Co., Dept. 12, Burlington, Wisconsin

COMMERCIAL TRADES'

GRADUATES GET THE BETTER JOBS

PRACTICAL SHOP TRAINING IN
AIR CONDITIONING — REFRIGERATION
ELECTRICITY MAJOR APPLIANCES
SERVICE, MAINTENANCE & INSTALLATION

Write for Catalog PM4

COMMERCIAL TRADES INSTITUTE

200 SOUTH 20TH ST. BIRMINGHAM, ALA.

Member: Southern Association of Private Trade Schools
An approved school to TRAIN Veterans & Non-Veterans

HIGH POWER TELESCOPE

60 POWER-ALUMINUM TUBES—OPENS TO 33"

Variable Power Eyepiece Adjustable
to 15X, 30X and 60X.

\$4.50



Leather
Case Included

5 Sections, 4 Lenses. Also used as 50X Microscope.
Money Back Guarantee. Only \$4.50 POSTPAID.

**BROWNSCOPE CO. Dept. 6M, 24 W. 45th St.
NEW YORK 19, N. Y.**



MANSKE & MANSKE

3157 S. 9TH PLACE, MILWAUKEE 7, WIS.

Removes Hook Without Handling Fish

MARVEL Fish Hook Extractor

Protect Your Hands, only **\$1.95**

Be A Sportsman, Don't Maul Fish

MANSKE & MANSKE

3157 S. 9th Pl., Dept. 269, Milw. 7, Wis.

See Local Dealer or Order Direct
Dealers & Distributors Invited

YOU CAN BE AN

All Around

HE-MAN

All 5 famous courses by George F. Jowett,
world's greatest body builder in 1 complete
muscle building volume (valued at
\$5 each) now only **25c**. Packed with How-
to-Do-it pictures. 1. How to Mold a Mighty Arm.
2. Mighty Chest. 3. Mighty Back. 4. Mighty Grip.
5. Mighty Legs. Free strong men photo book. Quick
results or money back! Send 25c. name, address, age.

JOWETT INSTITUTE, Dept. PM-96, 230 Fifth Avenue, New York City

AUTOMOBILE DRIVERS

Flash Your Turns

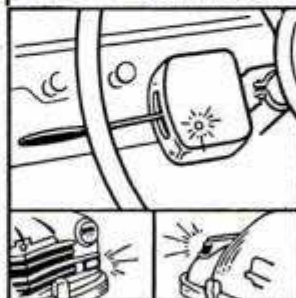

New Model **SIMPLEX DIRECTION
SIGNAL KIT** fits most cars. Gives
new safety and comfort when making
turns. Eliminates arm signals. Flash-
ing parking and tail lights show other
cars which way you're going to turn.
Flashes 60 to 80 times a minute.
Works like factory installed models on
expensive cars. Does not interfere with
operation of present lights. Install it
yourself. All parts furnished. For
most 1942 to 1949 cars. **SPECIFY
MAKE AND YEAR. BACK GUARANTEE.**

\$8.95 Postpaid in U.S.
Send check or
money order.
Postage extra on C.O.D.'s.

DEALER INQUIRIES INVITED

The LESTER COMPANY, P. O. Box 5939-M6, Chicago 7, Ill.

UNUSUAL OPPORTUNITY TO MAKE-BIG-MONEY-QUICK

LEARN TO REBUILD SEALED REFRIGERATION UNITS

Millions of Refrigeration Sealed Units

Why get in a crowded field—HERE IS A REAL OPPORTUNITY—to get in on the ground floor of BIG BUSINESS . . . The Refrigeration Business is here to stay . . . Millions of Units NOW IN USE and Millions more coming . . . BUT . . . Most of the Sealed Units are rebuilt at the factory . . . BECAUSE of limited repair service on sealed units locally . . . WHY, because it requires skilled training . . . We Offer a POST-GRADUATE COURSE lasting only 16 weeks to graduates of responsible schools or those who have had a few years service experience. NOTHING LIKE THIS IS OFFERED ANYWHERE . . . A REAL COMPREHENSIVE COURSE. For Veterans and Non-Veterans . . . BETTER HURRY!

Be Independent In Your Own Business

PRACTICAL TRADES INSTITUTE, INC.
25 University Ave. S.E., Dept. PR-6, MINNEAPOLIS 14, MINN.

Built Prior To 1942 Will Need Rebuilding—

—MILLIONS MORE WILL FOLLOW.

LEARN NOW—

—WE TEACH YOU HOW



Mail This Coupon Today

Today Most Sealed Units are rebuilt at factories. The charge is usually from \$80 to \$100 per unit.

MAIL THIS COUPON TODAY

PRACTICAL TRADES INSTITUTE, INC.

25 University Ave. S.E., Dept. PR-6
Minneapolis 14, Minn.

Gentlemen: I am interested . . . Please mail at once complete information. This does not obligate me and the information is FREE.

Name _____

Street _____

City _____

Zone _____

State _____

A Real Opportunity FREE PARTICULARS

TRAVEL-for 'UNCLE SAM'

ARE YOU JOB-SATISFIED?

GET A U. S. GOVERNMENT JOB

Many Positions to Be Filled

Railway Mail Clerks—Postoffice Clerks—Mail Carriers—Stenographers—Typists—Statistical Clerks—Liquor Inspector, etc. 40 page Civil Service Book—FREE.

MEN—WOMEN

Veterans Get Preference

Mail Coupon immediately—today sure.

Although not government controlled, this can be your first step toward a secure Civil Service Career.

As high as \$3,351.00

FIRST YEAR



COUPON

FRANKLIN INST., Dept. R85, Rochester 4, N. Y.

Gentlemen: Rush to me without charge, 40 page book with list of U. S. Government big paid positions. Advise me also regarding salaries, hours, work, vacations, etc. Tell me how to qualify for a position.

Name.....

Address..... Vet?.....

SURPLUS BRAND NEW AIR COMPRESSORS

for Garage - Shop - Factory - Farm or Home. Height 9" - Weight 7½ lbs. Uses ¼ HP Motor

A sturdy, well built air compressor of steel and die cast metal constructed to give satisfactory and lasting service. 20-30 lbs. continuous pressure. Higher pressure for intermittent service. Formerly sold for \$14.50. Synthetic rubber hose with fitting, 12½ feet \$1.70, 23½ feet \$3.00.

COMPRESSOR CORPORATION OF AMERICA
ST. JOSEPH, MICH.



Syphon Type Spray Gun \$4.90

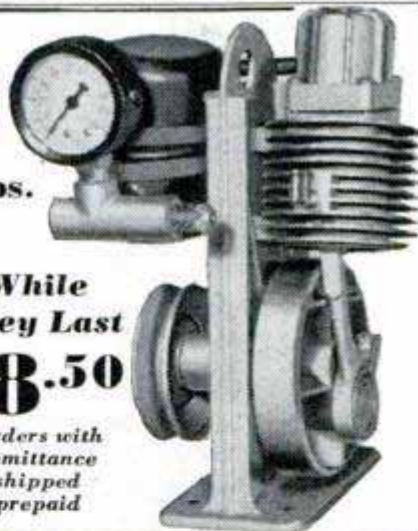

While They Last \$8.50

Orders with remittance shipped prepaid

Sensational New Electric

① WELDER ② CUTTER!

FOR 110-115 AC or DC • WELD—BRAZE—CUT—SOLDER—HEAT TREAT INSTRUCTIONS INCLUDED • LOWEST PRICE IN HISTORY!

The WELDRITE Combination—tested and proved by countless commercial and amateur users, is now offered direct to you at the amazingly low price of only \$12.00. No Gas—No Gauges—No Spark Lighter needed. Always ready for immediate use—Just plug WELDRITE into 110-115 AC or DC outlet. Uses standard welding and brazing materials. WELDRITE furnished complete with Converter Unit, #1 Single Holder for welding metal to ¾" thickness, using up to 3/32" rod, and #2 Double Holder with Copper Coated Carbon Electrodes for Brazing, Cutting, Heat Treating, etc. Starting welding

materials and instructions included.

Ideal for home workshop. Invaluable for garages, repair shops, farms, etc.

SEND NO MONEY! 10 DAY TRIAL. Order your WELDRITE Electric WELDER-BRAZER-CUTTER C.O.D. today. Pay postman \$12 plus postage charges (wt. 4 lbs.) or send \$12 and we pay postage. Either way, if not satisfied, return WELDRITE in 10 days for refund, less postage charges. **WELDER HOOD**—Approved Arc Welding lens—only \$3.95. Calif. orders add 2½% tax.

BOTH only \$12

① WELDER

② BRAZER-CUTTER

CALIFORNIA TECHNICAL PRODUCTS CO.

Dept. A-6, 448 So. Hill St., Los Angeles 13, Calif.

For Your

**AUTO
HOME
BOAT**

SPRAZIT

FIRE EXTINGUISHER



\$1.49

**3 for
\$4.35**

Don't take chances with fire! Keep one of these economical **SPRAZIT** Fire Extinguishers handy in the glove compartment of your auto . . . in every room of the house . . . in your boat . . . wherever fire may strike. This low-cost fire protection requires no periodic inspections or refilling. **SPRAZIT** is a compact, efficient fire fighter . . . contains 16 full ounces of smothering, non-damaging fluid! **SPRAZIT** will instantly put out almost any type of fire. Get **SPRAZIT** today! If your dealer can not supply you MAIL THIS COUPON:

*Copyright 1948

PLASTI-KOTE, INC., 425 Lakeside Ave., N.W., Cleveland, Ohio

Please send me **SPRAZIT** Fire Extinguishers as checked below:
 1 **SPRAZIT** Extinguisher at \$1.49 3 **SPRAZIT** Extinguishers at \$4.35

Send C. O. D. plus postage, I will pay postman.

I enclose payment. Send postpaid.

Send catalog and price list explaining the complete **SPRAZIT** packaged power line—Plastic Spray, Air Conditioner, Insect Killer, Moth Proofer and Auto and Furniture Wax.

Name _____

Address _____

City _____ Zone _____ State _____

BUILD YOUR OWN TRAILER

with **NATIONAL'S**
Easy-to-Read **PLANS**

Here it is! Your own full size house on wheels . . . or if you prefer, a sleek sports trailer that will add new thrills to your vacation. Easy to read, easy to follow instructions and a complete "cost of materials" with every plan.

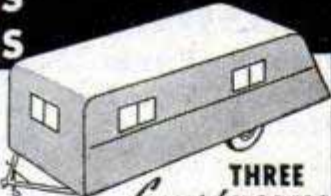

THREE
Smart **MODELS**

**ORDER ALL THREE
GET ONE FREE!**

Set of 3...\$2

FREE!

Big illustrated parts Catalog with Any Order!

- ➔ **Model 27** 27-foot Luxury Liner, 35¹/₀₀ rooms, toilet. Sleeps 6.
- ➔ **Model 20** 20-foot Cabin Trailer, \$1⁰⁰/₀₀ tops for looks. Sleeps 4.
- ➔ **Model 10** Sports Trailer for hunting, fishing. Sleeps 2. 50^c

NATIONAL TRAILER STORES

Dept. PM-Box 2353 Terminal Annex - Los Angeles 54, Calif.

READY CUT HOMES

Order Now

Homes \$1835.00 and up, freight paid. Orders filled in order received. Save up to \$1000 on modern production method homes. Much more compared with builders' prices. Anyone can assemble. Complete, including paint, hardware, roofing, glass, nails, etc. Send 35c in coin for full color catalogue showing 57 modern low-priced homes and floor plans. Complete low cost building plans ready for filing. Sold separately if desired.



**NEW COLOR CATALOG
FOR ONLY**

Dept. PM-69
**INTERNATIONAL MILL
& TIMBER CO.**
Bay City, Mich.

35c



125
Illustrations

**SPEED & MILEAGE
MANUAL**



**EASILY OBTAIN GREATER
SPEED, MILEAGE, RACING
PERFORMANCE FROM
ANY AUTOMOBILE!**

Famous new book shows simplified soup up methods—Speed Tuning—Mileage Secrets—Economy Tips! "Hot Rods!" Sports Cars! Complete instructions on building inexpensive superchargers, Hi-Speed Heads, Dual Mufflers, Manifolds, "Water Injectors!" All about engines, "Economy Tuning," Restyling, "Racing Tricks"—Fuel! Reveals Track Proven Methods that will give your car thrilling new get-away—with up to 40% more speed and mileage!

Also shows latest "Hollywood Custom Styling" methods! Streamlining! Sport changed! Money-Saving Speed Conversions! California Roadster Drawings! Racer Plans! Working Diagrams! Speed Catalogues! Photographic Complete Data—PLUS "Beautiful Custom Car & Hot Rod Pictorial Supplement!"

SATISFACTION GUARANTEED—ONLY COMPLETE \$1.98 Post-book of its kind. ONLY paid

ALMQUIST ENGINEERING, Milford 91, Pennsylvania

Catalog
FREE

PRISM BINOCULARS
PRECISION OPTICS—BRAND NEW



7x50
\$44
Ht. 7 in.
Wt. 37 oz.

**10x50 WIDE ANGLE
IND. FOC. \$55**

**8x32 COATED
CEN. FOC. \$39.50**

**6x30 GERMAN
CEN. FOC. \$37.50**

20% Federal Tax
Leather Cases Incl.

**Money Back Guar.
We Pay Postage**

BROWNSCOPE CO. Dept. 6M, 24 W. 45th St.
NEW YORK 19, N. Y.

BOMB HOIST WINCH

\$15⁹⁵



2500 LB. CAPACITY

PERFECT for garage, trucks, shops, boats, farms, etc. BRONZE worm gear with 24-1 controlled ratio. 19' of 1/4" steel cable with hook. DUAL

SPEED handle for greater leverage. A WAR SURPLUS VALUE. F.O.B. Los Angeles. 20% with C.O.D.'s. **MONEY BACK GUARANTEE.**

Semlers' ASSOCIATED SURPLUS CO.
10838 VENTURA BOULEVARD • NO. HOLLYWOOD, CALIF.

Sounds the Alarm for

**FIRE
Burglary
FLOOD**

BUZZ-O-LARM



BUZZ-O-LARM plugs in any 110 V AC outlet, automatically sets off a loud penetrating alarm in case of fire, burglary or flood—one unit protects several danger zones. Warns of flood or sump pump failure before water rises 1/8". Underwater 160° fusible links used with alarm for fire. Acclaimed by insurance underwriter's and protective associations—it's built for lifetime use—no upkeep—no repairs—no worries. Order yours today—only \$4.95 postpaid. Fusible links 25c each or 5 for \$1.00. **Money Back Guarantee**
C. W. CARBERT CO., 939 HAZEL, BIRMINGHAM 1, MICH.

OIL TANKS GASOLINE

- 525 Gal. round 42" x 86", 12 gauge, 3 opening. F.O.B. \$65.00 South Bend, Ind.
- 1065 Gal. over or under ground, 12 gauge, 3 opening \$104.00 46" x 148". F.O.B. South Bend, Ind.
- 275 Gal. oval 14 gauge, basement, 26" x 46" x 60" with leg lugs. F.O.B., K. C., Mo., or Tulsa, Okla. \$37.50
- 275 Gal. farm tank, standard openings, oval. F.O.B., K.C., Mo., or Tulsa, Okla. \$37.50
- 275 Gal. farm tank standard openings, complete with 6 ft. stand, hose nozzle, gauge, valves, etc. F.O.B., Tulsa, Okla. \$72.50
- 300 Gal. farm Tank 14 gauge round. F.O.B., Tulsa, Okla. and Warren, Ohio. \$37.95
- 300' Gal. farm Tank 14 gauge complete with stand hose, nozzle valves, gauge, etc. F.O.B., Warren, Ohio. \$87.00
- 300 Gal. Septic Tanks 14 gauge. F.O.B., K. C., Mo. \$60.00
- 500 Gal. Septic Tanks 14 gauge. F.O.B., K. C., Mo. or South Bend, Ind. \$78.00

Deposit or payment in full with order.

DIRECT SALES 921-PM- W. 17th ST.
KANSAS CITY, MO.

WESTINGHOUSE Air Compressor

WITH 20 FT. AIR HOSE
AND
DETACHABLE TIRE CHUCK

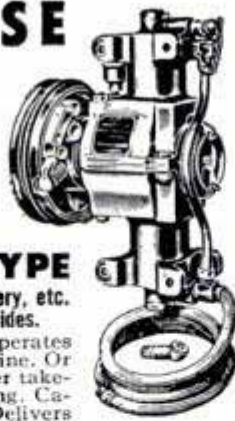

2-CYLINDER PISTON TYPE

Spray paint your buildings, cars, trucks, machinery, etc.
Inflate tires, grease machinery, spray insecticides.

Built to sell for 3 times our low price. Operates from 1/2 h.p. motor or equivalent gas engine. Or may be run from truck, tractor, jeep power take-off or fan belt; designed for easy mounting. Capacity up to 6 1/2 cu. ft. 100 lb. pressure. Delivers filtered "Oil free air". Air output double that of similar compressors. Rugged, super-efficient, portable.

Special \$22.95 price F.O.B. Chicago area includes compressor, 20 ft. double braid heavy duty air hose, Schrader Air Chuck. You save over 1/2. Act now! Money back guarantee. Send check or money order to:

A & K EQUIPMENT & SUPPLY COMPANY
Dept. 10, Burlington, Wis.

War Surplus — DYNAMOTORS

D-2 Converts to 110 V AC in ten minutes, diagram included, contains integral gear box having four 1/4" drive shafts turning simultaneously at the following speeds:
4000 RPM—Grinders, buffers, flexible shaft tools, etc.
150 RPM—Wrapping fishing rods, slow speed tools.
25 RPM—Dev. tray rocker for photodarkroom.
5 RPM—Turning barbecue spits.

Adv. Disp. Beams. A Thousand Other Uses Around the Work Shop. ONLY **\$7.95**

D-1 Converts to 110 V AC in ten minutes, diagram included, has shaft with squirrel cage blower, also gear reducer with 2 shafts and pulleys at the other end. 1001 uses. New **\$6.95**

All prices F.O.B. Chicago. 20% deposit required on all C.O.D. Orders. Write for free catalog.
NESCOP ELECTRONICS Dept. PM. 2635 W. Grand Ave. Chicago 12, Ill.

NEW! FOR PROFIT & PLEASURE

IN COPPER TOOLING & ETCHING
No Experience needed — start at once. BIG MONEY waiting in COPPER ART field. Plaques, Bowls, Trays, Gifts, Souvenirs of all kinds. Start on the road to success NOW! Here is an opportunity to get started in your own Big Paying Business—FREE DETAILS don't wait—WRITE NOW!
HOLLYWOOD COPPER ART—Dept. PM-6
4257 Beverly Blvd., Los Angeles 4, Calif.

DO IT AT HOME

STOP FUMBLING FOR SMALL CHANGE!

Kar Kashler holds pennies, nickels, dimes handy for parking meters, Drive-ins, papers, etc., right at your finger tips. Excellent for ladies' handbags.

CAN'T SCRATCH OR MAR YOUR CAR — Of lightweight, sturdy rubber. No Suction Cups—Just press on dash board or upholstery. Coins can't fall out. Send only \$1.00. (We pay All coins visible—Pat. Pending postage). No C.O.D.'s.
SEXTON PRODUCTS MFRS., 2700 N. Sacramento, Chicago 47, Ill.

SAVE 25% ON QUALITY BALL-BEARING WHEELS!

Garden carts, laundry carts, wheelbarrows, any cart you build or repair with Bilt-Rite wheels rolls smoothly and easily—and you save up to 25%! Bilt-Rite Wheels are semi-pneumatic, ball-bearing, red wheels, guaranteed top quality. Compare Bilt-Rite's quality and price—then get your order in today!

Bilt-Rite Bargains on Ball-Bearing Wheels (For 1/2 inch Axles)			
6 x 1.00\$1.30	10 x 1.75 in.	\$2.15
8 x 1.751.80	10 x 2.00 in.	2.45
6 x 1.50\$1.60		
(For 5/8 in. axle)			
10 x 2.75 in.Only \$4.65!		



Bilt-Rite Guarantee
No better wheels are made regardless of price; 10 day return privilege.

If size you need isn't listed, write for Folio A
ORDER TODAY—Send cash, check, or M.O.—Pay postage on arrival.
BILT-RITE WHEEL COMPANY
520 EAST MISSOURI AVE. KANSAS CITY 6, MISSOURI

Learn AUTO BODY & FENDER REPAIR

This New, Easy Way!



Hear Instructor's Voice At Home!

Get into big money Auto Body and Fender Repair! Take UEI Audio training for basic knowledge which can bring you experience leading to fine pay, perhaps your own profitable shop. Revolutionary new training method brings instructor's voice to your home on records. Easy listening helps you master printed lessons quickly and thoroughly. Keep your present job and LEARN IN SPARE TIME. Follow with actual practice in our shops. Training covers metalwork, welding, painting, etc.

Cash In On This Big Opportunity Trade

Demand—and pay—for trained Auto Body and Fender mechanics is big. If you are mechanically inclined, get the training to make the most of it. National Placement Service or start your own shop. UEI has helped men get ahead in money-making trades since 1927. Get all the facts FREE. Fill out and mail coupon now!
UTILITIES ENGINEERING INSTITUTE
2523 Sheffield Avenue, Dept. XC-2, Chicago 14, Illinois

UTILITIES ENGINEERING INSTITUTE
Autocrafts Division
2523 Sheffield Ave., Dept. XC-2, Chicago 14, Ill.
O.K.! Rush FREE facts about the opportunities in Auto Body and Fender Repair and UEI training with new Audio Service.

Name _____ Age _____
Address _____
City _____ ZONE Or COUNTY _____ State _____
 Check here for special information if you are under 17.

EARN MORE MONEY IN ELECTRICITY!

with APPLIED PRACTICAL ELECTRICITY



Coyne's new set helps men get ahead in Electricity. 8 great books give you complete A to Z know-how, explained in easy-to-follow language with hundreds of charts, examples, pictures. Covers all branches of electricity including appliance repairing; AC and DC equipment; electrical refrigeration; industrial electronics and much more. Brings you 10,500 electrical facts; 3,400 subjects; hundreds of wiring diagrams, tables, formulae, short-cut methods. Backed by 50 years of Coyne experience in training that has put hundreds of men on the road to top earnings.

USE SET FREE FOR 7 DAYS!

You have to SEE these books to know how much they'll help you. See them FREE! Just fill out coupon below and mail it in. SEND NO MONEY. Examine the set for 7 days AT OUR RISK!

HANDBOOK OF RESIDENTIAL WIRING FREE FOR PROMPT ACTION

Act promptly and we will include FREE, the valuable new booklet, "Handbook of Residential Wiring Design." If you return the Set at our expense in 7 days, you owe nothing. To keep Set, send either \$23.75 in cash or \$3.00 after 7 days and \$3.00 per month until \$25.50 is paid. Either way, you keep the Residential Wiring Book FREE! Coupon below is just a request to see APPLIED ELECTRICITY Set and to get FREE Wiring Book for doing so. Mail coupon AT ONCE!

FREE TRIAL COUPON—MAIL NOW!

Educational Book Publishing Division.
COYNE ELECTRICAL & RADIO SCHOOL,
500 S. Paulina St., Dept. A9-R6, Chicago 12, Ill.
YES! Send Coyne's new, 8 volume set, "Applied Practical Electricity" to me, postpaid, for 7 days FREE TRIAL per your offer. Include "Handbook of Residential Wiring" FREE.

Name _____ Age _____
Address _____
Town _____ Zone _____ State _____

PAINT YOUR CAR

2 FULL COATS for ONLY **\$2.95**
ONE QUART DOES ENTIRE JOB

or any other Metal or Wood Surface

WITH **WYPE** TRADE MARK REG.

NO SPRAYING · NO MASKING · NO BRUSHING

AMAZING NEW BRUSHLESS AUTO ENAMEL
You JUST WIPE ON
with a POWDER PUFF
instead of Brushing or Spraying



ANYONE CAN DO BEAUTIFUL JOB

Dries Dust Free One Hour · No Streaks or Lapmarks

Get Beautiful Mirror-Like Finish That Looks Like Spray Job!

No previous car-painting experience necessary. You get a beautiful high-gloss job that gives you an expensive finish such as is sprayed on by Professional Auto Painters. With WYPE you need **NO BRUSH, NO SPRAY, NO MASKING!** Just **WIPE ON** with Powder Puff — which we furnish at no extra charge. You get a brilliant, glossy finish that is truly "factory-like." No streaks. No lap-marks. Guaranteed for **TWO** years not to crack, peel, chip or fade, if simple directions are followed. Takes about an hour to apply. Dries dust-free in an hour. WYPE comes in most popular shades. Goes over any other color, lacquer or enamel.

NO OTHER PRODUCT Gives You This Protection

2-YEAR GUARANTEE
We Guarantee WYPE against cracking, peeling, fading or chipping for two years after application, if applied according to directions furnished. Your money cheerfully refunded if WYPE does not live up to this Guarantee.

Hundreds of other uses for WYPE!

MOST POPULAR COLORS
Black Brewster (dark) Green
Maroon Jewel (light) Green
Red Washington (dark) Blue
Gray Monticello (light) Blue
White Sun Beige (light) Tan

\$2.95 PER QUART

The ONLY Brushless Enamel CERTIFIED

by U.S. Testing Co., Inc. **WORLD-FAMOUS Testing Laboratory** and found to conform to the claims and guarantee of the Wype Corporation. U. S. Testing Co. is the largest impartial testing laboratory of its kind, and conducts scientific tests for the world's foremost companies. Before you buy any automobile paint, ask for proof that it has passed tests by a nationally-known testing laboratory whose name is given in the advertising. You're **SURE** you are **SAFE** when you paint with WYPE.



APPLY in ONE HOUR — DRIES to GLISTENING PROFESSIONAL FINISH

WYPE is a new Miracle Enamel for Autos. It is **NOT** a wax or polish but a hard high lustre ENAMEL finish! With WYPE, **ANYONE** can do a beautiful job! Order a quart to paint your car or to get started in this **BIG-MONEY** Business!

NO STREAKS OR LAPMARKS LOOKS LIKE SPRAY JOB

Paint Anything At Home
Repaint outdoor & indoor furniture, bicycles, hardware, damaged white enamel stoves, refrigerators, etc., and any other article of steel or wood.



DEALERS & JOBBERS WANTED Write Today

\$1.75 a Pint—2 pints Do a 2-Tone Job

SEE YOUR DEALER or ORDER DIRECT SEND NO MONEY · Get WYPE Today!

If your dealer can't supply you, just send us a postcard. We'll ship C.O.D. Just pay mailman for Wype, plus postal charges. Or send remittance with order and WE pay postage.

Some of the FAMOUS DEPARTMENT STORES that Sell WYPE

VISIT or PHONE THE STORE IN YOUR CITY . . .
If you live in one of the cities shown here, it will be more convenient to buy from your favorite department store. Ask your dealer! Leading merchants and gas stations everywhere sell WYPE.

Akron: M. O'Neil Co.; Baltimore: May Co.; Boston: Jordan Marsh Co.; Buffalo, N. Y.: J. N. Adam & Co.; Chicago: Goldblatt's 15 Dept. Stores (Goldblatt's, also, at Joliet, Ill.; Hammond, Gary & South Bend, Ind.); Chicago: Wieboldt Stores, Inc.; Cincinnati: Fair Store Co.; Cleveland: May Co.; Dallas: Sanger Bros., Inc.; Denver: May Co.; Detroit: People's Outfitting Co.; Ft. Worth: W. C. Stripling Co.; Grand Rapids, Mich.: Herpolsheimer Co.; Hackensack, N. J.: Packard-Bamberger Co.; Houston: Foley's; Indianapolis: Wm. H. Block Co.; Kansas City, Mo.: Jones Store Co.; Little Rock, Ark.: The Gus Blass Co.; Los Angeles: May Co.; Louisville: Kaufman-Straus Co.; Memphis: B. Lowenstein & Bros.; Milwaukee: Ed. Schuster & Co., Inc.; Minneapolis: Donaldson's; New Orleans: Maison Blanche Co.; Newark, N. J.: Bamberger's; New York: Gimbel's; Philadelphia: Lit Brothers; Pittsburgh: Kaufmann's; Portland, Ore.: Meier & Frank; Providence, R. I.: The Shepard Co.; Richmond, Va.: Miller & Rhoads, Inc.; Rochester, N. Y.: Sibley, Lindsay & Curr; St. Louis: Famous-Barr Co.; St. Paul, Minn.: The Golden Rule; San Antonio: Joske's of Texas; San Diego: Whitney's; San Francisco: Hale Bros. (Also Hale Bros., Oakland and San Jose); Seattle: The Bon Marche; Spokane: Spokane Dry Goods Co.; Syracuse, N. Y.: Dey Bros. & Co.; Toledo: Lion Dry Goods Co.; Warren, O.: Griswold's; Washington, D. C.: Lansburgh & Bro.; Youngstown, O.: Strouss-Hirschberg Co.

WYPE CORP. Dept. 16-F 2214 DOLMAN ST. ST. LOUIS 4, MO.

**WORLD'S
BEST
WANT AD
MEDIUM**

CLASSIFIED Advertisements



Advertisements in this section 75 cents per word, each insertion, minimum 10 words, payable in advance
To be inserted under proper classification, copy must be in our office the 22nd of the
second month preceding date of issue

F. W. Johnson, Manager, Classified Advertising
Popular Mechanics Magazine, 200 East Ontario Street, Chicago 11, Illinois

1091

CLASSIFIED ADVERTISEMENTS

1091

OPPORTUNITIES FOR YOU

AUTOMOBILES, MIDGET CARS

AUTOMOBILE Racing, Sixth Edition. 100 illustrations. Working drawings with building instructions for Ford-60 midget, California roadster, Offenhauser racer. Details on racer parts. Sample entrance blank. World's record 158.5 m.p.h. rear engine four-wheel drive car. Interesting information for fans, drivers, mechanics. \$2.00 postpaid; \$2.40 c.o.d. Ray Kuns, Department 63, Cincinnati 27, Ohio.

INDIANAPOLIS Race history book. All races since 1909. 1100 photos. 340 pages. \$3.50. 1948 Race Book \$1.50 postpaid. Clymer, Dept. A-500, 1268 So. Alvarado, Los Angeles 6, Calif.

CHEVROLET Hotrod Manual gives full details and photos on how to obtain terrific speed, acceleration and hotrod performance from your 1937 thru 1949 Chevrolet. 54 pages, expertly written. Packed with accurate data you can use! Sent postpaid for \$2.00. California Bill, Box L-1, Eaglerock, Los Angeles 41, Calif.

FREE Trial! Save gas! Gane needles give better idling, faster pickup. \$1.50 ea. (8's take 2). Send make car and carburetor. Gane, 10-01 2nd, Fairlawn, New Jersey.

NEW Ford Speed Manual. 128 pages chock full of cutaway construction drawings, photos, and valuable easy to read and understandable technical data. Neatly bound with colorful eye-catching cover. Includes complete data on installing V-8 motor in model A chassis, hydraulic brakes for any Ford, roadster and fast road car info. How to rework these engines for speed: V-8, Merc., Ford 6, Zephyr, model A. Guaranteed the finest manual of its type published to date. Sent postpaid for \$2.00. California Bill, Box L-1, Eaglerock, Los Angeles 41, Calif.

CLYMER'S New catalog illustrates, describes all 1949 American cars. Complete detailed specifications all makes, including Tucker, Playboy, Del Mar, Davis, Keller, all G-M, Ford, Chrysler lines and independents. Compare all cars in one book. Sensational. 100 photographs. \$2.00 postpaid. Clymer, Dept. A-49, 1268 So. Alvarado, Los Angeles 6, Calif.

CALIFORNIA Custom accessory headquarters. Buy direct from original designers and save. Solid hood sides, grille panels, lowering kits, fender skirts, dual pipes, chrome motor accessories, speed equipment. 1949 catalog just out. 32 illustrated pages, jam packed with California accessories. 25c. Eastern Auto Supply, 3319-A South Grand, Los Angeles 7, Calif.

TED Horn Number 1. A new book on life, racing experiences late American automobile racing champion. 224 pages with 70 photographs Horn and famous cars. Fascinating, colorful record entire career. Royalties go to Horn estate. Beautifully bound fabrioid memorial edition with gold leaf lettering \$3.50. Paper edition \$2.00. Postpaid. Clymer, Dept. A-TH, 1268 So. Alvarado, Los Angeles 6, Calif.

POWER-TONE Mufflers for all cars. Gives that power plus tone. Singles and dual sets for Ford and Mercury. Also the new Power dual intake manifold for Ford and Mercury cars. Many other items. Dealer inquiries invited. Power Engineering Company, Dept. PM-6, 4506R Delmar, St. Louis 8, Mo.

GARAGE Door opener. "Build yourself" plans 25c. Kaytor Laboratories, Lynwood,

CLYMER'S New steam traction engine album. 160 large pages. Just out. 470 photographs, charts, drawings, early advertisements U. S. and foreign makes steam engines and threshing equipment. 105 different makes steam engines shown. See Case, Advance, Reeves, Rumley, Avery, Westinghouse, others, from 1855 to 1929. Unique, historical, educational book of real Americana. Postpaid \$2.50. DeLuxe edition fabrioid bound \$3.50. Clymer, Dept. A-ST, 1268 So. Alvarado, Los Angeles 6, Calif.

DUALTONE Crystalline packed California mufflers and dual sets. California chromed accessories, lowering blocks all automobiles. Speed and doll-up equipment. Catalogue 20c. streamlining manual \$2.00. Dealers request dealership information. Dualtone Mufflers, 2636C India Street, San Diego 1, California.

SEE Our ad under motorscooters for midget car bargains. Midget Motors Directory, Athens, Ohio.

FORD Model "A" complete service manual \$1.00. Model T manual \$1.50. Fordson Tractor \$1.00 postpaid. Clymer, Dept. A-AT, 1268 So. Alvarado, Los Angeles 6, Calif.

BREATHAKING Performance! Hotrods! Fast stock cars! Instructions! Photographs! Only \$1.50! Speed and beautifying equipment list 25c. We pay shipping! Hollywood Hot-Rod, Box 9226-P3, Hollywood 27, Calif.

SPEED Equipment for all cars. All known brands. Lowest prices in U.S. Free catalog. Speedomotive, Box 364, Covina, Calif.

AUTOMOBILE Racing book, fifth edition, well illustrated. Instructions on building bodies, frames, engines. Ford A and B conversions. Plans. AAA rules, specifications. Roadster racing. Indianapolis cars. \$1.00 postpaid, \$1.40 C.O.D. Ray Kuns, Dept. 47, Madisonville, Cincinnati 27, Ohio.

HOW To Build Racing Automobile. New, revised. Complete information. \$2.00 postpaid. Clymer, Dept. A-NRB, 1268 So. Alvarado, Los Angeles 6, Calif.

NEW Hot rod book. Revised, 1946, 1947, 1948 speed record cars, photos, descriptions. \$1.50 postpaid. Clymer, Dept. A-6NV, 1268 So. Alvarado, Los Angeles 6, Calif.

OUTBOARD Book. Complete servicing information all makes. 252 pages. Postpaid \$3.50. Clymer, Dept. A-OM, 1268 So. Alvarado, Los Angeles 6, Calif.

GASOLINE Guide book. Tells 15 methods saving gasoline. Describes all octane gasolines, anti-knock fuels, 72 charts, drawings. \$1.50 postpaid. Clymer, Dept. A-GG, 1268 So. Alvarado, Los Angeles 6, Calif.

FAMOUS Car catalog reprints. 1949 Alfa-Romeo, 1949 German Volkswagen, 1949 Italian Maserati racing and new sport car, 1949 rear-engined Isotta-Fraschini V-8, Rolls-Royce "Silver Wraith," Dusenber Supercharged, Mercedes-Benz, Miller race cars, Cord, Rayfield Cyclecar, V-8 Chevrolet, Stanley Steamer, Doble Steamer, 1916 Metz, 1912 Ford. Specify catalog desired. \$1.00 each postpaid. Clymer, Dept. A-6X, 1268 So. Alvarado, Los Angeles 6, Calif.

SAGA Roaring Road. Complete early American automobile racing history book. Illustrated. \$2.00 postpaid. Clymer, Dept. A-SRR, 1268 So. Alvarado, Los Angeles 6,

INTERCHANGEABILITY Bearing book. Saves dollars for garagemen, dealers, fleets, mechanics, owners. Many bearings are of same identical specifications 100 percent interchangeable, but their identity is hidden because of wide spread in different car manufacturer's prices, \$5.00 per copy. Covers cones, cups, pins, roller, ball; for (wheels, transmissions, differentials, axles, generators, steering, etc.) Order now at special price. Send only \$2. Automotive Research Publications Inc., PM59, Islip, New York.

"SPEED & Mileage" Manual—(New, revised!) Easily obtain greater speed, mileage, racing performance from any automobile! Famous authentic book shows simplified soup up methods; speed tuning; mileage secrets; speed equipment plans; 125 illustrations. Complete instructions on building inexpensive power equipment! Hi-speed heads! Superchargers! Dual mufflers! Manifolds! "Water injectors!" Fast conversions, "Hot Rods," custom cars! All about engines, economy tuning, restyling, compression, fuels, racing tricks! Track-proven methods! Latest Hollywood customizing information! Streamlining! Sport changes! Money-saving speed conversions! (Plus) California roadster plans! Parts lists! Speed catalogues! Beautiful pictorial supplement! Folios! Photographs! Working diagrams! Complete data! Everything \$1.98 (satisfaction guaranteed). Almqvist Engineering, Milford 90, Pennsylvania.

"SPEED & Power" Handbook—Very latest methods! Build your own dual manifolds, superchargers, water injectors, hi-compression heads, fuel saving devices—easily. Save many dollars! Get racing speed, acceleration, dynamic power increases from any automobile! Build fast stock cars! California roadsters! Hotrods! Get construction diagrams! Ingenious formulas! Speed secrets! Also "economy information"—Mileage tricks! Conversion ideas! Tuning techniques! Picture catalogues. Plans! Drawings! Including "California restyling ideas"—Glossy photographs! Plexi-Tops! Model revising! Streamlining! Customizing!—\$1.98 complete. Newhouse Automotive Industries, 5805-B2 East Beverly, Los Angeles 22.

PREMIUM Tire prices slashed. Mileage boosted. Double savings. Free literature. Alto, 2319-J Walnut, Texarkana, Texas.

"SPEED Handbook"—Just published! Latest speed data for all cars! Shows how to easily construct your own speed equipment. Build 145 m.p.h. racers! Hollywood hot rods! Sport cars! Fast street, track conversions! Illustrates California customizing! Body restyling! Motor rebuilding! Speed changes! Tuning! Streamlining! Gives complete hop up information, speed tricks, fuel formulas, mileage tips, conversion plans. Covers channeling, multiple carburetion, water injection, ignition, ratios, porting, balancing, time trials. Latest California methods! Equipment catalogs! Hot rod plans! Drawings! Working sketches! Photographs! Charts! Graphs! Terrific book \$2. Speed Publications, Drawer 716, Port Jervis 10, New York.

"HOLLYWOOD" Motorboat tone mufflers—Singles, all cars \$4.85, V-8 duals \$17.50. Satisfaction guaranteed! Almqvist Engineering, Milford 90, Pennsylvania.

BUILD Airplane type mixture control cheaply, greater mileage. Plans \$1.00. Johnson's, H 33 B Stad. Terr., Champaign, Illinois.

NEW Custom Styling Manual—(Jumbo edition!) Shows how to easily make your car look beautifully custom! Latest restyling, streamlining, customizing methods! Hollywood sport changes! Fast model conversions! Jam-packed with photographs, illustrations, drawings! "Hop-up" specifications. Complete restyling information. (Including custom car catalog and amateurs "idea starter" kit.) Everything \$2. Alquist Engineering, Milford 90, Pennsylvania.

"VAPO-STEAMATIC" Water injector. Easily built! Finest automatic "moist-humidity" system. Engineering triumph—Gets up to ten extra miles per gallon! Tremendously increases horsepower! Eliminates ping, carbon, overheating. Reduces wear—Lengthens engine life. Copyrighted "Quick-Installation Handbook"—including illustrated plans, diagrams, instructions—\$1.00 complete. Newhouse Automotive Industries, 5805-B1 East Beverly, Los Angeles 22.

SPEED Equipment bargains! "California" mufflers \$4.50, duals \$17.50, V-8 heads \$45.00, dual manifolds \$9.95, water injectors \$4.95, chrome echo cans \$1.65, super-charger stacks \$2.98, lowering kits \$2.95, chrome fender trim 90c, many others! Illustrated "Speed Catalog" 25c. Alquist Engineering, Milford 90, Pennsylvania.

RACING Car equipment for all cars, engines, racing heads, manifolds, carburetors, mufflers, etc. Speed instructions and literature \$1.00—refunded first order. Lee Motorcraft Co., 1412-D Great Northern Bldg., Chicago 4, Ill.

INITIALS—Beautiful gold one inch decals for auto doors, luggage, bicycles, etc. Won't rub off. 6 for \$1. Kessler's Accessories, Centerville, Maryland.

NEW Sensational seat cover. Mono, 6545 Santa Monica Blvd., Hollywood, California.

WE Sell direct to customers over 200 speed equipment parts manufactured by us. Ford A-B-V8-6-4 (Ferguson), Studebaker Champion, Chevrolets and Willys. Cylinder heads, dual intake manifolds, flywheels, oversize valves, compound springs, camshafts and other supplies. Complete engines ready for race for cars, boats and midgets. \$1.00 to cover illustrated literature and price sheet. R & R Mfg. Co., Robert M. Roof, Box 546, Anderson, Indiana.

FROM Speedway to roadway! Track-proved hi-speed heads and manifolds now available for your passenger car! No special tools needed! Increase horsepower 25%! Astounding getaway! Free illustrated catalog. Speedsport, 6215AA Diversey, Chicago 39.

AUTO SUPPLIES AND EQUIPMENT

CHROME Wheel disc. Save to \$5.00; only \$8.50 set. Moneyback satisfaction. Cash or c.o.d. Cash orders postpaid. Specify car and wheel size. Free catalogue on request. R & E Sales, Box 611, Grand Rapids, Mich.

BUICK Parts—Enjoy new-car pep and power in your old Buick. Same day service from world's largest stock of new (not rebuilt) Buick parts and engines. Ship anywhere. Write today. Robertson Buick Co., 1001 S. Wabash Ave., Chicago 5, Ill.

PRES-A-LITE Automatically hands you lighted cigarettes while driving. Free literature. Leung, 19 South Village, Rockville Centre, N. Y.

NATIONALLY Known parts at wholesale prices. Give year, make and model. Ship c.o.d. Parts, P.O. Box 325, Willimantic, Conn.

"AIRFLOW Needles." Save gasoline. Free trial! Send make car and carburetor. Neher Industries, La Verne, Calif.

OIL Filter that cools oil. Remarkably efficient. \$8.60. Write for folder. Stonewall Company, 2005-M Cedar, Alhambra, Calif.

AUTO Key chain flashlight—Complete with battery. No more trouble finding key-hole at night. \$7.20 dozen; sample \$1. Joseph Fleischman, 1535 Broadway, Tampa, Fla.

HOLLYWOOD "Razz" horn. Humorous efficient signal with a smile. \$3.50. Ki-Yi barking dog horn \$3.50. Cadet vacuum twin air horns, spun brass, chrome finish. Complete \$29.75 postpaid. E-Z installation any car. Clymer, Dept. A-KY, 1268 So. Alvarado, Los Angeles 6, Calif.

HYDRAULIC Jack repair kits. Repair your own. Send for prices. Berman Machine Works, 2000 So. Claiborne, New Orleans 13, La.

"WATER Injection." Free descriptive, illustrated, information. Neher Industries, La Verne, Calif.

VAPOR Injector complete, \$8.00. Cools engine, improves operating efficiency. If not satisfied after ten days trial, we refund. Thomas Engineering & Novelty Co., Box 5528, Washington 16, D.C. Send make of car or truck, year and type.

YOUR Initials on your car. Six for 50c. Stillwell, Empress Building, Decatur 64, Illinois.

PARTS, New, used, for all cars. Auto Parts Service, 111 Sunset Ave., Fairfield, Conn.

HANDBOOK All Ford cars 1932 to 1949 inclusive. Complete detailed information, service operations, 100 illustrations. A "must" for every Ford owner. Includes V-8 and 6. Entirely new, just out. \$1.50 postpaid. Clymer, Dept. A-WL, 1268 So. Alvarado, Los Angeles 6, Calif.

MOTORISTS Save gasoline by Vacuumating overrich mixtures. Fits all cars. For free particulars write Vacuumatic, Dept. 1534, Wauwatosa, Wis.

SAV-T-PIN. Sensational new device replaces carburetor idling pin. Improves mixture, better combustion, smoother performance. E-Z installation. State make car, carburetor. \$1.25 each postpaid. Eight require two. Clymer, Dept. A-SAV, 1268 So. Alvarado, Los Angeles 6, Calif.

COPPER Tubing, brass fittings for oil, gas, water lines. Wholesale catalog. Brass Products, 10607 South Campbell Avenue, Chicago 43, Illinois.

NEW Patent, Lachapelles motor and motor fuel treatment stops ping, gives more power, more miles per gallon, more miles per motor, enough for 100,000 miles. \$3.00 postpaid. Ferns Products, 8120 Walnut Dr., Los Angeles 1, Calif.

AUTOMOTIVE Surplus tool specials! Pullers, wrenches, socket sets, reamers, other bargains. Nationally advertised merchandise. Free catalogue. Glenco Supply, 7519 Myrtle Avenue, Glendale 27, N. Y.

GOVERNMENT Surplus. Low voltage circuit tester in steel box. Cost \$202.00. Our price \$27.50. Will test batteries, starters, generators, voltage regulators, grounds, short circuits. Wilt Electrical Company, 7829 S. Racine Ave., Chicago 20, Ill.

FIBRE Seat covers \$9.98, plastic \$17.98. State make, model. Arnold, 382 Livonia, Brooklyn 12, New York.

HYDRAULIC Brakes Ford model "A," all V-8's. Modernize your old Ford. Specify model. E-Z installation. Complete kit new units replacing mechanical type. \$85.00. Clymer, Dept. A-HB, 1268 So. Alvarado, Los Angeles 6, Calif.

RUSTED-Out bodies, doors, fenders repaired without welding, soldering. Professional results. Instructions \$1. Gibes, 2134 Haddon, Chicago 22.

CARS Glisten! Easy, inexpensive. Details. Mailord, 204-a East 81, New York 28, N. Y.

"SMITHYS Mufflers" for all cars. Free list. Buck's Auto Parts, 1296H, Merced 8, California.

GASOLINE Saver. \$1.00. Stromberg carburetors EE1-AAV16. Walert Co., 3429 No. 10th St., Milwaukee 6, Wis.

WELDING Bodies, blocks, fenders, bumpers—easy with Hobart Welders. Adds dollars to profits. Free catalog. Write Hobartweld, Box M-692, Troy, Ohio.

1949 SUPERIGNITIONITER. Starting, pep, mileage. \$4.85. E G Mfg., Elmsford, New York.

BRILLIANT. Windproof, waterproof, safety flares. Box of 8 fits glove compartment. \$1.00 postpaid. VBM Sales, 924 North 16, Omaha 2, Nebraska.

MECHANICS—Be independent. Smooth all crankshafts. \$15.00. Free literature. D. McGee, 719A Cascade, Wenatchee, Wash.

"LEKTRON" Atomic coil booster saves gas. Instant starting. Only \$2.00. Money-back guarantee. Easily installed. Specify car. Electronic Industries, Cleveland 11, Ohio.

PISTONS—American and foreign makes. Racing types made. Free price sheet. Mertryman Co., Lawndale, PM2, California.

AUTO Parts for all cars, transmissions, motors, differentials, fenders, carburetors. Security Auto Parts, 1923-PM Grace, Chicago 13.

CHEVROLET Parts. Scarce motor, body, sheet metal parts. Grossman Chevrolet,

HARD-TO-GET Auto body parts. We supply. Miller Auto Parts Service, 192 N. Clark Street, Chicago.

BRUSH Plating outfits connect to a battery. No tanks or shop required. Free particulars. Gunmetal Co., Avenue J, Decatur, Illinois.

AUTO Parts. Buy direct. Get dealers' prices. Represent us in your territory. Write requirements. Specify car make. Mechanics Auto Parts, Factory Warehouse, 3807-PM N. Ashland, Chicago 13.

AUTO TRAILERS

FREE Lowbed trailer plan, Dept. 7, Airplane Tire Company, Tulare 1, California.

BUILD Your own trailer! Save money! Have every feature you want! Plans for house, sport, camp and utility trailers. Catalog describing 9 models 10c. 15c in Canada and overseas. Jim Dandy, Box 125-A, Wausau, Wisconsin.

MOTORCYCLES, BICYCLES, MOTORSCOOTERS AND SUPPLIES

WHEELS—10" Aluminum disc: 1 1/4" semi-pneumatic tires; for 7/16" shaft: \$2.50 for set of four. Metalcraft Toy Company, Paul Brown Bldg., St. Louis.

MOTORCYCLISTS! Save up to 50% on new high quality accessories and parts! Send dime for bargain bulletins. Bob's Trading Post, 4168 Fletcher, Chicago 41, Ill.

USED Motorscooter \$4.50, motorbike \$5, midget racer \$10, new Regal motorscooters \$37.50, less motors. Super-Cycles, Cushmans, Salsburys. Briggs motor \$8, others \$3 up. New motorbike conversions \$5. Plenty of brand new motorscooters, midget cars, homebuilders parts, automatic clutches, transmissions, engines, tires, etc. at factory prices. Special sale: Four balloon tires for \$3. Over 4500 tires in stock. Mailorder only. Send 25c for big war-bargain catalogue Number 31, just out listing these and hundreds of other bargains. (35c by first class mail.) Midget Motors Directory, Athens, Ohio.

WORLD'S First jet turbine bicycle engine. Fits any bike. Smooth, economical. \$1.50. Dealers wanted. Literature 25c. Jet Engine Co., St. Augustine, Fla.

MOTORCYCLE Books. Complete servicing information all American motorcycles \$1.50. Triumph, Ariel, B.S.A., Norton, Villiers, \$1.50 each. Modern Motorcycle Mechanics large book all foreign, American makes \$4.00. How Obtain Speed, \$1.50. How to Manage Motorcycles, \$1.50. Catalog free. Clymer, Dept. A-MC, 1268 So. Alvarado, Los Angeles 6, Calif.

CASH For Harley 74 O.H.V. wrecks or parts. Motorcycles, 5205 S. Honore, Chicago.

MOTOR Scooters, bicycle engines. 120 miles gallon. Dime for catalog. Clymer, Desk A-65, 1268 So. Alvarado, Los Angeles 6, Calif.

MOTORCYCLE Accessories, apparel. Send 20c (credited on first order) for Rider's Catalog. 45 pages. 300 deluxe items. Limex, Dept. M, Bellerose 6, N. Y.

WHIZZER Bike-motor \$25.00; Cushman motorscooter \$15.00; midget racer \$40.00; Shaw bicycle-motor \$15.00; Harley-Davidson motorcycle \$15.00; Smith motor-wheel \$25.00; Good motorscooter (twist grip) \$22.50. Rush 25c for new catalog #14 listing many other amazing bargains in motorscooters, used motors, midget cars, parts, wheels, etc. Gall, 538 Erie, Toledo, Ohio.

BICYCLE Supplies. Wholesale, retail list 10c. Universal, 4713 Virginia, St. Louis, Missouri.

COMPLETE One stop Harley Davidson sales service. Comprehensive accessory catalogue 25c. 813 Ohio St., Wichita Falls, Texas.

BICYCLE Repairing made easy. Illustrated "Bicycle Repair Manual," \$1.00. Klausner Cycles, Shelbyville, Ill.

MOTORCYCLE Illustrated news, monthly. Subscription \$1.00. Introductory copy 15c. Worldwide information. Motorcycle News, 5424-A Sawyer, Chicago 25.

GENUINE Elgin motorcycle bags. \$20.00 to \$65.00. Allen Streamlined Bag Co., 106 Brook St., Elgin, Ill.

JET Propelled bicycle. Assemble your own. Photo and instructions \$1.00. Rush order. Maupin, Tipp City 5, Ohio.

HARLEY-DAVIDSON Parts, accessories, batteries, and tires. 24 hour service. Authorized factory dealer. Philadelphia Harley-Davidson Company, 857 North

MOTORBIKE Outfit \$5.00; midget car (complete) \$35.00; Indian motorcycle \$30.00; Cushman motorscooter (complete with extra tire) \$20.00; 1946 Whizzer \$35.00; other motorscooters \$10.00 up; motors \$3.00 up. Send 25c for new catalog #942 listing many other sensational bargains in used motors, motorscooters, motorcycles, parts, etc. Associated, Box 1764-CS, Toledo, Ohio.

MOTORSCOOTERS, New design, 6 big features. Literature 10c. Rollaway Motors, Lancaster, N. H.

RECONDITIONED Motorcycles and motors. Chromium accessories. Complete stock Indian parts. Expert rebuilding. Fast service. Indian Motorcycle Sales, Kansas City 1, Mo.

HARLEY-DAVIDSON Parts, accessories, oil, expert service. Tires all sizes. Rebuilt 45" motors. Send \$2.25 for Army 45 Motorcycle Manual. 25c for accessory catalog and bulletins. Knuth's (Harley-Davidson Dealers), 2491 Fondulac, Milwaukee, Wis.

WHEELS! Build wagons, scooters, mowers, trailers, wheelbarrows, grocery carts, baby carts, play pens, baby carriages. 4" to 16". Free list. Trulsen Mfg. Co., 811 E. 31, Kansas City, Mo.

TIRES And industrial wheels, suitable for scooters, wheelbarrows, farm equipment, etc. All sizes. Bicycles and accessories. Largest assortment in America. Send dime for list. Cycle Transport Company, 1241 So. Michigan Ave., Chicago 5, Illinois.

AVIATION

JET Engine: Build the miniature M.E.W. 601, requires only hand tools. Construction plans \$1.00; parts available. Send 10c for illustrated literature and parts list. Minnesota Engine Works, Dept. PM, 387 University Ave., St. Paul 3, Minnesota.

THREE Blade pusher propeller. Finest birch construction, brass tipping. 50 to 145 h.p.—boats, sleds. Same type used on famous CallAir SnowCar. SnowCar plans, \$10.00. CallAir, Afton, Wyoming.

USED Airplane bargains. Read Flying Reporter, 10c copy, Hibbing, Minnesota.

PROPELLERS, Plans, skis, engines, for ice-snow sleighs, air boats. Literature 10c. Banks-Maxwell, R.F.D. 12, Ft. Worth.

PROPELLERS—2-3 Blade for sleds, air-drive boats. Catalog. Standard Aero Craft, Box 387, Ft. Worth, Texas.

BATTERIES, GENERATORS

COMPLETE Rebuilding service. Fully guaranteed. Save money; generators, starters, armatures, carburetors. Polaris, 4615PM Ravenswood, Chicago, Illinois.

EDISON Non-acid storage batteries for all uses. Fully guaranteed. Interesting literature. Generating plants, all makes and sizes at bargain prices. Hawley Smith Co., Croton Falls 1, N. Y.

ELECTRICAL SUPPLIES

ELECTRONIC Door lock. Sensational. Invisible. Positive protection. Inexpensive. Ends losing keys. Send only \$2 for thoroughly engineered drawings and complete simplified instructions. Satisfaction guaranteed. Ainsworth, 17544 Raymer, Northridge, California.

BUY Lamp parts wholesale. Parts you need for building, repairing, or assembling. Save money on large or small orders. New catalog for 10c. Gearon Company, Dept. 300-B6, 27 South Desplaines, Chicago, Illinois.

POWERFUL Professional Wahl electric hair clipper \$9.75. Schramm Company, 5212 Madison, Skokie, Illinois.

WIRE Kits—Color coded assortments for easy circuit wiring and identification. Samples 5c. Wirecraft, Box 347, West Brookfield, Mass.

LAMP Parts—Catalog 10c showing all parts to build or repair. Dealers, send business card for quantity discount. Gyro Lamps, 5402P Clark, Chicago 40.

LAMPS—Build own originals, parts wholesale, any amounts. Catalogue 10c. Brown Lamp Co., Box 501, Wellston, St. Louis 12, Mo.

WATT HOUR Meters, reconditioned, calibrated, guaranteed. All types and sizes, \$2.75 up. Write for illustrated bulletin. Maspenco Electric Light Co., Room 601, 44 Starr Lane, Jamaica Plain, Mass.

ELECTRIC Pencil—Writes, engraves all metals. 6 volt model \$1.25. 110 volt model \$2.95. Reb Industries, 265-DU, Elmhurst, Illinois.

TECO Motor kit—Complete parts for small low voltage a.c.-d.c. motor. Quality product for electrical students in high school, industrial, vocational, and home laboratories. Arranged for demonstrating squirrel cage and wound rotor, series, shunt and compound connections, brush settings, air gaps, and other salient technical points pertaining to electric motor operation. (Not merely a toy.) Write Teco Incorporated, P.O. Box 127, Boonton, New Jersey.

ELECTRIC Pencil: Engraves all metals \$1.25. Beyer Mfg., 10511-H Springfield, Chicago 43.

MOTORS New General Electric $\frac{1}{2}$ h.p. \$12.50. Also others. Free literature. Plenge, 114 Elliot Place, Bronx 52, New York.

WELDING, SOLDERING, PLATING

ELECTROPLATING Units—Complete. \$2.00 and up. Free literature. Regency Sales, Dept. M, 5316 So. Justine, Chicago 9, Ill.

NEW Allis-Chalmers welders, 50% discount. Bertelli, 2133 South 13th, Springfield, Ill.

GOVERNORS. Two-speed, fully automatic for welding engines. Candee-Smith, 2641 Hill, Los Angeles 7.

RADIATOR Repairing, cleaning, recoring. How to equip small shop at low cost. Supply sources, trade secrets, instructions. Now only \$3.50 postpaid. Radiator Service, McBain, Mich.

ACETYLENE Welding outfits, new, \$54.50; Arcwelders \$46.50. Eagle Welding, Dept. PM, 5085 Broadway, Chicago 40, Ill.

WELDING—Profitable trade. Learn quickly at low cost. Best equipped school in U. S. Free catalog. G. I. approved. Write Hobartweld, Box M-694, Troy, Ohio.

RECTIFIERS 0-4 V.D.C. \$9.50, 0-8 V.D.C. \$12.50, 0-12 V.D.C. \$18.50. All 0-100 amps. Starkweather, Ottawa, Kansas.

"BUILD-UR-OWN" Welder. Portable. Send 10c for valuable instruction book. Shows you how Hobart Generator plus your engine saves \$350. Get profitable jobs anywhere. Write Hobartweld, Box M-693, Troy, Ohio.

AUTO Radiator repairing supplies, equipment, books, gasoline torch. Write, Curfman Co., Maryville, Mo.

WELDER! New portable Champion Special transformer welder; 110/120 volts a.c. develops to 75 amps.; 9 heat stages. Welds, brazes, solders, cuts all metals. Easy to use. Simple instructions. Special flame weld torch free. Splendid for shop, farm, home repairs. Saves hundreds of dollars yearly. Only \$27.50. Also heavier models. 10 day free trial. Magic Welder Co., 239 MP Canal St., New York, N. Y.

WELDERS 110v. Welds $\frac{1}{2}$ " steel \$32.50. Morris Welding Service, 1850A State, Schenectady 4, N. Y.

BUY Direct from factory. Welding outfit, \$48.36. Soldering outfits \$7.76 to \$10.16 complete prepaid. Box 331, Hamilton, Ohio.

OWN Mirror shop. Resilver mirrors. Glass sign making. Electroplating. Supply prices. John Sprinkle, V55, Marion, Indiana.

MACHINERY, TOOLS, SUPPLIES

HIGH Grade machine tools, low prices. 19" x 18' engine lathe \$430. 27" x 12', \$940. 18" x 8', \$180. Brown & Sharpe milling machine \$220. #2 Miller \$680. 20" drill press \$110. 30", \$280. 16" shaper \$280. 24", \$720. Hobart 300 Amp. welder \$145. Battery chargers \$30 to \$70. Money back guarantee. Conversion Parts Co., 278 Adams Street, Boston 22, Mass.

DRILL Press attachment instantly converts to wood shaper. Complete, for $\frac{1}{2}$ " chuck, with 5 different blades \$3.98 postpaid. Extra blank blades, 3 for \$1.00. Free circular. Thayercraft, Box 182, Culver City, Calif.

CONCRETE Block machines. Standard sizes, economical, dependable, low prices. \$39.50. Free catalog. Concrete Machine Co., 5129 S. Compton, St. Louis, Mo.

BUILD Own commercial lawn mower sharpener, plans. Mowerman, Hayward, Wis.

A.C. Welders, power mowers. Retail, wholesale. Holgerson's Service, Canton, Kans.

MACHINE Tool accessories. Catalog. Montgomery, 53 Park Place, New York City 7.

BALL Bearings: Fafnir S5K, $1\frac{1}{4}$ " o.d., $\frac{1}{2}$ " i.d., $\frac{1}{4}$ " thick, bargain. Metalcraft Toy, Box 8900, Elgin, Ill.

ELECTRIC Saws and drills. Albert Schantz, Baden, St. Louis 15, Mo.

ARMY Weasels. Cargo snow sleds. Synington's, Union Bay Place, Seattle 5, Wash.

BENCHES, Cabinets, drawer cases and complete line of workshop equipment. Free catalog. Burkel Equipment, 1627 W. Fort, Detroit 16, Michigan.

WAR Surplus in small tools for machine shop. Send 15c for bulletin. Travers Tool Co., Dept. P, 5 Court Square, Long Island City 1, N. Y.

ANGLE Plate 3" x 3" x 4" precision ground, 6 sides, \$4.75 ppd. Circular stamp. Model Tool Service, Rock Falls, Ill.

TIRES—Save $\frac{1}{3}$. New, rugged all purpose airplane tires. 10 inches to 56 inches high. Complete wheel assemblies attach easily to your axles. Free details. Write card today. Airplane Tire Co., Box 1201A, Tulare 4, California.

DRILLS And rule bargain—\$1.00 postpaid 10 assorted drills $\frac{1}{4}$ " to #50 Cleveland & Morse and 1 Union 6" steel scale. Bryant Supply Company, 4491 Anaheim-Telegraph Road, Los Angeles 23, California.

THE Acme Sharpener will produce a smooth, fast cutting edge on any kind of circular saw. Send for literature. Max Mfg. Co., 138 Stockton Ave., San Jose 11, California.

NEW Combination—7" bench saw, 9" sander, with tilting adjustable tables. Also has drilling, buffing, polishing and grinding features. Also wood lathe attachment available. Sturdy, cast construction. Buy direct from factory at new low price \$23.95 less blade. Send only \$5.00 with order, balance c.o.d. Fully guaranteed. Send for free special work shop accessory bulletin. Duo Master Industries, Dept. P, Sparta, Michigan.

FIRE Extinguishers, C-0-2, from manufacturer. Domanos, 98-A6, Newark 6, N.J.

14" x 6' HENDEY Engine lathe \$625.00. 18" x 8' Rahn Larmon engine lathe \$225.00. #1 $\frac{1}{2}$ Valley universal milling machine \$425.00. 15" Potter Johnston metal shaper \$490.00. 20" Barnes drill press \$55.00. Cincinnati Machinery Co., Dept. B, 217 2nd St., Cincinnati, Ohio.

BOATS, OUTBOARD MOTORS

TWENTY Plywood boat plans \$1.00. The Rudder, 15 Murray Street, New York 7.

BOAT Plans, kits—Hardware, conversions, plywood. See Marine Mart display ad page 285.

MIAMI Pram. Build this 8 foot dinghy. 25 page book of instructions with 8 blue prints. Send 25c for set actual photographs. Free literature. Captain Hayward, 4050 Hardie Road, Miami 33, Florida.

SAILS, Canvas, hardware for all boats featured by Popular Mechanics. Catalogue P.M. Alan-Clarke, 96 Chambers, New York City 7.

WATERPROOF Plywood—Oak lumber finished to size for boat building. Prefabricated kits, marine finishes, supplies, plans. Send 25c today for complete literature, details, price lists. Trans-Marco, Dept. B, 61 Beekman, New York 7, N. Y.

P38 BELLY Tank boat plans, complete instructions \$1.00. Details free. Anzio Boat Company, 1635 T, Merced, California.

GEM Oil measuring disc for outboard motors. Right mixture always. Oil measured directly from round standard quart can. Acts as cover. Keeps oil clean. Send 25c. W. L. Rives Company, 87 Riverside Viaduct, Jacksonville, Florida.

SAVE $\frac{2}{3}$ Cost. Build your own boat with our ready cut parts by the Welch system. No experience necessary. Rowboats to cruisers. Illustrated catalog 25c. Midwest Boat Company, Menomonee Falls, Wisconsin.

OUTBOARD Motors—Used bargains. \$45 up, free list. Used parts, most models, save money! Boat and motor equipment and accessories. Big catalog, send dime. Crandall-Hicks, 911 Commonwealth, Boston, Mass.

KNOCK Down boat kits. Outboards, inboards, sail, racing, molded shapes. Easy to assemble, enjoyable, minimum cost. Illustrated catalog 25c. Brooks Boat Company, Carrollton P5, Michigan.

BOAT Plans: Over 300 designs easy-to-build outboards, sailboats, runabouts, cruisers, etc. Get free catalog now. Motor Boating, 572C Madison Avenue, New York 22, N. Y.

BOAT Plans: Wood; steel. Book, "Modern Designs for Boats and Yachts," \$1.00. John B. Clark, Yacht Designer, 329 Kenmore Drive, Bay Village, Ohio.

NEW, Used, rebuilt marine motors. Marine conversions, fittings. Free catalog. Stokes Marine Supply, Dept. 24, Coldwater, Michigan.

BUILD Marine motors, Ford or Jeep. Federal Marine Motors, 9011 Cottage Grove, Chicago 19, Ill.

BOATS And all about them. How to select, build, repair and operate. For 40 years the leading practical boating magazine. Half price trial subscription. 12 issues for \$1.00. Motor Boat, 62 Gold Street, New York 7.

MARINE Conversions for Ford and Jeep engines. Catalog 10c. Lehman Manufacturing Company, Department D, Newark 2, New Jersey.

ENGINES, MOTORS, DYNAMOS

MOTORS— $\frac{1}{2}$ horse, 1750 r.p.m., \$18.50. 1 horse \$35.75. $\frac{1}{2}$ horse, 3450 r.p.m., \$17.00. 1 horse \$32.50. Roberts, 7232 Madison, Forest Park 3, Ill.

WATER Motors—All sizes. For any purpose. Rotary and semi rotary. Duplex Motors, Burlington, Iowa.

MAGNETOS—New Fairbanks-Morse one cylinder flange mount impulse coupling \$8.75. Marvel-Schebler $\frac{1}{2}$ inch venturi carburetors \$2.75. Lovolt Appliance, Dobbs Ferry, New York.

WELDERS For all requirements. Free catalog. Write Hobartweld, Box M-695, Troy, Ohio.

MOTOR Repair men, send for free literature on motor testing and winding equipment. Motor Industries, Quincy, Illinois.

WINDING Data, listing 225 motors, single and three phase, \$1.00. Motor Data Co., Box 7631, Kansas City 3, Mo.

ATHLETIC EQUIPMENT, BODY BUILDING COURSES

ACROBATS! Strength, health. Free booklet. Write! Ec. Knoff, Pewaukee, Wisconsin.

BARBELLS—Finest quality \$8.98 up. Free catalog. Lurie Barbell Co., 1729-M6 Rockaway Parkway, Brooklyn, New York.

ALL Barbell men who have not reached their desired bicep development, write to: Dymeck Curling Bar, 2421 Dove St., Williamsport, Pennsylvania.

BARBELLS! Muscular physique, strength. Send stamp. Jackson Barbells, Springfield, N. J.

BARBELLS, Exercise equipment. Courses. Free booklet. Good Barbell Co., Reading, Penna.

DEADLY Judo—Fiercest fighting technique. Trick knockouts. (200 photographs, plus illustrations.) Expert instructions, three volumes. Complete \$2.25. Variety House, Box 46-B, Wall Station, New York 5.

SPORTING GOODS, GUNS, FISHING TACKLE, ARCHERY, TRAPPING

MOLDS—For fishermen's sinkers. Ocean City Sinker Mold Co., 649 Wilcox Ave., New York 61, N. Y.

GOLFERS, Earn good side money. Mail postcard for particulars. Clyde L. Rhoads, 602 N. Griffith Pk. Dr., Burbank, Calif.

CATFISH: How to catch them. 44 pages, pound of bait \$2.00. For carp with pound of bait \$2.00. For trout (no bait) \$1.00. All 3 \$4.00. Guaranteed. Grigg's, Hopkinton, Iowa.

FISHWORM Raising—This book "Raising Worms For Pleasure or Profit" tells how. Price \$1.00. Tennessee Worm Hatchery, Box 265PM, Nashville 2, Tenn.

180 PAGES Antique and modern pistol, sword, etc. values, 50c. Robert Abels, A860 Lexington Ave., New York 21.

USED Guns—Close-out bargains. List 10c. Rywell, Harriman, Tenn.

WATERSCOPE—Amazing new invention—guaranteed to enable you to see under water as far as light will penetrate. Can be truthfully called "your under water eyes." Priceless for fishermen. Indispensable to students of underwater animal and plant life. Only \$6.95. Order today. Outdoor Enterprises, Rt. 1, Box 348-EM, San Antonio, Texas.

WE Swap guns, scopes, binoculars. Catalog 10c. Livingston Shooters Supply, East Corinth 17, Maine.

SEND 10c For list 100 used guns. Frayseth's, Willmar, Minn.

BARGAINS In popular and unusual fishing specialties. Write for free catalogue. Hobby Specialty Company, 415 Francis Palms, Detroit 1, Michigan.

TENTS, War surplus, all sizes; cots, hammocks, camping equipment, canvas covers, fishing and sporting goods, rope. Morsan, 10-19E 50th Avenue, Long Island City 1, N. Y.

FREE Folder fishing needs. Patti, 2945 So. 46 St., Milwaukee 7, Wis.

MOLDS For fishermen's sinkers, squids, and jigs. Sweet's Molds, Tonawanda, N. Y.

FISHERMEN; Tested and proven plug retriever. Rescues plugs snagged underwater. Retrieve-O-Ring \$1.00 postpaid. Literature on request. Kentucky Tackle Company, R.R. 6, Louisville, Ky.

BOWS, Arrows. Quality archery equipment. Popular prices. Catalog 10c. Illustrated archery instruction book 50c. Archery, 617-K So. State, Chicago 5.

5000 BARGAINS. Firearms, binoculars, war relics. Catalog 40c. Smith Firearms, Runnemed, New Jersey.

PISTOLS, Revolvers, rifles, shotguns, ammunition. List 25c. Frank Farish, Vicksburg, Mississippi.

SHOTGUNS, Rifles, revolvers, over 500 modern, obsolete. Also cartridges, list 10c coin. Ed Howe, 52 Main, Coopers Mills, Maine.

TAXIDERMY

"MODERN Taxidermist Magazine," Greenfield Center, N. Y. Devoted exclusively to taxidermy. Two sample copies 25c.

BINOCULARS, TELESCOPES, MICROSCOPES, MAGNIFIERS

"TERRIFIC" Bargains—Government surplus telescopes, binoculars. Send \$1.00 for 10 piece hobbyist lens set. Contains magnifying and reducing lenses. Send stamp for "bargain" list. P. Jaegers, 93-08 95th Ave., Ozone Park 16, N. Y.

POCKET Size 40X microscope \$15.00, 6X telescope \$10.00. Both items are precision instruments of fountain pen size and have pocket clips. Shipped prepaid, satisfaction guaranteed. Free literature. Thayercraft, Box 182, Culver City, Calif.

BINOCULARS. New Zeiss type 10 x 50, \$52. 7 x 50 \$40; 8 x 30 \$30; 6 x 25 \$20; plus tax. Money back guarantee. Bushnell Importers, 676-6 South Lafayette, Los Angeles 5.

WAR Surplus bargains. Binoculars, telescopes, sextants, millions of lenses, prisms, reticles, eyepieces, objectives, etc. Request free Catalog CH. Edmund Salvage Co., Audubon, N. J.

REFLECTING Telescopes, 60X, completely assembled \$25.00. Guaranteed observatory clearness. Free information. Skyscope, 475 Fifth Avenue, New York 17.

BINOCULARS, Telescopes, watches, guns. Buy, sell, trade. Schweer's, Donnellson, Iowa.

POWERFUL Astronomical telescopes easily made. Perfect lenses and instructions; 100X \$3.00. 100X and 200X \$4.00. 100X, 200X and 400X \$6.00. Clear vision, full power guaranteed. Instructions alone 10c. Suffolk Science Service, Manorville, N. Y.

ASTRONOMICAL Telescopes, binoculars, microscopes; bought, sold, repaired. Books. Lists 10c. Rasmussen-Reece, Amsterdam, N. Y.

TELESCOPES, Binoculars, microscopes, big bargain catalog free. Brownscope Company, 24 West 45th Street, New York.

DOGS, PETS, BIRDS, RABBITS

RAISE HDS rabbits. Howard O'Neill, Brookville, Penna. received \$713.50 in 3 months from three rabbits. Why not you? Details, 10c. Hansen's Rabbit Institute, 1347 Miller Ave., Salt Lake City 6, Utah.

RAISE Guinea pigs. Make money at home. Booklet free. Taylor, Box 426A, Hapeville, Georgia.

CATNIP—Sample free. Thomas Fuscald, 429 Preakness Ave., Paterson 2, N. J.

ANGORA Rabbits for pleasure and profit. Fred Wellen, Elkhart, Iowa.

HAMSTERS—Free information, and price list. Earl Thiele, Columbia, Illinois.

\$300 MONTHLY Raising Angoras for our market. Particulars free. Associated Breeders, 610 Marshall, St. Paul, Minn.

SEE Gulf Hamstery ad on page 30. Shows picture of Hamster.

HAMSTERS. Fine breeding stock, \$5.50 per pedigreed pair. Prompt service. Literature free. Mount Clemens Hamstery, 94 Church, Mount Clemens, Mich.

\$300 MONTHLY Raising Angoras for our market. Illustrated booklet free. Johnsons, 610 Marshall, St. Paul, Minn.

RAISING Hamsters is profitable. Information. Pem's Hamstery, 3010-10th Ave., No., St. Petersburg 6, Fla.

HOHL'S Hamsters. Clean, odorless pets. \$4.50 pair. Literature, picture free. Lab. Stock, 317 Mt. Vernon Rd., Newark Ohio.

MAKE Extra cash. Raise Giant Chinchilla rabbits. Waters Rabbit Farm, Glennville, Ga.

\$400 MONTHLY. Raising Angora rabbits. Wool \$9 pound. Plenty markets. Details free. White's Rabbitry, Newark, Ohio.

GRINSTEAD'S Famous Angoras! Giant Chinchillas! World's most profitable rabbits. Finest pedigreed, heavy-producing, prize-winners. Literature free. Grinsteads, Edwardsville, Illinois.

RAISE Chinchilla rabbits. Year-round money-makers from furs, meat, breeders. Experience unnecessary. Write today. Willow Farm, Sellersville 15, Penna.

MINK Raising information free. Complete. Lake Superior Mink Farm, Superior, EEL, Wisconsin.

INCREASE Your income by raising domestic rabbits. Small space needed. Ready market for delicious meat, fur and wool. Largest magazine in the industry tells you how. \$1.50 per year. Sample 15 cents. No stamps. Small Stock Magazine, Lamoni 20, Iowa.

\$3000 YEARLY Raising Angora rabbits. We buy your output. Contract particulars free. Kise's Enterprises, St. Paul 8, Minn.

FARMS, FARM LANDS, REAL ESTATE

FLORIDA Garden farms—10-acres only \$595, payable \$15 monthly. Splendid location near beautiful Green Hills. Fastest growing town in Florida. Fine railway and bus service. 28 miles north of Panama City, famous beach and fishing resort. Marvelous year-round climate. High and dry. Grow vegetables, fruits, berries, grapes, pecans, tung nuts, etc. Low building costs. Electricity. Make good money raising broilers. Wonderful fishing, hunting, bathing. Write today for full information. Owen Alden Wood, Box 873, Houston, Texas.

BIG Free summer catalog of farm bargains, many states, some equipped, many illustrated! Write for your free copy today! United Farm Agency, 1408-PM Consumers Bldg., Chicago 4, Illinois.

STROUT'S Farm catalog! Time and money-saver—Free! Describes 2790 bargain properties, 35 states coast-to-coast. Write today for your free copy! Strout Realty, 255-P 4th Ave., New York 10, N. Y. 20 W. 9th St., Kansas City 6, Mo. 453 S. Spring, Los Angeles 13, Calif.

\$5.00 MONTHLY Buys 40 acres near town; price \$200.00. Free list. Box 425-P, Carthage, Mo.

WEST'S New time and money saving catalogue, over 1000 farm and business bargains. Free. West's Farm Agency, CK-2, Pittsburgh 17, Penna.

GOVERNMENT Lands \$2.00 acre up. Information all states twenty-five cents. National Tax Service, 901-A Majestic Bldg., Detroit.

BIG Lists farms, ranches, water frontage properties. Free descriptive folders, prices. Splendid opportunities, Washington, Idaho, Montana, Dakotas, Upper Michigan, Wisconsin, Central Corn Belt. Information regarding Columbia and Missouri River Basin irrigation projects. L. H. Robbins, Milwaukee Railroad, 736K Union Station, Chicago 6, Illinois.

GOOD Farms—Ranches, Washington, Minnesota, Montana, Idaho, Oregon, North Dakota. Dependable crops, favorable climate. Write for literature, lists describing typical farm opportunities. Specify which state. J. W. Haw, 119 Northern Pacific Railway, St. Paul 1, Minn.

SOLD For taxes. Calif., Oregon, Washington timber, grazing, ranch and mining lands. 25c to \$3 acre min. bid. 10c (coin) brings circulars, photos, maps. Pacific Lands, Box 2350-PM, Hollywood, Calif.

OZARK Magazine, Eureka Springs 11, Arkansas. For homeseekers, tourists. Year, \$1.50.

LOTS \$300—Convenient payments. California's finest garden section. On Morro Bay's scenic shores. Wonderful fishing, hunting, boating, bathing. Fertile soil, softest water, temperate climate, congenial community. Free literature. Richard Otto, Department M, San Luis Obispo, California.

OZARK Lands for all purposes. Actual river frontages. 5 acres \$90.00 and upwards. Free list and literature. Hubbard, 424-I Minnesota Ave., Kansas City 4, Kansas.

POULTRY, FARM SUPPLIES

RAISE Turkeys the new way. Write for free information explaining how to make up to \$3000.00 in your own backyard. Address National Turkey Institute, Dept. 3, Columbus, Kansas.

GROW Chicken of tomorrow today with chicks from Pilch's Famous Old Hen Breeders. You too will like Pilch's chicks because so many other people do. 14,000 Pullorum Clean Breeders. Reds, Rocks, Crosses, Sex-Links, White Rocks, Hamps, Started Pullets, Started Chicks, Capons. Write for valuable '49 calendar. Pilch's Chicks, Box M, Thompsonville, Conn.

RAISE Fryers new easy way. One man home plant earns \$500 monthly. Circular free. Poultrymans Institute, 1046-A So. Olive, Los Angeles 15, Calif.

KNOW How to raise poultry for profit. Read Northeastern Poultryman. Every issue packed with helpful hints and practical suggestions. Latest articles on breeding, feeding and management. Subscribe now. 1 year 65c. 2 years one dollar, foreign subscriptions \$1.00 a year. Northeastern Poultryman, Dept. P.M., 376 Boylston St., Boston 16, Mass.

EARN \$4 to \$12 hourly. Chick sexing, culling and caponizing. G.I. approved. Pilch's School, Box PM, Thompsonville, Connecticut.

PROFITABLE OCCUPATIONS

SENSATIONAL! It's easy to earn big money with your own profitable business. Earn \$10.00 to \$50.00 a day. Make lamps at home. General illustrated course teaches you quickly. Course and wholesale supply catalog only \$2.00. Gearon Company, Dept. 200-B6, 27 South Desplaines, Chicago, Illinois.

"EVERYBODY Likes candy." Learn to make professionally. Our 39th year. Ragsdale Candies, D6, East Orange, New Jersey.

QUICK Profits raising Golden Hamsters for laboratories. Fastest multiplying animal. Particulars 25c. Golden Bear Hamstery, 704 W. Second, Medford, Oregon.

FREE Details. Successful local or mail order plans, complete. Copyrighted. Odell's, Box 86B, Meeker, Okla.

STAMP Business—New illustrated book \$2, included 100 different stamps from Austria, 75 Germany, 50 France. Fairbrook, 764 Lincoln, Long Beach, N. Y.

PROFITABLE Hobby. Raise Golden Hamsters for breeders, pets, laboratories. Buyback plan. Profitable Hamster Raising 25c. Information. Outdoor Industries, Inc., 4042 Kimball Ave., Chicago 18, Illinois.

RESILVER Mirrors at home. Formula 25c. Ideal Service, Park Ridge 7, Illinois.

LOCKSMITHING Secrets! Key fitting. Lock repairing, opening; prices, sources. Illustrated book \$1.00. Wexler, 7 West 36, New York City.

MANUFACTURE Cosmetics. Cheap! Easy! No machinery. Chemical engineer's booklet gives formulas, tells how. \$1.00. "Better Cosmetics Formulary," Box 1898, Milwaukee 1, Wisconsin.

TYPISTS, Profitable business at home. Complete copyrighted information 50c. Rosdahl Industries, 72-A West Washington St., Chicago 2, Ill.

MUSHROOMS Grown. Boxes. Barrels. Instructions 50c. Spawm \$1.00. Manureless Process \$2.00. Gordons, 553 William, Winnipeg, Manitoba.

FREE Book "372 Unusual Worldwide Business Adventures!" South America, New Zealand! Work delightful, "different" plans home. Publishers-C4, Carlsbad, Calif.

NEW Home-moneymaker business! With latest discovery bases and concentrates make finest perfumes, start selling locally, by mail, thru agents. No experience required. 25c brings exciting "How-to-do-it" plan, details. H. Bonheim, 610 W. 204th, New York 34, N. Y.

OUTDOOR Work for extra income. Information free. Morris, 328-A Parkway NE, Atlanta 5, Georgia.

START Profitable hobby. Fabulous money. No cost, no work. Details for stamp. American, 385 Latijera Station, Los Angeles 43, California.

WOULD You pay 3%—First \$350 made? Color-illustrated book "505 Odd, Successful Enterprises" free! Work home. Expect something odd! Pacific, Oceanside, Calif.

YOU Can make real money raising Golden Hamsters. New tiny animal. Easily raised at home. Write for details. Hudson Hamstery, Newfoundland 1, N. J.

FOREIGN Employment? Latest bulletin, overseas directory and application forms: \$1.00. (C.O.D. \$1.32.) Foreign Service Institute, P.O.B. 3934, Miami, Fla.

WANTED—Purchasing agents. No money or experience required. Write Dept. C, Purchasing Manager, 2719 Lawrence, Chicago, Ill.

PROFITABLE Business making and building with easy-laying interlocking building blocks. Rex Products, Dept. 10, Piqua, Ohio.

CONSTRUCTION Report—Send \$1.00 for world wide job project listings. Up-to-minute-facts for construction men. Global Reports, P.O. Box 883-DX, Hollywood 28, Calif.

EXCELLENT Profits. Make, sell holiday flowers, novelties. Literature free. Velve Artcrafts, 324-M East 14, New York 3, N. Y.

"FROG-RAISING"—New book explains everything! Marlboro, 1035 Marlborough, Detroit 15, Michigan.

BE The Popular Mechanics representative in your neighborhood and earn big profits in your spare time. Write Popular Mechanics Magazine, Room 408M, 200 E. Ontario St., Chicago, Ill.

\$46 FROM Square foot plywood; jigsaw necessary. Write, Woodarts, P-38, Bridgewater, Mass.

OWN Mirror shop. Resilver mirrors. Glass sign making. Electroplating. Supply prices. John Sprinkle, V50, Marion, Ind.

\$40.00 WEEKLY Made growing mushrooms, fresh, dried. Dominion patent 331583. Free spawn. North American, 169P Yonge, Toronto, Canada.

INTERESTED In Latin American and foreign employment? \$1.00 brings Foreign Service Directory listing exporters and importers, oil, construction, mining, aviation companies. Hot tips for applications. Global Reports, Box 883-M, Hollywood 28, Calif.

ALASKA—The Last Frontier offers unlimited opportunities, \$1 brings government map and directory listing firms in fishing, construction, mining, aviation, fish and game rules, homestead data. Alaska Opportunist, Box 883-M, Hollywood 28, Calif.

BOOKS, PERIODICALS, PICTURES, POSTCARDS

SUBJECT Index Bible. Free literature. Kelley, Box 376P, Athens, Ohio.

QUICK Profits taking magazine subscriptions, handling greeting cards. Cassell Publishers Service, Westfield, New Jersey.

BACK Number magazines, used books. Reasonable. Reedmore, 240 East 9th, New York, N. Y.

BOOKS And phonograph records 10c each. Write Books, Birdseye, Indiana.

25 DIFFERENT magazines \$2.00. Reading pleasure 1/2 cost. 10 lbs., postpaid \$2.00 cash. Foreign \$3.00. Aztec Supply, Rock Island, Illinois.

BOOKHUNTERS! Any subject, any language. Send wants! Atlantic Book Service, Charlestown 29, Massachusetts.

FREE Catalogue. Special interesting psychology books. Bartel, 1324 Wilshire, Hollywood 14, California.

NATIONAL Geographic Magazines 1888-1949. Any issue, Box 327-PM, Periodical Service, Swarthmore, Penna.

SELF-EXPLAINING Bible: Illustrated circular free. Box 446-P, Minneapolis, Minn.

BOOKHUNTERS! All subjects. Send wants! Jaher Book Service, 620-P East 178 Street, New York 57.

GAMES, ENTERTAINMENT

PLAY 45. Fascinating 1949 outdoor game with rockets. Description free. D. D. Products, Box 621, Evanston, Ill.

MICHIGAN Rummy—With fascinating new twist. Fun for young, old, expert or inexperienced at cards. You get durable leathertex layout 25" x 32" and instructions, \$1.00 postpaid. Gamlin, 411 East 8th, Kansas City, Mo.

BUILD Zippo and his act for hours of fun. Complete data and design charts in book form \$1.00. Send to Louis Dentroux, 217 Center Street, Princeton, West Va.

MAGIC TRICKS, PUZZLES, JOKER NOVELTIES

LARGE 160 Page catalog, just published, 35c. We have supplied the best tricks to beginners and professionals for 38 years. Chicago Magic Company, 2300-R No. Mason Avenue, Chicago 39.

NOVELTIES, Tricks, jokes. Illustrated catalog 10c. Mann, Box 6521, Los Angeles 55, Calif.

SEND Only 50c for book "84 Card Tricks" and catalog of 500 amazing tricks. Robbins Co., 152-P W. 42nd St., New York.

MAGIC Books, magazines, bought, sold, exchanged. Russell Duck, Philipsburg, Penna.

125 AMUSING Card tricks and catalog 25c. Lynch, 402-A Hazlett, Baltimore 29, Maryland.

MAGIC Monthly. Year 25c. Sample and 1949 catalogue free. Eagle Magic, Minneapolis 2, Minn.

MAGICIANS Two headed or tailed nickels \$1.00 each. Discount to dealers. Jet Motivation, 13 Harrison Place, Clifton, N. J.

MAGIC Tricks, jokes, dice, books, cards, etc. List 10c. Behnke Sales, 5721 Leland, Chicago 30, Ill.

MYSTIFY Your friends with mystic numbers. Send 25c for 2 sets. Ed's Hobby Press, 2508 Mass. Ave., Cambridge 40, Mass.

PUZZLES—Just like a pocket-size pinball machine. 3c stamp brings catalogue. Joseph W. Druke Co., Box C127, Grand Rapids 6, Mich.

500 TRICKS New 1949 edition. Send 10c for Douglas famous catalog showing best in good magic, lowest prices, fastest same-day service. 30 years in business. Douglas Magician, Dept. 1, Dallas, Texas.

3 MAGIC Tricks you can do anytime. 10c. Edwin, Box 406, Cambridge 39, Mass.

AMAZING Trick disappearing watch. Vanishes mysteriously from open hand, given with great magic catalog. Over 400 tricks that astonish, amuse and confuse, only 25c. The Magician, 2463 P Kensington Ave., Philadelphia 25, Penna.

BE A magician. Large professional magic catalog of latest tricks, 35c. Ireland, C-109 North Dearborn, Chicago 2.

SNEEZING, Itching, powders. Eighteen other tricks free with joker's catalog 25c. 2404-N Fifteenth, Philadelphia.

PROFESSIONAL Catalog. 124 pages, 25c. Williams, 900 Plymouth, Ellwood City, Penna.

VENTRILLOQUISM Taught. 3c stamp bring particulars. Smith, 801 Bigelow, Peoria 5, Ill.

WORLD'S Largest professional magic shop. keeps you in touch with latest tricks. To receive mailings, send 50c for new catalog. Holden's, M220 West 42nd St., New York.

LEARN Magic, ventriloquism, mind-reading. Write for particulars. Quackenbus, Bir Flats, N. Y.

"VENTRILLO," Professional voice throwing instrument and "unusual" catalog 25c. POB-971, Philadelphia.

FREE Catalog magic tricks, jokes, novelties. Laramie Sales, 4800 So. Laramie Ave., Chicago, Ill.

MAGIC Tricks, puzzles, books, cards, punch boards. Catalog 15c. Specialty, Box 671, St. Louis 1, Mo.

LARGE Catalogue of the best magic for professionals and amateurs. Send 35c. Mazda Magic Co., 1135 Westgate Ave., Oak Park, Ill.

16 CARD Tricks and catalog 25c. Sterling Magic, Royal Oak, Mich.

400-PAGE Catalogue of 2000 tricks, pocket, parlor, stage. World's finest magic. Send \$1.00 for catalogue (refundable first \$5.00 order). Kanter's, M-1311 Walnut, Philadelphia 7.

ENTERTAIN, Mystify! 96 page catalog magic, joke and party goods, 25c. Riley-Borin, P-7909 Rhodes, Chicago 19.

DOLLAR Magic set free with mammoth catalog 25c. "Mysto," 4462-PM Germantown, Philadelphia.

STAMP COLLECTING

FREE—Famous Americans set, plus Flag Set, plus the National Parks Set, plus the Presidential Set to the \$5. A total of 90 stamps absolutely free to customers for our unsurpassed U. S. or foreign selections. Send 3c postage for 15 of the above mentioned stamps and full particulars. Triboro Stamp Company, 145 Nassau St., Dept. 106, New York.

VICTORY Packet free—Includes stamps from Tanganyika, British Cayman Islands, animal, scarce babyhead, Coronation, early Victorian, airmail, map stamps. Including big illustrated catalogue. Send 5c for postage. Gray Stamp Company, Dept. PM, Toronto, Canada.

WORLD OF stamps (100 different) for 5c to approval applicants. Free U. S. commemorative and air mail price list. Cosmopolitan Stamp Co., 1457 Broadway, New York City.

10 ASSORTED U. S. Commemorative stamps 15c. Five U. S. Air Mail 15c. Both 25c. Ideal Stamp, Box 179, Park Ridge, Ill.

A REAL Roosevelt bargain. No stamps are more attractive, none are more popular than the famous Roosevelt issues by 17 different countries. We have them all for approvals and will send the complete Roosevelt issue of Honduras, the complete Roosevelt issue of Cuba, The Nicaragua bi-colored Roosevelt, and the Monaco Roosevelt triangle, all for only 10c to approval applicants. Please state whether approvals shall consist of U. S. or foreign stamps or both. Globus Stamp Company, 266 Fourth Avenue, New York 10, N. Y., Dept. 214.

312 MIXED U. S.—Including airmails! Commemoratives! Revenues! Possessions! High values! Only 10c to "Gold Nugget approval" applicants. Kessel's, Folsom, California.

1862 PRINCE Edward Islands—Just 3c with approvals. Viking, 130-Z Clinton St., Brooklyn, N. Y.

FREE "Stamp Finder." Tells instantly country to which any stamp belongs. 32 pages profusely illustrated. Approvals. Garcelon, Calais 17, Maine.

125 DIFFERENT U. S. commemoratives \$1. Columbian, 1138E North 21 Street, Milwaukee, Wisconsin.

GIFT Three U. S. centenary San Marino to approval applicants. Deane Stamps, Box 87, Miami 35, Florida.

INEXPENSIVE Approvals—Hundreds of penny bargains. Department K, 1267 Tutwiler, Memphis 7, Tennessee.

FREE! United States stamps nearly 100 years old to applicants U. S. approvals. Wakonda, 140-G Nassau, New York 7.

115 DIFFERENT, Hitlers, Roosevelt, Vatican, Liberia, etc., 25c. Buckley, 208 Ludlow Bldg., Dayton 2, Ohio.

2,000 FOREIGN Mission mixture \$1.00. Arrowhead, Box 82, San Antonio, Texas.

FREE Catalogue mail auction. Dealers. Collectors. Midwest, Box 6009, Kansas City 4, Missouri.

25c BOOK For 3c postage! Identifies stamps, explains philatelic terms, plus valuable information. Approvals. Moulton, 740 Hegnag, Bronx 56.

FREE! Nicaragua colorful triangles and beautiful Danish set. Bargain approval included. "PG," 195 Park, Lewiston, Maine.

100 DIFFERENT 10c; 1,000, \$1.00; 2,000, \$3.00. Free U. S. France, German price list. Masser, 322 East 9th Street, Brooklyn, N. Y.

FREE! United States commemorative price list. Historical Stamp Co., 1280 Ocean Ave., Brooklyn 30, N. Y.

SALE! Foreign packets—All different. 500, 95c; 1000, \$1.95; 2000, \$4.95; 3000, \$8.95; 4000, \$13.95; 5000, \$19.95. U. S. 200, \$1.50. Postpaid. Ewing Stamps, 109 N. Dearborn, Chicago 2.

UNBELIEVABLE! 550 Mixed worldwide, including Nicaragua triangles, just 10c. Approvals. Frontier Stamps, Box 277, San Bruno, California.

FREE—Vatican, Georgia, Ceylon, Serbia. Foreign approvals. National, Box 326A, Passiac, N. J.

PENNY Approvals by country. M. H. Hoerning, 15, Farmington, Ark.

FREE. Irish commemoratives with approvals. Raymax, 123-Z William St., New York City 7.

ISRAEL! All sets including shilling: \$1. Homesh, Holon 30, Israel.

SCARCE Nova Scotia. Ninety year old stamp. Only 5c with approvals. Garcelon, Box 700, Calais, Maine.

50 DIFFERENT U. S. 6c. Approvals. "PG," 195 Park, Lewiston, Maine.

ALBUMS, Used, new, 25c up. Lists 3c. Alatelo, Maynard, Massachusetts.

FREE With approvals. British, Spanish, French Colonies, Vatican, Hitler heads, and airmail packet. Pan-American Stamp Co., Box 145, New York 33, N. Y.

START Your stamp collection right! 2000 varieties worldwide, with premium, \$3.50. C. Ritchie, Watertown, So. Dak.

U. S. Bargain. List free. Sliques, 1831 E. Allegheny, Philadelphia 34, Penna.

FREE—Illustrated catalog. Kenmore Stamp Co., Dept. 37, Arlington 74, Mass.

AIRMAIL Packet—Worldwide. Big bargain. With approvals 5c. A. Wirth, Norwichtown, Conn.

NEXT Ten issues 10c. Interesting stamp weekly. Southern Philatelist, Miami 42, Florida.

SWAZILAND, Venezuela map. Free with economical collection building "Hidden Treasure" approvals. Stratton Snow, Box 1898, Delray Beach, Florida.

200 BRITISH Empire stamps only 3c to approval buyers. Kenmore, Dept. 36, Arlington 74, Mass.

TASMANIA, Victoria, Ukraine, Sicily, Persia, all free to approval applicants. Exotic Stamp Corner, Box 867, Miami 5, Florida.

CLEARANCE 500 Foreign, domestic \$3.00. Stuart Wingard, Academy Street, Amsterdam, N. Y.

300 BOOKS Sold and not one complaint! "How to Operate a Stamp Business," plus 100 collectors names, plus \$1.00 worth of stamps. Everything for only \$1.00. Alfred Fahsing, Topanga, California.

25 ARGENTINE, 25 Canadian, 25 Danish, 25 Dutch, 25 Switzerland, 25 U. S. 150 different 10c. Approvals included. Alatelo, Maynard, Massachusetts.

MOZAMBIQUE Triangulars, unused. Set 10c with approvals. Vargo Stamps, 6044 South Fairfield, Chicago 29, Illinois.

FREE! \$1, \$2, \$5 United States stamps to applicants U. S. approvals. Metropolitan, 140-B Nassau, New York 7.

50 DIFFERENT U. S. 10c. No approvals. Price list free. Seidenberg, Cassopolis, Mich.

HAWAII, Genuine, 4 different 25c, 10 different \$1.00; United States mint commemoratives, 50 different \$3.00. Free price list. Tam, Box 3028, Honolulu 2, Hawaii.

STAMP Magazine! Copy free! "Stamp Post." South Catalina, Pasadena, Calif.

307 ALL Different 10c. Commemoratives, triangles, bi-colored beauties, high values! Strange countries! New varieties galore. Only 10c with approvals. Garcelon, Box 400, Calais, Maine.

FREE! Volcano pictorial! Madagascar! Burmese! Nigeria! Approvals. Keating, 637-P Bergen, Jersey City, New Jersey.

GENUINE "Goya Nude" set (catalogs 55c) 15c. Approvals. Royal Stamp Company, Tamaqua, Penna.

1/18th CATALOGUE. Beautiful Bulgaria parcel post complete. Catalogue \$1.87, dime. Approvals accompany. Corley, A285 Carlton, E. Rutherford, New Jersey.

ILLUSTRATED Wholesale price list free. Transcontinental Commerce Co., 337-PM East 94th Street, New York 28.

\$2.00 CAT. Free. Approval applicants. 50,000 1c up. Everglades, 279 Northwest 57th St., Miami, Fla.

FREE. Fifteen different Switzerland with approvals. Stampchest, Box 164-M, Teaneck, New Jersey.

THEY'RE Unusual, sensational bargain. Our penny approvals. Roscoe Stamp, 1321 Roscoe, Chicago 13.

CASH For your duplicates! Particulars free. Goliath, Bethlehem 7, N. H.

ZEPPELIN—Columbian, Roosevelt, Hitler, airmail etc., only 10c to applicants requesting our approvals. Thirdco, 101 Third Ave., Newark 4, N. J.

U. S. Price catalogue. Postage 3c. Stone, Box 52-P, Dorchester 24, Mass.

STAMPS Wanted! Spot cash paid for collections, accumulations, old envelopes, mixed lots of stamps and unused postage. Clean out the attic, and send them to us for our best offer. Correspondence invited. Cosmopolitan Stamp Co., 1457 Broadway, New York 18, N. Y.

FREE: China navigation issue with foreign approvals. Modern Stampco, Box 12, Wakefield Station, N. Y.

128-PAGE United States catalog—1000 illustrations, 25c. Harris & Co., 202 Transit Bldg., Boston.

SENSATIONAL! Set each Honduras, Martinique, Guadeloupe, Guiana, also \$2,000,000.00 stamp, Brunel, over 100 different others. Everything 10c with approvals. Whitehead 315P So. 5th Ave., Canton, Ill.

FREE Triangle Roosevelt, Vatican, Ethiopia, Hitler Heads. Request approvals. Florida Stamp Company, Box 807, Miami 5, Fla.

BEAUTIFUL Set free approvals. Ruches, 941 Enfield St., Thompsonville, Conn.

STAMP Wallet, perforation gauge, millimeter ruler free with approvals. Granada, 4891 Southwest Fifth Street, Miami 34, Florida.

HUGE Roosevelt, Bolivia music set, free with approvals. Stone Stamps, Box 604, Coral Gables 34, Florida.

EXOTIC Pictorial collection; Sakalava Chieftain, Pezzan Ghadames, Djibouti, Togoland, Reunion, Andorra, Algeria, Miquelon, Tunisia, Monaco, Guadeloupe, Martinique. Many others. Everything 5c. Imperial Stamps, Tampa, Florida.

FREE! Illustrated United States catalog. Low prices! Americo, Bristol, Conn.

1/2c UP U. S. or foreign approvals by countries. Hurt & Fosse, Blue Ridge, Virginia.

\$5.00 CATALOG Price for 10c! (1) Big collection 112 all different stamps from Africa, South America, South Sea Islands. (2) Four desirable unused U. S. cataloging 40c. (3) Fine packet 25 British Colonies; Burma, Solomon Islands, etc. (4) U. S. \$5.00 high value. Everything (all four items) only 10c with approvals. Crystal, Littleton 41, New Hampshire.

FREE! Unusual illustrated lists. Littleton Stamp Co., Box 65, Littleton, New Hampshire.

SIX Triangles 3c! Ask for new type approvals. Bob Harris, 1308 E. Rio Grande, El Paso 1, Texas.

55 DIFFERENT U. S. stamps 10c. with approvals. Robert Anderson, Route #1, Madrid, Iowa.

PENNY Approvals that satisfy. Neil Gronberg, Box 5441-P, Philadelphia 43, Penna.

SENSATIONAL Bargain! 100 all different from China! Includes mint sets! Airmails! High values! Commemoratives! All this for only 5c to approval applicants! Star Stamp Company, Jamestown, New York.

66 DIFFERENT Stamps, including U. S. battleships 6c. World wide approvals. Telic-Arts, Devon, Conn.

AROUND The world—30 different countries; Basutoland, Nyassaland, Tangier, Cyprus, St. Helena. 10c with approvals. Excello Stamps, P.O. Box #95, Hackensack, N. J.

SCOOP! Sensational \$1.00 packet 25c to approval applicants. Newhouse of Stamps, Box 222, Mineola, N. Y.

FREE, 12 Different U. S. approvals accompany. Village Stamps, 90-39P 214 St., Queens Village 8, N. Y.

WOW! \$10.00 Worth of fun 10c! What a treasure hunt! Big package 500 foreign stamps, including airmails, pictorials and others from the world over; stamps worth up to 25c each. This offer sent for 10c to approval applicants only. Jamestown Stamp Co., Dept. 22, Jamestown, New York.

UNITED States approvals complete coverage, fine quality, attractive prices. Seminole Stamps, Box 1138-P, Coral Gables, Florida.

GERMANY (Greater) 500 diff. \$2.00. Masser, 322 E. 9th St., Brooklyn 18, N. Y.

100 DIFFERENT With approvals. Jacobson, 59 Nagle Ave., New York 34, N. Y.

ILLUSTRATED Stamp magazine, 26 weeks 25c. Stamp Journal, Kalamazoo, Michigan.

FREE! U. S. monthly lists, fine stamps! Cole, 43-A Rinewalt, Buffalo 21, N. Y.

\$1.00, \$2.00, \$5.00 U. S. Free. Approval applicants. Flamingo, Box 4038, Miami 38, Florida.

"MAN Size" United States approvals! Illustrated catalog! Sullivan, Endicott Arcade, St. Paul 1, Minn.

FRENCH Colonies, 50 colorful, large pictorials, 10c only with approvals. Fields, 1939 E. 85, Cleveland 6, Ohio.

FLAG Stamp free with U. S. approvals. Wenigman, 1933 Patterson, Chicago.

50,000 STAMP Grabbags 25c each. Anderson, 630 Bingaman 1, Reading, Penna.

WORLDWIDE Different. 200, 25c; 500, 50c; 1000, \$1.25; 2000, \$3.00, 5000, \$15.00. Beacon Sales, Maynard 2, Mass.

U. S. Price list. Send postage. State Stamp Service, 1225 Park Building, Pittsburgh 22, Penna.

200 DIFFERENT Including Roosevelt triangle, 5c to approval applicants. M. Avalon Stamp Company, Springfield, Mass.

FREE! Crystal-mount samples! Har-risco, 202 Transit Bldg., Boston.

BINGO! Jackpot collection! Triangles, maps, animals, midgets. All for 5c to approval applicants only. Southwest Stamps, Box 117, Long Beach 1, California.

FREE U. S. price list, postage 3c. Mark Hanna, 335 5th Ave., Pittsburgh 22, Penna.

WORLD—500 Diff. 50c, 1000 \$1.25, 75 Canada 25c, approvals, lists. Victoria Stamp Co., London 4, Canada.

WORLD'S Largest stamp (7 1/2 x 14 inches). A real curiosity! Retail for 50c, only 3c to approval applicants. Tatham Stamp Co., Springfield 30, Mass.

FREE! 100 Worldwide different stamps to approval buyers. Big U. S. and illustrated bargain lists sent with approvals. Bookman, Maplewood, N. J.

STAMP Collections wanted. Complete collections, duplicate lots, surplus stock, mint and used. Prefer trade for printing or other items, buy outright if priced right. What have you, what's wanted? Vanroy Shirk, Lebanon, Penna.

DEALERS—Wholesale list. Postage 3c. Frank, 5031 Queensberry, Baltimore 15, Md.

OLD Scarce U. S. seconds on approval. Slightly defective, bargain prices. Her-nfeld, Clintonhill Station, Newark 8, N. J.

POUND Stamps containing thousands \$1.00. Longacre Shop, 108 West 42nd, New York 18.

BERLIN Bears, complete set of eight and 100 different stamps only 10c to approval applicants. Reich Stamp Co., 4647 Kenmore, Chicago 40, Ill., Dept. M11.

25 ALL Different stamps 10c. Tunis, Wakeman Ave., Newark 4, New Jersey.

NICARAGUA "Tin Pan Alley" dia-mond. Ecuador showing George Washing-ton, and American flag in natural colors. Fezzan, Trieste. "American Army" stamp, first U. S. commemorative, \$100.00 Shang-hai, Corsica, Anzac, Antique, others. All 5c. Approvals, Capital Stamp Co., Dept. 2, Little Rock, Ark.

ZOWIE-E! A barrel of fun for only a dime. 500 United States stamps—absolutely unpicked and unsorted—just as received from church missions. Many varieties, including large commemoratives, airmails, high denominations up to \$5.00! Stamp-dom's biggest package of fun—and you might find something really valuable! Price only 10c to serious approval service applicants. Money back if not delighted. Illustrated bargain lists with each order. Mystic Stamp Company, Dept. 80, Cam-den, New York.

COINS, TOKENS, CURRENCY

OLD Money wanted. Will pay \$100.00 for 1894 dime, S. mint. \$50.00 for 1913 Liberty head nickel (not buffalo). Big premium paid for all rare coins. Send 4c for large coin folder. May mean much profit to you. Numismatic Co., Dept. 20, Fort Worth, Texas.

35 WORLD Coins \$1.00. Harry Elsholz, Box 9014, Pittsburgh 24, Penna.

60 COINS And bills, \$1.00. 100 bills, \$1.00. 35 coins, \$1.00. Oddehon, Box 482, St. Louis, Mo.

BARGAIN! United States half dollar over 110 years old, 1909 VDB cent, 1883 nickel, 1913 nickel, 1862 Maryland currency, ancient Roman coin over 1500 years old and our complete buying and selling catalogue for \$3.00. Catalogue alone 25c. 20 different Indian cents \$1.00. Worthy Coin Corporation, 294 Washington (D-113), Boston, Mass.

10 WOODEN Nickels \$1.00. 3-legged buffalo nickel \$1.25. 100 different foreign coins \$3.95. Giant catalogue 15c. Bebee Coin Company, 1180 East 63rd, Chicago 37, Illinois.

1949 PRICE List of U. S. coins 15c. 44 pages. Worldwide price list of gold coins 15c. 32 pages. James Randall, 116 South Michigan Avenue, Chicago 3, Illinois.

GET Profit and pleasure in collecting old coins. Send 10c for 56 page illustrated coin catalog. You'll be delighted with it. Send for it now. B. Max Mehl, 370 Mehl Bldg., Fort Worth, Texas. Largest rare coin establishment in U. S. Established 49 years.

FREE! Foreign coin, banknote and coin collectors illustrated catalog to approval service applicants. Send 3c postage. Tatham Coinco, Springfield 30, Mass.

4-IN-1 Special \$1.00 bargain offer: (1) United States 1893 Columbian world's fair half dollar; (2) album for holding coins; (3) large 56 page coin catalog; (4) genuine wooden nickel. Yes! All four items for only \$1.00. Order today. Money back if not pleased. Ben's Coin Company, 72 W. Washington, Chicago 2, Illinois.

COINS Wanted, will pay up to \$2000 for certain coins, send 25c for catalogue. Burton's, 111 So. Third, Columbus, Ohio.

COMMEMORATIVE 1/2, Oregon, Texas, Kentucky, Cleveland, Long Island, \$2.00 ea. Illustrated catalogue 25c. Norman Shultz, Salt Lake 9, Utah.

PRECIOUS STONES, MINERALS

ZIRCONS, Alexandrites, rubies, others. Direct importation guarantees best quality; lowest prices. 3 sparkling, diamond-like, polished zircons, over 2 carats \$4.00. Catalog 10c. Imhusex, Box 232, White Plains, N. Y.

BEAUTIFUL Arizona variegated agate, large slice \$1.50. Three slices \$4.00. Satisfaction guaranteed. Chas. Hill, Caye Creek, Arizona.

"GENUINE" Deep red Arizona rubies (Garnets). Send quarter for packet. Bitner's, Box 2651, Phoenix, Arizona.

URANIUM Prospector's Handbook \$1. Non-technical. Craft-Connor Publishing Co., Dept. G, 601 S. Vermont, Los Angeles 5, Calif.

METAL Detectors. The very latest circuit. Send 25c for literature. Hedden Metal Detectors, 3329 Liberty Ave., Pittsburgh 1, Penna.

FOOLS Gold 25c, cassiterite 25c, bixby-ite 50c. Other minerals. Prospector, Win-ston, New Mexico.

ZIRCONS, Loose. Genuine Siam im-ports. Pure white. Special: 3 genuine zircons, from 1/2 kts. to 1 1/2 kts., \$6.00 tax included. We can supply zircons in all sizes and mountings of all types. Send order or write for details today. B. Lowe, Holland Bldg., Dept. PM, St. Louis, Mo.

GEMSTONES, Rough, polished. Mineral specimens. Every variety, lowest prices. List free. Plummer's, 2177 Bacon, San Diego 7, California.

HOBBIES AND COLLECTIONS

50 DIFFERENT Army embroidered patches \$1. Other bargains. Insignia Mart, 703A Broadway, New York 3, N. Y.

MAKE Inexpensive electric pottery kiln. Complete instructions \$1.00. Fireside Hobbies, Box 548, Seattle, Wash.

WANTED Old cigarette cards. Write Charles Bray, East Bangor, Penna.

30 DIFFERENT American, foreign military insignia; complete catalog 50c. Five different metal emblems 25c. Japanese sur-render document 25c. Hobbyguld, 57-B Sumner, Brooklyn, N. Y.

MINIATURES, 400 Household items scale 1"=1' for doll houses and collectors. 8 page New York Times (1 1/2" x 2 1/2") and illustrated list 25c. Stover, 1503 West First Ave., Columbus 12, Ohio.

UNUSED Matchbook covers—100 dif-ferent \$1.00. Catalog 10c. Charles Edel-man, 1311C East 84, Cleveland 3, Ohio.

INVENTING Can be an interesting and profitable hobby. Write for complete particulars. Institute of American Inventors, Dept. 40-E, 1926-Eye St. N. W., Washing-ton 6, D. C.

CAMERAS, PHOTO SUPPLIES

REFLECTO Frame displays color trans-parencies like real pictures daylight or artificial light. No light bulbs to burn or fade the transparency. No dragging electric cords. No bulky boxes any size. Reflecto Frame Co., P.O. Box 1084, Seattle, Wash.

1949 PHOTO Catalog, 124 pages, 700 il-lustrations. Send 10c stamp. Bloom's Camera Center, 1657-PM Main, Spring-field, Mass.

MASTERPIECE Art slides in beautiful, natural colors. Send \$1 for 4 slides, cata-log and volume price list. Zal Studios, 241 Lafayette St., New York City 12.

BELLOWS Installed, winding keys, flanges made. Kensington Camera Shop, Kensington, Md.

BASS Says: Bargaingram 257 ready and waiting for you. The book which tells all. The finest in new and used camera equip-ment, a veritable encyclopedia. Write, phone or call the sign of the old "Horse Trader." 39th year of satisfaction or your money back dealing. Bass buys, sells and trades. Bass Camera Company, Dept. AG, 179 W. Madison St., Chicago 2.

PHOTOCOPY Anything, papers, books. No darkroom. 8 1/2 x 11" complete, \$6.95. Potoflek, 4801 Yarmouth, Cincinnati 29, Ohio.

HIGHEST Prices paid for still, movie cameras, projectors. Ace Camera Ex-change, 136 East 58th Street, New York P-22, N. Y.

PHOTO FINISHING

EXTRA-HEAVY Velvet finish prints! 8 exposure roll custom developed, care-fully hand printed on beautiful National velour paper, 60c. Reprints 6c. Write for list 44 other quality services. Satisfaction guaranteed. National Photo Laboratories, New Hyde Park 46, N. Y.

BETTER For less. Send us your film. Fine grain developing. Blublack, hi-gloss, jumbo deckle-edge prints are different. Any 8-exposure roll developed and printed 30c. 12 exposure 45c, 16 exposure 60c, 36 exposure \$1.00. Dept. M-1, L. A. Photo Lab., Box 9385, Station S., Los Angeles 5, Calif.

8 PRINTS From your roll or negatives 30c; 12-40c; 16-55c. Or 8 double size en-largements 35c; 12-45c; 16-65c. Highest quality. Overnight service. Young Photo Service, 405-E, Albany 2, N. Y.

COLORFOTOS—Ansco and Extachrome processing, roll \$1.00. Quality work. Com-plete color service. ColorRoyal, Box 213 College Station, New York, N. Y.

SEND Your photo and \$1.00. You receive dozen friendship photos. Original re-turned. Wolco, Box 534, Maywood, Illinois.

8 LIFETIME Enlarged prints in album 40c, 12 exposures 60c, 16 exposures 75c. Album reprints 5c. Contact reprints 4c. Superior Finishers, Box 411, Milwaukee 1, Wis.

FILMS Developed and enlarged double size, 8 exposures 35c; 12 exposures 50c; 16 exposures 65c. Prompt service. Mailing envelopes on request. Real Fotos, P.O. Box 172 M, Station B, Brooklyn, N. Y.

ROLL Films developed and 8 super (oversize) prints 35c. Free mailing en-velopes. Finest quality. O. Henry Photo Service, Box 2458, Greensboro, North Carolina.

STAMP-SIZE Photographs made from your photo or snapshot. Small, 10 for 30c, 20 for 50c, 50 for \$1.00. Large, 5 for 30c, 10 for 50c, 25 for \$1.00. Photo returned unharmed. Prompt service. Agents want-ed. Details sent with first order of 30c or over. H. & M. Photo Service, Box PM 525, Chicago 90, Illinois.

PROMPT Service. Beautiful sparkling Higloss enlargements from your roll or negatives 3c each. Gorek's Studios, Dept. P5, 3619 East 131st, Cleveland 20, Ohio.

PHOTOGRAPHS—Hand oil colored by specialist, to 8" x 10" \$1.50. Lundy Studio, 48 Sodus St., Clyde, New York.

35MM. Films developed each exposure enlarged to 3 1/4 x 4 1/2 deckle-edge lifetime enlargements. Finest quality. Satisfaction guaranteed. 36 ex. \$1.25. 20 ex. 75c. Free mailers. May's Studios, Dept. K-69, La Crosse, Wis.

MAKE Your own reprints, 1c each. New process. No darkroom. Nielson, 960-E Haight, San Francisco, Calif.

MOVIE Star photos with eight exposure rolls developed, 16 prints, 35c. Exciting premium coupons. Hollytints, P-1350, Hollywood 28, California.

JUMBO Prints. 8 exposure roll 35c; 12 ex. 40c; 16 ex. 65c. Ace Photo, P.O. Box 25, Melrose Park, Illinois.

ENLARGEMENTS, 8" x 10", 30c. Oil col-oring. Special trial offer. Write Suralg Photos, 3300 Beach, Chicago 51, Ill.

10c AND This ad brings one print each first roll, regular 25c value. Swift Photo, Box 23PM, Springfield, Missouri.

VALUE Plus! Your roll carefully developed, and enlarged to double-size jumbo prints, individually bound in attractive pocket-album. Handy, compact; preserves your pictures. "An album of enlargements from your roll of films." 8-exp. only 30c. 12-exp. 40c. Jumbo-album re-prints, 4c each. Send for free mailers and price list, or mail film to Jumbo Prints, Box 399, Dept. E, New Haven, Conn.

ROLLS Developed and enlarged 2 to 6 times larger. 8 exposures 30c coin; 12 exposures 50c; 16 exposures 60c. Enlarged reprints 4c each. Alden Photos, 94-5 Astor Sta., Boston, Mass.

FREE Snapshot magazine, photofinishing list, mailers. Henry Houghton's, Athol, Massachusetts.

16 ENLARGED, Jumbo, oversize decked prints from any 6-8-12-16-20 or 36 exposure roll film developed only 35c and this ad. Electronically exposed. Enlargement coupon free. Skrudland, 6444-R Diversey, Chicago.

ENLARGEMENTS, Any size. Photomurals made from your own pictures or choose ours. Beautiful scenic sample 3½ x 5 feet for \$15.00. Studio Photo Service, 521 No. La Cienega, Hollywood 36, Calif.

35MM. Rolls developed—Enlarged 3½x5 prints, 36 exposures \$1.00, 20 exposures 65c. 8 exposure rolls developed, printed oversize 30c, 12 exposures 45c, 16 exposures 55c. MacDonald's Photos, Box 228-J, Congress Park, Illinois.

BEAUTIFUL Enlargement from each picture on roll 30c. Cut Rate Photos, Dept. B4, Janesville, Wis.

FREE Price list on quality developing, printing, enlarging. Write for it today. Bryan's Photo Shop, Dept. M, Panama City, Florida.

EXPERT Finishing. Roll developed and 8 prints 30c. Rancho Photo, Dept. P, Ontario, Calif.

8 BEAUTIFUL Double size pictures and roll developed 30c. 8 hour service. Free mailers. Pacific Photo Service, Box 666, San Francisco, Calif.

2 BEAUTIFUL Hi-Gloss prints each good negative and enlarging coupon with each 8 exposure roll developed 28c. Free mailers. Owlphoto Co., Weatherford, Oklahoma.

8 PRINTS All enlarged to nearly post-card size from your roll or negatives 25c; 16-50c. (Trial offer). Willard Studios, Box 3535A, Cleveland, Ohio.

MOTION PICTURES AND SOUND EQUIPMENT

SEND 10c for 1949 photographic catalogue. Bargain list included. Sterling's, 679 Northampton, Easton, Pennsylvania.

GUARANTEED Fresh 25' spools double 8 mm full color film! Processing free! \$3.80 each, 3 spools \$11.00. Catalog. Filmcraft, 47th Holly, Kansas City 2, Mo.

SEND 10c for giant 16mm sound bargain lists. Waverly, 5707-A South Christiana, Chicago 29.

FREE Movies—Hundreds of subjects. Thrilling, entertaining, fascinating. National directory of free motion pictures, \$1.25. Satisfaction guaranteed. Educational Publications, B-7PM, Adams, Mass.

EXPERT Processing service. 88 mm 25 ft. 65c. Magazines 85c. 16 mm 100 ft. \$1.25. Boneck's Films, 65 Highland Ave., Keasbey, New Jersey.

NEW 16MM sound projectors, Cine Service, Box 582, Ithaca, N. Y.

UNIQUE Movies equipment. Free catalogue. Home Pix, 1674 Broadway, New York 19.

1949 CLEARANCE Sale. Want a real buy in 16mm sound films? Take advantage of the I.C.S. 1949 clearance sale of 16mm sound films, features, comedies, educational, cartoons, novelties, etc. Send for our giant list "A" today stating machine you own (make and model). Institutional Cinema Service, Inc., 1560-P2 Broadway, New York 19, N. Y.

COLOR Titles, slide shows. Intro. offer: 6 for \$2.00 incl. "Let's Go" and "The End." Free list. Jaycee Colorslides, 3961 Sacramento St., San Francisco, Calif.

BETTER 8MM. and 16mm. movie camera film. Lower prices. Better Films, 742 New Lots, Brooklyn 7, N. Y.

BE Direct factory representative: sell and demonstrate professional 16mm. sound projector to churches, schools, industry, individuals. Big profits. Write: G. N. Jessen, 5 S. Wabash, Chicago 2, Illinois.

FREE Movie list. Superior Film Service, Box 713, Troy, N. Y.

SOUND, Silent 35mm. features, and shorts. Also 16mm. sound films. Simpson, 155 High, Dayton, Ohio.

SAVE 50% On movies. Free circulars, sample film. Fromaders, Davenport 4, Iowa.

8-16MM. Films, free listing. De Photo, 648 Helen, Detroit 7, Michigan.

GUARANTEED Fresh anti-halo outdoor movie film! Weston 12! Daylight loading! Processing free! Three spools double 8 mm. \$3.45! Six single 8 mm. for Univex, \$4.60! Postpaid! Catalog. Filmcraft, 47th Holly, Kansas City 2, Missouri.

"THE World's Greatest Passion Play." 8mm. 16mm. and 35mm. Specify silent or sound. Rent or purchase. Hemenway Film Co., 33-F Melrose St., Boston 16, Mass.

TITLE Making, free booklet. Westwood Company, 635 Victoria Street, San Francisco, California.

LEARN Professional motion picture technique at home. Approved for veteran training under G.I. Bill. Free catalog. Motion Picture Institute, Birmingham 4, Mich.

LEARN Movie projection, management. Free catalog. Theatre Institute, Elmira, N. Y.

I BUY, Exchange, swap movies. What have you? What do you want? Lowest exchange rates in world. Catalogue \$1.00. Refundable. Harvey Iris, Box 539, Brockton, Mass.

LOWEST Prices, raw film 8mm.-16mm. Free list. MK Photo, 451 Continental, Detroit 14, Michigan.

BASS Says: 39 years of leadership guarantees satisfaction. Finest cine equipment, 8mm., 16mm., and 35mm., silent and sound. Write the old "Horse Trader." Satisfaction or your money back always! Bass Camera Company, Dept. A, 179 W. Madison St., Chicago 2.

8-16MM. Silent-sound films. Complete rental library. All latest subjects. Free catalogue. (sample film 10c). Garden Film, 317 West 50th, New York 19.

MUSIC AND MUSICAL INSTRUMENTS

STREAMLINE Accordions below wholesale. Circular. Metro, 44 North Albany, Chicago.

SONGWRITERS—Sell your songs! Un-usual composing-arranging offer. Free details. Pleis & Guptill, 345 Hudson St., New York 14.

POEMS Wanted. Percentage basis collaboration. Terry, Tune Master, 709½ PM North Broadway, Oklahoma City 2.

POEMS Set to music. Splendid offer. Rush poems. Radio Composers, W D P, Clinton, N. C.

SONGWRITERS: Send poem for free examination and outstanding offer. United Music, 155, Salem, Indiana.

PLAY Your guitar through your radio. Complete plans; hookup instructions; where to get materials \$1.00. Star Enterprise, Dalton, N. Y.

FREE Phonograph record: 79c record (our choice) included free with order. All new hillbilly, popular, spirituals at standard prices. Order records wanted now. Or send for famous record catalog. Mailorc, Dept. 44, 570 N. Gay Street, Baltimore 2, Md.

1949 ACCORDIONS, Wholesale, free catalogue. American Accordion Center, 5329 Belmont, Chicago.

POEMS Wanted for musical setting. Send poems for free examination. Five Star Music Masters, 630 Beacon Bldg., Boston, Mass.

PLAY Most popular piano! Send 20c for home study folder and novel breaks for hit-tunes. Christensen Studio C, P.O. Box 185, Wheaton, Ill.

ACCORDIONS, Mikes, amplifiers. Save up to 50%, cash or terms. Buy direct, save middle man's profits. Del Principe, 307 South Wabash, Chicago.

YOUR Poems set to music, recorded by professional artists. Send poems or write. Free booklet, attractive offer. Song Service, 331-C West 46th, New York.

SONGWRITERS! Outstanding, ethical offer. Hibbler, C5, 2157 N. Avers, Chicago.

SONGWRITERS—Publication collaboration. Newart Publishers, G.P.O. Box 1226, Syracuse, N. Y.

MUSIC Arranged, songs printed. Frank Wildt, Music Publisher, Lancaster, Penna.

SONGWRITERS Attention! The amazing demand for phonograph records, accelerated by countless juke-boxes, warrants your immediate investigation. We are offering new writers the rare opportunity of having celebrated "hit" composer furnish music on reduced percentage basis for any likely poems received this month. Phonograph records are outselling piano copies 5 to 1. Recoia Records, Hollywood 28, Calif.

POEMS Wanted to be set to music. Free examination. Send poems. McNeil, Master of Music, 510-PM S. Alexandria, Los Angeles, California.

WRITE Songs. Big money and reputation. Write for information. J. Gordon Pub. Co., 201 N. Hoyne Ave., Chicago.

RADIOS, SUPPLIES, INSTRUCTION

BUILD Your own radio. No batteries. Non-electric. Easily assembled, everything furnished. Amazing reception. No parts to wear out. 3c stamp brings plan, illustration. American Boy Supply Co., Box 219, Chicago.

FIX Any radio. Amazing new instrument locates radio troubles double quick. Simple instructions show you how. Thousands now in use. Free—write today for 28-page illustrated technical manual. "The Inside Story." Feiler Engineering Company, Dept. 6PM9, 945 George St., Chicago, Illinois.

FREE—Money saving bargain bulletins in radio and television sets, record changer, tubes, parts, amplifiers, speakers, etc. Write today. Radionic Equip't Co., Dept. 2006, 170 Nassau St., New York 7, N. Y.

TELEVISION Sets 7" \$140. 10" \$220. Mahogany cabinets. Richards, 33 Phillips, Andover, Mass.

MAKE Loudest crystal radio. Instructions, loudest crystal, catalog: 25c. Amoroce, Route 4, Richmond, Virginia.

TELEVISION—Build your own receiver with simplified low cost kit. Details free. Radio Shop, P.O. Box 748, Freeport, New York.

ATTENTION Radio repairmen, platers, hobbyists. Eliminate wires. Use conductive paint applied by brush or spray. Air dry. Eliminate wiring and soldered connections. Fast, clean, economical. Also suitable for static shielding and as plating base. For details write John R. Marple & Co., Westfield, N. J.

RCA Record player attachment. Retail \$16.95. Special \$9.95 postpaid. Guaranteed. Record Center, 1514 E. 51, Chicago 15, Illinois.

RECORD Changer parts for leading makes. We ship everywhere. Friend's Wholesale Distributors, 106 North Sixth Street, Philadelphia 6, Penna.

TELEVISION, Radio, tubes, parts. Send for free bargain list. Hallmark, 592B Communipaw, Jersey City, New Jersey.

COMMUNICATION And radio course: Not a correspondent course, but mailed complete. Written by a former Tech. Rep. with the Army Air Forces. Practical, includes necessary theory with physical explanations, absolutely necessary in radio repair, television, and communications. Not a basic course. \$4.00 postpaid. Mr. Arthur Arruda, 70 Acushnet Avenue, New Bedford, Mass.

FREE Morse code lesson. Complete course \$1.00. Dept. M. Otto Luther, New Preston, Conn.

BUSINESS OPPORTUNITIES

MORE And more automatic fire control men are changing to Red Ball Inc., Box 1552, Salt Lake City, Utah. Best product, highest profits.

CARPENTERS—Own profitable business installing kitchen cabinets. Write Thombert Company, Box 447C, Newton, Iowa.

FIGURINES, Gift ornaments. Un-painted, many to choose from. Start a profitable business—hobby. Write for free circular and information. Suiter Art Industries, 314 Westport, Kansas City, Mo.

\$15 - \$50 DAILY Renewing rugs, upholstery, quickly, scientifically. Lifetime business opportunity. Puraclean, 17-D East 42nd, New York 17.

SELL Big money-maker to men and women. Easy handwork makes fast-selling useful articles. Sunmade Company, Brockton 64, Mass.

A Profitable mail-order business can be yours. Over 20 years of knowhow. Mathews, 4501 Oakmont St., Philadelphia 36, Penna.

MAKE Money selling startlingly new clear plastic button made in two separate pieces—a button-base with cavity carved therein, and clear window that fits into cavity over whatever is placed in cavity. By putting into cavity a piece of the material she uses for making a garment any woman can, without any equipment, easily make up costume buttons to exactly match in cloth, pattern, color any dress, suit, other garment that she makes. Large, medium and small buttons with screweye for sewing to garments are available. Write for free information. Inquiries from dress-makers, professional or for own family, especially invited. Gift shops can mount photos, miniature paintings, other items in button cavity to sell as novelties. William E. Moore, Costume Button Jewelry, Box 546-M, Winnemucca, Nevada.

EARN \$50.00 Or more weekly operating nut and gum vending machines in your spare time. Details free. Danco Coin Machine Co., Dept. PM, 1304 E. Baltimore St., Baltimore 31, Maryland.

"WATERLESS Hand cleaner." Make, sell. No machinery. Build profitable business. Formula \$1.00. "Wax-o-Glass" cleans glass; polishes metals. Formula \$1.00. "Wipe-on auto paint" formula \$1.00. Metallizing baby shoes, complete process \$1.00. All four formulas only \$3.00. Satisfaction guaranteed. Ideal Formula Service, Park Ridge 5, Illinois.

START Bottled natural gas business. New, amazing opportunity. Demand enormous. Pays big profits. Literature free. Enseo, Pasadena 16, California.

RAISE Fishworms. Complete instructions 2c stamp. Huffmans Worm Ranch, D6, Rives Junction, Mich.

PROVED Profitable mail order business selling merchandise specialties to women. Small home sparetime development project. Complete "starter," operating, instructions outline, "National Specialty-Sales Plan," 25c. Grant Lovell, 2166 South Shore, Erie 3, Penna.

TRADE Magazines help you get ahead. Latest single copies. Over 1000 covering every trade, business and interest. List with prices, free. Commercial Engraving Publishing Co., 34C North Ritter, Indianapolis 19, Indiana.

NO Competition. Two new products. Exclusive territory. Must have, or able to organize own sales force. Cobrecite Corp., 335 W. Washington, Pasadena 3, Calif.

FOR An extremely profitable lifetime business operate a collection agency-credit bureau. Easily learned. Free folder. Cole & Associates, Syracuse 2, New York.

EARTHWORM Breeding. Valuable bulletins on successful methods mailed free. Earthmaster Publications, Dept. 14, Sun Valley, Calif.

AMIDON Adjustable tubular metal scaffolds. Midon Engineering Company, Elyria 4, Ohio.

CO-PUBLISH And advertise in The Central Mail Advertiser. Sample copy 10c. Low rates. Large circulation. Bagby Printing Co., Georgetown, Ohio.

"THIS Is it!"—Learn sewing machine repairing, plus profitable installing our motor kits, etc. Write Taylor Service Co., Hamilton 3E, Ohio.

BE Independent—Operate America's lowest price penny vending machine. Big profits. Immediate shipments. Write for bulletin and prices. Fielding Mfg. Co., Desk 69, Jackson, Mich.

START Your own business on credit. Always your own boss. 1554 dealers, sold \$5,000 to \$26,500 in 1948; their average \$6,742. We supply stocks, equipment on credit. 200 home necessities. Sales experience not needed to start. Wonderful opportunity to own pleasant, profitable business backed by world-wide industry. Write Rawleigh Co., Dept. F-U-PPM, Freeport, Ill.

EXCEPTIONAL Money making opportunity for live-wire distributor. Dealer's county franchise now available for fast selling low-priced fire extinguisher and alarm. Made of glass, modern as tomorrow. Tremendous market. Big profit. Write for full information. Autofyrstop Co., Dept. E-6, 2035 Washington Avenue, Philadelphia 46, Penna.

START Home manufacturing business making Cleaning Compounds, Soaps, Insecticides, Cosmetics, Polishes, Food Flavors. No machinery. Literature free. Kemix, Park Ridge, Ill.

HOW To sell profitably by mail, 39 page booklet, tips, ideas only 25c. Free information on 100 money-making opportunities. Enterpriser, 16102W Descanso, San Lorenzo, California.

BIG Money. Spare or full time in your home. No selling! Spray new miracle finishes, plush and suede on signs, radios, automobiles, figurines, lamps, toys, etc. Our business is booming—new easy Flok-Kraft methods—material costs few pennies, you get dollars. Free samples, complete powerful money making plan free. Write now! Coast, 1010 E S. Los Angeles, Los Angeles 15.

TESTED Money-makers: 68 page book, 25 cents, postpaid. Ideas, plans, formulas, supply sources. Money back if dissatisfied. L. Clay, Box 1063, Wichita, Kansas.

100% PROFIT Selling shampoo. Free details. MacMillan, Pine-Aire, Bay Shore, N. Y.

10,000 FORMULAS And trade secrets. Free literature. Stillman Co., 555 Kingston Ave., Brooklyn 3, N. Y.

\$5.00 PER Hour metallizing baby shoes. Original "go in business on a shoestring" success plan offers new way to big profits at home, full or spare time. Complete details free. Send postcard now. Kiktavi Co., 2111B W. Manchester, Los Angeles 44.

YOUR Own business. This plan is all-profit. No selling. Write: The Jay-Cee Company, 929 West Maple Street, Milwaukee, Wisconsin.

DEPRESSION Insurance! Own money-making business. Information free. Pru-Ax, Kingsport, Tennessee.

START Profitable home direct selling business. Sample Tel-Timer 10c. Information free. Write Specialty Co., Amherst, Ohio.

100 BUSINESS Ideas—10,000 formulas. Mail order, home, farm, workshop. Particulars free. Flasco Sales, 2505VL 150 Street, Flushing, New York.

SELL Television, radios, appliances, sporting goods, hardware. Wilson, 1416 Vilet, Milwaukee 5, Wisconsin.

FREE Illustrated instructions casting novelties. Genuine latex for molds. Major Chemical Co., 164 Portland Street, Cambridge 39, Mass.

UNPAINTED Wall plaques, figurines, statues. List, instructions, dime. Perry Novelty Co., Perry, N. Y.

SELL By mail! Ideas galore! Join mail selling opportunities club! Details free! N. Wehner, Box 142-A, Roxbury 19, Mass.

MAILORDER Advertising written to order. Big, positive results reported! Finkle Associates, 257-M South Spring, Los Angeles 12.

DOLLARS in the mail. Free particulars. Alfred Haseman, Beecher, Illinois.

BABY Shoe metallizing. Secrets never before revealed. Schoettle, Friendship, Ohio.

GOT \$24,500 Using "Schemes" from "Schemer" magazine. Box 775M, Alliance, Ohio. Year \$1.00. Three samples 25c.

"HOW To get the job you want." Amazing plan. Works wonders. Secrets revealed. Write. Parker, Box 576, Cleveland, Tenn.

1/2 MILLION Articles wholesale. Directory 25c. Publisher's, Box 1302-P6, Detroit 31.

WHERE To buy 800,000 articles wholesale! Details free. Schibani, Box 1576, Birmingham 1, Alabama.

SELL By mail—Unusual opportunities. 10c brings 60 page trade magazine. Isbell, Suite 619-PM, 216 West Jackson, Chicago 6, Ill.

"101 WAYS To Be Your Own Boss." 101 practical new opportunities requiring little capital. Send \$1.25 for copy. Arco Publishing, 480 Lexington Ave., New York City.

SELL Business cards by mail. Repeat orders. Everything furnished reasonable. Lynn Art Products, 5711 Bankfield, Culver City, California.

WOULD You pay 3%—first \$350 made? Color-illustrated book "505 Odd, Successful Enterprises" free! Work home. Expect something odd! Pacific, Oceanside, Calif.

SELL Delicious snowballs. 400% profits. Ice shaver and flavor for 500, \$2.00. Supplies list free. Snowball Company, Dept. PM-6, Jacksonville 4, Fla.

WHICH Do you want first, more profits or more time? Becomes easy for you. Particulars free. Miller Sales Builders, 155 Kissinger Road, Rimersburg, Penna.

OPERATE Your own floor waxing, polishing business. Easy dollars year-round. We tell you how. Write Floorola Floor Service, Box 69, York, Penna.

BE Our dude ranch representative. Year around vacation paradise. Free booklet.

SAWDUST. Turn it into cash. Six methods. Instructions 25c. Charles, 12-APB, Norwood, Ohio.

BABY Shoe mounts "lamps." Carter Picture Lamps, 608 So. 83rd Place, Birmingham 6, Ala.

MAKE Up to \$350 a month in spare time keeping books for small businesses on a report system. Do work at home. No previous experience necessary. Simplified course gives complete instructions and specimen set of books. Just follow directions. System designed and used successfully by a public accountant. Full price only \$17.50. Send \$5.00 and pay balance of \$12.50 when delivered plus postage. Southeastern Accounting Co., Tyson Bldg., Montgomery, Alabama.

OWN Your mail order business. No investment. Omaha Envelope Service, 4721-T California, Omaha 3, Nebr.

MAKE Perfume. Profitable business. Information free. "International," 6347 Parnell, PM-6, Chicago 21, Illinois.

OPERATE Profitable mail-order business. Brand-new book gives complete low-down. Send \$2.00 for "Success in Mail Order." Arco Publishing, 480 Lexington Ave., New York City.

MAKE Tough plastic 1c pound. Makes durable floors, walls, mantels, roofs. 101 uses. Build attractive home yourself. Material cost \$150 room. Bays Laboratories, Oklahoma City 9.

BIG Money! Made in lettershop operation! Easy pleasant work. Free details! Woods Letter Service, Bedford, Penna.

FREE Book "372 Unusual Worldwide Business Adventures!" Australia, South America, New Zealand! \$800 month reported (exceptional). Work delightful enterprises home. Prepare for surprise! Publishers-C5, Carlsbad, Calif.

BRONZING Baby shoes is big business, start your own business for \$4.95 includes materials and instructions. No equipment required. Particulars free. Metaloids, Box 2095, Wichita, Kansas.

HOW And where to obtain capital. Small and large loans. Free particulars. Star Service, Wapakoneta, Ohio.

150% SELLING EZC needle threaders 10c. Remit \$1.00 for 25 on card. 6 cards \$5.00. Money back guarantee. E.Z.C. Co., 194P Chestnut St., Springfield, Mass.

GET Amazing literature on 400 money making deals. Mail order ideas, tips, plans galore. M & M Sales, Box 9194, Dallas 15, Texas.

MAKE Big money in home mail business! Few dollars starts you—interesting, profitable. Write: Smith, Box 2592-A, Hines, Illinois.

MAKE Money at home by mail! Thousands do! Fascinating details free! Write: Morris, 356 South Spring Street, Concord, North Carolina.

GET Free literature. Wholesale supply sources. Money making items. Formulas. Allen Service, 245 Main, Ganges, Mich.

START Home candy kitchen. Complete course \$1.00. Joseph Burnley, Box 287, Dayton, Ohio.

OWN—Operate 24-record Wurlitzer coin operated juke boxes. Factory reconditioned. \$150 each. Immediate delivery. Cameo Vending, 432 W. 42nd, New York.

BALL Pen ink. Ten to twenty year personal supply. Instructions and exclusive distributor offer. \$1 postpaid. Pen cartridges refillable many times. Millions discarded monthly. Consumer needs this now. Ink cost 5c to 10c year. W. G. Treanor, 1113 Walnut, San Gabriel, Calif.

SELL Watches, locally and by mail. Quick, easy profits. Metro, Box 1794, Houston, Texas.

SEEK Expert advice before starting local business. Necessary important steps fully explained in my own treatise. \$1.00. Moneyback guarantee. D. E. Van Volkenburg, 509 Empire Bldg., St. Petersburg, Fla.

\$50 WEEKLY On \$10 investment. Particulars free. Wilsons, Stanton, Calif.

CAN You use \$35 a week extra? Profitable mail order business. Details free. Robert Shockey, 1243 S. Maryland, Glendale 5, Calif.

METALLIZE Baby shoes. Excellent profits. New system assures success. Free details. Treasures Forever, 89-B Henry Ave., Lynn, Mass.

BRONZED Baby shoes mountings; metals, onyx, plastics. Hardening solution. Wholesale, Box 2095, Wichita, Kansas.

ALPHABET Flexible mold \$1. Make monograms, names, numerals. Personalize your craftwork. Sample free. Allan Graeme, Box 1307, Chicago, Ill.

LEARN Piano tuning, repairing at home. Tremendous field! Piano parts, tools furnished. Established 1935. Empire School of Piano Tuning, Dept. 16-A, 1753 S.W. 23rd Terrace, Miami 33, Florida.

START Mail order business. Postal brings helpful hint. Shaw, Box 438, Coconut Grove, Fla.

STEADY Cash income by mail. Details 10c. Suproco, Ogema, Wisconsin.

MAIL Order News (55th year) brings you the mail order ideas you're looking for. Copy 25c. Clarence Woodfall, Publ., R. 3, Charleston, Ill.

METAL Mountings for bronze baby shoes. Also shoe plating for the trade. Urbans, 2806 Holliday, Wichita Falls, Tex.

PROFITABLE New plastic business. Free details! Colonial Plastics, 216 S-7th, St. Louis, Mo.

\$100.00 WEEKLY, Servicing, repairing radiators. Home Study, Radiatorman, Hayward 1, Wis.

MAKE Rubber stamps, metalize baby shoes, repair dolls, silver mirrors, make plaster novelties. Catalogue of "30 ideas" free! Universal, Box 1076-A, Peoria, Ill.

NATURAL Molding Latex. Extra thick. Free sample. W. Wooley, 115-A Donald, Peoria, Ill.

ELECTRIC Pencil—Writes, engraves all metals. 110 volts. \$2.95. Reb Industries, 265-DW, Elmhurst, Illinois.

HALF Million articles wholesale. Directory 25c. Krueger, 3418 Wolcott, Chicago 13.

MAIL Order offers increased income, independence, unlimited possibilities; free literature. Manhattan House, 126 Lexington, New York 16.

SPECIAL Rubber for making molds. Literature and sample free. Universal, Box 1076-A, Peoria, Ill.

GETTING Orders by mail easy when one knows how. Revealing booklet free. Howard House, Melrose 900, Massachusetts.

AUTOMATIC Saw setter for Foley filer users. Conrad Stadick, Inventor, Searles, Minnesota.

EARN Money at home with your typewriter! Full, spare time. Write postal for free details. Edwards, 3915-P, 12th, Des Moines 13, Iowa.

SELL Jewelry by mail. Everything furnished ready to go. Orders filled; small capital. Tremendous possibilities! Jomay, Box 1224-A, Toledo 3, Ohio.

RUBBER—Molds, models, casting, finishing, metalizing materials; wholesale catalog, sample free. Plastic Products, 3151-NE, Southport, Chicago.

\$400 MONTHLY. Raising Angora rabbits. Wool \$9 pound. Plenty markets. Details free. White's Rabbitry, Newark, Ohio.

CASH For your idea, 280 manufacturers need inventions, patented or unpatented. List free. Invention Bureau, 208M Clinton, Oak Park, Illinois.

MAKE Money making new greaseless doughnuts at home on electric machine. Wholesale to grocers, drug stores, cafes, hamburger shops. Send for free recipes and plans. M. Ray Company, 3605 South 15 Ave., Minneapolis 7, Minnesota.

LIQUID Marble—Colorful, glossy! Molded, brushed, sprayed! Cast novelties, statuary, colored tiles. Flexible molds. Composition floors, Particulars free. Marbleizing Service, Edwardsville, Illinois.

LIQUID Rubber, make flexible molds. Free sample. Chaney, 1130 E. 16th St., Jacksonville 6, Fla.

RECAST Old batteries into new. Latest achievements. Battery Laboratories, Minneapolis.

"SPECIALTY Manufacturing." Big money business. Start on small capital with dependable formulas. Send for free interesting booklet. Howard Robinson, Ph. G., 1300-A South Ohio Street, Sedalia, Mo.

FIRST Steps in Mail Order tells how to start a mail order business the right way. Will save you hundreds of dollars in costly mistakes. Send 25c for this 35-page book now. Ralph A. Long, 208 West Broad St., Tamaqua 2, Penna.

HOME Workers. Hand-spin Angora wool into yarn. Either sex. House of Angora, PM, Springfield, Illinois.

MAILING Postcards selling repeat merchandise is profitable. Everything supplied. Details free. Gordon Publishers, Box 23, Pawtucket, R. I.

LEARN The three keys to success. (1) Choosing the right products. (2) Sources of supplies. (3) How, where and when to advertise. Free particulars. Business Plans Foundation, Box 56, Madison Square Sta., New York 10.

"HOW To start a successful mail order business." The guide to sound, profitable mail merchandising. 25c. Manhattan House, 126-B Lexington, New York 16, N.Y.

PLASTERCRAFT Supplies. Rubber molds, natural liquid rubber, rayon and cellophane flock finishes, etc. Illustrated catalog and "Plastercraft" course free on request. Blue Rapids Supply, Blue Rapids, Kansas.

LEARN Piano tuning at home in thirty days. Unlimited income. Sound recordings, electric record player, tools and instructions furnished. Write Capitol City Tuning School, Department PM, 211 East Michigan, Lansing, Michigan.

MAKE Money spare or full time, casting metal toys and novelties. Latest scale model autos, original ashtrays, savings banks, water pistols, etc. Enormous wholesale and chain store demand keeps manufacturers busy. No experience or special place necessary. Write for details and illustrations of patterns needed. Metal Cast Products Co., Dept. A, 1696 Boston Road, New York 60, N. Y.

VENDING Machines earn big money! An investment as low as \$10.50 will start you in this fascinating, profitable business that can lead you to the road of success and independence. Routes can be established and operated in either full or spare time with no experience needed. Write for full details and our free catalog illustrating our nut, candy, gum and stamp vendors; also pin ball machines, music boxes, etc. Write immediately to Parkway Machine Corporation, Dept. 7, 623 W. North Avenue, Baltimore 17, Maryland.

YOUR Own profitable home business. Preserve live flowers to last forever. New simple discovery. Enormous demand all year 'round. Tremendous profits! Light fascinating work. Send \$2.00 for working equipment, instructions, and valuable sales plans. Satisfaction guaranteed or money promptly refunded. Alfred Hermansen, 210 Fifth Ave., Suite 1102A, New York 10, N. Y.

NOW Available! 1949 edition of Official Concessionaire's Guidebook. Jam-packed with money-making ideas, games, formulas, equipment for concessions, roadside stands, carnivals, medicine business, etc. Buyers guide. Send \$1.00 today for copy. Concessionaire's Guidebook, Box 133B Sta. B., Toledo 6, Ohio.

POPCORN Equipment, potato chip outfits. Long Eakins Company, 4960 Hi Street, Springfield 99, Ohio.

NO Selling, operate vendors, amazing profits, details free. Silver-King, Suite B, 622 Diversey, Chicago 14, Ill.

HOME Business making statuettes, plaques, artificial marble, rubber molds. Metalizing baby shoes. Silvering mirrors. Formulas. Folder free. Creative, 236-I, Winnetka, Illinois.

RAISE Ginseng. Roots bring \$10.00 pound. Circular free. Fezler Seed Co., Patchogue, N. Y.

MAKE Money addressing envelopes. Our instructions reveal how. Glen Glenway, 5713 Euclid, Cleveland 3, Ohio.

I MAKE Big money in the mail-order business. You can do the same at home with copyrighted system. Write me. I'll tell you how. F. Little, R.D. #1, Glenshaw, Penna.

ENVELOPES Addressed accurately, reasonably. Fast service. We have capable addressers in your city. Glenway System, 5713-Y Euclid, Cleveland 3, Ohio.

OWN Mirror shop. Resilver mirrors. Glass sign making. Electroplating. Supply prices. John Sprinkle, V60, Marion, Indiana.

READ "Advance"—The voice of mail order. Offers money-making opportunities, sources of supply, personal guidance, etc. Issued monthly. Sample copy 25c. Yearly subscription \$2.00. Advance Publishing Company, 313 East 21st Street, Suite 450, New York 10, N. Y.

UNPAINTED Bookends, plaques, statues, figurines. List. Haverty Products, 1219 8th Ave. Altoona, Penna.

A BUSINESS In your own home! Our chemicals, plus free water and cheap "grocery store" materials can bring you over \$500 monthly earnings. Plans and formulas free. Chemica Division, 1269 S. Norton, Los Angeles 6.

A FACTORY In your home garage! Mfg. and sales rights, mechanics' waterless hand cleaner, \$500-\$800 monthly. No special equipment necessary. Formula free. Western Aircraft Mfg., Dept. D, Los Angeles 6, Calif.

QUICK Money. "Repairing car batteries." At home! Easy tool Batteryman, Grand Junction, Colorado.

\$46 FROM Square foot plywood. Jigsaw necessary. Write, Woodarts, X-38, Bridgewater, Mass.

OPERATE Profitable mail order business. Write Walter Service, 4159-A East 112th, Cleveland 5, Ohio.

COLORGLAZED Concrete pottery made without molds. Patented method, Cemetery products, novelties, tiles. Basement leak-sealing. Money-making projects. Booklet, details free. Men only. National Potteries Company, Grand Rapids, Minnesota.

START Mailorder bookshop—Everything furnished. 25c brings booklet, samples, exciting ideas. General Publications, Ossining, N. Y.

\$25 WEEKLY Working two hours daily. No canvassing. No manufacturing. Lycke, Box 2471, Cleveland 12, Ohio.

137 WAYS To make money, in home or office, business of your own. Full particulars free. Elite Co., 220 Grand St., New York 13.

BRUSH Plating outfits connect to a battery. No tanks necessary. Good paying business at home plating autoparts, bathroom fixtures, bicycles, reflectors, silvering mirrors. No shop or experience required. Outfits furnished. Free booklet. Gunmetal Co., Ave. H, Decatur, Ill.

COPUBLISH Leading m.o. paper. Latest copy Mail Sale Advertiser and proposition, dime. Vanroy W. Shirk, Lebanon, Penna.

MONEYMAKING OPPORTUNITIES

POPCORN Poppers, vendors, peanut roasters, copper kettles, bottled gas, gasoline burners; new, used. Northside Sales, Indianola, Iowa.

"EVERYBODY Likes candy." Learn to make professionally. Our 39th year. Ragsdale Candies, D4, East Orange, New Jersey.

NECKTIE Clean n' press. Neat forms, 3 for \$1.00 postpaid. Be independent. Operate an essential full-profit home business. Ryane's, 61 Freeman St., Buffalo 15-M, New York.

BIG Money making opportunities. Write Springer, 1126 E. Apache St., Phoenix, Arizona.

DEPRESSION Insurance! Own profitable business. Information free. Pru-Ex, Kingsport, Tennessee.

15 MINUTES Masters advertising and sign lettering. \$1; free circular. Abenterprizes, Box 875-M, Peoria, Illinois.

UNUSUAL Back yard money-making opportunities! Fully outlined! Write: Pickett's, 62-A Sanders, Florence, Kentucky.

THOUSANDS Articles wholesale. "Supply Source Directory" 10c. Ideal Service, Park Ridge 40, Illinois.

\$200 - \$800 MONTHLY Possible operating home candy business with our professional methods. Write: Etterman, 1991-B6 Lake, Muskegon, Michigan.

FREE Book "372 Unusual Worldwide Business Adventures!" Successful! Australia, South America, New Zealand! Not hokum! Work home. "Different" plans. Prepare for surprise! Publishers-C3, Carlsbad, Calif.

EARN Money evenings, copying and duplicating comic cartoons for advertisers. Adservice, Argyle 1, Wisconsin.

UNPAINTED Figurines. Illustrated list free. Oman, 642 Broadway, St. Paul, Minn.

FORTUNES In nationally advertised cream shampoo. Formula, complete instructions, \$2.00. Ruiz, 3933 Greenview, Chicago.

RECEIVE 644 Business facts and figures! Start a national or local business. Write for free Information Guide. Vargo Co., 9080-A Lyon Street, Detroit 17, Michigan.

MAKE Money in profitable home business of your own! Full, spare time. Read interesting mail selling plans, tips, in Mail Order World. Sample copy, 25c. Romax, Box 4654, Kansas City 3, Missouri.

FISHWORMS. Easy raise, sell, hundreds, millions. Surface without digging. Instructions 50c. Charles, 12-APC, Norwood, Ohio.

WOULD You pay 3%—first \$350 made? Color-illustrated book "505 Odd Successful Enterprises" free! Proven! Work home. Expect something odd! Pacific, Oceanside, Calif.

HOME Sweet shop opportunities for men; women. Fully described. Unusual earning possibilities, security, independence! Write: Brady, 1216-A Park Row Building, New York 7, N. Y.

700 SECRETS For making money with small capital. This book is crammed full of ideas and plans. \$1.00. Robert Shockey, 1243 S. Maryland, Glendale 5, Calif.

MAKE \$100 Per week or more in a full or spare time baby shoe metalizing business of your own. Write now for free literature on this easy to learn highly profitable business. Joseph B. Kushner, Metal Finishing Engineer, Stroudsburg 18, Penna.

\$100.00 PER Square yard of concrete. \$3.50 starts business. Patent pending. Send \$1.00 now to hold territory. Refund if not satisfied. Holston Potteries, Vermont Drive, Kingsport, Tenn.

PAINTING! Photograph portraits on glass. Instructions 25c. Gerald McNeely, Box 524, Rochester, Minnesota.

START Profitable home business in spare time. Make extra money raising Golden Hamsters. Small, clean, odorless. New. Unlimited market. Literature free. Golden Gate Hamstery, 631-H Richmond Street, El Cerrito, California.

FREE Offer. Cash income for life. Write "Succeed," Box 612, Portland 7, Oregon.

SOMETHING New. Silhouette pictures on glass. Fascinating, profitable hobby. Businessmen pay well for these decorations. Details free. Rothbart, RFD 4, New Brunswick, New Jersey.

PROFITABLE Articles made cheaply. Orenstein, 1653 East 9th, Brooklyn 23, N. Y.

WIN Contest prizes regularly! Others do! 10c brings latest issue "Contest Flyer," other revealing information. Lawrence, 687 Morgan, Camden 4, N. J.

LEARN Professional candy making, easy method, free details. Philip Pate, Kissimmee, Florida.

ANALYZE Handwriting for profit! Complete outfit \$1.00. Graphologists, POB-971, Philadelphia.

READ Progressive Mailtrade, the magazine that tells how to make money by mail. Dime brings sample and special offer. Progressive Mailtrade, Box 357, Sheboygan, Wisconsin.

PROFIT With Larson Leathercraft. Belts, purses, 100 other ideas. Largest supply in U. S. Catalog 10c. Larson, Dept. C, 824 S. Tripp, Chicago 24.

WIN Contest money. General Contest Bulletin gives hundreds of tips. Lists current contests and rules. Sample 25c. General Contests, 1609½ East 5th, Duluth, Minn.

EARN Money at home! Thousands do! "Home Worker Magazine" tells how. Sample, 25c. Sizemore, Box 7, 4917 Kostner, Chicago 30, Ill.

PRIZE Contest bulletin gives various contests now operating, and valuable hints. 3c stamp. National Contest Bulletin, Box 2685P, Miami, Florida.

PUBLISH Your own magazine. Handsome 52 page format, well edited, illustrated. Cost low as \$1.00 month. Brings you prestige, profits. 25c brings sample, details. National. Ord. Nebr.

FORMULAS, PLANS, ETC.

MAKE—Sell cleaners, soaps, polishes, flavors, cosmetics. No machinery. Formula literature free. Kemico, Park Ridge 16, Illinois.

10,000 FORMULAS And trade secrets. Free literature. Stillman, 555 Kingston Ave., Brooklyn 3, N. Y.

TEN Moneymaking formulas \$1.00. Northern Specialties, Box 384, Eau Claire, Wisconsin.

11,146 FORMULAS. Postal brings literature. Formulab, 1707 Maryfield, Ann Arbor, Michigan.

\$1.00 GETS You 21 money-making popcorn, candy apple formulas. We supply equipment. Concession Supply Company, Dept. A, Station B, Toledo, Ohio.

HOT Tamale. Making for profit. Particulars. Box 384, Altus, Okla.

FORMULAS For nearly everything. Catalog free. Write Creative, Winnetka, Ill.

PRODUCTS Analyzed. Duplicated. Improved. Formulas. Consulting Scientific Company, Swarthmore, Pennsylvania.

TESTED Formulas. Interesting descriptive booklet free. Pont, Box 635-PM, Terre Haute, Indiana.

REAL Manufacturing formulas. Lists free. Cummings, Chemist, Gordon Ave., Syracuse 4, N. Y.

PLASTICS

SPECIAL Prime masked 6" x 12" plexiglas sheets 1/16". 3 for \$1.45 postpaid. 1/8" 3 for \$1.75 postpaid. Free catalogue. Craft Plastics, Somerville, New Jersey.

LUCITE, Plexiglas. Any size sheets, masked. Square foot (12 x 12) cost, 1/16" 90c; 1/8" \$1.20; 3/16" \$1.40; 1/4" \$1.70. Colors add 10%. Include 10% postage. Almac Plastics, 230 Fifth Avenue, New York 1, New York.

LIQUID Rubber guaranteed for molds \$1.00 pint. \$4.95 gallon. Flamingo Studio, 910 Florida Avenue, Jacksonville, Fla.

GLASY-CAST: The liquid plastic that works the quick and easy way. Cold-Set. 15 to 30 minutes for finished product. Free samples and instructions. Make novelties, embeddings, machine parts, etc. for real profits. Two lbs. for \$2.95. Elastomold: Flexible production molds made in 20 minutes. Also finest quality rubber latex. Wholesale prices. Plastic Service, 294 Washington St., Dept. PM6, Boston 8, Mass.

DOUBLE Your income. Do highly skilled plastics work at home. New short training course. Free materials during training. Old established plastics organization offers this opportunity. Act now. Plastics Laboratories, 3324 Park Blvd., Oakland, California.

AMAZING Liquid plastic. Beautiful results in half hour. Embed photographs, coins, keepsakes. Make solid objects. Clear, colors. Complete kit \$3.25. Kristalon Plastics, Box 29, Dept. P-7, Wilmette, Illinois.

PLASTIC, Sheets, rods, tubes, etc. Free list. Plastic Supply Co., 2901 N. Grand Blvd., St. Louis 7, Mo.

PLASTIC Materials and supplies for your hobby or business. Catalog and internal carving instructions free. Art Plastics of Calif., 8125 East 14th Street, Oakland 3, Calif.

INTERNAL Carved roses, orchids, swans, goldfish, butterflies, etc. Jewelry and gifts. Crystal Floral Novelty Co., Bound Brook, New Jersey.

PLASTICS—Supplies, findings, shells. Illustrated fabricating manual, bargain catalog, 10c. Gem-O-Lite, Box 686P, North Hollywood, Calif.

BOOKS—All Kinds—Homecraft, Radio, Plastics, Boat Building, Photography, Model Building. Catalog free. Popular Mechanics Press, 200 E. Ontario St., Chicago 11, Ill.

CHEMISTRY

HANDBOOK For chemical experiments, illustrated, hundreds of experiments, 50c. Experiment booklet, 15c. Reading Scientific Company, Reading, Penna.

NEW Chemical supply catalog 5c. C-L Chemical Co., 4634 Garfield, Minneapolis, Minn.

MAKE Chemistry your hobby. Fascinating, educational, recreational, vocational. Large general catalogue chemicals and apparatus 15c. Microscopic stain catalogue 20c. Both for 25c. National Scientific Company, Est. 1916, 2204 W. North Ave., Chicago 47.

NEW Idea chemical and apparatus outfits for home experimenting. Photo-scales, microscopes, chemicals, biological and laboratory supplies in small quantities. Catalog 15c. Established 1931. John H. Winn, 124A West 23rd Street, New York, N. Y.

NEW Catalog: Chemistry, mineralogy, biology, 10c. Tracey Laboratories, Evanston, Illinois.

NEW Laboratory supply catalog of chemicals and apparatus. Contains many thousands of items with illustrations. Send 25c. Standard Science Supply Company, 1232 N. Paulina St., Chicago 22, Ill.

CHEMICALS And apparatus for industrial, analytical, and private laboratories. Catalog 15c. Dept. M-50. Biological Supply Co., 1176 Mt. Hope Ave., Rochester, 7, N. Y.

HELP WANTED

BOYS Wanted. Over \$2.00 hour! Sell name plates for front doors. Free sample. Write Dept. 49, National Engravers, 214 Summer, Boston, Mass.

AGENTS WANTED

"AMAZING Plastic finish." Coats autos, furniture, anything. Simply wipe on. Touch dries brilliantly 20 minutes. Resists heat, alcohol. Whirlwind seller. Tremendous profits. Sample free. Reyam Plastics, Chicago 15, Ill.

SALESMEN, Agents, men and women wanted to sell our new "fits-all" plate-hanger. Fits any size or shape plate. Retail for only 10c. Big profits. Decorative plate hanging now fashionable. One minute demonstration sells 3 to 12 or more to home, 4 doz. to a gross to stores. Item attractively carded for display. Excellent sideline. Sell to stores and/or homes. Sample 10c, or send \$4.00 for 100 and get started immediately. Every home a prospect. J. F. Bergander Company, 1051 Althea Drive, Houston 18, Texas.

SPORTFLEX, Nationally advertised men's support offers excellent opportunity to agents throughout the country. Most men wear Sportflex for health, work and sport. Keeps men in trim. Every man a potential customer. Retail at \$3.00. Attractive commissions. Write for full details. Sportex Foundations, 14 W. 17 St., New York 11, N. Y.

FREE Sample to introduce our Bible text mottoes. Get yours today. Special Kut Signs, Dept. 10, Sidney, Ohio.

EXCELLENT Profits. Sell new DDT product at one fourth regular price. Write M. Walker, 68 Oak St., New Haven, Conn.

BE First! Clean up selling brilliant new, metal Christmas cards featured in America's greatest box assortment line. Special metal, plastic, foil and novelty assortments. Five portfolios of personal cards. Fast imprint service. Free samples. Elmcraft Chicago, 5930 South Western, Chicago 36, Ill.

QUICK Profits selling new "Fisherman's Depth-Measuring Casting-Plug." Many other uses gauging water depths. Distributors wanted. Specialties, 508 New York St., Aurora, Illinois.

SENSATIONAL Non-electrical burglar alarm for doors or windows. Untouched market. Retail \$2.95. 100% profit. Millions of prospects. Earl Denton Co., 221 N. LaSalle, Chicago.

AMAZING Offer—\$40 is yours for selling only 50 boxes Christmas cards. Also 50 and 25 for \$1.00 with or without name. Free samples. Other boxes on approval, including entirely new, different deluxe assortment with feature television card. Cute plastic assortments. Write today. It costs nothing to try. Cheerful Card Co., 708 White Plains, N. Y.

HOUSE Paint: Wholesale \$2.70 gallon. Agents wanted. Free advertising offer. Certified Products, 812-E 38th, Louisville, Ky.

PLASTIC Tablecloth covers, curtains, drapes, baby pants, bowl covers and other plastic articles selling like wildfire! Make big money now! Free details. Write L & M Co., Dept. 58-F, 510 St. Charles, St. Louis, Mo.

WANT Extra cash? Sell friends unusual gift wrappings, birthday, illness, everyday cards. Profits to 100%. Bonus. Write for free samples. Birchard, 27A Lester, Springfield, Mass.

LOOK Here! Wanted—Men and women to start in business on credit. Sell some 200 farm-home products. Thousands our dealers now make quick sales, big profits. For particulars write Rawleigh's, Dept. P-192-PPM, Freeport, Ill.

MAKE Extra money fast! Sell Christmas and everyday cards to friends, neighbors, club members, others. Amazing profits, 100 sell-on-sight items, 6 plastic assortments; "Little Stars," "Jack Frost," "Little Ones," Glamorous "Gleam'n' Glo" metallic cards, "Mild Animals," "Smile Please," stationery, wrappings, juveniles, Christmas trees, gifts. Write today for feature box on approval. Hedenkamp, 343 Broadway, Dept. PM-1, New York.

\$6.00 HOURLY Showing Firestone velon handbag; opens into large shopping bag. Fastest seller in America. Women buy several for gifts. Commissions advanced daily. Sample furnished. LeNard, 179-C West Washington, Chicago 2.

\$1 STARTS You in business. Sell lined ties, 100% wool interlining. Costs you only \$7 per dozen, you make \$5.00 dozen. Send \$1.00 for special introductory offer two ties. Catalog complete line free. Phillip's Neckwear, 20 West 22nd St., Dept. K-36, New York 10.

FREE Nylons given if Kendex hosiery runs or snags! World's only women's hosiery sold with written guarantee amazing everybody. Mere words could not express unbelievable money-making opportunity. Fantastic earnings become reality. Armstrong earned \$202 in 9 days. Watkins sent 92 orders in one day. Imagine replacing hosiery free regardless of cause—whether use or abuse! Truly sales dynamite for terrific profits. Even if you never sold before, three magic words: "Guaranteed Against Everything" will open doors for you—make women listen and pour money in your pocket. Complete line from sheerest to service (15-20-30-40-60 denier) all lengths 28 to 35 inches—latest colors—seamed full fashioned and seamless. No competition because Kendex guaranteed nylons not sold in stores. Also complete line men's hosiery actually guaranteed for one full year! Nothing like this anywhere. Includes rayon, nylon, lisle, wool, cotton, mixtures, etc. All styles, patterns, colors, prices to please everybody. Thousands shipped daily, 100,000 pairs constantly in stock for fast delivery. Over 30 years in business. You need no money or experience. Nothing to pay now or later. Show free outfits. Write orders. We deliver and collect. Big advance cash plus huge bonus. Earn money spare or full time—exclusively or side line. No restrictions. Become manager—appoint others to sell for you—earn steady income on their sales. Complete money-making outfits including salesbooks in color, samples of hosiery materials, etc. furnished free and prepaid. Simply mail name and address to: Kendex Company, Babylon 63, N. Y.

EVERYDAY Cards. Earn \$5.00 with every ten \$1.00 boxes of everyday cards you sell. Also new Plastic cards, personalized stationery, note paper and wrappings. Send for samples today. Howard P. Ellis, Dept. PM-6, Pitman, N. J.

MAKE More money! Sell 1949 every day assortments. Plastic cards. Personalized napkins and stationery. Free portfolios. Commission. Richar's, 16A East 18, New York 3.

\$4.00 PROFIT every sale. Columbia Bookkeeping Systems, 319 Dell, Pittsburgh 16, Penna.

BOYS! Earn big money easy, spare time, selling brass name plates for neighbor's doors. Write Hubstamp, 359-C Congress, Boston, Mass.

LARGE Profits, selling leading American colored granite memorials. Mihelich Monument Co., St. Cloud, Minn.

HOTTEST Item today. Combination ball pen; cigarette lighter. All gold finish. Year around seller. Suitable men or women. Retail for only \$1.00. Fertig Products, Dept. N-6, Bronx 60, N. Y.

POCKET Pal: Replaces pocket knives, new, safe, beautiful. Always razor sharp. 50c seller. 321% profit. \$15.00 or more daily. Agents, salesmen, distributors. Sample 10c. Nelson Mfg. Co., 222 W. Kellogg, St. Paul 2, Minn.

ABSOLUTELY Free! Big package actual sample fabrics and style presentation of dresses, lingerie, hosiery, etc. Take orders. Commissions big. Send no money. Melville Co., Dept. 5103, Cincinnati 3, Ohio.

SELL Amazing new wax applicator. Every home needs one. Details free. Amspeco, Amherst, Ohio.

LEARN Mailorder free. Technicalities, tips. Diehl's, 168 Clinton, Buffalo 4, New York.

BUY Thousands of nationally advertised products direct from manufacturers. Write for "Buy Direct and Save." Consumers Assn., 218-F Investment Bldg., Pittsburgh 22, Penna.

DISTRICT Agents. Power mower, \$79.50. Sell users and dealers. Sales kit, free. Smith Agency, S-1006, Excelsior Springs, Mo.

BIG Money fast. Electric shavers, four headed, \$22.50. Label cost \$3.00. Particulars free. National Distributing, Calumet Building, Miami, Florida.

MUSIC Greeting cards. All occasions. Dorby Music Cards, P.O. Box 738, Morris-town, New Jersey.

1/2 MILLION Articles wholesale. Directory 25c. Printers, Box 1302-P6, Detroit 31.

NEW Notion millions need. Sensational profits. Tyform, 5829 Napoleon, Chicago.

SIGNS, No trespassing, etc., 25 different, 100-\$2.50. Retail \$10.00. Details, write, Feld Printing, Cincinnati 26, Ohio.

\$100 WEEKLY. New complete, modern plastic line. Tablecloths, etc., over 25 items. Every home prospect. 100% profit. Free samples. Carwell, 6828-C South Chicago Ave., Chicago 37.

"EAR-BUDS"—Perfume earring sensation. Use own perfume. Big profits. Particulars free. Minot, P.M.M. Box 77, Dorchester 22, Massachusetts.

RUST Eradicator. 125% profit producer. Liberal offer. Rex, Scarsdale, New York.

BIG Profits. Every auto owner buys at \$1.50. Unusual but proven product. Guaranteed. Jackson, 728 W. Peachtree, Atlanta, Georgia.

MAKE Good money. Sell home permanent wave kits. Proven wonderful seller all year round. Big commission, bonus, vacation pay. Write for samples. Henri Company, 8687 Melrose, Hollywood 46, Calif.

EARN Extra money selling magazine subscriptions. Good profits. Raymax, 123-Z William St., New York City 7.

BOYS, Girls. Earn money in your spare time. No investment. Metal Stampers, Box 233, Los Angeles 34, Calif.

EXTRA Money quick! Take easy orders low cost-high profit Christmas cards. Wonderful new type plastic, metallic assortments. Send at once for free 48-page catalog, feature samples on approval and free name imprinted Christmas card sample portfolios. Special offers. New England Art Publishers, North Abington 51, Mass.

SENSATIONAL! Beautiful picture enlargements on stunning hardwood plaques. Terrific appeal! Big profits! No competition! Gotham Products, Box 5427M, Philadelphia 43, Penna.

SELL Powerful \$3.50 automatic fire extinguishers. Firebal, 3505 Hope, Los Angeles 7.

FIRE Extinguishers, pressurized liquid. Sells \$2.00. Costs \$1.00. Demonstration kit \$2.25 prepaid. Free details. Firecom, Southport, Connecticut.

AGENTS, Distributors: Huge profits! Sensational, new "Combination, Shopping Bag-Purse." Lightning seller! Other merchandise; novelties! Royalty, Box I-748, Passaic, N. J.

FAST Selling attractively packaged deodorant spray. Double your money every sale. Send for details. Sample \$1.00. Lincoln Research, Toledo 6, Ohio.

A Dress yours with every 3 you order for yourself and family. Amazing new bonus plan. Everything free. Harford Frocks, Dept. A-135, Cincinnati, Ohio.

SELL 5 x 6 1/2" stock signs to all kinds of businesses. Big profits. Many prospects. Free list. Al Hawkins Sign Co., Sioux City 7, Iowa.

BE Renewal headquarters for all magazines. Handle everything at home. Big profits. No experience. No capital needed. Free catalog tells how. Write McGregor Magazine Agency, Dept. 129, Mount Morris, Ill.

SELLS On sight. New reversible plastic table cloth. Patented. Write Beta-Plastic Products Co., 350 West 25th Street, New York 1, N. Y.

AMAZING Seller: "home mechanics paint kit." No competition. Not sold in stores. Splendid profit. Anderson, Box 3381, Merchandise Mart, Chicago 54.

LOOK! Make money all year round selling personal initialed individualized belts, buckles, cap badges, western buckles, tie holders, name plates. 2000 emblems to choose. Big profits, whole or part time. Please write today special outfit offer. Hook-Fast Specialties, Box 1425, Dept. 6, Providence, R. I. Established 1926.

BIG Profits. Retractable ball point pen. \$3.60 per dozen. Metal Products Mfg., 2067 Broadway, New York, N. Y.

FREE Samples. Big profits showing amazing glow-in-the-dark specialties. House numbers, pictures, plastic novelties, religious and nursery objects, etc. Large manufacturer. Madison Mills, 303 Fourth Ave., New York 10, N. Y.

SEWING Machine electrification kit. Nationally advertised. Has Good Housekeeping Guaranty Seal. Can be demonstrated and sold in 5 minutes. Make at least \$5 per sale. For complete details write today to Brownell Distributors, Inc., Dept. PM, 308 Canal St., New York 13, N. Y.

FREE Water and our concentrates, make flavors, lotions, shampoos, 125 products, labels, bottles supplied. Qualco, E20030 Russell, Detroit.

MEXICAN Feather pictures. Unusual novelty. \$1.00 (stamps) brings \$2.00 worth samples, details. Refunded if unsatisfied. Aztec Art-P, Apartado 762, Mexico City.

BIG Money—Fast! Sell quality plastic tablecloths (from \$4.00 dozen), curtains, aprons, etc. Factory prices. Free samples! Durever, 282-C Albany Ave., Brooklyn 13, N. Y.

SELL By mail books, novelties, bargains! Ready made circular service! Large profits! Catalog free! Elfco, 432 North Wells, Chicago 10.

BIG Money selling cast iron and aluminum cooking utensils direct to consumer, exclusive designs. Free illustrations. Jones Machine & Foundry Co., Chattanooga 2, Tenn.

MAGIC Cleaner—Laundry soap deal. Hotter than a firecracker. Big profits. Sample free. Bestco, 4642 No. Central, Chicago.

AGENTS: Stamping names on pocket-key protectors. Sample check with your name, address, 25c. Stamping outfits. Emblem checks, check-fobs, name plates. Hart Mfg. Co., 303 Degraw St., Brooklyn, N. Y.

PHOTO-Salesmen-agents. Sell beautiful hand-colored plastic enlargements. Collect deposit, we deliver. Profitable sideline. Send card, for free sample kit. Novel Portrait Co., 3343 North Ave., Chicago, Ill.

GOLD Lacquered window sign letters. Large sizes penny each. New foils. Absolutely beautiful. Free samples. Atlas, 544 W. 79th, Chicago 20.

EXCELLENT Sideline for printing and advertising salesmen. Decalomania name plates in small quantities. Great demand. Also, make money with our line of automobile initials and sign letters. Free samples. "Ralco" XL-Roxbury, Boston 19, Mass.

AGENTS—300% Profit selling genuine gold window letters; stores and offices. Free samples. Metallic Letter Co., 438-B North Clark, Chicago.

HIGH-GRADE SALESMEN

MAKE Money. You can sell. We'll teach you how and tell you where to get a job. Be independent for life. Send just \$1.00 to The Detroit Sales Plan, P.O. Box 2234, Detroit, Michigan.

UP To \$50.00 in a week and tailored suit for yourself without paying one cent. Write for plan. Progress Tailoring Co., Dept. T-217, Congress & Throop, Chicago 7, Ill.

SOAP Saver, stainless steel, re-usable. Send 20c for two and dealers prices. Lang, 633 Fifth, Louisville, Ky.

ADVERTISING Book matches—Cash in on big demand; sell union label matches. Cuts for all businesses and political parties. Free powerhouse selling kit, low prices, protection guaranteed on repeat orders. Cash commissions. Superior Match Co., Dept. M-59, 7530 Greenwood, Chicago.

MAKE Big money selling fine imported briar pipes for 100% profit. Union Distributing Company, 210 5th Avenue, Suite 1102-2, New York City 10.

SELL Ultra-blue stock signs to stores. 1000 slogans, comedy, general, religious. "7x11" cost 6c, sells 35c. Make money. 15 samples ultra-blue signs "7x11" \$1.00 postpaid. Lowy, 8 West Broadway, Dept. 470, New York City 70.

SELL Chemicals to taverns thru jobbers. Override. All you sell is free, less jobber commission, or be jobber. Samples 50c. Riesen Chemical, 419 Villet, Milwaukee.

PROTECTED Territory now being allotted on new auto safety invention—Tierod Safety Clamps. Service stations buy moment approached. Repeat orders roll in. Retail \$1.50. We are after quick distribution so write for particulars in order receive your choice of territory. Lox-It Mfg. Co., Clarksdale, Miss.

WHOPPER Commission selling nationally advertised sports item to dealers. We ship and collect. Mail repeat orders credited. Write Ev Selby Co., Decatur 301, Illinois.

SCISSORS Sharpeners. Fast 25c seller. Mar, 74 Park, Webster, New York.

SPRAY-WAY: Sensational new compound. 1 pint makes 1/2 gallon; retails \$1.25. Cleans rugs, car upholstery. Demonstration does the selling. \$1.00 brings sample instructions sales plan. Spray-Way Co., Dept. 28, 4101 No. Vincent Ave., Minneapolis 12, Minnesota.

NEW Jobs open in selling! Send name, address for five free issues of Opportunity Magazine's money-making guide, listing hundreds of companies who'll pay you well, full or part-time. No experience needed. Opportunity, 28 E. Jackson, Dept. 17, Chicago 4, Ill.

STOP! Want to make money all year round selling a complete line, wool uniforms, shirts, caps, ties, badges, 2000 emblems, personal initialed buckles, belts, and hundreds of other easy-to-sell items? Sales kit furnished. Please write today. Hook-Fast Company, Box 480PM, Roanoke, Va.

BIG Money taking orders. Shirts, ties, socks, pants, jackets, sweaters, shoes, uniforms, etc. Sales equipment free. Experience unnecessary. Nimrod, 4922-AN Lincoln, Chicago.

EDUCATIONAL AND INSTRUCTION

"HOW To Break and Train Horses"—A book every farmer and horseman should have. It is free, no obligation. Simply address, Beery School of Horsemanship, Dept. 1106, Pleasant Hill, Ohio.

REFRIGERATION Servicing means financial independence. Ordinary mechanical ability plus proven home study are all you need. Free booklet. Dept. RS, Penn-Weston Training Institute, Box 189, Concord, N. H.

SPEED And skill in radio code to qualify for amateur or commercial radiotelegraph license. Learn at home with the famous Candler System used to train radiotelegraph experts and champions. Good pay or fascinating and profitable hobby. Free book. Candler, Dept. 5-G, Box 928, Denver, Colo.

LEARN Machine design thru individualized home study course from Graduate Mechanical Engineer. Complete seven month course only \$9.85. Free details. Clifford Hill, 210 5th Avenue, Suite 1102-1, New York City 10.

MAKE Up to \$30-\$40 week as a trained practical nurse! Learn quickly at home. Booklet free. Chicago School of Nursing, Dept. M-6, Chicago.

BE A real estate broker through home study or classroom instruction. Write for free book. Approved for veterans. Weaver School of Real Estate, 15 E. Pershing Rd., Box CP-6, Kansas City 8, Mo.

CALCULUS, Trigonometry, algebra, geometry. Individualized instruction. Johns Correspondence School, Box 27, St. Johns Station, Brooklyn 13, New York.

PARENTS—Help your 5 year old to be outstanding. Let them learn while they play. Complete pre-school kit, with directions, \$4.95. Money refunded if not delighted. Educational Supplies, Holly Ave., Ingleside Norfolk 2, Va.

LEARN Spanish quickly. Simplified lessons. Personal Counseling, Box 1411, St. Petersburg, Florida.

CHIROPODY—Extension course. Degree. Qualifies for practice in Alaska. Details, 1. Alaska Chiropractic College, Juneau 1, Alaska.

HOW To be "top supervision" and get top money. By assistant to works manager, 25,000 man plant. \$1.00 postpaid. Money back guarantee. Box 87, Framingham, Mass.

BUILD a writing career in trade journalism. The best field for the beginning writer. Good pay, huge markets, little competition. Send for details. John F. Bristol, 23 Wayne Road, Bridgeton, New Jersey.

EXPORT! Learn at home from established world trader. Big paying positions. Your own profitable world-wide business by mail order without capital; or travel abroad. Experience unnecessary. Free booklet. Mellinger, 106W, Los Angeles 24, Calif.

ANYBODY Can paint: Simplified home study. Beginners, shutins, advanced. \$1.00 brings sample lesson. Major Prickett, Ivory Gull Studio, York Harbor, Maine.

INEXPENSIVE Manual teaches air conditioning. Write. Don Nelson, Warner Robins, Georgia.

WORK For U. S. government. Start \$64.44 week. Secure positions. Qualify now at home. Free 40-page book, lists jobs, sample tests. Write: Franklin Institute, Dept. R-24, Rochester, New York.

GET Into advertising. Glamorous. Big salaries. Learn, earn at home. Write Kimball Advertising, 31-A Norway, Berlin, N. H.

USED Correspondence courses and educational books bought, sold, rented. Catalog free. Educational Exchange, Summerville, Ga.

PHOTOGRAPHIC Mind! Amaze, earn, learn! Facts, figures, names stick like burrs with Supermemory. Write Thor Books, M6, Box 1210, Chicago.

GOOD Jobs and a sound substantial future await you in hotel and institutional field. Men and women—all ages—needed for well-paid positions that offer color, excitement, ever-new and fascinating duties. Record-breaking travel means even greater opportunities for trained men and women in hotels, clubs and institutions. Lewis School receiving calls for managers, assistant managers, stewards, hostesses, purchasing agents and 55 other types of important positions! From coast to coast there are important positions that offer splendid opportunities for advancement in a business where you are not dropped because you are over 40. Previous experience proved unnecessary! No need to leave your job to qualify. A good grade school education, plus Lewis Training qualifies you at home, in spare time. Our National Placement Bureau helps to place you—and our amazing Certified Job Plan—actually certifies you will "make good" when placed. Write today for free book! Veterans: Course approved for Veteran's training. Lewis Hotel Training School, Room PH-368, Washington 7, D. C. (First and only school of its kind—now in its 33rd year.)

LEARN Neon trade: 7½c lesson! Read attractive offer page 38.

VOICE—Strengthen, train your voice this tested, scientific way. Self-instruction course; no music or piano required. Silent exercises develop your voice power. Results guaranteed! Sensational details free. State age. Perfect Voice Institute, Dept. 2F-2, Kimball Building, Chicago 4.

JOB Opportunities are present for men trained in safety engineering. Qualify for this attractive profession by studying at home. Accident Prevention Institute, Box 646, Chicago, Ill.

3800 LATEST Used correspondence courses cat. 50c EG, Elmsford, N.Y.

HOME Study course, drugless therapy. Free literature. Institute of Drugless Therapy, Tama, Iowa.

SPANISH Quickly, with Speed-O-Way phonograph records. Complete course \$7.95. Free folder. Speed-O-Way, Dept. 113, Box 2301, Houston 1, Texas.

SCIENCE Of memory amazingly simplified. Analysis and report. Free explanatory booklet "Art of Memory Development." Memorology Studio, 2016-P Sunnyside Ave., Chicago 25, Illinois.

EARN Extra money, working with figures. Write Jimmy Sherrod, Pavo 1, Ga.

INVESTIGATOR Training. Phillips Secret Service System, 1917B North Kenneth, Chicago 39, Illinois.

MEDICAL Laboratory technicians in great demand. We train you in your own home. Catalogue free. Imperial Technical Institute, Box 973-J, Austin, Texas.

DENTAL Technician's practice kit. Artificial teeth, plastic, etc. Instructions included. Grant Laboratory, S-219 W. 7th, Los Angeles, Calif.

BE A mathematical wizard. Add columns instantly. Free details. Vanderdrift, 517 Lincoln Place, Orange 2, New Jersey.

PIANO Tuning pays. Learn this profitable profession at home. Our Tonometer and mechanical aids make learning easy. No knowledge music necessary. Diploma granted. Largest and oldest school—50th year. G.I. approved. Write for booklet. Niles Bryant School, 78 Bryant Bldg., Washington 16, D.C.

BOOKKEEPERS! Increase your earnings! Operate your own simplified "Dollar-A-Week" bookkeeping and tax service. Full or spare time. Details free. No obligation. Ellis, Box 200, Cedar Grove, North Carolina.

LINGUAPHONE Makes languages easy. At home learn to speak Spanish, Portuguese, Italian, French, German, Russian, by quick, easy Linguaphone Conversational Method. Save time, work, money. Linguaphone correspondence courses are available to veterans under G.I. bill of rights. Send for free book. State if G.I. Linguaphone Institute, 83 RCA Bldg., New York, 20, N. Y.

USED Correspondence courses and books bought, sold, rented and exchanged. Catalog free. Lee Mountain, Pisgah, Alabama.

SECRET Investigation. Experience unnecessary. Investigators particulars free. George Wagner, M 125 West 86th, New York.

PLAYS, STORIES, MANUSCRIPTS

I WANT New writers to cash checks offered daily. The easiest way to write for pay. No previous experience necessary. Free details. Saunders M. Cummings, 468-11 Independence Bldg., Colorado Springs, Colo.

BUSINESS SERVICE

WASHINGTON, D.C., New York City, Philadelphia, remailing service 25c each, 3 for 50c. Richards, 6709 Elmwood Ave., Philadelphia 42, Penna.

LETTERS Remailed. Confidential. \$1.00 month. Simpson, 549 Wilson, Midwest City, Okla.

INCORPORATE Your business, free details. Tax Research Bureau, Inc., Delaware Trust Building, Wilmington, Delaware.

SPECIAL SERVICES

WHAT Can I do for you? Personal-business Kansas City information, representation, purchasing, investigations, mail forwarding. Crown, Box 7041, Kansas City 2, Mo.

TREASURES In your closet! Do you have old or recent bank books, insurance policies or stock certificates in some forgotten drawer? They may be worth a fortune! Let us investigate for you. Write today. National Evaluators, P.O. Box 5852, Cleveland 1, Ohio.

SUPPLY Sources, contacts, services details. Spada Enterprises, 10 Lexington, Wethersfield 9, Conn.

WE Receive, remail letters; \$3.00 monthly or 25c each. Hawkins, 1300 Taylor, Washington 11, D. C.

LETTERS Remailed from Miami, 25c; cards 10c. Send stamped mail to Box 604, Coral Gables, Florida.

INFORMATION

SKILLED Workers—Subscribe now for monthly news-letter listing \$400,000,000 in newly awarded world-wide construction contracts. Send \$1.00 single copy, \$3.00 six months, \$5.00 year. Letters, Box 232, Knoxville, Tenn.

WHERE-To-Buy-It information; most products, material or equipment, \$2.00 per item; manufacturer or wholesaler. Send no money. We trust you. Pay on approval. State wants. One day airmail service. Donald Kelly, AR-9544 Whitcomb, Detroit 27, Michigan.

FOREIGN Employment for you. Excellent permanent job opportunities for U. S. citizens. Wages at least 20% higher, less taxation, lower living costs. Improved social position. Transportation and housing furnished. Choice of climate and location. South and Central America, Far East, China, Alaska, Australia, New Zealand, Africa. Send \$1.00 for copyrighted digest showing oil, shipping, construction, mining, etc., companies working and hiring. Includes sample application letter, advice on wages, tips, etc. World Wide Company, Dept. PM-6, Madison 1, Wisconsin.

CARTOONING, COMMERCIAL ART, SHOWCARD WRITING, SIGN PAINTING

9 ALPHABET 3 Numeral pattern sets and catalog. \$1.00. Sign Letter Distributors, P.O. Box 101, Mineola, N. Y.

LEARN Cartooning. Complete 35 lesson course including 700 illustrations only \$1.00. Cartoonland Schools, 2019 Emerald, Grand Rapids 5, Mich.

"HOW To Make Money With Simple Cartoons"—a book everyone who likes to draw should have. It is free; no obligation. Simply address Cartoonists' Exchange, Dept. 96-C, Pleasant Hill, Ohio.

PROFESSIONAL Showcard letter patterns. Samples dime. Demonstrators, 1743P Harrison, Chicago.

SIGN Painting taught at home. Test lesson free. Ben Kerns, Box 812-T, Greenville, S. C.

CHALK Talks. Laugh producing program, \$1.00. Catalog 10c. Balda The Cartoonist, Oshkosh, Wisconsin.

ADVERTISING AGENCIES, LETTER WRITERS, FOR ADVERTISERS

AVOID Costly advertising mistakes. Get enlightening Ad-Guide and Ratebook leading newspapers, magazines, mailing lists, 10c. Chicago Advertising Agency, (Established 1900), Chicago 4.

DOUBLE The results from your advertising after reading Successful Advertising. Only \$2.00, postpaid. Satisfaction guaranteed. William Bennett, 114-35B 116th Street, Ozone Park 16, New York.

GET More mail order profits! "Big time" specialist who developed many small sparetime enterprises to Big Daily Mail sales, gives you plan and complete instructions in his booklet "How To Build Your Own Mail Order Business," and make it pay. "Must" for beginners. Test-plan-guide for established operators. 25c brings this revealing, exciting booklet. Edition limited. Order yours now. Newberrys, 524 PM Williams, Citronelle, Alabama.

ADVERTISE: 24 Words, 40 newspapers \$3.50. Lists free. Advertising Bureau, 10511-C Springfield, Chicago 43.

INCREASE Your mail order sales. Sell to the farm market. Let us show you what others are doing. Free information. Farm Journal, 201 Farm Journal Building, Philadelphia 5, Penna.

ADVERTISERS! Reach nearly 18,000,000 readers. 25 Sunday national key newspapers, 18 words, \$51.50. "Terrific pullers." 20 popular newspapers, \$10.00. "Free booklet." Special—One inch display 2-821,198 circulation, \$48.30. Newmark's Advertising Agency, (Established 1893), 217-7th Ave., New York 11.

24 WORDS In 50 weeklies, \$4.96. J. Darnell, 730 Hays, Jackson, Tennessee.

ADS Placed in out of town newspapers and magazines. Low rates. Catalogue free. Ideas that pay. Baker Advertising Agency, Successors Ankrum Agency, 189 W. Madison, Chicago 2.

MAILING Lists, certified, productive, inexpensive, \$5.00 1000. Homeworkers, agents, buyers, etc. Write Dixie Service, King, N. C.

TYPEWRITERS, DUPLICATORS, OFFICE DEVICES

STANDARD Typewriters \$17.50; duplicators \$12.50; adders \$12.50. Nationwide service. Typewriters, 118 Spruce, Wichita, Kansas.

BOOM Your business with postcard stencil duplicator, \$4.75 complete. Guaranteed. Postgraph, Box 181, Cincinnati 1, Ohio.

BIG Discounts all makes typewriters including portables. Dupligrath, River Grove, Illinois.

PRINT-O-MATIC Selffeeding post card stencil printing duplicator \$13.50. All office machines. Supplies. Bargains. Type-write for free literature. Pittsburgh Typewriter Supply, 336-7 Fourth Avenue, Pittsburgh 22, Penna.

RECONDITIONED Typewriters, mimeograph, multigraph printing devices, appliances, supplies. Catalog. Dixiegraph Service, King, N. Carolina.

RUBBER STAMPS AND OFFICE SUPPLIES

PENCILS—Finest hexagon 5 cent soft lead with eraser. Guaranteed, 24 for \$1.00. Lang's Specialties, 633-X Fifth, Louisville 2, Ky.

SHIPPING Supplies—Free catalogue. Tags, labels, bags, cartons, sealers, etc. Fountainhead, 1049 Bluff, Beloit, Wisconsin.

3 LINES 45c; pads 35c. 500 printed note-heads, \$3. Postpaid. Stampright, Wauwatosa, Wis.

3 LINES, 50c. 125 Letterheads, 125 envelopes printed, \$1.98. 1949 catalogue. Johnson Press, Box 6-A, New York City 26.

PRINTING, MULTIGRAPHING, MIMEOGRAPHING, GUMMED LABELS

100 LETTERHEADS 8 1/2 x 11 Watermarked bond. 100 envelopes \$1.75. Quality printing. Art's Print Shop, Virginia, Minn.

100 HAMMERMILL Letterheads, 100 envelopes \$2.00. Postpaid. Ruled forms, cards. R. Ruane, 634 S. Blakely St., Dunmore, Penna.

QUALITY Photo offset printing. Lowest prices. 48 hour service. ABC Press, 1041 Eighteenth Avenue, Newark 6, New Jersey.

QUALITY Printing—5,000 6x9 circulars \$21.50; 4-page folders \$38.50. Fast service. Bagby Printing Company, Georgetown, Ohio.

200 5 1/2 x 8 1/2 HAMMERMILL Letterheads; 200 envelopes \$2.98 postpaid. Odom, Box 9345, Tampa, Florida.

500 BOOK Matches printed your advertisement, \$3.75 delivered. Scholler, 530 Dunloe, Pittsburgh 12, Penna.

SEND For samples of better printing. Har-Vis, 1011A Parkwood, Richmond, Va.

1000 NAME-ADDRESS Labels \$1.00. Kay Press, 1560 South Fifth, Milwaukee 4, Wis.

SAVE Money on your printing. Send for free direct mail layout information. Mail your requirements for quotations. Winchester Printing Company, Grand Rapids 2, Michigan.

QUALITY Printing! Send copy for estimate. Nationwide Printing Company, Dept. PM, 2337 Bath Avenue, Brooklyn 14, N.Y.

BLACK-ON-WHITE Photostat prints from drawings, tracings, etc. 25c per copy up to 8 1/2 x 11", 50c per copy up to 14" x 17", plus postage. United Industries, Dept. A, Box 449, Madison 1, Wisconsin.

BETTER Printing—Reasonable prices. Send requirements for free samples and new 1949 catalogue. Mills Burnham, No. Abington, Massachusetts.

SAVE Money on printing. Tell us what you need. Journal Printing Co., Newark, Ark.

BUSINESS, Personal stationery, state requirements. Samples. Herbert Hudson, Centredale, R. I.

1000 BUSINESS Cards \$2.50 prepaid, samples free. Reliable Print Shop, 905 East Jefferson, Louisville 6, Ky.

400 8 1/2 x 5 1/2 LETTERHEADS \$1.35. Mango, 555-A South 20th, Newark 3, N.J.

SEND 10c Now, for our 48 page 1949 price list—refunded first order. McCall Press, 1326 South 27th, Omaha, Nebraska.

500 3/4 x 2 1/4 FOUR Line gummed stickers 35c; red border 50c. Moritz Printery, Saginaw, Mich.

MIMEOGRAPHING—Letters, pricelists, formulas, instructions. Lowest prices. Lem's Letter Shop, 5710 Stanton, Detroit 8.

PRINTING OUTFITS AND SUPPLIES

PRINTING Presses, type, supplies. Send stamp for details or dime for complete illustrated printer's supply book and samples. Kelsey Corp., J-11, Meriden, Conn.

PRESESSE, Type, cabinets, supplies. List for stamp. Lincoln Press Company, 220 Hartwell, Fall River, Mass.

BARGAINS—Hand presses, supplies. Catalog 10c. Customprint, 211-R, Springfield, Missouri.

USED Type, printing presses, type cabinets, etc. cheap. Visit our store. Edward Van Dillen, Inc., 74 Beekman St., New York 7, N. Y.

HOBBY Printers—Join American Amateur Press Association, 822 South Orleans, Tampa, Florida.

BUILD Printing press yourself. Descriptive literature free. Otancop, Box 114E, Akron 5, Ohio.

MAKE Your own Plastex printing cuts. New Plexiplast process. Plastex, Argyle 1, Wisconsin.

PRINTING Presses, type, supplies. Lists 3c. Turnbaugh Service, Loysville, Penna.

INEXPENSIVE Home-made printing press. Details free. Novelty Shop, Downsville, Louisiana.

PATENT ATTORNEYS

INVENTORS—Patent laws encourage the development of inventions. The Rules of Practice of the U. S. Patent Office advises—unless an inventor is familiar with such matters—that he employ a competent registered attorney or registered agent, as the value of patents depends largely upon the skillful preparation of the specifications and claims. Write for further particulars as to patent protection and procedure and "Invention Record" form at once. No obligation. Mc Morrow, Berman & Davidson, Registered Patent Attorneys, 1348 Victor Building, Washington 1, D. C.

PATENTS—Trade marks. Gustave Miller, Registered Patent Attorney, 69-A Warner Building, Washington 4, D. C. Patent Lawyer.

PATENTS—If you have a valuable invention, the usual procedure is to authorize a preliminary search through appropriate classes of U. S. patents. This firm is registered to practice before the Patent Office, is available to make such a search and report to you concerning the probable patentability of your invention. Booklet and convenient "Evidence of Invention" form sent upon request. Victor J. Evans & Co., 431-G Merlin Building, Washington 6, D. C.

CANADA—Ramsay Company Registered, 272 Bank St., Toronto, Ont., Canada.

PATENTS. "Proof of Invention" folder mailed without obligation. E. E. Vrooman, Registered Patent Attorney, 505 McKim Building, Washington 5, D. C.

PATENTS—Trade marks. Irving L. McCathran, 315 McLachlen Bldg., Washington 1, D.C. Registered Patent Attorney.

PATENTS, Trade marks. Sanders, 6430 Evans, Chicago. (Registered U. S. Patent Office.)

INVENTORS: Learn how to protect your invention. Unless the inventor is familiar with patent matters, he should engage a competent registered patent attorney or agent to represent him. We are registered to practise before the U.S. Patent Office and prepared to serve you in handling your patent matters. "Patent Guide for the Inventor" containing detailed information concerning patent protection and procedure with "Record of Invention" form will be forwarded to you upon request—without obligation. Clarence A. O'Brien & Harvey Jacobson, Registered Patent Attorneys, 91B-D District National Building, Washington, D. C.

INVENTORS: When you are satisfied that you have invented something of value write me, without obligation, for information as to what steps you should take to secure a patent. Write Patrick D. Beavers (Formerly Randolph & Beavers) Registered Patent Atty., 935 Columbian Bldg., Washington 1, D. C.

C. A. SNOW & Co.—M-427, Snow Building, Washington 1, D. C. Registered Patent Attorneys. Write for information.

INVENTORS: Without obligation, write for information explaining the steps you should take to secure a patent. John N. Randolph, Registered Patent Attorney, 203 Columbian Bldg., Washington 1, D. C.

"INVENTOR'S Guide" free on request. Frank Ledermann, Registered Patent Attorney, 154 Nassau St., New York 7, N. Y.

INVENTORS: Write for free brochure "Evidence of Invention." Labiner, World Building, New York 7.

PATENT Practice before U. S. Patent Office. Validity and infringement investigations and opinions. Booklet and form "Evidence of Conception" forwarded upon request. Lancaster, Allwine & Rommel, Registered Patent Attorneys, Suite 411, 815-15th Street, N.W., Washington 5, D. C.

INVENTORS. For "Record of Invention" form, contact Carl Miller, Registered Patent Attorney, Woolworth Building, New York.

FOR INVENTORS

INVENTORS—Patent laws encourage the development of inventions. The Rules of Practice of the U. S. Patent Office advises—unless an inventor is familiar with such matters—that he employ a competent registered attorney or registered agent, as the value of patents depends largely upon the skillful preparation of the specifications and claims. Write for further particulars as to patent protection and procedure and "Invention Record" form at once. No obligation. Mc Morrow, Berman & Davidson, Registered Patent Attorneys, 1349 Victor Building, Washington 1, D. C.

INVENTORS—Send today for booklet "Patent Protection for Inventors" containing detailed patent information and preliminary steps to take toward patent protection, also "Evidence of Invention" form. Victor J. Evans & Co., 432-G Merlin Building, Washington 6, D. C.

LIST Your invention with qualified brokers. Write Elo Development Co., Long Island City 1, New York.

INVENTORS! Have you good, patentable ideas? Write Patent Agent Metzler, 11 West 42nd, New York.

INVENTIONS Promoted—Book "Dollars and Sense in Inventions" tells how. \$2.00 postpaid. Adam Fisher Co., 61 Enright, St. Louis 8, Mo.

1st INTERNATIONAL Invention and Hobby Show, Miami, Florida. Oct. 15-23. Make space reservations now. 15 sq. ft. \$15.00. Booth space available. Rights protected. Proper display guaranteed. Send check or money order to Greater Miami Publicity Bureau, 239 Civic Bldg., Miami, Florida.

PATENT Searches \$5.00. Reports air-mailed within 4 days. Invention protection forms free. Write Miss Ann Hastings, Patent Searcher, P.O. Box 176, Washington 4, D. C.

PATENT Searches \$5.00. Reports air-mailed within 4 days. Invention protection forms free. Write Raymond L. Smith, Patent Searcher, 410 Bond Building, Wash-

PATENT Searches \$5.00. Includes nearest patent copies. 48 hour service. Free protection forms. Patent Research Engineering, 318 Evans Building, Washington 5, D. C.

CASH In your inventions with professionally built models, drawings. Free details. Dayton Inventors Laboratory, 1941 Riverside Drive, Dayton 5, Ohio.

INVENTORS' Financial assistance. Investment Development Company, Box 1462, Amarillo, Texas.

INVENTORS: Learn how to protect your invention. Unless the inventor is familiar with patent matters, he should engage a competent registered patent attorney or agent to represent him. We are registered to practise before the U.S. Patent Office and prepared to serve you in handling your patent matters. "Patent Guide for the Inventor" containing detailed information concerning patent protection and procedure with "Record of Invention" form will be forwarded to you upon request—without obligation. Clarence A. O'Brien & Harvey Jacobson, Registered Patent Attorneys, 91A-D District National Building, Washington, D. C.

CASH For your idea. 280 manufacturers need inventions, patented or unpatented. List free. Invention Bureau, 208M Clinton, Oak Park, Illinois.

PATENT Searches \$5.00. Includes patent copies. 48 hour service. Free protection forms. Patent Service Institute, 945-A Pennsylvania Ave., Washington 4, D. C.

PROMPT Patent office search. Analysis your invention for technical, commercial merit. Both \$5.00. Invention protection forms free. Industrial Patent Reports, Box 1081, Massachusetts Ave. and North Capitol, Washington 13, D. C.

INVENTORS: If you have an invention for sale, patented or unpatented, write Institute of American Inventors, Dept. 40A, 1926 Eye St. N.W., Washington 6, D. C.

"INVENTOR'S Guide" free on request. Frank Ledermann, Registered Patent Attorney, 154 Nassau St., New York 7, N. Y.

INVENTORS: Without obligation, write for information explaining the steps you should take to secure a patent on your invention. John N. Randolph, Registered Patent Attorney, 202 Columbian Bldg., Washington 1, D. C.

INVENTORS. For "Record of Invention" form, contact Carl Miller, Registered Patent Attorney, Woolworth Building, New York.

INVENTORS—Possibly I can help you. Many years experience. Charles A. Scott, 773PM Garson Avenue, Rochester 9, N. Y.

PATENTED. Unpatented inventions promoted. M. Joyce Humphries, 1424 Landtitle, Philadelphia 10, Penna.

INVENTORS: The usual first step is to have a search of the U. S. Patents conducted, so I can report on patentability. Write, without obligation, Patrick D. Beavers (Formerly Randolph & Beavers), Registered Patent Atty., 936 Columbian Bldg., Washington 1, D. C.

INVENTIONS WANTED

HONEST Service for inventors. Patented, patent pending. Booklet free. Market Contacts, 11106-S Longwood, Chicago 43.

YOU Too! May enjoy quick cash by inventing. Simple, useful items always in demand. Helpful, instructive guidance \$1.00. Creative Service, 312 Fay Building, Los Angeles 13, Calif.

FAST Sales, cheap protection, details free. McLoughlin, 1101 Meade Avenue, Scranton 8, Pennsylvania.

INVENTORS—Charges from royalties only. Inventors-Manufacturers Associates, 5 Beekman Street, New York.

SMALL Inventions wanted by manufacturers. I'll help you sell your invention. Write for circular. Stanley Hull, 7829 Euclid, Cleveland 3, Ohio.

CASH For your idea. 280 manufacturers need inventions, patented or unpatented. List free. Invention Bureau, 208M Clinton, Oak Park, Illinois.

HIGHEST Royalties — Cash. Official U. S. I. R. C. certification. Request free Booklet "M". Universal Marketing Co., 354 South Spring St., Los Angeles 13, Calif.

INVENTORS: Hundreds of manufacturers have requested our assistance in locating marketable new products. Complete information, free. Institute of American Inventors, Dept. 40-D, 1926-Eye St. N.W., Washington 6, D. C.

INVENTIONS Wanted Patented or pending only. Inventors' Exchange-B, Hartford 1, Conn.

PATENTS FOR SALE

PATENT Pending. Automobile and house gadgets. Dr. Roberts, Cross City, Fla.

NEWLY Patented, automatic cap pistol. Kids go wild over it. Only \$2500 cash. Wm. Rederich, 2442 Miller Rd., Flint, Michigan.

INVENTORS: Test the commercial value of your patented or unpatented inventions, quickly and inexpensively. Write for free information. Institute of American Inventors, Dept. 40-B, 1926-Eye St. N.W., Washington 6, D. C.

MANUFACTURING

PRESSED Metal stampings, any quantity, also die designing. Backed by 20 years experience in design of high production dies for automobile fenders, hoods, grilles, etc. Sterling Manufacturing Company, 3168 Irish Road, Davison, Michigan.

PARTS; Manufacturing; booklet. Arizona Tool & Die Co., 33 Rillito St., Tucson, Arizona.

WANT Something made? We'll make it. Consultation free. Write Jayemm Company, Burlington, Kentucky.

MODELS. Tools, dies, experimental work, large and small lot manufacturing. R. Strom, 2310 Bryant Ave. N., Minneapolis 11, Minnesota.

MODELS — Small lot manufacturing. Metals, plastics, etc. Milburn, Burlington, Kentucky.

MODELS. Tools, dies, experimental work; large and small lot manufacturing. Van-Ess Specialties Company, 212 W. 14th Street, Covington, Ky.

MODELS, MODEL SUPPLIES

BUILD Historic ship models, complete kits, 39c to \$9.00. Catalog 10c. Ideal Models, 19 West 18th, New York 11, N. Y.

TURBO CO2 racer. 20 machined balsa parts, plastic accessories 75c. Free catalog. Vancraft, 17792 Northrop, Detroit 19, Michigan.

KEEP In touch with the activities of the British modelmaking fraternity. Send a dollar bill for year's subscription (4 issues) Modelcraft Magazine and list, 77 Grosvenor Road, London, S. W. 1.

MIGHTY Midget motor—Dandy little 1/4-horse electric motor for experimenting and running toys. \$1.98 postpaid, cash or c.o.d. Sunshine Sales, Dept. MM, Loudonville, Ohio.

LANDLOCKED Sailors! Here's a beautiful, richly illustrated, fully descriptive catalogue of famous model ships—whalers, slavers, corvettes, etc., authentic in every detail. Send for it today. Only 25c. Halesite Yacht Service, Inc., Department B.L., Halesite, Huntington, N. Y.

BASSWOOD Sheets, select, smooth, light weight, uniform, works easily, 1/8" x 3/4" x 18", twelve sheets \$1.00. 3/16" x 4" x 18", ten sheets \$1.25. Whittlerscraft, F-269 Canal St., Providence, R. I.

RAILROADERS—50c Gets 1949 catalog reference manual. State O or HO gauge. Walthers, 247 Erie, Milwaukee 2, Wis.

SHIP And yacht model fittings; blueprints. Send 25c for illustrated catalog No. 21—listing hundreds of items. A. J. Fisher, 1002-1 Etowah Ave., Royal Oak, Mich.

MINIATURE Steam locomotives, 1/4", 1/2", 3/4" scales. Castings, parts, rail, steam fittings! Thorough drawings with instructions. Catalog 25c. Little Engines, Wilmington, Calif.

SHIP Models and yacht supplies complete. Large 64 page catalogue 30c. Bill Wild's, 510 East 11 St., New York City 9.

HOME CRAFTSMEN

LEATHERS. Cut projects, designs, lacings, tools, dyes, polishes, moccasins, metallic acetate, Prang colorings, sea shells. Illustrated catalogue 50c. Refunded after purchases. Govan Craft, 3908 Grove Street, Oakland 9, California.

CERAMIC Supplies for the hobbyist, craftsman and teacher. Write for catalogue No. 5. Anderson's Ceramic Supplies, Route 1, Box 207, Martinez, California.

FREE: Handicraft supplies catalogue. Crafts, 672-C East 91 Street, Brooklyn 12, New York.

BEAUTIFY Your yard with an accurate sundial. Send \$1.00 for complete plans. Lodge, 765 Ventura, Altadena, Calif.

LAWN Chairs, garden figures, furniture, novelties, toys, etc. 68 popular plans with full size patterns, \$1.00. Mastercraft 6M, 7041 Olcott, Chicago 31, Illinois.

LEATHERCRAFTERS Link belt kits direct from manufacturer. Write D-E Products, Dept. H, 8 E. Huron St., Chicago 11, Ill. Sample 50c.

FREE Catalog. Complete line of supplies. Lucite, plexiglas, shells, jewelry findings. Plastic Land, 1210 Spruce Street, Philadelphia, Pennsylvania.

SHELLCRAFT. Make beautiful seashell jewelry! (Buy direct). Pace's, Box 279 P.M., Bradenton, Fla.

LEATHERCRAFTERS! Free catalog! Leathers, tools, supplies. Rosenblum Leather, 518 N. 8th, Sheboygan, Wis.

CRAFT Supplies for craftsmen, hobbyists, inventors. Send for illustrated catalog containing useful information. Sola Sales Service, 1142 1/2 El Centro, Los Angeles 38, California.

90 ALL New, full size lawn ornament and novelty patterns up to 20" high. Only \$1.00. Mastercraft 6M2, 7041 Olcott, Chicago 31, Illinois.

SAVE Thousands building your own home. Practical 47-lesson home-study course explains home-building A to Z. Includes plans and specifications for 6-room house. Others using with great success. Big 22-page book sent free. Commercial Trades Institute, Dept. DC26, 1400 Greenleaf Ave., Chicago 26, Ill.

BARBECUE Fireplaces. Necessary finished castings, parts to build. Bulletin upon request. Smith-Matthews Foundry, 6036 Charlevoix, Detroit 7, Michigan.

LEATHERCRAFT. Monthly price list guarantees best prices. Catalog free upon request. Tandy Leather Company, Dept. PM-69, P.O. Box 397, Tulsa 1, Oklahoma.

LEATHERCRAFTERS: Belt kits, projects, leather, supplies. Free catalog. Art Leather, 411 Joseph Ave., Rochester 5, N.Y.

THE Electric Red Pek Versa-Tool with twelve bits used for engraving, carving, leather tooling comes complete \$5.95. Canterbury Sales, 1121 Fourth Avenue, Rockford, Illinois.

COMPLETE Line of leather-craft supplies. Quality leather, tools and accessories. Write for latest catalog. Dept. 69PM. Wilder-Craft, 1038 Crosby St., Chicago 10, Illinois.

YARD-PORCH Chair project. Parts ready for assembly. Cabinet lumber and veneer deals. Sedio Company, P.O. Box 7161, New Orleans, La.

ALUMINUM—Rounds, squares, sheets, etc. Bulletin APM free. Kale Crafts, 2250 Milwaukee, Chicago 47, Illinois.

JUMBO Box world's finest genuine leather. Pigskins, alligators, lizards, ostrich, cowhide, many other varieties, assorted. 20 lbs. — \$5.00, 10 lbs. — \$3.00. Satisfaction guaranteed. Order today. Leathercrafters, Box 11-A, Lake Bluff, Ill.

JEWELRY Findings, rhinestones, pearls, sequins, cameos, J & M Novelties, Box 464P, Griffith, Ind.

SHELLS, Plastics, findings. Lowest prices. Free catalog. Frances Jones, Box 251, Sarasota, Fla.

TURN Your workshop into cash. Send postcard for catalog of modern saleable projects. Craftplans, 7241-P Madison, Kansas City 5, Mo.

LEATHERCRAFT Lacing, bargains! Francis Byrd, 3406 Montrose Ave., Richmond, Virginia.

MAKE Your own jewelry! All types of findings, metal and plastic; cameos, beads, shell kits. Illustrated catalog. 20c. Hobby Art, P.O.B. 276, Dept. 7, New York 18, N. Y.

CATALOG: Patterns plywood novelty furniture, lawn ornaments, letters, numerals, plaques, frames, silhouettes, weathervanes, toys. Decal transfers. Over 100 other items. 200 articles illustrated. 25c. refunded first order. (No stamps please). Wo-Met Shop, Box 167, Ashburn, Georgia.

KNOCKDOWN Cedar chests, Lumber and veneers. Free price list. Giles & Kendall Company, Huntsville, Ala.

LEATHER, Retail, mail orders, catalog, tools, lacing, supplies. National Handicraft Co., 30 Frankfort St., New York City 7.

COPPER And brass materials. Complete line for craftsmen and workshops. Catalog A free. Groundmaster Company, Boulder, Colorado.

LEATHERCRAFT! Complete stocks of leathers, tools, supplies. Immediate shipment. Free catalog. Kit Kraft, 3203 W. Washington Blvd., Los Angeles 16, California.

MAKE IT YOURSELF

BUILD Your own garden tractor. Save money. We furnish everything. Red Rock Machine Company, Benton 2, Penna.

SAVE Thousands building your own home. Practical 47-lesson home-study course explains home-building A to Z. Includes plans and specifications for 6-room house. Others using with great success. Big 22-page book sent free. Commercial Trades Institute, Dept. DC26-A, 1400 Greenleaf Ave., Chicago 26, Ill.

DESCRIPTIVE Plans of easy blueprints for farmers, home owners, 25c. Details free. Dealers wanted. Edman, Box 307T, New York 19.

BUILD Concrete block machine. Easy. Inexpensive. Motor vibrator or hand operated. Literature, dime. Clyde Lee, Dept. A, Mountain View, Oklahoma.

ABOUT 80c Of each fuel dollar is unnecessary; wasted up your chimney. Easy made combination; chimney-heat-reclaimer, water-heater, incinerator is the remedy. Send one dollar for instructions. Heating Expert, 177 Hill, Detroit 3, Mich.

EASY Built quilt chest. Remove or replace either quilt without moving the others. Plan \$1.00 refundable. Jennings, 5319 Beeman, Dallas 10, Texas.

GRANDFATHER Clock easily built. Big savings. See ad on page 282.

BUILD Your own trailer for boats, general utility. New axle and wheel assemblies, with Timken bearings. \$26.35 without tires or tubes. Write Standard Equipment Co., Dept. PM, Cedar Rapids, Iowa.

RAMMED-EARTH Houses are beautiful, permanent. Straight walls, stormproof. Use earth from site. Instructions, \$1.00. Copeland, Box 6241, Portland 9, Oregon.

BUILD Your own garden tractor. Plans, easy instructions. Light or heavy duty. Send postcard for free information. Ellsworth Tractor Co., Dept. A, Camptonville, California.

"CONCRETE Block Homes." 32 page booklet on how to build. \$1.00. H. C. Lightfoot, Civil Engineer, Richboro 1, Penna.

PLANS AND BLUEPRINTS

HOME Designing. Expert, complete, reasonable. Free details. Planners, Box 2766M, Lakewood, Colorado.

WATCHES, OLD GOLD, JEWELRY

HIGHEST Prices paid for old gold, silver, platinum, diamonds, watches, gold teeth, old jewelry. Send now. Cash immediately. Goods returned if offer is not satisfactory. Government license TGL12. United Smelting Works, (The Old Reliable), 39-B South State, Chicago 3.

WATCHMAKERS' Tools, supplies, sold—bought. Catalogue! Bengal Company, Culver City, California.

WATCHMAKERS. Beginners: watches; movements. Price list! Box 1874, Chicago 90, Ill.

SWISS Wristwatches, shockproof, waterproof. Seventeen jewels. Special price \$7.95. Sydney Eisenberg, 1009 Stockton, Jacksonville, Fla.

GEMS. Precious and semi-precious, all genuine, from world wide sources. Deal direct, no overhead, save money. Catalog 10c. Hill Co., Route 7, Salem, Oregon.

HIGHEST Cash for old, broken jewelry. Mail gold teeth, watches, rings, silverware, diamonds, spectacles. Satisfaction guaranteed. Free information. Rose Smelting Co., 29-A East Madison, Chicago.

TOBACCO, SMOKERS' SUPPLIES

DON Q. "he smokes his own," mentholated cigarettes. Offered for the first time at \$1.60 per carton, 2 cartons \$3.10. 5 cartons or more, \$1.50 each. Ancient blend fine pipe tobacco \$1.50, 8 oz. can. Cash with order, postpaid. Quotations furnished on any cigarette. Geegee Co., Box 229, Blackstone, Va.

FREE Literature—Pipe carving kits \$1.00. Pipe "seconds," 2 for \$1.00. Carvapipe, 2829-G Dixie, Hamilton, Ohio.

TOBACCO Blenders Handbook. 28 jam packed pages of authentic information on tobacco blending. Learn never before revealed "inside" trade secrets and tricks. Thrilling aromas. Formulas. Sauces. \$1.00. Blair House, P2, Montclair, N. J.

CIGARS Direct from manufacturer. Catalog free. Eastern Penn Cigar Company, York 15, Penna.

CIGARETTES \$1.50 Carton, 3 or more postpaid, \$1.53; 5th zone up. Cigarette Sales, 1122 E. 31st, Kansas City, Mo.

CIGARETTES—Popular brands \$1.50 per carton postpaid. West of Mississippi add 8c per carton. Min. order 3 cartons. Send check or money order. King Co., Box 569D, Dover, Del.

SURVEYING INSTRUMENTS

GUARANTEED Factory rebuilt transits and levels, sale, or rent, with purchase option. We will repair, trade or buy old instruments. Write for list M-49. Warren-Knight Co. (Manufacturers of Surveying Instruments), 136 North 12th St., Philadelphia 7, Penna.

RAZORS, BLADES, SHARPENING

SAFETY Razor Co., Box 14, New York City 14. Guarantees 200 regular or 100 single-edge or 50 stainless steel blades \$1. Clip this ad now.

FOR THE HOME

AWNINGS, Canopies; aluminum, adjustable. Moneymaking, moneysaving opportunity. Shade-King, 5314-A Olcott, Chicago 31.

YOUR Name, beautifully engraved, on a heavy polished brass doorplate, 1 3/4" x 9". Postpaid \$2.00. H. V. Ackerman, Malden on Hudson, N. Y.

FROZEN Food storage of most prewar refrigerators tripled by accessory costing \$19. Write Mailbox Mart, Palo Alto, California. No obligation.

FOR SALE—MISCELLANEOUS

PAINT—House and barn paint for wagon jobbers, auctioneers and house to house men. White, gray, red, \$1.25 gallon; extra bright aluminum paint, \$1.45 gallon, all in 5-gallon cans. Gallon cans 10c higher. Will repeat. Chance to make big money. Mail check or money order for immediate shipment. Trading Post, 2104 Burlington, North Kansas City 16, Mo.

BARGAINS Galore—Power lawn mowers, shop equipment, machinery, hand tools, million other surplus items. Atlas Equipment, 229B Southwest Blvd., Kansas City, Mo.

WANTED—MISCELLANEOUS

WE Have swappers-sellers-cash buyers for anything. Write for free lists. Swappers' Guide, Box 415, Evansville, Indiana.

CHEMICAL Games and novelties wanted. Also, any proven methods to make plants grow quickly by chemical methods and to make better production. Garden Chemical Company, 3101 Ludlow St., Philadelphia 4, Penna.

ANYTHING Of value. Robert, 207 North 5th Street, Springfield, Illinois.

QUICKSILVER (Mercury) urgently needed! Immediate payment. Wholesale Terminal, Norwood, Massachusetts.

PERSONAL

WRITER Prepares letters, essays, speeches. Any subject \$1. McDowell, 1530-B South Lumpkin, Athens, Georgia.

CASH For old guns, pistols, powder flasks. Rywell, Harriman, Tenn.

"INTERESTING Mails."—One month listing 25c; three months 50c; six months \$1.00. Bentz, Jr., Chatawa 58, Mississippi.

MEXICAN Mailing service. Letters received, forwarded 20c. Photographic postcards 15c. Tillotson, Apartado 1405, Guadalajara, Jalisco, Mexico.

JOIN The California Tie of the Month Club and wear the most terrific ties in the country. Ties are \$2.50 values and are yours for \$1.35. For full particulars write, California Tie of the Month Club, Box 429, Culver City, California.

NECKTIE Press-Em-Neat forms. Save cleaning bills. 50c or 3 for \$1.00. Fast service. Ryane's, 61 Freeman St., Buffalo 15, N. Y.

HAIR Falling? Dandruff? Write. Elson, 137 Lewis St., Phillipsburg, N. J.

ITALY Mailing service. From Rome, letters received and forwarded 50c. Illustrated postcards addressed by you mailed from Rome, Italy 25c. "Capitol," Suite 7, 342 Hanover Street, Boston, Massachusetts.

CIGARETTES. Postcard brings confidential prices. Magills', Drawer 430-PM, Springfield, Missouri.

MEXICAN Law. General Practice Attorney, 1203 Arizona Street, El Paso, Texas.

HOW You can find out! Information discreetly developed, any matter, person, problem, anywhere. Personal-business assignments, representations undertaken. Nation-wide. Officially licensed, bonded service established 1922. Reasonable, Confidential. William Herman, 170 Broadway, New York.

MISCELLANEOUS

ATTENTION Salesman: For practical household advertising specialties, side line or full time job. Well-known line by a long established manufacturer. Write for details on open protected territories. Patent Novelty Co., Dept. PM, Fulton, Illinois.

NOVELTY Toy manufacturers. Process small wooden parts; beautiful colors; no dipping or spraying; less effort; economical, details and catalogue 25c. Noveltycraft Counselors, 7259 Fulton, North Hollywood, California.

CARPENTER Saws reconditioned with machine. Priced according to condition. Conrad Stadick, Searles, Minnesota.

LIGHT Reflecting crystals, color glass crystals and luminous powdered pigments. Liberal combination trial offer. \$1.00 prepaid. Glowelco, 475-MP Fifth Ave., New York 17.

"RECEIVE Mail." Moneymaking offers, opportunities, catalogs. Name listed 10c. Ideal Service, Park Ridge 10, Ill.

SQUARE Dance instruction book, \$1.00. Wesley Rader, 1922 Grant, Denver, Colorado.

PANNING Gold—Free instruction booklet. Catalogue mining books; supplies. Old Prospector, B-250 Dutch Flat, Calif.

PUSH Button knives. Guaranteed mechanically perfect. Instant action. This hard to get item only \$2.00 postpaid. Midwest Knife Company, 13722 Woodward Avenue, Detroit, Michigan.

51/15 SHEEREST Nylons first quality. \$12.00 dozen pairs f.o.b. Brownsville. Robert Celaya, Brownsville, Texas.

ELECTRIFY Your wife's sewing machine. Free details. Louis Jackson, Duncansville, Penna.

COMIC Cartoon of yourself! Accurate, 7 x 10 inches, pencil cartoon for \$1! Picture returned. Artist—Ralph Martin, 250 6th Ave., South, St. Petersburg, Fla.

GROW Huge tomatoes at home in sand and chemicals. 2 gal. chemicals \$2.00. Write Bill Cope, Box 284, Troy, Alabama.

PANTS By mail for less. High quality gabardine. Regular \$12.50, our low price only \$7.95. Expert tailoring. Popular colors. Nation-wide clientele. Over 50 years in business. Free catalog, cloth sample. Money-saving prices. Lincoln Tailors, Dept. P, Lincoln, Nebr.

100 MARKETS For homemaker's products. Wood, leather, metal, knit, etc. Bulletin \$1.00. Free details. Research, 2409 12th Avenue, Los Angeles 16, Calif.

PERSONAL: The razor blade problem is solved; 15 additional and better shaves per blade can be had with Blade-Master; no honing or stropping, easy and quick to use, works with all blades, lasts a lifetime. Saves up to 85% of blade bill. Send for your Blade-Master now. Price only \$1.00 with order; we pay parcel post. The Blade-Master Co., 5038 Harper Ave., Chicago 15, Ill.

GEIGER Counters. Uranium quickly located with new, super-sensitive, 5 lb. detector. Sensational low price. The Detector Company, 5637 Cahuenga, No. Hollywood, Calif.

GEIGER Counter, miniature. Under one pound. \$48.50 complete with phones, directions, and radioactive sample. Guaranteed. Western Radiation Laboratory, 1107 West 24th Street, Los Angeles 7, Calif.

INTERESTING Mails. Free gift, 25c. Scott, 521 North Memorial, Rockford, Illinois.

OUT Of print books found quickly. Send wants, no obligation. Coast Bookfinders, Box 8686, Los Angeles 46, California.

ANTIQUE Toys handbook. 500 pictures \$3.50. Kowal 1846 Collerton, Chicago.

MAIL Six neckties and \$1.00. Receive six beautifully reconditioned different neckties. Mail twelve and \$2.00, receive beautifully goldplated gift absolutely free. Tie Exchange, 159/c North Wabash, Chicago 1, Illinois.

INDIAN Textile lady dresses from \$5.95; belts, dolls, \$1; purses. Postpaid prices. Full information send dime. Native Curiosities Distributor House, G. Solis, Av. Fed. Vasquez 9, Guatemala, Central America.

1001 ITEMS Free for postal card requests. Big mails, opportunities, samples, books, magazines, and many other useful articles free. The wonder book of the year. Send \$1.00 now. Satisfaction or money refunded. Heaney, Sr., 2950 Clark, Chicago 14, Illinois.

NAMES Of all manufacturers in the U.S. Order direct from the factory. Over 100,000 manufacturers names. State kind of manufacturers you want. Ten names for \$1.00. Write to the Central Supply Co., Dept. B#2, Hays, Kans. Box 634.

ELECTRIC Pencil—Writes, engraves all metals. 110 volts. \$2.95. Reb Industries, 265-DV, Elmhurst, Illinois.

END Your travel worries and cares—"Home of a Thousand Addresses." Build it yourself. It features complete house-keeping facilities and will sleep four comfortably. Inside dimensions are 7' 6" x 17' x 6' 4". Any car will tow it. All-steel chassis and rugged framework permit it to roll along safely on the roughest roads. Send \$1.50 for complete set of blueprints and material lists. Popular Mechanics, Room 604, 200 E. Ontario St., Chicago 11, Ill.

WORLD'S Uranium deposits tabulated! Detection and exploration methods explained. Details free. Woodwid Industries, 5217-A Hollywood Blvd., Hollywood 27, California.

PREVENT Garden damage by rabbits. Buy Rabbit Scat, it works. 6oz. \$1.00, 1 lb. \$2.50. Keep dogs and cats away. Dog-N-Cat Scat, 6 oz. \$.60. A free sample of the miracle Plantgro with each order. Garden Chemical Company, 3101 Ludlow St., Philadelphia 4, Penna.

BIG Men only: Quality shoes, sizes 10 to 16. Widths AAA-EEE. Dress, work, hand-woven shoes, loafers, moccasins, wing tips, sox. Guaranteed. Write for free catalog. King-Size, 888 Brockton, Mass.

TREASURE Finders! Goldak's 11 pound featherweight gold, silver and mineral locator. Guaranteed superior to any other device. Also Geiger counters for uranium prospectors. Free information. The Goldak Co., 1542 West Glenoaks Blvd., Glendale 1, Calif.

PROTECT Valuable photos—Frequently used printed matter. We'll enclose any size in electronically, edge-welded, transparent, plastic envelopes. Can't discolor or harm material. Wallet size only 25c. Send for circular and prices. Seal-view, R2, Lancaster, Penna.

70 BIBLE Lessons, 25c. Bulletin, Box 87, Cathedral Station, New York 25.

"RECEIVE Mail." Moneymaking offers, opportunities, catalogs. Name listed 10c. Ideal Service, Park Ridge 10, Ill.

TATTOOING Outfits, supplies. Illustrated list free. Zeis, 728 Lesley, Rockford, Illinois.

SQUARE Dance instructions. Calls, 25 sets, \$1.00. Rayburne, Eureka Springs, Arkansas.

TREASURE Locators. New electronic lightweight M-Scope mineral and metal finders are now available for immediate shipment. Built for arctic-tropic use. Revolutionizes locating of minerals, gold, silver, metal objects. Unsurpassed efficiency, factory guaranteed. Low prices, time payment plan available. Send for free 16-page illustrated booklet. Fisher Research Laboratory, Inc., Palo Alto, California.

GEIGER Counters for finding uranium ores. Simple operation. Low prices. Interesting literature free. Fisher Research Laboratory, Inc., Palo Alto, California.

TATTOOING Machines, outfits. Free catalogue. Jensen, 120 West 83rd Street, Los Angeles 3.

NOW Ready: New, amazing Classified Advertising Record Book—prepared especially for classified advertisers. Here is a book that tells you instantly whether or not your advertising in any publication is paying you real results. You can tell immediately how many inquiries each publication produced—how much cash received from every ad. Spaces are provided for the name and address of the publication, date of issue, space used, rate, cost of ad, key number, etc. You have a complete record of each publication right before your eyes. Plenty of space to keep accurate record of 28 separate publications. You can have a copy by sending only 10c to cover postage and handling. Send for your copy now. W. F. Johnson, Classified Adv. Mgr., Popular Mechanics Magazine, 200 E. Ontario Street, Chicago 11, Illinois.

BRONZE FOUNDRY Schools and Home Workshops

Make your own castings of aluminum, copper, bronze, silver. Foundry sets are available in three sizes including 2400 Deg. F. blast Furnaces. \$22.50; \$29.50; and \$42.00, f.o.b. Kansas City. Free Circular.

KANSAS CITY SPECIALTIES CO.
P. O. Box 6022, Dept. P-5 Kansas City, Mo.

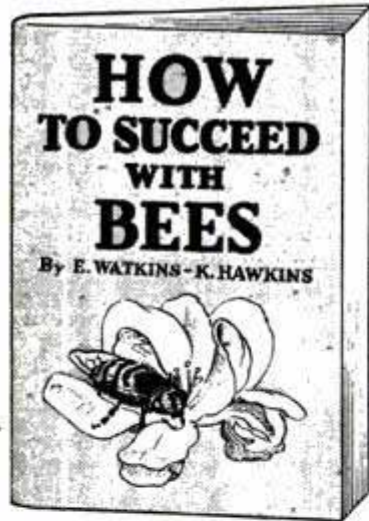

RAISE BEES SELL HONEY MAKE MONEY!

Get How to Succeed with Bees, written by two experts, which tells you all you need to know. Contains 190 tested successful plans to produce big crops of honey. Easy work and little capital required. There is always a ready market for honey and working with bees is fascinating. This 96-page well-illustrated book is only \$1.00 and is absolutely guaranteed to satisfy you or we shall refund your money. Send for your copy today!

POPULAR MECHANICS PRESS
200 E. ONTARIO STREET
CHICAGO 11, ILLINOIS

Build Your Own Motorized Workshop

This Famous Book
Shows How to
DO IT!



Easy-to-Make 40 Different Power Machines

Make them yourself—lathes, drill presses, sanding machines, shaper, circular, band and scroll saws and other power tools—from wood, pipe, and discarded parts that cost little or nothing. Get the new edition of "Forty Power Tools You Can Make" even though you have the older edition. This new book has 20 new tools. Make yourself up-to-date, efficient power machines that will save you hundreds of dollars. Send \$1.50 with order and save high C. O. D. charges. Your money back if not satisfied.

POPULAR MECHANICS PRESS, 200 E. Ontario St., Chicago 11, Ill.

WOOD SHAPER \$34.95 SWING SAW \$99.50

Write for Other Bargains

DEALER INQUIRIES INVITED

J-M MACHINE WORKS, Inc.
SYLACAUGA 1, ALA.

SENSAMO BIKE MOTOR OUTFIT

A Complete Low Cost Power
Unit for ANY Bicycle.



Sensamo is the complete low-cost bike motor that fits any bicycle—boy's or girl's. Outfit consists of base, braces, guards, clutch, rim pulley, belt, twist grip gas control and powerful light-weight Mono-Cycle engine. Can be installed in one hour. Built for real service, Sensamo starts easy, provides smooth power with minimum vibration, does not alter balance of bicycle. Engine develops 2 1/2 to 3 h.p., yet weighs only 18-lbs.

\$89.50

Plus \$4.48
Federal
Excise Tax

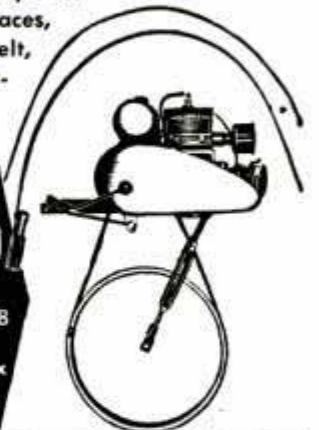

SEND COUPON TODAY

Please rush me illustrated folder with complete information on low-cost Sensamo Bike Motor.

NAME.....

ADDRESS.....

CITY.....

SENSATION MOWER, INC. BOX PM 649
RALSTON, NEBR.

Modernizing? Remodeling? Use..
CHROMTRIM
"Trim-it-Yourself"
METAL MOULDINGS



You'll find hundreds of uses for this handy metal trim around your home. Kitchen, bathroom, stairs or attic can be streamlined in a jiffy. Chromtrim comes in convenient 6' lengths, 8 shapes, all ready to tack on.

Chromtrim is easy to cut — Economical to use — Bends simply to any shape.

Send 10¢ for "Trim Ideas"—16 pages brimming with Chromtrim projects, ideas, and directions for use.

R. D. Werner Co., 295 Fifth Ave., N. Y. 16
 Enclosed is 10¢ for CHROMTRIM "Trim Ideas" booklet PM-6.

Name _____
 Address _____
 City _____ Zone _____ State _____

R. D. WERNER CO., INC.
 295 Fifth Avenue, New York 16, N. Y.

BUILD THIS HOUSE Yourself

The Famous Popular Mechanics House

The picture below is from an actual photograph of the Build-It-Yourself House with breezeway and garage, as built by Jack Brownson, 23-year-old veteran, in Aurora, Illinois.



Mail Coupon for New Book and Plans!

Build It Yourself or Have It Built — Save Hundreds of Dollars!

Designed by Popular Mechanics and Famous Architects. Every Detail Simplified and Explained. No Previous Experience Needed!

Can you use everyday tools as well as the average Popular Mechanics reader? Then you, too, can easily build this modern house in any of its five designs, doing every part of the job yourself. The new Popular Mechanics Book, "Your Home—How to Build It Yourself" will show you how.

Space for Living and Family Growth

This beautiful, modern house is 1½ stories, with basement, living room, kitchen, dining nook, two bedrooms, bath, plenty of closets and space for two additional bedrooms on second floor. The house itself is 35' 9"x28' 11"; breezeway 20' 10"x8'; garage 20' 10"x12'.

The House That Has Everything

Designed for easy construction and the most living space for the least cost, the Build-It-Yourself House is also most attractive and suitable for any community and most income groups. The basic plan is adaptable to four other exterior designs.

Get Book and Plans Now—Build When You Can

You may never have thought about actually building a house yourself, but now that building restrictions have been lifted, it is easier than you think. So order book and plans today. Even if you engage a contractor to build for you, you will need the plans. And you certainly will want the book which can easily save you hundreds of dollars, whether you build this or any other house.

PLANS YOU CAN READ AND FOLLOW

Plans consist of ten working-size blueprints—floor plans, elevations, construction notes, framing, joints, lumber and mill list, specifications, plumbing and wiring diagrams. Every measurement is marked—every detail made clear as ABC. Book has 100 pages—three-fifths are photographs and drawings. Some sections in colors, showing just how your house will look when finished.

BIG BOOK 8½x11 inches

MAIL COUPON FOR BOOK AND PLANS

POPULAR MECHANICS PRESS
 200 E. Ontario St., Chicago 11

I enclose \$_____. Send me the items checked at once.

Your Home and How to Build It Yourself.....\$ 3.00
 Complete set of plans for Popular Mechanics Home.. 12.50
 Book and plans at reduced price..... 14.00
 Duplicate sets of plans..... 5.00

Name _____
 Address _____
 City _____ Zone _____ State _____

Say You Saw It in POPULAR MECHANICS THOUSANDS BUILD

U-MAK-IT BOATS

EASY TO ASSEMBLE KITS

START NOW! NO EXPERIENCE NECESSARY
 Everything Complete in Kit. Quality Material. Simple as ABC instructions. Immediate Delivery. Save Money, Big Value, Sturdy

ROWBOATS, KAYAKS, DINGHIES, INBOARDS, OUTBOARDS, RUNABOUTS, CABIN CRUISERS

SEND 25¢ (COIN) FOR CATALOGS
 Colorful Illustrations show all '49 Models, 8 to 23 Ft., and Construction Details.

U-MAK-IT PRODUCTS
 MARINE DIVISION
 Formerly Kayak Boat Co.
 703P- WHITTIER ST., N. Y. 59, N. Y.

3 NEW ATOMIC RACERS NOW READY



POPULAR MECHANICS PRESS
 200 E. Ontario St., Chicago 11

MAIL COUPON FOR BOOK AND PLANS

I enclose \$_____. Send me the items checked at once.

Your Home and How to Build It Yourself.....\$ 3.00
 Complete set of plans for Popular Mechanics Home.. 12.50
 Book and plans at reduced price..... 14.00
 Duplicate sets of plans..... 5.00

Name _____
 Address _____
 City _____ Zone _____ State _____

\$4.95 REAL ENGINE VALUE

A miniature gas engine that really operates.

Thousands of Buzz "B" gasoline engines have been sold at twice the price. Now is your chance to buy a real 1/6 H.P. gas engine for only \$4.95. Turns up over 8,000 r.p.m. For boats, planes, midget cars, etc. Guaranteed and ready to run. Includes Champion spark plug and tank. Send only \$1.00, engine shipped collect for balance, same day.



WRITE FOR FREE CATALOG OR SEND 10c FOR NEW MAMMOTH ILLUSTRATED CATALOG OF THOUSANDS OF HOBBY ITEMS.

America's Hobby Center, Inc. Dept. B-69, 156 West 22nd St., N. Y. 11

Learn BAKING At Home

Baking is one of America's high industries in wages. Nearly depression-proof. Thorough basic home course lays sound foundation. If you have aptitude, write for FREE BOOKLET, "Opportunities in Commercial Baking."

National Baking School, 1315 Mich. Ave., Dept. 135A, Chicago 5



Helps you s-t-r-e-t-c-h your dollars on TV, electronics, radio and tools.

Write today for the 1949 Lafayette-Concord catalog. A penny postcard will do the trick. You'll find pages and pages of the finest equipment at new low prices. Use the catalog to order everything you need and save. It's free. Write to Lafayette-Concord, Dept. LF9, 100 Sixth Ave., New York 13, 901 West Jackson Blvd., Chicago 7.

LEARN WATCHMAKING JEWELRY REPAIRING

Start your training now for a better paying job or your own profitable business. Intensive practical training by experienced craftsman. Write for free catalog. APPROVED FOR VETERANS.

SCIENTIFIC SCHOOL OF WATCHMAKING, DEPT. PM-6
3923 SAN FERNANDO ROAD GLENDALE 4, CALIFORNIA

HELPFUL BOOKS

Send post card asking for FREE catalog

Popular Mechanics Press, 200 E. Ontario, Dept. 601, Chicago 11

SMALL INBOARD

PROPELLERS, SHAFTS, STRUTS, RUDDERS

BY THE MAKER OF FAMOUS

COLUMBIAN PROPELLERS

Send for free bulletin #48-D

COLUMBIAN BRONZE CORPORATION

FREEMONT, L. I., N. Y.

TOOL AND DIE DESIGN

FREE COPY of our catalog explains comprehensive 12 month course in tool or die design. Expertly planned curriculum. Highly individualized instruction. Housing, employment problems aided.

Write today for complete information.

TECHNICAL EDUCATION, INC. (Acme School)
Dept. PM, 2804 Belmont Chicago

ELECTRIC ARC FURNACE FOUNDRY

MELTING AND CASTING OF IRON, STEEL, BRONZE. HEAT TREATING, FORGING

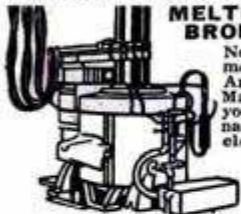

Now you can melt steel, iron, bronze, or any of the metals that require high temperatures. The Electric Arc Foundry Furnace will do this quickly and easily. Many metallurgical problems can be solved. Complete your work shop with the Electric Arc Foundry Furnace. \$52.50 f.o.b. Chicago, Ill. 110 volt A.C. or D.C. electricity required for operation. Write for circular enclosing 25 cents, for complete information on model foundry equipment.

MODEL FOUNDRY EQUIPMENT COMPANY
1322 Hood Ave. Chicago 40, Ill.

ARTISTS MAKE MONEY

Do you like to draw? Send name, address, age and occupation for FREE ART TEST, to find out your ability.

ART INSTRUCTION, Inc.

6139 ART INSTRUCTION BLDG., MINNEAPOLIS 15, MINN.

Make Your Own POWER LAWN MOWER with this DRIVE CUTTER ASSEMBLY

Constructed for those who desire to build their own mower or to replace your old cutter assembly. Complete with 18" blade and double ball bearing drive, only \$11.95

Add 50c to cover handling & shipping. No COD's

ATLAS EQUIPMENT CO., Dept. P.M.6A
229 SW BLVD. KANSAS CITY, MO.



SURPLUS BARGAINS ASSEMBLE YOUR OWN BINOCULARS!

Complete Optics! Complete Metal Parts!
Save More Than 1/2 Regular Cost

GOVERNMENT'S 7X 50 BINOCULARS

We supply full instructions



METAL PARTS—Set includes all Metal Parts—completely finished—for assembly of 7 X 50 Binoculars. No machining required. A sturdy Binocular carrying Case is optional with each set of Metal Parts.

Stock #842-H \$39.40
Postpaid, plus \$4.80 for Case—Total \$44.20

OPTICS—Set includes all Lenses and Prisms you need for assembling 7 X 50 Binoculars. These are in excellent condition—perfect or near-perfect—and have new low reflection coating.

Stock #5102-H \$25.00 Postpaid (These are standard American made parts—not Jap, French or German.)

NOTICE! If you buy both Binocular Optics and Binocular Metal Parts, add 20% Federal Excise Tax to above prices.

ARMY'S 6 X 30 BINOCULARS—We have complete Optics and Metal Parts. Write for Catalog H.

SLIDE PROJECTOR SETS—Consist of all unmounted lenses you need to make the following size projectors:

Stock #4038-H—2 1/4"x2 1/4" \$3.35 Postpaid

Stock #4039-H—2 1/2"x3 1/2" \$3.35 Postpaid

Stock #4029-H—35 mm. \$2.85 Postpaid

MOUNTED TELESCOPE EYEPIECE—Kellner type. Excellent astronomical and other telescopes. War Surplus. Government cost about \$18.00. Focal length 24 mm. Lens diameter 23 mm. Unusually wide field.

Stock #5189-H \$3.25 Postpaid

MOUNTED ANASTIGMAT LENSES—Use for Projectors, Etc.

Stock #8004-H Speed f/7.7, focal length approx. 127 mms. Suitable for pictures, negatives, positives up to 3 1/2"x4 1/4". \$7.50 Postpaid

Stock #8006-H Speed of f/7.7, focal length approx. 100 mms. Suitable for pictures, etc. up to 2 1/4"x3 1/4". \$8.50 Postpaid

Stock #8007-H—Speed of f/6.3, focal length approx. 100 mms. \$9.50 Postpaid

We have literally millions of war surplus lenses and prisms for sale at 10c and up. Write for Catalog "H"—Sent Free!

Satisfaction Guaranteed Order by Stock No.

EDMUND SALVAGE COMPANY

P. O. AUDUBON, NEW JERSEY

FURNITURE FOR YOUR BEDROOM

YOU'LL BE THE ENVY of your neighbors with this beautiful bedroom suite in honey maple, oak or walnut! Here's a bed with storage space . . . a three-piece vanity with cosmetic compartment and makeup mirror . . . a Mr. and Mrs. dresser . . . twin night stands with drawers!



Send for Complete PLANS Only \$2.00

YOU MAKE IT YOURSELF! Only two power tools, a saw and a jointer, are needed to turn out this modern bedroom furniture. No other project of Popular Mechanics Magazine in recent years has captured the fancy of home craftsmen as has this easy-to-build suite. Letters demanding detailed plans poured in after the suite was pictured in Popular Mechanics. And now the plans are ready! They're detailed scaled drawings—a complete set of 4. Send for them today!

POPULAR MECHANICS PRESS
200 East Ontario Street, Chicago 11, Illinois

I enclose _____ for a complete set of plans for making the modern bedroom suite illustrated above.

Name _____

Address _____

City _____ Zone _____ State _____



Build Your Own TOW TRUCK

The Easy
"Jack Heil"
Way

A Rugged, Heavy Duty, Lifetime Unit by the manufacturers of the "World's Finest Towing Equipment"

All parts cut and shaped to fit, exact duplicates of parts used in our production line. Only a welding machine needed to complete this power winch, universal model. Capable of handling trucks, cars, tractors and trailers. Includes complete operator's manual showing proper step by step procedure of doing heavy hi-way wrecking, and towing, diagrams, technical information, etc. Solve your own problems. Complete units also available at great savings.



Also available: A complete line of bodies, cranes, winches, spacer bars, cable, other towing equipment. Operator's manual free with each order. Otherwise, send \$2.50.

JACK HEIL "Builds Truck Bodies"
Dept. PM, 2112 N. Clybourne, Chicago 14, Illinois
Experienced Salesmen now calling on automotive trade, write for territories!

"SEA CRAFT" BLUEPRINTS READY NOW!



Build this luxurious cabin cruiser yourself and save money. What a beauty it is! A 25-foot boat readily adaptable as a sport fisher, express cruiser, or utility boat. Cruises effortlessly at 15 knots with a marine engine or converted auto motor. Its spacious cabin sleeps four and has a galley complete with fresh-water tank, sink, and cook stove. Has open cockpit large enough for fishing, lounging, etc.

During war the Coast Guard used "Sea Craft" for ship-shore travel. Order today your complete set of seven large-size blueprints scaled 1 inch to the foot. These, plus a 40-page two-color illustrated booklet giving step-by-step instructions, only \$10.00.

POPULAR MECHANICS PRESS
200 EAST ONTARIO ST. CHICAGO 11, ILL.

PILOT^{type} SUNGLASSES LENS WIPER and CASE



Only
\$2.95
Retail \$6.75

Send NO money - Mail a 1¢ post card, with your name, and your address. Pay postman \$2.95 plus small government charges. If you send money order we pay postage.

**MITCHELL OPTICAL CO., DEPT 2A BOX 28, FEDERAL SQ.
NEWARK, NEW JERSEY**

Mechanics! Repairmen! Hobbyists!

10 DRAWER All-Steel CABINETS

12 section steel drawers with adjustable dividers. Size 16 1/4" wide x 8" high x 10" deep—drawers 1 1/2" deep with card holders. All electric welded in brown hammerloid finish.



\$11.75

At your dealers or write direct

MODEL BOX and CABINET COMPANY
205 WEST WACKER DRIVE CHICAGO 6, ILLINOIS

POWER HACKSAW \$47.25

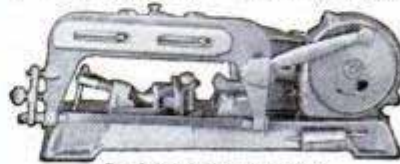

LESS MOTOR
F. O. B. Benton Harbor

• Rugged cast iron construction. Wt. 56 lbs. bronze bearings. Draw cut. Auto. return lift. Auto. shut-off. Vise swivels 45°. Cap. 4" x 4".

Send for full details and name of nearest dealer.

EXCEL MACHINE TOOLS BENTON HARBOR, MICHIGAN

LIQUID STAINLESS STEEL

Under Coat your Car, Metallize Anything. Apply like paint to Wood, Metal, Plaster, Concrete. Quick drying. Permanent. Protective. Eliminates corrosion. Entirely New Process. 1/4 Pint \$2.35, 1 Quart \$3.85, 1 Gal. \$12.00. Postpaid anywhere in U.S.

THOMAS HADLEY CO., Dept. PM-2, Box 91, Franconia, New Hampshire

WHEELS - WHEELS

5" disc wheel, 5/8" tire, 5/16 or 3/8" sleeve.....	\$0.30
6" disc wheel, 5/8" tire, 5/16 or 3/8" sleeve.....	\$0.35
7" disc wheel, molded tire, 3/8" sleeve.....	\$0.45
8" disc wheel, 1 1/8" tire, 1/2" sleeve.....	\$0.70
7" disc wheel, 1" tire, 1/2" ball bearing.....	\$0.80
8" disc wheel, 1 1/8" tire, 1/2" ball bearing.....	\$1.00
10" disc wheel, 1.75 semi-pneumatic tire, 1/2" B.B.....	\$1.50
10" cast alum. wheel, 2 3/4" semi-pneumatic tire, 5/8" ball bearing.....	\$4.50
Hub caps for 5", 6", 7" wheels.....	3c each Plus postage

UNITED WHEEL STAMPING CO., Dept. PM-6

2756 W. 115th St. Chicago 43, Ill.



TRAILER BUILDERS' SUPPLIES! TO BUILD, REPAIR OR MODERNIZE!

And save money. You must have our big Catalog. We are the largest and most complete trailer supply house in the States. Our new large 1949 catalog 10c; blue prints and building instructions, 25c.

NATIONAL TRAILER EQUIPMENT CO., 1007 N. Water St., Milwaukee 2, Wis.



ACCURATE DRILL GAGE

DO YOU WANT YOUR TWIST DRILLS TO REALLY CUT? Then you need this modern drill gage to show you how. It checks both cutting angles and clearances at the same time. When drills are hand or machine ground to this gage, there is absolutely no doubt of maximum efficiency. For mechanics, tool and die makers, machinists, hobbyists, craftsmen, mechanical students, in fact, anybody that uses and sharpens twist drills. Precision made of 1/2 hard aluminum stamping for 1/8" to 3/4", only 75c. Postpaid anywhere in U.S.A.

**TINGLE INDUSTRIES 8731 Orangelawn
Detroit 4, Michigan**

FENDER SKIRTS.....\$16.95 PER PAIR

FOR FORD, CHEV., MERC., PLYM., DeSOTO, CHRY., DODGE, KAISER-FRAZER AND BUICK

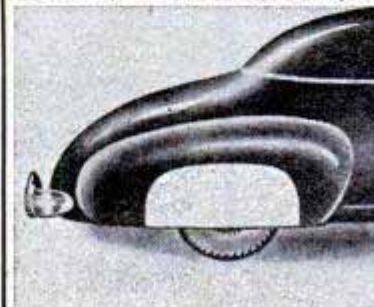

Beautify your car — bring out the flowing lines inherently designed there. Sparkling beauty you'll like. Constructed of heavy gauge body steel, finished in prime. Perfect fit.

SANDEE MUFFLER CO.
Box 296, La Tijera Sta.
Los Angeles 43, Calif.
Gentlemen: Please send me one set of Sandee Fender Skirts to fit my _____ (year and

make of car) _____ (year and
 Check for \$16.95 enclosed
 Ship C.O.D.

PAY RAISING—EXTRA MONEY BOOKS

Use these books to prepare for a better job—bigger pay—to start a profitable spare time or full time business of your own, improve your home, start a hobby. Popular Mechanics specializes in Popular Mechanics specializes in supplying outstanding self-help books on many subjects. Send for our FREE catalog.

- Outdoor Sports Manual**
Hunters, Fishermen, Trappers, Campers, Archers, Boatmen, here is your book! . . . \$2.00
- Shop Notes Library**
4 Vols. — 1948, 48, 47, 44 (No. Dup. Mat.) . . . \$2.48
- Painting, Furniture Finishing and Repairing** . . . \$1.50
- Rewinding and Servicing Electric Motors (No. 75)** . . . 25c
- Photo Handbook**
An entirely new and different book from our Popular Photo Guide. It's a complete guide to better pictures and dark-room technique, and features dozens of handy gadgets you can make yourself. . . . \$2.00
- Motor & Truck Repair Manual**
Mechanics, Truck Specialists, Service Stations, Fleet Owners! Here is your book. Covers every job on every truck made since 1936 — 1400 pictures. 932 Pages . . . \$8.00
- Garden Book**
Build own trellises, lawn furniture, fireplaces, ornaments, etc. . . . \$1.25
- Diving, Cutting and Welding in Underwater Salvage Operations**
Only book of its kind . . . \$2.00
- Picture Framing**
Modern methods for making and painting picture frames. Fully illustrated. . . . \$2.75
- If You Want to Write You Can**
Write! Learn through actual examples . . . \$1.75
- A-B-C Shorthand**
This easy to learn system can be mastered in 12 easy lessons . . . \$1.00
- Modern Illustration**
A practical art course covering all branches of commercial drawing, painting and methods of reproduction . . . \$3.00
- 210 Deluxe Small Homes** \$1.00
- Into the Freezer and Out**
A complete handbook on the home freezing of foods. \$2.50
- Concrete Handbook**
New book on using concrete around home, garden, farm . . . \$1.50
- Zero Storage in Your Home**
How to prepare, store and freeze food properly. . . \$2.50
- This Way Up**
The successful philosophy of practical business men \$2.00
- Welding, Brazing and Soldering**
How to build own equipment and how to use it effectively . . . \$1.25
- Modern Refrigeration**
Electric, Gas. Be service expert . . . \$5.00
- Dyke's Auto Ency. (includes Diesels, airplane engines)**
New 20th Ed. World's greatest book for mechanics \$7.00
- Household Mechanics**
The "fix-it" book to end all "fix-it" books. Covers electric appliances, painting, carpentry, etc. . . . \$2.75
- Oil Burner Handbook** . . . \$2.50
- Build Your Own Boat**
Describes 17 popular boats—rowboats, sailboats, plywood outboard, etc. 192 pages \$1.50
- House Wiring (No. 89)** . . . 25c
- Turn Scrap Into Money**
Convert old auto generators into motors, welders, etc. . . . \$1.00
- Popular Mechanics Farm Manual**
Packed with practical ideas and usable information that an easily be worth hundreds of dollars to every farm family and to homeowners everywhere. Send for free descriptive folder giving complete contents! . . . \$3.00
- Woodworking for Every-body** . . . \$2.75
- Sheet Metal Work** . . . \$3.00
- Tool and Saw Sharpening (No. 92)** . . . 25c

- Forging Practice** . . . \$1.50
- Action Toys (No. 66)**
Plans for 21 easy-to-make toys . . . 25c
- Foundry Work** . . . \$2.25
- Pattern Making**
Wood, metal . . . \$2.25
- Forty Power Tools**
Build own saw, drill, lathe, sander, etc., from scraps—save money . . . \$1.50
- Carpentry** . . . \$2.50
- The Young Craftsman boys can make** . . . \$1.50
- Five Acres and Independence**
How to make money on small farm . . . \$2.50
- Your Home and How to Build It Yourself**
Step by step construction of the famous POPULAR MECHANICS house. Wonderfully illustrated . . . \$3.00
- Drake's Householders Cyclopaedia**
This is the time to save money on those necessary home repair jobs—Repairing, Remodeling, Carpentry, Painting, Decorating, Plumbing, Heating, Electric Wiring and Appliance Repairs, Furniture Repairs—This new book covers them all . . . \$5.00
- Motorist's Handbook**
Popular Mechanics scores again. A 160 page guide to automotive happiness . . . \$2.00
- Knots, Ties and Splices**
For everyone who uses rope . . . \$1.25
- What to Make for Children**
Build Junior tough on toys? Build him playthings that will last. . . . \$2.00
- LeJay Manual of Homemade Electric Equipment**
How to construct 100 items that are scarce and valuable . . . \$1.50
- How to Estimate for the Building Trades: Material and labor costs for masonry, plumbing, electricity, carpentry, heating, hardware, painting, etc.** 629 pp. . . . \$5.50
- Rabbits for Food and Fur** . . . \$2.50
- Tool Making** . . . \$4.00
- Tool Design** . . . \$4.50
- Plumbing Installation & Repair** . . . \$2.00
- Ropp's Calculator**
Figuring made easy . . . 75c
- Slide Rule Simplified** . . . \$2.75
- Drake's Refrigeration Service Manual** . . . \$2.00
- Primer for Home Builders**
All the information you need to know in building a house . . . \$2.50
- How to Read Aircraft Blueprints** . . . \$4.40
- America's Best Low Cost Homes**
125 popular practical designs . . . \$1.00
- Toys You Can Make of Wood** . . . \$2.50
- A.B.C. of Poultry Raising** \$2.50
- Ice Cream for Small Plants**
Some technical formulas for ice cream, ices and frozen desserts on a commercial scale . . . \$2.50
- Furniture Joinery** . . . \$2.00
- Essentials of Upholstery** . . . \$3.25
- Radio Physics Course**
A thorough training in radio fundamentals . . . \$5.00
- Lessons in Ornamental Penmanship**
You can easily learn to write beautifully. Delight and amaze your friends with the skill you can acquire by using this book —Only . . . \$1.50



CALEN-CULATOR

COPYRIGHT 1949

THE CALCULATING CALENDAR

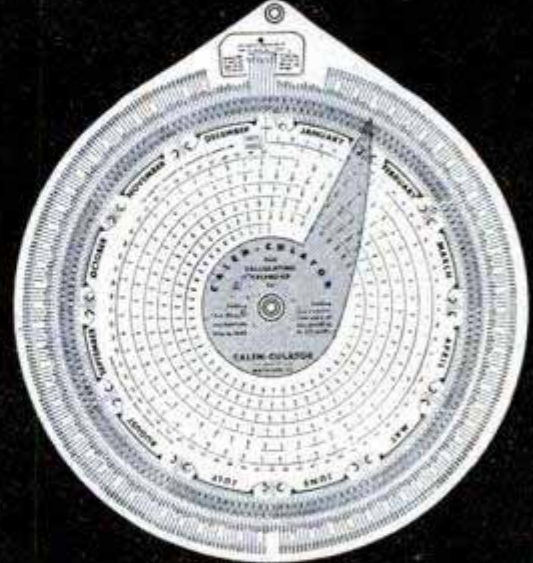

For finding the number of days between any two dates (up to 6 years apart) • For finding the beginning or ending date of any period (up to 6 years) before or after a given date • For adding intermittent periods • For use as a calendar for any year from **1 B. C. TO... FOREVER!**

To Be Used By:

- Manufacturers, Business Houses, Contractors,** to find date and day of week goods will be delivered, to work out production schedules, compare production periods of other years, to find number of working days in any period, length of break-down runs in lab or operation period of machinery.
- Doctors, Farmers, Crop Speculators,** to find date offspring is expected to be born, or date disease symptoms will appear after exposure, or date crops will mature or hit market, or days left in season.
- Banks, Investors,** to find number of days money was invested, or date and weekday loan is due.
- Lawyers, Police,** to find date and weekday events relative to a case occurred or check calendar continuity and validity in a case.
- Families,** can find weekday any member was born on or weekday future birthdays will fall on, or plan next years vacation, or use as a lifetime calendar.
- Schools,** can find dates students will complete courses when training is continuous, or use to plan next years school calendar. It is very useful to schools giving instruction under GI Bill for finding remaining entitlement or date it will expire. It is also a valuable training aid in teaching calendar construction and progression.
- Students of Logistics and Marketing,** can quickly find time factor values in problems of supply and demand.

IT HELPS YOU TO PLAN YOUR WORK AND WORK YOUR PLAN

CALEN-CULATOR, P. O. BOX 421, MAYWOOD, ILLINOIS

At \$3.00 per CALEN-CULATOR, please mail me _____ CALEN-CULATORS.
Find enclosed a money order check for \$ _____ Send postpaid to:

NAME _____
STREET _____
CITY _____ STATE _____

MAIL THIS COUPON TODAY

Check the books you want, write your name and address below, and mail this advertisement with money order or check. Outside U. S. A. include 15% additional for shipping charges.
Books selected will be mailed promptly on our "money back if you're not entirely satisfied" guarantee.

Name _____
Address _____
City _____ State _____

Mail to POPULAR MECHANICS PRESS
Dept. 700—200 East Ontario St., Chicago 11, Ill.

Now Your
Dream Home
Comes True!

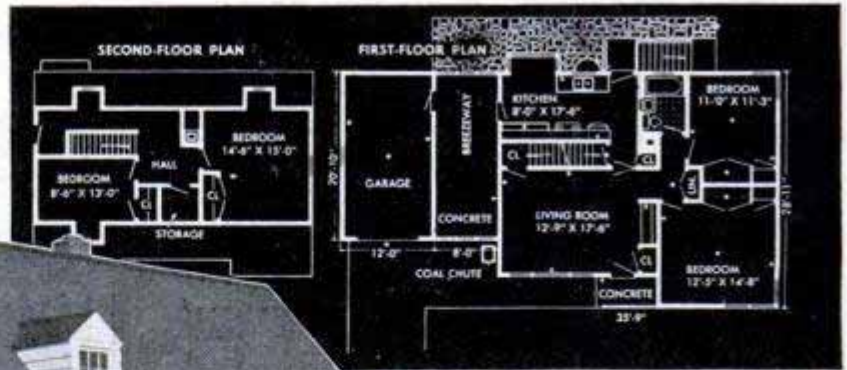
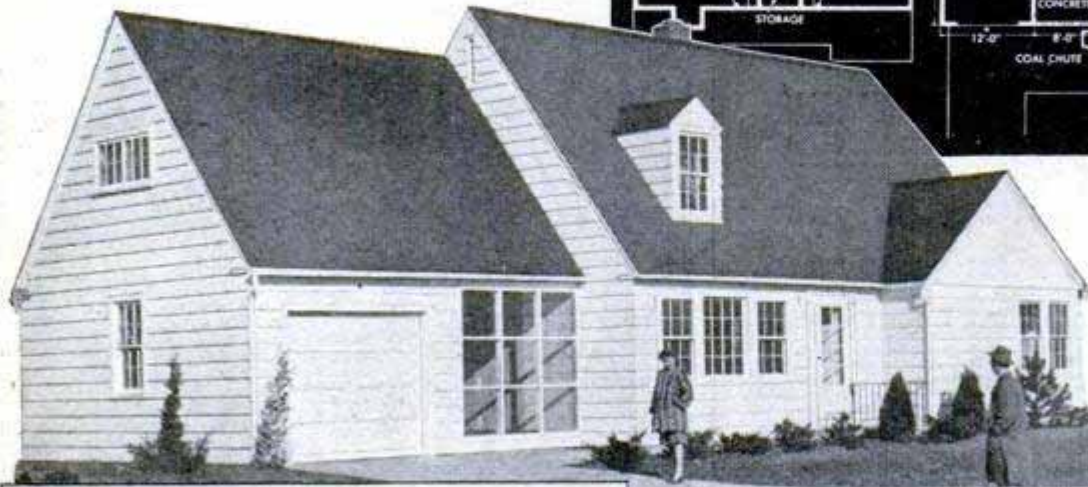

The House That Jack Built

From actual photograph of Build-It-Yourself House with breezeway and garage as built by Jack Brownson, Aurora, Illinois, a twenty-three-year-old veteran.

YOU CAN BUILD THIS HOUSE YOURSELF!

GET THE BOOK NOW! STUDY THE PLANS NOW!

Start Building When You Can

You can get "Your Home and How to Build It Yourself" and complete plans by mailing the coupon below. Book is plastic bound and contains 100 pages, size 8½ x 11 inches. Three-fifths of the book consists of photographs and drawings. Several sections are printed in extra colors and a four-page, four-color insert shows just how your own house will look in actual colors. Every detail of the house and its construction are discussed in this book with minute details of Build-It-Yourself instruction that will guide you in every step.

PLANS YOU CAN READ AND FOLLOW

Plans consist of ten working size blueprints, giving floor plans, elevations, notes on construction, framing, lumber list, millwork list, specifications, plumbing and wiring diagrams. Every measurement is marked, every detail made as clear as A-B-C. With the book to guide you and the plans to follow, any handyman who can use simple tools can build this remarkable house and enjoy every minute of the work while saving thousands of dollars.



MAIL COUPON FOR BIG NEW BOOK AND PLANS • BUILD IT YOURSELF OR HAVE IT BUILT AT A BIG SAVING!

Can you use a hammer—saw a board straight—use common, everyday tools as well as the average *Popular Mechanics* reader? Then, startling as it may at first seem, you too, can build this modern house in any of its five designs, and do it easily and quickly, at a tremendous saving. *Popular Mechanics* and a famous firm of architects have designed it and worked out every detail so you can do every part of the job yourself, even though you have no experience whatever.

SPACE FOR LIVING AND FAMILY GROWTH

Illustrated is the *Popular Mechanics* "build-it-yourself" house Jack Brownson built from our plans, in Aurora, Illinois, with one inexperienced helper. This beautiful, modern house is 1½ stories, with basement, living room, kitchen, dining nook, two bedrooms, bath, plenty of closets and space for 2 additional bedrooms on the second floor. The house itself is 35'-9" x 28'-11"; breezeway 20'-10" x 8"; garage 20'-10" x 12 feet.

THE HOUSE THAT HAS EVERYTHING

The big, basic idea behind the design is ease of construction and the most living space and the most useful space, at the least cost, considering attractiveness and suitability for any neighborhood and most income groups. On top of this is its adaptability to other types of architecture, such as modified Dutch Colonial, modified Cape Cod, plain gable roof house without dormer windows, or the house as pictured, but without garage and breezeway.

USE CONVENIENT ORDER COUPON

You may never have thought about actually building your own house, but you can do it. And now that building restrictions have been lifted, it's easier than you think. So send for the big new book—Your Home and How to Build It Yourself, and set of construction plans, today. Even if you engage a contractor or builder to build this house for you, you will need the plans. Then too, you will certainly want the book, which can easily save you countless hundreds of dollars whether you build this house or any other house of your choosing.

100 Pages
52 in Color
60% Illus.
8½"x11"

MAIL COUPON FOR BOOK AND PLANS

Popular Mechanics Press,
200 E. Ontario Street, Chicago 11.

I enclose \$_____ Send me the items checked at once.

- | | | |
|--------------------------|--|---------|
| <input type="checkbox"/> | Your Home and How to Build It Yourself | \$ 3.00 |
| <input type="checkbox"/> | Complete set of plans for Popular Mechanics Home | 12.50 |
| <input type="checkbox"/> | Book and Plans at reduced price | 14.00 |
| <input type="checkbox"/> | Duplicate sets of plans | 5.00 |

Name _____

Address _____ Zone _____

City _____ State _____

BUILD a BOAT

FOR PLEASURE OR PROFIT DESCRIBES 17 LOW COST BOATS
Get this outstanding book and build a boat at home for your own use or to sell at a profit. You can do it. Just the boat you've always wanted—power, sail or row boat—17 different kinds and sizes.

Order **BUILD A BOAT** on postal card and pay only \$1.50 plus postage on delivery. Return in 5 days if not pleased and get money back. Or send \$1.50 with order and we'll pay postage. (Outside U. S. \$1.70 with order.) Order today.

POPULAR MECHANICS PRESS
Dept. 598, 200 E. Ontario, Chicago 11

Row Boat—12 Foot
Dinghy—8 Foot
Training Ship—6 Foot
Sea Sled—9 Foot
Outboard—12 Foot
Cruiser—18 Foot
Bicycle Boat—Kayak
Row Boat—Sectional
Dinghy—Sailing
Dinghy—16 Foot
Canoe—12 Foot
Sailing—12 Foot
Outboard—12 Foot
Outboard—Runabout
Pontoon Ice Yacht

AMERICA'S LOWEST PRICED GARDEN TRACTOR

MODEL C SPEEDEX



\$155.00

AT NO EXTRA COST
You Get the Cultivator and Gauge Wheel. Nothing Else to Buy for Cultivation.

6 H. P. SPEEDEX BIG BOY HANDLES LARGER ACREAGE

\$285.00

WITH CULTIVATOR AND TWO GAUGE WHEELS

- Fully enclosed gears running in oil.
- Pulls 10-inch plow, 4-section tandem disc.
- 7.50 x 16 tractor type tires.

TODAY'S BEST BUY!



SEND PENNY POSTAL TODAY FOR FREE CIRCULAR!

GARDEN TRACTOR CO.
BOX 216-D1 • RAVENNA, OHIO
Pacific Coast Write } 5821 FIRST AVE. SO. SEATTLE 8, WASH.

P-349-9

RADIO ENGINEERING

Broadcasting, Television, FM, Servicing, Electronics, Aviation, Marine & Police Radio taught thoroughly. Engineering course equivalent to 3 years' college radio work. Approved Veteran Training. Catalog free.

VALPARAISO TECHNICAL INSTITUTE, Dept. D, Valparaiso, Ind.

NOW AVAILABLE!



The Gas Powered Scale Model Racing Car that Broke the World's Record is now in Full Production



WRITE FOR FREE INFORMATION—TODAY!
MODEL INDUSTRIES, INC., DEPT. 96-P
63 FOREST VIEW DRIVE, SAN FRANCISCO 16, CALIF.
DEALER'S INQUIRIES INVITED

PLASTICATED "GI" CLOTHS

WATERPROOF, LIGHTWEIGHT, 8 X 8 foot, 1001 uses as painter's dropcloth, lawn, furniture, machinery, merchandise cover, beach blanket, or shelter. Many uses camping, fishing, or picnic trips. Send \$1.25, and we will ship one cloth prepaid. (\$2.50 for 9 X 12 size.) C.O.D.'s accepted.

SAX-ON • Dept. 401 • 3840 Fullerton • Chicago 47, Ill.

ENSHRINE THEIR MEMORIES WITH U.S. MONUMENTS

Erected. Freight paid.

There is none better. Our free catalog is ready for you. Write today. **A-18, U. S. Marble & Granite Co., Oneco, Fla.**

Earn \$300 to \$500 monthly with ARC WELDING

Be independent. Do arc welding. It's easy. Use equipment with welding skill built in. Turn out more—better work. Earn big money. Investigate. Write today.

Both electric and engine driven
Hobart Welders for every need—shop, production or field work. Start with modest investment. No limit to possibilities. Tell us your plans. Get details.

HOBART
HOBART Bros. Co., Box M-69, Troy, Ohio

"One of the world's largest builders of arc welders"

ONLY \$9.75 POST PAID

JET PERFORMANCE FOR YOUR CAR WITH VAPOJET

VAPOJET gives your car super aircraft power and performance. VAPOJET users report 25% more mileage from regular gas. A double saving! Eliminates carbon, vaporlock and overheating. Complete kit permits easy installation—fits all cars. Order today—\$9.75 complete, postage prepaid. \$1.00 deposit on C.O.D.—your check or money order in full saves postage. You take no chances—satisfaction guaranteed or money back! Specify car, year, number of cylinders. MAIL COUPON NOW!

VAPOJET MANUFACTURING COMPANY
11424-M BIONA DRIVE LOS ANGELES 34, CALIF.

—ORDER TODAY—
Gentlemen: Please rush me—Vapojet units, complete with necessary linkage, instructions, etc. Enclosed is my check (or money order) in amount of \$ _____
Car _____ No. of cyl. _____ Year _____
NAME _____
STREET _____
CITY _____ STATE _____

FOR ALL MAKES AND MODELS

DOUGLASS Steel-Pack MUFFLERS

Performance that excels • Stamina that endures
Rugged construction. Steel tubing. Straight-thru-design. Solid tube with steel packing. "Throbbing Deep Tone." Complete for Easy Installation Satisfaction Guaranteed

32-40 FORD V-8	\$5.96	29-48 CHEVROLET	\$5.96
41-49 FORD V-8	6.85	31-41 PLYMOUTH	5.96
39-49 MERCURY	6.85	42-48 PLYMOUTH	6.85
35-49 FORD & MERCURY DUAL SETS			\$23.00
49 FORD & MERCURY DUAL SETS			25.00

ORDER NOW! Specify Year and model • Enclose Money Order or Check with Order. DEPT. M-4

DOUGLASS MUFFLER MANUFACTURING COMPANY - 1916 W. VALLEY BLVD. - ALHAMBRA, CALIF.

New!
COMPLETE RACING EQUIPMENT CATALOG
25c
WRITE RACING EQUIPMENT DIVISION

Mow 'Em Down with PRONTO POWER LAWN MOWER

Give your lawn the new
look with Pronto

After 4 years production a proven, well Engineered, original, safe, lifetime, quick action, easy handling, economical, most simple and practical of all power lawn mowers.

Pronto first with quiet enclosed spiral gear 4 ball bearing drive. No troublesome belts, pulleys, chains, sprockets, friction wheels or inefficient cutter revolving at engine speed.

Four 10 inch ball bearing (sealed) rubber tired wheels.

Pronto design 20 inch blade whirling type with removable safety type manganese steel cutter tips (new set postpaid \$1.00).

Cutter arm readily adjustable any height from ground to suit operator, and will cut grass as close as any mower. Pronto cutter assembly has highest cutter torque for horse power of any mower known, and up to three times more cutting power at blade than other mowers.

Pronto base is cast of light strong Aircraft metal. Axles extend entirely through base for strength. Steel handles are adjustable for height and position.

Our long experience and know how in the whirling blade mower field qualifies us to offer the Pronto as a satisfactory mower, proved by hundreds of satisfied users for every type and condition of grass as well as weeds, long and short, light and heavy, also uneven, rough and terraced lawns. Cutter blade trims to within 1/2 inch of any desired object, therefore ideal for cutting around trees, shrubbery, walks, fences, etc.

Briggs and Stratton or Clinton 4 cycle gasoline Engines are used on the Pronto mower as both Engines are well known for their reliability and easy starting, as well as nation wide service facilities.

COMPLETE MOWER \$89.50

MOWER LESS ENGINE, OTHERWISE COMPLETE \$54.50

GEAR DRIVE CUTTER ASSEMBLY

For those who desire to construct their own mower, or want a replacement cutter assembly, we furnish the complete gear driven cutter assembly as used on Pronto mowers, with flexible connection to Engine shaft, (give diameter of Engine shaft when ordering) and 20 inch blade with safety cutter tips complete as shown for \$22.50

All prices FOB factory, check or money order in full with order, no COD's, all orders filled in rotation as received by us. We have one price to all, and no dealers or agents.

PRONTO MOWERS
OLDSMAR, FLORIDA

Happy Highways Ahead!

With Popular Mechanics new **MOTORIST'S HANDBOOK**, 160 pages of authoritative advice to keep your car rolling smartly—longer. Brakes, body, spark plugs, battery, starter—every automotive part is covered in this up-to-the-minute manual of year 'round driving pleasure.

Your news dealer has the 60c paper edition. Order the clothbound \$2.00 volume from

POPULAR MECHANICS PRESS
200 E. ONTARIO ST. CHICAGO 11

HELPFUL BOOKS

Send post card asking for FREE catalog
Popular Mechanics Press, 200 E. Ontario, Dept. 601, Chicago 11

FENDER GUARDS...\$4.00 set



For Ford & Mercury '41-'48 incl.
Protect and Beautify Your Car
Give it the "Bold" look
CONSTRUCTED OF HIGHLY POLISHED
STAINLESS STEEL
AVAILABLE FOR IMMEDIATE SHIPMENT

AKRON METAL STAMPING, INC.
2705 Wingate Ave.
Akron 1, Ohio
Gentlemen: Please send me one set of Gravel Guards for my _____ (year and make of car).
Enclosed find check or money order for \$4.00.



YOU CAN MAKE THESE WITH POPULAR MECHANICS PLANS AND BLUEPRINTS

- 501—Colonial Grandfather's Clock. 25c
- 507-508—Doll-House, 5-Rooms, Open staircase, fireplace. . . . 50c
- 526—Queen Anne Coffee Table: True replica of antique. . . . 25c
- 528—Duncan Phyfe Console Table: 30 in. high. . . . 25c
- 529—Lawn Chair: Southern style. 25c
- 593—Three Attractive Corner Shelves: Scroll-sawed. . . . 25c
- 596—Three Hanging Type Shelves: Hold books, china, etc. . . . 25c
- 661—Rocking Horse: Scroll-sawed from plywood. . . . 25c
- 707—12 Ft. Rowboat: Flat-bottom, four seats. . . . 25c
- 795—Two Handsome Cedar Chests. 25c
- 811-812—16 Ft. Canoe: Canadian type, cedar planking. . . . 50c
- 813-814—Pops Outboard Racer: 10 ft. long, stepped bottom. . . . 50c
- 828-835—Sovereign of the Seas: English warship model. . . . \$2.00
- Sovereign of the Seas: Instruction Book. . . . \$1.00
- 836—12 in. Bandsaw: Uses plywood, cuts two in. stock. . . . 25c
- 839—McLrose Corner Cabinet: Old Colonial design. . . . 25c
- 846-848—Governor Winthrop Desk: True copy of original. . . . 75c
- 896-897—Three Easily Made Workbenches—Simplified construction. 50c
- 906-909—Midget Auto: 58 in. wheelbase, 1/2 to 3/4 h.p. . . . \$1.00
- 910—Circular Saw Table: Hardwood, 24" x 36", Stationary. . . . 25c
- 917—Outdoor Fireplaces: Several simple but practical. . . . 25c
- 920-922—Lawn and Garden Furniture: Swings, arbors, tree seat. . . . 75c
- 923—Indoor Fireplaces: Standard Sizes. . . . 25c
- 926-927—Venetian Blinds: Three elegant styles. . . . 50c
- 930—Hooked Rug Frame. . . . 25c
- 933—Cape Cod Cupboard: 4 ft. wide, 5 ft. 8 in. high. . . . 25c
- 935—Knee-Hole Desk: 40 in. long, 30 in. high, 31 1/2 in. wide. . . . 25c
- 936—Modern Coffee Table: 24 in. long, 15 in. wide. . . . 25c
- 952—Child's Crib in Maple. . . . 25c
- 958—Colonial Corner Cupboard: 8 ft. 8 in. high. . . . 25c
- 961—Hanging China Cabinet: 38 in. long, 40 in. high. . . . 25c
- 969—Combined Chest and Writing Desk: 35 1/4 in. high. . . . 25c
- 970—Modern Clothes Chest: Built of Plywood. . . . 25c
- 977—Bookcase in Chippendale Style: 47 in. high, 10 in. wide. 25c
- 978—Lawn Chair on Wheels: Lightweight, easy to wheel. . . . 25c
- 981—Colonial Wall-Shelf: 30 in. high, 19 in. wide. . . . 25c
- 984—Duncan-Phyfe Drop-Leaf Table: Reproduction of historic piece. 25c
- 986-987—Utility Trailers: Built of old auto parts. . . . 50c
- 989-990—Speedy Motor Scooter: Gas engine, 40 to 60 miles on gal. of gas. . . . 50c
- 991—Gun Cabinet: Handy cabinet includes rack for rifles. . . . 25c
- 993—Twin-Deck Beds: 6 ft. 4 in. long, 31 1/2 ft. wide. . . . 25c
- 1106-1112—SEACRAFT—25 FT. CABIN CRUISER: Adaptable as sport fisher, express cruiser, or utility boat. Cruises at 15 knots with marine engine or converted auto engine. Cabin sleeps four. Galley has fresh-water tank, sink, and cook stove. Set of seven large-sized blueprints scaled 1 in. per ft. plus 40-page two-color illustrated booklet, only. . . . \$10.00
- 1011—Fireplace Fittings: Andirons, log rack, etc. . . . 25c
- 1080-1081—Banta: 12 Ft. Plywood Runabout: Vee-Bottom, 3-passenger. . . . 50c
- 1086—Black Forest Corner Shelf: Scroll-sawed. . . . 25c
- 1089-1090—Home-Constructed Freezing Unit: reaches 30 degree temp. . . . 50c
- 1091-1096—17 ft. trailer, 7 ft. wide. Steel chassis. . . . \$1.50
- 1102-1105—Midget Trailer: "Teardrop" body. Sleeping quarters for two. . . . \$1.00
- 1113-1114—Gold Rush of '47: The A.M.A. Open Class B Record Holder Plane Model. . . . \$1.00

FILL OUT AND MAIL THIS COUPON NOW

POPULAR MECHANICS CO.
200 E. Ontario St., Chicago 11

Please send the following plans _____

_____ I am enclosing \$_____

Name _____

Address _____

BURN WATER IN YOUR CAR!

GET MORE
SPEED
POWER
MILEAGE

The
Octagane
Water
Injector



HOW?

JUST SEND US A POST CARD FOR FREE INFORMATION ON WATER INJECTION—BUT DO IT TODAY!

COMMONWEALTH CARBURETOR CORPORATION
DIV. 18-B, BERKELEY 2, CALIFORNIA

Dealer's Inquiries Invited

BUILD YOUR OWN ELECTRIC MOWER AND SAVE \$\$\$\$

Electric mower reduces lawn care time by half. No raking required. Chops clippings into a fine mulch. Adjustable cutting height. Build your own and save. Mail 25c for complete plan telling you how. Catalogue listing parts sent free with plan.

MOWER PARTS COMPANY
510 ELECTRIC BLDG. OMAHA, NEBR.

Mail
25c
FOR PLANS



IS YOUR MIND ASLEEP?

Wake it up! "THINKING-ALPHABET" helps hundreds. May help you FIND YOURSELF... the REAL YOU, your Dormant Powers, Your Rich Creative Ability, Hidden Talents, Opportunities and Earning Power. Write Frank Tibbitt, 6258A N. 4th St., Philadelphia.



HAMSTERS LET THE PROLIFIC GOLDEN SYRIAN HAMSTER earn you a steady income. Tremendous laboratory and pet market; 1000's needed. No experience required. Can be easily raised anywhere. Clean, odorless. Send for FREE illustrated "Hamster Handbook" or \$5.00 for pair and Handbook. F.O.B. Mobile, Ala.

Azalea City Hamstery, 1412 East Linwood Drive, Dept. F, Mobile 18, Alabama

"TWICE the FISH"

with the amazing new
TWO-TIMER* LURES



Enthusiastic users report "twice as many fish with Two-Timer* lures." One landed 5 doubles in 1 day.

Different color patterns on opposite sides of each Two-Timer* give you two chances with every cast - better fishing every time.



"BASSIE" \$1.50



"MINNOW" \$1.50

THESE COMBINATIONS AVAILABLE IN BOTH LURES

- YP-SF.. Yellow Perch & Silver Flash
- SF-BC.. Silver Flash & Black Chub
- YP-GS.. Yellow Perch & Grass Shiner
- RS-BC.. Red Shiner & Black Chub
- YP-BC.. Yellow Perch & Black Chub
- RS-YP.. Red Shiner & Yellow Perch
- YP-P.. Yellow Perch & Pike
- SF-P.. Silver Flash & Pike
- RS-P.. Red Shiner & Pike

GET TWO-TIMERS FROM YOUR DEALER OR BY MAIL TODAY SATISFACTION GUARANTEED OR YOUR MONEY REFUNDED

SAN LUCO, Inc.
533 F Street
SAN DIEGO, CALIF.

Enclosed find check or M. O. totaling ___ for ___ Two-Timers @ \$1.50. Quantity and desired patterns are indicated below.

- | | | | | | |
|-----------------------------------|-----------|----------|-----------------------------------|-----------|----------|
| TWO-TIMER "Minnow" (Surface Lure) | | | TWO-TIMER "Bassie" (Semi-surface) | | |
| ___ YP-SF | ___ SF-BC | ___ YP-P | ___ YP-SF | ___ SF-BC | ___ YP-P |
| ___ YP-GS | ___ RS-BC | ___ SF-P | ___ YP-GS | ___ RS-BC | ___ SF-P |
| ___ YP-BC | ___ RS-YD | ___ RS-P | ___ YP-BC | ___ RS-YP | ___ RS-P |

*Pat. Pend.

NAME _____
ADDRESS _____
CITY _____ STATE _____

MAKE BIG MONEY! IN YOUR OWN HOME

FULL OR SPARE TIME

\$5.00 PER
HOUR IS
EASY



METALIZING Baby Shoes

NEED EXTRA MONEY? Would you like to double your income in spare time?

Want a big full time business of your own? Then preserve baby shoes in real bronze, silver, gold, pearl and glass right at home! IT'S EASY—no experience needed! There's five million new customers waiting to buy every year! You can be your own boss—do as you please!

PAY DAY EVERY DAY

DAILY CASH—yes, our plan shows you how to start making money immediately—the very day you get our plan, money can jingle in your pocket. It works like magic—every step tried and proven! DO IT NOW! This is too good to miss—don't put it off. WRITE NOW—There isn't a minute to waste!

FREE!
Offer of
**COMPLETE
MONEY
MAKING
PLAN**

KIKTAVI CO. DEPT. PM-6

2111 W. Manchester, Los Angeles 44, Calif.

OK—as long as it's free tell me about it!

Send No Money
MAIL COUPON
NOW!

Name _____
Street _____
City _____ Zone _____ State _____

SAVE UP TO 90% SURPLUS BARGAINS!

BILLFOLDS!



While they last! Values to \$10. Finest Morocco, Goat or Calf Skin. Zipper leaves. Transparent compartments. It's wonderful for only **1.95**

LIMIT ONE



SWISS WATCH (ARMY TYPE)

Unbreakable crystal. Sweep second hand. Radium dial. Chrome or Stainless steel case. Leather or metal stretch band. Tremendous value. Originally sold to \$19.95. Buy now — only...

ADD 6% TAX

Outstanding Value!

6.95

Guaranteed by mfr. for FULL YEAR



9.75
Plus 9% TAX

DE LUXE SHEFFIELD CHRONOGRAPH WRIST WATCH

Has everything—plus new low price. It's a timekeeper, stop watch, measures distance, speed of planes, cars, horses, etc. Sweep second hand, chrome case, unbreakable crystal, precision Swiss movement. Sold to \$29.95. **LIMIT ONE**

Write For
**FREE
Surplus
Catalog**

WAYNE SALES CO.

Send Cash, Check, M. O. (Postage Prepaid) or C.O.D. 423 American Ave.
All merchandise is brand new. Long Beach 12, Calif.
Money-Back Guarantee.

Make Use of
**POPULAR
MECHANICS
BOOKS**

STREAMLINED HELP



**BETTER JOBS
HOBBIES
AND PASTIMES
HOME AND FARM
WORKSHOPS
HOME REPAIRS-
IMPROVEMENTS**

THE INEXPENSIVE PRACTICAL BOOKS WITH A MILLION READERS!

Want help on your job—extra knowledge that brings extra pay? Want to save money on home repairs? Want practical information to better enjoy hobbies and home and farm workshop projects? Then get a Popular Mechanics Book. These easy-to-use books, written in plain, everyday how-to-do-it English, and extravagant with pictures, plans, diagrams, etc., will give you the practical help you need. Full library size, cloth bound book unless otherwise described. Rush order on coupon today. Money back if not satisfied.



FORTY POWER TOOLS YOU CAN MAKE

Have your own powered workshop at low cost. Tells how to make forty different machines such as lathes, drill press, jig saw, band saw, circular saw, sanders, from pipe fittings, old auto parts, wood, etc. New 1948 edition. \$1.50

POPULAR MECHANICS PHOTO HANDBOOK

An entirely new and different book from our popular Photo Guide. It's a complete guide to better pictures and darkroom technique, and features dozens of handy gadgets you can make yourself. \$2.00

BUILD A BOAT FOR PLEASURE OR PROFIT

How to build 17 low-cost boats at home—power, sail or row boat. Prepared especially for the home builder with limited tools, no experience and little money to spend. Plans, diagrams and illustrations. \$1.50

WHAT TO MAKE FOR CHILDREN

A Popular Mechanics book for Dad, Mother and the whole family. Shows how to make toys, dolls, doll houses, slides, see-saws, rocking horses, furniture. 175 projects to make from discarded or inexpensive materials. \$2.00

THE GARDEN BOOK

How to build your own trellises, fences, lawn furniture, outdoor fireplace, attractive ornaments and other things for your yard and garden. Beautify your grounds—enjoy attractive equipment—at low cost. \$1.25.

OUTDOOR SPORTS MANUAL

220 helpful articles and hints for fishermen, hunters, campers, trappers, archers and boatmen. If you love the outdoors, double your enjoyment with the help of this new book. Contains 334 illustrations. \$2.00

WHAT TO MAKE. 10 Volumes



The famous annual craftsman's guide. Shows what to make and how to make hundreds of things in spare time for fun or profit. Novelties, gifts, toys, games, furniture, etc. Cloth bound and filled with instructive pictures. Single volumes, each \$1.75. Save money on 10 volume set, complete, only \$15.00.

POPULAR MECHANICS SHOP NOTES

New 1949 volume. Latest in series of practical and helpful year books for every man who uses tools. Contains 240 pages and 750 illustrations. This book will make money for you and make your job easier. Soil-proof paper cover. \$1.00

POPULAR MECHANICS MOTORIST'S HANDBOOK

For every man who drives a car and wants to do his own servicing and simple repairs. A money-maker for the professional auto repairman. Hundreds of ideas, helps, and kinks you can use every day. \$2.00.

CONCRETE HANDBOOK

How to do all types of concrete work and make ornamental things of cement—walks, driveways, foundations, steps, vases, benches, etc. Ideal book for home owner, handyman and construction men. \$1.50

WELDING, BRAZING AND SOLDERING

How to construct welding equipment and use it effectively—small arc welder, spot welder, arc torch. Best approved methods, tricks and kinks to use in soldering, brazing, heat treating iron and steel. \$1.25

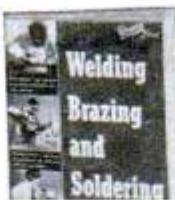

YOUR HOME and HOW TO BUILD IT YOURSELF

Step by step instruction by which anyone with ordinary knowledge of use of hand tools can build a five-room house complete. Every detail is shown in pictures with amazing clarity. Will save hundreds of dollars building any house. Spiral bound. \$3.00. Complete set regular builders plans \$12.50. Book and plans \$14.00.

FARM MANUAL

Hundreds of articles on making farm implements and equipment, maintaining the home, farm workshop, live stock and poultry, many farm hints and kinks. A book for every member of every farm family. 284 pages. Hundreds of illustrations. \$3.00



THE BOY MECHANIC

One of the most popular and best known Popular Mechanics publications. Describes hundreds of things for boys to do and make. Develops natural talents and industry. Crammed with how-to-do-it illustrations. The perfect gift for every boy. \$2.00

PAINTING, FURNITURE FINISHING AND REPAIRING

A book for craftsmen, home owners, shop workers and furniture repairmen and finishers. Covers repairs and finishing, restoring antiques, spray and brush painting of all kinds. An all 'round book for everyone. \$1.50

USE THIS HANDY COUPON • Mail Today

POPULAR MECHANICS PRESS, Dept. 128, 200 E. Ontario St., Chicago 11

Send Popular Mechanics books checked. I will pay postman, plus charges (U.S.A. only). Remittance enclosed—send fully prepaid. I will return books in five days for return of money if not satisfactory. Outside U.S.A. please add 15% for postage and wrapping.

Forty Power Tools . . . \$1.50	What to Make (Children) . . . \$ 2.00	Boy Mechanic . . . \$ 2.00
Painting, Finishing, etc. 1.50	Garden Book . . . 1.25	Concrete Handbook . . . 1.50
Motorist's Handbook . . . 2.00	What to Make (1 Vol.) 1.75	Welding, Brazing . . . 1.25
Photo Handbook . . . 2.00	10 Volumes . . . 15.00	Your Home . . . 3.00
Build a Boat . . . 1.50	Shop Notes . . . 1.00	Book with Plans . . . 14.00
Sports Manual . . . 2.00		Farm Manual . . . 3.00

Name _____

Address _____

City _____

State _____

Check
for
FREE
Cata-
log

15 JEWEL STOP WATCH
U. S. AIR CORPS SURPLUS



Genuine Elgin 15 Jewel movement. Ideal for split second timing in racing, sports, time study, etc. Full sweep split second hand graduated in 1/10th seconds. Stem wind, start, stop and reset. Used but guaranteed perfect.

Wgt. 1 oz.
No. 200—Each..... **\$9.95**

MESS HALL BENCHES



For picnics, social gatherings, clubs, lodges, etc. Used but perfect. Hardwood top 9 x 72 inches seats 4 or 5 people. Folding type angle iron legs with metal brace and lock. Best and cheapest seating you ever bought for this money. Weight each 25 lbs. Stock No. 440. Each... **\$2.48**
10 or More, Each..... **\$2.00**

RUBBER OVERBOARD SUIT



Here is a buy! Fits over your regular clothes and shoes. Can be cut apart for waist high waders, hip high or knee high boots, also arm length rubber gloves. Heavy gum rubber over fabric. Fine for commercial fishermen, sewer diggers, etc. Use it as is or cut it up for waders. All brand new!
Wgt. 14 lbs. No. 183, Each... **\$4.95**

Please include 75c for postage.

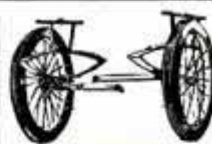

TRAILER UNDER-CARRIAGE



OVERSIZE TIRES
Build your own trailer for boat, camping gear or delivery service. Fitted with 26 x 2.125 U. S. Royal Tires. Motorcycle type wheels. Solid steel axle, leaf type springs and body mounting brackets. All brand new! Hitch not included. Folds to fit trunk of car. Shipped express collect only. **\$18.95**
No. 199, Ea.

AVIATION CABLE



Flexible 133 strand wire cable, 5/32 in. diam., 3300 lb. break test. Lengths up to 450 ft. Use for tow rope, guy wire, clothes line, etc. Wgt. per 100 ft. 4 lbs. Specify length wanted.
No. 421—
Per Ft..... **4c**

MESS KITS



Regulation two-piece Army Mess Kits with folding handle. Used, but perfect. Weight 2 lbs. No. 69c
A116—Ea. **69c**

CANTEENS

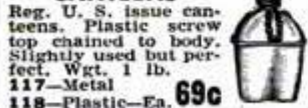

Reg. U. S. issue canteens. Plastic screw top chained to body. Slightly used but perfect. Wgt. 1 lb.
117—Metal **69c**
118—Plastic—Ea.

CANTEEN COVERS

Heavy canvas. Button fastener. New No. 530— **69c**
Each
Used No. 119— **35c**
Each

U.S. Govt. BOLO KNIFE



Extra heavy. For farm, home or jungle use. Blade of Govt. formula cutlery steel. Walnut riveted handle. 3 1/2 inch hilt. 10 1/2 inch blade. You'll find hundreds of uses for a Bolo knife. Blade will take and hold a keen cutting edge. Wt. 2 lbs. A112—
with Army Sheath **\$2.95**

WIRE CUTTER



Heavy duty, compound leverage. Cuts up to 1/4 inch wire. Upper jaw acts as feeder to cutting edges. Insulated handles. Ideal for farm fence work and shop use. Shp. wgt. 2 lbs.
Stock No. 392—Each **\$1.95**



Heavy Duty RUBBER GLOVES
BRAND NEW
Extra heavy—extra long. Brand new, high quality gum rubber for softness and ease in use. Designed for heavy duty industrial service—protection in handling chemicals, acids, etc. A real bargain at this low price. Stock No. 295—Per Pair, Only **79c**

WAR SURPLUS AND HUNDREDS OF OTHER BARGAINS

SILVERED OPTICAL PRISMS
Solid glass, with 1 silvered facet precision ground and polished—5 3/4" long, base 2 1/2 in. wide, sides 1 1/2 inches. Free from scratches, abrasions and imperfections. Use in any type optical system—photography, telescopes, etc. Weight each 3/4 lb. A \$25.00 value.
Stock No. 556, **\$2.00** Four for **\$5.00**
Each

MEDICAL STERILIZER
Consists of alcohol burner and sterilizing tray in hinged metal case 1 7/8 x 1 1/8 x 2 3/8 inches. Burner may be used separately. Bright nickel finish. All brand new. **98c**
A125—Ea.

CAVALRY SPURS
Genuine wishbone type cavalry spurs. Nickel brass.
A102, Pair... **98c**
A103 Spur straps per set of four **50c**

POPULAR RECORD ASSORTMENT
Fifty records of modern dance, race, blues and hillbilly selections. No two alike. Famous name bands and artists included. Used in juke boxes, but guar. perfect. Shipped exp. collect only—no exchanges or refunds. Wgt. 28 lbs.
No. A303—50 records..... **\$9.64**

No. A300—25 Records, All Dance. Wgt. 14 lbs. \$4.88	No. A301—25 Records, Hillbilly, Race and Blues. Wgt. 14 lbs. \$4.88	No. 302—25 Records, All Hillbilly numbers. Wgt. 14 lbs. \$4.88
--	--	---

ELECTRIC MOTOR
Small but powerful. Shaded pole type, designed for fan application. 115 v. 60 cycle. Has 1/4 inch shaft, one inch long, operates at 3150 RPM under no load, 2000 RPM under 2.33 oz. inches load. Full load current .6 amp. Ideal for use on toys, window displays, etc. Shp. wgt. 1 1/2 lb.
Stock No. 555—Each **\$1.95** only

MCCLELLAN SADDLE
Brand new! Top grade cowhide, 12 inch seat. Hair girth. Has straps for blanket roll and knapsack. Gun boot and sabre loops. Shipping weight 15 lbs. Stock No. A145. Each... **\$16.95**

BAYONET BLADE
Fine forged steel. Ground but not polished. May be made into throwing or hunting knife or spear. Blade 6 3/4 x 1 3/8 inches, 1 1/4 inches overall. Will take and hold a fine edge. Shp. wt. 1 lb.
No. 664-R—Each **49c**

7 LB. EXPERIMENTER PARTS ASSORT. KIT



Valuable radio and electronic parts by weight—resistors, trimmers, condensers, capacitors, etc., plus stamped out metal chassis. Shipped in chassis form with parts ready to demount as needed. A real bargain surprise package. No. 130R—7 lbs. **\$1.79**
No. 130Y—
12 lbs..... **\$2.95**

RAIN SUITS
New 2 piece rain suits. Of durable wear resisting wader and wind repellent OD fabric. Bib style pants, zipper fly. Jacket has parka attached. Guaranteed 100% weatherproof. Small, medium and large sizes. Shp. wgt. 3 lbs.
No. R549— **\$4.95**
Ea.....

Officers Watch Compass
Brand new gov't surplus. Army-Navy model. Single jewel mounted needle. Silver colored dial. A splendid value. Shp. wgt. 1 lb.
A174—Each... **98c**

OXYGEN TANK
Loaded with aviator's breathing type oxygen at 1800 pounds pressure. Tank measures 13 1/2 x 5 1/2 inches with rounded ends. Tank is of solid metal fitted with brass release valve at top. Brand new! Loaded—ready for all types of emergency use. Shp. wgt. 13 pounds. Ship exp. only. Stock No. 399—Each, **\$3.50** only

RADIO HEAD-PHONES
Extremely sensitive with 4000 ohms resistance. Brand new and fully guaranteed. With moisture-proof cord and phone plug. A splendid value for the radio serviceman and experimenter.
A106—PAIR..... **\$2.95**
New supersensitive phones, A108—Pair **\$5.95**

LIFE PRESERVER BELTS
Right from the invasion beaches. Consists of two air chambers. May be inflated automatically with "sparklet" cartridges or manually by attached hose. Adjustable in waist size. These belts are brand new and guaranteed water tight—a bargain at this low price. **\$1.00**
No. 1261—Each

SPARKLET CARTRIDGES
May be used with above belts. In boxes of 10. Stock No. 254. **50c** Per Box.

ORDER DIRECT FROM THIS AD
Values galore! Hundreds of hard-to-find items for home, shop and outdoors. Make remittances by money order, bank draft or personal check. Send 25% deposit on C.O.D. orders. No C.O.D.'s on orders for less than \$5.00. Include sufficient postage on parcel-post orders—any overage will be promptly refunded. All quotations F.O.B. Chicago. Used items and materials are guaranteed serviceable and as described. Your money back if not more than satisfied.
NEW CATALOG 10c To Cover Postage and Mailing
Now Ready — Send **10c** Dept. PM6
STARK'S 509 So. State St. CHICAGO 5, ILL.

PUP TENTS
Regulation Army Pup Tents of durable, brown canvas. Used, but in good condition. Fine for campers, outdoorsmen, boy scouts, etc. Wgt. 8 lbs. A100—Tent only **\$3.95**
A110—Tent, new..... **\$7.95**
A101—Ropes, wooden poles and stakes for above. Per set **\$1.00**

It's a happy meeting
when you get **p.a.***

The NEW
HUMIDOR TOP—
locks OUT the air
—locks IN
the freshness
and flavor.

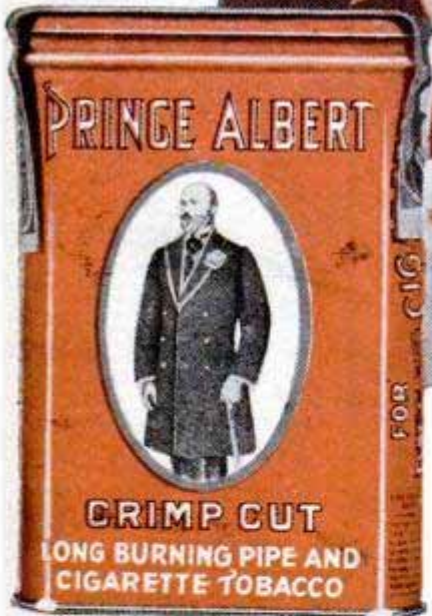

The
National
Joy Smoke

p.a.* means pipe appeal
means prince albert

● Yes... a girl enjoys meeting a man with Pipe Appeal —that extra attractiveness of the man who smokes a pipe. And when a man has "met up" with Prince Albert, he has found a rich-tasting tobacco that's mild and tongue-easy!

● Did you know that P.A.'s choice, crimp cut tobacco is *specially treated to insure against tongue bite?* No wonder it's America's largest-selling smoking tobacco! Get P.A. today for smoking joy and comfort!

WITH P.A., YOU CAN
ROLL A BETTER-
TASTING CIGARETTE



B. J. Reynolds Tobacco Co., Winston-Salem, N. C.

CD 2-19-49 8H

ALL STATIONS

WE HOLD FELONY WARRANT FORGERY GRAND THEFT FOR JANE DOE
 MARY K DOE WHITE FEMALE AMERICAN TWENTY EIGHT FIVE FOOT
 ONE HUNDRED THIRTY SEVEN BLONDE HAIR BLUE EYES OBTAINS A
 TICKETS ON CREDIT ALTERS THEM AND RECEIVES CASH REFUNDS
 EXTRADITE

PD LOSANGELES CALIF (FORGERY LECHNER C-2139)
 284 KGPL GR 43 1513 FEB 19 HS

KGPL/1544/19/RS

POPULAR MECHANICS

JUNE 1949

WRITTEN SO YOU CAN UNDERSTAND IT
 VOL. 91 NO. 6

Voice of the Prowl Car

THE GREEN SEDAN with the freshly crumpled fender swung hurriedly out of a side street and joined the flow of traffic on Adams Boulevard. Just a little suspicious, the two officers in the cruising patrol car kept their eyes on it while one of them picked up the radio mike.

"This is car 36," he reported, "Give me a rolling make on California 6X9914. And check it for hit and run. New green two-door sedan."

"Thirty-six stand by," replied the loudspeaker on the instrument panel and then,

a block later, came the report: "A new green two-door was used in a market robbery at Western and La Plaine 15 minutes ago. Hit a parked car in getting away."

That was enough. The police car moved up alongside the other and herded it toward the curb.

The "rolling make" is a fast-action information service developed by the communications division of the Los Angeles police department. Officers can ask by radio for any available information concerning a car or individual of whom they are suspicious.

Police in radio patrol car call communications center for "rolling make" on suspicious-looking automobile





A radio operator at headquarters checks the latest crime reports and transmits any pertinent information back to the officers, often within 30 seconds of the time the call comes in. Within a minute he can also supply the name and address of the registered owner of any California car.

By means of the rolling make, officers questioning a suspect on the street can obtain an almost immediate report of the suspect's past police record, if any. Recently, when officers found a man prowling in an alley behind a warehouse, they questioned him and checked his name against papers he carried in his pocket, then asked headquarters for any information available. The report came back within a minute: "We have a warrant for his arrest. He's wanted for questioning about some fur thefts three weeks ago. Bring him in."

Recently, too, a pair of officers investigating a minor traffic accident on Sepulveda Boulevard found that the name of one driver didn't match with the name of the registered owner of the car he was driving, with Col-



Top, operator at KGPL takes down radiogram coming to Los Angeles from East on transcontinental police relay system. Below, only two bolts have to be loosened to replace transmitter in car trunk



In addition to radio transmitter in trunk, Los Angeles prowler cars have tape measures, flash cameras and other equipment used to take and record evidence, particularly if it pertains to traffic accidents



Incoming calls for police assistance are received at complaint telephone board. Messages are then put on endless belt and carried to dispatcher in microphone room next door, the "radio central" of the system

orado plates. The driver explained that he was using his uncle's car on a trip, with permission. Probably he was, the officers agreed, but then again the car might have been stolen. It would take only 10 minutes to find out.

They phoned a description of the car to the communications center in the city hall, where in turn a radiogram was sent to Denver. A few minutes later the officers were being informed that Colorado had no report that the car had been stolen and that the driver need not be detained.

Los Angeles has the largest and most complex communications system of any law-enforcement agency in the country. The police need it, for they have their hands full these days. Geographically, the city is the largest in the United States. Its 452 square miles of area are about 90 square miles larger than all five boroughs of New York City. Crime has been increasing along with the stepped-up inflow of population, which now amounts to more than two million people. Citizens call for police assistance on an average of every 30 seconds or so, between 2000 and 3000 calls every 24 hours.

Many of the calls are concerned with minor matters and can be handled in stride, but a citizen gets instant action if the matter is serious. Sometimes officers arrive while he is still on the phone. Frequently, they get there in time to capture a burglar or prowler.

Speed like this is possible because of a new radio dispatching system. A few years ago the city's four main police radio transmitters were operated as four separate systems; now they are all operated direct from one room in the city hall.

Today police calls are answered by an officer on duty at the central emergency telephone board, who writes down the address and the nature of the complaint and flips the message up onto an endless belt that carries it to the dispatcher in the adjacent microphone room.

The microphone room is the "radio central" of the system. Ten women radio and telephone operators are always on duty,

Teletype machines in communications headquarters link the Los Angeles police with law-enforcing agencies throughout state





Each button on microphone-room operator's panel represents prowl car and indicates its operating status

sitting in glass-walled booths around a semicircular table that partly surrounds the dispatcher.

Six of the operators have microphones and earphones that are connected directly to KGPL, the main transmitter for the metropolitan area. One operator is connected to KQJN in the West Los Angeles-Venice area, and one operator handles KQJP in the San Pedro area and KQJO in the San Fernando Valley. The two additional operators handle emergency messages over direct telephone lines that connect with the receiving hospitals, ambulances, the sheriff's office, the state motor-vehicle office and the record bureau where the latest information for answering rolling makes is compiled.

The panel in front of each operator contains a button for each radio car in her area. They can be turned to indicate when a car has been assigned to make an investigation, then turned back to show that the car is free again after the officers report that their investigation is complete. Also on the panel are lights that show whether the transmitter is in use by another operator or whether it is clear and ready for use. Most calls are made to individual cars, but it is also possible to broadcast through all transmitters at the same time to reach all cars on duty.

Messages coming into the microphone room from the complaint phone board are

examined by the dispatcher who determines the radio area of the address, pencils on the slip the number of the radio car that is to be assigned, and passes it to the proper operator. She time-stamps the paper, flips open her microphone switch, and calls and talks to the car that is to respond to the call.

This centralized control permits fast action and allows a tremendous volume of traffic to and from cars spotted over a large territory. On New Year's Day, for instance, 8986 different messages were transmitted from or were received at the radio central. The communications division is commanded by Lieut. William H. Durham, with Lieut. John D. Brady as assistant. Frederick C. Crowder, chief radio technician, is in charge of installation and maintenance.

The Los Angeles police have 475 cars equipped with receivers and transmitters, with a minimum of 150 always on duty. The automobile transmitters have 60 watts input and the equipment may be removed from a car as a unit and replaced with an identical unit if service is needed. Police motorcycles, now carrying receivers only, are being equipped with transmitters of 20 watts input. Late this year, the department will have a total of 950 vehicles equipped with two-way radio.

The central microphone room and the transmitters are linked by land wires. The whole system is designed to operate under

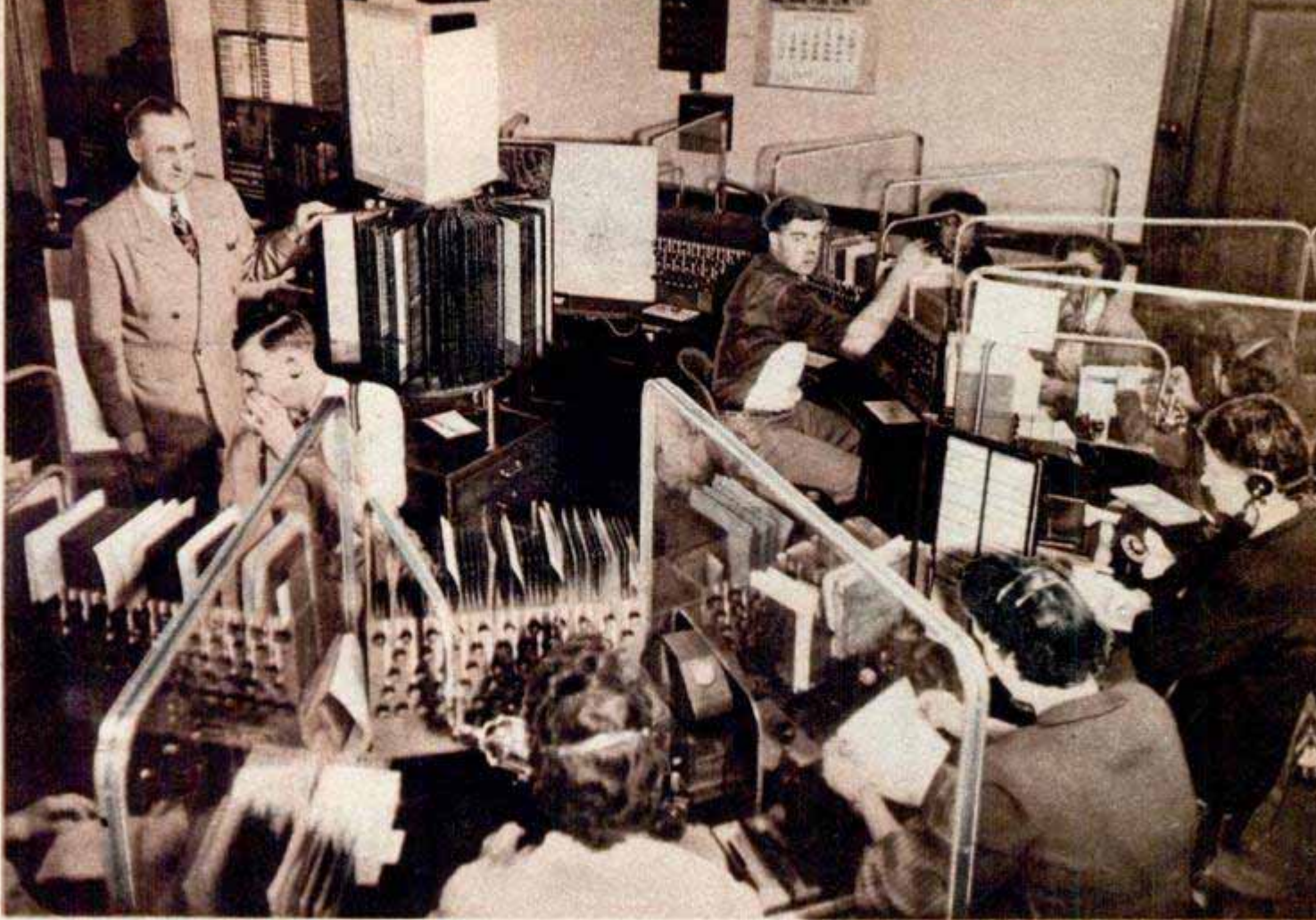

Dispatchers, within semicircle, determine radio area of complaint message and pass it to area's operator

various kinds of emergency conditions. Each of the three outlying, untended transmitters, for instance, is remotely controlled by operators on duty at KGPL, the key transmitter of the system. Each transmitter has an emergency power source that starts up automatically and takes over the load if the normal power supply fails.

If a transmitter itself breaks down, its traffic can be handled by one of the other transmitters. If the land lines go out of operation, communication is switched to a radio link that connects with KGPL. While this link can't handle the ordinary flow of

traffic, it would be satisfactory for a steady flow of emergency messages that would be radiated by KGPL. Too, each separate transmitter can be operated as an independent unit by operators who are sent out to man it. A mobile motor-generator stored at KGPL can be towed behind a fast car to any part of the city to act as a temporary transmitting station.

Incoming messages from cars in all parts of the city normally are picked up by antennas on top of the dome of Griffith Observatory that overlooks much of the city.

(Continued to page 246)

Transmitters on motorcycles are distributed between two boxes flanking rear wheel to equalize the weight





Bayou Oil Hunt

HUNTING OIL in the bayou country near Orange, Tex., is a rough-and-tumble battle with nature! Shell Oil geologists, always seeking new oil fields, take their sensitive instruments into the snake-infested swamps by jeep, sometimes along trails they have hacked out with machetes. One of their instruments is a gravity meter, which reveals the characteristics of the underground strata, thus providing a valuable clue in the search for oil-bearing deposits. The delicate meter has to be placed in a special shock-absorbing mount while traveling.

Top, left, even a jeep needs help in bayou country. Above, determining the elevation of next station by sighting through a Wye level. Left, the next station is plotted. Below, left, tripod goes right through floor. Below, reading the gravity meter





Focusing Magnifier For Reflex Cameras

By magnifying the complete picture as it appears on the ground glass of a reflex camera, a wide-field magnifier enables the photographer to compose and focus at the same time. The metal base of the magnifier covers the top of the viewing hood completely, thus preventing extraneous light from dimming the image. It is instantly attached or detached and the lens mount is threaded so that it can be raised or lowered to match the photographer's vision. The magnifier is produced in 10 models to assure a perfect fit on any standard reflex camera.

Car Bunk for Children

Small children can take naps during car trips on a collapsible bunk that fits above the back seat. The bunk completely fills the area between the two seats so children can't roll off. It raises them above the seat level, permitting them to see out the windows when they are awake. The bunk frame is made of hardwood and the top is water-repellent duck, 30 inches wide and 46 inches long. Collapsed like a card table, the bunk requires little storage space.

☐ The average farm laborer in the United States produces enough to feed 14 persons.



Hand Sprayer Pumps From Bucket

Because it can be used with a bucket, barrel or knapsack tank, a portable hand pump will handle all spraying jobs not large enough to warrant using a power spray. Completely self-contained and weighing only three pounds, the pump is operated by sliding the nozzle in and out of a metal cylinder that is attached to the end of the hose. Interchangeable nozzles and graduated disks make it possible to spray various intensities ranging from a fine mist to a straight stream. The pump sprays only on the downward stroke, eliminating the usual loss of solution that results from two-way pumping action.



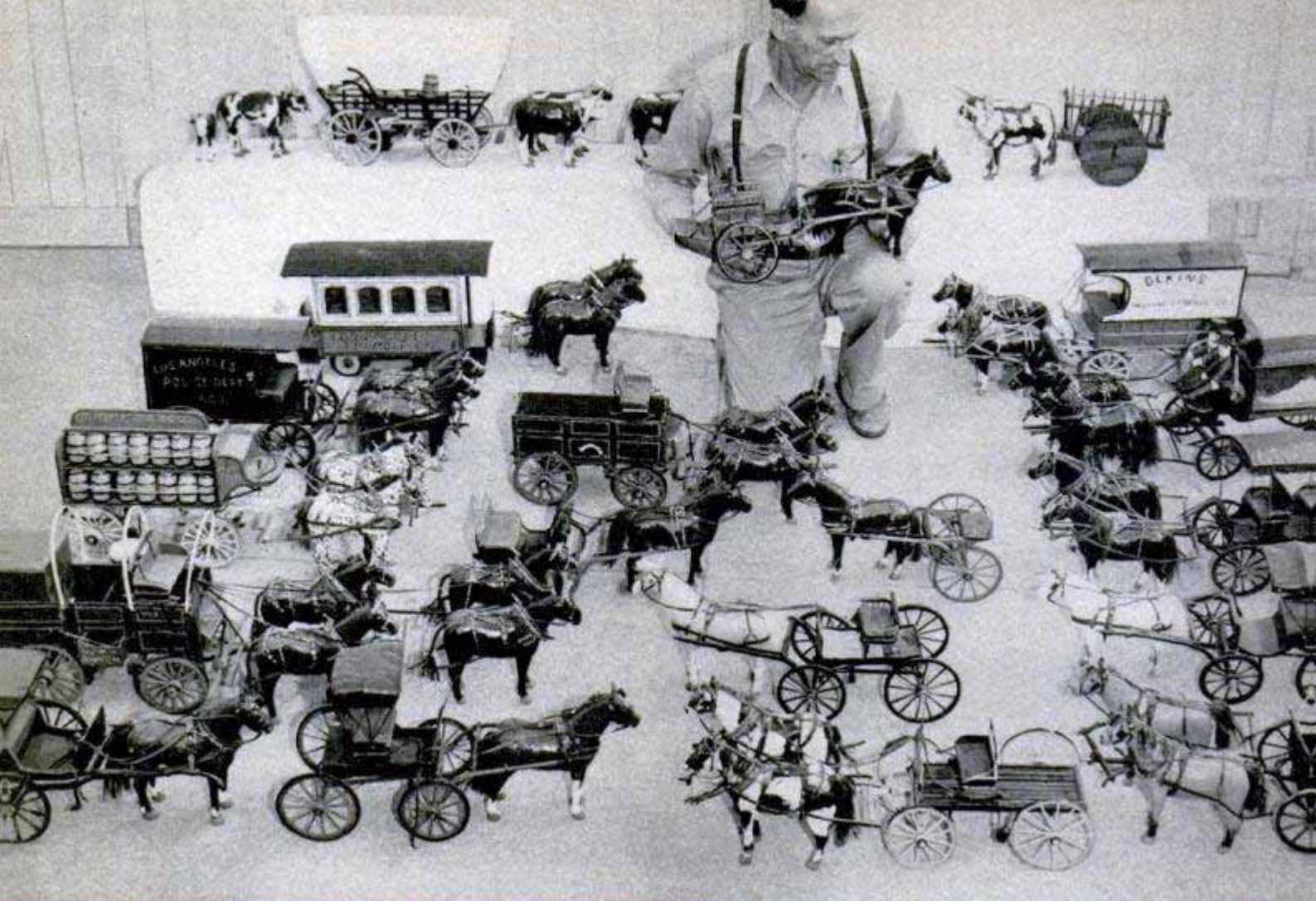

Here's just part of the hobbyist's collection of models. Included are a horse-drawn streetcar, beer wagon, express wagon, prairie schooner, "paddy wagon", oxcart

FRONTIER DAYS in balsa

Ward carves the horses from balsa and glues on the legs. Manes and tails are made of goat hair or unbraided rope



SEVERAL years ago Lee L. Ward of Los Angeles fashioned a number of miniature saddles and sets of harness from old leather. Then he decided to carve some horses from balsa wood to hang the trappings on. Next he built a cart for one of the horses to haul. Today, Ward has a growing collection of horse-drawn vehicles that range from an Indian travois to the vehicles of a funeral procession. The collection includes a horse-drawn streetcar and a four-horse stagecoach complete with driver and armed guard. A covered wagon, drawn by oxen, is followed by a cow and calf. Ward has completed 25 vehicles and is at work on the next, one of the early RFD wagons used by the Post Office. Tails of the animals may be a short piece of unbraided rope or string; sometimes he makes tails and manes from goat hair. Rooster spurs make good horns for oxen and cattle. All the wagons are built of scrap material found around the home and workshop.

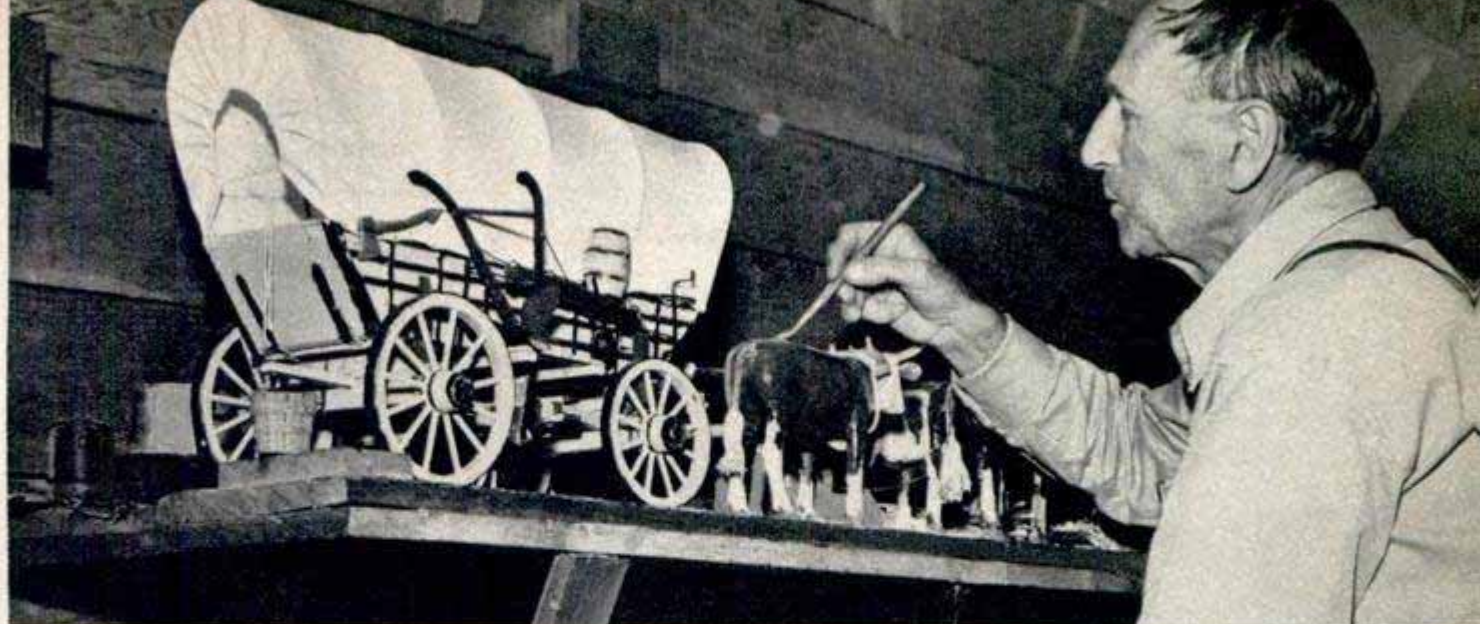

The craftsman touches up the oxen that pull authentic scale model of a covered wagon, complete with water barrel and farm tools. Below, Western stagecoach has leather springs; an armed guard sits beside the driver

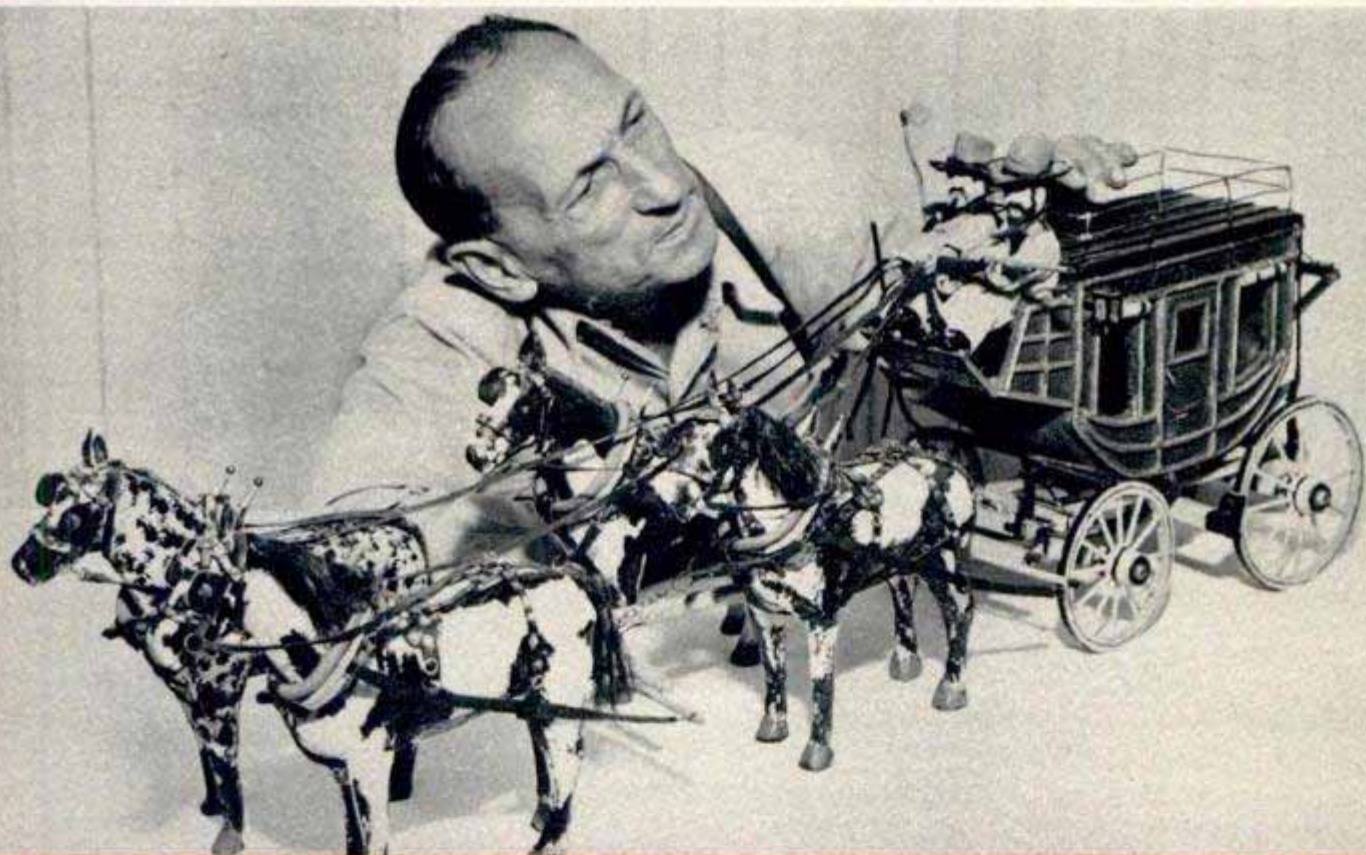

Below, black horses pull an ornate early hearse. Hacks for mourners complete the funeral procession



Hobby started when Ward fashioned a miniature saddle from scraps of leather and needed a horse to carry it

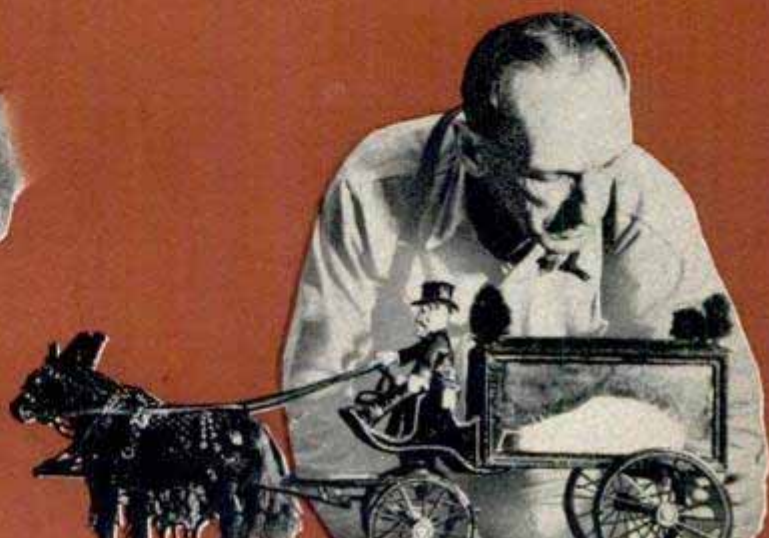



One-Legged Table

Weighing only four pounds, a one-legged table adjusts to a height convenient to the user. The top, made of $\frac{1}{4}$ -inch Masonite, measures about 16 by 28 inches. When not in use, the metal leg swings up parallel with the top, permitting the table to be stored in a narrow space.

Accidents Take Biggest Toll Of Man's Productive Years

Fatal accidents take a greater toll of the productive years of the people of this country than do deaths from any one natural cause, according to a report of the American Medical Association. While more individuals were killed by heart disease and cancer than by accidents, the natural deaths occurred in persons who were older and therefore had fewer working years to live. Working years are considered those from 20 to 65. In 1945, for example, the number of working years lost from accidental deaths was 1,750,000, compared with 1,680,000 from heart diseases.

Video Multiscope Shows Time, News

Late news reports, the correct time and the weather forecast all are thrown simultaneously on television screens by an ingenious projection machine that may bring video stations close to the break-even point for the first time. Called the Multiscope, the projector has a lens system which throws a picture of a clock in the upper left corner of the screen and the weather report in the upper right corner. At the same time a ticker tape moving across the bottom of the screen shows the latest news. In the center is room for the name of the program's sponsor. Because the Multiscope replaces the test pattern, it can be used during hours when no programs are scheduled, providing a substantial new source of income to the station. Only one man is



News tape on reel appears with time and weather on television screen

needed to operate the projector. S. C. Quinlan and John H. Mitchell of television station WBKB in Chicago developed the instrument, which soon will be available to other stations.

ENGINE 'TROUBLE SHOOTER'

AIRCRAFT engineers now have an instrument they've long hoped for—an engine analyzer which tells them in advance that trouble may occur and locates the exact parts that aren't functioning properly. Developed by the Sperry Gyroscope Company, the instruments are being installed in Pan American Airways' Constellations and Boeing Stratocruisers. They give a continual visual check of the plane engines while the craft is in the air. When engine parts are not functioning properly, the trouble shows up in a graph pattern on a cathode-ray "scope" similar to a radar scope. Two kinds of images are seen—ignition patterns and vibration patterns. In the case of ignition patterns, the operator sees a wave form representing the voltage in the primary circuit of the ignition system. Every variation that occurs in the ignition system is reflected instantly in this pattern, making it possible to see the condition of magnetos, spark plugs, cables, breaker points, malfunctioning of the injection system, lack of combustion, engine roughness and other details. The vibration patterns show characteristics of combustion, knocks and detonations, the seating of intake and exhaust valves, piston slap and the failure of piston rings and wrist pins, among other troubles. Each trouble produces a particular pattern by which it is recognized. Vibration signals come from pick-ups mounted on each cylinder head, which "feel" all the noises in the engine. Pan American expects the instruments to reduce the time required for servicing and expense by locating troubles while planes are in flight, and to increase safety by anticipating imminent trouble.

Patterns below are shown as they appear to the flight engineer. Directly below is a normal vibration pattern. Pattern at upper right shows a spark plug firing normally, and below, graph of a fouled spark plug



Compact engine analyzer fits the plane's control console. Flight engineer is pointing to the "scope" which shows the wave pattern. Below, nerves of the analyzer are vibration pick-ups mounted on cylinders

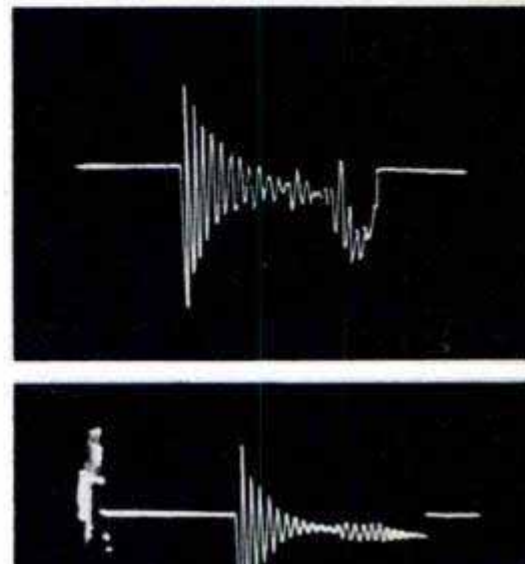
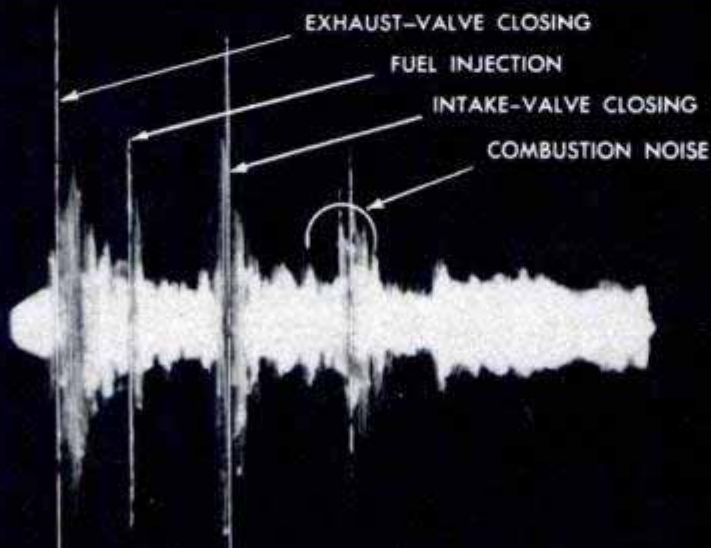

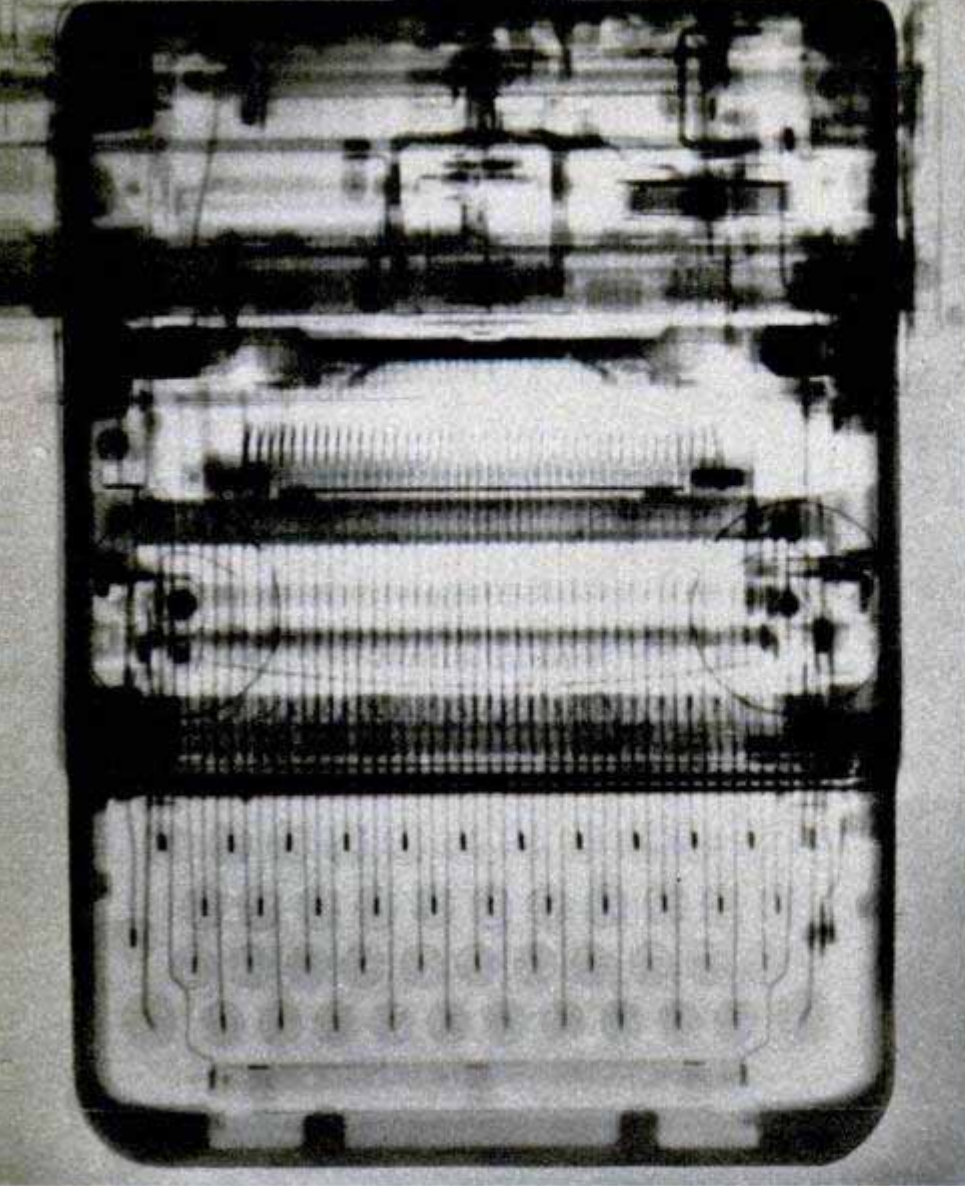

▲ Typewriter

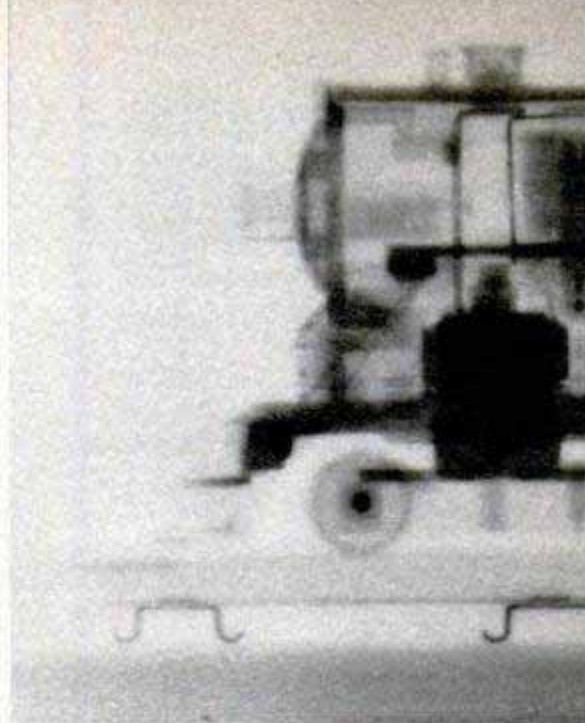

▲ Model Locomotive

Take a look at ghosts of some familiar objects through the eye of a betatron, one of the powerful new instruments of the atomic age. Its real job is to peer through heavy castings; a physicist had a sort of "postman's holiday" taking these X-ray pictures

Phantom Photos With 20 Million Volts

By Joseph J. Miller

Assistant Physicist, Armour Research Foundation



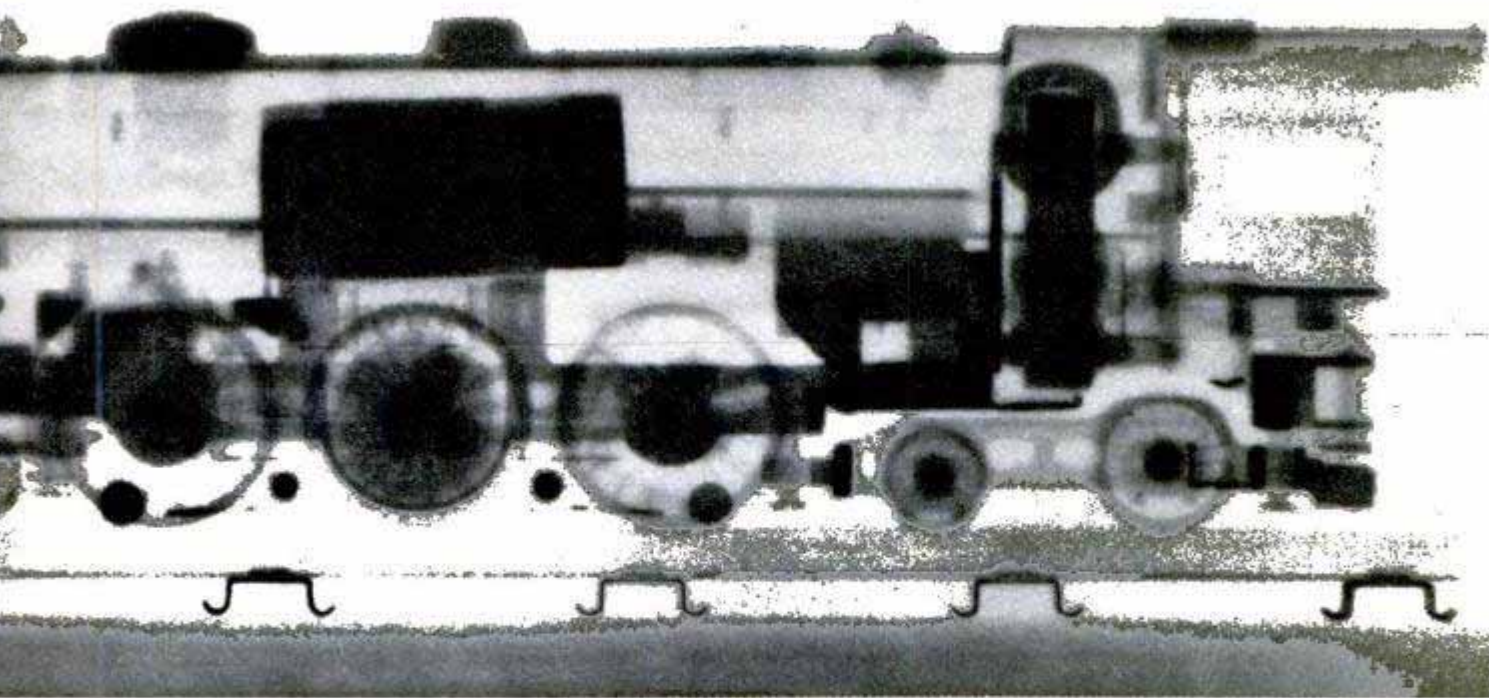

Armour Research Foundation and Rock Island Arsenal photos

TAKING 20-million-volt X-ray pictures with a betatron isn't exactly a hobby, but I decided to try my hand at photographing everyday objects with this modern research tool.

The betatron is a powerful instrument used in nuclear research and in the quest for more basic medical information. Industry already is using the betatron as a super-eye which can peer through 12 inches of steel and detect a flaw as small as $\frac{1}{32}$ inch.

In my work for the Armour Research Foundation, I have been privileged to use the betatron at the Rock Island Arsenal. The accompanying radiographs—X-ray pictures—show the extraordinary effects that can be produced with the instrument.

The Rock Island betatron, usually used to inspect heavy castings, is an induction electron accelerator which produces an output of 20 million electron volts. The heart of the unit is the "doughnut," a circular vacuum tube with a hole in the center. Into

the tube are shot small particles called electrons which whirl at high speed around the circle, sometimes traveling 200 miles in less than a hundredth of a second before they leave the tube. As they emerge from the tube, they strike a metal plate where they produce X-rays.

The rays ejected by the betatron are so powerful that they can destroy the structure of tissue cells in flesh, bone and blood, and therefore would be fatal to a person insufficiently protected. For that reason, the betatron is installed in a "house within a house"—a room with concrete walls two to five feet thick, inside another building.

The X-ray pictures shown on these pages were made by James Bolton of the Rock Island Arsenal and myself in the same way that castings are examined. Photographers and technicians may be interested in the procedure.

Suppose you want to penetrate to the heart of a casting, or take novel radiographs

▼ Submachine Gun



Author mounts a typewriter in front of the X-ray film holder. The rays from the betatron emerge at the square white spot

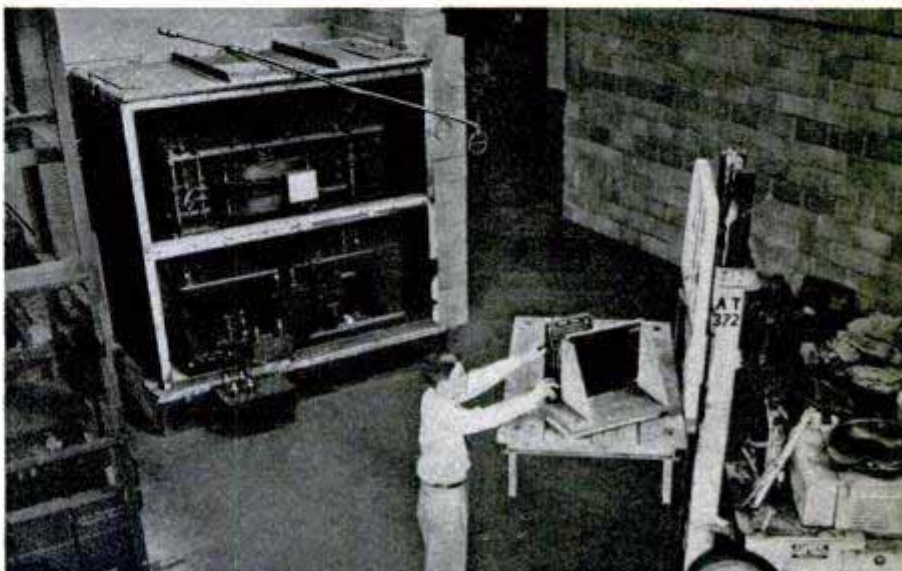

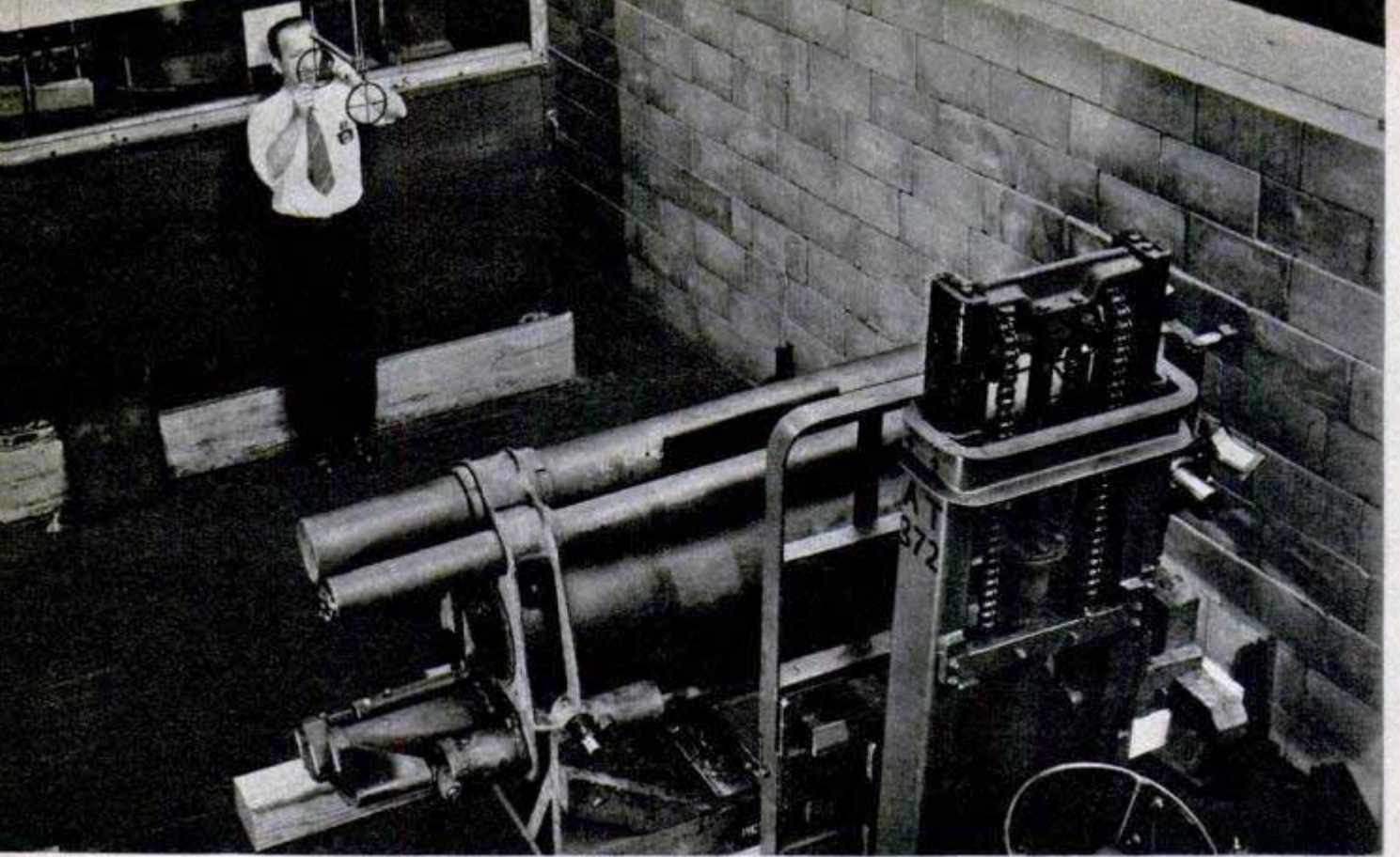

Bolton, who helped take these photos, lines up recoil mechanism of 155-mm. gun for inspection to detect flaws

of ordinary objects. Let's imagine that you are going to take an X-ray picture of a model train engine.

Since it takes approximately five minutes for the betatron to warm up, you first throw a switch which heats the filaments of all tubes and low-voltage supplies.

While you are waiting for the green "ready" light, you prepare the setup for your radiograph. In the darkroom you mount an ordinary type of X-ray film into a special holder, which keeps out all light but will not stop X-rays. Next, you mount the film a definite distance from the instrument, a distance you compute by taking the length of the locomotive and mul-

tiplying it by five, which will give you the minimum distance. You mount the train directly in line with the beam and place the film directly behind it.

Now you measure the approximate thickness of the metal in the locomotive and with the distance measured from the film to the betatron, you refer to a chart which tells you how much exposure to give the film. The chart is computed in roentgens, which is very similar to the amount of light you use in ordinary photography. You set the number of roentgens on a meter on the control panel, and the betatron automatically will shut off when it reaches the end of this exposure. It's almost as simple as setting the shutter on your own camera.

With the betatron warmed up, you push

▼ Telephone



the switch marked "magnet power" and hasten out of the immediate area to escape the loud noise. After you've calmed yourself, you set the voltage indicator to 20 million volts, which is quite a bundle of energy. You adjust two other controls to get the maximum output indicated on the output meter.

The rest of the process is automatic. The rays go through the locomotive and strike the film to expose it. At the proper time the betatron turns itself off.

The pictures on these pages were taken on Eastman industrial type-M film, and a piece of lead .040 inch thick was placed just in front of the film to increase the density for a given exposure. The distance of the target from the betatron was 12 feet. The exposure time was from one to two minutes.

Now that you have something on your negative, you can develop and print it in the same way you handle ordinary film except that you use X-ray developer and fixer.

The only catch to taking pictures in this manner is that the betatron costs \$85,000, and if you are wealthy enough to afford such an ingenious "camera" you still must build a double building around it.

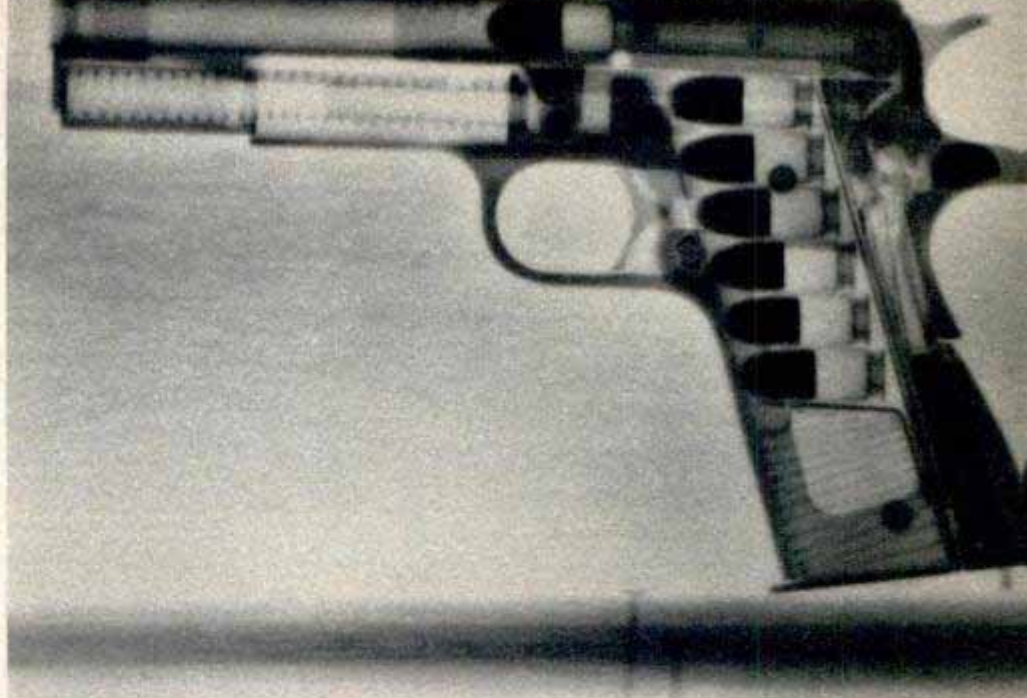

▲ Pistol

▼ Binocular

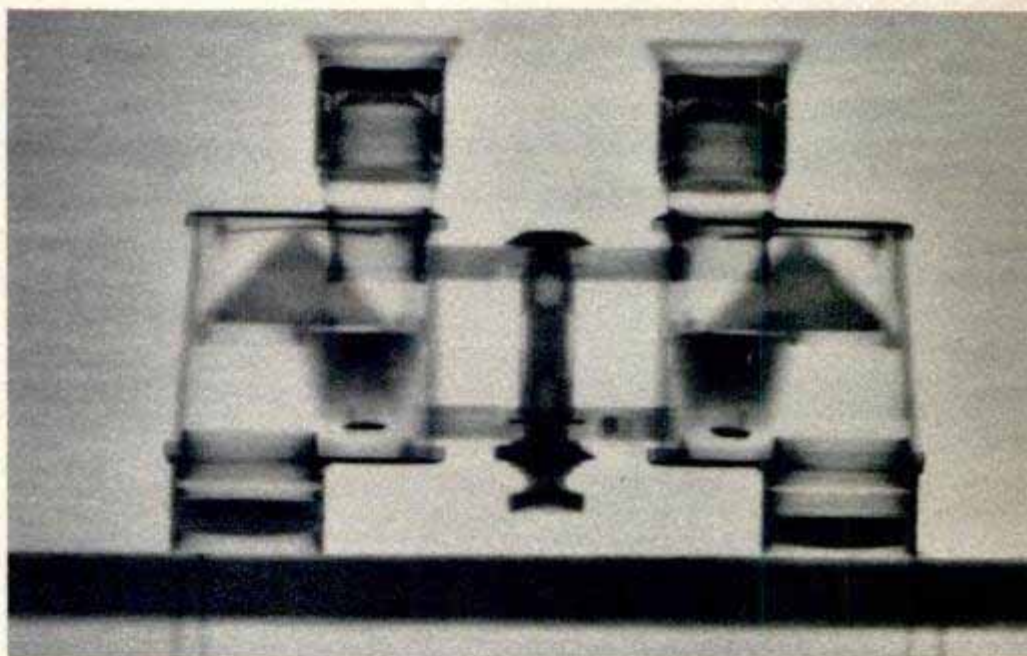

▼ Hand-Drill Motor

▼ Candid Camera

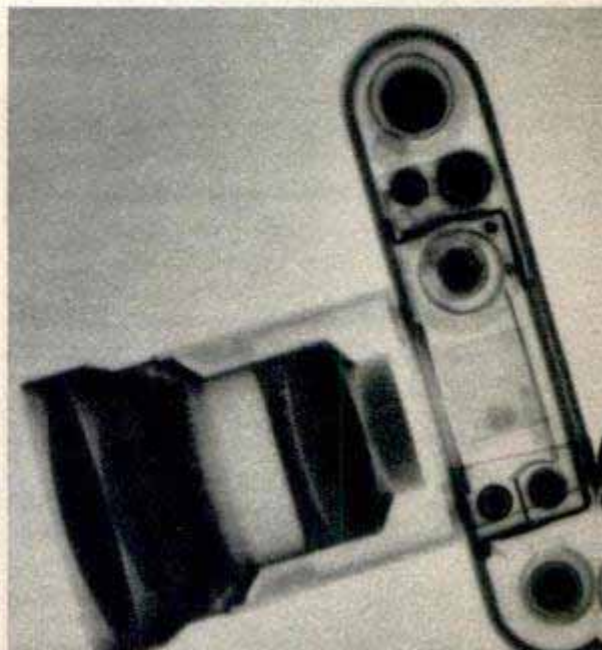
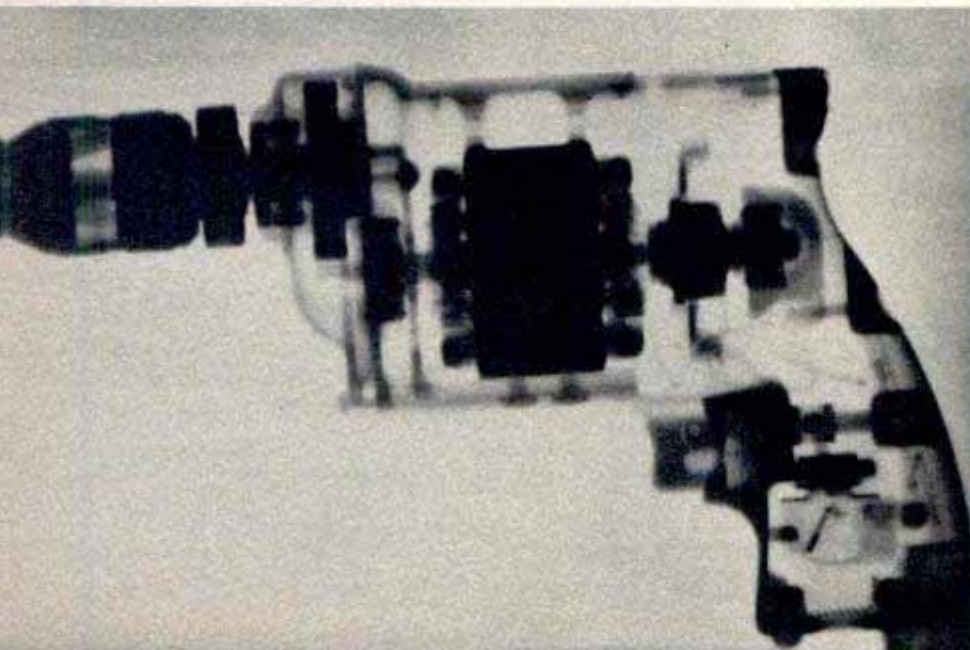

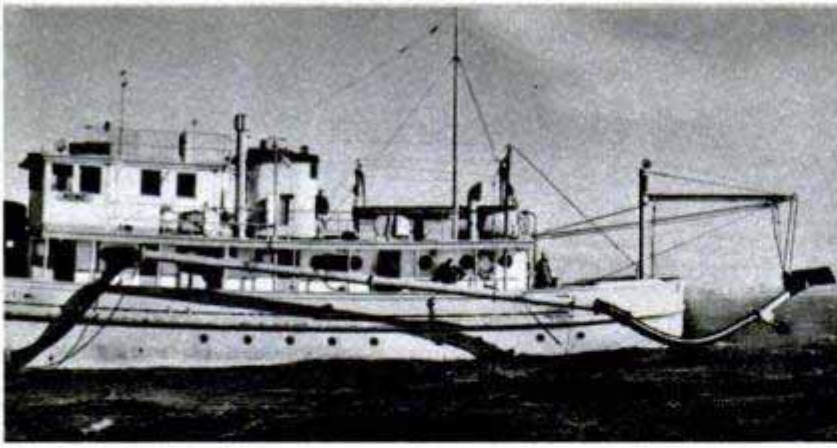

Vacuum Harvests Oysters

Oyster cultivators now are harvesting their crop with a giant "vacuum cleaner." The machine sucks oysters and almost everything else from the ocean floor. The nozzle, six feet wide and seven inches high, rides along the bottom on a dolly equipped with a rubber tire. A centrifugal pump creates a vacuum great enough to lift 2400

gallons of oysters and water a minute. The rate of catch is about 1000 bushels of oysters hourly. The process is reversed to unload the ship and deposit the catch on a dock conveying system that carries the oysters to a processing plant. Because the vacuum line also sucks oyster drills, a destructive snail, off the ocean floor, the machine helps in clearing this pest from the oyster beds.



"Hospital" Helicopter Evacuates Wounded

Battle casualties may be evacuated by helicopter in the event of another war. The British Royal Air Force recently demonstrated a method of carrying casualties on the outside of a helicopter's fuselage. A stretcher is secured to a special rigging on the side of the wingless craft. The wounded man then is strapped to the stretcher and the helicopter takes off for a hospital.

House-Number Post Holds Produce Signs

Farmers can put up produce signs in front of their homes quickly with a house-number post that is slotted to hold paddle-type advertising signs. As many as four paddles can be attached to the vertical post, on which the house number or farmer's name is printed with reflecting paint. Blackboard-type paddles are available if desired. The vertical post is made of aluminum to prevent rusting.



Many of the items described in this issue are already commercially available or ready to be marketed. For manufacturers' names and addresses, turn to the WHERE-TO-BUY-IT INDEX, page 10



How to Tempt a Fish

PART III SALT-WATER FISHING

By Joe Godfrey, Jr.

LIFE IS TOO SHORT not to find time for salt-water fishing.

There is a mystery about the sea that forever lures the angler. The all-connecting waters of the oceans, seas, bays and coves may lead to a sudden and surprising catch. Starting out to fish for snook, the angler may end up with a record tarpon; searching for mackerel, he may boat a broadbill swordfish, rarest of all the sea's great angling trophies.

The big, swift, ocean-roving fish may be caught in sheltered inland waters where they occasionally congregate, but are normally sought in their natural feeding haunts in the open sea. The catch may be measured in pounds or hundreds of pounds, but the pleasure of the sport can never be meas-

ured in numbers, but only in its thrills.

The bonefish has long been near the top of the list of the ocean's sporting fish. It is blessed with a speed that few can equal. It is shy and difficult to approach and is caught in warm, shallow, quiet waters where fishing conditions are close to ideal. For many years bonefish have been caught on special rods and light, matching lines coupled with reels that cast the lightly-weighted baits near the fish without alarming them. In recent seasons, standard fresh-water fly-fishing tackle has been

used to hook and hold them. Since they are far swifter than any fresh-water fish is known to be, this opens a new field to ambitious anglers.

Homer Rhode, Jr., Coral Gables, Fla., has pioneered this type of fishing and

Striped bass is still a favorite of the surf caster



Striped Bass



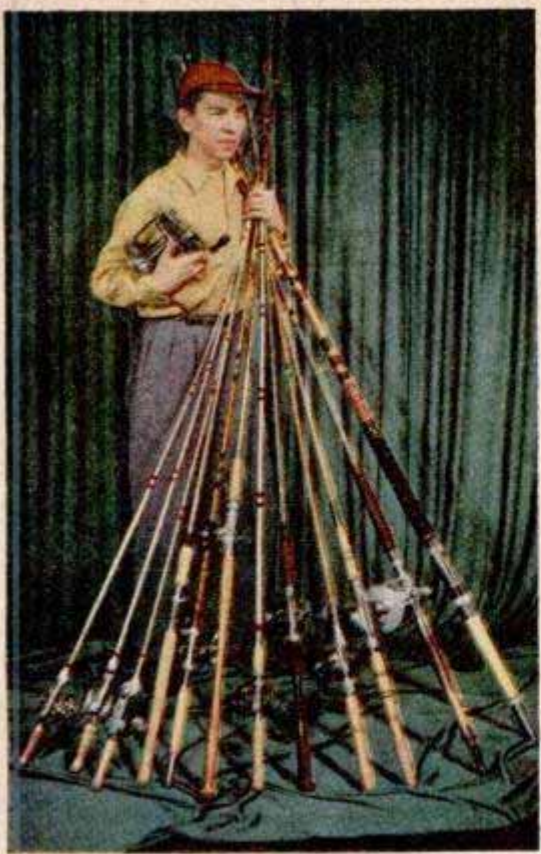

Rods for salt-water angler range from light glass ones to wood and steel heavyweights

BAITS FOR STRIPED BASS: (opposite page)

- 1—Johnson's Caper Spoon. 2—Jointed Pikie Minnow. 3—Striper Squid. 4—Bass-Aqua Plug. 5—Jointed Striper Atom. 6—Pike-Oreno. 7—Fishmaster Blue Mullet. 8—Trolling Squid. 9—Salt Water Squid. 10—Giant Amazin' Maizie. 11—Striper Popper Plug. 12—Martin Salt Water Plug. 13—Striper Atom Lure. 14—Eel Skin Rig. 15—Giant Walkie Talkie. 16—Fishmaster Mullet Plug. 17—Trix-Oreno.

developed a special streamer-type fly that closely imitates in shape and action the shrimp on which the bonefish feed.

The most successful plugs in bonefishing are the zaragossa type (surface plugs). These plugs are so balanced that they can be worked equally well on the surface or beneath the surface. The best retrieve is over grass beds and small channels on the flats with a moderate zigzag surface retrieve for a distance of about 30 or 40 feet, then smashing the plug underneath, working it in an erratic manner and increasing the tempo

BAITS FOR PACIFIC SALMON:

- 18—Red and White Rosegard Plug. 19—McMahon Spoon. 20—Buck White Spoon. 21—Williams Wabler. 22—Record Spoon. 23—Reflecto Spoon. 24—Canadian Spoon Bait. 25—Martin Plug. 26—Lucky Louie Plug. 27—Limper Jigger Spoon. 28—Rosegard Salmon Plug.

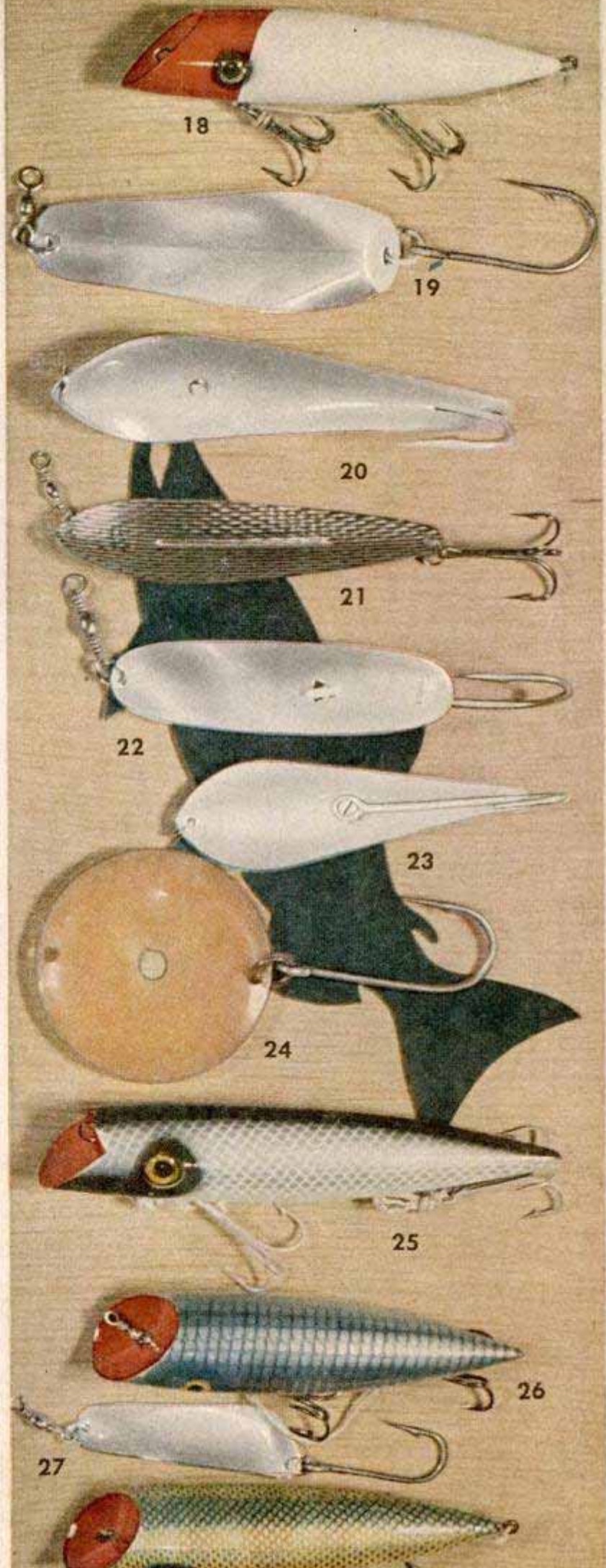

Bluefin Tuna



Bonefish



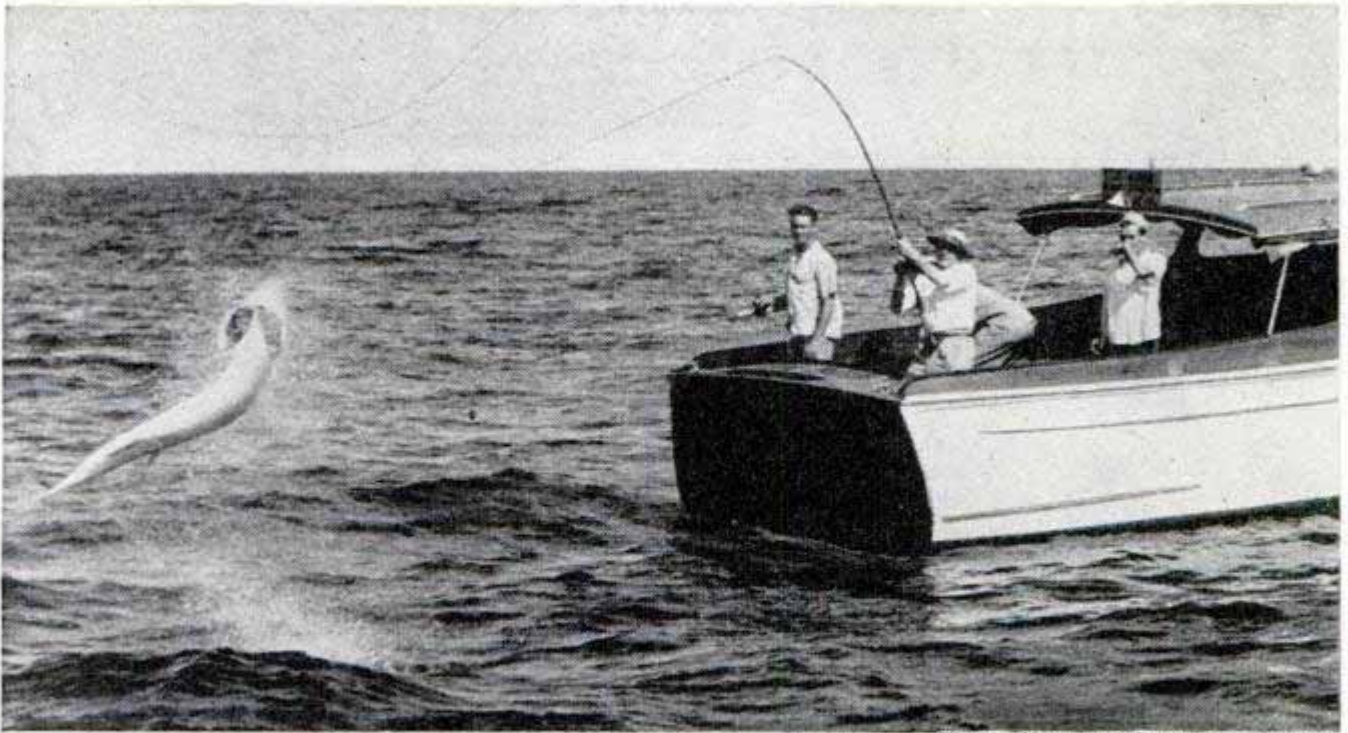

Florida News and Photo Service photo

← **BAITS FOR BLUEFIN TUNA:** 29—East Coast Feather Jig. 30—Bullet Head Nylon Jig. 31—Barracuda "J" Jig. 32—Full Feather Jig. 33—Jumbo Japanese Feather. 34—Bull Nose Feather Jig. 35—"K" Dude Jig. 36—Trolling Feather Jig. 37—'Cuda Feather Jig. 38—Bimini Feather Jig. 39—"J" Feather Jig.

↑ You can see right through the giant gills of this silver king tarpon, one of scrappiest fish in ocean

of the retrieve to an extremely rapid pace.

For casting the channels from midstream to the banks, a red-headed yellow feather is best. This is the same type that is used in Florida waters for pompano and bluefish. Big bonefish are seen regularly in the waters of the Florida Keys.

A recent dispatch tells of a bonefish from the Hawaiian Islands, caught by C. M. Cooke, III, which raises the world's angling record to 16 pounds.

Bonefish tackle (a four-ounce casting rod and six-thread line or a bass-weight fly rod with 200 yards or more of backing and a 15-pound test leader next to the fly) will also give an angler all the thrills he

needs if he hooks into any of the other game fish of the same waters like the ladyfish, permit, barracuda, snook or tarpon.

Tarpon are among the ocean's best performers. They strike artificial baits, can be caught by casting light tackle and are swift in their runs and endlessly spectacular in their leaps. Because their mouths are hard and bony, they are both hard to hook and hard to hold. All these sporting qualities are combined in a silvery fish that goes up to a record weight of 247 pounds, taken in the Panuco River near Tampico, Mex. The tarpon frequents the quiet inland or inshore waters where the great leaps and runs bred of the open sea are accentuated.

Flies and fly rods will take tarpon in the shallow bays and canals or any of the confined waters. Bait-casting rods will cover the same waters and either rod can be used

Big-game-fish accessories include a giant gaff with needle-sharp barb, harness, rod belt, teaser to lure fish and persuader to knock them out

← **BAITS FOR BONEFISH:** 40—Miracle Minnow. 41—Keys Bonefish Fly. 42—Eger Dillinger. 43—Fisherman's Favorite Wig-gling Minnow. 44—Polar Bear Fly. 45—Divided Wing Shrimp Fly. 46—Paul Bunyan Weaver. 47—Lunker Lure Pop-It. 48—Hot-Shot Lure. 49—Rhode Bonefish Fly. 50—Quilby Minnow. 51—Mustang Minnow. 52—H.R. Shrimp Fly. 53—Shrimp Fly. 54—Shrimp Bait. 55—May Wes Plug. 56—Gentleman Jim. 57—Fish-Obite. 58—Manning's Tasty Shrimp. 59—Midget Sea Witch.

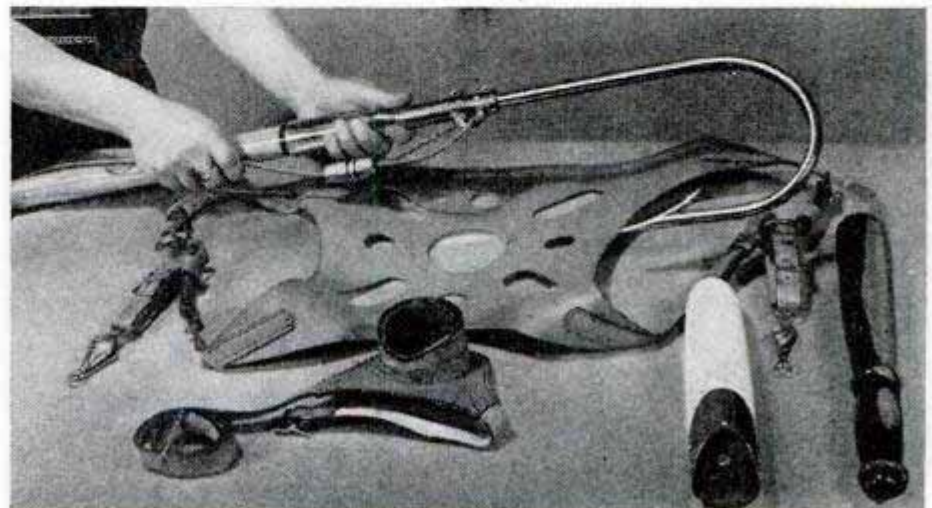

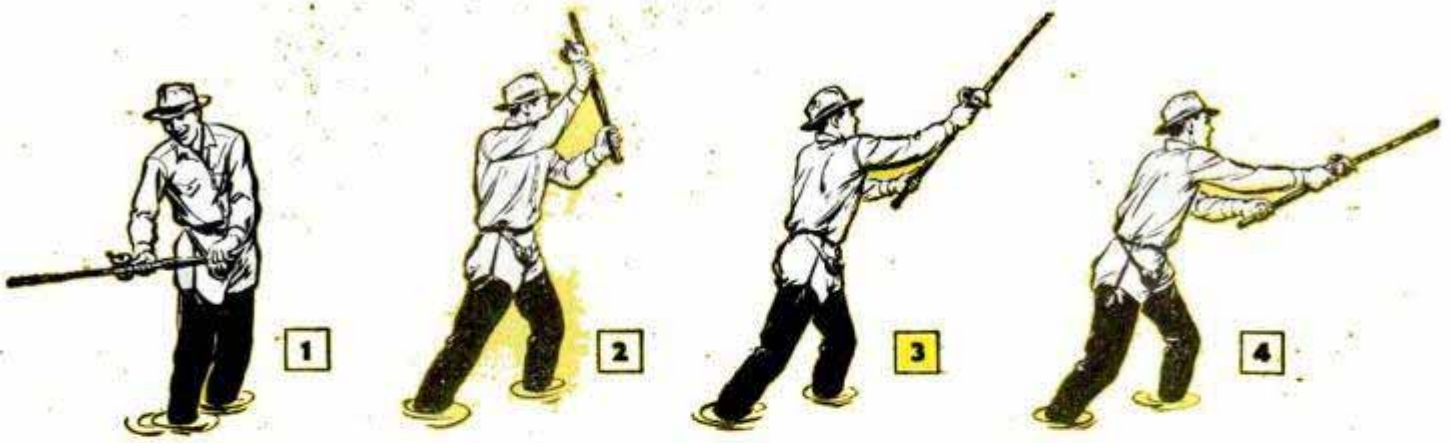

In surf casting, hold right hand directly under reel with thumb resting on side of reel. Left hand grasps the butt of rod solidly almost at the end

As lure hits the water, drop butt of rod in whip socket; hold rod as shown for retrieving line or playing fish



Below, barracuda is most vicious of fish in southern waters, averages 25 lbs. It does much of the damage that is blamed on shark

for tarpon under 50 pounds with regularity, but when these silvery fish pass the 100-pound mark, either the angler's skill must increase prodigiously or the weight of his tackle must rise to match a heavier foe.

Tarpon in channels and small rivers go for streamer flies on fly rods and for plugs on bait-casting equipment. In the Gulf of Mexico they hit big plugs and spoons that are trolled. At hot spots such as Boca Grande Pass it's a game of drifting with live crabs as bait.

There are millions of tarpon along the west coast of Florida in April, May and June; then along the coasts of Mississippi, Alabama and Louisiana in May, June and July; off Texas from May to September, and off Mexico from March to July.

It was in 1915 that Captain Bill Hatch worked out the drop-back method of fishing and opened the angling door to the sailfish and the marlin. These spearfish tap a bait with their spears and, having stunned it, turn and take it into their mouths. Hatch's development brought the marlin

Marine Studios photo

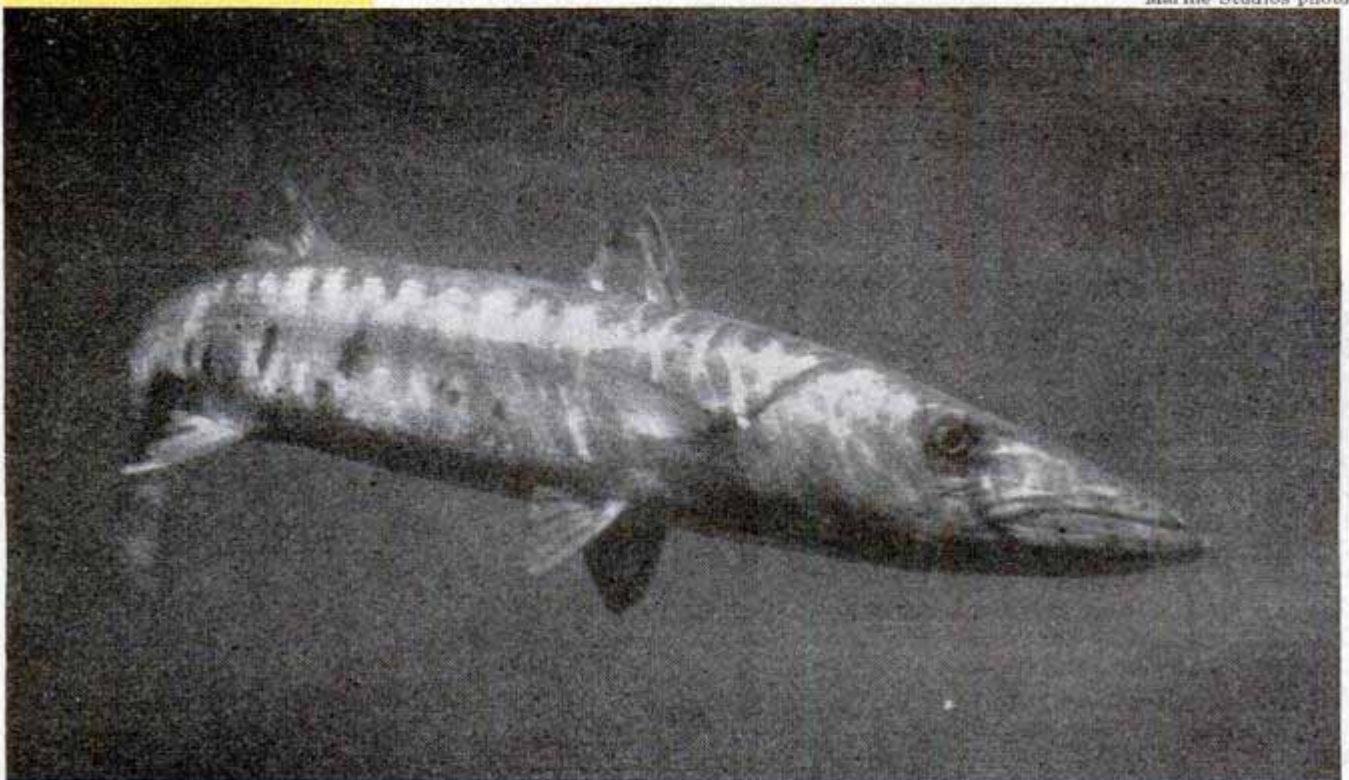



Numbered sketches show motions of body during a surf cast. Line should be wet before it is cast. Speed of right arm is increased until greatest power is applied as the rod passes perpendicular. At this point, most of thumb pressure on the reel spool is released

and sailfish, which had previously been considered only nuisances, into the forefront of the big-game-fishing field. Their amazing power to leap thrilled the angling world.

Hatch's discovery changed the contours of the fishing cruisers. They sprouted long, thin bamboo poles that swept out from their decks. The angler's line passes from his rod tip out to the outrigger's tip where it is held gently by a clothespin. From there it drifts astern to take the bait out to one side of the propeller wash, to hold it high and make it skip like a frightened fish.

When a sailfish or marlin surges up and strikes the bait with his bill, the strike is sharp enough to pull the line free from the clothespin. The slack lets the bait drift in the water while the sailfish turns to take it into his mouth before the line tightens again. The pressure is timed to come just when the bait is taken.

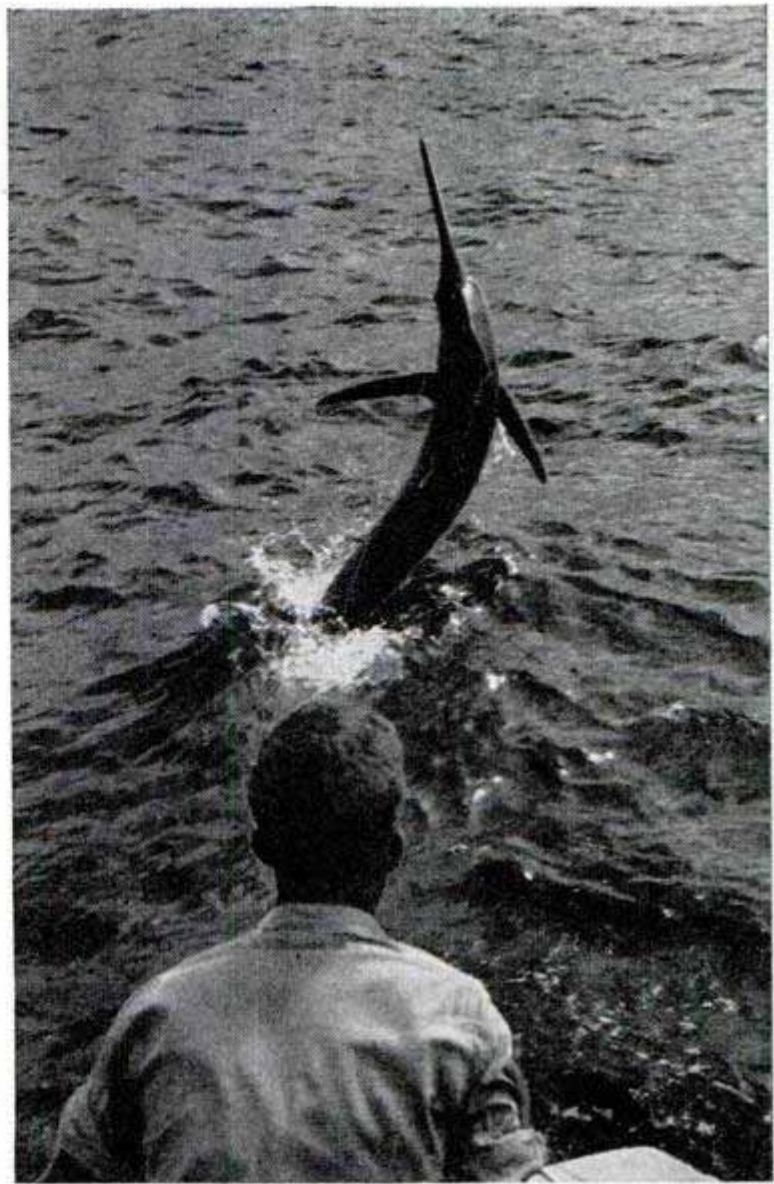

City of West Palm Beach photo

Giant blue marlin gives a mighty lunge in desperate effort to free himself beside boat. Average weight of this deep-sea monster is from 200 to 450 pounds. Below, St. Petersburg children try luck at surf casting during the annual Fishathon





Rocketing striped marlin puts up spectacular battle. Below, angler with surf-casting rod lands a huge snook

Marine Studios photo



The sailfish, long and slender, can skitter across the surface of the sea like a skipping stone. The word "tailwalking" was added to our language to describe this sailfish stunt.

There are many varieties of sailfish, but the two most important are: (1) Atlantic sailfish, and (2) Pacific sailfish. Most Atlantic sails are caught in the blue Gulf Stream waters from Stuart to Key West, Fla., but every summer some of them are caught off the Texas Gulf coast. The Pacific sails are most plentiful at Acapulco and at Guaymas, Mex.

The marlin lacks a sailfish's high distinctive dorsal but has him trimmed for strength and speed. Most sailfish fall well below the 100-pound mark; most marlin go well above it and some go more than 1000 pounds. They are heavier throughout and more difficult to handle on a rod and reel.

Striped marlin are found in the warm waters of the world. The biggest ever taken on hook and line weighed 692 pounds—caught off Balboa, Calif. Blue marlin are found mostly in the Atlantic between Cuba, Cat Cay and Florida. The biggest weighed 737 pounds—caught off Bimini in the Bahamas. White marlin are smaller and range from Maryland in the summer to Key West in winter. The biggest weighed 161 pounds and was taken off Miami, Fla. Biggest Pacific black marlin weighed 976 pounds and was taken off Bay of Islands, N. Z.

The school tuna, ranging from 10 to more than 100 pounds, suddenly became the public's favorite. They were great sport, they were good food and there were lots of them.

(Continued to page 238)

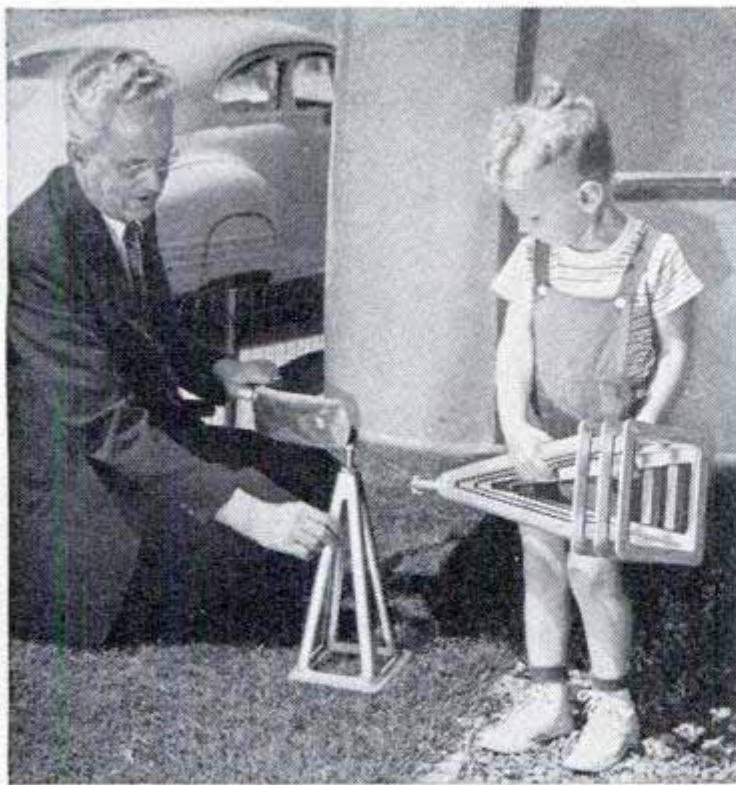

Aluminum Trailer Supports Are Nested for Storage

Parked trailers are leveled and stabilized quickly by four cast-aluminum supports that nest together to require little storage space when traveling. Adjustable from a height of 13½ to 17½ inches, the stabilizers make it easy to bring the trailer to level. Although each stabilizer weighs only 2½ pounds, it will support up to 8000 pounds.



Floating Arm Supports Microphone

Adapted from an adjustable arm used on fluorescent lamps, a floating support permits movement of a radio or public-address-system microphone to any position instantly and quietly. No lock screws are used. Brackets to fit all makes of microphones are available and the support can be used with or without a floor stand.

Winder Takes Snarls and Kinks Out of Fishing Line

Twisted fishing line—frequently the cause of backlash and snarl—is eliminated by a new line winder that can be attached to the tackle box. The winder consists of a series of spools and a crank. It can be used to wind new line from its spool to the reel, for removing line when the reel is to be cleaned and oiled or for reversing a used line to move the “work end” to the bottom of the reel as filler. The spools on the line winder serve to store extra line. The winder is designed especially for use with spinning-type reels, and winds the line on them so evenly that a spinning spool will hold from 10 to 25 percent more line.

□ Paper pillows stuffed with shredded paper are being offered to overnight railway coach travelers in England on an experimental basis.

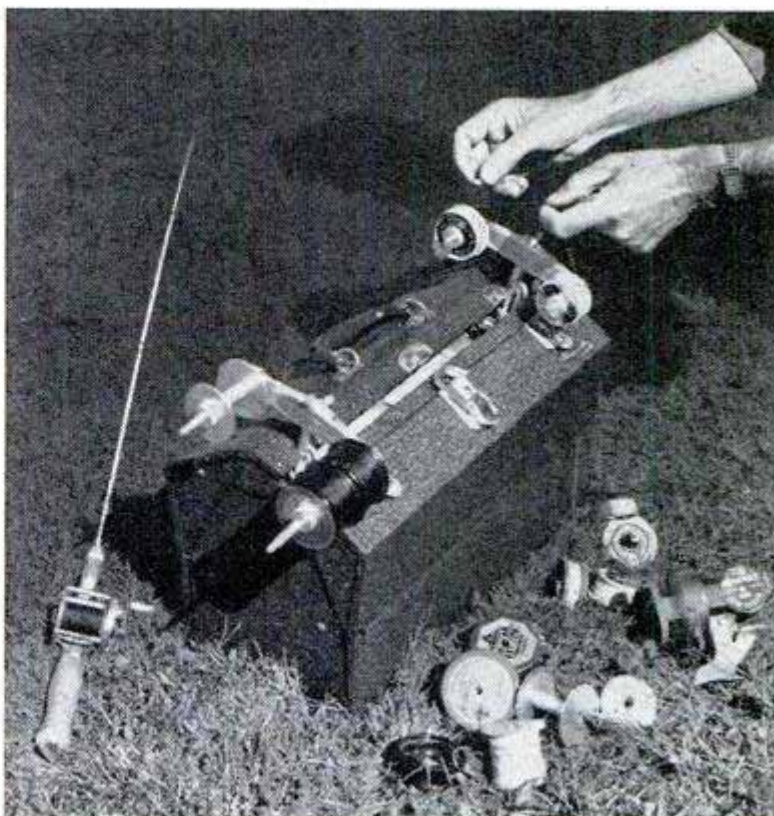

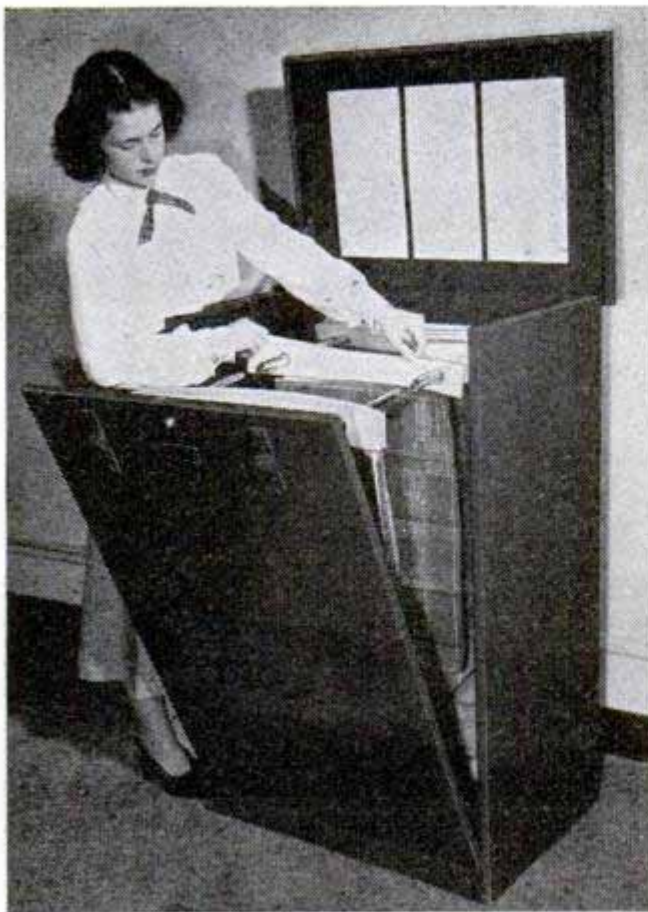

Cabinet Files Unfolded Blueprints

As many as 1000 blueprints and drawings can be filed in a fire-resistant steel cabinet which holds large sheets without folding. The prints hang smoothly and can be indexed. When the front panel is opened, the two suspension rods slide apart, permitting any one of the prints to be removed or inserted in its indexed position.

Duck Delivers Cigarettes

Cigarettes are delivered in push-button fashion by a tiny duck that dips into a disappearing drawer when a lever is pressed and comes up with a cigarette in its bill. The hopper, which takes both standard and king-size, holds slightly more than a package of cigarettes. There are two operating levers, one on each side of the bird.

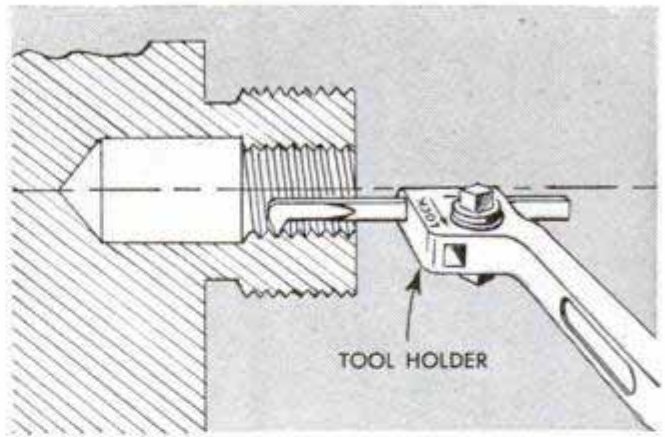
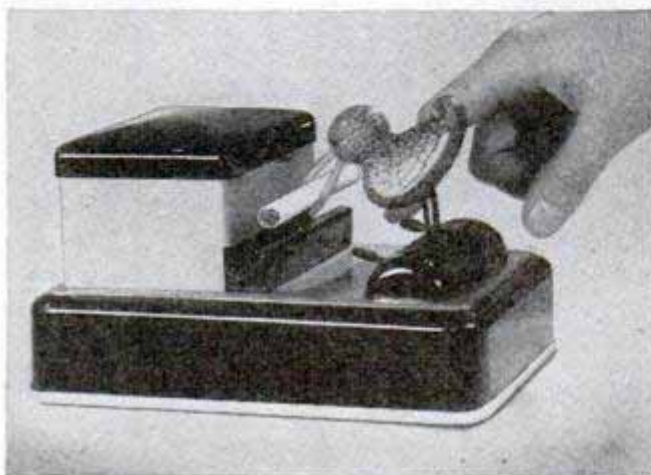

Multi-Purpose Tool Holder Can Be Reversed in Tool Post

Capable of a variety of jobs from shoulder turning to internal boring and threading, a multi-purpose tool holder replaces the large number of holders generally required for the workshop lathe. Because the holder has two tool-bit openings and can be reversed in the tool post, it makes possible a wide range of work including both right and left-hand operations. A quick-change bit-locking device allows the operator to change from one setup to another in a few seconds. Bits can be removed for sharpening without disturbing the position of the holder on the tool post.

Plastic-Surfaced Paper Plates

Paper plates coated with plastic won't soak up any food, oily or watery, and have a surface that is hard enough to cut steak on. A thin film of odorless, tasteless plastic is bonded to heavy paper board to make the plates. They are manufactured in two colors and three different sizes. Plastic knives, forks and spoons also are available. The blade of the knife is sharp enough to cut meat.

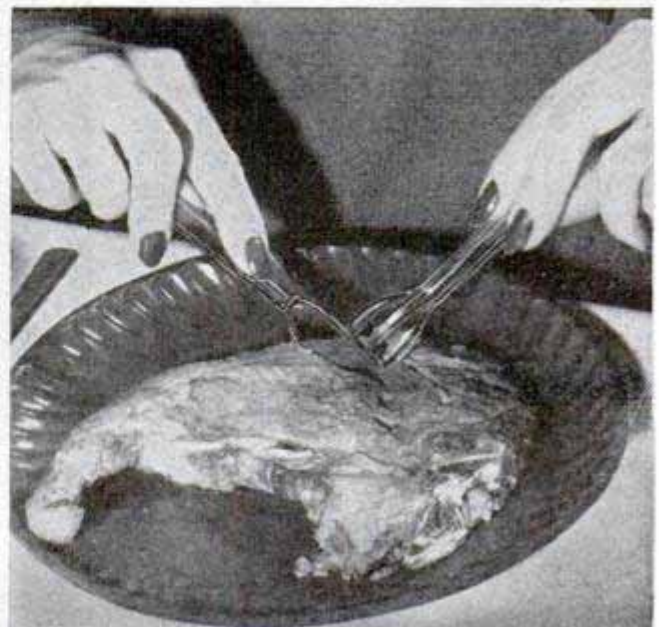

Soiless-Garden Kit For City "Farmers"

Even though your back yard is paved with concrete, you can still have a vegetable or flower garden, thanks to a soiless-garden kit that produces good crops with a minimum of work. The kit includes a large plastic bed with drain fitting, a short length of hose and a baffle strip. You fill the bed with gravel, crushed rock or cinders and you're ready to raise a crop. Chemical plant food is dissolved in water and sprinkled over the bed twice daily. The solution drains through the hose and is reused for several weeks. Plants are set 10 to 15 times closer than they can be in soil, thus giving you a much larger garden plot than the size of the bed would indicate.

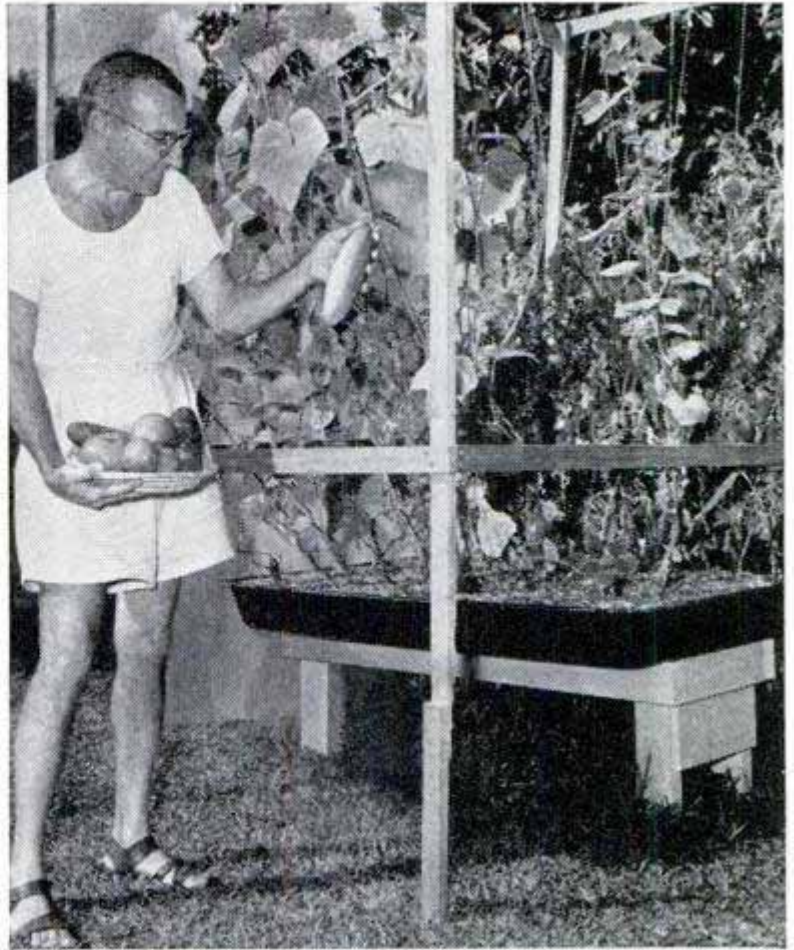

Radio-Frequency Checker

With a new instrument no larger than an egg crate, engineers can discover when a radio station is broadcasting off its assigned frequency by as little as five cycles in a million. The monitor counts electrical impulses per second. In addition, it measures the amplitude of the waves being broadcast

and the amount of power being transmitted. The instrument, developed by General Electric, is about half the size of equipment now in use for the same purpose.

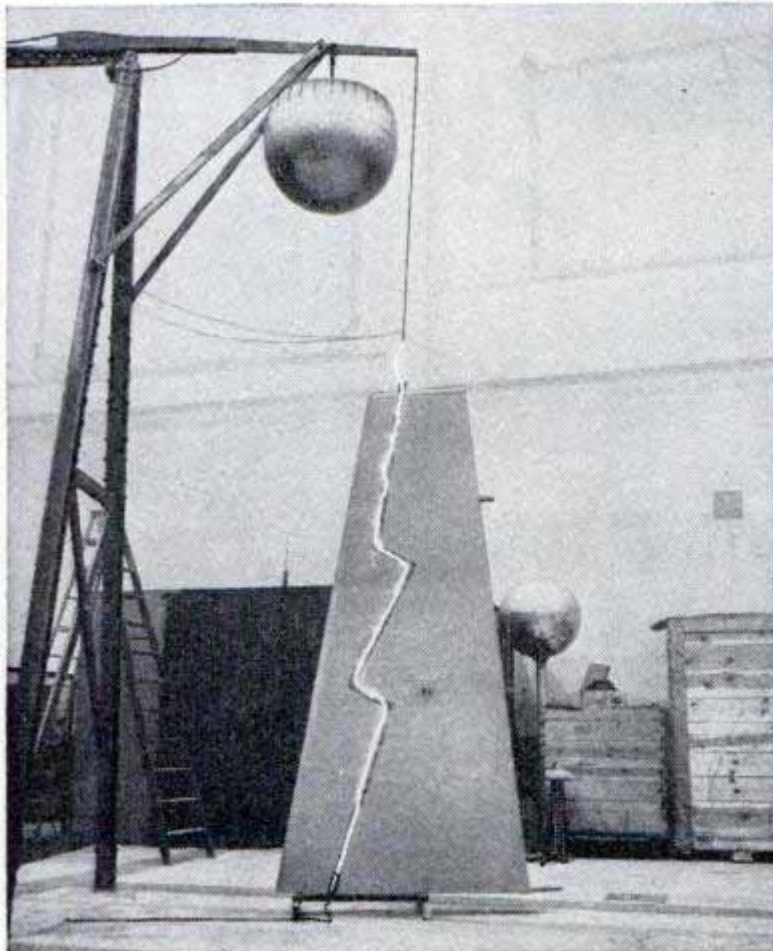

Paint Conducts "Lightning" Across Glider Elevator

Part of an experiment to determine a means of protecting airplanes from lightning, a two-million-volt charge of electricity was shot across a glider elevator without damage. The charge of man-made lightning was conducted harmlessly across the plywood elevator by a stripe of conducting paint. The stripe was painted in a zigzag shape to demonstrate how the high-voltage charge will follow the conductor around a sharp bend.

Plastic-Coated Work Gloves

Hands are protected against acid, alkali, heat and flame by a plastic-impregnated work glove. It conforms to the hand's natural grip and is washable. In tests the plastic-toughened glove has demonstrated higher electrical insulation qualities than gloves coated with rubber of the same thickness.

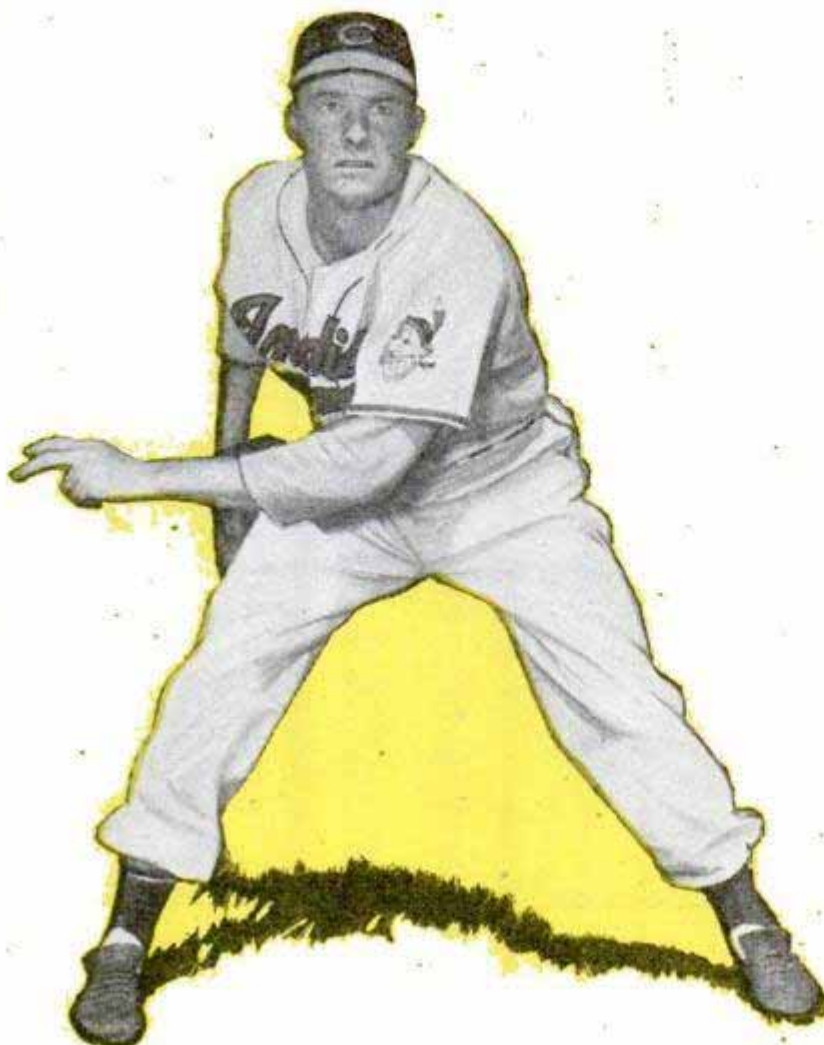

WHAT does it take to be a big-league pitcher?

Experts in the best position to observe, like catcher Jim Hegan of the world's champion Cleveland Indians, generally agree that speed and control are the biggest factors. The game's great have varied widely in size, shape and temperament, and many were famous for a particular kind of pitch, but every one had better-than-average speed and fine control.

Hegan knows how star hurlers perform. He catches a Cleveland staff that has been called the best ever assembled on one team. Two of its members, Bob Lemon and Gene Bearden, were 20-game winners last season. A third, Bobby Feller, with nearly 200 major-league victories and over 2000 strikeouts to his credit, ranks as one of baseball's all-time greats.

Take a lesson from champion pitchers

By Aubrey O. Cookman, Jr.

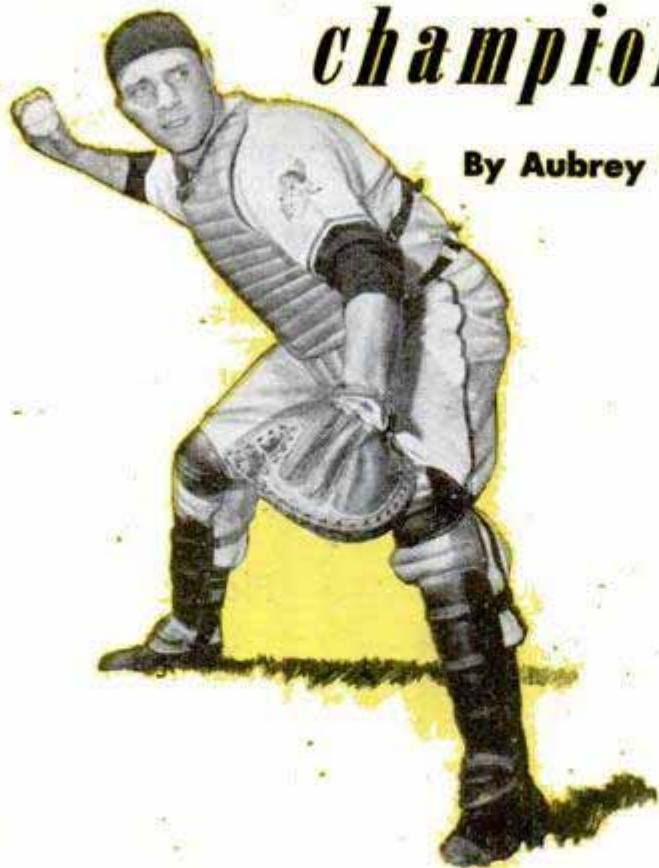

Above, demonstrating the proper position for a pitcher at the finish of his delivery — ready to move in either direction for a batted ball—is Gene Bearden of Cleveland. In '48 he won 20 games for the world's champions

Left, catcher Jim Hegan selects speed and control as two main attributes for a star pitcher. Indian staff he catches is one of the greatest ever assembled



Elaborate windmill windup wastes a pitcher's energy. Here Bob Lemon illustrates, from left to right, three stages in the smooth delivery with which he pitched 294 innings last year to top the American League

A government timing device clocked Feller's fast one at 99.5 miles an hour. Batters have a split second to decide whether or not to swing with the ball hurtling toward them from only 60 feet 6 inches away—the distance between the mound and home plate. But even with his natural speed, Feller couldn't climb to stardom until he mastered control.

Some pitchers laid the groundwork for good control as youngsters by throwing for hours at a time at stationary targets. Some would pitch stones or balls at a hole in the fence. Others have rigged up "picture frames" of canvas or poles, with a 17-inch-wide and 38 or 39-inch-high opening representing the strike zone for an average-size batter.

Reduced to its simplest explanation, pitching skill is the ability to throw consistently what the batter least expects or wants. Watching the pitchers work from Hegan's vantage point behind the plate, you get a better idea of the finesse that makes a champion.

Deceiving sharp-eyed big leaguers takes grade-A performance at all times. In their constant duel of wits, the pitcher can't afford to give the hitter an inkling as to what kind of a pitch he'll serve up. Coaches and rival players are watching him constantly for telltale signs.

Unconscious mannerisms sometimes betray a rookie pitcher's intentions. George Earnshaw of the Philadelphia Athletics originally had a habit of scuffing ground around the mound with his toe when catchers flashed the curve sign, while the call

for a fast ball brought no such response. Until corrected, it was like posting an announcement each time for the hitter.

Urban "Red" Faber of the Chicago White Sox, a famous spit-ball pitcher, would overdo preparations for the saliva-applying operation when he was faking his favorite delivery. Opponents noting the exaggerated facial contortions could be reasonably sure Faber's wicked "spitter" wasn't shortly coming their way.

Babe Ruth, in his youthful pitching days, would unconsciously stick out his tongue when preparing to throw a curve. Others have unknowingly tipped off rivals by hitching up their shoulders prior to a certain type pitch, or crooking their wrist significantly during the start of the windup.

Managers and coaches are always on the alert to detect and correct these faults in their players. Occasionally a cagey pitcher will use these "giveaways" to his own advantage in double crossing rivals. Dizzy Dean used to allow the opposition to "discover" his preliminaries for a certain type pitch, adding to its authenticity by using it a few times in the expected manner, then crossing them up at crucial moments by switching at the last minute to a completely different kind of pitch.

Coaches teach youngsters to deliver all pitches with the same motion, generally a three-quarter style, about midway between sidearm and overhand. Except for a few freak specialty pitches, the fingering—the way the ball is gripped—is basically the same for all pitches. A smart pitcher masks the fingering with his gloved hand.

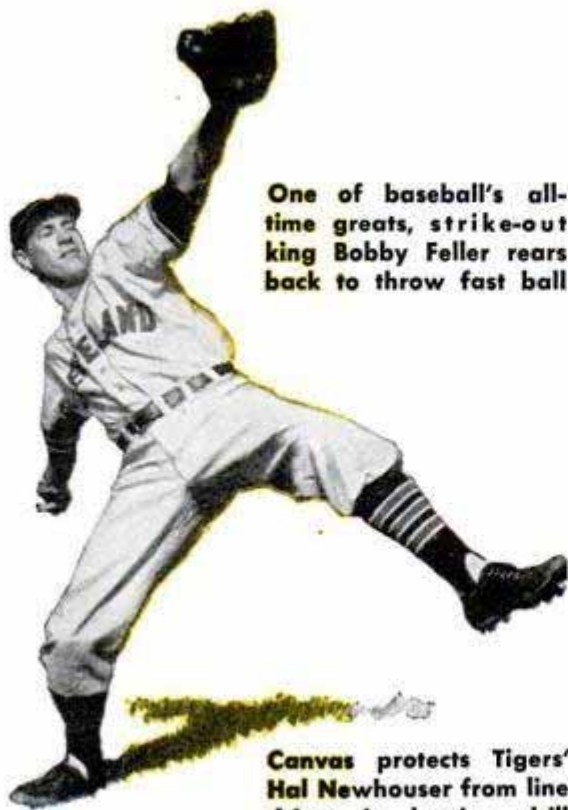

One of baseball's all-time greats, strike-out king Bobby Feller rears back to throw fast ball

Canvas protects Tigers' Hal Newhouser from line drives in batting drill

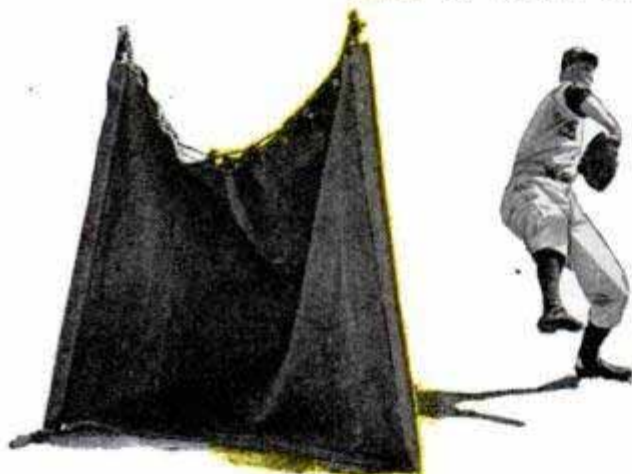

In contrast to three-quarter delivery of most stars, Satchel Paige of the Indians uses sidearm motion

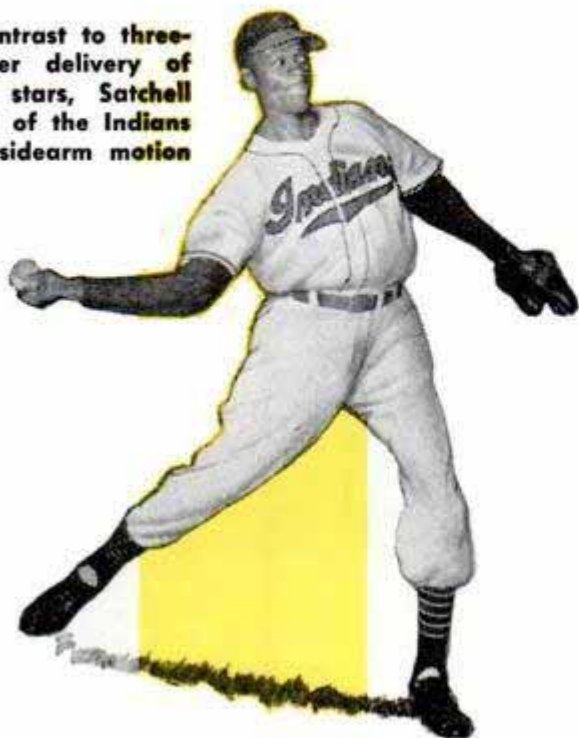

For about 75 percent of all pitches, the forefinger and second finger are on top of the ball, the thumb is below it and the two remaining fingers fold down against the palm. Most experts advocate gripping the ball across the seams, rather than with them, to get better control.

A fast ball behaves differently from a curve because of the way the ball is released. There isn't time then for a batter to react to the knowledge, even if he had it.

Fast balls leave the hand with a downward snap of the wrist. A good, "live" pitch, in baseball parlance, shoots upward when it nears the batter. One that fails to rise and comes straight, level across the plate, is easy to hit, despite its speed, and it travels farther than breaking-type pitches.

Though held the same, a curve is thrown with an outward snap of the wrist so that the back of the pitcher's hand ends up facing the plate. The ball rolls off the first two fingers. Most effective curve-batters put pressure on the second finger, just before the release, and use the first solely as a guide. The ball has to be made to spin in order to curve.

Some hurlers finger a slow ball, or "change up," just as they do a fast ball or curve, but lift the top two fingers just as the ball is released. When thrown with the same motion as a fast one—except for the last-second wrist snap—it throws a batter's timing off badly.

The sharpest change of pace in baseball today is the "blooper ball" thrown by Rip Sewell of Pittsburgh. It floats platewards so slowly that batters can see the ball's seams and it arches down to them from as high as 12 to 15 feet, but Rip uses it sparingly and hitters aren't able to adjust their timing for solid swings.

Among the most effective "extra" deliveries is the knuckler. Manager Lou Boudreau of Cleveland claims it is the most baffling ball his star Bearden throws. Gene grips it with the nails of his first three fingers and the sphere sails up to the plate with virtually no spin, breaking downward. Some knucklers, like Dutch Leonard of the Chicago Cubs, hold it with two fingers on top, pressing the first joints against the ball.

Carl Hubbell, the former New York Giant southpaw, perfected a screwball that he held just like a curve. The difference was in the terrific inward snap he gave the ball on release, ending up with his palm facing the batter. This spin made the ball act like a reverse curve.

Early Wynn, another Cleveland star, has a bothersome slider which he grips like a curve, but holds slightly off center, and throws with less wrist snap. It breaks several inches but, unlike the curve, it "slides"



Hand of Yankee hurler Joe Page, above, shows his fast-ball grip. Wrist snaps downward as ball is released

away from right-handed batters without also breaking downward.

Some of the more methodical hurlers keep notebooks in which they jot down the data on the batting strengths and weaknesses of rivals. When a hitter like Rudy York displays a liking for pitches that catch the outside edge of the plate, it is pretty certain he'll never get one there when the game is close.

Hurlers have equally long memories for weak points. Feller, who has been playing against Joe DiMaggio for 10 years, thinks the Yankee star normally does the least damage to a ball that breaks low, on the outside corner.

Catchers are important to pitchers in analyzing the batter's stance and swing. This is particularly true when a newcomer is at bat. If he is a plate crowder, the catcher will probably call for balls that break in close to his bat handle. Or, if he stands too far back, the catcher might ask for a curve or fast ball that nicks the corner.

Ewell Blackwell of Cincinnati holds ball with his first two fingers slightly spread, below, for curves and fast one



Looking down an imaginary corridor from mound to home plate, drawings below show how ball acts as it nears batter. Strike zone is the 17-inch width of plate and from hitter's knees to his shoulders

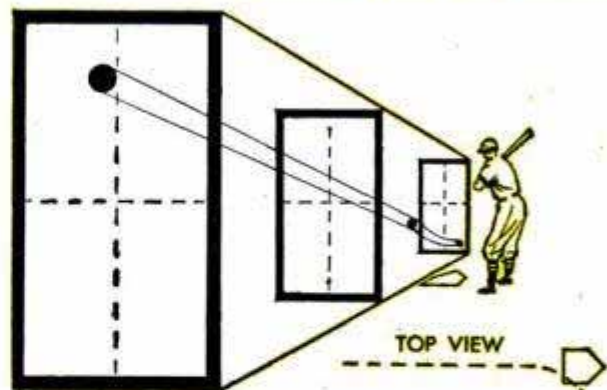

Bearden's knuckler veers downward and to right

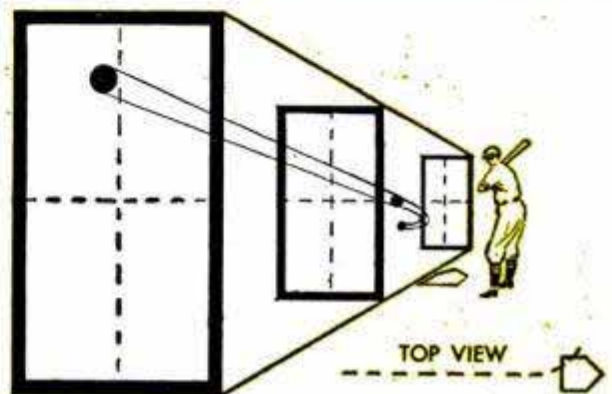

Feller's curve ball breaks both down and to left

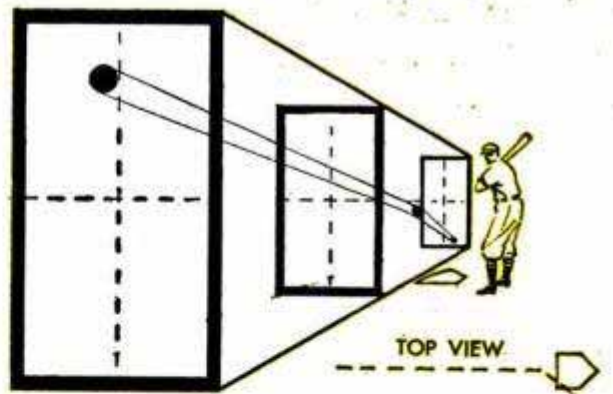

Lemon's sinker pitch drops sharply and veers right

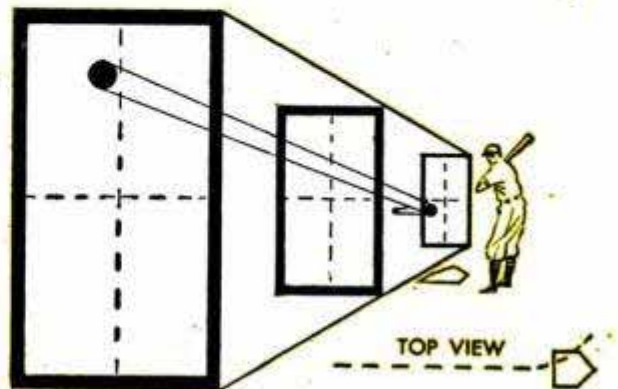

Wynn's slider curves left sharply, but doesn't drop

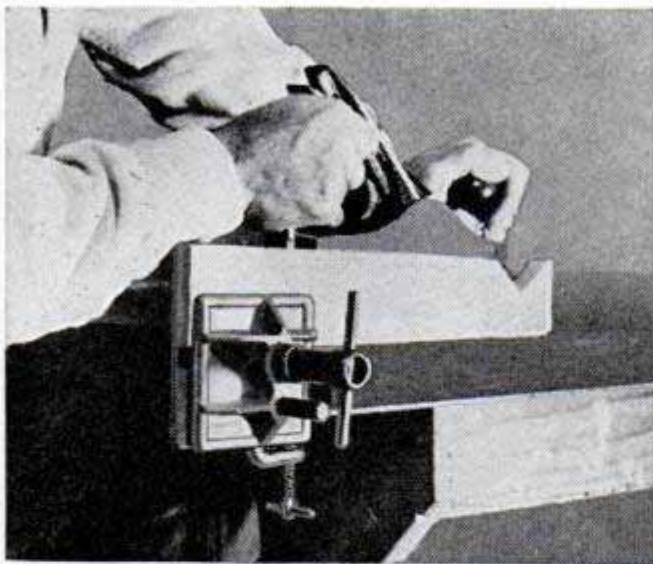

Sliding Lawn Edger Turns Furrow

Lawns are edged neatly and quickly with a new yard tool that slides along the grass. The depth of the cutting blade is adjustable. A curved plate on the rear of the edger turns the earth and grass aside to leave a furrow along borders. When the edger is used along walks and drives where such a furrow is not desirable, the curved plate can be lifted out of the way. All metal parts of the tool are cadmium plated.

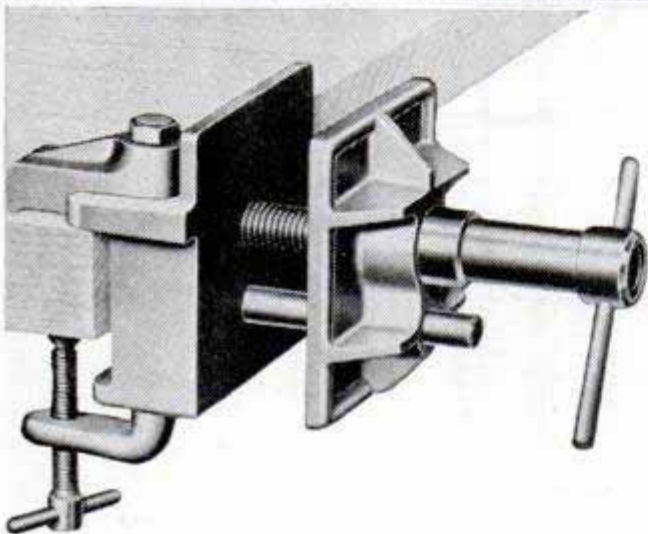

Vise With Telescoping Screw Can Be Carried in Tool Kit

Weighing less than $3\frac{1}{4}$ pounds, a portable vise that fits in your tool kit can be clamped almost anywhere. The main screw telescopes into the drilled handle. A reversible clamp permits clamping the vise to the side or end of a bench or saw horse.

Aluminum Nails Won't Streak Siding

Aluminum nails that will not rust or produce unsightly streaks now are available for the siding and roofing of homes. The metal resists corrosion and its oxides have no objectionable color. An "etched" finish on the entire surface of the nail increases its holding power and helps paint adhere to the head. Used to fasten siding on homes, the nails need not be counter-sunk and puttied. They are available in a variety of sizes for most types of siding.

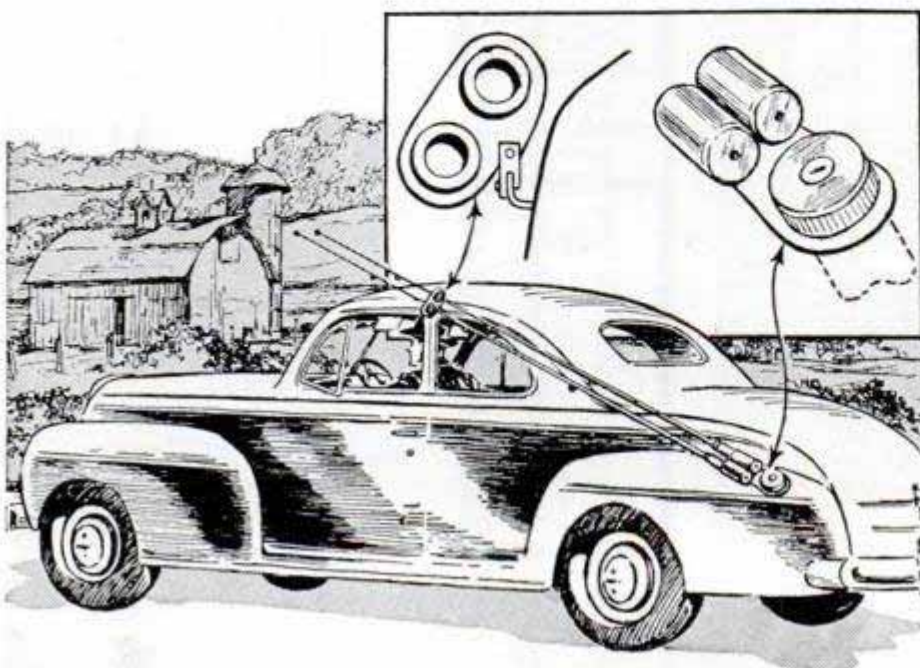

Fish-Pole Holder Clamps To Car

Fishermen who have trouble carrying long poles now can slip them into a holder that attaches to the car. One part of the holder consists of two tubelike pockets fastened to a metal ring. The ring is held in place by the gas-tank cap. Another part clamps above the window of the car. The tips of long poles can be inserted through holes in this part and held securely in the pockets.

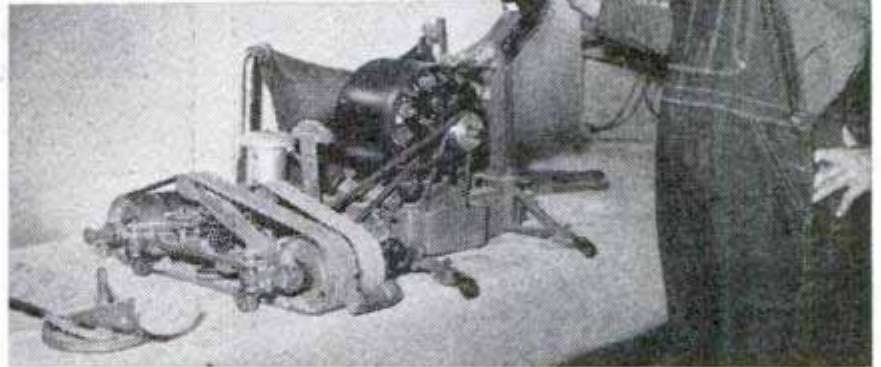
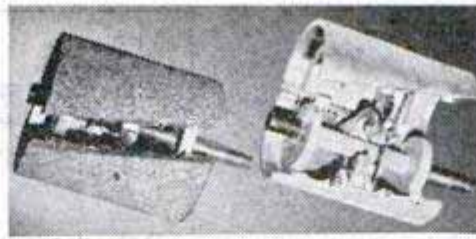

Left, the combination sander in its normal position. Right, the two-belt bowling-alley sander. Insert at top shows the new sanding drum. Below, combination sander with side spinner in place for sanding edges

Power Sander Has "Edger" Adapter

Serving as both a standard floor sander and an edger, a combination power sander has a side adapter that enables it to sand close to the baseboard. Invented by O. E. Hadwiger of Pueblo, Colo., the machine uses a hinged aluminum drum that snaps open for quick replacement of the paper. The adapter consists of a caster-equipped carriage on which is mounted a horizontal sanding disk. Attached to the side of the machine, the carriage supports it when it is tipped on its side for edge sanding. Hadwiger also designed a sander for bowling alleys. Its two sanding belts travel in opposite directions. The sander moves down the alley at a steady speed and reverses when it reaches the end of the alley.

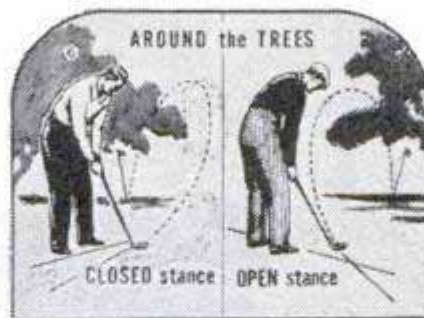
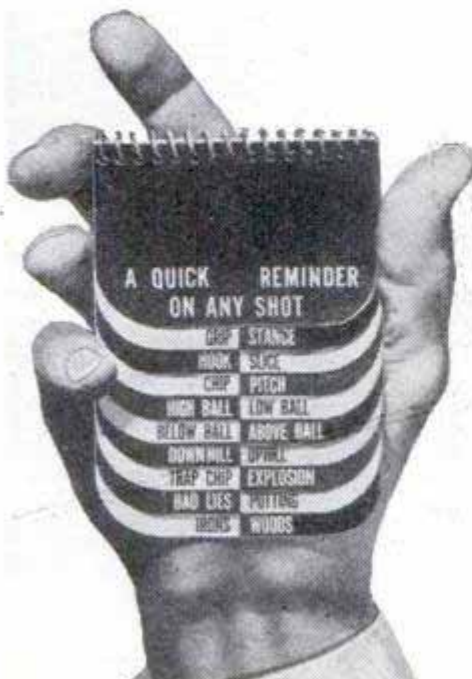

Book Gives Golfers Coaching on Links

Proper club, grip, stance and stroke for every golf shot is described in a booklet small enough to be carried in the hip pocket and consulted during play. Each shot is diagrammed to help the golfer keep a mental picture of the correct swing.

☐ In 1948, traffic deaths in the United States dropped one percent from 32,500 in 1947 to 32,200, but injuries increased eight percent to an all-time high of 1,471,000.

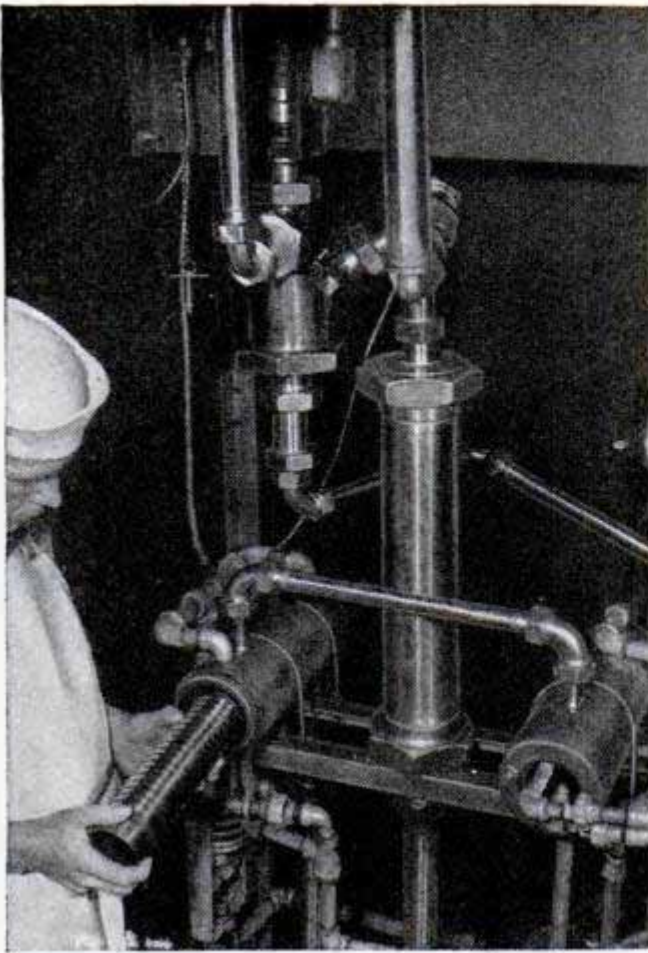

Above, removing the core of the flash pasteurizer which heats milk without burning it. Below, yellow portion of drawing is path of milk from cow to can

Canned Fresh Milk Is Coming



THAT GOOD old American custom of stepping out on the porch each morning to bring in the milk may soon take its place beside the morning jaunt to the well in history books and memoirs. If a fresh-milk canning process under development at an Indiana dairy farm proves successful, housewives may buy milk in cans at the corner grocery just as they buy canned vegetables today.

For years, canners have tried to can fresh milk. The new Stambaugh-Graves process

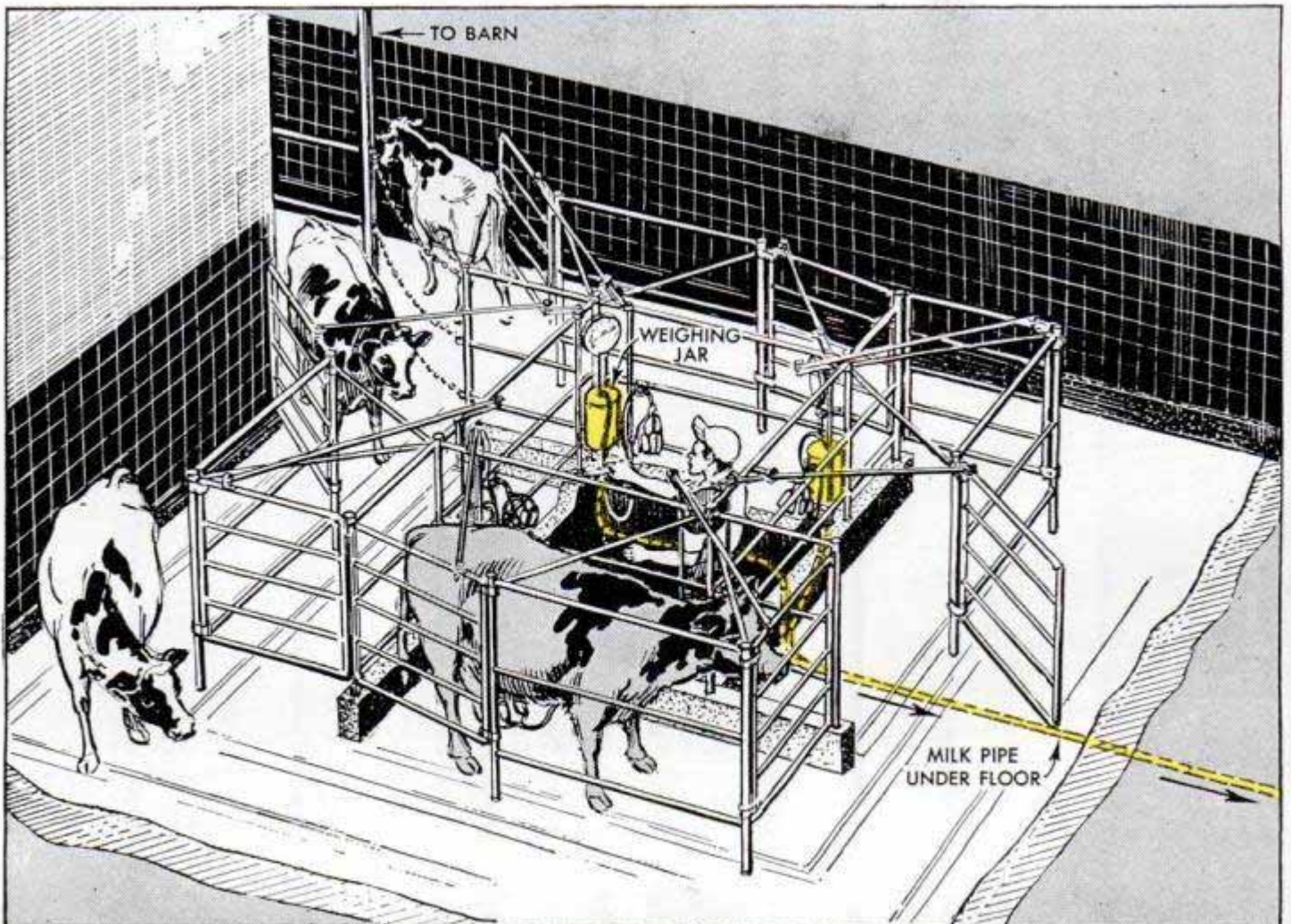

may be the solution. Developed by Dr. Roy R. Graves, former scientist with the Department of Agriculture, the technique has produced sample batches of milk that kept its fresh flavor several months after it left the cow.

There's a double secret behind the process. First, the milk is produced with an amazingly low bacteria count (less than 500 per cubic centimeter) and is piped from the cow to the can without exposure to the air. Second, a flash pasteurizer, developed by Graves, kills what few bacteria are present without leaving a heated taste.

In groups of four, the cows are milked in a spotless milking parlor and the milk is drawn through pipes into a vacuum tank in the canning room. From the tank, the milk goes through a homogenizer and the new flash pasteurizer where it is heated to 190 degrees. The pasteurizer consists of two steam jackets between which the milk is forced in a fast, turbulent stream to prevent scorching. Spiral grooves in the core section create the turbulence. A diversion valve sends the milk back into the tank for repasteurization if, for any reason, the temperature is not high enough to meet the requirements of the process.

After partial cooling, the milk is piped to a tank on the canning machine. A positive pressure of nitrogen inside the tank and

canning chamber of the machine keeps all air away from the milk. After a final sterilization inside the can, the milk can be stored at room temperature.

Still not perfected for commercial production, the system has produced test milk that tastes fresh after several months. The big unknowns as yet are the best preheating and sterilization temperatures. Because milk has to be heated to high temperatures so that it will not lose its fresh flavor over long periods of time, the problem is to do this without spoiling its delicate taste.

The pilot-model canning machine, provided by the Continental Can Co., sterilizes the cans and covers in boiling water before they enter the filling chamber. This is standard aseptic canning procedure. The canner's problem is to determine the best lining for the can so that no tinned flavor will be given to the milk.

These problems can be solved and Graves is sure that canned fresh milk is coming. When his process becomes commercially practical, you'll buy fresh milk at the store by the case. Distribution problems will be simplified since canned milk can be handled like any canned food. When you're ready to use it, you'll chill the can in the refrigerator and the milk you pour will look and taste just like the milk you used to get down on the farm.

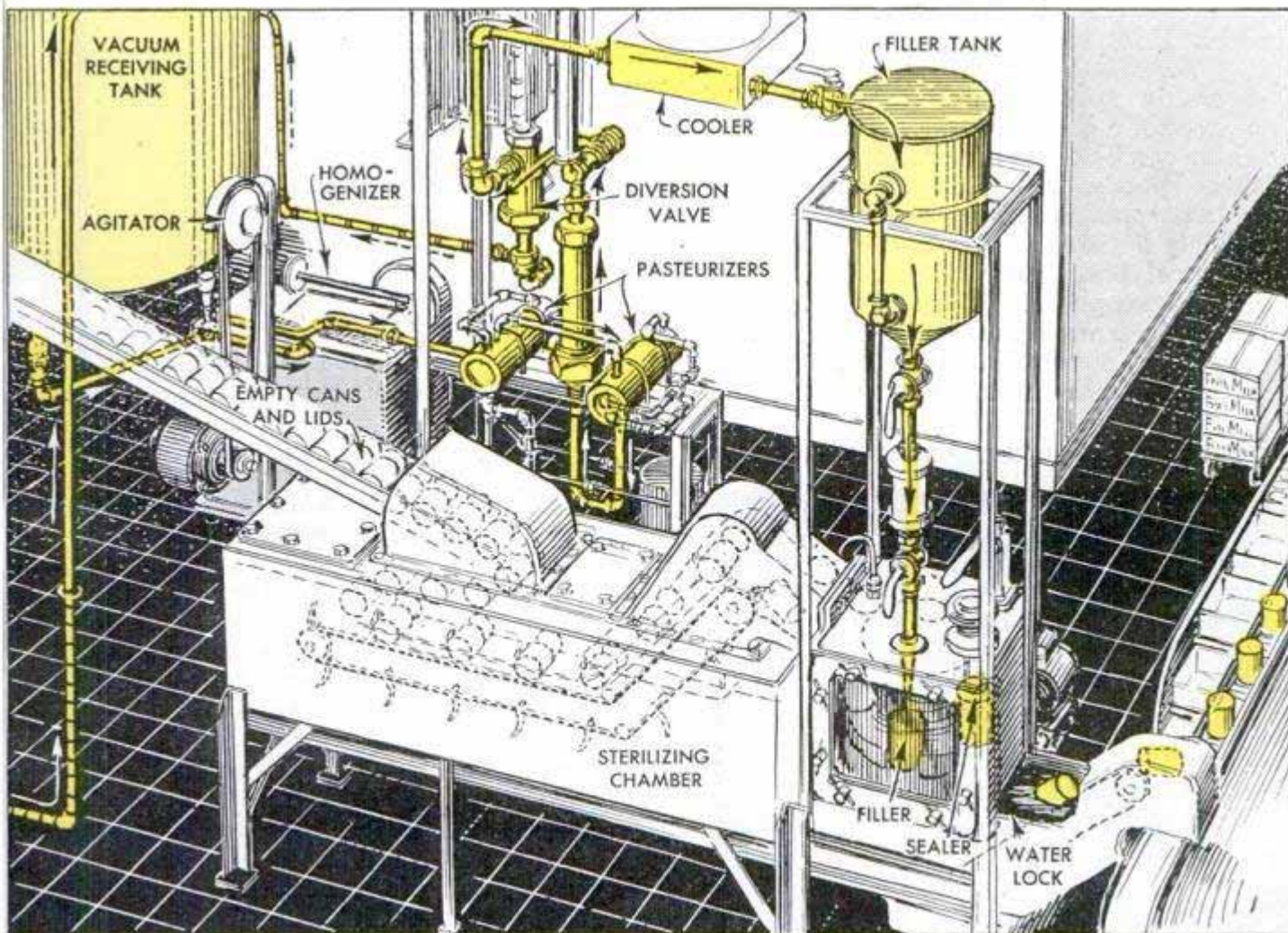

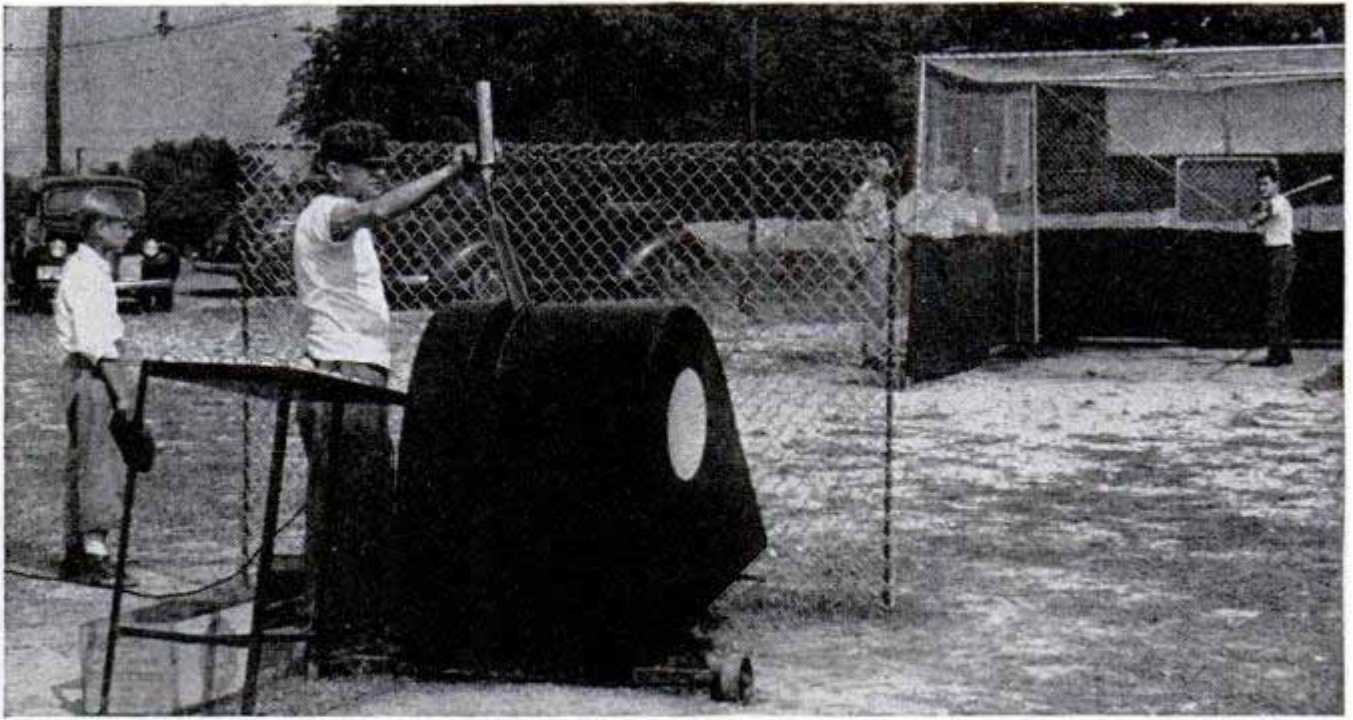

Mechanical pitchers, like the one being "loaded" above, are making public batting ranges popular in the East. The screen protects the operator. Below, a compressed-air pitching gun

Mechanical Pitchers For Batting Practice

Delivering an overhand fast ball that is always over the plate, a mechanical hurler can pitch all day without tiring. The machine, unlike the gun-type mechanical pitcher, throws with an overhand motion that enables the batter to time his swing just as he does in a ball game. Used by the Brooklyn Dodgers in spring training and also at public batting ranges, the machine can be set to throw at any of three speeds. The pitches have an unusual spin that gives them an extremely flat trajectory. Another mechanical ball tosser resembles a long telescope that is mounted on a tripod and fires baseballs by compressed air. A muzzle on the tube can be adjusted to make the balls curve, spin and

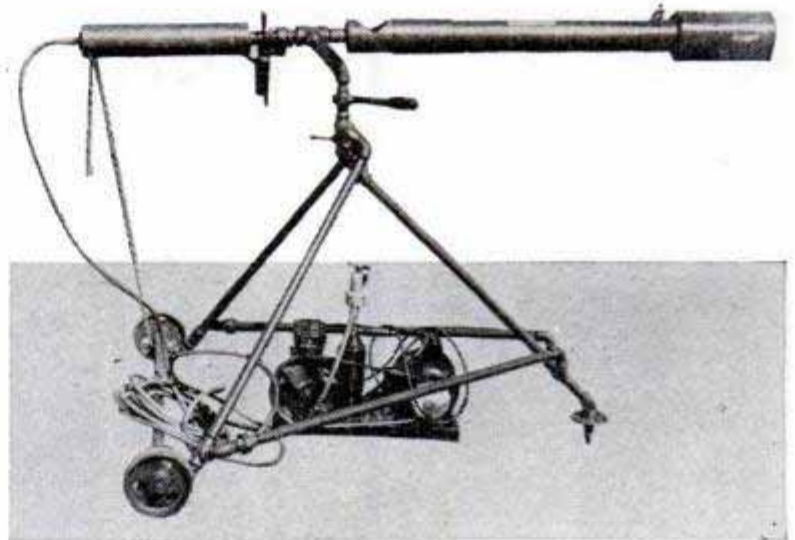

thus throw a curve in any desired direction. The device is also used to throw grounders, flies and line drives for field practice.

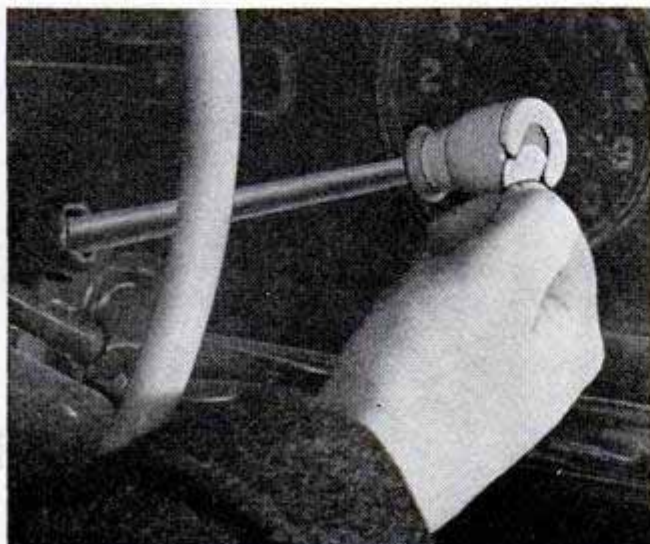

Coin Holder on Gearshift Lever

Small change for parking meters, toll bridges and newspapers is kept handy for the motorist by a gearshift coin holder that replaces the knob on the shift lever. Made of a plastic, the coin holder has a coiled spring that feeds the coins toward the removal slot. It will take any coin from a cent to a quarter in any sequence.

By quick-freezing bacteria and evaporating the ice under a high vacuum, Department of Agriculture veterinaries have preserved for more than nine years the cultures necessary for inoculation of cattle against shipping fever.



Driving Light Inside Grille Turns With Front Wheels

Designed to fit inside the center circle of the new Ford grille, a driving light swings laterally as the wheels are turned, illuminating the road when the car goes around a corner. The light is a Sealed-Beam fog-light unit with a clear lens. Because it swings about one third faster and farther than the wheels, the light shows the driver what's around the corner. A disconnecting mechanism frees the light's turning mechanism should the unit become frozen in the grille by an accumulation of ice or snow during winter driving.



Sidewalk Automat

Holland has copied New York City's Automat and moved it outdoors. The coin-operated cafe takes up the entire front wall of a small restaurant. You drop in your money and take your food to a nearby table on the sidewalk.

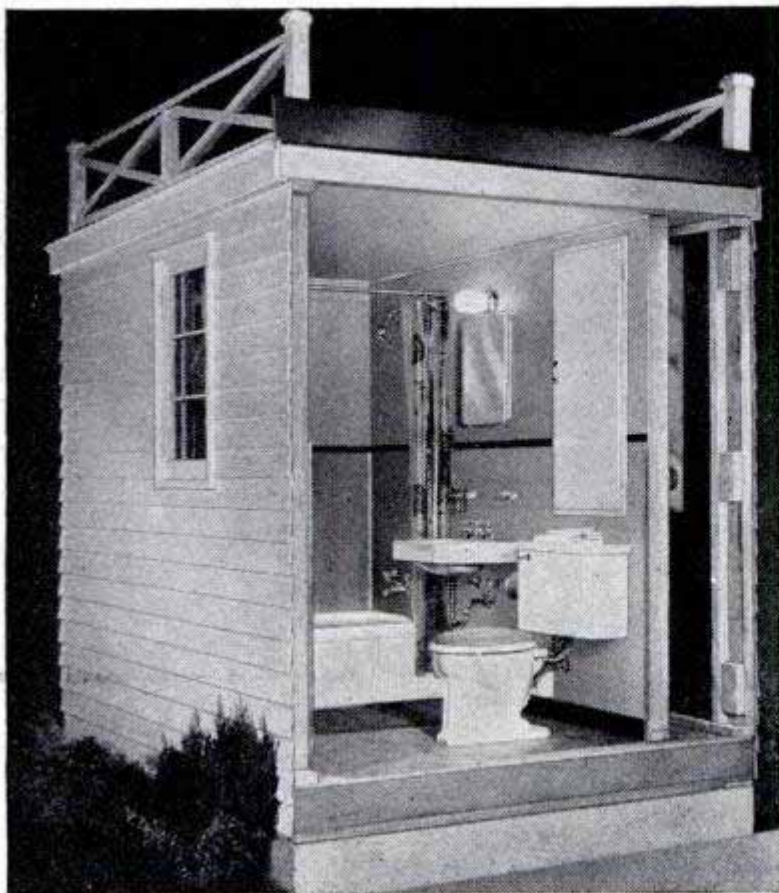

Bathroom for Home Shipped As a Unit

Shipped as one big package, an extra bathroom for your home comes complete with everything from a linen cabinet to a built-in electric heater. All fixtures are factory installed and adding the room to your home requires only four connections, one electrical, two water and one for the soil pipe. Of frame construction, the bathroom unit is insulated on walls, ceiling and floor. A specially designed connection assures a tight, permanent junction to the exterior wall of the house, whether it is frame, stucco, brick or veneer.

Many of the products described in this issue are already available or are ready to be marketed. For the names and addresses of manufacturers or distributors, turn to the WHERE-TO-BUY-IT INDEX, starting on page 10

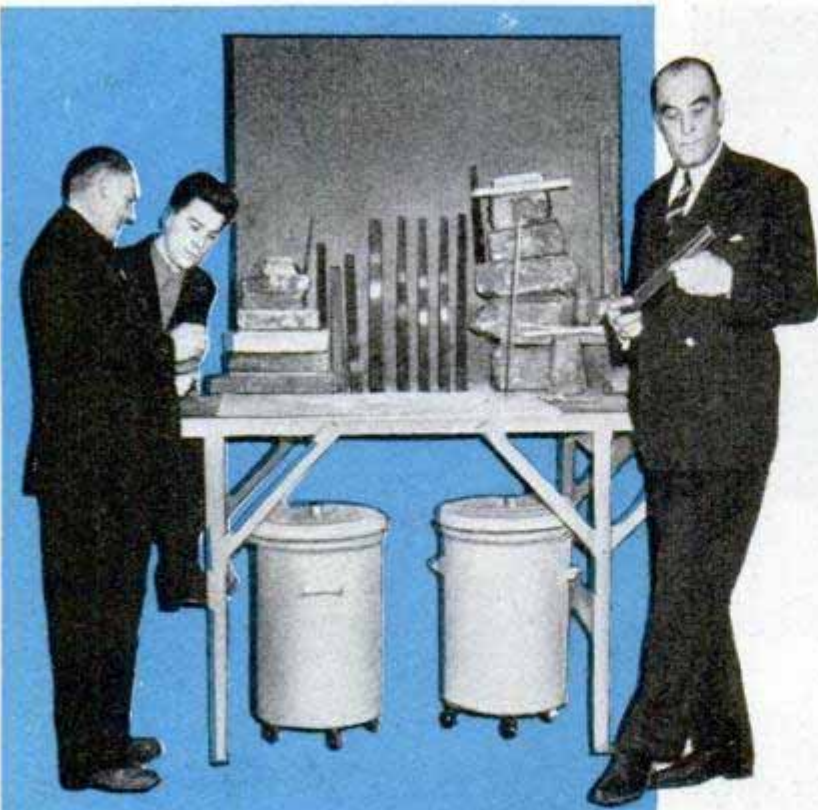

Dudley (at right) and assistants examine some of the pig iron and stainless-steel bars the little steel mill can turn out in a few minutes

IMAGINE a factory that produces any kind of finished steel within an hour of the time ore is poured into the machinery. Imagine a steel mill that converts any type of iron ore, even the lower grades, into pig iron or stainless-steel bar—and does it without smoke, noise or dust.

Such a steel mill exists—a pilot plant in Canada that may be the forerunner of similar plants. They could produce any type of processed steel right at the locations where the ore is mined. The pilot plant at St. Johns, Que., is as spick-and-span as a modern metropolitan shop and occupies an area measuring only 55 by 60 feet.

The new process, which could produce a steelmaking revolution, is the invention of Walter E. Dudley, who has demonstrated publicly that he can pour a batch of low-grade ore into one end of his machinery, talk for an hour or so and then pick up a finished bar of stainless or high-grade tool steel from the other end. Furthermore, he says it is possible to produce higher grade and higher heat-resisting steels or metals than those now turned out by conventional processes.

Timing, weight transit and heat control form the heart of the Dudley method. Dudley moves a definite amount of ore through the machinery at a rate timed almost to the split second. He thereby saves the valuable time generally lost in heat-

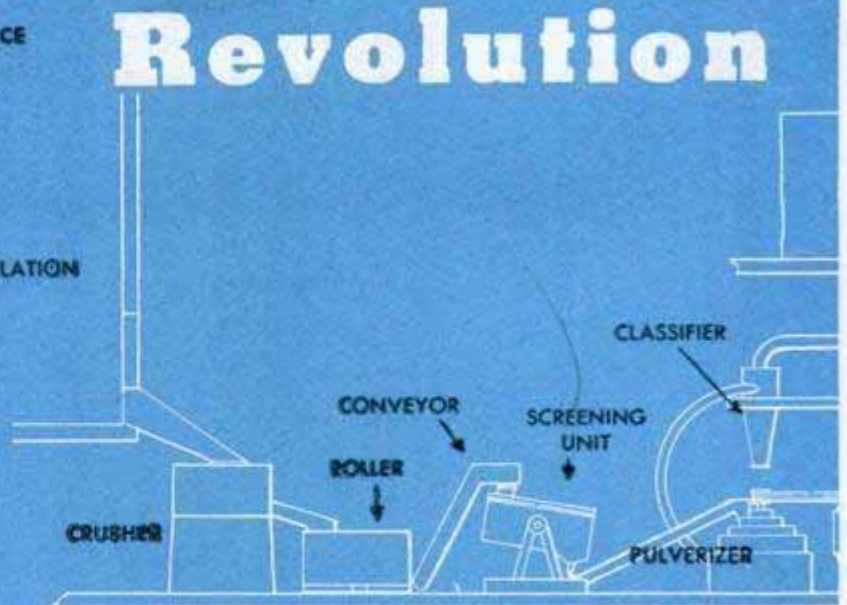
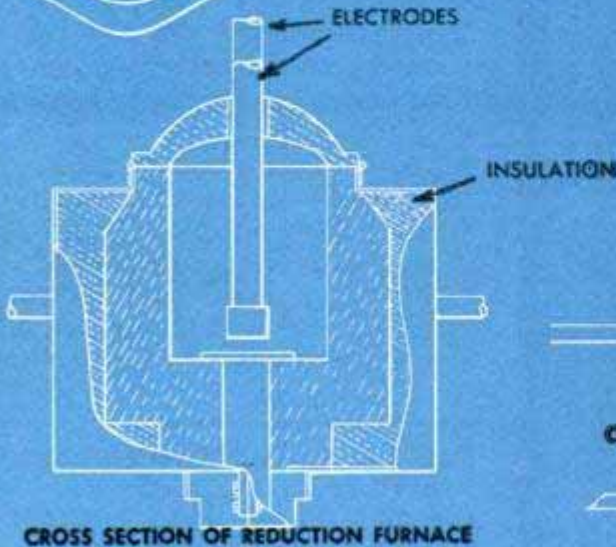
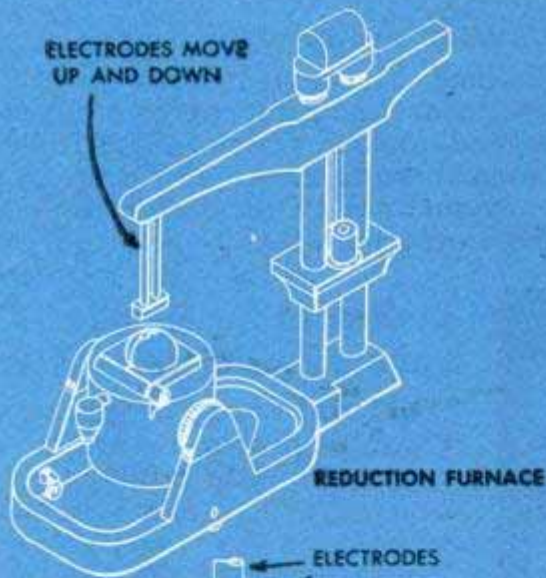

Revolution

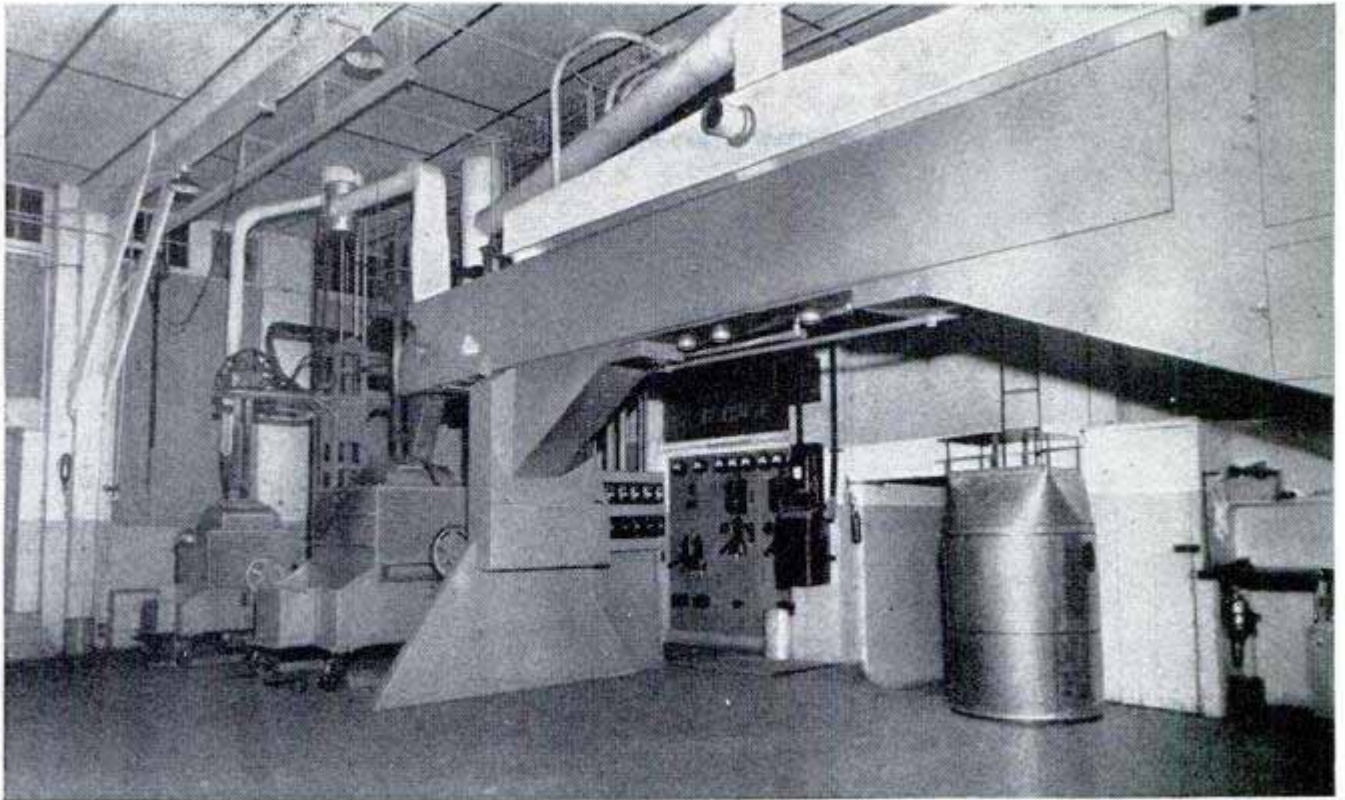

Long enclosure in this "assembly line" is the preheating oven. Beyond is the efficient little reduction furnace

ing, cooling and reheating the material.

Ore, weighed to exact poundage per minute, is transferred into the crusher, where it is crushed to small particles. Clay and sand ores may be used without crushing, but must pass through the pulverizer.

After leaving the crusher, the ore passes through a set of rolls, then on to a screening unit where the particles are sized. The particles then travel to a pulverizer, where they are reduced to a fine powder—300 mesh or finer. Inside a classifier these particles are sorted even further and air that

has been introduced into the powdery mass is eliminated. All ore except the very finest dust particles is reclaimed, thus keeping the weight virtually unchanged.

This powdery mass of ore then pours into the batch mixer where it is thoroughly combined with ingredients that include material for binding the powdered ore into briquettes, and reducing agents that yield iron from ore inside the furnace. These ingredients are mixed with the ore to produce a moist mass.

The ore then passes through a mechanical

In Steelmaking

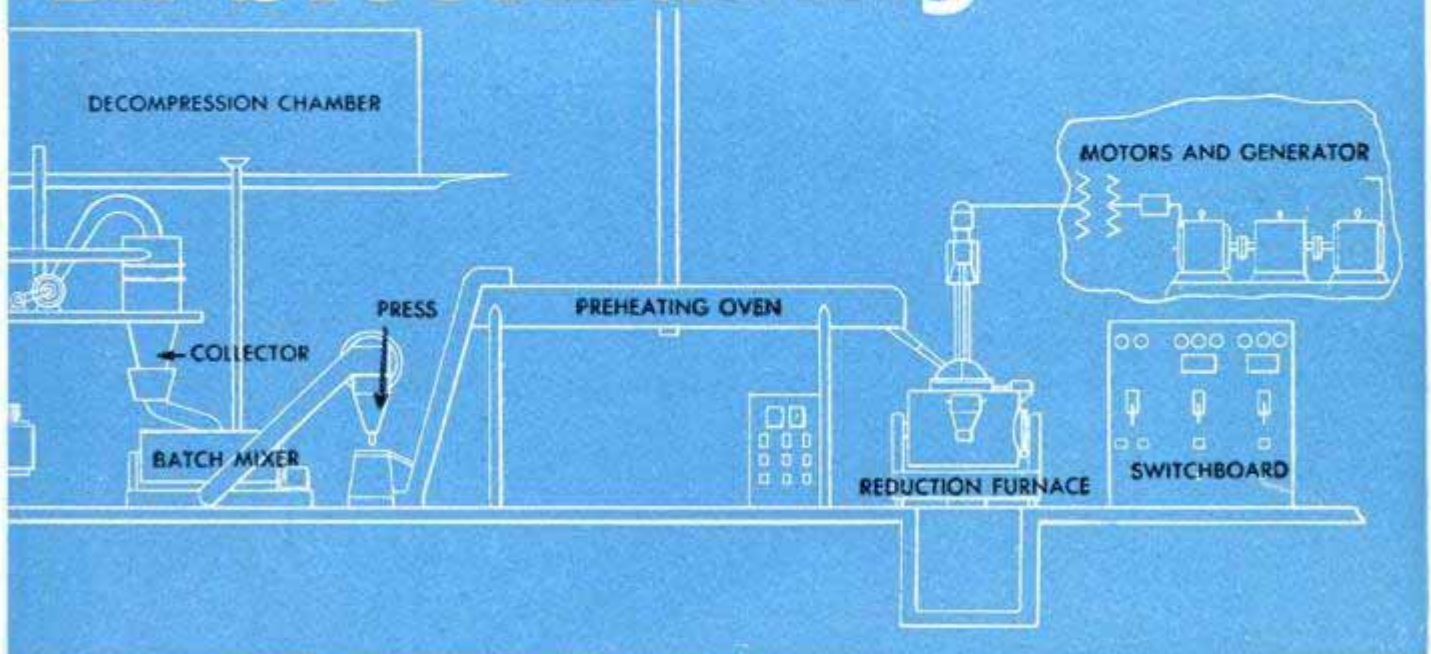

device that spreads it evenly upon a traveling preheated belt conveyor, which carries it to a press. It is then pressed into briquettes about $\frac{1}{2}$ inch in diameter. From there the briquettes are carried, still on a minute-poundage basis, to a preheating oven about 25 feet long. At the beginning

they are subjected to a temperature of about 200 degrees, but by the time they drop from the oven to the furnace the temperature is 500 degrees.

The briquettes fall through a metal spout which is discharging the heated gases from the furnace. The actions of the furnace's electrodes and the preheating belt are closely timed. When the hot electrodes go down, the oven stops delivery; when they rise, the oven begins delivery.

This reduction furnace, which corresponds to the blast furnace in conventional operations, deserves special attention. Electric current plus the reactions of the reducing ores, produce a temperature of 3000 to 7000 degrees with maximum efficiency, yet if you touch the outer shell of the furnace with your hand, you'll find it to be room temperature. The secret is a special type of insulation that holds all the heat in the melting zone of the furnace. Because the operation is continuous, the furnace is small and can be operated at the ore source.

At this stage in the process the furnace has converted the ore briquettes into molten iron, which is poured off at definite time intervals. The resulting pig iron may be shipped out for later use, or can be poured, still in a molten stage, into a small refining furnace. In this furnace the iron is processed to produce any type of steel.

The capacity of Dudley's pilot plant is small — 500 pounds of low-grade steel or 100 pounds of high-grade steel per hour—but the product can be turned out at a cost which Dudley says is below conventional methods.

Such plants might be moved right to the low-grade ore beds to turn out steel billets. Thus, only the steel instead of a large mass of ore would be shipped.

With the equipment operating at a continuous high speed, the operator can pour finished steel bars or billets every half hour.

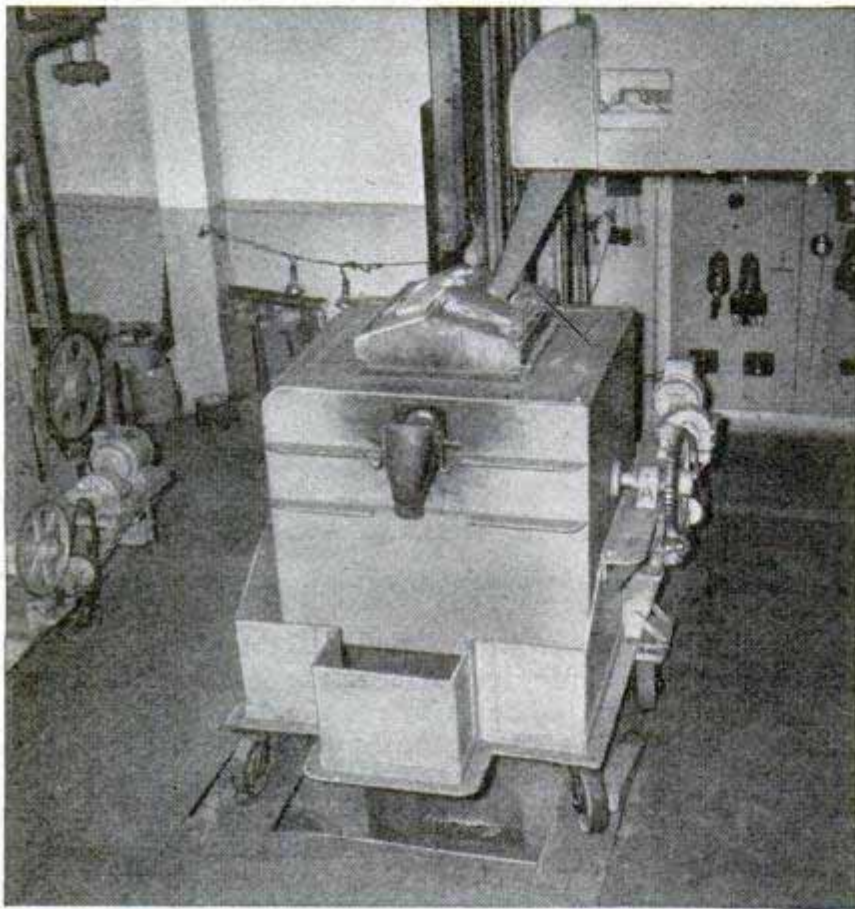

Reduction furnace has hot electrodes that move up and down at timed intervals to heat the ore briquettes. Below, ore is fed into the crusher. The assistant at the right is inspecting the resulting powdery mass

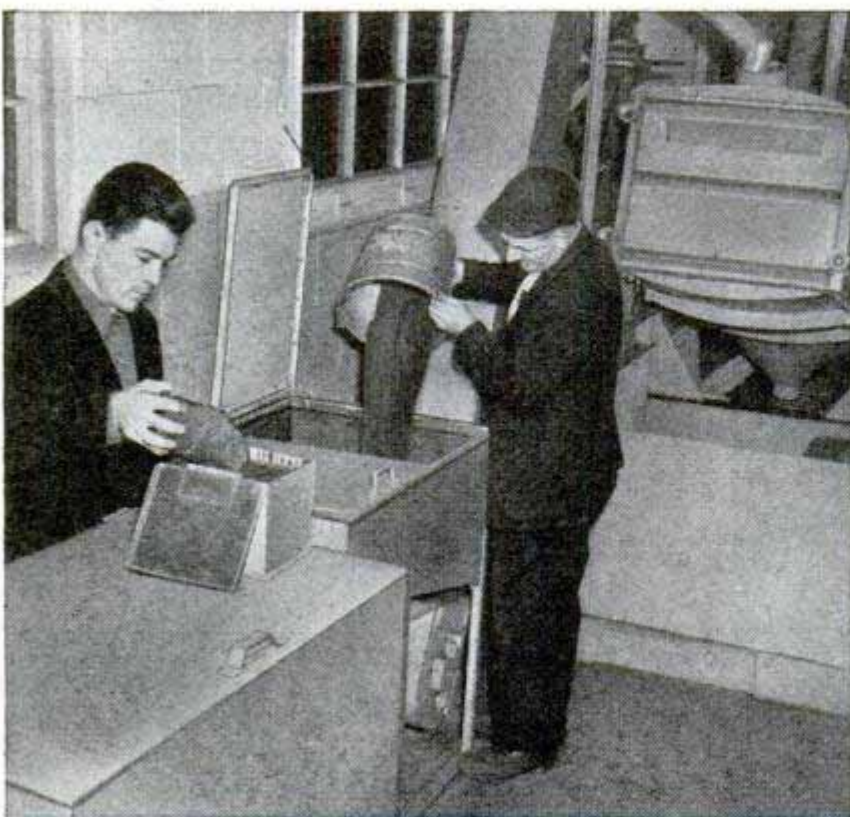

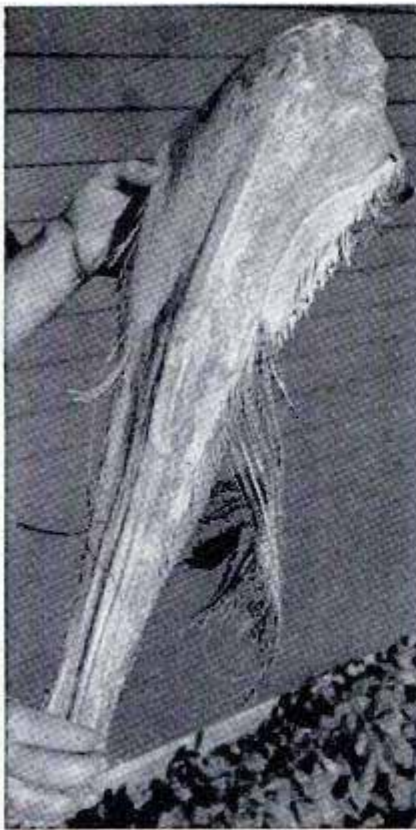

Above, the mask-maker selects a palm stem that is the right size and shape for the finished face. Above right, completed masks become wall decorations. Right, features are painted over base coat

Palm Stems Make Eerie Masks

Some people see portraits in clouds or profiles on jagged mountainsides, but Richard Romecq of Sherman Oaks, Calif., has found imagery in the stem of a palm leaf. He creates such unusual masks from the stems that they are fast becoming popular for masquerade and theatrical use and for wall decorations. The hobbyist uses the bulging center of the stem as the nose. He paints the entire stem with quick-drying enamel to give it complexion, then adds the features suggested by African and Indian ceremonial masks. The fiber on the edges of the stems is sometimes left on to give the mask a whiskery effect.

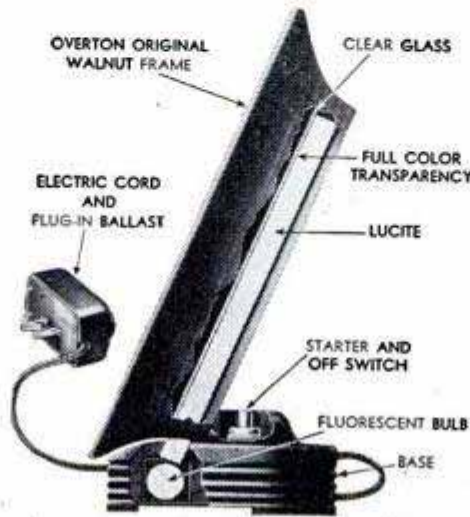
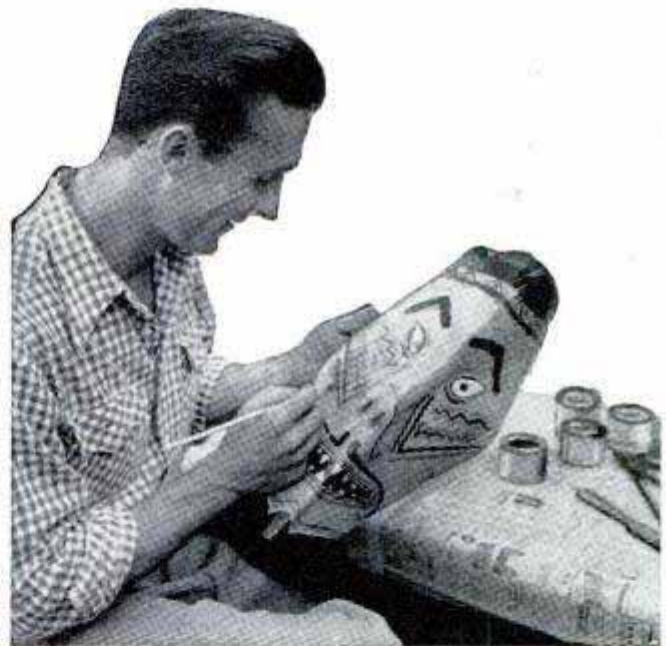

Edge-Lighted Frame Shows Color Pictures

Color transparencies can be displayed without a projector when mounted in an illuminated walnut frame. The transparency is sandwiched between a sheet of glass and a piece of Lucite. In the bottom of the frame is a four-watt fluorescent bulb. When the switch is turned on, the light passes up through the Lucite block to illuminate the color photograph.

"SPIDER" carries a human fly

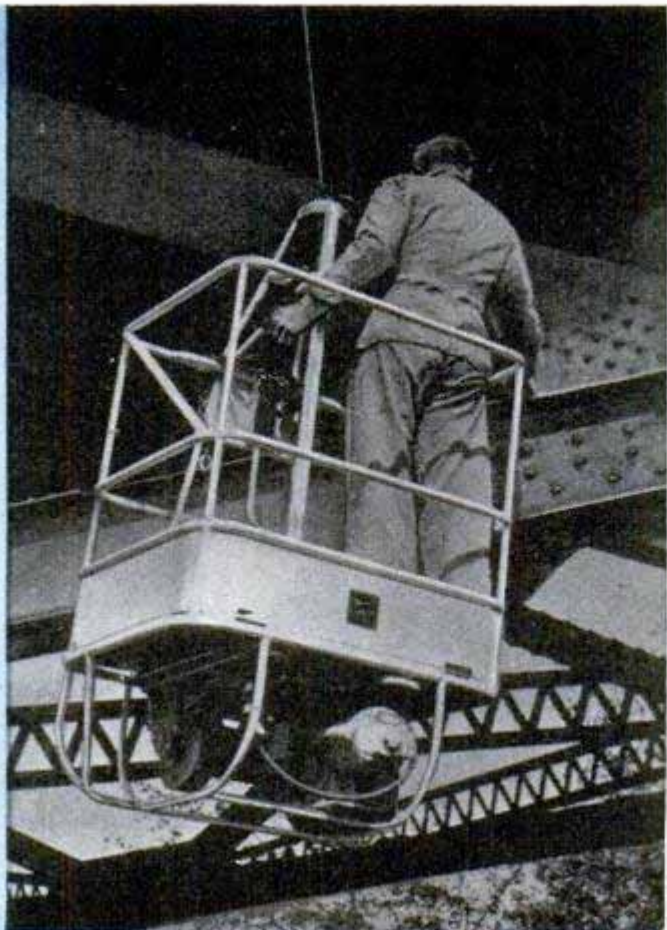

Dangling beneath a bridge, the staging supports a repairman directly in front of his work, regardless of where that work may take him on the structure

PAINTERS or repairmen can scale a steel tower or crawl beneath the girders of a bridge aboard a small platform that travels under its own power. The agile little stage can go almost anywhere on a steel structure. It is built of aluminum alloy and has a double guard rail that surrounds the operator. The stage is suspended on a wire rope which winds on an electric power drum beneath the platform. The workman can ascend or descend vertical drops up to 650 feet at an average speed of 18 feet per minute. Furthermore, he can move horizontally along a girder. When he comes to a cross member, he reaches beyond it and attaches a transfer chain which supports the platform as it swings under the obstruction. Three independent braking systems prevent the stage from falling.

← When workman meets a cross member while moving horizontally beneath bridge, he swings himself beyond with a transfer chain. Below, the drum and $\frac{1}{3}$ -horsepower motor are beneath stage

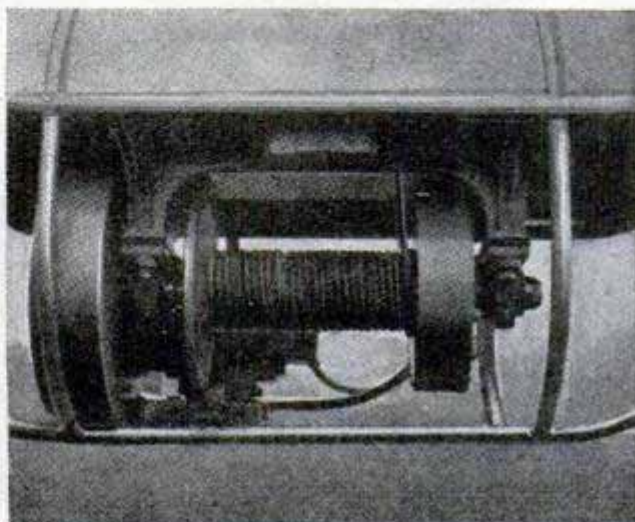



The Bay Bridge Is to Have a Twin

Here's how the San Francisco-Oakland Bay crossing will look when the twin, shown in black, is finished

By Thomas E. Stimson, Jr.

ALREADY spanned by the two largest bridges in the world, San Francisco Bay is to have a third great structure built across its deep, turbulent waters.

The Golden Gate Bridge that stretches across the entrance of the bay is the longest single suspension span in the world. In total length it is second to none except its neighbor around a corner of the harbor, the San Francisco-Oakland Bay Bridge that reaches across $4\frac{1}{2}$ miles of navigable water. This mighty double-deck structure

connects San Francisco to Yerba Buena Island by means of two suspension bridges placed end to end, then tunnels through the island and continues on to Oakland by a series of cantilever and simple truss spans. Counting its approaches, the crossing has a total length of $8\frac{1}{4}$ miles.

When it was built in 1936, it was thought to be adequate for at least half a century. No one dreamed that its six lanes for cars, three lanes for trucks and two lanes for trains would become choked with traffic

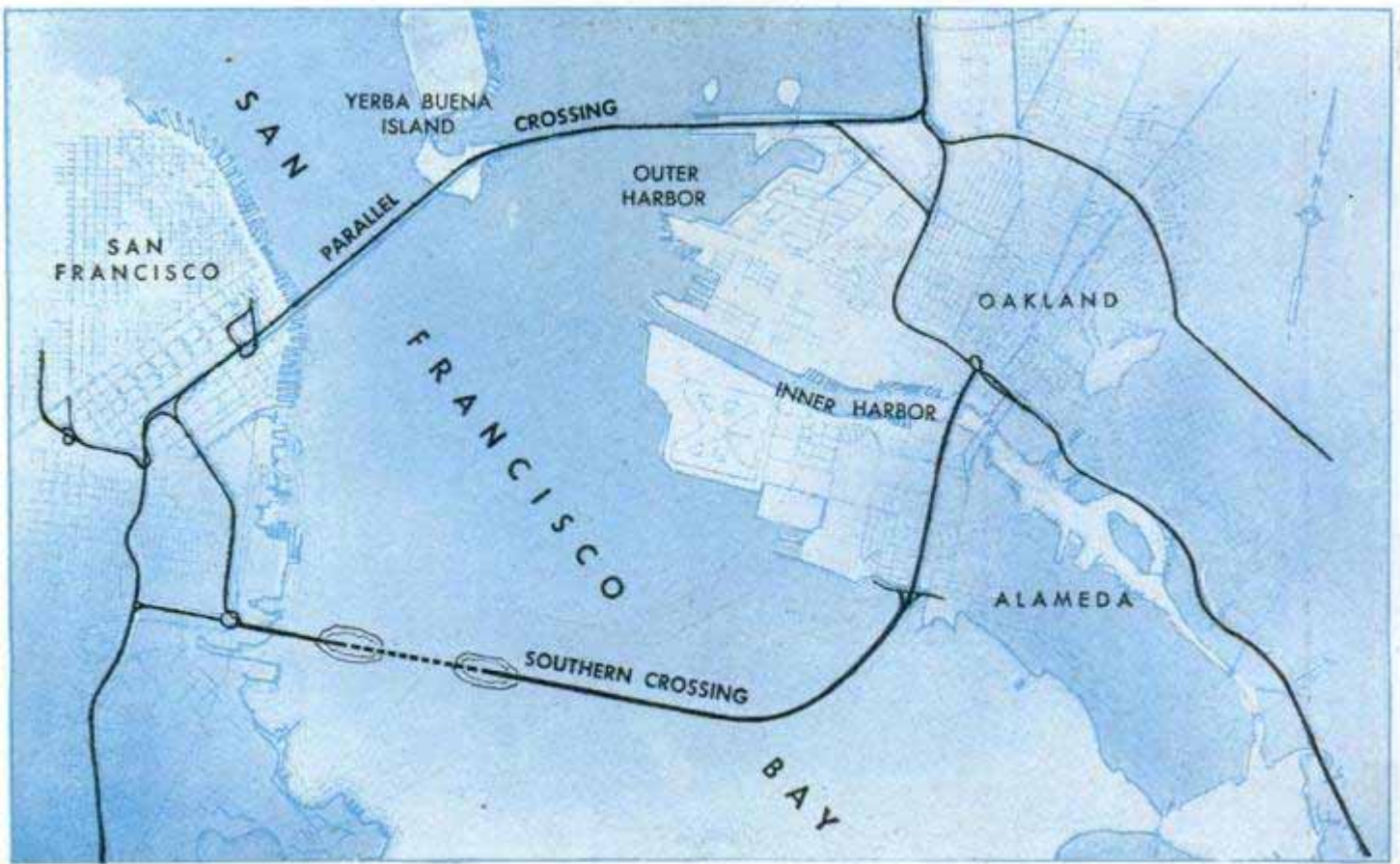

Parallel crossing will help carry northern traffic, proposed underwater crossing would span bay farther south

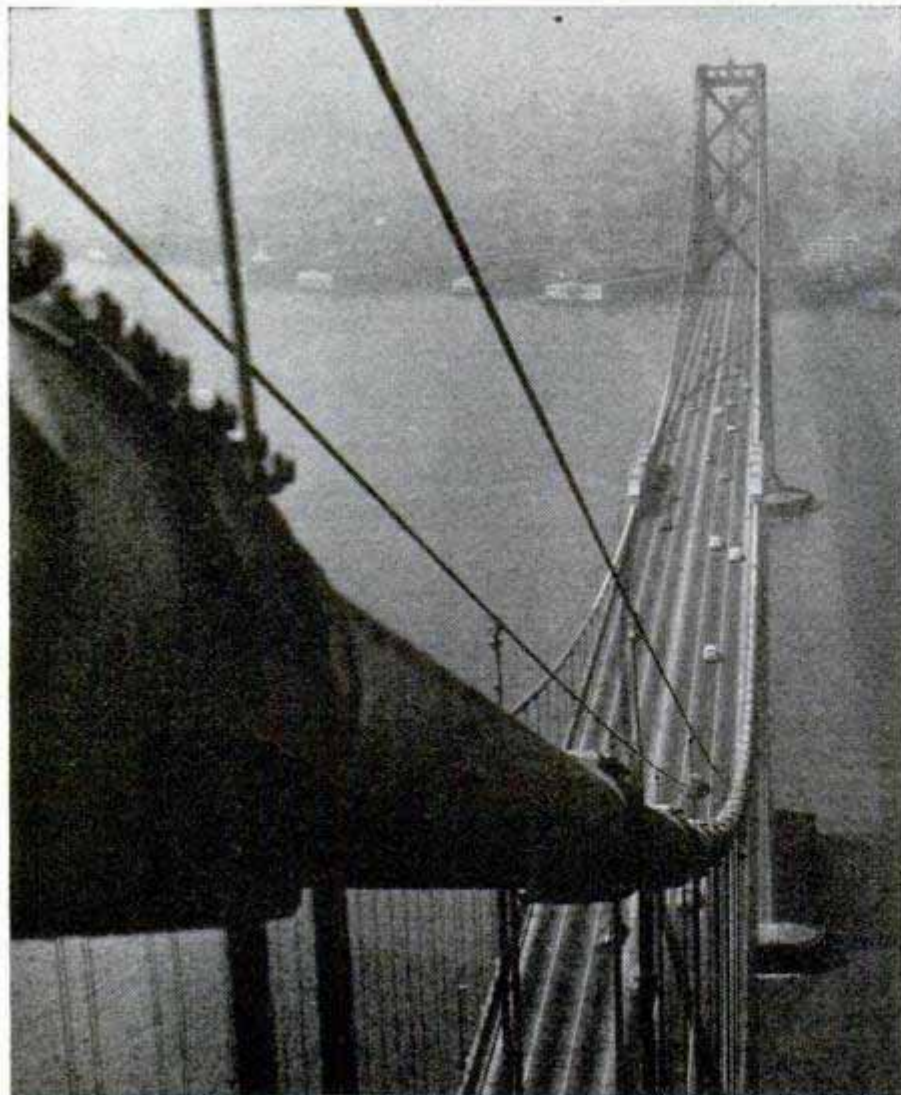

Bay Bridge, shown during a lull, handles 4500 cars per hour during rush

in little more than a decade. Today, some two million cars are using the bridge every month, a total of some 26 million vehicles for 1948. During morning and evening rush hours the traffic is at the rate of 4500 cars per hour. Including all types of transportation 200,000 people cross the bridge every day.

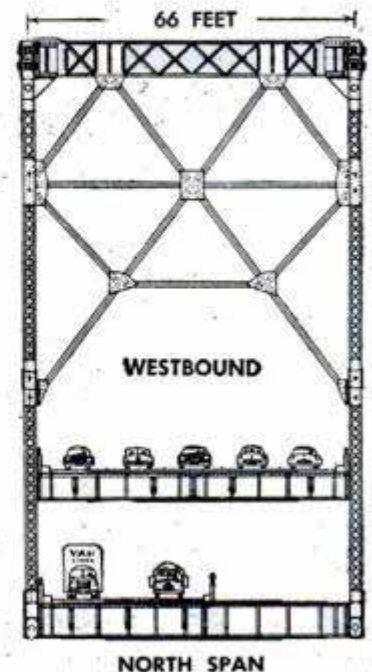



Mighty Golden Gate Bridge across the entrance to the bay is the longest single suspension span in the world

On one busy Sunday when an accident tied up several lanes on the bridge, cars were stacked up for 10 miles and it was hours before the jam was untangled.

To relieve this congestion and to prepare for greater traffic in the future, California is planning to build a duplicate bridge beside the existing one, then make each structure a one-way crossing. This would reduce the number of accidents, ease the present crowded condition and permit traffic to continue to move at its present speed

of 45 miles per hour. Construction is scheduled to start next year, with the bridge to be opened for use in 1954. Test borings have been completed and preliminary plans have been drawn.

The new structure will parallel the existing bridge about 325 feet north of it. Because of its greater radius around one curve, the new bridge will be slightly longer than the present bridge and thus will become the world's longest, by a fraction of a mile, when it is completed.

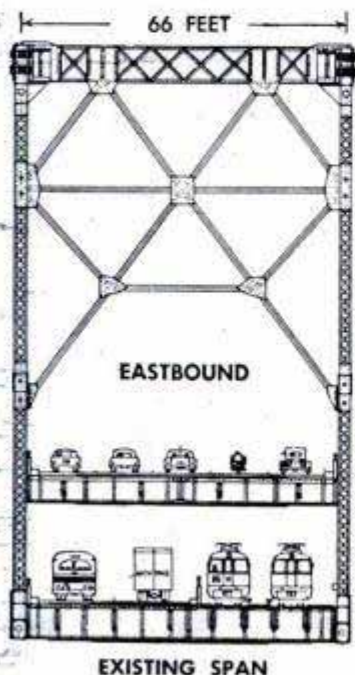

Right, using a barge with derrick, engineers make sediment samplings of bottom. Samples will be used in designing the new span

← Sketches show how traffic will move on the existing span and the parallel bridge. Each bridge will carry traffic one way, with the lower lanes for truck use only

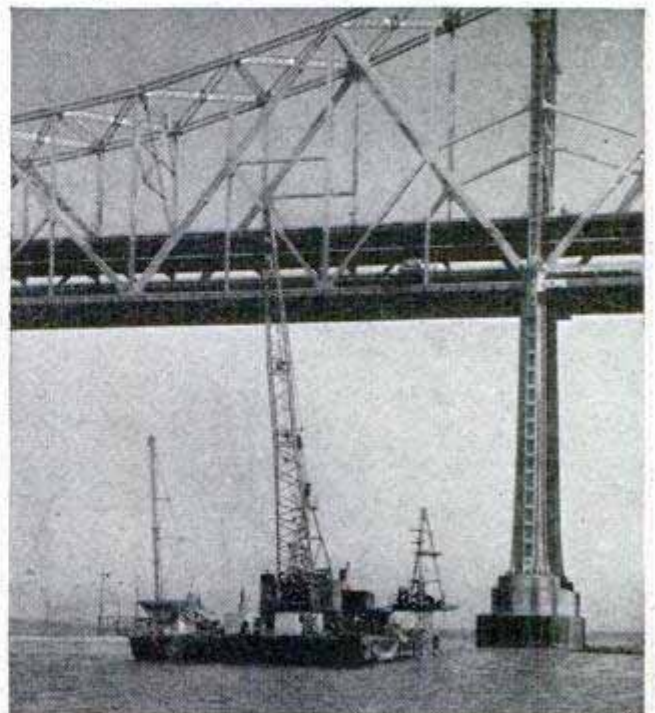

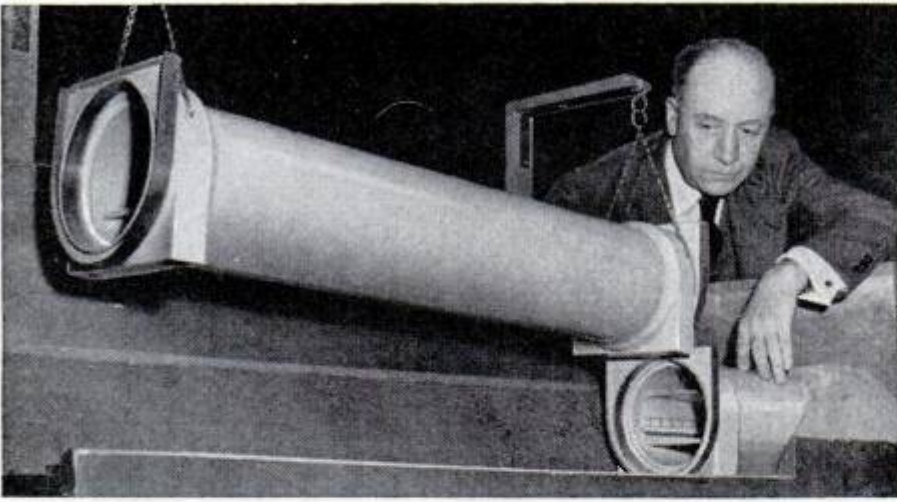

Southern crossing will consist of underwater tubes. This model was built by engineers to help work out system for sealing tube sections together

California has been making plans for some kind of additional bay crossing since 1945. During the past three years the state Department of Public Works has studied numerous proposals including high-level bridges at various locations and tunnels under the bay. One suggestion contemplated a series of dams with a highway along the top.

Of all the suggestions, the idea of a par-

allel bridge seemed the most suitable after surveys showed that 82 percent of cross-bay traffic would best be served by increasing the facilities at the present location. A percentage of traffic would prefer a crossing somewhat south of the present bridge. Possibly before the new bridge is completed a so-called "southern crossing" that will connect southern San Francisco with Alameda across the bay will also be under construction.

Another reason why the engineers recommended a parallel bridge is that the existing structure has proved eminently satisfactory from the standpoints of design and construction. It was a daring and unprecedented achievement at the time it was built, and time has proved that the plans were sound and the materials adequate.

The towers of the present bridge rise 700 feet above bedrock, 520 feet above the

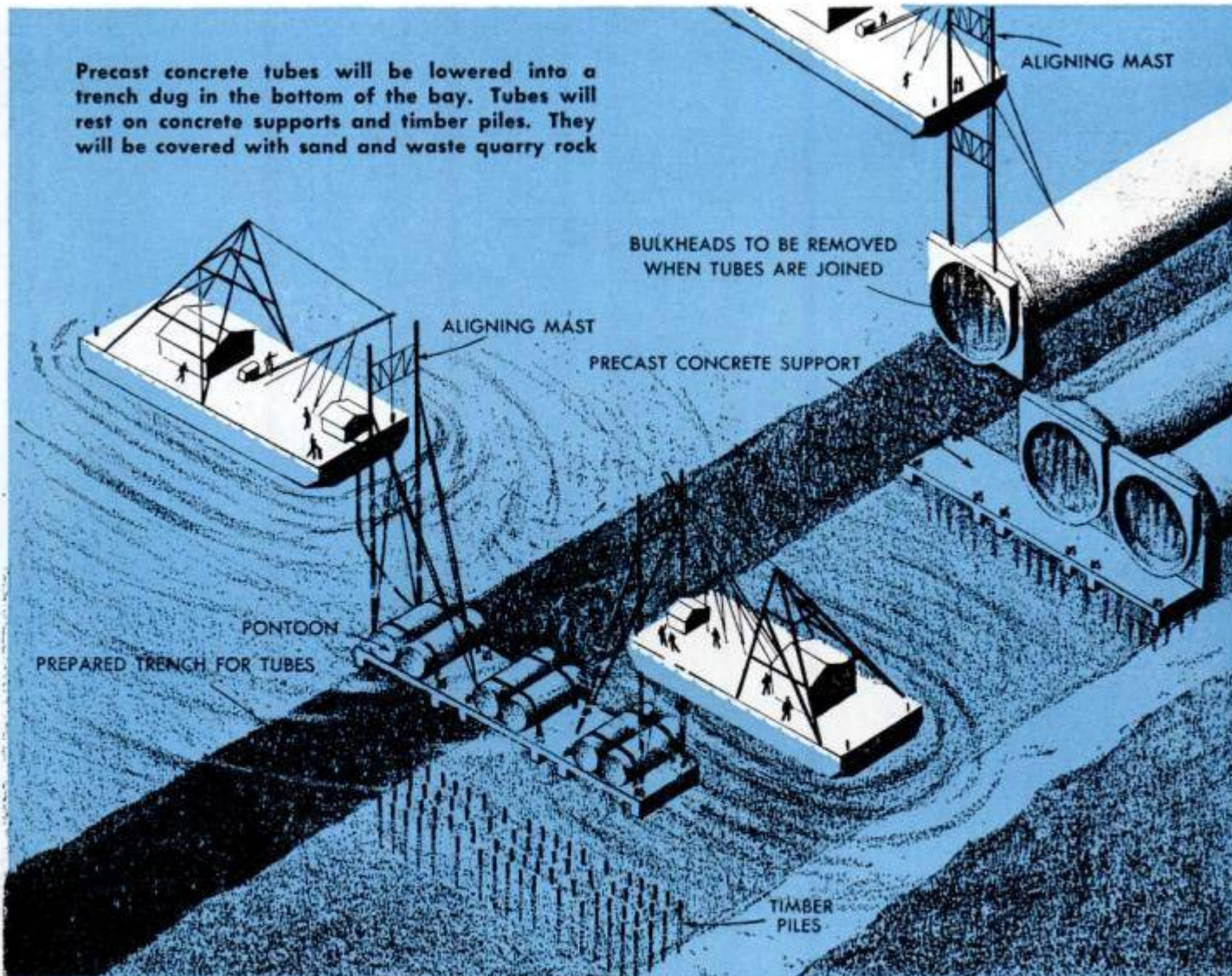

surface of the water. Each suspension span is 2310 feet long between its towers, with side spans of 1160 feet each. The two suspension spans come together at a central anchorage that contains 335,000 tons of steel and concrete and that rises up from the bottom of the bay to the level of the bridge roadway.

Each of the two suspension cables that supports the roadway contains 17,464 individual strands of wires. At the San Francisco end these cables are anchored in a monolithic concrete block that contains 68,000 cubic yards of material; at Yerba Buena, the island itself serves as the anchorage for its end of the cable.

It would be difficult to improve the present bridge, so only a few minor changes will be made in building the new one. Some of the rolled structural shapes are no longer available and other shapes of equal strength will be substituted. Possibly the cable saddles on top of the towers will be made of welded steel rather than of cast steel. These would be as satisfactory and somewhat cheaper. The portion of the bridge extending from Yerba Buena Island to Oakland, likewise, would duplicate the present structure in most of its features.

The principal difference between the old and the new bridges, the engineers declare, will be the cost. The old one, with its approaches, was built for less than 78 million dollars, a huge sum that now appears to have been a bargain. The cost of its duplicate will total about 155 million.

The present bridge is designed to withstand any anticipated earthquake shocks and is insured against all except war risks to the amount of 34 million dollars. The parallel structure will be just as strong but insurance companies will increase their present protection by no more than five million dollars to cover both bridges. The trouble is that there is not a sufficient combined insurance capacity in the world to warrant doubling the present coverage.

The present San Francisco-Oakland bridge has three lanes in each direction on its upper deck and these will be changed to provide five wider lanes, eastbound, when its mate is finished. The new bridge similarly will have a five-lane one-way upper deck for westbound travel. The lower deck of the present structure will be changed to provide two wide eastbound lanes for trucks and busses, while the lower deck of the new bridge will have two wide

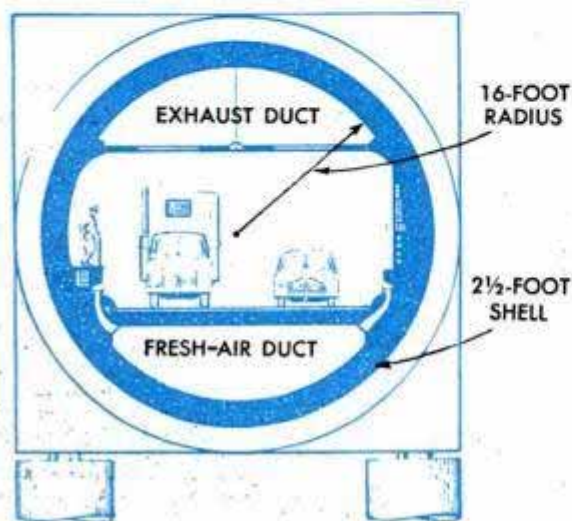
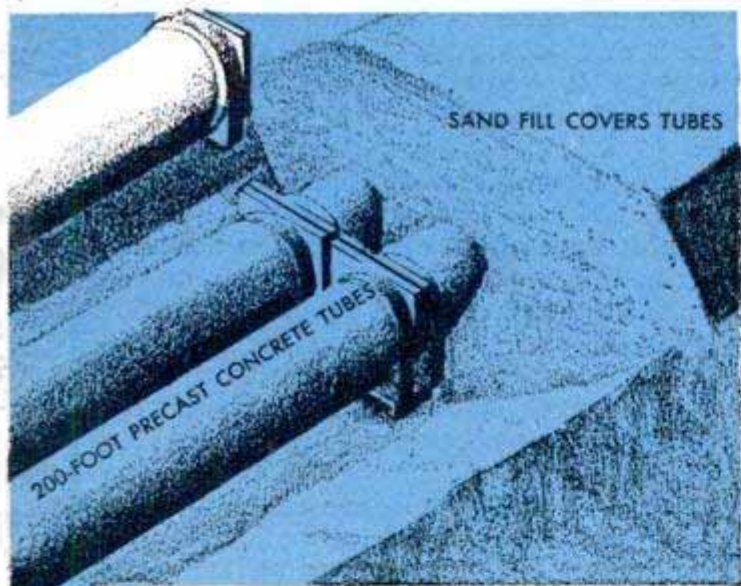

Model of the rotary system shows how traffic will be collected and distributed for the southern crossing. Elevated roadways will eliminate the local traffic

Concrete tubes will have a fresh-air duct beneath roadway and an exhaust duct above. The diameter of each of the three parallel tubes will be 37 feet

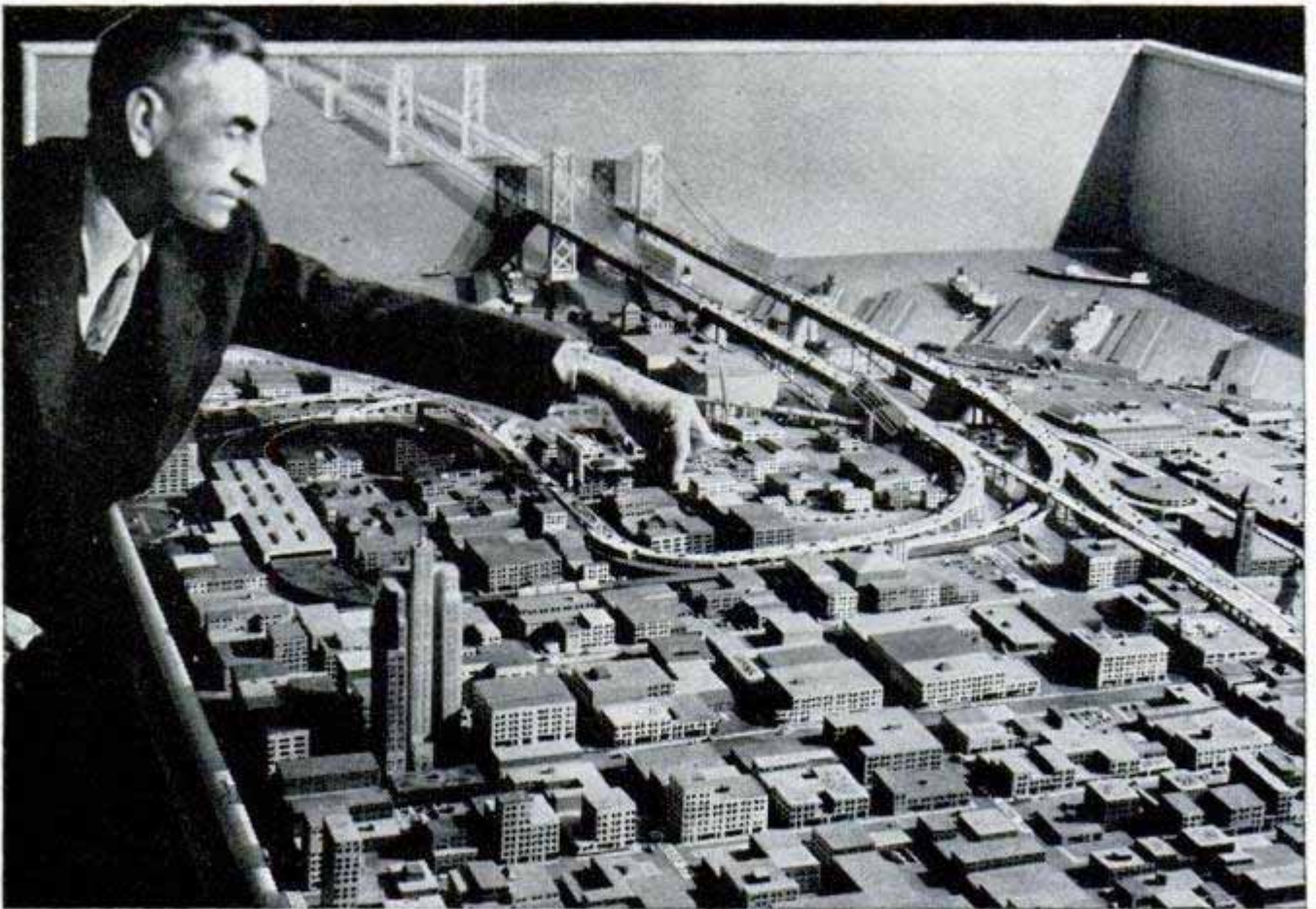

Model shows roadway system that will be built to handle traffic at San Francisco end of twin bridges

Traffic entering or leaving east or Oakland end of bridges will be served by this complex road system



westbound lanes. Space for two electric train tracks is provided on the new bridge although this space eventually may be paved for vehicular use. The pair of bridges, it is expected, will be adequate for handling the traffic load up to and probably beyond 1970.

Traffic pays about eight million dollars a year in tolls on the present bridge, and in turn the state spends more than one million a year in maintenance and running expenses. Cost of the bridge will be paid off by 1953 in spite of the fact that the original toll of 65 cents per car was long ago reduced to 25 cents per car.

A staff of 250 people are on the bridge payroll and range from toll collectors and patrolmen to fire fighters and radio operators, not including a detail of state highway patrol officers who are stationed at the bridge headquarters.

The staff uses 23 trucks, 19 pieces of auxiliary equipment, six passenger cars and a 43-foot work boat for maintenance work. Fourteen of the vehicles carry two-way FM radio equipment.

Preserving the bridge with paint, of course, is one of the big tasks. Repainting the structure started practically on the day it was completed but because of war delay, the first complete repaint job will not be finished until late this year. The bridge has 16 million square feet of surface and the complete paint job requires 75,000 gallons

(Continued to page 250)

Machine Drives 2800 Nails A Minute

Wooden assemblies that include boxes, crates and picket fences are rapidly fabricated by an automatic nailing machine that can drive 24 nails at once in practically any nailing pattern at speeds up to 120 strokes a minute. An oscillating nail reservoir feeds the nails to chucks that position them and then punch them into the wooden assembly that is held on the operating table. The machine uses from 3 to 10-penny nails and is available in various sizes up to an operating width of 72 inches. Wooden pallets, panels for pre-fabricated houses, grids for industrial cooling towers and refrigerator cases, as well as many other wooden articles can be quickly assembled by the machine.

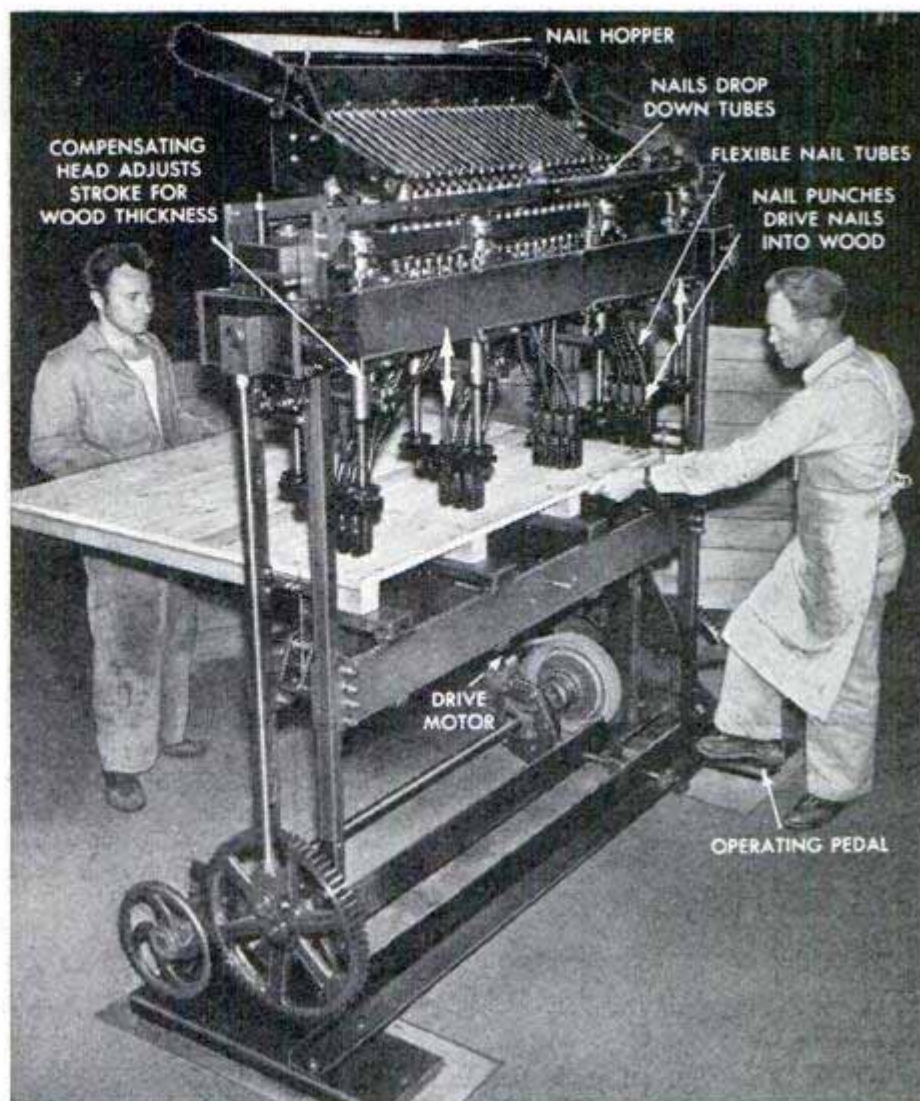

Hot-Dog Stand In Car Trunk

When Arthur Guyotte of Ashland, N. H., parks his business coupe and opens the trunk compartment he is ready for business. The trunk contains a complete built-in hot-dog stand with facilities for turning out hot dogs, toasted cheese sandwiches, popcorn and cold drinks. Guyotte cooks with gas carried in a pressure tank and a grill swings back for popping corn over the flame. The base of his boxlike stand has compartments for hot dogs, popcorn and buns. Outside racks on both sides hold extra pop bottles. Also in the base is an icebox where soft drinks are chilled. Guyotte carries 18 cases of pop in the car and 40 pounds of wieners.

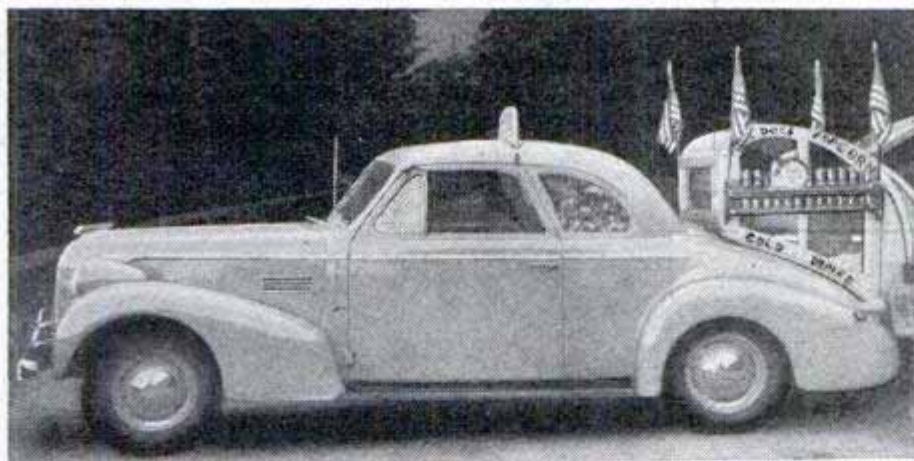

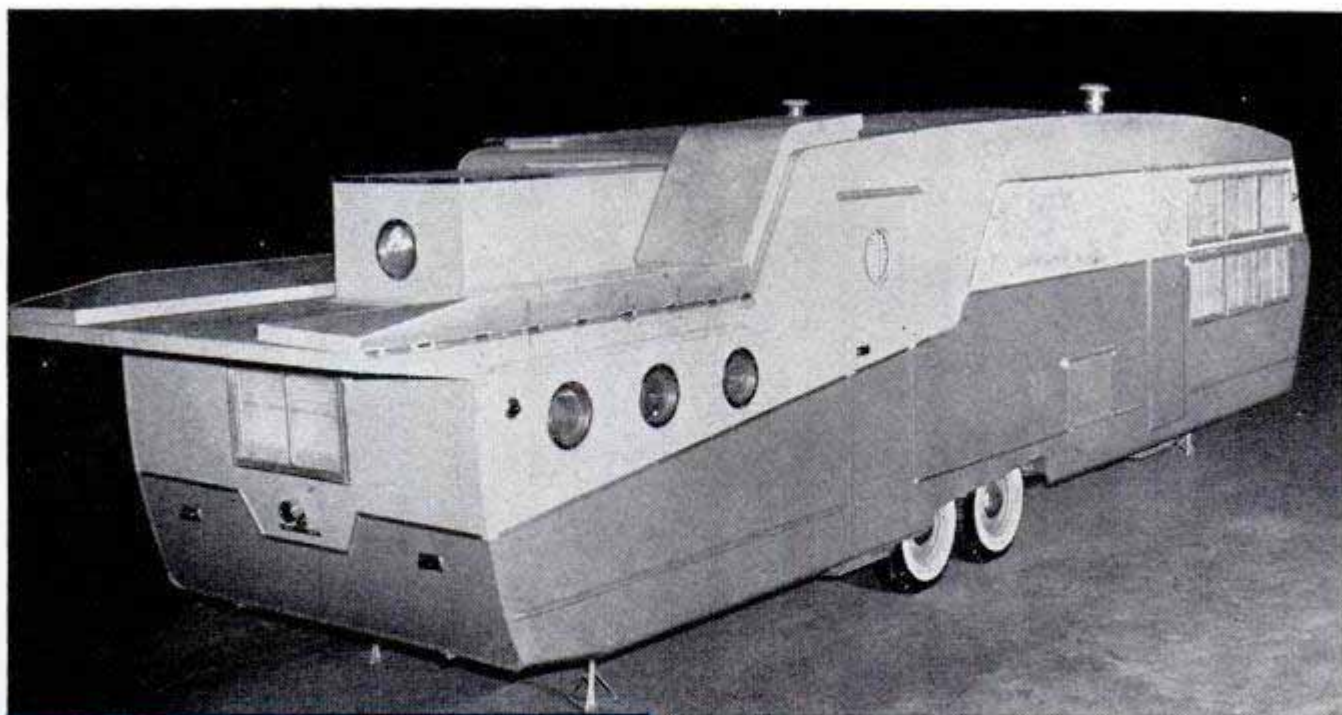

Highway Yacht with a Sun Deck

Everything from a "pooch porch" to a sun deck that seats up to 16 is included in a new Flagship trailer. Above, as it appears en route, the nautically styled luxury coach is 32 feet long and 8 feet wide

Lower left, in harmony with the vehicle's seagoing lines, the twin beds are arranged bunk style, with a four-foot clearance to ceiling. Aisle between beds gives added headroom and space for dressing table

Below, living room soundproofed with a new plastic has Astro Dome in center of ceiling to admit more sunlight. Room is at front end of trailer, separated from the kitchen by a bar and a vine-covered trellis





Above, completely assembled sun deck has awnings and plastic screens. Two feet of side sections fold down to enlarge floor space. Dog porch is in right foreground

Right, putting up the pipe framework for the porch takes about 1½ hours. Material is stowed on coach roof and covered when not in use. Disassembly takes ½ hour



Below, floor plan illustrates the compact arrangement of facilities. The full-size bath has a separate shower stall. Interior height of trailer is 6 feet 10 inches

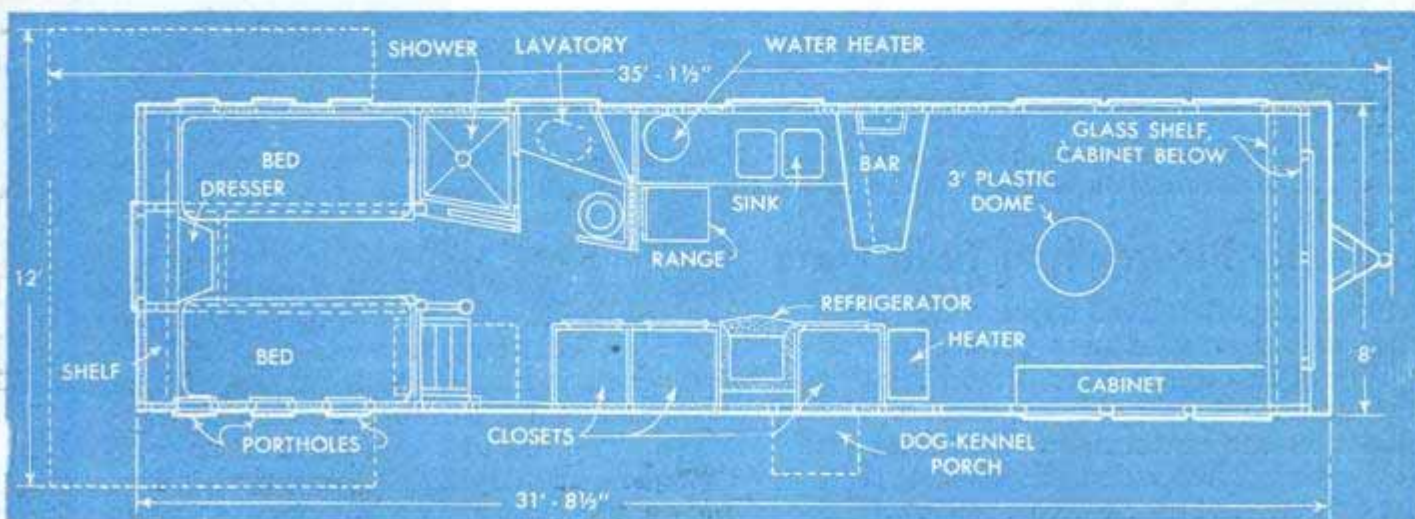

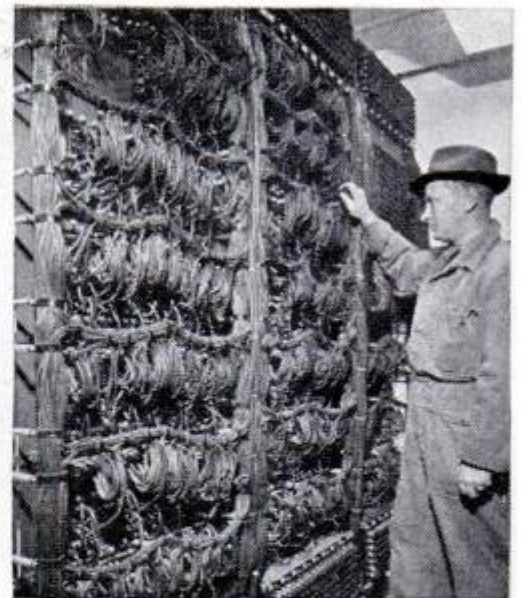
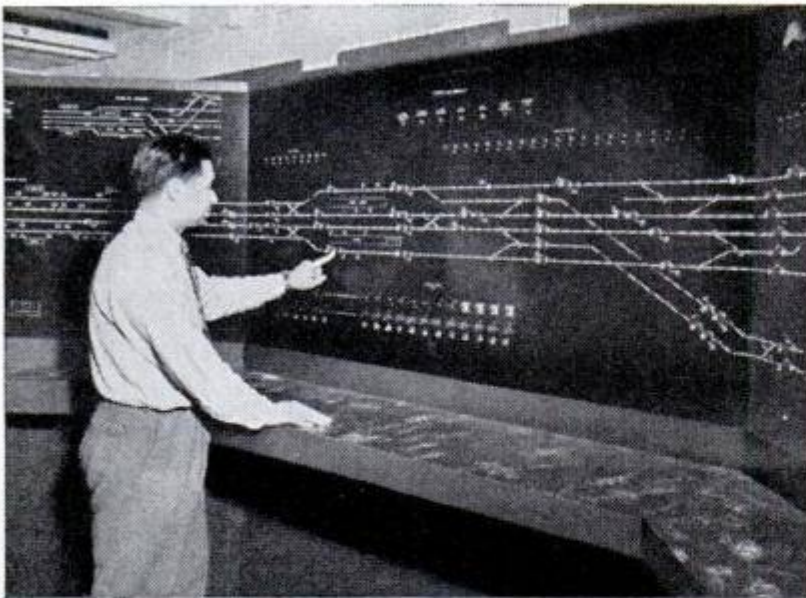

Buttons on replica of track automatically set switches and signals through maze of wiring behind panel

Push-Button Subway Controls

By pushing only two buttons of a new control panel, the towerman of a subway division in Brooklyn can set all switches and signals for routing a train. The same operation formerly required the towerman to throw as many as 30 switch-and-signal levers. In the new system he pushes one button at the point where he wishes the train to enter a track and a second button to show the destination. All intermediate

switches and signals then fall into place automatically. The control panel is a replica of the track pattern with each push button corresponding to a signal. If the towerman selects two conflicting routes simultaneously, red lights flash on the panel. The train movements can't be governed by a motorman; if he runs past a red signal, a trigger in the roadbed automatically applies the train's brakes. The signal system cost \$2,000,000 and can be operated by one man at the control panel.

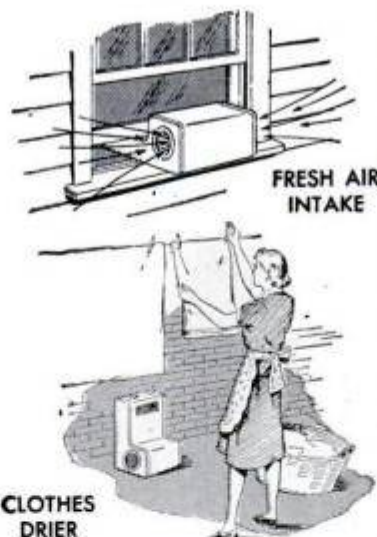
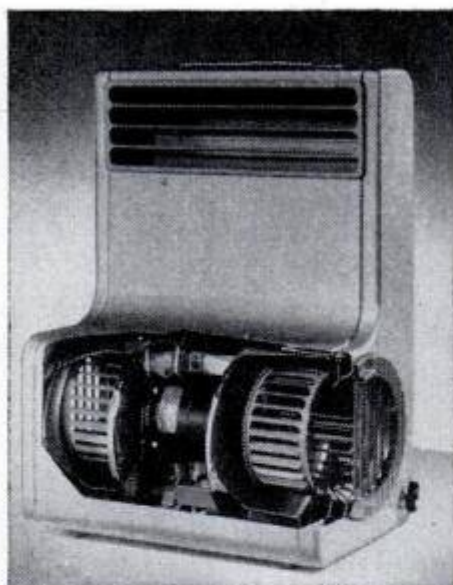

Base of fan contains two separate blades that draw air into cabinet and discharge it at the top. Versatile fan can be used to dry clothes inside the house and for drawing fresh air into room or expelling stale air

Versatile Blower Has Twin Fans

Twin impeller blades draw air into the base of a versatile new blower and discharge it through a streamlined duct. The fan has an L-shaped cabinet with the blades in the bottom and the outlet grille at the top. The grille is adjustable so that the direction of air flow can be changed. A

carrying handle on the top of the fan makes it easy to move from place to place. The fan can be installed with the outlet grille outside a kitchen window to exhaust cooking odors and heat. With the outlet inside the window, the fan forces cool air into the room. The fan also can be used as a hair drier and for drying clothing that is hung inside the house.



Rifle Features Automatic Safety

Safety is an outstanding feature of a low-priced .22-caliber rifle designed especially for the beginner. Opening the bolt cocks the rifle and, at the same time, locks the safety so that it has to be released manually before each shot, thus reducing the chance of accidental discharges.

Automatic Transparency Projector Eliminates Handling of Slides

Operated by remote control, an automatic projector enables you to change slides from any place in the room merely by pressing a push button at the end of the control cable. From 35 to 75 slides can be placed in a metal magazine in the desired sequence and each time the control button is pressed a slide drops into place behind the lens. After projection, the slides fall into another magazine in proper sequence for future showings. To prevent warping, each slide is preheated before dropping into the projection slot. Between slides, a shutter closes the lens aperture, eliminating the usual slide wipe.



Gas-Powered Sprayer

Pressure for spraying insecticides and other chemicals is provided by a CO₂ gas cylinder mounted on a three-gallon tank. The tank can be filled to capacity with spraying solution. Turning a valve releases gas into the tank, where a constant pressure of 30 pounds is maintained. One cylinder contains 10 ounces of liquefied gas, enough for spraying 15 gallons or five tanks full of the spraying liquid. The cylinders may be sent to the factory to be refilled. A hand pump on the sprayer may be used to build up pressure if a gas cylinder is not available. The sprayer has a 30-inch hose with a 24-inch brass extension and nozzle.

Multiple Fuse Plug Has Replaceable Insert

Containing five separate fuse links, a multiple fuse plug eliminates the usual search for a new fuse when the lights go out. The inner section of the two-part plug contains five links and rotates within the outer shell to bring a new fuse into operating position. When all five fuses have burned out, you buy a new inner section.



WHAT'S NEW *For Your Home*



SAFETY BIB not only catches spilled food, but also prevents the child from standing up in his high chair. The strings of the bib tie to the chair legs, acting as a restraining harness

AIR CIRCULATOR, below, left, is also a coffee table. Beneath the flat top is a quiet-running fan that keeps air circulating without the usual uncomfortable drafts. It has a 3-speed switch



REVOLVING BRUSH is driven by water pressure from a faucet. Actually, there are two brushes: The center section that spins and the outer stationary brush that keeps water from splashing

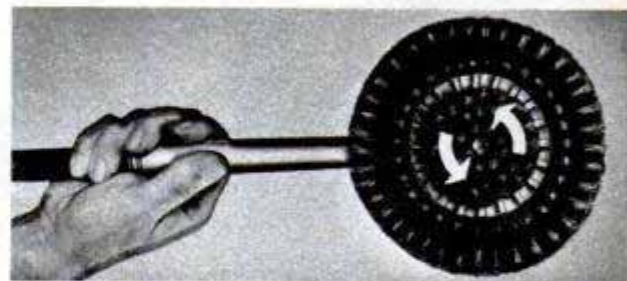



STEAM VAPORIZER operates from 2 to 12 hours without refilling and it turns itself off when the water supply is exhausted

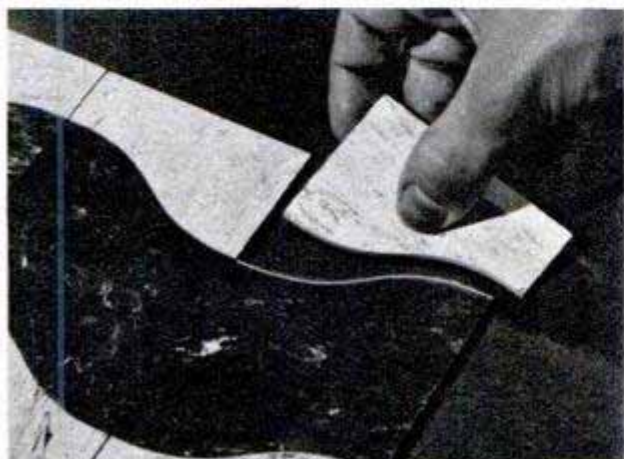

PATTERNED FLOORS are formed by a rubber tile cut in half on a double curve, making it possible to create many designs



BREAD BOX feeds a slice at a time as knob is turned, keeping loaf from drying

MEAT TOASTER cooks hot dogs and hamburgers when slipped into pop-up toaster



BASKET CART will haul anything from groceries to laundry. The tubular-steel frame has a folding stand that holds it upright when you park the cart. The two large wheels roll easily, even up and down stairs. The rack holds a standard bushel basket and pivots on the sides for dumping



HEAT AND COLD are provided by a combination range and refrigerator. You have a choice of gas or electric range. The electric refrigerator has four cubic feet capacity. It's just the right size for small apartments





helicopter on the newsfront

Starting out on an assignment, the Journal's Dragonfly can get up to 100 miles an hour within a few blocks



View of the Journal's new location on the Portland waterfront. The city had to be convinced aircraft could operate with safety over congested area before a roof-top landing permit was granted

Cutaway illustration of newspaper's plant, one of the most modern in world. The arrows trace the path of stories and photos from time Dragonfly lands until printed papers are distributed

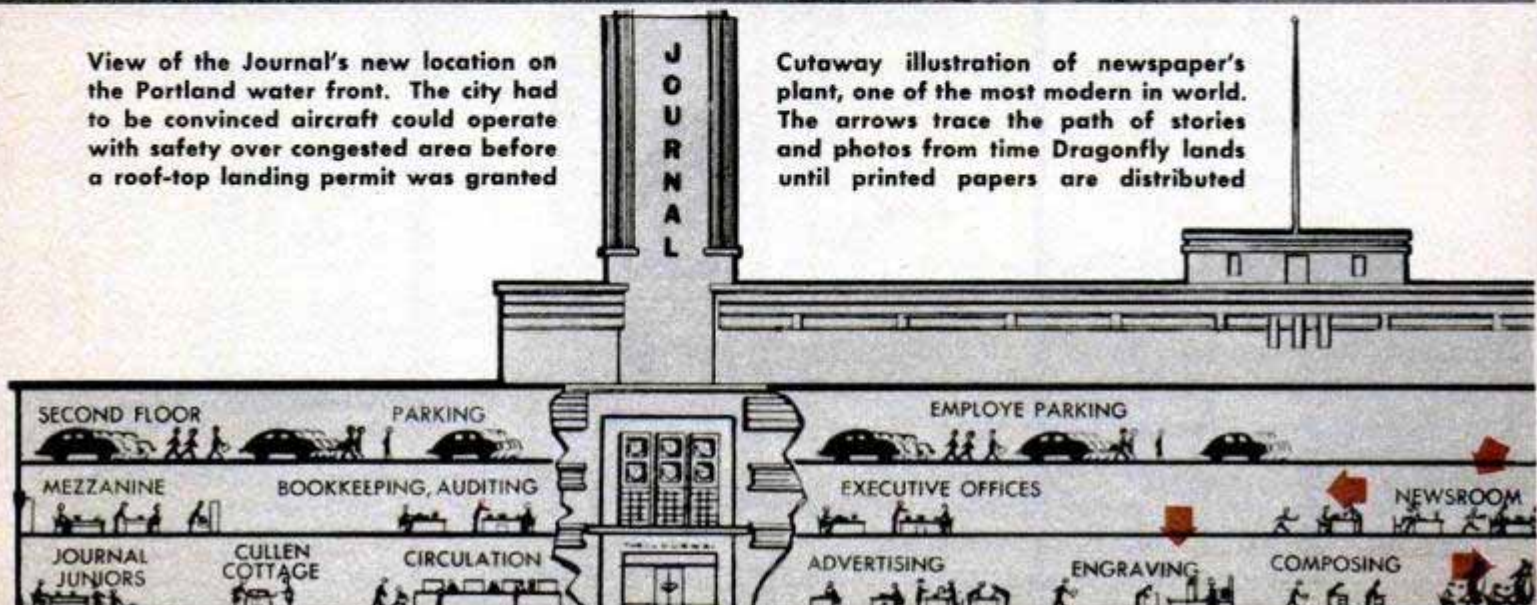

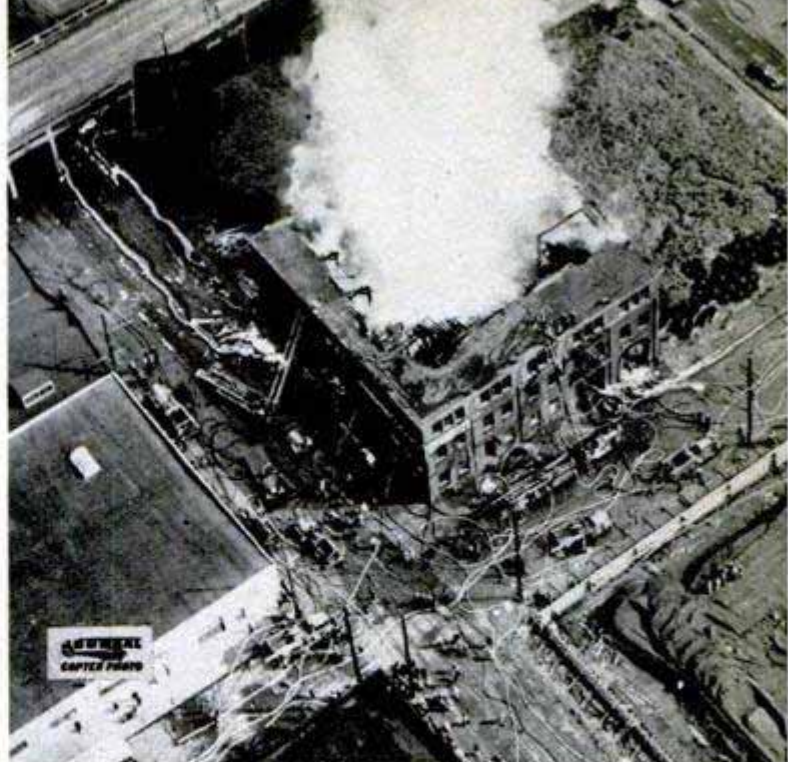

Helicopter's low oblique perspective gave photo of train wreck, left, more complete conception than a dozen ground shots. Firemen studied hose patterns above to evaluate efficiency of respective units

By Hal Cooley

NEWS COVERAGE in the Oregon Journal (Portland) is slanted from the sky. It is produced with the help of a giant mechanical insect, the Dragonfly, that roosts on the Journal's roof during off-duty hours, 10 seconds from the city editor's desk.

The Journal helicopter is the first to be operated permanently by a newspaper. With it, pilot-reporter and photographer teams are injecting an original touch in the handling of assignments as diverse as fires, murders, man hunts, sports events and outdoor festivals. Distance means little to the new helper with 100-mile-an-hour "legs."

Appropriately, the versatile newcomer's 100-square-foot home field is perched on top of a new three-story building housing some of the world's most modern newspaper-producing equipment.

In the Pacific Northwest, one of the most picturesque areas of the U. S., it has carried reporters and photographers into settings as primitive and remote as the Indians first found them. The machine once landed in a tiny clearing along the rugged, wooded shores of the Rogue River, which churns madly through the twisting canyons of the Siskiyou Mountains in southern Oregon, to dispatch by wire and radio the story of a crazed killer who had terrorized five people. Dramatic photos were returned to Portland by air.

Less hazardous and much more pleasant assignments are big football games. With the helicopter, it is possible to cover games on the same day at both the University of Oregon, in Eugene, over a hundred miles from Portland, and Oregon State College at Corvallis, and beat the deadline with action photos for the sport fans from both games.

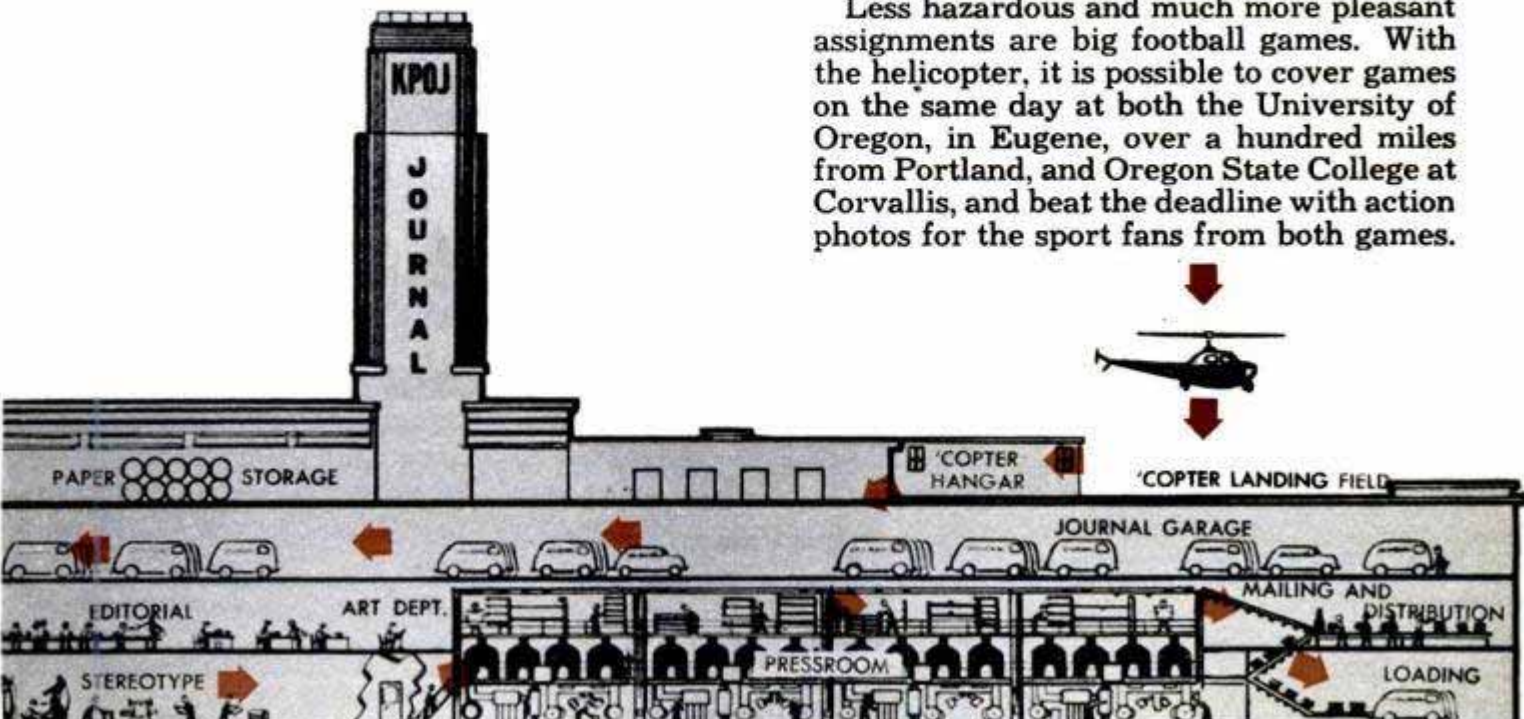

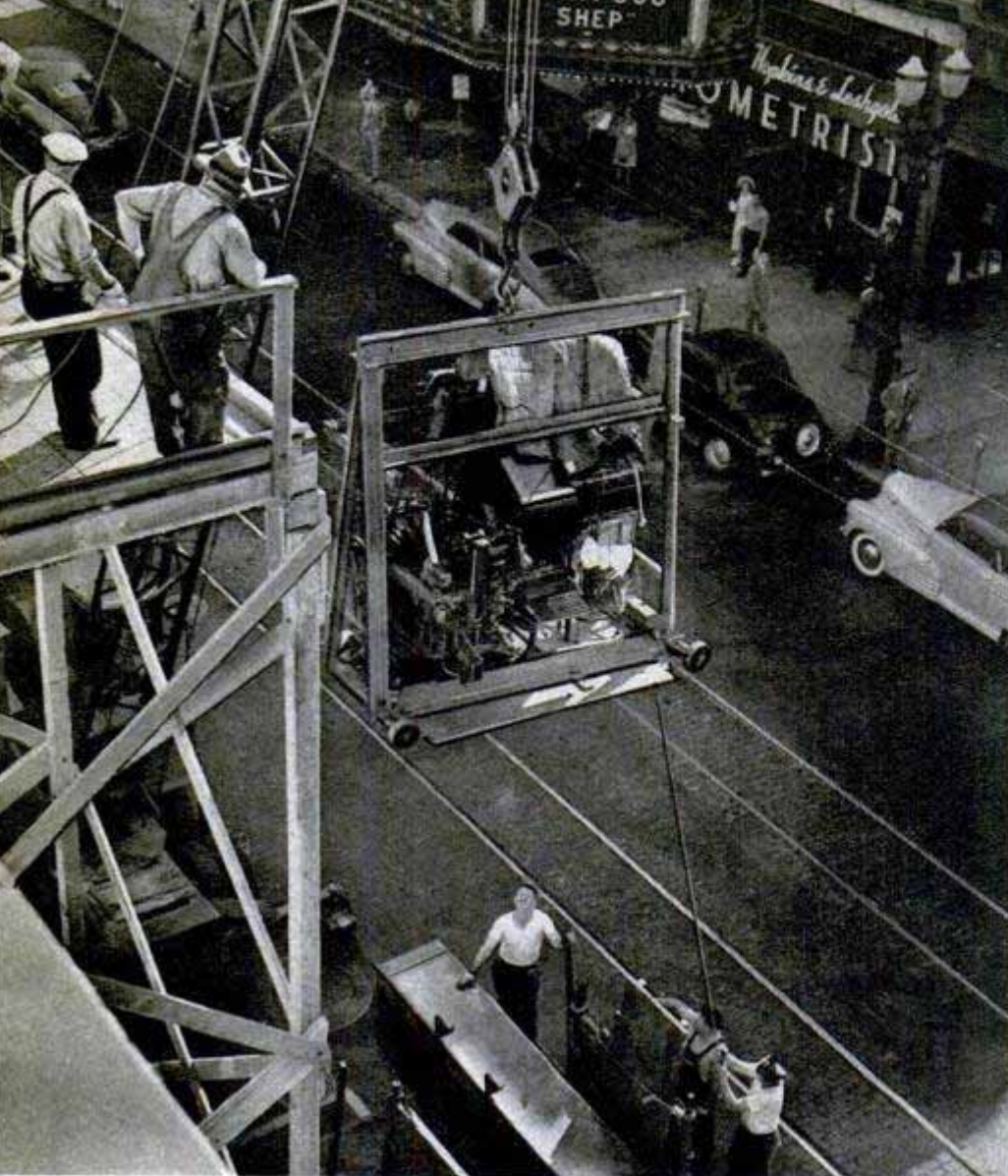

Use of a specially designed carriage made it possible to move intricate and delicate Linotype machines to new building without injury. It was done so quickly they were operating again before metal pots had cooled

In a business that has always emphasized speed of operation, another Dragonfly accomplishment merited special plaudits. Pictures made from the air of Portland's world famous rose festival were flown back to the roof-top roost within 75 seconds after the last scene was snapped. The best a car and a police escort could do was 17 minutes. Copies of the newspaper with pictures of the prize-winning floats were being sold to spectators near the end of the parade route before they saw the last of the procession.

The aerial platform also gives Journal photographers a chance to shoot from unusual angles. It has enabled many Portlanders to get close-up views for the first time of the tops of many tall monuments and landmarks that had previously been just distant specks. Ship pictures, always a strain on the photographer's originality, are likewise open to new treatment by flying lensmen.

Photography is more difficult than would be supposed from ground observations of the craft. Although its ability to remain

stationary at low altitude is a wonderful virtue, a strong vibration in the cabin necessitates using shutter speeds of $\frac{1}{400}$ to $\frac{1}{800}$ second to get negatives of good definition.

Some of the helicopter-borne photographers have, however, made exposures as slow as $\frac{1}{50}$ second in emergencies when the light was poor and secured passable pictures. This is possible only through perfect coordination of pilot and photographer in manipulating the ship for the minimum vibration and torque, and by timing the camera at the split second when the most advantageous conditions prevail.

A technique employed by the Journal photographers, when making pictures from the Dragonfly, is to avoid having their cameras in contact with the sides of the cabin during an exposure. By so doing, their bodies absorb much of the vibration from the engine.

Most pictures are made through the side windows of the cabin, although good results have been

obtained by shooting down through the plastic nose of the machine.

The helicopter has also been the means of obtaining many formerly impossible news pictures from the ground. Its faculty for landing in a small area, less than 50 feet square, has placed Journal photographers in formerly inaccessible positions for picture scoops.

For example, during the Vanport flood, the helicopter landed a photographer on a flooded dike for exciting pictures that were made a second before a section of the dike gave way. The photographer was able to get away in perfect safety, where men with any other means of conveyance would have been stranded.

A faster, conventional-type plane, also owned by the newspaper, is sometimes teamed with the helicopter on news coverage. When distances are great, the paper can take advantage of the latter's greater versatility to secure material at the scene of the action, then utilize the former to relay it at a much greater speed back to the office in Portland.



Stories from aerial newsmen, and others, are edited and have heads written for them at the copy desk

The helicopter is a coupe model, built by Bell Aircraft and capable of speeds from one mile an hour to 100, at 10,000 feet or one foot. It flies backward, forward and sideways, or can hover stationary in the air. Full swiveling front wheels make it easier to handle on the ground in tight places.

Its two-blade rotor is powered by an air-cooled Franklin engine. A small tail rotor provides directional control and offsets torque. It has been refueled at roadside gasoline stations.

The 'copter is painted white above and green below, split by an orange stripe, the same as the newspaper's delivery trucks. Two-way radio equipment keeps users in frequent touch with ground stations.

It wasn't easy to get authority from the city to fly a helicopter off a building downtown, where the Journal is located. But they got it when authorities were convinced that a dead engine wouldn't mean death and destruction in the center of their busy metropolis.

When and if the engine quits, the craft can be brought safely down in a controlled glide, with air rushing through the big rotors to keep them spinning. Athletic fields, parks and even the less-busy streets that are found in even the biggest cities could be used for emergency landings.

The Dragonfly of the newsroom has won its laurels and the admiration of the entire staff, even the drama editor. He became an enthusiastic booster after being rushed to an important open-air Elizabethan Shakespeare performance, and returned with pictures in time for his Sunday layout.

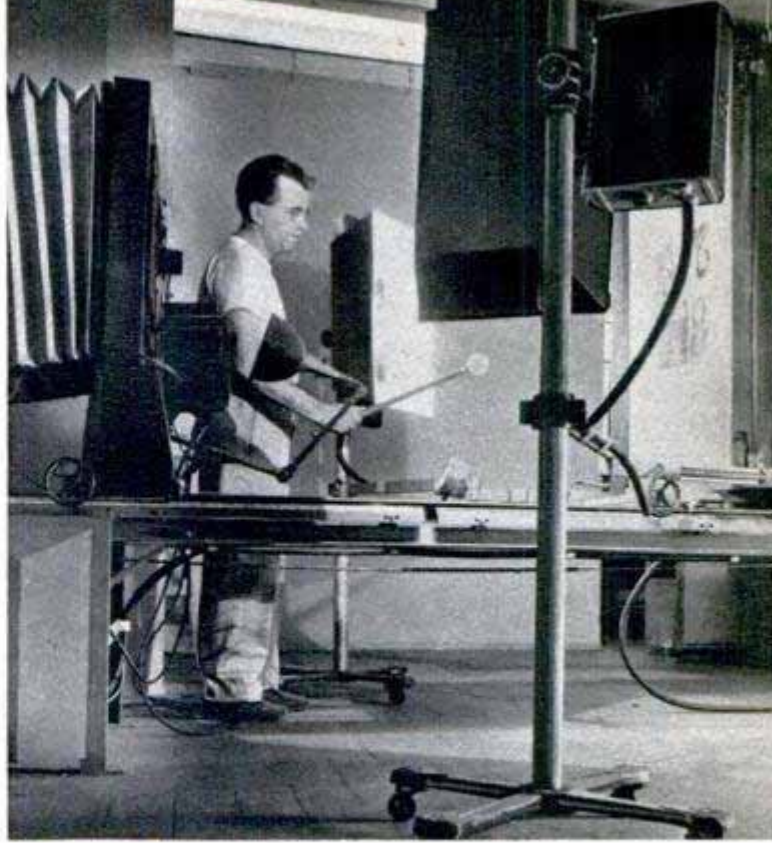

Photos sped back to Journal office are transformed into printable zinc plates by the engraving camera

The Journal's helicopter and splendidly equipped plant offer a perfect exhibit to illustrate the amazing machine triumph of a newspaper. It starts the transformation of the reporter's story through highly complicated and speedy Linotype machines, and then moves it on into the stereotype department, where story and pictures are transformed into a metal cylinder, and then on through conveyors to the huge presses, perhaps one of the impressive monuments to present-day mechanical engineering.

Next it goes through a maze of mechanical conveyors which function in the mailing department. With unerring accuracy and speed they dispatch hundreds of thousands of daily papers into their respective loading chutes, where a perfectly organized system of fast trucks deliver them to newsstands and carriers, who swiftly continue the work of presenting you with the news of the world at your doorstep.

The Journal's new Hoe press is the most modern and efficient machine of its kind. It is the largest newspaper press in the Northwest and can produce more newspapers per hour (135,000 forty-page papers) than any other. Its 700-ton weight rests on a concrete slab 12 feet wide, 150 feet long and 18 inches thick.

The slab is supported by 36 ten-inch concrete and steel piles, 30 to 60 feet long and driven to bedrock. This press foundation is separate from the main building, so the press vibration is not communicated to other offices. The sixteen units in the press, and their folders, extend 158 feet and are 26 feet high. The press units required 19

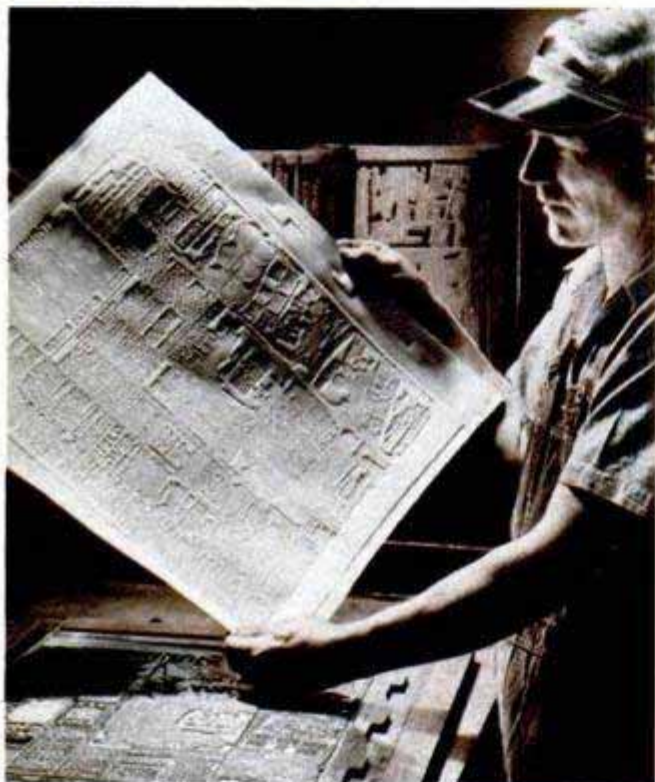
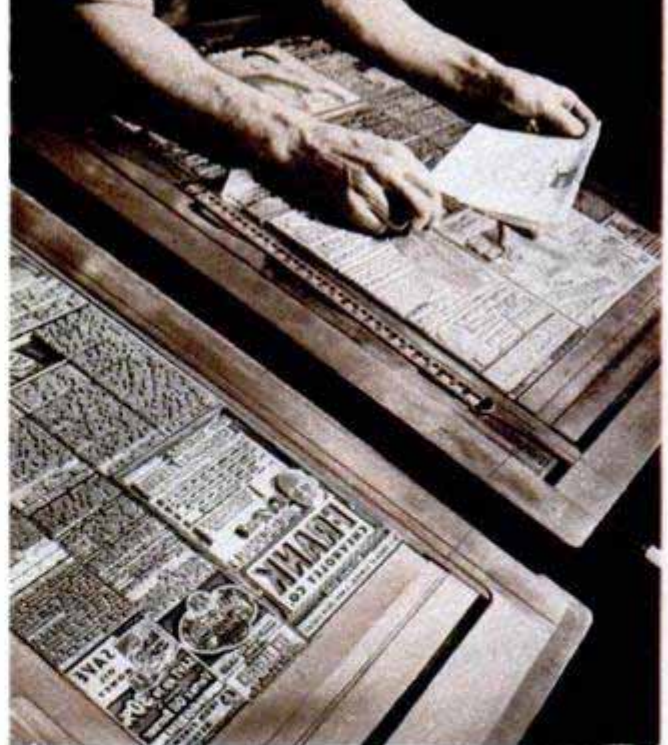

Linotype machines, upper left, set written word into type that spells day's news. Zinc plates, or cuts, and type are put in page form, above, in composing room

freight cars when shipped from New York.

To operate the press and its accessories, 102 motors are required. Over 700 push buttons control the operation. Throughout this are 2010 electrical contacts and 35 miles of wiring. Four-color printing is possible on many pages, and two-color printing on virtually any page.

Thirty-five dynamic brakes on the press, aided by separate brakes on each motor, stop the press in four revolutions of the cylinder, even when the 700-ton machine is traveling full speed. This is not the stopping distance for emergencies only, but the normal stop.

If something serious should happen to the press while in motion, a shearing pin will break instantly at the point of trouble, thus freeing the gears. A new shearing pin can be installed in a matter of minutes after the trouble is remedied.

The plant uses 6,000,000 kilowatt hours of

Above, under 1600 pounds pressure, deep impression of page form is made on paper-composition matrix. Below, molten metal forced against matrix in casting forms a curved plate that goes to pressroom, right

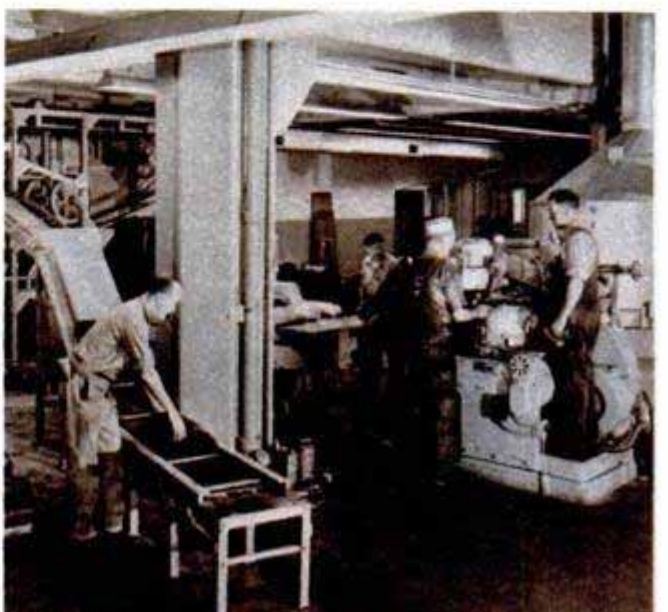
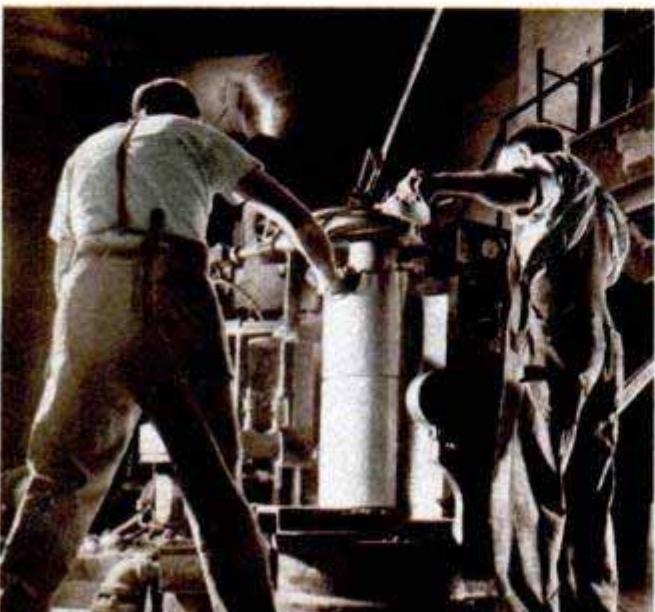

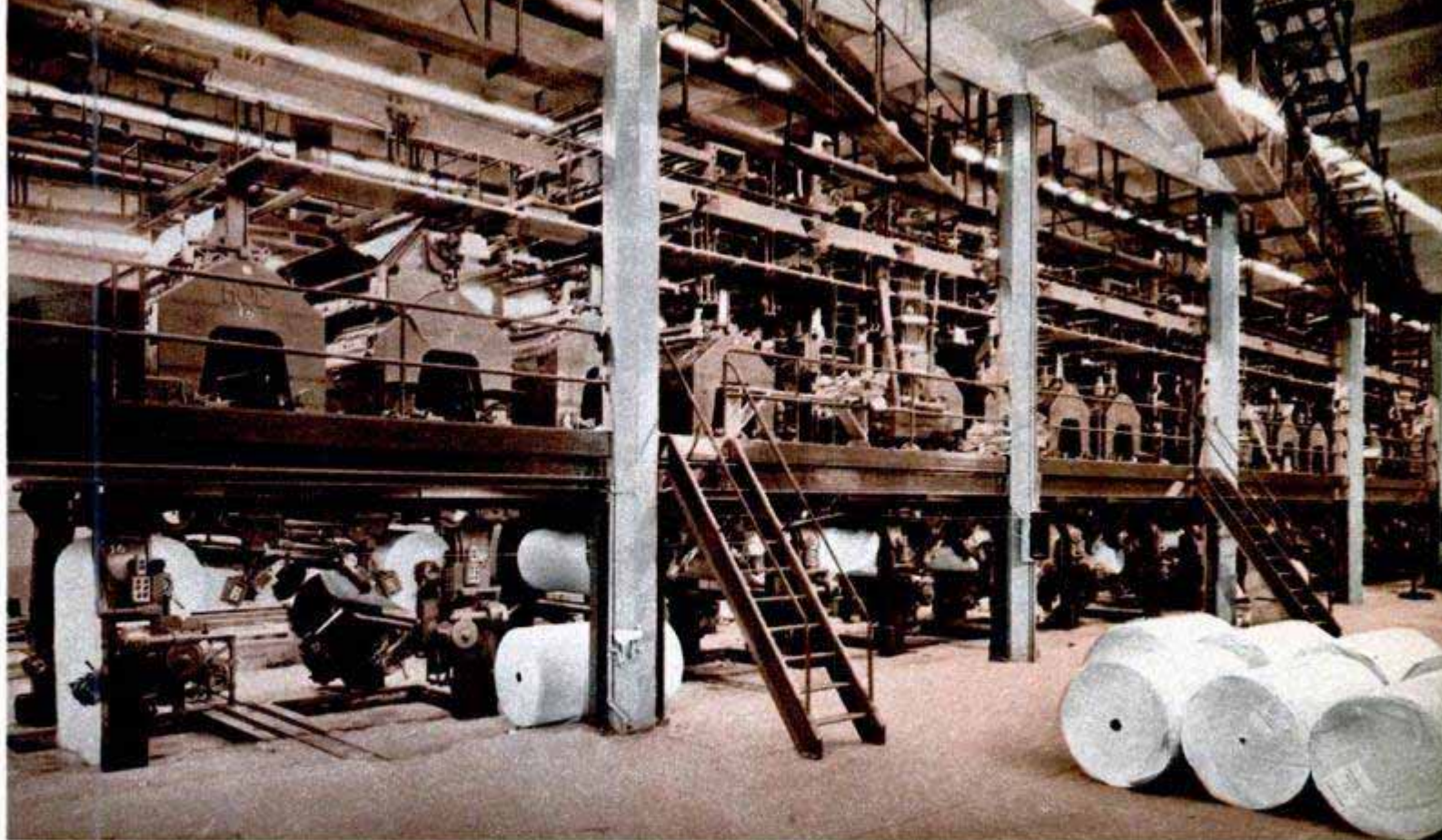

Curved metal plates are next positioned and locked on cylinders of giant Hoe press, which prints, trims and folds completed newspaper. Largest press in the region, it turns out 135,000 forty-page papers an hour

electricity a year, an amount sufficient for the needs of 1482 average homes. The 27,000 watts of electricity required to heat the big metal pot in the stereotype room alone would keep 2700 lamps of 100 watts burning simultaneously.

The machine shops are needed to maintain the newspaper's extensive mechanical equipment. One, just off the pressroom, has a lathe, three drill presses, a shaper and a grinder. It is also equipped for doing both electric and acetylene welding. Another machine shop, in the Linotype department and specializing on work there, has a drill press, lathe and grinder.

Much of the equipment in the new plant was specially designed by members of the Journal staff. Particularly impressive and successful is an elaborate conveying device on which the newly cast stereotyped cylinders are moved from the stereotype department to the higher level of the big, two-story-high presses.

This machine has two arteries of travel. One is set for a casting unit which operates at four casts per minute, and the other for one that turns out three casts a minute. Both deliver plates in perfect synchronization to their respective positions by the press. It runs the chromatic scale in modern control devices, from synchronous electric contact mechanisms to electric eyes. The conveyor also returns the plates after their edition is run, for remelting in the electrically heated pots.

Viewing this vast panorama of giant-size,

precision mechanism, it occurs to one that the repertorial departments of modern newspapers have to ride hard to keep abreast of the color and drama that is constantly being unfolded through invention and engineering for their brother newspaperman of the apron and micrometer.

Newspapers move along on conveyors to the mailing room, to be counted, wire bundled, routed. Finally, they go down chutes to the waiting delivery trucks

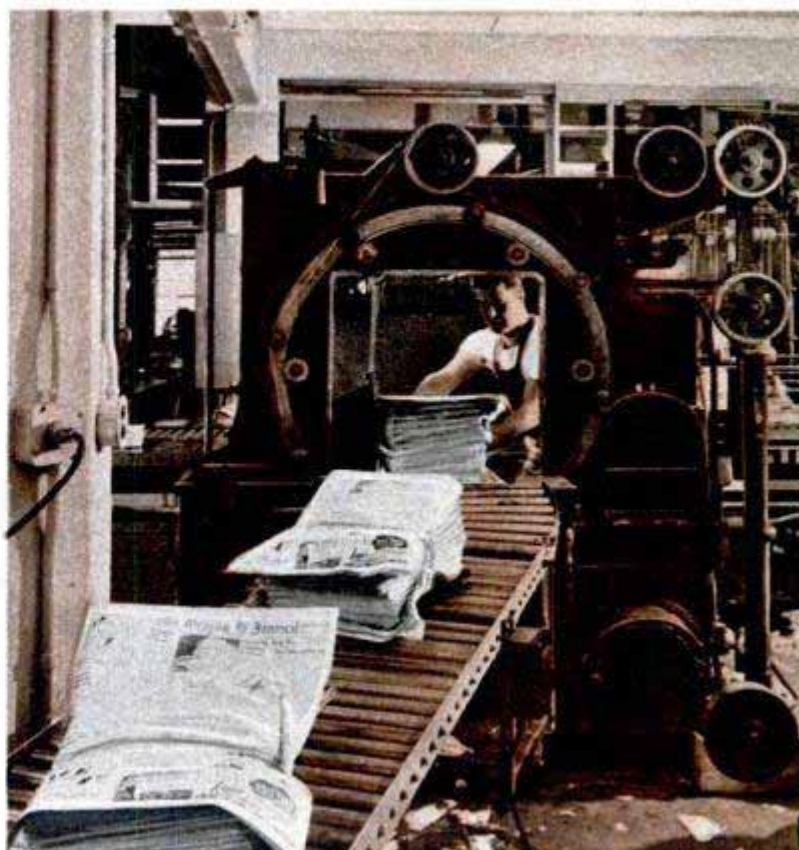

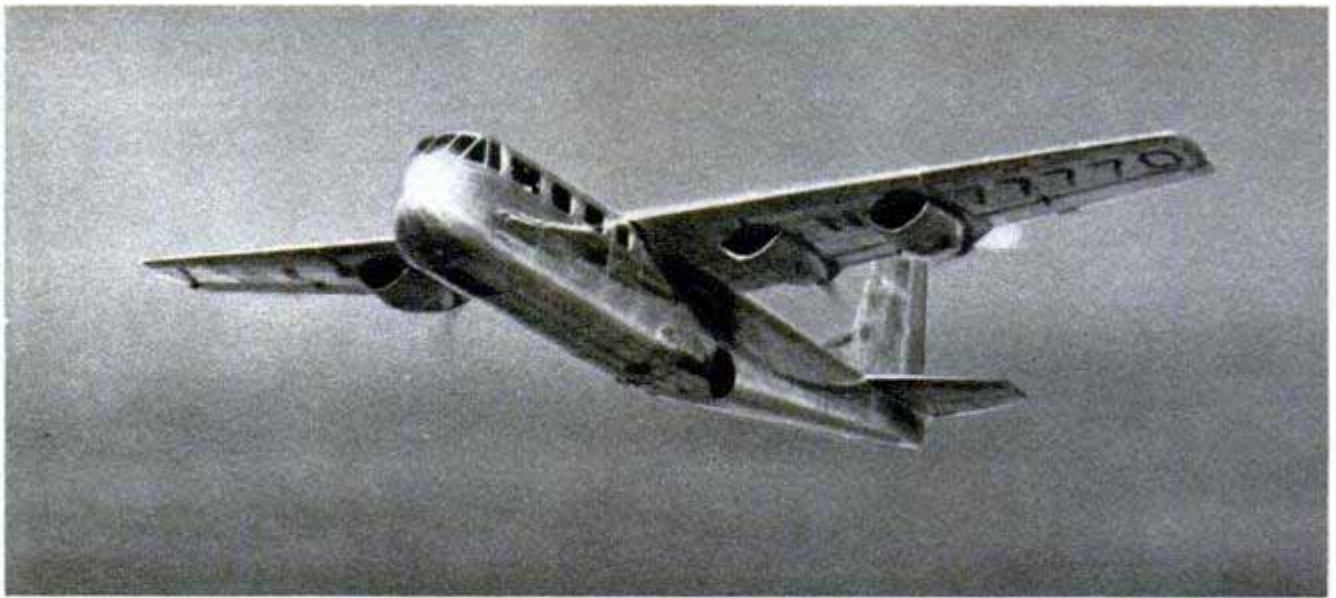

First Four-Engine Personal-Type Plane

What is believed to be the world's first four-engine executive-type plane has been flown at New Orleans. Its builders claim the four comparatively low (115) horsepower engines provide a greater margin of safety than using one or two engines of equivalent power. Engines are mounted in pusher-type installations. The plane can be flown day or night in any kind of weather suitable for airline operation. Carrying five, it cruises at about



155 miles an hour and has a range over 1000 miles. The new plane is 34 feet long and has a 48-foot wingspan.



Ribbon-Eradicator Combination Makes Perfect Typing Simple

Erasing errors in typewritten material is simple when you use a ribbon designed for use with a liquid eradicator. Complete sentences can be eradicated from the page without the faintest smudge or trace of the deletion. The liquid removes the impression and leaves the paper clean and ready for retyping. A special ribbon, available in sizes and colors to fit any standard make of typewriter, must be used with the eradicator.

Better Light Diffusion

Almost perfectly spread light comes from a bulb coated on the inside with a newly developed silica substance. Unlike previous diffusion experiments, the coating does not appreciably limit light output. It was perfected by Marvin Pipkin of General Electric, who developed the first inside-frosted lamp in 1925.

repair your own plane

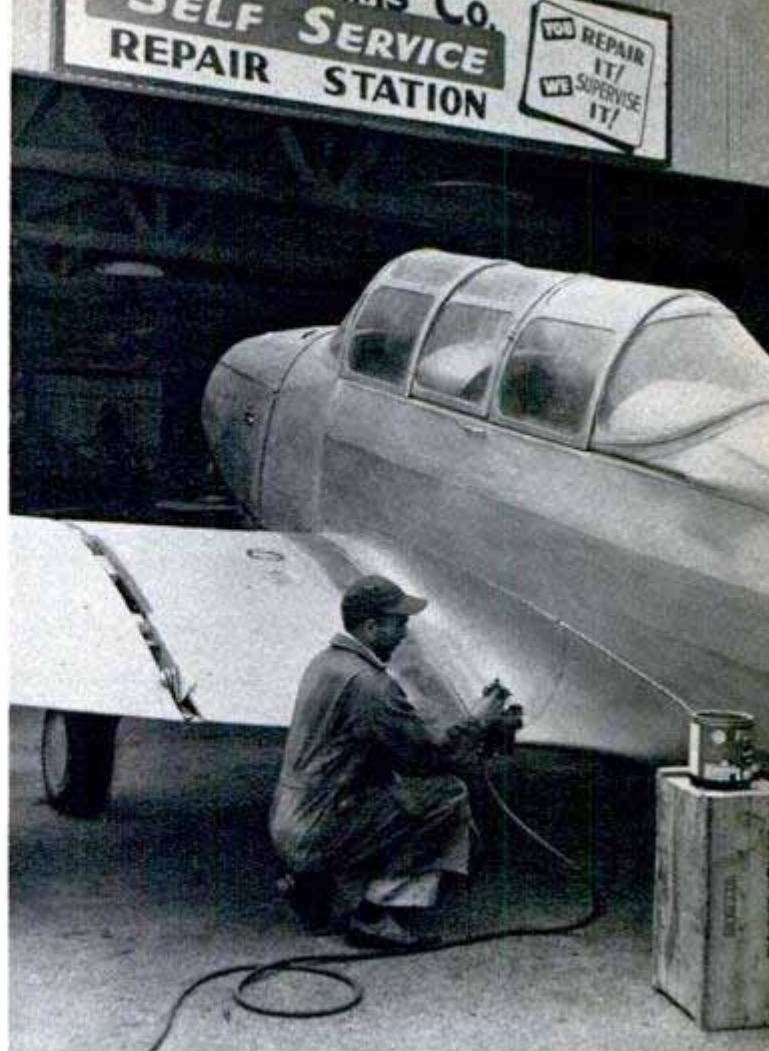

Most work, like the paint job above, is charged at a flat rate. Extensive operations, such as soundproofing a fuselage, at left, get a monthly rate

Private-plane owners help themselves to lower maintenance costs at the Compton, Calif., airport where the Stolp-Adams Co. runs a "cafeteria style" repair hangar. Under the close supervision of George Adams and Lou Stolp, partners in the self-service station, plane owners do their own repair work, thus cutting costs to a fraction of the usual charge. The company supplies the tools and sells the necessary materials, incidentally at a discount, for the job. Adams is a CAA-designated aircraft inspector and his supervision makes the repair work legal.

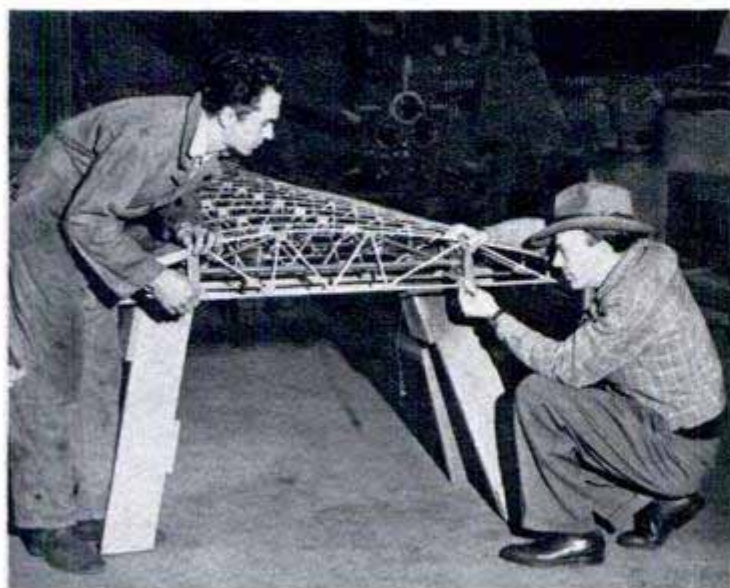

Complete overhaul jobs are done by plane owners at the self-service hangar. Above, installing a rib spar in a lightplane wing. Stolp supervises at left. Right, as Adams watches, flyers assemble engine after overhaul





Sight-seers wave to the cranberry workers from the rear platform of the old-fashioned observation car



ALL ABOARD!" With the last sight-seer swinging up the steps, the welterweight train chugs slowly out of the station and puffs along its narrow track toward the cranberry bogs.

According to Ellis D. Atwood, the owner of the strange little railroad, it's the only narrow-gauge steam line still operating commercially in the United States. The tracks of the Edaville Railroad are only 24 inches apart, making it less than half the gauge of its big brothers.

That's why it is a welterweight railroad—a line that falls somewhere between a kiddieland special and the standard lines that have survived through the boisterous history of American railroading. Don't think for a minute, though, that the Edaville is a toy or a back-yard hobby. The little railroad does a man-size job of hauling freight in and out of the cranberry bogs near South Carver, Mass., and more than pays for its operating expenses.

Atwood conceived the idea of operating a miniature railroad in 1941 when he learned that the equipment of one of the

← You can pay or ride free on this friendly railroad. Most passengers prefer to buy a ticket, have it punched by the conductor, then keep it as a souvenir

↓ Narrow-gauge Edaville line really earns its keep by hauling workers to the bogs and the cranberries back to the unloading platform during the harvest



CRANBERRY



Workers use big scoops to sweep up the cranberries while one of the little trains stands by for a full load

defunct narrow-gauge roads was about to be scrapped. He bought part of the equipment and has been running down extra cars ever since to provide complete rolling stock for his six-mile line.

Today Atwood has a total of 80 of the little engines and railroad cars including seven locomotives, and various passenger cars, parlor cars, baggage cars, box and tank cars, flat cars, cabooses, snowplows, a flanger and dump cars.

Five days each week the little railroad chugs along its narrow tracks hauling sand for the cranberry bogs, equipment, pickers and, at harvest time, cranberries. If Atwood had no railroad for these freight

operations, he would be forced to pay trucking costs that would far exceed the operating costs of the line. It has been estimated that during the cranberry harvest season he saves about \$200 per day through use of his little railroad, described as "1800 acres long and only two feet wide."

Once every two or three years the bogs must be covered with sand, and Atwood's railroad hauls about 10,000 cubic yards of sand each winter. Every winter, too, the bogs must be flooded to prevent the cranberry plants from being dried out by bitter winds. Atwood has combined the most modern equipment with the most old-fashioned, for at times you can see a miniature

Atwood, who bought the equipment and built his own railroad, pauses for a chat with one of the engineers. Trains are run by his cranberry workers

SPECIAL

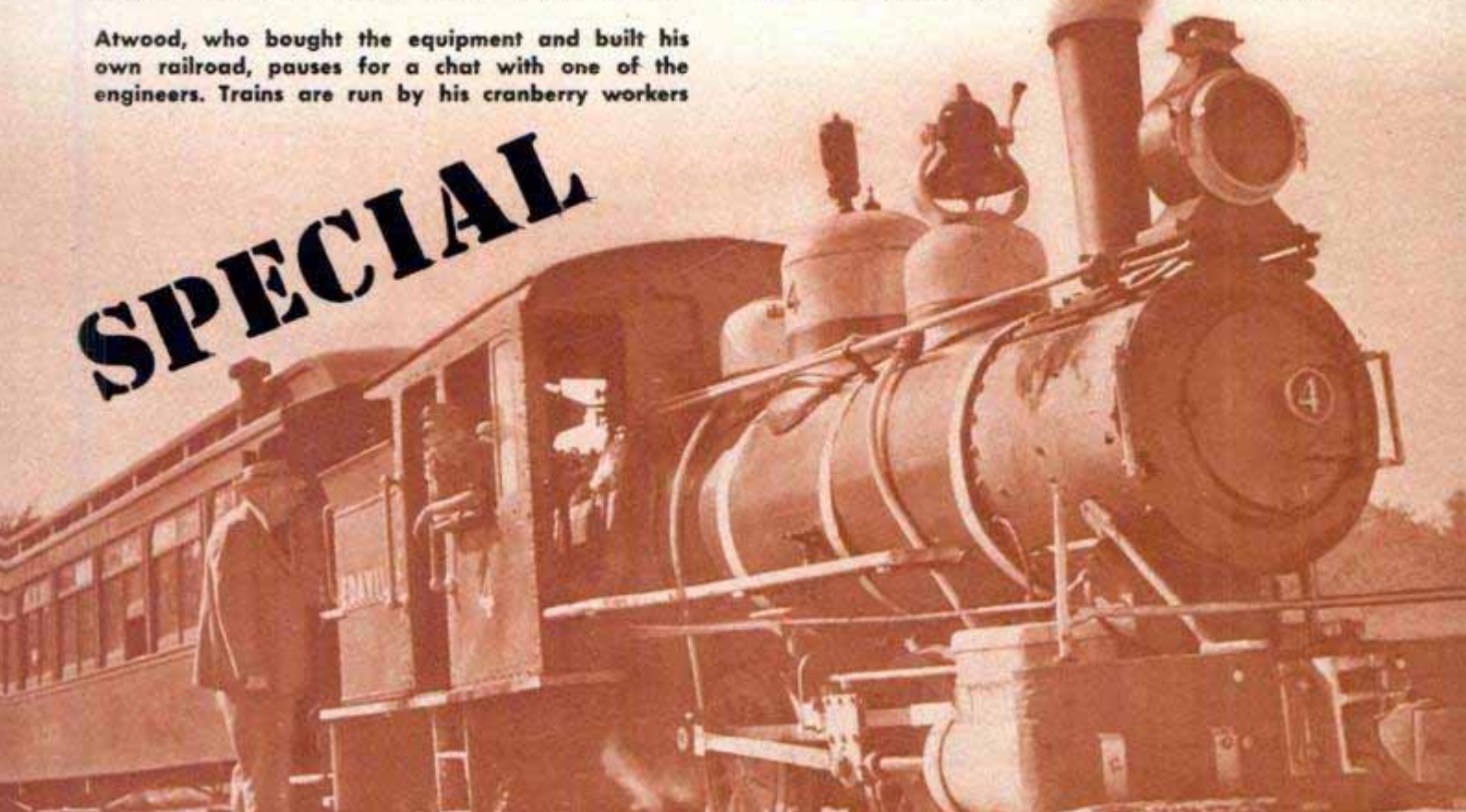



Engines are small but consume lots of coal. The men who run the trains don't consider them toys. Below, the railroad has a complete repair yard for keeping the equipment in top shape. Note extremely narrow, two-foot gauge of the little railroad

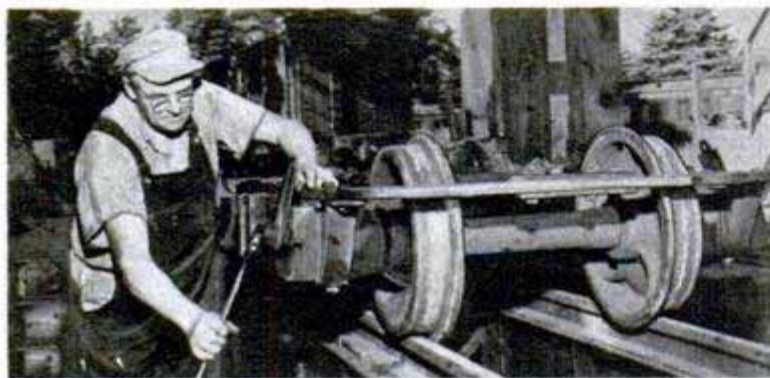

engine pulling a line of old-time cars loaded with workers to the fields, while overhead a helicopter hovers, dusting and spraying the bogs against insects.

But the Edaville line isn't all business. Atwood has made it his hobby, too, and every week end thousands of visitors take a ride in the old-fashioned, high-styled cars. In one year the railroad hauled 125,000 sight-seers.

It doesn't cost you a cent to ride on the railroad, but most people prefer to buy a 25-cent ticket, submit it to the conductor's punch and then keep it for a souvenir. The ornate passenger cars reflect the styling of the turn of the century. Repairs have been made but the coaches and parlor car look much as they did when they first were built.

During the Christmas season floodlights are placed atop a 10-car train and passengers enjoy a night ride around the cranberry loop.

The equipment of the narrow-gauge railroad includes a station, switching yard, repair yard, turntable and bridges. A regular crew is constantly busy repairing the engines and cars, for they can't be replaced once they are gone.

Operating personnel of the Edaville Railroad are cranberry work-

With the engine chuffing into the station the conductor waves the traditional red flag for the benefit of the sight-seers





Hard-working engine rolls around one of the bends hauling a coach, two sight-seeing cars loaded with harvesters, a caboose

ers turned engineers, conductors and brakemen. A man may be working in the bogs one day and collecting tickets the next.

A trip around the bogs is a lesson in how cranberries are raised. The berries grow on land useless for other crops, but are a fairly expensive crop to cultivate. At harvest time the pickers kneel in the fields and sweep two-handed scoops through the plants, picking up the berries. After the bogs are hand-picked, they are flooded and a power boat cruises about, agitating the water to bring the loose berries to the surface where they can be gathered in wire nets.

You can't tell as much about a cranberry by its color as by its bounce. Good berries bounce higher than bad berries, so that is how they are sorted. They are dropped into a container, and those that bounce over the sides land on a conveyor belt for a long trip to a Thanksgiving table.

Atwood, with the help of his little railroad, produces from 10,000 to 12,000 barrels of cranberries each year on his 1800 marshy acres. His pride in his business is matched only by his pride in the Edaville Railroad, which Atwood claims is a railroad that really runs on time.

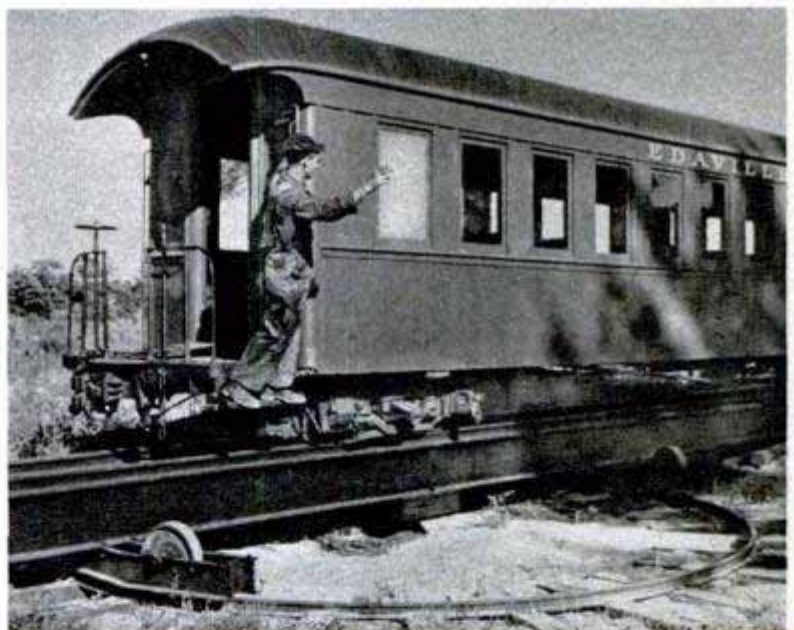

Turntable reverses cars on the narrow track. Repairs are made with care as the equipment can't be replaced. Below, the cab of the engine seems just as complicated as that of a full-size locomotive. Here the engineer eases throttle to start the train

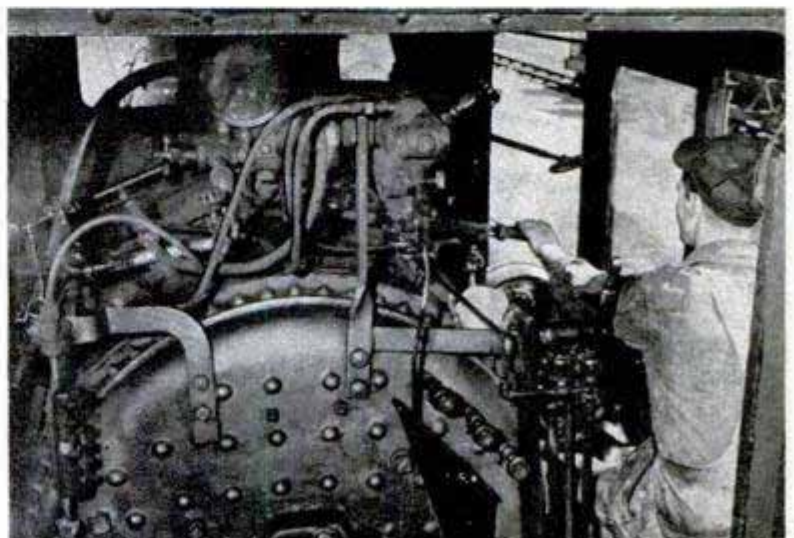

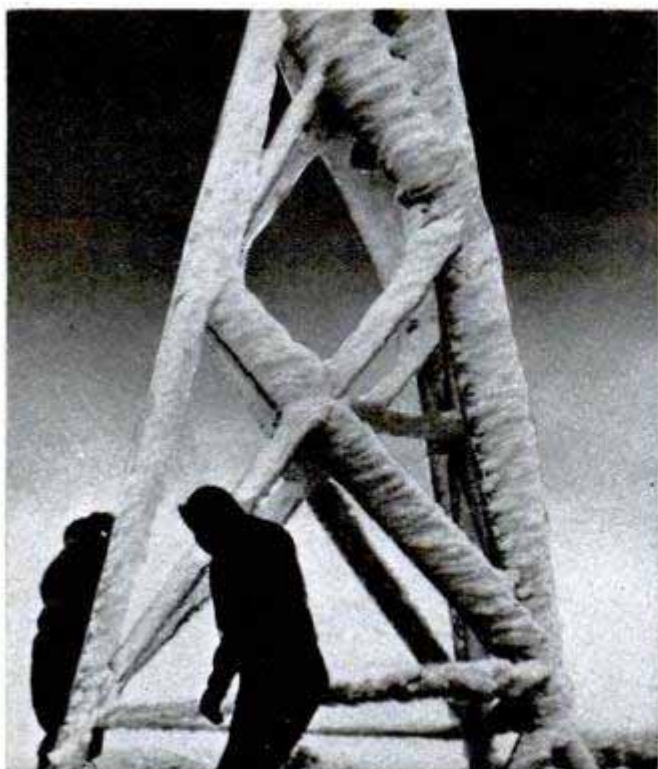

Robot Weather Stations

Wind-operated stations that send automatic weather reports are under test by the U. S. Signal Corps. Scientists of the Army and the Wind Turbine Company have developed a wind-driven generator which charges a bank of storage batteries. The batteries power a radio connected with instruments which automatically report the temperature, pressure, relative humidity, wind speed, wind direction, precipita-

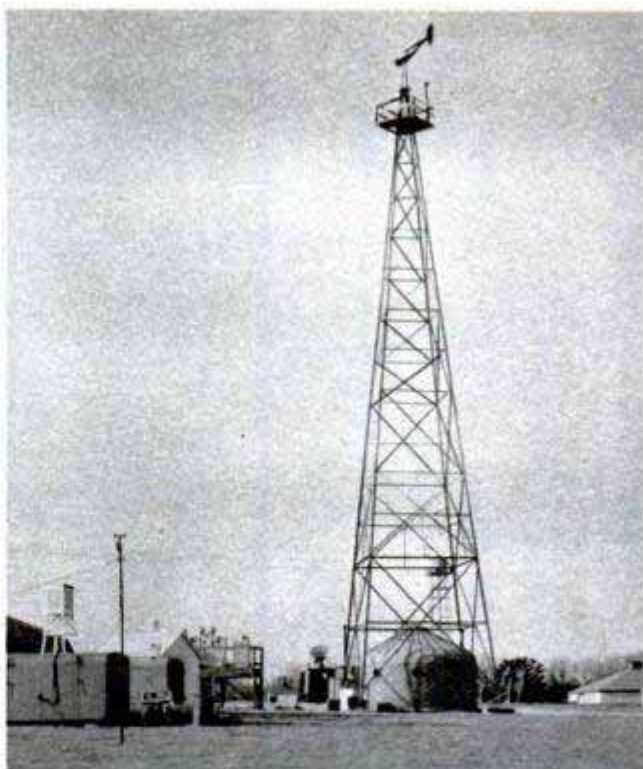

U.S. Signal Corps photos

tion and sunshine intensity. A wind of seven miles per hour is sufficient to generate electricity, and one of 24 miles per hour will produce the generator's rated output. A regulator prevents overcharging of batteries. The equipment has undergone preliminary tests at Mt. Washington, N. H. If the experiments are successful, the weather stations will be installed at various spots, where they will report the weather for years without attention.

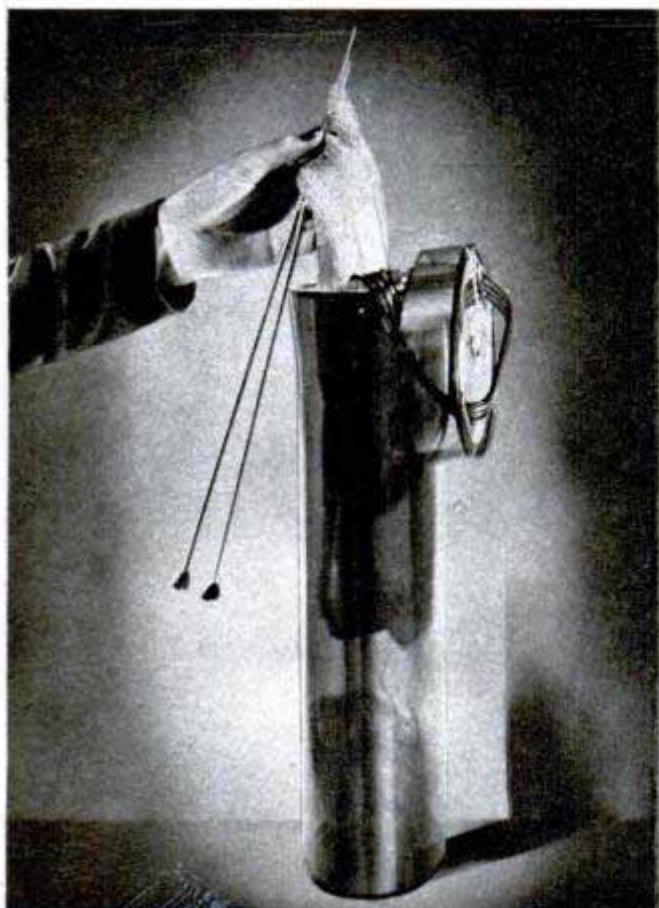

Transparent Knitting Bag

In step with the current vogue for knitting Argyle socks "on the go" is a lightweight bag made of Lumarith, a transparent plastic. Shaped like a cylinder, it comes in blue, red, green and amber in lengths of 8 to 14 inches.

Exhaust-Gas "Fertilizer" Increases Soil Yield

Exhaust gases from gasoline and diesel engines are being used in the Southwest to add the necessary acid elements to irrigation water to make the soil more productive. The usual method of reducing excessive alkalinity is to add sulphur to the soil, but this process is expensive. By using the exhaust fumes from engines that pump irrigation water, farmers acidify soil at virtually no cost except the initial cost of the equipment that mixes the gases with the water. The mixing is done by turbine agitators. This equipment costs about \$700 and provides the equivalent of \$400 worth of soil-acidifying chemicals every year at almost no operating cost.

Video Camera Lens "Sees" in Dim Light

Dim lighting is no longer an enemy of the television camera now that an extremely fast lens has been developed for video use. The new lens, called the Video Balowstar, picks up a bright image with only one foot-candle of illumination whereas previous lenses have required as much as 80 foot-candles. Designed for use under the most adverse lighting conditions, the lens makes possible the telecasting of concerts, night street scenes, church services and a variety of on-the-spot news events without supplementary lighting. Rated at f:1.3 with a 7-inch focal length, the "owl" lens is fully corrected for infra-red illumination, eliminating the fuzzy im-



Inventor Frank G. Back inspects his "owl's eye" Video Balowstar lens. Designed for television pickups under dim light, the lens costs \$2700

age that results when incandescent and natural lighting are used simultaneously on TV pickups.



Mattress Massages Patient By Air-Pressure Action

Gently massaging the body of a bedridden patient, a plastic mattress reduces the danger of bed-sores and also cuts down the amount of nursing care. The mattress consists of a series of air cells running across the width of the bed. Alternate cells are connected to a manifold which forms the edge of the mattress. The two sets of cells are alternately deflated and inflated by a small pump, producing a massaging effect on the body.

Soil-Heating Cables Save Birds

Small electric cables buried six inches underground saved the lives of hundreds of rare tropical birds last winter. R. H. Gibson of St. Helena, Calif., installed the heating cables in the bird pens on his game farm. Developed by General Electric, the cables saved many of the 4000 birds, as temperatures around 60 mean certain death to some species. A thermostat kept the pens at 70 degrees.

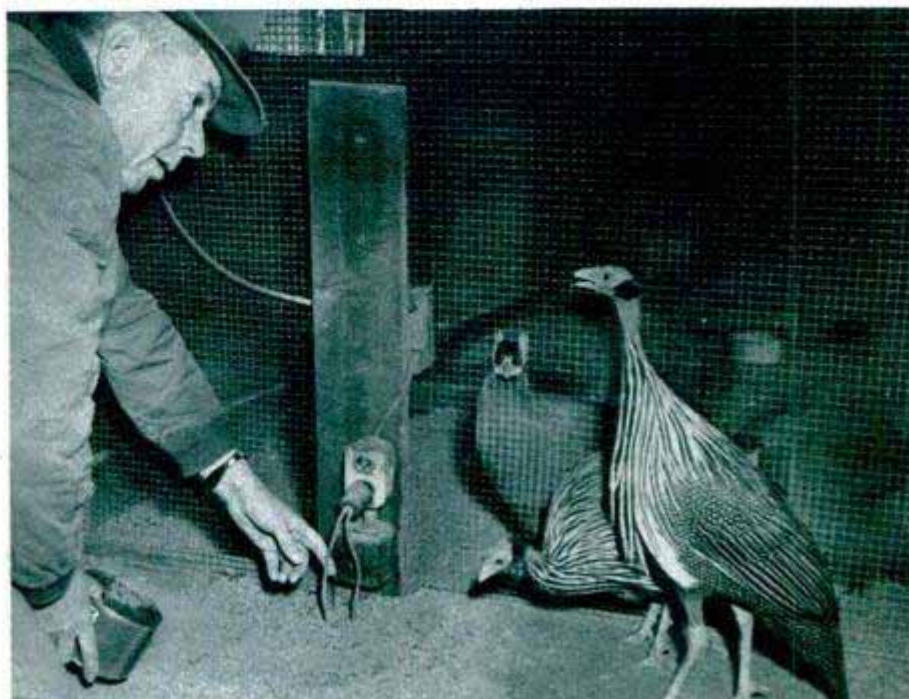

\$100,000 speedboat to challenge the world

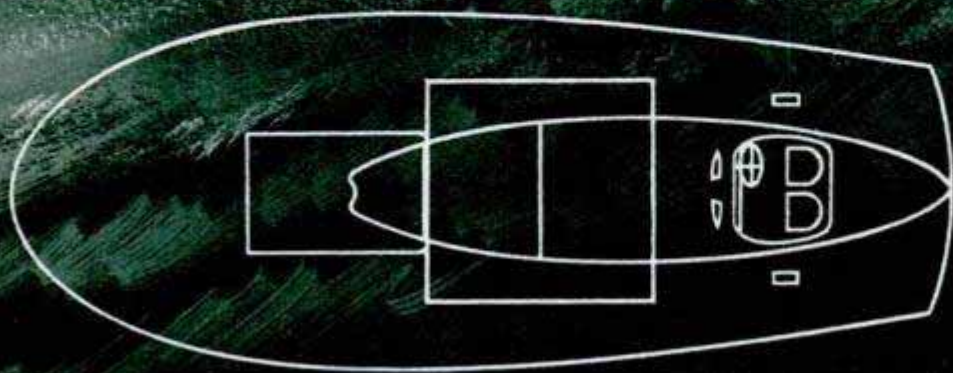
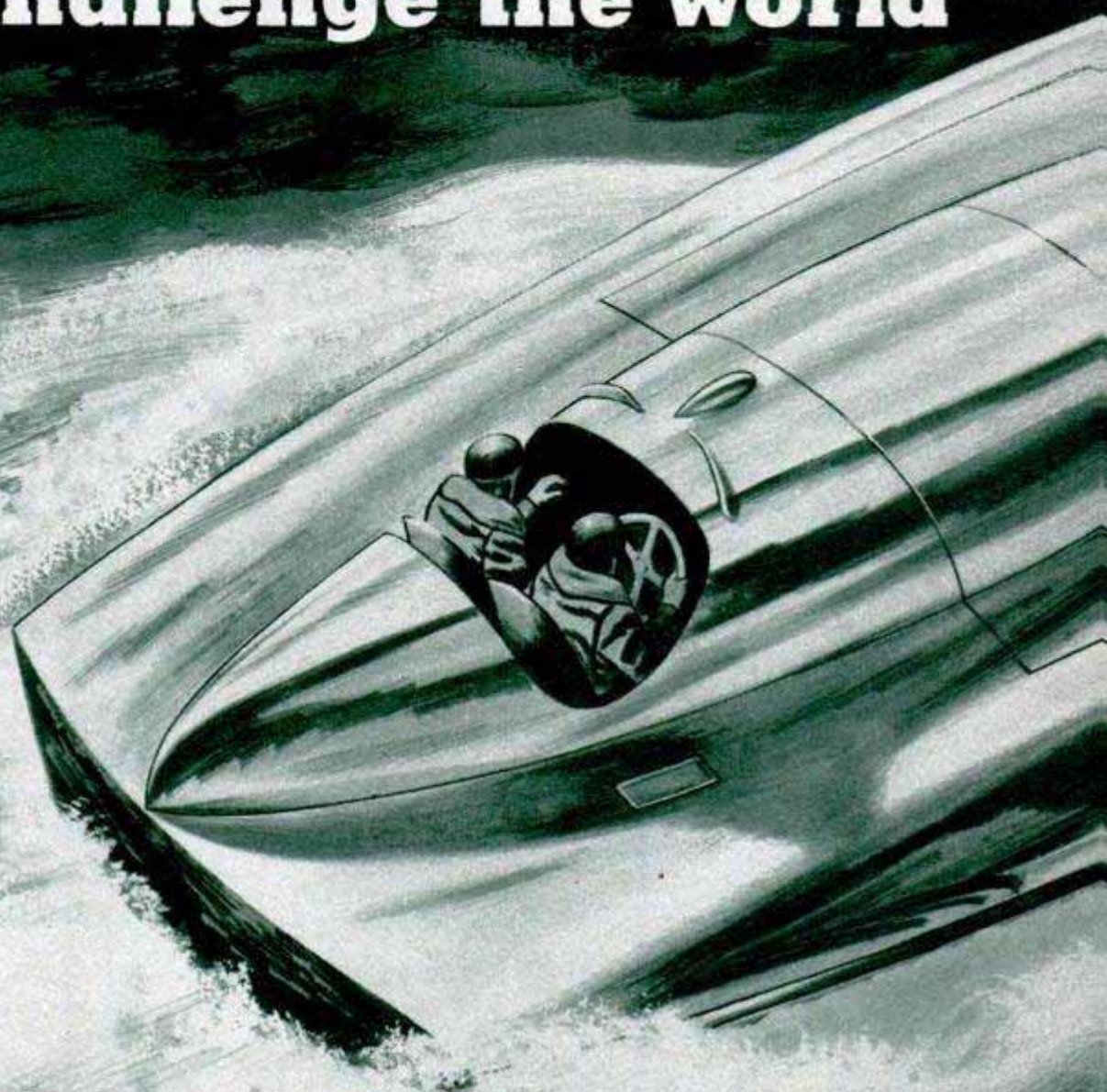

Drawings show top and side contours of 32-foot super speedboat. "Step" in hull is visible in lower drawing. As boat gains speed, it rides on two forward stabilizers and aft bottom to reduce frictional drag and gain "air lift." With 3000-hp. engine, estimated speed is 160 m.p.h.



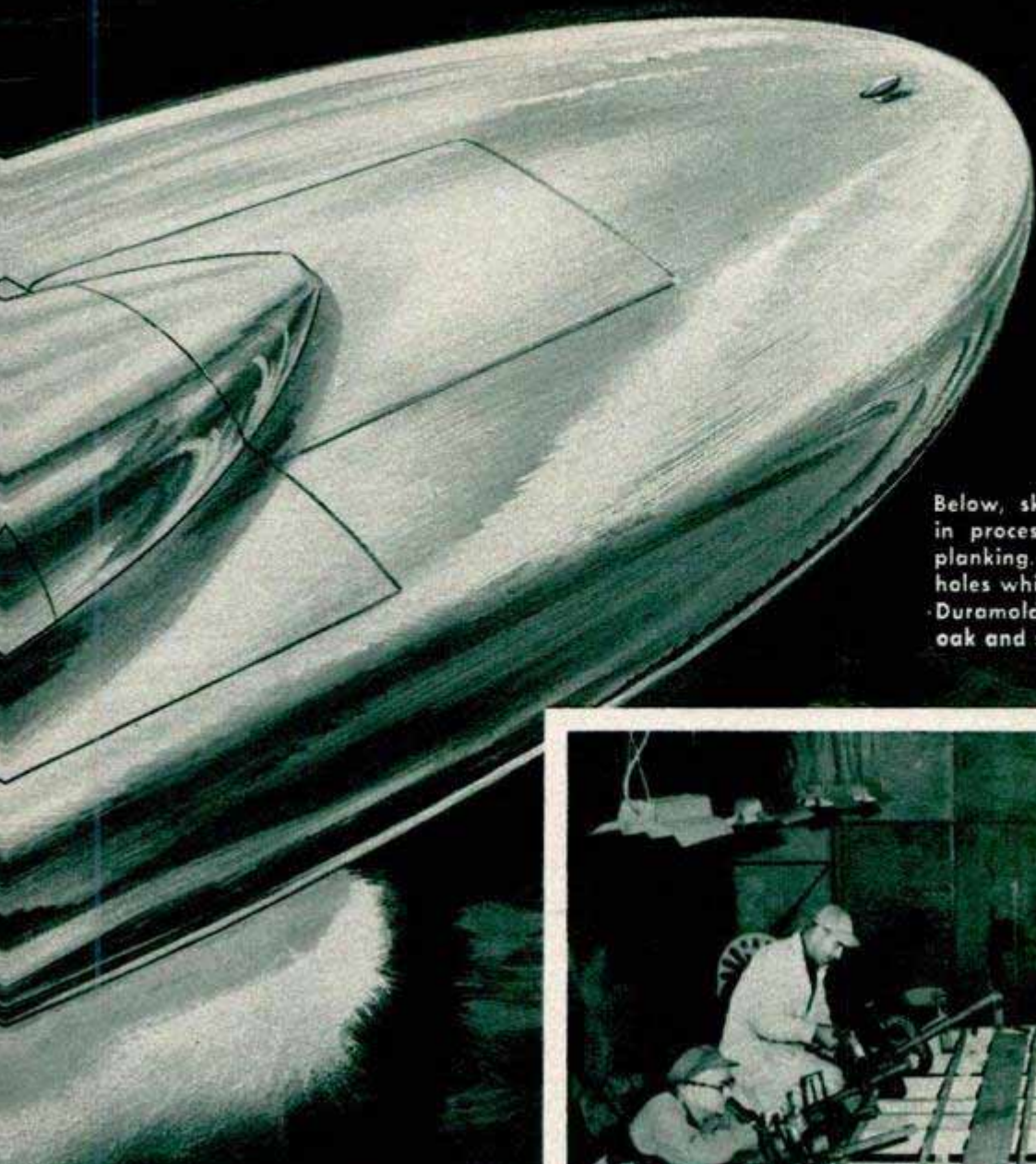

Below, skeleton hull of speedboat in process of being covered with planking. Workmen are drilling the holes while C-clamps hold material. Duramold birch plywood, laminated oak and spruce make a sturdy craft

WITH AN ESTIMATED top speed of 160 miles an hour, a flashy 32-foot speedboat is aiming toward a new world's record at the Harmsworth Trophy race which will be held on Detroit's St. Clair River July 29, 30 or August 1. The anticipated speed is 18 miles an hour faster than any boat that ever roared its way past a finishing marker.

The \$100,000 craft, now undergoing tests, is powered by a 3000-horsepower 24-cylinder Allison engine of the "W" type—two "Vs" in one crankcase. Engines of this design were originally planned for high-speed reconnaissance planes before jets upset the aviation appletart.

The speedboat is owned by Henry J. Kaiser, the industrialist, and was designed and built by the Ventnor Boat Corporation at Pleasantville,

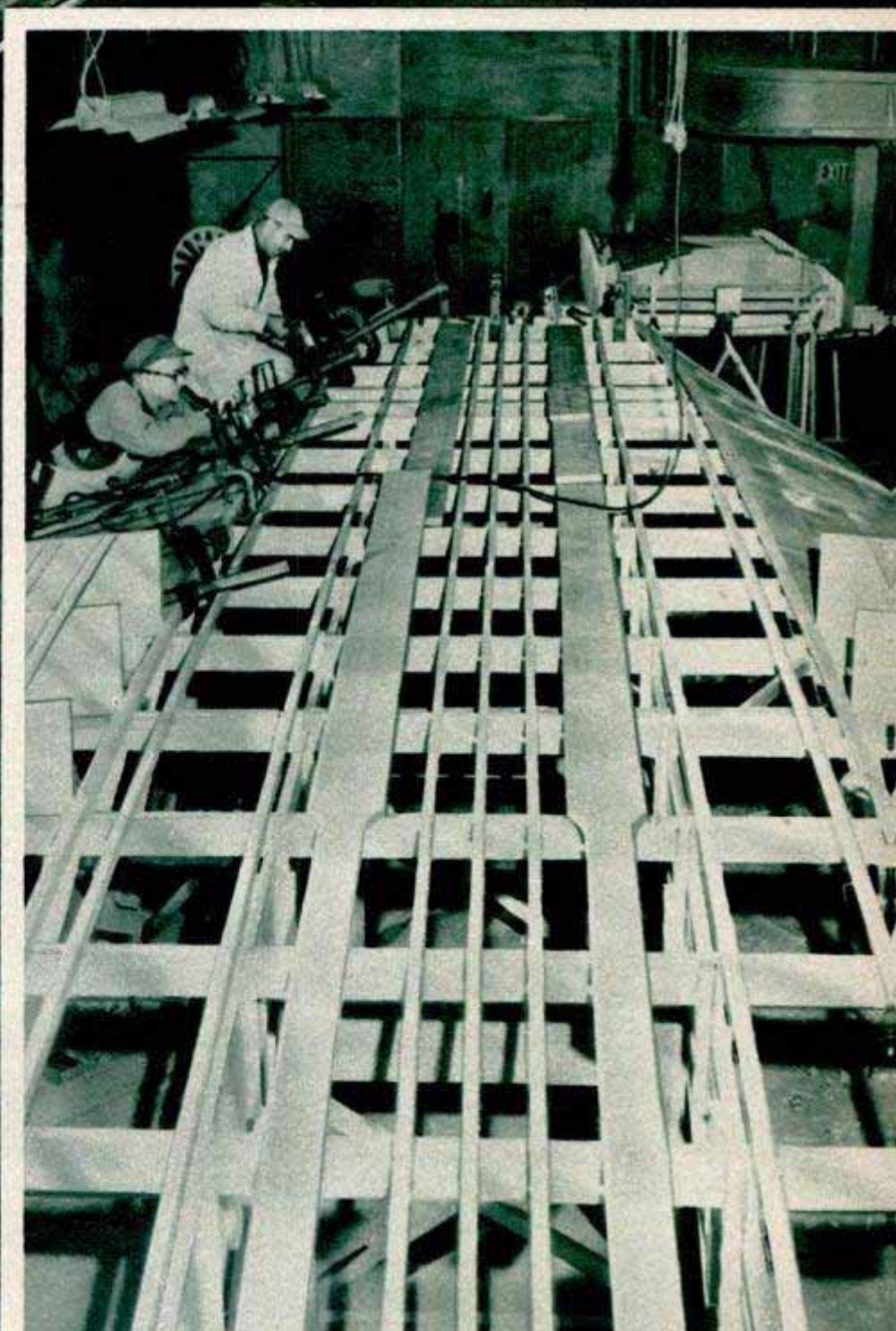

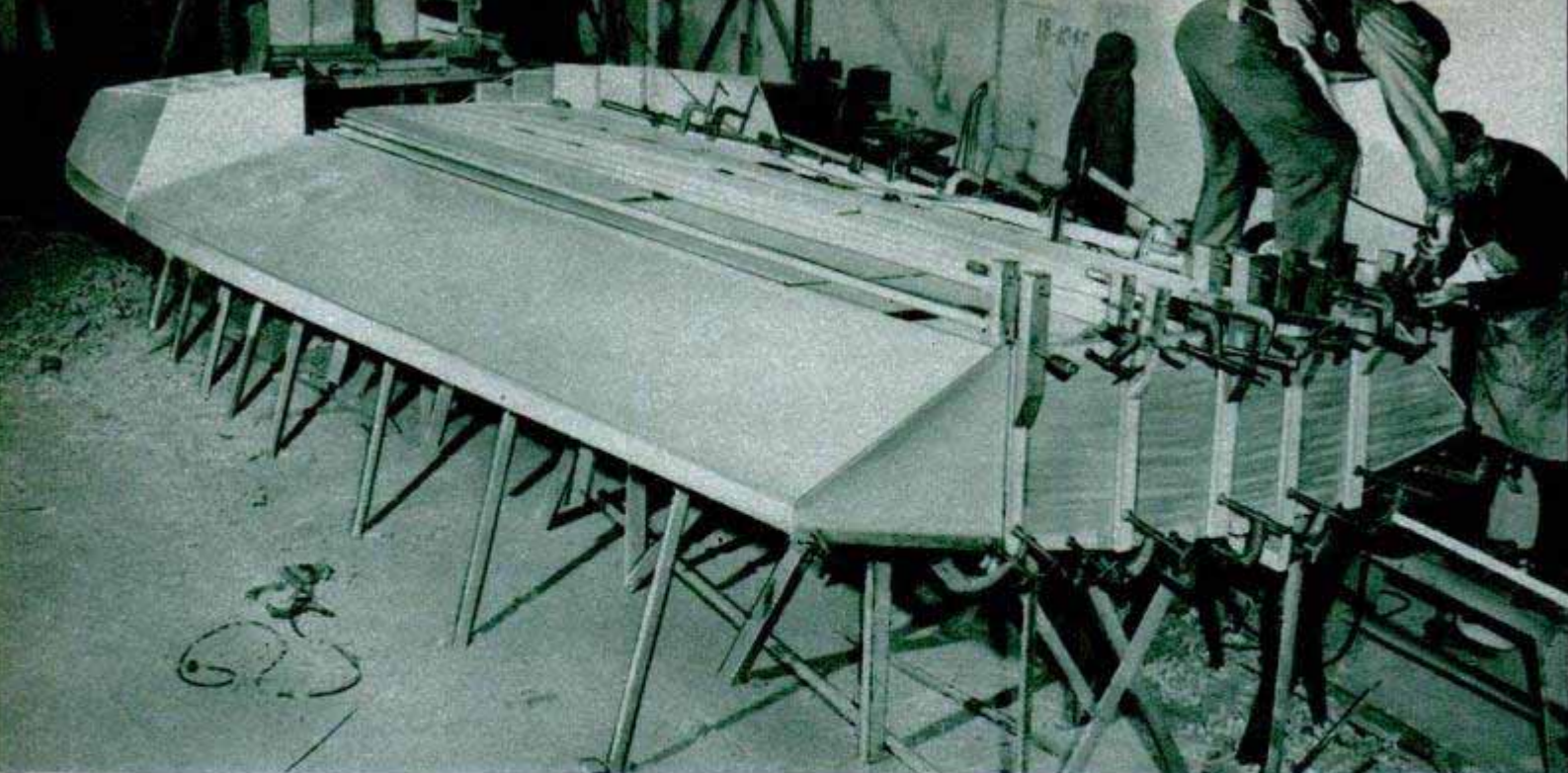

Stern-to-bow view of hull under construction. Builders hope it will stand the strain of 160 m.p.h. speed

N. J. This company has built some of America's fastest racing boats and designed the Bluebird, the speedboat in which Sir Malcolm Campbell set the world's record of 141.74 miles an hour in 1939. The Kaiser boat will probably be piloted by Guy Lombardo, noted orchestra leader and racer.

A distinctive feature of the new speedboat is its three-point suspension. When the boat is in motion it rides on its two front stabilizers and aft bottom. This reduces frictional drag, according to designer Arno Apel, and concentrates air under the bottom of the boat, giving it "air lift." At high speeds the boat is approximately 50 percent airborne.

Speedboat power plant — 3000-horsepower 24-cylinder aircraft engine

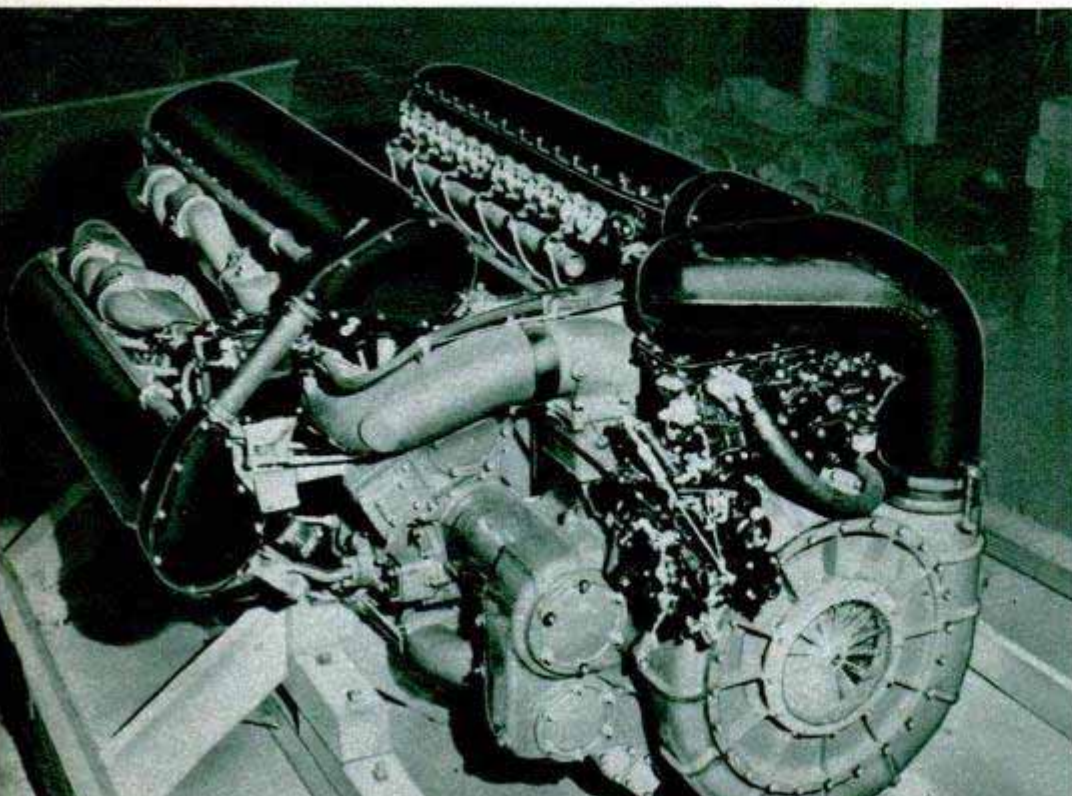

The boat is constructed of Duramold birch plywood and laminated oak and spruce framing. Engine spar girders are constructed of high-tensile aluminum and the deck is covered with aluminum alloy sheet. The high-powered, double-crankshaft engine will burn up aviation gasoline at rates estimated from 300 to 600 gallons an hour, depending on the speed. At 40 cents a gallon, this tremendous thirst will run the fuel bill up to \$240 an hour at top speed. The twin crankshafts, mounted in a common crankcase, turn two contrarotating propellers.

The Harmsworth Trophy race is being revived after a lapse of 16 years and will be conducted by the Yachtsmen's Association of America. Competing nations are represented by teams of a maximum of three boats. A committee of 10 chosen by Sheldon Clark of Chicago, commodore of the Y.A.A., selects the American competitors. Challengers from Canada and Italy will also be in the race. The Harmsworth Trophy has been held by the United States since Gar Wood, Sr., of Algonac, Mich., won it on Osborne Bay, England, in 1920. The Kaiser boat is expected to travel 35 miles an hour faster than Wood's famed Miss America X.

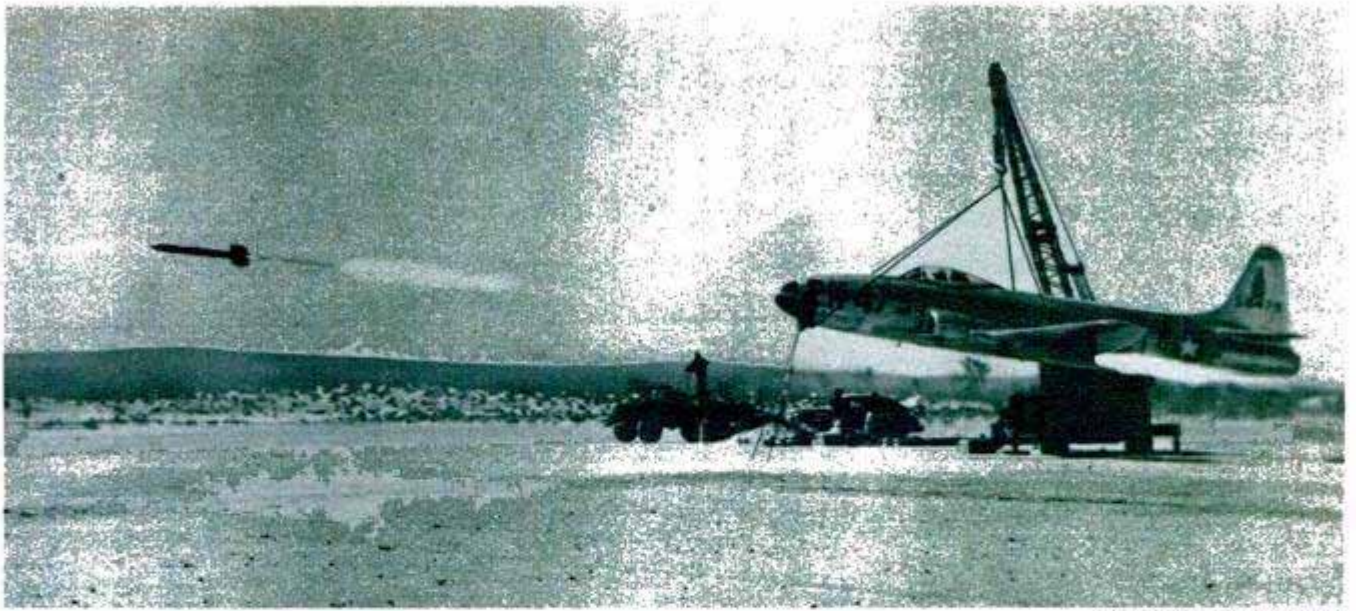

Lockheed Aircraft photos

Retractable Rocket Mounts for Fighter Planes

Development of a new disappearing rocket mount may make rockets standard equipment on all U. S. Air Force fighters. They retract into the wing when the last rocket is fired, eliminating the drag of old-type fixed mounts that reduced the plane's speed. Jets like the 600-mile-an-hour Lockheed F-80 will carry eight five-inch high-velocity rockets, four under each wing. The rockets travel 1350 feet a second under their own power, plus the speed of the plane.

Top, an F-80 with its retractable rocket mounts being tested on the range. Right, close-up of mounts with rockets in place

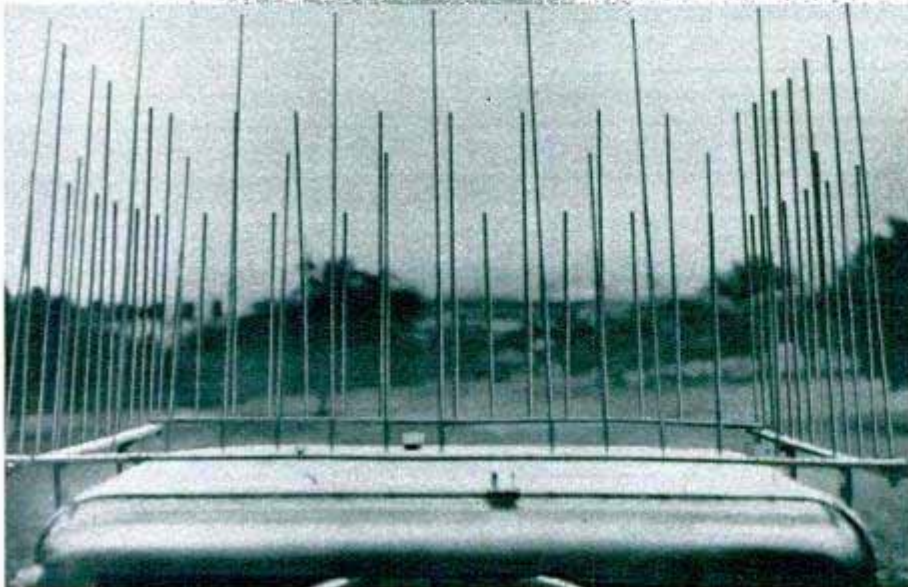
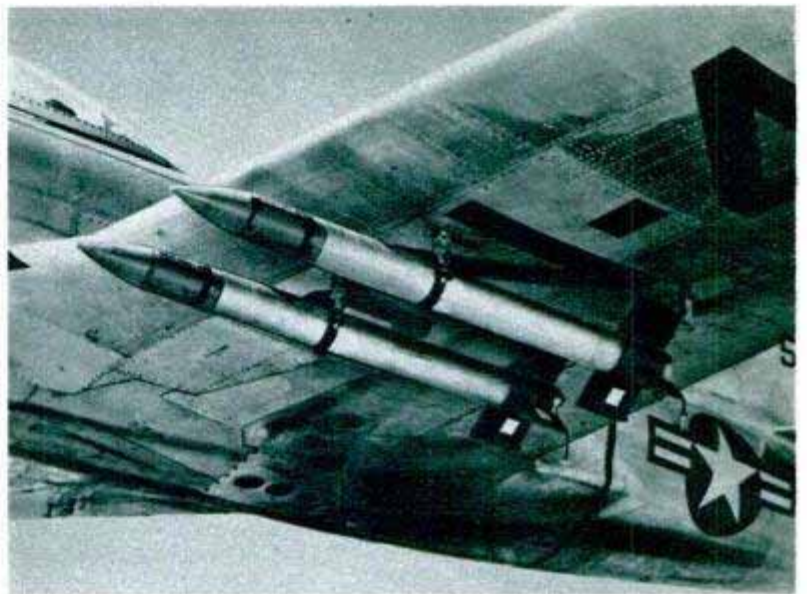

Pronged "Scarecrow" Keeps Pigeons Away

Faced with the problem of keeping birds off newly developed airport approach lights, Westinghouse engineers came up with a many-pronged "scarecrow" that is proving a puzzler to roost-seeking pigeons. It keeps birds from obscuring the lights and from flying into the path of landing planes. Called most powerful in the world, the lights penetrate 1000 feet of thick fog to guide incoming craft to the runway.

Under his own power and without mechanical help, man's top speed is just over 22 miles an hour.

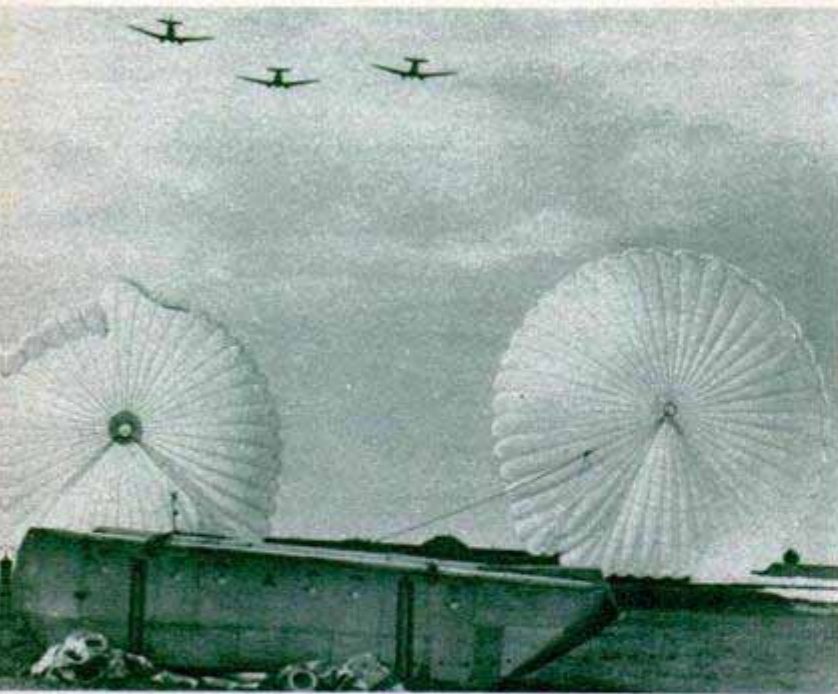

Metal Crate Delivers Jeep by Parachute

Any type of freight can be loaded in a metal universal container and parachuted from a plane. A fully assembled jeep and trailer combination, ready for instant use, was dropped from a Halifax bomber in a demonstration by the British School of Land and Air Warfare.

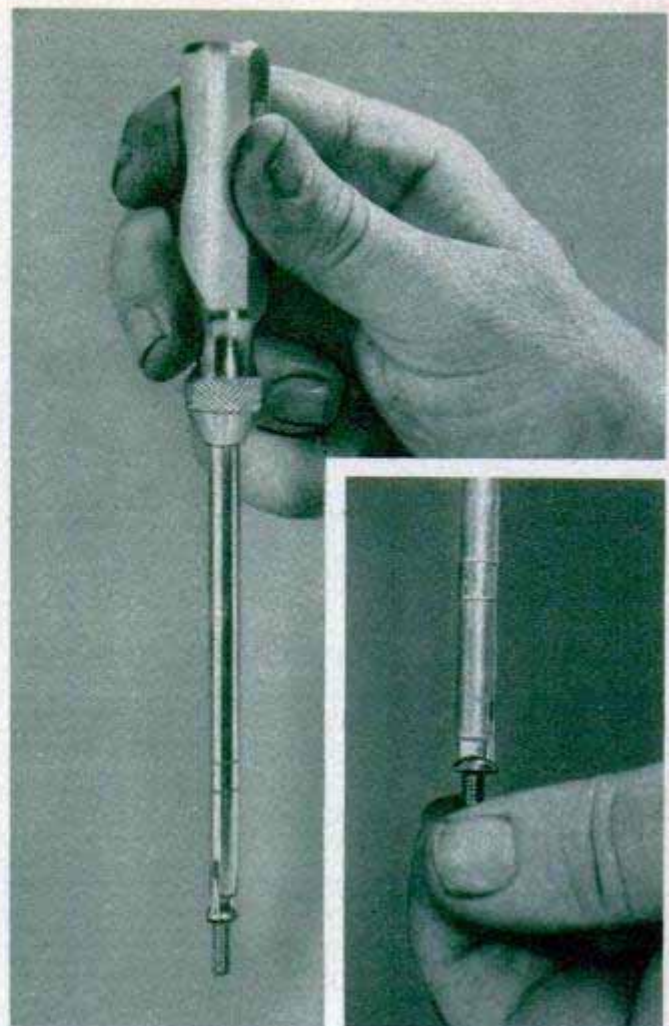
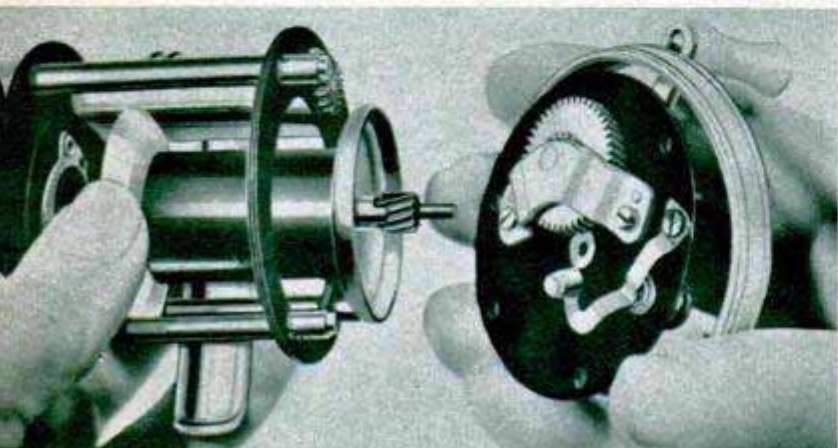

Spring-Action Screwdriver Holds Screw Firmly

By the spring action of its two slender bits, a new screwdriver grips the screw firmly, allowing it to be started in those hard-to-reach places. Pressure on the bits forces them into the shank, closing the gap between them so they can be inserted in the screw slot. When pressure is released, a spring inside the shank forces the bits out so they grip the sides of the slot. The tubular end of the shank rests against the screw head to keep the screw properly aligned during the driving.

Twist of Wrist Opens Reel For Cleaning or Oiling

By simply unscrewing a large ring an angler can expose the parts of a new fishing reel for cleaning and oiling. He can open the mechanism without any tools and without losing any of the small parts. Grit and old lubricant are brushed out, the parts re-oiled and the reel screwed together again without disturbing the adjustment. The reel is designed for casting light lures.

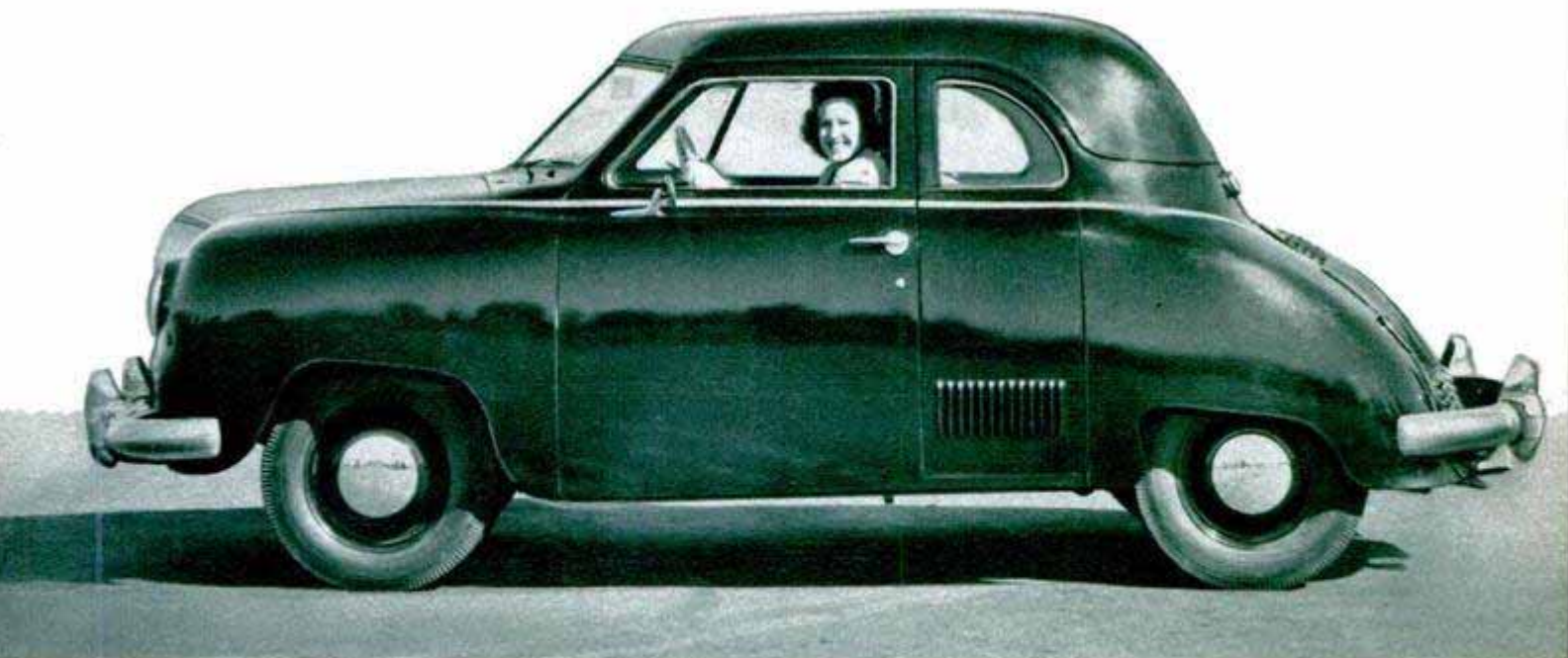

Midget Makes Bow

Getting into production in Kansas City, Mo., is the latest midget sedan in the automotive field. The car has a front-wheel drive, an airplane-type air-cooled four-cylinder rear engine, and present plans call for a body of molded plastic Fiberglas. Designed by Ben F. Gregory, the car will bear his name. It has been undergoing tests for 3½ years. The Gregory has an over-all length of 153 inches and its width of 67 inches accommodates three passengers in front and two on the back seat. Height of the car is 61 inches. Other specifications include hydraulic brakes, full knee-action springs, pressure lubrication, box-type frame construction with 13 attached panels, a tire size of 5.50 by 15 and a top speed of 70 miles an hour. The rear engine, which places noises and fumes behind the passengers, is installed in such a manner that it can be removed and replaced by one man in less than an hour.



Side view of the rear engine Gregory, top, shows simplicity of line and trim also evidenced in the front view at right. Below, a plan of the front-wheel-drive midget and the airplane-type engine

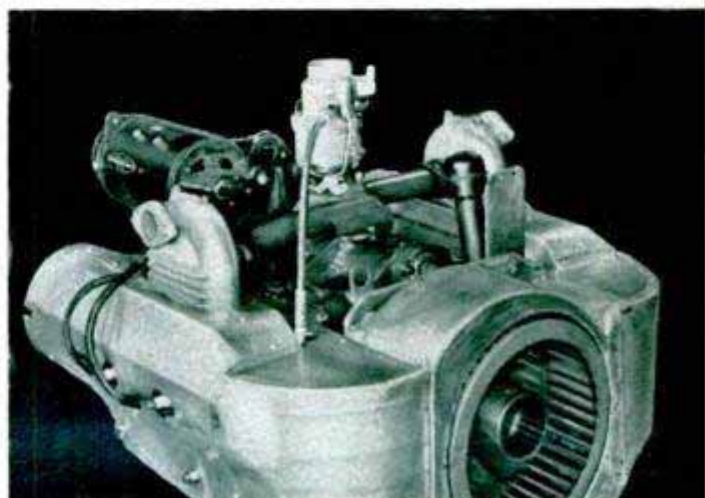
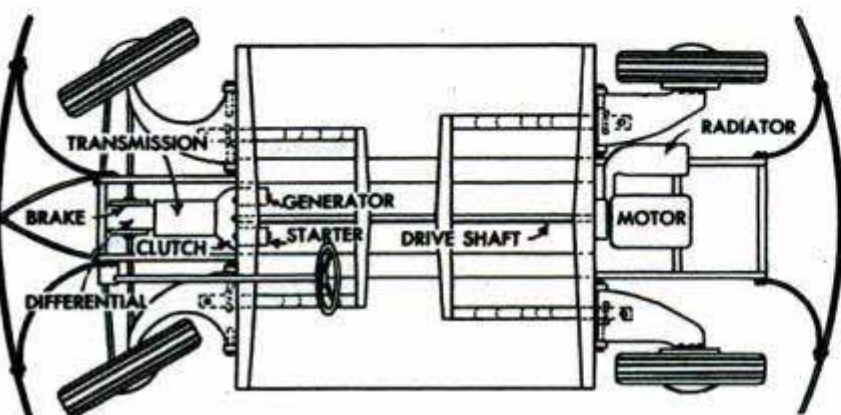

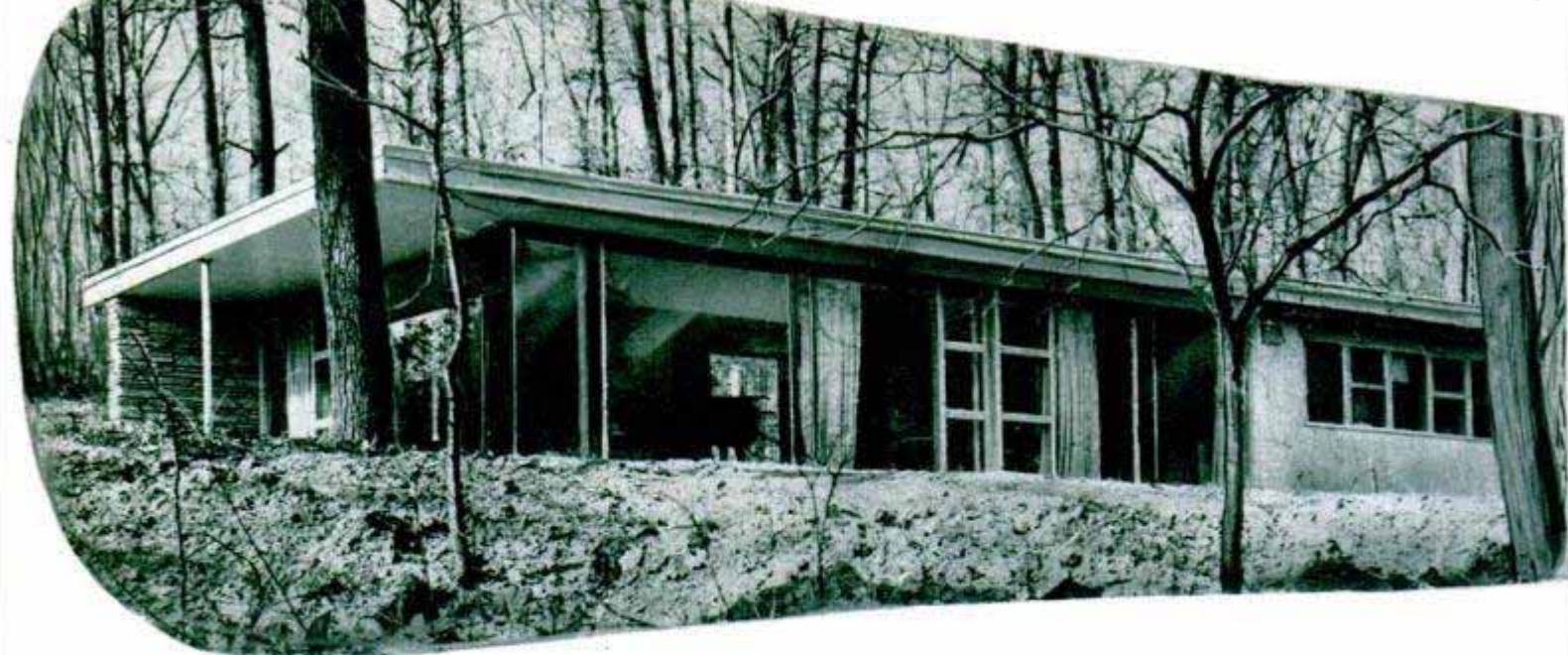

This striking house, completed by its owner, blends with the rustic surroundings despite its modern lines

TEN MONTHS of spare-time work by a young Pittsburgh engineer transferred his dream house from an architect's drawing board to a wooded hillside. It's the dream house he brought back to civilian life after the war.

The engineer, Robert J. Kirkpatrick of Westinghouse Electric Co., almost had to give up his dream while it was still on the drawing board. When he showed the architect's drawings to contractors their estimates ranged from \$17,000 up. Figures like that were too steep for the family budget.

But he didn't let his dream get away. After all, he thought, an engineer ought to

be able to do some more or less skilled labor to help chop down the \$17,000-plus figure. Then, he and his wife talked it over and decided they could postpone the two extra bedrooms for a while and that cut down the cost even more. Today, the Kirkpatricks and their three small sons are living very comfortably in a prize-winning home that cost them \$10,000.

Plumbing, concrete pouring, rough timbering and electrical work were done by contractors. The Westinghouse engineer did the rest. For 10 months, he worked at the task nights, week ends and even during his vacation.

Left, Mrs. Kirkpatrick tends garden all winter right in the comfort of her big living room, thanks to this corner flower bed. Right, the man of the house made these book shelves with aluminum tubes and pine planks



he built his own dream

The floors of the one-story house are concrete and contain the hot-water radiant-heating pipes. Two walls, the south and east, of the combination living-dining room are entirely glass. Some of the plate-glass sheets measure 8 by 10 feet. These transparent walls are continuously decorated by Nature's handiwork on the shrubbery outside, providing at least four changes in decorations every year.

Eliminating the two extra bedrooms created a sleeping-space problem that was solved with three-tier bunks in a storage area near the master bedroom. The three boys, one five years old, another three and the baby only a year old, almost think going to bed in the Pullman-car arrangement is fun.

Both interior and exterior walls are sandstone that Kirkpatrick laid himself with cinder blocks forming the core. A snack bar in the kitchen has "adjustable" stools that can be lowered as the boys grow taller. They're merely logs standing on end.

The house was awarded second prize in an architectural competition. The Kirkpatricks are proud of this, but they don't like you to call their home modernistic. They say, it's just a real homey house, modern in appearance and utility, but extreme only in comfort.



Above, monk's-cloth draperies cover the glass walls, providing both privacy and insulation. Below, a family portrait in front of the fireplace that dominates the living-dining room. Bottom, stools for the snack bar are logs that will be shortened as the boys grow up





"Light Pipe"

Despite twists or knots, a new flexible "light pipe" carries a beam to its target with four or five times the intensity of a flashlight. It is made of an amber-colored translucent plastic called Fosterite developed by Westinghouse during the war as insulation for radar equipment. Where light traveling through air diverges and spreads, the pipe's highly polished inside acts as a series of reflecting mirrors to prevent light leakage en route. The development of the pipe was a by-product of plastic research and no commercial application of it has yet been planned. It can be made in lengths up to six feet, with thickness varying from $\frac{1}{4}$ inch to 2 inches.

Fence With a Bounce

Erection of a rubber corral fence has cut down cattle injuries on a California ranch. The "fence with a bounce" was made from discarded oil-field-machinery belting.



Shock Absorber for Light Planes

Bad bounces on plane landings are almost completely eliminated by an air-and-oil shock-absorbing strut. A landing ram which forces oil through a small opening into a compressed-air chamber absorbs the initial shocks of impact. The opening's size and the amount of air varies with the weight of the plane. Taxiing shocks are taken up with a knee-action effect by the air chamber. The strut adds only seven pounds to the net weight of small planes.

Talking Traffic Lights

Traffic lights that talk have been demonstrated in England. The talking attachment can be synchronized with existing traffic lights to broadcast messages that change as the color of the lights changes. A wide variety of messages in both male and female voices can be used. The talking signals are the invention of K. T. Barlow, a London engineer.

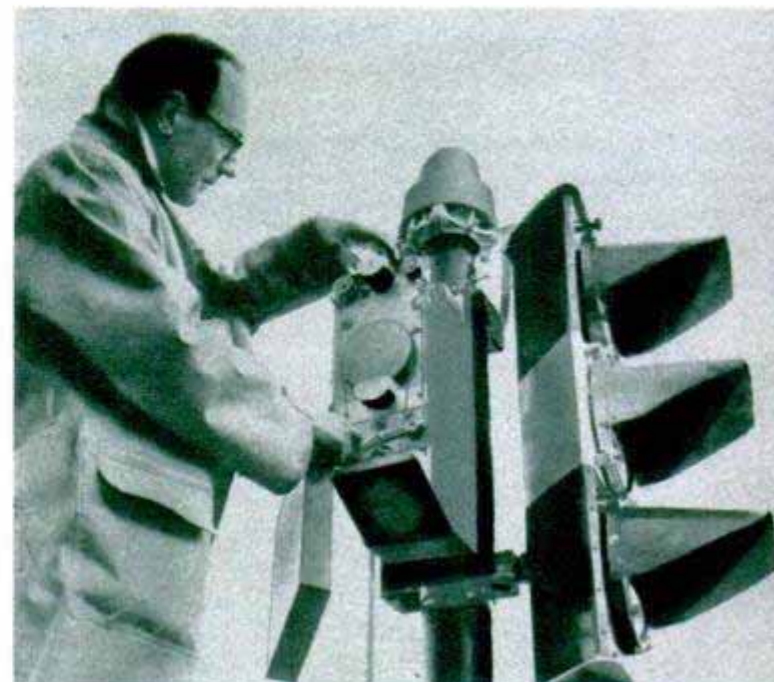

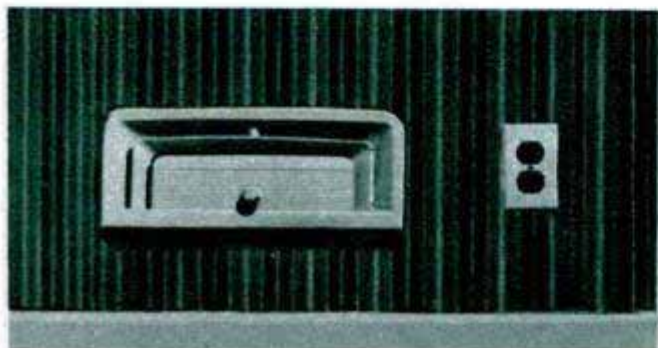

Above, fitting the plenum chamber to the top of the furnace. Circles near top are punched out to take the stovepipe ducts. Top left, installing a register between studs, showing the use of four-inch stovepipe. Left, completed installation of wall register

Stovepipe Heating System Cuts Installation Costs

Producing a blanket of warm air in front of outside walls, a warm-air heating system gives the sensation of radiant heating without its high cost of installation. Special registers direct the forced air upward in a fanlike pattern in front of the wall, instead of out into the room. The use of standard four-inch stovepipe instead of the more ex-

pensive rectangular ducts cuts installation costs as much as 50 percent, according to General Electric engineers who designed the system. An additional feature of the system is the freedom of furniture placement in rooms since pieces may be placed directly in front of registers without interfering with circulation.

"Window Shopper"

When a passer-by sees an item he wants in the window of a Detroit men's store, he can order it even though the shop is closed. Installed in front of the glass is a microphone connected with a tape recorder inside. The window shopper merely deposits a coin to operate the recorder and then leaves his verbal order for the desired item. Employees mail out the merchandise the following day. The coin is returned in the package.



Fortune Hunt in a Cave

Skip platform, right, carries guano along 1200-foot cableway from below cave to narrow-gauge railway. Below, miners inside the ancient bat cave sink knee deep in thick accumulation of mineral-rich deposit



By Gene Segerblom

Photos by Mark Swain

DISCOVERY of a fortune in guano in an ancient bat cave high on the lower north rim of the Grand Canyon has led to the most unique mining venture in Arizona.

The guano, rich in nitrogen used in fertilizer, had lain there undisturbed for thousands of years, until the waters of Lake Mead backed up the Colorado River, raising its level to within 2000 feet of the cave's 10 by 30-foot opening.

Then veteran river pilot Murl Emery, investigating the cave, found the guano — still perfectly preserved by the dry desert air.

That was nine years ago. It has taken Emery and his partner, Walter Swartz, from then until a few months ago to devise a practical method of turning the bat dung into pay dirt. Now, with a crew of six, they have set up a camp and worked out an ingenious scheme for getting the guano 2000 feet down the solid-rock mountain and out of the Grand Canyon.

Inside the cave, the guano is hand-shoveled onto a treadmill and carried to the entrance.

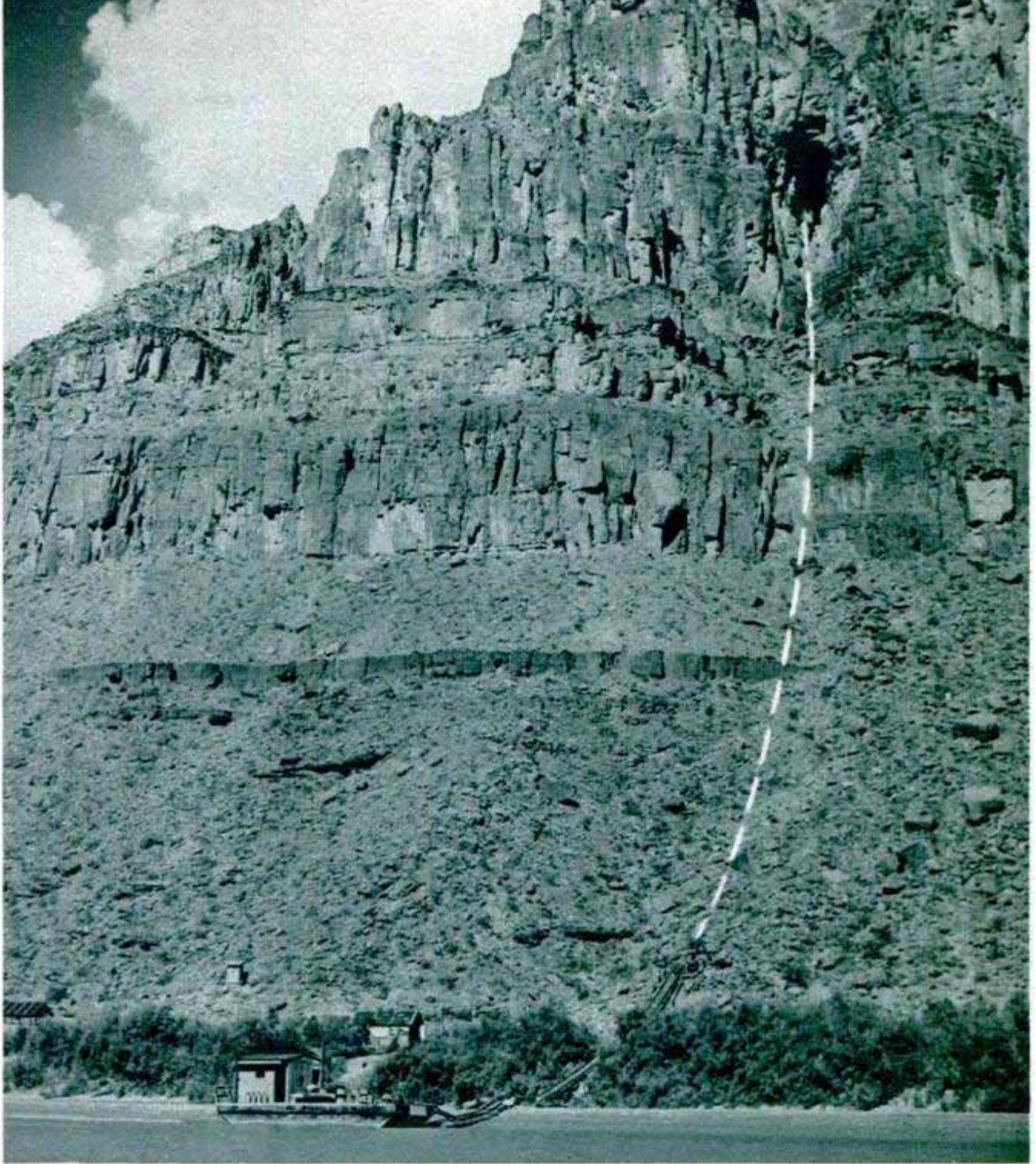

Broken line indicates path guano travels from cave to narrow-gauge railway that moves it last 150 feet to the Colorado River. Workers' camp and the barge are at lower left. Below, controls for the cableway

There it falls into a chute and goes through 400 feet of pipe.

At this stage the guano is automatically sacked and loaded on a skip. From there it descends a cableway to a narrow-gauge railway. The rail cars move it the last 150 feet to the river's edge. Barges transport the sacks to Pierce Ferry, 14 miles downstream at the mouth of the Grand Canyon.

Because of the elaborate handling required, the guano-mining project has to pay well. Emery isn't certain how rich a strike they've made, but the part being worked now contains about 16 percent nitrogen and is worth around \$150,000 for fertilizer.

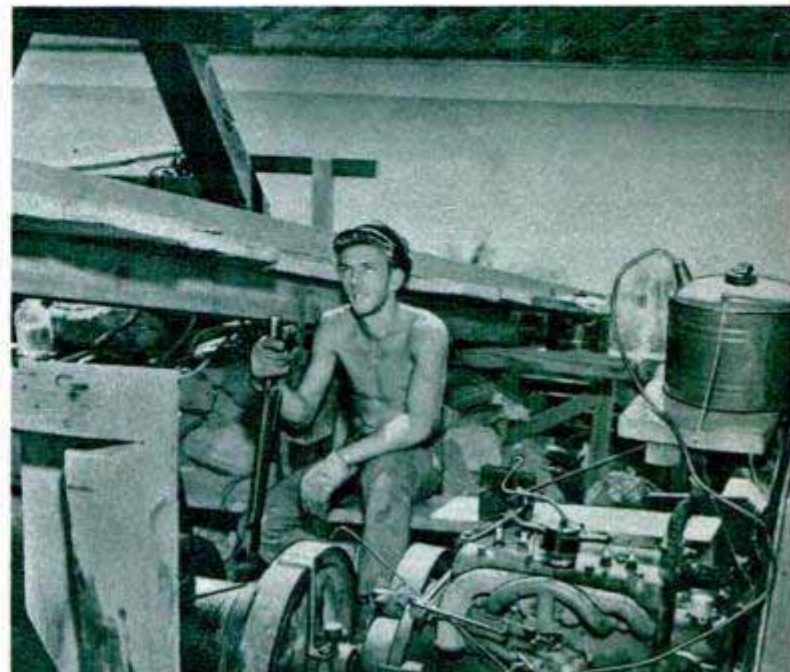



After bat manure has been chuted to sacking machine, it is taken to skip landing, above, for cable trip down steep canyon wall. Opposite bank of Colorado River is visible in background. Long, flat silt bar in the middle of the river, below, will be used for plane landings in dry season

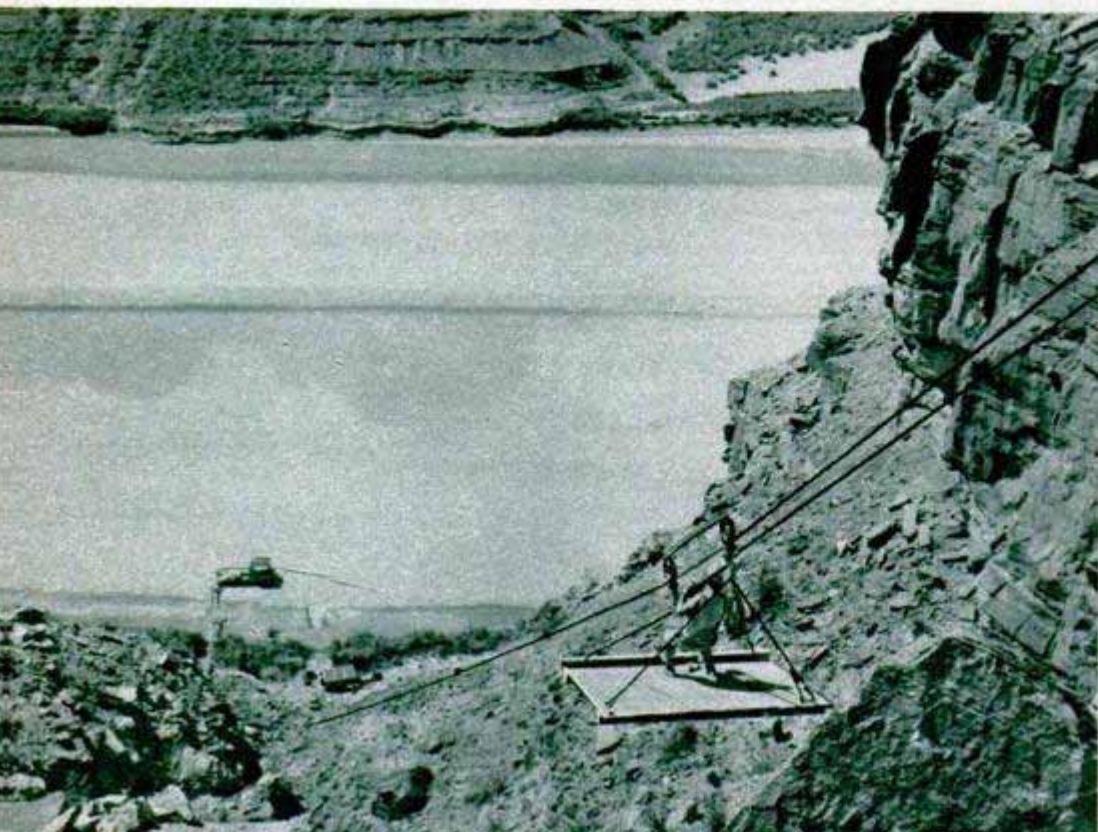

The partners have already explored 1000 feet of the cave and dug out accumulations 22 feet deep without striking bottom. Emery believes there is still plenty of high-grade "ore" present to keep the operation going for a long time.

Although the first sackfuls cost more to mine and ship than they were worth, Emery and Swartz expect to have the operation perfected soon to the point that they can profitably deliver 300 tons monthly. It brings \$45 to \$75 a ton.

Few people would have struggled through all the red tape and difficulties the partners encountered before actual mining could get under way. First, permission to mine had to be obtained from the National Park Service, since the prehistoric cave lies inside the Grand Canyon National Park.

Transportation posed a second obstacle. The only means of reaching the cave is by the Colorado River, which is too silt-filled for large craft to navigate.

It takes a skilled pilot to get through the muddy waters even in a small outboard. Luckily, they have one in Pat Emery, Murl's son, who has spent much time on the river with his father. He can pick his way between hidden mud banks and avoid dangerous submerged logs and driftwood with uncanny accuracy.

Another difficulty is that the silt-packed water is "too thin to plow and too thick to drink," to quote an old saying. To top off the bad water, the high summer temperatures make thirst terrific. The miners haul in hundreds of cases of soft drinks for personal use and even make ice cubes out of soda pop.

The unique mining re-



Army-surplus telephones connect all points on guano transportation system. Right, entrance to cave is a slit 10 feet wide and 30 feet high. Workers climb the ladders in foreground to scale 100 feet of vertical cliffside

quirements necessitated the installation of a Model-A motor hoist to run the skip, an electrical generator for lighting and raising equipment the 400 feet from the skip to the cave entrance, and a narrow-gauge railroad. Other unusual features that had to be brought in were an Army-surplus trench phone, used for calls between the camp and the cave, and the automatic sacking machine.

Both Murl and Pat are licensed pilots and expect to use the cake mud flat on the opposite bank for an airplane landing strip when the river recedes. That means of outside contact, however, will be lost for part of each year when snow and rain waters raise the level of Lake Mead and the river.

With the cave a full day's travel from Hoover (Boulder) Dam, work isn't likely to be slowed down by casual sightseers.

Grand Canyon has always been an awe-inspiring sight for tourists. Now it is also going to help make a small fortune for two energetic rivermen.

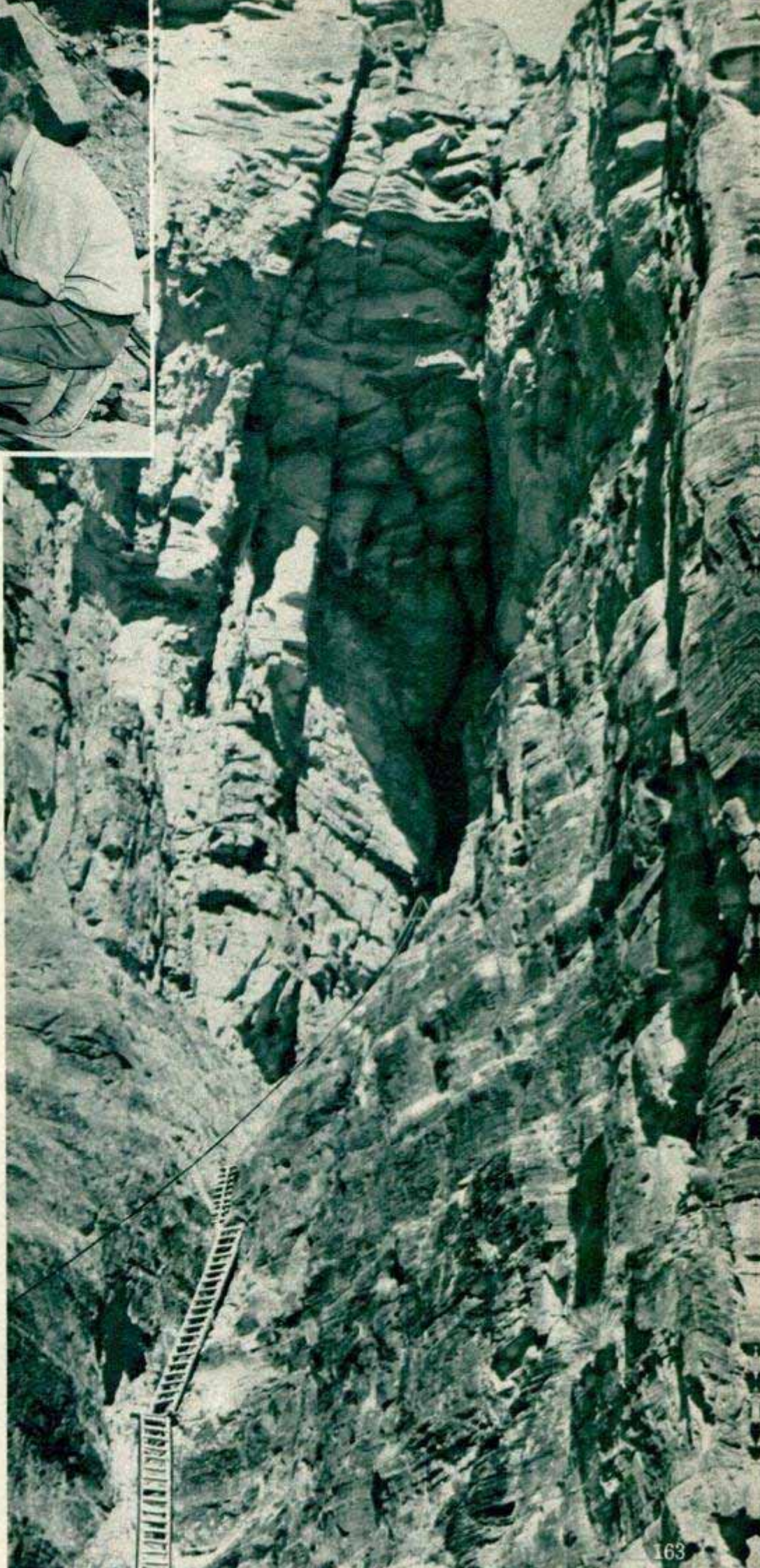



Lightweight Baby Carriage Carried Like a Basket

Weighing less than 35 pounds, a sturdy baby carriage can be collapsed and carried up and down stairs like a market basket. The cab, made of pressed wood, has two metal handles and is quickly removable for



use as a bassinet. The aluminum chassis is hinged in the center, allowing it to fold for carrying. Waterproof and stainproof, the quilted upholstery is Vinylite plastic. Baby's comfort is assured by bump-absorbing springs attached to the four cab supports. When the time comes, the carriage chassis can be converted into a stroller.

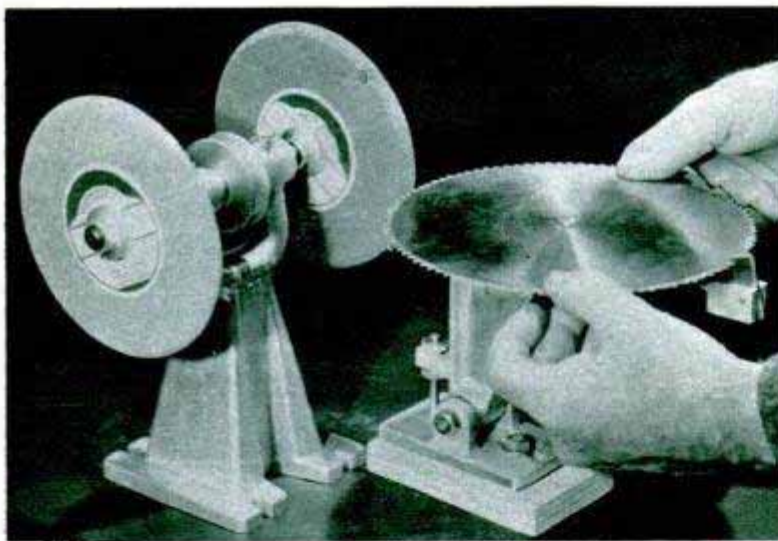

Circular-Saw Sharpener

Circular saws are sharpened quickly with the aid of a holder that keeps the blade perfectly round. The blade is mounted on the table of the holder and a projection engaged between two teeth. Then the blade is moved forward into the shaped grinding wheel until a block stops the motion. The projection is engaged between successive teeth until the entire blade has been sharpened. The holder will sharpen a crosscut blade in three minutes and a rip-saw or combination blade in five.

Paper Tape Used as Strapping For Packaging Metal Pieces

With a tensile strength of 180 pounds per inch of width, a new adhesive paper tape is much easier to use than metal strapping and it eliminates the need for packaging machinery. Two turns around the strips, sheets or tubes and the fastening job is completed. The unusual strength of the tape is partly attributed to a reinforcing of paper backing with threadlike fibers running lengthwise.

Pyrethrum, a potent insecticide made from imported flowers, can be produced synthetically by a process developed by scientists at the Department of Agriculture.



Italian Sports Coupe

Although still bearing the scars of war, the famed Alfa Romeo automobile manufacturing plant in Milan, Italy, is getting back into production with its sports and "super sports" models. These cars have won 68 prizes since 1924. In contrast to postwar American cars, the Alfa Romeo models have more curved than straight lines and a minimum of chrome trim. An innovation in the sports coupe is a window in the roof. The sports-model engine has six cylinders and a compression ratio of 7 to 1. This ratio is boosted in the super sports car to 7.5 to 1 which gives it greater power with a speed well over 100 miles per hour. The chassis for both models is a one-piece, electric-welded, sheet-steel structure of box form. The front wheels have independent suspension and coil springs that are enclosed with hydraulic shock absorbers.

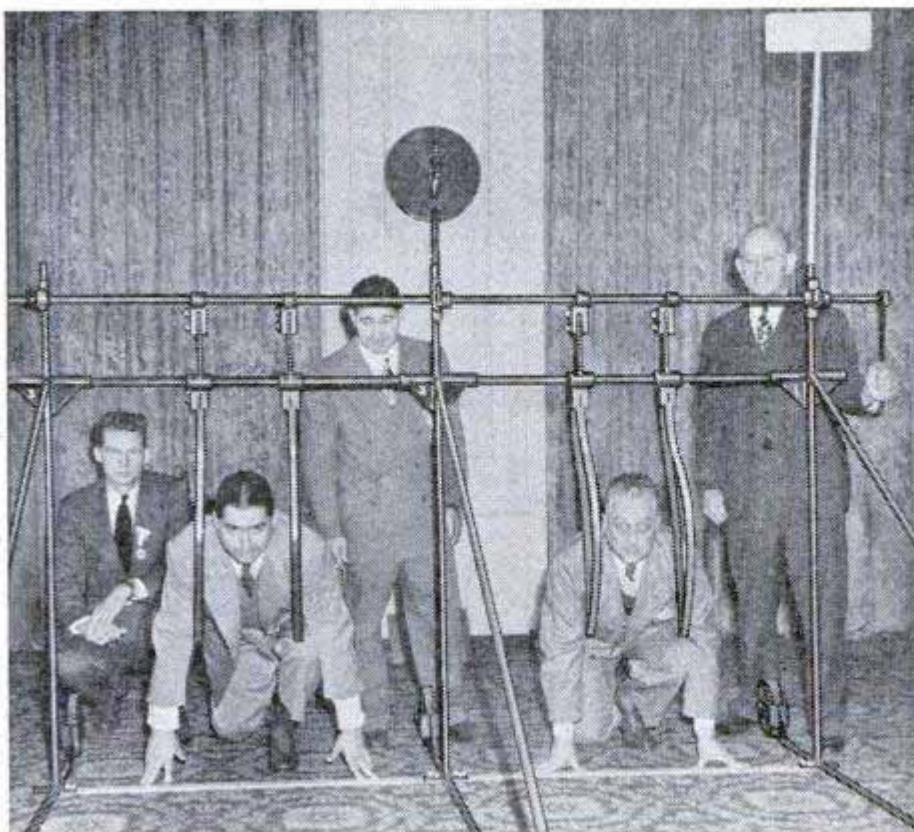

Starting Gate For Sprinters

False starts by sprinters are impossible with a starting barrier which fires a gun at the instant the gates are raised. The runners lean against the straps as they wait for the starting signal. When the starter pulls a lever at the end of the gate, the barriers swing up and trip a mechanism which fires the gun.

Many of the products described in this issue are now available or are ready to be marketed. For names and addresses of manufacturers or distributors, turn to the WHERE-TO-BUY-IT INDEX, on pages 10, 12 and 14

Twist, Stretch and Smash, Inc.

By Bill Reiche

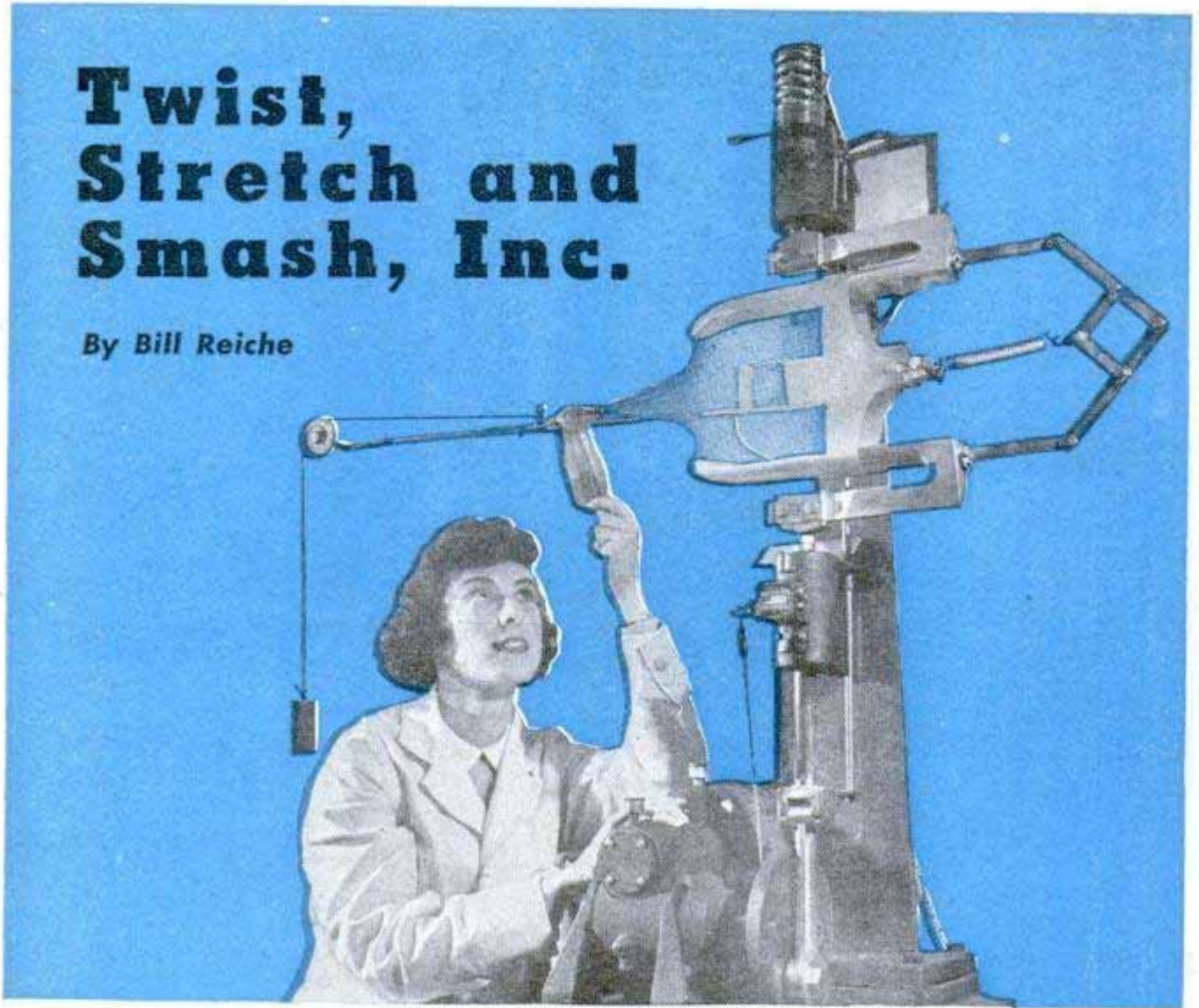

Above, milady's nylon hose gets rough treatment on this scientific stretching machine. Below, a slide fastener is given the supreme test by this machine which opens and closes it more than 10,000 times

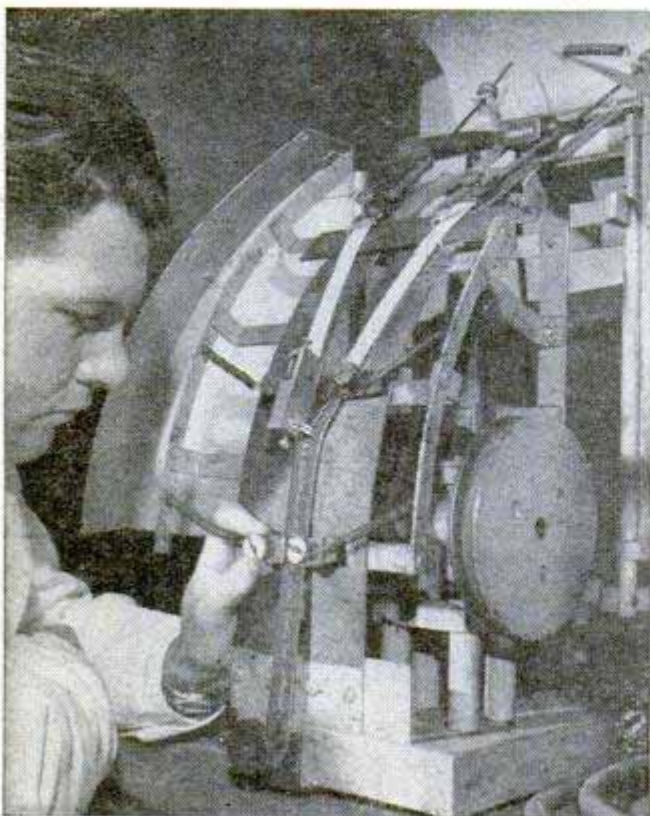

AMERICAN manufacturers pay the United States Testing Company more than a million dollars a year to have their products torn to pieces. Working for this company are hundreds of men and women who are among the most skeptical people in the world. They believe nothing until they have the proof. To them, claims mean nothing, because it's their job to discover by tests how good or bad a product is.

Hundreds of machines, many of them especially designed by UST, crowd its five-story, block-long building in Hoboken, N. J., making it a temple dedicated to the business of destruction.

Articles and materials of every description are subjected to abrasion, are pulled, pushed, flexed, struck, immersed and ignited—all to find out how good they are and, frequently, to develop better products.

This methodical vandalism is carried on for more than 30,000 American firms and totals more than 200,000 tests a year.

Started as a silk-testing concern in 1880, UST still does a substantial part of its testing in the field of fibers and fabrics, where the paramount factor is wear-resistance, which can be readily ascertained.

If your new blanket or coat is warmer

than the old one, the lab's warmth tester for thermal conductivity may have been responsible. This device maintains two temperature conditions at the same time, one at 98.6 degrees to simulate body heat and the other at lower temperatures accompanied by anything from a zephyr to a 15-mile wind. By placing the fabric between these two extremes, experts determine whether it retains the body heat or dissipates it.

A more rigorous test of color fastness than the hottest summer sun is the fadeometer, which revolves fabric around a 230-volt carbon arc light in a humidity-controlled chamber. Acetate rayon is tested for fading in the presence of illuminating-gas fumes, which have a particularly depressing effect on its colors.

Some of the roughest, toughest moths in captivity have 28 days in heaven with UST acting as host. Specially bred for good appetites, they are placed in small cups containing various woolen materials to find out the inherent moth-resistance of each type. Temperature and humidity are held at the optimum figure for happy eating, 100 degrees Fahrenheit and 80 percent, and the result is gauged not only by the amount of fabric missing but by weighing the excrement of the moths.

Yarn has to be oiled to prevent snagging and breaking when it is woven, but the quantity of lubricant must be closely controlled so that it does not result in a too oily fabric. The test used to measure this oil content might have been invented by someone who recalled sliding down banisters as a child. A slotted piece of metal,

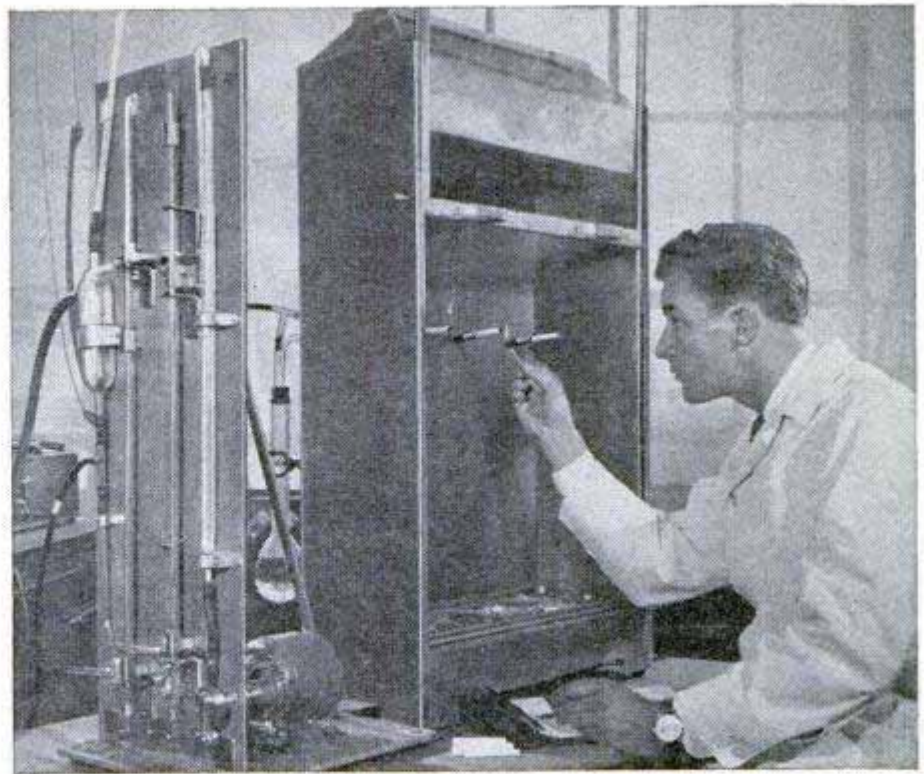

Even cigarette smoke takes a beating in the laboratory. Technician lights three cigarettes which are puffed mechanically as their smoke is analyzed

Unlike the bull in a china shop, this weighted pendulum breaks pieces of chinaware scientifically to determine points of weakness for manufacturer

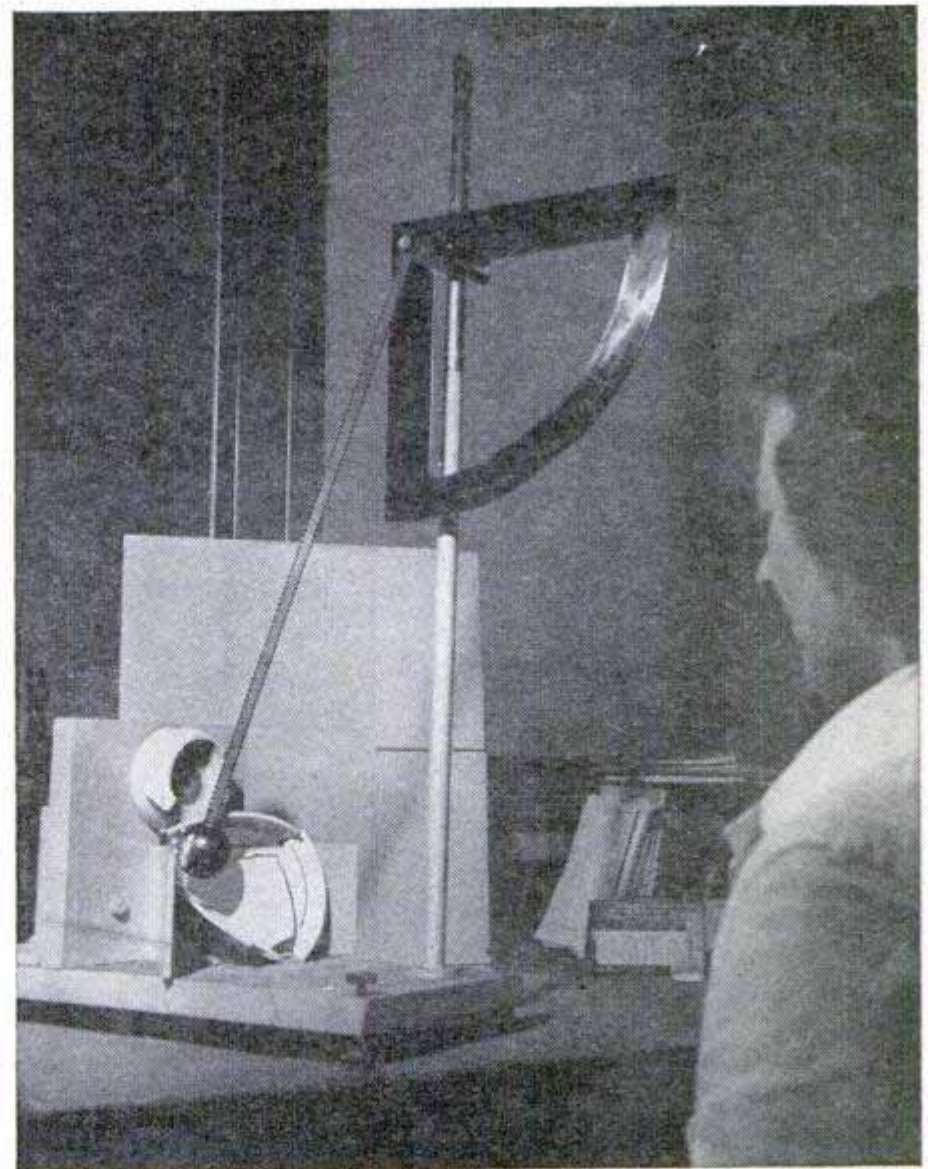



This machine rubs socks 20,000 times to test their durability



Above, extractor measures the oil, fat and grease in various materials. Below, mason's trowels are placed in this machine that rubs them back and forth on emery boards to test quality

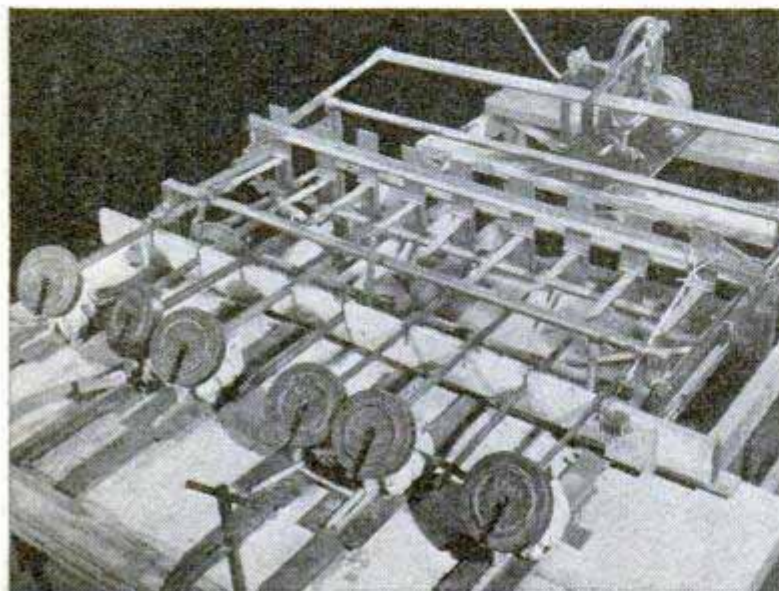

called a rider, is placed at the upper end of an inclined 18-inch length of the yarn and permitted to slide down. The elapsed time indicates lubricity of the strand.

Women's stockings really take a beating at UST. One mechanical "leg" flexes continually to test resistance to knee action and garter strain. Another leglike test device has metal triggers at thigh, knee and ankle, which strike and extend the fabric many times a minute. Stocking heels and toes are rubbed by a fabric which approximates shoe-lining material.

Wheels run for days or weeks over carpeting to find out how long it will survive the moving of chairs and furniture in home use. A length of fishline is pulled back and forth over a rough surface to test its abrasion under load, and eventually perhaps to reduce the total of tales of woe about "the one that got away." Elastic is stretched well toward its limit by a tireless machine and then jerked a couple of extra inches.

Atomic science is not being ignored in the laboratory's constant search of new and better testing methods. One of its scientists, Joseph J. Pescatore, recently was graduated from the first class given at Oak Ridge in the uses of radioactive isotopes.

These tracer materials are expected to be of infinite value in quantitative and what might be called "fugitive" analysis and measuring. For instance, when the plasticizer leaves a plastic material, such as in a shower curtain, the material becomes brittle and cracks. It is known that the plasticizer "moves" to the edge of the material and bleeds off. By introducing Carbon 14 into the plasticizer as a tracer, both the movement and the rate of diffusion can be measured more exactly than heretofore.

By introducing Cobalt 60, another radioactive isotope, into paint which is tested by artificial weathering, the process can be speeded up so that the month previously required for a year's normal erosion can now be cut to a few days. The ability to measure minute amounts of cobalt allows the technician to discover just how much paint has been lost by the amount of isotope lost.

The use of these same materials may also lead to the development of new colors for luminescent signs and permit closer control of lacquer and other coating materials.

While the testing of yarns and fabrics is only one phase of the company's operations now, this activity still looms very large. Ninety-five percent of the silk imported by this country is examined in the Hoboken establishment.

The ingenuity displayed at the lab is often amazing and amusing. One client sent in a batch of diapers and wanted to know how absorbent they would be—with babies of a given age wearing them in a supine position. The average weight of such babies was learned; then the weight which rested on the diaper; a rubber-covered surface, similar to a mattress was rigged up; a bowling ball was sectioned so one piece was the proper weight. A hole was bored through the ball and it was properly diapered. Ink-colored water was poured through the hole. The

(Continued to page 248)

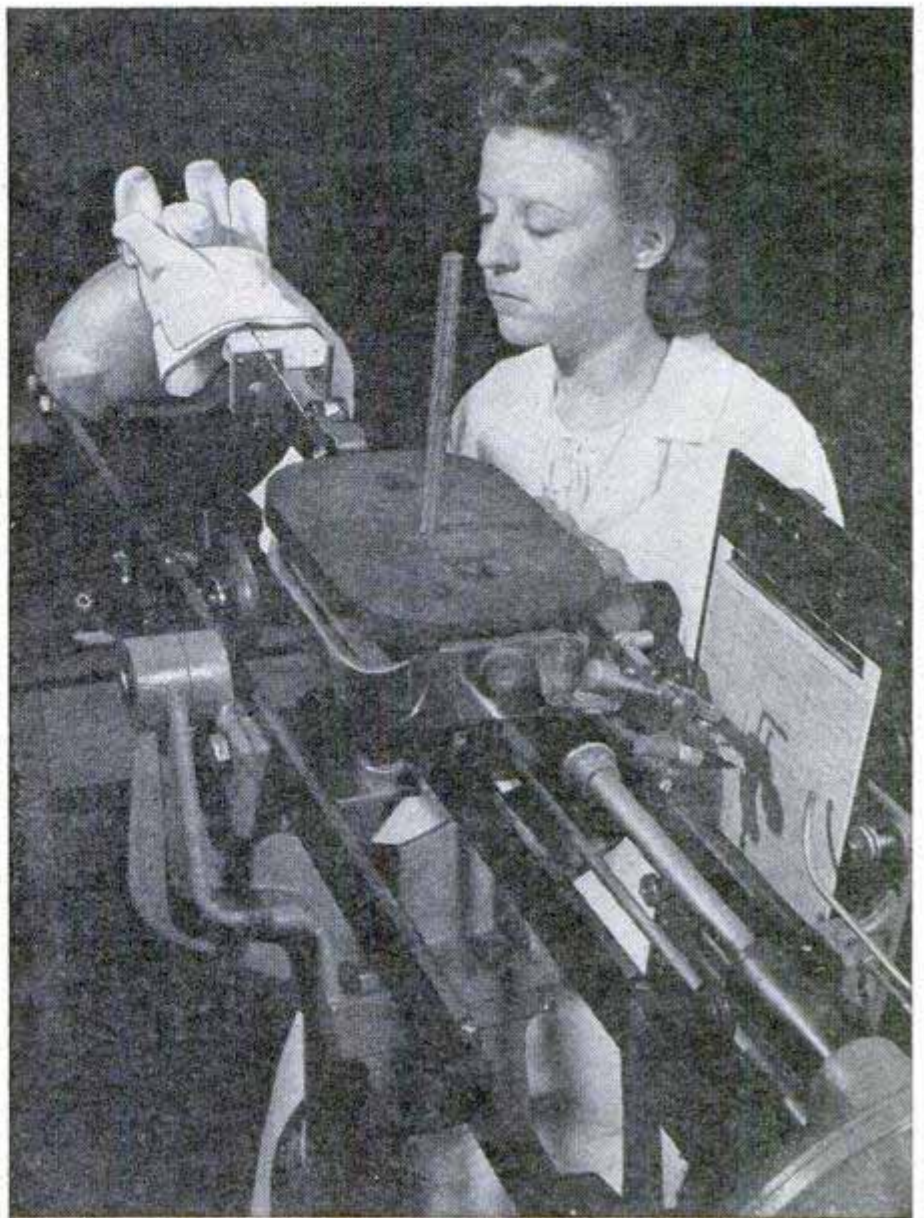

Above, test device is so sensitive it measures accurately the force required to flex the finger of a work glove. Below, left, exposing fabric to carbon arc light in this fadeometer tests its resistance to fading. Below, right, the ability of nylon thread to take dyes is measured here

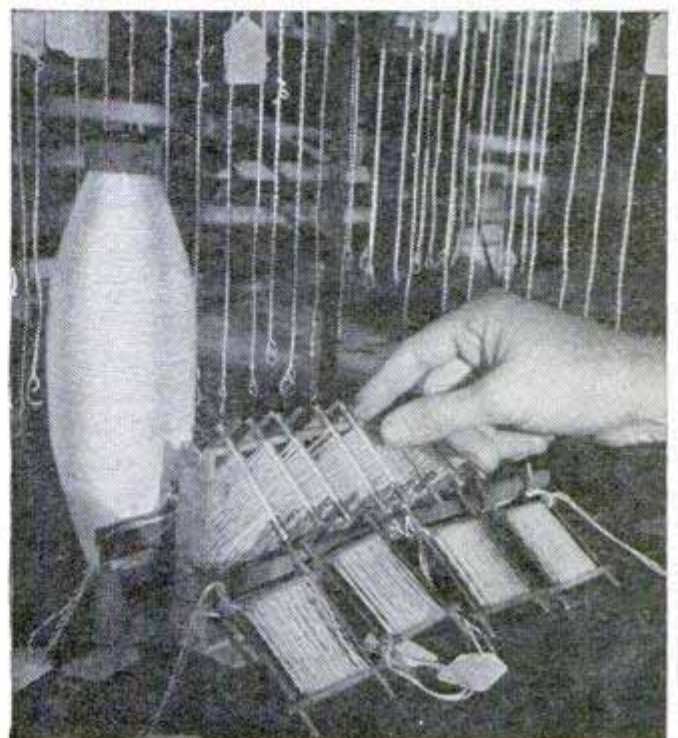

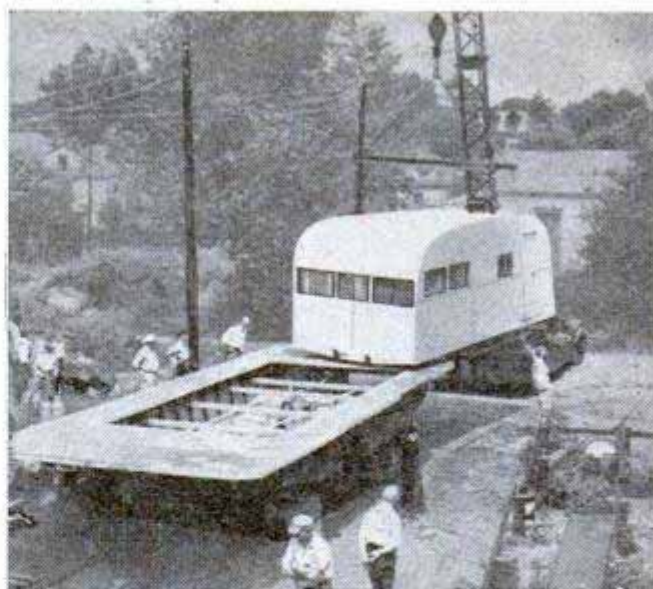

"Amphib" Trailer Sleeps Four

Regular house-trailer bodies, minus undercarriage, serve as cabins for a steel-hull houseboat that provides a comfortable floating home for four persons. The trailer body is lifted off its chassis by a crane and lowered onto the hull. Accessible through a hatch in the cabin floor, the houseboat engine is mounted in the welded hull. It takes only a few hours to convert the trailer into a houseboat. The owner can live on land in winter and on water in summer. The manufacturer is now designing a new model with which the owner can make the changeover himself by towing the house trailer off the hull, eliminating the need for the crane.



Top left, this houseboat also travels on land! In summer, it's a home afloat and, come winter, it goes ashore as a house trailer, above, when wheels are added. Top, a crane makes changeover for summer



REAR-VIEW MIRROR fastens to the top of the car door and can be adjusted easily from inside the auto. It is theftproof when the doors are locked. The mirror is attached with only one screw clamp and no holes need to be drilled in the door. It has a four-inch diameter and a face of beveled glass

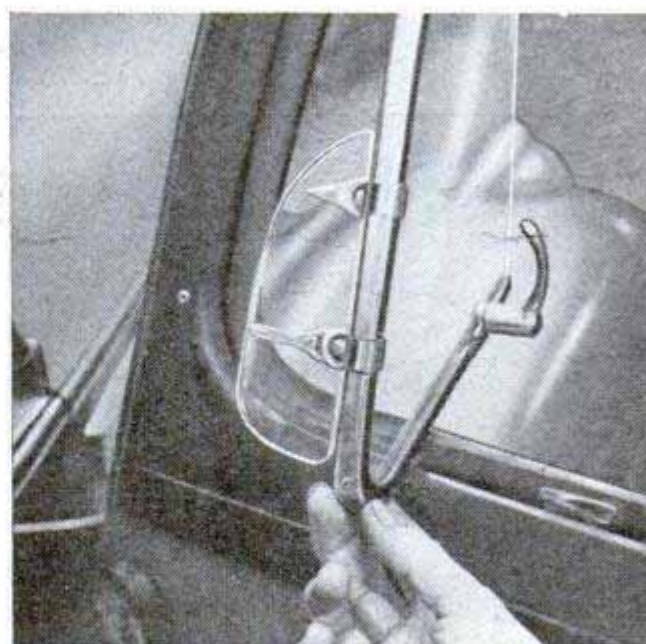

PLASTIC DEFLECTORS clip to the front ventilating windows of a car, improving air circulation and preventing rain from splashing inside. The curved wings do not interfere with normal movement of the windows. With the window partly open, the ventilator induces a sucking action to draw out stale air

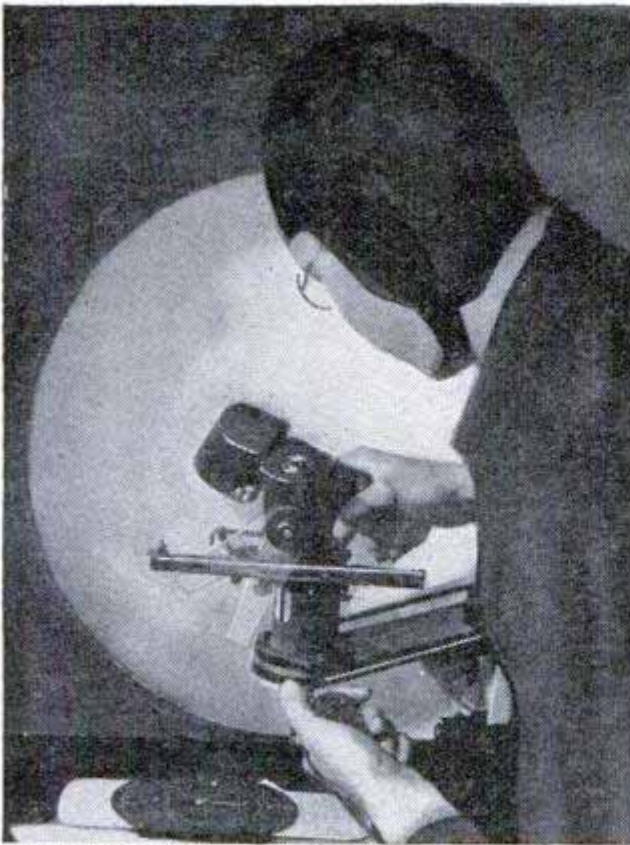

Signal Corps photo

Cloud-Height Indicator

With a modified illuminated gun sight, Air Corps pilots now can determine accurately the height of a cloud while flying above or below it. The instrument has two arms that slide along a graduated scale. The pilot trains the gun sight on some prominent cloud feature and tracks it for a minute or longer. During this period, one

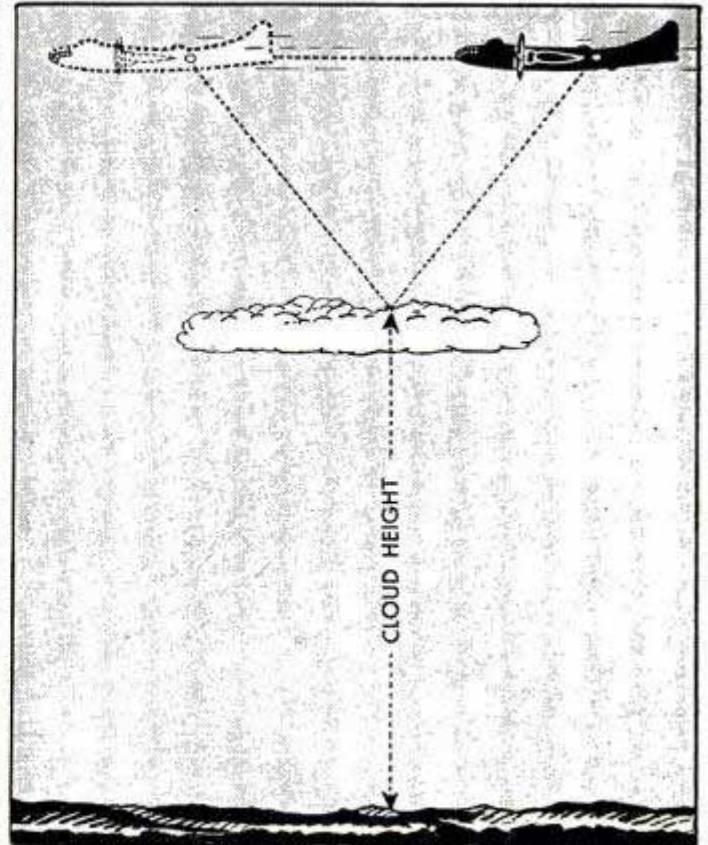

of the arms remains fixed and the other moves. The vertical distance between plane and cloud then can be computed from the scale readings at the two arms, the air speed and time of tracking. The actual cloud height is this distance added to or subtracted from the plane's altitude, depending on whether the cloud was above or below the aircraft. The instrument was developed by the Army Signal Corps.

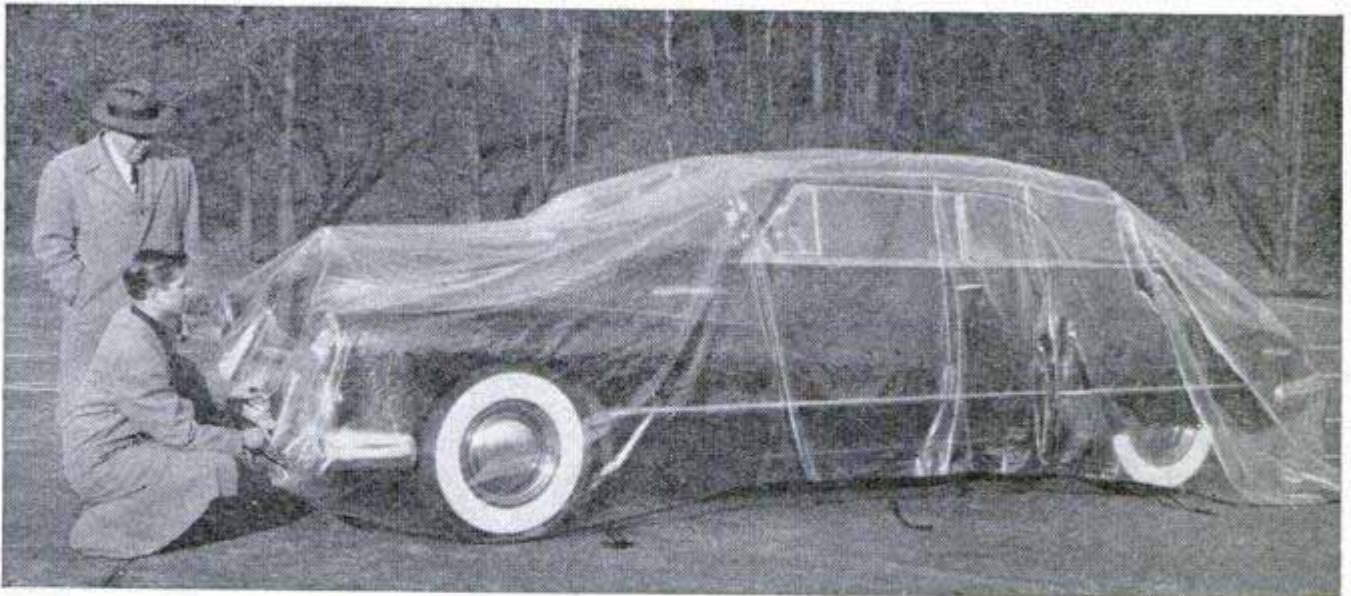

Plastic Auto Cover

Motorists can "tie a garage" over their cars in the form of a plastic blanket large enough to cover the entire automobile. The translucent plastic sheet measures 20 by 30 feet, yet it can be stored in a 24 by

27-inch pouch only three inches thick. It is weather and acidproof, protecting the car against ice, snow, dust and salt spray. The edges are bound and have tie strings for fastening the cover to bumpers, wheels or other parts. The cover also can be used to protect cars stored for long periods.



← Soldiers file into the C-122, the new cargo plane that can transport 30 fully equipped men

Below, large truck is driven up the rear ramp and into plane, which carries a five-ton load

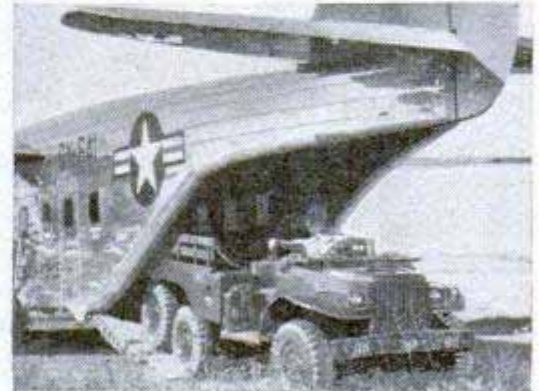

Flying Boxcar

Thirty fully equipped soldiers or five tons of military equipment can fly into a battle area in Uncle Sam's newest cargo plane, dubbed the flying boxcar. Officially

designated the C-122, the plane recently underwent its test flights and first public demonstration. It has a top speed of 250 miles an hour and a ceiling of 25,000 feet. A large truck can be driven up the rear ramp and into the fuselage.

Rain or Shine?

With an instrument that works like a slide rule, anyone can forecast the weather with reasonable accuracy. The weather guide gives forecasts for both 12 and 24-hour periods within the operator's immediate vicinity. It consists of a metal case containing a compass for calculating the direction of the wind, a set of colored pictures that show typical cloud formations, and knobs by which a pointer may be moved opposite the proper wind direction beside any of the cloud pictures. The forecast then is read through a slot in the device. The instrument is based on the principle that a particular type of weather can be expected to follow any combination of cloud types and wind direction. Each instrument is calibrated according to one of seven regions in the United States. The instrument, invented



by Dr. Irving P. Krick, is based on data obtained from a study of 50 years of Weather Bureau records.

BACK-YARD
STREAMLINER



The CRAFTSMAN

★ Exciting news will travel fast among young rail-road fans when Dad sets up this new back-yard streamliner for the first time. It looks and runs like the real thing, but it's only junior size, of course, and it operates at a safe forward and reverse speed. A housed third rail and a positive dead-man control are the built-in safety features. Construction story begins on page 182.

★ A new type of milk cooler, detailed on page 226, will be of special interest to dairymen because it is so easily built in a wide range of sizes. Bottom, ends and sides of the tank are insulated and the installation is designed to accommodate a drop-in type refrigeration unit.

★ Chessmen in the Staunton pattern turned and carved from crystal-clear plastic are a compliment to the skill of any accomplished chess player. You'll find complete information on page 195.

★ The practical shop article for the month, page 218, deals with safe operation of a circular saw.



INSULATED
MILK COOLER



PLASTIC CHESSMEN



HOW TO RUN A
BENCH SAW



DESIGNED

By Benj. Nielsen



TRAYS CLOSED

THREE compartments for cigarettes plus an ash tray are all concealed in this attractive hardwood lamp base. When closed, the sections look like a solid wood turning, but swinging the sections to the right or left discloses the compartments for cigarettes and reveals the ash tray in the bottom section. In addition to its usefulness from the smoker's angle, the lamp also provides an excellent hiding place for jewelry and money. Using a good grade of walnut or maple, turn the five sections to an equal outside diameter as shown in the sectional view, Fig. 1. Then round the corners and, while the work is still in the lathe, finish the edges only, by applying a French polish. This is done by dipping a cloth pad in a mixture of sweet oil and shellac and holding the pad against the rotating work. The friction produces a glazed finish which is built up by repeated

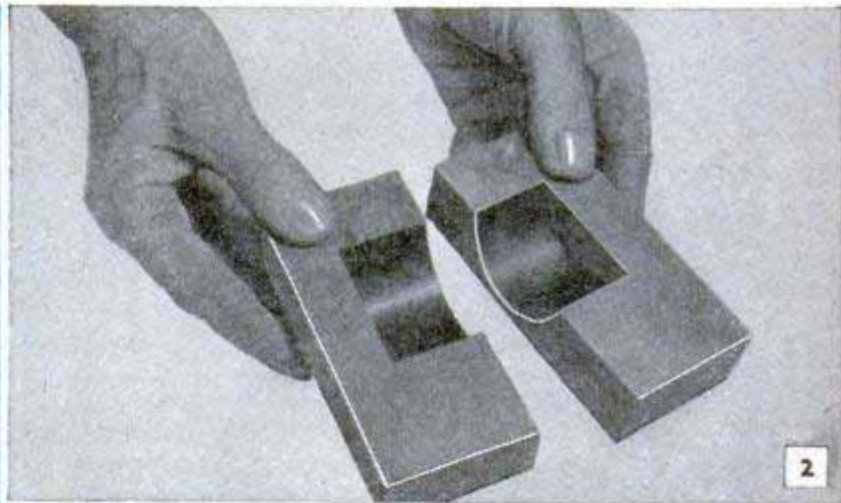
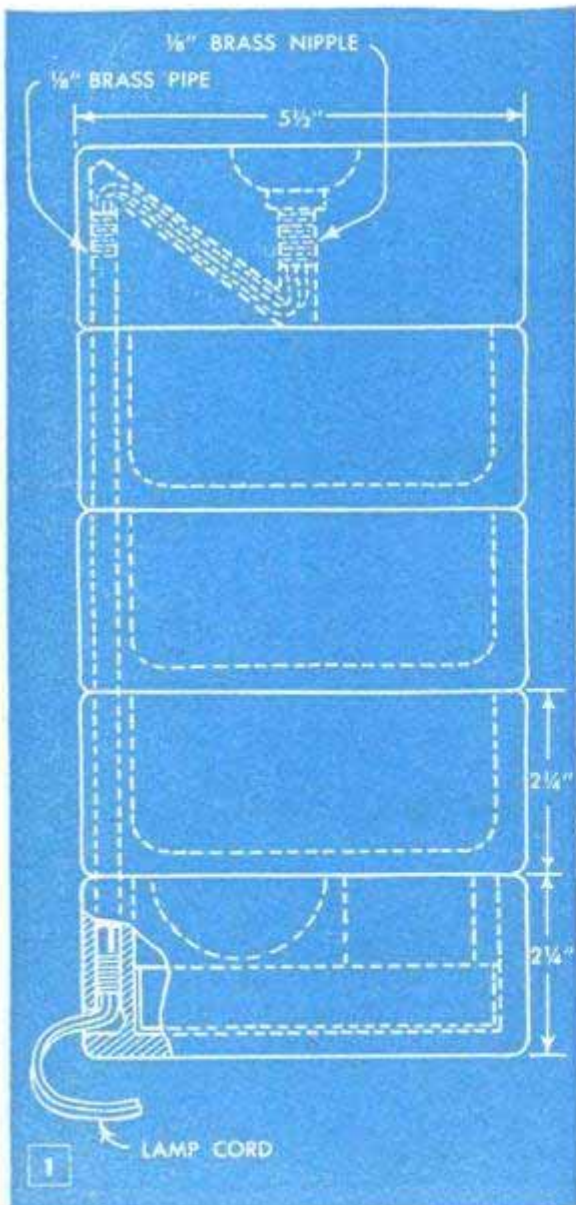

2

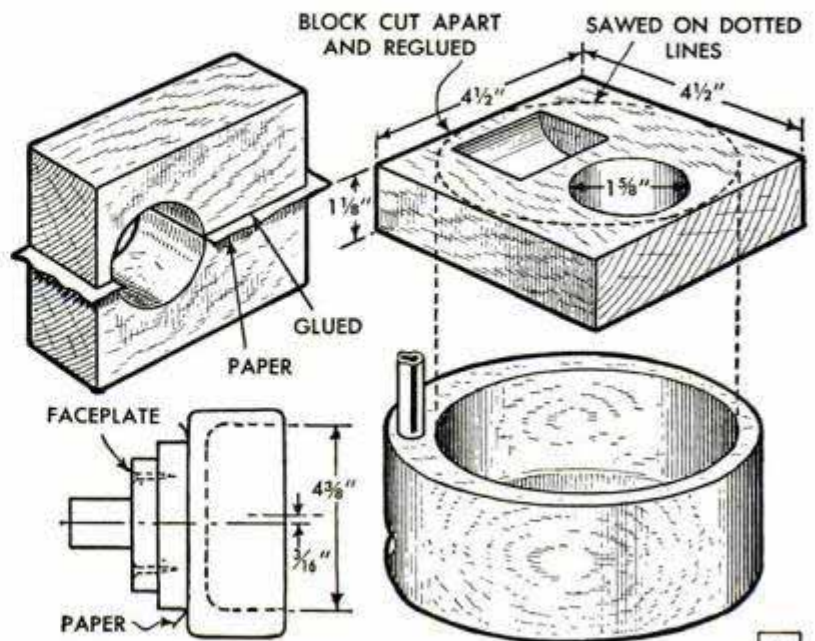

3

for SMOKERS

applications. Next, glue a wooden disk to the bottom of each of the four lower sections, sandwiching a sheet of paper between the pieces so the parts can be separated easily. Mount each section for turning by screwing the backing disk to the faceplate $\frac{3}{16}$ in. off-center, and then turn the recess to the diameter given in Fig. 3. Recesses in the original trays were turned to a depth of $1\frac{7}{8}$ in. but, of course, this can be varied to suit. Note that the recesses in the three center sections are turned with a fillet in the lower corner, but that the corners of the recess in the bottom section are cut square to accommodate a metal ash tray. A wooden cover, having a recess for matches and an opening to the ash tray, fits in the recess in the lower section and rests on top of the ash tray, Fig. 3. Two blocks of hardwood, $1\frac{1}{8} \times 2\frac{1}{4} \times 4\frac{1}{2}$ in., are used to make this cover. These blocks are glued together, separated with a sheet of paper, to form a block $2\frac{1}{4} \times 2\frac{1}{4} \times 4\frac{1}{2}$ in. Then a $1\frac{3}{8}$ -in. hole is drilled about $1\frac{1}{4}$ in. deep at least $\frac{1}{2}$ in. in from one edge of the block. This hole must be centered exactly on the joint of the two blocks. The blocks are cut apart along the joint and their edges glued together permanently to form the recess for matches, as shown in Fig. 2. After this, a $1\frac{5}{8}$ -in. hole is bored through the blocks between the recess and the edge of the cover, and the block is sawed to a disk shape, indicated by the dotted line. If desired, the ash tray and cover may be omitted and the lower section merely recessed in the same way as the other three. To hinge the base sections together, drill registering holes through the thickest portions of the sides, forming blind counterbored holes



slightly undersize in the top and bottom sections, so the threads of a length of $\frac{1}{8}$ -in. brass pipe will "take" in the wood. To assure perfect alignment of the holes, the three sections should be stacked and drilled at one time, and then one of these sections should be used as a guide to drill the blind holes in the top and bottom sections. Drill a hole for the lamp cord through the side of the bottom section, and drill and recess the top section as shown by the dotted lines in Fig. 1. Finally, assemble the parts and wire the lamp socket, feeding the cord through the brass pipe and fishing the end of the cord through the slanting hole with a length of wire bent to form a hook.

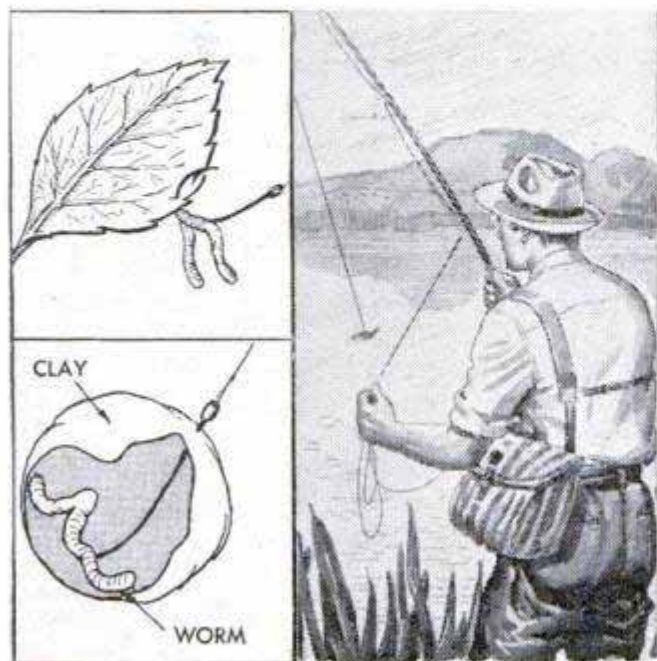

Bait-Shy Trout Lured Successfully With Camouflaged Worms

Even in the most hard-fished streams, trout find it difficult to resist a worm offered in either of these two ways. One successful method utilizes a twig with a leaf or two attached. After the worm-baited hook is pushed through the edge of the leaf, as in the upper detail, the twig is allowed to float downstream. When the leaf drifts over a likely looking pool, the hook is jerked free by a twitch of the rod tip. The bait then sinks slowly to the bottom, coaxing the trout into striking. The other method is to mold a ball of clay or mud over the worm and hook, as in the lower detail. The ball is lowered slowly into the water which washes away the covering and exposes the worm.

Debris Catcher Under Workbench Keeps Shop Floor Clean



Instead of sweeping shavings and sawdust from the workbench onto the shop floor, sweep the debris into a burlap catcher which pulls out like a drawer from under the bench top. Make the catcher by tacking a burlap bag to a square wooden frame and nailing strips of wood to the underside of the bench top to form runners for the frame.—Victor H. Lamoy, Upper Jay, N. Y.

Corncob Handles on Jumping Rope



Excellent nonslip handles for children's jumping ropes are provided by punching the pithy centers from corncobs. The ends

of the rope are passed through the corncobs, which are held in place by tying large knots at the ends of the rope.

Bicycle Seat Protected From Rain

When it is necessary to park a bicycle out in the open during rainy weather, the seat can be kept dry by covering it with a waterproof bag or plastic bowl cover. A sheet of any waterproof material, such as plastic or rubber, is made into a suitable seat cover simply by fitting it with a drawstring.



Arthur Trauffer, Council Bluffs, Iowa.

Paper Perforated for Ring Binder Without Using Punch

If the occasional need to perforate sheets of paper to fit a ring binder does not warrant buying a paper punch, you can perforate the sheets with the aid of holes made in one cover of the binder. Drill holes along the outer edge of the cover to correspond with the spacing of the rings and then lay the sheet to be perforated on the cover, positioning it over the holes. Perforate the paper with the point of a pencil as shown in the drawing.



Necktie Serves as Shoehorn To Slide Foot Into Boot

Next time you find it difficult to slide your foot into a rubber boot, try using an old silk necktie as a shoehorn. Place one end of the tie in the boot and hold the other end. Then slip your foot in the boot, with the heel sliding along the necktie, withdrawing the tie after the foot is all the way in the boot.

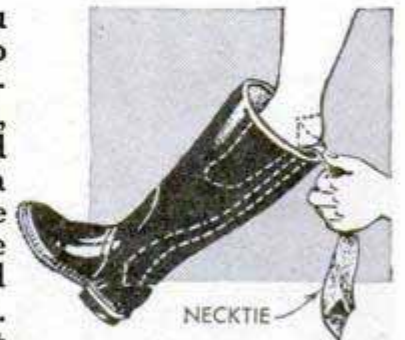

¶ To remove grass stains from clothing, sponge the stained portion of the fabric with ammonia and water before washing.

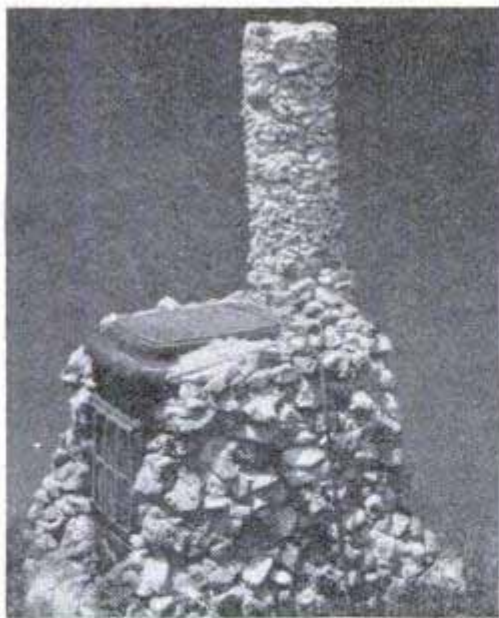

The outdoor fireplace, above, left, is simply a small stove camouflaged with rough stone set in mortar. Above, right, the top of this fireplace has a circular opening to take an old-fashioned iron kettle which can be replaced with an ordinary grate. The large stone unit, shown below, is ideal for a spacious yard

Dine in the Open

By Paul Hadley

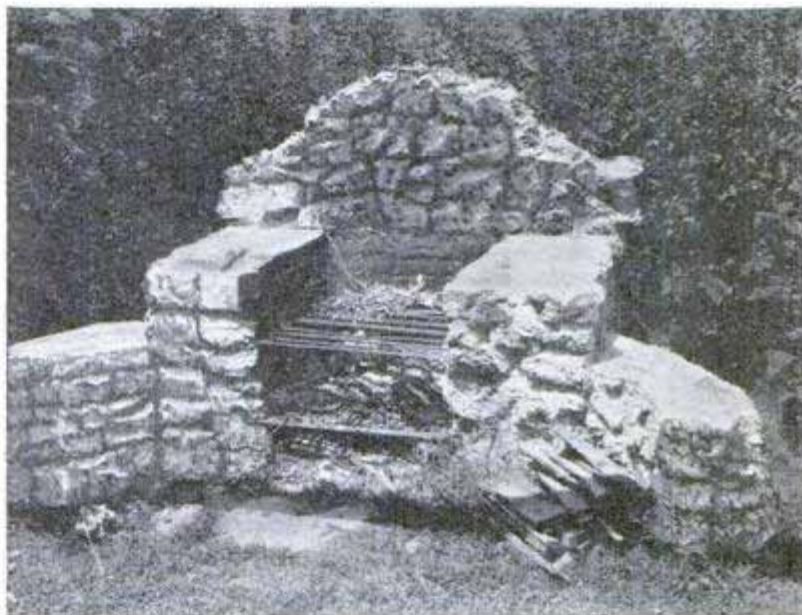

No previous experience in bricklaying is necessary to build a serviceable fireplace like the one shown in the lower left-hand picture. The double fireplace, below, right, has two separate fireboxes, both using a single flue. Built of stone, it is economical for small camps where it serves the purpose of two fireplaces

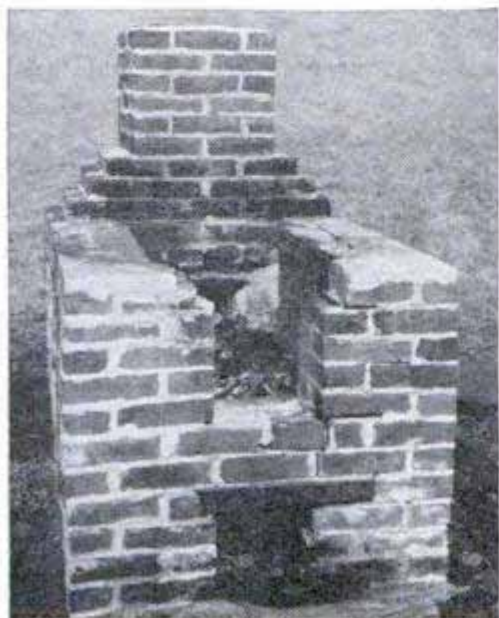

Solving

REMOVING ICE CUBES from the freezing compartment of a refrigerator is no problem if the trays are placed on pads cut from rubber stair treads. The trays will not stick tightly to the rubber, making them easy to remove

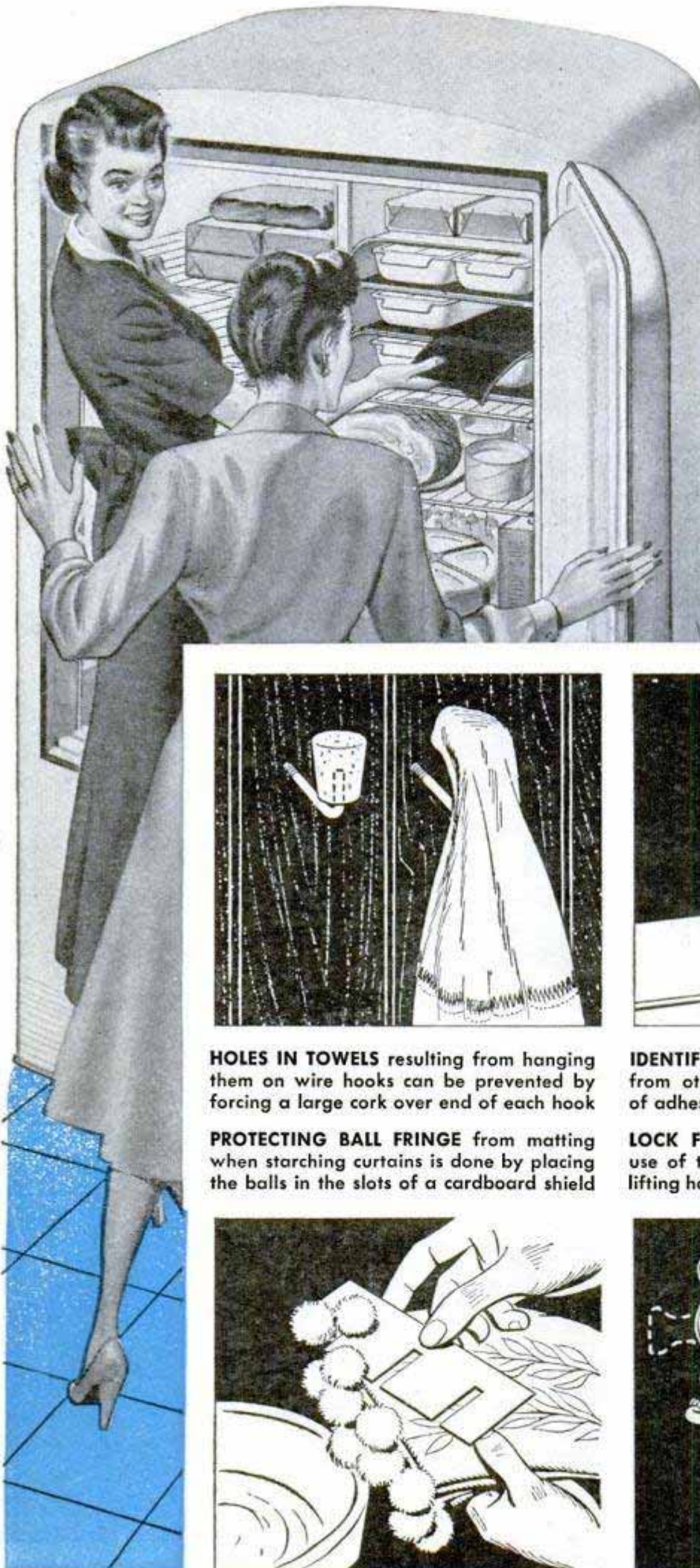

HOLES IN TOWELS resulting from hanging them on wire hooks can be prevented by forcing a large cork over end of each hook

PROTECTING BALL FRINGE from matting when starching curtains is done by placing the balls in the slots of a cardboard shield



IDENTIFY BOTTLES of poison in the dark from other medicines by sticking a piece of adhesive tape over the cap of the bottle

LOCK FOR SCREEN-DOOR HOOK makes use of turn button to thwart entrance by lifting hook with wire poked through screen

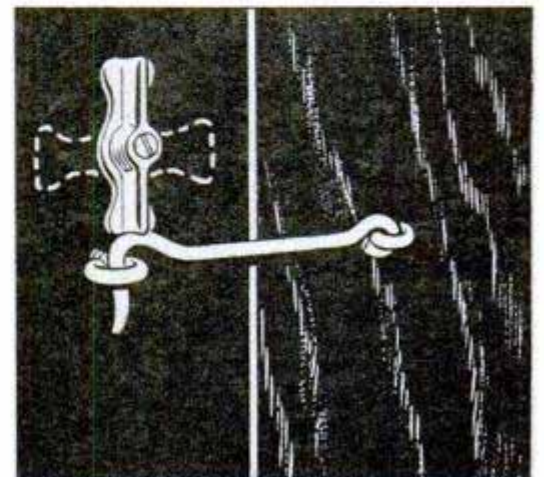

HOME PROBLEMS

STORING HOSE by coiling it around four old horseshoes nailed to the studs of a garage wall will keep the hose in excellent condition. Space the shoes so that the hose will wrap around them in a natural coil rather than in a rectangular shape, which would kink and damage it.

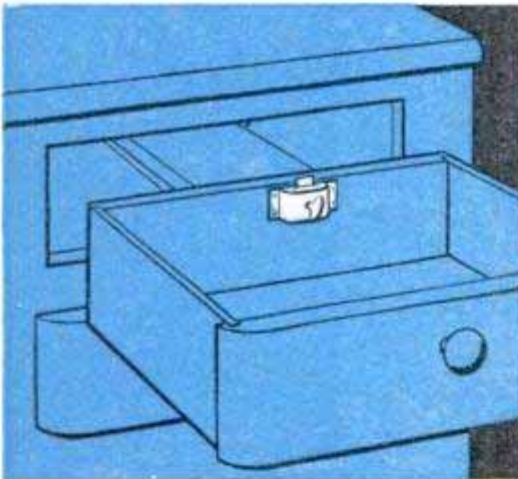
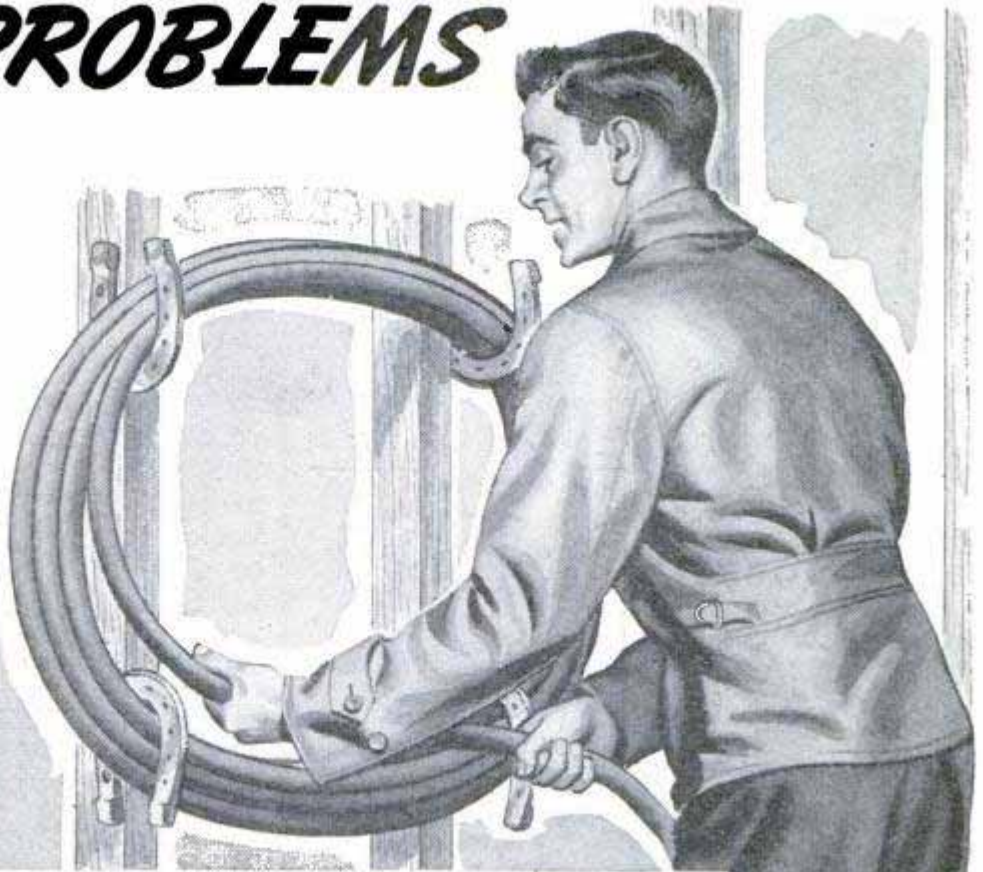

IMPROVED DRAWER STOP which permits easy removal of drawer is had by attaching cupboard latch to the back of the drawer

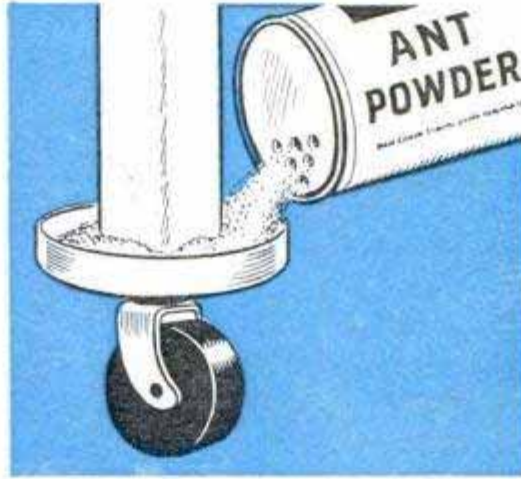

ANT TRAPS, consisting of can covers filled with insect powder and fitted to the legs of a table, keep ants from reaching food

KEY WON'T FALL from lock when a door slams if a piece of rubber is slit and cemented to back of the escutcheon plate

ON-A-DOOR WASTEBASKETS for a kitchen sink are provided by cutting round metal basket in half and fitting each with back

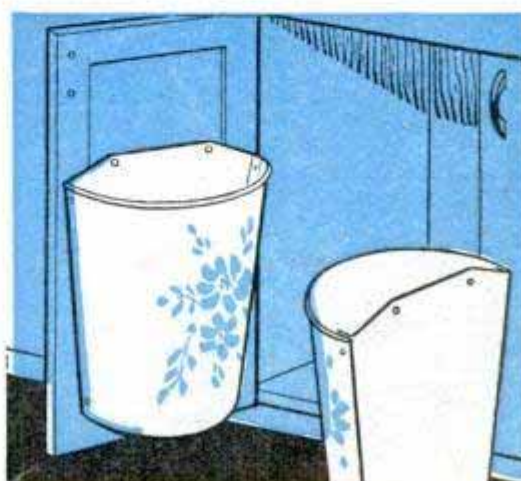
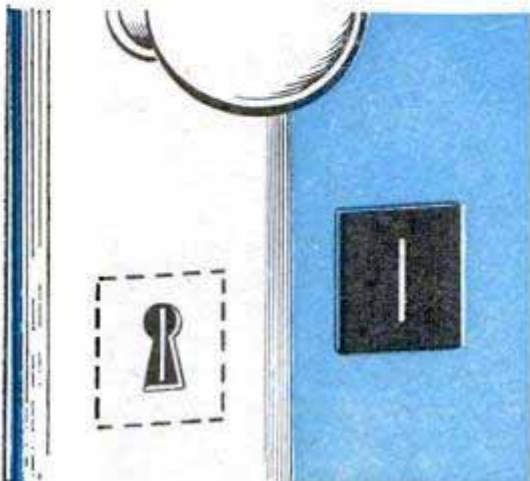

Utility Bag Becomes Fishing Creel When Fitted With Screen Panels



If you want to put an old canvas utility bag to good use and, at the same time, save the cost of a fishing creel, install screen panels in the bottom and ends of the bag to provide a serviceable creel. Use bobbinet for the screen and reinforce the edges of the panels with adhesive tape. Then, cut a rectangular opening in the flap of the creel to permit inserting the fish, and reinforce the edges of this opening with adhesive tape.—Opie Read, Jr., Chicago.

Use of String as Gluing Clamp Improved by Dampening

Common practice of using strong cord as a clamp when gluing irregularly shaped work can be improved if the cord is first dampened. Wrapped tightly around the work and tied securely, the damp cord will

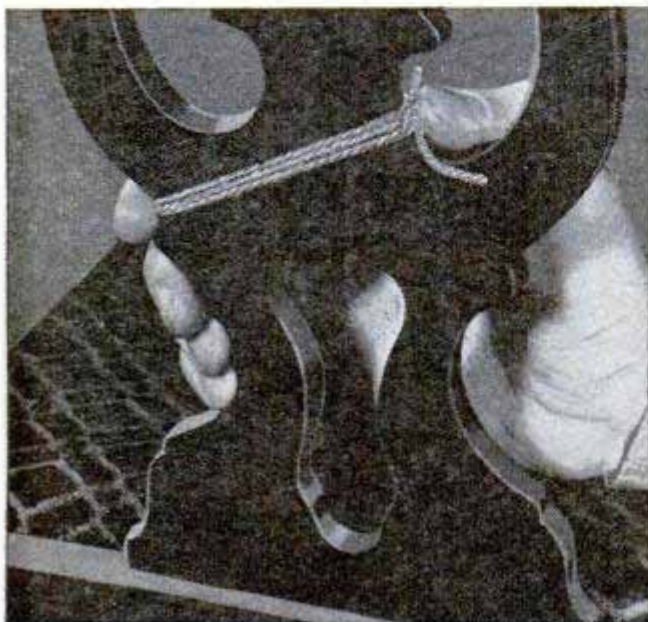

gradually shrink and draw tighter as it dries, thus applying continuous pressure to the joint. The cord is cut to remove it.

R. F. Donovan, Jersey City, N. J.

Retrieving Debris From Cistern

Pieces of wood floating in a deep cistern can be removed without the aid of a ladder if they are speared with a fishhook tied to the end of a cane pole. The hook is straightened and then tied tightly to the pole with fishline or strong cord, passing the line through the eye of the hook to keep it from being pushed upward.

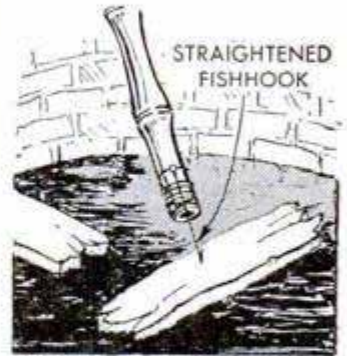

Padlock Secured to Boat Chain

To keep an opened padlock from slipping from a boat chain and being lost, fasten it to the chain with a strip of friction tape. Several turns of tape are wrapped around the bow of the padlock and the tape is entwined around the last link of the chain as shown.

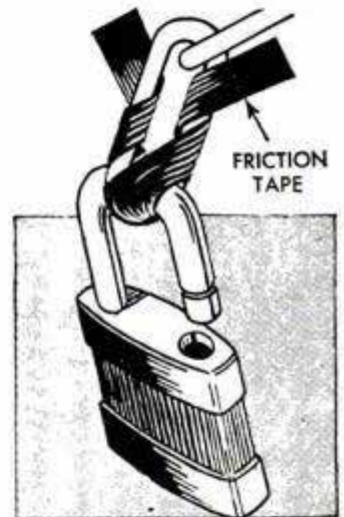

Friction Tape Holds Oilstone

A good job of honing cannot be done unless the oilstone is held stationary. When at the workbench, the stone is simply clamped lightly in a vise. However, when out on the job, a strip of friction tape placed under the stone provides an excellent nonslip surface. Thumbtacks can be used to hold the tape, although, if it is quite sticky, the tape will stay in place under the stone without being fastened.

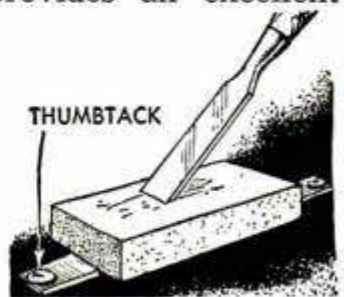

Provide a small child with his own laundry bag. This will teach him to place soiled articles of clothing in the bag and also save considerable time ordinarily spent in sorting and searching for misplaced items.



COLORFUL BEACH SUN HOOD

REMINISCENT of an old-time buggy top, this colorful sun hood is a popular adaptation of the common beach umbrella. The hood consists of four ribs of $\frac{1}{2}$ -in. seamless steel tubing, $7\frac{1}{2}$ ft. long, all being curved alike by bending over a wooden form. The ends of the ribs are flattened and drilled and then bolted to flat-iron quadrants. The covering is made of three sepa-

rate pieces of awning cloth. In sewing the pieces together, the edges are lapped $1\frac{1}{2}$ in. to form hems for the ribs. Card-table-leg braces are used to hold the hood open, these being fastened to the outer ribs with small machine screws. In bolting the ribs to the quadrants, peen the ends of the bolts so that the nuts can be backed off slightly to allow the ribs to pivot freely.

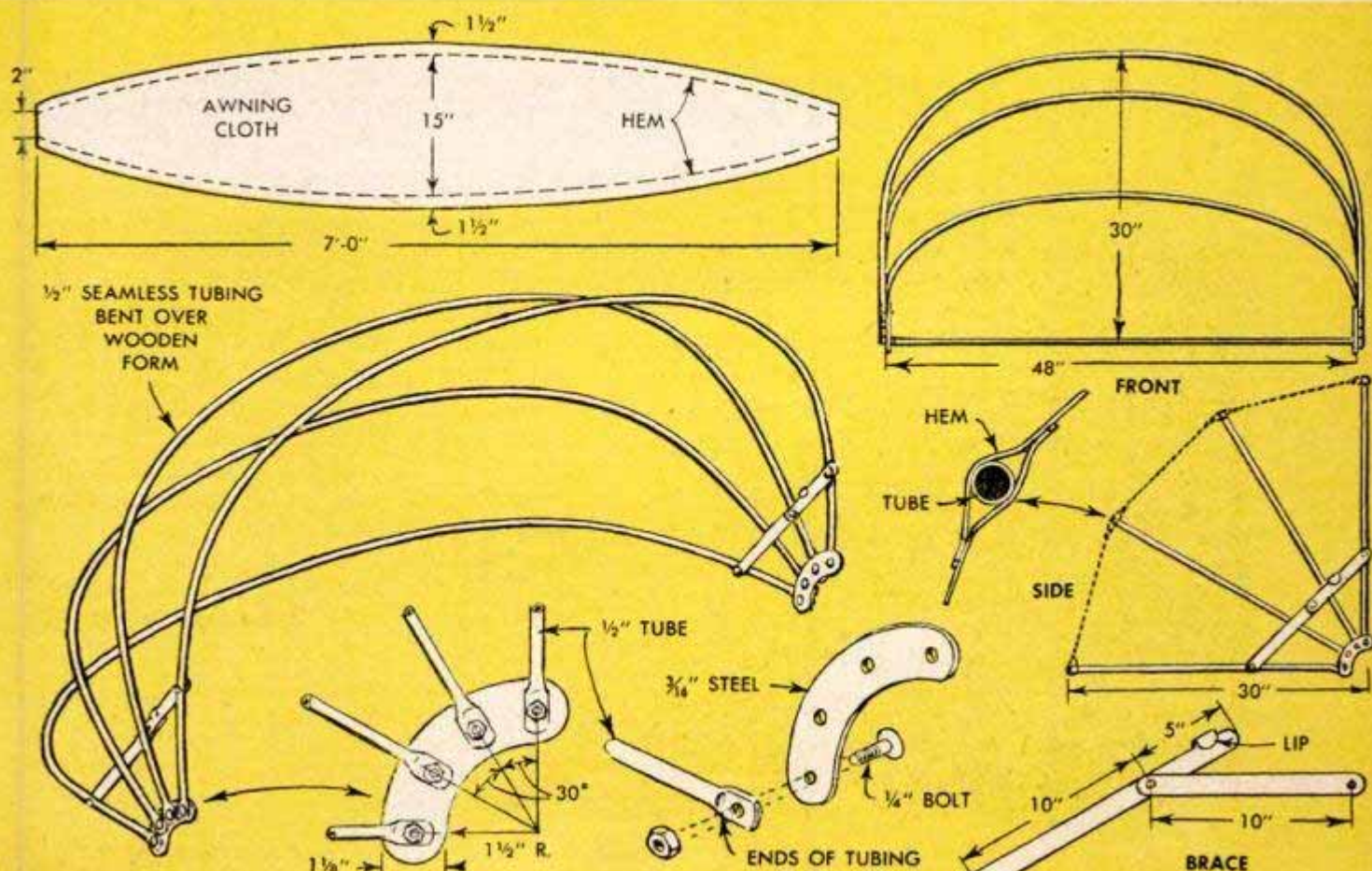

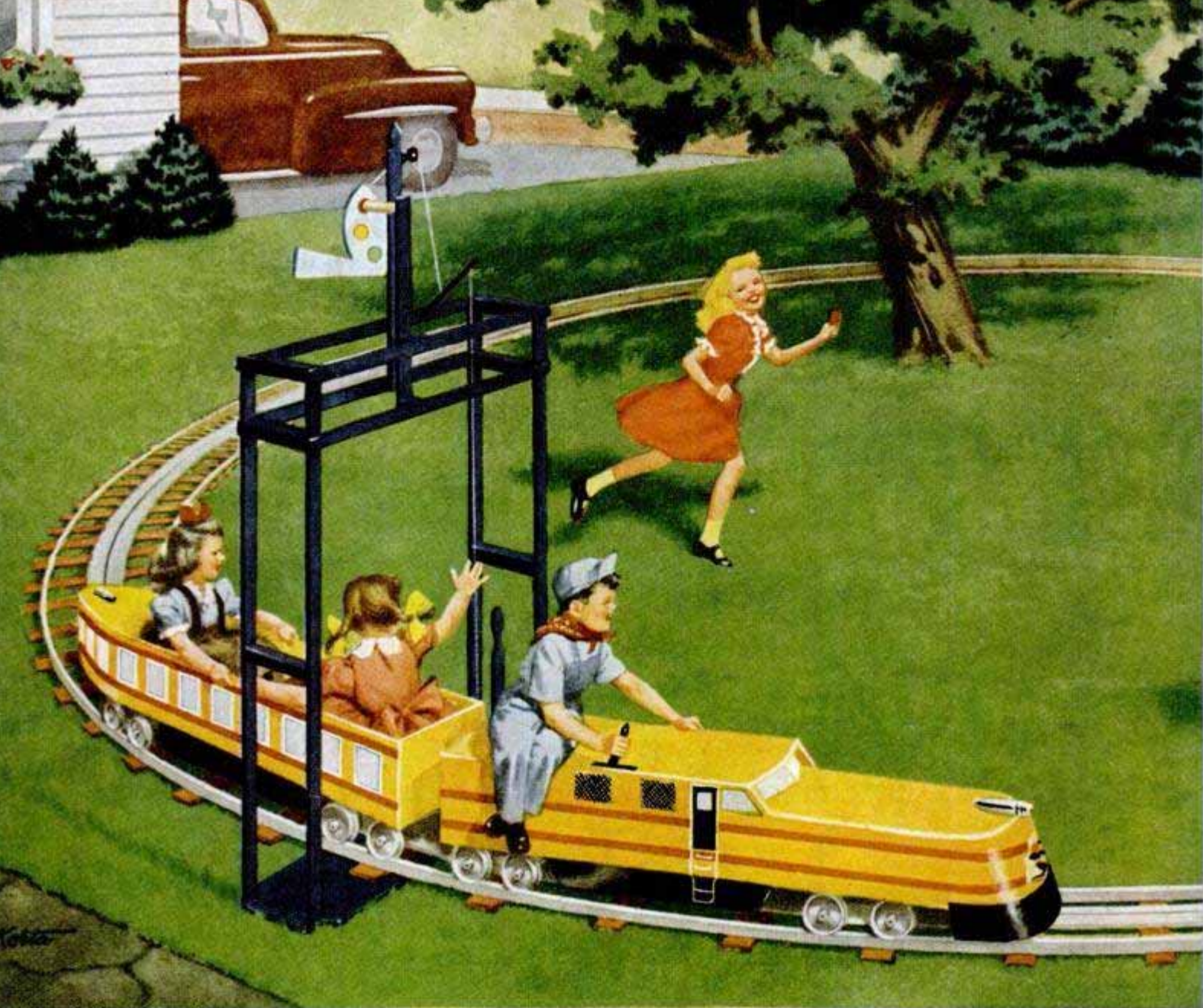

ALL ABOARD FOR FUN!

Exciting, electrified streamliner. Has one speed forward and one reverse. Dead-man control and fully enclosed third rail make toy perfectly safe. Compact power unit swivels with rear engine truck. Stock parts used throughout

By Marvin Hartley

WHEN WORD gets around that Billy has a real streamliner in his backyard, complete with semaphore, the small fry are sure to come running, for Billy will be the most popular Casey Jones in the neighborhood. Although the train is powered by 110-volt current, the toy is perfectly safe for a youngster to operate. All electrical connections are fully enclosed and the third rail is designed to make it practically impossible for children to contact. A dead-man throttle prevents the train from "running away." Pushing the

lever forward causes the train to move forward and pulling it backward reverses direction. When released, the throttle returns to a "dead" position. Using a worm-and-gear drive (40 to 1 ratio), the train travels at a speed of approximately $\frac{1}{2}$ m.p.h. While this is a slow yet safe speed for small tots, it can be increased to satisfy older youngsters by reducing the gear ratio and using a more powerful motor. The power unit, mounted on the rear truck of the engine, transmits power to the wheels by a sprocket-and-chain drive.



The engine and the coach are made from 1-in. lumberyard material. Both sides of the engine are cut exactly alike, according to Fig. 2. The cab begins at a point 14 in. from the front. Note that the nose of the engine is built up of six separate blocks, totaling $8\frac{1}{4}$ in. in thickness. The width of each block is given individually in the plan view in Fig. 1. The radius for each block is the same, $6\frac{3}{4}$ in., and is drawn on the bottom side of the work. Then the band-saw or jigsaw table is tilted approximately 15 deg. to produce an angle cut. After the pieces are cut, they are glued and clamped together in bread-and-butter fashion. This will give you a block that flares on three sides, which means that the side flare must be worked down with a wood rasp and sandpaper so it will gradually become flat at the point where it meets the sides of the engine. When this is done, a $\frac{3}{4}$ -in.-deep rabbet is cut on each side of the nose block to receive the sidepieces flush.

The top piece of the body is rounded and notched so that it will be flush with

The streamliner pictured in the illustration above varies somewhat from the original engine shown below, primarily in the location of the rear engine truck. This was changed to provide a better type of drive





Curved sections of track are made as a single unit and are braced with a wooden framework to retain proper radius

Painted windows continue around end of coach and red cellulose tape is applied to add striping on yellow body



the top edges of the sidepieces. A hinged section in the top of the cab opens to provide a padded seat for the engineer. Cleats which support the seat and the board to which it is hinged are screwed to the inside as shown. The section covering the power unit is fastened with screws to permit easy removal for servicing the unit. A sheet-metal windshield is added to the cab and an opening is cut in the top of the cab for the throttle. Note that the power unit is enclosed by a slanting board fitted as indicated by the dotted lines, and also that a floor board is added to the cab compartment. The front truck is pivoted on a board placed flush with the bottom edges of the body. Finally, a sheet-metal cowcatcher and a 3 x 23-in. skirt on each side of the body completes the engine. Fender-type bicycle lamps make neat lights for the train. If bullet-shaped ones are used, a recess can be made to embed them slightly in the wood and holes drilled for wiring them from the inside.

Fig. 3 details construction of the coach. Two 1 x 10 boards form the sides. These are screwed to top and bottom boards which are rounded at the rear end, following the pattern given in the squared drawing. The rounded end of the coach is covered with a piece of sheet metal, 8 $\frac{3}{4}$ in. wide, and brought around to lap the sides about 1 in. Note that a block is added to the underside of the top piece for nailing the top edge of the metal. The kingpin for the rear truck must be in place before enclosing the end of the coach. This is located 17 in. from the end. Both trucks for the coach and the front one for the engine are made alike, as shown in Fig. 3. Here, the wheels rotate on the axles, being held in place with washers and cotter pins. The axles are drilled and pinned to the trucks in half-round notches which are formed with a file in the $\frac{3}{4}$ x 1-in. cleats that are screwed to the truck base. A large washer is used to provide clearance between the truck and the body of the coach. As was done on the engine, 3-in. skirts are added on each side of the coach between the two trucks. The couplings, consisting of flat-iron pieces bent L-shape, are positioned one slightly above the other so that they will lap to take a small bolt.

The throttle detailed in Fig. 4 is actually a reversing switch, designed as a safety measure to return to an "off" position when released. This is

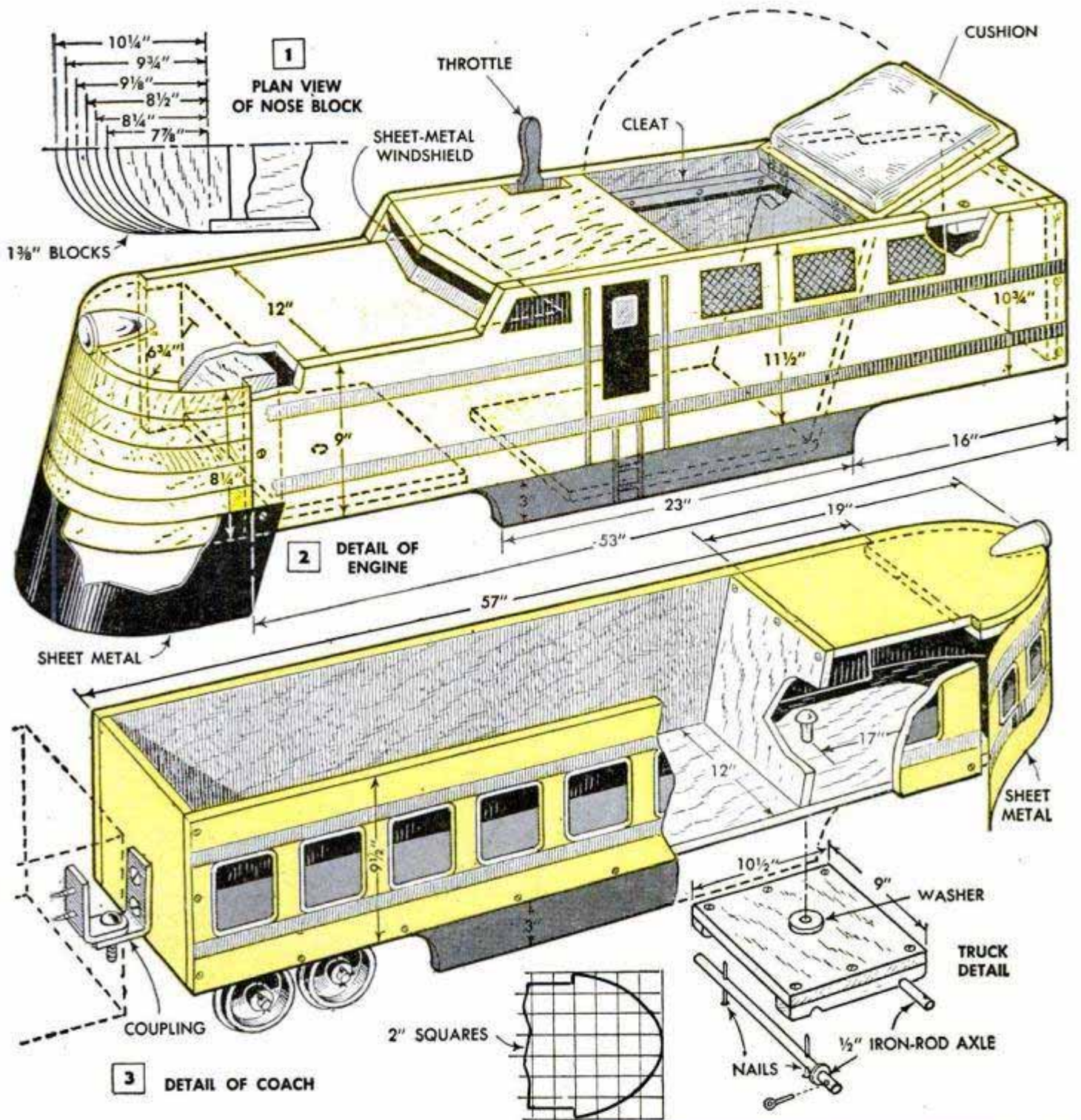

accomplished by two light-tension springs attached to the lever with screw eyes to exert an equal pull. The switch is so wired that the train lights will remain on when the throttle is closed. Brass contact strips in the switch are arranged in the manner shown. The strips fastened to the handle of the switch, which is pivoted with a flat-headed screw, make contact by passing under the others. When the switch is in the "off" position, the only parts making contact are the two shown with rounded ends and the narrow one at the side. The switch is wired as indicated and mounted with screws below the slot in the cab top.

Fig. 8 details the power truck. A worm, supported by pillow-block bearings and coupled to a 1/4-hp. motor, drives a

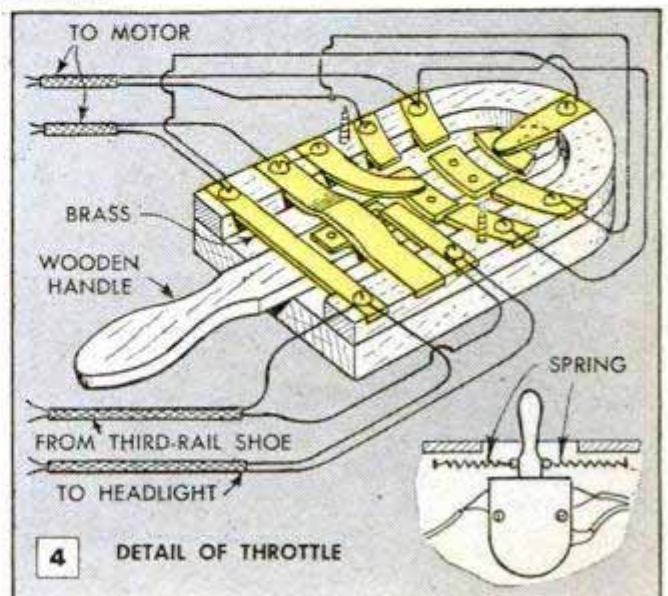

worm gear and a sprocket mounted on a jack shaft. The sprocket is chain-belted to a sprocket on the axle directly below. A second sprocket on the same axle is chain-belted to a sprocket on the other axle to furnish a positive four-wheel drive. The motor and worm-gear assembly are bolted to two flat-iron bars supported by four hardwood spacer blocks which in turn are bolted to the base of the truck. The complete unit is pivoted by a kingpin through a hardwood cleat fastened to the body of the engine with sections of angle iron. Note that the cleat passes between the truck base and the flat-iron bars and permits the whole drive unit to swivel on curved track. Gray-iron castings for the 16 wheels required can be purchased or they can be machined from cold-rolled

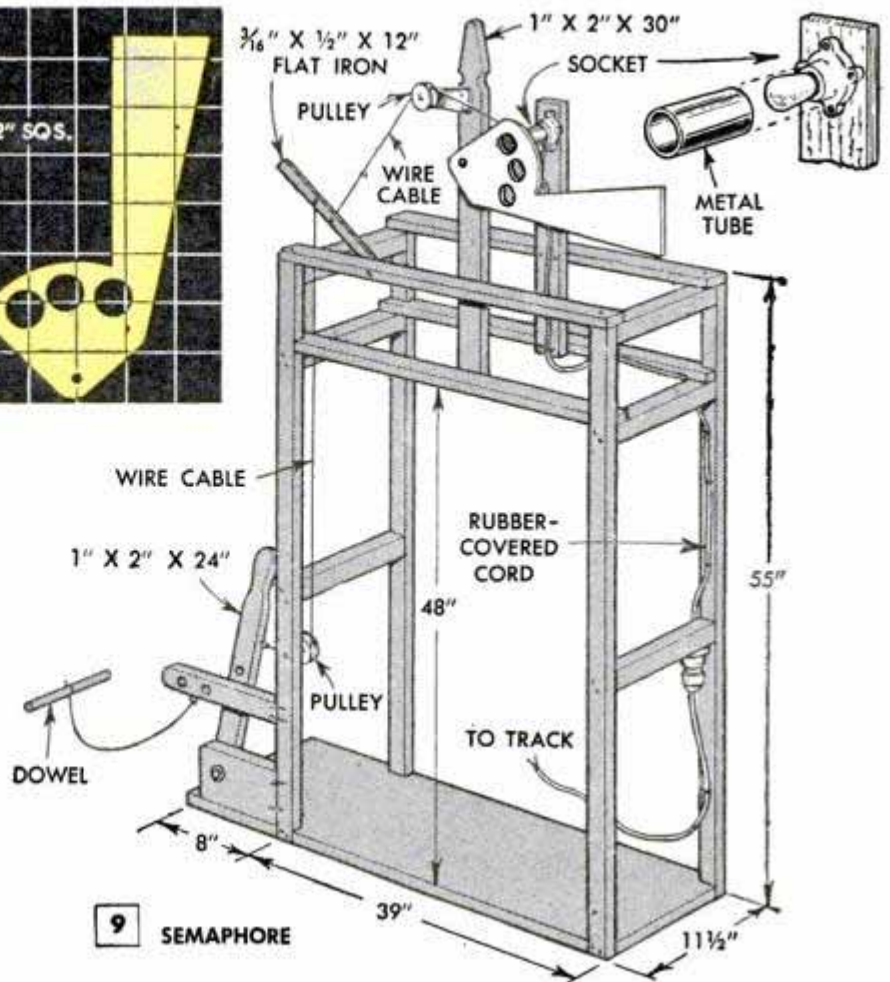

stock to the dimensions shown in the detail.

Power is transmitted from the third rail to the motor by a shoe coupled to the truck. In operation, the truck pulls the shoe along as it wipes against metal strips lining the sides of the third-rail assembly. Construction of both the third rail and the shoe is given in Figs. 6 and 7. The shoe consists of two wooden blocks spaced apart with small bushings and screwed together. The bottom block is fitted with brass contacts which are bent outward sufficiently to wipe lightly against the third-rail contacts. A duplex convenience outlet of the screw-on, baseboard type is fastened to the top block of the shoe and is wired and soldered to the contact strips in the manner shown. One side of the outlet is for plugging in the motor and the other is for the taillight. The shoe is coupled to the truck with a loose-fitting bolt which merely falls into a hole in the top of the shoe. The 3/4-in. wooden strips of the third rail are spaced apart with 4-in. cleats placed every two feet. Overhanging members screwed to the 3/4-in. strips provide a 1/2-in. slot for the shoe. Thus the electrical contacts of both the shoe and the third rail are fully enclosed from the top. The third rail is electrified by soldering a wire to each contact and fitting the wires with a plug.

An all-wood track, made up in 10-ft. sections, Fig. 5, uses 1 x 2s for the rails and 1 x 3s for the ties, the third-rail assembly

being centered between the rails and screwed to the ties. In making curved sections of track, the rails are bent to the desired radius and held so by a framework similar to the one shown in the upper photo on page 184. In the case of the third rail, it is made up of several short curved sections butted end-to-end.

A trestle, complete with a manually operated semaphore, keeps the engineer alert. Backed by a bulb and socket and controlled by a hand lever, the semaphore can be set to indicate either a stop, go or caution signal. Fig. 9 shows how the trestle is constructed. A pattern for the semaphore is made from the squared drawing and cut from 1/2-in. plywood. The 1 1/2-in. signal holes, which are backed with red, green and yellow Cellophane, are located on a radius drawn from the pivot point. A cable-and-pulley arrangement is used to raise and lower the semaphore and the lever to which the cable is attached is held in the desired position by a dowel stop. A porcelain socket, of the type having concealed terminals and fitted with a two-way plug, is mounted in an inverted position as shown. The third rail and 110-volt lines are plugged into this socket which is wired to the semaphore socket. Thus the track can be dismantled by unplugging the connections. A shade on the semaphore bulb directs the light through the holes. Use heavy rubber-covered cord for all the wiring.

Novel Coasters Turned From Hardwood Pinch-Hit as Decorative Wall Plaques

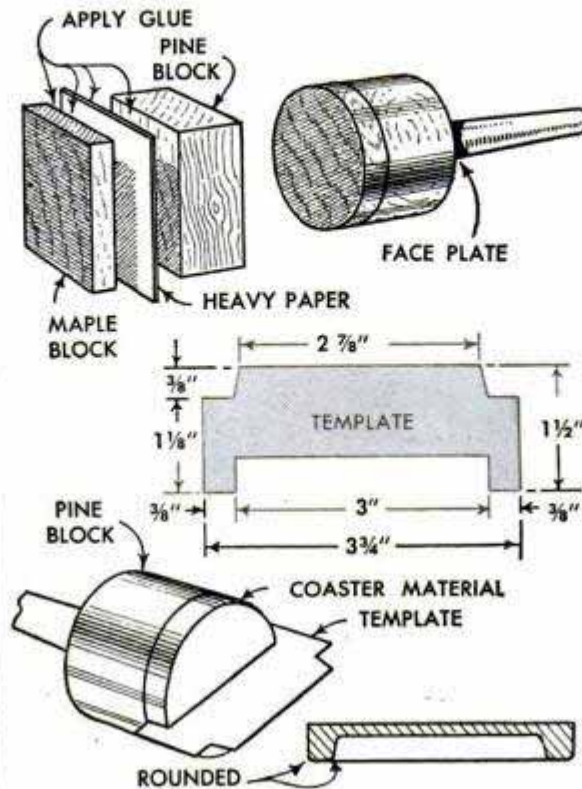
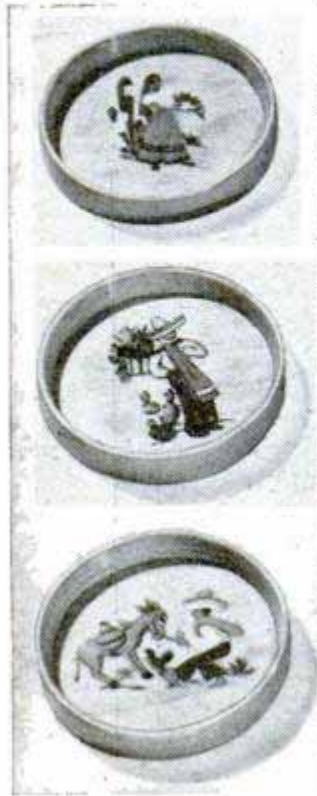

When not in use, these unusual maple coasters form attractive wall plaques. Their back edges are drilled to permit hanging from a nail and the dished centers are hand-painted or decorated with decals. To prepare the hardwood for mounting on a lathe faceplate, glue it to a matching block of pine, inserting heavy paper between the blocks to facilitate separating them. A template of sheet metal or plastic, cut to the dimensions given, serves as a guide. After sanding the coasters, apply a thin coat of lacquer sanding sealer and affix the decal. Allow the decal to dry for 24 hours, apply several thin coats of lacquer and then polish.—Wallace W. Buffmire, Evanston, Ill.

Pecan Shells Ballasted With BB Shot Provide Hulls for Tiny Ship Models

Utilizing BB shot for ballast, tiny ship models that really float are made by gluing wooden keels to pecan or walnut-shell hulls. When sawing the pecan shells in half, the tips are left intact to support the bowsprit, or jib. Masts are of matchsticks, the yardarms are cut from toothpicks and the rigging is thread. Paper sails are glued to the yardarms and heavy paper forms the decks. After painting, the hull is given a coat of spar varnish.—C. D. Bassett, Ypsilanti, Mich.

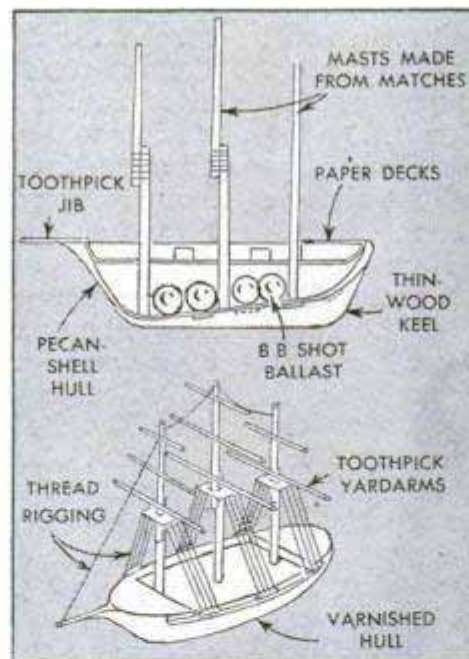

Flameproofing Curtains and Drapes Helps Prevent Rapid-Spreading Fires

Washable curtains and drapes of cotton, linen or rayon can be flameproofed by immersing them in a solution of crystalline borax, 1 lb., boric acid, 13 oz., and water, 2 gal. The water is heated to dissolve the ingredients and the solution is cooled to room temperature. Then the fabric, which should be dry and clean, is immersed in the solution. Light fabrics require only dipping, but heavy fabrics should be soaked

from 10 to 15 min. to insure thorough impregnation. The fabric is wrung out by hand, dried and then ironed at a lower temperature than usual. This treatment does not affect the color of most dyes and it must be renewed after each washing.

Minnow nets and trotlines can be made rotproof and water resistant by dipping them in raw linseed oil and then drying.

RECIPE FILE

PATTERNED after the old-fashioned spice chest, this little cabinet features a drop front which opens to expose a handy recipe file. The front forms the bottom of the card compartment, which is pivoted at the lower end by two screws. The drawing shows how the parts go together. Note that the card compartment is slanted at the rear to counterbalance it when closed. The drawing shows how the parts go together. Note that the card compartment is slanted at the rear to counterbalance it when closed. Slant the saw cuts in the sides about 5 deg.

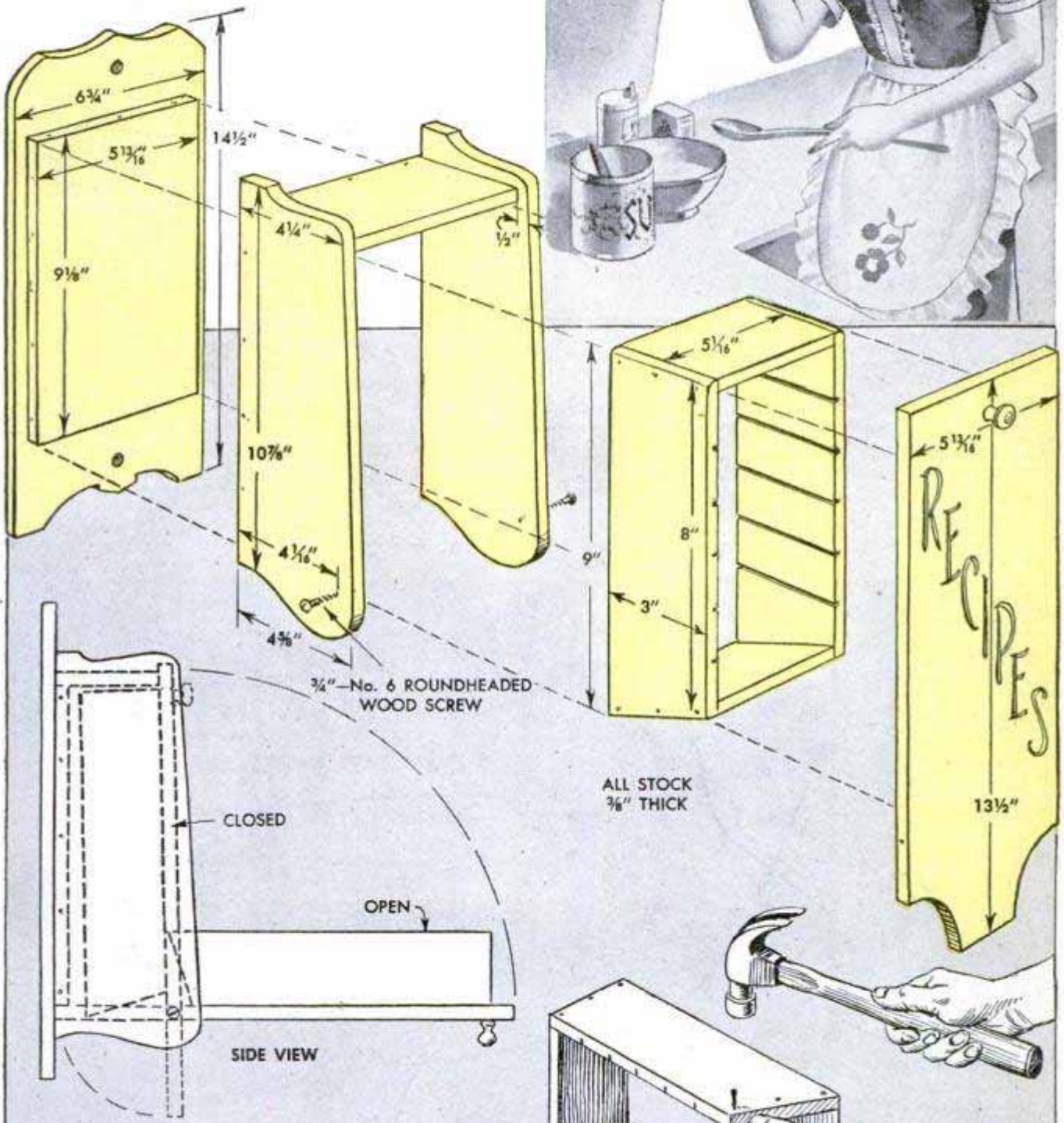

The extra piece nailed to the face of the back panel not only provides a nailing edge for the sides but it also serves as a stop for the tilting front when it is pulled open. The file compartment is balanced so that it will stay closed

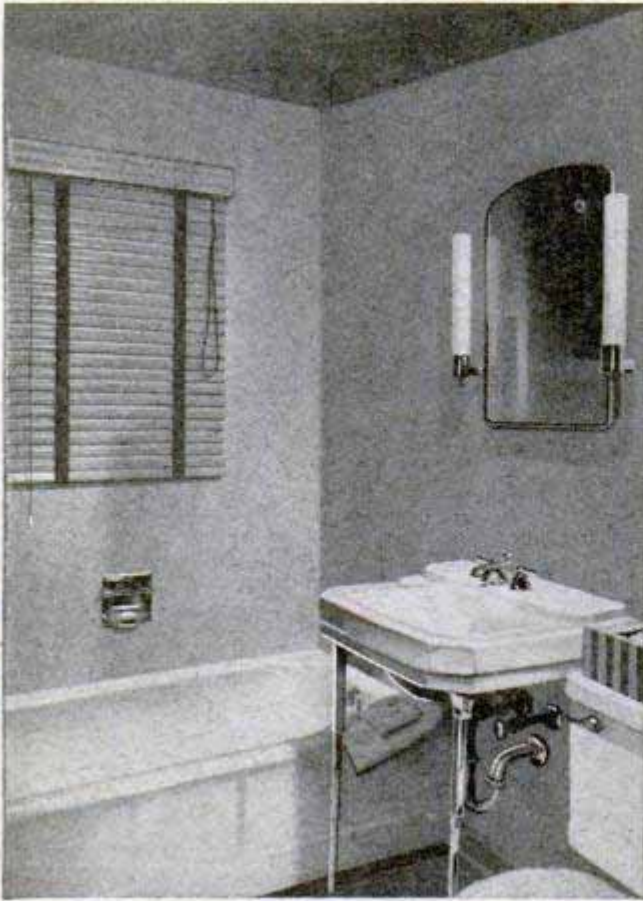

Locating bathroom adjacent to utility room simplified plumbing and cut cost. Opening from utility room provides access to tub connections. Total cost of all fixtures, even including floor tile, came to \$169

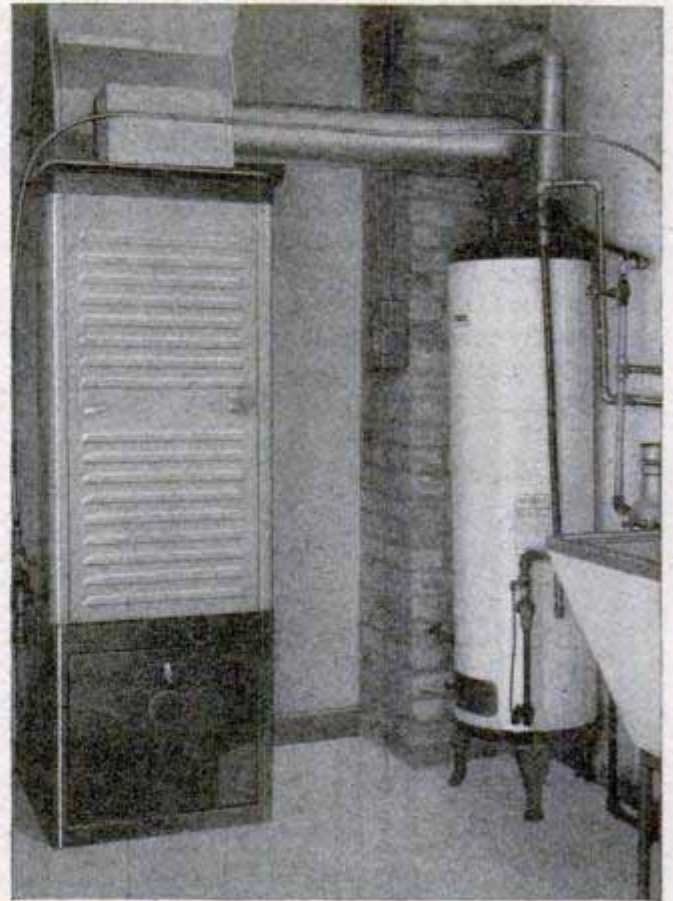

This view of the utility room shows the compact arrangement of the heating unit, water heater and laundry tubs. Cold-air returns under the floor enter the furnace through a pit located below unit

Complete with eave troughs and front walk, here's your dream home fully landscaped and ready to occupy. Ornamental iron railings and colorful window shutters are final touches that will dress up the front



build-it-yourself

CONCRETE - BLOCK HOUSE

PART II

by Wayne C. Leckey

WITH CONSTRUCTION completed to the stage described in Part I, you are about ready to tackle the inside of the house. First, however, it is best to go ahead and shingle the roof, covering the chimney opening with tar paper or a tarpaulin to keep the inside of the structure dry. As the house does not have a basement, that part of the plumbing which is buried and the cold-air returns for the heating unit have to be installed before the concrete floor is poured. The pipes for the cold-air returns are formed from lengths of chimney flue lining, cemented end-to-end. The three returns required terminate in a pit located under the heating unit. This pit and the ones into which the pipes enter at the walls are cast at the time the floor is poured. Fig. 11 shows how the pits are lined with a wooden form and made a size to accommodate a standard floor grille. All plumbing, including the city water and gas lines, is located to enter the utility room. The drum trap for the bathtub, the drain for the laundry tubs and the connection for the closet are brought slightly above the floor line and stuffed with paper. Then, the sink drain is installed and the vent stack carried up through the roof.

Next comes the floor. If the window and door frames have not been installed, do this first so that the sash can be hung. Fig. 12 shows sectional views of the frames. A cross section of the insulated floor is shown in Fig. 10. After ground installations are filled in, a 4-in. layer of gravel or cinders is spread over the entire area. This is tamped and then covered with a $\frac{1}{8}$ -in. layer of insulating paper to form a vapor barrier. The paper is brought

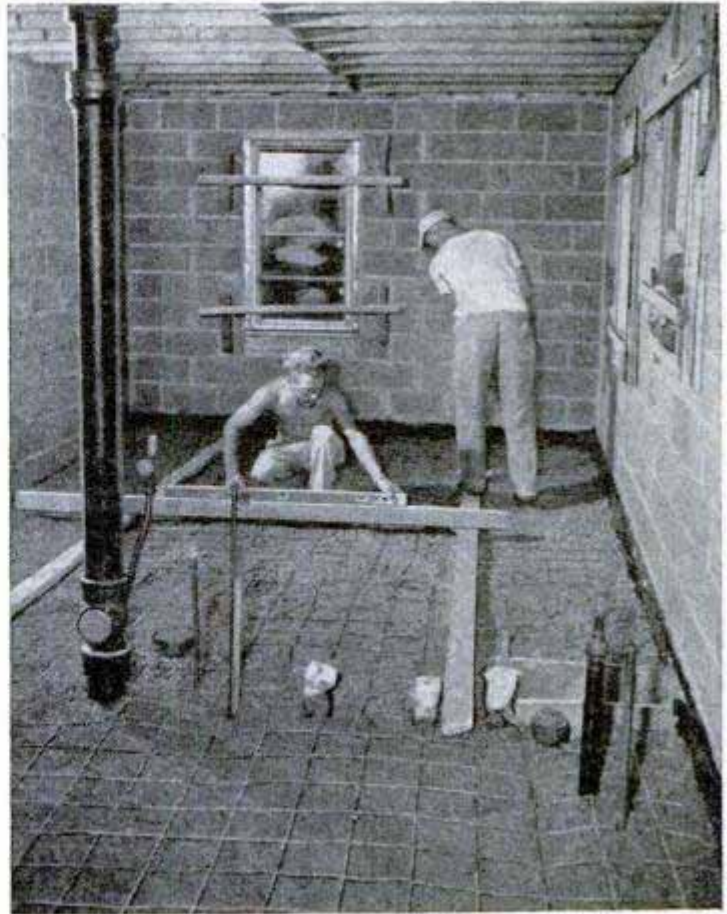

Here the floor is being poured. This is done, of course, after the plumbing and cold-air returns are in place, but before the remainder of the room partitions are erected

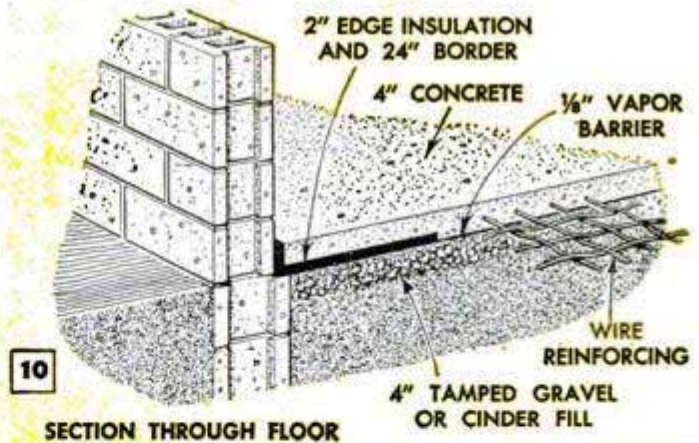

10

SECTION THROUGH FLOOR

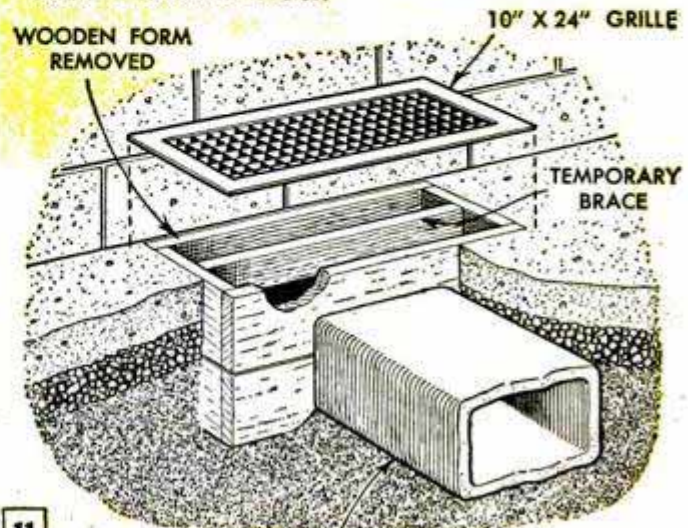

11

8" X 12" FLUE TILE USED FOR COLD-AIR RETURNS

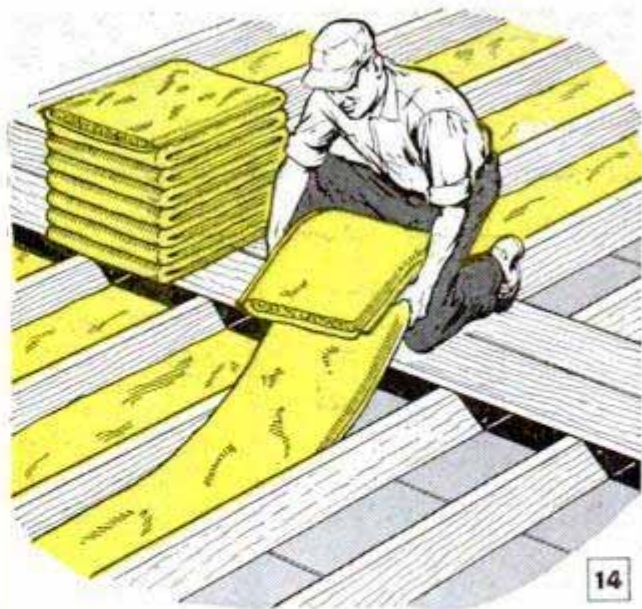

14

Left, plaster is applied directly to the walls of room partitions. Note all corners, including the ceiling line, are reinforced with metal lath. Plastering job, including materials, cost \$380

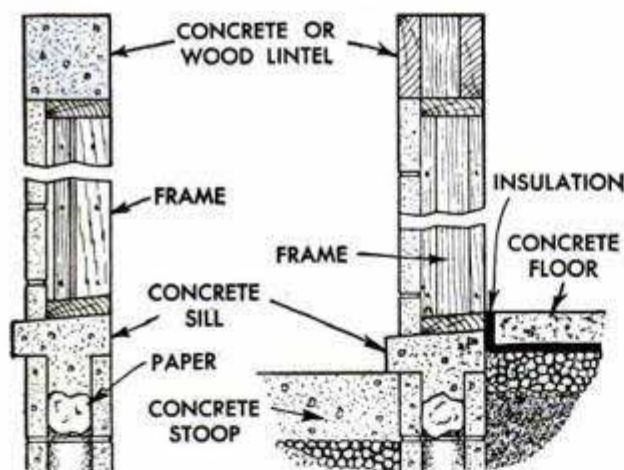

12 SECTION THROUGH WINDOW

SECTION THROUGH EXTERIOR DOOR

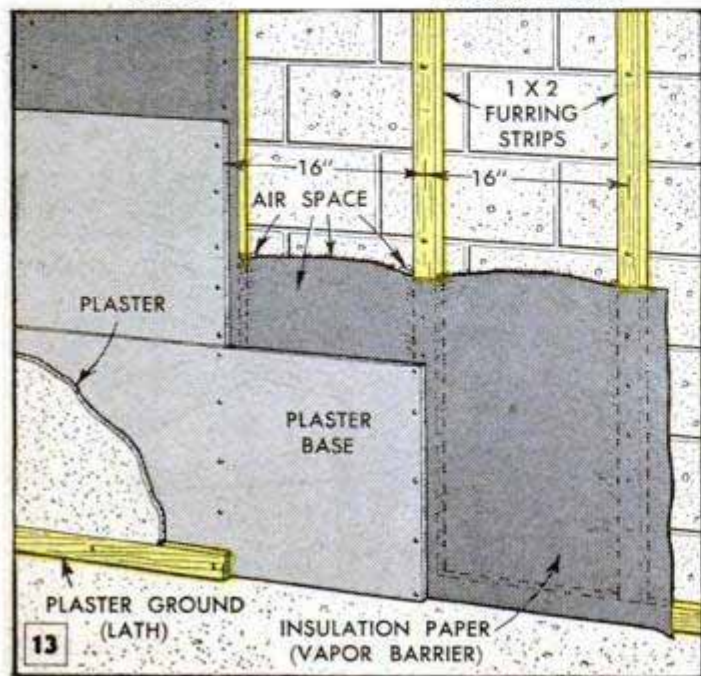

13

up above the floor line at the outside walls and a 2-ft. border of rigid insulation is laid all around the exterior walls. A 2-in. layer of concrete is poured over the paper and then wire reinforcing is laid in the soft concrete, after which it is covered with another 2-in. layer.

When the floor is completed, the 4-in. block partitions are erected. Where the walls run parallel with the joists, the top row of blocks merely extends above the ceiling line. But, where they run at right angles to the joists, it is necessary to notch the blocks to fit around the joists. The inside of the exterior walls is furred with 1 x 2-in. strips, as indicated in Fig. 13. These are placed vertically, spacing them 16 in. apart. No furring is necessary on the partitions. Insulating paper is applied to the furring strips in the manner shown in Fig. 13. However, before this is done, openings for convenience outlets must be cut in the wall and armored cable passed down through the wall from the attic. Note that the insulating paper is cupped slightly by pressing it inward to produce a double air space between the wall and the plaster base or lath. After lathing the walls and ceilings, strips of metal lath, called Cornerite, are nailed in all the corners.

The chimney, which is located in a corner of the utility room, Fig. 17, is erected before the walls are plastered. After two or three brick courses are laid, chalk lines are tied to nails inserted in the mortar joints and stretched to the opening in the roof. The lines are plumbed and positioned to allow for clearance where the chimney passes through joist and rafter openings, Fig.

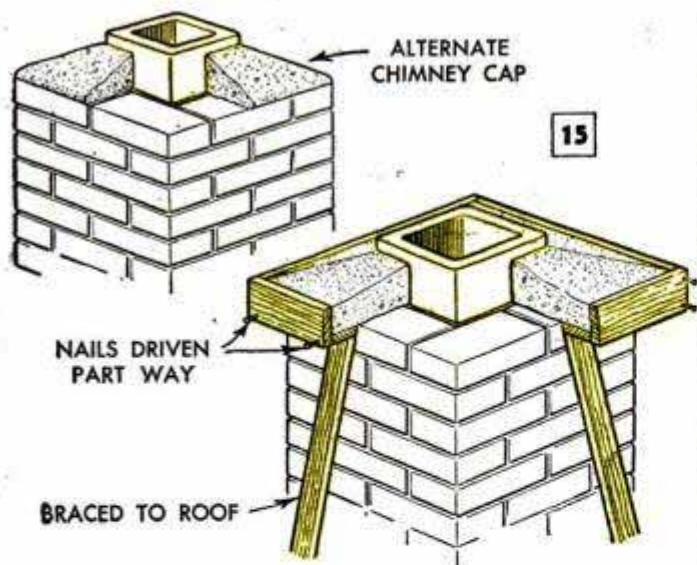

16, and are used as a guide in keeping the chimney running straight. Fig. 15 gives a choice of two types of chimney caps.

Heating registers enter each room through the ceiling. A main duct connected to the furnace is located in the attic and is parallel with the bearing partition. Short leads to each room branch off from this duct. After the walls are plastered, all that remains is applying the trim to the doors and windows, completing the wiring and insulating the ceiling, as in Fig. 14. Final outside jobs consist of stuccoing the exterior surface and installing gutters.

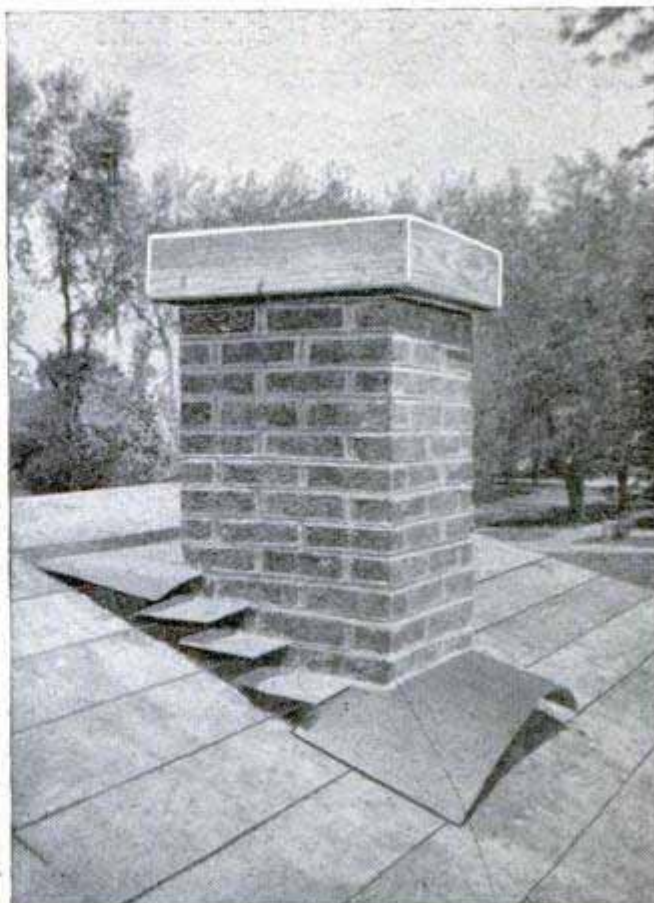

Below, the chimney, resting on a footing under the floor, is erected in a corner of the utility room. Bricks are laid to chalk lines plumbed from starting course to roof, clearance being allowed at openings

NOW THERE ARE TWO . . .

Popular Mechanics Build-It-Yourself houses, the Concrete-Block House described here, and Your Home And How To Build It Yourself, which was a frame-type house. Blueprints and the books on both houses shown below may be obtained by writing Popular Mechanics Book Dept., 200 East Ontario Street, Chicago 11, Illinois.



THE CONCRETE-BLOCK HOUSE, BOOK.....\$ 2.00
 Complete Set of Blueprints.....12.00
 Book and Blueprints.....12.50
 Duplicate Set of Blueprints..... 5.00

YOUR HOME AND HOW TO BUILD IT YOURSELF, BOOK\$ 3.00
 Complete Set of Blueprints.....12.50
 Book and Blueprints.....14.00
 Duplicate Set of Blueprints..... 5.00

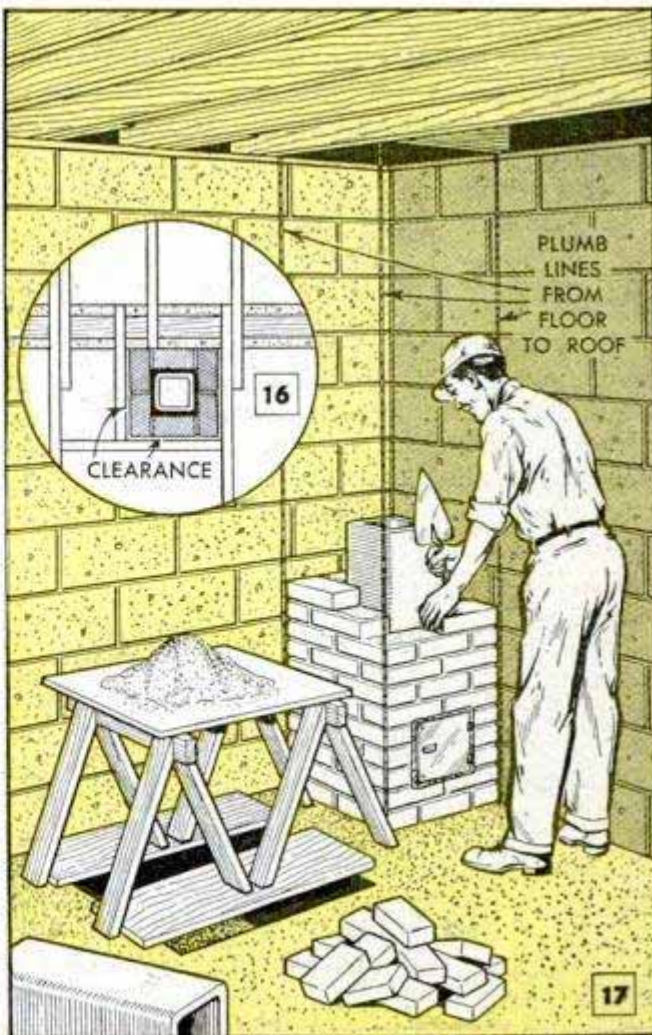

Notched Jig Spots Electric Drill On Vertical Surfaces

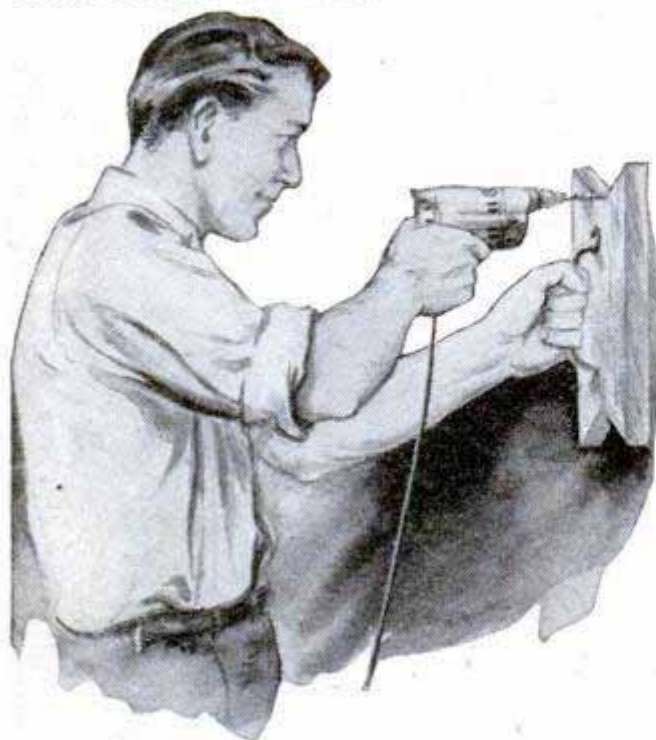

If you have difficulty spotting an electric drill when boring holes in plastered walls or other vertical surfaces, this notched jig will permit you to spot the drill accurately every time. The jig consists of a wooden block with a V-shaped notch cut in each end, the bottom of the vee being rounded slightly for the drill bit. To guide the drill, center the bottom of the vee exactly over the position of the hole and rest the bit in the notch. A screen-door handle facilitates holding the jig, and a rubber facing, glued to the underside of the jig, reduces vibration and slipping.

Mirror Frame Provides Shoehorn

The plastic frame of a broken hand mirror can be quickly fashioned into a useful shoehorn. Leaving the handle intact, cut the back of the mirror frame to the shape of a shoehorn and round the edges.

N. P. Smith, New York City.

Winding Fishing Rods

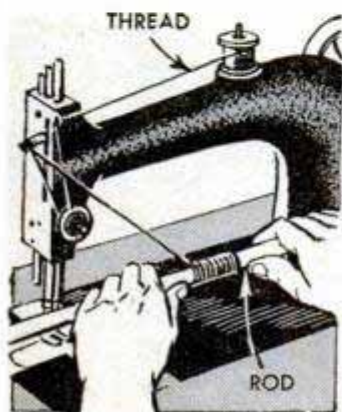

With the aid of a sewing machine, it is a simple matter to do a professional-like job of winding your own fishing rods. Just mount a spool of silk winding thread on the machine and run the thread through the tension arm as

shown. This holds the silk taut, allowing both hands to be used to rotate the rod.

Jack T. Kelley, Brooklyn, N. Y.

Manila Envelope Tacked to Wall Stores Sheets of Sandpaper

Drawer or shelf space can be conserved by storing sheets of sandpaper in large Manila envelopes tacked to a wall. The tacks are driven through the flaps of the envelopes so they are held open, and different grades of sandpaper are stored in separate envelopes.

Richard Hanscom, Elmhurst, Ill.



Brick Incinerator for Back Yard Reinforced With Iron Rod

Combining distinctive appearance with economy, this back-yard incinerator is built of 3-hole brick reinforced with iron rod. It is set up merely by inserting the rods through the holes in the brick as shown in the detail, the rods being long enough to permit driving them into the ground about 6 in. A wire grate can be installed near the bottom of the incinerator, if desired, and a hardware-cloth spark cover placed over the top.

W. A. Andrews, Sr., Kansas City, Mo.



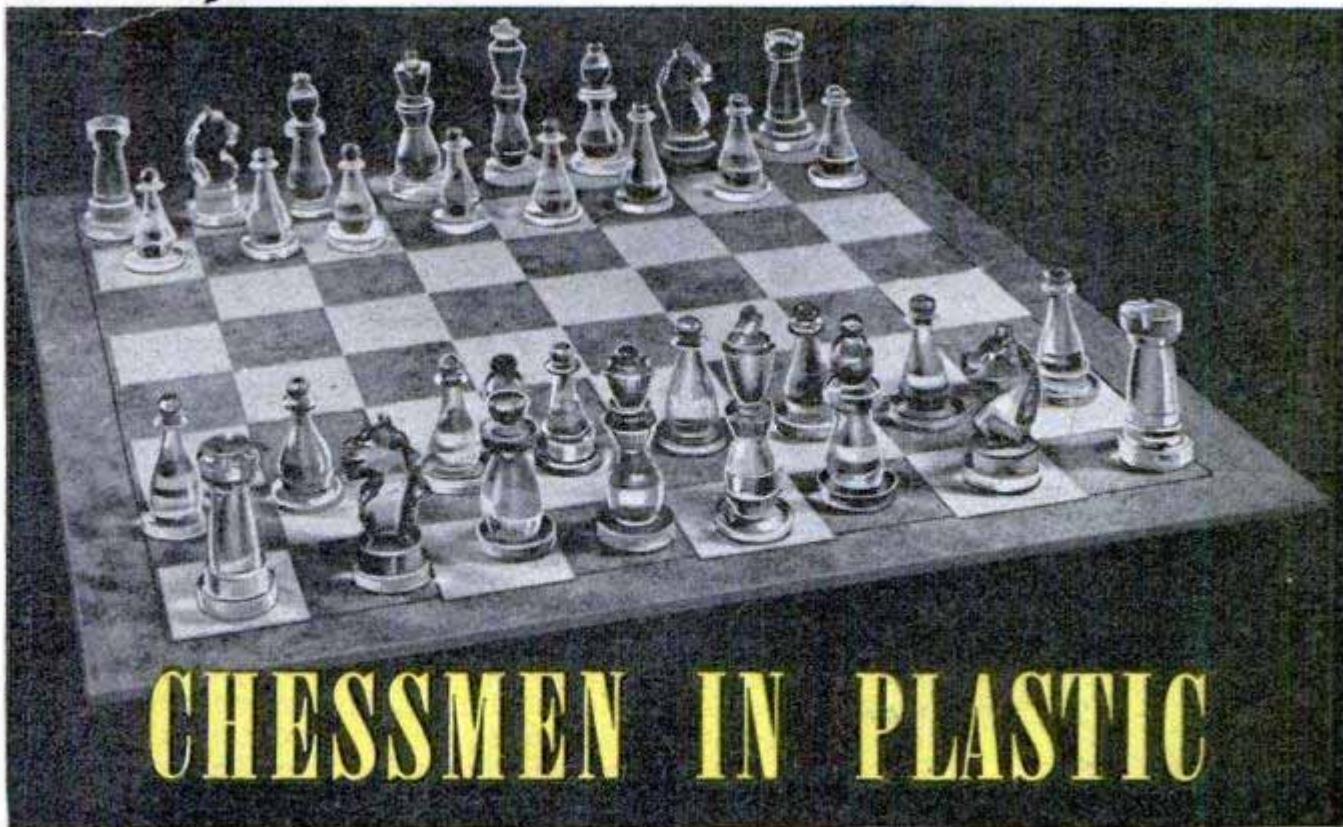

By Elma Waltner

TURNED and carved from crystal-clear plastic, these distinctive chessmen are ideal for your own use or as a gift that will compliment the skill of any chess enthusiast. One set is left the natural color of the plastic and the other set is stained red. The chessmen generally follow the Staunton design, the kings, which are the largest pieces, being 3 in. high, and the pawns $1\frac{3}{4}$ in. high. All pieces are turned from 1-in. transparent plastic rod.

When turning the plastic, it is a good idea to form the base of the piece at the tailstock end of the rod. In this way, there is a minimum waste of plastic, as the hole made by the tailstock center is in the base of the piece and the entire length of the rod thus can be utilized. The work can be centered accurately by mounting one end of the rod lightly in the lathe chuck and bringing the tailstock against the other end. The chuck jaws are adjusted in or out so the tip of the tailstock center is in the exact center of the end of the rod. Cardboard templates for all pieces except the knights aid in turning the work to the correct proportions. These are made by using a half pattern of each design, following the squared pattern in Fig. 7. Calipers are employed to check the contours of each piece, Fig. 1, and, by the combined use of templates and calipers, the corresponding pieces can be turned to identical size.

After the turning is completed, each piece is polished in the lathe before it is cut from the rod. To do this, hold jewelers'

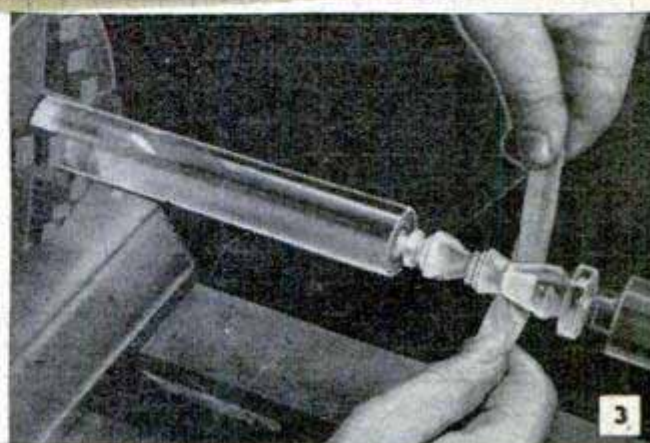

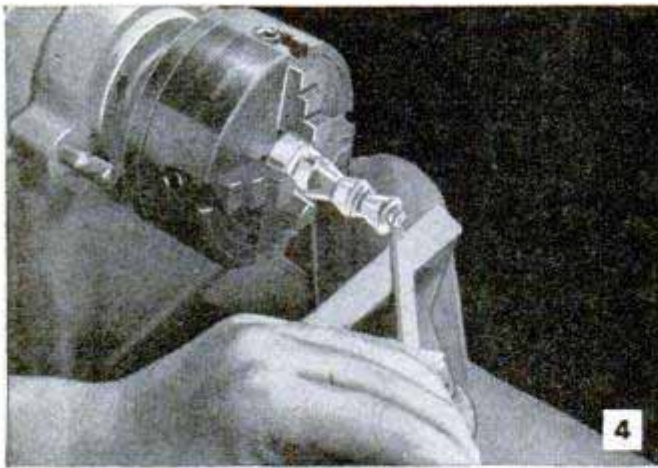

4



5

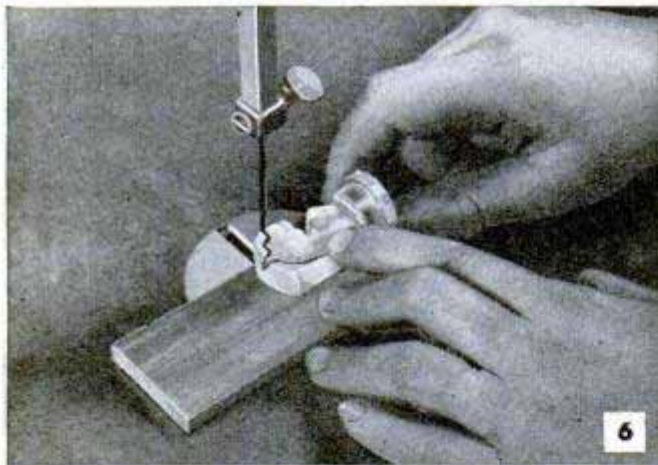

6

rouge against one side of the rotating piece and hold a dampened cloth pad against the other side, as shown in Fig. 2. This wet-polishing method will quickly produce a high luster on the surface of the plastic. With the piece still rotating in the lathe, it is given a final polish by holding a strip of soft cloth against it as illustrated in Fig. 3.

When the piece has been polished, it is cut free from the rod with a parting tool. Then, after removing the rod stock from the chuck, the base of the piece is chucked in the lathe and turning of the top portion is finished, Fig. 4. This is polished while the piece is still in the chuck. Then the work is reversed end for end in the chuck and the base is turned slightly concave, as in Fig. 5, so the piece will not tip easily. When chucking polished pieces, protect the surface in contact with the jaws by wrapping it with heavy paper. Give the pieces a final buffing or polishing by hand.

Now, square the crosses on the kings' crowns by sawing them flat on two sides and then polish. Carve the tops of the queens and castles (rooks), as shown in Fig. 7, and cut a slot in the top of each bishop. If available, use hand-grinder burrs for carving, chucking them in a drill press instead of a hand grinder to leave both hands free to manipulate the work.

When making the knights, turn the upper portions roughly to shape and finish-turn the bases. Then, saw away the surplus stock on the upper portions so the sides are flat and about $\frac{3}{8}$ in. thick. Lay out the profile of the figure on one of the flat sides and saw it out. If a jigsaw is used for this purpose, a piece of wood must be laid between the saw table and the underside of the flat surface of the work to hold the piece level with the table, Fig. 6. When

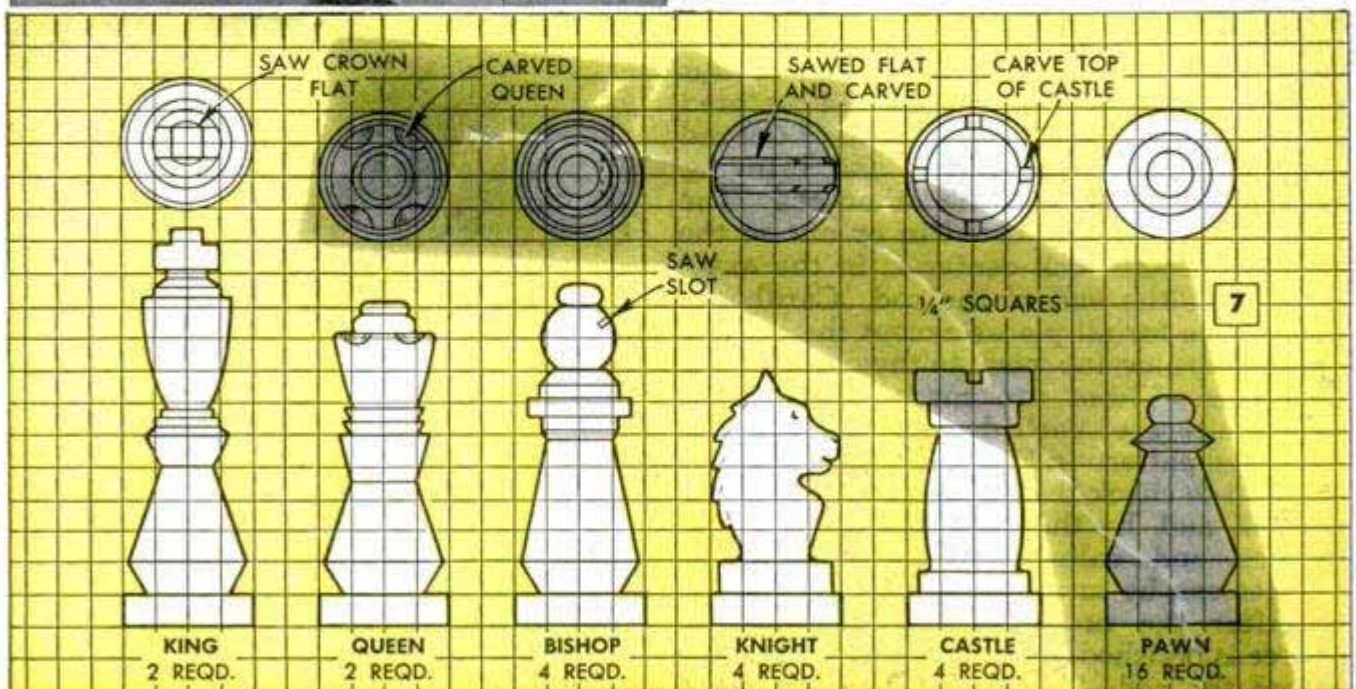

7



8

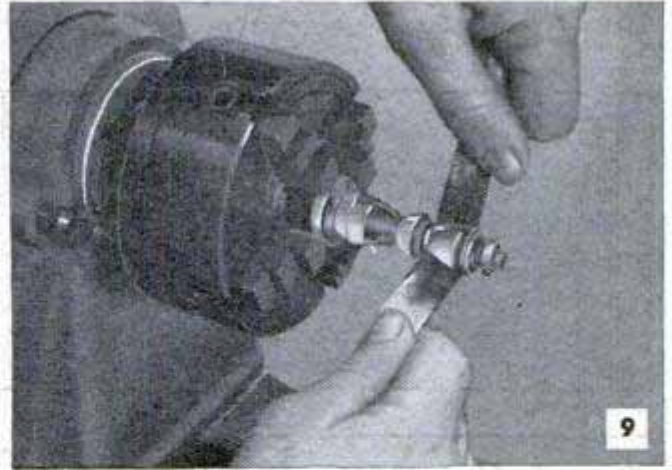

9

sawing the pieces, it is best to use a skip-tooth blade or a blade having widely spaced teeth. The saw should be run at slow speed to avoid overheating and possible melting and distortion of the plastic. The carving of the knights is also done with hand-grinder burrs chucked in a drill press, as in Fig. 8. As the knights cannot be chucked in the lathe for polishing, they are finished with a buffing wheel charged with buffing compound.

After all the pieces have been polished, one set must be stained to distinguish it from the other. An easy way to do this is to mount the pieces to be stained in a lathe chuck, remembering to protect the polished surface from being marred by the

chuck jaws. Then the stain is applied to a soft cloth which is held against the piece as the latter turns in the lathe, Fig. 9. The pieces are reversed in the chuck to complete the staining. This method, of course, cannot be used for the knights, and the stain must be rubbed in them by hand. Applying the stain in this way does not produce a deep color, but rather a pale tint that is especially attractive in plastic. If deeper shades are preferred, the pieces may be stained by immersing them in a dye bath until a particular depth of color is attained. Although red stain was used for one of the original sets and the other was left clear, any desired color or color combinations may be used.

Orange Crates Covered With Fabric Provide Inexpensive Bookcase

Covered with brightly-colored fabric and topped with imitation leather, this inexpensive bookcase consists merely of three or four fruit crates stacked one on top of the other. The crates are bolted to-

gether or fastened with strips of sheet metal, and the sides of the case and the edges of the shelves are covered with fabric. The shelf edges are covered to a depth of 2 or 3 in. To attach the fabric to the sides of the case, fasten it to the front edges with strips of cardboard, as shown in the detail, and stretch it across the sides. Then, pleat the fabric or stretch it taut and tack it to the back of the case. After cutting a piece of heavy cardboard large enough to cover completely the top of the bookcase, spread glue on one side of the cardboard about 1 in. in from the edges. Lay the cardboard with the glue side upward on a piece of imitation leather which is about an inch larger all around. Miter the corners of the leather, fold it around the edges of the cardboard and smooth it over the glued surface. Hold the leather in place with weights until the glue dries, and then fasten the top to the bookcase with upholsterer's tacks or furniture nails.

Ned S. Goss, Wilmington, Ohio.

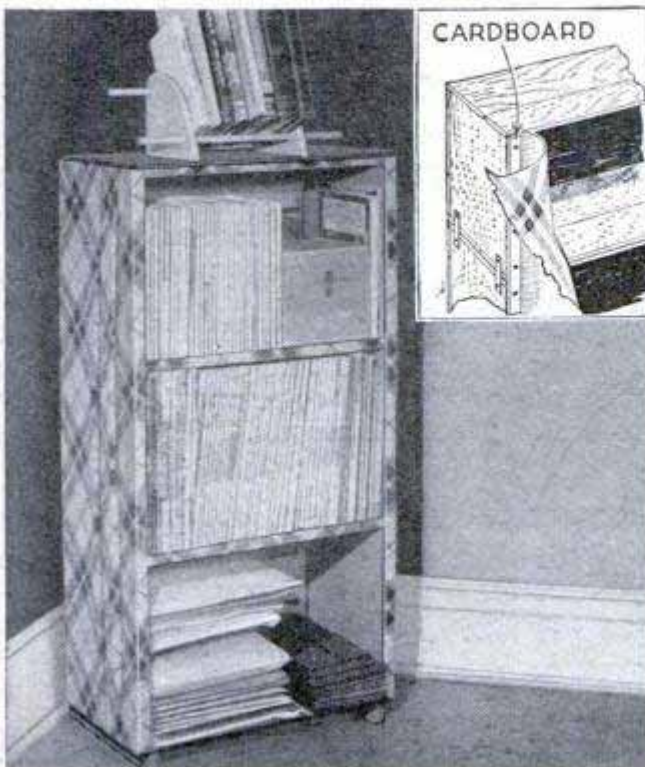

☞ To prevent a cut in oilcloth from becoming an unsightly hole, place a strip of adhesive tape sticky side up on the underside and press the edges down smoothly.

Paper-Knife-and-Bookmark in Hammered Metal

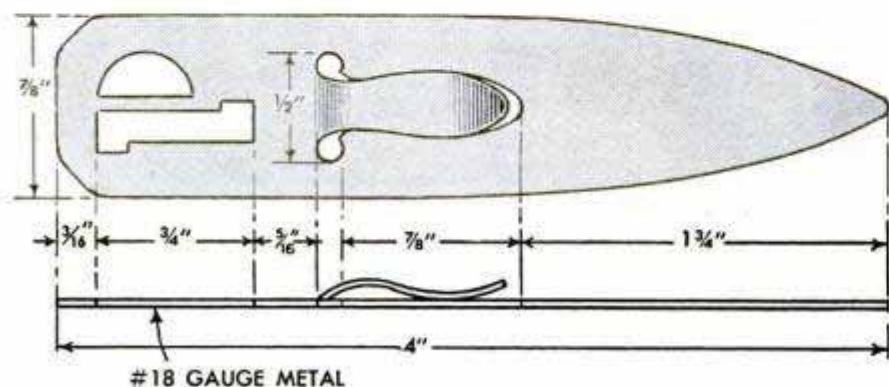
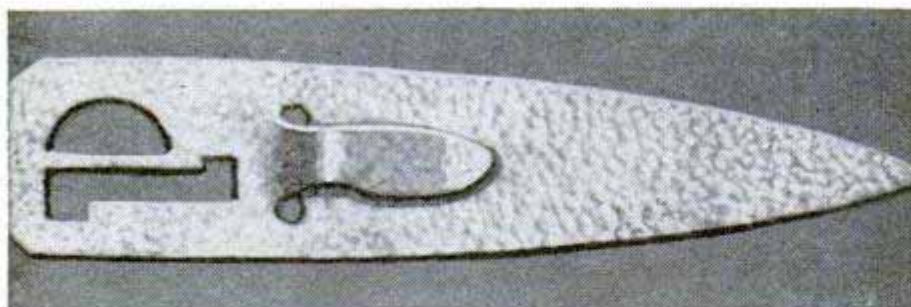

Made of hammered sheet metal, this initialed bookmark is handy for opening mail or severing untrimmed pages of a book. After the metal has been cut to shape, the clip is formed by drilling $\frac{1}{8}$ -in. holes $\frac{1}{2}$ in. apart and sawing with a jeweler's blade. Using the same procedure, an initial is cut into the upper end of the bookmark. Then the surface of the metal is hammered lightly with a ball-peen hammer and the clip is bent to an S-shape as shown in the lower detail. Finally, all edges are filed smooth and the metal is polished.

Attractive Rack Made From Plastic Permits Quick Selection of Ties

Bent from a length of heat-forming plastic, this novel rack keeps ties separated for instant selection. Dimensions of the rack are determined by its location and the number of ties to be held. The individual tie hangers are cut out U-shaped and staggered, as shown, to display each tie. The ends of the plastic are made pliable by heating in an oven set for 250 deg. F. Then, they are bent L-shaped for attaching to a wall or door with roundheaded screws. Handle the plastic with gloves and form in a vise or jig to produce the sharp bends.

A. V. Malone, Los Angeles, Calif.

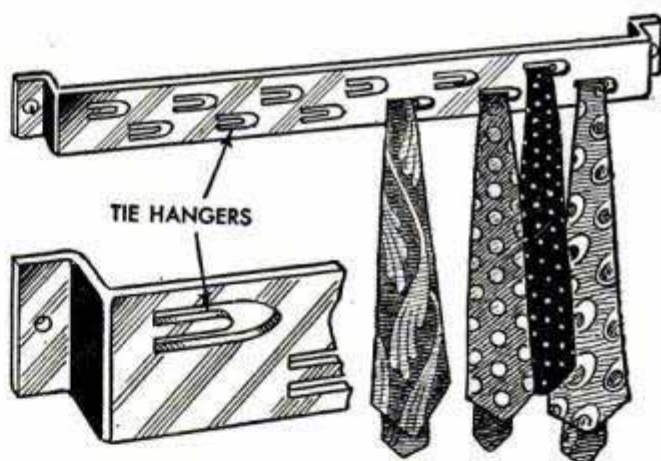

Window for Head Net Protects Face While Allowing Unobstructed Vision



To relieve eyestrain caused by looking through the mesh of a head net for long periods of time, one fisherman mounted a rectangular piece of transparent plastic in the netting directly in front of his eyes. This permits clear vision while still giving the head complete protection from insects. An opening for the window is cut in the netting and the latter is cemented directly to the edges of the plastic.

Lemon Juice Provides Invisible Ink

With a little lemon juice and a new pen point, children can have a good time writing messages in invisible ink. When the lemon juice dries, the writing is not apparent. It is brought out by holding the paper over a source of heat, such as a hot lamp bulb.—Domenick Bava, Detroit, Mich.

TIDEWATER PIER

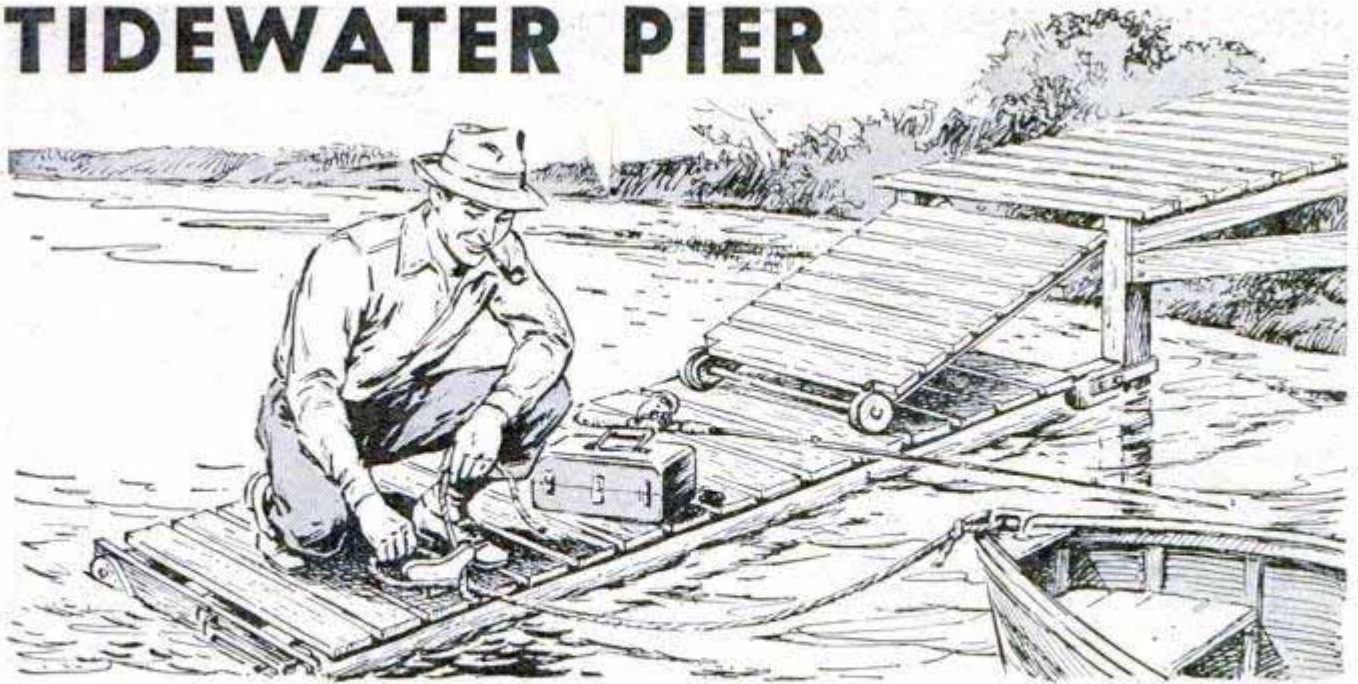

By Hi Sibley

REQUIRING no pilings, this inexpensive boat landing which floats with the tide or water level is ideal for lake or river use. Designed to ride up and down on the posts of a fixed pier, one end of the landing is fitted with flat-iron yokes while the other end is anchored to a concrete block by means of a pantograph-type extension. Tared telephone poles are excellent for the timbers of the landing. These are braced diagonally on the underside, after

one end of each outer timber is shaped to take the flat-iron yokes, and then the surface is floored with narrow boards.

The pantograph extension, which checks side movement of the landing in rough weather, and the cast-concrete block to which it is anchored are attached to the outboard end of the poles in the manner shown. The whole assembly is floated into position, using the landing as a raft. Bolt- ing the yokes in place and adding a small ramp complete the job. Metal parts should be copper-painted for salt-water use.

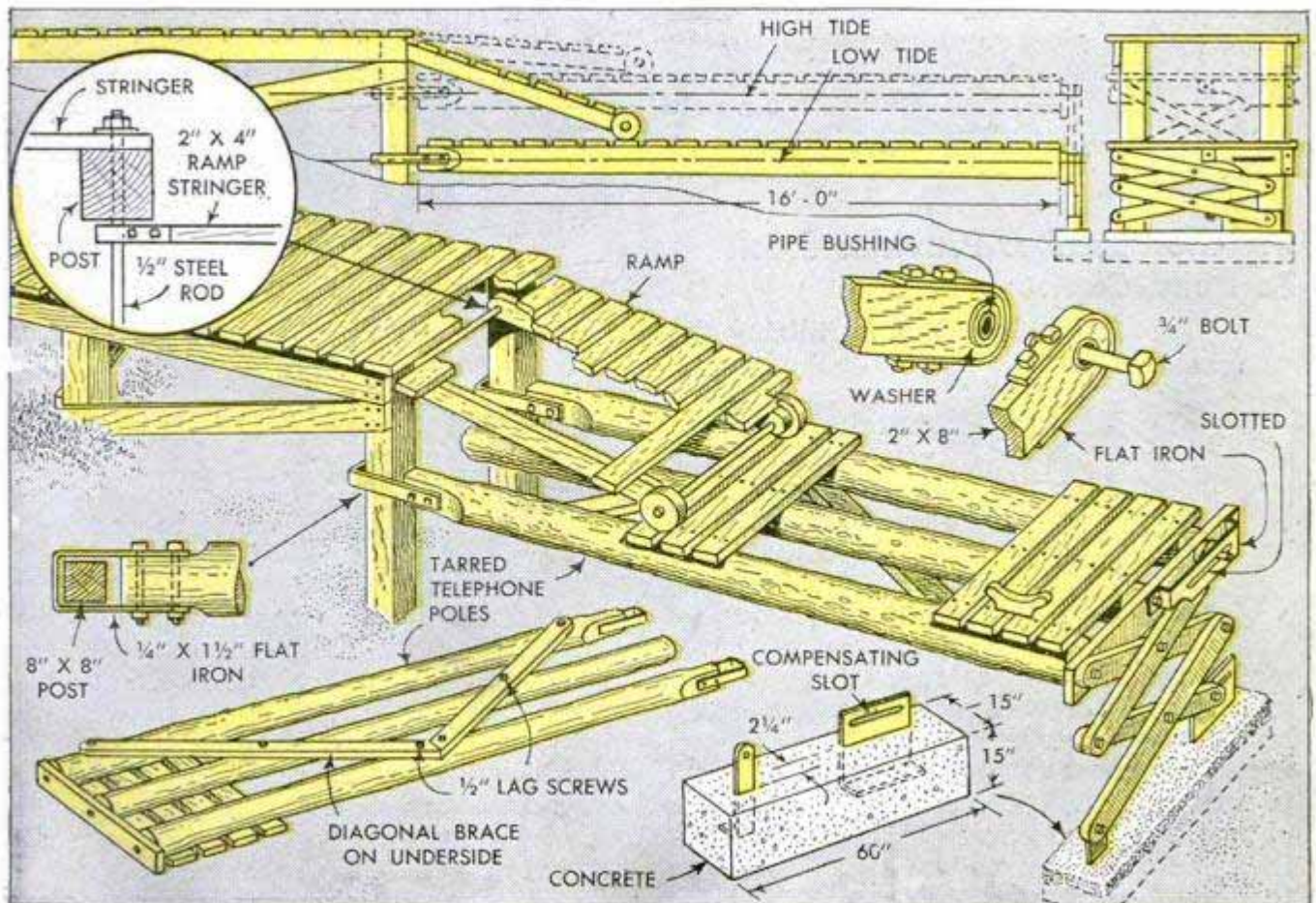

Pencil Holder and String Dispenser Made From Distributor Cap

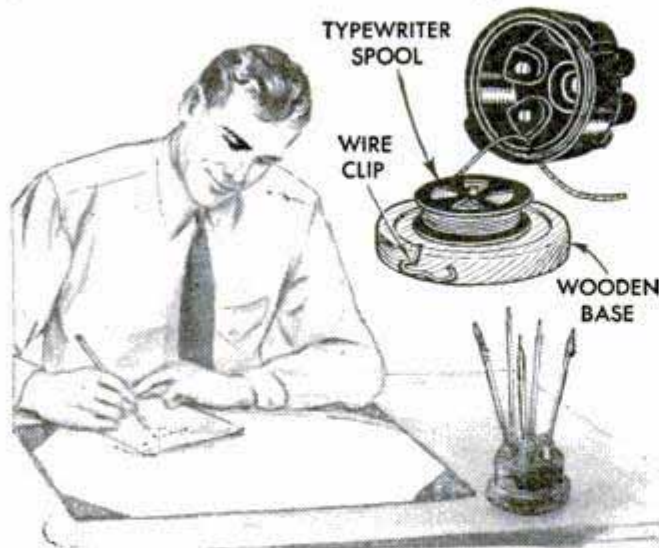

Consisting simply of a car distributor cap mounted on a wooden base, this novel desk accessory holds several pencils or pens for easy selection. The cap is set in a groove or recess in the top of the disk-shaped base. To prevent the cap from turning, a small notch is chiseled outward from the groove to receive the lug on the bottom edge of the cap. If the cap is not a tight fit in the groove, it can be held in place with two wire clips bent to fit over the projections on opposite sides of the cap. The lower ends of the clips are inserted in holes drilled in the edge of the base. If desired, the pencil holder can be made to serve as a string dispenser by installing a typewriter-ribbon spool under the cap. The spool rotates on a nail driven into the center of the base and is wound with string which is passed through a hole made in the side of the distributor cap.

John M. Avery, Dexter, N. Y.

Matched Lumber Provides Stock To Build Cupboard Doors

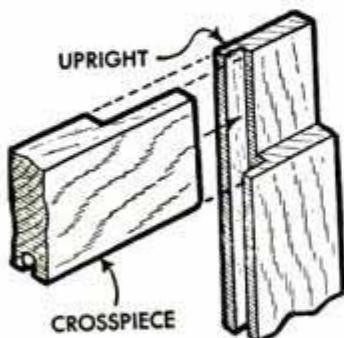

By utilizing the grooved edge already cut in 1 x 6 matched flooring, you can make the frame members of paneled cupboard doors with just a handsaw. With the groove for the plywood insert ready-

made, the flooring is merely ripped for width and the ends of the pieces half-lapped to fit together flush at the corners. If the thickness of the plywood is slightly greater than the width of the groove, a pass or two of a hand plane along both sides of the panel at the edges will taper it enough to allow it to fit snugly in the groove. Glue

and flat-headed screws, driven from the back side, are used to fasten the members together at the corners.

Herbert Fey, New Braunfels, Tex.

Spectacle Case Sheathes Lure

When walking along the bank of a stream to try to locate a new fishing spot, keep the lure or baited hook from becoming tangled in the brush by placing it in a spectacle case and snapping the cover closed. Either carry an old spectacle case for this purpose or use the case from a pair of sunglasses.

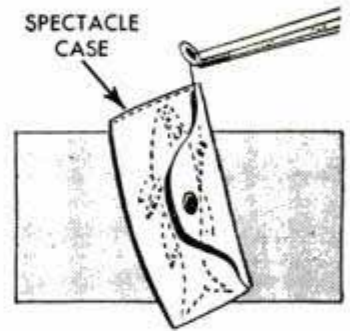

Tape on Edges of Book Pages Facilitates Turning Them

To facilitate turning the pages of reference books and manuals and also to protect them from wear, fasten cellulose tape to the edges of the pages. Cut the tape the same length as the page and stick half the width of the strip to the edge of the page. Then fold the strip neatly around the edge and attach the other half.

Frank G. Harris, New Orleans, La.

Jig for Disk-Sanding Thin Stock Insures Even Thickness

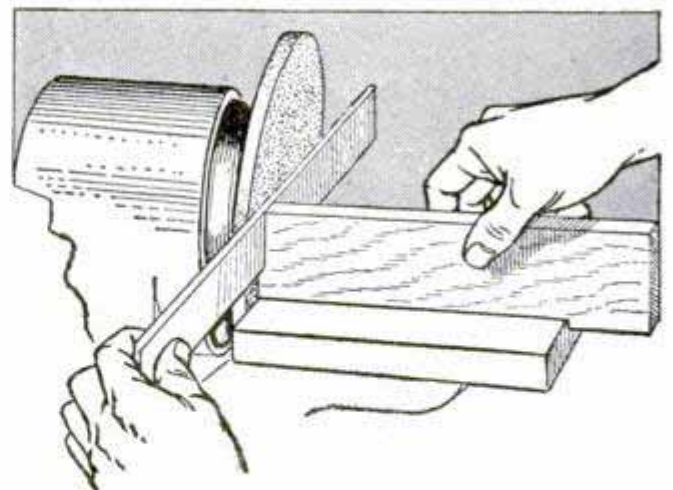

For sanding thin pieces of wood on a disk sander, this jig assures even thickness along the full length of the work, and also keeps the work from dropping between the disk and the table. The jig is merely a wooden block, which is notched to the required thickness. A portion of the underside is cut away to provide a stop by hooking over the edge of the table.

Dick Hutchinson, El Monte, Calif.

CAR NOISES HAVE MEANING

By C. E. Packer

UNDERSTANDING the meaning of the various sounds which may develop in any car during use will pay off in safety and savings. Often a trained ear will save a big repair bill or avoid a serious accident. Harmless noises, such as body squeaks and rattles and certain minor chassis noises, have a way of developing and then disappearing during regular use. But noises of a sharp or dull metallic tone that persist, or that increase in volume or frequency, should be investigated. Noises developing in the rear axle, clutch or engine generally are of such a nature as to make location and identification of the trouble comparatively simple. But certain other noises indicating trouble in vital parts are not so easy to track down. A good example of this is the peculiar sound given out by a failing front-wheel bearing, Fig. 1. This failure rarely occurs except as the result of neglect in inspecting and lubricating the bearings at regular intervals. Lack of lubrication eventually will cause complete breakdown of the bearing and at the same time create a serious accident hazard. In the development stage, the unusual grind of a dry wheel bearing will be heard when first starting away from the garage or curb. On the highway, the sound will be "drowned" by the usual chassis and road noises.

The tip-off, telling the driver that the front wheels are unbalanced, usually comes through the steering column and wheel, but only after considerable damage has been done to bushings, shock absorbers and tires. The slightest perceptible drag on the steering wheel, a developing tendency of the car to wander from side to side on the highway, or a noticeable vibration

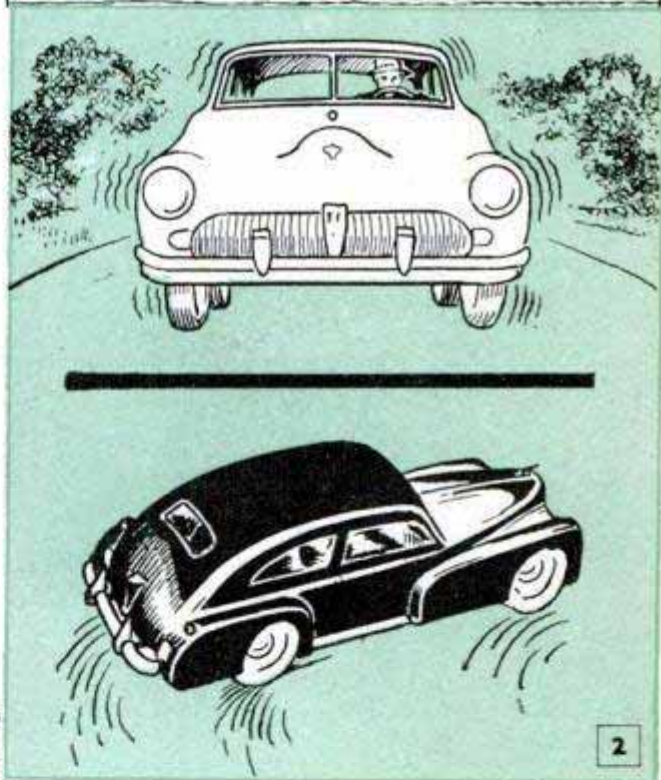
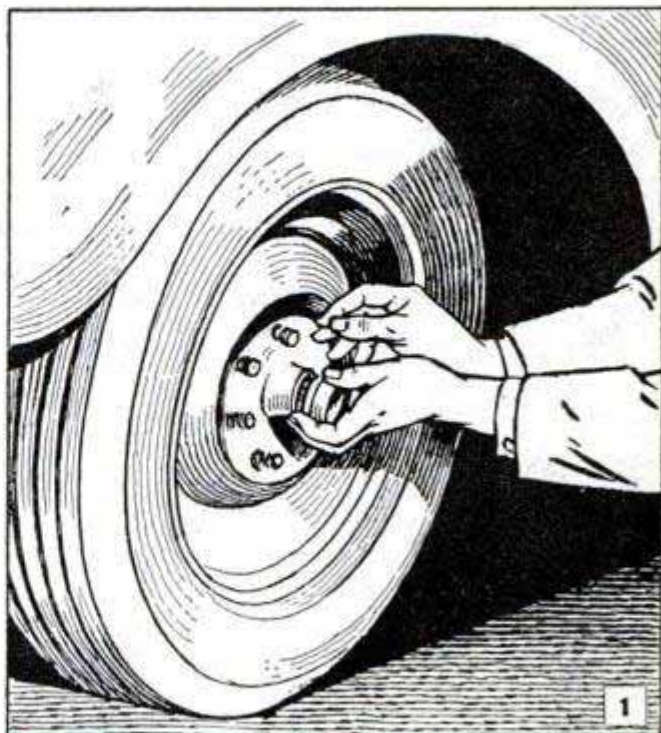

Leaks anywhere along the exhaust line from the manifold to the tail pipe may release dangerous gases into the car

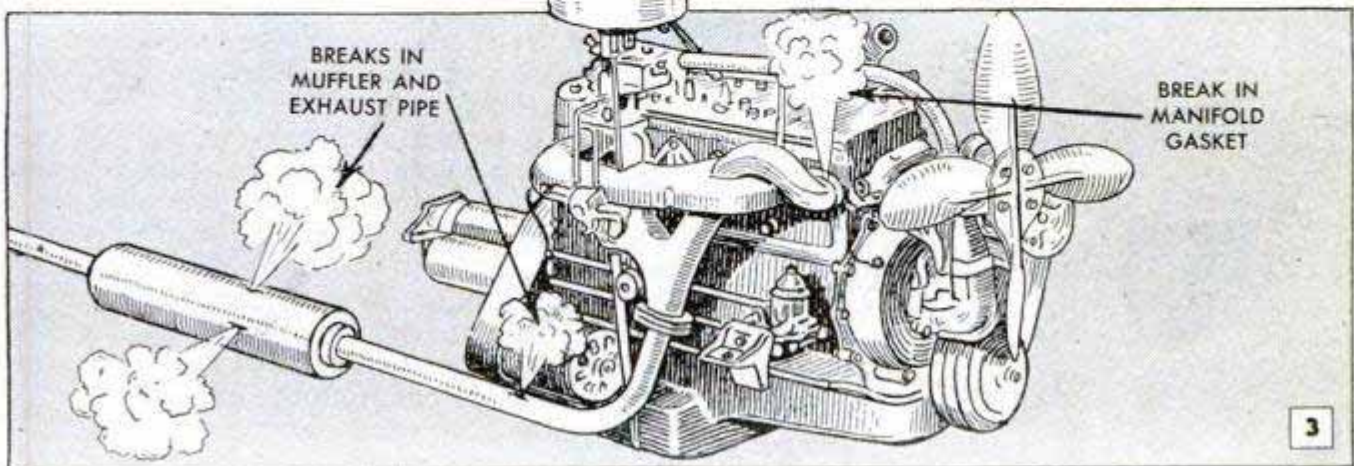

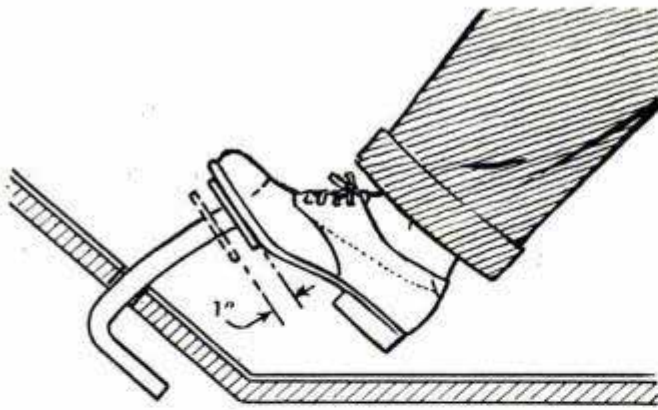

4 ADJUST CLUTCH PEDAL

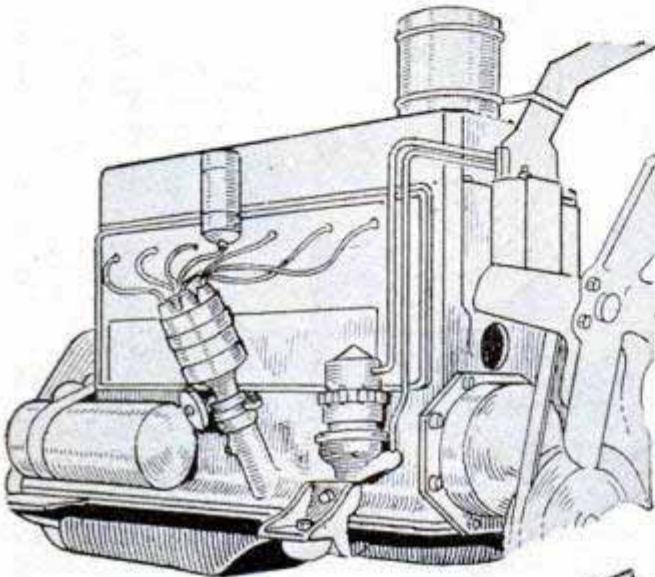

5 LOOSE ENGINE MOUNT

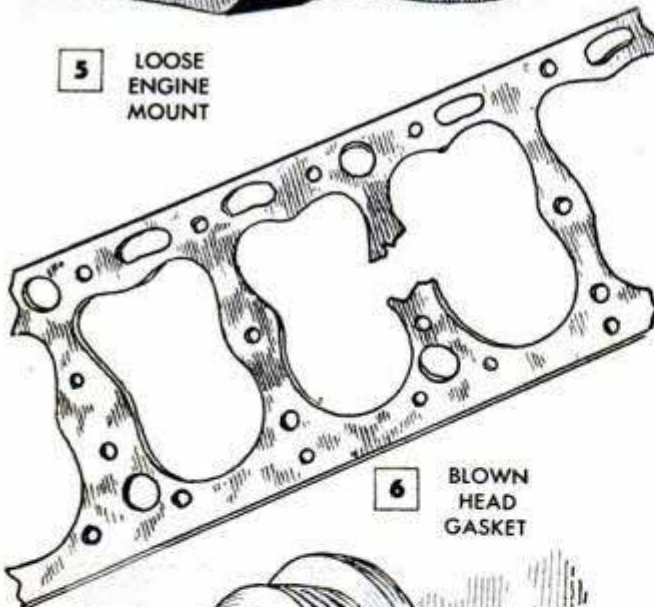

6 BLOWN HEAD GASKET

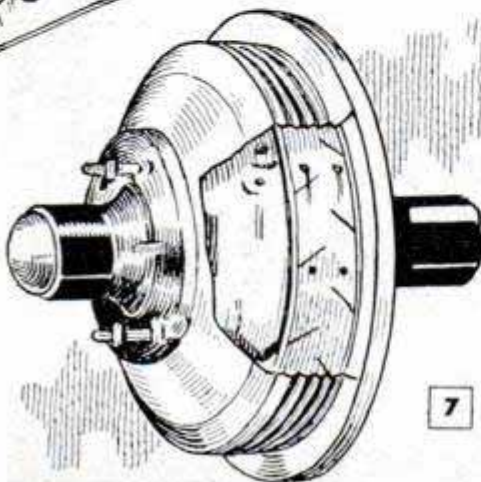

7 SCORED BRAKE DRUMS



8

of the front end at certain speeds, Fig. 2, are indications that a bad front-end shimmy is developing. If the cause is not found and corrected immediately, the faulty condition can lead to a big repair bill. A serious accident hazard also is present, for front-end shimmy can cause a dangerous skid in wet weather.

The deep-throated roar caused by a rusted-out muffler is unmistakable evidence of the need of immediate repair but the low, rasping whistle of a pinhole break in the exhaust pipe or the muffled "beep" caused by a break in the manifold gasket may be even more hazardous to the occupants of the car, Fig. 3. Leaks at either of the latter points will release large concentrations of toxic gases into the engine compartment from which they may find their way into the interior of the car.

A defective clutch can cause a lot of unnecessary expense. Clutch chatter is not only annoying to the driver; it also delivers sledge-hammer blows to both the transmission and rear-axle gear train, and may seriously damage the universal joint within a short time. Check the free travel of the clutch pedal at regular intervals. On most cars, this should be from $\frac{3}{4}$ to 1 in., Fig. 4. If it is less than $\frac{3}{4}$ in., adjust the pedal clevis, Fig. 8, to give the right amount of free travel. It is well to remember that loose engine mounts, Fig. 5, can give out all the symptoms of clutch chatter, grabbing or slipping. The indications are so similar that it's easy to mistake one for the other. Any time you suspect the clutch, it's a good idea to examine the engine mounts, especially if the car is several years old.

A sharp, intermittent whistling sound



may indicate a blown head gasket, Fig. 6. Immediate and costly damage can result if the gasket blows between the cylinders as shown. Water or antifreeze will leak past the pistons into the crankcase and develop an emulsion which can damage bearing surfaces to such an extent that a costly overhaul will be necessary.

Shrilly squealing brakes are the advance warning of scored brake drums, Fig. 7. The first telltale squeal of protest does not mean that a drum is already scored, of course, but the thing to remember is that while new linings or new shoes are comparatively inexpensive, it costs money to renew drums or have them turned down.

If you are driving on the highway at a good clip and suddenly hear a heavy, intermittent thudding sound, you have anywhere from 10 minutes to 10 seconds to stop before that tire lets go. Sometime prior to the blowout, the tire picked up a short nail or brad which passed through the tread and entered the fabric but did not puncture the tube, Fig. 9. Water and mud forced in through the opening soon rot and weaken the fabric, causing it eventually to bulge and then tear as a result of the air pressure. In most cases of this kind, the driver gets only a few seconds warning before the blowout occurs. If the treads of the tires are examined occasionally, it is possible to detect small nails, tacks or pieces of glass that have been picked up on the road and have become embedded in the rubber. Tires that "talk" on a turn are telling the driver that he's either going too fast for the radius of the turn, operating with insufficient air pressure, or that the wheels are slightly out of line. If you're lucky, you'll hear only the noise, but it's well to remember that squealing tires sometimes precede a dangerous skid, Fig. 10.

The hard, sharp rap of engine detonation, or compression ignition, is very destructive to vital engine parts. Ease off on the throttle the instant you hear it and, if it persists, switch to a higher grade of fuel. In some engines, retarding the spark timing slightly will correct the condition.

Door locks that squeak and are hard to operate will be helped by an application of benzene, Fig. 11. This will wash away the dust and grime and a few "whiffs" of dry graphite from a special applicator, Fig. 12, will make the lock work like new.

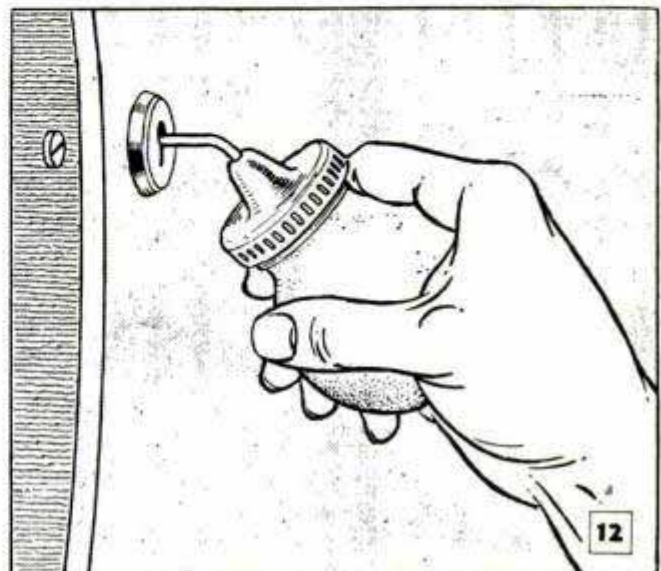
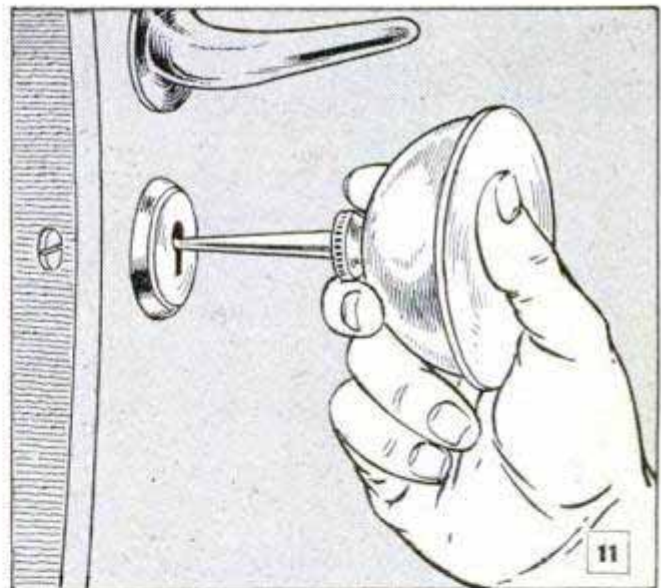
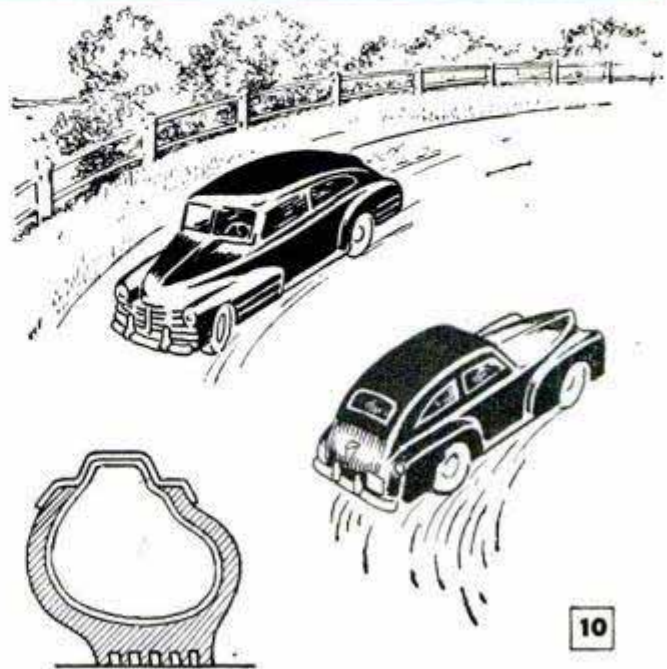

Roughing Out Pitch of Blades With Handsaw Simplifies Carving Model-Airplane Propeller

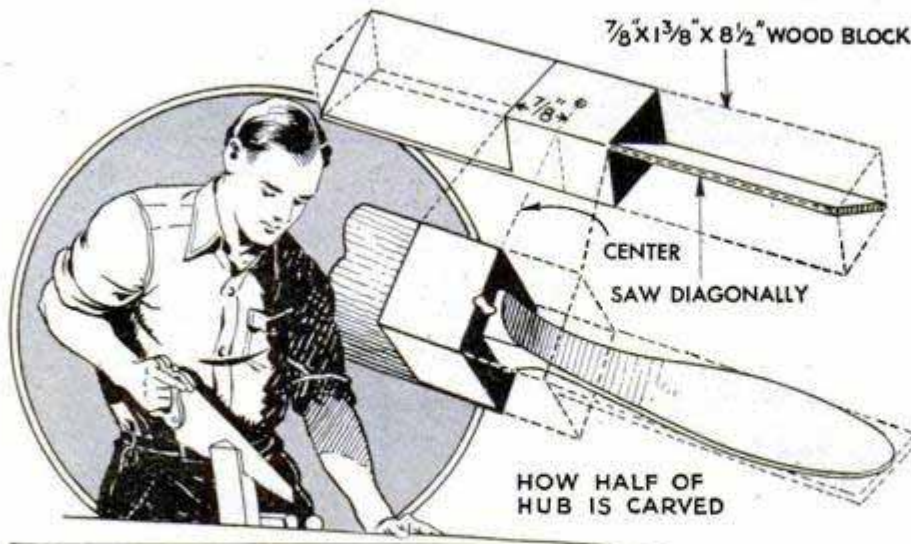

Before carving a two-bladed propeller for a model airplane, I first saw the block on each side, as indicated, leaving stock for the blade diagonally between opposite corners of the block. This roughs out the blades and insures that the pitch of both of them will be identical. After cutting away the waste stock, I carve the blades and hub to shape. The proportion of the width of the block to its thickness determines the pitch of the propeller blades.—Russell Thomas, Jr., Plaistow, N. H.

Inverted Mixing Bowl Forms Sturdy Base to Prevent Tipping Varnish Can

When varnishing a floor, the can of varnish is less likely to be accidentally upset if it is fastened to the bottom of an inverted bowl. A large mixing bowl will provide a wide base which is easily slid along the floor. Use pieces of adhesive tape to attach the can to the bowl.



Rubber Tip for Cane Handle

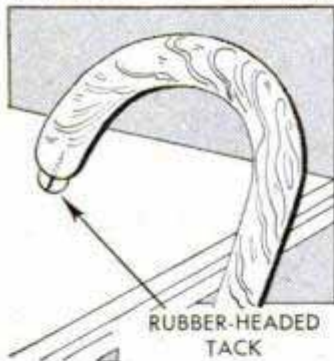

A rubber-headed tack provides a nonslip tip for the crook handle of a cane or umbrella. When the tip is in place, the handle will not tend to slip off the edge of a counter or window sill.

Trouser Hanger Mounted on Closet Wall Saves Much Time and Trouble

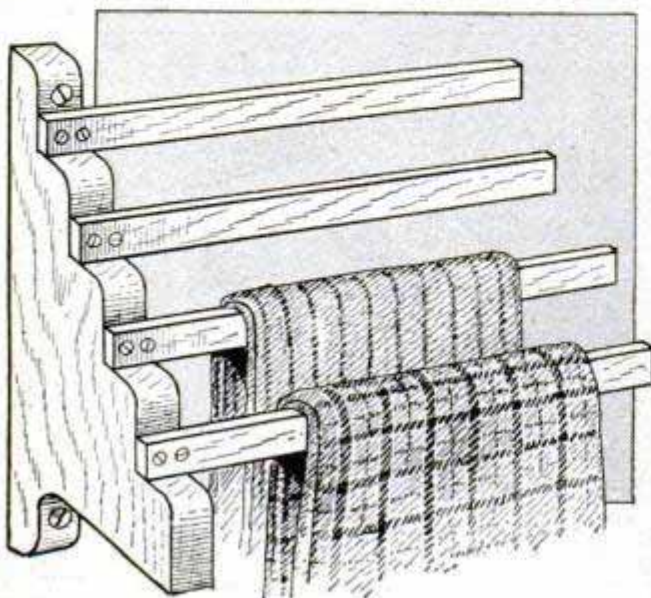

Instead of taking time to thread trousers through a conventional clothes hanger and then having to search for them when they are needed, you can keep four or more pairs of them ready for immediate selection on this convenient wall hanger. It consists of a wall bracket sawed from solid stock in a series of steps with a strip arm screwed to each step. Flat-headed screws, countersunk, are used throughout and the rack can be painted or stained to match the woodwork or other fixtures in the closet.

☐ To keep worms lively in the hottest weather, pack them in damp florists' moss in a clay flowerpot. For transporting long distances, wrap the pot in damp newspapers and cover with moist burlap.

Suspended between four posts or trees with lengths of rope, an empty oil drum provides a realistic imitation of a bucking bronco. The drum is fitted with a saddle blanket and a bucking rig is cinched tightly around it. Two or more people control the roughness of the ride by pulling and pushing on the ropes. Four hooks for attaching the ropes are welded or riveted to the ends of the drum, and the other ends of the ropes are fastened to the trees or posts about 10 ft. from the ground. To simplify setting up the outfit, hooks can be attached permanently to the posts with wire cable. The loops at both ends of the rope should be reinforced with metal thimbles to minimize wear. The ropes are adjusted to hold the drum about 3 ft. above the ground. A pile of sand or a gymnasium pad placed directly under the

Bucking Bronco Simulated by Oil Drum Suspended With Rope Between Posts

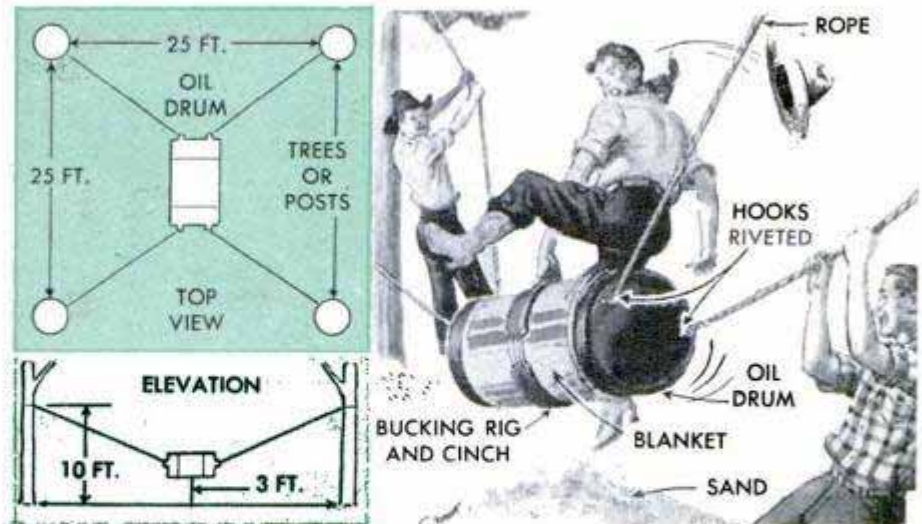

drum will cushion falls. If the hooks are welded to the drum and it has recently contained gasoline or other volatile liquids, remember first to fill it completely with water to prevent ignition of the fumes or, if possible, have the drum steam-cleaned.
Doreen Foote, Long Beach, Calif.

Compact Portable Picnic Table Folds to Suitable Size for Carrying in Car

Hinged at the center and its legs stored on the side of one panel for compactness, this 3 x 6-ft. picnic table, when folded, takes up little more room than a card table. It's a convenient size for carrying in either the trunk or the back seat of the car. The

table consists of two plywood panels joined with two butt hinges set flush with the top surface so that the hinge joints are on the upper side when the table is open. A leather or canvas handle is attached to the edge of one panel to facilitate carrying. Hooks and eyes turned into the ends of the table lock it in the folded position. The legs, made from lengths of 2 x 2, are pointed at one end for easy driving into the ground. A strip of heavy cloth or canvas is tacked to the underside of one panel to form loops through which the legs are inserted for storage. When setting up the table, use the opened top to position the legs and drive two of them into the ground at each end and two at the joint.

M. K. Voedisch, Rockford, Ill.

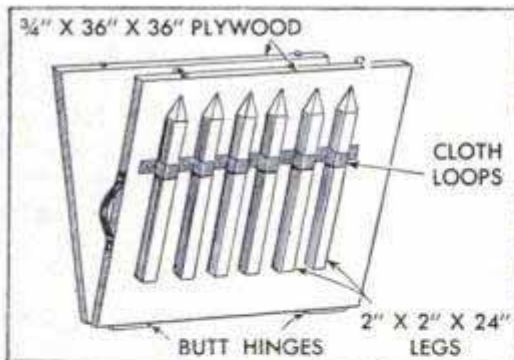

U.S. '57 Magnets Hold Fishhooks on Hatband

Attached to a hatband, two or three small magnets will hold several fishhooks within easy reach. The magnets are fastened with strong thread.

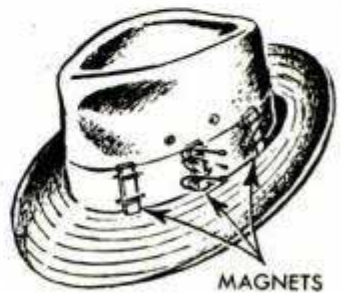

Ⓜ To prevent wax paper from slipping when rolling dough, moisten the table top before placing the paper on it.

TAKE IT EASY IN THIS GARDEN

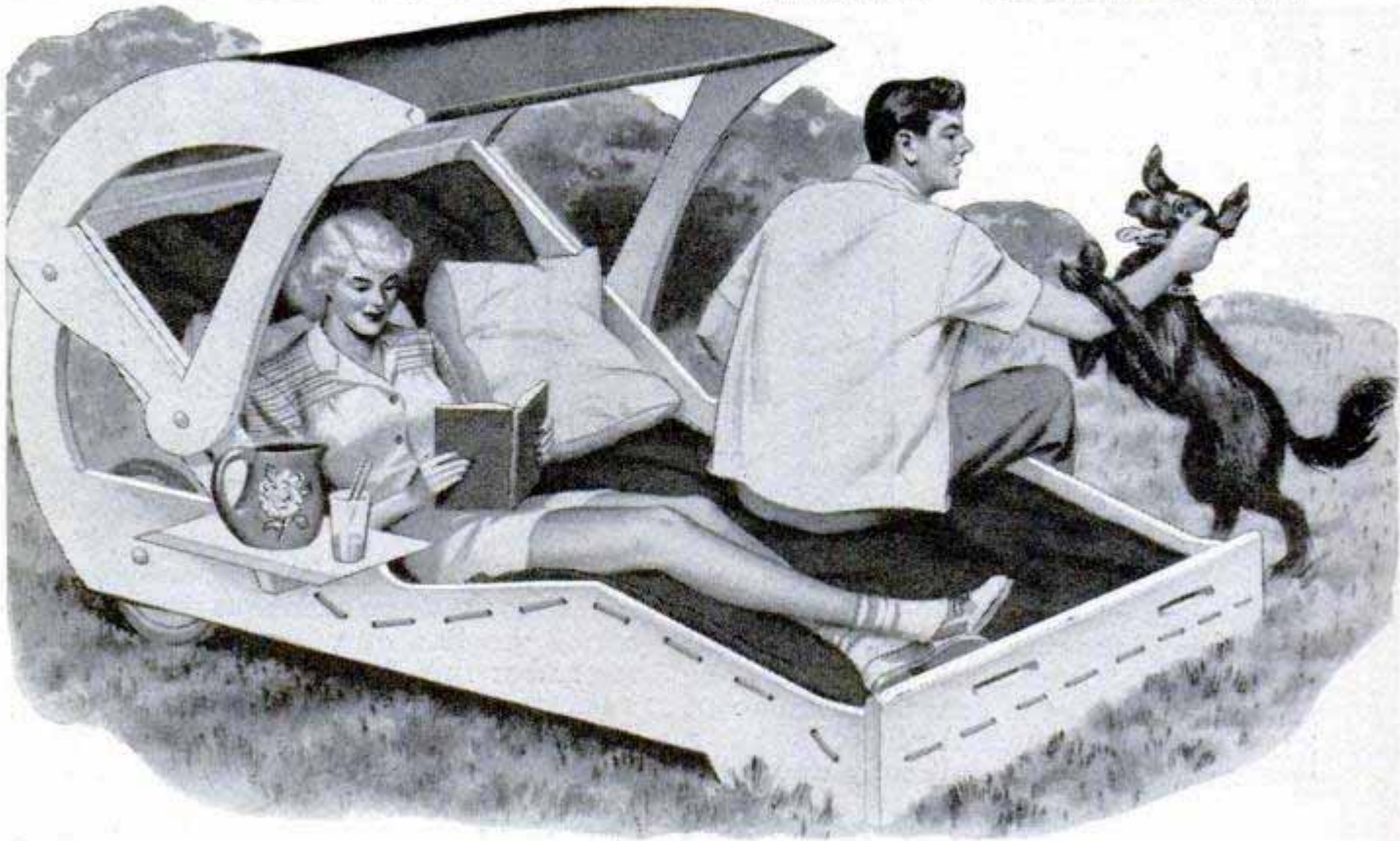

By Tom L. Johnson

DESIGNED for lazy days in the shade, this big, comfortable garden lounge can be rolled where you want it like a wheelbarrow. In addition to being portable, the lounge features a sun hood, wide arms to serve as trays for refreshments, and a comfortable rope spring.

Only 28 pieces are required to build it, many of them being duplicate parts which can be sawed two at a time. The curved parts required for the hood are detailed in Fig. 1. These are keyed with the drawing, Fig. 3, to show where each part goes. Full-size patterns of the parts are made by ruling 4-in. squares on paper and drawing in the contours to correspond with the outlines given. A duplicate is required of each of the four parts, and also of the side rail of the chassis. A bandsaw is ideal for cutting the parts, especially the 2-in. stock. However, in the case of 1-in. stock (actually $\frac{3}{4}$ in. thick), the parts can be cut two at a time with a jigsaw. Note in Fig. 2 that pieces B and C are dovetail-notched to receive the three hood ribs. A fourth rib or nosepiece, around which the top covering is drawn and tacked, is shaped from $1\frac{1}{2}$ -in.-square stock as shown and fastened across the front.

The chassis is made of 2-in. material (actually $1\frac{1}{2}$ in. thick). While the pattern for the side rail is shown a full 8 in. wide,

Fig. 3, a 2 x 8 plank can be used for this by narrowing the pattern slightly. The front ends of the rails are built up with 8-in. blocks of 2 x 4, doweled and glued with waterproof glue. The footboard of the chassis is bolted to the sides like a bed rail, which permits tightening the framework to take up wear. The pull-apart detail in Fig. 2 shows how $\frac{1}{4}$ -in. bolt holes are bored into the ends of the side rails to meet larger holes bored at right angles. The larger ones are for the nuts of the bolts. Hand-holes are cut in the footboard, the top edge is rounded, and then notches are cut in the side rails to receive 2 x 4 stretchers which are fitted flush and attached with lag bolts. The slanting back rest of the lounge is made of 2 x 6 stock. One end of each side member is cut at the angle indicated in Fig. 3 and the opposite end is cut off squarely and screwed to the ends of a 2 x 6 crossrail. Pieces D are doweled and glued to the slanting members and then the whole back rest is doweled to the chassis.

If a drill press is available, the holes for the rope can be drilled before the parts are assembled, or afterwards, if a brace and bit are used. Heavy sash cord or braided-cable clothesline is used to weave the spring. This is laced from side rail to side rail and then lengthwise over and under the alternate strands. When the spring is completed, the hood is bolted to the back rest and the top is covered with colorful awn-

LOUNGE



ing material. Standard 10-in. rubber-tired disk wheels are attached to the chassis with flat-iron brackets as shown. Wooden wheels cut from 2-in. stock can be used if desired. The tray-type arms are notched to fit around the side members of the back rest and are supported by blocks cut from 2 x 6 stock. All wooden parts of the lounge are coated with linseed oil and then painted white. Two standard cotton-filled mattress pads measuring 27 x 72 in. were used to provide a soft cushion.

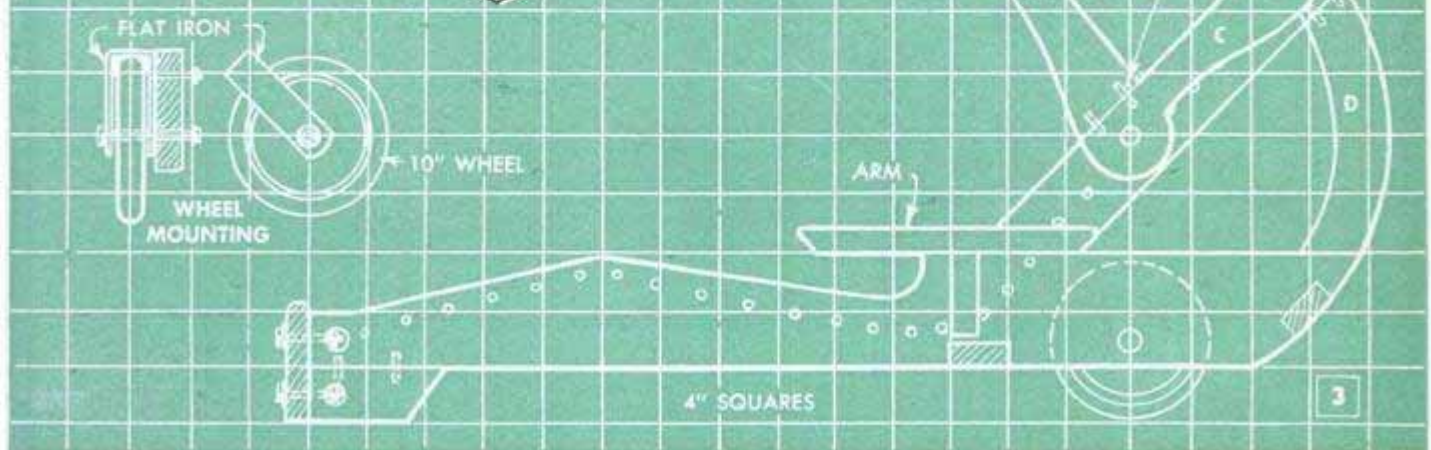
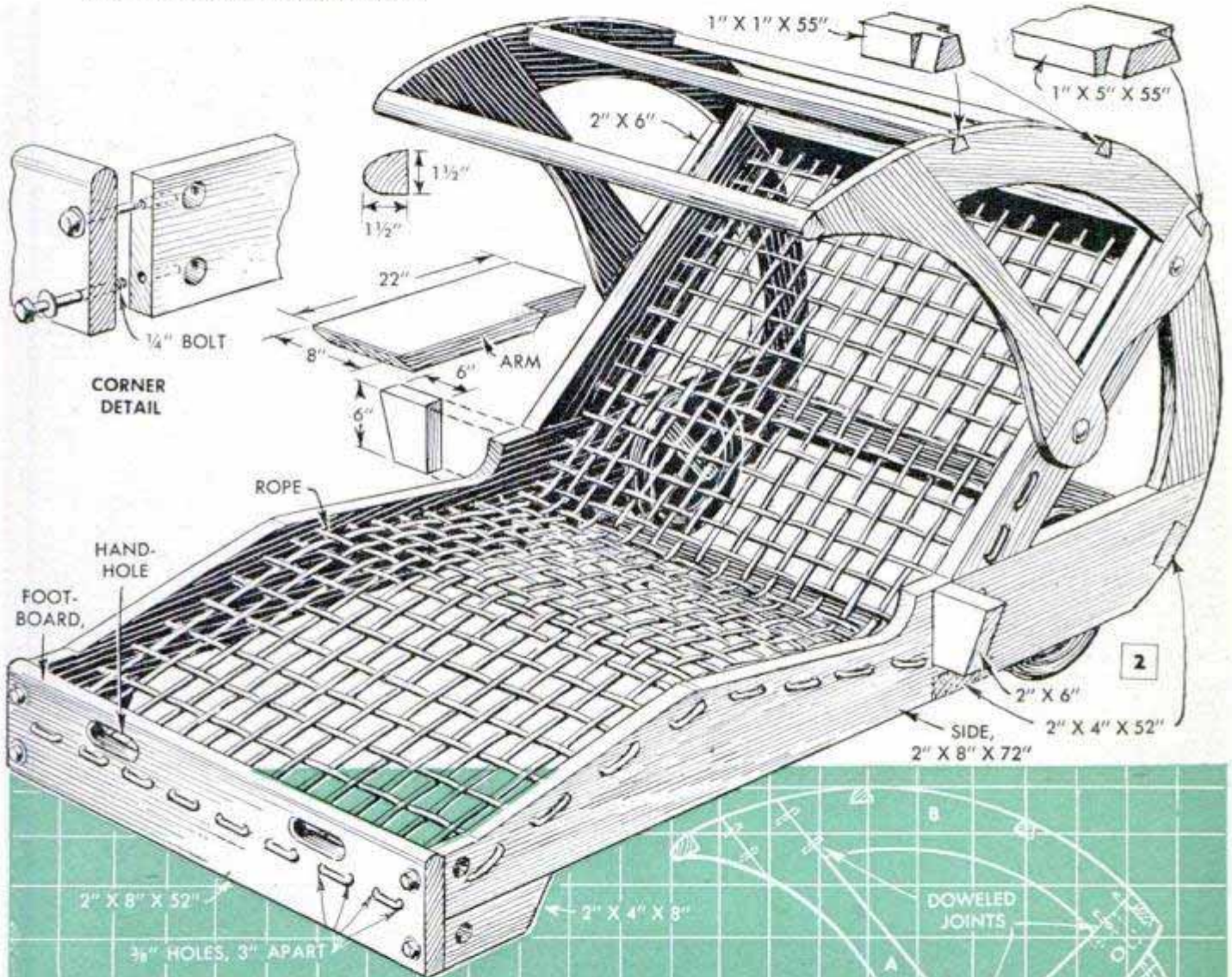
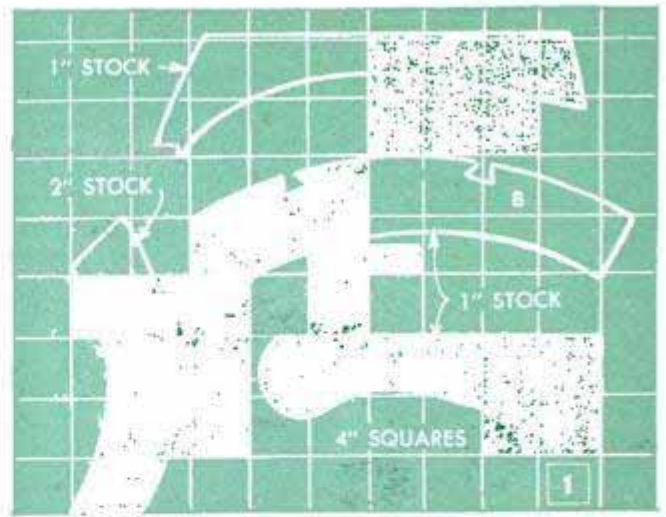

Bring the Beach to Your Back Yard With This Portable Lawn Shower

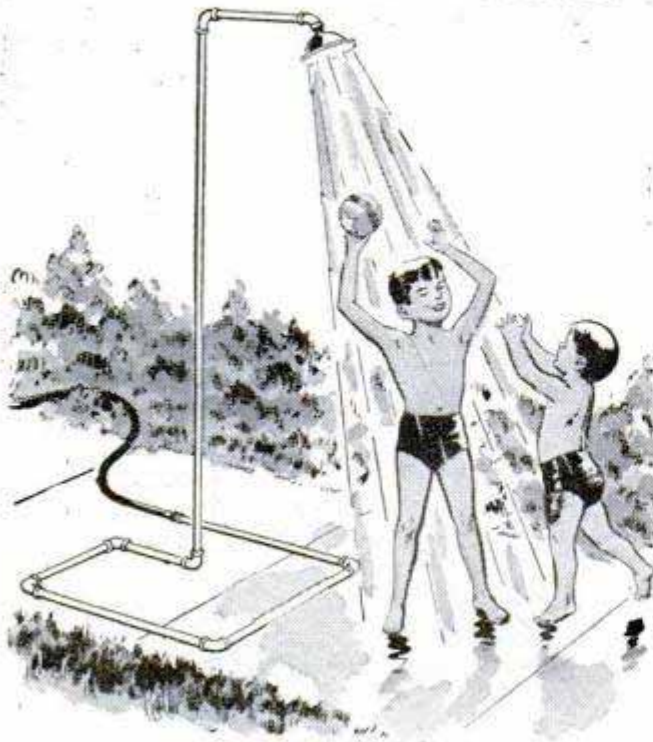

Your youngsters will look forward to sweltering summer days if they can cool off under this portable lawn shower. Supplied with water by a garden hose and made from standard pipe and fittings, it is easy to set up and take apart for storage. A little pipe compound, applied to the threads of the permanent joints, will prevent leaks.

Tape Backing on Sandpaper Strips Aids Sanding Lathe Turnings

When regular sandpaper is used in strips to sand lathe turnings, it will last longer if it is backed with several strips of friction tape. In addition to permitting application of greater pressure without tearing the paper, the tape allows the paper to conform

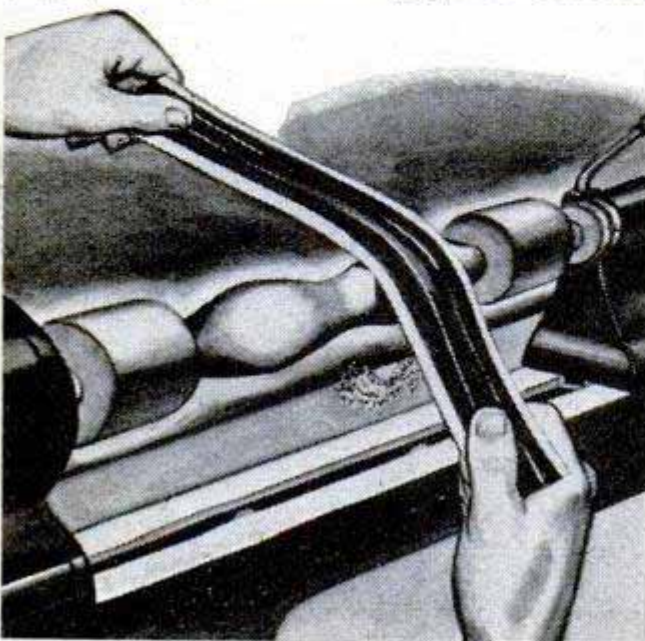

to the contours of the turning without buckling. The tape strips should be the same length as the sandpaper and enough of them should be used to cover almost the entire width of the paper.

Sliding Marker Improves Rule

Transferring measurements with a yardstick is facilitated by fitting a sliding marker to the rule. The marker, made by bending a small piece of sheet metal around the yardstick, should slide readily but also should be tight enough to remain in position. Before bending the sheet metal, file all edges smooth to keep them from scratching the rule or causing the marker to snag.

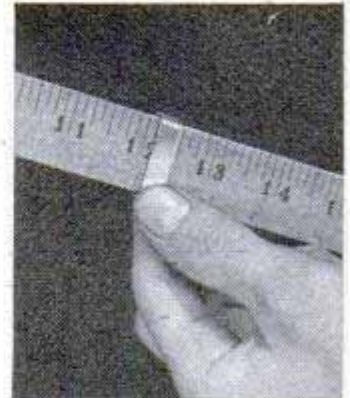

Novel Paint Can Is Dirtproof

If foreign matter is likely to fall into an open can of paint, pour the paint into a motor-oil can which has been cut away as shown. The top of the can serves as a canopy to protect the paint, and the brush can be dipped from the side, the straight side of the can being ideal for wiping the brush. The sharp edges of the can should be dulled with a file.—John D. Billings, Manset, Me.

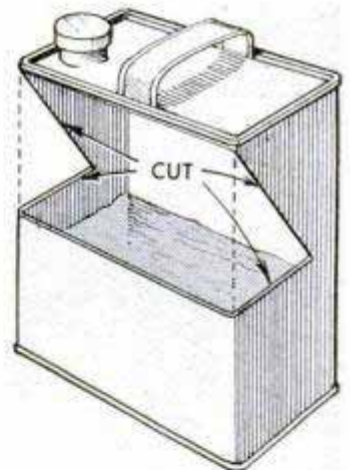

Coat Hanger Forms Minnow Dipper

Instead of trying to scoop those evasive minnows from a bucket with your hands, save time by dipping them out with this handy net. It consists of a wire coat hanger, which is straightened and bent to form a hoop at one end, and a circular piece of plastic screen mesh sewed to the wire hoop. Make the dipper small enough to fit in the tackle box.

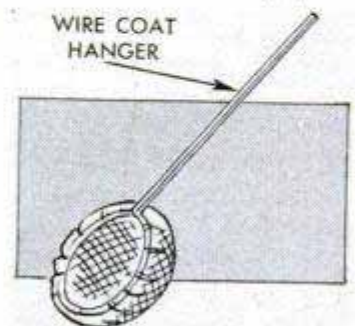

M. B. Birge, Hinsdale, Ill.

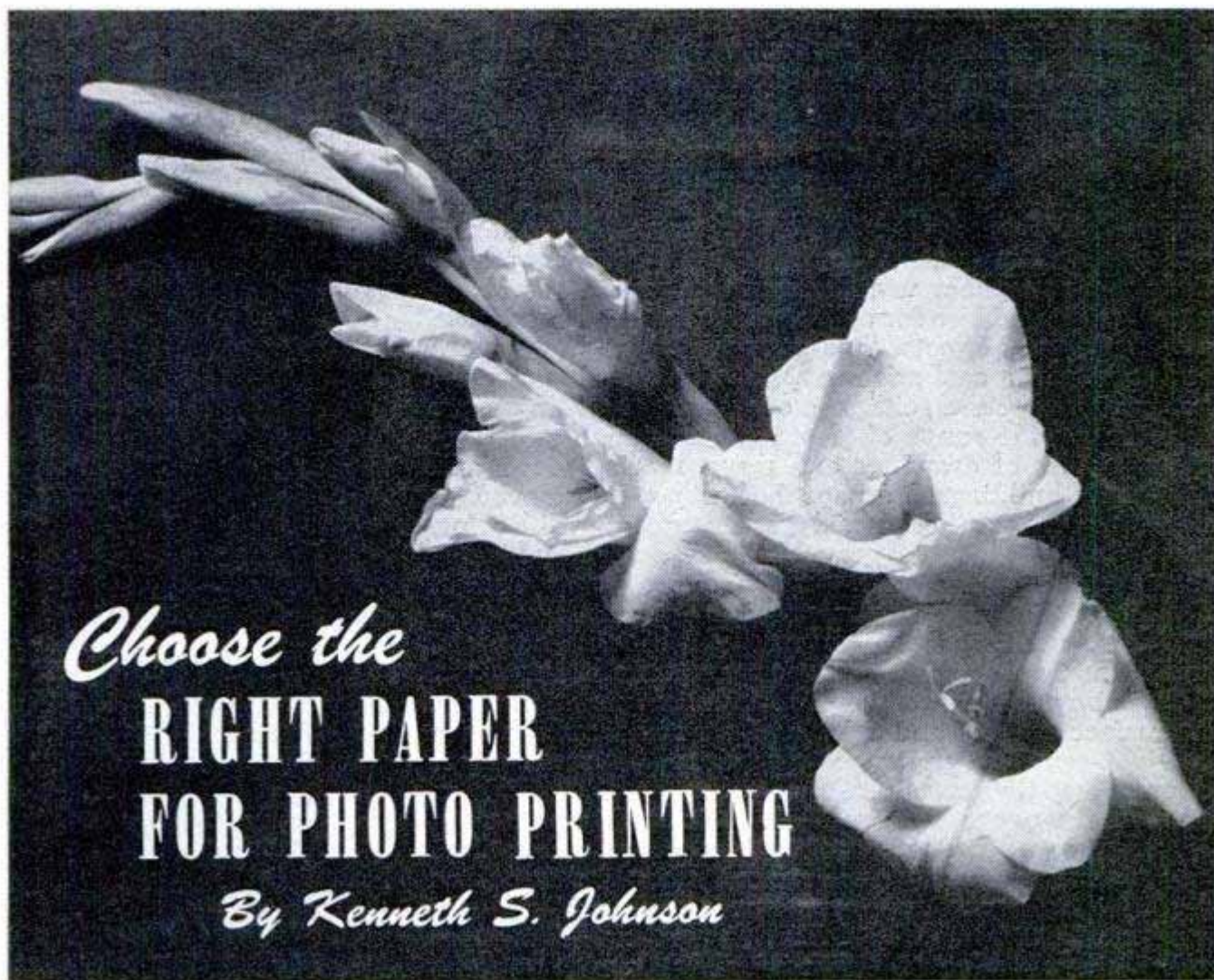

Choose the
RIGHT PAPER
FOR PHOTO PRINTING

By Kenneth S. Johnson

BY CHOOSING a printing paper to fit the subject, you can make those vacation pictures into something more than just a snapshot record of the trip. Moreover, that once-in-a-lifetime shot you took may yield a negative so thin and flat that it looks hopeless, but there are printing papers available which will get the most from such a negative. When printing from certain negatives, especially those vacation record shots, you will want to picture the soft warmth of the afternoon sun on a landscape, re-create in the print the weathered texture of unpainted wood. You may wish to subdue detail and bring out a fairly bold rendering of light and shadow, as in informal portraits or character studies. There also are papers that will capture the cold brilliance of moonlight on water, emphasize minute detail in some texture or pattern and record delicate high light and shadow on almost any picture subject.

The structure of the paper and the type of surface determine its ability to emphasize or subdue fine detail in a negative. Subjects which are attractive because of minute detail or pattern ordinarily are printed on glossy paper and dried to a high gloss on ferrotype tins. Somewhat less detail will be brought out in a print made on

Above, flower negatives having deep blacks and gray tones print well on medium-hard papers. Below, here special emphasis is placed on architectural detail

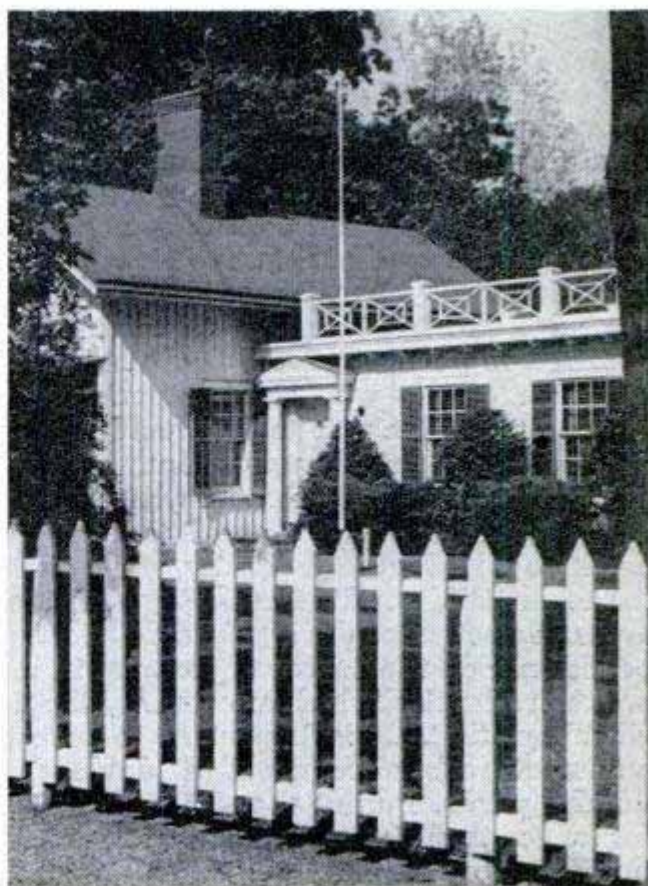

glossy paper, unferrotyped. Printing papers with a velvet, pebbled or eggshell surface absorb increasing amounts of detail in the order named. The velvet, or matte papers, are suited for character studies of elderly persons, landscapes of a pastoral composition and certain distant seascapes where mass and not detail is the desired feature of the print. Papers having either a pebbled or eggshell surface subdue detail to an even greater degree; yet they give the print much of the quality of brightness of the glossy paper. Many photographers use these rough papers for character studies and also for detail shots where it is desirable to create special effects. The pure-white printing papers tend to impart a cool crispness, snap and sparkle to brilliantly lighted scenes, either in or out of doors. These are ideal for a wide range of photo subjects such as snowscapes, copies of drawings and maps, marine views and light-toned buildings. Perhaps the best papers for average all-around use are those toned a warm, cream-white color. These do not give the gray-black separation which is characteristic of the pure-white papers, but their soft blending of the image values is especially desirable in outdoor close-ups of people, certain types of still-life shots, sunlit landscapes and in some types of exhibition prints.

These physical properties of the various papers, that is, the surface texture and color of the stock, combine with the light-sensitive emulsion to produce the tonal values that make up the reproduction of the image. The emulsion speed of the paper is a rough guide to the image tone it will produce when developed in standard solutions. Fast papers usually give tones ranging from neutral to blue black, while the medium-speed papers give warmer blacks or slightly brownish blacks. Rich, brown-black tones are consistently possible only with the slow papers. For general work, the fast bromide papers give the brilliant blue blacks needed to picture effectively such subjects as flood-lighted buildings, light reflections on wet pavements and work pictures of machinery and other industrial subjects. The chlorobromide papers, ranging from medium to slow speed, give the warm tones needed in nearly all types of outdoor photography, in informal portraits of both young and older persons, and for printing exhibition pictures on a rough-surfaced paper.

In the series of prints reproduced at the right, note that by choosing the correct paper good prints can be made from flat, normal and contrasty negatives of the same subject. Each type of negative gives the best results only on one grade of paper. The prints reproduced on the opposite page are not intended to establish any rule to be followed in portrait procedure. They are merely representative of the way most experienced photographers would classify the results obtained from the various types and grades of printing papers commonly used. When classifying negatives to determine what printing paper to use, keep in mind that the over-all tone, or blackness, of the negative is its degree of density, while contrast refers only to the variation, or difference, between the light and dark areas. Selection of the right grade and type of paper depends only on the degree of contrast in the negative, and not on its density, which affects only the time of exposure when printing. It is important to follow carefully the manufacturer's recommended developing time when making prints. Pulling the prints too soon or forcing them for longer than the recommended time usually gives very unsatisfactory results.



Flat, dense negative lacks contrast



Normal negative has right contrast



Hard, contrasty, with heavy tones

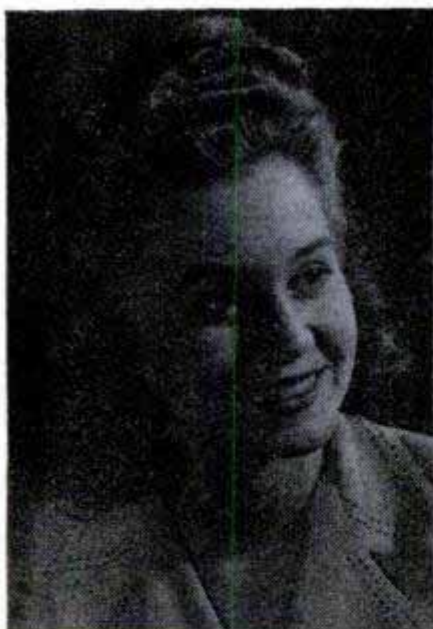

On soft paper, prints much too soft



Medium paper better, but still soft



On hard paper, it prints just right



Lacks contrast on most soft paper



On medium paper, comes just right



Hard paper emphasizes high light



Negative prints best on soft paper



It loses values on medium papers



Blacks too heavy on hard papers

Extra Socket on Photo Reflector Adds Built-In Focusing Spot



When firing flash bulbs in a photoflood reflector, the bothersome job of having to remove a hot focusing bulb each time and then screw in a flash bulb when ready to shoot is eliminated when an extra socket is mounted on the reflector as shown. Wired separately from the reflector socket so it can be controlled independently, the extra socket permits a photoflood bulb to be left permanently on the reflector for focusing purposes. The extra socket also allows two photofloods to be used when greater light intensity is desired to overcome flatness. The wire from the extra socket can be spliced into the rubber-covered wire of the reflector.

Reclaiming Silver From Hypo

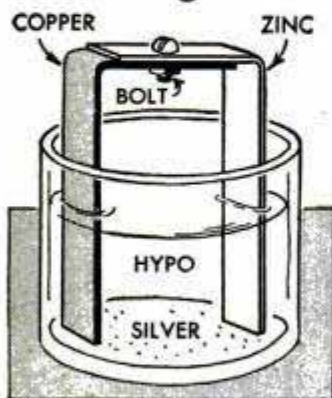

together as shown and placed in a glass jar containing the exhausted hypo. The metal strips provide an electrolytic cell in which the zinc from the electrode replaces the silver in the solution, the silver being pre-

cipitated. Adding a few drops of acid short-stop solution will speed the electrolytic action. At first, the solution will turn a dirty gray in color, but after a few days it will clear, the silver having settled to the bottom. The clear solution remaining on the top is poured off carefully and the rest is allowed to evaporate. The reclaimed silver will become an appreciable amount in a fairly short time.

Rubber Band Around Holder Indicates Unexposed Film

Although the sheaths of most film holders are marked to indicate when the holder is loaded, the markings on some make it difficult to tell without a close examination. In such cases, a rubber band stretched around the holder



as shown will indicate a loaded holder at a glance. As the band must be removed to slip the holder in the camera and is not replaced thereafter, the absence of the band indicates immediately that the film has been exposed.

Stirring With Ice-Filled Test Tube Cools Developer Solution

If hot humid days play havoc with keeping developer solution cool, an ice-filled stirring rod will help maintain the proper temperature. Such a rod can be made by filling a test tube with ice and salt and capping the end with a rubber cork. Developer can be cooled by merely stirring it with the rod occasionally, or the rod can be left submerged in the liquid to bring the solution to the recommended temperature.



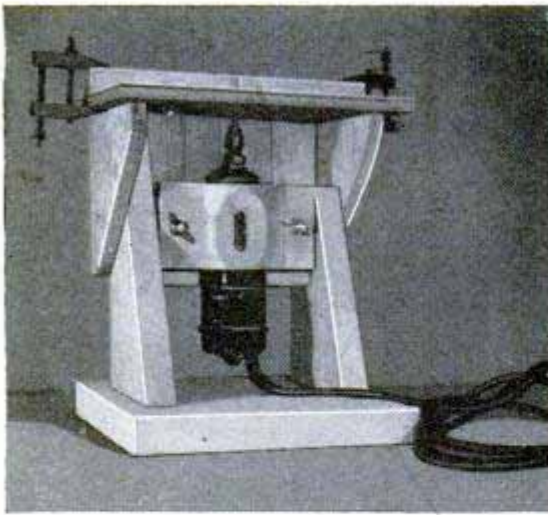

the headstock block first, cutting out the top cap, if necessary, to make the motor switch accessible. Then clamp the motor unit in place and carefully measure the distance from the top of the lathe bed to the center of the collet chuck. Use this measurement in locating the hole for the tailstock center. Be sure that the hole is centered laterally and drilled squarely through the tailstock base, as it is essential that the tailstock center be exactly aligned with the collet chuck to prevent binding and heating of the work. The tool rest is built up entirely of metal parts as dimensioned in Fig. 2. If the diameter of the stock to be turned is greater than the maximum capacity of the collet, it will be necessary to form a tenon on one end of the stock as in the lower detail, Fig. 1. The tenon should fit loosely in the chuck. The shaper, Fig. 3, consists of a base with a motor-unit clamp and a small plywood table attached to an

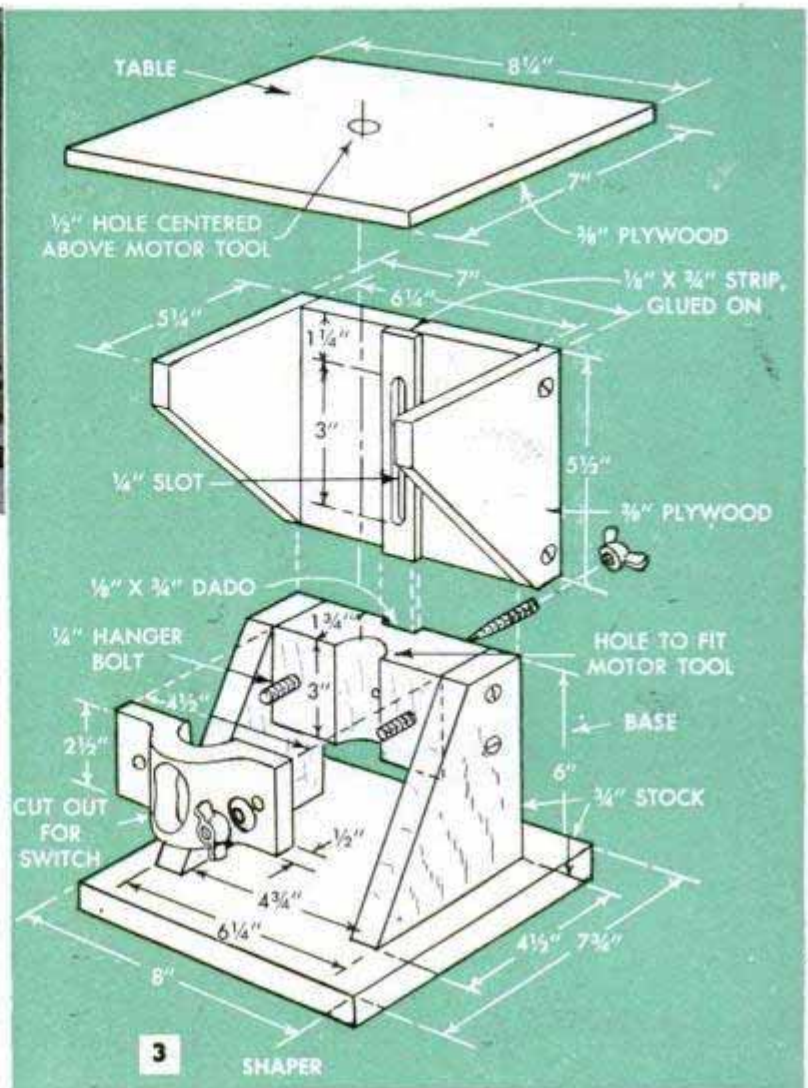

adjustable bracket. The up-and-down adjustment of the table permits changing the depth of cut. With the tiny shaping cutters available for hand grinders, you can cut many different molding shapes in miniature sizes suitable for scale-model homes, stagecoaches and other projects which require molded parts in small-scale sizes.

Hot-Water Tanks Buried Under Farm Lane Form Excellent Culvert

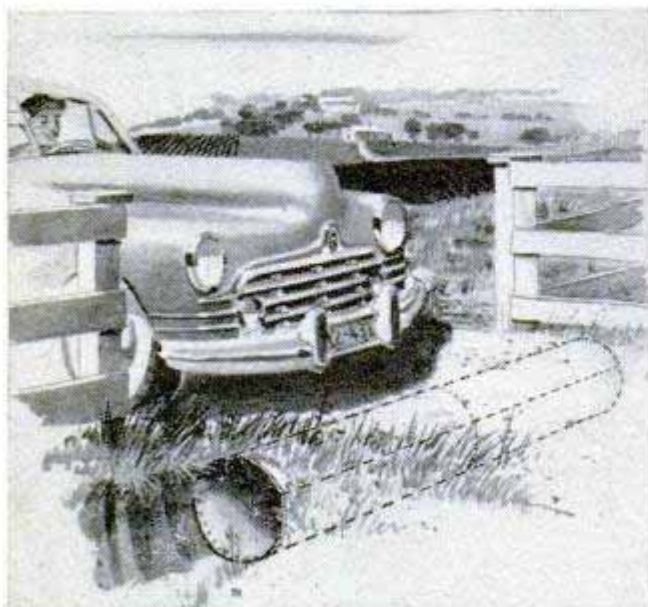

Placing two hot-water tanks end-to-end in a ditch provides a culvert for a farm lane that will last for years. Because of the smooth sides of the tanks, the culvert is free-flowing and easy to clean out. The ends of the tanks must be removed, and this can be done easily with a cutting torch.

Chute Blinders Aid Loading Cattle

Observing that cattle are more reluctant to enter an open loading chute when they can see out through the sides, one truck driver in loading livestock for market drapes a tarpaulin over the slatted sides of the chute. The "blinders" keep the animals from being frightened by the height and they enter the chute willingly.

John Krill, North Lima, Ohio.

Curved Segments Pattern-Cut With Bench Saw

Pattern-sawing a sweeping curve in thin stock can be done quickly and accurately with a circular saw. The thickness of the blade determines the minimum radius that it is advisable to cut, and the teeth must have a wide set to prevent excessive heating and damage to the blade. The latter is raised to project only the thickness of the work, the right-hand face of the blade being flush with the end of a template guide which is clamped to the saw table on a line with the axis of the blade. A master pattern or template is tacked to the top of the work. Then both are fed slowly to the saw, keeping the template in contact with the overhanging guide. The work should be only slightly wider than the template to

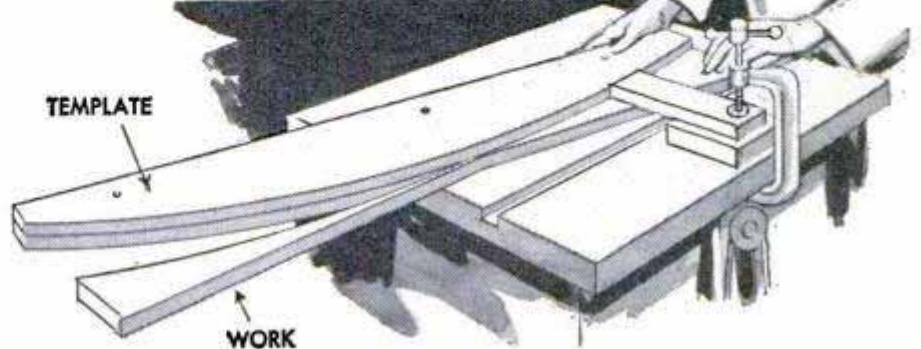
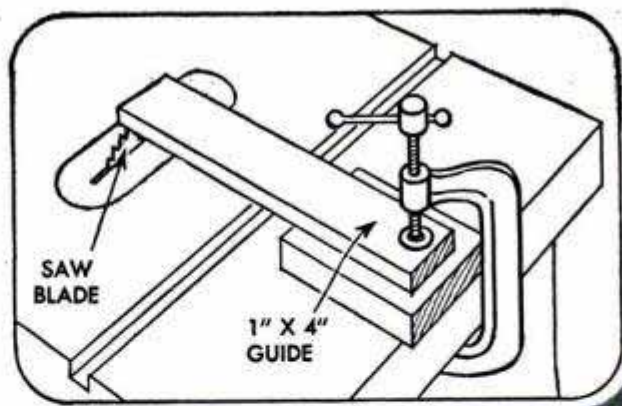

permit the waste to spring aside and open up the cut, thus easing the friction on the blade to prevent binding.

Metal Lathe Used as Shaper Forms Keyways in Bronze Bushings

Using the metal lathe as a shaper, one man found that he could cut accurate keyways in bronze sizing bushings by a simple adaptation of a discarded boring bar of the type held in a tool-post holder. The hole in the bar which takes the boring tool is counterbored and tapped for a headless setscrew. This setscrew provides for the necessary depth adjustment of the cutting tool. A second hole is drilled and tapped at right angles to the first to take a socket-headed setscrew, and a flat is milled on the forward

end of the bar to provide chip clearance ahead of the cutting tool. A short length of $\frac{1}{4}$ -in. tool-bit stock is ground with shaper-tool clearances on one end. The other end is squared. The tool is then locked in position in the holder with the socket-headed setscrew, and the headless setscrew is run down on the end of the tool to give depth adjustment. To set up for use, the bar is mounted in a boring-bar holder which is locked in the tool post. The work is centered in a 3-jaw chuck and the bar and cutting bit are positioned to take the first light cut. The tool is passed through the work by operating the lathe carriage with the hand feed, thus utilizing the carriage as a shaper ram. To cut the keyway to the required depth, several passes of the carriage are made, adjusting the tool bit for a slightly greater depth each time it is passed through the work.

Earl R. Goddard, Denver, Colo.

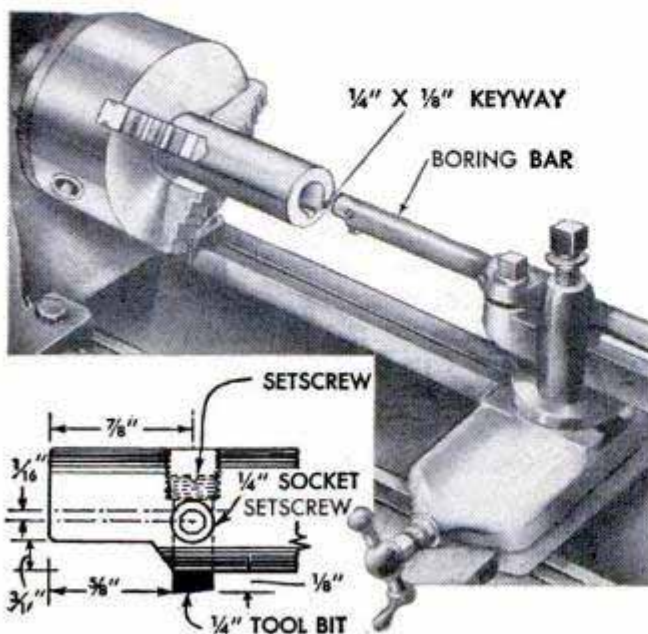

Cellophane Improves Stencils

Next time you hand-letter or draw on a duplicator stencil, try stretching a sheet of Cellophane over the stencil. Working on the Cellophane is easier than lettering directly on the stencil and results in clearer reproduction.

Louis Falcone, Hyattsville, Md.

Handy Spacer Blocks of Bar Stock Save Time in Layout Work

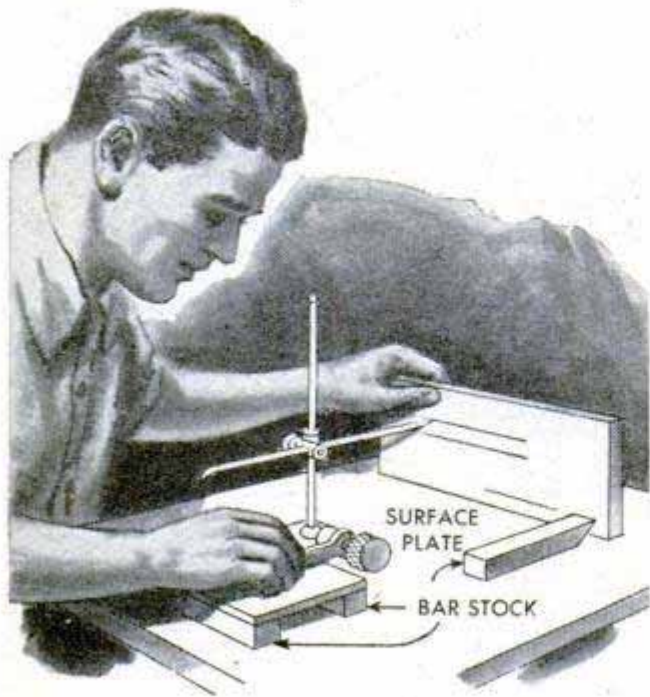

When doing layout work, time spent in adjusting a surface gauge can be saved if several pieces of bar stock are kept handy to raise the base of the gauge a specific distance above the surface plate. For instance, if two parallel lines must be scribed, the surface gauge is adjusted and the bottom line scribed in the usual way. Then the gauge is set on two pieces of bar stock of the same thickness which raise it for scribing the upper line. By grinding a 45-deg. angle on one end of a length of bar stock, lines can be scribed the same distance above the surface plate as the thickness of the bar. This method also can be used as a substitute for a surface gauge by placing several bars one on top of the other to obtain the desired height.

Wm. McGinley, Waterloo, Iowa.

Cylinder-Head Guide Pins Made From Bolts

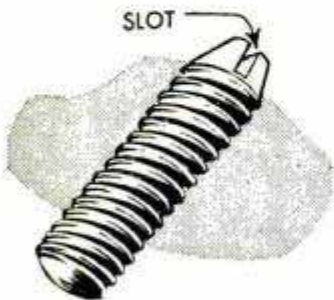

If you do not have a pair of standard guide pins to align a cylinder head when replacing it, you can make them from two bolts of the proper thread size. Cut the heads

from the bolts and taper and slot the head ends. In use, turn one guide pin into a bolt hole at the front of the block and another at the rear. After tightening several of the cylinder-head bolts sufficiently to hold the head in alignment, remove the pins and complete bolting the head in place. If the

tops of the guide pins do not extend above the cylinder head, they can be removed by using a magnetized screwdriver.

Circle Stamp for Shipping Tag Emphasizes Important Data

To call attention to specific information on shipping tags or to emphasize important data on identification tags, a rubber cap from an extension-cord plug can be used to stamp a circle of ink around the particular words



or numbers. These caps are readily available and require no alteration for this purpose.—G. E. Hendrickson, Argyle, Wis.

Wrapping Packages Facilitated By Corrugated-Metal Platform

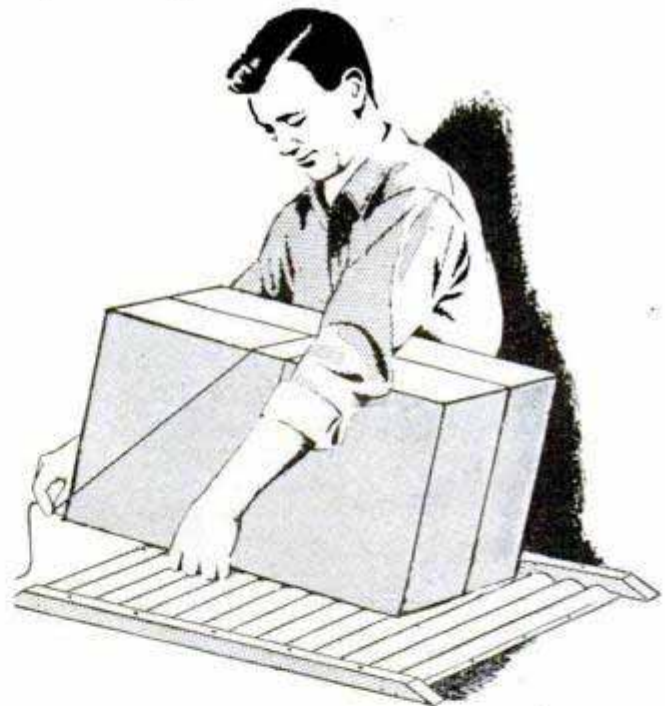

Difficulty of picking up and turning heavy parcels for wrapping and tying on the shipping table may be overcome by tacking a sheet of corrugated metal to the table top. The corrugations in the metal make it easy to slip the fingers under the package when lifting it. To protect the fingers from the sharp edges of the sheet, tack a wooden strip along each side.

☐ When washing walls, start at the bottom and work up. In this way, drippings of the washing solution will run down the cleaned surface and not leave streaks.

File Tang Used to Make Box-End Wrenches

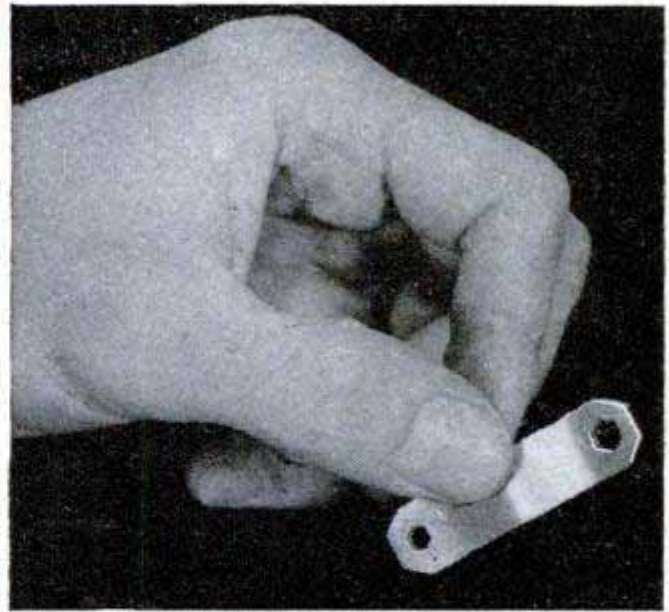
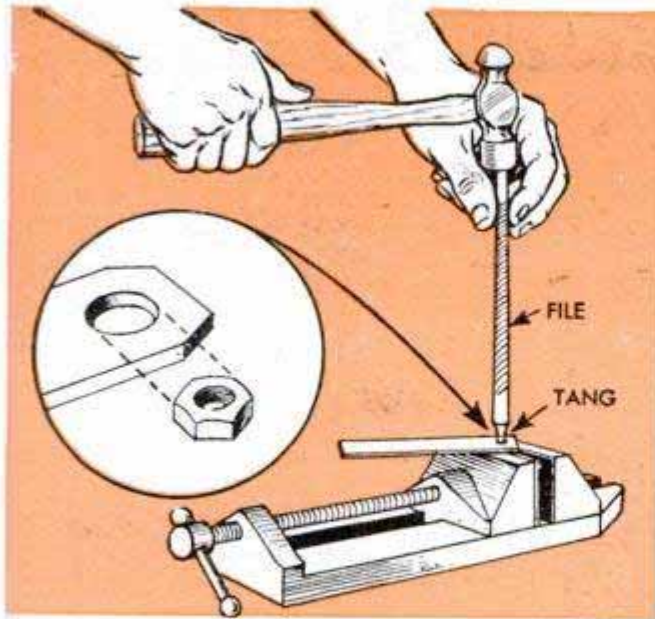

Repairing or adjusting clocks, radios and other home appliances often is delayed or completely halted for lack of a wrench small enough to fit tiny hexagon nuts. Next time you run into this trouble, take a strip of brass and make a box-end wrench to fit the particular nut. This can be done in a few minutes, simply by drilling a hole near one end of the strip and broaching it with the hexagon-shaped tang of a three-cornered file. To broach the hole, lay the strip across the open jaws of a vise and

drive the file tang into the hole as shown above. Then file the corners of the strip at a 45-deg. angle to provide maximum clearance. Remember that the diameter of the hole drilled in the brass must be equal to the distance across the flats of the nut. Using sheet brass up to $\frac{1}{16}$ in. thick, wrenches can be made to fit nuts ranging from the smallest standard size to $\frac{1}{4}$ in. Double-end wrenches and a variety of similar tools for special jobs also can be formed in this manner.

Production Jig Setup Speeded With This Quick-Acting Clamp Screw

When certain types of repetitive work setups are made in the same jig or fixture, it's a waste of time to run a continuous-thread clamping screw in and out each time the work is changed. The clamp screw detailed can be fitted to a variety of clamping jigs, the action of the screw being very

similar to that of the clamping screw on a quick-acting woodworker's vise. The screw consists of two parts—a clamping rod, or plunger, fitted with a turning handle, and a threaded sleeve. The squared section of the plunger passes through a square hole broached in the threaded sleeve, which turns into a tapped hole in the jig. The sleeve is slotted across one end, the width of the slot being equal to the corner-to-corner dimension of the squared hole measured at a slight angle with the diagonal, as in the end view showing the tightening position. In assembling the two-part screw, the plunger is inserted in the squared hole in the sleeve and a stop pin is driven into a hole drilled near the outer end of the plunger to prevent loss of the sleeve. Then the assembled clamping screw is turned into the tapped hole in the jig and the plunger is slid forward until its end contacts the work. A slight turn to the right locks it. To release the work, turn the handle to the left and withdraw the plunger. A few drops of light oil on the parts will keep them working freely.

H. Moore, Kirkstall, Leeds, England.

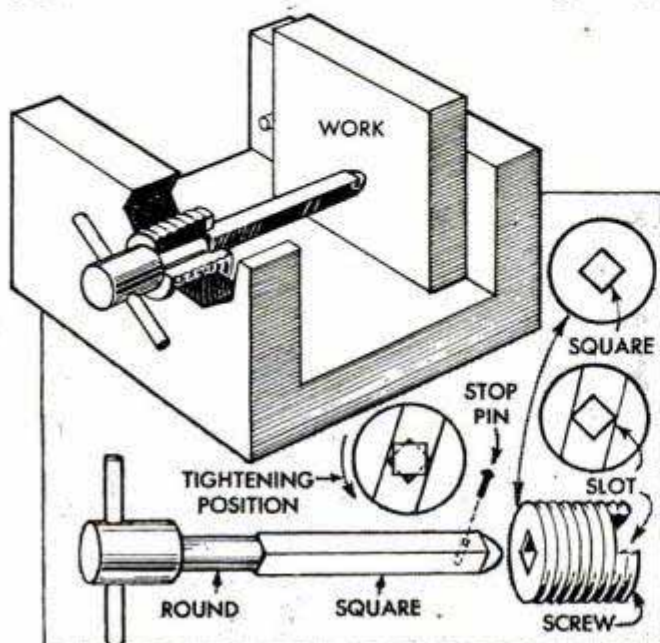

NEVER TRUST A

By Sam Brown

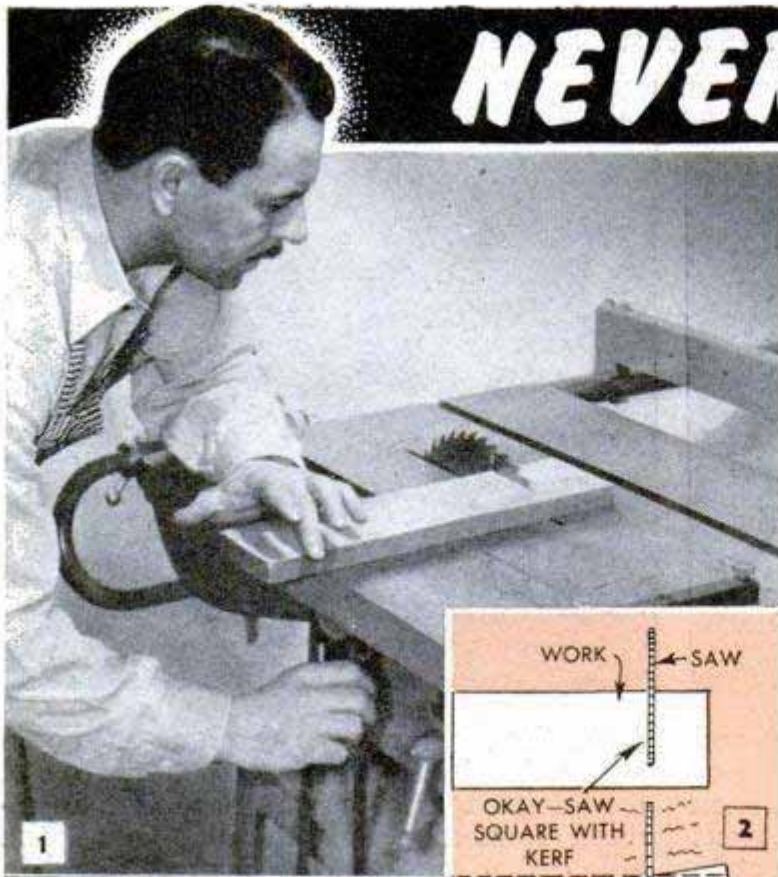

1

THE KICKBACK

KICKBACK ACTION CAN BE SHOWN BY SAWING A BOARD AND THEN SPINNING SAW BY HAND WITH BELT WHILE TWISTING WORK UNTIL BLADE KICKS WORK FREE

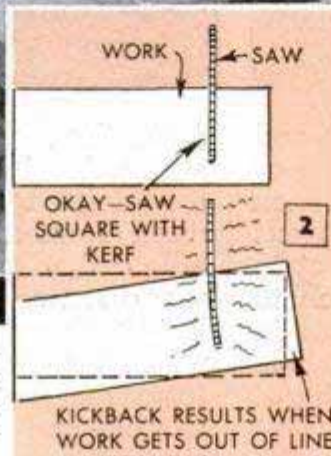

2

KICKBACK RESULTS WHEN WORK GETS OUT OF LINE

THE OPERATOR who acquires the habit of never relaxing vigilance while using a circular saw rarely suffers a serious injury. The machine seldom is at fault mechanically. It's that moment of inattention during an operation calling for the use of ordinary precautions that can cost you a finger or result in a less serious but painful injury. Most of the common operations are so simple and the work is done so quickly and easily that there frequently is a tendency for the operator to become a little careless in observing ordinary precautions. Simple know-how will eliminate or greatly minimize the hazards of the more tricky operations, such as running moldings and certain angle cuts. Late-model machines are provided with protective guards designed to cover the saw blade completely during nearly all the common



3

LENGTH OF SAW IN KERF



4

LENGTH OF SAW IN KERF

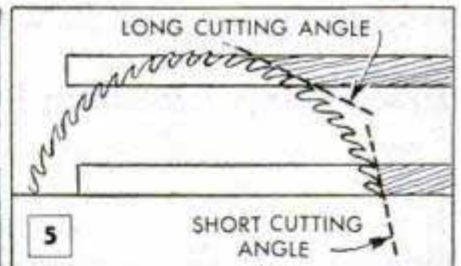

5

SHORT CUTTING ANGLE

SAW PROJECTION—low blade, although faulty mechanically, is safest

AVOID SCANT AND EXTREME PROJECTIONS—THE SAW SHOULD ALWAYS BE $\frac{1}{4}$ TO $\frac{1}{2}$ IN. ABOVE SURFACE OF WORK

HIGH BLADE PUTS TOO MUCH OF THE SAW AREA IN THE KERF WHICH IS APT TO CAUSE KICKBACK OF THE WORK

HIGH BLADE POSITION CUTS WITH THE LEAST POWER AND DOES CLEAN CUTOFF WORK WITHOUT FEATHERING



6

NOT LESS THAN 2"

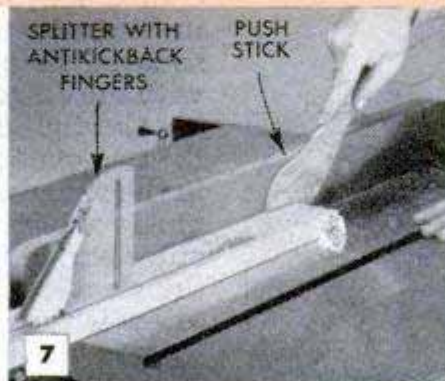

7

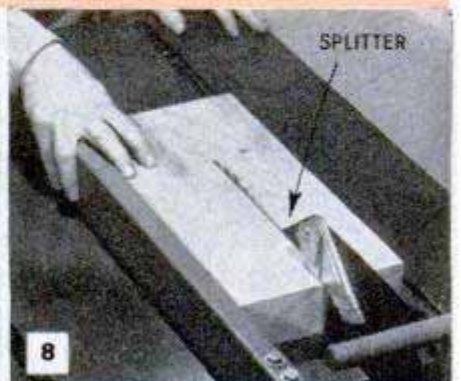

8

RIPPING FEED—splitter plus push stick is best system for narrow work

HAND ALONE CAN BE USED FOR FEED IF DISTANCE BETWEEN BLADE AND FENCE IS AT LEAST 2 IN. NOTE HOW FINGER IS ANCHORED OVER FENCE

PUSH STICK IS ALWAYS USED WHEN RIPPING NARROW STRIPS. AT END OF CUT, LEFT HAND IS REMOVED AND WORK FED WITH RIGHT HAND ONLY

A SPLITTER WITH ANTIKICKBACK FINGERS IS THE BEST PROTECTIVE DEVICE FOR ANY SAW. ALWAYS USE THE SPLITTER WHEN RIPPING WORK

CIRCULAR SAW

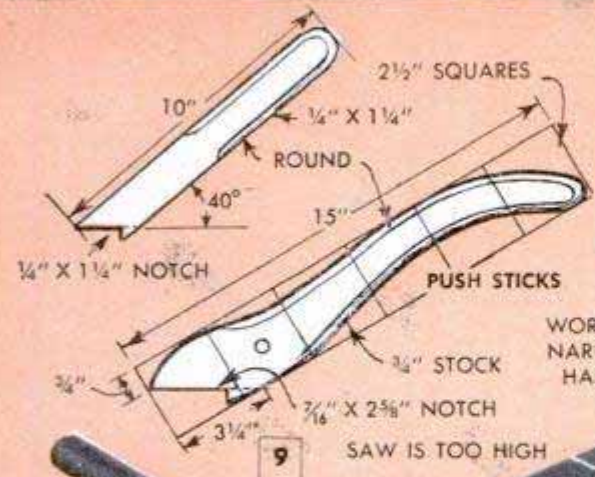

LONG SAW KERF
OFTEN CLOSES AND
BINDS BLADE

NO SUPPORT AT
END OF WORK

LOOSELY ROLLED
SLEEVES ARE AL-
WAYS DANGEROUS

WORK IS TOO
NARROW FOR
HAND FEED

SAW IS TOO HIGH

LEFT HAND SHOULD NOT
BE USED FOR FEEDING
WORK AT END OF CUT

10

RIPPING FEED—six ways to take chances

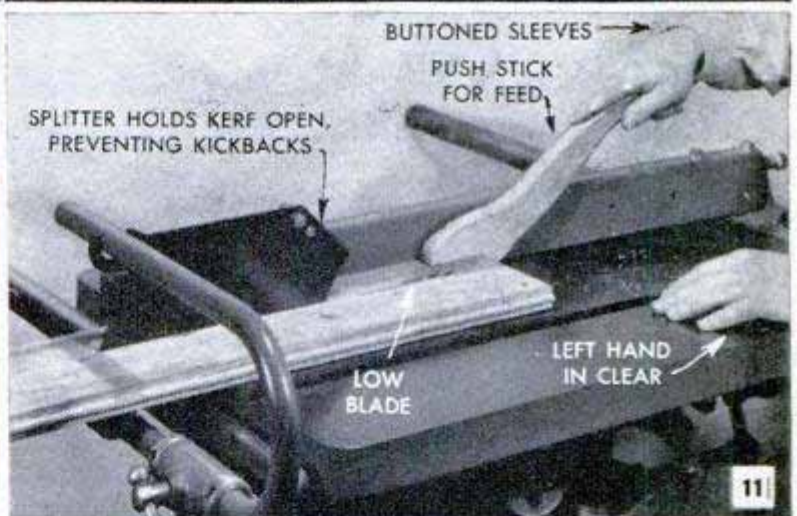

RIPPING FEED—safest way to feed work

THE LITTLE CHANCES WHICH MANY CRAFTSMEN TAKE ARE SHOWN IN TOP PHOTO. PICTURE AT RIGHT IS PREFERABLE TECHNIQUE. LEFT HAND IS USED FOR FEED AT START OF CUT BUT IS REMOVED WHEN CUT IS NEARLY COMPLETE. THE LEFT-HAND PIECE OF WORK REMAINS ON TABLE AND CAN BE GENTLY TOUCHED WITH PUSH STICK IF IT SHOWS A SMALL UNCUT SECTION AT EXTREME END OF CUT. OUTFEED TABLE IS NECESSARY FOR LONG WORK, OR, WORKER CAN USE PULL-THROUGH TECHNIQUE

operations, such as ripping or crosscutting.

The kickback: This can be dangerous. You get a graphic idea of what happens by making the simple test shown in Fig. 1 and also detailed in Fig. 2. If the work is placed in any position on the table where it may bind suddenly while the cut is being made, the kickback results. In some cases, the stock may be caught by the blade and thrown with great force. Most circular saws are now fitted with a special guard having a built-in device, Fig. 8, which is effective in preventing kickback. The guard also includes a splitter which prevents the saw cut closing immediately behind the blade and causing it to bind. These fittings should be in place when the ma-

chine is used for ripping and crosscutting operations. In all the accompanying photos, the guard has been omitted for purposes of clarity.

Saw-blade projection: Saw operators do not observe any definite rule about this. The blade will cut equally well, whether it is lowered so that the teeth just clear the top surface of the work as in Figs. 3 and 6, or raised to the full height as in Figs. 4 and 5. With the blade in the lower position, more power will be required and also slightly more feeding pressure on some types of work. Where the blade guard is not used, the lower position is safer.

Ripping feed: Two things to watch especially when making ripping cuts are the

Two Good Ways to Rip Long Work

OUTFEED-TABLE METHOD, SHOWN AT RIGHT, IS PRACTICAL BUT OFTEN A BOTHER TO SET UP. THE BEST WAY OF HANDLING ANY WORK OVER 30 IN. LONG IS THE PULL-THROUGH, AS SHOWN IN THE PHOTO BELOW

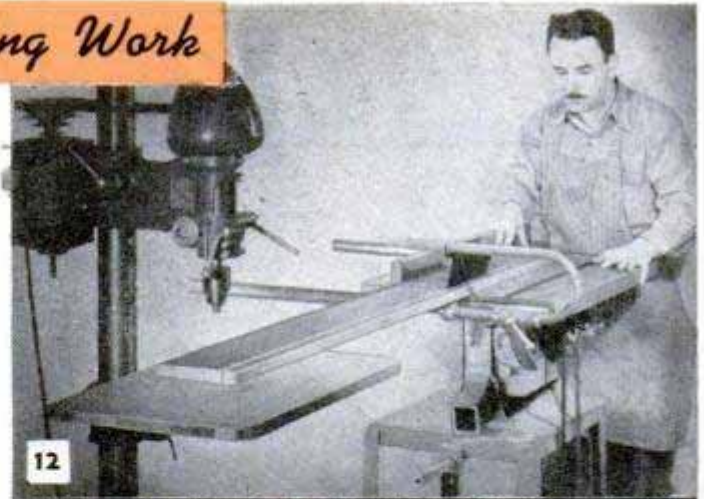

12
DRILL PRESS SERVES AS OUTFEED TABLE TO SUPPORT SAWED END OF WORK FOR SAFELY RIPPING LONG STOCK



13

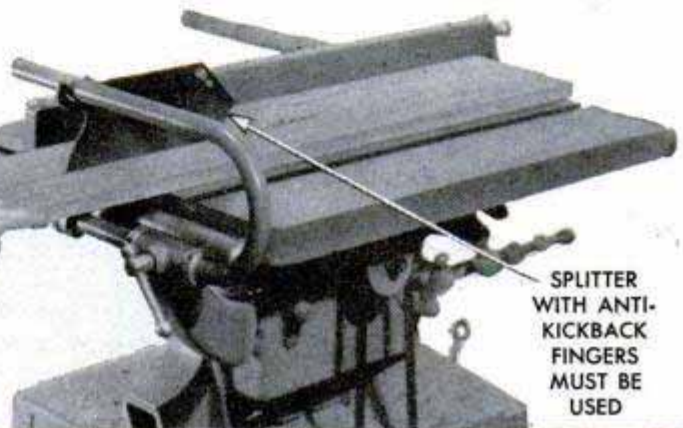

SPLITTER WITH ANTI-KICKBACK FINGERS MUST BE USED

PULL-THROUGH METHOD IS SAFE AND SIMPLE — PREFERRED BY MOST CRAFTSMAN FOR RIPPING LONG STOCK



14

USE AN AUXILIARY FENCE WHEN CROSSCUTTING LONG STOCK. USE BOTH HANDS FOR FEEDING WORK

danger of the blade binding due to closing of the saw cut or kerf, and the possibility of the blade lifting a splinter as it passes through the stock. If a splitter is used, the danger of binding is taken care of, but watch out for a splinter that lifts suddenly above the blade. Where the width of the stock between the fence and the blade is too narrow for safe hand feeding, use the push sticks, Figs. 7, 9 and 11. There is nothing wrong technically with the ripping procedure illustrated in Fig. 10 but the notes outline the added precautions to be taken, especially as the blade nears the end of cut. Fig. 11 pictures the safest procedure.

Long work: A safe method of handling

long work over a small saw table is to rig an outfeed table to support the overhang of the work as it is passed over the saw table, Fig. 12. In this case, the drill-press table is being used. Another way which is used by many craftsmen on small tables is the pull-through method shown in Fig. 13. Of course, a splitter and antikickback must be used, as it is necessary to release the work momentarily to change positions. The first half of the cut is made from the front of the saw table. Then the operator releases the work, steps to the rear of the table and pulls it the rest of the way.

Crosscutting: Crosscuts in long work are safe when you use an auxiliary cutoff fence as in Fig. 14. This fence is screwed to the miter gauge and supports the overhang of the work. The points to watch in crosscutting stock of any regular length are pictured in Figs. 15 to 26 inclusive. The methods detailed—what to do and what not to do—are especially applicable to the smaller machines. However, they also apply in a general way to large, production machines.

Work contact: Full contact of the work with the ripping fence and also with the miter gauge is important to safe operation. Figs. 27, 28 and 29 show why this is so. First, make sure that the fence is exactly aligned with the blade. It is easy to make

Here's Best Way to Crosscut

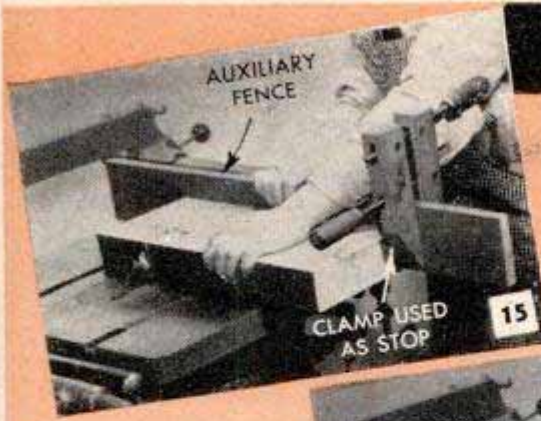

HOLD WORK AGAINST FENCE WITH LEFT HAND AND FEED WITH RIGHT UNTIL SAW HAS COMPLETELY CUT OFF WORK

PULL THE WORK BACK TO STARTING POSITION. DO NOT TOUCH PIECE CUT OFF UNTIL SAW HAS STOPPED

1 USE AN AUXILIARY FENCE INSTEAD OF A PLAIN MITER GAUGE IF CUTTING DUPLICATE PARTS TO EXACT LENGTH

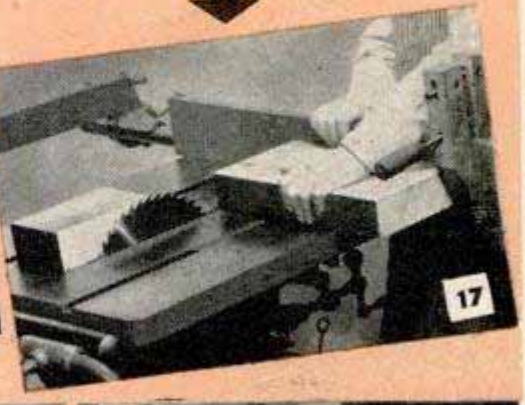
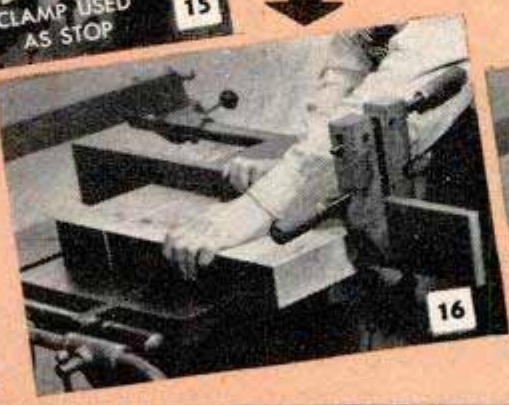

Points to Watch

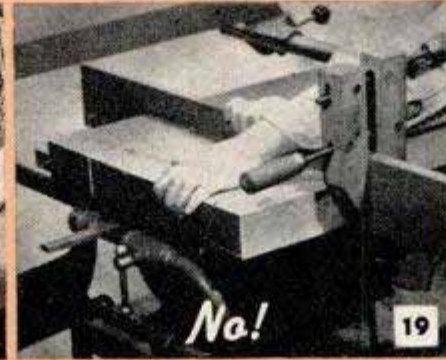

NEVER PICK UP ANY FREE PIECE OF WORK WHILE SAW BLADE IS TURNING

AVOID AWKWARD AND DANGEROUS FEEDING OF WORK BEYOND SAW

NEVER USE RIGHT HAND TO HELP FEED WORK WHEN CROSSCUTTING

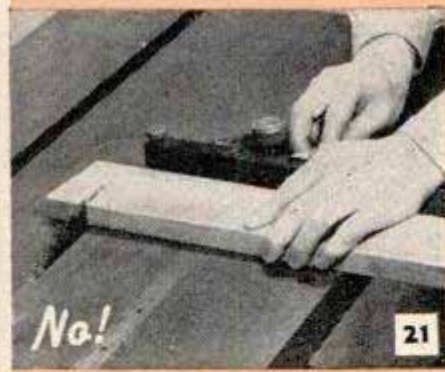

WHEN USING MITER GAUGE AVOID EXTREME HAND POSITION. INSTEAD...

PLACE YOUR HAND AT THE CENTER OF THE MITER GAUGE AS SHOWN ABOVE

AUXILIARY FENCE IS BETTER, ESPECIALLY WHEN CUTTING SHORT WORK

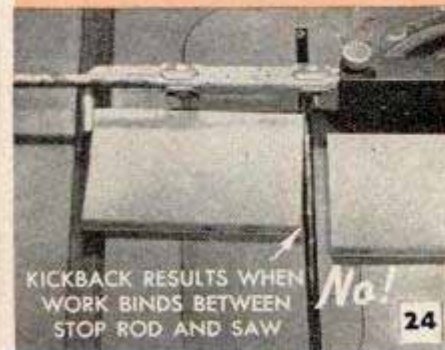

KICKBACK RESULTS WHEN WORK BINDS BETWEEN STOP ROD AND SAW

No!

Yes!

Yes!

NEVER CUT OFF WITH THE STOP ROD SET AGAINST THE FREE END OF WORK

STOP ROD AGAINST SUPPORTED END OF THE WORK ELIMINATES BINDING

CLEARANCE BLOCK LOCATES AND PREVENTS BINDING OF FREE WORK

Watch Your Contact!

This type of error is the most common of all unsafe practices - uneven or small contact causes twisting or binding of work, leading to kickbacks and possible injury to operator

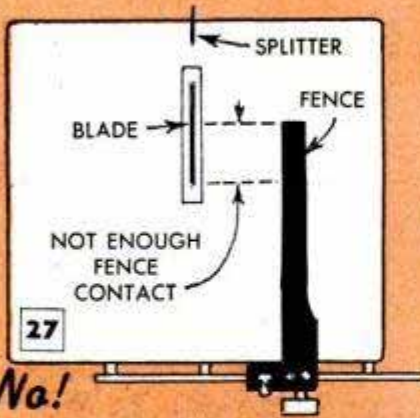

No!

A STUB FENCE, AS SHOWN ABOVE, IS DANGEROUS - EQUIP FENCE WITH WOODEN FACE SPANNING TABLE

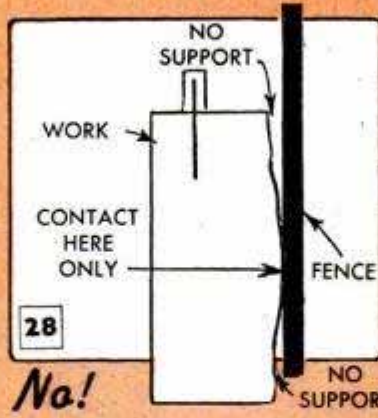

No!

NEVER TRY TO RIP ANY WORK UNLESS IT IS FLAT AND HAS A STRAIGHT EDGE FOR CONTACT WITH THE FENCE

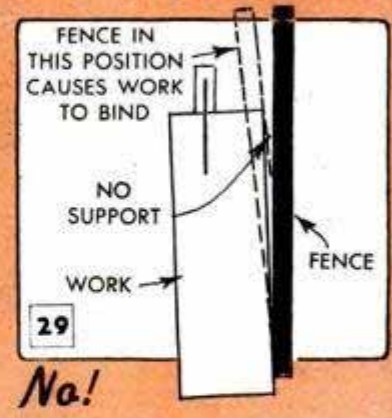

No!

FENCE AND WORK MUST BE KEPT PARALLEL WITH SAW BLADE TO PREVENT BINDING AND KICKBACK OF WORK



30

No!

POOR CONTACT

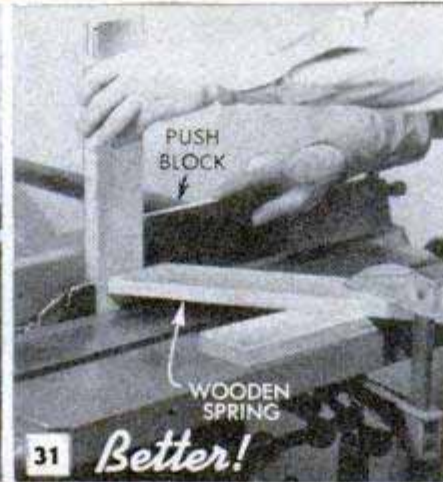

31

Better!



32

Best!

CUTTING A TENON—always use a jig or wooden spring and push block to hold work



34

No!

NO SUPPORT



35

Yes!

GOOD SUPPORT

AUXILIARY FENCE SLIGHTLY ABOVE TABLE

RABBETING WITH DADO HEAD—good support needed

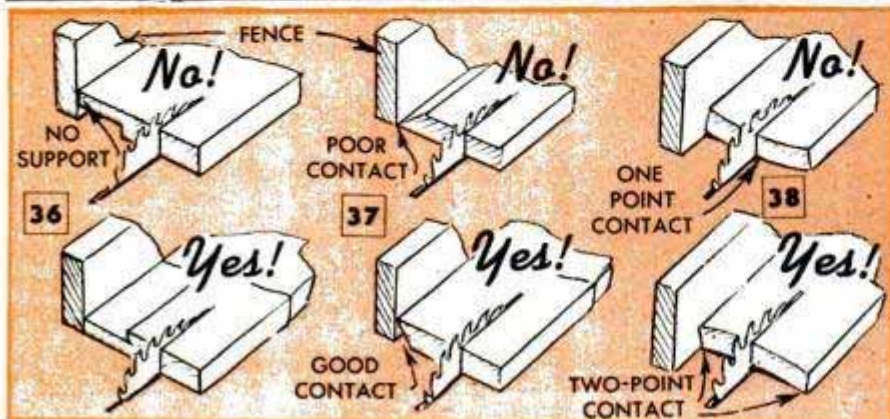

36

No!

NO SUPPORT

37

No!

POOR CONTACT

38

No!

ONE POINT CONTACT

Yes!

Yes!

Yes!

GOOD CONTACT

TWO-POINT CONTACT

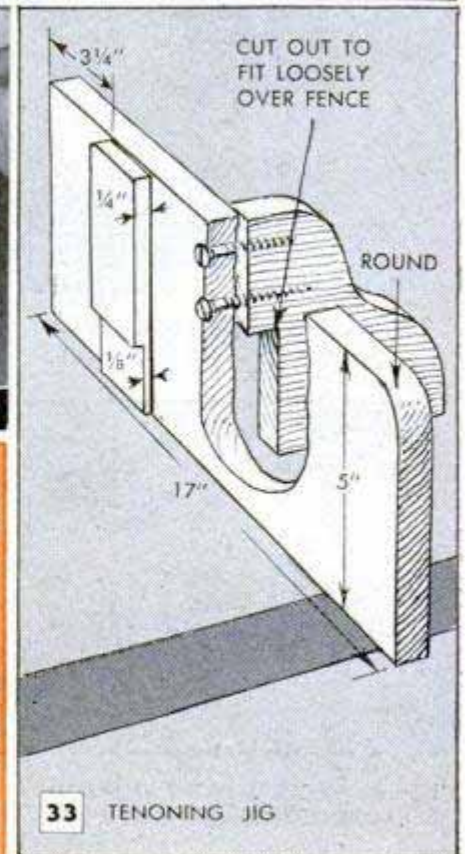

33

TENONING JIG

Take the Risk out of Resawing

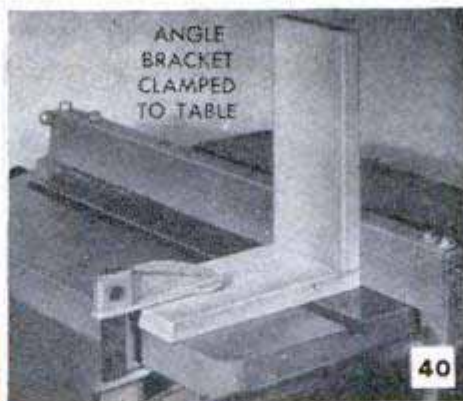
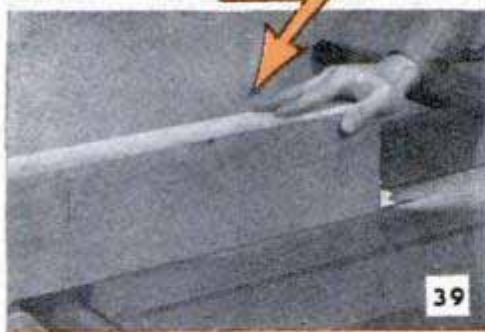

No! A SLIP OR KICKBACK AT THIS POINT MIGHT CAUSE INJURY

this adjustment and it's a good idea to check it occasionally, just to make sure. Then if the edge of the stock is slightly irregular, plane it true so that you have a good bearing against the fence. Fig. 30 pictures an unsafe way of cutting a tenon. Fig. 31 details a better method and Fig. 32 shows the safest and surest method of all, using the tenoning jig detailed in Fig. 33. Good, firm support is needed when cutting a rabbet with the dado head. Fig. 34 shows what to avoid and Fig. 35 the right way to do it. Figs. 36, 37 and 38 show how to handle other less common ripping operations. The right way detailed in Fig. 38 applies only to narrow strips. Do not attempt to rip wide, deeply cupped boards in this manner. Either plane the board flat and true, or rip through the center with a handsaw. If the board is of short length and only a narrow strip is to be ripped from one side, you can do the job safely as in the upper detail by simply holding down firmly on the edge next to the ripping fence. A blade with a wide set will cut through without binding.

Resawing: The purpose of resawing is to obtain thin strips from stock of standard thicknesses. For example, if you have only $\frac{3}{4}$ -in. stock and need several narrow strips approximately $\frac{3}{8}$ in. thick, these are easily produced by resawing. Center-mark one end of the piece, place it on the saw table as in Fig. 42 and raise the blade until the teeth project about $\frac{1}{8}$ in. above the mark. Locate the ripping fence so that the blade will make the first cut through the exact center of the stock when it is placed on edge against the fence. Complete the setup as in Figs. 40 and 41 by clamping a wooden angle bracket against the back of the fence and adding the spring hold-in. The purpose of the angle bracket is to support a

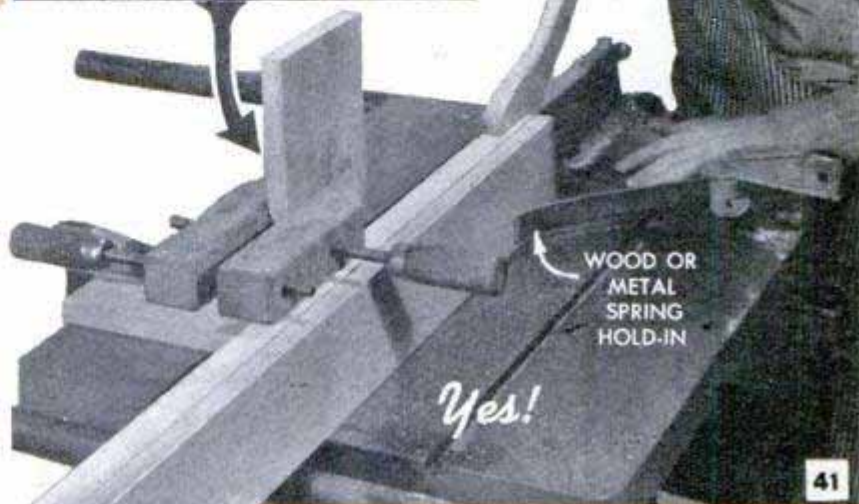

KEEP YOUR HANDS IN THE CLEAR WHEN RESAWING



hand clamp positioned on the upright arm of the bracket to allow enough clearance so that the stock will pass under it without binding. The clamp prevents the piece being thrown upward should the blade bind slightly at any point along the length of the cut. Finish the cut with a push stick as in Fig. 41. Do not use the hand as in Fig. 39. When the first cut has been finished, turn the piece end-for-end and make the second cut in the same manner. This gives you two pieces each slightly less than half the thickness of the original piece, a fact due, of course, to the width of the saw kerf. Use a blade with a medium-wide set for resawing, but do not use a hollow-ground blade (planer saw) for this work.



Bumper Jack Serves as Stretcher To Draw Barbed Wire Taut

When stringing a barbed-wire fence, one farmer uses an ordinary car bumper jack to draw the wire taut. The bumper lift is slotted to grip the wire and one end of the shaft is bent to hook around a fence post. With the jack in place on a properly braced post and the barbed wire inserted in the slotted lift, normal operation of the jack handle will draw the wire as taut as necessary.—L. A. Burk, Burbank, Calif.

Taping Transformer Coils Speeded With Aid of Wooden Shuttle

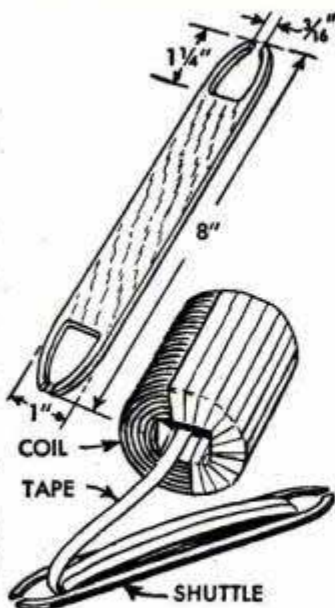

A real timesaver for wrapping transformer and generator coils, this wooden shuttle simplifies bringing the tape through the center of the coil. The shuttle is made approximate to the dimensions given and a slight twist releases a length of tape through the slot in either pincers-shaped end.—R. L. MacLean, Highbank, P. E. I., Can.

Use a sweeping motion of the brush when painting inside walls, entering from an unpainted area to avoid brush marks.

Labels Smoothed on Cartons With Blackboard Eraser

Addressed labels can be glued to a shipping carton quickly and without smearing the writing, if they are smoothed in place with a blackboard eraser. Similarly, the strips of gummed paper tape, which are used to seal the cartons, also can be smoothed in place with an eraser, saving a considerable amount of time.

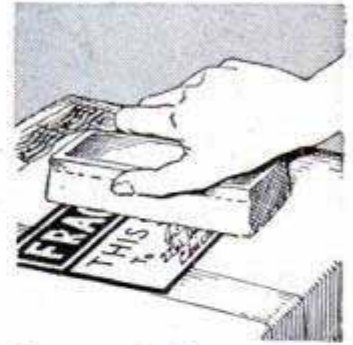

Brush Torch Has Corncob Wick

For igniting brush fires, a long-burning torch can be made by forcing a dry corncob into the end of a length of pipe. Oil is poured into the top of the pipe and the corncob at the lower end serves as a wick.



Milk Can Provides Funnel For Filling Grain Sacks

Cutting the bottom from an old milk can converts it into a handy funnel for sacking grain. The can is nailed to a stud or post in an inverted position, and the open end of the grain sack is wrapped around its mouth. A piece of sheet metal bolted loosely to the can rim clamps the sack in place.

Harold Severson, Kenyon, Minn.



Side Carrier for Ladder Protects Car Finish

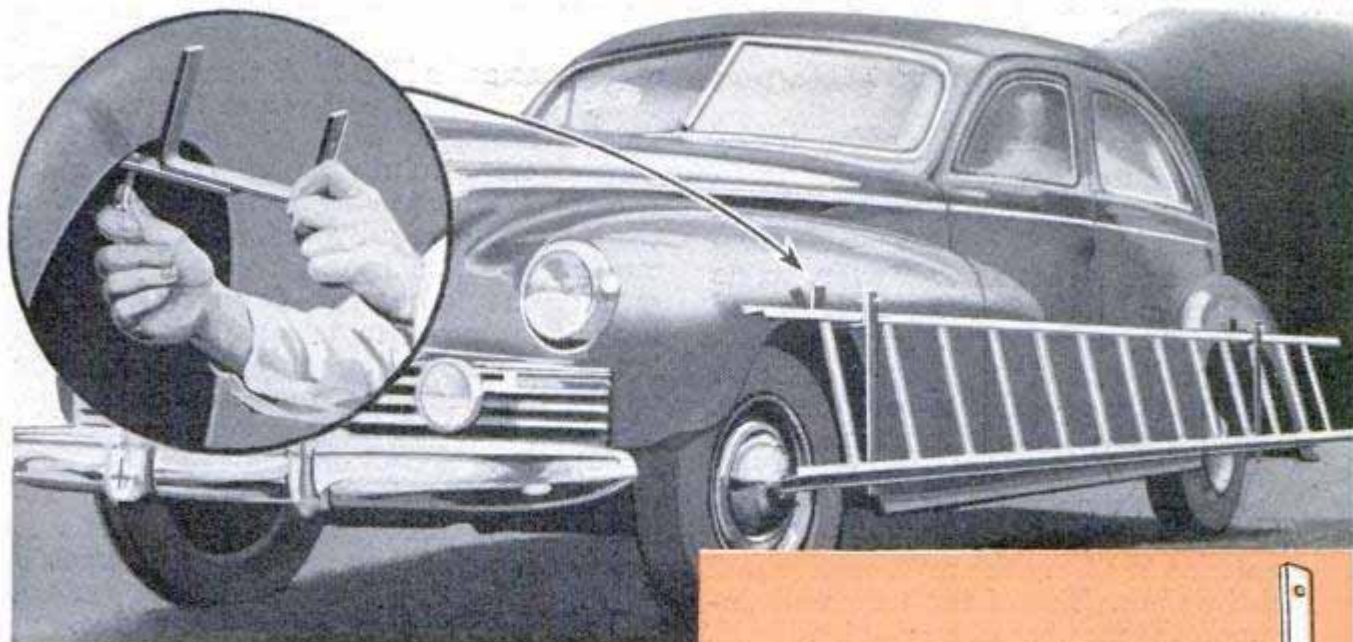

Confronted with the problem of carrying ladders and boards needed for repairing a newly purchased home, the Rev. Joseph S. Wright, Yonkers, N. Y., designed a pair of fender hooks which permit carrying the equipment on the side of a car without scratching the finish. The hooks are fastened to the fender bead with a thumbscrew and locknut in such a way that they cannot mar the exposed surface of the fender. Flat-iron guards hold the equipment away from the side of the car. Tightened with thumbscrews, the guards are hung downward when ladders are carried, and are swung upward when carrying wide boards. Equipment is quickly secured with lengths of rope.

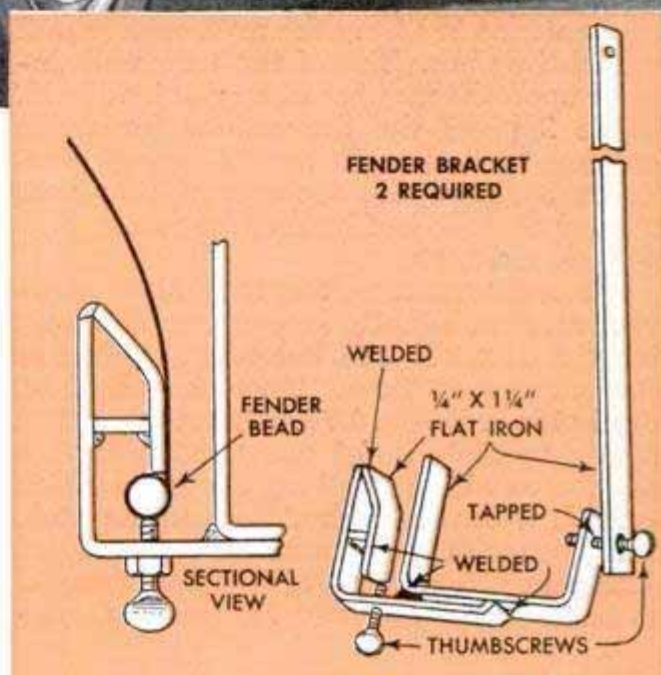

Poultry Fountain Kept Sanitary by Setting on Three-Sided Platform

Setting a poultry fountain on a raised, three-sided platform keeps the chickens from scratching litter into the water and

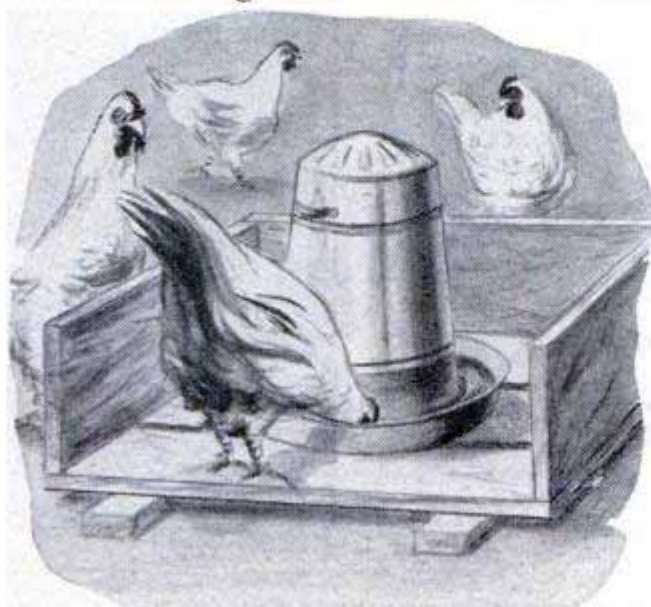

also prevents water from accumulating around the fountain. The platform is made simply by removing one side from a crate or wooden box and placing the box on two boards to raise it off the ground. The boards on the bottom of the box should be spaced apart slightly to allow the water to drain.—Hi Sibley, Nuevo, Calif.

Hook Mounted at Front of Tractor Aids Pulling Hay Rope

Attaching a hook to the front of a tractor permits pulling a hay rope by backing away from the barn, making it easier to watch the tackle. In addition, returning to the barn is faster because the tractor does not have to be turned around.

☐ Typing paper will not slip on a worn typewriter platen if it is backed with a sheet of blotting paper.

INSULATED MILK-COOLING

By A. E. Youngquist

TO KEEP investment costs for milk-cooling equipment at a minimum, a number of farmers are building concrete cooling tanks in which electrical refrigerating units are installed. However, to do this economically the cooling tank should be insulated to avoid overloading the refrigerator unit during the summer and also to reduce the time needed to cool the milk.

When possible, the cooling tank should be located against two adjacent walls of a milkhouse or other building with the bottom of the tank below the floor level for convenience in lifting the milk cans in and out of the tank. Size of the tank will depend upon the number of cans it is to hold. Table 2 gives the dimensions for tanks holding from 4 to 12 cans of 40-qt. size. Table 3 shows the amount of materials needed exclusive of lumber for forms, pipe fittings, nails, etc.

After determining the tank size, excavate an area slightly larger than the tank to a depth of 2 ft. 7 in. below the surface of the milkhouse floor. Then install 2-in. drainpipe as in Fig. 4. Note that the vertical piping is made up of two lengths of pipe connected with a coupling, the top of which is flush with the finished floor in the tank. The bottom of the excavation is then filled with gravel to a depth of 6 in. and tamped to make firm foundation for the 4-in. con-

crete base as in Fig. 1. A temporary form of 2 x 4-in. stock will retain the concrete until it hardens. The concrete should be leveled off carefully to provide an even surface on which to lay insulation material. Cork board or equivalent rigid insulating material, 3 in. thick, and thoroughly waterproofed should be used. After the concrete hardens, remove the temporary forms and lay the floor insulation. A hole must be cut in the insulation over the drainpipe. The hole must be large enough to provide a 1/2-in. opening all around the pipe. This opening is then filled with hot asphalt. Insulation for the end and side walls is erected next. All butt joints and exposed edges of the insulation must be waterproofed with hot asphalt or seam filler.

Construction of the forms is shown in Fig. 1. These are held exactly 10 in. apart by placing wooden spacer blocks, 4 in. wide, between the outer forms and insulation and 3-in. wide spacers between inner forms and insulation. Spacers are removed as the forms are filled with concrete. Faces of the forms that will be in contact with the concrete should be oiled. Tar paper is placed against the foundation walls, as in Fig. 1, to prevent damage to the tank in the event there is any settling of the foundation walls. A concrete mixture of cement, 1 part, sand, 2 1/4 parts, and gravel or crushed rock, 3 parts, is recommended. The largest crushed rock used should not

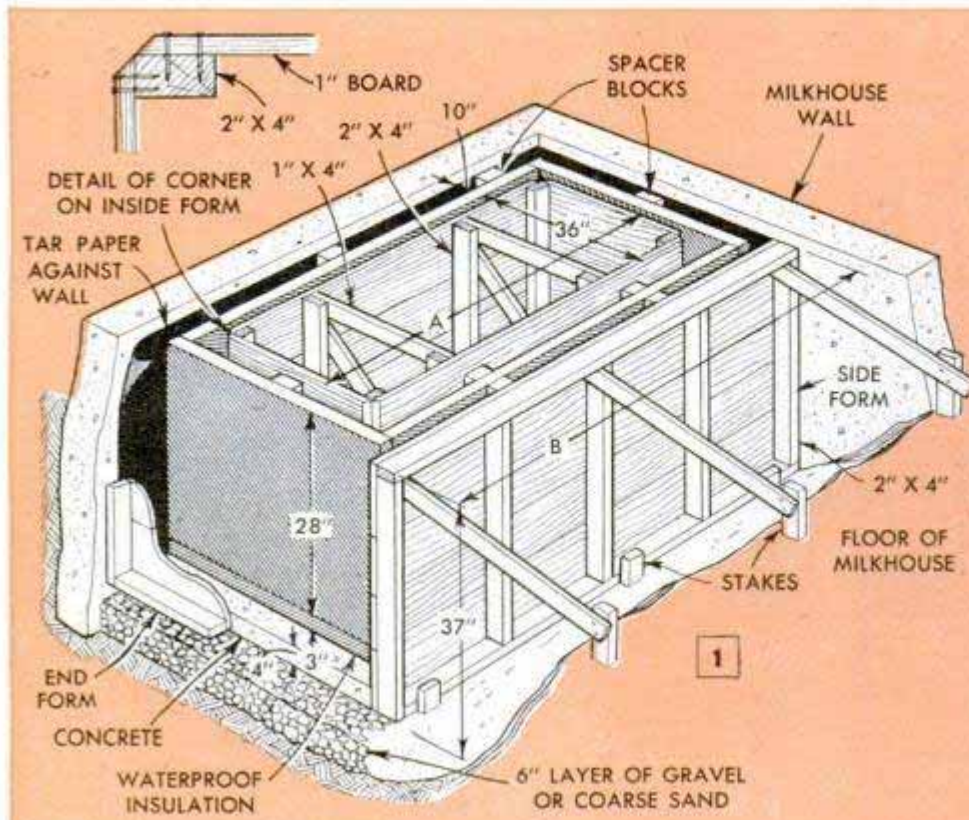

TABLE 2

TOTAL STORAGE CAPACITY 40 QT. CANS	DIMENSIONS (SEE FIG. 1)	
	A	B
4	4 ft.	5 ft. 8 in.
6	6 ft.	7 ft. 8 in.
8	8 ft.	9 ft. 8 in.
10	10 ft.	11 ft. 8 in.
12	12 ft.	13 ft. 8 in.

ALL TANKS ARE 36 IN. WIDE AND 27 IN. DEEP INSIDE.

IF COOLED NIGHT'S MILK IS TAKEN OUT TO MAKE ROOM FOR MORNING'S MILK, TANK NEED BE ONLY LARGE ENOUGH FOR CANS OF ONE MILKING.

TANKS

exceed $\frac{3}{4}$ in. in size. Before pouring the concrete, a tin collar is placed around the drainpipe coupling to leave a $\frac{1}{2}$ -in. space all around the coupling. When the concrete hardens, the collar is removed and the space filled with hot asphalt. Concrete for the tank floor is poured first. It should be troweled to slope slightly toward the drain. Concrete for the walls is poured in the forms in layers about 4 in. deep. Care must be taken to fill both the inner and outer walls to the same depth to prevent movement of the insulation.

When the forms are completely filled, $\frac{1}{2}$ x 6-in. anchor bolts are embedded 2 ft. apart around the top edge of the concrete with the threaded ends projecting about

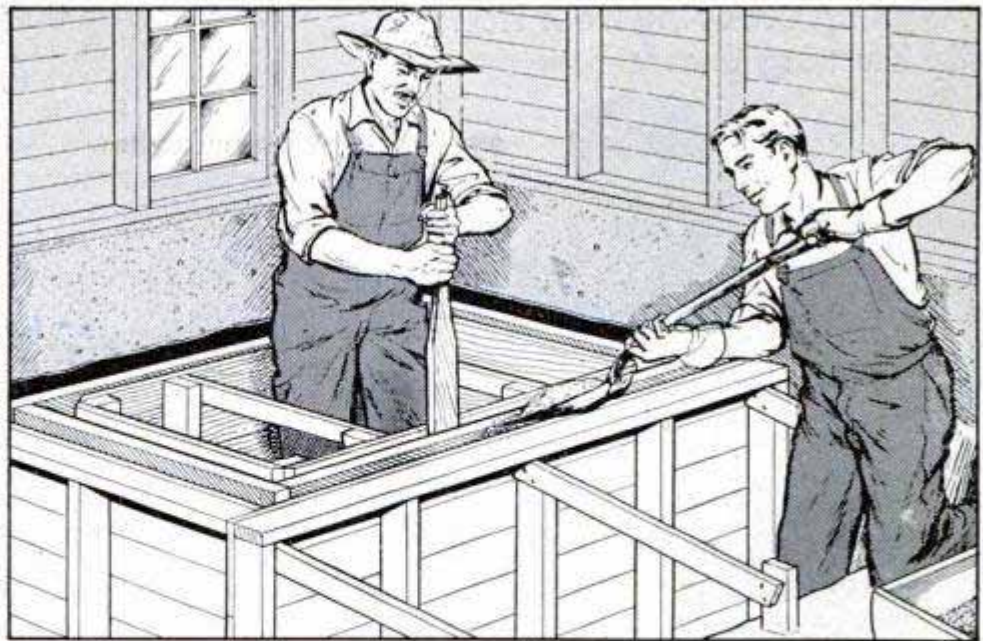

Concrete for walls is poured on both sides of the insulating material simultaneously. Avoid damaging waterproof covering on insulation when spading

TABLE 3. BILL OF MATERIAL

KIND OF MATERIAL	SIZE OF TANK					
	Amount	4 Can	6 Can	8 Can	10 Can	12 Can
Sand	Cu. Yd.	1.0	1.3	1.5	1.8	2.1
Gravel - $\frac{3}{4}$ in. Maximum	Cu. Yd.	1.1	1.4	1.7	2.0	2.3
Cement	Sacks	10	13	15	18	20
3" Vaporproof insulation	Sq. Ft.	60	77	94	111	128
Tar-paper cover	Sq. Ft.	18	24	30	36	42
1x6s Cover	Lin. Ft.	78	104	130	156	182
2x10s	Lin. Ft.	30	38	46	54	62
2x6s	Lin. Ft.	4	4	4	4	8

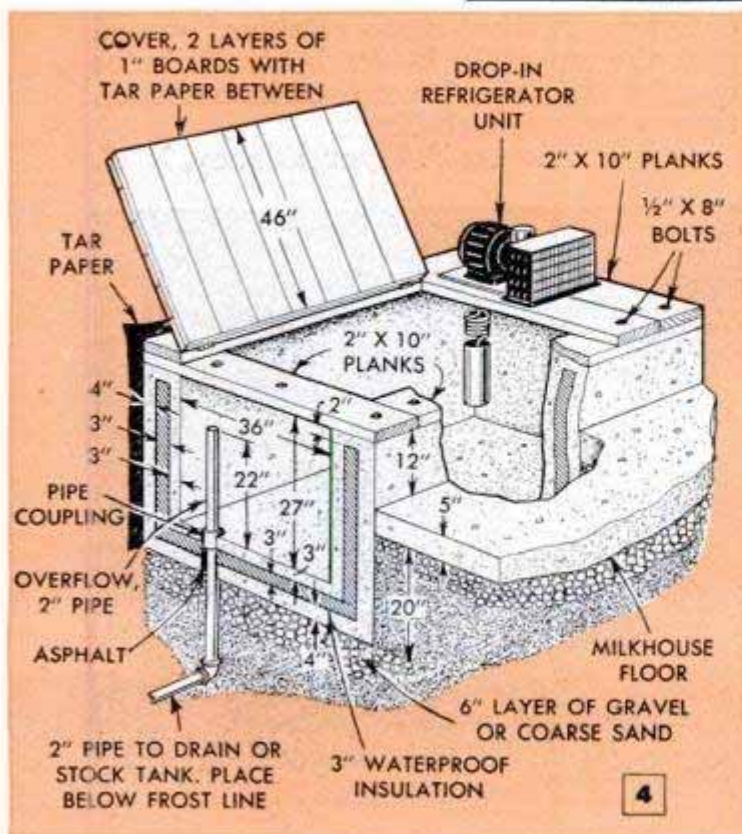

$1\frac{3}{4}$ in. After the forms are removed, 24 to 48 hours after pouring, the inside surface of the tank is given a wash coat of cement and water having the consistency of thick cream. The concrete should be cured by covering the tank with burlap which is kept constantly moist for 7 days. This is essential to assure strong, watertight concrete. The tank should be at least two weeks old before it is used. After curing, a thin layer of mortar consisting of cement, 1 part, and sand, 2 parts, is spread over the top edges of the tank. Wooden planks are then bolted to the top edges while the mortar is still wet, thus assuring a tight fit between the planks and concrete tank. All anchor-bolt nuts should be counter-sunk flush with the surface of the planks. A portion of the tank opening is covered with planking to support the refrigeration unit, Fig. 4. Details of installation are included with each unit when purchased. The remaining portion of the tank opening is enclosed with a hinged cover, Fig. 4.

Information courtesy Westinghouse Electric & Mfg. Co.

Aligning Drooping Door Handles By Twisting Shank



If your car looks prematurely old and neglected because of drooping door handles, you can remedy this situation quickly and inexpensively. First, note how far the handle sags from its normal position, measuring the distance with a rule. Then, loosen the setscrew, which is usually located in the edge of the door, and pull out the handle. Clamp the square shank of the handle in a vise at the same depth as it sets in the lock. The part of the shank which fits inside the lock will be noticeably worn. Now, with a monkey wrench, bend the shank exactly the amount needed to correct the sag in the handle, sighting the bend carefully and measuring it accurately. Try the handle in the door to see if it is properly aligned and rebend the shank slightly if necessary to correct any deviation.

Ed Packer, Chicago.

Prolonging Life of Fence Posts With Chemical Treatment

The useful life of newly cut, bark-covered fence posts is prolonged by introducing a preservative solution of chromated zinc chloride into the wood through the sap stream. This can be done by the glass-jar method which amounts to placing an inverted container full of the solution on top of the post and allowing gravity to distribute it. First, a disk-shaped wick of cotton or wool cloth, wetted with the solution, is tacked to the top of the post. This should completely cover the top end. A glass jar with a screw-type lid is selected, and eight or nine holes are punched through the lid with a nail. The lid is tacked over the wick, and the post is in-

verted while the jar, filled with preservative solution, is screwed to the lid. Then the post is set upright, and gravity does the rest. Sections of pipe or tin cans may be substituted for jars, and the method can be used any time of the year when the wood is not frozen. However, the posts must not be split. To make the solution, add 1 pound of the chemical to each gallon of water.

U. I. '51

Seat Cushion for Tractor Made From Inner Tube

A serviceable and comfortable tractor-seat cushion is easily made from an inner tube which is covered with canvas or heavy cloth. The inner tube is partially inflated and then bent and tied, as shown in the drawing, to fit the tractor seat.

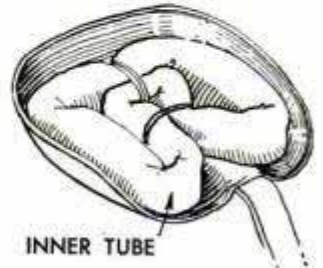

Charles E. Mason, California, Mo.

Fluorescent-Bulb Rack on Ladder Speeds Electrician's Work

Maintenance men in factories and offices will find the changing of fluorescent bulbs of ceiling fixtures easier if several of them are carried in a special rack on one leg of a stepladder. Use of the rack allows a burned-out bulb to be removed and a new one installed with only one trip up the ladder. The lower ends of the bulbs are set in a large tin can screwed to the ladder leg about 3 ft. from the bottom in order to clear desk tops. A sheet-metal retainer fastened near the top of the ladder holds the bulbs upright. This ring is wrapped with friction tape to protect the bulbs.

Thomas F. Flynn, Albany, N. Y.



IMPROVED PICTURE TUBES

BETTER TV tubes at lower cost are now available due to improved design and mass production. RCA's 16-in. metal picture tube in photo A furnishes a sharp contrast to the standard 10-in. tube as demonstrated by Miss Diane Myers. Providing a picture fully $2\frac{1}{2}$ times that of the 10-in. tube, the new 16-in. tube has a metal cone to which the glass face plate and neck section are sealed by a special technique. The 16-in. tube provides a picture size intermediate between that of the 10-in. standard tube and the screens of projection-type TV receivers.

The slow process of molding glass blanks for picture tubes has been replaced by a standardized separate face-plate process developed by the Pittsburgh Plate Glass Company. The grinding and polishing operations are completed while the glass face plate is still flat. A close-up of the fusing operation which flame-seals the face plate to the tube proper is shown in photo B. These face plates may also be used on the new metal tubes. Caroline Tufts of RCA is holding one of the new face plates in photo D. Another TV-tube improvement by the Pittsburgh Plate Glass Company is a curved protection, or implosion plate of impact-resisting tempered glass that covers the tube face as illustrated in sketch C.

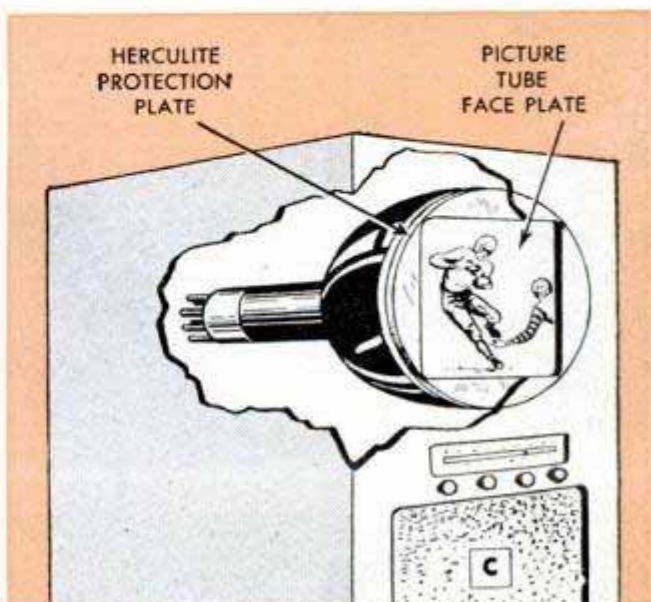
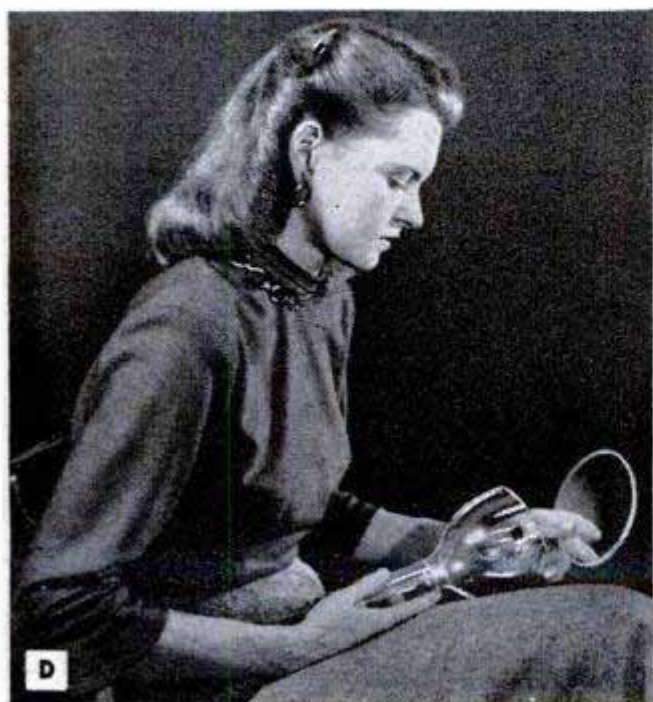
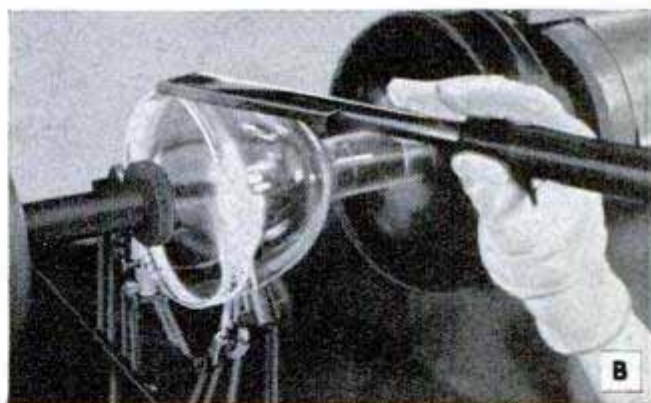

TWO-TUBE SUPER BATTERY

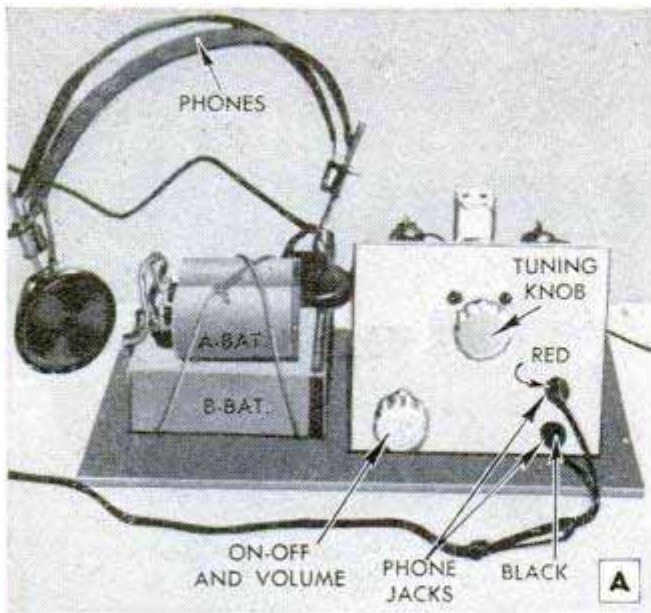

EASILY constructed and economical to build, this rugged little two-tube student-type super is ideal for camping trips or wherever a compact, sensitive, battery-operated broadcast receiver is required. For knockabout use, the small chassis base and the batteries can be mounted on a piece of hardboard and strapped down as shown in photos A, D and F. It is compact enough to carry in a small cardboard container or, if the builder prefers, it can be housed in a cabinet. The components are not critical and may be obtained from any radio supply house. Adjustment of the completed receiver is simple and requires no test equipment.

With a 15 or 20-ft. piece of wire for an antenna, all local broadcast stations may be received with clarity and good volume. The set has good selectivity and even sensitivity over the entire broadcast band. When a good outside antenna and ground are used, the distance-getting performance obtained with this receiver is equal to or better than that obtained from any 2-tube regenerative receiver, and it is without the squeal that is always present in the output of a regenerative set. The low battery drain of the two miniature tubes assures a long battery life. Two ordinary 1½-volt flashlight batteries, connected in parallel, provide the A-battery supply for the tube filaments; the B-battery consists of a portable-type 67½-volt battery for maximum sensitivity and volume. However, a 45-volt B-battery can be used for receiving local stations. Any type of crystal or magnetic headphones having a 2000-ohm impedance or higher may be used.

The 1R5 miniature tube operates in the same manner as the first detector in any type of superheterodyne receiver. The local oscillator section of this tube operates at a frequency that is 455 kc. higher than

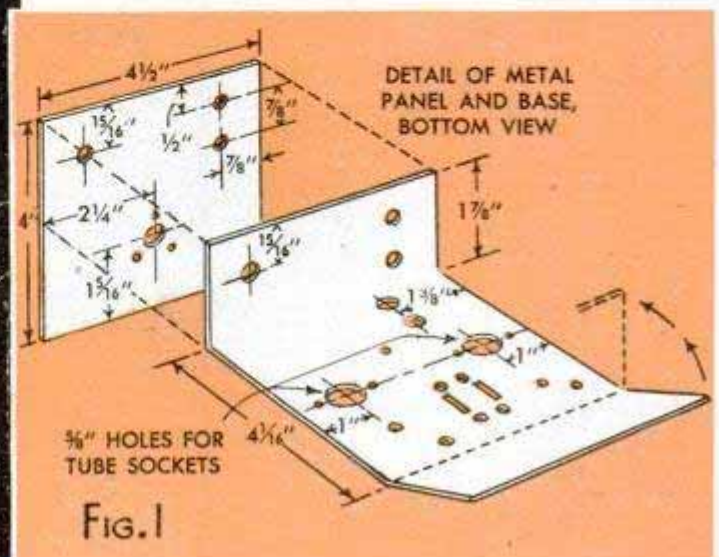
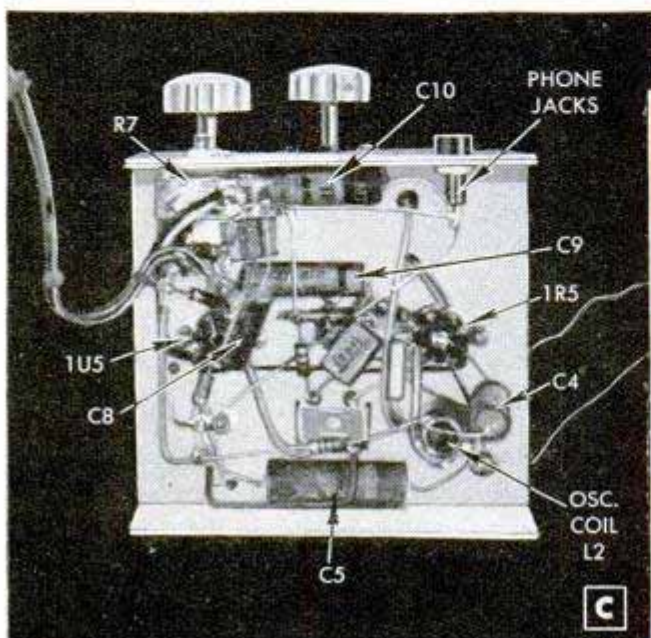
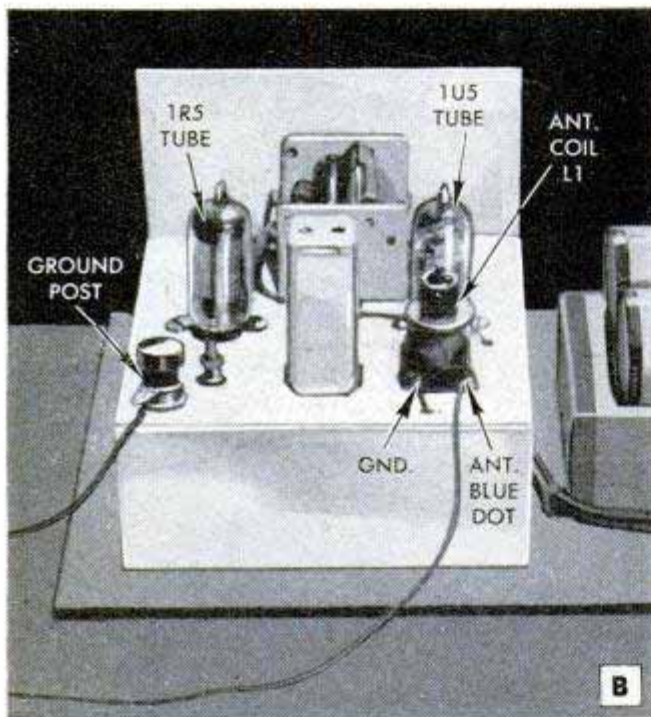

FIG. 1

PACK SET FOR VACATIONS

the received signal. This signal from the local oscillator is mixed within the tube with the received signal to produce the intermediate frequency.

Construction should start with the forming and punching of the metal panel and chassis base detailed in Fig. 1. Either aluminum or sheet steel may be used; however, aluminum is preferred as it is easier to work. The front panel is fastened to the base by the volume control and the phone-tip jacks, the red phone jack being insulated from the panel and chassis. The miniature 2-gang superhet tuning condenser with trimmers is supported by the panel at front and a small bracket on the rear of the condenser frame, which is common with ground. Mount the tube sockets with the blank "key" spaces pointing out to each side of the chassis. Any cut-plate 2-gang variable condenser designed for a 455 to 456 intermediate frequency may be employed; the 27-plate section is 420 mmfd; the 15-plate oscillator section is 162 mmfd. However, the Meissner-type 14-1040 oscillator coil should be used as specified. Any universal-type antenna coil will function properly in case the Carron-type S469 is not stocked by your local dealer. The Stanwick-type SM107S I.F. transformer is a spade-bolt mounting style and the terminals are color-coded as indicated in diagram, Fig. 2.

All parts above and below the chassis are clearly indicated in photos A, B, C, D and

(Continued to page 234)

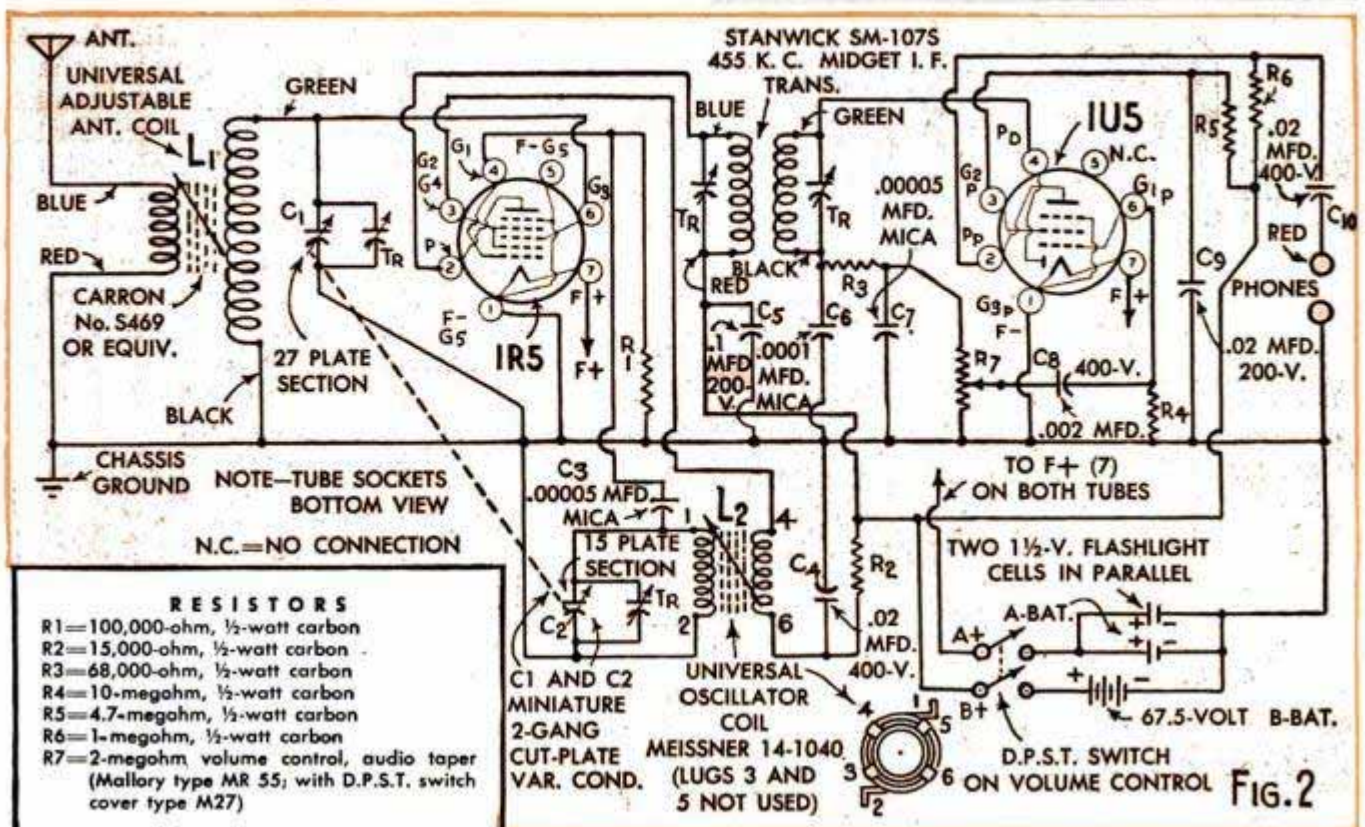
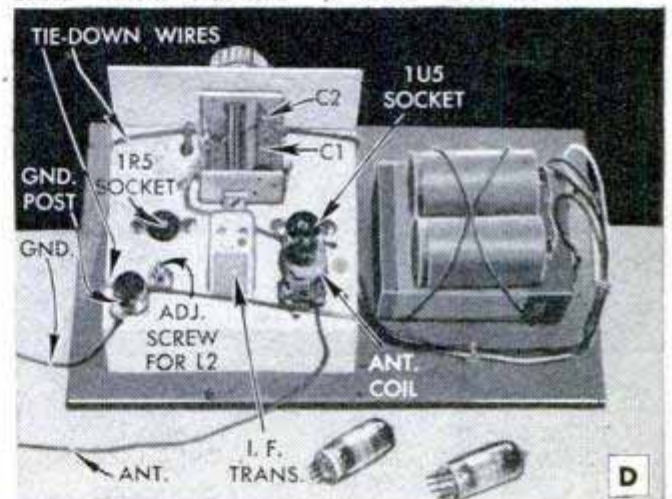

SIGNAL-SHIFTER KIT FOR RADIO "HAMS"

MANY AMATEURS favor the use of variable-frequency oscillators as exciters for final amplifiers. Constant research and refinements have resulted in a higher order of stability in this type of oscillator. In fact, stability equal to crystal control is possible, with the important feature that the transmitter frequency may be varied. Variable-frequency oscillators may be purchased commercially or built from plans described in handbooks. However, units built from these sources require a considerable amount of skill and careful adjustment afterwards. A well-known commercial signal shifter has been the Meissner. This unit is now available in kit form, including built-in power supply, at about half the price of the completely wired instrument.

Now, any "ham," even the one with the new license, can build his own signal shifter. The kit includes the neat cabinet which matches well with other equipment on the operating table as shown in photo A. This new signal shifter features a rotating turret-coil unit for band switching. The coil appears in photo B, which was taken during actual assembly. It has six positions and provides for output on the amateur 80, 40, 20, 15 and 10-11 meter bands. These positions are indicated by the band-switch letters on the front panel in photo D. Photo C is a top view of the chassis with all tubes indicated. The kit includes assembly and wiring diagrams, and all tubes and necessary parts.



A

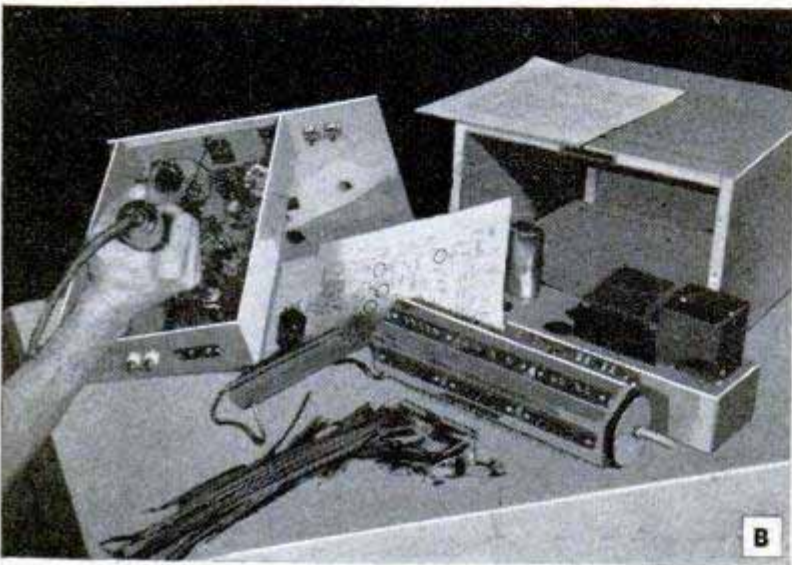

B

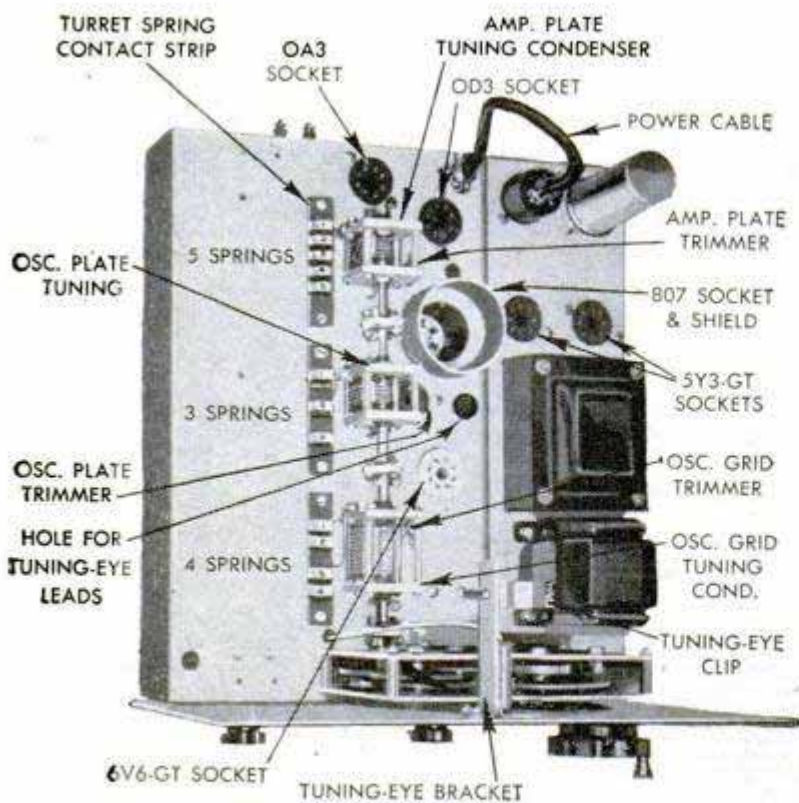

TOP VIEW OF CHASSIS

C

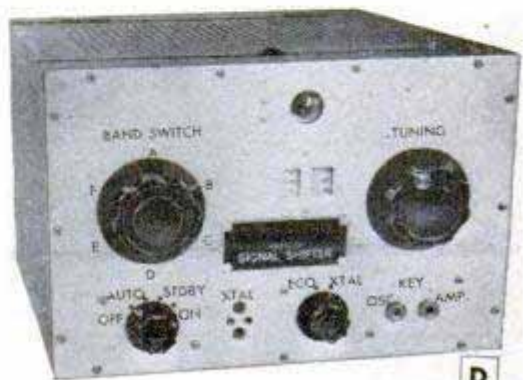

D



**KODAK
FLASH BANTAM
f/4.5
CAMERA**

**Leads to "double
reward" in color**

This trim camera, so small that it slips into your pocket, leads to *brilliant screen showings* of Kodachrome transparencies... gorgeous *Kodachrome Prints* (superb black-and-white enlargements, too). 4-element Kodak Anastar *f/4.5* Lumenized Lens... 4-speed 1/200 shutter... automatic film stop... die-cast body. 8 exposures on Kodak 828 Films. Camera, \$57.75; Flashholder, \$11.08. Prices include Federal Tax.

SMART COLOR TEAM



**KODASLIDE
PROJECTOR
MODEL 1A**

**Projects bright images
up to 7 feet wide**

You'll enjoy sparkling color shows with this moderately priced projector. Lumenized optical system steps up screen brilliance 50%. And you can focus to a hair with the Kodak Projection Ektanon Lens, 4-inch *f/3.5*. Tripod Socket provides handy mounting on Projecto Case. 150-watt lamp and slide carrier included. \$27.50.

Other brilliant performers in the color field—

Kodak 35 Camera with range finder—has worry-free automatic controls. \$86.75, including Federal Tax.

Kodaslide Projector, Model 2A—with Kodak Ektanon Lens, 5-inch *f/3.5*. \$47.50.

Kodaslide Projector, Master Model—outshines all others. 1000-watt lamp;

superb optical system. \$181 to \$295, depending upon lens choice.

Kodaslide Table Viewer—screen, projector, and slide changer all in one unit. \$95. At your Kodak dealer's.

(Prices subject to change without notice)

"Kodak" is a trade-mark

EASTMAN KODAK COMPANY, ROCHESTER 4, N. Y.

Kodak

The mark of a REAL CRAFTSMAN



The right

NORTON abrasives **CRYSTOLON® OILSTONE** for every tool

A real craftsman knows the value of sharp tools. For chisels and planes, he has a CRYSTOLON Combination factory-oil-filled Bench Stone — sized and shaped just right — with a coarse side for fast cut and a fine side for keen finish. For his wood carving, model making and gardening tools, he has other CRYSTOLON stones, such as round edge slips, utility files, pocket stones, scythestones, axe stones and any others his tools require. There's a "right" CRYSTOLON stone for every tool.

Be sure you pick CRYSTOLON stones. They're best because they're made of famous Norton Abrasive electric furnace silicon carbide grit — hard, sharp and uniform. Get the CRYSTOLON stones you need at your local Hardware store today.

Send for "How to Sharpen"

48-page booklet packed full of informative data on sharpening home workshop tools. Complete with illustrations and diagrams. Write for your free copy today.



BEHR-MANNING
NORTON abrasives TROY, N.Y.

Two-Tube Super Battery Pack Set for Vacations

(Continued from page 231)

E; the filament circuit of the two tubes should be wired first. Complete circuit-wiring details appear in the schematic circuit diagram, Fig. 2; no pictorial diagram is given as this is not intended for a beginner's set. Make sure that all leads are as short and direct as possible. All connections should be well soldered, using rosin-core wire solder only. A good common-ground connection is important; in the model, all points which are grounded are connected together by a wire with the ground being made to the bolt holding the rear bracket of the variable tuning condenser. The small circular tube protruding from the bottom center of the miniature tube sockets acts as a shield between the socket prongs and should be connected to ground. The positive clips for the A-batteries were made from two $\frac{3}{8}$ -in. grid caps; the negative connection is made with a $\frac{1}{4}$ -in. strip of thin metal cut from a tin can. The strip is about 3 in. long and is bent double. The negative lead for the A-batteries is then soldered to the doubled strip at the bend, leaving two metal blades which are inserted between the paper jackets and the outside negative metal shells of the A-batteries. When connecting the clips on the positive terminals of the A-batteries, it may be necessary to scrape away some of the insulation or to cut the

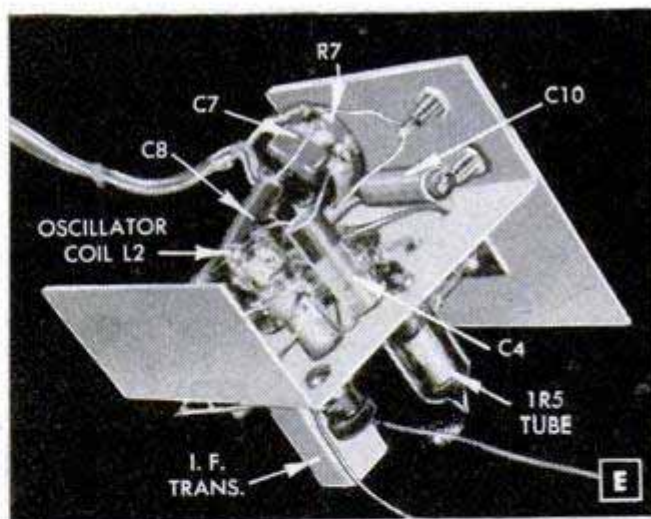

clips so they will fit tightly. These clips do away with soldering when it is necessary to renew the cells for the A-battery.

To operate the receiver, connect the batteries, antenna and ground wires, plug in the headphones and turn the volume control to maximum. By adjusting the tuning condenser, several stations should be heard. With the variable condenser set at a point 15 to 20 degrees from the fully

(Continued to page 236)

Now-a new way to decorate with paint!

EAGLE-PICHER 10 decorator colors

Harmonize with each other and with any color
in your present furniture, rugs, and drapes

These ten pre-harmonized colors are not only beautiful... they harmonize completely with each other and with all colors in your present furniture, drapes and rugs! Result? They are extremely popular with discriminating homeowners everywhere... because color selection is simplified, professional effects secured easily. You can work decorating miracles—make small rooms seem larger, brighten dingy rooms—and be sure of a unified, harmonious color scheme. You'll get matching walls and woodwork with Eagle-Picher flat, semi-gloss and gloss decorator paints. They're easy to apply, cover almost any surface in one coat, and they're washable, because they're genuine oil base paints. One gallon does the average-size room!

The color in this illustration, matched as closely as printing ink will permit, is Elfin Green. Other colors available in Eagle-Picher Decorator Paints are: Roman Ivory · Twilight Gray · Desert Sand · Dresden Blue · Harvest Peach · Lettuce Green · Daffodil · Potters Blue · Dusty Rose. There is a complete line of Eagle-Picher paint—for all interior and exterior painting.



**3 exactly
matching
finishes**



for walls, for woodwork, for kitchens,
ceilings cabinets bathtubs

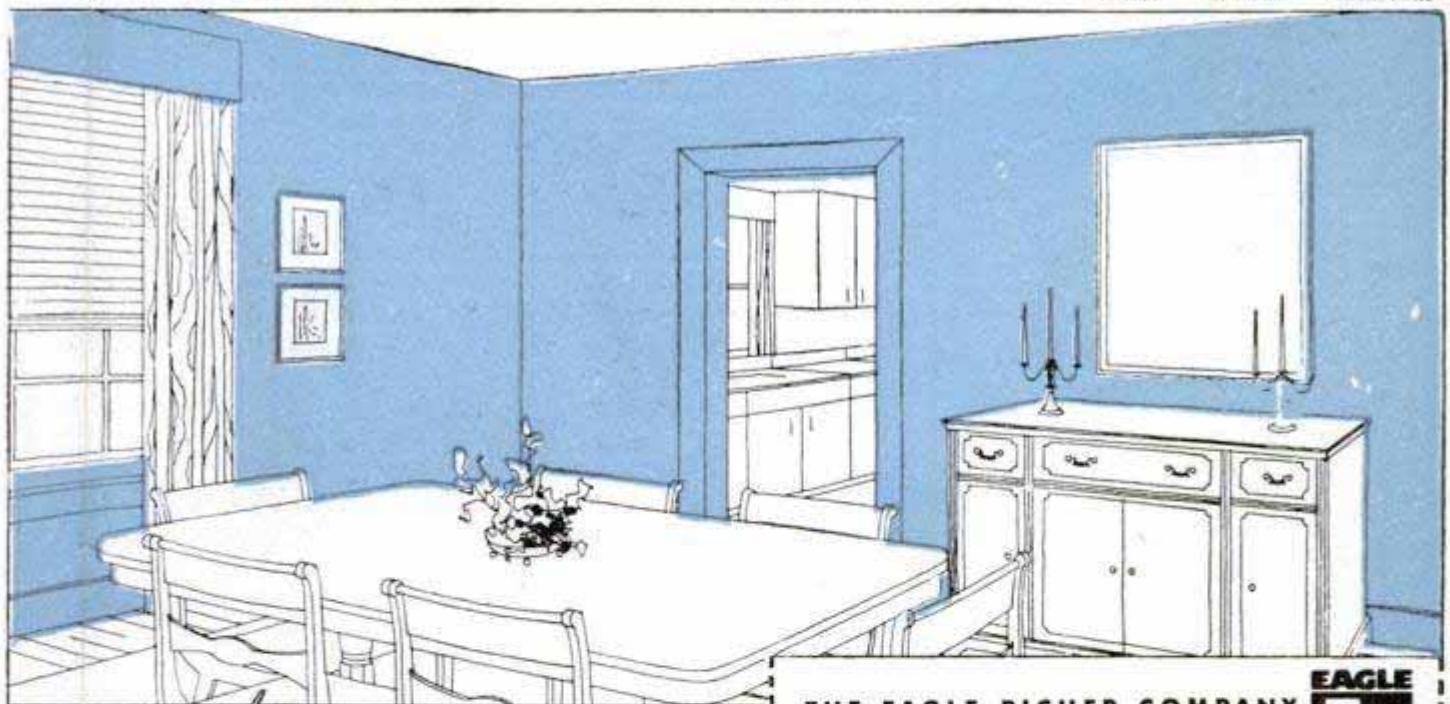

See your local dealer or
mail this coupon today! ➔

**Get out the crayons,
Color it yourself!**

See how this one shade of decorator paint harmonizes with the colors in your own furniture, drapes, rugs.

THE EAGLE-PICHER COMPANY
Cincinnati (1), Ohio, Department PM-69
Makers of Eagle White Lead Since 1843



Please send me, without obligation, your
booklet, "Helpful Hints on Interior Painting."

Name _____

Address _____

City _____ Zone _____ State _____

DINGHIES,
CANOES,
AUTO-TOP BOATS



FISHING AND
FAMILY BOATS

EVINRUDE
POWERS THEM ALL!

RUNABOUTS
AND SPEEDSTERS



CRUISERS AND
HOUSEBOATS

CHOOSE EVINRUDE—for finer performance on *any* boat! Choose from the line that's *really complete* . . . "singles"—"twins"—and thrilling four-cylinder models . . . 1.5 to 50 certified horsepower . . . a motor that's *right* for every type of hull! Only Evinrude gives you the revolutionary FISHERMAN DRIVE that lets you power over snags, rocks, shoals—through reeds and thick weed beds—"wherever there's water to float your boat." SEE YOUR EVINRUDE DEALER! Look for his name under "Outboard Motors" in the yellow pages of your phone book. Catalog FREE . . . write today. EVINRUDE MOTORS, 4335 N. 27th St., Milwaukee 9, Wis.

In Canada: Evinrude Motors, Peterboro, Ontario.



EVINRUDE

FIRST IN OUTBOARDS • 40th YEAR

closed position, adjust the iron core in the mounting end of the oscillator coil until a station around 600 kc. can be received. After making this adjustment, the locknut on the oscillator-coil adjusting screw should be tightened. Now, without changing the setting of the tuning condenser,

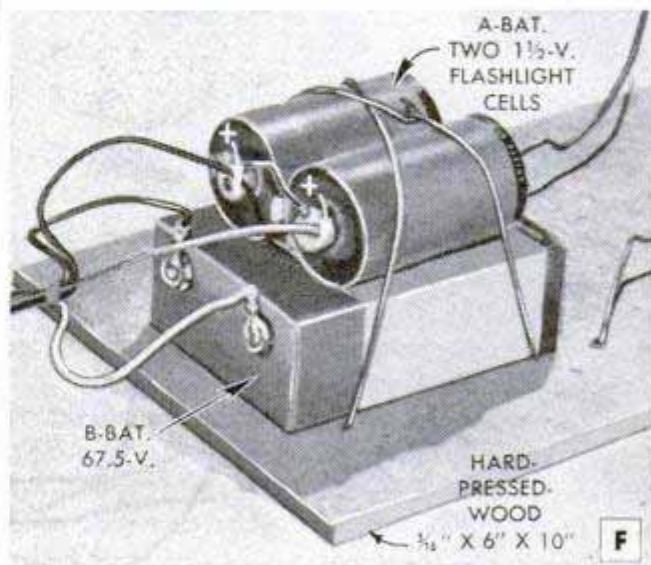

adjust the iron core in the antenna coil for maximum volume; lock the antenna coil core in this position with cement, or by tightening the locknut if one is provided. The next step is to turn the tuning-condenser plates out until you can tune in your highest-frequency local broadcasting station. With an insulated screwdriver, adjust the trimmer condenser C1 on the antenna section of the tuning condenser for maximum volume. This is the section with the largest number of rotor plates. In the event that the station on the extreme high end of the band cannot be received, the trimmer condenser on the oscillator section C2 of the tuning condenser should be loosened until this station is received. The I.F. transformer is factory-set and no adjustment should be necessary. However, it may be found that a slight adjustment will increase the volume. Adjustment of the I.F. transformer should be made only after all other adjustments have been made and the receiver is operating properly. In the preliminary tune-up, or if the set does not operate, do not change the adjusting screws on the I.F. transformer. Once the factory setting of the I.F. transformer is lost, it will be impossible to align this receiver without the use of a signal generator. Lack of operation is an indication of a wiring error, or a defective part.

In some cases where a long outdoor antenna is employed, the ground connection is not necessary. Detailed student material list R-378 is available from Popular Mechanics Radio and Electronics department upon receipt of ordinary letter postage.

6.6 to 1

17.4 to 1

4.11 to 1

58 to 1

1.36 to 1

15.44 to 1

1.83 to 1

1.405 to 1

Every little ratio has a meaning of its own

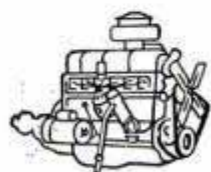

Compression ratio has been increased to a new high (6.6 to 1) in the 1949 Chevrolet valve-in-head engine—the ninth increase since 1925, when it was only 4.33 to 1, each increase meaning better efficiency. Today, in their search for higher power plus better fuel

economy, other manufacturers are following Chevrolet's lead and adopting the valve-in-head principle. Six makers have it in 1949; only three had it in 1941. . . . Other ratios also are important to top performance and ease of operation. Thus, the 1949 Chevrolet



steering ratio (17.4 to 1) assures easy control . . . and a new braking ratio (1.36 to 1) between front and rear permits faster stopping, without sliding the rear wheels. These and other ratios—such as transmission and final-drive gears, starter to engine, fan and generator speeds—have been worked out to a nicety. The result is a new high in Chevrolet's traditionally outstanding qualities—performance, economy, comfort, ease of control—and a new high in value and satisfaction to the owner.

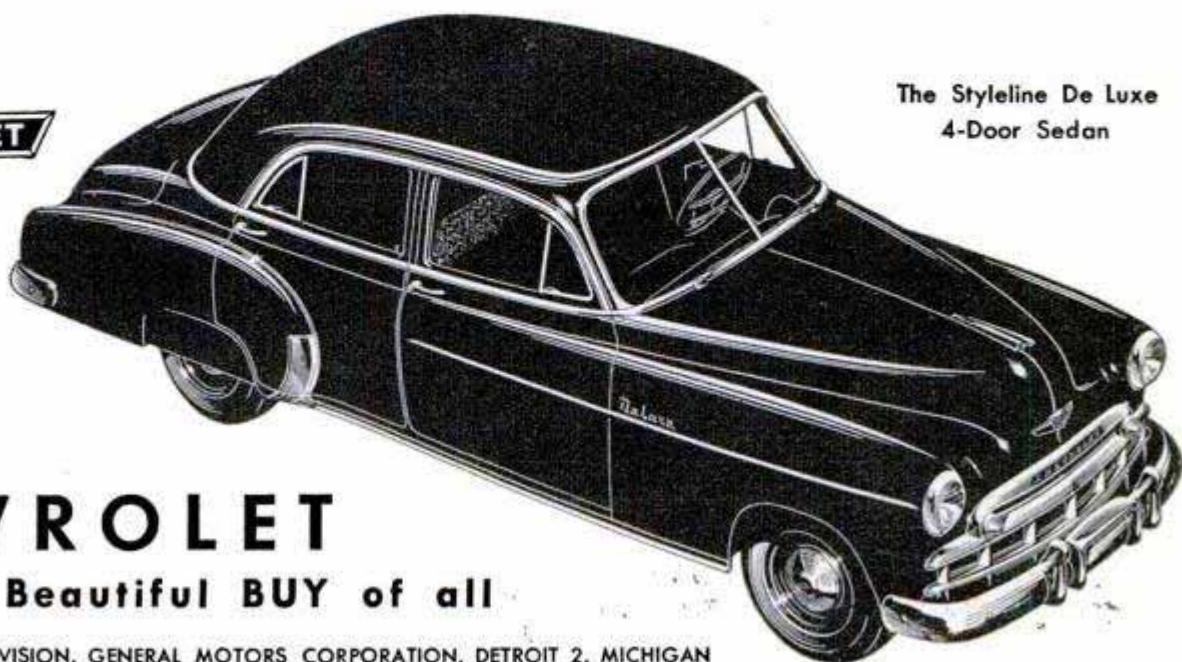
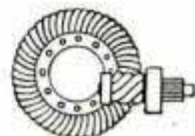

The Styleline De Luxe 4-Door Sedan

CHEVROLET

The most Beautiful BUY of all

CHEVROLET MOTOR DIVISION, GENERAL MOTORS CORPORATION, DETROIT 2, MICHIGAN

How to Tempt a Fish

(Continued from page 104)

Big tuna are tough. They have a habit of heading for the bottom when exhausted and only fairly heavy tackle can bring them to the boat. They make no spectacular leaps when hooked; every bit of their abundant energy is turned to racing speed.

Throughout the years the broadbill swordfish, first caught on fishing tackle in the Catalina area, remains the highest trophy of them all. These fish are rare and seldom inclined to strike when found. They are powerful and swift, occasional leapers. Their mouths are soft and difficult to hold a hook in. In all the years of fishing in all the waters of the world, less than 350 have been caught by anglers. Like spearfish, the swordfish is caught by using the drop-back method. The average fish is somewhere between 300 and 400 pounds but the record, from the Humboldt Current where it presses close to the steeply rising shores of Chile near Tocopilla, weighed 860 pounds.

The flounder fisherman with his simple tackle and his one-pound catch shares a thrill with a record-holder and his giant fish. The flounder, often called fluke, is one of the best eating fish and therefore is most popular with summer fishermen.

Flounders often hit a trolling feather jig

but mostly they go for a hardhead minnow. The fluke lies in the sand at the bottom and when a minnow passes by he streaks after the bait.

Although you can catch fluke while still-fishing with cut bait, by far the most interesting way is with a live bait that is moving. It requires a two or three-ounce sinker and a 1/0 or 2/0 hook. When a fluke strikes, the tugs are sharp and he has enough flap in his system to come in fighting at the boat.

One of the most popular ways to fish for flounder is drifting, using a cork that drifts with the tide.

Flounders are abundant from Massachusetts to the Carolinas, wherever the inlets have a sandy bottom. They are a light-tackle sport fish and anglers use a bay rod or a bait-casting rod, a 1/0 reel and a nine-thread line.

The weakfish is perhaps the most popular of the small sport fishes along our Atlantic coast. Thousands of anglers catch weakfish in New York, in Peconic Bay, in Gardiner Bay, off the Jersey coast, in Delaware Bay and as far south as Cape Hatteras, N. C.

The spotted weakfish is most plentiful from Virginia south to Florida, especially off Sea Island, Georgia, Jacksonville Beach, in the Indian River and off Melbourne.

(Continued to page 244)

FAVORITE SALT-WATER FISH

FISH	BEST GROUNDS	BEST SEASON	METHODS FOR CASTING AND LURES	AVERAGE WEIGHT	RECORD
Striped bass	Maine to the Carolinas; northern California to Washington	May 1 to Nov. 15	Still fishing; surf casting with metal squids or feather jigs; trolling spinner baited with worms; casting large plugs	2 to 20 pounds	73 pounds
Bonefish	Shallow, quiet waters of tropical seas, Florida Keys, Cuba, Bermuda, Hawaiian Is.	All year	Fly fishing with streamer-type shrimp fly; casting with surface plugs; live shrimp, hermit crab, finny crab, squid	2 to 8 pounds	16 pounds
Tarpon	Gulf of Mexico, up rivers in tropical waters, east coast of Florida	January to September	Still fishing with live crabs, mullet, sea robin; trolling with big plugs, spoons, some streamer-type flies	60 to 90 pounds	247 pounds
Sailfish	Gulf Stream, west coast of Mexico, Panama, Gulf of Lower Calif.	Atlantic, Dec. to May; Pacific, Jan. to Oct.	Trolling with cut strip mullet	Atlantic, 35 to 40 pounds; Pacific, 75 to 100 pounds	Atlantic, 106 pounds; Pacific, 221 pounds
Blue marlin	Cuba and West Indies	Off Bimini, Feb. to June.	Trolling with whole bonito, mackerel and bonefish	200 to 450 pounds	737 pounds
Tuna	Waters of the world	Off Cat Cay in April; Nova Scotia and California, summer months	Trolling with fresh bait, feathered jigs, strip bait, herring and mackerel	10 to 200 pounds	927 pounds
Swordfish	Off New York, Mass., Calif., Nova Scotia, Turkey and Chile	Atlantic, July to Sept.; Pacific, Aug. to Oct.	Trolling with cut bait, whole mackerel or squid	200 to 300 pounds	860 pounds
Summer flounder	Sandy bottoms from Mass. to the Carolinas	May to Nov.	Still fishing with live or cut bait; surf casting; sandworms, clams, night crawlers	1/2 to 4 pounds	19 pounds
Weakfish	New York to Florida	South Atlantic, January to June; north Atlantic, July to October	Shrimp or worms; casting small plugs, spoons, zaragossas; squid, sandworms, shedder crab; flies	1 to 6 pounds	17 1/2 pounds
Pacific salmon	Large rivers of the Northwest	June to Oct.	Trolling, "mooching," still fishing, casting; spoons, plugs, herring	10 to 25 pounds	83 pounds

The thrill
of a lifetime...



Riding a World Champion
HARLEY-DAVIDSON
with the **HYDRA-GLIDE FORK**

"You ain't seen nothin' . . ." in motorcycling 'til you swing aboard this Harley-Davidson HYDRA-GLIDE streamliner! Man! What performance! You take off like a "jet job", skim over rough roads like a flying cloud, float like a breeze over bumps, steer with finger-tip ease, stop at a touch of the brakes! Even on longest trips you're fresh as a daisy, ever ready for more fun as you take in exciting race meets, endurance runs, hillclimbs, gypsy tours, and wonderful vacation trips. Whether you're an oldtimer or a newcomer, if you're looking for the greatest thrill in the world's greatest sport . . . *this is it!* One ride will convince you. See your dealer today. Mail the coupon now!

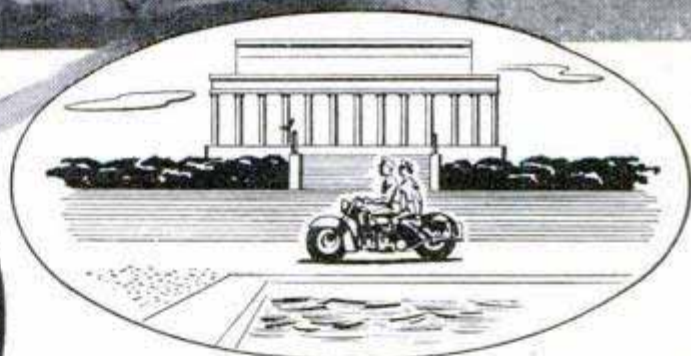

HARLEY-DAVIDSON MOTOR COMPANY
Dept. P, Milwaukee 1, Wisconsin

Send free copy of **ENTHUSIAST** magazine, filled with motorcycle action pictures and stories; also literature on latest models.

Name.....

Street or R.F.D.....

City.....Zone.....State.....

Now it's **EASY**
to have modern
oak floors

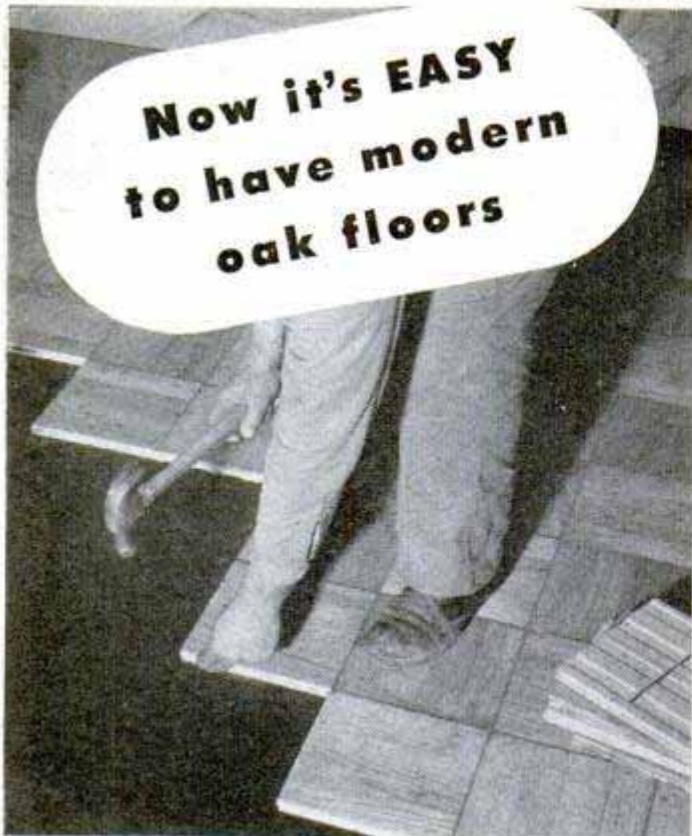

Your choice of block or strip design

Just lay prefinished Bruce oak flooring right over your old floors...no sanding or finishing

You can give your home new beauty at low cost with a prefinished Bruce Hardwood Floor. Completely finished—even waxed—at the factory, this highest quality oak flooring can be nailed right over old floors. No sanding or finishing...no mess or smell. Ready for use as soon as laid. Made in strip or block (parquet) design.

"Scratch Test" Finish — The Bruce factory-applied finish is baked into the pores of the wood. The "Scratch Test" (left) will prove to you that this durable finish does not scratch or chip or mar like an ordinary floor finish.



Moderate in cost — A new Bruce Hardwood Floor will cost you less than a good rug or carpet. Easy to keep clean and beautiful, too. It's just the thing to use in fixing up or adding a room. Let your lumber dealer give you an estimate. Mail coupon below for colorful literature.

MAIL FOR FREE LITERATURE

E. L. Bruce Co., Box 397-M, Memphis 1, Tenn.
Send complete information on prefinished Bruce Hardwood Floors.

Name.....

Address.....

City..... State.....



Bruce Hardwood Floors
Product world's largest hardwood flooring maker

Clinic



for Homemakers

As a service to our readers in solving the hundreds of problems pertaining to a home—inside or out—the editors of *Popular Mechanics* invite you to present your problems to The Clinic Editor for help and advice. Address your questions to The Clinic Editor, *Popular Mechanics Magazine*, 200 East Ontario Street, Chicago 11, Ill.

Objectionable Odor in Newly Papered Rooms

Q—Recently we finished papering our new home and immediately we noticed an unpleasant odor throughout the house. It still persists even though we have used deodorants. We noticed that several spots on the walls in two of the rooms did not dry for several days but finally the dampness disappeared, leaving some discoloration of the paper. What is causing this odor?

R.M.—Sacramento, Calif.

A—It is not possible to say positively what is causing the odor you describe but we suspect that the wallpaper paste is at least indirectly at fault. If moisture was still present in the plaster at the time you papered, it would work its way to the surface. Pastes made with a starch or a wheat or rye-flour base would decompose, or "sour" under this condition, especially if no antiseptics were added or were present in the dry powder at the time of mixing. Some wallpaper pastes also tend to develop an unpleasant odor if they are mixed in solution and allowed to stand overnight before using. The only really permanent remedy for this trouble is to remove all the old paper and paste, allow the walls time to dry out, then apply a wall size and repaper. Use a prepared size and paste and follow the manufacturer's directions carefully when mixing both of these materials.

Lawn Mowing

Q—What is the correct way to mow a lawn? Should the mower blade be set to cut low, about 1 in. or lower, or should it be set to cut the grass 1½ to 2 in. high? Some say that low mowing will help to eradicate weeds. Is this right? R.B. — Grand Rapids, Mich.



A—No, except that low mowing is sometimes recommended when the lawn is infested with crab grass. In this case, low mowing late in the season helps to prevent reseeding of this pest. Good lawns seeded with the common native grasses should not be cut lower than 1½ in. high at each mowing throughout the entire season. If the lawn is rough or ridged in places, set the mower to cut 2 in. high. Exceptions to this rule are the methods of mowing bent grass and certain other lawn grasses grown in the South. The general practice is to mow these grasses quite close during the entire growing season. Special mowers having blades more closely spaced than regular lawn mowers are often used on bent-grass lawns.

(Continued to page 242)

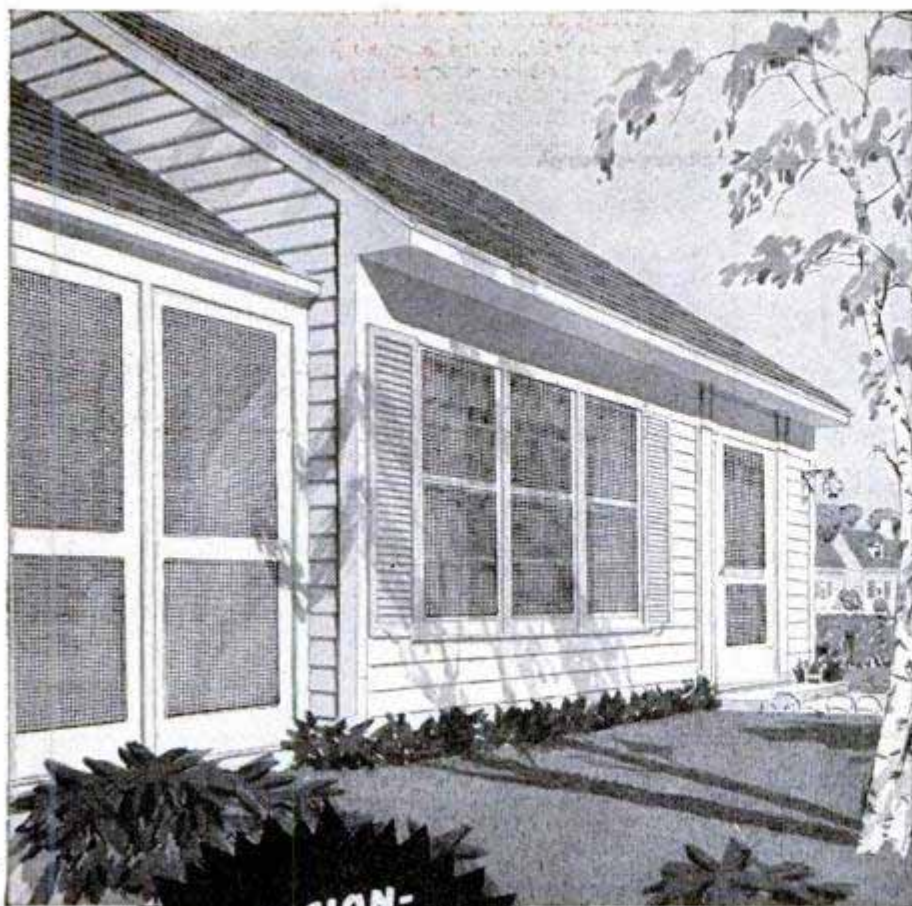

amazing
LUMITE
 screening is
LONGER LASTING
 because
it's rustproof

**CORROSION-
 PROOF
 CAN'T STAIN
 THE HOUSE
 AMAZINGLY
 STRONGER**

Facts for Architects and Builders:

Effects of acids, alkalies and solvents—Essentially none.

Effect of age—Independent scientific tests indicate that LUMITE is more durable than any other type of screen cloth under all climatic conditions that might normally be encountered.

Non-inflammable—Will not support flame . . . is self-extinguishing. Softening point, 240°F.

Tensile strength—Up to 40,000 lbs. per square inch.

Impact strength — Greater than conventional screening.

Installation—Cut with ordinary scissors. Fold edges under one-half inch. Tack or staple the screening smoothly and evenly every 1½". Because of inherent characteristics, LUMITE will gradually draw itself into a snug, firm fit. For correct methods of machine framing, consult LUMITE engineers.

*Registered Trade-mark

Name the enemies of ordinary screening:— salt air and salt fog . . . industrial smoke . . . rain or snow. *Not one of these has any effect on LUMITE.*

Here at last is a screening that can be unconditionally guaranteed never to rust, rot or corrode . . . guaranteed never to stain your house. Yet this new miracle plastic screening costs only 11½¢-12¢ per square foot—little more than the cheapest . . . less than any other quality screening.

It's easy to frame . . . and so strong that when properly framed it will never sag or bulge. Punch it. You'll see it give, then regain its original tautness.

Insist on LUMITE for your new house or when replacing old screens. On sale at leading hardware, lumber and building supply dealers.

For free sample and further information, write Dept. PM-3, LUMITE DIVISION, Chicopee Manufacturing Corporation of Georgia, 47 Worth Street, New York 13, N. Y.

INSIST ON RUSTPROOF



LUMITE

woven saran screening



Lawn Settee

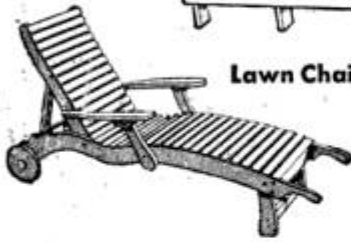

Lawn Chaise



Lawn Chair

SAVE MONEY, HAVE FUN, BUILD LAWN FURNITURE..

with EASI-BILD* Full-size Patterns

You can build this lawn furniture at less than 1/2 the store cost—without special tools or skill! Easi-Bild Full-size Patterns are easy to use. It's the dress pattern idea applied to flat lumber. Just trace, saw, and assemble. And for stronger joints throughout, use CASCOPHEN, Casco's new, waterproof glue.

Copr. 1949, Easi-Bild Pattern Co.

How to choose a glue!

Follow these directions and you'll solve all your gluing problems:



For boats, outdoor furniture, sports equipment—joints that must withstand outdoor exposure—CASCOPHEN (Resorcin Resin Glue). The first completely durable glue available to home craftsmen.



For furniture, toys, heavy-duty home repairs—Use CASCAMITE (Urea Resin Glue) where you want a light-colored or mold-proof glue line. Use CASCOD (Casein Glue) for loose-fitting joints, general heavy-duty jobs. Both easily mixed in cold water.



SEND COUPON FOR FURNITURE PATTERNS TO:

Casco Pattern Dept. PM-69
P. O. Box 215, Pleasantville, N. Y.
Enclosed is for patterns checked below.
() Lawn Chair, Pattern No. 32—25¢
() Lawn Settee, Pattern No. 39—35¢
() Lawn Chaise, Pattern No. 78—35¢
() Pattern book illustrating 94 pattern projects —20¢

Name _____

Address _____

City _____ Zone _____ State _____

THE BORDEN CO. • CHEMICAL DIVISION
Makers of Casco Glues

Plastering Directly on Masonry Wall

Q—I am planning a new brick home and the cheapest wall construction seems to be brick backed by cinder blocks with the plaster applied directly to the inner face of the blocks. However, I'm told that such a wall draws dampness and that the moisture comes from the air in the house; not from the outside or from the ground. I'm wondering, is this information correct?

D.G.—Dallas, Texas.

A—Your informant is correct in stating that moisture will likely condense on walls of this construction. Such walls become cold when the outside temperature falls below that inside the house. Moisture from the air in the room condenses on the cold inner surface of the wall and the process is likely to continue as long as there is a wide variation between the inside and outside temperatures. Masonry walls should be furred with wooden furring strips to gain an air space between the inner wall surface and the back of the plaster. Usually 3/4-in. strips are sufficient, but some builders use strips 1 1/2 and even 1 3/4 in. thick, with a blanket-type insulating material between the strips. Over this they install a vapor barrier and then the lath and plaster. A new plaster base having a backing of aluminum foil is now coming into use in certain types of construction.

Regluing Old Chairs

Q—Some time ago I dismantled several old dining chairs and reglued the joints. For some reason the glue did not hold. Now all the joints in each chair are loose again. Joints are of the mortise-and-tenon type. What's wrong with this job? G.G.—East St. Louis, Ill.



A—You did not say what kind and type of glue you used and this leaves us rather uncertain of the cause. If you used a dry-powder glue, our guess would be that the powder was exposed to dampness sometime during storage. Either that or the glue—any of the dry-powder glues—was not properly mixed. Proportions of the mixture are quite critical and unless one follows the directions explicitly, the resulting mixture is apt to be either too thick or too thin. If the mixture is too thick, it will not bond the parts together at full strength. If too thin, most of the glue will be absorbed by the wood, resulting in a weak joint. There also is the possibility that not enough glue was used to assure an even coating on all the meeting surfaces of each joint. We suggest that you do the job over, using fresh glue carefully mixed in the proportions given by the manufacturer. Make sure there is sufficient glue in the joints so that a small quantity oozes out of the joints when the clamps are drawn up.

Lacquer Lifts Finish

Q—Recently I attempted to refinish an old chest of drawers with colored lacquer. The lacquer set so quickly I couldn't apply it with a brush, but had to use a spray gun. The lacquer wrinkled and peeled only a few minutes after application. What is wrong? C.M.—Kansas City, Mo.



A—There are several possible causes of the result you describe but we think it is likely that you used an industrial-type lacquer containing a fast-acting solvent. This would be practically certain to raise any nonlacquer finish over which it is applied, causing it to wrinkle and peel. You should have used a nonraising lacquer for this job. This lacquer contains a slower solvent and can be applied over most oil-base finishing materials, provided there is no trace of wax, grease, mineral oil or furniture polish on any part of the surface. Of course, you will have to remove all the damaged finish.

DEPENDABLE

CHAMPION

SPARK PLUGS



← America's Favorite

... **WITH THE KIDS, TOO!** When you practically live on motorbikes, scooters, outboards and jalopies—when you'd rather race model powerboats, airplanes or cars than eat—you get to know something about what makes 'em tick, including spark plugs! Today's American kids, many of them engine experts in their own right, use dependable Champion Spark Plugs in vast majority for all their engines. Here again the reason must be better performance . . . and it is! That is why Champion has led in public acceptance for over a quarter of a century. Champion Spark Plug Company, Toledo 1, Ohio

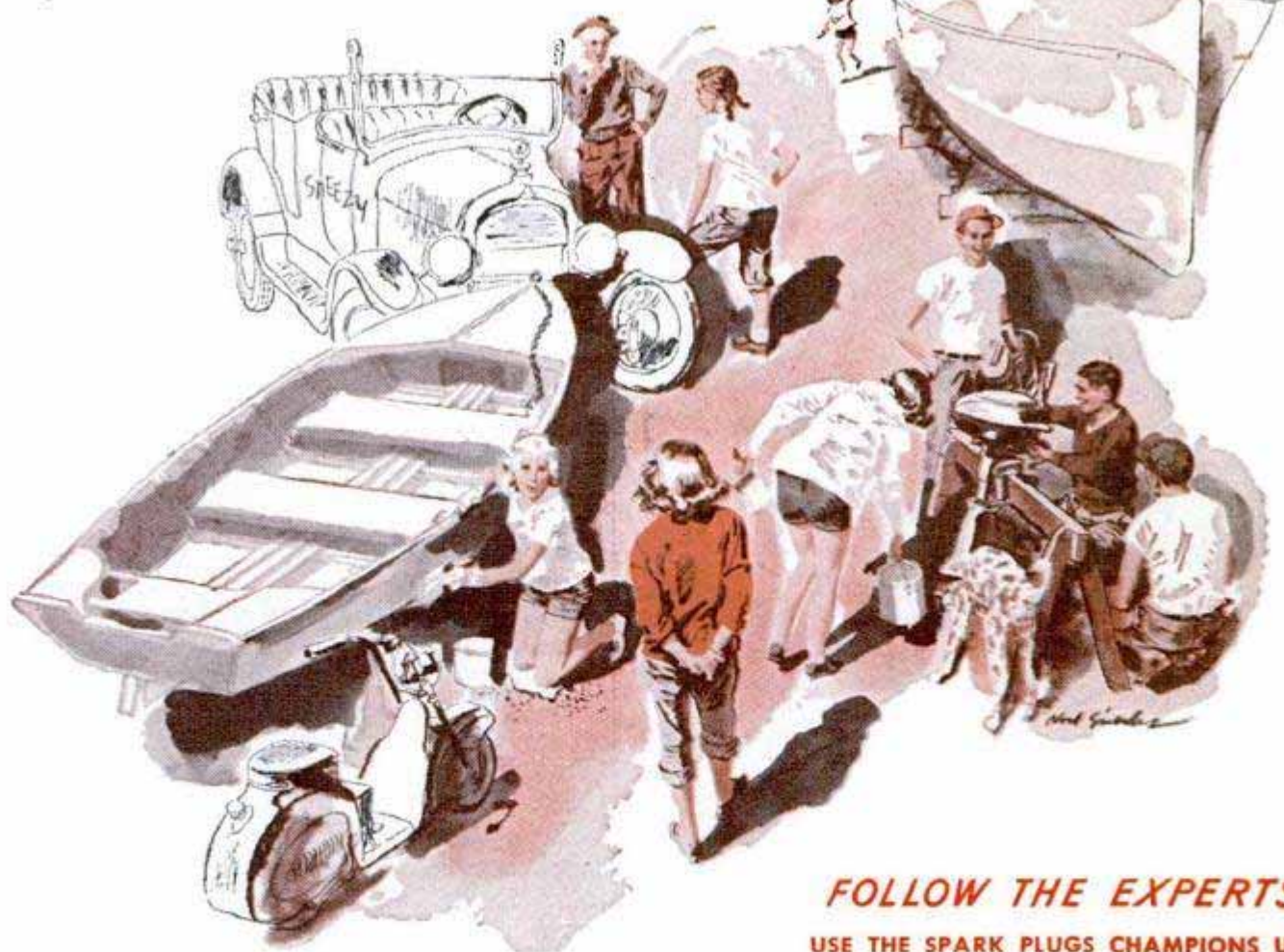

FOLLOW THE EXPERTS

USE THE SPARK PLUGS CHAMPIONS USE!

Listen to the CHAMPION ROLL CALL : : : Harry Wisner's fast sportscast every Friday night, over the ABC network

This die-cast resilient mount, with precision-fit rubber insert, is one reason Hoover Motors run so smooth, so quiet.

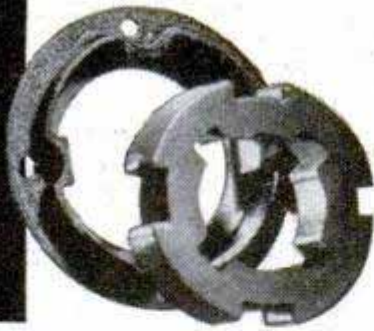

HUSH!

Yes—even under the toughest conditions of continuous operation, Hoover Motors run smooth, quiet, and cool.

Into each one goes the same engineered efficiency that has made the Hoover Cleaner world famous for forty years.

If you use a motor in the $\frac{1}{4}$ to $1\frac{1}{2}$ h.p. range, you need a Hoover Motor. Available at your nearest dealer's in sleeve or ball bearings, rigid or resilient mounts that meet NEMA dimensions.

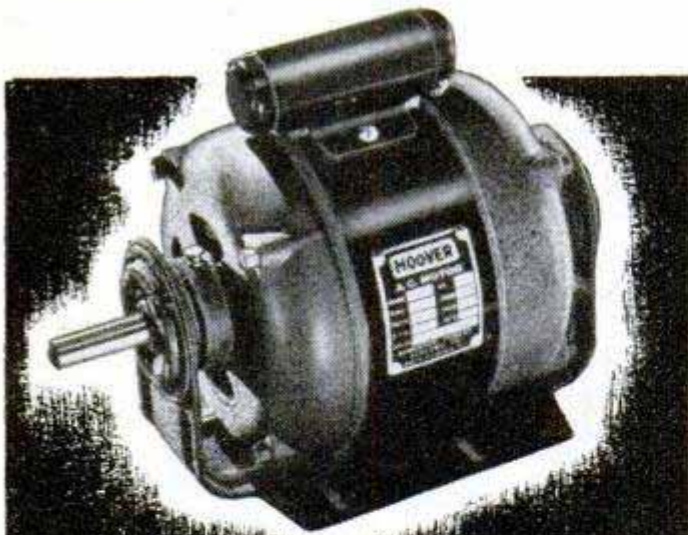

HOOVER MOTORS

Made in capacities of $\frac{1}{4}$ to $1\frac{1}{2}$ H. P.
Product of Kingston-Conley Division,
The Hoover Company, North Canton, Ohio

Light tackle is also used in catching weakfish. Shrimp is the best bait on a very small hook, or you can use a small block tin squid with a worm on the hook. Small fishing plugs are used to catch big ones in Florida waters.

Top fish of them all, in the opinion of New Englanders and of some anglers on the Pacific coast too, is the striped bass. It attracts the special attention of close to a million sportsmen. The range is Maine to the Carolinas, and stripers were introduced in California and are plentiful there.

You catch stripers surf casting, trolling and plug casting. For fly casting you will need a six-ounce rod and a reel that holds 30 yards of fly line and 100 yards of 15-pound-test nylon line or six-thread cutty-hunk as backing. Big streamer flies will attract a striper on a running tide at dusk. Hook a big one and you may still be there at the break of day. The season is May to October.

Trolling requires a rod of 6 to 12-ounce tip and a free-spool reel with 200 yards of 6, 9, or 12-thread linen or nylon line. Troll a spinner baited with worms or an eel-skin rig, or a bass plug, and troll slowly.

If you like surf casting from the beach, then you need surf-rod tips six or seven feet long with a 30-inch butt, a free-spool reel and 200 yards of 9 or 12-thread line. For lures there is a nice variety from metal squids to feather jigs and plugs.

When the stripers are running along the eastern shores, the Pacific salmon are coming in to spawn in the Northwest. The hysteria is about even. The largest salmon is the Chinook, called king salmon in Washington and Alaska, and referred to as Tye salmon in British Columbia. Up the Columbia and other great rivers of the Northwest comes this monster; in August and September the fishermen go in for great salmon derbies. The biggest Chinook ever caught on hook and line weighed 83 pounds.

These great fish are caught while trolling, spinning and mooching. What is a "moocher?" A moocher is a salt-water troller in Puget Sound. A moocher differs from a troller in that he puts out many yards of line, using little weight, and depends on the length of the line and the slowness of the boat to put the bait on the bottom. He rows the boat with short strokes which makes the bait dart on and near the bottom. This often catches the large salmon.

In addition to the fishing in Puget Sound and Campbell River, we like the fishing below Bonneville Dam and also at the mouth of the White Salmon, the Little Salmon River and the Celio Falls district. They go to 40 pounds at Bonneville Dam and the steelhead trout go to 20 pounds and more.

Exclusive Du Pont formula makes car polishing easy



Get a "super shine" with less rubbing!

DU PONT NO. 7 POLISH



Contains
"stroke-saving"
methyl cellulose

For a dry, brilliant shine with less work . . . in less time . . . use DU PONT NO. 7 POLISH. Quickly and easily, it removes dull traffic film . . . produces a glittering new lustre to the finish of your car.

"Stroke-saving" methyl cellulose . . . found only in this patented formula . . . is an impor-

tant ingredient of DU PONT NO. 7 POLISH! It accelerates the clean-up—helps to bring back the original color and sparkling beauty of the finish.

More and more car owners are finding that DU PONT NO. 7 POLISH is the fast, easy way to new-car beauty. Buy it . . . try it *once* . . . and you'll see why!



For Better, Faster Car Washing

. . . DU PONT CAR WASH. Here's a new synthetic detergent that makes car washing a cinch! It cleans away grease, oil and dirt in a jiffy, without harming the finish or a polish job. And you don't have to dry the car. It will drain dry and bright—without streaks or spots.

DU PONT

REG. U. S. PAT. OFF.

BETTER THINGS FOR BETTER LIVING
. . . THROUGH CHEMISTRY

Twelve perfect files in every dozen

—the Nicholson guarantee

Inspecting finished files for straightness . . . one of the many check-ups and tests made at every stage of Nicholson file manufacture.

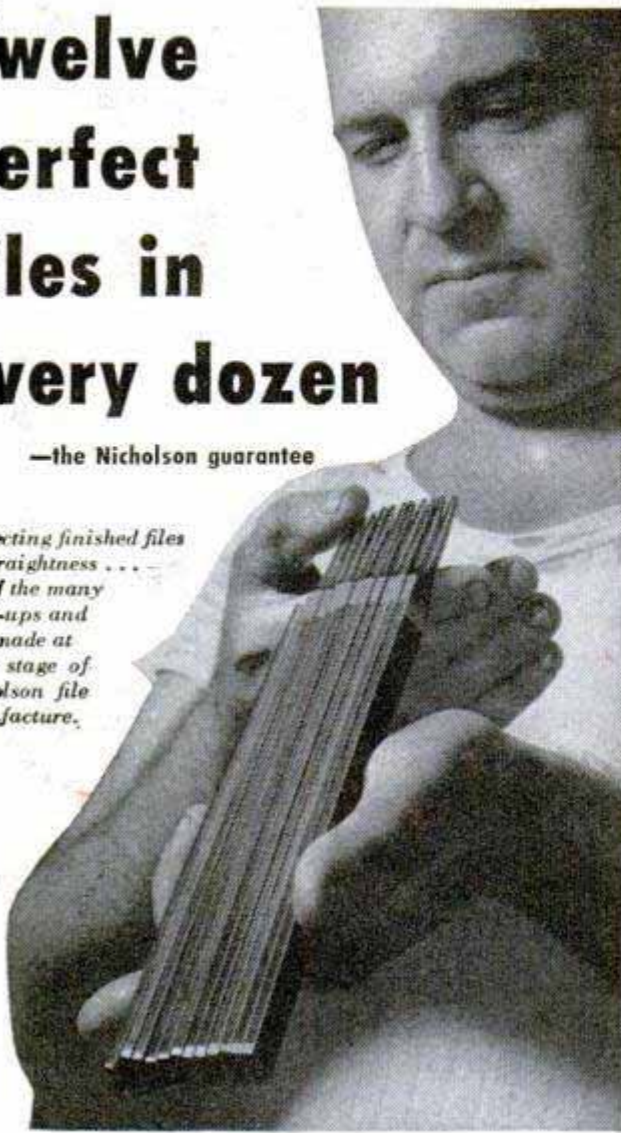

We have to make good files or we could not make good on that guarantee. A "perfect" file is one which in practical use does the best job that is possible through being precisely straight, carefully balanced, uniformly hardened, accurately cut (with teeth even in height and sharpness), and made of the finest file steel obtainable.

Nicholson has had 85 years of experience in manufacturing files *exclusively*. Every Nicholson or "Black Diamond" file is designed, made and tested to give you the best file performance, the longest file life, and therefore the most file value. There's more satisfaction in making files that way, because we know there's more satisfaction in using them. As a craftsman you'll agree that makes a lot of sense. At good hardware stores throughout the continent.

• **FREE BOOK, "FILE PHILOSOPHY"** — tells about file kinds, use and care . . . 48 interesting illustrated pages. Post-card request brings you your free copy.



NICHOLSON FILE COMPANY
22 Acorn St., Providence 1, R.I.
(In Canada, Port Hope, Ont.)



NICHOLSON FILES FOR EVERY PURPOSE

Voice of the Prowl Car

(Continued from page 85)

Stand-by receivers are located at each transmitter for use if the main receivers happen to break down.

In addition to its city-wide system, Los Angeles participates in an inter-city police network that links it with communities from Santa Barbara, on the north, to San Diego on the south. A main repeater transmitter on Santiago Peak, in Orange County, picks up messages broadcast to it on its own frequency and radiates them at higher power over the whole region.

Tie-in with other cities in California and with state and other law-enforcement bodies is made by means of a battery of Teletype machines in the communications headquarters. The statewide Teletype system serves about 90 offices, including several located in adjoining states.

For communication with police in other parts of the country, the division uses the transcontinental police radio-relay system, of which Chicago, Kansas City and Denver are main relay points. KGPL is the California terminal of the system. An incoming radiogram that is destined, say, for San Francisco is received at KGPL, Teletyped to the communications center in the city hall, and from there is carried to its destination over another Teletype circuit.

The whole Los Angeles city police radio system is now being converted from AM to FM. Frequency modulation will help reduce noise levels in the receivers and will minimize interference from the numerous medical diathermy machines in the area. It will improve communication, too, when a car happens to move into a radio shadow area. Four mountain ranges, including one with a peak 5000 feet tall, are inside the city limits.

Even when the shift to FM is complete, radio technicians won't consider their system to be perfect. The next step, Fred Crowder says, will be to install radio facsimile equipment in the cars. Instead of listening to a voice and possibly making an error while copying the message, officers will pull printed slips of paper from their receivers, exact records of the commands and information transmitted to them.

Slip-Resistant Enamel

With Vinylite resins as a base, a new enamel for concrete, metal and wood floors has worn at least twice as long as other enamels in tests. It provides a slip-resistant surface that can be cleaned with soap and water. The coating dries fast and can be applied with brush or spray.

Only **AUTO-LITE**

**OFFERS CAR AND TRUCK OWNERS EVERYWHERE
THE SENSATIONAL ADVANTAGES OF A**

Resistor Type **SPARK PLUG**

Now standard equipment
on leading makes of
cars and trucks



Get these 4 Star Benefits

- ★ **A SMOOTHER ENGINE IDLE**
Wider spark gap helps eliminate occasional missing.
 - ★ **IMPROVED GAS ECONOMY**
Permits burning of leaner mixtures and reduces misfiring.
 - ★ **INCREASED ELECTRODE LIFE**
Up to 200% and more.
 - ★ **IMPROVED RADIO RECEPTION**
Reduces plug interference with radio, radar and television within 35 mv/m from 540 kc. to 150 mc. at 50 ft.
- ★ Because of its low rate of electrode erosion, the new Auto-Lite Resistor Spark Plug permits wider initial gap settings and makes these advantages possible.

ACCLAIMED BY CAR OWNERS COAST TO COAST!



OWN YOUR BUSINESS

Start in Spare Time with a FOLEY SAW FILER

Here is a steady repeat CASH business you can start at home in your basement or garage, while you are working at your regular job. No experience is necessary to turn out perfect cutting saws—"the first saw I sharpened came out 100%. I think the Foley Saw Filer is a marvel of perfection," writes Clarence E. Parsons. Every saw you sharpen will bring you new customers. You will find you can make up to \$2 or \$3 an hour—\$20 to \$30 a week in your spare time as a starter.

With a Foley Saw Filer you can file all hand saws, also band and cross-cut circular saws. It is easy to operate—simple adjustments—no eye-strain. Patented jointing principle evens up all irregular teeth and makes an old saw cut just like new.

This Free Book Shows How to Start

"INDEPENDENCE AFTER 40!" shows you how to get plenty of saws to file without canvassing, and how you can develop into a general repair shop that will be your own business. This is a helpful, practical book that tells just what to do—send for your free copy today.



Send For FREE BOOK

FOLEY MFG. CO., 616-9 Foley Bldg.,
Minneapolis 18, Minn.

Send me free book "INDEPENDENCE AFTER 40!"

Name _____

Address _____

Twist, Stretch and Smash, Inc.

(Continued from page 169)

diapers passed the test with flying colors—mostly blue.

The bacteriological laboratory has a number of functions, one of which is to cause its women staff members to break out in rashes. If a fabric or material which is to be worn or handled is suspected of toxicity, a small piece of it is fastened to the arm of one or more girls. If skin irritation follows, it gets a very low rating. Baby foods, candy, food wrappers and plastic dishes are among the many items checked.

This section performs such tasks as checking foods and medicinal preparations for vitamin content and bacteria, and it also sniffs scientifically at a variety of things. Its osmometer measures the intensity of odors in cosmetics, textiles, foods, plastics, insecticides and deodorizers.

The detergent laboratory, in addition to testing cleaning agents for a number of characteristics, is probably one of the few agencies which produces standard soiled fabrics. Carbon black and other efficient dirtying agents are precisely introduced into the material, giving it a superb tattle-tale-gray shade, which serves as a yardstick during the subsequent laundering.

Laminates, plywoods and plastics are tested by a 50-ton press in the plastics lab. Here also aircraft cameras are tested at 100 degrees below zero Fahrenheit.

Heavy hemp hawsers are broken under pulls of as much as 200,000 pounds and concrete blocks collapse under tremendous pressures. In the ultrasonics department, normally incompatible fluids are mixed in a transducer while being shaken at 400,000 cycles per second.

Much of the UST work is done for large companies, which never publicize the results. One firm had an electric appliance tested, not only by the laboratory, but by 25 housewives, serving as a consumer panel for UST. The women found everything wrong with it and the technicians rated it twelfth in the field of such appliances. The company re-engineered and re-designed it and it is now a satisfactory and fast-selling product.

Highest accolade of the company is its seal of certification, placed on products after rigid examination of the materials and of the process of manufacture, with periodic tests being made of the product as taken from the production line and from regular commercial outlets. Twenty-six manufacturers now use the seal and applications are under consideration from about 15 others.

ANNOUNCING MODEL "L"

30% More Power

Lowest Price for this type of machine in our 15-year history

Thousands of men, both in the cities and in the country, have discovered that Servi-Cycle is the right answer to the problem of getting to and from work—or wherever you want to go, day or night—quickly, safely, comfortably, dependably, and economically. When you ride a Servi-Cycle, you ride *all* the way, and you take the shortest route. This light, safe, easy-to-handle powercycle takes you along the open road or through city streets with amazing ease.

Traffic studies show that Servi-Cycle cuts bus-travel time in half. On busy streets, Servi-Cycle is faster than an automobile. By saving travel time, "The Servi-Cycle Way" adds many minutes to your day.

RIDE TO WORK



ON A

**SAFE
DEPENDABLE**

NEW LOW PRICE

\$248⁰⁰
Delivered
Anywhere in U.S.A.

**U.S.
TAX
PAID**

ECONOMICAL

Servi-Cycle costs only a fraction of a cent per mile to operate. Many thrifty car owners go to work daily on a Servi-Cycle, and leave their more-expensive-to-operate automobile at home. With a Servi-Cycle, parking is not a problem . . . The New Model "L" Servi-Cycle—acclaimed "The World's Best Powercycle"—incorporates many refinements that have resulted from 20-years of engineering research and powercycle production. Material and workmanship are guaranteed.

OUTSTANDING FEATURES

- 30% More Power
- Three-Speed Foot Shift
- Balanced "V" Drive
- Twist-Grip Controls
- Double-Action Fork Springs
- Aluminum Cylinder
- "Kwick-Klean" Air Cleaner
- Dependable Kick Starter
- Quiet, Efficient Muffler
- Super-Safe Brakes
- Sponge-Rubber-Filled Saddle
- Sturdy Safety Guards
- Safety Parking Stand
- Low Center of Gravity
- 100 Miles Per Gallon

SIMPLEX MANUFACTURING CORPORATION

540 N. Carrollton Ave., Dept. "L," New Orleans 19, U.S.A.

Please mail me FREE folder telling all about Servi-Cycle; also the name and address of nearest Servi-Cycle Dealer.

Name _____

Street _____

City _____ State _____

LOWEST PRICED COMPLETE POWERCYCLE

Greenlee Chisels

WITH HARD-WEAR HANDLES

FOR FAST, ACCURATE WORKMANSHIP...

New for you... GREENLEE Socket Chisels with handsome, transparent and tough Hard-Wear handles. Beauties to look at. Beauties to hold with their correctly shaped handles of special hand-fitting design. And beauties to work with. For, they are in perfect balance and have those fine, bevel-edged GREENLEE blades so long the choice of true craftsmen. See your dealer for these fine new chisels. And remember, to get top quality always, get GREENLEE.



TOOLS FOR CRAFTSMEN

GREENLEE



SPECIAL OFFER... ONLY 10¢ FOR HANDY WOODWORKING CALCULATOR

Quick solutions to countless woodworking problems. Just set dial: convert linear feet to board feet; compare characteristics and workability of various woods. Also shows bit

sizes; nail specifications; tool sharpening hints; etc. Heavily varnished cardboard, 6" diameter. Send 10c to Greenlee Tool Co., 2106 Columbia Avenue, Rockford, Illinois, U. S. A.



The Bay Bridge Is to Have a Twin

(Continued from page 128)

of materials. Surfaces are first steam-cleaned and are also sandblasted where necessary. Two coats of lead paint are applied, then a finish coat of aluminum. Ninety percent of all painting is done with hand brushes because the wind might spread sprayed paint over passing cars.

Besides the plans for the new bridge, test borings and engineering details have also been completed for the proposed southern crossing. Instead of a high-level bridge under which ocean ships could pass, this crossing would consist of long trestles stretching out from either shore and joined by three parallel 6200-foot-long underwater tubes, each containing a two-lane highway. The idea is practical because the bay is relatively shallow at the site that has been selected.

The tubes would be buried in the bay bottom and would present no obstacle to shipping, nor would they interfere with flying-boat operations at the adjacent Alameda Naval Air Station. At each end of the underwater portion of the crossing a great artificial island would be built of sand to support ventilation and shop buildings and other structures.

To prepare a foundation for the tubes and for the sand islands, the existing mud bottom will be trenched to a depth of 70 feet, some 120 feet below sea level. This trench will be partly filled with a sand foundation and at its ends the sand will be built up above sea level to form the artificial islands. Tops of the islands will be some 134 feet above the bottom of the excavation and their sloped sides will be protected from wave and tide action by thick layers of waste quarry rock.

Each of the tubes will be 37 feet in diameter. The lower portion of each tube, under the roadway, will serve as a fresh-air duct, with a similar duct over the roadway ceiling for carrying off exhaust air.

The tubes will be built of reinforced concrete. The plan is to precast them in 200-foot sections in a convenient dry dock, then bulkhead each 5200-ton section at its ends and tow it to the site. Each section would be sunk into place by admitting water through a sprinkler system onto a thick layer of sand placed temporarily on the roadway. This technique would hold the water in place and avoid any shifting of balance during the sinking process.

The ends of the tubes would rest on precast reinforced concrete slabs previously placed in the trench and the slabs in turn would each be supported on 68 huge timber

(Continued to page 252)

YOU CAN LICK

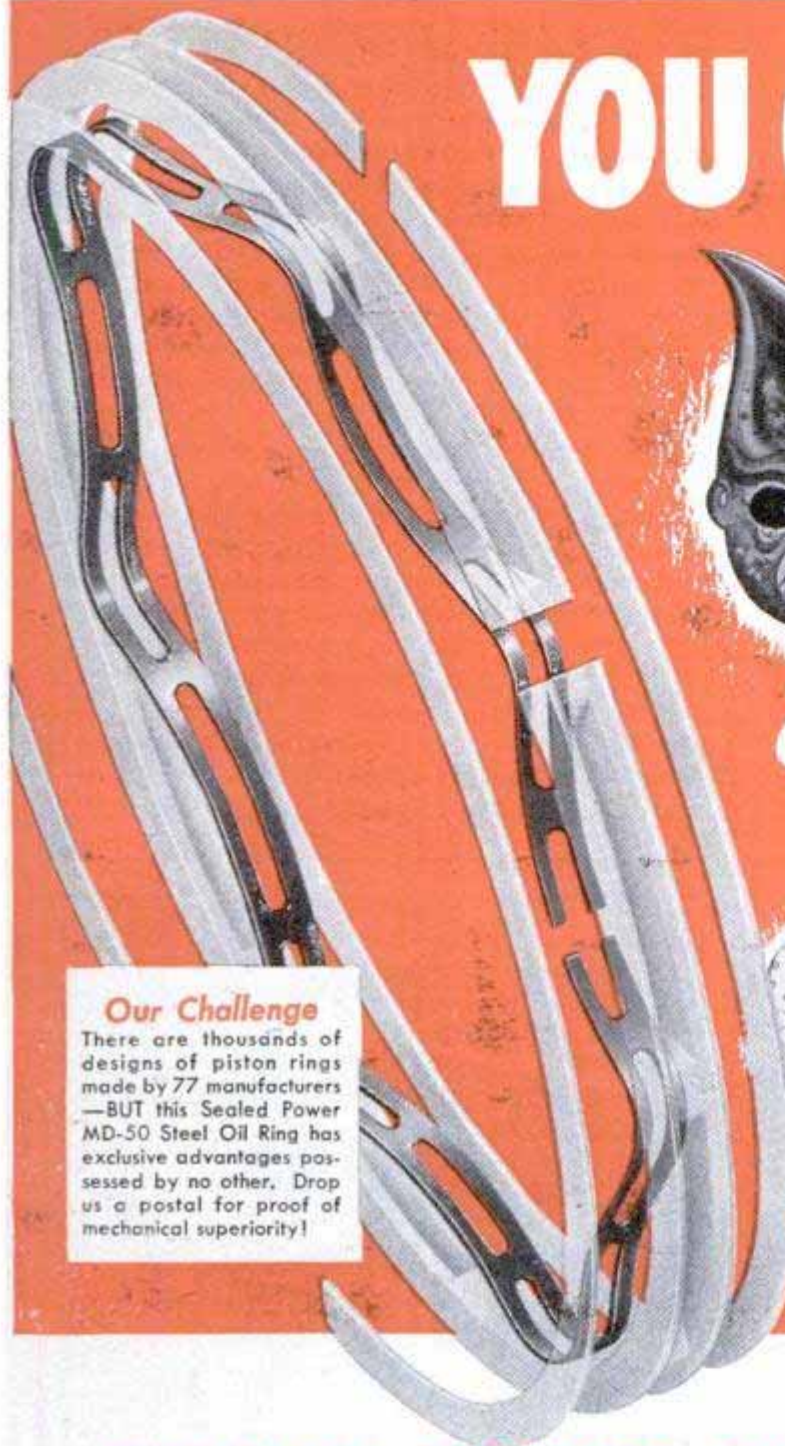

Oil Waste



Gas Waste



and Failing Power



Our Challenge

There are thousands of designs of piston rings made by 77 manufacturers —BUT this Sealed Power MD-50 Steel Oil Ring has exclusive advantages possessed by no other. Drop us a postal for proof of mechanical superiority!

SEALED POWER PISTON RINGS

Save Oil, Save Gas, Seal Power!

This great 4-piece Sealed Power Piston Ring can give your present car, truck or tractor 1949 pep, 1949 economy! It is the only piston ring with the exclusive Sealed Power Full-Flow Spring. All over America, it has helped thousands of car owners to end oil and gas waste and to restore original power. Ask your Sealed Power Dealer for the whole story!

Mail a postal card today for proof to back up our challenge! At the same time we'll send you our new illustrated booklet on 7 ways to save oil. It's free, and may save you real money. Sealed Power Corporation, Dept. G-6, Muskegon, Michigan.

Ask for Sealed Power Pistons, Cylinder Sleeves, Valves, Water Pumps, and Chassis Parts.

There is a Sealed Power Set specifically engineered for your car, truck or tractor—whatever the make, model, or engine condition!



Sealed Power
PISTON RINGS
BEST IN NEW CARS! BEST IN OLD CARS!

Great News for
FISHERMEN!

Shakespeare
WEXFORD
A WONDER LINE

...WEARS
up to 3 TIMES
LONGER



Averages
7 TIMES
MORE WATER
RESISTANT



Yes, of 10 other leading lines tested impartially, Shakespeare WEXFORD proved *much longer wearing, much more water resistant* . . . proof Shakespeare manufacturing experience and special processing have produced the finest nylon line ever made! Casts better, saves you money. Fishermen agree. You will, too. Get it at your sports store—ask for it by name.



FREE 1949 TACKLE BOOK
and Pocket Fishing Calendar.
Newest in Reels, Rods, Lines,
Accessories, Fishing Tips.
Write Shakespeare Co., Dept.
PM-6, Kalamazoo 2, Mich.



Shakespeare
FINE FISHING TACKLE
HONOR BUILT FOR OVER 50 YEARS

WORK GLOVES

Riegel
**WORK
GLOVES**

Riegel makes the
right glove for
every job.

Riegel Textile Corp.
342 Madison Avenue
New York 17, N. Y.



"THIS TRADE MARK IS YOUR GUARANTEE OF VALUE"

piles driven down through the sand and into the clay bottom. Special means have been devised for joining the sections of the tubes so as to provide a watertight seal during the time that they are being permanently connected with concrete and steel. After the tubes are completed, they will be covered by a five-foot layer of sand plus an additional five feet of waste quarry rock. The southern crossing and its approaches, it is estimated, will cost about 178 million dollars and will require 5½ years to build.

One of the problems connected with both the parallel bridge and the southern crossing will be to provide extensive distribution highway systems for conducting traffic to and from the crossings. The planned road systems will be in the nature of elevated freeways that will tie in with the super-highway systems that are now under construction on both sides of the bay. The approach systems will also include elevated roadways that will lead direct to various points on each side of the bay.

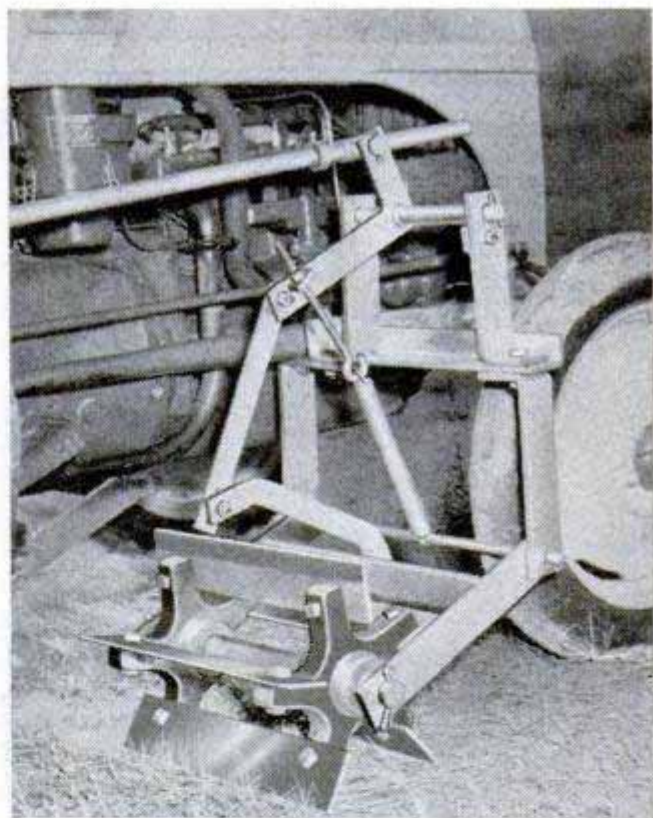

Double-Row Stalk Cutter

Invented by a Texas farmer who had difficulty getting enough help and gasoline to run his farm during the war, a double stalk cutter has two rotary blades, one being mounted behind each of the tractor's front wheels. The cutter chops two rows of stalks at a time and turns them under. The Texan is now manufacturing a universal model that will fit any tractor.

Snap-on's

Blue-Point Supreme

Open End Wrenches

are unequalled for strength,
toughness and
fatigue-resistance

Here are the eight superior qualities that make them the finest tools money can buy: 1. Thinner heads. 2. Narrower jaws. 3. Precision machined openings. 4. Greater strength. 5. Lighter weight. 6. Balanced design. 7. Sure-grip handle. 8. Finest alloy high carbon steel, heat treated from skin to core.

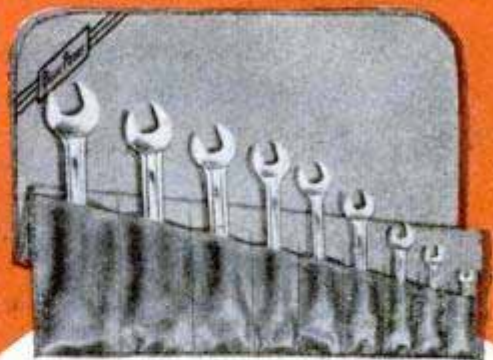

Blue-Point Supreme 9-Pc. Wrench Set

\$16¹⁵

In Kit Bag

TOOLS ONLY - - - - \$14.50

Here is one of Snap-on's most popular Open End Wrench Kits. There are 18 different wrench sizes that range from 1/4" to 1 1/4". They solve many of your nut-turning problems.

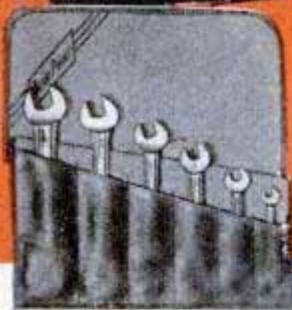

6-PC. WRENCH SET

12 popular wrench sizes on six handles. Sizes from 3/8" to 15/16". No duplication of sizes. In leatherette kit bag - - **\$8.50**

Tools only - - - **\$7.70**

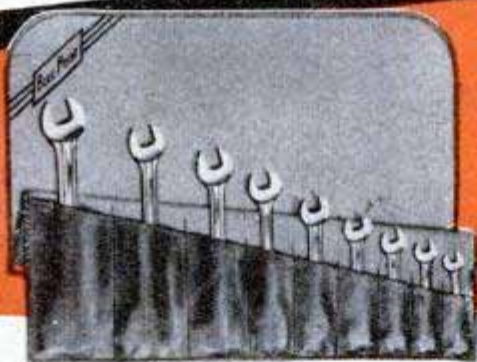

STURDY 9-PC. WRENCH SET

13 wrench sizes with 5 most popular sizes duplicated on different handles. Sizes from 3/8" to 1". In leatherette kit bag, only - - **\$12.75**

Tools only - - - - **\$11.10**

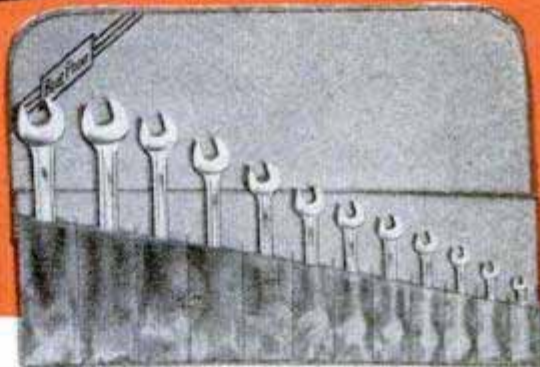

POPULAR 12-PC. WRENCH SET

Full range of sizes from 1/4" to 1 1/8" with 7 most used wrench sizes duplicated on different handles. Complete in leatherette kit bag, only - - - - **\$17.00**

Tools only - - - - **\$15.35**

MAIL THIS COUPON — TODAY!

SNAP-ON TOOLS CORP.

8062-F 28th Avenue • Kenosha, Wisconsin

Snap-on tools are sold only through authorized Snap-on representatives and not available at hardware stores, etc. Use this coupon to order — we deliver from nearest branch.



Enclosed find Check Money Order or Company Purchase Order for the Open End Wrench Kit checked below.

\$17.00 \$16.15 \$12.75 \$8.50
 \$15.35 \$14.50 \$11.10 \$7.70

NAME.....

ADDRESS.....

CITY..... STATE.....

**NOT A
HOLLOW TUBE**

A real filter with
66 baffles inside
to Whirlclean
your smoke



Replaceable
Filters
10 for 10¢

Patented filters in Medico pipes stop flakes and slugs... absorb juices... reduce tongue bite. Smoke goes round and round 66 times... and it comes out clean... cool

MEDICO V. F. Q. (VERY FINE QUALITY)

Rich-grain imported briar Pipes. Wide variety of shapes. With 10 filters \$2

Frank Medico Standard Pipes \$1

Frank Medico Cigarette Holders \$1 & \$2

MEDICO
FILTERED SMOKING

S. M. FRANK & CO., INC., 5th AVE., N. Y. 22

**Have Fun and
Make Money with a
MENDELSON
SPEEDGUN**

* Reg. U. S. Pat. Off.

\$7⁵⁰ and up

Write for bulletin F6

MENDELSON SPEEDGUN CO., INC.
457-461 Bloomfield Avenue • Bloomfield, N. J.



Inhaler-Vaporizer Uses No Steam

Medicated vapor is delivered directly into the nostrils by a combination inhaler-vaporizer that requires no water or steam. Two tubes with plastic tips direct the vapor into the nasal passages. The device can also be used for vaporizing a room by removing the cover and its attached tubes. Heating action of an electric element vaporizes the medicine, such as tincture of benzoin or oil of eucalyptus.

Paper-Plastic Skin for Plywood

Plywood is strengthened and made abrasion resistant by a thin paper-plastic surfacing that is fused to both sides of the panel. The durable skin consists of special paper stocks impregnated with Bakelite phenolic resins. Fused to the plywood at the time it is produced, the surfacing provides an excellent surface for painting and finishing. It has also proved valuable for use as a concrete form material since its water-resistant quality permits it to be reused scores of times.

Ship-Steering Recorder

Even slight deviations from a ship's set course are recorded by a new naval instrument. Developed by General Electric engineers, the recorder automatically traces the ship's course. Connected electrically with the rudder and compass are two metal points in the instrument. A 12-inch roll of waxed paper passes beneath these points. The recorder calculates the deviation from the set course on the moving paper. Engineers report that the instrument will detect an error as slight as .2 degree.

SPECIAL 30-DAY BARGAIN!

Genuine **CRAFTSMAN** Socket Set

REG. U.S. PAT. OFF.

Save \$4.94 during this Sale!



32-PIECE SET
1/2 and 3/4-in. Drive
SEARS REGULAR PRICE \$24.89
Now at this special 30-day offer
ONLY \$19.95*
Post-paid
IN THE UNITED STATES ONLY

Why **CRAFTSMAN** quality is the best you can buy!

FORGED 1/2-inch drive sockets! Costlier to make than usual type sockets, but **25% STRONGER** . . . **25% LIGHTER!** THINNER WALLS . . . fit into tight places easier!



Tapered forged Flex "T" handles! "Live," torque-like spring-effect tells when nut is tight. No stiff, "dead" pull, as in ordinary handles!

Larger tension balls; stiffer springs; grip firmly. Sockets stay on tight, in use!



Ratchet wrench heads and handles forged in ONE-PIECE! Stainless steel ratchet pawl and pin; stronger, longer wearing; **RUST-PROOF!** Will not break off! Reverses instantly; won't trip accidentally!

TRIPLE PLATED, longer lasting finish: chrome over nickel over copper!



GUARANTEED unconditionally against defective materials and workmanship! Any tool not giving complete satisfaction replaced without charge!



Now! Outstanding **CRAFTSMAN** quality, with **FORGED SOCKETS . . . at a real saving!**

A terrific bargain at this special low price! In our belief, it's the finest set you can buy . . . and get such quality and craftsmanship; so many extra-value features! Designed for toughest automotive, aircraft and other professional use. 32-piece set includes: 1/2-in. square drive; ten forged 12-point sockets (7/16 to 1-in.); universal joint; 6 and 10-in. extensions; 9 3/4-in. reversible ratchet; 18-in. speeder wrench; 15-in. flex "T" with crossbar; and heavy duty, 19 3/4 x 6 x 3 3/4-in. steel tool box. 1/4-in. square drive; seven 6-point sockets (7/32 to 7/16-in.); 1/4 and 5/16-in. 8-point sockets; 3 and 6-in. extensions; 5 1/4-in. reversible ratchet; 5 3/4-in. flex "T" with crossbar; 4 1/2-in. slide bar; and 7 x 3 1/4 x 1 1/8-in. steel tool box.

Buy it NOW!

Get it TODAY at your nearest SEARS RETAIL STORE, or order DIRECT from your nearest SEARS MAIL ORDER HOUSE, using coupon at right. See the complete line of famous CRAFTSMAN tools in Sears Big Catalog, or nearest retail store.

ACT NOW! Mail this coupon TODAY to your nearest SEARS, ROEBUCK AND CO. MAIL ORDER HOUSE, as listed below: Chicago 7, Ill.; Philadelphia 32, Pa.; Boston 15, Mass.; Kansas City 14, Mo.; Minneapolis 1, Minn.; Atlanta, Ga.; Memphis 2, Tenn.; Dallas 2, Texas; Greensboro, No. Carolina; Seattle 4, Wash.; or Los Angeles 54, Calif.

Please send me CRAFTSMAN 32-piece Socket Wrench Set, No. 99 C 01199, offered in the United States only, at your special price of \$19.95*, postpaid.

I enclose check or money order for \$19.95*.

*PLUS additional correct amount for Tax on Sales, if required by your State or City.

Name _____

Address _____

City and State _____

Please Print

PM 6

CRAFTSMAN Hand and Power Tools by SEARS, ROEBUCK AND CO.
Famous for fine quality . . . precision performance . . . low price!

What makes the difference?

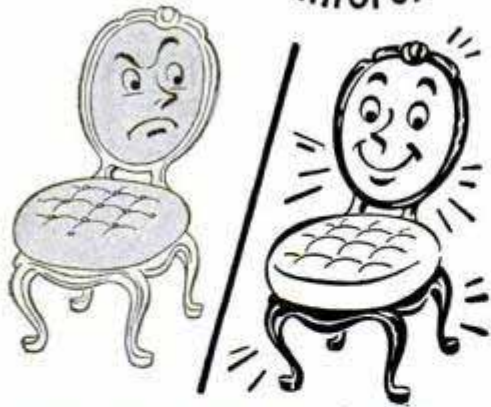

LIN-X

CLEAR-GLOSS VARNISH

Yes, and what a difference! That clear, tough, long-lasting coat of Lin-x Clear-Gloss Varnish protects and beautifies floors, woodwork, furniture, printed linoleum, boats, countless other surfaces—resists boiling water, sizzling cooking greases, alcoholic beverages. *And* so EASY to use—just brush it on!



At your paint, hardware and department store!



Distributed by

Acme White Lead & Color Works, Detroit • The Lowe Brothers Co., Dayton • John Lucas & Co., Inc., Philadelphia • The Martin-Senour Co., Chicago Rogers Paint Products, Inc., Detroit • The Sherwin-Williams Co., Cleveland

IT TASTES BETTER

cooked on an

OUTDOOR FIREPLACE

It's fun to build your own fireplace... choosing your own



ONLY \$17.95 COMPLETE

materials and design! Costs so little! Simply build masonry around this durable, all-metal Model OF-28 fireplace unit. Rugged, cast iron doors. Grates arranged for either charcoal or wood! Size 21" high, 26" long, 13½" wide. Larger size available. See your dealer or send money order or check today. The *Majestic Co.*, 199 Erie St., Huntington, Ind.

SEND FOR THIS BOOK OF DESIGNS 48 pages of helpful tips on fireplace and outdoor cookery. Send 25c for your copy.



Another *Majestic* Product



Lift Truck Forms Broadcast Tower

Radio announcers covering sports events at Gull Lake, Mich., are using an industrial lift truck as a movable observation and broadcast tower. A pallet-type platform is attached to the truck for the announcers. The truck then wheels them from one vantage spot to another and raises or lowers them at will for interviews and a clear view of the sports event.

Science Shivers to a New Low

Brrr! Scientists at Ohio State University have achieved laboratory temperatures as low as .05 degree above absolute zero. They say absolute zero is unattainable. Absolute zero is 459 degrees below zero on the Fahrenheit scale and 273 below, Centigrade. The cooling device which produced this record low is known as a "cryomagnetic generator." The temperatures are so low they must be calculated from variations in an electrical circuit, since ordinary thermometers won't function under such conditions. The new device will help scientists study the atomic nucleus, as almost all molecular and atomic motions are "frozen out" at very low temperatures.

Crude oil is produced in 25 of the 48 states, the leading producers being Texas, California, Louisiana, Oklahoma, Kansas and Illinois, while Pennsylvania—where the petroleum industry began in 1859—ranks 13th.

LOT of REVOLVER for LITTLE MONEY



"922"

Solid Frame .22 Caliber

\$24.75



See the many features of the "922" . . . its clean-cut design, its luxurious finish . . . feel its natural balance and its "fit-the-hand" grip. You'll be amazed at the low price for such high quality. Shoot the H & R "922" with pride and satisfaction. Solid frame construction assures maximum accuracy and long service.

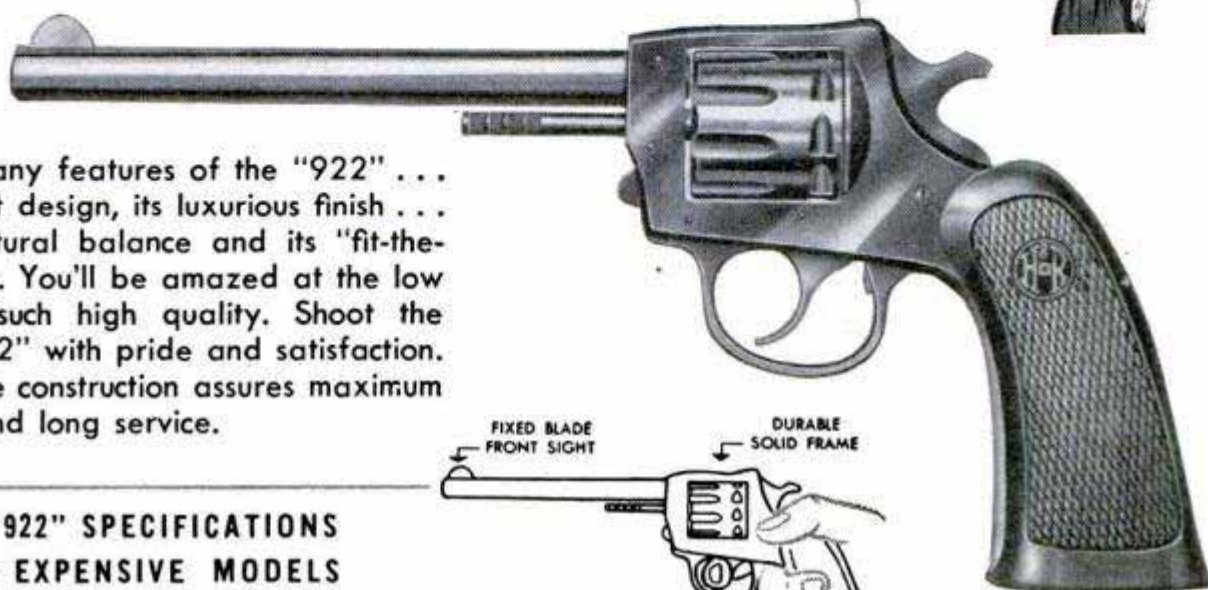

COMPARE "922" SPECIFICATIONS WITH MORE EXPENSIVE MODELS

- 9-shot chamber
- 3 barrel lengths — 6", 4", 2½"
- Crown-lustre blue finish
- Fixed blade front sight
- Checked Tenite stock
- Chambered for .22 short, long or long rifle

See the H & R "922" at your gun dealer's. It's a thrifty investment in long-time fun and service.

For FREE catalog on other fine H & R sporting arms — write

Harrington & Richardson Arms Co.

373 Park Avenue, Worcester 2, Mass.

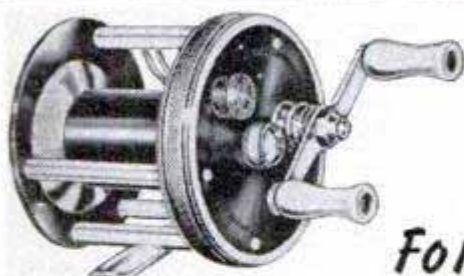

For

smoother, longer casts

Light tackle enthusiasts like this new Heddon "Pal" Reel because its light, sturdy construction assures smoother, longer casts. (Takes 100 yds. 12½ lb. line.) Its patented new head ring unscrews by hand. Head and spool pull out without disturbing adjustments, or losing parts. This permits better cleaning, oiling and assures the free, effortless operation of this fine, precision reel. Write for new catalog on Heddon Rods, Reels, Baits, Fishing Tips. It is the most interesting one we have ever published.

JAMES HEDDON'S SONS, 1286 W. ST., DOWAGIAC, MICHIGAN

New Heddon "Pal" Reel

with removable head ring

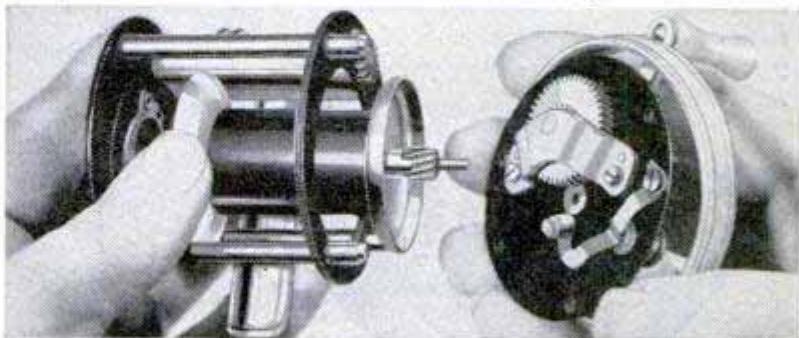

Heddon

Heddon Made Is Well Made

FOR YOUR OWN WORKSHOP.

the same automatic screw driver used for mass assembly



Wasted time...wasted motion . . . in mass assembly screw driving cut down production and profits. That's why so many manufacturers use Millers Falls automatic spiral ratchet screw drivers.

You can save time for more important work by using the same screw driver in your home workshop. Use it to drive or draw screws automatically . . . use it as a right- or left-hand ratchet, or as a rigid screw driver. And for easiest one-hand work, get a Millers Falls automatic with quick return action.

Millers Falls automatics are powerful, smooth acting, thoroughly dependable. Use yours with regular slotted or Phillips head bits . . . or convert it to an efficient automatic drill with a special chuck. Many sizes . . . the model shown costs \$4.90 at your hardware store — slightly higher in the West.

MILLERS FALLS TOOLS

SINCE 1868

**MILLERS FALLS COMPANY
GREENFIELD, MASSACHUSETTS**

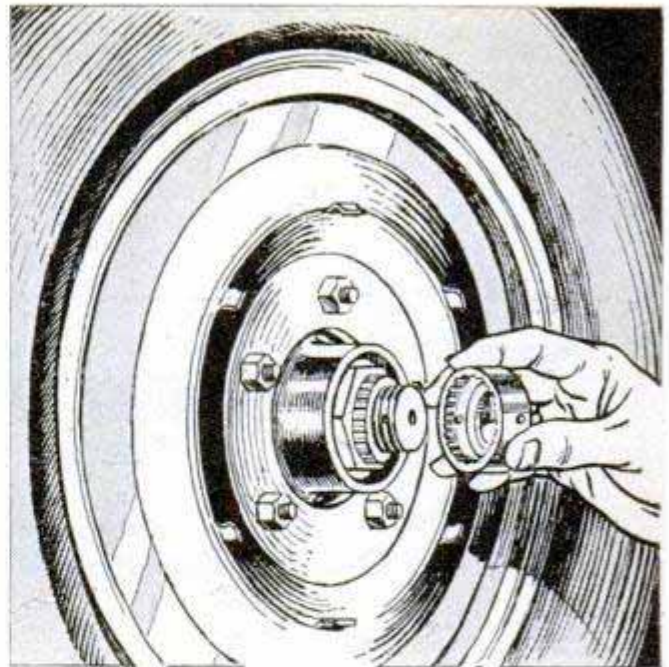

"Educated" Nut for Wheel Bearings

To guard against improperly adjusted front-wheel bearings, which are the cause of many accidents, an "educated" nut makes adjustments to one thousandth of an inch. Sixty serrations in the two-unit nut make it possible to lock and secure the bearing at its proper clearance. This is impossible with a regular castellated nut because it has only six adjusting points. With the new nut any mechanic can make a proper adjustment by running the nut section of the unit up to a firm seat, then loosening it to the point where the wheel rolls free. The cap section is then lined up with the cotter-pin hole, placed over the nut and secured with a cotter pin.

Underground Radio Broadcasting May Aid Mine Rescuers

Miners trapped underground may soon be able to direct their rescuers with a radio-communication system using low-frequency waves. Developed by the Bureau of Mines, the system successfully transmits voice through ground strata. The surface set uses 110-volt current while the underground receiver and transmitter are powered by a six-volt battery and vibrator power pack. The three-watt transmitter also sends signals along trolley wires, pipes and other metallic installations.

☞ Contrasted with American production of a daily average of 12 barrels per well, the 189 oil wells in the Middle East deliver an average of 5000 barrels each, for a total of 945,000 barrels. The 440,000 wells in the United States produce about 5,300,000 barrels daily.

WITH MOLLY YOU CAN FASTEN ANYTHING
and do it quickly, neatly and safely. MOLLY will hold fixtures securely to floors, ceilings or any hollow wall construction... Simple to install, all you need is a screw driver. Sold by leading hardware stores everywhere.

Write for Free Descriptive Folder

INSERT MOLLY
TURN SCREW
FULLY INSTALLED
REMOVE SCREW

PLACE FIXTURE
FIXTURE MOUNTED

MOLLY CORPORATION 522 COURT ST. READING, PA.

MOLLY
SCREW ANCHORS

WHERE SCREWS WON'T HOLD!
... USE MOLLYS ...

WRITE FOR YOUR FREE COPY OF THE NEW KRW HYDRAULIC PRESS BOOK

Describes all manner of Production and Shop Work on KRW Hydraulic and Bench Type Presses. 32 pages illustrating the new KRW Hand-operated, Electric-operated and Air-operated Hydraulic Presses. 25 to 100-ton capacities.

Write for your copy today.

K. R. WILSON, DEPT. 17, 215 MAIN ST., BUFFALO 3, N. Y.

4 SPEED MOTOR
WITH 1000 USES!

The built in integral gear box has four 1/4" drive shafts turning simultaneously at the following speeds:
 4000 RPM for grinders, buffers, small drills, flex shaft tools, etc.
 150 RPM for wrapping fishing rods, driving pumps, slow speed tools, fans.
 25 RPM—rocker for photo developing tray, cabinet makers glue wheel, erector sets, film puller for 16 mm, developer, operating laboratory equipment, etc.
 5 RPM for turning barbecue spits, advertising displays and antennas.

A THOUSAND OTHER USES AROUND THE WORKSHOP
 This 1/20th HP, 115 V., 50/60 cycle, AC motor is precision built throughout.

Fully guaranteed—Money refunded if not satisfied
 Pulleys, belts, shaft couplings, Mandrels and other equipment at 15c to 60c. List sent with motors. **SPECIAL—while they last... \$9.95**
Californians please add 22c sales tax **\$9.95** postpaid

- For amateur beam & television antenna
- Drives working models, toys and gadgets
- For action displays, miniature fountains
- For doctors, dentists, jewelers, technicians

TROUP ENGINEERING CO., 2225A Grand Ave., Long Beach, Calif.

\$9.95 SENT POSTPAID

THE AMAZING TYLER SPIRAL BLADE IT "SPIRALS" THROUGH THE WORK
CUTS IN ANY DIRECTION **NO CHIPS — NO DANGER**

CUT THESE INTRICATE DESIGNS IN WOOD ★ PLASTICS ★ METAL

Tyler Spiral Blade slices cleanly through practically everything from foam rubber to steel. Cuts in any direction. Unusual design protects careless fingers. Unique, continuous blade edge opens new cutting techniques never before thought possible.

DELTA AND WALKER-TURNER OWNERS: Adapters available to make your machines perform these miracles. Guides and two Spiral Blades—\$24.50. Guides soon available for other Band Saws. Write.

Tyler Variable Speed Steel Cutting Band Saw—\$385.00
 Tyler High Speed Band Saw—\$225.00
 Tyler Hack Saw Adapter Sets—\$0.69
 Tyler Spiral Blade Coping Saw with two Spiral Blades—\$1.00

ORDER DIRECT OR WRITE FOR FULL DETAILS
TYLER MFG. CO., 6151 W. 98th ST., LOS ANGELES 45, CALIF.

**DARKNESS MEANS
... DANGER**

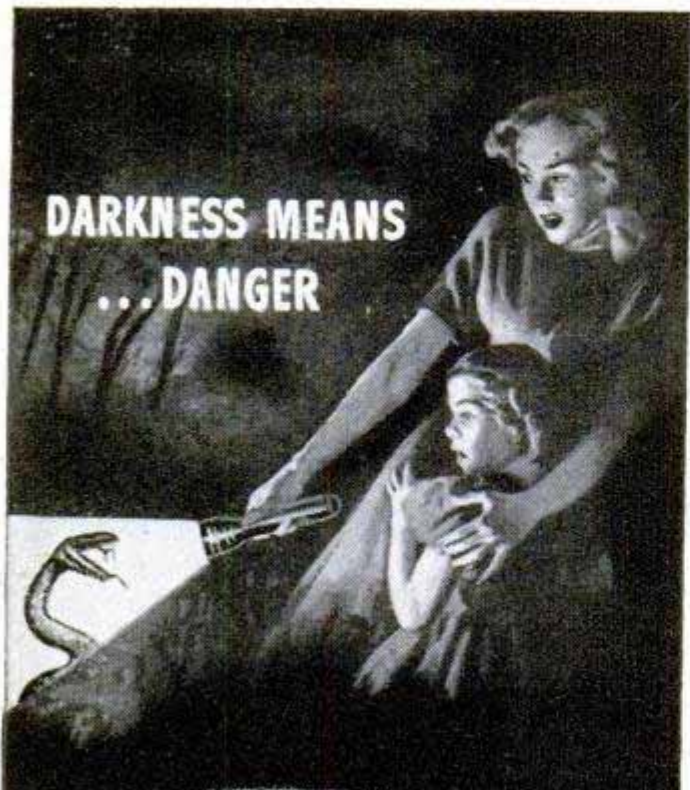

Protect yourself after dark
with **REAL LIGHT**



**GUARANTEED
BY** 

Specialists in electro-chemistry and metallurgy:

- Winchester Repeating Arms Co.
- Bond Electric Corp.
- Western Cartridge Co.
- Liberty Powder Co.
- Western Brass Mills
- Equitable Powder Mfg. Co.
- Columbia Powder Co.
- Egyptian Powder Co.
- Texas Powder Co.

OLIN INDUSTRIES, INC.

Meter Tests Painted Surface To Determine When to Repaint

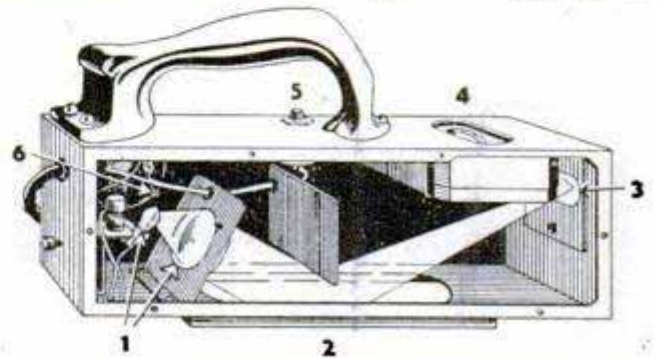

Top, testing the paint on a house wall to determine its reflectance value. Below, cutaway of glossmeter showing how it works: 1. Lamp and lens; 2. Painted surface being tested; 3. Target against which light is reflected; 4. Light meter; 5. Switch; 6. Rheostat

Whether or not a building needs repainting can be determined scientifically by an instrument that measures the gloss with a photoelectric cell. A companion instrument measures the reflectance value of the paint. The two meters are portable and have their own light supply. They operate from standard outlets or from a battery power pack.

Planes Sow DDT on Arctic Snow To Kill Mosquito Larvae

Mosquito-fighting has taken a new turn in the far North, where scientists have found that sowing DDT on Arctic snow in the winter keeps down the swarms of insects that make life miserable during the summer. The experiments have been made by Department of Agriculture entomologists in cooperation with Army and Canadian scientists. The DDT is sowed from airplanes. Melted snow forms a wet sheet on the plants of the tundra. Mosquitoes lay their eggs on this sheet, which now has become a deathtrap for both themselves and their young. One pound of DDT is sufficient to treat 10 acres effectively, the scientists have discovered.

King Midget

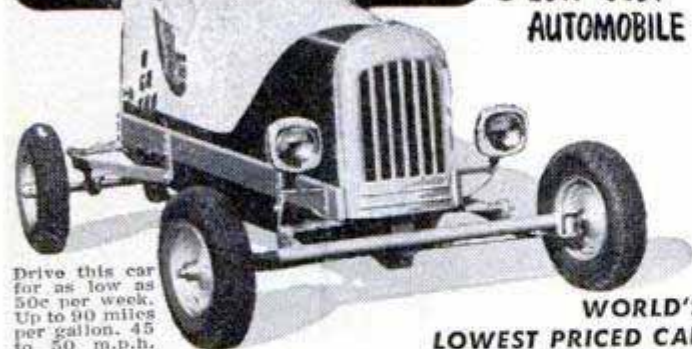

- HOME ASSEMBLED
- MASS PRODUCED
- LOW-COST AUTOMOBILE

Drive this car for as low as 50c per week. Up to 90 miles per gallon. 45 to 50 m.p.h. Large enough for a husky six footer. A pleasure to assemble. Just bolt together our precision built parts. Get the facts. Send 25c for detailed circular with large photo, 4 view drawings, price of all parts. Better still, send \$1 (refunded first order) for this plus actual assembly book with 42 photos, drawings; blueprints of snow and ice conversions, etc.

WORLD'S LOWEST PRICED CAR

MIDGET MOTORS MFG. CO., Athens 1, Ohio

ORIGINALLY \$30 to \$55 **MEN'S FULLY GUARANTEED NEW 15-JEWEL WRIST WATCH** \$13.95 PLUS TAX

Sacrificed because they're post-war surplus
WATER REPELLENT SHOCK PROTECTED
 1 year written guarantee
 Luminous dial... sweep second hand
 Super-accurate... imported Swiss precision movement and case. You get them now for a small fraction of original prices. Don't delay! Order now... while they last. Send only \$1 down payment with order. Pay balance to postman on arrival, plus postage. Or we pay postage if you enclose \$13.95 plus \$1.39 Fed. Tax. Handsome expansion band included with prepaid order. Money back in 5 days if not delighted. Order now.



MARYLAND DISTRIBUTORS, Dept. 28
 501 E. Baltimore St. Baltimore 2, Md.



Carve for Fun and Profit!
 No skill needed with Dumore Carvit
 Anyone can make woodcarvings with a Carvit! It copies low-cost models you can buy in any dime store. The result—beautiful ornaments, unusual gifts, fine carvings that sell. Write for Free folder with full details
The Dumore Company
 Dept. F-51 Racine, Wisconsin

See for MILES with the REMARKABLE RANGER TELESCOPE!



See 5 Times Larger **\$2.00**

See 5 Times Closer **POSTPAID**

- RACING
 - HUNTERS
 - SPECTATORS
 - BOY-SCOUTS
- Super telescope with brilliant definition—2 highly polished lenses—2 brass, nickel plated sections—rugged, handsome, compact, lightweight. Money back guarantee!
- EYE-GLASS PRODUCTS, INC., PM-2**
 29 E. Madison St. Chicago, Ill.



CROSLLEY of U.S.A. — leads the way

Here's the new economy car styled for the U.S.A.—made in the U.S.A. Larger, longer body lines, a clean sweep of design that's truly American.

New Crosley Station Wagon (above) is the biggest selling station wagon in the world. Sleek body lines. Seats 4, or 2 with 1/4 ton load. All steel. No increase in price. New Crosley Sedan Deluxe (below) is bigger, with speed-line styling, rich interior, choice fabrics. Seats 4 with ample luggage room.

All 5 new Crosley models—including Convertible, Panel Delivery and Pick-up Truck—look big, feel big, act big—cost little to buy or drive. Powerful Crosley engine takes steep hills in high, gives you up to 50 miles on a gallon of regular gasoline. And a Crosley costs less than an 8-year-old, high upkeep used car. Prices range downward from the Station Wagon at only \$929 F.O.B. Marion, Indiana.

For complete new catalog, write your name and address on the margin of this page, tear out and send to Crosley Motors, Inc., 2530-HF Spring Grove Ave., Cincinnati 14, Ohio.



BASEMENT DAMP?

NEW! IMPROVED! SOLVAY AIR-DRYETTE JR.

with SOLVAY CALCIUM CHLORIDE



absorbs moisture—the cause of rust, warping, mildew in workshops, darkrooms, closets, playrooms, storage rooms, vaults. New, improved design gives 50% greater capacity, simplifies filling and emptying. Compact, inexpensive, clean, safe, odorless, thousands in use. Write for booklet and name of your nearest dealer.

Dept. 89-6, Solvay Sales Division
 Allied Chemical & Dye Corporation
 40 Rector St., New York 6, N. Y.

PLUMB TOOLS

ARE MADE TO LAST
AND DO JOBS FAST

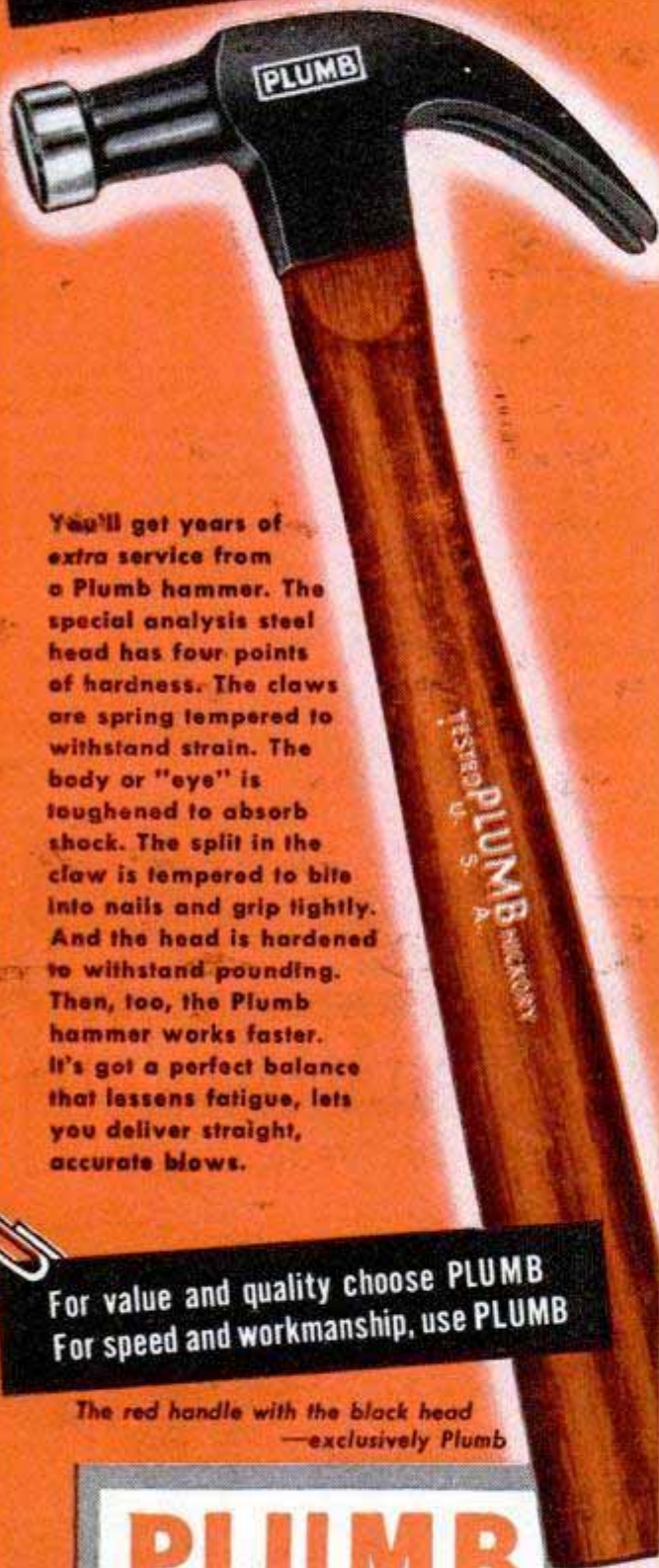

You'll get years of extra service from a Plumb hammer. The special analysis steel head has four points of hardness. The claws are spring tempered to withstand strain. The body or "eye" is toughened to absorb shock. The split in the claw is tempered to bite into nails and grip tightly. And the head is hardened to withstand pounding. Then, too, the Plumb hammer works faster. It's got a perfect balance that lessens fatigue, lets you deliver straight, accurate blows.

For value and quality choose PLUMB
For speed and workmanship, use PLUMB

The red handle with the black head
—exclusively Plumb

PLUMB

HAMMERS • HATCHETS • AXES • FILES

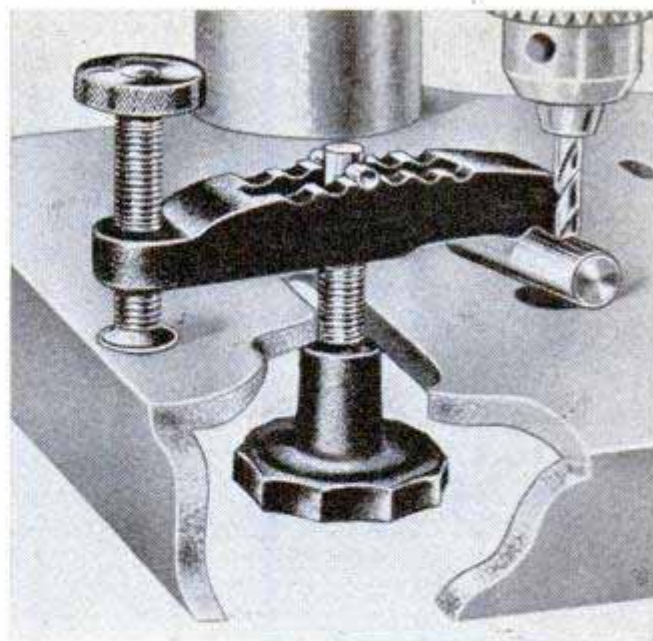

Clamp for Drill Press Holds Work Securely

Capable of holding work of any shape and up to 2½ inches thick, a drill-press clamp has a T-design that permits instant installation and removal. Six pairs of grooves on top of the clamp make it flexible enough to fit any drill-press table with a slot at least 7/16 inch wide. Made of steel and cast iron, the clamp is especially useful for holding round work.

Papermaking Technique Ends River Pollution

Chemical wastes in papermaking that pollute rivers are eliminated by a new process in which the wood is digested with magnesium oxide instead of the calcium base traditional to sulphite pulp manufacture. The chemicals are reclaimed for reuse after the wood chips have been turned into pulp. Other parts of the wood, usually dumped into the river, are separated from the liquid by evaporation and burned to generate electricity. The process is being used in a new mill at Longview, Wash.

Fly Killer Surpasses DDT

DFDT, an insecticide developed by Germany during the war, is more potent than DDT in killing house flies and other flying insects, according to the U. S. Public Health Service. The chemical does not possess the broad killing power of DDT toward all insects, but is more effective against flying pests. It penetrates certain tissues of the insect's body more rapidly, but is not active for as long as DDT. However, it is less toxic to fish and animals that are warm-blooded.

AUTOMATIC RETOOTHER

MAKES NEW PROFITS

Cuts new teeth in 50 seconds — any size 4 to 16 points. Old teeth fall off as chips. Easy to operate. A perfect job.

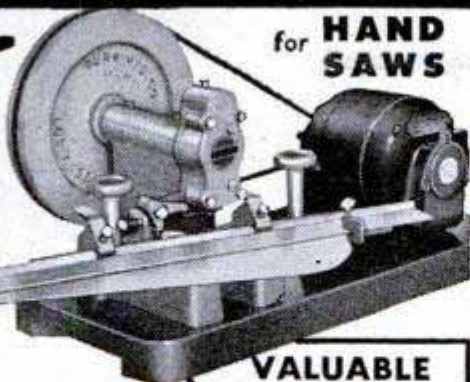

for **HAND SAWS**

IMMEDIATE DELIVERY

BURR MFG. CO.
8933 VENICE BLVD.
LOS ANGELES 34, CALIFORNIA

VALUABLE BOOK
Order Burr's Blue Book of Coast to Coast prices for saw shop services. **25c**

Crosman TARGET PISTOLS

.177 or .22 Cal.

NOW you can shoot indoors as well as outdoors, for Crosman adjustable "power without powder" is safe, and there's no noise or powder reek. Fine balance, rifled barrel, push-type safety, adjustable rear sight; grip fits either hand. Only \$14.95! At your dealer's; write for literature.



Crosman Arms Co., Inc. 3 HENRIETTA STREET ROCHESTER 7, N. Y.

BRASS NAME PLATES OR KEY TAGS

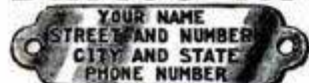

(INDIVIDUAL STAMPING)
40c each—3 for \$1.00

Half actual size
QUANTITY PRICE — SAME STAMPING
8 for \$2. - 15 for \$3. - 25 for \$4. - 50 for \$6.
LARGER QUANTITIES ON REQUEST
TAGCO, BOX 38X, WINGDALE, N. Y. STAMPING EQUIPMENT

Build your own JET ENGINE!

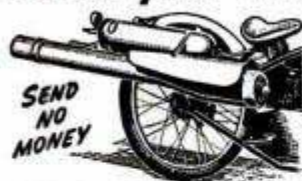

SEND NO MONEY

Order these plans today
1. JET PROPELLED BICYCLE. Assemble your own. Photo and instructions \$1.00.
2. HOW TO MAKE EXPERIMENTAL JET ENGINES. Seven sheets drawings with information and instructions \$2.95.
3. BOTH OF ABOVE in one order \$3.75. SEND NO MONEY. Order both at once \$3.75 C.O.D. in USA plus c.o.d. postage. Send check or Money Order and we pay postage. Get other information too. Rush Order.

J. HOUSTON MAUPIN, Dept. 55, Tipp City, Ohio

Mower Builder's Kit

M.B.K. KIT CONSISTS OF
1-TIMKEN BEARING EQUIPPED HI-SPEED SPINDLE
1-HI-CARBON STEEL 20" BLADE
2-10"x1.75" PUNCTURE-PROOF, SEMI-PNEUMATIC, RUBBER TIRES. BALL BEARING WHEELS
1-5" SWIVEL CASTER WHEEL



UNCONDITIONALLY GUARANTEED

\$28.50 COMPLETE

SPINDLE & BLADE ALONE ... \$18.75

FAMOUS MOZALL POWER MOWERS NOW AVAILABLE ... FREE FOLDER
SEND CHECK OR M.O. TO



Dept. M-6 **WIND-KING ELECTRIC MFG. CO.** MERRILL, IOWA

FASTER

STRONGER



FINER

LOW COST

EASY TYPING

Everything points to Smith-Corona as your choice in a portable. Trade in your old machine. Get a new Smith-Corona on easy terms.

Ask about these features

1. TOUCH SELECTOR
2. VARIABLE LINE SPACER
3. FLOATING SHIFT
4. ONE STROKE RIBBON REVERSE
5. TYPEBAR SPEED BOOSTER

Smith-Corona
PORTABLE TYPEWRITER

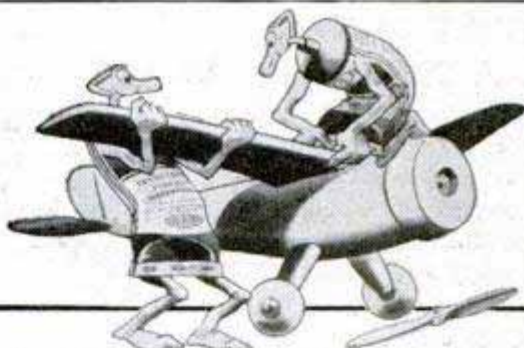

BUILD

STRONGER MODELS

It's transparent, waterproof flexible and durable.

Get a tube today.



DU PONT

DUCO CEMENT

REG. U. S. PAT. OFF.

SELF-CONTROL STARTS HERE



and to restore
CAR PERFORMANCE

OIL-CONTROL STARTS HERE

**TO STOP OIL-PUMPING REPLACE WORN
ENGINE CONNECTING ROD BEARINGS**

Next to a dead smelt, there's nothing as lifeless as your ailing car, drinking oil and puffing smoke clouds. Oil-pumping troubles start with worn connecting rod and crankshaft bearings. They let excess oil burn to power-stealing carbon. Give new rings a chance to do their own job—replace worn bearings, too! Use Genuine Federal-Mogul Bearings, engineered for the job of oil-control!

FEDERAL-MOGUL SERVICE
(Division of Federal-Mogul Corporation)
DETROIT 13, MICHIGAN



CONTROL OIL-PUMPING
WHERE IT STARTS—WITH

FEDERAL-MOGUL

OIL CONTROL BEARINGS

1899 • 50 YEARS OF CONTINUOUS BEARING EXPERIENCE • 1949



Suspension-Spring Tool Balancer

Tools weighing up to 10 pounds are always kept within reach by a new suspension-spring tool balancer. It has a working range of six feet. After the operation is completed, the released tool returns to its preadjusted position near the work area.

Swedish "Smoke Drinkers"

Smoke from Sweden's factories is providing cheaper carbon dioxide for carbonated soft drinks in that country. It had previously come to bottling plants in heavy steel bottles, weighing about twice as much as their contents and resulting in high transportation costs. Stockholm's Institute of Technology helped solve the problems of cleaning and separation.

Lemon-Peel Chemical Cuts Radiation Injuries

Derived from lemon peel, a chemical called calcium flavonate may aid in overcoming the blood-damaging effects of radiation injury, whether from atom bombs or in X-ray treatments for cancer. The lemon-peel chemical, given to guinea pigs in their drinking water, cut the mortality rate by about half when they were exposed to total body irradiation from X-rays. The chemical may be valuable in cancer treatments because with it patients could be given larger doses of X-rays without harm.

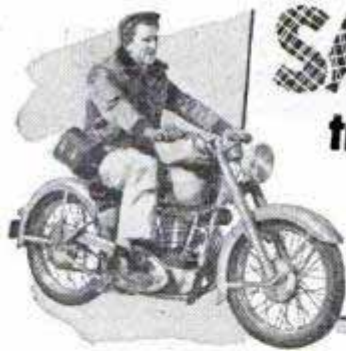

SAVE money on transportation... and have lots of fun besides

YOU CAN LEARN TO RIDE IN 5 MINUTES

Indian will give you up to 90 miles per gallon, get you to work faster, park easily, thread through crowded traffic. But the big reason for owning an Indian is FUN! Fun on the open road, club activities, exciting events to go to. Send for free booklet, "How to Ride a Motorcycle," by Bill Stern of NBC.

NEW Indian LIGHTWEIGHT MOTORCYCLES

"THE WORLD'S MOST MODERN MOTORCYCLES"
INDIAN MOTORCYCLE CO., Dept. PM69
Springfield, Mass. • DEALER INQUIRIES INVITED

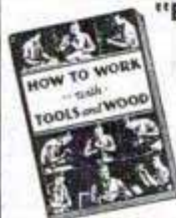

"BIBLE" FOR AMATEUR WOODWORKERS

Tells how to achieve skill with tools and make home repairs. 188 pages—cramped with illustrations, diagrams. Cloth bound. A "must" for the home workshop for only \$1.00, postpaid. Stanley Tools, 169 Elm St., New Britain, Connecticut.

BUILD YOUR OWN POWER LAWN MOWER

WHY BREAK YOUR BACK MOWING FIELD OR LAWN?

WRITE FOR **FREE** Building Instructions The Rite-Way Mower Attachment Ball Bearing



SAVE MONEY SAVE TIME

Now anyone can save time and effort mowing field or lawn by building their own whirl type power mower. Build according to your own ideas and needs at small cost. Cut close to fences, walks, buildings, etc. Build in short time with parts and instructions we furnish. Save hours of time and back breaking labor. Write today for FREE information.



IT'S FUN TO BUILD

T & H MFG. CO., Dept. PM21
811 E. 31, Kan. City 3, Mo.

SAY YOU SAW IT IN POPULAR MECHANICS

A 10-Ton Press at Low Cost

Pressing, separating, bending, and straightening jobs in your shop are easy with this press. Ten-ton capacity provides ample pressure. Adjustable table takes work up to 18 inches wide and 11½ inches high. Send for free bulletin showing press and wide variety of accessories.

UT-10A Press f.o.b. factory \$36.00

DAKE ENGINE COMPANY
624 Seventh Street, Grand Haven, Michigan



new low-priced electric paint sprayer



Only **\$12.95** Complete



for utility painting of tables—chairs—screens—floors—clothes hampers—car fenders—toys

Built-In-Head Motor and Compressor Unit



Now! An electric sprayer as easy to handle as a brush—and twice as fast! Sprays household enamel, lacquer, varnish, shellac, light oils and insecticides. No extras to buy! 25 oz. jar. 8 ft. cord. Mail the coupon for full information.



BURGESS BATTERY COMPANY, Handicraft Division
153 Rand Road, Lake Zurich, Illinois

Please send **FREE** 12-page instruction booklet and illustrated circular in color describing the New Burgess Vibro-Sprayer.

Your Name _____
Street Address _____
City _____ Zone _____ State _____

CASH IN ON THE BUILDING BOOM!

MAKE BUILDING BLOCKS RIGHT IN YOUR OWN BACKYARD AMAZING GENERAL BLOCK MACHINE

CAPACITY 1000 BLOCKS PER DAY

\$199 LESS MOTOR ONLY F.O.B. PLANT SHIPPING WEIGHT 400 lbs.



Cinder and Concrete Blocks in big demand. Sell all you produce, to contractors and builder supply yards, at 15c to 25c each. Easy to start your own profitable business.

GENERAL BLOCK MACHINE can be operated indoors or out, in floor space 9 ft. x 10 ft. All steel construction. Vibrator mounted in sealed ball bearings. Simple to run. Powered by ½ H.P. electric motor or 1 H.P. gas engine. Produces up to 1,000 8x8x16 blocks in 8 hour day. Superior 3 core type, meeting all building code requirements. Produces 4x8x16, 8x8x16, 12x8x16 blocks. Material for blocks, cinders, cement, and sand, obtainable anywhere. Full instructions and mixing formulas with each machine. Immediate Delivery. Mail coupon at once for full details, sent free without obligation.

HOW TO BUILD YOUR OWN CONCRETE BLOCK HOME
Only 1 Prepaid

Wonderful book written and illustrated by our staff of experts.

GENERAL ENGINES CO.
DEPT. SF — DREXEL BLDG., PHILADELPHIA 6, PA.

Shows you 8 ways to save money and how to make and lay blocks, laying out building lines, mixing your own concrete, building steps, porches and concrete floors, includes floor plans for 6 beautiful easy to construct concrete block bungalows. Mail coupon at once with \$1.

Name _____
Address _____
City _____ Zone _____ State _____

Great, New
HOME-UTILITY
5" SANDER-POLISHER
 only \$29.95

ALL this at ONE LOW PRICE!

- 5" Electric Sander-Polisher
- Plus these accessories:
- 5" Moulded Rubber Pad
- 3 Sanding Discs (coarse, medium, fine)
- Lambswool Polishing Bonnet
- 7 oz. can of Home-Utility Electric Wax



Here's a REAL MAN'S GIFT
 for **FATHER'S DAY!**

so many uses * so handy * so speedy
 around the house * in the workshop * on the farm



For Sanding • Polishing • Drilling • Grinding
 Sharpening • Cleaning • Buffing • Waxing
 In Metals • Wood • Plastics • Compositions
 SEE YOUR HARDWARE, ELECTRICAL OR IMPLEMENT DEALER

ELECTRIC
HOME-UTILITY
TOOLS

Products of The BLACK & DECKER Mfg. Co.
 Dept. H6M, Towson 4, Md.

SAY YOU SAW IT IN POPULAR MECHANICS

Thompson
BEATS
 the World
 on **BOATS**



Better Built
Lower Prices



Safe Boats With Full Length Spray Rails
 Keep passengers perfectly dry—even at high speeds. Catalog also shows two new models of "Take-Along" Boats. Two big factories—save you freight.

CATALOG FREE
 Write for your copy. State kind of boat in which you are interested.
THOMPSON BROS. BOAT MFG. CO. (151)
 213 Ann St. (Write to either place) 113 Elm St.
 PESHTIGO, WIS. CORTLAND, N.Y.

Light Boat for Auto

NU-WAY HEAVY DUTY CUTTING UNIT
 with Timken Roller Bearings

PRICE
\$16.50
 WHY PAY MORE



Build your own rotary type lawn or weed cutter. Take the hard work out of weed cutting. Build yourself an up-to-date weed and lawn mower with the Nu-Way heavy duty unit.

Write for Free Circular—We Supply Cutting Unit Complete
TRACTOR-LITE MFG. CO., Spirit Lake, Iowa

STANDARD GARDEN AND SMALL FARM TRACTORS



RIDE or WALK Powerful Gas Tractors for Small Farms, Gardeners, Florists, Fruit Growers, Poultrymen, Nurseries, 1 & 2 Cylinders Rubber or Steel Tires.

Plow Seed Cultivate Mow Haul Belt Work

High Wheels—Free Catalog

STANDARD ENGINE COMPANY
 MINNEAPOLIS, MINN. NEW YORK, N. Y.
 3221 Como Avenue 617 West 26th Street

ONE-MAN SAWMILL LESS THAN \$225.00
 Easy To Turn Trees Into Money



Makes lumber, ties, shingles, crates, lath, studding, siding.

Belsaw Models

in 10 to 24 foot sawing lengths. MECHANICAL FEED, accurate set works and positive dogs. Use tractor or old auto engine for low cost power. Thousands used for commercial sawing. Pays for itself quickly. Send post card today for FREE booklet, "How To Make Lumber" and Catalog of Woodworking Equipment.

BELSAW MACHINERY CO., 8115 Field Bldg. 315 Westport Road Kansas City 2, Mo.

FIBRE ARMS AND LEGS!



Light, correctly fitted, strong and comfortable. Natural appearance. Braces for all deformities. Scientific design. Fair Terms.

BUCHSTEIN-MEDCALF 223 S. 6th St., Minneapolis, Minn.



USE YOUR FOOT... NOT YOUR HAND!
TRIP HAMMER
 Saw Set

\$3.95
 Postpaid

- FOOT TREADLE OPERATED
- LIGHT WEIGHT
- TOOL BOX SIZE
- SETS UP EASILY

Save Time! Save Saws! Save Money! No cramped hands with the TRIP-HAMMER Saw-Set. Perfect action sets teeth uniformly, easily, efficiently. Sets 5 to 12 point Hand Saws, 3" to 10" circular Saws, Two Man Cross Cut Saws.

Guaranteed. Send Check, Money Order or Postal Note.
ARDEE TOOL CO. ROCKY RIVER STATION, OHIO

You Can Be the Local Manufacturer



More local plants are badly needed to make Dunbrik-Dunstone—America's finest masonry. Smart—modern—colorful. Yet costs less than lumber. Millions used annually for homes, stores, factories, public buildings. etc.

Write for portfolio "Blueprints for Profit"



With Dunbrik-Dunstone you can ride the tide of the biggest building cycle in history. Local plant—local materials—local labor. Equipment costs moderate. Liberal sponsor co-operation. 100%—150% mark-up on basic costs. Write at once.

W. E. DUNN MFG. CO.
600 W. 24th St., Holland, Michigan

DUNBRIK DUNSTONE

SCREWY-MIX BARGAINS

- 1-Assorted machine screws, sheet metal screws and bolts, sizes 2-56 to 3/8-24, various type heads. 3 LBS. \$1.15—5 LBS. \$1.50.
- 2-Mixed Steel Rivets 1/16 to 1/4 dia. Flat and Round Heads, Various lengths—five pounds \$1.00. Mixed Cotter Pins 35c LB.
- 3-Mixed Aluminum Rivets—50c LB. Mixed Wood Screws 35c LB.
- 4-Mixed lock and flat washers 30c LB. Mixed Nuts 50c LB.

Add 5c per LB. for parcelpost on Screw-mix.

BEARINGS

Minimum order bearings \$1.00 add 10c postage.

Bore	O.D.	Type	Price
5/32"	5/8"	Ball	15c
3/16"	1/2"	Needle	15c
1/4"	5/8"	Needle	15c
3/4"	3/4"	Ball	22c
1 1/8"	7/8"	Ball	25c
1 1/4"	1 1/4"	Needle	28c
5/8"	1 3/8"	Ball	40c

SANDING BELTS

Carborundum & Behr-Manning
Minimum Order \$1.00

Size	Grit	Each
4"x48 1/2"	80 & 100	45c
4"x36"	120	35c
1"x44"	100	25c

JAY-CEE SALES CO., 4554 Grand River Ave., Detroit 8, Michigan

SHARPEN CIRCULAR SAWS LIKE AN EXPERT



Precision file circular saws in your own workshop. No experience necessary. Two simple adjustments. Gets hollow ground, cross-cut or combination saw blades true and sharp. Fits 6" to 12" blades with 1/2" to 13/16" centers. Includes file and complete instructions. \$6.95 postpaid—check or money order. \$1.00 deposit on C.O.D.s. Guaranteed, money back if not satisfied after ten days trial. At your dealers or order direct.

\$6.95

SURE-SHARP MFG. CO., Dept. M-69, P. O. Box 24, Santa Ana, Calif.

New Quick-Selling CELL-U-MOP... others make BIG MONEY

DOES THE WORK OF 6 TOOLS IN 1
Holds 20 times its weight in water



Hands Never Touch The Water
Can Be Put In Boiling Water

"Enclosed find 56 orders representing 9 1/2 hours work on Monday and Tuesday." "Enclosed are 12 orders secured after supper this p.m."

Housewives Pleased
Everyone that sees this outstanding CELL-U-MOP immediately want one... That's the reason our distributors are so successful... For MOPPING, WAXING, WALLS, WINDOWS, AUTOS and CLEANING RUGS. Sells quick to Taverns, Clubs, Hotels, Hospitals, Stores, Restaurants, Homes, etc. Drain Bracket squeezes out water thoroughly. Write for FREE particulars

CELL-U-MOP CO., Dept. P-6 FREEPORT, ILL.

JUNE 1949

MORE

ELECTRIC HOME-UTILITY TOOLS

For Father's Day!

1/2" ELECTRIC DRILL... \$35.95

Drills up to 1/2" diam. in steel, 3/8" diam. in hardwood. Drives Hole Saws for cutting clean round holes up to 3" diam. in sheet steel.

3/4" ELECTRIC DRILL... \$18.95

1/4" ELECTRIC DRILL KIT \$39.95

Contains Home-Utility 1/4" Drill, horizontal stand, 13 high-speed twist drills, wire wheel brush, grinding wheel, buffing wheel, buffing compound, wheel arbor—all in sturdy metal carrying kit.

1/2" VERTICAL BENCH STAND

\$17.45

HORIZONTAL STAND

\$3.35

1/4" VERTICAL BENCH STAND

\$11.45

NEW DISC SANDING TABLE ATTACHMENT

\$8.25

BUFFING & POLISHING KIT

\$4.50

ABRASIVE KIT

\$4.50

P.S. REMEMBER—THE DATE'S JUNE 19th.

the PLACE is
Your Hardware, Electrical or Implement Dealer!

SAY YOU SAW IT IN POPULAR MECHANICS

THE BIGGEST SURPLUS BARGAINS IN YEARS

ELECTRIC MOTOR 1/2 H. P. 27 V.D.C. R. P. M. 4000 No. 750. For Intermittent or Continuous Duty 3/4" SHAFT. VARIABLE SPEED MOTOR CAN BE ADAPTED, TO 110V.A.C. or R.E.A. line by simple arranging armature brush leads. UNUSED. Instructions \$5.50 incl.



WEAVERS HYDRAULIC HAND PUMP — BRAND NEW. For hydraulic Jacks, presses, hoist, etc. For operating hydraulic cylinders, to pump oil or hydraulic fluid under pressure. Has built in check valve, and is capable of delivering 1000 lbs. pressure. Wt. 10 1/2 lbs. A \$50.00 value. Instructions incl. \$8.50

VICKERS CONSTANT DISPLACEMENT HIGH PRESSURE PUMP. Use it for any type liquid pumping job 375 gal. per hr. at 3750 R.P.M. 1000 pounds pressure per sq. in. Can be used as hydraulic motor O. Acq. \$100.00. \$8.95 post-Brand new directions incl. Wt. 7 lbs. \$8.95 paid

VICKERS UNLOADING VALVE. Brand New—By passes full amount output of the pump while the cylinder is not in operation. Takes starting load off of electric motor driving the pump. Price \$6.50 post-paid



BRAND NEW HYDRAULIC CONTROL VALVE. This is a TWO CYLINDER DOUBLE ACTION VALVE with unique arrangement allowing the operator to raise both cylinders simultaneously, to lower them simultaneously or to raise one and lower the other at any predetermined rate and speed. A \$75.00 value. \$8.95 paid

BRAND NEW HYDRAULIC CONTROL VALVE. Four Way control for use with two hydraulic double action cylinders. \$60.00 value. Price \$7.95 paid

GREATEST PUMP VALUES EVER OFFERED—PESCO AIRCRAFT ELECTRIC PUMP. NEW. Complete with 1/4 H. P. electric motor. Self contained. Explosion proof. Ideal for pumping gasoline, oils, water, liquids. FOR FARMS, COTTAGES, BASEMENTS, LABORATORIES, AND BOATS. 24 Volts A.C. or D.C. can be converted to other voltage. Wt. 6 lbs. Ea. \$7.50

THOMPSON BOOSTER PUMP. Use them for Homes, Farms, Ranch, and Shop. Motor driven centrifugal pump will empty 50 gal. drum of water in approx. 20 min. Runs on 24V. D.C. A.C. \$7.50 New

LUBE PUMP. BRAND NEW. Precision Gear Impeller Pump. Pumps liquids up to 3 gal. per minute. Pressure up to 200 lbs. per sq. in. Std 1/2" Threaded and keyed shaft. Instructions incl. Wt. \$3.95 4 lbs. Price.

SENSATIONAL FASCINATING MYSTERIOUS SELSYN. Two or more connected together, work perfectly on 110 V.A.C. For weather vanes rotating directional antennas or controlling distance operations. Complete with diagram and instructions. Wt. 3 1/2 lbs. \$3.50 PER PAIR

VALUABLE GEARS BARGAINS SPEED REDUCER 10-1 or 5-1 ratio, 90 degree angle. Shaft Driven 1/2" spline Shaft with 3 mounting holes 5/16". Gears held in forged and machined aluminum housing with two needle bearings, one bronze bearing, and three high speed shielded bearings. Sealed self lubricating chamber. \$3.50 Price.

BRAND NEW DYNAMOTOR. Model DY-22/ARC. Input 28 V.D.C. Output 210 V.D.C. Cont. Duty. Base \$1.65 mounting. Wt. 5 1/2 lbs. Ea.

DYN. New Model #23350. Input 27V.D.C. Output 285 V.D.C. Wt. 3 1/2 lbs. \$1.35

NEW PURULATOR GASOLINE FILTER. Aircraft type. Today's advanced Gasoline Re-refining Filter for all cars, Trucks and Tractors. Cleans and re-refines gasoline as you drive. Removes solids, Water, and prevents sludge formation. Install at home in a few minutes. STOP GASOLINE WASTE AND EXPENSE. Instructions \$4.95 incl. Permanent, needs no replacement. Ea.



NEW CUNO OIL FILTER, aircraft type, keeps oil clean without cartridge replacements. For Autos, Trucks and Tractors. Install at home in a few minutes. Stop Changing Motor Oil. Instructions incl. Ea. \$4.95

WRITE FOR HYDRAULIC LISTING

Send check or Money order. No c.o.d.'s. Prices f.o.b. K.C. except when marked postpaid.

GENERAL SALVAGE COMPANY

Dept. 17, 2920 E. 27th St. Kansas City, Mo.

MUCH MORE SPEED FOR OUTBOARDS!

All tests conclusively prove that MICHIGAN'S newly developed "AQUA-JET" propellers provide much more speed for motors of 7 1/2 HP to 50 HP on racing runabouts and step-bottom hydroplanes. No rebuilding of lower unit is necessary. Write for prices. Other propellers for superior performance for practically every outboard in every application. Write for catalog with recommendation charts. MICHIGAN WHEEL CO., Grand Rapids 3, Mich.—World's largest manufacturers of motor boat propellers. Dealers everywhere.



ARC WELDING FOR PROFIT OR PLEASURE

60 LBS. OF READY MADE PARTS

Only \$24.95

BUILD YOUR OWN HEAVY DUTY WELDER

SAVE Buy Only NECESSARY PARTS

All parts Ready-Made and easy to assemble. You can do all around welding on steel, cast iron and other metals after only a few hours practice. Illustrated instruction manual included. Sold on 30-Day Money-Back Guarantee!

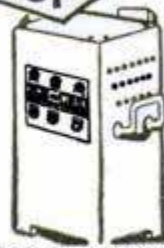

FREE: Write today for fully illustrated Pamphlet P-6

ATOMIC ARC WELDER CO.
1037 So. 19th St. OMAHA, NEBR.

Gives 100% penetration. Welds are stronger than original metal. Operates on 110 or 220 AC.

PORTABLE SAW

From Your Powerdrill

Lite-Saw converts standard 1/4" Drillmotor to 6" portable saw. Easy to attach. Rip, cross, bevel and cutouts. Satisfaction guaranteed. \$24.50 complete, postpaid. Send check or money order to

FUTURE PRODUCTS CO.
3625m N. Mississippi
PORTLAND 12, OREGON

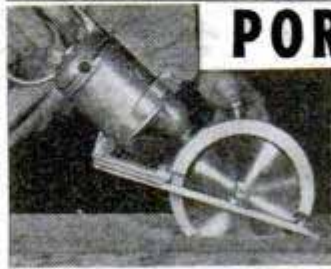

DRAINS CELLARS, WASH TRAYS CIRCULATES OIL

Pumps 1800 GPH 300 gal. 30' high, use 1/8 to 1/2 HP motor. Will not clog. \$6.50

Postpaid if cash with order. (Add 50c for west of the Mississippi.)

Thousands in use since 1936

LABAWCO PUMPS, BELLE MEAD 7, N. J.



"JIFFY" CAR WASHER

FOR WASHING CARS, WINDOWS, ETC.

Made of finest virgin wool. The only washer giving clear spray of water. Leaves surface with natural gloss, no chamois necessary. ORDER YOURS NOW. Send check or money order or will ship C.O.D. MONEY BACK GUARANTEE. \$3.95

E & N MANUFACTURING CO.
DEPT. A-1 BELOIT, WISCONSIN



FULLSIZE, CUT-TO-SHAPE BOAT PATTERNS

and specifications. Designed by Naval Architect. Cruisers, runabouts, sloops, outboards, sailing canoe, etc. Low prices. Send 10c (coin) for illustrated catalog. SPECIAL: Send \$1.00 for "HOW TO BUILD BOATS" book, postpaid. PolyWeg Houseboat Plans, \$10. Cleveland Boat Blueprint Co. Dept. 666, Cleveland 13, Ohio

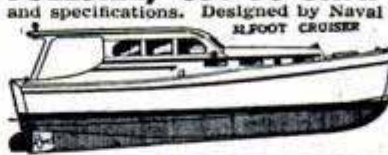

SAY YOU SAW IT IN POPULAR MECHANICS

LAWNMOWER SHARPENER OPERATORS

Increase your output... Year 'round business!

SHARPEN ALL STRAIGHT EDGE TOOLS

Model 50 Ideal Bench Grinder doubles your output of sharpening jobs, speedily grinds straight blade knives. Sharpens all kinds of straight edge tools and ice skates. Write for FREE, fact-filled folder.



THE FATE-ROOT-HEATH COMPANY
Dept. D-3, Plymouth, Ohio

POPULAR MECHANICS

Replace with a
DELCO BATTERY
for **GOOD SERVICE**
for a **LONG TIME**



DELCO BATTERIES FOR PASSENGER CARS, TRUCKS, BUSES AND
TRACTORS ARE SOLD BY DELCO BATTERY DEALERS EVERYWHERE

DELCO-REMY *WHEREVER WHEELS TURN OR PROPELLERS SPIN*

EARN BIG MONEY AND BE YOUR OWN BOSS Sharpening Lawn Mowers

Build a Business of Your Own With A UNIVERSAL GRINDER

In your own garage or basement, and earn \$25.00 a day or more. Mr. Hardy writes, "I am doing a fine business with the UNIVERSAL GRINDER. One customer sends another. I spent 40c for a newspaper ad and have done nearly \$500.00 worth of business." Mr. Helmeck of Canada writes, "We sharpened 750 mowers last year and are 1056 on this year's run. The Universal surely makes satisfied customers." Mr. Barton of California says, "The lawn mower business, with the Universal Grinder, has been a gold mine these last two years."



A Complete Single Unit • No Attachments Necessary
• Precision-Built • Simple to Operate • Sharpens
Reel Blades at Proper Angle • Grinds a Keen
Cutting Edge Full Length of Blade

Only on the UNIVERSAL GRINDER can the inside face and edge of the stationary blade, as well as the reel blades, be ground to proper clearance

ALL IN ONE SET-UP

WITHOUT REMOVING ANY BLADE FROM THE MOWER

Write for FREE Folder today!

Rogers Mfg. Co., Dept. M-69, Lindsey, Ohio

SO HANDY FOR
SO MANY USES

AT HOME
OFFICE AND SHOP

THE
JIFFY
METAL
CABINET

Now you can keep
nuts, bolts, screws,
nails, parts, wash-
ers, stamps, hobby-
ist needs, etc., at your fingertips.



32 DRAWER
MODEL PICTURED
ONLY
\$5.95
POST PAID

Just think, 32 or 64 drawer cabinet to keep those small items that usually get mislaid. Spot welded steel cabinet, enamel finish, metal drawer guides. Looks good anywhere. Send check or money order please—no C.O.D.'s. Prices below. Your money refunded if not satisfied.

SPECIFICATIONS

32 Drawer Unit
6" Deep
12 1/4" Wide
15 1/4" High
64 Drawer Unit
6" Deep
25 1/2" Wide
15 1/4" High
Drawer Size
1 1/4" Deep
2 3/4" Wide
6" Long

WITH ALUMINUM DRAWERS

One piece rustproof aluminum drawers for heavy service—good for work bench and industry use.

32 drw. \$8.95
64 drw. \$15.95

POSTAGE PAID

WITH CARDBOARD DRAWERS

Suitable for most home uses. Heavy board kraft covered. Metal drawer pulls.

32 drw. \$5.95
64 drw. \$9.95

POSTAGE PAID

KAYTEE PRODUCTS DEPT. M. BOX 588. CANTON, O.

ELECTRICITY Anywhere

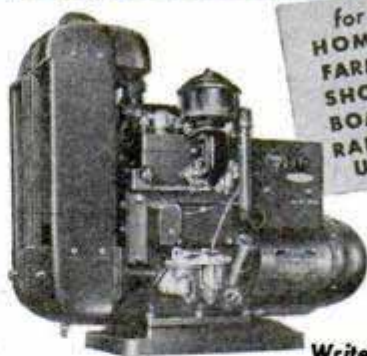

for
HOMES
FARMS
SHOPS
BOATS
RADIO
USE

● Onan gasoline-engine-driven Electric Plants supply reliable, economical electric service for any use. Portable, stationary or stand-by models. Water or air-cooled, compact and rugged.

A.C.: 350 to 35,000 watts in all standard voltages and frequencies. D.C.: 600 to 10,000 watts. 115 and 230 volts. BATTERY CHARGERS: 500 to 3,500 watts; 6, 12, 24, 32 volts.

Write for folder

D. W. ONAN & SONS INC.
5822 Royalston Ave., Minneapolis 5, Minn.



RUPTURED?

Get Relief This Proven Way

Why try to worry along with trusses that gouge your flesh—press heavily on hips and spine—enlarge opening—fail to hold rupture? You need the Cluthe. No leg-straps or cutting belts. Automatic adjustable pad holds at real opening—follows every body movement with instant increased support in case of strain. Cannot slip whether at work or play. Light. Waterproof. Can be worn in bath. Send for amazing FREE book, "Advice To Ruptured," and details of liberal truthful 60-day trial offer. Also endorsements from grateful users in your neighborhood. Write:

CLUTHE SONS, Dept. 31, Bloomfield, New Jersey

HOW TO CUT RAFTERS

New vest pocket book gives lengths, side cuts, plumb cuts, deductions. For all rafters for any building from one inch to forty feet wide. Gives numbers to cut on square. Also degrees for same cuts for Radial Saws. All standard pitches from 1/8 to 5/8. Just open book to pitch page and there are your lengths, side cuts, etc. Anyone who knows what a jack rafter is can frame a roof if he has this great book. Price \$1.50 prepaid. Builders' Topics, Dept. M, Lock Box 828, Seattle, Washington. CARPENTERS, PLUMBERS, PLASTERERS, ELECTRICIANS, ETC., subscribe for Builders' Topics, the monthly magazine for HE-MAN CONSTRUCTION WORKERS. Only \$2.00 per year. Sample copies 25c.

SPEED AND POWER HANDBOOK



Very latest methods! Build your own Dual Manifolds, Superchargers, Water Injectors, Hi-Compression Heads, Fuel Saving Devices—easily. SAVE MANY DOLLARS! Get racing speed, acceleration, dynamic power increases from any automobile! Build fast Stock Cars! California Roadsters! Hotrods! Get Construction Diagrams! Ingenious Formulas! Speed Secrets! Also "Economy Information"—Mileage Tricks! Conversion Ideas! Tuning Techniques! Picture Catalogues, Plans! Drawings! Including "California Restyling Ideas"—Glossy photographs! Plexi-Tops! Model Revising! Streamlining! Customizing!—\$1.98 complete.

Newhouse Automotive Industries, 5805-B4 East Beverly, Los Angeles 22, Calif.

DISCOVER URANIUM and Other Valuable Radioactive Ores!



The TX-8 GEIGER COUNTER—a superior instrument for locating deposits of radioactive ores. Compact, light weight, simple to operate, rugged. Extra sensitive—locates the ores and estimates the quantity and quality—right in the field. Made by world's largest exclusive manufacturers of Geiger Counters for prospectors.

Advance orders being taken for "URANIUM PROSPECTING" by Victor Shaw. A prospector's manual—tells where and how to look, what to look for, etc. \$2.00 per copy.

Write for details and prices

OMAHA SCIENTIFIC SUPPLY CO.
DEPT. P, 3601 N. 24th St., OMAHA 10, NEBR.



WAR SURPLUS AND OTHER ITEMS



PORTABLE DC LIGHT PLANT

3000 watt 110 volt DC powered by new 6 HP Briggs-Stratton model ZZZ gas engine. Rebuilt generator alone lists at \$243.00. Has volt meter, rheostat, 4 female plugs, and ball bearing 2.75 x 10 rubber wheels. Guaranteed. (Stock #320.)

ONLY
\$185



Hydraulic BUMPER JACK

Hydraulic bumper jack H.B.-15. Mfg. by Rausch Ind. Handles all cars. 1 1/2 ton cap. Collapsed height 30 1/2". Hydraulic lift 18". Saddle adj. low 33 1/2", high 17 1/2". List \$9.95. Stock #534. **\$5.95**
Our price.....
(lots of 6, \$4.95 ea.)

PLASTIC HOSE

Good for water, oil, air, electrical installations and radio work. Available in 100 ft. lengths. Min. order 50 ft.
1/8", 3/16", 1/4" 9/16" per ft.4c
(your choice) per 3/4", 1", (your choice), ft.2c per ft.6c
5/16" per ft. ...3c 1-3/8" per ft.8c

CENTRIFUGAL PUMP

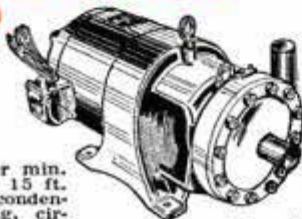

1" intake and outlet. Drip proof Master motor. 10 gal., per min. at a 48' head at 45 gal., per min. at a 20' head. 15 ft. lift. Ideal for condensation, sprinkling, circulating water in cooling systems and for air conditioning units. Stock #532.
AC-110 volt, Mfg. price 1/3 hp unit **\$75.00**
\$110.00 our price.
AC-110 volt, Mfg. price 1/2 hp unit **\$80.00**
\$120.00 our price.



All Bronze GEAR PUMP

All bronze corrosion resistant gear pump. Will lift water 25 ft. Will deliver 1020 gal. per hour at 1200 RPM. Develops 110 lbs. pressure or 250 ft. head. Self-locking packing nuts, drain cock, reversible head. Will pump brine, salt water, oil, vinegar, gasoline, etc. Dimensions: 10" L x 7" H x 5 1/2" W. Base holes 1 3/4" x 3". Shaft 1 1/16", 1" x 1" inlet & outlet. Wt. 24 lbs. Mfg. by Sherwood Brass Works. Requires 1/2 to 3 HP motor. \$80. value for only **\$195** new (Stock #314)

BALL BEARING ARBORS



Grinding and saw arbor, has 1/2" double end shaft, 1 1/2" long with 2" center pulley. New Departure double roll ball bearings. Right and left hand thread. Self aligning Dodge pillow block. 10,000 RPM. Bearings alone list at \$10. Complete arbor new. **\$495** (Stock #305).....only
HI-SPEED GRINDER (not pictured). Has 2 step pulley driven thru rear or base. **\$1095** (Stock #328).....

Swimming or Wading Pool

Made of heavy glass cloth with rubber impregnation on both sides. Diameter 12 ft., Height 5 ft. Holds 3000 gal. of water. Complete with cover, stays and guide lines. Cost gov't **\$79.50** approx. **\$350.** OUR PRICE.....
Due to handling, 50% deposit required on this item.



Electric Rubber Cable (ALL NEW)



CORD SETS

Extension cords, 100 ft. heavy duty. Plug, socket and guard. Number 16 wire. Worth at least \$10.
OUR PRICE..... **\$595**
(Stock #310)
Lots of 12 **\$4.45**
Same as above—50 ft. lengths **\$425**
Lots of 12 **\$3.15**

HEAVY DUTY ELECTRIC CABLE
3 wire—#10 Super cable, Stock #531
65' with lugs, Value **\$26.00.** **\$1300**
Our price.....
4 conductor neoprene covered #18 stranded tinned copper wire (two blacks & two whites). Run in parallel gives you #16 gauge. Lugs furnished for parallel run. Water & oil resistant. (Stock #346).
100 ft. 250 ft. 500 ft. 1320 ft. reel
\$4.25 \$10.00 \$19.00 \$36.00

HOSE 20' LENGTHS

Gas, oil or water resistant. Neoprene treated 1 1/4". Male and female brass connectors. Standard filling station size. VALUE **\$7.50**
\$20.00 our price.....
Stock #528 **\$3.00**
FOOT VALVE.....

HORNS and HOWLERS



Motor driven (not a vibrator). Heavy duty with great power and long life. Adjustable for high, medium or low tone. 110 volt AC current. Weather proof. For alarm or signal horn on boats, school yards, factories, etc. List price **\$47.00.** OUR PRICE..... **\$945** new.....

Stock #302

HALES FIRE PUMP



For fire depts., factories, forest fire protection, etc. 600 gal. per min. Can be operated with 4 or 6 cylinder gas engine. 4 1/2" intake... 2—2" outlets... 265 ft. head at 120 lbs. pressure. Passed by National Board of Fire Underwriters.
NEW, Stock #407... **\$109.00**



USED LIKE NEW

MARINE FLOAT

Made of heavy rubberized fabric. 1 1/2" rope encircles raft passing through dee rings as handles. Original cost \$525. Can be used as swimming pool, dock, diving raft, etc. Will support 4 tons! Cannot tip. Stock #412
6' W x 20' L. **\$59.50** 6' W x 25' L. **\$69.50**
Due to cost of handling, send full amount with order on this item.

HALF TON WAGON

"ASSEMBLED OR IN KIT FORM"
Heavy duty wagon with plate aluminum body 24" x 42".
Stock #332
WRITE FOR DETAILS



SPECIAL! SPECIAL! TABLE TOPS STAINLESS STEEL

22 x 19 1/2—11 lb... \$1.95 22 x 29 1/2—16 lb... \$2.95
22 x 21 1/2—12 lb... \$1.95 22 x 34—20 lb... \$3.45

23 x 27
15 lb.
\$2.45



22 x 37
22 lb.
\$3.95

Polished top dull bottom. Hard wood veneer center 3/4" thick. Suitable for work table, laundry tub, shelves, back bar work board. Stock #411.

GENERATORS and AC



LIGHT PLANTS

LIGHT PLANTS

300 WATT, 110-220 Volt AC, 60 cycle light plant powered by 1 HP gas engine, direct drive. Mounted on base weighs 40#. Stock #409. **\$99.50**

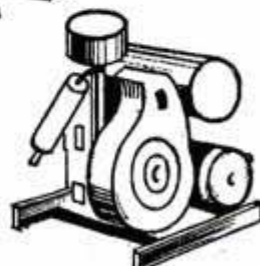

500 WATT, 110 Volt AC, 60 cycle. Onan direct connected. Stock #414. **\$149.50**

NEW 800 to 1000 WATT, 110 Volt 60 cycle, AC plant with Briggs & Stratton directly coupled to a Leland generator. **\$179.50**

NEW 1000 to 1200 WATT, 110 Volt 60 cycle, AC plant with Briggs & Stratton directly coupled to a Leland generator. **\$191.50**

2500 WATT, 110 Volt AC, 60 cycle with Briggs & Stratton Model Z and Leland generator. Stock #317. **\$225.00**

Used but like new. **\$295.00**

NEW Add \$10.00 for tools and spare parts.
5000 WATT, 110 Volt AC, 60 cycle with automatic remote control. Powered by 4 cyl Jeep gas engine. Used like new. **\$625.00**

7500 WATT, 110 Volt AC, 60 cycle powered by a VE 4 Waukesha 4 cyl gas engine. Continental or Hollingsworth generator. Remote control starting. Complete with switchboard. Used but like new. **\$675.00**

Stock #347 Add \$65.00 for transformer to make this plant 3 phase 220 volt.

10,000 WATT, 110-220 Volt AC, 60 cycle. Remote control. Powered by a Jeep 4 cyl gas engine. Used like new. **\$900.00**

Stock #319 NEW job, original crate only. **\$1100.00**

25,000 WATT 220 Volt AC, 3 phase. Spare parts. NEW packed for export. **\$1995.00**

GENERATORS

300 WATT, 12 Volt DC, 2000 RPM. Heavy duty with current cut out relay. High and low switch. 30 amp meter. Can be bought less shaft and base to be used directly mounted to a Briggs & Stratton 1 HP engine. **\$7.00**

Stock #323 NEW only Complete with shaft, base and bearing. **\$15.95**

Stock #324 300 WATT, 110-220 Volt AC, generator. Mfg. by Electric Specialties Co. Weights 20#. Stock #416. **\$34.50**

New only 800 to 1000 WATT, 110 Volt AC, 60 cycle generator with built in radio filter. Leland ball bearing 1800 RPM. **\$79.50**

Stock #526 1000 to 1200 WATT, 1800 RPM. **\$89.50**

Same as above. Stock #527 2500 to 3000 WATT, Leland generator 110 Volt, 60 cycle. 1800 RPM. Self excitor, radio filter, junction box for plug in. **\$145.00**

Stock #525, NEW 3000 WATT, Delco, 110 Volt DC. Plug in, ball bearing 2800 RPM. List price \$243.00. Used but like new. **\$79.00**

Stock #321

ALL ITEMS GUARANTEED AS REPRESENTED **C & H ELECTRIC Co.**
434 W. JUNEAU AVE.
MILWAUKEE 3, WISCONSIN

All prices F.O.B. Milwaukee. 25% deposit required on all C.O.D. orders. No C.O.D.'s under \$10.00. Use stock number when ordering. Many other bargain items not listed—write for our free circulars.

LOOK FOR THE NAME

Buckeye when you buy a

LAWN MOWER

Built by a factory noted for quality lawn mowers since 1880, the long experience behind BUCKEYE mowers assures you complete satisfaction with their fine, practical, labor saving performance. Streamlined design; light, strong, durable. Reasonably priced; recommended by reliable dealers. Send for free booklet describing the popular self propelled BUCKEYE Power King and the easy-to-push BUCKEYE hand mowers.



POWER KING #76

HAND AND POWER LAWN MOWERS

MAST-FOOS MFG. CO., Dept. PM-69, Springfield, O.

You may send descriptions of BUCKEYE Lawn Mowers, also name of your nearest dealer.

Name _____
Address _____
City _____ State _____

Learn A Trade NOW!
PRACTICAL SHOP TRAINING!

In Our Chicago Shops

- AUTO MECHANICS
- DIESEL MECHANICS
- REFRIGERATION
- BODY-FENDER
- WELDING—ARC and GAS
- MACHINIST
- PIANO TUNING

Above Approved For G. I.'s and Civilians
One of America's Leading Practical Schools
7 Floors of Fully Equipped Shops
Over 48,000 Successful Graduates
Expert Individual Instruction
Learn by Doing—Low Living Expense
Established 1902—Day and Evening Classes

Also the following Home Study Courses

- PLASTIC
- REFRIGERATION
- DIESEL

—CALL IN PERSON OR MAIL THIS AD TO—

GREER SHOP TRAINING

(Desk 16) 460 South State St., Chicago 5, Ill.

Please send without obligation free information regarding trade checked above. (Specify whether you are a Veteran or Civilian)

Name _____ Age _____
Address _____
City _____ State _____

STOP TAPPET NOISE!

Install **ADJUSTABLE TAPPETS**

for FORD and MERCURY V-8's (85-100 HP)



Johnson Adjustable Tappets guarantee better engine performance! Over 2,000,000 of these popular tappets are giving quiet, trouble-free service.

Simple and easy to install during valve grinding jobs.

Nothing complicated . . . no extra labor involved.

ASK YOUR SERVICE MAN OR NEAREST AUTOMOTIVE JOBBER TODAY

JOHNSON PRODUCTS INC. Muskegon, Michigan

- ELECTRIC TOOL KIT.**
Casco hand, new, complete with 15 accessory tools **\$14.95**
With metal case and 35 tools **\$19.95**
- ELECTRIC CLIPPER.**
Wahl, brand new, size 000, special **\$9.75**
- DUPLEX SLIDE RULE.**
10 inch, value \$10, special **\$5.95**
- WEATHER BAROMETER**
S. & A., Anchor Style, all brass precision instrument **\$12.50**
- AUTO COMPASS.**
Hull, new, Value \$3.95, special **\$2.75**
- LENSATIC COMPASSES,**
U. S. Govt., like new, cost \$12.50, special **\$2.95**
4th Annual Gun Digest and our New Catalog, \$1.50, Catalog separate, 25c.

PUBLIC SPORTS SHOPS

11 South 16th St., Phila. 2, Pa. (No COD's)

WOODWORKERS . . . Get this!
CONSTANTINE MASTER MANUAL

Get the Most Fun From Your Hobby

Indispensable to woodworkers. Newest, biggest edition, more pages, more color, helpful how-to-do-it articles, pre-war and new items, more bargains. Send 25c today and we will include **FREE! FULL YRS. SUBSCRIPTION** to Chips and Chats, published bi-monthly. Keeps you up-to-date on everything in woodworking, offers big money-saving bargains. Send now.

ALBERT CONSTANTINE & SON, Inc.
791-B East 135th Street, New York 54, N. Y.



THE GIFT FOR DAD THAT KEEPS ON GIVING

HULL
AUTOMOBILE COMPASS

Makes knowing the way sure, safe and easy. Beaconlite illuminated, \$5.95. Streamline standard, \$3.95.

At your dealer's. Write for circular.
HULL MFG. CO., P. O. BOX 246-D6, WARREN, OHIO



2 LITES-100!
USES!

A handy light.
In the home, garage, car, camp, on the farm—wherever there's night. 800-ft. spotlight or brilliant floodlight. Stands, hangs at any angle. At hardware, sport, electrical stores. Price, less 6-volt battery.



\$4.65

Delta POWERlite 2-LITE ELECTRIC LANTERN

DELTA ELECTRIC CO., MARION, INDIANA



TIME-SAVING TOOLS for SHOP and HOME

OWN A FAMOUS MOTO-TOOL

The "Pocket-Size Machine Shop"
HIGH-SPEED STEEL CUTTERS
—AT NO EXTRA COST

No shop or home is completely equipped without MOTO-TOOL . . . the correctly balanced motor-in-hand tool. It grinds, drills, carves, polishes—without vibration, 27,000 r.p.m. (approx.) does work better, faster, in wood, metal, glass, plastic. MOTO-TOOL Kit No. 2 includes high-speed steel cutters for longer life. MOTO-TOOL is backed by over 12 years of industrial use . . . packs years of pleasure. Due to wide popularity and increased production, Dremel's pre-war prices still prevail!



APPROX.
27,000 R. P. M.

MOTO-TOOL KIT NO. 2 with 23 accessories including high-speed steel cutters and Model 2 Moto-Tool in hard-wood case . . . **\$23.50**
MOTO-TOOL NO. 2 with one emery point . . . **\$16.50**
MOTO-TOOL KIT NO. 1 with 34 accessories and Model 1 Moto-Tool in wood case . . . **\$17.50**
MODEL 1 MOTO-TOOL with one emery wheel **\$9.85**



NEW DRILL PRESS
This 12" high, precision drill press is ideal for model making, wood carving, routing, etc. Utilizes No. 2 Moto-Tool. Only \$9.95 (Less Moto-Tool).



Look For These Moto-Tool Features

Dynamically balanced armature for vibrationless finger-tip control • Oilless (oil-sealed) bearings • Patented automatic chuck lock pin • Over-size armature shaft—hardened, ground, polished • 110 Volt AC-DC motor • Snap-type sliding switch • Cord protector • Shockproof bakelite housing • Dust-filtered air-cooling system • Weighs 13 oz.

NEW ELECTRIC "MOTO-SANDER" AND POLISHER

MAKES FUN
of
HARD WORK



Only
\$14.85
POSTPAID

Patented

Say "Good-bye" To Hand Sanding & Polishing!

Let speedy "Moto-Sander" do the work while you just guide it. Ideal for light sanding jobs. Use Moto-Sander for finishing, refinishing, redecorating. Quickly and smoothly sands furniture, walls, wood-work, wall board, plaster joints; boats, workshop projects, etc. Straight-line action (non-rotary) will not burn or scratch surface. Use Moto-Sander also for fast, effortless polishing of furniture, refrigerator cabinets, automobiles, other waxed surfaces. This versatile machine works on flat or curved surfaces—gets into tight corners. Moto-Sander is the lightest, most practical electric sander on the market. Delivers 7,200 strokes a minute . . . weighs only 2½ lbs. Furnished complete with 6 sheets assorted grade Garnet Paper for sanding, plus felt pad and sheepskin for wax polishing. Operates on 110-120 V., 60 cycle A. C. Thousands of users.



GETS INTO
TIGHT CORNERS



GREAT FOR
AUTO POLISHING

MOTO-SAW AN ELECTRIC SCROLL SAW SAFER THAN A HAND SAW

A high-speed power saw for boys from 8 to 80! Moto-Saw's 7,200 strokes a minute easily cuts intricate scroll designs—no limit to length of cut—averages 1 foot per minute through medium hardwood up to 3/4" thick. Four-way blade holder permits sawing in any direction . . . at any angle. Moto-Saw has only 2 moving parts—never needs oiling. Operates on 110-120 V., 60 cycle A. C. Thousands of satisfied users.



Only **\$5.85** POSTPAID
(WITH 3 BLADES)

JUST GUIDE IT!

The versatile Moto-Saw is as safe as a hand saw. A touch of the trigger switch sets it going . . . releasing stops it instantly.

WHERE TO BUY: Buy Dremel Tools from your dealer. If he cannot supply you, send full purchase price (check or money order) and we will ship post-paid. Or, send only \$2.00 now, and pay postman balance plus postage upon delivery. Your Money Back if not delighted after 5 days' trial.

DREMEL MFG. CO.

DEPT. 119-F

RACINE, WIS.

MAGNETS OF ALL TYPES—10c UP
AMAZINGLY POWERFUL!!
4 oz. Alnico Magnet, lifts 10 lbs. \$1.10. Our Leader, 15 oz. Magnet, lifts 40 lbs. \$2.50. New alloy—will not weaken! Useful for lifting valuables from tanks, lakes, or rivers easily! 7 small magnets \$1.10 with list of many shop and home uses. Satisfaction guaranteed.
R. EYRICH, 2566 N. 49TH ST., MILWAUKEE 10, WIS.

make your own Gems 29⁵⁰ F.o.B.
All necessary lapidary equipment is furnished, including a super-charged diamond blade for sawing, and all wheels for grinding, shaping and polishing; also complete instructions. The complete equipment as shown, less motor and belt, for only \$29.50, f.o.b., Burlington, Wisconsin. Write today for information and literature.
B&I MANUFACTURING CO.
Dept. S Burlington, Wis.

RE-STRING RACKETS AT HOME—EARN MONEY
EASY—PLEASANT—PROFITABLE
FREE Write for 1949 Catalog and Instruction Sheet NOW.
W. A. BICKEL & CO., 803 S. Boulevard, Dept. F-52, Oak Park, Ill.

SAVE 1/3! POWERBIKE
DIRECT FROM FACTORY TO YOU
Nationally known—Makes your bike a speedy streamlined Powerbike at new low cost. Ideal for work and play! Write for FREE LITERATURE!
SAGINAW PRODUCTS CORP.
108 RIVER ST., SAGINAW, MICHIGAN



DISCOVER
"NEW
FRONTIERS"

ON
Cushman
MOTOR SCOOTER

AMERICA'S PIONEER MOTOR SCOOTER



Ride anywhere — park anywhere! See America's scenic spots everywhere! Your Cushman Motor Scooter will get you there quickly, conveniently, economically. Overland users report more than 100 miles per gallon! Low initial cost—minimum upkeep—No battery, nor radiator to service. Get complete details and FREE demonstration from your dealer—or for illustrated literature WRITE DEPT. PM-59.

DEALER INQUIRIES INVITED

ESTABLISHED 1901

CUSHMAN MOTOR WORKS Inc.
LINCOLN, NEBRASKA USA

Why push a hand mower when you can drive a "Moto-Mower" . . . builders of quality power mowers for thirty years . . . write for literature and the name of the nearest dealer . . . a MOTO-MOWER is worth insisting upon . . . sizes 20" to 71"



When Junior wants the family car . . . let him drive the "MOTO-MOWER"

Best known name in power lawn mowers for thirty years



MOTO-MOWER
4615 Woodward, DETROIT 1
Since 1910 Company

It's so Easy... **CLEAN'em up SHINE'em up**

THE QUICK ZECOL WAY

Rub on—
let dry—
wipe off!

AT GARAGES AND SERVICE STATIONS
ZECOL INC., Milwaukee 1, Wisconsin

LUMBER

Big New 144 Page Catalog No. 16

OF HARD TO FIND WOODWORK ITEMS, HARDWARE AND SUPPLIES, the finest craftsman catalog Harold Hunt ever published—32 rare and fancy woods in natural colors—also in color, 43 matched veneer designs, multi-colored bandings, inlays, overlays, scroll patterns, etc. Only 15c, rebated on first order.

CRAFTSMAN WOOD SERVICE CO.
2729 S. Mary St. Dept. A-6 Chicago 8, Ill.

A Board or a Carload
TOP GRADE KILN DRIED

UNEQUALED BARGAINS

WALNUT, MAHOG., CHERRY, MAPLE, WH. HARD AND SOFT, POPLAR, PL-QTR. OAK, AROMATIC RED CEDAR

GET THIS FINE SUIT NO MONEY TO PAY!



BIG CASH EARNINGS, TOO!

Big news! This fine tailored suit yours without paying one cent—and big cash earnings, too! It's easy! Just take a few orders. Earn up to \$10 in a day and get your own suit as extra bonus. Dozens of rich new fabrics, superbly tailored in latest styles, at low prices produce orders on sight. Money-back guarantee.

FREE SAMPLES! Write today giving name, address, age, etc. for big complete outfit of actual samples and details of amazing new **BONUS SUIT** and money-making plan—**All Sent Free!** No experience. **SEND NO MONEY!** W. Z. GIBSON, Inc. 500 S. Throop, Dept. T-516, Chicago 7, Ill.

30" SHEET METAL BRAKE

Forms angles, channels, vees, dangles, locks, zees. Handles 26 gage sheet steel, heavier gages of aluminum, copper, plastic, etc. Portable. Can be held in a bench vise, or bolted down. All steel. Wt. 40 lbs. Shipped \$24.50 exp. collect.



12" BRAKE. Fits in vise to form difficult and compound bends, up to 20 gage steel 12" wide, \$12.50 PP.
SHEAR. Cuts 16 gage steel any length and width, \$12.50 P.P.
SHEET METAL PLIERS. 2 1/2" wide, \$2.00; 5", \$3.50.
Immediate delivery. Order direct, cash or C.O.D., or send for folder.

WISE BRAKE MFG. CO.
1116 SO. 27th ST. DEPT. P-6 OMAHA 5, NEBR.

AGENTS 300% Profit SIGN LETTERS

For Store Fronts and Office Windows. Anyone can put them on. Free Samples. Liberal Offer to General Agents.
METALLIC LETTER CO., 430 N. Clark, Chicago 10

Say You Saw It in Popular Mechanics

TENTS
WAR SURPLUS
ALL TYPES AND SIZES



- A Few of our Low Prices:**
- 5x7 wall tent, new, waterproofed, O.D. canvas, with poles and stakes \$10.95
 - 2-man mountain tent, like new. Floor insect proof. With poles and stakes \$9.50
 - 16x16 pyramidal tent, used, grade A. \$29.95
 - Poles \$3.95 Stakes \$3.00
 - 17x33 squad tent, new \$79.50
 - Poles and stakes \$12.00
 - Navy hammocks, new complete with ropes and clews . \$3.25
 - Tarpaulins, new, O.D. 9c sq. ft.

Send check or money order or 25% deposit for C.O.D. 5-day money back guarantee.

Also camping equipment, sporting and fishing supplies and rope.
LOW PRICES! FREE 24-PAGE CATALOG
MOR-SAN SALES 10-17E 50th Avenue Long Island City 1, N. Y.

Do a Better Job WITH ONE OF THESE EMPIRE LEVELS

EMPIRE TORPEDO LEVEL
Smallest, most handy and accurate Level made. "Cigar-shaped"—no sharp corners to tear pocket. Aluminum stock. Only 3 oz. wgt. 9" long. Has Level, Plumb, 45° Vials.
No. 26 \$2.00



ALUMINUM LEVEL — No. 151
Cast and Machined, a Beautiful Tool, with Patented, Removable Level and Vial.
With 2 Plumb, 2 Levels, 2 — 45° Vials. 18"..... \$6.40
24"..... \$6.80 28"..... \$7.80
Order **EMPIRE LEVELS** from your local dealer.
Write direct for literature.

EMPIRE LEVEL MFG. CO.
BOX 97, DEPT. P-252 MILWAUKEE 13, WISCONSIN

MACHINE SHOP EQUIPMENT



The 1949 edition of the famous Center Tool Co. Catalog is now ready! Every workshop owner should have a copy. 240 pages full of illustrations, descriptions, and prices of the latest tools made by best known manufacturers in U. S. You pay the cost of printing—50c. **We refund your 50c with your first order of \$10.00 or more.** Prompt delivery on most tools. Send check or money order today!

CENTER TOOL CO., 153 Centre Street, Dept. C, New York 13

G. I. DIVERS!

Don't let your training go to waste. Commercial Divers earn up to \$80 a day.
In your spare time you can do odd jobs—clean pools or tanks, retrieve golf balls or outboard motors, locate sunken boats, etc. Very **LOW COST** complete Gov't surplus **EQUIPMENT** available—either deep water or shallow water.

CATALOG 15c ON REQUEST.

Other marine surplus—sextants, barographs, bells, life preservers, M & T barge units, anchors, etc.

M & E MARINE SUPPLY CO. P. O. BOX 601-Y CAMDEN, NEW JERSEY

PAINTERS' STRIPING TOOL

A TOOL... NOT A BRUSH

NEW, IMPROVED

Modern—streamlined—fits the hand like a fountain pen! Easy to use as a pencil. Draws parallel lines—straight, curve or circular. Does expert job on autos, furniture, toys, bikes, model planes, signs, bulletins, linoleum. (Makes wall board look like tile.) Every painter and craftsman needs one! Type "M" MASTER Painters' Striping Tool complete with tip for 1/16" stripe, \$1.00. Tool with choice of 1/64", 1/32", 3/64", 5/64", 3/32", 1/8" tip—\$1.50... all tips 75c ea. Tool with complete set of 7 tips \$5.00. (COD's postage collect.) Paint dealers, write!

EASY AS USING A PENCIL!



\$1.00 POST PAID

WENDELL MFG. CO.
4234-B Lincoln Ave., Chicago 18, Illinois

You Won't Believe It!

When you start the new Johnson QD and your boat stands still, you're not dreaming. That's Neutral—you have Johnson Gear Shift Control. When you cruise for hours and still have lots of fuel, the fuel gauge isn't wrong—the separate Mile-Master Fuel Tank holds 5 gallons! When you give 'er the gun and hold your hat or when you throttle down to a steady troll—it's no miracle. That's the way this 10.0 h.p.* ball-of-fire is engineered. Its 40 great features give you an entirely new kind of outboard motor performance. And it weighs only 56 pounds!

See the QD at your Johnson dealer's. Look for his name under "Outboard Motors" in your classified telephone directory.



* OBC Certified Brake H. P. at 4000 r. p. m.

Neutral
Forward
Reverse
and MILE-MASTER Fuel Tank

This is the Gear Shift Lever. Now you *shift* from Neutral to Forward or Reverse. A new day in outboard motoring!

This is the Self-Seal "click-in" Connector on the 12-foot fuel line. Plugs into motor like an electric cord!

This is the Mile-Master Fuel Tank you can put anywhere in your boat. (5 gal.—16 lbs.). Complete with fuel gauge, fittings and fuel line.



FREE HANDY CHART. Write for the new 1949 Sea-Horse Handy Chart. Illustrates and charts the QD and the 4 other great Johnsons for '49. All features fully described.

JOHNSON MOTORS
400 Pershing Road, Waukegan, Illinois
Johnson Motors of Canada, Peterboro, Canada



JOHNSON SEA-HORSES
for **DEPENDability**

NEW Stanley "Handyman" Electric Drills

Make your work a lot easier with these two drills built for mechanics by Stanley. They'll pay for themselves over and over again.



No. 04

No. 04 — 1/4" capacity in steel, 1/2" in wood. Weighs only 3 1/4 lbs. \$26.00.

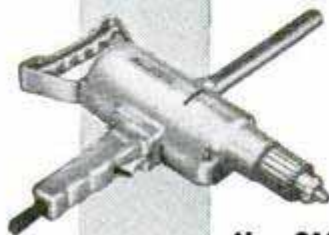

No. 012

No. 012 — 1/2" capacity in steel, 1 3/8" in wood. Offset spindle permits close quarter drilling without removing pipe or spade handle. Weighs 9 1/4 lbs. \$42.50.

Bench stands available to convert these drills into economical drill presses.

The greatest name in tools

STANLEY
HANDYMAN

HARDWARE • HAND TOOLS • ELECTRIC TOOLS • STEEL STRAPPING

Order from your hardware, electrical or implement dealer. Illustrated folder E9 on request. Stanley Electric Tools, 488 Myrtle St., New Britain, Conn.

MEASURE PROFIT 4 WAYS

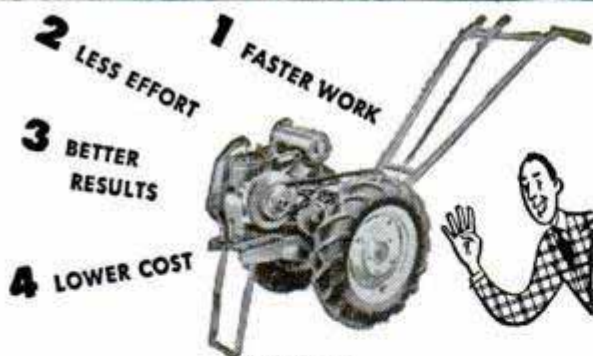

WITH BOLENS HUSKI POWER-HO

It's always ready to do a big job for you . . . any day of any season. Use it to plow, seed, cultivate, weed, mow lawns, spray, compress air or plow snow in winter. For really efficient work at low cost, you can't make a better buy than the 1 1/2 h.p., variable speed BOLENS HUSKI Power-Ho. See your Bolens dealer or write direct for complete information.

BOLENS HUSKI TRACTORS — the Complete Line From 1 h.p. to 5 h.p.—1 wheel, 2 wheel and 3 wheel models.



BOLENS PRODUCTS DIVISION
Food Machinery and Chemical Corp.

Better performance, better price... your best buy is BOLENS
265-6 Park Street • Port Washington, Wis.

Neptune OUTBOARDS NOW SOLD FACTORY-TO-YOU!



Model AA-2

\$89⁵⁰

SAVE UP TO 37 1/2% ON THESE FINE MOTORS 3.3 H.P. MODEL AA-2

Regular list price on this model is \$131.00. Save \$40.50. Full Reverse. O. B. C. Certified. Entire line reduced up to powerful 10.5 H.P. Buy a Neptune NOW. 12 Month Guarantee. Write for

FREE FOLDER
SHOWING ALL MODELS
MUNCIE GEAR WORKS
DEPT M4 MUNCIE, IND.

Now CHEAP OIL BURNER FOR HEATING AND COOKING STOVES-FURNACES

HEAT YOUR HOME, COOK YOUR MEALS WITH CHEAP FURNACE OIL

NO MORE SHOVELING COAL OR ASHES. Sensational Fuelizer Starter Vaporizing System turns Cheap No. 1 Furnace Oil, also Range, Heater, Tractor Distillate, Kerosene and like oils into oil heat—one of the quickest, hottest fires known. **LIFETIME GUARANTEE. \$1.00 Bonus Offer for Testing.**

We will let you try it in your own stove or furnace for one month. Get yours for introducing. Big profits QUICK. Be first. Send in your name today for details and cash in on the tremendous demand for this Amazing Invention.

NORTHWEST MFG. CO., 634-G, Mitchell, S. Dak.

Superette Dual Vacuum Auto Horns

The Voice of Authority on The Highway

One blast and those "road hogs" really move over. Superette Horns compare favorably to air horns costing \$75 to \$100. Can be installed under hood or on front fender. Beautiful lacquer finish. Operates from intake manifold of your car. No tank needed. Cost is only \$8.95 complete with all necessary fittings, control valve and simple installation instructions. Send check or money order today or order C. O. D. - Adds much to your car.

THE PROTECTUROD COMPANY, Dept. 553
4033 Windsor Road, Youngstown 7, Ohio

New 1949 PLASTICS SUPPLIES CATALOG

Just off press. Full details on Plexiglas, Lucite, rods, sheets, tubes, Acetates, cements, dyes, buffs, molding sets, tools, carving kits, accessories. Everything in plastics. Gives prices, sizes, colors, etc. Price 10c, stamps or coin, with ad for catalog.

PLASTICS MFG. & SUPPLY CORP.
DEPT. PM-6 • 4707 EUCLID • CLEVELAND 3, OHIO

MAKE MONEY MAKING DOUGHNUTS

Make new greaseless doughnuts at home on electric machine. Sell for cash to grocers, cafes, drug stores, etc. No exp. nec. Good profits. Small investment. Send for free recipes and plans.

MART RAY CO. • 3605 S. 15 Ave. • Minneapolis 7, Minn.

SAY YOU SAW IT IN POPULAR MECHANICS

MYSTERIOUS DEVICE WELDS BRAZES SOLDERS & CUTS ANYONE CAN OPERATE

ONLY \$9⁹⁵

FOUR-WAY WELDER

This newly invented **FOUR-WAY PORTABLE ELECTRIC WELDER** will do brazing, soldering, welding and cutting on brass, bronze, iron, steel, cast iron and other metals. It's easy to use. **WORKS INSTANTLY** off any properly wired 110 VOLT A.C. OR D.C. LINE. Does a thousand and one professional type repair jobs. **SAVES TIME AND MONEY** on auto, home appliance, farm and shop repairs. It's indispensable for maintenance men, farmers, repair shops, engineers, tin smiths, home and auto owners, bicycle and fix-it shops, etc.

10 DAY TRIAL OFFER The **FOUR-WAY** COMES COMPLETE WITH ALL SUPPLIES READY TO OPERATE including simplified instructions. **IT'S FULLY GUARANTEED.** Order one today for 10 DAY TRIAL or write for FREE particulars.

FOUR-WAY WELDER CO., Dept. PMF-69
3180 North Clark St., Chicago 14, Illinois

Get low-cost power with a **WITTE DIESEL**



3 KVA-AC Dieselelectric Plant

Whether you need a Dieselelectric Plant or a Power Unit, Witte is the name to choose. Witte specializes in the construction of Dieselelectric Plants (3 to 10 KVA-AC, 2.5 to 8 KW-DC) and Diesel Power Units from 4 to 12 H.P.

Witte concentration of effort on these popular sized diesels has developed units which are famous for trouble-free performance and low-cost maintenance, even under the most strenuous operating conditions. Witte gives you reliable power for a few cents an hour.

Save money and stop worrying. Order a Witte Dieselelectric Plant or Power Unit from your Witte dealer today. Write for free illustrated literature.



WITTE ENGINE WORKS
1610 Oakland Ave., Kansas City 3, Missouri
Division of Oil Well Supply Company

UNITED STATES STEEL

FASTEST PLANER in the WORLD at this Low Price... \$215.00

BELSAW Multi-Duty Planer

Speed up production! Increase your profits! BELSAW power self-feeds at 24 feet per minute...

The lowest-priced surfacer that will handle 12x6 in. stock. Planes green or dry sawed lumber into smooth, worked forms. Three high-speed steel knives make 42 cuts per inch. Multi-duty BELSAW takes inexpensive attachments for all planing mill operations—Jointing, Rabbering, Grooving, Matching. BELSAW is the only 12 in. planer providing attachments for jointing and grinding its own knives. Start planning NOW for BIGGER VALUE and BETTER PERFORMANCE, with BELSAW. Write for FREE specifications, illustrations and low prices.



● LARGER CAPACITY ● FASTER OUTPUT ● KNIFE SHARPENING ATTACHMENT
BELSAW MACHINERY CO. B1018 Field Bldg., 315 Westport Rd. Kansas City, Mo.

AMAZING NEW SAFE JIG SAW READY!

At last — a revolutionary, new electric jig saw small children may use, yet powerful enough to be the basic tool in Dad's workshop. Make "Standing Photo Silhouettes" of favorite snap shots... fancy what-nots, toys, for fun and profit! Just plug in! No motor to buy—no oiling. Thousands sold. Use in livingroom, apartments, etc. Patented. Nothing else like it. Mail postal NOW for illustrated, Free Circular, low price!



FREE Circular!

SYNCR0

Dealers Write!
SYNCR0 CORPORATION, Dept. H-69, Rochester, Mich.

Sensational TWIN CARBURETION

POWER • SPEED • ECONOMY
● Amazing Mani-Daptor Unit allows twin carburetors on any car. Steps up motor efficiency approx. 20%. Firing order at no time affected by fadeouts—yet saves gas. More high gear driving, faster pickup, more economy with a Mani-Daptor. Precision-built aluminum polished unit will last for years. Comes complete with necessary linkage, easy-to-follow instructions. ORDER YOURS TODAY!

For 8-cyl cars \$26.50 Chrome \$1.25 ea. Stacks
For 6-cyl cars \$32.00 Finned \$2.00 ea. Stacks

Free illus. Folder not included in price of unit. Cash, check or money order, C.O.D.'s o.k.
L. B. BACKUS MFG. COMPANY
P. O. Box 97-M Inglewood, Calif.

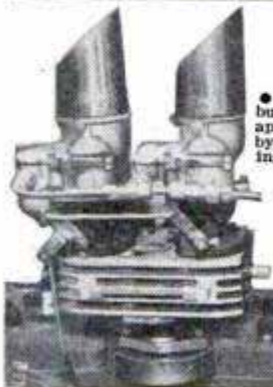

SAVE 1/2 NOW ON

"Master Mechanic"

PAINT SPRAY OUTFIT

with Genuine

Westinghouse Compressor

MAKE MONEY PAINT SPRAYING

SATISFACTION GUARANTEED



TWIN CYLINDER PISTON-TYPE COMPRESSOR

COMES WITH OR WITHOUT MOTOR

SAVE MONEY—MAKE MONEY

Spray a stunning, factory-like paint job on your car, truck, tractor or machinery. Do professional spray-paint jobs on buildings, inside of barns, poultry houses; for waterproofing basements, etc. Not just a compressor, but COMPLETE professional equipment. Quickly pays for itself. Sprays trees, gardens, weeds, inflates tires, greases machinery, blows out plugged lines, countless other home, shop, farm, factory uses.

Westinghouse Compressor runs from 1/2 h.p. motor or equivalent gas engine or may be easily mounted to run from power take-off or fan belt of jeep, tractor, truck. Delivers filtered, "oil free air"—twice the air output of other comparable units. Up to 6 1/2 cu. ft. capacity. 100 lbs. pressure. Powerful, rugged, easily portable. Send order today.

BARGAIN PRICES

- A "Master Mechanic" Spray Outfit; Compressor; drilled steel base; safety valve; fittings; gauge; Shrader Air Chuck; 20 ft. heavy duty air hose; 10 ft. heavy duty extension cord; spray painting manual. . . . \$34.95
 - B 1/2 H.P. Capacitor Motor. \$26.50
 - C Professional Type Spray Gun, 2 Nozzles. . . . \$7.45
- All Prices F.O.B. Chicago Area

MAIL COUPON TODAY

Master Mechanic Co., Dept. 11, Burlington, Wis.

Please ship item or items checked:

- A "Master Mechanic" Spray Outfit. \$34.95
- B 1/2 H.P. Capacitor Motor. \$26.50
- C Spray Gun, 2 Nozzles. \$ 7.45

Full remittance enclosed \$10.00 herewith; balance to be paid c.o.d.

I will pay freight on arrival

Name.....

Address.....

City.....State.....

SAY YOU SAW IT IN POPULAR MECHANICS

The only paint spray that gives you
1 HORSEPOWER PERFORMANCE
AT 1/3 HORSEPOWER COST



Binks PORTABLE
 PAINT SPRAY
 (DP* unit)

Brand new! Just out after exhaustive field and laboratory tests. Now you can have a really "professional" paint spray made by BINKS, manufacturers of world famous industrial spray equipment.

Compressor weighs only 47 lbs. but delivers 1 h.p. spraying performance for cost of only 1/3 h.p. unit. Built for easy portability—even up a ladder. For serious finishing, maintenance, craftwork, farm jobs, light production. Handles any finish from undercoater out. Supersafe; all moving parts enclosed. GUARANTEED. Operates on 110-120 v., A.C. Gives 40 lbs. pressure.

Free literature. Send today for free folders telling all about the BINKS new DP compressor, gun, and accessories. Or ask your local dealer to show it to you.

*DP means Direct-drive Piston.



Binks MANUFACTURING COMPANY
 Dept. DP1, 3114 Carroll Ave., Chicago 12, Illinois

GET AN OUTSTANDING "SPIN-KING"
FREE WITH THE
 EVER POPULAR
 "HONEY" BAIT!
 5/8 oz.

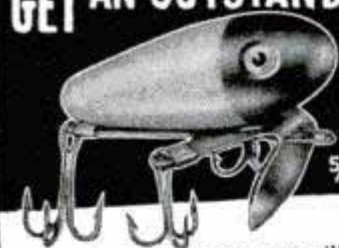

HONEY Trolling & Casting

Honey... Your first cast will tell you it's a honey. Here's a world of fishing success in this crazy looking plug. Skeptics have been amazed at the fish it takes. Try it against any bait and see if it doesn't bring in just as many or more fish. Here's why! Devilish action, all its own—casts like a bullet—hooks out from bait to make strikes a catch—made as good as any bait. Many hundreds sold at \$1.35 each—and worth it. To prove to you its superiority, here's our deal: A Honey, sinker or floater, any color, for only \$1.00 prepaid, and with it FREE the marvel bait SPIN-KING. What a buy! A break for you, but we want you to get acquainted with our baits. Thousands will be gobbled up at these prices—get your order in at once. Not sold by dealers. We are responsible—look us up.



Get YOURS TO-DAY
WHAT A THRILLING DIFFERENCE WHEN YOU USE THESE BAITS!

SPIN-KING Trolling & Casting

Extensive fishing tests definitely prove this little fellow is tops in taking fish. It's really a marvel. A JOY to use. No other bait can excel it! Once used, you'll swear by it! Perfect for spinning and light running reels. Natural shaped minnow 2 1/4" long. Beautifully finished. It's FREE with the purchase of a Honey.

ONE SPIN-KING FREE WITH EACH HONEY ORDERED

Staley-Johnson Mfg. Co. Inc., Box 152 - Fort Wayne, Indiana
 Included is \$1.00 or check for one HONEY and a FREE Spin-King postpaid. Order as many as you like.

Name
 Address
 City State

BACK ACHE? SORE MUSCLES?



When muscles are stiff and sore from unusual exercise or strain, use HEET®, the liniment that's strong yet does not burn the skin. Wonderful relief from muscular soreness comes as comforting HEET quickly starts to penetrate. Just brush it on with the applicator. HEET starts at once to ease muscular pain and keeps on working for hours, warms and soothes the painful area.

SURPLUS HIGH SPEED DRILLS MICROMETERS

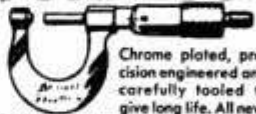

Chrome plated, precision engineered and carefully tooling to give long life. All new.

0-1" capacity . . . each \$2.25
 1-2" capacity . . . each 3.50
 2-3" capacity . . . each 5.50
 3-4" capacity . . . each 6.50

All New Drills! Orig. value \$15.
 30 assorted sizes and lengths \$3.50

SEND FOR FREE DESCRIPTIVE CATALOG
 Send check, money order or cash. 25% deposit required on C.O.D. orders. All prices F.O.B. Culver City, Calif.

AIRBORNE SALES CO., INC. DEPT. PM
 CULVER CITY, CALIF.

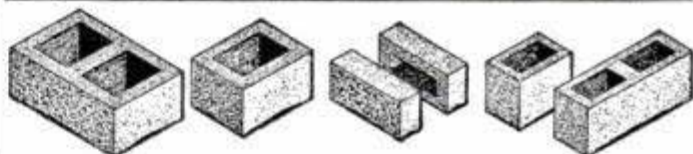

Make Concrete Blocks and Bricks

New superior method makes square, true, easy-to-lay units which will pass any building code. Small investment, high production, big profits. One \$30.00 machine will make four 5"x8"x12" blocks per minute—1000 per day. Pays for itself in a few days. Sell blocks or save 2/3 building cost by making and laying your own.

POST CARD BRINGS FREE FOLDER

Economy Manufacturing Company
 Dept. P Stone Mountain, Georgia

OTTAWA Buzz Master



A faster brush cutter and wood sawing machine. Propels itself while cutting saplings and brush. 7 H-P motor. Many outstanding and exclusive features. Available attachments: sickle bar, rotary tiller, sprayer, air compressor, snow plow and pulley for belt work. Thousands in use. Send for FREE booklet.

OTTAWA MFG. CO., 1-927 Brush Ave., Ottawa, Kansas

An Outstanding METAL HAND PUNCH with unusual performance

Needed by every
 Mechanic in every
 Shop



No. 5 Jr. HAND PUNCH

CAPACITY—1/4" THRU 16
 Ga. Mild Steel. 3/32" —
 1/8" — 5/32" — 3/16" —
 7/32" — 1/4" — 9/32" —
 Punches and Dies Furnished.

THROAT
 DEPTH
 2 inches

Weights
 2 3/4 lbs.

only \$8.75

ORDER YOURS TODAY!

Write for FREE Catalog on other tools.

WHITNEY METAL TOOL CO., Dept. P-6, Rockford, Ill.

Postpaid in
 U.S.A.

Fits Your
Electric Drill

Polish, Sand and Save with **BULL BUFFER!**

More than pays for itself the very first time you make your car, boat, floors, woodwork gleam like new!

More than 100,000 enthusiastic users will tell you that Bull Buffer has everything you want in a polisher-sander: (1) fits any electric drill or flexible shaft, (2) exclusive gear reduction that gives any drill real power, (3) exclusive swivel action that makes it easy to use, (4) exclusive angle head that helps get to all those hard-to-reach places other polisher-sanders can't touch.

Bull Buffer is built of lifetime materials and guaranteed. Order yours today, at your dealer, or send cash, check, or M.O. for your Bull Buffer, **\$9.95** complete as pictured below, only.....



Bull Buffer comes complete with sheepskin bonnet, and 2 sanding discs, only \$9.95.

ORDER THESE EXTRA ACCESSORIES FOR YOUR BULL BUFFER

These attachments (see price list below) will fit the Bull Buffer only.

- 1/2" Jacobs No. 6425 key chuck; with Bull Buffer increases 1/4" drill to 1/2" capacity — reduces speed, increases power..... **\$5.00**
- Extra sanding discs (0000-000-00-0-1-2 1/2-3-4) each..... **.10**
- 2 1/2" cup wire brush for removing paint, rust, scale, etc..... **1.75**
- Extra sheepskin bonnet..... **1.25**
- Adapter A—for direct drive at "same as" drill speed..... **1.00**
- Adapter B Set—for sanding at twice drill speed..... **2.00**
- Bull Buffer car cleaner..... **.50**
- Bull Buffer car polish..... **1.00**
- 1/2" pile wool pad with rubberized back, to be used with cleaning compound, each **1.35**

✓ polish car
✓ sand boat
✓ polish furniture
✓ sand woodwork
✓ polish floors

BERTRAM P. ENGINEERING CO.
3121 MAIN STREET
KANSAS CITY, MO.
DEALERS WRITE FOR NAME OF NEAREST WHOLESALER

RUBINA opens NEW TRENDS... 16mm "Still" Photography!



A superb TINY precision camera that takes thrilling low-cost Salon pictures in Color or Black-and-White!

SEND
\$29.50
tax incl.

16mm rubix-RUBINA color photography rivals results of finest 35mm camera! Negatives enlarge to 8x10 without ANY loss of definition. Slides can be used in 16mm or 35mm standard projectors.

- Color corrected f/3.5 anastigmat lens.
- Shutter speeds, 1/25th, 1/50th, 1/100th & B.
- Ratchet Film Counter. • FREE — Leather Case.
- Anso Color Film, 20 exp. (incl. proc.)..... **\$2.00**
- B. & W. Film, 30 exp..... **\$1.00**

ORDER rubix-RUBINA NOW by MAIL

10-DAY MONEY-BACK GUARANTEE! Money Order or Check, Please.

Write for MYCRO CAMERA CO., INC. Dept. R-1
Literature! 527 FIFTH AVENUE, NEW YORK CITY

MAIL ORDERS—WAR SURPLUS!

NEW! 3-WAY FOLDING SHOVELS

FOR GARDENING—CAMPING!

For use as a shovel, hoe, pick, hammer or axe. Handiest tool you ever saw! Has sturdy 20" hardwood handle, 6"x9" pointed tempered steel blade with 2 cutting edges.



This Fine ALL-PURPOSE TOOL is \$1.95 VALUE!

49¢

New, but slightly weather-soiled — no damage to shovel at all.

SHIPPING WEIGHT 3 POUNDS, 13 OUNCES

NEW! CARRYALL Waterproof Canvas Fishing—Camping Bag

Dundy for FISHERMEN • BEACH HUNTERS • CAMPERS • BOY SCOUTS

EASILY A \$1.95 VALUE!

Inside opens to 10" x4"x7". Has 2 outside pouches with snap fasteners. Cover fastens with buckle straps. Web carrying straps included.



49¢

Shpg. Wt. 1 Lb., 12 Oz.

NEW—DUAL TUBE PNEUMATIC SWIM FLOATS

FUN in the WATER with SAFETY! Use as a RAFT — PLAYBOAT — HEADREST — LIFESAVER. LEARN TO SWIM etc. Inflates by mouth. In original carton!

FOR KIDS ADULTS **59¢** VAL. \$1.95 VAL.

Shipping Weight 3 1/2 lbs.



NEW! 8 1/2 FT. x 10 FT. DE LUXE "AIRFLO" CAMPERS WALL TENTS

5 1/2 FT. SIDEWALLS — 8 1/2 FT. CENTER "AIRFLO" SCREENING ON SIDES — WINDOW FRONT. ROLL-UP TIE-BACK CURTAINS FOR AIR, LIGHT, PERFECT VENTILATION. GREATEST CAMPING TENT EVER MADE!

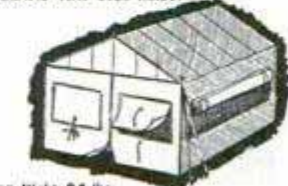

• \$69.50 VALUE!
• Full Zipper Front Door.
• Finest U. S. Waterproof Canvas
• Plenty of Room for 4 Cots, Table, Chairs, Etc.
\$32.45 WITH ALL POLS & PINS

SEND FOR FREE CATALOG — AMAZING VALUES!
UNIVERSAL ENTERPRISES

DEPT. 6 P.M., 946 S. MAIN ST. LOS ANGELES 15, CALIF.
ALL PRICES F.O.B. LOS ANGELES
1/3 Deposit on C.O.D.'s • Pay by Check or Money Order

LATHE CUTTER BIT GRINDING GAUGE

50¢ For checking clearance and rake angles.
SOUTH BEND LATHE WORKS
455H E. MADISON ST., SOUTH BEND 22, IND.

BUILD YOUR POWER TOOLS

WITH POLY BALL BEARING ARBORS
HEAVY DUTY GRINDER Model D-12 Pictured

3 1/4" x 17 1/2" precision spindle, self-lubricating ball bearings, heavy casting, V belt, 3 step pulley driven through rear or base.
ONLY **\$18.25**
Ship. wt. 13 pounds

FREE! Write for POLY Illustrated literature.
POLY BALL BEARING ARBORS
C4-1/2x12 1/2 spindle, housing 2x8, \$7.95 pp.
C5-3/4x12 1/2 spindle, housing 2x8, \$8.45 pp.
C6-3/4x12 1/2 spindle, housing 2 1/4x8, \$9.45 pp.
D8-1x17 1/2 spindle, housing 2 1/2x11, \$18.75 pp.
SHAPER ARBORS—Free literature on request.

POLY PRODUCTS, 2032-A E. Walnut, Pasadena 8, Calif.

Build Own ATTIC OR WINDOW FAN

**SAVE
2/3**

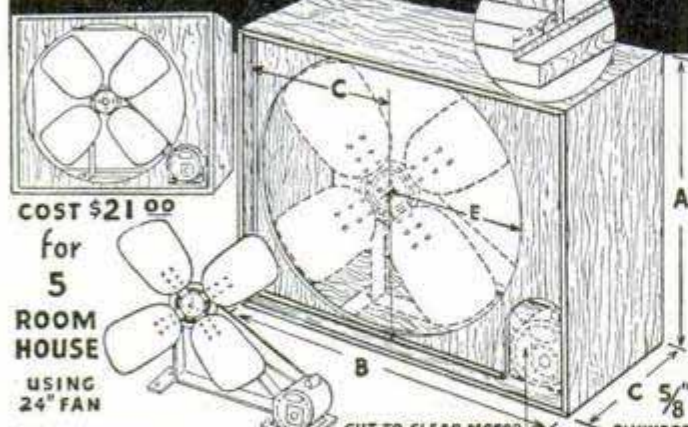

COST \$21.00
for
5
ROOM
HOUSE
USING
24" FAN

ASSEMBLY
Torrington Precision Balanced Steel Blade, Rigid Welded Construction, Adjustable motor mount, Correct pulley ratio to 1750 RPM Motor.

Size Fan	Dim -A-	Dim -B-	Dim -C-	Dim -E-	Price
20"	22"	29 1/2"	11"	10 1/2"	\$19.50
24"	26"	32 3/4"	13"	12 1/2"	\$21.00
28"	28"	34 1/4"	14"	13 1/2"	\$22.00
28"	30"	35 1/2"	15"	14 1/2"	\$24.50
30"	32"	37 1/2"	16"	15 1/2"	\$27.50
36"	38"	41 3/8"	19"	18 1/2"	\$29.95

24" FAN \$34.95 48" FAN \$39.95

Thousands in use. The assembly takes guesswork from your completed fan. Assembly comes complete with blade, pulleys, etc., all parts excepting motor and easily made wood box. Only work is to box assembly for attic or window, mount motor with 4 bolts and you'll have an efficient, sturdy, healthful, cooling fan. Order Model M-2 of size fan wanted. Send check, cash or money order plus \$2 for express and packing charges. For C.O.D. shipment send \$5 deposit. Satisfaction guaranteed or money back. (Special prices for quantities.)

TROUSDALE MFG. CO., 266 Madison, Memphis, Tenn.

PROFITS AND SPEED

THE MODERN LAWN MOWER SHARPENER

PRICE
\$241.50
LESS
MOTOR

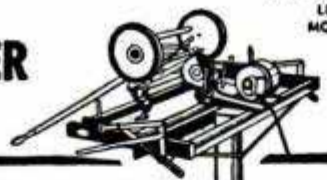

INCREASES PROFITS • INCREASES SALES!
FOR LAWN MOWER SHOPS
FIXIT SHOPS • LOCKSMITHS •
HARDWARE STORES • GOLF COURSES • SCHOOLS
PARKS • PLAYGROUNDS • INSTITUTIONS •
CEMETERIES • AND ALERT INDIVIDUALS!

Sharpens All Reel Type Mowers • Hand, Power or Gang • 10 to 20 Minutes • No Dismantling • No Extra Attachments Needed

All reel type mowers, from 5-inch edgers to 36-inch power mowers, are quickly sharpened to extreme ends of both left and right twist reel blades. Handle, wheels, roller and motor remain in place when sharpening is in process. Bed knife is sharpened in same brackets that hold mower in grinding position. No extra attachments required. One lever puts mower or bed knife in grinding position. 100% steel construction. Grinding head rides on five ball bearing races. Small, compact, easy to operate. Sharpens wood chisels, joiner knives and planer blades without extra attachments.

ORDER NOW
Immediate Delivery

Skate Sharpener Attachment Available
Send For Free Bulletin No. 10B

MODERN MFG. CO. 160 N. FAIR OAKS AVE. PASADENA, CALIFORNIA

Clean-up Time

... for car cooling systems, too!

Avoid engine overheating on hot summer days



with **Warner** care



WARNER RADIATOR CLEANER — Thoroughly cleans cooling system of rust, oil-muck and grease. Harmless to metals, hose and car finish.

WARNER COOLING SYSTEM PROTECTOR — Prevents rust and corrosion—keeps cooling system clean for maximum efficiency.

"Just Shake . . . Pour . . . and Forget No More!"
See your service man or do it yourself.

Warner-Patterson Company, 920 S. Michigan Ave., Chicago 5

SPECIAL OFFER!

LOCK-STITCH SEWING AWL

\$1.
Postpaid

Famous, patented lock-stitch sewing awl complete with needles, waxed thread and direction folder. Hundred uses — sewing, repairing leather goods, canvas, belting, harness, saddles, gun cases, awnings, golf bags. Extra needles and thread available. Satisfaction guaranteed or money back. Send currency, check or money order. Yates Mfg. Co., 611-H Main St., Lake Geneva, Wisconsin

FREE PLANS POWER MOWER KITS FREE PLANS

Have one of the finest mowers money can buy. Write for **FREE PLANS and PARTS LIST** showing you how to **SAVE up to 75%** by assembling Triangle's **POWER MOWERS**.

3 Wheel Model

SPECIAL FACTORY PRICES

Kits, Parts, Engines, Wheels, Etc. Also complete TRIANGLE MOWERS ready to mow, at Low Factory Prices, 3 and 4 wheel models.

4 Wheel Model

SAVE your back. Assemble or build your own 3 or 4 wheel power mower with our precision made kits and parts. Write today for full facts. Free Plans, Parts List, Low Factory Prices. DEALERS INVITED.

TRIANGLE MANUFACTURING CO., Dept. M-4, Box 185, Fort Scott, Kans.

Free Catalog BARGAINS FROM WORLD WAR II

Thousands of Bargains in Military, Outdoor and Sport Goods for Hunter, Farmer, Scout. Write for **FREE 32-page CATALOG OF BARGAINS**.

A and N SUPPLY CO. 4720 Lester St. Richmond 15, Va.

POWERMAX MIDGET AIR TOOL

- ★ Variable speeds 500 to 14,000 r.p.m.
- ★ Finger tip control
- ★ Only 4 1/2" long — 1" diameter
- ★ Powerful, cool running vane motor
- ★ 1/8" collet chuck
- ★ Requires only 3 c.f.m. air at 50 lbs.
- ★ Complete with 6' hose



Never before so much useful power in so small a package.

For Grinding • Sanding • Polishing • Drilling • Milling • Routing • Carving

FERRIOT BROS., INC.
2680 Mogadore Rd. AKRON 5, OHIO

Send check or money order — no C.O.D.'s please.

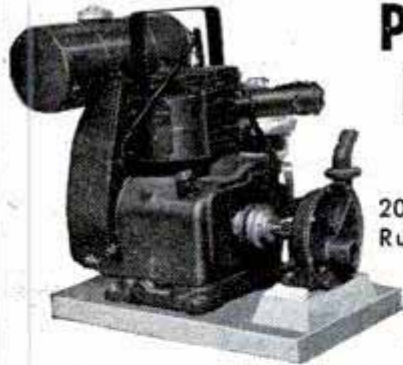

PORTABLE PUMPING OUTFIT

2000 gallons per hour. Rust proof non clog pump. 1 inch suction 3/4 inch discharge inside diam. for hose or pipe.

Forces water vertically 40 ft. 8 ft. lift. Clinton 4 cycle Gasoline Engine. Pumps 16,000 gals. of water on one gallon of gasoline in 8 hours. Can be used for Gasoline, Kerosene, oil or most liquids. Shipping weight 47 lbs., height 15 1/2 in., length 16 1/2 in. Aluminum base.

NEW COMPLETE **\$65.00** EACH FOB.

Send Check or Money Order, No. COD's. We have no agents or representatives.

PRONTO MOWERS, OLDSMAR, FLORIDA

MODERNIZE YOUR KITCHEN

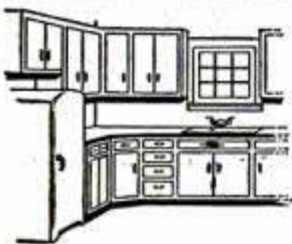

SAVE 2/3 THE COST!

New, illustrated manual shows every step in easy-to-understand charts and directions. How to modernize for yourself and get "professional" results at 1/3 the cost. Includes free design for your kitchen, plus net factory costs on knock-down cabinet fronts and other items. Have fun modernizing your own kitchen and save 2/3. Mail \$1.00 for complete kit to—

THOMBERT CO.
NEWTON 1, IOWA



NEW SAW EASY HANDLING BIG POWER

New American Portable Electric Saw saves time, labor and money in production work. Not a hobby tool. One hand operation. Cuts any angle. 8" blade. Write... give occupation.

AMERICAN

FLOOR SURFACING MACHINE COMPANY
535 So. St. Clair St. Toledo 3, Ohio

"EVEREADY"

THE FLASHLIGHT BATTERY WITH "NINE LIVES"

Recovers Power Between Uses—
Bounces Back for Extra Life!

← YOUR MOTOR

Freedom PRESTO-FLEX

with PENCIL-SIZE Handpiece \$5.95

WITH MARVELOUS EASE, you can grind, polish, drill, rout, mill, saw, sharpen, clean, carve, engrave, etc., etc. — on metal, wood, glass, plastic or linoleum. Simply attach to your electric drill, drill press or motor. Presto—a flexible shaft machine! Off again in a jiffy! Pencil-sized handpiece gives finger-tip control. Gets into tight places. Handy 35" overall length. And—only \$5.95 complete! ORDER NOW. If you order Presto-Flex for use on motor, specify motor shaft diameter. Add 50c for motor coupling. (Available for 1/4", 5/16", 3/8" and 1/2" shafts.) No. 50 Accessory Set available \$1.50 extra.

Or, order the Freedom Model 99, ONLY \$15.95 complete with universal motor, flexible shaft and pencil-sized handpiece. Write for Catalog E-1118 and see the many Freedom models now available.

FINGER-TIP CONTROL

FOREDOM ELECTRIC CO., Dept. E-1118
27 PARK PLACE NEW YORK 7, N. Y.

Thousands of Parts For Military TRUCKS

PURCHASED FROM U. S. GOVT.
OUR PRICES CAN'T BE BEAT.

We have for immediate delivery genuine parts for all makes and models, 4x2 - 4x4 - 6x4 and 6x6. All models from 1/4 ton to 20 tons. All makes: Auto-car, Biederman, Brockway, Chevrolet, Diamond T, Dodge, Federal, Ford, GMC, International, Mack, Oshkosh, Reo, Studebaker, White, Willys and Jeeps. We have parts lists available on some models. Write stating model of Truck.

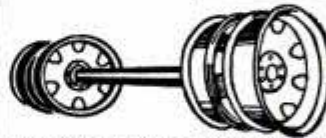

TRAILER AXLE

Heavy duty trailer axle suitable for many types of trailer construction. Also excellent for building of heavy farm trailers and wagons. It is a 12,000 lb. capacity square type straight trailer axle complete with Timken roller bearings, hubs, and 6 hole 750 x 20 Budd Wheels. Without brakes. Axle is 2 inches square and 69 inches between wheel mounting flanges. Std. width. AN EXCELLENT BUY.

With Single Wheels. \$59.50 With Dual Wheels. \$69.50

DIAMOND T 4 Ton WRECKER



With 3 power axle. Equipped with Hercules RXC engine. Complete with Twin Booms, Holmes Wrecker Crane, 9:00 x 20 tires. Complete with closed steel cab and Holmes Wrecker from \$4250 to... **\$3750.00**

With Open Cab.....\$3250.00
Chassis and Closed Steel Cab without Holmes Wrecker.....\$2950.00
Open Cab.....\$2750.00

These trucks are commercially unused but have been slightly used by Army. Are in A-1 condition. Write for detailed information. Subject to prior sale.

NEW POWER WINCHES

All are Brand New and Suitable for front or rear mounting.

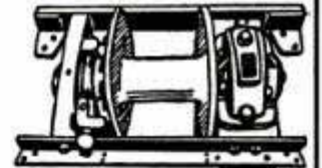

WINCH, GARWOOD OR HEIL —15,000 lb. capacity..... **\$1500**
GARWOOD WINCH—25,000 lb. capacity..... **\$2000**

We have hundreds of other parts and supplies. Tell us your needs.

All prices quoted good 30 days FOB, Kansas City. 25% deposit required on COD orders.

American AUTO PARTS CO.
1830 LOCUST — DEPT. PM
KANSAS CITY, MISSOURI.



EASY PROFIT IN PAINT SPRAYING

Paints walls, ceilings, screens, furniture and machinery faster, better. All complete as shown less motor. Carry anywhere. Fully guaranteed. Could be used with 1/4 H.P. motor or less. Price \$35.00 less motor F.O.B. Chicago. \$5.00 deposit balance C.O.D. or see your dealer. With motor \$55.00.

IDEAL AUTOMATIC PUMP CO., Dept. P.M. 8
801 W. Washington Blvd. Chicago 7, Ill.

Say You Saw It in Popular Mechanics



CAPE COD CHAIRS TRELLISES • ARBORS DUTCH WINDMILLS

Chairs style B-C A PLANS 50c Ea., all 3 only \$1.00. 12 different

ent trellis designs PLAN of all 12 only 50c. Authentic 40" high Dutch Windmill Detailed PLAN only 75c. Unique 40" high Light-house having copper lantern, ideal for garden or on lake shore of summer home. Large detailed PLAN 75c.

SPECIAL ALL PLANS ABOVE \$3.00 VALUE ONLY \$2.50
SEND 10c for catalogue of many fine projects.
CRAFTSMAN'S MODEL CO. Dept. P5, 2030 No. 41st Street Milwaukee 8, Wis.

Keep Brushes like New

BEFORE

AFTER

DICADOO PAINT BRUSH BATH

Clean and Restores PAINT BRUSHES

5c
10c
25c

At Paint, Hardware, Dept., and 5 & 10c Stores
Patent Cereals Co. Geneva, N. Y.

"MOWER POWER"

Requires No Welding

PRECISION BUILT To Last a Lifetime

COMPLETE ATTACHMENT. For Either Electric Motor or Gasoline Engine. Fits Any Make or Size of Lawn Mower. POSITIVE CHAIN DRIVE and FREE WHEELING. Easy to Install, in Less Than an Hour. IMMEDIATE DELIVERY. Sold Direct to you at Factory Price. ATTACHMENT **\$27.80**

ENGINE

Powerful 2 H.P. 4 cycle air cooled gasoline engine. Weight 30 lbs. Precision made for years of dependable service. Designed for rugged work. Smooth running and quick starting at any temperature. No vibration. Sold direct to you at Factory Price **\$55.50**

"ROYAL" ROTARY MOWER

New "Royal Rotary Mower" for either gasoline or electric motor is the most economical and practical mower ever made. Cuts with a smooth finish through any Lawn. Spike grass, dandelions and high weeds. Clippings are scattered evenly. No need for racking or after turning. 20 inch cut. Easy to adjust cutting height. Weighs only 34 lbs. Sold direct at factory prices. Without motor,

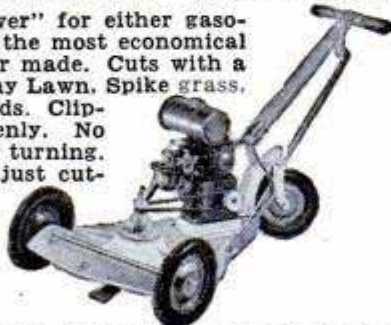

\$50.00

ABSOLUTE MONEY-BACK GUARANTEE
WRITE FOR FREE FOLDER TODAY

ROYAL OAK LAWN MOWER SHOP
P.O. Box 48 Royal Oak 1, Michigan

TUBE GIVEN WITH EVERY TIRE

"VETS" TAKE 10% DISCOUNT

OUR GUARANTEE OUR TIRES must make good or WE WILL NEEDLESS TO PAY MORE RISKY TO PAY LESS

OUR LONG EXPERIENCE INSURES YOUR SAFETY You get what we advertise Highest Quality Lowest Prices Slightly Used

HIGH ORIGINAL TRENDS BUY IN CONFIDENCE safe dependable selected POPULAR BRANDS—Guaranteed to give A-1 SERVICE. Do not confuse these tires with re-caps or re-treads.

SELECTED for TOUGHEST JOBS Not just good... THE BEST These are genuine Values! One Trial will CONVINCE YOU

TOPS IN VALUE		TOPS IN SAFETY	
600-16	\$5.32	650-16	5.32
650-15	5.02	700-15	6.12
		750-16	6.32
			7.92

World's Best Truck Tire Values Top Service Minimum Prices

6.00-20(6)	\$9.42	7.50-20(10)	\$12.92	11.00-20(12)	\$16.42
8.50-20(6)	9.62	8.25-20(10)	14.92	11.00-22(12)	18.42
7.00-20(8)	10.32	9.00-20(10)	15.42	32x6 (8)	10.42
7.50-20(8)	10.72	10.00-20(12)	16.22	32x6 (10)	12.82

750-20 MILITARY 8 PLY REGULAR \$8.62—SUPER \$12.42
900-16 MILITARY 8 PLY REGULAR \$7.22—SUPER \$9.72
ONE QUALITY THE BEST AVAILABLE

HERE'S MAXIMUM QUALITY IN THESE O. K. SAFE TIRES

600-16	\$3.62	650-16	\$3.92	700-16	\$4.62
650-15	3.92	700-15	4.02	750-16	5.92

6.00-20 (6)	\$8.42	7.50-20(10)	\$10.92	11.00-20(12)	\$13.92
8.50-20 (6)	8.72	8.25-20(10)	11.22	11.00-22(12)	16.92
7.00-20 (8)	9.32	9.00-20(10)	11.92	32x6 (8)	9.42
7.50-20 (8)	9.52	10.00-20(12)	12.22	32x6 (10)	11.22

OUR SPECIALTY—TIRES FOR SCHOOL BUSES AND AMBULANCES

Thousands of Tires Shipped to Satisfied Customers Throughout United States and Many Distant Points. Please Note: We've made Thousands of Friends by giving a Tube with Passenger and Truck Tires. MAIL ORDERS given Personal Attention—Send This Ad with Check or Money Order. Dep't. 2

STANDARD 834 N. Broad St., Phila. 30, Pa.

Build YOUR OWN BOAT



Complete parts cut to exact size—ready to assemble. Marine waterproof plywood, rustproof oarlocks. Ideal for car top. Also models with laminated frames; mahogany decked runabouts. Build for sale at attractive profit. Exclusive franchise to local builders. Send 10 cents (dime) for illustrated literature.

\$39⁵⁰
and up

OZARKA

669 BORDEN ST.

WOODSTOCK, ILL.

NEWEST OTTAWA LOG SAW

SELF-PROPELLED — MOVES ANYWHERE on OWN POWER

World's fastest Log Saw. Powerful 6 H-P air-cooled motor. Attachments for sawing down trees, buzzing limbs, post hole digging and pulley for belt jobs. Big demand for wood, pulp, posts. Make big money sawing wood this easy way. Low factory-to-user prices. Nothing like it. FREE details.



OTTAWA MFG. CO., 7-927 Pine St., Ottawa, Kansas



BUILD FINE GRANDFATHER CLOCK NOW

The simple sensible Red-i-Kut way as thousands have—SAVE HALF. SHOP TESTED PLANS "SPIRIT OF THE CENTURY" Narrow waist 83" tall or stately "SPIRIT OF AMERICA" straight side model with pictures. EASY-TO-FOLLOW PLANS tell all—plus BROCHURE of heavy brass weight Westminster, tube chime, movements, dials, solid mahogany case kits. Send \$1.00 today—Both Plans \$1.50 NOW. KUEMPEL CHIME CLOCK CO., #4 Kuempel Bldg., Minneapolis 16, Minn.

Hydraulic SPEED REDUCER of many uses

Variable Speeds and INSTANT REVERSE

Zero to 600 or 700 R.P.M.

For LATHES, REAMERS, TRANSMISSION, MIDGET CARS, MILLING MACHINE TABLE, SHAPER, THREAD MILLING FIXTURES, HOME MADE WOOD WORKING LATHE, EXHAUST FAN, PUMP, HOIST, GENERATOR, OVERHEAD TROLLEY, PRODUCTION BELT, OPENING and CLOSING DOORS, and MANY OTHER USES. Industrial or Home Use. Cost Government \$300.00. High Quality Precision Workmanship. Case measures 7 1/2" Long, 7" High, 6 1/2" Wide. Input and Output Shafts 5/8" diameter. Beautiful Red Crackle Finish Case.

FINGER TIP CONTROL

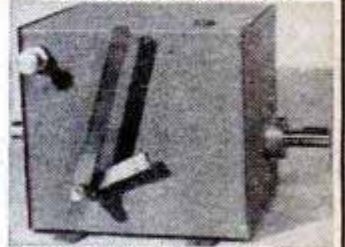

Shipping Wght. 25 pounds

Only **\$54.50**

If C.O.D. is requested a 10% deposit must accompany order, and we ship F.O.B. Chicago.

1 1/2" 8 thread Lathe Chuck Adapter, \$3 extra

PREPAID 2 quarts oil included FREE

DIRZIUS MACHINE SHOP G, 1423-25 So. 52nd Ave., CICERO 50, ILL.

Stucco Spraying Earns High Incomes

It's today's biggest business opportunity in the building field. High returns from a low investment. Easy, fascinating work. Large waiting market because Colorcrete is applied over all kinds of old and new masonry surfaces — exterior and interior.



Beautifies and Protects All Types of Buildings

Pneumatic pressure sprays plastic-like Colorcrete to give enduring beauty and water-resistant values. Range of 30 gleaming colors; many textures. Easy to wash. Smartly modern. Write or wire today for Opportunity Portfolio.

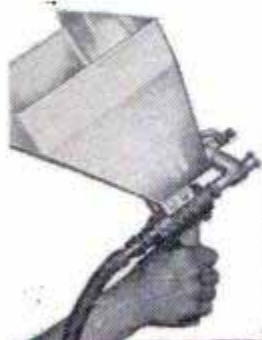

COLORCRETE COLORCRETE INDUSTRIES, INC.
570 OTTAWA AVE., HOLLAND, MICH.

"Fleas Don't
Bother Me
I'm Dusted with
PULVEX DDT"



PULVEX ... KILLS FLEAS
FLEA POWDER ... KEEPS 'EM OFF

AIRCRAFT CONTROL CABLE

Lay-set Preformed, Tinned or Galvanized, Strongest Cable Made.

Diameter	No. of Wires	Price Per 100 ft. & Over	Breaking Strength (in Pounds)	Approx. Wt. Per 100 ft.
1 1/16"	7x7	4-	5.32	480
1 1/8"	7x7 ⁸	6-	5.58	460
3/32"	7x7	5-	4.36	920
3/32"	7x7 ⁸	10-	9.10	920
1 5/8"	7x19	6-	7.15	3000
1 8/8"	7x19 ⁸	10-	17.50	3000
5/32"	7x19	9-	8.05	2800
3/16"	7x19	11-	10.60	4200
7/32"	7x19	11 1/4-	10.90	5600



Both the 7x7 (49 wires) and the 7x19 (133 wires) cable is constructed of special heat treated and tempered high grade steel wires. Each tough wire is performed to the exact shape it assumes in the finished cable—making it as near mechanically perfect as possible.

15 ft. lengths 3/32" 7x7 30¢ per length (Weight of drums not included)
15 ft. lengths 5/32" 7x19 59¢ per length

EXTRA FLEXIBLE

We suggest enclosure of sufficient postage to avoid delay

AIRCRAFT MATERIAL CENTER

BOX 1440-A • FORT WORTH 1, TEXAS

EXTRA PROFITS FOR SAW SHOPS WITH BEMACO RAPID SAW SET

IT'S AUTOMATIC
Sets hand saw teeth in 60 seconds—Approx. 400 band saw teeth. 4 1/2 to 12 points with one adjustment. Hammer and anvil action does precision job. Every tooth alike—no breakage.

IMMEDIATE DELIVERY

WRITE TODAY



802-D South Isis Avenue, Inglewood, California

BEAVER MFG. CO.

Get a CASITE TREATMENT

for your car,
today!

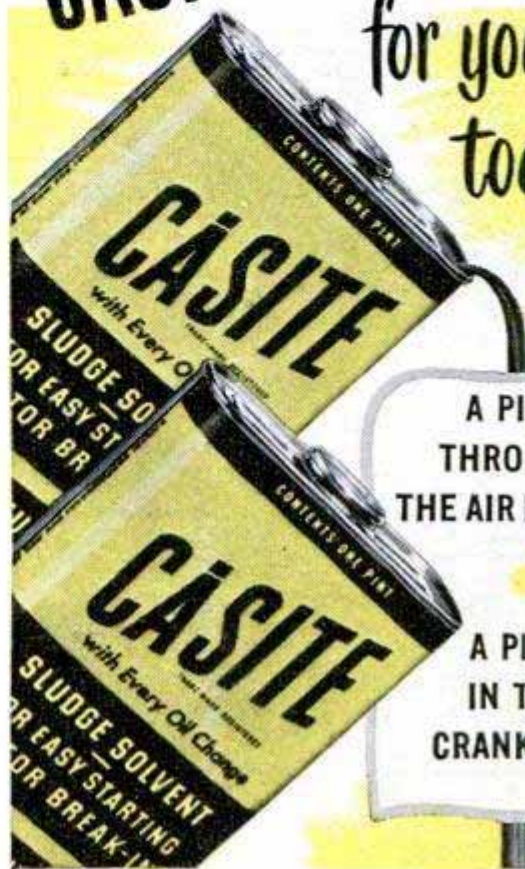

A PINT
THROUGH
THE AIR INTAKE

A PINT
IN THE
CRANKCASE

You'll take to the road with a load off your mind—after a Casite Treatment. It releases power . . . removes binding goo . . . relieves sticky valves and rings.

A Casite Treatment cleans your engine, keeps it clean, slows formation of sludge and gum. When added to any motor oil, Casite gets it around quickly and into the tight spots, retarding wear, cutting repair bills.

Your garage, service station, or car dealer will give you a Casite Treatment today—at a very low cost.

THE CASITE CORPORATION
HASTINGS, MICHIGAN
Casite Division, Hastings Ltd., Toronto

BETTER AND SMOOTHER PERFORMANCE
OR *Double-Your-Money-Back*

The easy way to paint!



Speedy Sprayer



ONLY \$26.95 LESS MOTOR

Favorite of home owners and craftsmen for 20 years! SPEEDY SPRAYER gives your work that professional paint finish everyone admires. Sprays paint, enamel, varnish, lacquer, etc. . . . 4 to 7 times faster than hand brushing! Lightweight, portable, uses any 1/4 H.P. motor. Improved diaphragm principle assures clean, oil-free air. You'll find dozens of time and money saving uses for SPEEDY SPRAYER, including spraying insecticides 2-4-D and DDT. Complete outfit, without motor, only \$26.95.

At leading hardware, lumber, and auto supply dealers. FREE—write for handy booklet "How to Spray."

W. R. BROWN CORPORATION
5717 Armitage Ave. • Chicago 39, Ill.

Tighten Loose Handles TO STAY



Use the "repairman's standby" — Smooth-On No. 1 Iron Cement — to anchor loose tool and cutlery handles, knobs, pulls, casters, clothes-hooks, bolts, screws, etc. You apply it like putty — no heat required. It hardens like metal. And because Smooth-On expands slightly as it sets, your repairs stay tight. Buy Smooth-On No. 1 in 1 3/4-oz., 7-oz. or 1-lb. size at your hardware store. If they haven't it, write us.

FREE Repair Ideas

40 pages of time-saving, money-saving ways to stop leaks, seal cracks, tighten loose parts. 170 illustrations. Clear, simple directions. Send now.

SMOOTH-ON MFG. CO., Dept. 37F,
570 Communipaw Ave., Jersey City 4, N. J.

Do it with

SMOOTH-ON

THE IRON CEMENT OF 1000 USES



NOW YOU TOO CAN BUILD 15 RADIOS COMPLETE KIT \$14.75

Absolutely No Knowledge of Radio Necessary

You Need NO Additional Parts

The PROGRESSIVE RADIO KIT is THE ONLY COMPLETE KIT. Contains everything you need. Instruction Book, Metal Chassis, Tubes, Condensers, Resistors and all Radio parts.

The 36-Page Book written by Expert Radio Instructors teaches you to build radios in a Professional Manner. You start with a 1-tube receiver. Before you are done with this kit, you will have built 11 Receivers, 1 Public Address System and 3 Transmitters. **SPECIAL FREE OFFER!**

Electrical and Radio Tester sent absolutely FREE with each Progressive Radio Kit. PLUS FREE membership in Progressive Radio Club. Entitles you to free expert advice and consultation service with licensed radio technicians.

Write for further information, or ORDER your KIT **\$14.75** NOW! ONLY (Postage prepaid with check or money order (Postage not prepaid with C.O.D. orders))

PROGRESSIVE ELECTRONICS CO., Dept. PM-25
497 Union Avenue Brooklyn 11, N. Y.

SKYSCOPE



The new 3 1/2 inch astronomical telescope that is sweeping the country. This is the first, truly efficient and completely assembled telescope ever offered at such a low price. Equatorially mounted, 1/4-wave aluminized mirror, 60 power standard ocular, as illustrated—\$25.00.

Incredible as it may sound, we invite your attention to our free brochure describing its amazing performance and construction.

THE SKYSCOPE COMPANY, INC.
475-K Fifth Avenue New York 17, N. Y.

Start a NEW BUSINESS Or Add to Your Present Repair Business

Sharpen Dull Pipe Wrenches
Pipe Taps & Dies
"Gum" Circular Saws

Write for Information.

J. C. MOORE INDUSTRIES P. O. Drawer 276 FREDONIA, PA.



Pat. applied for

LAW STUDY AT HOME for Business Success and LARGER PERSONAL EARNINGS. 40 years expert instruction — over 114,000 students enrolled. LL.B. Degree awarded. All text material furnished. Easy payment plan. Send for FREE BOOK — "Law and Executive Guidance," NOW!

AMERICAN EXTENSION SCHOOL OF LAW
Dept. 15-PM 646 N. Michigan Ave. Chicago 11, Ill.

OWN A Printing Business

Cards, Tickets, Stationery, etc. Good profit in spare time. PRINT YOUR OWN greeting cards, movie titles, church work, etc. Save money. Easy rules supplied. Raised printing like engraving too. Have home shop. Sold direct from factory only. Pays for itself in short time. Write for free catalog of outfits and all details.

KELSEY PRESSES, O-37, MERIDEN, CONNECTICUT



Say You Saw It In POPULAR MECHANICS

REAL DIESEL ENGINE

\$2.95



WE'RE CRAZY, they tell us, giving away a real diesel engine, complete with cylinder and piston, carburetor, crankshaft and connecting rod. All parts completely machined, ready for easy assembly. **ONLY \$2.95**. How do we do it? We're selling thousands of **DEEZILS**. So production's up; costs tumble down. **DEEZIL** is a precision engine. Actually runs at 7500 RPM. Produces 1/7 HP.

Ideal for planes, boats, midget cars. Send \$2.95 plus 25c postage today.

GOTHAM HOBBY CORP.
107 East 126th Street New York 35, N. Y. Dept. "P"

MIRACLE CAR! WORLD WIDE SENSATION!!

MOST AMAZING MECHANICAL TOY CAR IN THE WORLD!



8 ALL-AUTOMATIC CONTINUOUS MIRACLES

1. Car Speeds Off
2. Changes Direction
3. Stops and Door Opens
4. Driver Comes Out
5. Car Hood Goes Up
6. Inspection-Time Over Hood Closes
7. Driver Goes In Again, Door Closes
8. Car Speeds Off Again

Imagine Only
\$298
complete



WATCH IT IN ACTION!

Here is the action-packed MIRACLE CAR to thrill and amaze you for hours. Imagine! A car door which opens itself, a driver who comes out automatically, a hood which goes up "for inspection", an auto which starts, turns and stops by itself. This astounding all-automatic action is made possible by an all-metal powerful clockwork mechanism. NEVER A DULL MOMENT with door and hood opening and closing, a driver who goes into action. No wonder MIRACLE CAR is acclaimed as an amazing toy car! SEND NO MONEY! Remit with order and we pay postage or C.O.D. plus postage.

NOVELTY MART 59 East 8th Street, Dept. 133 New York 3, N.Y

World Famous PACKAGED BOAT KITS

\$34.50 UP



1949 LINE—18 MODELS—8 TO 18 FT.

New models offer increased performance! Simplified building instructions! Low prices! 8 ft. dinghy \$34.50, 16 ft. Runabout \$159. Dinghies, skiffs, fishing and speed boats. All parts pre-cut, frames pre-assembled. SEND 25c (coin) FOR LITERATURE or send \$1.00 for literature plus booklet "Plywood Boats."



BOAT PATTERNS

100 designs by Deed, Lord, Crandall etc., Plank, steel, and plywood. All types, 6-35 ft. Detailed blueprints, full-size paper patterns. Catalog 35c (coin). Catalog and booklet "Boat Building" \$1.00.

PLYWOOD CONVERSIONS HARDWARE

—and Marine lumber. Stock list 10c. List and handbook "Plywood Hints" 50c (coin). Drives, gears, engines, kits. Catalog 50c (coin). With booklet "Conversion Hints" \$1.00. Send \$1.00 for 250-page Builders Guide. 15,000 items pictured, priced.

MARINE MART-DEPT. 24-BUFFALO 7, N. Y.



CALIFORNIA

CURB-L-ARMS

PROTECTS FENDERS — HUB CAPS — WHITEWALL TIRES!

- SIMPLIFIES PARKING FOR EVERY MOTORIST.
- ROAD STATIC DISCHARGED TO GROUND.
- EASILY ATTACHED TO FRONT AND REAR FENDERS WITH A SCREW DRIVER.

CURB-L-ARMS warn motorist when nearing curb and other unseen objects. Resonant warning sounds prevent costly damage to fenders, hub caps and white wall tires, simplifies parking. Antenna is made of high carbon, heat-treated steel, chrome-plated to automotive specifications—extends below fender level to reach low and high curbs. Needed on and fits all cars, old and new. NO ELECTRICAL CONNECTION. FULLY GUARANTEED—Money refunded if not satisfied. See local dealer or order direct. Send check or money order to



U. S. Pat. No. 2464365

BE SURE — GET THE ORIGINAL CURB-L-ARMS

\$100 worth of protection for ONLY **\$125** Set of 2 Postpaid

Distributor Inquiries Invited

AECO PRODUCTS Dept. PM-6, Beverly Hills, Calif. (Use margin for ordering)

M-SCOPE TREASURE-MINERAL LOCATORS

WRITE FOR FREE, ILLUSTRATED 16-PAGE BOOKLET

M-SCOPE TREASURE-MINERAL LOCATORS. Low priced, unsurpassed efficiency, lightweight models. Factory guaranteed. Immediate shipment. Credit plan available. Write for free 16-page booklet.

GEIGER COUNTERS for finding Uranium ores. Several models. Simple operation. Low priced. Immediate shipment. Interesting free literature.



URANIUM

FISHER RESEARCH LAB., INC., PALO ALTO, CALIF.

GOLD

2 Pages of GROBAN'S WAR SURPLUS Specials!

MINIATURE High Speed ELECTRIC MOTOR

IDEAL FOR MODEL BUILDERS, MODEL RAIL-ROADERS, EXPERIMENTERS, HOBBYISTS. AC or DC. Reversible, speed may be regulated by varying voltage. Has miniature Kilxon thermo-static switch. All connections are external and accessible. Has 3 mounting feet for easy installation. Double-end ball bearing supported shaft with small gear on one end. Die-cast housing with laminated field. Overall Dimen.: 3 1/4" long x 2 3/4" wide x 1 3/8" high. Net wt. 12 oz. A \$22.00 value.



Brand New

\$2.95 post-paid

Self-Priming ELECTRIC PUMP

APPLICATIONS: oil burners, aquariums, fluid metering, fuel pump, tool post grinder, coolant pump, pressure lubricating pump, general industrial, etc.



Compact - BRAND NEW

MOTOR MFD. BY BLACK & DECKER: double ball bearing series wound, continuous duty, 1/30 H.P. electric motor, rated 12,000 R.P.M. Transformer included for use on 110 V AC current. Also applicable for 24-32 V DC.

PUMP MFD. BY WELDON TOOL CO. with standard 1/4" tubing ports; rated 2 G.P.H.; remove pump and use motor as high speed grinder.

OVERALL DIMENSIONS: 7 3/4" long x 3 1/4" wide x 3 1/4" high. Approx. wt. 5 lbs. \$51.00 value.

\$12.95

postpaid

Hydraulic Pressure Gauge

BRAND NEW

Ideal for high pressure hydraulic systems, adjusting pressure, relief valves, etc.

Range 0 to 2000 P.S.I. Black plastic case 2 3/8" square, 1 3/4" deep. Black instrument face with white pointer and numerals. Worth many times this low price of..... postpaid



\$2.95

SCREW JACK Ideal for raising, lowering, leveling and adjusting. Use on tables, machine tools, toys, etc.

Overall length closed; 9 inches. Open; 14 inches. Worm Gearbox with 54 to 1 reduction, with double end drive shaft. Extension screw shaft 30 to 1 reduction.

An outstanding buy for **\$3.95** POST PAID

Outstanding Surplus Value!

BRAND NEW - GUARANTEED

GRINDING WHEEL KITS

HUNDREDS OF ASSORTED ITEMS - A \$50 VALUE

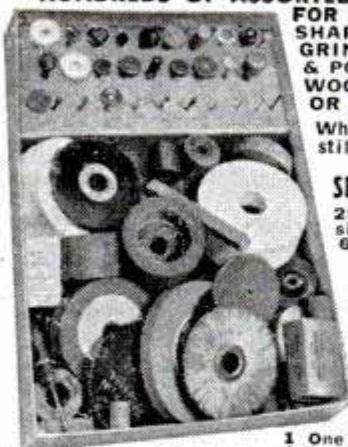

FOR CUTTING, SHAPING, GRINDING, & POLISHING WOOD, METAL OR PLASTIC.

\$8.95 Per Complete Kit

While supply still lasts, only

F.O.B. Chicago

SET INCLUDES OVER 300 ITEMS

- 25 Grinding and cut-off wheels, sizes 1 to 5 inches, 1/8 to 3/4 hole
- 6 Cut-off Wheels on 1/2" m'ndr'l.
- 3 Steel cutters 1/2"
- 5 Steel cutters 3/32"
- 1 Steel circular saw mounted on mandrel
- 1 Drum sander 1/2" mounted on 3/32" mandrel
- 1 One inch buff on 1/8" mandrel
- 2 Leather wheels
- 1 Roughing stone
- 3 Honing stones
- 2 Felt bobs
- 10 Sanding rolls
- 6 Sanding sleeves

- 1 One inch felt wheel on 1/8" mandrel
- 1 7/8" rubber wheel on 1/8" mandrel
- 2 High speed rotary files 1/4" shank
- 100 3/4" cloth butterfly abrasive discs
- 1 Box paper discs-100
- 1 Rag wheel-4 inch
- 10 Mounted stones-3/32", 1/8", 1/4"
- 1 One inch wire wheel 5/8" hole, brass center

In sturdy compact container 13 1/4 x 9 1/4 x 2 1/2", weight 8 1/2 pounds; with installed rack for all drills.

1 4" Wire brush
1 Bristle brush 3", 5/8" hole, brass center

I enclose \$8.95 Check M. O. Send C. O. D.

Name _____

Address _____

Brand New GENERAL ELECTRIC

8" Sealed Beam

FLOODLIGHTS

300 Watts, 110 Volts, A.C. - D.C.

Has countless uses for:

- Homes
- Garages
- Workshops
- Driveways
- Outdoor advertising
- Displays
- Beach lighting
- Private air ports
- Photography

Bought by the U. S. Army for signal use. This is the greatest surplus bargain ever offered.

Lens, reflector and electrode vacuum sealed in one dust-proof, air tight unit. 300 Watts, 110 Volts. Weighs only 2 1/2 lbs. List price \$10.50.

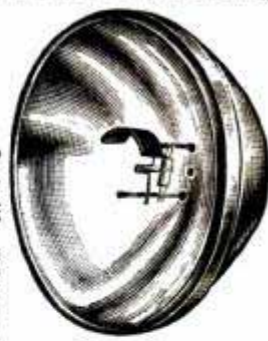

A TREMENDOUS **\$2.75** ea. VALUE for.. postpaid

Wherever you need flood-lighting!

12 or more..... **\$2.50** ea. postpaid

Self-Priming Bronze Pump

Positive Pumping Pressure

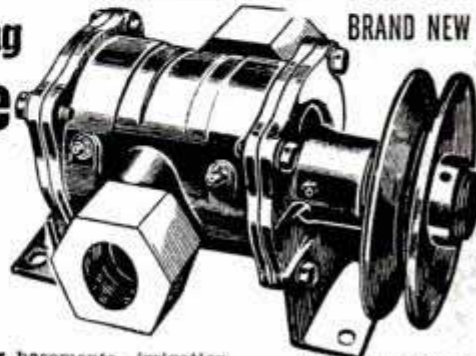

BRAND NEW

Perfect for draining basements, irrigation, fire fighting, sprinkling, pressure booster, insecticide and other spraying, fuel transfer, stock watering, industrial pumping, deep well jet pumping and home water systems. Rated 25 ft. suction and 150 ft. head pressure at 80 gallons. Use from 1/2 to 5 H.P. motor.

Complete engineering report and instructions FREE with pump

\$32.50

Supplied with mounting brackets and 5" V belt pulley, ready for instant use. Standard 1 1/2" pipe thread inlet and outlet. Dimensions: 9 1/2" x 7 1/4" x 4 1/4". Ship. wt. 18 lbs. A \$142.00 value....

F.O.B. Chicago

GEAR TYPE

INSECTICIDE PUMP

Brand New!

All Manganese Bronze FOR SPRAYING D.D.T., 2-4D, SULPHUR COMPOUNDS, ETC.

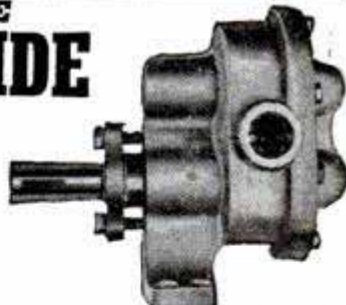

Pressures up to 150 lbs. to 8 gallons per minute-1500 R.P.M. Will not rust, pit, foul or freeze up. Use rubber hose inlet, pipe or tubing outlet. Equipped with 1/2" standard pipe thread port. Weight 10 lbs. Standard 1" manganese bronze shaft with keyway, U. S. Gov't. Acquisition Cost.....\$62.00. NOW ONLY

\$15.00

F.O.B. Chicago

18" Wire Spoke WHEEL

For use on motorcycle or adaptable for midget cars, trailers, small trucks, any wheeled vehicle. With bearing races and gear. Takes 18" tire. Wt. 19 lbs. A REAL VALUE at.....

\$3.95 ea.

F.O.B. Chicago

HIGH PRESSURE AIR COMPRESSOR

For pneumatic tools, filling hi-pressure vessels, paint spraying, insecticide vaporizing and other uses. Rated 450 P.S.I. at 1200 R.P.M. Used on Packard Merlin Engine, this aluminum air pump with air filter intake weighs only 4 1/2 lbs. 9" x 5" x 3 1/2". Gov't. Acq. Cost \$185.00. NOW ONLY.....

\$15.00

postpaid



ORDER DIRECT FROM AD
Send payment or purchase order today
SATISFACTION GUARANTEED



Vickers MF9 Hydraulic PUMP or MOTOR

complete with mounting kit ready to install

\$75.00 value

\$19.90 POST-PAID

Pump is compact, powerful, rated 1,000 P.S.I., .507 cu. in. per revolution, 8 gal. per min. at 3750 RPM. Change rotation by reversing flow. Delivers up to 6 H.P. Requires 1/3 to 6 H.P. to drive directly or by pulley. **BRAND NEW.**

Mounting kit has been especially designed to provide maximum utility and ease of mounting MF Series Vickers Pumps. Brackets are constructed of heavy steel plate; shaft is made of 1/2" steel with one end splined to fit pump; other end of shaft has machined flat for mounting a standard pulley with 1/2" hole. Shaft runs in oilite bronze bearings.

Pump only \$14.95 postpaid
 Mounting kit only \$ 4.95 postpaid
 Both as complete unit \$19.90 postpaid

Logan Heavy Duty HYDRAULIC PUMP

BRAND NEW . . . for operating hydraulic cylinders and hydraulic motors on tractors, bulldozers, construction machinery, lift trucks, industrial applications, etc. Delivers 5 GPM at 1200 RPM at 1000 P.S.I. using 5 H.P. Has 1 1/2" pipe thread inlet, 3/8" pipe thread outlet, 3/4" shaft with flat and key-way for direct or pulley drive. Has flange with 4 bolt holes for convenient mounting. Ship. wt. 22 lbs. Overall dimen.: 7" L x 5 1/2" H x 5 1/2" W. A \$105.00 value. **FOR ONLY**



\$22.50

F.O.B. Chicago

LOGAN Heavy Duty HYDRAULIC CONTROL VALVE

BRAND NEW control valve with built-in adjustable relief valve, will operate one double-acting hydraulic cylinder or a reversible hydraulic motor. Valve handle latches in neutral position. Made of rugged cast aluminum alloy. Open center unloads the pump in neutral position. Throttling control allows operator to regulate the speed of movement of the hydraulic cylinder or motor. Has removable mounting brackets with 4 bolt holes, 3/8" pipe thread connections. Overall dimen.: 12 1/2" H x 8 1/2" D x 8" W. Ship. wt. 17 lbs. Govt. Acquisition Cost over \$100.00. **AN EXCELLENT BUY FOR**



\$21.95

F.O.B. Chicago

GENERAL ELECTRIC D C GENERATOR

For Farm—Home—Factory Welding—Light Plants

Delivers 30 volts, 267 amps. at 4000 RPM. Rated 8 Kilowatts, ball-bearing supported. Fan cooled armature. Drive it off of farm tractor, gas engine of 10 H.P. or more. Ship. wt. 65 lbs. U. S. Government acquisition cost—\$277.00. **\$28.50** F.O.B. Chicago



ADJUSTABLE RELIEF VALVE... \$2.95 postpaid

FREE: New, 20-page illustrated Hydraulic Manual featuring diagrams, photographs and instructions—FREE with each hydraulic order.

BRAND NEW Hale Fire and Irrigation HIGH VOLUME CENTRIFUGAL PUMP

FOR FIRE PROTECTION, IRRIGATION, DE-WATERING, INDUSTRIAL USES, FARM USES, ETC.
PUMPS RATED 500 GALLONS PER MINUTE AT 275 FT. HEAD PRESSURE

Equipped with 1 1/2" diameter straight splined shaft for direct coupling drive; 4 1/2" threaded suction intake; two—2 1/2" threaded discharge outlets; Hale Pump Co. Model CF volute type; use any 4 or 6 cylinder gas engine or couple directly to front of truck or auto; or use 25 H.P. electric motor; dimensions 21" x 24" x 28". Complete with full accessory kit including suction and pressure gauges, priming equipment, and instruction book. Ship. wt. 415 lbs.

Gov't. acquisition cost \$425.00 **NOW \$149.50** F.O.B. Chicago

GROBAN SUPPLY CO.
 1507 SOUTH MICHIGAN AVE.
 Chicago 5, Ill. Dept. PM-6

SHOP BY MAIL and SAVE at GROBAN'S Buy direct from ad!

Brand New Air or Oil HYDRAULICS



Use hydraulics on arbor presses, hydraulic presses, hay lifts, manure loaders, lift trucks—push or pull, tilt or turn, press or squeeze, open or close, lift or lower—and other hydraulic and industrial applications. Use with either air or oil . . . of finest precision workmanship.

- Double action, 1" bore, 3" stroke, will lift 770 lbs. in 1/10 of a second using MF Pump. All steel barrel. Ideal for controls, door openers, positioning, etc. An \$18.00 value. postpaid **\$4.95**
- Double action, 1 1/2" bore, 5" stroke, will lift 1760 lbs. in one second with Vickers MF9 Pump. Wt. 3 lbs. A \$35.00 value. postpaid **\$8.95**
- Double action, 1 1/2" bore, 9" stroke, will lift 1760 lbs. in one second with Vickers MF9 Pump. Wt. 4 lbs. A \$45.00 value. postpaid **\$10.95**
- Use these cylinders on farm trucks, bulldozers, hay lifts, manure loaders, etc. Double action, 1 1/2" bore, 27" stroke. (Will lift 1760 lbs. in 2 seconds with Vickers Pump.) Wt. 8 lbs. A \$55.00 hydraulic cylinder value for only. postpaid **\$12.95**
- Double action, 2 3/8" bore, 8" stroke. (Will lift 4400 lbs. in one second with Vickers Pump.) Will withstand 1500 P.S.I. against wall. Wt. 7 lbs. A \$65.00 value. postpaid **\$14.50**
- Double action 2 3/8" bore, 4" stroke, two-way solid 5/8" alloy steel shaft (will lift 4400 lbs. in one second with Vickers Pump). A \$73.00 value. postpaid **\$16.50**
- Double action, 3" bore, 8 1/2" stroke. All steel hydraulic cylinder, will lift up to 12,000 lbs. (7000 lbs. in 3 seconds with Vickers Pump.) Complete with fittings. Wt. 12 lbs. A \$78.00 value. postpaid **\$19.50**
- Double action, 3 1/2" bore, 11" stroke. (Will lift 9600 lbs. in 7 seconds using Vickers MF9 Pump.) Complete with fittings. Wt. 15 lbs. A \$92.00 value. postpaid **\$22.50**
- Double action, 3" bore, 23" stroke, hydraulic cylinder will lift 7070 lbs. in 5 1/2 seconds using MF9 Hydraulic Pump. Especially suited for farm and construction machinery. Clevis mounting for easy use. Wt. 22 lbs. A \$145.00 value. **\$27.50**

F.O.B. Chicago

Fittings available for above cylinders.



Hydraulic Control Valves Brand New

- Four-way control valve for use with double action hydraulic cylinder, may be used with 1500 P.S.I. hydraulic system to open and close hydraulic cylinders. Brand new. Ship. **\$7.95** wt. 4 lbs. A \$38.00 value. postpaid
- Four-way control valve for use with two hydraulic double action cylinders. Each cylinder may be operated independently of the other or in conjunction with the other. Oil may be locked in any of the cylinders to hold the piston at any required position. Brand New. Ship. Wt. 6 lbs. A \$60.00 value. postpaid **\$10.95**
- A two cylinder double action valve with a unique arrangement, allowing the operator to raise both cylinders simultaneously, to lower them simultaneously or to raise one and lower the other at any predetermined rate and speed. Brand New. Ship. Wt. 8 lbs. **\$14.95** A \$75.00 value. postpaid

Brand New Double-Action Pneumatic — Hydraulic

PRESS \$300.00 value offered at a fraction of original cost

Using air or oil, this device is ideal as a punch press, vise, arbor press, etc. An excellent tool for industrial and shop use. Use 150 lbs. of air pressure or 250 lbs. of oil pressure. Cushioned double action "Logan" Model AC ram, 6" bore and 6" stroke. Capable of up to 4200 lbs. of pressure using air. Has 3" throat. Lubricated gibs provide perfect alignment. Has adjustable work space. Hardened alloy steel piston rod 1" diameter. Frame constructed of cast steel with 3/4" base plate. Manufactured by Sipp-Eastwood Co. Unit is 40" high. Base is 9 1/2" wide by 18" deep. Wt. approx. 300 lbs. **AN OUTSTANDING BUY at . . . \$79.50** F.O.B. Chicago



HAND HYDRAULIC PUMP Brand New

Used for hydraulic jacks, presses, hoists and other hydraulic applications. For operating hydraulic cylinders to pump oil or hydraulic fluid under pressure. Hand pump has built-in check valve and is capable of delivering 1000 lbs. of pressure. Has alloy aluminum housing. Dimen.: 8" long x 3 1/2" high x 2 3/4 wide. Ship. wt. 3 lbs. A \$45.00 value. Now **\$8.95** postpaid



WRITE FOR OUR NEW FREE CATALOG!



DO EVERY JOB
*better-faster-
 cheaper-*
**WITH
 COMPRESSED AIR**

Paint Buildings, boats, tractors, trucks; refinish furniture and fenders; inflate tires; grease and lubricate motors, engines, implements. Destroy weeds. Rid livestock, poultry and pens of pests with portable air power.

Free Literature explains relative advantages of 4-cylinder **PRESSURE QUEEN** and single-cylinder **PRESSURE PRINCESS** spray painting outfits. Tells how to save material, time and money by using the proper outfit at the right price.

*It Is Yours For The Asking
 Write Today*

THE CAMPBELL-HAUSFELD CO.
 1046 RAILROAD AVE. HARRISON, O.

Pioneers **BENJAMIN** Leaders
AIR RIFLES WITH SAFETY LOCK AIR PISTOLS
SEND FOR FREE FOLDER OF LATEST MODELS TODAY
 If you want a REAL GUN for PRACTICAL USE inside or outdoors, get a **SAFE-CLEAN-ECONOMICAL-BENJAMIN** with Adjustable Power and Amazing Accuracy. Use **BENJAMIN H-C PELLETS** for BEST RESULTS in all rifled models. **WRITE AT ONCE.**
BENJAMIN AIR RIFLE CO., 812 MARION ST., ST. LOUIS 4, MO.

JARI POWER SCYTHE



Cuts & Trims

- Grass, weeds, brush, shrubs.
- Right up to trees, fences, and buildings.
- Shorelines, below and above water.

Ideal for estates, lakeshore property, gardens, small farms, orchards, parks.
 Self-propelled,
 lightweight, portable, easy to handle.

WRITE TODAY for more information.

JARI PRODUCTS, INC.
 2940-D Pillsbury Ave. • Minneapolis 8, Minn.

**4th OF JULY
 SKY ROCKETS**

Be the first in your neighborhood to celebrate with a modern sky rocket... fire each rocket over and over all day long... zooms up over 200 feet... legal in every state.



Comes equipped ready to fire with special launching stand and full instructions. Send \$2.95, we pay postage. Or send no money, C. O. D. \$3.50.

\$2.95

WALSH PRODUCTS, INC.
 209 (M-6) MAPLE AVENUE, EAST ORANGE, N. J.



GERSTNER Tool Chests
 for the exacting needs of Machinists and Tool-makers, will care properly for good tools. Free catalog.
GERSTNER TOOL CHESTS
 449 Columbia St. Dayton 7, Ohio

PLYWOOD BOAT KITS



\$67.50
 (Freight Included)

Build the 12 ft. V-Bottom "Sportsman" as shown. Ready-cut kits include all hardware, paint, etc. Send for free folder on all models as low as \$29.95, freight included.

TAFT MARINE WOODCRAFT
 Dept. "R," 636 39th Ave. N.E. Minneapolis 21, Minn.

BUILD YOUR OWN FAN
 One-piece cast aluminum propellers for cooling and ventilating.

Size	Polished	Unpolished	Bore				
Inches 2 Blade 3 Blade 2 Blade 3 Blade			Inches				
15	\$3.00	\$4.00	\$2.50	\$3.00	1/2	3/8	3/4
18	3.75	4.50	3.00	3.50	1/2	3/8	3/4
20	4.00	5.00	3.25	4.00	1/2	3/8	3/4
24	4.50	5.50	4.00	4.50	1/2	3/8	3/4

Let us give you our prices on your aluminum castings. Write for pamphlet on larger fan blades, wire guards, fan bases, shutters, pillow blocks, exhaust fan frames, etc., shipped prepaid if money accompanies order. Dealers write for discount.

KLOPPENBORG ALUMINUM FDY., Dept. PM69, Davenport, Iowa

Free Booklet on FLEX-O-SHAFT
 illustrating this all-purpose power machine with hand-piece that handles as easily as a pen. Motor with switch, foot-operated rheostat, and 66 accessories at special low price. Write
FLEX-O-SHAFT SALES CO.
 Dept. C Prairieview, Illinois.

Say You Saw It in
POPULAR MECHANICS



**DIE-LESS
 DUPLICATING**

with **DI-ACRO SHEAR**

Many small parts can be rapidly duplicated without dies, to accuracy of .001" with DI-ACRO "Die-Less Duplicating" Machines — Benders, Brakes, Shears, Rod Parters, Notchers, Punches. Save die expense and time delay. For experimental work, samples, models, etc., as well as regular production runs. Write for "Die-Less Duplicating" circular.

O'NEIL-IRWIN MFG. CO., 341 8th AVE., LAKE CITY, MINN.

Sensational New MOTOR Offering John Oster Heavy Duty Fractional H.P.

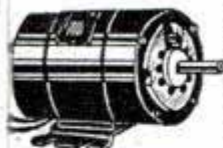

1/40 HP Induction Type, single phase, 110 V. AC, 60 cycle, bronze bushings, 5/16" shaft, 1725 RPM. Standard Base. Ideal for Hobbyists for many uses. Window and regular fans, grinders, etc. Shpg. wgt. 6 lbs.

\$4.95

Add 35c handling and mailing

It takes only 30 minutes to make your own WORK BENCH

National known makes heavy gauge steel bench legs. Just attach to wood or metal top. Used, good condition.



Heavy Duty Legs

28 1/2" w x 28h.....4.95 pr.
28 1/2" w x 31 1/2".....5.50 pr.
27 1/4" w x 30h.....4.95 pr.
27 1/4" w x 32 1/2".....5.25 pr.
34 1/2" w x 33 1/2".....7.50 pr.
40 1/2" w x 31 1/2".....9.50 pr.

Light Duty Legs

18w x 28h.....2.50 pr.
28 1/2" w x 28 1/2".....3.50 pr.
34 1/2" w x 28 1/2".....4.50 pr.
44w x 34 1/2".....5.75 pr.
47w x 34 1/2".....6.50 pr.

CROSS BRACE FOR BENCH { 5' @ 1.25 ea. 8' @ 1.75 ea.
6' @ 1.50 ea. 10' @ 2.00 ea.

FOB. Kansas City, Mo. No COD's

ATLAS EQUIPMENT CO., Dept. PM6x
229 SW Blvd. Kansas City, Mo.

LAWN ORNAMENT-NOVELTY PATTERNS

28 Lawn Ornament Patterns, 25c. Other patterns: 15-20" high; Dutch Girl, Dutch Boy, Pirate, Bull Terrier, Mexican Girl, Mexican Boy, Dwarf, Penguin, Flower Girl, 10c each. 25 Novelty Patterns, 30c. All 62 Full Size Patterns, \$1.00 Postpaid. Strother Pattern Service, Dept. BC-8, Box 128, Belington, W. Va.

SAVE GAS • get 1 to 4 EXTRA miles per gal.



Give make of CAR and CAR-BURETOR. 6 cyl. cars use one needle—8 cyl. cars use two.

New GANE AIRFLOW NEEDLES replace present idle adjustment screw on your carburetor. SAVES GAS. SMOOTHER IDLING. EASIER STARTING. Users report up to 4 more miles per gallon. Thousands in use. 10-day money-back guarantee! Easily installed in few minutes. ORDER YOURS TODAY—\$1.50 each postpaid—Complete with instructions.

NEHER INDUSTRIES, Box 177, La Verne 4, California

LIQUID MARBLE COMPOSITION FLOORS FLEXIBLE MOLDS MOLD NOVELTIES, Statuary, Art Goods in Flexible Plastic Molds; 5c material makes \$1 seller. Make Marbleized floors, Tile Walls. Colorful, glossy, amazing! Easily learned; start in garage or basement. Particulars free. MARBLEIZING SERVICE, Dept. 10-F, Edwardsville, Ill.

Say You Saw It in Popular Mechanics

One Swipe of NEW PLASTIC Makes these LEATHER and LEATHERETTE Items LIKE NEW

Get Into A Money Making Business

Make like new, worn, scuffed or faded leather and artificial leather equipment. Either your own to renew, recolor and beautify, or cafe, restaurant and hotel equipment as a business. Single stroke with a brush renews. Does not crack, peel or scuff. Resists acid, alcohol, caustics and weather. All colors. Mail coupon for free sample.

FREE Sample SHOWS EFFECT



\$50 to \$500 Profit On One Job Possible

Let me show you how, as I have shown others. Get your own exclusive territory while available. Mail coupon today, I'll do the rest. — Jack Edwards, Sales Mgr.

LEATHER-NEW PRODUCTS, 6082 Sunneslope, Kansas City, Mo. Send me without obligation a sample of Leather-New coated material so I can inspect it.

Name
Address.....
City..... State.....

Nothing Like it For the Money



MODEL 60 **Mall Saw**

6" BLADE—2" CAPACITY

Model 60 Mall Saw Has Everything—Does Everything around the Home, Farm, Factory or Building Job. It rips, crosscuts, angle cuts rough or dressed lumber up to 2". It makes 45-degree bevel cuts 1/4" to 1-11/32" and 90-degree angle cuts 5/16"

ONLY **\$61.95**

Complete with Bevel-Depth Attachment

Saw Only **\$54.95**

Attachment **\$7.00**

All Prices F.O.B. Chicago

to 1-31/32". It will also cut metals, cut and score tile, concrete, aggregate compositions, and groove mortar joints. When set in a Mall Saw Table, available attachments equip it as a table saw, drum or face sander, wire brush or shaper. Light-weight, die cast housing. Ruggedly constructed for long, trouble-free service. Furnished for 115-volt AC-DC or 230-volt AC-DC. For 32-volt battery lighting systems without Bevel-Depth Attachment—\$58.95.

Ask your Hardware or Power Tool Dealer TODAY and write for FREE Booklet "Mall Portable Power Tools" and name of nearest dealer.

MALL TOOL COMPANY

7805 SOUTH CHICAGO AVE., CHICAGO 19, ILL.

LOOKING AT POWER EQUIPMENT? LOOK FOR VERSATILITY!

GARDEN-ALL DOES EVERYTHING!

Garden-All
LAWN and GARDEN TRACTOR

Lawn Mower 24", 26", 30".

Sickle Bar 30", 32", 36".



WRITE FOR FOLDER

4 Tractor Models starting at \$159.50 F.O.B. Factory

You can't beat Garden-All for versatility! Because Garden-All does everything! Not just one job... or two... but every lawn and every gardening job! You pay only once for power; from then on the power unit can be used for every job. Off with the lawn mower! On with the cultivator! Any attachment on or off in a minute! Attachments are not expensive. Buy them one at a time if you wish. Invest your money wisely in equipment that does the most jobs! For a sound, long-term investment in versatility buy a Garden-All! You'll like it!

GARDEN-ALL TRACTOR, INC.

Dept. P, 110 W. UNION STREET, LIBERTY, INDIANA

**OH! OH! ANOTHER
WET LUNCH!
GET WISE TO...
"SNAP-TITE"**



No more flooded lunches
...no messy corks, when
you use the...

Snap-Tite

Adjustable BOTTLE STOPPERS

Millions in use prove its worth. Never leaks. Large size fits half-pint, pint and quart vacuum bottles. Snap-Tite goes in easily... stays tight... comes out freely. It's quickly adjustable... a simple turn of the lever, right or left, increases or decreases the size of stopper.

Small size fits beverage bottles, catsup and other bottles. Nothing finer, more convenient. Saves the fizz, and saves money.

HANDY, DURABLE, SANITARY

Snap-Tite is made of stainless steel and other rust-proofed materials, and specially high-grade pure gum rubber. No sticking, no taste, no odor... easily cleaned... durable. Every home needs several.

ON SALE

at stores everywhere. Be sure to ask for "Snap-Tite." If your dealer cannot supply you, please send us his name and address.



MOELLER MFG. CO., INC.
Dept. P-1 Racine, Wisconsin

A PROFITABLE HOBBY PAINT SPRAYING

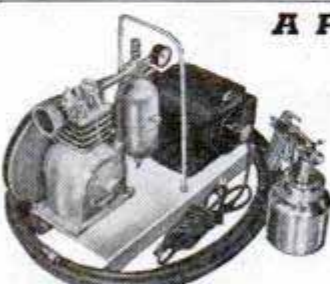

Piston Type Compressor

dependable service. Air chamber removes pulsation of air, traps oil and water. 2" Bore, 1 3/4" stroke, Dis. 2.5 CFM Working pressure 60 lbs. Single phase 1/3 HP motor with 10 Ft. cord. Fully Guaranteed. Send for Free Spray Equipment Circular.

Complete with 1/3 HP motor, with 20 Ft. hose and spray gun, FOB Chicago. **\$55.00**

\$10.00 Deposit — Balance C. O. D.

HARRIS MFG. CO.

1710 SO. MICHIGAN AVE.

CHICAGO 16, ILLINOIS

BUILD YOUR OWN TILTING ARBOR SAW!



- 27x28 in. table stays level. Blade tilts full 45 degrees
- 10 in. blade cuts 3 1/4 in. deep, jack-screw depth adjustment
- Floor model, 34 in. table height
- New Departure ball bearing arbor, 3/4 in. precision shaft, ready to run, 3/8 in. bore blades
- Quick-positioning, self-aligning rip fence guide
- Sturdy wood, steel and aluminum construction
- No machining—Build easily with hand tools only
- Capacity and performance of floor saws selling for \$150.00 and up!

**SAVE
\$50
OR MORE**

GIL-BILT Step-by-Step pictorial plans (No blueprint reading required), full scale patterns, 11 actual photographs... **\$1.00**

GIL-BILT Metal Parts Kit—includes Plans, ball-bearing arbor, cast aluminum miter gauge and bar, rip fence guide, machined lock knobs, jackscrew mechanism with 4 1/2 in. handwheel, and all other metal parts including every screw, bolt, nut and washer (less blade). **\$20.95**
Same Kit with 10" combination blade... **\$25.90**
Same Kit with 8" combination blade... **\$24.90**

Return in 10 days for full refund if not satisfied. (Prices include postage up to 600 miles.)

Also available—Plans and Metal Parts Kits for 8" Tilt/Table Saw and 12" Band Saw. Order Plans at \$1.00 each—sent postpaid anywhere in the world, or write for FREE descriptive Catalog.

GILLIOM POWER TOOLS P.O. BOX 1-PF, LAMBERT FIELD ST. LOUIS 21, MISSOURI

101 Uses For Model TX-8 QUINCY COMPRESSORS

Compressor is single stage, duplex cylinder, maximum piston displacement 8.6 c.f.m. Dustproof crankcase. Ideal for home work shop; garage; filling stations; paint spraying; farms; factories, etc. Brand new, shipping weight 36 lbs. FOB, Kansas City, Mo. **\$42.80**



Write for new 1949-52 page illustrated catalog filled with thousands of new items and War Surplus Bargains. Send 10c to Cover Handling and Mailing Costs.

MIDWEST SALES CO.

2533 INDIANA DEPT. PM6 KANSAS CITY, MO.

WAR SURPLUS BARGAINS

Substantial Savings on WAR SURPLUS and other MERCHANDISE **OVER 200 TIMELY ITEMS**

SEND FOR FREE CIRCULAR **SIoux FALLS SURPLUS STORE** **SIoux FALLS S.D.**

Only \$498

OTTAWA Mule Team Tractor

Finest of all low cost tractors. Costs too little to do without. Has the toughness and strength of a team of mules. Over 4,000 in use. With ease and low operating cost, it plows, discs, harrows, mows, plants, cultivates, etc. Weighs nearly 1,000 lbs. and has Bull-Dog traction. Sold only direct to user. Write quick for FREE details.

OTTAWA MFG. CO., 2-927 Garden St., Ottawa, Kansas

Save! Save! Save!

POWER MOWERS

\$74.95 (FOB K.C.)

Gas Powered REEL TYPE

- 2 cycle gas engine
- Cutting width 20"
- Precision Built

MODEL B (reg. list \$129.50)

Spring return starter. Needle and Ball Bearings throughout. Easy to use. Economical. Wght. 75 lbs. A reel power mower value.

Price FOB, K. C. Send chk. or M.O. — No COD's.

ATLAS EQUIPMENT CO.

229 S.W. BLVD. DEPT. PM6 KANSAS CITY, MO.

SOCKET SET

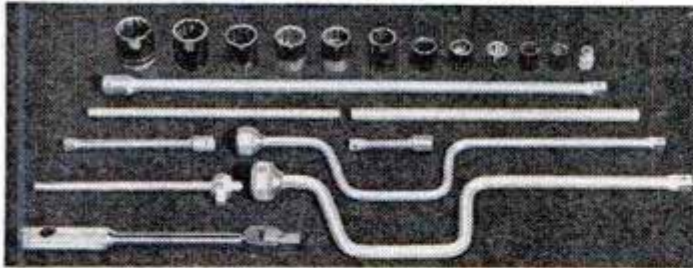

\$20.00 VALUE — PRICE \$9.50

Our purchase of over 200,000 wrenches as unused U. S. Air Force surplus makes this low price possible. All sockets are 12 point and plated. All tools are NEW. They are well-known popular standard makes such as Plomb, Snap-On, etc. Set consists of 22 pieces, 1/2" and 3/8" drive. Shipping weight 10 pounds. This is what you get.

- | | | |
|-----------------|------------------|---------------------|
| 1-5/16" Socket | 1-13/16" Socket | 1-2" Extension |
| 1-3/8" Socket | 1-7/8" Socket | 1-4" Extension |
| 1-1/2" Socket | 1-15/16" Socket | 1-18" Extension |
| 1-9/16" Socket | 1-1" Socket | 1-T Handle |
| 1-5/8" Socket | 1-1-1/16" Socket | 1-1/2" Flex Handle |
| 1-11/16" Socket | 1-1-1/8" Socket | 1-3/8" Speed Handle |
| 1-3/4" Socket | 2-Bar Handles | 1-1/2" Speed Handle |

All sets shipped via parcel post same day we receive order.
Money Order or Check. 25% Dep. on C.O.D.'s.
Prices F.O.B. Fresno.

ARMY SURPLUS SALES

1820 TULARE ST. OF FRESNO FRESNO, CALIF.

DARK ROOM VENTILATORS

13 1/2"
D
I
A
M
E
T
E
R



4 1/2"
T
H
I
C
K

STEEL

VENTILATE YOUR DARK ROOM

\$25 VALUE—Price \$7.50 Set, \$4.00 Each
— New Government Surplus —

Air flows through these louvers freely. Due to arrangement of baffle plates, light does not show through ventilators. Hundreds of these vents have been installed in dark rooms. You will need two for your dark room. Install one in or near ceiling and one near floor.

\$7.50 Set of two, or \$4 each. Pay by money order or check. 25% with order on C.O.D.s. Prices FOB Fresno, Calif. Shipping weight 29 lbs. per set of two.

ARMY SURPLUS SALES

1820 TULARE ST. OF FRESNO FRESNO, CALIF.

KILL YOUR ATHLETE'S FOOT

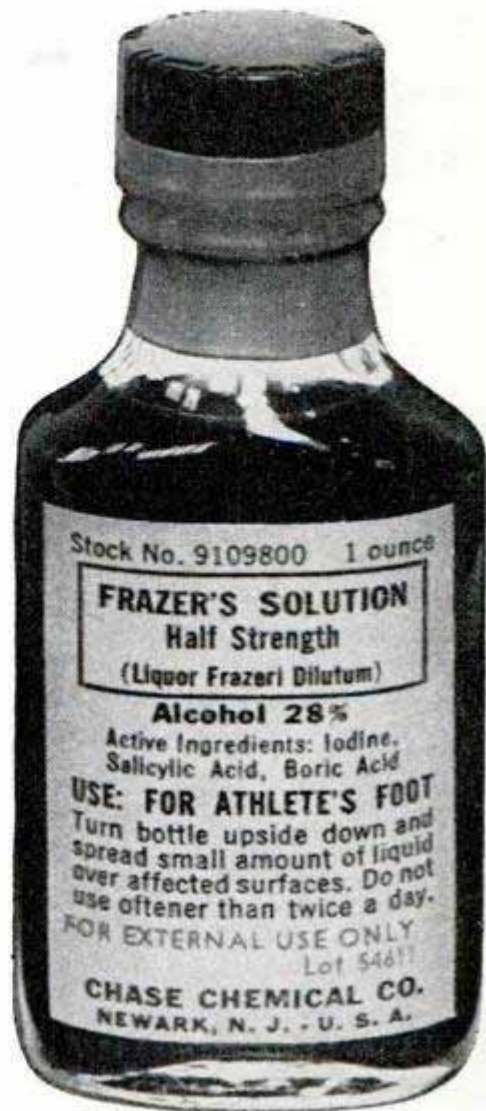

Stock No. 9109800 1 ounce

FRAZER'S SOLUTION
Half Strength
(Liquor Frazeri Dilutum)

Alcohol 28%

Active Ingredients: Iodine,
Salicylic Acid, Boric Acid

USE: FOR ATHLETE'S FOOT
Turn bottle upside down and spread small amount of liquid over affected surfaces. Do not use oftener than twice a day.

FOR EXTERNAL USE ONLY

Lot 54611

CHASE CHEMICAL CO.
NEWARK, N. J. - U. S. A.

ATHLETE'S FOOT KIT 50c

Famous Frazer's Solution used by the U. S. Army all over the world. Kit consists of one bottle Frazer's Solution and two packs of Scholl Foot Powder.

ALL ORDERS FILLED THE DAY THEY ARRIVE, WE PAY ALL POSTAGE.

DO NOT DELAY, MAIL YOUR 50c TODAY

ARMY SURPLUS SALES

1820 TULARE ST. OF FRESNO FRESNO, CALIF.

HIGH PRESSURE HYDRAULIC PUMP

FOR HOME, SHOP AND FARM USE

Genuine Vickers constant displacement high pressure pump. Use it for any type of liquid pumping job. Will pump 400 gal. per hour at 3750 R.P.M. Precision piston type design provides 1000 lbs. per square inch pressure. Self priming. Standard thread 3/4 inch intake and discharge ports. With 3/8 inch splined shaft — just add pulley and power and you're ready to go.

HAS HUNDREDS OF USES

These pumps are brand new. Original acquisition cost approx. \$100.00. Can also be used as hydraulic motor; for rams, opening doors, hydraulic lifts, etc.—also for any liquid transporting job. War surplus, but brand new. Shp. wgt. 7 lbs. Will include at no extra charge an hydraulic control valve and ship postpaid when remittance accompanies order. (Control valve, only \$1.95.) F.O.B. Houston. Satisfaction guaranteed. Rush your order today.

\$9.95



SOUTHWEST AERO SUPPLY DEPT. PM6, DRAWER 488 SOUTH HOUSTON, TEXAS

ZIPSCOOT \$49.75

America's Outstanding Scooter Value!

This smart looking speedster is easily and quickly assembled from our factory finished kits. Uses standard gasoline motor. Speeds up to 30 miles per hour. 100 miles per gallon of gas. Send 25 cents for assembly information, drawings, and illustrations. Kits available for immediate shipment.

Zipscot Company, Toledo 6, Ohio



SAY YOU SAW IT IN POPULAR MECHANICS

WORLD'S FIRST Pellet REPEATER

AIR PISTOL HY-SCORE

Don't buy ANY air pistol until you see the NEW Hy-Score six-shot repeater—completely different from any other. First and ONLY made. Load six Hy-Score pellets in new patented magazine mechanism, "break" once between each shot. Highest muzzle velocity. Rifled barrel. Pin point accuracy at 30 feet. Looks and feels like a Luger. Only \$24.95 in cal. .177 and .22 pellets or BB's. If your dealer cannot supply, write for catalog. Single shot air pistols and rifles \$18.95 up.



HY-SCORE ARMS CORPORATION
23 LAFAYETTE ST. BROOKLYN 1, N. Y.

Do it
Faster
and
Easier
with
the

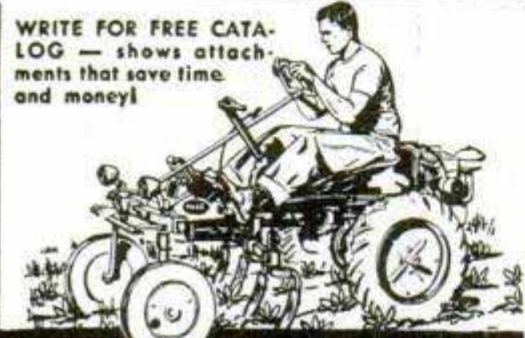

PAGE Garden Tractor

New 1949 line with extra features! Riding and walking models, 1½ to 5 HP. Complete gear drive, no cheap belts or chains. Large tires—high clearance—easy to handle—power turn. Low factory prices—\$188 to \$436 with cultivator. Get benefits of 24 years of garden tractor experience!

PAGE DAIRY and FARM EQUIPMENT
1904B S. 81st STREET • MILWAUKEE 14, WIS.

Collector's Items SCALE MODELS Authentic Americana



Selden's Horseless Carriage—Kit #C744
Surrey with the Fringe—Kit #C842
I-H Tractor—Kit #146-1

Model builders have been waiting for these. Each an authentic collector's item—½" scale—steering gear works on all models—COMPLETE—wood parts cut to shape—plastic wheels, springs, brackets. Trim of die cut plastic—tractor and horseless carriage—includes decals. EASY-TO-FOLLOW DIRECTIONS and plans. Interesting, educational and decorative for den or office. Geo. B. Selden's Horseless Carriage, Pr. \$1.50. Surrey with Fringe, Pr. \$1.75. International Harvester Tractor TD-14, Pr. \$1.50. Also Victoria with Calash Top—Kit #C8411—Pr. \$2.35. ORDER NOW! Add 25c for packaging and postage—no C.O.D.'s.

ORDER YOURS TODAY

BUY-BYE MAIL SALES CO., Dept. PM-6, P.O. Box #366, La Tijera Station, Los Angeles 43, California.

Enclosed is \$_____ Please send me kits No. _____
Print name and address in margin.

ROYAL EAGLE RULE

FOR THE MAN WHO IS FUSSY ABOUT HIS TOOLS

ASK FOR AN EAGLE RULE FOR STRENGTH AND ACCURACY

Only Eagle rules have riveted strike-plate joints

EAGLE RULE MFG. CORP.
NEW YORK 59, N. Y.

RELIEF OR YOUR MONEY BACK RUPTURE



You will get natural relief with a Web Truss . . . the simple sturdy support that costs a modest price. If you have rupture trouble write for free folder . . . learn about Money Back Guarantee if you are not relieved.

WEB TRUSS CO. Dept. M-63 Hagerstown, Md.

MARCOT KEY MACHINE

Immediate Delivery

MARCOT No. 8 KEY MACHINE, mounted on Cabinet, less motor. \$ 95.00
Auto Code Book and Auto Depth Keys 12.50
100 Dz. Popular Cylinder Key Blanks 60.00
Set—Key File, Follow-Through Rods, Lock Picks, Bit Key Gauge, Thimble, Pins, Springs, 10.50
"Locksmith Trade Books" 6.75
How to Open Locks without Keys or Picks; Secret of Locksmithing; How to Make Keys by the Impression Method; Master Key Systems.
TOTAL COST \$184.75

A. J. MARCOTTE CO., 1200 N. Kedzie Ave. Dept. PM, Chicago 51, Ill.

NEW IMPORTED 17-JEWEL MEN'S HIGH GRADE WATERPROOF WRIST WATCHES

Waterproof! Dustproof, shockproof, stainless steel back, sweep second hand, radiant dials, finest 17 Jewel Incabloc movement, waterproof leather strap.

Made to retail at \$49.95 Special New Low Price \$14.95 Same as above in automatic self-winding watches. \$22.95

WHOLESALE ONLY—3 WATCHES MINIMUM Complete line of Famous Watches—Write for Catalog

JOSEPH BROS. Dept. 59 E. MADISON ST. CHICAGO 3, ILL.

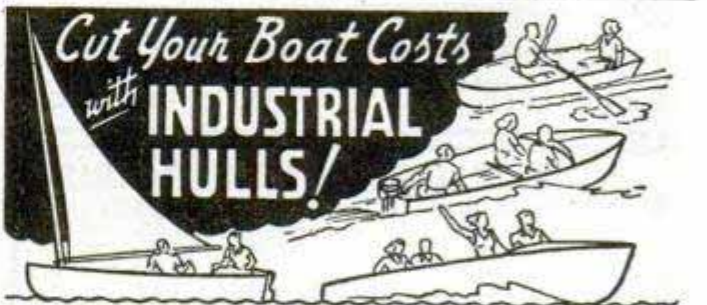

Cut Your Boat Costs with INDUSTRIAL HULLS!

Yes, and secure the finest hulls as designed by Lindsay Lord, Richard Cole, etc. And the best built—molded of laminated birch and real mahogany veneers in ONE SEAMLESS PIECE. Leak proof—lighter—faster—stronger. 16 outstanding designs—8 to 18 ft. . . Also in kits with molded hull, pre-cut parts and easy-to-follow instructions. Kit for 14 ft. Outboard only costs \$189 (including duty) while finished boat costs \$399. YOUR SAVING \$210. Write NOW for folder.

INDUSTRIAL SHIPPING COMPANY LIMITED
156 Hollis St., Halifax, N. S., Canada

NOW a DYNAMIC HEAVY DUTY INDUSTRIAL WELDER

FOR AUTO—HOME APPLIANCE & FARM IMPLEMENT REPAIRS! **ONLY \$28.50 COMPLETE**

WORKS ON IRON, STEEL & other metals . . . does work you'd expect from a larger, costlier machine; portable, easily carried; OPERATES FROM ANY properly wired 110 VOLT LINE. Also available for 220 volt operation at slight additional cost; has 8 metallic & carbon arc welding heat stages. **EASY TO OPERATE TRANSFORMER TYPE WELDER**—If inexperienced you can learn to do professional work by following the **SIMPLIFIED WELDING & OPERATING INSTRUCTIONS FURNISHED**—comes complete ready to operate with helmet, rods, cable, instructions. **SAVE TIME AND MONEY**—Do your own welding—Just a few repair jobs will pay for this machine. A practical and profitable machine tool for any workshop. Make money doing repair work for others. Costs a few cents to operate.



SPECIAL GIFT OFFER! WORTH \$6.80

ARC TORCH YOURS at NO EXTRA COST!

Write today for FREE DETAILS, ARC TORCH GIFT OFFER and DYNAMIC WELDER 10-Day Trial Offer.

DYNAMIC WELDER CO., Dept. TDD-69,
15 EAST 23rd STREET CHICAGO 16, ILLINOIS

★ SAVE TIME and MONEY with the MARCLIFF Saw ARBOR



DEALERS WANTED

GUARANTEED ACCURACY
Built for service. Inner collar assembled to shaft. Then faced after assembly to INSURE ACCURACY. Bearing spots ground to .0001. Fabricated from Seamless Steel tubing. Top quality bearings for smooth operation. Available in 1/2" or 3/4" Shaft sizes. Size Housing 8", overall length 11 1/2", Pulley end 11 1/2".

MARCLIFF MFG. CO., Hudsonville, Michigan

SEND **\$7.20**
Check or Money Order Shipped prepaid

SHARPEN DRILLS IN 30 SECONDS!

\$2.95 SPEED DRILL GRINDER



ADJUSTING WHEEL PROTRACTOR GRINDING SURFACE

No experience necessary. Sharpen your old 3/32" to 1 1/2" drills with factory accuracy. Sturdy, all steel construction. Used by thousands. Ideal for production or home workshop. Use with hand or power grinding wheel. Money back guarantee. \$2.95 postpaid. C.O.D. postage extra.

SPEEDCOR PRODUCTS DEPT. PM
512 N. E. 73 Portland 16, Oregon

BURN YOUR NAME ON TOOLS WITH ARKOGRAF PEN



Protect Your Tools From Theft

Write with electricity any name or design on hardest tools, instruments, parts, metals. Easy as writing with pencil. A real tool, not toy! Approved by Auto. Test Lab. Lasts years. Mfrd. since 1921! Operate from 6V Auto Battery, Dry Cell, or Transformer. Postpaid \$4.95 Complete—Guaranteed. Free Circular.

Gourley Mfg. Co., 7057-A S. E. Powell, Portland 6, Ore.

LEARN CELESTIAL NAVIGATION

COMPLETE COURSE OF INSTRUCTIONS AND VALUABLE ACCESSORIES GIVEN FREE WITH \$200.00 SEXTANT

ALL FOR ONLY \$14.95



IT'S A ONCE-IN-A-LIFETIME VALUE!

Learn navigation from same course as used by the Gov't to train our birdmen. Take readings from the sun or other heavenly bodies from your porch or back yard to determine your position within a few feet on land; within a mile when on a ship at sea.

GENUINE LINK PRECISION SEXTANT

This famous (war surplus) Sextant originally cost \$200.00. You can buy it now for only \$14.95 and with it we will give you the instruction course on Celestial Navigation; also complete sextant instructions. Sextant is fitted with night lighting attachment, easy reading vernier scale and good indicating bubbles. Slightly used but guaranteed perfect. Carrying case included. Shp. Wgt. 12 lbs. Send check or money order. Only.....

\$14.95

AERO PARTS SUPPLY, Dept. PM6
Municipal Airport Houston 17, Texas

HI-SPEED DRILL and WOOD BIT SET with TOOL BOX

ONLY \$9.90 COMPLETE

Shipped Prepaid in U.S.A.

M-12 includes:
7 HI-SPEED TWIST DRILLS
Sizes 1/16" to 1/4"
Drill rack provides holes for 6 intermediate 64th sizes.
For Iron, Steel, Wood, Plastic, Etc.
5 WOOD BITS with 1/4" SHANK
Sizes 1/4" to 1/2"
For Use in Wood Only. Designed especially for use in 1/4" capacity portable electric drills.

ALL-METAL TOOL BOX
Compartment designed to hold all popular priced 1/4" electric drills.



CENTURY'S NEW WOOD BITS

SET W-5
Contains 5 Wood Bits with 1/4" round shank, sizes 1/4", 5/16", 3/8", 7/16", and 1/2", packed in cardboard box.

The only drills expressly made to drill holes up to 1/2" Dia. in wood with 1/4" electric drills.

Shipped Prepaid in U.S.A.

set \$3.95



New Improved 7" Flex Sander and Polisher

ONLY \$4.95 Not including drill

Shipped Prepaid in U.S.A.

BENDS POLISHES BUFFS
1/4" Shank for use in Lathes, Electric Drills, Drill Press, Flexible Shaft tools on AC or DC motors.

We have tested many sanders, some cost more, some less, but consider, in our estimation, this 7" Flex-Sander and Polisher to be today's best value—The Electric Drill King.



On Flat Surface
Bends To Take Curved Surfaces
On Curved Surface
Polishes

An Excellent COMBINATION PACKAGE

We would like to suggest the M-12 Hi-Speed Drill and Wood Bit Set and Tool Box, the 1/4" Black & Decker Home Utility Drill, and the New 7" Flex-Sander and Polisher. **ALL 3 FOR \$33.33**

Shipped Prepaid in U.S.A.



Complete Distributors of Electric Drills and Accessories

SORRY—NO C.O.D.'s ACCEPTED WITHOUT 25% DEPOSIT

MAIL ORDERS TO

THE ELECTRIC DRILL KING
Mail order Div. of Carl-Sons Best Hardware
1627-29 N. DAMEN AVE. CHICAGO 47, ILLINOIS

ATTIC WINDOW FANS

PARTS—Build Your Own—SAVE MONEY

QUIET, deep-pitched, TORRINGTON, painted fan blades. Precision-bored, rubber-mounted bronze bearings, shaft, "V" belt and pulleys for 1725 RPM motors, and all nuts, bolts, set screws, collars, etc. required for assembly. Motors are 115 volt, 60 cycle, 1725 RPM, rubber-mounted. You make the mounting best suited for your job. Instructions included.

FAN DIA.	CU. FT. per MIN.	Kit Less Motor	Kit With Motor
20"	3,200	\$17.00	1/6 hp \$30.00
22"	4,000	18.00	1/6 hp 31.00
24"	5,000	19.00	1/6 hp 32.00
30"	7,000	24.00	1/4 hp 38.00
36"	10,000	27.00	1/4 hp 41.00
42"	12,500	30.00	1/3 hp 45.00

F.O.B. Trenton, N. J.

Specify fan diameter wanted. Send check or Money Order (No C.O.D.)

ENGINEERING SALES CO. 124 NORTH MONTGOMERY ST. TRENTON 8, N. J.

STOP CHANGING Motor Oil!

RE-REFINE IT As You Drive—with... RECLAIMO

The Famous HEATED Oil RECLAIMING Filter!

NOTE! U. S. Bu. of Standards (Bul. 86) states: "Oil DOES NOT WEAR OUT Mechanically"

FOR PROOF—NOT Propaganda write for STARTLING Free Book "Oil Facts."

RECLAIMO MFG. CO.,
Dept. M, 5083 ELSTON AVE., CHICAGO 30, ILL.



SPECIAL VALUE! BUY NOW!

CASCO POWER TOOL
40 ACCESSORIES
NEW WALL RACK

ALL \$ **17⁹⁵**
FOR

CASCO
TOOL 'N' RAK
40 PC. SET
HANGS UP WHERE YOU WORK!

Now you can keep a complete shopfull of motor-driven tools fingertip handy—yet hanging-up out of the way! Beautifully-finished solid hardwood rack cradles cutters, saws, drills, sanders, carvers, buffers, grinders, polishers! Vibrationless *super-speed* AC-DC Casco Power Tool speeds every job on wood, metal, fibre, glass, leather, plastics! You can build models, etch glass, tool leather, rout metal—*fix, make, repair, create!* Fully guaranteed, TOOL 'N' RAK set is the biggest power tool value yet—now at Department, Hardware, Auto Supply, Appliance, and Jewelry stores **\$17⁹⁵** ...all 40-pieces complete

CASCO PRODUCTS CORPORATION, Bridgeport 2, Conn.
SAY YOU SAW IT IN POPULAR MECHANICS

**3-WAY LATHE WORK
FOR YOUR SHOP**



\$113⁵⁰ F. O. B.
Less Motor

Atlas Back-geared Screw-cutting
6" LATHE

Turn metals, wood, and plastics... triple the work range and usefulness of your shop... with this low cost precision Atlas lathe. Has 6" swing, 4 1/8" over carriage, 18" between centers. 16 speeds, back gears, wide thread-cutting range... precision ground bed, Timken bearings. Atlas 10" lathes \$212 and up. Send postcard for free catalog.

ATLAS PRESS COMPANY
643 N. Pitcher St., Kalamazoo, Mich.



**MATCHED PRECISION TOOLS FOR
METALWORKING AND WOODWORKING**

Mows and Trims Lawns



In One Simple
Easy Operation
8 1/4 Lbs.



Save Time
and Labor with a

MONTAMOWER

New model. New type metal handle has special device to adjust cutting height. Drive shaft now mounted on free rolling, factory lubricated, sealed ball bearings. No tired backs or aching arms. 8 1/4 lbs. live precision made mechanism that first gathers, then cuts smoothly a clean 16" swath through grass, dandelions, spike grass, lawn weeds. No noise or clatter. As modern and efficient as your electric razor. Cuts right up to walls, fences, trees or posts; leaves no fringes to be trimmed by hand. Cutters self-sharpening. Built to last many years. Many thousands in use. Sold direct from factory for 26 years. Costs little. Write at once for trial on your own lawn "approval offer," guarantee information and literature.

MONTAMOWER DISTRIBUTING CO.

96 Keeler Bldg. GRAND RAPIDS 2, MICHIGAN

**SEND FOR THESE
AUTOMATIC SHUT-OFFS**

FOR WATER HEATERS • INCINERATORS • WATER SOFTENERS

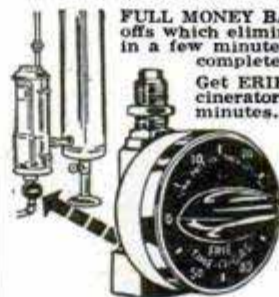

FULL MONEY BACK GUARANTEE on these automatic shut-offs which eliminate return trips to the basement! Installed in a few minutes with ordinary tools. Comes with simple, complete instructions. Order direct from factory.

Get ERIE TIME-O-GAS for your water heater or incinerator. To operate, set knob to burn for 2 to 55 minutes. ERIE TIME-O-GAS shuts off gas automatically! Works on manufactured, natural, mixed gas. Use with or without pilot. Pilot lighter included FREE with each unit.

Get ERIE TIME-O-FLOW for your water softener. Just set it for proper flushing time, after regenerating. ERIE TIME-O-FLOW shuts off rinse water automatically!

Send only \$8.95 for postpaid ERIE TIME-O-GAS; \$14.95 for ERIE TIME-O-FLOW; or C.O.D. plus postage; or write for FREE information. (Specify if ERIE TIME-O-GAS is for heater or incinerator).

ERIE MFG. CO., Dept. P-8 — 300 N. 8th St., Milwaukee 3, Wis.



DUST-O-VAC FOR ALL MACHINES

For Home Workshops & Industry. DUST-O-VAC collects & bags wood & plastic chips, wood & metal dust, wood shavings. Free Bag. Attaches to circular saw, planer, bend saw, grinder, belt or disc sander, shaper, drill press with shaper or sander attachment, spindle shaper, wood lathe, jig saw. 110 A.C., D.C. Send for mounting instr. for all machines.

\$19⁹⁵

Free Ship. east of Miss. West of Miss., add \$1. Check. M.O.

HEAVY CAST ALUMINUM BLOWER — ONLY \$10
110V, AC 50-60 cycles, cont. duty motor, deliver app. 100 C.F.M. For workshop, lab, kitchen, cellar, etc. Install yourself. Send for circular.
UNIVERSAL YONKERS CORP., 137 Alexander St., M6, Yonkers 2, N. Y.

**NOW IT'S EASY
TO REMOVE PAINT**



Remove paint, varnish, enamel, lacquer, or shellac—without burning, without hard scraping! Wonder-paste does the trick quickly, easily. That's why painters have been using it for years.

Simply apply Wonder-Paste directly over the old finish with a paint brush. Allow time for complete penetration—then slide off the soft, sludgy mass with a putty knife. Leaves no raised grain or scorched areas to be sanded. Write for Wonder-Paste Leaflet and ask for advice on your particular removing problem. Get Wonder-Paste from your paint or hardware store.

WONDER-PASTE

Wilson-Imperial Company, 119 Chestnut Street, Newark 5, N. J.

MOTORISTS! SAVE MORE at J.C. WHITNEY & CO.

CHROME PLATED!
Rear Fender
Pebble Deflectors



- No Extra Holes to Drill
- Easy to Install

Ford, Mercury 42, 46-48
Chevrolet 42, 46-48
Plymouth 46-48, also
All Chrys. Corp. cars

\$4.95 PER PAIR

GUTTED MUFFLERS
FOR ALL CARS



Gives that Motorboat Tone. Universal type to fit all cars, ea.

\$4.95

1935-48 FORD V8 & 1939-48 MERCURY

DUAL MUFFLERS

Increases power. Reduces back pressure. Saves gas. MD20N-208—Complete Set.

\$14.95

DUALS FOR 1949 FORDS, Set \$19.95

1949 NEW TRIM RINGS



MODERNIZES ANY CAR TO LOOK LIKE 1949 MODELS

Chrome Plated. Universal Fits All Cars. Theftproof—Easy to Install—Fastens with small bolt on both sides of fenders or hood. Set of 6, only

\$1.95

8 in. CURVED Rear View MIRROR



Gives 3 times the vision of ordinary mirror. Fits all General Motors, Chrysler, 48 Fords and others. Lifetime stainless steel frame. Glare-proof polished plate glass. EA.

\$4.95

Foam Rubber Wedge Cushion



Filled with Shredded Foam Rubber

Gives the feeling of riding on air . . . it is so comfortable. Leatherette and piped all around. Size 15"x14"x3". Each

\$1.95

HI-SPEED ELECTRIC SIREN



6 Volt. Used by hundreds of Fire and police departments, buses, ambulances, etc. Complete with bracket screws, and push button. Ea.

\$10.95

"HOLLYWOOD" WOLF WHISTLE



Intake Manifold Whistle!

Gives the Wolf Call. Imitates a Barking Dog, etc. Simple to Install. EA.

\$2.69

\$35.00 Transparent Heavy Plexiglas

SUN VISORS

Relieves eye strain and glare. Permits full vision of stop lights. Green Plexiglas panels, chrome plated center strip and wings. Universal—fits all cars. EA.

\$22.95

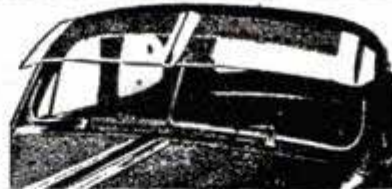

ALL METAL SUN VISORS Air Flow Style. Fits ALL CARS. **\$8.95**

Stainless steel center strip. Complete with fittings.

NEW CONVERTIBLE TOPS

100% Waterproof, Weatherized Material. Not Affected by Snow or Rain. Choice of Black or Tan.

AS LOW AS **\$24.95**

"ZIPPER TYPE"



Easy to Install

Consists of main top proper, rear curtain and all needed binding and fittings. (Glass is not supplied.) All metal parts are of heavy bright chrome plated rust resistant. Tops are heavily stitched with treated thread and sewed for durability.

2 Pass. Ford A 28-31 Roadster & Coupes	\$24.95
2 Pass. Ford 33-39 Roadster & Coupes	29.50
5 & 6 Pass. Ford 36-49 & Mercury 39-49 Coupes	33.75
& 4 Pass. Ply., Chry., De Soto & Dodge 35-39 Cpes.	29.50
4 & 6 Pass. Ply., Chry., De Soto & Dodge 40-48 Cpes.	35.45
2 & 4 Pass. Chev., Buick, Olds., Pont. & Cad. 36-38 Cpes.	37.50
4, 5 & 6 Pass. Chev., Buick, Olds., Pont. & Cad. 39-48 Cpes.	34.50
5 & 6 Pass. Nash 37-41; Packard 36-48; Stude. 1948 Cpes.	43.75

NOTE: SPECIFY COLOR WANTED ALSO MODEL OR SERIES, BODY STYLES, YEAR AND MAKE WHEN ORDERING.

3 PLY RUBBER AND FABRIC MATERIAL

A. Treated, weather-proofed cotton fabric.
B. Absolutely WATER-PROOF heavy, live rubber ply bonded to both cotton sheets.
C. Tightly loomed, specially treated cotton, finished for utmost beauty.

Our Finest Precision REBUILT

MOTOR BLOCK ASSEMBLIES



\$5.00 Crating Charge

Sold Outright or Exchange

Rebuilt by skilled mechanics. Assembly has Reborn Block with New Pistons, Pins, Rings, Reground Crankshaft, all New Bearings. Guaranteed 90 Days.

Allowance on Old Motor

We ship at outright price. Send your motor prepaid, must be suitable for rebuilding. Send in notarized bill of sale showing title number if any. We refund difference when we receive your motor.

BUICK	Outrt.	Exch.
34-47 8 cyl..	\$209.00	\$165.00
CHEVROLET	Outrt.	Exch.
29-47 6 cyl..	115.00	95.00
CHRYSLER	Outrt.	Exch.
34-47 6 cyl..	157.00	132.00
35-47 8 cyl..	209.00	165.00
DE SOTO	Outrt.	Exch.
34-47 6 cyl..	157.00	132.00
DODGE—3 1/4" bore	Outrt.	Exch.
33-47 6 cyl..	150.00	120.00
3 3/8" bore	Outrt.	Exch.
34-47 6 cyl..	157.00	132.00
FORD	Outrt.	Exch.
28-31 4 cyl..	107.00	87.00
32-34 V8 . . .	129.00	109.00
35-47 V8 . . .	149.00	109.00
37-39 60 HP.	154.00	109.00
MERCURY	Outrt.	Exch.
39-47 V8 . . .	149.00	109.00

HUDSON-TERRA.	Outrt.	Exch.
35-36 6 cyl..	\$181.00	\$137.50
37-42 6 cyl..	199.50	149.50
LINCOLN-ZEPHYR	Outrt.	Exch.
36-37 also fits 38-39 . . .	232.00	192.00
39-40	299.50	234.00
Oldsmobile	Outrt.	Exch.
37-47 6 cyl..	177.50	137.50
35-47 8 cyl..	209.00	165.00
PACKARD	Outrt.	Exch.
37-42 6 cyl..	199.50	149.50
35-42 8, 120.	212.50	172.50
PLYMOUTH	Outrt.	Exch.
33-47 6 cyl..	145.00	120.00
PONTIAC	Outrt.	Exch.
37-47 6 cyl..	177.50	137.50
35-47 8 cyl..	209.00	165.00
Studebaker	Outrt.	Exch.
35-47 Comm.	181.50	137.50
39-46 Cham.	159.50	126.50
35-47 8 cyl..	209.00	165.00

Send 25% Cash With All Orders, Balance C.O.D.

J.C. WHITNEY & Co.

1919 Archer Ave. Chicago 16, Ill.

FENDER SKIRTS



Made of all metal, prime finish, with Rubber beading to prevent rattle. Easy to Install. MC31N-9. Per Pair.

\$12.95

Be sure to specify year, make and model of car.

FLYING SWAN

CHROME PLATED! 2 stud one piece mounting easily installed. Ea.

\$3.95



BUFFALO HEAD for KAISER-FRAZER

Massive design 18 1/2 in. long. Gleaming triple chrome plate. Nuts, bolts and template supplied. EA.

\$6.95

CHROME or WHITE WALLS



15" & 16" Wheel sizes Dresses up your car.

Dressy wheel walls snap on instantly under regular hub caps.

Set of 4—**\$9.95**

Chrome

Set of 4—**\$5.95**

White

(Specify Year, Make & Size)

CHROME PLATED FRONT & REAR



TUBE GUARDS

Chrome finish, extra heavy gauge steel tubing, 1 1/4-in. diameter. Installed easily in 5 minutes with original equipment bumper guards.

CHEVROLET 46-49	FRONT OR REAR	\$3.95
FORDS 47-49		
PLYMOUTH 46-49		
DODGE 46-49		
DE SOTO 46-49		

Dual Tail Pipe Extension



Universal for all cars. Deep Tone produced by double 2 1/2" outlets. Each

\$2.95

NEW GEAR DRIVEN

HAND WINCH



2 Ton winch, gear driven wheel length of chain and hook. Ea.

\$29.50

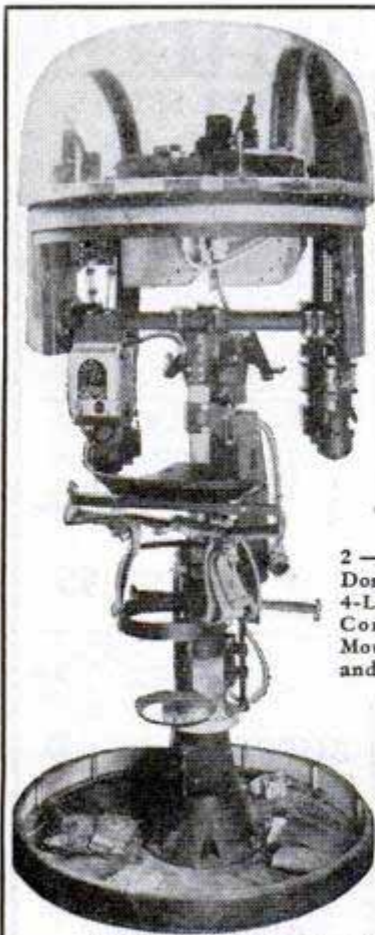

A \$2500 PIECE OF
Electrical and
Mechanical Equipment
for

\$25.00

GOVERNMENT SURPLUS

PILOT Trainer TURRET

3 1/2 ft. in diameter
6 1/2 ft. high

Chuck full of all kinds of
gadgets, including:

2 — 1 H.P. Motors — Plexiglas
Dome — Motorcycle Saddle —
4-Lens Gunsight — Pistol Grip
Controls — Oscillating Gun
Mounts — Electric Trouble Lamp
and 100 other attachments.

WHILE THEY LAST

\$25.00

EACH

Approximate shipping
weight — 500 lbs.

IMMEDIATE SHIPMENT

Send Cash, Check, or Money Order to:

JOSEPH STERN

610 West Court Street, Dept. 6, Cincinnati 2, Ohio



America's Finest ...

RESIDENTIAL COACHES BY "M" SYSTEM



WRITE FOR FREE
CATALOG P-49

LOW COST HOUSING
FOR A FAMILY OF
FOUR. This 25 1/2 foot all-
aluminum residential coach
boasts 3 spacious rooms with
aluminum lined shower. The
kitchen is fully equipped with
apartment style range and 6
cu. ft. electric refrigerator.
The bedroom has a double bed
with inner-spring mattress
and the living room couch
opens up to provide sleeping

accommodations for 2 more.

You can settle down com-
fortably in a permanent
location or travel where you
will, and all year 'round
you're cozy and secure. For
the most carefree, economical
living you have ever known,
investigate mobile housing.
Write for Catalog.

"M" SYSTEM MANUFACTURING CO.
U. S. HIGHWAY 81 N. VICKSBURG, MISS.



Say You Saw It in Popular Mechanics

Easy and
Cheap to
Operate



SAVE TIME, WORK, MONEY!

**SHAW
DU-ALL**

and "PEPPY PAL" TRACTORS

PLOW



These rugged walking or riding tractors ideal for
farm, truck garden, orchard, poultry farm. They
operate on a few cents an hour. A child can handle
them.

DO DOZENS OF JOBS

The Shaw Du-All or Peppy-Pal does many jobs
quickly and easily. Plows, cultivates, harrows, disks,
bulldozes, sprays, hauls, grinds, and saws wood.

CULTIVATE



BUILT FOR RUGGED WORK

Sturdy, extra-strength construction means low up-
keep, long life. Full year's guarantee.

MOW



LOW FACTORY PRICES

Buy direct or through your dealer! Almost anyone
who owns a garden can afford a Shaw Du-All or
Peppy Pal. Mass production holds prices down
—quality up.

RIDE

**SHAW
MFG. CO.**

RIDING TRACTORS

4 models, from 5 to 12 1/2 H. P., 58 in. wheel-
base, 36 in. wide, 24 in. plant clearance. Hand
or electric starter. Improved steering device,
brakes enclosed in differential housing. Heavier
frame and bearings. Standard hitch for trailers
and wagons. Plow, harrow, cultivator, cutter
bar, snow plow, bulldozer available.

FREE: Illustrated folders giving complete de-
tails and price lists—write today!

4506 Front St., Galesburg, Kan.
668-G North 4th St., Columbus, O.

SURPLUS BARGAINS

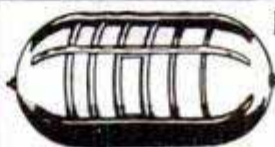

HIGH PRESSURE TANKS

Stainless steel, 400# pressure, with
fitting on each end. Shatterproof,
rustless, 12 1/2" x 24",
2100 cu. in. capacity. **\$4.75**
Slightly used



HOSE CLAMPS

Adjustable, made by Wit-
tek Mfg. Co. Sizes from
3/8" - 1 3/8". Assortment
of 150, new, a **\$5.00**
\$20 value, only.

UTILITY CLAMPS

Rubber insulated, used
for wiring, conduits,
pipes, metal tubing.
Mfg. by Adel and Tin-
norman. Hundreds of
uses. Sizes from 1/4"-
1 1/2", 400 assorted, a
\$20 value, **\$5.00**
new



ALL PURPOSE PRESSURE GAUGE

Registers up to 60# pressure, 1 1/2" dial,
3/8" fitting. Mfg. by U. S. Gauge Co. New,
postpaid.

\$1.00



SEND 25% WITH ORDER, BALANCE C.O.D. ALL EQUIPMENT F.O.B.

C & H SALES COMPANY

DEPT. M-6, 1850 E. Colorado St. Pasadena, Calif.

BRUSH PLATING OUTFITS

• for re-plating articles in the home and •
shop. No tanks necessary. Free particulars.
GUNMETAL CO., AVE. M, DECATUR, ILLINOIS



**HANDY
WOODWORKING
BOOKS!**

15 years of THE DELTAGRAM®
reprinted in hard-bound volumes

15 years of this popular woodworking
hobby magazine reprinted in full. Gives
you the chance to own tested project
material otherwise out of print! All
plans accurately dimensioned—so you can
complete projects with little delay, fuss, or
bother. Bound in dark red buckhorn cloth.
Gold title imprints. Be the proud owner
of these rare Deltagram volumes. Send cur-
rency, check, or money order today.

Save
\$125!
Get all 3 together—
\$10
Postpaid

Vol. 1—1932 to 1936..\$3.75

Vol. 2—1936 to 1941..\$3.75

Vol. 3—1941 to 1946..\$3.75

DELTA MANUFACTURING DIV.
Rockwell Manufacturing Company
680F E. Vienna Ave., Milwaukee 1, Wis.

POPULAR MECHANICS

MAKE ANY CUT WITH THESE NEW WOODSHAPERS for YOUR CIRCLE SAW or DRILL PRESS!

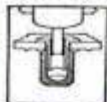

MODEL #60—Originally designed for heavy industrial use, now priced for home workshop. Can be attached directly in chuck of your drill press. Exclusive pilot bearing (see illustration) eliminates side thrust, chatter and vibration—assures smooth cutting action. Blades can't come out—set screws hold them securely. Complete, with YOUR CHOICE OF ANY 6 PAIR DOUBLE-GROUND BLADES SHOWN BELOW, only \$12.95.

MODEL #50—Same as Model #60 but without exclusive pilot bearing. Designed for intermittent shaping; over 100 different shapes can be cut. Complete, with ANY 6 BLADES OF YOUR CHOICE SHOWN BELOW, only \$8.95.

All Aladdin tools are guaranteed. Postage prepaid with all cash orders. C. O. D. plus postage. **GET YOUR ORDER IN TODAY.**

ALADDIN MFG. CO., INC.

3121 Main Street Kansas City, Missouri
Dealers Write Today



MODEL SA-10—Heavy-duty, industrial-type shaper of solid steel, now priced in home workshop range. Absolutely safe—blades locked in position with screws all the way through. In ordering, state diameter of shaft. Complete WITH ANY 6 PAIR OF READY-GROUND BLADES SHOWN BELOW, only \$14.95.

ALADDIN WOODSHAPING BLADES

Specify by number the blades you want. Additional blades \$1.50 each, \$3.00 per set.

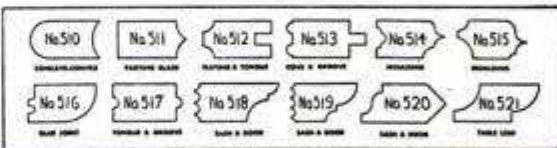

QUALITY TILTING TABLE SAW

TABLE INCLUDING EXTENSION 18" x 14"

\$24.95

Complete as shown
F.O.B.
Royersford, Pa.

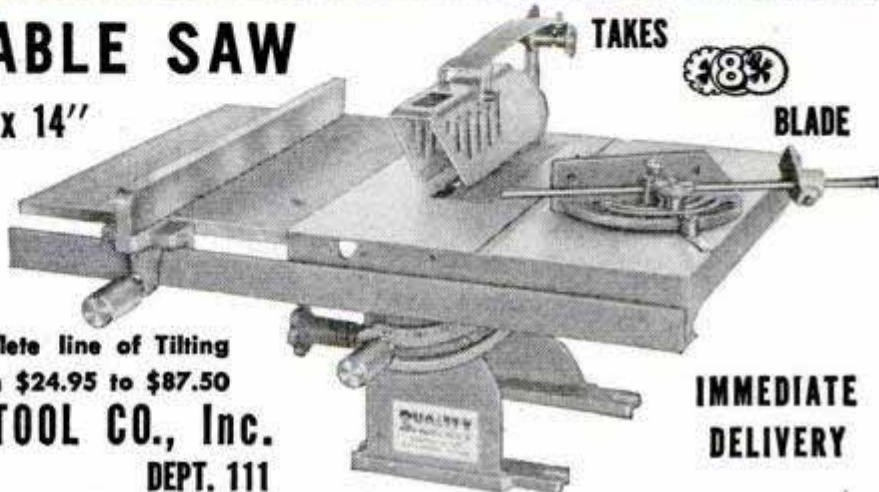

TAKES



BLADE

IMMEDIATE
DELIVERY

Send for catalogue showing complete line of Tilting Table and Tilting Arbor Saws, from \$24.95 to \$87.50

AMERICAN MACHINE & TOOL CO., Inc.
ROYERSFORD, PA. DEPT. 111

Sensational Bargains: LOWEST PRICES! All Items Guaranteed As Represented



BACKGEAR MOTOR

90 RPM 110V, 60 cycle, A.C. slow speed motor. All brass construction. Sturdy gears & bearings. Drives

window displays, toys & useful experimental work. 6"x2 1/2", 5/32" shaft. Pulley FREE. \$3.50 ea. Postpaid. In lots of 6 ONLY \$2.95 each.



ELECTRIC MOTORS . . . Brand New General Electric 110 V—60 cy. 1 ph. A.C.

TWO SPEED FAN MOTORS
1/6 H.P. 1725 & \$23.50
1140 RPM. Feb.
1/8 H.P. 1140 & \$26.50
860 RPM. Feb.

HOME WORKSHOP MOTORS
1/4 H.P. 1725 \$11.95
RPM. Feb. . . .
1/2 H.P. 1725 \$13.75
RPM. Feb. . . .

Bargain Workshop 1/2 H.P. Motors

Westinghouse . . . Leland . . . G. E. & Sunbeam, etc. 1/2-110 V. A.C. 60 cy. 1 phase, 1750 RPM. Capacitor & Repulsion Induction types. Like New . . . Fully Guaranteed . . . Only \$19.75 Feb.
General Electric . . . Delco . . . Leland & Others . . . 1/2 H.P. A.C. 110 V. 60 cy. 1 ph. 3450 RPM. Capacitor & Repulsion Induction Types. Fully Guaranteed . . . Only \$22.50 Feb.

Write for our BARGAIN FAN & MOTOR Circular and SAVE MONEY

C. MARSHALL SALES, 3546 W. Fullerton Ave., Dept. P-6, CHICAGO 47, ILL. • RUSH ORDER TODAY

New C-Breeze Powerful Electric Window Ventilator

Two Fans in One

Fits Any Window or Transom. Quiet Operation. 12 inch Blades. Moves 1500 CFM. Beautiful Cream Streamlined Design. Puts comfort in your home at the finger touch . . . Reversible to draw out odors or draw in fresh air. Any Window 24 to 34 inches. Height 16". Wgt. 27 lbs. CW-1110 V.-60 cy. AC-1ph. \$29.75 ONLY. Feb.



New C-Breeze Floor Circulator

COOL COMFORT AND HEALTHFUL LIVING
Completely enclosed motor, quiet in operation. Cools with a maximum air delivery in a 360° area. 12 inch blades deliver 1500 CFM. 3 Speeds. 15 inches in Diameter. 16 inches Overall Height. Immediate Delivery from Chicago's Largest Fan and Motor Stock. Shipping Wgt. 20 lbs. CP-2-110 V.-60 cy. A.C. 1 ph. . . . ONLY \$29.75 Feb.



Dealer Inquiries Invited

SET THE PACE WITH THE

- Cruises at 45 MPH—with faster pickup than car
- 39" high, 71" long overall, wt., 190 lbs.
- 8 HP motorcycle engine
- 50 miles to the gallon
- Automatic clutch
- Internal expanding brakes—handle-grip throttle controls

POWELL MANUFACTURING COMPANY

DEPT. PM649 • COMPTON, CALIF.

Powell
P-81!

ONLY \$247.34
AT COMPTON, CALIF.
EXCISE TAX INC.

Write for FREE folder and name of nearest dealer



Build your own combination welder and power plant with this generator

Arc Welding plus Power for tools, lights

Save \$300 to \$500 over cost of factory built unit Double your earnings doing repair and construction work, away from power lines. Use a gasoline engine or hook to drive shaft with V-belts for a combination outfit to weld or run lights, tools, motors, etc. Tell us your plans. Get details.

HOBART Brothers Company, Box M-691, Troy, Ohio

"One of the world's largest builders of arc welders"

Send for Book How To Build Your Own Welder Send 15c for postage and handling.

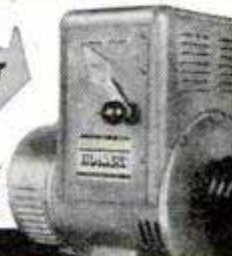

Send for this FREE DIESEL BOOKLET



See how the economy and long life of a

Sheppard DIESEL

reduces power costs by at least 75%!

Send for this new Sheppard Diesel booklet. It tells the complete Sheppard story of simplified fuel injection . . . full diesel operation on any 1 of 15 different fuels . . . 3 to 5 times longer engine life. Send for your free copy today.

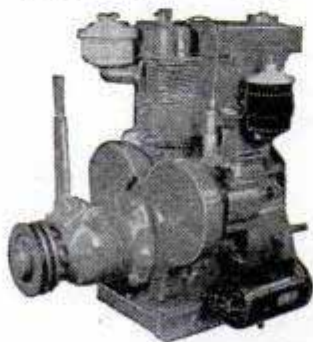

5.4 H.P. AIRCOOLED single cylinder power unit. Others up to 100 H.P. Generating sets from 2 to 36 K.W.

Sheppard Diesels Hanover 4, Pa.

DEALERS—Send for details on profitable Sheppard franchise.

STATIONARY • AUTOMOTIVE • MARINE

DIESEL'S THE POWER... *Sheppard's* THE DIESEL

WAR SURPLUS BARGAINS



WE PAY ALL FREIGHT AND P.P. CHARGES

● **POWER PLANTS.** 110-V, 60-C, 3,000-W. Remote switch electric self-starter. Fine instrument control panel. Army's finest plants. Full maintenance-operation instructions. Ideal for farmers, sportsmen, contractors. New condition. Cost Gov't. \$756.

Sale Price **\$345.00**

Also lower priced plants. Freight prepaid.



● **INDUSTRIAL ENGINES.** New single cyl. Briggs 3.5 h.p., heavy duty, air cooled. Excellent for boats, garden tractors, weed sprayers, elevators, pumps, scooters, saws, etc. Complete instructions. Standard price \$130.00. Prepaid price only \$77.50. Same engine with Utility Clutch. **\$87.50**



● **CAPSTON WINCH.** 5000 lb. cap. Useful—boats, trucks, docks, etc. New. **\$29.90** Nearly new **\$24.95**



● **G.E.-D.C. WELDER GENERATOR**—brand new—250 to 350 amp. (do not confuse with small plane type 200 amp. generators). Drive with tractor or gas engine, hundred uses business or farm, build and repair machinery—does professional work. Weight approx. 100 lbs. original cost over \$275.00—Price **\$89.90**

● Above unit complete with helmet, cables, holder, rods, etc. **\$104.50**

MISCELLANEOUS BARGAIN ITEMS

- Clutch. For engines or motors. (Max cap. 6.5 h.p.) Price **\$13.95**
- Selsyns. G.E. Precision Small Size. Fine for 110-v, 60-C. Pair **\$ 3.39**
- Telephone Intercom. System. Two Station. Selective call. Price **\$ 9.58**
- Telephone Western Electric. Desk or Wall. With ringer. **\$ 4.99 ea.**
- Burglar-Alarm Unit. (Parts cost over \$19.00). Price **\$ 5.90**
- Eavesdropping Unit. Selective station type. (Ultra-sensitive). Price **\$ 6.70**

● Other values include vacuum and electronic tubes, photo cells, Wheatstone bridges, test instruments, etc. Card brings complete Mechanical, Electronic Bargain catalogue. We pay freight or postage all items. We accept personal checks. Order direct from ad or write for bargain cat. Our references—17 years' business in Lincoln and the Nat'l. Bank of Commerce.

LECO ENGINEERING CO., Box 908 PM-19, Lincoln, Nebr.

VERNIER CALIPER

FOR STUDENTS, ENGINEERS, MACHINISTS, MECHANICS, DESIGNERS, CRAFTSMEN AND HOBBYIST—FOR ANYONE WHO NEEDS A MEASURING TOOL

A DEPENDABLE MEASURING TOOL Available for the first time since the war!

Made in U. S. Occupied Germany

If not entirely satisfied, return within 5 days; your money will be refunded.



Money Back Guarantee

\$5.00

Complete with silver stamped fabric case C.O.D. Plus Postage Charges —or send check or money order, we pay postage.

MEASURES INSIDE AND OUTSIDE, DIAMETER AND DEPTH Look at these precision features: made of hardened steel, finely nickel plated; knurled roller for moving and setting; bar and left jaw one piece . . . can never become loose; Vernier readings 1/128 and 1/10 mm; reading lines deeply cut; one hand operation, with convenient lock bar; sharp upper points for scribing.

Instruction sheet for proper reading included with each caliper. JOBBER INQUIRIES INVITED

GLOGAU CO., INC., Dept. PM, 1910 Birchwood Avenue., Chicago 26, Ill.

KERMATH

For 40 years KERMATH has produced the largest range of marine engines.

GASOLINE
5 to 550 H.P.
1 to 12 cylinders

SCREWBALLS
5 to 140 H.P.
1 to 8 cylinders

DIESEL
27 to 200 H.P.
2 to 6 cylinders

SMALL ENGINES
5 to 10 H.P.
62 to 100 lbs.

GEAR RATIOS

—you name it, KERMATH has it

KERMATH MANUFACTURING COMPANY
5862 Commonwealth Ave., Detroit 8, Michigan
Canadian Factory: 619 King St. W., Toronto, Ontario

SUMP PUMPS 2,200 GALLON CAPACITY

1 1/4" outlet—No screen to clog—fool proof

The time tested Lokomona sump pump is absolutely automatic—has a special fool proof trap at the intake—rubber bearing at the bottom. Made of aluminum castings, it's 42" high and carries a 1/4 H.P. 110 V. A.C. heavy duty motor. The pump is designed for continuous dependable service. Any standard motor will fit this pump. Order yours today. COD, or cash with order, we pay postage.

\$36.00

COMPLETE

\$22.00

LESS MOTOR

\$18.00

PUMP ONLY

LOKOMONA PUMP CO., BOX 86, ROYAL OAK 1, MICHIGAN

PROTECTS YOUR TOOLS! METAL ETCHING & SOLDERING TOOL

Permanently Etches name on Tools & Other Valuables . . . Solders Instantly. Instructions Furnished for operating from 6 Volt Car Battery or Transformer. SEND ONLY \$1 or pay postman c.o.d. MAIL COUPON TODAY!

NAME _____ ADDRESS _____ CITY _____ ZONE _____ STATE _____

DYNAMIC WELDER CO., 13 E. 23rd St., Dept. EPM-69, Chicago 16, Ill.



Just dial
ANY WIDTH CUT ON YOUR PRESENT CIRCULAR SAW BLADE!

Guaranteed to cut clean grooves—12 widths—no sanding. No fuss—no trick assembly. 5 sizes—1/2", 3/8", 1/4", 1", 1 1/2". SEE WARREN DADO SAWING WASHERS AT YOUR DEALERS, OR WRITE. **\$4.95** Set
WARREN WASHERS CO., 70 MEDBURY—DETROIT

"Wellworth" Sensational Offer! Reg. \$60.50 WESTINGHOUSE AIR COMPRESSOR

Model T-1
Brand
New!

plus pressure tank, air gauge, air chuck, 20 ft. hose, pop valve, and fittings as shown.

COMPLETE OUTFIT OF 6 ITEMS ONLY....

IDEAL for HOME • FARM • FACTORY
Wherever Compressed Air Is Needed

A fortunate purchase from the Government enables us to offer you this amazing buy at a small fraction of the price of the manufacturer and of leading mail order houses. All brand new. You get the WESTINGHOUSE COMPRESSOR and all of the accessories shown for **Only \$31.50**. Shipping wt. 50 lbs. Designed for automotive truck or tractor mounting. Can be run off fan belt or power take-off, or mounted horizontally. Comes with automatic clutch. Can be installed for use on farm trucks, jeeps, tractors, tire or garage service trucks, contractor or road building machinery, pneumatic devices, etc. Can be operated with 1/2 H.P. or more electric motor or equivalent portable gas engine. Replacement parts available.

This low price is but a fraction of the price of manufacturer and of leading mail order houses.

\$31.50

COMPRESSOR SEPARATELY

\$21.50

Equipment less \$12.50
Compressor.....

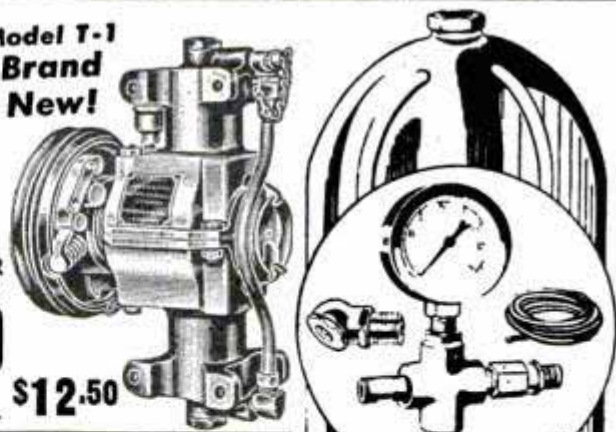

THE COMPRESSOR

Piston Type, 2-cylinder, 2 inch bore, 1 1/2" Stroke Ball Bearing AUTOMATIC CLUTCH, OIL FREE AIR 3.27 C.F.M. at 600 R.P.M. 6.54 at 1200. Suggested operating pressure 75 P.S.I. DIMENSIONS: 9" wide, 11 3/8" high, 6 5/8" deep. Wt. 26 lbs.

TANK AND ACCESSORIES

12" x 24" stainless steel tank suitable for 150 lb. pressure. Two 1/4" openings. Air gauge, pop valve, air chuck, 20 ft. hose and fittings as shown.

12" x 24" Tank
Stainless Steel
Capacity 12 Gal.

PORTABLE SPRAY OUTFIT

Brand New

1/4 H.P. Heavy Duty

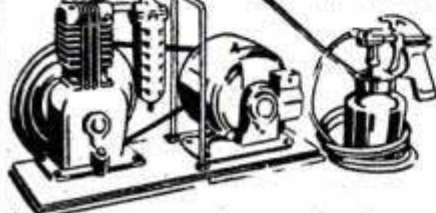

Compressor only\$17.50
Compressor and filter ..\$19.50
Spray gun and hose..\$10.45
Adj. 1/4" pop valve ...\$1.50
2 1/2" air gauge ...\$1.75

well balanced Portable Spray Painting Outfit for use where painting job requires a larger quantity of material. Sprays all types of average viscosity paints, enamels, lacquers, varnishes, etc. Piston type, single cylinder air compressor has 2 in. bore by 1 3/4 in. stroke. Displacement 2.86 C.F.M.; maximum working pressure 40 lbs. Mounted on sturdy wood base with rubber feet attached. Pulsation chamber is equipped with safety valve, drain cock, 1/4 H.P. motor, 110-volt AC, with cord and plug; 20 ft. air hose and fittings. Spray Gun is pressure feed type, internal atomizing, with one quart metal cup. Fan and round spray nozzle furnished. Shipping Wt. 50 lbs.

\$45.00

Same outfit less motor, \$35.00

300 GAL. COOLANT PUMP

A HEAVY-DUTY PUMP AT 40% LESS

You pay less and get a larger, higher pressure, higher capacity, heavy duty coolant-type, recirculating pump. Also extensively used on evaporative coolers. Will deliver 60 gal. per hr. at 8 ft. head and 300 GPH at no head. Heavy duty 1/30 H.P. totally enclosed, 110V., 60C. motor with long life oiling. Noncorrosive shaft and pump. 10 1/2" high, 3/4" I.P.T. Shpg. wt. 12 lbs.

\$19.50



140 CFM "WELLWORTH" BLOWER

Single-inlet blower that gives top performance on heating, ventilating, exhausting, cooling, drying and similar applications. 5 1/8 x 4" mounting flange with 2 1/2" square discharge. 3 1/2" dia. blower wheel powered by direct-connected 1/15 H.P., 110V., 60C., A.C. motor with conduit box and .20" leads. 7 1/2" wide less flange by 7 1/4" H. x 6 3/4" D. Suited for hundreds of new and replacement uses. Shpg. wt. 6 lbs.

\$16.50

PNEUMATIC AIR TOOLS

Riveting and chipping hammers for many uses: riveting, chipping, hammering, auto body work, concrete breaking, etc.; used, guaranteed like new.

CHICAGO PNEUMATIC RIVETER & CHIPPING HAMMER

CP4X Pistol grip handle with air control. Takes up to 3/16" rivet. Weight 6 lbs. List price \$73.00.



Special Price **\$14.50** Same as above, brand new **\$22.50** Size CP3 Takes 5/32" Rivet **\$10.95**

"Wellworth" CHECK VALVES



1/4" valve 1/2" valve
\$2.75 \$4.50

A.V.C. 11 INGERSOLL RAND

Push button, takes 5/32" rivet. Wt. 3 lbs. List price \$10.95 price \$65.00. Only



Ingersoll Rand AIR DRILL

With 1/4" Jacob Chuck. Wt. 2 lbs. List price \$17.50 \$55.00. Only

6 FT. STOW FLEXIBLE SHAFT

Heavy Duty, 3/4" Core. Best piano wire. Ball bearing handle and arbor, rubber covered housing; for 1/2" motor shaft; for 1/2" bore wheels. Operates on 1/4 H.P. Motor at 1725 or 3450 R.P.M. \$29.00 Value, \$14.50. Wt. 8 lbs.



Reduced Price
Only **\$14.50**

AUTOMATIC PRESSURE SWITCH WITH UNLOADER

Double pole, with 2 way release valve. Set at 125 to 150 lbs. pressure. \$10.25 Wt. 4 lbs. Only



AUTOMATIC WATER OR AIR PRESSURE SWITCH. Range 5 to 60 lbs. Set 20 to 40 lbs. Wt. 2 lbs. \$5.50

Prices f.o.b. Chicago. Immediate delivery. All items sold on money back guarantee. Send check or money order today. Write for free catalog.

AUTOMATIC COMPRESSOR UNIT

1/3 H.P. heavy duty capacitor motor AC 110/220 volt 60 cycle, 2 x 1 3/4 inch piston type compressor, splash feed lubrication, 12 x 24 inch tank, automatic pressure switch, pressure range 100 to 125 lbs., check valve, safety valve, air regulator with gauge and filter, 20 ft. air hose with air chuck for inflating tires. V. belt drive. Shipping wt. 90 lbs.

Special Price **\$79.50**

Same unit as above with 1/2 H.P. motor, furnished with 13" x 24" tank. Ship- **\$98.50** ping wt. 125 lbs.

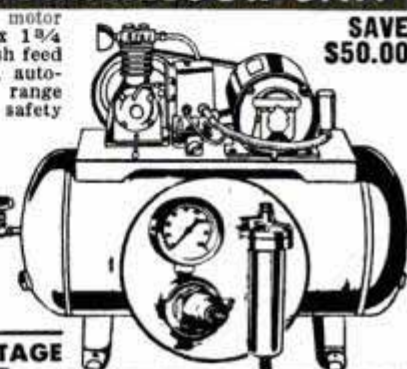

SAVE **\$50.00**

"WELLWORTH" TWO STAGE COMPRESSOR UNIT

Ideal for paint spraying and general use

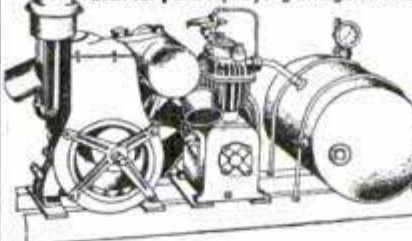

Compressor with unloader, wt. 160 lbs.\$128.00
Engine only, wt. 90 lbs. 87.50
Tank and accessories, wt. 110 lbs. 62.50

Compressor: Size 3 1/2 x 2 x 2 1/2 with unloader for continuous pressure service; displacement 10 C.F.M. at 200 lbs. pressure. Unloader set at 150 to 165 lbs. Compressor idles when 165 lbs. is reached, starts pumping again when pressure is down to 150 lbs. Wisconsin Gasoline air cooled, easy starting engine. 3 1/2 H.P. at 1800 R.P.M. 4.1 H.P. at 2400.

Air Tank: A.S.M.E. 200 lbs. working pressure; size 16" x 20" with safety valve, drain, two 3/8" globe valves and pressure gauge. 2 "V" belts and pulley. 40 ft. air hose and fittings.

Reg. price \$400 less mounting base \$225 Shipping wt. 350 lbs.

WELLWORTH TRADING CO.

Merged with
C & M Equipment Co.

1831 S. STATE ST., DEPT. D-6
CHICAGO 16, ILL.

2 DRILLS IN 1



This attachment gives you two drills in one. It converts any 1/4 inch electric drill to 1/2 inch capacity. Reduction gears reduce the drill speed 5 to 1, the average speed of a 1/2 inch drill, and thereby increases the power. Absolutely indispensable for all shop work and home craftsmen. Satisfaction guaranteed. Order yours now.

\$11.95
post paid

Send check or Money Order with order. Jobbers write for special information.

G. M. CO. MANUFACTURING, INC.
1308 43rd Ave.
Long Island City 1, New York

WE FURNISH ALL MACHINED METAL PARTS, EVERY SCREW, NUT, BOLT, WASHER, AND COMPLETE PLANS FOR THIS...

BIG 10" POWER SAW

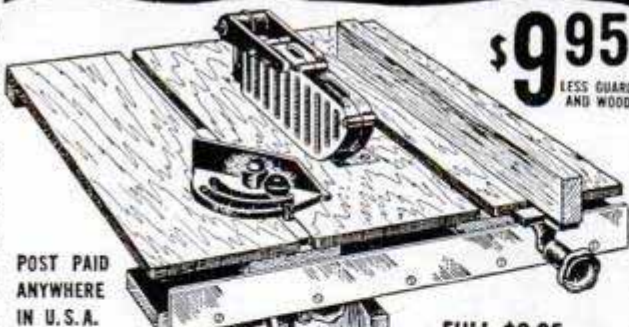

\$9.95
LESS GUARD AND WOOD

POST PAID ANYWHERE IN U.S.A.

FULL \$9.95 REFUND IF NOT SATISFIED WITHIN 10 DAYS



ASSEMBLE IT YOURSELF WITH SIMPLE HOUSEHOLD TOOLS!

TABLE 24" x 20" • TILTS TO 45°
CUTS 0" TO 3/4" DEEP • TAKES 10" BLADE

COMPLETE PLANS (WITHOUT PARTS) 10c

AMERICAN MACHINE & TOOL CO., Inc.
DEPT. 44, ROYERSFORD, PA.

AMAZING VALUE!

144 Asst. MOUNTED

ABRASIVE WHEELS & POINTS

LIST PRICE \$72

\$28.50
postpaid in U.S.

Ideal for industrial use—grinding soft and hard metals, plastics or wood. Brand new, first quality, guaranteed perfect. 16 SIZES
—9 NUMBERS OF EACH mounted on 1/8" shanks. In sturdy container



All wheels & points mounted on finest steel mandrels



18 ROTARY CUTTERS

\$5.85
Post Paid in U.S.A.

Assorted sizes cutter on 1/8" or 3/32" shank. Will fit all hand grinders. Ideal for cutting wood, metal, or plastic. Brand new. SCHUPACK SUPPLY CO., 7331 Cottage Grove, Dept. M6, Chicago 19, Ill.

HYDRAULIC—PNEUMATIC

ACTUATING CYLINDER

WITH ATTACHED HIGH PRESSURE SWIVEL CONNECTOR. DOUBLE ACTION Raise, lower machinery, garage doors, dump trucks, bulldozer blades, shovels, other uses. Brand new, war surplus, genuine Bendix Aviation part #402685; 4" bore, 18" stroke, 31 1/2" long; solid impeller shaft, 1 1/2" diam.; mounting holes 3/8" I.D. 100-2000 p.s.i.; shipp. wt. 50 lbs.; fitting 1/4"-16 thread. Only \$24.50 F.O.B. Chicago area. Gov. cost \$200; a top value; a powerful worker. Don't delay. Order today! Send check or money order, 25% with C.O.D.'s. Satisfaction guaranteed.

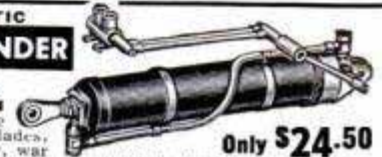

Only \$24.50

Quantity Buyers' Dealers write for special discount. STAHLER DISTRIBUTORS — PM6 — 810 Michigan, Evanston, Ill.

Would You Believe It? POWER TOOLS

Only \$8.00 Each!

5 Big Capacity power tools in ONE machine: Lathe, Drill Press, Saw Arbor, Grinder and Sander—uses 1/4 to 1/2 H.P. motor. Equals in performance equipment costing up to 8 TIMES MORE. Factory-to-you only \$39.95 cash, or on Easy Payment Plan. 10-day FREE trial. Money-Back Guarantee. Write for FREE Catalog.



EMRICK, INC., 1671 Clinton, Kalamazoo, Mich. 10-DAY FREE TRIAL



NOW! FILE YOUR OWN SAWS

Do expert saw filing at home. Precision filing easy without experience. Two simple adjustments. Keeps any hand saw extra sharp and true-cutting. Complete with file. Money back guarantee. Cash with order, prepaid. (COD postage extra.) Order today.

\$2.95
EACH

THE SPEED CORP., Dept. PM1
2025 N. E. Sandy, Portland 12, Oregon

BUILD HEAVY DUTY MACHINES

SAVE UP TO 90% — You can build, using our practical, easy-to-read plans, all kinds of machines, for home, farm or shop — scooters, portable sawmills, metal working machines, concrete machinery of all kinds, printing equipment, woodworking machines, midget autos, dish washers, farm equipment, freezers, tractors.



FREE CATALOG HANDBOOK 183 SETS OF PLANS VALUABLE INFORMATION

NICHOLS EQUIPMENT COMPANY
D-2310 PURVIS, MISS.

Our FE-109 DIRECT CURRENT Power Plant

This power plant consists of a gasoline engine that is coupled to a 2000 watt 32 volt DC generator. This unit is ideal for use in locations that are not serviced by commercial power or to run any of the surplus items that require 24-32v-DC for operation. The price of this power plant tested and in good condition is only \$79.95 F.O.B. Buffalo, or we can supply in strictly "as is" condition for \$58.95 F.O.B. our New York City warehouse. These latter are exactly as received, in heavy steel-strapped gov't cases, and we are unable to determine if the individual units are new, or what the condition is if used, while the \$79.95 are some of the same that we have brought to Buffalo for testing and repair if necessary. We do not recommend gambling on the "as is" condition, except for quantity purchasers. We can also supply a converter that will supply 110v AC from the above unit or from any 32v DC source for \$12.95.

\$6.95 TAKES ALL THREE BIG BARGAINS

- (1) BANDSWITCHING TUNING TURRET** made by Western Electric. Covers 4 bands above 100 MC. ALL coils wound with #14 silver plated wire. Complete with tuning condensers and powerful electric driving motor. Diagram included. **ONE OF OUR MOST TERRIFIC VALUES—ONLY \$2.95.**
- (2) DUAL METER**—One 50 uA and one 200 uA movement in the same case. This meter is ideally suited for use as a combination modulation percentage and carrier shift indicator. If desired the movements may be removed from the case and used separately for voltmeters, ohmmeters, ammeters, etc. ALL meters are in perfect condition, but a few have cracked glasses. This super value costs only—\$1.95.
- (3) AUDIO AMPLIFIER**—Brand new, dual triode amplifier having 2 of the valuable and scarce ounce type audio transformers that sell for over \$10.00 apiece. Neat aluminum case, fully enclosed (largest dimension 6 inches). Perfect for intercom system, phone amplifiers, mike amplifiers, or signal tracer amplifier for testing radio sets. A sensational bargain at only—\$3.40 each.

COMPRESSED AIR INSTANTLY ANYWHERE

Portable Air Compressor and storage tank. Ruggedly built of best materials using lifetime lubricated ball-bearing on connecting rod and oil impregnated main-bearing on shaft. Unusual design forever eliminates valve trouble, the most common fault in air compressors.

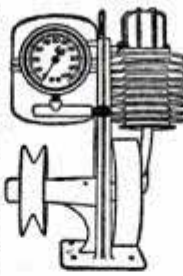

PATENTED unique air intake system increases efficiency tremendously over other compressors so that air output is much greater than that from larger compressors powered by heavier motors. Will deliver approximately 3500 cu. inches of air per minute at maintained pressure of 30 lbs., or will inflate a 90 lb. truck tire in less than one minute. Comes complete with 100 lb. gauge, although finger-tip adjustment allows setting of output pressure at any value, which will automatically be maintained. Works from any 1/4 H.P. motor. Useful for spraying paints or lacquers, disinfectants, insecticides, annealing or brazing with natural gas, inflating tires, etc. Price \$14.50 postage prepaid anywhere in the U. S. Efficient, completely adjustable syphon type spray gun complete with 12 ft. of 100 lb. tested hose available for only \$7.75 with pint container, also prepaid. 25% required on all C.O.D. orders.

SCR-274N COMMAND SETS

(Made by Western Electric for U. S. Gov't)
THE GREATEST RADIO VALUE IN HISTORY!!

A mountain of valuable equipment that includes not 1 but 3 of the hottest superhet Communications Receivers, each of which has a tuned R.F. stage, 3 gang condenser, crystal, and 6 working tubes not counting rectifiers. Also included are 2 Tuning Control Boxes; 1 Antenna Coupling Box with R.F. meter to measure power fed into antenna; four 28V Dynamotors (alteration of set to 110V operation is quick and simple); two 40 Watt Transmitters including crystals; and Pre-Amplifier and Modulator so that transmitters can be used for voice as well as for code. 29 Tubes supplied in all. In guaranteed electrical condition. Transmitters and Receivers instantly removable from mounting racks which hold them in position in aircraft use, so that they can be split up and used separately at different locations just like any other sets. Only a limited quantity available, so get your order in fast. A super value at \$49.95.

FCC AUTHORIZES RADIO for PRIVATE SERVICE!!!!

(The FCC announced that effective June 1, any American over 17 years of age is eligible for a 5 year station permit. In the "Citizens" band, neither code test nor technical knowledge is necessary.)

GENERAL ELECTRIC 15 TUBE TRANSMITTER-RECEIVER SET. This brand new 15 tube transmitter-receiver was designed for mobile storage battery powered service. It will operate in the "Citizens" band where no amateur license to transmit is necessary. It's a cinch for any experimenter to connect this unit for 110 V AC operation by following the instructions and diagrams supplied, which cover numerous applications, including television. For those intending to use on car or boat, a new dynamotor, exactly as originally supplied, costs only \$15.00. Don't fail to write for FREE descriptive bulletin. Order our RT-1248 for only \$29.95, or two for \$53.90.

BUFFALO RADIO SUPPLY, 219-221 Genesee St., Dept. PM, BUFFALO 3, N. Y.



CLAMPS ON YOUR MOWER IN A JIFFY!
Sold Direct on 5 Day Approval

NOW—MAKE YOUR MOWER A POWER MOWER
Attach a LeJay MIDGE-TRACTOR. Less than half the cost of many power mowers. Makes mowing fun. Sold with or without engine. \$4995
Fits mowers from 16" to 22" width.

FREE Literature Write today
If You are a Handyman
You can build your own MIDGE-TRACTOR. Send 35c for complete plans and literature.

LEJAY MOTORS CORPORATION
2947 So. Emerson, Minneapolis 8, Minn.

NEW POLISHING SENSATION!

GIVE YOUR AUTO, FURNITURE or BOAT a PROFESSIONAL FINISH

CUMMINS
1/4" AC-DC DRILL
2200 R.P.M. with Perpetual Factory GUARANTEE.

POLISHER-SANDER UNIT
with high pile Lambswool Bonnet and sandpaper, if purchased separately \$2.25

THE ORDER MART



with **JACOBS KEY CHUCK!**

DRILL, POLISHER-SANDER UNIT and STURDY METAL BOX

ALL FOR ONLY \$18.95 COMPLETE PREPAID
MONEY BACK GUARANTEE if not satisfied
Send check or money order today. WE PAY POSTAGE

Dept. 2J, 62 Warren St., N. Y. C. WO 4-3497

For Finest Performance Use **SHOPMASTER TOOLS**

SHOPMASTER INC.
1214 THIRD ST. S., MINNEAPOLIS 15, MINN.

ELECTRIC MOTOR BARGAIN

We have a surplus of 1/150 HP motors. Original cost \$2.00 each. 110 volts, A.C., induction type. Self-aligning bearings.

FINE FOR FANS, HEATERS, BLOWERS, TOYS, DISPLAYS.

Special, each ... 95c

STANDARD ELECTRIC MFG. CO.
WEST BERLIN, N. J.

Postpaid if \$1.00 is sent with order. Otherwise, C.O.D.

ELECTRO BAND SAW BRAZER

FOR RESISTANCE BRAZING OF BAND SAW BLADES

Repairs broken saw blades without delay. Permits savings by making new blades from coil stock. Simplifies inside sawing. Welds up to 1/2" blade in one operation and up to 1" blade in two operations. Portable. Uses 50 C-60 C, 110 V. Fully guaranteed.

only \$19.75 COMPLETE WITH SERVICE KIT OF FLUX AND SOLDER
See your dealer or write

The ERWOOD Company
CRYSTAL LAKE, ILLINOIS

Say You Saw It in Popular Mechanics

NEW! POWER KING CATALOG AND SHOP HINTS!



Just off the press! Send today for this unusual new Power King catalog. Gives you complete information about Atlas-built low-cost Power King tools for your shop plus helpful hints on types of joints for furniture and other projects. Gives facts about various woods, lists and describes Atlas Easi-Bild patterns. Write today.

SEND THIS COUPON FOR YOUR COPY

NAME _____
 ADDRESS _____
 CITY _____
 STATE _____

ATLAS PRESS CO.
 635 N. Pitcher St., Kalamazoo, Mich.



MATCHED PRECISION TOOLS FOR WOODWORKING AND METALWORKING

Sensational SCRAPER

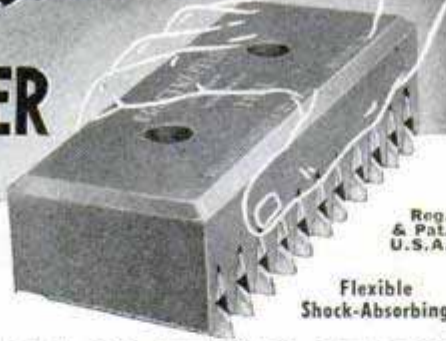

Reg. & Pat. U.S.A.

Flexible Shock-Absorbing

"THE CRAFTMASTER"

With Eleven Floating Action Blades Saves You Time, Work and Money

Hundreds of tests prove it will do the finest of woodwork, or smooth down the roughest steel welds, while doing most jobs in one-fifth the time with far less work than a one blade scraper.

IT'S EVERYBODY'S TOOL, Painters, Carpenters, Housewives, butchers (meat blocks), machinists, etc.

Distributed by **WILKES-BARRE EQUIPMENT CO.** ONLY **\$2.50**
 Wilkes-Barre 51, Penna. P.P.D.

MAIL COUPON TODAY

WILKES-BARRE EQUIPMENT CO.
 Wilkes-Barre 51, Pennsylvania
 Enclosed find check or money order. Money back if not satisfied.

NAME _____
 ADDRESS _____
 DEALER INQUIRIES INVITED



AIR COMPRESSORS NEW LOW PRICES!



Complete with motors

1/4 H.P. \$49.50 (Reg. \$79.50)

1/3 H.P. \$55.00 (Reg. \$89.50)

FULLY AUTOMATIC — EASY TO USE! Piston type, 2" bore, 1 3/4" stroke. High pressure steel tank, 12" x 23". AC-110 volt Capacitor Motor. Shut off at 60#. Start at 40#. 2.55 C.F.M.

Splash lubrication. "V" belt drive. Cord & Plug.

SPECIAL! 1/2 H. P. AIR COMPRESSORS. High pressure tank 14" x 30"—A.C. Automatic 110-220 Volt Capacitor Motor — 3.3 C.F.M.—150 lbs. Max. Pressure—Shut off at 125#—Start at 85#. **\$89.50** (Reg. Price \$127.50)

For inflating tires, spraying, lubricating, dusting, operating air tools. Saves money, time, labor!

FULLY GUARANTEED. FOB. WHSE., NYC. 25% DEPOSIT WITH ORDER.

PARISER ELECTRIC MOTOR CO., INC.
 DEPT. 15, 165-167 CENTRE ST., NEW YORK 13, N. Y.



WORLD'S LOWEST PRICED ADDING MACHINE

IDEAL FOR BUSINESS AND PERSONAL USE — GUARANTEED ACCURATE. Not a toy. Operates with only a finger flick. Adds, subtracts, multiplies, divides. Counts up to one billion. Pays for itself over and over. Ideal Gift — for Business, Income Tax and School use. **\$2.95** Vest Pocket Size FREE TRIAL

TOTAL COST \$2.95 SEND NO MONEY MONEY BACK GUARANTEE. Send name and address. Pay postman only \$2.95 plus postage. (Send full cash if outside U.S.) Beautiful rich-looking Leatherette Case included at no extra cost. Money back in 10 days if not delighted. AGENTS WANTED.

Calculator Machine Co., (Mfrs.) Dept. 215, P.O. Box 248 Glenview, Illinois

DUAL CROSS and ROTARY FEED

PALMGREN ROTARY, INDEX, MILLING TABLE No. 83

Has 8" table, 360° movement and 4" cross feed travel. Adjusting wheels and dials graduated in degrees and thousands. Slotted for holding to table. No. 83 Priced \$49.50. No. 82 without rotary feed \$39.75.

Write for Circular No. 10 CHICAGO TOOL and ENGINEERING CO. 8365 South Chicago Ave., Chicago 17, Ill.



NONE BETTER! SUPER DRILL GRINDER



Sharpens round shank drills from 3/32" to 1/2" in diameter, up to 6" long. Grinds old drills like new in 4 different point angles, using hand or power grinding wheels. Money-back guarantee.

Price only \$2.95

At Dealers or Postpaid

CRANDALL MFG. CO. 1512 W. Slauson, Dept. FA-42, Los Angeles 44, Calif.

15 ESSENTIAL WORKSHOP OPERATIONS ON YOUR DRILL PRESS

Barron Precision Drill Press Tools and Accessories—Planers, Router Bits, Shaper Fences, Molding Cutters, Dovetail Cutters—a host of other useful drill press items give complete workshop facilities at 1/4 the cost. Over 200,000 Barron owners. Get the facts on these popular, versatile drill press tools today. Sold on 10 day money back guarantee.

BARRON TOOL CO. Inc. 669 ARCHITECTS BLDG. DETROIT 1, MICHIGAN

FREE Workshop Guide & Catalog

SAVE UP TO 85% IN WAR SURPLUS-SENSATIONAL VALUES

NEW 1949 CATALOG 92 PAGES-ILLUSTRATED SEND 25c TODAY!

IN MANY ITEMS WE HAVE THE WORLD'S LARGEST SUPPLY

New Hydraulic Cylinders, Valves, Pumps, Fittings, Hose and Tanks

51 SIZES AND TYPES. WORLD'S LARGEST SUPPLY 1001 Labor Saving Adaptations for Pulling, Pushing, Lifting Operations. Finest Precision workmanship and materials. Liquid end or Air Operation, developing terrific power. 20,000 Available. Write for Catalogue Priced to sell at 15% Gvt. Cost

WINCH HOISTS

Thousands of satisfied users. Hundreds have written, the most wonderful tool in the world.

No. 100 WINCH HOIST

Cap. 2500 lbs. with 24:1 ratio controlled bronze worm gear, 1 1/2" alloyed steel cable with hook, two speed handle. Ideal for Boat Garage, etc. \$100 Val. **\$15.99**

CONTINENTAL GAS ENGINE

Genuine Red Seal 4 Cycle Air Cooled L head standard equipment inc. Mesh type air cleaner, flywheel, magneto, float type carburetor, blower housing, muffler, fuel tank, fuel filter with shut off valve, starter pulley, etc. The ideal power package for light tractors, lighting plants, compressors, boats, lawn mowers, etc. And cast your eyes at this price

A \$75.00 VALUE NEW For ONLY **\$47.95**

New BRIGGS & STRATTON MODEL "A" GAS ENGINE

Rating 2.10 H. P. 4 cycle, single cylinder. Complete in original Factory Crates. A \$102 Value for Only **\$64.95**

PNEUMATIC AND AIR TOOLS

10,000 in various popular makes, sizes, types. Cleco, Aero, Ingersoll Rand, Chicago, Pneumatic, Buckeye, etc.

RIVET GUNS

Pistol & Gooseneck Type -131 Use. Chipping, Driving, Hammering, Breaking cement, Auto body work.

Chicago Pneumatic, Cleco, Ingersoll Rand Makes, E3, E2, 3X, 2X, OY.

\$55 VALUE **\$8.95**

#186 SQUEEZER PNEUMATIC ALLIGATOR SQUEEZER

\$80 Value **\$15.95**

AIR DRILLS OR MOTOR SPECIAL ARO PISTOL

with 1/4" Jacobs Chuck **\$15.00**

THOR #210R Model 4526 REVERSIBLE AIR DRILL

2300 R.P.M. **\$19.95**

Xlnt. for Tapping

PNEUMATIC ANGLE DRILL

With Terry Adapter ea. **\$12.50**

Send for Catalogue and List of Other Sizes. Types of Pneumatic Tools.

New Electric Motors

#500 new 1/2 H.P. 27 Volt D. C. 24 Volt A. C. This motor can be readily adapted to 110 A. C. by the simple method of rearranging armature brush leads. We furnish free diagram of instructions with each order. A Sensational Value **\$5.95**

Converted to 110 A. C. Equipped with plug and 3/4" ft. Heavy Duty Cord **\$8.49**

1/16 H. P. 24 Volt D. C. Motor. Series Wound. New. #501. **\$3.95**

#502 - 2 H.P. 24 V.D.C. used. **\$8.95**

DC GENERATORS

Direct Current Generator, especially suited for adaptation to homemade welding unit

Type G-1—140 amps—27 V.—NEW **\$17.95**

Used but guaranteed condition. Type R-1—300 amps—30V **\$32.50**

Type P-1—200 amps—27.5 V **\$22.50**

Type T-1—25 amps—12 V. A Real Value NEW **\$13.95**

POWER UNIT

The Complete Model G33 12-24-100 Consists of a Single Cylinder, Air-Cooled, Four-Cycle Briggs-Stratton Gasoline Engine, Type-Single Cylinder, Air Cooled, L-Head, Four-Cycle, 6 H. P. Bore 3", Stroke, 3 1/4". Governed for Speed Between 1300 - 3200 R. P. M.

Directly Connected to a Direct Current Generator of 2000 Watts, Rating 28.5 Volts, 100 Amps, to form an Integral Unit. Fuel Container 1 1/2 Gallons.

The Engine and Generator are Mounted on Fast Shock Absorbing Rubber Motor Mounts Attached to a Channel Iron Base. 4 Wheelies for Mobility can be used as Lighting Plant or Power Supply. A TERRIFIC VALUE!

RECONDITIONED GUARANTEED ONLY **\$109.89**

New Westinghouse AIR COMPRESSOR

Thousands now in use for spraying, inflating, tractors, trucks, garage, laboratory, air tools, industrial use, etc. Lightweight but powerful, can be run by 1/2 H. P. Motor or Gas Engine. Operates in either Direction, or rotation. Gives approximately 3.27 CFM at 600 RPM. 6.54 CFM displacement at 1200 RPM. Has 2 inch bore, 1 1/2 inch stroke. Suggested pressure 75 P.S.I. Size 9" x 12" x 16 1/2". Weight approximately 23 pounds. AT THIS NEW LOW PRICE **\$23.95**

Motors, Tanks, Fittings to Adapt this Unit also Avble.

MECHANIC'S 15" MONKEY WRENCH

Cod. Plated **89c**

Adjustable 4" jaw opening. Black **79c**

Drop forgs. Auto. type.

GADGET MIX

Especially prepared for the HOBBYIST. Rivets, Spacers, Bolts, Screws, Nuts, Gears, etc. A gold mine. **\$1.19**

#106, 1 LB. **\$1.19**

BEARING MIX

Needle, Ball & Roller Bearings in excellent assortment. Sizes from 1/4" to 3". One of our "BEST SELLERS". 15 BEARINGS **\$2.95**

#170 for ONLY **\$2.95**

HINGE MIX

12 pieces of steel and brass hinges. Sizes 1" x 1" to 1 1/4" x 4" in length to 8" drop. #170K. A \$10.00 Value FOR ONLY **\$1.09**

ABRASIVE AND GRINDING WHEEL MIX

30 Pieces including bonding stone, pencil rolls, wheels, abrasive sheets, etc. A really sharp value. **99c**

#176AG.

SPRING MIX

Tension, Compression & Tension Springs, assmt. sizes. A treasure chest for your projects. #206 **89c**

COMBO MIX 2 LBS. for ONLY **89c**

Comb. of all above, all in one price. **\$5.79**

Send. At special introductory price.

SWITCH MIX

12 assorted types of Aircraft Switches. Including double & single throws, double & single poles & multiples. Voltage ratings from 5 to 20 amps. 125 Volts A. C. 35 amps. 24 Volts D. C. 1001 uses in Auto, Truck, Tractor, Jeep, Shop, Radio. **\$2.95**

FILE MIX

Ten Assorted Files of 6", 8", 10", 12". Includes 3 Vixens, half rounds, bastards, mills, etc. in seconds and used but in good condition. 1 Vixen alone worth our price for the entire mix **99c**

PULLEY MIX

You'll want this one around. 30 micarta and metal pulleys ranging from 1" to 5" with ball and one piece bearings. These are aircraft pulleys, the best made with hundreds of uses. **\$2.95**

A WONDERFUL BUY @

COUNTERSINK MIX

#168A - Countersink Assortment. Excellent condition - High Speed Steel. Assortment of ten 100° and 110° with pilot sizes ranging from 3/32" to 3/16". **\$2.69**

D. C. METERS

30 0-20+	0-100
40 0-20+	0-150
40 0-20+	0-200

Comb. Voltmeter-Ammeter, 30V - 30 Amp. **\$4.95**

30V - 60 Amp. **\$4.95**

30, 50, 120, 240 or 500 AMP. **\$1.00**

SHUNTS

required with use of DC Meters **\$1.00**

NEW PRESSURE TANKS

Stainless steel - Shatter proof. Rustless. 10,000 available in 4 different sizes. 1001 wts. O-1 1 1/2" x 24 inches - 2100 Cu. In. capacity 29 cu. ft. **\$4.75**

O-2 2 1/4" x 24 in. 500 Cu. In. capacity 7 cu. ft. Corrosion resistant steel. **\$2.49**

D-2 Stainless Steel **\$3.49**

F-2 4 x 4 in. - 1000 Cu. In. capacity 14 cu. ft. **\$3.95**

A-4 1" x 8" 104 cu. In. Capacity **\$1.35**

Ideal for painting, coating, spraying, scuba buoys, underwater fishing or diving. #OR-1 Oxygen Regulator with 150 lb. gauge will fit all tanks **\$1.39**

OXYGEN & ACETYLENE REGULATORS

OXYGEN REGULATOR Bottle Pressure Gauge 0-3000 PSI Regulating Press. Gauge 0-400 PSI

ACETYLENE REGULATOR Bottle Pressure Gauge 0-500 PSI Regulating Pressure Gauge 0-50 PSI

AIRCO & Other Popular Makes to fit ALL Standard Bottles ALL NEW! A Real Buy at... **\$12.95**

or Both for... **\$25.00**

#155 VICTOR CUTTING TORCH **\$15.75**

Type #400SS. Used but in gd. cond.

High Pressure Oxygen Bottle

New. Will hold up to 3,000 lbs. PSI, with Co2 used as fire inflator or fire extinguisher, with oxygen for sick room or deep-water diving, etc. Completely equipped with brass valve, 3/8" hose, Dial gauge, & canvas bag. **\$2.29**

FIRE EXTINGUISHER

Kiddle Lux Co2 Type. Built in Gov't. spec. windbound

Recharged Heavy Case. Fully recharged. 3 1/2 lb. 2 1/2" x 2 1/2" Trigger control with hose 478 type. \$35 Value **\$13.25**

#601A **\$13.25**

3 lb. Co2 type \$23 Value **\$11.75**

#602 **\$11.75**

10 lb. Charged with hem Co2 \$55 Value **\$25.75**

#603 **\$25.75**

13 lb. Break Disc type New **\$29.75**

#604A **\$29.75**

13 lb. Wheel Control **\$32.95**

#605B **\$32.95**

15 lb. Squeeze grip New **\$39.95**

#605C **\$39.95**

All above Co2 type. Fully charged and with form. Inexpensive for small or large planes, Trucks, Auto, Home, Factory, Etc.

ELECTRIC SOLDERING IRON

110 Volt A. C. Vulcan **\$8.50** Value

#198A 100 Watt **\$2.95**

Electronic Transmission Gear Train

GT-1 Containing approx. 50 Bronze Spur & Pinion Gears ranging from 3/8" to 4" dia. 5 sets of 7 cluster gears. 2 complete worm & worm gear drive sets. 40 N. D. ball bearings from 1/2" to 1 1/2" dia. watch springs, bushings, posts, face plates, housings, Micro Switches, 2 miniature, controlled clutches, etc. 13 lbs. of Pleasure and profit. A Tremendous Gadget Mine. Only **\$8.49**

Gears in above train are all in multiple size and sequence with identical teeth ratio giving hundreds of ideal gear reduction combinations.

NEW GILBERT ELECTRIC DRILL (1/4")

STRAIGHT EDGE - Sent by mail

Here it is! That Drill Sensation!

SMOOTH - POWERFUL - LIGHTWEIGHT RUGGED. A Guaranteed. Precision tool for wood or metal. Latest streamlined design. Fingertip switch control. Self Lubricating Shaft Bearings.

Tested at 115 Volts • R.P.M. 1620 Chuck: Jacobs Type 1/4" key chuck. Weight: 4 1/2 lbs.

It's Ready NOW! At your service at cut-to-the-bone-prices. ORDER TODAY!

Complete Drill & Chuck... ONLY **\$19.95**

Including Sander and Buffer... **\$21.95**

PIANO HINGE

Overall Width	Length	Price
1 1/4" (3/4" side)	72" alum.	\$1.00 ea.
2" (1" side)	72" alum.	\$1.19 ea.
1 1/2" (3/4" side)	52" cad. steel	.75 ea.
2 1/2" (1 1/2" side)	33" steel	\$1.00 ea.

Order from this Ad. All sales final. All Prices F. O. B. Los Angeles. Pay by M. O. or Check. P. O.'s. Acct'd. from D & B firms. 1/3 deposit with C.O.D.'s

Vickers Hydric Transmission

VT-1 Self contained. 2 H. P. constant torque at all speeds with variable volume reversible, piston pump (controlled by outside lever) supplying piston hydraulic motor. Automatic pressure, dash pot for smooth control. Power output R. P. M. - 0 to 1/2 input R. P. M. in both directions. Input R. P. M. 1800 continuous 4000 intermittent. Dash pot can be removed for greater R. P. M. Ideal for Lathes, Duplicator Setup on Mills, Conveyors, Small Cars, Drives, Gearing, Etc. COST GOVERNMENT APP. \$400.00 You'll Chortle when you get it for ONLY **\$19.50**

GEAR BOXES

VTG-1-85 1 1/2" to 1 level gear reduction. 1/2" dia. with lever control for engaging & disengaging positive clutch, dual proof housing, pre-lubricated, brns. size 7"x8". A lifetime value **\$3.95**

VTG-2-12 line spur gear reduction 15 to 1, 3 1/2" gears. Final take-off 4 1/2" dia. 35 shaft. 1/2" Alum. spur gear with lever control for engaging and disengaging positive clutch, dual proof housing, pre-lubricated, bearings size 1 1/2"x2". Only **\$6.49**

Both above gear boxes can be used with above Transmission.

RUBBER GOODS

NEOPRENE SHEET RUBBER

Thick-ness	Width	Price per sq. ft.
#325 .020"	1/64 36"	.75
#328 .032"	1/32 22"	\$1.39
#329 .125"	1/8" 46"	\$4.75

Item #319 is laminated rubber sheet with cloth center. Flexible but very fine and heavy wear. Rubberized Hosp. or Bed Shts. 54"x72". \$10.00 Value Only **\$2.29**

AIRCRAFT CABLE

Alloyed steel, rust resistant, 3/16" dia. 18 ft. long, with turnbuckle ends **99c** ea.

Delivered 7 x 13 strand-on reels in any length...

1/16"	3c ft.	5/32	5c ft.
3/32	4c ft.	3/16	6c ft.
1/8"	4 1/2c ft.	9/32	8c ft.

DOUBLE CASTER UNIT

2 Needle bearinged 5" Casters joined as a unit on a 7/8" x 8" rubber protected steel base plate. The unit is 9" high and will completely swivel. Ball bearings in swivel entirely enclosed. Bolts Furnished. If you have to move heavy machinery or rigs these are just the thing Unit **\$9.85**

... This New, Patented Front Coil Spring Assembly

Makes '35 to '48 Fords, Mercurys Ride Like a 1949!

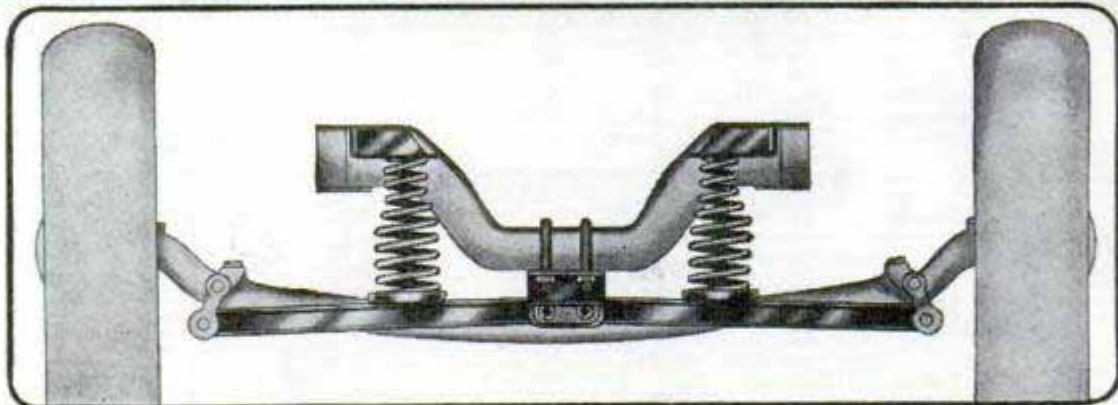

Works on "HYDRA-COIL" Principle.. Soaks up the bumps!

If your Ford is a 1935 to 1948 make, or if you drive a '42 to '48 Mercury, you can enjoy "Hydra-Coil" riding and driving qualities—the greatest achievement in automotive comfort in years—with the Front Coil Spring Assembly! Ruts and bumps flatten out. Jolts and jars lose their force. Road shock is cushioned to velvety smoothness! There is as great a difference between the old, flat-leaf springs on Fords and Mercurys and the new "Hydra-Coil" type of spring assembly, as in a Model "A" and V-8 motor! And in addition to greater riding comfort, easier handling and less driving fatigue, the Front Coil Spring Assembly also increases the value of your car . . . by commanding a higher price or allowance when you sell or trade it!



... "Hydra-Coil" Springs ...

TRIED, Tested, Proved!

Mr. J. Patton, M.E., for one of the largest steel fabricators in the country, did the mechanical engineering on the Front Coil Spring Assembly for Fords and Mercurys, and supervised tests of component parts. Additional experiments were made in the engineering laboratories of two of America's prominent spring and forging manufacturers. Mr. Wayne Hart, Ford Agency Superintendent at Idabel, Oklahoma, says: "For over a year, on 'washboard' roads and the worst highways in the State, I tested your new Front Coil Spring Assembly on a Mercury for thousands of miles under actual driving conditions. It does not affect steering or wheel-alignment; it does not cause car "sway" at high speed or on curves. The steel forg-

Quick, Easy to Install!

ings are made of identically the same type of material as used in the Ford front axle. The unit is as strong, safe, and durable as the original equipment. When the wheels get a sharp blow in hitting a bump or rut, the Coil Springs absorb the jolt and cradle the force of the bounce to a gentle glide."

You can install a Front Coil Spring Assembly on a '35 to '48 Ford or '42 to '48 Mercury in about 1 1/2 hours. Instructions are clear, simple, easy to follow. No special tools or equipment needed. If you can use a wrench, hammer, pliers and screwdriver, you can easily equip your car with the "Hydra-Coil" type of spring assembly!

WARRANTY: Front Coil Spring Assembly units are GUARANTEED for 1 year against defective materials and workmanship. Designed to meet exacting precision engineering standards, every part in the assembly kit of this "Hydra-Coil" principle for Fords and Mercurys is GUARANTEED AS ADVERTISED—or money refunded!

AUTOMOTIVE DIVISION FEDERAL IDENTIFICATION COMPANY, Inc.

Dept. FE • 1713-35 West Grand Avenue • Oklahoma City 6, Oklahoma

Gentlemen: Please ship a Front Coil Spring Assembly for my (state year of car, and if Ford or Mercury) _____
I enclose Check Money Order for \$45.00, plus \$1.00 Federal Excise Tax (total \$46.00) as payment in full.
Or: I enclose \$25.00 deposit, and will pay balance C.O.D.

My Name Is _____

My Address Is _____

City _____ Zone _____ State _____

AGENTS WANTED! For details on BIG profit-making deal—check . Also check if you are a Retailer or Wholesaler

MAIL
THIS
NOW

NOTE

WHEN
IT'S
AN
EXIDE
YOU START...



When you buy a battery for your car, choose one that you KNOW you can count on for dependable starting power . . . and for many extra months of good service. Exide-Hycap Batteries average 48% greater starting power and 81% longer life than required by the standards of the Society of Automotive Engineers. This means *real* battery economy.

Drive with confidence. Buy *starting assurance*. Remember, a single starting failure can be far more costly than the little extra you pay for a trustworthy, long-lasting Exide-Hycap Battery.

1888...DEPENDABLE BATTERIES FOR 61 YEARS...1949

THE ELECTRIC STORAGE BATTERY COMPANY, Philadelphia 32
Exide Batteries of Canada, Limited, Toronto

"Exide" and "Hycap" Reg. Trade-marks U. S. Pat. Off.



CREST DELUXE THREESOME
 Pen, \$17.50—Pencil, \$6.00
 Stratowriter, \$12.50
 Complete Set, \$36.00; plus fed. tax

Happy Birthday

GIVE Sheaffer's

AMERICA'S FIRST CHOICE

(BY ACTUAL SALES RECORDS)



Skilled craftsmanship, matchless beauty and perfection of performance—superiority in every fine detail have made Sheaffer's America's First Choice—*first* among all writing instruments. Make Sheaffer's your first choice for any gift occasion.

W. A. Sheaffer Pen Company
 Fort Madison, Iowa and Malton, Ont, Can.



SENTINEL TUCKAWAY THREESOME
 Pen, \$15.00—Pencil, \$5.00
 Stratowriter, \$10.00
 Complete Set, \$30.00; no fed. tax



"TRIUMPH"
 Desk Set, \$40.00
 Other Sheaffer Desk Sets:
 \$10.00 to \$108.00

SHEAFFER'S GOLD-FILLED PENCIL
 (Chased), \$7.50; plus tax

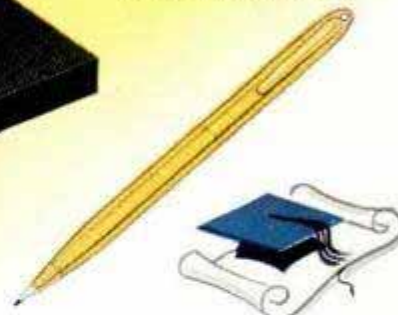

STATESMAN THREESOME
 Pen, \$10.00—Pencil, \$4.00
 Stratowriter, \$7.00
 Complete Set, \$21.00; no fed. tax

Every Sheaffer Writing Instrument, individually or in sets, makes a magnificent gift. Other Sheaffer Gifts from \$3.75.

SHEAFFER'S

WHITE DOT OF DISTINCTION

A GIFT MEANS MUCH MORE WHEN IT'S MADE BY SHEAFFER'S



WHITE DOT SAFEGUARD
 Desk Set, \$12.50

Scrip makes any pen write better, last longer.

