

ANC



POPULAR MECHANICS

MAGAZINE

WRITTEN SO YOU CAN UNDERSTAND IT

REG. GREAT BRITAIN, No. 410426

REG. U.S. PAT. OFF.

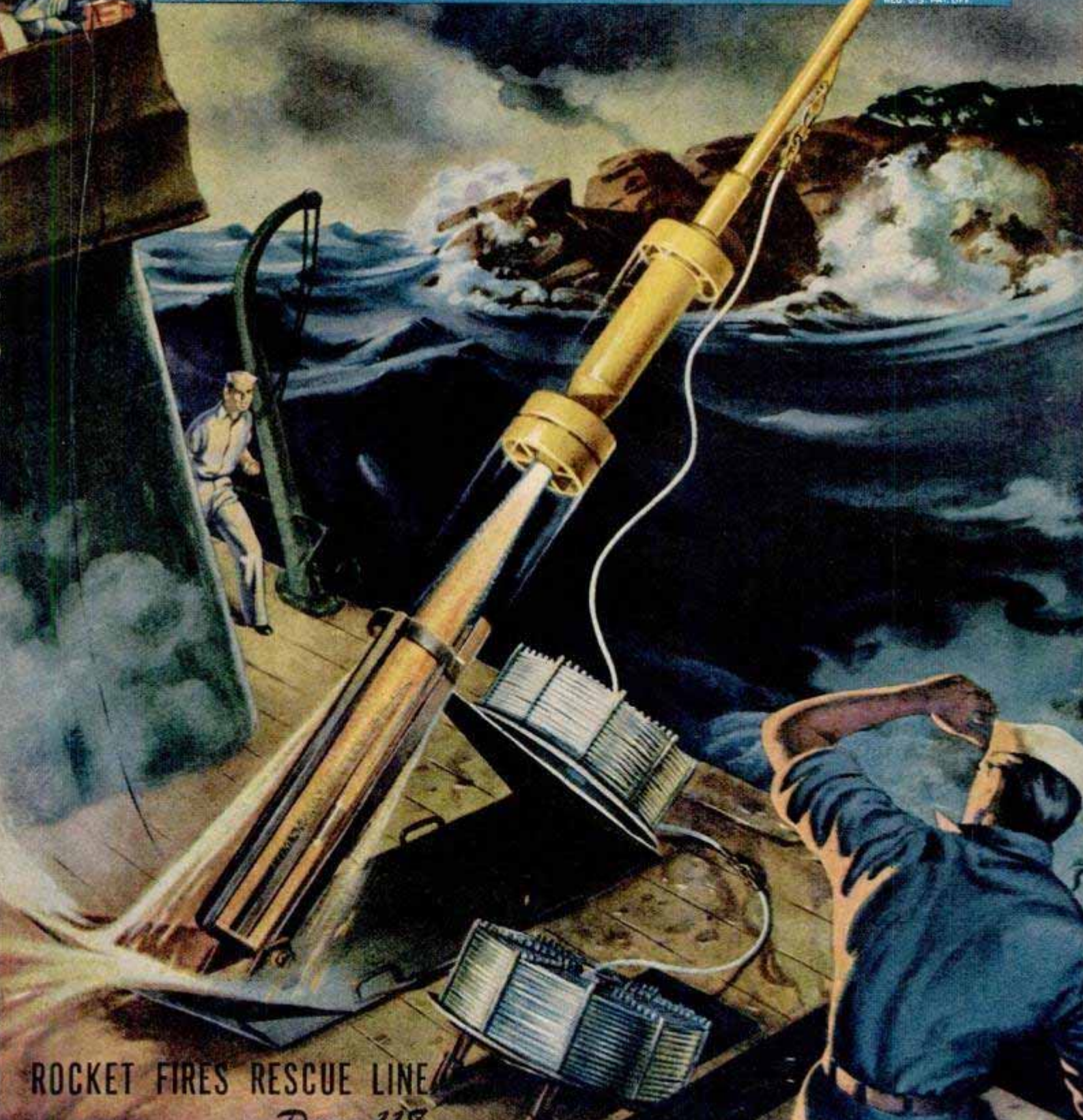

ROCKET FIRES RESCUE LINE

2 118



NOW... LIGHT
WHEN YOU NEED IT!

Ray-O-Vac leak-proof batteries
stay fresh for years!

(because they're sealed in steel!)

© 1949 BY RAY-O-VAC COMPANY, MADISON, WIS. RAY-O-VAC, CANADA LTD., WINNIPEG, MAN.

See how much more you get

in these truly modern batteries. Each Ray-O-Vac Leak Proof starts with a powerful, well made battery. Then . . .

1. Steel bottom is added.
2. And a steel top.
3. Next—multiple insulation. Nine layers of protection against corrosion.
4. Last—a steel jacket. This completes an air-tight seal, to stop corrosion and keep the battery fresh and powerful. Only Ray-O-Vac builds batteries with all four of these safeguards.

GUARANTEE on every Ray-O-Vac Leak Proof: "If your flashlight is damaged by corrosion, leakage or swelling of this battery, send it to us with the batteries and we will give you **FREE** a new, comparable flashlight with batteries."

Ask for Ray-O-Vac Leak Proofs

Buy Spares... they stay fresh

"TORTURE TEST" proves safety of amazing tube development!

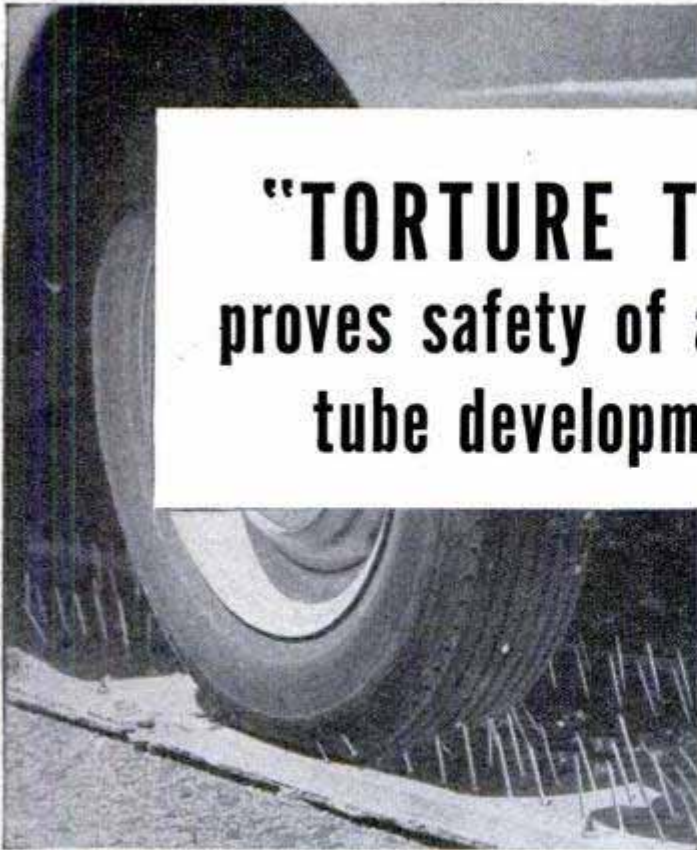

1. In severe "Torture Test", cars equipped with Seiberling Sealed-Air Tubes roll down "torture road", pick up hundreds of nails that pierce deeply through tires and tubes. But the tubes do *not* go flat, need no repairs!



2. Here, big torture knives cut deep two-inch gashes. Even such drastic punishment can't stop this Seiberling Sealed-Air Tube with patented Bulkheads. It seals these 2-inch gashes as the car rolls on!

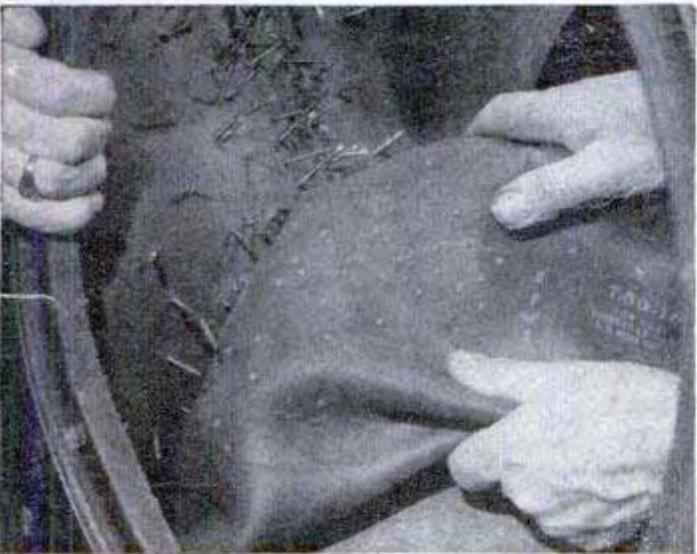

3. Seiberling Sealed-Air Tube being removed from tire for inspection after being pierced with more nails than you'll ever pick up. Each raised "rubber rivet" marks a spot where tube has *permanently* repaired itself! It's safe for many more thousands of miles of driving.

How can this tube take 1000 punctures WITHOUT GOING FLAT?

What is Bulkheading—the amazing principle perfected and patented by Seiberling—that makes this tube different from any other tube in the world? How can it outlast four tires, run more than 300,000 miles, be punctured many hundreds of times, *and not go flat*? How can it reduce your tire and tube costs, end the nuisance of flats, and protect you from the danger of blow-outs? The complete story is told in a new book which we'll be glad to send you. Just fill in and mail the coupon below.



Mail this coupon before you have another flat!
FREE! New book: "10,189 PUNCTURES — AND NOT ONE FLAT!"

Shows you how the *only* tube with Patented Bulkheads eliminates the trouble and expense of flat tires, protects your family from the danger of blow-outs — *and saves money!* Absolutely free. Send coupon *now*, to: Seiberling Rubber Company, Dept. P-2, Akron 9, Ohio.

Name _____

Address _____

City _____ State _____

SEIBERLING

Sealed-Air TUBES

WITH PATENTED BULKHEADS



THE EAR IS OUR CUSTOMER

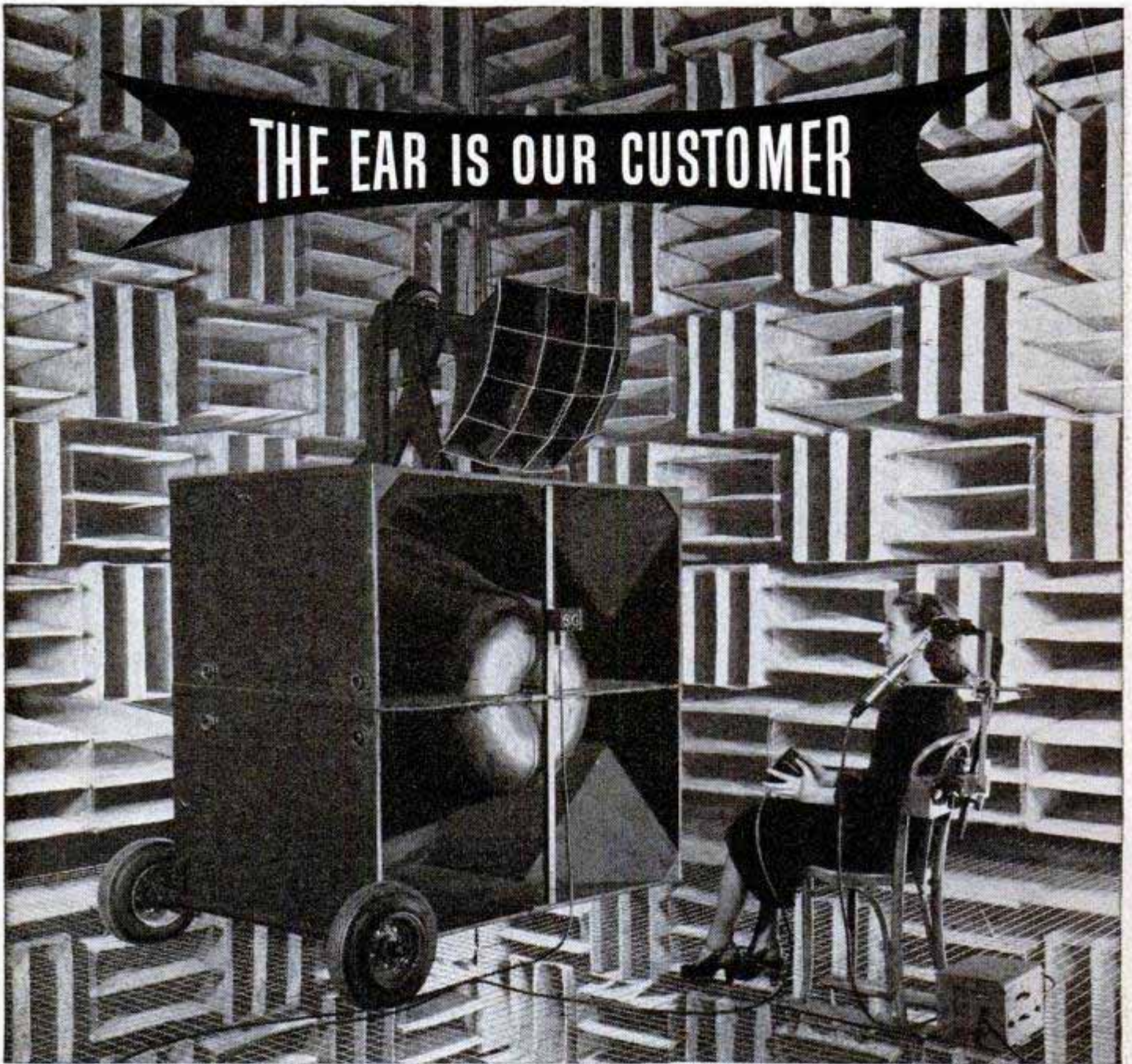

What happens when you hear? What happens *inside* your ear when sound waves come in from a telephone conversation?

Bell Telephone Laboratories scientists have developed special apparatus to help answer these questions, for the telephone system is designed to meet the ear's requirements for good listening.

In the test pictured above, the young lady sits before loudspeakers in a soundproofed room with a small hollow tube, reaching just inside the ear canal. Sounds differing slightly in frequency and intensity come from a loudspeaker. The subject seeks to tell one from another, recording her judgment electrically by pressing a switch.

Meanwhile, the same sound waves pass down the hollow tube to a condenser microphone, and a record is made of the exact sound intensities she identified. Results help reveal the sound levels you can hear clearly and without strain — the sounds your telephone must be designed to carry.

Scientists at Bell Telephone Laboratories make hundreds of tests in this manner. It's just one part of the work which goes on year after year at the Laboratories to help keep Bell System telephone service the finest on earth.

BELL TELEPHONE LABORATORIES

Exploring and inventing, devising and perfecting, for continued improvements and economies in telephone service.



Popular Mechanics Magazine

Registered in U. S. Patent Office and Canada

H. H. WINDSOR, *Founder*

H. H. WINDSOR, JR., *Editor and Publisher*



this month's cover

DESPERATE SAILORS are pinning high hopes on that shipboard rocket they are firing in the scene shown on this month's cover. It's an imaginative view of what may very well make headlines before long. The ship is breaking up near shore and the rocket is about to zoom through the air carrying a lifesaving cable. When the rocket lands, its stakelike nose will anchor itself in the ground. With the cable taut, a sailor will ride a breeches buoy ashore to secure the cable permanently for his mates to follow. The rocket equipment has been tested by the Coast Guard with promising results. Modern ships still carry the Lyle gun, used since 1870 for throwing a light line, but proponents of the rocket say the missile will carry a heavier cable much farther. In situations where life may hang by a thread, the best equipment must be found. For a detailed report, turn to page 118.

Published monthly by Popular Mechanics Company, 200 E. Ontario St., Chicago 11, Ill. H. H. Windsor, Jr., president; Paul H. Dunakin, vice president and general manager; D. F. Windsor, vice president and secretary-treasurer; William Harrison Petridge, vice president and assistant to the publisher; Clover L. Perkins, advertising manager; Alan M. Depoe, circulation manager. Single copy in the United States and Canada, 35 cents; subscription rates in United States and possessions, Canada, Philippines and countries of the Pan-American Postal Union, 1 year, \$3.50; 2 years, \$6.00; 3 years \$8.00. To all other countries add \$1.00 a year over United States prices for overseas postage. If you plan to move, notify us at least 30 days in advance so you will not miss an issue. Give both old and new addresses. Entered as Second Class Matter, September 15, 1903, at the Post Office at Chicago, Illinois, under Act of March 3, 1879. Entered as Second Class Matter at Post Office Dept., Canada. Copyright 1949 by Popular Mechanics Company. Copyright under International Copyright Union. Copyright in France. All rights reserved under Pan-American Copyright Union. Printed in the United States of America.

Volume 91

MAY 1949

Number 5

Managing Editor.....Roderick M. Grant
 Assistant Managing Editor.....Wayne Whittaker
 Shop Notes and Crafts Editor.....James R. Ward
 Radio-Television, Electronics Editor.....Frank L. Brittin
 Associate Editor, Aviation.....Aubrey O. Cookman, Jr.
 Associate Editor.....Clifford B. Hicks
 Western Editor.....Thomas E. Stimson, Jr.
 Art Director.....Frank Beatty

Assistant Editors
 Donald R. Brooks Dorothy E. Hoffmann Arthur R. Railton

Assistant Editors, Shop Notes and Crafts
 W.ClydeLammey WayneC.Leckey FrankN.Stephany A.E.Youngquist

IN THIS ISSUE

| | |
|-------------------------------|-----|
| Let the Engine Boil | 81 |
| Budget-Size Yachting | 92 |
| How to Tempt a Fish—Part II | 97 |
| Warming Up the Great Outdoors | 111 |
| Rocket Fires a Rescue Line | 118 |
| How to Build a Winning Racer | 122 |
| The Man Who Stops Bullets | 129 |
| Rough Riders of the River | 137 |
| Submarine Disaster School | 148 |
| Mural Magic | 154 |
| Do You Get What You Pay For? | 164 |
| He Lives in a House of Fun | 172 |

For the Craftsman

| | |
|--|-----|
| Coffee Table In Mahogany | 178 |
| Build this Concrete-Block House—Part I | 186 |
| Ten Laboratory Short Cuts | 194 |
| Window-Sill Gardens | 199 |
| "Torchy"—Prize-Winning Jet Speedster | 206 |
| Know Your Torch | 217 |
| Air-Condition Your Car | 221 |
| Electrochemistry of Voltaic Cells | 228 |
| Radio-Television, Electronics | 233 |
| Clinic for Homemakers | 244 |

Other items, and manufacturers of available products described, are listed on pages 10, 12 and 16



"Madame X" was the code name, during research and development, for an entirely new system of recorded music . . . perfected by RCA.

The remarkable background of "Madame X"

Now the identity of "Madame X," the *unknown* in a long search for tone perfection, has been revealed. From this quest emerges a completely integrated record-playing system—records and automatic player—the first system to be entirely free of distortion.

The research began 11 years ago at RCA Laboratories. First, basic factors were determined—minimum diameters, at different speeds, of the groove spiral in the record—beyond which distortion would occur; size of stylus to be

used; length of playing time. From these came the mathematical answer to the record's speed—45 turns a minute—and to the record's size, only $6\frac{7}{8}$ inches in diameter.

The record is of non-breakable vinyl plastic, wafer-thin. Yet it plays as long as a conventional 12-inch record. The new RCA Victor automatic record changer holds up to 10 of the new records—1 hour and 40 minutes of playing time—and can be attached to almost any radio, phono-

graph, or television combination.

Not only records are free of surface noise and distortion—the record player eliminates faulty operation, noise, and cumbersome size, common to many. Records are changed quickly, quietly . . . RCA Victor will continue to supply 78 rpm instruments and records.

This far-reaching advance is one of hundreds which have grown from RCA research. Such leadership adds value beyond price to any product or service of RCA and RCA Victor.



RADIO CORPORATION of AMERICA

World Leader in Radio—First in Television

Marlin ANNOUNCES

SENSATIONAL NEW SEMI-AUTOMATIC

\$32⁵⁰

MARLIN Model 88c
14-shot semi-automatic

New IN DESIGN

New IN PERFORMANCE

Marlin's 88C sets new standards of rapid-fire reliability in the .22 semi-automatic field!

Can you pull a trigger five times a second? This Marlin is faster! What about fouling? Marlin's new bolt and receiver design is virtually foul-proof! There is *no* opening back of ejection port to permit dirt-fouling.

Take-down is simple and fast. Action *cannot* be disassembled if rifle is cocked. Positive sear-locking Safety prevents accidental firing. Breech bolt specially designed to reduce smoke escape and blast to minimum.

Model 88C is a 14-shot tubular magazine semi-automatic rifle. Shoots .22 cal. long rifle ammunition, greased or waxed, regular and high velocity, with lightning speed and remarkable dependability.

American Black Walnut stock. Equipped with hooded ramp front sight and Rocky Mountain rear sight. Barrel length 24"; overall length 45"; weight approx. 6³/₄ lbs.

Marlin Guns and Marlin Blades
also available in Canada.

THE MARLIN FIREARMS CO.

NEW HAVEN, CONN.

Fine Guns Since 1870

Price slightly higher
west of Rockies and in
Canada



12 blades for 25¢
Single or Double Edge
Guaranteed by Marlin—
Fine Guns Since 1870

BOYS!

Be a Ranger!
Write Sportsmen's Service Bureau, 343 Lexington Ave., New York, for FREE booklet on marksmanship.



New catalog plus sample pack
4 double* or 4 single*
edge blades—yours for 10¢
to cover postage, handling.
*Check preference.

The Marlin Firearms Co., Dept. 75, New Haven, Conn.

Name

Address.....

SHIFT GEARS *on your bike*

with a
"FINGERTIP TOUCH"



This unit is all you need

It's as easy as downhill coasting—the smooth shifting you get from a New Departure "Speed Changer" on your bike. **LOW SPEED** for faster getaway, less work on hills, better control in traffic; **HIGH SPEED** for eating up the miles on level stretches—operates just like the gear shift on a car. The "Speed Changer" is simple to install, too—right in your New Departure Coaster Brake. Ask your bicycle dealer about it today!

On your new bike insist on America's favorite

New Departure COASTER BRAKES



FREE! Have fun mystifying your friends! Guess their ages, read their minds! Send a postcard for Magic Packet P2. Address:

NEW DEPARTURE • DIVISION GENERAL MOTORS • Bristol, Conn.

in this corner..... THE EDITORS

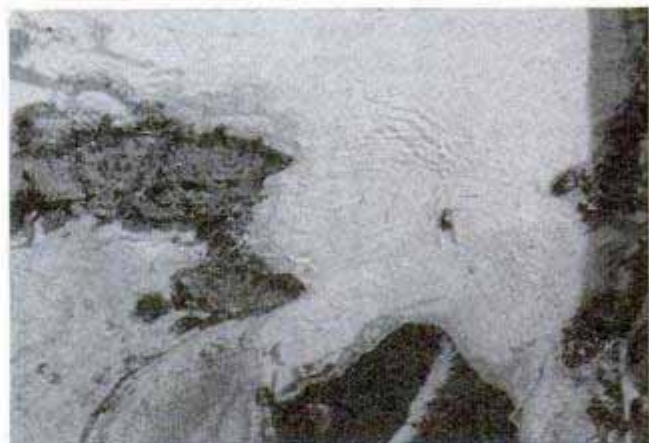

McGrady's boat locked tight in ice-clad Snake River

AS SEQUELS to our story in February of the "Hell's Canyon Mailman," come these letters from George Shreve of the KRLC radio station newsroom at Lewiston, Idaho:

"To the Editor: We read your recent item about Kyle McGrady, the Snake River mailman from Lewiston, and enjoyed it very much. Here are pictures that might make a good follow-up story. McGrady's



Zimmerly's plane drops supplies to isolated farmers

boat got stuck in Snake River ice at Buffalo Eddy, 17 miles south of Lewiston, on December 29 . . . he hopes to free it soon without trouble, now that a thaw has set in. One picture is an aerial view of McGrady's icebound boat, the Florence. The other shows the Zimmerly Air Transport plane dropping food, freight and sheep feed to residents up the Snake River normally served by McGrady. The river and air are the only transportation to people living in the wilds of north central Idaho

(Continued to page 8)

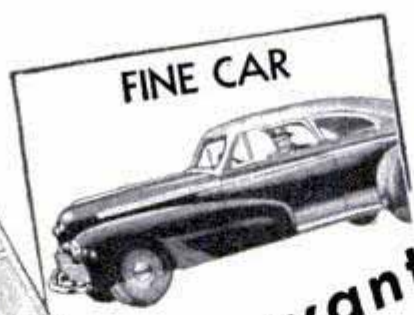

To the man who wants to enjoy
an ACCOUNTANT'S CAREER



IF you're that man, here's something that will interest you.

Not a magic formula—not a get-rich-quick scheme—but something more substantial, more practical.

Of course, you need something more than just the desire to be an accountant. You've got to pay the price—be willing to study earnestly, thoroughly.

Still, wouldn't it be worth your while to sacrifice some of your leisure in favor of interesting home study—over a comparatively brief period? Always provided that the rewards were good—a salary of \$3,000 to \$10,000?

An accountant's duties are interesting, varied and of real worth to his employers. He has *standing!*

Do you feel that such things aren't for you? Well, don't be too sure. Very possibly they *can* be!

Why not, like so many before you, investigate LaSalle's modern Problem Method of training for an accountancy position?

Just suppose you were permitted to work in a large accounting house under the personal supervision of an expert accountant. Suppose, with his aid, you studied accounting principles and solved problems day by day—easy ones at first—then more difficult ones. If you could do this—and could turn to him for advice as the problems became complex—soon you'd master them all.

That's the training you follow in principle under the LaSalle Problem Method.

You cover accountancy from the basic Principles right up through Accountancy Systems and Income Tax Procedure. Then you add C. P. A. Training and prepare for the C. P. A. examinations.

As you go along, you absorb the principles of Auditing, Cost Accounting, Business Law, Statistical Control, Organization, Management and Finance.

Your progress is as speedy as you care to make it—depending on your own eagerness to learn and the time you spend in study.

Will recognition come? The only answer, as you know, is that success *does* come to the man who is really *trained*. It's possible your employers will notice your improvement in a very few weeks or months. Indeed, many LaSalle graduates have paid for their training—with increased earnings—before they have completed it! For accountants, who are trained in organization and management, are the executives of the future.

Write For This Free Book

For your own good, don't put off investigation of *all* the facts. Write for our free 48-page book, "Accountancy, The Profession That Pays." It'll prove that accountancy offers brilliant futures to those who aren't afraid of serious home study. We'll also include "Ten Years' Promotion in One"—a book which has helped many men. Send us the coupon *now*.

Over 2800 Certified
 Public Accountants among
 LaSalle alumni

**LASALLE EXTENSION
 CHICAGO 5, ILL.**

- Other LaSalle Opportunities**
- Higher Accountancy
 - C.P.A. Coaching
 - Bookkeeping
 - Law: LL.B. Degree
 - Business Management
 - Salesmanship
 - Traffic Management
 - Foremanship
 - Industr'l Management
 - Stenotypy (Machine Shorthand)

**LASALLE EXTENSION UNIVERSITY
 A CORRESPONDENCE INSTITUTION**

417 S. Dearborn St. Dept. 564-HR Chicago 5, Ill.

I want to be an accountant. Send me without obligation, "Accountancy, the Profession that Pays" training program—also "Ten Years' Promotion in One."

Name.....Age.....
 Address.....
 City, Zone & State.....



SPRINGTIME is PYROIL TIME TOO . . .

Springtime means the open road . . . added driving, added mileage . . . and added wear and tear on your car. That's why the wise driver knows that Springtime is Pyroil time too, because Pyroil wraps a fine film of protective oil around piston and cylinder surfaces, reducing friction wear; carbon, sludge and gum formation. In the weeks ahead, to make sure those added miles of driving will be carefree and trouble-free, remember to add Pyroil . . . and add miles to your car.

PYROIL for Aircraft Engines

Use Aircraft Pyroil B for lubricating oil, Aircraft Pyroil A for gasoline.

GIVEN! An attractive Pyroil metal savings bank—takes coins up to 50c pieces—is yours for the asking—sent postage paid.



Manufactured and Guaranteed by Pyroil Company, 91 Pyroil Bldg., La Crosse, Wisconsin.

Canadian Distributors:
Central Purchasing Agencies, Ltd.
Toronto, Ontario

PYROIL COMPANY

91 Pyroil Bldg., La Crosse, Wisconsin

I want my car to last and run properly. Please tell me more about Pyroil and how it can accomplish this for me.

Name _____

Address _____

City or Town _____ State _____



and up the Snake River to Hell's Canyon."

Ten days later Shreve wrote us of the tragic sequel:

"Kyle McGrady's riverboat Florence has broken out of the ice. McGrady gave the warming weather a booster with dynamite Saturday, February 19, to break the ice fairly close to his boat. The rest of the nearby ice began sinking and the water rising until the boat was freed about midnight. McGrady brought the undamaged boat home.

"Bert Zimmerly, the mercy flyer who had carried freight to McGrady's customers during the latter's freeze-up, was flying to Lewiston from Spokane the evening of February 17. He was found dead beside his badly wrecked plane five miles south of Pullman, Wash., the next afternoon. So far the CAA hasn't reported the cause of the accident. The night was damp but visibility fair. The terrain was rolling but not rugged. The plane's motor dug four feet into the snow and dirt. This was a tragic climax for a 41-year-old enterprising aviator who had organized Zimmerly Air Transport in 1934. He had trained thousands of pilots, for the Navy during the war and under the GI Bill since. He was first to go out on a search for missing flyers, hunters or people in trouble. Bert Zimmerly had been giving free service to snow-isolated people on the open prairie and up the river valleys this past winter, when they needed medical or hospital attention . . ."

We salute a neighborly and heroic flyer.

* * *

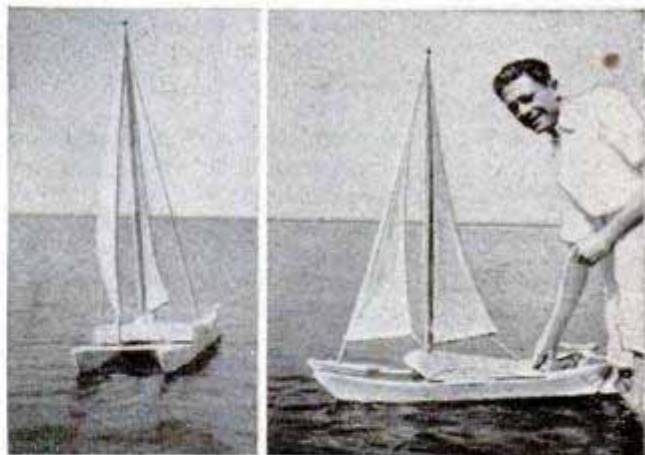

OUR JULY 1948 "cover girl," the Hawaiian catamaran, now has a miniature sister in Egypt. Flight Purser T. Patterson of TWA at Farouk Field, Cairo, built this one-inch to one-foot model from the article describing the Hawaiian Seabird, and writes: "You did not exaggerate the phenomenal performance of the Seabird, as in a light breeze I had to run to catch Marie. She was constructed and ran her trials in Bombay."

BETTERIN' the VETERAN

—a story about



had three choices back in 1946:



INTERNATIONAL CORRESPONDENCE SCHOOLS

400

He learned he had some courses to choose from. Each course sound, authoritative, easy to follow. Each course a *gold mine* of practical information.

So enrolled with I. C. S. and studied

IN HIS SPARE TIME.

Now is making good—in his studies and

ON THE JOB.

As a trained man, there will be practically no limit to how far he can go.

WITHOUT ADDITIONAL TRAINING.

was entitled to that training under the

G. I. BILL.

is like thousands of veterans who are cashing in on their opportunities through **I. C. S.**



WHAT ABOUT YOU? Do you have enough training to carry you to the top? Here's the coupon that can help open the door to a fuller, brighter, more rewarding future for you. **MAIL IT TODAY!**

SO HERE'S WHAT HE DID:

mailed a coupon. It put him in touch with the largest school in the world,

INTERNATIONAL CORRESPONDENCE SCHOOLS



BOX 5651-K, SCRANTON 9, PENNA.

Without cost or obligation, please send me full particulars about the course BEFORE which I have marked X:

- | | | | |
|--|---|---|--|
| <p>Air Conditioning and Plumbing Courses</p> <input type="checkbox"/> Air Conditioning <input type="checkbox"/> Heating <input type="checkbox"/> Refrigeration <input type="checkbox"/> Plumbing <input type="checkbox"/> Steam Fitting <p>Chemistry Courses</p> <input type="checkbox"/> Chemical Engineering <input type="checkbox"/> Chemistry, Analytical <input type="checkbox"/> Chemistry, Industrial <input type="checkbox"/> Chemistry, Mfg. Iron & Steel <input type="checkbox"/> Petroleum Refining <input type="checkbox"/> Pulp and Paper Making <input type="checkbox"/> Plastics <p>Civil Engineering, Architectural and Mining Courses</p> <input type="checkbox"/> Architecture <input type="checkbox"/> Architectural Drafting <input type="checkbox"/> Bridge and Building Foreman <input type="checkbox"/> Building Estimating <input type="checkbox"/> Civil Engineering <input type="checkbox"/> Coal Mining <input type="checkbox"/> Contracting and Building <input type="checkbox"/> Highway Engineering <input type="checkbox"/> Lumber Dealer <input type="checkbox"/> Reading Structural Blueprints <input type="checkbox"/> Sanitary Engineering <input type="checkbox"/> Structural Drafting | <p><input type="checkbox"/> Structural Engineering <input type="checkbox"/> Surveying and Mapping</p> <p>Communications Courses</p> <input type="checkbox"/> Electronics <input type="checkbox"/> Practical Telephony <input type="checkbox"/> Radio, General <input type="checkbox"/> Radio Operating <input type="checkbox"/> Radio Servicing <input type="checkbox"/> Telegraph Engineering <p>Electrical Courses</p> <input type="checkbox"/> Electrical Drafting <input type="checkbox"/> Electrical Engineering <input type="checkbox"/> Electric Light and Power <input type="checkbox"/> Lighting Technician <input type="checkbox"/> Practical Electrician <p>Internal Combustion Engines Courses</p> <input type="checkbox"/> Auto Technician <input type="checkbox"/> Diesel-Electric <input type="checkbox"/> Diesel Engines <input type="checkbox"/> Gas Engines <input type="checkbox"/> Aviation <p>Mechanical Courses</p> <input type="checkbox"/> Aeronautical Engineer's, Jr. <input type="checkbox"/> Aircraft Drafting <input type="checkbox"/> Forging <input type="checkbox"/> Heat Treatment of Metals <input type="checkbox"/> Industrial Engineering | <p><input type="checkbox"/> Industrial Metallurgy <input type="checkbox"/> Machine Shop <input type="checkbox"/> Mechanical Drafting <input type="checkbox"/> Mechanical Engineering <input type="checkbox"/> Mold-Loft Work <input type="checkbox"/> Patternmaking—Wood, Metal <input type="checkbox"/> Reading Shop Blueprints <input type="checkbox"/> Sheet-Metal Drafting <input type="checkbox"/> Sheet-Metal Worker <input type="checkbox"/> Ship Drafting <input type="checkbox"/> Tool Designing <input type="checkbox"/> Welding Engineering <input type="checkbox"/> Welding—Gas and Electric</p> <p>Railroad Courses</p> <input type="checkbox"/> Air Brake <input type="checkbox"/> Diesel Locomotive <input type="checkbox"/> Locomotive Engineer <input type="checkbox"/> Locomotive Fireman <input type="checkbox"/> Locomotive Machinist <input type="checkbox"/> Railroad Section Foreman <p>Steam Engineering Courses</p> <input type="checkbox"/> Boilermaking <input type="checkbox"/> Combustion Engineering <input type="checkbox"/> Engine Running <input type="checkbox"/> Marine Engineering <input type="checkbox"/> Steam Electric | <p>Textile Courses</p> <input type="checkbox"/> Cotton Manufacturing <input type="checkbox"/> Loom Fixing <input type="checkbox"/> Textile Designing <input type="checkbox"/> Rayon Weaving <input type="checkbox"/> Woolen Manufacturing <p>Business and Academic Courses</p> <input type="checkbox"/> Accounting <input type="checkbox"/> Bookkeeping <input type="checkbox"/> Business Administration <input type="checkbox"/> Business Correspondence <input type="checkbox"/> Certified Public Accounting <input type="checkbox"/> Commercial <input type="checkbox"/> Cost Accounting <input type="checkbox"/> Federal Tax <input type="checkbox"/> Foremanship <input type="checkbox"/> Good English <input type="checkbox"/> Higher Mathematics <input type="checkbox"/> Motor Traffic <input type="checkbox"/> Retail Store Management <input type="checkbox"/> Salesmanship <input type="checkbox"/> Sign Lettering <input type="checkbox"/> Spanish <input type="checkbox"/> Advertising <input type="checkbox"/> Commercial Art <input type="checkbox"/> First Year College <input type="checkbox"/> French <input type="checkbox"/> High School <input type="checkbox"/> Postal Civil Service <input type="checkbox"/> Secretarial <input type="checkbox"/> Stenography <input type="checkbox"/> Traffic Management |
|--|---|---|--|

Name _____ Age _____ Home Address _____

City _____ State _____ Working Hours _____ A.M. to _____ P.M.

Present Position _____ Employed by _____

Length of Service in World War II _____ Special tuition rates to members of the Armed Forces. Enrollment under G.I. Bill and P.L. 16 approved for World War II Veterans. Canadian residents send coupon to International Correspondence Schools Canadian, Ltd., Montreal, Canada.

Embry Riddle begins Your Aviation Career



Your Success in Aviation begins with thorough, practical Embry-Riddle training. Engineering and mechanic students work on live aircraft in airline size hangars... study design in spacious, well-lighted classrooms. Flight students train in the most modern aircraft... fly year-round in Miami's perfect flying weather. And at world-famous Embry-Riddle you live amidst the international hustle and bustle of the world's greatest air center.

Never has there been such opportunity for you in Aviation. The demand for trained men far exceeds the supply. Embry-Riddle prepares you in a few short months for all fundamental flight, engineering and mechanic positions, including the new, wide field for combination ability (pilot plus mechanic certification). Take advantage of the magnificent training facilities at vast Opa-locka Airport, operated entirely by Embry-Riddle. Study under the best instructors... backed by Embry-Riddle's quarter-century of aviation training experience. Live directly on the Airport. Enjoy Florida's matchless climate year-round, its wealth of sport and recreational facilities. Start your Aviation Career NOW at Embry-Riddle.



Send coupon today for new catalog and proof of career opportunities for Embry-Riddle graduates.

AUTHORIZED G. I. TRAINING

Dean of Enrollments - Dept. 99
Embry-Riddle School of Aviation
Miami 30, Florida

Please Print

NAME _____

ADDRESS _____

City _____

State _____ Age _____

I am interested in...

- A.&E. Mechanic
- Commercial Pilot
- Engineering
- A.&E. Combined with Commercial Pilot
- Flying Mechanic
- Drafting & Design

Check One Veteran Non-Veteran

TRAIN IN MIAMI -- AIR CAPITAL OF THE WORLD

WHERE-TO-BUY-IT INDEX

Source of supply appears after items commercially available

AUTOMOTIVE

| | |
|--|-----|
| "Picture" window for convertibles (The Patterson Co., 220 South 10th St., Minneapolis, Minn.)..... | 88 |
| Airplane instruments on auto dashboard..... | 90 |
| Car-washing mitt makes own suds (Pit-Bar Manufacturing Co., 3207 East 45th St., Los Angeles 11, Calif.)..... | 96 |
| Suitcases for car built into trunk..... | 115 |
| Midget British auto weighs 195 pounds..... | 115 |
| First "Aussie" car (General Motors-Holden Ltd., Fishermen's Bend, Australia)..... | 115 |
| Rear seat lifts out of "cargo" sedan (Kaiser-Frazer Corp., Willow Run, Mich.)..... | 117 |
| Car-top tent springs into place..... | 147 |
| Injection booster for automobiles (Thompson-Toledo Vitaminer Corp., 6402 Cedar Ave., Cleveland 3, Ohio)..... | 168 |

AVIATION

| | |
|---|-----|
| Jet plane photographs ducks..... | 86 |
| Timepiece opens parachute..... | 107 |
| Helicopter to be carrier "lifeguard"..... | 127 |
| Wings for jets have odd shapes..... | 128 |
| Jet transport plane..... | 143 |
| Flying-boat dry dock..... | 146 |
| Bomber has "brakes" on belly and sides..... | 160 |

FARM

| | |
|--|-----|
| Mobile tree cutter (Ottawa Manufacturing Company, Ottawa, Kans.)..... | 86 |
| Brush cutter..... | 87 |
| Fruit-picking "walks" swing into trees..... | 87 |
| Community mailbox..... | 90 |
| Gates for irrigation ditches (Page Metal Products Corp., 425 Lincoln St., Denver 9, Colo.)..... | 105 |
| Post driver from scrap parts..... | 106 |
| Skirted spray boom protects flower beds..... | 107 |
| Swamp crop..... | 134 |
| Spray discourages deer from eating vegetables in gardens (B. F. Goodrich Chemical Co., Rose Building, Cleveland 15, Ohio)..... | 163 |
| "Harvester" speeds rosebush pruning..... | 171 |

HOUSE AND HOME

| | |
|---|-----|
| Semipermanent plastic starch makes cottons wear longer.... | 107 |
| Paint-can holder (Worthington Specialty Co., 121 Chestnut St., Philadelphia 6, Pa.)..... | 110 |
| Plastic hooks slide in metal track (H. B. Dodge & Co., 332 S. Michigan Ave., Chicago 4)..... | 120 |
| Glazing stays elastic (The Armstrong Co., 4056 S. La Salle St., Chicago 9)..... | 136 |
| Adjustable height is feature of new ironing board (Yeoman Corp., 1124 Merchandise Mart, Chicago 54)..... | 144 |
| Rubber pads prevent soiling floors (Rubber Roost Co., 512 Rossmor Bldg., St. Paul 1, Minn.)..... | 144 |
| Child-level tray serves youngster at dining table (Kite and Koch Co., Box 1071, Pasadena 20, Calif.)..... | 144 |
| Plastic "paper" for walls and closets (Munising Paper Co., 135 S. La Salle St., Chicago)..... | 144 |
| Electric deodorizer (Costello-Mausure, Inc., 424 Book Bldg., Detroit 26, Mich.)..... | 145 |
| Glass fabric serves as table pad (Stanley Mfg. Co., 747 Santa Fe Drive, Denver, Colo.)..... | 145 |
| Mailbox large enough to hold unfolded magazines (Nor-Gee Corp., Jamestown, N. Y.)..... | 145 |
| House numbers on glass block are back-lighted (Burroway Industries, Phoenix, Ariz.)..... | 145 |
| Electric heater keeps piano dry (A. M. Foote, Electric & Manufacturing Co., Ft. Lauderdale, Fla.)..... | 153 |
| Junked bus body becomes a home..... | 170 |
| Injector squirts glue into rickety chair joints (Duplicon Company, Inc., Saddle Hill Road, Hopkinton, Mass.)..... | 171 |

INDUSTRY

| | |
|--|-----|
| Skating factory workers..... | 86 |
| Weight of feather twists steel shaft..... | 105 |
| Nontwist thread (Belding Corticelli Co., Putnam, Conn.)..... | 120 |
| Gasoline explosion "poses" for camera..... | 143 |
| Smoke-control system..... | 143 |
| Putting the ocean to work to help save metals..... | 152 |
| Carbon-monoxide detector (United States Safety Service Co., 1215 McGee St., Kansas City 6, Mo.)..... | 153 |
| Explosions above surface find underground oil deposits..... | 157 |
| Electrons help study metal surfaces..... | 157 |
| Trailer picks up derrick and carries it away..... | 158 |

OFFICE, SHOP AND STORE

| | |
|---|-----|
| Interoffice television verifies checks for bank..... | 110 |
| Electronic "traffic cop" for building elevators (Otis Elevator Co., Otis Building, 256 Eleventh Ave., New York City 1)..... | 117 |
| Speedy cheese cutter (Ste-Mar, Inc., 7004 15th Ave., N. W., Seattle 7, Wash.)..... | 158 |
| Hangers cling to magnetic walls (Alfred Hopkins and Associates, 415 Lexington Ave., New York City)..... | 162 |

OUTDOOR RECREATION

| | |
|---|-----|
| Tipping cradle drains rowboats..... | 87 |
| Fishhook extractor (Manske & Manske, 3157 S. 9th Place, Milwaukee 7, Wis.)..... | 117 |
| Football pump has gauge on shaft (Molex Products Company, 222 W. Adams St., Chicago 6)..... | 128 |
| Handle forms sheath for knife (Walteo Products, 2300 West 49th St., Chicago 9)..... | 133 |
| Players get practice cuts at baseball on "golf tee"..... | 136 |
| Sections of rowboat nest for storage..... | 162 |

(Continued to page 12)

AUDELS CARPENTERS & BUILDERS GUIDES—(4 Book Set).....\$6

A practical illustrated trade assistant on modern construction for carpenters, joiners, builders, mechanics and all woodworkers. 4 vols., 1800 pages, 3700 illustrations. Fully indexed, flexible covers. Each volume sold separately \$1.50 a vol.

AUDELS PLUMBERS & STEAMFITTERS GUIDES—(4 Book Set).....\$6

A Practical Trade Assistant & Ready Reference. Explains in plain language & by clear illustrations, diagrams, charts, graphs, pictures principles of modern plumbing practice including Marine Pipe Fitting and Air Conditioning. 4 Vols.—1670 Pages—3642 Diagrams & Illustrations. Each Vol. Sold Separately \$1.50 a Vol.

AUDELS OIL BURNER GUIDE.....\$1

384 Pages Covering Installation, Servicing & Repairs All Types Domestic & Industrial Burners. Illustrated. Highly Endorsed.

AUDELS HOUSE HEATING GUIDE.....\$4

1000 Pages Covering Working Principles, Installation, Service of All Modern House Heating, Ventilating & Air Conditioning Systems. Explains New Radiant Heating. Fully Illustrated & Indexed.

AUDELS REFRIGERATION & AIR CONDITIONING GUIDE.....\$4

New from Cover to Cover—1280 Pages, Fully Illus. Covering basic principles, servicing, operation & repair of household, commercial & industrial refrigeration & air conditioning. A gold mine of essential important facts for engineers, servicemen, users.

AUDELS SHEETMETAL WORKERS HANDY BOOK.....\$1

Practical inside information. Fundamentals of Sheet Metal Work. 388 pages. Illustrated. 11 sections. Clearly written. Essential & important facts, figures, pointers in everyday language. Ref. Index.

AUDELS SHEETMETAL PATTERN LAYOUTS.....\$4

Developed by Experts for Sheet Metal Workers, Layout Men & Mechanics. A Practical Encyclopedia in 10 Sections, size 7 x 10 x 2—1125 Pages—350 Layouts—1600 Illustrations, 1001 Key Facts. Fully indexed for ready reference in answering your layout problems. Covers all phases of sheet metal work including Pattern Cutting, Pattern Development & Shop Procedure.

AUDELS BLUE PRINT READING.....\$2

For Mechanics & Builders. Covers all types of blue print reading including ship & airplane. 416 pages, fully illustrated.

AUDELS MATHEMATICS & CALCULATIONS FOR MECHANICS \$2

Mathematics for home study or reference. 700 pages, 550 illus. Practical mathematics from beginning. How to figure correctly. Easy, correct methods covering complete review. Illus. & Indexed.

AUDELS AUTOMOBILE GUIDE.....\$4

A practical quick ready reference book for auto mechanics, service men, operators & owners. Explains theory, construction & servicing of modern motor cars, trucks, buses & auto type Diesel engines. 1700 pages, fully illustrated. 55 chapters. Indexed. A standard book for mechanics. New Hydraulic drive covered.

AUDELS DIESEL ENGINE MANUAL.....\$2

A practical, concise treatise with questions and answers on the theory, operation and maintenance of modern diesel engines. Over 400 pages, fully illus. All details plainly brought out, this book is of extreme value to engineers, operators & students.

AUDELS WELDERS GUIDE.....\$1

A concise, practical text on operation & maintenance of all welding machines for all mechanics. Over 400 pages, illustrated. Covers all methods of electric and acetylene welding including airplane work.

AUDELS MACHINIST & TOOLMAKERS HANDY BOOK.....\$4

Covers modern machine shop practice in all its branches. Tells how to set up & operate lathes, screw and milling machines, shapers, drill presses & all other machine & hand tools. 1600 pages, fully illustrated. Indexed. 5 sections. 1—Modern Machine Shop Practice. 2—Blue Print Reading & How to Draw. 3—Calculations & Mathematics for Machinists. 4—Shop Physics. 5—How to Use the Slide Rule. 60 chapters. Easy to read and understand. A shop companion that answers your questions.

AUDELS ELECTRIC MOTOR GUIDE \$4

Practical Information Covering Construction, Control, Maintenance & Wiring Hookups of All Types Electric Motors also Armature Winding. 1000 Pages Fully Illustrated & Indexed.

AUDELS ELEC. WIRING DIAGRAMS \$1

210 Pages. Illustrated. Gives practical facts on wiring of electrical apparatus. It shows clearly how to wire apparatus for practically all fields of electricity. Each diagram is complete & self-explanatory. Highly Endorsed Pocket Companion.

AUDELS PRACTICAL ELECTRICITY \$4

A key to a practical understanding of Electricity. For maintenance engineers, electricians & all electrical workers. 1440 Pages, 2600 illus. Covers important electrical information in handy form—including wiring for Light & Power. Indexed.

AUDELS RADIOMANS GUIDE.....\$4

A key to the practical understanding of radio including Frequency Modulation, Television, etc., Aircraft & Marine Radio. For radio engineers, servicemen, amateurs, 914 Pages, 633 Illustrations & Diagrams. Photos. Review Questions & Answers, Reference Index.

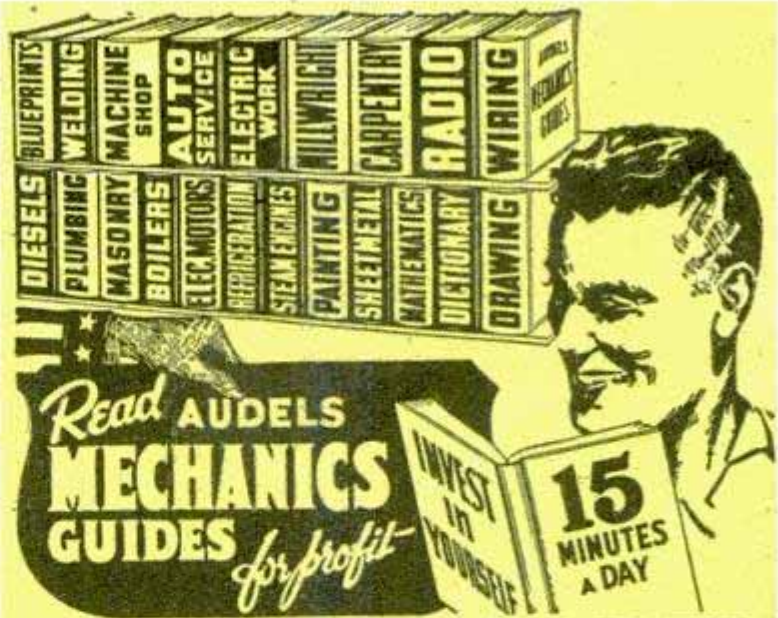

AN AUDEL GUIDE IS A GOOD FRIEND!

Step Up Your Own Skill with the Practical Facts and Figures of Your Trade. Save time and money with right methods, short cuts, labor saving ideas. CHECK NOW! You can look over any Audel Guide in your home. Start the Easy Payments if satisfied.

CUT HERE MAIL ORDER

AUDEL, Publishers, 49 W. 23 St., New York 10, N. Y.

Please mail me for 7 days' free examination the books marked (X) below. I agree to mail \$1 in 7 days on each book or set ordered, and to further mail \$1 a month on each book or set ordered until I have paid the purchase price. If I am not satisfied with Guides I will return them.

- AUTOMOBILE GUIDE, 1700 Pages \$4
- DIESEL ENGINE MANUAL, 400 Pages 2
- WELDERS GUIDE, 400 Pages 1
- CARPENTERS & Builders Guides (4 Book Set) 6
- PLUMBERS & Steamfitters Guides (4 Book Set) 6
- MASONS and Builders Guides (4 Book Set) 6
- BLUE PRINT READING, 416 Pages 2
- MASTER PAINTER & Decorator, 320 Pages 2
- GARDENERS & GROWERS GUIDES (4 Book Set) 6
- OIL BURNER GUIDE, 384 Pages 1
- HOUSE HEATING GUIDE, 1000 Pages 4
- REFRIGERATION & Air Conditioning Guide, 1280 Pages 4
- SHEET METAL WORKERS Handy Book, 388 Pages 1
- SHEET METAL PATTERN LAYOUTS, 1100 Pages 4
- AIRCRAFT WORKER, 240 Pages 1
- MECHANICAL DRAWING GUIDE, 160 Pages 1
- MECHANICAL DRAWING & DESIGN, 480 Pages 2
- MATHEMATICS and CALCULATIONS, 700 Pages 2
- MECHANICAL DICTIONARY, 968 Pages 4
- MACHINISTS & Toolmakers Handy Book, 1600 Pages 4
- MILLWRIGHTS & Mechanics Guide, 1200 Pages 4
- POWER PLANT ENGINEERS GUIDE, 1500 Pages 4
- ENGINEERS & FIREMANS EXAMINATIONS, 528 Pages 1
- PUMPS, HYDRAULICS & Air Compressors, 1658 Pages 4
- MARINE ENGINEERS Handy Book, 1280 Pages 4
- ENGINEERS and Mechanics Guides (8 Book Set) 12
- Answers on Practical ENGINEERING, 254 Pages 1
- ELECTRIC WIRING DIAGRAMS, 210 Pages 1
- ELECTRICIANS EXAMINATIONS, 250 Pages 1
- ELECTRIC DICTIONARY, 9000 Terms 2
- ELECTRIC MOTOR GUIDE, 1000 Pages 4
- PRACTICAL ELECTRICITY Handy Book, 1440 Pages 4
- ELECTRICAL POWER CALCULATIONS, 425 Pages 2
- RADIOMANS GUIDE, 914 Pages 4
- ELECTRONIC DEVICES, 216 Pages 2
- NEW ELECTRIC LIBRARY, 7000 Pages (12 Book Set) 18

Vols. I, II, III, IV, V, VI, VII, VIII, IX, X, XI, XII—\$1.50 Each

Name _____

Address _____

Occupation _____

Employed by _____

AUDEL, Publishers, 49 W. 23 St., N. Y. 10

SECRETS ENTRUSTED TO A FEW



The Unpublished Facts of Life

THERE are some things that can not be generally told—*things you ought to know*. Great truths are dangerous to some—but factors for *personal power and accomplishment* in the hands of those who understand them. Behind the tales of the miracles and mysteries of the ancients, lie centuries of their secret probing into nature's laws—their amazing discoveries of *the hidden processes of man's mind, and the mastery of life's problems*. Once shrouded in mystery to avoid their destruction by mass fear and ignorance, these facts remain a useful heritage for the thousands of men and women who privately use them in their homes today.

THIS FREE BOOK

The Rosicrucians (not a religious organization), an age-old brotherhood of learning, have preserved this secret wisdom in their archives for centuries. *They now invite you to share the practical helpfulness of their teachings*. Write today for a free copy of the book, "The Mastery of Life." Within its pages may lie a new life of opportunity for you. Address Scribe H. W. V.

The ROSICRUCIANS

(AMORC)

San Jose

California, U.S.A.

(Continued from page 10)

Golf kit (A. E. Burgess Leather Company, Grafton, Mass.)...171
Reel stores fishing leaders (Poulsen Brothers, 1222 N.E. Alberta, Portland 11, Ore.).....175

PHOTOGRAPHY

"Jet" print washer (Hydrojet Corporation, Trenton, Mich.)...133
Aerial camera with an owl's eye.....159
Microfilmer for long maps (Diebold, Inc., 2 West 45th St., New York City 19).....170
Miniature camera can be worn on key chain (Mycro Camera Co. Inc., 527 Fifth Ave., New York City).....175
Tester for photo flash bulbs clips in pocket (The Kriser Corp., 30 East 10th St., New York City 3).....175

TOOLS

Saw attachment for electric drill (Future Products Co., 3625 N. Mississippi Ave., Portland 12, Ore.).....105
Tubular frame on hacksaw ends blade twisting (Machine Rebuilding Co., 2738-42 Chene St., Detroit 7, Mich.).....106
Log loader.....116
Combination hoist and tank speeds radiator repairs (Kennedy Machine Co., Platteville, Wis.).....120
Hammer has magnifier built into head (L. S. Starrett Co., Dept. 29, Athol, Mass.).....121
Finishing tool holds strip abrasive (Master Specialty Co. Inc., 3016 E. Lake St. Minneapolis 6, Minn.).....153
Bone saw won't cut flesh (Zimmer Manufacturing Co., Warsaw, Ind.).....162
Power grinder cools by spray (The DoAll Company, 254 North Laurel Ave., Des Plaines, Ill.).....169
Vise has four uses (Charles Clamp Co., 756 Fourth Ave., Aurora, Ill.).....175

TOYS AND NOVELTIES

Heirlooms in miniature.....88
Willie the robot.....91
Toy motor is battery-operated (Technical Toy Co., 403 S. Raymond, Pasadena, Calif.).....96
Rare watches.....116
Tire playpen.....127

MISCELLANEOUS

Music lessons are fun now.....90
Pedal violinist.....96
Jungle voices on wire.....96
Paint has baked-enamel luster (Sherwin-Williams Co., 101 Prospect Ave., N.W., Cleveland, Ohio).....106
Electric lunch box heats food (Electro Lunch Co., Algonac, Mich.).....106
"Apple pie" sound movies.....108
Tokyo police bus acts as mobile lab.....110
"Stone" blocks of concrete (Art Craft Blocks, 1821 Brownlee N.E., Station A, Box 176, Canton, Ohio).....121
Baby buggy "walks" upstairs.....133
Parachutist-size teletypewriter for the Army.....136
Snap-on holster (John Chatham and Roy J. Nelson, 117 East Spruce St., Compton, Calif.).....147
Plastic sleeves in incubator allow nurse to reach baby.....160
Homemade loader has engine in rear.....160
Bee-sting harvest.....161
Refreshment trailer has hydraulic top (Kolstad Co., 700 Plymouth Ave. N., Minneapolis 11, Minn.).....163
Jeep lays its own road.....168
Lifeguard's vest inflates to form raft.....169
Rancher uses jeep to get cattle to market.....176
Pocket pillow (Belthor Trading Co., 96 Warren St., New York City 7).....176

Craftsman and Shop Notes Index

AUTOMOTIVE

Emergency headlight fuse.....192
Tire gauge clipped to seat back.....202
Wire soldered to valve keys allows safe installation.....224
Sealed-beam headlamp provides trouble light.....225
Grille guard from cultivator wheel is attached to bumper.....225
Hoisting ring for V-type motors permits easy handling.....232

BOATING AND CAMPING

Stovepipe over camp-table legs protects duffel from rodents.....180
Starting flooded outboard motor.....180
Emergency camp constructed entirely with ax.....181
Cork float for starter rope.....184
Ridding cabin of insects.....196

FARM AND GARDEN

Worm-free radishes grown with aid of screen-covered frames 193
Pipe braces set in corner post provide sturdy fence support...197
Hose bumper fastened to handle improves posthole digger...198
Tar paper wrapped around graft prevents rerooting of tree...198
Weighted tin cans support line when marking garden rows...204
Attaching sacks to hoist rope.....226
Homemade rock or gravel washer provides clean aggregate...226
Plank in stock tank prevents chickens from drowning.....227

FISHING

Suction cups hold fishline drier on rear window of car.....184
Escapeproof bait jar.....202
Spinner attached to streamer fly provides effective lure.....212

HOUSE AND HOME

Storm-sash rack is built under basement stair.....182
Novel design for cookies made with potato masher.....182
Yarn kept from tangling while knitting.....182

(Continued to page 16)

LEARN RADIO

BY PRACTICING IN SPARE TIME

As part of my Course, I send you the speaker, tubes, chassis, transformer, loop antenna, EVERYTHING you need to build this modern, powerful Radio Receiver! In addition I send you parts to build other real Radio circuits, some of which are pictured below. You use material to get practical Radio experience and make EXTRA money fixing neighbors' Radios in spare time.

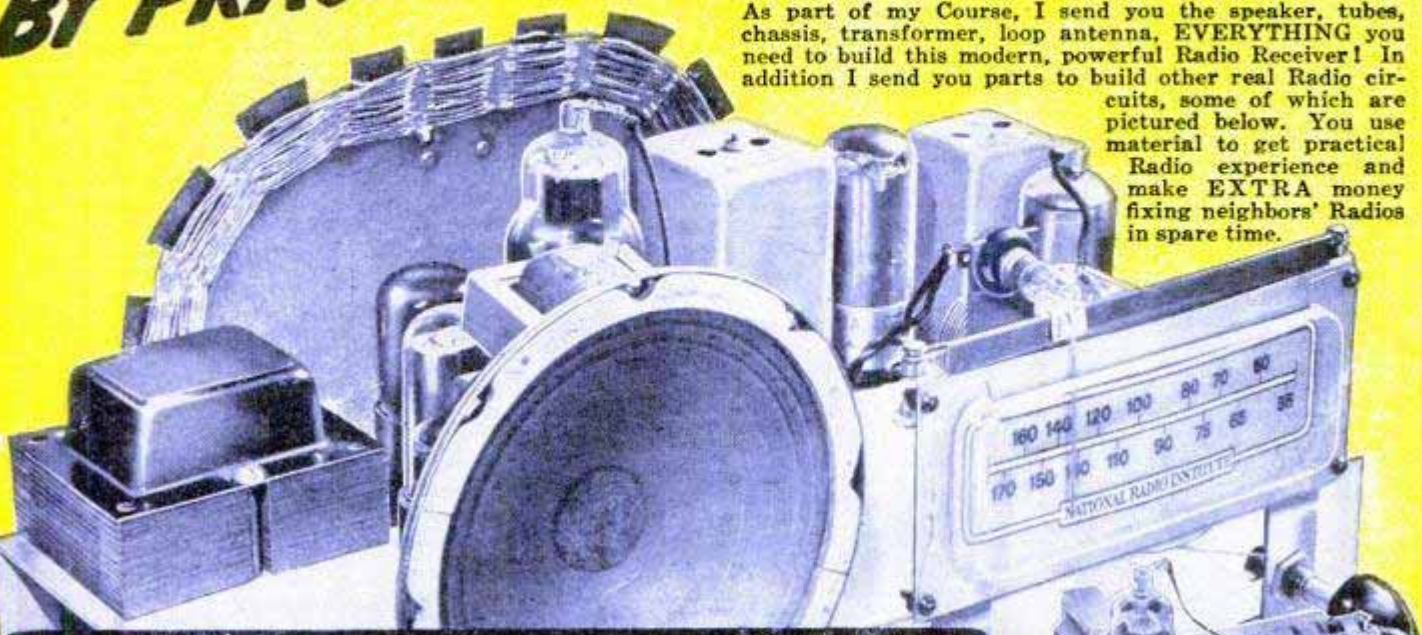

I SEND YOU BIG KITS OF PARTS

**You Build and Experiment
With this MODERN RADIO
AND MANY OTHER CIRCUITS**



**J. E. SMITH, President
National Radio Institute**

TRAINED THESE MEN



"AM NOW GETTING \$69 a week and over-time as Radio Serviceman for The Adams Appliance Co."—W. A. ANGEL, Blythesville, Arkansas.



"KNEW NOTHING ABOUT RADIO when I enrolled. Now am doing spare time work. I have more than paid for my Course and about \$200 worth of equipment."—RAYMOND HOLT-CAMP, Vandalia, Ill.

Want a good-pay job in the fast-growing RADIO-TELEVISION Industry? Want a money-making Radio-Television shop of your own? I've trained hundreds of men to be Radio Technicians . . . men with no previous experience. My tested and proved train-at-home method makes learning easy. Learn Radio-Television principles from illustrated lessons. Get practical experience with MANY KITS OF PARTS I send. All equipment yours to keep.

Make EXTRA MONEY in Spare Time

The day you enroll, I start sending SPECIAL BOOK-LETS that show you how to make EXTRA MONEY fixing neighbors' Radios in spare time. From here it's a short step to your own

shop, or a good-pay Radio-Television servicing job. Or get into Police, Aviation, Marine Radio, Broadcasting, etc. Think of opportunities in the booming Television Industry.

See What N. R. I. Can Do For You

Act now! Mail coupon for lesson and 64-page book, "HOW TO BE A SUCCESS IN RADIO AND TELEVISION—ELECTRONICS." Tells how quickly, easily you can get started. Send coupon in envelope or paste on penny postal. **J. E. SMITH, President, Dept. 9EP, National Radio Institute, Pioneer Home Study Radio School, Washington 9, D. C.**

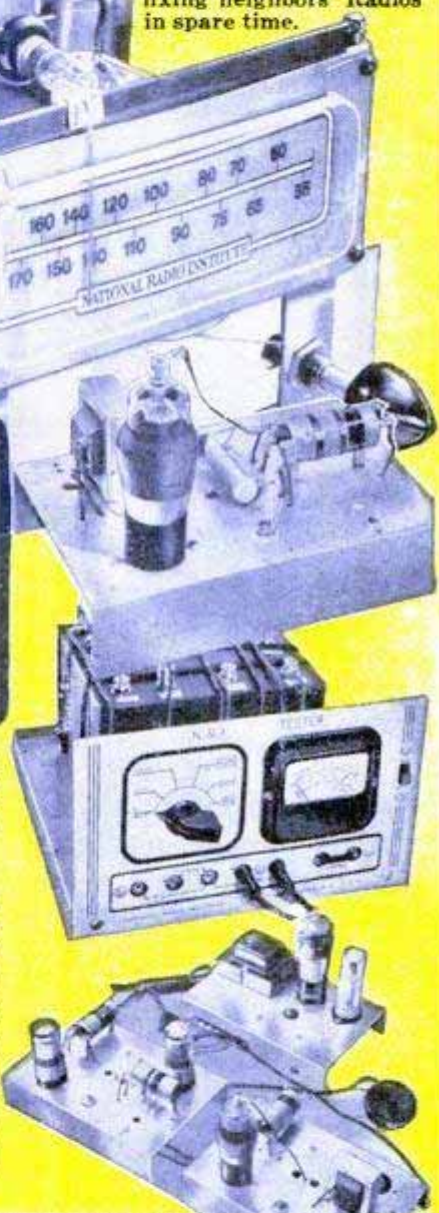

VETERANS

You can get this training without cost under G. I. Bill

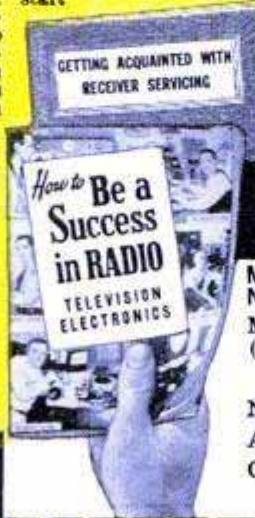

Good for Both—FREE

MR. J. E. SMITH, President, Dept. 9EP, NATIONAL RADIO INSTITUTE, Washington 9, D. C.
Mail me FREE, Sample Lesson and 64-page book. (No salesman will call. Please write plainly.)

Name _____
Address _____
City _____ Zone _____ State _____
 Check if Veteran

MY COURSE INCLUDES TELEVISION

Funny How You Happened To Stop Here!

CALL IT A "BREAK" . . . twist of fate . . . destiny . . . coincidence . . . or "just one of those things." The fact remains that at this *ONE moment in your life*, you are facing the *ONE advertisement in your lifetime* that can quickly lead to **BIG THINGS**. For example, have you ever thought of building your own home? A lot of fellows built for themselves soon after meeting us on a page like this. And how about going into the building business? Fortunes have been made that way. Or maybe you'd like a steady, respectable-paying job with a big building firm. Well, plenty of our men have gotten such jobs.

Success is Our Business

That's right! That's our business. Showing men like you how to succeed in building; how to build for yourself at a big savings, how to qualify for a good job in the booming building industry. We'll even show you how to do remodeling, like putting on a wing or converting the basement into a game room. Yes, if you want *one* or **ALL THREE** of these things, you can make your start right **HERE** and **NOW**.



You Get Complete Plans For This House

Each man receives complete professional **PLANS** and **SPECIFICATIONS** for this modern Early American Style six room House. The famous **C. T. I. Course** shows how to build this house or any other house, and **SAVE** Hundreds or Thousands of dollars. Course covers every part of home-building construction from basement to roof. Shows you **HOW** to read **Blue Prints**, **Estimate Costs**, let **Contracts** and **Sub-Contracts**, understand and supervise all parts of construction. Vets obtain this training under the **G.I. Bill**. Others secure at small cost on easy payment plan. The **Big FREE Book** explains. Use coupon below.

Get the Book that Has Helped Hundreds

There is more to the story, but you can read all about it in the big book shown right here at the bottom of the page. This is the book that has helped hundreds make hopes and dreams come true. It will tell you about great opportunities within easy reach. It will show how you can learn all about modern Home-Building methods in spare time and then how you can use those methods to get into building yourself.

John Samos down at Newport News, Va., read a book like this and soon he built himself the house he had always wanted. Stanley Radwanski over at Vincennes, Ind., read this book and he used our methods to remodel his home and then make extra money doing remodeling for other people. And there was Joe Clavet in Wilmington, Del. He read the book and got a good job with a big firm which values his knowledge of construction methods.

Now It's Your Turn

There are many others we could mention. But none of them had a thing on you. It was just that when they came to such a page, they said "THIS is for me." But it's your turn now. The book that started Samos and Radwanski and Clavet is ready for you. No, we **DON'T KNOW** how you happened to stop here. But we **DO KNOW** what can happen from this time on. The book has the answers. Use the "Opportunity Coupon" **TODAY**.



OPPORTUNITY COUPON

COMMERCIAL TRADES INSTITUTE

Dept. D2-5, 1400 Greenleaf Ave.
Chicago 26, Ill.

Approved under
G. I. Bill

Send me complete information on the course I have checked below:

- | | |
|---|--|
| <input type="checkbox"/> Home Building | <input type="checkbox"/> Electricity |
| <input type="checkbox"/> Diesel Mechanics | <input type="checkbox"/> Radio and Television |
| <input type="checkbox"/> Auto Mechanics | <input type="checkbox"/> Refrigeration and Air Cond. |
| <input type="checkbox"/> Body and Fender Rebuilding | <input type="checkbox"/> Drafting |

Name _____

Address _____ Zone _____

City _____ State _____

Vet

Non-Vet



INVENTORS



Learn how to protect your invention. The U. S. Patent Laws provide that any new and useful art, machine, article of manufacture, or composition of matter, or any new and useful improvement thereof, may be patented if the act of invention is involved. Therefore, every inventor with a valuable invention should take advantage of the Patent Laws and proceed for patent protection in order to safeguard his rights.

A patent gives the inventor the exclusive right to prevent others from making, using, or selling the invention claimed in the patent for a period of seventeen years.

The Patent Laws were enacted for the benefit of the inventor to give him protection for the features of his invention which are patentable. These features must be properly and concisely set forth and claimed in a formal application for patent, in order to comply with the requirements of the Patent Laws. For that reason, unless the inventor is familiar with patent matters, he should engage a competent registered patent attorney or agent to represent him. We are registered to practice before the U. S. Patent Office and are prepared to serve you in the handling of your patent matters.

A specially prepared booklet entitled "Patent Guide for the Inventor", containing detailed information with respect to patent protection and procedure, together with a "Record of Invention" form will be promptly forwarded to you without obligation upon request.

CLARENCE A. O'BRIEN & HARVEY JACOBSON

Registered Patent Attorneys

91-E DISTRICT NATIONAL BUILDING • WASHINGTON 5, D. C.

Patents
Trademarks
Copyrights

CLARENCE A. O'BRIEN & HARVEY JACOBSON

Registered Patent Attorneys

91-E District National Bldg., Washington 5, D. C.

Please send me copy of "Patent Guide for the Inventor" and also "Record of Invention" form. This request does not obligate me.

Name _____

Address _____

City _____ State _____

(Please write or print plainly.)



Satisfied with my JOB and PAY? NOT ME!!

"Some day I'll really get a break and go right on to the top." That's wishful thinking.

You know that the "breaks" go to the man or woman who is prepared to take advantage of them—to the person who can fill the better job and is worth more money. He makes the "breaks" instead of waiting for them.

You can influence your own future by preparing now for the step forward—so that openings come because you are equipped for them—not as the result of luck.

Why not take the road that thousands of ambitious men and women have taken to help them to better jobs and more money.

Prepare now. Send the coupon below—check the business field of your choice and we'll send you without obligation our FREE 48-page book describing the opportunities and complete information on that field—plus "Ten Years' Promotion in One"—a book which has helped many men.

Send the coupon Now. It may be the turning point in your life to that better job and more money.

LASALLE Extension University
A Correspondence Institution
Dept. 564-R Chicago 5, Ill.

LASALLE Extension University
A Correspondence Institution

417 S. Dearborn St., Dept. 564-R, Chicago 5, Ill.

I want to make my own "breaks" by preparing for a better job. Send free 48-page book on the subject I have checked.

- | | |
|--|--|
| <input type="checkbox"/> Higher Accountancy | <input type="checkbox"/> Salesmanship |
| <input type="checkbox"/> C.P.A. Coaching | <input type="checkbox"/> Traffic Management |
| <input type="checkbox"/> Bookkeeping | <input type="checkbox"/> Foremanship |
| <input type="checkbox"/> Law: LL.B. Degree | <input type="checkbox"/> Industrial Management |
| <input type="checkbox"/> Business Management | <input type="checkbox"/> Stenotypy (Machine Shorthand) |

Name Age

Address

City Zone State

(Continued from page 12)

| | |
|--|-----|
| Efficient utensil for removing tightly packed canned goods from container..... | 183 |
| Clothespin holds spool of thread on spindle..... | 183 |
| Making razor blade easy to hold..... | 183 |
| Jar rubbers used for paraffined jars of jam..... | 183 |
| Matted fringe straightened with ordinary comb..... | 183 |
| Funnel aids in applying liquid plant food..... | 183 |
| Sewing box..... | 185 |
| Repairing broken tenon in rung without dismantling chair..... | 192 |
| Pipe flange on wooden block provides flagpole bracket..... | 196 |
| Hideaway breakfast table for small kitchen..... | 197 |
| Adjustable pointer on kitchen scale subtracts container weight..... | 198 |
| Nonslip clothesline props..... | 202 |
| Homemade rattrap..... | 203 |
| Keeping hypodermic sterile..... | 204 |

OFFICE, SHOP AND STORE

| | |
|---|-----|
| Tape strips placed on glass are kept ready to use..... | 180 |
| Lead shot balances container to permit easy weighing..... | 184 |
| Bottles of carbon tetrachloride provide fire extinguishers..... | 202 |
| Novel signwriting method..... | 220 |
| Weighted advertising pennants are not whipped by wind..... | 232 |

PAINT AND PAINTING

| | |
|--|-----|
| Staples clean paint from scraper..... | 184 |
| Hoe blade on bottom of ladder provides handy foot scraper..... | 192 |
| Cold-water paint rolled on board assures even application..... | 202 |
| Cardboard brush keeper protects bristles..... | 212 |

PHOTOGRAPHY

| | |
|---|-----|
| Reflector wings control photo lighting..... | 213 |
| Discolored lenses can be salvaged by recementing them yourself..... | 214 |
| Photo frames from bits of plastic..... | 215 |
| Inexpensive easel for enlarger automatically centers paper..... | 216 |
| Switch fitted to darkroom timer turns off enlarger or drier..... | 216 |
| Pen provides etching knife..... | 216 |
| Rubber band marks beaker..... | 216 |
| Finger grip on cable release..... | 216 |

TOOLS

| | |
|--|-----|
| Case for jigsaw blades made from garden-hose section..... | 196 |
| Adapting auger bit for drill press by reshaping spur center..... | 198 |
| Metal tap replaces jigsaw file..... | 204 |
| Pin vise holds phonograph needle to provide inexpensive scriber..... | 204 |
| Snub nose on spring clothespin improves it for clamping..... | 204 |
| Stump serves as vise when sharpening cordwood saw..... | 212 |
| Sawhorse saddles hold pipe for cutting on job..... | 212 |
| Sliding armrest aids lettering at bottom of drawing board..... | 220 |
| Pencil mark guides wheel dressing..... | 220 |
| Oiling high-temperature bearings..... | 224 |
| Vise holds screw for cutting..... | 224 |
| Positive-locking scriber clamp..... | 224 |
| Spots of color identify files..... | 225 |
| Hose clamp on welder lead secures rubber insulation..... | 226 |
| Protective sheath for triangle..... | 226 |
| Improvised foot feed for drill-press routing..... | 227 |
| Pipe hangers of scrap material improvised on job..... | 232 |

TOYS AND NOVELTIES

| | |
|---|-----|
| Wooden wheels secured to dowel with corrugated fasteners..... | 192 |
| Modern plant holder in hammered aluminum..... | 193 |
| Balloon forms swimming-pool toy..... | 196 |
| Sambo, novel lawn sprinkler..... | 205 |

MISCELLANEOUS

| | |
|---|-----|
| Identification for your binocular..... | 180 |
| Installing wallboard around pipe..... | 180 |
| Dimension table for standard pipe minimizes measuring errors..... | 181 |
| Tie secures collar stay..... | 184 |
| Tape protects rimless spectacles..... | 192 |
| Talcum powder keeps stamps dry..... | 196 |
| Stainless-steel knife cuts and loosens orange peel..... | 211 |
| Dents in solder dissipate heat..... | 211 |
| Dispenser made from tape spool stores odd lengths of wire..... | 212 |
| Locating leaks in vertical pipe by measuring water volume..... | 220 |
| Removing rusted caster sleeves..... | 220 |
| Floating test tube in water bath..... | 226 |
| Nailing corrugated roofing to prevent leaks..... | 232 |

Radio-Television, Electronics

| | |
|--|-----|
| Tape recorder and player for the home (Home tape recorder and player, Elcor, Inc., 1501 W. Congress St., Chicago 7; recording music on tape in mass production, Minnesota Mining and Mfg. Co., St. Paul, Minn.)..... | 233 |
| Record player for small children..... | 234 |
| Television and electronics today (Low-cost metal-type TV tube, General Electric Co., Electronics Park, Syracuse, N. Y.; three-speed record player, Scott Radio Laboratories, Chicago; shielded 300-ohm lead-in for TV antennas, Federal Telephone and Radio Corp., 100 Kingsland Road, Clifton, N. J.; antenna matching device, Standard Transformer Corp., 3580 N. Elston Ave., Chicago; drill-hammer adapter for electric drill, Drill-Hammer Company, Box 158 Planetarium Station, New York City 24; Pindex Tube-Base Diagram booklet, RCA Manufacturing Co., Camden, N. J.)..... | 236 |

IMPORTANT NOTICE—It is the intention of this magazine to provide its readers with information regarding the latest developments in the mechanical arts. We take no responsibility as to whether the disclosures contained in our articles are covered by patents and advise readers to investigate this subject before making, using, or selling any of the products, machines, or processes described in order to avoid possible liability for patent infringements.

INVENTORS

Patent laws encourage the development of inventions.

We recommend that an inventor employ a registered Patent Attorney or agent, if the inventor is not familiar with patent matters. This is because the value of a patent depends largely upon the skillful preparation of the specification and claims in the patent application.

The firm of McMorrow, Berman and Davidson is registered to practice before the United States Patent Office. Additionally it engages patent attorneys able to readily understand inventors' disclosures, to advise concerning patentability, and to prepare appropriate specifications and claims.

If an inventor believes he has an invention, a search of the most pertinent prior U. S. patents should be made and a report obtained relative to its patentability. Where such report indicates that the invention appears patentable, in order to secure protection, diligence should be exercised in making application for a patent.

Send for a copy of Patent Booklet entitled "How To Protect Your Invention." This booklet contains information on patent protection and procedure. You will also receive an "Invention Record" blank. This will be promptly forwarded to you upon request—no obligation.

McMORROW, BERMAN & DAVIDSON

Registered Patent Attorneys

PATENTS • TRADE MARKS • COPYRIGHTS

135-Z VICTOR BUILDING, WASHINGTON 1, D. C.

McMORROW, BERMAN & DAVIDSON

Registered Patent Attorneys

135-Z Victor Building, Washington 1, D. C.

Send me your Patent Booklet, "How To Protect Your Invention", and also "Invention Record" form at once. I understand this request does not obligate me.

Name.....

Address.....

City.....

(WRITE OR PRINT NAME CLEARLY)

**"GIVE ME
YOUR MEASURE AND
LET ME PROVE
I Can Make
You
A NEW MAN!"**

**Here's What Only
15 Minutes a Day
Can Do For You**

I DON'T care how old or young you are, or how ashamed of your present physical condition you may be. If you can simply raise your arm and flex it I can add **SOLID MUSCLE** to your biceps—yes, on each arm—in double-quick time! Only 15 minutes a day—right in your own home—is all the time I ask of you! And there's no cost if I fail.

I can broaden your shoulders, strengthen your back, develop your whole muscular system **INSIDE** and **OUTSIDE**! I can add inches to your chest, give you a vise-like grip, make those legs of yours lithe and powerful. I can shoot new strength into your old backbone, exercise those inner organs, help you cram your body so full of pep, vigor and red-blooded vitality that you won't feel there's even "standing room" left for weakness and that lazy feeling! Before I get through with you I'll have your whole frame "measured" to a nice, new, beautiful suit of muscle!

What's My Secret?

"Dynamic Tension!" That's the ticket! The identical natural method that I myself developed to change my body from the scrawny, skinny-chested weakling I was at 17 to my present super-man physique! Thousands of other fellows are becoming marvelous physical specimens—my way. I give you **no gadgets or contraptions** to fool with. When you have learned to develop your Strength through "Dynamic Tension" you can laugh at artificial muscle-makers. You simply utilize the **DORMANT** muscle-power in your own God-given body—watch it increase and multiply double-quick into real, solid **LIVE MUSCLE**. My method—"Dynamic Tension"—will turn the trick for you. No theory—every exercise is practical. And, man, so easy! Spend only 15 minutes a day in your own home. From the very start you'll be using my method of "Dynamic Tension" unconsciously every minute of the day—walking, bending over, etc.—to **BUILD MUSCLE** and **VITALITY**.

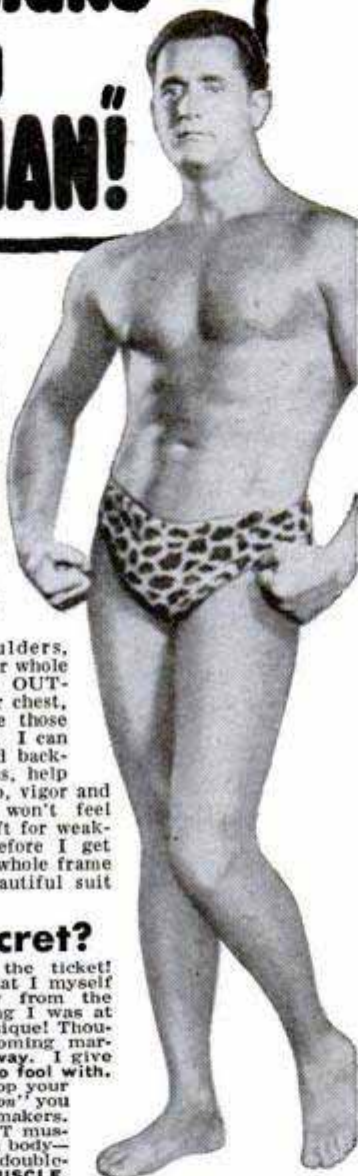

Actual photo showing how CHARLES ATLAS looks TODAY

FREE BOOK "Everlasting Health and Strength"

In it I talk to you in straight-from-the-shoulder language. Packed with inspirational pictures of myself and pupils—fellows who became **NEW MEN** in strength, my way. Let me show you what I helped THEM do. See what I can do for YOU! For a real thrill send for this book today. **AT ONCE, CHARLES ATLAS, Dept. 88, 115 East 23rd St., New York 10, N. Y.**



**CHARLES ATLAS, Dept. 88,
115 East 23rd St., New York 10, N. Y.**

I want the proof that your system of "Dynamic Tension" will help make a New Man of me—give me a healthy, husky body and big muscular development. Send me your free book, "Everlasting Health and Strength"—and full details of your **TRIAL OFFER**.

Name _____ Age _____
(Please print or write plainly)
Address _____
City _____ State _____

SAY YOU SAW IT IN POPULAR MECHANICS

FIND OUT FREE—HAVE YOU GOT WHAT IT TAKES...

to be a FINGER PRINT EXPERT or TRAINED INVESTIGATOR?

Send for free IAS Qualification Questionnaire. If in our opinion your answers indicate that you "have what it takes," then you will receive absolutely free the famous "Blue Book of Crime" . . . plus full details on how to train at home in Crime Detection and Finger Printing! IAS graduates are key men in over 800 Police Bureaus. See if YOU can train for this exciting, steady, "good pay" work! No obligation. No salesman will call. Write today, stating age.

WRITE TODAY

INSTITUTE OF APPLIED SCIENCE
1920 Sunnyside Ave., Dept. X-1355, Chicago 40, Ill.

WATCHMAKING

JEWELRY ENGRAVING AND REPAIR

Enter this high-paying, time-honored profession, or prepare for a business of your own. Watchmakers in great demand. More jobs than qualified workers. Study under expert instructors in a long-established, nationally recognized school. Receive recognized diploma and certificate. Placement service. Approved under G. I. Bill. Write for **FREE** booklet.



The Baronian School, Inc.

2116 WALNUT ST. (DEPT. C) PHILA. 3, PA.

NEW! LOW COST! RESPIRATOR

Wear when sanding, grinding, paint spraying, sweeping, dusting, furnace cleaning, etc. Handy as a pair of glasses. Just keep mouth closed and breathe through nose is all you do to operate. Protects against nuisance dusts, lint, coal, cement, grain dust, hay fever pollen. Has 9 sq. in. filter. For **EYE** protection against paint spray, dusts, gases, fumes, smoke, order our **Fog-Proof Rubber GOGGLES** \$2.00 p.p.



Order Today \$1.00 POST PAID

**JERRY BRYANT, Dept. PM
919 N. Michigan Ave. Chicago 11, Ill.**

REAL ESTATE BE A BROKER

PAYS BIG! SEND FOR FREE, BIG, ILLUSTRATED CATALOG NOW! No obligation. Graduates report making substantial incomes. Start and run your own business quickly. Men, women of all ages, learn easily. Course covers Sales, Property Management, Appraising, Loans, Mortgages, and related subjects. **STUDY AT HOME** or in our classrooms in big cities. Diploma awarded. G.I. approved. Nationally known.

FREE BOOK TELLS HOW

**WEAVER SCHOOL OF REAL ESTATE (Est. 1936)
15 E. Pershing Road Dept. PM-5, Kansas City, Mo.**

STRENGTHEN Your VOICE!

YES—you can now build yourself a powerful speaking and singing voice with this amazing new scientifically sound tested method. Self-training . . . no music or piano required. Results **GUARANTEED**. Just send your name for the sensational details. **FREE** chart of your vocal mechanism included!

PERFECT VOICE STUDIOS, Studio E-10, Kimball Hall Building, Chicago 4, Ill.

"LEARN-BY-DOING"

NATION'S LARGEST EXCLUSIVE ELECTRICAL SCHOOL

ELECTRICITY

PRACTICAL TRAINING NOT "HOME STUDY"

G.I. APPROVED Get actual experience in great shops of M.T.I. Learn all phases Practical Electricity; Housewiring, Motors, Const., Maintenance, etc. Living arrangements, Part-time jobs, etc.

Send coupon TODAY.

MICHIGAN TECHNICAL INSTITUTE Veteran
2281 W. Fort St., Detroit, Mich., Dept. PM-5

Name _____
Street _____
City _____ State _____

POPULAR MECHANICS

YOU'LL HAVE TO GO FASTER TO

KEEP UP!

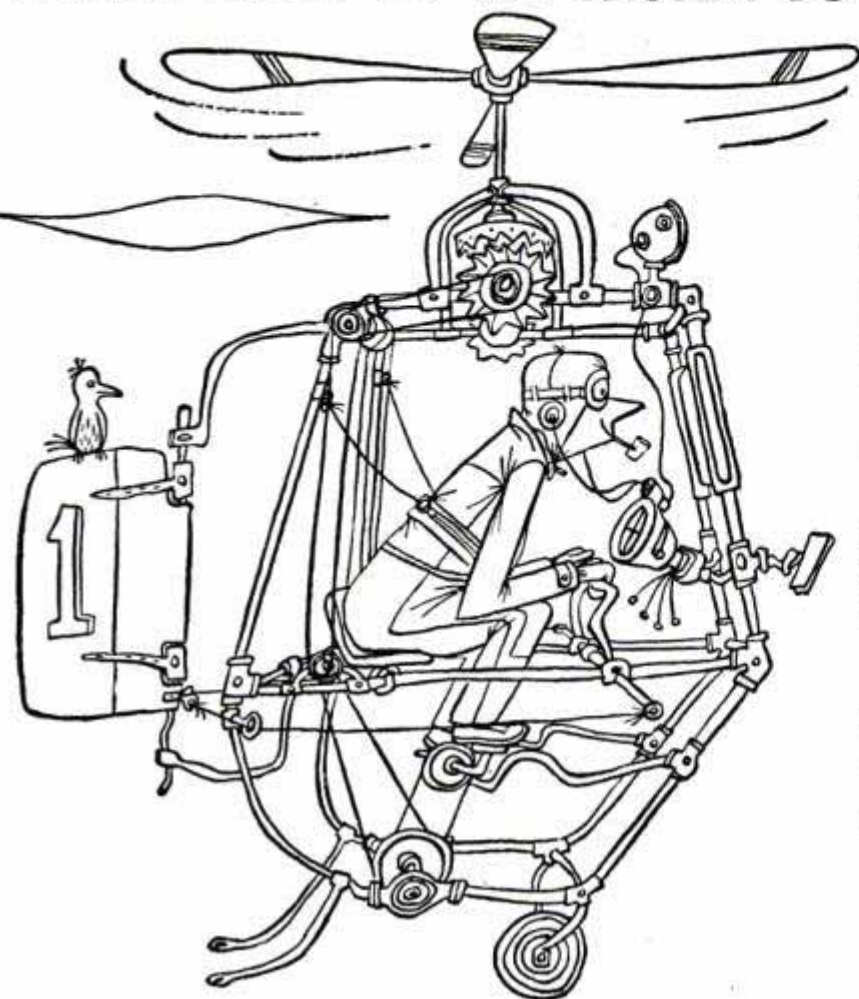

Schools and colleges are graduating record classes. Those *trained* young men and women are going to be *your* competition. Don't let the lack of *proper training* handicap you.

When you study with International Correspondence Schools, you pick from 400 courses . . . study in your spare time . . . advance as rapidly as your ability and ambition demand.

In a single four-month period—as many as 1920 student letters reported advancement in salary and position!—There's proof that I.C.S. helps you *keep up* and *get ahead!* Your name and address on this coupon start you on your way!

INTERNATIONAL CORRESPONDENCE SCHOOLS



BOX 5652-K, SCRANTON 9, PENNA.

Without cost or obligation, please send me full particulars about the course BEFORE which I have marked X:

- | | | | |
|--|--|--|---|
| <p>Business and Academic Courses</p> <ul style="list-style-type: none"> <input type="checkbox"/> Accounting <input type="checkbox"/> Bookkeeping <input type="checkbox"/> Business Administration <input type="checkbox"/> Business Correspondence <input type="checkbox"/> Certified Public Accounting <input type="checkbox"/> Commercial <input type="checkbox"/> Commercial Art <input type="checkbox"/> Cost Accounting <input type="checkbox"/> Federal Tax <input type="checkbox"/> First Year College <input type="checkbox"/> Foremanship <input type="checkbox"/> Good English <input type="checkbox"/> Higher Mathematics <input type="checkbox"/> Motor Traffic <input type="checkbox"/> Retailing <input type="checkbox"/> Salesmanship <input type="checkbox"/> Sign Lettering <input type="checkbox"/> Spanish <input type="checkbox"/> Traffic Management <input type="checkbox"/> Air Conditioning and Plumbing Courses <input type="checkbox"/> Air Conditioning <input type="checkbox"/> Heating <input type="checkbox"/> Refrigeration | <p>Chemistry Courses</p> <ul style="list-style-type: none"> <input type="checkbox"/> Chemical Engineering <input type="checkbox"/> Chemistry, Analytical <input type="checkbox"/> Chemistry, Industrial <input type="checkbox"/> Chemistry, Mfg. Iron & Steel <input type="checkbox"/> Petroleum Refining <input type="checkbox"/> Pulp and Paper Making <input type="checkbox"/> Civil Engineering, Architectural and Mining Courses <input type="checkbox"/> Architecture <input type="checkbox"/> Architectural Drafting <input type="checkbox"/> Building Estimating <input type="checkbox"/> Civil Engineering <input type="checkbox"/> Contracting and Building <input type="checkbox"/> Highway Engineering <input type="checkbox"/> Lumber Dealer <input type="checkbox"/> Reading Structural Blueprints <input type="checkbox"/> Sanitary Engineering <input type="checkbox"/> Structural Drafting <input type="checkbox"/> Structural Engineering <input type="checkbox"/> Surveying and Mapping <input type="checkbox"/> Communications Courses <input type="checkbox"/> Electronics <input type="checkbox"/> Practical Telephony <input type="checkbox"/> Radio, General <input type="checkbox"/> Radio Servicing | <p><input type="checkbox"/> Telegraph Engineering</p> <p>Electrical Courses</p> <ul style="list-style-type: none"> <input type="checkbox"/> Electrical Drafting <input type="checkbox"/> Electrical Engineering <input type="checkbox"/> Electric Light and Power <input type="checkbox"/> Lighting Technician <input type="checkbox"/> Practical Electrician <input type="checkbox"/> Power House Electric <input type="checkbox"/> Ship Electrician <input type="checkbox"/> Internal Combustion Engines Courses <input type="checkbox"/> Auto Technician <input type="checkbox"/> Diesel-Electric <input type="checkbox"/> Diesel Engines <input type="checkbox"/> Mechanical Courses <input type="checkbox"/> Aeronautical Engineer's, Jr. <input type="checkbox"/> Aircraft Drafting <input type="checkbox"/> Forging <input type="checkbox"/> Heat Treatment of Metals <input type="checkbox"/> Industrial Engineering <input type="checkbox"/> Industrial Metallurgy <input type="checkbox"/> Machine Shop <input type="checkbox"/> Machine Shop Inspection <input type="checkbox"/> Mechanical Drafting <input type="checkbox"/> Mechanical Engineering | <p><input type="checkbox"/> Mold-Loft Work</p> <p><input type="checkbox"/> Patternmaking—Wood, Metal</p> <p><input type="checkbox"/> Reading Shop Blueprints</p> <p><input type="checkbox"/> Sheet-Metal Drafting</p> <p><input type="checkbox"/> Sheet-Metal Worker</p> <p><input type="checkbox"/> Ship Drafting</p> <p><input type="checkbox"/> Tool Designing</p> <p><input type="checkbox"/> Welding Engineering</p> <p><input type="checkbox"/> Welding—Gas and Electric</p> <p>Railroad Courses</p> <ul style="list-style-type: none"> <input type="checkbox"/> Air Brake <input type="checkbox"/> Diesel Locomotive <input type="checkbox"/> Locomotive Engineer <input type="checkbox"/> Locomotive Fireman <input type="checkbox"/> Locomotive Machinist <input type="checkbox"/> Railroad Section Foreman <input type="checkbox"/> Steam Engineering Courses <input type="checkbox"/> Boilermaking <input type="checkbox"/> Combustion Engineering <input type="checkbox"/> Engine Running <input type="checkbox"/> Marine Engineering <input type="checkbox"/> Steam Electric <input type="checkbox"/> Steam Engineer <input type="checkbox"/> Textile Courses <input type="checkbox"/> Cotton Manufacturing <input type="checkbox"/> Rayon Weaving <input type="checkbox"/> Woolen Manufacturing |
| | <p><input type="checkbox"/> Advertising</p> <p><input type="checkbox"/> French</p> <p><input type="checkbox"/> High School</p> <p><input type="checkbox"/> Postal Civil Service <p><input type="checkbox"/> Retail Store Management <p><input type="checkbox"/> Secretarial <p><input type="checkbox"/> Stenography</p> <p><input type="checkbox"/> Plumbing <p><input type="checkbox"/> Steam Fitting </p></p></p></p></p> | <p><input type="checkbox"/> Coal Mining <p><input type="checkbox"/> Coal Mining <p><input type="checkbox"/> Gas Engines <p><input type="checkbox"/> Aviation <p><input type="checkbox"/> Flight Engineer <p><input type="checkbox"/> Foundry Work <p><input type="checkbox"/> Steam Engineer <p><input type="checkbox"/> Loom Fixing <p><input type="checkbox"/> Textile Designing </p></p></p></p></p></p></p></p></p> | <p><input type="checkbox"/> Ship Fitting <p><input type="checkbox"/> Toolmaking <p><input type="checkbox"/> Car Inspector </p></p></p> |

Name _____ Age _____ Home Address _____

City _____ State _____ Working Hours _____ A.M. to _____ P.M.

Present Position _____ Employed by _____

Length of Service in World War II _____ Enrollment under G.I. Bill and P.L. 16 approved for World War II Veterans. Special tuition rates to members of the Armed Forces: Canadian residents send coupon to International Correspondence Schools Canadian, Ltd., Montreal, Canada.

A D V I C E F O R T H E I N V E N T O R

Unless an inventor is thoroughly familiar with such matters, he is advised to employ a competent registered patent attorney or agent as the value of patents depends largely upon the skillful preparation of the specification and claims.

For his guidance, the following are the usual preliminary steps which the inventor takes toward patent protection.

The "Evidence of Invention" form mentioned below is offered as a convenience to the inventor in making his disclosure of invention.

The inventor should date and sign his disclosure and have it witnessed by two or more persons who are capable of understanding his invention. The disclosure should then be mailed to the registered patent attorney or agent whom he

selects to assist him. The disclosure should be accompanied by a letter authorizing the patent attorney or agent to conduct a preliminary search among previously granted U. S. patents for similar types of invention. The patent attorney or agent then prepares a report of the probable patentability of the invention and recommends the further course the inventor should take, provided the report indicates possible patentability.

This firm is registered to practice before the U. S. Patent Office and is available to assist inventors in the preparation and prosecution of their cases. The coupon below is suggested as a convenience to the inventor in starting action on his invention.

VICTOR J. EVANS & CO. • *Merlin M. Evans*

REGISTERED PATENT ATTORNEY

430-E MERLIN BUILDING, WASHINGTON 6, D. C.

• • • • •

• **VICTOR J. EVANS & CO. • Merlin M. Evans** •

• *Registered Patent Attorney* •

• 430-E Merlin Building, Washington 6, D. C. •

• *Please send me without obligation a copy of your booklet "Patent Protection For Inventors" together with your convenient "Evidence of Invention" form.* •

• Name..... •

• Address..... •

• City and State..... •

• • • • •

PATENTS

TRADEMARKS

COPYRIGHTS

THESE MEN ARE GETTING PRACTICAL TRAINING

IN ELECTRICITY



On Real:

**A.C. and D.C. MOTORS
GENERATORS
SWITCHBOARDS
CONTROLLERS
WIRING JOBS
APPLIANCES
ELECTRONIC UNITS**

(Shown at left—Instructor demonstrating latest type of Test Unit for checking output of a Generator.)

AND RADIO-TELEVISION

On Real:

**TELEVISION SETS
RADIO RECEIVERS
F.M. (Frequency Modulation)
RECORD CHANGERS
AUTO RADIOS
AIRPLANE RADIOS
PUBLIC ADDRESS Systems**

(Right—Instructor explaining operation of 20-inch Cathode Ray tube used in Dumont Television Set.)



Just Like YOU Can Get in the Great SHOPS OF COYNE

Prepare NOW for a real future the quick, practical way. Come to the Great Shops of COYNE in Chicago. Largest and best equipped school of its kind—now celebrating our 50th Anniversary. GI approved. Finance plan for non-veterans. Mail coupon.

NOT "HOME-STUDY" COURSES! At Coyne you learn on real, full-size equipment. Trained instructors show you how, then you do typical jobs yourself. We don't teach by mail.

CLIP COUPON NOW for big new illustrated Coyne book on either ELECTRICITY or RADIO-TELEVISION. Both books sent FREE if you wish. No obligation; no salesman will call. Get the facts now!

COYNE B. W. COOKE, Pres.
ELECTRICAL & RADIO SCHOOL
500 S. Paulina St., Dept. 59-72H
Chicago 12, Ill.



Mail Coupon for
2 FREE BOOKS!



B. W. COOKE, President
COYNE ELECTRICAL &
RADIO SCHOOL, Dept. 59-72H
500 S. Paulina St., Chicago 12, Ill.

Send FREE, the book or books checked below, and details of your training offer. This does not obligate me and no salesman will call.

ELECTRICITY RADIO-TELEVISION

NAME

ADDRESS

CITY.....STATE.....

BE A WINNER AT ANYTHING YOU TACKLE WITH **PROGRESSIVE POWER** Now **ALL 5 FAMOUS JOWETT COURSES** in 1 Volume For only **25c**

DARLING, THAT BULLY WON'T PICK ON YOU AGAIN.

JOE YOUR NEW ENERGY AND APPEARANCE SURE DO A GOOD JOB. YOU EARNED YOUR PROMOTION.



George F. Jowett
Whom experts call "Champion of Champions!"

- World's wrestling and weight lifting champ at 17 and 19.
- World's Strongest Arms.
- 4 times World's Perfect Body — plus other records.

Let's Go, Pal! I'll prove I can make YOU an "ALL-AROUND" HE-MAN

FAST — OR NO COST!
says George F. Jowett
World's Greatest Body Builder

Enjoy My "Progressive Power" Strength Secrets! Give Me 10 Easy Minutes a Day — Without Strain! I'll teach you the "Progressive Power Method" through which I rebuilt myself from a physical wreck the doctors condemned to die at 15, to the holder of more strength records than any other living athlete or teacher! "Progressive Power" has proven its ability to build the strongest, handsomest men in the world. And I stand ready to show you on a money back basis—that no matter how flabby or puny you are I can do the same for you right in your own home. Let me prove I can add inches to your arms, broaden your shoulders, give you a man-sized chest, powerful legs and a Rock-like back—in fact, power pack your whole body so quickly it will amaze you! Yes, I'll jam you with power and confidence to master any situation—to win popularity—and to get ahead on the job! Through my proven secrets I bring to life new power in you inside and out, until YOU are fully satisfied you are the man you want to be.

PROVE IT TO YOURSELF IN ONE NIGHT
Send only 25c for my 5 easy-to-follow, picture-packed courses now in 1 complete volume "How to Become a Muscular He-Man." Try it for one night! Experience the thrilling strength that surges through your muscles.

I am making a drive for thousands of new friends fast—REGARDLESS OF COST!
SO GET NOW MY 5 Muscle Building COURSES (Valued at \$5 each)
All in 1 Great Complete Volume Packed With How-To-Do-It Pictures!

Now, this "get-acquainted," extremely low price of only 25c is your chance to build a body you'll be proud of! Follow Jowett's easy method of muscle building NOW!

For Only 25c



10 DAY TRIAL!
Think of it—all five of these famous courses now in one picture-packed muscle-building volume for only 25c. If you don't actually FEEL results within ONE WEEK, send it back and your money will be promptly refunded!
Photo Book Of Famous Strong Men!

FREE!
Photos that inspire you to might and muscle. Free with order.

FREE GIFT COUPON!

Jowett Institute of Physical Culture DEPT. PM-95
230 Fifth Avenue, New York 1, N. Y.

Dear George: — Please send by return mail, pre-paid, **FREE** Jowett's Photo Book of Strong Men, along with all 5 Muscle Building Courses. 1. Molding a Mighty Chest. 2. Molding a Mighty Arm. 3. Molding a Mighty Grip. 4. Molding a Mighty Back. 5. Molding a Mighty Leg—Now all in One Volume. How to Become a Muscular He-Man." Enclosed find 25c. NO C.O.D.'S.

NAME _____ AGE _____
(Please Print Plainly, Include Zone Number)

ADDRESS _____

K-R-O KILLS RATS

• K-R-O BIS-KITS are ready-made, easy to use; containing *fortified red squill*, they're safer around livestock, pets, and poultry. K-R-O POWDER is 100% *fortified red squill*; economical to use in badly infested areas when mixed with natural baits. BIS-KITS, 35c and \$1.00; POWDER, 75c at drug, seed, and feed stores. Money-back guarantee. *The K-R-O Company, Springfield, Ohio.*

LEARN TO WRITE
a Good Hand!
FOR BUSINESS AND SOCIAL SUCCESS!

Easy to improve your handwriting at home quickly with my new instruction books just off the press. Master all the secrets of better penmanship. Simple and easy, fully illustrated, highly endorsed. Begin today. Write for: New, Free Book, "How to Become a Good Penman," or check books wanted, \$1.00 each. Business Writing Artistic Writing Card Writing Engraving Alphabets Bird and Design Flourishing Complete Set \$4.50 Enclose 10c for your name beautifully written and special penpoint for shaded writing.

S. A. Ziller, President, **TAMBLYN SCHOOL OF PENMANSHIP**
441 Ridge Bldg. In Business Over 52 Years Kansas City, Mo., U.S.A.

HYDROPONIC\$
Grow out-of-season vegetables, rare flowers or house plants by hydroponics WITHOUT SOIL!

Fascinating hobby or profitable business in your home; minimum space needed for big returns. Easy, clean, pleasant way to grow any plant indoors or out, year-round. Send postcard for FREE book showing how others are succeeding.

CHAPMAN-GILBERT, 824 W. IVY, SAN DIEGO, CALIF.

THERE'S MONEY IN CARTOONS!

RAYE BURNS will teach you HOW to CREATE ORIGINAL CARTOONS at home that you may SELL! Course contains 26 lessons and over 600 illustrations. All for **Only... \$2.85**

Send name and address for free details.

RAYE BURNS SCHOOL, Dept. M, Box 3583, Cleveland, Ohio

LEARN WATCH REPAIRING

AT HOME. By our modern and original system of instruction you can learn every part of the **WATCH REPAIRING TRADE AT HOME.** Prepare yourself for a well-paying position or start in business after completing our course of instruction. Good watch repairers are in demand and generally earn very good salaries. For particulars apply to the **Wisconsin School of Watch Repairing** 759 North Milwaukee St., Milwaukee 2, Wis.

WOULD \$400 PER MONTH INTEREST YOU?

It is easily possible to earn \$400 to \$500 a month raising **ANGORA RABBITS**. No experience required. Wool brings \$9 lb. Plenty markets. **WRITE TODAY for FREE INFORMATION, PRICES & WHERE to SELL.**

WHITE'S RABBITRY
NEWARK 10, OHIO

WHICH OF THESE *Opportunities* INTERESTS *You* MOST?

Accounting
Air Conditioning
Architecture & Building
Automotive Engineering
Aviation—Practical
Aviation Drafting & Design
Better Foremanship
Bookkeeping
Business Management

Contracting
Diesel Engineering
Drafting & Design
Electrical Engineering
Electricity—Practical
Electronics, Industrial
High School Courses
Machine Shop Operations
Mechanical Engineering

Plastics Engineering
Plumbing—Practical
Private Secretary
Radio Operating & Servicing
Railway Training
Refrigeration
Sheet Metal Pattern Drafting
Shop Management
Tool Making

THINK! LOOK FORWARD!

Business is making big, new plans

Men and Women are preparing for the future

WHAT ARE YOU DOING ABOUT YOUR TOMORROWS?

● *Today*, choose the job you want—and prepare for it. Or if you are already engaged in the work you like best, start training *now* for quicker promotion. Acquire the knowledge that will help you to get ahead faster, make more money and have greater security.

Invest part of your spare time in more rapid progress. Start training now, in spare time in your own home. Be ready to grasp your opportunity and step out ahead of those who lack the ability you have attained.

American School, founded in 1897 as an educational institution *not for profit*, can help you to reach your goal just as it has helped others during the past fifty-two years. Give serious thought to the list above. Pick one or more subjects that interest you. Then check the coupon at right, add your name and address and mail it at once. The school will send you details on its training plan and outline of study prepared by specialists. There is no charge, no obligation, so send the coupon immediately.

PRACTICAL, EFFECTIVE HOME - STUDY TRAINING SINCE 1897

Take This First Easy Step

CHECK, CLIP AND MAIL COUPON NOW

AMERICAN SCHOOL, Dept. G545, Drexel at 58th, Chicago 37, Ill.
Without obligation. Please send FREE and postpaid, bulletin and details of the Subject checked.

- | | | |
|--|--|--|
| <input type="checkbox"/> PLASTICS ENG'R | <input type="checkbox"/> Accounting | <input type="checkbox"/> Drafting and Design for Men and Women |
| <input type="checkbox"/> Refrigeration | <input type="checkbox"/> Electrical Engr. | <input type="checkbox"/> Radio |
| <input type="checkbox"/> Architecture and Building | <input type="checkbox"/> Electricity-Pract. | <input type="checkbox"/> High School |
| <input type="checkbox"/> Contracting | <input type="checkbox"/> Electronics, Industr. | <input type="checkbox"/> Air Conditioning |
| <input type="checkbox"/> Practical Plumbing | <input type="checkbox"/> Bookkeeping | <input type="checkbox"/> Mechanical Eng. |
| <input type="checkbox"/> Automotive Engineering | <input type="checkbox"/> Private Secretary | <input type="checkbox"/> Shop Management |
| <input type="checkbox"/> Aviation Drafting | <input type="checkbox"/> Diesel Engineering | <input type="checkbox"/> Tool Making |
| <input type="checkbox"/> Aviation | <input type="checkbox"/> Sheet Metal | <input type="checkbox"/> Better Foremanship |
| <input type="checkbox"/> Business Mgmt | <input type="checkbox"/> Pattern Drafting | <input type="checkbox"/> Machine Shop Operations |
| <input type="checkbox"/> Railway Training | | |

Name Occupation

Address Age

City State

AMERICAN SCHOOL

Dept. G545, Drexel at 58th Street, Chicago 37

**Train Now in Spare Hours at Home
for a Better Job at Better Pay in...**

REFRIGERATION and AIR CONDITIONING



1. FIRST: You get vital basic knowledge at home—during spare hours. Train as fast or as leisurely as you like.

2. THEN: You come to ITI's giant shops in Chicago—for a Full Four Weeks of practical instruction and actual work on newest, most modern equipment.

RICH Rewards for the Trained Man

Now is the time to lay your plans for a better job at better pay! Get the facts about your future in the amazingly FAST GROWING field of Refrigeration, Air Conditioning and Heating! Men who know how to install, repair, rebuild and maintain this equipment are going ahead FAST! But many more fine jobs are open NOW in this rapidly expanding industry in both the home and commercial equipment fields. Experts say the opportunities are almost unlimited. . . . **BUT ONLY PROPERLY TRAINED MEN CAN QUALIFY FOR THE BETTER PAYING JOBS!**

Investigate the Industrial Training Institute's 2-Way Course in Refrigeration, Air Conditioning AND Heating. In a few months this training gives you solid, practical, down-to-earth knowledge and experience you need. You don't need any special schooling or experience to master the ITI course. It's so simple, easy, and practical that you can finish your Training in a short few months' time. And after completing your Training ITI's wonderful job placement service is available to you without extra cost!

TRAINING MEN FOR INDUSTRY SINCE 1916!

ITI Training is backed by more than 30 years of success and experience. We have given training to over 400,000 men since 1916. Today thousands of ITI graduates hold down top paying jobs. ITI occupies five large buildings, with over \$500,000.00 invested in shops and training facilities. Instruction staff of more than 100 men.

VETERANS!

ITI residence training is fully approved under the G I Bill of Rights. Check coupon for special veterans' bulletin.

THIS BIG BOOK FREE!

Find out about ITI Training. See for yourself how easy and simple it is to start at home, in your spare time, and prepare yourself for a fine job with a real future. It's all in ITI's fascinating, illustrated FREE book, "Your Future in Refrigeration and Air Conditioning." Just fill out and mail the coupon below NOW! Take this first step toward success TODAY!

INDUSTRIAL TRAINING INSTITUTE
Dept. T-1
2150 Lawrence Avenue, Chicago 25, Ill.



INDUSTRIAL TRAINING INSTITUTE
2150 Lawrence Avenue
Dept. T-1, Chicago 25, Ill.

Please send me FREE the ITI book, "Your Future in Refrigeration and Air Conditioning" and information about the opportunities for trained men in this fast growing field. I understand I'm under no obligation.

Name _____ Age _____

Address _____

City _____ Zone _____ State _____

Are You A Veteran? _____

SAY YOU SAW IT IN POPULAR MECHANICS



VETERANS
training is FREE
under G. I. BILL.

Learn WOOD PRODUCTION ENGINEERING

GET THIS FREE BOOK
Today

It tells you how you can learn to become a successful WOOD PRODUCTION ENGINEER . . . by the Klok Home Study Correspondence Method . . . or by studying here in Grand Rapids in our Resident School . . . Training in WOOD PRODUCTION ENGINEERING offers you great opportunities . . . either to get a top position or to operate your own plant successfully.

The Klok Course teaches you SKETCHING, ROD-MAKING, DETAILING, STOCK BILLING, TIME STUDY, COST and MANAGEMENT.

WRITE FOR FREE BOOK TODAY! State preference whether Home Study or Resident course, with name, age, occupation and if veteran.

KLOK INSTITUTE
LOUIS ST., N.W.
GRAND RAPIDS, MICHIGAN



MONEY for MEN ALL DATA FREE

THE PLASTEX Industry needs manufacturers on small scale and for big production of Lamp and Clock Stands, Art Goods and Novelties in Plastex and Marble imitation. Experience unnecessary. 1/2c material makes regular 10c store sellers. Rubber moulds furnished for speed production. Small investment brings good returns. Big chain store orders now being placed. Ambitious men have chance for real prosperity. Our Free booklet will interest and benefit you.

PLASTEX INDUSTRIES, Dept. A
3400 Third Ave. New York 56, N. Y.

Free Book RAISE HAMSTERS

The new wonder animals from Syria. Often called Toy Bears. Delightful pets. Everyone wants them. Laboratories need thousands. Clean, odorless. Raise anywhere. A profitable and interesting hobby or business. We furnish breeding stock with manual of instructions.

Write today for free illustrated literature.
GULFHAMSTERY, 1536 BASIL, MOBILE, ALA.

'How to Make Money with Simple Cartoons'

A book everyone who likes to draw should have. It is free; no obligation. Simply address

FREE BOOK

CARTOONISTS' EXCHANGE
Dept. 95-D Pleasant Hill, Ohio

BE A NOTARY PUBLIC

For effortless lifetime income. You notarize only legal papers with your signature and official seal, as a public notary, collect and keep the fees. No training needed, no course to study. Like compound interest, money intake grows as your official capacity becomes known. Income modest but steady, never-ending, like paid-up annuity. If you qualify as to character and age, old legal-supply firm, 22 cities, will see you appointed by governor and equip you for \$25. Every business person, steno, accountant should be a notary. Apply . . .

STATIONERS EXCHANGE, BOERNE 35, TEXAS

Have an OFFICE of YOUR OWN!

LEARN NEW PROFITABLE PROFESSION
At Home in 60 Days, Men & Women, 18 to 70!

Be Your Own Boss and the Boss of Others. Be Respected. Meet Interesting People.

Earnings of men and women in this profession run as high as \$5,000-\$15,000 yearly. Others make good money in spare time. Little money needed to start. A business where your earnings begin sooner. Easy to learn. No selling or goods to buy. No experience necessary. A depression-proof business. A course of action to guide you step by step as you earn. All 53 lessons sent at once to use as operating manuals. Easy terms. Diploma. Money-back agreement. Write for FREE BULLETIN.

FRANKLIN CREDIT SCHOOL
Dept. 75-E ROANOKE 7, VIRGINIA

BY MAIL in Easy Lessons

See how we may help you
get started toward a

profitable, exciting future in

TELEVISION RADIO-ELECTRONICS

Get the facts about our
GREATEST OFFER IN 17 YEARS

Here's your big chance to get started toward **FASCINATING WORK** . . . **GOOD MONEY** . . . a **THRILLING FUTURE!** Mail the coupon today. See how **YOU** may prepare to tie in your future with a field that includes one of America's fastest-growing new industries—Television. You'll find out, too, about the many other thrilling opportunities in **FM Radio** . . . **Aviation and Broadcast Radio** . . . **2-Way Taxi, Truck and Police Radio** . . . **Industrial Electronics** . . . even the chance to start your own profitable **Television-Radio Sales and Service business**. And to top it all, you'll see that you don't need to know a thing about this subject at present—that **NOW** you can get the very training and *starting help* you need by means of our **GREATEST OFFER IN 17 YEARS**.

Send for **FREE** information

See **HOW**—in your own home—DeForest's Training, Inc., now brings you one of today's most complete combinations of major home training aids. You (1) **Learn-by-Reading** from well-illustrated lessons. (2) **Learn-by-Seeing** from D.T.I.'s exclusive instructive Home Movies. (3) **Set up your own HOME LABORATORY** where you **Learn-by-Doing** from 16 shipments of Radio-Electronic parts which you use and **KEEP** to work over 300 instructive, fascinating projects. This includes building the valuable 6 tube "Superhet" **RADIO**, commercial-type **OSCILLOSCOPE**, **R-F SIGNAL GENERATOR**, and Jewel-Bearing **MULTI-METER**, pictured at the right.

You may use this test equipment to help you earn real money—both in your spare time and later when working full time in the field. Get complete facts. Mail coupon today!

EMPLOYMENT SERVICE

When you complete your training, our effective Employment Service is available to you without extra cost—a grand aid to help you get started.

OSCILLOSCOPE

MULTI-METER

R-F SIGNAL GENERATOR

6-TUBE RECEIVER

YOU BUILD and KEEP THIS EQUIPMENT TO WORK OVER 300 HOME EXPERIMENTS

MODERN CHICAGO LABORATORIES

Train quickly, using a wide variety of commercial equipment. D. T. I.'s new laboratories are among the finest of their kind. Ample instructors . . . every major training advantage. Write for details.

You also use HOME MOVIES

. . . a **D. T. I. Exclusive!** D. T. I., alone, includes the use of today's most effective training aids . . . **MOVIES** . . . to help you learn important fundamentals faster, easier, at home. What an advantage to see electrons on the march, and other fascinating "hidden action"—a remarkable home training advantage that speeds your progress.

DeFOREST'S TRAINING, INC.
CHICAGO 14, ILLINOIS

Affiliated with the DeVry Corporation, Builders of Electronic and Movie Equipment

MAIL THIS OPPORTUNITY COUPON NOW!

DeForest's Training, Inc.
2533 N. Ashland Ave., Dept. PM-F5
Chicago 14, Illinois

Without obligation, send me complete facts showing how I may make my start in Television-Radio-Electronics.

Name Age

Street Apt.

City Zone State

MAKE BIG MONEY FAST



**STEVINSON TRAINED
AUTO, ELECTRICAL, and
REFRIGERATION EXPERTS
GET TOP MONEY**

Approved for Civilian and Veterans Training
The steady work, backed by proved time-saving methods of Stevinson training and experience has won approval from civilians and veterans alike. If you are a qualified G I, don't delay a day. Write today. Approved under laws 346 and 16.

EARN WHILE YOU LEARN

No wasted time. Be an expert in latest modern methods . . . you work with most advanced new equipment. We help you arrange part-time work . . . help you get best jobs or set up your own business on graduating. Don't limit yourself. Get on the quick road to success with a solid Stevinson foundation. 27 years of successful training.

GET FULL FACTS FREE. MAIL COUPON NOW!

**Stevinson Auto & Electrical School,
Dept. PMM, 2008 Main St., Kansas City 8, Mo.**

Common sense tells me the practical 27 years success of Stevinson classroom-shop training means faster earning of big money for me. Send me full facts on the training courses I have checked, at no cost or obligation.

- Auto Air Conditioning
 Refrigeration Electrical Appliance
 Auto Body & Fender Rebuilding

Name _____
Street _____
Town _____ State _____

STEVINSON TRAINING

Learn JEWELRY MAKING WATCHMAKING ENGRAVING

TRADES WITH
GREATER SECURITY—
HIGHER EARNINGS



Earn MORE All of Your Life

Increasing Demand for Trained Men and Women. No Age Limit. Learn Thoroughly—Quickly by KCSW's Special Application Method. Day and Evening Classes. Write for free Catalog. Approved for Veteran Training.

KANSAS CITY SCHOOL OF WATCHMAKING

1218 Admiral Blvd.

Kansas City 6, Mo.

STUDY AT HOME

With An Educational Institution

Men with specialized training win higher positions, insure larger earnings, and are bigger successes in business and public life. Opportunities NOW greater than ever before. Send for our Catalog.

ARTS and SCIENCES

Courses in Philosophy; Education; Letters; Public Health; Medical Jurisprudence; Psychology; Sociology; Physics; Chemistry; Plastics; Geology; Political Science; Theology; Business and Commerce; Accounting; Mathematics; Statistics; Agriculture.

ENGINEERING

Courses in Electrical, Civil Mechanical, Drafting, Architectural, Steam, Aeronautical, Radio, Structural, Mining, Industrial, Petroleum, Marine, Chemical, Diesel, Automobile, Refrigeration, and Air Conditioning Engineering.

LAW

Complete Professional Law Course includes 18 Hornbook Series college grade textbooks. Courses also in Commercial Law, Patent Law and Medical Jurisprudence.

McKinley-Roosevelt Incorporated, 4610-K, Sheridan Rd., Chicago 40, Ill.

REPAIR PARTS

Start Your Own Washing Machine Repair Business

Tremendous field, excellent profits! Get our large complete wholesale catalogue showing thousands of repair parts illustrations: wringer rolls, V-belts, motors, gears, etc. Price \$1.75 per copy postpaid in U. S. Send check or money order today—price of catalogue refunded on first order.

Established 20 Years

WESTERN APPLIANCE CO., Inc.

5650 Grand River Ave., Detroit 8, Mich.



GREAT PROFITS

MAKE YOUR OWN RUBBER MOLDS

X.L. RUBBER MOLDS

will realize you great profits quickly!
WRITE FOR NEW FREE CATALOG

YOU can EASILY learn to cast thousands of perfect plaques, book ends, figurines, ash trays, etc. IT'S EASY, FUN, PROFITABLE!

X.L. Rubber, Pts. \$2.00;
Qts. \$3.50; Gallons \$8.95;
Molds and enough rubber for 3 molds \$1.00—plus postage.

SEND FOR FREE FACTS

PLASTIC ARTS STUDIO • Route 2 • Dept. 2 / Muncie, Ind.

IF I Send YOU THIS FINE SUIT—

Will You Wear It and Show It to Friends?
I need a reliable man in your town to get a fine, made-to-measure, all-wool suit without paying cash, but by taking a few orders from friends. Wear it—show it—to help you take more orders with my line of nearly 100 guaranteed quality fabrics. You can make up to \$12 in a day without experience or investment. I supply everything required FREE. Write for FREE outfit. **John Grant, STONE-FIELD Corp., 5325 Throop St., Dept. S-816, Chicago 7, Ill.**

SAY YOU SAW IT IN POPULAR MECHANICS

Learn FINGERPRINTING AND IDENTIFICATION

**IN YOUR OWN HOME
IN YOUR SPARE TIME**

Specially prepared correspondence courses make it easy to learn this fascinating study essential in the field of CRIME DETECTION.

Under the Private Correspondence School Law of Pennsylvania, Licensed by the Dept. of Public Instruction.

FREE
Booklet
On Request

PENNA. INSTITUTE OF CRIMINOLOGY

Dr. W. Nisson Brenner, Director
DEPT. NO. 17
Extension Division
135 So. 2nd Street
Philadelphia 6, Pa.

The Success Story of Bill Smith... OR YOU!



Mails coupon to National Schools in Los Angeles, and receives Free Lesson and book of information about Radio, Television and Electronics training.



Enrolls... studies in spare time. Finds personal attention from instructors, interesting material and practical equipment, all increase his interest.



Builds actual units as part of Course. Earns money doing spare time repair and installation work.



Completes Course and receives Diploma... is now a qualified Radio, Television and Electronics Technician.



Applies for—and GETS—a good pay, full time job in industry. Finds that employers know National Schools and like to hire their graduates.



Or he opens own profitable Service Shop, with valuable counsel and aid from National Schools. Now for real happiness and success!



You Build This Superheterodyne Receiver With Parts We Send

You receive complete standard equipment, including latest type High-Mu Tubes, for building various experimental and test units. You progress step by step until you build a complete Superheterodyne Receiver. It is yours to use and keep.

Professional Multitester Included!

This portable instrument (see right) enables you to perform many practical tests, make delicate adjustments and do service work. Complete with test leads.

You receive a series of special laboratory experiment lessons to guide your practical exercises with your equipment. These lessons have been prepared with a special technique of illustrating radio principles by numerous easy-to-understand examples.

Both Resident and Home Study Courses Offered

Send Coupon Today for These Two Valuable Free Books



GET INTO RADIO, TELEVISION and ELECTRONICS by NATIONAL SCHOOLS SHOP METHOD HOME TRAINING

THIS PRACTICAL, TECHNICAL RESIDENT TRADE SCHOOL TRAINS YOU AT HOME FOR BIG RADIO OPPORTUNITIES!

Never in history has such rapid progress been made as in the great Radio, Television and Electronics Industry today! This exciting, fast-moving development means new and greater opportunities for the trained, skilled man—for you—in Television and Radio Broadcasting, Installing, Servicing; in Frequency Modulation; in Applied Electronics in many industries; in a business of your own!

National Home Training is Practical
Your National Schools Course fully covers basic, advanced and specialized instruction in all phases, including basic radio principles, receivers, am-

plifier systems, transmitters, television, aviation radio, electronics. You get complete instruction material, including shop manual, tube manual, job sheets, radio dictionary, special laboratory experiment lessons, experimental equipment. You receive complete, modern television lesson texts.

Your Home Study is supervised by our staff of highly trained instructors who daily teach our resident students here. Let the Free Books shown below tell you more about National Home Training. Use coupon today!

APPROVED FOR VETERANS

NATIONAL SCHOOLS

LOS ANGELES 37, CALIF. • EST. 1905



FIND OUT NOW... MAIL COUPON TODAY

National Schools, Dept. 5-PMR (Mail in envelope 4000 South Figueroa Street Los Angeles 37, California or paste on postcard)

Mail me FREE the book, "Your Future in Radio," and a sample lesson of your course.

NAME.....AGE.....

ADDRESS.....

CITY.....ZONE.....STATE.....

Check here if veteran of World War II

AUDELS Carpenters and Builders Guides 4 vols. \$6



Inside Trade Information for Carpenters, Builders, Joiners, Building Mechanics and all Woodworkers. These Guides give you the short-cut instructions that you want—including new methods, ideas, solutions, plans, systems and money saving suggestions. An easy progressive course for the apprentice and student. A practical daily helper and Quick Reference for the master worker. Carpenters everywhere are using these Guides as a Helping Hand to Easier Work, Better Work and Better Pay. To get this assistance for yourself, simply fill in and mail the FREE COUPON below.

Inside Trade Information On:

How to use the steel square—How to file and set saws—How to build furniture—How to use a mitre box—How to use the chalk line—How to use rules and scales—How to make joints—Carpenters arithmetic—Solving mensuration problems—Estimating strength of timbers—How to set girders and sills—How to frame houses and roofs—How to estimate costs—How to build houses, barns, garages, bungalows, etc.—How to read and draw plans—Drawing up specifications—How to excavate—How to use settings 12, 13 and 17 on the steel square—How to build hoists and scaffolds—skylights—How to build stairs—How to put on interior trim—How to hang doors—How to lath—lay floors—How to paint



AUDEL, Publishers, 49 W. 23rd St., New York 10, N. Y.

Mail Audels Carpenters and Builders Guides, 4 vols., on 7 days free trial. If OK I will remit \$1 in 7 days and \$1 monthly until \$6 is paid. Otherwise I will return them. No obligation unless I am satisfied.

Name _____

Address _____

Occupation _____

Employed by _____ PM

Don't Envy The PLUMBER—Be One

Make \$15 to \$50 a Day

Every skilled workman will tell you Plumbers have the best of it. WINTER and SUMMER the Plumber is busy at top wages. No skilled Plumber is ever out of a job. Compare his opportunities with any trade. To the man with know how, Plumbing means profit. Investigate Universal Plumbing School. Not a "war born School," but a plumbing school developed and operated by plumbers since 1923.



The Plumber Protects The Health of the Nation

Own Your Own BUSINESS

Have your own business and big profits with little other than training and a kit of tools.

JOURNEYMAN Gets Good Salary

Master Plumbers own their own shop. A Journeyman works for a Master. With this training journeymen can depend on high wages.

G. I. Approved. Established 1923

UNIVERSAL PLUMBING SCHOOL

877 Holmes Street

Kansas City, Mo.

BE A PLUMBER IN JUST 32 WEEKS
Learn With Tools—Not Books
No need ever serve an apprenticeship. Don't envy the plumbers big profits—enjoy them. Learn every trick of the trade—Leadwork—Blueprint for plan reading, etc. under Licensed Master Plumbers.

Over 7,000 Successful Plumbers Recommend This School

This system has made more than 7,000 plumbers. Investigate our past performance. If you like to work with tools this is your opportunity. Become a Plumber in America's largest and only school devoted exclusively to plumbing. Write today for FREE information.

SAY YOU SAW IT IN POPULAR MECHANICS

Famous BAILEY TECHNICAL SCHOOLS

OFFER THE FOLLOWING COURSES:
PRACTICAL DIESEL ENGINEERING
REFRIGERATION - AIR CONDITIONING
COMMERCIAL ELECTRICITY
RADIO - TELEVISION MECHANICS

Your future success depends largely on the reputation of the school you attend. Don't take chances! Train at America's foremost school of mechanical specialization. Bailey is recognized and approved by industry. Bailey graduates get the top pay jobs! G.I. Approved. Send for FREE Catalog.

BAILEY TECHNICAL SCHOOLS
1655 So. Grand Blvd., St. Louis, Mo.

Easy, Easy Money!

Nothing to buy. We supply FREE SAMPLE, solid brass front door name plate; beautifully engraved; bright lasting finish. Sells on sight. Every home buys. Show sample. Take order. Collect \$1 deposit. Keep it. Mail order to us. We deliver and collect \$1.98 balance. Make \$25, \$50 and more every week, spare time. Write NOW for FREE sample and simple selling help hints.

Dept. 181, NATIONAL ENGRAVERS
214 SUMMER STREET, BOSTON, MASS.



Bar Bells

Buy Direct From Factory

Write for free booklet and price list **\$8.95 up**

INDEPENDENT IRON WORKS
2416 East 23rd Street, Dept. B
Los Angeles 11, Calif.



LEARN MEAT CUTTING

through actual practice. Profitable Meat Cutting and Successful Meat Merchandising taught easily, quickly. LEARN BY DOING at Toledo in just six short weeks under actual market conditions. For beginners or men with experience. All subjects taught thoroughly and completely. Diploma. Job help. Got store of own. People must eat. School in operation over 25 years. Approved for GI training. Send today for FREE illustrated catalog. No obligation. NATIONAL SCHOOL OF MEAT CUTTING, Dept. 50M, Toledo 4, Ohio

FREE!

BIG 180 PAGE BARGAIN GUIDE

SAVES YOU MANY DOLLARS ON ELECTRONICS, TV, RADIO & TOOLS

A penny postcard will bring you the 1949 Lafayette-Concord catalog, pages and pages of the finest equipment at amazing low prices. Use it to order everything you need, and pocket the difference. It's FREE!

Write to LAFAYETTE-CONCORD, Dept. LE-9
100 Sixth Ave. 901 W. Jackson Blvd. 265 Peachtree St.
New York 13 Chicago 7 Atlanta 3

FREE HOBBY BOOK

For MEN and BOYS TELLS HOW TO LEARN TO

MOUNT BIRDS and animals, fish, pets, and all game. Learn to TAN SKINS with wonderful Krome-Tan. Simple as ABC. Many earn big PROFITS in spare time mounting for others. Great FUN. Wild game not needed. Over 500,000 students since 1903. RUSH postal TODAY for STRANGE BOOK, over 100 game pictures. FREE. No obligation. State AGEI N. W. School of Taxidermy, 2505 Elwood Bldg., Omaha 2, Neb.



POPULAR MECHANICS

Now YOU-TOO-Can Be a "WHIZ" on ANY AUTO REPAIR JOB!



"Motor's Manual paid for itself on the first 2 jobs, and saved me valuable time by eliminating guess work."—W. SCHROP, Ohio



"Instructions so clear, have no trouble learning anything about any car. Now working as mechanic in big plant."—S.A.M. ORDONEZ, Cal.



"Fixed motor another mechanic had worked on half a day. With your Manual, I did it in 30 minutes!"—C. AUBERRY, Tenn.



"So complete, easy to understand—have done jobs with Manual I would not have attempted without it."—C. L. VAN-ERSTROM, Mich.

MoToR's AUTO REPAIR MANUAL Is Showing Thousands of Men How to Handle ANY Job on ANY Car—Faster and Easier! Now Let It Go To Work For YOU!

FREE-7 Day Offer

HERE'S the book YOU need to "Whiz through" every auto repair job—including those "ornery," extra-hard ones that give other mechanics such a "headache"!

THOUSANDS of men like the four above are letting MoToR's AUTO REPAIR MANUAL help them "lick" even the toughest repair problems—in LESS TIME, with LESS work and MORE profits than ever before!

Complete "How-To-Do-It"

Now let these 200,000 factory-correct instructions and facts, 1900 "how-to-do-it" pictures, 200 "quick-check" charts and tables, go to work for YOU! With them you

can repair anything from carburetor to rear end, Ford to Cadillac, shaky '35 model to shining '49—quickly, easily, right!

Just look up make, model, job in quick index; then let official instructions, "boiled down" from 150 auto manufacturers' factory shop manuals, show you how, step-by-step! Sturdy binding, 8½ x 11 inches, 800 big pages.

SEND NO MONEY

Find out for yourself how this book can pay for itself first few days you use it. Try it FREE 7 days! Just mail coupon. Pay postman nothing. Put Manual to actual test. Then, if not entirely satisfied with it, return book in 7 days, pay nothing. Mail coupon today! MoToR Book Dept., Desk 15, 250 West 55 St., New York 19, New York.

Every Job on Every Car Built Since 1935!

Over 200,000 service and repair facts on:

American Bantam • Auburn • Austin • Buick • Cadillac • Chevrolet • Chrysler • Cord • Crosley • DeSoto • Dodge • Ford • Frazer • Graham • Hudson • Hupmobile • Kaiser • Lafayette • LaSalle • Lincoln • Lincoln Zephyr • Mercury • Nash • Oldsmobile • Packard • Pierce Arrow • Plymouth • Pontiac • Reo • Studebaker • Terraplane • Willys.

700 big pages; including 70 pages of carburetor text, charts, illustrations covering all models. Over 200 charts, tables: Tune-up Chart; Valve Measurements; Torque Wrench Reading; Starting Motor; Engine Clearances; Generator; Body Service; Dash Gauges; Brake Specifications; Front End Measurements, etc., Engines; Electric, Fuel,

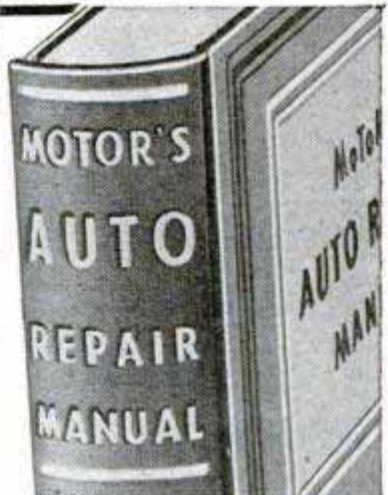

Cooling, Lubricating Systems; Transmissions; Universals; Front Ends; Wheels; Rear Ends, etc.

MoToR Published by MoToR, The Leading Automotive Business Magazine. MoToR's manuals assure high standards of repair work.

Same FREE 7-Day Offer Applies on MoToR's Truck Repair Manual

For mechanics, truck specialists, service stations, fleet owners. Covers EVERY job on EVERY truck made from 1936 to 1946. 1400 pictures, 952 pages, 300,000 facts. Used by Armed Forces. Warranted to contain every essential fact you need. Strong binding size 8½ x 11.

Covers all types Gasoline Engines; Diesels and Hesselmans. Fuel Sys-

tems, Governors, Lubrication Systems, Ignition Systems, Starters, Generators, Clutches, Transmissions, Axles, Torque Dividers, Transfer Cases, Brakes, Steering, etc., etc.

Also services buses, farm and industrial tractors, contractor, and road building equipment, stationary power machinery, etc. (on all parts described in Manual.)

Offered on same FREE 7-Day examination as Auto Repair Manual. Check box in coupon at right.

MAIL COUPON NOW FOR 7-DAY FREE TRIAL

MoToR Book Dept., Desk 15, 250 West 55 St., N. Y. 19

Rush to me at once: (Check box opposite book you want)

MoToR's AUTO REPAIR MANUAL. If O.K. I will remit \$1 in 7 days, (plus 35c delivery charge), then \$2 monthly for 2 months, and a final payment of 95c a month later. (Foreign price, remit \$8 cash with order).

MoToR's TRUCK REPAIR MANUAL. (Described at left.) If O.K. I will remit \$2 in 7 days, and \$2 monthly for 3 months, plus 35c delivery charge with final payment. Otherwise I will return book postpaid in 7 days. (Foreign price, remit \$10 cash with order.)

Print Name _____ Age _____

Print Address _____

City _____ Zone No. _____ (if any) _____

State _____ Occupation _____

Check box and SAVE 35c delivery charge by enclosing WITH COUPON entire payment of \$5.95 for Auto Repair Manual (or \$8.00 for Truck Repair Manual). Same 7-day return-refund privilege applies.

9 BIG BUILDING BOOKS

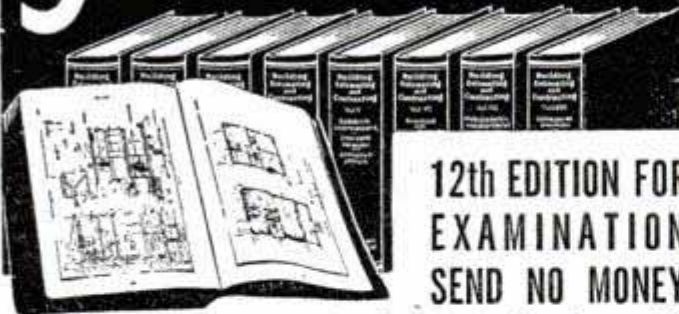

12th EDITION FOR EXAMINATION SEND NO MONEY

Learn to draw plans, estimate, be a live-wire builder, do remodeling, contracting. These 9 practical, profusely illustrated books cover subjects that will help you to get more work and make more money. Masonry, concrete forms, carpentry, steel square, roof framing, construction, plumbing, heating, painting, decorating and many other subjects. More than 4000 pages — 2750 illustrations.

BETTER JOBS — BETTER PAY UP-TO-DATE EDITION

A nationwide building boom is in full swing and trained men are needed. Big opportunities are always for MEN WHO KNOW HOW. These books supply quick, easily understood training and handy, permanent reference information that helps solve building problems.

These books are the most up-to-date and complete we have ever published on these many subjects.

Coupon Brings Nine Big Books for Examination

AMERICAN TECHNICAL SOCIETY—Publishers since 1898
Dept. G519 Drexel at 58th Street Chicago 37, Ill.

You may ship me the Up-to-Date edition of your nine big books, "Building, Estimating and Contracting," without any obligation to buy. I will pay the delivery charges only, and if fully satisfied in ten days, I will send you \$2.00, and after that only \$3.00 a month, until the total price of only \$34.80 is paid. I am not obligated in any way unless I keep the books.

Name _____

Address _____

City _____ State _____

Please attach a letter stating your age, occupation, employer's name and address, and name and address of at least one business man as a reference. Men in service, also please give home address.

Learn this Profitable Profession



IN 90 DAYS AT HOME

Money-Making Career Open to Men and Women, 18 to 50

Hundreds of men and women between 18 and 50 make \$10 to \$20 in a single day giving scientific Swedish Massage and Hydro-Therapy treatments. There is big demand from doctors, hospitals, sanatoriums and clubs. Graduates earn large full time incomes from these or in private practice in their own offices. Others make good money from home treatments given in spare time. Learn this interesting, money-making profession in your own home, through our home study course. Same instructors as in our nationally known resident school. You can win independence and prepare for future security by qualifying for your Diploma. Course can be completed in 3 to 4 months. Many earn while they learn. Begin your training at once.



Anatomy Charts & Booklet FREE

Enroll now and we will include, at no extra cost, many needed supplies. Fit yourself to help meet growing demand for Scientific Swedish Massage. Send the coupon at once for complete details. Anatomy Charts and 32-Page Illustrated Booklet, FREE, postpaid.

THE COLLEGE OF SWEDISH MASSAGE
Dept. 964E, 41 E. Pearson, Chicago 11, Illinois

Please send me FREE and postpaid, Anatomy Charts, 32-page Booklet and complete details on Home Training.

Name _____ Age _____

Address _____

City _____ State _____

Command Bigger Money! STUDY LAW

STUDY AT HOME for BUSINESS SUCCESS and LARGER PERSONAL EARNINGS. 40 years expert instruction — over 114,000 students enrolled. LL.B. Degree awarded. All text material furnished. Easy payment plan. Send now for FREE BOOK — "Law and Executive Guidance." It explains the course — how you may enroll and the many ways you can profit from Law Study. Write TODAY to:

AMERICAN EXTENSION SCHOOL OF LAW
Dept. 14-PM, 646 N. Michigan Ave., Chicago 11, Ill.



OWN a Business

Clean and Mothproof rugs and upholstery "in the home." Patented equipment. No shop needed. Duraclean dealer's gross profits up to \$20 a day on EACH serviceman. These Nationally Advertised services create repeat customers. Easy to learn. Quickly established. Easy terms. Send today for FREE Booklet — Full details.
DURACLEAN CO., 16-5 Pl., Deerfield, Ill.

SHORTHAND in 6 Weeks at Home

Famous Speedwriting system. No signs; no symbols; no machines; uses ABC's. Easy to learn; easy to write and transcribe. Fast preparation for a job. Surprisingly low cost. 100,000 taught by mail. Used in leading offices and Civil Service. Write for free booklet.
SPEEDWRITING, Dept. 1505-9, 55 W. 42 St., New York 18

LEARN PLASTICS AT HOME

Get 7 Big Kits with course—make useful attractive articles.

Write for free catalog

Approved for Vets—Non-Vets

PLASTICS INDUSTRIES TECHNICAL INSTITUTE

1601 South Western Avenue, Dept. PM-59
Los Angeles 6, California

Learn PHOTOGRAPHY

Win success in photography by spare time Home Study or at our famous Resident School in the heart of New York. Commercial, Advertising, Portrait, Color, etc. 39th year. Write today!

NEW YORK INSTITUTE OF PHOTOGRAPHY

Dept. "49", 10 W. 33 St., New York 1, N. Y.

ORIGINALLY \$30 to \$55 **MENS FULLY GUARANTEED NEW 15-JEWEL WRIST WATCH \$13.95 PLUS TAX**

Sacrificed because they're post-war surplus
WATER REPELLENT SHOCK PROTECTED

1 year written guarantee

Luminous dial . . . sweep second hand . . . Super-accurate . . . imported Swiss precision movement and case. You get them now for a small fraction of original prices. Don't delay! Order now . . . while they last. Send only \$1 down payment with order. Pay balance to postman on arrival, plus postage. Or we pay postage if you enclose \$13.95 plus \$1.39 Fed. Tax. Handsome expansion band included with prepaid order. Money back in 5 days if not delighted. Order now.



MARYLAND DISTRIBUTORS, Dept. 277
501 E. Baltimore St. Baltimore 2, Md.

GET INTO DIESEL-AUTO MECHANICS

Master All Phases

JOB'S LIKE THESE ARE AVAILABLE TO TRAINED MECHANICS. CHOOSE THE FIELD YOU LIKE BEST

Get Complete Training

- Diesel Fuel Injection
 - Automotive Motor Tune-up
 - Diesel Engine Rebuilding
 - General Garage Mechanic
 - Agricultural Implements
 - Auto Engine Rebuilding
 - Auto Elec. Service
 - Public Utilities
 - Parts Dealers
 - Bus & Truck Lines
 - Industrial Maintenance
 - Contracting & Excavating
 - Business of Your Own
- AND MANY other similar openings.

As a National Schools graduate, you are trained for ALL opportunities in the Diesel & Auto Industries

EARN WHILE YOU LEARN

With our practical Master Shop-Method Home Training, you study at home in your spare time. You receive Spare Time Work Lessons, which show you how to earn while you Learn . . . for extra money and experience. You Learn by DOING.

TOOLS AND EQUIPMENT

To make your training complete, we give you selected mechanic's tools and equipment, illustrated below, including all-metal toolbox — as a regular part of your instruction.

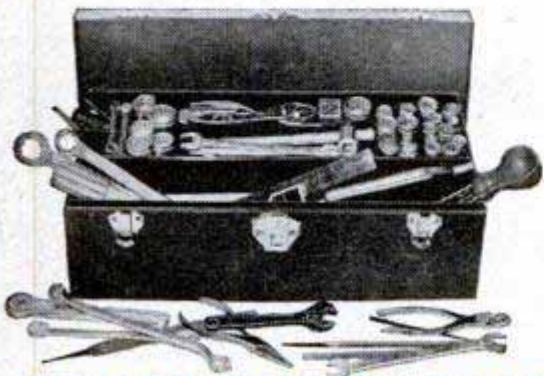

WE GIVE YOU TOOLS OF YOUR TRADE



Shop-Method Home Training by an Established Resident School Prepares you for Many Good Jobs

Opportunity is everywhere for the trained Diesel-Auto Mechanic. Highways throng with cars, busses, trucks, tractors. Garages and Service Stations are kept busy. Factories, ships, farms, railroads, general industry, are dependent upon engine power. Here's a dynamic, fast-growing field that needs trained men who know ALL phases: installation, operation, maintenance and repair. Now—National Schools offers you a *practical, all-embracing Diesel-Auto Mechanic's Course*, including all of these advantages:

Complete training, covering—Diesels, High Speed and Heavy Duty; Semi-Diesels, Gasoline and Special Fuel Engines AND Allied Mechanics.

- Basic Lesson Texts
- Diesel Installation
- Operation - Maintenance
- Diesel Chart Manual
- Spare Time Lessons
- Engine Service Manuals
- Engine Repair
- Drive Systems
- Diesel Electric Power
- Thermodynamics

TOOLS AND EQUIPMENT

INVESTIGATE
Secure Full Information

NEW, ILLUSTRATED BOOK & SAMPLE LESSON SHOW HOW WE TRAIN YOU . . . SEND FOR THEM TODAY!



NO COST
NO OBLIGATION

APPROVED FOR VETERANS
Check coupon below

NATIONAL SCHOOLS

LOS ANGELES 37, CALIF. • EST. 1905



FIND OUT NOW... MAIL COUPON TODAY

NATIONAL SCHOOLS, DEPT. 5-PMO
4000 South Figueroa Street
Los Angeles 37, California

(Mail in envelope or paste on penny postcard)

Mail me FREE the book, YOUR FUTURE IN DIESEL-AUTO MECHANICS, together with the Sample Lesson. I understand I may keep and use the information with no obligation.

Name _____ Age _____

Address _____

City _____ Zone _____ State _____

Check here if Veteran of World War II

Draw me!

\$1000.00 in Valuable Prizes

1st, 2nd, and 3rd prizes . . . COMPLETE ART COURSES including Drawing Outfits (Value of each course \$240.00); 4th, \$100.00; 5th, \$50.00; 6th, \$30.00 and 10 prizes, \$10.00 each.

Copy the girl and try for a prize! Splendid opportunities now for trained artists in all fields. Find out how much ability you really have. Mail this coupon with your drawing.



ART INSTRUCTION, INC.

Dept. 5139C, 500 South Fourth Street, Minneapolis 15, Minn.
Please enter my drawing (attached) in your \$1000.00 contest for May. (Please Print)

Name _____

Occupation _____ Age _____

Address _____ City _____

Zone _____ County _____ State _____



RULES:

You must be amateur. Our students not eligible. Make copy of girl 5 inches high. Pencil or pen only. Omit lettering. All drawings must be received by May 31, 1949. None returned. Winners notified. If desired, send stamped, self-addressed envelope for list of winners.

PRACTICAL AUTO INFORMATION

Keeps Cars Rolling by Making Repairs and Adjustments Easy!

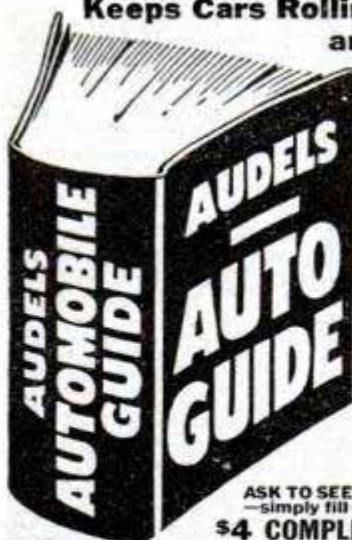

AUDELS AUTO GUIDE
For Every Mechanic, Driver, Owner and Repair Shop.

Sent on 7 Days Approval
Shows How to Tune Up—Keep Brakes Safe—Batteries Powerful—Tire Mileage Up—Save Gas—Lubricate Correctly.

ANSWERS YOUR QUESTIONS
Contains all you need to know about 1—Construction, 2—Operation, 3—Service, 4—Repair of Modern Motor Cars, Trucks, Buses & Diesel Engines in every detail.

NEW FLUID DRIVE TREATED
Easy to understand—1540 Pages, 1540 Illustrations. Gives definite directions on How to handle service jobs.

ASK TO SEE IT—Get this information for yourself—simply fill in and mail coupon today.

\$4 COMPLETE • PAY ONLY \$1 A MO.

AUDEL, Publishers, 49 West 23rd St., New York
Mail AUDELS AUTOMOBILE GUIDE (\$4) for free examination. If O. K., I will send you \$1 in 7 days; then remit \$1 monthly until \$4 is paid. Otherwise, I will return book promptly.

Name _____
Address _____
Occupation _____
Employed by _____ PM

SAY YOU SAW IT IN POPULAR MECHANICS

LAW FREE BOOK



Your FREE copy of "The Law-Trained Man" shows how to gain prestige and greater earnings through Blackstone home law study. All instruction material furnished including 18-volume Law Library written by 65 well-known law authorities. Lawyers, Judges among our graduates. LL.B. degree. Low cost; easy terms. Write today.
BLACKSTONE COLLEGE OF LAW 225 N. Michigan Ave.
Dept. 55, Chicago 1, Ill.
A Correspondence Institution Founded in 1890

LEARN MEAT CUTTING At Home—In Spare Time



Get into the vital meat industry. Concise, practical Home Training based on 25 years proven instruction methods used at National's famous resident school. Prepares you for bigger pay as Meat Cutter, Supervisor, market manager or more money in your own store. Go as rapidly as your spare time permits. Diploma. Start NOW to turn your spare hours into money. Send for FREE bulletin today. No obligation.

NATIONAL SCHOOL OF MEAT CUTTING, INC., Div. U-105, Toledo 4, Ohio

WANTED JEWELRY

We buy old or broken jewelry. Highest cash prices paid immediately. Mail us gold teeth, watches, rings, diamonds, silverware, eyeglasses, old gold, silver, platinum, etc. Satisfaction guaranteed or your merchandise returned. Write for free information.
ROSE SMELTING CO., 29-AA East Madison St., Chicago 2, Ill.

Be an INVESTIGATOR

JAMES S. BOLAN, FORMER POLICE COMMISSIONER OF NEW YORK CITY offers MEN & WOMEN an attractive opportunity to prepare for a future in *Investigation & Criminology* by comprehensive Home Study Course. Free placement service assists graduates to obtain jobs. APPROVED UNDER G. I. BILL OF RIGHTS.

Write for Free Booklet PM

THE BOLAN ACADEMY, INC.
EMPIRE STATE BLDG., NEW YORK 1, N. Y.

TO THOSE WHO THINK LEARNING MUSIC IS HARD

Just strike these notes and you're playing the beginning of the 'Merry Widow' Waltz

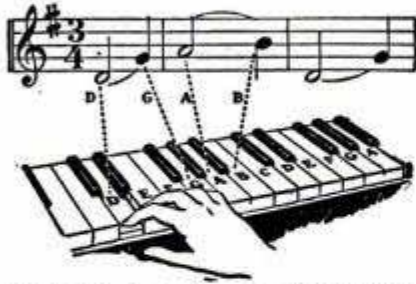

Look at the diagram. The first note of the music is "D." Following the dotted line to the keyboard you'll find "D" is the white key between the two black keys near the middle of the keyboard. Now read below how you can learn to play any instrument quickly and easily.



EASY AS A-B-C— COSTS JUST A FEW CENTS A DAY!

● Perhaps you think learning music is a tedious grind. It isn't any longer! Long hours of practicing scales and monotonous exercise are over.

You have no excuse for not getting started toward musical good times now! For through an easy method you can now learn to play right at home—without a teacher—for a few cents a day.

Learn to Play by Playing

The lessons come to you by mail from the famous U. S. School of Music . . . complete instructions, clear diagrams, and all the music you need. You learn to play by playing real tunes by note. First you are told how to do a thing. Then a picture shows you how. Then you do it yourself and hear it. Remember, don't confuse our method with any system claiming to teach music "by ear" or by trick methods. We teach you to play only from real notes!

SUCCESS!

Here's what one of our thousands of pupils writes: "I learned more from your course than many of my friends who studied under private teachers have for years. The fact that I've already taken 2 courses and am now enrolling for a third should speak for itself." F. A. S., Indiana.

Then you do it yourself and hear it. Remember, don't confuse our method with any system claiming to teach music "by ear" or by trick methods. We teach you to play only from real notes!

Don't delay. Send now for our Free Booklet and "Print and Picture" Sample which fully explain this remarkable method. So decide which instrument you want to play and mail coupon today. Instruments supplied when needed, cash or credit. U. S. School of Music, 75 Brunswick Bldg., New York 10, N. Y. (Successful 51st Year)

FREE PRINT AND PICTURE SAMPLE

U. S. School of Music, 75 Brunswick Bldg., New York 10, N. Y.

Please send me Free Booklet and Print and Picture Sample. I would like to play instrument checked below.

| | | |
|--|--|---|
| <input type="checkbox"/> Piano | <input type="checkbox"/> Saxophone | <input type="checkbox"/> Modern Elementary |
| <input type="checkbox"/> Guitar | <input type="checkbox"/> Trumpet, Cornet | <input type="checkbox"/> Harmony |
| <input type="checkbox"/> Hawaiian Guitar | <input type="checkbox"/> Reed Organ | <input type="checkbox"/> Mandolin |
| <input type="checkbox"/> Violin | <input type="checkbox"/> Tenor Banjo | <input type="checkbox"/> Practical Finger Control |
| <input type="checkbox"/> Piano Accordion | <input type="checkbox"/> Clarinet | <input type="checkbox"/> Have You Instrument? |

Name _____

Address _____

City _____ State _____

Save 2c—Stick Coupon on Penny Postcard

MAKE MONEY IN LANDSCAPING

Thorough training by Internationally known Landscape Architect to start your own business, improve your home or advance in this well paid field. Many Opportunities. Approved for Veterans. Send for FREE BOOK.



NATIONAL LANDSCAPE INSTITUTE
Dept. P-5, 310 So. Robertson Los Angeles 36, Calif.

WATCH REPAIRING

Be a Master Watchmaker! Graduates earn big money—many in business for themselves. The famous Sweazey System of Instruction teaches you quickly and easily. Our 41st year.

Write today for free information.

CHICAGO SCHOOL OF WATCHMAKING
Dept. 159, 1608 Milwaukee Ave. Chicago 47, Ill.

LEARN Photo-Engraving



You can get into this big demand, high profit, high wage field. Learn at home or in our modern, friendly, approved school in Aurora where training costs you less than \$1.00 per hour with everything furnished.

Famous Tasope' photo-engraving plants are again available. You can start your own full or part time photo-engraving business right in your own home. With the Tasope' plant there is profit and fun for the whole family. Be independent, be your own boss or pave the way to a high pay job with experience gained in your own shop. Write to-day for details. No obligation.

The Aurora School of Photo-Engraving
Dept. P9M, Tasope' Bldg. Aurora, Missouri

HIGH PAY JOBS

FOR MEN WHO QUALIFY IN
DIESEL



ASSURE YOUR FUTURE. Steady, big pay jobs await men qualified in Diesel, Tractor and Heavy Equipment. Can you take advantage of Diesel job and advancement opportunities in this fast-growing field?

COMPLETE DIESEL COURSE AVAILABLE.

If you are ambitious and want to get ahead in this lucrative field, you'll want to know about the complete training in Diesel provided by Interstate. Trains you at home in spare time. Does not interfere with your present job. Covers all phases of operation. Up to the minute. Revised regularly to cover new developments. Free placement advisory service.

YOU OWE IT TO YOURSELF

to investigate I.T.S. home Diesel training. Thousands of students agree it has helped them to better jobs . . . better pay. It can do the same for you!

SEND FOR FREE BOOK TODAY!

We'll gladly send you our big 24-page book "Getting Ahead In Diesel" FREE! Paste coupon on penny card and mail to



INTERSTATE TRAINING SERVICE
4035 N. E. Sandy, Portland 13, Oregon



Please see that I receive FREE BOOK "Getting Ahead In Diesel":

Name _____ Age _____

Address _____

City _____ Zone _____ State _____ (E-3)

NEW TROUBLE SHOOTER

Every Electrician Needs

Yours FREE
for 7 DAYS TRIAL!

Here, in one great volume, are the wiring diagrams and data you need to quickly locate troubles in G.E., Westinghouse, Square D, Bodine, Allis Chalmers, other electrical equipment. Complete, practical, a real time-saver on the job! Includes 600 large 8 1/2 x 11 wiring diagrams on transformers, single-phase and poly-phase motors, magnetic line starters, AC-DC generators, converters, much more. Also Refrigeration and Industrial Electronics. Experienced electricians are finding the new Trouble-Shooter as necessary as the tools you use everyday.

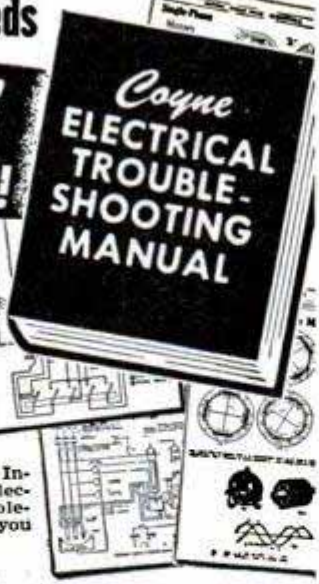

SEND NO MONEY—

Just fill out and mail coupon below. Big, new Trouble Shooting Manual will be sent to you, postpaid. Use it FREE for 7 days. Then, if you don't agree it's the most practical electrical reference manual you've ever used, send it back and owe nothing. If you keep the book, send either \$6.95 cash or \$2.50 after 7 days and \$2.50 a month until \$7.50 is paid.

FREE BOOK IF YOU ACT NOW! For prompt action we will include new "Handbook of Residential Wiring Designs." It's yours FREE whether you keep the Manual or not! Mail coupon AT ONCE!

MAIL THIS FREE TRIAL COUPON NOW!

Educational Book Publishing Division
COYNE ELECTRICAL & RADIO SCHOOL, Dept. 59-R6
500 S. Paulina St., Chicago 12, Ill.
O.K.I. Rush COYNE'S new Electrical Trouble-Shooting Manual per your FREE trial offer. Include Residential Wiring book FREE.

Name _____ Age _____
Address _____
Town _____ Zone _____ State _____
Where Employed _____
 Check here if you want Manual sent C.O.D.—pay \$6.95 plus fee on delivery. YOUR MONEY BACK IF NOT 100% SATISFIED.

CODE SPEED SHORT CUT

Be an expert. Learn to be a Telegraph or Radio Operator. Qualify for amateur or commercial license. Intensely interesting work—good pay. Learn at home or wherever you are, quickly, easily with the famous Candler Speed System. Book of particulars Free.
CANDLER SYSTEM CO., Dept. 5-E, Box 928, Denver 1, Colo., U.S.A.

TOOL AND DIE DESIGN

FREE COPY of our catalog explains comprehensive 12 month course in tool or die design. Expertly planned curriculum. Highly individualized instruction. Housing, employment problems aided.
Write today for complete information.
TECHNICAL EDUCATION, INC. (Acme School)
Dept. PM, 2804 Belmont Chicago

High School at Home

Many Finish in 2 Years

No classes. No time wasted going to and from school. Progress as fast as your time and abilities permit. Standard H. S. texts supplied. Thousands enroll each year in this 52-year-old school. Send for FREE descriptive booklet.

AMERICAN SCHOOL, Dept. H545
Drexel at 58th St., Chicago 37, Ill.
Without obligation, please send FREE descriptive booklet.
Name _____
Address _____

STEP OUT FOR EASIER WINDOW WORK

WITH

WINDOSTEP



Makes all outside window work easy & enjoyable!
SAVES TIME • SAVES MONEY
SAVES LADDER-LIFTING!
HELPS YOU Wash windows . . . Hang screens, storm windows & awnings . . . Paint, putty & repair.
IT'S STRONG . . . Supports 1000 lbs.
IT'S STURDY . . . Has steel rail & wood platform.

IT'S PORTABLE . . . Easy to carry - Weighs 11 lbs.

IT'S AUTOMATICALLY GRAVITY LOCKED to window sill from inside. (It's installed from inside.)

IT'S GUARANTEED

Or Your Money Back!
Low priced, only \$9.85 Plus C.O.D. & P.P. or \$10.50 Prepaid. Add 50c west of Rockies. Dealer Inquiries Invited. Patent Pending

MORRISON CRAFTERS INC.
709 Miami St., Toledo 5, Ohio

ORDER TODAY!

For Better Housekeeping, Your Home needs a WINDOSTEP!

TRI-STATE COLLEGE

B. S. DEGREE IN 27 MONTHS
ENGINEERING—Courses in Civil, Electrical, Mechanical, Chemical, Aeronautical and Radio (including Television). Also Bus. Admin., Acct. and Sec. Science. Low living costs. Modern cafeteria on campus. Graduates in demand. Enter June, Sept., Jan., March. Write for Catalog. 459 College Avenue, Angola, Indiana.



CARTOONING

HAVE FUN! MAKE MONEY! Cash in on your sense of humor AT HOME—BY MAIL. No experience needed to start. Write today FOR FREE TRIAL LESSON and full particulars.
MooN Gag Cartoon School, Dept. B, Fall Creek, Wis.



FOR PROFIT & PLEASURE

IN COPPER TOOLING & ETCHING

No Experience needed—start at once. BIG MONEY waiting in COPPER ART field. Plaques, Bowls, Trays, Gifts, Souvenirs of all kinds. Start on the road to success NOW! Here is an opportunity to get started in your own Big Paying Business—FREE DETAILS don't wait—WRITE NOW!
HOLLYWOOD COPPER ART—Dept. PM-5
4257 Beverly Blvd., Los Angeles 4, Calif.

APTITUDE TESTS

discover the kind of work or studies best for your success! You get a personal report—a guide for life—more happiness—more prosperity. For men, women, boys and girls. Write for complete facts.
VOCATIONAL COUNSELING INSTITUTE
956 Maccabees Bldg., Detroit 2, Michigan



Learn to Write at Home in Spare Time

You are often judged by your handwriting. Why write a poor hand when it's so easy to become a Good Penman? Hundreds have become Expert Penmen at home in spare moments by my Simplified Method, who never thought before they could learn. Regardless of how you Now write, You, too, can learn Expert Penmanship at home in spare moments. Write for Complete Information and my FREE BOOK, "How to Become an Expert Penman," which shows what others have accomplished by taking my Courses. If you wish, enclose 10c for Special Penpoint and your name with a flourished bird written on a card. Write TODAY.



Learn BAKING At Home

Baking is one of America's high industries in wages. Nearly depression-proof. Thorough basic home course lays sound foundation. If you have aptitude, write for FREE BOOKLET, "Opportunities in Commercial Baking."
National Baking School, 1315 Mich. Ave., Dept. 1355, Chicago 5



SURPLUS BARGAINS



LARGE BLOWER UNITS
 Single exhaust blower delivers approx. 420 cu. ft./min. at 1 oz. static pressure. **EXCELLENT** for furnace draft, or blowing system for removing sawdust, wood and plastic chips, etc. American Blower Corp. Size "C." Type "P." impeller type fan; 3 1/2" outlet, 6" intake; 1/2 H.P. motor (3450 r.p.m., 110V-A.C.-single phase. Like new (unused). Unit wt. 97 lbs. Govt. cost over \$125 **\$49.50**

SMALL BLOWER UNIT

Ideal for darkrooms, trailers, kitchens; may also be used as hair dryers, etc. Single exhaust with squirrel-cage type fan. 2 1/2" intake, 2" outlet. Delivers approx. 55 cu. ft./min. 115V-A.C. (60 cycle) DELCO Motor. Simple to install for any use. Govt. cost \$20.00. Like new (unused) . . . **\$9.95**



DELCO CARBON PILE GENERATOR VOLTAGE REGULATOR (24 Volt)
 While they last . . . this hard to get item is being offered at a give-away price. No. 94-32276-A. Up to 200 amps. **ONLY \$3.95** SLIGHTLY USED

SPECIAL!!! This 10 lb. choice assortment of aircraft **NUTS and BOLTS . . . for the handy-** **\$1.95**
 man or hobbyist. 10 lb. Package

HIGH PRESSURE TANK
 Carries up to 1800 lbs. pressure. Tank measures 19 1/2" high by 6 3/4" wide with rounded ends. Solid metal construction fitted with brass release valve at top. Normally used for CO2. Excellent for use as oxygen storage tank or compressed air auxiliary tank. Slightly used. **\$5.95**



CLIMBING EQUIPMENT SAFETY BELT
 Good Leather **\$2.95**
 Used
POLE CLIMBERS and straps. **\$1.95**
 Used, good. Pair



Send 25% with Order, Balance C.O.D. All Equipment F.O.B. Pasadena. Write TODAY for Catalog!

C. & H. SALES COMPANY

DEPT. M5, 1850 E. Colorado St., Pasadena 8, California

Learn TELEVISION-ELECTRONICS

2 Big Books FREE Train at Home—Get Big Kits of Radio Parts! Prepare now in spare time. Practical instruction. Approved for Veterans. Write for details and 2 Radio Books—ALL FREE! Rush name today! **SPRAYBERRY ACADEMY OF RADIO** Dept. 10-R, 20 N. Wacker Drive, Chicago 6, Illinois

PLASTICATED "GI" CLOTHS

WATERPROOF, LIGHTWEIGHT, 8 X 10 foot, 1001 uses as painter's dropcloth, lawn, furniture, machinery, merchandise cover, beach blanket, or shelter. Many uses camping, fishing, or picnic trips. Send \$1.25, and we will ship one cloth prepaid—
SAX-ON • Dept. 367 • 3840 Fullerton • Chicago 47, Ill.

FURNACES FOR HOME AND SHOP

COAL—LP—GAS—OIL. Fittings, pipes and registers. Water heaters, Ranges and floor furnaces. **BLOWERS** with motors. Get the parts you need and modernize your own heating system. Wholesale & Retail. Lowest prices. **FREE BOOKLET**

PEERLESS SALES & SUPPLY
 4318 Sheridan Lincoln 6, Nebr.

Say You Saw It in POPULAR MECHANICS

Rebuilt Transmissions **PLYMOUTH — DODGE \$25.95** Exch. 35-39 only Price Guaranteed
 F.O.B. Chicago

Also Transmissions for all other cars **REBUILT GENERATORS** Chevrolet — Ford — Plymouth **\$6.95** Guaranteed
 Exch. Price F.O.B. Chicago
 We carry a full line of automotive parts, starters, transmissions, rear-ends, and generators at tremendous savings. Rebuilt by factory trained experts. **LOWEST PRICES IN MIDWEST**

WORLD AUTO PARTS CO. ORDER from one of the nation's largest replacement dealers
 2200 N. Ashland Chicago 14, Ill.

"TWICE the FISH"

with the amazing new **TWO-TIMER* LURES**



Enthusiastic users report "twice as many fish with Two-Timer* lures." One landed 5 doubles in 1 day. Different color patterns on opposite sides of each Two-Timer* give you two chances with every cast - better fishing every time.

THESE COMBINATIONS AVAILABLE IN BOTH LURES
 YP-SF.. Yellow Perch & Silver Flash SF-BC.. Silver Flash & Black Chub
 YP-GS.. Yellow Perch & Grass Shiner RS-BC.. Red Shiner & Black Chub
 YP-BC.. Yellow Perch & Black Chub RS-YP.. Red Shiner & Yellow Perch
 YP-P.. Yellow Perch & Pike SF-P.. Silver Flash & Pike
 RS-P.. Red Shiner & Pike

GET TWO-TIMERS FROM YOUR DEALER OR BY MAIL TODAY SATISFACTION GUARANTEED OR YOUR MONEY REFUNDED

SAN LUCO, Inc.
 533 F Street
 SAN DIEGO, CALIF.

Enclosed find check or M. O. totaling ___ for ___ Two-Timers @ \$1.50. Quantity and desired patterns are indicated below.

TWO-TIMER "Minnow" (Surface Lure) **TWO-TIMER "Bassie" (Semi-surface)**
 ___ YP-SF ___ SF-BC ___ YP-P ___ YP-SF ___ SF-BC ___ YP-P
 ___ YP-GS ___ RS-BC ___ SF-P ___ YP-GS ___ RS-BC ___ SF-P
 ___ YP-BC ___ RS-YD ___ RS-P ___ YP-BC ___ RS-YP ___ RS-P

*Pat. Pend.
 NAME _____
 ADDRESS _____
 CITY _____ STATE _____

HYDRAULIC—PNEUMATIC ACTUATING CYLINDER

WITH ATTACHED HIGH PRESSURE SWIVEL CONNECTOR **DOUBLE ACTION**



Raise, lower machinery, garage doors, dump trucks, bulldozer blades, snovels, other uses. Brand new, war surplus, genuine Bendix Aviation part #402685; 4" bore, 18" stroke, 31" long; solid impeller shaft, 1 1/2" diam.; mounting holes 5/8" I.D. 100-2,000 p.s.i.; shipp. wgt. 50 lbs. Only \$24.50 F.O.B. Chicago area. Gov. cost \$200; a top value; a powerful worker. Don't delay. Order today! Each. **ONLY \$24.50**
 (*Quantity buyers, dealers, write for special discount.)

ALLIS-CHALMERS POWER TAKEOFF

FOR HD-7 CATERPILLAR TRACTOR
 Genuine Allis-Chalmers part #047642, fits any HD-7 Caterpillar tractor. War surplus, brand new; with forward, neutral, reverse, and gear shift bracket. Gear down ratio, approx. 3 1/4 to 1. A remarkable value, worth \$225. Now only \$52.50 each. F.O.B. Chicago area. Sh. wgt. 100 lbs. It's tops in versatile, portable power. Order now. Each. **ONLY \$52.50**

Special discount in lots of 5. Dealers please write. Send Check or Money Order, 25% with C.O.D.'s. Full Satisfaction Guaranteed.
STAHLER DISTRIBUTORS, PM-5, 810 Michigan, Evanston, Ill.

POWERMAX MIDGET AIR TOOL

- ★ Variable speeds 500 to 14,000 r.p.m.
- ★ Finger tip control
- ★ Only 4 1/2" long — 1" diameter
- ★ Powerful, cool running vane motor
- ★ 1/8" collet chuck
- ★ Requires only 3 c.f.m. air at 50 lbs.
- ★ Complete with 6' hose



Never before so much useful power in so small a package.
 For Grinding • Sanding • Polishing • Drilling • Milling • Routing • Carving

FERRIOT BROS., INC.
 2680 Mogadore Rd. AKRON 5, OHIO

Send check or money order — no C.O.D.'s please.

An Invitation To INVENTORS

Here is the rare opportunity for inventors. The primary purpose of this Exposition is to aid inventors in the promotion of their ideas to both the public and industrial leaders.

First International Inventors Exposition

Sponsored by the American Inventors Association

GRAND CENTRAL PALACE

NEW YORK CITY

JUNE 4-11, 1949

The International Inventors Exposition is open to any inventor with an invention that has merit in the opinion of the Exposition Committee.

Private inventors can exhibit at the Exposition on equal footing with commercial entrants because the American Inventors Association arranged for them to join the Association and present exhibits at a greatly reduced fee.

Please send photograph of your invention with complete description thereof, and also photograph of yourself, to the Exhibition Committee, International Inventors Exposition, 525 Lexington Avenue, New York 17, New York. If your invention meets the requirements of the Committee, application for inclusion in the Exposition and complete details will be sent to you promptly.

INVENTORS

When you are satisfied that you have invented a matter of value—write me, without obligation, for full information as to what steps you should take to secure a Patent.

The usual first step is to have a search of the prior U. S. Patents conducted, so that I can report to you on the question of Patentability.

PATRICK D. BEAVERS

(Formerly RANDOLPH & BEAVERS)

Registered Patent Attorney

934 Columbian Building Washington 1, D. C.

PATRICK D. BEAVERS, Registered Patent Atty.
934 Columbian Bldg., Washington 1, D. C.

Please send me full information on how to secure Patent Protection and Trademark Registration.

Name _____

Street _____

City _____ State _____

TRADE MARKS •
COPYRIGHTS •

PATENTS

The Time to Contact
a Patent Attorney is Promptly
After You Have Finished Your Invention

Write for FREE "INVENTOR'S GUIDE" & "Record of Invention"

FRANK LEDERMANN Registered Patent Attorney

154 Nassau St. • 20th Floor • New York 7, N. Y.



PATENTS

AND TRADE MARKS

C. A. SNOW & CO.

REGISTERED PATENT ATTORNEYS

WRITE FOR INFORMATION TO

428 SNOW BUILDING, WASHINGTON 1, D. C.



INVENTORS

Whether an invention is patentable can be substantially determined by a search of the U. S. Patent records. Without obligation, write for information explaining the steps you should take to secure a patent.

JOHN N. RANDOLPH

Registered Patent Attorney

201 Columbian Building, Washington 1, D. C.

INVENTORS

HIGHEST ROYALTIES and CASH

FOR YOUR INVENTIONS

Write for FREE booklet without obligation

UNIVERSAL MARKETING CO.

354 South Spring St. (Suite M)

Los Angeles 13, Calif.

PATENTS PATENT LAWYER

TRADE MARKS
GUSTAVE MILLER
59PM WARNER BLDG.
WASHINGTON 4, D. C.

ASSOCIATE EXAMINER
U. S. PATENT OFFICE 1922-1929
REGISTERED PATENT ATTORNEY
Send for Form
"INVENTOR'S RECORD"

INVENTING

—FOR PROFIT! If you have an inventive turn of mind, write for free 28-page booklet explaining how the Institute of American Inventors is helping inventors pre-test the profit possibilities of proposed devices to fill today's unprecedented demand for useful new inventions.

INSTITUTE of AMERICAN INVENTORS

Dept. 4, 1926 Eye St., NW, Washington 6, D. C.

PATENTS

"Proof of Invention"
Folder mailed without
obligation.

E. E. VROOMAN, Registered Patent Atty.
505 McKim Building, Washington 5, D. C.

INVENTORS

IF YOU WISH TO PROTECT YOUR INVENTION, You should take steps to protect it by a U. S. Patent. Write me for "Record of Invention" form.

CARL MILLER
REGISTERED PATENT ATTORNEY

Woolworth Bldg., 35th Floor, Dept. 59-A, New York City
Please send me "Record of Invention" form.

NAME _____

ADDRESS _____



GET INTO DRAFTING

The Draftsman Plays a most Important Part in INDUSTRY

DRAWING OUTFIT INCLUDED with Drafting courses

All the tools you need including folding drawing table. With them you can put your ideas on paper quickly and with accuracy. With training you are all set to master Drafting in months, — not years — at home.

Learn in Spare Time—At Home!

(or at the College in Chicago)

A few hours of pleasant home study every week — that's all. With Chicago Tech's help, you train yourself step by step. This tested method — developed over 44 years of C.T.C. progress — prepares men for good positions in industry.



Practically everything that's built or manufactured these days is constructed from blue print drawings prepared by the draftsman. He is the KEY man in industry. No new machines can be built, no bridges erected, no buildings constructed until the draftsman has completed his work.

Drafting is clean, interesting, professional-type work. The draftsman is paid well to start. And he has real opportunities for advancement to high-pay jobs in Engineering. The tremendous production programs ahead in industry will require more draftsmen than ever before.

Send today for free information. See what this training has done for others, what it can do for you. Simply MAIL COUPON TODAY in an envelope or use a penny postcard.

**CHICAGO
TECHNICAL COLLEGE**
E-212 Tech Building, 2000 South Michigan Ave.
Chicago 16, Illinois

MAIL COUPON NOW

Chicago Technical College
E-212 Tech Bldg., 2000 So. Michigan Ave.
Chicago 16, Illinois

Mail me FREE Drafting Lesson with information about big opportunities in DRAFTING and how I can train at home.

- | | |
|---|--|
| <input type="checkbox"/> Architectural Drafting | <input type="checkbox"/> Electrical Drafting |
| <input type="checkbox"/> Machine Drafting | <input type="checkbox"/> Structural Drafting |
| <input type="checkbox"/> Builders' Course | |

Name _____ Age _____

Address _____

CITY _____ Zone _____ State _____

Engineers Say:

BURN WATER IN YOUR CAR!

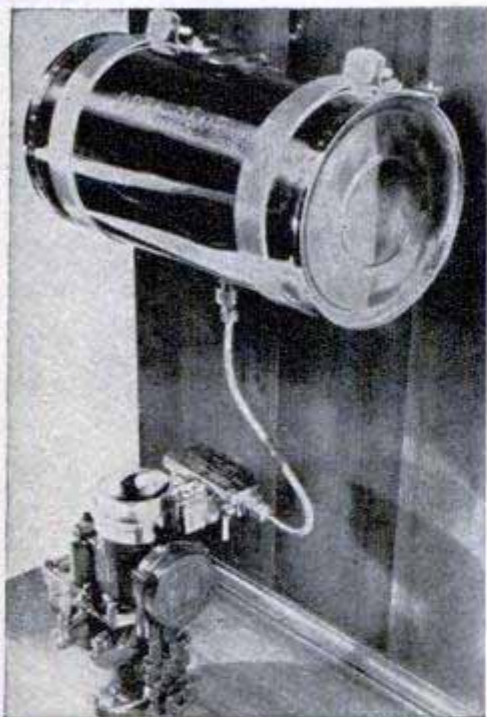

Engineers and scientists have achieved great results with water injection. They have found that startling increases in performance, efficiency, economy, and acceleration of internal combustion engines result when water vapor is injected into gas vapor.

Now these benefits are available to every motorist in the Octagane Water Injector, a fool-proof, fully automatic, precision injector. If you want to get premium performance, smoother operation, better pick-up, and all the other proven benefits of water injection, write for free information about the Octagane.

*Send Card Today for Details of
Special Introductory Offer*

COMMONWEALTH CARBURETOR CORPORATION
DIV. 17-B, BERKELEY 2, CALIFORNIA
Dealer's Inquiries Invited

REGULAR + OCTAGANE = PREMIUM PERFORMANCE

For Fun & Money!

quick-selling
money-making
3-dimensional

PLASTIC PHOTO STATUETTES

Easily Made From Any
Photograph or Negative



Make lifelike Plastic Photo Statuettes at home for pleasure and profit. Easy to make from any photograph or negative; no special tools or machinery required. We provide all necessary materials and advertising circulars at wholesale cost, and we furnish complete easy-to-follow instructions. Make these Statuettes for yourself, for your friends, or sell them. Drug and department stores, photographic stores and photo studios, will gladly act as your agent. Also, you can sell them easily house-to-house or by mail.

\$2.98 starts you on your way! For only \$2.98 we send you complete manufacturing instructions, sample of a finished Statuette, illustrated circular and FREE materials sufficient to produce two Statuettes. Send \$2.98 right now and get in on a good thing!

Only
\$2.98
with all materials



ACT TODAY, IMMEDIATE DELIVERY

Remit by cash, check, M.O. No C.O.D.'s.

CHEMICAL RESEARCH CO.

214 West 42nd St., Dept. PM-5, N. Y. 18, N. Y.

\$5000.

of Old Line Legal Reserve
LIFE INSURANCE

FOR ONLY **\$4.50** A MONTH*

AT AGE 21 (other ages in proportion)

*One Half Permanent Rate in effect 5th year

Or you can buy as little as \$1500 of this unique protection at only 90c per \$1000. Policy offers all Standard Provisions under rigid New York State Insurance Laws.

For 42 years POSTAL has sold life insurance by mail and over the counter; has satisfied policyholders in every state; has over \$14,000,000 in assets and has paid out over \$62,000,000 in benefits. All Standard Policies, men or women, ages 10-60 at low cost.

DIVIDENDS, payable annually, further reduce the low cost of your insurance. Send coupon for further details and rates. Life Insurance is vital!

GET THE FACTS BY MAIL

POSTAL LIFE INSURANCE COMPANY
511 Fifth Avenue, New York 17, N. Y.—Dept. M-878
Mail me without obligation complete information about your low cost "Modified 4 Policy" at my age.

Name _____
Occupation _____ Date of Birth _____
Address _____

No Waiting to LEARN
START NOW TO EARN!
This BIG BOOK SHOWS HOW



PRACTICAL IDEAS—

GIVE QUICK RESULTS

Never before such a book of helps for you who wish your own business. In this book are formulas, recipes, secrets that have amazed the world. Use these tips to make many needed money-making products.

Experts wrote this book in simple terms, with supply sources for materials, short-cuts and methods for profitable results.

START NOW—Become Independent

Lots of profitable businesses have started with a single recipe. Choose from the 162,000 facts and 10,000 formulas such as:

— Adhesives, Cosmetics, Beverages, Candy, Ceramics, Cheese, Cleaners, Concrete, Dentifrices, Dyes, Depilatories, Enamels, Gum, Home formulas, Inks, Insecticides, Lacquers, Linoleums, Lubricants, Metals, Mirrors, Oils, Ointments, Paints, Perfumes, Polishes, Remedies for Man, Beast & Fowl, Soaps, Solders, Varnishes, etc. 1000's of others to make all sorts of profitable items.

BE READY, IF YOUR JOB FOLDS

This big book tells what to do and how. No experience needed. You work from the money-making facts and ideas that are explained in words easily understood. Many fortunes have been made with a single formula. Mail in your order and start right NOW!

POSTPAID
\$3.98
ANYWHERE IN THE WORLD

\$3.98 postpaid throughout the world. (C.O.D. plus postage in U. S. only.) Shipped at once.

ADAMS BROWN COMPANY, BOSTON 67, MASS. U.S.A.



There's No "Mystery" in Watchmaking!
YOU CAN LEARN THIS PROFITABLE SKILL!

For 300 years, watchmakers' skills have been closely-guarded secrets. Now, you can learn skilled watchmaking in scenic, mile-high Denver. I'll give you everything in practical benchwork from hair-spring manipulation to position adjustment. Nationally accredited, veteran approved. Write Orville R. Hagans for information, no obligation. No salesman will call. FREE BOOKLET.

AMERICAN ACADEMY INC.
SCHOOL OF HOROLOGY
1549 Lawrence St., Dept. 1, Denver 2, Colo.

RUPTURE-EASER

A strong, form fitting, washable support. Back lacing adjustable. Snaps up in front. Adjustable leg strap. Soft, flat groin pad. No steel or leather bands. Unexcelled for comfort. Also used as after operation support. For men or women. Mail orders give measure around the lowest part of the abdomen. Specify right or left side or double. Save postage—send money with order—or sent C.O.D.



Right or left
Side **\$3.95**

Pat. Pend. Double **4.95**

PIPER BRACE CO.

308 East 12th Dept. PM-5 Kansas City 6, Mo.

PRINT YOUR OWN POST CARDS

COMPLETE
OUTFIT
only
\$7.50



Amazing results in sales, inquiries and contacts... saves time and money... very easy to use GEM STENCIL DUPLICATOR is ideal for Advertising, Announcements, Notices, Labels, Forms, Price Lists—hundreds of uses for every type of business and organization. Comes complete with all supplies, instructions and 60-page Book of Ideas.

FREE TRIAL OFFER: Try it before you buy it! Write and a GEM OUTFIT will be sent you postpaid. After 10 days, send only \$7.50 or return the GEM, no questions asked. The GEM must sell itself; you be the judge.

BOND EQUIPMENT CO. • Dept. 135
6633 Enright • St. Louis 5, Mo.

SEND NO MONEY • FREE TRIAL OFFER

MAKE MONEY by coin-metering your

WASHING MACHINE, RADIO
HAIR DRYER, IRONER
CLOTHES DRYER, etc.



YOU can make any electrical appliance earn steady profits for you—by coin-operating it. The Robco Meter coin-operates any device using 15 amps or less. Nickel, dime or quarter sizes. Adjustable timing: 10 to 120 minutes for each coin. From 1 to 25 coins can be inserted at a time. 110 volts, 60 cycles, AC.

Complete unit-mechanism and money-box — \$32.50. Send 50% with order, balance C.O.D. plus postage. Order now, specifying denomination.

ROBCO CORP., 202 E. 44th ST., NEW YORK 17, N. Y.

WANTED TO BUY

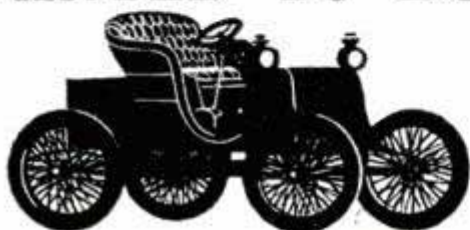

Will pay cash prices for automobile catalogs, instruction books, sales leaflets, any years and models; also automobile magazines but *not* single ads clipped from regular magazines. Write, describing fully what you have to Museum. Dept. PM — 140 W. Ontario St., Chicago, Ill.

Guaranteed by mfr. for FULL YEAR

Handsome Swiss wrist watch...

Marvelous value in a good-looking watch, built by skilled Swiss craftsmen. So well-made that a printed one-year guarantee is given. Has sweep second hand, glow-at-night dial, rugged chrome case, unbreakable crystal. Timed and tested movement; leather strap.

Send no money—10 day trial
Pay postman \$6.95, plus tax and postage for send check and we pay postage. Return in 10 days, if not delighted.

Swiss Watch Distr.

Dept. 905C
Sandy Springs, Georgia



ONLY
\$6.95
plus
ESC
tax



CARTOONING

Taught by 9 Professionals

Here's a new idea in cartooning schools—45 Lessons created by NINE Famous Professionals: Boltinoff, Lariar, Nofziger, Roir, Ross, Roth, Salo, Schus and Wolfe. Over 2000 Instruction Drawings! Complete course includes: COMIC STRIPS • MAGAZINE CARTOONING • SPORT CARTOONS • POLITICALS • ANIMALS • ADVERTISING COMICS • BOOK ILLUSTRATION • CUTE GIRLS, etc.

Learn the modern way! Your homework personally criticized by all 9 famous teachers. Up to 2 years to finish. Approved as a Correspondence School under the laws of the State of New York. Approved for Veterans. For literature write to:

The PROFESSIONAL SCHOOL OF CARTOONING, Inc.
Dept. PM-3, 505 Fifth Avenue • New York 17, N. Y.

SPECIALIZE



BECOME AN ELECTRICAL ENGINEER

Industry needs technically trained men. Our time-tested Concentric System enables you to build your career step by step in 6 to 36 months at vocational, technician and professional level. Select the course in which you are most interested. More than 1,500 students now enrolled from 48 states and 18 overseas countries. Faculty of 85 specialists. 35,000 former students in industry all over the world. Alumni counselors everywhere. Terms start July, September, January, April.

B.S. DEGREE

*in Electrical Engineering
Major in Electronics or Power*

OTHER COURSES

SERVICE—6 to 12 months

- Practical Electricity
- Practical Welding
- Refrigerator Service
- Heating Service

TECHNICIAN—1 to 2 years

- Electrical Power
- Radio and Television Technician
- Electronics Technician
- Refrigeration, Heating and Air Conditioning Technician

PROFESSIONAL—3 years

- Electrical Engineering
- Bachelor of Science Degree
- Major in Electronics and Power

SEND COUPON TODAY.

MILWAUKEE SCHOOL of ENGINEERING



A Technical
Institute Founded
1903 by
Oscar Werwath

MILWAUKEE SCHOOL OF ENGINEERING

Dept. PM-549, N. Broadway and E. State, Milwaukee, Wis.
Without obligation send me free booklet "Career Building" and more details on course in _____

NAME _____ AGE _____

ADDRESS _____

CITY _____ STATE _____

SAY YOU SAW IT IN POPULAR MECHANICS



AUTO BOOKS ON APPROVAL



SEND NO MONEY. Just mail the coupon for a complete set of 4 Big, Thick Auto Books. 20th Edition. Over 2700 Pages! Whether you are a mechanic or helper, expert or apprentice, auto owner or driver, take immediate advantage of this **FREE EXAMINATION OFFER.**

MAKE GOOD MONEY NOW HOLD A PERMANENT JOB

America wants its automobiles kept in good repair. Men with "know how" are in demand, at big pay. These books will help you get and hold an important job, or give you a chance to go into business for yourself now or later. Any man who half tries to improve himself can learn auto servicing and repairing by this quick reference method. Use the **JIFFY INDEX** to find easily understood answer to any auto problem. These wonder books prepared by eleven of America's great automobile engineers. Many hundreds of valuable illustrations. Send the coupon **TODAY.**

A year's consulting privileges with our engineers now given with these books without extra charge.

Publishers Since 1898

CAN YOU FIX IT?

These wonder books tell step by step **HOW** to make difficult repairs and adjustments, how to keep a car at maximum efficiency, including latest improvements in car design and operation. Engine troubles and how to correct them well covered.

4 BIG, THICK VOLUMES

Over 2700 pages, 2000 illustrations, wiring diagrams, etc. Beautiful modernistic, washable cloth binding.

AMERICAN TECHNICAL SOCIETY, Dept. A519
Drexel Ave. at 58th St., Chicago 37, Ill.

I would like to examine your 4-Volume Set of Auto Books. I will pay the delivery charges only, but if I choose I may return them express collect. If after 10 days' use I prefer to keep them, I will send you \$2 and pay the balance at the rate of only \$3 a month until \$24.80 has been paid. Include consulting service as offered above.

Name _____
Address _____
City _____ State _____
Please attach letter stating age, occupation, employer's name and address and name and address of at least one business man as reference. Men in service, also please give home address.



HIGH PAY • SECURITY When You LEARN A TRADE

Get ready for a well-paid, lifetime job or a business of your own in one of these **FIVE ESSENTIAL TRADES.** Complete training under expert instructors with practical experience prepares you to step into a good paying job with a future and security.

ELECTRICITY: Basic electricity, Residential and Industrial Wiring and Appliance Repair.

PLUMBING: Every phase — pipe cutting and threading to complete installations, blue print reading.

AUTOMOTIVE & TRACTOR: Engine overhaul, Transmissions, Carburetion, Generator-Ignition Systems, Tune Up.

DRAFTING: College level training in general Machine and Architectural Drafting

SHOE REPAIRING: Complete practical training includes reconditioning and rebuilding.

Approved For Veteran's Training

NATIONAL TRADE SCHOOL 2610 Grand • Kansas City 8, Mo.

Without obligation to me please send full information on the course checked.

.....Automotive and Tractor Technician .. Drafting
.....Plumbing ..Electricity ..Shoe Repairing

Name.....Age.....

Address.....

City.....State.....

Veteran?.....

BIG MONEY! SECURE FUTURE! LEARN WATCH REPAIRING AT HOME



With our ENLARGED Self Training Kit **START NOW** in this uncrowded field! **EASY** to learn! Earn while you learn! Even as a sideline you can make \$50 and up each week.—Our **PRACTICAL SELF TRAINING KIT** contains: **REAL PROFESSIONAL TOOLS** (Loupe, 3-4 power; Complete Set of 8 Special assorted Screw Drivers; Tweezers AA; Plastic Material Tray; Case Opener & Knife) and **COMPLETE BOOK** on Modern Watch Repairing. Fully illustrated, easy to understand, shows every step in repair, adjustment and use of tools. Only... **\$7.25** Post Paid

(If C.O.D., plus charges.) Money Back Guarantee.
MODERN TECHNICAL SUPPLY CO.
Dept. MMC, 55 W. 42nd Street, New York 18, N. Y.

New Complete Catalog on all Modern Precision Tools, Materials & Books with clear Descriptions & over 600 Illustrations for Watch-Clockmaking, Jewelry, Tool-Instrument Making, Handcrafters. Useful for years because catalog entitles you to future supplements.
Catalog **FREE** with kit or 50c credited to 1st order

CARBURETOR TOO RICH MAKES MOTORIST TOO POOR



Car owners who are wasting money and not getting proper gas mileage due to over-rich mixtures will be pleased to learn how to save gasoline by **VACU-MATING** over-rich mixtures. **VACU-MATIC** fits all cars, trucks and tractors. It is automatic and operates on the supercharge principle. Easily installed in a few minutes.

SALESMEN WANTED! Big Profits! Send name, address on penny postcard for free particulars and how to get yours for introducing.

VACU-MATIC CO., 1434-1511 W. State St., WAUWATOSA, WIS.

Short-Cut Mathematics COMBINED WITH Practical Mechanics Simplified

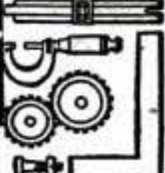

COMPLETE COURSE — ONLY \$1.49

Be a "master mind." Learn how to juggle figures, do balling tricks with numbers. Add long columns of figures this lightning-quick, short-cut way. Multiply 4 figures by 4 figures without old-fashioned multiplication. Here are speedy, simplified systems used by stage "wizards," expert accountants, engineers. Course includes illustrations, worked-out problems, answers, etc. **SEND NO MONEY.** Just send name and address. On arrival, pay postman only \$1.49 plus C.O.D. postage. Or send \$1.49 with order and we ship postpaid. If not amazed with this sensational course just return it for full refund. Mail order **TODAY** to **NELSON-HALL CO., Dept. 2E2, 1139 S. Wabash Ave., Chicago 5, Ill.**

BARBELLS

Save Money — Buy the finest barbell equipment direct from our foundry — No other company can match our low price or value! Send to-day for our **FREE Barbell Catalog**
BUR BARBELL CO.
Lyndhurst 17, New Jersey

LEARN MOVIE PROJECTION THEATRE MANAGEMENT

The Motion Picture Theatre Business offers big opportunities for trained men. Get into a fascinating field with a promising future. Train at home in spare time. Free Catalog. Established 20 years.
THEATRE SCHOOL, 370 Washington St., Elmira, New York

LUMINOUS PAINT GLOWS IN THE DARK!

FOR SAFETY NOW you can paint any article or part of an article **Bright Green, Misty Violet, Bright Blue, Radiant Orange, Blue-Green, Golden Yellow and Orchid.** Beautiful, standard colors by day that glow brilliantly at night! Thousands of uses! Liberal size can any color sent postpaid for only 89c. **FREE** illustrated catalog, luminous sample display cards show how **RADI-GLOW** paints can be used.

CHEMICAL PRODUCTS COMPANY
1412 Great Northern Bldg.,
Dept. 401, Chicago 4, Ill.

89¢

SEND FOR FREE CATALOG! PER CAN



Like To Work With Your Hands? Then Get Into **ELECTRIC APPLIANCE** Repair & Service

Recent University Discoveries prove that one of three major classifications of men are only thoroughly happy when working with their hands. Nature intended A BIG GROUP of men to be the builders, artists, sculptors, surgeons, fixers and servicers of life. If you are in this group — not completely happy in your present work — seeking increased income, and handy with tools — **SOME SOUND ADVICE:** Get into electrical appliance service and repair. This great growing field gets better every day as more homes are wired for electricity.

OPEN YOUR OWN SHOP Be Independent

Our practical, thorough course teaches you this interesting good paying business **AT HOME — DURING YOUR SPARE TIME.** A Grade School Education is all you need. You can start small—in your basement or garage—with the tools we send you and **GROW AS BIG AS YOU LIKE** without fear of losing your job if a depression comes. Or, you can take a well-paid job for there is a big need for service men in this active field!

LEARN AT HOME

In Spare Time
How To Repair
Washing Machines
Vacuum Cleaners
Electric Ranges
Lamps, Motors,
Irons, etc.
REFRIGERATION
and
House Wiring



We Include This BIG KIT of APPLIANCE TOOLS At No Extra Cost!

With the tools and testers we send, you can actually start making money before your course is finished. With your first set of lessons we show you easy jobs you can do in your spare time. And remember—only one good repair job will pay for the cost of the entire course. Our lessons are not only practical but understandable and easy to grasp. You'll enjoy every minute of them—just as you'll enjoy this work when you get into it. Let's talk it over by mail. There's a lot more we want to tell you—including our assistance in helping you start your own business—and line up customers.

MAIL COUPON for FREE BOOKLET

PACIFIC TRAINING SCHOOL — Dept. P-95
7217 So. Broadway, Los Angeles 3, Calif.

Please send me your **FREE BOOKLET** on:

Elec. Appliance Servicing Refrig. Home Course
 Refrig. Shop Course in L.A. I am W. War II Vet.

NAME _____ AGE _____

ADDRESS _____

CITY _____ STATE _____

RAISE REAL CHINCHILLAS

(not rabbits)

Matched breeding stock — Little space needed
PROFITABLE — GENTLE — HARDY

Write for free information . . . or
History and Handbook \$2.50

ALLIED DISTRIBUTORS, Dept. A, Gardena, Calif.

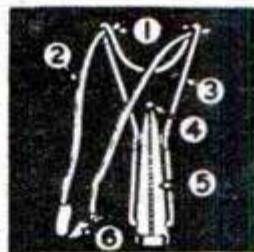

Repeating Slingshot

AMAZING NEW repeating slingshot. Shoots 150 B.B. shot. Loads from handle. Just the thing for hunters and trappers, young and old. Shoots thru ordinary 100 page magazine. More powerful than an air rifle. Send \$1 in coin, money order or stamps (coins and money order preferred) for one of these **REPEATERS.**

THE SLINGO COMPANY
Dept. B5 Alexandria, Va.

Here's How CREI Prepares You for a Professional Career with
Industry-Recognized training in a minimum of time

RADIO-ELECTRONICS-TELEVISION ENGINEERING

GRADUATES of the Capitol Radio Engineering Institute residence school are preferred by industry because of their *training* and *ability*. This recognition is the reason that CREI men quickly find good jobs in radio-electronics-television engineering and technical fields.

With 22 years of practical teaching experience in these highly technical fields, CREI offers an outstanding faculty, modern and complete laboratories, shops and equipment.

New students are accepted twice monthly and each may advance as rapidly as he is capable. The basic

Approved for
Veterans' Training



CAPITOL RADIO ENGINEERING INSTITUTE

An Accredited Technical Institute Founded in 1927
Dept. 175A, 16th and Park Rd., N.W., Washington 10, D. C.

MAY 1949

course with one specialized course requires an average of 20 months to complete, depending on the ability of the individual student.

CREI is recognized as one of the country's leading technical institutes. Its work is of college level. It prepares the young man for a good job in industry in a minimum of time.

MAIL COUPON FOR FREE CATALOG

Capitol Radio Engineering Institute, Dept. 175A
16th and Park Rd., N. W., Washington 10, D. C.

Please send me your illustrated catalog and complete details.

Name _____ Age _____

Street _____

City _____ Zone _____ State _____

I am entitled to training under G.I. Bill.

**Your stepping-stone
to a BETTER-PAYING
MACHINIST'S JOB**

**Master shop work quickly
with these books**

This big home study and reference course gives you the practical facts on machines and methods you need to advance in machine shop work. Take advantage of the other man's experience as found in books, to solve your problems, increase your efficiency with



Revised and Enlarged
These 6 volumes give you not only accepted methods and practices, but latest developments in machine shop work, enabling you to meet today's shop requirements and needs.

3 volumes, 2645 pages
2747 illustrations

**THE AMERICAN
MACHINISTS' LIBRARY**

This library of machine shop practice was written for practical men. It gives you the best methods for every kind of machine shop work. It fully explains lathes, drills, and other machine tools and their operation, automatic screw machines, speeds and feeds, gear design and production, jigs and fixtures, punch and die work, metal surfacing, etc., etc. All plainly written and fully illustrated.

NO MONEY DOWN—Easy payments

EXAMINATION COUPON

McGraw-Hill Book Co., Inc., 330 W. 42 St., N. Y. C. 18, N. Y.
Send me for ten days' free examination the AMERICAN MACHINISTS' LIBRARY. If satisfactory I will send you \$3.75 and \$4.00 monthly until the price of \$23.75 is paid. If not wanted I will return books postpaid.

Name _____
Address _____
City _____ Zone _____ State _____
Company _____
Position _____ PM-5-49

**Learn A Trade NOW!
PRACTICAL
SHOP TRAINING!**

In Our Chicago Shops

- AUTO MECHANICS
- DIESEL MECHANICS
- REFRIGERATION
- BODY-FENDER
- WELDING—ARC and GAS
- MACHINIST
- PIANO TUNING

Above Approved For G. I.'s and Civilians
One of America's Leading Practical Schools
7 Floors of Fully Equipped Shops
Over 48,000 Successful Graduates
Expert Individual Instruction
Learn by Doing—Low Living Expense
Established 1902—Day and Evening Classes

Also the following Home Study Courses

- PLASTIC
- REFRIGERATION
- DIESEL

CALL IN PERSON OR MAIL THIS AD TO

GREER SHOP TRAINING

(Desk 10) 460 South State St., Chicago 5, Ill.

Please send without obligation free information regarding trade checked above. (Specify whether you are a Veteran or Civilian)

Name _____ Age _____
Address _____
City _____ State _____

MAJIC SUN PRINTER!



Prints Negatives in Day Light
Make your own personal
Greeting Cards
Completely safe,
even for children.
Economical—gives instant
prints at low cost.

Here is real fun and instruction for the whole family, children, too. Print your own personal greeting cards and announcements as well as your favorite negatives. No darkroom or complicated chemicals needed. Perfect for teaching a child the fundamentals of photography. SET CONTAINS: • Instructions • 50 sheets of special printing papers • Glass, blotter, frame and clip for making exposures • Bottle of "Quick Fix" liquid for instant developing and fixing • Scenic negative for practice prints • Clear negative base for making greeting cards, announcements, etc. • Cotton applicator.



ACT TODAY. We pay postage on prepaid orders. C. O. D. add postage. **STRAUB & CAMPBELL,** Grant Bldg., Pittsburgh, Pa.

\$1.00
POST PAID

LEFAX

**ENGINEERING AND BUSINESS
DATA SHEETS—BLANK FORMS
DOLLAR DATA BOOKS**

Use Lefax Technical Data Sheets in research, designing, estimating, or wherever you need accurate, dependable information. Printed on loose leaf, six hole, 6 3/4 x 3 3/4 paper, Lefax sheets are pocket size. A price list and complete data index will be sent on request.

LEFAX, DEPT. PM1, PHILADELPHIA 7, PA.

**Be a Safety Engineer
or Personnel Manager**

Train at home for these well paid professions. These are practical courses with a money back guarantee. Write for information.

National Safety & Personnel Training
P. O. Box 4114 Shreveport, La.



**AGENTS WANTED
BIG PROFITS**

Send \$1 for gunsmith course, ammunition and Remington, Winchester and Savage shotguns & rifles catalog and big profits wholesale price list.
NEW YORK GUN CO. • Wholesale W80 • Ridgeway, Penna.

**NEW YORK SCHOOL of
MECHANICAL DENTISTRY**

SINCE 1920—The outstanding Training Center for all phases of Dental Laboratory Technology. Licensed by New York and New Jersey States. Approved for Veterans G.I. BILL & P.L. 16. Visitors Welcome. Ask for Free Bulletin "P."
NEW YORK SCHOOL OF MECHANICAL DENTISTRY
America's Oldest School of Dental Technology
138 Washington Street NEWARK 2, NEW JERSEY
Also: 125 W. 31 Street NEW YORK 1, N. Y.
Immediate Enrollment—Day and Evening

Paint It With Rayon

Revolutionary. Complete kit \$7.95. Write for information
DONJER PRODUCTS CO., 1115 Sterling Place
Brooklyn 13-D, New York

SAY YOU SAW IT IN POPULAR MECHANICS

Superette Dual Vacuum Auto Horns

**The Voice of Authority
on The Highway**

One blast and those "road hogs" really move over. Superette Horns compare favorably to air horns costing \$75 to \$100. Can be installed under hood or on front fender. Beautiful lacquer finish. Operates from intake manifold of your car. No tank needed. Cost is only \$8.95 complete with all necessary fittings, control valve and simple installation instructions. Send check or money order today or order C. O. D. . . Adds much to your car.

THE PROTECTUOD COMPANY, Dept. 453
4033 Windsor Road, Youngstown 7, Ohio

NOW you
can make
Your BIKE
a "Motorbike"
\$69.95



plus \$2.27
Fed. Tax
including all necessary attachments
In Illinois Add \$1.40 State Tax

NOW, at this new, low price, everyone can own and drive a "motorbike." No installation cost. Apply TRAVIS Motor yourself in less than half an hour, on any balloon-tire bicycle (except front spring type). Mounted on front fork, driving on front wheel, away from driver. Quickly, easily disengaged. Anyone can operate it immediately.

5 to 25 SAFE Miles per Hour
Authorities say bicycles are built for top speed of not over 25 mph. Ride in Safety—and Go Ten Miles for a Cent. Students, shop and office workers; savings on car and bus fares soon pay low cost of TRAVIS "Bike" Motor.

LIGHTWEIGHT; but Built to Last
Complete power-package weighs only 17 lbs. Ruggedly built, two-cycle, 1 H.P. completely enclosed, smooth-running air-cooled motor. Safe. No moving parts exposed; no belts; no pulleys; no gears. Weatherproof; all parts covered and protected; will operate in rain, snow, any weather.

PRECISION Engineered
Aluminum cylinder with cast-iron sleeve; cast aluminum piston. Ball bearing throughout; drop-forged

crankshaft, fully counterbalanced; self-contained magneto; automobile type carburetor; motorcycle control.

Fully Guaranteed
Workmanship and material fully guaranteed. Return motor in 10 days if not completely delighted with it, and money will be refunded.

How to Get Yours at Once
If no TRAVIS dealer yet in your vicinity send check or money order for \$69.95 plus \$2.27 Federal Tax and we will ship, postage prepaid (or send \$25 and we will ship C.O.D. for balance plus shipping charges). Thrilling gift for anyone, any age. Send for complete descriptive literature.

DEALERS . . .
Write for liberal proposition.
TRAVIS PRODUCTS COMPANY
Dept. P, 224 West Huron Street,
Chicago 10, Ill.

TRAVIS "BIKE" MOTOR

SHOE REPAIR OFFERS BIG INCOME LEARN IN 12 WEEKS TIME



You can own your own shop or earn big income as skilled shoe repairman. Growing demand everywhere at top wages for men who know how. We teach you quickly by actually working on shoes and modern machines. School open to all from 18 to 60 years of age. **FREE BIG 20 PAGE BOOK** explains everything. Send for your copy today.

MODERN SHOE REBUILDING SCHOOL
Approved for Vets. Established 1927. Dept. PM
2937 Belmont Ave., Chicago. 361-12th St., Oakland, Calif.
806 So. Figueroa St., Los Angeles 14, Calif.

BE A GOVERNMENT LICENSED AIRPLANE AND ENGINE MECHANIC Train Now at LINCOLN



EARN BIG PAY IN AVIATION

Our new enlarged school now offers these courses:
MASTER AVIATION MECHANICS, CAA Approved 1 Yr. Airplane & Engine Mechanics Course, **REFRESHER AIRPLANE & ENGINE MECHANICS**. Designed for veterans with aviation mechanics experience. Either course is available to veterans under the G. I. Bill of Rights. Write today for complete information.

LINCOLN AVIATION INSTITUTE

UNION AIR TERMINAL DEPT. P-5 LINCOLN, NEBRASKA

YOUR OWN

BUSINESS! WITH A FUTURE!

Get the facts
FREE!

a few cents
worth of materials
BRINGS YOU DOLLARS!!

Rich profits are waiting to be tapped in this new field. New **MIRACLE** finish gives a velvety, luxurious surface to radios, lamps, toys, signs, store displays, figurines, auto dashboards, and hundreds of other items. Make old objects beautiful and saleable — make new things worth much more with this soft, rich covering that can be applied to any surface, even if old and worn.



Have
**Your Own Lasting,
Successful Business—Be Your
Own Boss—Help Fill Huge Demand
... No Experience Is Necessary**

Yes, you can learn in a few days to start **MAKING MONEY!** Everything you need is furnished, including fully detailed, illustrated instructions that are complete and easy to understand. Every point is explained, to show you how to start on the road to big money, full or spare time, right in your own home.

EVERYTHING COMPLETE
In addition to full instructions, you get a complete set of materials that enables you to start at once. A few cents worth of materials can mean many dollars in return to you — you can earn up to \$500 or more per month full time; up to \$75 per week spare time.

ACT NOW
Grasp this opportunity **TODAY** — start your own business. It's too good to miss! **SEND NO MONEY** — fill out the coupon and stick it on a post card or in an envelope and mail today for full details, **FREE** sample of **FLOK-KRAFT** covered material, and hundreds of useful and profitable **IDEAS**. Do it **NOW** — be first!

**USE THIS
COUPON**

**SEND
NO
MONEY**

COAST INDUSTRIES

Dept. PM-5 1507 West Manchester, Los Angeles 44, Calif.
Please rush me all the details!

NAME _____
STREET _____
CITY _____
STATE _____

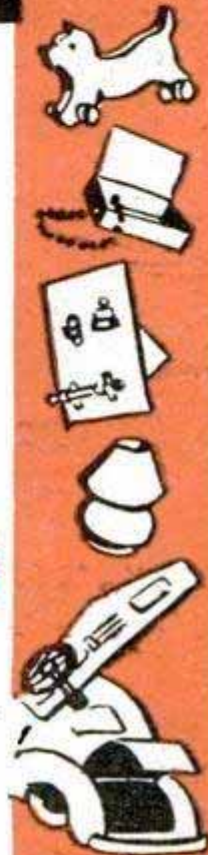

- TOYS
- JEWELRY BOXES
- DISPLAY PIECES
- LAMPS
- CAR DASHBOARDS
- CAR TRUNKS
- Covers Wood, Fabric, Metal, Plaster, Plastic Glass, or any Surface



YOU
can
acquire

LAW NIGHTS AT HOME! L. L. B. DEGREE

LaSalle's famous Law Library—used as reference in many Law libraries and Law offices—has enabled thousands to master Law surprisingly fast, in spare hours at home, for business and professional advancement.

These 14 remarkable volumes, compiled by leading professors and lawyers, cover the whole basic field of Law in condensed, orderly, simplified manner.

You advance rapidly with this great library, plus special lectures furnished. We guide you step-by-step with personalized Problem Method of instruction . . . you learn by doing—handling legal problems—not by memorizing rules.

Send for two FREE 48-page booklets, "Law Training for Leadership," and "Evidence," answering questions about Law and its value to you, and telling how LaSalle Law graduates are winning rapid advancement in business and public life. Mail coupon below. No obligation.

LA SALLE EXTENSION UNIVERSITY

A Correspondence Institution

417 S. Dearborn St. Dept. 564-L Chicago 5, ILL.

Send me your two FREE booklets described above, without obligation.

Name..... Age.....

Street.....

City, Zone & State.....

**FREE
BOOK**
TELLS HOW
TO BE AN . . .

*Accountant
Salesman
Secretary
Stenographer*

SECURED FUTURE . . . FREE EMPLOYMENT SERVICE

Enter one of the "substantial earnings" fields through Hill's "Success Plan" training. A lifetime opportunity to join thousands of successful graduates in positions secured through our nation-wide employment service. No matter where you live, what you are doing now, Hill's can train you by study at home or in the resident school. Big Free book shows you the way to substantial earnings and an assured future. G. I. Approved.

Hill's Extension School & Business University
Dept. PM-59, 619 W. Main St., Oklahoma City 2, Okla.
Please send your free book, "Through Hill's to Success."

NAME.....

ADDRESS.....

CITY..... STATE.....

Check here if eligible under G. I. Bill.

Please check course and training plan preferred.

Course..... Resident Home Study

EASY-TO-USE COUPON TODAY



MAIL ORDERS ARMY SURPLUS \$8.95 VALUE! BOOTS

IDEAL ALL WEATHER BOOT FOR WORK—SPORTS

LEATHER UPPERS—RUBBER BOTTOM

- Flexible double chrome, tanned, tough wearing leather uppers! • Leak-proof gusset tongue!
- Non-skid heavy duty rubber soles.
- Sizes 9-12-13-14

SAVE \$6
\$2.95

Reconditioned and LOOK LIKE NEW!
Shipping Weight 3 lbs.

NEW! MECHANICS TROUBLE LAMPS



50 FOOT CORD!

- 30 feet of Heavy Duty Rubber Coated Cord.
- Sturdy Switch built into handle.
- Heavy Duty Lamp Glass.
- 2 extra Plug-In lens sets included.
- Heavy duty steel wire guard.
- Removable Reflector Shield.

\$4.50 VAL. **\$2.95**
COMPLETE

Shpg. Wght. 3 lbs. 10 oz.

NEW—AUTO COVERS

WHITE DRILL—12" x 18" \$15 VAL. **\$8.95**

Shpg. Wght. 9 lbs. VAL.

NEW—100% WOOL BLANKETS



\$7.95
VALUE!

\$4.95

Soft, fleecy, warm. Closely woven nap, whipped ends. Ideal for every purpose.

Shipping Weight 4 lbs. Choice of GREY or KHAKI (30% Pure Wool—70% Pure Processed Wool)

NEW—DUAL TUBE PNEUMATIC SWIM FLOATS

FUN in the WATER with SAFETY! Use as a RAFT—PLAYBOAT—HEADREST—LIFESAVER. LEARN TO SWIM etc. Inflates by mouth. In original carton!

FOR KIDS ADULTS **59c**
\$1.95 VAL.

Shipping Weight 3 1/2 lbs.

SEND FOR FREE CATALOG—AMAZING VALUES!

UNIVERSAL ENTERPRISES

DEPT. 5 P.M., 946 S. MAIN ST. LOS ANGELES 15, CALIF.

ALL PRICES F.O.B. LOS ANGELES

1/3 Deposit on C.O.D.'s • Pay by Check or Money Order

HIGH POWER TELESCOPE

60 POWER—ALUMINUM TUBES—LENGTH OPEN 33"

Brings distant objects 60 times as close. Eye-piece adjustable to 3 different magnifications, 15X, 30X and 60X.

\$4.50



Leather Case Included

All 5 tubes made of hardened aluminum. 4 precision lenses. Also used as powerful microscope. Directions included. Money back guarantee. Only \$4.50 postpaid.

BROWSCOPE CO. Dept. 5M, 24 W. 45th St. NEW YORK 19, N. Y.

LIQUID STAINLESS STEEL

Anything. Apply like paint to Wood, Metal, Plaster, Concrete. Quick drying. Permanent. Protective. Eliminates corrosion. Entirely New Process. 1 1/4 Pint \$2.35, 1 Quart \$3.85, 1 Gal. \$12.00. Postpaid anywhere in U.S.

THOMAS HADLEY CO., Dept. PM-1, Box 91, Franconia, New Hampshire

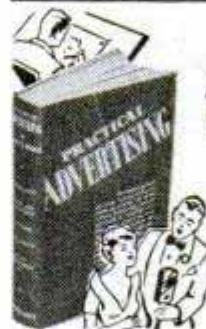

There's BIG MONEY in ADVERTISING!

Train at home in spare time

Let this big new 842-page book, PRACTICAL ADVERTISING be your "Open Sesame!" to one of the most glamorous, best paid jobs of all! Written for beginners by the president of a well-known ad agency. Self-test review questions, actual advertising assignments and over 300 illustrations guide you every step of the way. Helpful tips show how to make spare or full time ad profits!

RADIO—TELEVISION—PUBLICATION—DIRECT MAIL

Copy—Layout—Art—Production . . .

. . . all are fully and clearly explained by Harry Bridge, president of the Bridge Advertising Agency. Also, you get complete training in typography, sales letters, programming, catalogs, outdoor advertising, research, house organ editing, printing processes, displays, packaging and dozens of other subjects.

10 DAYS' FREE TRIAL! Just write your name and address in margin and mail. We'll mail PRACTICAL ADVERTISING and, after 10 days, you can send us only \$6.50 plus few cents postage or return book postpaid. Postage paid on cash orders—same return privilege.

Dept. **MURRAY HILL BOOKS, INC.** 232 Madison Ave. PM-59 New York 16, N. Y.

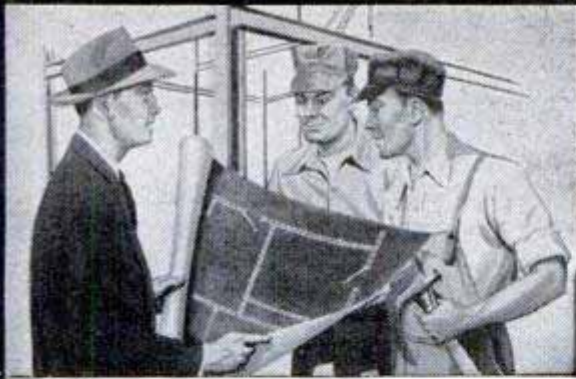

Learn BUILDING

AT HOME • All Blue Print Building Plans, Specifications, Lessons Furnished

Earn more money as a building tradesman. Prepare for advancement and increased pay as a building foreman, superintendent, inspector, estimator, material buyer or salesman. Train to be a building contractor, have your own money-making business in this busy, prosperous building field.

More than 19 million new homes needed in U. S., say experts. New building now at rate of one million homes a year, plus 200,000 commercial buildings, plus expanding farm building construction.

Mail coupon today. FREE book tells how you learn Building Construction — How to Read Blue Prints, and Estimate Building Costs — at home in your spare time. Learn modern construction methods and materials, how to lay out work and direct all building operations. This is the training needed for rapid advancement to higher-paid jobs, or your own successful building business.

FIND OUT ABOUT TRAINING AND OPPORTUNITIES FOR YOU IN BUILDING

Established in 1904, Chicago Technical College offers you thorough, practical training in Building, by home-study. Mail coupon for free information. See what this Course has done for others, what it can do for you. Read what Chicago Tech graduates say about their work, earnings, success. Learn the rewards awaiting you as a trained builder—and how quickly, easily you can get started. Simply MAIL COUPON TODAY in an envelope or paste on a penny postcard.



CHICAGO TECHNICAL COLLEGE
Tech Building, 2000 South Michigan Ave.
Chicago 16, Illinois

MAIL COUPON NOW

CHICAGO TECHNICAL COLLEGE
E-153, Tech Bldg., 2000 So. Michigan Ave.
Chicago 16, Illinois

Mail me FREE building Lesson with information about big opportunities in BUILDING and how I can train at home.

Name _____ Age _____

Address _____

City _____ Zone _____ State _____

NEW FLUORESCENT FIXTURE with CIRCLINE LAMP!



GUARANTEED FOR 1 YEAR!

A strikingly beautiful fixture in polished aluminum finish. Suitable for every room. Model C-32AP (illustrated), \$8.95. Model C-32S with etched glass shade, \$12. Sent POSTPAID anywhere in the U. S. upon receipt of cash order. C. O. D.'s sent F. O. B. factory.

Write for free literature on full line. **\$8.95**

HANOVER
Box 186D LIGHTING
Dept. ME, Hanover, Pa. SALES **POST PAID**

SALESMEN!

10-Second
Demonstration
Nets You
\$9.95



Yes — Storekeepers now "Write with Light" — wipe off and write new sign — all in 10 seconds. Fastest seller in years. 10-second demonstration pays you \$9.95 cash in advance. Orders pour in HAND-OVER-FIST. Get started in your territory while "LITEWRITER" is brand new and hot as a pistol.

Litewriter "MAGIC CRAYON"
MAKES SIGNS THAT GLOW LIKE BRILLIANT NEON!

Merchants everywhere — in small town and big city — all stare with amazement at this newest of all Fluorescent Sensations! They write on glass with "MAGIC CRAYON" — and Presto! — before their very eyes — there's a 5-color Advertising Message that glows like a brilliant Neon Sign!

FREE! Complete Sales Kit. Send name on penny postcard NOW for Big FREE Sales Kit and Free offer of Sample Demonstrator. No cost now or ever. Rush postcard now.

MAXILUME CO., 125 W. Hubbard St. DEPT. L-85 CHICAGO 10, ILLINOIS

CORRESPONDENCE COURSES IN RADIO and ELECTRICAL ENGINEERING

Tuition **\$25**

ELECTRICAL ENGINEERING. Get good grasp of wide electrical field. Modern. Very understandable. Theory made easy.
RADIO ENGINEERING. Extra fine course in radio, public address, photo-electric work. Trains you to be super-service man, real vacuum tube technician. Tuition ONLY \$25, either course. Deferred payment plan. Servicemen needed badly.
FREE Electronic Kit given to students enrolling by June 1st. Write for free copies of school catalogs, student magazines, etc.
LINCOLN ENGINEERING SCHOOL, Box 931-PM-5, Lincoln, Nebr.

SAVE 1/3! POWERBIKE

DIRECT FROM FACTORY TO YOU

Nationally known — Makes your bike a speedy streamlined Powerbike at new low cost. Ideal for work and play! Write for FREE LITERATURE!



SAGINAW PRODUCTS CORP.

108 RIVER ST., SAGINAW, MICHIGAN



• Northrop engineering students in a huddle on design for rudder of student project aircraft—a scene to be repeated many times in their careers.

CREATIVE or PRACTICAL

• Making channel bending tests, measuring loads with dynamometer—a practical training assignment that duplicates actual engineering duties.



There's a Big Future for You in AERONAUTICAL ENGINEERING

► From drawing board through flight test, engineers of many different talents bring new aircraft into being. The choice of many *creative* duties, or of many *practical* kinds of work, is open to you in the interesting career field of Aeronautical Engineering.

► You have wide opportunities for specialization. Design, Aerodynamics, Structures, Stress Analysis, Hydraulics, Electronics, Power Plants... these are only a few of the fields *within* Aeronautical Engineering. Your rewards—in achievement and earnings—can be great. You can write your own ticket for the future.

► Northrop gives you the training it takes to grasp this big opportunity... training right in the midst of important research, development, engineering and manufacturing activities. Get complete information NOW.

Send Coupon for Catalog



Northrop Aeronautical Institute
 Division of Northrop Aircraft, Inc. James L. McKinley, Mng. Dir.
 1527 E. Broadway, Hawthorne, Los Angeles County, Calif.

APPROVED FOR VETERANS

NORTHROP AERONAUTICAL INSTITUTE
 1527 E. Broadway, Hawthorne, Los Angeles County, Calif.

Please send me the Institute catalog and complete information, including starting dates of classes. I am interested in:

Aeronautical Engineering • Aircraft & Engine Mechanics

Name _____ Age _____

Address _____

City _____ Zone _____ State _____

Check one: Veteran Non-Veteran

SAY YOU SAW IT IN POPULAR MECHANICS

REPAIR

— RANGES • SHAVERS
 • HEATERS • IRONERS • WASHING MACHINES
 • WASHERS • MOTORS • TOASTERS • FANS
 • VACUUM CLEANERS • AIR CONDITIONERS
 • REFRIGERATORS • SUN LAMPS . . . AND ALL
 TYPE MOTORS FROM FRACTIONAL H.P. TO 2 H.P.



THE MODEL 50 ELECTRIC TESTER

Tests Thermostats under ACTUAL WORKING CONDITIONS: Measures the ACTUAL CURRENT CONSUMPTION of any appliance either A.C. OR D.C. WHILE THE UNIT IS IN OPERATION—reading will be direct in amperes. Incorporates an ultrasensitive direct-reading resistance range which accurately measures all appliances and utility resistances. Indicates excessive leakage between motor and line. Will measure the actual voltage and indicate whether the current is A.C. or D.C. and if the frequency is 25 cycles or 60 cycles.

The Model 50 Utility Tester comes housed in a round cornered molded bakelite case. Complete with all test leads and operating instructions—only.....

\$13.90

Sold on money-back-if-not-satisfied basis.

20% DEPOSIT REQUIRED ON C.O.D. ORDERS

GENERAL ELECTRONIC DISTRIBUTING CO.
 DEPT. PM-5 98 PARK PLACE NEW YORK 7, N. Y.

A "REEL" BARGAIN WHITE DUPONT NYLON FISHING LINE WAXED

only **\$1.35** post paid

APPROXIMATELY 1500 FEET!
 25 LB. BREAKING STRENGTH!

\$1.35 PER CONE DELIVERED

35 lb. test—white—400 ft. 95c ppd.
 45 lb. test—white—400 ft. 95c ppd.
 72 lb. test—braided white or black—300 ft. \$3.00 ppd.
 100 lb. test—braided white or black—300 ft. \$3.50 ppd.

Amazing rot-proof fishline! Never before offered at these low prices! A must for every fisherman!

CATALOGUE ON REQUEST

MONEY BACK GUARANTEE

Send check or money order.
 J. B. SMITH, Dept. PM
 667 Broadway New York 12, N. Y.

NEW—at Amazing Savings

Steel AMO BOXES

Ideal for tool chest, fire safe, bait, camping, etc.
 CAL. 30 MI—10" long x 7" high x 3 1/2" wide. Wt. 3 1/4 lbs. Handle and snap lock. ONLY



49c each

PLASTIC BATTERIES

Wonderful for spotlight, bench testing car radios. Many other uses. 11 plates per cell. 6 volts—40 amps. Wt. 12 1/2 lbs.



\$3.75

GASOLINE ENGINES

for Home, Farm, Factory. Unexcelled for use with pumps, bench tools, lawnmowers, etc. 1 1/2 H.P. G.E. 4 cycle—sircooled, ball bearing, rope starting. Wt. 36 lbs.



\$37.50

PRICES F.O.B. NEW YORK CITY. SEND CHECK OR M.O. TODAY.
ACE EQUIPMENT CO., 307 Canal St., N.Y.C.

LET ME SEND YOU ALL OF THIS...



OWN YOUR OWN BUSINESS
 Servicing Electrical equipment, appliances, etc. Work full or part time. Collect up to \$5-\$6.00 an hour!

NEW SHOP METHOD
 Home Training System. Call on friends, neighbors, etc. Carry back to your work bench their Sewing Machine, Iron, etc. Use the Christy Course and Christy Electronic Kit to help you locate the trouble and fix it. I also show you what to charge as YOUR PROFIT!

RUSH Name TODAY For FREE BOOK
Mr. S. T. Christensen CHRISTY TRADES SCHOOL
 2835 N. Central Ave. Dept. D-6903 Chicago 34, Ill.

Learn RADIO-TELEVISION In Your Own HOME WORKSHOP

Build interesting Radio Circuits, acquire real experience, do scores of practical experiments—all through RTA's complete balanced training plus 10 BIG KITS of parts which RTA GIVES YOU! Get finest instruction direct from Hollywood, nerve-center of broadcasting, television and radio activities.

FREE BOOK
 Send postal for complete details plus FREE BOOK "How to Make Good in Radio-Television."

RADIO TRAINING ASSOCIATION OF AMERICA
 5620 Hollywood Blvd. Dept. 5-PM Hollywood 28, Calif.

LIQUID MARBLE COMPOSITION FLOORS FLEXIBLE MOLDS
 MOLD Novelties, Statuary, Art Goods in Flexible Plastic Molds; 5c material makes \$1 seller. Make Marbleized floors, Tile Walls. Colorful, glossy, amazing! Easily learned; start in garage or basement. Particulars free.
MARBLEIZING SERVICE, Dept. 10-F, Edwardsville, Ill.

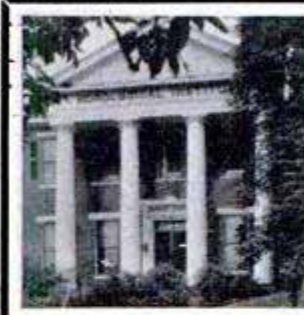

THE WORLD'S LARGEST WATCHMAKING SCHOOL GIVES YOU:

- G.I. APPROVED, NATIONALLY ACCREDITED COURSES
- MOST ABUNDANT WORKING AND TRAINING FACILITIES
- INDIVIDUAL INSTRUCTION BY EXPERIENCED FACULTY
- FREE PLACEMENT SERVICE FOR PART-TIME WORK AND HOUSING DURING TRAINING
- FREE EMPLOYMENT SERVICE UPON GRADUATION
- COMPLETE SET OF WATCHMAKER'S TOOLS TO VETERANS
- \$100 BONDED GUARANTEE OF PROFICIENCY TO PROSPECTIVE EMPLOYERS.

SEND FOR FREE 116-PAGE INFORMATION PACKET
WESTERN PENNSYLVANIA HOROLOGICAL INSTITUTE, INC.
 DESK 40, 808 RIDGE AVENUE PITTSBURGH 12, PA.



BURN WATER IN YOUR CAR
 Amazing Acceleration—Smoother Performance

- The OCTA-GANE Water Injection Carburetor gives you:
1. HIGHER SPEEDS—MORE POWER
 2. COOLER, CARBON-FREE MOTOR
 3. DECREASED ENGINE WEAR
 4. MORE MILES PER GALLON
 5. SMOOTHER ENGINE—NO PING
- THOUSANDS IN USE
 Completely Automatic

The OCTA-GANE Injection Carburetor is engineered in solid bronze—has stainless steel water supply tank and quick-installation fittings. Built to last a lifetime. Soon pays for itself. Only \$24.95 complete. Mail coupon today. Send for free catalogue. DEALERS: Write for discounts in case lots.

NEWHOUSE AUTOMOTIVE INDUSTRIES
 5805-B6 EAST BEVERLY BLVD., LOS ANGELES 22, CALIF.

Newhouse Automotive Industries
 Gentlemen: Please ship me immediately one complete OCTA-GANE system.

\$1.00 enclosed, pay balance c.o.d.
 \$24.95 enclosed, ship fully prepaid. (PLEASE PRINT)

Name _____
 Address _____
 City _____ State _____
 Make, Year & Model Car _____



DIESEL is Going Places Come Along!

Yes, Diesel is a trade with a future. Look at the way trains, busses, boats, trucks, factories... everywhere... are changing to Diesel Power. It is going to take man power to keep the engines going. That means a great demand and great opportunities for the Diesel-trained man! That man can be YOU, if you are an average, ambitious, mechanically-inclined man.

KEEP YOUR JOB—LEARN AT HOME!

You don't have to give up your present job to learn Diesel. With U. E. I. training, you get complete fundamentals in practical, easy-to-understand home-study lessons. Includes operation, fuel systems, repairs, auxiliary equipment, etc. You may also get practical training in our modern, well-equipped shops. Experienced Diesel men show you short-cut methods, help you learn faster. High school diploma not necessary. Our 22nd year.

Success Demands Action, Act Now!

If you want to go places with DIESEL, act promptly. Fill out and mail coupon below for all the facts. No obligation. Do it AT ONCE!

Utilities Engineering Institute
 Diesel Division, 2521 Sheffield Avenue
 Dept. DC-2, CHICAGO 14, ILLINOIS

UTILITIES ENGINEERING INSTITUTE
 Diesel Division, 2521 Sheffield Ave.
 Dept. DC-2, Chicago 14, Illinois

YOU BET, I want to go places with Diesel! Rush FREE FACTS on U. E. I. training and Diesel opportunities.

NAME _____ AGE _____
 ADDRESS _____
 CITY _____ ZONE OR COUNTY _____ STATE _____
 Check here for special information if you are under 17.



Carve for Fun and Profit! No skill needed with Dumore Carvit

Anyone can make woodcarvings with a Carvit! It copies low-cost models you can buy in any dime store. The result—beautiful ornaments, unusual gifts, fine carvings that sell. Write for Free folder with full details

The Dumore Company
 Dept. E-51 Racine, Wisconsin

\$ AGENTS 300% Profit SIGN LETTERS

For Store Fronts and Office Windows. Anyone can put them on. Free Samples. Liberal Offer to General Agents.
METALLIC LETTER CO., 430 N. Clark, Chicago 10

**Sensational
New Electric**

**① WELDER
② CUTTER!**

**NOW!
10 DAY TRIAL** **BOTH only
\$12**



Uses 110-115 AC or DC

WELD - BRAZE - CUT

MELT - SOLDER - HEAT TREAT

WELDRITE furnished complete with Converter Unit, #1 Single Holder with attached Alligator clip, for welding metal up to 3/16" thickness, using up to 3/32" rod, and #2 Double Holder with Copper Coated Dual Carbon Electrodes for Cutting, Brazing, Heat Treating, Soldering, etc. Starting welding materials and instructions included.

Ideal for home workshop. Invaluable for body and fender shops, garages, repair and machine shops, manufacturers, etc.

WELDER HOOD
With Wilson Weld Lens No. 10, approved by American Optical Company. Used in Hoods costing to \$10, only **3 95**

NAME _____

ADDRESS _____

SEND NO MONEY! 10 DAY TRIAL OFFER \$12 plus P.O. charges. Order your WELDRITE Electric WELDER-CUTTER C.O.D. today. Pay postman \$12 plus postage charges (wt. 4 lbs.) or send \$12 and we pay postage. Either way, if not satisfied, return WELDRITE in 10 days, and money will be refunded. WELDER HOOD—Approved lens found in hoods costing to \$10—only \$3.95. California orders please add 2% sales tax. **CALIFORNIA TECHNICAL PRODUCTS CO.** 448 So. Hill St., Los Angeles 13, Calif. Dept. A-5

- Send Weldrite C.O.D. \$12 plus P.O. charges.
- Send Weldrite & Hood C.O.D. \$15.95 plus chgs.
- Send Weldrite postpaid. I enclose \$12.
- Send Weldrite & Hood postpd. I enclose \$15.95 Same 10 day Trial Offer
- Send Free Folder.

**Get into BUSINESS
for Yourself!**

**METALIZING
BABY SHOES
AT HOME IN
SPARE TIME**



Get facts now about amazing money-making Warner Success Plan that shows you every easy step in completely charted path to personal independence—with your home as your headquarters... This proved and tested Plan is working like magic. It's backed by an old, reliable company... And we send it to you on a No-Risk Trial Money Back Guarantee.

QUICK CASH WAITING
Demand for METALIZED Baby Shoes and other keepsakes is growing bigger daily. Our Tested Plan Shows How to Do the Work, How to Bring in the Business, How to Make as much as \$5 an Hour. Spare or full time, big steady profits are waiting for you. Send penny postcard or mail coupon for FREE Facts. Act! Time is precious.

**FREE
offer of
COMPLETE
MONEY
MAKING
PLAN
•
SEND NO
MONEY
Just Mail
COUPON**

Ray Brandell, Mgr., Warner Electric Co.
1512 JARVIS AVE., DEPT. 35, CHICAGO 26, ILL.

Please rush complete details about your No-Risk Trial Money Back Plan for Metalizing Baby Shoes. Everything you send is FREE and costs me nothing—now or ever.

NAME _____

ADDRESS _____

CITY _____ ZONE _____ STATE _____

Say You Saw It in Popular Mechanics

**BUILD IT — FIX IT
WITH
AMBROID**



"IT STAYS STUCK"

Since 1910 Ambroid Cement has been the Standard product in its field. Ready-to-use, quick drying Ambroid is Waterproof, Transparent, Flexible, Extra Strong. Heat and Corrosion Resistant. Hobby enthusiasts and Industry alike use Ambroid. For assembling and repairing, keep Ambroid handy. At your supplier or send 25c for big 2 oz. tube postpaid. Money back guarantee.

Also 50c 4 oz. tube. Pts. qts., gals., for industrial use.



303 Franklin St., Boston 10, Mass.

**TRAINED MEN GET THE BETTER JOBS
PRACTICAL SHOP TRAINING
in AUTOMOTIVE MECHANICS
BODY and FENDER REBUILDING**

If interested write for catalog or wire

ATLANTA MOTIVE TRADES INSTITUTE

Dept. P, 254 IVY St., N.E., Atlanta, Georgia
Member of the Southern Association of Private Trade Schools
Veterans ask about G I Training



Balance 4" x 9" Base. With either \$8.00 Metric or Avoirdupois Weights ..

Catalog with 3000 illustrations of laboratory apparatus, and over 10,000 prices sent for \$1.50.

LABORATORY MATERIALS CO.
7321 Vincennes Ave. Chicago 21, Ill.

PUSH-BUTTON POCKET KNIFE

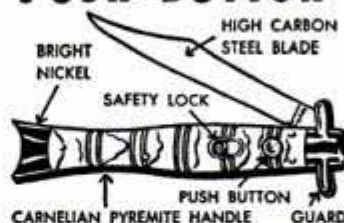

Quick as a flash, blade flies open when you push button! Finest quality high carbon steel blade, mirror finished — Brass lining. Beautiful Carnelian Pyremite handle with bright nickel trim and guard. 3" blade can be locked open or closed. Overall length 4". Only \$4.50 postpaid. Send check or m. o. to Fine Cutlery, P.O. Box 1833, Wilshire-LaBrea Station, Los Angeles 36, California.

AXLES. Save money. Build your own trailer or utility wagon with these new axles.

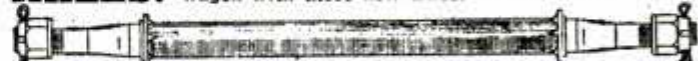

58" thread standard. 1 1/2" x 1 1/4" sq. tube. 2000 lbs. capacity. Sold direct at factory price. Send check or money today. **\$6.75** F.O.B. Detroit
East Side Mfg., 2444 Mt. Elliot, Detroit 7, Mich.



**REPLACE Old wood or metal venetian blind slats with
LIFE TIME FLEXIBLE STEEL**

24 beautiful baked enamel colors to choose from in all sizes. Write for color book and full information and a free 12 inch ruler.

LIFE TIME PRODUCTS CORP.
P.O. Box 2742 631 E. Florence Ave.
Haselton Sta. or Los Angeles 1,
Youngstown 8, Ohio California

USE **Nu-Glaze**
INSTEAD OF PUTTY!



Nu-Glaze
REALLY STAYS PUT!

Here's the perfect material for all types of glazing. Nu-Glaze is applied like putty, but it does not dry out, harden, crack or peel. Requires no working up. Clean to handle. Sets to a rubber-like consistency . . . always "stays put."

**IDEAL FOR BOATS AND
MANY OTHER USES!**



GLAZING WOOD & STEEL SASH, RE-
PLACING OLD PUTTY, FILLING CRACKS,
SETTING PLUMBING AROUND PIPES, SINKS, BATHTUBS.



MACKLANBURG-DUNCAN CO.
OKLAHOMA CITY 1, OKLA.

SOLD ONLY THROUGH HARDWARE
STORES, BUILDING SUPPLY DEAL-
ERS AND LUMBER YARDS.

THE GREATEST
THING IN
PLASTICS!

PLASTICAST



A NEW HOME INDUSTRY AND HOBBY!

PLASTICAST is a transparent liquid plastic; can be poured into ANY kind of mold or container. Hardens in a few minutes into a transparent solid, clear-as-glass, tough as steel plastic! No tools, machinery or skill required. **IDEAL** for imbedding pretty flowers, butterflies, photos, medals, souvenirs, biological specimens, etc. Makes a **PERMANENT** and **ATTRACTIVE** display. Make attractive jewelry, gems, lenses, knock-knacks, novelties. Easily cast into sheets, rods, blocks, ANY color, ANY shape! **EVERYTHING** furnished, including molds, for making about \$50.00 worth of unusual novelties! **PLASTICAST OUTFIT, Complete \$3.50 with 3 molds. Illustrated Instruction Manual included.**

Our Casting Plastics are as easy to use as pouring water out of a glass! **PLASTIDUR . . . (LIQUID IVORY).** Ideal for casting all OPAQUE articles. Hardens in a few minutes into an extremely hard IVORY-like plastic! May be dyed any color or cast into any shape. Works in **EVERY** type of mold! Non-inflammable, waterproof. **DURABLE.** Ideal for statuary, novelties, figurines, toys, gadgets, tools, knobs, bases . . . a million useful applications! Outfit comes complete with molds, dyes, accessories, instructions, etc. for making about \$100.00 worth of attractive jewelry, etc! **\$5.00**

PLASTIDUR OUTFIT, Complete with 3 molds \$5.00

TERMS: We pay the postage (U.S.A.) if full cash accompanies your order. C.O.D. accepted (U.S.A. only) if \$1.00 deposit is included for each item ordered. C.O.D. orders not postpaid. A very attractive novelty made with one of above plastics **FREE** with our **BIG** catalog! Catalog lists largest selection of **MOLD MAKING and CASTING** materials in the **WORLD!** Liquid Plastics, Liquid Ivory, Liquid Marble, Liquid Glass, Ceramics, Liquid Porcelain, Moulage, Latex, Multiplex, Etc. Also Sheetcraft, Internal Carving, Plastics, Glazes, Jewelry Accessories, etc. Price of catalog only 10¢ U.S.A. (25¢ Canada).

DEALERS: WRITE FOR ATTRACTIVE WHOLESALE PRICE LISTS
PLASTICAST CO. (Dept. C)

4637 N. Kedzie Ave. Write to P. O. Box 987
Chicago 25, Illinois Nearest Address Palo Alto, Calif.
CANADIAN CUSTOMERS, please order directly from: Canadian
Industrial Plastics, Ltd., 1056 1/2 Pender, West Vancouver, B. C.

"THE KEY TO METAL BUMPING"



Complete course in famous Fairmount method of body and fender repair. Step by step procedure from damage analysis to metal finishing. Over 100 illustrations. Send \$1.00 to

MANZEL, INC., 315 Babcock St., Buffalo 10, N. Y.

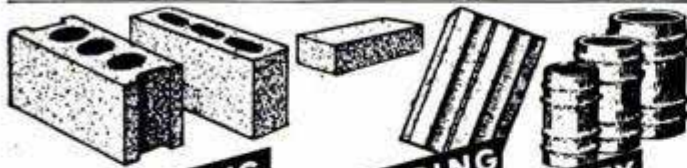

**OUTSTANDING
MANUFACTURING
OPPORTUNITY**

**YOU CAN
Get in this Growing Industry**

The great building industry is your profitable market for masonry products. Low investment . . . high returns . . . wide-open opportunity to establish a lifetime business.

The biggest building years in the nation's history are just beginning. New construction, involving billions of dollars, means huge demands for block, drain tile, and other masonry products which **YOU** can manufacture locally, from local materials with local labor for local consumption. Remember, **MASONRY** products mesh with today's building demands.

Use our modern machines and equipment to insure the finest quality products at pared-to-the-bone manufacturing costs. Sold direct from factory to you. Backed by 40 years of pioneering and manufacturing. Liberal selling cooperation.

Write for catalog.
Gives prices and
full information.

CONCRETE EQUIPMENT CO.
512 Ottawa Ave., Holland, Mich.

STAMMER ?

This new 128-page book, "Stammering. Its Cause and Correction," describes the Bogue Unit Method for scientific correction of stammering and stuttering—successful for 48 years. **Benj. N. Bogue, Dept. 4914, Circle Tower, Indianapolis 4, Ind.**

GET THIS
FREE
BOOK!



**ART FOR
PLEASURE
AND PROFIT**

Here's How You Can Learn at Home
in Your Spare Time To **BE AN ARTIST**

Trained Artists Are Capable of Earning
\$60, \$85 AND MORE A WEEK

**COMMERCIAL ART, DESIGNING, CAR-
TOONING**—all in one complete home study course. You can become your own boss. Many students earn extra money while learning by designing posters, rendering signs, lettering, etc. **W.S.A.** is now in its 35th successful year. No previous art experience necessary, we teach you step-by-step. **TWO ART OUTFITS** included with training. **FREE BOOK, "Art for Pleasure & Profit"**—tells about our course, instruction, what our graduates say, and commercial opportunities in Art. Low tuition—easy terms.

VETERANS! Course G.I. Approved

FREE BOOK gives details

Washington School of Art, Studio 125R
1115—15th St., N.W., Washington 5, D. C.

Please send me full information and your Free Book
"Art for Pleasure and Profit."

Name _____ Age _____

Street _____

City _____ Zone _____ State _____

I am entitled to training under the G.I. Bill





U. S. Army Air Force Type SUN GLASSES

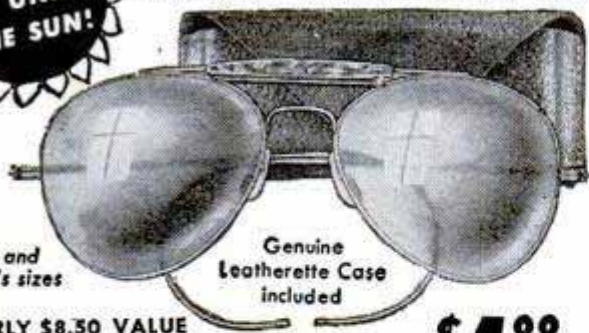

Men's and Women's sizes

Genuine Leatherette Case included

FORMERLY \$8.50 VALUE

Super-Sensationally Priced at only... **\$1.88**

postpaid

- ★ Cool green meniscus curved, polished lenses.
- ★ Gold Plated adjustable frames
- ★ Pearlloid Sweat-bar and Nose-pads
- ★ Reinforcing bar for greater durability
- ★ Lenses meet specification of U. S. Gov't. Bureau of Standards.

LIFETIME GUARANTEE

Included with every pair of glasses

10-DAY TRIAL • MONEY-BACK GUARANTEE

CHICAGO GOGGLE SALES CO., Dept. 110
20 E. Delaware Pl., Chicago 11, Ill.

Please send me.... Men's.... Women's Sun Glasses.

- Send C. O. D.
 Enclosed find \$..... Mail Postpaid.

MAIL THIS

COUPON TODAY!

Name.....
Address.....
Town..... State.....



U.S. GOVERNMENT JOBS



START AS HIGH AS \$3,351 YEAR

Many Early Examinations Expected. Prepare NOW! Veterans Get Special Preference! 40 Page Civil Service Book FREE Mail Coupon Today SURE

Franklin Institute
Dept. P85
Rochester 4, N. Y.
(Not Government Controlled)

Gentlemen: Rush to me, FREE of charge, list of U. S. government big pay jobs. Send FREE 40-page book describing salaries, vacations, hours, work, etc. Tell me how to qualify for one of these jobs.

Name.....
Address..... Vet?.....

See for MILES with the REMARKABLE RANGER TELESCOPE!



See 5 Times Larger **\$2.00**

See 5 Times Closer POSTPAID

- RACING Super telescope with brilliant definition—2 highly polished lenses—2 brass, nickel plated sections—rugged, handsome, compact, lightweight. Money back guaranteed!
- HUNTERS
- SPECTATORS
- BOY-SCOUTS

EYE-GLASS PRODUCTS, INC., PM-1
29 E. Madison St. Chicago, Ill.



LEATHERCRAFT FOR FUN FOR PROFIT

Make your own Leather Novelties, Belts, Bags, etc., in spare time. A hobby you will love. Complete kits and equipment for tooling, carving and embossing at very low cost. Send 15c for catalog describing tools, leather and instructions. Your 15c refunded on 1st order.

JONAS HANDICRAFT CO. (Dept. M-2), 32 Frankfort St., New York 7, N. Y.

ELECTRICAL TRAINING

Intensive 32 weeks' residence course in fundamentals of industrial electrical engineering, including radio, electronics. Prepares for technician, engineering aides. Approved for veteran training. 56th year. Enter September 6, January 9. Catalog.

BLISS ELECTRICAL SCHOOL
7632 TAKOMA AVENUE
WASHINGTON 12, D. C.

MAKE MONEY MAKING DOUGHNUTS

Make new greaseless doughnuts at home on electric machine. Sell for cash to grocers, cafes, drug stores, etc. No exp. nec. Good profits. Small investment. Send for free recipes and plans.

MART RAY CO. • 3605 S. 15 Ave. • Minneapolis 7, Minn.

GET THIS FINE SUIT NO MONEY TO PAY!



BIG CASH EARNINGS, TOO!

Big news! This fine tailored suit yours without paying one cent—and big cash earnings, too! It's easy! Just take a few orders. Earn up to \$10 in a day and get your own suit as extra bonus. Dozens of rich new fabrics, superbly tailored in latest styles, at low prices produce orders on sight. Money-back guarantee. FREE SAMPLES! Write today giving name, address, age, etc. for big complete outfit of actual samples and details of amazing new BONUS SUIT and money-making plan—All Sent Free! No experience. SEND NO MONEY! W. Z. GIBSON, Inc. 500 S. Throop, Dept. S-516, Chicago 7, Ill.

RUPTURE RELIEF

Advanced method. No leg straps, no elastic, no steel. Entirely different. Guaranteed. Write: SMITH MANUFACTURING COMPANY DEPT. PM PRESTON, ONT., CAN.

LAWN ORNAMENT-NOVELTY PATTERNS

28 Lawn Ornament Patterns, 25c. Other patterns; 15-20" high; Dutch Girl, Dutch Boy, Pirate, Bull Terrier, Mexican Girl, Mexican Boy, Dwarf, Penguin, Flower Girl, 10c each. 25 Novelty Patterns, 30c. All 62 Full Size Patterns, \$1.00 Postpaid. Strother Pattern Service, Dept. AZ-8, Box 128, Belington, W. Va.

Say You Saw It in Popular Mechanics

Mechanics! Repairmen! Hobbyists!

10 DRAWER All-Steel CABINETS

12 section steel drawers with adjustable dividers. Size 16 1/4" wide x 8" high x 10" deep—drawers 1 1/2" deep with card holders. All electric welded in brown hammeroid finish.

At your dealers or write direct

MODEL BOX and CABINET COMPANY
205 WEST WACKER DRIVE CHICAGO 6, ILLINOIS



\$11.75

INSURE YOUR FUTURE

• toolmaking
• drafting
• design

KEY POSITIONS OPEN



- MACHINIST TRADE
- TOOL & DIE MAKING & DESIGNING
- DRAFTING TOOL ENGINEERING
- PRODUCT ILLUSTRATION & DESIGN
- HOME STUDY—DRAFTING

ENDORSED BY INDUSTRY
APPROVED FOR VETERANS

Write for FREE Catalog
A 1¢ Postcard will do.

ALLIED SCHOOL
OF MECHANICAL TRADES, INC.
1338-1340-1342 So. Michigan Avenue
425 Allied Building • Chicago 5, Illinois

INDUSTRY
YOU CAN TRAIN AT
ALLIED'S BIG SHOPS OR
STUDY AT HOME UN-
DER ALLIED'S SUPER-
VISOR HOME PLAN

**SPEED & MILEAGE
MANUAL**

125
Illustrations



EASILY OBTAIN GREATER
SPEED, MILEAGE, RACING
PERFORMANCE FROM
ANY AUTOMOBILE!

Famous new book shows simplified
soup up methods—Speed Tuning—
Mileage Secrets—Economy Tips!
All about engines, "Economy Tuning," Restyling, "Racing Tricks"—Fuels!
Reveals Track Proven Methods that will give your car thrilling new get-
away—with up to 30% more speed and mileage!
Also shows latest "Hollywood Custom Styling" methods, streamlining sport
changes! Money-saving Speed Conversions! Includes California Roadster
Plans! Working Drawings! Speed Catalogues! Photographs! Complete
Data—PLUS "Beautiful Custom Car & Hot Rod Pictorial Supplement!"
SATISFACTION GUARANTEED—ONLY COMPLETE \$1.98 Post-
BOOK OF ITS KIND. ONLY..... paid

ALMQUIST ENGINEERING, Milford 80, Penna.



HAMSTERS

LET THE PROLIFIC GOLD-
EN SYRIAN HAMSTER earn
you a steady income. Tremendous
laboratory and pet market; 1000's needed. No experi-
ence required. Can be easily raised anywhere. Clean, odorless.
Send 25c for illustrated "Hamster Handbook" or \$5.00 for pair
and Handbook. F.O.B. Mobile, Ala.

Azalea City Hamstery, 1412 East Linwood Drive, Dept. F, Mobile 18, Alabama

NEW! Miracle GOLF CLUB!
THE All-In-One CLUB!

Saves strength—adjustable head plays all shots, driving iron through niblick and putter. Saves caddy fees, costs only small part of set of clubs and bag. Precision engineered of finest tool steel, with perfect balance. Change position of head in seconds! Play all day without tiring. 3 lengths—36", 37" and 38". Left hand clubs also available. You haven't enjoyed golf until you play with a Miracle. Try it for ten days at our risk—if you aren't more than satisfied, return it for full refund. Only \$19.95 postpaid. Absolute satisfaction guaranteed. See your dealer today, or order direct.



GOLF PRODUCTS, INC.
82 W. WASHINGTON ST., ROOM 404-A
CHICAGO 2, ILLINOIS

JUST IN TIME FOR GRADUATION!

1949 **NEW**
Royal Portable Typewriters
Arrow Model

Full Size Office
Typewriter
Keyboard and
Controls



BUY NOW
ONLY
\$79.50

Plus \$4.98
Fed. Exc. Tax

Royal-World's No. 1 Typewriter. Students make 10 to 30% Better Marks when work is typed. Perfect for Homemakers, Business-people, Doctors, Nurses, Bowling Secretaries, etc. FREE TOUCH TYPING BOOK. FREE CARRYING CASE.

CLIP THIS COUPON

OFFICE EQUIPMENT SERVICE COMPANY

111 S. Fourth Avenue
Ann Arbor, Michigan

Please rush _____ Royal Arrow Model Portable Type-
writers at \$84.48 each; (postage prepaid in: money order
or check send C.O.D.—and I'll pay postman \$84.48 plus
C.O.D. fees.

Name _____
Address _____
City _____ Zone _____ State _____

**Barber's Dream About Hair
Comes True After 40 Years!**

As a young man, I was beginning to get bald. I decided to find a cure. After many years of research I discovered that I COULD GROW HAIR! In 40 years of barbering, thousands of cases of scalp and hair trouble came under my observation. Result—a remedy to grow hair. If you suffer from dandruff, itching scalp, falling hair, or baldness, HODER'S HAIR REMEDY will help you. It won't grow new roots, but it will restore old ones! It will grow hair if you have fuzz on your scalp. It will banish dandruff, itching, further loss of hair. HODER'S HAIR REMEDY contains no alcohol, no coloring, no odor, no harmful ingredients. Use it on every member of your family.



HODER'S HAIR REMEDY

999 LONG BEACH ROAD, OCEANSIDE, L. I., N. Y.

Mail this coupon now and receive a full 3 months supply. You will thank me for the rest of your life. The price is only \$3 plus 60 Fed. tax. Phone orders accepted in N. Y. Phone Rockville Centre 6-10378.



HODER'S HAIR REMEDY Dept. PM5
999 Long Beach Road, Oceanside, L. I., N. Y.
Please send me immediately _____ bottles of
Hoder's Hair Remedy @ \$3.60 Per Bottle.
 Check Money Order C.O.D.
If prepaid, Hoder's Hair Remedy will pay postage.
No C.O.D.'s outside U.S.A.

Name _____
Address _____
City _____ Zone _____ State _____

DEAL DIRECT WITH WARNER

ELECTROPLATING

EQUIPMENT AND SUPPLIES - FACTORY TO YOU!



TANK PLATERS

5 to 100 Amps

Finest quality made. Post-war engineered for lifetime of use. Guaranteed capacities with tested ratings. Perfect for small shops, mechanics, metal workers, jewelers and craftsmen. See CATALOG for DESCRIPTION and PRICES.

Your GUARANTEE of Professional Quality

Warner Electroplating Supplies are known and used by professional electroplaters now throughout the world. Many superior formulas are exclusive with Warner. No higher quality at any price. Prime manufacturers of Rectifying Equipment made and guaranteed by the same company. Get EVERYTHING IN ELECTROPLATING from one dependable source. This page shows only partial listing. Get frequent special offerings. It pays to be on our customer list.

WE GLADLY SHIP SMALL QUANTITIES

| | | |
|------------------------------|---------|--------|
| Aluminum Sulphate . . . | 3 lbs. | \$1.65 |
| Ammonium Chloride . . . | 3 lbs. | 1.63 |
| Boric Acid . . . | 3 lbs. | 1.98 |
| Cadmium Oxide . . . | 1/4 lb. | 3.86 |
| Calcium Carbonate . . . | 3 lbs. | 1.55 |
| Calcium Hydroxide . . . | 3 lbs. | 1.45 |
| Chromic Acid . . . | 3 lbs. | 2.63 |
| Copper Carbonate . . . | 3 lbs. | 3.69 |
| Copper Chloride . . . | 3 lbs. | 6.45 |
| Copper Cyanide . . . | 3 lbs. | 2.85 |
| Copper Sulphate . . . | 3 lbs. | 1.29 |
| Ferric Chloride . . . | 3 lbs. | 2.45 |
| Ferrous Sulphate . . . | 3 lbs. | 1.26 |
| Magnesium Sulphate . . . | 3 lbs. | 1.45 |
| Mercuric Chloride . . . | 1/4 lb. | 2.43 |
| Nickel Amm. Sulphate . . . | 3 lbs. | 2.67 |
| Nickel Chloride . . . | 3 lbs. | 4.45 |
| Nickel Sulphate . . . | 3 lbs. | 2.62 |
| Potash of Sulphate . . . | 3 lbs. | 3.84 |
| Potassium Bisulphate . . . | 3 lbs. | 4.10 |
| Potassium Carbonate . . . | 3 lbs. | 2.41 |
| Potassium Cyanide . . . | 3 lbs. | 3.30 |
| Potassium Dichromate . . . | 3 lbs. | 1.95 |
| Potassium Ferrocyanide . . . | 3 lbs. | 2.95 |
| Potassium Gold Cyanide . . . | 1 oz. | 26.45 |
| Potassium Hydroxide . . . | 3 lbs. | 1.95 |
| Rochelle Salts . . . | 3 lbs. | 2.62 |
| Silver Chloride . . . | 1 oz. | 2.26 |
| Silver Cyanide . . . | 1 oz. | 1.79 |
| Sodium Acetate . . . | 3 lbs. | 1.41 |
| Sodium Bisulfite . . . | 3 lbs. | 1.25 |
| Sodium Bicarbonate . . . | 3 lbs. | .89 |
| Sodium Carbonate . . . | 3 lbs. | 1.37 |
| Sodium Chloride . . . | 3 lbs. | .59 |
| Sodium Cyanide . . . | 3 lbs. | 2.24 |
| Sodium Dichromate . . . | 3 lbs. | 1.61 |
| Sodium Hydroxide . . . | 3 lbs. | 1.26 |
| Sodium Perborate . . . | 3 lbs. | 2.25 |
| Sodium Phosphate . . . | 3 lbs. | 1.59 |
| Sodium Sulphate . . . | 3 lbs. | 1.10 |
| Sodium Thiocyanate . . . | 1 lb. | 2.56 |
| Sodium Thiosulphate . . . | 3 lbs. | 1.85 |
| Trisodium Phosphate . . . | 3 lbs. | 1.59 |
| Zinc Chloride . . . | 3 lbs. | 1.45 |
| Zinc Cyanide . . . | 3 lbs. | 2.30 |
| Zinc Oxide . . . | 3 lbs. | 1.59 |
| Zinc Sulphate . . . | 3 lbs. | 1.53 |
| Stop-Off Lacquer . . . | 1 pint | 1.89 |

WOOD ELECTRO-PLATING TANKS

Professional, commercial quality. Tongue and groove construction. Bolted ends. Tank sealer included. THREE Gal. \$8.30. FIVE Gal. \$9.95. TEN Gal. \$12.95. FIFTEEN Gal. \$19.20. TWENTY Gallon \$21.25. BABY SHOE SPECIAL . . . 25 Gallon \$28.75.

WELDED STEEL TANKS

Heavy 12-gauge Steel. All seams and joints electrically welded. No seepage. Outside finished in Gray Enamel. THREE Gallon \$9.75. FIVE Gal. \$11.75. TEN Gal. \$15.95. FIFTEEN Gal. \$27.75. 20 Gal. \$34.95. 30 Gal. \$42.75.

Plating Tank Sealer

Waterproof, Acid-resistant, seals, lines, and protects Electroplating Tanks. Pint . . . 75¢

RUBBER COVERED ACID-PROOF HANDLING UTENSILS



CAN'T CRACK, CHIP
2 Qt. DIPPER, long handle \$8.95
2 Qt. PITCHER \$8.95
EXTRA LARGE 4 Qt. FUNNEL
Also used as Filter Pack \$12.75

Chemical Proof Crock

Stone-ware. Resistant to all acids and chemicals. Proof against extreme heat. Permanent, lustrous fired finish . . .
2 Qt. size \$2.85. 1 Gal. size \$3.95

Long-Handled WIRE BRUSH

6-in. area. . .
1 in. bristles, \$1.35 ea. **MINYMA**

GREASELESS BUFFING COMPOUNDS

Cut the buffing and polishing time down to a few minutes. Insure GREASE-FREE surfaces. No. 1-COARSE. No. 2-MEDIUM. No. 3-FINE. 2 lb. bar . . . \$1.48

PREPARED COMPOUNDS ADD ONLY WATER

DEGREASER. Easy to use - Shipped Dry. 2 lbs. 46¢
PICKLING BATH. Warner's Formula No. 181. Removes scale and rust. 2 pounds . . . \$1.45
METAL CLEANER. For heavy-duty soak-cleaning of Brass, Copper, and Zinc. 2 lbs. . . 95¢

For Baby Shoe and Other Non-Metallic Electroplating

ELECTROPLATING ANODES GUARANTEED Pure

| METAL | SIZE | Shipping Weight | Price Each |
|----------------------|----------------------------------|-----------------------------|------------|
| All anodes | COPPER | 6" x 9" .082" thick, 1 lb. | \$.83 |
| have sus- | COPPER | 6" x 9" .14" thick, 3 lbs. | 3.38 |
| pension | NICKEL | 6" x 9" .05" thick, 1 lb. | 1.54 |
| holes for | STAINLESS STEEL | 6" x 9" .025" thick, 1 lb. | .83 |
| horizontal | LEAD | 6" x 9" 1/16" thick, 2 lbs. | 1.27 |
| or vertical | SILVER | 4" x 6" 1/16" thick, 1 lb. | 15.26 |
| suspension | ZINC | 6" x 9" .065" thick, 1 lb. | .72 |
| | BRASS 6" x 9" .032" thick, 1 lb. | | .89 |

PLATING TANK SUSPENSION BAR SETS

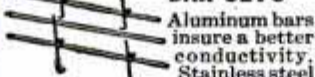

Aluminum bars insure a better conductivity. Stainless steel Anode hooks. For tanks of all sizes. SMALL: Set of three 24" bars, 3 foot lead cables, 4 adjustable anode clamps. For 3, 5, 10 gal. tanks. \$6.26. LARGE: Set of three 36" bars, 6 foot lead cables and 4 adjustable Anode clamps. For 15, 20, 30 gal. tanks. \$10.35. SPECIAL "25" TANK SIZE: Set of five 30" bars complete with 6-foot lead wire, 12 Anode clamps and . . . \$19.38

Superfine Bronze Powder

Finest grade and purest quality assures good results. WARNER BRONZE, 2 lbs. \$2.95
WARNER Bronze, .98¢ No. 6-1 lb.

CHEMICALLY PURE FILTER PAPER-20"

cone shaped. Heavy weight. Superior quality. Pkg. of 10 \$1.59 Pkg. of 100 \$12.60

Felt Polishing Wheels

6 inch diameter, 1-2 in. hole. Designed to give long polishing life. Produces fine surface and bright plating. \$3.29
1-2 inch width . . . \$3.29
1 inch width . . . \$4.32

FORM WHEELS CUP OR DISK STYLE

Super-fine wire bristles produce a beautiful satin finish on all plated metals . . .
DISK STYLE - 6 in. Diameter, 1-2 in. Hole Brass, \$2.40. Steel, \$1.80.
CUP STYLE - 2 1/2 inch deep, 2 1/4 inch diam. Fits tapered spindle. Brass, \$2.20. Steel, \$2.70.
4, 5, 6 IN. HIGH SPEED GRINDING WHEEL
Aluminum oxide-silicon carbide wheels. Abrasive grain specially bonded for fast, cool cutting. 3-4 in. face, 1-2 inch hole, 4 in. Diam. 59c. 5 inch Diam. 79c. 6 in. Diam. 98c. Specify Coarse, Med. or Fine.

CLOTH BUFFING. POLISHING WHEELS

High-grade, full 20-ply wheels for coarse buffing & high polishing. 1-2 in. hole.
6 inch Stitched Buffing Wheel . . . 68c
6 in. Unstitched Polishing Wheel . . . 62c
4 inch Stitched Buffing Wheel . . . 42c
4 in. Unstitched Polishing Wheel . . . 38c

Warner IMPROVED BUFFING CAKES

Shipping weight 1 lb. each

EMERY . . . Graded for coarse polishing of steel and other metals. 72c per cake. TRIPOLI . . . Compounded for cutting down Copper, Brass, Aluminum, Die Castings, etc. . . 72c per cake. RED ROUGE - Imparts brilliant finish to Silver, Gold & other metals. 95c per cake. WHITE ROUGE - Special formula for brilliant finish on Chromium & other hard metals . . . 83c per cake.

Hardening & Acid-Proofing COATING BASE

Recently developed in Warner Laboratories for pre-plate coating. Easy to handle . . . fast drying. Gives rock-hard surface to soft materials. 1 gallon (for 115 pairs of shoes) . . . \$4.85

OXIDIZING Solution for ANTIQUE-ing Coppers

Concentrated Solution. Dilute for use. Approximately eight ounces makes gallons. . . . \$1.75

ELECTROPLATING BATH CONCENTRATES. Special Warner formulas . . . laboratory quality.

Add water to use. Copper "A" (Acid). 1 gallon \$5.36
Copper "C" (Cyanide) 1 gal. \$3.85
Nickel . . . 1 gal. 4.40
Cadmium . . . 1 gal. 4.20
Chromium . . . 1 gal. 9.85
Silver . . . 1 gal. 18.75
Gold . . . 1 gal. 3.95
Bran "G" (Cyanide) . . . 1 gallon \$3.95
Zinc "A" (Acid) . . . 1 gal. 5.35

"WARNER-LAB" BLUE-DIP FORMULA

Prepares Copper and Brass for Silver Plating. Makes ONE GALLON . . . \$1.25

NYLON ANODE BAGS

Acid-proof. Have 3 to 4 times the life of any other! Keeps carbon and other impurities from entering bath. Size 6 in. x 9 in. Each . . . \$1.35

ACTIVATED CARBON

Cleans and purifies liquids and solutions. An unusually effective absorbent. Directions on package. 1 lb. package . . . 85¢



FREE!

BIG 40-PAGE CATALOG
More than 400 Shop Requirements listed - 329 Pictures of latest in Equipment and Supplies. Buy direct from the manufacturer. Prompt deliveries of smallest orders. Catalog FREE with order for \$2.00 or more. Or enclose 10c to cover mailing.

CLIP, MAIL COUPON TODAY!

WARNER ELECTRIC CO., Dept. X-35, 1512 Jarvis Ave., Chicago 26, Ill.

I am enclosing an order amounting to \$_____. You are to send Catalog FREE.
 I am enclosing 10c to help cover cost of wrapping and mailing. Send Catalog, postage paid.

NAME _____

ADDRESS _____

CITY _____ ZONE _____ STATE _____

WARNER ELECTRIC CO., Dept. X-35, 1512 JARVIS AVENUE • CHICAGO 26, ILLINOIS

**WORLD'S
BEST
WANT AD
MEDIUM**

CLASSIFIED Advertisements



Advertisements in this section 75 cents per word, each insertion, minimum 10 words, payable in advance
To be inserted under proper classification, copy must be in our office the 22nd of the
second month preceding date of issue

F. W. Johnson, Manager, Classified Advertising
Popular Mechanics Magazine, 200 East Ontario Street, Chicago 11, Illinois

1192

CLASSIFIED ADVERTISEMENTS

1192

OPPORTUNITIES FOR YOU

AUTOMOBILES, MIDGET CARS

NEW "1949" Crosleys—"Come, get 'em." Bus ticket with car anywhere U.S.A. to Marion \$5.00 extra. Advise body model, color desired. Sedan \$998. Station wagon \$1031. Walraven Motors, Marion, Ohio. Phone 2761.

"VAPO-STEAMATIC" Water injector. Easily built! Finest automatic "moist-humidity" system. Engineering triumph—Gets up to ten extra miles per gallon! Tremendously increases horsepower! Eliminates ping, carbon, overheating. Reduces wear—Lengthens engine life. Copyrighted "Quick-Installation Handbook"—including illustrated plans, diagrams, instructions—\$1.00 complete. Newhouse Automotive Industries, 5805-B1 East Beverly, Los Angeles 22.

DUALTONE Crystalline packed California mufflers for all automobiles; California chromed accessories, lowering blocks all automobiles, dual manifolds, hi-compression heads, flywheels, camshafts, fender skirts, plexi-tops. Send 20c illustrated catalogue; Streamlining Manual \$2.00. Dualtone Mufflers, 2636C India Street, San Diego 1, California.

PISTON Rings, 1½ to 4 inch in diameter, compression or oil, 20 and 25c each, one ring or thousands. Piston Ring Co., Bath, N. Y.

RACING Car equipment for all cars, engines, racing heads, manifolds, carburetors, mufflers, etc. Speed instructions and literature \$1.00—refunded first order. Lee Motorcraft Co., 1412-D Great Northern Bldg., Chicago 4, Ill.

AUTOMOTIVE Trouble shooting. 500 questions and answers. \$1.00 postpaid. Charles Nelson, 2908 Washington Ave., Santa Monica, California.

"SPEED & Power" Handbook—Very latest methods! Build your own dual manifolds, superchargers, water injectors, hi-compression heads, fuel saving devices—easily. Save many dollars! Get racing speed, acceleration, dynamic power increases from any automobile! Build fast stock cars! California roadsters! Hotrods! Get construction diagrams! Ingenious formulas! Speed secrets! Also "economy information"—Mileage tricks! Conversion ideas! Tuning techniques! Picture catalogues. Plans! Drawings! Including "California restyling ideas"—Glossy photographs! Plexi-Tops! Model revising! Streamlining! Customizing!—\$1.98 complete. Newhouse Automotive Industries, 5805-B2 East Beverly, Los Angeles 22.

CALIFORNIA Custom accessory headquarters. Buy direct from original designers and save. Solid hood sides, grille panels, lowering kits, fender skirts, dual pipes, chrome motor accessories, speed equipment. 1949 catalog just out. 32 illustrated pages, jam packed with California accessories. 25c. Eastern Auto Supply, 3319-A South Grand, Los Angeles 7, Calif.

POWER-TONE Mufflers for all cars. Gives that power plus tone. Singles and dual sets for Ford and Mercury. Also the new Power dual intake manifold for Ford and Mercury cars. Many other items. Dealer inquiries invited. Power Engineering Company, Dept. PM-5, 4506R Delmar, St. Louis 8, Mo.

INITIALS—Beautiful gold one inch decals for auto doors, luggage, bicycles, etc. Won't rub off. 6 for \$1. Kessler's Accessories, Centreville, Maryland.

DUAL Muffler sets for Ford and Mercury. Famous Power-Tone only \$16.95 per set. Power dual intake manifolds for Ford and Mercury (up to 1949 only) \$24.95. Immediate delivery. Write for descriptive literature on other hot-rod supplies. Certified Welding Co., Dept. 10-E; Taylor & Delmar, St. Louis 8, Mo.

SEE Our ad under motorscooters for new and used midget car bargains. Midget Motors Directory, Athens, Ohio.

CLYMER'S New steam traction engine album. 160 large pages. Just out. 470 photographs, charts, drawings, early advertisements U. S. and foreign makes steam engines and threshing equipment. 105 different makes steam engines shown. See Case, Advance, Reeves, Rumley, Avery, Westinghouse, others, from 1855 to 1929. Unique, historical, educational book of real Americana. Postpaid \$2.50. DeLuxe edition fabrikoid bound \$3.50. Clymer, Dept. A-ST, 1268 So. Alvarado, Los Angeles 6, Calif.

BREATHTAKING Performance! Build hot-rods! Soup-up stock cars! Photographs! Instructions! Only \$1.50. Speed and doll-up equipment list 25c. We pay freight! Hot-Rod, Box 9626-P2, Hollywood 27, Calif.

WATER Injection. Free descriptive, illustrated information. Neher Industries, La Verne, Calif.

HOW To Build Racing Automobile. New, revised. Complete information. \$2.00 postpaid. Clymer, Dept. A-NRB, 1268 So. Alvarado, Los Angeles 6, Calif.

"SUPERCHARGER" Airfeed needle—Increases speed, power, pep! Starting! 10% more mileage guaranteed! Free trial! Quickly replaces idling jet. Specify car, \$1.50 (Eight's take 2, six's 1). Almqvist Engineering, Milford 78, Pennsylvania.

FORD Speed Manual just off the press! Guaranteed finest speed manual you can buy! This book contains the information you need to hotrod any Ford V-8, Mercury, Ford Six, Model A, Lincoln-Zephyr. Filled with photographs. Cutaway drawings by Medley explaining installation of hydraulic brakes on any year Ford. How to install V-8 engine in Model A. All expert proven data which you can use! Not just another pamphlet, but a real 128 page book! \$2.00 postpaid. California Bill, Box L-1, Eaglerock, Los Angeles 41, Calif.

MODEL "A" Ford Complete Service Manual \$1.00. Model T Manual \$1.50 postpaid. Clymer, Dept. A-AT, 1268 So. Alvarado, Los Angeles 6, Calif.

SANDEE Mufflers—Singles, duals. Echo pipes, skirts, velocity stacks, wheel discs. Charles Hohenrath, 36 Main St., Port Washington, New York.

"HOLLYWOOD" Motorboat tone mufflers—Singles, all cars \$4.85. V-8 duals \$17.50. Satisfaction guaranteed! Almqvist Engineering, Milford 78, Pennsylvania.

HOT Rod book. New, revised. 1946, 1947, 1948 speed record cars, photos, descriptions. \$1.50 postpaid. Clymer, Dept. A-5NV, 1268 So. Alvarado, Los Angeles 6, Calif.

"AIRFLOW Needles." Save gasoline. Write for free trial! Give make car and carburetor. Neher Industries, La Verne, Calif.

OUTBOARD Book. Complete servicing information all makes. 252 pages. Postpaid \$3.50. Clymer, Dept. A-OM, 1268 So. Alvarado, Los Angeles 6, Calif.

SPEED Equipment bargains! "California" mufflers \$4.50, duals \$17.50, V-8 heads \$45.00, dual manifolds \$9.95, water injectors \$4.95, chrome echo cans \$1.65, supercharger stacks \$2.98, lowering kits \$2.95, chrome fender trim 90c, many others! Illustrated "Speed Catalog" 25c. Almqvist Engineering, Milford 78, Pennsylvania.

CHEVROLET Speed Manual for Chevrolet owners desiring real hotrod performance from their 1937 to 1948 Chevrolets. Filled with photographs, complete information, proven methods. How to make your road car capable of 100 mph plus! How to build Chevrolet hotrod engines for road, track, or marine use. 54 excellent pages! \$2.00 postpaid. California Bill, Box L-1, Eaglerock, Los Angeles 41, Calif.

FAMOUS Car catalog reprints. 1949 Alfa-Romeo, 1949 German Volkswagen, 1949 Italian Maserati racing and new sport car, 1949 rear-engined Isotta-Fraschini V-8, Rolls-Royce "Silver Wraith," Dusenber Supercharged, Mercedes-Benz, Miller race cars, Cord, Rayfield Cyclecar, V-8 Chevrolet, Stanley Steamer, Doble Steamer, 1916 Metz friction driven, 1912 Ford. Specify catalog desired. \$1.00 each postpaid. Clymer, Dept. A-5X, 1268 So. Alvarado, Los Angeles 6, Calif.

NEW Customizing Manual—(Jumbo edition!) Shows how to easily make your car look beautifully custom! Latest restyling, streamlining, customizing methods! Hollywood sport changes! Fast model conversions! Scores of photographs, illustrations, drawings! "Hop-up" specifications. Complete restyling information. (Including custom car catalog and amateurs "idea starter" kit.) Everything \$2. Almqvist Engineering, Milford 78, Pennsylvania.

AMAZING New "De-Acid Oil Drain Plug" reduces acid corrosion. Saves your motor. Does away with up to 90% of engine wear. Protects vital parts. Acts as neutralizer. Acids attack core of plug rather than motor. Easy to install. Safe. Developed by prominent Diesel engineer. Write at once for this wonderful engine saver. Only \$2.50. Money back guarantee. State make and year of car. Johns Manufacturing Company, Dunellen 4, New Jersey.

"HOTROD Handbook"—Just published! Latest speed data for all cars! Shows how to easily construct your own speed equipment—build 145 m.p.h. racers! California roadsters! Sport cars! Fast street, track conversions! Illustrates "Hollywood customizing"! Body restyling! Motor rebuilding! Speed changes! Tuning! Streamlining! Gives complete hop up information, "speed tricks," fuel formulas, mileage tips, "Conversion Plans"—covers channeling, multiple carburetion, water injection, ignition, ratios, porting, balancing, time trials—latest California methods! Equipment catalogs! Hot rod plans. Working drawings! Photographs! Consultation data! Charts! Graphs! Terrific book \$2. Speed Publications, Drawer 716, Fort Jervis 3, New York.

NEW Consumers Gasoline Guide Book. Tells 15 ways save gasoline. Describes all octane gasolines, anti-knock fuels. 72 charts, drawings. \$1.50 postpaid. Clymer, Dept. A-GG, 1268 So. Alvarado, Los Angeles 6, Calif.

NEW Racing book. Saga roaring road. Complete early United States automobile racing history. Illustrated. \$2.00 postpaid. Clymer, Dept. A-SRR, 1268 So. Alvarado, Los Angeles 6, Calif.

"SPEED & Mileage" manual—(New, revised!) Easily obtain greater speed, mileage, racing performance from any automobile! Famous authentic book shows simplified soup up methods; speed tuning; mileage secrets; speed equipment plans; "Customizing Ideas"! 125 illustrations—complete instructions on building inexpensive power equipment! Economizers! Superchargers! Dual mufflers! Manifolds! "Water Injectors"! Fast conversions. "Hot Rods," custom cars! All about engines, "Economy Tuning," restyling, compression, fuels, cams, "Racing Tricks"! Latest "Hollywood Stylizing"! Streamlining! Sport changes! "Money-saving" speed conversions! (plus) California roadster plans! Parts lists! Speed catalogues! Beautiful pictorial supplement! Folios! Photographs! Working diagrams! Complete data! Everything \$1.98 (satisfaction guaranteed). Almqvist Engineering Milford 78, Penna.

AUTOMOBILE Trouble Shooting: by an old timer. Written so you can understand it. For car owners, helpers, hot-rodders, mechanics and shop foremen. \$2.00 postpaid. H. Woodbury, 2021 Francisco St., Berkeley, Calif.

"SPEED Directory"—Lists all speed equipment. Hotrod. Racing parts suppliers, manufacturers, dealers, speed shops, custom builders, wholesalers, racing associations, hotrod clubs! Save up to 50%! Complete money-saving "Buyer's Guide" including "Hotrod Building Information & Speed Equipment Plans." \$1.00. Speed Publications, Drawer 716, Port Jervis 3, New York.

INDIANAPOLIS Race history book. All races since 1909. 1100 photos. 340 pages. \$3.50. 1948 Race Book \$1.50 postpaid. Clymer, Dept. A-500, 1268 So. Alvarado, Los Angeles 6, Calif.

FORD Owners and mechanics, we supply several simple replacement parts making Ford and Mercury brakes free floating, super powerful with soft pedal; eliminating squeal, chatter and groan—\$4.25-\$6.90. All models, 1928-1948. Easily installed by yourself. Write for details. Super Brake-Floater Company, 4022 West Lake Street, Chicago 24, Illinois.

NEW Sensational seat cover. Mono, 6545 Santa Monica Blvd., Hollywood, California.

RACE Car photos, 1000 different, catalogue. Sample 25c. Smith, 17 Watson St., Paterson, New Jersey.

WE Sell direct to customers over 200 speed equipment parts manufactured by us. Ford A-B-V8-6-4- (Ferguson). Studebaker Champion, Chevrolets and Willys. Cylinder heads, dual intake manifolds, lynchite flywheels, oversize valves, compound springs, camshafts and other supplies. Complete engines ready for race for cars, boats and midgets. \$1.00 to cover illustrated literature and price sheet. R & R Mfg. Co., Robert M. Roof, Box 546, Anderson, Indiana.

CUSTOMIZE Your car! Authentic California restyling plans galore! Working sketches, specific model changes. Comprehensive; complete! 130 photographs! Largest, finest or refund! Includes accessory catalog! \$2 postpaid. Post Publications, Box 723-ME, Arcadia, California.

AUTOMOBILE Racing book, fifth edition, well illustrated. Instructions on building bodies, frames, engines. Ford A and B conversions. Plans. AAA rules, specifications. Roadster racing. Indianapolis cars. \$1.00 postpaid; \$1.30 C.O.D. Ray Kuns, Dept. 47, Madisonville, Cincinnati 27, Ohio.

FROM Speedway to roadway! Track-proved hi-speed heads and manifolds now available for your passenger car! No special tools needed! Increase horsepower 25%! Astounding getaway! Free illustrated catalog. Speedsport, 6215AA Diversey, Chicago 39.

AUTOMOBILE Racing, Sixth Edition, 100 illustrations. Working drawings with building instructions for Ford-60 midget, California roadster, Offenhauser racer. Details on racer parts. Sample entrance blank. World's record 158.5 m.p.h. rear engine four-wheel drive car. Interesting information for fans, drivers, mechanics. \$2.00 postpaid; \$2.25 c.o.d. Ray Kuns, Department 63, Cincinnati 27, Ohio.

AUTO SUPPLIES AND EQUIPMENT

NEW Grilles for all cars. Lowest prices. Write today. Harvey Automotive Products, P.O. Box 26, Phillipsburg, New Jersey.

"SMITHYS Mufflers" for all cars. Free list. Bucks Auto Parts, 1296H, Merced, California.

WOLF Whistles for all make cars, precision make. Retail \$2.95, will send two for \$3.00. Sell the new Clean-O-Wax. Saves 50% labor, cleans, polishes, waxes, one operation. Retail \$1.00, two full size cans for \$1.00. Complete sales proposition. Charter Oak Co., 256 Cedar Blvd., Pittsburgh 16, Penna.

SAVE Costly repairs. Trap dangerous abrasive steel particles with inexpensive magnetic plugs. Free literature. Jacques Company, Rumson, N. J.

WELDING Bodies, blocks; repairing fenders boosts your profits. Easy with Hobart welders. Low cost. Free catalog. Write Hobartweld, Box M-592, Troy, Ohio.

AUTOMOTIVE Surplus bargains! Welding outfits, hones, bearing pullers, sockets, wrenches, also large stock of industrial tools. Catalog free. Glenco Supply, 75-19 Myrtle Ave., Greendale 27, N. Y.

CAR-BED. Make it yourself. Inexpensive. Fits any 2 or 4 door sedan. Detailed plans \$2.00, easy to follow. Martin's, Box 297, Upper Darby, Penna.

BRILLIANT. Windproof, waterproof, safety flares. Box of 8 fits glove compartment. \$1.00 postpaid. VBM Sales, 924 North 16, Omaha 2, Nebraska.

AUTO Motors, transmissions, rear ends, carburetors, starters, generators, voltage regulators. Auto Parts, 1601 Clybourne Ave., Chicago, Ill.

WELD Cast iron. AC, DC. Free instructions with trial package of Hobart "nickel-cast" electrodes. Send \$1.00 for generous sample postpaid. Hobartweld, Box M-596, Troy, Ohio.

PATENTED—Lachapelle's motor and motor fuel treatment stops ping, gives more power, miles per gallon and miles per motor enough for 100,000 miles. \$3.00 postpaid. Ferns Products, 8120 Walnut Dr., Los Angeles 1, Calif.

1949 **SUPERIGNITIONER.** Starting, pep, mileage \$4.85. EG Mfg., Elmsford, N. Y.

"**PRES-A-LITE**." Amazing safety invention. Automatically delivers lighted cigarette ready to smoke while driving. Holds 23 cigarettes. Fits all cars. Precision built, foolproof, attractive. Price \$6.95 postpaid. Winchester Company, 6411 Hollywood Blvd., Hollywood 28, California.

MECHANICS—Be independent. Smooth all crankshafts. \$15.00. Free literature. D. McGee, 719A Cascade, Wenatchee, Wash.

REPLACE Glass license plate covers with durable, clear, unbreakable plastic. Specify size. Pair \$2.00. C. D. Cahoon, 18 Northstone Rd., Swampscott, Mass.

FORD, Chevrolet radiators. Tremendous savings. Direct from factory. New, guaranteed. Autocraft, 2538 Cottage Grove, Chicago 16, Ill.

DUAL Controls—For cars used in training of motor vehicle drivers. Approved, safe, compact, easy to install. Individually engineered for most late model cars, \$37.50. Specify year and make. Send remittance with order. Satisfaction guaranteed. Elloyan Engineering, 263 Park Avenue, Worcester, Mass.

"**LEKTRON**" Atomic coil booster saves gas. Instant starting. Only \$2.00. Money-back guarantee. Easily installed. Specify car. Electronic Industries, Cleveland 11, Ohio.

SENSATIONAL Convertible top cover made in black or tan. Heavyweight water repellent material. Makes it unnecessary for convertible car owner to replace car top each year. Opens or closes without removing cover. Custom tailored, requires no tools, instructions for simple speedy installation. Specify car year and model when ordering. Price \$19.95 plus postage. Ames Auto, 1184 Bedford Avenue, Brooklyn 16, N. Y.

MOTORISTS Save gasoline by Vacuumating overrich mixtures. Fits all cars. For free particulars write Vacuumatic, Dept. 1508, Wauwatosa, Wis.

PISTON Rings—All sizes, oversizes, odd sizes. Individually engineered sets for every motor and motor condition by outstanding proving ground research group. Northwestern Auto Supply, 750 Division, Grand Rapids, Mich.

AUTOMOBILE Glass! Direct savings! Write requirements. Cooper's, 3135 Lawrence, Chicago 25.

PISTONS—American and foreign makes. Racing types made. Free price sheet. Meryman Co., Lawndale, PM2, California.

AUTO Parts for all cars, transmissions, motors, differentials, fenders, carburetors. Security Auto Parts, 1923-PM Grace, Chicago 13.

NEW Grilles for all cars. Wagner Grille Co., Route 2, Bernville, Penna.

CHEVROLET Parts. Scarce motor, body, sheet metal parts. Grossman Chevrolet, Minneapolis, Minnesota.

HARD-TO-GET Auto body parts. We supply. Miller Auto Parts Service, 192 N. Clark Street, Chicago.

BUICK Parts. We stock a complete line of new Buick parts and engines. Same day service on orders and inquiries. We ship anywhere. Write today. Robertson Buick Co., 1001 S. Wabash, Chicago 5, Ill.

BRUSH Plating outfits connect to a battery. No tanks or shop required. Free particulars. Gunmetal Co., Avenue J, Decatur, Illinois.

AUTO Parts. Buy direct. Get dealers' prices. Represent us in your territory. Write requirements. Specify car make. Mechanics Auto Parts, Factory Warehouse, 3807-PM N. Ashland, Chicago 13.

AUTOGRAM—Chrome custom-styled all metal automobile monogram \$1.95. Illustrated page 288. Autogram Inc., 3242 N. Pulaski Rd., Chicago 41.

TRANSPARENT Waterfilled auto battery caps for continual water supply. \$1.65 per set. Give battery type. Marshall, 412 Clark Bldg., Jacksonville, Fla.

SAVE \$20.00! Convertible tops \$34.95. Mono, 6545 Santa Monica Blvd., Hollywood, California.

AUTO TRAILERS

WHOLESALE: Trailer running gears—All capacities. Utility bumper hitches for all new cars! Austin Company, 31742 Sheridan, Garden City 1, Michigan.

PHOTOGRAPHS, Plans for famous 12' camp and travel trailer, plus all-size Planner's Guide. \$1.00. Ed Christensen, Box 687, Thief River Falls, Minn.

BEAT The housing shortage with an Indian house trailer. \$4050 and \$2730. F.O.B. Chicago. Otho Dewitt, Factory Representative, Center Line, Mich.

STREAMLINER Manual \$1.00. Circular illustrating eight designs 20c. Craftsmann Books, Box 1153, Milwaukee 1, Wisconsin.

BUILD Your own trailer! Save money! Have every feature you want! Plans for house, sport, camp and utility trailers. Catalog describing 9 models 10c. 15c in Canada and overseas. Jim Dandy, Box 125-A, Wausau, Wisconsin.

MOTORCYCLES, BICYCLES, MOTORSCOOTERS AND SUPPLIES

INDIAN Motorcycle \$35; Harley \$45; Briggs motorbike \$25; Cushman motorscooter \$9, three wheeled motorscooter \$16.50; Springcycle \$10, midget car \$15, less motors. Briggs motor \$2.50. New motorbike conversions \$5. Four balloon tires for motorscooters or midget cars \$3. Mail order only. Over 5000 tires in stock. Plenty new midget cars, motorscooters, engines, automatic clutches, transmissions, etc., in stock at factory prices. Send 25c for big war-bargain catalogue Number 30 just out listing these and almost 400 other bargains. (35c by first class mail). Midget Motors Directory, Athens, Ohio.

WHIZZER Bike-motor \$25.00; Cushman motorscooter \$15.00; midget racer \$40.00; Shaw bicycle-motor \$15.00; Harley-Davidson motorcycle \$15.00; Smith motor-wheel \$25.00; Good motorscooter (twist grip) \$22.50. Rush 25c for new catalog #14 listing many other amazing bargains in motorscooters, used motors, midget cars, parts, wheels, etc. Gail, 538 Erie, Toledo, Ohio.

POWERBIKES, Motorscooters, 5c for illustrated booklets. Johnson's Scooter Sales, Milford, Ind.

BICYCLE Supplies. Wholesale, retail list 10c. Universal, 4713 Virginia, St. Louis, Missouri.

JOIN Motorcycle Research Society (\$1.00 annually), free magazine. Elgin 1, Illinois.

HARLEY And Indian parts catalog, 15c. Pistons, motor parts, batteries, tires, chrome accessories. Bootz, 1700 East University, Des Moines 16, Iowa.

NEW Motorcycle jackets of sturdy black horsehide—\$29.95 value for \$24.95 postpaid. Similar style in black capeskin, \$14.95. Give chest and waist measurements. Dev-Jackets, P.O. Box 3342, St. Paul 1, Minn.

COMPLETE One stop Harley Davidson sales service. Comprehensive accessory catalogue 25c. 813 Ohio St., Wichita Falls, Texas.

BICYCLE Repairing made easy. Illustrated "Bicycle Repair Manual." \$1.00. Klausner Cycles, Shelbyville, Ill.

REVOLUTIONARY New Weber high-compression aluminum cylinder heads for Whizzer motorbikes, Cushman motorscooters and Mustang cycles. Increased power; greater economy; eliminates gasket troubles. Whizzer head \$5.95; Cushman head \$6.95; Mustang head \$9.95. C.O.D. or cash with order. Write for catalog page. Dept. M-5, Weber Tool Co., 4200 Whiteside, Los Angeles 33, California.

MOTOR Scooters, bicycle engines. 120 miles gallon. Dime for catalog. Clymer, Desk A-55, 1268 So. Alvarado, Los Angeles 6, Calif.

MOTORCYCLE Illustrated news, monthly. Subscription \$1.00. Introductory copy 15c. Worldwide information. Motorcycle News, 5424-A Sawyer, Chicago 25.

MOTORCYCLE Pistons and parts, new, used. Harley, Indian, Henderson, Super-X. List 10c. Ballak, 811 N. 9th, St. Louis 1, Missouri.

GENUINE Elgin motorcycle bags. \$20.00 to \$65.00. Allen Streamlined Bag Co., 106 Brook St., Elgin, Ill.

JET Propelled bicycle. Assemble your own. Photo and instructions \$1.00. Rush order. Maupin, Tipp City 5, Ohio.

HARLEY-DAVIDSON Parts, accessories, batteries, and tires, 24 hour service. Authorized factory dealer. Philadelphia Harley-Davidson Company, 857 North Broad Street, Philadelphia 23, Penna.

MOTORBIKE Outfit \$5.00; midget car (complete) \$35.00; Indian motorcycle \$30.00; Cushman motorscooter (complete with extra tire) \$20.00; 1946 Whizzer \$35.00; other motorscooters \$10.00 up; motors \$3.00 up. Send 25c for new catalog #942 listing many other sensational bargains in used motors, motorscooters, motorcycles, parts, etc. Associated, Box 1764-CS, Toledo, Ohio.

MOTORSCOOTERS, New design, 6 big features. Literature 10c. Rollaway Motors, Lancaster, N. H.

RECONDITIONED Motorcycles and motors. Chromium accessories. Complete stock Indian parts. Expert rebuilding. Fast service. Indian Motorcycle Sales, Kansas City 1, Mo.

HARLEY-DAVIDSON Parts, accessories, oil, expert service. Tires all sizes. Rebuilt 45" motors. Send \$2.25 for Army 45 Motorcycle Manual. 25c for accessory catalog and bulletins. Knuth's (Harley-Davidson Dealers), 2491 Fondulac, Milwaukee, Wis.

WHEELS! Build wagons, scooters, mowers, trailers, wheelbarrows, grocery carts, baby carts, play pens, baby carriages. 4" to 16". Free list. Truilen Mfg. Co., 811 E. 31, Kansas City, Mo.

TIRES And industrial wheels, suitable for scooters, wheelbarrows, farm equipment, etc. All sizes. Bicycles and accessories. Largest assortment in America. Send dime for list. Cycle Transport Company, 1241 So. Michigan Ave., Chicago 5, Illinois.

AVIATION

FAMOUS "Zweng Texts" with examinations: Mechanic's Rating \$3.00; Flight Engineer \$4.00. (Free catalog). Pan American Navigation Service, 12021-6 Ventura Blvd., N. Hollywood, Calif.

4'-6" PUSHER Propeller. Finest construction for boat-sleds \$99.00. Callair, Afton, Wyoming.

AIRCRAFT Engines and propellers for boats, swamp buggages, and snow sleds. Write for price list. Thomas Flying Service, Oak Hill, West Virginia.

PROPELLERS—2-3 Blade for sleds, air-drive boats. Catalog. Standard Aero Craft, Box 387, Ft. Worth, Texas.

LIGHTPLANE Manuals, blueprints. Circular illustrating designs, motors 20c. Craftsman Books, Box 1153, Milwaukee 1, Wis.

BATTERIES, GENERATORS

NEW Double voltage generator. 110 volt, 1200 watt a.c. and 200 amps. 28 volt d.c. Excellent for welding and experimental. \$19.75 f.o.b. If interested in other surplus, send 25c for list. Surplus Sales, 224-24th Street, Niagara Falls, N. Y.

EDISON Non-acid storage batteries for all uses. Fully guaranteed. Interesting literature. Generating plants, all makes and sizes at bargain prices. Hawley Smith Co., Croton Falls 1, N. Y.

ELECTRICAL SUPPLIES

ELECTRIC Pencil: Engraves all metals \$1.25. Beyer Mfg., 10511-H Springfield, Chicago 43.

BUILD Your own electric motor and learn the how and why of more than six different types of motor operation. New amazing motor kit has complete parts for small special design take-a-part low voltage a.c.-d.c. motor. \$13.95. del. in U. S. \$1.00 check or money order must accompany c.o.d. orders. Illustrated literature free. Teco Inc., Box 127, Boonton, New Jersey.

ELECTRIC Pencil—Writes, engraves all metals. 6 volt model \$1.25, 110 volt model \$2.95. Reb Industries, 265-DU, Elmhurst, Illinois.

LAMPS—Build own originals. Parts wholesale, any amounts. Catalogue 10c. Brown Lamp Co., Box 501, Wellston, St. Louis 12, Mo.

BUILD Shunt controlled transformer welders, sell garages, shops, farmers. Costs \$30.00, sells \$125.00; latest design for 110-220 volts, 10-180 amps, output. Engineered drawings, instructions, plus list jobbers, \$5.00 or descriptive circular 25c. Phillip Wilson, Childersburg, Alabama.

WATTHOUR Meters, reconditioned, calibrated, guaranteed. All types and sizes, \$2.75 up. Write for illustrated bulletin. Maspenock Electric Light Co., Room 501, 44 Starr Lane, Jamaica Plain, Mass.

30 AMPERE Continuous duty selenium electroplaters! Write, Lectralabs, Wakefield, Rhode Island.

BUY Lamp parts wholesale. Parts you need for building, repairing, or assembling. Save money on large or small orders. New catalog for 10c. Gearon Company, Dept. 300-B5, 27 South Desplaines, Chicago, Illinois.

"ELECTRICAL Contractors Estimating Handbook." Takes guess-work out of estimating. Write, The Estimator, 1805-A Sixtieth Street, Kenosha, Wisconsin.

ELECTRONICS Kit builds ac-dc voltmeter, oscillator, electric eye. \$2.95 complete. Literature free. Precise Measurements Co., 942-A Kings Highway, Brooklyn, N. Y.

FREE Catalog—Motors, welders, welding supplies, generators, home freezers, electric lawn mowers, many other electrical bargains. LeJay Company, Minneapolis, Minnesota.

MOTORS New General Electric 1/2 h.p. \$12.50. Also others. Free literature. Plenge, 114 Elliot Place, Bronx 52, New York.

WHOLESALE—Sewing machines, vacuum cleaners, fans, appliances. Jeannette Electric, 159 West 23rd Street, New York 11, N. Y.

WATTHOUR Meters. Reconditioned, guaranteed. Ideal for cabins, trailers, shops. \$2.95. T. Price, 310-14th, Raymond, Wash.

OIL Lamps—Instructions for electrifying, restoring. Also 44 page illustrated catalog, all parts 10c. Gyro Lamps, 5402P N. Clark, Chicago 40.

SAVE Money on electrical appliances, motors, radios, tools. One hundred page illustrated discount catalogue fifty cents. Mechanics Discount Stores, Box 85, Canandaigua, N. Y.

WELDING, SOLDERING, PLATING

"BUILD-UR-OWN" Welder. Portable. Hobart Welder plus auto engine saves \$350. Instruction book free. Write Hobartweld, Box M-593, Troy, Ohio.

BUILD Your own d.c. arc welder. Up to 300 amperes. New design, made from surplus materials and aircraft generators supplied by us. Plans only 35c, including new catalog. LeJay Mfg. Co., 847A LeJay Bldg., Minneapolis 8, Minnesota.

WE Repair all kinds of welding equipment of any kind. Big stock, new and used. Welding Headquarters, 2425 Milwaukee Ave., Chicago 47, Ill.

WELDING Training pays. GI approved. Best equipped school in U. S. Free catalog. Write Hobartweld, Box M-594, Troy, Ohio.

SILICON Steel 6c cubic inch f.o.b., no c.o.d. Ernest Noyes, 32328 Brush, Royal Oak, R5, Mich.

ACETYLENE Welding outfits, new, \$54.50; arcwelders \$46.50. Eagle Welding, Dept. PM, 5085 Broadway, Chicago 40, Ill.

AUTO Radiator repairing supplies, equipment, books, gasoline torch. Write, Curfman Co., Maryville, Mo.

PORTABLE 250 Amp. d.c. welders. \$137.50. A leading farm welder. Distributors wanted. Haddican Mfg. Co., Satanta, Kans.

ELECTROPLATING Units — Complete sets. Copper, nickel, cadmium \$1.50, silver \$2.00, gold \$4.50. Write for free literature. Regency Sales Co., 5316 So. Justine St., Chicago 9, Ill.

GOVERNORS. Two-speed, fully automatic for welding engines. Candee-Smith, 2641 Hill, Los Angeles 7.

OXY-ACETYLENE "Demurrage-free" Linde cylinders, Purox apparatus, Oxweld supplies, Metalmaster outfits, Miller electric hobby welders, approved fire extinguishers. Free literature. A-A Welding Supply Company, Dept. A, 9228 So. Ada St., Chicago 20, Ill.

PLATING Equipment, supplies and chemicals for copper, gold, silver, etc. Ramyr platers; 10, 30, 50, 100 amp. Complete silver plating assembly, includes rectifier, tank, anodes, solutions, etc. Full price \$109.50. Complete bronze baby shoe plating assembly \$97.50. Instructions free. Send for list. Hollywood Bronze Supply, Plating Div., 1770 N. Vermont, Hollywood 27, Calif.

P-1 GENERATOR Owners: make yourself a better welder using our reactor and resistance coil unit; complete with plug-in panel, cables, ground clamp, electrode holder, and our patent applied-for fingertip control system. \$51 postpaid. Free literature. Thorndyke Manufacturing, Pipestone, Minnesota.

WELDER! New portable Champion Special transformer welder; 110/120 volts a.c. develops to 75 amps.; 9 heat stages. Welds, brazes, solders, cuts all metals. Easy to use. Simple instructions. Special flame weld torch free. Splendid for shop, farm, home repairs. Saves hundreds of dollars yearly. Only \$27.50. Also heavier models. 10 day free trial. Magic Welder Co., 239 MP Canal St., New York, N. Y.

WELDERS 110v. Welds 1/2" steel \$32.50. Morris Welding Service, 1850A State, Schenectady 4, N. Y.

BUY Direct from factory. Welding outfit, \$48.36. Soldering outfits \$7.76 to \$10.16 complete prepaid. Box 331, Hamilton, Ohio.

OWN Mirror shop. Resilver mirrors. Glass sign making. Electroplating. Supply prices. John Sprinkle, V55, Marion, Indiana.

MACHINERY, TOOLS, SUPPLIES

AMAZING New wood-turning tools, sharpen once in 12 years! Tipped with tungsten carbide. Razor-like edge works free hand equally well in wood, plastic, soft metals. Finest tools available. Write for free literature. Johns Mfg. Corp., Dunellen 3, New Jersey.

CLOSEOUT Electric drill presses 1/4" Jacob chuck, \$10. Tilt-Arbor bench saws including 8" blade, \$25. New! Guaranteed! \$5 with order, balance collect. Cordray Motors, Wellington, Ohio.

"TIRES"—Save 1/2. New, rugged all purpose airplane tires, 10 inches to 56 inches high. Complete wheel assemblies attach easily to your axles. Free details. Write card today. Airplane Tire Co., Box 1201A, Tulare 3, California.

BUILD Own commercial lawn mower sharpener. Plans. Mowerman, Hayward 1, Wis.

ASSORTED To your order! Nuts, bolts, screws, etc. for every need. Rush postal, free bargain catalog. Scientific Assortments, 4554 Maplewood, Chicago 25, Ill.

1/2" **ELECTRIC** Drill \$8.95, 1/2" electric drill \$22.95, 1/4 hp. bench grinder \$22.95. New and guaranteed, catalog 10c. Box 1161, Oklahoma City, Oklahoma.

#3 **MORSE** Taper tailstock spindle fits most 9-12" lathes. Use larger drills, reamers! Tang grip, no slippage! Request folder. Box 10265, Tampa 9, Florida.

TOOLS, Machinery, supplies for home craftsmen, mechanics, hobbyists. Discounts to dealers. Precision Tool Service, 55 E. Washington, Chicago 2, Illinois.

BENCH Power tools, motors, supplies. Wholesale prices. Homecrafters Co-operative. Grand Rapids 6, Mich.

FIRE Extinguishers. 15-pound C-O-2, \$42.50. Domonkos, 98-A5 Vermont, Newark 6, New Jersey.

BALL Bearings one-fourth list price. Free list. Burgess, Box 168, Ferguson, Mo.

SURPLUS Bargain. \$14.00 value, now \$2.95; 2" 3-jawed precision universal chuck. Send check or money order. Har-Mur, 2349 Devon Ave., Chicago 45, Ill.

GAGE Your grinding of twist drills, hand or machine ground, for clearance and both cutting angles simultaneously. Your drills will really cut when ground to this gage. 1/16" to 3/4" size 75c postpaid. Descriptive postcard free. Tingle Industries, 8731 Orangelawn St., Detroit 4, Mich.

14" x 6' HENDEY Engine lathe \$625.00.
18" x 8' Rahn Larmon engine lathe \$225.00.
#1 1/2 Valley universal milling machine \$425.00.
15" Potter Johnston metal shaper \$490.00.
20" Barnes drill press \$55.00.
Cincinnati Machinery Co., Dept. B, 217 2nd St., Cincinnati, Ohio.

SURPLUS Machinery, tools, etc. Rush name. Wayne Engineering, Elkins 1, W. Va.

CHUCKS. (Genuine Westcott) Independent, Universal; threaded 1 1/2"-8 for South Bend, Atlas, Logan, Clausing, Craftsman lathes. Other chucks to 16". Top value. Tell us type and size chuck you want, make of your lathe and spindle nose dimensions so we can submit definite quotation and free literature. No obligation. Westcott Chuck Company, 3600 Walnut, Oneida, N. Y.

COMPACT Amerline beam compass has self-contained scale giving rapid and accurate settings for circles up to 12 feet in diameter. \$3.00, postpaid. United Industries, Box 449, Madison 1, Wisconsin.

OFFER Several thousands bronze bushings 2 x 15/16 x 3/4 at \$10.00 a hundred. Write Box 45, Reno, Penna.

DRILL Grinder for twist drills, \$2.95. See ad on page 269.

BOATS, OUTBOARD MOTORS

SAVE 3/5 Cost. Build your own boat with our ready cut parts by the Welch system. No experience necessary. Rowboats to cruisers. Illustrated catalog 25c. Midwest Boat Company, Menomonee Falls, Wisconsin.

FULL Sized paper patterns for 16 foot vee-bottom boat, one dollar. Snyder, 1412 9th Ave., No. St. Petersburg, Fla.

OUTBOARD Motors—Used bargains. \$45 up, free list. Used parts, most models, save money! Boat and motor equipment and accessories. Big catalog, send dime. Crandall-Hicks, 911 Commonwealth, Boston, Mass.

WATERPROOF Plywood—Oak lumber finished to size; for boat building. Prefabricated kits; marine finishes; supplies; books; plans. Send 25c today for complete literature, details, price lists. Trans-Marco Corporation, Mount Vernon 3, N. Y.

KNOCK Down boat kits. Outboards, inboards, sail, racing, molded shapes. Easy to assemble, enjoyable, minimum cost. Illustrated catalog 25c. Brooks Boat Company, Carrollton P5, Michigan.

BUILD Your boat from our accurate paper patterns, thirty designs, 7-54 feet. Forty years careful designing. Send 10c for folders. Illustrated book, small boat construction, \$1.50 postpaid. German Boat Company, W. Saginaw, Michigan.

BUILD 8 Ft. dinghy, kit complete with all hardware, marine plywood, \$45. Free literature. Ideal, 19A West 19 Street, New York 11, N. Y.

BOAT Plans: Over 300 designs easy-to-build outboards, sailboats, runabouts, cruisers, etc. Get free catalog now. Motor Boating, 572C Madison Avenue, New York 22, N. Y.

OUTBOARD Motor parts, new and used, all makes. We can save you money. Write for price quotation. Cylinders rebored. Oversize pistons and rings for all makes, regardless of age. Outboard Motor Mart, Inc., 309-B Atlantic Ave., Boston 10, Mass.

P38 BELLY Tank boat plans, complete instructions \$1.00. Details free. Buck's Auto Wrecking, 1635 T, Merced, Calif.

SPORTSMEN! Make Kayak from economical, easy-construction kit! Literature. Dedham Kayaks, Dedham, Mass.

BOAT Plans: Wood; steel. Book, "Modern Designs for Boats and Yachts." \$1.00. John B. Clark, Yacht Designer, 329 Kenmore Drive, Bay Village, Ohio.

NEW, Used, rebuilt marine motors. Marine conversions, fittings. Free catalog. Stokes Marine Supply, Dept. 24, Coldwater, Michigan.

BUILD Marine motors, Ford or Jeep. Federal Marine Motors, 9011 Cottage Grove, Chicago 19, Ill.

BOATS And all about them. How to select, build, repair and operate. For 40 years the leading practical boating magazine. Half price trial subscription. 12 issues for \$1.00. Motor Boat, 62 Gold Street, New York 7.

MARINE Conversions for Ford and Jeep engines. Catalog 10c. Lehman Manufacturing Company, Department D, Newark 2, New Jersey.

STEERING Wheels, windshield brackets, from \$6.95. Modern fittings at lowest prices. Complete pre-cut plywood boats. Bargains galore. Folder 10c. Marine, Box 681, Mendota, Minnesota.

BOAT Plans, kits—Hardware, conversions, plywood. See Marine Mart display ad page 277.

COMPLETE Constructional details on seventeen low-cost boats—power, sail, row. Designed for home builder with limited tools, no experience and little money to spend \$1.25. Popular Mechanics Press, (C-43), 200 E. Ontario, Chicago.

ENGINES, MOTORS, DYNAMOS

"BUILD-UR-OWN" Gas drive welder. Portable. Get profitable jobs anywhere. Your engine plus Hobart generator saves \$350. Free instruction book. Write Hobartweld, Box M-595, Troy, Ohio.

WELDING Generators, 150 ampere \$47.50. 1/2 horse, 3450 r.p.m. motors \$17.00. 3/4 horse, \$22.00. Compressors \$17.50. Butler, 1885 Milwaukee, Chicago.

MOTOR Repair men, send for free literature on motor testing and winding equipment. Motor Industries, Quincy, Illinois.

MOTORS! 1/2 H.P. D.C. converted to A.C. All new. High speed 110 volt, 25 or 60 cycle, ball bearing motors. Actual value about \$75.00. Now \$15.00 each or 3 for \$40.00. Countless uses for home mechanics. Can be used in any position. Order today! Immediate delivery! No c.o.d. orders. "Amazing Bachman's," 27 Herman Street, Rochester 5, New York.

WINDING Data, listing 225 motors, single and three phase, \$1.00. Motor Data Co., Box 7831, Kansas City 3, Mo.

MOTORS—1/2 H.P., 3450 r.p.m., \$17.50. 1 h.p., \$28. 1/2 h.p., 1750 r.p.m., \$18.50. Roberts, 7232 Madison, Forest Park 3, Ill.

ATHLETIC EQUIPMENT, BODY BUILDING COURSES

ALL Barbell men who have not reached their desired bicep development, write to: Dymek Curling Bar, 2421 Dove St., Williamsport, Pennsylvania.

BARBELLS! Muscular physique, strength. Send stamp. Jackson Barbells, Springfield, N. J.

ACROBATS! Strength, health. Free booklet. Write! Eb. Knoff, Pewaukee, Wisconsin.

BIG Bargains, 12 courses \$1.00. News 10c. Sid's System, Southgate, California.

BARBELLS, Exercise equipment. Courses. Free booklet. Good Barbell Co., Reading, Penna.

DEADLY Judo—Fiercest fighting technique. Trick knockouts. (200 photographs, plus illustrations.) Expert instructions, three volumes. Complete \$2.25. Variety House, Box 46-B, Wall Station, New York 5.

SPORTING GOODS, GUNS, FISHING TACKLE, ARCHERY, TRAPPING

CAMPERS, Hikers, climbers! Go right with lightweight equipment. Outdoor tested for outdoor men. Packs, tents, sleeping bags, plastic mattresses, axes, knives, stoves, reflector ovens, Swiss mountaineering equipment. Write for free catalog. Camp and Trail Outfitters, 112D Chambers Street, New York 7.

FREE, New Spring Catalog of guns, fishing tackle, athletic goods, camping equipment, cameras, western goods. Write Andy Anderson's Sporting Goods Co., 120 W. Grand, Oklahoma City, Okla.

SURPLUS Camping supplies, Bargains. Free catalog. R. McManus, Cuttingsville 4, Vermont.

SEND 10c For list 100 used guns. Frayseth's, Willmar, Minn.

BARGAINS In popular and unusual fishing specialties. Write for free catalogue. Hobby Specialty Company, 415 Francis Palms, Detroit 1, Michigan.

TENTS, War surplus, all sizes; cots, hammocks, camping equipment, canvas covers, fishing and sporting goods, rope. Morsan, 10-19E 50th Avenue, Long Island City 1, N. Y.

RIFLE Scopes. New. Latest models; Weavers, Lymans, Unertls at big savings. Free list. Stan Wentling, Palmyra, Penna.

AVAILABLE High power rifles guaranteed new. Remington model 721, 300 caliber \$74.95. Savage 99Y, 300 caliber \$96.45. Remington 81, 300, autoloading \$129.50. Winchester 94 30-30, \$62.00. Stevens, model 325, 30-30 \$39.00. Certified check or money order, delivered prepaid. Pulver's Sporting Goods, Hudson, N. Y.

FREE Folder fishing needs. Patti, 2945 So. 46 St., Milwaukee 7, Wis.

MOLDS For fishermen's sinkers, squids, and jigs. Sweet's Molds, Tonawanda, N. Y.

FISHERMEN! Tested and proven plug retriever. Rescues plugs snagged underwater. Retrieve-O-Ring \$1.00 postpaid. Literature on request. Kentucky Tackle Company, R.R. 6, Louisville, Ky.

LUMINOUS Glow worms! Most sensational fishing bait developed, having a natural live-worm wiggle action and scientific irresistible fish-attracting scent. Results guaranteed. Last indefinitely. 25 inches \$1.00. Witt, 2527 North 38 Street, Milwaukee, Wis.

SHUR-KETCH Fish lures; for bass, blue gill, crappies. You'll get results with Shur-Ketch! Four for \$1.50 postpaid! H. J. Weber, 3601 Redding Street, San Gabriel, Calif.

FREE Bargain catalog! Write Klein's Sporting Goods, Department C, Chicago 6.

GOLFERS—Handmade woods; factory prices. Satisfaction guaranteed. Write Ed Gordon, Box 628, Oak Park, Ill.

MINNOW Traps, sportsmen's size \$2; professional's \$3. Professional's frog trap \$5. Trapcrafters; 1936 Delancey St., Philadelphia, Penna.

BOWS, Arrows. Quality archery equipment. Popular prices. Catalog 10c. Illustrated archery instruction book 50c. Archery, 617-K So. State, Chicago 5.

BASEBALL Uniforms: Team mgrs., buy direct and save. These big league cut, large roomy uniforms are quality tailored of sturdy, Cricket cloth. \$11.95 value—our price \$6.95. Jr. league size \$5.75. 10 letters sewn on free. Write for illustrated catalog and fabric samples. Equal savings on all other baseball equipment. Bacharach Rasin Co., Dept. 43, 14 N. Howard St., Baltimore 1, Md.

AMAZING New telescopic casting rod. 5 feet. Parts slide into handle 11 inches. Fits your pocket. Literature free. Rice & Rice, Box 566A, Muskegon, Mich.

5000 BARGAINS. Firearms, binoculars, war relics. Catalog 40c. Smith Firearms, Runnemed, New Jersey.

AMMUNITION—175 Sizes in stock. American, foreign. Dime for list. Central Sports, Delphos 5, Ohio.

PISTOLS, Revolvers, rifles, shotguns, ammunition. List 25c. Frank Parish, Vicksburg, Mississippi.

SHOTGUNS. Rifles, revolvers, over 500 modern, obsolete. Also cartridges, list 10c coin. Ed Howe, 52 Main, Coopers Mills, Maine.

ANGLERS' Almanac tells you when, where, how. Answers more questions on fishing than any other book. Only \$1 at your dealer or Anglers' Almanac, Dept. CC-16, 350 Broadway, New York 13, N. Y.

SPORTSMEN Join our club! Free information. Aggressive, Box 148, Kenosha, Wisconsin.

TAXIDERMISTRY

"MODERN Taxidermist Magazine," Greenfield Center, N. Y. Devoted exclusively to taxidermy. Two sample copies 25c.

BINOCULARS, TELESCOPES, MICROSCOPES, MAGNIFIERS

BINOCULARS, Many makes, surprising prices, list 10c. Wanted: large tripod binoculars for top cash. R. Beach, 703 S. Claudina St., Anaheim, California.

BINOCULARS, New 6X25 \$20.00; 8X30 \$30.00; 7X50 \$40.00, plus tax, money back guarantee. Bushnell Importers, 672 S. Lafayette, Los Angeles 5.

20X120 BINOCULARS. Excellent condition. \$25. Dr. Murphy, St. Francis Hospital, Honolulu, Hawaii.

REFLECTING Telescopes, 60X, completely assembled \$25.00. Guaranteed observatory clearness. Free information. Skyscope, 475 Fifth Avenue, New York 17.

BINOCULARS, Telescopes, watches, guns. Buy, sell, trade. Schweer's, Donnellson, Iowa.

POWERFUL Astronomical telescopes easily made. Perfect lenses and instructions; 100X \$3.00. 100X and 200X \$4.00. 100X, 200X and 400X \$6.00. Clear vision, full power guaranteed. Instructions alone 10c. Suffolk Science Service, Manorville, N. Y.

ASTRONOMICAL Telescopes, binoculars, microscopes; bought, sold, repaired. Books. Lists 10c. Rasmussen-Reece, Amsterdam, N. Y.

TELESCOPES, Binoculars, microscopes, big bargain catalog free. Brownscope Company, 24 West 45th Street, New York.

GIANT Astronomical telescope 100 diameters magnification, with tripod. Full power, clear vision. \$15.00. Suffolk Science Service, Manorville, N. Y.

DOGS, PETS, BIRDS, RABBITS

BOXER Puppies, Schwarzwald Hof Kennels, 5136 Cascade Road, Grand Rapids 6, Mich.

HOHL'S Hamsters. Clean, odorless pets. \$4.50 pair. Literature, picture free. Lab. Stock, 317 Mt. Vernon Rd., Newark Ohio.

RAISE Guinea pigs. Make money at home. Booklet free. Taylor, Box 426A, Hapeville, Georgia.

\$300 MONTHLY Raising Angoras for our market? Particulars free. Associated Breeders, 610 Marshall, St. Paul, Minn.

MAKE Extra cash. Raise Giant Chinchilla rabbits. Waters Rabbit Farm, Glennville, Ga.

HAMSTERS: Finest pedigreed breeding stock, reasonably priced. Mount Clemens Hamstery, 94 Church, Mount Clemens, Mich.

BEAUTIFUL Pure white pedigreed police puppies. Ansonia Kennels, Mose, N. Dak.

RAISING Rabbits, Cavies, Hamsters, Chinchillas is profitable. Big demand. Instruction book and magazine 25c. Book and magazine (monthly) one year, \$1. Small Stock Farmer, Fairlawn 2, New Jersey.

RAISING "Hamsters is profitable." Information. Pem's Hamstery, 3010-10th Ave. No., St. Petersburg 6, Fla.

\$400 MONTHLY. Raising Angora rabbits. Wool \$9 pound. Plenty markets. Details free. White's Rabbitry, Newark, Ohio.

GRINSTEAD'S Famous Angoras! Giant Chinchillas! World's most profitable rabbits. Finest pedigreed, heavy-producing, prize-winners. Literature free. Grinsteads, Edwardsville, Illinois.

BEAUTIFUL Great Danes—Loving companion, guard. Sidney Baucom, Salt Lake City, Utah.

RAISE Rabbits. Four pound fryers in eight weeks. Ready market for meat, fur, wool. Illustrated book, describing leading breeds, housing, breeding, feeding, marketing. By America's largest Rabbit Association. 10 cents. American Association, 12 AR&CBA Building, Pittsburgh 17, Penna.

\$1.00 FOR Booklet "Canary, Its Care, Breeding and Training," and three copies cage-bird magazine. American Canary, 2839PM N. Halsted, Chicago 14, Ill.

RAISE Chinchilla rabbits. Year-round money-makers from furs, meat, breeders. Experience unnecessary. Write today. Willow Farm, Sellersville 15, Penna.

MINK Raising information free. Complete. Lake Superior Mink Farm, Superior, EE1, Wisconsin.

INCREASE Your income by raising domestic rabbits. Small space needed. Ready market for delicious meat, fur and wool. Largest magazine in the industry tells you how. \$1.50 per year. Sample 15 cents. No stamps. Small Stock Magazine, Lamoni 20, Iowa.

\$3000 YEARLY Raising Angora rabbits. We buy your output. Contract particulars free. Kise's Enterprises, St. Paul 8, Minn.

SEE Gulf Hamstery ad on page 24. Shows picture of Hamster.

RABBIT Hutch and housing. New, revolutionary patented features, automatic, economical enabling two persons care for 1000 does. Plans, photographs \$5.00 post-paid. Reliable Fur Industries, Dept. P.M., Montebello, Calif.

PLANTS, SEEDS, NURSERY AND GARDEN SUPPLIES

GIANT Bushel size gourds easily grown in your back yard. Package seed, instructions, 35c. No stamps. W. H. Jones, Dubberly, Louisiana.

RAISE Your own trees and shrubs from seed for shade, windbreak, erosion control, etc. Write for free planting guide and price list. Woodlot Seed Co., Norway 4, Michigan.

FARMS, FARM LANDS, REAL ESTATE

WANTED: Chicago real estate (vacant or improved). Send description and price for quick sale. Bernerd L. Wells, 188 West Randolph, Chicago 1.

BIG Free summer catalog of farm bargains, many states, some equipped, many illustrated! Write today for free copy! United Farm Agency, 1408-PM Consumers Bldg., Chicago 4, Ill.

OREGON'S Willamette Valley. Catalog for asking. Kingwell Agency, Corvallis, Oregon.

HEALTHFUL; Security; prosperity. Ozark glamour lands. Lowest bargains. For retirement farming. Vacations, fruit, poultry, investment. Free list. Write Armstrong, Shook, Missouri.

JUST Out Strout's Red Farm Catalog! Spring-summer time and money-saver—Free! Describes 2790 bargain properties, 35 states coast-to-coast. Write today for your free copy! Strout Realty, 255-P 4th Ave., New York 10, N. Y. 20 W. 9th St., Kansas City 6, Mo. 453 S. Spring, Los Angeles 13, Calif.

GOVERNMENT Lands \$2.00 acre up. Information all states twenty-five cents. National Tax Service, 901-A Majestic Bldg., Detroit.

BIG Lists farms, ranches, water frontage properties. Free descriptive folders, prices. Splendid opportunities, Washington, Idaho, Montana, Dakotas, Upper Michigan, Wisconsin, Central Corn Belt. Information regarding Columbia and Missouri River Basin irrigation projects. L. H. Robbins, Milwaukee Railroad, 736K Union Station, Chicago 6, Illinois.

GOOD Farms—Ranches. Washington, Minnesota, Montana, Idaho, Oregon, North Dakota. Dependable crops, favorable climate. Write for literature, lists describing typical farm opportunities. Specify which state. J. W. Haw, 119 Northern Pacific Railway, St. Paul 1, Minn.

OZARK Magazine, Eureka Springs 11, Arkansas. For homeseekers, tourists. Year, \$1.50.

SOLD For taxes. Calif., Oregon, Washington timber, grazing, ranch and mining lands. 25c to \$3 acre min. bid. 10c (coin) brings circulars, photos, maps. Pacific Lands, Box 2350-PM, Hollywood, Calif.

LOTS \$300—Convenient payments. California's finest garden section. On Morro Bay's scenic shores. Wonderful fishing, hunting, boating, bathing. Fertile soil, softest water, temperate climate, congenial community. Free literature. Richard Otto, Department M, San Luis Obispo, California.

OZARK Lands for all purposes. Actual river frontages. 5 acres \$90.00 and upwards. Free list and literature. Hubbard, 424-I Minnesota Ave., Kansas City 4, Kansas.

POULTRY, FARM SUPPLIES

GROW Chicken of tomorrow today with chicks from Pilch's Famous Old Hen Breeders. You too will like Pilch's chicks because so many other people do. 14,000 Pullorum Clean Breeders. Reds, Rocks, Crosses, Sex-Links, White Rocks, Hamps, Started Pullets, Started Chicks, Capons. Write for valuable '49 calendar. Pilch's Chicks, Box M, Thompsonville, Conn.

RAISE Fryers new easy way. One man home plant earns \$500 monthly. Circular free. Poultryman's Institute, 1046-A So. Olive, Los Angeles 15, Calif.

BABY Chicks, champion mated, 52 varieties, 6 hybrids, licensed inspected, bloodtested. Rush postal, large colored book free, low prices. Berry's Farm, Route 12, Clarinda, Iowa.

KNOW How to raise poultry for profit. Read Northeastern Poultryman. Every issue packed with helpful hints and practical suggestions. Latest articles on breeding, feeding and management. Subscribe now. 1 year 65c. 2 years one dollar, foreign subscriptions \$1.00 a year. Northeastern Poultryman, Dept. P.M., 376 Boylston St., Boston 16, Mass.

EARN \$4 To \$12 hourly. Chick sexing, culling and caponizing. G.I. approved. Pilch's School, Box PM, Thompsonville, Connecticut.

RAISE Turkeys the new way. Write for free information explaining how to make up to \$3000.00 in your own backyard. Address National Turkey Institute, Dept. 3, Columbus, Kansas.

PROFITABLE OCCUPATIONS

DIESEL Troubleshooting pays big money! An amazing new system developed by George H. Frank, Chief Instructor, Diesel Division, Adcox School, makes it easy for any man, with a working knowledge of diesel, to become a diesel troubleshooter. It's new! It's different! Not a book, just a simple index guide to the trouble. If you really want to advance to diesel troubleshooting, mail \$10.00 now for Frank's Diesel Trouble-Shooting Guide. Address George H. Frank, 237 N. E. Broadway, Portland 12, Oregon.

SELL Auto seat covers at factory prices! Every car owner a prospect, big profits. Write National Process, Hempstead, Long Island.

OREGON'S Business Opportunities. Catalog for asking. Kingwell Agency, Corvallis, Oregon.

SENSATIONAL! It's easy to earn big money with your own profitable business. Earn \$10.00 to \$50.00 a day. Make lamps at home. General illustrated course teaches you quickly. Course and wholesale supply catalog only \$2.00. Gearon Company, Dept. 200-B5, 27 South Desplaines, Chicago, Illinois.

MUSHROOMS Grown. Boxes. Barrels. Instructions 50c. Spawn \$1.00. Manureless process \$2.00. Gordons, 553 William, Winnipeg, Manitoba.

LOCKSMITHING Secrets! Key fitting, lock repairing, opening; prices, sources. Illustrated book \$1.00. Wexler, 7 West 36, New York City.

FREE Book "372 Unusual Worldwide Business Adventures!" South America, New Zealand! Work delightful, "different" plans home. Publishers-C4, Carlsbad, Calif.

MAKE Men's and ladies' plastic wallets. Pleasant and profitable. Details free. Lakeshore Supply, Dept. PM5, 534 Surf St., Chicago 14, Ill.

GROW Dwarf trees. No cost. Fabulous prices paid. Instruction folio \$5.00. American, 385 Latijera Station, Los Angeles 43, California.

TYPISTS. Profitable business at home. Complete copyrighted information 50c. Rosdahl, 72-A W. Washington St., Chicago 2, Ill.

WOULD You pay 3%—First \$350 made? Color-illustrated book "505 Odd, Successful Enterprises" free! Work home. Expect something odd! Pacific, Oceanside, Calif.

INEXPENSIVE Manual teaches air conditioning. Write. Don Nelson, Warner Robins, Georgia.

YOU Can make real money raising Golden Hamsters. New tiny animal. Easily raised at home. Write for details. Hudson Hamstery, Newfoundland 1, N. J.

FOREIGN Employment? Latest bulletin, overseas directory and application forms: \$1.00. (C.O.D. \$1.32.) Foreign Service Institute, P.O.B. 3934, Miami, Fla.

WANTED—Purchasing agents. No money or experience required. Write Dept. C, Purchasing Manager, 2719 Lawrence, Chicago, Ill.

PROFITABLE Business making and building with easy-laying interlocking building blocks. Rex Products, Dept. 10, Piqua, Ohio.

CONSTRUCTION Report—Send \$1.00 for world wide job project listings. Up-to-minute-facts for construction men. Global Reports, P.O. Box 883-DX, Hollywood 28, Calif.

ELECTRIFY And convert sewing machines. Easy, profitable. Inquire Ray's Distributors, Dept. PM, 107 Ray St., Mishawaka, Ind.

"EVERYBODY Likes candy." Learn to make in a professional manner. (Our 39th year.) Ragsdale Candies, D6, East Orange, New Jersey.

EXCELLENT Profits. Make, sell holiday flowers, novelties. Literature free. Velva Artcrafts, 324-M East 14, New York 3, N. Y.

"FROG-RAISING"—New book explains everything! Marlboro, 1035 Marlborough, Detroit 15, Michigan.

BE The Popular Mechanics representative in your neighborhood and earn big profits in your spare time. Write Popular Mechanics Magazine, Room 408M, 200 E. Ontario St., Chicago, Ill.

\$46 FROM Square foot plywood; jigsaw necessary. Write, Woodarts, P-38, Bridgewater, Mass.

OWN Mirror shop. Resilver mirrors. Glass sign making. Electroplating. Supply prices. John Sprinkle, V50, Marion, Ind.

\$40.00 WEEKLY Made growing mushrooms, fresh, dried. Dominion patent 331583. Free spawn. North American, 169P Yonge, Toronto, Canada.

INTERESTED in Latin American and foreign industry? \$1.00 brings Foreign Service Directory listing exporters and importers, oil, construction, mining, aviation companies. Hot tips for applications. Global Reports, Box 883-M, Hollywood 28, Calif.

ALASKA—The Last Frontier offers unlimited opportunities, \$1 brings government map and directory listing firms in fishing, construction, mining, aviation, fish and game rules, homestead data. Alaska Opportunist, Box 883-M, Hollywood 28, Calif.

BOOKS, PERIODICALS, PICTURES, POSTCARDS

QUICK Profits taking magazine subscriptions, handling greeting cards. Cassell Publishers Service, Westfield, New Jersey.

FREE Catalogue. Special interesting psychology books. Bartel, 1324 Wilshire, Hollywood 14, California.

THE Complete Home Handyman's Guide, \$3.95; free catalogue interesting books. A. Faller Company, 201 Dewey Street, Newark 8, New Jersey.

NATIONAL Geographic Magazines 1888-1949. Any issue, Box 327-PM, Periodical Service, Swarthmore, Penna.

MAPS, World globes, atlases—Free catalog. Belanger's, 51-R Talcott Ave., Rockville, Conn.

BOOKFINDERS! (Scarce, out-of-print, unusual books). Quickly supplied. Send wants. Clifton, Box 1377-PM, Beverly Hills, Calif.

SELF-EXPLAINING Bible: Illustrated circular free. Box 446-P, Minneapolis, Minn.

BOOKHUNTERS! All subjects. Send wants! Jaher Book Service, 620-P East 178 Street, New York 57.

GAMES, ENTERTAINMENT

MICHIGAN Rummy—With fascinating new twist. Fun for young, old, expert or inexperienced at cards. You get durable leathertex layout 25" x 32" and instructions, \$1.00 postpaid. Gamlin, 411 East 8th, Kansas City, Mo.

MAGIC Trick, fun catalog, 10c. "Marean" Magic Shop, Hopewell, Virginia.

MAGIC TRICKS, PUZZLES, JOKER NOVELTIES

LARGE 160 Page catalog, just published, 35c. We have supplied the best tricks to beginners and professionals for 38 years. Chicago Magic Company, 2300-O No. Mason Avenue, Chicago 39.

PUZZLES—Just like a pocket-size pinball machine. 3c stamp brings catalogue. Joseph W. Druke Co., Box C127, Grand Rapids 6, Mich.

500 TRICKS New 1949 edition. Send 10c for Douglas famous catalog showing best in good magic, lowest prices, fastest same-day service. 30 years in business. Douglas Magicland, Dept. 1, Dallas, Texas.

3 MAGIC Tricks you can do anytime. 10c. Edwin, Box 406, Cambridge 39, Mass.

MIRACLE Horse races—20 cards per box \$1.00 and get illustrated literature free. Rone's, Box 97, Katonah, N. Y.

BELLY-LAUGH Getter! Attractive ready-knotted "Roll-Up" necktie under your complete control. Rolls up when pretty girl appears etc. Get set for lots of fun. Send \$1.00. Dynamic Sales, Box 2414A, Cleveland 12, Ohio.

FREE List of our novelties, toys, tricks, etc. Visco Brothers, Box 4705, Philadelphia 34, Penna.

TRICKS, Secrets, cards, punchboards, etc. explained. Big illustrated circulars 10c. Mack, Box 1278-E, San Francisco.

AMAZING Trick disappearing watch. Vanishes mysteriously from open hand, given with great magic catalog. Over 400 tricks that astonish, amuse and confuse, only 25c. The Magician, 2463 P Kensington Ave., Philadelphia 25, Penna.

READ Sealed writing. Three different methods \$1.00. Details free. Welches, 333 W. Tipton, Huntington, Indiana.

SCHOOLBOYS—Earn spare money instantly! Sell "secret envelopes!" Sample free! Stampico, Detroit 4, Mich.

BE A magician. Large professional magic catalog of latest tricks, 35c. Ireland, C-109 North Dearborn, Chicago 2.

FREE Deck trick cards with catalogs 25c. 12-PM Churchlane, Philadelphia.

MAGICIAN'S Trick wand (Vanishes handkerchief!) Free with catalog 25c. Box 4228-PM, Philadelphia.

JOKERS Novelties. Handshakers, squirters, whoopee cushions, table jokes, 5c brings catalog. Jokertrix, Box 274, Dallas, Texas.

SNEEZING, Itching, powders. Eighteen other tricks free with joker's catalog 25c. 2404-N Fifteenth, Philadelphia.

PROFESSIONAL Catalog, 124 pages, 25c. Williams, 900 Plymouth, Ellwood City, Penna.

VENTRILLOQUISM Taught, 3c stamp bring particulars. Smith, 801 Bigelow, Peoria 5, Ill.

WORLD'S Largest professional magic shop, keeps you in touch with latest tricks. To receive mailings, send 50c for new catalog. Holden's, M220 West 42nd St., New York.

LEARN Magic, ventriloquism, mind-reading. Write for particulars. Quackenbush, Big Flats, N. Y.

"VENTRILLO," Professional voice throwing instrument and "unusual" catalog 25c. POB-971, Philadelphia.

SEND No money. Jiffy coin trick free with Doty's exploding pencil \$1.50 c.o.d. Tauton, 1925 Shaftesbury, Dayton 6, Ohio.

FREE Catalog magic tricks, jokes, novelties. Laramie Sales, 4800 So. Laramie Ave., Chicago, Ill.

MAGIC Tricks, puzzles, books, cards, punch boards, Catalog 15c. Specialty, Box 671, St. Louis 1, Mo.

LARGE Catalogue of the best magic for professionals and amateurs. Send 35c. Mazda Magic Co., 1135 Westgate Ave., Oak Park, Ill.

16 CARD Tricks and catalog 25c. Sterling Magic, Royal Oak, Mich.

ENTERTAIN, Mystify! 96 page catalog magic, joke and party goods, 25c. Riley-Borin, P-7909 Rhodes, Chicago 19.

400-PAGE Catalogue of 2000 tricks, pocket, parlor, stage. World's finest magic. Send \$1.00 for catalogue (refunded first \$5.00 order). Kanter's, M-1311 Walnut, Philadelphia 7.

DOLLAR Magic set free with mammoth catalog 25c. "Mysto," 4462-PM Germantown, Philadelphia.

STAMP COLLECTING

FREE—Famous Americans set, plus Flag Set, plus the National Parks Set, plus the Presidential Set to the \$5. A total of 90 stamps absolutely free to customers for our unsurpassed U. S. or foreign selections. Send 3c postage for 15 of the above mentioned stamps and full particulars. Triboro Stamp Company, 145 Nassau St., Dept. 105, New York.

GIBRALTAR Packet free—Nice collection Gibraltar, New Zealand Centennial, British Uganda, French Colonials, early British Colonial, West Indies, South American, war stamps plus Philatopic Monthly Magazine. All for 5c postage. Empire Stamp Company, Dept. PM, Toronto 5, Canada.

FREE! Canadian sets, royal visit, George VI, George V, coronation, jubilee, others, to approval applicants. Ensign, Box 118-M, South Orange, N. J.

10 ASSORTED U. S. Commemorative stamps 15c. Five U. S. Air Mail 15c. Both 25c. Ideal Stamp, Box 179, Park Ridge, Ill.

SENSATIONAL! Set each Honduras, Martinique, Guadeloupe, Guiana, also \$2,000,000.00 stamp, Brunel, over 100 different others. Everything 10c with approvals. Whitehead 315P So. 5th Ave., Canton, Ill.

TREMENDOUS Bargain. 2000 foreign stamps \$1.00, 5000 \$2.00; 2000 U. S. stamps \$1.00, 5000 \$2.00. Standard Products Company, Atlantic Building, Washington 4, D. C.

FINE Approvals. Fast, personal service. What countries do you prefer? I'll send their stamps. Skinner, 438 Locust, Long Beach 12, Calif.

DIAMONDS, Triangles packet, with approvals, sent for fifty duplicates and dime. Kiowa Stamps, Greensburg, Kansas.

FREE Triangle Roosevelt, Vatican, Ethiopia, Hitler Heads. Request approvals. Florida Stamp Company, Box 807, Miami 5, Fla.

WHOLESALE Approvals. Lists free. Johnson, Box 267, Morgan Hill, California.

FREE—200 Old issues, etc! Foreign approvals. National, Box 326A, Passaic, New Jersey.

BEAUTIFULLY Illustrated U. S. bargain catalog. Send postage. Paramount, 116P Nassau, New York 7, New York.

25 INCLUDING Mozambique, Madagascar, Cooks. 6c. Burgett Stamps, Lima, Ohio.

FREE 350 Different stamps to approval buyers only. Superior Stamp, 6908 Zoeter, Cleveland 3, Ohio.

100 VARS. Foreign, penny approval grade or better, 25c. C. Ritchie, Watertown, S. Dak.

150 DIFFERENT U. S. \$1. Polzin, 1138 N. 21 St., Milwaukee, Wis.

GIVEN! Attractive airmails to approval applicants. Bargains, Verne, 916-A Fallowfield, Charleroi, Penna.

ABSOLUTELY Free—Gilbert Ellice, Cook Islands, Tonga, Seychelles, Ascensions—free to approval applicants. Viking, 130-Z Clinton St., Brooklyn, N. Y.

500 DIFFERENT Worldwide given customers buying my approvals. Alatelo, Maynard, Massachusetts.

EXCHANGE Stamps universe. Particulars free. "Exchangers," Bry 126, Seine, France.

4c CANADA, Newfoundland. Used copy on cover and a mint enclosed of this historic new commemorative. 5c with approvals. J. Yates, Box 580, Vancouver 8, Canada.

STAMPS, Packets, albums, supplies. Send 10c for big money saving catalog. Ewing, 109 N. Dearborn, Chicago 2.

BEAUTIFUL Set free approvals. Ruches, 941 Enfield St., Thompsonville, Conn.

STAMP Wallet, perforation gauge, millimeter ruler free with approvals. Granada, 4891 Southwest Fifth Street, Miami 34, Florida.

40 FRENCH Colonies, 3c. Approvals. Super Stamp Shop, 2 Madison, Greencastle 5, Indiana.

FREE Upon request, U. S. price catalogue for stamps, albums, supplies. Stone, Box 52-P, Dorchester 24, Mass.

MONACO, Beautiful set commemorates 1948 olympic games, "quality approvals," 3c. William Deems, Ravenswood, West Virginia.

50 U. S. Airmails, commemoratives, 25c. Norwood Exchange, 4005 Ivanhoe, Norwood, Ohio.

HUGE Roosevelt, Bolivia music set, free with approvals. Stone Stamps, Box 604, Coral Gables 34, Florida.

LIBERIAN Triangulars, 10c with approvals. Vargo Stamps, 6044 South Fairfield, Chicago 29, Illinois.

EXOTIC Pictorial collection; Sakalava Chief, Fezzan Ghadames, Djibouti, Togoland, Reunion, Andorra, Algeria, Miquelon, Tunisia, Monaco, Guadeloupe, Martinique. Many others. Everything 5c. Imperial Stamps, Tampa, Florida.

FREE! Illustrated United States catalog. Low prices! Americo, Bristol, Conn.

1/2c UP U. S. or foreign approvals by countries. Hurt & Fosse, Blue Ridge, Virginia.

FREE! Sample traders book for duplicates. Economy, Littleton 2, New Hampshire.

\$5.00 CATALOG Price for 10c! (1) Big collection 112 all different stamps from Africa, South America, South Sea Islands. (2) Four desirable unused U. S. cataloging 40c. (3) Fine packet 25 British Colonies; Burma, Solomon Islands, etc. (4) U. S. \$5.00 high value. Everything (all four items) only 10c with approvals. Crystal, Littleton 41, New Hampshire.

312 MIXED U. S.—Including: Airmails, commemoratives, revenues, possessions, high-values; only 10c to "gold nugget approval" applicants! Kessel's, Folsom, California.

LOOK! Free! It's amazing! Exciting! Exclusive! The "Old Gold Treasure" stamp packet combination offer. It's the treasure of them all and the biggest stamp bargain offer on the market. Designed for your pleasure, today, tomorrow, and always, never out of date. Fulfills every collector's album, young and old. It's a mighty fine investment. Now! New low-priced and high in value combination offer. No. 1—The free gorgeous packet, "The Old Gold Treasure" stamp packet of fine quality, choice selection of either U. S. or foreign stamps (approximately 200) given with the No. 2 offer, "The Old Gold Treasure" stamp packet de luxe (approximately 200) full of choice U. S. fine selection, high quality stamps consisting of commemoratives, hi-values, revenues, air mails, pictorials, some mixed. Many to have a Roosevelt stamp included. All offered to you for 49c. Worth many times more. Only "Old Gold" offers you these high values at a low cost. Guaranteed. Hurry! Mail today. For limited time only. Reliable Stamp Mart, Coal City, Illinois.

FREE! Unusual illustrated lists. Littleton Stamp Co., Box 65, Littleton, New Hampshire.

SIX Triangles 3c! Ask for new type approvals. Bob Harris, 1308 E. Rio Grande, El Paso 1, Texas.

FREE 1,200 Diff. stamps with approvals, postage 3c. Including 100 diff. airmails, Roosevelts, diamonds, triangles. Lemke Stamp Co., R-2, Box 965-P, Bremerton, Washington.

55 DIFFERENT U. S. stamps 10c. with approvals. Robert Anderson, Route #1, Madrid, Iowa.

2,000 DIFFERENT Stamps free to approval buyers. Box 301, Long Beach, Calif.

50 DIFFERENT Stamps—Good ones! For only 15c to approval and "grab bag" applicants. Shirley Jason Inc., 505 5th Avenue, New York 17, N. Y.

PENNY Approvals that satisfy. Neil Gronberg, Box 5441-P, Philadelphia 43, Penna.

550 INTERESTING Foreign including set Nicaragua triangles, 10c with approvals. Frontier Stamps, P.O. Box 277, San Bruno, California.

FREE: China navigation issue with foreign approvals. Modern Stampco, Box 12, Wakefield Station, N. Y.

PENNY Approval bargains. Write Department PM, 1267 Tutwiler, Memphis 7, Tennessee.

SENSATIONAL Bargain! 100 all different from China! Includes mint sets! Airmails! High values! Commemoratives! All this for only 5c to approval applicants! Star Stamp Company, Jamestown, New York.

OPPORTUNITY! \$5.00 American stamp, Grenada, Korea, Saxony, Abyssinia, triangle and over 100 different others cataloging to 60c each. Everything 10c with approvals. Trader Horn Stamp Co., Department P, Ludington, Michigan.

ATTRACTIVE Low-priced approvals. Write Larry, Box 51, South Station, Fall River, Mass.

FREE! United States price list. 50 different U. S. 10c. Arthur Terreson, Box 479, Bellmore, N. Y.

UNPICKED: 5000 U. S. \$2.00; 5000 foreign \$3.00. Kuhn, 81-10 Broadway, Elmhurst, N. Y.

FREE Copy interesting stamp collectors newspaper. Southern Philatelist, Miami 42, Florida.

55 DIFFERENT United States—5c. 8 different U. S. cacheted first day covers \$1.00. Approvals. Utechts, 1143G North Keeler, Chicago 51.

66 DIFFERENT Stamps, including U. S. battleships 6c. World wide approvals. Telic-Arts, Devon, Conn.

U. S. Illustrated price list 10c. Lush, 12863A Caldwell, Detroit 12, Mich.

MIXTURES. Worldwide. 1,500. \$1.00. Missions Outlet, Reverend Marshall, Paterson 1, New Jersey.

UNITED States Collection. 100 different commemorative Columbians, flags, famous Americans only \$1.00. 150 different foreign \$1.00. Approvals on request. Cameron Stamp Co., Box 116, Verona, N. J.

FREE. Irish commemorative collection, many colorful issues. Approvals sent. Raymax, 123-Z William St., New York City 7.

AROUND The world—30 different countries: Basutoland, Nyassaland, Tangier, Cyprus, St. Helena, 10c with approvals. Exello Stamps, P.O. Box #95, Hackensack, N. J.

FREE \$1—\$2—\$5 United States stamps to applicants. U. S. approvals. Metropolitan, 140-B Nassau, New York 7.

FREE! United States stamps nearly 100 years old to applicants. U. S. approvals. Wakonda, 140-G Nassau, New York 7.

FREE! Mint United States, Armenia, South America, Russia packet, approvals. Greenwood, 263 Meridian, Miami Beach, Florida.

SCOOP! Sensational \$1.00 packet 25c to approval applicants. Newhouse of Stamps, Box 222, Mineola, N. Y.

WOW! \$10.00 Worth of fun 10c! What a treasure hunt! Big package 500 foreign stamps, including airmails, pictorials and others from the world over; stamps worth up to 25c each. This offer sent for 10c to approval applicants only. Jamestown Stamp Co., Dept. 22, Jamestown, New York.

FREE, 12 Different U. S., approvals ac- company. Village Stamps, 90-39P 214 St., Queens Village 8, N. Y.

GENUINE "Goya Nude" set (catalogs 55c) 10c. Approvals. Royal Stamp Company, Tamaqua, Penna.

50 DIFFERENT United States 10c. Price list free. Seidenberg, Cassopolis, Mich.

COLORFUL Croatian Legion issue (4) complete 3c with approvals. George Richie, 840 Oak, Alameda, California.

THESE Are them! Unusual penny approvals. Roscoe Stamp, 1321 Roscoe, Chicago 13.

DESIRABLE Approvals for junior collectors. Phoenix, 120 West 44th Street, New York 19, N. Y.

10,000 PENNY Approvals waiting for you. Many from exotic countries, pictorials, airmails, new issues. Tilbury, Box 862, Newark 1, N. J.

UNITED States approvals complete coverage, fine quality, attractive prices. Seminole Stamps, Box 1138-P, Coral Gables, Florida.

IRISH Convent mixture, 2500, and 6000 British. The lot \$2.00. Catalogue free. Price Company, Killogrange, Dublin, Ireland.

A WORLD Of stamps for 10c. 19th century U.S., pictorials, air mails, British Colonies, etc., to new approval applicants; also a fine approval selection included. Send 10c today to Cosmopolitan Stamp Co., 1457 Broadway, New York City.

GERMANY (Greater) 500 diff. \$2.00. Masser, 322 E. 9th St., Brooklyn 18, N. Y.

100 DIFFERENT With approvals. Jacobsen, 59 Nagle Ave., New York 34, N. Y.

UNITED States commemorative collection. Thirty-three different unused, Columbians to 1943 commemoratives only. Price \$1.00. Request approvals. "Stamps," Albany 1, New York.

ILLUSTRATED Stamp magazine, 26 weeks 25c. Stamp Journal, Kalamazoo, Michigan.

FREE! U. S. monthly lists, fine stamps! Cole, 43-A Rinewalt, Buffalo 21, N. Y.

\$1.00, \$2.00, \$5.00 U. S. Free. Approval applicants. Flamingo, Box 4038, Miami 38, Florida.

"MAN Size" United States approvals! Illustrated catalog! Sullivan, Endicott Arcade, St. Paul 1, Minn.

FRENCH Colonies, 50 colorful, large pictorials, 10c only with approvals. Fields, 1939 E. 85, Cleveland 6, Ohio.

FLAG Stamp free with U. S. approvals. Wenigman, 1933 Patterson, Chicago.

50,000 STAMP Grabbags 25c each. Anderson, 630 Binghamton 1, Reading, Penna.

WORLDWIDE Different. 200. 25c; 500. 50c; 1000, \$1.25; 2000, \$3.00. 5000, \$15.00. Beacon Sales, Maynard 2, Mass.

15,000 DIFFERENT Stamps 2c each! Gordon Davison, Box 1019B, Manchester, N. H.

U. S. Price list. Send postage. State Stamp Service, 1225 Park Building, Pittsburgh 22, Penna.

200 DIFFERENT Including Roosevelt triangle, 5c to approval applicants. M. Avalon Stamp Company, Springfield, Mass.

128-PAGE United States catalog—1000 illustrations, 10c. Harris & Co., 202 Transit Bldg., Boston.

FREE! Crystal-mount samples! Har-risco, 202 Transit Bldg., Boston.

BINGO! Jackpot collection! Triangles, maps, animals, midgets. All for 5c to approval applicants only. Southwest Stamps, Box 117, Long Beach 1, California.

FREE—Illustrated catalog! Kenmore Stamp Co., Arlington 74c, Massachusetts.

307 ALL Different 10c. You will find scores of new varieties here for your collection! Big and little stamps, bisected stamp, commemoratives, triangles, high values! Bicolored beauties! Strange countries! Every stamp is different. All for only 10c to approval applicants. Write today and receive special Ionian Island stamp extra. Garcelon Stamp Company, Box 400, Calais, Maine.

200 BRITISH Empire stamps; only 3c. Kenmore Stamp Co., Arlington 74c, Massachusetts.

YOU'LL Like our American and British Colonial approvals. Write now. Chesapeake Stamps, 748 Overbrook, Baltimore 12, Maryland.

FREE U. S. price list, postage 3c. Mark Hanna, 335 5th Ave., Pittsburgh 22, Penna.

WORLD—500 Diff. 50c, 1000 \$1.25, 75 Canada 25c, approvals, lists. Victoria Stamp Co., London 4, Canada.

WORLD'S Largest stamp (7 1/2 x 14 inches). A real curiosity! Retail for 50c, only 3c to approval applicants. Tatham Stamp Co., Springfield 30, Mass.

FREE! 100 Worldwide different stamps to approval buyers. Big U.S. and illustrated bargain lists sent with approvals. Bookman, Maplewood, N. J.

STAMP Collections wanted. Complete collections, duplicate lots, surplus stock, mint and used. Prefer trade for printing or other items, buy outright if priced right. What have you, what's wanted? Vanroy Shirk, Lebanon, Penna.

DEALERS—Wholesale list. Postage 3c. Frank, 5031 Queensberry, Baltimore 15, Md.

OLD Scarce U. S. seconds on approval. Slightly defective, bargain prices. Hernefield, Clintonhill Station, Newark 8, N. J.

POUND Stamps containing thousands \$1.00. Longacre Shop, 108 West 42nd, New York 18.

BERLIN Bears, complete set of eight and 100 different stamps only 10c to approval applicants. Reich Stamp Co., 4647 Kenmore, Chicago 40, Ill., Dept. M11.

25 ALL Different stamps 10c. Tunis, Wakeman Ave., Newark 4, New Jersey.

NICARAGUA "Tin Pan Alley" dia- mond, Ecuador showing George Washington, and American flag in natural colors. Pezzan, Trieste, "American Army" stamp, first U. S. commemorative, \$100.00 Shanghai, Corsica, Anzac, Antique, others. All 5c. Approvals. Capital Stamp Co., Dept. 2, Little Rock, Ark.

ZOWIE-E! A barrel of fun for only a dime. 500 United States stamps—absolutely unpicked and unsorted—just as received from church missions. Many varieties, including large commemoratives, airmails, high denominations up to \$5.00! Stampdom's biggest package of fun—and you might find something really valuable! Price only 10c to serious approval service applicants. Money back if not delighted. Illustrated bargain lists with each order. Mystic Stamp Company, Dept. 80, Camden, New York.

FREE Illustrated list. "Treasure Hunt" penny approvals on request. Reed Company, Box 980, Chicago 90, Illinois.

COINS, TOKENS, CURRENCY

OLD Money wanted. Do you know that coin collectors pay up to \$100.00 for certain U. S. cents? And high premiums for all rare coins? We buy all kinds. Send 4c for large coin folder. May mean much profit to you. Numismatic Co., Dept. 20, Fort Worth, Texas.

TWO Wooden nickels with world's great- est stamp and coin magazine 10c. Lawrence Brothers, Anamosa, Iowa.

UNCIRCULATED Foreign coin and banknote with huge price list 10c. Six uncirculated cents in Whitman folder 50c. Tousseau Coins, 109 So. Mathilda, Sunnyvale, Calif.

1949 PRICE List of U. S. coins 15c. 44 pages. Worldwide price list of gold coins 15c. 32 pages. James Randall, 116 South Michigan Avenue, Chicago 3, Illinois.

20 DIFF. Coins. 50c. Free lists. Appro- vals upon application. Bishop, Box 2201, Kansas City, Mo.

FREE Indianhead penny with price list. Nelson's, Box 346-M, Rye, N. Y.

60 COINS And bills, \$1.00, 100 bills, \$1.00. 35 coins, \$1.00. Oddehon, Box 482, St. Louis, Mo.

COINS Wanted. Write for list. Elsholz, Box 9014-M, Pittsburgh 24, Penna.

BARGAINS! Large cent before 1857, White Indian cent, 1899 cent, 1909 VDB cent, 1923-S cent, 2c piece, 3c piece, 1883 nickel, 1913 nickel, foreign coin, foreign bill and our complete buying and selling catalogue all for \$1.00. Catalogue alone 25c. 40 different Indian cents \$3.00, 25-50c, 15 different large cents \$3.00, 40-100c. Worthycoin Corporation, 294 Washington (D-111), Boston, Mass.

BARGAINS—3-legged Buffalo Nickel \$1.25. 1932-D Quarter \$1.00, 1932-S Quarter \$1.00. Large \$1.00 Bill \$1.60; Large \$2.00 Bill \$3.40. 4 Whitman Folders \$1.00; Handbook 75c; 254 page Guidebook \$1.50; New Type Folder \$1.00. Large Retail Catalogue 10c. Bebee Coin Company, 1180 East 63rd, Chicago 37, Illinois.

UNCIRCULATED Foreign coin included with huge bargain list 10c. Many specials. 4 Whitman folders \$1.00. Little, 337 North Menard, Chicago 44.

GET Profit and pleasure in collecting old coins. Send 10c for 56 page illustrated coin catalog. You'll be delighted with it. Send for it now. B. Max Mehl, 370 Mehl Bldg., Fort Worth, Texas. Largest rare coin establishment in U. S. Established 49 years.

FREE! Foreign coin, banknote and coin collectors illustrated catalog to approval service applicants. Send 3c postage. Tatham Coinco. Springfield 30, Mass.

4-IN-1 Special \$1.00 bargain offer: (1) United States 1893 Columbian world's fair half dollar; (2) album for holding coins; (3) large 56 page coin catalog; (4) genuine wooden nickel. Yes! All four items for only \$1.00. Order today. Money back if not pleased. Ben's Coin Company, 72 W. Washington, Chicago 2, Illinois.

COINS Wanted. Will pay up to \$2000 for certain coins, send 25c for catalogue. Burton's, 111 So. Third, Columbus, Ohio.

COMMEMORATIVE 1/2. Oregon, Texas, Kentucky, Cleveland, Long Island, \$2.00 ea. Illustrated catalogue 25c. Norman Shultz, Salt Lake 9, Utah.

PRECIOUS STONES, MINERALS

GEM Mineral Labradorite; selected for cabochons, 50c each; per lb. \$2.50. A. Milburn, 1347 Foch Ave., Verdun, Montreal, Quebec.

CONCENTRATES In vials, gold \$1.00, cassiterite 25c, azurite 25c, amethyst 25c, fool's gold 25c, lead 25c. All six \$2.00. Prospector, Winston, New Mexico.

ZIRCONS, Alexandrites, Rubies, others. Direct importation guarantees best quality; lowest prices. 3 sparkling, diamond-like, polished Zircons totaling over 2 carats \$4.00. Catalog 10c. Imhusex, Box 232, White Plains, N. Y.

GEMSTONES, Rough, polished. Mineral specimens. Every variety, lowest prices. List free. Plummer's, 2177 Bacon, San Diego 7, California.

METAL Detectors. The very latest circuit. Free literature. Hedden Metal Detectors, 3329 Liberty Avenue, Pittsburgh 1, Penna.

HOBBIES AND COLLECTIONS

WANTED Old cigarette cards. Write Charles Bray, East Bangor, Penna.

UNPAINTED Figures and novelties, new original designs. Illustrated folder free. Creekturn Pottery, Hainesport, N. J.

EARN Money with your hobby. Free details. Raynor, 21335 38th Avenue, Bayside, New York.

UNUSED Matchbook covers—100 different \$1.00. Catalog 10c. Charles Edelman, 1311C East 84, Cleveland 3, Ohio.

INVENTING Can be an interesting and profitable hobby. Write for complete particulars. Institute of American Inventors, Dept. 40-E, 1926-Eye St. N. W., Washington 6, D. C.

CAMERAS, PHOTO SUPPLIES

BASS Says: Bargaingram 257 ready and waiting for you. The book which tells all. The finest in new and used camera equipment, a veritable encyclopedia. Write, phone or call the sign of the old "Horse Trader." 39th year of satisfaction or your money back dealing. Bass buys, sells and trades. Bass Camera Company, Dept. AG, 179 W. Madison St., Chicago 2.

HOW To make more money in selling and protecting films with Porter self-sealing film mounts. Every one wants them. Write Porter Mfg. & Supply Co., 2500 W. 6th St., Los Angeles 5, Calif.

BARGAINS! Certix 120, f/4.5 Radionar, Compur Rimset 1-250 sec. \$42.50. Certo Dollina, 35 mm., f/2.8 Xenar Compur shutter, coupled rangefinder \$64.50. National Graflex 2 1/4 x 2 1/2, f/3.5 B. & L. Tessar, focal plane, filter, sunshade \$62.50. Super Ikonta B, 6 x 6, f/2.8 Tessar, Compur Rapid 1-400 sec. \$178.00. Voigtlander 9 x 12 f/4.5 Skopar, Compur 1-200, double extension, with holder, pack adapter, \$49.50. Zeiss Ikon 6 x 9, f/4.5 Tessar, Compur 1-250 sec. holder, pack adapter \$42.50. All with cases. Trades accepted. Camera, accessory lists free. Mogull's, 68 W. 48th St., New York.

SELL Cameras, vacuums, typewriters. Revere, Kodak, Weston, Royal. Large discounts. Diamond Company, 17 East 42 Street, New York City.

CAMERA "Specials" for P.M. readers. Argus, Revere, Kodak. Buy, sell, write or wire. Charles Wolfe, 167 Canal St., New York 13, N. Y.

MASTERPIECE Art slides in beautiful, natural colors. Send 50c for sample, catalog and volume price list. Zal Studios, 241 Lafayette St., New York City 12.

FREE Camera catalog, and for prompt replies a copy of "Pictures." The Snapshot Magazine. Pittsburgh Photo Shop, Dept. A-21, 1618 Westmont Ave., Pittsburgh 10, Penna.

COMPLETE Printing developing kit \$4.95. Details, Spada Enterprises, 10C Lexington, Wethersfield 9, Conn.

FREE! 124-Page illustrated revised 1949 photo catalog. Send 10c stamp. Bloom's Camera Center, Inc., 1657-PM Main, Springfield, Mass.

PHOTOCOPY Anything, papers, books. No darkroom. 8 1/2 x 11" complete, \$6.95. Fotoflek, 4801 Yarmouth, Cincinnati 29, Ohio.

HIGHEST Prices paid for still, movie cameras, projectors. Ace Camera Exchange, 136 East 58th Street, New York P-22, N. Y.

PHOTO FINISHING

8 HOUR Service, Box 468, San Francisco. Your 8 exposure roll printed jumbo or regular size 30c; 12 exposures 35c; 16 exposures 50c; 36 exposures \$1.00. Reprints, jumbo or regular 3c. Regular prints deckled. Fine grain developing. Send for free mailers. Quality Photo Service, Box 468, San Francisco 1, Calif.

GUARANTEED Repairing on Foreign and American cameras since 1935. Bellows \$1.75 up; installed \$2.75 up. Fast service. Reasonable prices. Write for estimates. Willman Camera Service, 3222 North 21 Place, Phoenix 2, Arizona.

ANY Size roll developed and 4x6 or 3 1/4 x 4 1/2 oversize glossy Velox prints: 8 exposure 35c, 12 exposure 55c, 16 exposure 70c. Clement Photo Service, 1318 W. Columbia Ave., Philadelphia 22, Penna.

35MM. Films developed each exposure enlarged to 3 1/4 x 4 1/2 deckle-edge lifetime enlargements. Finest quality. Satisfaction guaranteed. 36 ex. \$1.25. 20 ex. 75c. Free mailers. May's Studios, Dept. K-59, La Crosse, Wis.

ONE 8 Exposure film developed and printed only 30c. Ness Studio, Wells, Minnesota.

FREE Snapshot magazine, photofinishing list, mailers. Henry Houghton's, Athol, Massachusetts.

STAMP-SIZE Photographs made from your photo or snapshot. Small, 10 for 30c, 20 for 50c, 50 for \$1.00. Large, 5 for 30c, 10 for 50c, 25 for \$1.00. Photo returned unharmed. Prompt service. Agents wanted. Details sent with first order of 30c or over. H. & M. Photo Service, Box PM 525, Cicero 90, Illinois.

ALBUM Prints. 8 exposures, 30c; oversize, 35c 12—55c; 16—65c. 35mm., 36—3 1/4 x 4 1/2, \$1.25; 20—\$1.00. Reprints, 4c. Free mailers. Graphic Services, Box 72, Wilkes-Barre, Pennsylvania.

PORTRAITS — Beautifully oil-painted natural color to 8"x10". \$1.00. Sural Photos, 3300 Beach, Chicago 51, Ill.

EXTRA-HEAVY Velvet finish prints—60c. 8 exposure roll custom developed, carefully hand-printed on beautiful National velour paper. Reprints 6c. Write for list 44 other quality services. Satisfaction guaranteed. National Photo Laboratories, New Hyde Park 28, N. Y.

16 ENLARGED, Jumbo, oversize deckled prints from any 6-8-12-16-20 or 36 exposure roll film developed only 35c and this ad. Electronically exposed. Enlargement coupon free. Skrudland, 6444-R Diversey, Chicago.

ENLARGEMENTS, Any size. Photographs made from your own pictures or choose ours. Beautiful scenic sample 3 1/2 x 5 feet for \$15.00. Studio Photo Service, 521 No. La Cienega, Hollywood 36, Calif.

IF You are particular send us your films. Blublack highloss jumbo prints are different. Any 8 exposure roll developed and printed for 30c. On deckle edged paper. L. A. Photo Lab., P.O. Box 9385, Station F, Los Angeles 5, Calif.

FOUR Photos your favorite stars with eight exposure roll developed—16 prints 35c. Free enlargement coupons. Hollytints, P-1350 Hollywood, California.

35MM. Rolls developed—Enlarged 3 1/2 x 5 prints, 36 exposures \$1.00, 20 exposures 65c. 8 exposure rolls developed, printed oversize 30c, 12 exposures 45c, 16 exposures 55c. MacDonald's Photos, Box 228-J, Congress Park, Illinois.

TWO Beautiful prints from each picture on roll 30c. Twenty-eight years of satisfied customers. Quick service. Lens Photos, Dept. J4, Janesville, Wisconsin.

BEAUTIFUL Enlargement from each picture on roll 30c. Cut Rate Photos, Dept. B4, Janesville, Wis.

FREE Price list on quality developing, printing, enlarging. Write for it today. Bryan's Photo Shop, Dept. M, Panama City, Florida.

FILMS Developed and enlarged double size. 8 exposures only 30 cents, 12 exposures 45 cents, 16 exposures 60 cents. Prompt service. Mailing envelopes on request. Real Fotos, P.O. Box 172, Station B, Brooklyn, N. Y.

EXPERT Finishing. Roll developed and 8 prints 30c. Rancho Photo, Dept. P, Ontario, Calif.

8 BEAUTIFUL Double size pictures and roll developed 30c. 8 hour service. Free mailers. Pacific Photo Service, Box 666, San Francisco, Calif.

2 BEAUTIFUL Hi-Gloss prints each good negative and enlarging coupon with each 8 exposure roll developed 28c. Free mailers. Owipphoto Co., Weatherford, Oklahoma.

8 PRINTS All enlarged to nearly postcard size from your roll or negatives 25c; 16-50c. (Trial offer). Willard Studios, Box 3535A, Cleveland, Ohio.

MOTION PICTURES AND SOUND EQUIPMENT

RIN Tin Tin—"Vengeance of Rannah," 6 reels, 16 SOF, James Oliver Curwood story. New optical reduction prints \$85.00. Trades accepted. Film lists free. Mogull's, 68 W. 48th St., N. Y.

YOUR 16MM. silent projector converted to sound, \$69.95. Do it yourself. Simple to attach. Plays through radio or amplifier. Not a gadget, but a permanent engineered sound head and radio film adapter for your 16mm. silent projector; any make or model. Approved and recommended by sound engineers. Send for large illustrated folder or order, giving make and model of your projector. Enclose \$69.95 for complete sound head, adapter, attachments, instructions and everything you need. Money-back guarantee. Also ready now; extension reel arms. Permits use of 2,000-ft. reels. Designed especially for each make and model 16mm. silent projector. Guaranteed to fit. \$9.50 set, postpaid. Apex Video Co., Dept. C-59, 813 Central Ave., Balboa, Calif.

SILENT 16MM.-8MM. films; \$1.00 per reel up. Lists free. Films bought, sold, traded. Mogull's, 68 W. 48th St., N. Y.

16MM. SOUND Feature rentals—We rent you two 16mm. sound features in one shipment for \$7.90. Three hours of fun, drama, mystery, adventure or music with well-known Hollywood stars. Many 1948 releases. No obsolete or dated films. Join this new "Club Plan." References required. Location approval unnecessary. Address: Associated Film Libraries, Inc., 51 High Street, Hartford, Connecticut.

BARGAINS 16MM. sound film, miscellaneous "as is," one cent per foot. Sound features from \$22.50, shorts from \$2.50. 1600' reels \$1.35, storage cans, take 2-1600' reels 95c. Eastman film cement 97c pint. Bell Howell film cleaner 60c. Heavy duty 2000' rewinds \$12.85. Wire belts 49c. Minimum order \$2.00. Include postage. Films, equipment bought, sold, exchanged. Lists free. Mogull's, 68 W. 48th St., N. Y.

SOUND Projectors, 16mm., 35mm. from \$97.50. Screens, reels, cans, amplifiers, speakers, microphones, splicers, processing equipment, lenses, cameras, bought, sold, traded. Lists free. Mogull's, 68 W. 48th St., N. Y.

BARGAINS In good used 16mm. sound films. Complete one reel subjects often available at \$2.95. List for stamp. Blackhawk Films, Davenport, Iowa.

FREE Movie list. Superior Film Service, Box 713, Troy, N. Y.

THRILLING Documentary films, "Tank Patrol" 2 reels, "Vis Persia" 1 reel 16 SOF \$6.25 per reel new. Film equipment, bought, sold, traded. Lists free. Mogull's, 68 W. 48th St., N. Y.

FAMOUS Holmes educator type 8, 35mm. portable sound projector with 1000 watt Mazda lamp, 2000 foot capacity magazines, series I lens, 15 watt Movietone amplifier, speaker; fully rebuilt and refinished, complete and ready for operation \$375 f.o.b. New York. Same as above but with two projectors for continuous projection, \$587 f.o.b. New York. Paromel Company, 475 Fifth Avenue, New York City 17.

BUILD Your own 8mm. sound projector. Send \$1.00 for plans, source of supply for parts and 8mm. sound films. Standard Sales Co., Box 7525, North Kansas City, Mo.

SEND Ten cents for lists 8mm. and 16mm. motion pictures plus old time comedy star photographs. Film Classic Exchange, Fredonia, N. Y.

FREE Lists. 16mm. sound films. Waverly, 5707 So. Christiana, Chicago 29.

WORLD'S Best Passion Play, sound; silent, 16-35 mm. prints only. Bay State Film Co., 36-38 Melrose, Boston 16, Mass.

SOUND, Silent 35mm. features, and shorts. Also 16mm. sound films. Simpson, 155 High, Dayton, Ohio.

FREE! 2000 Sound films. Send \$1 for listings. Stasi Service, 133-M Murray St., Elizabeth 2, N. J.

PROCESS Your Ansco color movies! Complete equipment, chemicals, instructions \$99.00. Laboratory lists free. Mogull's, 68 W. 48th St., N. Y.

NEW 16MM. sound musicals produced by Universal Pictures. List for stamp. Adair Company, 6926 Roosevelt, Oak Park 9, Illinois.

SAVE 50% On movies. Free circulars, sample film. Fromaders, Davenport 4, Iowa.

8-16MM. Films, free listing. De Photo, 648 Helen, Detroit 7, Michigan.

GUARANTEED Fresh anti-halo outdoor movie film! Weston 12! Daylight loading! Processing free! Three spools double 8 mm. \$3.45! Six single 8 mm. for Univex, \$4.60! Postpaid! Catalog. Filmcraft, 47th Holly, Kansas City 2, Missouri.

"THE World's Greatest Passion Play." 8mm. 16mm. and 35mm. Specify silent or sound. Rent or purchase. Hemenway Film Co., 33-F Melrose St., Boston 16, Mass.

CLEARANCE 16MM. sound projectors \$155 up, sound films, equipment, silent films. Write promptly for free listing. Harris, 303 West 42nd Street, New York 18.

EXCLUSIVE—Select movies. Viewers, unique film-strips, projectors, screens. Free catalog. Home Pix, 1674 Broadway, New York 19.

TITLE Making, free booklet. Westwood Company, 635 Victoria Street, San Francisco, California.

GUARANTEED Fresh 8mm. color, indoor and outdoor types. \$3.80 per 25' spool, 3 spools \$11.00. Filmcraft, 47th Holly, Kansas City 2, Mo.

I BUY, Exchange, swap movies. What have you? What do you want? Lowest exchange rates in world. Catalogue \$1.00. Refundable. Harvey Iris, Box 539, Brockton, Mass.

NEW 16MM. sound projectors. Free lists. Cine Service, Box 582, Ithaca, N. Y.

BRAND New 16mm. sound projectors \$129.50. Send 10c for photographic catalog. Sterling's, 679 Northampton, Easton, Pennsylvania.

LOWEST Prices, raw film 8mm.-16mm. Free list. MK Photo, 451 Continental, Detroit 14, Michigan.

BASS Says: 39 years of leadership guarantees satisfaction. Finest cine equipment, 8mm., 16mm., and 35mm., silent and sound. Write the old "Horse Trader." Satisfaction or your money back always! Bass Camera Company, Dept. A, 179 W. Madison St., Chicago 2.

WE Buy, sell, rent, exchange home movies. Details for dime. Midland, Box 429, Oak Park 4, Ill.

8-16MM. Silent-sound films. Complete rental library. All latest subjects. Free catalogue, (sample film 10c). Garden Film, 317 West 50th, New York 19.

LEARN Professional motion picture technique at home. Approved for veteran training under G.I. Bill. Free catalog. Motion Picture Institute, Birmingham 4, Mich.

LEARN Movie projection, management. Free catalog. Theatre Institute, Elmira, N. Y.

MUSIC AND MUSICAL INSTRUMENTS

JIMMIE Rodgers, Ernest Tubb, other records bought, sold. Evans, 2215-A, 7th, Lubbock, Texas.

PHONOGRAPH Records cheap. Catalogue. Paramount, BM-313 East Market, Wilkes-Barre, Penna.

MUSIC Printing \$5-100. Composing, arranging, publishing. Auto-Litho, Jensen, Fla.

SENSATIONAL Composing offer. Terry, 709½ PM North Broadway, Oklahoma City 2.

SONGWRITERS—Send your best poem for immediate consideration and free rhyming dictionary. Richard Brothers, Music Composers, 24 Woods Building, Chicago.

1949 ACCORDIONS, Wholesale, free catalog. American Accordion Center, 5329 Belmont, Chicago.

POEMS Wanted for musical setting. Send poems for free examination. Five Star Music Masters, 630 Beacon Bldg., Boston, Mass.

PLAY Most popular piano! Send 20c for home study folder and novel breaks for hit-tunes. Christensen Studio C, P.O. Box 185, Wheaton, Ill.

GUARANTEED New-rebuilt instruments by mail. Save. Catalog 10c. Harden's Music, Marion, Mo. Ohio.

SING Or play with our musical background records. Standard tunes, professionally styled. Rhythm Records Company, 6463-K Firmament Ave., Van Nuys, California.

ACCORDIONS, Mikes, amplifiers. Save up to 50% cash or terms. Buy direct, save middle man's profits. Del Principe, 307 South Wabash, Chicago.

FREE Phonograph record: Regular 79c record, our choice, included with first shipment. Order records wanted now. Standard prices. Or send 10c for famous record catalog. Mailorc, Dept. 43, 570 N. Gay Street, Baltimore 2, Maryland.

YOUR Poems set to music, recorded by professional artists. Send poems or write. Free booklet, attractive offer. Song Service, 331-C West 46th, New York.

SONGWRITERS Publishing, printing service. Stuckmann Music Press, 4737 Broadway, Chicago 40.

SONGWRITERS Attention! The amazing demand for phonograph records, accelerated by countless juke-boxes, warrants your immediate investigation. We are offering new writers the rare opportunity of having celebrated "hit" composer furnish music on reduced percentage basis for any likely poems received this month. Phonograph records are outselling piano copies 5 to 1. Recola Records, Hollywood 28, Calif.

SONGWRITERS! Outstanding, ethical offer. Hibbler, C5, 2157 N. Avers, Chicago.

SONGWRITERS—Publication collaboration. Newark Publishers, G.P.O. Box 1226, Syracuse, N. Y.

MUSIC Arranged, songs printed. Frank Wildt, Music Publisher, Lancaster, Penna.

POEMS Wanted to be set to music. Free examination. Send poems. McNeil, Master of Music, 510-PM S. Alexandria, Los Angeles, California.

SONGWRITERS: Send poems for free examination and outstanding offer. United Music Service, 150, Salem, Indiana.

WRITE Songs. Big money and reputation. Write for information. J. Gordon Pub. Co., 201 N. Hoynes Ave., Chicago.

ELECTRIC Hawaiian guitar at tremendous savings. For student or professional. Melcor eye beam string pickup. \$50.00 value, only \$23.95. \$5.00 with order, balance c.o.d. Trusound Inc., 630 W. Randolph, Chicago 6.

SONGWRITERS—Sell your songs! Unusual composing-arranging offer. Free details. Pleis and Guptill, 345 Hudson St., New York 14.

BOOKS—All Kinds—Homecraft, Radio, Plastics, Boat Building, Photography, Model Building. Catalog free. Popular Mechanics Press, 200 E. Ontario St., Chicago 11, Ill.

RADIOS, SUPPLIES, INSTRUCTION

FIX Any radio. Amazing new instrument locates radio troubles double quick. Simple instructions show you how. Thousands now in use. Free—write today for 28-page illustrated technical manual, "The Inside Story." Feller Engineering Company, Dept. 5PM9, 945 George St., Chicago, Illinois.

MAKE Loudest crystal radio. Instructions, loudest crystal, catalog: 25c. Amorse, Route Four, Richmond, Virginia.

"RADIOBUILDER" For crystal, tube experimenters. 3 issues 25c. Catalog. Laboratories, 578-C, San Carlos, Calif.

TELEVISION, Radio, tubes, parts. Send for free bargain list. Hallmark, 592B Communipaw, Jersey City, New Jersey.

RADIO Tubes, surplus radio equipment, bargains. Ask for list. Kay Electronics, Box 25, Hollis, New York.

RADIO Tubes, Kits, Free lists. Potter, 1314 McGee, Kansas City 6, Mo.

SHOOT AC-DC radio troubles like the experts with this fascinating, instructive locator. Reads troubles automatically when obvious symptoms are set on rotating discs. Tested, approved by electronics students. Circuit diagram, handy hints included. \$2.00 prepaid. Moneyback guarantee. Shoreline Radio Lab., 821 Lakeside, Chicago 40.

COMMUNICATION And radio course: Not a correspondent course, but mailed complete. Written by a former Tech. Rep. with the Army Air Forces. Practical, includes necessary theory with physical explanations, absolutely necessary in radio repair, television, and communications. Not a basic course. \$4.00 postpaid. Mr. Arthur Arruda, 70 Acushnet Avenue, New Bedford, Mass.

FREE Morse code lesson. Complete course \$1.00. Dept. M, Otto Luther, New Preston, Conn.

27 YEARS Of experience radio repairing. Simplified system. No calculations. No formulas. Total price \$2.00 postpaid or c.o.d. Moneyback guarantee. Ross Radio, 14615 Grandriver, Detroit 27, Mich.

FM On old radios! Free data! Topical Emprise, 1527 Highland, Box 42 A, Louisville 4, Ky.

HEADPHONES. Guaranteed U. S. Signal Corps used double headsets with adjustable leather headbands and black bakelite earphones. Reg. \$3.00. Special now \$1.49. Allen Radio, Dept. HPM, Clinton, Missouri.

SAVE Money. Guaranteed tubes 34c ea. 25 popular types. Many other bargains in radio and television sets, parts, amplifiers, record-changers. Write today for free bulletin. Radionic Equip't Co., Dept. 2005, 170 Nassau St., New York 7, N. Y.

BUSINESS OPPORTUNITIES

BIG Money. Spare or full time in your home. No selling! Spray new miracle finishes, plush and suede on signs, radios, automobiles, figurines, lamps, toys, etc. Our business is booming—new easy Flok-Kraft methods—material costs few pennies, you get dollars. Free samples, complete powerful money making plan free. Write now! Coast, 1505-D West Manchester, Los Angeles 44.

START Your own business on credit. Always your own boss. 1554 dealers, sold \$5,000 to \$26,500 in 1948; their average \$6,742. We supply stocks, equipment on credit. 200 home necessities. Sales experience not needed to start. Wonderful opportunity to own pleasant, profitable business backed by world-wide industry. Write Rawleigh Co., Dept. E-U-PPM, Freeport, Ill.

BE Independent—Operate America's lowest price penny vending machine. Big profits. Immediate shipments. Write for bulletin and prices. Fielding Mfg. Co., Desk 59, Jackson, Mich.

"THIS Is it!"—Learn sewing machine repairing, plus profitable installing our motor kits, etc. Write Taylor Service Co., Hamilton 3D, Ohio.

"WATERLESS Hand cleaner." Make, sell. No machinery. Build profitable business. Formula \$1.00. "Wax-o-Glass" cleans glass; polishes metals. Formula \$1.00. "Wipe-on auto paint" formula \$1.00. Metalizing baby shoes, complete process \$1.00. All four formulas only \$3.00. Satisfaction guaranteed. Ideal Formula Service, Park Ridge 5, Illinois.

METAL Mountings for bronze baby shoes. Also shoe plating for the trade. Urbans, 2806 Holliday, Wichita Falls, Tex.

EXCEPTIONAL Money making opportunity for live-wire distributor. Dealer's county franchise now available for fast selling low-priced fire extinguisher and alarm. Made of glass, modern as tomorrow. Tremendous market. Big profit. Write for full information. Autofyrstop Co., Dept. E-5, 2035 Washington Avenue, Philadelphia 46, Penna.

FREE Samples and instructions to manufacturers and hobbyists. Glasy-Cast, the cold-set liquid plastic. Pours like syrup. Hardens like glass. Make novelties, toys, jewelry, machinery parts, etc., the quick and easy way, with Glasy-Cast. Special introductory offer 2 1/4 lb. can \$2.95. Elastomold: Flexible production molds made in 20 minutes. Also finest quality rubber latex. Free instructions and samples. Wholesale prices. Plastic Service, 294 Washington St., Dept. PM5, Boston 8, Mass.

TRADE And class magazines. Keep posted. Latest single copies. Over 1000 covering every trade, business and interest. Price list free. Commercial Engraving Publishing Co., 34C North Ritter, Indianapolis 19, Indiana.

WEAVING Moth-holes, burns, tears in wearing apparel from your own home or store. Method copyrighted. Work done by hand. \$120. Amber Weaving Service, 611 Main Street, Buffalo 3, N. Y.

EARN Money, make beautiful braided rugs from old materials, sparetime. Details free. Hobnob Products, Dept. A10, Box 1191, St. Louis, Mo.

ALPHABET Flexible mold \$1. Make monograms, names, numerals. Personalize your craftwork. Sample free. Allan Graeme, Box 1307, Chicago, Ill.

LEARN Piano tuning, repairing at home. Tremendous field! Piano parts, tools furnished. Established 1935. Empire School of Piano Tuning, Dept. 16-A, 1753 S.W. 23rd Terrace, Miami 33, Florida.

"DOLLARS In Your Mail From Women." One man made quarter million first year. Folio 25 cents, refundable. Grant Lovell, 2166 South Shore, Erie 2, Penna.

BECOME a finance man. Particulars free. George Lenhoff, Lincoln 8, Nebr.

MANUFACTURE And sell new rug and upholstery cleaner. Instructions 25c. Masco, 822 Penna. Ave., Erie, Penna.

PERFUME—Make it yourself. Learn how free. Profitable sparetime, home business. Men, women write "International," 6347 Parnell-PM-5, Chicago 21, Ill.

FOR An extremely profitable lifetime business, operate a collection agency-credit bureau. Easily learned. Free folder. Cole & Associates, Syracuse 2, N. Y.

FIRE Control consultants write Red Ball, Box 1552, Salt Lake City, Utah. Discover why Red Ball Automatic Sales have increased over 500% in last five months.

EXTRA Money made at home. Literature free. Louis Siegel, Box 183, New York 2.

START Mail order business. Postal brings helpful hint. Shaw, Box 438, Coconut Grove, Fla.

SMALL Modern shop building, with apartment. Owen Stout, Paoli, Indiana.

STEADY Cash income by mail. Details 10c Suproco, Ogema, Wisconsin.

START Home manufacturing business making Cleaning Compounds, Soaps, Insecticides, Cosmetics, Polishes, Food Flavors. No machinery. Literature free. Kemix, Park Ridge, Ill.

MAIL Order News (55th year) brings you the mail order ideas you're looking for. Copy 25c. Clarence Woodfall, Publ., R. 3, Charleston, Ill.

MAKE Money by mail—Details. Ged-gard, Box 798-G, New York 1, N. Y.

AMBITIOUS, Sell guaranteed 3-color pen. Write blue, green, red. Big profits, volume sales. Free details. Herbert Spooner Greetings, 115 Chauncy, Boston, Mass.

"ELECTROPLATING Know-How"—Get the professional know-how of modern electroplating, fascinating money making field, simply and quickly! Write for free illustrated booklet. Joseph B. Kushner, Electroplating Engineer, Stroudsburg 17, Penna.

DOLLARS In the mail, free particulars. Alfred Haseman, Beecher, Ill.

PROFITABLE New plastic business. Free details! Colonial Plastics, 216 S-7th, St. Louis, Mo.

\$100.00 WEEKLY, Servicing, repairing radiators. Home Study, Radiatorman, Hayward 1, Wis.

MAKE Up to \$350.00 a month in spare time keeping books for small businesses on a report system. Do work at home. No previous experience necessary. Simplified course gives complete instructions and specimen set of books. Just follow directions. System designed and used successfully by a public accountant. Full price only \$17.50. Send \$5.00 and pay balance of \$12.50 when delivered plus postage. Southeastern Accounting Co., Tyson Bldg., Montgomery, Alabama.

OPPORTUNITIES Galore. Mail everywhere from everywhere. Name listed 10c. Arthur Sibley, Mendon, Mass.

START A mail order business. Details 10c. Raymond Rigor, Box 125, Columbus, Indiana.

25c TO 96 1/2c Profit mailing postcards. Samples, 10c. "Faucher," P.O. Box 381, Fall River, Mass.

MAKE Rubber stamps, metalize baby shoes, repair dolls, silver mirrors, make plaster novelties. Catalogue of "30 ideas" free! Universal, Box 1076-A, Peoria, Ill.

BRONZING Baby shoes is big business. Start your own business for \$4.95, includes materials and instructions. No equipment required. Free particulars. Metaloids, Box 2095, Wichita, Kans.

NATURAL Molding Latex. Extra thick. Free sample. W. Wooley, 115-A Donald, Peoria, Ill.

DOUBLE Your money back if not more than pleased with "Opportunities Preferred"—the big 8 1/2 x 11 slick paper magazine jam packed with ideas for operating a profitable "mail order" business. Latest issue 25c. Griffin & Company, 756 Broadway, Everett 49, Mass.

ELECTROPLATING Instructions, and formulas for brass, copper, cadmium, chromium, nickel, gold and silver plating. All for 25c. M. Hyde, Box 2099, Station V, Los Angeles 3, California.

FREE Instruction casting novelties. Finest latex for molds. Dry sample sent. Major Chemical Co., 164 Portland Street, Cambridge, Mass.

ELECTRIC Pencil—Writes, engraves all metals. 110 volts. \$2.95. Reb Industries, 265-DW, Elmhurst, Illinois.

HOUSE Paint: wholesale \$2.70 gallon. Agents wanted. Free advertising offer. Certified Products, 812-E 38th, Louisville, Ky.

ANNOUNCING: Complete simplified shoe repair course, big demand, in depression proof trade, \$7.95 complete, information free. Shoe Service System, Conway, N. H.

MAIL Order opportunities. 10c brings leading trade magazine. Isbell, Suite 619-PM, 216 West Jackson, Chicago 6, Ill.

SELL By mail! Ideas galore! Join Mail Selling Opportunities Club! Details free! L. Wehner, Box 142-A, Roxbury 19, Mass.

HALF Million articles wholesale. Directory 25c. Krueger, 3418 Wolcott, Chicago 13.

AMAZING Opportunity. Start oriental art shop selling exotic art and silks. Andrade Imports, 5932 Foothill Blvd., Oakland 5, California.

MAIL Order offers increased income, independence, unlimited possibilities; free literature. Manhattan House, 126 Lexington, New York 16.

WHICH Do you prefer—More profits or more time? Now made easy for you—Particulars free. Miller Sales Builders, 155 Kissinger Road, Rimersburg, Penna.

METALLIZE Baby shoes. Excellent profits. New system assures success. Free details. Treasures Forever, 89-B Henry Ave., Lynn, Mass.

FREE Booklet — "\$4,000 Annually." Home-grown orchids, herbs, roses, coffee. Enterprises-Q, Toronto 12, Canada.

MAILORDER Advertising written to order. Big, positive results. Guaranteed! Finkle Associates, 257-M South Spring, Los Angeles 12.

MY Little book, "Money-Making Plans" talks to you like a Dutch uncle. It shows you what pitfalls to avoid in business, and gives important information on money-making plans you can easily follow with practically no capital at all. Send one dollar for it today. Worth its weight in gold. A. Roy Pierce, P.O. Box 235, St. Louis, Mo.

FREE Book "372 Unusual Worldwide Business Adventures!" Australia, Africa, South America, New Zealand! \$800 month reported (exceptional). Work delightful enterprises home. Prepare for surprise! Publishers-C5, Carlsbad, Calif.

SPECIAL Rubber for making molds. Literature and sample free. Universal, Box 1076-A, Peoria, Ill.

BRONZED Baby shoes mountings, metals, plastics, onyx. Bronzing supplies. Wholesale. Box 2095, Wichita, Kansas.

BIG Time profits! Handling popular, fast-selling books by mail. Everything furnished. Unusual possibilities; small capital; no experience. Write: National Distributors, Box 88-A, Dorchester, Mass.

PROFITABLE Business plans collection. Details free. Wold, 16102 Via Descanso, San Lorenzo, California.

\$15-\$50 DAILY Renewing rugs, upholstery quickly; scientific method; lifetime opportunity. Puraclean, 17-C East 42nd St., New York 17.

GETTING Orders by mail easy when one knows how. Revealing booklet free. Howard House, Melrose 900, Massachusetts.

AUTOMATIC Saw setter for Foley filer users. Conrad Stadick, Inventor, Searles, Minnesota.

EARN Money at home with your typewriter! Full, spare time. Write postal for free details. Edwards, 3915-P, 12th, Des Moines 13, Iowa.

"HOW To Build Your Own Mail Order Business." Book for beginners. 25c satisfaction guaranteed. Gold Seal Mail Order Service, 509-C So. Harris St., South Bend 19, Ind.

START Making money at home. 100's of small-business ideas, yours today in the new 1949 treasury of "New Products and Services" exciting new Journal of Commerce, 80-page handbook. Lists and describes 1,000 new money-making opportunities. Be your own boss. Send 50c for your copy today. Leon Publications, 607 So. Dunsuir, Los Angeles, Calif.

\$5,000 YEARLY In advertising. Top-flight course. Mathews, 4501 Oakmont, Philadelphia 36, Penna.

MAKE Rubber stamps. Supply sources, complete instructions \$1.00. Free information! Th. Law, 54 East 99th, New York 29.

MAKE Big money in home mail business! Few dollars starts you; interesting, profitable. Write: Smith, Box 2592-A, Hines, Illinois.

RUBBER Moulds, the new sensational liquid rubber for manufacturers of novelties, in plaster, plastic, and marbelizer material, (marbelizer hot pouring), send for sample. We make also rubber moulds to order, send your model for free estimation, work is guaranteed for fine details. Artilliano, Dept. P, 1080 N. Main St., Waterbury 12, Conn.

SAWDUST. Turn it into cash. Six methods. Instructions 25c. Charles, 12-BX, Norwood, Ohio.

EARN Money at home! Make, sell, delicious candies. Full, spare time. Get professional instructions. Easy, pleasant. Write: Etterman, 1991-A Lake, Muskegon, Michigan.

UP To \$30.00 a day as sideline! Sensational new proposition for homes and businesses. Limited exclusive territories still available. Send 3c stamp to National Key Insurance Co., Room 900-15, 30 West Washington, Chicago, Ill.

PACKAGED Offer gives all help needed to start you in mail order. Details free. Terwilliger, 303 PS Chestnut Street, E. Bound Brook, New Jersey.

100 BUSINESS Ideas—10,000 formulas. Mail order; home, farm, workshop. Particulars free. Flasco Sales, 2505VK 150 Street, Flushing, New York.

BALL Pen ink. Ten to twenty year personal supply. Instructions and exclusive distributor offer. \$1 postpaid. Pen cartridges refillable many times. Millions discarded monthly. Consumer needs this now. Ink cost 5c to 10c year. Treanor, 1113 Walnut, San Gabriel, Calif.

FORTUNES In formulas. Literature free. Lexington Service, 5538 Lexington, Chicago 44, Ill.

SELL Jewelry by mail. Everything furnished ready to go. Orders filled; small capital. Tremendous possibilities! Jomay, Box 1224-A, Toledo 3, Ohio.

300% PROFIT Manufacturing an amazing product. No special equipment. Faudree, Box 924-B, Fort Wayne, Indiana.

LEARN How to sell by mail. 25c. Culver, 16102 Via Descanso, San Lorenzo, Calif.

EARN Money selling auto radio speakers for rear seat. Buy direct from factory at \$4.95 including postage, sell for \$10.75. Every car owner a prospect. Wester Mfg., 1618 Greenleaf, Chicago 26.

RUBBER—Molds, models, casting, finishing, metalizing materials; wholesale catalog, sample free. Plastic Products, 3151-NE. Southport, Chicago.

BEGINNERS, Advertisers, co-publishers, ten mail trade magazines, 50c. William Stivers, 40 Salem, Medford, Mass.

LOCKSMITHING And keymaking—Learn at home. Excellent full or part time earning opportunities. Professional outfit includes supplies, tools, key making machine—everything needed to start your own business. Get practical training from master locksmiths on house locks, auto locks, padlocks. Booklet of information free. Write today. United Supply & Service, Dept. PM-5, 3327 Madison Street, Chicago, Illinois.

SHARPEN Saws, lawnmowers. We supply fast, dependable equipment. Write for folders. Ace Machinery Co., 309-C Laurel, Modesto, Calif.

\$400 MONTHLY. Raising Angora rabbits. Wool \$9 pound. Plenty markets. Details free. White's Rabbitry, Newark, Ohio.

NOVEL Action jigsaw toy. Winter, 4200 Harford Terrace, Baltimore 14, Maryland.

UNPAINTED Figurines, plaques, statues, etc. List. Dept. P, Valents, Perry, New York.

CASH For your idea, 280 manufacturers need inventions, patented or unpatented. List free. Invention Bureau, 208M Clinton, Oak Park, Illinois.

MAKE Money making new greaseless doughnuts at home on electric machine. Wholesale to grocers, drug stores, cafes, hamburger shops. Send for free recipes and plans. M. Ray Company, 3605 South 15 Ave., Minneapolis 7, Minnesota.

FIGURINES, Gift ornaments. Unpainted, many to choose from. Start a profitable business—Hobby. Free catalog and information. Suiter Art Industries, 314 Westport, Kansas City, Mo.

LIQUID Marble—Colorful, glossy! Molded, brushed, sprayed! Cast novelties, statuary, colored tiles. Flexible molds. Composition floors. Particulars free. Marbleizing Service, Edwardsville, Illinois.

LIQUID Rubber, make flexible molds. Free sample. Chaney, 1130 E. 16th St., Jacksonville 6, Fla.

RECAST Old batteries into new. Latest achievements. Battery Laboratories, Minneapolis.

UNLIMITED Profits from used fluorescent tubes. Thousands available—no overhead. Free details. Welday, Box 61, Seville, Ohio.

"SPECIALTY Manufacturing." Big money business. Start on small capital with dependable formulas. Send for free interesting booklet. Howard Robinson, Ph. G., 1300-A South Ohio Street, Sedalia, Mo.

WOULD You pay 3¢—first \$350 made? Color-illustrated book "505 Odd, Successful Enterprises" free! Work home. Expect something odd! Pacific, Oceanside, Calif.

HOME Workers. Hand-spin Angora wool into yarn. Either sex. House of Angora, PM, Springfield, Illinois.

200 NEW Money making plans, tips, ideas for increasing your income. Folio free. Reynard Pub., Smithfield 3, Ohio.

MAIL Order success even for beginners. Details free. Condello, Box 443, Fords, N. J.

MAILING Postcards selling repeat merchandise is profitable. Everything supplied. Details free. Gordan Publishers, Box 23, Pawtucket, R. I.

EXPORT-IMPORT. Represent manufacturers! Conduct two-way profit, barter exchange business without capital. Buy-sell abroad, make huge profits. Uncrowded fields, unlimited opportunities. Learn at home in spare time. No previous experience necessary. Send \$1 for two 1949 bulletins, supplying hundreds business connections. Money refunded if unsatisfied. International Trade Promotion, 246-P, Fifth Ave., New York 1.

FIRST Steps in Mail Order tells how to start a mail order business the right way. Will save you hundreds of dollars in costly mistakes. Send 25c for this 35-page book now. Ralph A. Long, 208 West Broad St., Tamaqua 2, Penna.

\$100 WORTH Of orders at a cost of \$4. "How." Send for details. Murphy, Box 522, Gary, Indiana.

LEARN The three keys to success. (1) Choosing the right products. (2) Sources of supplies. (3) How, where and when to advertise. Free particulars. Business Plans Foundation, Box 56, Madison Square Sta., New York 10.

MAKE Hollywood style marble-glazed cement pottery, birdbaths. Home-shop. Benches, fountains, stucco-rock walls, garden ornaments; chemically colored. Dime brings sample, amazing pictures. Hollywood Cementcraft, 8527-R Wonderland, Hollywood 46, California.

WHERE To buy 800,000 articles wholesale. Details free. Schibani, Box 1576-A, Birmingham 1, Alabama.

"HOW To start a successful mail order business." The guide to sound, profitable mail merchandising. 25c. Manhattan House, 126-B Lexington, New York 16, N. Y.

DOLLARS In personalized baby record books. Sell by mail. Use same literature we do. No-Co-Ro, Oakland 6, California.

PLASTERCRAFT Supplies. Rubber molds, natural liquid rubber, rayon and cellophane flock finishes, etc. Illustrated catalog and "Plastercraft" course free on request. Blue Rapids Supply, Blue Rapids, Kansas.

LEARN Piano tuning at home in thirty days. Unlimited income. Sound recordings, electric record player, tools and instructions furnished. Write Capitol City Tuning School, Department PM, 211 East Michigan, Lansing, Michigan.

MAKE Money spare or full time, casting metal toys and novelties. Latest scale model autos, original ashtrays, savings banks, water pistols, etc. Enormous wholesale and chain store demand keeps manufacturers busy. No experience or special place necessary. Write for details and illustrations of patterns needed. Metal Cast Products Co., Dept. A, 1696 Boston Road, New York 60, N. Y.

VENDING Machines earn big money! An investment as low as \$10.50 will start you in this fascinating, profitable business that can lead you to the road of success and independence. Routes can be established and operated in either full or spare time with no experience needed. Write for full details and our free catalog illustrating our nut, candy, gum and stamp vendors; also pin ball machines, music boxes, etc. Write immediately to Parkway Machine Corporation, Dept. 7, 623 W. North Avenue, Baltimore 17, Maryland.

BABY Shoe plating for the trade only. 5 day service. Beautiful samples always available. Thoro Plate Co., 6260 Romaine St., Hollywood 38, Calif.

YOUR Own profitable home business. Preserve live flowers to last forever. New simple discovery. Enormous demand all year 'round. Tremendous profits! Light fascinating work. Send \$2.00 for working equipment, instructions, and valuable sales plans. Satisfaction guaranteed or money promptly refunded. Alfred Hermansen, 210 Fifth Ave., Suite 1102A, New York 10, N. Y.

NOW Available! 1949 edition of Official Concessionaire's Guidebook. Jam-packed with money-making ideas, games, formulas, equipment for concessions, roadside stands, carnivals, medicine business, etc. Buyers guide. Send \$1.00 today for copy. Concessionaire's Guidebook, Box 133B Sta. B., Toledo 6, Ohio.

POPCORN Equipment, potato chip outfits. Long Eakins Company, 4960 Hi Street, Springfield 99, Ohio.

NO Selling, operate vendors, amazing profits, details free. Silver-King, Suite B, 622 Diversey, Chicago 14, Ill.

HOME Business making statuettes, plaques, artificial marble, rubber molds. Metalizing baby shoes. Silvering mirrors. Formulas. Folder free. Creative, 236-I, Winnetka, Illinois.

RAISE Ginseng. Roots bring \$10.00 pound. Circular free. Fezler Seed Co., Patchogue, N. Y.

MAKE Money addressing envelopes. Our instructions reveal how. Glen Glenway, 5713 Euclid, Cleveland 3, Ohio.

I MAKE Big money in the mail-order business. You can do the same at home with copyrighted system. Write me. I'll tell you how. F. Little, R.D. #1, Glenshaw, Penna.

ENVELOPES Addressed accurately, reasonably. Fast service. We have capable addressers in your city. Glenway System, 5713-Y Euclid, Cleveland 3, Ohio.

OWN Mirror shop. Resilver mirrors. Glass sign making. Electroplating. Supply prices. John Sprinkle, V60, Marion, Indiana.

READ "Advance"—The voice of mail order. Offers money-making opportunities, sources of supply, personal guidance, etc. Issued monthly. Sample copy 25c. Yearly subscription \$2.00. Advance Publishing Company, 313 East 21st Street, Suite 450, New York 10, N. Y.

A BUSINESS In your own home! Our chemicals, plus free water and cheap "grocery store" materials can bring you over \$500 monthly earnings. Plans and formulas free. Chemica Division, 1269 S. Norton, Los Angeles 6.

A FACTORY In your home garage! Mfg. and sales rights, mechanics' waterless hand cleaner, \$500-\$800 monthly. No special equipment necessary. Formula free. Western Aircraft Mfg., Dept. D, Los Angeles 6, Calif.

UNPAINTED Bookends, plaques, statues, figurines. List. Haverty Products, 1219 8th Ave., Altoona, Penna.

BRONZED Baby shoe mountings and supplies. All metal bronze bookends, picture frames, ash trays, etc. Onyx ash trays, desk sets, plaques. Hardening solution, 30-amp. plating rectifiers with powerstat control, \$85.00. Geared motors for agitation \$20.00. Lead lined tanks. Write for list. Hollywood Bronze Supply, 1770 N. Vermont, Hollywood 27, Calif.

QUICK Money. "Repairing car batteries." At home! Easy too! Batteryman, Grand Junction, Colorado.

\$46 FROM Square foot plywood. Jigsaw necessary. Write, Woodarts, X-38, Bridgewater, Mass.

OPERATE Profitable mail order business. Write Walter Service, 4159-A East 112th, Cleveland 5, Ohio.

COLORGLAZED Concrete pottery made without molds. Patented method. Cemetery products, novelties, tiles. Basement leak-sealing. Money-making projects. Booklet, details free. Men only. National Potteries Company, Grand Rapids, Minnesota.

START Mailorder bookshop—Everything furnished. 25c brings booklet, samples, exciting ideas. General Publications, Ossining, N. Y.

\$25 WEEKLY Working two hours daily. No canvassing. No manufacturing. Lycke, Box 2471, Cleveland 12, Ohio.

137 WAYS To make money, in home or office, business of your own. Full particulars free. Elite Co., 220 Grand St., New York 13.

BRUSH Plating outfits connect to a battery. No tanks necessary. Good paying business at home plating autoparts, bathroom fixtures, bicycles, reflectors, silvering mirrors. No shop or experience required. Outfits furnished. Free booklet. Gunmetal Co., Ave. H, Decatur, Ill.

COPUBLISH Leading m.o. paper. Latest copy Mail Sale Advertiser and proposition, dime. Vanroy W. Shirk, Lebanon, Penna.

CO-PUBLISH And advertise in The Central Mail Advertiser. Sample copy for stamp. Low rates. Large circulation. Bagby Printing Co., Georgetown, Ohio.

MAIL Order opportunities. Full or spare time. Hundreds of chances. No charge. Postal brings copy. Blackstone Press, Somerville, New Jersey.

MONEYMAKING OPPORTUNITIES

NEW. Different mail order business. Starting opportunity! Complete, original, small capital starting plan. Instructions quarter prepaid. Everything furnished to start you. Bonheim, 610 W. 204 St., New York 34, N. Y.

UNPAINTED Figurines, beautiful models, finest quality, smooth, hard plaster. Reasonable prices. Illustrated list free. Oman, 642 Broadway, St. Paul 1, Minn.

WANTED: Party paying patent, receive interest. New machinery invention. Enormous money-making possibility. E. H. Schrieber, Nashville, Ill.

THOUSANDS Articles wholesale. "Supply Source Directory" 10c. Ideal Service, Park Ridge 40, Illinois.

\$100.00 PER Square yard of concrete. \$3.50 starts business. Patent pending. Send \$1.00 now to hold territory. Refund if not satisfied. Holston Potteries, Vermont Drive, Kingsport, Tenn.

RESIDENTS In communities of 25,000 to 500,000 population can earn \$35 weekly in spare time. H. E. Hewitt, 813 E. Nebraska, Peoria, Illinois.

PAINTING! Photograph portraits on glass. Instructions 25c. Gerald McNeely, Box 524, Rochester, Minnesota.

15 MINUTES Masters advertising and sign lettering; complete system; sign painter's secrets; cartooning book; all three \$1.00; free circular. Abenterprizes, Box 875-M, Peoria, Illinois.

MAKE \$100 Per week or more in a full or spare time baby shoe metalizing business of your own. Write now for free literature on this easy to learn highly profitable business. Joseph B. Kushner, Metal Finishing Engineer, Stroudsburg 17, Penna.

SNOWBALLS And ices. Make them yourself. Tremendous profits. Ice shaver with four flavors and instructions. Enough for 500 snowballs; \$2.00 plus 4 lbs. postage. Free folder. The Snowball Company, Route 3, Jacksonville 4, Florida.

START Home business in spare time. Make extra money. Experience unnecessary. Free literature. Personal Counseling, Box 1411, St. Petersburg, Fla.

START Profitable home business in spare time. Make extra money raising Golden Hamsters. Small, clean, odorless. New. Unlimited market. Literature free. Golden Gate Hamstery, 631-H Richmond Street, El Cerrito, California.

EARN Money evenings, copying and duplicating comic cartoons for advertisers. Adservice, Argyle 1, Wisconsin.

FREE Offer. Cash income for life. Write "Succeed," Box 612, Portland 7, Oregon.

FREE Book "372 Unusual Worldwide Business Adventures!" Successful! Australia, Africa, South America, New Zealand! Not hokum! Work home. "Different" plans. Prepare for surprise! Publishers-C3, Carlsbad, Calif.

MAKE Extra dollars in your own back yard! Real opportunities fully outlined. Rush name. Pickett's, 62-A Sanders Drive, Florence, Kentucky.

SOMETHING New. Silhouette pictures on glass. Fascinating, profitable hobby. Businessmen pay well for these decorations. Details free. Rothbart, RFD 4, New Brunswick, New Jersey.

SUCCESS Even for beginners in Post-way proven mail order methods. Details free. Write Hugo Hansen, 5 W. 137 Street, New York City 30.

HOME Sweet shop opportunities for men, women. Fully described. Unusual earning possibilities, security, independence! Write: Brady, 1216-A Park Row Building, New York 7, N. Y.

TIN Cans. Turn them into cash. Nine methods. Instructions 50c. Charles, 12-BY, Norwood, Ohio.

FISHWORMS. Easy raise, sell, hundreds, millions. Instructions 50c. Surface without digging. Charles, 12-BZ, Norwood, Ohio.

WIN Contests: Free information. Contest Advisory Service, 60 E. Scott Street, Chicago 10, Ill.

SELL 3c Booklet for \$1.00. How? Write, Van, 1316 West Genesee, Syracuse, N. Y.

PROFITABLE Articles made cheaply. Orenstein, 1653 East 9th, Brooklyn 23, N. Y.

DEPRESSION Insurance. Business of your own. Postal brings free information. Pru-Ex, 1010 Watauga, Kingsport, Tennessee.

WIN Contest prizes regularly! Others do! 10c brings latest issue "Contest Flyer," other revealing information. Lawrence, 687 Morgan, Camden 4, N. J.

WOULD You pay 3¢—first \$350 made? Color-illustrated book "505 Odd Successful Enterprises" free! Proven! Work home. Expect something odd! Pacific, Oceanside, Calif.

INVESTIGATE Mail order opportunities. Details free. Moy's, 517-7th S.W., Washington 4, D. C.

BUILD With concrete blocks: Walls, garages, houses. Professional Instructions \$1.00. "Blockmasons," 1256 Amanda, San Bernardino, Calif.

HELICOPTER. 14" Rotors, rubber motor, \$3.00 dozen, \$1.00 two samples. Heliotoy, R. 8, Dallas 11.

LEARN Professional candy making, easy method, free details. Philip Pate, Kissimmee, Florida.

MEN—Women — "Most everybody likes candy." Learn to make in a professional manner. (Our 39th year.) Ragsdale Candies, D4, East Orange, New Jersey.

ANALYZE Handwriting for profit! Complete outfit \$1.00. Graphologists, POB-971, Philadelphia.

DEALERS Wanted! Sell new merchandise item by mail, from home. Everything furnished! Novelty Products, 1200-B Goldsboro, Sanford, N. C.

UNPAINTED Plaster ornaments, easily decorated. Firestone's thick, white, natural-latex Loxite for rubber molds. Midwest Novelty Manufacturers, 524-A East Park, Anaconda, Montana.

READ Progressive Mailtrade, the magazine that tells how to make money by mail. Dime brings sample and special offer. Progressive Mailtrade, Box 357, Sheboygan, Wisconsin.

PROFIT With Larson Leathercraft. Belts, purses, 100 other ideas. Largest supply in U. S. Catalog 10c. Larson, Dept. C, 824 S. Tripp, Chicago 24.

WIN Contest money. General Contest Bulletin gives hundreds of tips. Lists current contests and rules. Sample 25c. General Contests, 1609½ East 5th, Duluth, Minn.

EARN Money at home! Thousands do! "Home Worker Magazine" tells how. Sample, 25c. Sizemore, Box 7, 4917 Kostner, Chicago 30, Ill.

RESILVER Mirrors at home. Formula 25c. Ideal Service, Park Ridge 6, Illinois.

PRIZE Contest bulletin gives various contests now operating, and valuable hints. 3c stamp. National Contest Bulletin, Box 2685F, Miami, Florida.

PUBLISH Your own magazine. Handsome 52 page format, well edited, illustrated. Cost low as \$1.00 month. Brings you prestige, profits. 25c brings sample. details. National. Ord. Nebr.

FORMULAS, PLANS, ETC.

TEN Moneymaking formulas \$1.00. Northern Specialties, Box 384, Eau Claire, Wisconsin.

ANY Five formulas, trade secrets or processes, \$1.00. Satisfaction guaranteed. Star Enterprise, Dalton, N. Y.

MAKE Cosmetics, perfumes, soaps, etc. 100 formulas \$1. M. Elsbury, 717 N. Dearborn, Chicago 10.

10,000 FORMULAS And trade secrets. Free literature. Stillman, 555 Kingston Ave., Brooklyn 3, N. Y.

HOT Tamale, Making for profit. Particulars. Box 384, Altus, Okla.

MAKE—Sell cleaners, soaps, polishes, flavors, cosmetics. No machinery. Formula literature free. Kemico, Park Ridge 16, Illinois.

FORMULAS For nearly everything. Catalog free. Write Creative, Winnetka, Ill.

PRODUCTS Analyzed, Duplicated, Improved. Formulas. Consulting Scientific Company, Swarthmore, Pennsylvania.

\$1.00 GETS You 21 money-making popcorn, candy apple formulas. We supply equipment. Concession Supply Company, Dept. A, Station "B," Toledo, Ohio.

TESTED Formulas. Interesting descriptive booklet free. Pont, Box 635-PM, Terre Haute, Indiana.

REAL Manufacturing formulas. Lists free. Cummings, Chemist, Gordon Ave., Syracuse 4, N. Y.

PLASTICS

NEW Liquid plastic. Clear, colors. Cast without heat. Embed flowers, insects, coins. Saw, drill, carve. Fascinating, profitable. Use home tools. Send only 25c for exciting new home project manual showing how to get started. Castolite, Dept. E-101, Box 391, Woodstock, Ill.

PLEXIGLAS, Lucite, acetate, sheets, rods, tubes, jewelry findings, craft supplies, over 1700 items. 25c which brings catalog internal carving folder, information on fabricating plastics, deducted from first order. Plastic Parts, Dept. H-2059, 1157 S. Kingshighway, St. Louis, Mo.

LUCITE Scrap 7/8" x 1 1/4" x 1/2" approximate, suitable internal carving, jewelry, 50c pound and postage. C & C Enterprises, 132 Rumsey Road, Yonkers, New York.

PLEXIGLAS, Lucite, clear, masked sheets 12" x 12" 1/16-90c. 1/8-\$1.25; 3/16-\$1.40; 1/4-\$1.70; 3/8-\$2.60; 1/2-\$3.40 postpaid. Free list. Minimum order \$3.00. Colors add 10%. Mercer Plastic Company, 23 Irving Court, Trenton 10, N. J.

PLASTIC: Plexiglas; Lucite; sheet and scrap. Scrap 20c per lb. up. Special assortment \$1.00. Write for price list and free fabricating manual. Regal Plastics Supply Company, Dept. B, 720 Main Street, Kansas City, Mo.

INJECTOR Press. Rapid! Inexpensive! Salable objects cost 1/10c! Sample, free! Technicraft, 1156 Commonwealth, Boston 34, Mass.

LIQUID Plastic. Beautiful results in half hour. Embed photographs, coins, keepsakes. Make solid objects. Clear, colors. Complete kit \$3.25. Kristalon Plastics, Box 29, Dept. P-6, Wilmette, Illinois.

PLEXIGLAS. Write for free price list. The Unique Glass Shop, 309 Cowardin Ave., Richmond 24, Virginia.

COLORED Plastic catalog of finished masterpieces, carving instructions, supplies. You produce professional jewelry and gifts. Profitable line, for hobbyists, schools, dealers, salesman. Only 25c. For the "Mrs." instructions and material for making birds of paradise 50c. Plastic Mart, 2443 East 14th St., Oakland, Calif.

LUCITE, Plexiglas—Any size sheets masked. Square foot cost 1/16" 96c; 1/8" \$1.25; 5/16" \$1.52; 1/4" \$1.80; up to 1 1/2" available. Colors add 10%. Include 10% postage. Almac Plastics, 230 Fifth Avenue, New York 1, N. Y.

BARGAINS In plastics. Lucite, Plexiglas, Catalin. Many colors and sizes. Details free. George Plastics, 6938A George St., Chicago 34, Ill.

PLASTIC, Sheets, rods, tubes, etc. Free list. Plastic Supply Co., 2901 N. Grand Blvd., St. Louis 7, Mo.

PLASTIC Materials and supplies for your hobby or business. Catalog and internal carving instructions free. Art Plastics of Calif., 8125 East 14th Street, Oakland 3, Calif.

INTERNAL Carved roses, orchids, swans, goldfish, butterflies, etc. Jewelry and gifts. Crystal Floral Novelty Co., Bound Brook, New Jersey.

PLASTICS—Supplies, findings, shells. Illustrated fabricating manual, bargain catalog, 10c. Gem-O-Lite, Box 686F, North Hollywood, Calif.

PLEXIGLAS—12" x 12" Masked sheets. 1/16"-\$1.00. 1/8"-\$1.25. 3/16"-\$1.55. 1/4"-\$1.85. Include 10% postage. Dyes, rods, tubes, luminous powders, carving blanks, drills, jewelry findings. Free catalogue. Craft Plastics, Somerville, New Jersey.

CHEMISTRY

NEW Idea chemical and apparatus outfits for home experimenting. Photo-scales, microscopes, chemicals, biological and laboratory supplies in small quantities. Catalog 15c. Established 1931. John H. Winn, 124A West 23rd Street, New York, N. Y.

CHEMICALS, New, used supplies. Catalog 10c, refunded, first order. Atlantic Laboratory Supply, 21 Wenham, Boston JF, Mass.

NEW Catalog: Chemistry, mineralogy, biology. 10c. Tracey Laboratories, Evans-ton, Illinois.

NEW Laboratory supply catalog of chemicals and apparatus. Contains many thousands of items with illustrations. Send 25c. Standard Science Supply Company, 1232 N. Paulina St., Chicago 22, Ill.

CHEMICALS And apparatus for industrial, analytical, and private laboratories. Catalog 15c. Dept. M-50, Biological Supply Co., 1176 Mt. Hope Ave., Rochester, 7, N. Y.

HANDBOOK For chemical experimenters, illustrated, hundreds of experiments, 50c. Experiment booklet 15c. Supply catalog 5c. Reading Scientific Company, Reading, Penna.

HELP WANTED

BOYS Wanted. Over \$2.00 hour! Sell name plates for front doors. Free sample. Write Dept. 48, National Engravers, 214 Summer, Boston, Mass.

AGENTS WANTED

AGENTS To sell a fast moving item. Acclaimed by users throughout the country. Exclusive territories open for honest proven salesmen. Big profits to aggressive agents. If you can sell, then this is your opportunity. Write today. Speed Waxer Company, Dept. PM-3, 4451 Elston Ave., Chicago 30, Illinois.

COLORFUL, attractive, ready-made signs. Amazing sellers, good profit. B. Garfield, 5534 5th St. N. W., Washington 11, D. C.

DE-ODORIZER—Refrigerator and ice-box unit. Sell finest, retails \$2.00, and profit 100 to 300%. Exclusive territory. Write L. A. Muffler, Continental Bldg., Los Angeles.

WRITE 3 Words—collect \$9.95. Make \$9.95 on 10-second demonstrations to merchants. Write on glass with Amazing Magic Crayon and presto—a 5-color Advertising Message takes fire and glows like a brilliant Neon Sign! Three sales a day and \$29.85 profit is for "lazy" men. Workers can double or triple that amount. Don't wait. Rush penny postcard for full details, complete Sales Kit—all free. Maxilume Co., Dept. LC-85, 125 W. Hubbard St., Chicago 10, Ill.

BIG Money career. Sell guaranteed Nylon uniforms—white, colors. No investment. Highest commissions. Easy, quick sales to waitresses, beauty shops, hotels, nurses, etc. Complete variety fabrics. Exclusive styles. Free catalog sales kit. Upland Uniform, 255 West 28th Street, Dept. G-2, New York.

A DRESS For you with every 3 you order for yourself and family. Amazing new plan. Everything free. Harford Frocks, Dept. D-9128, Cincinnati, Ohio.

PLASTIC Tablecloth covers, curtains, drapes, baby pants, bowl covers and other plastic articles selling like wildfire! Make big money now! Free details. Write L & M Co., Dept. 58-E, 510 St. Charles, St. Louis, Mo.

LOOK Here! Wanted—Men and women to start in business on credit. Sell some 200 farm-home products. Thousands our dealers now make quick sales, big profits. For particulars write Rawleigh's, Dept. E-192-PPM, Freeport, Ill.

BE Renewal headquarters for all magazines. Handle everything at home. Big profits. No experience. No capital needed. Free catalog tells how. Write McGregor Magazine Agency, Dept. 129, Mount Morris, Ill.

YOUR Success story come true! \$1.00-\$3.00 advance commissions selling popular priced quality shoes. Bonus. Amazing features. 70 styles entire family. Experience unnecessary. Free outfit. Moench Shoes, 10C, Boston, Mass.

I'LL Put a "shoe store business" in your pocket! Nation's leader trains you to make big money! Fit men, women. Free sample outfit—Write today! Consolidated Shoe System, Dept. S-316, Chippewa Falls, Wis.

NEW "Sponge" dish cloth. Replaces messy dishrags. Banishes dishwashing drudgery. Lightning seller. Samples sent on trial. Kristee 119, Akron, Ohio.

POCKET Pal: Replaces pocket knives. New, safe, beautiful. Always razor sharp. 50c seller. 321% profit. \$15.00 up daily. Agents, salesmen, distributors. Sample, elaborate sales kit 25c. Nelson Company, Moore Bldg., St. Paul 2, Minn.

HOTTEST 39c Item on the market. Write National Sales & Service, Greenville, Penna.

EVERYDAY Cards. Earn \$5.00 with every ten \$1.00 boxes of everyday cards you sell. Also new plastic cards, personalized stationery, note paper and wrappings. Send for samples today. Howard P. Ellis, Dept. PM-5, Pitman, New Jersey.

MAN Or woman. Fastest selling item on the market. Selling direct. A venetian blind cleaning tool. Can earn \$3.00, \$6.00 an hour full or part time. Mystic Banks Co., 5491 Drexel, Chicago 15, Ill.

AUTO seat covers. Strong fabrics with leatherette trim. Plastic piping. Tailorized to fit any car. Direct from our factory; up to 50% saving. Write for free circular. Agents wanted. National Process, Hempstead, Long Island.

NEWEST Money making sensation. Sell hand painted ties with personal initial. 100% profit. Experience unnecessary. Special offers. Write for free 20 page catalog complete line ties, mufflers. Philip's Neckwear, 20 West 22nd St., Dept. K-35, New York 10.

PINKING Shears bring big profits! Full or part time dealers, canvassers, brush salespeople, etc. wanted. Jarian Company, 5-H Beekman St., New York 7.

SALESMEN—Put yourself in line for big money, real future. Keep stores supplied with 5c-10c to \$1 counter goods. Nationally advertised merchandise. Top profits for you, merchants. Liberal deals boost sales. Sideline or full time. World's Products, Dept. 10-S, Spencer, Ind.

EARN Cash during spare time. Sell gift wrappings, birthday, illness, everyday cards to neighbors. Profits to 100% plus bonus. Send 25c for sample box. Birchard, 27A Lester, Springfield, Mass.

SELLS On sight. New reversible plastic table cloth. Patented. Write Beta-Plastic Products Co., 350 West 25th Street, New York 1, N. Y.

INSTANT Acting Fireball fog type automatic fire extinguisher smotherers fires. Beautifully designed. Volume seller at only \$4.50. 3505 Hope, Los Angeles 7.

HOME Agents. Power mower; only \$79.50. Terms. Sells on sight. Sales kit free. Smith Agency, 450-C, Excelsior Springs, Mo.

AMAZING Seller; "home mechanics paint kit." No competition. Not sold in stores. Splendid profit. Anderson, Box 3381, Merchandise Mart, Chicago 54.

MAKE More money! Sell 1949 everyday assortments. Plastic cards. Personalized napkins and stationery. Free portfolios. Commission. Richar's, 16A East 18, New York 3.

NYLON Uniforms, immediate delivery, immediate profits. Sell to doctors, dentists, nurses, waitresses, beauticians, housewives. Free sales kit. Superior Fabrics, Dept. P5, 3936 Market, Philadelphia 4, Penna.

\$100 WEEKLY—New complete, modern plastic line. Tablecloths, etc.—over 25 items. Every home prospect. 100% profit. Free samples. Carwell, 330-C So. Wells, Chicago 6.

\$6.00 HOURLY Showing Firestone Velon handbag; opens into large shopping bag. Fastest seller in America. Women buy several for gifts. Commissions advanced daily. Sample furnished. LeNard, 179-C West Washington, Chicago 2.

BIG Cash quick! Best in field! 4 rapid-fire money makers—Modern Wonder Book of Knowledge; only complete war history; new Home Medical Book; special illuminated Bible. No personal delivery. Get full facts. Universal House, 1020-I Arch St., Philadelphia, Penna.

AGENTS, Distributors: Huge profits! Sensational, new "combination, shopping bag-purse." Lightning-fast seller! Other merchandise; novelties! Royalty, Box I-748, Passaic, N. J.

SENSATIONAL Non-electrical burglar alarm for doors or windows. Sells on sight or sound. Retail \$2.95. Attractive, sturdy. Millions of prospects. 100% profit. Untouched market. Write Robertson Company, 228 N. LaSalle, Chicago 1, Illinois.

LEARN Mailorder. Dollar maker tips. Free information. Diehl's, Buffalo 4, New York.

LOOK! Make money all year round selling personal initialed individualized belts, buckles, cap badges, western buckles, tie holders, name plates. 2000 emblems to choose. Big profits, whole or part time. Please write today special outfit offer. Hook-Fast Specialties, Box 1425, Dept. 6, Providence, R. I. Established 1926.

NEW! Hardware, Plumbers' item. Particulars free. Lincoln, 10-A South 18th, Philadelphia 3.

CASH In on brand new idea. Personalized keepsake notes. Samples free. Lincolncraft, Dept. PM, Whitestone, N. Y.

AGENTS, Distributors, Jobbers, stop! Never buy plastic aprons, tablecloths, etc. until you get our new low prices. They're amazing. Riddell Sales Company, 1133A East 63rd Street, Chicago 37, Illinois.

BUY Thousands of nationally advertised products direct from manufacturers. Write for "Buy Direct and Save." Consumers Assn., 218-F Investment Bldg., Pittsburgh 22, Penna.

AGENTS Make big money selling "Ear-Buds" the perfume earring sensation. New designs. Particulars free. Minot Inc., 22 Minot, Dorchester 22, Mass.

QUALITY Plastics at lower prices! Proven hits in tablecloths, aprons, garment bags, utility covers. Free catalogue M95. Acclaim Products, 25 Hillside Ave., New York 34, N. Y.

MIDGET Bible, Lord's prayer; gold finish. Details, sample 25c postpaid. Mark, 153-D Fuller Building, Philadelphia 3, Penna.

AMAZING Seller! Fast profits! Hottest automobile accessory. No competition. Details free. Simon Brothers, 1908 South Broadway, St. Louis 4.

BIG Profits. Retractable ball point pen. \$3.60 per dozen. Metal Products Mfg., 2067 Broadway, New York, N. Y.

BOYS, Girls. Earn money in your spare time. No investment. Metal Stamps, Box 6325, Los Angeles 55, Calif.

OWN Your own business. Sell men's neckwear, spare or full time. Small investment; big profits. Free catalogue. Radio City Neckwear, Dept. M, 112 W. 50th, New York 19, N. Y.

FREE Nylons given if Kendex hosiery runs or snags! World's only women's hosiery sold with written guarantee amazing everybody. Mere words could not express unbelievable money-making opportunity. Fantastic earnings become reality. Armstrong earned \$202 in 9 days. Watkins sent 92 orders in one day. Imagine replacing hosiery free regardless of cause—whether use or abuse! Truly sales dynamite for terrific profits. Even if you never sold before, three magic words: "Guaranteed Against Everything" will open doors for you—make women listen and pour money in your pocket. Complete line from sheerest to service (15-20-30-40-60 denier) all lengths 28 to 35 inches—latest colors—seamed full fashioned and seamless. No competition because Kendex guaranteed nylons not sold in stores. Also complete line men's hosiery actually guaranteed for one full year! Nothing like this anywhere. Includes rayon, nylon, lisle, wool, cotton, mixtures, etc. All styles, patterns, colors, prices to please everybody. Thousands shipped daily. 100,000 pairs constantly in stock for fast delivery. Over 30 years in business. You need no money or experience. Nothing to pay now or later. Show free outfits. Write orders. We deliver and collect. Big advance cash plus huge bonus. Earn money spare or full time—exclusively or side line. No restrictions. Become manager—appoint others to sell for you—earn steady income on their sales. Complete money-making outfits including salesbooks in color, samples of hosiery materials, etc. furnished free and prepaid. Simply mail name and address to: Kendex Company, Babylon 53, N. Y.

SENSATIONAL New, plastic purse-secretary sweeping the country. Big cash profit on quick \$1.25 and \$1.75 sales. Amazing beauty, welded construction, self-seal pockets. Free sample offer. Boulevard Art, 75 West Van Buren, Dept. P-5, Chicago.

MEN—Women. New sensational floor mop. So clean to use woman can wash floors in evening gown. No drip or splash. Magic Mop Co., Dept. 143, Chicago 17, Illinois.

FASTEST, Easiest selling item ever offered man-market! Amazing new plastic Lic-Trol; placed in neck of liquor bottle automatically, accurately, quickly measures and pours drink; instantly adjustable to any size drink up to ounce; no jigger needed, no bother, no spillage. Nothing like it; to show it, is to sell it, at \$1.39; your profit half. Sensational demonstrator; sell scores daily, office to office; sell hundreds on noon-hour at plants employing men. Big added earnings selling wholesale to dealers. Free details. Marney's, Dept. M-1, Box 581, Ogden, Utah.

SURPLUS Household 10c. Retailer 3 doz. \$1.00. Sample 16c postpaid. No correspondence. Des Sales, Diamond Ave., Hicksville, N. Y.

FREE Samples. Big profits showing amazing glow-in-the-dark specialties. House numbers, pictures, plastic novelties, religious and nursery objects, etc. Large manufacturer. Madison Mills, 303 Fourth Ave., New York 10, N. Y.

SEWING Machine electrification kit. Nationally advertised. Has Good Housekeeping Guaranty Seal. Can be demonstrated and sold in 5 minutes. Make at least \$5 per sale. For complete details write today to Brownell Distributors, Inc., Dept. PM, 308 Canal St., New York 13, N. Y.

FREE Water and our concentrates, make flavors, lotions, shampoos, 125 products, labels, bottles supplied. Qualco, E20030 Russell, Detroit.

BIG Money—Fast! Sell quality plastic tablecloths (from \$4.00 dozen), curtains, aprons, etc. Factory prices. Free samples! Durever, 282-C Albany Ave., Brooklyn 13, N. Y.

MEXICAN Feather pictures. Unusual novelty. \$1.00 (stamps) brings \$2.00 worth samples, details. Refunded if unsatisfied. Aztec Art-P, Apartado 762, Mexico City.

SELL By mail books, novelties, bargains! Ready made circular service! Large profits! Catalog free! Elfco, 432 North Wells, Chicago 10.

BIG Money selling cast iron and aluminum cooking utensils direct to consumer, exclusive designs. Free illustrations. Jones Machine & Foundry Co., Chattanooga 2, Tenn.

MAGIC Cleaner—Laundry soap deal. Hotter than a firecracker. Big profits. Sample free. Bestco, 4642 No. Central, Chicago.

AGENTS; Stamping names on pocket-key protectors. Sample check with your name, address, 25c. Stamping outfits. Emblem checks, check-fobs, name plates. Hart Mfg. Co., 303 Degraw St., Brooklyn, N. Y.

PHOTO-Salesmen-agents. Sell beautiful hand-colored plastic enlargements. Collect deposit, we deliver. Profitable sideline. Send card, for free sample kit. Novel Portrait Co., 3343 North Ave., Chicago, Ill.

GOLD Lacquered window sign letters. Large sizes penny each. New foils. Absolutely beautiful. Free samples. Atlas, 544 W. 79th, Chicago 20.

EXCELLENT Sideline for printing and advertising salesmen. Decalcomania name plates in small quantities. Great demand. Also, make money with our line of automobile initials and sign letters. Free samples. "Raico" XL-Roxbury, Boston 19, Mass.

AGENTS—300% Profit selling genuine gold window letters; stores and offices. Free samples. Metallic Letter Co., 438-B North Clark, Chicago.

AGENTS, Make more money. Write today for free package of colorful gift cards; and receive our fast selling assortment of everyday cards on approval. Big profits selling our line of shopping and vanity bags. Mother Goose pop-ups and record, children's books, napkins, coasters, greeting cards, gift wraps, stationery. Act now! Get acquainted with our fast selling line. Fanmour Corporation, Department P5, 200 Fifth Avenue, New York 10, N. Y.

REPRESENTATIVE Wanted by seat cover manufacturer. Mono, 6545 Santa Monica Blvd., Hollywood, Calif.

HIGH-GRADE SALESMEN

\$20 To \$30 A day easy; sensational new Raised Letter Nameplate, beautifully framed in mahogany; amazing seller to homes, stores, offices, etc. Get our tested plan. Write Raised Letter Metal Company, Dept. 13, Fox Bldg., Philadelphia 3, Penna.

AMAZING Liquid auto wax and cleaner. Simply wipe it off—so easy you can use cleansing tissue. Distributors, jobbers, salesmen. Samples \$1.00. Master Products, 125 S.E. 30th Place, Portland 15, Oregon.

ADVERTISING Book matches—Cash in on big demand; sell union label matches. Cuts for all businesses and political parties. Free powerhouse selling kit, low prices, protection guaranteed on repeat orders. Cash commissions. Superior Match Co., Dept. M-49, 7530 Greenwood, Chicago.

SELL Calendars now. Be the first in your district. Good sideline or full time. Every business wants them. Few calendar salesmen are on the road now which means more sales for you. Fleming Calendar Co., 6539 Cottage Grove, Chicago 37.

MANUFACTURER'S Agents. Dry wash, waterless hand cleaner. Sell to industry, dealers, jobbers. Ridgefield Chemical Products Company, Inc., Ridgefield, New Jersey.

SELL Ultra-blue stock signs to stores. 1000 slogans, comedy, general, religious. "7x11" cost 6c, sells 35c. Make money. 15 samples ultra-blue signs "7x11" \$1.00 postpaid. Lowy, 8 West Broadway, Dept. 464, New York City 70.

SELL Sewing machine motor kits. Wholesale suppliers. Mixons Specialty, PM Box 394, Williamsport, Penna.

SOAP Saver, stainless steel, re-usable. Send 20c for two and dealers prices. Lang, 633 Fifth, Louisville, Ky.

UP To \$50.00 in a week and tailored suit for yourself without paying one cent. Write for plan. Progress Tailoring Co., Dept. S-217, Congress & Throop, Chicago 7, Ill.

SCISSORS Sharpeners. Fast 25c seller. Mar. 74 Park, Webster, New York.

SALESMEN—Sideline. Earn \$3,000 next 5 months selling calendars, advertising specialties. Buyers everywhere. Big comm. advanced. Samples free. Continental Calendar, 542-A South Dearborn, Chicago.

FANS—Fans. Salesmen making \$50.00 to \$100.00 per day selling our electric fans, sump pumps and printed self-sticking advertising tape. Write to Universal Fan Co., Inc., Peru, Indiana.

SPRAY-WAY: Sensational new compound. 1 pint makes 1/2 gallon; retails \$1.25. Cleans rugs, car upholstery. Demonstration does the selling. \$1.00 brings sample instructions sales plan. Spray-Way Co., Dept. 28, 4101 No. Vincent Ave., Minneapolis 12, Minnesota.

SALESMAN Sell automobile specialty "Dandy" back-cooler and back-rest. Every automobile owner wants one. Can make reasonable salary. Write P.O. Box 5, Columbus, Ind.

STOP! Want to make money all year round selling a complete line. wool uniforms, shirts, caps, ties, badges, 2000 emblems, personal initialed buckles, belts, and hundreds of other easy-to-sell items? Sales kit furnished. Please write today. Hook-Fast Company, Box 480PM, Roanoke, Va.

SELL Chemicals to taverns thru jobbers. Override. All you sell is free, less jobber commission, or be jobber. Sample 50c. Riesen Chemical, 419 Villet, Milwaukee.

MAKE \$200 Weekly and over taking orders outstanding quality metallized baby shoes. Free starting outfit. Marson's Bronze Art, 1059A Lewis, Long Beach 13, Calif.

SALESMAN! Make over \$30.00 a day. Sell nationally advertised adding machine for only \$12.95 complete. A desk model portable, precision built, fully guaranteed, every inch a business machine. Easy to operate, easy to sell, easy for you to make big money at 49% profit! For life-size color photo and full details, write today to Lightning Adding Machine Co., Inc., Dept. ZD-7, 543 So. Spring Street, Los Angeles.

SALESMEN Earn \$100 per week up calling on stores and individuals. Selling ventilating equipment. Everyone a prospect. Write for free 30 page catalog and plans. No investment required. Appliance Distributing Company, 163 Walton St., Atlanta, Ga. Dept. M8.

POPCORN Machines, all electric units, peanut roasters, caramelpop, heating appliances. Northside Sales, Indianola, Iowa.

NEW Jobs open in selling! Send name, address for five free issues of Opportunity Magazine's money-making guide, listing hundreds of companies who'll pay you well, full or part-time. No experience needed. Opportunity, 28 E. Jackson, Dept. 17, Chicago 4, Ill.

BIG Money taking orders. Shirts, ties, socks, pants, jackets, sweaters, shoes, uniforms, etc. Sales equipment free. Experience unnecessary. Nimrod, 4922-AN Lincoln, Chicago.

EDUCATIONAL AND INSTRUCTION

BE A hydraulics expert! Colored illustrations. Easy to understand. Diagrams of the DC-3, DC-6, Constellation, and Convair-Liner. Mail add with \$3.85. World Press, 1817 California St., Denver, Colo.

"HOW To Break and Train Horses"—A book every farmer and horseman should have. It is free, no obligation. Simply address, Beery School of Horsemanship, Dept. 1105, Pleasant Hill, Ohio.

ANYBODY Can paint: Simplified home course oils. Beginners, shutins. Catalog, supplies list free. Technocratic School Color, Studio PMX, York Harbor, Maine.

EXPORT! Learn at home from established world trader. Big paying positions. Your own profitable world-wide business by mail order without capital; or travel abroad. Experience unnecessary. Free booklet. Mellinger, 105W, Los Angeles 24, Calif.

BE A real estate broker through home study or classroom instruction. Write for free book. Approved for veterans. Weaver School of Real Estate, 15 E. Pershing Rd., Box CP-5, Kansas City 8, Mo.

NOW You can have an office. Many earn up to \$5,000-\$15,000 annually in the collection business. Learn by home study course, experience unnecessary. Write for free bulletin. No obligation. Franklin Credit School, Dept. 228-E, Roanoke 7, Virginia.

MAKE Up to \$30-\$40 week as a trained practical nurse! Learn quickly at home. Booklet free. Chicago School of Nursing, Dept. M-5, Chicago.

STAMMERING Corrected. Booklet gives full information. Write: William Dennison, 543-A Jarvis St., Toronto, Ont.

HOW To cast aluminum, silver or gold rings. Instructions 25c. Lauckner, Box 574-B, Great Falls, Mont.

GET U. S. Gov't job! Security, big starting pay. Prepare at home now for local exams. Free 40-page book, sample tests. Write: Franklin Institute, Dept. P24, Rochester, N. Y.

INTERNATIONAL And other used correspondence courses bought, sold, rented. Free literature. Baker, 5509-B Winthrop, Chicago 40.

GOOD Jobs and a sound substantial future await you in hotel and institutional field. Men and women—all ages—needed for well-paid positions that offer color, excitement, ever-new and fascinating duties. Record breaking travel means even greater opportunity for trained men and women in hotels, clubs and institutions. Lewis School receiving calls for managers, assistant managers, stewards, hostesses, purchasing agents and 55 other types of important positions! From coast to coast, there are important positions that offer splendid opportunities for advancement in a business where you are not dropped because you are over 40. Previous experience proved unnecessary! No need to leave your job to qualify. A good grade school education, plus Lewis Training qualifies you at home, in spare time. Our National Placement Bureau helps to place you—and our amazing Certified Job Plan—actually certifies you will "make good" when placed. Write today for Free book! Veterans: Course approved for Veteran's Training. Lewis Hotel Training School, Room PE-368, Washington 7, D. C. (First and only School of its kind—now in its 33rd year.)

BECOME A Doctor of Psychology or Metaphysics. Teach secret of contentment, happiness. Win degree of Ps.D. or MsD. Solve mental worries. Free book. College of Universal Truth, 5153-C North Clark, Chicago.

HOME Study course, drugless therapy. Free literature. Institute of Drugless Therapy, Tama, Iowa.

3800 USED Up-to-date correspondence courses. Cat. 50c. EG, Elmsford, N. Y.

LEARN Spanish quickly, easily. Simplified lessons. Details free. Personal Counseling, Box 1411, St. Petersburg, Fla.

DRAFTING—Learn at home; spare time. Monroe Institute, Alton, Illinois.

SCIENCE Of memory amazingly simplified. Analysis and report. Free explanatory booklet "Art of Memory Development." Memorology Studio, 2016-P Sunnyside Ave., Chicago 25, Illinois.

EARN Extra money, working with figures. Write Jimmy Sherrod, Pavo 1, Ga.

PHOTOGRAPHIC Mind! Amaze, earn, learn! Facts, figures, names stick like burrs with Supermemory. Write Thor Books, M5, Box 1210, Chicago.

SPANISH Quickly, with Speed-O-Way phonograph records. Complete course \$7.95. Free folder. Speed-O-Way, Dept. 113, Box 2301, Houston 1, Texas.

PRACTICAL Course—Automobile radiators, repairing, recoring, cleaning. Ralph Hendry, Galt, Canada.

INVESTIGATOR Training. Phillips Secret Service System, 1917B North Kenneth, Chicago 39, Illinois.

MEDICAL Laboratory technicians in great demand. We train you in your own home. Catalogue free. Imperial Technical Institute, Box 973-J, Austin, Texas.

LEARN Auctioneering by mail. Twenty copyrighted lessons and recordings. Sample lesson sent free. Diploma. Nelson Auction School, Renville, Minn.

DENTAL Technician's practice kit. Artificial teeth, plastic, etc. Instructions included. Grant Laboratory, S-219 W. 7th, Los Angeles, Calif.

HOME Bible course. Simple, helpful, instructive. Total cost \$4.00 includes textbooks, stationery, examinations, certificate. \$1.00 starts you, or simply request prospectus. The Bible Study School, 378 Van Houten Street, Paterson 1, N. J.

BE A mathematical wizard. Add columns instantly. Free details. Vanderdrift, 517 Lincoln Place, Orange 2, New Jersey.

PIANO Tuning pays. Learn this profitable profession at home. Our Tonometer and mechanical aids make learning easy. No knowledge music necessary. Diploma granted. Largest and oldest school—50th year. G.I. approved. Write for booklet. Niles Bryant School, 78 Bryant Bldg., Washington 16, D.C.

BOOKKEEPERS! Increase your earnings! Operate your own simplified "Dollar-A-Week" bookkeeping and tax service. Full or spare time. Details free. No obligation. Ellis, Box 200, Cedar Grove, North Carolina.

LINGUAPHONE Makes languages easy. At home learn to speak Spanish, Portuguese, Italian, French, German, Russian, by quick, easy Linguaphone Conversational Method. Save time, work, money. Linguaphone correspondence courses are available to veterans under G.I. bill of rights. Send for free book. State if G.I. Linguaphone Institute, 83 RCA Bldg., New York, 20, N. Y.

USED Correspondence courses and books bought, sold, rented and exchanged. Catalog free. Lee Mountain, Pisgah, Alabama.

SECRET Investigation. Experience unnecessary. Investigators particulars free. George Wagner, M 125 West 86th, New York.

PLAYS, STORIES, MANUSCRIPTS

I WANT New writers to cash checks offered daily. The easiest way to write for pay. No previous experience necessary. Free details. Saunders M. Cummings, 468-11 Independence Bldg., Colorado Springs, Colo.

BUSINESS SERVICE

NAME And address—10 or more manufacturers of any item. Guaranteed. Send dollar. Lang's Lists, 633 Fifth, Louisville, Kentucky.

CENTRAL American mail address. Business and private; profitable, inexpensive. Carlos Liebhaber, Volcan-Buenos Aires, Costa Rica, C. A.

INCORPORATE Your business, free details. Tax Research Bureau, Inc., Delaware Trust Building, Wilmington, Delaware.

SPECIAL SERVICES

LETTERS Retailed from Miami, 25c; cards 10c. Send stamped mail to Box 604, Coral Gables, Florida.

FLORIDA Mailing address. Letters received, forwarded. Three postcards 25c. Personal Counseling, Box 1411, St. Petersburg, Fla.

WE Receive, remail letters; \$3.00 monthly or 25c each. "Hawkins," 1300 Taylor, Washington 11, D. C.

WORKING And detail drawings made. Engineering services. Send sketch or specifications for estimate. Engineer Associates, Dept. A, 155 Cobb Ave., Decatur, Ill.

TREASURES In your closet! Do you have worthless bank books, insurance policies or stock certificates in some forgotten drawer? They may be worth a fortune! Let us investigate for you. Write today. National Evaluators, P.O. Box 5852, Cleveland 1, Ohio.

INFORMATION

FOREIGN Employment for you. Excellent permanent job opportunities for U. S. citizens. Wages at least 20% higher, less taxation, lower living costs. Improved social position. Transportation and housing furnished. Choice of climate and location. South and Central America, Far East, China, Alaska, Australia, New Zealand, Africa. Send \$1.00 for copyrighted digest showing oil, shipping, construction, mining, etc., companies working and hiring. Includes sample application letter, advice on wages, tips, etc. World Wide Company, Dept. PM-5, Madison 1, Wisconsin.

CALIFORNIA Opportunities, working conditions, housing, etc. \$1.00. G. E. Middagh, 2378 Sutter St., San Francisco, California.

FOREIGN Employment. \$1.00 brings foreign service; directory and bulletin on latest opening. (Worldwide) construction, aviation, mining, oil fields, etc. Robt. Kirkwood, 377 Dundas Street, West, Toronto, Canada.

CARTOONING, COMMERCIAL ART, SHOWCARD WRITING, SIGN PAINTING

"HOW To Make Money With Simple Cartoons"—a book everyone who likes to draw should have. It is free; no obligation. Simply address Cartoonists' Exchange, Dept. 95-C, Pleasant Hill, Ohio.

EARN Money evenings, copying and duplicating comic cartoons for advertisers. Adservice, Argyle 1-B, Wisconsin.

SIGNS Made easily. Instructions and ten sets modern alphabets, numerals, patterns. Sizes up to eight inches. All for \$1.00. Co-operative Business, 7 West Madison, Chicago 2.

LEARN Professional lettering in one week. Amazing new mechanical process. Complete instruction manual. 300 designs \$1.25. Major-Art System, 3510-F Palmer, Chicago 47.

SIGN Painting taught at home. Test lesson free. Ben Kerns, Box 812-T, Greenville, S. C.

9 ALPHABET 3 Numeral pattern sets and catalog, \$1.00. Sign Letter Distributors, P.O. Box 101, Mineola, N. Y.

BE A showcard writer. Learn at home in three weeks. Uncrowded. Big money field. Makes sales very first week. Write. R. J. Meisner, 1539 Wisconsin Ave., Dept. 12, Flint 6, Michigan.

DRAFTING And artists' material catalog, thousands of items, 25c (deductible first \$2 order). Draftsmen's, 187 Madison, Chicago.

CHALK Talks. Laugh producing program, \$1.00. Catalog 10c. Balda The Cartoonist, Oshkosh, Wisconsin.

ADVERTISING AGENCIES, LETTER WRITERS, FOR ADVERTISERS

ADVERTISING: Placed in any publication, anywhere. Write for mail-order rate sheet "M." LeGrand Advertising Agency (established 1923), Floral Park, N. Y.

SOUTHWEST—24 Words in 40 weeklies, \$3.50. Pennebaker Service, Box 141, San Marcos, Texas.

MAIL-ORDER—Sales letters, literature, advertising prepared to produce business! Muchnick Co., 150 Nassau St., New York 7.

CHOICE Names \$5.00 thousand. State classification. W. Northern, Lake City, Arkansas.

DOUBLE The results from your advertising after reading Successful Advertising. Only \$2.00, postpaid. Satisfaction guaranteed. William Bennett, 114-35A 116th Street, Ozone Park 16, New York.

ADVERTISE: 24 Words, 40 newspapers \$3.50. Lists free. Advertising Bureau, 10511-C Springfield, Chicago 43.

INCREASE Your mail order sales. Sell to the farm market. Let us show you what others are doing. Free information. Farm Journal, 201 Farm Journal Building, Philadelphia 5, Penna.

ADVERTISERS! Reach nearly 18,000,000 readers. 25 Sunday national key newspapers, 18 words, \$51.50. "Terrific pullers." 20 popular newspapers, \$10.00. "Free booklet." Special—One inch display 2,-821,198 circulation, \$48.30. Newmark's Advertising Agency, (Established 1893), 217-7th Ave., New York 11.

24 WORDS In 50 weeklies, \$4.96. J. Darnell, 730 Hays, Jackson, Tennessee.

ADS Placed in out of town newspapers and magazines. Low rates. Catalogue free. Ideas that pay. Baker Advertising Agency, Successors Ankrum Agency, 189 W. Madison, Chicago 2.

MAILING Lists, certified, productive, inexpensive, \$5.00 1000. Homeworkers, agents, buyers, etc. Write Dixie Service, King, N. C.

TYPEWRITERS, DUPLICATORS, OFFICE DEVICES

BOOM Your business with postcard stencil duplicator, \$4.75. Guaranteed performance. Postagraph, Box 181, Cincinnati 1, Ohio.

STANDARD Typewriters \$17.50; duplicators \$12.50; adders \$12.50. Nationwide service. Typewriters, 118 Spruce, Wichita, Kansas.

PRINT-O-MATIC Selffeeding post card stencil printing duplicator \$13.50. All office machines. Supplies. Bargains. Typewriter for free literature. Pittsburgh Typewriter Supply, 336-7 Fourth Avenue, Pittsburgh 22, Penna.

RECONDITIONED Typewriters, mimeograph, multigraph printing devices, appliances, supplies. Catalog. Dixigraph Service, King, N. Carolina.

PRINTING, MULTIGRAPHING, MIMEOGRAPHING, GUMMED LABELS

PRINTING At reasonable prices. Send for free direct mail layout information. Mail your requirements for quotations. Winchester Printing Company, Grand Rapids 2, Michigan.

BLACK-ON-WHITE Photostat prints from drawings, tracings, etc. 25c per copy up to 8 1/2"x11", 50c per copy up to 14"x17", plus postage. United Industries, Dept. A, Box 449, Madison 1, Wisconsin.

TACOGRAVURE, "photo-electric" printing. Picture of your product and up to 250 words, attractively presented, on 8 1/2"x11" sheet. \$27.75 per thousand. Samples 5c. Tacogravure, Box 389, Warsaw, Indiana.

BETTER Printing—Reasonable prices. Send requirements for free samples and new 1949 catalogue. Mills Burnham, No. Abington, Massachusetts.

100 8 1/2 x 11 MELBURN Letterheads with envelopes \$2.00. Box 140, Jersey City 3, New Jersey.

1000, 3/4x2 1/2 labels \$1.00. Free list. Box PM-135, Spiro, Okla.

SAVE Money on printing. Tell us what you need. Journal Printing Co., Newark, Ark.

100 ENVELOPES, 100 Letterheads, Monarch cabinet—\$2.75. Gillam Print Shop, 130 Sunset Ave., N.W., Atlanta, Ga.

5,000 LABELS \$4.50; Size 1 1/4" x 2". Free illustrated price list. M.P.S. Fine Labels, 336 Lawton Street, Fall River 3, Mass.

100 BOND Letterheads 8 1/2 x 11, 100 envelopes, \$1.65 postpaid (4 lines). Moyer Press, Windsor, Vermont.

USED Type, printing presses, type cabinets, etc. cheap. Visit our store. Edward Van Dillen, Inc., 74 Beekman St., New York 7, N. Y.

SAVE Money on your printing. Write for low price list and chart. We photograph and reproduce your copy on white or colored paper. Our art dept. will help with your advertising folders, catalogs, forms, etc. Direct mail sales our specialty. Winchester Printing Co., Grand Rapids, Michigan.

MIMEOGRAPHING—Excellent quality, reasonable prices. Free samples. Price list. Russell Mimeographing, Homewood, Alabama.

BUSINESS, Personal stationery, state requirements. Samples. Herbert Hudson, Centredale, R. I.

500 SHIPPING Labels 2 1/4 x 2 3/4, \$1.25, 2 x 3 two color \$2.25. Myers Company, 1228 Adams, Owosso 1, Michigan.

LOW Cost business stationery. Samples. Crow, 533 18th St., Huntington 3, W. Va.

MIMEOGRAPHING Experts. Samples free. Martin Mimeographing, 3212 Harper, Saint Louis, Missouri.

1000 BUSINESS Cards \$2.50 prepaid, samples free. Reliable Print Shop, 905 East Jefferson, Louisville 6, Ky.

400 8 1/2 x 5 1/2 LETTERHEADS \$1.35. Mango, 555-A South 20th, Newark 3, N.J.

MIMEOGRAPHING 100 8 1/2 x 11 \$1.10. Additional hundreds 50c. Mimeographing, Madison, Tenn.

SEND 10c Now, for our 48 page 1949 price list—refunded first order. McCall Press, 1326 South 27th, Omaha, Nebraska.

500 3/4x2 1/4 FOUR Line gummed stickers 35c; red border 50c. Moritz Printery, Saginaw, Mich.

QUALITY Printing—Reasonable prices. Fast service on catalogs, folders, publications. Write for prices. Bagby Printing Co., Georgetown, Ohio.

MIMEOGRAPHING—Letters, pricelists, formulas, instructions. Lowest prices. Lem's Letter Shop, 5710 Stanton, Detroit 8.

PRINTING OUTFITS AND SUPPLIES

PRINT Your own cards, stationery, circulars, advertising. Save money. Simple rules. Print for others, nice profit. Raised printing like engraving too. Have home shop. Details free. Kelsey Presses, L-11, Meriden, Conn.

MAKE Your own plastic printing cuts. New plexiplate process. Plexiservice, Argyle 1, Wisconsin.

HEMOCRAFT Presses, supplies. Catalog 10c. refundable. Riegel, 1111 Harrison, Philadelphia 24, Penna.

PRINTING Presses, type, supplies. Lists 3c. Turnbaugh Service, Loysville, Penna.

INEXPENSIVE Home-made printing press. Details free. Novelty Shop, Downs-ville, Louisiana.

RUBBER STAMPS AND OFFICE SUPPLIES

AGENTS, Quantity users! Big 48 page catalog of rubber stamps and marking devices sent for dime. (Refunded first order.) Miles Specialties, Kokomo 1, Indiana.

RUBBER Stamps, all kinds, catalogue 10c. Print and Stamp Co., Box 172, Boston 1, Mass.

3 LINES, Cushioned, indexed, 55c. Pads 35c. Printright, Wauwatosa, Wis.

3 LINES, 50c. 125 Letterheads, 125 envelopes printed, \$1.98. 1949 catalogue. Johnson Press, Box 6-A, New York City 26.

PATENT ATTORNEYS

INVENTORS—Patent laws encourage the development of inventions. The Rules of Practice of the U. S. Patent Office advises—unless an inventor is familiar with such matters—that he employ a competent registered attorney or registered agent, as the value of patents depends largely upon the skilful preparation of the specifications and claims. Write for further particulars as to patent protection and procedure and "Invention Record" form at once. No obligation. Mc Morrow, Berman & Davidson, Registered Patent Attorneys, 1347 Victor Building, Washington 1, D. C.

INVENTORS—If you consider your invention to be something of importance, you may take steps to protect it with a U. S. patent which gives you the right to exclude others from making, using and selling your invention as claimed. "Patent Protection for Inventors" booklet outlining steps to take to secure patent protection will be mailed promptly without obligation. Victor J. Evans & Co., Merlin M. Evans, Registered Patent Attorney, 431-E Merlin Building, Washington 6, D. C.

PATENTS—Trade marks. Gustave Miller, Registered Patent Attorney, 59-A Warner Building, Washington 4, D. C. Patent Lawyer.

PATENTS, Trade marks. Sanders, 6430 Evans, Chicago. (Registered U. S. Patent Office.)

INVENTORS: Learn how to protect your invention. Unless the inventor is familiar with patent matters, he should engage a competent registered patent attorney or agent to represent him. We are registered to practise before the U.S. Patent Office and prepared to serve you in handling your patent matters. "Patent Guide for the Inventor" containing detailed information concerning patent protection and procedure with "Record of Invention" form will be forwarded to you upon request—without obligation. Clarence A. O'Brien & Harvey Jacobson, Registered Patent Attorneys, 91B-D District National Building, Washington, D. C.

INVENTORS: When you are satisfied that you have invented something of value write me, without obligation, for information as to what steps you should take to secure a patent. Write Patrick D. Beavers (Formerly Randolph & Beavers) Registered Patent Atty., 935 Columbian Bldg., Washington 1, D. C.

C. A. SNOW & Co.—M-427, Snow Building, Washington 1, D. C. Registered Patent Attorneys. Write for information.

INVENTORS: Without obligation, write for information explaining the steps you should take to secure a patent. John N. Randolph, Registered Patent Attorney, 203 Columbian Bldg., Washington 1, D. C.

"INVENTOR'S Guide" free on request. Frank Ledermann, Registered Patent Attorney, 154 Nassau St., New York 7, N. Y.

INVENTORS: Write for free brochure "Evidence of Invention." Labiner, World Building, New York 7.

PATENT Practice before U. S. Patent Office. Validity and infringement investigations and opinions. Booklet and form "Evidence of Conception" forwarded upon request. Lancaster, Allwine & Rommel, Registered Patent Attorneys, Suite 411, 815-15th Street, N.W., Washington 5, D. C.

INVENTORS. For "Record of Invention" form, contact Carl Miller, Registered Patent Attorney, Woolworth Building, New York.

FOR INVENTORS

INVENTORS—Patent laws encourage the development of inventions. The Rules of Practice of the U. S. Patent Office advises—unless an inventor is familiar with such matters—that he employ a competent registered attorney or registered agent, as the value of patents depends largely upon the skilful preparation of the specifications and claims. Write for further particulars as to patent protection and procedure and "Invention Record" form at once. No obligation. Mc Morrow, Berman & Davidson, Registered Patent Attorneys, 1346 Victor Building, Washington 1, D. C.

MONEY From ideas. How? Free booklet. Grayland, 5312B Grace, Chicago 41.

CASH In your inventions with professionally built models, drawings. Free details. Dayton Inventors Laboratory, 1941 Riverside Drive, Dayton 5, Ohio.

INVENTORS—This firm is registered to practice before the U. S. Patent Office and is available to assist inventors in the preparation and prosecution of their cases. "Patent Protection for Inventors" booklet containing detailed information and steps to take toward patent protection will be sent upon request. No obligation. Victor J. Evans & Co., 432-E Merlin Building, Washington 6, D. C.

LEARN Machine design thru individualized home study course from Graduate Mechanical Engineer. Complete seven month course only \$10. Free details. Clifford Hill, 210 5th Avenue, Suite 1102, New York City 10.

PATENT Searches \$5.00. Reports airmailed within 4 days. Invention protection forms free. Write Raymond L. Smith, Patent Searcher, 410 Bond Building, Washington 5, D. C.

PATENT Searches \$5.00. Includes nearest patent copies. 48 hour service. Free protection forms. Patent Research Engineering, 318 Evans Building, Washington 5, D. C.

INVENTORS' Financial assistance. Investment Development Company, Box 1462, Amarillo, Texas.

IDEAS And inventions, patented and unpatented, developed, financed and sold. M. Cash, 8750 Charlevoix, Detroit 14, Michigan.

INVENTORS: Learn how to protect your invention. Unless the inventor is familiar with patent matters, he should engage a competent registered patent attorney or agent to represent him. We are registered to practise before the U.S. Patent Office and prepared to serve you in handling your patent matters. "Patent Guide for the Inventor" containing detailed information concerning patent protection and procedure with "Record of Invention" form will be forwarded to you upon request—without obligation. Clarence A. O'Brien & Harvey Jacobson, Registered Patent Attorneys, 91A-D District National Building, Washington, D. C.

CASH For your idea. 280 manufacturers need inventions, patented or unpatented. List free. Invention Bureau, 208M Clinton, Oak Park, Illinois.

PATENT Searches \$5.00. Includes patent copies. 48 hour service. Free protection forms. Patent Service Institute, 945-A Pennsylvania Ave., Washington 4, D. C.

INVENTORS! Make space reservation now for 1st International Invention and Hobby Show at Civic Auditorium. Show backed by national publicity. Your opportunity for gaining national recognition for your invention. For further information write Greater Miami Publicity Bureau, Rm. 239 Civic Bldg., Miami, Florida.

INVENTORS' Primer answers every question. Only \$1.00 postpaid. Adam Fisher Co., 61 Enright, St. Louis 8, Mo.

PATENT Searches \$5.00. Reports airmailed within 4 days. Invention protection forms free. Write Miss Ann Hastings, Patent Searcher, P.O. Box 176, Washington 4, D. C.

PROMPT Patent office search. Analysis your invention for technical, commercial merit. Both \$5.00. Invention protection forms free. Industrial Patent Reports, Box 1081, Massachusetts Ave. and North Capitol, Washington 13, D. C.

INVENTORS: If you have an invention for sale, patented or unpatented, write Institute of American Inventors, Dept. 40A, 1926 Eye St. N.W., Washington 6, D. C.

"INVENTOR'S Guide" free on request. Frank Ledermann, Registered Patent Attorney, 154 Nassau St., New York 7, N. Y.

INVENTORS: Without obligation, write for information explaining the steps you should take to secure a patent on your invention. John N. Randolph, Registered Patent Attorney, 202 Columbian Bldg., Washington 1, D. C.

INVENTORS. For "Record of Invention" form, contact Carl Miller, Registered Patent Attorney, Woolworth Building, New York.

INVENTORS—Possibly I can help you. Many years experience. Charles A. Scott, 773PM Garson Avenue, Rochester 9, N. Y.

PATENTED. Unpatented inventions promoted. M. Joyce Humphries, 1424 Landtitle, Philadelphia 10, Penna.

INVENTORS: The usual first step is to have a search of the U. S. Patents conducted, so I can report on patentability. Write, without obligation. Patrick D. Beavers (Formerly Randolph & Beavers), Registered Patent Atty., 936 Columbian Bldg., Washington 1, D. C.

INVENTIONS WANTED

SMALL Inventions wanted by manufacturers. I'll help you sell your invention. Write for circular. Stanley Hull, 7829 Euclid, Cleveland 3, Ohio.

IDEAS For plastic articles and toys: If you have any ideas or inventions, patented or unpatented, concerning new plastic toys or practical household articles that you think good enough for production, please contact us in reference to producing them on a royalty payment basis. If your idea is not practical for our type of manufacturing it will be returned to you. No cost or charge is involved on your behalf. Commonwealth Plastics Corp., Leominster, Mass.

WANTED: Patented, pending meritorious items. Charges from royalties only. Inventors-Manufacturers Associates, 5 Beekman Street, New York.

PRODUCTS Research Foundation—Is selecting new products, marketable ideas, designs, inventions for exploitation nationally. Is yours available? Write: Executive Secretary, Dept. B, Box 2106, San Francisco 26, Calif.

MARKET Inventions yourself! Write: Invention Market Research, 342-PM Madison, New York 17.

SELL Your ideas without a patent. Eliminate expensive red tape. Do as the professional inventors do. Complete proven information \$1.00. Walter H. Jones, 17763 Beach Drive N.E., Seattle 55, Washington.

CASH For your idea. 280 manufacturers need inventions, patented or unpatented. List free. Invention Bureau, 208M Clinton, Oak Park, Illinois.

INVENTIONS Wanted. Patented or pending only. Inventors' Exchange-B, Hartford 1, Conn.

HIGHEST Royalties — Cash. Official U. S. I. R. C. certification. Request free Booklet "M". Universal Marketing Co., 354 South Spring St., Los Angeles 13, Calif.

INVENTORS: Hundreds of manufacturers have requested our assistance in locating marketable new products. Complete information, free. Institute of American Inventors, Dept. 40-D, 1926-Eye St. N.W., Washington 6, D. C.

PATENTS FOR SALE

MAKE Offer—Patented. Nothing like it on the market. Seibel, 9332 Mackenzie Road, Afton, Mo.

SIDEWALK Snow plow—Patent pending. Cash or royalty. R. A. Harrington, Oelwein, Iowa.

PATENT Beer liner and separator taking out one dozen bottles at one time, unloading into cooler either standing up or laying down position. Three times faster than old hand method. Will subcontract on low royalty basis. Joe Kuchel, 807 N. Jackson St., Arlington, Va.

GARAGE Door holder, 2388490. Outright or royalty. J. E. Jimsey, Route 1, Houston, Arkansas.

INVENTORS: Test the commercial value of your patented or unpatented inventions, quickly and inexpensively. Write for free information. Institute of American Inventors, Dept. 40-B, 1926-Eye St. N.W., Washington 6, D. C.

MANUFACTURING

WANT Something made? We'll make it. Consultation free. Write Jayemm Company, Burlington, Kentucky.

MODELS. Tools, dies, experimental work, large and small lot manufacturing. R. Strom, 2310 Bryant Ave. N., Minneapolis 11, Minnesota.

MODELS — Small lot manufacturing. Metals, plastics, etc. Milburn, Burlington, Kentucky.

MODELS. Tools, dies, experimental work; large and small lot manufacturing. Van-Ess Specialties Company, 212 W. 14th Street, Covington, Ky.

MODELS, MODEL SUPPLIES

MODEL Supplies for craftsman, hobbyists, inventors. Send for illustrated catalog containing useful engineering information. Sola Sales Service, 1142½ El Centro, Hollywood 38, Calif.

SHIPMODEL Kits and fittings of highest quality. Send 15c for 1949 catalog. Model Shipways, Folio 60, 476 Main St., Fort Lee, N. J.

WESTERN Vehicle models. 35c to \$1.25. 3c brings literature. Frontier, 735 Aragon Ave., Los Angeles, Calif.

MODELLERS Catalogs! Ships, kits, fittings catalog, 164 pages with money back coupon 35c. Controllog-100 u-control gas planes 10c. Trix Twin H.O. tinplate trains, 12 pages 15c. Jetex-Jet engine booklet 5c. Modelcraft, 314 M59 Fifth Ave., New York 1.

TURBO CO2 racer. 2 machined balsa parts, plastic accessories 75c. Free catalog. Vancraft, 17792 Northrop, Detroit 19, Michigan.

LANDLOCKED Sailors! Here's a beautiful, richly illustrated, fully descriptive catalogue of famous model ships-whalers, slavers, corvettes, etc., authentic in every detail. Send for it today. Only 25c. Halesite Yacht Service, Inc., Department B.L., Halesite, Huntington, N. Y.

BASSWOOD Sheets, select, smooth, light weight, uniform, works easily, $\frac{1}{8}$ " x $3\frac{1}{4}$ " x 18", twelve sheets \$1.00. $\frac{3}{16}$ " x 4 " x 18", ten sheets \$1.25. Whittlerscraft, F-269 Canal St., Providence, R. I.

MODEL Railroad on a table top. Have fun building America's smallest railroad models. Scale 1/10"-1 ft. Operate electrically on TT gauge (15/32") track. Build from kits or buy ready-to-run. Big variety streamliners, diesels, steam locos, freight and passenger cars. Complete set, engine, 3 cars, 10 $\frac{1}{2}$ ft. track only \$29.95. Send 20c for big new 1949 catalog. H. P. Products, Dept. PM, Hartford City, Indiana.

RAILROADERS—50c Gets 1949 catalog reference manual. State O or HO gauge. Walthers, 247 Erie, Milwaukee 2, Wis.

STEAM Marine engines, 2 cylinder V-type precision machined. Bronze construction, with built in speed control. Free literature. Model Marine Engine Wks., Box 326, Evanston, Ill.

BRASS Gears and model supplies for the inventors. Send 10c for catalog. Pierce Model Works, Tinley Park, Ill.

BUILD Historic ship models, complete kits 39c to \$9.00. Catalog 10c. Ideal Models, 19 West 18th, New York 11, N. Y.

SHIP Models—Kits, fittings, plans, books, engines. Illustrated catalog 25c. James Bliss & Co., Inc., 220 State Street, Boston, Mass.

SHIP And yacht model fittings; blueprints. Send 25c for illustrated catalog No. 21—listing hundreds of items. A. J. Fisher, 1002-1 Etowah Ave., Royal Oak, Mich.

MINIATURE Steam locomotives, $\frac{1}{4}$ ", $\frac{1}{2}$ ", $\frac{3}{4}$ " scales. Castings, parts, rail, steam fittings! Thorough drawings with instructions. Catalog 25c. Little Engines, Wilmington, Calif.

SHIP Models and yacht supplies complete. Large 64 page catalogue 30c. Bill Wild's, 510 East 11 St., New York City 9.

HOME CRAFTSMEN

90 ALL New, full size lawn ornament and novelty patterns, up to 20" high. Only \$1.00. Mastercraft 5M2, 7041 Olcott, Chicago 31, Ill.

LEATHERCRAFT! Write for free catalog. Increase your income and start a spare time profitable business. Continental Leather Co., 201 $\frac{1}{2}$ W. Magnolia, Fort Worth 4, Texas.

SHELL Craft. Make beautiful seashell jewelry! (Buy direct). Pace's, Box 279 P.M., Bradenton, Fla.

NEW 1949 illustrated catalogue. 84 pages showing thousands of items for the leather crafter. Leathers, copper, tools, supplies, designs, patterns, books, and ready cut projects. Send 10c today to cover handling charges. Russo Handicraft Supplies, 245 South Spring Street, Dept. PM5, Los Angeles, California.

LEATHERCRAFT. Monthly price list guarantees best prices. Catalog free upon request. Tandy Leather Company, Dept. PM-59, P.O. Box 397, Tulsa 1, Oklahoma.

WONDER Drill sharpener. Successful precision grinding simplified. \$1.95. Ellery Thompson, Wonder, Oregon.

SEA Shells. California blue olives, \$1.00 pound. Clark Capehart, Box 787, Santa Paula, Calif.

LAWN Chairs, garden figures, furniture, novelties, toys, etc. 68 popular plans with full size patterns. \$1.00. Mastercraft, 5M1, 7041 Olcott, Chicago 31, Ill.

MAKE Your own "Hercules" belts! Complete kit includes finest calfskin links, tongue and metal buckle. Simple instructions enclosed. Send \$1.00, we ship prepaid. Arokraft, Dept. M, 32 W. Randolph, Chicago 1.

BEAUTIFY Your yard with an accurate sundial. Send \$1.00 for complete plans. Lodge, 756 Ventura, Altadena, Calif.

JUMBO Box world's finest genuine leather. Pigskins, alligators, lizards, ostrich, cowhide, many other varieties, assorted. 20 lbs. — \$5.00, 10 lbs. — \$3.00. Satisfaction guaranteed. Order today. Leathercrafters, Box 11-A, Lake Bluff, Ill.

PLYWOOD 10 Pc. $\frac{1}{4}$, 12" x 12" \$1.00. Package includes western fir, poplar, Philippine mahogany. Lakecity Plywood Co., 14028 Bothell Way, Seattle 55, Wash.

SWISS Music movements. Assorted tunes \$1.90. Direct from manufacturers agent. Helax Company, 233 West 72 Street, New York.

SENSATIONAL New pocket tool for the craftsman and model maker. 7 tools in 1. Write today! The Craftsmiths, 15427 Robson, Detroit 27, Michigan.

MAKE Draw drapes, modern window treatment. We make them free! Save you plenty on materials and rods. Samples and directions 25c. Altmeyer Home Decorators, New Kensington, Penna.

LEATHERCRAFTERS! Free bargain listing of large leather remnants. Big assorted kit; about 15 sq. feet of leather, \$2.98 postpaid. D-E Products, Dept. B, 8 E. Huron St., Chicago 11, Ill.

DECALCOMANIAS. $\frac{1}{2}$ Inch silver or gold letters. 3 complete alphabets and numbers. 50c postpaid. Mark your tools, kitchen cabinets, toys, etc. Quantities at discount. Andrews Decal Co., 1225 Cortland, Chicago 14, Ill.

SPECIAL 80 Full sized patterns, lawn ornaments, toys and novelties. \$1.00. Modern Woodcraft, Saginaw, Michigan.

CRAFT Catalog free "Artcraft's Little Giant." 6500 items covering several crafts, "Tops in our field." Artcraft Leather, Oakland 7, Calif.

LUMBER For home craftsmen and boat builders. Write Forest Products Company, Box 341, Binghamton, New York.

PLASTIC Brooch and ear ring kit, for internal carving. Includes polished blanks and findings. \$1.00, includes tax. 6 or more kits 15% off. Write Lor-Daun, 522 Securities Bldg., Des Moines 9, Iowa.

LAWN Ornaments. Ready cut patterns, full size. 20 assorted \$1.00 postpaid. Lincoln Craft Studio, Farmington, Conn.

HOME Bars. 25 designs built-in, portable, cellarettes, \$1.00. Craftplans, 7241-P Madison, Kansas City, Mo.

SAVE Thousands building your own home. Practical 47-lesson home-study course explains home-building A to Z. Includes plans and specifications for 6-room house. Others using with great success. Big 22-page book sent free. Commercial Trades Institute, Dept. DC2-5, 1400 Greenleaf Ave., Chicago 26, Ill.

FREE Catalog. Complete line of supplies. Lucite, plexiglas, shells and jewelry findings. Plastic Land, 1210 Spruce Street, Philadelphia, Pennsylvania.

CATALOG; Booklet, hobbycraft hints 10c. Leisure Hour Products, 416 Rose, West Hazleton 2, Penna.

LEATHERCRAFTERS: Free! 3 sheets new designs with latest catalog. Enclose 25c handling charge. Leather Specialties, 358 E. Broadway, Long Beach 2, California.

JEWELRY Findings, rhinestones, pearls, sequins, cameos. J & M Novelties, Box 464P, Griffith, Ind.

SHELLS, Plastics, findings. Lowest prices. Free catalog. Frances Jones, Box 251, Sarasota, Fla.

TURN Your workshop into cash. Send postcard for catalog of modern saleable projects. Craftplans, 7241-P Madison, Kansas City 5, Mo.

LEATHERCRAFT Lacing, bargains! Francis Byrd, 3406 Montrose Ave., Richmond, Virginia.

LEATHERCRAFTERS: Belt kits, projects, leather, supplies. Free catalog. Art Leather, 411 Joseph Ave., Rochester 5, N.Y.

BANDSAW, Jigsaw owners, let your machine bring extra profits, fun. Free details. Nu-Art, 33 Rosemont, Weymouth 91, Massachusetts.

MAKE Your own jewelry! All types of findings, metal and plastic; cameos, beads, shell kits, illustrated catalog. 20c. Hobby Art, P.O.B. 276, Dept. 7, New York 18, N. Y.

CATALOG: Patterns plywood novelty furniture, lawn ornaments, letters, numerals, plaques, frames, silhouettes, weathervanes, toys. Decal transfers. Over 100 other items. 200 articles illustrated. 25c. refunded first order. (No stamps please). Wo-Met Shop, Box 167, Ashburn, Georgia.

KNOCKDOWN Cedar chests. Lumber and veneers. Free price list. Giles & Kendall Company, Huntsville, Ala.

LEATHER, Retail, mail orders, catalog, tools, lacing, supplies. National Handicraft Co., 30 Frankfort St., New York City 7.

LEATHERCRAFT! Complete stocks of leathers, tools, supplies. Immediate shipment. Free catalog. Kit Kraft, 3203 W. Washington Blvd., Los Angeles 16, California.

COPPER And brass materials. Complete line for craftsmen and workshops. Catalog A free. Groundmaster Company, Boulder, Colorado.

MAKE IT YOURSELF

BUILD Your own garden tractor. Plans, easy instructions. Light or heavy duty. Send postcard for free information. Ellsworth Tractor Co., Dept. A, Camptonville, California.

DESCRIPTIVE Plans of easy blueprints for home owners, farmers, 25c. Details free. Dealers wanted. Edman, Box 307T, New York 19.

BUILDING Construction. All kinds. 100 ways to save. 100 illustrations. 52 page book, \$1.00. Home Industries, Omaha 5, Nebraska.

PRACTICAL Welder. Details free. Fain Electric, R12, Ft. Worth, Tex.

BUILD Concrete block machine. Easy. Inexpensive. Motor vibrator or hand operated. Write Clyde Lee, Dept. A, Mountain View, Okla.

WANT Leathers? See ad signed Leathercrafters under "Home Craftsmen" classification.

MAKE A cigar box or toy into a priceless gift with our Swiss musical unit. Satisfaction guaranteed. Pay \$2.98 plus postage to mailman. Donna Gracilla Co., 3330 Lake Shore, Chicago 13, Ill.

ELECTRIC Cigarette roller. Exclusive! Made from toys and cardboard. Absolutely guaranteed 100% automatic. Plans \$2.00. Clearprint Plans, Box 265-A, Muskegon, Michigan.

BUILD Your own power lawn mower from our kit of parts. Any or all parts furnished including engine and plans. Prompt delivery on complete B-M mowers. Free literature. B-M Mower Company, Box 66-PM, Blue Mound, Kansas.

"CONCRETE Block Homes." 32 page booklet on how to build. \$1.00. H. O. Lightfoot, Civil Engineer, Richboro 1, Penna.

GARDEN Tractor—1 $\frac{1}{2}$ to 3 h.p. No machining, auto, truck or special parts. Hundreds being used. Plans \$3.50. Clearprint Plans, Box 265-A, Muskegon, Mich.

MAKE Your own handy lightweight concrete blocks quickly with new block-maker. Circular stamp. Manual 25c. Peerless, New Lenox, Illinois.

SOLAR Water heater systems efficient any locality. Standard materials, low cost and easily built. Free facts. Solar Water Company, Box 175, Coral Gables, Florida.

GRANDFATHER Clock easily built. Big savings. See ad on page 273.

WATCHES, OLD GOLD, JEWELRY

SWISS Wristwatches, shockproof, waterproof. Seventeen jewels. Special price \$7.95. Sydney Eisenberg, 1009 Stockton, Jacksonville, Fla.

GEMS, Precious and semi-precious, all genuine, from world wide sources. Deal direct, no overhead, save money. Catalog 10c. Hill Co., Route 7, Salem, Oregon.

HIGHEST Cash for old, broken jewelry. Mail gold teeth, watches, rings, silverware, diamonds, spectacles. Satisfaction guaranteed. Free information. Rose Smelting Co., 29-A East Madison, Chicago.

TOBACCO, SMOKERS' SUPPLIES

CIGARS Direct from factory; at low prices. High quality cigars six brands, 6c to 15c. Smoke cigars that have a man's taste. Send dollar bill for assorted box, or write for prices, and commission. M. Wagman, Box 287-P, Dallastown, Penna.

CIGARETTES \$1.50 Carton, 3 or more postpaid, \$1.53; 5th zone up. Cigarette Sales, 1122 E. 31st, Kansas City, Mo.

PIPES Semifinished—Finest imported briar, \$1.25. Merely sand, polish. Carnauba wax, briar blocks, stems, bands, factory rejects. Free literature. Carvape, 2829-G Dixie, Hamilton, Ohio.

CIGARETTES—Popular brands \$1.50 per carton postpaid. West of Mississippi add 8c per carton. Min. order 3 cartons. Send check or money order. King Co., Box 569D, Dover, Del.

RAZORS, BLADES, SHARPENING

NEW Hone sharpens all types razor blades. Sells on sight. \$1.00 guaranteed. Territory open. H. M. Park, Distributor, 509 Fifth Ave., New York, N. Y.

100 **GILLETTE** Blue blades \$4.00; 120 Schick-type \$2.50; 100 single or double-edged \$1.00; no stamps. Island Supply, Box 224, Garden City, N. Y.

\$15 **NEW** electric shaver, free gift, \$5. Weiss, 3518 32nd Street, Union City, New Jersey.

100 **EXTRA** Sharp blades for Gillette razors \$1.00. Gilbert Benes, 10607 Campbell Avenue, Chicago 43, Illinois.

SAFETY Razor Co., Box 14, New York City 14. Guarantees 200 regular or 100 single-edge or 50 stainless steel blades \$1. Clip this ad now.

FOR THE HOME

ALL Makes oil burner parts, controls, pumps new and factory rebuilt at less than 1/2 list price. Immediate replacement from stock. Full year guarantee. J. Hoe Company, 111 Sanford St., Brooklyn 5, N. Y.

LEARN Crystal gazing \$1.00. Catalogue 10c. King, Box 192, Times Plaza, Brooklyn 17, N. Y.

AWNINGS, Canopies; aluminum, adjustable. Shade King, 5314 Olcott, Chicago 31, Ill.

FOR SALE—MISCELLANEOUS

WESTERN Style ladies belts, handbags, horn gun racks, unborn hair calf skins, photo lamps, etc. John F. Barnes, Pecos, Texas.

PAINT Brushes—4" \$1.00; 5" \$2.00. Bristle 4" \$2.00. Camel hair and marking \$1.00 dozen; others. Harlem Brush, 1547 Park Ave., New York 29, N. Y.

DRAFTING Stool cushions. Circular sponge rubber pads 2" thick, 14" diameter. \$3.00 each prepaid. Satisfaction guaranteed. Thayercraft, Box 182, Culver City, California.

PAINT—House and barn paint for wagon jobbers, auctioneers and house to house men. White, gray, red, \$1.25 gallon; extra bright aluminum paint, \$1.45 gallon, all in 5-gallon cans. Gallon cans 10c higher. Will repeat. Chance to make big money. Mail check or money order for immediate shipment. Trading Post, 2104 Burlington, North Kansas City 16, Mo.

BARGAINS Galore—Power lawn mowers, shop equipment, machinery, hand tools, million other surplus items. Atlas Equipment, 229B Southwest Blvd., Kansas City, Mo.

JIM, Bill, Bob, Dick, John, personalize car, toys, gadgets. Twelve attractive decals above names, assorted sizes to inch letters. Dollar. No c.o.d.'s. Elco Products Company, Box 191D, Napoleon, Ohio.

20 **VICTOR** Stamp machines in crates. \$20.00 each. Weinmann, 659 Chancellor Ave., Irvington, N. J.

WHIPPED Cream dispenser; pint makes 1/2-gallon for sundaes, \$17.50. Literature free. Domonkos 98-A5 Vermont, Newark 6, New Jersey.

SURPLUS—10,000 7/16" Automotive stud removers. Original cost \$1.35. Close out price, 2 for \$1.00. Write for special job lot discounts. Box 843, Youngstown, Ohio.

WANTED—MISCELLANEOUS

OLD Wanted buttons bring cash. Write E. Prozman, Nankin, Ohio.

HIGHEST Prices paid for old gold, silver, platinum, diamonds, watches, gold teeth, old jewelry. Send now. Cash immediately. Goods returned if offer is not satisfactory. United Smelting Works, (The Old Reliable), 39-B South State, Chicago 3.

I Have swappers-buyers-sellers for anything. Free lists. Toole, Box 415, Evansville, Indiana.

CHEMICAL Games and novelties wanted. Also, any proven methods to make plants grow quickly by chemical methods and to make better production. Garden Chemical Company, 3101 Ludlow St., Philadelphia 4, Penna.

PARTNER Wanted. Finance manufacturer of patented automatic door control. Will operate all type doors. Investigate this. Chas. Hanson, 1107 N.B. St., Wellington, Kansas.

ANYTHING Of value. Robert, 207 North 5th Street, Springfield, Illinois.

QUICKSILVER (Mercury) urgently needed! Immediate payment. Wholesale Terminal, Norwood, Massachusetts.

PERSONAL

SPORT Stationery \$1.25 box, agents wanted. Novelprint, 18 Central Street, Windsor, Vermont.

BOSTON! Until 1950. Letter remailed dime. Box 816, Boston 3, Mass.

RECEIVE "Interesting Mails"—25c keeps your name on mailing list for six months. Bentz, Jr., Chatawa 43, Mississippi.

POSTMARK Your mail Juarez Mexico. 25c per letter. McKechnie, 4021 Hastings, El Paso, Texas.

MEMORIAL Day May 30th. You'll appreciate reading "Letter To My Dead Son," Navy flier. 25c. Hubert Madere, Hahnville, Louisiana.

FOOT Sufferers get instant relief with a pair of soft sponge rubber arch supports. Price \$1.00. Free information. Cadwalader, 311-B Crosby Bldg., Buffalo 2, N. Y.

NECKTIE Press-Em-Neat forms. Save cleaning bills. 50c or 3 for \$1.00. Fast service. Ryane's, 61 Freeman St., Buffalo 15, N. Y.

MEXICAN Mailing service. Letters received, forwarded 20c. Photographic postcards 15c. Retailed free. Tillotson, Apartado 1405, Guadalajara, Jalisco, Mexico.

ITALY Mailing service. From Rome, letters received and forwarded 50c. Illustrated postcards addressed by you mailed from Rome, Italy 25c. "Capitol," Suite 7, 342 Hanover Street, Boston, Massachusetts.

49 **NECKTIE** Trade special! Mail 49 ties or any number less with \$1.00. We'll send you equal quantity—equally good—different ties. Unbelievable? Try it. Cleveland Neckwear Exchange, 3233 Chadbourn Road, Cleveland, Ohio.

MIAMI Beach Postmark! Letters 25c each. Lind, 2484 Prairie, Miami Beach, Fla.

FREE To victims of dandruff, dry thinning hair: Helpful booklet, prompt relief. Regime Products, 9-C South Clinton, Chicago 6.

STUTTERING Corrected at home. Send for free literature. The Athenium, PM-5, 1714 Chestnut, St. Louis 3, Mo.

FREE Catalog! War surplus clothing bargains! Men's, women's. New York Clothing Co., 2079-A, New York 29.

HAIR Falling? Dandruff? Write. Elson, 137 Lewis St., Phillipsburg, N. J.

CIGARETTES. Postcard brings confidential prices. Magills', Drawer 430-PM, Springfield, Missouri.

MEXICAN Law. General Practice Attorney. 1203 Arizona Street, El Paso, Texas.

HOW You can find out! Information discreetly developed, any matter, person, problem, anywhere. Personal-business assignments, representations undertaken. Nation-wide. Officially licensed, bonded service established 1922. Reasonable. Confidential. William Herman, 170 Broadway, New York.

MISCELLANEOUS

TIME-SAVER. Record keeper, automatic secretary for you who buy, trade, shop by mail. Pad of 75 lettersize mailing-forms printed and check-boxed to cover any requirement, interleaved plain sheets for carbon record, carbon. Only \$1.00. Imprinted with your name, address \$2.00. Copyrighted. Marj Specialties, 1360-A North Sedgwick, Chicago 10.

MONOGRAMS. Car, boat, six 1/2" to 2". Gold letters or numbers \$1.00. Appleton's, Anoka, Minnesota.

YOUR Name, beautifully engraved, on a heavy polished brass doorplate, 13/4" x 9". Postpaid \$2.00. H. V. Ackerman, Malden on Hudson, N. Y.

CARTOONS. The kinds you'll like. Samples 25c. Verret, Raceland, Louisiana.

TIRED Of your neck ties. Mail us six and \$1.00 cash, check, money order; receive six different beautifully reconditioned neckties and coupons for 24K. Gold plated free gift. The Tie Exchange, 159C North Wabash, Chicago 1, Illinois.

BARGAIN Catalog. 10c values galore. Tiptop, Box 9083PM, Dallas, Texas.

WORLD'S Uranium deposits tabulated! Detection and exploration methods explained. Details free. Woodwid Industries, 5217-A Hollywood Blvd., Hollywood 27, California.

URANIUM Mineral Handbook. New, comprehensive, practical. Official selling and bonus information. Radioactive ore occurrence, detection, testing. \$2.00. Science Books, 1935 Whitman Avenue, Butte, Montana.

ELECTRIC Pencil—Writes, engraves all metals. 110 volts. \$2.95. Reb Industries, 265-DV, Elmhurst, Illinois.

ATTENTION! Motorists, housewives, Chromalene wipes rust clean! Chrome, nickel, sinks, guns, tools. \$1 prepaid. Erner Products, St. Paul 8, Minnesota. Agents wanted.

EXCHANGE Neckties. Send 7 ties and \$1.00. Receive 7 different cleaned ties. Box 2297, Pensacola, Fla.

SEPTIC Tank problems solved. "What To Do" booklet compiled from experience. Order now. \$1.00 per copy. Reuben Selfridge, Septic Tank Consultant, Dept. M, Clymer, N. Y.

GOLD Prospectors need this guide. Send \$1.00. John Phillips, 1404—14th, Wichita Falls, Texas.

INFORMATION. Any subject. The Roxbys, 747 S. New Hampshire, Los Angeles 5.

PANNING Gold—Free instruction booklet. Catalogue mining books; supplies. Old Prospector, B-244, Dutch Flat, Calif.

GEIGER Counter 300V batteries. Set of three, \$20.00 postpaid. Fred's, Box 3491, Glendale 1, Calif.

PREVENT Garden damage by rabbits. Buy Rabbit Scat, it works. 6oz. \$1.00, 1 lb. \$2.50. Keep dogs and cats away. Dog-N-Cat Scat, 6 oz. \$1.00. A free sample of the miracle Plantgro with each order. Garden Chemical Company, 3101 Ludlow St., Philadelphia 4, Penna.

HUNDREDS Valuable, interesting items free. Send postcard. Box 552, Memphis 1, Tennessee.

SENSATIONAL New type fire extinguisher. Fits in palm of your hand. Only \$3.98. For home, car, boat, garage. Effective against electrical, oil, gasoline and all types of fires. Money back guarantee. Presto Fire Extinguisher, 55 E. Washington Street, Chicago 2, Illinois.

COCONUTS Off palms in husks \$2.00. Lind, 2484 Prairie, Miami Beach, Fla.

PUSH Button knives. Guaranteed mechanically perfect. Instant action. This hard to get item only \$2.00 postpaid. Midwest Knife Company, 13722 Woodward Avenue, Detroit, Michigan.

BIG Men only: Quality shoes, sizes 10 to 16. Widths AAA-EEE. Dress, work, hand-woven shoes, loafers, moccasins, wing tips, sox. Guaranteed. Write for free catalog. King-Size, 888 Brockton, Mass.

LAWN Mower sharpening. Easy method with simple equipment you can make yourself. Complete plans 25c coin. Goodwin, Box 175, Crab Orchard, Ky.

GEIGER Counters. Uranium quickly located with new, super-sensitive, 5 lb. detector. Sensational low price. The Detection Company, Cole Station, P.O. Box 8683, Los Angeles 46.

"**INTERESTING** Mails." (Free gift), 25c. Scott, 521 North Memorial, Rockford, Illinois.

HOSPITAL Patients! Send self-addressed envelope for materials and instructions for pair of pretty blue earrings. Supplies list included. Betty Kay, Box 274PM, Ridgewood, N. J.

LUMINOUS Reflective paints glow day and night. New angle money maker! Numerous samples 25c. Write today! Research, 1842-PM Byron, Chicago 13.

YOUR 20 Word inscription expertly engraved on brass trophy plaque, 3" x 5", bowling, hunting, memorial, etc. \$2.00 postpaid. H. V. Ackerman, Malden on Hudson, N. Y.

COLORED Glass tinsel, light reflecting crystals and luminous powdered pigments. Combination trial offer and listing. \$1.00 prepaid. Glowelico, 475-MP Fifth Ave., New York 17.

URANIUM Prospector's Handbook \$1. Non-technical. Craft-Connor Publishing Co., Dept. G, 601 S. Vermont, Los Angeles 5, Calif.

TREASURE Finders! Goldak's 11 pound featherweight gold, silver and mineral locator. Guaranteed superior to any other device. Also Geiger counters for uranium prospectors. Free information. The Goldak Co., 1542 West Glenoaks Blvd., Glendale 1, Calif.

PROTECT Valuable photos—Frequently used printed matter. We'll enclose any size in electronically, edge-welded, transparent, plastic envelopes. Can't discolor or harm material. Wallet size only 25c. Send for circular and prices. Seal-view, R2, Lancaster, Penna.

70 BIBLE Lessons, 25c. Bulletin, Box 87, Cathedral Station, New York 25.

"RECEIVE Mail." Moneymaking offers, opportunities, catalogs. Name listed 10c. Ideal Service, Park Ridge 10, Ill.

TATTOOING Outfits, supplies. Illustrated list free. Zels, 728 Lesley, Rockford, Illinois.

SQUARE Dance instructions. Calls, 25 sets. \$1.00. Rayburne, Eureka Springs, Arkansas.

SHIPPING Supplies—Free catalogue. Tags, labels, bags, cartons, sealers, etc. Fountainhead, 1049 Bluff, Beloit, Wisconsin.

MAKE Your own tractor, saw mill, home freezer, and scores of other farm devices. Amazing new book. "Popular Mechanics Farm Manual." 284 Pages packed with hundreds of illustrated plans and farm workshop ideas. Descriptive circular free. Popular Mechanics Press, Room 603, 200 East Ontario Street, Chicago 11, Illinois.

TREASURE Locators. New electronic lightweight M-Scope mineral and metal finders are now available for immediate shipment. Built for arctic-tropic use. Revolutionizes locating of minerals, gold, silver, metal objects. Unsurpassed efficiency. Factory guaranteed. Low prices, time payment plan available. Send for free 16-page illustrated booklet. Fisher Research Laboratory, Inc., Palo Alto, California.

OUT Of print books found quickly. Send wants, no obligation. Coast Bookfinders, Box 8686, Los Angeles 46, California.

GEIGER Counters for finding uranium ores. Simple operation. Low prices. Interesting literature free. Fisher Research Laboratory, Inc., Palo Alto, California.

TATTOOING Machines, outfits. Free catalogue. Jensen, 120 West 83rd Street, Los Angeles 3.

NOW Ready: New, amazing Classified Advertising Record Book—prepared especially for classified advertisers. Here is a book that tells you instantly whether or not your advertising in any publication is paying you real results. You can tell immediately how many inquiries each publication produced—how much cash received from every ad. Spaces are provided for the name and address of the publication, date of issue, space used, rate, cost of ad, key number, etc. You have a complete record of each publication right before your eyes. Plenty of space to keep accurate record of 28 separate publications. You can have a copy by sending only 10c to cover postage and handling. Send for your copy now. W. F. Johnson, Classified Adv. Mgr., Popular Mechanics Magazine, 300 E. Ontario Street, Chicago 11, Illinois.

SUCCEED IN THE POULTRY BUSINESS!



Poultry is providing many trained men and women with a good, comfortable living, either part or full time. For 28 years our Home Study Course has been helping thousands obtain training and "know how" that means extra income from the start. Don't delay — Write today for prospectus describing courses, methods, service, opportunities.

NATIONAL POULTRY INSTITUTE
DEPT. 50 ADAMS CENTER, N. Y.

ARTISTS MAKE MONEY

Do you like to draw? Send name, address, age and occupation for FREE ART TEST, to find out your ability.

ART INSTRUCTION, Inc.
5139 ART INSTRUCTION BLDG., MINNEAPOLIS 15, MINN.

RADIO ENGINEERING. Broadcasting, Television, FM, Servicing, Electronics, Aviation, Marine & Police Radio taught thoroughly. Engineering course equivalent to 3 years' college radio work. Approved Veteran Training. Catalog free.
VALPARAISO TECHNICAL INSTITUTE, Dept. D, Valparaiso, Ind.

REAL ESTATE BE A BROKER

PAYS BIG! SEND FOR FREE, BIG, ILLUSTRATED CATALOG NOW! No obligation. Graduates report making substantial incomes. Start and run your own business quickly. Men, women of all ages, learn easily. Course covers Sales, Property Management, Appraising, Loans, Mortgages, and related subjects. **STUDY AT HOME** or in our classrooms in big cities. Diploma awarded. G.I. approved. Nationally known.

WEAVER SCHOOL OF REAL ESTATE (Est. 1936)
15 E. Pershing Road Dept. NT-5, Kansas City, Mo.

STRENGTH

Become a Stronx Muscular Superman, in 12 easy lessons, for only \$2.00. Guaranteed. "World's best for results." Buy today, be Stronger tomorrow. Order now, from

SID'S SYSTEM (PMD1), SOUTHGATE, CALIFORNIA

100 GAMES ON HORSEBACK
Games from MEXICO • ARABIA • INDIA • • Cowboy Sports
Learn to play—scoring—Fields and Courses
Exhibitions—Over 100 Games and Contests described
ANIMAL LOVERS BOOK STORE • Box KA 111, TARZANA, CALIF. **ONLY \$1.50**

Say You Saw It in
POPULAR MECHANICS

BE A DETECTIVE

WORK HOME or TRAVEL. Experience unnecessary. DETECTIVE Particulars FREE. Write to **GEO. P. M. WAGNER**, 125 W. 86th St., N. Y.

Learn **PHOTOGRAPHY** at Home

Splendid opportunities. Prepare in spare time. Practical basic training. Long-established school. Send for free book. "Opportunities in Photography." No obligation.
American School of Photography, 1315 S. Michigan Ave., Dept. 1355, Chicago 5, Ill.

UP TO THE MINUTE!
★ **UNIQUE, COMPLETE CORRESPONDENCE COURSE NOW AVAILABLE IN**
WATCH REPAIRING
Learn this profitable profession through our excellent correspondence course or at our residence school. **Post Graduate Plan** at school for correspondence students.
WRITE FOR COMPLETE DETAILS TO—
Dept. 4 6 0.
American Institute of Specialized Watch Repair
270 East Bldg. Grand Rapids, Michigan
Act Now!

NEW ADVERTISING MACHINE FREE!
PRINTS and ILLUSTRATES 1c POST CARDS
Boost sales with **CARDMASTER** like thousands are doing. Not a toy... but a sturdy advertising machine... guaranteed for 5 years. Get money-making facts TODAY. SEND YOUR NAME to **CARDMASTER, 4546 Ravenswood, Dept. 135, Chicago 40, Ill.**

TRAVEL for "UNCLE SAM"

START as high as \$3,351 Year
Prepare NOW For Next Examinations

VETERANS GET SPECIAL PREFERENCE
20,000 appointments each month
Many examinations expected soon
City Mail Carriers
City Postoffice Clerks
Stenographers-Typists
Messengers,
Liquor Inspectors—and many others.
40-Page Book on Civil Service FREE
Mail Coupon today—**SURE**
★

FRANKLIN INSTITUTE
(Not Government Controlled)
Dept. P86
Rochester 4, N. Y.

Rush to me, entirely free of charge, 40-page book with:
(1) A full description of U. S. Government jobs; (2) A list of U. S. Government jobs; (3) Tell me how to qualify for a job.

COUPON
Name _____
Address _____
Vet? _____

Low **FACTORY-TO-YOU** Prices

New! MIDWEST TELEVISION

with **BIG**
75 Square Inch **SCREEN**



- Offering*
- 12½" PICTURE TUBE
 - 12 TELEVISION CHANNELS
 - PICTURE-HOLD CONTROL

Other Models Include:
SYMPHONY GRAND AM-FM RADIO-TELEVISION-PHONOGRAPH with DUAL-SPEED RECORD PLAYER

... also complete CHASSIS for Custom Installation—and Adapter Chassis and Console for use with 1947, 1948, 1949 Midwest Radio Models.

30 DAY TRIAL



Also—Sensational **NEW MIDWEST RADIOS** with **DUAL-SPEED Phonograph**

Send for **TELEVISION Folder Prices** and **NEW 1949 MIDWEST RADIO Catalog**

MIDWEST RADIO & TELEVISION CORP.
Dept. T2510, 909 Broadway, Cincinnati, Ohio

Name _____
Address _____
City _____ Zone _____ State _____

Say You Saw It in Popular Mechanics

GET YOUR COPY
OF
THIS AMAZING FOLDER
TODAY

FREE
REVEALS HOW
TO MAKE
BIG MONEY

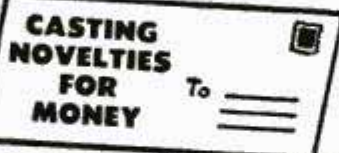

IN A BUSINESS OF YOUR OWN

No Experience or Special Education needed.
Tells All about the Miracle New FLOC-RITE the material with 1001 uses. Send for this FREE folder today.

BING PRODUCTS, 88 Broad St., Boston, Mass.

MAIL THIS COUPON for FREE FOLDER

Bing Products, Inc., Dept. PM5J, 88 Broad St., Boston, Mass.
Gentlemen: Please, rush me the FREE folder that tells All about this Big money-making business.

Name _____
Address _____
City _____ Zone _____ State _____

AUTOMOBILE DRIVERS



Flash Your Turns

New Model **SIMPLEX TURNING SIGNAL KIT** fits most cars. Gives new safety and comfort when making turns. Eliminates arm signals. Flashing parking and tail lights show other cars which way you're going to turn. Flashes 60 to 80 times a minute. Works like factory installed models on expensive cars. Does not interfere with operation of present lights. Install it yourself. All parts furnished. For most 1942 to 1949 cars. **SPECIFY MAKE AND YEAR.** Adaptable to earlier cars at extra cost. Money back guarantee.

\$7.95 Postpaid in U.S.
Send check or money order.
Postage extra on C.O.D.'s.

The **LESTER Company**, P. O. Box 5939-M5, Chicago 7, Ill.

Giffy **ELECTRIC HEATER**

HOT WATER IN FIVE MINUTES

For baby's bath, your washing, shaving and many other uses in the home, camping, business or on the farm.

One Year Guarantee
See your local Dealer or order direct . . .

AMBURY CORPORATION
Dept. MP-5 Hazel Park, Michigan

MICROSCOPES SUPPLIES-ACCESSORIES & SCIENTIFIC INSTRUMENTS

SPENCER NEW & USED **LEITZ ZEISS** **MEDICAL INDUSTRIAL AMATEUR**

BOUGHT-SOLD-EXCHANGED-REPAIRED

Send for **FREE LIST**

NATIONAL SCIENTIFIC INSTRUMENT CO. 119 CHAMBERS ST NY 7

SUPER JU JITSU

Now . . . get tough **DOUBLE-quick!**

Step up **YOUR** fighting power, learn lightning-quick American **SUPER JU JITSU**. Develop your body . . . be dangerous! Big illustrated home-study course, reveals secrets on how to make deadly weapons of just your bare hands. Easy to learn. Get these amazing lessons right away . . . you owe it to yourself. Complete price only **\$4.95**, nothing more to pay! **COD** plus postage—or send **\$4.95** full payment and we pay all charges. Satisfaction guaranteed or your money back! Order "Super Ju Jitsu Course" today. **NELSON-HALL CO., 1139 S. Wabash Ave., Dept. 3E2, Chicago 5, Ill.**

LEARN MONEY-MAKING CARTOONING

IN SPARE TIME — by Easy Picture Chart Method

Same Simplified Method that has helped train creators of "Terry & Pirates," "Freckles," "Out Our Way," "Winnie Winkle," "Regular Fellers," "Strange As It Seems," "The Neighbors," and many others. Earn while learning. Send 10c for Picture Chart (to test your ability), and full details. (State age.)

THE LANDON SCHOOL, 4905 Cleve. Transit Bldg., Cleveland, O.



WHAM-O **\$1.00**
SPORTSMAN* Postpaid

Powerful—New—Accurate
Kills Rabbits, Squirrels, Etc.
Routs Pests

Rivals Archery!
Fast Becoming a Major Sport.
Handy—Silent—Inexpensive. Easy to use.
Complete with 40 pellets and extra rubber straps.

WHAM-O MFG. CO., Box G 92, South Pasadena, Calif.
*Professional model used by members Nat'l Singshot Assoc.

BIG MONEY IN NEW SYSTEM of HEATING From **AIR, WATER and EARTH**

Learn about new system of heating **WITHOUT FUEL.** (Reverse cycle of refrigeration.) Wonderful opportunity to be miles ahead of others . . . **IF YOU ACT NOW** Get the **FACTS . . . They are FREE . . .** No obligation.

PRACTICAL TRADES INSTITUTE, INC.
25 University Ave. S.E., Dept. P-5, Minneapolis 14, Minn. Write Today

MOTOR WEAR? **AMAZING NEW "DE-ACID OIL DRAIN PLUG"**

Reduces acid corrosion. Saves your motor. Does away with up to 90% of engine wear. Protects vital parts. Acts as neutralizer. Acids attack core of plug rather than motor. Easy to install. Safe. Developed by prominent Diesel engineer.

Write at once for this wonderful engine saver. Only **\$2.50**. Money back guarantee. State make and year of car.

Johns Manufacturing Company, Dunellen 3, New Jersey

DO ANY JOB.. EASIER.. QUICKER
MAKE MORE MONEY in the
BIG OPPORTUNITY
FIELDS

SEND NO MONEY
 Select the Books
 YOU Need Now!
 We Ship C.O.D.
 Anywhere in U. S.
 and Will Refund
 Amount Paid if
 Not Satisfactory.

Here's the Help You Need
For Best Paying Jobs
Right NOW!

FREE TRIAL
IN YOUR OWN HOME

Used by Army, Navy, Other Government
 Depts., 200 Schools and Industrial Firms.

Do it now! Get the better pay that goes to men with specialized knowledge. Get into one of these big opportunity fields. Big money and many other advantages await you if you prepare now. Here is the help you need—EASY—QUICK—AT LOW COST. Thousands of men have already used these famous books. Beginners and experienced men alike have doubled and tripled their earnings with this help. You too, can now get the special knowledge you need for top pay, better jobs, or a business of your own. This is your GOLDEN OPPORTUNITY.

AIR CONDITIONING

Big air conditioning boom is Nation-wide and bigger than ever. Alive with new opportunities! Get this non-technical book by international authority and be ready for your share of millions to be spent. Covers whole field. 450 pages. Illustrated. \$4.00.

SHEET METAL LAYOUT

Makes sheet metal layout work so simple that anyone can learn. Get this new instructor and get into the easiest, cleanest and best paying part of all sheet metal work. 143 jobs worked out in drawings and carefully explained. Gives standard for all sheet metal fittings. \$3.50.

BAILEY'S HANDBOOK

World famous handbook of universal questions and answers for Stationary, Marine and DIESEL engineers and firemen. Prepares for any license examination in installation, maintenance and operation of Diesel and steam plants. Pocket size, \$2.00.

MODERN WELDING

Newest book on all types of welding and heat treatment of metals. Written by recognized specialists in training men for production jobs. 430 Pages, 277 illus. Practical and Non-Technical. Covers everything you need to know. \$4.00.

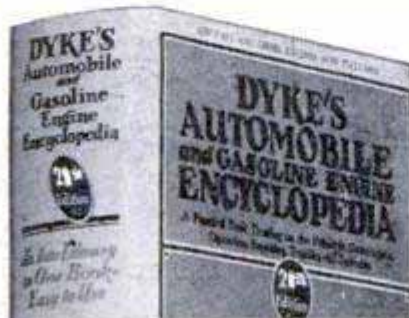

1948
21st
 EDITION
 Leading
 Auto
 Book
 for Over
 32 Years

World's **AUTO BOOK**

New Material, Specifications,
 1947 Cars, 1948 Trucks, Busses,
 Tractors, Diesels

Now with millions of cars needing repairs and thousands of men needed to do the work, you need the famous DYKE Auto Book more than ever before. New 21st Edition covers all principles, construction, repair, adjustments, testing, troubles and remedies. Over a half million copies of 20 editions of Dyke's have been sold. Buick Dynaflo, Farm and Outboard Motors and new electrical systems now covered. World's biggest book value. Only \$7.50.

This big book, a complete auto library in one volume, has 1483 pages—4600 illustrations and diagrams—weighs 6 lbs.—equal to 4 ordinary books.



The Easy Way to a
 Profitable Business
 Of Your Own!

Owners will spend big money to keep their good older cars looking like the new ones coming out. This is a practical money-making guide, ideal for shop owners and every man who wants a share of the millions to be spent in keeping old cars looking new. Tells how to get a good job or start business of your own with small capital. Covers everything including tools, methods and materials. Only book of its kind. 325 pages, 232 illustrations. \$3.50.

HOUSE WIRING — NEW EDITION

Get this new sixth edition of this standard and practical electrical wiring book. It gives complete practical instruction on every phase of house wiring in one handy volume. Goes further than most books on subject. Handbook style. Gives National Electric Code. 400 pages, 669 illustrations. Electrical work will reach a new high with millions of new homes to be built. Get started now. \$3.00.

CARBURETORS — Dyke

The standard guide in the best paying auto work for a generation. It has helped thousands of men make money. New edition covers engine tune-up, compression, ignition, carburetion, fuel pump valves, etc. Use this book to specialize in this big field. 244 pages. 549 illustrations. \$3.50.

Mail Coupon to GOODHEART-WILLCOX CO., Dept. 15, 1321 S. Michigan Ave., Chicago

20 Million Refrigerators
 Need Service and
 Repairs

SEND NO MONEY! Mail Coupon

GOODHEART-WILLCOX CO.,

1321 S. Michigan Ave., Dept. 15, Chicago 5, Ill.

Send books checked, C.O.D. I will pay postman, plus few cents charges. If not satisfactory I will return books in 5 days and you will refund money paid. (Outside U.S. or possessions remit with order.)

- | | |
|--|--|
| <input type="checkbox"/> Gas & Electric Refrigeration \$5.00 | <input type="checkbox"/> Air Conditioning \$4.00 |
| <input type="checkbox"/> Dyke's Auto Book \$7.50 | <input type="checkbox"/> Engineers Handbook \$2.00 |
| <input type="checkbox"/> Dyke's Carburetor Book \$3.50 | <input type="checkbox"/> Body and Fender Repair \$3.50 |
| <input type="checkbox"/> Modern Welding \$4.00 | <input type="checkbox"/> Shop Math. (2 vols.) \$3.00 |
| <input type="checkbox"/> Airplane Welding \$3.50 | <input type="checkbox"/> House Wiring \$3.00 |
| <input type="checkbox"/> Sheet Metal Layout \$3.50 | <input type="checkbox"/> A.C. Power Wiring \$4.00 |
| | <input type="checkbox"/> D.C. Power Wiring \$4.00 |

If remittance accompanies order we will pay all postage charges under same return privilege.

Name _____
 Address _____
 City _____ State _____

REFRIGERATION—Book of the Hour!

Biggest Opportunity in Many Years!

LATEST PRINTING — ALMOST 1000 PAGES

408 Pictures—17 Diagrams in Colors Makes All Refrigerator Service Maintenance, Repairs Simple as A. B. C.

Thousands of Refrigerators need repairs! Owners will pay big for competent service which will be needed more and more. Get MODERN GAS AND ELECTRIC REFRIGERATION, the non-technical guide to all types of refrigerators and get your share of this new profit. Get a job or start your own service business. This book will help you make money anywhere. It is the recognized standard book on the subject. Price \$5.00.



LEARN Radio TELEVISION ELECTRONICS



Get a Good Pay Job - or Start Your Own Business

Want to make *more* money? Want to be your *own* boss - have your own money-making business - with your future *assured*? Then learn Radio and Television with my proven two-way method (lesson instruction plus actual practice) that can help you get into this great and growing business *quicker*. You learn by doing, right in your home in spare time. During your training you get 10 big kits of radio parts with which you perform hundreds of tests and experiments, build scores of circuits and testers to help you learn faster, more thoroughly.

Since 1929 I have been training men all over the world for success in radio, television and electronics. To learn how I can help *you too*, take the first step *now* by sending for my big 56-page illustrated book that tells how you may cash in on radio and television's *big opportunities*. My book is Free but it may mean your future success. Send coupon for it today.

C. H. MANSFIELD, President

Hollywood Radio and Television Institute
810 West 6th Street, Los Angeles 14, Calif.

**APPROVED
FOR
VETERANS**
Check coupon



SEND for THIS BOOK

C. H. MANSFIELD, Pres., Dept. A-17
Hollywood Radio and Television Institute
810 West Sixth Street, Los Angeles 14, California, U. S. A.

Send me your FREE book "Your Opportunities in Radio, Television and Electronics" which explains your 2-way home study training method. No salesman will call.

NAME _____

Please print or write plainly

ADDRESS _____

CITY _____ ZONE _____ STATE _____

If a veteran of World War II, check here

Drive a
FORD



and **Feel** the DIFFERENCE!

ENGINEERING DEGREE IN 27 MONTHS

Big Demand for Graduates

Aeronautical, Chemical, Civil, Electrical, Mechanical and Radio Engineering (including Television)

Hundreds of young men are earning engineering degrees in this recognized institution each year—continuous operation. New terms start quarterly. Many students earn a major part of their college expenses in this large industrial center.

Low tuition. Competent instruction. Thorough intense practical program. Modern laboratory facilities including new physics lab. and modernized wind tunnel. Individualized instruction emphasized.

Approved for Veterans. Engineering preparatory courses. Students from 48 states and 21 foreign countries. Enter June, September, December or March. Send coupon for free catalog and full information. Enroll now.

INDIANA TECHNICAL COLLEGE

559 E. Washington Boulevard
Fort Wayne 2, Indiana

Please send me free information on B.S. Engineering Degree in 27 months as checked.

Aeronautical, Chemical, Civil, Electrical,
 Mechanical, Radio-Television.

Name _____

Address _____

RUBINA opens NEW TRENDS..
16mm "Still" Photography!

A superb TINY precision camera that takes thrilling low-cost Salon pictures in Color or Black-and-White!

16mm rubix-RUBINA color photography rivals results of finest 35mm cameras! Negatives enlarge to 8x10 without ANY loss of definition. Slides can be used in 16mm or 35mm standard projectors.

SEND \$29.50 tax incl.

- Color corrected f/3.5 anastigmat lens.
- Shutter speeds, 1/25th, 1/50th, 1/100th & B.
- Ratchet Film Counter. • FREE — Leather Case, Ansco Color Film, 20 exp. (incl. proc.)..... \$2.00
- B. & W. Film, 30 exp..... \$1.00

ORDER rubix-RUBINA NOW by MAIL

10-DAY MONEY-BACK GUARANTEE! Money Order or Check, Please.

You Take No Risk! **MYCRO CAMERA CO., INC. Dept. R-1**
527 FIFTH AVENUE, NEW YORK CITY

TELEVISION SCREEN VIEWING FILTERS

Make television far more enjoyable. Make your own filters at very low cost. Different colors, all very easy and inexpensive to make. Send 35 cents for complete instructions. Instructions do not include material.

Electronic Devices Co., Dept. P5, P.O. Box 1016, Morgantown, W. Va.

ELECTRICIANS' SCHOOL

HOUSE AND COMMERCIAL WIRING • MOTOR REPAIR AND REWINDING • ELECTRIC REFRIGERATION

Approved for Veterans Training

PENNSYLVANIA INSTITUTE SCHOOL OF ELECTRICITY

42nd and SPRUCE STS.

PHILADELPHIA 4, PENNA.

LEARN WATCHMAKING JEWELRY REPAIRING

Start your training now for a better paying job or your own profitable business. Intensive practical training by experienced craftsman. Write for free catalog. APPROVED FOR VETERANS.

SCIENTIFIC SCHOOL OF WATCHMAKING, DEPT. PM-5
3923 SAN FERNANDO ROAD GLENDALE 4, CALIFORNIA



SPORTSMEN! GIANT SPOOL Now Yours On SPECIAL INTRODUCTORY OFFER

DIRECT-TO-YOU FROM MILL Only

MEN! Here's your chance to get this amazing strong, almost unbreakable \$1.69 ~~2.00~~ DuPont NYLON thread for sewing leather and canvas, salt water fishing, net mending, bamboo rod wrapping. Used by Air Force on parachutes. **SEND NO MONEY.** Just name and address. Specify black or white thread. On arrival pay postman \$1.69 plus

C.O.D. postage. Test for 10 days. If not delighted, return for money back. Limited offer. Order TODAY. 2 Spools . . . \$3.29. LEEWARD PRODUCTS, Dept. F-49E, 189 W. Madison, Chicago 2, Ill.



HARD-TO-BREAK

Plastic FLEX-IT 6 Ft. Rule

7—Reasons why it is UNEQUALLED—7

1. Withstands abusive treatment; no cross grain
2. Graduations & numerals are burnt in plastic
3. Will not absorb moisture
4. Withstand all normal temperatures
5. Will not stretch or shrink
6. Accuracy maintained at all times
7. Excellent insulator

Mfg. in white & yellow with black figures

FLEX-IT RULE CO.
Box 121 Elyria, Ohio

\$1.00
Postpaid

SAY YOU SAW IT IN POPULAR MECHANICS

MOTOR TUNE-UP GAUGE

new — Simple to Use

• Aluminum case cast bronze movement — Guaranteed. Checks entire motor—Plugs, Points, Rings—Valves—Muffler—Fuel Pump—Carburetor, etc.

Dial in 4 colors—Instruct. chart included—4" — \$6.50; 8" — \$11.75; 12" — \$18.75 Postpaid. Works on vacuum. Attach to windshield wiper over 1,000,000 in use. Tune your own motor.

GALE HALL ENGINEERING CO.
DEPT. PM, BOSTON 18, MASS.

WORLD'S LARGEST MFG. OF AUTO GAUGES
POPULAR MECHANICS

PAINT YOUR CAR

2 FULL COATS for ONLY **\$2.95**
ONE QUART DOES ENTIRE JOB

or any other Metal or Wood Surface

WITH **WYPE** TRADE MARK REG.

NO SPRAYING · NO MASKING · NO BRUSHING

AMAZING NEW BRUSHLESS AUTO ENAMEL
You JUST WIPE ON
with a **POWDER PUFF**
instead of Brushing or Spraying



ANYONE CAN DO BEAUTIFUL JOB

Get Beautiful Mirror-Like Finish That Looks Like Spray Job!

Dries Dust Free One Hour · No Streaks or Lapmarks

No previous car-painting experience necessary. You get a beautiful high-gloss job that gives you an expensive finish such as is sprayed on by Professional Auto Painters. With WYPE you need **NO BRUSH, NO SPRAY, NO MASKING!** Just **WIPE ON** with Powder Puff — which we furnish at no extra charge. You get a brilliant, glossy finish that is truly "factory-like." No streaks. No lap-marks. Guaranteed for **TWO** years not to crack, peel, chip or fade, if simple directions are followed. Takes about an hour to apply. Dries dust-free in an hour. WYPE comes in most popular shades. Goes over any other color, lacquer or enamel.

NO OTHER PRODUCT Gives You This Protection

2-YEAR GUARANTEE
We Guarantee WYPE against cracking, peeling, fading or chipping for two years after application, if applied according to directions furnished. Your money cheerfully refunded if WYPE does not live up to this Guarantee.

Hundreds of other uses for WYPE!

COPYRIGHT, WYPE CORP.

The ONLY Brushless Enamel CERTIFIED



by U.S. Testing Co., Inc. **WORLD-FAMOUS**

APPLY in ONE HOUR — DRIES to GLISTENING PROFESSIONAL FINISH

- Paint Anything At Home**
Repaint outdoor & indoor furniture, bicycles, hardware, damaged white enamel stoves, refrigerators, etc., and any other article of steel or wood.
- -
 -

MOST POPULAR COLORS
Black Brewster (dark) Green
Maroon Jewel (light) Green
Red Washington (dark) Blue
Gray Monticello (light) Blue
White Sun Beige (light) Tan

\$2.95 PER QUART

Testing Laboratory and found to conform to the claims and guarantee of the Wype Corporation. U. S. Testing Co. is the largest impartial testing laboratory of its kind, and conducts scientific tests for the world's foremost companies. Before you buy any automobile paint, ask for proof that it has passed tests by a nationally-known testing laboratory whose name is given in the advertising. You're **SURE** you are **SAFE** when you paint with WYPE.

WYPE is a new Miracle Enamel for Autos. It is **NOT** a wax or polish but a hard high lustre ENAMEL finish! With WYPE, **ANYONE** can do a beautiful job! Order a quart to paint your car or to get started in this **BIG-MONEY** Business!

NO STREAKS OR LAPMARKS LOOKS LIKE SPRAY JOB

DEALERS & JOBBERS WANTED Write Today

\$1.75 a Pint—2 pints Do a 2-Tone Job

SEE YOUR DEALER or ORDER DIRECT SEND NO MONEY · Get WYPE Today!

If your dealer can't supply you, just send us a postcard. We'll ship C.O.D. Just pay mailman for Wype, plus postal charges. Or send remittance with order and WE pay postage.

Some of the FAMOUS DEPARTMENT STORES that Sell WYPE

VISIT or PHONE THE STORE IN YOUR CITY . . .
If you live in one of the cities shown here, it will be more convenient to buy from your favorite department store. Ask your dealer! Leading merchants and gas stations everywhere sell WYPE.

- Akron: M. O'Neil Co.; Baltimore: May Co.; Boston: Jordan Marsh Co.; Buffalo, N. Y.: J. N. Adam & Co.; Chicago: Goldblatt's 15 Dept. Stores (Goldblatt's, also, at Joliet, Ill.; Hammond, Gary & South Bend, Ind.); Cincinnati: Fair Store Co.; Cleveland: May Co.; Columbus, O.: F. & R. Lazarus Co.; Dallas: Sanger Bros., Inc.; Denver: May Co.; Detroit: People's Outfitting Co.; Ft. Worth: W. C. Stripling Co.; Grand Rapids, Mich.: Hernolsheimer Co.; Hackensack, N. J.: Paekard-Bamberger Co.; Houston: Foley's; Indianapolis: Wm. H. Block Co.; Kansas City, Mo.: Jones Store Co.; Los Angeles: May Co.; Louisville: Kaufman-Straus Co.; Memphis: B. Lowenstein & Bros.; Milwaukee: Ed. Schuster & Co., Inc.; Minneapolis: Donaldson's; New Orleans: Maison Blanche Co.; Newark, N. J.: Bamberger's; New York: Gimbel's; Omaha: J. L. Brandeis & Sons.; Philadelphia: Lit Brothers; Pittsburgh: Kaufmann's; Portland, Ore.: Meier & Frank; Providence, R. I.: The Shepard Co.; Richmond, Va.: Miller & Rhoads, Inc.; Rochester, N. Y.: Sibley; Lindsay & Curr; St. Louis: Famous-Barr Co.; St. Paul, Minn.: The Golden Rule; San Antonio: Joske's of Texas; San Diego: Whitney's; San Francisco: Hale Bros. (Also Hale Bros., Oakland and San Jose); Seattle: The Bon Marche; Spokane: Spokane Dry Goods Co.; Syracuse, N. Y.: Dey Bros. & Co.; Toledo: Lion Dry Goods Co.; Warren, O.: Griswold's; Washington, D. C.: Lansburgh & Bro.; Youngstown, O.: Strouss-Hirschberg Co. Also—Chicago: Wieboldt Stores, Inc.; Little Rock, Ark.: The Gus Blass Co.

WYPE CORP. Dept. 16-E 2214 DOLMAN ST. ST. LOUIS 4, MO.

Everything in Radio at Lowest Prices!

FREE

Send for ALLIED'S 180 Page Catalog



**BUILDER'S KITS
TELEVISION SETS
HI-FIDELITY SOUND
AMATEUR GEAR
THOUSANDS OF PARTS
TUBES, TOOLS, TESTERS
BOOKS & DIAGRAMS**

Everything for Servicemen, Engineers, Experimenters, Builders, Soundmen, Amateurs



Radio's Leading Buying Guide

Get ALLIED'S 1949 Catalog—biggest and most complete in Radio. Get *everything* you need from the world's largest stocks of top-quality equipment—at down-to-earth money-saving prices. Have the advantages of speedy reliable shipment, expert personal help, and complete satisfaction on every purchase. Get more for your money at ALLIED—Radio's Largest Supply House. Send today for your FREE ALLIED Catalog—the preferred Buying Guide to *everything* in radio and electronic equipment.

ALLIED RADIO

ALLIED RADIO CORP.,
833 W. Jackson Blvd., Dept. 5-E-9
Chicago 7, Illinois

FREE

Send FREE 1949 ALLIED Catalog.

Name.....

Address.....

City.....Zone.....State.....

SAY YOU SAW IT IN POPULAR MECHANICS

THOUSANDS BUILD



START NOW!

EASY TO ASSEMBLE KITS

NO EXPERIENCE NECESSARY
Everything Complete in Kit.
Quality Material. Simple as ABC instructions. Immediate Delivery. Save Money, Big Value, Sturdy

ROWBOATS, KAYAKS, DINGHIES, INBOARDS, OUTBOARDS, RUNABOUTS, CABIN CRUISERS



SEND 25¢ (COIN) FOR CATALOGS
Colorful Illustrations show all '49 Models, 8 to 23 Ft., and Construction Details.

U-MAK-IT PRODUCTS

MARINE DIVISION
Formerly Kayak Boat Co.
703P- WHITTIER ST., N. Y. 59, N. Y.

3 NEW ATOMIC RACERS NOW READY



TENTS

WAR SURPLUS ALL TYPES AND SIZES

Also camping equipment, sporting and fishing supplies and rope. LOW PRICES! FREE: 24 page catalog

MOR-SAN SALES 10-17 E. 50th AVE. LONG ISLAND CITY 1, N. Y.

URANIUM ORE DETECTOR — \$2.00

Simplified compact detector—easily carried in pocket. U. S. offers pot of gold for Uranium. Vacationers, hikers, miners in fact every person should carry these detectors. Even children can operate this detector. \$10,000.00 government offer plus value of ore can make you wealthy. Uranium is where you find it.

Complete with instructions — only \$2.00

LIBBEY RESEARCH DIVISION

66 PHOENIX ROW HAVERHILL, MASSACHUSETTS

You have seen our reliable Adv. month after month SO BEFORE BUYING ANY TIRE — CONSIDER YOUR FAMILY'S SAFETY — NOT JUST PRICE • BEST BRANDS, INCLUDING

GOOD YEAR Firestone
Goodrich U. S. ROYAL

SLIGHTLY WORN HIGH TREAD TIRES. NO RECAPS OR REBUILTS
→ VETS TAKE 10% DISCOUNT. YOU CERTAINLY DESERVE IT ←
FREE BUTYL TUBE 14 MONTH GUAR. BOND

| | | | |
|---------------|---------------|------------------|-----------------|
| 600-16 \$3.54 | 550-17 \$5.95 | 600-20 \$7.20 | 34x7 \$9.65 |
| 650-16 \$3.54 | 550-16 \$4.65 | 700-20 \$8.75 | 825-20 \$11.50 |
| 650-15 \$3.54 | 700-16 \$5.50 | 32x6 (8) \$8.75 | 900-20 \$11.65 |
| 700-15 \$3.74 | 750-16 \$6.75 | 32x6 (10) \$9.50 | 1000-20 \$11.65 |

You've Never Seen Tires Like These Factory Adjusted "ALL-PURPOSE" CAR & TRUCK TIRES "TRIPLE-A" "TOP GRADE"

| | | | |
|---|----------------|----------------|-------------------|
| GOLDEN-RULE GUAR. 24 MOS. AGAINST ANYTHING! | | | |
| 600-16 \$5.50 | 525-18 \$6.75 | 600-20 \$10.95 | 32x6 (10) \$12.50 |
| 650-16 5.50 | 550-17 8.00 | 650-20 11.50 | 825-20 15.45 |
| 650-15 5.50 | 700-16 7.50 | 700-20 11.95 | 900-20 15.45 |
| 700-15 6.50 | 750-16 8.50 | 32x6 (8) 11.95 | 1000-20 16.45 |
| 600-16(6) 7.00 | 650-16(6) 7.00 | 750-20 11.00 | 34-7 13.00 |



We've Shipped Tires to Canada, Italy, Puerto Rico, Alaska
Our Tires Used on School Buses and Ambulances
750-20 MILITARY Fits 32 x 6 700-20
8-ply Top Grade (Were \$9.75) \$9 Guar. 12 Mos.
Premium Grade (Were \$18) \$13 Guar. 26 Mos.
900-16 'A' \$7.75 900-16 'AA' \$10.75

Send check or money order & this ad for rush shipment. We won't ship a tire that WE wouldn't use. 31 years "know-how" in our pinpoint triple inspection. Please depend on us.

BLATT GIRARD AVE. TO LANCASTER AVE., DEPT. P.M. BLATT BLDG., PHILADELPHIA 31, PA.

EVERSPRAY UNDERGROUND Sprinkler System

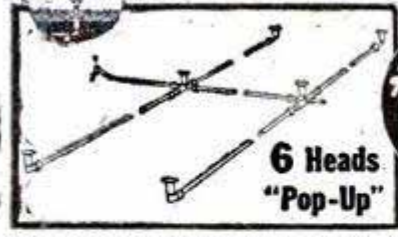

ONLY \$49.50
COMPLETE NO EXTRAS TO BUY!
WATERS 1000 SQ. FEET

INSTALL IT YOURSELF IN ONE EVENING
without Damage to Lawn!

All EVERSPRAY tubing is solid Copper—all fittings solid Brass, machined for perfect fit. Fingertip adjustment of spray from mist to heavy rain. No special tools needed. No pipe, pipe cutting or threading. No plumbers to pay. Simple Diagram makes connecting easy with small wrench. No upkeep. No repairs. No fear of freezing as entire system drains itself AFTER EVERY USE. Can't rust or rot—it's in for life. Yet a "renter" can take EVERSPRAY anywhere with him if he moves.

USER-AGENTS Get Money Back
 Everybody wants the EVERSPRAY when they see yours. Just send us their orders on our USER-AGENT Plan and quickly get back the cost of your own EVERSPRAY.

SALESMEN
 Make tremendous profits between now and August. Write or Telegraph for complete facts, Jack-Pot Pyramid Sales Plan, Demonstrator offer—all FREE. Hurry!

ORDER DIRECT FROM FACTORY
under money-back guarantee. (References Dun & Bradstreet or Your Bank.) Send name and remittance of \$49.50 for complete EVERSPRAY System... No extras to buy. Or send name on penny postcard for a beautiful folder that shows pictures and description of EVERSPRAY. It's FREE. RUSH name today.

EVERHOT PRODUCTS CO., Everspray Division
 2001 Carroll Ave., Dept. 25, Chicago 12, Illinois

SURPLUS BARGAINS ASSEMBLE YOUR OWN BINOCULARS!

Complete Optics! Complete Metal Parts!
 Save More Than 1/2 Regular Cost



GOVERNMENT'S 7X 50 BINOCULARS

We supply full instructions
METAL PARTS—Set includes all Metal Parts—completely finished—for assembly of 7 X 50 Binoculars. No machining required. A sturdy Binocular carrying Case is optional with each set of Metal Parts.

Stock # 842-H \$39.40
 Postpaid, plus \$4.80 for Case—Total \$44.20

OPTICS—Set includes all Lenses and Prisms you need for assembling in excellent condition—perfect or near-perfect—and have new low reflection coating.

7 X 50 Binoculars. These are in excellent condition—perfect or near-perfect—and have new low reflection coating.
 Stock # 5102-H \$25.00 Postpaid
 (These are standard American made parts . not Jap, French or German.)

NOTICE! If you buy both Binocular Optics and Binocular Metal Parts, add 20% Federal Excise Tax to above prices.

ARMY'S 6 X 30 BINOCULARS—We have complete Optics and Metal Parts. Write for Catalog H.

SLIDE PROJECTOR SETS—Consist of all unmounted lenses you need to make the following size projectors:
 Stock # 4038-H—2 1/4"x2 1/4" \$3.35 Postpaid
 Stock # 4039-H—2 1/2"x3 1/2" \$3.35 Postpaid
 Stock # 4029-H—35 mm. \$2.85 Postpaid

MOUNTED ANASTIGMAT LENSES—Use for Projectors, Enlargers, Copying Cameras. Complete with Shutter and Diaphragm. Value about \$20. An excellent buy. WE WILL INCLUDE FREE ILLUSTRATED BOOKLET on HOW TO MAKE YOUR OWN ENLARGER.
 Stock # 8004-H Speed f/7.7, focal length approx. 127 mms. Suitable for pictures, negatives, positives up to 3 1/2"x4 1/4". \$7.50 Postpaid
 Stock # 8006-H Speed of f/7.7, focal length approx. 100 mms. Suitable for pictures, etc. up to 2 1/4"x3 1/4". \$8.50 Postpaid
 Stock # 8007-H—Speed of f/6.3, focal length approx. 100 mms. \$9.50 Postpaid

We have literally millions of war surplus lenses and prisms for sale at 10c and up. Write for Catalog "H"—Sent Free!

Satisfaction Guaranteed **Order by Stock No.**
EDMUND SALVAGE COMPANY
 P. O. AUDUBON, NEW JERSEY



Let JOHN KIKTAVI give you the benefit of his years of experience in this fine field.

LET ME PUT YOU IN A BIG PAY BUSINESS OF YOUR OWN!

AT HOME—FULL OR SPARE TIME



METALLIZED BABY SHOES IN REAL METAL • BRONZE • GOLD • SILVER • PEARL AND GLASS

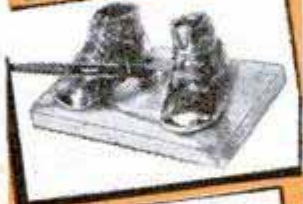

NO ADDITIONAL INVESTMENT REQUIRED

Yes! Profits can start without additional investment. NO OTHER COMPANY has a plan like this—mine is the original "go in business on a shoe string" success plan. READ THE FACTS—it doesn't cost you a cent to investigate my wonderful plan—IT'S ABSOLUTELY FREE—it doesn't cost you anything NOW or EVER!

We Supply Everything

Largest variety of mountings & supplies.
 Lowest Prices
 Big Savings
INVESTIGATE

Look into this year round lifetime business NOW. Complete details sent FREE. No obligation NOW or EVER.

Go in Business on a Shoe-String

DON'T WAIT - SEND TODAY

KIKTAVI COMPANY
 DEPT. PM-5, 2111 W. Manchester
 Los Angeles 44, Calif.

As long as it's Free—tell me about it!

NAME _____
 ADDRESS _____
 CITY _____ STATE _____

KIKTAVI CO. Dept. PM-5 2111 W. Manchester Ave
 Los Angeles 44, Calif.

LEARN AVIATION

AN ESSENTIAL INDUSTRY IN PEACE OR WAR
MAXIMUM TRAINING IN MINIMUM TIME

for 19 years Cal-Aero Technical Institute has specialized in....

✓ AERONAUTICAL ENGINEERING

2 year course - kept abreast of new research and scientific development.

✓ MASTER AVIATION MECHANICS

1 year course - C. A. A. approved for Airplane and Engine License.

Modern "live" training equipment, including helicopters, jets, rockets, wind tunnel... Classes start monthly - Room and board available on our airport... Cal-Aero Tech Training is carefully designed for just one thing - **TO MAKE MORE MONEY FOR YOU.** More than 7000 successful graduates in addition to 26,000 pilots and 7500 mechanics trained for Army & Navy Air Forces, prove that our career training is unsurpassed. **APPROVED FOR VETERANS**



CAL-AERO TECHNICAL INSTITUTE

GRAND CENTRAL AIR TERMINAL
 GLENDALE 1, CALIFORNIA
 LOS ANGELES COUNTY

MAIL THIS COUPON TODAY!

Please send full information on Aviation Training FREE - without obligation.

Name _____ Birth Date _____
 Street _____ Zone _____
 City _____ State _____

CHECK ONE VETERAN NON-VETERAN PM-5

ELECTRICAL CONTACTS

TUNGSTEN-SILVER Assorted sizes for standard repair jobs on motors, switches, appliances, controls, etc. With this assortment of points on hand you save time; give quick service, prevent costly tie-ups of important equipment. 15 varieties, 20 of each. All in transparent plastic "See-Thru" boxes. Each box nests securely in a sturdy metal hinged cover dust-proof KIT only 7"x7"x8 1/4". Highest quality contacts backed by 20 years of specialized manufacturing experience. Let us tell you how KIT users are cutting most repair bills in half and making more money. Write at once for full details.

In Handy KIT

RICH ENGINEERING CO., 1729 N. Cicero Ave., Dept. 15, Chicago 39, Ill.

INVENTORS



NO PATENT PROTECTION... NO PROFITS. Authoritative book on patent law, already bought by thousands of **INVENTORS, ENGINEERS & EXECUTIVES** will pay for itself... **YOU CAN'T AFFORD TO BE WITHOUT IT.** Learn simply and easily how protected inventions can make money for you; how to deal with your attorney... **A MUST FOR INVENTORS, MECHANICS, ENGINEERS,** who have money making patentable ideas... Easy to read and understand, only \$2.95. **FREE:** for cash or money order with your order, we will send a set of 8 1/2"x11" invention records. Check or money order only.

RESEARCH PRESS, 137 N. Perry St., Dept. B, Dayton 2, Ohio

Send me "Patent Law for the Executive and Engineer."
 Check or Money Order enclosed (You pay postage and send FREE complete set of Invention Records).
 Five days approval. I'll remit \$2.95 plus postage or return the book in five days.

Name _____ Title _____
 Address _____
 City _____ Zone _____ State _____ PM10

ELECTRIFY your SEWING MACHINE



NEW REDUCED PRICE

\$12.95

1 YEAR GUARANTEE

Now, make mother's or wife's sewing a pleasure. Easy to install. Fits ALL machines.

- Motor & Bracket
- AC-DC 60c. 115v.
- PULLEY & BELT
- 7 Speed Foot Control
- Cord Set
- Complete Instructions

SEND NO MONEY, pay postman plus C.O.D. or enclose money order and we will pay postage. **MONEY BACK** after five days if not completely satisfied. Shipping Wt. 6 lbs. State whether wheel on your machine turns towards or away from you.

LUGGAGE CARRYING CASE \$9.95
 Specify base width, length and make of your machine. Wt. 11 lbs.



FREE CHROME plated SEW-LITE (as illustrated) completely eliminates eyestrain.

CONTINENTAL SALES CO.

Dept. PM-2, 235 E. 59th St., New York 22, N. Y.

\$10,000 REWARD

Earn the government bonus by locating Radio-Active Ores with the

P.R.I. GEIGER COUNTER

Weight about 2 lbs. Price only \$75.00 complete. Enclose check to save C.O.D. charges.

PRECISION RADIATION INSTRUMENTS, INC.
 1101-P N. Paulina St. Chicago 22, Ill.

LOCKSMITHING & Key Making

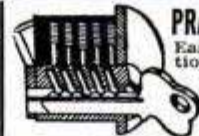

PRACTICAL UP-TO-DATE COURSE—ONLY \$3.95

Easy-to-learn modern information for self-instruction. How to work on locks, de-code, make master-keys, repair, install, service, etc. For every handyman, home owner, carpenter, mechanic, service station operator, fix-it shop, hardware dealer, runsmith, 53 plain illustrated lessons.

FULL PRICE ONLY \$3.95. SEND NO MONEY.

Just pay postman plus C.O.D. postage. Or send \$3.95 with order, we'll ship postpaid. Satisfaction guaranteed or refund.
NELSON-HALL CO., 1139 S. Wabash Ave., Dept. E-2, Chicago 5, Ill.



PENNANT BALL-POINT PEN YOUR NAME IN 24K GOLD **50¢**
 Fine-writing; even flow - same as expensive pen. Streamlined beauty. Money-Back Guarantee. Postpaid. (No stamps).
NATION-WIDE, 442 N. Wells St., Dept. 35, Chicago 10, Illinois

FREE FOR YOU TECHNICAL DATA CARD
 RADIO ELECTRICAL COLOR CODES, FORMULAS, HELPFUL HINTS. SEND FOR YOURS TODAY.

| | |
|--|---|
| PHONO AMPLIFIER | PHONO OSC. |
| 2 Tube AC-DC...\$1.39 | 2 Tube AC-DC...\$2.75 |
| 50L6-35Z5...\$1.00 | 125A7-35Z5...\$1.20 |
| 3 Tube AC-DC...\$1.69 | All Wired & Tested |
| Volume & Tone 125Q7 | Output trans...35c |
| 35Z5 50L6...\$1.45 | 5" PM Speaker...\$1.19 |
| Velvet Mixer Record Changer, Plays 10" & 12" | Records at the same time, 14"x14" \$15.50, 2 for \$28.00. |

Order from this ad today. Free 1949 Catalog—25% on COD orders. Radio Mail Orders, 2 W. Broadway, Dept. P.M., New York 7, N. Y.

EXPORT PAYS BIG

Large World Trade firm offers men and women quick preparation for big pay positions or unlimited-profit businesses of their own. Mail order World-wide without capital, from home; or travel abroad. Represent manufacturers. Past experience not needed. Write today for **FREE BOOK.** State if veteran. Airmail reaches us over night.
Mellinger Co., 1422-FN Westwood Blvd., Los Angeles 24, California

CLOSE-OUT SURPLUS BARGAINS!

SAVE UP TO **90%**

Lenox Deluxe or Supreme Pure Brier. All styles. Given with order a \$1 Seal Tite Leather Pouch. Originally sold for \$3.50 ea. Close out

PIPES 2 for \$1.00

TOWN & COUNTRY



Spark Plugs
Unconditional Guarantee

Outstanding performance and durability. Engineered for quick starting, less gas consumption, smooth idling. Prevents excessive missing. Added power zip. Always dependable. Send make and model car. Finest plug at any price. **ONLY 29¢ each**

MARCO LIGHTER

Attractive case. Windproof. Mfg. Lifetime Guarantee. Order now.

(Reg. \$3.50) **ONLY 69¢**



it's unbelievable, but it's

TRUE!

NAVY FLASHLIGHT

Utility light for car, fishing, hunting, etc. Waterproof. Shockproof. Non-breakable plastic lens. Belt clip attachment. Compact. Strong beam. Uses standard battery. **ONLY 39¢**

ARMY P.X. PRICE SLASHING SPECIALS

- | WAS | NOW SPECIAL |
|---|-------------|
| \$1.00 Canvas Water Buckets | .45 |
| 1.00 Everready Shave Brush | .35 |
| 1.00 Gillette Razor & Blue Blades | .45 |
| .50 Shave Cream-any brand | .20 |
| .60 Foot Powder-giant size | .29 |
| 2.00 Sewing Kit & Scissors [Deluxe-includes everything] | .65 |
| 1.00 Stationery-Regal pack | .39 |
| 1.00 Style King Craftsman Apron | .39 |
| .60 Faber Pencils (5c) Doz. Box | .29 |
| .45 McKesson Toothpaste-Lg. | .20 |
| 1.50 Sun Glasses | .45 |

FAMOUS BLUE DEVIL

HOBBY-VISE

3 1/2" vise. Perfect for home or shop work bench. Sturdy. Dependable grip. Designed to perfection. Every man should have one. You can't afford to be without it at this value. **ONLY 1.95**



Plastic TABLE COVER

Speaks for itself. 54"x54". Hemmed. Laboratory tested and approved. Economical. Waterproof. Stainproof. Time Saving. Appealing. Durable. Sanitary. Modern. Damp cloth cleans it. **ONLY 45¢**

ATTENTION STAMP COLLECTORS

Close-out Bargains. Over 1 million stamps. Commemoratives, Pictorials, Airs, High Values. Over 500 types, \$15 or more catalog value. U. S. & Foreign Mint & Used. Best buy on the market. Limit One Lot. **ONLY per lot 1. FREE BARGAIN LIST**

STOCK UP ON ALL YOUR NEEDS SUPER-THRIFT VALUES

BILLFOLDS!



While they last! Values to \$10. Finest Morocco, Goat or Calf Skin. Zipper leaves. Transparent compartments. It's wonderful for only **1.95**

GUARANTEED ONE YEAR BY MFG.

LIMIT ONE

SWISS WATCH (ARMY TYPE)



Unbreakable crystal. Sweep second hand. Radium dial. Chrome or Stainless steel case. Leather or metal stretch band. Tremendous value. Originally sold to \$19.95. Buy now — only **6.95**

Outstanding Value!

DE LUXE SHEFFIELD CHRONOGRAPH WRIST WATCH



Has everything—plus new low price. It's a timekeeper, stop watch, measures distance, speed of planes, cars, horses, etc. Sweep second hand, chrome case, unbreakable crystal, precision Swiss movement. Sold to \$29.95. **9.75** Plus 97c TAX

WORK SOX

Get them while they last. Durable cotton. All sizes. Good lengths. Many colors. \$2.50 Value. Look! **6 pr. ONLY 1.15**

RAZOR BLADES

Year's supply. 100 blades. Over 25 pts. Extra thin. Values to 25c pk. Given with order 50c Sharpener. Only **1.00**

Royal Chef

COFFEE-MAKER



4 or 6 cups. Drip-a-matic. Heavy gauge solid aluminum. Attractive, combination server for perfect coffee. Ideal for the ideal hostess. Guaranteed by mfg. Sensational value. **ONLY 1.65**

AMERICA'S GREATEST VALUES!

HONE STONE SET

Terrific! Reg. \$1.65 set. Includes Big Ben Stone (75c), Razor Stone (50c), Knife Stone (15c) & Oil (25c). Complete set only **35¢**

TOBACCO POUCH

Genuine Leather. Zipper and Pipe holder compartment. Reg. \$2. Only **29¢**

RIFLE

Your kid will love it. Rifle type pop-gun with string tied cork. HARMLESS. He'll be the leader of his gang. Regular \$2.00. Only **65¢**

GUARANTEED PENS

Onyx type finish. Heavy base. Home or office use. Regular \$3.00. **98¢** Desk Pen Sets. Lifetime guarantee.

Penman Fountain Pens. Write right! Price right! Factory guarantee. Regular \$1.35. Imaginel Only **35¢**

LADIES RAINCOATS

Sensational value. Reg. \$10. Plastic with belt and hood. Styled in all colors. Small, Med.-Lg. **1.98!**

JUNIOR GENIUS ELECTRIC MOTOR KIT



Educational. Entertaining. Anyone can make an electric motor—guaranteed to work. Complete directions. Assemble in 2 hours. Unique. One of the best on the market. **1.00**

LAMP WIRE (ROYAL ELECTRIC)

Nylon Covered. For any electrical use. Buy of a lifetime! Any length. Only **3¢ PER FOOT**

ORDER BY MAIL AND SAVE
Send Cash, Check, M.O. (Postage Prepaid) or C.O.D.
All merchandise is brand new.
Money-Back Guarantee.
Write for free catalog.

WAYNE SALES CO.
423 AMERICAN AVE.
LONG BEACH 12, CALIF.

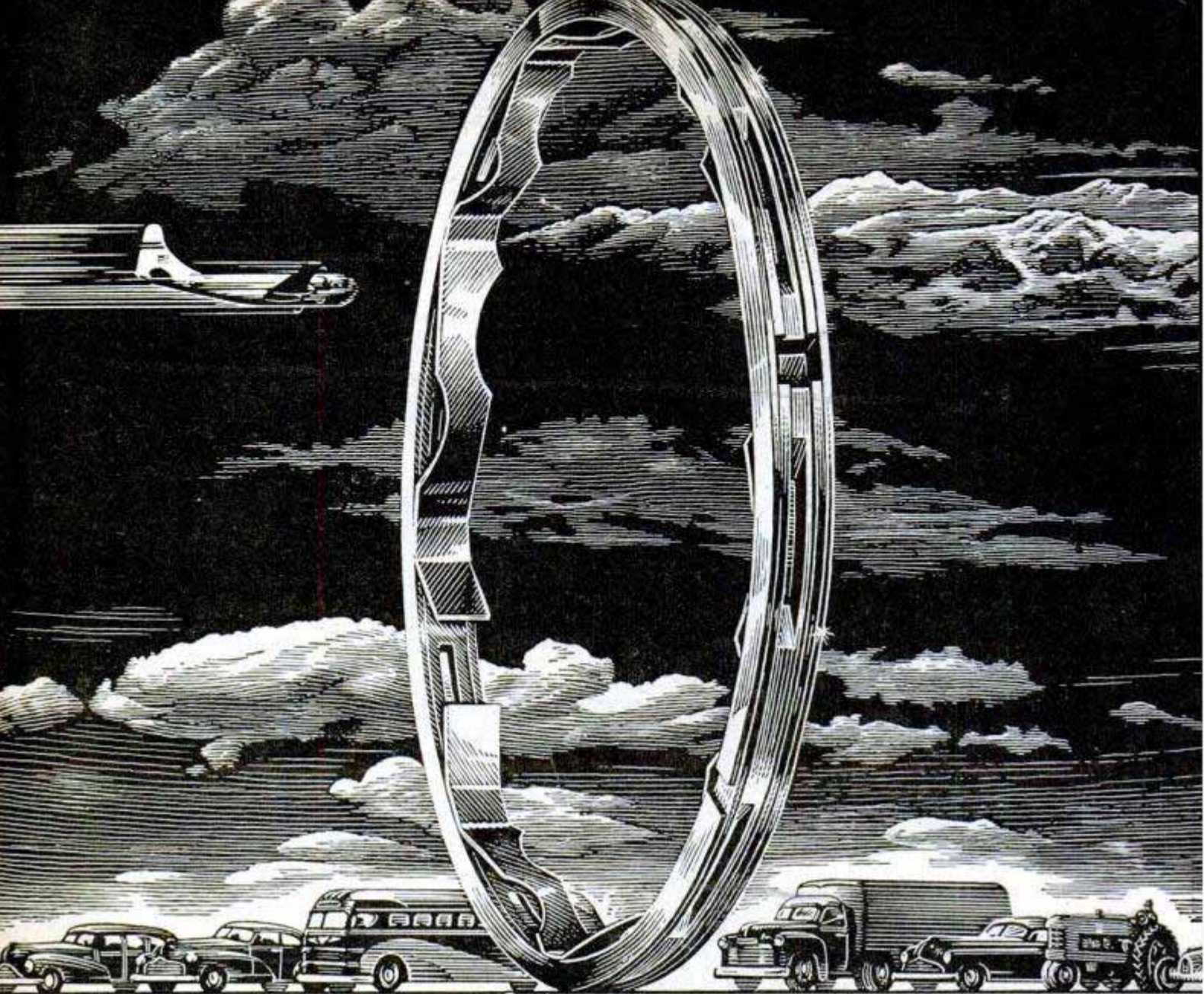

Perfect Circle

The Most Honored Name in Piston Rings

Honored by America's foremost automotive engineers, who recently acclaimed Perfect Circle Piston Rings as best engineered—4 to 1.*

Honored by Doctors of Motors, America's expert mechanics, who actively express their piston ring preference by installing millions of Perfect Circles every year.

Honored by motor-wise car owners all over America, who in survey after survey have invariably named Perfect Circle their first choice by a wide margin.

Honored by Racing Drivers. Long the favorite of drivers in the Indianapolis 500-Mile Classic, Perfect Circle is the leading choice with men who race and win on speedways and waterways throughout America.

* *In a recent independent survey among automotive engineers—maintenance men, fleet operators and designers of new equipment—Perfect Circle was first choice as the best engineered piston ring—first by more than 4 to 1—and received more votes than ALL other brands combined!*

Perfect Circle Corp., Offices: Hagerstown, Ind., and Toronto, Can. Plants: Hagerstown, Richmond, New Castle and Tipton, Ind., and Toronto, Can.

(Illustrated—Sectional Steel Oil Ring—one of 61 types of Perfect Circle Piston Rings.)

LISTEN TO
THE
INDIANAPOLIS
500-MILE RACE!

MONDAY, MAY 30th

over the entire Mutual
Broadcasting System

See your local newspaper
for time and station

STEAM LINE TO CONDENSER

STEAM-SEPARATION CHAMBER

CONDENSER COOLS STEAM AND CONVERTS IT INTO WATER

WATER AT 212 F. FROM ENGINE COOLING SYSTEM

ENGINE

WATER IS PUMPED BACK TO ENGINE

VAPOR PHASE COOLING CYCLE

POPULAR MECHANICS

MAY 1949

WRITTEN SO YOU CAN UNDERSTAND IT
VOL. 91 NO. 5

In "vapor phase" cooling system, water follows clockwise route. After engine heats it to the boiling point, steam is converted back to water

BY COOLING your automobile engine with boiling water you can drive it for a quarter of a million miles or more without need of a major overhaul. At the same time you'll get more power and better fuel mileage and will use much less oil.

Other advantages include faster warm-ups on cold mornings and better cooling of the engine on hot days.

This sounds absurd, of course. Common sense tells you that a good way to ruin your motor is to allow the radiator water to remain at a boil. Many engineers have preached that water temperature should never be allowed to rise above 180 degrees, if that high.

Yet a Chevrolet with an experimental high-temperature cooling system is still going strong after 165,000 miles. Mechanically the engine is as sound as if it had run no more than 30,000 miles. Valves, rings and cylinders are in excellent condition. The motor uses virtually no oil and delivers up to 19 miles per gallon of fuel in traffic.

High-temperature

In automobile experiments, the radiator was strengthened and made to function as condenser to change steam back to water

LET THE ENGINE BOIL

By Thomas E. Stimson, Jr.

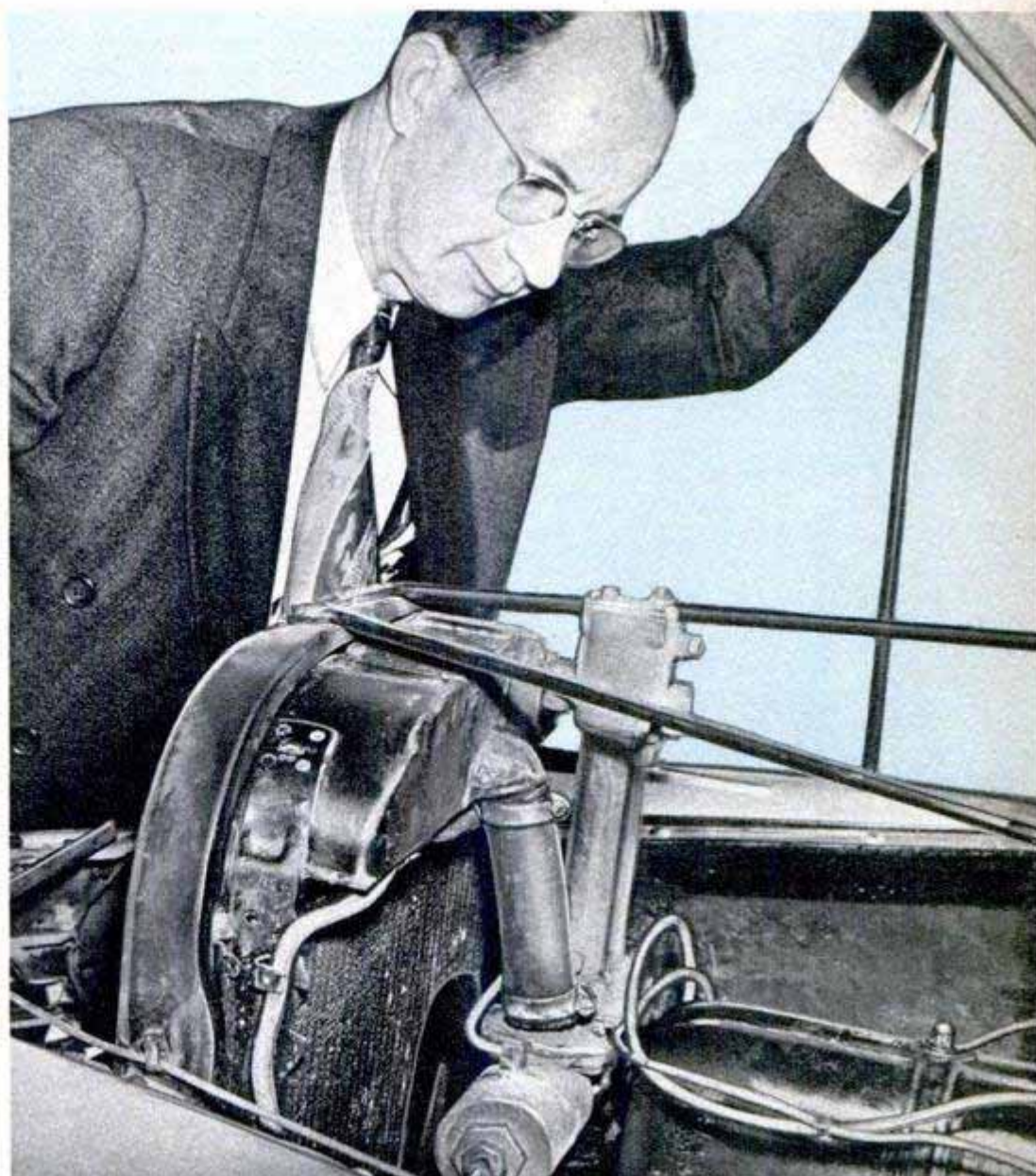

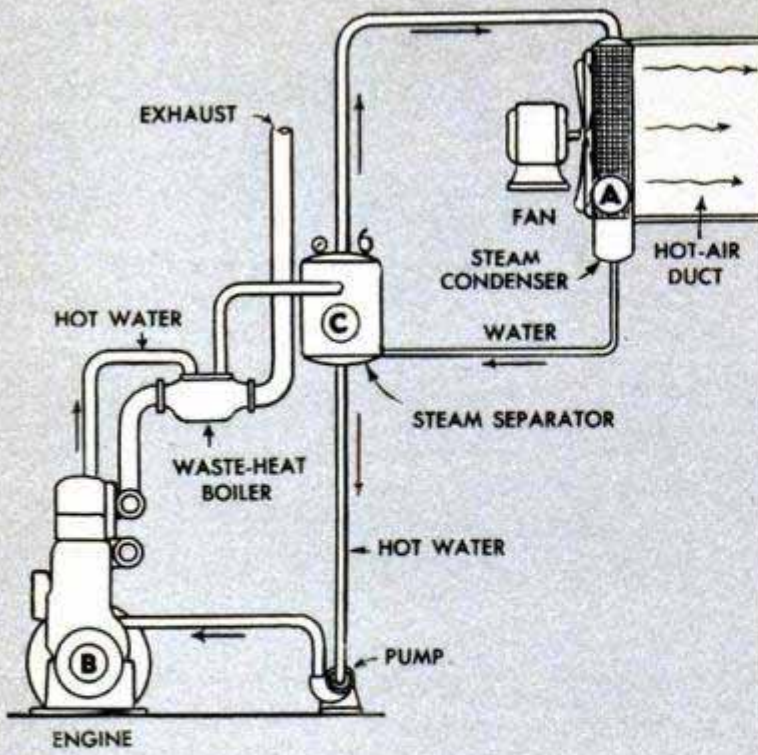

VAPOR PHASE WASTE HEAT RECOVERY SYSTEM

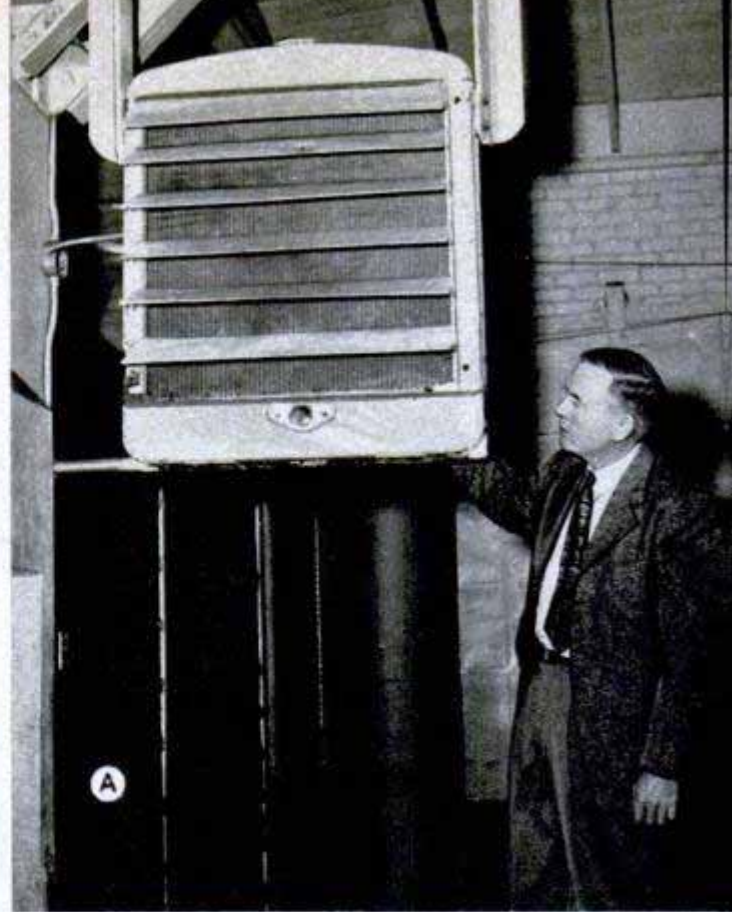

Instead of being wasted, engine heat not converted to mechanical energy can be used to warm building

Overhead radiator, with fan invisible behind it, acts as the condenser for system shown at bottom of page

Diesel-electric power plant employs vapor cooling, plus exhaust boilers, to capture B.T.U.s formerly wasted for space heating. Radiators cool lubricating oil and water lines are insulated to prevent heat losses

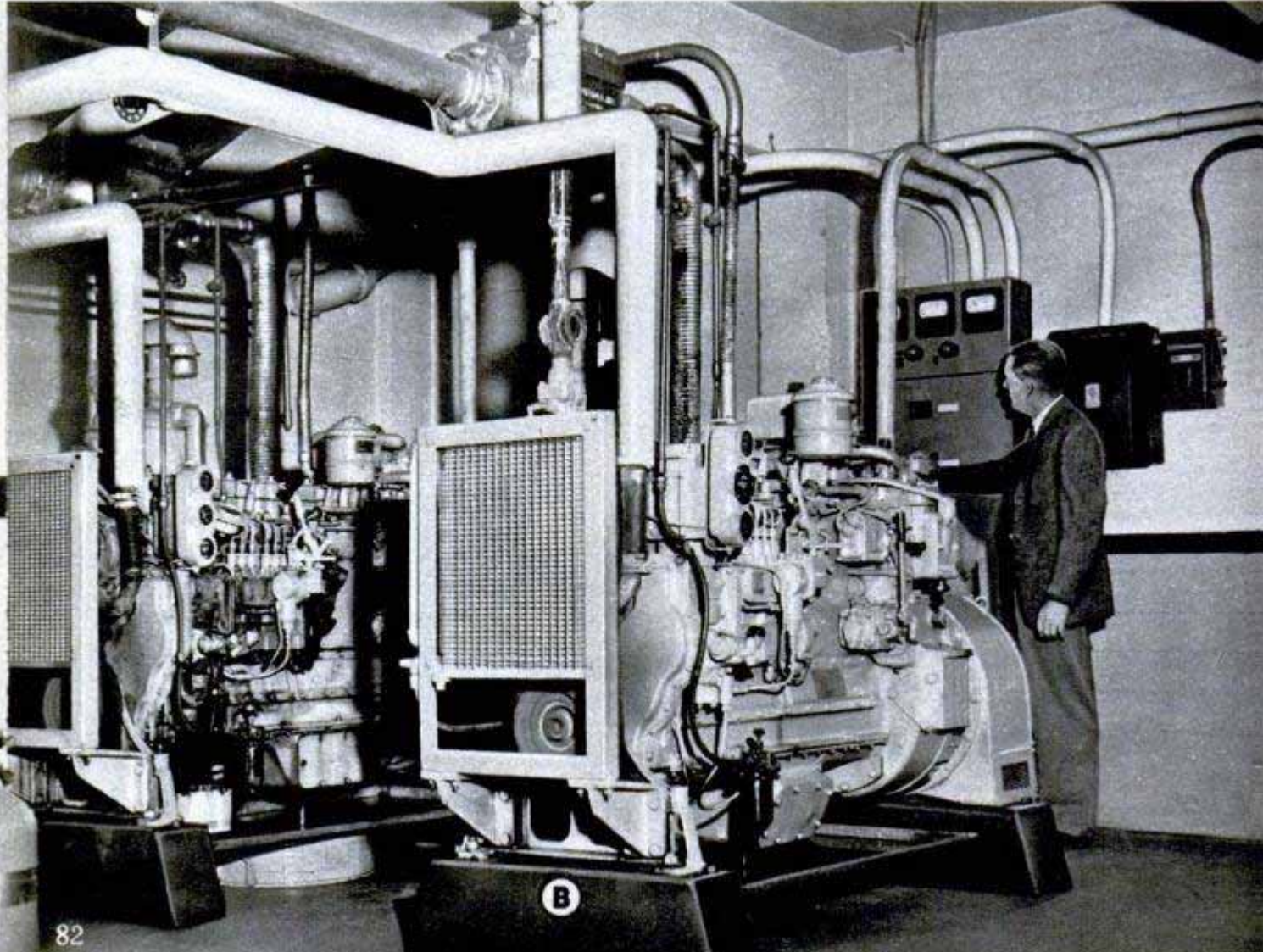

cooling, in fact, is causing a behind-the-scenes revolution in the internal-combustion-engine industry. The new principle is known as "vapor phase" cooling because the coolant liquid is deliberately allowed to produce steam. For some types of installations in which the waste heat is put to work instead of being allowed to dissipate, vapor-phase cooling actually doubles the thermal efficiency of an engine.

Unfortunately for automobile owners, it will be several years at least before the new system is available for them. Engineering a vapor-phase cooling system for stock cars that everyone can use is going to take time. Besides, the originators of the idea have their hands full already, making installations on large stationary plants.

Simply stated, vapor-phase cooling works this way: the water in the cooling system is allowed to heat up to 212 degrees and circulated to a steam separation chamber. There the steam is removed and the water is pumped back into the car's cooling system. The steam passes through a radiator or condenser, where it loses its latent vaporization heat and condenses back into water again, after which this water is returned to the cooling system.

Being a closed system, no water or steam escapes and the engine cannot boil dry. Neither can the water temperature rise above 212 degrees, the point at which it boils, unless the system is purposely designed to produce more than a minimum amount of steam.

Any good grade of commercial antifreeze may be used with the vapor-phase system. Since the system is closed, the antifreeze lasts much longer than it does in a low-temperature system which is open to air.

The new cooling system has been installed on about 5000 engines to date, ranging from small engine-generators for Army mobile radio equipment to heavy-duty stationary engines used for pumping or for generating electric power. Without exception, the substitution of high-temperature cooling for low-temperature cooling has materially increased the life and efficiency of the power plants.

Stationary engines that use sewage gases as fuel, for instance, are good for years of operation when equipped

with vapor-phase cooling. Sewage gases are so highly corrosive that in the past this type of fuel has virtually junked a new engine after about six months' use.

Similarly, marine diesels cooled with boiling water are 10 to 20 percent more efficient mechanically, can use cheaper grades of fuel without harm, and for considerably longer periods between overhauls.

The main reason why vapor-phase cooling does all these things is because it maintains the engine block above the critical 194-degree temperature. This is the dew point at which water condenses in engines.

The combustion process produces about a gallon of water in vapor or steam form for every gallon of fuel burned. Most of this and other products of combustion are removed in the form of exhaust vapors. However, when part of the engine such as the lower cylinder walls is colder than the dew point, some water vapor condenses on the cold metal surfaces. Other products of combustion, including sulphur dioxide, combine with the water and corrode the metal. Too, some of the liquid is blown down into the crankcase where it sludges the oil, further hastening engine wear.

When engine temperatures are kept above the dew point, no condensation of the combustion vapors and gases takes place. All corrosive materials are removed by the exhaust and wear is kept at a minimum.

Another benefit of vapor-phase cooling is that the whole engine block acquires an even temperature. Piston-cylinder clearances are uniform throughout the full stroke, insuring better lubrication of the walls and rings. Heat transfer from the combustion chambers is improved, so there is no increased tendency for a fuel to

Insulated chamber where steam and water are separated is at upper right

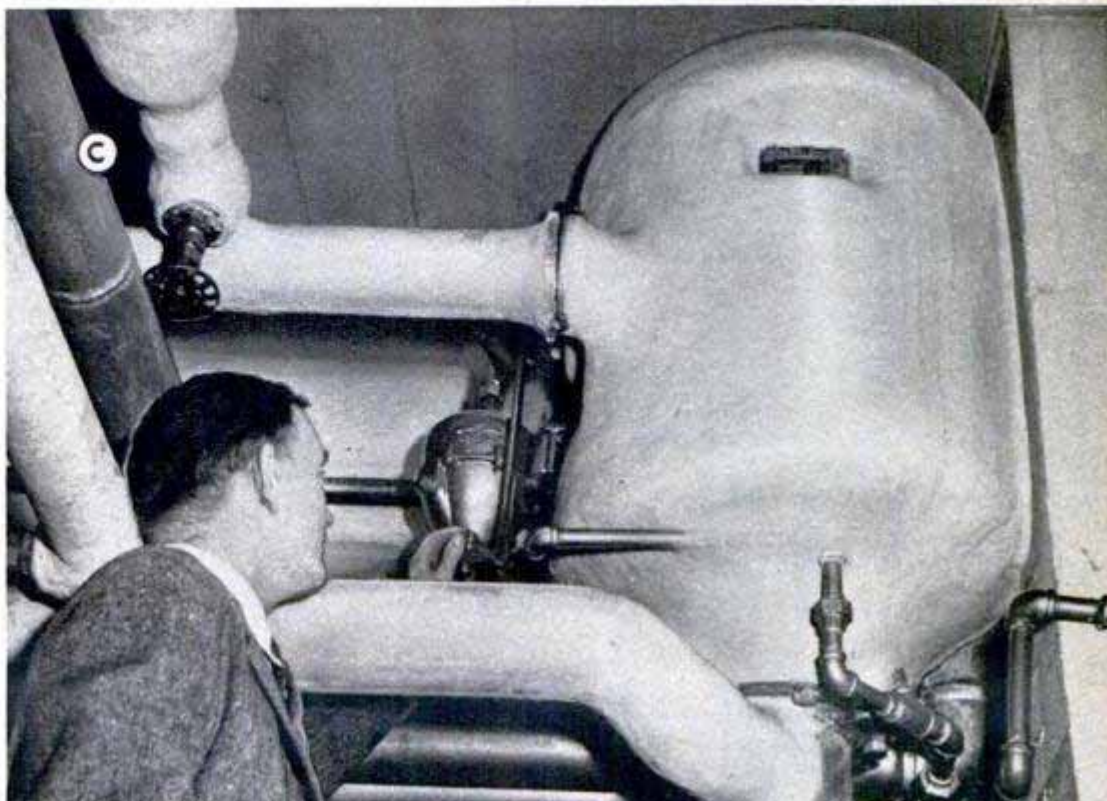

detonate. Being a closed system to which liquid is added only to make up for mechanical leaks, scale and rust in the cooling system are almost completely avoided.

The ambient temperature on even the hottest day is "cold" compared to the temperature of the steam in the condenser, and so the cooling system continues to operate at peak efficiency even when the outside temperature climbs to 110 or 120 degrees. Similarly, the water temperature remains constant regardless of load.

Vapor-phase cooling got its start about 10 years ago when L. C. Harbert, J. H. Wallace, William G. Corey and R. A. Newton of Los Angeles sought a way of reducing the excessive wear that was occurring to engines that used raw sewage gas or "sour" oil-field gases as fuels. These gases are heavy in sulphur and other corrosive elements. The only existing remedy was to install expensive equipment that "scrubbed" some of the corrosive materials from the fuels.

Harbert and his companions knew that some research, especially in England, had indicated that corrosion was almost completely eliminated when engine temperatures were kept above 194 degrees. Starting from there, they designed a high-temperature cooling system that used the boiling point of water as a natural control. The idea worked and they applied for patents, then formed Engineering Controls, Inc., to manufacture and market the system.

At that time Visalia, Calif., was having typical difficulties with a 50-horsepower engine in its sewerage works. Sewage gas was used as fuel, and a new engine installed in February was so badly worn by July that it was beyond repair. A new engine, equipped with vapor-phase cooling, was installed and carefully watched. That was back in 1939.

By keeping engine-block temperature above 194 degrees, vapor cooling avoids condensation that leads to corrosion of metal surfaces

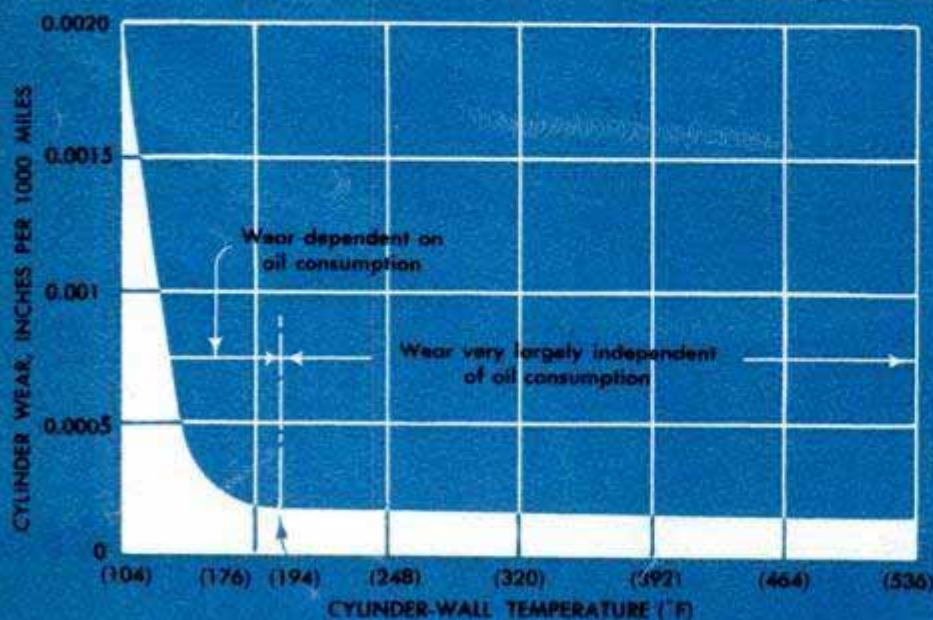

Today the same engine is still in use, still using the same corrosive fuel. The engine gets a routine overhaul about every 18 months and in 10 years some \$300 has been spent on replacement parts. If the engine had been powering a truck it would have traveled about 2½ million miles by now.

An example of how vapor-phase cooling helps double the thermal efficiency of an engine is found in the power plant of the Shepherd Tractor Company, Los Angeles. They have two diesel-type motor-generators that manufacture power for operating arc welders, air compressors, power tools and other equipment. About 31 percent of the B.T.U.s per pound of fuel are converted into mechanical energy. Most of the balance would be thrown away as waste heat if the plant followed conventional lines.

Instead, a pressure-type vapor-phase system, operating at a water temperature of 240 degrees, is used to cool the engines. Exhaust boilers that recover much of the heat that is usually dissipated by the engine exhausts are also used. The result is that enough steam is produced to keep part of the tractor plant warm during cold weather. The net over-all thermal efficiency of the power plant is in the neighborhood of 70 percent. G. G. Thomas, Sr., plant engineer, is now thinking about using the waste heat to operate a refrigeration system for keeping part of the factory cool during summer.

Recently a prospective client of Engineering Controls wondered whether the low-pressure steam of vapor phase could be used to distill fresh water from the ocean. The client's plant is about 100 yards from the Pacific on a lonely part of the coast. Wells in the vicinity produce only salt water and the company hauls in fresh water at considerable expense for domestic use and for its high-pressure boilers.

The engineers examined the company's power plant, four 600-horsepower natural-gas engines each driving a 400-kilowatt generator, and concluded that at average load the waste heat from these engines could operate a simple evaporator that would distill 458 barrels of fresh water from the ocean every day. Not only would the water be produced at no cost but the engines themselves would operate more efficiently on high-temperature cooling.

For oil-field clients, Engineering Controls provides an "engine attendant" by which a gas or diesel engine can operate automatically for weeks, without human supervision.

(Continued to page 258)

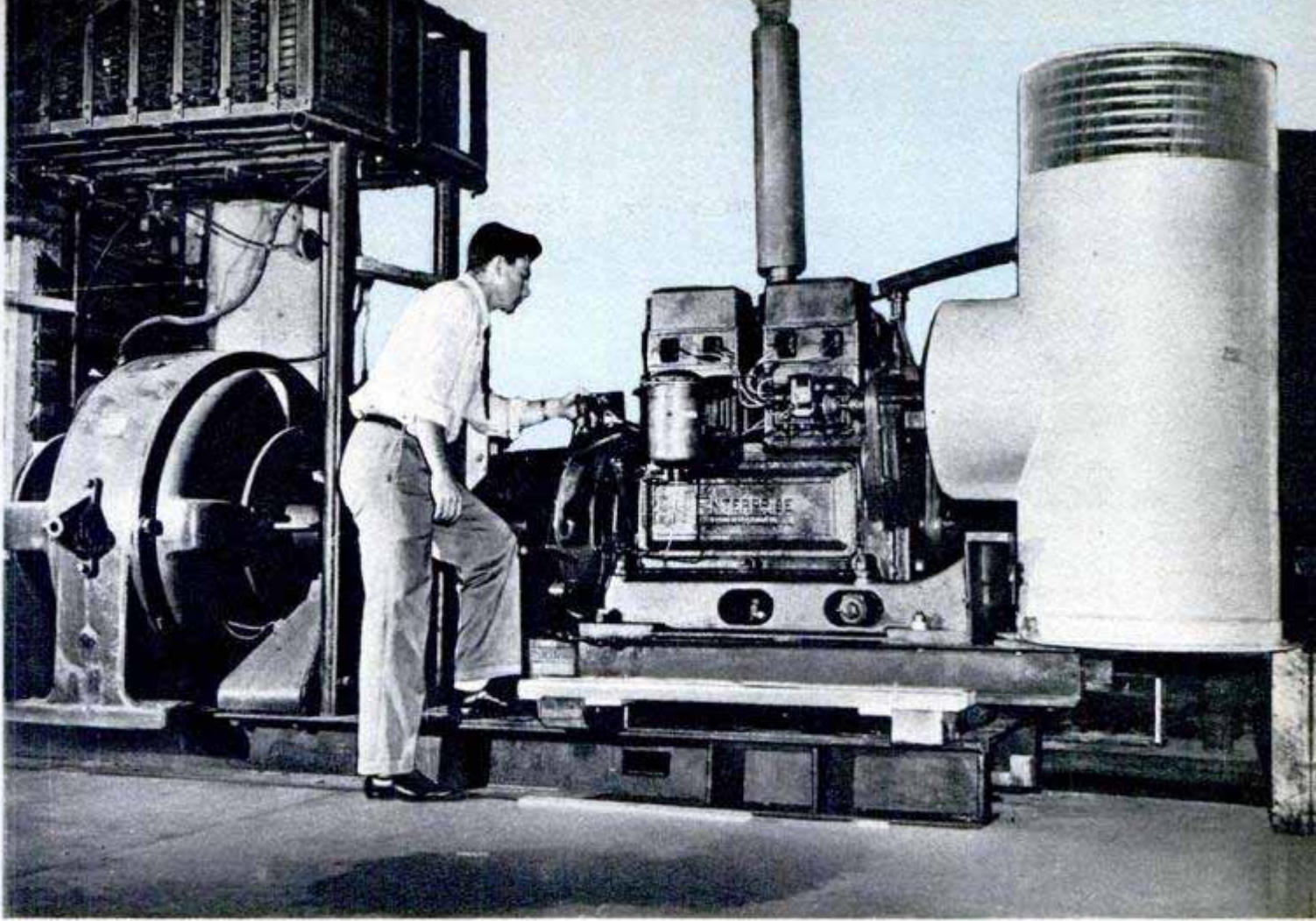

"Engine attendant" at the right is being built for operation in oil fields. It can operate diesel or gas engines automatically for weeks and weeks, without human supervision. The apparatus feeds oil to them as needed

Putting together a steam separation chamber for a 50-horsepower engine. Equipment used in auto experiments is considerably smaller

Cooling condenser coils form top section of the "attendant" and oil-storage tank is located below. Engine fan, visible in picture, draws air through condenser to insure cooling

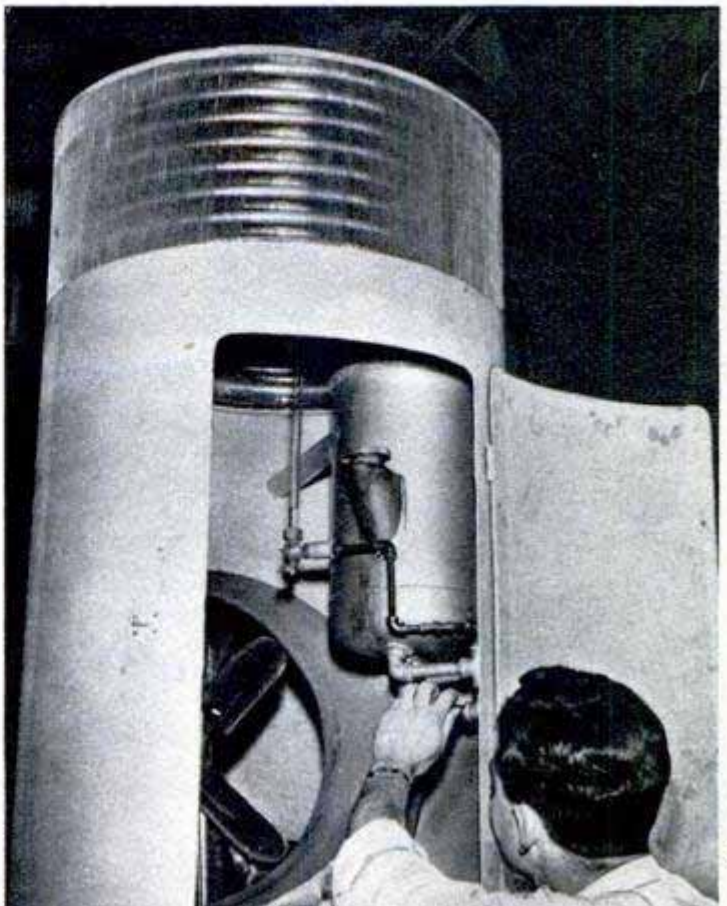
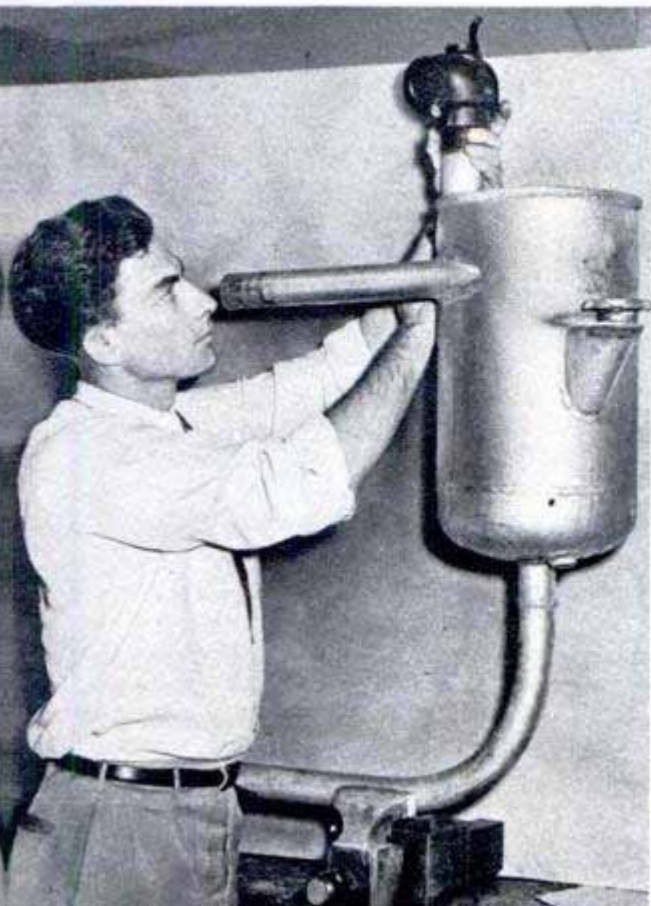



Self-Propelled Power Saw Clears Brush or Cuts Logs

One man can clear two to three acres of brush and scrub trees a day with a mobile power saw that propels itself. The clearing is done without disturbing the topsoil. The saw has a 30-inch circular blade, adjustable at various heights and angles from the ground. The outfit has two speeds and a neutral position, working through heavy brush and saplings at 1¼ miles an hour and in thin growth at 3 miles an hour. The saw is mounted on a swivel axle that can be swung free while the wheels stand still and a safety clutch stops the blade instantly if it pinches in a tree or log.

Convertible 'Picture' Window Folds Down With Top

Any convertible owner who has tried to back out of a parking space and keep an eye on approaching traffic will welcome a rear "picture" window. It is made of "flexible glass" and folds down with the top like a regular panel. The big window offers 500 percent greater rear visibility than is provided in most convertibles. The window can be installed in a few minutes with ordinary

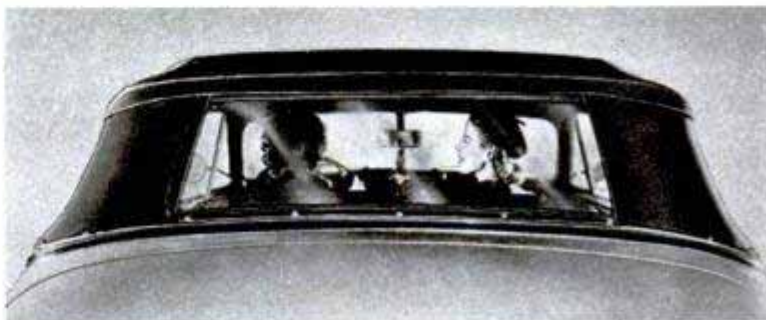

tools, cleans easily with water and is available for 12 different makes and 56 models of convertibles.



Skating Factory Workers

Girl workers zip from job to job on roller skates in a Japanese spinning factory. The spinners must move rapidly between the machines. According to the plant superintendent, the roller skates have substantially increased the efficiency and boosted the workers' speed in the factory.

Jet Plane Photographs Ducks Before They Hear It Coming

Jet planes flying 400 miles an hour at an altitude of 300 feet "sneak up" on flocks of ducks feeding in marshland so fast that they can be photographed before they are frightened into flight. Ordinary planes cannot be used for an accurate photo census of wildfowl because the noise of their engines scares the birds away before the plane gets overhead. The Fish and Wildlife Service is now using an RF-80 jet-propelled plane equipped with a strip camera to assist in the annual census of ducks in the San Joaquin Valley of California.

University of Maine athletes who wear glasses have been fitted with contact lenses of nonshatterable plastic to eliminate the danger that is present when ordinary spectacles are worn in strenuous sports.

Fruit-Picking 'Walks' Swing Into Trees

Catwalks swing out from the four corners of a mobile orchard machine to provide platforms for picking, thinning and pruning fruit trees. The four catwalks are raised and lowered hydraulically and can be swung right and left to permit each worker to cover his side of the tree. The machine is in use on the Merrill Orchards in California. The owner estimates he will use the machine about 160 days this year and cut his costs by 50 percent. He plans to make the machine self-propelled before the end of the season.

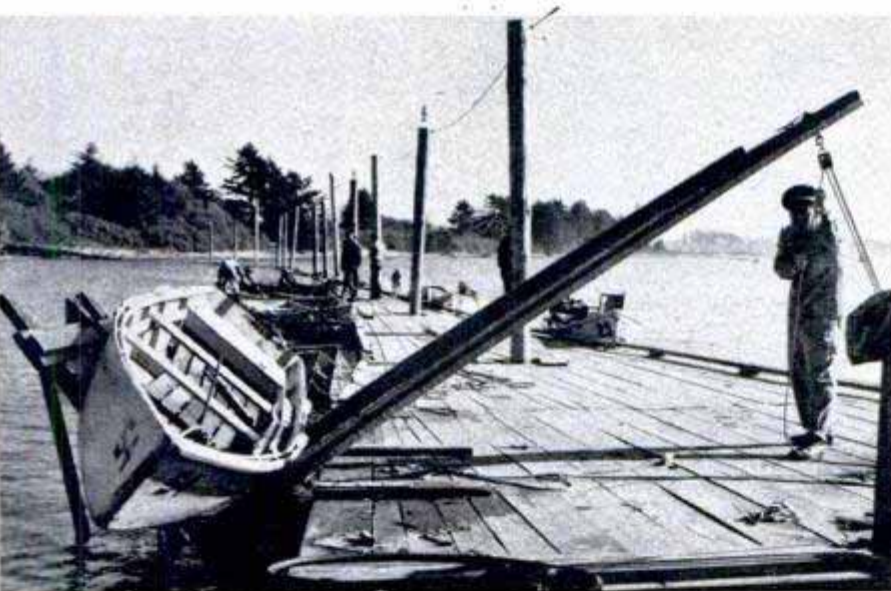
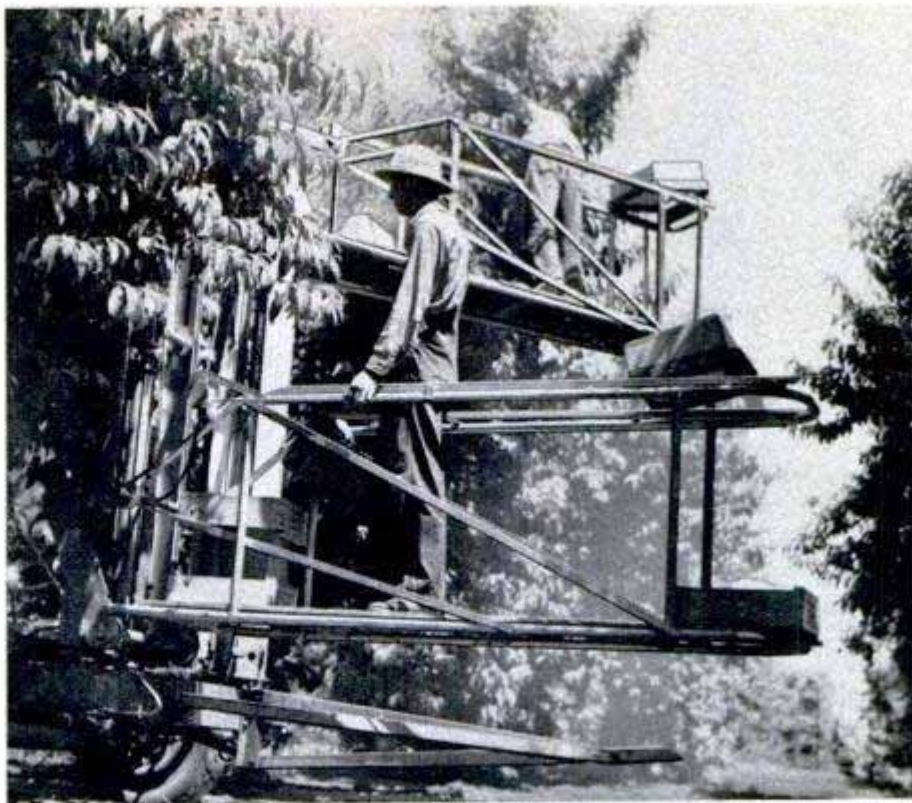

Tipping Cradle Drains Rowboats

Instead of laboriously pumping bilge water from rowboats after every rain, the operator of a boat landing in California lifts each boat on a special hinged cradle and tips it until all rainwater and seepage runs out. The cradle, hinged to the pier, consists of an underwater platform over which the boat is floated. An upright arm attached to the cradle is pulled down by a tackle, raising the boat out of the water and turning it on its side.

Brush Cutter

Three whirling saw blades on a new brush cutter mow a seven-foot path through weeds and small trees. The cutter can be installed on a jeep, bulldozer or small tractor. The blades will slice through timber up to six inches in diameter. From 20 to 50 acres of brush per day can be mowed with the machine. A triangular guard pushes the brush to each side and an overhead framework protects the driver from trees that might fall toward him.



Heirlooms in Miniature

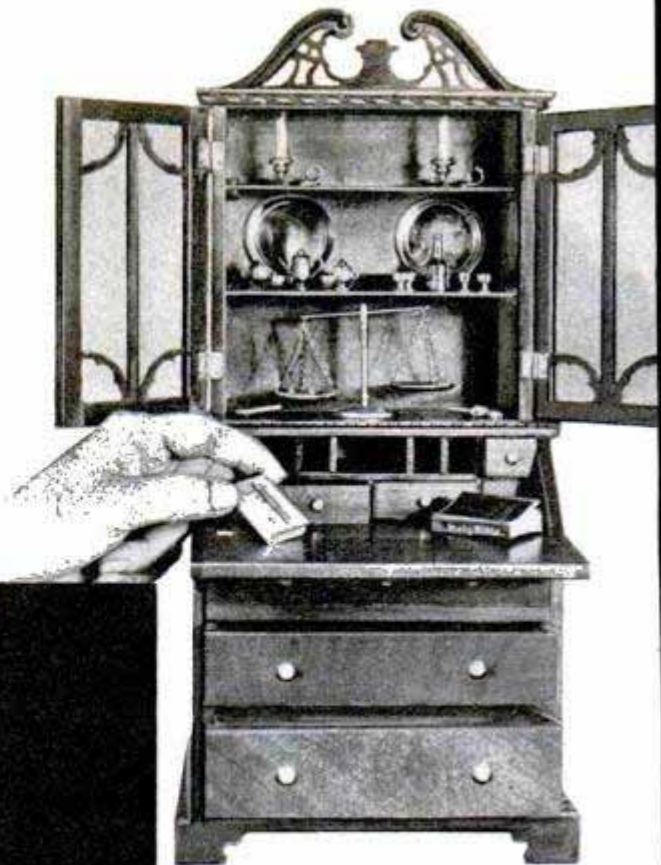

↑ Governor Winthrop secretary holds miniature scales, Bible, candlesticks and tiny goblets. Made of mahogany, it is 14 inches high, plays a tune when the drawer is out



← Elaborately carved organ is nine inches long and has red-velvet pedals. Knee lever controls volume. Below, spinet desk is made of walnut. The gold-leaf cabinet holds tiny crystal glassware

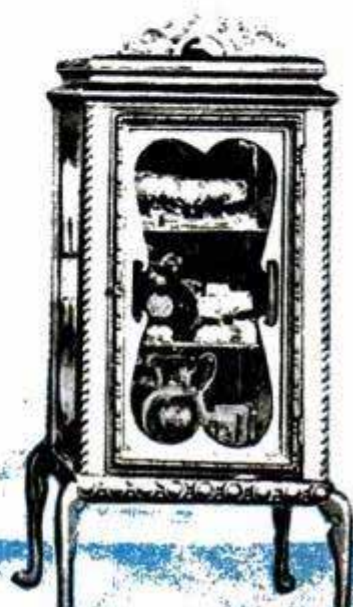

IN A WORKSHOP fitted with lilliputian tools, Helen Armitage of Altadena, Calif., turns out exquisite family heirlooms only a few inches high. Her miniature pianos and melodeons play appropriate tunes and her grandfather clocks keep accurate time. Miss Armitage copies only the treasured heirlooms of her own family and the articles of furniture she particularly admires in the homes of friends. Each of her pieces has been copyrighted, there are no duplicates and she refuses to sell any of her miniature masterpieces. She started her hobby several years ago when the family's grandfather clock, which she admired, was given to someone else. To take its place, Miss Armitage made an exact copy 27 inches high. Today, her tiny heirlooms include melodeons, pianos, desks, perfume cabinets, organs and clocks. She uses a jewelers' lathe and other tiny precision instruments in her work. The heirlooms, made of rosewood, walnut and other fine woods, are authentic in period and design.



Miss Armitage holds miniature clock, a perfect copy of the original. Below, the tiny metal clock parts are turned on a jewelers' lathe

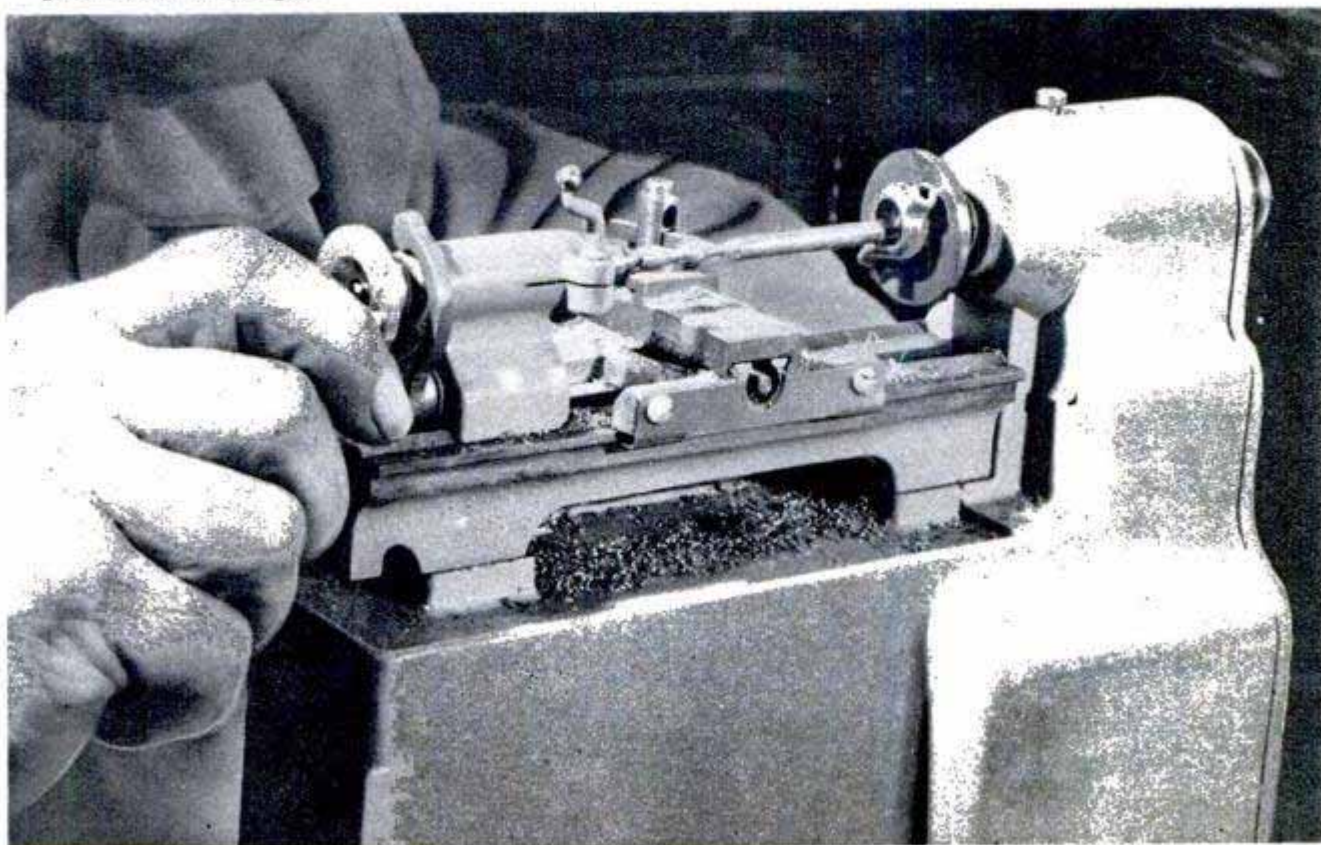



Community Mailbox

Rural mailboxes are often anything but beautiful, but there's one crossroads near Grangeville, Idaho, where the community mailbox is not only attractive but also practical. Seven mailboxes are mounted in gables of a small houselike shelter at the correct height for easy accessibility. The lower part of the shelter is a weatherproof parcel room. Also included is a neat sign showing direction and mileage to each farm.

Music Lessons Are Fun Now

Music lessons are as much fun as a game of marbles when the teacher has a training table that uses real marbles to teach everything from key names to harmony. Marbles representing each note of the scale are placed on a large staff printed on the table top and the student tries to hit as many as possible by shooting another marble into the group. If he can identify the struck marbles, he places them on a simulated keyboard in front of him. As many as eight students take part in the game at one time and competition enlivens the lesson. Not limited



to elementary training, the table has many varieties of games for instruction in all stages of pianoforte.

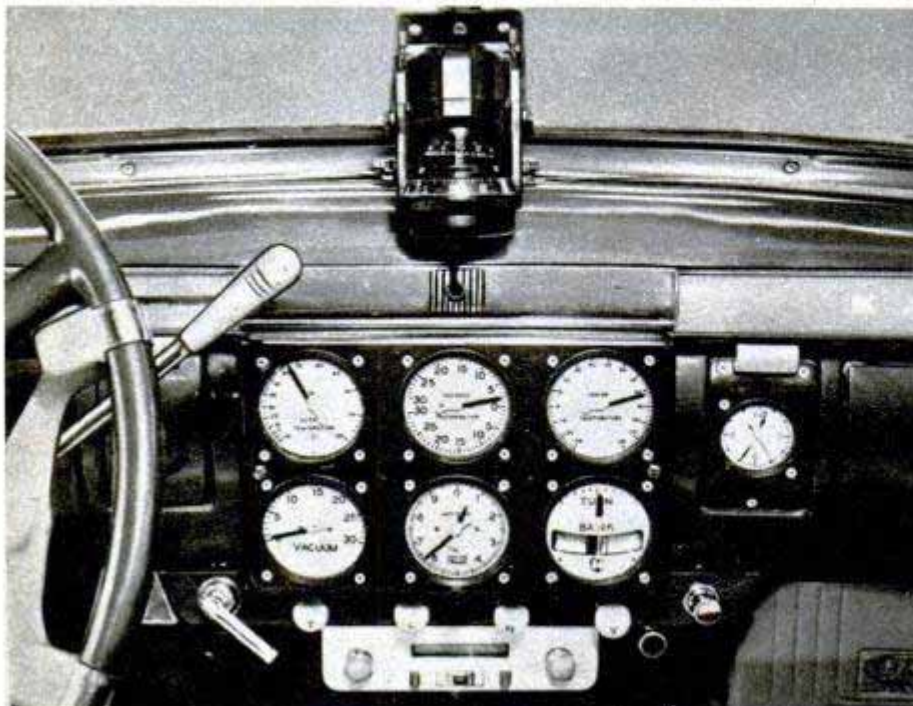

Airplane Instruments On Auto Dashboard

When W. H. Dietzel of Detroit, Mich., drives his new car he has almost as many dials on his instrument panel as the pilot of a trans-Atlantic airplane. Not satisfied with the standard dashboard, he installed a group of instruments that tells him everything from the outside temperature to the height above sea level. The airplane-type instruments include outside and inside temperature gauges, vacuum gauge, inclinometer, turn-and-bank indicator (which he admits is merely a novelty), clock and compass.

WILLIE the ROBOT

WILLIE is a dapper little citizen of Hammond, Ind., with a leer in his eye and a stomach chock full of wires and gears. He's a robot, the mechanical child of Andy Bober. If you ever meet Willie, there's any number of things he may do. He introduces himself politely, puffs a cigarette, answers your questions, walks, dances, turns in any direction, sings, plays a horn or harmonica and even aims and fires a pistol. Bober has worked 15 years on Willie. He won't reveal all his secrets, but explains that electrical impulses from the control box travel along a cable, up one of Willie's legs and into coils in his body. Willie hears through microphones in his ears and answers questions through a loudspeaker installed in his stomach.

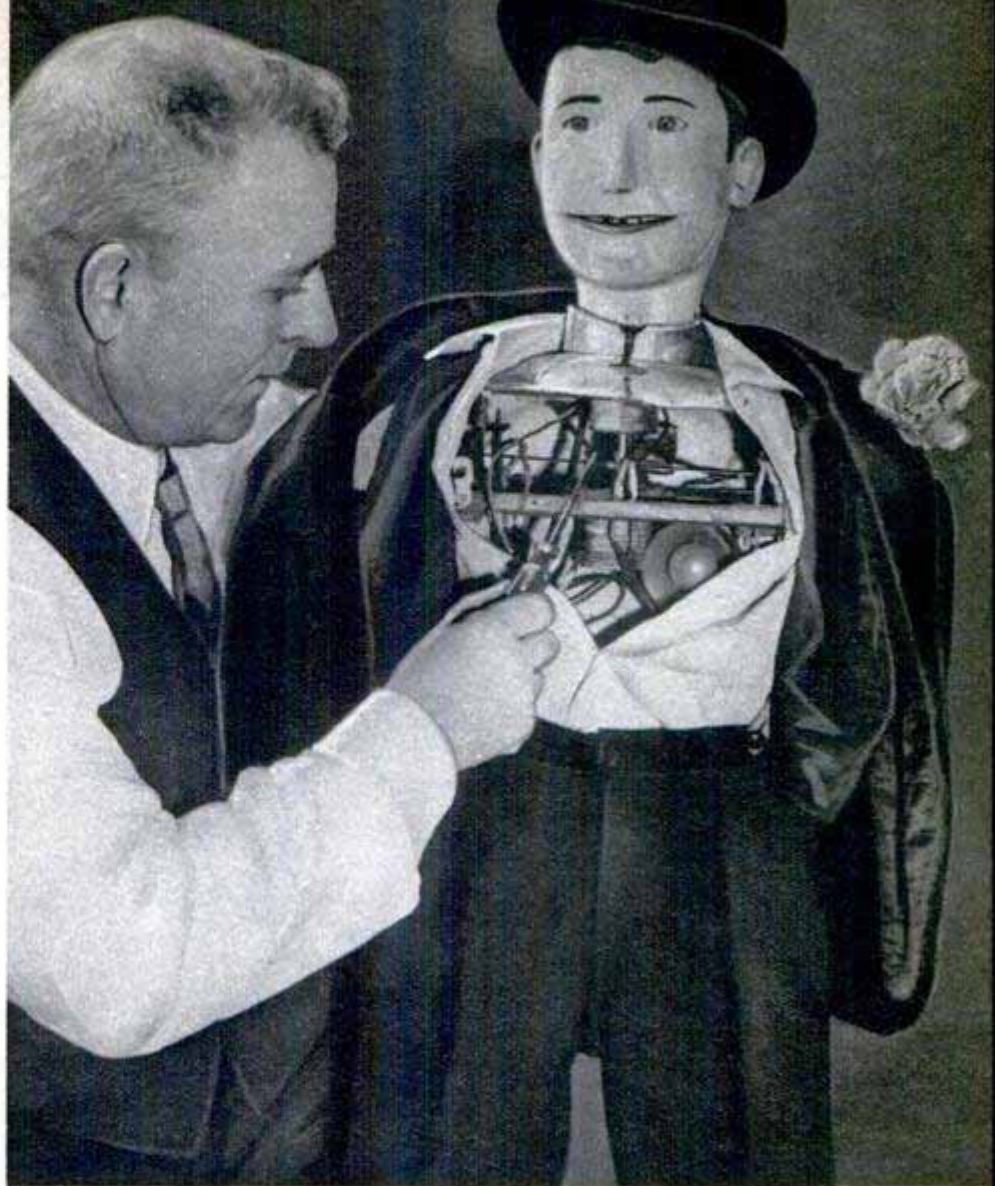

Above, Willie smiles bravely with his shirt peeled back so his creator can make some minor adjustments. Below, the robot pauses for a light during a stroll around the room. Below, left, Bober operates dapper mechanical man by remote control from switch box



Budget-Size Yachting



Light enough to pick up and carry, as the girl at the left proves, the Sabot is a sailboat that will fit your budget

small and maneuverable that it can be sailed on small lakes and fair-sized rivers. And if the wind is too light for sailing, you can strip off the sailing equipment and the versatile boat becomes a handy, light-weight rowboat.

It is the Naples Sabot, an eight-foot leeboard dinghy of the pram type, the official plan of which was presented in the fall of 1946 when the Naples Sabot One-Design Association was formed.

A distinctive feature of the Sabot is the leeboard which provides the keel effect necessary for any sailing craft to keep it from sliding away with the wind. This leeboard is a paddle-shaped piece of wood on the starboard side that can be raised or lowered when necessary. With the leeboard up, the boat can be dragged along the beach like a light rowboat. The leeboard, as well as the rudder and mast, can be removed quickly to convert the Sabot into an easy-to-handle rowboat for hunting and fishing.

Boats of this type had been sailed previously, but it was only when they became an official class of yacht design that they came into their own and started the burst of popularity in racing circles.

There are several other boat designs similar to the Sabot. These include the El Toro, the Balboa Dinghy and the Seashell. But, at present, the Sabot seems to be a leading contender for the number-one spot on the hit parade of the budget-size yachtsman.

Merely sailing over the bounding main, with nothing but the fresh breeze for motive power, is an exciting and enjoyable

By Eugene M. Hanson

Photos by the Author

YACHT RACING is no longer the exclusive hobby of millionaires, nor is it limited to those who live near the ocean or large lakes. A new kind of yacht club, which brings sailboat racing within the financial reach of almost everyone, is having a mushroom growth around California's lakes, bays and coastline.

Making possible the popularity of these sailing organizations is a new type of small sailing boat. Recently developed and accepted as a standard by the North American Yacht Racing Union, this new class fits neatly into the workingman's budget.

Besides being so inexpensive that almost anyone can afford it, the new boat is so

sport, but the real thrill of sailing comes in yacht racing. It is the competition among rival boatmen that makes sailing enthusiasts such fanatics among sportsmen.

The original fleet of Naples Sabots is in Long Beach, Calif., where the design originated. But new clubs are springing up all over California and Sabot fans freely predict that this versatile little craft will bring about the formation of yacht clubs everywhere, even on the smaller inland lakes and rivers.

It is easy to form a yacht club and the cost is virtually nothing, aside from the actual cost of the boat. And when the club members stick to the Sabot, that cost is very low.

There are many reasons why sailing enthusiasts band together into yacht clubs. The primary reason, of course, is to provide racing. Without a race, no sailor can know for sure that he is getting the proper speed out of his boat and speed is the test of sailing skill.

Unless he is racing other boats of the same design as his, the sailor has no true test of his skill, either. Other things being equal, the longer boat will always have an edge in speed over a shorter boat. For this reason, the budget-size yacht clubs nearly all favor restricting their membership to a single design, such as the inexpensive Sabot.

Since competition is so important, the clubs make it their first order of business to set up racing facilities, marking off a course with buoys and handling such details as setting race dates and interpreting the rules for beginners.

If there is one experienced sailor in the club, he can soon bring the newcomers up to the mark. Even without such help from a club member, many clubs have been able to prosper, thanks to the help they get from other clubs in the vicinity. Affiliating your club with one of the yachting associations is a sure way to get the benefits of this advice.

There's a lot more to sailing than simply letting the wind blow the boat over the water. You'll learn skill and judgment, so essential to good yachting, much more quickly if you can get some help from an "old salt."

The lack of harbor or docking facilities should not discourage sailing enthusiasts from going ahead with plans for a yacht club. The

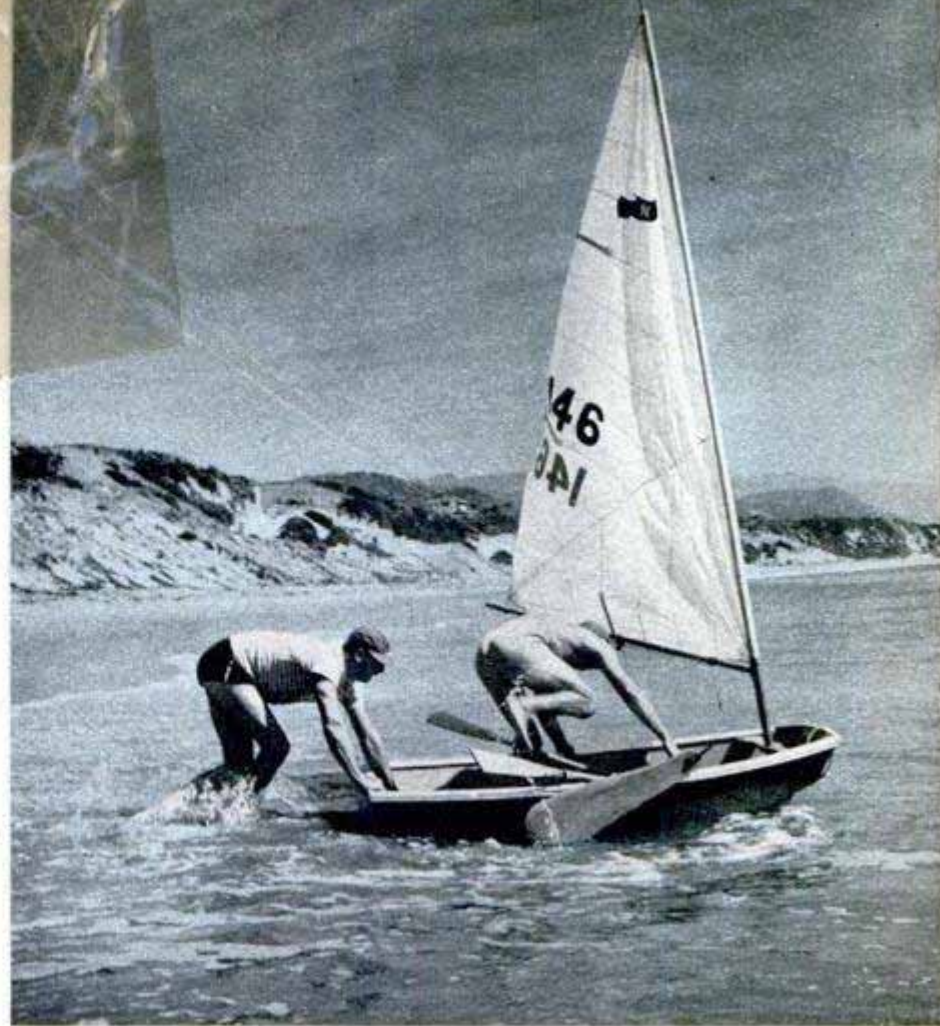

Launching the Sabot is easy. You just push it out into the water. That's Jimmy Wallington, the radio announcer, at the stern. The 10-year-old California girl, below, is already a veteran behind the mast of the safe and easy-to-handle boat





Rigged and ready to sail, the Sabot can be dragged across the beach, eliminating the expense of a dolly

members of Malibu Yacht Club, who sail the Sabot exclusively, launch their boats right through the surf into the open sea. They pull out beyond the breaker line with the oars and then let the wind take over.

Members of the Malibu club swear by the Sabot, as do others who sail this tiny craft. Foremost among the desirable qualities of the Sabot is its economy, both in first cost and in upkeep. Equipped, all ready to sail, the Sabot costs only \$275. You can cut more than \$100 from this price by buying an unfinished boat from one of several manufacturers and finishing it yourself.

A screwdriver, a paintbrush and some sandpaper are about the only tools you need to finish one of these boats in your workshop or back yard. Nor do you have to be a skilled craftsman to turn out a shipshape job.

Finishing consists of puttying the screw holes in the hull, applying two coats of marine flat paint and a coat of enamel, installing floor boards and fittings. These fittings include the rudder gudgeons and pintles, tiller fittings, oarlocks, towing-ring bolt in the bow, traveler in the stern, leeboard fitting and bracket.

The mast and boom come from the manufacturer already roughed out. All you do is the sanding and varnishing and then add the fittings supplied with the boat.

Or, if you're handy with tools and want to start from scratch, you can build your

own Sabot. Plans for the boat can be obtained from the association. Working only on week ends, boatowners have built the Sabot in about six weeks.

Upkeep cost of the Sabot is virtually zero. Just a little time and effort in sanding and painting are all that is needed to keep your boat in good shape.

Next to the economy of the Sabot, its most appealing characteristic is its fine response to sailing skill. Jimmy Wallington, the well-known radio master of ceremonies who is the vice commodore of the Malibu Yacht Club, gave up a 39-foot yawl when he found out how much more fun it is to handle a tiny Sabot.

Wallington, who weighs 215 pounds, and Howard Splane, commodore of the club and another 200-pounder, often sail together in their boat, *The Grunion*. Their combined 415 pounds give an indication of the Sabot's amazing weight-carrying ability.

Weight of the boat itself is only 65 pounds, ready to sail. The lightness of the Sabot is another reason for its popularity and the low cost of upkeep.

It's so light and compact that you don't need a dolly to get it from your car into the water. You just drag it along the beach and launch it, just as you would a canoe or rowboat.

Two persons can pick it up and carry it easily. With the mast, rudder and leeboard removed, it will ride on the roof of your

car safely. When you are ready for a day's sailing, you merely haul the Sabot out of the basement or garage, tie it on your car and drive to the nearest water. It's as simple as that. No rental fees for moorings or dock space are necessary.

Anyone within driving distance of lake, sea or large river can thus enjoy sailing. The Sabot is so easily maneuvered that it doesn't require great expanses of water even for racing. Races are held by the Malibu club over a triangular course in the ocean where space is unlimited, but the longest distance between buoys is only about 300 yards.

The reason for using such a small course is that it requires more skill to round the buoys several times to cover a given distance than to sail over a longer course only once or twice. The small course also makes it easy for spectators to watch the progress of the race from starting gun to finish line.

The safety features of the Sabot are particularly appealing qualities for parents who want to teach their children the thrill of sailing. In case of a hard blow coming up when the boat is at sea, it is easy to take down the sail and row to a landing. With the sail and leeboard removed, the boat is as safe as a rowboat.

If a Sabot is capsized, which is possible if the boat is pushed too hard in a stiff wind when racing, it floats well and the crew can use it as a raft while awaiting help. Nor does the boat have to be towed ashore if it does capsize. It is easy to right because there are no stays to unbuckle before removing the mast. The mast simply slips into a tube-shaped well near the bow. Because the mast is round, it can turn in any direction during sailing.

Other qualities which Sabot owners like to point out are that it can be rigged in a matter of seconds, that it tows beautifully without any tendency to yaw, that it has a high resale value because it is a standard design and that it is one of the sturdiest of craft despite its small size and lightness.

Specifications for the Sabot are stipulated by the yacht-racing union and the manufacturers are not permitted to vary from them by more than a quarter of an inch.

Roughly, the Sabot is 8 feet long, 46 inches wide, weighs 65 pounds, has a 13-foot mast and a 7-foot boom. It carries 36 square feet of sail. The oars are 66 inches long and stow easily.

Besides being a sailboat and a rowboat, the Sabot takes an outboard motor nicely and its shallow draft makes it ideal for hunting and fishing.

With all its versatility, however, the Sabot is really best suited for one specialized job—the job of introducing beginners, at low cost, to the joys of sailing.



Working from official plans, this young enthusiast built his own Sabot. It takes about six week ends to complete the boat. The photo below shows the leeboard which provides the keel effect for the craft. When the boat is sailing, the leeboard is vertical

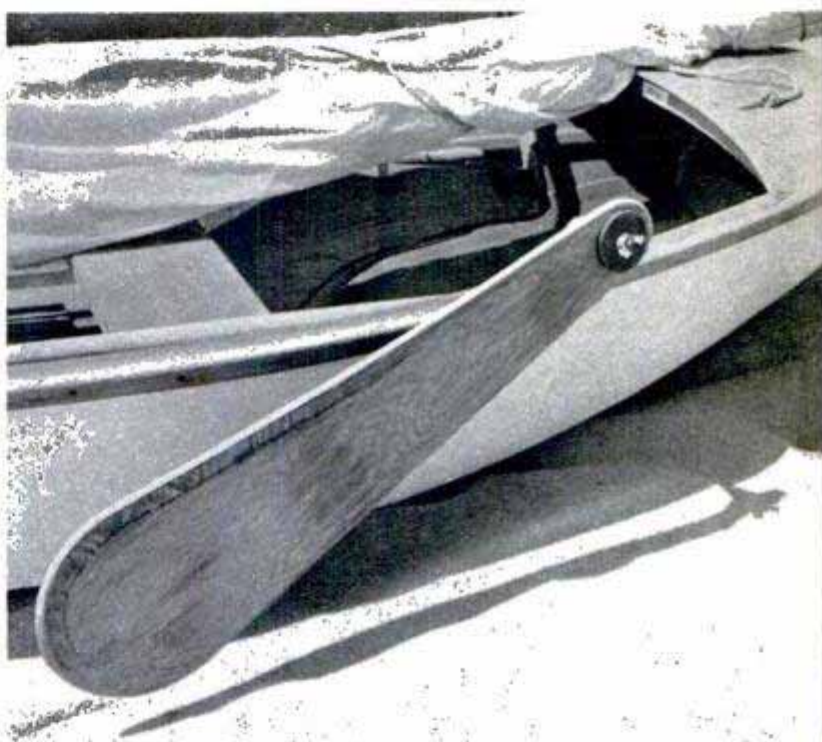

Stepping the round mast of the Sabot is simple. You merely slip it into the tube-shaped well at the bow

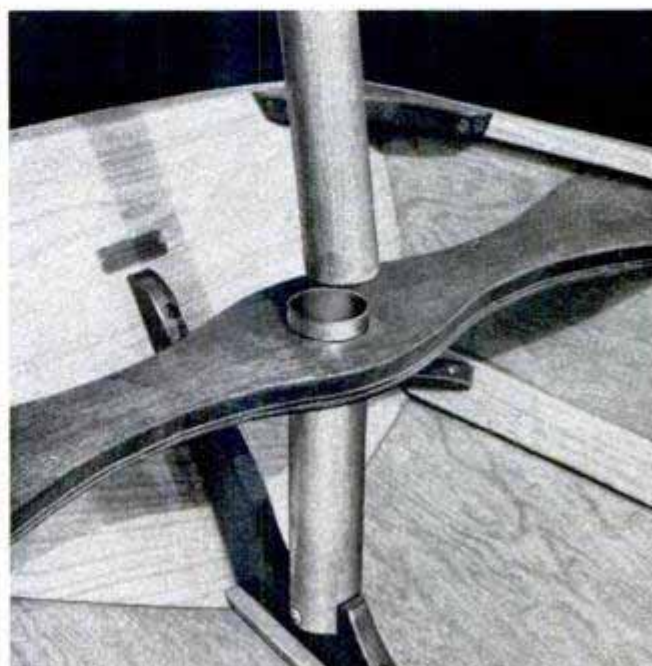



Jungle Voices on Wire

When he needed the chatter of monkeys as sound effects for one of his movies, Capt. Hassoldt Davis, an explorer, sat down in a cage full of chimpanzees and persuaded them to speak into the microphone. Captain Davis recently returned from an expedition into French Guiana sponsored by France and the United Nations. He wanted to reproduce the monkey voices accurately for his movies, and a cage full of monkeys plus the recorder provided the answer.

Pedal Violinist

Even though he has only one arm, Luther Caldwell, a farmer of Columbia, Mo., still plays his violin. Caldwell uses a pedal-operated rig of tubular steel that rests on the floor in front of his chair. When he pumps the pedal with his foot, a steel arm draws the bow across the strings.

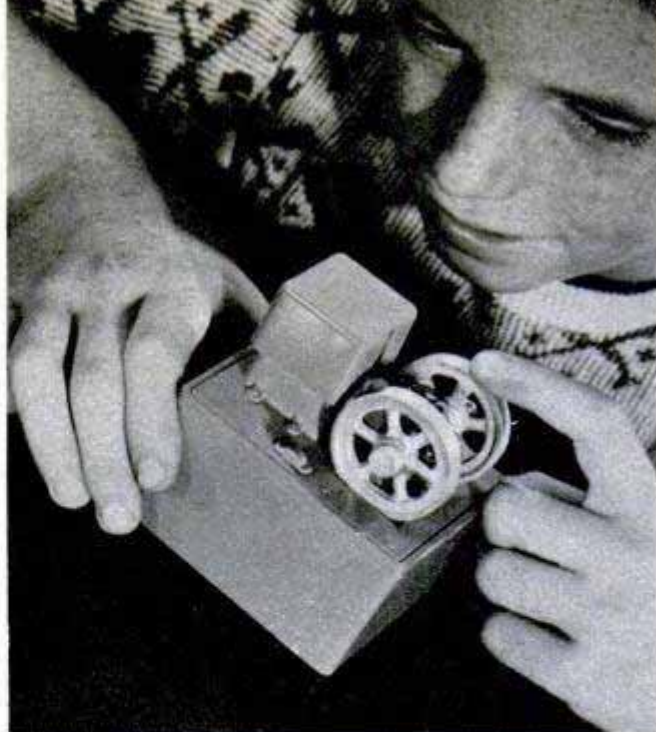

Toy Motor Is Battery-Operated

Powered by two flashlight batteries, a toy electric motor eliminates the need for a transformer and power line. With its base and battery container made of Tenite plastic, the motor is designed so that its base becomes a cover for the unit when it is not in use. A push-button switch on the base starts the motor running. Speed can be regulated and power is transmitted to other toys by a belt wrapped around a hub cap.

Car-Washing Mitt Makes Own Suds

Detergent pellets slide into a lamb's-wool mitten to make car washing easier. You hose the car thoroughly, then wet the mitten and wipe it over the car. The water dissolves the pellets forming suds that remove dirt and grime. The suds are then rinsed from the surface and the car dries clean. It is not necessary to chamois or wipe the surface.





How to Tempt a Fish

PART II BAIT CASTING

By Joe Godfrey, Jr. [64 W. RANDOLPH, Chicago]

IT WAS THE PLACE and time a bass fisherman finds only in his dreams. Only this wasn't a dream. It was the real thing. It was the glory of a summer sunset coloring the water, the dimple of feeding bass, the little rings spreading over the golden red surface of the bay.

It was the roll of dorsal fins, the lusty slap of a forked tail, the sudden leap of a heavy fish at a minnow skipping across the surface of the water.

Now was the time to snap on a small wiggly plug and cast it into those rings. It was bass feeding time.

Not so many years ago bait casting was just another way to catch muskellunge, northern pike, pickerel, walleyes, lake trout, white bass, panfish, largemouth bass, smallmouth bass and spotted bass, but in recent years our fishermen have made it the most popular form of fishing. Now with a bait-casting outfit you can catch dozens of the salt-water game fishes including tar-

pon, snook, bonefish, ladyfish, barracuda, weakfish, snappers and others, if you fish in Florida.

It is an easy sport to learn, and millions of fishermen are luring the fish with plugs, spoons, spinners, feathers, bucktails and pork strips. Usually one quick lesson will do it—then practice makes for perfection. You must remember to keep a slight thumb pressure on the spool of the reel to prevent a backlash (overspin), often referred to as a "bird's nest." Bait casting is easy to master; but just in case you happen to be the impatient type and you fail to become an expert after three casts, the manufacturers now have an answer—level-wind reels that won't backlash.

It is not only the art of bait casting that attracts the lads and the lasses to this popular sport, but also the environment. It offers a panorama of beauty from the glacial lakes of Alaska, the mountain lakes in the Rockies, the 10,000 jewels and gems of

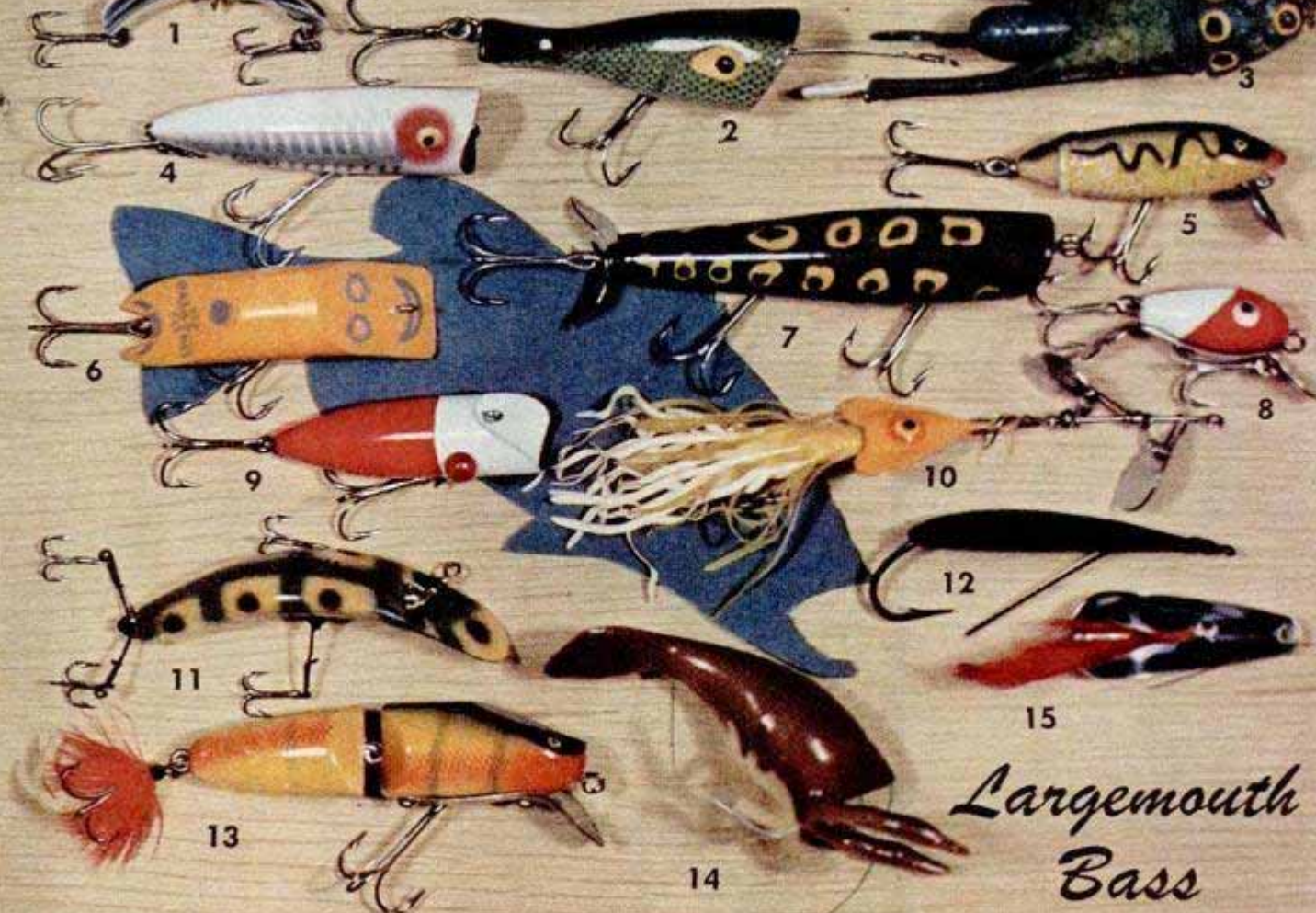

Largemouth Bass

BAITS FOR LARGEMOUTH BASS: 1—Russelure. 2—Walkie Talkie. 3—Gee Wiz Frog. 4—Chugger Spook. 5—Fish-Obite. 6—Flat-Head. 7—Dalton Special. 8—Dopey. 9—Wiggle-Plug. 10—Hawaiian Wiggler. 11—Flatfish. 12—Black Silver Minnow. 13—Lucky Tail Jointed Wobbler. 14—St. Croix Crab. 15—Rex Spoon

Minnesota, to the colorful flats of Florida.

If you want action in fishing, none of that sitting all day soaking live bait, give bait casting your best efforts. If you want action from a fish that leaps, rears, flips and bucks, try your luck at bass fishing. Any kind of bass fishing will do, whether it be for white bass, spotted bass, largemouth bass or smallmouth bass. If you have a bait-casting rod that you prize highly, don't

use it when going after big bass because sometimes the smallmouth (bronzeback) or even the largemouth (lunker) just ain't no gentleman. If you have never been in the ring with a black bass, put on your fishing togs, go to a lake where there are bass, and climb into your corner. If you tie into one, you will find him a real battler.

So important has bait casting become in fishing circles that the Metropolitan Miami Fishing Tournament, an annual \$15,000 prize event attracting more than 300,000 participating anglers, has added many prizes for the biggest fish taken on plug-casting equipment. These sport anglers have turned in such outstanding fish as a 99-pound tarpon, a 27-pound channel bass, a 40-pound cobia and a 29-pound barracuda. It is possible to take at least 30 different kinds of salt-water game fish using plugs, spoons and spinners.

The International Game Fish Association, official organization that recognizes world-record salt-water fish, has announced the establishment of a new subdivision for world records—plug casting. This is because casting for marine fish on light rods and artificial baits has been a major sport of anglers in recent years. No

Crystal-clear tackle box made of Plexiglas permits angler to see through the trays to find the desired bait

POPULAR MECHANICS

*Richmond Walker
Practical Plastics, Inc*



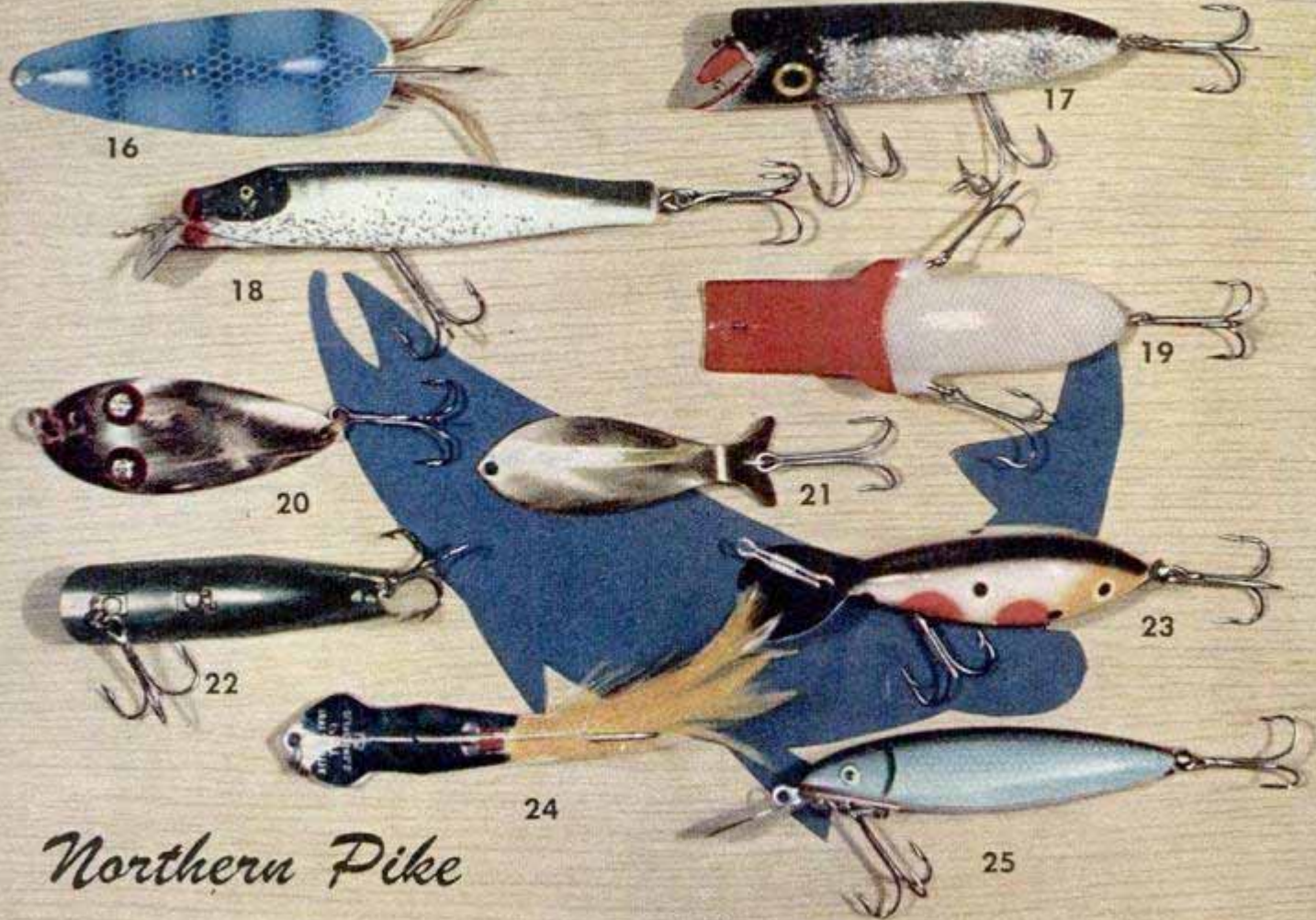

BAITS FOR NORTHERN PIKE: 16—Dardevle Spoon. 17—Two-Timer Bassie. 18—Pike-Oreno. 19—Mercury Minnow. 20—Flash Eye Spoon. 21—Wig-a-Roo. 22—Russelure. 23—Whopper Stopper. 24—Pet Spoon. 25—Cisco Kid.

distinction is made in bait casting between the catches of men and women as it is felt that no handicap is involved in the use of such very light tackle.

Let's run over the history of fishing to see how bait casting fits in. The hooks that we often see in museums, made from the bones of animals and the beaks of birds, are proof enough that fishing first began in prehistoric times. We have also seen picture stories of fishing dating back to the days of the Egyptians, about 3000 B.C., and these pictures on rocks show fishing rods and lines as well as fish. The first book on fishing to be printed in English was "A Treatyse of Fysshynge Wyth An Angle" by Dame Juliana Berners in 1496.

The first fishing rod of split bamboo was made in the United States by Samuel Philippi of Easton, Pa., in 1848. The first split-bamboo bass rod was made by Charles F. Murphy of Newark, N. J., in 1866 and consisted of four glued strips of bamboo. Hiram Leonard of Bangor, Me., made the

Above, right, telescoping beryllium copper rod a foot long fits in pocket. Below, it extends 4 feet 10 inches



MAY 1949

*The Handle Rod
Champion Products
Co.*

Barracuda

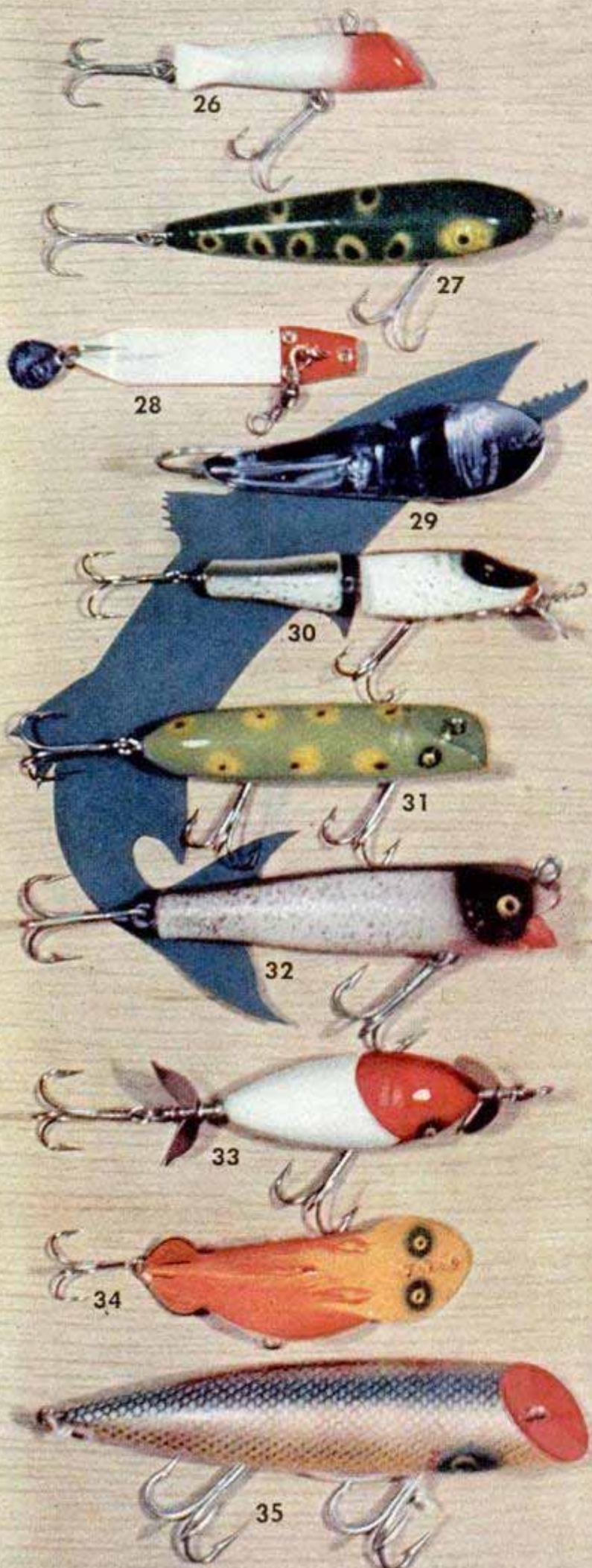

BAITS FOR BARRACUDA: 26—May Wes. 27—Runt Johnson Frog. 28—Trix-Oreno. 29—Reflecto Spoon. 30—Jointed Pike-Oreno. 31—Bass-Oreno. 32—Silver Flash. 33—Surf-Oreno. 34—Spoonplug. 35—Rose-gard Salmon Plug.

first six-strip split-bamboo rod.

Dr. James Alexander Henshall, father of black-bass fishing in this country, made the first six-strip bait-casting rod in 1875. It was about seven feet long. Charles F. Orvis made the first of these that sold in the stores.

Although split-bamboo bait-casting rods are still considered among the best for bait-casting purposes, the most popular casting rods today are made of tubular or solid steel because most of them are stronger and they duplicate the sporty action of split bamboo. They also cost less.

The newest rod, and a major departure, is an underslung rod with a larger but still comfortable handle that carries the line beneath the rod—no drag on the wet line—permitting longer casts.

Another new one is the beryllium copper rod that telescopes into the handle. Collapsed to only a foot long, it fits in your pocket or your tackle box. Extended, it measures 4 feet 10 inches long and casts beautifully. There are some two-piece tubular rods of beryllium copper that are excellent.

Now, too, there are many rods made of glass. These rods have the casting action of the finest split bamboo or tubular steel, and they will not take a "set" (acquire a bend). They have the power needed for catching muskies or tarpon and they cast easily. Whenever I go fishing I now take the following favorite rods: a bait-casting rod of split bamboo, a solid-steel rod, a tubular-steel rod, a laminated rod, the beryllium telescope rod and a glass rod. Bait-casting rods should be six feet long or less. Short, stubby rods are good for muskies or salt-water use. The 5½ and 6-foot rods are for bass

BAITS FOR MUSKELLUNGE: (opposite page): 36—Lucky Tail Wobbler. 37—Porky Weedless Minnow. 38—Musky Jitterbug. 39—Musky Shiner. 40—Doodler. 41—Zara-Spook. 42—Jointed Pike-Minnow. 43—Mud Puppy. 44—Musk-E-Munk. 45—Two-Timer Minnow. 46—Weazel Sparrow. 47—Daily Double. 48—Jointed Vamp-Spook.

Muskellunge

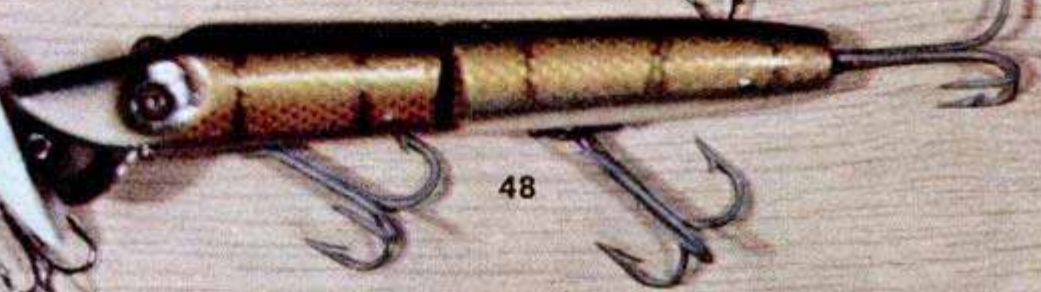
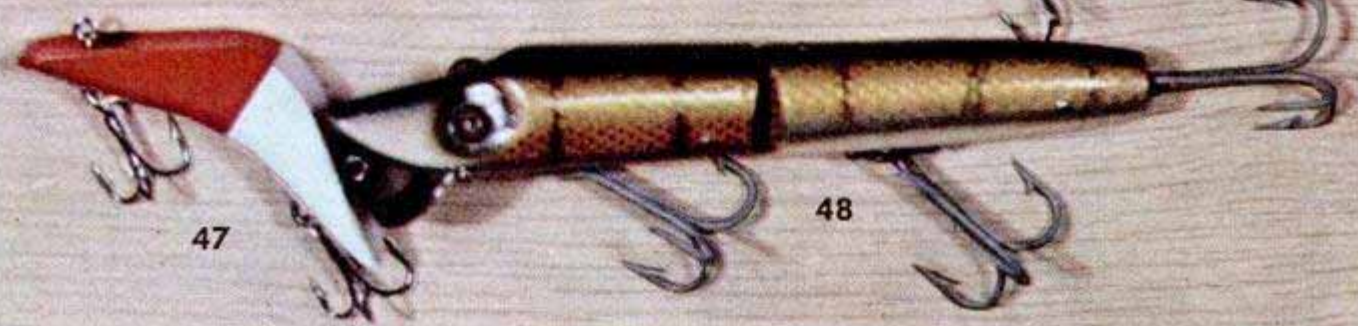
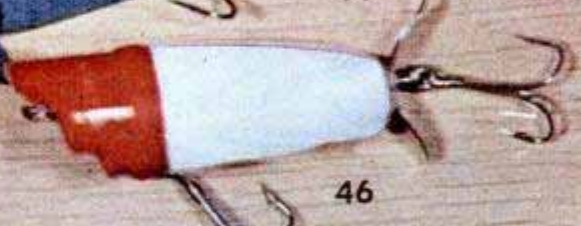
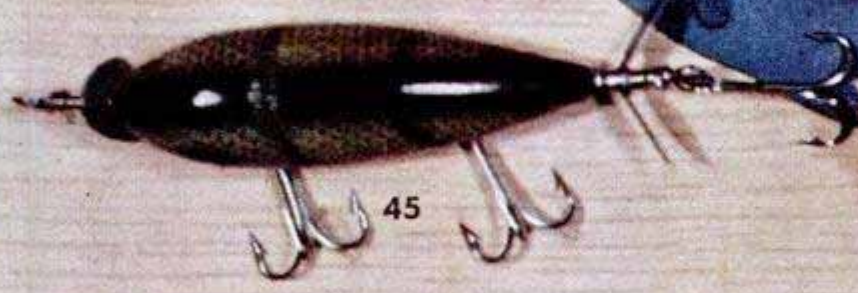
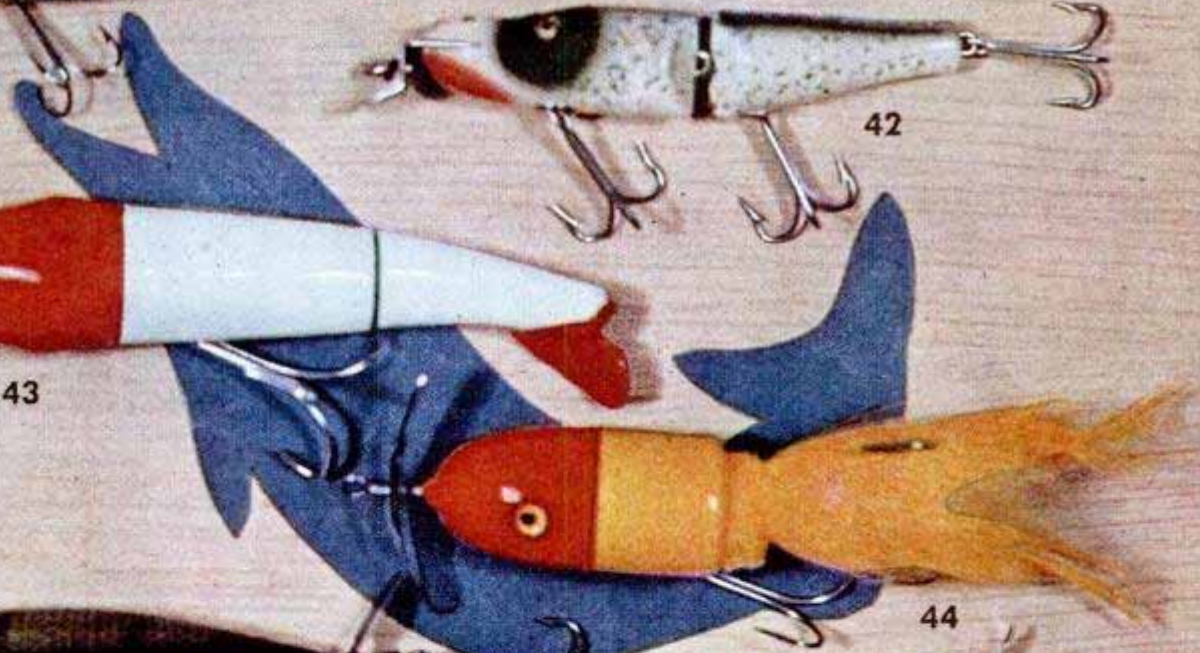
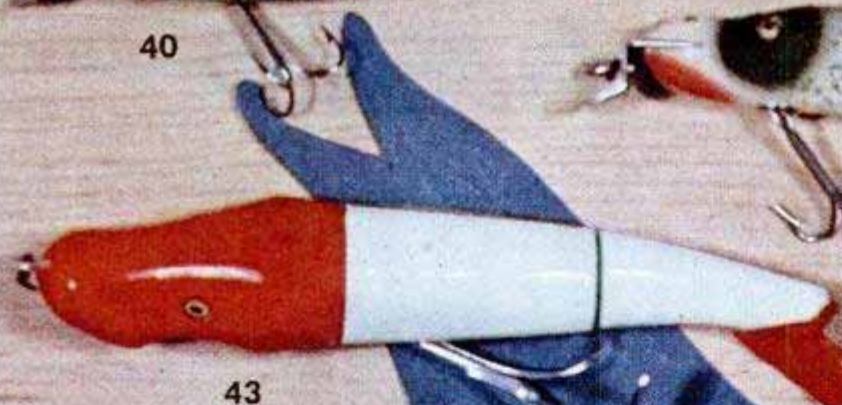
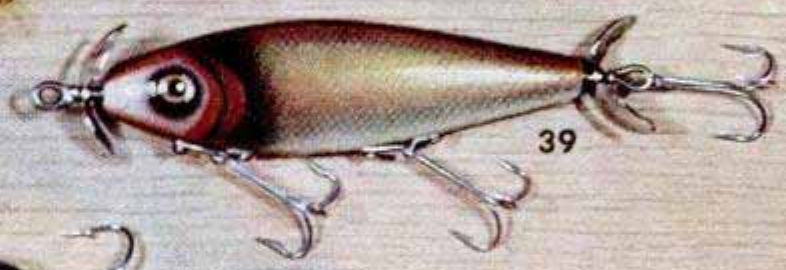
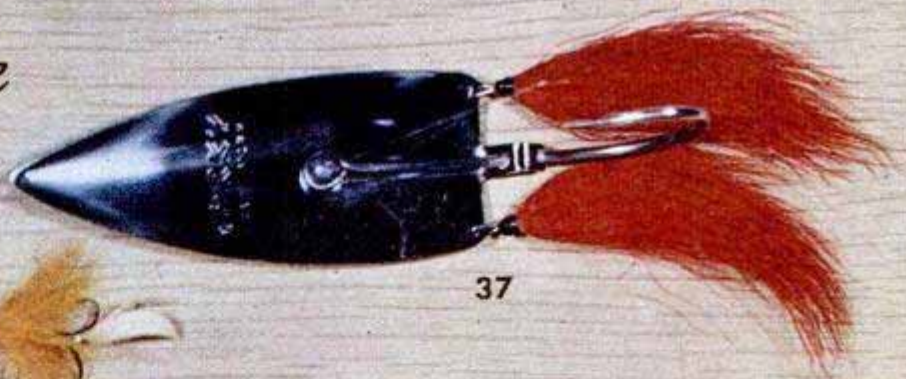

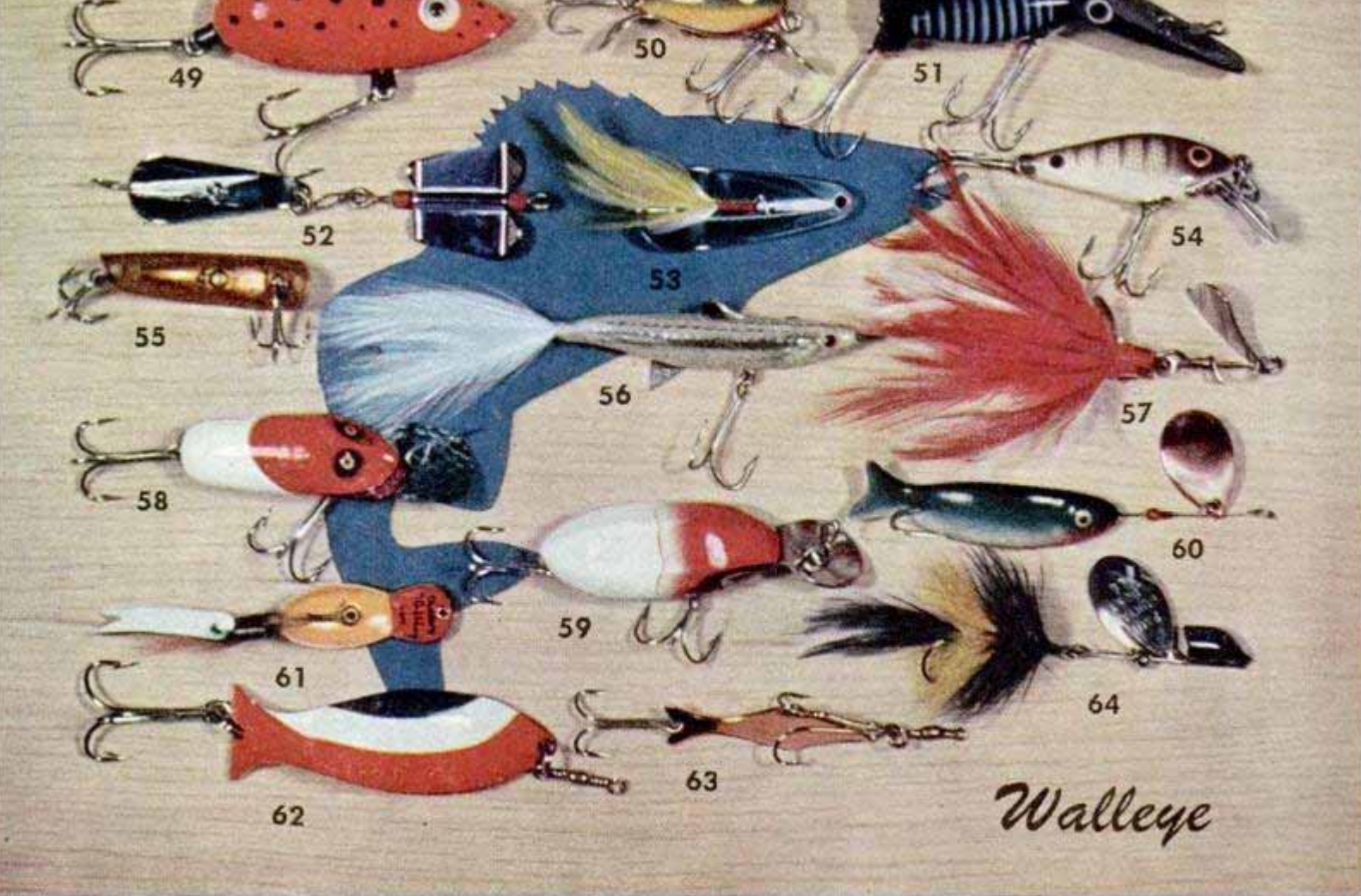

Walleye



BAITS FOR WALLEYE: 49—Aqua-Bat. 50—Dopey. 51—Hot Shot Bait. 52—Twirling Wobbl-E. 53—Rex Spoon. 54—Spot Tail. 55—Russelure. 56—Weighted Finned Shiner. 57—River Devil. 58—Dive-Oreno. 59—Bottom Scratcher. 60—Minnie the Swimmer. 61—Wobbling Bait. 62—Worth Wobbler. 63—Lur-All Wobbler. 64—Lucky "66."

fishing. The five-foot rod is most popular.

The first reel ever made was carved out of a block of wood and had a handle for turning the block. The first multiplying reel used for bait casting was made by George Snyder in 1810. He was a watchmaker of Paris, Ky., and his reel was so geared that the spool revolved four times to every turn of the handle. Jonathan Meek, B. F. Meek and W. H. Talbot came along with multiplying reels which are still in use here and there by the old-timers who enjoy the ever-increasing sport of tournament casting.

The no-backlash feature on many of the reels made today has proved to be of great help to the millions of fishermen who enjoy casting a spoon or a plug into the lily pads for their smallmouth bass. This reel makes a novice look like a professional in 10 minutes. I have a personal preference for the smaller-size reels with the level-

Gaff made in England telescopes into handle with hook protected, extends full length for a long reach



Smallmouth Bass

BAITS FOR SMALLMOUTH BASS: 65—Gizmo Bait. 66—Wonderlure. 67—Tweedler. 68—Bright Eyes. 69—The Pupette. 70—Gehf-Lure. 71—Brook's Bait No. 7. 72—Weedless Reflecto Bass Spoon. 73—Slim Eli Zebra Spinner. 74—Miracle Minnow. 75—Dipsy Doodle. 76—Lucky Tail Wobbler. 77—Babe-Oreno. 78—Jitterbug

wind feature for muskie fishing. Before you go fishing, oil your reel. Keep it in a cloth bag and then drop it in a leather container. It will last longer.

Fishing lines for bait casting once were made of twisted horsehair and braided silk, cotton and linen. Today, however, we see a great improvement in the braided fishing lines. Now they are braided of silk and nylon, and the silk lines are treated in a way that makes them more water resistant than ever before. We use the nylon line in salt and in fresh water. It's good.

The first plug was called the "200" and was carved out of wood by Jim Heddon of Dowagiac, Mich. Why he named it that no one seems to know. The story goes that he invented it while he was squirrel hunting. Resting his weary feet along the bank of a lake, he whittled a plug out of a piece of wood and tossed it into the water. A bass struck at it, so he carved another, put some hooks on it and found that it was a real bass-getter.

Later, he carved a bait similar in appearance, put spinners on it and called it the Dowagiac. This was the first underwater bait ever put on the market. Today, there are hundreds of bait makers who have imitated everything that swims and then some. There are designs resembling a swimming frog, mouse, chipmunk, duck,

Well-equipped angler carries a lightweight rod, a large net with aluminum frame, a transparent tackle box, a gaff and his own high hopes for a lucky day



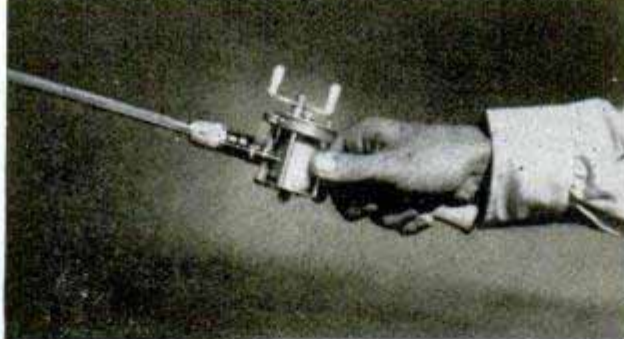

When preparing for a cast, hold the rod with the reel handles up and carry through the cast with the reel in the same position. This will give the reel its best action, as it will ride smoothly on its bearings. Note that thumb presses lightly against the spool

sucker, crab, minnow, crippled minnow and many others. The first plugs were made of white cedar but today most of them are of plastic. Never before have anglers and fish had such a choice of lures.

No part of the fisherman's equipment is more colorful than the lures he uses; in fact, since all fish are color-blind it is well known that the hues of modern baits have reached the peak of artistic perfection just to sell the fishermen, not the fish. It is presumed, of course, that fish can see shades of lightness or darkness. It is the action of the bait rather than the color that attracts the fish. All baits will catch fish under favorable conditions. Those lures which are shown in this article are only a few of the many wiggling spoons and wobbling plugs that will help you bring home the fish.

There are three definite types of lures: surface lures, near-surface lures and deep-running or deep-diving lures. The depth reached during the retrieve will vary from six inches to around four feet or more. Surface lures wiggle in. Some glide from side to side, others throw a spray of water and there are a few that require the angler to pop them in. Poppers work best when the water is calm.

Catching a largemouth bass requires a rather slow retrieve of the lure; a little faster retrieve for smallmouth bass; and much faster for white bass, walleyes, pickerel, northern pike and muskies. A bait caster gets his full reward on earth when a big game fish hits his surface lure. There is an explosion on the surface of the water and the fight is on.

Be sure your tackle box has a few weedless plugs and spoons for fishing in lily pads and weeds. And be sure your box has some lures of all sizes from those for panfish up to the muskie and tarpon size.

To be properly equipped a bait caster should have two complete outfits—one for casting lures that weigh from a half ounce up to an ounce, and the second for casting heavier lures for muskies, northern pike, tarpon, barracuda and snook. The trend today is toward smaller lures which require less effort to cast. The exception

(Continued to page 242)

HOW TO CAST A BAIT

Overhead cast is the most important and should be mastered first. Panel at left, from top to bottom, shows proper arm and rod movement to execute a good cast. At the beginning, the arm should be close to the side with forearm parallel with the ground. Then bring the rod up briskly with the wrist acting as a hinge. The movement is straight over the right shoulder. Stop the rod when the handle is straight up and immediately begin the forward cast, starting slowly but increasing the speed. Apply the thumb lightly to the spool while the lure is in flight to prevent a backlash. Keep your eyes constantly on the target and hold the rod in alignment with the outgoing line. Good average cast travels about 75 feet

Weight of Feather Twists Steel Shaft

How much force does it take to twist a steel shaft one inch thick? A supersensitive machine developed by Westinghouse has proved that the weight of a feather will do it. The twist is incredibly small and the machine measured it as less than one millionth of an inch. The twist detector consists of a steel shaft 25 inches long and one inch thick, bolted to the center of a crossarm at one end and held immobile at the other. When a weight is placed on one end of the crossarm, the shaft is twisted by an amount proportional to the weight. Sensitive electrical contacts measure the movement at the sur-

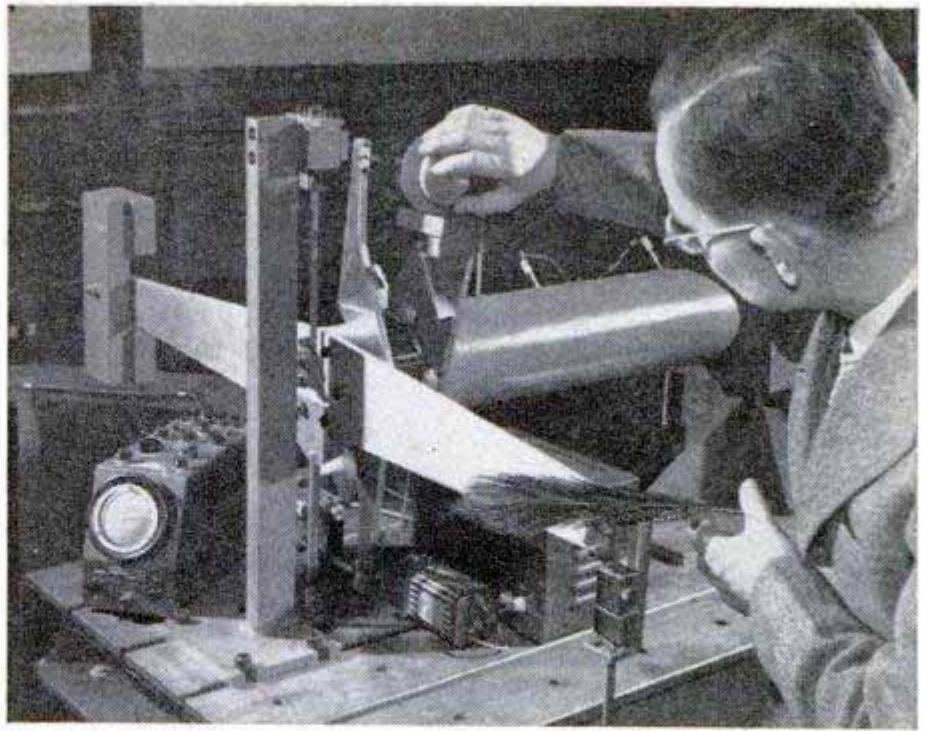

face of the shaft. The machine is used for measuring the torque of jet engines and other powerful machines.



Gates for Irrigation Ditches Control Flow of Water

Metal gates with adjustable doors control the flow of water down irrigation ditches and can be used without building dams. The doors can be locked at various openings to provide the desired flow down the irrigation ditch. Semicircular in shape and made of aluminum alloy, the gates can be moved from one location to another. They are rust and corrosion resistant and are available in various sizes to fit all lateral and head ditches. The gates eliminate the need for earth, sacks and canvas in building dams.

Saw Attachment For Electric Drill

With an attachment that fits any standard $\frac{1}{4}$ -inch drill motor, you can convert your electric drill into a portable power saw. Easily mounted on the drill, the saw attachment has a six-inch blade and an adjustable shoe that can be set to cut any angle up to 45 degrees. The lightweight attachment rips, cuts and bevels light panels and thin stock speedily. Heavier wood, up to two inches thick, can

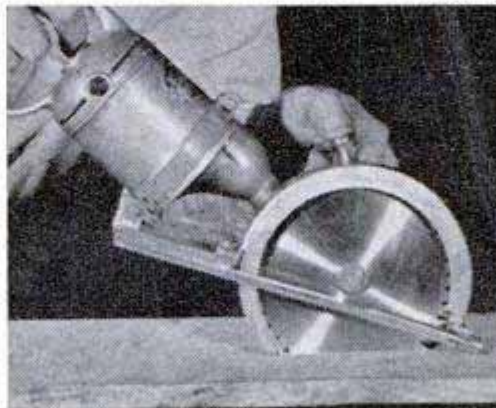

be cut, but more slowly. A control lever opens and closes the lower guard to permit the saw to enter the work at any point.

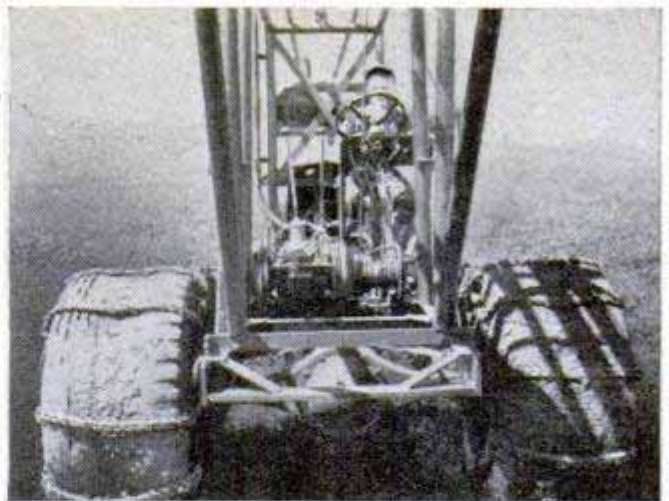
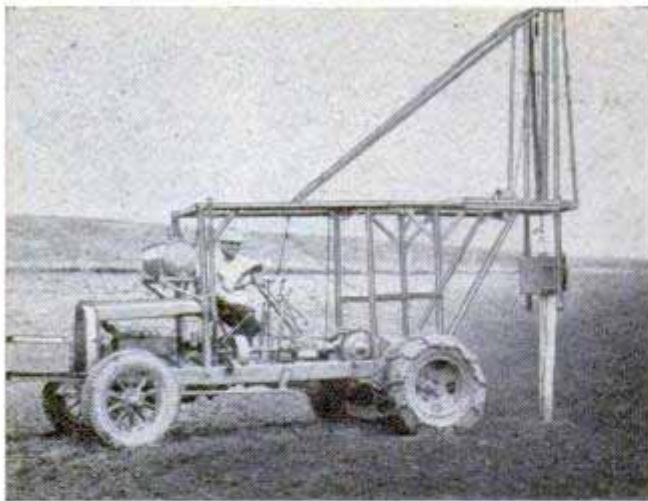

Rig Built From Scrap Drives 55 Posts Per Hour

Five blows from the 250-pound block of a homemade post driver sink a post deep into the ground. The rig, built by George Brenner of Genesee, Idaho, can drive 55 posts in an hour. Parts of a dozen different automobiles, some framing pipe and scrap metal went into the handy machine. At haying time, Brenner can replace the post-

driver attachment with a buck rake. Other simple attachments make the odd vehicle into a manure loader, dirt shovel, bulldozer or machinery hoist. The heart of the machine is the rear end of a car, cut down and installed upside down. The driving tracks can be tilted on hillsides so the heavy weight will fall straight down.

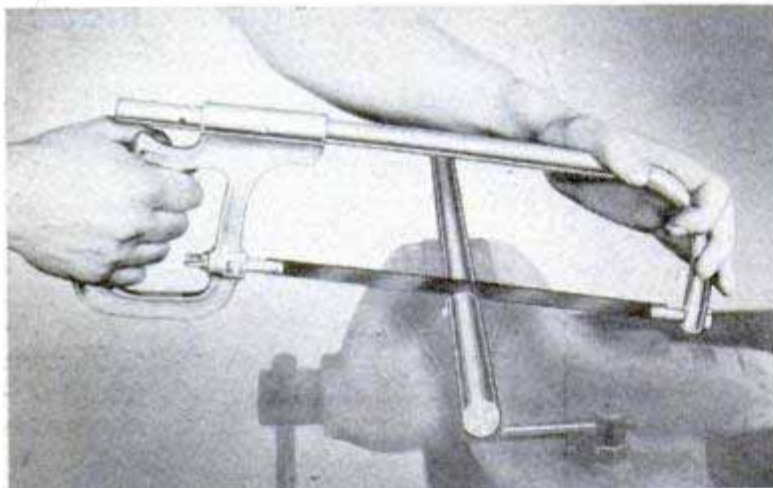

Tubular Frame on Hacksaw Ends Blade Twisting

Hacksaw blades last longer and cut more accurately in a precision-made frame that eliminates blade twisting. A curved steel tube forms the back, sliding smoothly into the cast-aluminum handle. The design prevents distortion or twist when the blade is tightened to a high tension. The frame is adjustable to take 10 and 12-inch blades and it does not collapse when blades are changed.

Electric Lunch Box Heats Food

Stews, soups and meats with gravies and sauces are quickly heated in a lunch box that plugs into an electric outlet. There is a separate compartment for cold foods. A rack in the top holds eating utensils.

Paint Has Baked-Enamel Luster

One coat of a new paint with a baked-enamel luster is all that is needed to cover old surfaces. Especially designed to provide a scrubbable finish for kitchens and bathrooms, it requires no thinning and dries in three to four hours. When used on new wood or bare plaster, it can be painted over in four to five hours. Hot cooking spatters, beverage stains and boiling water will not mar the finish. It is made in nine pastel colors and a nonyellowing white.

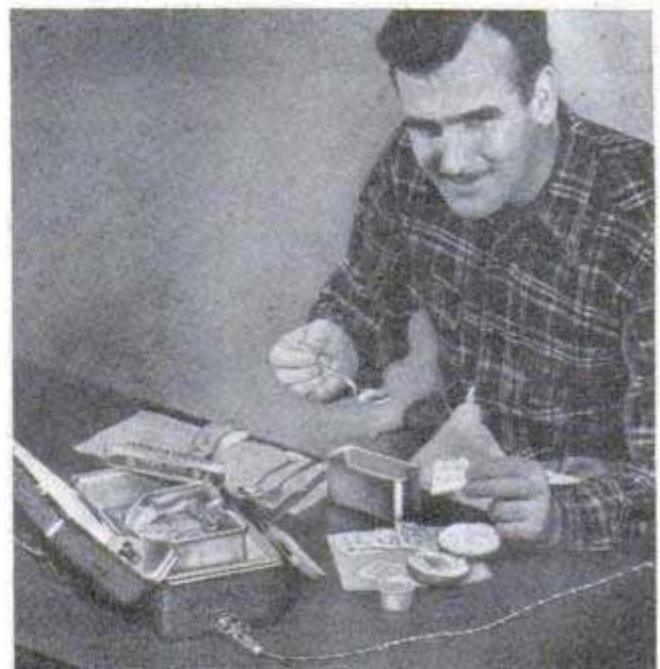

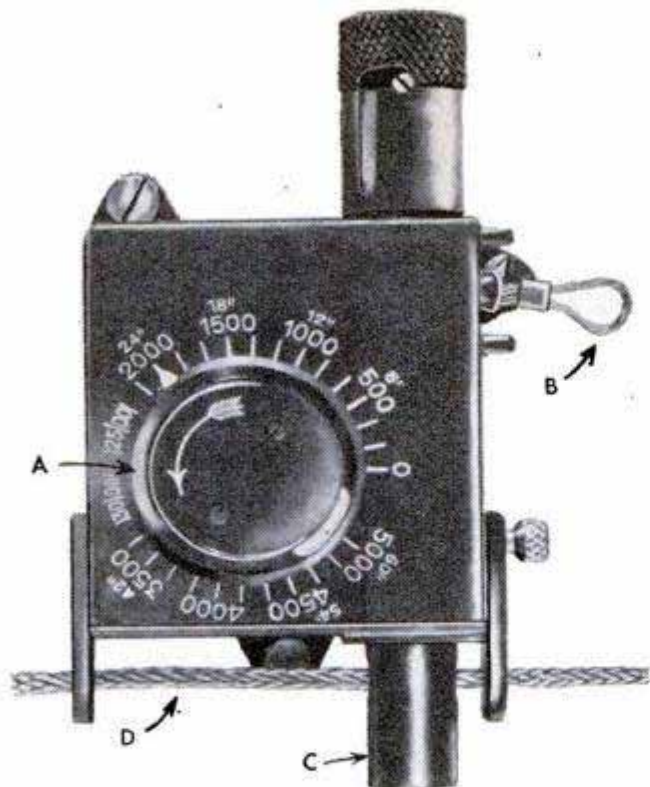

How the timepiece works: Dial A is set for the proper altitude. When parachutist jumps, loop B is pulled, starting timepiece. Rip cord D passes through tube C and a knife cuts cord at proper time to open chute

Timepiece Opens Parachute

Famed for their accurate watches, the Swiss now are making a timepiece that opens a parachute at any desired altitude, thereby eliminating the human element in pulling a rip cord. Many standard watch parts go into the instrument. When the parachutist leaps from the plane, a watch starts ticking and the rip cord passes through a metal tube. When the proper altitude is reached a small knife cuts the cord and the parachute opens.



Semipermanent Plastic Starch Makes Cottons Wear Longer

Clothes stay crisp through as many as 10 launderings with only one application of a plastic starch that requires no heating. Tests also show that the new starch makes cottons wear twice as long as they do when starched with the usual preparations. One test consisted of using the new starch on one half of a curtain and ordinary starch on the other. After eight launderings, the new-starched half was still in good condition while the other half was badly torn.

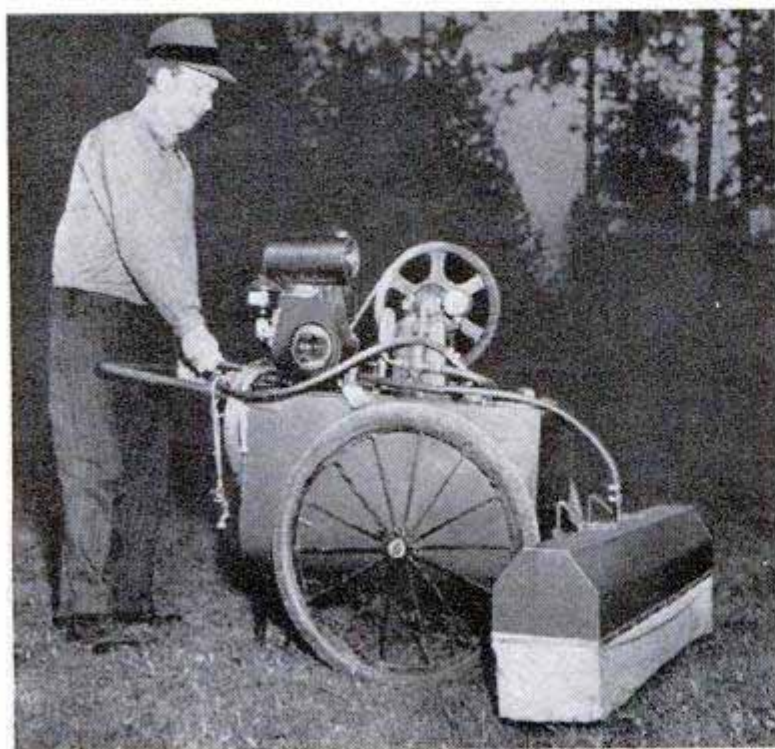

Skirted Spray Boom Protects Flower Beds

With a spray boom that is skirted to prevent dispersion of the weed killer, a Washington gardener is able to kill dandelions in his lawn with 2,4-D without damaging the adjacent flower beds. A five-foot boom containing six nozzles, spaced to give complete coverage over the strip, was mounted in front of the 25-gallon, bicycle-wheel sprayer and enclosed with a metal hood and canvas skirt that just clears the grass. The skirt keeps the spray localized, preventing it from drifting or being blown over delicate flowers nearby. A quick-action shutoff valve was installed between the handles for instant control over the spraying action.



“APPLE PIE” SOUND MOVIES

You don't have to thread or rewind film when you see and hear these movies on records

The sight-and-sound recordings are easy to play. You put on a record, press the button and the show begins



YOU SEE as well as hear recordings on a phonograph that reproduces both pictures and sounds. Developed by two Hollywood film makers, the Visatone record player brings sound movies into the home without the bother of film-threading or rewinding. Merely by placing a special record on the turntable, you can see and hear Mickey Mouse, Donald Duck, your favorite musical comedy stars and even operatic productions. Phonovision, Inc., the manufacturer, has a contract to release Walt Disney shorts in recorded form.

The secret of the sight-and-sound phonograph is a thick record that can be compared to an apple pie. The top crust of the pie is a conventional phonograph record. Beneath the top crust, where the filling would be in the pie, is an 8-mm. movie film that carries the visual half of the recording. The side and bottom, to continue the pie analogy, are aluminum.

As the record spins, the film unwinds on a horizontal plane, passing in front of an aperture in the

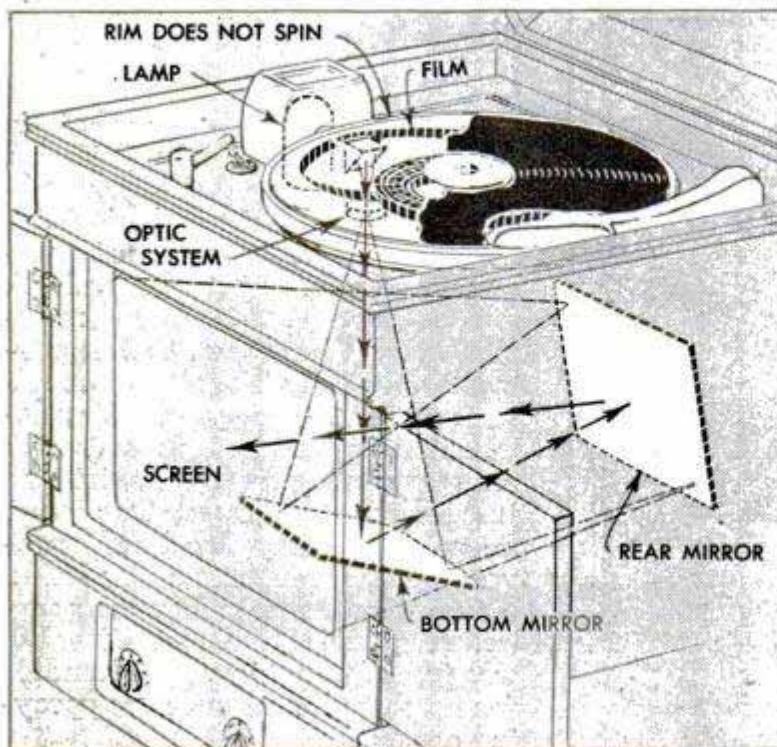

The model with the built-in screen is a complete movie theater. Arrows in sketch show how images are projected on screen

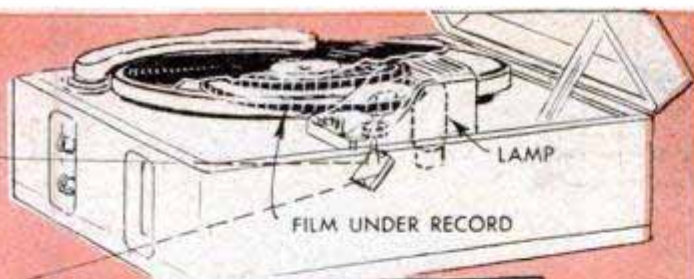

Portable model projects movies through opening in cabinet. Right, new record, top, compared with regular type

side crust, which does not spin with the record. A projection lamp shines through the side-crust aperture and then through the film, picking up the images that are projected on the translucent screen by a lens and prism arrangement. Mirrors reflect the light rays onto the screen.

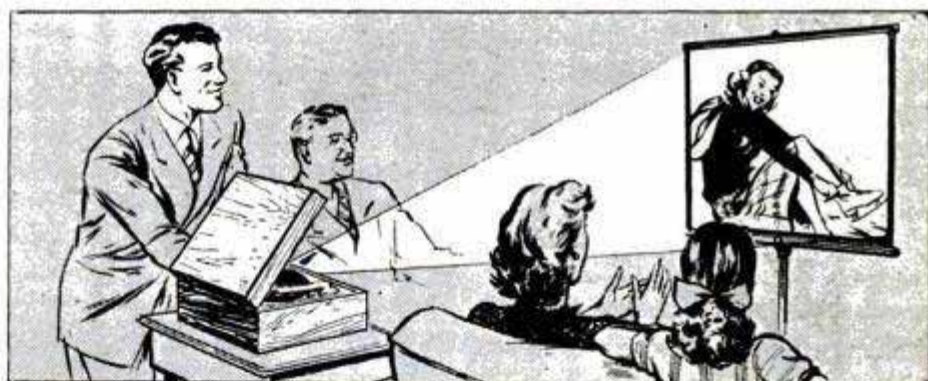

Two models are being produced. One, a completely self-contained unit, has a large screen in the front. The other, a portable model, has no screen, the images being projected against a wall or screen through an opening in the case.

You never touch the film. It is enclosed in the record away from dust and fingerprints. When the record has been played, the film is ready for another showing without rewinding.

An underside view of the portable player. The top drawing shows how this model is used

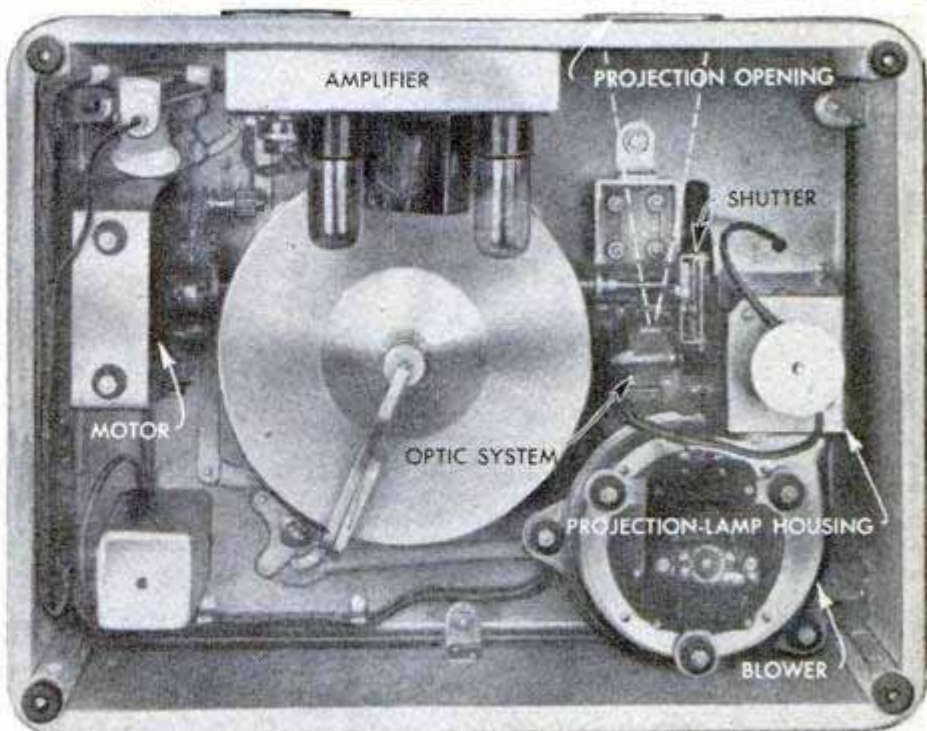



Television Verifies Checks at Bank

Signatures on checks are verified by television at the Franklin Square National Bank, Long Island, N. Y. The bank teller places the check in question over a television tube and closes the panel which activates the machine. A picture of the check

then appears on a television screen in the bookkeeping department on another floor. The bookkeeper can tell at a glance whether the signature matches with the sample signature in the bank's files. The teller and the bookkeeper talk over the phone to verify the signature, while another instrument records their conversation.



Tokyo Police Bus Acts As Mobile Lab

To make the force more mobile, Japan has put into use its first police-operations bus. It is equipped with a photo laboratory, lookout tower, public-address system, short-wave receiver and searchlights. The 9-ton vehicle is 24 feet long and accommodates 20 persons. It has been turned over to the Tokyo headquarters of the recently established National Rural Police.

Paint-Can Holder

Paint cans are clamped securely in a holder that protects all surfaces upon which it is placed. The base plate is indented to seat either pint or quart cans. A handle and clamp fasten down the can, protecting the hands from overflowing paint. The clamp also acts as a brush rest and a stripper for wiping excess paint off the brush.

Portland cement is ground so fine that about 90 percent of it will pass through a sieve with 40,000 openings per square inch—a sieve so fine that it will hold water.



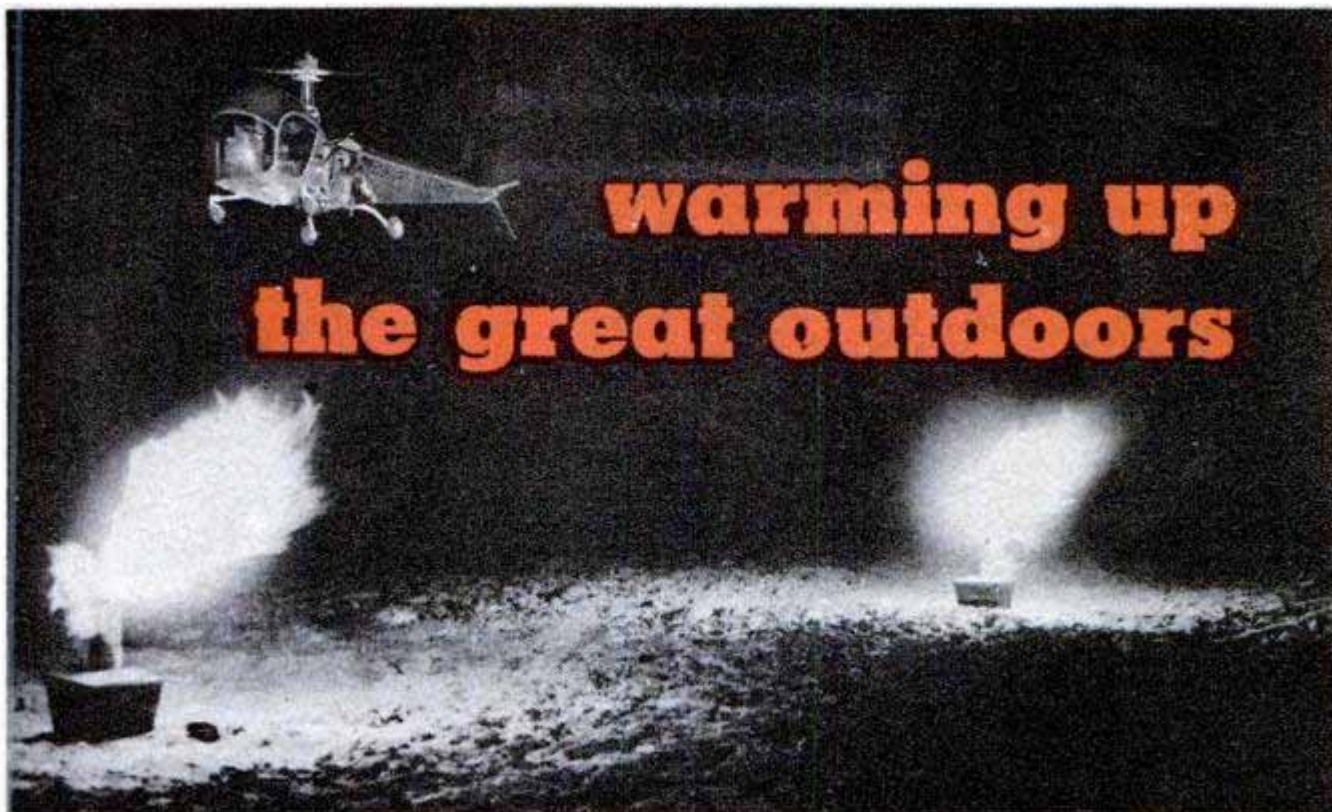

warming up the great outdoors

Its landing area lit by orchard heaters, a helicopter descends for fuel during an all-night frost battle

By Ewart Thomas

GROTESQUE infrared heaters, huge wind machines and even helicopters are helping save millions of dollars worth of fruits, vegetables and flowers that otherwise would be destroyed during unseasonal freezes or unusual cold spells.

In the North, a late spring freeze is apt to kill the tender buds of plants that are just starting to grow, while an early autumn freeze can ruin a mature crop that is about ready for harvest. In the South, es-

pecially in Florida and California, "unusual" cold weather in midwinter can damage or destroy vast acreages of citrus fruits and other semitropical plantings.

Farmers can't change the weather, but they have learned how to modify it when a difference of only a few degrees can mean losing or saving a valuable crop. One of the new protective devices is the Frostguard heat machine, also known as the Michigan heater because it was developed at the

Infrared heater looms over field of winter-blooming flowers. The small stacks in rear are orchard heaters

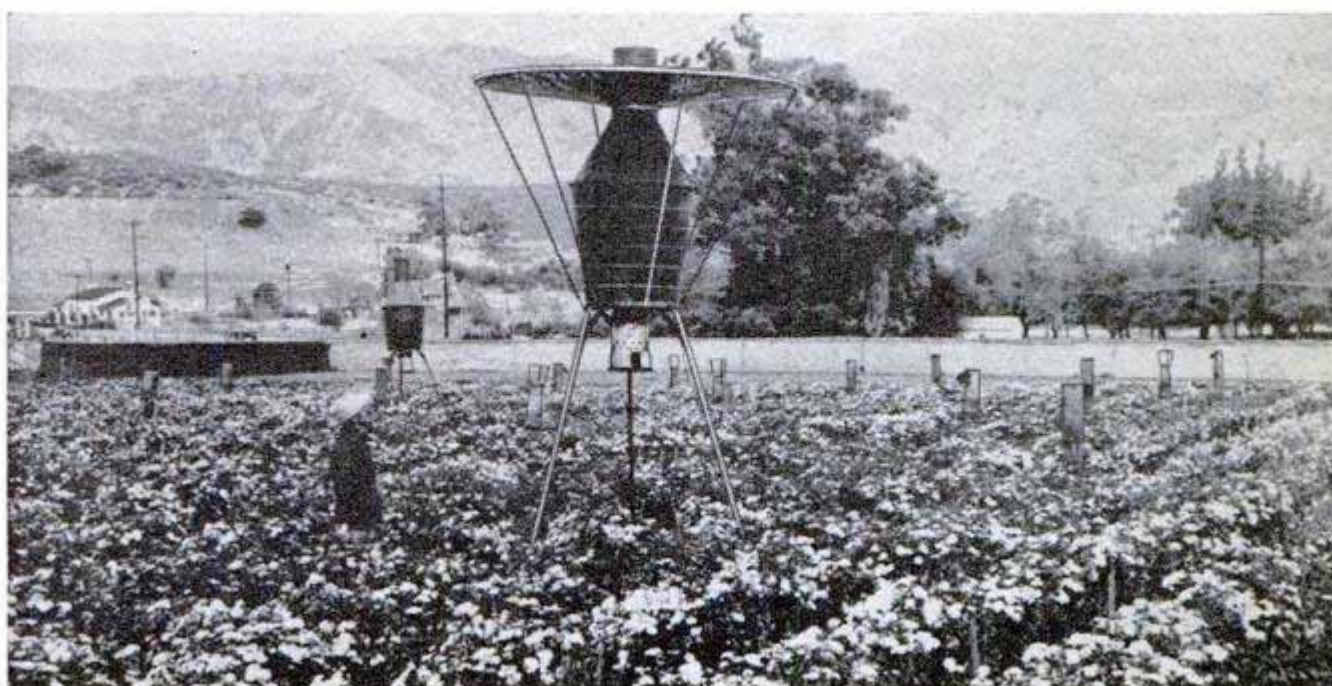

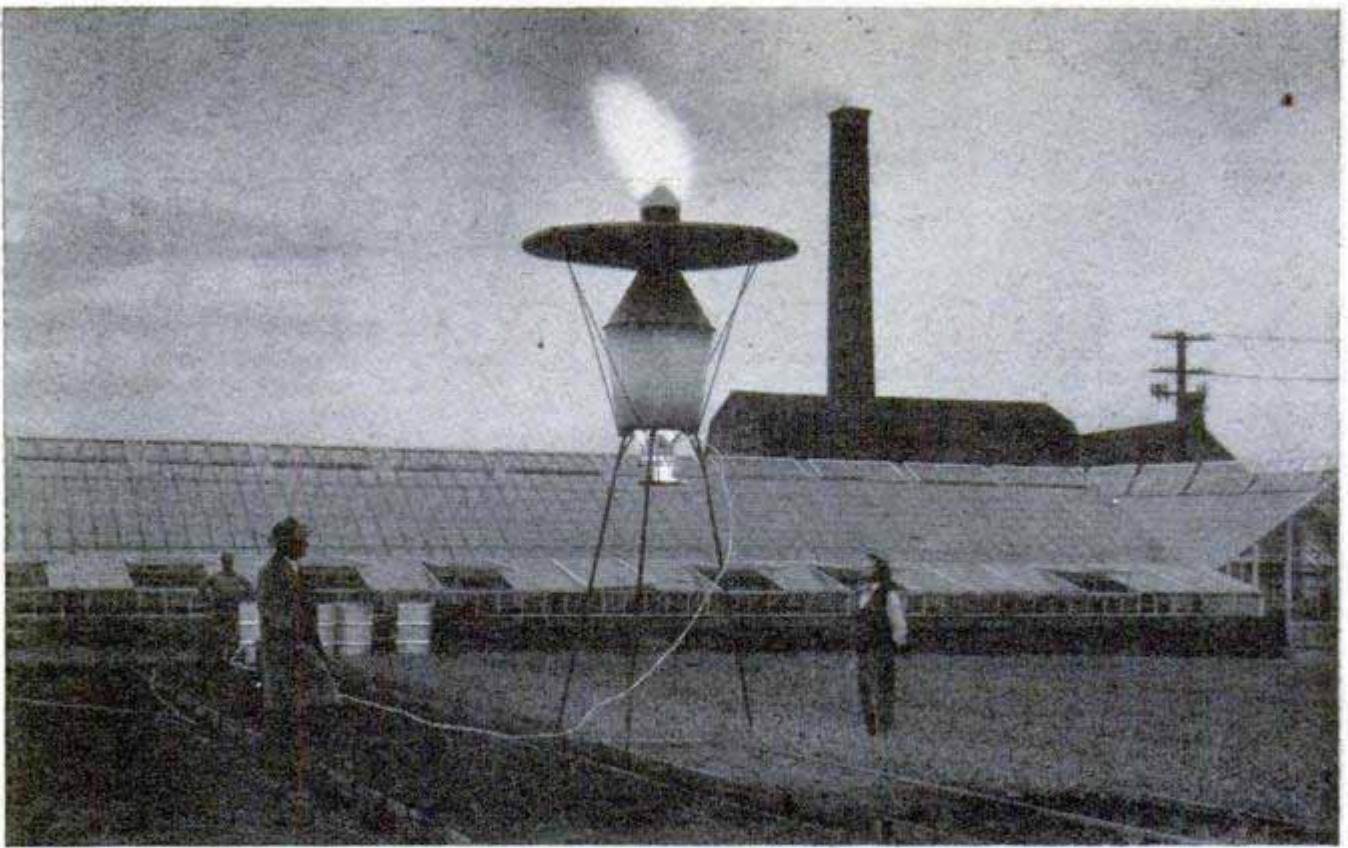

Glowing cherry red in the dawn, this infrared heater protects young plants from damage by late spring frost

Michigan State College. This apparatus keeps a crop warm on cold nights by infrared radiation.

Essentially, the heater is a round sheet-metal stove or chamber, mounted on tall tripod legs, and topped by a wide polished reflector that slants the heat rays downward. Fuel oil, pumped up to the heat chamber from a tank, is vaporized under pressure and the chamber glows cherry red in the dark. Placed out in the field, it

protects vegetation within a radius of 30 to 100 feet, depending on the type of crop and severity of the freeze.

One nurseryman who put 30,000 carnation plants out in the field a month ahead of the usual time saved them all when the temperature slumped to 28 degrees by using infrared heaters. Inside his protected plot the temperature ranged from 36 degrees to as high as 40 degrees. In West Virginia two infrared machines saved an

On cold mornings, any orchard heaters that are not needed to protect the crops are set up in nursery workshops where they provide smokeless heat



acre of currants that were coming into bloom when the temperature dropped to 25 degrees.

In the Imperial Valley in California last winter infrared heaters saved a large portion of a crop of green peppers even though the temperature went down to 12 degrees above zero. In this severe freeze the machines protected every plant within a radius of 30 feet.

Infrared heaters produce their effect by direct radiation. For best results, four or more machines are placed so that their radii overlap, strengthening the effect on plants at a distance. Beside protecting vegetables and flowers, the



In the early morning hours, orange-grove workers light smudge pots as the mercury skids below 27 degrees

heaters are used to guard against spring frost damage in orchards that are just coming into bud. They are not considered adequate for orchards that are in full leaf unless allowance is made for absorption of heat by the foliage.

The Frostguard is the most recent of a long line of outdoor heating appliances. Oldest and still widely used is the crude smudge pot that burns low-grade oil and is used principally for orchard heating, particularly in the citrus groves of southern California. The pot consists of a large oil reservoir, plus a stack or chimney, and it heats mainly by convection. It produces objectionable clouds of dense smoke but when used in numbers of up to 40 units per acre it can protect large, closely spaced orange trees in full foliage against temperatures as low as 22 degrees.

Improved orchard heaters are equipped with a return stack or with a stack ventilated by a number of openings that give the flame a spiral motion, making for more complete combustion. The improved heaters create virtually no smoke, especially when better grades of fuel are used.

Many orchards now are protected by smokeless pipe-line heating systems which consist of

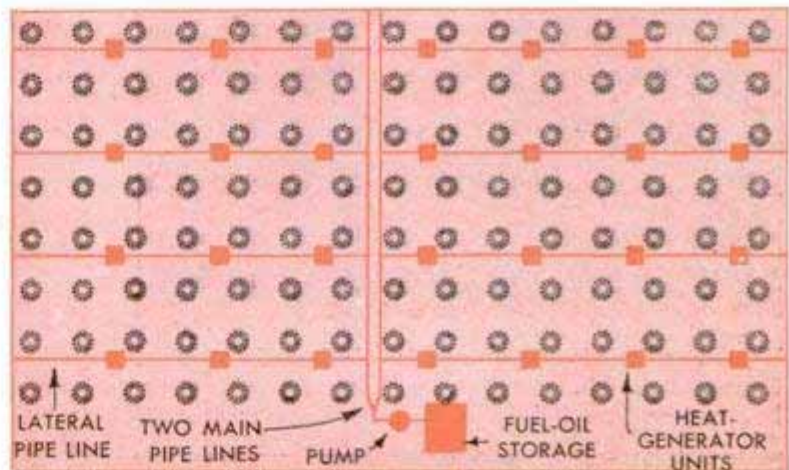

Sketch shows layout of pipe-line heating system. Below, testing a heat-generator unit such as used in pipe-line heating systems



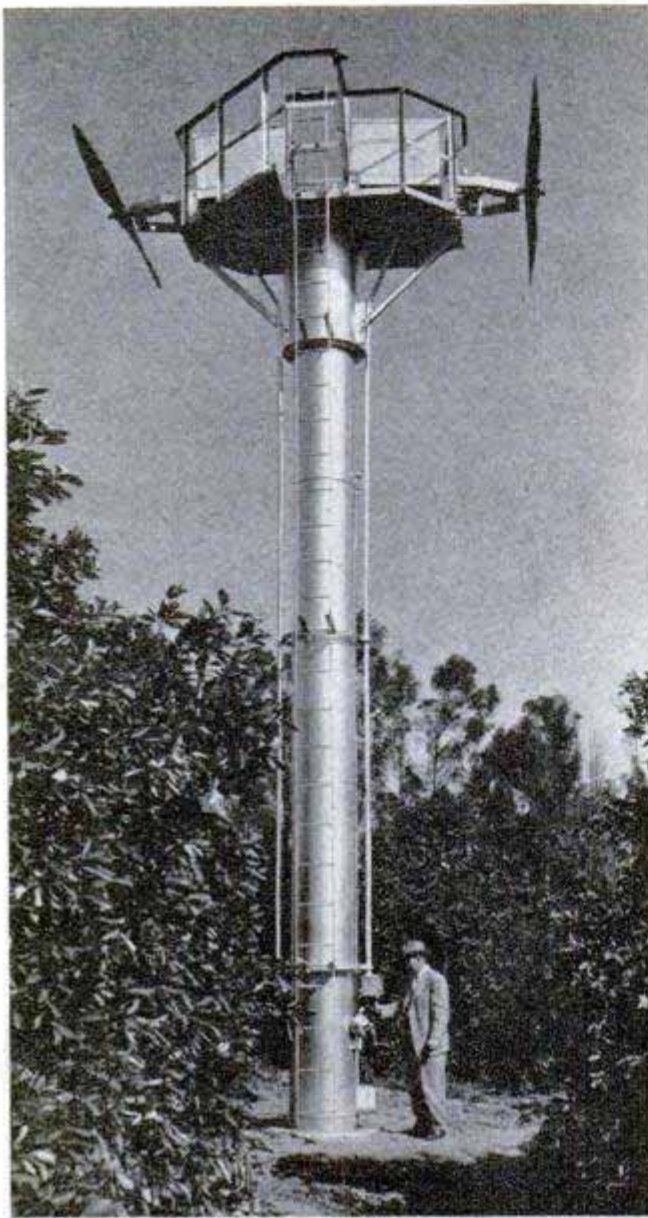

Wind machine blows warm upper air down into grove. Below, snow blanket protects fruit from mild frost, but heaters are lighted if a hard freeze threatens



many heat generators placed almost flush with the ground and connected by copper tubing to a central fuel tank. The generators operate under pressure and produce a hot, white flame of about 2000 degrees. Heating is accomplished both by convection and radiation. The pipe lines may be buried to permit between-the-trees cultivation. In noncultivation groves, the lines are merely laid along the ground.

Some orchardists and other growers have installed overhead networks of infrared electric lamps to protect against frost damage but the consensus so far seems to be that other methods are less expensive or more positive.

Fighting frost with the wind created by large overhead propellers seems silly at first thought and yet the wind machine is now an accepted and valued frost-prevention device. In fact, some lemon growers claim that because of their wind machines they now get two crops a year instead of one! The delicate blossoms that appear in the winter are saved from the frost, enabling the tree to produce a summer crop as well as the usual winter harvest.

Wind machines are valuable chiefly on still, cloudy nights when a temperature inversion exists. Under these conditions the air 30 or 40 feet above the surface may be a number of degrees warmer than the temperature at ground level. When the ground temperature drops to freezing, the wind machine blows drafts of warm upper air down into the grove or field.

One popular wind machine consists of two 100-horsepower gasoline engines mounted on top of a 30-foot steel column. Each engine drives a 12-foot steel propeller at 900 revolutions per minute. Both propellers are tipped down seven degrees from horizontal and the whole engine platform rotates, making one revolution every nine minutes. Fuel is stored inside the support column and engine starters and controls are at ground level. One machine for each 18 acres of oranges, on the average, can raise ground temperatures from two to four degrees under the right conditions.

Similarly, electrically driven wind machines are mounted about 30 feet above ground. They use motors ranging from 10 to 100 horsepower, depending on the propeller size and the speed at which it is driven. Most electric machines turn themselves on automatically.

About 1500 wind machines are in use, mostly in southern California citrus areas. Other machines on the West Coast furnish protection against spring frosts to almonds, avocados, grapes and pears. In New Jersey they are used to protect holly and other specialty crops.

(Continued to page 266)

First "Aussie" Car Built in One Model

Australians will soon be riding in their first "home built" car as mass production of the Holden gets under way in General Motors-Holden's Ltd. plants. The car is being built only in one model, a four-door five-passenger sedan, and it is said to travel 30 miles on an American gallon of gasoline. The Holden has an overhead-valve, six-cylinder engine with a rating of 21.6 horsepower and a development of 60 brake horsepower. Curb weight is only 2200 pounds, a low figure for a sedan of 103-inch wheelbase, 172-inch over-all



length and a height of 61 $\frac{11}{16}$ inches. The transmission is conventional and the brakes hydraulic.

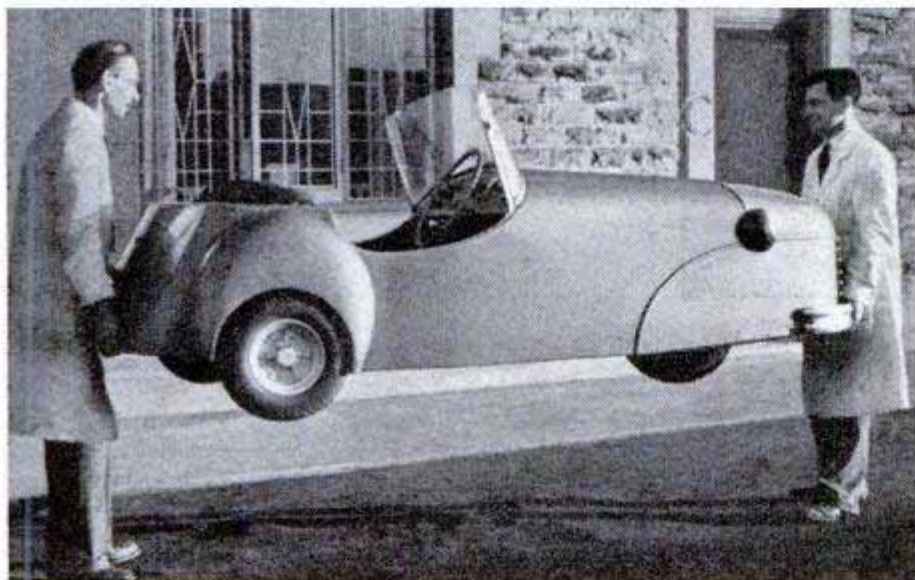

Midget British Auto Weighs 195 Pounds

Parking a new British automobile is simple—you can pick it up and place it in the tightest space because it weighs only 195 pounds. A three-wheeler, the Mini-car travels 100 miles to the gallon and costs less than \$800. Its single-cylinder engine gives it a maximum speed of 40 miles an hour. It will hold two adults and one child without crowding.

Suitcases for Car Built Into Trunk

Two suitcases are built into the rear compartment of the new English Bristol car. The suitcases provide maximum space while keeping the contents neat and clean. They are held in place with straps. The car was exhibited at the International Motor Show in London recently.

☞ Climbing 7 $\frac{1}{2}$ miles in 7 $\frac{1}{2}$ minutes, a British Beryl-Meteor twin-jet fighter set what is believed to be a record for both piston and jet planes.



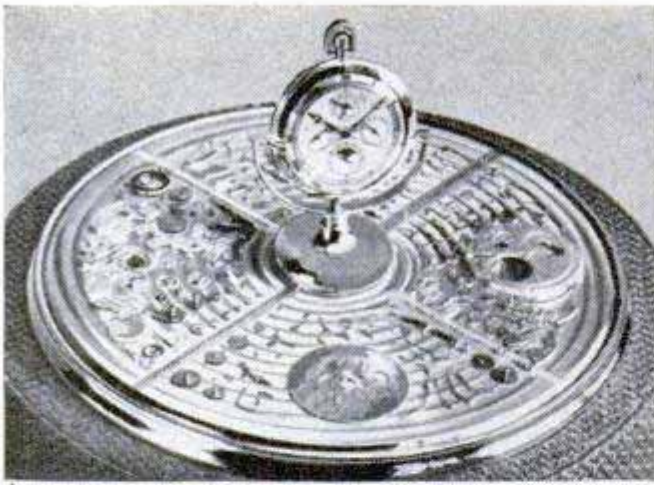

With 900 parts, this watch, shown assembled and disassembled above, is called the world's most complex

Another unusual timepiece, the slender Swiss watch below is thin enough to fit between teeth of comb



Rare Watches

So thin that it will fit between the teeth of a comb, a man's pocket watch has been produced by Swiss craftsmen. Another Swiss watch, called the most complex in the world, contains 900 parts. It has two faces and tells you the hour, minute, second, day, month, year and moon phase.

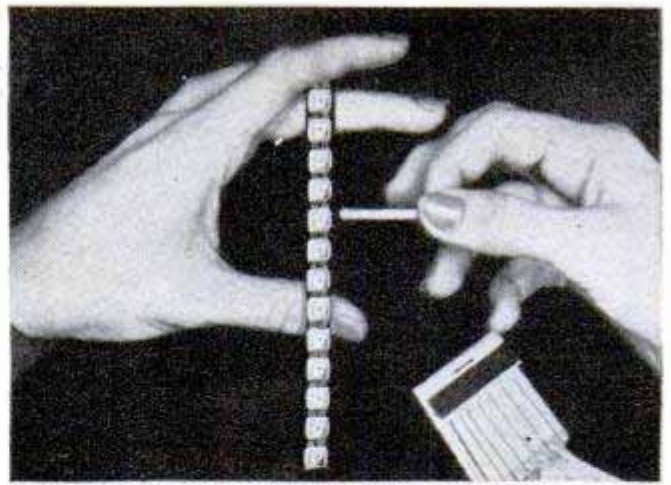

You need good eyes to tell the time on this midget watch, the face of which is as tiny as a match head

Below, accountants and engineers will like this two-purpose watch that has a slide rule around its dial



There is a stop watch built into the movement and the calendar mechanism automatically adjusts for leap years. A third unusual model is a tiny watch scarcely larger than a match head. One novelty-minded Swiss made a wrist watch that has a precision slide rule built around its dial. It is designed for architects, accountants, engineers and scientists.

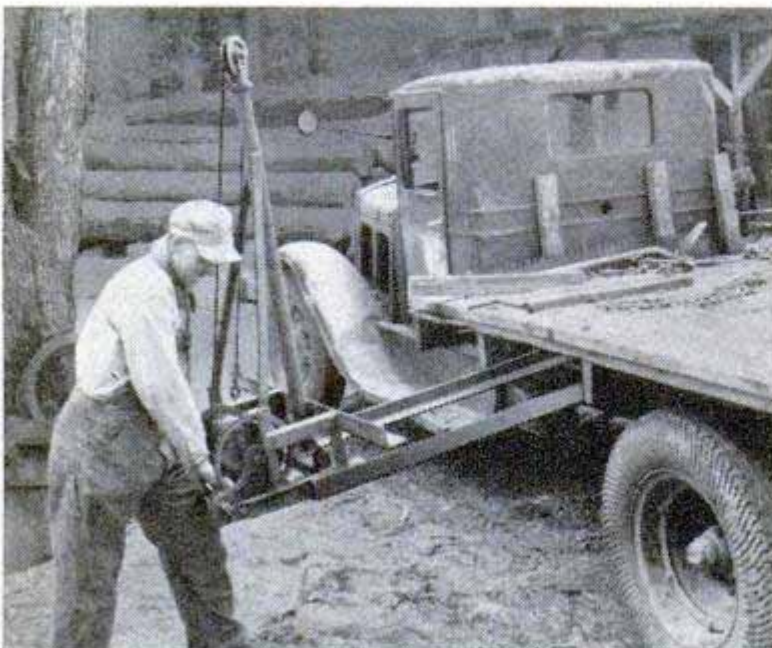

Log Loader

Loading huge logs on a truck is a one-man operation when he's using a loading device built by an Indiana sawmill operator. The loader is supported by two horizontal angle irons that fit under the truck bed between the cross-pieces. A hand winch, which can be cranked from either side, winds up the cable dragging the attached log onto the floor of the truck from the opposite side.

Many of the products described in this issue are already commercially available. For information concerning manufacturers' names and addresses, turn to the WHERE-TO-BUY-IT INDEX, page 10

Fishhook Extractor

Anglers now can remove their fishhooks without even touching the catch. An extractor releases the hook when a trigger is pulled. Holding the line about a foot from the fish, the fisherman inserts it in a guide on the extractor. He then pushes the extractor down the line until it reaches the hook. When the trigger is pulled, a pointed rod holds the fish while the hook is forced in the opposite direction.

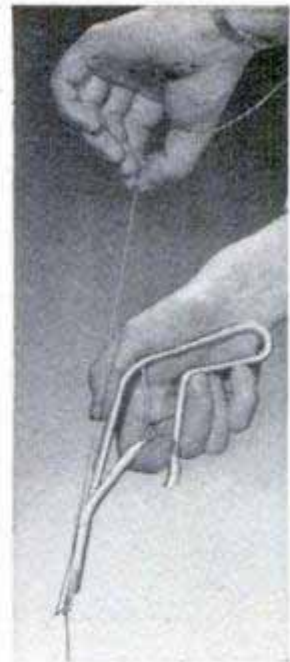

Electronic "Traffic Cop" For Building Elevators

Control of elevator movements in a busy office building can now be handled by an electronic "traffic cop" that adjusts to compensate for periods of heavy loads. Normal waiting time is reduced to 30 seconds or less under normal conditions. During rush hours, electronic circuits time each call and if, after 60 seconds, the caller has not been picked up, the control unit dispatches a car di-

rectly to that floor. This is especially important during noon and night rush hours when most movement is downward and customers waiting on lower floors are passed up by filled cars. The control can be set to any one of six patterns, depending upon the traffic conditions of the moment.

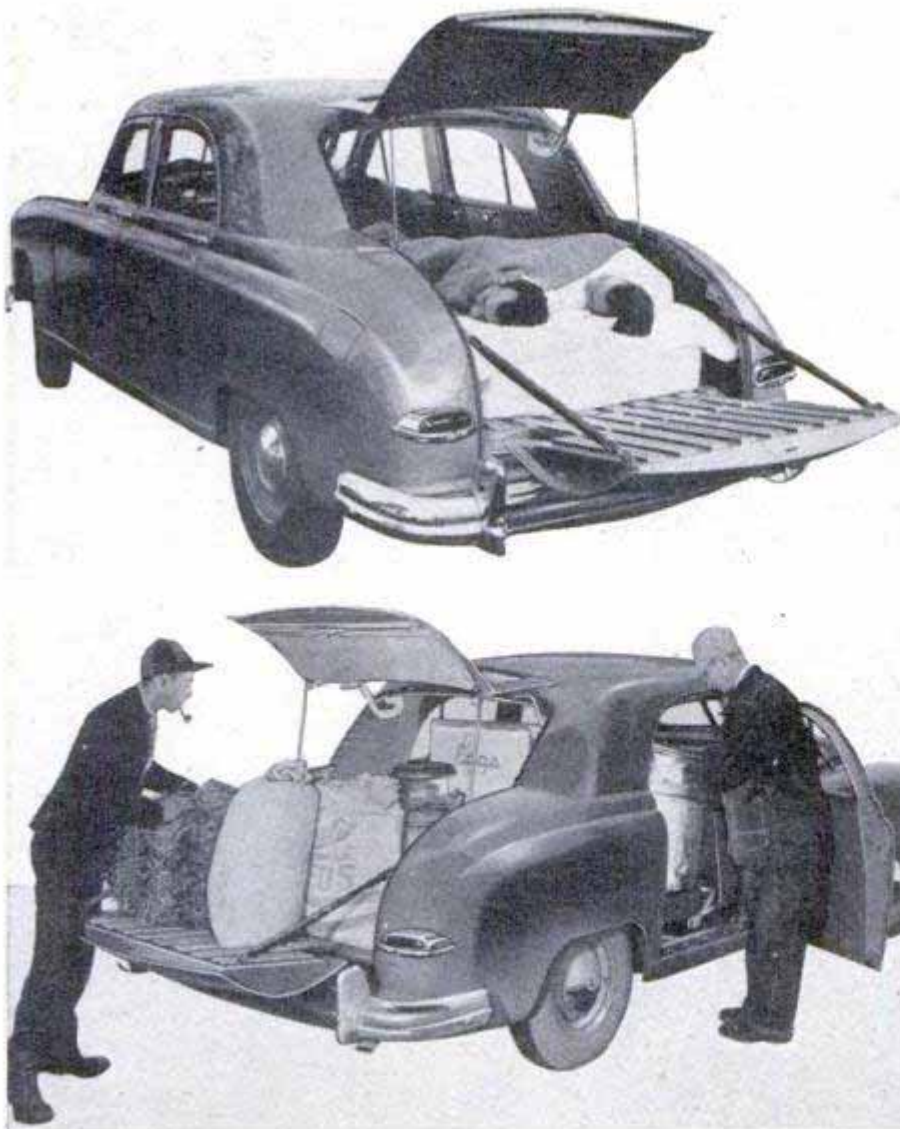

Rear Seat Lifts Out Of "Cargo" Sedan

In 10 seconds the new Kaiser Traveler can be changed from a six-passenger sedan to a station wagon. Key to the conversion is a collapsible rear seat which can be removed to accommodate up to 94.5 cubic feet of cargo. The floor space provided is 92 inches long and 46 inches wide between the wheel housings. Two hinged body panels, one lowering to become a tailgate, make it possible to open the entire back end of the car for easy loading. Even with the back seat in place, there is still nearly three times more usable space at the rear than there is in conventional four-door sedans. It comes equipped with heavy-duty springs.

Motorcycles use special four-foot parking stalls, complete with meters, in San Diego, Calif.

Rocket



Stake fastened to the rocket motor plunges deep into the ground, providing a strong anchor that could be used with breeches buoy

EXPERIMENTS are under way that may lead to the use of small rocket motors for firing steel cable ashore from ships in distress. One method of firing rescue lines by rocket has already been tested by the Coast Guard, which must approve all life-saving equipment used on Uncle Sam's merchant vessels.

In one experiment, a 3.25-inch Navy rocket zoomed out 1171 feet, carrying along a

self in the earth or takes hold in bushes or trees, providing a strong anchor for the line. After the stake is secure, the cable could be rigged for a breeches buoy to take ashore a crew member who would then make the line permanently secure for his mates to follow.

In the case of a ship in distress on the open sea, the rocket could be fired either from the helpless ship or from a rescue

Setup for firing the cable-carrying rocket is simple. Note the way the steel cable is coiled in the reels

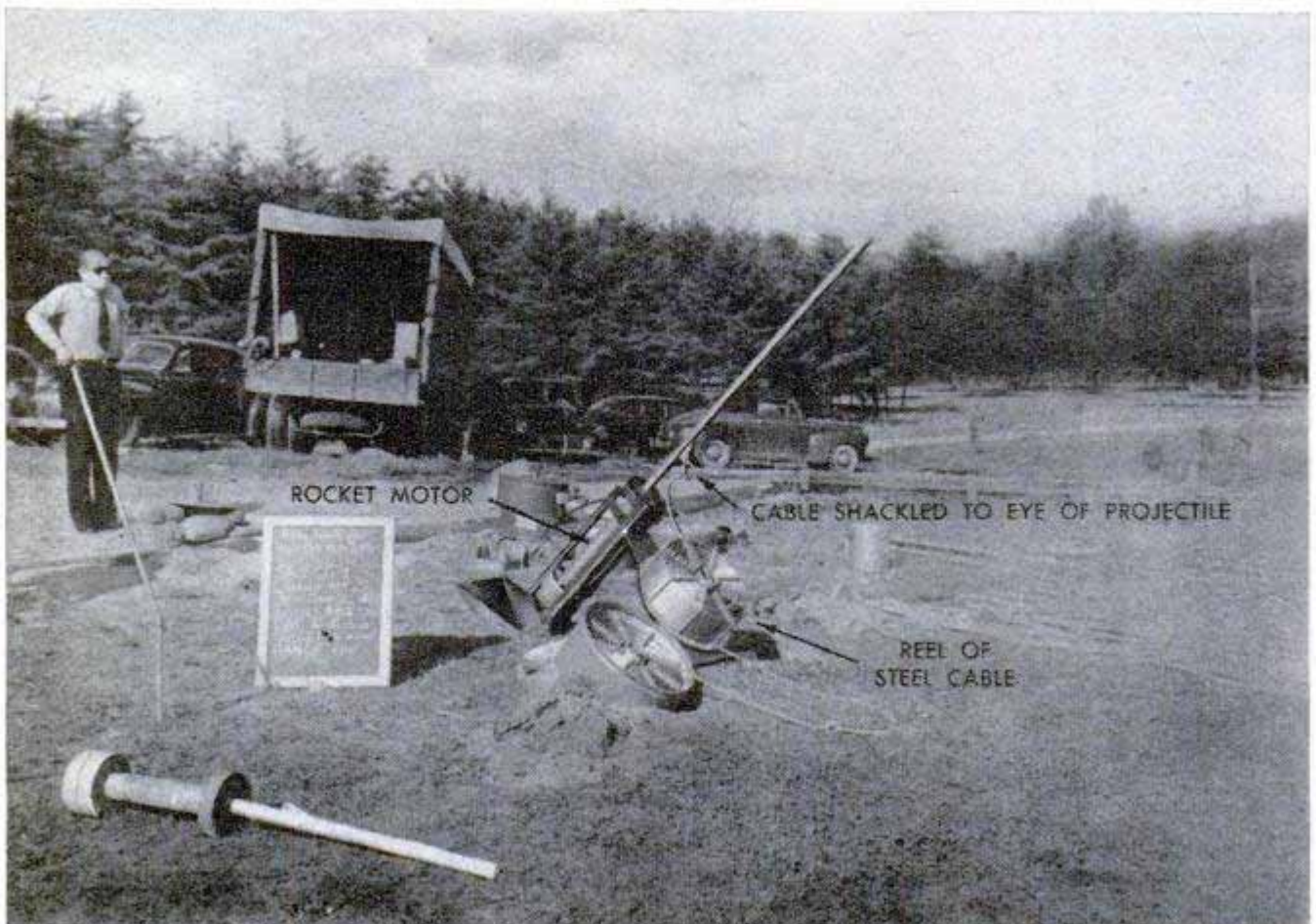

Fires a Rescue Line

craft. Then a towing hawser could be hauled into place.

The preliminary tests showed that rockets can carry the line successfully with reasonable accuracy. Its proponents hope that some form of rocket propulsion will replace the traditional Lyle guns used since 1870 for shooting light lines. These guns can handle only a 500-pound-test line, which requires that successively heavier lines must be pulled over until the giant hawser can be transferred. A major drawback of this method is that ships, often in a heavy sea, must remain in dangerous proximity for a considerable time. The shoulder gun, used on smaller ships, throws a very light line, lengthening this period.

The tests indicate that rockets, too, have their drawbacks, some of which will have to be overcome if rocket projectors are to be accepted by the Coast Guard. The cost of a rocket is about 20 times that of operating a Lyle gun, a factor that could be disregarded if only rescue operations were involved, but must be considered because of the large number of practice shots required and the amount of equipment needed for refitting each ship and shore station. Another objection is that personnel

must stay at some distance from the launcher when the rocket is being fired because of the blast of hot gases. However, the rocket can be fired electrically from a remote point as simply as setting off a photographer's flash bulb.

The Testing and Developing Division of the Coast Guard has been conducting studies of many different line-throwing techniques. Rifles, mortars, rockets and pulse-jets all are possibilities. Each has its good points and its limitations. According to Commander R. T. Alexander, Chief of the Division, "The present thought is that a combination missile brought to high speed by a propellant explosive such as smokeless powder or cordite with a rocket or jet booster that cuts in after the projectile has attained speed may be most practicable."

Cable-carrying rockets also have been proposed as anti-aircraft weapons. They could protect key points from low-level strafing, as did the cables hung from barrage balloons during the war. The rocket installations can be concealed easily and the rockets fired at a moment's notice to a height of 500 feet for a total duration of 10 seconds. The cables might bring down aircraft or at least divert bombing runs.

Rocket zooms away from the launcher, this time carrying two 1/8-inch cables with their ends fastened together



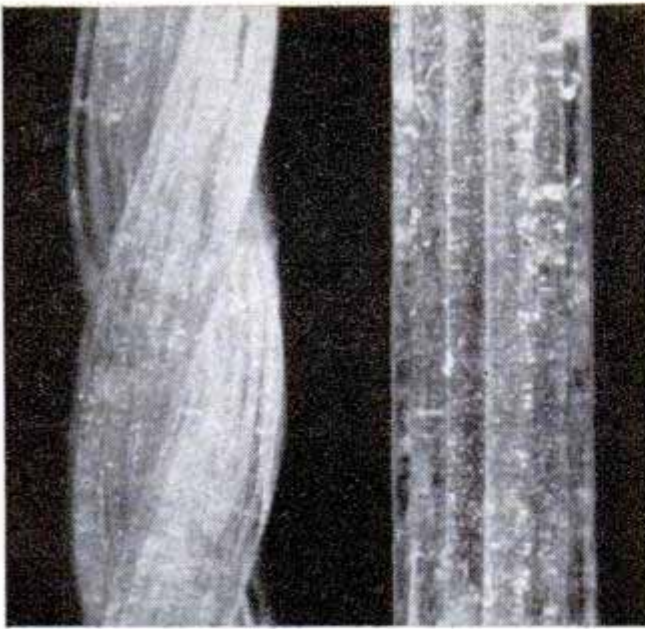

Thread at right is made of fibers welded together without a twist. At left is a conventional thread

Nontwist Thread

Thread made of several nontwisted filaments won't kink, snarl, split or ravel. The new thread eliminates the spirals and ridges of conventional threads and may be made of almost any kind of fiber, either synthetic or natural. Although no details of the manufacturing process have been released, the manufacturer states that the thread is neither coated nor resin-treated, but consists of fibers welded together without a twist. The first commercial thread produced by the process is made of nylon and is called "nymo."

☐ Traffic lights in Hayes, England, have been synchronized with a talking device to repeat at intervals: "Now, children, mind how you cross."

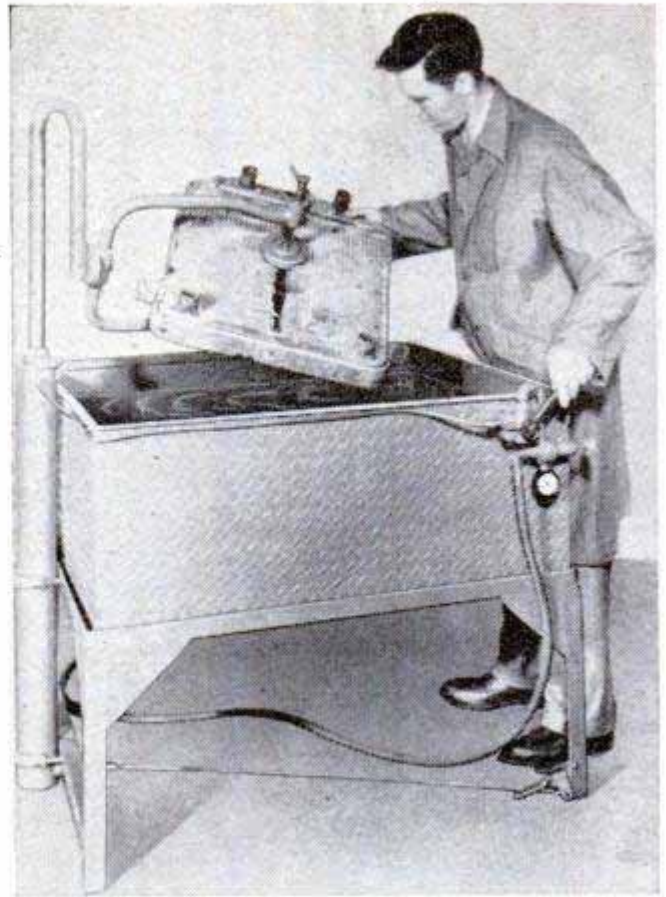

Combination Hoist and Tank Speeds Radiator Repairs

Automobile radiator repair work is speeded and made less tiring by an adjustable stand that holds the radiator firmly and moves it in and out of the test tank by an air-operated lift. Rubber pads on the clamps protect the radiator fins from damage. Movement is controlled by either a hand or foot lever. The radiator can be rotated 360 degrees either above the tank or in it. The limit vertical movement is 24 inches.

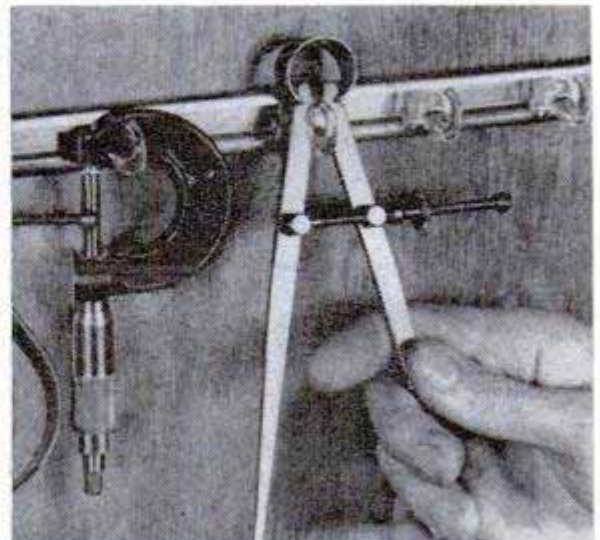
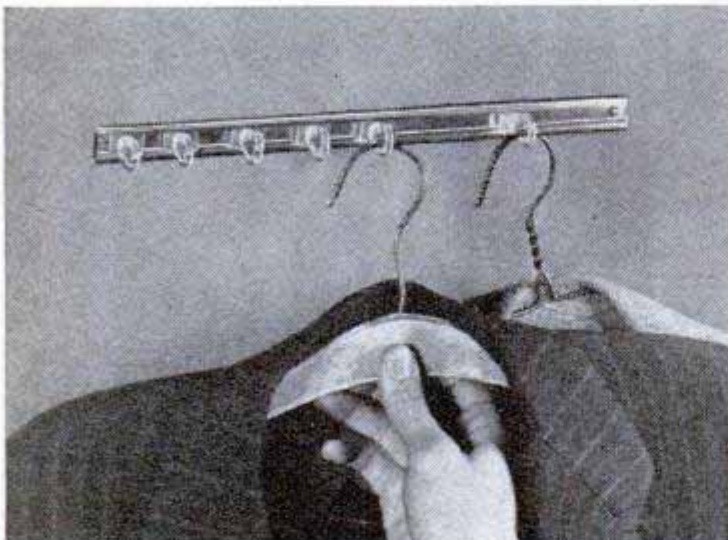

PLASTIC HOOKS THAT SLIDE IN A METAL TRACK provide an adjustable arrangement for hanging anything from tools to clothing. The hooks have a capacity of 15 pounds each. The stainless-steel track can be mounted vertically on a wall or horizontally on the underside of a shelf as it would be for hanging cups in a china closet. Several foot-long sections of track can be butted together if a longer track is desired

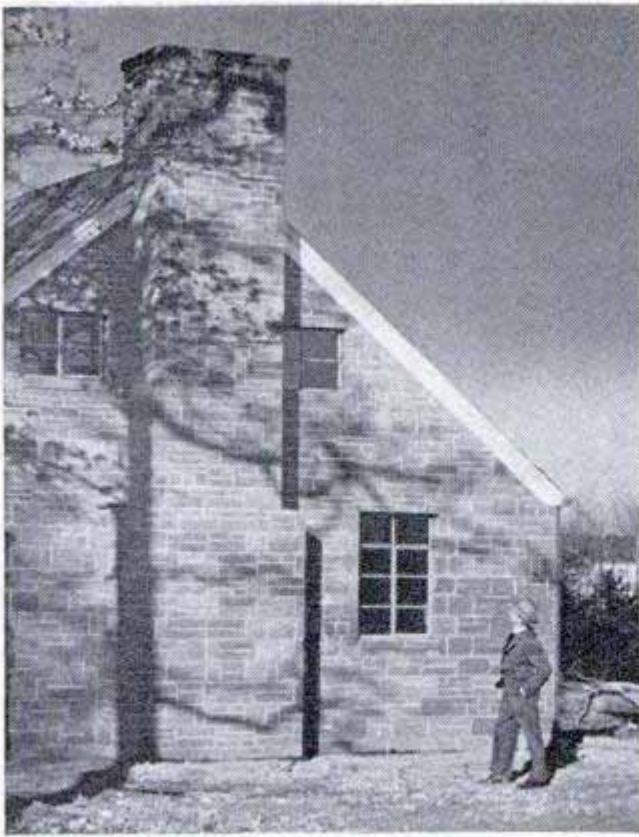

"Stone" Blocks of Concrete Cast in Shaped Molds

Walls that appear to be made of cut stone can be erected with concrete blocks that are tamped in a standard block machine with a special die. The blocks give the effect of stone at much less cost than real stone. The molds produce a variety of textures on the outer surfaces. The blocks then are tinted with several metallic colors, which have proved permanent. Some blocks are grooved to simulate several small pieces of stone, and the grooves are covered with light mortar. Others are grooved for steel sash, or are cast as keystone blocks for doorways and in other shapes. The blocks come in three sizes, 8 by 8 by 8, 4 by 8 by 16 and 8 by 8 by 16 inches.

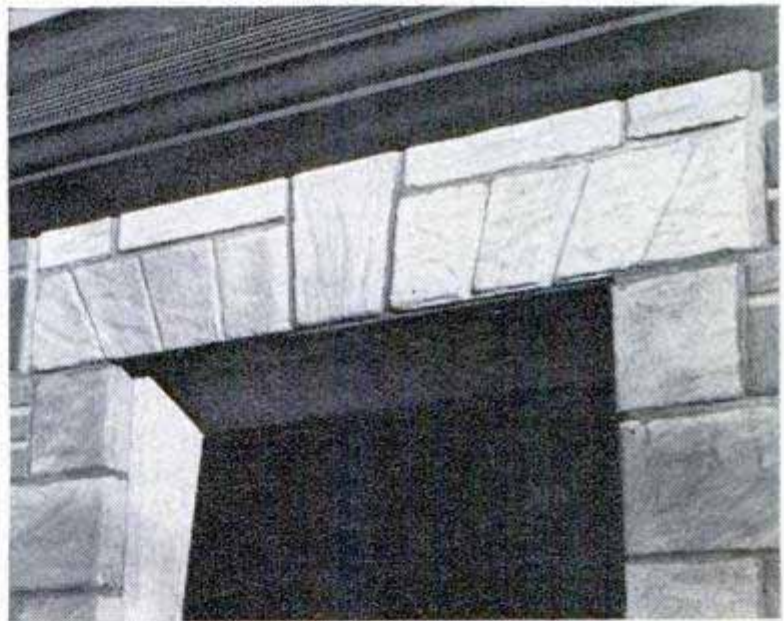

Top, left, when tinted with metallic colors and used in a building, the concrete blocks appear to be cut stone. Top, some of the irregular-textured blocks have grooves to simulate mortar lines. Above, special keystone blocks are cast for doorways

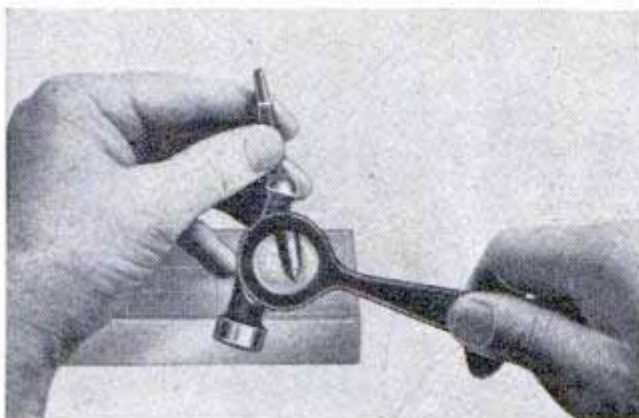

Hammer Has Magnifier Built Into Head

Precise spotting of punch marks is speeded by a hammer that has a built-in magnifier. The seven-power lens is mounted in the head of the hammer and eliminates the usual looking away that results when separate glass and hammer are used. With the new hammer, which weighs only four ounces, the punch can be spotted exactly and then struck without the worker having to look away from his work.

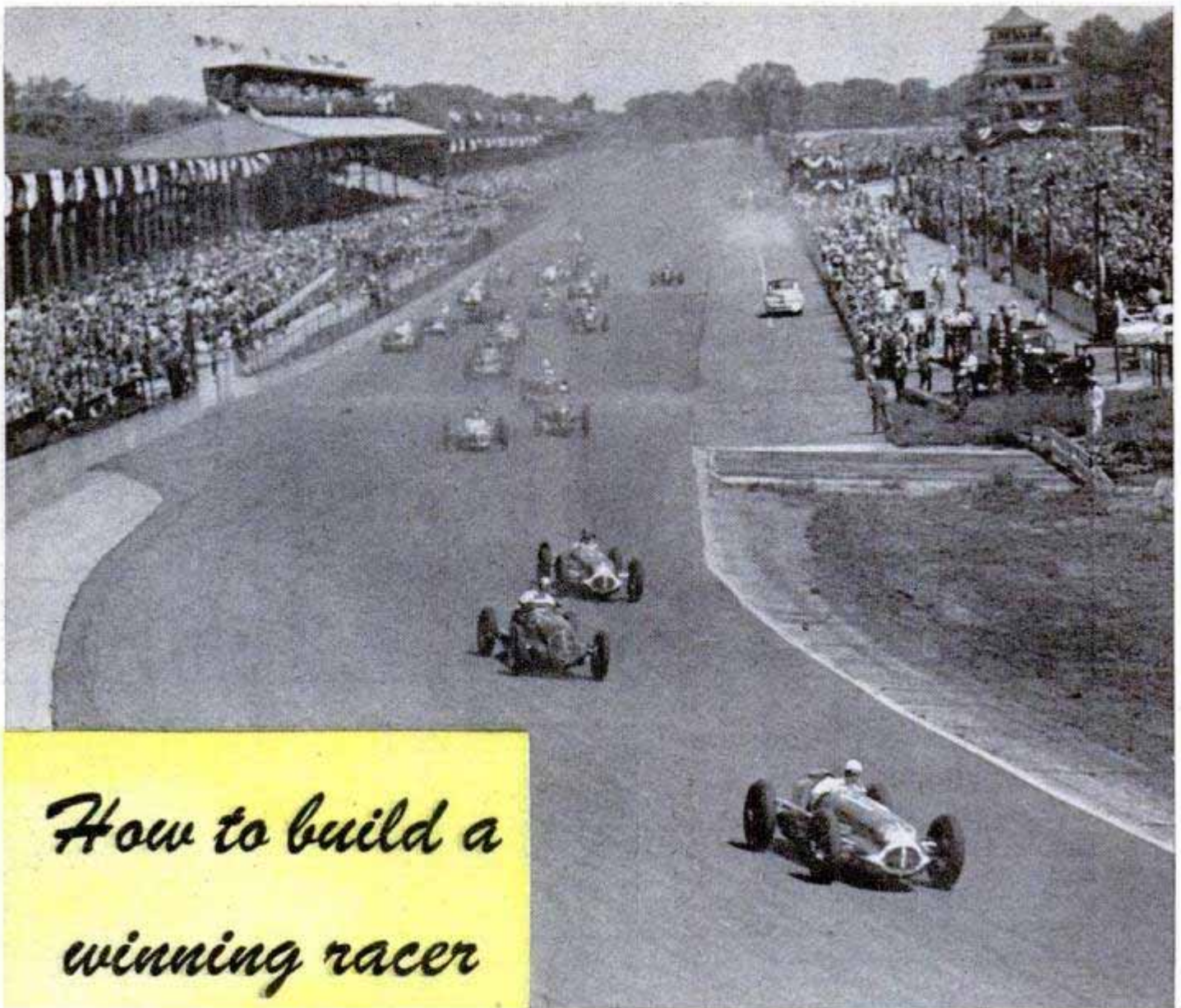

How to build a winning racer

By Lou Moore

As told to Thomas E. Stimson, Jr.

IN THE 16 TIMES that I've competed at Indianapolis, either as driver or owner, my cars have won the 500-mile race four times, have placed second three times, and have finished in third place on three other occasions.

That's something of a record and in this article I'll tell you how an Indianapolis winner is put together.

In the first place, what kind of car has the best chance of winning the race? Remember that it will have to average something like 118 or 120 miles per hour for 500 miles.

Some designers have put their faith in supercharged engines, some have used two small engines in the same car, some experiment with new types of springs for better roadability, some favor a four-wheel drive.

Green flag waves and the nation's fastest racers zoom down the speedway as the 1948 classic begins

My own experience has been that you can't beat a front-drive car at that track as long as the motor is running well. The value of the front drive is that 65 percent of the car's weight is on the driving wheels and thus provides good traction in the turns.

My favorite engine, for power and endurance, is the 270-cubic-inch, four-cylinder, nonsupercharged Meyer-Drake, formerly known as the Offenhauser. It's a simple engine and hence reliable. Its 350 horsepower allow a driver to average as high as 130 miles per hour on the 2½-mile track in time trials.

When I built two brand-new cars for the 1947 race, I designed them around that combination, a front-end drive and a Meyer-Drake engine. Both were known as Blue Crown Spark Plug Specials. Mauri Rose drove one of them and won the race. Bill Holland drove the other and placed second. Last year Mauri won the race again in the same car and Bill once more took

second. This year there's a chance that one of the two drivers will win the race again. There's even an outside chance that we'll take first, second and third, for there will be three cars in my team this year.

The new car that I've just finished building is also powered with a Meyer-Drake but has a rear drive instead of a front drive. I designed it especially for the dirt tracks and yet it is fast enough and handles well enough to place among the leaders on Memorial Day. George Connors will drive it on the brick-and-asphalt Indianapolis track and we'll enter it in a dozen dirt-track events this summer.

I began to get ready for this year's race last July in my shop in North Hollywood, Calif., and I've been at it ever since, except for three weeks off in December. Besides building the new car, I've torn down and rebuilt the two cars that I built for the 1947 race. Every part that showed wear or fatigue was replaced, including timing gears, crankshafts, rods, pistons and valves. I put in new clutch

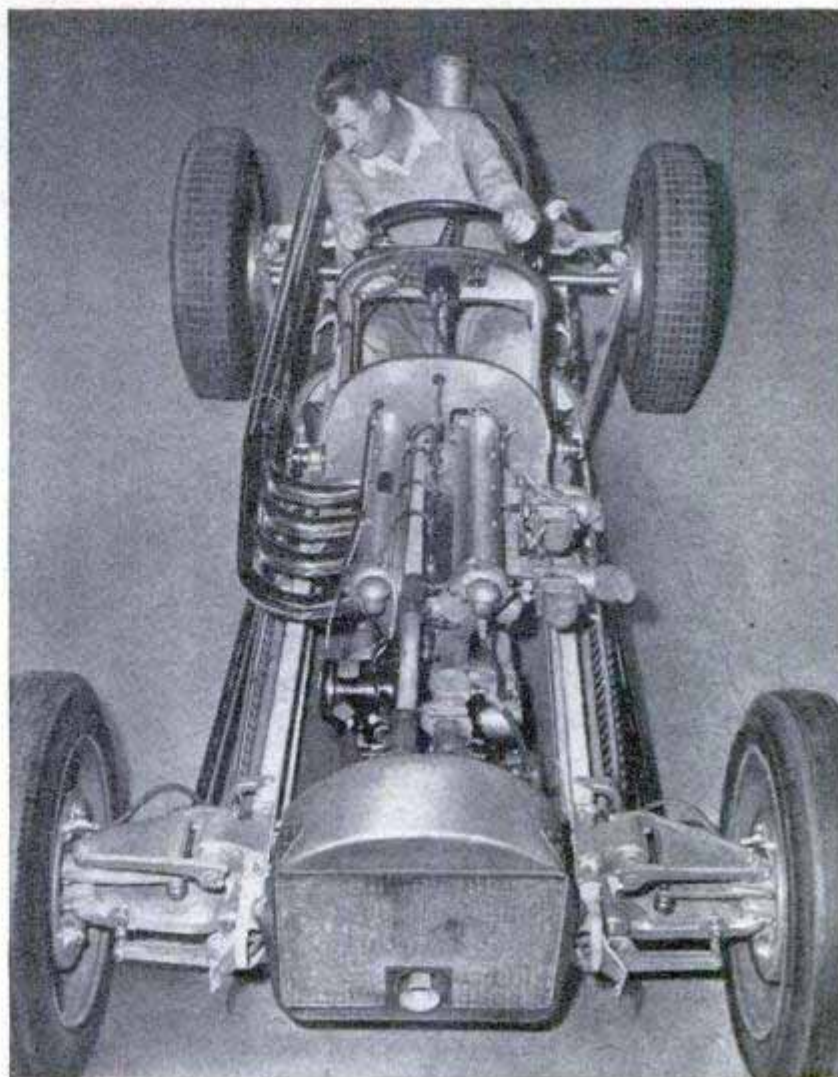

Moore checks the cockpit design of one of three cars he has built for this year's race. Below, this car built by Moore and driven by Mauri Rose won the Indianapolis classic both in 1947 and in 1948

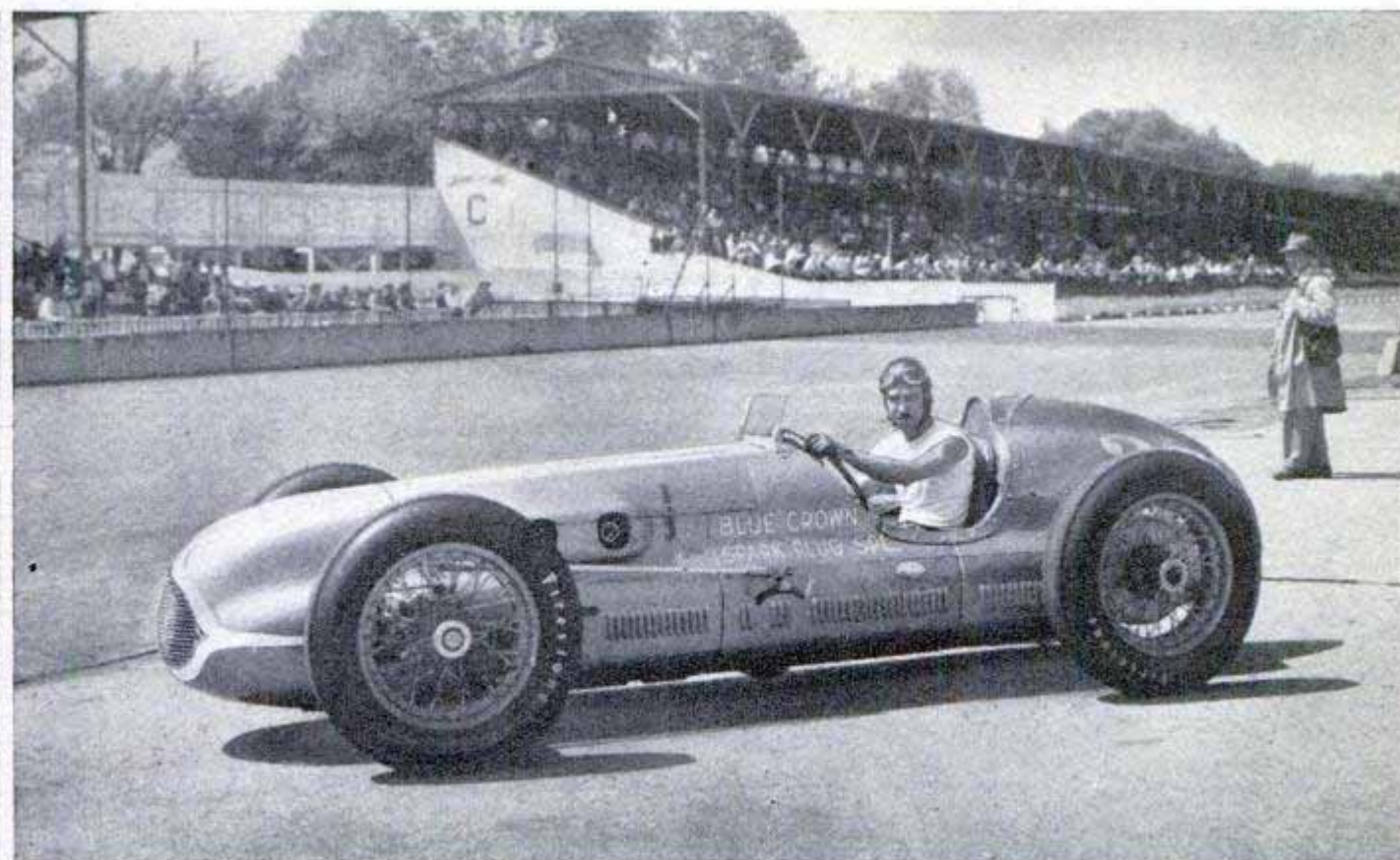

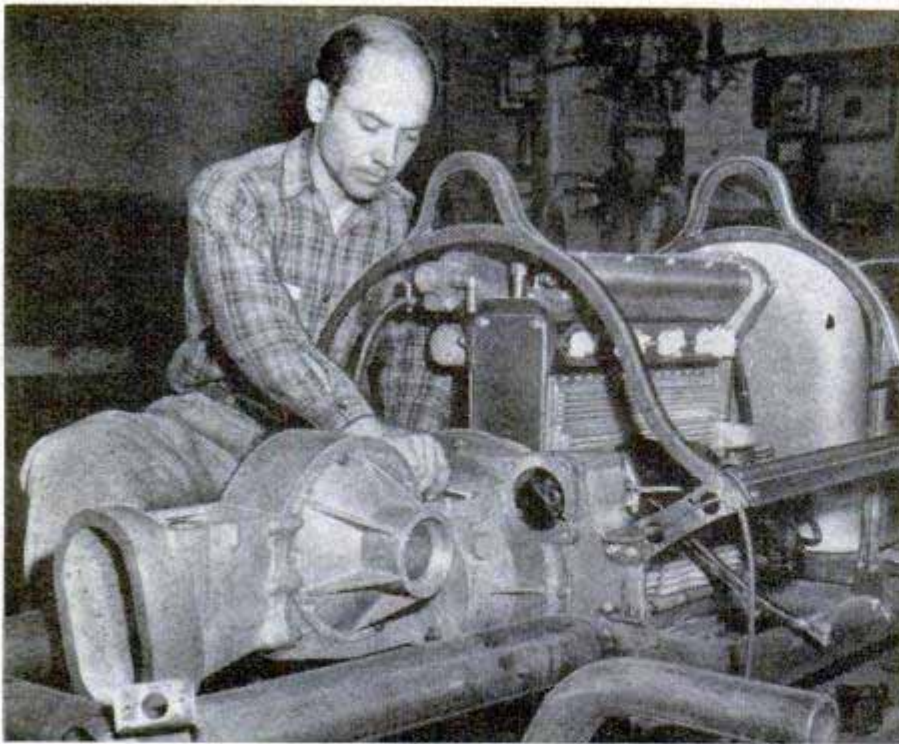

Builder of champions installs gearbox and transmission in a new car

parts and replaced the radiators of both cars. No doubt most of the parts have thousands of miles of life left in them but it's safest to replace them after two races.

My schedule called for having all three cars ready to go by the 15th of April. Then they were towed on trailers across country to Indianapolis. That left about five weeks for settling down in the garages at the track, getting the cars officially inspected, tuned up and qualified. That's more time than most owners like to spend at the track but it's good insurance. If any bugs show up, we'll have time to correct the trouble.

"Belly" tanks under the driver's seat will provide more fuel capacity

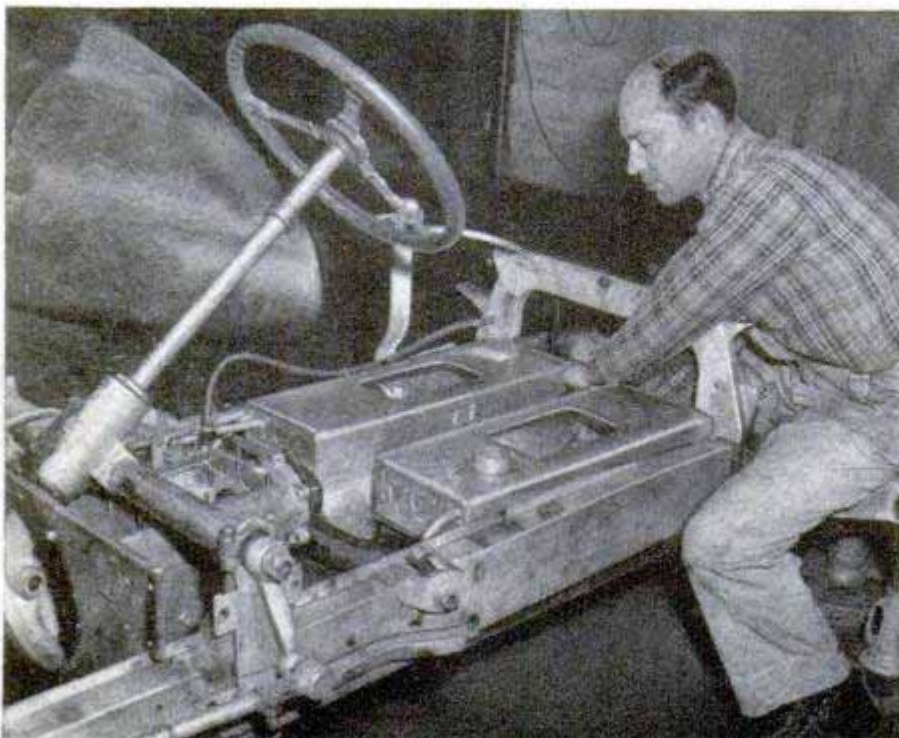

troubles develop we put the car back in the garage. It will sit there until the time comes for the qualifying run. The only attention it will need on qualifying day and on the day of the race will be carburetor adjustments. These will depend on the fuel mixture and on the humidity of the day.

Many of the owners use straight alcohol as fuel for their qualifying runs. It would be a good fuel for the big race itself, for it produces the most power and keeps the engine cool. The trouble is that it delivers no more than three miles per gallon at high speeds. For the Memorial Day "500" we blend some alcohol with gasoline in a ratio that yields about 10 miles per gallon. With that mixture only one pit stop for refueling will be needed.

I'll signal one of the cars into the pit somewhere between 250 and 300 miles, after which the other cars will follow at 10-lap intervals. Usually a couple of tires need to be changed and meanwhile fuel will be poured, under pressure, into the car's 35-gallon tank. Water and oil are checked and the car is ready to go again, well within 90 seconds of the time it stops.

Of the 33 cars that start the race I figure that no more than five or six will give us real competition.

You can scratch a number of the drivers because they haven't the skill and endurance for hurtling around the track for 200 laps. You can eliminate a number of the other entries because the cars are compromise jobs that can't do their best at Indianapolis. You can cross off a few more of the cars because they won't be tuned up properly. The head mechanics and the pit crews just won't have found the right combinations of fuel, gear ratio and carburetor adjustment by the time of the race. Barring accidents and unlikely mechanical failures, that leaves seven or eight cars, counting my own, as the most dangerous contenders.

My drivers and I go over our strategy the day before the race, after the qualifying runs are finished. By then we have a pretty good idea about whether the race will be "hot" or whether everyone is going to hit the speed that they think will win and then try to outlast the competition.

That, in fact, is the best plan. The trick is to estimate the average speed that will be necessary to win the race and



Steering wheel of one of Moore's three new racers is geared to drag-link arms that in turn are connected with the front wheels. Below, Moore's new rear-engine, rear-drive car has a 3½-inch tubular frame. It will have only five inches of clearance with the wheels installed

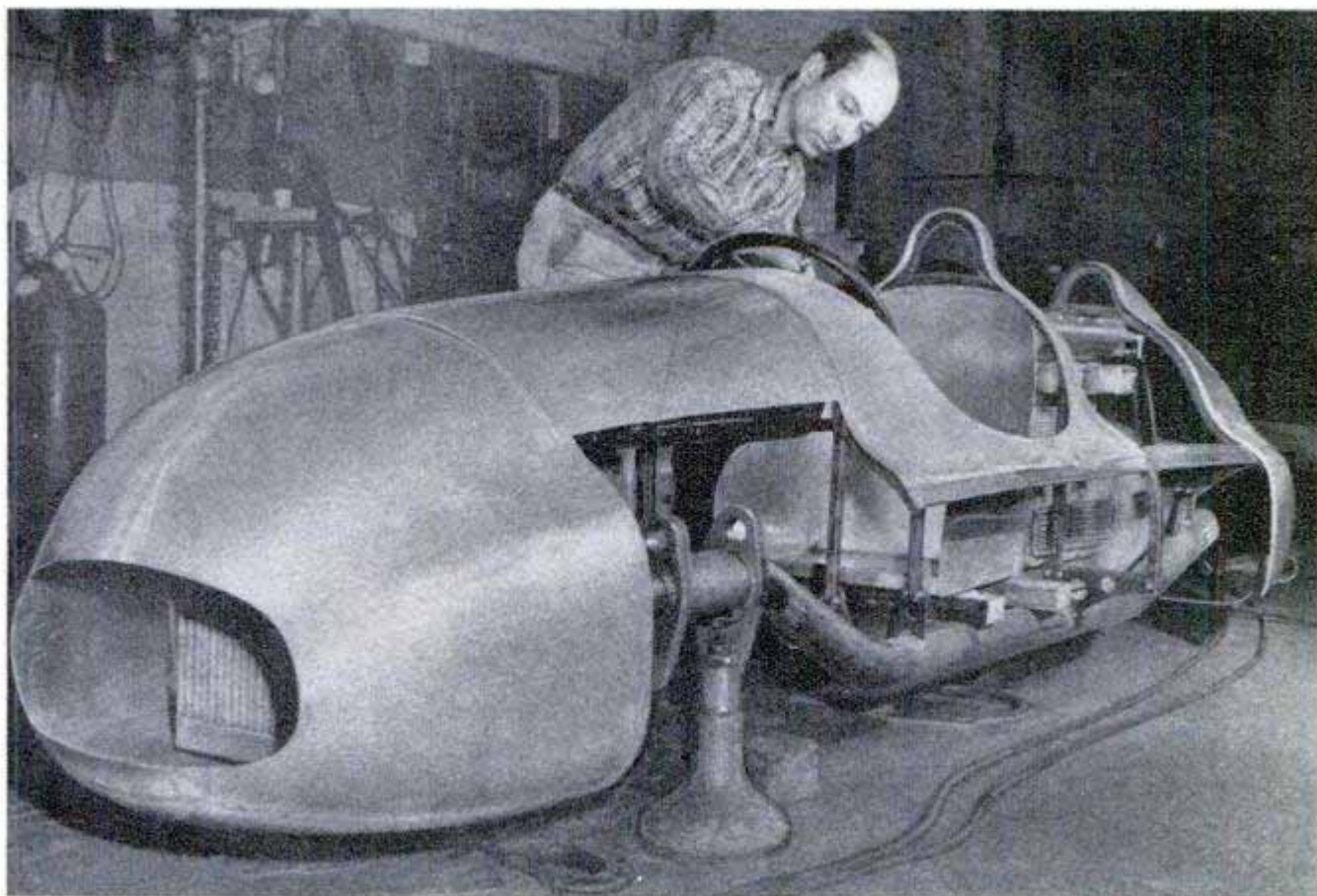

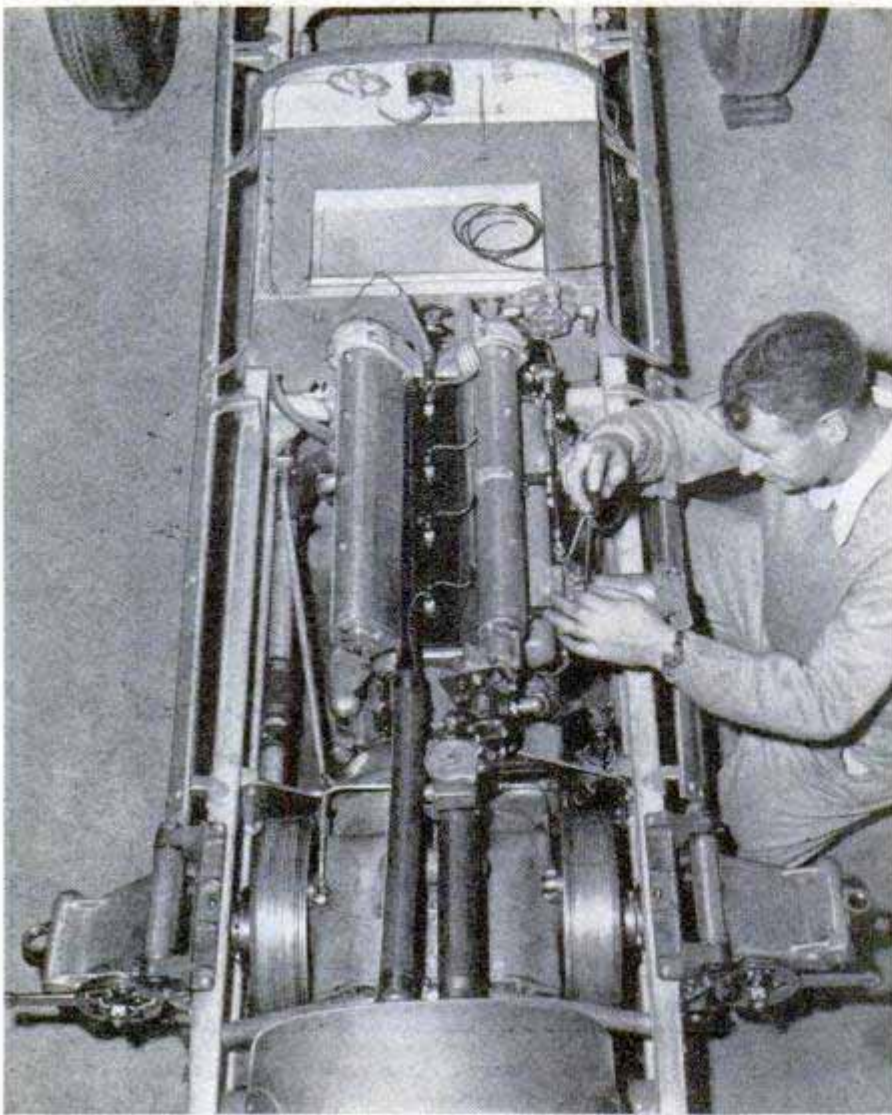

Moore tunes up the engine of the car that won second place both in 1947 and 1948. All the parts that show wear or fatigue are replaced. Below, the polished chrome caps projecting from the side of a new racer pick up air from outside car and pass it into the twin carburetors

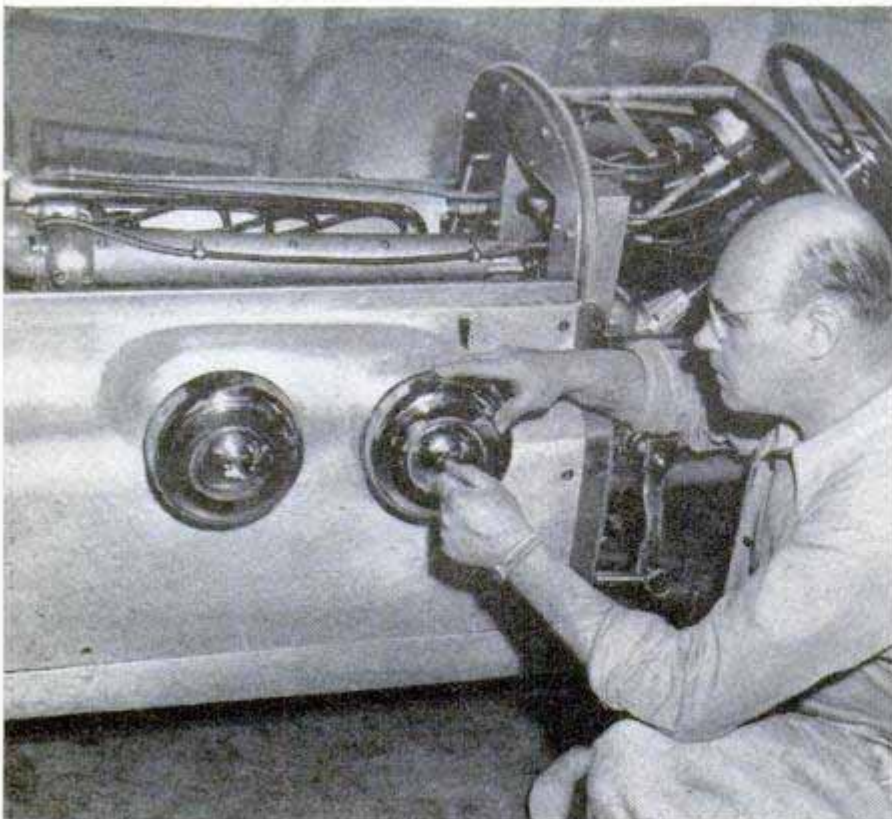

then drive just fast enough to maintain that average. If some "hot shot" wants to burn up the track and get a long lead early in the race, none of the smart drivers chase him. The chances are that he'll wind up in the pits with serious motor trouble or will require extra stops for fuel and rubber.

As the race runs on, however, the top drivers in the best cars try to close in on whoever happens to be in the lead. They want to drive as slowly as they dare to conserve tires and fuel and yet they must stay close enough to the leader to have a chance of overtaking him when the time comes. Meanwhile the leader wants to stay in front and he begins to work at it if there happen to be better drivers in faster cars creeping up on him.

It's hard to say what will happen in the race this year because, for the first time since the war, there will be a good number of new, postwar cars. Frank Kurtis, for instance, has built a bulletlike front-drive car, powered with a Meyer-Drake, for one owner, and a pair of rear-drive cars with the same power plants for other enthusiasts. One of these has a variable wheelbase that will be set at 100 inches for the Indianapolis race and reduced to 94 inches for dirt-track competition.

Diedt & Lesovsky, race-car builders, have turned out a novel rear-engine rear-drive car for N. J. Rounds of Beverly Hills. The design is intended to provide a steady ride and to maintain the same balance all through the race. In most cars the fuel supply is carried in the tail and the car's handling characteristics change as the fuel load lightens. Round's car will carry

(Continued to page 264)



Piasecki Helicopter Corp. photos

Loop-the-Loop Helicopter To Be Carrier "Lifeguard"

Speed runs of 131 miles an hour, an unofficial world's record for helicopters, have been made by the Navy's new all-metal XHJP-1. It is also the first helicopter known to have performed a successful loop. The craft carries seven and will serve with aircraft carriers as a "lifeguard." It can follow planes taking off and landing and be ready to make quick rescues when pilots are forced to ditch. A hydraulically operated hoist, mounted near the pilot's seat, will bring rescued personnel directly up into the cabin.

Hydraulically operated hoist, left, will bring rescued flyers up through wide hatch next to pilot. Above, helicopter moving litter patient and, below, blades folded for parking on carrier



Tire Playpen

With one side wall cut away, a tractor tire serves as a playpen for a child. It is high enough to prevent a small child from crawling out. The lower rim serves as a shelf.

Once dependent on waste vegetable and animal material, the fertilizer industry today is chiefly chemical with sales totaling \$600,000,000 in the U. S. and consumption of about 17 million tons a year.



Republic Aviation photos

Swept-back wing of the XF-91, left and above, reverses usual design and appears widest at tip. The Delta wing of XF-92, below, is expected to be most effective in supersonic realm



Consolidated-Vultee Aircraft photo

Wings for Jets Have Odd Shapes

Unusual wings distinguish the U. S. Air Force's two newest jet-rocket interceptors. Both are sharply swept-back. In the Republic XF-91 it appears to be wider at the tip than at the junction with the fuselage. The Convair XF-92 has a triangular-shaped wing, with movable portions at the trailing edge for aileron and elevator action, eliminating the need for tail sections. A vertical stabilizer and rudder provide directional control and

stability. Test models of both planes have been flown numerous times but their performance figures have not been revealed.

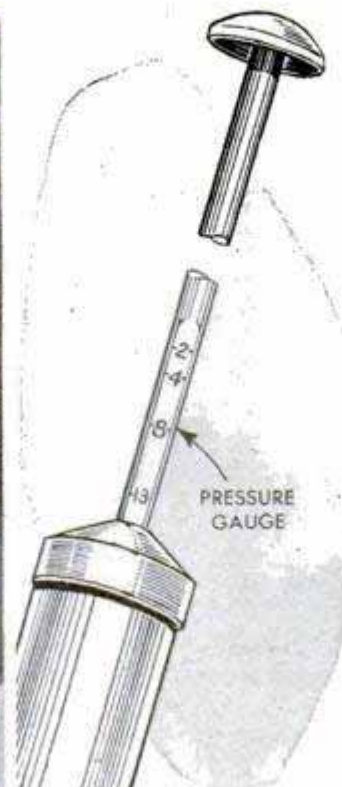

Hand Pump for Football Has Gauge on Shaft

You don't need a separate gauge to know how much air you've pumped into a football when you're using a hand pump with a built-in gauge. The gauge, etched in the rod of the pump, registers pressures from 2 to 13 pounds. When the handle is released, the pressure forces the piston against a spring, pushing the scale out where it is easily read.

Cement Paint From Powder

Dissolving a new enamel powder in turpentine makes an acid and alkali-resistant paint especially adapted to cement and masonry. It can also be used on wood and metal. The powder is composed of three resins and pigment.

the man who stops bullets

By *Bernard W. Crandell*

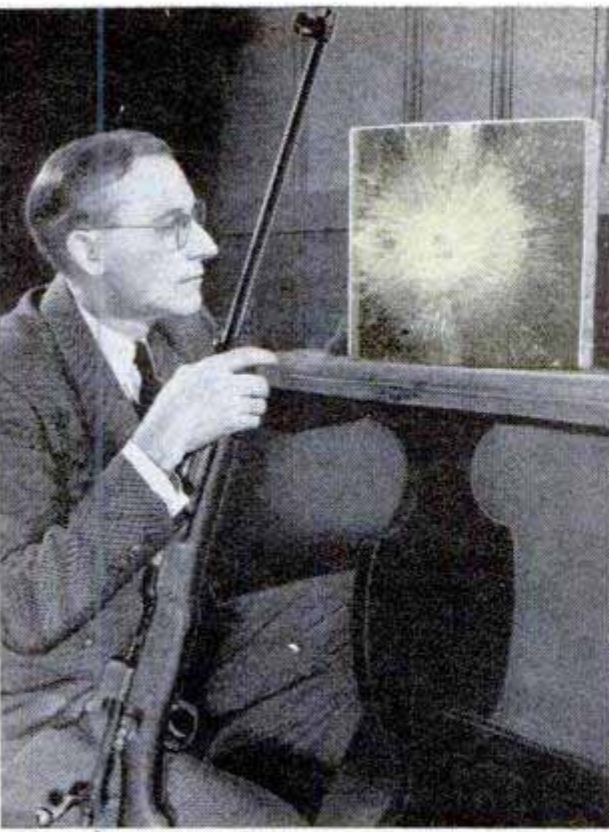

STANDING at the end of a quiet residential street in Highland Park, Mich., is a mysterious brick factory building without a name. It is guarded across the front door by bulletproof steel mesh and at the rear by a red, armor-plated jeep.

The idea of an armor-plated jeep in suburban Detroit is enough to provoke mild amusement. The husky war wagon, hung in armor $\frac{1}{2}$ inch thick, is the pickup truck of the Smart Safety Engineering Company, which makes a business of armoring limousines.

Carroll M. Smart, an inventor-engineer, armor-clad the jeep early in World War II to act as a fast reconnaissance car but it was turned down by the Army in favor of something larger. What happens

Carroll M. Smart, builder of bulletproof cars for presidents and kings, studies effect of bullet fired at nine-ply armor glass used in his big limousines

Below, Smart takes aim with an Army .45 at a heavy piece of armor glass. He carefully tests all glass of laminated type for degree of protection needed

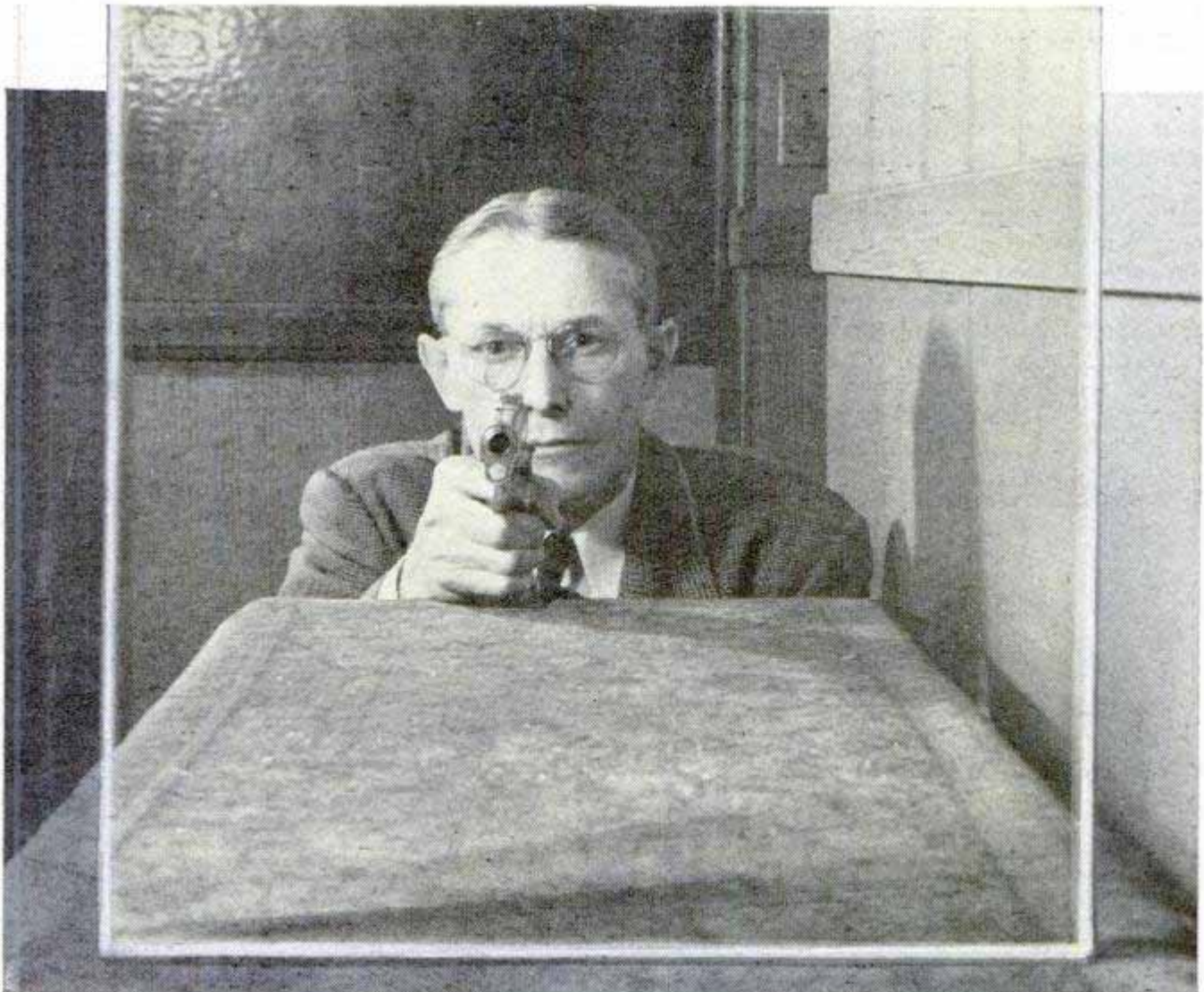



Scotland Yard inspectors liked the gun ports on windows of Smart car. This car was used by royal family

in Smart's factory is for the particular benefit of presidents, kings, high government officials or millionaires who want to ride in bulletproof automobiles. This instinct of self-preservation has kept alive a specialized type of engineering that ordinary car manufacturers have ignored. Smart and one or two others, notably the Federal Laboratories, Inc., of Pittsburgh, are alone in this field, which is called engineering "safety" and is worth a modest gross of around \$100,000 annually.

Stopped during the war except for a few special jobs, the Smart business is beginning to pick up and the neighbors again are

seeing four by eight-foot sheets of armor steel moving into the building, and limousines, apparently normal except for a slight greenish tinge to their windows, rolling out.

The science of converting automobiles into pillboxes impervious to small-arms fire is far from being a cut-and-dried operation. As orders arrive from all parts of the world, Smart deciphers the postmarks as a tip-off on foreign politics. After 13 years' experience, it is his theory that requests for armored limousines are indicative of forthcoming attempts to overthrow a government. Just for the record, Smart recently armored a seven-passenger sedan

Chrome-nickel armor plate (shown in yellow) is placed beneath shell of modern car to make it bulletproof

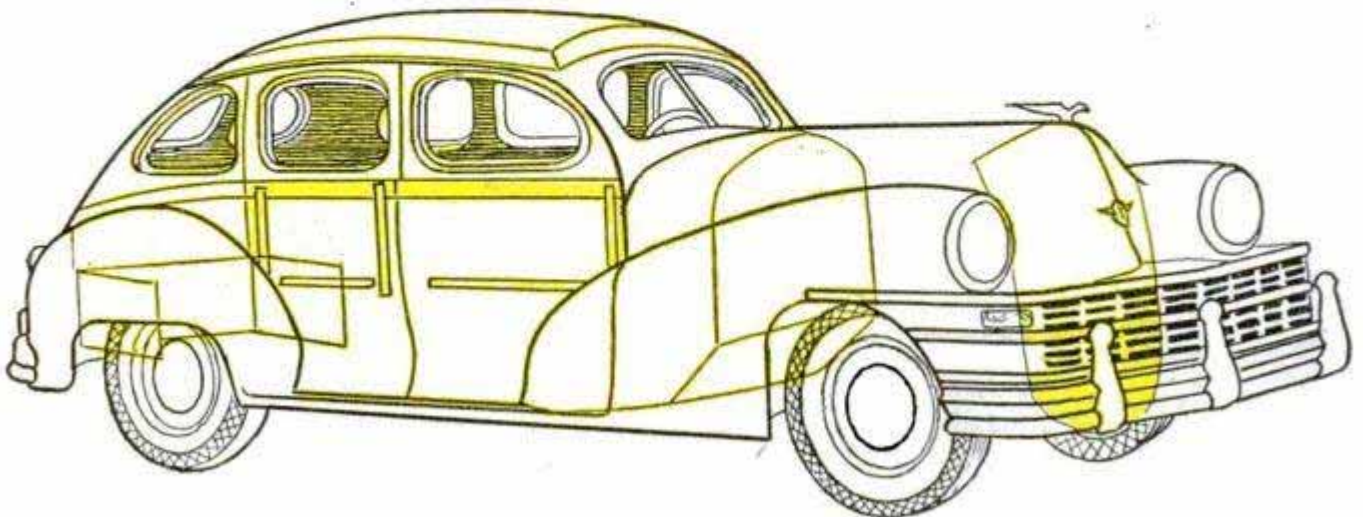

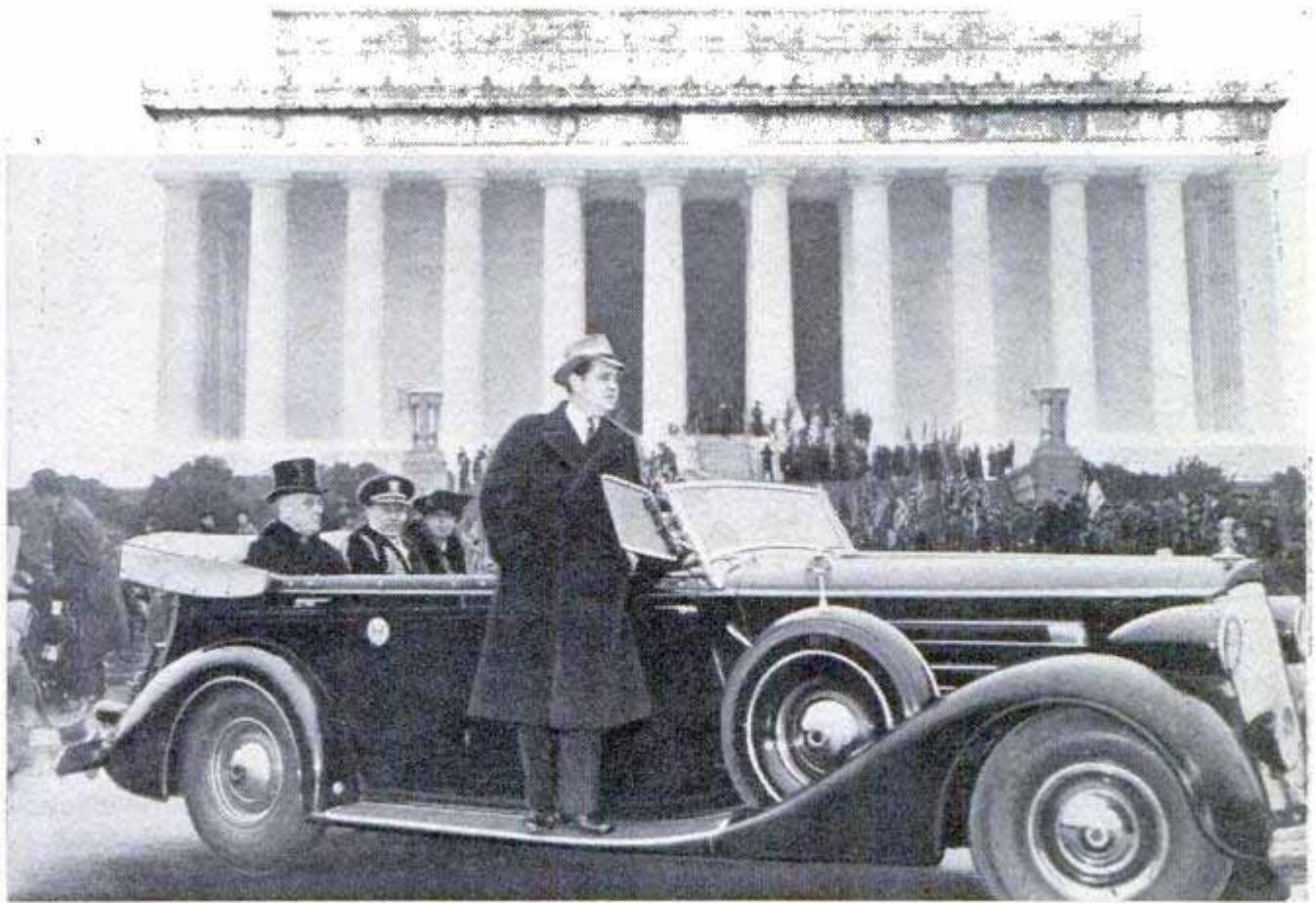

This is one of White House cars armored by Smart. Bulletproof spring-release windows can pop up in jiffy

ordered by a South American republic, presumably for use by the President.

Orders from within the United States, however, are just thorough precautions against assassination, generally taken only by the highest of our government officials. During the war Smart fixed two automobiles for the late President Roosevelt.

One of the Roosevelt jobs, a Packard touring car, probably was the toughest job Smart ever handled. The Secret Service, entrusted with the President's safety, specified in addition to the usual armoring, that the windows had to be of bullet-resistant glass two inches thick; that they had to jump automatically from the "down" to "up" position; that the rear seat had to conceal a plate of armor that, like the windows, would jump head-high in a split second; and, finally, that the canvas top be fixed to withstand a 6½-pound object—the weight of a hand grenade—dropped from a height of 32 feet.

To solve the window problem, Smart installed high-tension springs in the doors which would lock when the windows were

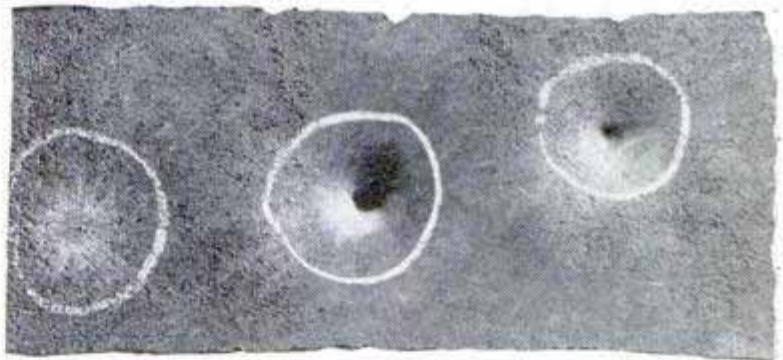

Dents in armor plate, left to right, were made by a .38-caliber police special, a .30-caliber Army ball with steel jacket, and a .30-caliber lead-nose bullet. Below, this jeep was armored by Smart during the war and tested at Aberdeen Proving Ground



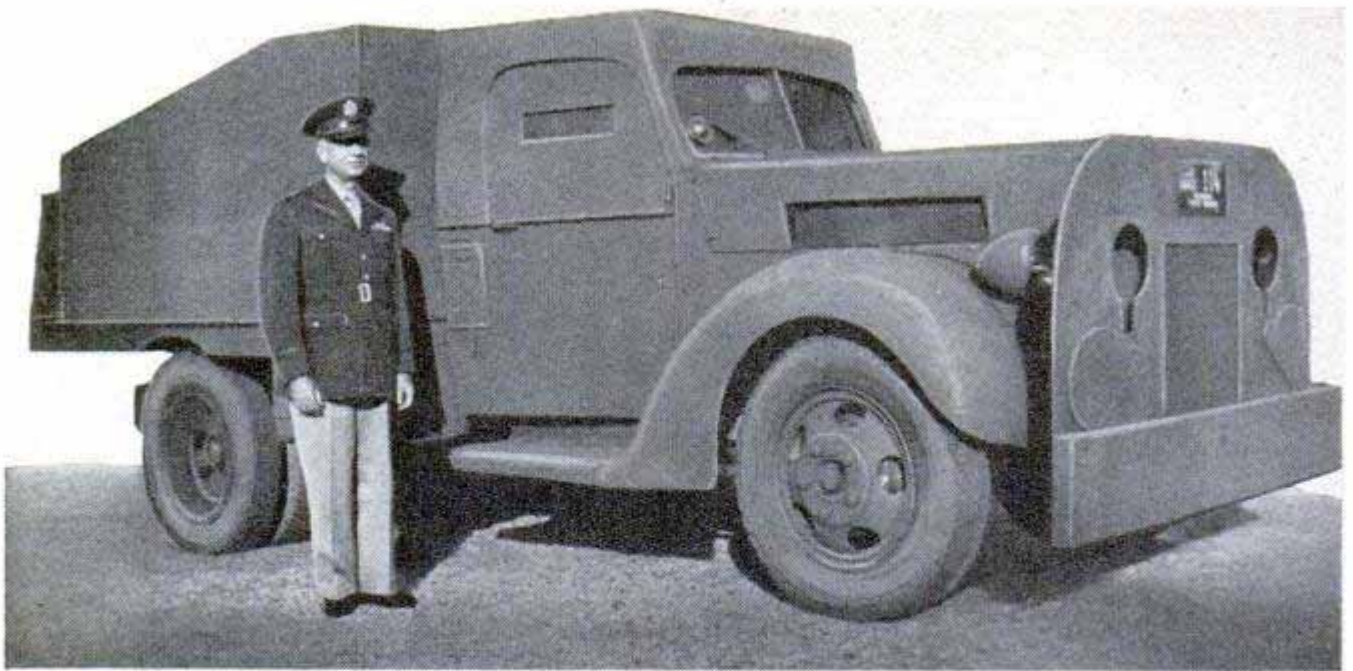

This is a riot squad car built in Smart's armoring shop for the Michigan State Troops to use in Detroit

cranked down, and release upon the touch of a switch. There were three such switches, one on either side of the rear trunk where Secret Service agents rode during parades, and one on the dash within reach of a third Secret Service man in the front seat. If danger threatened from any direction, the President could instantly be made secure from any assassin's weapon up to a .50-caliber machine gun. The grenadeproof roof presented a bigger headache. Clarence Bruce from the Bureau of Standards in Washington flew to Detroit with two live hand grenades in his pocket to help make the tests.

"We drove the President's car out to the Detroit race track and parked it beside one of the stables," Smart relates. "I wired a grenade to the center cross bow of the roof, attached a long wire to the pin, and with the other end of the wire in my hand took shelter in the stable. Then I pulled the pin."

The resulting explosion not only blew the top off the car but nearly got Smart and Bruce in the bargain. Fragments flew through two sections of stable wall, missing them only because they were squatting.

"The canvas top was in shreds and the top of the front seat panel was badly damaged, making it obvious to us that if a man were sitting in the back seat he would have been killed," Smart said.

After getting the seat repaired, Smart installed a tough cloth webbing just beneath a new canvas top and made another test. This time, however, they dropped a grenade without pulling the pin from a barn window 32 feet above the car roof, and found that the reinforced roof easily withstood the impact. President Truman now is using this combination grenade-bulletproof car.

Despite a limited volume of business, safety engineers have made their trade more exacting than automobile manufacture itself. The tiniest crack in the armor, they know, might be the crack that would kill the customer. They have run tests on armor plate and bullet-resistant glass with guns varying from pea-shooting .22s on up to .50 caliber. The company has had to meet scores of different specifications for cars—all according to what the customer thought was going to be shot at him. Also, the armor had to be placed so it wouldn't show, and it isn't easy to make a window inconspicuous.

There are reasons why a person riding in a rolling fortress, like a man wearing a bulletproof vest, would just as soon keep the news about it quiet. However, Smart loves to tell of a general in a South American country who, thinking that the idea of an armored limousine reflected upon his courage, specified that the car have protection only in front. It turned out that the general, who must have been bucking for president, wanted to give his constituents the impression that he would always meet an attacker head-on, never offering an ignominious potshot at his posterior.

Smart started his business in 1933 when, as an engineer with the Highland Park Fire Department, he got upset over the killing of policemen while chasing gangsters' cars. In his spare time, he armor-plated a scout car for the Dearborn Chief of Police, which drew so much attention that the Detroit Police Department handed him a fleet order for 52.

Since then, Smart has handled jobs for many police departments here, for Scotland Yard, Chiang Kai-shek, the Rajah of

(Continued to page 254)



Handle Forms Sheath for Knife

With a handle that folds completely around the blade, a new sports knife combines the advantages of a sheath knife with the safety and compactness of a pocket-knife. The knife comes in two models, one for fishermen and one for hunters. The hunting model has a single-edge blade. On the fishing knife, the blade is saw-toothed and hooked on one side with a cutting edge on the other. Shaped to fit the palm, the handle is made of Tenite plastic trimmed with aluminum.



Baby Buggy "Walks" Upstairs

Getting a heavy baby carriage up and down stairs is made easy by a British inventor. He mounted three wheels on each end of the rear axle in a triangular fashion, permitting the buggy to "walk" up and down stairs as the three wheels rotate around the common axle. When pushed on the level, the buggy rolls on two of the three wheels.



"Jet" Print Washer

Any large tray or dish-pan becomes an efficient print-washing tank when a print washer with a jet-pump action is used. The plastic water distributor, attached to the side of the tray by suction cup, directs the flow of water so that one jet washes and agitates the prints while another forms a pumping action that sucks the "dirty" water out a discharge tube, keeping the water level constant. The tray can be placed below the sink level, since the jet-pump will elevate the discharge water several feet. The hose connector fits any standard household faucet.

Swamp Crop

Digging around in the black bogs of Minnesota, a chemist came up with a jackpot idea—peat pellets

By Agnes Harrigan Mueller

FOR YEARS timbermen, farmers and miners wrote off the muskeg swamps of northern Minnesota as wasteland. Today, their minds are being changed by a crude pilot plant that turns out peat pellets which point toward a prosperous future for the bogs.

Clayton Plummer, a former Manhattan Project chemist, was commissioned by the state of Minnesota to discover the potential of the vast peat deposits. Since Minnesota has more peat than all the other states combined, an estimated 50 billion tons, the economic value of the deposits would be tremendous if practical processes and economic uses could be found.

As a result of Plummer's study, peat pellets are being produced in small quantities at a cost of about \$4 a ton, much cheaper than the methods used in Europe where peat is commonly used as fuel.

When dug from the ground by power shovels, peat contains about 90 percent water. It is piled in huge mounds to drain. Still saturated, the peat is taken to a large meat grinder that serves as a macerater. The grinding process breaks down the cells and releases more water, producing a jellylike material. This material is then fed into a large revolving cylinder, open at both ends, mounted on a slight angle so the peat rolls through the cylinder. Continuously rotated by an old Ford engine, the cylinder rolls the peat into hundreds of pellets about an inch in diameter. As they fall out the lower end of the cylinder, the pellets are gathered and placed on racks where the sun and air dry out the remaining water. When dry, the pellets are hard and look like large black marbles. Plummer has used the pellets as furnace fuel with good results.

"I'm convinced, however," he says, "that fuel is not necessarily the best use for peat.

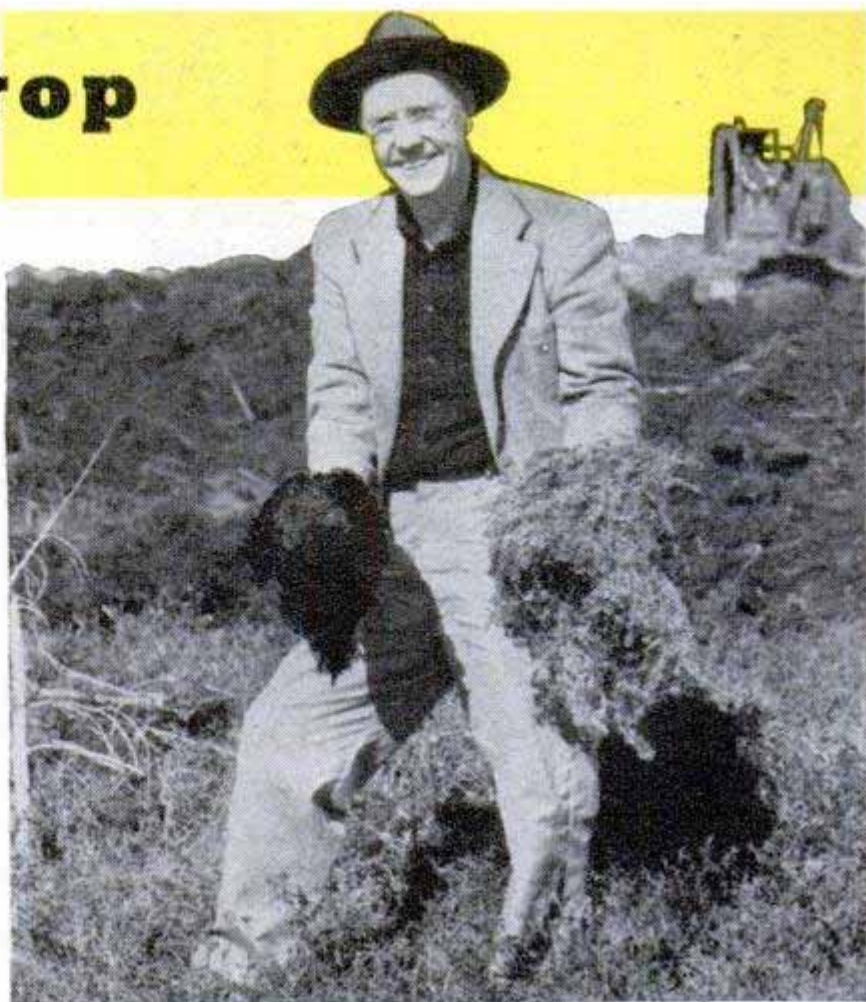

Top, Plummer holds clumps of peat. The one in his right hand is 10,000 years old. Above, the peat is dug by a power shovel

My experiments show that it can be used for waxes, diesel oil, fertilizer, sweeping compound and many other products. It has almost endless possibilities."

But even if used solely as fuel, the Minnesota bogs have a tremendous economic value. According to Plummer, the one bog he is working has enough peat to heat the homes of Chisholm and Buhl for 25 to 40 years. With thousands of acres of bogs, Minnesota expects to turn this wasteland into a valuable resource.

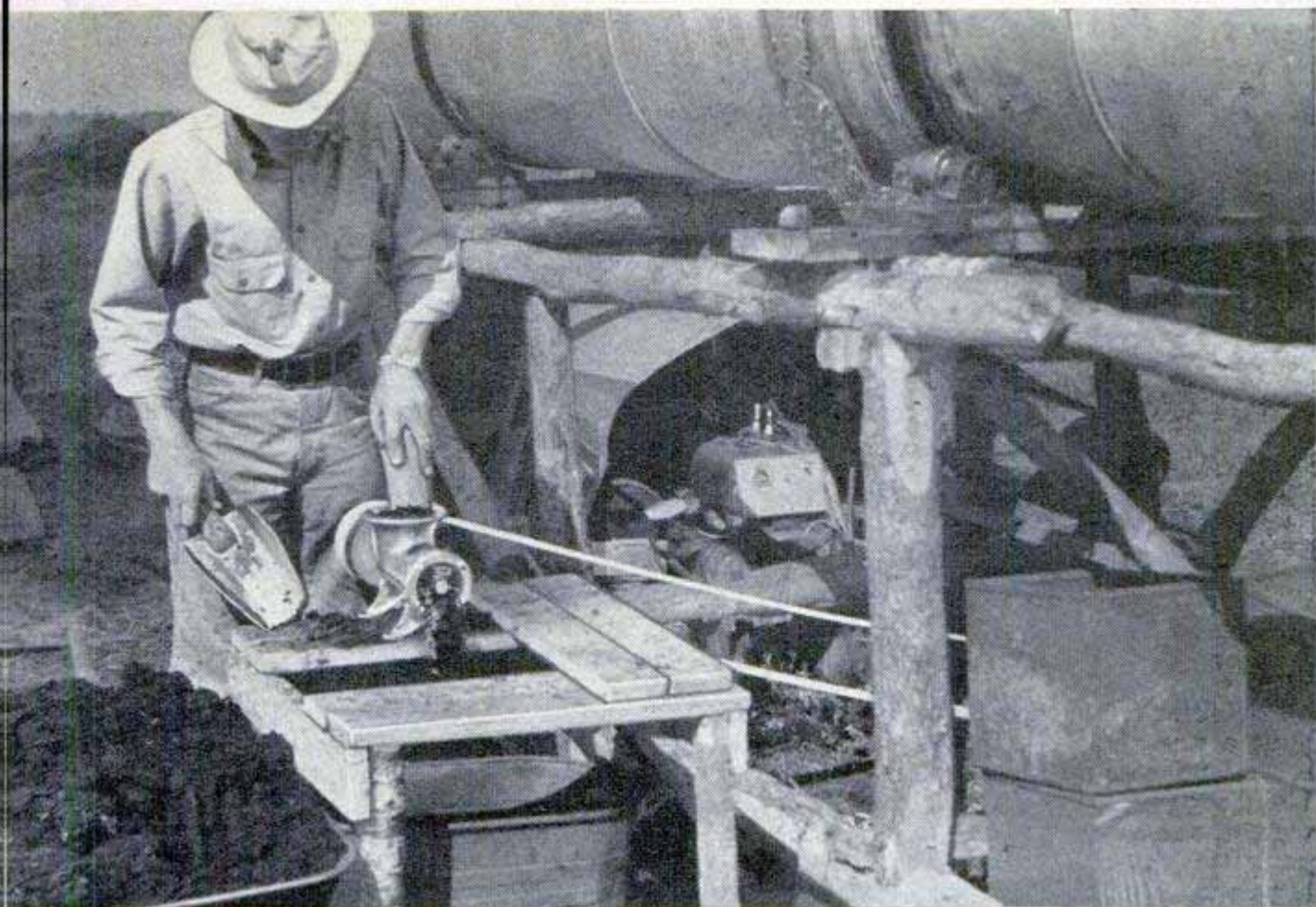

After it has drained, the peat is ground into a jellylike mass by this large meat grinder to break down the cells, releasing much of its high water content

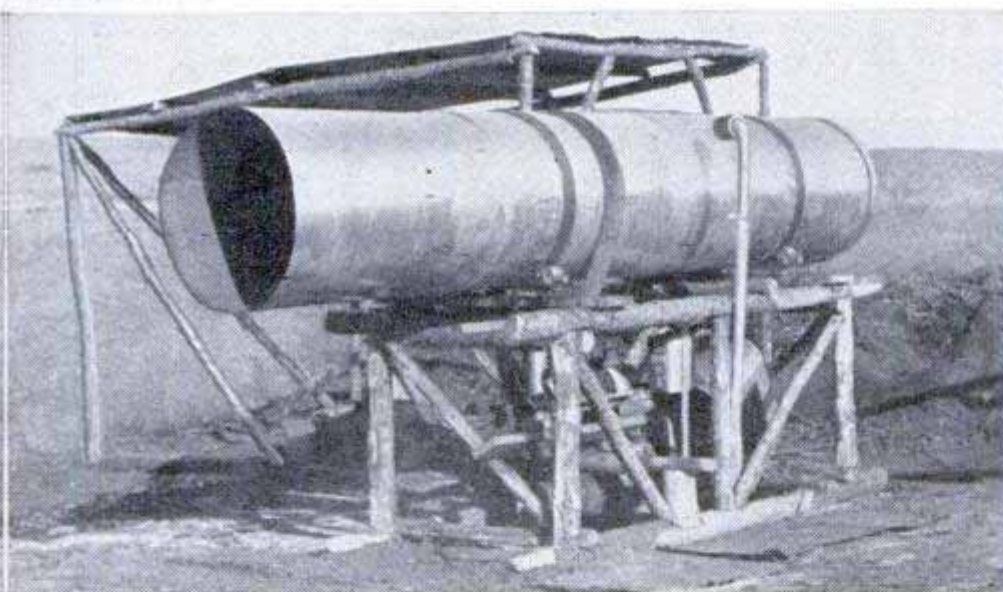

This crude-looking machine, at left, rolls the jellylike mass of peat into pellets about one inch in diameter. The pellets drop from the end of the tube

After they leave the large revolving cylinder, the pellets are placed in the screen racks at right where they are dried by the action of the sun and air. In four or five days, pellets are dry enough to use as fuel





Army Signal Corps photos

Army Has Parachutist-Size Teletypewriter

Portable teletypewriter equipment so light a parachutist can jump with it has been developed by the Army Signal Corps. Weighing only 45 pounds, it is one fifth the weight, one fourth the size and operates 66 percent faster than existing types. It is waterproof and could be floated onto a beach in amphibious landings. Either wire or radio circuits can be used and the new equipment has 300 fewer parts than the old. Be-

cause of the reduced weight and bulk, it could be used much closer to the front lines than was possible during World War II, when teletyped messages could move only as far forward as division headquarters. Previous field equipment totaled more than 400 pounds and required either a vehicle or seven men to carry it. Two parachutists can jump with the new teletypewriter, its power unit and accessories.



Players Get Practice Cuts At Baseball on "Golf Tee"

Made of rubber piping, an unusual "golf tee" helped San Francisco Seals' baseball players sharpen their batting eyes for this season. The ball is a stationary target at the top of a tee that can be adjusted for both height and horizontal location.

Glazing Stays Elastic

Neither time nor weather causes a new glazing compound to contract and harden like ordinary window putty. A special processing to retain natural oils prevents it from drying out in the container between widely spaced uses. The material remains elastic and can be used to patch cracks immediately before painting.

☐ First commercial use of the turbo-supercharger that enabled warplanes to fly higher and faster is in the new 75-passenger Boeing Stratocruiser.

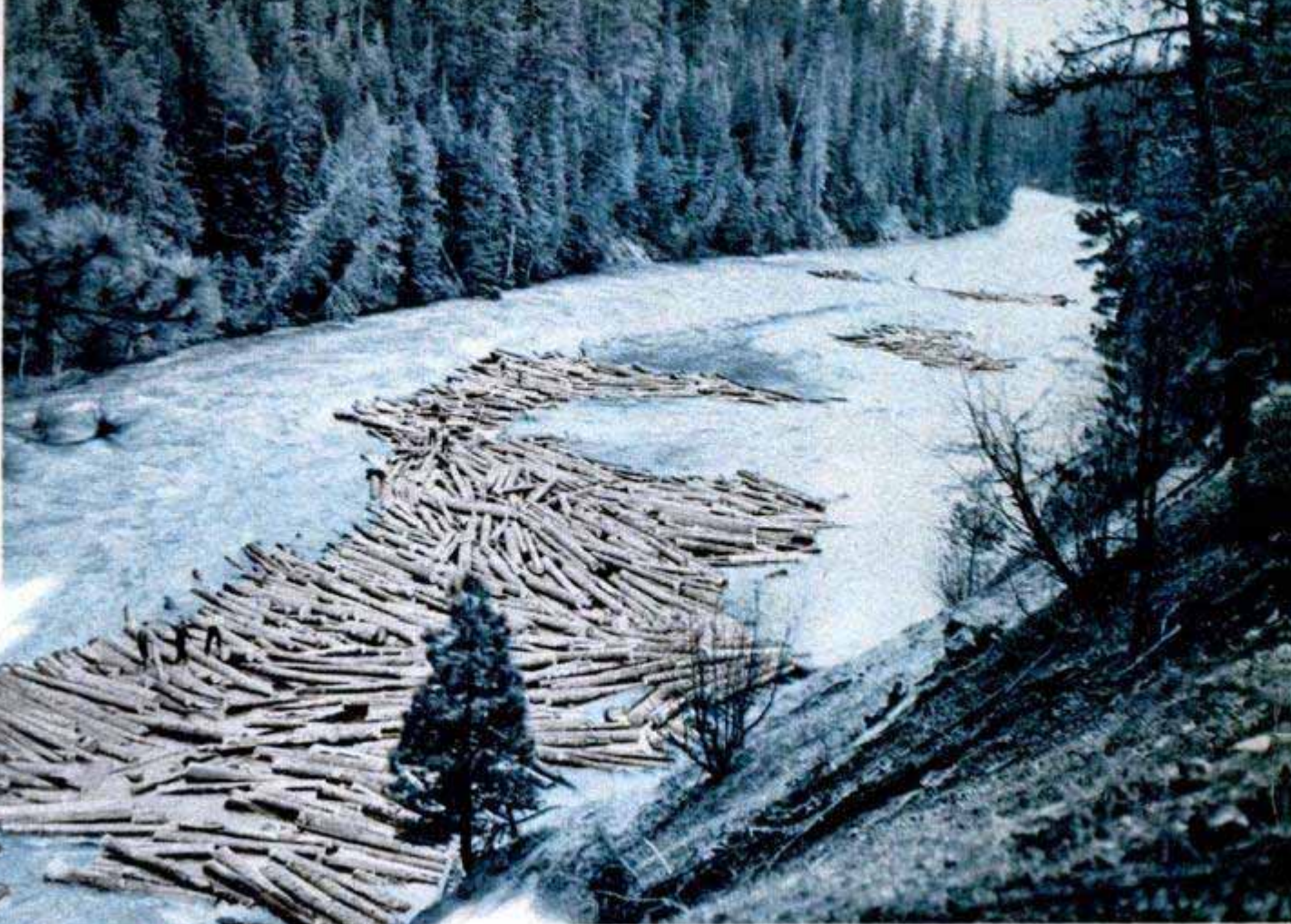

Rough Riders of the River

That water is icy cold and one misstep means you're in up to your neck. Agile footwork is essential here

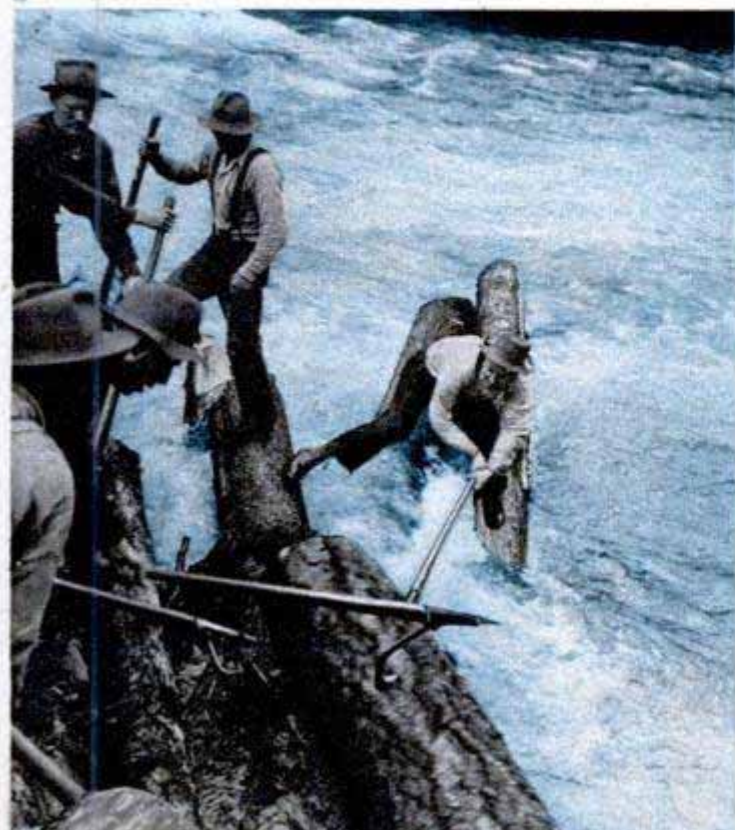

IT WAS a center jam—a potential man-killer. Huge 16-foot saw logs, weighing up to 2000 pounds, crunched against one another like shoestring potatoes in a crazy man's skillet. The wooden carpet that had been slithering, jostling and churning toward the sawmill stopped dead. Logs were jammed up for half a mile back.

The river boss was all over the place, trying to find the key log. When he spotted it, a dozen men set their peavey hooks into it and strained. No go. Then the river boss ordered a charge of dynamite. "Whoomp!" went the explosion and a white plume of water shot skyward. That did it.

"She's a-pullin'!" went up the cry.

As the grumbling logs began to move downstream like half-submerged alligators, the men scrambled to safety. One of them miscalculated and plunged into the icy water. A pal gave him a helping hand. Another, unable to reach dry land, dug his spiked boots into a slippery timber and birlled down-river.

That's a log drive—one of the most

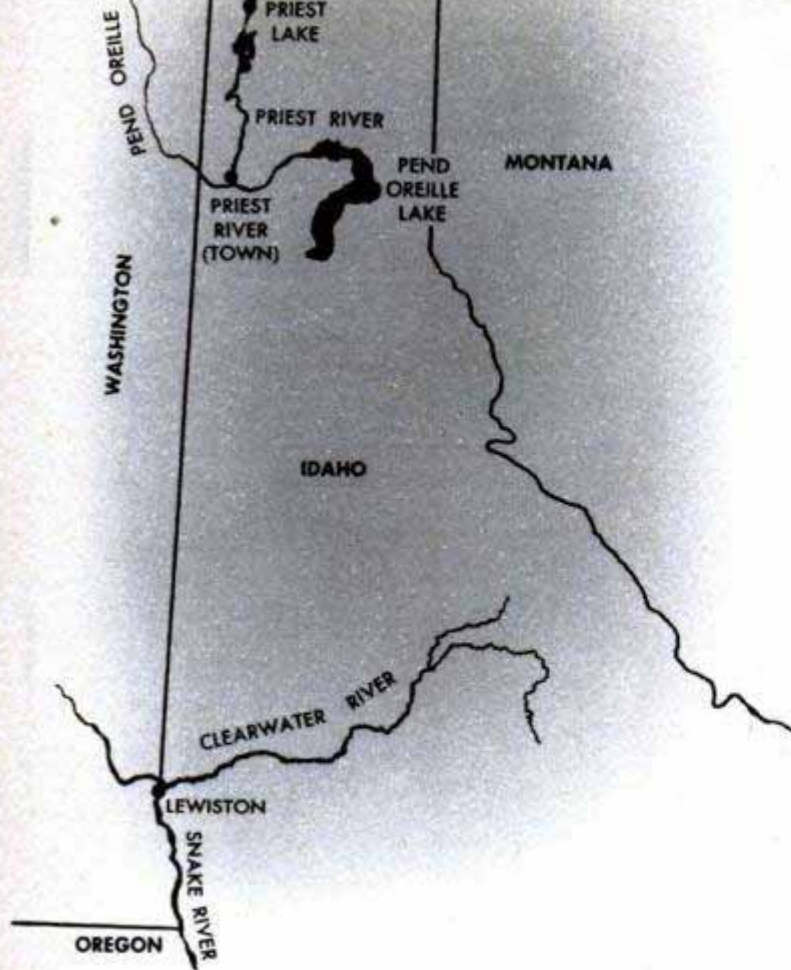

Map shows the Priest and Clearwater Rivers away up in northern Idaho. Below, a lumber crew rolls logs into a wooden flume in which they will float down to the river. Some of these flumes are five miles long

spectacular and action-packed features of America's annual timber harvest that reaches a total of 35 billion feet a year.

It's true that railroads and trucks have relegated most American and Canadian log drives to the history books. But this spring, two of the biggest drives in history are being conducted in the wilderness of Idaho's panhandle. Both will be at their height this month.

One drive is down the north fork of the Clearwater River and is bossed by "Boots" Edelblute for Potlatch Forests, Inc., who operate a 300,000-acre tree farm, one of the largest in America. This drive was temporarily abandoned during World War II, but is being resumed this spring on a larger scale than ever. Some 50 million feet of timber are herded down 120 miles of the Clearwater River from Beaver Creek to the sawmill at Lewiston.

The other is the Priest River drive, under the direction of veteran Bill Whetsler who runs logs for the Diamond Match Company. Since 1901 this drive has sent logs swirling down the 65-mile stretch of white water between Priest Lake and the Pend Oreille River.

Men who work the log drives are called "riverjacks" or "riverhogs." Like whooping cranes, sea otter and passenger pigeons, they are an extinct species in most parts of the United States. But today in rough and

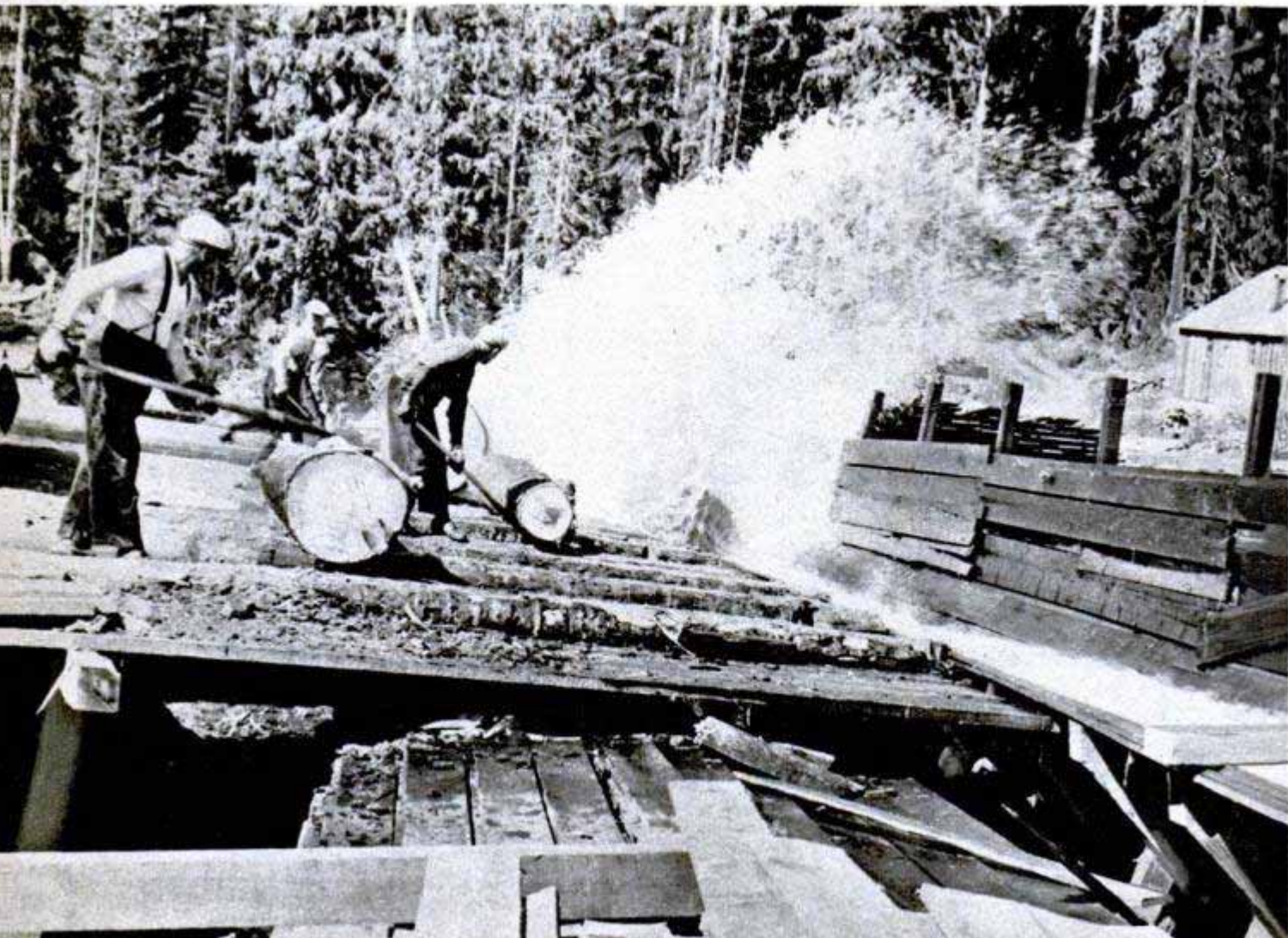



There are 12 million board-feet of lumber piled up in this giant log jam at Big Riffle on Clearwater River

rugged northern Idaho you'll find them as numerous as ever.

What lures a man into this arduous, dangerous life?

It's certain not merely the wages. Riverjacks average about \$90 a week and board. It's something more than money. Perhaps it's that thrilling brush with death that airplane test pilots experience. Or the struggle with nature that a deep-sea diver knows. Maybe it's the challenge of physical skill required of a tightrope walker.

Whatever the lure, it's something that gets into a riverjack's blood and stays there for life. Men who leave the river for safer jobs in cities and on farms, often drift back. After the war, riverjacks who had been drafted promptly returned and asked for their old jobs.

During the sawmill days of summer and the backbreaking task of winter logging,

lumberjacks may find their work a chore and a bore. But when spring comes and ice begins to break up on the river, they suddenly become the aristocrats of the lumbering industry—riverjacks. And for four months—March, April, May and June—the riverjack is king of the North Woods.

Because the 65-mile Priest River is flanked by a good highway, Bill Whetsler's Diamond Match crew drives out from the town of Priest River each morning in trucks, drives back again at night. That's luxury unheard of in the old days. On the other hand, the Potlatch riverjacks enjoy no such conveniences. They run a log drive like their forefathers 100 years ago.

During the summer and winter preceding the drive, logs are cut in the woods and flumed to Clearwater River. Some logs are floated as much as five miles in the flumes. Other logs are trucked to the river and

Riverjacks usually work in groups for protection. If one man falls in, the others help him out of the water

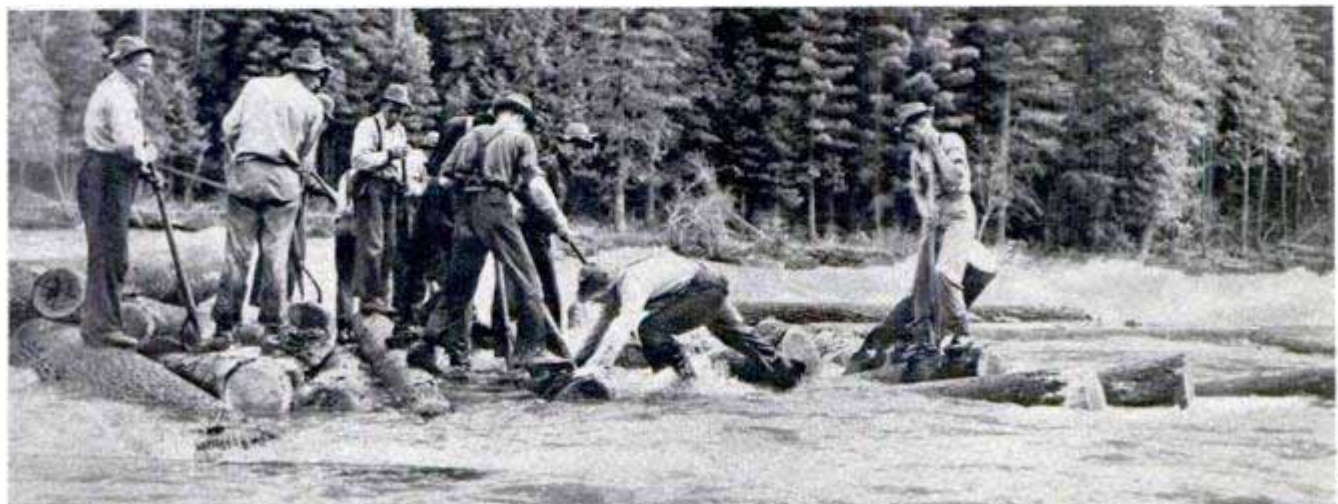



When the riverjacks can't break up the jam with their peavey hooks, a dynamite charge blasts the logs loose. Below, two of the crew are in the icy water as they start the logs moving on the down-river end of the jam





Downstream where the riverbanks are not steep, a bulldozer is used to break up the log jams near the shore

dumped in. The logs float downstream until they hit an obstruction forming a jam.

Then when spring comes, the Potlatch crew goes to work — freeing logs which have lodged on the riverbanks and in jams at the center.

Working with pike, peavey, brawn and sure-footed skill, the riverjacks follow the tree trunks downstream like cowboys driving a herd of cattle over the old Chisholm Trail. Most logs float downstream without any trouble; it's a small 10 to 15 percent that makes riverjacks necessary. Logs get stuck in the mud or entangled in low-hanging branches, jam on submerged rocks, against islands or in the elbows of curves.

Annoying pile-ups that latch on one bank or another are wing jams. Logs jammed against a sand bar in the middle of a river are center jams. They're the trickiest and most dangerous.

Center jams are unraveled from the down-river end of the pile-up. There are two very good reasons for this

point of attack: (1) The key log, the one that holds up all the others, is probably at the lower end of the jam and when it is freed the others can move. (2) Should a riverjack lose his footing and fall into the water, he can be rescued at the down-river end.

One of the biggest jams on the Clearwater occurs each year at Big Riffle, about

When a man falls into the deep water, this boat comes to his rescue





Steering the clumsy wannigan in swift water is hard work. It takes three men to handle the 50-foot rudder

halfway down, where the river narrows between rocky banks. A solid phalanx of from 12 to 15 million feet of timber blocks the river at this spot until rising water frees it.

When working on jams, riverjacks always have nearby a bateau—a double-prow, flat-bottom boat 32 feet long, 6 feet wide, manned by two men with oars and two others with long poles. When a man goes overboard, the bateau can be quickly maneuvered into position so that he can be pulled out.

Much of the time, riverjacks work in ankle-deep icy water and frequently up to their chests in water. A man who plunges in up to his neck is said to have "washed his clothes"; if he goes in over his head, he's said to have "closed the door." But no matter how wet they get in the icy

water, riverjacks keep on working. Woolen clothes and exercise keep them fairly warm if not dry.

Principal tools of a riverjack are his pike pole and peavey. The pike is an eight-foot staff with a hickory handle and a steel point at the end. It's used mainly for pushing and guiding logs. The peavey is a five-foot tool with a hook at the end—used principally for turning logs over. These two tools, plus the old reliable, dynamite, have a long history among American loggers.

No riverjack would get near a log without a pair of well-calked boots. He calks his own—as often as once a week, depending upon how soon the needle-sharp points are dulled by granite rocks. A slippery shod pair of feet is an invitation to disaster. Worn-out calks are removed promptly with chisel and hammer. This leaves gap-

ing holes in the outer sole of the boot. These holes are filled with square pegs of white pine and new calks driven into the wood. As the wood gets wet, it swells, the calks becoming a solid and inseparable part of the boot. Some riverjacks prefer to use small pieces of overall cloth instead of wood.

When a riverjack finds himself on a single log rushing downstream, he's thankful for his calked boots. It's a highly skilled art to remain upright on a slippery log, 24 inches in diameter, as it bounces along in rough water.

(Continued to page 262)

At a sheltered spot along the river, the cookhouse and bunkhouse wannigans pull up to the shore to take on more food for the always-hungry riverjacks

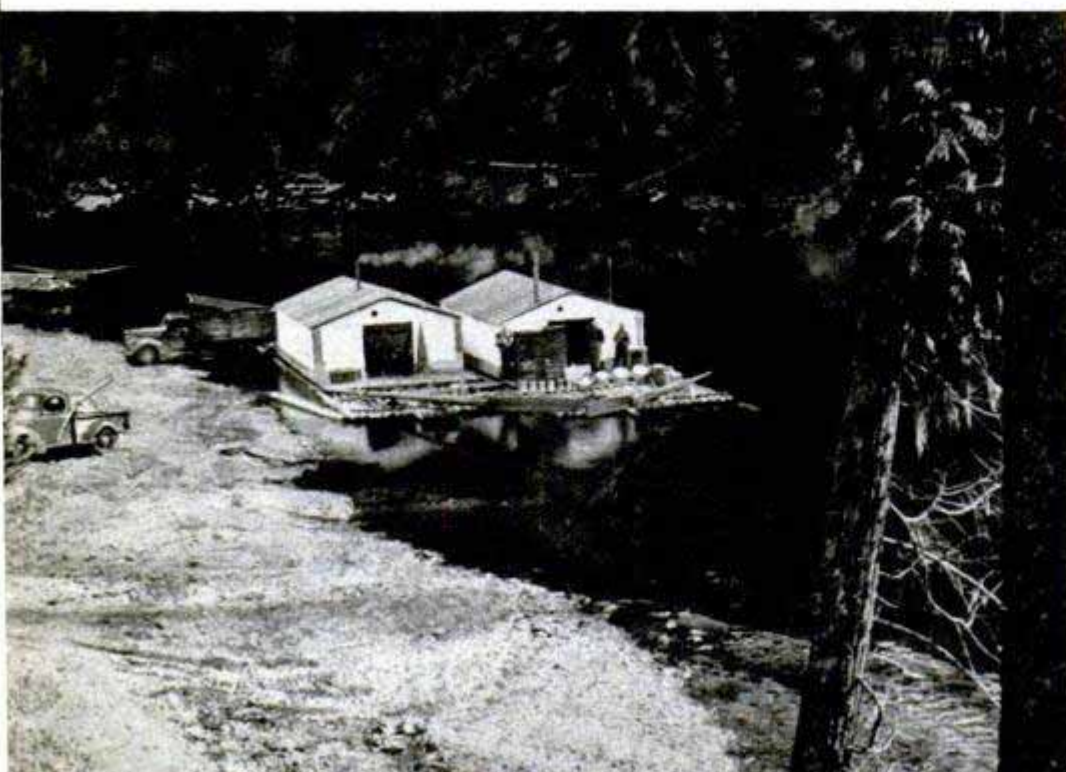

Smoke-Control System

In less than 10 seconds an exhaust system can detect smoke inside a building, draw it into collection ducts and blow it out through the roof. The system, installed recently in the Sage-Allen department store in Hartford, Conn., prevents the chimney-like spread of smoke and fire gases through a burning building. It supplements a sprinkler system for fighting fires. Through six small inlets on each floor, samples of air are drawn continuously and joined into a composite sample in the basement. When there is even a slight amount of smoke present, an electric eye detects it, stops the store's electric stairways, rings an alarm and starts the exhaust system. The exhaust fan pulls smoke into the collection ducts and blows it from the building while cool, fresh air is drawn into the building through another duct.



Gasoline Explosion "Poses" for Camera

Making a gasoline-vapor explosion "pose" for its picture is one step toward preventing such explosions from taking place in aircraft electrical equipment. Engineers at Westinghouse make motion-picture records of carefully planned explosions inside a test cylinder. From these films, the engineers are learning new ways of controlling any explosion so that its force is smothered before damage is done. One method of control consists of covering ventilation openings of aircraft with an aluminum-foil mesh. The mesh dissipates heat and flame and allows expanding air to escape harmlessly.



Jet Transport Plane

Passengers soon may be zooming across the continent in jet-propelled airliners. The first commercial jet transport built in North America is expected to be test-flown this spring at the plant of A.V. Roe Canada, Ltd., in Toronto. Built to carry from 36 to 40 passengers, the plane is expected to cruise at more than 400 miles an hour at 30,000 feet. Four Rolls-Royce Derwent jet engines, paired in twin nacelles on the wing, will power the speedy transport. The air-



craft has a wingspan of 98 feet and a length of 82½ feet. It will have wing fuel tanks and a tricycle undercarriage.

WHAT'S NEW *For Your Home*



ADJUSTABLE HEIGHT is the back-saving feature of a new ironing board, available in either aluminum or wood. With it, you can sit or stand as you iron

RUBBER PADS, left, will prevent those wet and dirty boots and rubbers from soiling the floor. The ridges allow the water to drain off and to dry very quickly

CHILD-LEVEL TRAY, below left, clamps on the dining table, lowering the child's food so that he can use an adult's chair without any extra padding

PLASTIC "PAPER," below, is stainproof and has a variety of uses from wallpaper to closet liners. Made of synthetic resins, it's coated with Vinylite





ELECTRIC DEODORIZER plugs into any outlet. It uses tablets which release scented fragrance in the room

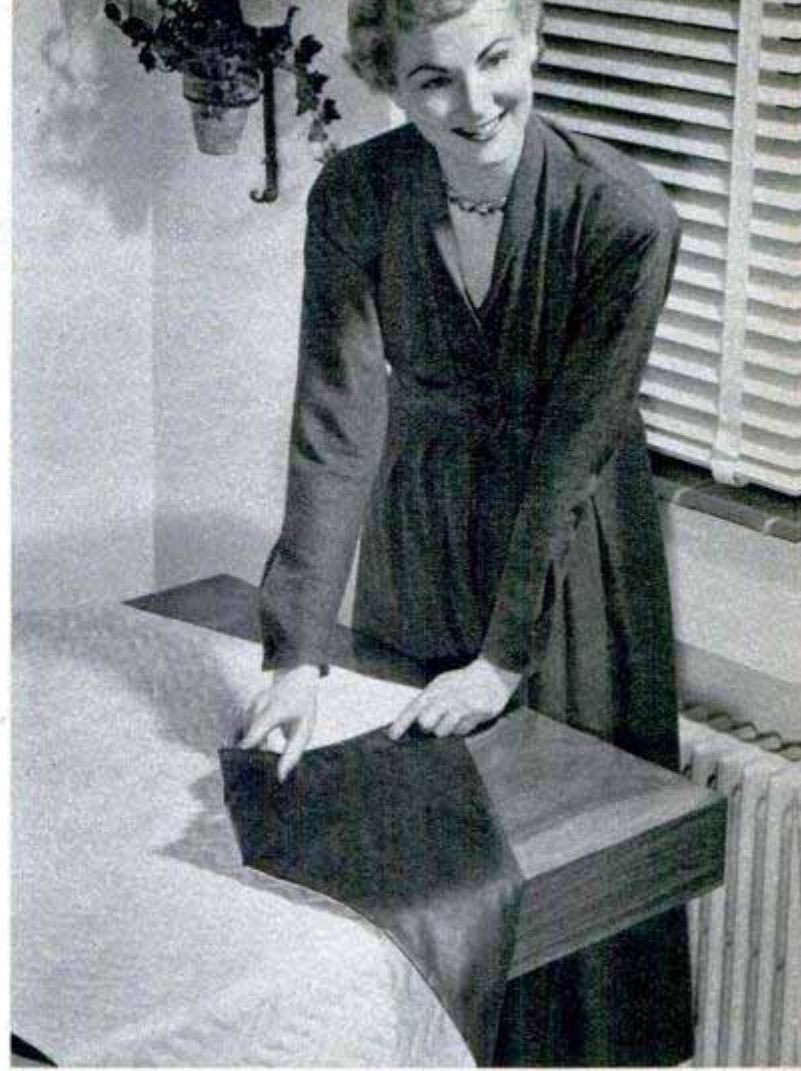
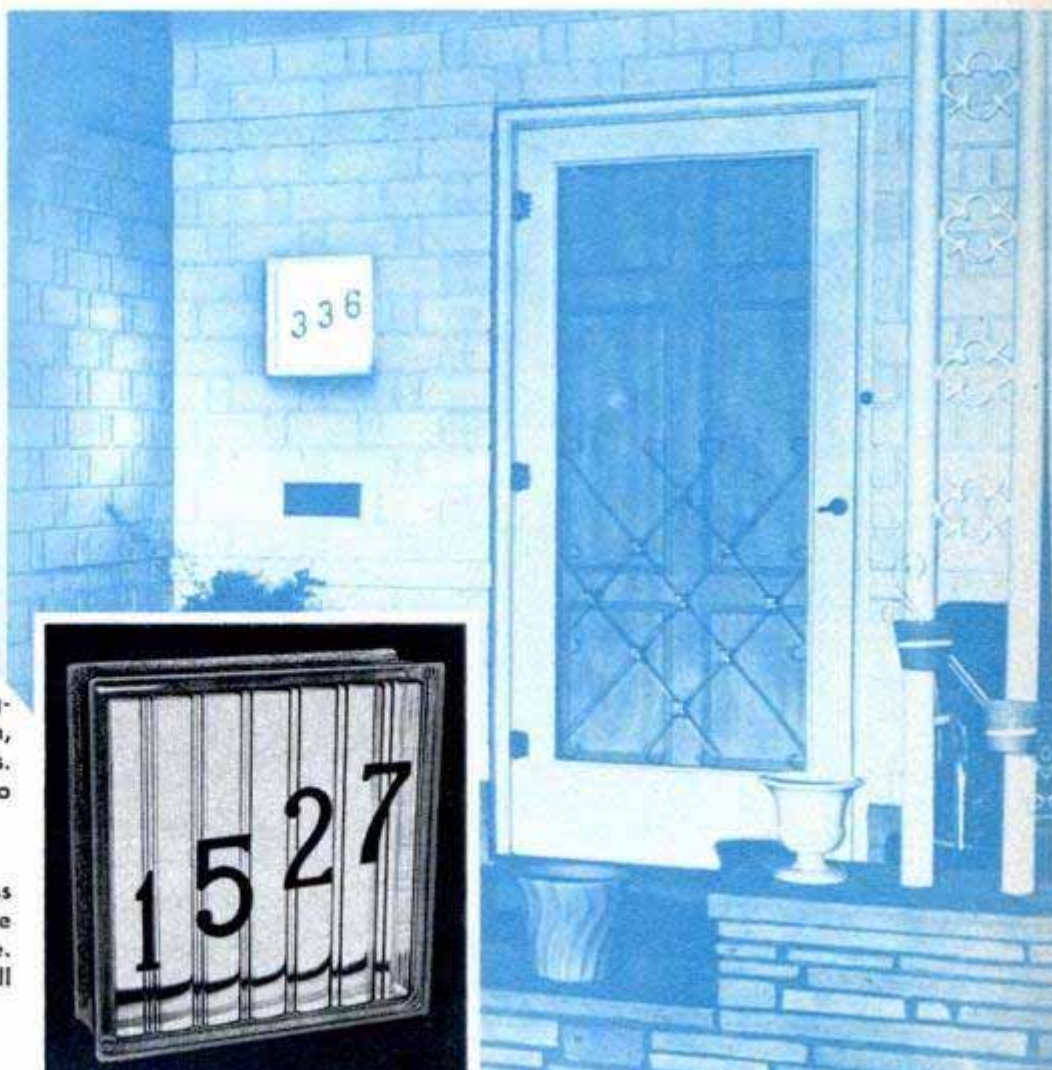

TABLE PAD made of glass fabric protects your dining table from heat and liquids. It's quilted on top



GIANT MAILBOX holds large magazines without folding. Aluminum, it won't rust, comes in four colors. It has a clip for outgoing mail, too

HOUSE NUMBERS mounted on glass block show up clearly in silhouette when lights are on inside the house. The glass block is set into the wall





Water jets on each side of the entrance "steer" a flying boat into the submerged dry dock for hull repairs

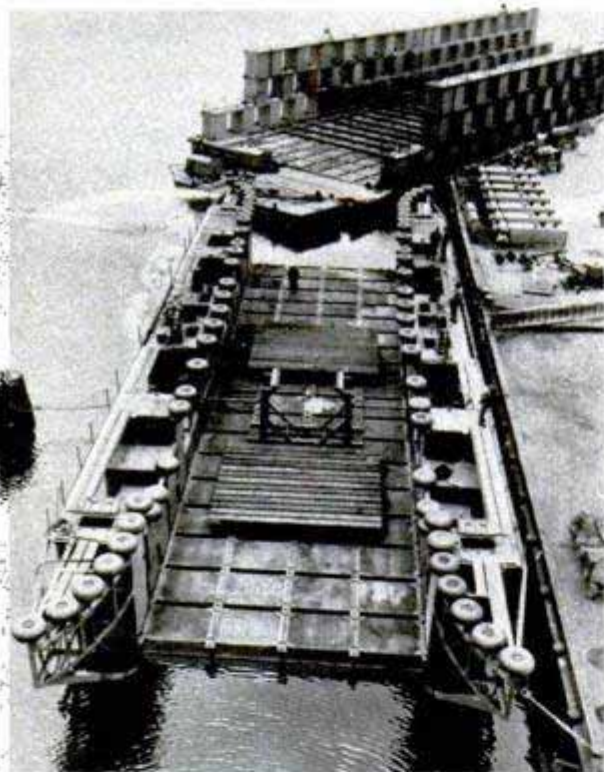

Flying-Boat Dry Dock

Huge flying boats of the U. S. Navy are dry-docked for hull repairs in a few minutes by means of an advance-base dry dock patterned after those used for ship repairs. Constructed of pontoons, the dock has a pumping system that empties the water from the many chambers to float the dock. Inside edges of the dock are lined with partially inflated aircraft tires to prevent damage to the aircraft. Three water jets on each side of the entrance maneuver the plane into position by shooting streams of water against the hull.

Left, the dry dock in the raised position. The tires along the sides serve as bumpers. Below, with tanks pumped dry, the dry dock lifts the plane out of the water for repairs

U. S. Navy photos





Car-Top Tent Springs Into Place

Carried atop the family auto, a combination tent and folding bed has solved the problem of overnight accommodations for Master Sergeant Charles C. Altomare of the Marine Corps. Altomare teamed with Earl Gurley of Springfield, Mass., to invent the car-top room. It consists of a plywood box 6 feet by 4 feet by 10 inches

which holds an air or cotton mattress. When released, a tent springs up over the box, complete with plastic screens on all four sides for ventilation. The windows also are provided with canvas covers. A light on an extension cord can be plugged into the cigarette-lighter outlet. The box is held on top of the auto with suction cups and safety straps. Altomare's car-top tent has proved so popular that he now is manufacturing it.

Snap-Open Holster

Police officers may save a split second in drawing their guns with a new holster that snaps open when a release is touched. Most police guns are cross-drawn from the opposite hip. The new holster hangs from a swiveled tab on the policeman's "shooting side" and opens with a snap, ready for use, as soon as the trigger finger touches the release. Thus, the officer need not draw his weapon—he merely grips it and fires. The holster also prevents the gun from being fired in the case. Developed by two patrolmen of Compton, Calif., it is made of aluminum and covered with leather.

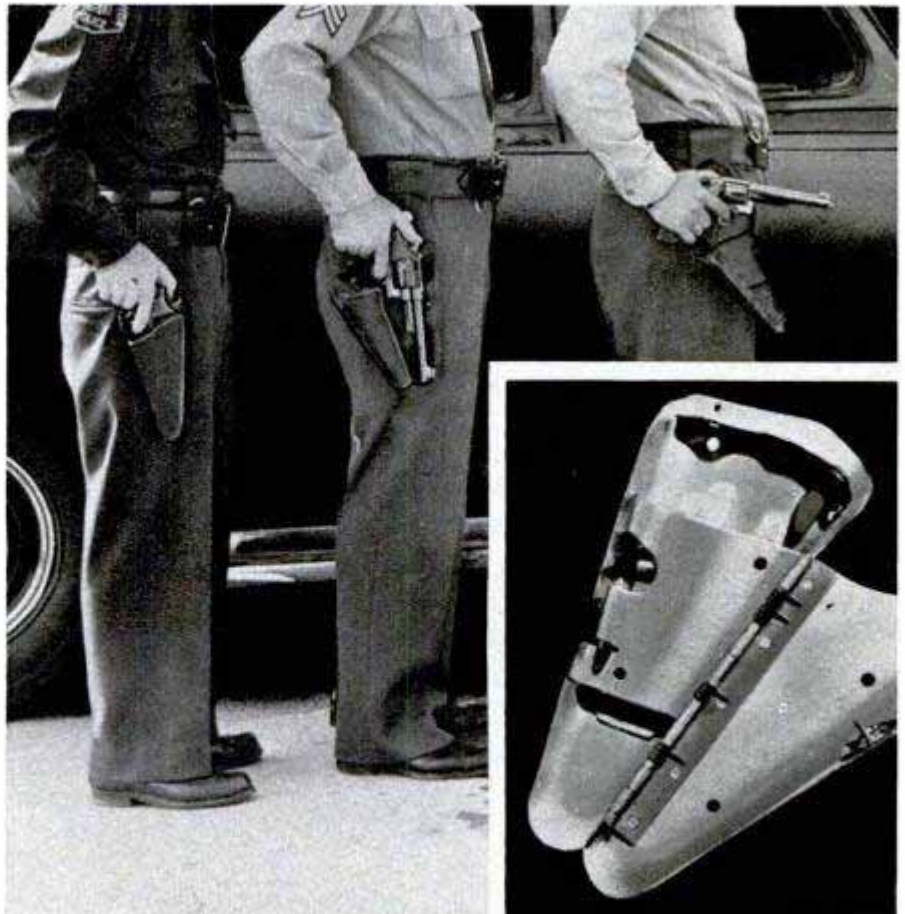

Man's deepest penetration of the earth has been to nearly 9000 feet in gold mines of South Africa.

Three officers demonstrate how revolver snaps from holster, ready for firing. Inset shows the metal case that opens with a touch of the finger

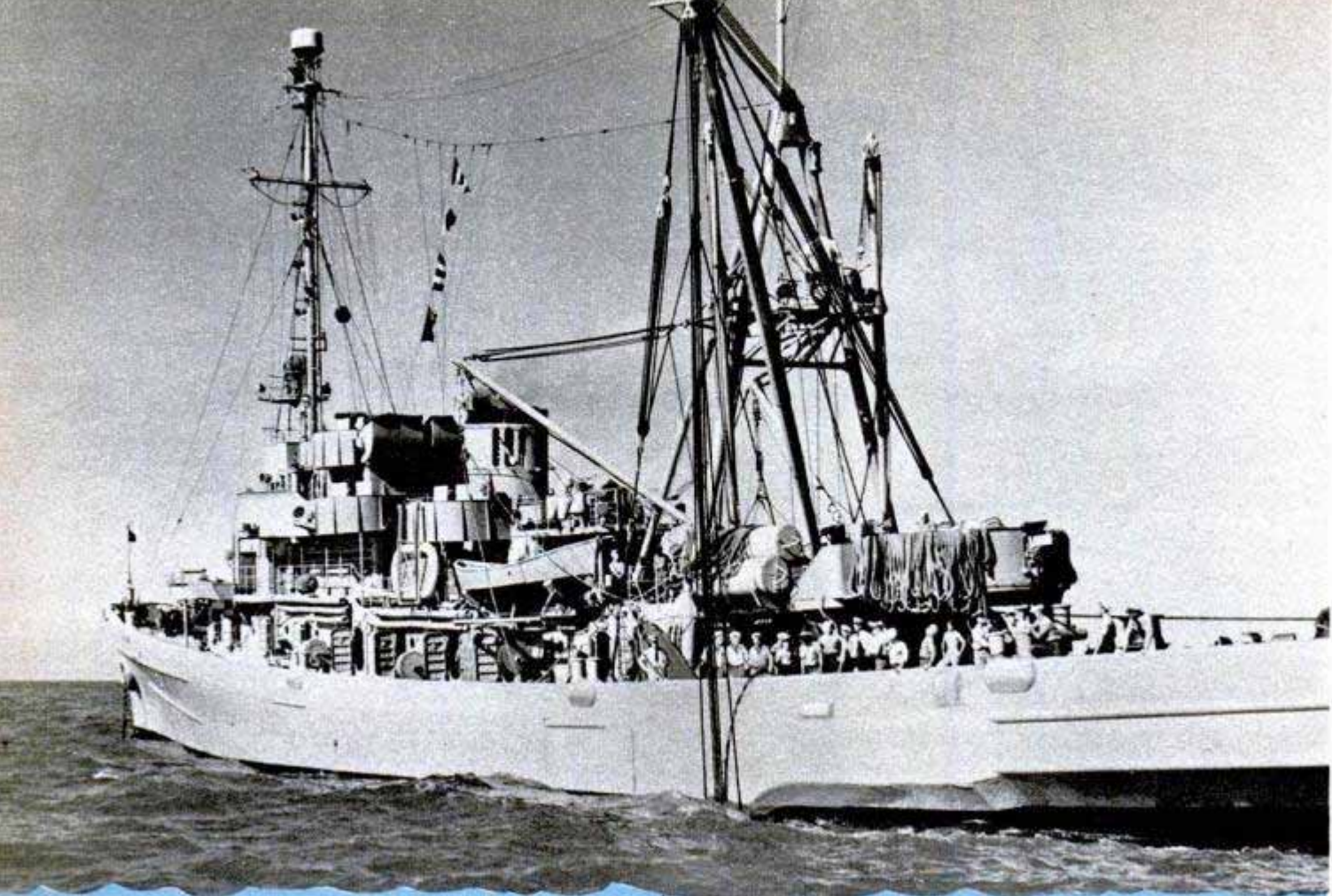

submarine disaster school

By Verne O. Williams

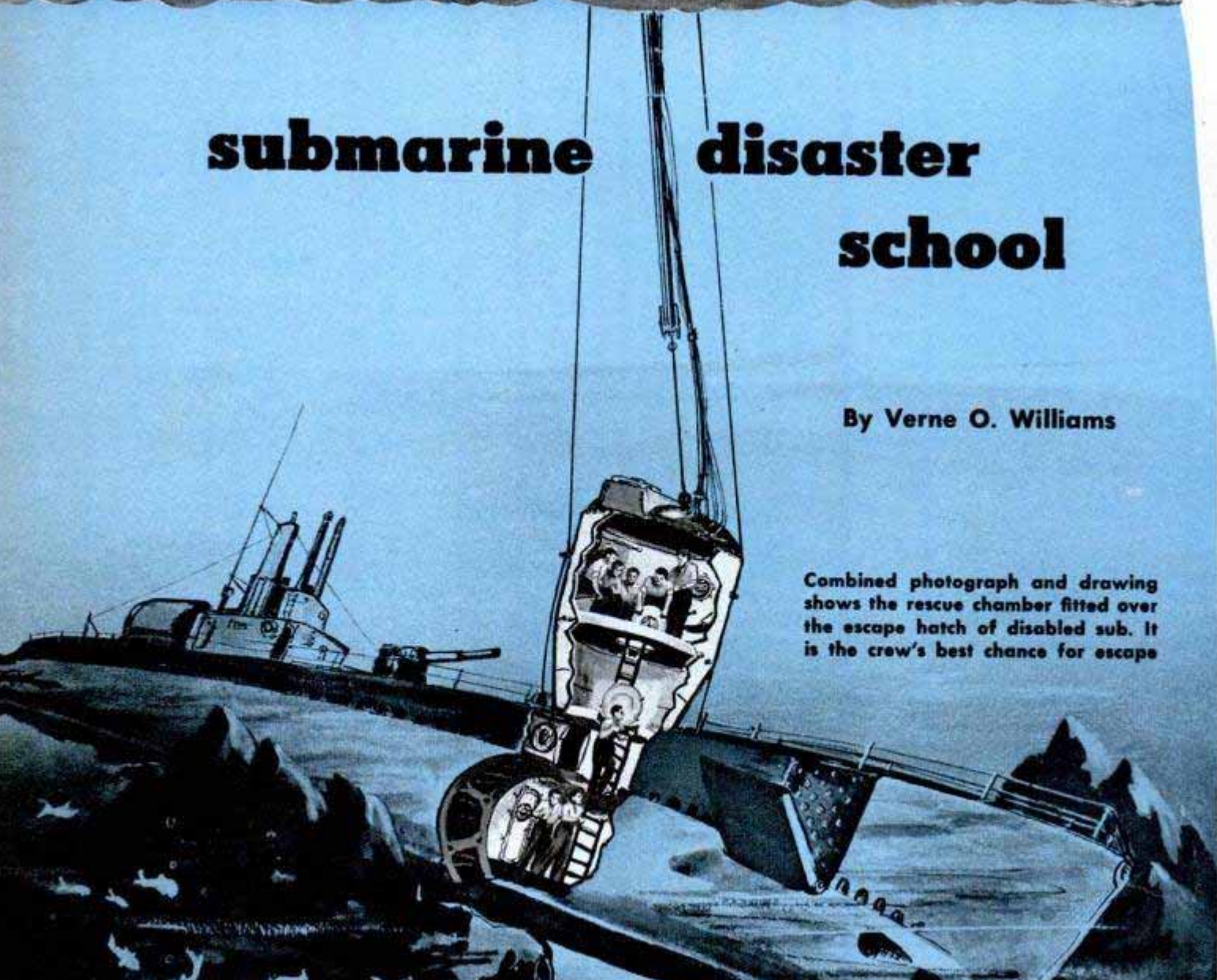

Combined photograph and drawing shows the rescue chamber fitted over the escape hatch of disabled sub. It is the crew's best chance for escape

MINIMIZING the dangers faced by the men who go down under the sea in the slender subs that deliver the Navy's underwater punch is continuously a high-priority project with the top brass.

The subs of today have underwater escape locks and their crews are trained to ascend a buoy line to the surface by the use of their Momsen lungs. But this is a last resort and it is extremely hazardous.

Standing guard over the fleet's submarines as they maneuver in training operations and practice Schnorkel runs, dives and torpedo firing are the Navy's ASRs, or submarine rescue vessels.

In the event of a submarine disaster, the fate of the survivors will almost surely depend upon the outcome of a desperate race between the rescue ship and the diminishing air supply of the sunken sub.

The USS Chanticleer, a typical rescue vessel, has been stationed at the Key West naval base with Subron Four, Navy jargon for Submarine Squadron Four. First of the type built specifically for the job in 1942, she carries the most modern equipment devised for saving subs.

Safety is the watchword of naval training, explains Capt. Alan B. Banister, USN, commanding Subron Four. So far all the Chanticleer's rescues since the war have been practice ones. Her record time for the training operation of search, moor, personnel rescue and raising the "disabled" sub is 6 hours and 35 minutes.

The Navy code word for the schedule of action to be followed when a sub actually is reported missing or disabled on the bottom is "Event 1000."

To understand how the Chanticleer does her rescue job, let's suppose one of Subron Four's submarines fails to radio a report on a practice dive at the scheduled time.

Event 1000 goes into effect and a hubbub of activity begins. By means of shore patrols, telephone calls, announcements over radio and in theaters, personnel are recalled. Sea and air units start to search the diving area.

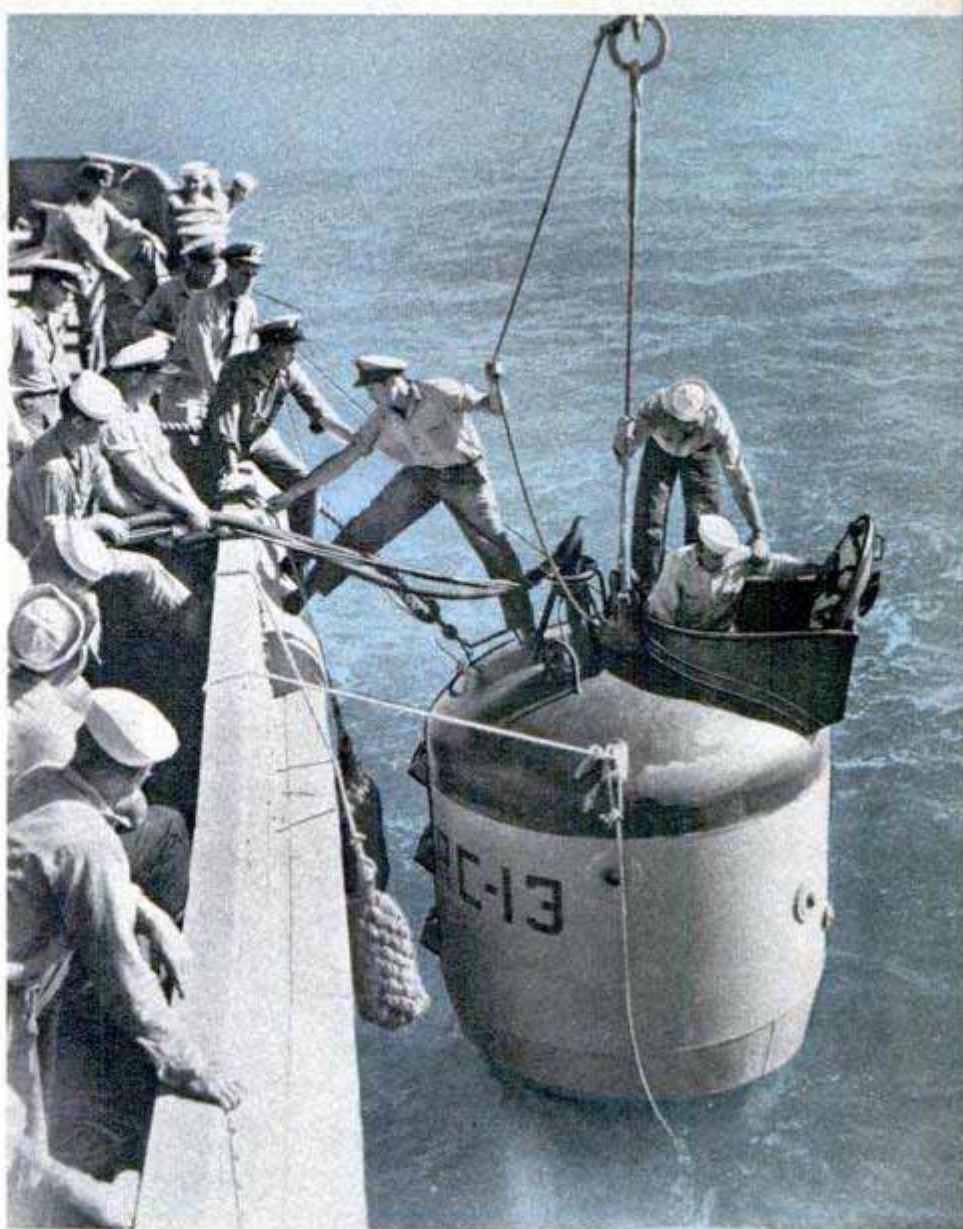

Crew members of the Chanticleer climb into the rescue chamber for a quick trip to the disabled sub. Below, marker buoys sent up by the sub carry a phone for immediate contact with rescuers

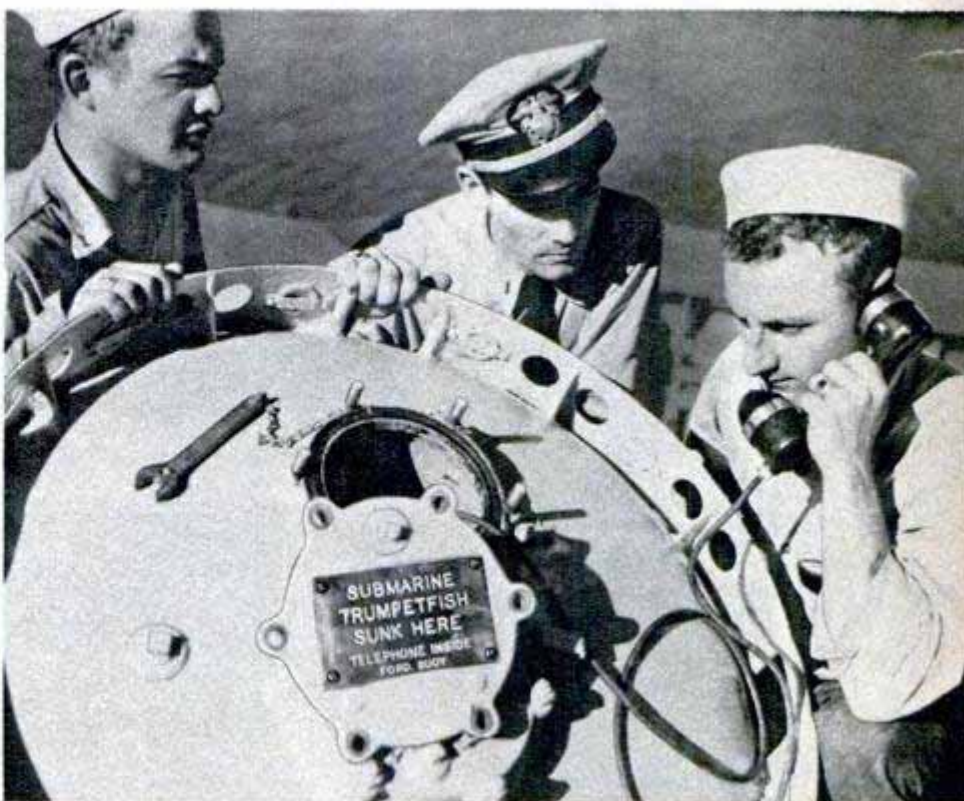

The crew of the Chanticleer, always under a one-hour sailing alert, swiftly rigs the long coils of wire cable that festoon the ship's sides like spaghetti when the ship is going out on a "moor."

Subron Four's high brass hurries aboard and the Chanticleer puts out from the dock as her crew continues rigging the thousands of feet of buoy cables for quick, smooth release over the spot where the sub is found.

In the meantime, what happened aboard the sub?

After notifying the base by radio that he was about to submerge on an hour-long dive, the commander of the submarine took her down to 50 feet.

As the craft was straightening out horizontally at that depth, he was notified that water was pouring into the after part of the ship. Instantly, he orders the blowing of ballast tanks. For a moment the sub hesitates, then begins to sink by the stern, coming to rest on the sea bottom 200 feet down.

The cause of the disaster might have been the failure of the main surface air-intake valve to close during the dive, as actually happened to the Squalus in 1939. The entire submarine, in that case, would have been flooded if a quick-acting crewman in the control room had not closed a watertight bulkhead door, saving the lives of the men forward.

A check of conditions proves the sub can't raise herself. As a last resort her crew can use the escape lock and their Momsen lungs, but that is extremely hazardous at this depth. Now the crew must help the rescuers locate the sunken sub.

Diver's job is to attach the downhaul cable of the rescue chamber to escape hatch of helpless submarine

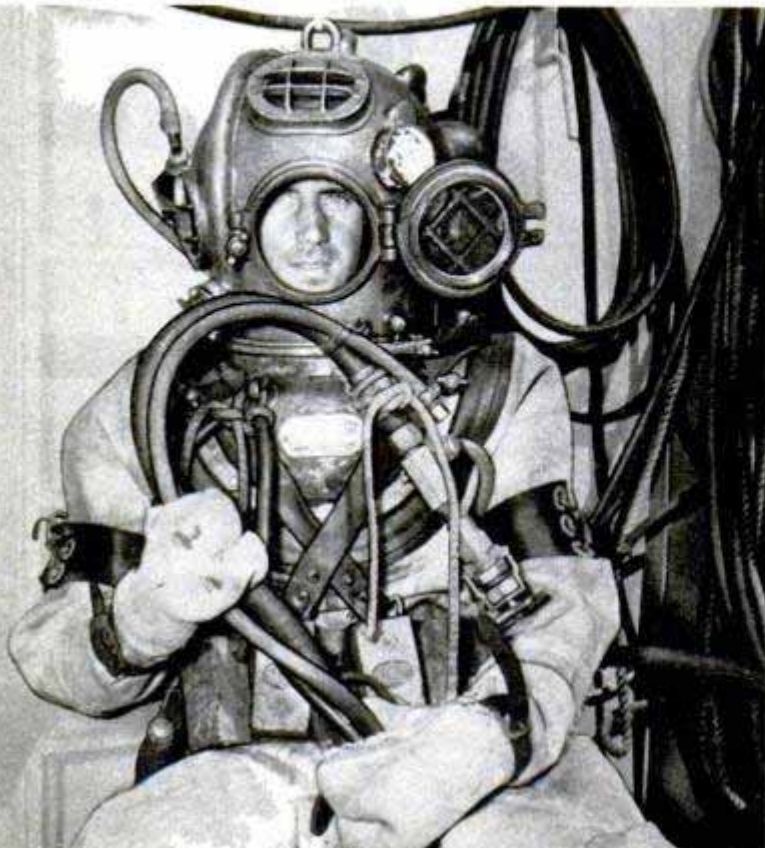

The two marker buoys fore and aft are released and shoot to the surface. The crew also can release bubbles, oil, sea dyes, and at regular intervals send up flares and smoke bombs which explode on reaching the surface.

Search planes sight these and radio the Chanticleer. Arriving at the spot, the Chanticleer establishes sonar communication with the sub while one of her two motor whaleboats goes to pick up one of the sub's marker buoys and establish telephone contact through the circuit carried by its cable. Meantime, the other whaleboat grapples for the sub to provide a descending line for the divers.

In the Chanticleer's wheelhouse her skipper, Lt. Harry J. Messick, and his executive officer, Lt. William E. Cook, plot the depth of water, current and position of the sub on the bottom preparatory to planting a six-point moor to hold the rescue ship in position for diving.

Each of the six mooring anchors held ready to drop is connected by one of the long cables festooning the Chanticleer's sides to its own buoy in a release rack on the fantail. To plant the moor, the Chanticleer swings in on a bearing and range plot on the submarine, laying down three of the anchored buoys 60 degrees apart.

With a neat figure-eight maneuver she turns and puts down the other three buoys. Then she enters the moor and her whaleboats quickly run out lines to the six anchored buoys which are adjusted to center the Chanticleer over the submarine like a spider in a web.

New buoy developed for subs carries a cable to surface, eliminating need for dangerous deep-sea diving

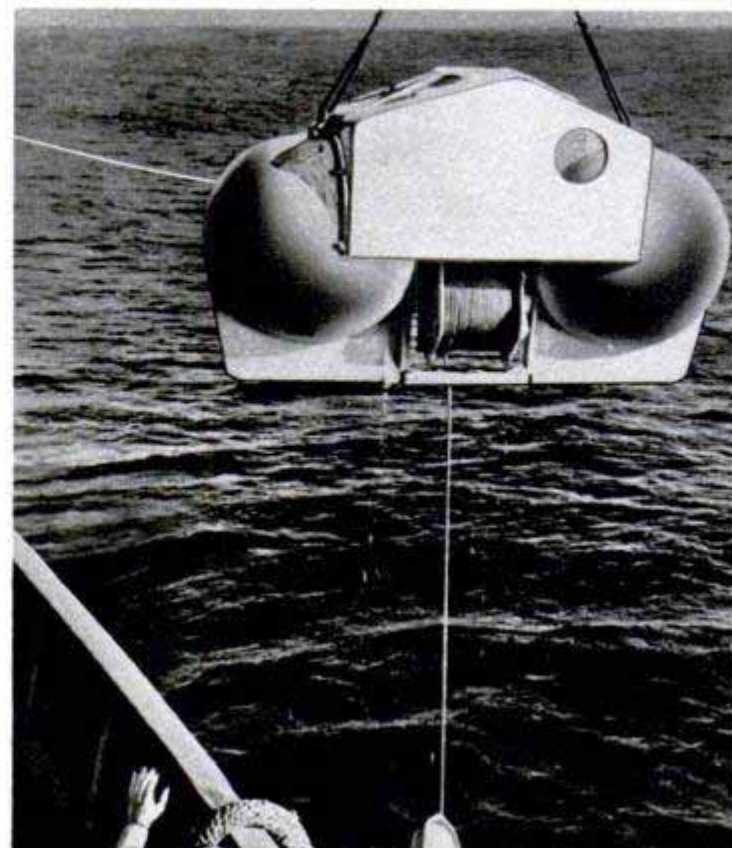

Now the divers take over. In her crew complement the Chanticleer has 20 deep-water Navy divers. Just a few months ago a new U. S. diving record was established when one of them, G. W. McCullough, together with W. G. Singleton of the Navy's experimental diving unit, went to 485 feet in the Gulf Stream.

As the diver in his ungainly 200-pound suit enters the water on the stage, he gives himself a shot of air so he can "square himself around" in the suit. He tests his telephone and air supply—actually he's probably diving on "gas," the oxygen-helium mixture used for deep work.

The reason divers use gas is that the nitrogen in compressed air has a narcotic effect under deep-water pressure and can knock a diver out, as will straight oxygen. Thus, to attain depths over 200 feet, a regulated mixture of oxygen and helium, which research has proved nontoxic, is used instead.

The diver slides down the descending line with one hand. The other must be on the air valve to increase the suit pressure, offsetting that of the sea at succeeding depths. A 10-foot differential, such as an underwater fall from the conning tower of the sub to its deck would mean a nasty "squeeze" by the suit.

The rescue diver's first job is to attach the downhaul cable of the Chanticleer's rescue chamber to the escape hatch over the sub's forward torpedo room.

Landing on the deck of the sub with visibility limited to 20 feet, the diver finds a nearby fitting and counts its "buttons. From their number, the diving master topside, checking a blueprint of the sub, can tell him where he is.

Thus informed, the diver starts forward, possibly forced to crawl on his hands and knees to buck the strong currents prevailing in the depths. He exercises extreme care not to foul his lines by going around the hole. Other divers, fully dressed, are standing by, topside, in case he gets into trouble.

Finding the escape hatch, the diver secures the downhaul cable. For safety the

(Continued to page 260)



Diver stands on stage ready to be lowered to sub's deck for first physical contact with the disabled craft. Below, when wreckage holds up rescue work, divers cut it away with hydrogen underwater torches
U. S. Navy photo



Fleet-type sub recently was converted into a transport. Watertight tank carries landing equipment
U. S. Navy photo



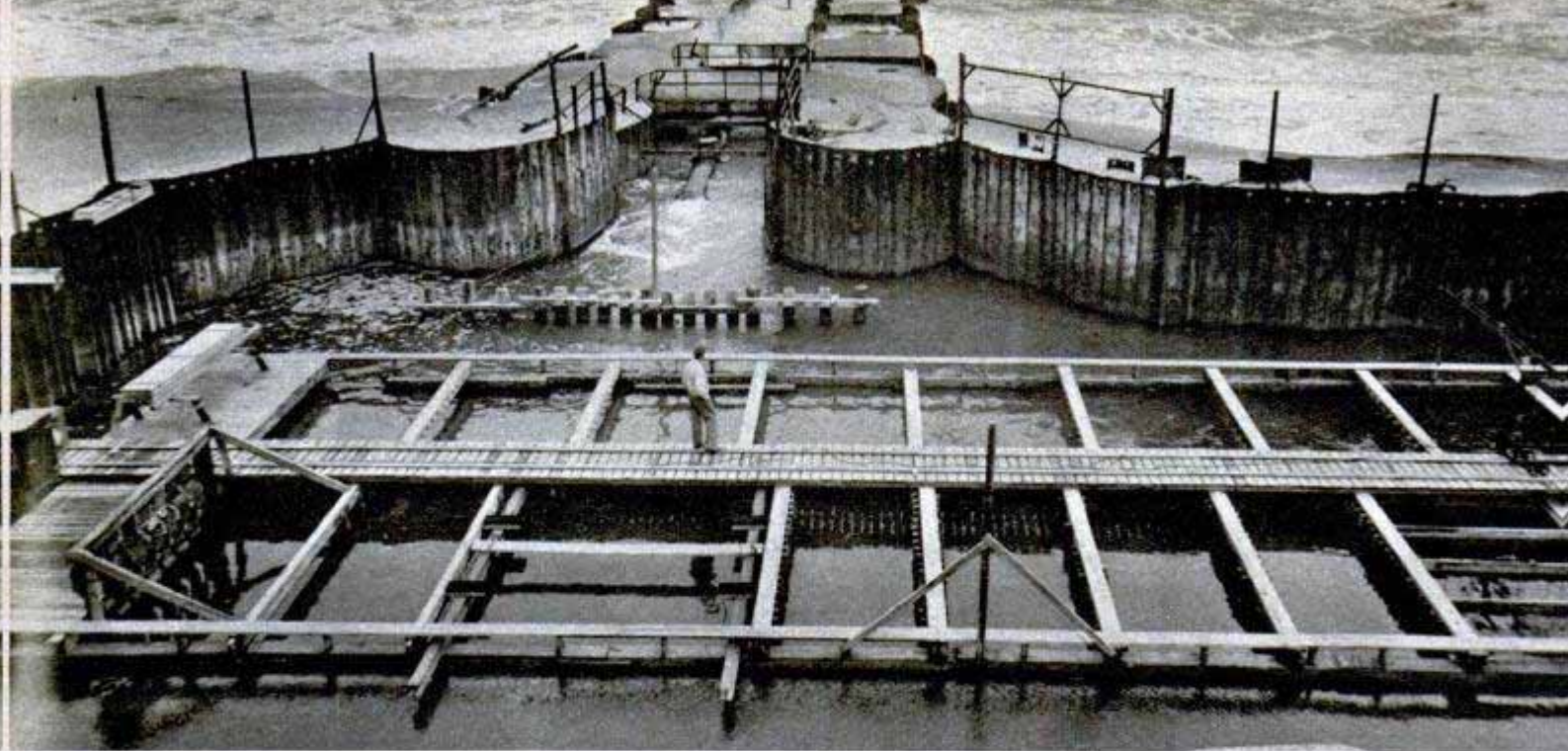

Marine testing basin along the ocean at Kure Beach, N. C., has metal racks for testing various alloys; intake is at the top

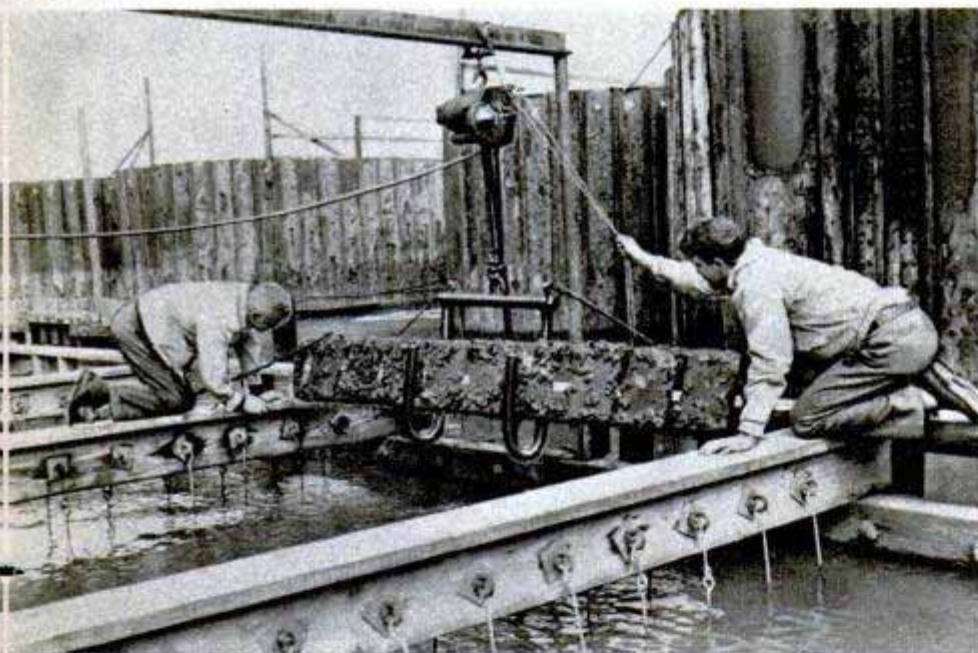

Technicians make periodic examinations of specimens—most of them are of metals to be made into underwater parts for ships. Below, examining alloy specimens tested with natural salt spray

International Nickel Co. photos

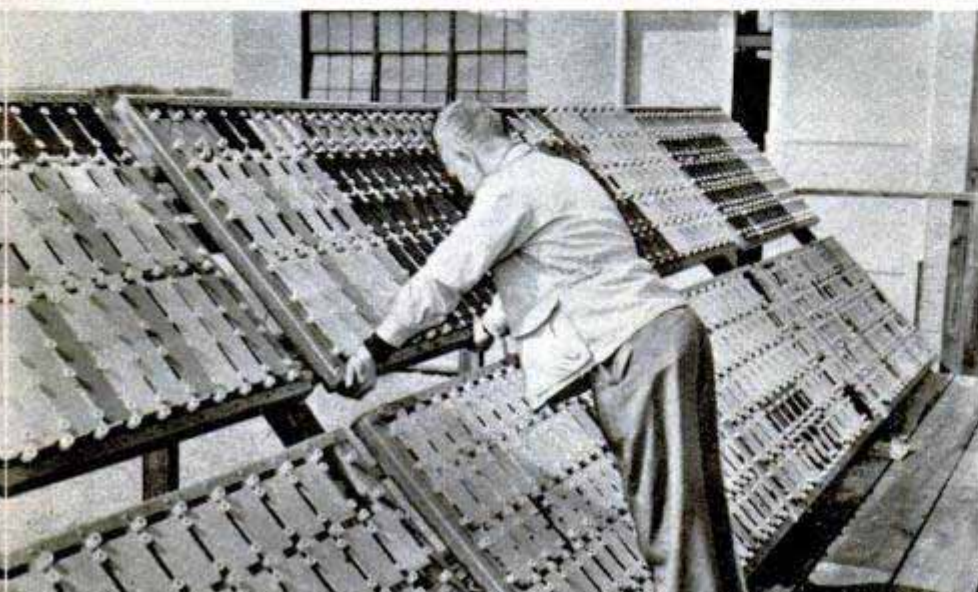

Putting The Ocean to Work To Help Save Metals

THE COMMON ENEMY of metals—corrosion—is fighting a losing battle against modern science and, as a result, thousands of dollars are being saved annually by American industries.

Since 1935 the International Nickel Company has been conducting extensive corrosion tests at its sea-water testing station at Kure Beach, N. C. These tests include comparing the corrosion resistance of low-alloy steels with carbon steel, comparative tests on all kinds of ferrous and nonferrous metals and alloys, observing the behavior of various types of metallic and organic protective coatings and the effects of marine growth on wood and metals.

Specimens to be tested are fastened to racks constructed of Monel, or an alloy which contains 70 percent copper and 30 percent nickel. Periods of exposure vary from six months to several years and the number of specimens exposed varies from about 1000 to 2000. Testing the erosive effects on metals for condenser tubes, pump impellers, propellers and underwater parts of ships is done by fastening the specimens on a disk which whirls through the water at velocities up to 30 feet per second.

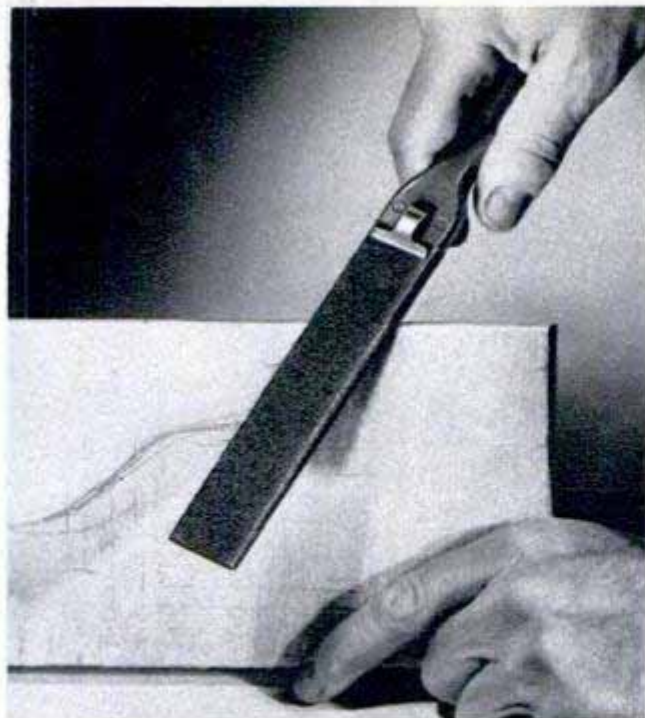

Finishing Tool Holds Strip Abrasive

Standard one-inch abrasive strips can be clamped in a file-shaped tool for sanding wood, polishing metal, removing sharp edges from machined parts and sharpening other tools. A threaded knob on the handle of the tool permits the clamps to be released so a worn strip of abrasive can be replaced with a new one. A one-inch strip cut from a standard sheet of abrasive or sandpaper also will fit the tool.

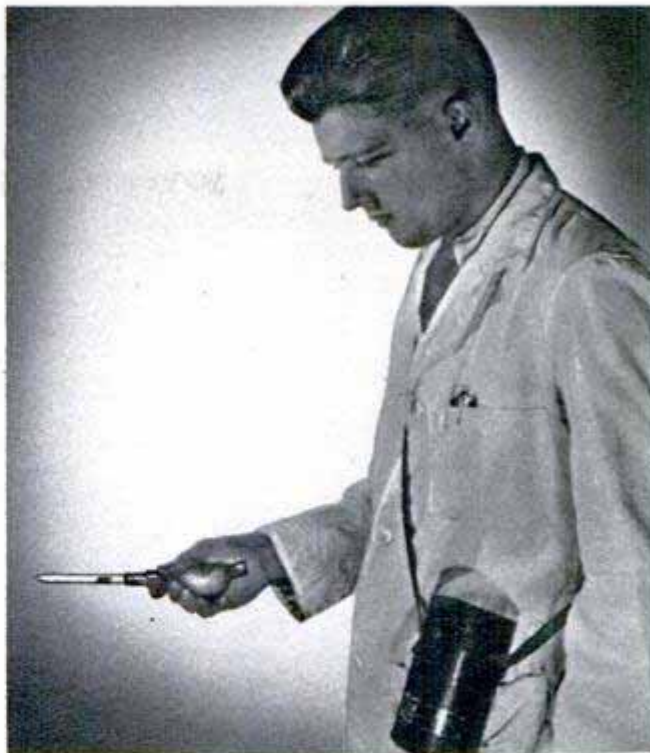

Carbon-Monoxide Detector

About the size of a pencil, a sensitive detector indicates the presence of less than one part of carbon monoxide in 500 million parts of air. Developed by the National Bureau of Standards during the war, the detector now is available for use in airplanes, busses, automobile repair shops, refineries, mines and homes. It consists of a rubber bulb and a small glass tube sealed at both ends. When carbon monoxide is suspected, the tips of the tube are broken off and one end is inserted in the bulb. Squeezing the bulb draws a sample of air through the chemicals in the tube. If the gas is present, the yellow chemicals turn green within 30 seconds; the darker the shade of green the higher the concentration of gas. A color chart indicates the amount of carbon monoxide.



Electric Heater Keeps Piano Dry

Dampness is kept out of pianos, closets and sensitive electronic instruments by an aluminum tube containing an electric heating element. The tubes come in various lengths and can be operated from any household outlet. By maintaining a constant heat inside the instrument or closet, the unit prevents dampness and mold from damaging the contents. The low heat will not char or burn.



Manhattan sky-line mural, shown on opposite page, here is used as a background to be seen through a window. The camera, out of range at left, picks up actors in the foreground against the realistic sky line

Paul, who makes the murals, sits in front of a 9 by 12-foot photo of a hallway and seems to be sitting in the hall itself. His technique for making huge backdrops is widely used in producing motion pictures



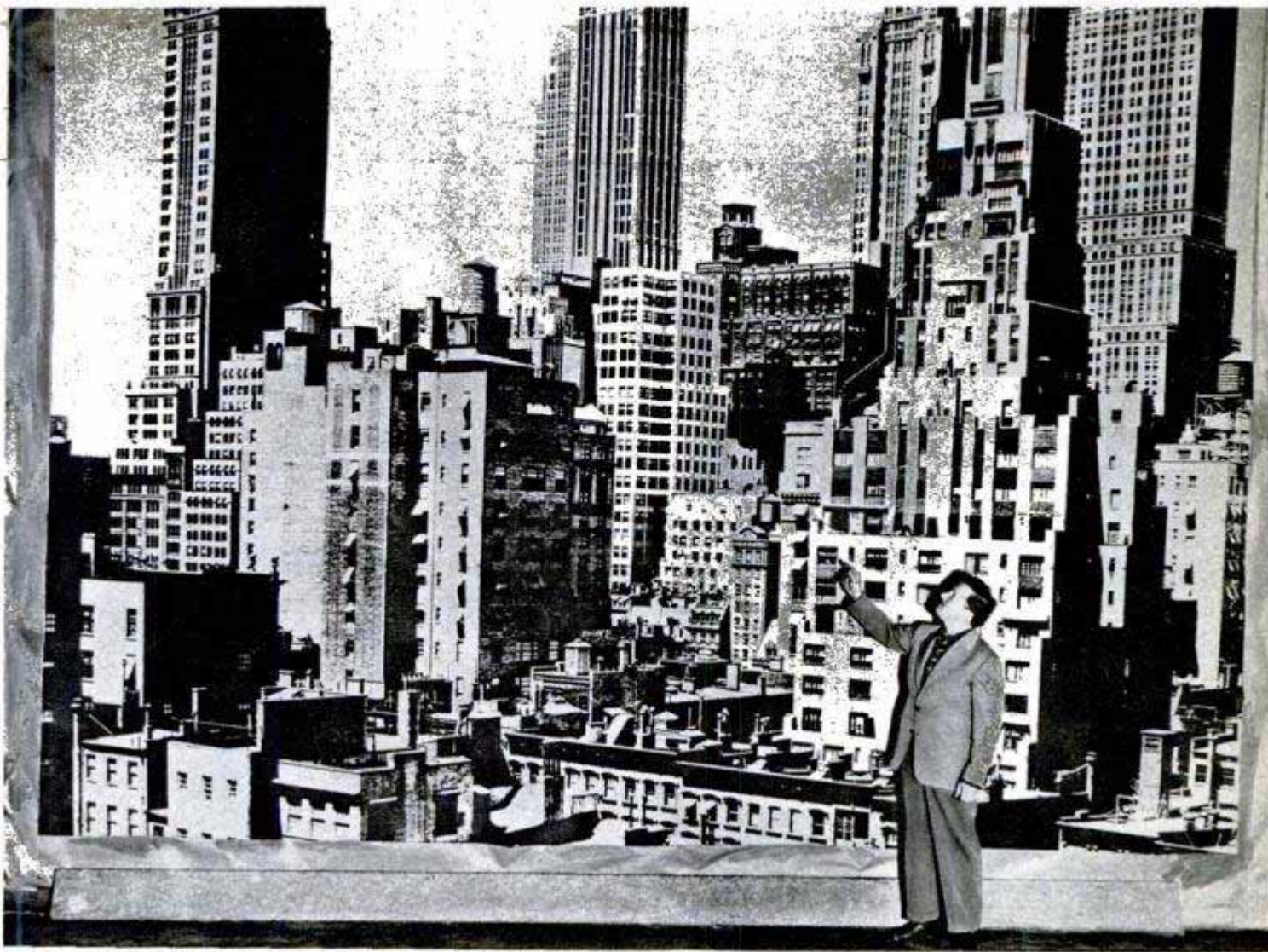

Sky-line mural is black and white when lighted from the front, appears in natural colors when lights are behind it

Mural Magic

Mural maker uses dodging panels to hold back or "burn in" image portions while he is making huge enlargement

A GIANT PHOTOGRAPH of a portion of the midtown Manhattan sky line is used as a backdrop by Hollywood motion-picture studios. Measuring 15 by 20 feet, it is said to be the largest single photo ever made. The huge enlargement was made from a 4 by 5-inch negative by means of a new technique developed by M. B. Paul, motion-picture cameraman.

When viewed by ordinary reflected light, the photograph appears to be a standard picture in black and white. When light is transmitted through the translucent material from behind, the photograph acquires the colors that are natural to the scene, making the picture adaptable for either color





Paul compares a 12 by 20-foot photo with an 8 by 10-inch print of the same scene. Below, oil paints are sprayed on rear of a photo to make it appear in natural colors



or black-and-white motion-picture use. Oil colors, sprayed on the back of the picture, and not visible when it is lighted from the front, produce the two effects.

Giant pictures on a single sheet of material and made from a single image have long been a photographic ideal but previous experimenters were unable to solve the numerous problems involved. The largest pictures made in the past were created by painstakingly matching and pasting together a number of strips of material, each containing a portion of the picture. The new technique can be applied to single enlargements measuring as much as 20 by 45 feet.

Paul manufactures his own seamless translucent backing material to the dimensions desired, flows on a liquid gelatin emulsion and cures it in the dark. The picture is then projected onto the emulsion by a special condenser-type photo enlarger, and the image is later developed and fixed in huge tanks. The finished photograph is sharp and clear and has a minimum of grain.

The method is applicable to motion-picture "process" screens and backdrops of all kinds, murals and giant display advertisements, either indoor or outdoor.

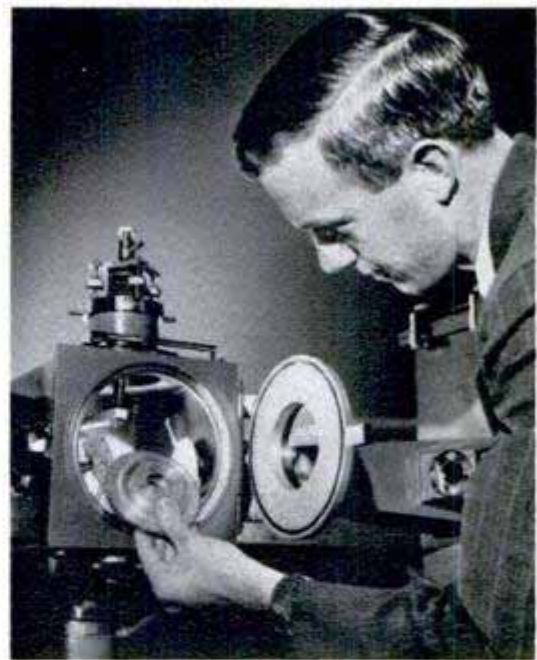
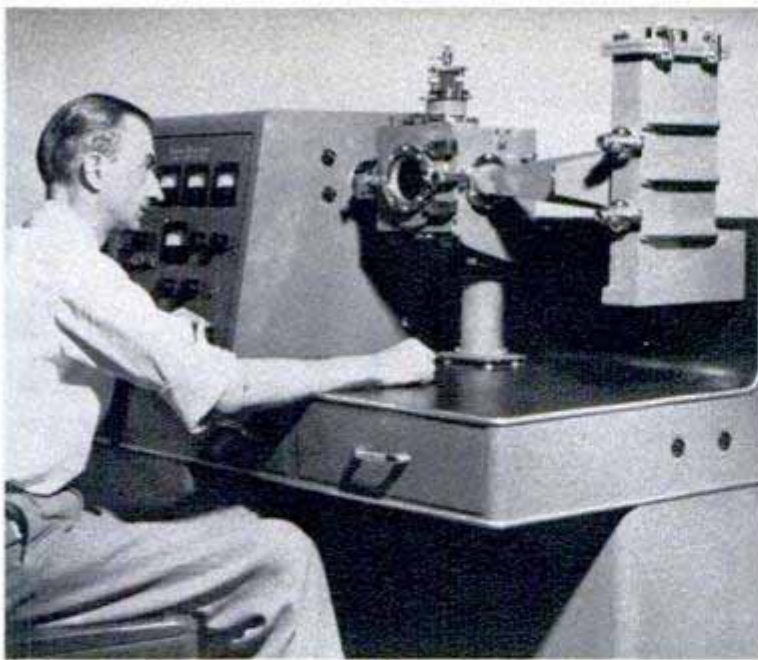

Electrons Help Study Metal Surfaces 1/250,000 Inch Thick

Electrons shot from a tube aid in studying corrosion and crystal structure of metal surface layers less than 1/250,000 inch thick. The new instrument is used by General Electric for developing longer-wearing metals for aircraft engines and bearings. Tests are made in a chamber pumped to

a high vacuum, since electrons will not travel through air. An electronic beam is passed through or slanted off sample metal to produce an image on a fluorescent screen. Photographic film can be substituted for the screen to make a permanent record for study.

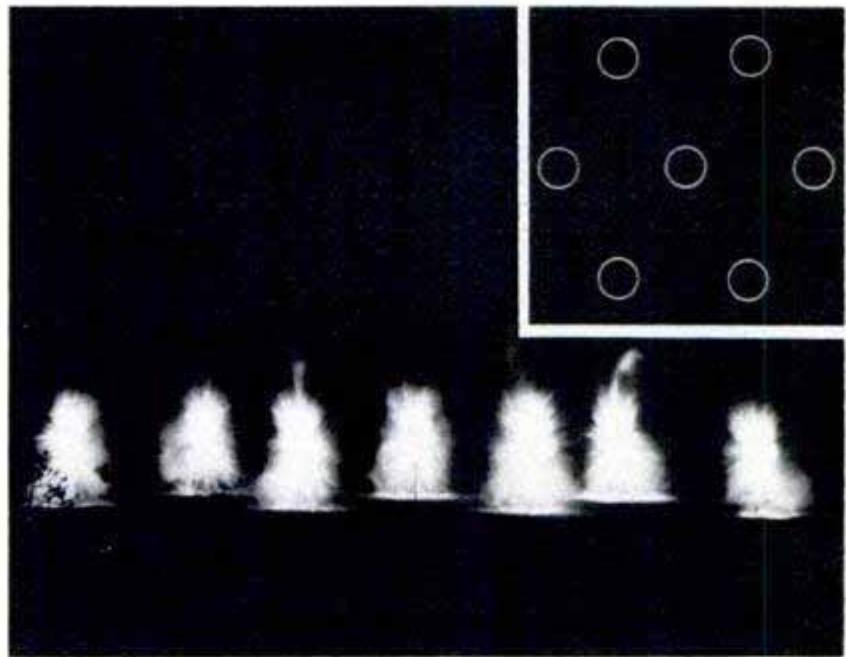

Explosions Above Surface Find Underground Oil Deposits

Firing explosive charges above the ground is the latest method of locating probable underground oil deposits. The method, developed by Dr. Thomas C. Poulter of the Institute of Inventive Research, is a variation of the seismic method, in which an explosive is detonated within the earth, and shock waves are reflected back from some types of underground structures to instruments on the surface. Dr. Poulter discovered that a pattern of

charges detonated above the earth would produce a shock wave which could be used in the same way. In the new method, charges that are hollow on one side are placed on poles in a hexagonal design, with one charge in the center. When the charges are fired, the wave echoes are picked up by a seismograph and interpreted to find out whether the underground structure is likely to contain oil. The method eliminates boring holes, which is costly in some areas.

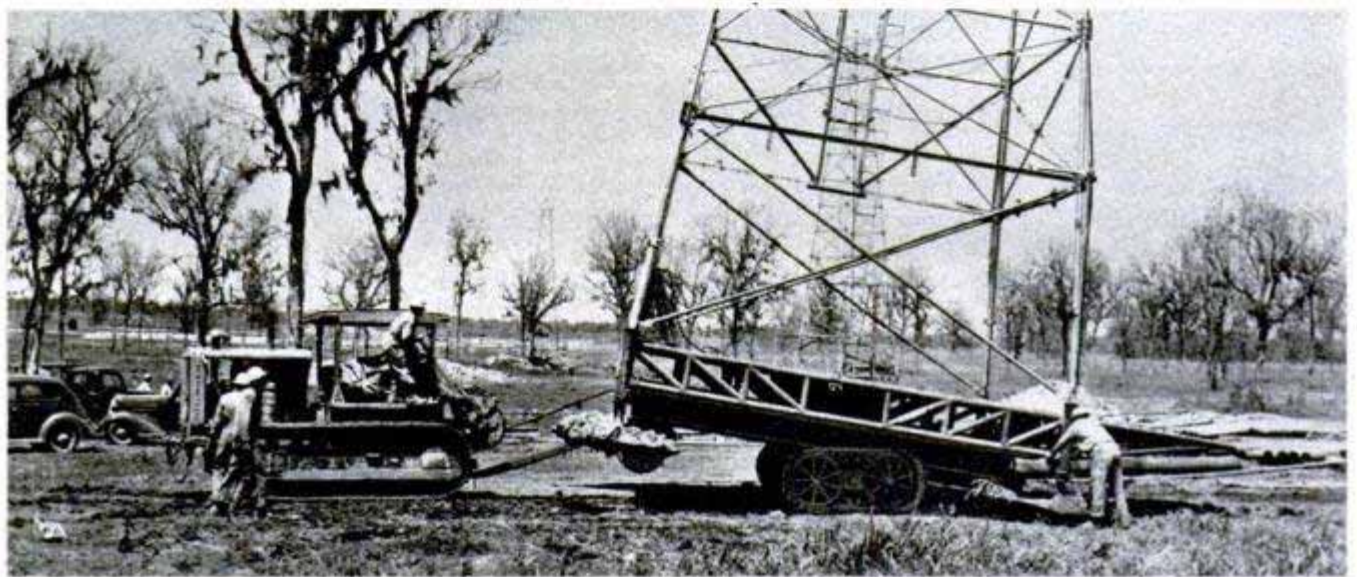
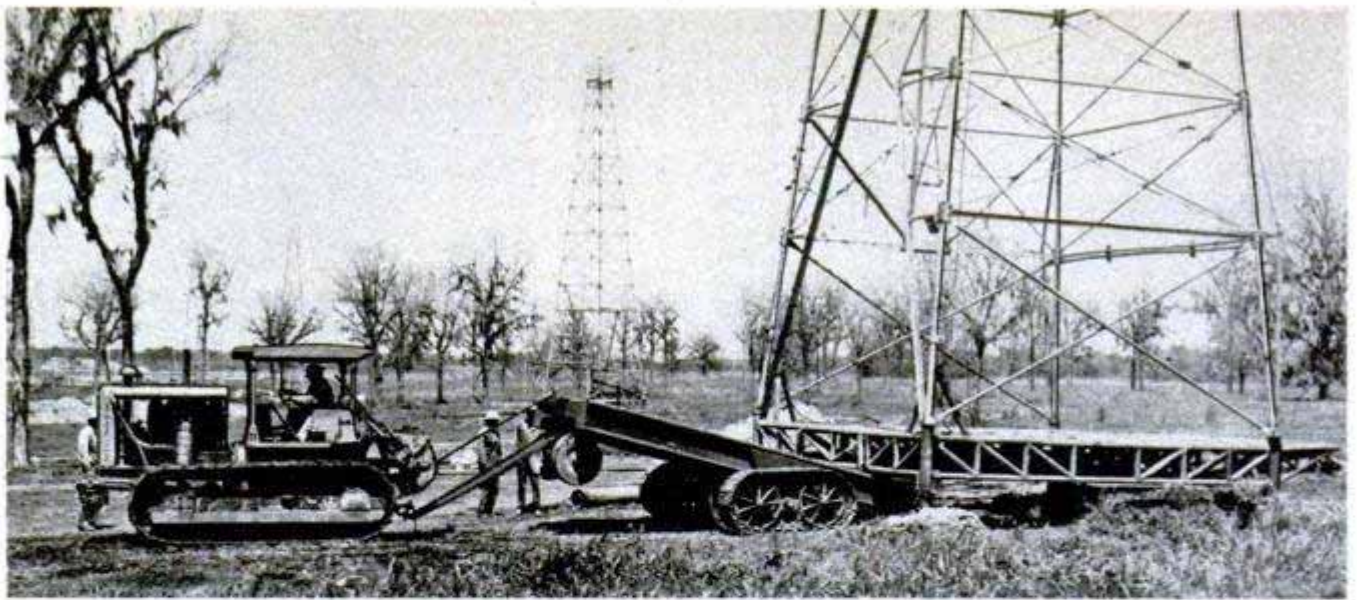

Trailer Picks Up Derrick and Carries It Away

Sulphur-well drillers have to be able to move their 87-foot derricks quickly and inexpensively and one company has solved the problem by using a trailer that picks up the derrick and carries it to the new location. The trailer, equipped with crawler treads, consists of a heavy bed mounted on a bearing between the axles. The bed

tilts to slide under the drilling platform. When the trailer is completely under the 24,000-pound derrick, the bed is swung down to a horizontal position and the derrick is ready to roll. A Caterpillar tractor pulls the load. No guy wires are used and it is not necessary to jack up the derrick during loading or unloading.

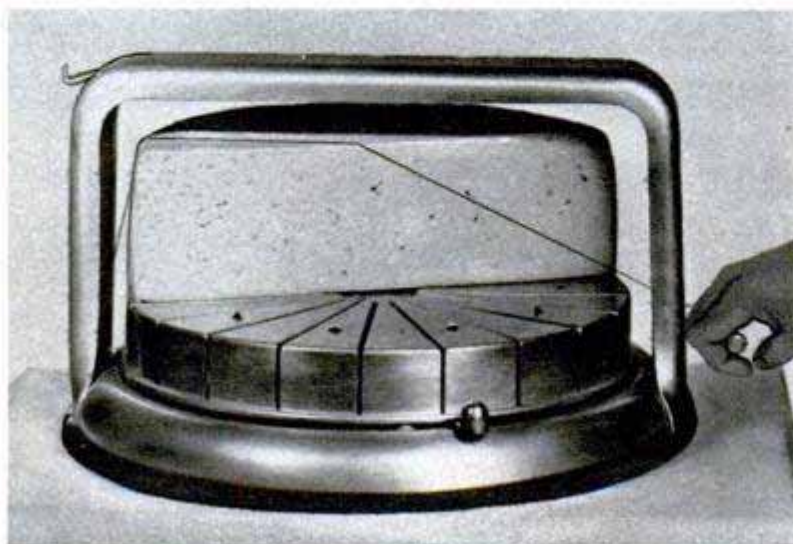

Speedy Cheese Cutter

Wheels of cheese are cut into pound slices in a fraction of the time usually required by a cutter using a stainless-steel wire. The cuts are clean and accurate since the revolving base on which the cheese rests is slotted for cutting one-pound pieces. A take-up wheel under the base keeps the wire taut. After each cut, the operator trips a lever which turns the base for the next cut. With the cutter, a 24-pound wheel of cheese can be cut into pound slices in one minute.

With an eye like an owl, this aerial camera takes photos of high image quality under poor light. Right, one small flash bulb was enough to make this night shot. The trees in distance were 600 feet from lens

Aerial Camera With An Owl's Eye

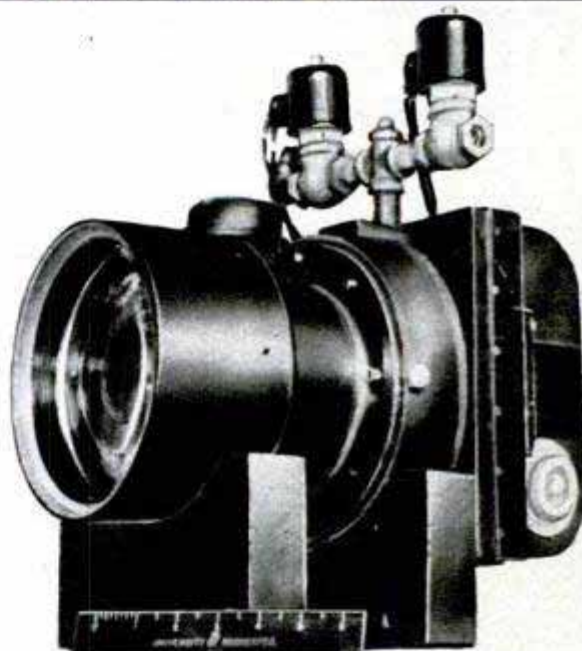
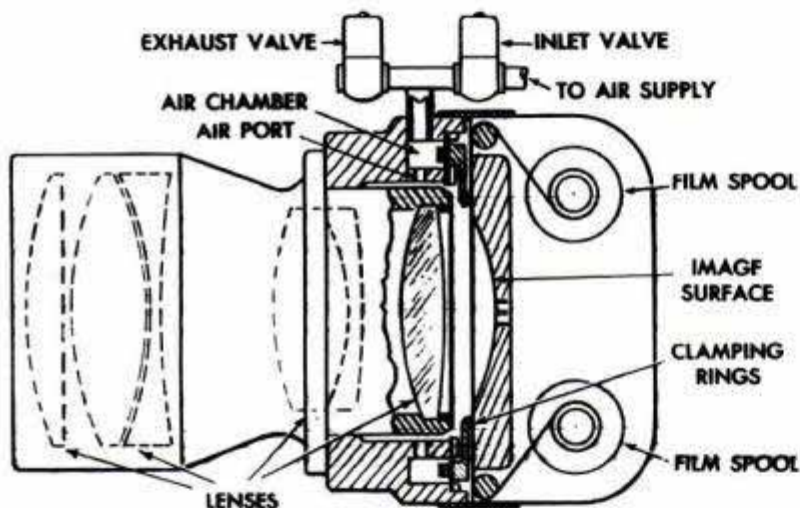

Above, no midget, the camera weighs 55 pounds, of which 30 are lenses. Because the image surface is spherical, the film has to be curved during exposure. Compressed air stretches the film against the spherical image surface behind the rear lens. The film can be printed on standard equipment. The f:1 lens has a six-inch focal length. Shutter speed is 1/45

Designed for aerial work, the camera also takes fine indoor photographs. This basketball court was photographed using only the normal room lighting



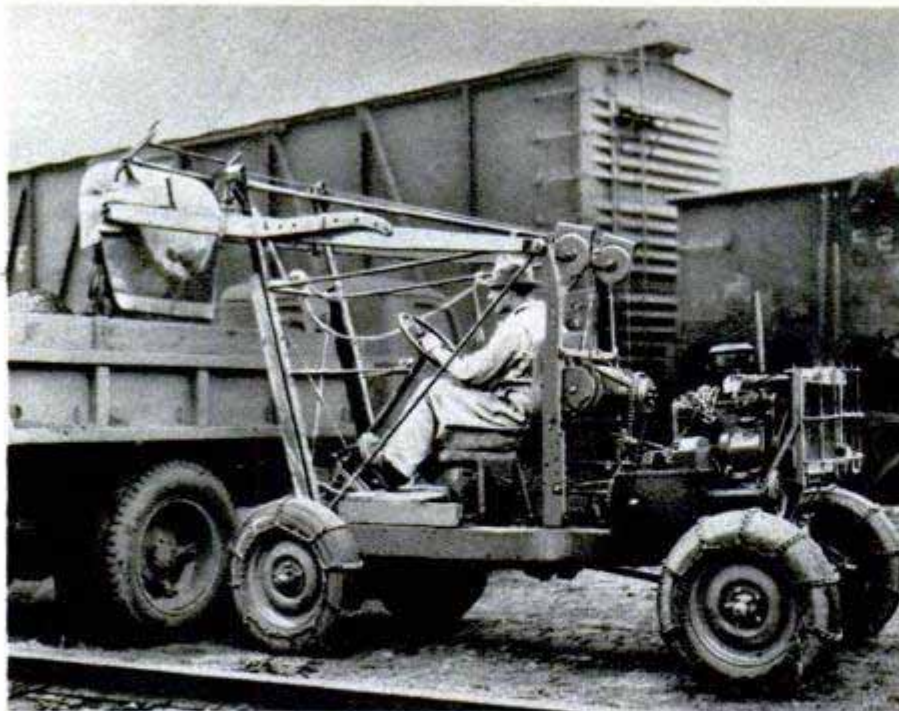

Homemade Loader Has Engine in Rear

Turning around on a dime is almost a possibility with a homemade power loader that has four-wheel steering. Made by two Idaho mechanics, the loader also has four-wheel drive and a rear engine, giving the operator unrestricted vision. Parts of surplus Army jeeps, a Model-T clutch, frames of two cars and a truck, some chains and incidental parts of worn-out combines were used in the machine. The engine in the rear balances the loaded scoop.

Bomber Has "Brakes" On Belly and Sides

Unique flaps open on the sides and bottom of the Douglas Skyraider to slow it in high-speed dives, carrier approaches and for combat maneuvers. Newest version of the Navy utility bomber, it carries three times the rocket-torpedo-bomb load of the original of the series, conceived at the close of World War II.



Douglas Aircraft photo



Plastic Sleeves in Incubator Allow Nurse to Reach Baby

Babies can be cared for inside a new incubator without opening the unit. The incubator is enclosed in a transparent cover. The nurse or mother inserts her arms through plastic sleeves which fit tightly around the wrists. The arm openings remain closed when not in use, maintaining constant atmospheric conditions inside the incubator. One of the incubators was flown to England recently as a gift of the American people. At the suggestion of Princess Elizabeth, it was given to King's College Hospital in London.

☐ Gasoline consumption in the U. S. hit a new high in 1948 when 30.7 billion gallons were used.

bee- sting harvest

BEE STINGS are welcomed by Alfred Guy Holmes of Devon, England. In fact, the more stings he gets, the better he feels—for he is in the unique business of collecting bee venom. Each week he removes venom-filled sacs from 10,000 bees and ships them to a London chemist, who processes the venom into ampules and ointment. Efficacy of bee venom in treatment of arthritis, rheumatism and neuritis has long been studied by physicians and is still not fully accepted by the profession, but demand for the stings continues and Holmes is busy filling his weekly quota.

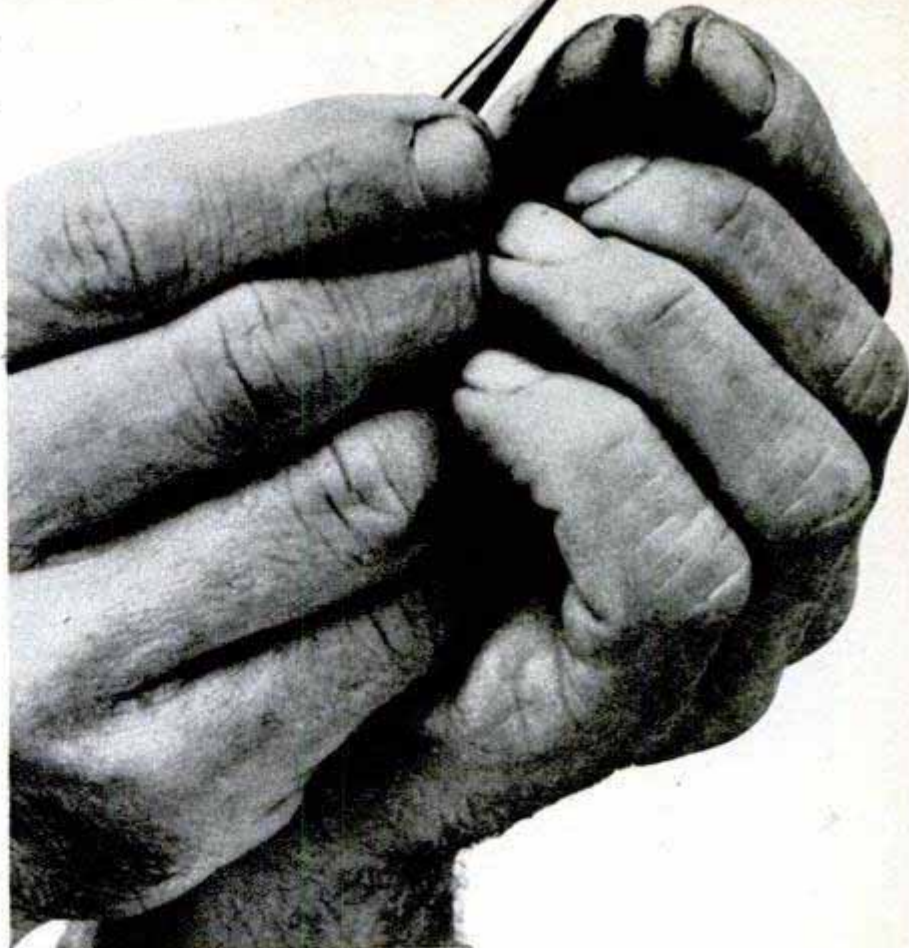

Holmes can remove 500 sacs an hour from dead bees. He is working on a method for rapid removal of venom from live bees, but as yet he chloroforms the bees first. Above, he squeezes the bee's body gently and picks the minute sac from its tail with sharp tweezers



Right, chloroforming the bees before removing their stings. Upper right, the dead bees are on the plate at right as Holmes places the venom-filled sacs in the dish at the left. Above, pouring the sacs into a test tube for shipment to a manufacturing chemist



Copyright Transatlantic News Features, Inc



Sections of Rowboat Nest for Storage

Nested like a stack of dishes, the four sections of a collapsible rowboat can be carried in the rear compartment of a car. The boat, built by Fred Shoemaker of Evanston, Ill., is made of $\frac{1}{4}$ -inch plywood. The four watertight compartments are fastened together with cotter pins. The craft is 9 feet long, 42 inches wide at the beam and holds three people. Handles on the largest section permit the collapsed boat to be carried easily.

Bone Saw Won't Cut Flesh

Accidental cuts in flesh during bone-removal operations are almost impossible with an oscillating bone saw that cuts bone quickly but merely massages the flesh. The blade oscillates in a $\frac{3}{8}$ -inch arc and will not cut anything that has "give" to it. When held against the flesh, the blade merely moves the surface back and forth with a massaging motion. If desired, the saw can be converted for rotary motion by adjusting a setscrew near the chuck.



Hangers Cling to Magnetic Walls

Clothes hangers seem to cling magically to the walls of a New York clothing store. They hang without any visible means of support. The secret of the wall is a magnetic core a few inches wide and several feet long, which is installed beneath the surface at a certain height. Salesmen nonchalantly place hangers against the wall where they stick, to the amazement of shoppers. The wallboard and wallpaper diminish the magnetic power only slightly.



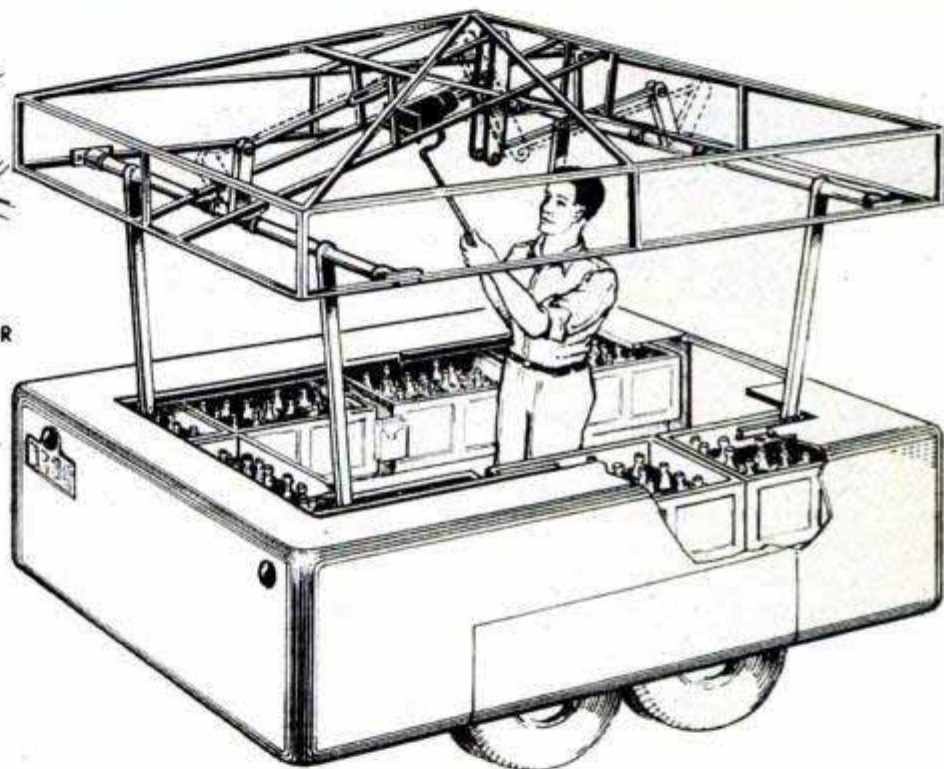
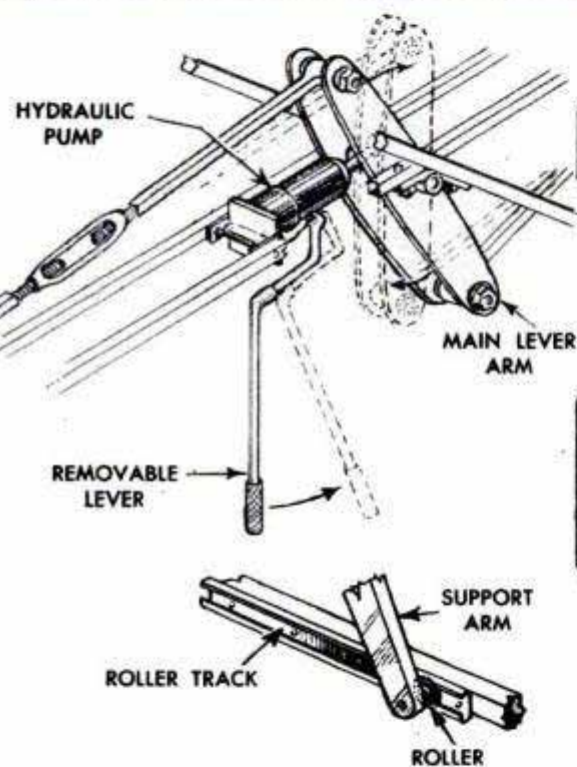

Refreshment Trailer Has Hydraulic Top

Thirty-six hundred bottles of iced drinks are carried in a refreshment trailer which has a hydraulically operated roof. The roof is lowered for transport between jobs and is raised easily by pumping a built-in hydraulic-jack mechanism. Releasing a valve lowers the roof to a locked position. The

Top, left, portable refreshment stand collapses into a compact unit for transport. Top, right, when top is hoisted, the vendor is ready for business. Sketch shows how easily one-man hydraulic top is operated

trailer is cradled in "no tip" coil springs and is equipped with electric brakes, operated from the truck cab. Its entire cargo of 150 cases is iced in five coolers under the counters. The trailer is painted in bright colors to lend a carnival atmosphere to any occasion.

Spray Discourages Deer From Eating Vegetables in Gardens

Deer are discouraged from eating vegetables in farm fields by a chemical which is sprayed on the crops. Safe to use on garden products, the chemical causes a temporary irritation of the deer's palate. One

to three pounds of the material mixed with water will provide an effective spray for an acre of truck crops. The annual crop loss in the United States due to deer runs well into the millions of dollars.

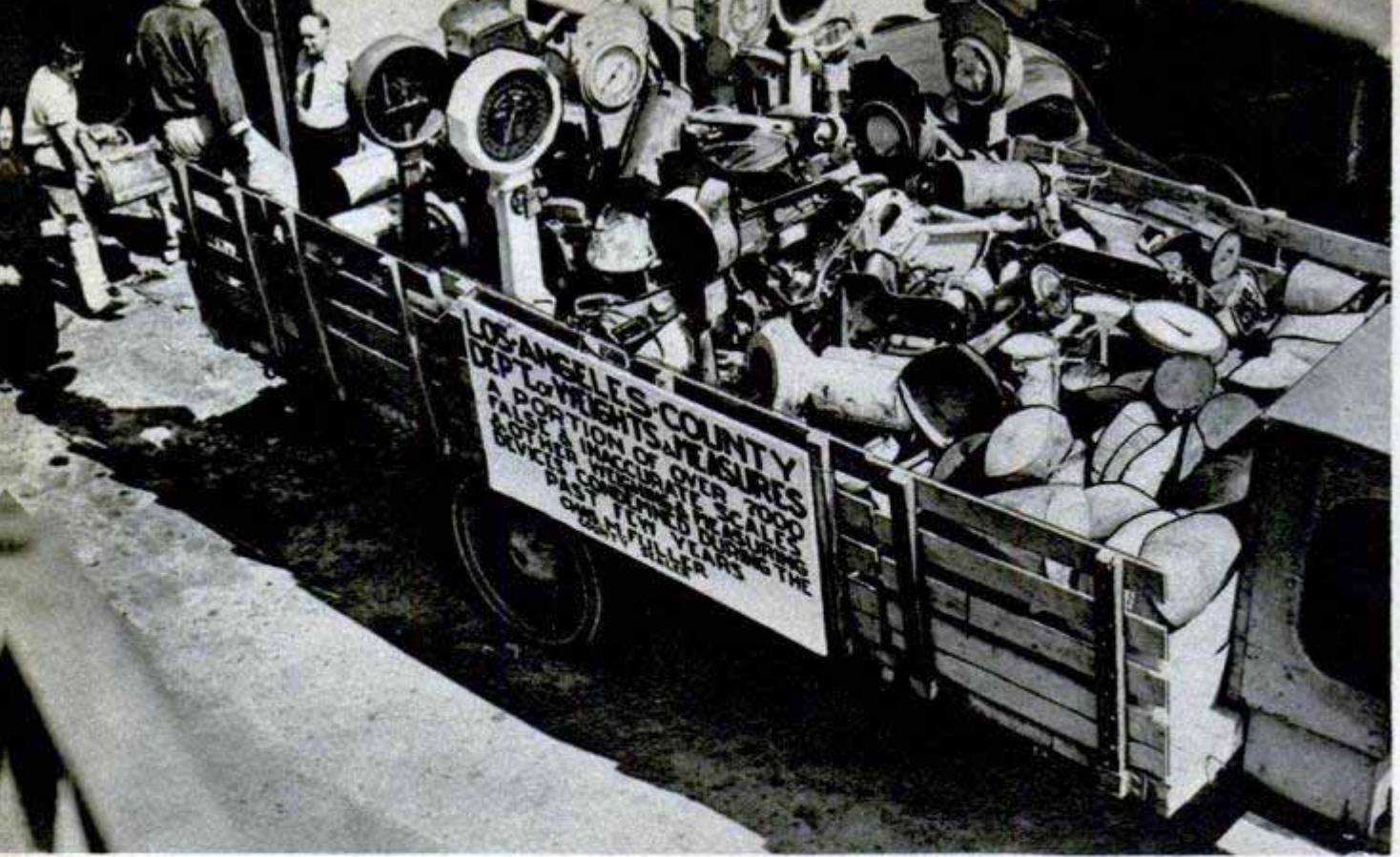

Do You Get What You Pay For?

By Andrew Hamilton

BILL JONES drove into a service station. "Fill 'er up." He noticed that the gas pump was started at the one-gallon mark instead of at zero. When he called attention to this discrepancy, the attendant quickly explained: "Fellow in here on a motor-bike a minute ago. Sold him one gallon of gas.

Guess I just forgot to turn the pump back."

The same day Mrs. Jones went to market to buy Sunday groceries. She paid \$3 for what she thought was a five-pound roasting chicken. She reweighed the bird at home and discovered it was only a four-pounder. At that rate she had paid 75 cents

Checks on petroleum meters are made with a big "bandwagon" that has 400 and 800-gallon testing chambers

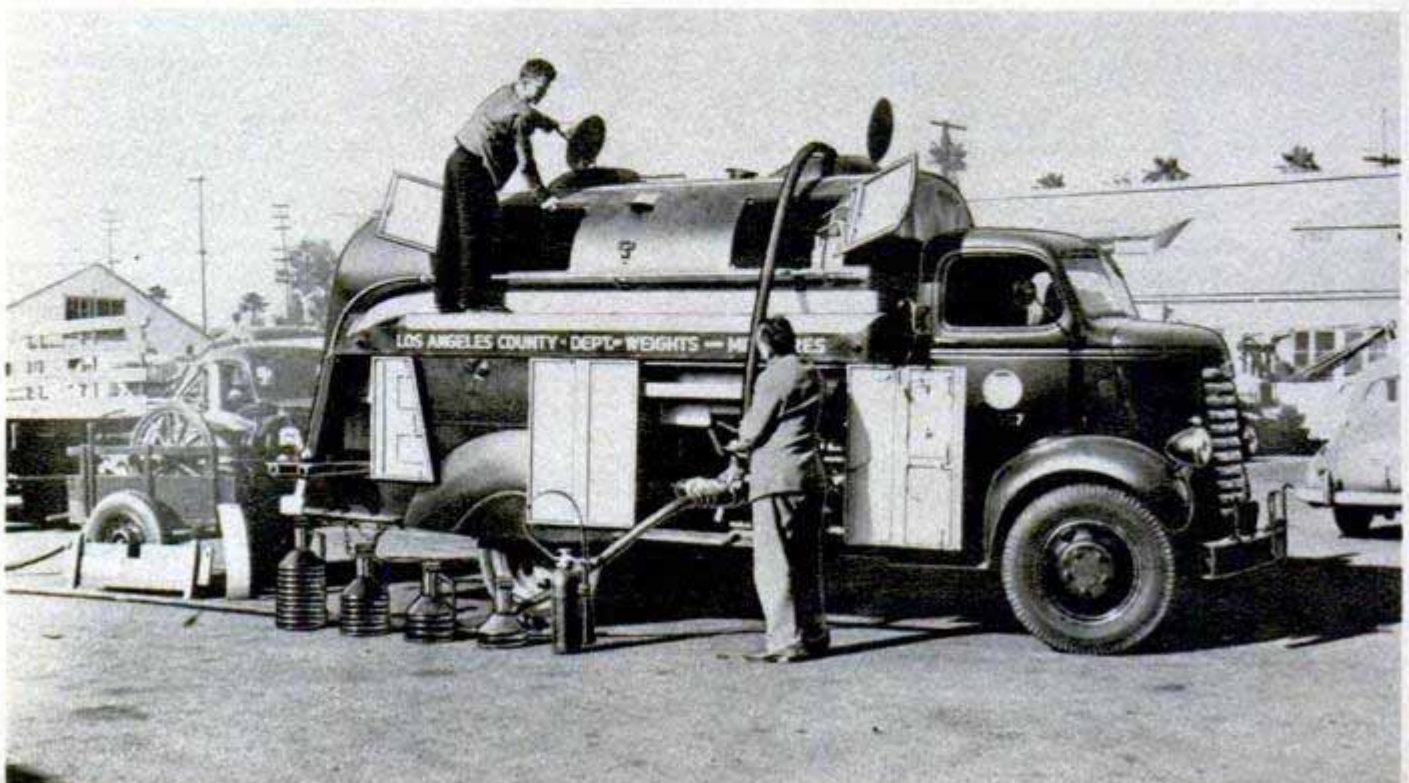

make test purchases,
then check scale and
have items reweighed



On opposite page, a
few of over 1300
scales condemned in
a year at Los Angeles
and sent to junk heap

a pound instead of the 60-cent price tag in the butcher's showcase.

Bill's kids skipped down to the corner candy store to buy a dime's worth of jelly beans. The proprietor's scales were set about an ounce ahead. He cheated a few pennies on each sale—not much, but by the end of the day it had mounted up to several dollars.

These are just a few of the ways in which the buying public gets gypped. It's a never-ending battle, but we're slowly winning—thanks to America's short-weight sleuths.

They are the little-publicized investigators and technicians of the Departments of Weights and Measures in America's city

and state governments. Quietly and persistently they work to protect the public from being gouged by inaccurate scales, substandard measuring devices and fast-talking gyp artists. They save shoppers approximately \$3,000,000,000 a year.

Most merchants are honest. They are among the first to applaud the nation-wide campaign against what has been called "the lowest kind of crook"—one who steals pennies, nickels and dimes out of what you spend for gasoline, meat, groceries, milk and drugs—because such schemes hurt honest business.

Short-weight sleuths work in close cooperation with the Office of Weights and Measures of the U.S. Bureau of Standards in Washington, D.C. This office maintains in air-conditioned, dustproof rooms the highly accurate standard devices by which America weighs and measures its goods—such as the standard quart, the standard yard and the standard gallon. Actual enforcement of laws pertaining to weights and measures, however, is left to the cities and states.

One of the most up-to-date Weights and Measures Departments is run by Charles Morris Fuller of Los Angeles. He's been on the job for 34 years. Last summer he moved his staff into a brand-new \$250,000 building, with testing and calibration devices ranging from equipment to measure highly accurate druggists' and jewelers' scales (so sensitive that they will record a



Testing accuracy of service-station gasoline pumps with cans measuring one, two, three and five gallons

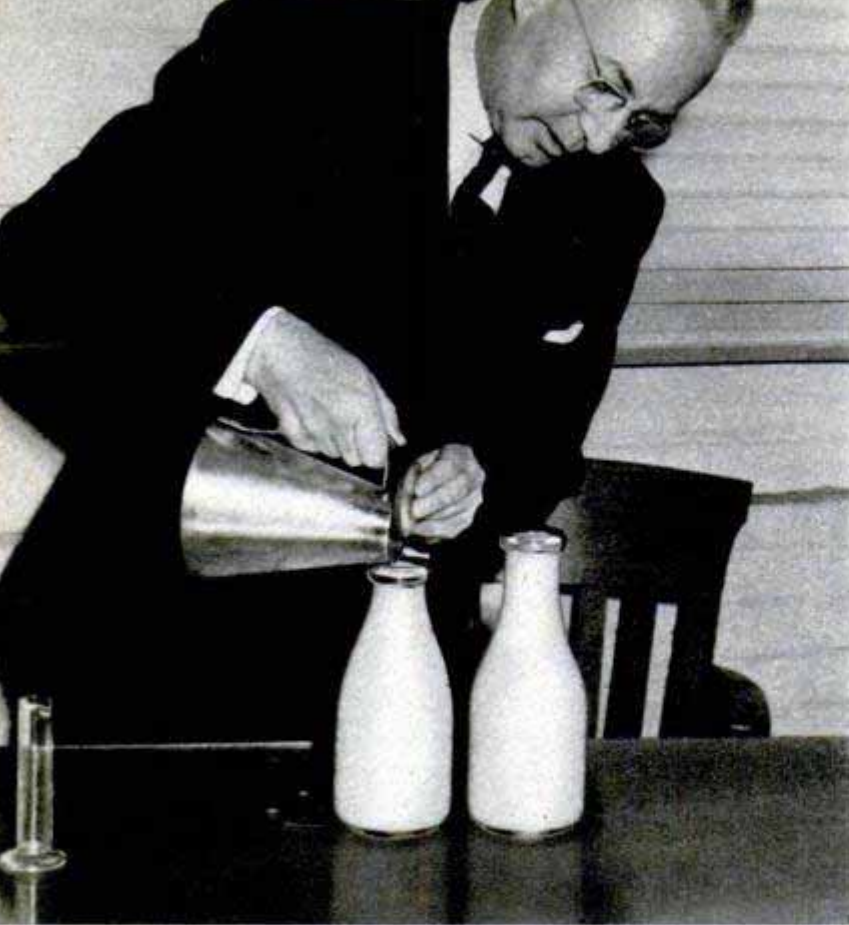

pencil mark) to a jumbo-size 100,000-pound-capacity scale that will handle the largest truck-trailer rig on the highway. They built much of their own equipment and some of it has been adopted by other cities.

Last year they tested approximately 182,000 scales, 100,000 liquid-measure devices, 26,000,000 milk bottles and 240,000 other containers. Approximately 200 of the more serious cases were hauled into court and fined a total of \$15,485.

"The real value of our work is not represented by the fines," Fuller points out. "For every person brought to trial, scores of others are kept in line by the knowledge that short weight does not pay."

Perhaps the 43-man staff's most important job is to keep accurate the scales and balances in Los Angeles' 36,000

Some containers have a deceptive appearance. Milk bottle being checked by Charles Morris Fuller, head of the Los Angeles Weights and Measures Department, holds the same quantity as the taller one. Running water into a giant truck tank, below, for an accurate test of its capacity



places of business. Since scales are mechanical devices, they can get out of whack through no fault of the merchant who owns them. Of the 182,000 scales tested last year, 39,081 had to be adjusted, 9822 were condemned for use until overhauled or repaired, and 1307 were destroyed and sold as scrap metal because they were hopelessly out of working order.

By law, each scale is required to be checked and stamped with the department's seal at least once a year. Twelve crews, each bearing a kit of highly accurate weights and a set of adjustment tools, spend full time in going from grocery to hardware store to meat market.

If a citizen should telephone in with a complaint—an average of 12 calls is received daily—a special crew of shopping investigators is sent out. Such crews consist of a woman and a man. The woman pretends she is a housewife and does the shopping. Then the man steps in, the scale is checked, and the purchase is reweighed.

In this way, many law violators have been caught. One crooked meat-market proprietor trained an overhead fan on his scales, pushing it down several ounces. A buyer of old gold used copper pennies instead of regular pennyweights, thereby cheating the seller out of half his gold. A poultry dealer placed a one-pound lead



Secret tank, right, powers sleuth's car. Test gas goes into separate tank

weight inside each chicken in the showcase. It was weighed with the chicken and then allowed to slide out onto a shelf behind the counter in the process of wrapping.

Large scales used for weighing trucks, trailers or livestock are also carefully checked and adjusted by the short-weight sleuths. For this task, Los Angeles has developed a heavy-capacity unit. It looks something like a light tank and is loaded with pig iron and lead, sealed to exactly 20,000 pounds. It is the largest single-unit test weight in the United States. The truck that hauls it also carries a number of 500-pound test weights. This equipment keeps the large vehicle scales, on which millions of dollars' worth of agricultural products

(Continued to page 250)

Chemists in department's petroleum laboratory analyze sample of gasoline

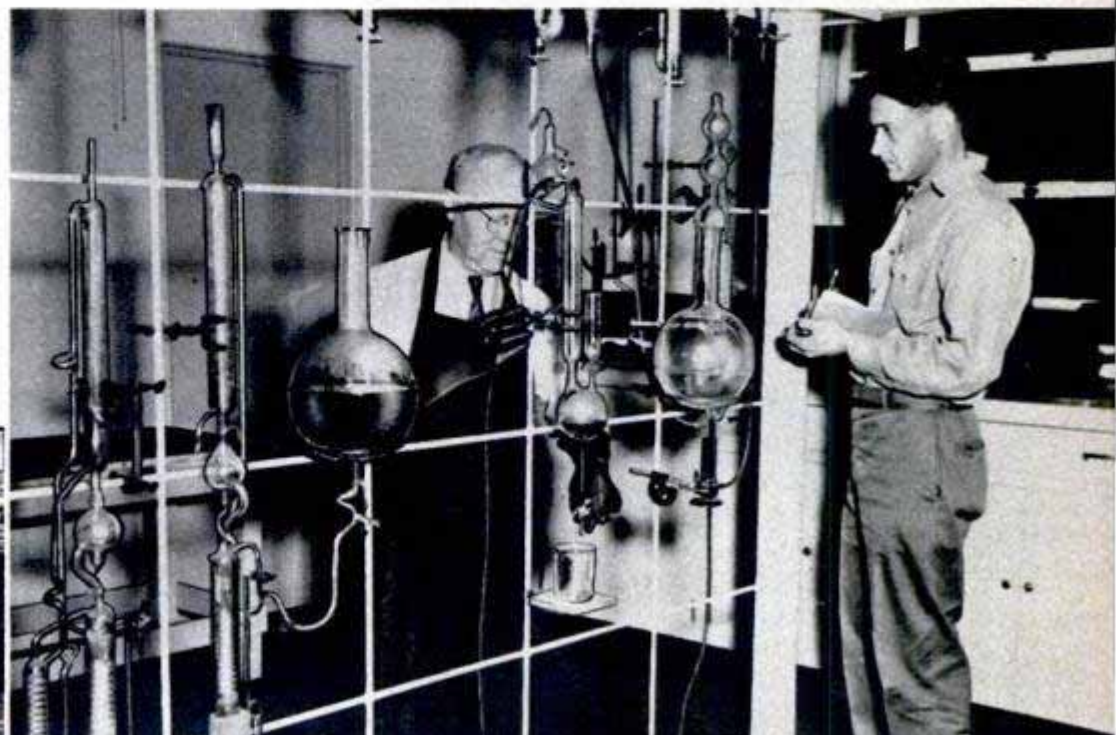

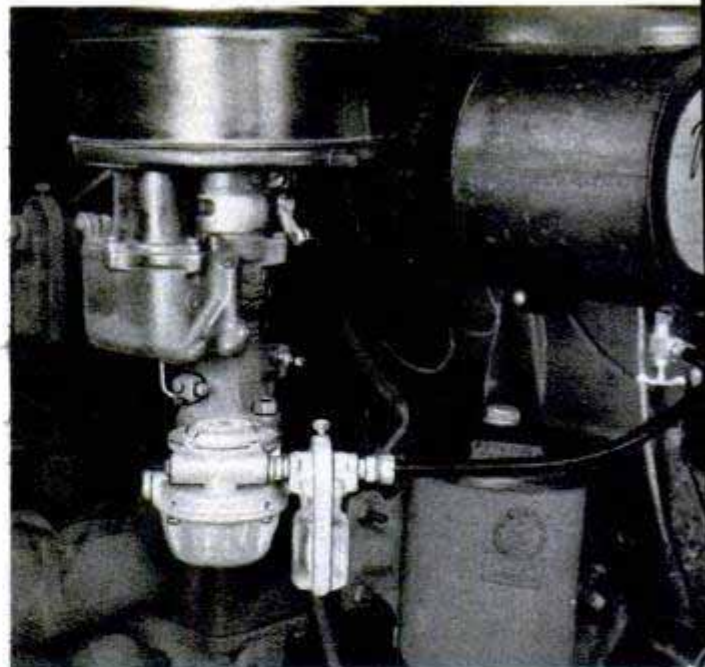
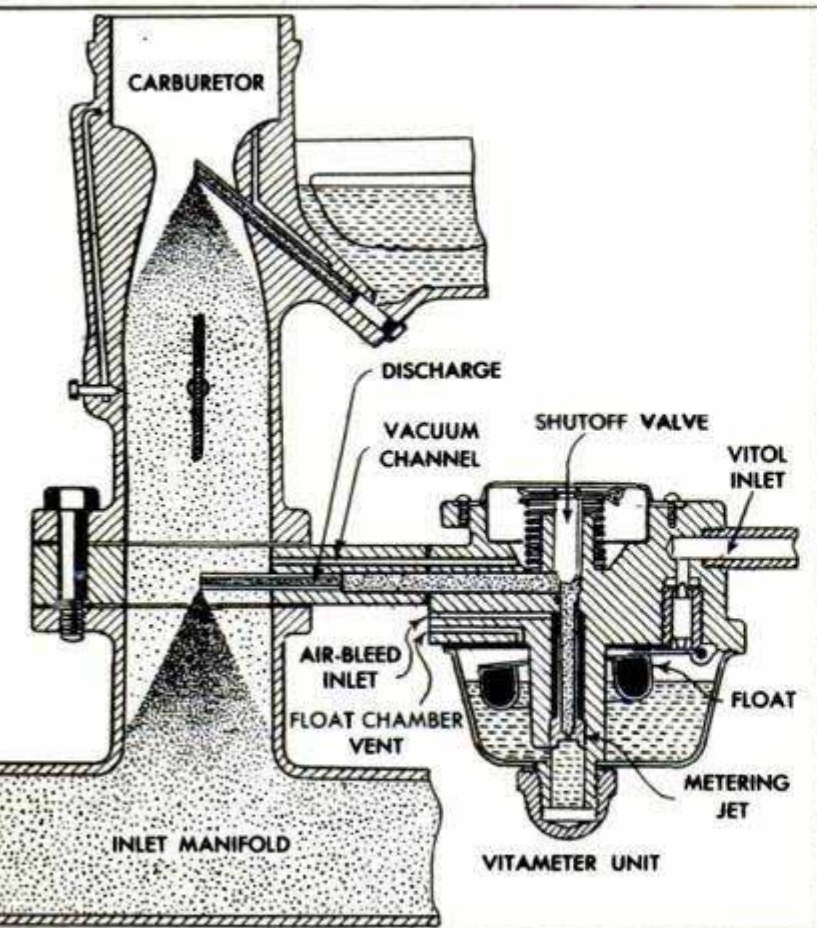

line's octane rating by 10 to 20 numbers to realize the full power of an engine without knock, according to engineers of the Thompson-Toledo Vitameter Corporation. Installation involves an auxiliary carburetor and a fluid called Vitol, composed of 85 percent alcohol, 15 percent water, 3 cubic centimeters of tetraethyl lead and a soluble oil. Airplane engines use a 50-50 alcohol-water solution. A five-quart tank of Vitol contains enough for 500 to 700 miles of driving, depending on the motorist's driving habits. The complete unit can be installed in a car in less than one hour.

Injection Booster for Automobiles

Carburetor injection, similar to that used on fighter planes for combat and more recently on commercial airliners for take-off, has been modified for automobile engines. The antidetonant injection raises a gaso-



Jeep Lays Its Own Road

Seeking new uses for the versatile jeep, the Marine Corps has designed a continuous matting that enables the small vehicle to travel over swamps, bogs, soft beaches and heavy underbrush. Supported by a light metal frame, the continuous mesh

is driven by the wheels of the jeep. Called the "squirrel cage," it is undergoing tests at the Quantico Marine base. Also being tested is a system of laying the mesh roadway from trucks. A frame, mounted above the truck body, carries 250 feet of matting and, as the truck moves ahead, the matting is fed forward and down in front of it.

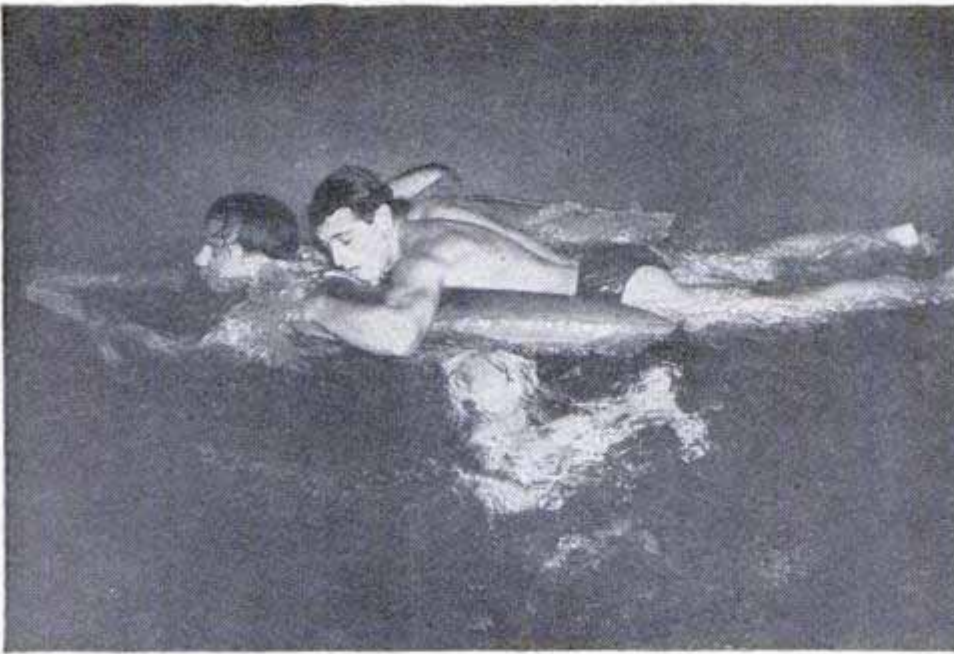

Lifeguard's Vest Inflates to Form Life Raft

Lifeguards now can carry a life raft with them as they swim out to rescue a drowning person. Demonstrated in Paris, the lifesaving apparatus consists of a rubber raft that is worn, deflated, as a vest by the

lifeguard. When he reaches the drowning person, the rescuer inflates the raft by means of an oxygen tube. The distressed person is then pulled up on the raft and towed safely ashore.

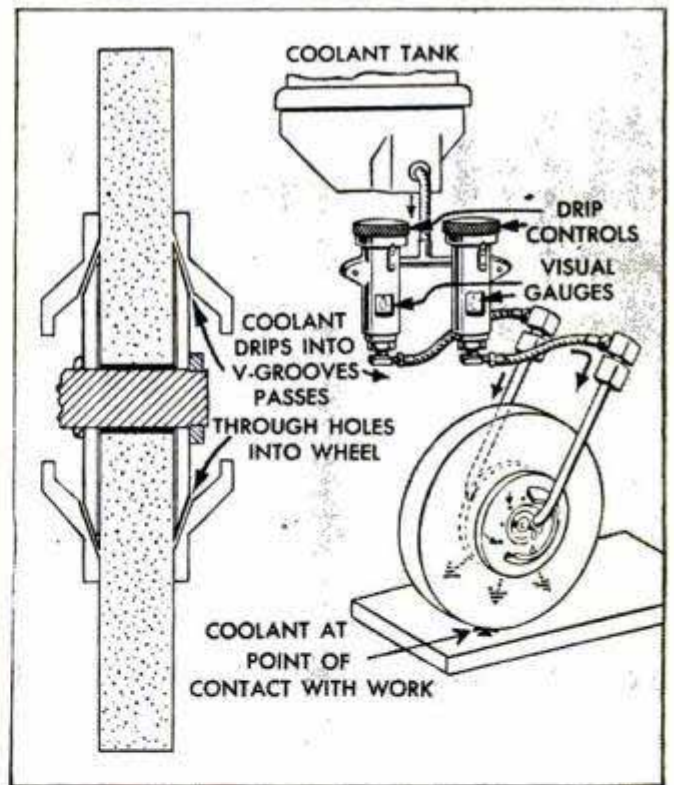
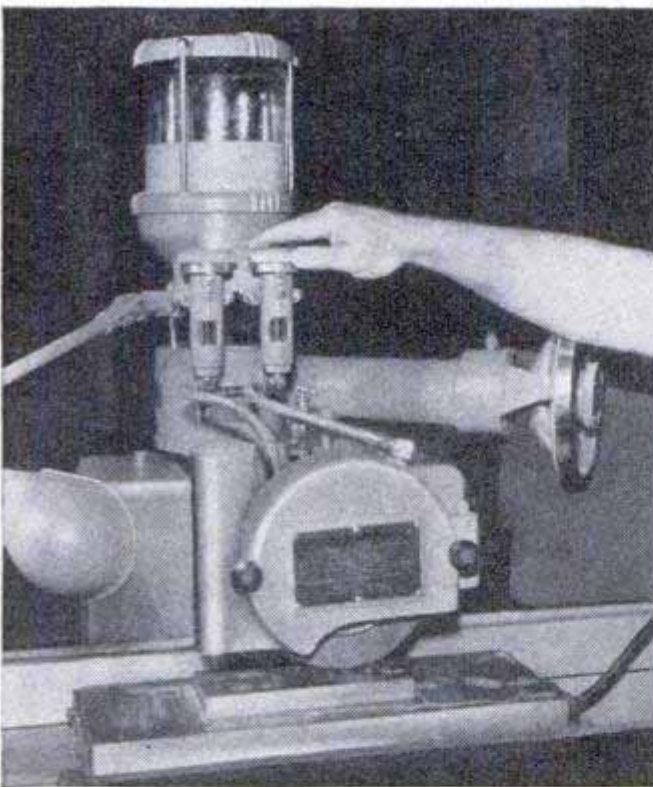

Power Grinder Cools by Spray

Instead of flooding work with liquid to keep it cool, a new grinder sprays the coolant over the work in a fine mist by introducing it into the wheel and allowing it to be applied by centrifugal force. Only small quantities of coolant are necessary since it is introduced at rates from two to eight drops a second. The liquid drips into the

collar, which can be attached to any wheel, and seeps into the pores of the wheel. As the wheel spins, centrifugal force throws the liquid out from the rim of the wheel covering the work with a fine mist that keeps operating temperatures as much as 500 degrees lower than usual cooling methods. Another advantage is that the point of grinding is not hidden by the liquid, thus making possible more efficient work.

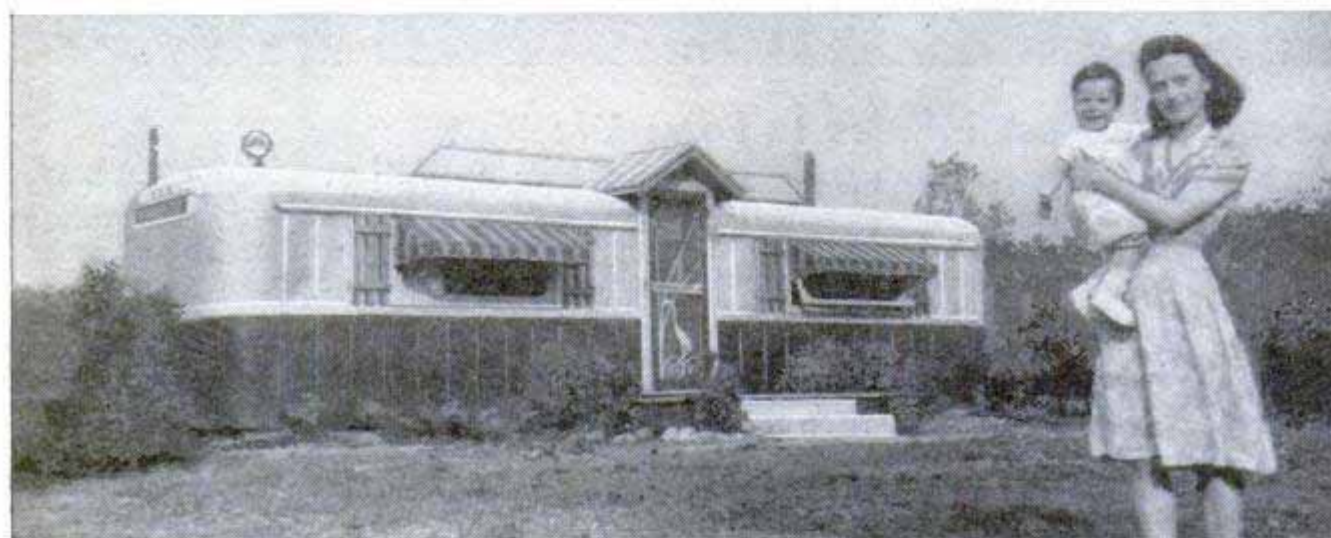
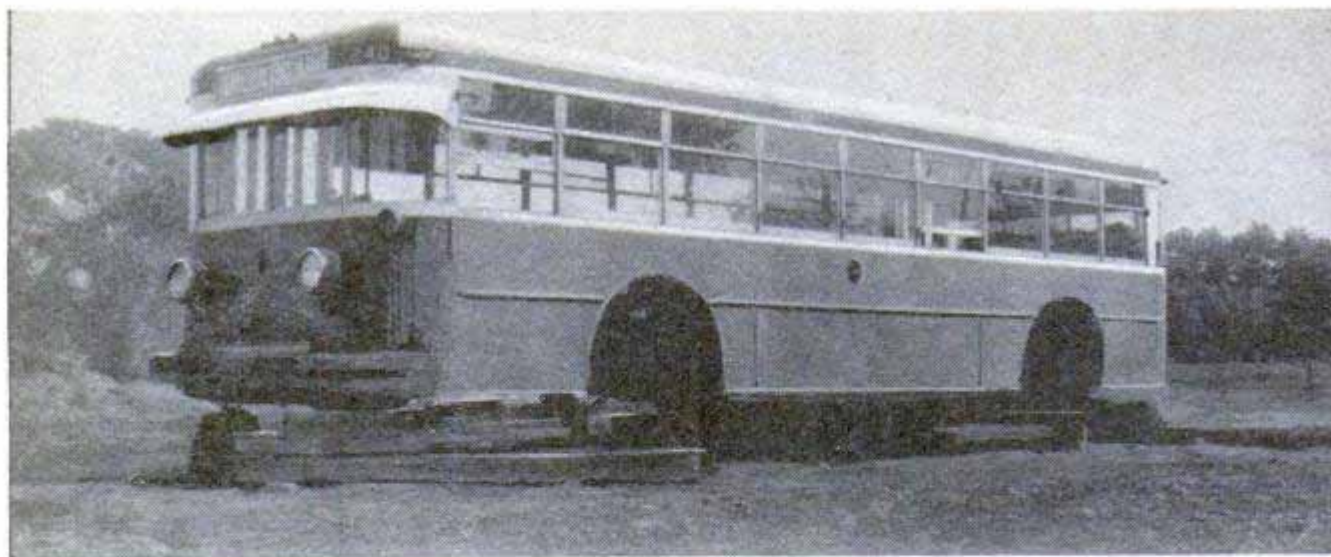

Junked Bus Body Becomes a Home

Houses are hard to find in this day of shortages, but one New York State resident solved the problem temporarily at least by converting an old bus body into a comfort-

able small home. The completed house has several rooms and bears little resemblance to its original appearance. The owner plans to convert additional busses into cabins for the tourist trade. Well equipped, the cabins can be as attractive inside as out.



Microfilmer for Long Maps

Long maps, drawings or blueprints are microfilmed in a continuous strip by a triple-purpose camera that handles large copy up to 42 inches wide and as long as desired. The camera, which also serves as a film printer and enlarger, will microfilm a half-mile-long drawing on a 100-foot roll of film. Resembling a household ironer, the camera is built upside down with the lens and film being beneath the copy rather than above it as usual.

Many of the products described on these pages are now on the market and available to readers. For names and addresses of manufacturers, turn to the WHERE-TO-BUY-IT INDEX, on page 10

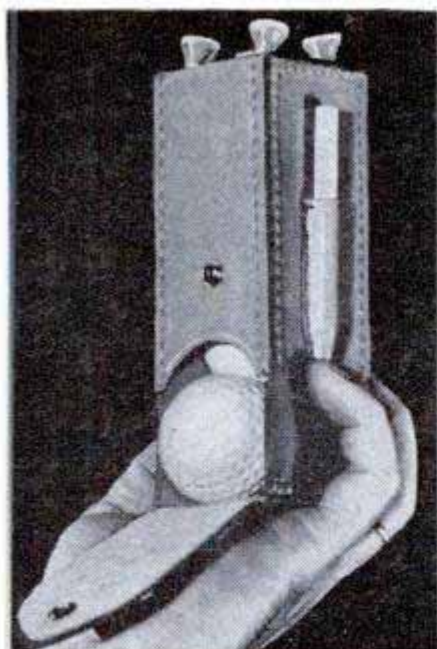

Golf Kit

Golf balls, tees and a pencil are always on tap in a leather kit that fastens to the belt. The kit holds three balls and four tees in a Neoprene lining that prevents them from falling out. The flap locks tight with a grip snap. When the kit is opened a ball rolls out into the golfer's palm. A socket on the side of the kit holds a pencil. The kit is waterproof and weighs four ounces empty.

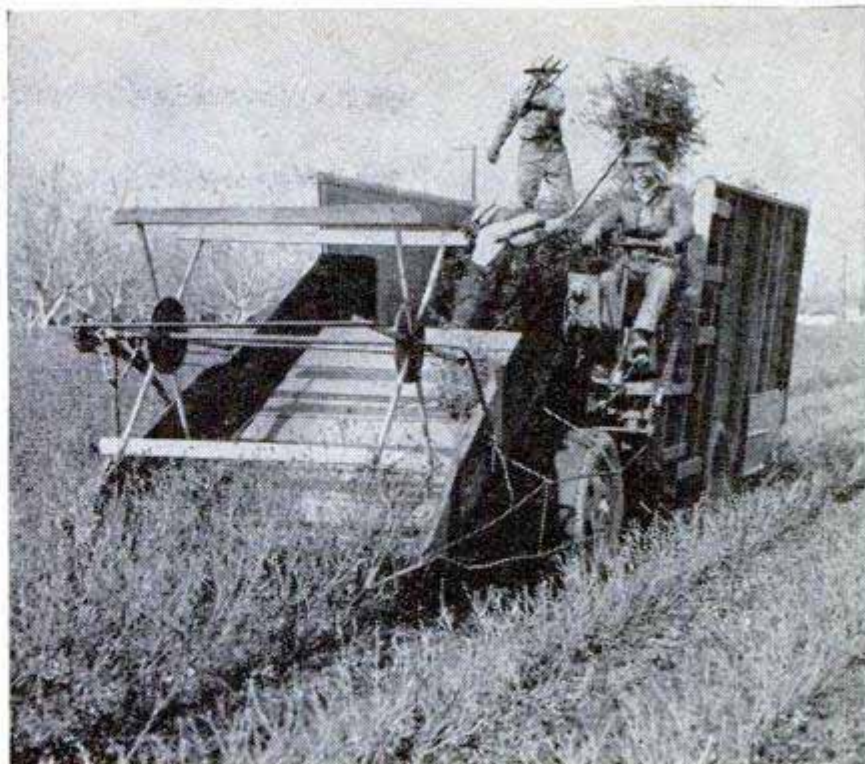

"Harvester" Speeds Rosebush Pruning

Pruning the tops off more than 600,000 young rosebushes in a field near Ontario, Calif., has been simplified by a novel mower sickle and harvester combination on a truck chassis. An overhead reel throws the clippings onto an inclined chute leading into the truck body. One man runs the machine and two others fork clippings toward the back of the truck as they accumulate. It does the job in a fraction of the time required by large gangs of men equipped with hand clippers. Tractor-operated diggers later uproot the bushes and dump them into rows for delivery to the sorting and grading tables.

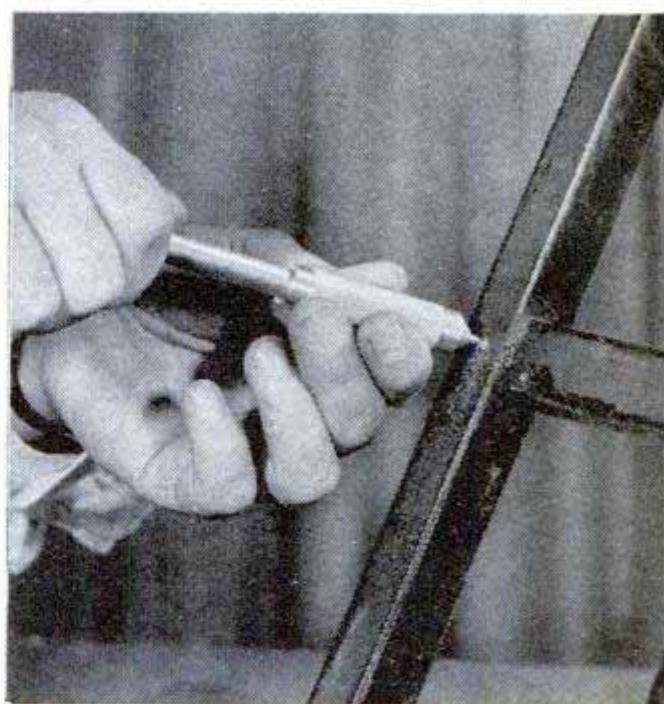
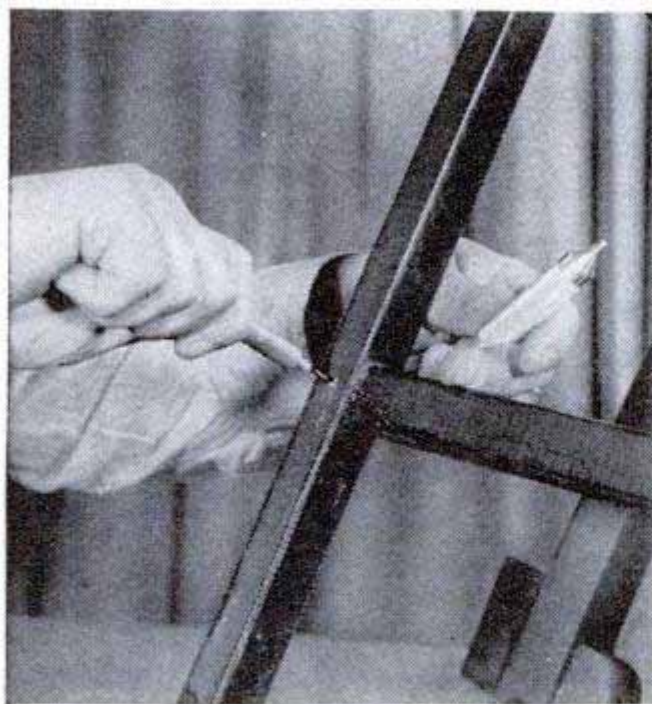

INJECTOR SQUIRTS GLUE into rickety chair joints, filling all the space resulting from shrinkage and wear. One end of the injector holds a very small drill which is used to bore a hole into the heart of the joint. The operator then fills the tool with glue and uses it as a syringe to force glue into the joint under pressure. If the hole is drilled on the underside of the joint, no sign of the repair work can be seen.

he lives



Flicking a switch starts light fixture revolving slowly about workshop ceiling until it is exactly where Tomlinson wants it



On signal, the floor opens and compressed air pushes up a "talking" refuse pail. In the back yard, a concrete lizard rears up to chase a bumblebee. When squeezed, the bee complains, "Ouch, you're hurting me!"

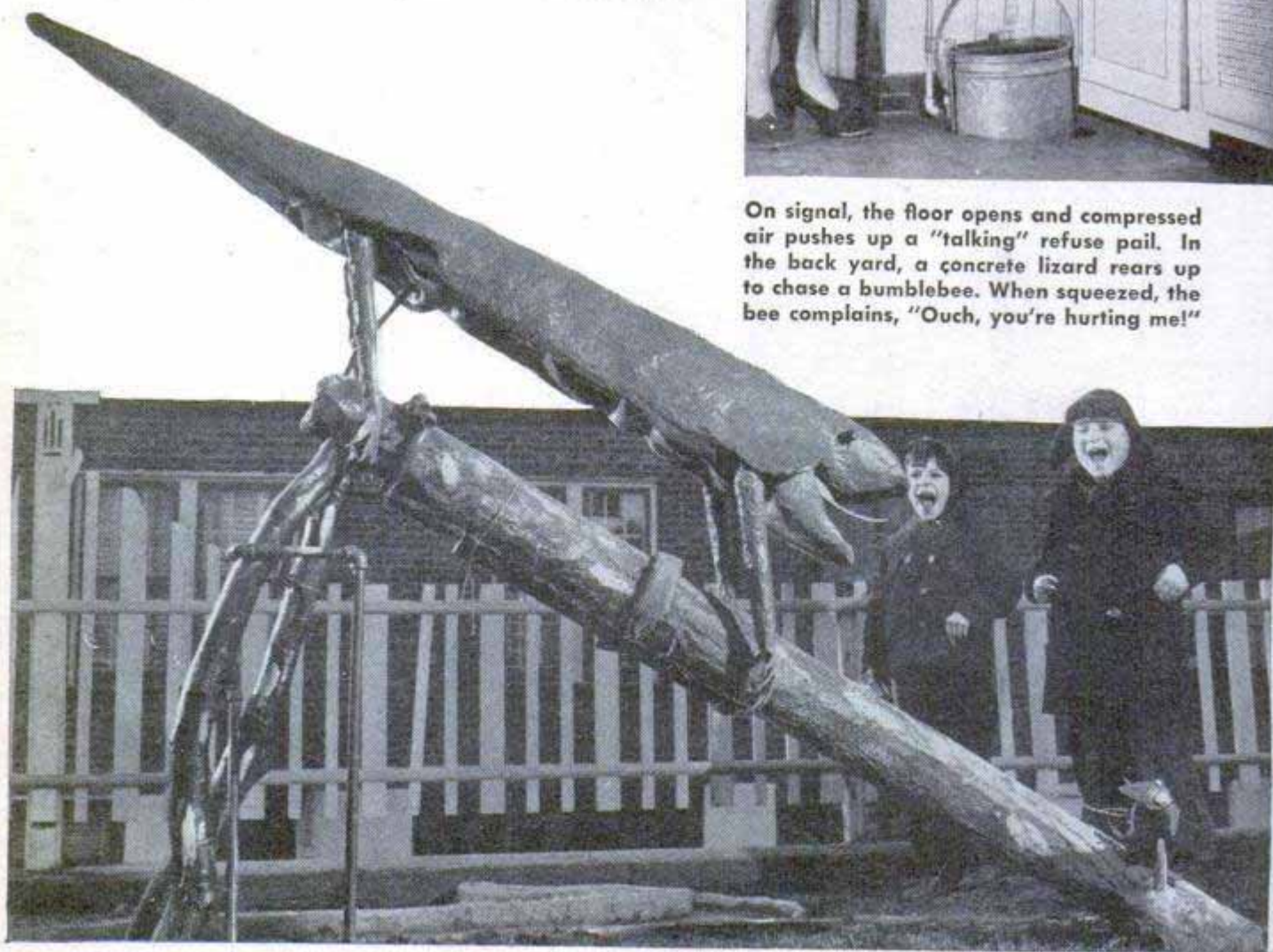

in a house of fun



When Tomlinson twists knob on his automobile dashboard, radio impulses start work of opening garage doors

ONE OF America's most mechanized homes is that of Alfred Tomlinson in St. Albans, N. Y. It boasts such bizarre gadgets as hands which pop out of the wall to receive your cigarette ashes, a snake which lowers itself from a ceiling to frighten guests, a motorized pencil sharpener and a disappearing garbage pail.

Tomlinson is a studious-looking Englishman who studied Sanskrit, Greek and Latin at Cambridge University, but no mechanics or engineering. He is entirely self-taught and, years ago, began to evince a mechanical ingenuity which has now led to the creation of the most fascinating house in New York.

A sales manager for a milk concern, Tomlinson does all of his work evenings and week ends in the basement of his home, where some \$8000 worth of tools are stored in neatly charted compartments. Arriving home, he twists a black knob on his dashboard and, miraculously, the garage doors some 10 feet ahead slowly rise to permit the entry of his car.

What really happens is this—the knob sends impulses to a radio in the basement workshop which, by means of electrical and air controls, opens his garage door. Once in the house, Tomlinson presses another button that just as "mysteriously" closes and locks the garage doors.

He uses some 79 motors for his gimmicks,

ranging in power from $\frac{1}{2}$ to $\frac{1}{100}$ horsepower. Nine air motors are used for the snake, garbage pail, garage doors and the giant animals in his garden. These include a bird, lizard, bumblebee and alligator. They are concrete and (except for the bumblebee) weigh several hundred pounds each. Their weight does not hamper them much. When their master presses a button, the bee starts up a log towards the lizard but.

Cigar ashes dropped into a giant papier-mache hand are neatly deposited on the other side of the wall





Card-playing guests are startled by snake that drops out of the ceiling, rolls its eyes and hisses, "Cheese it—the cops!" One of few nontalking gadgets is motorized pencil sharpener



Lunging for this disappearing snake, cat has given baseboard a thorough clawing

soon, the lizard rears up and makes for the bee.

Neighbors' youngsters who wander into his garden get the surprise of their lives. One boy, fondling the bee, was startled out of a few weeks' growth by its cry, "Ouch! You're hurting me!" He hasn't been tempted to venture into the garden since.

Tomlinson records short sayings on disks with home-recording apparatus and "wires" his animals for sound. The snake, which pops out of the ceiling during a tense poker game, hisses, "Cheese it—the cops!" then slowly, and with dignity, withdraws into the ceiling. In the kitchen, a twist of a wall switch sends the garbage pail soaring up through an opening that mysteriously appears in the floor. If the pail isn't loaded quickly, it is apt to bark, "For Pete's sake, Mama—shut off the air!"

This is one gimmick Tomlinson must remedy. His womenfolk know that it's only the pail talking but, somehow, they take offense, and his next assignment is to change the recording disk to, "Would you please shut off the air?" This would re-establish peace in the house, every room of which has its loudspeaker.

One device which does not talk back is a motorized pencil sharpener. A standard device, with motor attached, all it does is cut a fine point in a second or two—with no back talk. However, Tomlinson is considering "wiring" it to say, "Get the point?"

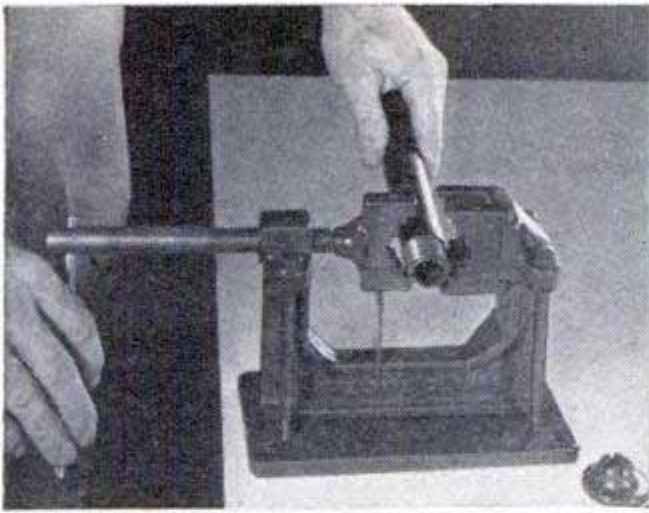

Vise Has Four Uses

Serving a variety of purposes, a combination vise and C-clamp is a handy tool for home workshops. Steel pipe jaws convert the vise into a powerful pipe vise. Removed from its base, it becomes a handy pipe wrench. For use as a regular vise, a snap-on swivel plate replaces the pipe jaws. The vise also can be made to serve as a C-clamp when removed from the bench-mounted base.

Reel Stores Fishing Leaders

Fishing leaders and the material from which they are made are stored neatly in a reel that prevents uncoiling and tangling. The reel, made of plastic, will fit into a shirt pocket. It is divided into five sections to permit the angler to store various sizes of leader material. A built-in blade cuts off the desired length. Gut leaders can be softened by winding a wet string around the section holding the gut.

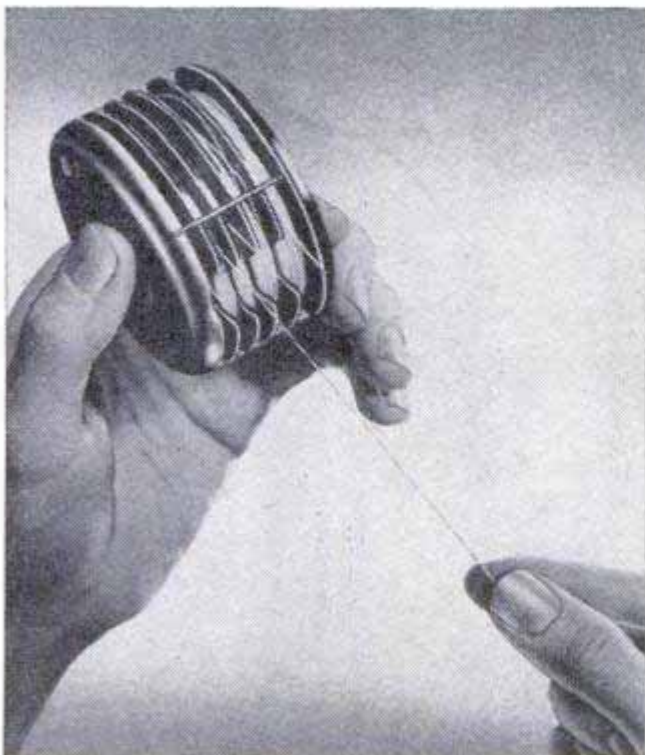

Tester for Photo Flash Bulbs Clips in Pocket

To prevent waste of film and possible loss of a picture, a simple flash-bulb tester clips into a pocket and does not have to be removed when testing. The instrument makes it possible to test a bulb before taking a picture. The tester lights up when the bulb is good. It is safe to use as it cannot flash the bulb during the test.

Miniature Camera Is Small Enough To Be Worn on a Key Chain

Not much bigger than a fifty-cent piece, a circular candid camera can be worn as a lapel camera or on a key chain. Special film cartridges containing six exposures are used and the cost of the film includes developing and printing of enlargements. Loading is practically automatic and a safety feature prevents accidental exposures.



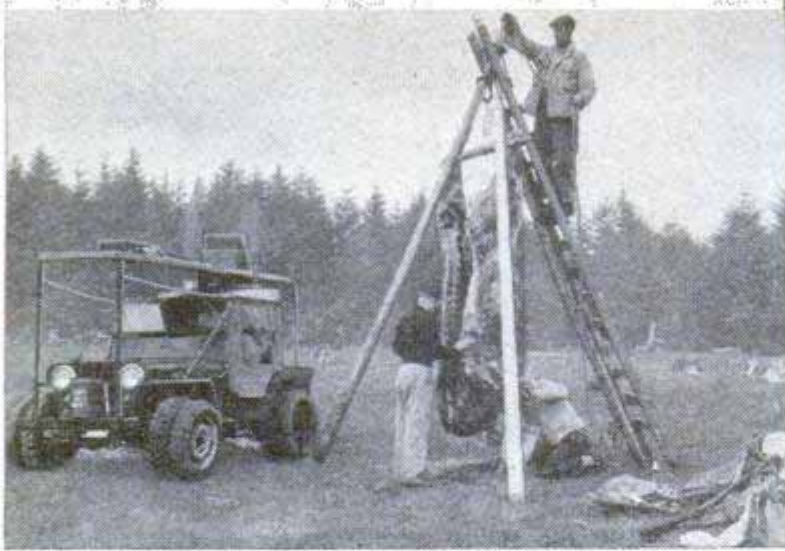

Rancher Uses Rifle and Jeep To Get Cattle to Market

Bringing his beef cattle to market is as exciting as hunting wild animals for Ernie Perlstrom of Queen Charlotte Islands, B. C., because his herd has been running wild for years. His range, 50 miles from the nearest town, is located on the coast and is accessible only by driving along the beach for 35 miles. To haul his beef to market, Perlstrom equipped his jeep with double wheels, a power winch and an overhead frame on which the beef is carried. The dual wheels prevent the jeep from bogging down during the 70-mile run along the sandy beach. At the range, he stalks his herd with the jeep and brings one of the cattle down with a shot from his hunting rifle. He then sets up a tripod and hauls the carcass to the peak with the winch. When the animal is butch-

Left, butchering a 600-pound bull on the range. Right, rancher shoots cattle to get them to market. Below, he can drive past this stump on his 35-mile beach trip only when the tide is out



ered, it is covered with canvas and hung for 24 hours, after which the 600 to 900-pound load is packed on the quarter-ton jeep for the trip to the market.



Pocket Pillow

As small as a book of matches when deflated, a plastic pillow can be inflated to support up to 250 pounds pressure. After the pillow is inflated, two plastic flaps are joined to prevent air from leaking through the opening. When the pillow is to be deflated, a paper tube is inserted in this opening and the air rushes out.

When inflated, pillow supports 250 pounds. Inset shows size compared to match book

☐ In 1948, U. S. motorists drove 395 billion miles in their 41 million automobiles, a government survey disclosed.

MODEL JET PLANE, prize winner in the 1948 Second International Model Plane Contest at Detroit, Mich. Complete plans for building this "air splitting" model will be found on page 206

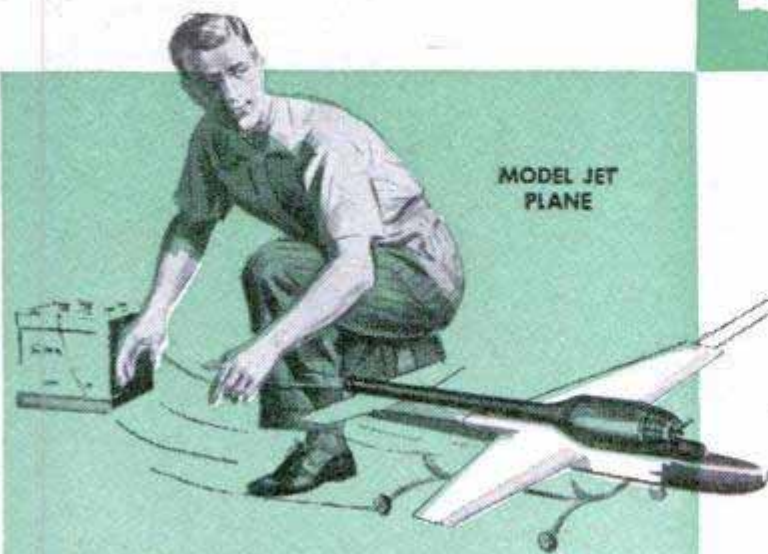

MODEL JET PLANE



MASONRY HOUSE

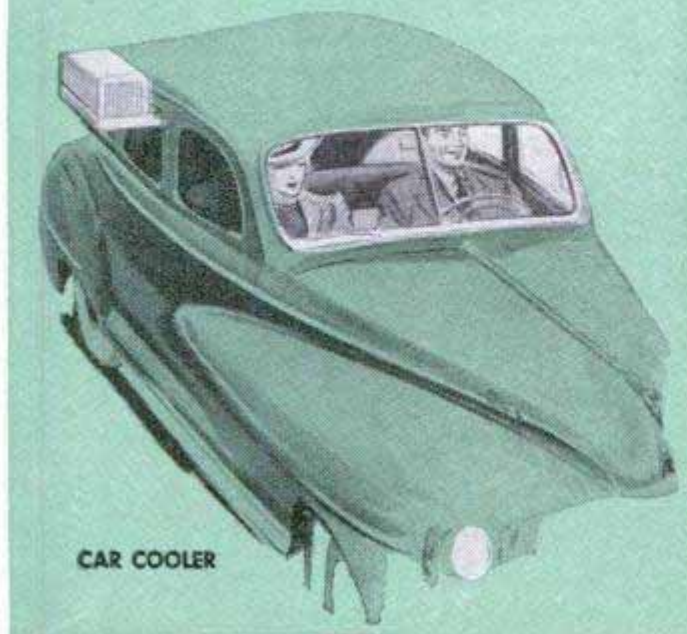

CAR COOLER

Craftsman Section



MASONRY HOUSE of concrete blocks, brick, etc., has insulated floors and walls, and is damp-proofed. Build this cozy house yourself and save money. Story on page 186

CAR COOLER lets you ride in comfort even on the hottest days. It will not increase the humidity inside the car. Evaporation of water cools the air. See page 221 for details

COFFEE TABLE in rich mahogany. Just the thing for the home furnished in modern style. Simple lines make construction easy for any craftsman. The plans are on page 178



COFFEE TABLE

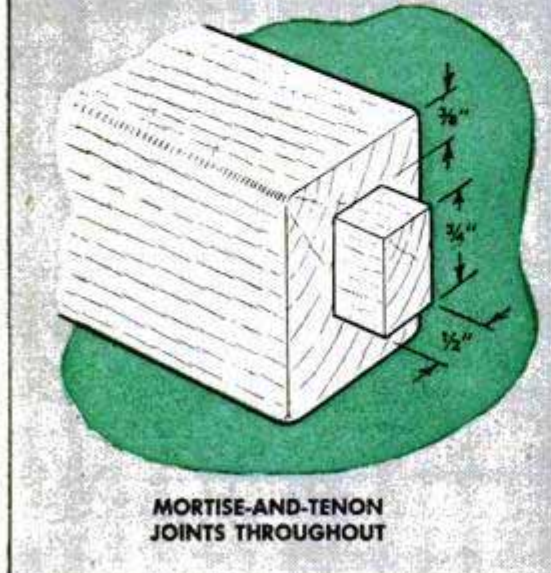
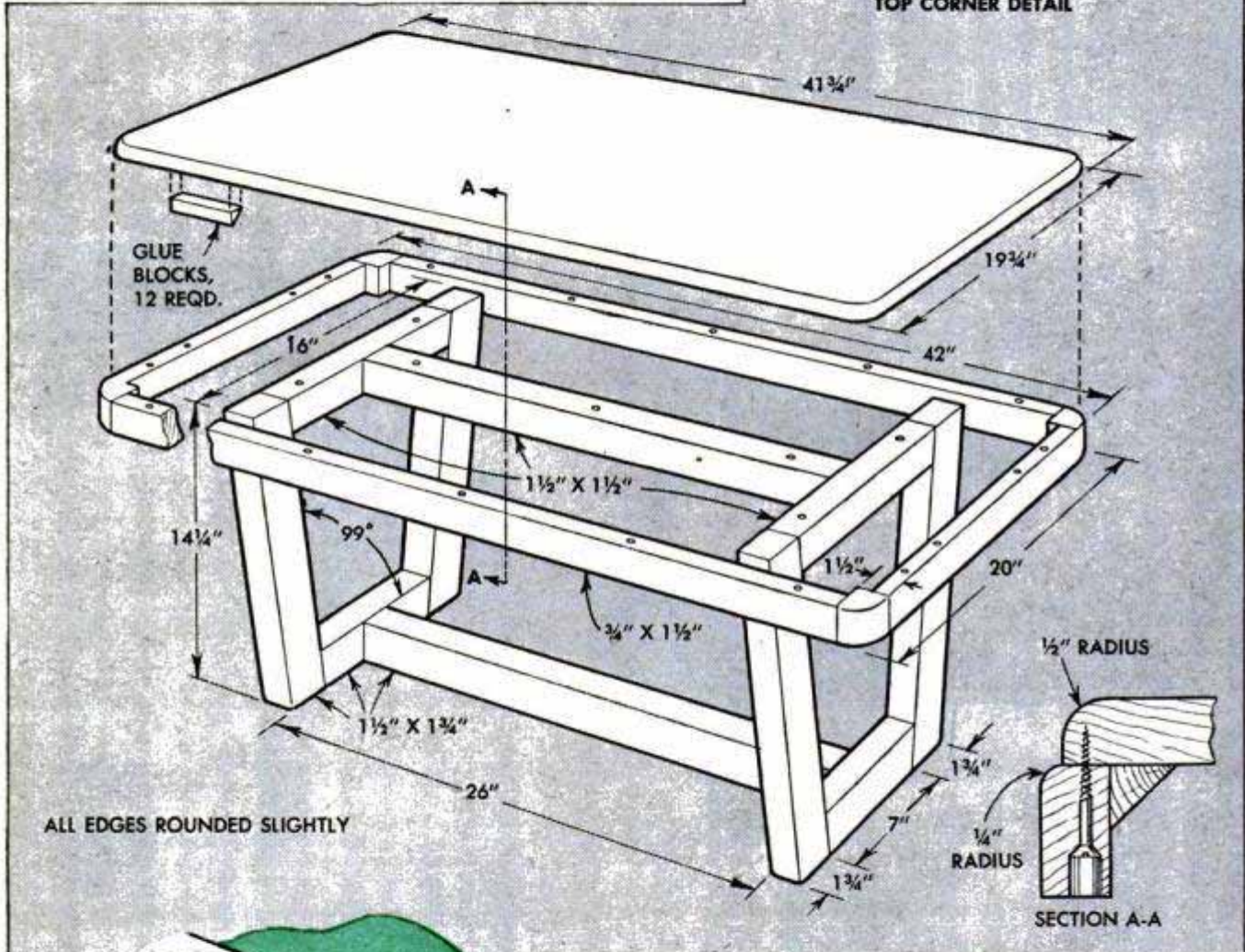
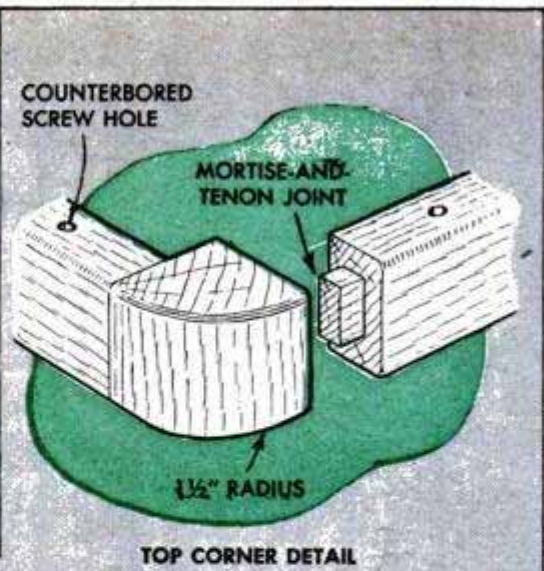
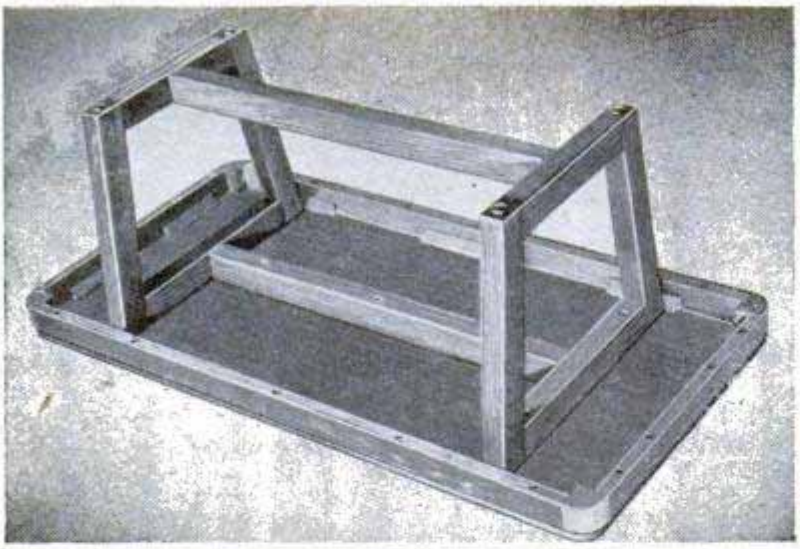

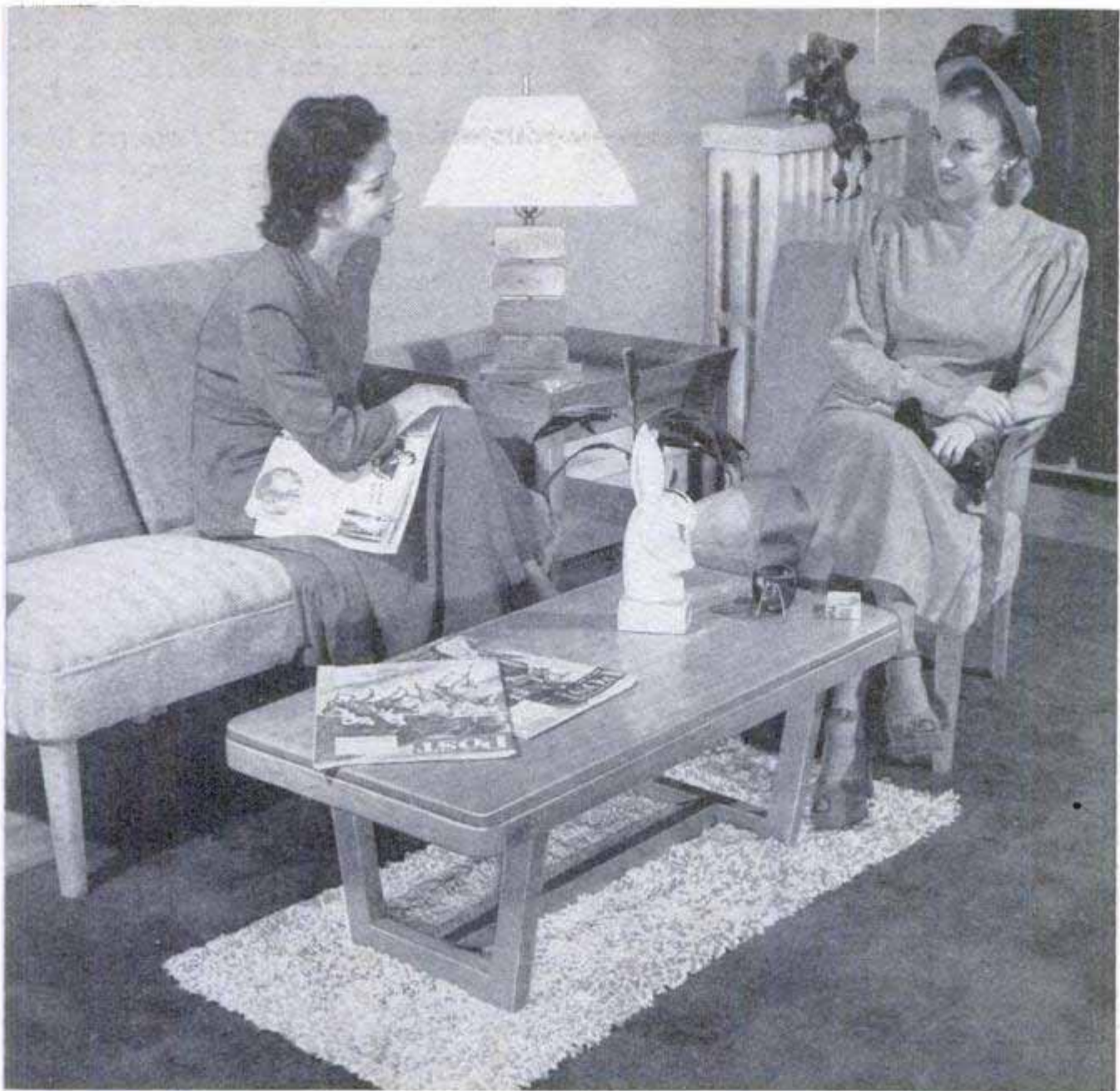

Furniture You Can Build p.57

By Richard A. Buell

SIMPLE modern styling, which features an offset top rail and a subdued combination of straight and curved lines, individualizes the design of this smart-looking coffee table. Although the table shown was made of mahogany, other woods can be used when it is desirable to match the finish of other furnishings in both color and graining. White mahogany (primavera) is a popular choice as it finishes light colored with an attractive ribbon grain. The top is built up to the required width by gluing together a number of narrow strips of $\frac{3}{4}$ -in. stock. Use five $\frac{3}{8}$ -in. dowels equally spaced in each joint. After the glue is dry, sand the top smooth, trim it to the finish dimensions given on the opposite page and round the edges to a $\frac{1}{2}$ -in. radius.

The top rail is built up as a frame, the side and end members being mortised into rounded corner blocks. Note also that the corners of the top are rounded to the same radius as the blocks. The top corners of the rails and blocks are rounded to a $\frac{1}{4}$ -in. radius as in section A-A of the assembly details. The completed rail is then attached to the top with screws and 12 triangular glue blocks spaced as shown. The legs are assembled as units, each consisting of two posts joined to a top and bottom rail with mortise-and-tenon joints. These units then are joined to top and bottom stretchers with mortise-and-tenon joints as in the assembly detail. Tenons on the top and bottom rails of the leg units are $\frac{3}{4}$ in. long and must be shouldered at an angle to give the posts the proper slant. Width of the top shoulder is given in the lower detail.

Stovepipe Over Camp-Table Legs Protects Duffel From Rodents



Before leaving a camp for an indefinite period of time, protect equipment and food from rodents by storing the articles on top of a table, the legs of which are set inside lengths of stovepipe. Force the lower ends of the pipe into the ground an inch or so to hold them steady and rodents will be unable to reach the table top. This treatment, of course, will not offer protection from leaping rodents or animals large enough to stand on the ground and reach the top of the table.—John Krill, North Lima, Ohio.

Tape Strips Placed on Glass Are Kept Ready to Use

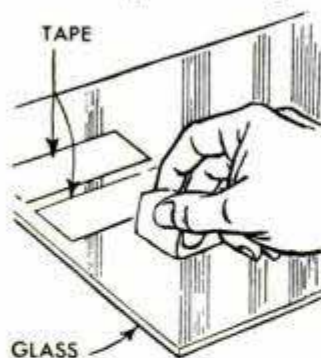

If a number of strips of tape must be used for masking purposes or sealing of packages, cut them to size and place them, adhesive side down, on a piece of glass. They will stick lightly to the glass and can be picked up with one hand as needed. This will not affect the adhesive quality of the tape.—Michael Ligocki, Gary, Ind.

Starting Flooded Outboard Motor

Should your outboard motor flood while trying to start it, shut off the fuel at the gas tank. A couple of pulls on the starter rope will clear the carburetor of fuel, after

which the motor will often start and run for a few seconds. Then open the fuel valve and the motor should start easily.

Installing Wallboard Around Pipe

When wallboard must be fitted around a pipe, unsightly saw cuts are practically eliminated by cutting out an angular segment of board instead of making straight cuts from the edge of the board to the pipe hole. Whether cut out for one pipe, A, or two pipes, B, the sides of the angular segment will fit snugly and the saw cuts can be hidden with a coat of paint. With the segment in place, the edge of the wallboard is slightly uneven because of the saw cuts, but this irregularity can be hidden by covering it with quarter round.

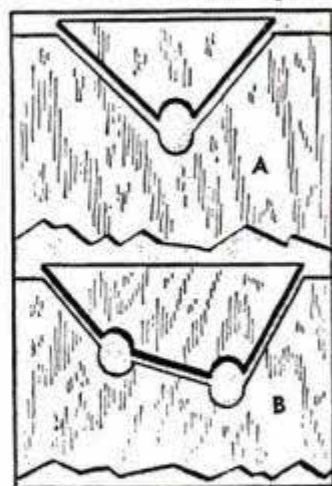

John W. LaLonde, West Allis, Wis.

Identification for Your Binocular

By simply sticking a gummed label, containing your name and address, inside one of the eyepiece covers of your binocular, you have a positive yet secret means of identifying it if it is lost or stolen. In this position, the label is protected and it takes only a moment to remove the binocular cover and prove ownership.



Emergency Camp Constructed Entirely With Ax

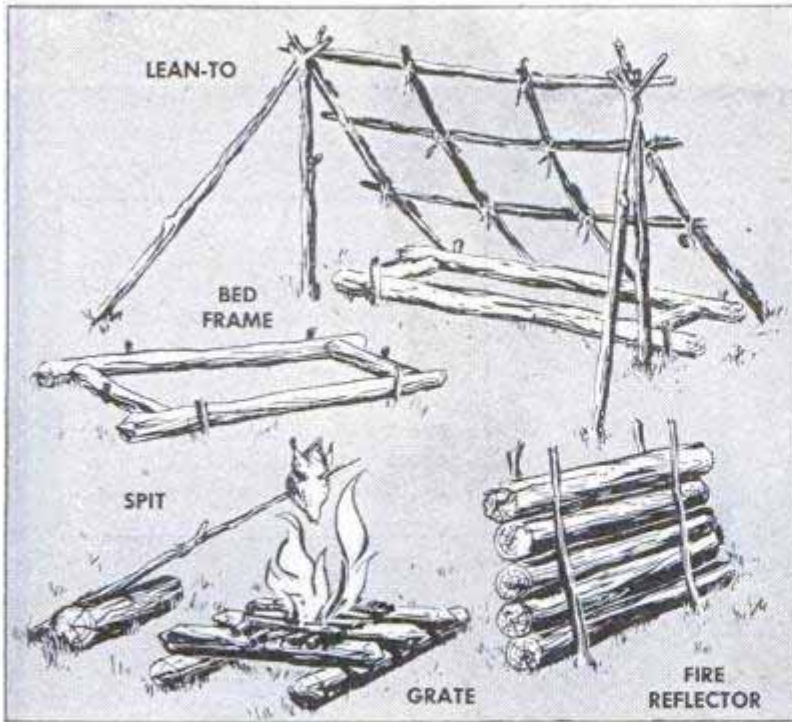

An ax is the only tool needed to build a complete emergency camp for spending an unexpected night in the woods. With its help and a means of lighting a fire, you can be comfortable without blankets even though the night is chilly. The first step in setting up the camp is to make a lean-to. For the uprights, use two 6-ft. saplings with forks and set them firmly in the ground, spacing them about 7 ft. apart. Then cut a long pole and lay it across the forks. Four 6 or 7-ft. saplings are leaned with their ends resting on the crosspole. Then two or three poles are cut and laid across the leaning poles. The front of the lean-to is braced with two 10-ft. poles with forked ends, and all the poles are tied securely with strips of thin bark cut from a young tree. Next, the bedframe is made from logs held in place by stakes driven in the ground. After this, gather pine or cedar branches. Lay the smaller branches in the bedframe to provide a soft mattress and lay the larger branches in rows, with their tips downward, on the lean-to roof, starting at the

bottom and working up. Several layers of cedar branches will make the lean-to roof almost watertight.

A properly made campfire is extremely important. As it must have plenty of draft, cut five small, green logs about 4 ft. in length. Place two of these on the ground several feet in front of the lean-to and lay the other three logs across the first two. Then build a fire of small, dry sticks on top of the logs so the coals will fall between them and smoulder, making a bed of coals for an all-night fire. If the night is cold or stormy, set up a reflector in back of the fire so it will throw the heat into the lean-to. This is done by placing four or five green logs one on top of the other, holding them with four stakes driven into the ground. If you are fortunate enough to have some kind of meat, impale it on a spit and broil it over the fire. Use a limber, green stick for the spit and prop it over a small log to hold the meat far enough above the fire to permit cooking it without burning.—R. A. Jenkins, St. Louis, Mo.

Dimension Table for Standard Pipe Minimizes Measuring Errors

When making plumbing or heating repairs in the home, costly waste of pipe is likely to result from inaccurate measurements, such as, forgetting to allow for the threaded ends of the pipe inside the fittings. This table, which gives pipe diameters and thread lengths in fractions of an inch, will help you obtain correct measurements.

Regis R. Pfoff, Homestead, Pa.

| PIPE SIZE | 1/8" | 1/4" | 3/8" | 1/2" | 3/4" | 1" | 1 1/4" | 1 1/2" | 2" |
|-------------------------------------|---------|---------|---------|---------|---------|---------|----------|----------|---------|
| INSIDE DIAMETER | 5/16" | 3/8" | 1/2" | 5/8" | 1 1/16" | 1 1/2" | 1 3/8" | 1 5/8" | 2 1/16" |
| OUTSIDE DIAMETER | 1 1/32" | 1 1/32" | 1 1/16" | 2 1/32" | 1 1/16" | 1 1/16" | 1 21/32" | 1 29/32" | 2 3/8" |
| APPROXIMATE THREAD LENGTH ONE END | 1/4" | 3/8" | 3/8" | 1/2" | 5/8" | 1 1/16" | 1 1/16" | 1 1/16" | 3/4" |
| APPROXIMATE THREAD LENGTH BOTH ENDS | 1/2" | 3/4" | 3/4" | 1" | 1 1/8" | 1 3/8" | 1 3/8" | 1 3/8" | 1 1/2" |

Solving HOME PROBLEMS

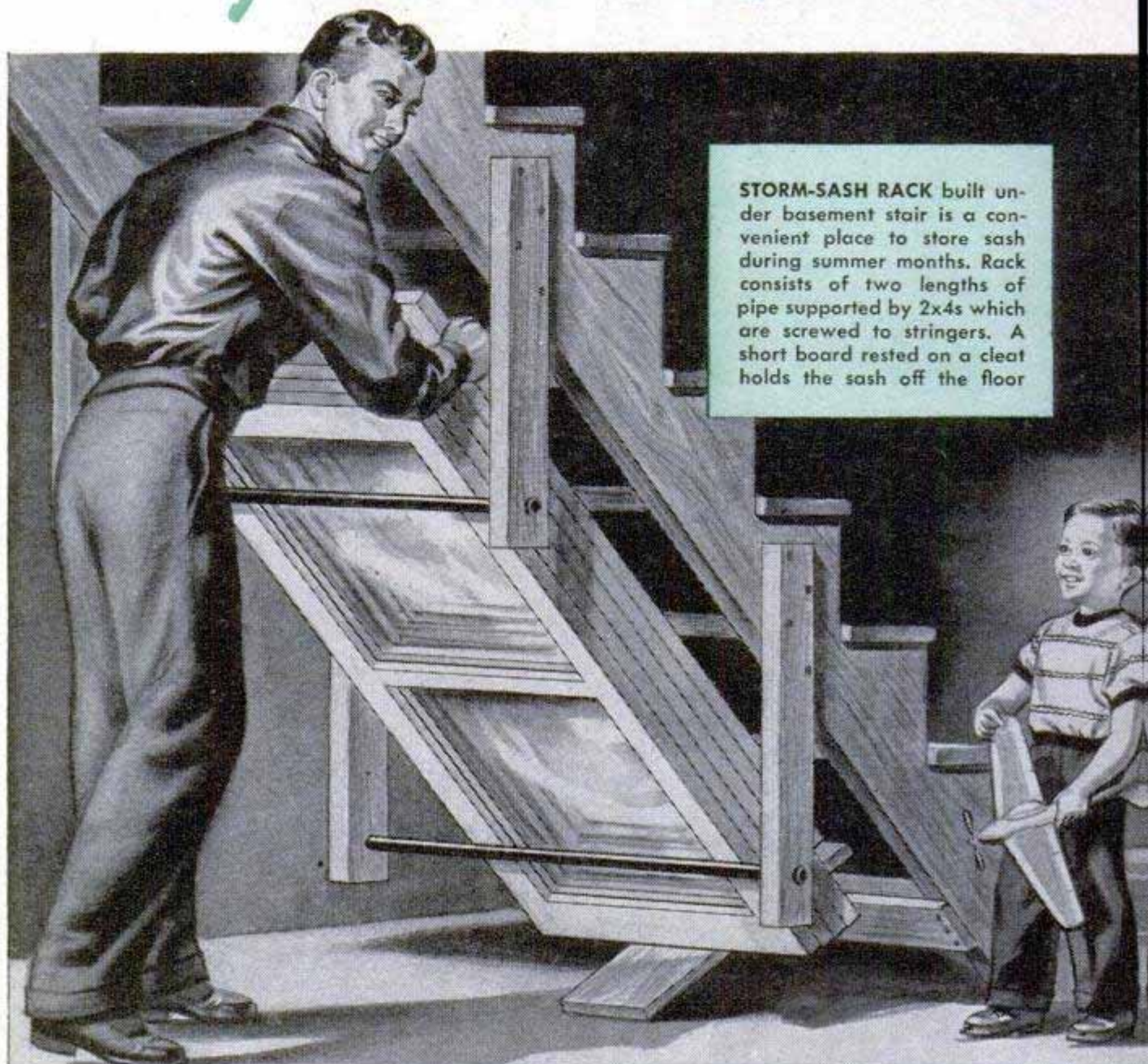

STORM-SASH RACK built under basement stair is a convenient place to store sash during summer months. Rack consists of two lengths of pipe supported by 2x4s which are screwed to stringers. A short board rested on a cleat holds the sash off the floor

NOVEL WAFFLE EFFECT on top of cookies is made quickly by indenting the dough with a potato masher

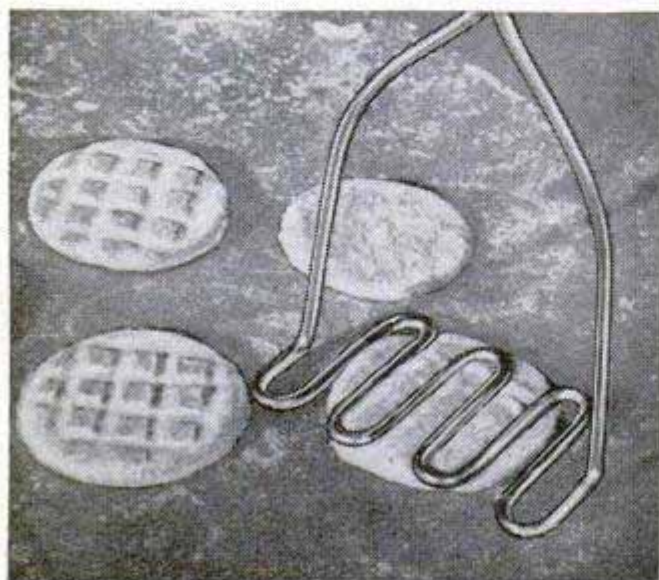

YARN WON'T TANGLE when knitting Argyle socks if the balls are stored in a cardboard egg carton

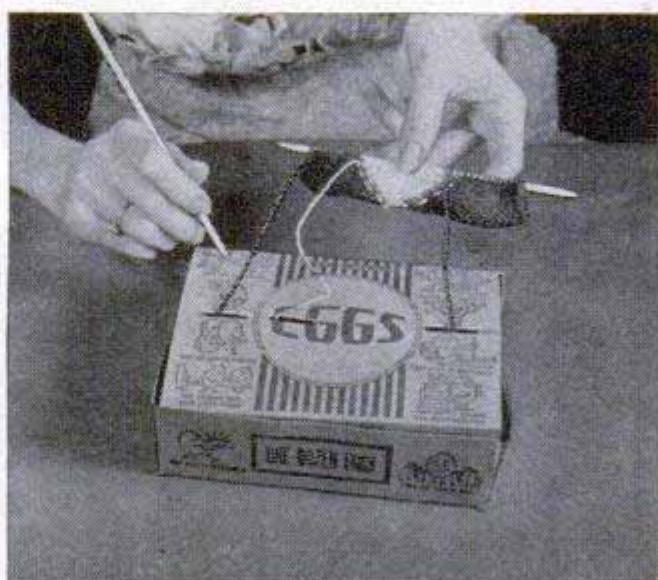

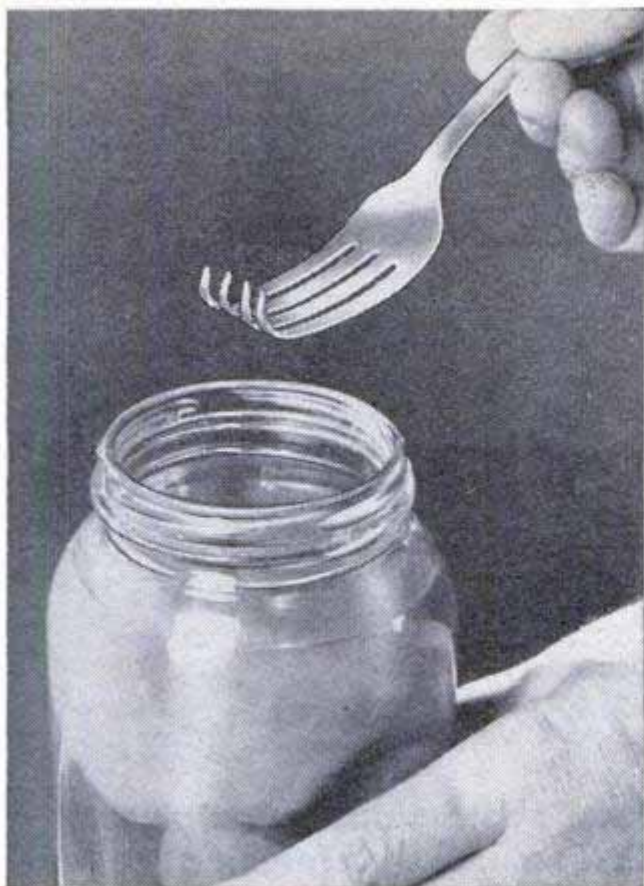

PICKLES OR OLIVES are removed from a tightly packed jar with an old fork that has tines bent upward. The tines can be bent with a pair of pliers

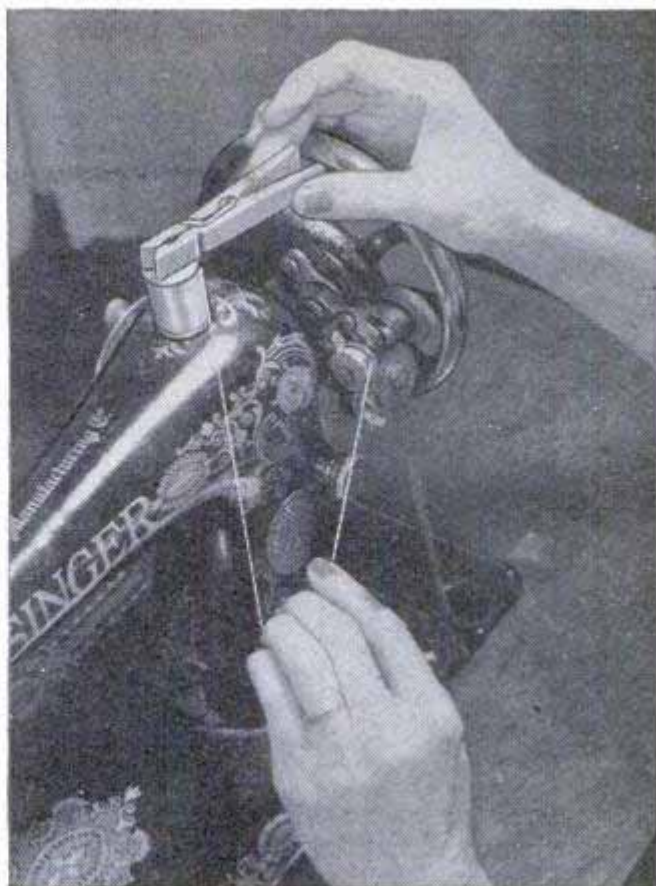

CLOTHESPIN HOLD-DOWN clamped to the spindle of a sewing machine keeps the spool of thread from jumping off the spindle when winding the bobbin

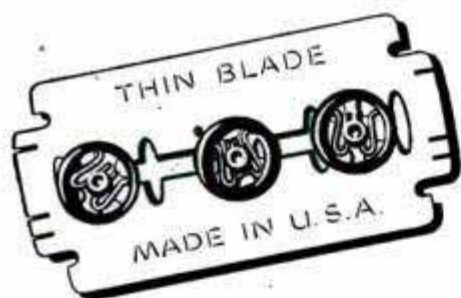

HOLDING A RAZOR BLADE is easier when ripping seams if dress snaps are placed in holes of the blade

COMBING REMOVES SNARLS from the matted fringe of a luncheon cloth or scarf after it has been ironed



WAX-PAPER COVERS for paraffined jars of jam or jelly can be held securely with ordinary jar rubbers

APPLYING LIQUID PLANT FOOD is done without injuring leaves if funnel spout is embedded in dirt



Suction Cups Hold Fishline Drier On Rear Window of Car

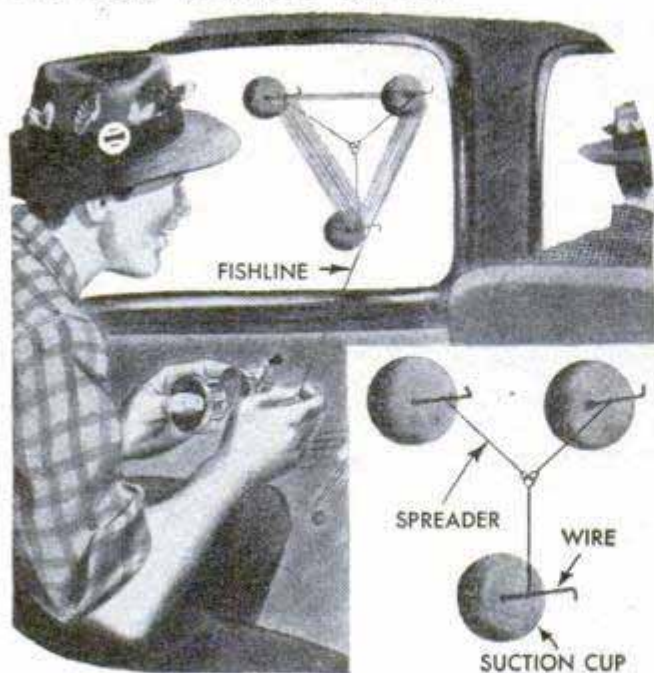

Mounted on a car window with suction cups, this novel fishline drier permits drying the line while traveling in the car. It is made by cutting three sections from a wire coat hanger and bending them to form hooks. The bases of the hooks, which are bent loop-shape, are simply bolted to the suction cup. If desired, a three-pronged spreader can be made to reinforce the hooks when fishline is wrapped around them.

Lee H. Schrimpf, Palatka, Fla.

Staples Clean Paint From Scraper



Keeping the scraper blade clean by drawing it between two staples driven into the side rail of a ladder speeds scraping burned paint from the side of a house. The staples should be spaced a distance

approximate to the thickness of the blade and located at an easily reached point on the rail.—G. E. Hendrickson, Argyle, Wis.

Cork Float for Starter Rope

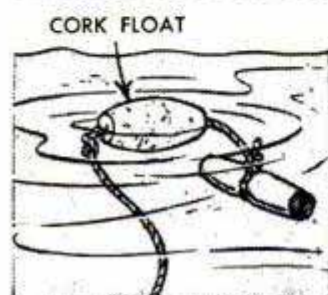

If the handgrip on the starter rope of your outboard motor is not sufficiently buoyant to float it, make sure that it will not sink, if dropped in the water, by slip-

ping a large cork float onto the rope. Push the float almost to the handle so it will not interfere with starting the motor, and then tie a large knot just below the float to keep it from sliding off the end of the rope.

Tie Secures Collar Stay

Looping a tie around the cross-piece of a wire collar stay holds the stay in place and keeps the tie centered. This also prevents the wire crosspiece from showing above the knot, improving the general appearance.—Johnny Kane, Lakewood, Ohio.

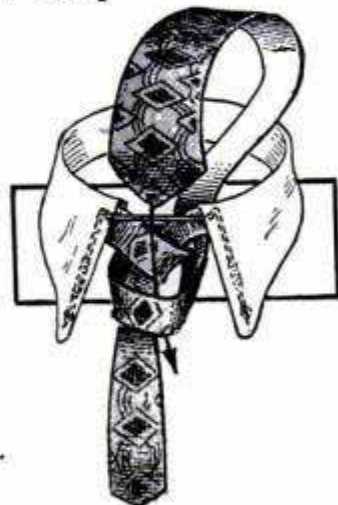

Lead Shot Balances Container To Permit Easy Weighing

To eliminate deducting the weight of duplicate containers when repeated weighings are made on a balance scale, one workman uses lead shot to balance the empty container. In use, the container is placed on one pan of the scale and an empty bottle on the other. Shot is poured into the bottle to balance the container, after which the bottle is corked to prevent spilling. Then the regular weights are employed in the usual way.



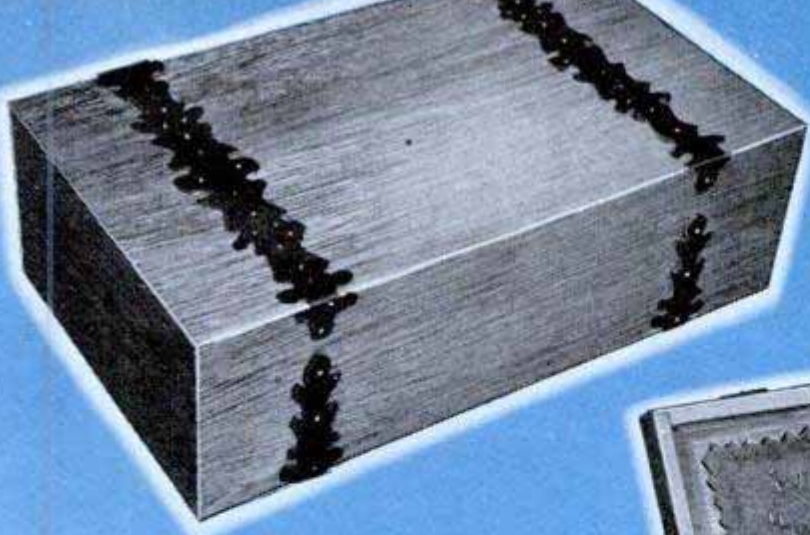

Everything will be at hand when you sit down to sew if your sewing essentials are kept in this fancy box. The box is made as a single unit, the top piece being glued and clamped to the sides, and then the unit is ripped through at the hinge line to form the lid. The bottom is fitted inside the assembly and is held with small brads. The partitions are merely glued in place. The plastic overlays are bent over the edge of the lid by heating them to make them pliable. Select small brass hinges and a support chain for the lid

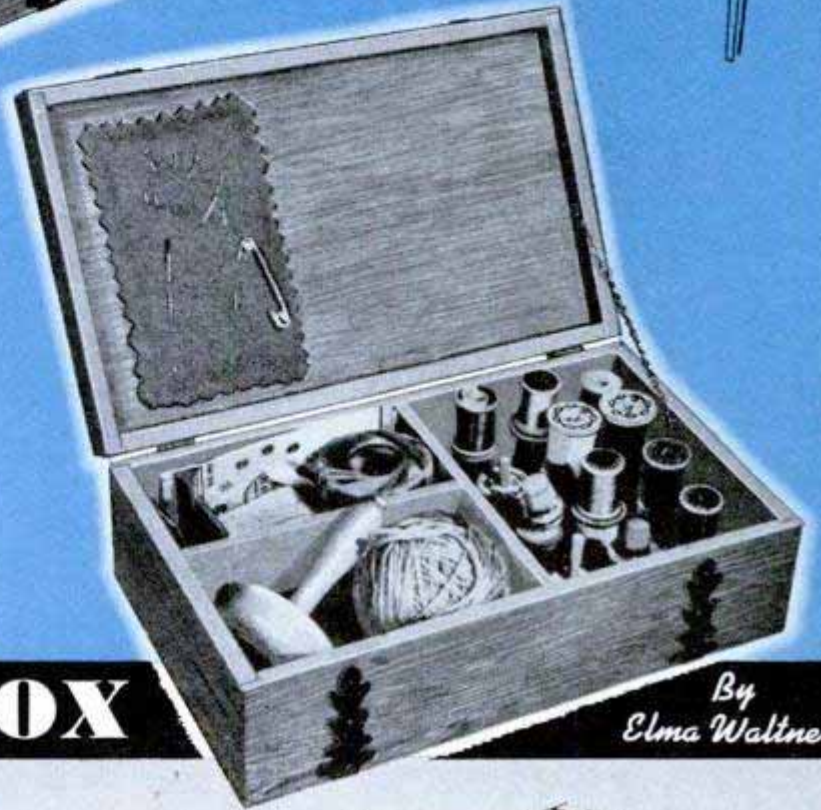

SEWING BOX

By
Elma Waltner

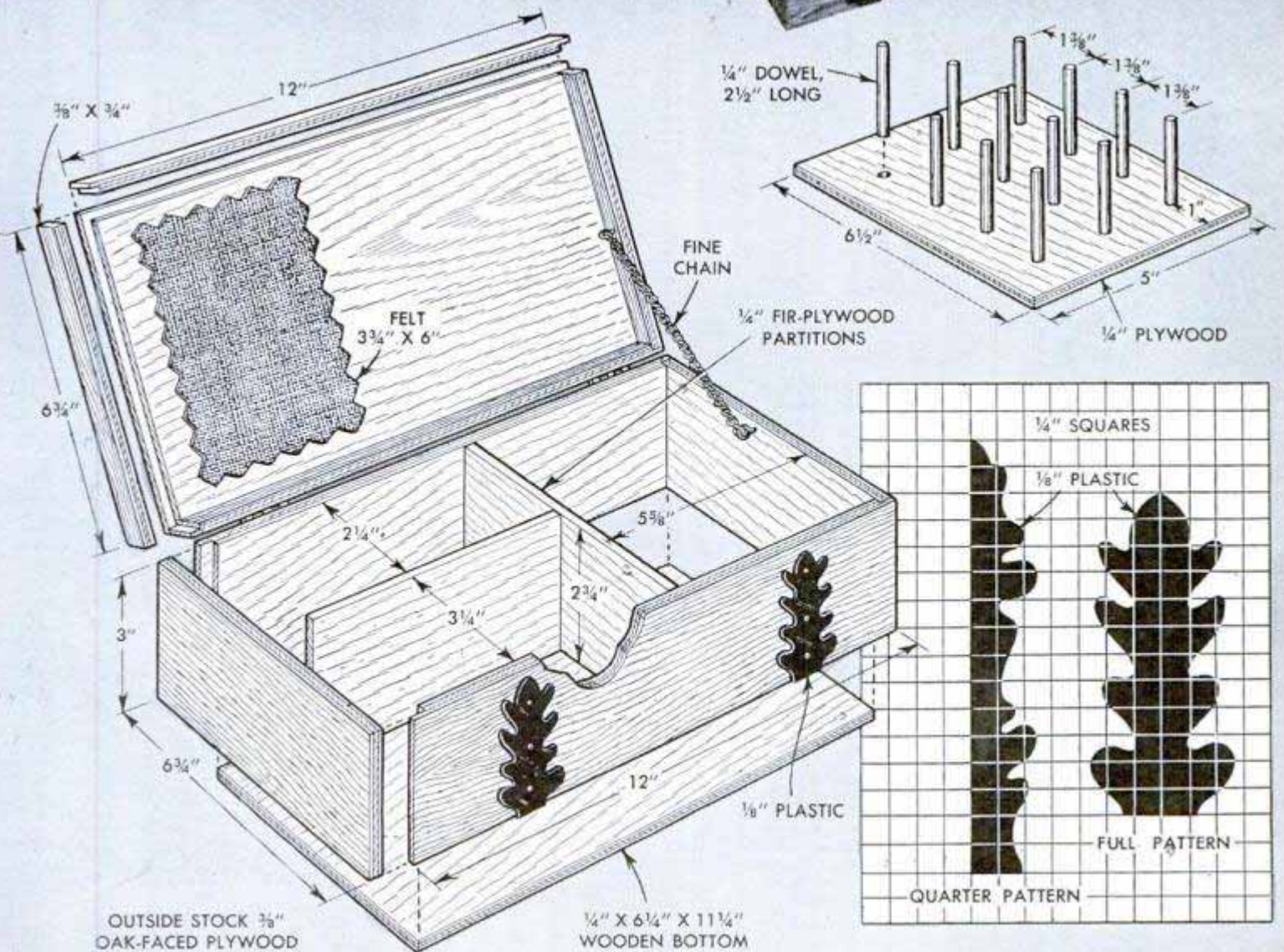



This dream home in stuccoed masonry, consisting of cabinet kitchen, two bedrooms, living room, bathroom and utility room, complete with laundry and heating plant, is yours for less than \$3650 if you build it yourself. Block construction is within the ability of an average man

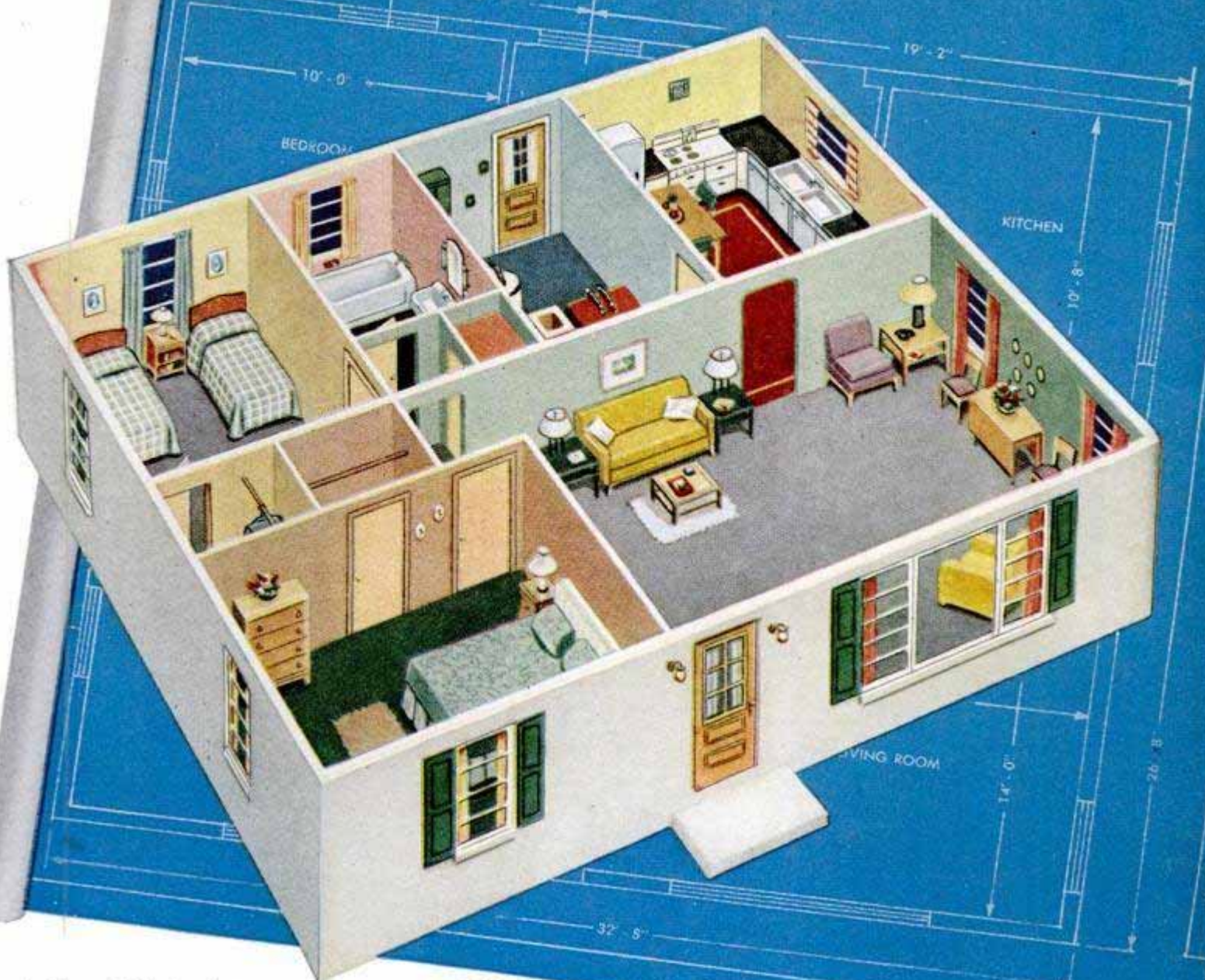

build-it-yourself

CONCRETE-BLOCK HOUSE

FIVE COZY ROOMS FOR \$3650

by Wayne C. Leckey

Part I

ARE YOU one of the thousands caught in the net of housing shortages? Do high costs make the problem seem insurmountable? If you are willing to devote your spare time to the problem for a few months, it can be solved by building this cozy little concrete-block house. It's not so little either—just take a look at the interior view above and then study the floor plan on page 189. Here is a home that will accommodate a family of four, and it's all yours, ready to occupy, complete with heating plant, laundry and a beautiful cabinet kitchen, for less than \$3650—merely the cost of a fine new car. That's what the

materials, including the plastering, cost Henry Nehrbaas, an artist on the *Popular Mechanics* staff, who built it in Palatine, Ill., for his young married daughter.

Now, about building it! If you can mix mortar and concrete, and saw a board straight, you can build it yourself—it's that simple. Yes, it means a lot of hard work, but it takes practically no skill. A complete instruction book giving step-by-step directions along with easy-to-follow blueprints has been prepared by the *Craftsman Editors*—just as was done for *Popular Mechanics* build-it-yourself frame house. This house, as you may know, was greeted

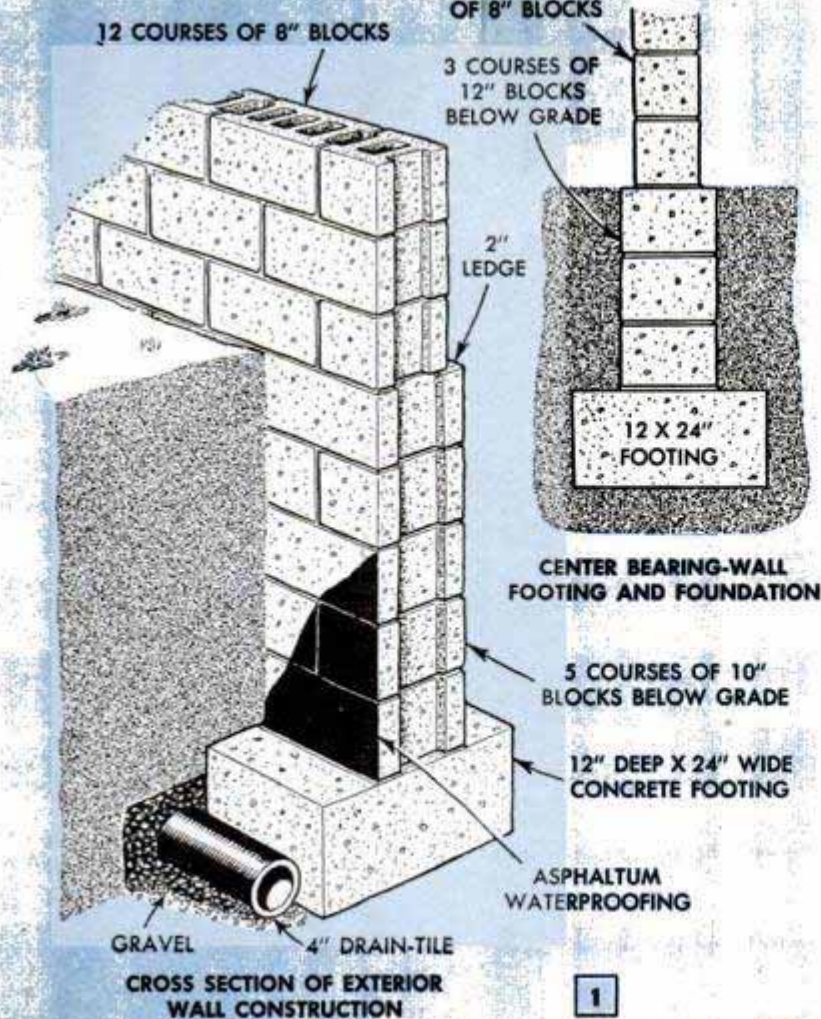

CROSS SECTION OF EXTERIOR WALL CONSTRUCTION

1

The number of courses of blocks required below grade varies with the depth of the frost line in different regions. Note that heavier blocks are specified for use below grade for all walls including the bearing partition. Waterproofing the walls with asphaltum paint is optional although it helps keep the earth dry below the concrete floor. Tiling, however, is very important, especially if the lot grade is low, and it is unwise to omit it for the sake of economy. The tile is laid around the footings and connected into the regular storm or sewer drainpipe

with enthusiasm by thousands of people. The editors followed the building of the block house as the work progressed and have hundreds of photos, diagrams and details which, together with a down-to-earth descriptive text, cover the entire construction of the house from the first shovelful of dirt to the last stroke of the paintbrush. The book and blueprints will be available from our Book Department about May 31st.

Like its famous predecessor, this house, too, was test-built to prove soundness of construction and to determine its actual cost. The \$3650 figure is based on prices in the Chicago area, a relatively high-cost region, and in a fairly high-cost year. In other regions, this home, no doubt, can be built for considerably less. Additional savings can be had by selecting less expensive bathroom and kitchen fixtures and doing without some of the refinements for the time being.

The original house was constructed of lightweight building blocks, which are easy to handle and have high insulating qualities. However, walls can be built of regular concrete blocks, cinder blocks and even brick backed with tile. Standard 8-in. blocks were

Below, except for stuccoing the outside face of the blocks and pouring the stoops, this view shows the outside work completed



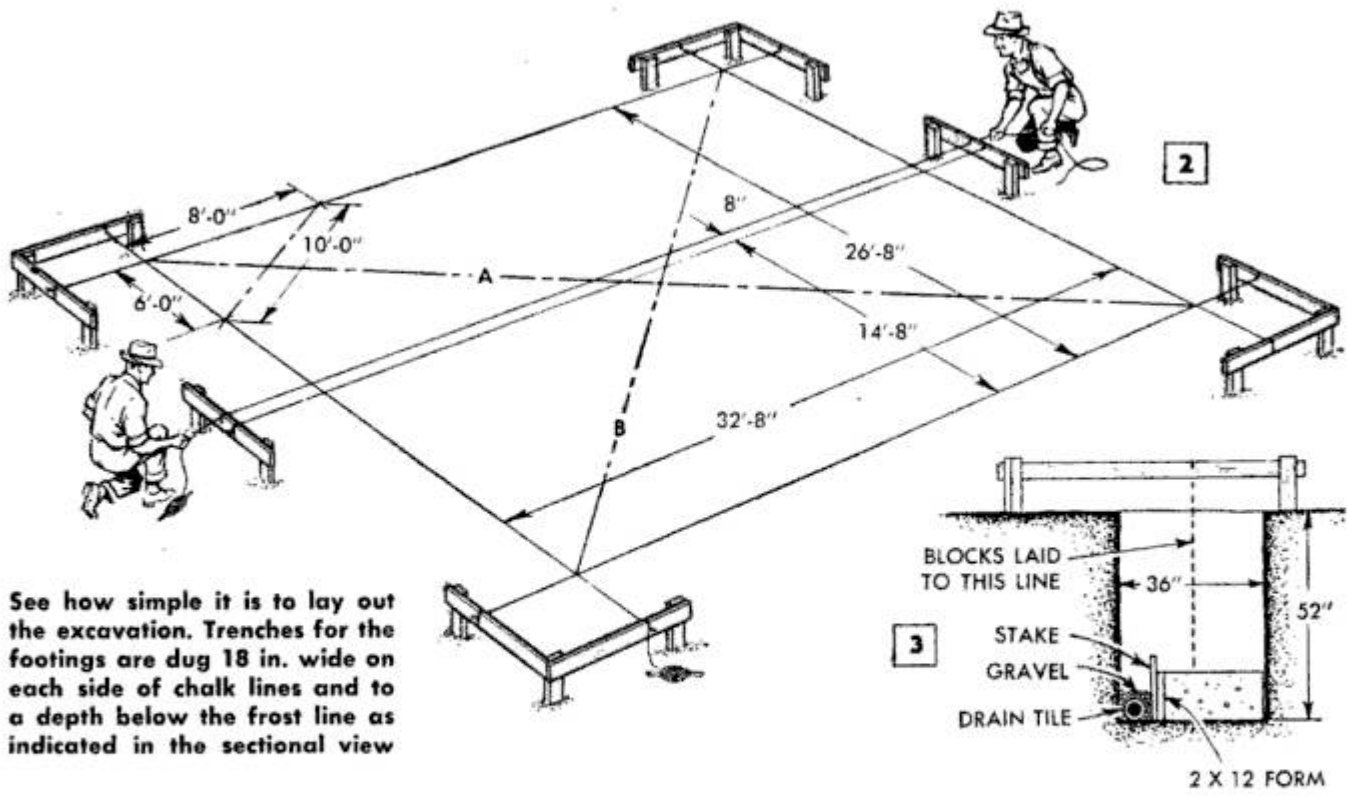

See how simple it is to lay out the excavation. Trenches for the footings are dug 18 in. wide on each side of chalk lines and to a depth below the frost line as indicated in the sectional view

used above grade for the exterior walls and the main bearing partition wall. All other walls were laid of 4-in. blocks. Exterior walls are furred on the inside and insulated before being lathed and plastered, whereas the plaster on the partitions is applied directly to the blocks. The insulated concrete floor is poured 4 in. thick over a tamped gravel fill with a vapor barrier placed between as recommended by the results of recent tests conducted by the University of Illinois.

The utter simplicity of construction is apparent in the accompanying photos and sketches and those to follow in Part II. As space in the magazine does not permit giving a detailed description of the construction, these articles are presented merely to acquaint you with the basic steps. The initial step showing how simple it is to lay out the excavation is pictured in Fig. 2. A 3-ft. trench is dug completely around the house and also through the center for a main bearing partition. Where fairly severe winters prevail, the trench should be at least 4 ft. deep. Forms for the footings are erected by merely staking 2 x 12-in. planks on edge, as in Fig. 3, using the earth wall as one side of the form.

With the footings poured and the drain tile in place, you can start laying the blocks that form the foundation. Use 10-in. concrete blocks for the foundation of exterior walls and 12-in. blocks for the main bearing partition, as indicated in Fig. 1. When the grade line is reached, start using 8-in. blocks, which are laid twelve courses high. Each row of blocks is laid to a chalk line stretched from corner to corner. The starting row is plumbed from the building line,

using a long mason's level. Window and door frames can be mortared in place as you go along or set later. Half blocks are used at all openings, and the corners of the structure are plumbed and built up ahead of the rest of the wall as shown in the photo at the bottom of pages 190 and 191. Method of assembling and installing wooden lintels over the window and door openings is shown in Fig. 4, and a typical form for casting window sills is detailed in Fig. 6. Wherever an electrical convenience outlet is to be installed in a wall, keep an opening clear at that point for conduit by ramming a stick through the blocks from top to bottom as in Fig. 5. When the top course of blocks is laid, anchor bolts spaced about 4 ft. apart are embedded in concrete poured into the openings in the blocks. The bolts are used to anchor 2 x 8-in.

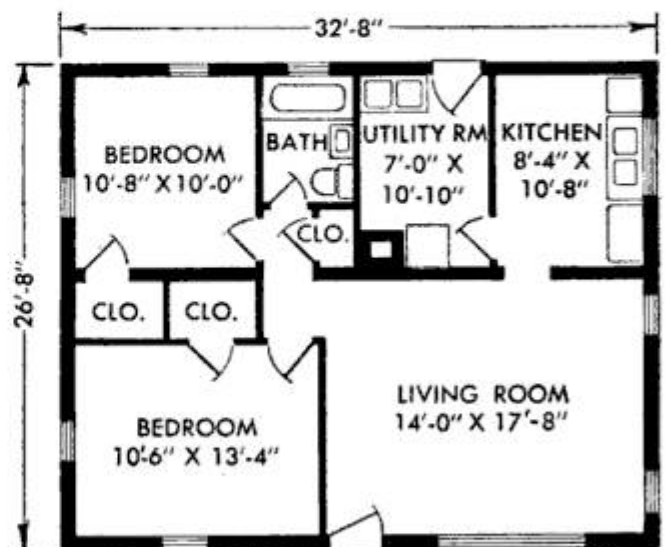

FLOOR PLAN

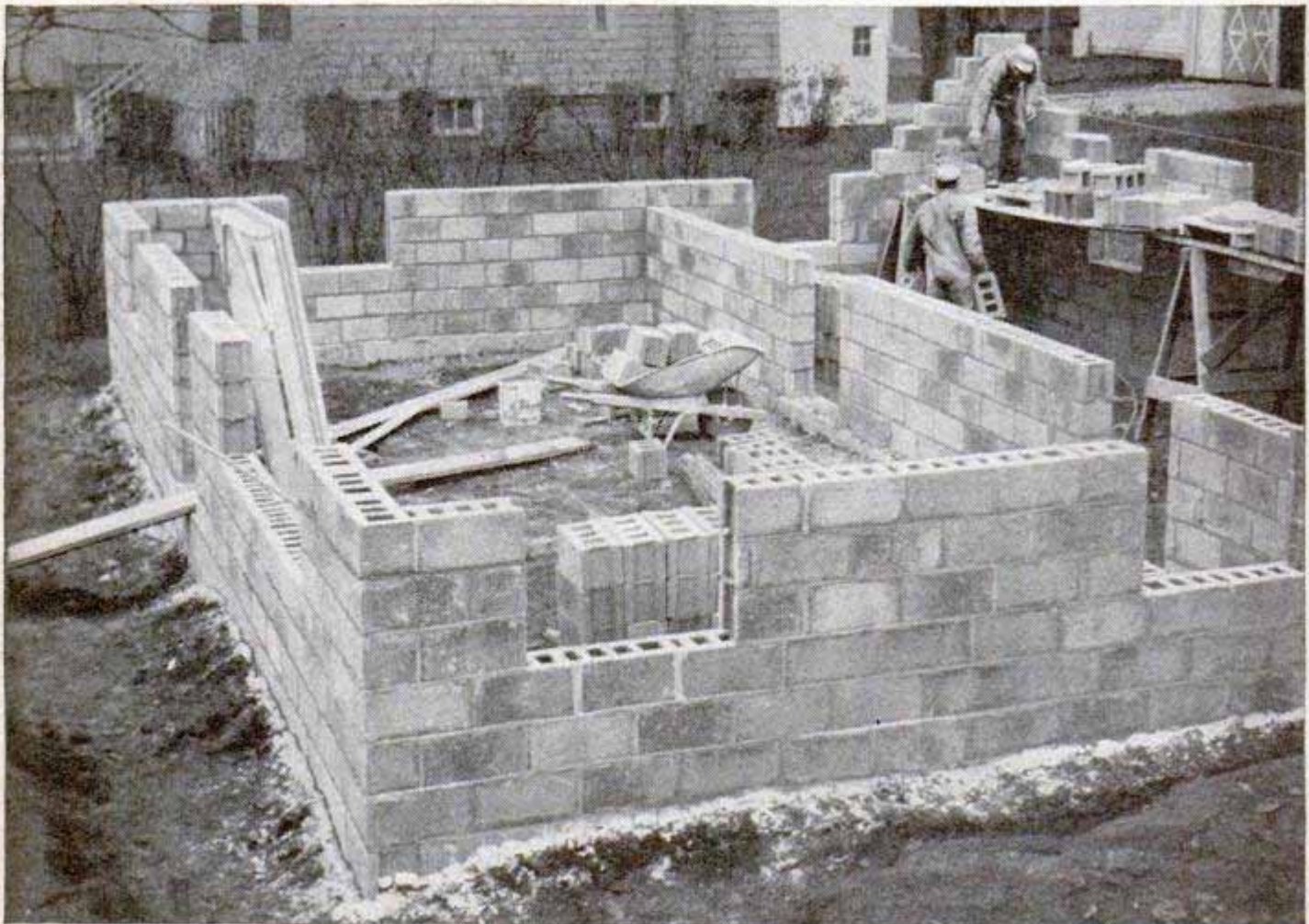
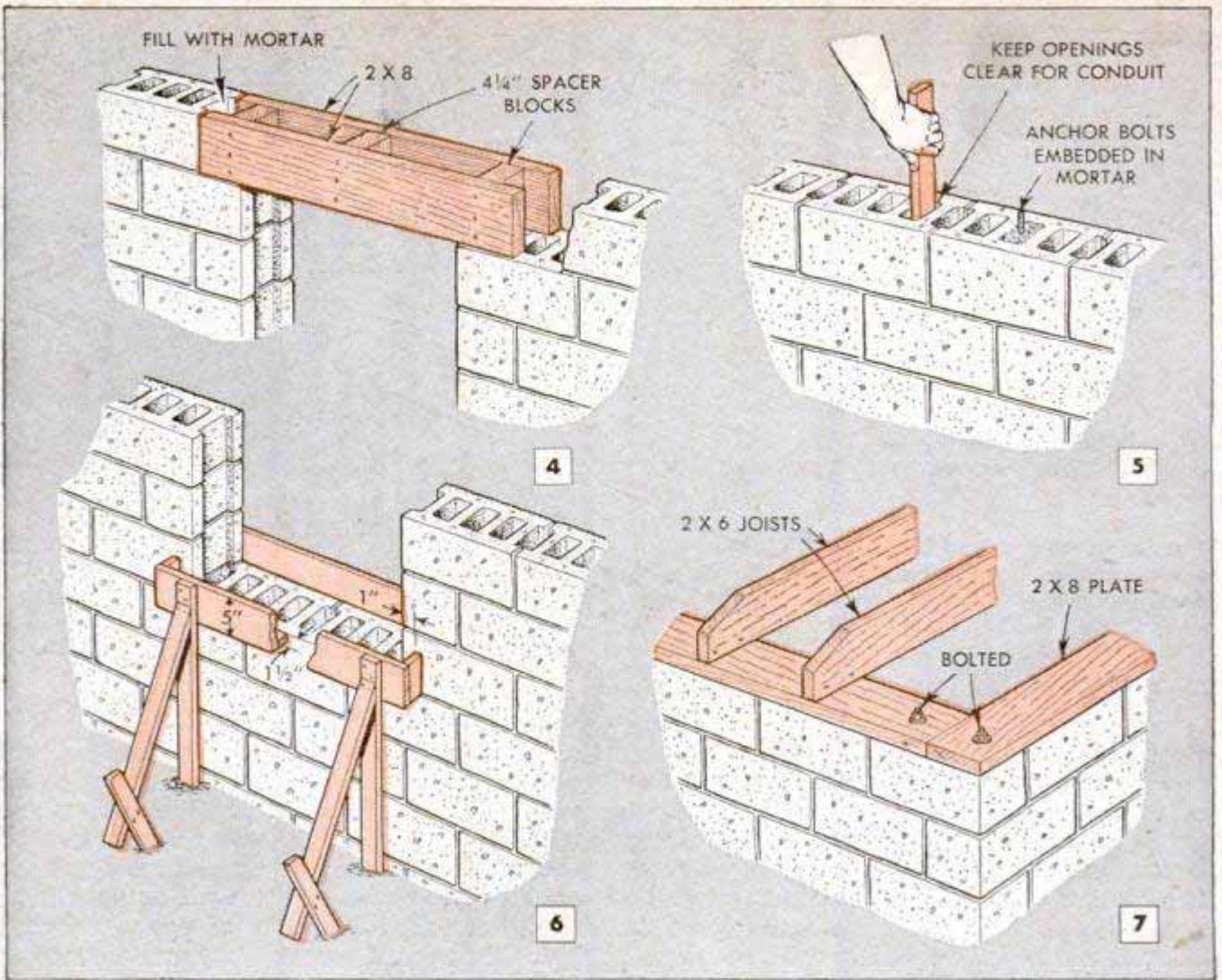

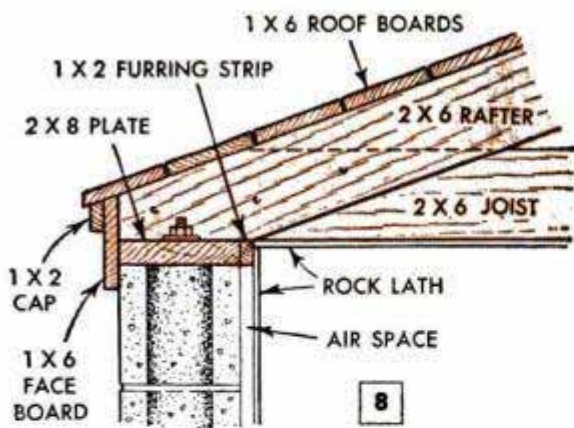

This sectional view and the photo at the right show the simplicity of the roof framing and the cornice. Rafters are spiked to the face of the joists and toenailed to a plate bolted to the top of exterior walls

plates which are placed on top of the blocks all around as in Fig. 7.

With the plates in place, the ceiling joists can be installed. These rest on a 2 x 4-in. plate bolted to the top of the main bearing partition, Fig. 9, and are lapped, spiked together and toenailed to both center and outside plates. Stock timbers (2 x 6 x 16s and 2 x 6 x 12s) are required for the joists which are spaced 16 in. on centers. When the joists are in place, they are cross-braced by bridging them with short lengths of 2 x 6-in. stock as shown in Fig. 9. A row of bridging is installed on each side of the

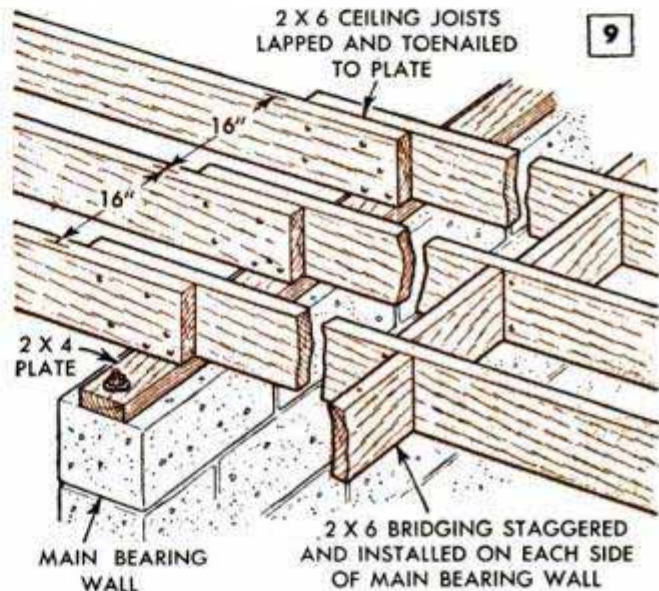
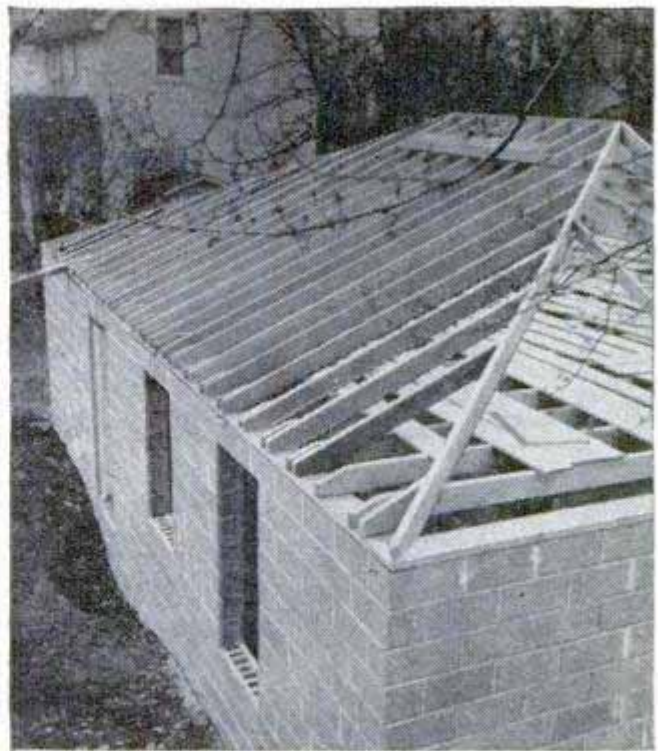

Ceiling joists rest on a plate bolted to the top of the main bearing partition. Ends are lapped, spiked together and toenailed to the plate. Bridging members are nailed between all joists to brace them

main bearing partition, the pieces being staggered to permit nailing.

Next come the rafters. Those in the center span of the house are raised first, using a 2 x 6-in. plank for a ridge board. These rafters are erected as if the house had a gable roof, spiking them to the face of the ceiling joists at the plate and into each other at the ridge board. With this section of the framing in place, a rafter is installed at each end, butting it against the end of the ridge-board plank. Then the long hip rafters are erected and short jack rafters are cut to fill in. The cornice around the roof consists of a 1 x 6-in. frieze board, which is nailed to the ends of the rafters as in Fig. 8. A 1 x 2-in. cap gives a slight overhang to the roof.

(To be continued)



U. L. 51

Hoe Blade on Bottom of Ladder Provides Handy Foot Scraper



Especially useful when working on newly constructed houses where the ground is muddy, half of a hoe blade screwed to the bottom rung of a ladder provides a handy foot scraper. Its use will prevent tracking mud up the ladder, thus making the rungs slippery. However, when descending the ladder, be careful not to step on the scraper.

Repairing Broken Tenon in Rung Without Dismantling Chair

A broken tenon in a chair rung or slat can be repaired by replacing it with a spring-held dowel without dismantling the



chair. After the damaged rung is removed, the broken tenon is drilled out and the depth of the tenon hole is increased. A small compression spring is placed in the hole and a new dowel is pressed down over the spring so its top is flush with the end of the rung. Then the rung is replaced in the chair, the dowel being depressed with a knife blade. When the rung is in position, the knife is pulled away, allowing the spring to force the dowel into the hole in the chair rail. The spring holds the dowel securely in place, resulting in a neat repair.

Donald F. Pecheck, Los Angeles, Calif.

Emergency Headlight Fuse

If a headlight fuse burns out while you are driving on a dark highway, a substitute fuse can be quickly improvised on the spot by wrapping the carburetor filter screen around the fuse and replacing it in the clips.

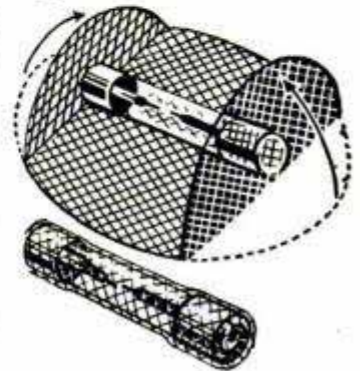

Although a disk-type screen is shown, a cylindrical one also can be used. An emergency fuse of this type will offer no protection to the wiring of the car circuit and, therefore, care should be taken to avoid any possibility of fire.

Ed Packer, Chicago.

Tape Protects Rimless Spectacles

Before attaching sunglasses or reading lenses to rimless spectacles, use small pieces of clear cellulose tape to protect the lenses of the spectacles from scratches. Fasten the tape at the points where the clips of the special lenses fit over the spectacles.—Sarah Schuster, Clearwater, Pa.

Wooden Wheels Secured to Dowel With Corrugated Fasteners

When making toys, a simple way to attach wooden wheels to a dowel axle is to drive a corrugated fastener into the end of the dowel so that its ends embed in the wheel. The end of the dowel, of course, must be flush with the outside of the wheel, and the fastener should be driven across the grain of the wheel.—J. E. Long, Bethel, Vt.

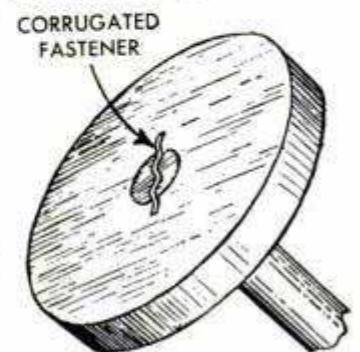

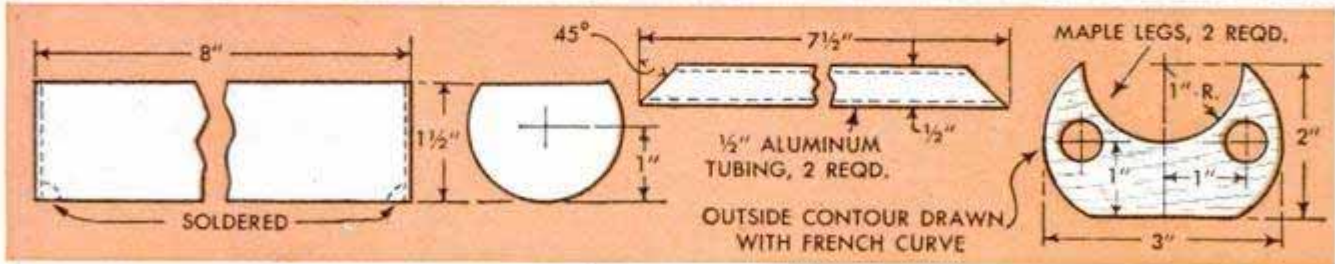
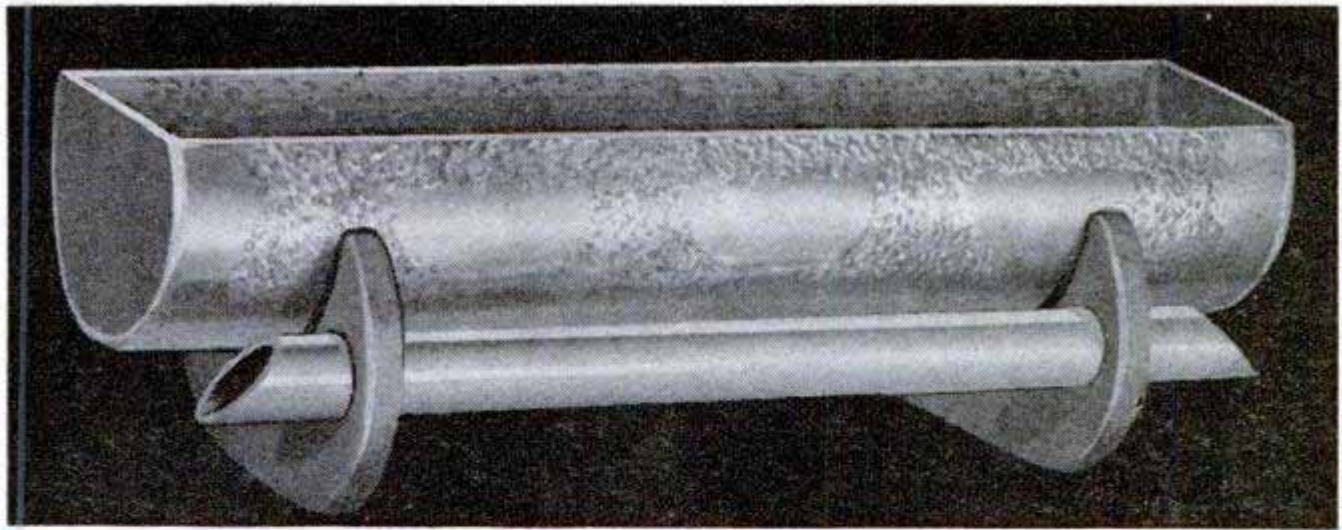

Modern Plant Holder in Hammered Aluminum

Combining hammered aluminum with polished maple in a pleasing modern design, this one-evening project offers something different in plant holders. The small size pictured is just right for a window sill, coffee table or chest of drawers, and the holder can be made larger to serve as a centerpiece on a buffet or dining-room table. The plant holder consists of a length of 2-in. aluminum tubing set on legs, which are cut from $\frac{1}{4}$ -in. maple as shown in the right-hand detail. Holes are drilled in the legs for two lengths of $\frac{1}{2}$ -in. aluminum tubing and the legs are waxed and polished. To give rigid support to the legs, the tubes should be a snug fit in the holes. The side of the 2-in. tube is cut away as indicated and the ends are sealed with pieces of alu-

minum. This can be done by soldering or merely forcing oversize pieces in place. If the joints are to be soldered, use a special solder made for soldering aluminum. After the ends of the tube have been sealed, the corners are filed to a slight radius so the joints will not be noticeable. Designs are then outlined in pencil on the sides of the tubing and the background is dimpled with a ball-peen hammer. A piece of round bar stock or pipe, slightly smaller in diameter than the tubing, forms an excellent anvil for the hammering process. For a dull satin finish, the aluminum can be rubbed with fine steel wool and oil, or it can be buffed with jewelers' rouge if a highly polished finish is preferred.

R. J. DeCristoforo, New York City.

Worm-Free Radishes Grown With Aid of Screen-Covered Frames

Radishes can be kept worm free if they are protected by wooden frames covered with screen wire or mosquito netting. Although the frames prevent the cabbage fly from laying its eggs on the radishes, they still admit a sufficient amount of sunlight, air and moisture for healthy plant growth. The frames are made of 1 x 12-in. boards to enclose the radish beds completely, and the screen or netting is stretched taut and tacked over them. To pick the radishes, one side of the frame is lifted and supported by a wooden prop, bolted loosely to each end, which folds against the frame.

Bill Brown, Willits, Calif.

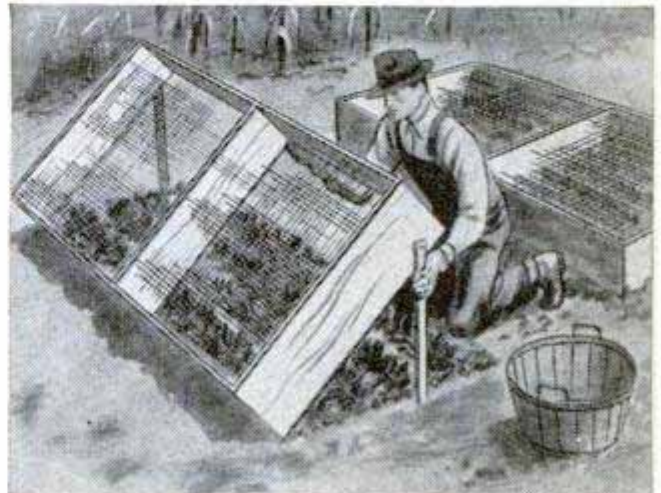

10 HOME-LABORATORY



Finger grips for hot glassware are made by cutting rubber hose into short lengths and slitting one side so that it can be slipped over the edge of the dish

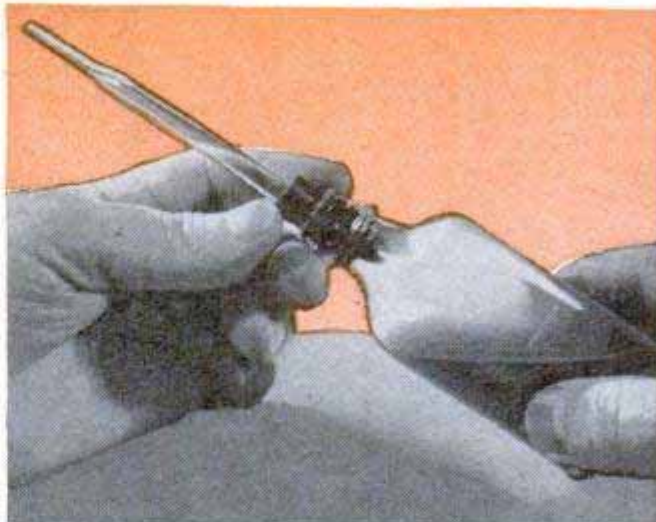

To release the contents of a bottle, one drop at a time, cut off the top of a medicine-dropper bulb and insert the bulb tightly in the mouth of the bottle



Caps of bottles containing highly volatile liquids are sealed with a hot solution of plain granulated gelatin, 10 grams, water, 6 c.c., and glycerin, 8 drops

To make a funnel tube for the home laboratory, cut a small bottle in half and insert a one-hole rubber cork in the mouth. Push a glass tube into the cork



A cigarette lighter, with wick removed, is just the thing for lighting a Bunsen burner. Fit a new flint and clean the wheel so it gives a shower of sparks

Ordinary metal food tongs are perfectly shaped for handling test tubes. The tongs also are useful for holding irregularly shaped containers when pouring

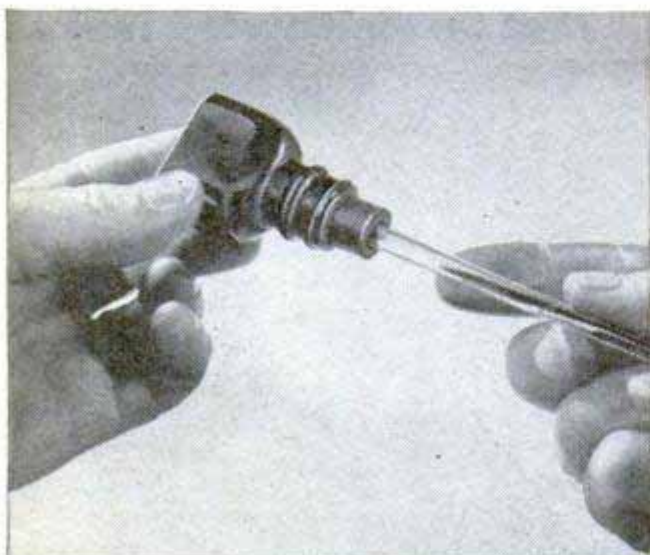

SHORT CUTS

By Kenneth Murray

HOME CHEMISTS confronted with laboratory problems requiring new solutions will find these simple short cuts especially useful. In many cases, lab equipment already at hand can be adapted to serve a dual purpose when making experiments, thus eliminating the cost of additional items not often used. In other instances, equipment not ordinarily used in the laboratory can be made to serve the purpose. For example, a cigarette lighter with the wick removed comes in handy for lighting a Bunsen burner. A pair of food tongs, usually available in the kitchen, serves as a test-tube holder and is excellent for handling hot glassware. Various adaptations are pictured on this and the preceding page.



To prevent test tubes or any other glassware from shattering during an experiment, coat outside of the glass with a thick layer of modeling clay or putty

Test tubes that are incrustated with hard deposits are cleaned quickly by "lapping" with steel wool. Twist the wool around the end of a wooden stick

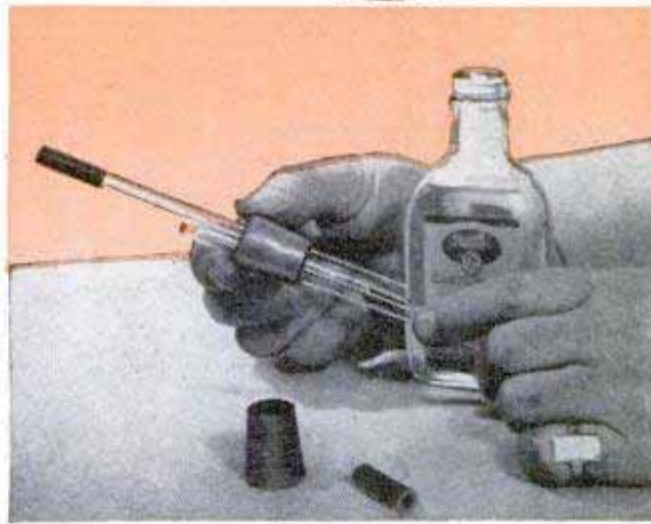

Glass tubing can be slipped easily inside rubber tubing or corks if castor oil is used as lubricant. This does not cause swelling or softening of rubber

To ignite chemicals from a safe distance, use a steel-wool filament wound across bared wires of a lamp cord. Hold wires apart with putty. Connect to dry cells

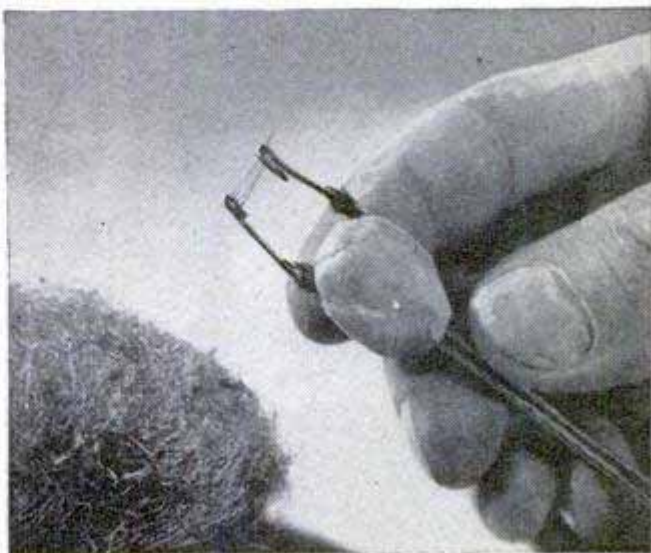
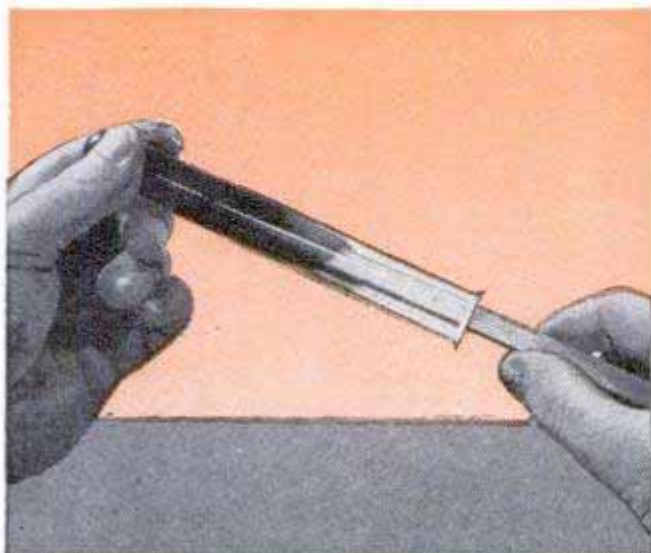

Protective Case for Jigsaw Blades Made From Garden-Hose Section



A handy container for storing extra jigsaw blades is made from a length of garden hose. A section of hose, slightly longer than the jigsaw blades, is sealed at both ends with tight-fitting corks. The hose is cut partially through near one end to provide a hinged cover, leaving the full thickness of one side intact to serve as a sturdy hinge. The case is easily opened, as pictured in the drawing, and the resiliency of the rubber holds the cover securely closed.

Balloon Forms Swimming-Pool Toy

Weighted with water, a toy balloon provides an excellent ball for swimming-pool or beach games. Enough water is poured into the balloon to permit it to be thrown with accuracy and then it is blown to the size of a softball. The ball is buoyant and will skip across the water. It also is safe, as it is too soft to cause injury.

Talcum Powder Keeps Stamps Dry



Stamps which are mailed for return postage or in payment for merchandise are kept from sticking together or to other enclosures by dusting talcum powder over the mucilage. If a

number of stamps are handled in this way, the talcum is applied quickly and neatly by rubbing the stamps across a powder puff.

Ridding Cabin of Insects

Here is a quick way to rid a summer cottage or cabin of flies, mosquitoes, ants, spiders and other insects. First make a solution consisting of water, $\frac{1}{2}$ pint, menthol crystals, 3 tablespoonfuls, and oil of cedar, 30 drops. After making sure that all doors and windows of the cabin are tightly closed, pour the solution into an old pan or skillet and allow it to simmer on the stove for at least 10 minutes.

Pipe Flange on Wooden Block Provides Flagpole Bracket

Displaying the flag on national holidays requires just a few seconds if you fasten this mounting bracket permanently to the front of the house. It will hold the flagpole securely even in a high wind and prevent the pole from being pulled loose by inquisitive children. The bracket is made by screwing a brass pipe flange to a triangular wooden block, as shown, so the flagpole will be held at the proper angle when the block is fastened to the side of the house. Then, a drain groove is cut in the face of the block to prevent water from collecting in the flange. A short length of threaded pipe is fitted snugly over the end of the flagpole and fastened with a roundheaded screw. The pipe is turned into the flange when the flag is mounted.

Arthur Trauffer, Council Bluffs, Iowa.



Hideaway Breakfast Table for Small Kitchen

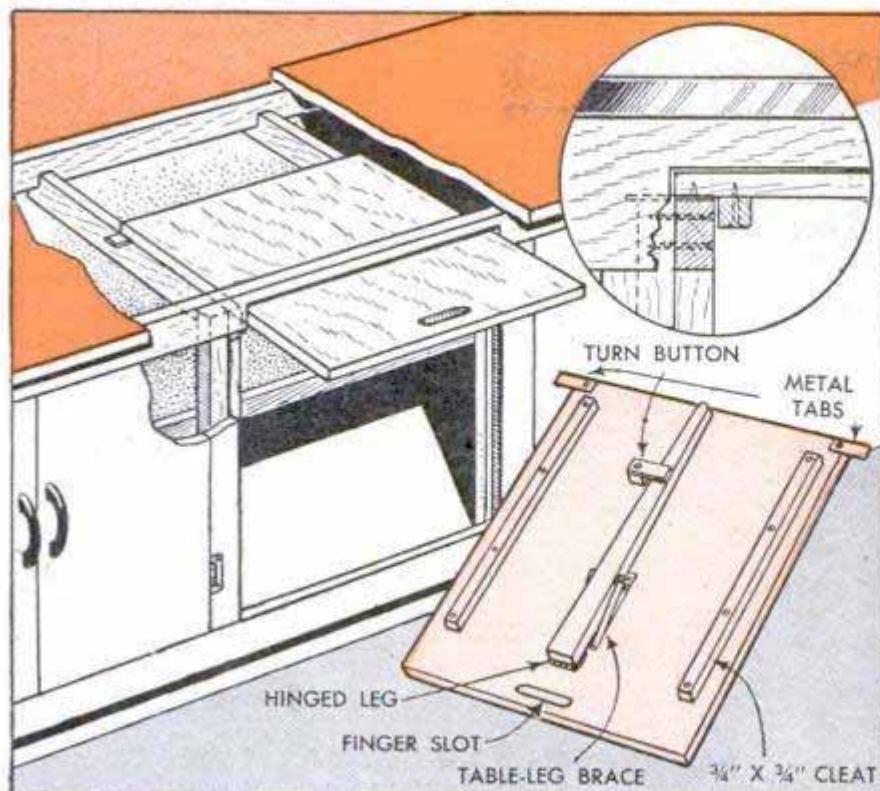

If your home does not have a breakfast nook and there is no room in the kitchen for a full-size table, this folding one will provide plenty of space for two people. Being installed in the utensil compartment of a built-in kitchen cabinet, the table doubles as a cabinet door and is out of the way until needed. The table top is a piece of $\frac{1}{2}$ -in. plywood which slides into the cabinet on 1 x 2-in. runners and pivots on metal tabs screwed to the underside at the rear corners of the top. These tabs project a short distance from each side of the table and are stopped by the front rail of the cabinet where they pivot on the cabinet uprights. Note in the circular detail that a portion of the rail is cut out to allow the

table to drop down flush with the front of the cabinet. When making this cut, be sure to allow enough clearance for the back edge of the table to swing up and under the rail when pivoted. Wooden strips are fastened to the inside of the cabinet uprights to provide stops for the table when it is closed. Guides for sliding the table top along the runners are made by screwing $\frac{3}{4}$ x $\frac{3}{4}$ -in. cleats to the underside of the top. The hinged leg is held in the closed position with a wooden turn button, and a card-table-leg brace holds it open. A finger slot can be cut near the front edge of the table or a handle to match those on the cabinet doors can be used.

Peter B. Horsley, Brandon, Man., Can.

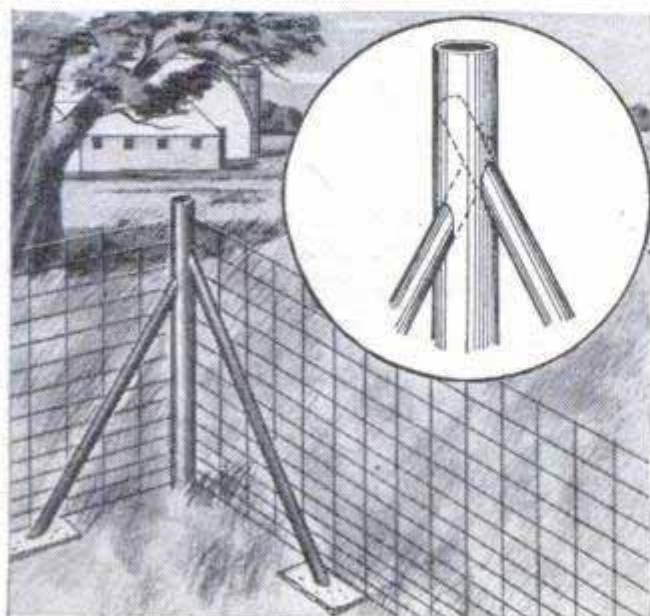

Pipe Braces Set in Corner Post Provide Sturdy Fence Support

When putting up a pipe fence on my property I supported the corner posts by embedding two lengths of small-diameter pipe, at right angles to each other, in each post. I drilled a series of small holes to rough out openings in the post for the pipe supports, knocking out the waste portions with a chisel. The braces, as well as the post, are set in concrete.

Gene Brock, Monterey Park, Calif.

☐ Rose bouquets will stay fresh longer if the stems are cut off under water. This prevents tiny air bubbles from blocking the small openings in the stems through which the water rises to the flowers.

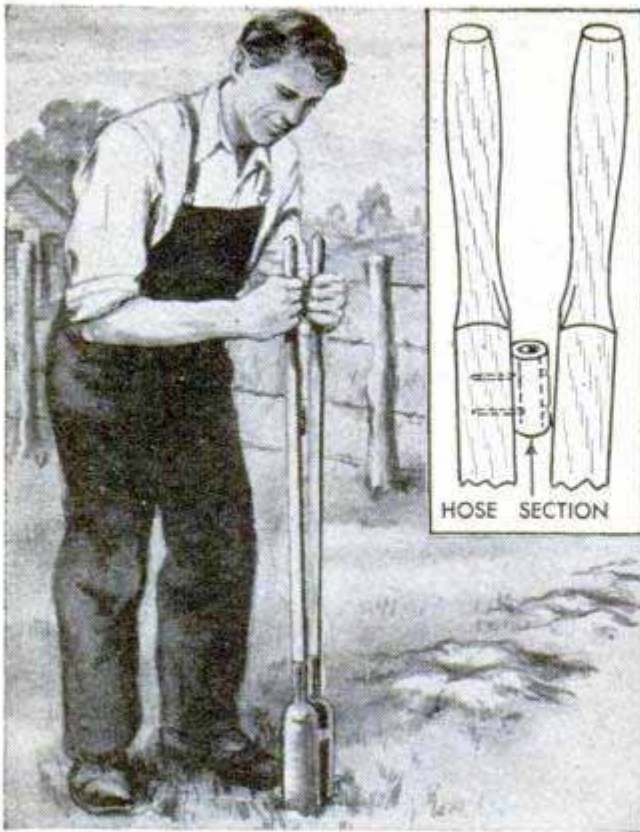

Hose Bumper Fastened to Handle Improves Posthole Digger

Working with a posthole digger is likely to result in sore fingers, as the hands are often brought sharply together when opening the tool. This is avoided by mounting a short length of garden hose between the handles to serve as a bumper. Nailed to the inside of one of the handles, the hose will keep them spread apart sufficiently to protect the fingers.

Tar Paper Wrapped Around Graft Prevents Rerooting of Tree

Even though a dwarf apple tree is planted properly with the graft above the ground, sometimes the top part of the tree will send out roots which cause it to grow to full size. This can be prevented by wrapping tar paper around the graft and tying it with cord. After one or two seasons, the tar paper will fall apart but, by this time, the dwarf rootstock will have taken a good enough hold to eliminate the possibility of roots growing out from the lower end of that portion of the trunk which has been grafted onto the rootstock.

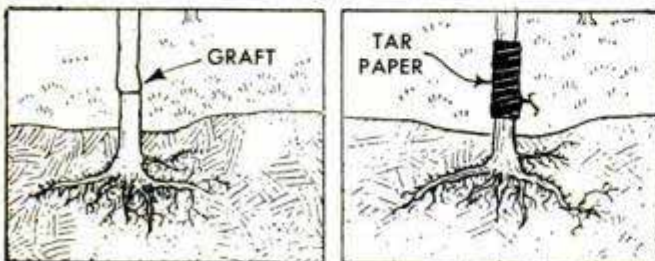

Adapting Auger Bit for Drill Press By Reshaping Spur Center

An auger bit can be adapted for drill-press use by first grinding the threads from the spur center and then shaping the center into a three-sided pyramid. If the sides are hollow-ground with a hand grinder, finer cutting control can be attained. After this, of course, the tapered shank must be cut off to fit the drill-press chuck, as indicated by the dotted line.

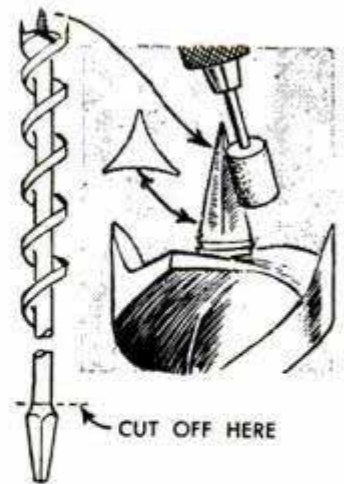

Simon S. Palestrant, Bronx, N. Y.

Adjustable Pointer on Kitchen Scale Subtracts Container Weight

Especially useful when canning fruits or vegetables, an adjustable hand added to a kitchen scale permits the exact weight of the ingredients to be read at a glance and eliminates deducting the weight of the container. The hand is cut from sheet metal and riveted to another piece of sheet metal

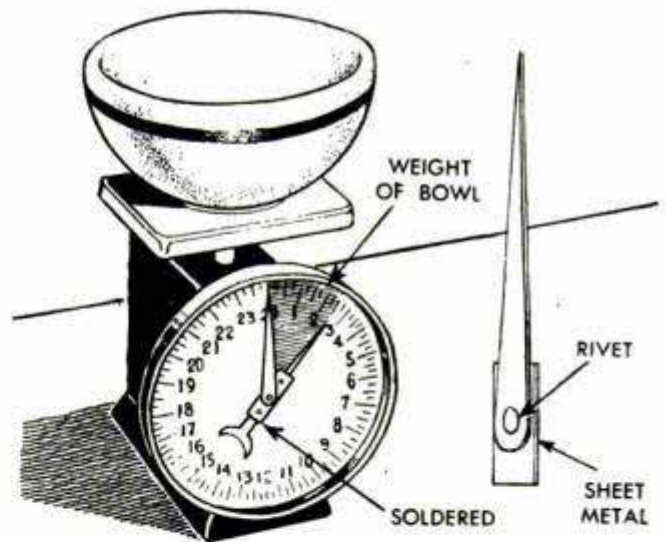

which is soldered to the original pointer. The rivet should be loose enough to allow the adjustable hand to be moved and should be centered over the shaft of the scale. Before weighing the food, set the container on the scale and move the adjustable hand back to zero. Then, when the ingredients are placed in the bowl, the adjustable hand will indicate their weight while the original pointer indicates the total weight.

☐ Fishhook leaders can be dyed by soaking them overnight in strong coffee or tea.

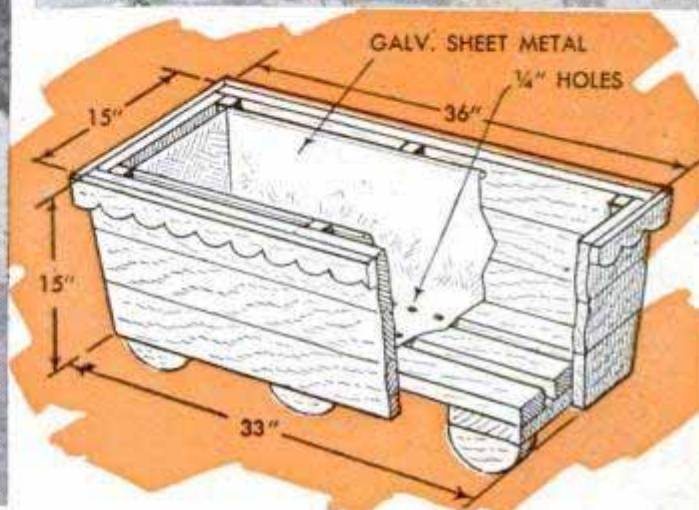
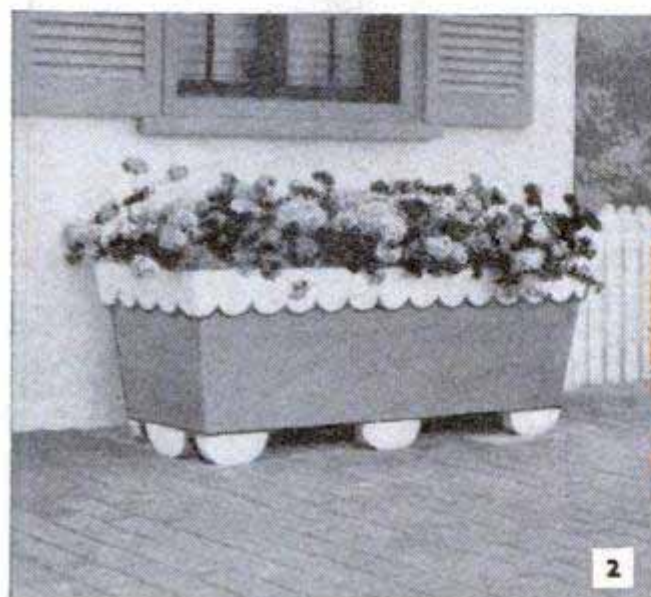
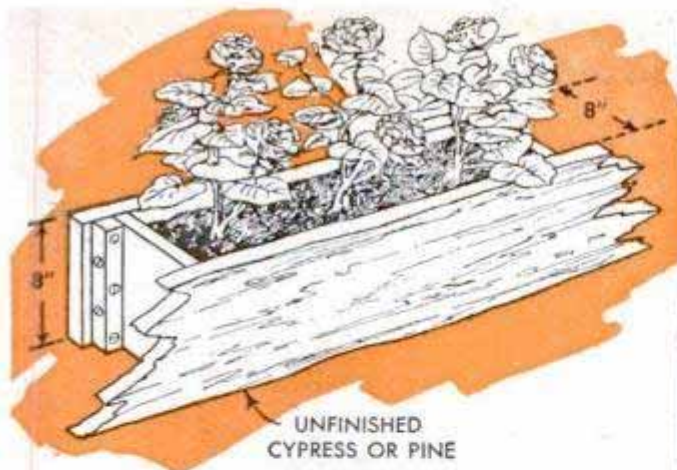

WINDOW-SILL GARDENS

HANGING gardens placed at the window-sill level are of immense decorative value to both the interior and exterior of any home. Foliage and flowering plants, certain dwarf shrubs, evergreens, potted slips, succulents, and even trailing vines can be grown in a window-sill garden and they will thrive with a minimum of care. Some varieties grow best in full sunlight; others do well in partial shade, and some in full shade. This means that, by carefully selecting the plants, you can grow luxuriant hanging gardens on all four sides of the house in a single season. Groups of plants selected for a given location should have the same or similar soil preferences, and also similar temperature and sunlight requirements. Only low-growing plants with heavy stems and short foliage should be selected for second-floor window gardens, as these will be more directly exposed to high winds and beating rains. If shelves are used at the second-story windows, holes should be scrollsawed in the shelf boards so that the plant pots can be set in the holes to about half their depth.

This arrangement prevents the potted plants from being blown off the shelves. If soil is to be placed directly in the box, the latter should be made of wood with a removable metal lining of zinc or aluminum. Cypress is the most durable wood, with redwood and pine a second choice. The selection and preparation of soils are important. As the amount of soil is limited by the size of the box, the plant food of an ordinary soil will soon be depleted. A good mixture for window boxes is composed of dark garden loam, rotted leaf mold and sand in the proportions of 2 parts loam, 1 part leaf mold and 1 part sand. After these components are mixed, a complete fertilizer is added. Then the whole mass is mixed thoroughly and sifted through a $\frac{1}{2}$ -in.-mesh screen. To grow most varieties of succulents, proportions of the soil mixture should be 2 parts loam to 1 part coarse sand, no leaf mold being used.

In preparing the window box for planting, $\frac{1}{2}$ -in. drainage holes are drilled in the bottom in an over-all pattern measuring about 3 in. each way. Small pieces of

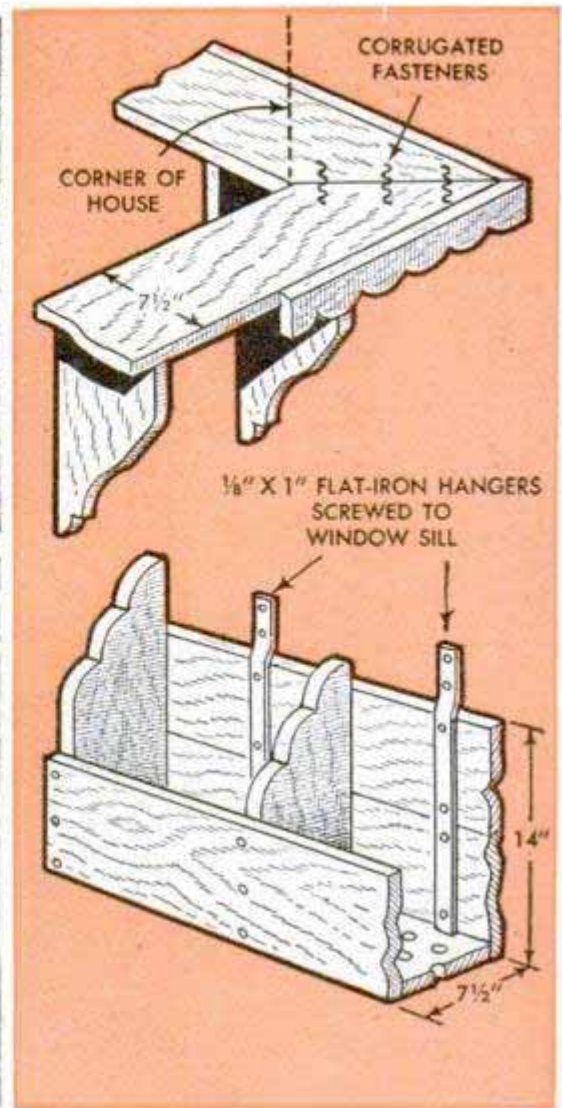
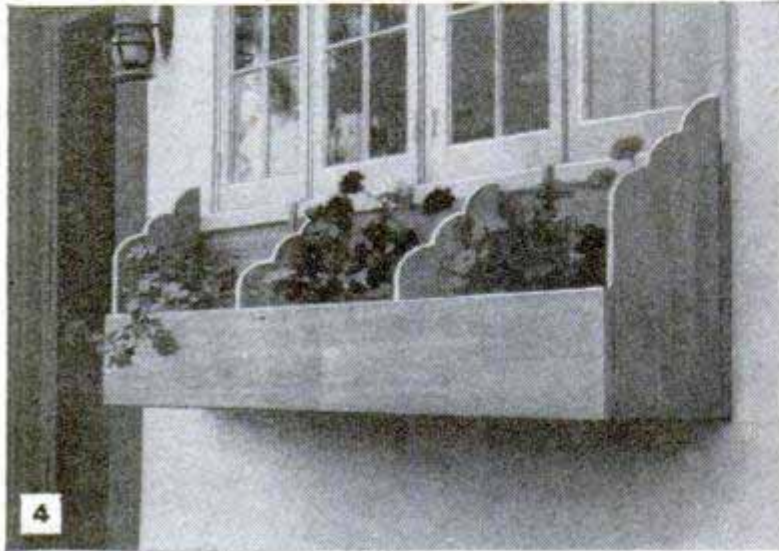
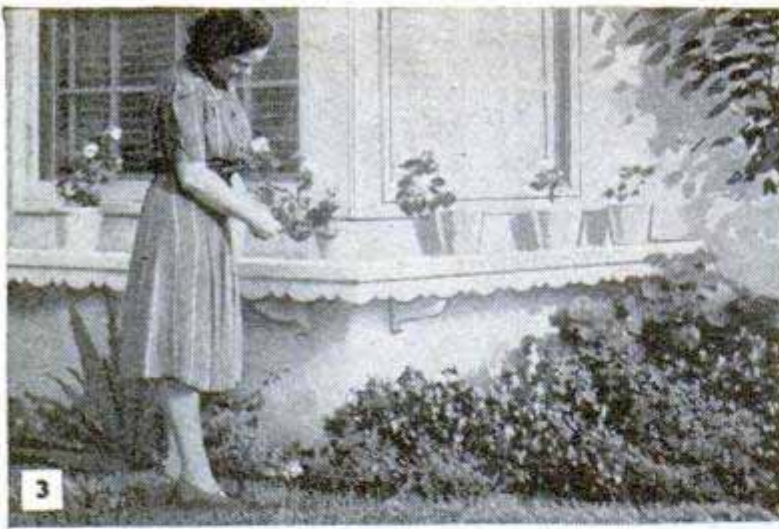

broken pottery (pieces from a flowerpot will do) are placed over each of the holes to keep fine material from sifting through. Then a 1-in. layer of coarse gravel, cinders or small pieces of broken pottery is placed in the bottom of the box. If the box is to be planted with succulents, the layer of this material should be 2 in. thick. Fill the box with the soil mixture to within about $\frac{1}{2}$ in. of the top, pressing it down firmly. The mixture should be dry enough to handle easily without sticking to the fingers.

Plants to be grown in such a confined space as the average window box should be selected for type and habits of growth. Foliage plants with large individual leaves should not be planted adjacent to small, low-growing plants, except in extra-long boxes where the large plants can be placed at the ends of the box or in the center. If planted at random or alternately in a smaller box, the large leaves of the taller foliage plant will shade the smaller plants during some part of the day and may thus affect the rate and extent of growth. As a result of spreading root systems, large and vigorous growers also will rob small plants of needed soil fertility. Window-box gardeners generally select low-growing flowering plants for the sunny side, foliage

plants and trailing vines for the areas of partial and full shade and small evergreens for the year-round window garden. Suitable evergreens may be any of the low, spreading varieties which grow slowly. Certain plants that will not mature fully in the shorter growing seasons of the colder regions are suitable for outside plantings only in the warmer climates.

Most window-box plantings must be sprayed or dusted regularly to keep off insects and prevent disease. Spray solutions can be applied with a syringe, and prepared dusts with an applicator usually furnished with the product. As a rule, only annuals are planted in outside window boxes in temperate regions. In most cases, potted plants placed in or on window boxes or shelves are taken inside during the colder months. This simplifies the insect and disease-control problem, at least to some extent. Plantings of evergreens that are well established will flourish the year 'round in exposed locations if they are properly cared for during the summer and are thoroughly watered just before the coming of freezing temperatures. At this time, a thorough watering is especially important for if the soil freezes "dry" the plants are likely to die.

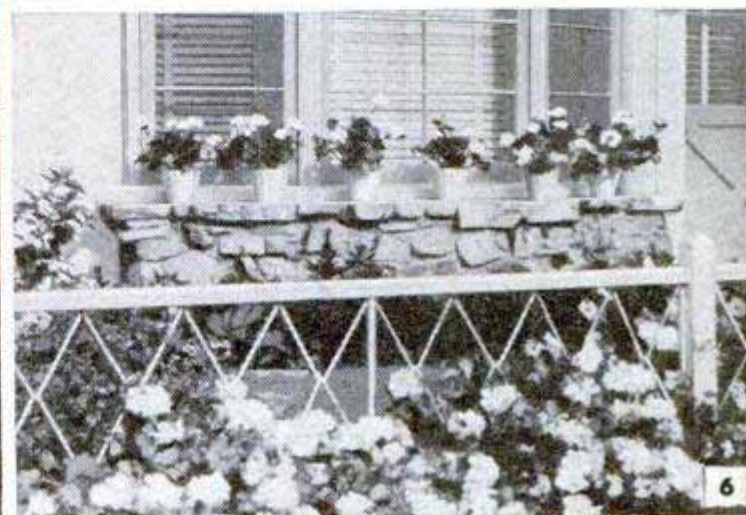
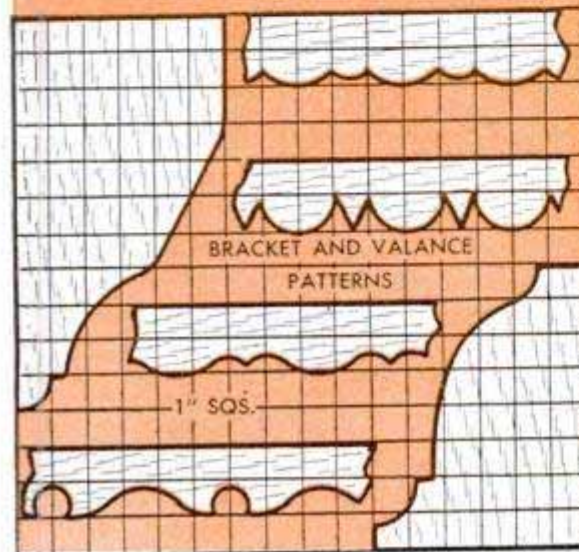
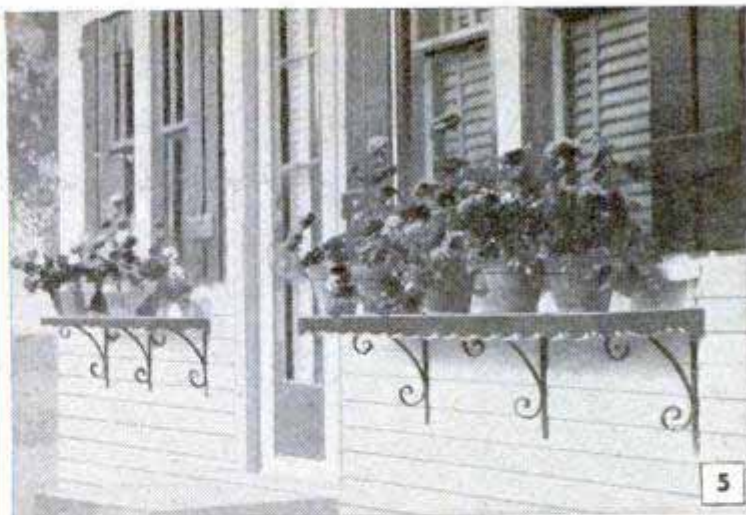
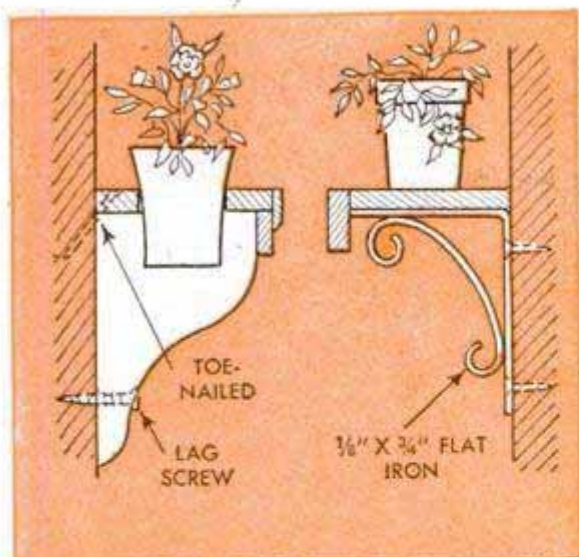

Window boxes and shelves pictured and detailed in Figs. 1 to 5 inclusive are designed for mounting outside the window. Those shown in Figs. 6, 7 and 8 are built as a part of the house and, in the warmer climates, can be used for plantings of perennials. Shelves are supported on bandsawed brackets and decorated with an edging or valance in a scrolled design as shown on the corner shelf in Fig. 3. Several scrollsawed designs for brackets and edgings are shown in the crosshatched detail above. The shelf in Fig. 5 is supported by flat-iron scrolls which are especially attractive when used on walls of white siding or stucco. When shelves are attached to the wall with brackets, the inner edge should be set out from the wall about $\frac{1}{4}$ to $\frac{1}{2}$ in. so that water and dirt do not collect at this point. Use brass screws for fastening the brackets to wooden walls and masonry drive nails or expanding fasteners on masonry walls. In either case, the fastenings should be sufficiently strong to support the weight of the box when it is full of damp soil.

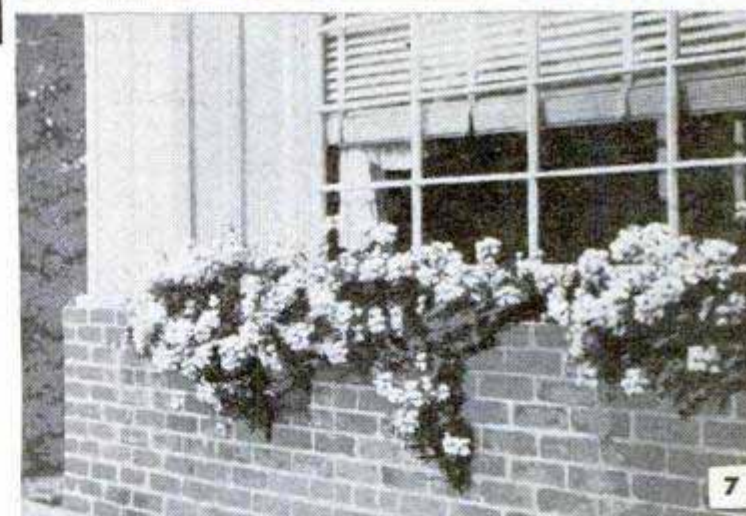

Bottles of Carbon Tetrachloride Provide Fire Extinguishers

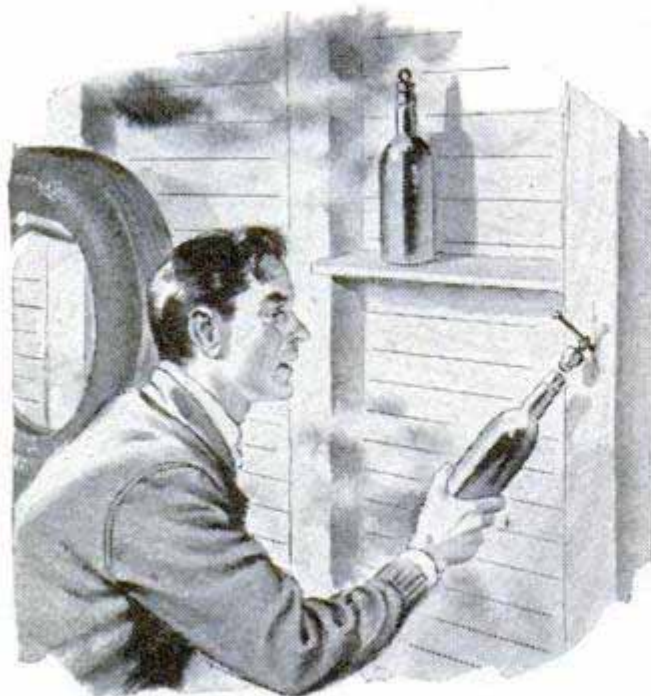

If you do not have a regular fire extinguisher in your shop or garage, a few bottles of carbon tetrachloride kept at strategic locations will allow you to extinguish small fires or, at least, keep them under control until help can be summoned. Ordinary quart bottles, painted red, are used to store the chemical. These are sealed with corks fitted with screw eyes so that they can be pulled open quickly by slipping the screw eyes over a nail driven into a near-by wall or post.

Cold-Water Paint Rolled on Board Assures Even Application

When cold-water paint is applied to the walls of a house with a roller, it is usually a problem to charge the roller with the

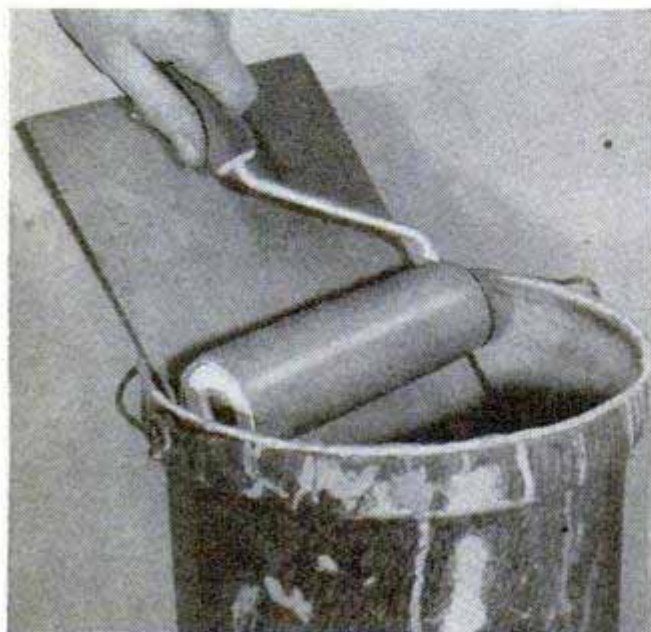

proper amount of paint. However, this can be assured by placing a "wiping" board in the paint bucket, resting it against the rim. The roller is dipped in the paint and then rolled out on the board to insure a smooth, even coat on the roller.

Escapeproof Bait Jar

While fishing with live grasshoppers or crickets, keep them in a jar with a piece of inner tube stretched tightly over its top. Cut a slit in the inner tube wide enough to permit inserting your thumb and forefinger. In this way, the grasshoppers can be inserted or withdrawn one at a time and the others cannot jump from the jar. Sufficient air will pass through the slit to keep the bait alive.—Roland Cueva, New York City.



Nonslip Clothesline Props

Attached to the end of a clothesline prop, a short section of garden hose will keep the prop from blowing over in a high wind. One end of the hose is cut and slotted on opposite sides so that it grips the clothesline tightly, and the other end of the hose is forced over a round tenon cut on the top end of the prop.

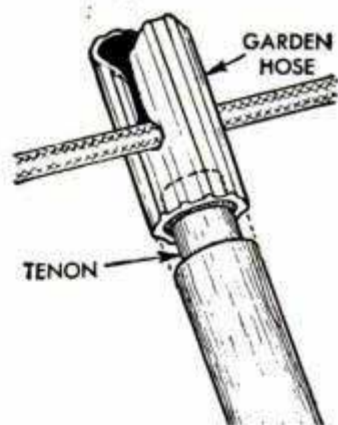

Victor H. Lamoy, Upper Jay, N. Y.

Tire Gauge Clipped to Seat Back

A tire gauge which is carried in the car will always be within easy reach if it is held to the back of the front seat with fuse clips. The corner of the seat near the floor is both a convenient and out-of-the-way location. Sheet-metal screws driven tightly into the seat back are used to fasten the clips one above the other, as shown.

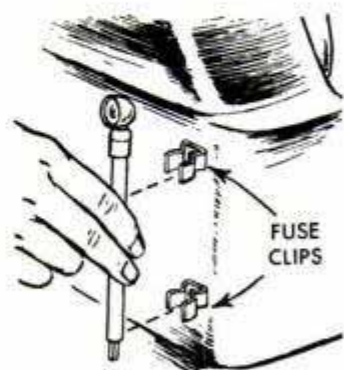

HOMEMADE RATTRAP

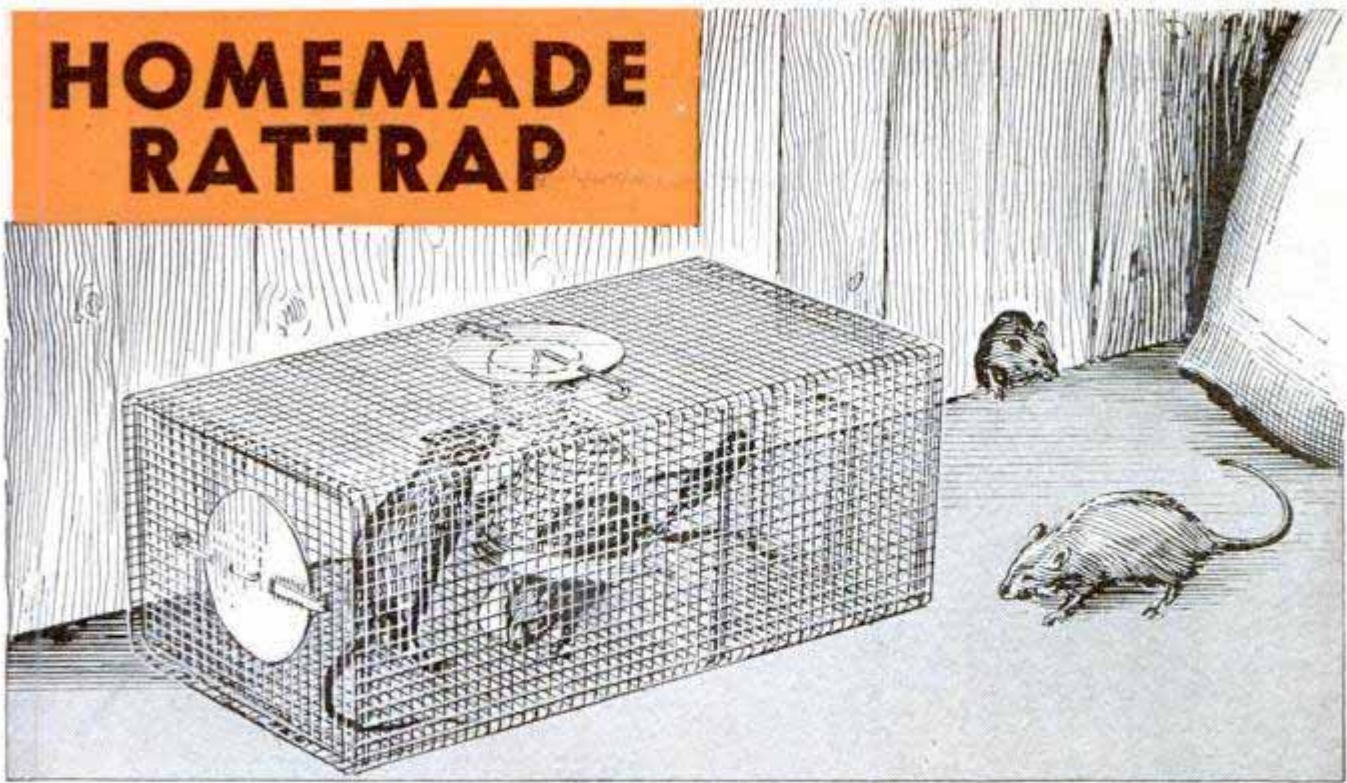

UTILIZING a one-way trapdoor, this efficient rattrap is capable of catching a number of rats without resetting or replacing the bait. After the rats are trapped, they can be drowned simply by immersing the whole unit in water. The trap is made in the form of a box divided into two sections, hardware cloth being used for the sides and partitions and sheet metal for the doors. A partition containing the trapdoor separates the bait from the front compartment. The rat, entering through the front door of the trap, must pass through the trapdoor to reach the bait and is confined in the rear section of the trap. As the hardware-cloth bait container prevents the rat from obtaining the bait, several rats can be caught without tending the trap. Note how the trapdoor is pivoted on a stiff wire bar and counterweighted to return to the closed position. Another door, which is secured over a round hole at the rear of the trap, is opened to remove the rats after they have been drowned. One side of the door is hooked into the wire mesh and the other side is fastened with a spring-wire catch. A similar door covers the open end of the bait container at the top of the trap. All joints of the hardware cloth should be securely soldered together and a wire handle can be fitted to the trap.

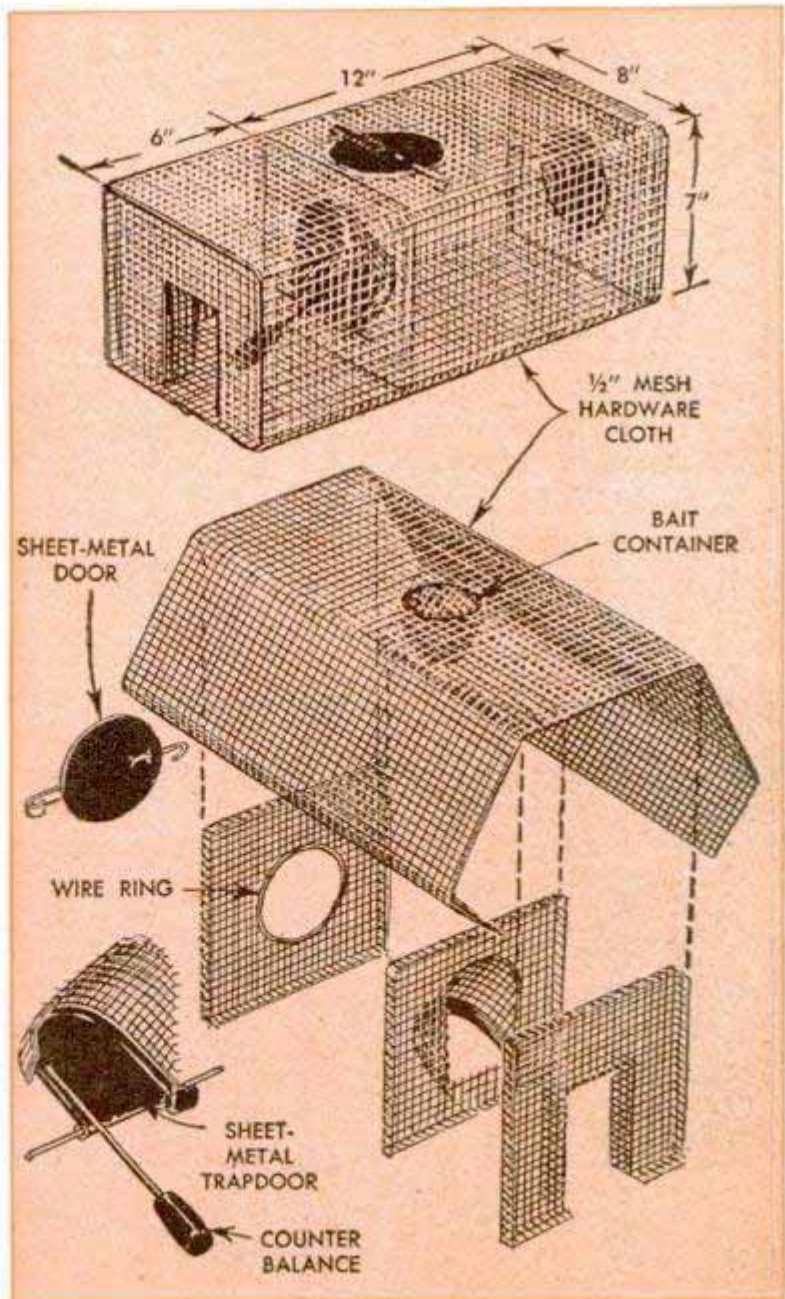

Weighted Tin Cans Support Line When Marking Garden Rows



To mark pairs of garden rows at different depths, such as shallow rows for radishes and deeper rows for beets, one gardener uses weighted tin cans to hold a length of guide line straight. Holes are punched in the sides of the cans and one end of the line tied to each can. Then the cans are filled with soil, which adds sufficient weight to hold the line taut when the cans are spaced apart. Using a wooden marker notched at the center to fit over the line, the gardener marks two rows at a time, the slack in the line allowing him to apply pressure on the marker to vary the depth of each pair of rows.

Metal Tap Replaces Jigsaw File

If a jigsaw file is lost or broken, you'll find that a tap makes a good substitute. The tap must be long enough to project

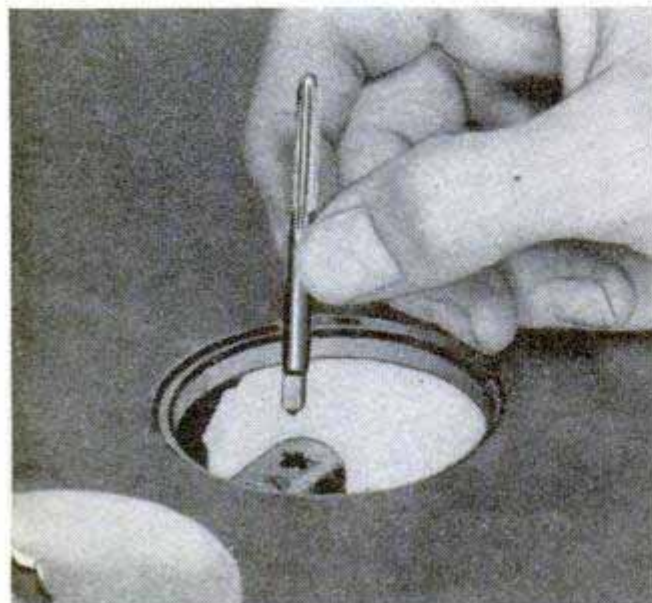

above the jigsaw table when the chuck is at the bottom of the stroke. With the saw operating at slow speed, the work is filed the same as with a regular jigsaw file.

Keeping Hypodermic Sterile

Where a hypodermic syringe must be used at home, here is a way the syringe and needles can be kept sterile and ready for use. Select a fruit jar with a screw-type cap and sterilize both jar and cap. Then soak a sponge or a wad of cotton in alcohol and drop it into the jar. After sterilizing the syringe and needles, insert the points of the needles in a sterilized cork. Then place these items in the jar and screw the cap on tightly.

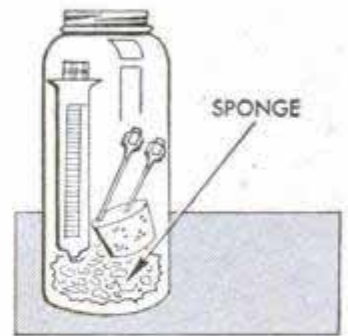

Fred Cornelius, El Paso, Tex.

Pin Vise Holds Phonograph Needle To Provide Inexpensive Scriber

Clamped in a pin vise, a phonograph needle provides an excellent inexpensive scriber. The hard steel of the needle scribes a fine line, and it is inexpensive enough to discard rather than sharpen. If you do not have a pin vise, a little knurled holder fitted with a setscrew can be turned easily on a lathe.

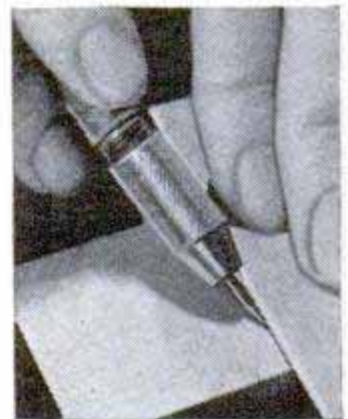

William S. Kals, Vancouver, B. C., Can.

Snub Nose on Spring Clothespin Improves It for Clamping

When gluing small, hard-to-clamp parts to the hull of a ship model, I use snub-nosed clothespins to hold them in place. These are made by rounding the tips of spring-type clothespins to bring their clamping surface to the extreme end of the pins. This permits the clamps to be used flush with the side of the hull.

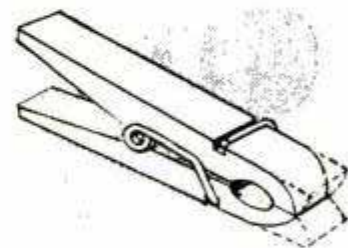

Albert W. Stein, Union, N. J.

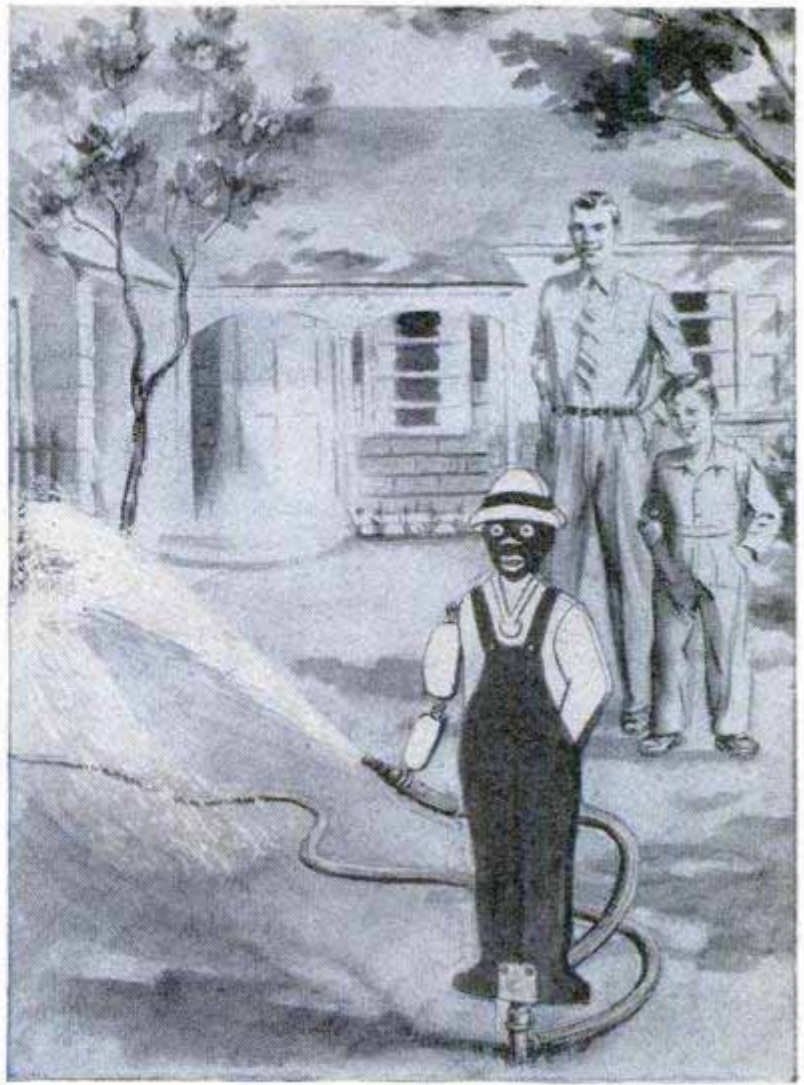
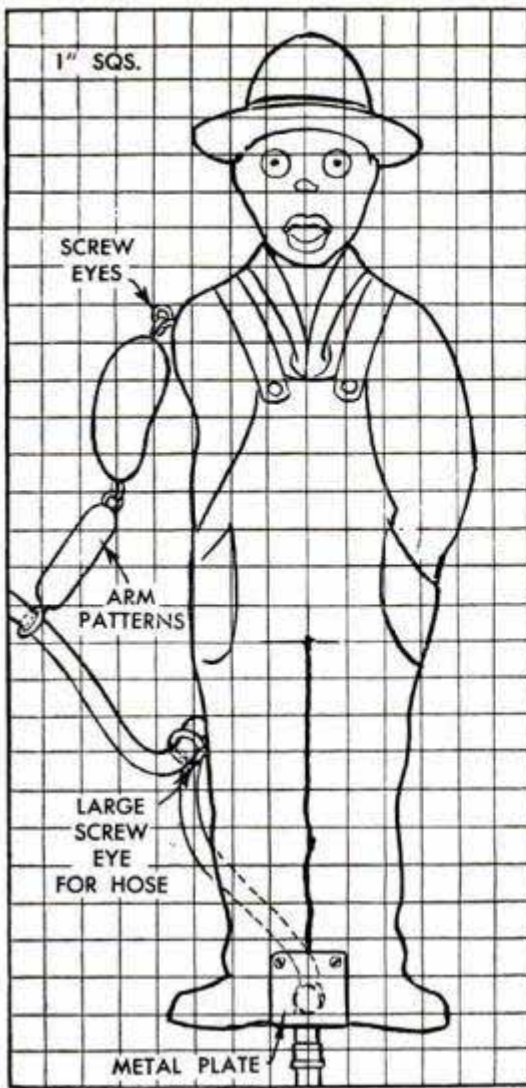

SAMBO

novel lawn sprinkler

By F. W. Ferguson

Sambo sprinkles a circular section of the lawn at each setting

ONCE he has been assigned the job, Sambo sprinkles the lawn with efficient thoroughness. When the regular hose is connected and the water turned on, Sambo rotates slowly, watering a circular section of the lawn. To make the cutout, first sketch a full-sized paper pattern from the crosshatched detail above and trace it on $\frac{5}{8}$ -in. waterproof plywood. After jigsawing the cutout, sand the edges smooth. The two parts of the right arm are cut from the plywood waste and joined to the body with screw eyes, the eye of one being opened to engage the other. Paint the cutout with a priming coat of white. Then paint the face and hatband in flat black and the overalls blue, giving the shirt and hat another coat of white. Sambo rotates on a low standpipe made from pipe fittings as in the detail. A flanged bearing, part A, which turns on a washer, is made by brazing a brass collar onto a short length of brass pipe threaded at one end. Note that the inside corners of the upper pipe cap must be machined square to receive the bearing. The cutout is attached with screws to metal plates brazed to the upper pipe elbow and a short length of hose fitted with a nozzle is screwed onto the upper nipple.

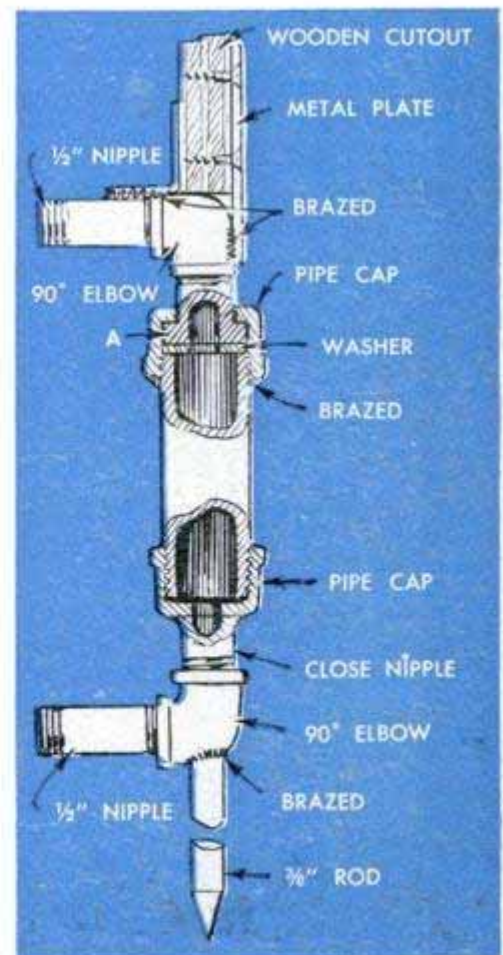



Hundreds of contestants made and broke records in the Second International Model Plane Contest sponsored by Plymouth Motor Corporation at Detroit last August. This year the Third International Contest opens on August 22nd and continues through August 29th. There will be 50 events flown in four age classes, novice, junior, senior and open, with the jet entries being restricted to senior and open-class contestants. Cash prizes totaling \$8750 in U.S. Savings Bonds, plus 167 trophies will be awarded to first, second and third-place winners in each event



"TORCHY" Prize-Winning Jet Speedster

By Bob Thor and H. H. Lundquist

AT ALL the recent model-plane contests, jet-powered speedsters put on the most spectacular show of all, and to win at the Third International Model Plane Contest at Detroit this summer your jet job must be capable of scorching speeds. "Torchy," a pulse-jet-powered model speedster, last year tacked up a record of 141.34 m.p.h. to win in the open class for jets. Topping that record in the coming contest is going to take something really super in both plane and pilot. Yet, the record will be equaled and quite likely broken, for all model-plane technicians will make full use of contest experience to design and build still faster planes. In entering any contest, the first thing is to know the rules and make sure your entry blank is properly filled out and presented to the contest sponsor. If, for example, you are entering the Third International Model Plane Contest this summer, get the official entry blank from your local Plymouth dealer. Then put everything you've got

into the construction of your own jet plane. Here are the construction details on Torch, a careful study of which will give you valuable pointers on building and flying your jet-contest winner.

Fuselage: The pulled-apart view in Fig. 1 gives you a complete picture of the construction of Torch at a glance. The first part to make is the fuselage and the first step is to trace the bottom profile, Fig. 2, onto a 2-in.-square piece of balsa, bandsaw to the line, then glue the waste piece back in place with a sheet of paper in the joint so that it can be removed later. Then trace the top profile on the block and bandsaw as before. This step shapes the fuselage ready for installation of the fuel tank, Fig. 3. Note particularly the unusual position of the tank and the V-shaped bottom. The latter feature has been found an advantage as it tends to trap fuel and prevents the engine from cutting out when the plane is dived or climbed steeply. As light weight is essential, the tank is made from brass shim

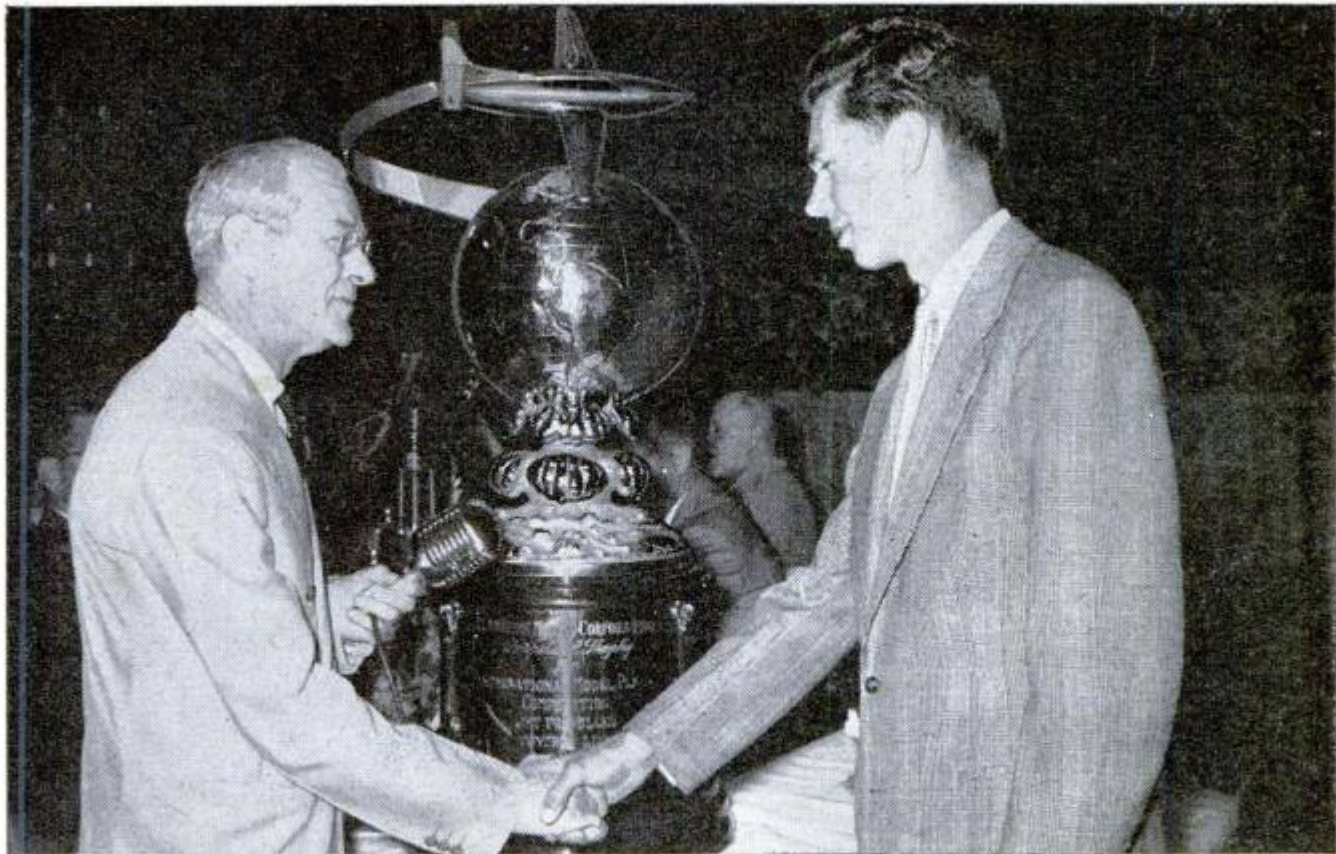

Bob Thor, of Minneapolis, Minn., accepts Plymouth Motor Corporation's Perpetual Trophy in behalf of himself and his partner, H. H. Lundquist, also of Minneapolis. Thor and Lundquist worked as a team

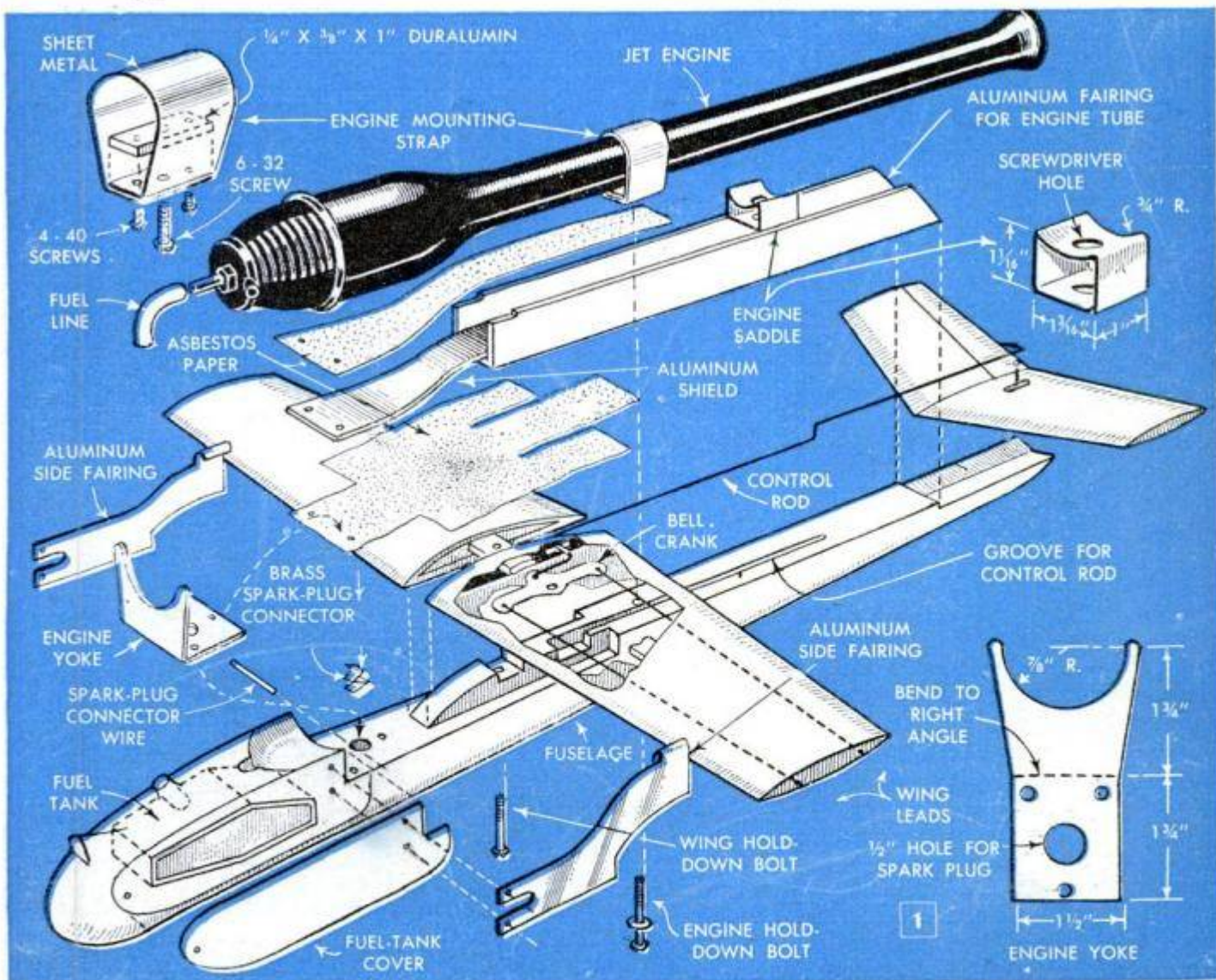

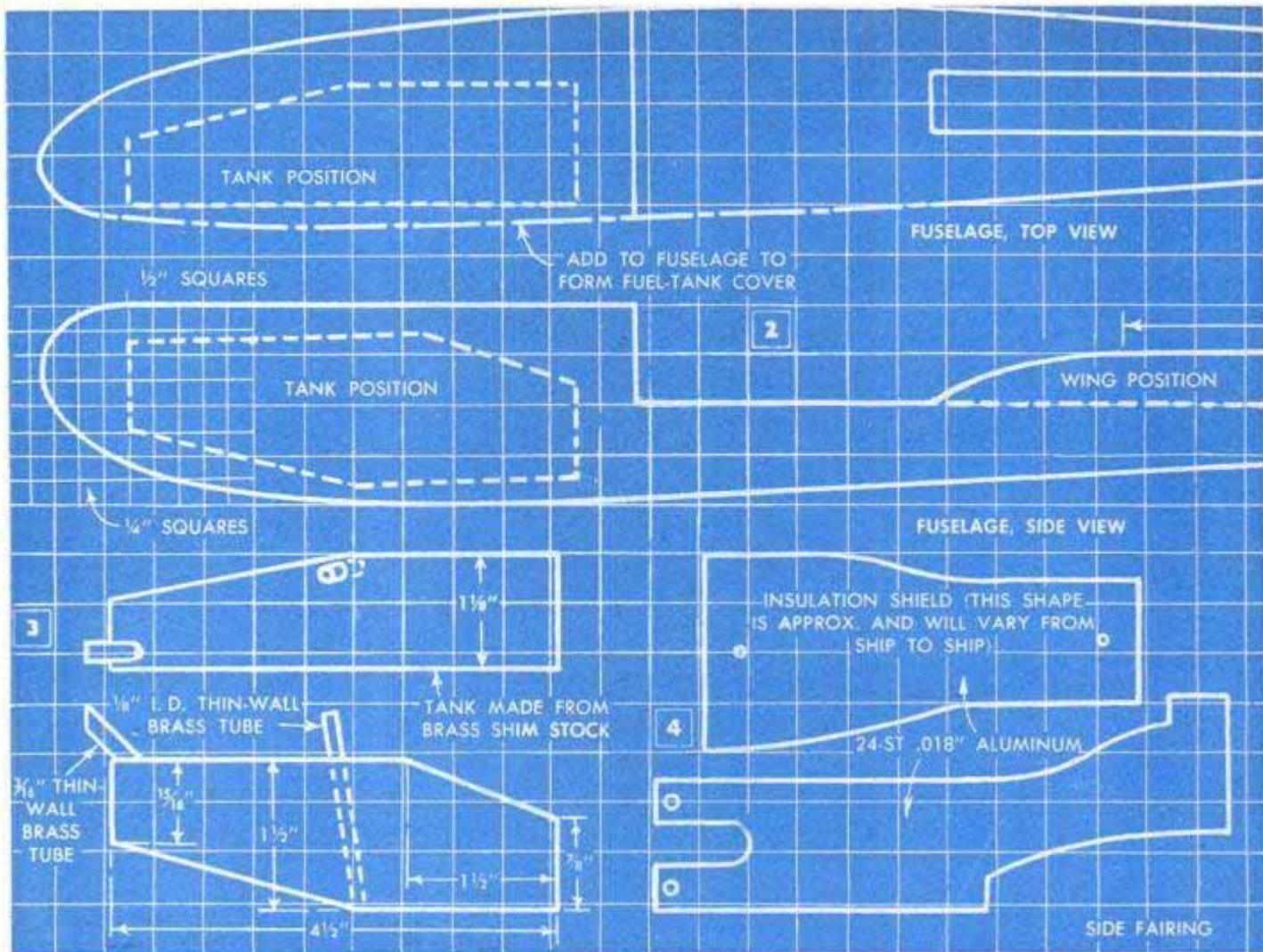

stock, .005-in. thickness, and all joints are sweat-soldered. Test the tank for leaks before installation. In Fig. 2, the top view, the nose of the fuselage is shaped for counterclockwise flight as most model-plane pilots prefer to fly their planes in this direction. The opening in the fuselage for the fuel tank is carefully cut with a chisel. First trace the outline of the tank on the wood. Then, when the opening is nearly to required size, fit the tank by trial so that you do not risk removing too much wood. The tank is anchored in place with glue and the opening is fitted with a cover of 1/4-in. sheet balsa, which is screwed into place and then faired into the curve of the fuselage. Next, cut and fit the engine mounting yoke, Fig. 1. This is made from sheet aluminum, .040 in. thick. Drill a hole 1/2 in. in dia. and 5/8 in. deep in the fuselage and a 1/2-in. hole through the yoke for the spark plug. Bend a 3/8 x 1 1/8-in. strip of spring brass to a Z-shape and place this in the bottom of the hole in the fuselage. A piece of 1/16-in. wire driven through the body from the outside locks this spark-plug connector in place, Fig. 1. The wire should project 1/4 in. to serve as a terminal for the high-tension lead from the coil. Note that when the engine is mounted, the forward section of the fuselage just above

the fuel tank is relieved to the exact curve of the engine tube at this point. Be careful to get a snug, true fit here. When the final installation is made, the engine tail pipe is supported in a saddle at the rear and the engine is held firmly in place by means of a mounting strap, Fig. 1.

Wing construction: Fig. 6 details the wing ribs full size and shows a cutaway view of the wing assembly. After sawing the ribs, each of which is duplicated, glue them to the bottom sheet of balsa. When assembling the wing sections on the spar, allow a 5/8-in. gap at the center between the two sections. Glue on the 1/16-in. plywood reinforcing strip for the bell crank, Fig. 6, and install the crank, wing leads and control wires before gluing on the top wing covering. Then sand the wing to the finish contour and fit it on the fuselage as in Fig. 1, making the groove for the control rod at the time of installation. When installing, be sure the wing has a zero incidence with reference to the flat portion on top of the fuselage body, Fig. 2.

Tail surface: Plywood is recommended for construction of the tail surface, although balsa also is specified in Fig. 7. The single control flap pivots on a steel wire which passes through an aluminum tube. The control rod, Fig. 1, is attached to an

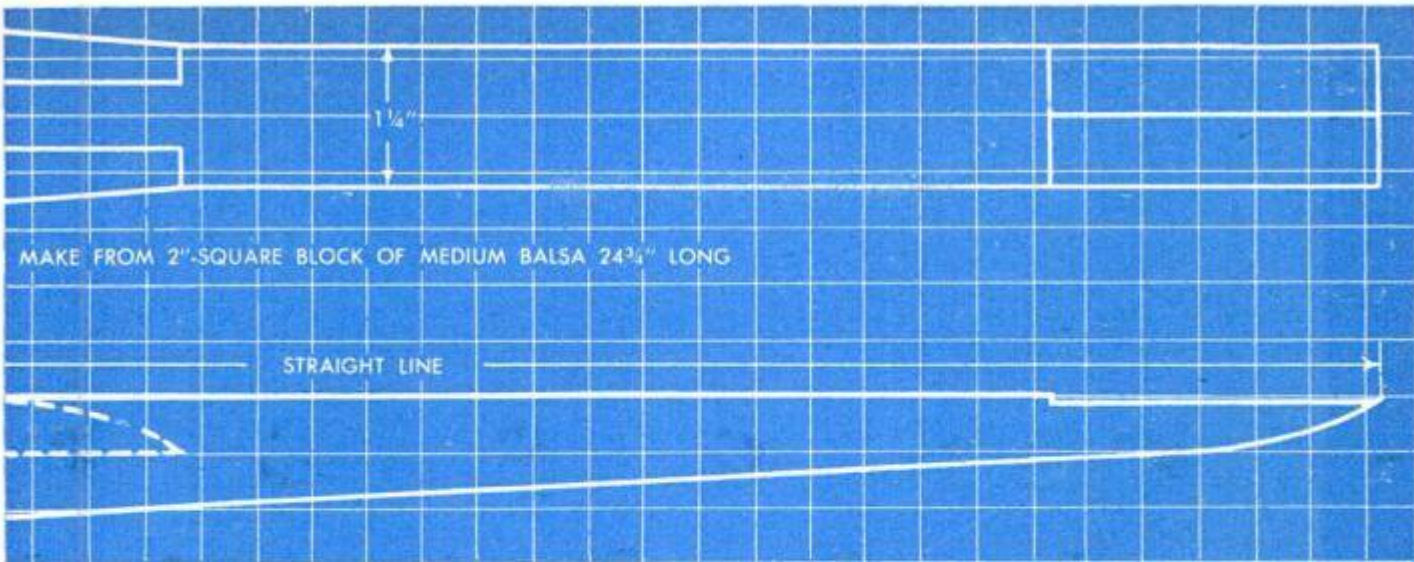

MAKE FROM 2" SQUARE BLOCK OF MEDIUM BALSA 24 3/4" LONG

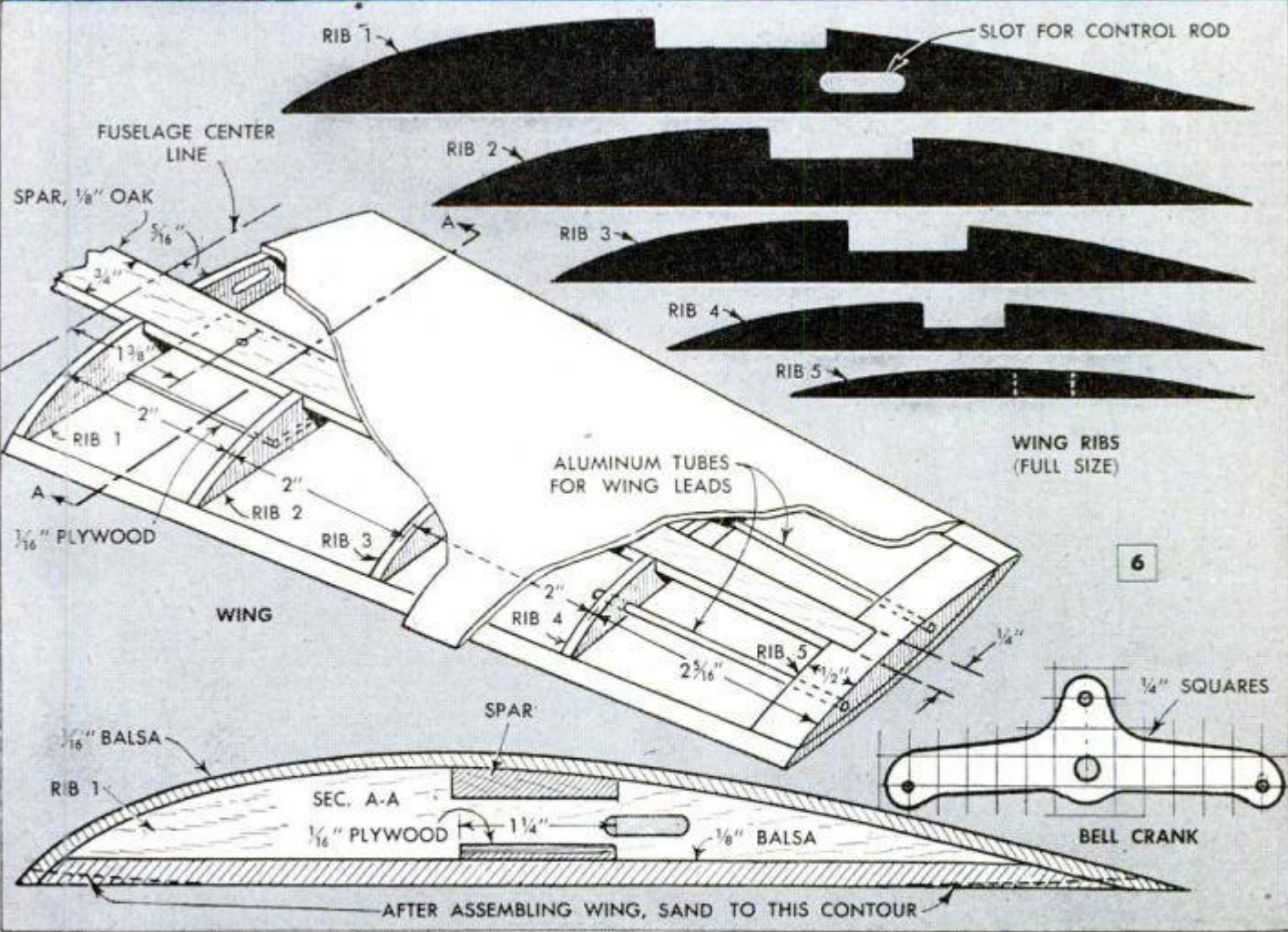
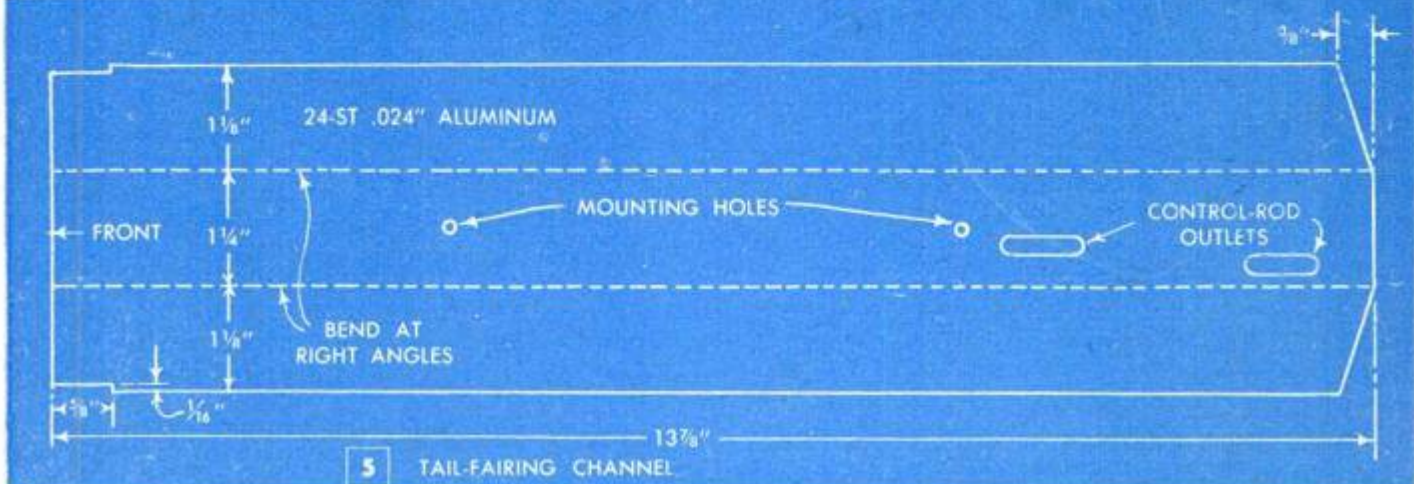

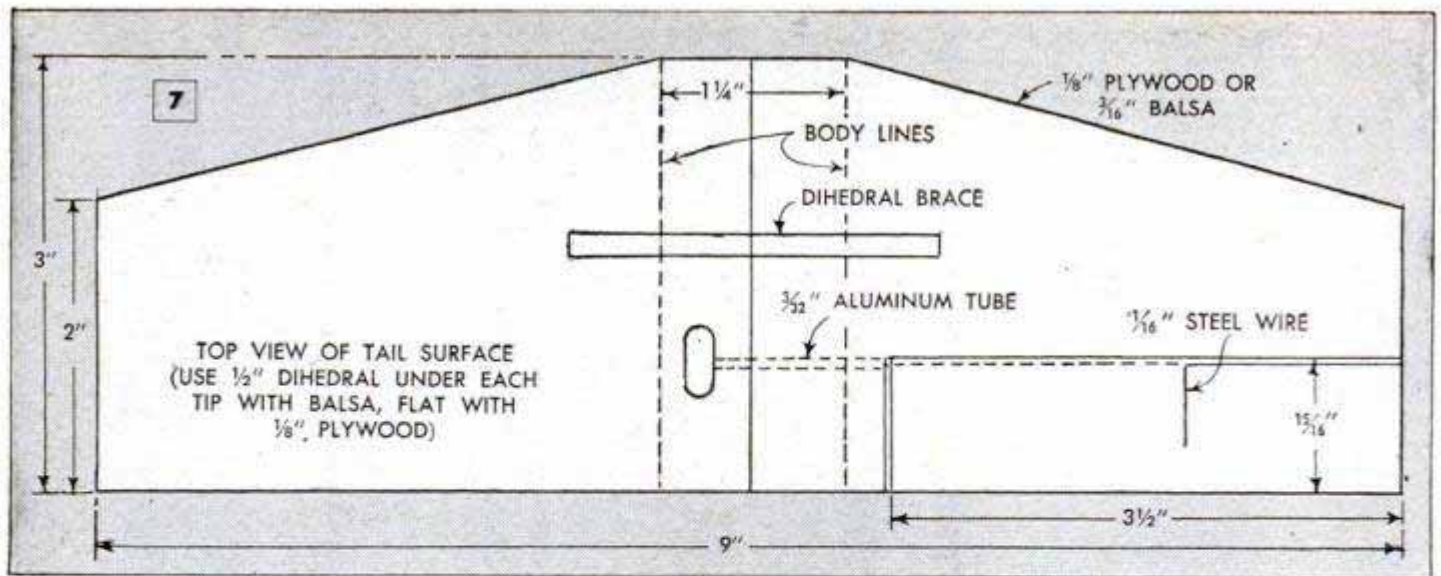

arm soldered to the pivot wire. The tail surface is slotted, Fig. 7, to allow movement of the arm. Strips of crinoline glued over the opening between the tail surface and the flap serve as a "hinge" and also as a fairing to give a smooth, unbroken surface. When installing the tail surface, notch the body of the fuselage so that the tail surface is at zero incidence with its upper surface flush with the top surface of the fuselage.

Metal fairing: This is designed to fair in the space under the jet engine and is shown in Fig. 1 and detailed in Fig. 5. It is notched, drilled and slotted and then bent to the form of a channel before installation. The fairing member and the aluminum shield, shown in Fig. 1 and detailed in Fig. 4, protect the wooden fuselage from the intense heat of the engine. Slip the channel

over the control rod, bend the latter if necessary to clear, and screw the channel in place. Then install the engine by following the details in Fig. 1. Note the location of the asbestos-paper insulation strips placed under and on top of the aluminum shield. These are held in place with a coating of water glass (sodium silicate). The aluminum side fairings, Fig. 1, follow the contour of the engine tube. It is important that these be fitted to perfect contact with the tube.

Launching dolly: The important feature of the dolly is its ability to run straight during the ground run. If it veers even slightly, it is nearly impossible to get the ship away smoothly. Fig. 8 details a dolly which has proved satisfactory for launching model jets from all runways except

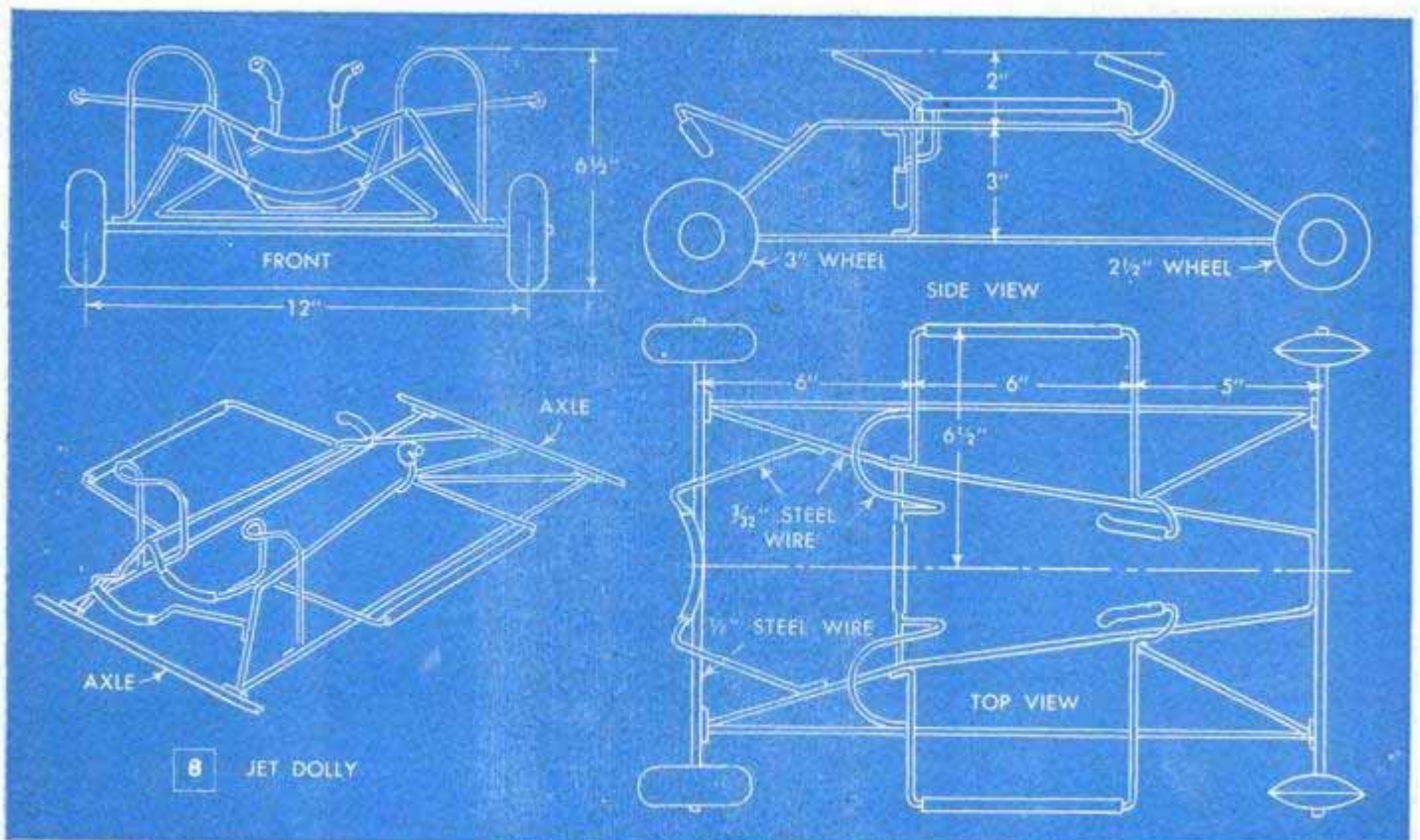

those covered with grass. The frame is made from pieces of heavy wire bent and soldered together to give the frame shape detailed in the front, top and side views. After assembling, slight bends can be made in the wire cradles so that the dolly will hold the ship in the correct position for take-off.

Finish: Many builders of this type of plane prefer to fit all metal parts and then remove them when doing the final sanding and finishing of the wooden parts. In this case, the asbestos insulation strips are installed with the metal parts after all of the sanding and finishing have been completed. In finishing the fuselage, apply a layer of gauze to the bottom and fill with glue until the surface is perfectly smooth. Fill the wing with any preferred filler, leaving an area 1 in. wide on each side of the fuselage center line. Water glass is applied to this area when cementing the asbestos strips in place. Although a portion of the lower asbestos strip has been omitted in Fig. 1 for purposes of clarity, this strip extends from the engine

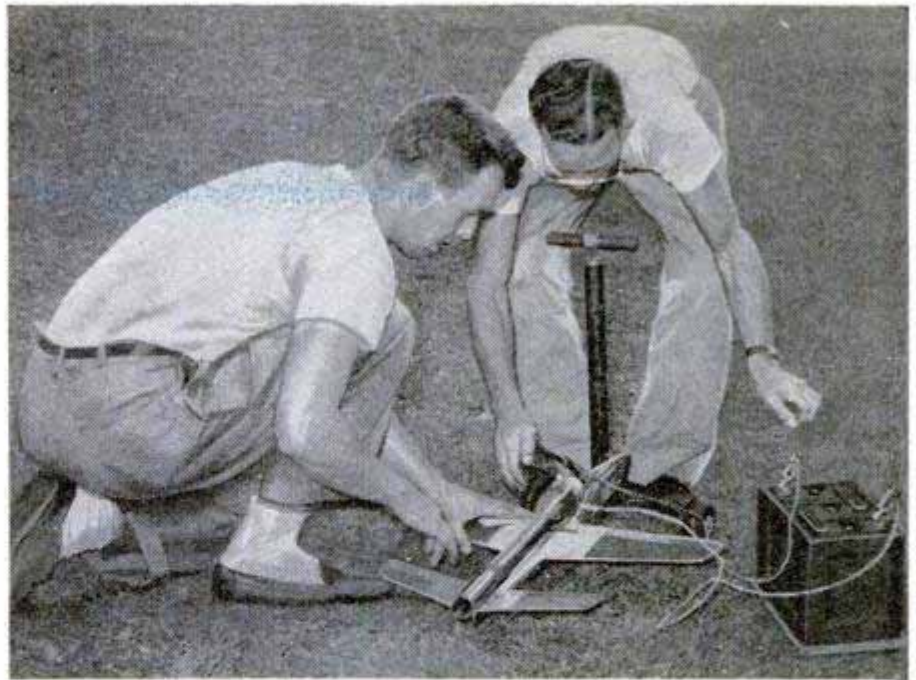

A jet-propelled model is readied for take-off in recent model-plane contest

yoke to the forward edge of the tail surface underneath the engine-fairing channel. After finishing, reassemble all metal parts on the fuselage. Be especially careful in fitting the engine hold-down clamp. Avoid drawing the 6-32 hold-down bolt too tightly. As this bolt is infrequently removed, it's a good idea to fit it with a lock washer. After finishing and reinstallation of metal parts and the starting ignition system, the plane is ready for test flights.

Stainless-Steel Knife Cuts and Loosens Orange Peel Simultaneously

This novel orange peeler lifts the edge of the peel while cutting, making it easy to get the fingernails under the peel. Usu-

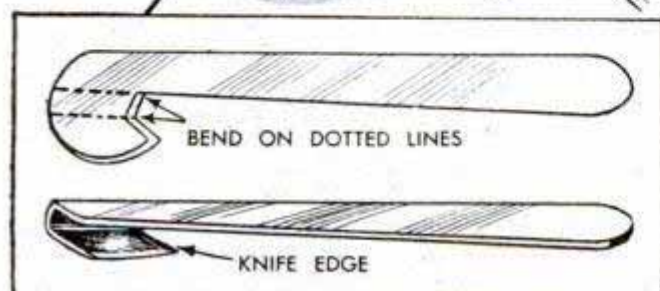
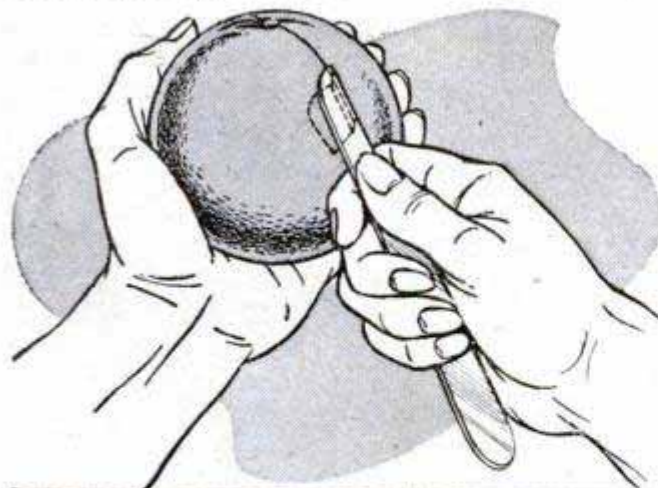

ally, two cuts, made at right angles to each other, around the orange, are all that is necessary. The peeler is cut and bent from thin, stainless steel and the cutting edges are filed. Then, all other edges are smoothed and the tool is finished with fine emery cloth. To use, push the point under the peel and pull the peeler around the orange.—E. A. Rerucha, River Grove, Ill.

Dents in Solder Dissipate Heat

When using fairly short pieces of coreless wire solder, they ordinarily become too hot to be held comfortably with the fingers. You can prevent this trouble by making dents in the solder about 1/2 in. apart, using the wedge-shaped head of a riveting hammer. Deeply dented, the depressions dissipate and slow the travel of heat.

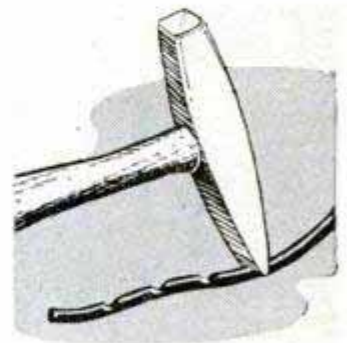

Stump Serves as Improved Vise When Sharpening Cordwood Saw



A saw cut made across the top of a tree stump provides an on-the-spot vise for holding a cordwood saw when sharpening it. The blade is inverted and set in the saw cut, which should be 2 or 3 in. deep. It is held securely in place by one or two wooden wedges driven into the saw cut.

Dispenser Made From Tape Spool Stores Odd Lengths of Wire

Instead of discarding odd lengths of wire, save them for future use by winding them on large dispensers made from adhesive-tape spools. First, set an eyelet in a hole drilled through the center of the spool cover. Then, straighten the wire and wind it loosely around the spool. After inserting the loose end of the wire through the eyelet, press the cover over the spool. Now, when you want a piece of the wire, just pull

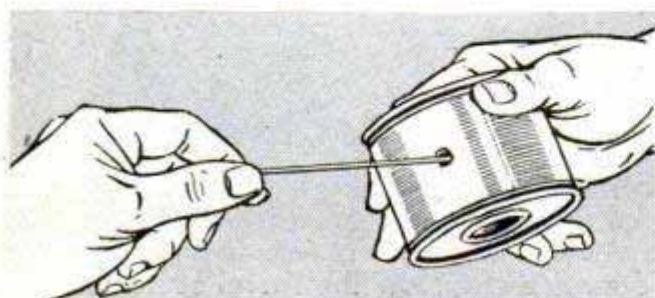

on the loose end and cut off the wire as desired. A spool rack can be made by mounting a dowel between brackets.

Spinner Attached to Streamer Fly Provides Effective Lure

An effective lure for trout, bass and pickerel is improvised from a streamer fly and a spinner. To do this, first remove the spinner from the shank. Then, slip the latter onto the hook of the streamer fly. In this way, the streamer is provided with a flapping silver tail which is very appealing to the fish.

Donald S. Shiner, Nescopeck, Pa.

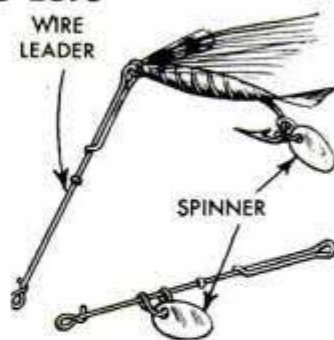

Sawhorse Saddles Hold Pipe For Cutting on Job

Lengths of pipe to be cut to size on the job are held conveniently for sawing by means of two saddles attached to the ends of a sawhorse. Each of the saddles is bent from a length of iron rod, a vee being formed at the center to hold the pipe. The saddles are mounted on the sawhorse by inserting hooks, bent at the ends of the rods, in holes drilled in the sawhorse. With this arrangement, the saddles are swung up into position when needed and dropped out of the way when not in use.

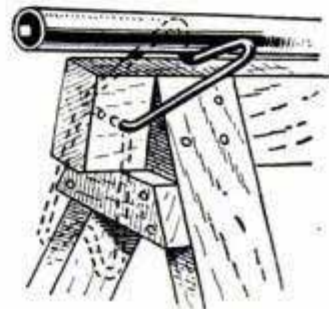

Cardboard Brush Keeper Protects Bristles

The fine bristles of water-color brushes are kept in good condition by storing the brushes in a holder made from a piece of corrugated cardboard. Slip the brushes, handle first, between the corrugations and pull them through until the paper covers the bristles.

Nancy Varney, New Rochelle, N. Y.

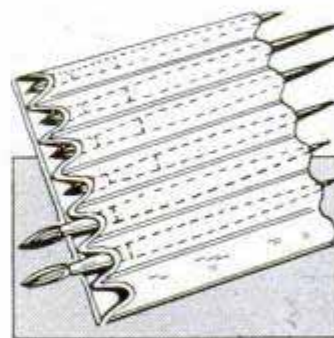

☞ To clean and extend the life of a broom, dip it in warm water once a week.

REFLECTOR WINGS

Control Photo Lighting

By Alexander Maxwell

WHEN photographing table-top setups, close-ups and studio stills, reflector wings on the floodlights give a closer control of lighting intensities. By adjusting the wings, you can easily eliminate glare from both the subject and the camera lens and throw high lights just where you want them. The wings are specially designed to be attached to any floodlight reflector of the clamp-on type. They are cut from sheet aluminum approximately $\frac{1}{16}$ in. thick. Dimensions are not given as the size must be varied to suit the reflector. For best results, the length of the long side should be about 2 in. greater than the diameter of the reflector and the short side a little less. The width of the wing should be slightly greater than half the diameter of the reflector. The special hinge which clamps over the beaded edge of the reflector is sawed and filed from brass or aluminum as in Figs. 1 and 2. Only the length and thickness of the metal block is given in Fig. 2. Normally, the width should be $1\frac{3}{4}$ in. but it may be necessary to vary this in order to shorten or lengthen the slots A and B. Sawing the metal block, Fig. 1, at the points indicated by dotted lines produces two clamps, each of which forms one part of the hinge, Figs. 2 and 3. The yoke member of the hinge, which is attached to the wing, Fig. 2, is cut from the same material as the clamp. The important thing in fitting the parts is close fit of the lug on the clamp member in the slotted yoke. For a small wing, cut the slot in the yoke member $\frac{1}{4}$ in. wide and file the

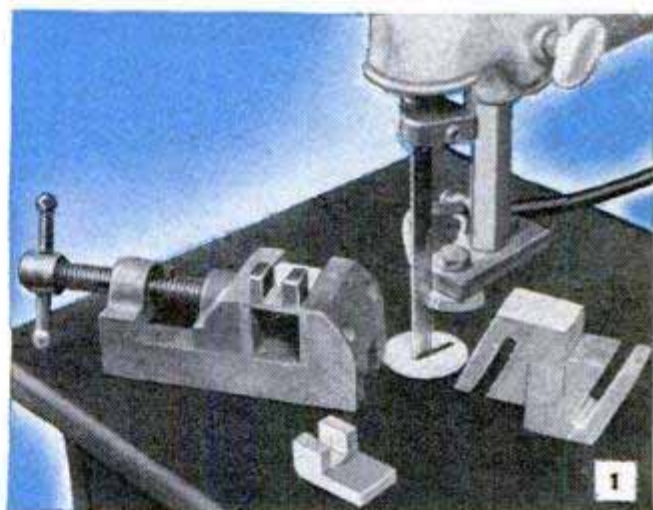

Hinge parts are sawed to the rough form on the jig-saw. Parts can be held conveniently in a drill vise

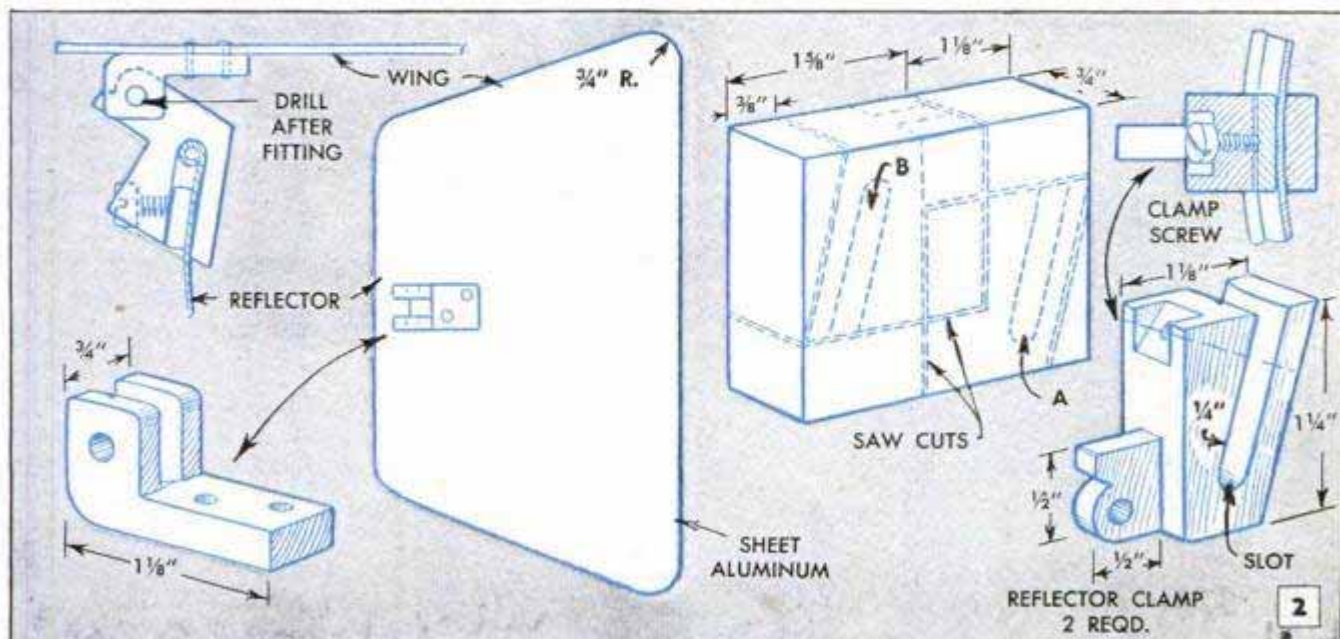

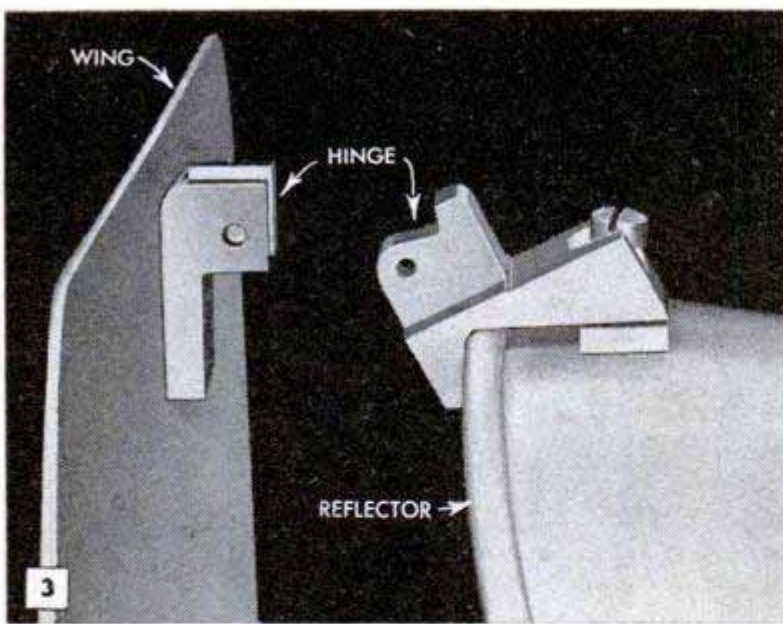

lug to fit. If the hinge must support a larger wing on a big reflector, cut the slot $\frac{1}{16}$ in. wide. Cut the lug $\frac{1}{32}$ in. thick and file to fit. Slots A and B in Fig. 2 will need filing to fit the rolled edge of the reflector. Ordinarily, the width of the slot should be $\frac{1}{4}$ in. as given in Fig. 2, but this may have to be varied to suit the reflector at hand. File a flat on each clamp member and drill and tap for an 8-32 machine screw as in the two right-hand details and the upper-left detail in Fig. 2. Polish the reflecting surface of each wing and attach to the reflector as in Fig. 3. The hinge pin should be a snug fit in both members.

Discolored Lenses Can Be Salvaged by Recementing Them Yourself

Because of age, exposure to sunlight or heat from an enlarger lamp, the balsam used to cement lens elements together frequently deteriorates. This results in a frosted discoloration of the lens or a crackled effect which starts at the edges and sometimes covers the entire lens. If the lens is not one which requires precise factory adjustment, the elements can be recemented to eliminate these conditions. Examine the mounting, and, if it is of the type in which the lens glass is held against a metal shoulder by a threaded ring, this repair can be made.

First, remove the retaining ring, using a rubber stopper to loosen it, as in Fig. 1. Now, the balsam between the lens ele-

ments must be dissolved. This is done by placing the lens in a covered jar filled with xylol, allowing the lens to remain in the liquid until the elements come apart. This may take from one to several days, depending on the condition of the balsam. Use either a separate container for each lens or make an identifying mark on the edge of the lens as in Fig. 2. When the elements have been separated, clean them thoroughly with xylol, applying it with a soft cloth, and remove dust and lint particles with a camel's-hair brush.

To recement the lens, place a drop of Canada balsam in the hollow of the concave element, as in Fig. 3, and bring the convex element in contact with it. Then

press the elements together gently to remove air bubbles and excess balsam. After checking to be sure that the edges of the elements are even, tie the assembly together with string, Fig. 4, winding it around in all directions. Allow the cemented lens to dry for several days and then remove the string and clean off the smeared balsam. Use only a small amount of xylol for this, especially on the edges of the lens, to avoid possible separation of the elements. Cover the worktable with a clean, soft towel to prevent scratches and to minimize the possibility of damage.—W. A. Conway, Macedonia, Ohio.

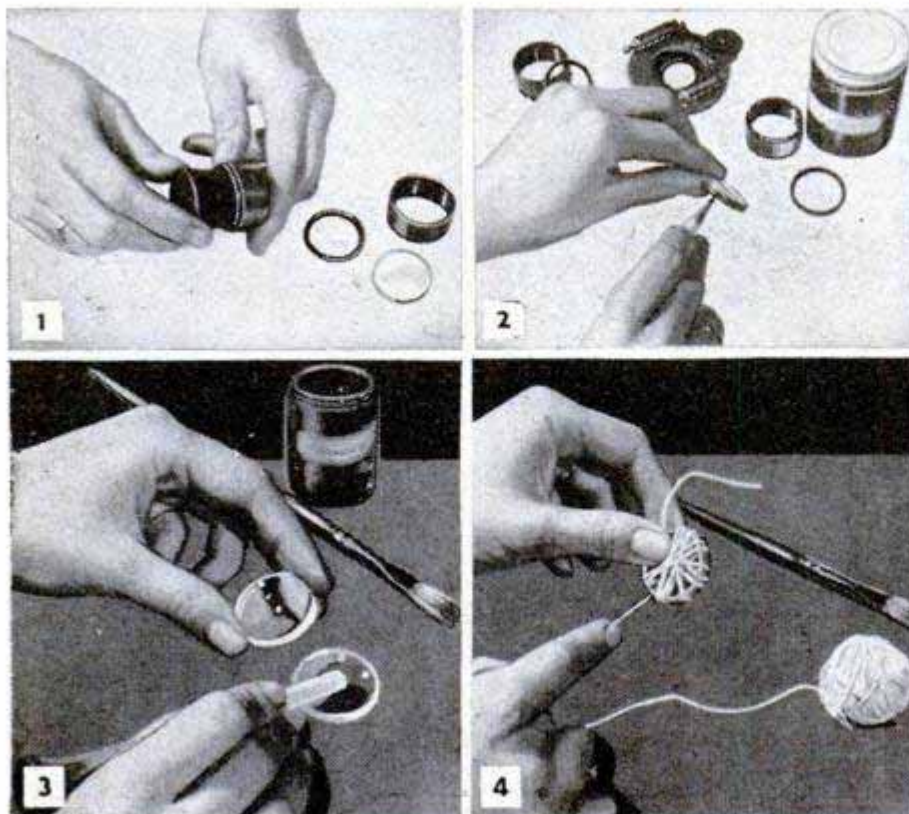
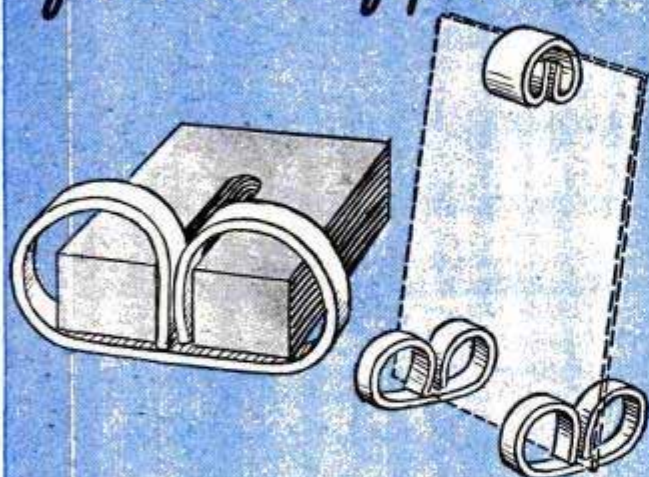
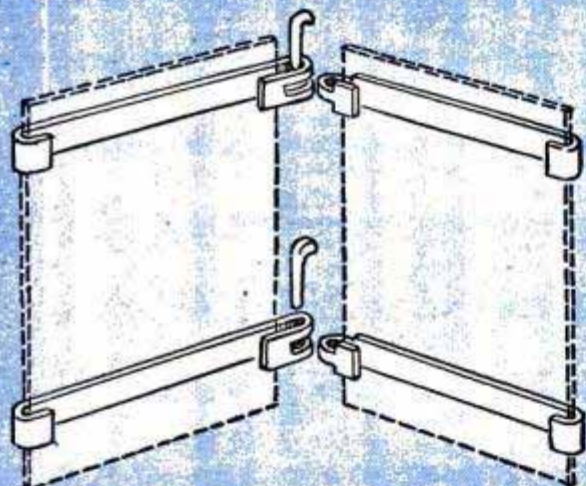

PHOTO FRAMES

from bits of plastic



This attractive frame is merely two pieces of glass having a photo sandwiched between them and held together with $\frac{1}{8}$ -in. plastic clamps, which are heated and formed as shown



When assembled, this double-hinged frame opens as a book. Plastic strips which clamp the photo and cardboard backing to glass panels are slotted and notched as shown to form hinges

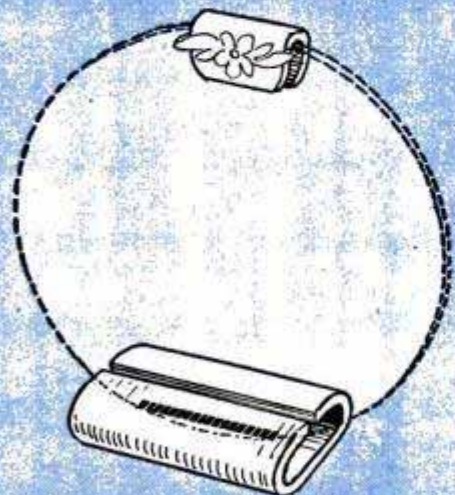

Two wide plastic clips hold glass and picture securely. Bottom clip forms base and the top one is decorated with colored-plastic overlay

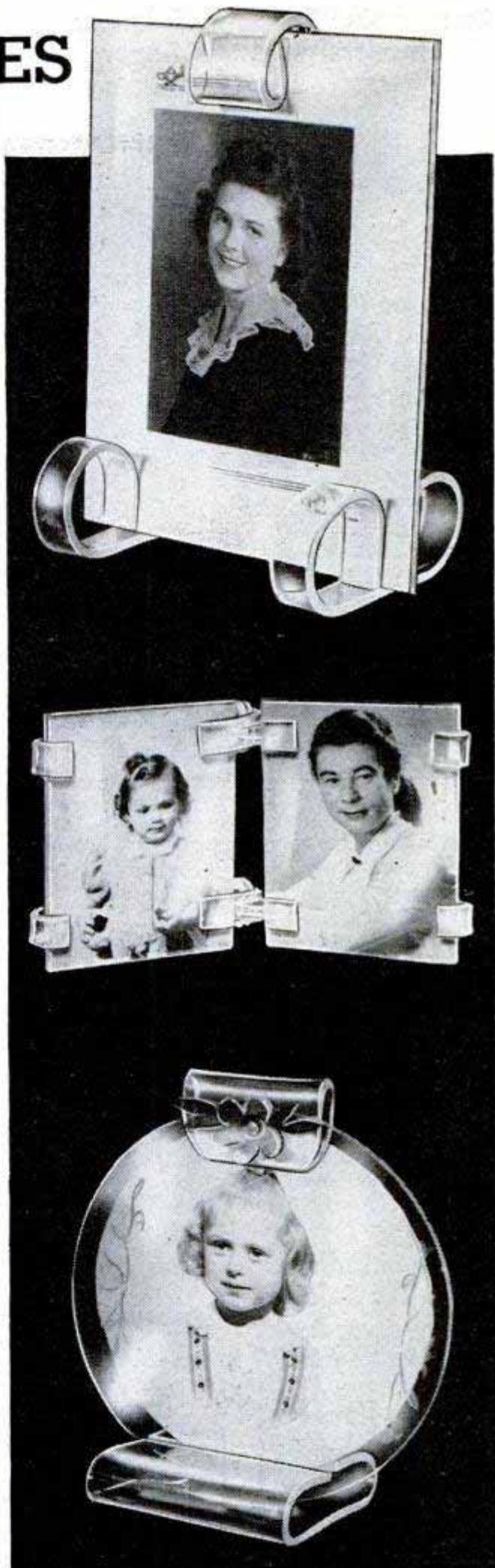

Inexpensive Easel for Enlarger Automatically Centers Paper

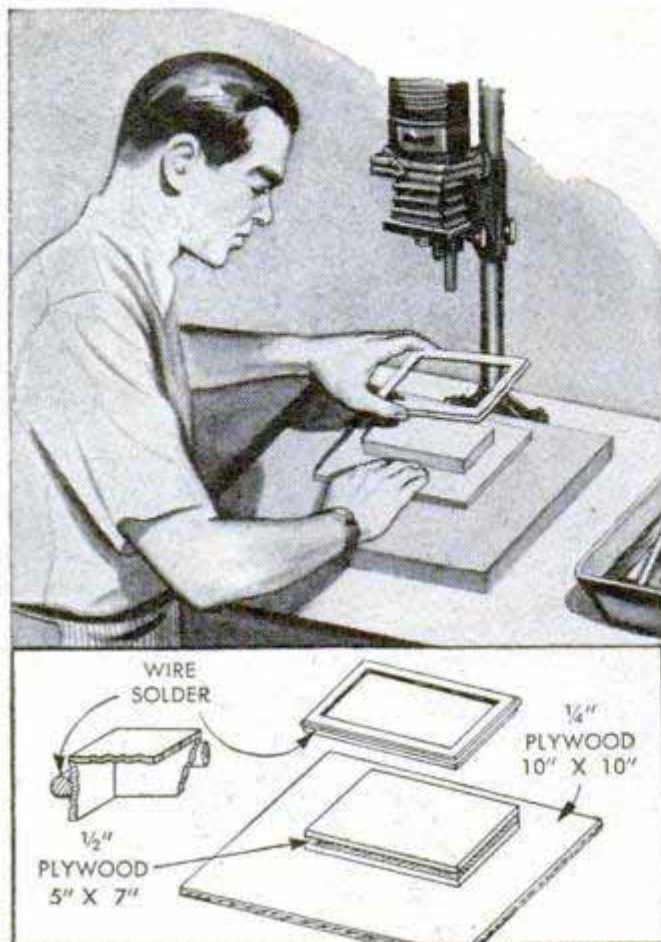

Whether an enlarger is used only for an occasional print or really put to work on a production basis, this inexpensive easel will prove itself well worth the short time required to make it. A metal frame which centers the paper on a plywood block forms a border around the print, thus doing away with masking. The support block is a piece of $\frac{1}{2}$ -in. plywood cut exactly to the size of the photo paper. This piece is screwed to the easel base, and its face is covered with white paper to facilitate focusing of the enlarger. The sheet-metal frame is made to fit snugly over the block and is weighted with wire solder which is tack-soldered around the sides of the frame.

Clyde Cameron, New Orleans, La.

Switch Fitted to Darkroom Timer Turns Off Enlarger or Drier

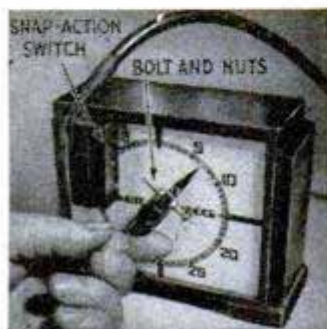

By fitting a snap-action, sensitive switch to a darkroom timer, the latter is quickly converted into a timer-switch to turn off an enlarger or print drier. A switch of the

type that is normally in the closed position is wired into the circuit to be controlled and is cemented to the face of the timer as shown. The timer knob is drilled for a bolt adjusted by two nuts, which depresses the sensitive switch when the knob returns to the zero position.

Kenneth Murray, Colon, Mich.

Pen Provides Etching Knife

If your negative etching knife is mislaid and one is needed right away, you can make a satisfactory knife from an ordinary pen. Just break off one side of the point as shown and file the other side diagonally until the desired angle and width of cutting edge are reached. To hold the etching knife for use, simply insert it in a penholder.

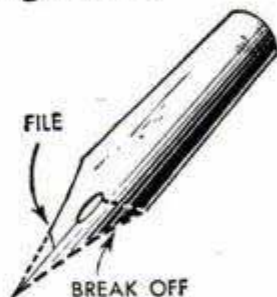

M. A. Richardson, Milton Junction, Wis.

Rubber Band Marks Beaker

Measuring photographic solutions in a glass beaker that is difficult to read is simplified by first slipping a rubber band around the beaker and carefully adjusting it to the desired graduation. In this way, an accurate measurement is had by merely filling the beaker up to the rubber band.



Henry Hanscom, Elmhurst, Ill.

Finger Grip on Cable Release

A more convenient grip for a camera cable release is had by means of a $\frac{3}{4}$ -in. rubber or fiber washer pressed over the shoulder of the plunger. To do this, detach the cable release from the camera and slip the washer over the threaded end. A fuller ball also can be used for this purpose, in which case the ball is slit lengthwise and forced around the cable.

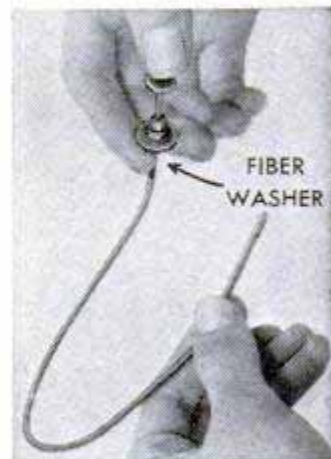



Shop Notes

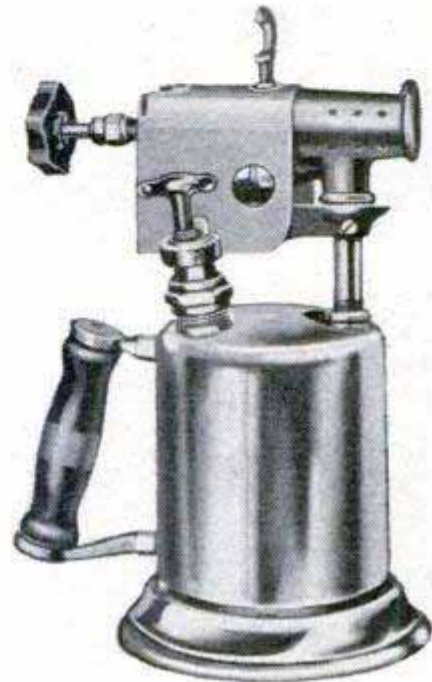
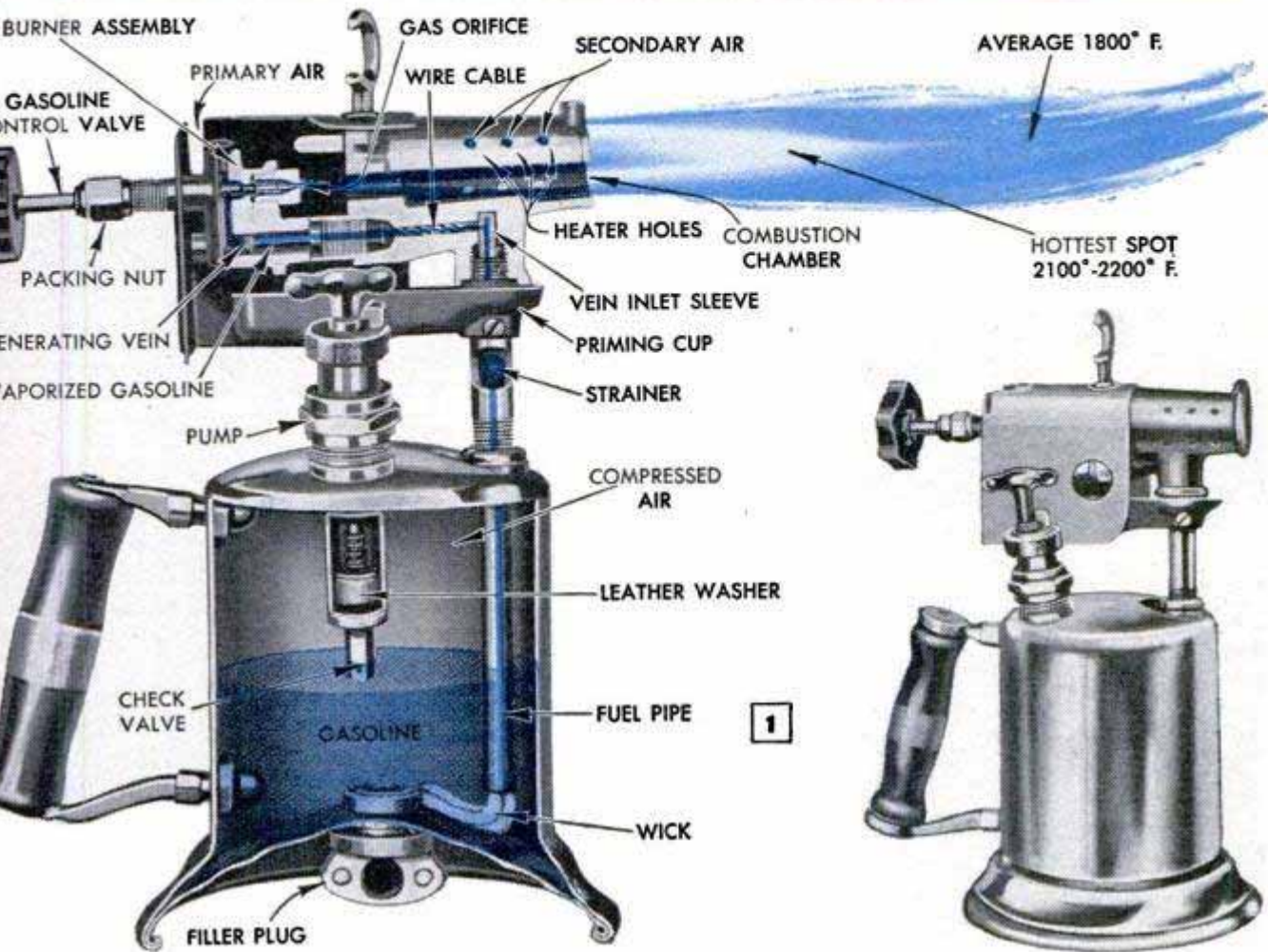

Courtesy Clayton & Lambert Mfg. Co.

KNOW YOUR TORCH

To keep your blowtorch in top operating condition, a knowledge of the principles of operation and how to clean and adjust the burner is most essential

By A. E. Youngquist

A BLOWTORCH is a versatile little heater and, if correctly maintained, it will give years of efficient service for hundreds of small heating jobs both around your home and in your shop. The mechanism of a torch, Fig. 1, is relatively simple, but it must be kept clean and correctly adjusted.

In operation, gasoline in the tank is forced up to the burner through the feed pipe and generating vein or fuel passage by air pressure inside the tank, which is maintained by occasional use of a small hand pump installed as a part of the tank unit. As the gasoline passes through the generating vein, it is vaporized by heat conducted from the combustion chamber when the torch is burning.

When a cold torch is to be ignited, the burner casting

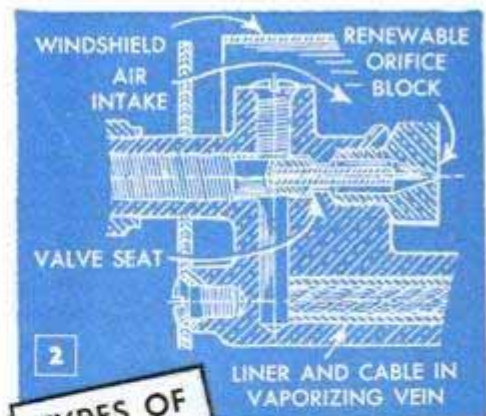

TYPES OF BURNERS

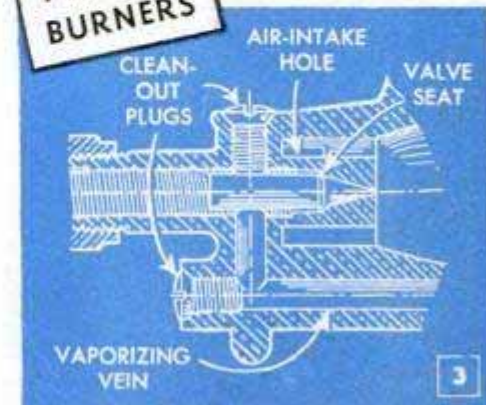

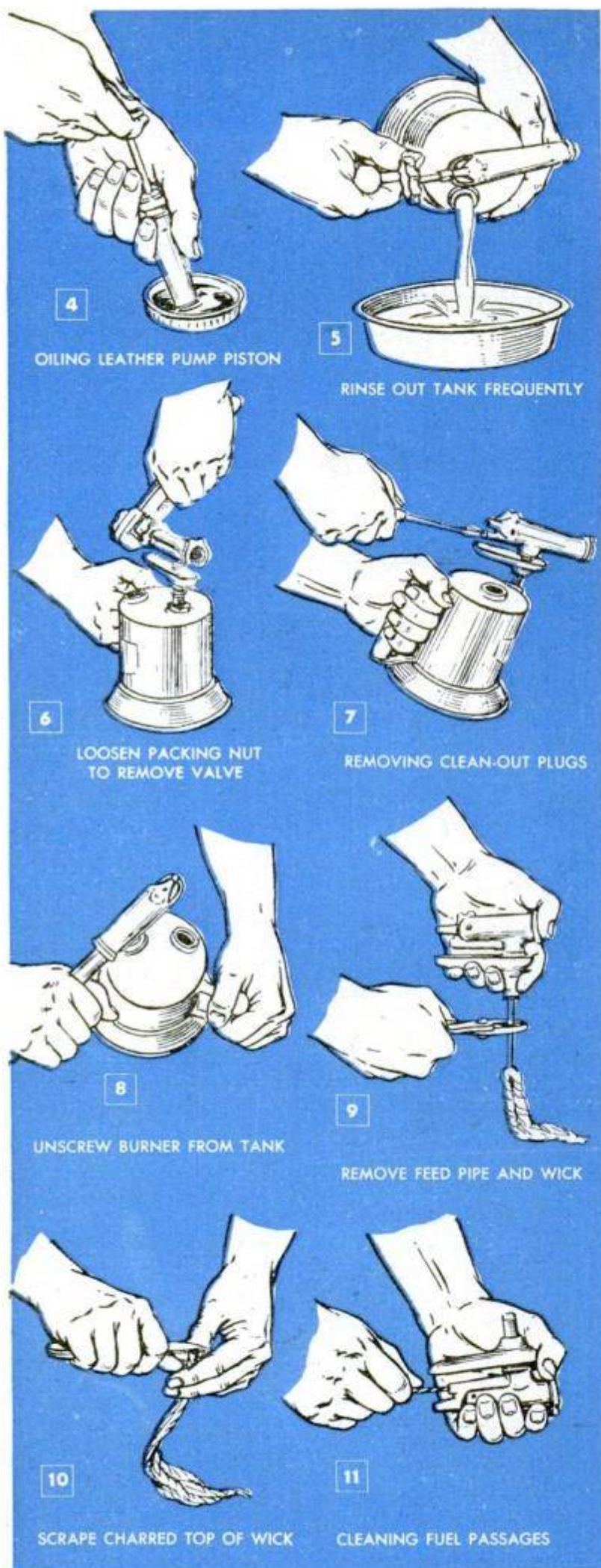

must first be heated by burning liquid gasoline in the priming cup. The gas vapors generated in the vein emerge from the gas orifice and mix with incoming primary air. This mixture passes into the combustion chamber where it ignites and burns, causing a long, blue flame at the mouth of the burner. Secondary air passes into the flame through the heater holes in the combustion chamber to complete burning of the gas vapors. Two types of burners are used on blowtorches. The type shown in Fig. 2 has a renewable orifice block and liner and cable in the vaporizing vein. It provides a smooth flame and long-burning life before carbonizing. The type of burner shown in Fig. 3 is of the simplest construction and, therefore, the least expensive of the two. It will give a hot, blue flame and the veins are easily cleaned. Temperature of the flame, Fig. 1, is fairly constant at any given tank pressure for various torch models. However, the volume or size of the torch flame varies.

If the flame is too small and weak in force, open and close the gas-control valve several times to clear the burner orifice. If this does not return the flame to normal, the torch needs cleaning.

Allow the torch to cool before dismantling it for cleaning. Then unscrew the pump and remove and clean the check valve. Draw oil into the pump cylinder, as in Fig. 4, to lubricate the leather washer on the pump piston. Before replacing the pump, rinse out the tank, Fig. 5, with gasoline to clean out any sediment. To inspect the gas-control valve, loosen the packing nut, as shown in Fig. 6, and unscrew the control valve. Then hold the nozzle to a light and look through the fuel passage. If the orifice is enlarged, the orifice block should be replaced with a new one, if it is of the type shown in Fig. 2. Burners of the type shown in Fig. 3 should be sent to the manufacturer for repairing. Poor operation often results from carbonization of the veins. To clean the veins, remove the clean-out plugs, Fig. 7, and unscrew the burner assembly from the tank. A short length of pipe may be inserted in the

nozzle, as in Fig. 8, for leverage. After removing the burner, unscrew the feed pipe containing the wick, Fig. 9. If the upper end of the wick is charred, it should be scraped clean with a pocket-knife, Fig. 10. The fuel passages, or veins, can be cleaned with a drill turned by hand, as in Fig. 11. Before assembling the torch, carefully apply brown laundry soap, as shown in Fig. 12, to the threads of each part to prevent leaks. There's a trick to getting the wick back into the tank. First twist it tightly, then push it through the feed-pipe inlet with a screwdriver as in Fig. 13. When the torch is assembled, fill the tank three quarters full with clean, uncolored and unleaded gasoline. Most torches must be turned upside down, as in Fig. 14, to fill. After checking to make sure the gasoline control valve is closed, pump about 20 strokes of air into the tank for starting pressure, Fig. 15. The torch can be tested without lighting it by pointing the nozzle toward a container and opening the control valve. If a small stream of gasoline sprays out as in Fig. 16, the torch will burn when properly generated. To start a cold torch, open the control valve slightly to allow gasoline to flow slowly into the priming cup until about three quarters full. Some torches, Fig. 17, are equipped with a priming valve for this purpose. Then ignite the gasoline in the cup. The burning gasoline, Fig. 18, will heat the burner casting to the generating temperature. When the gasoline in the cup has nearly burned, open the control valve. Often the torch will light itself from the priming flame. If not, hold a lighted match close to the heater holes or just below the nozzle as in Fig. 19. An intense blue flame should result. A yellow flame indicates the burner has not been properly generated. When this happens, shut off the torch and allow it to cool; then fill and relight the priming cup. To increase the flame volume, regulate the control valve and increase the air pressure in the tank. After shutting off the torch, back out the control valve one eighth turn to prevent jamming when it cools.



Sliding Armrest Aids Lettering At Bottom of Drawing Board

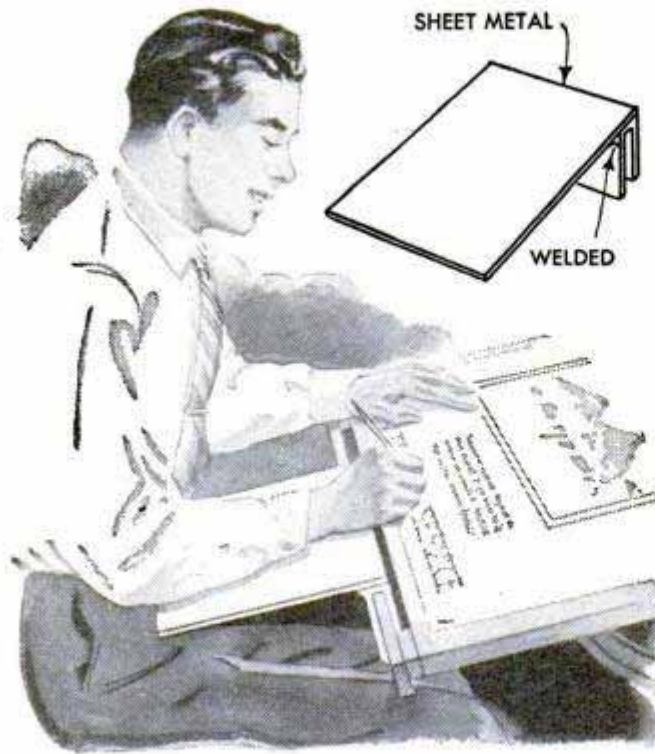

With the aid of this sliding armrest, the lower portion of a drawing can be lettered neatly without moving the drawing up on the board. The armrest is made from two pieces of heavy sheet metal, welded together as shown, and slides on a wooden strip screwed to the bottom edge of the drawing board. Wooden spacer blocks are inserted between the strip and the board.

T. P. Ilari, Louisville, Ky.

Pencil Mark Guides Wheel Dressing

When using a diamond dresser to true a wheel on a lathe tool-post grinder, it was difficult for me to tell when the wheel was true. However, I discovered that blackening the surface of the wheel with a heavy



pencil before starting the work made it easy to see any low spots remaining on the wheel.—Richard Hanscom, Elmhurst, Ill.

Novel Signwriting Method

For a novel effect in display-window signs, one grocery-store proprietor prints the signs in reverse, that is, the background is painted and the letter left clear. He does this simply by stippling the required area of glass with

STIPPLE APPLIED WITH SPONGE



a whitening mixture and drawing in the lettering with his finger. The whitening can be applied in a variety of designs.

Removing Rusted Caster Sleeves

Rusted caster sleeves are quickly removed by turning a drill bit, slightly oversize, into the end of the sleeve. The bit will bite into the metal, gripping it so that a few turns will loosen the sleeve.

Locating Leaks in Vertical Pipe By Measuring Water Volume

By the following method, it is easy to locate a hidden leak in a run of water pipe or steampipe. This applies only to vertical runs or those in which the rise per foot in inches is equal to or greater than

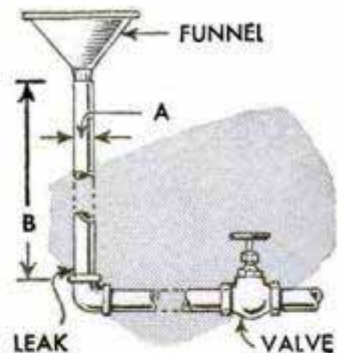

the inside diameter of the pipe, A. To begin with, disconnect the pipe above the leak and close a valve at a point beyond the leak. The pipe must be full of water between the leak and the valve, so fill the pipe from the upper end, allowing the water to drain out through the leak. When the portion between the top of the pipe and the leak is empty, quickly refill the pipe using a container with a known volume. Noting the amount of water required, you can determine the distance of the leak from the end of the pipe, B. The following lengths of various sizes of standard pipe hold 1 pt. of water: 7.9 ft. of $\frac{1}{2}$ -in. pipe, 4.5 ft. of $\frac{3}{4}$ -in. pipe, 2.78 ft. of 1-in. pipe, 1.6 ft. of $1\frac{1}{4}$ -in. pipe, 1.17 ft. of $1\frac{1}{2}$ -in. pipe, .715 ft. of 2-in. pipe, and .5 ft. of $2\frac{1}{2}$ -in. pipe.

AIR-CONDITION YOUR CAR

for summer driving



By Hi Sibley

THAT LONG vacation drive to the summer camp, or across the desert, can be made in air-conditioned comfort if you install this efficient car cooler before starting. Although the cooler operates on the well-known principle that air is cooled by rapid evaporation of water, it does not raise the humidity of the air in the car. Only dry, cool air reaches the car interior through ducts which are located at right angles to the air stream passing through the cooler.

The cutaway view, Fig. 1, shows how it works. Air passes through a core which consists of a series of ducts having $\frac{1}{2}$ -in. openings between them. Each duct is closed at the rear and is covered with a fabric "wick" or jacket. The space within the walls of the duct is filled with crimped copper screen, Figs. 1 and 4. Water from the baffled supply tank drips through pin-sized holes onto the jackets, and air passes through the openings between the ducts, evaporating the water from the saturated fabric. Air passing into the ducts at the open ends is retarded by the crimped-screen baffles until its temperature is lowered by contact with the cooled sides of the ducts. It is then deflected by the slanting closure at the rear end of each duct into right-angle ducts leading to the car interior. Water that drains into the lower tank at the rear of the cooler is returned to the upper tank by a fan-operated "bucket lift" detailed in Fig. 2. Air passing between

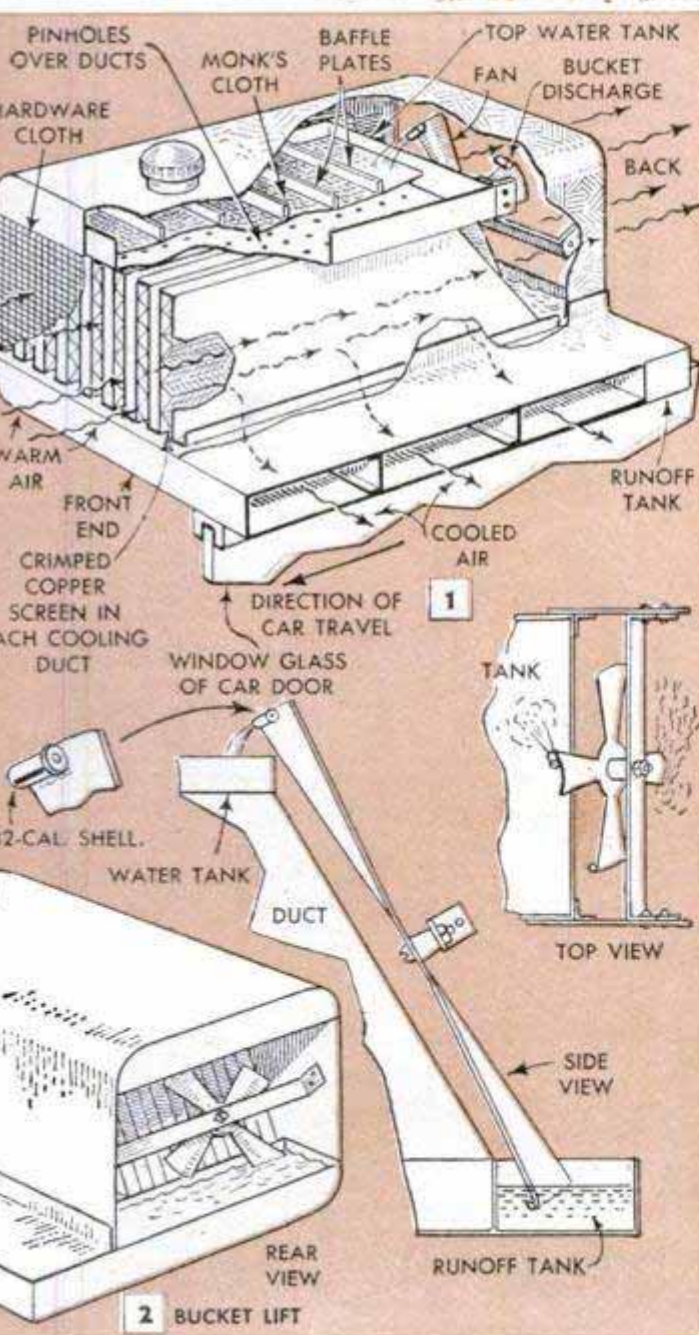

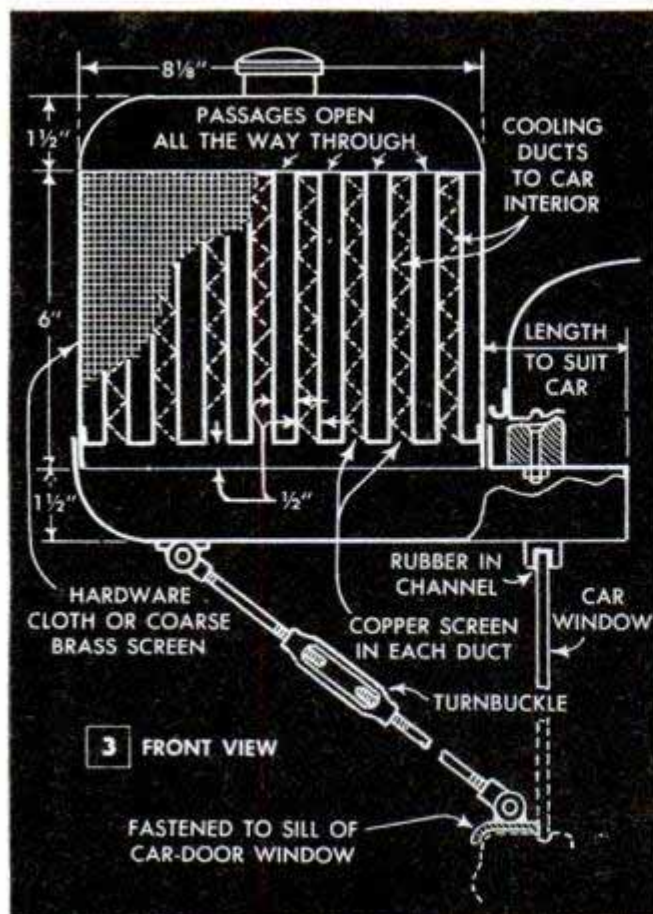

the ducts of the cooler rotates the fan, each blade of which is fitted with a bucket made from an expended .32-cal. shell. As the fan rotates, the buckets dip into the water in the lower tank and spill their loads into the upper tank, thus replenishing the water supply while the car is in motion. The speed of the fan can be altered by changing the pitch of the blades. This arrangement works satisfactorily on long trips where the car is driven at a fairly high speed. A somewhat more efficient arrangement for slower driving is the fan-driven pump detailed in Fig. 4. All parts of the pump should be of brass to prevent corrosion.

Figs. 3 and 5 are front and side views giving general over-all dimensions. The length of the ducts which carry the cooled air into the car, Fig. 3, should be carefully determined beforehand, as the required length will vary. The front of the unit is covered with a heavy brass screen and the rear end of each duct is closed by a channel bent from sheet metal and soldered over the opening as in Figs. 4 and 8. The core and upper tank, which are separate units, are covered by a removable shell made

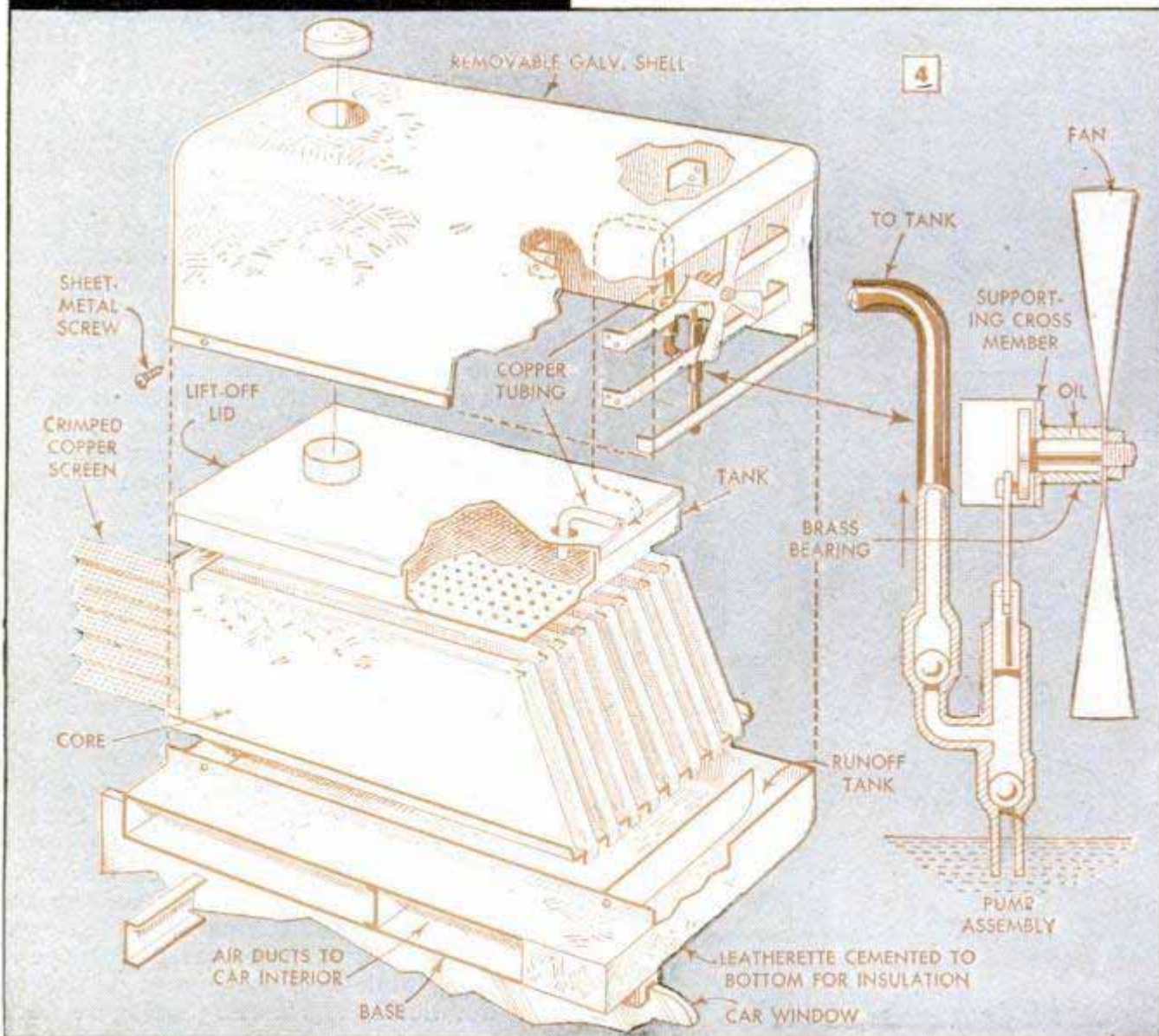

from galvanized sheet metal as in Fig. 4. When in position, the shell houses all parts and prevents them from shifting. Where a fan-operated pump is used, the upper tank is covered, as in Fig. 4, with a sheet-metal lid. Figs. 6 to 9 inclusive detail the construction of the core. It is bent from a single piece of sheet metal laid out as in Fig. 9. The crimped retarders are made from 16-mesh bronze or copper fly screen. Reinforcing sheet-metal strips are soldered at both ends of the core as in Fig. 6 and notches are filed at the open, or front, end of each duct to form tabs under which the tie cords of the monk's-cloth jackets, Fig. 7, can be knotted as shown. The fabric jackets should be carefully cut to size so that, when tied in place over the ducts, they will be uniformly tight and without wrinkles. The runoff tank, Figs. 1, 4 and 5, is made by soldering a sheet-metal baffle in the bottom of the unit. Test it before installation to see that it is watertight. After it has been completed and the air-duct dividers have been soldered in place, set the core and upper tank in position and cut, bend and fit the shell, Fig. 4. Where the upper tank is covered, it is necessary to fit a filler neck and cap as in Figs. 3 and 4. Next, install the fan and pump, attaching the supporting cross members to the sides of the shell as shown. Fasten the shell and the core to the bottom tank with sheet-metal screws as in Fig. 4. Fig. 3 shows how the cooler is mounted on the car. A wooden strip, bandsawed to the curve of the door mold, is bolted to the top of the air-duct extension and a channel fitted with a rubber filler strip is soldered to the bottom of the duct extension. This fits over the top edge of the car window. A special brace with a turnbuckle adjustment supports the cooler in the horizontal position. The exact position of the brace lugs and the channel must be determined by trial. As the length of the cooler will not fully cover the opening at the top of the window, fit strips of sheet metal to the ends of the cooler so that they will block the opening completely. For a neat, attractive job, spray-paint the cooler with the same color and type of finish as that on the car body. To operate, fill the top supply tank with water a few minutes before starting. This will permit the water in the tank to drip down onto the fabric jackets and saturate them. Then fill the runoff tank and the cooler will be in operation as soon as the car is moving. When using the cooler on extended trips or where the air is especially hot and dry, take along an extra supply of water to refill the tank.

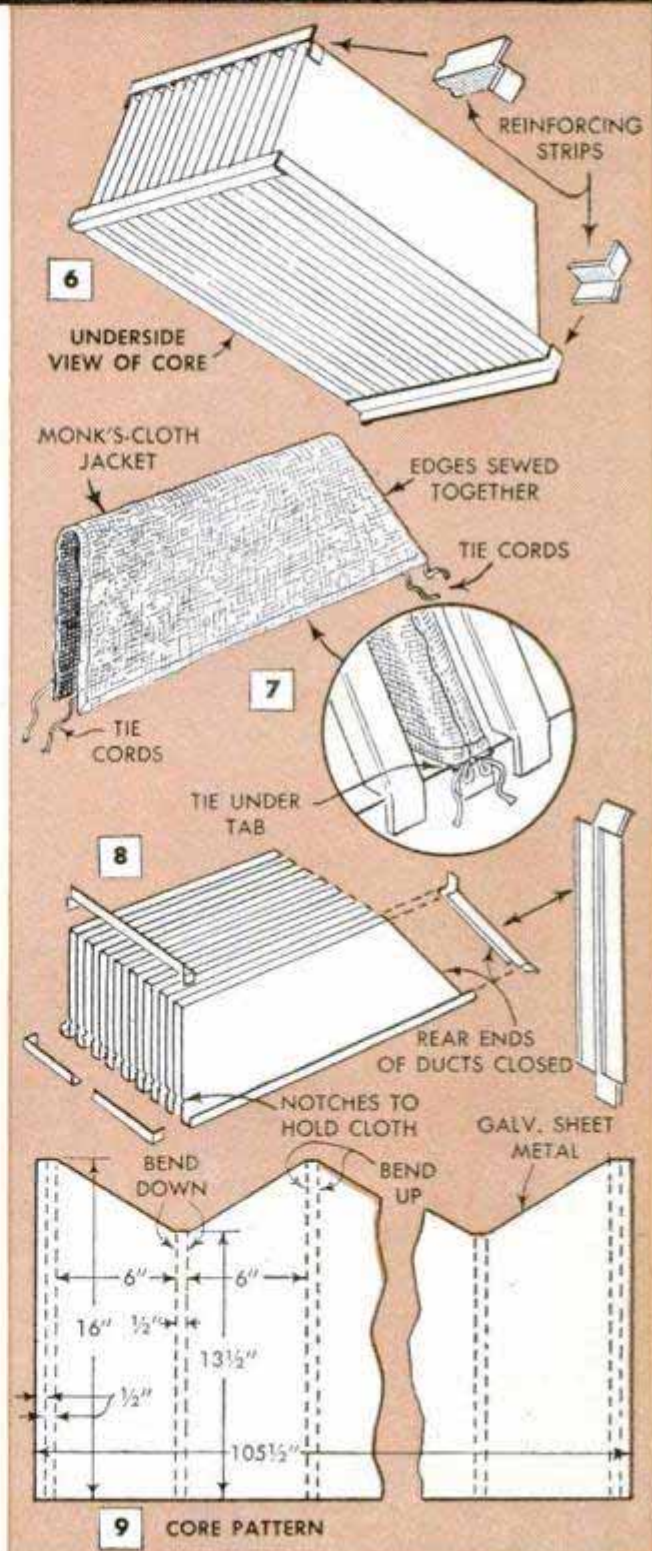
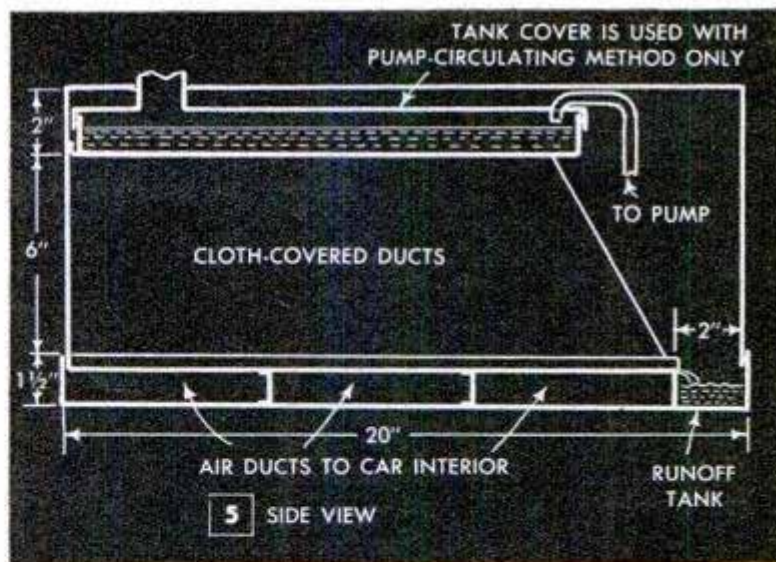

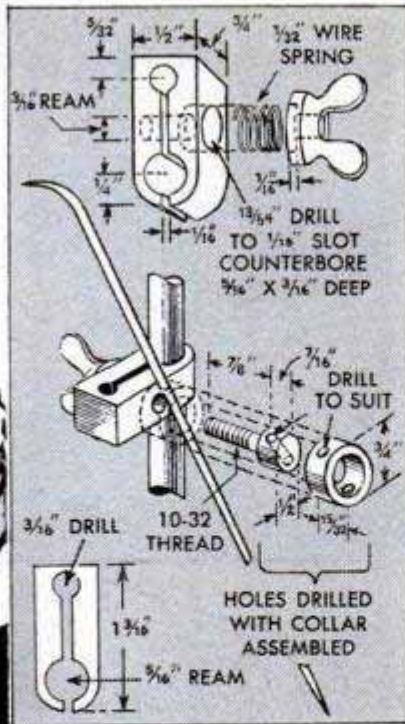

Positive-Locking Scriber Clamp On Surface-Gauge Spindle

Holding adjustment of the universal scriber clamp on a surface-gauge spindle is somewhat uncertain after prolonged wear has enlarged the spindle hole. However, by making a new clamp, it is possible to restore the original accuracy of the tool. The body of the clamp is made from cold-rolled steel, finish-ground all over with a $\frac{1}{4}$ -in. radius worked on one end. Holes $\frac{3}{16}$ and $\frac{5}{16}$ in. in diameter are drilled through the blank from one edge. After reaming the $\frac{5}{16}$ -in. hole, the blank is slotted through both holes, the $\frac{1}{16}$ -in. slot running through from edge to edge of the piece, and only opening one side of the $\frac{3}{16}$ -in. hole. These operations produce the integral jaws of the spindle clamp. Next, the partly finished blank is drilled, counterbored and reamed for the scriber clamping bolt, as indicated. The $\frac{7}{8}$ -in. shouldered section of the clamping bolt is threaded 10-32, and the head is lapped to a slip fit inside a steel sleeve, which is $\frac{3}{4}$ in. o.d. The transverse hole for the scriber is then drilled with the sleeve in position over the head of the bolt. In this manner, registering holes are drilled through both parts simultaneously. Recess the bottom of the wing nut to $\frac{5}{16}$ -in. diameter and $\frac{1}{16}$ -in. depth. Obtain a coil spring of $\frac{1}{32}$ -in. wire size to fit the counterbore, then assemble the clamp with the spring under the wing nut. The spring holds all parts under a slight tension and gives a smooth, easy action when adjusting the scriber.

Thomas Coles, Detroit, Mich.

☞ A toothbrush and pipe cleaner are handy for cleaning firearms and fishing reels.

Vise Holds Screw for Cutting Without Damaging Head

When it is necessary to cut or file the thread of a flat-headed screw, I clamp the head of the screw in a vise as shown. With the tapered side of the head resting against one jaw and the other jaw engaging the screw slot, the vise holds the screw securely without damaging the head.

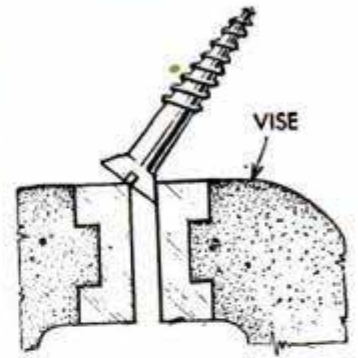

A. W. Larson, Minneapolis, Minn.

Oiling High-Temperature Bearings

Bearings which ordinarily give trouble due to excessive heat can be lubricated effectively by adding oil when stopping the drive instead of when starting it. In this way, the grease absorbs the oil and is kept from hardening. If oil is applied directly to the grease while the motor is in motion, centrifugal force causes the oil to throw and it is not absorbed by the grease.

W. F. Schaphorst, Newark, N. J.

Wire Soldered to Valve Keys Allows Safe Installation

Soldering a length of wire to a pair of valve keys permits installing it quickly and without injuring the fingers. A 3-in. length of stovepipe wire is cut for each valve and bent to a U-shape. Then the ends of the wire are tack-soldered to the lower edges of the valve keys as shown in the photo. Using the wire as a handle, the keys are placed over the valve stem and the washer is lowered, locking them in place. After this, the wire is pulled off the keys with a pair of pliers.

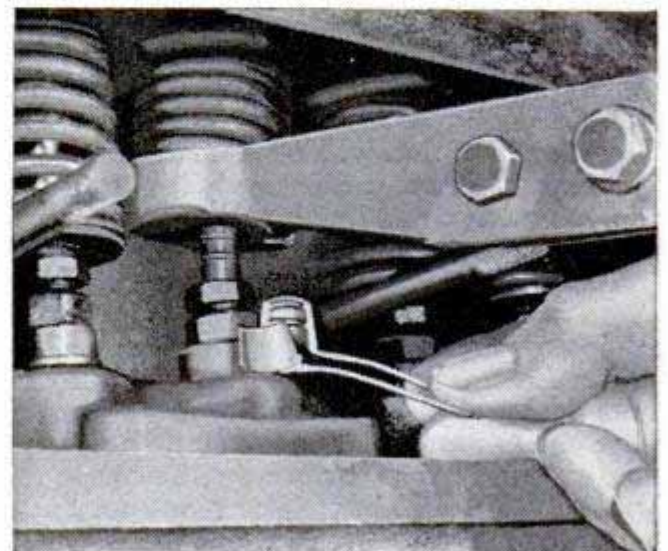

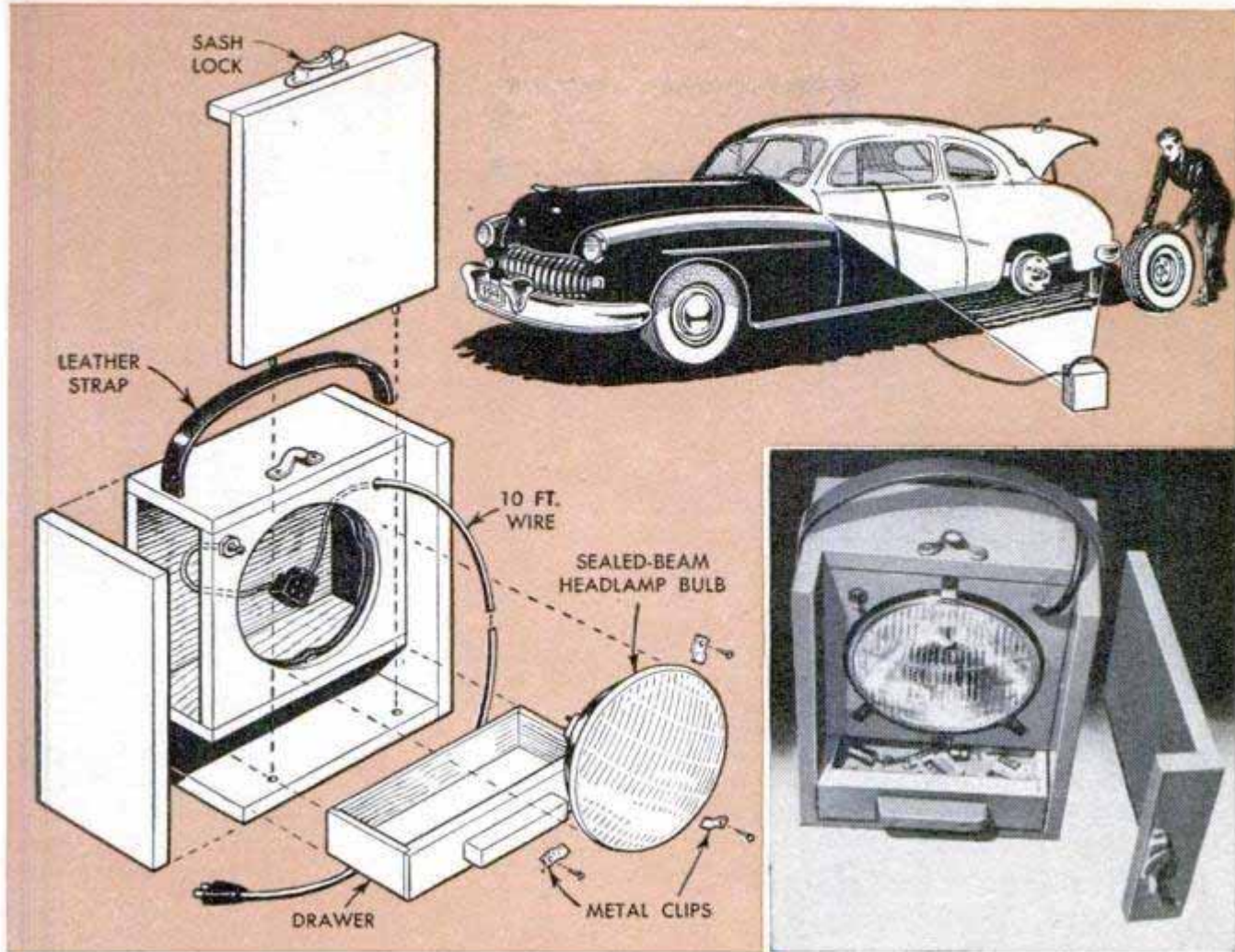

Sealed-Beam Headlamp Provides Trouble Light

If you have ever had to change a tire on a dark country road without enough light to see what you were doing, you will appreciate this easily made trouble light. It throws a powerful beam of light for making tire or engine repairs and consists simply of a sealed-beam headlamp bulb mounted in a wooden carrying case. The case, which can be tucked away in a corner of the trunk compartment, is made of 1/2-in. stock and is fitted with a small draw-

er for storing spare bulbs, fuses and other items for emergency repairs. Metal clips hold the bulb in a circular opening in the front of the case, and a rubber gasket cushions the bulb. The lamp is equipped with a long extension cord that is plugged into the battery circuit of the car. For this purpose, a standard receptacle can be mounted in the engine compartment, under the dashboard or in the trunk.

John M. Avery, Dexter, N. Y.

Grille Guard From Cultivator Wheel Is Attached to Truck Bumper

A section cut from an old cultivator wheel provides a rugged and inexpensive grille guard for a truck. The wheel section is bolted or welded to the truck bumper and braced with pieces of flat iron bolted to the bumper brackets.

Lee C. Black, Georgetown, Tex.

Spots of Color Identify Files

Files or milling cutters used on brass can be distinguished at a glance from those used on steel if each type is identified with a spot of a different color. For instance, red can be used for brass and blue for steel.

William A. Decker, Nutley, N. J.

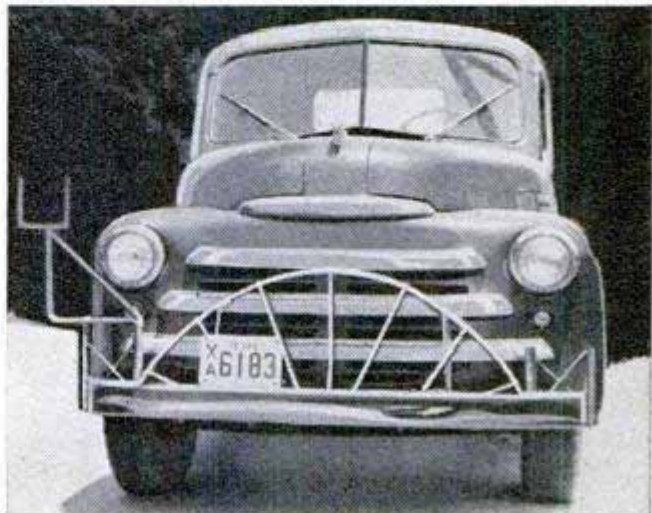

Hose Clamp on Welder Lead Secures Rubber Insulation

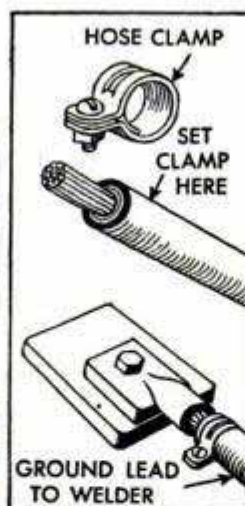

To keep the rubber insulation of a welder lead from pulling back or fraying at the ground-clamp connection, fasten an ordinary hose clamp around the lead at this point. In addition to holding the insulation in place, the clamp keeps oil and grease from working beneath the rubber.

Protective Sheath for Triangle

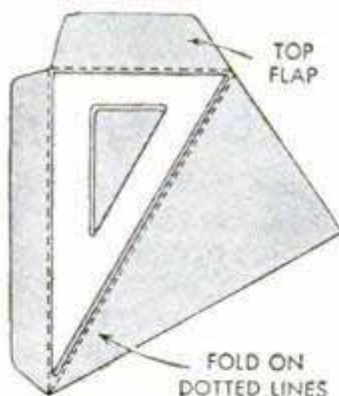

Storing a triangle in a sheath made of heavy paper keeps it in good condition indefinitely, preventing nicks in the edges that usually occur when a triangle is stored unprotected in a drawer. The paper is cut as shown, folded along the dotted lines, and the side flaps are glued together. The top flap is left open and pushed under the side flap when the sheath is closed. To permit easy insertion and removal of the triangle, the sheath is made about $\frac{1}{8}$ in. larger.

Harry Radzinsky, Great Neck, L. I., N. Y.

Attaching Sacks to Hoist Rope

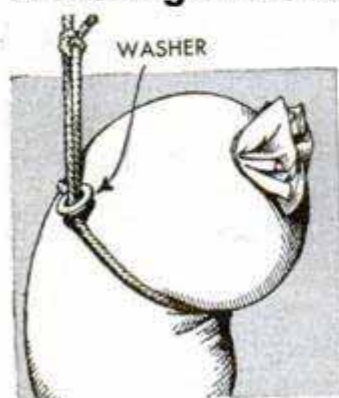

Heavy sacks which are lifted with a hoist can be attached quickly and securely to the rope by means of an ordinary metal washer. The washer is slipped over a large loop made at the end of the rope. After the

loop is thrown around the sack, the washer is pulled down and pressed against the sack, tightening the rope around it. A large knot should be tied at the end of the loop to keep the washer from slipping off the rope when the sack is released.

Floating Test Tube in Water Bath

If you do not have a cork handy when it is necessary to float a test tube in a water bath, attach an inverted empty test tube to the filled tube. Use rubber bands or string to hold the test tubes together.

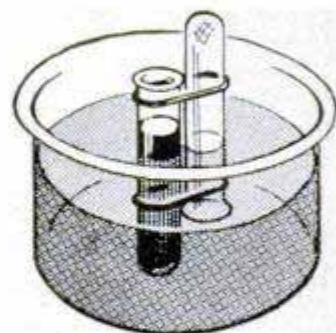

Because of the air trapped in the inverted test tube, the filled one can be floated at any desired depth.

Homemade Rock or Gravel Washer Provides Clean Aggregate

When he needs especially clean aggregate for a concrete job, one farmer runs crushed rock or gravel through this novel washer. The washer consists of a 4-in. belt, driven by a $\frac{1}{4}$ -hp. motor. The belt carries the rock uphill in a chute against a stream of water from a garden hose. Dirt and fine stone are washed out at the bottom of the chute, while larger pieces of gravel are carried up the belt and dumped out at the upper end of the chute. The spray, of course, must be adjusted to suit.

O. A. Fitzgerald, Moscow, Idaho.

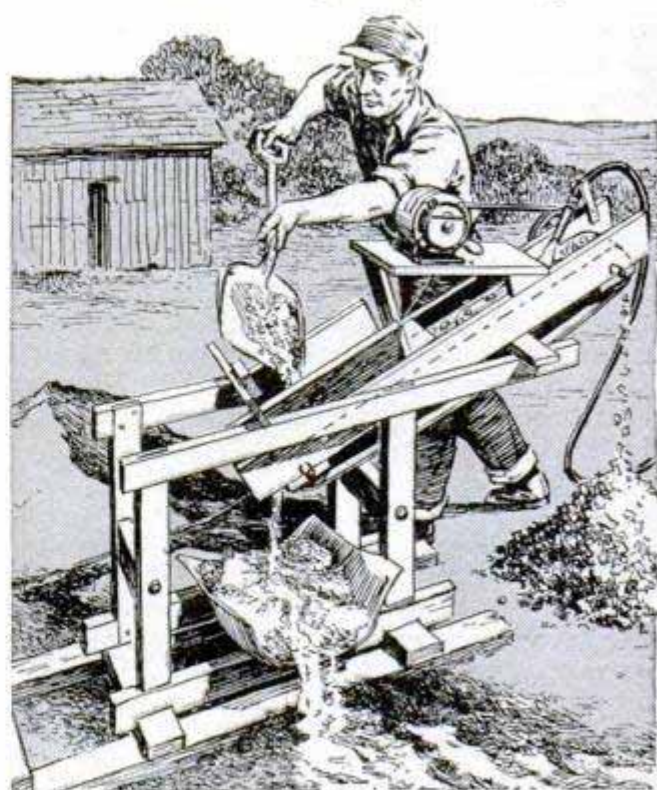

IMPROVISED FOOT FEED for drill-press routing

By Dick Hutchinson

CONFRONTED with the problem of routing a recess in the center of a large number of duplicate pieces, I saved considerable time by equipping my drill press with this improvised foot feed. In addition to leaving both hands free, the foot feed eliminated locking and unlocking the spindle, as the routing operation in each piece was only momentary. This same setup also is useful for rapid drilling where both hands are needed to hold the work. The end of the wooden treadle bar can be bolted to a stud or fastened to a hinge which is screwed to the floor. The treadle lowers the drill-press spindle by means of a cable linkage, and a spring arrangement helps return the spindle. The $\frac{3}{16}$ -in. wire cable is fastened to one end of the hand feed bar, and passed upward through an awning pulley and down to a screw eye turned into the treadle bar. The spring is attached to the other end of the hand feed bar and to a bracket welded or bolted to the drill-press frame. Where the work is curved, a handy routing guide can be set up in a jiffy by clamping a semi-circular piece of wood to the drill-press table directly in back of and in line with the spindle.

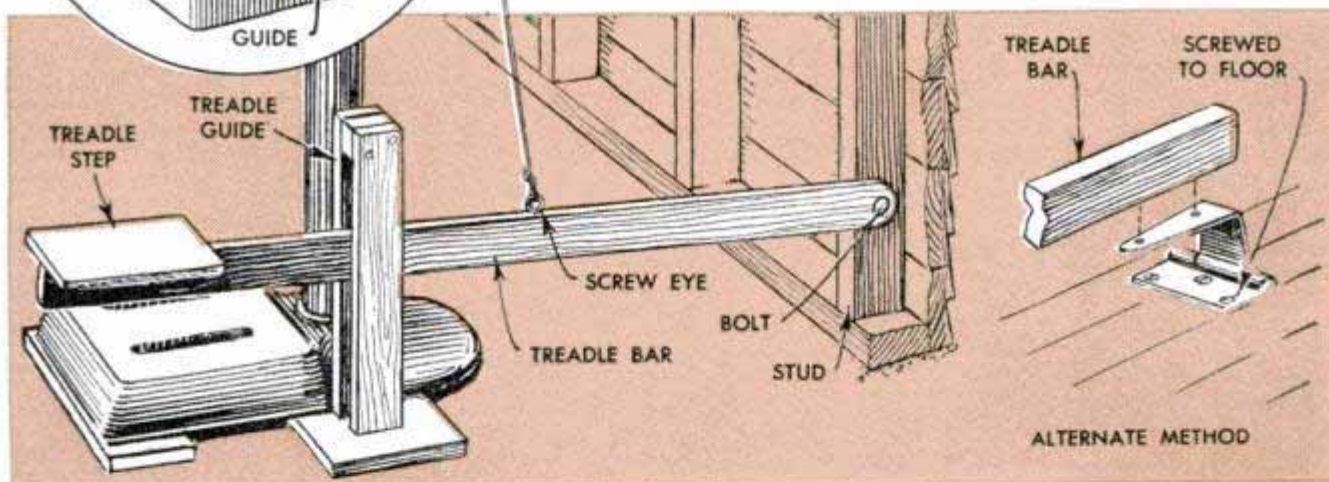
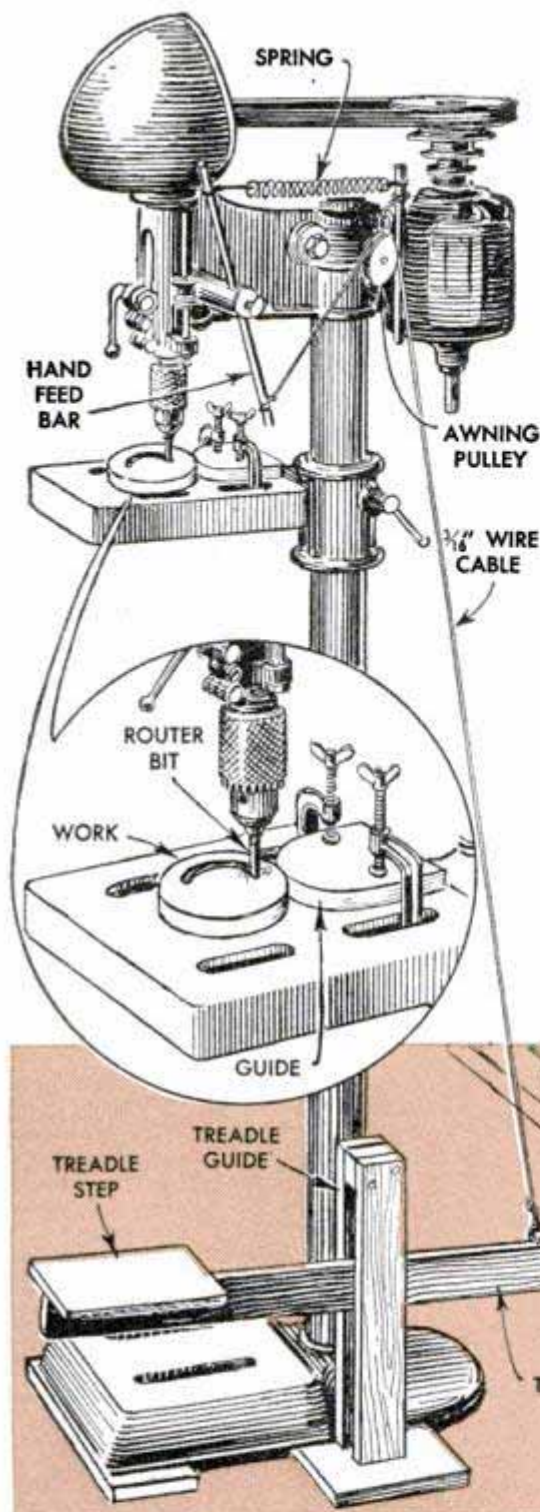

Floating Plank in Stock Tank Prevents Chickens From Drowning

Attracted by the water, chickens frequently perch on the edge of a stock tank. One farmer found that occasionally a chicken would fall into the water while trying to drink, and drown because there was no way for it to climb out. To keep from losing chickens in this way, the farmer placed a 12-in. plank, about 2 ft. long, in the stock tank and allowed it to remain floating on the water. Now, a chicken perching on the edge of the tank will jump to the plank to drink and is able to get back out of the tank without falling into the water. The plank does not interfere with stock drinking.—Opie Read, Jr., Chicago.

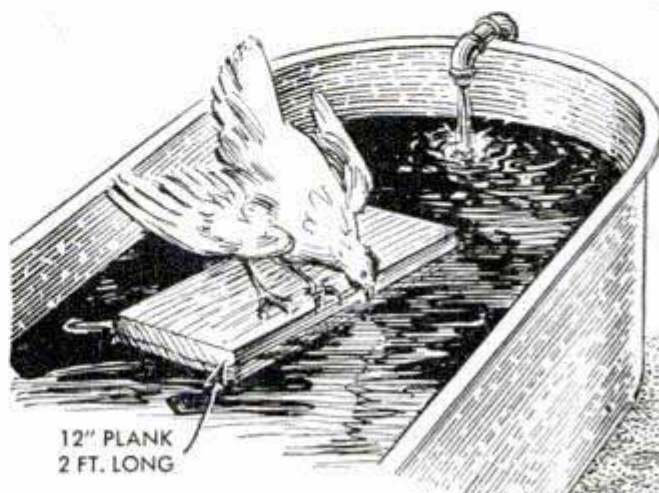

ELECTROCHEMISTRY

Simple experiments, easily and safely performed at home, clearly demonstrate how electrochemical processes work

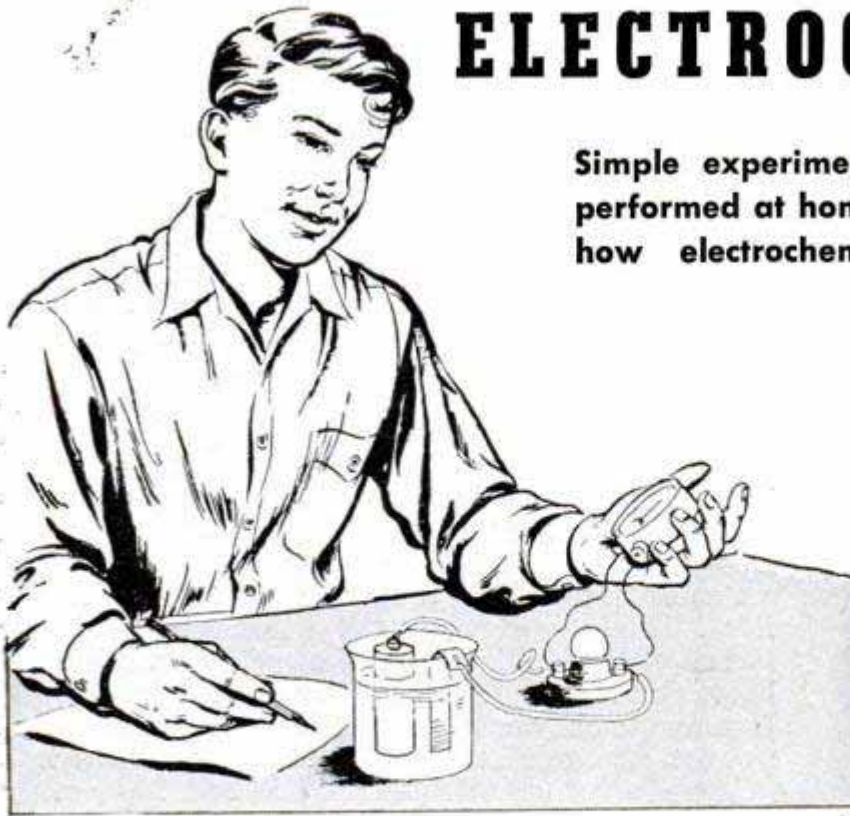

1 TABLE

METALS ARE IN ORDER OF DECREASING ACTIVITY

SODIUM
MAGNESIUM
ZINC
IRON
NICKEL
TIN
LEAD
COPPER
SILVER

A simple gravity cell is detailed below. It is made by dissolving copper and zinc sulphate in a beaker containing water and inserting copper and zinc electrodes

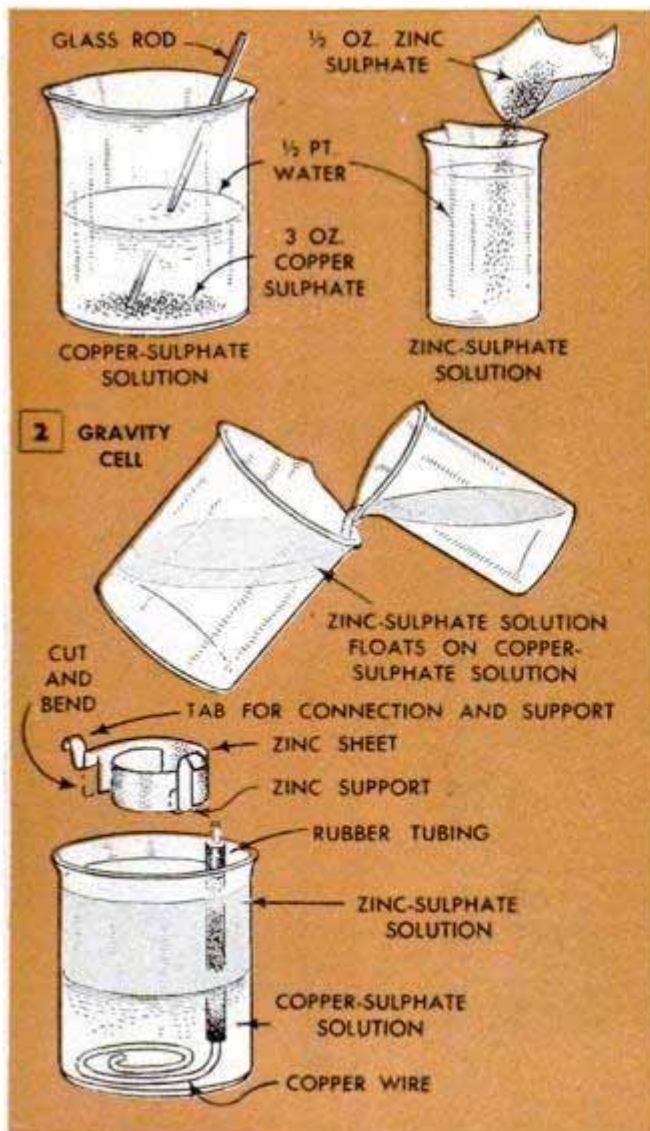

WHILE they are unspectacular, electrochemical processes afford vital services on which we constantly depend. In addition to the familiar flashlight and storage battery, electrochemistry is the basis of electroplating processes, the refining of various chemicals and certain metal-finishing processes. Left to itself, electrochemical action is the cause of destructive corrosion of metals. However, when properly controlled, the action can be used to prevent corrosion.

An electrical cell consisting of a combination of any two metals immersed in a conductive solution and capable of producing an electrical current is commonly called a voltaic cell. However, comparatively few combinations of metals can be used to make useful cells, that is, cells capable of producing electrical energy for a practical duration. A gravity cell, which is a useful type of voltaic cell, uses a combination of copper and zinc. It is made, as shown in Fig. 2, by first dissolving 3 oz. of copper sulphate in a large beaker or jar containing $\frac{1}{2}$ pt. of water and then carefully pouring in a solution of $\frac{1}{2}$ oz. of zinc sulphate dissolved in $\frac{1}{2}$ pt. of water. The large jar should be tilted slightly and the zinc-sulphate solution poured slowly down the side of the large jar, as shown, so it will not mix with the copper-sulphate solution, but form a layer above it. The copper or positive electrode is made of heavy wire, coiled as indicated in the lower detail of Fig. 2, and rests on the bottom of the jar in the copper-sulphate solution. A short length of rubber tubing is used to

OF VOLTAIC CELLS

By J. B. Mullen

insulate the copper where it passes through the zinc-sulphate solution. The zinc or negative electrode is a coiled strip of sheet zinc suspended in the zinc-sulphate solution with small hooks of zinc, plastic or glass. The wire connection to the zinc electrode should be made by cutting and bending a small strip of the zinc electrode as indicated. A single-cell flashlight bulb connected to the two electrodes as in Fig. 5 will glow, although it may be at somewhat less than full brilliance. If tested with a voltmeter, the cell should register about 1 volt.

Gravity cells are best suited for applications where a steady current is required because the zinc electrode dissolves continuously. When the cell is not in use, the zinc electrode should be removed. If this is not practicable, a resistor connected permanently across the electrodes will prevent zinc deterioration to a certain extent. When the cell is in use, as shown in Fig. 5, the zinc electrode slowly dissolves into the solution leaving a surplus of electrons—negatively charged atomic particles—on the electrode, which is then at a different electrical potential or voltage than the copper electrode. The zinc particles, or ions, in the solution are positively charged because of the removal of the negatively charged electrons from the zinc atoms. The copper going from the solution to the copper electrode takes up electrons from the electrode, leaving it positively charged. When the two electrodes are connected to a light bulb, the electrons flow through the wire because of the difference in electrical potential between the electrodes. This stream of electrons is the electric current. The flow of electrons relieves the electrical unbalance between the electrodes thus permitting the reactions to continue supplying more electrons to maintain the current. When the light bulb is disconnected, these processes are automatically stopped by the electrically unbalanced condition in which the electrodes are left.

Many electrode combinations are of no practical use because the chemical reactions that occur stop themselves. This is called polarization. For example, in Fig. 3 a strip of zinc and a carbon from a dry cell are hung in a

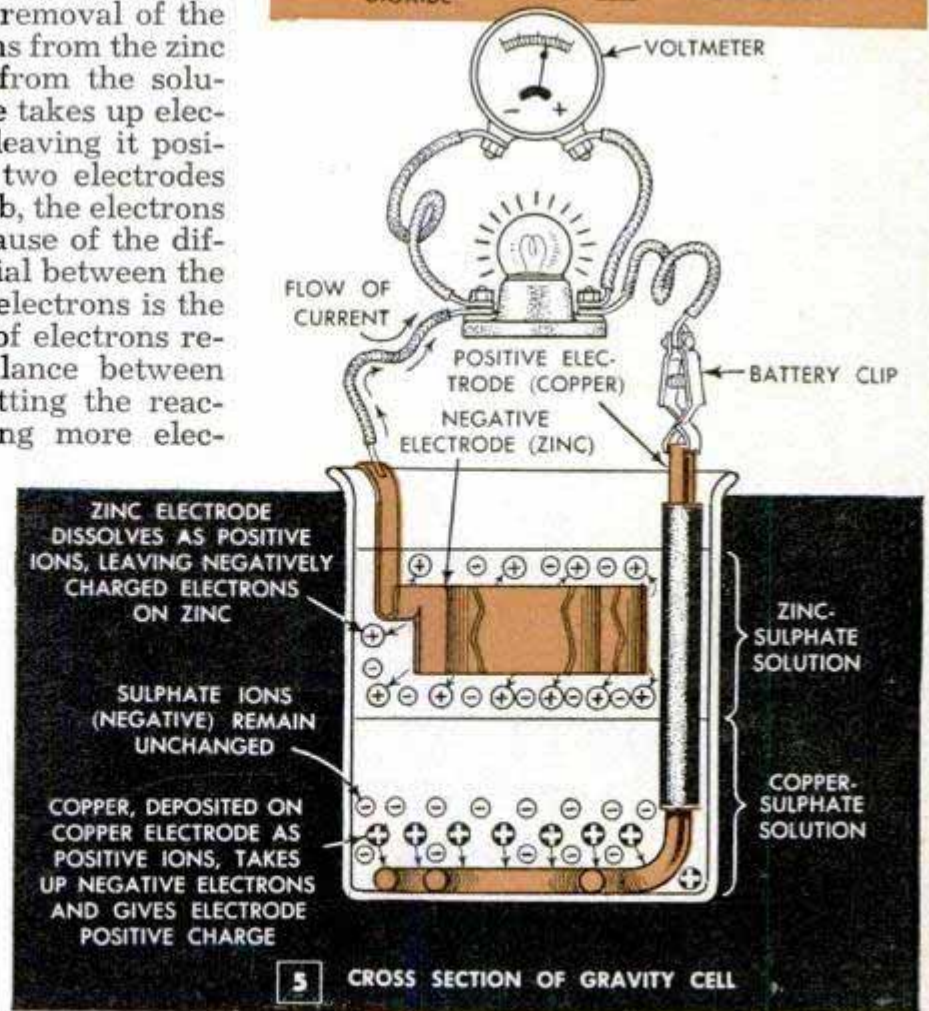
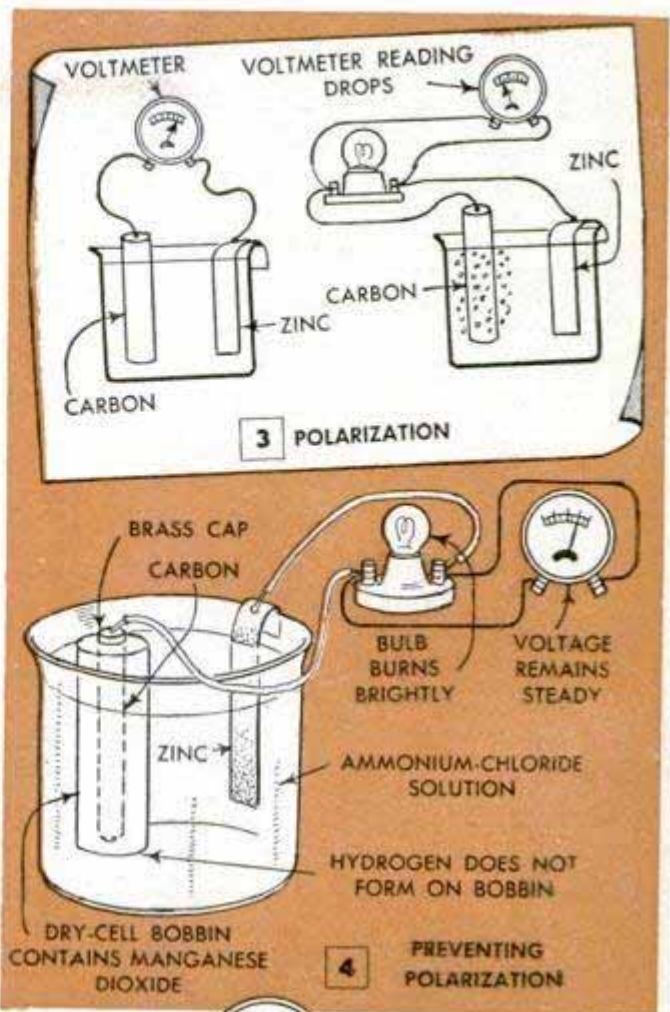

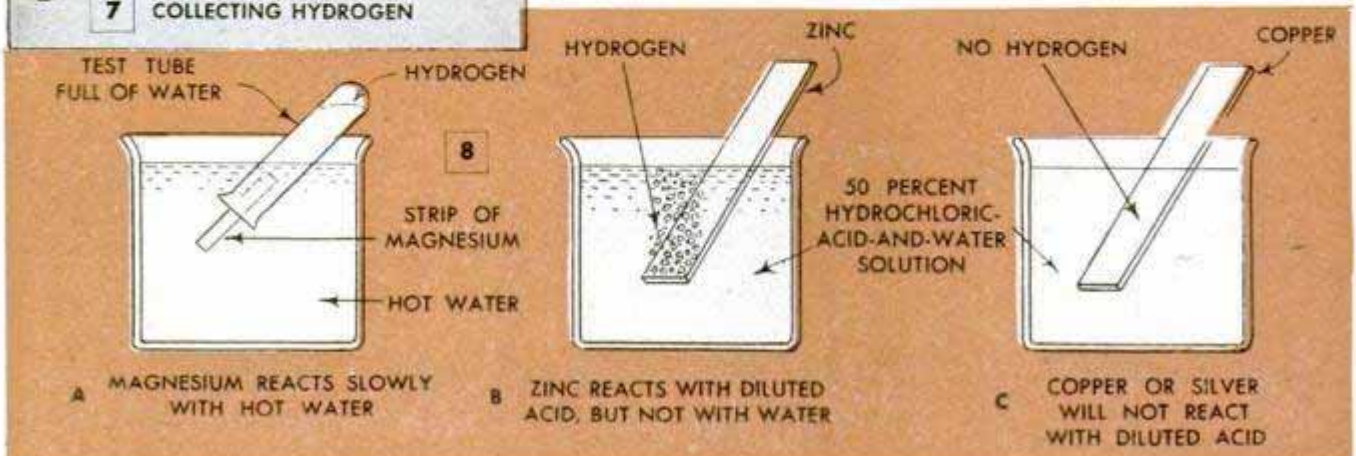
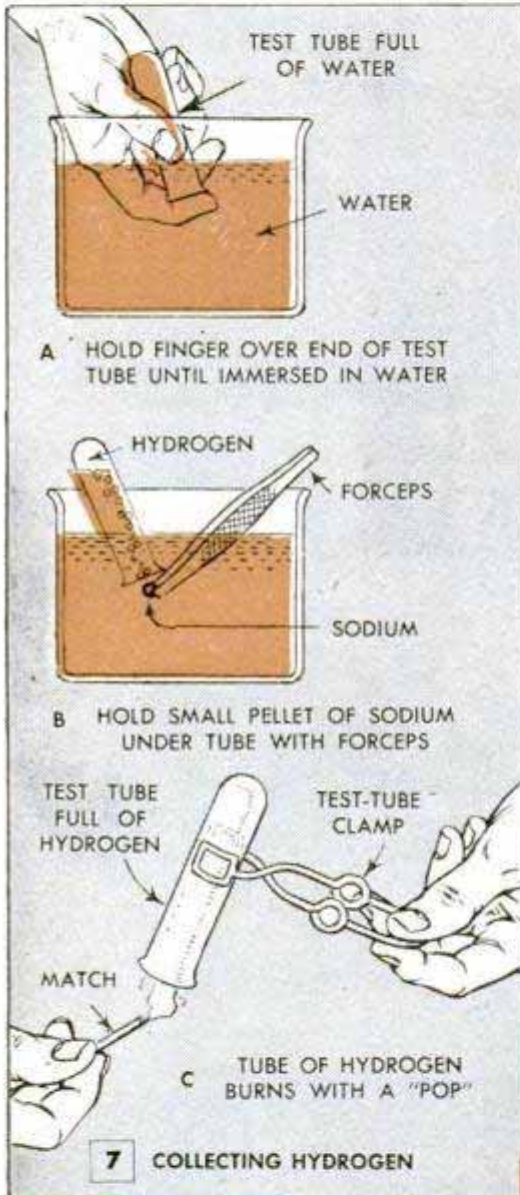
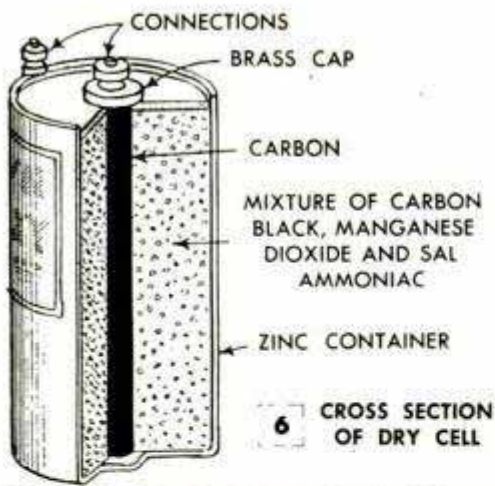

solution of 2 oz. of ammonium chloride (sal ammoniac) in $\frac{1}{2}$ pt. of water. A voltmeter connected to the terminals of this cell will give a brief reading of about 1.5 volts. If a flashlight bulb is connected to the cell, the bulb will grow dim rapidly as the voltage drops. At the same time, fine bubbles of hydrogen gas form on the carbon. The hydrogen, which is one of the products of the chemical reactions in the cell, coats the carbon and stops the action of the cell. Electrochemists prevent this drop in voltage by adding another substance called a "depolarizer" around the carbon. If the entire mass or "bobbin" around the carbon of a dry cell is substituted for the carbon alone, as shown in Fig. 4, the light bulb will remain lighted. The bobbin contains manganese dioxide as a depolarizer mixed with carbon, and in the cell the manganese dioxide reacts to form other compounds in preference to hydrogen. Since no hydrogen is formed, the chemical action in the cell is not blocked by gas bubbles, polarization is prevented, and the voltage does not fall off. In the dry cell, Fig. 6, the zinc is in the form of a can, in which are placed the bobbin and the conductive solution in the form of a jellylike paste.

In any voltaic cell, the more active metal, or the one that will be dissolved, is always the negative electrode. The relative activities of common metals are given in Fig. 1, with the more active metals at the top. The experiments, shown in Figs. 7 and 8, demonstrate the relative activity of various metals. The most active metal, sodium, is so eager to dissolve that it reacts vigorously with water. Care must be taken when handling sodium. A piece no bigger than a pea should be used in this experiment, and it must be handled with forceps. The gas given off is hydrogen, and can be collected as shown in Fig. 7. The hydrogen will burn if a match is held close to the mouth of the test tube. Sodium is so active it cannot be used successfully in a voltaic cell.

Fig. 8 shows that less active metals, like magnesium, will react only slowly with water, and considerable time is required for the test tube to fill with gas even when hot water is used. Zinc, being less active, does not react with water, but reacts with dilute hydrochloric acid. Copper and silver, being comparatively inactive, do not react even with dilute hydrochloric acid. Since the negative electrode is the one which dissolves in the cell, it is easy to see why the more active of the two metals, with its greater tendency to dissolve, always be-

comes the negative electrode in the cell.

The greater the difference in activity between the two metals in a voltaic cell, the higher the voltage of the cell will be. By using different combinations of metals and conductive solutions, voltaic cells with different voltages and other properties can be made. For example, iron or magnesium can be substituted for zinc in a cell with carbon and manganese dioxide. Iron will deliver a lower voltage and magnesium a higher voltage. However, the magnesium will not last long as it dissolves rapidly when no current is drawn from the cell.

Tarnish can be removed from silverware by a simple process that actually makes use of voltaic-cell action. The silverware is put into an aluminum kettle containing a boiling solution of sodium bicarbonate (baking soda). As long as there is any tarnish, which is silver sulphide, it will be chemically changed to silver; when the tarnish is all gone, hydrogen bubbles form on the silverware. Thus no silver is removed as in ordinary polishing nor is there danger of scratching by abrasives. The aluminum dissolves but, as the process takes only a few minutes, the attack on the aluminum is slight. The silverware must be touching the aluminum kettle so the current can flow directly from one metal to the other and produce chemical change.

In many cases, an electrochemical action like that of a voltaic cell is responsible for the corrosion of metals. When two dissimilar metals are in contact and wet, a corrosion cell is formed. The voltage of such a cell may be small or great, depending on which metals are involved and whether the solution is water or a more conductive one, such as a solution of salt or fruit juice. As in any voltaic cell, the most active metal will gradually dissolve or corrode. The steel pipe in Fig. 9 will corrode as it is more active than the bronze of the valve. Note that the current flows from the pipe to the valve and that gas bubbles form on the surface of the bronze valve.

It is important which metal corrodes. For example, when a tin-plated steel pan is worn or damaged so the steel is exposed, as in Fig. 10, the steel will corrode. Tin is an excellent corrosion-resistant coating for steel but, if the tin is perforated, the steel is subject to corrosion at an accelerated rate because of the cell formed by the steel and tin. Other electroplated coatings, zinc for example, will exert a protective influence even if perforated. Fig. 11 shows how the zinc, being more electronegative or "active" than iron, is dissolved while the iron is left unattacked. This prolonged protective action of zinc is one reason for the widespread utilization of zinc-coated or "galvanized" steel.

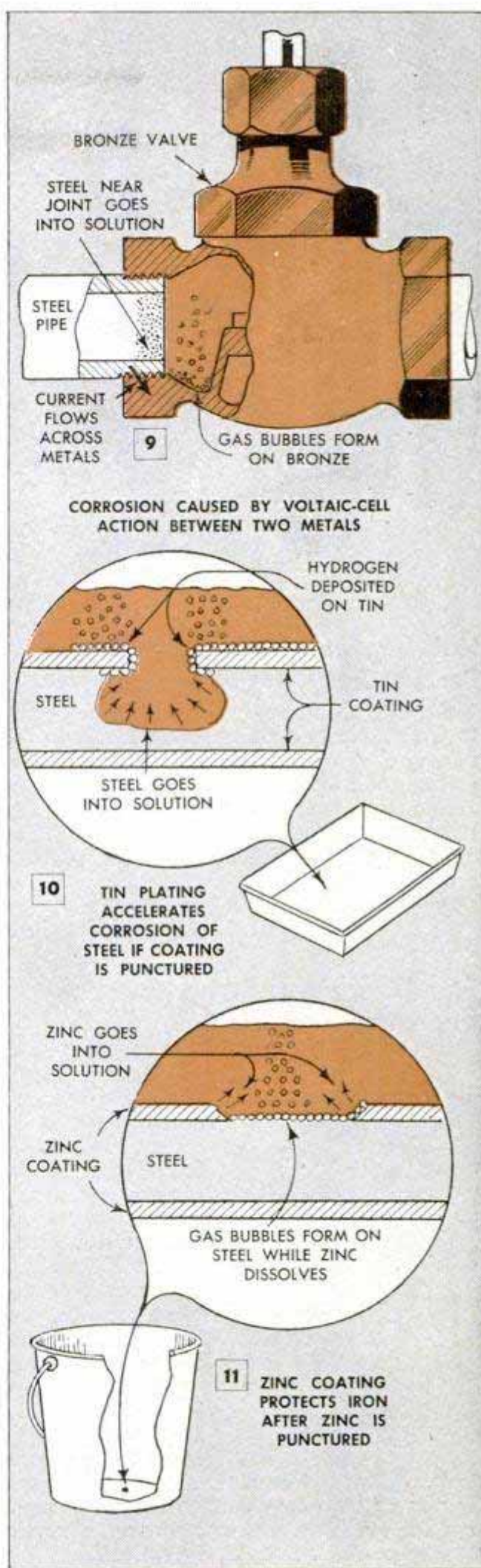

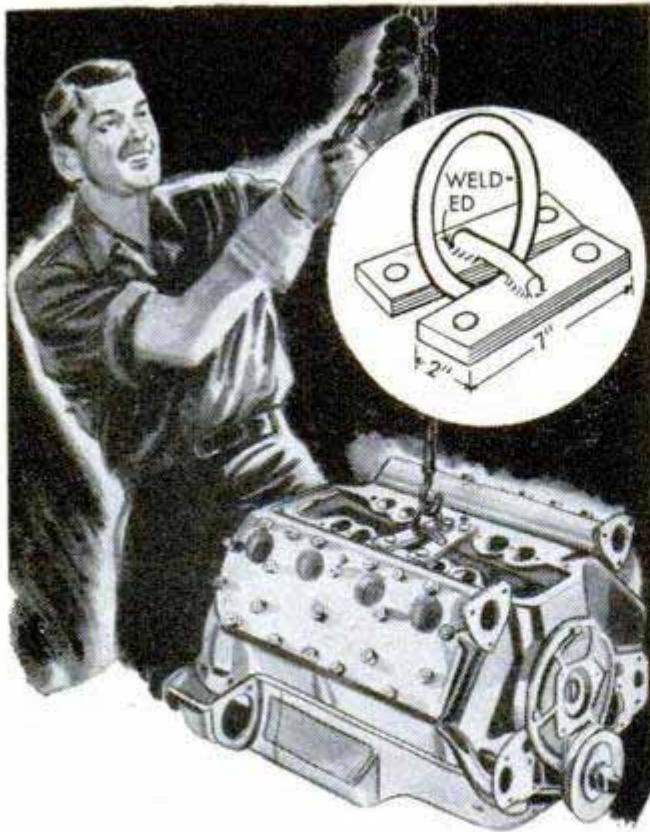

Hoisting Ring for V-Type Motors Permits Easy Handling

Finding that a V-type motor hoisted by looping a chain around it is difficult to tilt, one mechanic hoists the motor by means of a ring, making it easy to handle. The ring is held by a short length of rod welded between two pieces of steel, the latter being drilled for four bolts. This ring plate is bolted to the intake-manifold bolt holes after the manifold has been removed.

Hi Sibley, Nuevo, Calif.

Pipe Hangers of Scrap Material Improvised on Job

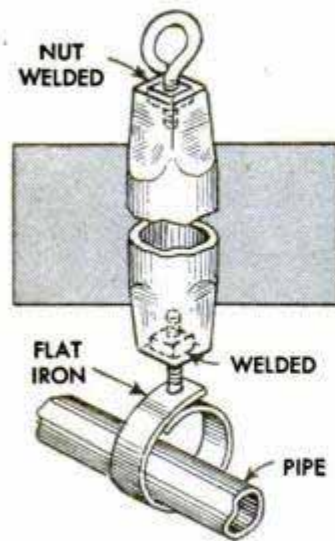

Pipe hangers of any desired length can be made quickly from scrap pieces of pipe. Each end of the pipe is crimped around a nut which is welded in place. A suitable eyebolt is turned into the top nut and a machine bolt into the lower one. A hanger ring for the pipe is bent from flat iron and held in place by the lower

bolt. If the flat-iron ring is large enough, minor adjustments can be made by turning the machine bolt with an angled socket wrench.—Jack Bronte, Surf, Calif.

Nailing Corrugated Roofing To Prevent Leaks

Many times, leaks in corrugated roofing are due to incorrect nailing of the lapped joints. If these joints are nailed similar to the one shown in the upper detail, a bulge is formed at the ridge between the two nails affording an opening for water to enter under the roofing. However, if the joints are nailed as in the lower detail,

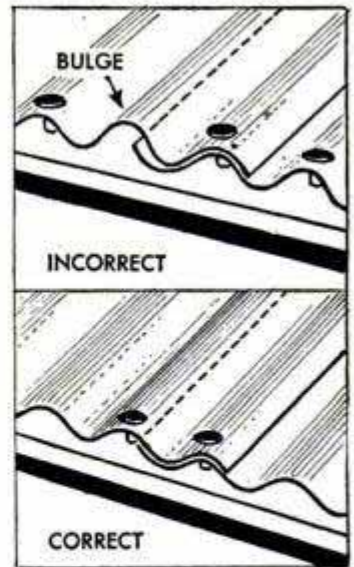

as in the lower detail, that is, one nail through the lapping ridges of both sheets and the other nail through the second ridge of the top sheet, the nail through the second ridge eliminates the bulge. In addition, this nail tends to hold the joint tightly closed even though the nail through both sheets should pull loose, thus preventing leaks.

Weighted Advertising Pennants Are Not Whipped by Wind

Outdoor advertising pennants will hang steady and remain readable on windy days if split-shot sinkers are clamped to their pointed ends. The weight of the sinkers also keeps the pennants from being whipped by the wind and entangled in the line.

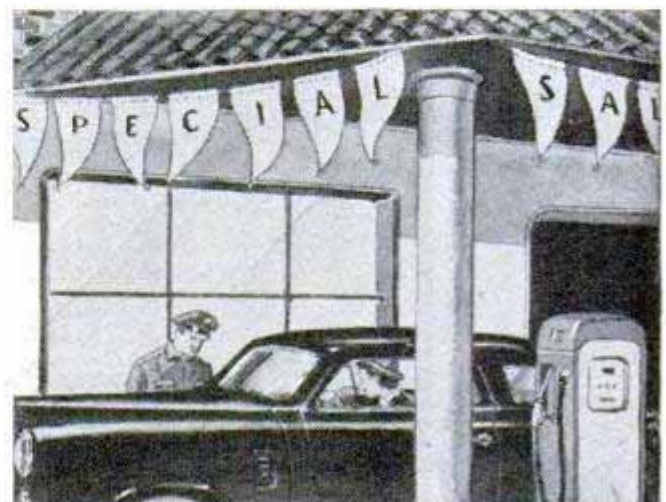
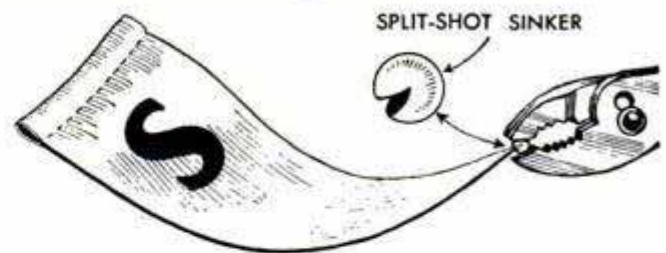

TAPE RECORDER and PLAYER For the HOME

COMPLETE with built-in five-tube speaker-amplifier and crystal microphone, this home tape recorder and player records anything you can hear, and will play it back instantly as many times as you wish. The tape on which this instrument magnetically records sound is claimed to provide excellent fidelity; it can be edited easily by snipping out unwanted material with a scissors and splicing the cut ends with a bit of cellulose tape. After a recording has once been made on a reel of tape, it may be kept as a permanent recording, or it may be used again by simply re-recording over the original sound, the old sounds being erased as the new are recorded.

Favorite programs may be recorded off the air and played back through your radio as illustrated in photo A. By using the microphone as shown in photo B, you can make a tape recording of the baby's first words, and "snap shots" in sound of all members of the family for listening groups, as in photo D. Photo C shows a machine that has been perfected recently by a manufacturer of sound-recording tape to reproduce simultaneously 48 hour-long recordings in mass production from a master transcription. This prerecorded tape will compete with disk records.

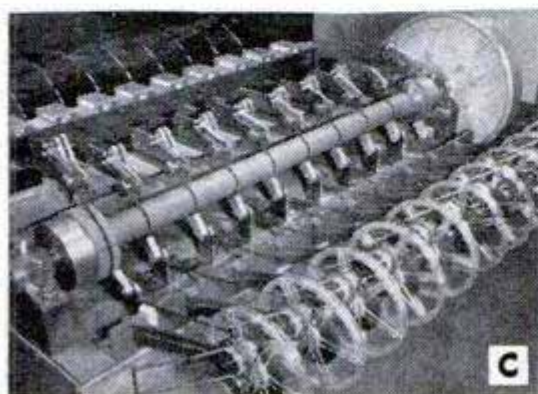

Record Player for

By Robert W. Hawkins

THIS STURDY and safe record player has been used by the author's young son for about eight months without requiring repairs of any kind. The wiring is completely inaccessible to the children's small prying fingers, and there are only two switches to operate. One is a power switch and the other turns the phono motor on and off. No volume control is used because the plate load resistor, R3, in the 1L4 tube circuit has been selected to give proper volume. A variable volume control with high gain in the hands of small children is not a good idea.

Construction should start with the audio amplifier, which is housed in a small stand-

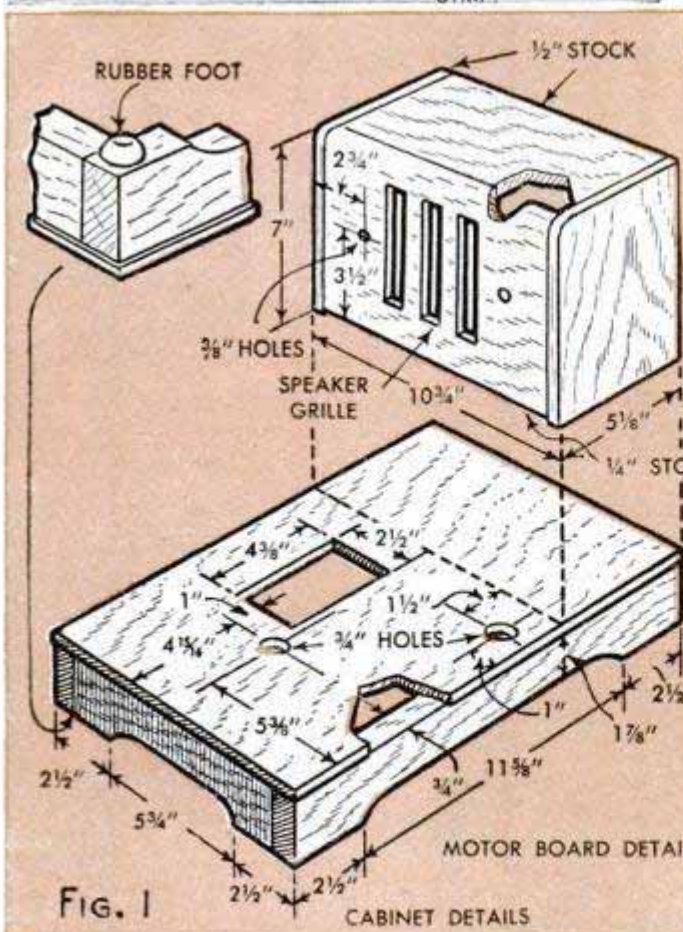
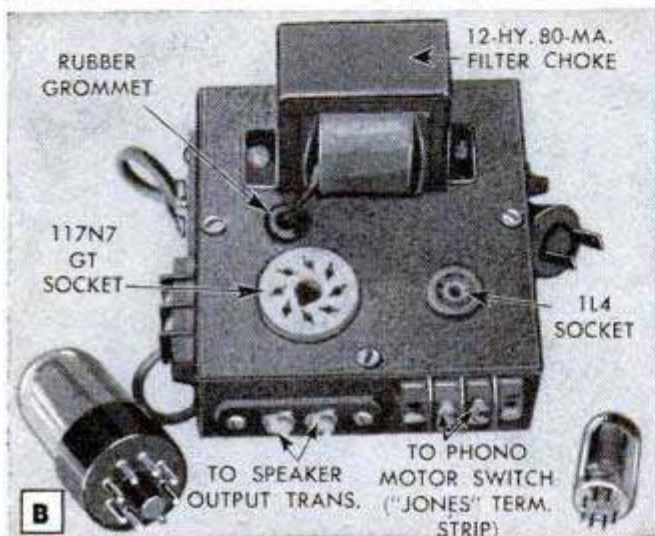
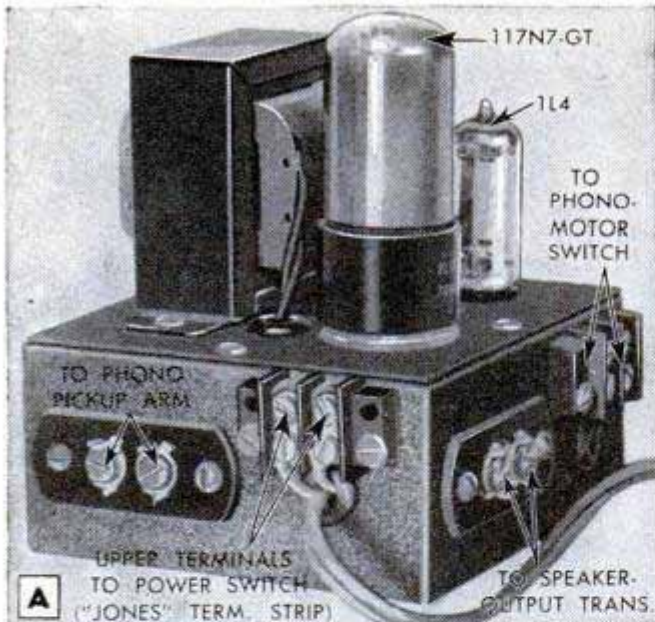

FIG. 1

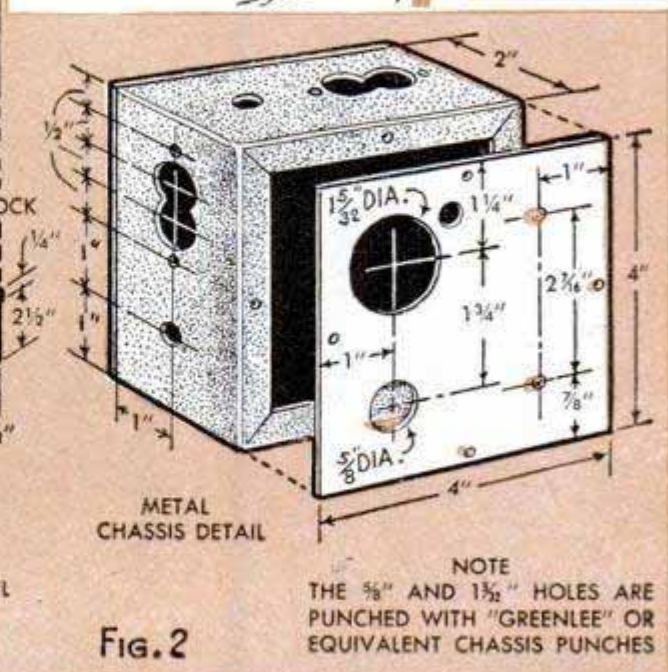
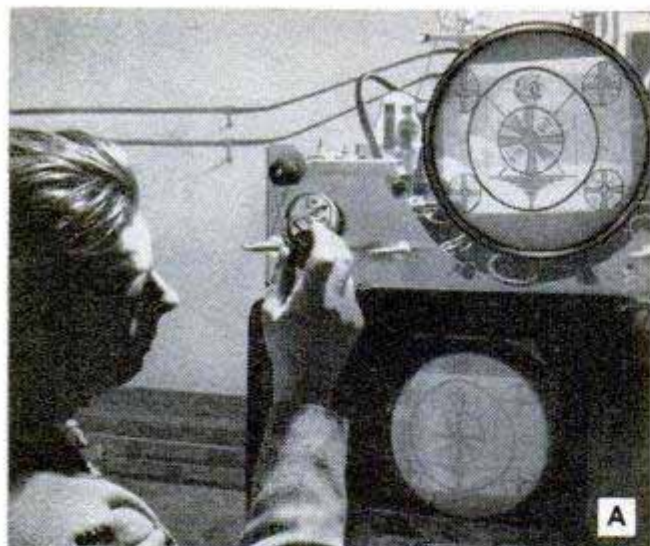

FIG. 2

NOTE
THE 5/8" AND 1 1/2" HOLES ARE PUNCHED WITH "GREENLEE" OR EQUIVALENT CHASSIS PUNCHES

Television and Electronics Today



A—Metal-type television picture tube, designed to give more viewing area in low-priced sets, has a diameter of 8½ inches and will cost no more to build than the 7-in. tubes that are now in common use. The laboratory photo shows the new tube in the top chassis compared with the 7-in. television tube below

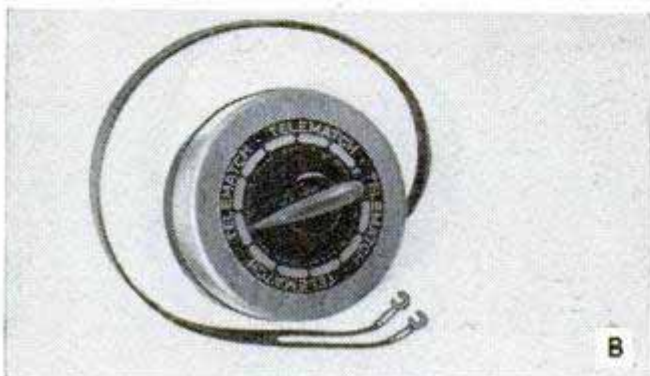

B—TV antenna-matching device aids reception on both low and high channels. It is also claimed to reject adjacent channel interference and to pass full TV bandwidth for picture and sound fidelity. Engineers agree that in most television installations there is a mismatch between the antenna and receiver



C—Shielded 300-ohm lead-in cable for television receivers is claimed to eliminate all the interference normally induced in the transmission line by electrically powered industrial equipment, auto ignition and fluorescent lighting. In some cases, it is claimed to eliminate need for special TV antennas



D—Adaptor makes your electric hand drill a power hammer for drilling holes in tile, brick, cement or stone for installing TV-antenna systems on buildings. It is also useful wherever rapid, moderately heavy hammering may be required in electrical installation work. May be "chucked" in any ¼-in. drill



E—Any three tube-base diagrams out of over 475 different types are at the finger tips of the serviceman and experimenter with this handy pin guide. It also provides a very necessary reference book for the radio workbench. The listings are arranged in numerical and alphabetical tube-type sequence

F—Record player handles all three speeds. Conventional records are played at 78 r.p.m.; long-playing Columbia records are played at a speed of 33½ r.p.m. The new RCA 45-r.p.m. records require a 1½-in.-diameter spindle which is provided for with a brass collar that slips over the regular spindle



Its distinctive styling goes far beyond just pleasing the eye. Here's design that flows naturally from advanced engineering . . . to fit form to function . . . to offer you a great New Plymouth that, inside and out, is better in every way!

Beauty with Reason

That sweeping, new low silhouette is something to see. And this is beauty with a reason. It helps give you a car that's easier to use in all ways. Easy to start—easy to drive—easy to park—easy to see out of.

Beauty for Comfort

The beautiful new interior styling is even better than it looks. The famous chair-height seats are now even wider. There's plenty of room for long legs and high hats. Windows lift and lower easier.

Beauty for Safety

The increased glass area is nice to look at from the outside. But it's there to look out of from the inside. Both windshield and rear window are larger. You get a clear, undistorted view of the road.

Just your style!



Special De Luxe 4-Door Sedan with Longer 118" Wheelbase

the great new **Plymouth**

For More Safety

New body construction makes the New Plymouth a sturdier, safer car. Frame and body are 23% more rigid. The New Plymouth has a lower center of gravity. It hugs the road better. And it handles with ease.

Beauty for Performance

There's a more powerful engine. This is the result of a newly designed cylinder head, increased compression ratio and a new intake manifold. New chrome compression ring gives even longer engine life.

Beauty for Value

To see how new car beauty helps make a better new car—see your Plymouth dealer now! You'll find that the great New Plymouth—feature for feature, dollar for dollar—hits a new high in automobile value!

NOW there's more difference than ever in low-priced cars—and the great New Plymouth makes the difference. See this new car at your Plymouth dealer's now.

PLYMOUTH Division of CHRYSLER CORPORATION, Detroit 31, Michigan

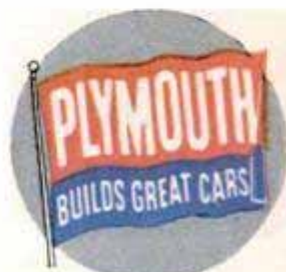

DEPENDABLE

CHAMPION

SPARK PLUGS



← America's Favorite!



"It's Spring—Let's go" is the friendly reminder you'll see at gas stations and service garages everywhere . . . a friendly reminder to you that your winter-wearied spark plugs should be checked and cleaned . . . may even need replacement. Spark plugs are vitally important to every phase of

performance of your car at all times, and a new set of Champions represents the ultimate in quality, value, performance and dependability. That's why engine experts, like most racing champions, will use no others . . . why they are America's Favorites. Champion Spark Plug Company, Toledo 1, Ohio.

FOLLOW THE EXPERTS

DEMAND DEPENDABLE CHAMPIONS FOR YOUR CAR

Listen to the CHAMPION ROLL CALL . . . Harry Wismer's fast sportscast every Friday night, over the ABC network

Famous 35mm. Miniature

... now finer than ever

**KODAK
RETINA II
CAMERA
f/2**



Ultra-fast f/2 coated lens. Ask your Kodak dealer for a demonstration of this famous Kodak miniature. \$197.75, including Federal Tax.

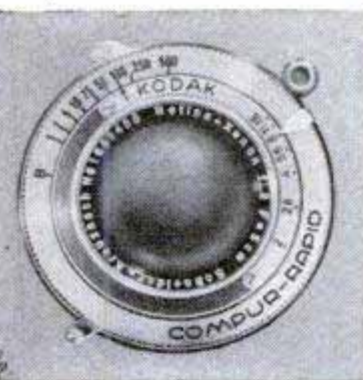

All ready for action with ultra-fast Schneider Xenon f/2 Lens and Compur-Rapid 1/500 Shutter—nine speeds plus bulb. Uses black-and-white Kodak 135 Films and Kodachrome Film.

New all-in-one view and range finder. Figure 1 shows subject out of focus with two images in the center area. Figure 2 shows subject *in focus* with one image superimposed on other.

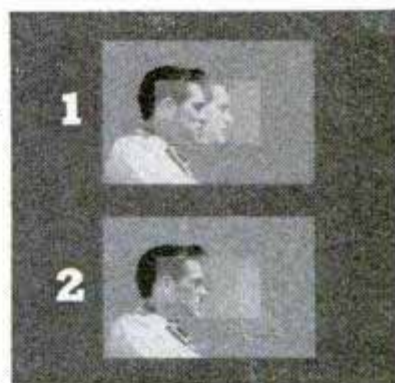

Finger-tip operation means easy control of the camera and a better picture on every shot. A, focusing knob; B, single view-and-range-finder window; C, film-wind knob (with automatic film stop and double-exposure prevention); D, shutter release; E, automatic exposure counter.

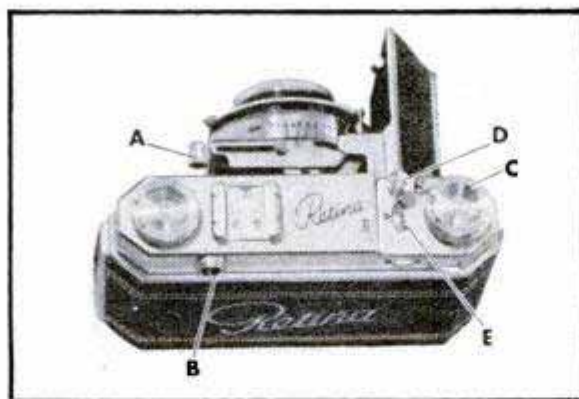

Extreme Compactness—folds up to fit small pocket or handbag. Built for long life—with strong but light die-cast aluminum alloy body and pin-grain leather covering. Its handsome design and watchlike workmanship are unique features. You'll like its solid feel and balance.

Also ask your dealer to show you the Kodak Retina I Camera with f/3.5 lens, a wonderful buy at \$72.75, including Federal Tax. Trim and sleek in styling. One look will convince you of its value.

(Prices subject to change without notice)

"Kodak" is a trade-mark

Kodak

EASTMAN KODAK COMPANY, Rochester 4, N. Y.

Neutral
Forward
Reverse

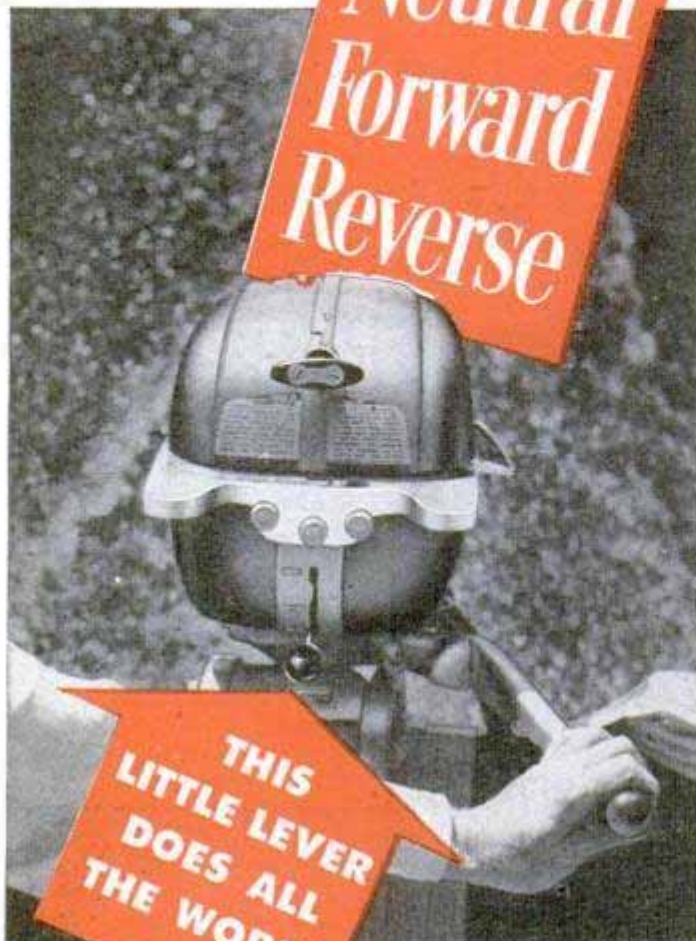

THIS
LITTLE LEVER
DOES ALL
THE WORK!



1949 OUTBOARD
SENSATION!
NEW JOHNSON QD!

You operate it by Gear Shift Control. Move the knob (shown above) and go from Neutral to Forward or Reverse. It's so easy!

Fuel is automatically fed to the motor from the separate, Mile-Master Fuel Tank (5 gal.-16 lbs.). Cruise for hours without refueling.

High power* — a compact, 56-pound ball-of-fire — yet it trolls!

See the QD at your Johnson dealer's. Look for his name under "Outboard Motors" in your classified telephone directory.

JOHNSON MOTORS
400 Pershing Rd., Waukegan, Ill.
Johnson Motors of Canada
Peterboro, Canada

*10.0 — O. B. C. Certified
Brake H.P. at 4000 r.p.m.

FREE Handy Chart

Write for the 1949 Sea-Horse Handy Chart. Illustrates and charts the QD and the 4 other great Johnsons for '49. All features are fully described.

JOHNSON SEA-HORSES
for *DEPENDABILITY*

Record Player for Small Children

(Continued from page 235)

leads to the phono-pickup arm of the record player. All of these terminal strips are clearly identified in photos A, B and F.

The large intersecting holes in the sides of the metal chassis case, detailed in Fig. 2, are $\frac{5}{8}$ in. in dia. and are necessary to clear the soldering terminals on the rear of the twin-screw Bakelite terminal strips; the

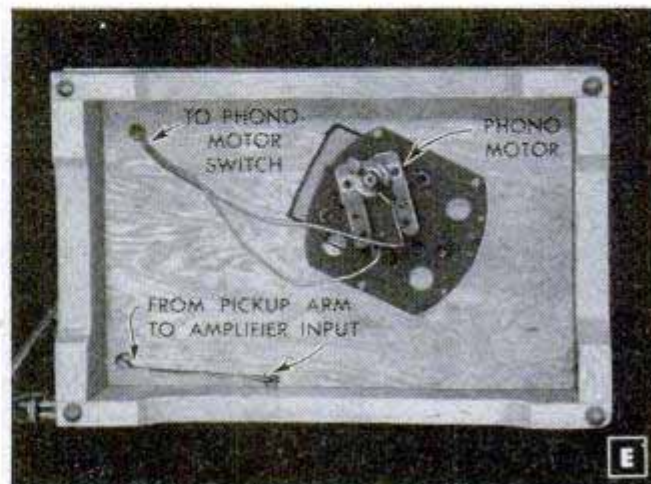

small mounting holes at each side are for 6-32 machine screws. Grommet holes are indicated and their size will depend upon the diameter of the rubber grommets used to bring out the leads to the "Jones" terminal strips. No mounting-screw holes are shown for these strips. However, they are easily located by using the terminal strip for a

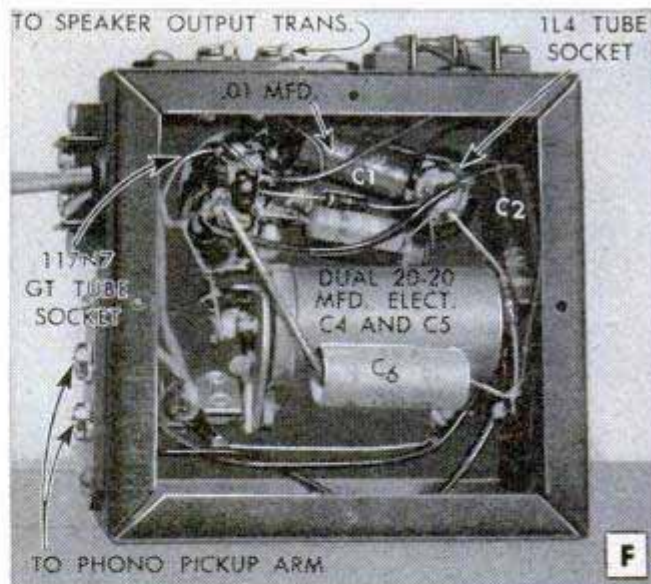

template. The large intersecting holes in the sides of the chassis case, and the holes in the top panel for mounting the octal socket for the 117N7 tube, and the smaller socket for the 1L4 miniature-type tube may be made with a "Greenlee" or similar chassis punch. If you do not have one, you can have them punched at your local tin shop.

(Continued to page 240)

IF YOUR HOME REPAIRS
LOOK LIKE THIS...IT'S TIME
TO BUY SOME TOOLS...

IF YOUR CAR FEELS LIKE THIS
and IT'S TIME FOR MARFAK
CHASSIS LUBRICATION

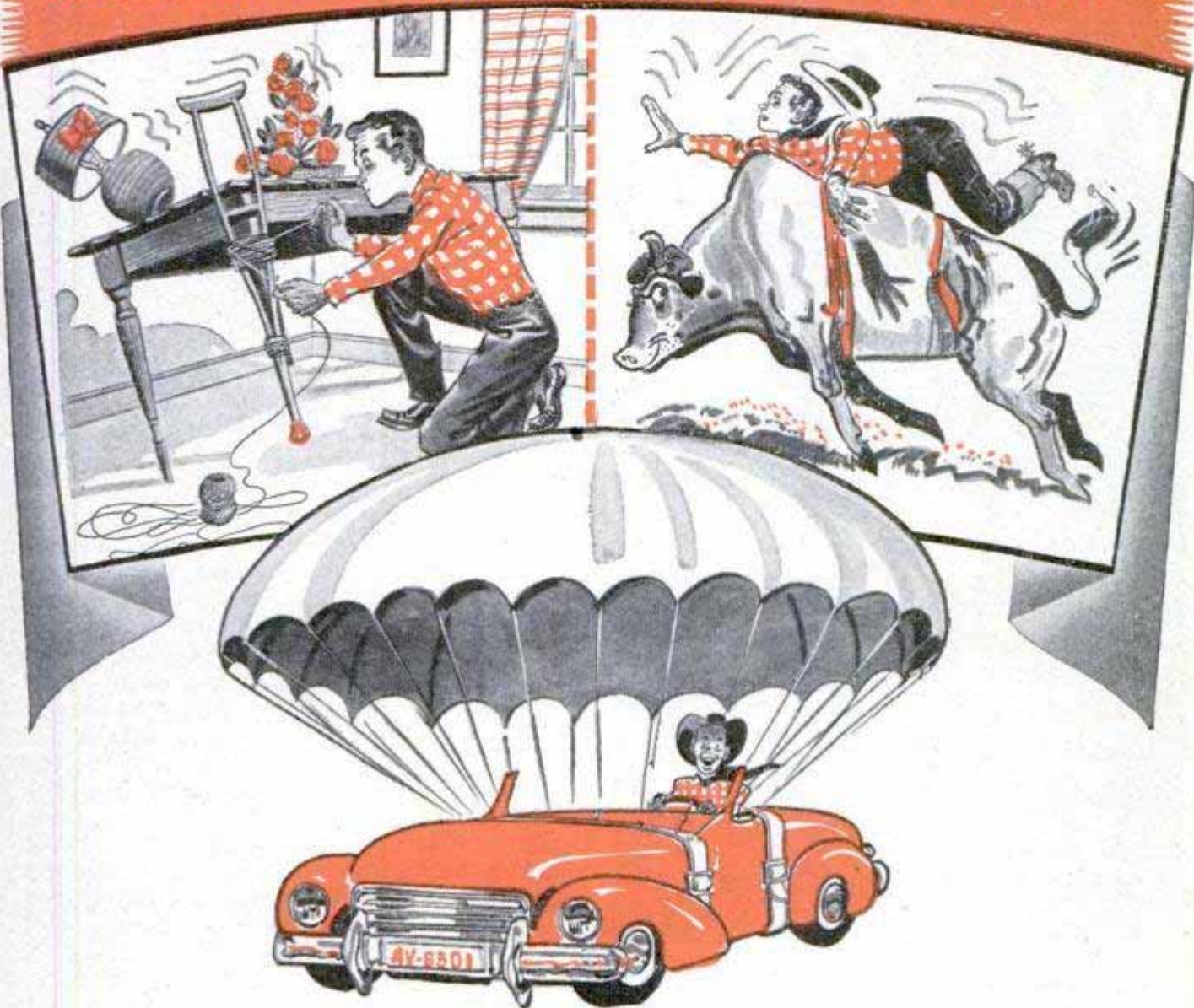

THAT CUSHIONY FEELING LASTS LONGER WITH MARFAK!

It's a hard, tough job to protect your car's vital wear points. So for longer-lasting, sure protection, get *Marfak* Chassis Lubrication. It is specially compounded to fight wear and friction — not for just a couple of hundred miles but for 1,000 miles and *more!* You can tell this is so by that grand "cushiony" driving ease that *stays* with you. Ask for *Marfak* today at your neighborhood Texaco Dealer, *the best friend your car ever had.*



THE TEXAS COMPANY
TEXACO DEALERS IN ALL 48 STATES

Texaco Products are also distributed in Canada

TUNE IN . . . TEXACO STAR THEATER every Wednesday night starring Milton Berle. See newspaper for time and station.

EXTRA COMFORT

EXTRA WEAR

2-PLY GLOVES



Riegel's 50-50

2-ply palm, thumb and index finger.

Knit wrist or gauntlet

Twin plys of soft but sturdy fabric make Riegel's 50-50 Work Gloves a big value in comfort, safety and long wear.

OTHER STYLES FOR EVERY NEED

Canvas, jersey, leather . . . knit wrist, band top, gauntlet . . . double palm, reversible, quilted. Ask for the Riegel brand wherever work gloves are sold. Free catalog if requested on business letterhead.

Riegel Textile Corp.
342 Madison Avenue
New York 17, N. Y.



"THIS TRADE MARK IS YOUR GUARANTEE OF VALUE"

The tube sockets are both of the Amphenol retainer-ring type.

You will note the leads from the filter choke are brought down through a hole in the top panel. The leads to the power switch and the phono-motor switch are brought out through holes and rubber grommets located under each "Jones" terminal strip, which provide dual external connecting screws. By bringing the leads out in this manner, no connections need to be unsoldered to remove the amplifier from the wooden cabinet.

The cabinet and motor-board base are detailed in Fig. 1. Drill and cut the necessary holes in the plywood motor board before assembling it on the base. When the base is assembled, it should be given two coats of cream enamel, sanding lightly between each coat. Mount the phono motor, which may be any standard rim-drive type with 9-in. turntable and crystal pickup arm, on the motor board. Then cover the top of the motor board with red leatherette, gluing it in place. Binding tape may be used for trim—it is held down with upholsterers' tacks. Photo E shows an underside view with the leads running up to the phono-pickup arm from the amplifier unit, and from the phono motor up to its switch on the front of the speaker cabinet. This plywood cabinet mounts directly on the top of the motor board and is also detailed in Fig. 1. Although any small receiver replacement cabinet may be used, the one shown is very simple to construct. It provides a housing for the small amplifier unit and a baffle for the loudspeaker. The speaker grille cloth used was a bright red to match the top of the motor board. The toggle switches are mounted on this cabinet in the positions indicated in photo C. Label the on-off switch, and mount so that both are "off" when pulled down. Four small screws hold the cabinet on the base. The cabinet is painted with cream enamel to match the base, and it is then decorated with nursery-rhyme decals. Four rubber feet are mounted on the corners of the base to prevent scratching table tops. The assembly is completed by wiring the switches and installing the amplifier and speaker as shown in photo D; the line cord can be brought out under the base either at the rear or on one side. The final step is to cover the back of the cabinet with a perforated fiber or metal screen, which should be securely screwed in position. This cover must necessarily be perforated to provide ventilation. Detailed student material list R-377 is available from Popular Mechanics Radio and Electronics department without charge upon receipt of ordinary letter postage.

SURE CURE FOR

Oil Waste



Gas Waste



and Failing Power



Our Challenge

There are thousands of designs of piston rings made by 77 manufacturers—BUT this Sealed Power MD-50 Steel Oil Ring has exclusive advantages possessed by no other. Drop us a postal for positive proof of sheer mechanical superiority!

SEALED POWER PISTON RINGS

Save Oil! Save Gas! Seal Power!

Wouldn't you rather drive with 1949 pep and 1949 economy—than to plug along with a grunting, groaning, oil-gulping engine? Sealed Power Piston Rings will help you save oil, save gas, restore original power—no matter when your car, truck or tractor was built! The amazing Sealed Power MD-50 Steel Oil Ring has caused a sensation throughout the industry! It is giving thousands of owners the benefits of sealed-in power. It is

praised by mechanics from coast to coast. It is the only piston ring with the exclusive Sealed Power Full-Flow Spring. Ask your Sealed Power Franchised Dealer to tell you the whole story now!

Mail a postal card today for proof to back up our challenge. At the same time we'll send you our new illustrated booklet on 7 ways to save oil. It's free and may save you real money. Sealed Power Corp., Dept. G-5, Muskegon, Michigan.

There is a Sealed Power Set specifically engineered for your car, truck or tractor—whatever the make, model, or condition!



Sealed Power Piston Rings are original equipment in 15 makes of passenger cars and 24 makes of trucks and busses.

Sealed Power
PISTON RINGS
BEST IN NEW CARS! BEST IN OLD CARS!

MECHANICS - See this Improved "Mike" Now at your dealers



7 SUPERIOR FEATURES: "Chrome Clad," Non-Glare Satin Finish, Easy to Read, Rust and Wear Resistant • One Piece Spindle • Hardened Ground Thread • Easy Adjustment • Cutaway Frame • "Rapid Reading" (Each Thousandth Numbered) • Micro-Lapped Mirror-Like Finish on Anvil and Spindle Ends.



◀ The large throat depth and cutaway frame make entry possible in minimum clearance and enable easy measuring to maximum depth in narrow slots.



It is well balanced. Ratchet stop eliminates overpressure, gives consistently accurate measurements—important when your "feel" is off. ▶



◀ Easy to take apart and clean inside thimble and thread. Reading line keeps original position after adjusting for wear or lapping of anvil, and spindle faces.

Buy
LUFKIN

Precision Tools • Tapes • Rules • FROM YOUR DEALER
The Lufkin Rule Company • Saginaw, Michigan

FREE! Send for this booklet—
"The Amazing Story of Measurement"
Write Dept. M

How to Tempt a Fish

(Continued from page 104)

to this trend is found in Florida where the bass in fresh water run up to 16 and 18 pounds and the salt-water fishes now and then tip the scales at close to 100 pounds. The expert or the stunt fisherman may use these small lures with light rods and fast reels for big fish, but we recommend having two outfits.

You can catch bass, crappies, bluegills, rock bass, perch, pickerel, northern pike, lake trout, and all the salt-water species that come into the bays, bayous, rivers, canals and ditches, but you really haven't fished until you've taken a muskellunge on light tackle.

My favorite fish is called by many many different names: muskellunge, maskinonge (Canada), muskie, muskalonge, masquel-longe (French Canadian), lunge, kin-nonge, mascanonge, mascallonge, muskal-longe, maskenosha, muscallunge, nosca-nonge and dozens more.

The muskie is a top fresh-water game fish—always ready for a fight. Because of its size, running up to 100 pounds, it is the biggest of all fresh-water game fish.

With the possible exception of bonefish addicts or tarpon enthusiasts, no anglers are more enthusiastic about fishing than those who go for muskies. At least a million have caught the great tiger-striped battler and now they are afflicted with "muskellunge-itis."

There is but one cure. A doctor's prescription for these victims reads: "Three weeks in Ontario in July, August or September on any of the following streams or lakes: Lake of the Woods, Lake Manitou, Eagle Lake, the Vermilion lakes, Lac Seul, Cliff Lake, Cedar Lake, the Winnipeg River, Georgian Bay, French River or Lake Nipissing."

There is nothing meaner or tougher than a muskie unless it's his salt-water ruffian of a brother called the greater barracuda. He's the fightin'est fish that ever tore a plug to pieces. It's no wonder muskies are so often called "tackle busters."

Muskie tackle is special. A 5 or 5½-foot rod with a stiff backbone is best. A level-wind, quadruple-multiplying reel is just right. A 12-inch wire leader is essential. A 15 or 18-pound-test line is good for a 60-pound fish. Use large plugs or spoons: surface plugs, semisurface plugs, and deep-running plugs, spoons or bucktails.

When a muskie strikes, anything can happen. The big tail lashes the water to a foam. Meanest sight of all is a muskie that takes off and heads for the boat. Until you

(Continued to page 248)



**"My race
for life
against a
Rattler's Poison!"**

A true experience
of **WILLIAM F. COLLEY**
San Diego, Calif.



1 "A piercing shriek cut the silence as I lay in wait for deer in the Laguna Mountains near San Diego. I dashed to Sam Reardon, my hunting companion. A 3½-foot rattler had dug his fangs into Sam's ankle! Twice in my own life, I'd felt the rattler's sting. I knew what to do.

2 "I shot the rattler. Then I opened up my snake kit. Night was closing in. I needed light—good, steady light. My flashlight with its 'Eveready' batteries was the answer. By its light, I made a tourniquet, cut a cross incision, removed the venom.



3 "Those long-life 'Eveready' batteries gave plenty of bright light as I carried Sam and flagged a car. I thank my flashlight for saving Sam's life. Now I know why 'Eveready' are the batteries with 'Nine Lives'!"



Just as an
active cat
...takes



a cat nap ... and



bounces
back with
new pep

...so "Eveready"
flashlight batteries re-
cover power between
uses and bounce
back for
extra life!



THE FLASHLIGHT
BATTERY WITH

"NINE LIVES"!



"Eveready," "Nine Lives," and the cat symbol are trade-marks of
NATIONAL CARBON COMPANY, INC.:

30 East 42nd Street, New York 17, N. Y.

Unit of Union Carbide **UCC** and Carbon Corporation



SAVE MONEY—EARN MONEY

EASI-BILD* Full-Size Pattern

simplifies sign-making:



• Name Plates



• Signs for Commercial use

• House Numbers



THESE professional-looking signs are ideal for your own use—also a profitable spare-time business. Full-size pattern contains three different size alphabets with matching numbers, plus four background signs. Just trace letters on wood or metal; saw and assemble. Use CASCOPHEN glue for outdoor use, CASCOREZ for indoor use or CASCO Flexible Cement for gluing metal to wood.

*Copr. 1949, Easi-Bild Pattern Co.

Follow These Directions.

Solve All Your Gluing Problems:



For boats, outdoor furniture, sports equipment—joints that must withstand outdoor exposure—CASCOPHEN (Resorcin Resin Glue). The first completely durable glue available to home craftsmen.



For furniture, toys, heavy-duty repairs—strong, stainfree, moldproof, highly water-resistant CASCAMITE (Urea Resin Glue). Mixes quickly with cold water!



For models, photo prints, labeling—general home, school, or office gluing, use the new, clean, white, fast-setting CASCOREZ (Polyvinyl Resin Glue). Liquid, ready to use!

SEND COUPON FOR SIGN PATTERN TO:

Casco Pattern Dept. PM-59
P. O. Box 215, Pleasantville, N. Y.

Enclosed is\$ for pattern and book checked below.

() Signs and Name Plates, Pattern No. 74—25¢.

() 32-page Pattern Book illustrating 94 pattern projects—20¢.

Name _____

Address _____

City _____ Zone _____ State _____

THE BORDEN CO. • CHEMICAL DIVISION
Makers of Casco Glues

Clinic



for Homemakers

As a service to our readers in solving the hundreds of problems pertaining to a home—inside or out—the editors of *Popular Mechanics* invite you to present your problems to The Clinic Editor for help and advice. Address your questions to The Clinic Editor, *Popular Mechanics Magazine*, 200 East Ontario Street, Chicago 11, Ill.

Strawberry Leaf Spot

Q—What causes the purplish, red spots on leaves of the strawberry plant? Also, what is the cause of the tiny, round holes which appear in the leaves of the plants in the early spring? G.B., Portsmouth, O.

A—The red spots on the leaves are caused by a plant disease variously known as leaf spot, sunscald and leaf blight. The remedy is either to destroy the infected strawberry bed and to plant disease-resistant varieties or to spray existing plants with Bordeaux mixture just before the blossoms open and also once or twice immediately after the berries are harvested. Small, round holes in the plant leaves usually are caused by the strawberry flea beetle. Spraying the plants with lead-arsenate solution will discourage the beetles.

Rainwater Disposal

Q—I live in an area where there are no storm sewers and water from the downspouts has washed large holes in the lawn near the foundations. I tried filling these holes with fine gravel but this does not help. What should I do to prevent this trouble? S.W., Creston, Iowa.



A—Provide concrete splash blocks under each downspout. These are easily made by using the earth as a form. Dig a pear-shaped hole about 5 in. deep and 36 in. long. The narrow end of the pear-shaped recess should be dug directly under the end of the elbow at the lower end of the downspout. Fill the hole with cement flush with the grade and trowel the surface slightly convex. This will spread the stream of water from the downspouts and prevent the soil from washing away. Another method frequently used in outlying sections is to provide an old-fashioned cistern, or "dry well." Dig a hole not less than 6 ft. from the house foundations to a depth of 6 to 8 ft. and 5 ft. or more in diameter. Line this with bricks laid in broken courses, without mortar. Cover the bottom with gravel to a depth of 6 to 8 in. By laying each course of brick slightly overhanging the preceding course, the brick lining can be made to draw inward to a conical shape, making the opening at the top considerably less than the maximum diameter. This opening should be covered with a reinforced concrete top and provided with a manhole. All the house downspouts are then arranged to empty into the well.

(Continued to page 246)



Euclid didn't know about *steering* geometry

... and you won't know its highest development till you try Chevrolet's new Center-Point Steering.

Two-wheeled carts and chariots didn't need any steering mechanism; they just naturally followed wherever the horses led. When four-wheeled horse-drawn vehicles came into use, the front axle was pivoted to swing on a central king pin—but it was the horses, not the driver, that supplied the power

needed to swing the axle left or right. Then came the automobile—and, for the first time, the driver of the vehicle had to do the steering by his own muscular effort. That's when

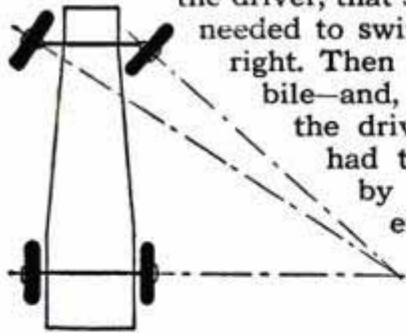

the modern steering arrangement—each front wheel swinging on its own king pin—came into use.

Today, a new high in perfection has been attained in Chevrolet's Center-Point Steering. Road shock is eliminated, wheel-fight is banished, tire wear is reduced; it brings a new ease of handling, a more positive and effortless control. As test drivers at the Proving Ground summed it up, the new Chevrolet, thanks to its advanced steering, is a car that has *road sense*. You're invited to drive the new Chevrolet, to experience a new high in steering satisfaction.



The Styleline De Luxe
2-Door Sedan



CHEVROLET

The most Beautiful BUY of all

CHEVROLET MOTOR DIVISION, GENERAL MOTORS CORPORATION, DETROIT 2, MICHIGAN

What makes the difference?

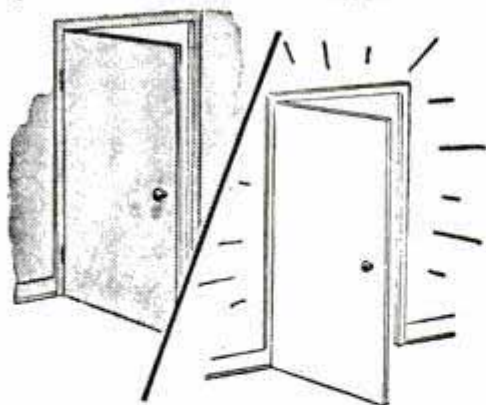

LIN-X CLEAR-GLOSS VARNISH

Yes, and what a difference! That clear, tough, long-lasting coat of Lin-x Clear-Gloss Varnish protects and beautifies floors, woodwork, furniture, printed linoleum, boats, countless other surfaces—resists boiling water, sizzling cooking greases, alcoholic beverages. And so EASY to use—just brush it on!



At your paint, hardware and department store!



Distributed by

Acme White Lead & Color Works, Detroit • The Lowe Brothers Co., Dayton • John Lucas & Co., Inc., Philadelphia • The Martin-Senour Co., Chicago • Rogers Paint Products, Inc., Detroit • The Sherwin-Williams Co., Cleveland

IT TASTES BETTER cooked on an OUTDOOR FIREPLACE

It's fun to build your own fireplace... choosing your own



materials and design! Costs so little!

Simply build masonry around this durable, all-metal Model OF-28 fireplace unit. Rugged, cast iron doors. Grates arranged for either charcoal or wood! Size 21" high, 26" long, 13 1/2" wide. Larger size available. See your dealer or send money order or check today. The Majestic Co., 199 Erie St., Huntington, Ind.



ONLY
\$17.95
COMPLETE

SEND FOR THIS BOOK OF DESIGNS
48 pages of helpful tips on fireplace and outdoor
cooking. Send 25c for your copy.



Another Majestic Product

Limed-Oak Finish

Q—I have an old chest of drawers in solid oak with overlay carving. I'd like to modernize this chest by removing the carvings and the finish and then refinish it in limed oak. Is this practical, and, if so, how do I proceed?

J.M., Fresno, Calif.

A—We assume that the chest still is in good condition structurally and that the carvings are all overlays and not relief carvings. Use care in removing the carved overlays as they probably are glued on. Then remove the old finish with successive applications of varnish remover and scrape off all remaining residues to the bare wood. If a dark stain was used under the original finish, considerable sanding will be necessary to remove this from exposed end grain. Now apply a wood bleach to lighten the oak wood to a uniform color. (Caution: Handle bleaching materials with care as the chemicals used in these preparations are highly caustic.) After bleaching, it may be necessary to scrape all surfaces with a sharp, cabinet scraper to remove any of the old filler remaining. Sand the work thoroughly and apply a white filler. Remove all excess filler by rubbing across the grain with a coarse cloth. Allow the filler to dry thoroughly, then again sandpaper lightly and apply a sanding sealer. Sand this coat lightly and finally finish with varnish or wax.

Noisy Water Heater

Q—Our hot-water tank is heated with a coil-type gas heater. After the heater has been started and the water has been warmed, there is a peculiar, sharp rumble, and opening the warm-water faucet causes a loud, hammering sound. What is wrong with the installation? B.C., Birmingham, N.Y.



A—It could be that the tank is air-locked, although this condition usually causes noise only when the faucet is opened. The heater coil may be clogged with a hard lime deposit. If the faucets are of the older type having a fuller-ball valve, wear in the actuating parts will allow movement of the ball valve against the water pressure. This will cause a hammering sound when the faucet is opened. However, according to your description, we are inclined to believe that you are heating the water to the point where steam is generated in the tank. Steam will cause the rumbling sound you describe. Installation of a thermostat to control the gas heater probably will correct the trouble.

Killing Tree Sprouts

Q—Two years ago I cut down a tree growing in my yard, leaving a stump about 4 ft. high. Sprouts have grown from the stump each season. Seemingly, no amount of cutting will get rid of them. Is there any way I can kill the sprouts and still leave the stump? B.W., Birmingham, Ala.



A—Wait until the sprouts get a good start in the spring and are growing vigorously. Then sprinkle them with a strong solution of 2,4-D weed killer. About the best way to apply the weed-killing solution is with an ordinary sprinkling can. However, this particular can should not be used at any time thereafter for watering flowers or any other choice plants, as residues from the weed-killing solution may remain in the can indefinitely, thus endangering any other plants sprinkled with water from this particular can. If you do not wish to contaminate a sprinkling can with the herbicide solution, then cut the sprouts near the stump with pruning shears and place a drop or two of the full-strength weed killer on the cut end. Several applications may be necessary.

Only **AUTO-LITE**

**OFFERS CAR AND TRUCK OWNERS EVERYWHERE
THE SENSATIONAL ADVANTAGES OF A**

Resistor Type

SPARK PLUG

Now standard equipment
on 6 leading makes of
cars and trucks



Get these 4 Star Benefits

A SMOOTHER ENGINE IDLE
Wider spark gap helps eliminate occasional missing.

IMPROVED GAS ECONOMY
Permits burning of leaner mixtures and reduces misfiring.

INCREASED ELECTRODE LIFE
Up to 200% and more.

IMPROVED RADIO RECEPTION
Reduces plug interference with radio, radar and television within 35 mv/m from 540 kc. to 150 mc. at 50 ft.

★ Because of its low rate of electrode erosion, the new Auto-Lite Resistor Spark Plug permits wider initial gap settings and makes these advantages possible.

ALREADY OVER 11,000,000 IN USE IN CARS AND TRUCKS EVERYWHERE!



**"Why do it the hard way?
Get an Actionrod!"**

Once you've tried Actionrod's *live* action, you won't forget it!

Actionrod is solid steel—delicately balanced, responsive to the touch. Its "custom-built" feel—the result of years of experience in tapering and tempering—is as comfortable as your old fishing hat.

For easy, effortless casts . . . for greater accuracy every time . . . you need an Actionrod. Your favorite sports store has it.

ORCHARD INDUSTRIES, Inc. • Detroit 5, Mich.

Complete price range



Wedge-Type Reel Lock



Owner's Name on Handle

ACTIONGLAS Orchard's great new development in glass rods. Available in casting and fly rods. \$25 to \$35.

Actionrod

**"SOLID STEEL
WITH LIVE ACTION"**

know his intentions, it's just a question of what to do—when and if. Many an angler has tossed his whole outfit in the water and wanted no more of muskie fishing. And many a muskie has driven straight for the boat and then leaped out of the water so high that he has cleared the craft. Others have landed inside.

When one wild muskie landed in a row-boat, the excited fisherman whipped out his six-shooter and let Mr. Muskie have it, then he and the guide had to row for shore to save themselves from drowning.

Muskies are a favorite sport and food fish and are found in weed beds and on bars in lakes and rivers of the north country.

The northern muskellunge (*Esox im-maculatus*) has a golden bronze appearance, often with reddish fins and tail, and inhabits the waters of Wisconsin, Minnesota, and from the Mississippi basin northward almost to Hudson Bay.

The Chautauqua or Ohio muskie (*Esox ohiensis*) is yellowish green in color and has a barred pattern that resembles worm tracks. It is found in the waters of the Ohio River and in many of its tributaries in New York, Ohio, Pennsylvania, Indiana, West Virginia, Kentucky, Alabama, Tennessee and North Carolina.

The St. Lawrence muskie (*Esox masquinongy*) is silvery and gray-green in color and is found in the Upper St. Lawrence River, parts of the Great Lakes and some of the rivers and lakes of eastern Ontario and western Quebec. It is famous in Lake Nipissing, Lake Ontario, the Niagara River and in French River.

The new muskie, the True Tiger (*Esox masquinongy amentus*), discovered by Mike Ament of Sioux Lookout, Ont., is a sub-species of the northern muskie. I have caught a dozen of them myself and can attest to the vast differences. There are two different muskies in Muskie Lake and in Little Lake Vermilion—the northern muskie and the True Tiger. The latter has a white skin with tigerlike bars that stand out like the stripes of a zebra. The body is shorter and the fish is heavy. The head is large for the length of the fish and the fighting qualities are greater. Biologists who have studied the differences agree—we have found a new muskie.

Tungsten-Carbide Glass Cutter

Four miles of glass can be cut by a wheel made of tungsten carbide. It is three times as hard as the best hardened steel and will cut half the length that an average-grade diamond will before the diamond needs resetting.

Every day is fun day



ON A
HARLEY-DAVIDSON
with the new **HYDRA-GLIDE FORK**



EVER ride on a cloud? Ever wish you had a motorcycle that would give you that feeling? Well, brother, here it is... the 1949 Harley-Davidson with the Hydra-Glide Fork! Glide is a *mild* word for it! Never before has such riding comfort, steering ease and roadability been built into a motorcycle. You *float* over bumps, *skim* over rough roads, *sail* down the straight-aways, enjoy every mile as never before. Even on longest trips, you're fresh as a daisy, ever ready for fun as you take in exciting race meets, endurance runs, hillclimbs, gypsy tours, sightseeing trips. Try a glide-ride and be convinced! See your Harley-Davidson dealer today. Mail coupon now.



HARLEY-DAVIDSON MOTOR COMPANY
Dept. P, Milwaukee 1, Wisconsin

Send free copy of ENTHUSIAST magazine, filled with motorcycle action pictures and stories; also literature on latest models.

Name.....

Street or R.F.D.....

City.....Zone...State.....

Time for your **SPRING** PurOlator-Change



A CLOGGED OIL FILTER IS DANGEROUS. Engine-wrecking sludge and abrasives threaten sizable repair bills.



"MICRONIC" CONSTRUCTION MAKES THE DIFFERENCE. Pores so tiny they trap *all* the sludge, all the abrasives.



INSTALLED IN A FEW MINUTES—and now you can be sure that your oil will stay cleaner, your engine will be safer.



COSTS SO LITTLE . . . and can save so much in engine repairs. Only \$1.38 to \$2.50, depending on make of car.

Make the Spring changeover complete . . . new oil and a clean oil filter. Put in a PurOlator "Micronic" Refill. PurOlator, remember, is the filter that traps *all* the engine-wrecking sludge and abrasives.

PurOlator "Micronic" Refills fit *all* oil filters. \$1.38 to \$2.50, depending on make of car; inserted in a few minutes. If your car is *not* equipped with an oil filter, install a PurOlator. \$6.50 up, also depending on make of car.

PurOlator

MICRONIC OIL FILTER

. . . the oil filter that traps all the abrasives, all the sludge



Do You Get What You Pay For?

(Continued from page 167)

and building materials are sold, up to standards of accuracy.

Another important job is keeping gasoline pumps, trucks, storage tanks and meters in true measure and good working order.

The department's big, red "bandwagon" truck checks petroleum meters at wholesale yards, loading racks and docks in the harbor. It contains two testing chambers, one of 800 gallons capacity and one of 400. They are equipped with fittings and connections for testing and sealing meters with flows up to 300 gallons a minute.

Tank trucks and trailers are also measured and sealed for capacity. Each year hundreds of trucks roll into Los Angeles' Weights and Measures Department to receive an official O.K. on their stated capacity. Two vertical tanks, each holding 500 gallons of water, are the measuring devices. Overlapping gauge glasses, with calibrations from 0 to 500 on the sides, make rapid and accurate measurement possible.

When a motorist like Bill Jones complains that the gas pump at the corner service station is not accurate, an investigating crew is promptly sent out. Its car is powered from a secret gas tank and the regular gasoline feeder pipe leads to a test tank. If the measurement is correct, the surprised service-station operator gets his gasoline back. If not, he may be cited to appear in court.

Quality as well as quantity is important when it comes to gasoline and motor oil. In Los Angeles, suspicious samples of gasoline are put in a "Knockmeter" engine to get an accurate octane rating. Trained chemists put motor oils through elaborate tests with viscosimeters, distillation units, colorimeters, centrifuges, polarimeters and other laboratory equipment.

Not long ago, Los Angeles motorists began to complain about the quality of a certain well-known brand of Pennsylvania oil. The weights and measures men discovered that a slick crook had been buying up empty cans from service stations, filling them with crankcase drippings, recapping and selling them at standard prices. Caught red-handed, he paid a stiff fine and served a jail sentence.

Butane, a liquefied petroleum gas so volatile that it must be kept under pressure or it vaporizes, posed a new problem for the short-weight investigators. More than 200,000,000 gallons are now sold in California alone for trucks and other engines.

(Continued to page 252)

a new high...



● A New High in spark plug reliability.

Owners of cars, trucks, tractors, or boats will find that new AC Spark Plugs set a new high in reliability . . . because of AC's patented CORALOX Insulator.*

They withstand the punishment of heavy going or day-to-day driving better than plugs have ever done before.

They give you the benefits of easy starting and reliable performance in all seasons.

Get a set . . . and enjoy the new high in spark plug reliability.

AC SPARK PLUG DIVISION • GENERAL MOTORS CORPORATION



SPARK PLUGS

BUY WHERE YOU SEE THIS SIGN

AC's patented processes make Coralox the finest insulator in spark plug history. Improved electrical insulation, no matter how high the temperature. Better heat conduction. Maximum resistance to heat shock. Less fouling. Harder, stronger, longer-lived.

MORE NEW CARS AND TRUCKS
ARE EQUIPPED WITH AC SPARK PLUGS
THAN WITH ANY OTHER MAKE

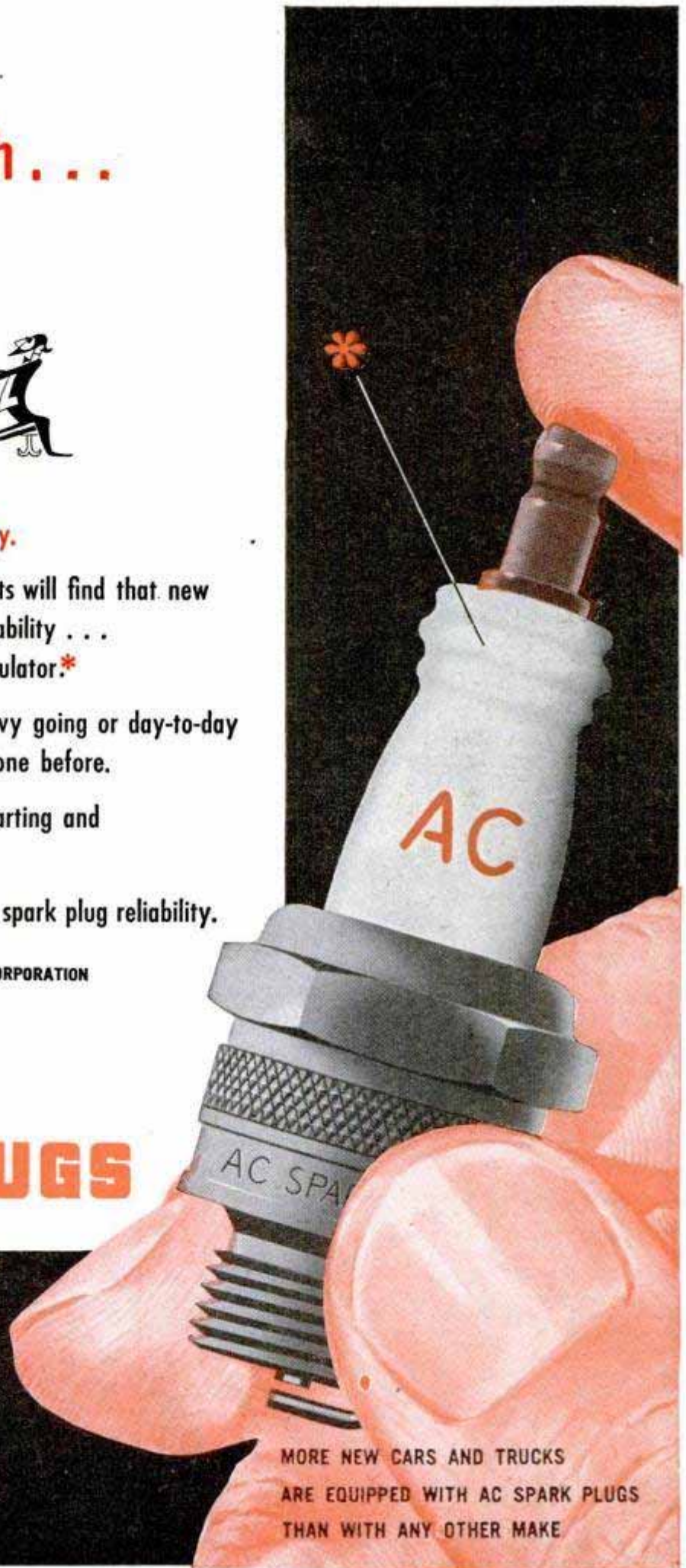

Here's America's most advanced outboard!

THE SENSATIONAL NEW

Scott-Atwater 1-16 SHIFT

5 HP* TWIN 1-16 MPH \$179.50

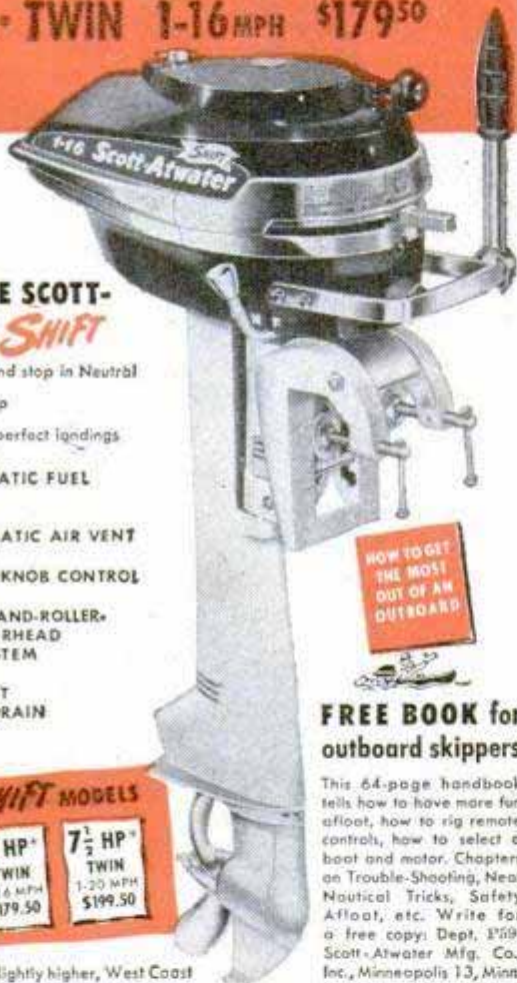

IT HAS THE SCOTT-ATWATER *SHIFT*

SHIFT to start and stop in Neutral
SHIFT to back up
SHIFT to make perfect landings

- IT HAS AUTOMATIC FUEL SHUT-OFF
- IT HAS AUTOMATIC AIR VENT
- IT HAS SINGLE KNOB CONTROL
- IT HAS A BALL-AND-ROLLER-BEARING POWERHEAD AND GEAR SYSTEM
- IT HAS INSTANT CARBURETOR DRAIN

| THREE <i>SHIFT</i> MODELS | | |
|---|---------------------------------------|--|
| 4 HP* SINGLE 1-14 MPH \$149.50 | 5 HP* TWIN 1-16 MPH \$179.50 | 7½ HP* TWIN 1-20 MPH \$199.50 |

4 and 5 HP models slightly higher, West Coast

HOW TO GET
THE MOST
OUT OF AN
OUTBOARD

FREE BOOK for outboard skippers

This 64-page handbook tells how to have more fun afloat, how to rig remote controls, how to select a boat and motor. Chapters on Trouble-Shooting, Neat Nautical Tricks, Safety Afloat, etc. Write for a free copy: Dept. P59, Scott-Atwater Mfg. Co., Inc., Minneapolis 13, Minn.

YOU'VE NEVER SEEN an outboard like this. It gives you cruiser control with the Scott-Atwater *SHIFT*—just *SHIFT* to Neutral, Reverse and Forward. It gives you the latest, greatest features—Rubber-Cushioned Shock Absorber Drive, Rotoflex Water Pump, Duo-Grip Carrying Handle, New Slip Clutch, Full-Expansion Exhaust—*plus all those above!* Yet the revolutionary Scott-Atwater 1-16 *SHIFT* actually costs no more than an old-fashioned outboard!

*OBC Certified
@4200 RPM

SHIFT

For information
write Dept. P59,
Scott-Atwater
Mfg. Co., Minne-
apolis 13, Minn.

to Scott-Atwater

Charlie Fuller's experts devised a butane-testing rig, which has been copied widely in other parts of the United States. It looks like an old-fashioned fire-engine boiler. Because butane boils at a temperature that freezes water, a specific-gravity kit is used to lower samples to 70 degrees below zero, Fahrenheit, where it remains a liquid at atmospheric pressure and readings may be taken on special hydrometers and thermometers. The exact weight of one gallon of the liquid is thus determined—making it possible to estimate the actual amount delivered in the test run.

Once, a well-known brand of butter began to appear in grocery stores short about one ounce. A quiet investigation followed and it was found that the Los Angeles distributor was cutting a slice from each pound and wrapping it up again. The slices were repacked and sold as additional pounds.

In one campaign, Fuller and his men destroyed more than 250,000 short-weight milk bottles. It resulted in an annual saving of \$90,000 to Los Angeles consumers. Milk bottles are now inspected before being placed in use by testing a sample taken at random from each shipment. A slight variation, over and under, is allowed, but the average must be full measure.

During the postwar building boom, the Los Angeles Department of Weights and Measures has taken on the additional task of measuring the square footage of carpeting for new homes. Cutting a carpet to allow for odd-shaped rooms, registers, doors and hallways sometimes produces wastage that a homeowner doesn't count upon. Fuller's men try to establish confidence between the homeowner and the carpet company.

Grease-measuring devices were a problem until the job was tackled by the Los Angeles investigators. Many of the early-type guns were crude affairs. They were supposed to deliver a pound of grease per "shot" to gear cases and differentials. Tests showed, however, that they would deliver anywhere from ½ to 1¼ pounds. Fuller and his men drew up specifications for accurate grease guns which have been adopted nationally.

How much does it cost to maintain an honest balance between the buyer and the seller?

Fuller figures that his department, operating on an annual budget of \$163,000, costs the Los Angeles citizen about four cents for a year of service that saves him many dollars. That's not much to pay for "A Square Deal for All," the motto of the short-weight sleuths.

MOISTURE AND DIRT CAN'T GET IN



...that's why All-Glass

G-E HEADLAMPS DO NOT GROW DIM!

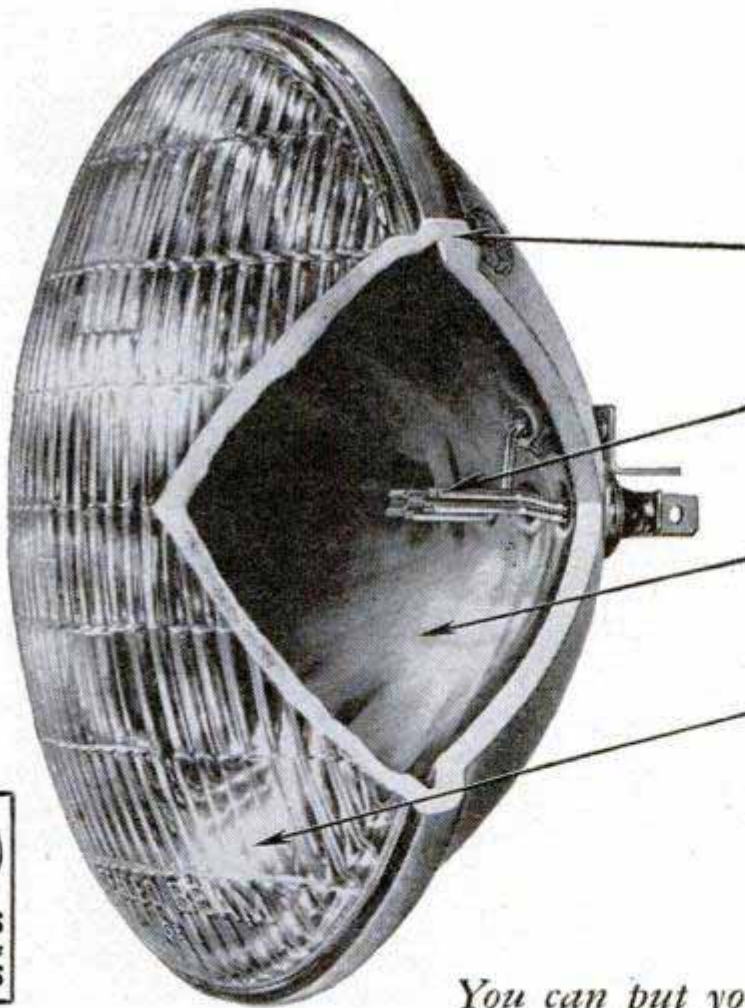

Rugged, one-piece construction keeps out *all* light-dimming dirt and moisture. The average General Electric headlamp gives 99% of original light output even at the end of lamp life.

Improved filaments give 12% more light on the road. And they won't shake loose.

Moisture and dirt can't get in to tarnish reflector. It stays mirror bright for life.

Lens is made of shock-resistant hard glass. Precision-built to put maximum light on the road.

Be sure you have your headlamps checked next time you leave your car for service—and be sure to insist on General Electric.



You can put your confidence in—

GENERAL ELECTRIC

FREE PLAN

Tells How to Start
Your Own Business

FILING SAWS

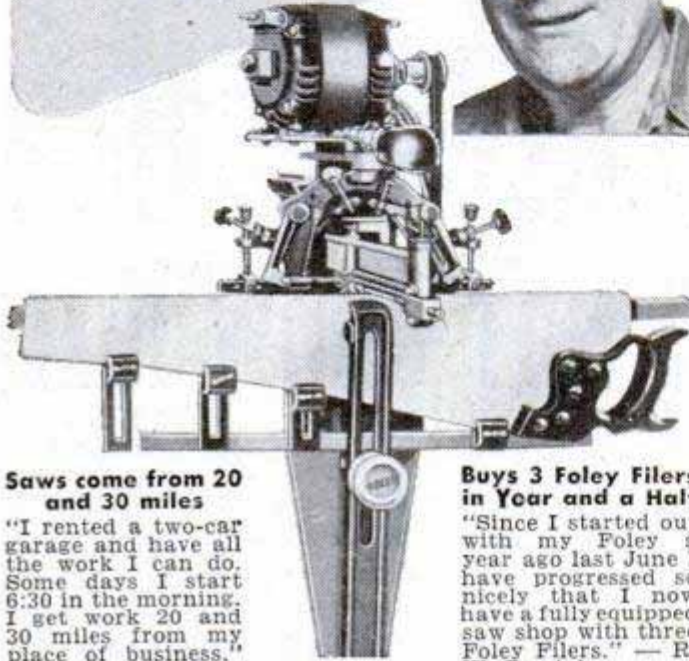

Saws come from 20
and 30 miles

"I rented a two-car garage and have all the work I can do. Some days I start 6:30 in the morning. I get work 20 and 30 miles from my place of business."
—Charles H. Smith.

Buys 3 Foley Filers
in Year and a Half

"Since I started out with my Foley a year ago last June I have progressed so nicely that I now have a fully equipped saw shop with three Foley Filers." — R. W. Persinke.

FOLEY FILED SAWS BRING NEW CUSTOMERS

Here is a steady repeat CASH business you can start in your own basement or garage in your spare time. Every saw you sharpen with the machine accuracy of the Foley Saw Filer is an ad that brings you more customers. S. M. Hollingshead wrote to us: "I am doing very well with my Foley Filer, and I am glad I invested in your machinery. It is very satisfactory and works very well in the small community in which I live."

You can file all hand saws, also band and cross-cut circular saws on the Foley Saw Filer. The adjustments are simple—there is no eyestrain—and you can start right away to turn out perfect cutting saws. "The first saw I sharpened with my Foley Filer came out 100%. I think it is a marvel of perfection."—writes Clarence E. Parsons.

FREE BOOK Shows How to Start

"INDEPENDENCE AFTER 40" explains how you can get business from hardware stores, home owners, farmers, carpenters, schools, mills, factories, etc. Just think—with a modest investment, no overhead, no stock of goods to carry, you can start right in on a cash business that will help pay the rent, buy groceries, or a new car. Start now—you can get IMMEDIATE DELIVERY on a Foley Saw Filer.



Send For **FREE BOOK**

FOLEY MFG. CO., 516-9 Foley Bldg.
Minneapolis 18, Minn.

Send me free book "INDEPENDENCE AFTER 40!"

Name _____

Address _____

The Man Who Stops Bullets

(Continued from page 132)

Jodhpur and other foreign dignitaries. He's not always sure just who will ride in the limousine because the orders usually are placed by a government department rather than an individual.

Some of the orders leave him mystified. One day he received a rush request from the Chinese government for four armored disk wheels to go on a seven-passenger sedan. A few months previous, Smart handled a complete armoring job on a seven-passenger, including armored disk wheels to protect the hydraulic brake system, for Chiang Kai-shek. Word filtered back that the Generalissimo had a decoy automobile of the same make but one had disk wheels and the other regular artillery wheels. After Smart's second shipment arrived, the decoy, flashing its new disk wheels—the only armored portion of the entire car—was outwardly the same as the Generalissimo's.

Europeans, more than Americans, have needed a lot of convincing that Smart's limousine was impregnable to small-arms fire. During a demonstration at Belgrade for the late General Mikhailovitch, Smart was asked to give the car the "human" test. It was a situation that Smart, who was to be the "human," never will forget.

"Mikhailovitch asked if I would ride in the car and allow his officers to shoot at it," Smart recalls. "I knew it would mess up the looks of the car on the outside, which was my only concern. But I would have been on an awful spot had I refused.

"'This car is for sale, General,' I told him. 'You write out your check for it and then I'll get inside and let you shoot at me.'"

The big Yugoslav chieftain and his party roared with laughter, declining incidentally to buy the car.

Smart went into several other European countries but turned down an invitation from Moscow to put on a show there. "Those were the days when the Russians were rounding up American engineering talent, so I decided to stay away," he said knowingly.

Later Smart's engineering shop was starting work on an order from the Russian Embassy in Washington when a Russian colonel burst through the doorway carrying a leather case in which were two new pistols of Russian manufacture, a .38 and a .45, copied after the American Colt. The colonel also had his own cartridges and asked that every piece of armor plate going into the car be fired upon. Smart assured

(Continued to page 256)

"That
WHIZZER 'Pacemaker'
 is the sharpest thing
 in town!"

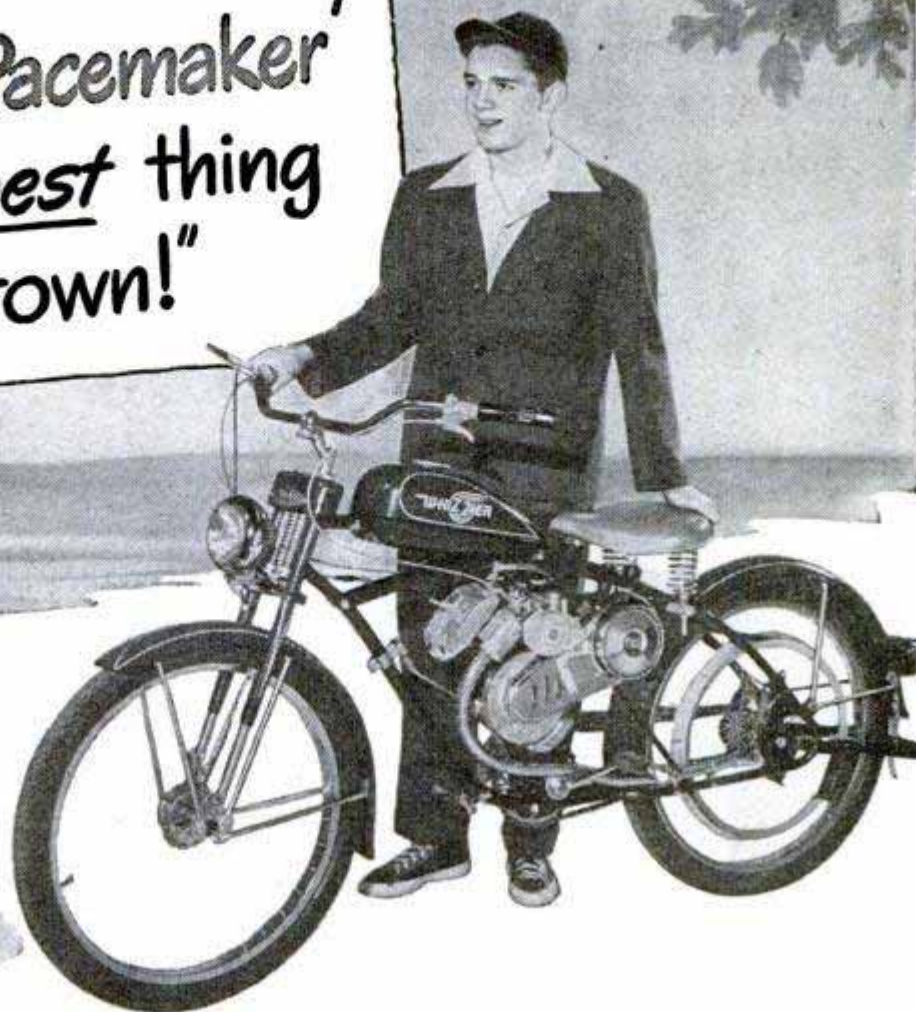

The only COMPLETE MOTOR BIKE specially designed for the
 famous Whizzer Motor
AT A NEW LOW PRICE!

Check these exclusive features...

- ★ Extra safety—special, heavy duty motorbike frame.
- ★ "Racy" look—long, low lines.
- ★ Smooth ride—Whizzer-developed special Telescopic Front Fork, Dual-Coil Spring Suspension.
- ★ Better control—24" wheels provide safer, extra-low center of gravity.
- ★ Travel comfort—adjustable motorcycle-type saddle, sponge rubber filled, genuine cowhide cover.
- ★ Smooth stops—positive braking power, safety reserve for emergencies.
- ★ Powered by the famous Whizzer Bike Motor... 2½ sturdy horsepower... 35 miles per hour... 125 miles per gallon... Twist-Grip controls... 4-cycle design. Finest in the field for over ten years.

ASK YOUR DEALER ABOUT BUDGET TERMS!

For Quick Guide to your Nearest Whizzer Dealer—call Western Union, ask for Operator 25 for dealer's address. No charge of any kind to you!



*Model illustrated includes following optional, extra-cost equipment: Bi-Lite generator and light set; automatic clutch.

NOW ONLY
\$199⁵⁰

COMPLETE*
 F.O.B. Pontiac, Mich.,
 Fed. Tax Extra

FREE! "FULL-DETAIL" CATALOG

Close-ups of "Pacemaker." Describes parts, operation. Shows complete line of special Whizzer accessories.

WHIZZER MOTOR CO., PONTIAC, MICH.

Please send special illustrated catalog.

Name _____
 Street _____
 City _____ Zone _____ State _____

FREE "SCREEN TEST"

shows amazing improvement
in your pictures!



Project your pictures on
Free Sample of Radiant's
new "Million Mirror"
screen fabric—and see
for yourself the remark-
able difference it makes!

See how millions of tiny glass mirrors,
firmly imbedded in the pure white screen surface, make your
pictures fairly glow with life! See what happens when light
is reflected instead of absorbed! You will enjoy clearer,
sharper black and whites—richer, brighter, more brilliant
colors. Here is projection as real as life itself! The new 1949
Radiant Screens have many unusual and exclusive features.
Priced as low as \$12.50!

Write today and get absolutely FREE
a sample of the new Radiant "Million Mirror" Screen Fabric
ALSO a copy of the *Basic Film Source Directory* your guide
to film sources.

RADIANT MANUFACTURING CORP.
1257 South Talman Avenue Chicago 8, Illinois

READY CUT HOMES

Order Now

Homes \$1835.00 and up,
freight paid. Orders filled in
order received. Save up to
\$1000 on modern production
method homes. Much more
compared with builders' prices.
Anyone can assemble with sim-
ple plans furnished. Complete,
including paint, hardware, roof-
ing, glass, nails, etc.
Send 35c in coin for full color
catalogue showing 57 modern
low-priced homes and floor plans.
Complete low cost building plans
ready for filing. Sold separately
if desired.

Dept. PM-59
**INTERNATIONAL MILL
& TIMBER CO.**
Bay City, Mich. **35c**

him that the material had been thoroughly tested, but the colonel insisted upon individual tests. Smart found out afterward the car was for Stalin.

The extra weight of the armor plate does not hurt the driving qualities of any car, according to Smart. If an automobile is fully armored to resist up to and including a .30-06-caliber rifle, the added poundage will amount to between 400 and 600 pounds, which usually calls for beefing-up the springs but will not affect the handling of it on the highway. For this sort of protection, in case you're considering buying a fully tailored job for one of the more expensive makes of cars, you should be prepared to pay up to \$10,000, which will include the purchase price of the car itself.

In the early '30s, gunmen in Cicero and Chicago occasionally tried to buy Smart's engineering services but the Chicago police, answering Smart's inquiries, said: "No." For a while Smart and his wife feared reprisals but eventually discovered that the cars for gangsters were being handled by back-alley garages. "Blacksmith jobs," Smart calls them.

Extra Handgrip for Hacksaws

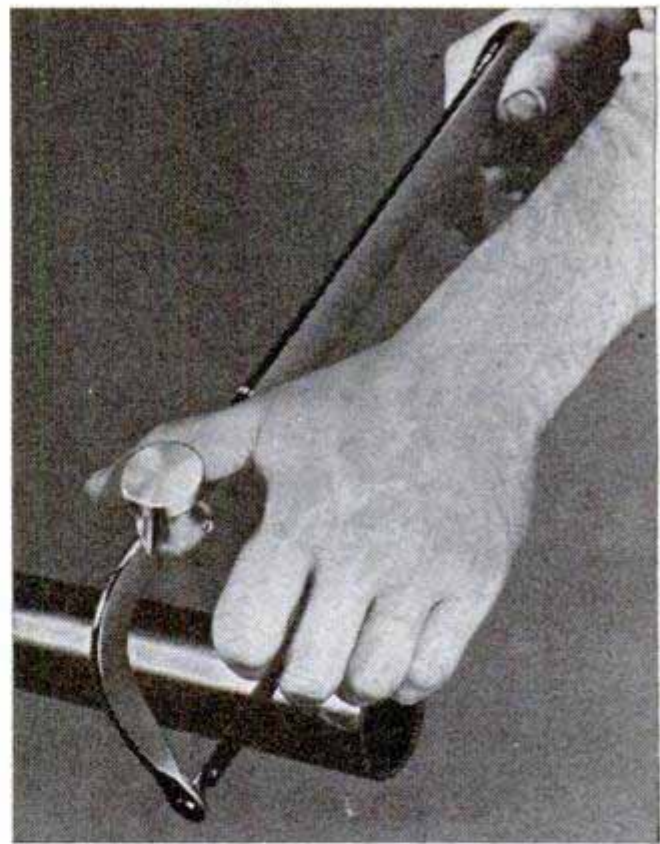

You can avoid smashing your knuckles while using a hacksaw by means of an extra handgrip that clamps to the frame. Made of aluminum, the grip enables you to grasp the saw more firmly and comfortably, lessening fatigue and increasing sawing speed.

Piston Rings need replacing, too!



OIL-PUMPING in your car most often means your piston rings are worn and should be replaced . . . immediately. Delay not only wastes oil but leads to excessive, costly engine wear.

Fortunately, piston rings are easily replaced. And it pays to

replace them with Hastings Steel-Vent Piston Rings. They *stop* oil-pumping, *check* cylinder wear and *restore* performance. It's the best money you can spend on your car.

HASTINGS MANUFACTURING CO. • Hastings, Mich.
Hastings Ltd., Toronto



HASTINGS Steel-Vent Piston Rings

"TOUGH... BUT OH SO GENTLE"

TOUGH on oil-pumping • **GENTLE** on cylinder walls

Pick up DOLLARS off the floor!



Start your own floor finishing business...
big profits—no overhead—small investment



Yes, YOU can make real money—and put the profits in your own pocket! Now's the time to cash in on new housing and construction. No experience needed. Our booklet instructs you completely in setting up, operating and selling your services. Get started now!



HOLT MANUFACTURING CO.
651 20th Street, Oakland 12, Calif.

Gentlemen: I enclose 25¢ in coin or stamps for your complete booklet: "How to Make Money in the Floor Business." I understand there is no further obligation.

NAME _____

ADDRESS _____

CITY _____ STATE _____

PROFITS AND SPEED

THE MODERN LAWN MOWER SHARPENER

PRICE
\$241.50
LESS
MOTOR

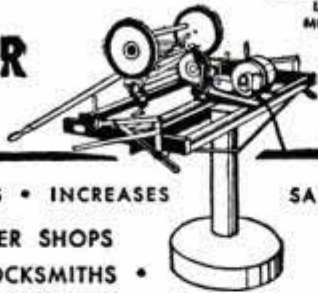

INCREASES PROFITS • INCREASES SALES!
FOR LAWN MOWER SHOPS
FIXIT SHOPS • LOCKSMITHS •
HARDWARE STORES • GOLF COURSES • SCHOOLS
PARKS • PLAYGROUNDS • INSTITUTIONS •
CEMETERIES • AND ALERT INDIVIDUALS!

*Sharpens All Reel Type Mowers • Hand, Power or
Gang • 10 to 20 Minutes • No Dismantling
No Extra Attachments Needed*

All reel type mowers, from 5-inch edgers to 36-inch power mowers, are quickly sharpened to extreme ends of both left and right twist reel blades. Handle, wheels, roller and motor remain in place when sharpening is in process. Bed knife is sharpened in same brackets that hold mower in grinding position. No extra attachments required. One lever puts mower or bed knife in grinding position. 100% steel construction. Grinding head rides on five ball bearing races. Small, compact, easy to operate. Sharpens wood chisels, joiner knives and planer blades without extra attachments.

**ORDER
NOW**
Immediate
Delivery

Skate Sharpener Attachment Available
Send For Free Bulletin No. 10B

MODERN MFG. CO. 160 N. FAIR OAKS AVE.
PASADENA, CALIFORNIA

Let the Engine Boil

(Continued from page 84)

The apparatus consists of a vapor-phase cooling unit that is mounted on a pedestal alongside the engine and that maintains the engine at 212 degrees regardless of the ambient temperature. Inside the pedestal is a storage tank from which lubricating oil is added to the engine crankcase automatically at need. The fuel is untreated, sour, oil-field gas that is piped to the engine. Thus, with constant supplies of fuel, lubricating oil and coolant, the engine keeps working for week after week. Safety controls automatically shut down the engine in case of fan-belt failure, mechanical leakage of the cooling water, or other trouble.

A mass-production closed vapor-phase cooling system for automobile engines, when it is built, will use no thermostat. The radiator, or condenser, could be about half the size of present radiators. Size of the cooling fan could be reduced and there is a possibility that steam could be used to drive a small turbine that would spin the cooling fan, saving the engine horsepower now used for that purpose. In fact, there is the possibility that the low-pressure steam of the cooling system could be made to do other work as well, such as operating an effective cooling system for the car.

Until an especially designed system is available, however, the Engineering Controls research people suggest that amateur experimenters do not try to rebuild their present cooling systems because of the difficulties they will encounter. One stumbling block, for instance, is the pressure that is built up in an enclosed system by the inevitable leakage of combustion gases through the head gasket, a leakage that is of no consequence in the present "open" cooling systems. The patented vapor-phase cooling system has a means of relieving this pressure, without permitting water or steam to escape.

Test for Sugar in Blood Is Speeded by Technique

Dangerous amounts of sugar in the blood can be detected rapidly by a new chemical test so simple that the doctor can carry all the necessary equipment in his little black bag. The secret of the new test is a recently developed substance which, by chemical reaction, indicates the amount of sugar and starch in any liquid. The procedure, accurate to within 10 percent, is expected to be valuable in detection of diabetic coma in a patient when the usual laboratory facilities are not available.



A Real Rifle

TO ANY MAN'S LIKING!

the finest single shot bolt action .22 in its price range



"Pioneer"

Model 765 \$13.50



FEATURES? Plenty of 'em — some not found on models twice as expensive!

ACCURACY? The kind that only H & R "Bull's-Eye" Broach Rifling provides!

ECONOMY? Yes, sir! You'll gasp at the low \$13.50 price.

See the H & R "Pioneer" at your gun dealer's.

For complete specifications on the "Pioneer" and FREE catalog on all H & R fine quality arms, write today.

LOOK AT THESE EXTRA "PIONEER" FEATURES!

- 1 EXCLUSIVE: "Redi-Feed" drop-in loading platform.
- 2 EXCLUSIVE: "Red-Devil" hooded front sight.
- 3 SPECIAL: Side thumb safety — self-cocking.

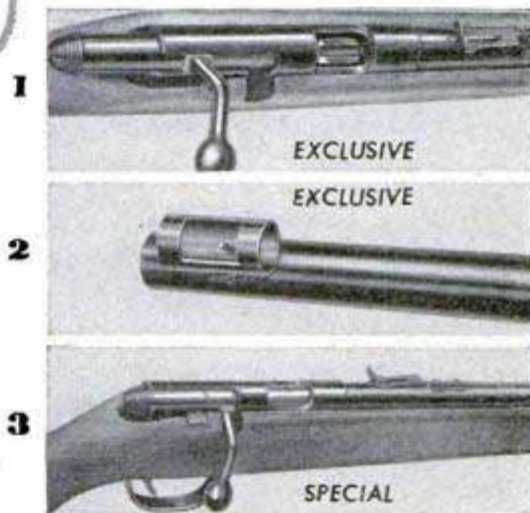

Harrington & Richardson Arms Co.

372 Park Avenue, Worcester 2, Mass.

FOR ALL MAKES AND MODELS

DOUGLASS Steel-Pack MUFFLERS

Performance that excels • Stamina that endures

Rugged construction. Steel tubing. Straight-thru-design. Solid tube with steel packing. "Throbbing Deep Tone." Complete for Easy Installation Satisfaction Guaranteed

| | | | |
|--------------------------------|--------|-----------------|---------|
| 32-40 FORD V-8 | \$5.96 | 29-48 CHEVROLET | \$5.96 |
| 41-49 FORD V-8 | 6.85 | 31-41 PLYMOUTH | 5.96 |
| 39-49 MERCURY | 6.85 | 42-48 PLYMOUTH | 6.85 |
| 35-49 FORD & MERCURY DUAL SETS | | | \$23.00 |
| 49 FORD & MERCURY DUAL SETS | | | 25.00 |

ORDER NOW! Specify Year and model • Enclose Money Order or Check with Order. DEPT. M-4



1949 COMPLETE RACING EQUIPMENT CATALOG 25c

WRITE RACING EQUIPMENT DIVISION

DOUGLASS MUFFLER MANUFACTURING COMPANY - 1916 W. VALLEY BLVD. - ALHAMBRA, CALIF.



Distributor Inquiries Invited

CALIFORNIA CURB-L-ARMS

PROTECTS FENDERS — HUB CAPS — WHITEWALL TIRES!

- SIMPLIFIES PARKING FOR EVERY MOTORIST.
- ROAD STATIC DISCHARGED TO GROUND.
- EASILY ATTACHED TO FRONT AND REAR FENDERS WITH A SCREW DRIVER.

CURB-L-ARMS warn motorist when nearing curb and other unseen objects. Resonant warning sounds prevent costly damage to fenders, hub caps and white wall tires, simplifies parking. Antenna is made of high carbon, heat-treated steel, chrome-plated to automotive specifications—extends below fender level to reach low and high curbs. Needled on and fits all cars, old and new. NO ELECTRICAL CONNECTION.

FULLY GUARANTEED—Money refunded if not satisfied. See local dealer or order direct. Send check or money order to



U. S. Pat. No. 2464365

BE SURE — GET THE ORIGINAL CURB-L-ARMS

\$100 worth of protection for ONLY \$125 Postpaid

AECO PRODUCTS

Dept. PM-5, Beverly Hills, Calif. (Use margin for ordering)

**NOT A
HOLLOW TUBE**

**A real filter with
66 baffles inside
to Whirlclean
your smoke**



Replaceable
Filters
10 for 10¢

Patented filters in Medico pipes stop flakes and slugs... absorb juices... reduce tongue bite. Smoke goes round and round 66 times... and it comes out clean... cool

MEDICO V. F. Q. (VERY FINE QUALITY)

Rich-grain imported briar Pipes. Wide variety of shapes. With 10 filters \$2

Frank Medico Standard Pipes \$1

Frank Medico Cigarette Holders \$1 & \$2

MEDICO
FILTERED SMOKING

S. M. FRANK & CO., INC., 5th AVE., N. Y. 22

**TELEVISION Self Starting
ELECTRIC CLOCKS**

The Modern Way To Tell The Exact Time
HOUR - MINUTE - SECOND - at a glance



DIRECT READING
NUMECHRON
Electric Clocks

All 110 Volts, 60 cycles. AC.

Price \$8.95

OTHER MODELS up to \$14.95

5 1/2 in. long. 3 3/8 in. high. 3 3/8 in. deep. Shipping Weight 2 1/2 lbs.

Deposit or payment in full with order. We pay freight.

STARLET
Model #200
Walnut (In Plastic)
WE CAN ALSO USE DEALERS

DIRECT SALES 921-PM-
W. 17th St. **Kansas City, Mo.**

Submarine Disaster School

(Continued from page 151)

rescue chamber can't start until he's up, so to speed the operation he returns to the surface without pausing. To prevent the "bends" it is necessary for him to decompress in one of the Chanticleer's two "iron doctors," or decompression tanks.

These are cylindrical metal tanks the size of a small room in which the pressure corresponding to the condition of the nitrogen bubbles formed in the diver's tissues by sea pressure is recreated by compressed air. Then he gradually is returned to normal.

A new underwater-rescue device just announced by the Navy permits the disabled vessel herself to haul down the rescue chamber, eliminating the need for dangerous deep-sea diving. The equipment consists of a set of buoys attached to wires at the sub's bow and stern. The trapped crew can release the buoys, which carry the wires to the surface. The wires and their winches then are strong enough to haul down the rescue chamber.

The rescue chamber is an odd pear-shaped diving bell operated from the inside by several crewmen. It floats alongside the Chanticleer for a moment while its buoyancy is adjusted by admitting sea water to ballast tanks until it barely floats.

Then the slack in the downhaul cable is pulled in with an electric winch and the chamber moves weirdly across the surface a few feet to disappear in a swirl of foam. In 8 to 10 minutes it will clank on the sub's escape hatch 200 feet down and make a watertight seal. Then, its operators will open the lower hatch and that of the sub, and take on a load of survivors.

When the submarine Squalus went down in 1939, the rescue vessel Falcon put her chamber down on the escape hatch of the Squalus, six miles offshore in 240 feet of water, before noon the following day. In four trips the diving bell brought the 33 survivors to the surface by eight o'clock that evening.

Once the crew of a sub is rescued, Event 1000 is concluded. The rescue vessel then will raise the sub with compressed air from her extensive high-pressure compressor system if enough of the sub's ballast tanks are undamaged. Otherwise, as in the case of the Squalus, a tedious salvage job with pontoons will be necessary.

But no matter what the difficulties, the men of the Navy's submarine rescue vessels are trained and equipped to handle the situation.

☐ Mines in the United States yielded minerals worth over 15 billion dollars in 1948.

\$23575

without motor
or switch rod
Price subject to change
without notice



You rip or cross-cut work
on the circular saw



You plane it smooth
on the jointer

Its extra convenience cuts costs and
boosts output for:

- Builders
- Cabinet Shops
- Pattern Shops
- Furniture Makers
- Other Woodworking Plants

DELTA MILWAUKEE

DELTA-MILWAUKEE® Saw-Jointer Combination

*Two machines mounted together...
to save space, time, and money*



Send for
free copy of
catalog B-48!

Circular saw and jointer are mounted on one steel stand. 10" saw blade cuts 3 1/4" stock. Rips to center of 50" panel. Jointer surfaces boards 6" wide; cuts rabbets 1/2" deep. Saw table tilts 45° to right. Both tools have lubricated-for-life ball bearings.

Either machine may be used singly or both together — by one man or two. There is no interference between

saw and jointer. Both are driven from below by the same motor. You save the extra cost of an additional motor — and enjoy lower power costs.

See this Delta-Milwaukee Saw-Jointer Combination at your nearby Delta distributor. Look for his name under "Tools" in the classified section of your telephone directory. Ask him about buying on easy credit terms.

TEAR OUT COUPON AND MAIL TODAY!

DELTA  **MANUFACTURING DIVISION**
Rockwell Manufacturing Company
680E E. Vienna Avenue
Milwaukee 1, Wis.

Send me free copy of
Delta-Milwaukee catalog B-48.

Name.....
Title.....
Company.....
Address.....
City..... (.....) State.....

HM-68

EVINRUDES with Fisherman Drive

The *only* motors that let you go *anywhere*

...over snags, rocks, shoals, thru thick weeds . . . ANYWHERE there's water to float your boat!



SPORTSMAN—The only light "Single" with FISHERMAN DRIVE. Top choice for small fishing craft, canoes, auto-top and rental boats. Simplex starter, Co-Pilot, Full Pivot Reverse. 1.5 O.B.C. certified brake H.P. at 4000 R.P.M.

SPORTWIN —

The only alternate firing "Twin" with FISHERMAN DRIVE... the only motor with fuel gauge. Years ahead in engineering and advanced features. Full Pivot Reverse . . . 3.3 O.B.C. certified brake H.P. at 4000 R.P.M.



ZEPHYR—The only "Four" with FISHERMAN DRIVE... the only motor that offers four-cylinder performance with freedom to power anywhere there's water to float your boat. 5.4 O.B.C. certified brake H.P. at 4000 R.P.M.



See Your Evinrude Dealer... look for his name under "Outboard Motors" in the yellow pages of your phone book. For free catalog of the complete

line of 40th Anniversary Evinrude Models—1.5 to 50 certified H.P. —write EVINRUDE MOTORS, 4300 N. 27 St., Milwaukee 9, Wis. In Canada — Evinrude Motors, Peterboro, Ontario



EVINRUDE

FIRST IN OUTBOARDS... 40th YEAR

Rough Riders of the River

(Continued from page 142)

Balancing with the body and arms and turning the log with the feet is an accomplishment known as birling. In some parts of the United States, birling contests are annual events. Someone has called them "one of the few truly native American sports."

Following behind the riverjacks are two wannigans—24 by 84-foot log rafts on which are built a canvas-covered bunkhouse and cookhouse. Only a few old-timers still possess the knack of constructing a wannigan that will survive the log drives.

These rough-hewn "showboats" of the log drive are put together at the upper end of the river and follow the riverjacks downstream—tying up along the bank each night. When they reach the millpond, they're knocked down, thus adding a few more logs to the supply.

Guiding the clumsy flatboats calls for expert navigation. Frequently, the bows are under water in the rapids. Fifty-foot sweeps, fore and aft, are used to guide the craft. They lumber along, scraping over half-concealed rocks, slamming into the river's banks. But somehow the wannigans hold together, principally because of the tough vines used to bind the logs.

Riverjacks work from 7 a.m. to 4 p.m. This means breakfast at 6 a.m., first lunch at 10 a.m., second lunch at 2:30 p.m. and dinner at 7 p.m. Breakfast and dinner are served from the wannigans. Lunches are brought to the riverjacks on the job.

And man, what food! Great platters of ham and eggs, loaves of oven-hot bread and pans of browned biscuits, enormous two-inch steaks, great pots of beans, cookies and doughnuts by the score, huge cups of steaming coffee, crates of oranges and apples. The diet is heavy on the side of sugars and starches because they provide quick energy.

"You can get a lot of logs down the river with a sack of sugar," one millowner is fond of saying.

At night, the riverjacks make camp alongside the river. After dinner, a big black caldron is suspended over a roaring fire. This provides hot water for bathing, shaving and laundering. Boots are rinsed free of sand and hung to dry atop the hickory handles of peaveys jabbed into logs. When the boots shrink, it's easy to fill them with hot water before breakfast and pull them on—a kind of self-inflicted hot foot!

A "cat raft" (a Caterpillar tractor mounted on a raft) floats downstream in the wake of the main body of logs to help in "picking

(Continued to page 264)

Are You Building A —

- Golf bag carrier
- Outboard motor carrier
- Whirling blade mower
- Silage or feed cart
- Garden tractor
- Portable sprayer
- Compressor
- Generator
- Power saw
- Camera dolly

Or any one of a hundred mobile items?

You'll Need Wheels!

*Semi-pneumatic, puncture-proof rubber tires, ball bearings, welded

GLEASON WHEELS

If You Need a Set of Wheels — HERE'S GOOD NEWS for You!



Lug Type wheels for powered units, smooth rim for other use.

Now you can get the rubber tire wheels you need to finish your project at your local hardware or farm supply store. Ask for Gleason Farm and Industrial Wheels!

12 MODELS and CASTERS Too!

Gleason Wheels are available in sizes from 4" to 16" dia., for 60 to 1,000 lb. loads. Swivel and rigid casters complete with 4", 6", 8" and 10" puncture-proof wheels too!

See and TEST GLEASON WHEELS before you buy!

Spin them on the Gleason WHEEL-SELECTOR at your local dealer. Check hub, bearing and tire sizes at the counter.



SEE YOUR HARDWARE or FARM STORE Today!

Buy quality wheels where you know the supplier and the delivered cost. If your dealer can't supply you, write direct for the name of your Gleason Wheel supplier.

GLEASON CORPORATION

530 N. 9th St., Milwaukee, Wis.
Who's my nearest Gleason dealer?

Name.....

Address.....

City..... State.....

BRASS NAME PLATES OR KEY TAGS

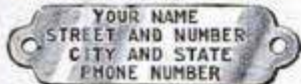

(INDIVIDUAL STAMPING)

40c each—3 for \$1.00

Half actual size
QUANTITY PRICE — SAME STAMPING
8 for \$2. - 15 for \$3. - 25 for \$4. - 50 for \$6.

LARGER QUANTITIES ON REQUEST
TAGCO, BOX 38X, WINGDALE, N. Y. STAMPING EQUIPMENT

Do it
Faster
and
Easier
with
the

WRITE FOR FREE CATALOG — shows attachments that save time and money!



PAGE Garden Tractor

New 1949 line with extra features! Riding and walking models, 1½ to 5 HP. Complete gear drive, no cheap belts or chains. Large tires—high clearance—easy to handle—power turn. Low factory prices—\$188 to \$436 with cultivator. Get benefits of 24 years of garden tractor experience!

PAGE DAIRY and FARM EQUIPMENT
19048 S. 81st STREET • MILWAUKEE 14, WIS.

Be Your Own Boss



There's a great feeling to being in something for yourself, where all the profits go into your own pocket. American floor sanders make it possible for you to realize this ambition without special schooling or a big investment. Begin small and work up to as large an enterprise as you desire... It all depends on your ambition to get ahead.

Ask for "tell-all" booklet entitled "Opportunities in Floor Surfacing". Use coupon and enclose 25 cents in coin or stamps to cover handling.

AMERICAN FLOOR SURFACING MACHINE CO.

- 535 So. St. Clair St. • Toledo 3, Ohio
- Gentlemen:
- Enclosed find 25c in stamps or coin for booklet "Opportunities in Floor Surfacing," telling me how I can start my own floor sanding business.

● Name.....
● Street.....
● City..... State.....



when you
think of pliers...

think of
CHANNELLOCK

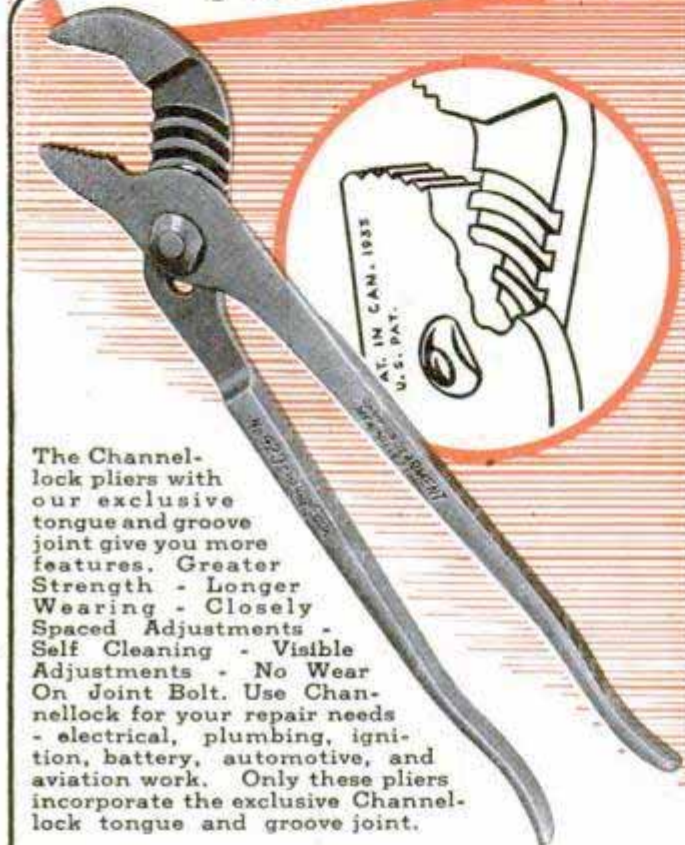

The Channellock pliers with our exclusive tongue and groove joint give you more features. Greater Strength - Longer Wearing - Closely Spaced Adjustments - Self Cleaning - Visible Adjustments - No Wear On Joint Bolt. Use Channellock for your repair needs - electrical, plumbing, ignition, battery, automotive, and aviation work. Only these pliers incorporate the exclusive Channellock tongue and groove joint.



There is a line of standard pattern pliers, too, with Channellock quality construction . . . including diagonal cutters, needle-nose pliers, linemen's and electricians' pliers, battery and standard slip-joint pliers.

Choose the pliers that fit your needs . . . Choose Channellock. Send for Free Catalog, A-10

CHAMPION DEARMENT TOOL CO.
MEADVILLE, PA.

Only Champion DeArment makes

CHANNEL LOCK

off" or "sacking" the rear—freeing logs that have become stuck or stranded.

In the rough upper country, as a general rule, logs are moved by manpower, peavey, pike and dynamite. "Cats" can't be used because timbered slopes come right down to the river's edge and at flood crest tree trunks are below water. Down-river, nearer civilization where the river is less turbulent, snorting cats on the banks are used to unsnarl jams and free stranded logs.

A line pulled by the winch of a tractor on the riverbank is used to straighten out wing jams and to snake logs away from bridge piers. Larger cats with bulldozer attachments are used to push log jams out into the river. They can operate in water almost up to the driver's seat.

At the end of the drives, logs are stored in millponds until they can be sorted according to species and mill schedule. The Clearwater millpond of Potlatch Forests, Inc., for example, has a backwater of 769 acres, which can easily handle the 50 million feet of a log drive. Potlatch's Clearwater sawmill at Lewiston, incidentally, is the largest pine mill in the world.

Because they're breath-taking, action-packed shows and a colorful part of the American heritage, the Potlatch and Diamond Match Co. log drives have become an important tourist attraction in northern Idaho. Highways parallel the Priest River along part of the 65 miles from Priest Lake to Pend Oreille River. You can watch the Potlatch drive along the 40-mile stretch from Ahshahka to Lewiston. During June 2, 3 and 4 this year, the Priest River Chamber of Commerce is sponsoring a "Log Drive Celebration" including displays of logging equipment and demonstrations of birlers, sawyers and axmen.

Log drives may be a vanishing art in most parts of the world—but not in northern Idaho. Riverjacks are still riding logs down the Clearwater and the Priest where the cry "She's a-pullin'!" rings across the turbulent white water.

How to Build a Winning Racer

(Continued from page 126)

most of its fuel alongside the driver in the middle of the car where its varying weight will have little effect.

The same builders are using a similar idea in an eight-cylinder rear-drive car that they have rebuilt for the Bowes racing team. The car will carry 90 gallons of fuel, some of it in the tail and some of it in belly tanks placed between the frames under the driver's seat. The car will test out

(Continued to page 266)

GET THIS USEFUL . . .

"Teddy" KIT

for
**SANDING!
POLISHING!
GRINDING!**

FITS
ANY
ELECTRIC
DRILL



Has over 1000 uses — polishing furniture, autos, etc., waxing, sanding and refinishing wood and metal, smoothing welds, etc.

6" heavy flexible rubber disc, bends into curved surfaces. 6 heavy backed, garnet sanding discs, of ass't grits, superior lambs wool bonnet. Disc and bonnet are attached in a jiffy without cementing. A handy kit to own.

OTHER KIT SIZES

3 1/2" \$1.50 5" \$2.85
4" \$1.75 7" \$4.00

MONEY BACK GUARANTEE

See your nearest dealer or order direct enclosing check or money order.

FRED V. FOWLER CO.

137 FEDERAL ST., BOSTON 14, MASS.

**NOW ONLY
\$3 25**



Build Your Own BICYCLE TRAILER or UTILITY CART

Enjoy camping trips, make extra money running errands. Will carry up to 200 pounds. Handy cart around home. Change bicycle hitch to cart handle in second. Kit of complete parts, including special hitch to bicycle with body and tongue metal parts already shaped.

COMPLETE PARTS for only \$7.95
FOR UTILITY CART HANDLE with easy attachable joint, **\$1.85** add

Full instructions how to build. Easy and enjoyable. If not completely satisfied return in five days for refund. You pay return post charges. Send cash or money order to Dept. T-4 or write for free literature.

WHIPPLE MFG. CO., Inc.
SPIRIT LAKE, IOWA

Build YOUR OWN BOAT

Complete parts cut to exact size—ready to assemble. Marine waterproof plywood, rustproof oarlocks. Ideal for car top. Also models with laminated frames; mahogany decked runabouts. Build for sale at attractive profit. Exclusive franchise to local builders. Send 10 cents (dime) for illustrated literature.

\$39⁵⁰ and up

QZARKA 659 WASHINGTON AVE.
WOODSTOCK, ILL.

8 ways to make a FRIENDLIER YARD . . . JUST 10¢

[STANLEY] PLAN SET No. 14

Reg. U.S. Pat. Off.

• Lure the birds you like by building them a home . . . 5 types plus a feeding box. Plans also for garden seat and a trellis. Hours of pleasure and a better yard. Send 10c for Plan Set No. 14 and list of others. Stanley Tools, 159 Elm St., New Britain, Conn.

Free...



YOUR 1949 PHOTOGRAPHIC CATALOG

OVER 1000 ILLUSTRATIONS—descriptions and prices of more than 1700 pieces of photographic equipment are included in Montgomery Ward's big, new Photographic Catalog.

THE NEWEST IN STILL CAMERAS—the sensational new Land camera that gives you a finished print just 60 seconds after you snap the shutter! The new Bell & Howell Foton automatic 35 mm. (takes up to six pictures a second); the new low-priced Bolsey miniature with twin lens reflex focusing; and many others.

THE LATEST IN MOVIE CAMERAS—the new Cine Kodak Special II (approaches the capacity of professional movie cameras), the new De Jur 8 mm. with Fade-Matic control, plus Wards new complete line of sound equipment.

NEW ACCESSORIES—the latest still projectors, new enlargers, and lighting equipment. In this section you'll find everything to help you get the most from your photographic hobby.

EDITORIALS ON PHOTOGRAPHY—valuable information on developing, printing, enlarging and movie making, plus many other useful tips.

Convenient monthly payments if you wish!

MONTGOMERY WARD

Chicago • Albany • Baltimore • Denver
Ft. Worth • Kansas City • Oakland
Portland, Ore. • St. Paul

Clip and Mail this Coupon Now!

MONTGOMERY WARD, Dept. PM-59
Please send me the new 1949 Photographic Catalog as soon as printed (about May 1).

Name _____
(PRINT plainly)
Street Address _____
or Box _____
Postoffice _____ State _____

MOTORISTS WISE SIMONIZ

T. M. REG. U. S. PAT. OFF.

MAKES CARS STAY BEAUTIFUL

*Better than 10
'Here-Today...
Gone-Tomorrow'
Polishings!*



Simonizing saves you time as it saves the finish!

Don't waste your time with 'temporary polishings'! Simonizing gives long lasting beauty... protects the finish and keeps colors from fading. Do as millions of motorists... Simoniz your car. It's easy to do yourself.

THE SIMONIZ COMPANY, CHICAGO 16, ILL.



Use Simoniz Kleener (liquid or paste) to clean finish.
Then Simoniz for lasting beauty. Sold everywhere!

a new spring suspension, too, as it has been equipped with "torsilastic" rubber torsion bars. Torsion-bar suspension of one design or another is common to most of the new cars because of the easy ride and good handling that it provides.

I got into racing away back in 1922 when I put a car together and raced it at San Luis Obispo. The car blew up in practice, then I built another and won a lot of West Coast dirt-track races with it.

By that time racing was in my blood and in 1928 I had a chance to drive at Indianapolis. I placed second and from then on I was in every race until 1936. I broke down on every occasion except twice and on those times I finished third. Once a con rod failed when I was in second place with half a lap to go, once I ran out of gas 15 laps from the finish when a pin-hole leak developed in the pressure fuel tank.

For the 1938 race I put some of my ideas together and built a car that I thought could win. I was right, for Floyd Roberts won the race in it. Next year he was killed in a three-cornered crack-up on the track. In 1940 I entered two cars; one placed third, the other broke an oil line. Next year I entered three cars and Mauri Rose won the race in one of them. Since the war we've made a clean sweep of first and second places in the two races that I entered cars.

Winning at Indianapolis has won me a lot of money but it costs a lot to win. The drivers and pitmen get part of the purses, the expenses are heavy and race cars cost money to build. Counting my three cars, the shop and my tools, I've invested close to a fifth of a million dollars for the thrill of watching my cars get the checkered flag. That's what I work for, because when you figure up my winnings against the expenses and the time that I put in, it turns out that I make about a dollar an hour.

Warming Up the Great Outdoors

(Continued from page 114)

This past winter a flying service in California kept two helicopters on the job every night during freezing weather, fanning citrus groves from above. A helicopter does the same job as a wind machine by sending the warm upper air down into a grove. Its results are often more effective since the blast from the rotors is straight down, producing an immediate temperature rise.

For optimum results the helicopter flies 60 feet above the ground at a speed of 10 miles an hour, making wide sweeps across and around the trees. One plane can protect upwards of 80 acres, creating and

(Continued to page 268)

King Midget



- HOME ASSEMBLED
- MASS PRODUCED
- LOW-COST AUTOMOBILE

Drive this car for as low as 50¢ per week. Up to 90 miles per gallon. 45 to 50 m.p.h. Large enough for a husky six footer. A pleasure to assemble. Just bolt together our precision built parts. Get the facts. Send 25¢ for detailed circular with large photo, 4 view drawings, price of all parts. Better still, send \$1 (refunded first order) for this plus actual assembly book with 42 photos, drawings; blueprints of snow and ice conversions, etc.

WORLD'S LOWEST PRICED CAR

MIDGET MOTORS MFG. CO., Athens 1, Ohio

PLYWOOD BOAT KITS

\$67.50

(Freight Included)



Build the 12 ft. V-Bottom "Sportsman" as shown. Ready-cut kits include all hardware, paint, etc. Send for free folder on all models as low as \$29.95, freight included.

TAFT MARINE WOODCRAFT

Dept. "R," 636 39th Ave. N.E. Minneapolis 21, Minn.

Fascinating-Practical

50 LOG CABIN DESIGNS

72 large pages, packed with practical know-how on construction, costs, prefabrication, etc. Plus floor plans and drawings of 50 different cabins. 1 to 10 rooms, all types . . . modern, rustic, chalet, etc. Build for summer or year-round home. Learn how to build yourself, or pointers to save 40% if you have work done. Architects charge many times the cost for similar information and drawings.

Postpaid—**SEND \$1.00**
No C.O.D.

LOG CABIN SALES CO., Dept. P

1218 W. Walnut St. Milwaukee 5, Wis.



NOW! PAINT STRIPING MADE EASY!

PAINTERS' STRIPING TOOL

Easy to use as a pencil! Draws parallel lines, straights, curves, circles with paint, enamel, lacquer, etc. Do your own striping on autos, furniture, toys, bikes, model planes, signs, linoleum . . . make wall board look like tile. Painters - craftsmen, order today! Type "M" Master Painters' Striping Tool complete with tip for 1/16" stripe, \$1.00. Tool with choice of 1/64", 1/32", 3/64", 5/64", 3/32", 1/8" tips—\$1.50 . . . all tips 75¢ ea. Tool with complete set of 7 tips \$5.00. (COD's postage collect.) Dealers write!

WENDELL MFG. CO.

4234-B Lincoln Ave., Chicago 18, Illinois

Get More Fishing THRILLS Cast Better With

Shakespeare WEXFORD

- A WONDER LINE
- WEARS UP TO 3 TIMES LONGER
- AVERAGES 7 TIMES MORE WATER-RESISTANT



When you hook 'em, WEXFORD holds 'em . . . because it wears up to 3 times longer than any of 10 leading lines tested. This is a fact, based on independent laboratory tests.

And WEXFORD averages 7 times more water-resistant . . . a quality that gives you smoother casts, extra enjoyment every time you fish!

Ask for WEXFORD in the two-spool blue and red box, at your favorite sports store.



FREE 1949 TACKLE BOOK and Pocket Fishing Calendar. Newest in tackle, fishing tips. Write Shakespeare Co., Dept. PM-5, Kalamazoo 2, Michigan.

Shakespeare FINE FISHING TACKLE HONOR BUILT FOR OVER 50 YEARS

BUILD YOUR OWN POWER LAWN MOWER

WHY BREAK YOUR BACK MOWING FIELD OR LAWN?



WRITE FOR **FREE LITERATURE**
The Rite-Way Mower Attachment Ball Bearing



SAVE MONEY SAVE TIME
Now anyone can save time and effort mowing field or lawn by building their own whirl type power mower. Build according to your own ideas and needs at small cost. Cut close to fences, walks, buildings, etc. Build in short time with parts and instructions we furnish. Save hours of time and back breaking labor. Write today for FREE information.

T & H MFG. CO., Dept. PM20
811 E. 31, Kan. City 3, Mo.

SAY YOU SAW IT IN POPULAR MECHANICS

Provides PRECISION CONTROL..

because
FOREDOM #99
FLEXIBLE SHAFT
MACHINE with
PENCIL-SIZE
HANDPIECE..



KEEPS YOUR WORK WELL IN VIEW



35"
FLEXIBLE
SHAFT
\$15.95
COMPLETE
WITH
MOTOR

GRIND - POLISH - SAW - SAND -
ETCH - ENGRAVE - ROUT - CARVE -
MILL - CLEAN

Use on all metals, wood, plastics,
glass, leather, linoleum, etc.

REMEMBER that in the precision-made FOREDOM you get MORE POWER—LONGER MOTOR LIFE because MOTOR IS NOT DWARFED TO FIT HAND. DOES HUNDREDS OF JOBS WITH MARVELOUS EASE because pencil-size handpiece gets into hard-to-reach places—provides positive, easy, precision control.

Profit by experience of many thousands of Foredom users—over a quarter century experience stands behind the product. Other heavier-duty models at proportionately reasonable prices. No. 25 Accessory Set (a truly versatile assortment) \$5.50 extra. Also No. 999 Kit, comprises No. 99 Machine, Illustrated, and set of 12 accessories, all in wooden case for only \$19.95. 6-step Foot Rheostat \$4.85. Over 70,000 Foredoms in use.

AND HERE'S ANOTHER AMAZING FOREDOM PRODUCT



YOUR MOTOR

Foredom PRESTO-FLEX
with PENCIL-SIZE Handpiece \$5.95

Now turn your old motor, drill press, or electric drill into a Flexible Shaft Tool. Simply attach to your electric drill, drill press or motor. Presto—a flexible shaft machine! Off again in a jiffy! Pencil-size handpiece gives you finger-tip control. Gets into tight places you can't reach with any other tool. Handy 35" overall length. And—only \$5.95 complete! Not to be confused with inferior imitations. Precision made, backed by 1/4 century experience in this field. All parts replaceable. Order NOW. If ordered for use on motor, specify motor shaft diameter and add 50c for coupling. (Available for 1/4", 5/16", 3/8", and 1/2" shafts.) No. 50 Accessory Set available \$1.50 extra. Order TODAY.

FOREDOM ELECTRIC CO., Dept. A-1117 Mail Coupon

27 Park Place, New York 7, N. Y.

Now

Please send me FOREDOMS checked below on 10-day trial.

- Presto-Flex Tool (\$5.95) No. 50 Accessory Set (\$1.50)
 Motor Coupling (50c) No. 25 Accessory Set (\$5.50)
 No. 99 Machine (\$15.95) Foot Rheostat (\$4.85)
 No. 999 Kit (\$19.95) Free Catalog

- Send C.O.D. plus postage. I will pay postman.
 I enclose payment. Send postpaid.
(Money back either way if not delighted)

Name _____

Address _____

City _____

Zone _____ State _____

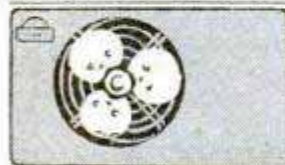

SIZE ADJUSTABLE WINDOW FAN

Includes motor, fan front, guard, blade. Adjustable end for installation.

| BLADE | MOTOR | MODEL No. | TESTED CFM | PRICE |
|-------|------------|-----------|------------|---------|
| 16" | 1/25 H. P. | 48-DD-16" | 1500 | \$17.95 |
| 18" | 1/15 H. P. | 48-DD-18" | 2100 | \$22.50 |

Shipped knocked down. Guaranteed satisfaction or money back. Thousands in use. Fits narrow or wide window. Famous Torrington Blade. All Steel. Close out. Over 50% reduction. F.O.B. Memphis, Tenn. Send check or money order. If C.O.D. make \$5 deposit.

TROUSDALE MFG. CO., 266 Madison, Memphis, Tenn.

maintaining a temperature rise of two to four degrees.

Several attempts have been made to heat artificially the air streams produced by wind machines but the most satisfactory combination under extreme conditions seems to be the use of orchard heaters at ground level, plus wind machines. Often two or more rows of heaters are placed around the edges of the grove as a barrier against cold air, while the wind machines inside the barrier keep the warm air in motion or help prevent its upward escape.

American agriculturists have spent millions of dollars for frost-prevention equipment and they are still far from satisfied. All protective devices are satisfactory under some conditions; few, if any, give adequate protection from extreme cold.

Most frozen fruits and vegetables can be detected at a glance but a frozen orange may look perfectly normal even though its interior is dry and pithy. To cull out the bad fruit, packing houses move them through a water separator. Dry oranges float high in the water, good moist fruit floats low. The operator separates them according to their gravities. In some packing houses the oranges are moved by traveling belt across a fluoroscopic X-ray screen that allows the operator to see right through each orange. When a frozen fruit shows up, the operator presses a lever, tipping the orange from the belt. Frozen and partly frozen fruit are processed for their oil and pulp in by-product plants.

The search for methods that will provide even better protection against occasional low temperatures is still going on. One of the requirements is low initial cost as well as low cost of operation, otherwise growers may not be able to recover their costs when their produce is sold. Even at 10 cents a gallon for the cheapest fuel oil, it costs 10 cents per hour to operate an ordinary orchard heater. Multiplied by 40 heaters, this amounts to \$4 per acre per hour. Multiplied by 150,000 acres, representing the citrus acreage in southern California that is protected by heating equipment, the bill amounts to \$600,000 per hour for fuel, exclusive of labor. Some orchardists spent more money for fuel alone last winter than they received for their crops, because of the prolonged cold spell.

Nevertheless, antifrost devices of one sort or other are saving millions of dollars worth of crops every year. If and when better methods of cheap protection are devised, farmers will be able to increase materially the length of their growing seasons and will be able to raise fragile, semitropical plants in hardy climates.

New Quick Selling CELL-U-MOP...

DOES THE WORK OF
6 TOOLS IN 1
Holds 20 times its
weight in water

others make
BIG MONEY

"Enclosed find 56 orders representing 9 1/2 hours work on Monday and Tuesday." "Enclosed are 12 orders secured after supper this p.m."

Housewives Pleased
Everyone that sees this outstanding CELL-U-MOP immediately want one... That's the reason our distributors are so successful... For MOPPING, WAXING, WALLS, WINDOWS, AUTOS and CLEANING RUGS. Sells quick to Taverns, Clubs, Hotels, Hospitals, Stores, Restaurants, Homes, etc. Drain Bracket squeezes out water thoroughly. Write for FREE particulars



Hands
Never
Touch
The
Water
..
Can Be
Put in
Boiling
Water

CLOSED CELL-U-MOP CO., Dept. P-5 FREEPORT, ILL.

"Fleas Don't
Bother Me
I'm Dusted with
PULVEX DDT"



PULVEX ... KILLS FLEAS
FLEA POWDER ... KEEPS 'EM OFF

NONE BETTER! SUPER DRILL GRINDER



Sharpens round shank drills from 3/32" to 1/2" in diameter, up to 6" long. Grinds old drills like new in 4 different point angles, using hand or power grinding wheels. Money-back guarantee.

Price only \$2.95
At Dealers or Postpaid

CRANDALL MFG. CO. 1512 W. Slauson, Dept. FA-41, Los Angeles 44, Calif.

EASIEST, SUREST WAY TO END DIRECTION WORRIES Drive with a HULL AUTOMOBILE COMPASS

Beaconlite Illuminated \$5.95

Streamline Standard, \$3.95

At your dealer's. Write for circular.

HULL MFG. CO., P. O. Box 246-D5, Warren, Ohio



HULA POPPER

DIDN'T KNOW FISH WEREN'T BITING



They said the fishing was extremely poor... but look what he caught. This nice string of Florida Largemouth was taken in December by Toby Shopper of Akron, Ohio, who has this to say of Hula Popper: "Just snap one on your leader, drop it into a likely pocket, pop it lightly and wait about 15 seconds for the ol' Hula Skirt to start squirming. Then... look out! The whole lake's liable to explode!"

HULA POPPER A DEADLY TOP WATER LURE

5/8 oz. Casting Size \$1.21 each
Colors: Red Head, Frog, Black, Yellow, Pearl, and Luminous. Extra Hula Skirts (small) 17c each

For Fly Rod Fishing, Try the 1/16 oz.

Hula Popper 75c each

SEND FOR
FREE CATALOG



Hula Popper—T. M. Reg. U. S. Pat. Off.

FRED ARBOGAST & Co., Inc.
1655 W. North St., Akron 3, Ohio

A-449-39

NEW SAWMILL EQUIPMENT CATALOG

ANNOUNCING THE NEW WARD-AMERICAN LINE, OTHER SAWING
AND FINISHING EQUIPMENT. SEND FOR FREE COPY

Bigger than ever—completely new from cover to cover. Pictures and describes the new Ward-American line of heavy-duty sawmills, plus an improved line of Ward light-duty expandable-type mills... sawmill modernization and replacement parts... planers, edgers, trimmers, and other lumber finishing equipment.

Gives you complete details on the Set-A-Matic control that, in addition to sawing, enables you to haul large or small, straight or irregular logs onto the carriage—roll

them over in either direction—set and recede the headblocks—and do it with just one source of power. Pictures and describes the Porta-Mill—outstanding low-priced mill that can be moved easily right into timber stands, yet is ruggedly built for production cutting.

Write for free copy of Wards Sawmill and Lumber Finishing Equipment Catalog. Address Dept. P59, Wards nearest Mail Order House.

MONTGOMERY WARD

Chicago Baltimore Albany Kansas City St. Paul Denver Portland Oakland Ft. Worth



WAR SURPLUS BARGAINS

"THE BOTTOM OF THE SURPLUS BARREL IS IN SIGHT"

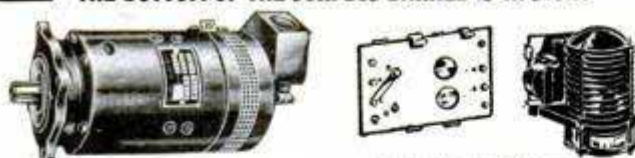

COMPLETE GENERATOR SET. Includes Aviation type generator (Type L3, 28 Volt, 25 Amp, rotation CW, 2500 RPM) measures 12 x 5 inches, weighs 24 lbs. Output also includes famous Carbon Pile type voltage regulator (AN3080-1) with mounting base for same. Holds voltage within given operating range at varied generator speeds. Complete set, generator, regulator and base (all like new) now offered at approx. 10% of AAF acquisition cost. Complete set only \$24.50. Generator only (shp. wgt. approx. 35 lbs.) only **\$17.50**

PORTABLE FOOD WARMER KIT

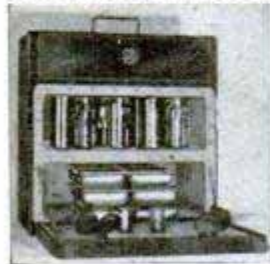

Used by AAF for warming liquids, food, etc. Operates on 110 V, AC or 28 V, DC. Keeps foods hot for hours. Case measures 11 x 17 x 17 in. Equipment includes 6 4 1/2 in. stainless steel cups with lids, 4 stainless food trays or plates with lids, 6 each knives, forks, spoons, 1 water container, plugs, etc. Use at home, on boats, planes, etc. to warm canned goods, etc. and to keep them warm. May be packed with dry ice to keep things cold. Use also on hunting and fishing trips, picnics, etc. Shp. wgt. approx. 35 lbs. Complete, only **\$19.95**

LIGHT PLANT "HOMELITE" PORTABLE

A complete, self powered portable light plant of 14 V, DC; 1000 watts. Powered by approx. 3 H.P., air cooled gas engine. Complete with meter, etc. Mounted on pneumatic tired wheels and dolly. Crated and guaranteed like new. (Shp. wgt. approx. 115 lbs.) Each only **\$74.50**

NAVIGATOR'S CELESTIAL SEXTANT

Link A-12 type, good serviceable condition; in carrying case, instructions, navigation study book (AAF), etc. (Shp. wgt. 9 lbs.) Reduced to less than 10% of AAF cost. Now only **\$14.95**

AUTOMATIC RADIO DIRECTION FINDER

Bendix, type SCR269G (AAF), receiver type 433G. The famous ADF set used to guide vessels and aircraft throughout the world (simplest form of navigation known to man). Turn set on, tune to station you wish to navigate to (frequency 200-1750 KC, includes marine beacons, aircraft beacons with weather, all broadcast stations); then "follow the electronic needle into port." This set is complete in every detail with all components needed. Installed it weighs 85 lbs. Reception is wide, tone clear. Operates from 24-32VDC aircraft or boat power. Sets are perfect but used, bench checked and operated prior to shipment. Complete with full instruction booklet, diagrams, not wired up to plugs (wire not furnished). Now selling at 5% of cost. (Shp. wgt. approx. 100 lbs.) Reduced **\$124.50** to only.....

AERO MAGNETIC COMPASS. Panel mounting type, made by Pioneer. Original cost approx. \$75.00. New, reduced to only **\$5.95**

AIR COOLED AIRPLANE ENGINE. 6 cyl. in-line inverted, Ranger Mfg.; 175 H. P., net weight approx. 375 lbs. Engines are new, in factory box with tools. Two magnetos, (no carburetors) etc. Total shp. wgt. approx. 750 lbs. Original cost over \$3000. To close out **\$295.00** balance of stock, reduced from \$495 to.....

Send check or money order. All F.O.B. Houston. Can ship mail, express or freight, transportation charges collect. Order today while these bargains are available.

AERO PARTS SUPPLY, Dept. PM5
MUNICIPAL AIRPORT HOUSTON 17, TEXAS



Newest CROSLLEY STATION WAGON

Larger, longer body lines, new luxury interior appointments, speed styling, headlights in fenders, turn indicators, etc. All steel. Costs less than an 8-year-old, high upkeep used car. Real economy—up to 50 miles on a gallon. Prices range downward from the Station Wagon at only \$929 F.O.B. Marion, Ind. For complete catalog of all 5 new models, write your name and address on the margin of this page,

CROSLLEY
a FINE car

tear out, send to Crosley Motors, Inc., 2530-HE Spring Grove Ave., Cincinnati 14, Ohio.

SEND FOR THESE AUTOMATIC SHUT-OFFS

FOR WATER HEATERS • INCINERATORS • WATER SOFTENERS



FULL MONEY BACK GUARANTEE on these automatic shut-offs which eliminate return trips to the basement! Installed in a few minutes with ordinary tools. Comes with simple, complete instructions. Order direct from factory.

Get **ERIE TIME-O-GAS** for your water heater or incinerator. To operate, set knob to burn for 2 to 55 minutes. **ERIE TIME-O-GAS** shuts off gas automatically! Works on manufactured, natural, mixed gas. Use with or without pilot. Pilot lighter included FREE with each unit.

Get **ERIE TIME-O-FLOW** for your water softener. Just set it for proper flushing time, after regenerating. **ERIE TIME-O-FLOW** shuts off rinse water automatically!

Send only **\$8.95** for postpaid **ERIE TIME-O-GAS**; **\$14.95** for **ERIE TIME-O-FLOW**; or C.O.D. plus postage; or write for FREE information. (Specify if **ERIE**

TIME-O-GAS is for heater or incinerator).

ERIE MFG. CO., Dept. P-7 — 300 N. 8th St., Milwaukee 3, Wis.

OTTAWA Tiller & Mower

Patents Pending



New Tiller and Mower with 2 H.P. "Red Seal Continental Motor." **Two speeds and free wheeling.** Does most any kind of mowing. Cuts close to trees and fences. Attachments for soil tilling, etc.

Thousands in use. Sold direct to user. Now in our 45th year. **FREE** details. Low price.

OTTAWA MFG. CO., 4-927 Lawn Ave., Ottawa, Kansas

New 1949

PLASTICS SUPPLIES CATALOG

Just off press. Full details on Plexiglas, Lucite, rods, sheets, tubes, Acetates, cements, dyes, buffs, molding sets, tools, carving kits, accessories. Everything in plastics. Gives prices, sizes, colors, etc. Price 10c, stamps or coin, with ad for catalog.

PLASTICS MFG. & SUPPLY CORP.

DEPT. PM-5 • 4707 EUCLID • CLEVELAND 3, OHIO

BURIED TREASURE, MINERALS AMAZING NEW GOLDAK LOCATORS

SENSATIONAL NEW MODEL!

ONLY 11 pounds weight! One hand operation! Money-Back Guarantee of Superiority. Write for full details.

THE GOLDAK CO.

1542 WEST GLENOAKS BLVD.
GLENDALE 1, CALIFORNIA

World's largest maker of fine locators.



MODERNIZE Your Refrigerator with DEFROST-O-MATIC

Automatically defrosts refrigerator each night while you sleep. Simply hang on wall and plug in refrigerator. Set once and forget. Saves electricity—Prolongs refrigerator life. Frozen foods unaffected. Years of dependable service. 110 Volt 60 cycle AC. **SEND NO MONEY:** Pay postman \$9.95 plus postage. Or send M. O. and we pay postage. Money back guarantee.

MODERN EQUIP. CO., Lohrville 1, Iowa, U. S. A.

Say You Saw It in Popular Mechanics

Hydraulic SPEED REDUCER of many uses

Variable Speeds and INSTANT REVERSE

Zero to 600 or 700 R.P.M.

For LATHES, REAMERS, TRANSMISSION, MID-GET CARS, MILLING MACHINE TABLE, SHAPER, THREAD MILLING FIXTURES, HOME MADE WOOD WORKING LATHE, EXHAUST FAN, PUMP, HOIST, GENERATOR, OVERHEAD TROLLEY, PRODUCTION BELT OPENING and CLOSING DOORS; and MANY OTHER USES. Industrial or Home Use. Cost Government \$300.00. High Quality Precision Workmanship. Case measures 7 1/2" Long, 7" High, 6 1/2" Wide. Input and Output Shafts 3/4" diameter. Beautiful Red Crackle Finish Case.

OUTPUT TORQUE ADJUSTMENT ZERO TO 100 INCH POUNDS



Shipping Wght. 25 pounds

Only **\$54.50**

PREPAID 2 quarts oil included FREE

If C.O.D. is requested a 10% Deposit must accompany order and we ship F.O.B. Chicago.

1 1/2" - 8 thread Lathe Chuck Adapter, \$3 extra

DIRZIUS MACHINE SHOP E, 1423-25 So. 52nd Ave., CICERO 50, ILL.



TIME-SAVING TOOLS for SHOP and HOME

OWN A FAMOUS MOTO-TOOL

The "Pocket-Size Machine Shop"
HIGH-SPEED STEEL CUTTERS
—AT NO EXTRA COST

No shop or home is completely equipped without MOTO-TOOL—the correctly balanced motor-in-hand tool. It grinds, drills, carves, polishes—without vibration. 27,000 r.p.m. (approx.) does work better, faster, in wood, metal, glass, plastic. MOTO-TOOL Kit No. 2 includes high-speed steel cutters for longer life. MOTO-TOOL is backed by over 12 years of industrial use . . . packs years of pleasure. Due to wide popularity and increased production, Dremel's pre-war prices still prevail!



APPROX.
27,000 R. P. M.

MOTO-TOOL KIT NO. 2 with 23 accessories including high-speed steel cutters and Model 2 Moto-Tool in hard-wood case . . . \$23.50
MOTO-TOOL NO. 2 with one emery point . . . \$16.50
MOTO-TOOL KIT NO. 1 with 34 accessories and Model 1 Moto-Tool in wood case . . . \$17.50
MODEL 1 MOTO-TOOL with one emery wheel \$9.85



NEW DRILL PRESS

This 12" high, precision drill press is ideal for model making, wood carving, routing, etc. Utilizes No. 2 Moto-Tool. Only \$9.95 (Less Moto-Tool).



Look For These Moto-Tool Features

Dynamically balanced armature for vibrationless finger-tip control • Oilless (oil-sealed) bearings • Patented automatic chuck lock pin • Over-size armature shaft—hardened, ground, polished • 110 Volt AC-DC motor • Snap-type sliding switch • Cord protector • Shockproof bakelite housing • Dust-filtered air-cooling system • Weighs only 13 oz.

New "MOTO-SANDER" AND POLISHER

MAKES FUN of HARD WORK



Only \$14.85 POSTPAID

Patented

Say "Good-bye" To Hand Sanding & Polishing!

Let speedy "Moto-Sander" do the work while you just guide it. Ideal for light sanding jobs. Use Moto-Sander for finishing, refinishing, redecorating. Quickly and smoothly sands furniture, walls, wood-work, wall board, plaster joints; boats, workshop projects, etc. Straight-line action (non-rotary) will not burn or scratch surface. Use Moto-Sander also for fast, effortless polishing of furniture, refrigerator cabinets, automobiles, other waxed surfaces. This versatile machine works on flat or curved surfaces—gets into tight corners. Moto-Sander is the lightest, most practical electric sander on the market. Delivers 7,200 strokes a minute . . . weighs only 2½ lbs. Furnished complete with 6 sheets assorted grade Garnet Paper for sanding, plus felt pad and sheepskin for wax polishing. Operates on 110-120 V., 60 cycle A. C. Thousands of satisfied users.



GETS INTO TIGHT CORNERS



GREAT FOR AUTO POLISHING

MOTO-SAW AN ELECTRIC SCROLL SAW SAFER THAN A HAND SAW

A high-speed power saw for boys from 8 to 80! Moto-Saw's 7,200 strokes a minute easily cuts intricate scroll designs—no limit to length of cut—averages 1 foot per minute through medium hardwood up to 3/4" thick. Four-way blade holder permits sawing in any direction . . . at any angle. Moto-Saw has only 2 moving parts—never needs oiling. Operates on 110-120 V., 60 cycle A. C. Thousands of satisfied users.



Only \$5.85 POSTPAID (WITH 3 BLADES)

JUST GUIDE IT!

The versatile Moto-Saw is as safe as a hand saw. A touch of the trigger switch sets it going . . . releasing stops it instantly.

WHERE TO BUY

Dremel products are sold everywhere. See these popular time-saving tools at your local dealer's. If he is unable to supply you, order direct from factory.

5 DAY TRIAL—MONEY-BACK GUARANTEE

We will ship postpaid if you send cash with order (use check, draft or money order), or send only \$2.00 now, and pay postman balance plus postage. Try the tools for 5 days. Money back if not delighted.

DREMEL MFG. CO.

DEPT. 119-E

RACINE, WIS.

SAY YOU SAW IT IN POPULAR MECHANICS

EVERY CAR OWNER WANTS TO KNOW MILEAGE and EXPENSE

get **KEE-PA-COUNT**
"Your Traveling Bookkeeper"
A REAL ADDING MACHINE

KNOW YOUR Miles per Gallon—Fuel Costs—Motor Condition—Grease Charges—Tax Deductions.

QUICK — EASY — SAVES WRITING
No installation—attaches to visor. All metal. Finished in handsome Maroon and White enamel on Brass.

LASTS A LIFETIME GUARANTEED ACCURATE MAKES IDEAL GIFT

MONEY BACK GUARANTEE
Send cash, money order or check, or pay postman \$2.95 plus postage upon receipt. **\$2.95**

AUTOMATIC GAS-LOK CO.
21 E. VAN BUREN, CHICAGO

ZIPSCOOT \$49.75

America's Outstanding Scooter Value!
This smart looking speedster is easily and quickly assembled from our factory finished kits. Uses standard gasoline motor. Speeds up to 30 miles per hour. 100 miles per gallon of gas. Send 25 cents for assembly information, drawings, and illustrations. Kits available for immediate shipment.

Zipscoot Company, Toledo 6, Ohio

Build Own ATTIC OR WINDOW FAN

SAVE 2/3

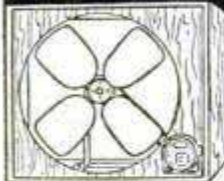

COST \$21.00

for 5 ROOM HOUSE USING 24" FAN

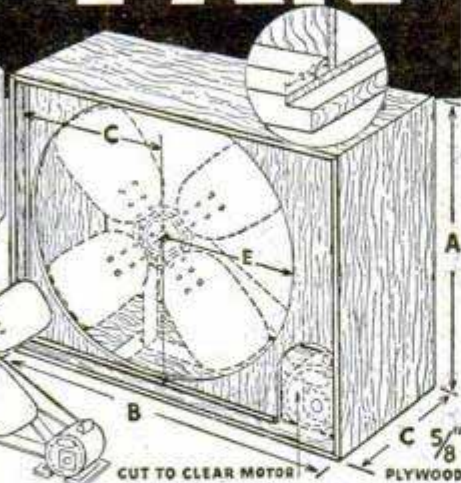

ASSEMBLY
Torrington Precision Balanced Steel Blade, Rigid Welded Construction, Adjustable motor mount, Correct pulley ratio to 1750 RPM Motor.

| Size Fan | Dim -A- | Dim -B- | Dim -C- | Dim -E- | Price |
|----------|---------|---------|---------|---------|---------|
| 20" | 22" | 29 1/2" | 11" | 10 1/2" | \$19.50 |
| 24" | 26" | 32 3/4" | 13" | 12 1/2" | \$21.00 |
| 26" | 28" | 34 1/4" | 14" | 13 1/2" | \$22.00 |
| 28" | 30" | 35 1/2" | 15" | 14 1/2" | \$24.50 |
| 30" | 32" | 37 1/2" | 16" | 15 1/2" | \$27.50 |
| 36" | 38" | 41 3/8" | 19" | 18 1/2" | \$29.95 |

42" FAN \$34.95 48" FAN \$39.95

Thousands in use. The assembly takes guesswork from your completed fan. Assembly comes complete with blade, pulleys, etc., all parts excepting motor and easily made wood box. Only work is to box assembly for attic or window, mount motor with 4 bolts and you'll have an efficient, sturdy, healthful, cooling fan. Order Model M-2 of size fan wanted. Send check, cash or money order plus \$2 for express and packing charges. For C.O.D. shipment send \$5 deposit. Satisfaction guaranteed or money back. (Special prices for quantities.)

TROUSDALE MFG. CO., 266 Madison, Memphis, Tenn.

EARN BIG MONEY AND BE YOUR OWN BOSS Sharpening Lawn Mowers

Build a Business of Your Own With A UNIVERSAL GRINDER

In your own garage or basement, and earn \$25.00 a day or more. Mr. Hardy writes, "I am doing a fine business with the UNIVERSAL GRINDER. One customer sends another. I spent 40c for a newspaper ad and have done nearly \$500.00 worth of business." Mr. Helmbeck of Canada writes, "We sharpened 750 mowers last year and are 1056 on this year's run. The Universal surely makes satisfied customers." Mr. Barton of California says, "The lawn mower business, with the Universal Grinder, has been a gold mine these last two years."



A Complete Single Unit • No Attachments Necessary
• Precision-Built • Simple to Operate • Sharpens Reel Blades at Proper Angle • Grinds a Keen Cutting Edge Full Length of Blade

Only on the UNIVERSAL GRINDER can the inside face and edge of the stationary blade, as well as the reel blades, be ground to proper clearance

ALL IN ONE SET-UP

WITHOUT REMOVING ANY BLADE FROM THE MOWER

Write for FREE Folder today!

Rogers Mfg. Co., Dept. M-59, Lindsey, Ohio

A NEW TIRE GUARANTEE WITH EVERY REMODELED TIRE

| TRUCK TIRES (30x5) | | 750x20-8 \$17.45 | |
|--------------------|---------------|------------------|-----------------|
| 550x16 \$5.65 | 650x15 \$6.65 | (600x20) \$10.45 | (750x20) |
| 550x17 5.65 | 700x15 7.65 | (32x6-8) | (34x7-10) 19.45 |
| 600x16 5.95 | 700x16 7.65 | (650x20) 13.45 | 825x20 21.45 |
| 650x16 6.65 | 750x16 8.65 | (32x6-10) | 900x20 23.45 |
| | | (700x20) 14.95 | 10.00x20 .25.95 |

HIGH QUALITY USED TIRES

| TRUCK (600x20) | | TRUCK (750x20) | | TRUCK (10.00x20) | |
|----------------|----------------|------------------|------------------|------------------|----------------|
| 600x16 \$3.90 | (30x5) \$7.35 | (34x7-10) \$9.65 | 10.00x22 \$11.95 | 11.00x20 12.95 | 11.00x22 12.95 |
| 650x16 3.90 | (650x20) | 750x20-8 8.45 | 11.00x22 13.95 | 11.00x24 15.95 | 14.00x20 18.95 |
| 700x16 4.40 | (32x6-8) 8.65 | 825x20 10.45 | | | |
| 550x17 3.90 | (700x20) | 900x20 10.95 | | | |
| 650x15 3.90 | (32x6-10) 9.45 | 10.00x20 11.95 | | | |
| 700x15 3.90 | | | | | |

Military Mud & Snow Tread

750x20 FITS 32x6-700x20-650x20-34x7 \$7.95

| | | | |
|---------------|------------------|----------------|-----------------|
| 900x16 \$6.95 | 10.00x20 \$12.95 | 1100x18 \$9.95 | 1200x20 \$15.95 |
| 900x20 10.95 | 10.00x22 11.95 | 1100x20 13.95 | 1400x20 19.95 |

Largest Stock of Tires in the East
Hundreds of Satisfied Customers
Special Prices to Dealers
Mail Orders Given Prompt Attention
Send Money Order or Check

PYRAMID TIRE CO.
1333-35 NORTH 5th ST.
PHILADELPHIA 22, PA.

STURDY ALL STEEL CABINET



EACH DRAWER 7 x 12 x 2" DEEP
Made of 20 gauge paint lock steel genuine Hammerloid exterior finish. Ideal for small parts, tool, or hobby shop. Drawers are drawn from one piece of steel with smooth rounded corners. Price only \$14.85. Send cash, check or M.O. for postpaid delivery. **\$14.85** Postpaid BUY DIRECT FROM MANUFACTURER. SAVE

VENDORLATOR MFG. CO., 4000 Railroad Ave., Fresno, Calif.

Build your own JET ENGINE!



Order these plans today
1. JET PROPELLED BICYCLE. Assemble your own. Photo and instructions \$1.00.
2. HOW TO MAKE EXPERIMENTAL JET ENGINES. Seven sheets drawings with information and instructions \$2.95.
3. BOTH OF ABOVE in one order \$3.75. SEND NO MONEY. Order both at once \$3.75 C.O.D. in USA plus c.o.d. postage. Send check or Money Order and we pay postage. Get other information too. Rush Order.

J. HOUSTON MAUPIN, Dept. 55, Tipp City, Ohio

HOW TO CUT RAFTERS

New vest pocket book gives lengths, side cuts, plumb cuts, deductions. For all rafters for any building from one inch to forty feet wide. Gives numbers to cut on square. Also degrees for same cuts for Radial Saws. All standard pitches from 1/8 to 5/8. Just open book to pitch page and there are your lengths, side cuts, etc. Anyone who knows what a jack rafter is can frame a roof if he has this great book. Price \$1.50 prepaid. Builders' Topics, Dept. M, Lock Box 828, Seattle, Washington. CARPENTERS, PLUMBERS, PLASTERERS, ELECTRICIANS, ETC., subscribe for Builders' Topics, the monthly magazine for HE-MAN CONSTRUCTION WORKERS. Only \$2.00 per year. Sample copies 25c.

SWISS MUSIC MOVEMENTS

FINE IMPORTED Movements. Ideal for musical toys, novelties and children's furniture. Many tunes available. 1-Tune Movement..... \$2.25
2-Tune Movement—\$3.25. Postpaid.

NU-DESIGNS • 1503 Trails End, Kalamazoo 26, Mich.

6 PIECE War Surplus

IGNITION ANGLE WRENCH SET

\$3.00 Value \$1.39 PRE-PAID FOR ONLY

1/2 7/16 3/8 11/32 5/16 1/4

MANY VALUES

Order COD, or save postage and COD charges by mailing check, cash or M.O. No stamps please. WRITE TODAY FOR FREE CATALOGUE

E. J. BUCHANAN, Distributor
2016 S. QUANNAH TULSA, OKLA.

FAMOUS MAKE



What a Watch! What a Buy!
17 JEWELS • 2 PUSH BUTTONS

CHRONOGRAPH

formerly up to \$71.50 **\$24⁹⁵**
• WRITTEN GUARANTEE

A precision instrument. 10% Fed. tax plus
Wrist watch, stop watch, tachometer, tele-
meter all in one. Sweep-second hand. Radium
dial, stainless steel back. Ideal for
mechanics, sports, science, medicine, engi-
neering. 10-day money-back guarantee of
satisfaction.

FAMOUS MAKE
DURABLE, PRECISE, 17 JEWEL
GUARANTEED SWISS WATCH

- Water-resistant
- Shock-resistant
- Radium Dial
- Anti-Magnetic
- Sweep-Second Hand

\$49.50 RETAIL VALUE . . . only
\$19⁷⁵ plus 10% Fed. tax
HANDSOME thin-model, expensive-looking, with matching expansion bracelet. Chromed top with stainless-steel back. Incabloc shock-feature found only in more expensive watches. 10-day money-back guarantee of satisfaction.

LAYAWAY PLAN—Send a little each month till purchase price is accumulated. We reserve your watch for you. No extra charge.

SUPERIOR WATCH DISTRIBUTORS
580 FIFTH AVE., NEW YORK 19, N. Y.
Department PM



★ **SAVE TIME and MONEY with the MARCLIFF Saw ARBOR**



GUARANTEED ACCURACY
Built for service. Inner collar assembled to shaft. Then faced after assembly to INSURE ACCURACY. Bearing spots ground to 0003. Fabricated from Stainless Steel tubing. Top quality bearings for smooth operation. Available in 1/2" or 3/4" Shaft sizes. Size Housing 8" overall length 1 1/4" Pulley and 1 1/2" PULLEY.

MARCLIFF MFG. CO., Hudsonville, Michigan

• DEALERS WANTED

SEND **\$7.20**
Check or Money Order Shipped prepaid

WORLD'S LOWEST PRICED ADDING MACHINE Vest Pocket Size FREE TRIAL



IDEAL FOR BUSINESS AND PERSONAL USE — GUARANTEED ACCURATE. Not a toy. Operates with only a finger flick. Adds, subtracts, multiplies, divides. Counts up to one billion. Pays for itself over and over. Ideal Gift — for Business, Income Tax and School use. **\$2⁹⁵**

MONEY BACK GUARANTEE. Send \$2.95 plus name and address. Postman only \$2.95 plus postage. (Send full cash if outside U.S.) Beautiful Fich-looking Leatherette Case included at no extra cost. Money back in 10 days if not delighted. AGENTS WANTED.

CALCULATOR MACHINE CO., (Mfrs.)
Dept. 214, P.O. Box 248 Glenview, Illinois

BUILD FINE GRANDFATHER CLOCK NOW

The simple sensible Red-i-Kut way as thousands have—**SAVE HALF. SHOP TESTED PLANS "SPIRIT OF THE CENTURY"** Narrow waist 83" tall or stately **"SPIRIT OF AMERICA"** straight side model with pictures. **EASY-TO-FOLLOW PLANS** tell all—plus **BROCHURE** of heavy brass weight Westminster, tube chime, movements, dials, solid mahogany case kits. Send \$1.00 today—Both Plans \$1.50 NOW.

KUEMPEL CHIME CLOCK CO., #3 Kuempel Bldg., Minneapolis 16, Minn.

Command Bigger Money!

STUDY LAW

STUDY AT HOME for BUSINESS SUCCESS and LARGER PERSONAL EARNINGS. 40 years expert instruction — over 114,000 students enrolled. LL.B. Degree awarded. All text material furnished. Easy payment plan. Send now for **FREE BOOK** — "Law and Executive Guidance." It explains the course — how you may enroll and the many ways you can profit from Law Study. Write **TODAY** to:

AMERICAN EXTENSION SCHOOL OF LAW
Dept. 14-PM, 646 N. Michigan Ave., Chicago 11, Ill.

SAVE \$300.00 TO \$500.00
... "BUILD YOUR OWN" ARC WELDER!



HOBART shows how to start a profitable welding business. No limit to possibilities. Equipment also made for specialized fields.

HOBART Welding Generator (for building your own) Complete in every way except for motor, this full capacity generator can be used to build portable gas engine driven welder, or can be operated with electric motor, or belt driven from power shaft.



- Gas Engine Driven D. C. Welder** for repair and construction in field.
- Electric Driven D.C. Welder** for speedy production and maintenance work.
- Transformer Type A. C. Welders.** Sizes 180 to 500 amp. for most all shops.
- A.C. Generator Only "Build Your Own"** power plant to do welding or operate lights, tools, etc.
- AC Weld—AC Power** Complete gas engine driven A. C. Welding and A. C. power anywhere.
- DC Weld—DC Power** Gas engine driven. Ideal for field work. Weld, operate tools, hoists.

LEARN WELDING QUICKLY AT THE HOBART SCHOOL



It's easy and cost is small. Latest methods and equipment for all types of welding. Qualified under G. I. Bill.

HOBART Brothers Co., Box M-59, Troy, Ohio
"One of the world's largest builders of arc welders"

clip coupon and mail today!

Hobart Brothers Company, Box M-59, Troy, Ohio
Check the items on which you want more data and receive free copy of "Guide to Better Welding." capacity _____ amperes

- D. C. Generator to "Build Your Own"
- Gas Engine Driven D. C. Welder
- Electric Driven D. C. Welder
- A. C. Transformer Welders
- A. C. Generator to "Build Your Own"
- Gas Driven A. C. Welder, Power Unit
- Gas Driven D. C. Welder, Power Unit

NAME _____
ADDRESS _____
use margin space if necessary

TUBE GIVEN WITH EVERY TIRE



"VETS" TAKE 10% DISCOUNT
OUR GUARANTEE
OUR TIRES must make good
OR WE WILL
NEEDLESS TO PAY MORE
RISKY TO PAY LESS
OUR LONG EXPERIENCE
INSURES YOUR SAFETY
 You get what we advertise
 Highest Quality Lowest Prices
 Slightly Used

HIGH ORIGINAL TREADS
BUY IN CONFIDENCE safe dependable selected **POPULAR BRANDS**—Guaranteed to give A-1 SERVICE. Do not confuse these tires with re-caps or re-treads.

SELECTED FOR TOUGHEST JOBS Not just good... **THE BEST**
 These are genuine Values! One Trial will **CONVINCE YOU**

| TOPS IN VALUE | | TOPS IN SAFETY | |
|------------------|------------------|----------------|--|
| 600-16 .. \$5.32 | 650-16 .. 5.32 | 700-16 .. 6.32 | |
| 650-15 .. 5.02 | 700-15 .. \$5.32 | 750-16 .. 7.92 | |

World's Best Truck Tire Values Top Service Minimum Prices

| | | |
|---------------------|-------------------|-------------------|
| 600-20(6) .. \$8.72 | 750-20(10) 12.22 | 1100-20(12) 16.42 |
| 650-20(6) .. 8.72 | 825-20(10) 14.92 | 1100-22(12) 18.22 |
| 700-20(8) .. 10.32 | 900-20(10) 15.42 | 32x6(8) .. 9.82 |
| 750-20(8) .. 9.22 | 1000-20(12) 16.22 | 32x6(10) .. 12.22 |

750-20 MILITARY 8 PLY REGULAR \$8.62—SUPER \$11.92
 900-16 MILITARY 8 PLY REGULAR \$7.22—SUPER \$9.22
ONE QUALITY THE BEST AVAILABLE

HERE'S MAXIMUM QUALITY IN THESE O. K. SAFE TIRES

| | | |
|---------------------|-------------------|-------------------|
| 600-16 .. \$3.62 | 650-16 .. \$3.92 | 700-16 .. \$4.62 |
| 650-15 .. 3.92 | 700-15 .. 4.02 | 750-16 .. 5.92 |
| 600-20(6) .. \$8.02 | 750-20(10) \$9.22 | 1100-20(12) 13.92 |
| 650-20(6) .. 7.72 | 825-20(10) 11.22 | 1100-22(12) 16.92 |
| 700-20(8) .. 9.32 | 900-20(10) 11.92 | 32x6(8) .. 9.22 |
| 750-20(8) .. 8.22 | 1000-20(12) 12.92 | 32x6(10) .. 11.22 |

OUR SPECIALTY—TIRES FOR SCHOOL BUSES AND AMBULANCES

Thousands of Tires Shipped to Satisfied Customers Throughout United States and Many Distant Points. Please Note: We've made Thousands of Friends by giving a Tube with Passenger and Truck Tires. MAIL ORDERS given Personal Attention—Send This Ad with Check or Money Order. Dep't. 2

STANDARD 834 N. Broad St., Phila. 30, Pa.

SAY YOU SAW IT IN POPULAR MECHANICS

DIAL your SAW CUTS!



AMAZING NEW

Warren

DADO SAWING WASHERS MAKE ALL THESE CUTS ON YOUR SAW!

Smooth, accurate grooves—12 widths, any angle. No chatter, no burning, chewing, or sanding! Just dial desired width with Micro-matic adjustment! 5 sizes fit any saw arbor— $\frac{1}{2}$ ", $\frac{3}{8}$ ", $\frac{1}{2}$ ", 1", 1 $\frac{1}{2}$ ". See your dealer or use coupon below! Satisfaction guaranteed.

DEALERS, ORDER DIRECT!

WARREN WASHERS CO., DEPT. 25
 70 Medbury Ave., Detroit 2, Michigan

Enclosed \$4.95 for one set of Warren Washers, postpaid. My arbor size is _____

NAME _____

ADDRESS _____

CITY _____ STATE _____



\$4.95 set
 pat. pend.

FREE SCREEN TEST



Special offer! Simple 3 minute test shows amazing "Theater-Quality" brilliance you get in showing slides, movies, film strips on DA-LITE Crystal-Beaded Screen Surface. Black-and-white and color pictures "come to life" in sharp detail.

Da-Lite Screens, first choice of theaters for 40 years. 5 popular models to suit any purse or purpose. Guaranteed. Any photo dealer will demonstrate.

Send for **FREE SAMPLE SWATCH.**
OFFER LIMITED. WRITE TODAY!

Da-Lite Screen Co., 2721 N. Pulaski Rd., Chicago 39, Ill.

DA-LITE THEATER QUALITY SCREENS

make your own Gems 29.50 F.O.B.

All necessary lapidary equipment is furnished, including a super-charged diamond blade for sawing, and all wheels for grinding, shaping and polishing; also complete instructions. The complete equipment as shown, less motor and belt, for only \$29.50, f.o.b., Burlington, Wisconsin. Write today for information and literature.

B&I MANUFACTURING CO.
 Dept. S Burlington, Wis.

GLOWS IN THE DARK **Free Sample!**

Big profits showing amazing **GLOW-IN-THE-DARK SPECIALTIES**. House numbers, pictures, plastic novelties, religious and nursery objects, etc. Large manufacturer. Enormous demand. Sell on sight. Write at once for **FREE SAMPLES.**

MADISON MILLS, Dept. T-4
 303 Fourth Ave. NEW YORK 10, N. Y.

STANDARD GARDEN AND SMALL FARM TRACTORS

RIDE-WALK Powerful Gas Tractors for Small Farms, Gardeners, Florists, Fruit Growers, Poultrymen, Nurseries, 1 & 2 Cylinders Rubber or Steel Tires. High Wheels—Free Catalog

STANDARD ENGINE COMPANY
 MINNEAPOLIS, MINN. NEW YORK, N. Y.
 3221 Como Avenue 617 West 26th Street

Plow Seed Cultivate Mow Haul Belt Work

RE-STRING RACKETS AT HOME—EARN MONEY

EASY—PLEASANT—PROFITABLE

FREE Write for 1949 Catalog and Instruction Sheet NOW.

W. A. BICKEL & CO., 803 S. Boulevard, Dept. F-52, Oak Park, Ill.

UTICA TOOLS
 For More Tool Mileage

TOOL No. 654
 Long Chain Nose Side Cutting Pliers

SEE YOUR DEALER

UTICA DROP FORGE & TOOL CORP.
 UTICA 4, NEW YORK

MAIL ORDER BARGAINS



All Bronze GEAR PUMP

All bronze corrosion resistant gear pump. Will lift water 25 ft. Will deliver 1020 gal. per hour at 1200 RPM. Develops 110 lbs. pressure or 250 ft. head. Self-locking packing nuts, drain cock, reversible head. Will pump brines, salt water, oil, vinegar, gasoline, etc. Dimensions: 10" L x 7" H x 5 1/2" W. Base holes 1 3/4" x 3/4". Shaft 1 1/16". 1" x 1" inlet & outlet. Wt. 24 lbs. Mfg. by Sherwood Brass Works. Requires 1/2 to 3/4 HP motor. \$80. value for only **\$24.95** new (Stock #314)

PLASTIC HOSE

Good for water, oil, air, etc. Will stand 75 lbs. pressure. Available in 100 ft. lengths. 1/4", 3/16", 1/4" 9/16", 5/8" (your choice) **2c** per foot. 3/4", 1" (your choice) per foot. **6c** 5/16", 1/2" (your choice) per foot. **3c** 1 3/8" per foot. **8c**

Electric Rubber Cable

(ALL NEW)



CORD SETS

Extension cords, 100 ft. heavy duty. Plug, socket and guard. Number 16 wire. Worth at least \$10.

OUR PRICE..... **\$5.95**

(Stock #310)

Same as above—50 ft. length. (Stock #311)..... **\$4.25**

HEAVY DUTY ELECTRIC CABLE

3 wire #10 Super Cable, Stock #408

100 ft. . . **\$22.00** 250 ft. . . **\$48.00**

4 conductor neoprene covered #18 stranded tinned copper wire (two blacks & two whites). Run in parallel gives you #16 gauge. Lugs furnished for parallel run. Water & oil resistant. (Stock #346).

100 ft. **\$4.25** 250 ft. **\$10.00** 500 ft. **\$19.00** 1320 ft. reel **\$36.00**

150 ft. reels, 3 wire #6 with 4, 60 amp Crouse & Hines connectors—2 male & 2 female. Perfect for welders, hay loaders, saws, electric ranges, etc. List price **\$65.00** \$190. per reel. OUR PRICE..... **\$65.00** (Stock #313)



BARKER AIR COMPRESSOR

Barker model 28 air compressor. Piston type with 2 x 1 3/4" bore, V-belt drive. Maximum continuous pressure 100 lbs. 2.3 CFM with 1/4 HP motor. New. **\$15.95** Stock #502..... only



Portable BUZZ SAW

Powered by 6 1/2 HP Briggs & Stratton air cooled gas engine. Adjustable hinge, requires no clutch. 28" blade, will take up to 12" hardwood. 1 3/8" ball bearing mandrel. Has power take-off. Complete unit mounted on two wheels with 400 x 8 pneumatic tires. Has tow bar for trailing. Wt. approx. 400 lbs. Sold complete or less blade, engine or wheels. Make \$25 to \$50 a day sawing wood with this sturdy unit. WRITE FOR FREE CIRCULAR. (Stock #350)



MARINE FLOAT

Made of heavy rubberized fabric. 1/2" rope encircles raft passing through dog rings as handles. Original cost \$325. Can be used as swimming pool, dock, diving raft, etc. Will support 4 tons! Cannot tip. Stock #412

6' W x 20' L. **\$59.50** 6' W x 25' L. **\$69.50**

Due to cost of handling, send full amount with order on this item.

War Surplus and Other Items

BALL BEARING ARBORS



Grinding and saw arbor, has 1/2" double end shaft, 1 1/2" long with 2" center pulley. New Departure double roll ball bearings. Right and left hand thread. Self aligning Dodge pillow block, 10,000 RPM. Bearings alone list at \$10. Complete arbor new. **\$4.95** (Stock #305)..... only

HI-SPEED GRINDER (not pictured). Has 2 step pulley driven thru rear or base. **\$10.95** (Stock #328)..... only



CLUTCH

for motor-scooters, motor-bikes, lawn mowers, etc.

Mercury centrifugal clutch for use with any small gas engine. 3" "A" belt pulley, 5/8" bore. Brand new only. (Stock #400)..... **\$9.95**

SPECIAL!



Centrifugal PUMP

Powered by Lauson 3/4 HP gas engine. Pumps 3000 gal. per hour. 1" inlet, 3/4" outlet. The perfect answer for quick easy pumping of any liquids. Easily portable. Limited quantity available at this bargain price. Stock #501

BRAND NEW only \$59.50

HORNS and HOWLERS



Motor driven (not a vibrator). Heavy duty with great power and long life. Adjustable for high, medium or low tone. 110 volt AC current. Weather proof. For alarm or signal horn on boats, school yards, factories, etc. List price \$47.00. OUR PRICE, **\$9.45** new.....



Automatic AIR COMPRESSOR

Complete. Piston type with 10 gal. tank, 1/8 HP capacitor type, AC, 110-220 volt 60 cycle motor—approx. 2 cu. ft. Brand new. (Stock #340)..... only **\$79.50**

Assemble yourself and save \$10. ABOVE tank with legs and saddle..... **\$11.95**

AS ABOVE—1/2 HP motor, 2 cyl. Westinghouse compressor. 3 CFM at 75 lbs..... **\$109.50**



AC ARMY LIGHT PLANTS

300 Watt, 110-220 volt AC, 60 cycle light plant powered by 1/4 HP gas engine, direct drive. Mounted on base. **\$99.50** Stock #409.....

New 750 watt 110 volt 60 cy. light plant with Briggs-Stratton model AP gas engine. (Stock #315)..... **\$149.50**

New 1000 watt 110 volt 60 cy. light plant with Briggs-Stratton model BP gas engine. (Stock #316)..... **\$179.50**

New 2500 watt 110 volt 60 cy. light plant Briggs-Stratton model Z 6 HP gas engine. Used, like new... **\$225.00**



New..... **\$265.00**

Add \$10 for tools and spare parts. Rebuilt 5000 watt 110 volt 60 cy. light plant with automatic remote control. Powered by Jeep 4 cyl. gas engine. Rebuilt like new and guaranteed. (Stock #318)..... **\$625.00**

7,500 watt, 110 volt AC light plant powered by VE-4 Waukesha 4 cyl gas engine, Continental or Hollinsworth generator. Remote control starting with 100 ft. starting cable, and 100 ft. of 3 wire #6 cable. Complete switch board. Used, like new and guaranteed. (Stock #347)..... **\$675.00**

Add \$65.00 for transformer to make plant 3 phase 220 volt.

10,000 watt 110 and 220 volt 60 cy. light plant with automatic remote control. Powered by Jeep 4 cyl. gas engine. Rebuilt like new and guaranteed. (Stock #319)..... **\$900.00**

PORTABLE DC LIGHT PLANT

3000 watt 110 volt DC powered by new 6 HP Briggs-Stratton model Z2P gas engine. Rebuilt generator. Generator alone lists at \$243.00. Has volt meter, rheostat, 4 female plugs, and ball bearing 2.75 x 10 rubber wheels. Guaranteed. (Stock #320)..... only **\$185.00**

GENERATORS

AC—750 watt 110 volt 60 cycle with voltmeter, rheostat, 3/4" shaft. Dimensions: 9"H x 12"W x 13"L. Wt. 52 lbs. Shielded to prevent radio interference. Mfg. by Ecor. \$125.00 value. **\$69.50** OUR PRICE, new (Stock #322)



AC 1000 watt — **\$79.50** (Stock #403).....

DC-300 watt, 12 volt, 2900 RPM. Heavy duty, with current cut-out relay, high and low switch, 30 amp. meter. Can be bought less shaft and base to be used direct mounted to Briggs-Stratton 1 HP engine. NEW (Stock #323)..... **\$700**

Complete with base, shaft and bearing. (Stock #324)..... **\$15.95**

HALES FIRE PUMP



For fire depts., factories, forest fire protection, etc. 600 gal. per min. Can be operated with 4 or 6 cylinder gas engine. 4 1/2" intake . . . 2—2" outlets . . . 265 ft. head at 120 lbs. pressure. Passed by National Board of Fire Underwriters. NEW, Stock #407 . . . **\$109.00**

HALF TON WAGON

"ASSEMBLED OR IN KIT FORM"



Heavy duty wagon with plate aluminum body 24" x 42". Stock #332 Completely assembled **\$42.50**

ALL ITEMS GUARANTEED C & H ELECTRIC Co.
AS REPRESENTED
434 W. JUNEAU AVE.
MILWAUKEE 3, WISCONSIN

All prices F.O.B. Milwaukee, 25% deposit required on all C.O.D. orders. No C.O.D. orders under \$10.00. Use stock number when ordering. Many other bargain items not listed—write for our free circulars.

LOOK FOR THE NAME

Buckeye when you buy a

LAWN MOWER

Built by a factory noted for quality lawn mowers since 1880, the long experience behind BUCKEYE mowers assures you complete satisfaction with their fine, practical, labor saving performance. Streamlined design; light, strong, durable. Reasonably priced; recommended by reliable dealers. Send for free booklet describing the popular self propelled BUCKEYE Power King and the easy-to-push BUCKEYE hand mowers.

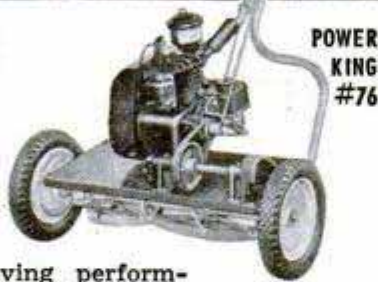

POWER KING #76

HAND AND POWER LAWN MOWERS

MAST-FOOS MFG. CO., Dept. PM-59, Springfield, O.

You may send descriptions of BUCKEYE Lawn Mowers, also name of your nearest dealer.

Name _____
Address _____
City _____ State _____

Keep Brushes like New

BEFORE

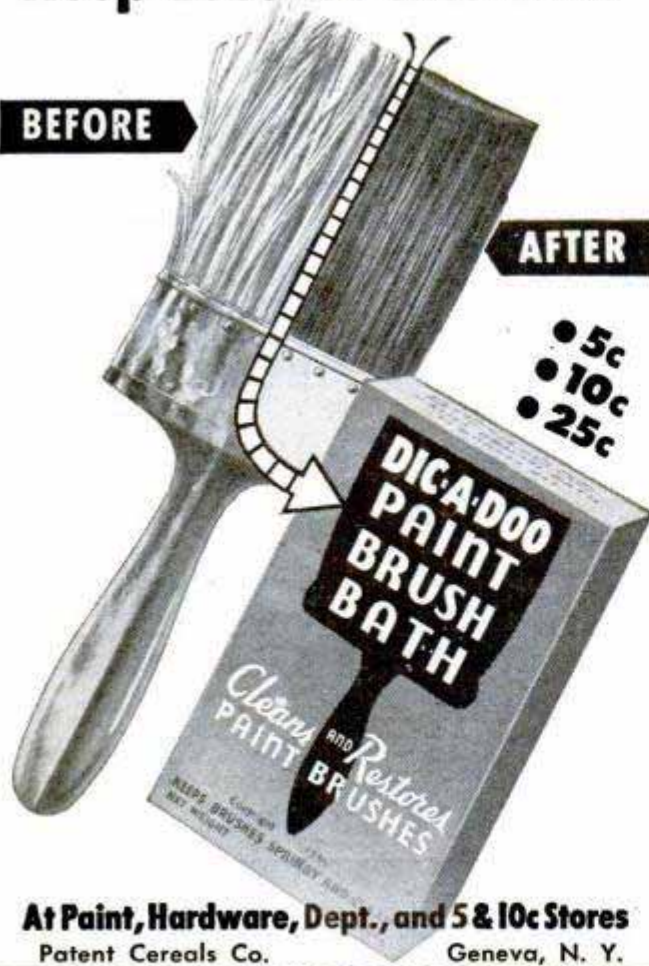

AFTER

• 5c
• 10c
• 25c

At Paint, Hardware, Dept., and 5 & 10c Stores

Patent Cereals Co.

Geneva, N. Y.

SAY YOU SAW IT IN POPULAR MECHANICS

HOW DEEP?

EXACTLY 27 FEET!

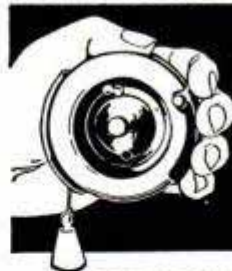

Quit guessing! Know your depth when fishing or boating. Get accurate measurement to 100 FT. at a glance! Locate holes, channels, drop-offs with IMPROVED all chrome DEPTHometer. Sturdy, compact. NEW BACKLASH RELEASE.

THE DEPTHometer \$2.00

Sent postpaid

DEPTHOMETER CO., P.O. BOX 1466-P, SOUTH BEND, IND.

* FENDER SKIRTS \$17.20 PER PAIR *

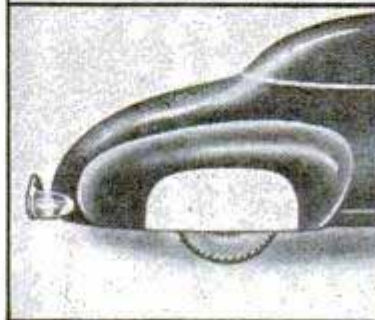

For Ford Chev., Merc., Plym., DeSoto, Chry., Dodge Kaiser-Frazer and Buick. Beautify your car bring out the flowing lines inherently designed there. Sparkling beauty you'll like. Constructed of heavy gauge body steel, finished in prime, perfect fit.

SANDEE MUFFLER CO
Box 296, La Tijera Sta.
Los Angeles 43, Calif.

Gentlemen Please send me one set of Sandee Fender Skirts to fit my _____ (year and make of car)
 Check for \$17.20 enclosed
 Ship C.O.D.

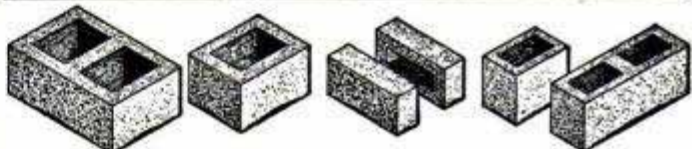

Make Concrete Blocks and Bricks

New superior method makes square, true, easy-to-lay units which will pass any building code. Small investment, high production, big profits. One \$30.00 machine will make four 5"x8"x12" blocks per minute—1000 per day. Pays for itself in a few days. Sell blocks or save 2/3 building cost by making and laying your own.

POST CARD BRINGS FREE FOLDER

Economy Manufacturing Company
Dept. P Stone Mountain, Georgia

HANDEE CAR WASHER



RINSES AS IT WASHES!

Thousands of tiny sprinklers wash car in a flash! Waterproof glove bonded to live-foam sponge rubber pad, can't scratch or mar. Attach to any garden hose! Constant water flow rinses as it washes! Soft, light, strong! Order yours today! Send no money—Pay postman only \$1.98 plus postage. Satisfaction guaranteed! (Salesmen write!)

MICHIGAN MERCHANTISERS

BOX 223

FENTON, MICH.

FREE parts catalog

Build Better Trailers with Safety-Engineered



- ★ Torq-less Axles
- ★ Bull Dog Hitches
- ★ Parking Jacks

... Send for your copy TODAY!



HAMMER BLOW TOOL CO.

Dept. 132, Wausau, Wisconsin

COMPLETE LOCKSMITH SHOP *only*

ALL NEW MERCHANDISE!
POPULAR STANDARD EQUIPMENT

\$149.00

START YOUR SHOP NOW!

At Home, Garage, Basement, or rent a small store, or add a key department to your present business.

- A. 1 Champion Precision Key Machine.
- B. 1,000 Popular Key Blanks.
- C. 1 Key Board with Key Hooks.
- D. 4 Popular Locksmith Books.
- E. 2 Locksmith's Warding Files.
- F. 1 Set Lock Picks in Case.
- G. Big Assortment Parts and Tools.



ALL FOR ONLY \$149.00. EASILY WORTH \$175.00!

Slightly higher out of U.S.A. 25% deposit on C.O.D. orders. Start making money at once! Order your outfit today! Complete satisfaction guaranteed! Write for FREE catalog today!

REPAIR SHOP SERVICE • Box 264M • SKOKIE, ILL.

MAKE ANY CUT WITH THESE NEW WOODSHAPERS for YOUR CIRCLE SAW or DRILL PRESS!

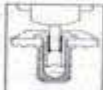

MODEL #60—Originally designed for heavy industrial use, now priced for home workshop. Can be attached directly in chuck of your drill press. Exclusive pilot bearing (see illustration) eliminates side thrust, chatter and vibration—assures smooth cutting action. Blades can't come out—set screws hold them securely. Complete, with YOUR CHOICE OF ANY 6 PAIR DOUBLE-GROUND BLADES SHOWN BELOW, only \$12.95.

MODEL #50—Same as Model #60 but without exclusive pilot bearing. Designed for intermittent shaping; over 100 different shapes can be cut. Complete, with ANY 6 BLADES OF YOUR CHOICE SHOWN BELOW, only \$8.95.

All Aladdin tools are guaranteed. Postage prepaid with all cash orders, C. O. D. plus postage. GET YOUR ORDER IN TODAY.

ALADDIN MFG. CO., INC.

3121 Main Street Kansas City, Missouri
Dealers Write Today



For Your Circle Saw

through. In ordering, state diameter of shaft. Complete WITH ANY 6 PAIR OF READY-GROUND BLADES SHOWN BELOW, only \$14.95.

MODEL SA-10—Heavy-duty, industrial-type shaper of solid steel, now priced in home workshop range. Absolutely safe—blades locked in position with screws all the way through. In ordering, state diameter of shaft. Complete WITH ANY 6 PAIR OF READY-GROUND BLADES SHOWN BELOW, only \$14.95.

ALADDIN WOODSHAPING BLADES

Specify by number the blades you want. Additional blades \$1.50 each, \$3.00 per set.

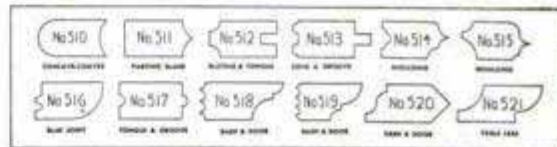

World Famous PACKAGED BOAT KITS

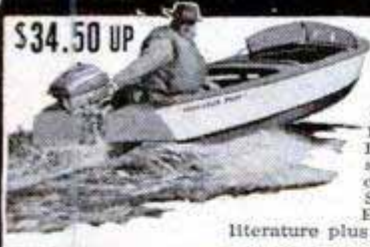

\$34.50 UP

1949 LINE—18 MODELS—8 TO 18 FT.

New models offer increased performance! Simplified building instructions! Low prices! 8 ft. dinghy \$34.50, 16 ft. Runabout \$159. Dinghies, skiffs, fishing and speed boats. All parts pre-cut, frames pre-assembled. SEND 25c (coin) FOR LITERATURE or send \$1.00 for literature plus booklet "Plywood Boats."



BOAT PATTERNS

100 designs by Deed, Lord, Crandall etc., Plank, steel, and plywood. All types, 6-35 ft. Detailed blueprints, full-size paper patterns. Catalog 35c (coin). Catalog and booklet "Boat Building" \$1.00.

PLYWOOD CONVERSIONS HARDWARE

—and Marine lumber. Stock list 10c. List and handbook "Plywood Hints" 50c (coin). Drives, gears, engines, kits, Catalog 50c (coin). With booklet "Conversion Hints" \$1.00. Send \$1.00 for 250-page Builders Guide, 15,000 items pictured, priced.

MARINE MART-DEPT. 24-BUFFALO 7, N.Y.

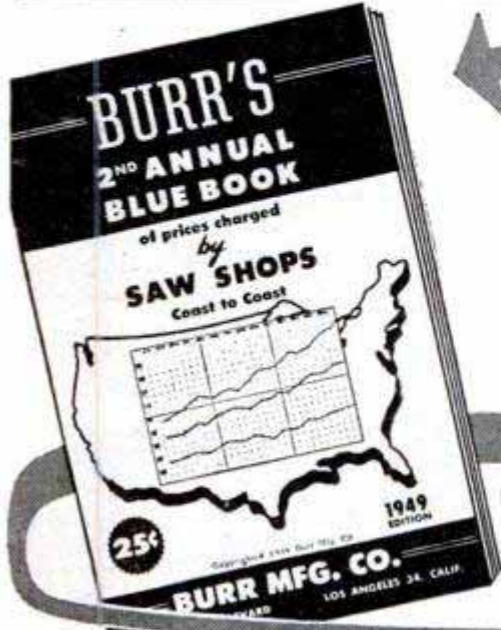

HOW TO EARN MORE SHARPENING SAWS!

Get a fair price for your work! Use the Blue Book for saw shop prices . . . tells prices in 48 states. THIS VALUABLE BOOK 25c
Leading saw shops earn more with fast, accurate machines. Write for free information on these profit makers today!
Automatic Retooler—cuts new teeth in 50 seconds.
Automatic Saw Set—sets 400 teeth per minute.
Circular Saw Sharpener—gums and joints saws 5" to 5'



BURR MFG. CO.
8933 VENICE BLVD. LOS ANGELES 34, CALIF



Power YOUR BOAT

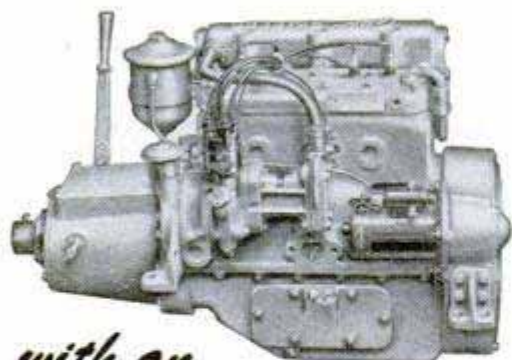

with an ATLAS "SKIPPER"

There is such a definite relationship between hull and horsepower and boat speed, that you ought to determine just what you want in an engine, before you get too far along with hull plans or construction. Here is a compact 55 H.P. heavy duty gasoline engine, made by one of America's foremost builders of Marine Diesel engines. With direct drive, it weighs under 500 pounds. Its heavy flywheel cushions power impulses and provides that smooth operation that delights every yachtsman. We make this one size and type only, because it is ideal for the requirements of so many sportsmen, fishermen, lake and river boatmen. For pleasure craft or small commercial vessels, investigate "The Skipper." Write for complete specifications and prices.

ATLAS IMPERIAL DIESEL ENGINE CO.
1000 - 19th Ave. Oakland, California, U.S.A.
Branches in Principal Ports

Biggest buy in Hobby history!

"FORTY-NINER"

Complete set of X-acto Hobby Knives and Tools in portable wooden chest **\$25**

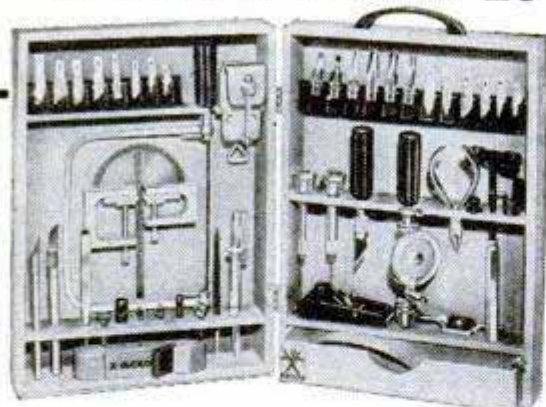

Every knife, tool and blade in the famous X-acto line. Precision made, easy to handle, joy of amateur and expert hobbycrafters in every field. X-acto knives and tools sell singly and in sets, 50¢ to \$50 at hobby, gift, hardware and department stores. (Prices slightly higher in Canada.)

x-acto

X-acto Crescent Prod. Co., Inc., 440-4th Ave., N.Y. 16
In Canada: Handicraft Tools, Ltd., Hermant Bldg., Toronto

RIVETED STRIKE-PLATE JOINTS



ONLY ON EAGLE RULES

Insist on an EAGLE RULE

The Royal Eagle is a jewel of a rule . . . a rule for the craftsman who is fussy about his tools. Made of finest hard maple for extreme durability. Double edge graduations. Joints cannot slip, stretch or twist apart. At better dealers everywhere.

EAGLE RULE MFG. CORP.
NEW YORK 59, N. Y.

GENUINE GOATSKIN A-2 FLIGHT JACKETS

Brand New. Sizes 36-46. **\$14.95**
Were \$21.95.

SUNGLASSES



\$2.38 WITH CASE

Men's and Women's. Sweat Bar. 4 Base Ground and Polished Lenses.

Full line of Sports, Camp and Work Items



Send for **FREE Catalogue**
Orders sent postpaid. Sorry no C.O.D.'s Satisfaction or money back

CONSUMER'S CLOTHING CO. Inc., Box P, 26 Greene St., New York 13, N. Y.

FISHERMAN'S WATER-PROOF VARNISH



Beats anything you have ever tried for beauty, durability, resistance to wear and weather. Use it on your finest rods and equipment Wonderful for any surface requiring a clear, protective finish. You'll find dozens of uses for this high-grade, original Fisherman's Varnish. Only \$1 for 4 oz. bottle, enough for several rods. Money back if not satisfied. Send check, money order or currency today to:

THE OLD FISHERMAN, 1220 East 9 Mile Road, Hazel Park, Mich.

OVER 500 WAR SURPLUS BARGAINS!



NEW! SPRING & SUMMER

CATALOG FREE!

FISLER SALES CO. 723 WALNUT KANSAS CITY, MO.

Free Booklet on FLEX-O-SHAFT

illustrating this all-purpose power machine with hand-piece that handles as easily as a pen. Motor with switch, foot-operated rheostat, and 66 accessories at special low price. Write

FLEX-O-SHAFT SALES CO.

Dept. C

Prairieview, Illinois.

LAWN MOWER SHARPENER

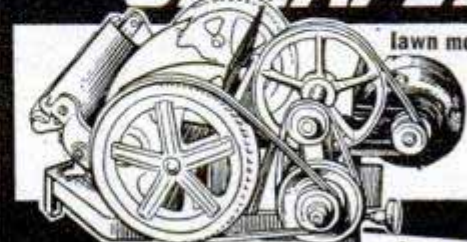

lawn mower sharpening at low cost!

\$4250

less motor.

turn spare time into dollars

Order direct from **QUAD CITY PRODUCTS Company, Inc.**
Box 42, Rock Island, Ill.



SURPRISE VALUE
100 PIECES
for ELECTRIC
GRINDERS **\$1.00**

Grinding Wheels, Cut-off Wheels,
Sanding Discs, Mounted Stones,
Sharpening and Honing Stones,
Rotary Cutting Burs, Abrasive
Cartridges, and many other items. Rush check or Money Order.



**18 ROTARY
CUTTERS**
\$5.85
Value

Assorted sizes cutter on 1/8" or 3/32" shank. Will fit all hand
grinders. Ideal for cutting wood, metal, or plastic. Brand new.



2 CIRCULAR SAWS
ON 2 MANDRELS—ALL AT
ONE LOW PRICE... **\$1.50**

1" diameter saws on 1/8" Mandrels. For cutting wood, plastic, or soft metals. Order at once! Send Check or Money Order for this big bargain.

SCHUPACK SUPPLY CO., 7331 Cottage Grove, Dept. M5, Chicago 19, Ill.

Sand Casting — Forging — Heat Treating — Case Hardening
BRONZE FOUNDRY



In your own workshop allows you to design and build your own GASOLINE ENGINES, STEAM ENGINES, STATUARY, ART OBJECTS, SPECIAL TOOLS, NEW INVENTIONS, ETC. You can also make forgings and case harden steel. Your shop is not complete without a FOUNDRYETTE. Three sizes are available capable of making bronze castings of 1 1/2, 3 and 6 pounds weight, aluminum, copper, brass, etc., \$22.50, \$29.50, \$42.00 f.o.b. Kansas City. Domestic gas supply and 110 volt AC or DC energy required for operation. Write for circular.

KANSAS CITY SPECIALTIES CO.
Box 6022, Dept. P-4 Kansas City, Mo.

BURN YOUR NAME ON TOOLS
WITH **ARKOGRAF PEN**

Protect Your Tools From Theft
Write with electricity any name or design on hardest tools, instruments, parts, metals. Easy as writing with pencil. A real tool, not toy! Approved by Auto. Test Lab. Lasts years. Mfrd. since 1921! Operate from 6V Auto Battery, Dry Cell, or Transformer. Postpaid \$4.95 Complete—Guaranteed. Free Circular.

Gourley Mfg. Co., 7057-A S.E. Powell, Portland 6, Ore.

Build YOUR OWN LOG CABIN!

\$425 to \$5,000

Big Savings

Shipped In Sections — Ready to Erect
Build your log cabin yourself and save money! Braun Cabins (Patent No. 2320466) come to you prefabricated in sections, lettered and numbered—easy to erect. Beautiful Michigan White Cedar vertical half-logs. Weathertight joints. Interior—knotty cedar. Many designs to choose from, as low as \$425, F.O.B. Detroit—or we can adapt our material to your plan, FHA approved. Prompt shipment. Send 25c for 24-page Catalog, including overnight and guest cabins.

BRAUN LUMBER CO.
CEDAR CABIN DIVISION
1571 E. Davison Detroit 3, Mich.

Send 25c for Catalog

BRAUN CEDAR CABINS

RISLONE with your oil makes your car run better within 10 miles

... guarantees smooth new power by dissolving gum and sludge in your engine



Rislone keeps your car at peak performance as you drive... gives you immediate starting, power-surge pick-up, and smooth performance in all gears, at all speeds.

It's a super oil-alloy that keeps modern motor-oils doing their best. It dissolves gum and sludge to keep your motor clean and protected.

Rislone has no harmful ingredients; it is a full-time lubricant with plus features that get rid of sticking valves, sluggish power, and slow-speed jerkiness. Its "motor magic" works in cars of any age. Rislone in your motor-oil even permits normal driving speeds immediately in new and reconditioned cars.

Prove it to yourself. Try Rislone today. Available at car dealers, better garages, and service stations everywhere. If you can't feel a smooth-driving difference in 10 miles—you get a full refund.



Whenever you change your oil .. put in a quart of **SHALER**

Rislone

(2 quarts for larger cars). As you add oil, N2 make every fourth quart RISLONE.

3, 4, & 5 HORSEPOWER

RED GARDEN TRACTOR

NO BELTS • NO CHAINS
POWER TURNING

BUY DIRECT from FACTORY at FACTORY DISCOUNT write for BIG, FREE CATALOG

FLOW, DISC, HARROW, CULTIVATE and PLOW SNOW
3-4-5 H.P.
Easy to Operate • Economical

All-Gear Drive in Oil Filled Grit-Proof Housing
Adjustable Handles to Fit Your Grip

RED-E TRACTOR CO.
Does Over 30 Jobs
Thousands of Satisfied Users

All Tractors Guaranteed

RED E TRACTOR CO., Box 235, Richfield, Wisconsin
Please Send Me 32-page FREE Catalog.

NAME _____
ADDRESS _____

Say You Saw It in Popular Mechanics

Thousands of Parts For Military **TRUCKS**

We have for immediate delivery genuine parts for all makes and models, 4x2 - 4x4 - 6x4 and 6x6. All models from 1/4 ton to 20 tons. All makes: Auto-car, Biederman, Brockway, Chevrolet, Diamond T, Dodge, Federal, Ford, GMC, International, Mack, Oshkosh, Reo, Studebaker, White, Willys and Jeeps. We have parts lists available on some models. Write stating model of Truck.



JEEP TOPS and CURTAINS

(Weatherizing Kit), complete top with back curtain and side curtains with zip-in-doors. 5 windows. Waterproof O.D. color. Shipping weight 40 lbs. Wonderful value. FOB, K.C. **\$39.50**

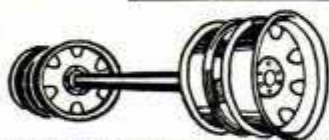

TRAILER AXLE

Heavy duty trailer axle suitable for many types of trailer construction. Also excellent for building of heavy farm trailers and wagons. It is a 12,000 lb. capacity square type straight

trailer axle complete with Timken roller bearings, hubs, and 6 hole 750 x 20 Budd Wheels. Without brakes. Axle is 2 inches square and 69 inches between wheel mounting flanges. Std. width. AN EXCELLENT BUY.

With Single Wheels. \$59.50 With Dual Wheels. \$69.50

WINCH CABLE — New with hook. 3/8" in diameter. 300 ft. length. **\$37.50**

Steel Wire Rope TRUCK TOW CABLE 3/8" diameter. 15 ft. overall length. Loop on each end. Shipping weight 14 lbs. Price, each **\$3.00**

TOW CABLE — 15 ft. long. 1/4" thick. Steel with clevis and eye. Every motorist should have for emergencies. Shipping weight 2 1/2 lbs. Each **\$1.50**



UTILITY GAS TANK

6 Quarts—New Surplus. Cylindrical 5 1/2" diameter, 15 1/2" length. Brackets for mounting in horizontal position. Complete with Filler cap in center, drain plug in bottom and pet-cock on end. Ideal fuel tank for small gas engines, stoves, etc. **\$1.50**

All prices quoted good 30 days FOB, Kansas City. 25% deposit required on COD orders.

American AUTO PARTS CO.

1830 LOCUST — DEPT. PM
KANSAS CITY, MISSOURI.



One Swipe of NEW PLASTIC
Makes these LEATHER and LEATHERETTE Items **LIKE NEW**

Get Into A Money Making Business

Make like new, worn, scuffed or faded leather and artificial leather equipment. Either your own to renew, recolor and beautify, or cafe, restaurant and hotel equipment as a business. Single stroke with a brush renews. Does not crack, peel or scuff. Resists acid, alcohol, caustics and weather. All colors. Mail coupon for free sample.

FREE Sample SHOWS EFFECT

\$50 to \$500 Profit
On One Job Possible

Let me show you how, as I have shown others. Get your own exclusive territory while available. Mail coupon today, I'll do the rest. — Jack Edwards, Sales Mgr.

LEATHER-NEW PRODUCTS,
6082 Sunneslope, Kansas City, Mo.

Send me without obligation a sample of Leather-New coated material so I can inspect it.

Name _____
Address _____
City _____ State _____

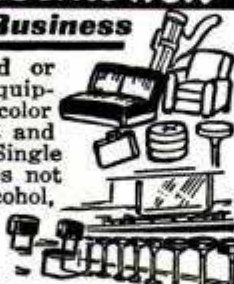

New **ARMY MINE DETECTOR**

An /PRS-1 is a portable device for detecting metallic and non metallic objects. Metals, Buried Cables and sewer Tile. **No C.O.D.**
Our Special Price **\$26.40** with battery
\$17.50 without battery

By lengthening dipole rods operator will be able to increase the depth sensitivity. This unit comes complete with spare tubes, antenna dipole and reflector, and instructions manual, in wooden chest 9 1/2" height x 28 1/4" length x 15 1/2" depth. Weight in operation is only 22 lbs. LESS Batteries. Power supply: Three 45 volt and one 6 volt batteries. Uses standard batteries. Original COST \$285.00. Shipping weight appr. 80 lbs. F.O.B. New York. No C.O.D.'s. Send Order to:

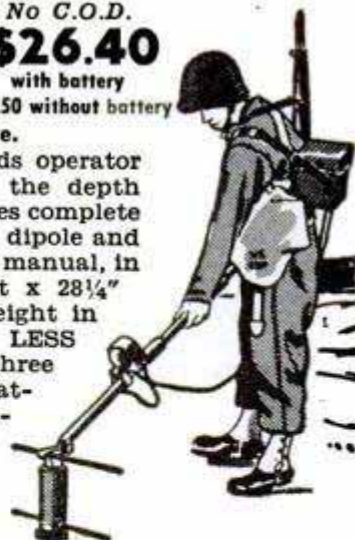

COLUMBO TRADING CO., INC.

304 CANAL ST. DEPT. PM NEW YORK 13, N. Y.

SHARPEN YOUR LAWNMOWER YOURSELF!

Patented sharpener saves \$100 money—saves work . . . only

Why dull your way through that lawn-mower chore? Make it easy for yourself by keeping your mower blades sharp with a Peerless Sharpener. Your machine will cut the grass cleanly . . . instead of gnawing or tearing it off. Grinds the rotary and stationary blades to keenness—and to perfect alignment. Easy to use. Satisfaction guaranteed. Send check, M.O. or dollar bill—and indicate size. Available in sizes 12 to 18 inches.

PEERLESS LAWNMOWER SHARPENER, Dept. PM5
217 Guilford Avenue, Collingswood, N. J.



UTILITY CABINET with 1001 uses

Ideal cabinet for storing small parts, screws, washers, etc. 8 removable compartments in each of 4 drawers. Index card holders in drawer handles. Sturdy steel construction in Silver Gray. Size: 6" wide x 6 1/2" high x 8" deep. \$3.25 postpaid—2 for \$5.95. No C.O.D.'s.

Money-back guarantee.

AFCO PRODUCTS CO.
DEPT. 3, LEXINGTON 73, MASS.



CENTRIFUGAL PUMP—SERIES 130

WILL All Purpose, ALL 2" PUMP BRONZE Pump—At a fraction of original cost. With Adjustable TO Pulley. Remit with 180 order. We Prepay GPM Freight. Free Literature.

While They Last—RUSH ORDER the freight

ARGO-SUMMIT SUPPLY CO., 7418 W. Archer Ave., Summit, Ill.



FASTEST PLANER in the WORLD
at this Low Price... **\$215.00**

BELSAW Multi-Duty Planer

Speed up production! Increase your profits! BELSAW power self-feeds at 24 feet per minute . . . The lowest-priced surfacer that will handle 12 x 6 in. stock. Planes green or dry sawed lumber into smooth, worked forms. Three high-speed steel knives make 42 cuts per inch. Multi-duty BELSAW takes inexpensive attachments for all planing mill operations—Jointing, Rabbeting, Grooving, Matching. BELSAW is the only 12 in. planer providing attachments for jointing and grinding its own knives. Start planning NOW for BIGGER VALUE and BETTER PERFORMANCE, with BELSAW. Write for FREE specifications, illustrations and low prices.



● LARGER CAPACITY ● FASTER OUTPUT ● KNIFE SHARPENING ATTACHMENT
BELSAW MACHINERY CO.

B1017 Field Bldg., 315 Westport Rd. Kansas City, Mo.

BASEMENT DAMP?

NEW! IMPROVED!
SOLVAY
AIR-DRYETTE JR.

with
SOLVAY CALCIUM CHLORIDE

absorbs moisture—the cause of rust, warping, mildew in workshops, darkrooms, closets, playrooms, storage rooms, vaults. New, improved design gives 50% greater capacity, simplifies filling and emptying. Compact, inexpensive, clean, safe, odorless, thousands in use. Write for booklet and name of your nearest dealer. Dept. 89-5, Solvay Sales Division, Allied Chemical & Dye Corporation, 40 Rector St., New York 6, N. Y.



Now CHEAP OIL BURNER

FOR HEATING AND COOKING STOVES - FURNACES
HEAT YOUR HOME, COOK YOUR MEALS
WITH CHEAP FURNACE OIL

NO MORE SHOVELING COAL OR ASHES. Sensational Fuelizer Starter Vaporizing System turns Cheap No. 1 Furnace Oil, also Range, Heater, Tractor Distillate, Kerosene and like oils into oil heat—one of the quickest, hottest fires known. **LIFETIME GUARANTEE. \$1.00 Bonus Offer for Testing.**

We will let you try it in your own stove or furnace for one month. Get yours for introducing. Big profits **QUICK**. Be first. Send in your name today for details and cash in on the tremendous demand for this Amazing Invention.

NORTHWEST MFG. CO., 634-E, Mitchell, S. Dak.



CAMILLUS KNIVES STAY SHARP LONGER

Blades of custom made steel, hand honed. Tough, rugged construction.



Ka-MILL-us

CAMILLUS CUTLERY COMPANY, NEW YORK 17, N. Y.



No. 67

3 7/8" closed

CHAMPION V-GLOW PLUGS

for model engines only

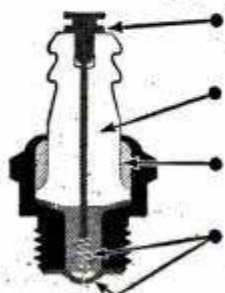

CHAMPION TERMINAL—assures better center electrode seal and provides sturdier electrical connection.

CHAMPION-CERAMIC INSULATORS—proved dependable in millions of Champion Spark Plugs.

CHAMPION SILLMENT SEAL—prevents excessive compression leakage between insulator and shell.

CHAMPION "THERM-O-FLEX" CONSTRUCTION—longer element life, more dependable performance.

Follow recommendations of plug types and fuels approved by engine manufacturer.

CHAMPION SPARK PLUG COMPANY, TOLEDO 1, O.

Preferred for Living or Travel

New advanced machine methods plus long years of Schult "know-how" produce a trailer which offers more for your dollar, greater satisfaction, higher resale value. Every Schult carries a three year warranty.



Write FOR FREE BOOK

Describes 5 sparkling, newly styled trailers designed to meet every demand for luxury and economy. Completely equipped for comfortable living or travel. See the new Schult "Heat-Saver"—greatest contribution to trailer comfort in years.



SCHULT CORP., Dept. 3205, Elkhart, Ind.

In Canada: John Inglis Co., Ltd., Toronto



Say You Saw It in POPULAR MECHANICS

SANDEE

Mufflers—All Ford, Chev., Ply.....\$4.45
All Buick, Pont., Olds., Chrys.,
Dodge, Hudson, K.F., Pack., etc. \$5.45
V-8 and Merc. Duals
(32-49 incl.)
\$15.95



DURABILITY

STONE

DEALERS
WANTED

**SPORTONE
MUFFLERS**
(Pats. Pend.)

Beautiful
SANDEE
Fender Skirts
\$16.95

A SANDEE Sportone will outlast two ordinary mufflers and give More Power! More Speed! More Mileage!—plus a tone quality unsurpassed.

Please ship (item): _____ Price _____
Car and Year _____ Name _____
Address _____

SANDEE MUFFLER CO. 5643 Corryne Pl. Culver City, Calif.

"I'll take the **WHITE** one every time!"



WYTEFACE Steel Tapes, with their jet black markings on a white background, are easier to read in any light. They are rust-resisting, hard to kink and easy to clean.

Protected by U. S. Patent 2,089,209

WYTEFACE

TRADE MARK

STEEL TAPES

KEUFFEL & ESSER CO.

PLASTI-LINER

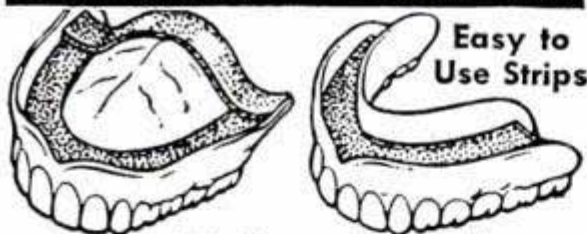

Easy to Use Strips

Makes False Teeth Fit

For the Life of Your Plates

If your plates are loose and slip or hurt, use this amazing, pliable, non-porous strip to refit them yourself, for instant and permanent comfort. It's easy. Just lay the strip on your upper plate or lower plate, then bite and it molds perfectly. Hardens for lasting fit and comfort. Helps stop the embarrassment of slipping, rocking plates or the misery of sore gums. Eat anything and talk freely without fear your teeth will loosen. Ends forever the mess and bother of temporary applications that last only a few hours or months.

Easy to Re-Fit and Tighten False Teeth

PLASTI-LINER is tasteless and odorless. Won't injure your plate. Guaranteed to give satisfaction or your money back. Removable as per directions. Users say: "Until I used Plasti-Liner I used several kinds of liners without success. Now I can eat anything." H. H. M. "My plates are now better fitting than new." E. H. C.

SEND NO MONEY: Just order a \$2.25 package of PLASTI-LINER to reline both upper and lower plates, or \$1.25 to reline one plate. Deposit money with your postman when he delivers. Or send the money now, and save C.O.D. charges. Generous sample of special plate cleaner supplied free.

PLASTI-LINER CO., Dept. 43-1, Buffalo 15, N. Y.

HOLD-E-ZEE
Automatic Grip
SCREWDRIVERS

... not only tools of finest quality, with chrome-vanadium blades, hand-ground bits, insulating, unbreakable handles ... but possessing the exclusive Gripper which holds, starts, and sets up screws in unhandy places. At leading dealers everywhere. **Upson Bros., Inc., 61 Broad St., Rochester 4, N. Y.**

QUALITY UNSURPASSED • CONVENIENCE UNEQUALLED

MYSTERIOUS DEVICE WELDS BRAZES SOLDERS & CUTS
ANYONE CAN OPERATE

ONLY \$9.95

FOUR-WAY WELDER

This newly invented **FOUR-WAY PORTABLE ELECTRIC WELDER** will do brazing, soldering, welding and cutting on brass, bronze, iron, steel, cast iron and other metals. It's easy to use. **WORKS INSTANTLY** off any properly wired 110 VOLT A.C. OR D.C. LINE. Does a thousand and one professional type repair jobs. **SAVES TIME AND MONEY** on auto, home appliance, farm and shop repairs. It's indispensable for maintenance men, farmers, repair shops, engineers, tin smiths, home and auto owners, bicycle and fix-it shops, etc.

10 DAY TRIAL OFFER The **FOUR-WAY** COMES COMPLETE WITH ALL SUPPLIES READY TO OPERATE including simplified instructions. IT'S FULLY GUARANTEED. Order one today for 10 DAY TRIAL or write for FREE particulars. **FOUR-WAY WELDER CO., Dept. PMDF-59 3180 North Clark St., Chicago 14, Illinois**

Who Ever Heard of **POWER TOOLS**

Only \$800 Each?

Own a power workshop. Have fun. Make money. Get heavy-duty Emrick Lathe, Drill Press, Circular Saw, Grinder, Sander—all in ONE machine. Use ¼ to ½ H.P. motor. Equals in performance equipment costing \$200 or more. Direct factory price \$39.95 complete. Send \$18.00 (balance c.o.d.) for 10-day FREE TRIAL. Money-back guarantee. Our fifty-first year. Write today for FREE Catalog.

EMRICK, INC., 1660 Clinton, Kalamazoo, Mich.

5-in-1 MACHINE

PROFITABLE HOBBY

SAY YOU SAW IT IN POPULAR MECHANICS

Apply like paint Forms adherent dry lubricating, conductive, opaque films on wood, metal, plastics, etc. **CRAFTSMEN, SPORTSMEN, REPAIRMEN** use NEOLUBE for pre-assembly coatings; also where oil collects dust or evaporates. Use on guns and ammunition, model railroads, toys, switches, hinges, etc. Contains Acheson's colloidal graphite. If you send 35¢ for 10 cc. sample or \$1.00 for regular 2 oz. with brush, we pay postage in U. S. A.

NEOLUBE
DRY FILM LUBRICANT

HURON INDUSTRIES, P. O. Box 557, PORT HURON 5, MICHIGAN

ZECOL
COOLING SYSTEM
CONDITIONER

EASY TO USE

No draining or flushing. Clean up rusty water while you drive! Rust and corrosion inhibitor. Lubricate water pump bearings and seals! At Garages and Service Stations

ZECOL INC., MILWAUKEE 1, WIS.

PREPARE AND REMOVE RUST
ZECOL
COOLING SYSTEM CONDITIONER
STOP RUST—CORROSION
EASY TO USE
DRAINING OR FLUSHING
TO REMOVE—CLEAN UP
WITH WATER—PUMP
AND SEAL



your garden hose has been waiting for. STEP OUT ahead of your friends with a WATER BOY, the new Rollaway Hose Reel. No kinks. No sprawling hose. Nothing to lift or carry. Your hose is always out of sight but ready for immediate use winter or summer.

Inside storage means a longer life. For full information and prices write . . .

THE ZIERDEN CO.

MILWAUKEE 7, WISCONSIN

3811 SOUTH KINNICKINNIC AVENUE, DEPT. B



WORLD'S MOST POWERFUL

Completely Different Than Any Other!

HY-SCORE

AIR PISTOL

Famed HY-SCORE used by experts. Expensively made. Looks and feels like a Luger. Revolutionary mechanism blasts pellets at close-to-firearm speed. EXTREMELY ACCURATE. Cal. .177 or .22. \$19.85 including 500 HY-SCORE pellets (pellet value \$1.49 for cal. .177, \$1.88 for cal. .22). Also sample dart.

If your dealer cannot supply, write for free booklet. Dept. PM-5

HY-SCORE ARMS CORP. • BROOKLYN 1, N.Y.



Make Money *Manufacturing* Ornamental Masonry



Eye Appeal Makes for Cash-and-Carry Sales

Millions of homes can use these Ornamental products—urns, vases, flower boxes, bird baths, lawn seats, flagstones, etc. Easily made of sand and cement. Permanently glazed in a range of smart colors. Distinctive—attractive—quick selling. Selling prices allow 200% to 300% mark up on basic costs. Only a small investment needed for supply of molds. Easily set up in shed or garage. Write immediately for catalogue OM and price list.

Colorcrete Industries, Inc.
710 Ottawa Ave. Holland, Mich.

A Profitable Whole-Time or Part-Time Opportunity

Choice of Professionals . . .

WISS

These famous snips easily cut 18 gauge. M3 cuts curves and circles as well as straight . . . ideal for the home workshop. \$4.25. Rubber grips recommended, 60¢ extra.

METAL MASTER COMPOUND ACTION SNIPS

WISS

HY-POWER PRUNERS

#908-8"

Finest pruners you can buy . . . and easiest cutting. Test before buying. They cut instantly . . . with less pressure . . . leave a clean "unchewed" clip. Anvil type blade stays keen and sharp indefinitely. \$2.50.

Prices slightly higher in Denver and west.



Quality for more than a Century

J. WISS & SONS CO.

Newark 7, N. J.

BUILD A PERMANENT BUSINESS OF YOUR OWN!

- STEADY, PROFITABLE INCOME
- SPARE TIME OR FULL TIME
- BE YOUR OWN BOSS

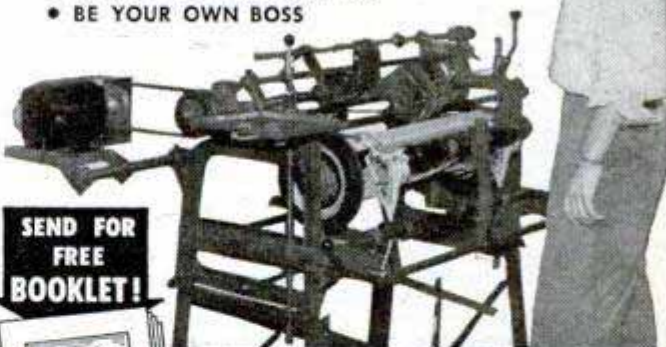

SEND FOR FREE BOOKLET!

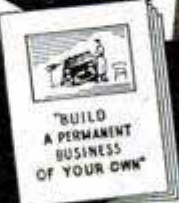

SHARPEN LAWNMOWERS ON THE IDEAL SHARPENER

Part time or full time—make up to \$5.00 an hour. No experience necessary. Hundreds of mowers in your neighborhood need sharpening. Get started now and get the only sharpener that grinds each reel blade to fit the bed knife. Send for free booklet today.

THE FATE-ROOT-HEATH CO.

Dept. D-3, Plymouth, Ohio

"BUSINESS OPPORTUNITY"



Cushman

MOTOR SCOOTER

OPERATE IT
FOR LESS
THAN 1/3¢
PER MILE

There's a CUSHMAN Motor Scooter for every transportation need—for all kinds of delivery, fits any kind of business. And CUSHMAN is America's BEST BUY in low cost transportation—proved by thousands of individual users. Go anywhere—Park anywhere . . . Start your own commercial delivery with CUSHMAN Motor Scooters—low initial investment, low operation and upkeep—a real BUSINESS OPPORTUNITY. See your dealer for demonstration or

WRITE DEPT. PM-49 for Details.

Established 1901

DEALER INQUIRIES INVITED



CUSHMAN MOTOR WORKS, Inc
LINCOLN, NEBRASKA USA

Learn A Trade NOW! PRACTICAL SHOP TRAINING!

In Our Chicago Shops

- | | |
|---|--|
| <input type="checkbox"/> AUTO MECHANICS | <input type="checkbox"/> WELDING—ARC and GAS |
| <input type="checkbox"/> DIESEL MECHANICS | <input type="checkbox"/> MACHINIST |
| <input type="checkbox"/> REFRIGERATION | <input type="checkbox"/> PIANO TUNING |
| <input type="checkbox"/> BODY-FENDER | |

Above Approved For G. I.'s and Civilians
One of America's Leading Practical Schools
7 Floors of Fully Equipped Shops
Over 48,000 Successful Graduates
Expert Individual Instruction
Learn by Doing—Low Living Expense
Established 1902—Day and Evening Classes

Also the following Home Study Courses

- | | | |
|----------------------------------|--|---------------------------------|
| <input type="checkbox"/> PLASTIC | <input type="checkbox"/> REFRIGERATION | <input type="checkbox"/> DIESEL |
|----------------------------------|--|---------------------------------|

—CALL IN PERSON OR MAIL THIS AD TO—

GREER SHOP TRAINING

(Desk 16) 460 South State St., Chicago 5, Ill.

Please send without obligation free information regarding trade checked above. (Specify whether you are a Veteran or Civilian)

Name _____ Age _____

Address _____

City _____ State _____

SORE MUSCLES?

BODY ACHES?



When muscles are stiff and sore from unusual exercise or strain, use HEET®, the liniment that's strong yet does not burn the skin. Wonderful relief from muscular soreness comes as comforting HEET quickly starts to penetrate. Just brush it on with the applicator. HEET starts at once to ease muscular pain and keeps on working for hours. Ask your druggist for HEET liniment.

Drill Masonry Fast, Easy

\$1.40
and up



Hard Kennametal (carbide) Blade

Kennametal Masonry Drills

- Drill Tile, Stone, Marble, Brick, etc.
- Drill up to 5 times as fast
- Last up to 100 times as long

Now, you can drill clean, accurate holes in practically every construction material. You can zip in masonry and save big money on drilling cost. Use the drill that gives contractors, electricians, plumbers, pest control operators and sign hangers these results: "8,000 holes in brick, 8 hours," "1 inch holes in limestone, 3 1/2 seconds," "50 holes in glazed tile, 33 minutes." Drill sizes are from 1/8" to 1 1/2" in diameter, can drill 6" to 10" holes. Fits hand braces, drill presses, rotary drills.

Write for special introductory offer Bulletin MK3 now.

KENNAMETAL Inc. Latrobe, Pa.

SHARPEN CIRCULAR SAWS LIKE AN EXPERT



\$6.95

Precision file circular saws in your own workshop. No experience necessary. Adjustable to any pitch or angle. Gets hollow-ground, cross-cut or combination saw blades true and sharp. Fits 6" to 12" blades with 1/2, 5/8, 3/4 or 13/16" centers. Complete with file, instructions, 4-different size mandrels. Money Back Guarantee. \$8.95 postpaid—check or money order. \$1 dep. on C.O.D.'s. Profit maker for fix-it shops. FREE ILLUSTRATED FOLDER! Order Today! Hardware dealers—send for prices.

SURE-SHARP MFG. CO., Dept. M-59, P. O. Box 24, Santa Ana, Calif.

GENUINE DIAMOND SCRIBER!

Writes on glass, metals, plastics. Hex. Aluminum 6". Money back guarantee. Agent inquiries invited.

\$2.00
Postpaid

CLIPPER DIAMOND TOOL CO., INC. 21-B W. 46 ST., N. Y. 19

Say You Saw It in Popular Mechanics

ELECTRICITY Anywhere

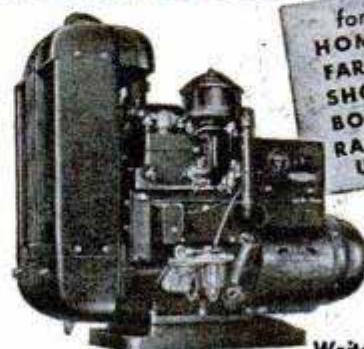

for
HOMES
FARMS
SHOPS
BOATS
RADIO
USE

• Onan gasoline-engine-driven Electric Plants supply reliable, economical electric service for any use. Portable, stationary or stand-by models. Water or air-cooled, compact and rugged.

A.C.: 350 to 35,000 watts in all standard voltages and frequencies. D.C.: 600 to 10,000 watts, 115 and 230 volts. BATTERY CHARGERS: 500 to 3,500 watts; 6, 12, 24, 32 volts.

Write for folder

D. W. ONAN & SONS INC.
5821 Royalston Ave., Minneapolis 5, Minn.



Plastic Coasters
and Tiles

EMBED REAL FLOWERS in NEW Magic PLASTIC

Now, create many unusual things like the distinctive pansy coaster shown—made by embedding real pansies in Castolite—the "magic" liquid plastic that "pours cold like honey . . . sets like glass" . . . at room temperature. Comes crystal clear or may be dyed for brilliant color effects. Embed other flowers, too, also coins, butterflies, medals, favorite photos, etc. Make really different jewelry, candlesticks, picture frames for gifts or to sell.

POUR GORGEOUS BOOKENDS

Castolite makes it easy to cast exquisite bookends like the one shown. Make copy duplicates of hundreds of art objects, figurines, etc. No special training needed. With new, easy-to-use Customold you make your own molds in minutes. Use only home utensils. Follow simple step-by-step method. New pleasure, fine profits are possible.

MASTER KIT \$7.75 Postpaid.

SPECIAL KIT \$3.95 Postpaid.

At your dealer. If he can't supply you, send check or money order, or send 25c for exciting new Castolite Instruction Manual packed with 62 actual pictures showing how to get started immediately. Write today.

THE CASTOLITE CO.
Dept. E-1
Woodstock, Ill.



AMAZING NEW SAFE JIG SAW READY!

At last—a revolutionary, new electric jig saw small children may use, yet powerful enough to be the basic tool in Dad's workshop. Make "Standing Photo Silhouettes" of favorite snap shots . . . fancy what-nots, toys, for fun and profit! Just plug in! No motor to buy—no oiling. Thousands sold. Use in livingroom, apartments, etc. Patented. Nothing else like it. Mail postal NOW for illustrated, Free Circular, low price!

FREE
Circular!

SYNCRQ



Dealers Write!
SYNCRQ CORPORATION, Dept. H-59, Rochester, Mich.

Genuine Snap-on Tools

Available Only Through Snap-on's
Direct-To-User Tool Service

WRITE FOR INFORMATION
SNAP-ON TOOLS CORP. • Kenosha, Wisconsin

Thompson
BEATS
the World
on BOATS



Better Built
Lower Prices



Safe Boats With
Full Length Spray Rails
Keep passengers perfectly
dry—even at high speeds.
Catalog also shows two new
models of "Take-Along"
Boats. Two big factories—
save you freight.

CATALOG FREE
Write for your copy. State kind of
boat in which you are interested.
THOMPSON BROS. BOAT MFG. CO. (151)
213 Ann St. PESHTIGO, WIS. Write to
(either place) 213 Elm St.
CORTLAND, N.Y.

new low-priced electric paint sprayer



Only
\$12.95
Complete



for utility
painting of tables—
chairs—screens—
floors—clothes hampers—
car fenders—toys

Built-In-Head Motor and Compressor Unit



Now! An electric sprayer as easy to
handle as a brush—and twice as fast!
Sprays household enamel, lacquer,
varnish, shellac, light oils and insecti-
cides. No extras to buy! 25 oz. jar.
8 ft. cord. Mail the coupon for full
information.



BURGESS BATTERY COMPANY, Handicraft Division
152 Rand Road, Lake Zurich, Illinois

Please send FREE 12-page instruction booklet and illustrated
circular in color describing the New Burgess Vibro-Sprayer.

Your Name _____

Street Address _____

City _____

Zone _____

State _____

At Last . . . Greatest QUICK PHOTO INVENTION in History!



Beautiful, everlasting photos—black
and white or sepia, size 2 1/2 x 3 1/2
in. Guaranteed not to fade. No
dark room needed. Photos are taken
DIRECT on "SUPER-SPEED" direct
positive paper. Loads enough paper
for 50 shots in half a minute—in
broad daylight.

Be a PDQ Photog-
rapher. No experi-
ence required.
Simple instruc-
tions tell how to
operate the Cham-
pion Photomaster.
This portable photo
studio weighs
only 6 lbs. Size
4 1/2" x 5" x 10".



Work at home or
travel—make ex-
penses plus extra
profits. Most
amazing money-
maker ever in-
vented.

YOUR PROFIT OVER 700%

Pictures cost you only 2c. Sell for 15c to 25c. Folks just grab
for 'em. They are amazed to see their own photos come to life in
broad daylight. Photomaster "shoots" any subject—individuals
or groups—buildings and scenes. This new and fascinating busi-
ness offers unheard-of money making opportunities everywhere—
every day throughout the year.

WRITE AT ONCE FOR DETAILS

P D Q CAMERA CO.

1161 N. Cleveland Ave, Dept. PM, Chicago 10, Ill.

short-wave
in your car!

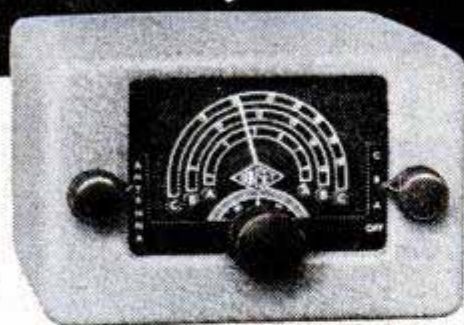

GONSET "3-30" CONVERTER

attaches to your automobile radio
continuous coverage, 3 to 30 mc.
four working (r. f.) tubes.

extremely compact.
bandspread dial.

\$39.95 net

see your dealer



GONSET CO.
BURBANK, CALIF.



SENSATIONAL WIPE-ON PAINT DRIES IN 2 HOURS

KOTE-A-KAR

Here is the easy, speedy, economical way to paint your car... wears like the original factory paint... guaranteed to last for two years. Just wipe it on with Kote-A-Kar applicator... or brush or spray it on. Seven colors: Black, Airwing Grey, Plymouth Gunmetal, Glade Green, Chevron Blue, Military Maroon, Swift Red.



LARGE 40 OZ. CAN
\$3.95 WITH
APPLIERS

At Paint, Hardware and
Auto Supply Stores or send
\$3.95 with color choice to:

PLASTI-KOTE, INC. 425 LAKESIDE AVENUE N. W.
CLEVELAND 13, OHIO

LEARN WELDING AT HOME

60 LBS. OF READY MADE PARTS

Only
\$24.95

BUILD YOUR OWN HEAVY DUTY WELDER

SAVE!
Buy Only
NECESSARY
PARTS

Heavy Duty transformer coils ready wound. Laminations ready cut. Five heat stages. Easy to assemble... no special tools needed. With only a few hours practice you can do skilled welding on steel, cast-iron and other metals. Illustrated instruction manual included. Sold on 30-day unconditional Money-Back Guarantee.

FREE: WRITE TODAY FOR FULLY
ILLUSTRATED PAMPHLET P-5.

ATOMIC ARC WELDER CO.
1037 So. 19th St. OMAHA, NEBR.

Gives 100% penetration.
Welds are stronger than
original metal. Operates
on 110 or 220 AC.

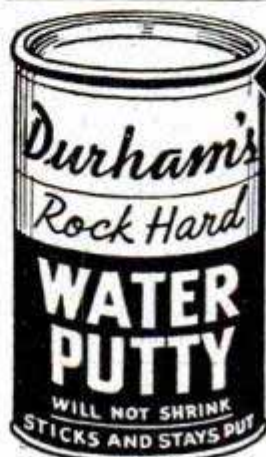
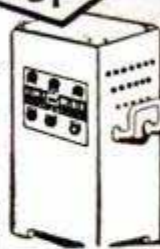

The Modern PLASTIC for lasting Home Repairs

PERMANENTLY mends cracks or holes in wood, tile, stone or plaster. Sticks and stays put—Does not chip, shrink or fall out. Easy to use. Economical! Mold it, chisel it, polish or paint it. If unobtainable from your lumber, paint or hardware dealer, the big 4-lb. can will be sent you post-paid (in U.S.) for only \$1. Full money-back guarantee, order now.

DONALD DURHAM CO.
Box 804-Q, Des Moines, Ia.

Memo to Prospectors...

Be ready. Your next trip in search of radioactive ores may pay out if you have the best equipment. TX-GEIGER COUNTERS were used in locating most of recent strikes. Write for details.

OMAHA SCIENTIFIC SUPPLY CO.
DEPT. O, 3623 LAKE ST., OMAHA 4, NEBR.



NEWEST OTTAWA LOG SAW

SELF-PROPELLED — MOVES
ANYWHERE ON OWN POWER

World's fastest Log Saw. Powerful 6 H-P air-cooled motor. Attachments for sawing down trees, buzzing limbs, post hole digging and pulley for belt jobs. Big demand for wood, pulp, posts. Make big money sawing wood this easy way. Low factory-to-user prices. Nothing like it. FREE details. OTTAWA MFG. CO., 7-927 Pine St., Ottawa, Kansas



WAR SURPLUS BARGAINS

\$500,000.00 INVENTORY
for QUICK LIQUIDATION

Surplus items—hundreds of them for home, shop, factory, farm and outdoor use. New items, used items, reconditioned items—all at tremendous savings—all priced for quick sale.

Page After Page of Values

This big catalog shows page after page of amazing money saving values. Write for your copy today. Send 10c to cover postage, mailing, etc. Write today!

SEND
TODAY
FOR YOUR
COPY

10c

STARK'S Dept. PMS 509 So. STATE STREET
CHICAGO 5, ILLINOIS

Introducing

THE NEW
1949

KAISER Convertible!
SPORT

ACTUAL SCALE MODEL
OF THE NEW SPORT CONVERTIBLE NOW
BEING MADE AT WILLOW RUN, DETROIT

SCALE OF MINIATURE '49 KAISER!
GOES 3 SPEEDS FORWARD!

It's super—It's terrific! It's the new sensational car every child will want (and mom and daddy, too). Kaiser has given this sparkling convertible a real "FACTORY APPROVED O.K." to tell you it's a sensational, exact scale miniature of the 1949 KAISER SPORT CONVERTIBLE. "Just like Dad's"—even dad will be amazed when he sees this new 3-speed mechanical model go into action. It goes 3 speeds forward! It reverses! It steers! Never before has a miniature car been so perfect in every detail. A 3 speed spring steel clock motor . . . a steering wheel that really steers . . . a precision build body 10" long, complete with real rubber wheels, bright metal bumpers and grill. Made of beautiful shining colored plastic and strong metal, this Kaiser Sport Convertible will thrill every youngster like no other car has ever before! Don't buy just any toy car! Rush your order today for the newest 1949 CONVERTIBLE KAISER, direct from the assembly lines. **SEND NO MONEY.** Remit with order and we pay postage or C.O.D. plus postage.



SUPER DASHBOARD!



4 INSIDE CONTROLS!

- R—REVERSE
- 1—FORWARD SLOW
- 2—FAST
- 3—FASTER
- STEERING WHEEL CONTROL AND
- BRAKE LEVER

Imagine Only
\$2.98
complete

NOVELTY MART • 59 East 8th Street, Dept. 113 New York 3, N. Y.

MACHINE SHOP EQUIPMENT



The 1949 edition of the famous Center Tool Co. Catalog is now ready! Every workshop owner should have a copy. 240 pages full of illustrations, descriptions, and prices of the latest tools made by best known manufacturers in U. S. You pay the cost of printing—50c. **We refund your 50c with your first order of \$10.00 or more.** Prompt delivery on most tools. Send check or money order today!

CENTER TOOL CO., 153 Centre Street, Dept. C, New York 13

25,000 M.P.H.

Speed at which a rocket must attain to escape the Earth's gravitational pull. This and many interesting facts supplied with scale Model of the V-2 Rocket. Have fun or experiment seriously with a Rocket that works like the real thing. Zooms over 200 feet.

Can be used over and over again.

Comes equipped ready to fire with special launching stand and full instructions. Send \$2.95 with order, we pay postage. Or send no money, C.O.D. \$3.50.

\$2.95

WALSH PRODUCTS, INC.
209 (M-5) MAPLE AVENUE, EAST ORANGE, N. J.

CASH IN ON THE BUILDING BOOM!

MAKE BUILDING BLOCKS RIGHT IN YOUR OWN BACKYARD AMAZING GENERAL BLOCK MACHINE

CAPACITY 1000 BLOCKS PER DAY

\$199 LESS MOTOR
ONLY F.O.B. PLANT
SHIPPING WEIGHT 400 lbs.



Cinder and Concrete Blocks in big demand. Sell all you produce, to contractors and builder supply yards, at 15c to 25c each. Easy to start your own profitable business.

GENERAL BLOCK MACHINE can be operated indoors or out, in floor space 9 ft. x 10 ft. All steel construction. Vibrator mounted in sealed ball bearings. Simple to run. Powered by 1/2 H.P. electric motor or 1 H.P. gas engine. Produces up to 1,000 8x8x16 blocks in 8 hour day. Superior 3 core type, meeting all building code requirements. Produces 4x8x16, 8x8x16, 12x8x16 blocks. Material for blocks, cinders, cement, and sand, obtainable anywhere. Full instructions and mixing formulas with each machine. Immediate Delivery. Mail coupon at once for full details, sent free without obligation.

HOW TO BUILD YOUR OWN CONCRETE BLOCK HOME
Only \$1 Prepaid

Wonderful book written and illustrated by our staff of experts.

GENERAL ENGINES CO.
DEPT. LA — DREXEL BLDG., PHILADELPHIA 6, PA.

Shows you 8 ways to save money and how to make and lay blocks, laying out building lines, mixing your own concrete, building steps, porches and concrete floors, includes floor plans for 6 beautiful easy to construct concrete block bungalows. Mail coupon at once with \$1.

Name

Address

City..... Zone... State.....

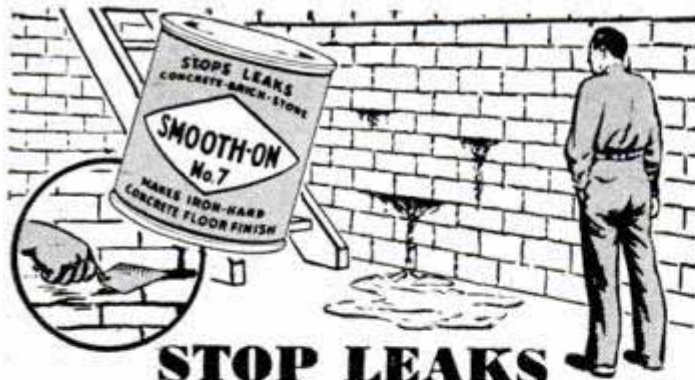

STOP LEAKS IN CELLAR WALLS

Do it with Smooth-On No. 7 Cement! Apply with trowel or stiff brush to leaky cracks, holes, porous spots, seams or other leaks in concrete, brick or stone walls and floors. The leaking will stop and Smooth-On will "stay put", for it expands slightly as it hardens. May be applied to wet or dry surfaces, indoors or outside. Use Smooth-On No. 7, too, to seal openings around pipes passing through walls. Buy Smooth-On No. 7 by name and number in 1-, 5-, 20- or 100-lb. size. If your hardware store hasn't it, write us.

FREE Leaflet and Handbook

We'll send you leaflet showing No. 7 uses, also the famous 40-page Smooth-On Repair Handbook describing other Smooth-On Cements and showing many helpful home repairs. 170 illustrations. Write today.

SMOOTH-ON MFG. CO., Dept. 37-E
570 Communipaw Ave., Jersey City 4, N. J.



Do it with
SMOOTH-ON
NO. 7 CEMENT



EASY PROFIT IN PAINT SPRAYING

Paints walls, ceilings, screens, furniture and machinery faster, better. All complete as shown less motor. Carry anywhere. Fully guaranteed. Could be used with 1/4 H.P. motor or less. Price \$35.00 less motor F.O.B. Chicago. \$5.00 deposit balance C.O.D. or see your dealer. With motor \$55.00.

IDEAL AUTOMATIC PUMP CO., Dept. P.M. 8
801 W. Washington Blvd. Chicago 7, Ill.

CHROME CUSTOM STYLED All Metal Automobile AUTOGRAM

5" long
1 1/4" wide
Fits All Cars
\$1.95



Specify Initials Wanted

Latest Triple Chrome Hood Ornaments UNIVERSAL — Fits All Cars



FLYING FLAMINGO 8" high, 6 1/4" long. Similar to Packard design. \$4.75
FLYING FISH 9" long, 5" high. Sleek and streamlined. \$3.75
FLYING BOMB IN RING, 6 1/2" long, 3 1/2" high. A beauty. \$1.95
FLYING GOOSE IN RING, 6 1/2" long, 3 1/2" high. Rich looking. \$1.95



Flying Fish

Exhaust Deflectors — Fit All Cars Sporty and Popular

JET CHIEF, 8 3/4" long, 3 1/16" wide. Beautiful Triple Chrome Plate. \$2.15

TUBULAR EXHAUST DEFLECTOR. A De-Luxe Model with dual air intakes. High luster Stainless Steel. 10" long, 2 1/4" wide. Universal. \$1.50

For "Tone" Quality

Send check or Money Order and we Pay Postage. 25% Cash with C.O.D. Order. Money Back Guarantee of Satisfaction.

AUTOGRAM, Inc., Dept. M, 3242 N. Pulaski Rd., Chicago 41, Ill.

Neptune OUTBOARDS NOW SOLD FACTORY-TO-YOU!



SAVE UP TO 37 1/2% ON THESE FINE MOTORS

\$49.50

Model A-1 at left weighs only 17 lbs. — 1.7 H. P. — O.B.C. certified. 1949 list price \$79.50. You save \$30. 12 month guarantee. All models reduced up to 10.5 H. P. New sales policy brings you pre-war prices!

FREE FOLDER SHOWING ALL MODELS

MUNCIE GEAR WORKS
DEPT. M4 MUNCIE, IND

BUILD DUTCH WINDMILLS

Lighthouses, Lawn Figures, Lawn Chairs, Trellises, Etc., Beautify Your Garden

Model B-30 Windmill 24" high. Wings operate farmer at backsaw. Blueprint. 50c
Model B-10 Windmill hexagon style, 40" high overall. A beautiful model. Blueprint. 75c
Model H-10 Lighthouse, 40" high. Blueprint. 75c
Comfortable, Sturdy Cape Cod Lawn Chair. Blueprint. 50c
12 Artistic Trellises. Blueprint all 12 only. 50c
Special All Blueprints mentioned above for only \$2.50.

"Over 35,000 Satisfied Customers"
Send 10c for Illustrated Catalog.
CRAFTSMAN'S MODEL CO.
Dept. P4
2030 N. 41st St. Milwaukee 8, Wis.



MODERNIZE YOUR KITCHEN

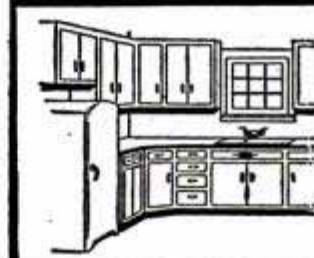

SAVE 2/3 THE COST!

New, illustrated manual shows every step in easy-to-understand charts and directions. How to modernize for yourself and get "professional" results at 1/3 the cost. Includes free design for your kitchen, plus net factory costs on knock-down cabinet fronts and other items. Have fun modernizing your own kitchen and save 2/3. Mail \$1.00 for complete kit to—

THOMBERT CO.
NEWTON 1, IOWA



CLEANS CLOTHES AT HOME! SAVES DRY CLEANING BILLS!

NEW INVENTION! Banishes old-style clothes cleaning... no messy chemicals, liquids, or powders. Use like brush. Simply glide over surface. Cleans Suits, Dresses, Coats, Hats, Ties, Suede Shoes. Also Window Shades, Wallpaper, Drapes, Upholstered Chairs, Davenport, Carpets, Hugs, Automobile Cushions. Keeps them spot and span. Saves costly cleaning bills. Sells like wild!
SAMPLES FOR AGENTS! Sample offer sent immediately to all who send name AT ONCE. A penny postal will do. SEND NO MONEY — just your name...
KRISTEE CO., 678 Bar Street, AKRON, OHIO

Ball-Bearing SPEED WHEELS



JUVENILE WHEELS

(No bearing, solid tires)

5".....45c 6".....65c
7".....75c

(Semi-pneumatic tires, ball bearing)

8x1.251.85 10x1.252.20
8x1.751.95 10x1.752.30
8x22.20 12x1.753.45

INDUSTRIAL WHEELS FOR HEAVY LOADS

5x1.75 Bolted. 3.65 10x2.75 HC.. 5.70
6x2 Bolted. 3.45 10x2.75 Pnc. 7.60
6x2 Bolted. 4.35 12x2.00 6.90
8x1 5.25 12x3.00 10.60
8x2.00 5.20 4.00x8-2 14.70
8x2.50 5.40 4.00x8-4 15.85
10x2.00 6.10 16x4.00 15.15

DEALERS, JOBBERS, AND MANUFACTURERS! OUR NEW PRICES WILL INTEREST YOU.

WRITE US NOW FOR COMPLETE NEW CATALOG

Send check with order. No C.O.D.

JIM BROWN TOY COMPANY
1097 Home Ave. Akron 10, Ohio

THE AMAZING ALL-METAL, ADJUSTABLE ACTION
Russelure FOR TROUT, BASS
 and all GAME FISH
 FLYROD • TROLLING • CASTING • SPINNING



actual size
 Flyrod Model
 #1 1/2

Two Salmon, weighing 30 lbs. and 26 1/2 lbs., caught by Al Pope, Burbank, Calif., on a flyrod and a Model #1 1/2 Russelure equipped with a single Salmon hook. Russelures are available for all kinds of fishing and all types of tackle, in 6 lustrous colors of permanent, tarnish-proof Alumilite finishes. Fair-trade priced, 80c to \$1.20 each.

SOLD AT LEADING DEALERS

Write for FREE Illustrated Folder
 (please include your dealer's name & address)

RUSSELURE
MANUFACTURING CO., INC.

Dept. 63, 2514 So. Grand Ave., Los Angeles 7 • Dealer Inquiries Invited

PRINT ANY PHOTO
 on Paper, Cloth, Leather or Wood

SIMPLE, EASY TO USE

Magic liquid takes only 2 minutes to reproduce any snapshot you have onto stationery, handkerchiefs, ties, scarfs, etc. Use same picture over and over again if you wish. Won't wash off. Won't hurt negative or fabric it's used on. Personalize your belongings! An ideal gift. Complete outfit enough to transfer 100 photos—only \$1.00 post-paid. Sent C.O.D. for \$1.28.



TIFFANY CO.

2128 Montrose Ave., Dept. J.D., Chicago 18, Ill.

BUILD YOUR POWER TOOLS

WITH OUR GUARANTEED INDUSTRIAL
POLY BALL BEARING ARBORS

New Departure
 Self Lubricating
 Bearings

10,000
 R.P.M.



(No extra charge
 for left hand
 threads)

C4-1/2"
 Pictured

B33—\$5.45 PP. C4-1/2x12 1/2 spindle, housing 2x8... \$7.95 PP.
 5/8 x 4 1/2 Spindle C5-5/8x12 1/2 spindle, housing 2x8... \$8.45 PP.
 B15 Plain Spindle C6-3/4x12 1/2 spindle, housing 2 1/4x8... \$9.45 PP.
 \$3.95 PP. D8-1x17 1/2 spindle, housing 2 5/8x11... \$18.75 PP.
 1 INCH BETWEEN WASHER AND COLLAR
 SHAPER ARBORS—Free literature on request.

POLY PRODUCTS, 2032-A E. Walnut, Pasadena 8, Calif.

SAVES TIME in
1000 Home Jobs!
Farm

Only
\$29.95

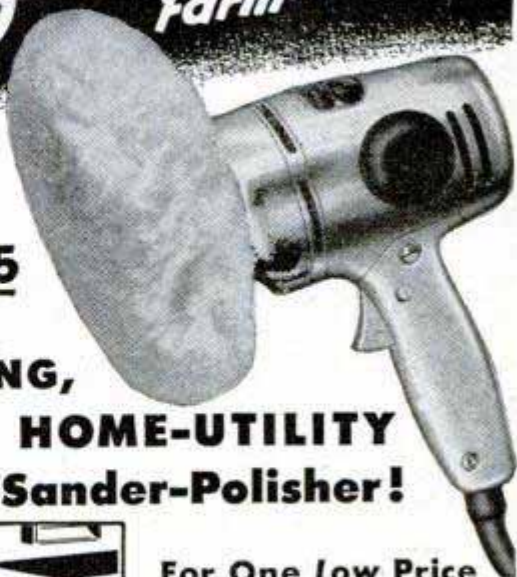

AMAZING,
NEW HOME-UTILITY
5" Sander-Polisher!

For One Low Price
 You Get:

- 5" Electric Sander-Polisher
- 5" Moulded Rubber Pad
- 3 Sanding Discs
- Lambswool Polishing Bonnet
- 7 oz. can of Home-Utility Electric Wax

SANDS • POLISHES
GRINDS • DRILLS

The Perfect Gift for
FATHER'S DAY

See it at your Hardware, Electrical
 or Implement Dealer!



ELECTRIC
HOME-UTILITY
TOOLS

Products of BLACK & DECKER Mfg. Co.
 Dept. H5M, Towson 4, Maryland

SAY YOU SAW IT IN POPULAR MECHANICS

WRITE FOR YOUR **FREE** COPY OF THE NEW
KRW HYDRAULIC PRESS BOOK

Describes all manner of Production and Shop Work on KRW Hydraulic and Bench Type Presses. 32 pages illustrating the new KRW Hand-operated, Electric-operated and Air-operated Hydraulic Presses. 25 to 100-ton capacities.

Write for your copy today.

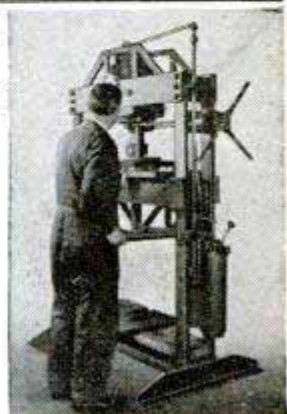
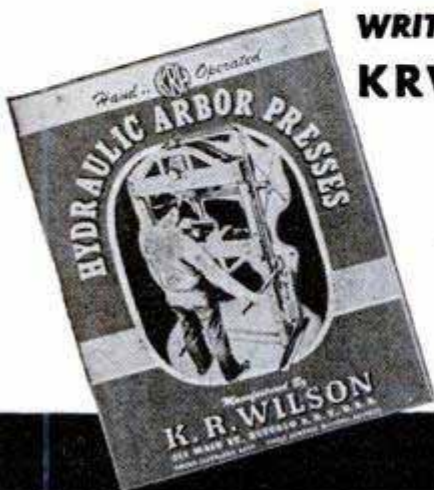

K. R. WILSON, DEPT. 17, 215 MAIN ST., BUFFALO 3, N. Y.

Sharpen Saws Yourself With TREYCO FIXTURES

Saws require setting only once to 5 or 6 sharpenings. Assures faster, cleaner cuts. Furnished complete with saw set and all accessories for all saws. Save money and earn extra money by sharpening saws for yourself and others. Tool makers precision . . . low prices . . . order by model numbers below . . . send check or money order . . . money-back satisfaction guarantee . . . shipped prepaid.

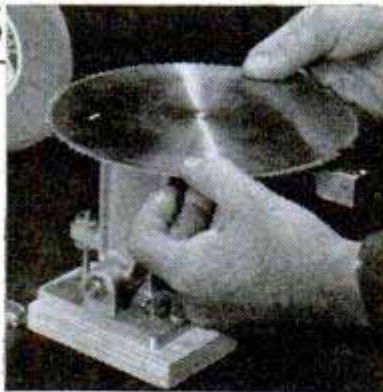

| Model No. | Saw Size | Price | Model No. |
|-----------|----------|---------|----------------------|
| 280 | 7" - 8" | \$11.95 | 280W \$5 extra |
| 100 | 7" - 10" | \$14.95 | 100W for 2 |
| 120 | 7" - 12" | \$16.95 | 120W grinding wheels |

BY POPULAR DEMAND MODEL 130 NOW AVAILABLE FOR SHARPENING SAWS FROM 2" to 12" IN DIAMETER. Only Saw Sharpening device of its kind. Used by America's leading plants. Precision built for accurate work. Sharpens all types of circular saws. Model 130 only \$23.50. Model 130W including 2 grinding wheels only \$28.50.

Specify your grinding wheel hole size.

*Quickly
Easily
PAYS
for
ITSELF*

TREYCO PRODUCTS
264 HARTFORD AVE. DEPT. PM5 BUFFALO 17, N. Y.

SURPLUS OXYGEN TANKS



Big 38 cu. ft. Capacity

Perfect. Take standard 1800 P.S.I. pressure. Standard valve. Non-shatterable. Wt. 20 pounds; 22" x 7". Portable. Welding, diving, experiments. Marked I.C.C. 3A1800. A \$45 value.

Send only \$5.75. Shipped R.R. Express, freight charges collect. No CODs please

THE BERTSCH COMPANY
14923 Sunset Blvd.
Pacific Palisades, Calif.

BUILD YOUR OWN FAN



One-piece cast aluminum propellers for cooling and ventilating.

| Size Inches | Polished 2 Blade | Polished 3 Blade | Unpolished 2 Blade | Unpolished 3 Blade | Bore Inches |
|-------------|------------------|------------------|--------------------|--------------------|---------------|
| 15 | \$3.00 | \$4.00 | \$2.50 | \$3.00 | 1/2, 3/8, 3/4 |
| 18 | 3.75 | 4.50 | 3.00 | 3.50 | 1/2, 3/8, 3/4 |
| 20 | 4.00 | 5.00 | 3.25 | 4.00 | 1/2, 3/8, 3/4 |
| 24 | 4.50 | 5.50 | 4.00 | 4.50 | 1/2, 3/8, 3/4 |

Let us give you our prices on your aluminum castings.

Write for pamphlet on larger fan blades, wire guards, fan bases, shutters, pillow blocks, exhaust fan frames, etc., shipped prepaid if money accompanies order. Dealers write for discount.

KLOPPENBORG ALUMINUM FDY., Dept. PM59, Davenport, Iowa

400 TRAILER AXLES



ONLY \$88. COMPLETE F.O.B.

Straight 2" Chrome Steel

with heavy duty ELECTRIC BRAKES

Comes complete with finger tip control unit and two 20" truck wheels, springs and fittings. Two ton load capacity. Easy to build your own trailer. For heavier load use dual wheels. Other new surplus truck and trailer parts. Write for free circular. 25% deposit with all orders.

BROADWAY TRAILER CENTER
31-23 Vernon Blvd., Astoria, L. I. 2, N. Y.



ACCURATE SLIDE RULE FOR ONLY \$1.00

For engineers, salesmen, draftsmen, machinists, students, hobbyists. Seven scales will compute multiplication, division, squares, square roots, cube roots, reciprocals, proportions. Laminated construction on long-life dimensionally stable plastic. Diameter 4 1/4". Complete instruction booklet and heavy storage envelope. Send \$1.00—Post Paid. Money back guarantee.

Allegheny Plastics, Inc., 306 Chestnut Rd. Sewickley, Pa.

RUPTURED?

Get Relief This Proven Way

Why try to worry along with trusses that gouge your flesh—press heavily on hips and spine—enlarge opening—fail to hold rupture? You need the Cluthe. No leg-straps or cutting belts. Automatic adjustable pad holds at real opening—follows every body movement with instant increased support in case of strain. Cannot slip whether at work or play. Light. Waterproof. Can be worn in bath. Send for amazing FREE book, "Advice To Ruptured," and details of liberal truthful 60-day trial offer. Also endorsements from grateful users in your neighborhood. Write:

CLUTHE SONS, Dept. 31, Bloomfield, New Jersey



She's some SMOOTHIE!
(YOUR CAR, THAT IS)

when equipped with

ADVANCE DEEP TONE MUFFLERS

(SINGLE STRAIGHT-THRU OR DUAL SET)

Rich, low, mellow tone. Also greater power, speed, and economy result from reduced back pressure. Rugged steel tube, blow-out proof. Simple to install. No welding. Dual set comes complete with rubber mounted clamps, fittings.

ADVANCE FENDER SKIRTS

Heavy duty steel skirts to beautify, streamline. Tight fit, no rattle, easy to install, prime painted.

KI-YI AND RAZZ HORNS

Get these novelty horns for laughs.

MAIL COUPON BELOW

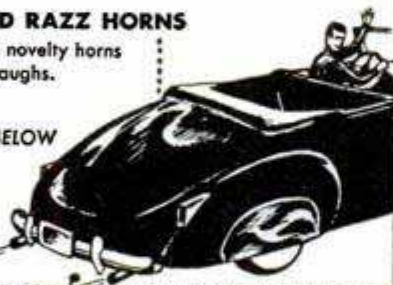

ADVANCE MUFFLERS Dept. PM 5-9
6800 S. VERMONT AVE., LOS ANGELES 44, CALIF.

Send check, money order, or we will mail C.O.D. You pay postage upon receipt.

| | | |
|---|---|---|
| <input type="checkbox"/> Dual Muffler Set (Ford, Mercury only) .. \$20.00 | <input type="checkbox"/> Single Muffler (other makes) .. \$5.50 | <input type="checkbox"/> Fender skirts, pr. \$16.95 |
| <input type="checkbox"/> Single Muffler (Ford, Chev., Plym.) .. 4.86 | <input type="checkbox"/> 2 1/2" Chrome tail pipe tips .. 1.75 | <input type="checkbox"/> Ki-Yi Horn, each 3.25 |
| <input type="checkbox"/> Send free catalog showing complete line. | | |

Car make _____ Year _____ Model _____
Name _____
Address _____ City _____ State _____

This Modern Masonry Has High Earning Power

An Outstanding Manufacturing Opportunity for Right Man



Tie in with today's demand for smart, colorful, low-cost masonry for homes and other buildings. Dunbrik-Dunstone has beauty, strength, modernity. Easily America's finest masonry, with tremendous appeal to building owners. Yet costs less than lumber because locally manufactured from local materials by local labor for local consumption.

More local plants are needed. You can be one of a national chain. Simple, compact equipment. Moderate in investment. 100%—150% mark-up on basic costs. Broad protection and liberal cooperation. Write for "Blueprints for Profit."

W. E. Dunn Mfg. Co.
600 W. 24th St., Holland, Mich.

DUNBRIK DUNSTONE



Now I remove paint the EASY WAY!

Homemakers everywhere are discovering what painters have known for years—that Wonder-Paste does a quicker, cleaner removing job every time!

WONDER-PASTE

Applied directly over the old finish. Wonder-Paste penetrates right through to the surface. Reduces the toughest finish to an unresisting sludge that peels off like putty! Leaves surface clean and smooth—with no sanding needed.

Get Wonder-Paste at your paint or hardware store. Write us for Wonder-Paste leaflet and for information about your removing problem.

WILSON-IMPERIAL COMPANY
119 Chestnut Street, Newark 5, N. J.



CRESCENT TOOLS

Give Wings to Work

ASK YOUR
HARDWARE
DEALER

MAKE YOUR OWN!

WITH

Griffin READYCUT LEATHER PROJECTS

Over 100 KITS in every kind of Tooling and Carving Leather, accurately cut, all parts included. Only Top Grade Leathers used. You do the choosing. You do the tooling, carving, stamping, the punching and assembling.

SEND FOR
COMPLETE CATALOG
Please send
10c to cover
mailing.

EVERYTHING FOR THE LEATHER WORKER

Largest, most complete stock of Leathercraft Tools and Accessories in U. S. A.



HIDES AND SKINS of Craft Leathers of every kind if you prefer to cut your own.

SINCE 1924
OUT OF THE WEST, THE HOME OF LEATHER CARVING
Griffin Craft Supplies

5515-A GROVE STREET
OAKLAND 9, CALIFORNIA

2 DRILLS IN 1



This attachment gives you two drills in one. It converts any 1/4 inch electric drill to 1/2 inch capacity. Reduction gears reduce the drill speed 5 to 1, the average speed of a 1/2 inch drill, and thereby increases the power. Absolutely indispensable for all shop work and home craftsmen. Satisfaction guaranteed. Order yours now.....

\$11.95
post paid

Send check or M.O. with order. Jobbers write for special proposition.

G. M. CO. MANUFACTURING, INC.

1308 43rd Ave.

Long Island City 1, New York



"SAVE IT AND
FIX IT"

MENDS

DISHES, FURNITURE, LUGGAGE

It's transparent, water-proof, flexible and durable. Get a tube today.



DUPO CEMENT

REG. U. S. PAT. OFF.

SAY YOU SAW IT IN POPULAR MECHANICS

Mow 'Em Down with PRONTO POWER LAWN MOWER

Give your lawn the new
look with Pronto

After 4 years production a proven,
well Engineered, original, safe,
lifetime, quick action, easy hand-
ling, economical, most simple and
practical of all power lawn
mowers.

Pronto first with quiet en-
closed spiral gear
4 ball bearing
drive. No trouble-
some belts, pul-
leys, chains,
sprockets, friction
wheels or ineffi-
cient cutter re-
volving at engine
speed.

Four 10 inch ball bearing (sealed)
rubber tired wheels.

Pronto design 20 inch blade whirl-
ing type with removable safety type manganese steel cutter tips
(new set postpaid \$1.00).

Cutter arm readily adjustable any height from ground to suit
operator, and will cut grass as close as any mower. Pronto cutter
assembly has highest cutter torque for horse power of any mower
known, and up to three times more cutting power at blade than
other mowers.

Pronto base is cast of light strong Aircraft metal. Axles extend
entirely through base for strength. Steel handles are adjustable for
height and position.

Our long experience and know how in the whirling blade mower
field qualifies us to offer the Pronto as a satisfactory mower, proved
by hundreds of satisfied users for every type and condition of grass
as well as weeds, long and short, light and heavy, also uneven,
rough and terraced lawns. Cutter blade trims to within 1/2 inch of
any desired object, therefore ideal for cutting around trees, shrub-
bery, walks, fences, etc.

Briggs and Stratton or Clinton 4 cycle gasoline Engines are used
on the Pronto mower as both Engines are well known for their
reliability and easy starting, as well as nation wide service facilities.

COMPLETE MOWER \$89.50

MOWER LESS ENGINE, OTHERWISE \$54.50
COMPLETE

GEAR DRIVE CUTTER ASSEMBLY



For those who desire to construct their own
mower, or want a replacement cutter assembly,
we furnish the complete gear driven cutter as-
sembly as used on Pronto mowers, with
flexible connection to Engine shaft,
(give diameter of Engine shaft when
ordering) and 20 inch blade with safety cutter tips com-
plete as shown for \$22.50

All prices FOB factory, check or money order in full with order,
no COD's, all orders filled in rotation as received by us. We have
one price to all, and no dealers or agents.

PRONTO MOWERS
OLDSMAR, FLORIDA

Genuine
HIDE GLUE
is best for all
WOOD
WORK

FRANKLIN
LIQUID HIDE GLUE

NO ODOR
NO MIXING
NO HEATING
NO CHILLED JOINTS
at most hardware stores

Used by furniture mfgs.,
craftsmen, schools. If
dealer cannot supply, send 20c
(postage and wrapping) to THE
FRANKLIN GLUE CO., Columbus 15, O.

15c
extra-large
TUBE

AMES UNIVERSAL DIAL INDICATOR SETS NEW SURPLUS

OUR \$⁵
PRICE **15.00**

Reg. sold for
\$23.00

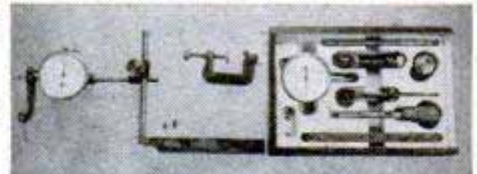

You get a complete set including Dial Gage with hole
Attachment, Bar with Upright, Clamp sliding swivel,
Dial holding rod and three contact points. Hole attach-
ment also, can be adjusted to almost any position, and
used in places inaccessible to ordinary indicators. All
this along with a beautiful box for only \$15.00.

Write today before limited supply of these AMES
KITS are exhausted.

VETERAN TOOL AND SUPPLY CO.

88 Baxter Street

New York 13, N. Y.

SPEED AND POWER HANDBOOK



Very latest methods! Build your own Dual
Manifolds, Superchargers, Water In-
jectors, Hi-Compression Heads, Fuel Saving
Devices—easily. **SAVE MANY DOLLARS!**
Get racing speed, acceleration, dynamic
power increases from any automobile!
Build fast Stock Cars! California Road-
sters! Hotrods! Get Construction Dia-
grams! Ingenious Formulas! Speed Secrets!
Tuning Techniques! Picture Catalogues. Plans! Drawings! Including
"California Restyling Ideas"—Glossy photographs! Plexi-Tops! Model
Revising! Streamlining! Customizing!—\$1.98 complete.

Also "Economy Information"—Mileage Tricks! Conversion Ideal
Newhouse Automotive Industries, 5805-84 East Beverly, Los Angeles 22, Calif.

DRAINS CELLARS, WASH TRAYS CIRCULATES OIL



Pumps 1800 GPH 300 gal.
30' high, use 1/8 to 1/2 HP **\$6.50**
motor. Will not clog.

Postpaid if cash with order.
(Add 50c for west of the Mississippi.)

Thousands in use since 1936

LABAWCO PUMPS, BELLE MEAD 7, N. J.

MARCOT KEY MACHINE

Immediate
Delivery



MARCOT No. 8 KEY MACHINE,
mounted on Cabinet, less motor. \$ 95.00
Auto Code Book and
Auto Depth Keys 12.50
100 Dz. Popular Cylinder Key
Blanks 60.00
Set — Key File, Follow-Through
Rods, Lock Picks, Bit Key Gauge,
Thimble, Pins, Springs. 10.50
"Locksmith Trade Books": 6.75
How to Open Locks without Keys
or Picks; Secret of Locksmithing;
How to Make Keys by the Impres-
sion Method; Master Key Systems.
TOTAL COST \$184.75

A. J. MARCOTTE CO.,

1200 N. Kedzie Ave.
Dept. PM, Chicago 51, Ill.

FIBRE ARMS AND LEGS!



Light, correctly fitted, strong and com-
fortable. Natural appearance.
Braces for all deformities.
Scientific design. Fair Terms.

BUCHSTEIN-MEDCALF

223 S. 6th St., Minneapolis, Minn.

Say You Saw It in Popular Mechanics

New! POWER DRILL PRESS

This new Power Drill Press has a
drill chuck with 1/4 inch capacity.
The chuck has 3 case-hardened ac-
curately centered jaws. The stand
is 13 inches high and has 4 1/2 inch clearance
from bed to chuck. All bearings are enclosed
and require no oiling. This drill press is an
ideal addition to any home work shop or
small shop doing light work. It is accurately
made for precision work.

\$8.95

Only post-
paid
Send check or M.O. Jobbers write for special information.

G. M. CO. MANUFACTURING, INC.

1308 43rd AVENUE
LONG ISLAND CITY 1, N. Y.



A TOOLSHOP IN YOUR HAND



There's Only One Genuine Handee

First tool of its kind—today's finest. Smooth, steady power at your fingertips. Easy to handle. Make ship, plane and train models, bookends, costume jewelry. Grinds, drills, polishes, routs, carves, sands, saws, engraves on metal, wood, plastic, glass, leather, etc. 25,000 r.p.m. AC or DC. Wt. 12 oz. With 7 accessories \$20.50. In case with 40 accessories \$27.50. At stores or sent postpaid. A fine gift for a friend or yourself. CHICAGO WHEEL & MFG. CO., 1101 W. Monroe St., Dept. PM, Chicago 7, Ill. Free 52-page manual.

HANDEE TOOL OF 1001 USES

REAL DIESEL ENGINE

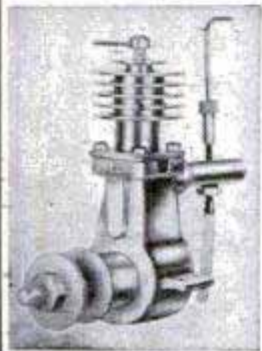

\$2.95

WE'RE CRAZY, they tell us, giving away a real diesel engine, complete with cylinder and piston, carburetor, crankshaft and connecting rod. All parts completely machined, ready for easy assembly. **ONLY \$2.95.** How do we do it? We're selling thousands of **DEEZILS**. So production's up; costs tumble down. **DEEZIL** is a precision engine. Actually runs at 7500 RPM. Produces 1/7 HP. Ideal for planes, boats, midget cars. Send \$2.95 plus 25c postage today.

GOTHAM HOBBY CORP.

107 East 126th Street New York 35, N. Y. Dept. "P"



America's most versatile rifle

Perfect for indoor and outdoor target shooting. Powerful and accurate enough for small game hunting. Features selective peep and open sighting combination. Power controllable for every shot. 177 and .22 caliber. Send for catalog.

Crosman Arms Co., Inc.

3 Henrietta St. • Rochester 7, N. Y.

FULLSIZE, CUT-TO-SHAPE BOAT PATTERNS

and specifications. Designed by Naval Architect. Cruisers, runabouts, sloops, outboards, sailing canoe, etc. Low prices. Send 10c (coin) for illustrated catalog. SPECIAL: Send \$1.00 for "HOW TO BUILD BOATS" book, postpaid. PolyWog Houseboat Plans, \$10. Cleveland Boat Blueprint Co. Dept. 666, Cleveland 13, Ohio

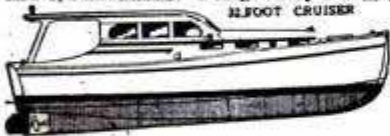

DOUBLE BUNK BEDS

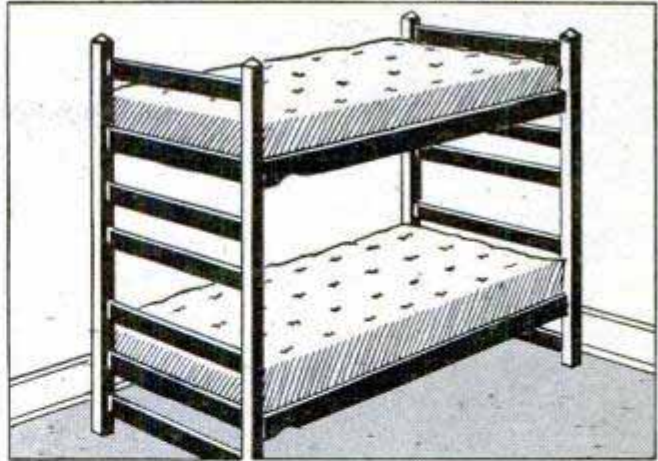

TWIN BEDS

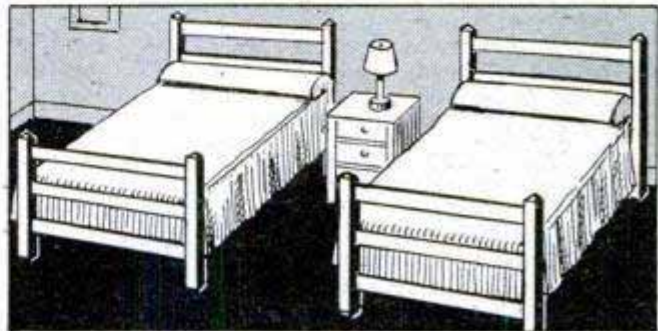

\$27.50 THIS PRICE INCLUDES **\$50.00 Value**
TWO (2) HARDWOOD BEDS, TWO (2) THICK COTTON MATTRESSES AND TWO (2) FLUFFY FEATHER PILLOWS.
Complete Set

Our purchase of over 5,000 hardwood beds from the U. S. Airforce makes this low price possible. These beds can be made into double bunks or twin beds and are real space savers for your summer cabin, guest room, childrens room, etc. These beds are of sturdy construction,, will hold over 600 lbs., 30" wide, 76" long. Mattresses have new ticking. The pillows have had the feathers removed, cleaned in live steam. The ticking is washed and bleached then refilled with soft fluffy, clean feathers. All sterilization regulations have been complied with. Seals on all mattresses and pillows. Shipping weight for complete set 150 lbs.

Price for one (1) twin bed, one (1) mattress, and one (1) pillow.....**\$14.00**
SHIPPING WEIGHT 75 LBS.

Steel beds also available. Same weight and size and price as above.

All beds shipped via truck or rail freight f.o.b. Fresno.

NEW 100% WOOL BLANKETS

SIZE 64x84 **\$5.95** ea.
COLOR GREY

We pay all postage or express charges on this item.

Pay by money order or check. 50% deposit on C.O.D.'s. All orders filled promptly.

ARMY SURPLUS SALES OF FRESNO

1820 TULARE STREET

FRESNO, CALIF.

ONLY **\$9.75**

POST PAID



Pat. No. 2,188,175

JET PERFORMANCE FOR YOUR CAR WITH VAPOJET

VAPOJET gives your car super aircraft power and performance. VAPOJET users report 25% more mileage from regular gas. A double saving! Eliminates carbon, vaporlock and overheating. Complete kit permits easy installation—fits all cars. Order today—\$9.75 complete, postage prepaid. \$1.00 deposit on C.O.D.—your check or money order in full saves postage. You take no chances—satisfaction guaranteed or money back! Specify car, year, number of cylinders. MAIL COUPON NOW!

VAPOJET MANUFACTURING COMPANY

11424-M BIONA DRIVE

LOS ANGELES 34, CALIF.

—ORDER TODAY—

Gentlemen: Please rush me _____ Vapojet units, complete with necessary linkage, instructions, etc. Enclosed is my check (or money order) in amount of \$ _____
Car _____ No. of cyl. _____ Year _____
NAME _____
STREET _____
CITY _____ STATE _____

GROBAN'S—WAR SURPLUS BARGAINS

SHOP BY MAIL and SAVE
Better buys • Satisfaction guaranteed



Vickers MF9 Hydraulic PUMP or MOTOR

complete with mounting kit ready to install

\$19.90 POST-PAID

\$75.00 value

Pump is compact, powerful, rated 1,000 P.S.I., .507 cu. in. per revolution, 8 gal. per min. at 3750 RPM. Change rotation by reversing flow. Delivers up to 6 H.P. Requires 1/2 to 6 H.P. to drive directly or by pulley. BRAND NEW.

Mounting kit has been especially designed to provide maximum utility and ease of mounting MF Series Vickers Pumps. Brackets are constructed of heavy steel plate; shaft is made of 1/2" steel with one end splined to fit pump; other end of shaft has machined flat for mounting a standard pulley with 1/2" hole. Shaft runs in oilite bronze bearings.

Pump only \$14.95 postpaid

Mounting kit only..... \$ 4.95 postpaid

Both as complete unit..... \$19.90 postpaid

GENERAL ELECTRIC D C GENERATOR

BRAND NEW

For Farm—Home—Factory Welding—Light Plants

Delivers 30 volts, 267 amps. at 4000 RPM. Rated 8 Kilowatts, ball-bearing supported. Fan cooled armature. Drive it off of farm tractor, gas engine of 10 H.P. or more. Ship. wt. 65 lbs. U. S. Government acquisition cost—\$277.00. Now Only \$28.50 F.O.B. Chicago



ADJUSTABLE RELIEF VALVE... \$2.95 postpaid

HAND HYDRAULIC PUMP Brand New



Used for hydraulic jacks, presses, hoists and other hydraulic applications. For operating hydraulic cylinders to pump oil or hydraulic fluid under pressure. Hand pump has built-in check valve and is capable of delivering 1000 lbs. of pressure. Has alloy aluminum housing. Dimen.: 8" long x 3 1/2" high x 2 3/4 wide. Ship. wt. 3 lbs. A \$45.00 value..... Now \$8.95 postpaid

FREE: New, 20-page illustrated Hydraulic Manual featuring diagrams, photographs and instructions—FREE with each hydraulic order.

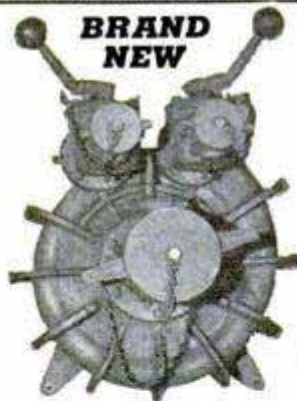

HALE FIRE and IRRIGATION High Volume CENTRIFUGAL PUMP

FOR FIRE PROTECTION, IRRIGATION, DE-WATERING, INDUSTRIAL USES, FARM USES, ETC.

PUMPS RATED 500 GALLONS PER MINUTE AT 275 FT. HEAD PRESSURE

Equipped with 1 1/2" diameter straight splined shaft for direct coupling drive; 4 1/2" threaded suction intake; two—2 1/2" threaded discharge outlets; Hale Pump Co. Model CF volute type; use any 4 or 6 cylinder gas engine or couple directly to front of truck or auto; or use 25 H.P. electric motor; dimensions 21" x 24" x 28". Complete with full accessory kit including suction and pressure gauges, priming equipment, and instruction book. Ship. wt. 415 lbs. \$149.50

Gov't. acquisition cost \$425.00

NOW

F.O.B. Chicago

WRITE FOR OUR FREE CATALOG!

Brand New Air or Oil HYDRAULICS

Use hydraulics on arbor presses, hydraulic presses, hay lifts, manure loaders, lift trucks—push or pull, tilt or turn, press or squeeze, open or close, lift or lower—and other hydraulic and industrial applications. Use with either air or oil . . . of finest precision workmanship.



1. Double action, 1" bore, 3" stroke, will lift 770 lbs. in 1/10 of a second using MF Pump. All steel barrel. Ideal for controls, door openers, positioning, \$4.95 etc. An \$18.00 value . . . postpaid

2. Double action, 1 1/2" bore, 5" stroke, will lift 1760 lbs. in one second with Vickers MF9 Pump. Wt. 3 lbs. A \$35.00 value . . . postpaid \$8.95

3. Double action, 1 1/2" bore, 9" stroke, will lift 1760 lbs. in one second with Vickers MF9 Pump. Wt. 4 lbs. A \$45.00 value . . . postpaid \$10.95

4. Use these cylinders on farm trucks, bulldozers, hay lifts, manure loaders, etc. Double action, 1 1/2" bore, 27" stroke. (Will lift 1760 lbs. in 2 seconds with Vickers Pump.) Wt. 8 lbs. A \$55.00 value . . . postpaid \$12.95

5. Double action, 2 3/8" bore, 8" stroke. (Will lift 4400 lbs. in one second with Vickers Pump). Will withstand 1500 P.S.I. against wall. Wt. 7 lbs. A \$65.00 value . . . postpaid \$14.50

6. Double action 2 3/8" bore, 5" stroke, two-way solid 5/8" alloy steel shaft (will lift 4400 lbs. in one second with Vickers Pump). A \$73.00 value . . . postpaid \$16.50

7. Double action, 3" bore, 8 1/2" stroke. All steel hydraulic cylinder, will lift up to 12,000 lbs. (7000 lbs. in 3 seconds with Vickers Pump.) Complete with fittings. Wt. 12 lbs. A \$78.00 value . . . postpaid \$19.50

8. Double action, 3 1/2" bore, 11" stroke. (Will lift 9600 lbs. in 7 seconds using Vickers MF9 Pump.) Complete with fittings. Wt. 15 lbs. A \$92.00 value . . . postpaid \$22.50

9. Double action, 3" bore, 23" stroke, hydraulic cylinder will lift 7070 lbs. in 5 1/2 seconds using MF9 Hydraulic Pump. Especially suited for farm and construction machinery. Clevis mounting for easy use. Wt. 22 lbs. A \$145.00 value. F.O.B. Chicago \$27.50

Fittings available for above cylinders.

Hydraulic Control Valves Brand New



1. Four-way control valve for use with 1500 P.S.I. hydraulic cylinder, may be used with 1500 P.S.I. hydraulic system to open and close hydraulic cylinders. Brand new. Ship. wt. 4 lbs. A \$38.00 value . . . postpaid \$7.95

2. Four-way control valve for use with two hydraulic double action cylinders. Each cylinder may be operated independently of the other or in conjunction with the other. Oil may be locked in any of the cylinders to hold the piston at any required position. Brand New. Ship. Wt. 6 lbs. A \$60.00 Value. . . postpaid \$10.95

3. A two cylinder double action valve with a unique arrangement, allowing the operator to raise both cylinders simultaneously, to lower them simultaneously or to raise one and lower the other at any predetermined rate and speed. Brand New. Ship. Wt. 8 lbs. A \$75.00 value . . . postpaid \$14.95

Brand New Double-Action Pneumatic — Hydraulic PRESS

\$300.00 value offered at a fraction of original cost

Using air or oil, this device is ideal as a punch press, vise, arbor press, etc. An excellent tool for industrial and shop use.

Use 150 lbs. of air pressure or 250 lbs. of oil pressure. Cushioned double action "Logan" Model AC ram, 6" bore and 6" stroke. Capable of up to 4200 lbs. of pressure using air. Has 3" throat. Lubricated gibs provide perfect alignment. Has adjustable work space. Hardened alloy steel piston rod 1" diameter. Frame constructed of cast steel with 3/4" base plate. Manufactured by Sipp-Eastwood Co. Unit is 49" high. Base is 9 1/2" wide by 18" deep. Wt. approx. 300 lbs. AN OUTSTANDING BUY at . . . \$79.50



F.O.B. Chicago

ORDER DIRECT FROM AD
Send payment or purchase order today
SATISFACTION GUARANTEED

GROBAN SUPPLY CO.

1507 SOUTH MICHIGAN AVE.

Chicago 5, Ill. Dept. PM-5

GROBAN'S-WAR SURPLUS BARGAINS

SHOP BY MAIL
and SAVE
Better buys - Satisfaction guaranteed

Brand New GENERAL ELECTRIC

8" Sealed Beam

FLOODLIGHTS

300 Watts, 110 Volts, A.C. - D.C.

Has countless uses for:

- Homes
- Garages
- Workshops
- Driveways
- Outdoor advertising
- Displays
- Beach lighting
- Private air ports
- Photography

Wherever you need flood-lighting!

Bought by the U. S. Army for signal use. This is the greatest surplus bargain ever offered.

Lens, reflector and electrode vacuum sealed in one dust-proof, air tight unit. 300 Watts, 110 Volts. Weighs only 2 1/2 lbs. List price \$10.50.



A TREMENDOUS VALUE for.. **\$2.75** ea. postpaid

12 or more..... **\$2.50** ea. postpaid

Self-Priming ELECTRIC PUMP

APPLICATIONS: oil burners, aquariums, fluid metering, fuel pump, tool post grinder, coolant pump, pressure lubricating pump, general industrial, etc.

MOTOR MFD. BY BLACK & DECKER; double ball bearing series wound, continuous duty, 1/30 H.P. electric motor, rated 12,000 R.P.M. Transformer included for use on 110 V AC current. Also applicable for 24-32 V DC.

PUMP MFD. BY WELDON TOOL CO. with standard 1/4" tubing ports; rated 2 G.P.H.; remove pump and use motor as high speed grinder.

OVERALL DIMENSIONS: 7 3/4" long x 3 1/4" wide x 3 1/4" high. Approx. wt. 5 lbs. \$51.00 value.

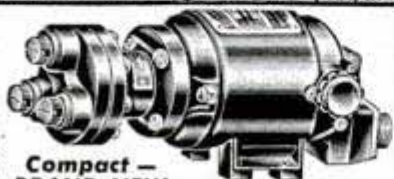

Compact - BRAND NEW

\$12.95 postpaid

MINIATURE High Speed ELECTRIC MOTOR

IDEAL FOR MODEL BUILDERS, MODEL RAILROADERS, EXPERIMENTERS, HOBBYISTS. AC or DC. Reversible, speed may be regulated by varying voltage. Has miniature Klaxon thermo-static switch. All connections are external and accessible. Has 3 mounting feet for easy installation. Double-end ball bearing supported shaft with small gear on one end. Die-cast housing with laminated field. Overall Dimen.: 3 1/4" long x 2 3/8" wide x 1 3/8" high. Net wt. 12 oz. A \$22.00 value.



Brand New

\$2.95 postpaid

Self-Priming Bronze Pump

Positive Pumping Pressure

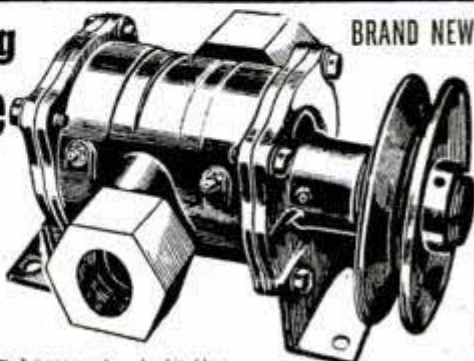

BRAND NEW

Perfect for draining basements, irrigation, fire fighting, sprinkling, pressure booster, insecticide and other spraying, fuel transfer, stock watering, industrial pumping, deep well jet pumping and home water systems. Rated 25 ft. suction and 150 ft. head pressure at 80 gallons. Use from 1/3 to 5 H.P. motor.

Complete engineering report and instructions FREE with pump

Supplied with mounting brackets and 5" V belt pulley, ready for instant use. Standard 1 1/2" pipe thread inlet and outlet. Dimensions: 9 1/2" x 7 1/4" x 4 1/4". Ship. wt. 18 lbs. A \$142.00 value....

\$32.50

F.O.B. Chicago

Outstanding Surplus Value!

BRAND NEW - GUARANTEED

GRINDING WHEEL KITS

HUNDREDS OF ASSORTED ITEMS - A \$50 VALUE



FOR CUTTING, SHAPING, GRINDING, & POLISHING WOOD, METAL OR PLASTIC.

While supply still lasts, only

\$8.95

Per Complete Kit

F.O.B. Chicago

SET INCLUDES OVER 300 ITEMS

- 25 Grinding and cut-off wheels, sizes 1 to 5 inches, 1/8 to 3/4 hole
- 6 Cut-off Wheels on 1/2" m'ndrl.
- 3 Steel cutters 1/2"
- 5 Steel cutters 3/32"
- 1 Steel circular saw mounted on mandrel
- 1 Drum sander 1/2" mounted on 3/32" mandrel
- 1 One inch buff on 1/8" mandrel
- 2 Leather wheels
- 1 Roughing stone
- 3 Honing stones
- 2 Felt bobs
- 10 Sanding rolls
- 6 Sanding sleeves

- 1 One inch felt wheel on 1/8" mandrel
- 1 7/8" rubber wheel on 1/8" mandrel
- 2 High speed rotary files 1/4" shank
- 100 3/4" cloth butterfly abrasive discs
- 1 Box paper discs-100
- 1 Rag wheel-4 inch
- 10 Mounted stones-3/32", 1/4", 1/2"
- 1 One inch wire wheel 5/8" hole, brass center

In sturdy compact container 13 1/4 x 9 1/4 x 2 1/2", weight 8 1/2 pounds; with installed rack for all drills.

- 1 4" Wire brush
- 1 Bristle brush 3", 5/8" hole

1 enclose \$8.95 Check M. O. Send C. O. D.

Name _____

Address _____

ALL-PURPOSE WATER PUMP

Mfd. by PACKARD MOTOR CAR CO.

Ready for use on any pumping need

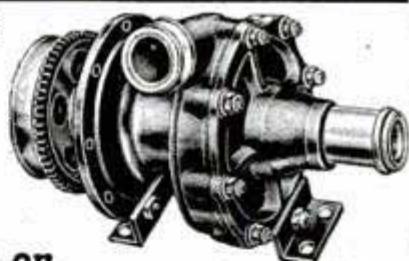

Brand New

Belt Driven - Centrifugal Pump

An extraordinary value for all types of intermittent or continuous pumping in the home... farm... factory. Built to exact specifications of Packard Motor Car Co. for use in Rolls-Royce Merlin Aircraft Engines. May be run with electric motor, gas engine or power take-off on tractor. Delivers up to 25 gallons a minute with 1/4 H.P. motor; 80 gal. a min. with one H.P. motor. Will deliver up to 44 ft. head or 25 ft. suction. Use 1" outlet hose; 1" or 1 1/2" inlet hose (recommended).

COMPLETE ENGINEERING REPORTS AND OPERATING INSTRUCTIONS FREE WITH PUMP

Has cast aluminum housing, accurately machined 5" bronze impeller; 3 1/2" V belt pulley and mounting brackets. Shaft rotates on ball bearing; has grease gun fitting.

\$21.50

F.O.B. Chicago

Complete with pulley and mounting brackets, ready for use.

Original cost approx. \$88.00. Shipping weight 10 lbs. A REAL BUY.

WRITE FOR OUR FREE CATALOG!

ORDER DIRECT FROM AD
Send payment or purchase order today
SATISFACTION GUARANTEED

GROBAN SUPPLY CO.

1507 SOUTH MICHIGAN AVE.

Chicago 5, Ill. Dept. PM-5

WE FURNISH ALL MACHINED METAL PARTS, EVERY SCREW, NUT, BOLT, WASHER, AND COMPLETE PLANS FOR THIS...

BIG 10" POWER SAW



\$9.95
LESS GUARD AND WOOD

POST PAID ANYWHERE IN U.S.A.

FULL \$9.95 REFUND IF NOT SATISFIED WITHIN 10 DAYS

ASSEMBLE IT YOURSELF WITH SIMPLE HOUSEHOLD TOOLS!

TABLE 24" x 20" • TILTS TO 45°
CUTS 0" TO 3/4" DEEP • TAKES 10" BLADE

COMPLETE PLANS (WITHOUT PARTS) 10c

AMERICAN MACHINE & TOOL CO., Inc.

DEPT. 44, ROYERSFORD, PA.

SO HANDY FOR SO MANY USES AT HOME OFFICE AND SHOP

32 DRAWER MODEL PICTURED ONLY
\$5.95
POST PAID

THE **JIFFY** METAL CABINET

Now you can keep nuts, bolts, screws, nails, parts, washers, stamps, hobbyist needs, etc., at your fingertips.



Just think, 32 or 64 drawer cabinet to keep those small items that usually get mislaid. Spot welded steel cabinet, enamel finish, metal drawer guides. Looks good anywhere. Send check or money order please—no C.O.D.'s. Prices below. Your money refunded if not satisfied.

SPECIFICATIONS

32 Drawer Unit
6" Deep
12 3/4" Wide
15 1/4" High
64 Drawer Unit
6" Deep
25 1/2" Wide
15 1/4" High
Drawer Size
1 1/4" Deep
2 3/4" Wide
6" Long

WITH ALUMINUM DRAWERS

One piece rustproof aluminum drawers for heavy service—good for work bench and industry use.

32 drw. \$8.95
64 drw. \$15.95

POSTAGE PAID

WITH CARDBOARD DRAWERS

Suitable for most home uses. Heavy board kraft covered. Metal drawer pulls.

32 drw. \$5.95
64 drw. \$9.95

POSTAGE PAID

KAYTEE PRODUCTS DEPT. M, BOX 588, CANTON, O.

New War Surplus **HOIST & WINCH**

Small But Mighty. Originally made to be used on B-29s for lifting bombs. Original Govt. cost approx. \$100.00. Mounted on a welded steel base 5" wide 12" long, 3/8" thick that can be attached to truck body or any other solid base. Ideal for lifting or moving loads in or onto trailers, trucks or tractors. Excellent for machine shops, garages or warehouses. Can be used to construct portable lifts and cranes. Gear ratio 24 to 1, bronze worm gear driven. Capacity 2,000 lbs. Drum may be disengaged for free wheeling if desired. Equipped with ratchet for holding load. Handle may be set at three different lengths. Equipped with 3/8" steel cable 18 ft. in length with forged steel hook. Housing, cover, and cable drum of aluminum. Working parts of steel with ball bearings and cast bronze graphited bearings used throughout. Actual weight 40 lbs. May be easily moved from one mounting position to another. Shipping wght. in carton 45 lbs. wooden box 50 lbs. FOB, K. C., Mo.

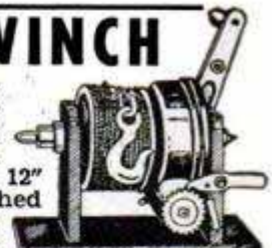

\$29.95

Send check or M.O. for immediate delivery. No COD's.
AMERICAN AUTO PARTS CO.
1830 LOCUST DEPT. P.M. KANSAS CITY, MO.

★ STOP DOING IT THE HARD WAY!



AMAZING PAINT REMOVER, U-MIXIT
Dip or spray it on, wash it off. Paints, enamels, lacquers come off in a jiffy. Cars, boats, farm equipment, etc. It's easy, simple, non-inflammable, safe, and non-toxic. A good degreaser. Money back guarantee. Send \$1 for quart sample and instructions. In bulk \$2 per gal. Ask for catalog "Unusual Supplies for Sportsman and Hobbyists."

MAIL ORDER SHOPPING CENTER

6432 Cass Ave., Dept. 5P, Detroit 2, Mich.

WOODWORKERS... Get this

CONSTANTINE MASTER MANUAL

Get the Most Fun From Your Hobby
Indispensable to woodworkers. Newest, biggest edition, more pages, more color, helpful how-to-do-it articles, pre-war and new items, more bargains. Send 25c today and we will include **FREE! FULL YRS. SUBSCRIPTION** to Chips and Chats, published bi-monthly. Keeps you up-to-date on everything in woodworking, offers big money-saving bargains. Send now.

ALBERT CONSTANTINE & SON, Inc.
791-A East 135th Street, New York 54, N.Y.



MAKE! FOLD-A-WAY
FOLDING TABLES - BENCHES - HORSES - IN A JIFFY
Channel Steel Legs
Shipped complete, ready to fasten to your top in a minute. Rubber tipped. Used on the job, in homes, workshops, ping pong tables, trailers, camps, boats, churches, lodges, banquet halls.
Send for free circular.

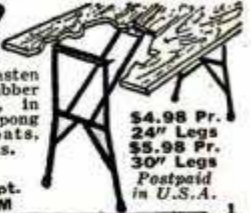

\$4.98 Pr.
24" Legs
\$5.98 Pr.
30" Legs
Postpaid in U.S.A.

THE DIAMOND MFG. COMPANY

1100 ALBANY AVENUE SCHENECTADY 7, N. Y.

Say You Saw It in Popular Mechanics

D.C. ARC WELDER

200 AMPERES CONTINUOUS DUTY **ONLY \$97.50**

Easily mounted on tractor or elsewhere. Welding range 0-250 amperes by dial type control. Includes proper pulley for your application. 12 months guarantee, with money-back 10-day trial period, (A \$300 value) at less than half. Write today for free literature or catalogue. Or send **35c** for PLAN "Build Your Own Welder from Surplus Aircraft Generator" and we'll include free literature and catalogue.



LEJAY MFG. CO.
847 LeJay Bldg., Minneapolis 8, Minn.

Fits Your
Electric Drill

Polish, Sand and Save with **BULL BUFFER!**

More than pays for itself the very first time you make your car, boat, floors, woodwork gleam like new!

More than 100,000 enthusiastic users will tell you that Bull Buffer has everything you want in a polisher-sander: (1) fits any electric drill or flexible shaft, (2) exclusive gear reduction that gives any drill real power, (3) exclusive swivel action that makes it easy to use, (4) exclusive angle head that helps get to all those hard-to-reach places other polisher-sanders can't touch.

Bull Buffer is built of lifetime materials and *guaranteed*. Order yours today, at your dealer, or send cash, check, or M.O. for your Bull Buffer, **\$9.95** complete as pictured below, only.....



Bull Buffer comes complete with sheepskin bonnet, and 2 sanding discs, only \$9.95.

ORDER THESE EXTRA ACCESSORIES FOR YOUR BULL BUFFER

These attachments (see price list below) will fit the Bull Buffer only.

| | |
|--|--------|
| 1/2" Jacobs No. 6425 key chuck; with Bull Buffer increases 1/4" drill to 1/2" capacity | \$5.00 |
| —reduces speed, increases power..... | |
| Extra sanding discs (0000-000-00-0-1-2 1/2-3-4) each..... | .10 |
| 2 1/2" cup wire brush for removing paint, rust, scale, etc..... | 1.75 |
| Extra sheepskin bonnet..... | 1.25 |
| Adapter A—for direct drive at "same as" drill speed..... | 1.00 |
| Adapter B Set—for sanding at twice drill speed..... | 2.00 |
| Bull Buffer car cleaner..... | .50 |
| Bull Buffer car polish..... | 1.00 |
| 1/2" pile wool pad with rubberized back, to be used with cleaning compound, each | 1.35 |

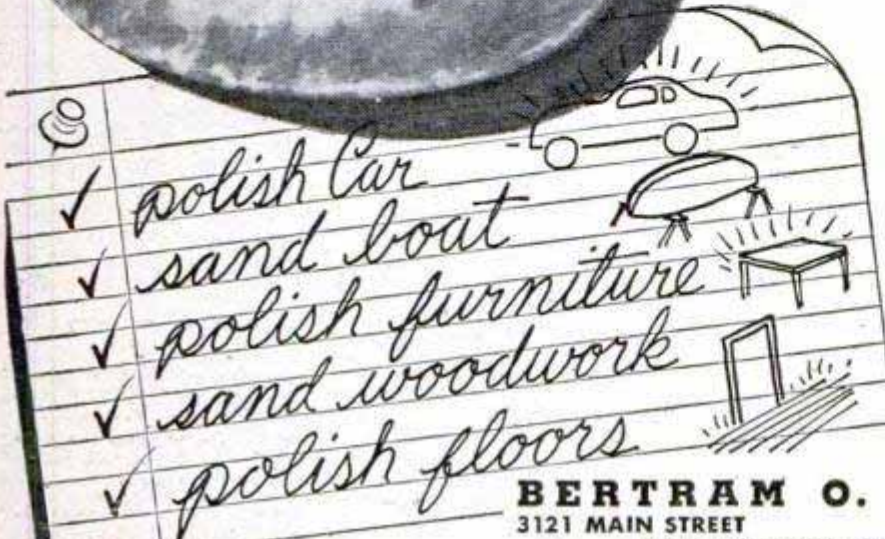

BERTRAM O. ENGINEERING CO.
3121 MAIN STREET
DEALERS WRITE FOR NAME OF NEAREST WHOLESALER
KANSAS CITY, MO.

DAISY AIR RIFLE \$2.59



Real Power in Every Shot

Immediate delivery on world famous Daisy High Powered Air Rifle. Accurate, hard-hitting, low in price. Everyone who has owned a Daisy knows what

a terrific thrill this hard hitting full-powered Daisy gun can give for target and outdoor shooting. Blued steel finish, natural hardwood stock, 31 inches long. Large, single stroke compression chamber. Individual colorful target box. Daisy Coppercoated BB's, 3 packages 25 cents, 12 for \$1.00.....GUN ONLY \$2.59

JOHNSON SMITH & CO.,

Dept. C-46

DETROIT 7, MICHIGAN

HANDY NEW POCKET CAN OPENER

You'll be a "lifesaver" many, many times with this new can opener that can be carried on your key ring. Only 1 1/2" long, it's a "mighty midget"—will open any can so easily a baby could handle it. Not just a gadget—it's completely practical and usable. There are no working parts to get out of order or wear out—it will last for years. Handiest thing in the World for camping, picnics, boating, auto trips, beach parties, etc. Simple operating instructions are included. Only 25c, postpaid, or get five for \$1.00 (your friends will all want one the minute they see yours).

U. S. ARMY & NAVY STORE

BOX 9622, STATION "S"

LOS ANGELES 5, CALIF.



SET THE PACE WITH THE

- Cruises at 45 MPH—with faster pickup than car
- 39" high, 71" long overall, wt., 190 lbs.
- 8 HP motorcycle engine
- 50 miles to the gallon
- Automatic clutch
- Internal expanding brakes—handle-grip throttle controls

Powell
P-81!

ONLY \$247.34
AT COMPTON, CALIF.
EXCISE TAX INC.

POWELL MANUFACTURING COMPANY
DEPT. PM549 • COMPTON, CALIF.

Write for FREE folder and name of nearest dealer



Dealer Inquiries Invited

M-SCOPE TREASURE -MINERAL LOCATORS

WRITE FOR FREE, ILLUSTRATED 16-PAGE BOOKLET

M-SCOPE TREASURE-MINERAL LOCATORS. Low priced, unsurpassed efficiency, lightweight models. Factory guaranteed. Immediate shipment. Credit plan available. Write for free 16-page booklet.

GEIGER COUNTERS for finding Uranium ores. Several models. Simple operation. Low priced. Immediate shipment. Interesting free literature.



URANIUM

FISHER RESEARCH LAB, INC., PALO ALTO, CALIF.

GOLD

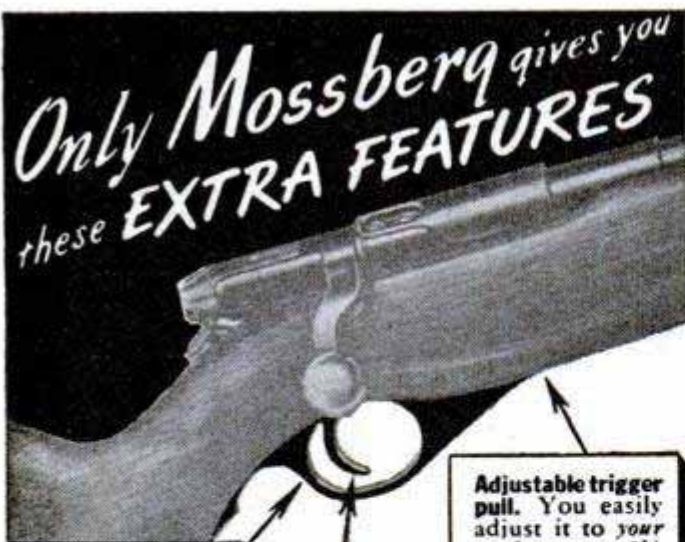

Only Mossberg gives you these **EXTRA FEATURES**

Streamlined trigger guard with molded finger grooves. Fits hand comfortably, improves trigger squeeze.

Grooved trigger—a de luxe feature usually found only on high-priced rifles (Models 42M, 44US, 46B, 46M.)

Adjustable trigger pull. You easily adjust it to *your* preference—2½ to 5 lbs. (Models 42M, 44US, 46B, 46M.)

Look for these features in the rifle you buy. They mean more rifle for your money.

● **Three of Many Exclusive Mossberg Features**

SEE THEM AT YOUR DEALER'S FREE catalog on request



No sales at factory
96505 St. John Street, New Haven 5, Conn.

FINER FEATURES GIVE YOU BIGGER VALUE!

See Garden-All before you buy!

Garden-All
LAWN and GARDEN TRACTOR



Garden-All Seeder plants all seeds with speed and efficiency. Assures uniform rows. Single or double. Adjustable for rows 10 to 42-inches apart.
Write for Folder

Compare Garden-All with any other garden tractor! See the outstanding features—like Instant Tool Attachment, Exclusive Depth Control, Plant Clearance and Variable Tread Width! You'll see that Garden-All gives you more value for your money! Garden-All is sturdy, powerful, efficient. And it's so extremely versatile in the number of ways you can use it in your lawn and garden work. Four great models, ranging from "The Culti-Vette," the sensational new 1½ h.p. light duty, economy model (at only \$159.50 F.O.B. Factory), to the rugged 3 h.p. Model "S3" shown above. Write today for name of nearest dealer.

GARDEN-ALL TRACTOR, INC.

Dept. P, 110 W. UNION STREET, LIBERTY, INDIANA



Catalog FREE

BINOCULARS

10x50 MILITARY WIDE ANGLE IND. FOC. \$55
8x32 COATED CENT. FOC. \$39.50
6x30 GERMAN FEATHERWEIGHT CENT. FOC. \$37.50
20% Federal Tax. Leather Cases Incl.

We pay postage — Brand new — Money back guarantee.

BROWNSCOPE CO.

DEPT. 5M, 24 WEST 45th ST., NEW YORK 19, N. Y.

WEED SPRAY PUMPS

Build your own power sprayer. Bronze gear type. 0-150 lb. pressure. Pumps to 90 gal. per hr. @ 100 lb. with ¼ hp Pump Head only \$10.95. With built-in pressure regulator \$15.45. Other sizes and types available. 15c for valuable pamphlet on construction and operation of Boom sprayers with parts lists and prices of Nozzles, hose, fittings, gauges, valves, etc. Free with pump order. New 1949 52 page Bargain Catalog 10c.



MIDWEST SALES CO.

2533 INDIANA DEPT. PM5 KANSAS CITY, MO.



NOW! FILE YOUR OWN SAWS

Do expert saw filing at home. Precision filing easy without experience. Two simple adjustments. Keeps any hand saw extra sharp and true-cutting. Complete with file. Money back guarantee. Cash with order, prepaid. (COD postage extra.) Order today.

\$2.95 EACH

THE SPEED CORP., Dept. PM1
2025 N. E. Sandy, Portland 12, Oregon

WHEELS - WHEELS

- 5" disc wheel, 5/8" tire, 5/16 or 3/8" sleeve.....\$0.30
 - 6" disc wheel, 3/8" tire, 5/16 or 3/8" sleeve.....\$0.35
 - 7" disc wheel, molded tire, 3/8" sleeve.....\$0.45
 - 8" disc wheel, 1 1/4" tire, 1/2" sleeve.....\$0.70
 - 7" disc wheel, 1" tire, 1/2" ball bearing.....\$0.80
 - 8" disc wheel, 1 1/4" tire, 1/2" ball bearing.....\$1.00
 - 10" disc wheel, 1.75 semi-pneumatic tire, 1/2" B.B.....\$1.50
- Above wheels painted red
10" cast alum. wheel, 2 3/4" semi-pneumatic tire, 5/8" ball bearing.....\$4.50
Hub caps for 5", 6", 7" wheels.....3c each Plus postage

UNITED WHEEL STAMPING CO., Dept. PM-5

2756 W. 115th St. Chicago 43, Ill.

\$1000.00 for 3 gallons of "worn out" motor oil

from your own motor! Details, page 30 in our FREE BOOK "Oil Facts."
RECLAIMO MFG. CO. 5083 Elston Ave., Dept. 94, Chicago 30, Ill.

BUILD YOUR OWN TRAILER

with NATIONAL'S Easy-to-Read PLANS

Here it is! Your own full size house on wheels . . . or if you prefer, a sleek sports trailer that will add new thrills to your vacation. Easy to read, easy to follow instructions and a complete "cost of materials" with every plan.

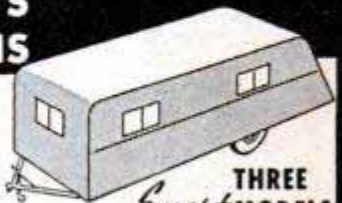

ORDER ALL THREE GET ONE FREE!

- Model 27 27-foot Luxury Liner, 35'00 rooms, toilet, Sleeps 6.
- Model 20 20-foot Cabin Trailer, 51'00 tops for looks, Sleeps 4.
- Model 10 Sports Trailer for hunting, fishing, Sleeps 2. 50c

FREE! Big illustrated parts Catalog with Any Order!

NATIONAL TRAILER STORES

Dept. PM-Box 2353 Terminal Annex - Los Angeles 54, Calif.

BUILD AUTHENTIC "Old West" scale MODELS



It's fun! Try your hand at these famous scale model souvenirs of early settler days. Complete kits with authentic miniature details, precision cut parts, free rolling wheels, formed ribs, leather springs, etc., etc. Order now—save at combination prices.

HANDY BUILDER'S TOOL!



New long-nose Glue Gun puts a dab of cement just where you want it—tight corners, edges, etc. **75c**
Postage 15c (With any kit order, postage free)

Buckboard Kit \$1.00
Plus 15c postage

Stage Coach Kit \$1.50
Plus 15c postage

Covered Wagon Kit \$1.50
Plus 15c postage

ALL 3 for Only \$3.75
Plus 25c postage

POST OFFICE BOX 389
BURBANK, CALIFORNIA

HOLLYWOOD MODELS

NU-WAY HEAVY DUTY CUTTING UNIT with Timken Roller Bearings

PRICE
\$16.50
WHY PAY MORE



Build your own rotary type lawn or weed cutter. Take the hard work out of weed cutting. Build yourself an up-to-date weed and lawn mower with the Nu-Way heavy duty unit.

Write for Free Circular—We Supply Cutting Unit Complete
TRACTOR-LITE MFG. CO., Spirit Lake, Iowa

SPECIAL OFFER!

LOCK-STITCH SEWING AWL

\$1.

Postpaid

Famous, patented lock-stitch sewing awl complete with needles, waxed thread and direction folder. Hundred uses — sewing, repairing leather goods, canvas, belting, harness, saddles, gun cases, awnings, golf bags. Extra needles and thread available. Satisfaction guaranteed or money back. Send currency, check or money order.
Yates Mfg. Co., 611-H Main St., Lake Geneva, Wisconsin

POWER HACKSAW \$47.25

LESS MOTOR
F. O. B. Benton Harbor

• Rugged cast iron construction. Wt. 56 lbs. bronze bearings. Draw cut. Auto. return lift. Auto. shut-off. Vise swivels 45°. Cap. 4" x 4".

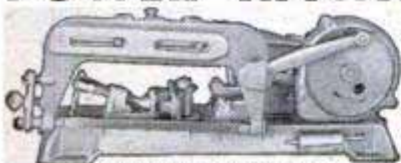

Send for full details and name of nearest dealer.

EXCEL MACHINE TOOLS Dept. PM-59 BENTON HARBOR, MICHIGAN

Free Catalog BARGAINS FROM WORLD WAR II

Thousands of Bargains in Military, Outdoor and Sport Goods for Hunter, Farmer, Scout. Write for FREE 32-page CATALOG OF BARGAINS.

A and N SUPPLY CO. 4720 Lester St. Richmond 15, Va.

Mower Builder's Kit

M.B.K. KIT CONSISTS OF
1-TIMKEN BEARING EQUIPPED HI-SPEED SPINDLE
1-HI-CARBON STEEL 20" BLADE
2-10"x1.75" PUNCTURE-PROOF SEMI-PNEUMATIC, RUBBER TIRES. BALL BEARING WHEELS
1-5" SWIVEL CASTER WHEEL



\$28.50 COMPLETE

SPINDLE & BLADE ALONE ... \$18.75

FAMOUS MOZALL POWER MOWERS NOW AVAILABLE ... FREE FOLDER
SEND CHECK OR M.O. TO

Dept. M-5 **WIND-KING ELECTRIC MFG. CO.** MERRILL, IOWA

NEW Mall REG. U.S. PAT. OFF.

7" Polisher • Sander Tool with Infinite Use



only **\$45.00**

F.O.B. Chicago

With polishing and sanding attachments and 1 pint can of polish. Complete with metal case ... \$48.00. Complete with 3/8" Jacobs chuck and metal case ... \$55.00

Also can be quickly converted for Hole Sawing • Slitting Saw • Grinding • Drum Sanding • Paint Stirring • Drilling and Shearing with interchangeable attachments.

Here is a heavy-duty industrial tool designed for long, tough wear that has infinite use around the home workshop, on the farm, in factories, auto body shops and furniture plants. It takes the work out of polishing the family car and waxed woodwork, sanding floors, sanding walls before sizing, drilling 3/8" holes in steel, masonry, concrete and 1" in wood, and many other jobs.

The Mall Polisher-Sander-Drill is light in weight, easy to handle, plugs into any regular electrical outlet. Equipped with trigger switch, locking device and 3-jaw chuck with key. Switch and back cover easily removed for service and inspection. Available for 115-volt or 230-volt AC-DC.

Write for FREE Booklet "Mall Portable Power Tools" and name of nearest dealer

MALL TOOL COMPANY

Power Tool Division
7805 South Chicago Ave., Chicago 19, Ill.

SAY YOU SAW IT IN POPULAR MECHANICS

The only paint spray that gives you
1 HORSEPOWER PERFORMANCE
AT 1/3 HORSEPOWER COST



Binks PORTABLE PAINT SPRAY (DP* unit)

Brand new! Just out after exhaustive field and laboratory tests. Now you can have a really "professional" paint spray made by BINKS, manufacturers of world famous industrial spray equipment.

Compressor weighs only 47 lbs. but delivers 1 h.p. spraying performance for cost of only 1/3 h.p. unit. Built for easy portability—even up a ladder. For serious finishing, maintenance, craftwork, farm jobs, light production. Handles any finish from undercoater out. Supersafe; all moving parts enclosed. GUARANTEED. Operates on 110-120 v., A.C. Gives 40 lbs. pressure.

Free literature. Send today for free folders telling all about the BINKS new DP compressor, gun, and accessories. Or ask your local dealer to show it to you.

*DP means Direct-drive Piston.

Binks MANUFACTURING COMPANY
 Dept. DP1, 3114 Carroll Ave., Chicago 12, Illinois



NEW! POWER KING CATALOG AND SHOP HINTS!

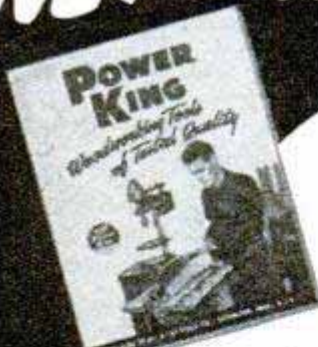

Just off the press! Send today for this unusual new Power King catalog. Gives you complete information about Atlas-built low-cost Power King tools for your shop plus helpful hints on types of joints for furniture and other projects. Gives facts about various woods, lists and describes Atlas Easi-Bild patterns. Write today.

SEND THIS COUPON FOR YOUR COPY

NAME _____
 ADDRESS _____
 CITY _____
 STATE _____

ATLAS PRESS CO.
 540 N. Pitcher St., Kalamazoo, Mich.



MATCHED PRECISION TOOLS FOR WOODWORKING AND METALWORKING

SAVE 25% ON QUALITY BALL-BEARING WHEELS!

This spring, save when you build or repair garden carts, kiddie velocipedes, laundry carts, wheelbarrows—anything that rolls on rubber! Bilt-Rite wheels are semi-pneumatic, ball-bearing, red wheels, guaranteed top quality. Compare Bilt-Rite's quality and price—then order today.



Bilt-Rite Guarantee
 No better wheels are made regardless of price; 10 day return privilege.

REPLACEMENT WHEELS FOR HOME USE
 (For 1/2 inch Axles)
 6 x 1.00.....\$1.30 10 x 1.75 in...\$2.15
 8 x 1.75..... 1.80 10 x 2.00 in... 2.45
 6 x 1.50.....\$1.60

INDUSTRIAL WHEEL FOR HEAVY LOADS
 (For 3/8 in. axle)
 10 x 2.75 in.....Only, \$4.65!

If size you need isn't listed, write for Folio A

ORDER TODAY—Send cash, check, or M.O.—Pay postage on arrival.
BILT-RITE WHEEL COMPANY
 520 EAST MISSOURI AVE. KANSAS CITY 6, MISSOURI

HEAVY CAST ALUMINUM BLOWER ONLY \$10

SINGLE EXHAUST BLOWER DELIVERS APP. 100 CU. FT. AIR PER MINUTE. For Workshops, Labs, Kitchens, Cellars, Electronic Tube cooling or any use where airblowers are needed. Install it yourself with any household tools. 110 V., A.C., 50-60 cycles, Cont. duty motor.

DOUBLE EXHAUST BLOWER. 2 heavy cast alum. housings. Double intake and exhaust. \$15. Shipped Parcel Post. Pay slight charge on arrival. Check, M.O. Money-back Guar. Send for circular on complete line of Blowers.



UNIVERSAL YONKERS CORP.
 137 Alexander St. (M-5) Yonkers 2, N. Y.

LUMBER

A Board or a Carload
TOP GRADE KILN DRIED
 WALNUT, MAHOG, CHERRY, MAPLE, WH. HARD AND SOFT, POPLAR, PL-QTR, OAK, AROMATIC RED CEDAR

Big New 144 Page Catalog No. 16

UNEQUALLED BARGAINS

OF HARD TO FIND WOODWORK ITEMS, HARDWARE AND SUPPLIES, the finest craftsman catalog Harold Hunt ever published—32 rare and fancy woods in natural colors—also in color, 43 matched veneer designs, multi-colored bindings, inlays, overlays, scroll patterns, etc. Only 15c, rebated on first order.

CRAFTSMAN WOOD SERVICE CO.
 2729 S. Mary St. Dept. A-5 Chicago 8, Ill.

30" SHEET METAL BRAKE

Forms angles, channels, vees, flanges, locks, zees. Handles 26 gage sheet steel, heavier gages of aluminum, copper, plastic, etc. Portable. Can be held in a bench vise, or bolted down. All steel. Wt. 40 lbs. Shipped exp. collect.



12" BRAKE. Fits in vise to form difficult and compound bends, up to 20 gage steel 12" wide, \$13.50 PP.
SHEET METAL PLIERS. 2 1/2" wide, \$2.00; 5", \$3.50.
 Immediate delivery. Order direct, cash or C.O.D., or send for folder.

WISE BRAKE MFG. CO.
 1116 SO. 27th ST. DEPT. P-5 OMAHA 5, NEBR.

REYNOLDS CIRCULAR SAW GRINDER

For jointing, gumming, tooth forming and resharpener. Cuts saw maintenance costs, increases saw sharpening profits. Any hook or pitch of tooth and depth of cut is quickly adjusted. Both hands are free to control position of saw while grinding. Ball bearing action sealed against grit and dust.



PROVIDENCE SAW & KNIFE COMPANY
 REYNOLDS MACHINERY CO. BLDG.
 303 EDDY STREET, PROVIDENCE 3, R. I.

Say You Saw It in Popular Mechanics

NO BLISTERS — NO BRUISES WITH THIS REVOLVING SPIN-BEARING TOP

A one-hand operating ratchetless Speed-Driver that gives you . . . a high speed screwdriver for easy turning screws . . . a low speed screwdriver for slow turning screws . . . and a push grip for tightening screws. Fine quality rust-proof steel, fireproof plastic.



SPEED-DRIVER

Only \$1.00 Postpaid No COD Please Order Direct
ROYAL-LITE SALES - Box 7686,
 Del Valle Station Los Angeles 15, Calif.

8 inches Overall

WIPE IT ON ENAMEL
 Choice of 5 Colors & Black
 Coach Green
 Gunmetal
 Sedan Red
 Royal Blue
 Rich Maroon
 Black

Amazing new enamel can be applied with a cloth, pad or powder puff. No skill needed. Flows out smooth as glass. Dries quickly to a porcelain-like, durable gloss finish.

\$5.95 Value
 Quart can covers most cars. **\$2.49**

AUTO BODY SOLDER PINT CAN
 Smooth working putty like filler. Hides dents and holes in auto bodies. Applied with putty knife. Dries to metallic hardness with no shrinkage. **\$1.50**

Our Finest Precision REBUILT MOTOR BLOCK ASSEMBLIES

Sold Outright or Exchange

Rebuilt by skilled mechanics. Assembled with the latest equipment. New Pistons, Rings, Bearings, Crankshaft, all New Bearings. Guaranteed 90 Day Allowance on Old Motor.

Save on motor block. Rebuilt motor block guaranteed. Save on motor block. Rebuilt motor block guaranteed. Save on motor block. Rebuilt motor block guaranteed.

55.00 Crating Charge

| BUICK | Outr. | Exch. |
|------------------|----------|----------|
| 34-47 8 cyl. | \$209.00 | \$165.00 |
| CHEVROLET | Outr. | Exch. |
| 29-47 6 cyl. | \$115.00 | \$95.00 |
| CHRYSLER | Outr. | Exch. |
| 34-47 8 cyl. | \$157.00 | \$132.00 |
| 35-47 8 cyl. | \$209.00 | \$165.00 |
| DE SOTO | Outr. | Exch. |
| 34-47 6 cyl. | \$157.00 | \$132.00 |
| DODGE | Outr. | Exch. |
| 33-47 6 cyl. | \$150.00 | \$120.00 |
| 34-47 6 cyl. | \$157.00 | \$132.00 |
| FORD | Outr. | Exch. |
| 28-31 4 cyl. | \$107.00 | \$87.00 |
| 32-34 V8 | \$129.00 | \$109.00 |
| 35-47 V8 | \$149.00 | \$109.00 |
| 37-39 80 HP | \$154.00 | \$109.00 |
| MERCURY | Outr. | Exch. |
| 37-47 V8 | \$149.00 | \$109.00 |

Latest 1949 NEW TRIM RINGS

MODERNIZES ANY CAR TO LOOK LIKE 1949 MODELS

Leaning Chrome Plated Universal Fit. All Cars. Fits Standard and its. Fastens with small bolt in both sides of fenders or fenders.

Set of 6. **\$2.95** only.....

\$150.00 Value 2 Wheel TRAILERS

1800 LBS. CAPACITY

Dimensions of body 76" long, 46" wide, 12" deep. Made of sturdy hardwood, well reinforced. Will carry heavy loads and withstand plenty of abuse. Complete with 16" wheels and 4.00x16 high tread used tires. 17", 18", 19", 20" or 21"

Complete with Coupling

NOTE! HEAVY CAR SUB FRAME AND 2 SPRINGS

wheels and tires if specified. With tow bar and hitch. The unit is composed of perfect used chassis complete with 2 springs. New hardwood box painted red.

COMPLETE with TIRES & TUBES. \$85.00

Shipped F.O.B. Chicago.....

USED Pass. Car TIRES

75-90% Original Tread

550 X 16
 400 X 14
 650 X 16

Tires have small repairs. Guaranteed for life of the tire.

Tires listed below have a continuous tread design. Tread depth will vary. Repairs are guaranteed for the life of the tire. Specify exact size when ordering.

| | | | | |
|--------|--------|--------|--------|--------|
| 550-16 | 600-17 | \$3.95 | 600-17 | \$6.95 |
| 600-16 | 700-17 | \$3.95 | 700-17 | \$6.95 |
| 600-18 | 700-18 | \$3.95 | 700-18 | \$6.95 |
| 600-19 | 700-19 | \$3.95 | 700-19 | \$6.95 |
| 600-20 | 700-20 | \$3.95 | 700-20 | \$6.95 |
| 600-21 | 700-21 | \$3.95 | 700-21 | \$6.95 |

AUTO-SERV Kleenex Dispenser

Simple to install Under Glove Compartment of the Car for Ready Service

ALSO: easily provides Kleenex Tissues for driver and passenger. carries a full package without overcrowding glove compartment. **\$2.50**

JEEP FRONT FLOOR MATS With Full Back For All Jeeps **\$3.95**

Send 25% Cash With All Orders, Balance C.O.D.

J.C. WHITNEY & Co.

1919 Archer Ave. Chicago 16, Ill.

FENDER SKIRTS

All metal in prime finish. Rubber beading to prevent rattle.

MC31N-9 **\$12.95** Per Pair

Be sure to specify year, make and model of car.

GUTTED MUFFLERS FOR ALL CARS

Gives that Motorboat Tone

Model 210 Universal at all cars. **\$4.95**

1935-48 Ford V8 DUAL MUFFLERS \$14.95

1939-48 Mercury Increases power. Reduces back pressure. Complete.

NEW CONVERTIBLE TOPS

100% Waterproof, Weatherized Material. Not Affected by Snow or Rain. Choice of Black or Tan. \$50.00 to \$130.00. Values As Low As \$24.95

"ZIPPER TYPE" REAR CURTAIN

Each top packed complete with all hardware and fittings. Choice in fast installation. Zipper fastens top for quick removal. Dual stability. Laboratory tested for strength and safety. All metal hardware of heavy light-strengthened rust resistant. Tops are properly attached with tension thread and secured for durability.

| | |
|--|---------|
| 2 Pass. Ford 28-31 Roadster & Coupes..... | \$24.95 |
| 2 Pass. Ford 33-39 Roadster & Coupes..... | 29.50 |
| Ford 29-39 Sedans & Phaetons..... | 42.00 |
| 5 & 6 Pass. Ford 36-49 & Mercury 39-49 Coupes..... | 33.75 |
| 2 & 4 Pass. Ply., Chry., De Soto & Dodge 35-39 Coupes..... | 29.50 |
| 4 & 6 Pass. Ply., Chry., De Soto & Dodge 40-48 Coupes..... | 35.45 |
| 2 & 4 Pass. Chev., Buick, Olds., Pont. & Cad. Coupes..... | 37.45 |
| 4, 5 & 6 Pass. Chev., Buick, Olds., Pont. & Cad. 39-48 Coupes..... | 34.50 |
| 5 & 6 Pass. La Salle 36-40; Hudson & Terra. 36-47 Coupes..... | 39.95 |
| 5 & 6 Pass. Nash 37-41; Packard 36-48; Stude. 1948 Coupes..... | 43.75 |

NOTE: SPECIFY COLOR WANTED ALSO MODEL OR SERIES, BODY STYLES, YEAR AND MAKE WHEN ORDERING.

Hi-Speed Equipment FOR ALL CARS

HI-COMPRESSION HEADS
 SINGLE & DUAL MANIFOLDS
 HI-SPEED CARBURETTORS

More Pick-up — You're away in a flash. No fuel waste — Every drop of fuel used. Extra horsepower — faster passing. More mileage per gallon. Better performance at all speeds.

FOR ALL CARS

Build your own SMITH Compressor

Operates spray guns, rock drills, tampers, paving breakers, sandblasting. Uses only 1 gallon of gas an hour!

Save Money—build your own Smith Air Compressor! Famous the world over! Capacity 60 cu. ft.; pressure up to 100 lbs. per sq. inch. Just order the Smith Compressor Head and Accessories with complete instructions for assembling. All you need is a Ford Motor and shop facilities. Head equipped with high speed compressor valves; automatic unloading and idling.

Write for complete information!

GORDON SMITH & COMPANY, Inc.
 410 College Street • Bowling Green, Ky.

EQUIP YOUR MALL SAW MODEL 60 with a ZMCO ANGLE-DEPTH ATTACHMENT

• Make perfect fitting straight and compound miter cuts quickly and easily. Regulate cutting depths with hair-line accuracy from 0" to 2". Bevel cuts to 45°.

Fastens securely to your Mall Saw Model 60 with no holes to drill. Lightweight, sturdy steel construction.

\$7.00 postpaid

Dealer Inquiries Invited

ZIEROLD MFG. COMPANY
 Box 509-D, Burbank 5, Calif.

FOUNTAIN BRUSH SCRUBS • WASHES • RINSES

Houses, Windows, Screens, Awnings, Cars, Trucks, Trailers, Boats and any other washable surface

All aluminum—rust proof—will last for years. Horsetail mixture bristles—genuine scratch proof rubber bumpers.

Brush 6 inch diameter fitted with 2 foot round handle to fit any garden hose. Any 1/2 inch standard pipe fits brush to make extension to reach gables, upstairs windows and other high places. Aluminum extensions with couplings available. No home or car owner should be without this brush—order yours today. Send cash, check or money order or will ship C.O.D. plus postage. **MONEY BACK GUARANTEE**

COMPLETE WITH 2 FOOT HANDLE AND HOSE NUT..... \$4.95 postpaid

WITH 4 FOOT HANDLE AND HOSE NUT..... \$5.95 postpaid

2 foot — 4 foot or 6 foot aluminum extensions with couplings — 50c per foot.

LITTLE WONDER • Dept. PM, 318 East 13th St., Kansas City, Mo.



WORLD'S MOST VERSATILE HAND TOOL

Does jobs no other tool can do. Double-lever action LOCKS jaws with tremendous grip—quickly adjusts to non-locking action. New involute Jaw Curve holds all shapes—nuts, rounds, irregular shapes, with unbelievable ease. Has Knurled Jaw Tips that do not slip. Thin Nose. Super Wire Cutter. New geometry gives more power—easier opening. Fine alloy steel. Nickel plated finish.

WITH Cutter—No. 7W, 7-in., \$2.25; No. 10W, 10-in., \$2.50
 WITHOUT Cutter—No. 7C, 7-in., \$1.85; No. 10C, 10-in., \$2.25
 Also world famous original model: No. 7, 7-in., \$1.65
 No. 10, 10-in., \$1.95

If not at your dealers, order direct.
 Postage paid if price accompanies order.

PETERSEN MFG. CO., Dept. M-5, DeWitt, Nebr.

The LAWNHAVER

SELF-PROPELLED

MAKES MOWING AS EASY AS WALKING EMPTY-HANDED



3/4 HP—\$125
 1 1/2 HP—\$139.50

Yes, the 3rd wheel drive does away with all controls. Start the LAWN-SHAVER, cut your lawn—to stop or turn around lift 3rd wheel from ground by raising the handle with fingertip ease (its perfect balance makes this simple). Trims flush with obstacles, can be operated in spots where no other power mower can go. Vertical height adjustment 1/2" to 3 1/4". Chain driven wheel and reel. Heavy duty solid steel construction. 4 cycle gas engine.

See Your Local Dealer or Order Today on Coupon Below

SEND FOR FREE BOOKLET

SOUTHERN METAL STAMPING CO., Inc.
 1111 S. Liberty St.,
 New Orleans, La.

Enclosed find check _____ money order _____ in the amount of \$ _____ for _____ LAWNHAVER. Please send to . . .
 NAME _____
 ADDRESS _____



COMPLETE ALL-IN-ONE SPRAYER

... JUST \$12.95
 PLUG IN AND SPRAY Post Paid

Unconditionally guaranteed for 90 days.
 Large size—24 oz. capacity.
 Over-all size—8 1/4" high x 6 1/4" deep.

For home, garage, farms, etc. Fast, economical for paint, varnish, oils, insecticides, etc. Plugs into any 115V A.C. outlet. Off-on switch, rubber cord and plug. Send 25c for our new 100 page Catalog. Your 25c refunded with first order.

SEND CHECK OR MONEY ORDER
 Enclose \$1.00 with C.O.D.'s

GENERAL AIRE CO.

447 W. Norris St. Dept. M Phila. 22, Pa.



GENSCO SWEDISH SAW SET

(Made in Sweden)
 Precision Tooth Setting on Saw Teeth up to 1/2" Long. For accurate and improved cutting—precision tooth size adjustment—clear vision operation for accuracy.



\$275
 SEE YOUR HARDWARE DEALER

GENSCO TOOL DIV. General Steel Warehouse Co., Inc.
 1830 North Kostner Avenue Chicago 39, Illinois

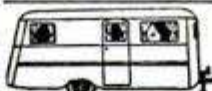

TRAILER BUILDERS' SUPPLIES! TO BUILD, REPAIR OR MODERNIZE!

And save money. You must have our big Catalog. We are the largest and most complete trailer supply house in the States. Our new large 1949 catalog 10c; blue prints and building instructions, 25c. NATIONAL TRAILER EQUIPMENT CO., 1007 N. Water St., Milwaukee 2, Wis.



BUILD HEAVY DUTY MACHINES

SAVE UP TO 90%—our practical, easy-to-read plans, all kinds of machines, for home, farm or shop—scooters, portable sawmills, metal working machines, concrete machinery of all kinds, printing equipment, woodworking machines, midget autos, dish washers, farm equipment, freezers, tractors.

FREE CATALOG HANDBOOK 183 SETS OF PLANS VALUABLE INFORMATION

NICHOLS EQUIPMENT COMPANY D-2210 PURVIS, MISS.

MAKE THESE WOOD SHAPES

With Your Drill Press and This LOW COST TOOL

Your drill press and this tool does all types of wood shaping—Routing, Tongue and Groove, Fluting, Notching, Inlay and any type of joint. Make window sills, cabinets, doors, grooved sash, etc. Complete with fence and platform to run professional work without slipping. Write today for FREE facts about this unit, and special offer.



Complete with 3 blades



T & H Mfg. Co., Dept. WP, 811 East 31st, Kan. City, Mo.

Build This Beautiful "CUBSTER" BODY

(Low Cost)

BODY

With Our BODY KIT

Fits Over Our Model "D" Chassis
(Write for Descriptive Circular)

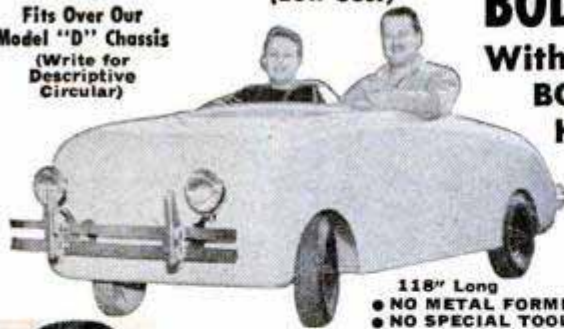

118" Long
● NO METAL FORMING
● NO SPECIAL TOOLS



● BALL BEARING STEEL WHEELS ●

12"x2 1/2" Ball Bearing Heavy Steel Wheels with Gates 225 lb. Load Semi-Pneumatic Tire, For 1/2" or 5/8" Axles.

Two for Only \$10.50
Four for Only \$21.00
25% DEPOSIT ON C.O.D. ORDERS.

Add 10% for prepaid Shipment in U.S.A.
32 other sizes and type wheels in stock.

ORDER NOW Descriptive Circulars and Lists of our products will be mailed promptly if you enclose 10c in your letter.

OSBORN WHEEL CO., 115 So. Main St., Dept. P-5, Doylestown, Penn.



FORD OWNERS!

Replace that gas wasting carburetor now! ALCOR flow tested, rebuilt carburetors for all Ford V-8's from 1932 through 1947—only \$4.29 postpaid with your old carburetor. Don't lay up your car! Send full amount \$8.29 first; return old unit in our carton and we'll refund the difference. State year and model car. Old units must be original equipment, complete and unbroken. DISTRIBUTORS (1932-1941) also available as above \$4.29 exchange price. Full amount \$9.29.

ALCOR, 115-03 Atlantic Ave., Richmond Hill 18, N. Y.

CARS and TRUCKS START

Instantly

with a STEWART-WARNER Electric Fuel Pump!



Save yourself the trouble and expense of a car that won't start instantly, stalls in traffic or dies at every stop. Stewart-Warner's Electric Fuel Pump feeds a steady flow of fuel to your carburetor the second you

turn on the ignition!

Save your battery with quick starts in any weather! Cut vapor lock and fuel pump failures, too. Hundreds of thousands already in use.

Easily installed—Replace your old mechanical pump with this dependable Electric Fuel Pump. Supplied complete with fittings for your particular car. Install it yourself or see your local Ignition & Carburetor Shop or Service Garage.

Free Illustrated Booklet sent on request. Write to—
STEWART-WARNER CORPORATION
1801 Diversey Parkway • Chicago 14, Illinois

QUALITY TILTING TABLE SAW

TABLE INCLUDING EXTENSION 18" x 14"

\$24.95

Complete as shown
F.O.B.
Royersford, Pa.



TAKES



BLADE

IMMEDIATE DELIVERY

Send for catalogue showing complete line of Tilting Table and Tilting Arbor Saws, from \$24.95 to \$87.50

AMERICAN MACHINE & TOOL CO., Inc.
ROYERSFORD, PA. DEPT. 111

Sensational Bargains: LOWEST PRICES!

All Items Guaranteed As Represented



BACKGEAR MOTOR

90 RPM 110V, 60 cycle, A.C. slow speed motor. All brass construction. Sturdy gears & Bearings. Drives

window displays, toys & useful experimental work. 6"x2 1/2", 5/32" shaft. Pulley FREE. \$3.50 ea. Postpaid. In lots of 6 ONLY \$2.95 each.



1000 Ft. BLOWER WITH 1/8 H.P. MOTOR

1000 cubic feet free air per minute for cooling, heating, drying, blowing, ventilating, air conditioning, dust collecting, etc. 1/8 H.P., 110 volt, 60 cycle, 1750 RPM, A.C. Motor. No. B-54, List Price \$65.00.
OUR SPECIAL \$45.00 Fob. Chgo. PRICE ONLY...

MOTORS: Westinghouse, Leland, AC-110-220, 60 cycle 1750 RPM. Like new—Totally enclosed 50° C—Fully Guaranteed... ONLY \$19.75 Fob Chgo.
NEW G.E. Capacitor Type. 110 V—60 cyc—3450 RPM, 1/2 H.P., ONLY \$23.50 Fob Chgo.
NEW G.E. Capacitor Type. 220 V—60 cyc—3450 RPM, 1/2 H.P., ONLY \$21.00 Fob. Chgo.



GENERAL ELECTRIC AMPLIDYNE MOTOR GENERATOR No. 5AN3INJ18A



An all purpose machine adaptable to many uses. Double ball bearing, can be mounted in any position. Brand New, in original factory cartons, original cost \$140.00. Use as 24/32 volt D.C. Motor, pulls over 1/2 H.P.; or 0/60 volt D.C. generator!

or belt driven will deliver 30/40 amps., for charging auto batteries. Amplidyne only... SPECIAL... \$5.95 Fob. Chgo.

You can make simple changes in connections (no winding necessary) and make a 110 volt, AC/DC, 10,000 RPM, 1/2 H.P. motor for grinding, polishing, routing, sanding, shaping or sawing wood. Amplidyne complete with shaft extension and instructions for reconnecting... SPECIAL... \$7.95 Fob. Chgo.

Write for our Illustrated Price List on Other Bargains and SAVE MONEY—

C. MARSHALL SALES, 3546 W. Fullerton Ave., Dept. P-5, CHICAGO 47, ILL. • RUSH ORDER TODAY

WAR SURPLUS AND OTHER BARGAINS

Aero-Torch

THE OUTSTANDING OFFER OF THE YEAR FOR MECHANICS OR HOBBYISTS!

for HEATING
BURNING
SOLDERING
or BRAZING

New!

A compact versatile torch for electricians, plumbers, painters, auto mechanics, dental technicians, jewelers, neon glass formers, plastic workers and radio repair men. Burns propane or butane for 13 continuous hours at cost of only 3c. No moving parts to get out of order. Burns in any position with non-varying flame at approx. temp. of 3660°. No hose connections to get in way. Always ready for use! Built to withstand 2800 lbs. p.s.i. 2 1/4" diameter, 10 1/2" long. Complete wgt., only 2 lbs! AN AMAZING VALUE . . .

Only
\$13.95
each



MICROMETERS
Chrome plated, precision engineered and carefully tooled to give long life. All new. 0-1" capacity . . . ea. **\$2.25**.
1-2" cap. **\$3.50**. 2-3" cap. **\$5.50**. 3-4" cap. **\$6.50**.



HAND MITRE

"It pays its way in just one day!"
IT'S SENSATIONAL!

New HAND MITRE saves the carpenter - picture framer - cabinet maker and craftsman hundreds of hours . . . a "flick" of the hand and a few seconds for a precision mitre every time.
The HAND MITRE will cut any desired angle. Its rugged construction will handle hard and soft wood mouldings, plastic trim, base shoe, dowels, laminated materials, rubber extrusions, leather, linoleums and asphalt tile. Made of heavy gauge stainless steel, electro polish finish. Will endure years of hard usage.
Eliminate bulky mitring equipment - save valuable hours and labor. **\$3.95** postpaid.



U. S. NAVY RUNNING LIGHTS

Many uses including on patios, homes, entrance ways, driveways, game rooms, boats, for guide and walk-around lights, etc. Multiple bulbs assure continuous burning. Vibration-proof screw-down top. Solid brass lamp base. Cadmium-plated, cast steel detachable mounting bracket included, or may be hung from steel hook. Solid brass, heavy-duty quick-change plug assures instant switch on/off. Weather proof! Available in red, blue or white. Burns intermediate type, screw base lamps on 12-24-32-110-115 or 220 Volt A.C. current simply by changing bulbs. Weight 12 lbs. Govt. cost about \$50. . . . Price less bulbs, **\$6.95** each.



CAMPERS' SPECIAL
Fancy briar pipes from Quarter Master Corp. Assorted shapes and sizes. All popular makes. Set of 7 . . . **\$3.50**

HIGH SPEED DRILL BITS
ALL NEW!
Original value **\$15.00**. 30 assorted sizes and lengths, **\$3.50**.

U. S. NAVY ALARM BELLS

ELECTRIC

For indoor or outside use -- on ranches, for schools, plant installations, as burglar alarm systems, signal systems, etc. Three different types: COW BELL TYPE Mfd. by Henschel (Wgt. 9 1/2 lbs.); VIBRATING TYPE -- high pitch -- (Wgt. 8 1/2 lbs.), and VIBRATING TYPE B4 -- medium tone -- (Wgt. 8 lbs.) both Mfd. by Edwards. All new in original packages! Heavy duty brass clapper with solid brass gong. Safety lock-nut secures gong permanently. Will work on 115 Volt A.C. lines. Govt. cost about \$65.00 each. Complete with mounting plate. Your choice, any type, each **\$12.50**.



Gong Diameter 8 1/2"



COOLER, BLOWER OR HEATER: Can also be used in trailers, offices, darkrooms, homes or may be used as dryer. **DUMORE** Motor 1/6 cont. H.P., Amperage 7.5, RPM 6400, 24 V. Radiator type circulation, copper coils. Very efficient for car or truck when connected to battery. Simple installation. Wgt. 13 lbs. . . . New! **\$15.00**.

TRANSFORMERS

Automatic Winding Company Transformer. 60 cycles A.C. Input, 75-125 Volts. 4-step output, 5-6.3 Volts. Single winding. For radio, radar, television, chimes, and all low voltage gadgets. Weight 5 lbs. . . . New! Each **\$3.50**
Stolle Engineering Co. Transformer. Primary Input, 115 Volts. 60 Cycles. Flexible color-coated leads. Output, 6-12-24 Volts. Will work aircraft gadgets, heater relays, signal systems, radio test filaments, home chimes, etc. off house current. A good item for the home gadgeteer. Weight 7 lbs. . . . New! Each **\$7.95**
Jefferson Electric step-up or step-down transformer. Input, primary 110-117 Volts A.C. Output, from 5 Volts to 650 Volts. Suitable for use with war surplus gadgets, heater relays, radio test filaments, electric trains, house chimes, etc. Wgt. 10 lbs. . . . New! Each **\$7.95**



SEND FOR FREE DESCRIPTIVE CATALOG

Send check, money order or cash. 25% deposit required on C.O.D. orders. All prices F.O.B. Culver City, Calif. unless otherwise indicated.

AIRBORNE SALES CO., INC. DEPT. PM 5-9
CULVER CITY, CALIF.



CEMENT DRAIN TILE

Money-Making Manufacturing Opportunity

Today's tremendous market for drain tile opens up opportunities for men of vision and aggressiveness to establish local drain tile plants. Particularly in rural communities, where supply lags far behind demand.

The Champion machine makes all sizes of tile up to 12-inch diameter. With such a range you can supply not only the huge farm market, but many others where drain tile is urgently needed -- reclamation projects, home building, road construction, subdivision activities, etc.



LOW COST - HIGH PROFITS

Tile made on the Champion are outstanding in quality -- dense, strong, uniform. Far better than clay tile yet can sell for less--even after allowing a handsome profit. Machine is simple, compact, easy to operate.
Get the facts. Write for interesting literature about the business and the moderate priced equipment.

CONCRETE EQUIPMENT CO.
522 Ottawa Ave. Holland, Mich.



NEW DUO-MASTER

LOW COST
Combination SAW
BENCH and SANDER

Every Home Workshop needs it -

\$23.95

Terms: \$5.00 down, bal. \$18.95 C.O.D. plus charges. Cash \$23.95 prepaid deliv.
7" Saw, 9" Sander with tilting table for both. Saw table and sander table raise and lower for rabbeting and dado work. Also equipped with ripping fence and miter. Oilite lifetime bearings, all aluminum casting construction. Sturdy, well-built, fully guaranteed. A nickel chrome moly saw blade \$3.49 additional.

DUO-MASTER INDUSTRIES, Dept. M SPARTA, MICH.

BUILD OR BUY A LAWN SWEEPER

No tiresome raking. The quick and easy way for cleaning your lawn. Picks up leaves, grass, acorns, sticks, and combs the grass. Easily built from available parts. Mail \$5c for complete plan telling you how. Catalog listing parts and factory-built sweeper, sent free with plan.



LeJAY MFG. CO. 147 LeJay Bldg. Minneapolis 8, Minn.

Print Your Own

Cards, stationery, circulars, tags, labels, photo and movie titles, advertising, etc. Save money. **Print for Others, Good Profit!** easy rules sent. Raised Printing like Engraving, too. Send dime for press samples, supply book, all details and advice on your needs. No obligation. **KELSEY INC., M-37, Meriden, Conn.**

A PROFITABLE HOBBY PAINT SPRAYING

Never before a quality compressor at this amazing low price

This compressor model gives you all of the latest engineering improvements. Provides pressure for dusting, spraying paint, insecticides, rust preventatives and inflating tires.

Piston type, heavy duty, machined cast iron construction; drop forged crankshaft, insures long life and dependable service. Air chamber removes pulsation of air, traps oil and water. 2" Bore, 1 3/4" stroke, Dis. 2.5 CFM Working pressure 60 lbs. Single phase 1/3 HP motor with 10 Ft. cord. Fully Guaranteed. Send for Free Spray Equipment Circular.

Complete with 1/3 HP motor, with 20 Ft. hose and spray gun, FOB Chicago. **\$55.00**

\$10.00 Deposit - Balance C. O. D.

HARRIS MFG. CO.

1710 SO. MICHIGAN AVE. CHICAGO 16, ILLINOIS

NEW DIRECT FLAME SOLDERING OUTFIT

RANSOME
NO. "99"

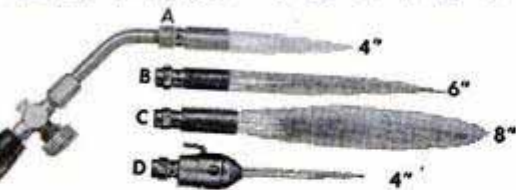

Operates on Bottled Gas
Complete Unit \$32.25, Exp. prepaid

Ransome "99" soldering outfit will permit you to do twice the work with half the effort. Torch operates on butane or propane (bottled gas). Lights with a match and stays lighted. No time lost refuelling, generating, pumping pressure, or reheating work. Torch weight only 12 oz. Is 14" long. 2½ gallon cylinder of fuel lasts 200 hours. Burns without smoke, soot, or odor. Ideal for home craftsmen, electricians, plumbers, sheet metal workers, radio repair men.

Ransome "99" Outfit consists of: Torch with choice of A, B, or C Tips; 2½ gallon ICC approved cylinder; gas regulating valve; 10' high pressure hose. \$32.25, express prepaid. Have your oil company fill cylinder and you are ready to go to work. Torch only with A, B, or C tip \$9.00, postpaid. Extra tips A, B, or C \$4.50 each. Tip D is \$8.00. Torch with all 4 tips \$26.00, postpaid.

To avoid time lapse for personal checks to clear, remit by bank draft, cashier's check, or money order.



RANSOME COMPANY

4032 HOLLIS STREET EMERYVILLE, CALIFORNIA

"MOWER POWER"

Requires
No Welding



PRECISION
BUILT
To Last a
Lifetime

COMPLETE ATTACHMENT. For Either Electric Motor or Gasoline Engine. Fits Any Make or Size of Lawn Mower. POSITIVE CHAIN DRIVE and FREE WHEELING. Easy to Install, in Less Than an Hour. IMMEDIATE DELIVERY. Sold Direct to you at Factory **\$27.80** Price, ATTACHMENT

ENGINE

Powerful 2 H.P. 4 cycle air cooled gasoline engine. Weight 30 lbs. Precision made for years of dependable service. Designed for rugged work. Smooth running and quick starting at any temperature. No vibration. Sold direct to you at Fac- **\$55.50** tory Price

"ROYAL" ROTARY MOWER

New "Royal Rotary Mower" for either gasoline or electric motor is the most economical and practical mower ever made. Cuts with a smooth finish through any Lawn, Spike grass, dandelions and high weeds. Clippings are scattered evenly. No need for racking or after turning. 20 inch cut. Easy to adjust cutting height. Weighs only 34 lbs. Sold direct at factory prices. Without motor,

\$50.00



ABSOLUTE MONEY-BACK GUARANTEE
WRITE FOR FREE FOLDER TODAY

ROYAL OAK LAWN MOWER SHOP
P.O. Box 48 Royal Oak 1, Michigan

TO THE MAN
WHO KNOWS
AND CARES
ABOUT HIS
CAR!

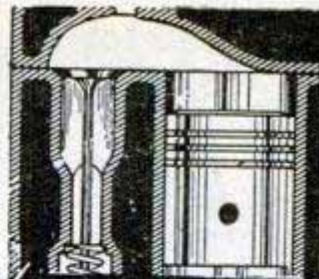

Over 80% of repair bills result from lack of proper lubrication of these vital parts in the HEAT-WEAR ZONE!



Improved Upper Cylinder Lubrication for the Hottest-Burliest parts of your car's engine is essential for performance — Power and Economy!

Permanently
Prevents

More Miles Per Gallon! — because AMPCO'S controlled oil spray seals in around each valve, ring and piston the compression you are losing now; reduces friction and engine heat by lubricating the "forgotten-zone". Thereby squeezes more miles out of each and every gallon of gas. Fuel savings are BIG right from the start!

More Power! — for clear sailing up hills where you once had to shift — and for pulling heavier loads. A tremendous reserve of power for surging confidently ahead in emergencies.

Faster Pick-Up! — so much faster you can actually feel the difference — feel the eager response of your friction-free engine as it pulls the seat against you under acceleration.

Far Less Carbon! — almost none at all, because AMPCO'S metered oil spray loosens and disperses stubborn, sticky gum and carbon deposits around valves, rings and pistons — keeps your engine cleaner.

A Far Quieter Engine! — so much quieter you will hear the difference! Quieter, because AMPCO'S oil spray reaches all moving parts in the heat-wear zone instantaneously to provide lubrication before ignition occurs within your engine!



Carbon-and-Gum fouled valves



Gum-varnished Cylinder Walls



Carbon-caked pistons

Decide now to experience for the first time the thrill of driving your car — with an engine you will have to hold back! Decide now to bank the money you pay out now for needless fuel, oil and repair bills! Get better — yes, Better*Than*New*Car*Performance* with an AMPCO installed on your car now!

Available at good dealers everywhere! Only \$14.95. If your car dealer, garage or service station does not stock AMPCO yet, send us his name and order direct, giving make — year and model of your car.

Automotive & Marine Prods. Corp.

87 Harvard Ave.
Boston 34, Mass.

*** GUARANTEED**

- Longer Engine Life!
- Smoother Performance!
- Savings Gas & Oil!
- Faster Pickup!
- More Power!



VAPOR
Ameco
LUBRICATOR



Handle-Rod

patent applied for

NEW COMPACTNESS

A FIVE FOOT CASTING ROD that COMPLETELY TELESCOPES INTO ITS HANDLE TO JUST ELEVEN INCHES!! Fits into pocket, tackle box, suitcase or glove compartment. Ideal for boat or plane. Rod sections made of *Beryllium Copper* Can never rust or corrode Weighs only Six ounces

\$13⁵⁰

NEW

DESIGN

A Precision Made casting rod, engineered for perfect balance, with all the action and Flexibility of a fine one-piece bamboo rod. Fully guaranteed.

If your Dealer can't supply you, send money direct to

CHAMPION PRODUCTS CO.
MUSKEGON HEIGHTS, MICHIGAN

MAGNETS OF ALL TYPES—10c UP
AMAZINGLY POWERFUL!!
4 oz. Alnico Magnet, lifts 10 lbs. \$1.10. Our Leader, 15 oz. Magnet, lifts 40 lbs. \$2.50. New alloy—will not weaken! Useful for lifting valuables from tanks, takes, or rivers easily! 7 small magnets \$1.10 with list of many shop and home uses. Satisfaction guaranteed.
R. EYRICH, 2566 N. 49TH ST., MILWAUKEE 10, WIS.

WAR SURPLUS BARGAINS



• **POWER PLANTS.** 110-volt, 60 cycle, 3,000 watt. Remote switch electric self-starter. Fine instrument control panel. Army's finest plants. Full maintenance-operation instructions. Ideal for farmers, sportsmen, contractors. New condition. Cost Gov't. \$756. Sale price—\$345.00. Also lower priced plants. Freight prepaid. (Write for details.)



• **MARINE ENGINES.** New single cylinder Briggs U. S. Fabric. 3.5 h.p. air cooled, flame arrester, thrust bearing, shaft coupler. Ideal for fishing boats. Also excellent for farm or industrial uses. Used for garden tractors, weed sprayers, elevators, pumps, scooters, saws, etc. Complete instructions. Standard price \$130.00. Prepaid price only \$89.90. Same engine with Utility Clutch... \$99.90



• **BRIGGS 6.5 H.P. ENGINE.** Model ZZ. Nearly new & excellent. Useful tractors, grain elevators, weed & paint sprayers, pumps, scooters, saws. Cost \$130. Our freight paid price... \$86.90



• **PRESSURE AIR UNIT AND SPRAYER.** Portable wheeled Briggs-N 1 1/2 h.p. engine driven unit. Bendix 2-cylinder compressor. Gauge, regulator, valves, hose—complete. Excellent for painting, weed or insect spraying, tire pumping, cleaning and greasing equipment, etc. Hundreds uses—our most popular item! Cost \$259. Special Freight Prepaid... \$99.50



• **A-C MOTORS.** New 110-volt, 60-cycle, with marvelous speed reduction gear. Speeds of 8, 32, 320 and 4000 r.p.m. on four shafts. Useful grinders, drills, coil winders, photo room, window displays. Cost over \$30.00. Prepaid price... \$8.75



• **ROTARY GEAR PUMPS.** Precision unit. New condition. High vacuum and pressure. Dozens of pumping uses on farm and in business—also pumps high vacuum. Full instructions. Cost \$36.50. Prepaid price... \$3.95

MISCELLANEOUS BARGAIN ITEMS

- **MIGHTY-MIDGET MOTOR** (Wt. 7 oz.) G. E. 110-v, 60-c, geared down to 150 R.P.M. Amazing power. Powerful pocket size grinder, drill. Cost over \$23.00... PRICE... \$5.95
 - **CLUTCH.** For engines or motors. (Max. cap. 6.5 h.p.) PRICE \$13.95
 - **SELSYNS.** G.E. Precision Small Size. Fine for 110-v, 60-c. \$3.39 PER PAIR
 - **TELEPHONE INTERCOM SYSTEM.** Two station. Either wall or desk instruments. Selective call. Cost over \$65.00... PRICE \$8.98 (extra stations \$4.49 each)
 - **BURGLAR-FIRE ALARM UNIT** (Parts cost over \$19.00) PRICE \$5.90
 - **EAVESDROPPING UNIT.** Selective station type. (Ultra-sensitive). PRICE... \$6.70
 - **TELEPHONES.** Desk or wall with ringer. Cost \$25.00. PRICE \$4.99 Other values include vacuum and electronic tubes, photo cells, Wheatstone bridges, test instruments, etc. Card brings complete catalog.
- WRITE FOR DETAILS ON 250-AMPERE D-C WELDER. A 4-STAR OUTSTANDING BARGAIN.
- **VACUUM PUMPS.** (high capacity). Many uses. Cost over \$30.00. PRICE... \$5.60
- We pay freight or postage all items. We accept personal checks. Order direct from ad or write for bargain cut. Our reference—The Nat'l Bank of Commerce.

LECO ENGINEERING CO.

BOX 908 PM-18

LINCOLN, NEBR.

STOP CHANGING Motor Oil!

RE-REFINE IT As You Drive—with...
RECLAIMO The Famous HEATED Oil RECLAIMING Filter!

NOTE! U. S. Bu. of Standards (Bul. 86) states: "oil DOES NOT WEAR OUT Mechanically"

FOR PROOF—NOT Propaganda write for STARTLING Free Book "Oil Facts."

RECLAIMO MFG. CO.,
Dept. M, 5083 ELSTON AVE., CHICAGO 30, ILL.



NEW POWER LAWNMOWERS



• Lightweight "easy to operate"

GAS MOWER

With 2 1/2 hp air cooled gas engine. Makes cutting lawns a pleasure

SEE YOUR DEALER OR WRITE



• Cast aluminum base with 18" Rotary Blade

Make Ur-Own POWER MOWER

Just add up to 2 hp gas engine or 1/2 hp electric motor Easy to install

ATLAS EQUIPMENT CO.



• Ball-bearing rubber tired wheels

ELECTRIC MOWER

Comes complete with 1/2 hp elec. motor and 75 ft of cord. Just plug it in.

229 S.W. Blvd. Dept. P.M.5
KANSAS CITY, MO.

4 SPEED MOTOR

WITH 1000 USES!

The built in integral gear box has four 1/4" drive shafts turning simultaneously at the following speeds:

- 4000 RPM for grinders, buffers, small drills, flex shaft tools, etc.
- 150 RPM for wrapping fishing rods, driving pumps, slow speed tools, fans.
- 25 RPM—rocker for photo developing tray, cabinet makers glue wheel, erector sets, film puller for 16 mm, developer, operating laboratory equipment, etc.
- 5 RPM for turning barbecue spits, advertising displays and antennas.

A THOUSAND OTHER USES AROUND THE WORKSHOP
This 1/20th HP, 115 V., 50/60 cycle, AC motor is precision built throughout.

Fully guaranteed—Money refunded if not satisfied
Pulleys, belts, shaft couplings, Mandrels and other equipment at 15c to 60c. List sent with motors. **SPECIAL—while they last.... \$9.95**
Californians please add 22c sales tax

\$9.95

SENT POSTPAID

- For amateur beam & television antenna
- Drives working models, toys and gadgets
- For action displays, miniature fountains
- For doctors, dentists, jewelers, technicians

TROUP ENGINEERING CO., 2225 Grand Ave., Long Beach, Calif.

SURPLUS BRAND NEW AIR COMPRESSORS

for Garage - Shop - Factory - Farm or Home. Height 9" - Weight 7 1/2 lbs. Uses 1/4 HP Motor

A sturdy, well built air compressor of steel and die cast metal constructed to give satisfactory and lasting service. 20-30 lbs. continuous pressure. Higher pressure for intermittent service. Formerly sold for \$14.50. Synthetic rubber hose with fitting, 12 1/2 feet \$1.70, 23 1/2 feet \$3.00.

While They Last
\$8.50

Orders with remittance shipped prepaid



\$4.90

Syphon Type Spray Gun

COMPRESSOR CORPORATION OF AMERICA
ST. JOSEPH, MICH.

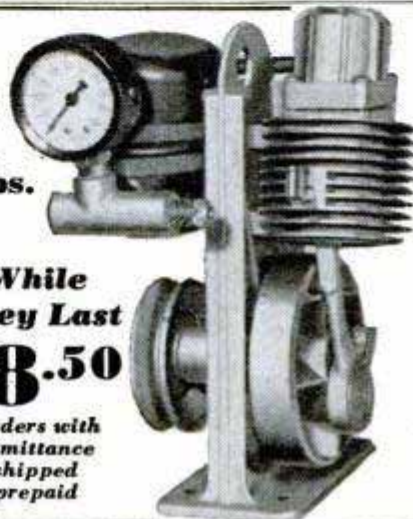

"Powertwist"

NOW! ONLY **\$27.50**
Post Paid



- POLISHER
- JOINTER
- DRILL PRESS
- GRINDER

WORKMANSHIP GUARANTEED

Flex shaft and foot control easily attached for carving, engraving, die sinking, deburring.

20,000 RPM AT YOUR COMMAND
MOST VERSATILE PRECISION TOOL

"POWERTWIST," the all-purpose tool—provides accurate, dependable control over work. Has sturdy adjustable table, complete with fence and special adjustments. "POWERTWIST" is a high precision tool, capable of finest operations. Ideal for home shop, machine shop, pattern shop, dental labs, schools. Especially adapted to production work by its design and rugged construction. "POWERTWIST" has powerful, dependable, high-torque, ball bearing motor, air-cooled, rubber mounted. 20,000 RPM—operates on 115 volts AC-DC.

14" long, 6" wide, 4 3/4" high. Table 6" x 3 3/4". Cast of special aluminum alloy. Will stand severe shock. "POWERTWIST" 1/4" chuck takes most all standard cutters, wheels, bits and sanders.

USE IT FOR { SAWING - MORTISING
DRILLING - GRINDING
ROUTING - POLISHING

ORDER YOURS TODAY

Pioneer Power Tool Company
Dept. PM, 1502 So. Main Street, Las Vegas, Nev.

Enclosed please find \$_____ for POWERTWIST tools. Chuck, key, table, fence, large saw, and mandrel incl.
\$5.00 deposit on C.O.D.'s. USE MARGIN OF SHEET FOR NAME AND ADDRESS. Print plainly.

Does **WELDING • CUTTING**
SOLDERING • BRAZING

The Amazing New All-Purpose DYNAMIC Super Charged ARC WELDER



Now You Can Make or Save Time and \$\$\$ Repairing Auto, Home Appliance, Farm and Shop Equipment for Yourself and Others with this tried and proven welder. Over 50,000 satisfied Home, Shop and Commercial users! Just a few jobs should more than pay for this machine. Works on Iron, Steel and Other Metals. Portable, easily carried. Has 8 metallic and carbon arc welding heat stages. 75 amp. capacity. Does work you'd expect from a larger, costlier machine. Comes complete ready-to-operate with helmet, rods, cable and **Simplified Welding and Operating Instructions** that any beginner can follow and learn to do professional welding. It's a Practical, Profitable Machine for any workshop. Costs but a **FEW CENTS TO OPERATE**. Write today for **FREE 10-DAY TRIAL Offer** particulars.

It's Easy to Operate from any properly wired **110 Volt, 60 Cycle AC line** Also available for other voltages at slight extra cost.

Genuine transformer type welder

ONLY **\$28.50**

DYNAMIC WELDER CO.
Dept. 59T, 15 E. 23rd St., CHICAGO 16, ILLINOIS

complete, ready-to-operate

SPECIAL INTRODUCTORY ONLY OFFER!

50¢ Tool Etching & Soldering Attachment
Protects your tools and other valuables. Heats instantly. Permanently marks name on metals. Mail coupon today and get this valuable \$1.50 tool for only 50¢.

SENSATIONAL GIFT OFFER!
THIS TWIN CARBON TORCH WORTH **\$6.80** IS YOURS AT NO EXTRA COST

For LIMITED TIME only we are giving this \$6.80 Twin Carbon Torch with every Dynamic Welder. Act now to get this valuable premium at the single low price of the welder alone. This torch will greatly increase the profitable uses of your welder. It's faster, easier and cheaper to use than a gas torch. Write today for **FREE** details.



SPECIAL INTRODUCTORY COUPON
Mail today for **FREE** DETAILS

DYNAMIC WELDER CO., Dept. 59T
15 E. 23rd STREET, CHICAGO 16, ILLINOIS

- Send me **FREE** particulars about your Arc Torch Gift Offer and Dynamic Welder 10-Day Trial Plan.
- Send me _____ Tool Etching and Soldering Attachment(s).
- I enclose 50¢ each or I will pay postman C. O. D.

NAME _____

ADDRESS _____

CITY _____ Zone _____ STATE _____

Start Saving Right Now!

WITH AN
Atlas

8"
TILT/ARBOR
SAW



Make home repairs...build summer furniture, cabinets, cupboards, garages, tool houses

The day you put this Atlas saw to work in your shop or on the job you can start saving money. It helps you gain hours of time on every project. Saves tedious hand-sawing. Makes your shop hours really productive.

The Atlas will handle your big work, too. Its 22" x 18" precision-ground table has 10 5/8" ahead of blade—table 22" x 35 1/2" with low-cost extensions. Blade cuts 2 3/8" deep—tilts 45°. Full length, quick-positioning rip fence, Vernier control for accuracy. Ball bearings for smooth dependability. See it at your Atlas dealers today, or send coupon.



FREE Catalog—Write

Please send your catalog on the 8" Tilt/Arbor Saw and other Atlas tools.

Name _____

Address _____

City, State _____

ATLAS PRESS CO.

543 N. Pitcher Street,
Kalamazoo, Michigan



MATCHED PRECISION TOOLS FOR WOODWORKING AND METALWORKING

Low-Priced
ROTARY TILLER

Unsurpassed for Tilling and Cultivating



The Mulsifier Soil Tiller! Makes it easy to work 1 to 20 acres of common crops. Pulverizes the soil as fine as if it were plowed, disced and harrowed. Spreads fertilizer as it tills. Ideal for cultivating. Has adequate power for all workable soils. Travels at speeds up to 2 1/2 miles per hour. Nothing to do but guide it. Compact—can be carried in trunk of car. Completely equipped—no extras to buy. Sells at a fraction of the price of a tractor. Send postcard for circular.

MULSIFIER CORPORATION

7758 HAMILTON, DETROIT 2, MICH.

*Trade Mark Reg. U. S. Pat. Office

Free CIRCULAR

Mulsifier
ROTARY SOIL TILLER

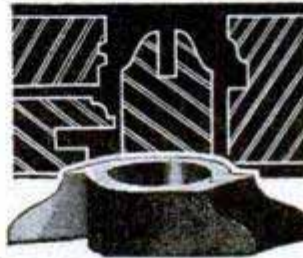

SHAPER & SASH CUTTERS

Dowled doors 1 1/4" to 1 3/4", Double Hung Sash, 1 1/4" to 1 3/4" cabinet doors, moulding knives, screens, bits, chisels, full line of Woodworking equipment.

Catalog # 103—40 pages postpaid, 10c

Catalog # 104—80 pages postpaid, 50c

WOODWORKERS' TOOL WORKS
QUINCY & JEFFERSON STS.
CHICAGO 6, ILLINOIS

FREE CATALOG! Electric motors and AIR COMPRESSORS at Wholesale Prices

MASTERAIRE COMPRESSOR CO. 3 Hamilton St., Newark 2, N. J.

BRUSH PLATING OUTFITS

• for re-plating articles in the home and shop. No tanks necessary. Free particulars. •

GUNMETAL CO., AVE. M, DECATUR, ILLINOIS

DRIVE TAPS STRAIGHT

with TOOLDRIVER This new tool drives taps, screwdriver bits, socket wrenches, reamers, etc.—straighter, easier, faster—and in close quarters. No wrist twisting! Folding power lever works through ratchet. Free-wheeling grip handle. Standard chuck capacity 1/4". Complete with two screwdriver bits and 1/4" sq. socket wrench drive. Easy to adapt other tools to fit chuck. Satisfaction guaranteed. Send \$3.75 (check or M.O.) to **WESPORT TOOL CO., 9840 S. W. 35th Drive, Portland 19, Ore.**



\$3.75 PREPAID

SURPLUS HIGH SPEED DRILLS



ALL NEW! Set of 60 High Speed wire gauge drills—sizes 1 through 60, complete with rust-proof metal drill stand. Keeps drills sorted. Always handy in shop or home. Wgt. 1 1/2 lbs. Original value \$25.00! Order now and save! Complete set, while they last. .each **\$8.95**

30 High Speed drills, assorted sizes and lengths (without stand). All new! Original value approx. \$15.00. Wgt. 3/4 lbs. Good assortment for any mechanic or craftsman! Limited supply. 30 drills. .each **\$3.50**

Prices F.O.B. Culver City, Calif. Send check, money order or cash. 25% deposit required on C.O.D. orders.

JACKSON-DUFFY CO., Dept. PM 5-9
P. O. BOX 168 **CULVER CITY, CALIFORNIA**

WAR Surplus

AND OTHER Startling BARGAINS.

BRAND NEW
Khaki SUN TAN SHIRTS & PANTS
 BRAND NEW! Pants made of 1/2 oz. and shirts of 6 oz. mercerized khaki santon twill materials. Well tailored. Add 3c per garment postage.

SHIRTS \$2.65 14 to 17
PANTS \$3.44 29 to 42

SENSATIONAL VALUE!



Aviator style SUN GLASSES
 Precision made. 24 K GOLD PLATED METAL FRAME. 4 base curve. Optic ground. Pearl sweatband. SHUTS OUT 98% OF THE ULTRA VIOLET RAY. We sold thousands at \$5.00. Add 15c postage and handling.

\$1.99

Greatest Watch Value in U.S.A!



17-JEWEL Military Style
 Think of it! Here is a genuine 17-jewel wrist watch with a GUARANTEED SWISS MOVEMENT. WATER & DUST REPELLANT. SHOCKPROOF. ANTI-MAGNETIC. RADIUM DIAL and SWEEP SECOND HAND. Set in a genuine stainless steel case with a fine leather strap. Save at least \$15.00. If you don't think this the greatest value in the U.S., return it for refund.

1995 PLUS 10% FED. TAX

50 FT HANK NYLON PARACHUTE CORD
 New. 1/8 inch diameter. Ideal for clothes lines and venetian blind and drapery cords. 550 lbs. tensile strength. Add 3c postage.

59¢

NAVY STYLE T-SHIRTS
 Brand new. Sizes, small, medium and large. White only. Fine long staple combed cotton yarn. Add 3c per garment postage.

55¢

O.D. wool serge SHIRTS-PANTS
 Used but in excellent condition, perfect. They have been designated for RE-ISSUE BY THE GOVT. Pure wool serge. Less than the price of the cheapest overall. Add 3c per garment for postage.

SHIRTS 259 13 to 15
PANTS 279 27 to 33

50% Wool SOCKS
 Men's mod. light-weight. Khaki and natural colors. Excellent value. Add 2c post. per garment.

39c 10 PR. \$3.80

Surplus DUST MASKS 33¢
 Brand new. For paint or insect spraying. For millers and farmers. Perfect dust protection. Add 5c postage.

SEND FOR FREE

U.S. NAVY WORK JACKETS
 Made of 8 oz. green herringbone twill. Tailored in Navy specifications. Ideal utility and work jackets. Add 15c per garment postage.

169

WAR Surplus CIRCULAR
 OVER 155 OUTSTANDING WAR SURPLUS BARGAINS -- also many other special offers.

DOWN AND FEATHER FILLED MUMMY TYPE SLEEPING BAGS
 BRAND NEW. Water repellent poplin outside. Complete with carrying bag. Down and chicken feather filled. Full size. Add 35c post.

13.99

WOOL LINED KHAKI PANTS \$2.88
 Used, perfect. Regular \$12.00 value. Khaki (ch)ma outside, all wool kersay lining. Sizes 28 to 34. Add 15c post.

ARMY STYLE 688 COMBAT BOOTS
 NEW. For sportsmen and outdoor wear. 19" high. Reversed uppers. Full oak leather sole. With composition outer sole. Add 27c post.

6 TO 12

NAVY STYLE FIELD SHOES
 Rugged and comfortable. Reversed uppers. Full oak leather sole. Composition outer sole. Sizes 6 to 12. E & EE. Add 22c post.

4.99

OFFICER STYLE OXFORDS 6.95
 Best quality uppers. Good-year welt. Top grade oak leather sole. Sizes 6 to 12. D & E. Add 20c post.

ORDER BY MAIL
 Please send remittance with order. Add postage. Absolute satisfaction or your money back.

SIoux FALLS SURPLUS STORE
 SIoux FALLS, S. D.

Unbreakable Amber Hammer Proof Shock Proof



TOOL STEEL PRICED FROM 5c TO \$1.00 EACH

Ask Your Hardware Store for FULLER'S Unbreakable Amber Handle SCREW DRIVERS

America's most popular line of moderately-priced screw drivers! Wide range of sizes. FULLER TOOL CO., Inc. 911 Faile St. New York 59 World's largest makers of Amber-Handle Tools

BARGAIN!

HIGH SPEED ROTARY FILES

| | |
|-------------------|---------|
| Set of 5 Assorted | \$ 2.00 |
| " " 10 " | 3.75 |
| " " 20 " | 7.25 |
| " " 30 " | 10.00 |

1/4" shank

WE BUY SURPLUS TOOLS

SID TOOL CO., 183 Grand St., N. Y., N. Y.

SMALL D. C. MOTOR LESS THAN 1 OZ.



Works on flashlight batteries 1 1/2 to 6 volts. Can be reversed. Ideal for model planes, cars, etc. Dealer inquiries invited. C.O.D.'s accepted -- send money we pay mailing costs.

\$1.50

GOLD GAME CO.
 Dept. E, 315 Gold St., Brooklyn 1, N. Y.

WRITE NOW FOR FREE CATALOG NO. MMY

THE Foster LINE

POWER TOOLS

FOSTER MFG. CO., 247 DELAWARE AVE., BUFFALO 2, N. Y.

ELECTRO BAND SAW BRAZER



FOR RESISTANCE BRAZING OF BAND SAW BLADES

Repairs broken saw blades without delay. Permits savings by making new blades from coil stock. Simplifies inside sawing. Welds up to 1/2" blade in one operation and up to 1" blade in two operations. Portable. Uses 50 C-60 C, 110 V. Fully guaranteed.

only \$19.75 COMPLETE WITH SERVICE KIT OF FLUX AND SOLDER

See your dealer or write

The ERWOOD Company
 CRYSTAL LAKE, ILLINOIS

Dept. PM

SAVE \$55.00 ON THE PRICE OF THIS VERSATILE HEAVY DUTY TOOL!



3/4 H. P. 115 v. AC-DC motor 4200 R. P. M.

ONLY \$42.50 Direct from mfg.

Get this bargain now! Limited offer from surplus stock. No "catch." Brand new A-1 Spinner. Send check or M.O. today. (No C.O.D.)

HOLT MANUFACTURING CO., 651 20th Street, Oakland 12, Calif.

1000 BRAND NEW INDIAN MOTORCYCLE MOTORS!

Ideal motive power for
TRACTORS, MOTORCYCLES, POWER-DRIVEN SAWS, MIDGET CARS, POWER UNITS, TOBOGGAN SLEDS, etc.

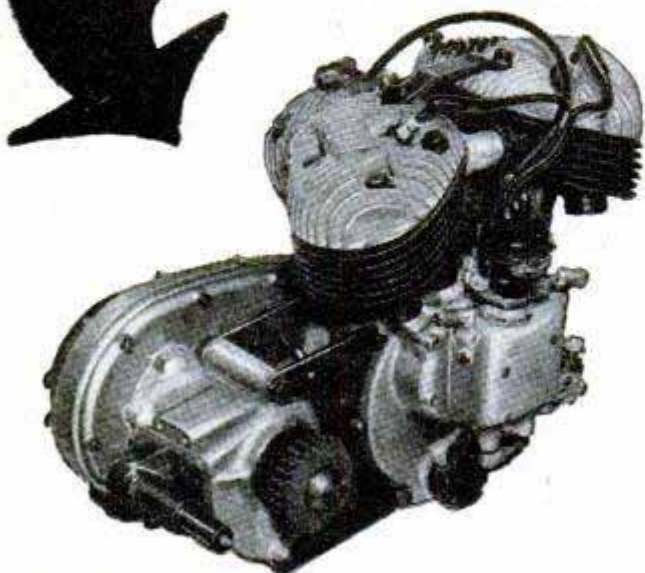

DESCRIPTION: Model 741 INDIAN twin cylinder motorcycle motor — 30.50 cubic inch; 5 NCA H. P.; approx., 10 Brake H. P.; complete with 3 speed transmission, clutch, carburetor and ignition.

Here is a real buy in a brand new (in original shipping crate) Model 741 INDIAN twin cylinder motorcycle motor. These powerful new motors are complete with a 3 speed transmission, clutch, carburetor and ignition — ready for installation. Will make your old motorcycle perform like new. Ideal for powering TRACTORS, MIDGET CARS, POWER-DRIVEN SAWS and TOOLS, TOBOGGAN SLEDS, etc. Limited number of these fine motors available for a short time. Foreign orders invited. Act IMMEDIATELY, if you want them!

TERMS & SHIPPING: Price: \$49.50 each, f.o.b. Atlanta, Georgia. Check or Money Order must accompany order, or send 25% deposit with order, and pay balance C.O.D. Write for special discount prices on quantity lots. Shipping weight: 203 lbs., per unit.

FULTON AUTO EXCHANGE

(Dept. "M")

190 EDGEWOOD AVENUE, N.E.
ATLANTA, GEORGIA, U. S. A.

SAY YOU SAW IT IN POPULAR MECHANICS

NOW! USE YOUR ELECTRIC DRILL for POLISHING! GRINDING! SANDING!

Work on curved or flat surfaces

You can use it to fix bodies, fenders; wax; polish cars, floors, linoleum; re-finish furniture, wood, metal surfaces; smooth, reduce welds, etc.

FITS ANY 1/4 IN. CHUCK or DRILL, FLEXIBLE SHAFT, MOTOR, etc.

Designed and engineered for high speed sanding, polishing, finishing, etc. Full 6 1/2 inch rubber face plate bends into curved surface. New clamp arrangement mounts sanding discs instantly—no cementing. Draw-string lamb's wool bonnet slips on for high speed polishing, finishing, etc. Outfit includes 6 1/2" flexible rubber disc with 1/4" metal shank, fibre backed sanding disc and heavy lamb's wool polisher. Equals \$75.00 outfit in performance. You'll find hundreds of time saving uses for it. Fully guaranteed. Shp. wgt. 2 lbs. F.O.B. Chicago. Complete, price for shipment in U.S.A. only

At your favorite hardware store or direct.

PREHLER PROVED PRODUCTS

Division Norbert Prehler & Co. Dept. PM-5 — 1623-25 Milwaukee Ave. Chicago 47, Illinois



\$4.95

SURPLUS HYDRAULIC PUMP

Genuine Vickers constant displacement high pressure pump. Use it for any type of liquid pumping job. Will pump 400 gal. per hour at 2750 R.P.M. Precision piston type design provides 1000 lbs. per square inch pressure. Self priming. Standard thread 3/4 inch intake and discharge ports. With 3/8 inch splined shaft — just add pulley and power and you're ready to go.

HAS HUNDREDS OF USES

These pumps are brand new. Original acquisition cost approx. \$100.00. Can also be used as hydraulic motor; for rams, opening doors, hydraulic lifts, etc.—also for any liquid transporting job. War surplus, but brand new. Shp. wgt. 7 lbs. Will include at no extra charge an hydraulic control valve and ship postpaid when remittance accompanies order. (Control valve, only \$1.95.) Satisfaction guaranteed. Rush your order today.

\$9.95



SURPLUS AIRCRAFT COMBUSTION HEATER

15,000 BTU, fuel vapor type heater utilizing air ram for greatest efficiency. Size 23" x 7" x 3". Complete with stainless steel heat exchanger, fuel filter, solenoid valve, metering device, 24V firing unit, relief valve, diaphragm switch, etc. Instruction booklet furnished. Shipped in original factory box, total \$12.95 weight 30 lbs. Now selling at only.....

F.O.B. HOUSTON. SEND CHECK OR MONEY ORDER
SOUTHWEST AERO SUPPLY DEPT. PM5, DRAWER 488
SOUTH HOUSTON, TEXAS



PRECISION BUILT Barron DRILL PRESS TOOLS!

15 Essential workshop operations now accomplished on any drill press with famous Barron Tools and Accessories... Planing, mortising, rabbeting, shaping, surface sanding, polishing, tenoning, grooving, routing, drum sanding, beading, paneling, veining, edging, molding, dovetailing, etc.

FREE! Workshop Guide
Including a complete catalog of time-proved, precision built Barron Workshop Tools. Convert ANY drill press into your most versatile, low cost power tool.
FULL 10 DAY MONEY BACK GUARANTEE
BARRON TOOL CO., INC.
669 ARCHITECTS BLDG. DETROIT 1, MICH.

-  \$7.50
-  \$5.95
-  \$9.00
-  \$9.50

ASSEMBLE YOUR OWN 8 FT. ROWBOAT

From Precision Cut Parts

- For outboard or oars
- Can be towed
- Ideal for car top

Save up to 50% in a few hours on this completely water-proof Marine Plywood Kit—no experience necessary. Assembly is simple; parts marked, keyed to Diagram Sheet. No forms or special tools required. Kit includes all hardware, glue, etc. Designed and engineered by MacLevy Equipment Corp., Manufacturers of Athletic and Sports Equipment since 1893.

The DELUXE
\$39.50



Write or Call for FREE Illustrated Booklet PM-5

MacLEVY BOAT DIVISION

189 Lexington Ave., N.Y.C. • Oregon 9-3600

FREE PLANS POWER MOWER KITS FREE PLANS

Have one of the finest mowers money can buy. Write for FREE PLANS and PARTS LIST showing you how to SAVE up to 75% by assembling Triangle's POWER MOWERS.



3 Wheel Model

SPECIAL FACTORY PRICES

Kits, Parts, Engines, Wheels, Etc. Also complete TRI-ANGLE MOWERS ready to mow, at Low Factory Prices. 3 and 4 wheel models.



4 Wheel Model

SAVE your back. Assemble or build your own 3 or 4 wheel power mower with our precision made kits and parts. Write today for full facts. Free Plans, Parts List, Low Factory Prices. DEALERS INVITED.

TRIANGLE MANUFACTURING CO., Dept. M-3, Box 185, Fort Scott, Kans.

BUILD ARC WELDER FROM OLD GENERATOR

For Light or Heavy Work. 75-200 amps. No previous experience needed. Complete PLANS and valuable Catalog 35c.

LEJAY MANUFACTURING CO.
1347 LeJay Bldg., Minneapolis 8, Minn.



Only \$16.95 DUAL PURPOSE SPRAY GUN



Complete USES ONLY 25 LBS. AIR PRESSURE FLOCKS AND SANDBLASTS

AT HOME: You can refinish Lamps, Radios, Book Ends, Statues and hundreds of things with lovely colorful flocking. ETCH GLASS: Many designs and initials can be sandblasted on shower doors, ash trays, glassware. AUTO INTERIORS: Transform ugly dirty auto interiors to "new car beauty" with a BLASTO DUAL PURPOSE SPRAY GUN. Merely spray flock similar to Velvet, Plush, Suede and Mohair inside your car. ANTIQUE WOOD . . . REMOVE PAINT. MAKE EXTRA MONEY by doing any or all the above for profit. BLASTO is highest quality and carries a 5 day money-back guarantee. Operates on small air compressor. Send \$16.95 cash, check or money order for postpaid delivery. Write for free information. Full line of Flocking Supplies.

BLASTO SPRAY GUN MFG. Dept. PM-5, 7007 Haas Avenue Los Angeles 44, California

HANDY 6 in 1 Socket Screw Wrench

HEX-UNI-KEY

Handy pocket tool for:
Mechanics Radio & Refrigeration
Tool Makers Service Men
Hobbyists Maintenance Men

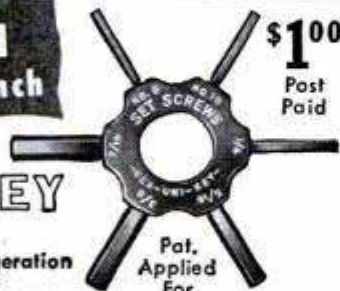

\$1.00 Post Paid

The six most popular sizes of socket screw wrenches, ingeniously anchored in a cast holder. Hardened and tempered for long life. Fits all types of Hex set and cap screws. See Your Hardware Dealer or Send \$1.00 (No C.O.D.'s)

EKLIND TOOL AND MFG. CO.

2627 North Western Avenue • Chicago 47, Illinois

RECOGNIZED BY THEIR STRIPES



The Better buy in portable radio batteries

BURGESS

To millions of portable radio users, the distinctive Burgess stripes mean power—dependable, vital, fresh!

And no wonder! Today, as always, Burgess quality speaks for itself. Burgess is the only dry battery that uses chrome protection to give you fresh power, longer. Burgess paces the field in dry battery manufacture, using finest raw materials and thoroughly testing each cell in every battery before it leaves the factory. Yes, and all Burgess Batteries are plainly dated for your assurance of freshness!

Whatever your battery need, you can be sure there's a power-packed black and white striped Burgess Battery for you! Ask for Burgess Batteries at your radio or hardware dealer. Remember, when you buy Burgess, you buy the best!

BATTERIES



REMEMBERED BY THEIR SERVICE

SAY YOU SAW IT IN POPULAR MECHANICS

LEARN TO RIDE IN 5 MINUTES!

BILL STERN OF NBC



NEW Indian LIGHTWEIGHT MOTORCYCLES

Send for FREE Booklet "How I Learned to Ride a Motorcycle" By Bill Stern, Sports Director, NBC

"WORLD'S MOST MODERN MOTORCYCLES"

For threading crowded traffic or parking in tight spots... for "going places" on weekends or vacation... for sheer, exhilarating sport, there's nothing like an Indian lightweight. So safe, so easy to ride, you can learn in 5 minutes. Amazingly economical. Get the facts—Send for FREE BOOKLET!

INDIAN MOTORCYCLE CO., Dept. PM59
Springfield, Mass. • DEALER INQUIRIES INVITED

Mows and Trims Lawns



In One Simple Easy Operation
8 1/4 Lbs.

Save Time and Labor with a

MONTAMOWER

New model. New type metal handle has special device to adjust cutting height. Drive shaft now mounted on free rolling, factory lubricated, sealed ball bearings. No tired backs or aching arms. 8 1/4 lbs. live precision made mechanism that first gathers, then cuts smoothly a clean 16" swath through grass, dandelions, spike grass, lawn weeds. No noise or clatter. As modern and efficient as your electric razor. Cuts right up to walls, fences, trees or posts; leaves no fringes to be trimmed by hand. Cutters self-sharpening. Built to last many years. Many thousands in use. Sold direct from factory for 26 years. Costs little. Write at once for trial on your own lawn "approval offer," guarantee information and literature.

MONTAMOWER DISTRIBUTING CO.

95 Keeler Bldg. GRAND RAPIDS 2, MICHIGAN

NOW YOU TOO CAN BUILD 15 RADIOS

Absolutely No Knowledge of Radio Necessary

You Need NO Additional Parts

The PROGRESSIVE RADIO KIT

is THE ONLY COMPLETE KIT. Contains everything you need. Instruction Book, Metal Chassis, Tubes, Condensers, Resistors and all Radio parts. The 36-Page Book written by Expert Radio Instructors teaches you to build radios in a Professional Manner. You start with a 1-tube receiver. Before you are done with this kit, you will have built 11 Receivers, 1 Public Address System and 3 Transmitters. **SPECIAL FREE OFFER!**

Electrical and Radio Tester sent absolutely FREE with each Progressive Radio Kit. PLUS FREE membership in Progressive Radio Club. Entitles you to free expert advice and consultation service with licensed radio technicians.

Write for further information, or ORDER your KIT \$14.75 NOW! ONLY

Postage prepaid with check or money order (Postage not prepaid with C.O.D. orders)

PROGRESSIVE ELECTRONICS CO., Dept. PM-24
497 Union Avenue Brooklyn 11, N. Y.



STABOND — THE ONLY ALL-PURPOSE CEMENT THAT RESISTS

OIL • GASOLINE • ACIDS • HOT WATER • FREEZING • SUNLIGHT

Amazing new Stabond does every home and workshop repair job. Use it to fix gasoline tanks and lines, crankcase leaks and for all the jobs other cements won't do. One coat insulates against 1500 volts. Weatherproofs auto electrical systems. Ideal for fishing tackle and all sports equipment. Retains flexibility, never gets brittle.



Used by major airlines for vital repairs. Now offered to home users.

ORDER TODAY \$1.00 postpaid
Half pint only... Or in tubes at your dealer.

MENDS • SEALS • WATERPROOFS • INSULATES
AMERICAN LATEX PRODUCTS CORP.

921-A Venice Boulevard, Los Angeles 15, Calif

MENDS:

- Wood
- Metal
- Glass
- Plastic
- Leather
- Rubber
- Fabric

ONE-MAN SAWMILL LESS THAN \$225.00

Easy To Turn Trees Into Money

Makes lumber, ties, shingles, crates, lath, studding, siding.



Belsaw Models in 10 to 24 foot sawing lengths.

MECHANICAL FEED, accurate set works and positive dogs. Use tractor or old auto engine for low cost power.

Thousands used for commercial sawing. Pays for itself quickly. Send post card today for FREE booklet, "How To Make Lumber" and Catalog of Woodworking Equipment. BELSAW MACHINERY CO., 8118 Field Bldg. 315 Westport Road Kansas City 2, Mo.



DUST-O-VAC FOR ALL MACHINES

For Home Workshops & Industry. DUST-O-VAC collects and bags wood & plastic chips, wood & metal dust, wood shavings. Free Bag. Attaches to circular saw, planer, band saw, grinder, belt or disc sander, shaper, drill press with shaper or sander attachment, spindle shaper, wood lathe, jig saw. 110 A.C., D.C. Send for mounting instr. for all machines. \$19.95 Free Ship. east of Miss. West of Miss., add \$1. Check, M.O.

UNIVERSAL YONKERS CORP., 137 Alexander St., M-5, Yonkers 2, N.Y.

Pioneers Leaders AIR RIFLES BENJAMIN AIR PISTOLS WITH SAFETY LOCK

SEND FOR FREE FOLDER OF LATEST MODELS TODAY
If you want a REAL GUN for PRACTICAL USE inside or outdoors, get a SAFE—CLEAN—ECONOMICAL—BENJAMIN with Adjustable Power and Amazing Accuracy. Use BENJAMIN H-C PELLETS for BEST RESULTS in all rifled models. WRITE AT ONCE. BENJAMIN AIR RIFLE CO., 812 MARION ST., ST. LOUIS 4, MO.

\$4.95 REAL ENGINE VALUE



A miniature gas engine that really operates. Thousands of Buzz "B" gasoline engines have been sold at twice the price. Now is your chance to buy a real 1/6 H.P. gas engine for only \$4.95. Turns up over 8,000 r.p.m. For Boats, planes, midget cars, etc. Guaranteed and ready to run. Includes Champion spark plug and tank. Send only \$1.00, engine shipped collect for balance, same day.

WRITE FOR FREE CATALOG OR SEND 10c FOR NEW MAMMOTH ILLUSTRATED CATALOG OF THOUSANDS OF HOBBY ITEMS.

America's Hobby Center, Inc., Dept. B-59, 156 West 22nd St., N. Y. 11

- BINOCULARS 6 x 30 Universal, \$4250 with coated optics \$5250 used, excellent condition, with case, \$500
- BINOCULAR CASES 6 x 30, two grades \$500 Pebble Grain \$750 of leather, new
- BINOCULAR CASES 7 x 50, all leather, \$750 new
- TELESCOPES U. S. Navy, 16 power, wood cabinet, excellent condition, value, \$125. SPECIAL \$2950
- HANDSIGHTING LEVELS, engineers, all metal, brand new \$200
- TRIPODS for level or transit, Govt. Surplus, used, good condition \$595
- NEW TRIPODS for transits, levels, etc., value \$75, SPECIAL \$1350

11th Annual Gun Digest and our New Catalog, \$1.50, catalog separate, 25c

Public Sport Shops

11 S. 16th St., Phila. 2, Pa. No COD'S

"Wellworth" Sensational Offer! WESTINGHOUSE AIR COMPRESSOR

plus pressure tank, pop valve,
gauge for tank, air regulator &
gauge, filter, 20 ft. air hose,
check valve & air chuck

10 items
All For **\$37.50**

IDEAL FOR HOME-FARM-FACTORY
Wherever compressed air is needed

A fortunate purchase from the government enables us to offer you this amazing buy at a small fraction of its original cost. All brand new. You get the WESTINGHOUSE COMPRESSOR and all of the accessories shown for only \$37.50. Shipping wt. 50 lbs. Designed for automotive truck or tractor mounting. Can be run off fan belt or power takeoff, or mounted horizontally. Comes with automatic clutch. Can be installed for use on farm trucks, jeeps, tractors, tire or garage service trucks, contractor or road building machinery, pneumatic devices, etc. Can be operated with 1/2 H.P. or more electric motor or equivalent portable gas engine.

Compressor separately, \$21.50

Equipment Less Compressor \$18.50

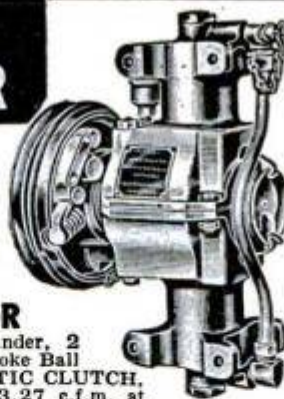

Brand New!

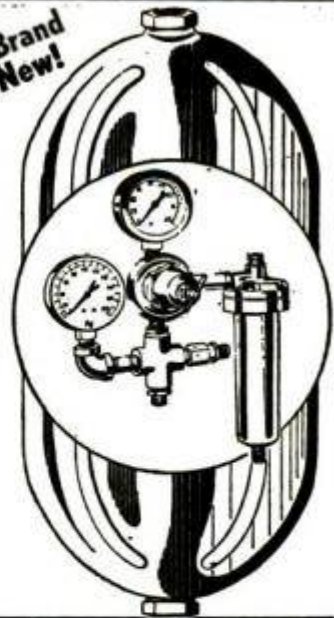

THE COMPRESSOR

Piston Type, 2-cylinder, 2 inch bore, 1 1/2" Stroke Ball Bearing, AUTOMATIC CLUTCH, OIL FREE AIR. 3.27 c.f.m. at 600 R.P.M. 6.54 at 1200. Suggested operating pressure 75 P.S.I. DIMENSIONS: 9" wide, 11 7/8" high, 6 5/8" deep. Wt. 23 lbs.

AIR TANK

Stainless steel, size 12" x 24" with 2 quarter inch openings. Suitable for 150 lb. pressure. Equipped with gauge to show tank pressure, air regulator & gauge to regulate pressure, safety valve, oil and water trap.



PORTABLE SPRAY OUTFIT

1/4 H.P. Heavy Duty

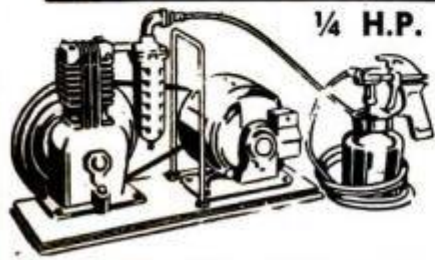

Compressor only\$17.50
Compressor and filter ..\$19.50
Spray gun and hose ..\$10.45
Adj. 1/4" pop valve ...\$1.50
2 1/2" air gauge ...\$1.75

Well balanced portable outfit for use where paint job requires large quantity of material. Sprays all types of average viscosity paints, enamels, lacquers, varnishes, etc. Piston type, single cylinder air compressor. 2 in. bore by 1 3/4 in. stroke. Displacement 2.86 c.f.m.; maximum working pressure 40 lbs. Mounted on sturdy wood base with rubber feet. Pulsation chamber equipped with safety valve drain cock. 1/4 H.P. motor, 110-volt AC, cord and plug; 20 ft. air hose and fittings. Spray gun is pressure feed type, internal atomizing, with one qt. metal cup. Fan and round spray nozzle furnished. Shipping wt. 50 lbs.

\$45.00

PNEUMATIC AIR TOOLS

Riveting and chipping hammers for many uses: riveting, chipping, hammering, auto body work, concrete breaking, etc.; used, guaranteed like new.

CHICAGO PNEUMATIC RIVETER & CHIPPING HAMMER

CP4X Pistol grip handle with air control. Takes up to 3/16" rivet. Weight 6 lbs. List price \$73.00.



Special Price **\$12.95** Same as above, brand new **\$19.50** Size CP3 Takes 5/32" Rivet **\$8.95**

Chicago Pneumatic Lever Type AIR DRILL



With 1/4" Jacob Chuck. Wt. 2 lbs. List price \$55.00 Only **\$15.00**



Ingersoll Rand AIR DRILL

With 1/4" Jacob Chuck. Wt. 2 lbs. List price \$55.00. Only **\$15.00**

AUTOMATIC COMPRESSOR UNIT

1/3 H.P. heavy duty capacitor motor AC 110/220 volt 60 cycle, 2 x 1 3/4 inch piston type compressor, splash feed lubrication, 12 x 24 inch tank, automatic pressure switch, pressure range 100 to 125 lbs., check valve, safety valve, air regulator with gauge and filter, 20 ft. air hose with air chuck for inflating tires. V. belt drive. Shipping wt. 90 lbs.

Special Price **\$79.50**

ONLY
Same unit as above with 1/2 H.P. motor, furnished with 13" x 24" tank. Shipping wt. 125 lbs. PRICE **\$98.50**

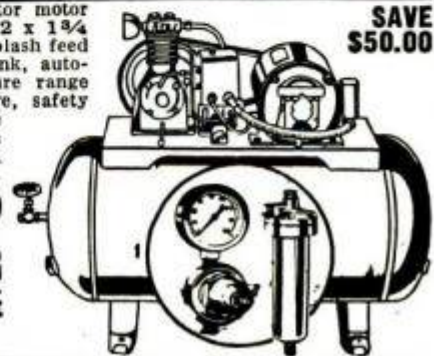

SAVE \$50.00

Price f.o.b. Chicago. Immediate delivery. All items sold on money back guarantee. Send check or money order today. Write for free catalog.

A.V.C. 11 INGERSOLL RAND

Push button, takes 5/32" rivet. Wt. 3 lbs. List price \$65.00. Only **\$8.95**

A.V.C. 10 INGERSOLL RAND

Takes 1/4" rivet. Wt. 3 lbs. List price \$80.00. Only **\$8.95**
AVC 13, takes 1/4" rivet. List price \$93.50. Only **\$22.50**

"WELLWORTH" CHECK VALVES

Dash Pot. Quiet Operating



1/4"\$ 2.75
3/8" 3.25
1/2" 4.50
3/4" 9.50
1" 12.50

AUTOMATIC PRESSURE SWITCH WITH UNLOADER



Double pole, with 2 way release valve. Set at 125 to 150 lbs. pressure. Weight 4 lbs. **\$10.25 ONLY**

WELLWORTH TRADING CO.

Merged with C & M Equipment Co.
1831 S. STATE ST., DEPT. D-5, CHICAGO 16, ILL.

U-BUILD IT

12 ft. Trailer Shell **\$299.00**; 16 ft. \$529.00; 20 ft. \$699.00; 24 ft. \$799.00; 28 ft. \$899.00; 32 ft. \$999.00
All prices F.O.B. Elkhart, Ind.

Easily Erected! This Modern Metal Trailer comes to you knocked down, complete with all parts for quick assembly. Windows, doors, exterior panels, complete chassis and axle assembly with tires, roof caps, bows, corners, roof ends. No expensive tools required — no experience necessary.

EXPORT TERRITORIES AVAILABLE

Write for working plans showing detailed construction and location of parts. **\$1** Each size

U-BUILD-IT Trailer Co. \$1.00 enclosed.
Dept. M, P. O. Box 354, Elkhart, Ind.
Send working plans for 12 ft., 16 ft., 20 ft., 24 ft., 28 ft., 32 ft., Custom Built.

Name _____ (print)
Address _____
City _____

WHAT MAKES IT WORK?

BECKER Spray-Gat

NEEDS **NO** COMPRESSOR
AIR HOSE
MOTOR
ELECTRICITY

TAKE IT ANYWHERE FOR

- Painting—Varnishing
- Mithproofing
- Disinfecting
- Fireproofing
- Exterminating
- Rustproofing
- Humidifying
- Insecticiding
- Oiling



ONLY
\$18.50

● Here—at last—is a completely portable spray gun. Becker Spray-Gat goes where you need it . . . simple to use as a flashlight. It's lightweight . . . self-contained . . . no bulky, expensive attachments or "extras." Pressure supplied by easy-to-load, inexpensive CO2 cartridge. Use Spray-Gat for all sorts of spraying and painting jobs in the home, workshop, garden and garage. Comes complete with 3 cartridges.

SATISFACTION GUARANTEED See the amazing Spray-Gat at your dealer. If he cannot supply, order direct. We ship postpaid if you send \$18.50 (check, draft, money order). Or send only \$2.00 now and pay postman balance plus postage. Extra CO2 cartridges, 10 for \$1.00.

SULLIVAN-BECKER CO. Dept. 119-E KENOSHA, WIS.

To introduce "Flywheel-Action":

**FREE TRIAL
95¢ GOLF BALL**

with factory-direct order! **6 for \$3.50** Postpaid



Here's why American's exclusive "Flywheel-Action" golf balls give you 14.9% more spin:
Other golf balls have weight concentrated near the liquid center.
American "Flywheel-Action" golf balls have weight distributed farther away from the liquid center.
That's why you get longer flight, more "bite," and truer putting, with American "Flywheel-Action."

Order 6 top quality, new, 95c "Flywheel-Action" High-Speed balls at 58 1/2c each. We ship 7—your order of 6 plus free "Sampler." You get American's finest 95c Tournament balls at 50c each.

OUR GUARANTEE: Give your free Sampler "the works" in actual play. If you're not convinced it's the sweetest-playing golf ball you've ever used, regardless of price, return all 7 balls for full refund. American Golf Ball Mfg. Co., 8629 W. 3rd St., Los Angeles 36, Calif.

American Golf Ball Mfg. Co. PM
8629 W. 3rd St., Los Angeles 36, Calif.
Send six 95c Golf Balls, & free Sampler.
 \$3.50 Check or Money Send C.O.D.
Order enclosed. (Postage extra)
Name _____
Address _____
City _____ State _____

SEND COUPON TODAY!

BUILD YOUR OWN TILTING ARBOR SAW!

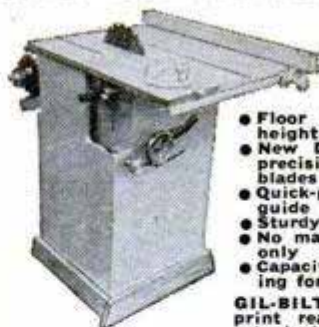

- 27x28 in. table stays level. Blade tilts full 45 degrees
- 10 in. blade cuts 3 1/4 in. deep, jackscrew depth adjustment

SAVE \$50 OR MORE

- Floor model, 34 in. table height
- New Departure ball bearing arbor, 3/4 in. precision shaft, ready to run, 5/8 in. bore blades
- Quick-positioning, self-aligning rip fence guide
- Sturdy wood, steel and aluminum construction
- No machining—Build easily with hand tools only
- Capacity and performance of floor saws selling for \$150.00 and up!

GIL-BILT Step-by-Step pictorial plans (No blueprint reading required), full scale patterns, actual photographs . . . \$1.00

GIL-BILT Metal Parts Kit—includes Plans, ball bearing arbor, cast aluminum miter gauge and bar, rip fence guide, machined lock knobs, jackscrew mechanism with 4 1/2 in. handwheel, and all other metal parts (less blade) . . . \$20.95
Same Kit with 10" combination blade . . . \$25.90
Same Kit with 8" combination blade . . . \$24.90

(Prices include postage up to 600 miles. Plans sent postpaid anywhere in the world)

Also available—Plans and Metal Parts Kits for 8" Tilt/Table Saw and 12" Band Saw. Order Plans at \$1.00 each, or write for FREE descriptive Catalog.

GILLIOM POWER TOOLS P.O. BOX 1-PE, LAMBERT FIELD ST. LOUIS 21, MISSOURI

OTTAWA Buzz Master



A faster brush cutter and wood sawing machine. Propels itself while cutting saplings and brush. 7 H-P motor. Many outstanding and exclusive features. Available attachments: sickle bar, rotary tiller, sprayer, air compressor, snow plow and pulley for belt work. Thousands in use. Send for FREE booklet.

OTTAWA MFG. CO., 1-927 Brush Ave., Ottawa, Kansas



GERSTNER Tool Chests

are built to highest standards to care for tools of Machinists and Toolmakers. Free catalog.

GERSTNER TOOL CHESTS

449 Columbia St. Dayton 7, Ohio



PORTABLE SAW

From Your Powerdrill

Lite-Saw converts standard 3/4" Drillmotor to 6" portable saw. Easy to attach. Rip, cross, bevel and cutouts. Satisfaction guaranteed. \$24.50 complete, postpaid. Send check or money order to

FUTURE PRODUCTS CO.
3625m N. Mississippi
PORTLAND 12, OREGON



ELECTRIC WELDER

AC or DC 110 Volts
Pre-war type—All metal—No chemical—5 year written guarantee. Welds 1/8" thick metal or money back. Repairs tanks, tools, fenders, machine parts, etc.

Comes complete with rods, unit directions and eye shield.
On C.O.D. mailing charges extra.

**\$645
COMPLETE**

ESSAY MFG. CO., INC., Dept. P.M., Quincy 69, Mass.

FARM AND HOME "HANDY PUMP"



An all 'round 3/4" pump for farm and home utility use. Weighs only 20 pounds—self-priming. Fits pipe or garden hose. 8 GPM at 40 lbs. pressure (more at lower pressures). Lifts up to 25 ft. Electric. Complete. Guaranteed.

Send your name on a post card for complete literature.



THE GORMAN-RUPP CO.
MANSFIELD, OHIO

RADIOMEN'S HEADQUARTERS : WORLD WIDE MAIL ORDER SERVICE!

Buffalo Radio Supply, one of America's largest electronic distributors, is in a position to supply most of the requirements of foreign purchasers directly from its gigantic stocks or those of its affiliates. Export inquiries are solicited both from export houses and from foreign govt. purchasing commissions here and abroad. Expense can be reduced and requirements filled with a minimum of delay by contacting Buffalo Radio Supply initially.

GENERAL ELECTRIC 15-TUBE TRANSMITTER AND RECEIVER SET

This brand new 15 tube transmitter-receiver was designed for mobile service on 12 volts, and will operate in the "Citizens Band," where no amateur license to transmit is necessary. It's a cinch for any experimenter to connect this unit for 110 VAC operation by following the instructions and diagrams supplied, which cover numerous applications, including television. For those intending to use on car or boat, a new dynamotor, exactly as originally supplied, costs only \$15.00. Don't fail to write for FREE descriptive bulletin. Order our RT-1248 for only \$29.95, or two for \$53.90.

Amazing PORTABLE RADIO

The Year's hottest sensation. Powerful superhet in beautiful maroon crackle finish case with built-in 3 foot gleaming chrome telescopic whip antenna. Exactly like a car radio except works off self-contained standard portable radio batteries, easily obtainable anywhere. Theft-proof mounting bracket attached by anyone to bike or motorcycle in 3 minutes. Readily installed on any vehicle from a wheelbarrow to a witch's broom. Radio removable from mounting bracket instantly by means of special key provided, so that it can be carried anywhere for use as a portable if desired. Weight 5 lbs. Your cost with batteries—\$24.95; without batteries—\$22.50.

COMPRESSED AIR INSTANTLY ANYWHERE

Portable Air Compressor and storage tank. Ruggedly built of best materials using lifetime lubricated ball-bearing on connecting rod and oil impregnated main bearing on shaft. Unusual design forever eliminates valve trouble, the most common fault in air compressors.

PATENTED unique air intake system increases efficiency tremendously over other compressors so that air output is much greater than that from larger compressors powered by heavier motors. Will deliver approximately 3500 cu. inches of air per minute at maintained pressure of 30 lbs., or will inflate a 90 lb. truck tire in less than one minute. Comes complete with 100 lb. gauge, although finger-tip adjustment allows setting of output pressure at any value, which will automatically be maintained. Works from any 1/4 H.P. motor. Useful for spraying paints or lacquers, disinfectants, insecticides, annealing or brazing with natural gas, inflating tires, etc. Price \$14.50 postage prepaid anywhere in the U. S. Efficient, completely adjustable syphon type spray gun complete with 12 ft. of 100 lb. tested hose available for only \$7.75 with pint container, also prepaid. 25% required on all C.O.D. orders.

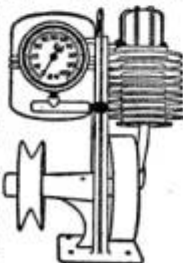

\$6.95 TAKES ALL THREE BIG BARGAINS

- (1) BANDSWITCHING TUNING TURRET** made by Western Electric. Covers 4 bands above 100 MC. ALL coils wound with #14 silver plated wire. Complete with tuning condensers and powerful electric driving motor. Diagram included. ONE OF OUR MOST TERRIFIC VALUES—ONLY \$2.95.
- (2) DUAL METER**—One 50 uA and one 200 uA movement in the same case. This meter is ideally suited for use as a combination modulation percentage and carrier shift indicator. If desired the movements may be removed from the case and used separately for voltmeters, ohmmeters, ammeters, etc. ALL meters are in perfect condition, but a few have cracked glasses. This super value costs only—\$1.75.
- (3) AUDIO AMPLIFIER**—Brand new, dual triode amplifier having 2 of the valuable and scarce oncure type audio transformers that sell for over \$10.00 apiece. Neat aluminum case, fully enclosed (largest dimension 6 inches). Perfect for intercom systems, phono amplifiers, mike amplifiers, or signal tracer amplifier for testing radio sets. A sensational bargain at only—\$3.40 each.

Our PE-109 DIRECT CURRENT Power Plant

This power plant consists of a gasoline engine that is coupled to a 2000 watt 32 volt DC generator. This unit is ideal for use in locations that are not serviced by commercial power or to run any of the surplus items that require 24-32v-DC for operation. The price of this power plant tested and in good condition is only \$79.95 F.O.B. Buffalo, or we can supply in strictly "as is" condition for \$58.95 F.O.B. New York City. These latter are exactly as received, in heavy steel-strapped govt cases, and we are unable to determine if the individual units are new, or what the condition is if used, while the \$79.95 are some of the same that we have brought to Buffalo for testing and repair if necessary. We do not recommend gambling on the "as is" condition, except for quantity purchasers. We can also supply a converter that will supply 110v AC from the above unit or from any 32v DC source for \$12.95.

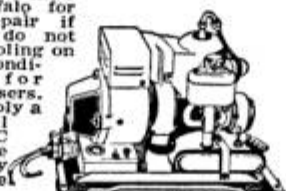

Brand New LS7 PM SPEAKER

in a fully-enclosed, black crackle finished metal cabinet. This speaker and case match communication receivers, and in addition make perfect intercom remote stations. Our price \$4.50. Including output transformer\$4.95



ELECTRONIC ALTIMETER

Only \$45.00

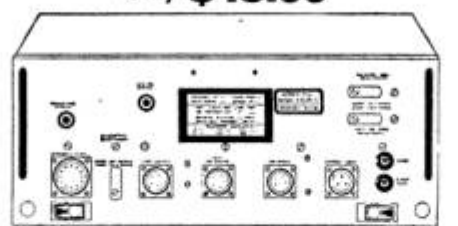

Brand new APN-1 14 tube electronic altimeter in original factory packing. This famous 18x8x7 unit, which weighs only 25 lbs. without plugs or cables, cost the govt \$2000 and includes a transmitter, a receiver, all tubes, an altitude metre, an altitude limit switch, and two easily installed 11" antennas. Working on the radar principle, the receiver measures the absolute altitude from 3 to 4000 feet, with precision enough for blind landings. In addition the altitude limit switch gives an alarm if the plane's height varies by more than 10 feet from a preadjusted value. Fills recent C.A.A. requirements effective Feb. 15, 1949, that all scheduled airlines must have terrain clearance indicators capable of giving warnings at 500, 1000 and 2000 ft. Another outstanding feature is that connections are provided to control an electronic automatic pilot. Send for our aircraft radio equipment catalog. Export inquiries invited. Model for 12 to 14 volts D. C.\$75.00 Model for 24 to 28 volts D. C.\$45.00

AUTO RADIO DEALERS! ATTENTION!

Nationally advertised brand of 1949 car radio which will fit practically any car and every pocketbook. Six tube superheterodyne with three gang condenser and 5 1/2" speaker. \$32.20 for sample, or Dealer price \$29.97 each, in lots of two or more.



"SO" RADAR RECEIVER complete with including picture tube. This Plan-Position-Indicator Oscilloscope has a self-contained pack designed to run from the 110V. power supply on LST or PT boats. It provides a 5" diameter picture adjustable at will to an 80, 40, 4 or 2 mile circle with the boat at the center, showing location of land, other ships or any obstruction, so that navigation can be carried out in pitch darkness or pea-soup fog with as much safety as in brightest sunlight. Also a natural for adaptation as a television set. Your cost \$39.95.

SUPER SPECIAL

FAIRCHILD bombsight POWER UNITS. Our quantity of these is too limited to justify the space required by a photo, but each unit is brand new, contains 9 tubes which alone have a total value of \$15.00; 8 electric motors or generators, 6 of which are of the permanent magnet field type; relays; and 20 valuable precision resistors plus a multitude of the ordinary kind, in addition to many condensers and potentiometers. All for only \$14.95. We will ship but one to a customer while our small quantity lasts.

STROMBERG CARLSON Power Switching Relay Box. Neat 3 1/2 x 4 x 5 1/2 steel case with tight fitting cover finished in Stromberg's usual beautiful chocolate color crackle finish. 98c.

REMOTE CONTROL UNIT—Aluminum case 4x3x2 containing 2 potentiometers, triple pole switch, 4 knobs, phone jack, gear mechanism and revolution counter. 99c. With 8 prong JAN connector to fit box \$1.39.

RECORD PLAYER BARGAIN



All you need for a record playing attachment for your radio except the cabinet. Special offer on phonograph arm and 115 V., 60 cycle motor, both top quality.....\$7.95

THE BUFRAD SECTIONAL TOWER

This latest addition to the famous line of BUFRAD antenna products makes up to a hundred foot tower from any desired number of ten foot sections of extremely strong welded construction. The sections are shipped assembled and painted, so that erection is a matter of minutes rather than hours. Assembly is a one man job, and is accomplished by climbing up the completed portion of the tower with the next 25 lb. section to be installed. Hand and footholds are provided to make the work safe and easy. Cap at top of tower provides bearing surface for rotating, and prevents water from entering tubes. Useful for police or amateur transmitters, and in addition the tower will provide satisfactory TV reception where otherwise it would be impossible. Ideal for supporting permanent or temporary power lines, wind generators, stadium public address speakers or spotlights for gas stations or parking lots. "B" and "C" sections together cost a total of \$15.75 and total 20 feet. "A" sections, which make up the entire tower except for the top, are each 10 feet long and cost but \$12.75 apiece. Those who wish a mast base will be able to obtain one (not shown above), for only \$6.00. The base is especially useful when erecting the tower on a sloping roof.

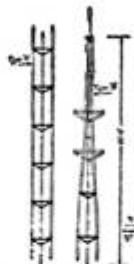

All sales final and no returns unless otherwise specified in ad of item. Right reserved to change prices and specifications at any time. Cable address BUFRAD.

BUFFALO RADIO SUPPLY, 219-221 Genesee St., Dept. PM, BUFFALO 3, N. Y.

SAVE UP TO 85% in WAR SURPLUS SENSATIONAL VALUES

at "GADGETEER'S HEAVEN" IN MANY ITEMS WE HAVE THE WORLD'S LARGEST SUPPLY

NEW 1949 CATALOG 92 PAGES-ILLUSTRATED SEND 25c TODAY!

WARM-UP SATIN JACKETS
For The Whole Family First Name Free with each jacket. In contrasting colors. Blue-Gold, Green-White, Maroon-White, Red-Black, etc. or your school colors.
Lined with Bannel. Full swing Raglan Shoulders, Knit Collar, Cuffs and Bottom. Zipper Front, Two Slash Pockets.
A Steel at

| | | |
|--------------|---------|----------|
| Sizes 2 to 6 | 8 to 18 | 36 to 48 |
| \$7.49 | \$8.49 | \$9.49 |

Aviation Emergency Vests
Sturdy. Yet Light Weight. Satin Lined with Tie Straps. 14 Outside Pockets. Plus Knife, Gun, or Tool Leather Holder. 2 large 11" x 8" Pockets Inside. Wonderful for Hunting, Fishing, or Mechanic. Cost the Government \$30. A Steel at

\$3.49

HUNTING KNIFE #107
6" chrome vanadium blade, handle, leather grip. In leather sheath.
Like above but black, Parkertized Finish **\$1.49**

BOLO KNIFE
10" x 2" Parkertized blade. 5" Grippid Handle. Weight 1 1/4 lbs. . . . Ideal for Hunting, Clearing Brush or Trails. With Case **\$1.19 ea.**

FOAM RUBBER CUSHIONS
Genuine Goodyear Airfoam Moulded and pre-shaped. Cement or cut to fit. Variety of sizes and shapes. For chair pads, auto & truck seats, trailer & boat seats, outdoor furniture and nooks.

| | | | |
|----------------|-------------|------------------|------------|
| 18" x 18" x 4" | \$4.89 ea. | 36" x 18" x 4" | \$5.39 ea. |
| 17" x 21" x 4" | \$4.89 ea. | 42" x 18" x 1/2" | \$6.89 ea. |
| 32" x 24" x 4" | \$10.95 ea. | | |

LEATHERETTE
Genuine Leatherette to cover Chairs, Patio Furniture, Nooks, Auto Seats, etc. 10 colors at a BARGAIN PRICE.

| WIDTH | COLORS | PRICE (per sq. yd.) |
|-------|------------------------------------|---------------------|
| 36" | Grey, Brown, Black | \$1.19 |
| 36" | Lt. Green, Dark Green, Blue | 1.85 |
| 36" | Red, Grey, Lt. Blue, Ivory, Yellow | 1.89 |

MESS TRAY 6 compartments, rustless, stainless steel. Barbecue, outdoor cooking, save dishwashing. Hospital, Restaurant, Home, or roughing. **\$3.00**
New **83c** ea.

#311A Used but in Fine Serviceable Condition **59c** ea.

SLEEPING BAG
NEW! 100% wool. Mummy type. Heavy duty 30" zipper. #303 Gov't. cost \$22.00. . . . **\$3.95**

Used water repellent cover \$1.95 extra. Sold only with Sleeping Bag.

FEATHER AND DOWN BAGS . . .
Water repellent Poplin cover . . . Heavy duty 3/4 length zipper . . . Weighs only 6 1/2 lb. . . . Prepare for that vacation NOW . . . We made a TERRIFIC BUY . . . Yours while they last for ONLY **\$13.95**

KAPOC BAGS with air mattress compartment and wind-breaker hood . . . Just the thing for the outdoor man. ONLY **\$15.95**

AIR MATTRESSES 25" x 72" **\$11.95**

CLAMP-ON ANYWHERE LAMP With adjustable ball and socket swivel head, long rubber covered cord and wall plug.
The All Purpose Lamp. Wonderful for Indoor Photography, Floodlights, Baby Spot or Large Spot, Personal Bed Reading, Workbench, Garage, etc. Lamp Alone **99c**
Highly Polished 9" diameter Parabolic Reflector or 5" diameter Spot Reflector at Only **85c** ea.

FINE FOR YARD OR PATIO

AIRCRAFT INSTRUMENT MIX
12 different new or good used cond

| | | |
|----------------------------|----------------------------|---------------------|
| Fuel Air Ratio | Right and Left Indicator | Oil Pressure Gauge |
| Air Speed Indicator | Flap Position Indicator | Liquidometer |
| Mainifold Press Indicator | A-8 or A-9 Oxyg. Reglators | Engine Gauge Unit |
| Autolan Ind. & Transmitter | Landing Instruction | Fuel & Oil Pressure |

These Instruments contain sensitive meter movements. Miniature gyros, jewels and ball bearings, gears, valves . . . a treasure trove of fine parts. **\$16.95**
APPROXIMATELY \$2000 GOVERNMENT COST FOR ONLY

KLEER-VUE NIGHT DRIVING GLASSES
With 57 mm yellow amber lenses. These lenses are 6 base especially PRECISION GRIND. and Polished to reduce Glare of headlights from on-coming cars, also to focus objects sharply and more clearly during night driving. Absolutely one of the greatest boons for Safe Night Driving, or during stormy, murky weather. Highway Patrolmen, Truck Drivers wear by them. A must for your Vacation or Nite Driving.

TELEVISION! These glasses help wonderfully! SHARPEN FOCUS. Aid in eliminating Glare. DISCOVER GREAT ENJOYMENT.

INTRODUCTORY OFFER
In Men's size or Ladies Harlequin style. ND-1 **\$16 VALUE \$5.89**

SAME GLASSES but clip-ons. Fit-over style without temple bars **\$4.59**

GENUINE GOGGLES
Aviators (AN-6530) Windproof & Dustproof
Sponge and leather protected frame with ground lens in clear, amber and green. Clear set in replaceable metal frame with blinged nose bar. Ideal for Motorcycling, etc. **\$1.69** ea.

SUNGLASSES HERE'S THE REAL McCoy!
ARMY AIR FORCE 4 base. Precision Polished and Ground. Glare-Free lens with leather case that can be attached to belt. Gold plated adjustable frame. Pearlid sweat bar and pads. **\$3.95**
A real Paddy \$17.50 Value for Only

ARMY AIR FORCE TYPE SUNGLASSES
4 base, polished and ground lens. 37. Ultra Violet Ray free, gold plated frame, pearlid sweat bar & pads, leatherette case. Our price **\$2.39** ea.

HERE ARE PLASTIC KITS
UNSURPASSED VALUES for ARTISTICALLY INCLINED HOME HOBBYIST!

Start Planning Now! Knows Gilt New!
Kit #1 contains 2 lbs. plexiglass & Lucite sheet in various shapes, 1 ea. bottle of clear cement, 1 ea. bottle color set cement and 4 bottles of colors in Orange, Red, Yellow, Peach, etc. Also a Plastic Handbook of uses and instructions. This set really worth \$5.50. Our Price **\$2.19**

Kit #2 contains 1 1/2 lbs. of plastic sheet, a 1 ea. bottle of clear cement, and the Plastic Handbook. A \$2.50 Value for ONLY **99c**

Plexiglass & Nascolite clear plastic shts. at Tremendous Savings to You!

NASCOLITE—Full sheets opp 1/4 x 37 1/2" **\$12.50**
48 1/2" opp. 10 1/2 lbs. Per Sheet

PLEXIGLASS—Full Sheet
5/16" x 36" x 24" . . . Per Sheet . . . **\$13.00**
5/16" x 36" x 48" . . . Per Sheet . . . **\$25.00**

Fabricators write in for our special quantity prices. All above are new & marked. Also inquire about our other large stocks of Plastics.

For Ocean and Stream NYLON FISHING LINE
Strong, Durable, Waterproof, Especially treated. A wide assortment for any purpose. **OR 20044K**

| | |
|--|---------------|
| a. 10 LB. TEST, 2500 FT. BLACK | \$1.75 |
| b. 25 LB. TEST, 1500 FT. BLACK or BROWN | \$1.95 |
| c. 50 LB. TEST, 400 FT. WHITE | \$1.15 |
| d. 75 LB. TEST, BRAIDED BLACK and GREY 200 Ft. | \$3.50 |
| e. 100 LB. TEST, 300 FT. WHITE | \$3.75 |

New SUN VISOR
Adjustable arm, Swivel lead. Can be swung in any direction. Made of clear glass plastic. Mid. for Air Corp by Faben Co. A very useful accessory for your Car, Truck, Tractor or Boat. **\$1.29**

NAVY PORTABLE SALTWATER STILL
Adaptable to Lab, distillation of Alcohol, liquids, and chemicals. Can also be used as Open Pot Cooker, Grill, Trailer, Tent, Camp Heater, or Stove. Equipped with Still Boiler, Stainless Steel Pot enclosed in copper elements for instant and constant heat. Burns canned heat or Gasoline. Simple to operate. Safe, asbestos lined & sealed thru-out. Complete with instructions & 15 accessories for distilling liquids. Also flint igniter, grill, enough canned heat for at least 45 hours. ceramic immersion block for use with Gasoline. A must for your Boat, Laboratory or outing. **\$14.95** 1 QT. **\$12.95** 3 QT.

AIRCRAFT PILOT SEAT
The AAF's most adaptable seat! Has 1/2" adjustments in 5 positions! Goes UP & DOWN, slides FORWARD & REVERSE on tracks, TILTS 90 to 180°. Swings away. CUSHIONED ARM RESTS. Equipped with safety belts . . . Easily mounted . . . Aluminum construction with Chrome-Moly tube frame. Ideal for Deep Sea Fishing, Power Boats, Tractors, Trucks, Planes, Shops, etc. **\$7.49**

CUSHIONS Mid. for Aircraft seat, but can be used in trucks, autos, boats, tractors. Made to Gov't. Spec. of finest imitation leather, yellow pigskin col. filled with kapok. Will float. Same as shown in LIFE magazine saving a man from drowning.
New Back Rest, 22" x 16" x 1 1/2" thick **\$2.95**
Used Back Rest, 22" x 16" x 1 1/2" thick **\$1.95**
SEAT, New, 17" x 16" x 3" thick **\$3.49**
SEAT, Used, 17" x 16" x 3" thick **\$2.29**

NEW TARPS - HEAVY CANVAS
Mildew & Flame 9' x 16' **\$11.95** ea.
Resistant, Cheap Outside Storage. They are Really Moving at These Prices!
5' x 7' **\$3.95**
16' x 22' **\$29.95**
8 1/2' x 10' **\$8.50**
16' x 22' **\$20.95**
Rubberized Linen 7' x 11' NEW **\$5.95**
Only 3 lb. light weight yet waterproof Ideal for outside car storage.

DEAD LINE FLASH! Just Purchased \$800,000 Inventory of New Cutting Tools, Taps, Drills, Milling Cutters, Metal Saws, TREMENDOUS SAVINGS! WRITE FOR LIST

Sperry Aircraft Directional GYRO COMPASS
Precision made for Positive direction. 360° swing calibrated in 1/30 degree (six min.) luminous dial. Built-in bank indicator and instrument light. Case is 4 1/2" square with 3" dia. face. Operates on vacuum. Ideal for autos, light planes and boats. Can be used in autos and boats by attaching one tube to intake manifold. Complete with caging and reset knob. Re-issuance—good condition. **\$4.49**

New Navigators Magnetic Compass
Type D-12 size 7" dia x 4 1/4 deep Rubber lined - rotating vane range rings calibrated in 1 degree from 0-360° with 2 parallel grid wires for alignment with N.S. line. Boat. **\$14.95**

COMPASSES #151 Marching. lensile, with luminous dial **\$1.59**
#152 Matchbox, both jewel & liquid floating dial **39c**
#154 Wrist Strap Compass **69c**
NEW 1 Jeweled Watch Pocket Compass #153 **\$1.59**

WRIST WATCHES Genuine Swiss Cluser - P-10. Radium Dial, Sweep Second Hand, Swiss Movement Guaranteed for 1 Year. A Terrific Value **\$5.95**
P-15 - 15 Jewel, Waterproof Case, Sweep Second Hand, Radium Dial, Either white or blk. face, Gem. 1 yr. Sold in Army PX for \$29.95. All New. Our Price **\$16.95**

THAT FAMOUS "GIBSON GIRL" RADIO TRANSMITTING SET #SCR578 A or B
This simple rugged emergency Transmitting System provides automatic code transmission. Anybody can send distress signals which will permit rescuers to obtain bearings. Can also be used as a hand-powered signal light with manual keying to transmit instructions or as a constant signal light. All electrical power for operating either the Radio Transmitter or signal light is furnished by Hand-powered Generator in transmitter case. Complete with maintenance and instruction hand book, balloons, kite, signal lamp, spare wire, hydrogen generator, inflating tubing, packing case, bags, accessory containers, etc. **\$17.99**
A real emergency friend to small boats, fishing boats, yacht owners, or adventurers. Complete set, \$100.00 VALUE.

HS 38 NEW LOW IMPEDENCE RADIO HEADSET
The latest and most improved style, currently in use in aircraft. New. Packed in original boxes. Rubber hand band, sponge rubber ear pads, includes CORD and JACK **\$3.25**
High to Low impedance Adapter **35c** ea.
HEADSET HS-30-U Two Magnetic Type receivers in waterproof brass case. Soft rubber inserts in each receiver to fit into waders' ear. Flexible steel head band. Ideal for communication, divers, workers in salty compartments, etc. **\$1.59**

Radio ANTENNA Reel
Just the thing for tuning beam antenna. Powered by 1 1/2 k. p. 24v. C. E. Motor. Removable 5" Reel-Limit Switch - Cam Worn gears, Bevel gear, Solenoid clutch. Motor engaged to gear reduction only when electrical contact made. Operates in either direction. Ideal for auxiliary power take-off opening and closing doors, etc. **\$4.29**

AT REAL VALUES!
3/16" dia. 3 strand, cotton .01 ft. **\$1.95**
1/4" dia. Treated Navy laynard. in 300 ft. rolls **\$1.95**
3/8" dia. 3 strand, treated jute .02 ft. **.02 ft.**
3/4" dia. 3 strand, jute .07 ft. **.07 ft.**
1" dia. 3 strand, sisal .08 ft. **.08 ft.**
1 1/2" dia. 3 strand, sisal .08 ft. **.08 ft.**

PALLEY THE LARGEST FIRM OF ITS TYPE IN THE WORLD DEPT. PM5 6321 SAN FERNANDO RD GLENDALE 1, CALIF.

Order from this Ad. All sales final. All Prices F. O. B. Los Angeles, Pay by M. O. or Check. P. O.'s. Acctd. from D & B firms. 1/5 deposit with C.O.D.'s.

HERE ARE THE NEW 1949 SPEEDEX GARDEN TRACTORS

RUGGED 6 H. P. SPEEDEX BIG BOY GARDEN TRACTOR

Only \$285.00 f.o.b. factory, complete with six-shovel cultivator and two gauge wheels . . . the greatest bargain in the garden tractor field for taking care of two to five acres. It has fully enclosed gears running in oil . . . 7.50 x 16 traction-type tires . . . easy to handle with power to spare.

ONLY \$285⁰⁰
WITH CULTIVATOR
F.O.B. FACTORY

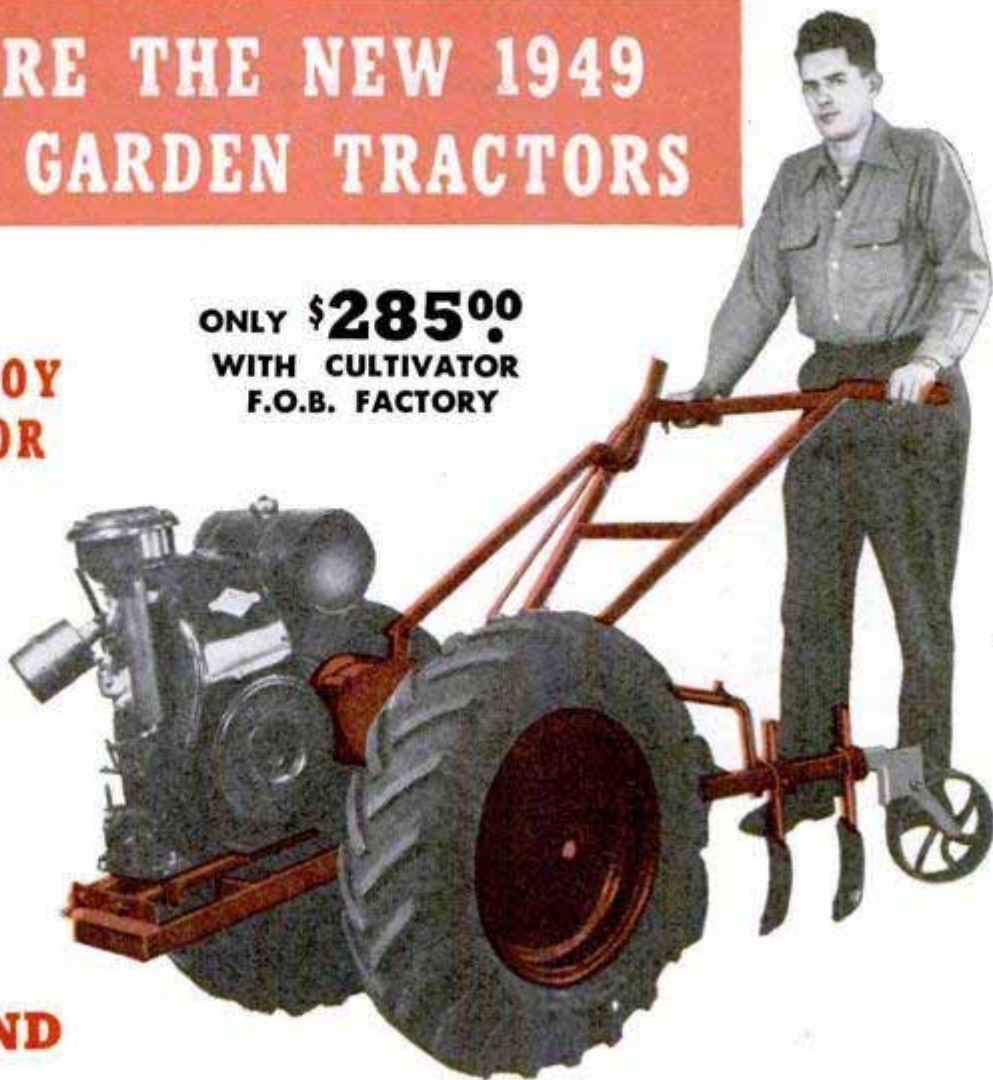

AND

STURDY 1½ TO 2 H. P. MODEL C SPEEDEX GARDEN TRACTOR

At only \$155.00 f.o.b. Factory. It's the Garden Tractor that is famous throughout America for its ease of handling. Also features fully enclosed gears running in oil . . . 5.00 x 12 traction-type tires.



ONLY
\$155⁰⁰
with Cultivator
f.o.b. Factory

Send Penny Postal For New 1949
Full Color Illustrated Folder

SPEEDEX
GARDEN TRACTOR CO.

Box 216-D1 • Ravenna, Ohio

Pacific Coast } 5821 First Ave. So.
Write } Seattle 8, Wash.

P-269-53

DELIVERIES NOW BEING MADE

HERE ARE THE NEW 1949 SPEEDEX GARDEN TRACTORS

RUGGED 6 H.P. SPEEDEX BIG BOY GARDEN TRACTOR

Only \$285.00 f.o.b. factory, complete with six-shovel cultivator and two gauge wheels . . . the greatest bargain in the garden tractor field for taking care of two to five acres. It has fully enclosed gears running in oil . . . 7.50 x 16 traction-type tires . . . easy to handle with power to spare.

ONLY \$285⁰⁰
WITH CULTIVATOR
F.O.B. FACTORY



AND

STURDY 1½ TO 2 H.P. MODEL C SPEEDEX GARDEN TRACTOR

At only \$155.00 f.o.b. Factory. It's the Garden Tractor that is famous throughout America for its ease of handling. Also features fully enclosed gears running in oil . . . 5.00 x 12 traction-type tires.



ONLY
\$155⁰⁰
with Cultivator
f.o.b. Factory

Send Penny Postal For New 1949
Full Color Illustrated Folder

SPEEDEX
GARDEN TRACTOR CO.

Box 216-DI • Ravenna, Ohio

Pacific Coast } 5821 First Ave. So.
Write } Seattle 8, Wash.

P-249-53

DELIVERIES NOW BEING MADE