



# POPULAR MECHANICS

## MAGAZINE

WRITTEN SO YOU CAN UNDERSTAND IT

REG. TRADE MARK, GREAT BRITAIN, No. 410426

REG. U.S. PAT. OFF.



BUILT THIS CABIN FOR \$300"— *Page 89*

WHO EVER HEARD OF DRIVING  
50 MILES FOR A DIME?

TED DID, POP,  
ON A WHIZZER

AT THAT RATE IT COSTS  
ONLY \$10 A YEAR TO RUN

YEP, THAT WHIZZER  
ON TED'S BIKE GETS  
125 MILES ON A GALLON

YOU KNOW, DAD, A WHIZZER  
WOULD BE FUN FOR SCHOOL  
AND ERRANDS

SAY, POP, JUST WHO'S GOING TO GET  
THIS WHIZZER?

FOR THAT MATTER, I SHOULD USE  
A WHIZZER MYSELF, FOR WORK

WELL, I GUESS YOU ARE...  
BUT I'M BORROWING IT  
NOW AND THEN

FOR FUN, FOR THRIFT,  
FOR WORK, IT'S WISE  
TO GO **WHIZZER!**

COMPLETE WITH ALL  
NECESSARY ATTACHMENTS

**\$109<sup>97</sup>**

Federal Tax Included. F. O. B. Pontiac, Mich.

*Fits any man's balloon-tire bike*

*Twist-Grip Controls*

*Steel Cable Core Notched*

*V-belt Drive*

*Rugged 2½ h.p. 4-cycle engine*

*Speeds up to 35 M.P.H.*

*Over 4000 Whizzer Dealers  
coast to coast*

For nearest Whizzer Dealer, call Western Union, ask for Operator 25. For catalogue,  
write WHIZZER MOTOR COMPANY, Pontiac, Michigan.

# Why a Valve in the Head Is Worth Two In the Block

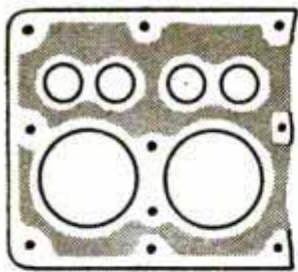

VALVE-IN-BLOCK

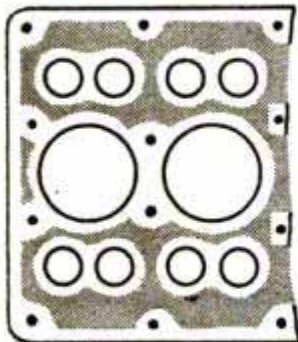

DUAL-VALVE

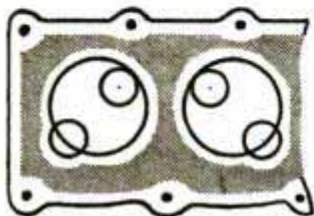

VALVE-IN-HEAD

Dual-valve engines, complicated and costly, develop more power than do single-valve engines of equal bore and stroke—because the greater area of *two* inlet and *two* exhaust valves per cylinder facilitates the flow of fuel mixture and exhaust gases . . . Chevrolet's valve-in-head design gains the same effect, simply and economically, with only *one* inlet and *one* exhaust valve per cylinder—because they open directly into the combustion chamber. That's why it can be said, "*A valve in the head is worth two in the block.*"

Among the most important automotive developments in years are advanced engines that are smaller in displacement yet develop more power than the engines they supplant. Significantly, their manufacturers changed *from* valve-in-block to valve-in-head design as one sure way of achieving increased efficiency—to give

*you more miles per gallon of gasoline.*

Today, six makes of cars have valve-in-head engines, as against four in 1947 and three in 1941 . . . Today, clearly, the trend is to valve-in-head design . . . and today, Chevrolet alone, among cars in its price range, offers motorists the proved economy and efficiency of the valve-in-head engine.



The Fleetline  
De Luxe 4-Door Sedan

## CHEVROLET

The most Beautiful BUY of all

CHEVROLET MOTOR DIVISION, GENERAL MOTORS CORPORATION, DETROIT 2, MICHIGAN

This One



# U.S. ARMY

Part of the Team for Security

Here come the career men and women who make our country strong. They are the regular soldiers of our peacetime Army, marching this Army Day as part of our great security team.

Their lives are productive and richly rewarding. They receive education and training in hundreds of skilled, technical specialties. Financially and job-wise, they have a real future—security as solid as the great Nation they serve.

These are the men and women who protect the peace!



## ARMY DAY - APRIL 6

# Popular Mechanics Magazine

Registered in U. S. Patent Office and Canada

H. H. WINDSOR, *Founder*

H. H. WINDSOR, JR., *Editor and Publisher*

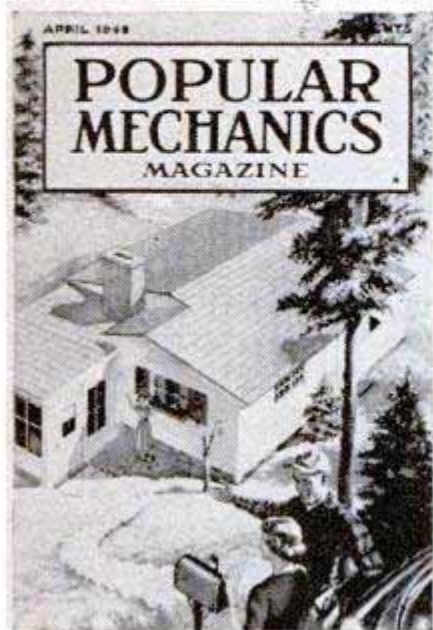

## this month's cover

NEAT AND TRIM as a clipper-ship's deck is the "Eastward Ho"—the seaside cabin shown on this month's cover. We couldn't believe it had been built for only \$300 until Norman E. Chaplin showed us the figures. He fashioned his cottage from stray materials that everyone else deemed useless, and offers the result as Exhibit A in his personal drive for homes for vets. He contends that any young man can build a year 'round home for a few hundred dollars if he has the grit to stay with the job. Apparently, it's not necessarily a youngster's project, as Chaplin is getting along towards 60. Mrs. Chaplin wields a deft trowel in laying up a neat brick wall. Daughter Rosemary dreamed up the cabin's name, which seems to fit the whaling-ship lore of the area. Turn to page 89 to read Chaplin's own story on how he cut a hundred corners to build his amazingly low-cost cabin on a Massachusetts shore.

Published monthly by Popular Mechanics Company, 200 E. Ontario St., Chicago 11, Ill. H. H. Windsor, Jr., president; Paul H. Dunakin, vice president and general manager; D. F. Windsor, vice president and secretary-treasurer; William Harrison Petridge, vice president and assistant to the publisher; Clover L. Perkins, advertising manager; Alan M. Deyoe, circulation manager. Single copy in the United States and Canada, 35 cents; subscription rates in United States and possessions, Canada, Philippines and countries of the Pan-American Postal Union, 1 year, \$3.50; 2 years, \$6.00; 3 years \$8.00. To all other countries add \$1.00 a year over United States prices for overseas postage. If you plan to move, notify us at least 30 days in advance so you will not miss an issue. Give both old and new addresses. Entered as Second Class Matter, September 15, 1903, at the Post Office at Chicago, Illinois, under Act of March 3, 1879. Entered as Second Class Matter at Post Office Dept., Canada. Copyright 1949 by Popular Mechanics Company. Copyright under International Copyright Union. Copyright in France. All rights reserved under Pan-American Copyright Union. Printed in the United States of America.

Volume 91 APRIL 1949 Number 4

Managing Editor.....Roderick M. Grant  
 Assistant Managing Editor.....Wayne Whittaker  
 Shop Notes and Crafts Editor.....James R. Ward  
 Radio-Television, Electronics Editor.....Frank L. Brittin  
 Associate Editor, Aviation.....Aubrey O. Cookman, Jr.  
 Associate Editor.....Clifford B. Hicks  
 Western Editor.....Thomas E. Stimson, Jr.  
 Art Director.....Frank Beatty

### Assistant Editors

Donald R. Brooks      Dorothy E. Hoffmann      Arthur R. Railton

### Assistant Editors, Shop Notes and Crafts

W. Clyde Lamme      Wayne C. Leckey      Frank N. Stephany      A. E. Youngquist

## In This Issue

<b>We Built a Cabin for \$300</b>	- - - -	<b>89</b>
<b>Rolling Out Man-Made Lumber</b>	- -	<b>96</b>
<b>Hobby: Mining Gold</b>	- - - -	<b>100</b>
<b>How to Tempt a Fish—Part I</b>	- - - -	<b>105</b>
<b>Chrysler Family Debut</b>	- - - -	<b>118</b>
<b>Moving Day for the Parabeavers</b>	- -	<b>130</b>
<b>Swing Like a Gate</b>	- - - -	<b>136</b>
<b>Iron Strike in Labrador</b>	- - - -	<b>145</b>
<b>Hollywood Boatman</b>	- - - -	<b>156</b>
<b>Handmade Papers</b>	- - - -	<b>162</b>
<b>Steeplechase Supreme</b>	- - - -	<b>172</b>
<b>Smog Sleuths</b>	- - - -	<b>178</b>

## For the Craftsman

<b>Ivy Balance in Brass</b>	- - - -	<b>186</b>
<b>Attractive Entrance Doors</b>	- - - -	<b>194</b>
<b>Furniture for Your Bedroom—Part III</b>	- -	<b>198</b>
<b>Steps in Concrete</b>	- - - -	<b>205</b>
<b>Take Care of Your Camera</b>	- - - -	<b>215</b>
<b>Portable Bench-Saw Cabinet</b>	- - - -	<b>221</b>
<b>Auto-Brake Servicing</b>	- - - -	<b>225</b>
<b>Tool Up With a Flexible Shaft</b>	- - - -	<b>230</b>
<b>Radio-Television, Electronics</b>	- - - -	<b>237</b>
<b>Clinic for Homemakers</b>	- - - -	<b>248</b>

Other items, and manufacturers of available products described, are listed on pages 8, 10 and 12

# Choose Your "22" From This Great Line-up



## FIRST IN THE FIELD

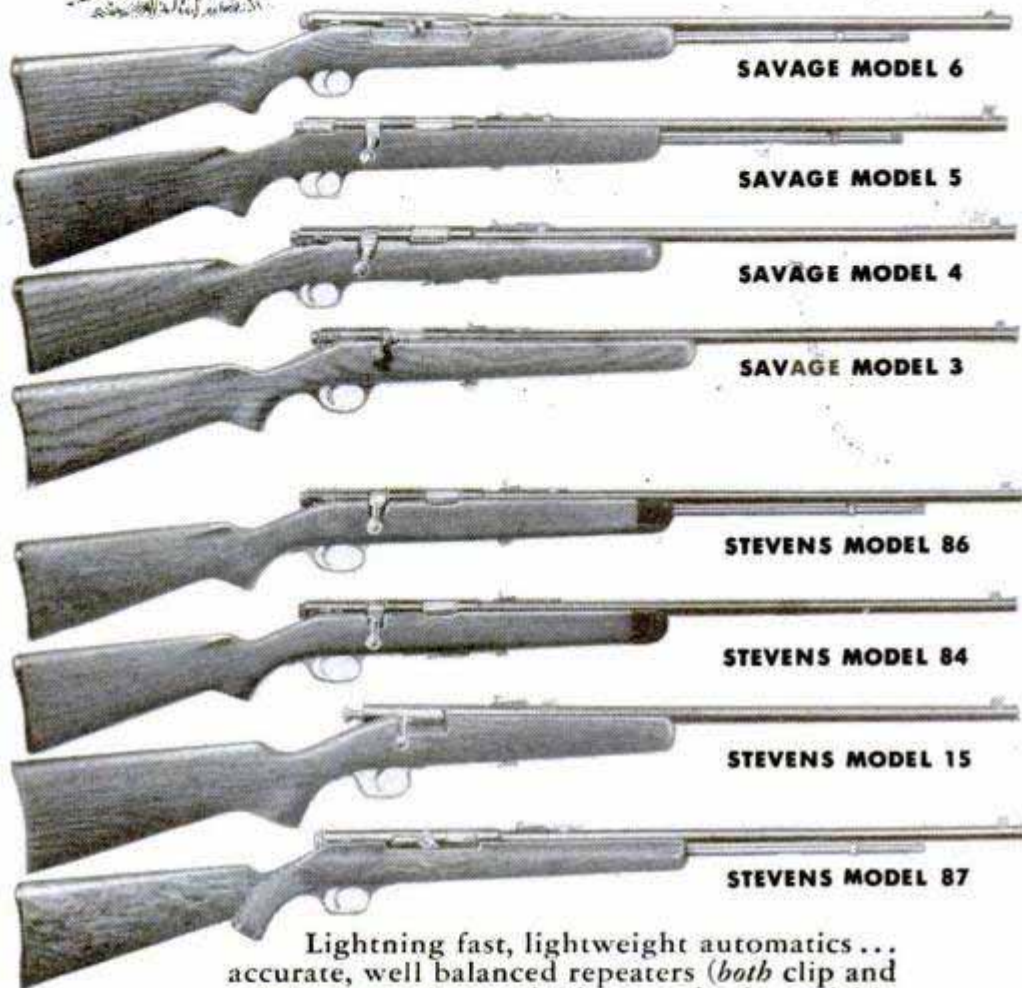

Lightning fast, lightweight automatics... accurate, well balanced repeaters (both clip and tubular magazine models)... sturdy, dependable "single shots". Take your pick and *pick a Savage or Stevens* "22" rifle for highest quality — greatest value. See these models at your dealer's — write for free catalog.

**SAVAGE ARMS CORPORATION**  
Firearms Division      Chicopee Falls, Mass.



### STEVENS .22 Rifles — First in value

**Model 86** — .22 cal. Bolt Action Tubular Magazine Repeating Rifle. Magazine holds fifteen .22 long rifle; seventeen .22 long or twenty-one .22 short cartridges. Military style stock with pistol grip.

**Model 84** — .22 cal. Bolt Action, Clip Magazine Repeating Rifle. Detachable clip holds five .22 long rifle; .22 long or .22 short cartridges. Self-cocking, bolt action. Independent safety.

**Model 15** — .22 cal. Bolt Action, Single Shot Rifle. Chambered for .22 long rifle; .22 long or .22 short cartridges. The lowest priced lightweight "22" in the field.

**Model 87** — Semi-Automatic .22 cal. Rifle. Shoots 15 shots as fast as trigger can be pulled. Also, instantly adjustable as single shot or bolt action repeater, shooting .22 long rifle; .22 long or .22 short cartridges.

Stevens Models 86S - 84S - 87S; same as above with No. 150 Micro Peep Sight with Hooded Front Sight illustrated above.

### SAVAGE .22 Rifles — First in quality

**Model 6** — .22 cal. Auto-Loading Rifle — shoots fifteen long rifle cartridges as fast as you can pull the trigger. Also, instantly adjustable as bolt action repeater; shooting .22 long rifle; .22 long or .22 short cartridges.

**Model 5** — .22 cal. Bolt Action Tubular Magazine Repeating Rifle. Magazine capacity — fifteen .22 long rifle; seventeen .22 long or twenty-one .22 short cartridges.

**Model 4** — .22 cal. Bolt Action 5-shot Clip Magazine Rifle. Chambered for .22 long rifle; .22 long or .22 short cartridges. Stock and forestock of walnut.

**Model 3** — .22 cal. Single Shot Bolt Action Rifle. Shoots .22 long rifle; .22 long or .22 short cartridges, regular or high speed. Positive safety. Walnut stock and forestock.

Savage Models 6S - 5S - 4S - 3S; same with No. 150 Micro Peep Sight with Hooded Front Sight illustrated and described above.

**MAN-SIZED STOCKS**  
Stocks and forestocks of Savage and Stevens "22" rifles are full size, attractively finished, and properly proportioned for steady holding.



**No. 150 MICRO PEEP SIGHT with HOODED FRONT SIGHT**  
Micrometer elevation and windage adjustment. Precision built. Helps build top marksmanship.

**TENITE**  
The beautiful, durable, service-proven gunstock material — permits custom stock features and appearance on guns priced with the lowest. Now available on the Stevens model 87 (illus. at left) as well as other Stevens rifles and shotguns.

# 48%

## **GREATER STARTING POWER**

**Exide-Hycap Batteries** average nearly one and a half times the starting-power standards set by the Society of Automotive Engineers. Why all that extra power? And what does it mean to you? It means surer starts, faster starts, and enough reserve power for all the other storage battery needs of your car.

More than that, Exide-Hycap Batteries average 81% longer life than S.A.E.

requirements. And battery life is one of the measuring rods that determine battery cost... proving that an Exide-Hycap is a profitable and economical battery investment.

When you buy a battery, buy starting assurance. *Remember*, a single starting failure can be far more costly than the little extra you pay for a trustworthy Exide-Hycap Battery.

**1888... DEPENDABLE BATTERIES FOR 61 YEARS... 1949**

*"Exide" and "Hycap" Reg. Trade-marks U.S. Pat. Off.*

**THE ELECTRIC STORAGE BATTERY COMPANY, Philadelphia 32**

*Exide Batteries of Canada, Limited, Toronto*



# Hooray! 2-SPEED BIKING IS BACK!



This unit  
does the trick

Now, without buying a new brake, you can give your present bike 2-speed operation. With a flick of your finger lever, you can slip from low to high—**LOW GEAR** for quicker getaway and easier pedaling on hills, **HIGH GEAR** for swift sailing on the level stretches.

Ask your bicycle dealer about installing the New Departure 2-Speed conversion unit. Learn how simple it is to have the slickest bike in town!

## New Departure

### COASTER BRAKES



**FREE!** Mystify your friends! Guess their ages; read their minds. Send postcard for Magic Packet P. Address

NEW DEPARTURE • DIVISION GENERAL MOTORS  
BRISTOL, CONN.

in this corner.....

## THE EDITORS



**T**HIS PICTURE means Stop! Look and Listen! to every reader. Not merely because it brings the exciting news that next month we present a new *Popular Mechanics* Build-It-Yourself House—but because there is nothing in the world that interests a reader more than his home.

Away back in 1933 we published plans for a \$700 home with four rooms and a lot of charm. Nobody knows how many thousands of these homes have been built by our readers, but today letters still come pretty regularly asking for the blueprints. We read with a nostalgic sigh the opening of that story in 1933: "Present low prices of materials make it possible for you to build this warm, livable four-room house for 700 dollars."

After the war we came to the aid of distressed home-hunters again, designing the now famous *Popular Mechanics* Build-It-Yourself House which a young veteran, under our guidance, built for himself. After this house appeared in April 1947, we followed with blueprints and a richly illustrated how-to-build-it book that has been read by over 50,000 home-hungry persons.

In this issue, the opening article shows a summer home built by a New Englander for \$300; it is full of money-saving ideas.

But look at what's coming! The new house which will make its debut in the May issue may well be the most sensational of our growing family of houses. The materials for this five-room home, complete with built-in kitchen cabinets, laundry and heating plant, cost less than \$3650! The exterior is of concrete blocks, stuccoed; the floor is concrete, with a vapor seal and insulation. Step-by-step drawings and photographs show its construction from vacant lot to lived-in home. It's attractive outside, spacious and homey within. Don't miss the new PM Build-It-Yourself Concrete-Block House in May.



# Become an EXPERT ACCOUNTANT

## through LASALLE'S PROBLEM METHOD

WHAT is the LaSalle Problem Method of acquiring Higher Accountancy Training?

Certainly not the dull routine associated with ordinary study—not "book-learning" in the theoretical sense.

Under the Problem Method each week you are given an important accounting principle—then shown how the principle is applied. You are given a problem and its solution. After you fully understand the principle and its application, you are then given a problem which you work out for yourself and send in to LaSalle. Your solution is returned to you with comments. If it has not been properly solved you are shown your error and the correct method.

The entire procedure is practically first-hand personal experience gained by you direct from capable accountancy instructors. These men take an interest in you, check your individual needs and work with you step by step as you progress.

You study and learn under a tested, proven plan built around the Problem Method. You continuously learn by actually handling important accountancy problems, analyzing, working them out and thinking out your own decisions.

Thus you are coached in the practical solving of the very problems you face in a higher accountancy position. Step by step you work mat-



### More Money—A Better Position

ters out for yourself. At the end of your training, you have real ability and practical experience—the kind which fits you for positions that business is glad to reward with real money.

Don't confuse Accountancy with bookkeeping. The Accountant is the executive, the man who makes the big money—the bookkeeper does only the detail routine jobs at low pay.

You can become an expert accountant through the LaSalle Problem Method without any preliminary knowledge of bookkeeping. You will be given what-

ever review you need. Mail the coupon now for full information.

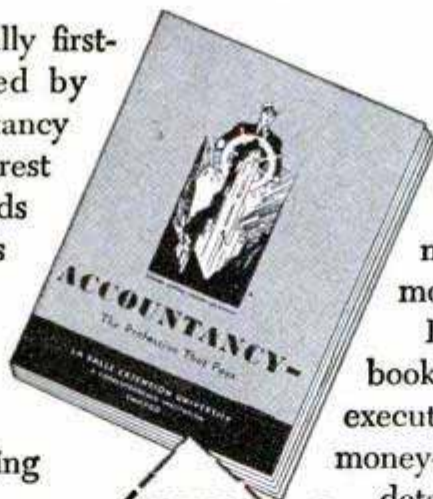

#### FREE ACCOUNTING BOOKLET

Send me, without obligation, your 48-page booklet "Accountancy, the Profession that Pays"—plus "Ten Years' Promotion in One" a book which has helped many men.

GET STARTED NOW

Send for the Facts TODAY!

NAME.....  
 ADDRESS..... AGE.....  
 CITY..... ZONE..... STATE.....

**LASALLE EXTENSION UNIVERSITY**  
 A Correspondence Institution

**Dept. 464-HR**  
 Chicago 5, Ill.

OTHER LASALLE OPPORTUNITIES

- |  |                                     |  |
|--|-------------------------------------|--|
| <input type="checkbox"/> C.P.A. Coaching     | <input type="checkbox"/> Management | <input type="checkbox"/> Stenotypy           |
| <input type="checkbox"/> Bookkeeping         | <input type="checkbox"/> Management | <input type="checkbox"/> (Machine Shorthand) |
| <input type="checkbox"/> Law: LL.B. Degree   | <input type="checkbox"/> For        |  |
| <input type="checkbox"/> Business Management | <input type="checkbox"/> Sales      |  |

# ADD PYROIL TO YOUR MOTOR DIET...

Your car will feel better, act better, run better, and live longer on a Pyroil diet, because Pyroil improves lubrication by coating vital engine parts with a constant, clinging film of oil. This film is your protection against metal-to-metal wear, battery drain and corrosion. Next time you stop for gas or oil, treat your car to Pyroil—and treat yourself to added miles of driving enjoyment.

## Pyroil for Aircraft Engines

Use Aircraft Pyroil B for lubricating oil, Aircraft Pyroil A for gasoline.

### GIVEN!

An attractive Pyroil metal savings bank—takes coins up to 50c pieces—is yours for the asking—sent postage paid.

Manufactured and Guaranteed by Pyroil Company, 90 Pyroil Bldg., La Crosse, Wisconsin.

Canadian Distributors: Central Purchasing Agencies, Ltd. Toronto, Ontario



**PYROIL COMPANY**  
90 Pyroil Bldg., La Crosse, Wisconsin

I want my car to last and run properly. Please tell me more about Pyroil and how it can accomplish this for me.

Name \_\_\_\_\_

Address \_\_\_\_\_

City or Town \_\_\_\_\_ State \_\_\_\_\_



## WHERE-TO-BUY-IT INDEX

Source of supply appears after items commercially available

### AUTOMOTIVE

Lifter handles truck tires (Can Tool Co., Inc., 288 21st St., Oakland 12, Calif.).....	94
Jeep becomes streamlined sedan.....	95
Back-seat clothes rack for car (Hang-All Corp., 333 Halsey St., Newark 2, N. J.).....	95
Homemade automobile.....	95
Twin-torpedo racer.....	125
Auto-dashboard fence (Armstrong Products Co., 204 West Washington St., Milwaukee 4, Wis.).....	128
Jeep adapter kit adds extra wheels (Welliver and Sons, 3203 West State St., Rockford, Ill.).....	128
Perch on auto door keeps pet off laps.....	129
Molding protects car finish.....	135
Scooter-car seats two (Imp Motor Sales, 3829 San Fernando Road, Glendale, Calif.).....	135
Valve cap has built-in tire gauge (U. S. Vitex Sales Products, Box 331, Hollywood 28, Calif.).....	141
Calculator measures lacquer deposits on pistons (The Texas Company, 135 East 42nd St., New York City).....	150
Auto tray.....	154
Garage lift-post jack rolls to job (Blackhawk Mfg. Co., Milwaukee 1, Wis.).....	171

### AVIATION

Flying fire fighters.....	98
Lights on helicopter rotor-blade tips make whirling patterns in the night.....	104
Twin booms distinguish the Anderson Greenwood 14.....	104
Test motor for trips to the moon.....	104
Bed for pilot lessens fatigue.....	125
Mauler flies record weight.....	128
Paint-bombing treetops.....	142
Ambulance with wings.....	154
Plane pitches first ball.....	176

### BOATS

Harbor sweep.....	126
River "paddle boat".....	167
Variable-pitch prop for outboard motor (Propeller Division, Kellogg Marine, Inc., Saugatuck, Conn.).....	177

### FARM

Sugar-beet harvester (International Harvester Co., 180 N. Michigan Ave., Chicago 1).....	95
Bermuda grass roots planter.....	113
Remote control for tractor.....	129
Radio on farm tractor (Tractoradio, Inc., 2305 Pennway Ave., Kansas City 8, Mo.).....	171
Cattle feed from cordwood.....	183

### HOUSE AND HOME

Tiny lens in door "inspects" visitors (Arthur-Lloyd Corp., 1133 Broadway, New York City).....	144
Magnet holds soap high and dry (Urey W. Edger, 4540 W. Broadway, Louisville 11, Ky.).....	150
Cooling unit for bedroom or trailer (Palmer Manufacturing Corp., Phoenix, Ariz.).....	152
Taper lighter for gas heaters (Specialty Manufacturing Co., Inc., Dept. R, 4408 Center, Houston, Tex.).....	152
Bathtub headrest cushioned with sponge rubber (Wallace-Davis Manufacturing Company, 2813 Dixwell Ave., Hamden 14, Conn.).....	152
Ice balls frozen in rubber trays (Ice Cubo Company, 930 Grant St., Box 29, Denver 1, Colo.).....	152
Bottle resealer for soft drinks (Panef Manufacturing Co., Inc., Milwaukee 1, Wis.).....	153
Child "shares" food with plastic puppy (Crest Specialty Products, Inc., 663 W. Washington, Chicago).....	153
Flower planter hangs on wall (Perfection Store Device Company, 637 East 71st St., Chicago 19).....	153
Push-button cooking with electric range (Hotpoint, Inc., 5600 W. Taylor St., Chicago 44).....	153
Needle threader is part of thimble (Magic Thimble, Inc., 22 West 15th St., New York City 11).....	153
Air vent for hot-water heating (Dole Valve Co., 1933 Carroll Ave., Chicago 12).....	170
Light "watchman" (Rjpley Company, Inc., Middletown, Conn.).....	272

### INDUSTRY

Precision-casting process based on wartime technique.....	99
130-mile belt to carry coal and ore.....	114
Mobile betatron.....	116
Getting the cold facts.....	151
Mesh-wire "cocoon" shields radar.....	177
World's largest testing machine.....	184

### LAWN AND GARDEN

Terraced garden grows strawberries.....	135
Seed pellets eliminate thinning (Henry A. Dreer, Inc., 1306 Spring Garden, Philadelphia, Pa.).....	140
Crank-up garden umbrella (Finkel Outdoor Products, Inc., 2534 East 177th St., New York City).....	149

(Continued to page 10)

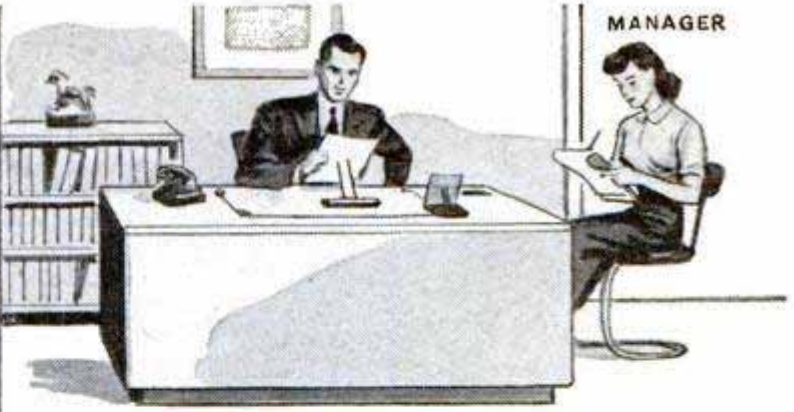
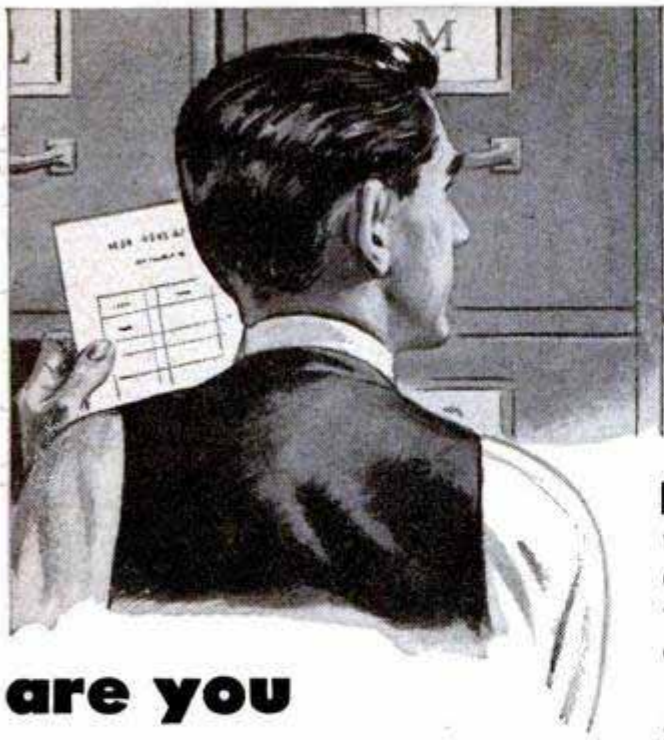

**are you  
SUFFERING  
from  
HIDDEN  
TALENTS?**

Do other people's successes make you feel unimportant? It may be that you've never given yourself a chance. Almost everyone has hidden talents which, when fully developed, open up new and challenging opportunities.

Helping men and women bring out the best that's in them has been the job of I.C.S. for more than 57 years. In every field of industry, you'll find leaders whose skills were developed through study with I.C.S.

They are the ones who sensed a latent ability within themselves—and who proceeded to do something about it. While others (equally gifted, perhaps) plodded along in routine jobs, they mastered I.C.S. courses . . . qualified themselves for rich rewards.

You can develop your hidden talents the same way they did. Start today and be ready for tomorrow's opportunities. Here's the coupon to mail:

**INTERNATIONAL CORRESPONDENCE SCHOOLS**



**BOX 5649-K, SCRANTON 9, PENNA.**

Without cost or obligation, please send me full particulars about the course BEFORE which I have marked X:

- |   |  |  |   |  |
|---|--|--|---|--|
| <p><b>Business and Academic Courses</b></p> <ul style="list-style-type: none"> <li><input type="checkbox"/> Accounting</li> <li><input type="checkbox"/> Bookkeeping</li> <li><input type="checkbox"/> Business Administration</li> <li><input type="checkbox"/> Business Correspondence</li> <li><input type="checkbox"/> Certified Public Accounting</li> <li><input type="checkbox"/> Commercial</li> <li><input type="checkbox"/> Commercial Art</li> <li><input type="checkbox"/> Cost Accounting</li> <li><input type="checkbox"/> Federal Tax</li> <li><input type="checkbox"/> First Year College</li> <li><input type="checkbox"/> Foremanship</li> <li><input type="checkbox"/> Good English</li> <li><input type="checkbox"/> Higher Mathematics</li> <li><input type="checkbox"/> Motor Traffic</li> <li><input type="checkbox"/> Retailing</li> <li><input type="checkbox"/> Retail Store Management</li> <li><input type="checkbox"/> Salesmanship</li> <li><input type="checkbox"/> Sign Lettering</li> <li><input type="checkbox"/> Spanish</li> <li><input type="checkbox"/> Traffic Management</li> </ul> <p><b>Air Conditioning and Plumbing Courses</b></p> <ul style="list-style-type: none"> <li><input type="checkbox"/> Air Conditioning</li> <li><input type="checkbox"/> Heating</li> <li><input type="checkbox"/> Refrigeration</li> </ul> | <p><b>Chemistry Courses</b></p> <ul style="list-style-type: none"> <li><input type="checkbox"/> Chemical Engineering</li> <li><input type="checkbox"/> Chemistry, Analytical</li> <li><input type="checkbox"/> Chemistry, Industrial</li> <li><input type="checkbox"/> Chemistry, Mfg. Iron &amp; Steel</li> <li><input type="checkbox"/> Petroleum Refining</li> <li><input type="checkbox"/> Pulp and Paper Making</li> </ul> <p><b>Civil Engineering, Architectural and Mining Courses</b></p> <ul style="list-style-type: none"> <li><input type="checkbox"/> Architecture</li> <li><input type="checkbox"/> Architectural Drafting</li> <li><input type="checkbox"/> Building Estimating</li> <li><input type="checkbox"/> Civil Engineering</li> <li><input type="checkbox"/> Contracting and Building</li> <li><input type="checkbox"/> Highway Engineering</li> <li><input type="checkbox"/> Lumber Dealer</li> <li><input type="checkbox"/> Reading Structural Blueprints</li> <li><input type="checkbox"/> Sanitary Engineering</li> <li><input type="checkbox"/> Structural Drafting</li> <li><input type="checkbox"/> Structural Engineering</li> <li><input type="checkbox"/> Surveying and Mapping</li> </ul> <p><b>Communications Courses</b></p> <ul style="list-style-type: none"> <li><input type="checkbox"/> Electronics</li> <li><input type="checkbox"/> Practical Telephony</li> <li><input type="checkbox"/> Radio, General</li> <li><input type="checkbox"/> Radio Servicing</li> </ul> | <p><b>Electrical Courses</b></p> <ul style="list-style-type: none"> <li><input type="checkbox"/> Electrical Drafting</li> <li><input type="checkbox"/> Electrical Engineering</li> <li><input type="checkbox"/> Electric Light and Power</li> <li><input type="checkbox"/> Lighting Technician</li> <li><input type="checkbox"/> Practical Electrician</li> <li><input type="checkbox"/> Power House Electric</li> <li><input type="checkbox"/> Ship Electrician</li> </ul> <p><b>Internal Combustion Engines Courses</b></p> <ul style="list-style-type: none"> <li><input type="checkbox"/> Auto Technician</li> <li><input type="checkbox"/> Diesel-Electric</li> <li><input type="checkbox"/> Diesel Engines</li> </ul> <p><b>Mechanical Courses</b></p> <ul style="list-style-type: none"> <li><input type="checkbox"/> Aeronautical Engineer's, Jr.</li> <li><input type="checkbox"/> Aircraft Drafting</li> <li><input type="checkbox"/> Forging</li> <li><input type="checkbox"/> Heat Treatment of Metals</li> <li><input type="checkbox"/> Industrial Engineering</li> <li><input type="checkbox"/> Industrial Metallurgy</li> <li><input type="checkbox"/> Machine Shop</li> <li><input type="checkbox"/> Machine Shop Inspection</li> <li><input type="checkbox"/> Mechanical Drafting</li> <li><input type="checkbox"/> Mechanical Engineering</li> </ul> | <p><b>Telegraph Engineering</b></p> <ul style="list-style-type: none"> <li><input type="checkbox"/> Telegraph Engineering</li> </ul> <p><b>Plastics</b></p> <ul style="list-style-type: none"> <li><input type="checkbox"/> Plastics</li> </ul> <p><b>Aviation</b></p> <ul style="list-style-type: none"> <li><input type="checkbox"/> Aviation</li> <li><input type="checkbox"/> Gas Engines</li> </ul> <p><b>Foundry Work</b></p> <ul style="list-style-type: none"> <li><input type="checkbox"/> Foundry Work</li> </ul> | <p><b>Ship Fitting</b></p> <ul style="list-style-type: none"> <li><input type="checkbox"/> Ship Fitting</li> <li><input type="checkbox"/> Toolmaking</li> </ul> <p><b>Railroad Courses</b></p> <ul style="list-style-type: none"> <li><input type="checkbox"/> Air Brake</li> <li><input type="checkbox"/> Diesel Locomotive</li> <li><input type="checkbox"/> Locomotive Engineer</li> <li><input type="checkbox"/> Locomotive Fireman</li> <li><input type="checkbox"/> Locomotive Machinist</li> <li><input type="checkbox"/> Railroad Section Foreman</li> </ul> <p><b>Steam Engineering Courses</b></p> <ul style="list-style-type: none"> <li><input type="checkbox"/> Boilermaking</li> <li><input type="checkbox"/> Combustion Engineering</li> <li><input type="checkbox"/> Engine Running</li> <li><input type="checkbox"/> Marine Engineering</li> <li><input type="checkbox"/> Steam Electric</li> <li><input type="checkbox"/> Steam Engineer</li> </ul> <p><b>Textile Courses</b></p> <ul style="list-style-type: none"> <li><input type="checkbox"/> Cotton Manufacturing</li> <li><input type="checkbox"/> Loom Fixing</li> <li><input type="checkbox"/> Rayon Weaving</li> <li><input type="checkbox"/> Textile Designing</li> <li><input type="checkbox"/> Woolen Manufacturing</li> </ul> |
|---|--|--|---|--|

Name \_\_\_\_\_ Age \_\_\_\_\_ Home Address \_\_\_\_\_

City \_\_\_\_\_ State \_\_\_\_\_ Working Hours \_\_\_\_\_ A.M. to \_\_\_\_\_ P.M.

Present Position \_\_\_\_\_ Employed by \_\_\_\_\_

Length of Service in World War II \_\_\_\_\_

Special tuition rates to members of the Armed Forces. Enrollment under G.I. Bill and P.L. 16 approved for World War II Veterans. Canadian residents send coupon to International Correspondence Schools Canadian, Ltd., Montreal, Canada.

OFFICE

Infrared rays erase recording disks (The Sound Scriber Corp., New Haven 4, Conn.).....113  
 Disk holds 30 minutes of dictation (Thomas A. Edison, Inc., West Orange, N. J.).....117  
 Electric stapling machine (National Business Systems, Inc., 8 South St., Baltimore 2, Md.).....135

OUTDOOR RECREATION

Sport caps with pockets (Westbrook Hats, Inc., 721-23 Broadway, New York City 3).....113  
 Reel indicates water depth (The Depthometer Co., Box 1466, South Bend, Ind.).....117  
 Nontwist reversing lure (Grayle Specialties, 5457 N. Paulina, Chicago 40).....141  
 Waxing iron for skis (Mission Metalcrafters, Inc., Box 658, Santa Barbara, Calif.).....149  
 Lunch box serves as table (Abercrombie & Fitch Co., 19 East 45th St., New York City).....167  
 Feeder tees golf balls (Fonkin Mfg. Co., 435 W. Palmer Ave., Glendale, Calif.).....171

PHOTOGRAPHY

Two-minute camera (P D Q Camera Co., 1161 N. Cleveland Ave., Chicago 10).....124  
 Shoulder holder steadies camera (Mr. Lyman B. Burnam, RFD 1, Box 110, Clarkston, Wash.).....140  
 Twin-light floodlight unit (James H. Smith & Sons Corp., Griffith, Ind.).....176

TOOLS

High-speed saw blade (U. S. Steel Corp. Subsidiaries, 429 Fourth Ave., Pittsburgh 19, Pa.).....94  
 Gun saw cuts rubber or steel (Transa, Inc., Gateway Bldg., Minneapolis 1, Minn.).....124  
 High-speed wood bit (Rex Laboratories, 1717 Gent Ave., Indianapolis 2, Ind.).....140  
 Dispenser for dry-wall sealing tape (Superior Drywall Applicator, 107 North Hydraulic, Wichita 7, Kans.).....141  
 Internal pipe wrench (Roddick Tool Company, Costa Mesa, Calif.).....150  
 Machine shop unfolds from truck (Couse Manufacturing, Inc., 300 Passaic St., Newark 4, N. J.).....161  
 Portable saw cuts tile (Anaheim Machine Works, 125 S. Clementine St., Anaheim, Calif.).....167  
 Spring winder (Crown Manufacturing Co., 1025 North Sixth St., St. Louis 1, Mo.).....170  
 Table saw converted into horizontal drill.....184

TOYS AND NOVELTIES

Kite-string "carrier" frees planes at 3000 feet (World Sales, Inc., 3220 W. Broad St., Columbus 4, Ohio).....116  
 Embossing plastic (Miracle Adhesives Corp., 214 East 53rd St., New York City 22).....150  
 Monkeys carved from peach stones.....176

MISCELLANEOUS

Ultrasonic therapy.....94  
 "Shrinking" truck dumps load (R. G. LeTourneau, Inc., Peoria, Ill.).....99  
 Cranes lift house and carry it away.....103  
 Street planer (Spears-Wells Machinery Co., 1832 West Ninth St., Oakland 7, Calif.).....103  
 Valve meters air into water tank (Shasta Pump Co., Oakland 3, Calif.).....117  
 Ruler fits notebook rings (Plastilite Products Company, Pawtucket, R. I.).....141  
 Rolling luggage (Carson Pirie Scott & Co., State & Madison Sts., Chicago).....144  
 Group microscope has 10 eyepieces (Scopicon, 215 E. 149th St., New York City 51).....144  
 Electronic "eye" for street lights.....149  
 Blanket of foam saves truck.....155  
 "Odorproof" cage tests sense of smell.....161  
 Taking down the screens above dam in Germany.....166  
 Hen tracks on sound tracks.....168  
 Self-righting life jacket.....170  
 Deposit box has combination lock (Johnson Manufacturing Co., 1338 W. Garvey Ave., Monterey Park, Calif.).....176

Craftsman and Shop Notes Index

AUTOMOTIVE

Checking cylinder wear.....224  
 Homemade car-parts washer agitated by compressed air.....236  
 Antifreeze drained without loss.....236

FARM

Cloth cover protects seedlings.....192  
 Concrete cover for shallow well cuts cost by saving tile.....196  
 Combination dibble and marker spaces plants uniformly.....203  
 Name plate on rural mailbox lettered with thumbtacks.....214  
 Sickle sections mounted on hoe adapt it for rocky soil.....224  
 Tether attached to long pole does not wrap around post.....224  
 Roosting on fountain discouraged by suspended barrel hoop.....228  
 Combination sweeper-sifter for poultry yards.....229  
 Concrete feed troughs made by molding in earth forms.....229  
 Grain sacks stenciled easily.....236  
 Sunken nail keg holds pail to feed young calf.....236  
 Half gate in farm fence ideal for occasional use.....236

(Continued to page 12)

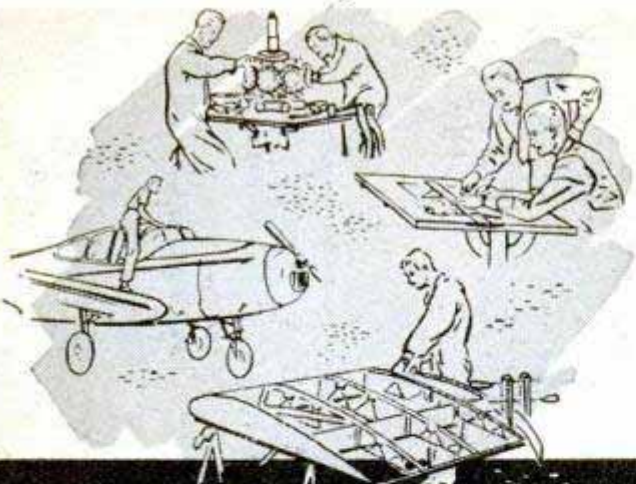

# HERE IS YOUR JOB in AVIATION

We have hundreds of urgent requests for Embry-Riddle ground and flight graduates -- many times the graduates we had available could have been placed in the last 3 months. Never has there been such opportunity for you in aviation. Begin your career now. A few short months at Embry-Riddle and you're ready for a good job with best pay.

EMBRY-RIDDLE OFFERS

Complete training in minimum time for A&E Mechanics and all fundamental flight, specialist and technical positions • Modern airline-size hangars, classrooms, shops and airplanes • Experience gained over a quarter-century of aviation training • Living facilities on the airport.

INDUSTRY NEEDS

Mechanics, technicians, specialists, engineers, pilots -- many, many more men than all aviation schools together can supply. The shortage of trained personnel is becoming more acute. Get in on the ground floor... Embry-Riddle students are spoken for well ahead of graduation. Don't delay. Write for proof of job opportunities TODAY. Begin your aviation career at Embry-Riddle NOW.



AUTHORIZED  
G. I.  
TRAINING

Dean of Enrollments - Dept. 99  
Embry-Riddle School of Aviation  
Miami 30, Florida

Please Print

NAME \_\_\_\_\_

ADDRESS \_\_\_\_\_

City \_\_\_\_\_

State \_\_\_\_\_ Age \_\_\_\_\_

I am interested in...

- A.&E. Mechanic
- Commercial Pilot
- Engineering
- A.&E. Combined with Commercial Pilot
- Flying Mechanic
- Drafting & Design

Check One  Veteran  Non-Veteran

**TRAIN IN MIAMI -- AIR CAPITAL OF THE WORLD**

**AUDELS CARPENTERS & BUILDERS GUIDES—(4 Book Set).....\$6**

A practical illustrated trade assistant on modern construction for carpenters, joiners, builders, mechanics and all woodworkers. 4 vols., 1600 pages, 3700 illustrations. Fully indexed, flexible covers. Each volume sold separately \$1.50 a vol.

**AUDELS PLUMBERS & STEAMFITTERS GUIDES—(4 Book Set).....\$6**

A Practical Trade Assistant & Ready Reference. Explains in plain language & by clear illustrations, diagrams, charts, graphs, pictures principles of modern plumbing practice including Marine Pipe Fitting and Air Conditioning. 4 Vols.—1670 Pages—3642 Diagrams & Illustrations. Each Vol. Sold Separately \$1.50 a Vol.

**AUDELS OIL BURNER GUIDE.....\$1**

384 Pages Covering Installation, Servicing & Repairs All Types Domestic & Industrial Burners. Illustrated. Highly Endorsed.

**AUDELS HOUSE HEATING GUIDE.....\$4**

1000 Pages Covering Working Principles, Installation, Service of All Modern House Heating, Ventilating & Air Conditioning Systems. Explains New Radiant Heating. Fully Illustrated & Indexed.

**AUDELS REFRIGERATION & AIR CONDITIONING GUIDE.....\$4**

New from Cover to Cover—1280 Pages, Fully Illus. Covering basic principles, servicing, operation & repair of household, commercial & industrial refrigeration & air conditioning. A gold mine of essential important facts for engineers, servicemen, users.

**AUDELS SHEETMETAL WORKERS HANDY BOOK.....\$1**

Practical inside information. Fundamentals of Sheet Metal Work. 388 pages. Illustrated. 11 sections. Clearly written. Essential & important facts, figures, pointers in everyday language. Ref. Index.

**AUDELS SHEETMETAL PATTERN LAYOUTS.....\$4**

Developed by Experts for Sheet Metal Workers, Layout Men & Mechanics. A Practical Encyclopedia in 10 Sections, size 7 x 10 x 2—1125 Pages—350 Layouts—1600 Illustrations. 1001 Key Facts. Fully indexed for ready reference in answering your layout problems. Covers all phases of sheet metal work including Pattern Cutting, Pattern Development & Shop Procedure.

**AUDELS BLUE PRINT READING.....\$2**

For Mechanics & Builders. Covers all types of blue print reading including ship & airplane. 416 pages, fully illustrated.

**AUDELS MATHEMATICS & CALCULATIONS FOR MECHANICS \$2**

Mathematics for home study or reference. 700 pages, 550 illus. Practical mathematics from beginning. How to figure correctly. Easy, correct methods covering complete review. Illus. & Indexed.

**AUDELS AUTOMOBILE GUIDE.....\$4**

A practical quick ready reference book for auto mechanics, service men, operators & owners. Explains theory, construction & servicing of modern motor cars, trucks, buses & auto type Diesel engines. 1700 pages, fully illustrated. 55 chapters. Indexed. A standard book for mechanics. New Hydraulic drive covered.

**AUDELS DIESEL ENGINE MANUAL.....\$2**

A practical, concise treatise with questions and answers on the theory, operation and maintenance of modern diesel engines. Over 400 pages, fully illus. All details plainly brought out, this book is of extreme value to engineers, operators & students.

**AUDELS WELDERS GUIDE.....\$1**

A concise, practical text on operation & maintenance of all welding machines for all mechanics. Over 400 pages, illustrated. Covers all methods of electric and acetylene welding including airplane work.

**AUDELS MACHINIST & TOOLMAKERS HANDY BOOK.....\$4**

Covers modern machine shop practice in all its branches. Tells how to set up & operate lathes, screw and milling machines, shapers, drill presses & all other machine & hand tools. 1600 pages, fully illustrated. Indexed. 5 sections. 1—Modern Machine Shop Practice. 2—Blue Print Reading & How to Draw. 3—Calculations & Mathematics for Machinists. 4—Shop Physics. 5—How to Use the Slide Rule. 60 chapters. Easy to read and understand. A shop companion that answers your questions.

**AUDELS ELECTRIC MOTOR GUIDE \$4**

Practical Information Covering Construction, Control, Maintenance & Wiring Hookups of All Types Electric Motors also Armature Winding. 1000 Pages Fully Illustrated & Indexed.

**AUDELS ELEC. WIRING DIAGRAMS \$1**

210 Pages. Illustrated. Gives practical facts on wiring of electrical apparatus. It shows clearly how to wire apparatus for practically all fields of electricity. Each diagram is complete & self-explanatory. Highly Endorsed Pocket Companion.

**AUDELS PRACTICAL ELECTRICITY \$4**

A key to a practical understanding of Electricity. For maintenance engineers, electricians & all electrical workers. 1440 Pages, 2600 Illus. Covers important electrical information in handy form—including wiring for Light & Power. Indexed.

**AUDELS RADIOMANS GUIDE.....\$4**

A key to the practical understanding of radio including Frequency Modulation, Television, etc., Aircraft & Marine Radio. For radio engineers, servicemen, amateurs, 914 Pages, 633 Illustrations & Diagrams. Photos. Review Questions & Answers. Reference Index.

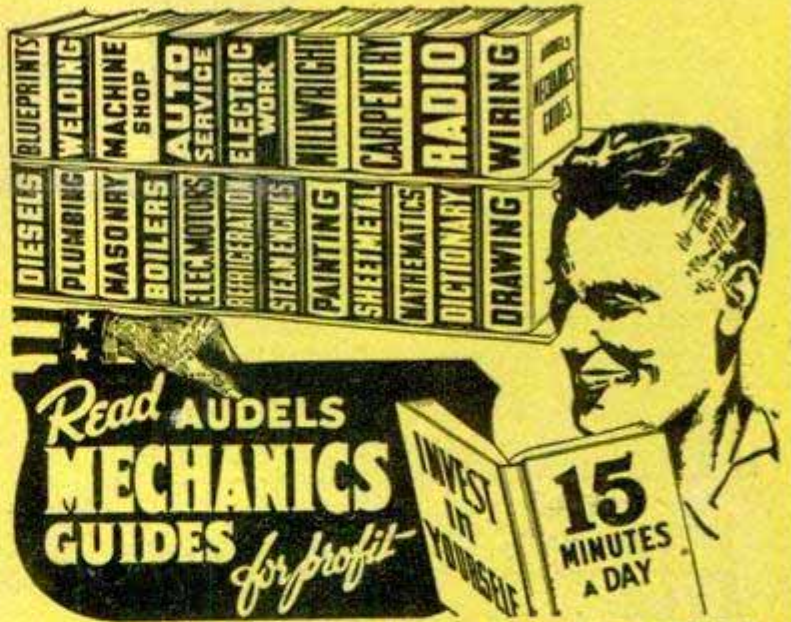

**AN AUDEL GUIDE IS A GOOD FRIEND!**

Step Up Your Own Skill with the Practical Facts and Figures of Your Trade. Save time and money with right methods, short cuts, labor saving ideas. CHECK NOW! You can look over any Audel Guide in your home. Start the Easy Payments if satisfied.

**CUT HERE MAIL ORDER**

AUDEL, Publishers, 49 W. 23 St., New York 10, N. Y.

Please mail me for 7 days' free examination the books marked (X) below. I agree to mail \$1 in 7 days on each book or set ordered, and to further mail \$1 a month on each book or set ordered until I have paid the purchase price. If I am not satisfied with Guides I will return them.

- AUTOMOBILE GUIDE, 1700 Pages . . . . . \$4
  - DIESEL ENGINE MANUAL, 400 Pages . . . . . 2
  - WELDERS GUIDE, 400 Pages . . . . . 1
  - CARPENTERS & Builders Guides (4 Book Set) . . . . . 6
  - PLUMBERS & Steamfitters Guides (4 Book Set) . . . . . 6
  - MASONS and Builders Guides (4 Book Set) . . . . . 6
  - BLUE PRINT READING, 416 Pages . . . . . 2
  - MASTER PAINTER & Decorator, 320 Pages . . . . . 2
  - GARDENERS & GROWERS GUIDES (4 Book Set) . . . . . 6
  - OIL BURNER GUIDE, 384 Pages . . . . . 1
  - HOUSE HEATING GUIDE, 1000 Pages . . . . . 4
  - REFRIGERATION & Air Conditioning Guide, 1280 Pages . . . . . 4
  - SHEET METAL WORKERS Handy Book, 388 Pages . . . . . 1
  - SHEET METAL PATTERN LAYOUTS, 1100 Pages . . . . . 4
  - AIRCRAFT WORKER, 240 Pages . . . . . 1
  - MECHANICAL DRAWING GUIDE, 160 Pages . . . . . 1
  - MECHANICAL DRAWING & DESIGN, 480 Pages . . . . . 2
  - MATHEMATICS and CALCULATIONS, 700 Pages . . . . . 2
  - MECHANICAL DICTIONARY, 968 Pages . . . . . 4
  - MACHINISTS & Toolmakers Handy Book, 1600 Pages . . . . . 4
  - MILLWRIGHTS & Mechanics Guide, 1200 Pages . . . . . 4
  - POWER PLANT ENGINEERS GUIDE, 1500 Pages . . . . . 4
  - ENGINEERS & FIREMANS EXAMINATIONS, 528 Pages . . . . . 1
  - PUMPS, HYDRAULICS & Air Compressors, 1658 Pages . . . . . 4
  - MARINE ENGINEERS Handy Book, 1280 Pages . . . . . 4
  - ENGINEERS and Mechanics Guides (8 Book Set) . . . . . 12
  - Answers on Practical ENGINEERING, 254 Pages . . . . . 1
  - ELECTRIC WIRING DIAGRAMS, 210 Pages . . . . . 1
  - ELECTRICIANS EXAMINATIONS, 250 Pages . . . . . 1
  - ELECTRIC DICTIONARY, 9000 Terms . . . . . 2
  - ELECTRIC MOTOR GUIDE, 1000 Pages . . . . . 4
  - PRACTICAL ELECTRICITY Handy Book, 1440 Pages . . . . . 4
  - ELECTRICAL POWER CALCULATIONS, 425 Pages . . . . . 2
  - RADIOMANS GUIDE, 914 Pages . . . . . 4
  - ELECTRONIC DEVICES, 216 Pages . . . . . 2
  - NEW ELECTRIC LIBRARY, 7000 Pages (12 Book Set) . . . . . 18
- Vols. I, II, III, IV, V, VI, VII, VIII, IX, X, XI, XII—\$1.50 Each

Name \_\_\_\_\_

Address \_\_\_\_\_

Occupation \_\_\_\_\_

Employed by \_\_\_\_\_

**AUDEL, Publishers, 49 W. 23 St., N. Y. 10**



# ME—in a Rut? —COULD BE!

YES—you may be in a rut—just getting by—and not fully realizing it.

Every day you stay in that rut you "dig deeper"—make it harder and harder to get out.

So today while you think of it, take stock of yourself—are you getting ahead as fast as you should—are you satisfied to go along in a small job at small pay the rest of your life?

Hundreds of thousands of our students have won promotion and more money—and the prestige and happiness that success brings—perhaps we can help you.

Better investigate—the coupon below is for your convenience. Just check the field of your choice and we'll send you without obligation full information on that field—the requirements and opportunities—plus "Ten Years' Promotion in One"—a book which has helped many men.

Take the first step to get out of that rut—make more money—get a better job.

**LASALLE Extension University**  
A Correspondence Institution  
Dept. 464-R Chicago 5, Ill.

**LASALLE Extension University**  
A Correspondence Institution

417 S. Dearborn St., Dept. 464-R, Chicago 5, Ill.

If I am in a rut, I don't want to stay in it. Please send me your free 48-page booklet on the field I have marked below and full information about your spare-time training.

- |   |   |
|---|---|
| <input type="checkbox"/> Higher Accountancy | <input type="checkbox"/> Business Management              |
| <input type="checkbox"/> C. P. A. Coaching  | <input type="checkbox"/> Traffic Management               |
| <input type="checkbox"/> Bookkeeping        | <input type="checkbox"/> Foremanship                      |
| <input type="checkbox"/> Law: LL. B. Degree | <input type="checkbox"/> Industrial Management            |
| <input type="checkbox"/> Salesmanship       | <input type="checkbox"/> Stenotypy<br>(Machine Shorthand) |

Name ..... Age .....

Address .....

City ..... Zone..... State.....

(Continued from page 10)

## HOUSE AND HOME

Solving home problems.....	190
Folding towel rack for kitchen or bathroom.....	193
Combination drier and utility shelf installed in waste corner space.....	193
Burned-out fluorescent tubes form novel porch trellis.....	196
Improvised pendant switch.....	201
Controlling flush-tank ball valve.....	203
Weatherproofing summer cottages.....	204
Ornamenting driveway gateposts.....	204
Flower trellis from porch gate is set up in a jiffy.....	212
Dog tethered to swivel post.....	212

## JIGS, MACHINES AND TOOLS

Plywood backing aids cutting plastic with magnetic scrollsaw.....	189
Easily made calculating scale speeds figuring dimensions.....	192
Plastic insert for jigsaw table.....	192
Home-workshop arbor press utilizes bottle capper.....	204
Record album holds saw blades for convenient storage.....	212
Rubber tubing on tip of file provides finger grip.....	212
Pulley cuts glazing putty.....	214
Tap serves as center punch.....	214
Accuracy of carpenter's level easily checked on any flat surface.....	223
Eraser starts nut in recess.....	228
Levels attached to yardstick aid sign painter.....	228
Graduated jig permits quick setup to bandsaw circles of various sizes.....	229
Trammels made from drill rod also used as beam compass.....	235
Increasing range of lathe milling attachment.....	235

## OUTDOOR RECREATION

Air-rifle target held on tree with auto-tire section.....	192
Trolling with outboard motor.....	196
Coffee can serves as camp stove.....	201
Car-top ski rack.....	202
Convenient car-top carrier for long fish pole clamps to drip molding.....	209
Torch for lighting campfires contained in lipstick holder.....	214

## PHOTOGRAPHY

Plywood case protects wide-angle lens from dust and damage.....	219
Condition of flash bulb checked with neon test light.....	220
Opening developer containers.....	220
Reminder for darkroom clock.....	220
Glass rod is substitute funnel.....	220
Alcohol dries sponges quickly.....	220
Tips of tripod legs painted white to minimize accidents.....	220

## SHOP

Scribing parallel lines on cylinder.....	196
Thin-wall tubing sawed quickly.....	201
Tools held on stepladder top by length of wire solder.....	201
Lacquer protects drawings.....	204
Staples hold sign cloth taut and are easy to remove.....	204
Metal "bridge" locks file drawer in large drafting table.....	224
Sash balance weights sheet metal when soldering seam.....	224
Oiling ball-valve fittings.....	224
Tire section provides tag rack.....	228
Modeling clay cleans pencil.....	228

## TOYS AND NOVELTIES

Lamps fantastic.....	197
Running water piped up tree trunk supplies hanging bird-bath and feeder.....	209
This toy "steam shovel" really digs.....	210

## WOODWORKING

Appropriate book ends for the home workshop.....	189
Round-cornered wooden boxes.....	212
Alsatian chairs.....	213

## MISCELLANEOUS

Rubber bands of different sizes cut from inner tube.....	192
Blotter removes decals.....	196
Paint can from cream carton.....	196
Lacing tip for leather thong fashioned from tin can.....	204
Ignition contacts on model airplane provided by dress snaps.....	209
Nonsplash water test tank checks outboard motors.....	214
Watertight expansion joint.....	228

## Radio-Television, Electronics

Portable civilian transceiver (Citizen's Radio Corp., Cleveland, Ohio).....	237
Low-cost 2-tube progressive beginner's set—unit No. 2.....	238
Sight and sound today ("Tele-Zoom" TV picture enlarger, Garod Radio Corp., 70 Washington St., Brooklyn 1, N. Y.; portable TV receiver, Motorola Inc., 4545 Augusta Blvd., Chicago 51; new RCA record player and records, RCA Victor Division, Camden, N. J.).....	240

**IMPORTANT NOTICE**—It is the intention of this magazine to provide its readers with information regarding the latest developments in the mechanical arts. We take no responsibility as to whether the disclosures contained in our articles are covered by patents and advise readers to investigate this subject before making, using, or selling any of the products, machines, or processes described in order to avoid possible liability for patent infringements.

**YOU PRACTICE** Radio Soldering with Soldering Equipment and Radio Parts I send you. Get practical experience mounting and connecting parts.



**YOU BUILD** this Tester with parts N. R. I. sends early in the course. Soon helps you fix neighbors' Radios and **EARN EXTRA MONEY** in spare time.

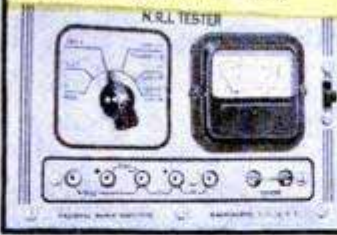

**YOU TEST** Radio circuits like this built with parts I send. Build special circuits; learn how to locate and repair circuit defects.

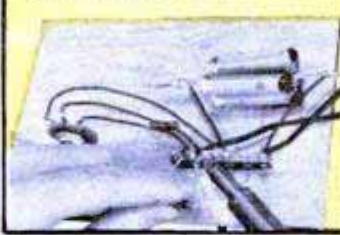

**YOU BUILD** Vacuum Tube Power Pack; make changes which give you experience with packs of many kinds. Learn how to correct Power Pack troubles.

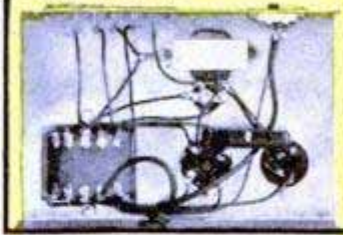

**YOU BUILD** this A. M. Signal Generator for more valuable experience. It provides amplitude-modulated signals for many tests and experiments.



**YOU PRACTICE FM** (Frequency Modulation) experiments, get more experience with this Superheterodyne Receiver Circuit you build with parts I send.



**I SEND MANY KITS to Give You Valuable PRACTICAL EXPERIENCE**

**YOU BUILD THIS** complete, powerful Radio Receiver that brings in local and distant stations. N. R. I. gives you ALL the Radio parts . . . speaker, tubes, chassis, transformer, sockets, loop antenna, etc.

# LEARN RADIO-TELEVISION

**AT HOME IN SPARE TIME**

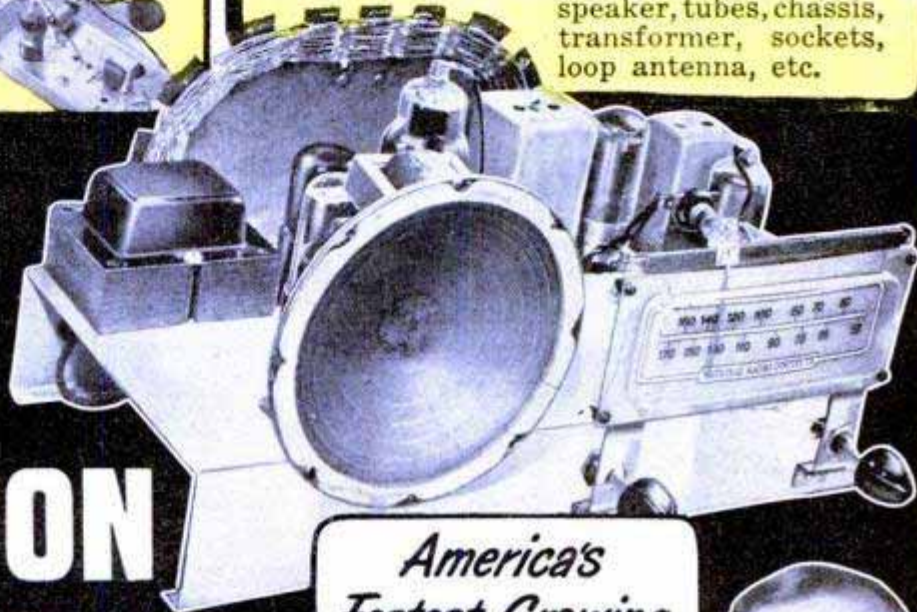

Want a good-pay job in the fast-growing RADIO-TELEVISION Industry? Want a money-making Radio-Television shop of your own? I've trained hundreds of men to be Radio Technicians. My tested train-at-home method makes learning easy. Learn Radio-Television principles from illustrated lessons. Get practical experience with **MANY KITS OF PARTS** I send. All equipment yours to keep.

**Make EXTRA MONEY In Spare Time**

The day you enroll I start sending **SPECIAL BOOKLETS** that show you how to make \$5, \$10 and more a week **EXTRA MONEY** fixing neighbors' Radios in spare time. From here it's a short step to your own shop or a good-pay Radio-Television servicing job. Or get into Police, Aviation, Marine Radio, Broadcasting, etc. Think of opportunities in the booming Television Industry.

**See What N. R. I. Can Do For You**

Mail coupon for **FREE** lesson and 64-page book, "HOW TO BE A SUCCESS IN RADIO AND TELEVISION-ELECTRONICS." Tells how quickly, easily you can get started. Send coupon in envelope or paste on penny postal. J. E. SMITH, President, Dept. 9DP, National Radio Institute, Pioneer Home Study Radio School, Washington 9, D. C.

**I TRAINED THESE MEN AT HOME**



**Has His Own Radio Business**

"Now servicing about 200 sets a month. Have largest service establishment in S. E. Missouri." — **ARLEY STUYVIN**, DeSoto, Missouri.



**\$15 A Week In Spare Time**

"For the past five years I have averaged \$15 and up a week in my spare time." — **STANLEY GENTON**, Cincinnati, Ohio.

*America's Fastest-Growing Industry Offers You*  
**GOOD PAY, SUCCESS, A BRIGHT FUTURE**



**GET BOTH 64 PAGE BOOK SAMPLE LESSON FREE**

MR. J. E. SMITH, President, Dept. 9DP  
NATIONAL RADIO INSTITUTE, Washington 9, D. C.  
Mail me Sample Lesson and 64-page book **FREE**.  
(No salesman will call. Please write plainly.)

Name.....Age.....  
Address.....  
City.....Zone.....State.....  
 Check if Veteran



# VETERANS

**GET THIS TRAINING WITHOUT COST UNDER G. I. BILL**

**APPROVED FOR TRAINING UNDER GI BILL**

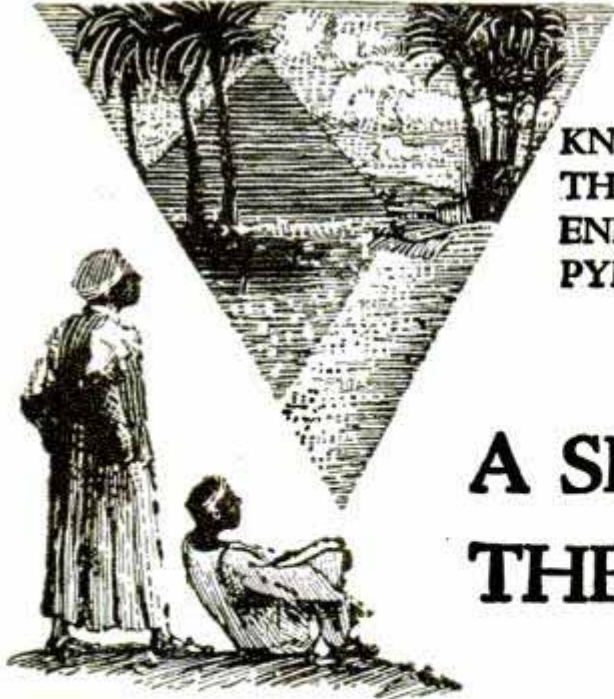

**KNOWLEDGE  
THAT HAS  
ENDURED WITH THE  
PYRAMIDS**

## **A SECRET METHOD FOR THE MASTERY OF LIFE**

**W**HENCE came the knowledge that built the Pyramids and the mighty Temples of the Pharaohs? Civilization began in the Nile Valley centuries ago. Where did its first builders acquire their astounding wisdom that started man on his upward climb? Beginning with naught they overcame nature's forces and gave the world its first sciences and arts. Did their knowledge come from a race now submerged beneath the sea, or were they touched with Infinite inspiration? From what concealed source came the wisdom that produced such characters as Amenhotep IV, Leonardo da Vinci, Isaac Newton, and a host of others? Today it is known that they discovered and learned to interpret certain *Secret Methods* for the development of their inner power of mind. They learned to command the inner forces within their own beings, and to master life. This secret art of living has been preserved and handed down throughout the ages. Today it is extended to those who dare to use its profound principles to meet and solve the problems of life in these complex times.

### **This Sealed Book—FREE**

Has life brought you that personal satisfaction, the sense of achievement and happiness that you desire? If not, it is your duty to yourself to learn about this rational method of applying natural laws for the mastery of life. To the thoughtful person it is obvious that everyone cannot be entrusted with an intimate knowledge of the mysteries of life, for everyone is not capable of properly using it. But if you are one of those possessed of a true desire to forge ahead and wish to make use of the subtle influences of life, the Rosicrucians (not a religious organization) will send you *A Sealed Book* of explanation without obligation. This *Sealed Book* tells how you, in the privacy of your own home, without interference with your personal affairs or manner of living, may receive these secret teachings. Not weird or strange practices, but a rational application of the basic laws of life. Use the coupon, and obtain your complimentary copy.

## **The ROSICRUCIANS**

**SAN JOSE (AMORC) CALIFORNIA**



**AMENHOTEP IV**  
Founder of Egypt's  
Mystery Schools

*Use this  
coupon for  
FREE  
copy of book*

-----  
SCRIBE H. N. X.  
The Rosicrucians (AMORC)  
San Jose, California

Please send free copy of *Sealed Book*,  
which I shall read as directed.

NAME.....

ADDRESS.....

CITY.....





# INVENTORS



Learn how to protect your invention. The U. S. Patent Laws provide that any new and useful art, machine, article of manufacture, or composition of matter, or any new and useful improvement thereof, may be patented if the act of invention is involved. Therefore, every inventor with a valuable invention should take advantage of the Patent Laws and proceed for patent protection in order to safeguard his rights.

A patent gives the inventor the exclusive right to prevent others from making, using, or selling the invention claimed in the patent for a period of seventeen years.

The Patent Laws were enacted for the benefit of the inventor to give him protection for the features of his invention which are patentable. These features must be properly and concisely set forth and claimed in a formal application for patent, in order to comply with the requirements of the Patent Laws. For that reason, unless the inventor is familiar with patent matters, he should engage a competent registered patent attorney or agent to represent him. We are registered to practice before the U. S. Patent Office and are prepared to serve you in the handling of your patent matters.

A specially prepared booklet entitled "Patent Guide for the Inventor", containing detailed information with respect to patent protection and procedure, together with a "Record of Invention" form will be promptly forwarded to you without obligation upon request.

## CLARENCE A. O'BRIEN & HARVEY JACOBSON

*Registered Patent Attorneys*

91-D DISTRICT NATIONAL BUILDING • WASHINGTON 5, D. C.

*Patents*  
*Trademarks*  
*Copyrights*

CLARENCE A. O'BRIEN & HARVEY JACOBSON  
Registered Patent Attorneys

91-D District National Bldg., Washington 5, D.C.  
Please send me copy of "Patent Guide for the Inventor" and also "Record of Invention" form. This request does not obligate me.

Name \_\_\_\_\_

Address \_\_\_\_\_

City \_\_\_\_\_ State \_\_\_\_\_

(Please write or print plainly.)

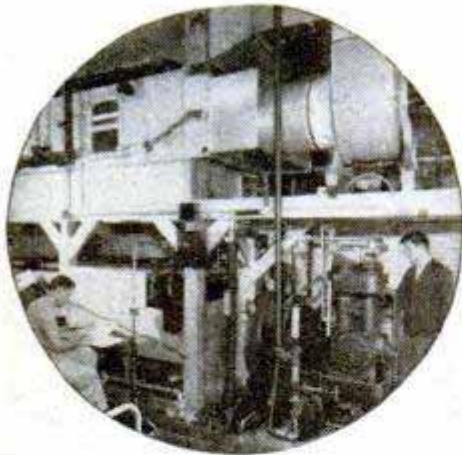

## Prepare Now For a Career in Refrigeration, Heating, Air Conditioning

In 6 months to 2 years you can train for a substantial career in industry, or a business of your own. Under the unique concentric curriculum at the Milwaukee School of Engineering each course unit is complete in itself and prepares you for specific occupational objectives. The length of training you receive varies with the goal you wish to reach. Over 1500 students from 48 states and 18 foreign countries are now enrolled. Faculty of 85 specialists. 35,000 former students in industry all over the world.

**Choose the Course That Interests You Most YOU CAN BECOME A—**

- Refrigeration Serviceman in 6 months
- Refrigeration and Heating Serviceman in 12 months
- Refrigeration, Heating and Air Conditioning Technician in 2 years

Terms Start April, July, September

### OTHER COURSES AVAILABLE

SERVICE	TECHNICIAN	PROFESSIONAL
6 to 12 Months	1 to 2 Years	3 Years
<ul style="list-style-type: none"> <li>• Electricity</li> <li>• Welding</li> <li>• Refrigeration</li> <li>• Heating</li> </ul>	<ul style="list-style-type: none"> <li>• Electrotechnics (Power)</li> <li>• Radio and Television</li> <li>• Electronics</li> <li>• Refrig., Heating and Air Cond.</li> </ul>	<ul style="list-style-type: none"> <li>• Electrical Engineering Bachelor of Science Degree</li> <li>• Major in Electronics or Power</li> </ul>

## MILWAUKEE SCHOOL of ENGINEERING



A Technical Institute Founded 1903 by Oscar Werwath

MILWAUKEE SCHOOL OF ENGINEERING, Dept. PM-449, N. Broadway and E. State, Milwaukee, Wis. Without obligation send me free booklet "Career Building" and more details on course in Refrigeration, Heating and Air Conditioning or \_\_\_\_\_ course.

Name \_\_\_\_\_ Age \_\_\_\_\_  
 Address \_\_\_\_\_  
 City \_\_\_\_\_ Zone \_\_\_\_\_ State \_\_\_\_\_

# FREE HOBBY BOOK

For MEN and BOYS TELLS HOW TO LEARN TO MOUNT BIRDS



and animals, fish, pets, and all game. Learn to TAN SKINS with wonderful Krome-Tan. Simple as ABC. Many earn big PROFITS in spare time mounting for others. Great FUN. Wild game not needed. Over 500,000 students since 1903. RUSH postal TODAY for STRANGE BOOK, over 100 game pictures. FREE. No obligation. State AGEI N. W. School of Taxidermy, 2504 Elwood Bldg., Omaha 2, Neb.

## WHY DON'T YOU WRITE?

Writing short stories, articles on business, homemaking, travel, gardening, shop crafts, local and club activities, etc., will enable you to earn extra money. In your own home, on your own time, the New York Copy Desk Method teaches you how to write the way newspaper men learn—by writing. Our unique "Writing Aptitude Test" tells whether you possess the fundamental qualities essential to successful writing. You'll enjoy this test. Write for it, without cost or obligation.

**Veterans: This course approved for Veterans' Training.**  
**NEWSPAPER INSTITUTE OF AMERICA**  
 SUITE 5599-D, ONE PARK AVENUE NEW YORK 16, N. Y.

## MAKE MONEY IN LANDSCAPING



Thorough training by Internationally known Landscape Architect to start your own business, improve your home or advance in this well paid field. Many Opportunities. Approved for Veterans. Send for FREE BOOK.

**NATIONAL LANDSCAPE INSTITUTE**  
 Dept. P-4, 310 So. Robertson Los Angeles 36, Calif.

### AT LAST—Modeling in Leather

No tools needed! Pre-cut and shaped leather parts, when cemented, sanded, and colored, become authentic 3-dimensional solid genuine leather models. Send check or money order Today! Choose 3 Geese as wall ornaments or Duck or Dog on pen stand or ash tray. **3.00** prepaid



Leathersmiths' Inc Dept M106 Water St N.Y. 5

## NEW YORK SCHOOL of MECHANICAL DENTISTRY

SINCE 1920—The outstanding Training Center for all phases of Dental Laboratory Technology. Licensed by New York and New Jersey States. Approved for Veterans G.I. BILL & P.L. 16. Visitors Welcome. Ask for Free Bulletin "P."  
**NEW YORK SCHOOL OF MECHANICAL DENTISTRY**  
*America's Oldest School of Dental Technology*  
 138 Washington Street . . . . . NEWARK 2, NEW JERSEY  
 Also: 125 W. 31 Street . . . . . NEW YORK 1, N. Y.  
 Immediate Enrollment — Day and Evening

## STRENGTHEN Your VOICE!

YES—you can now build yourself a powerful speaking and singing voice with this amazing new scientifically sound tested method. Self-training . . . no music or piano required. Results GUARANTEED. Just send your name for the sensational details. FREE chart of your vocal mechanism included!  
 PERFECT VOICE STUDIOS, Studio D-10, Kimball Hall Building, Chicago 4, Ill.

### SAY YOU SAW IT IN POPULAR MECHANICS

## An ASSURED FUTURE for You Learn Profitable WATCH REPAIRING

**BIG MONEY WHILE LEARNING**  
**Study at Home — or at Our Accredited School**  
 Complete Home Correspondence Course or G. I. Approved Residence School Plan. Also, Post-Graduate Plan at school for correspondence students.

Write Today for COMPLETE DETAILS to **American Institute of Specialized Watch Repair**  
 Dept. No. 100 270-76 East Building Grand Rapids, Michigan

# INVENTORS

Patent laws encourage the development of inventions.

We recommend that an inventor employ a registered Patent Attorney or agent, if the inventor is not familiar with patent matters. This is because the value of a patent depends largely upon the skillful preparation of the specification and claims in the patent application.

The firm of McMorrow, Berman and Davidson is registered to practice before the United States Patent Office. Additionally it engages patent attorneys able to readily understand inventors' disclosures, to advise concerning patentability, and to prepare appropriate specifications and claims.

If an inventor believes he has an invention, a search of the most pertinent prior U. S. patents should be made and a report obtained relative to its patentability. Where such report indicates that the invention appears patentable, in order to secure protection, diligence should be exercised in making application for a patent.

Send for a copy of Patent Booklet entitled "How To Protect Your Invention." This booklet contains information on patent protection and procedure. You will also receive an "Invention Record" blank. This will be promptly forwarded to you upon request—no obligation.

## McMORROW, BERMAN & DAVIDSON

*Registered Patent Attorneys*

PATENTS • TRADE MARKS • COPYRIGHTS

135-Y VICTOR BUILDING, WASHINGTON 1, D. C.

### McMORROW, BERMAN & DAVIDSON

*Registered Patent Attorneys*

135-Y Victor Building, Washington 1, D. C.

Send me your Patent Booklet, "How To Protect Your Invention", and also "Invention Record" form at once. I understand this request does not obligate me.

Name.....

Address.....

City.....

(WRITE OR PRINT NAME CLEARLY)

# Will You Let Me PROVE I Can Make YOU a New Man?

LET ME START SHOWING RESULTS FOR YOU



"Have put 3 1/2 in. on chest." — F. S., New York.



"Recommend you for quick results!" — W. G., N. J.



"Did weigh 141. Now 170." — T. K., N. Y.

I COULD fill this whole magazine with enthusiastic reports from OTHERS. But what you want to know is— "What can Atlas do for ME?"

## 15 MINUTES A DAY

Just give me 15 minutes of your spare time daily. That's all I ask. And even in that short time I'll start giving RESULTS. And it will be the kind of RESULTS that you (and anyone else) can SEE, FEEL, MEASURE with a tape.

## FREE BOOK

I myself was once a 97-pound weakling—sickly, half-alive. Then I discovered "Dynamic Tension." And I won the title, "The World's Most Perfectly Developed Man!"

"Dynamic Tension" has done so much for other fellows that I simply ask you to let me prove that it can make a New Man of YOU—that it can start new inches of power pushing out your chest—build up your shoulders to champion huskiness—put new, hard, firm muscles on your biceps—make those stomach muscles of yours hard ridges!

Why not risk a postage stamp? Send coupon for my 48-page illustrated FREE BOOK AT ONCE! Address me personally: Charles Atlas, Dept. 8R, 115 East 23rd Street, New York 10, N. Y.



CHARLES ATLAS, Dept. 8R,  
115 East 23rd Street, New York 10, N. Y.

I want the proof that your system of "Dynamic Tension" will help make a New Man of me—give me a healthy, husky body and big muscle development. Send me your free book, "Everlasting Health and Strength."

Name \_\_\_\_\_ Age \_\_\_\_\_  
(Please print or write plainly)  
Address \_\_\_\_\_  
City \_\_\_\_\_ State \_\_\_\_\_

Say You Saw It in Popular Mechanics

Electricity From THE FREE WIND WITH 6 VOLT WINCHARGER From Factory to You

**WORLD FAMED WINCHARGER WIND DRIVEN ELECTRIC GENERATOR**

Now use the FREE WIND to generate electricity for cottages, fishing camps, farms etc. for lights, radio, charge car and tractor batteries or electric outboard batteries. No fuel to buy. The wind does the work. Nearly 500,000 in use from the Arctic to the Sahara. 6 volt model #617 including 5 ft. roof mounting tower, 6 ft. propeller, generator and complete instruction book. (less battery) only **\$49.95**

Big value that can pay for itself. Satisfaction guaranteed or your money back. Free literature upon request. Send check or money order to:

DEPT. P  
WINCHARGER CORPORATION  
SIOUX CITY & IOWA

**FOR BIG MEN ONLY!**

SHOES IN SIZES 10 to 16

We specialize in large sizes only—sizes 10 to 16; widths AAA to EEE. Wing Tips, Loafers, Moccasins, Hand Woven Oxfords, Dress Oxfords, High Dress Shoes, Work Shoes, Sox. Styling specially designed for large sizes. Satisfaction guaranteed. Sold by mail only. Write now for FREE Catalog.

Write For FREE CATALOG KING-SIZE Inc., 850, Brockton, Mass.

**NEW! LOW COST! RESPIRATOR**

Wear when sanding, grinding, paint spraying, sweeping, dusting, furnace cleaning, etc. Handy as a pair of glasses. Just keep mouth closed and breathe through nose is all you do to operate. Protects against nuisance dusts, lint, coal, cement, grain dust, hay fever pollen. Has 9 sq. in. filter. For EYE protection against paint spray, dusts, gases, fumes, smoke, order our Fog-Proof Rubber GOGGLES. \$2.00 p.p.

JERRY BRYANT, Dept. PM  
919 N. Michigan Ave. Chicago 11, Ill.

Order Today \$1.00 POST PAID

**REAL ESTATE BE A BROKER**

PAYS BIG! SEND FOR FREE, BIG, ILLUSTRATED CATALOG NOW! No obligation. Graduates report making substantial incomes. Start and run your own business quickly. Men, women of all ages, learn easily. Course covers Sales, Property Management, Appraising, Loans, Mortgages, and related subjects. STUDY AT HOME or in our classrooms in big cities. Diploma awarded. G.I. approved. Nationally known.

WEAVER SCHOOL OF REAL ESTATE (Est. 1936)  
15 E. Pershing Road Dept. PM-4, Kansas City, Mo.

FREE BOOK TELLS HOW

FREE MRS. BERRY'S POULTRY BOOK

BABY CHICKS or STARTER. Champion-Mated, Licensed-Inspected, B.W.D. TESTED. 52 BREEDS, 6 HYBRIDS. Sexed or straight. Mature fowls, Hatching Eggs and Remedies. LOW PRICES. The ORIGINAL Berry's Farm—over 50 years' service. LARGE BEAUTIFUL BOOK FREE. Stamps appreciated.

BERRY POULTRY FARM, Box 29, CLARINDA, IOWA

"LEARN-BY-DOING"

NATION'S LARGEST EXCLUSIVE ELECTRICAL SCHOOL

**ELECTRICITY**

PRACTICAL TRAINING NOT "HOME STUDY"

G.I. APPROVED Get actual experience in great shops of M.T.I. Learn all phases Practical Electricity; Housewiring, Motors, Const., Maintenance, etc. Living arrangements, Part-time jobs, etc.

Send coupon TODAY.

MICHIGAN TECHNICAL INSTITUTE  Veteran  
2281 W. Fort St., Detroit, Mich., Dept. PM-4

Name \_\_\_\_\_  
Street \_\_\_\_\_  
City \_\_\_\_\_ State \_\_\_\_\_



# VETERAN'S CHOICE

More than 400 I. C. S. Courses are available to Veterans entitled to benefits under the G.I. Bill of Rights.

Here's your chance to start a program of Personal Advancement—through training. You select your own course, study in your spare time, progress as fast as your ability and ambition permit.

Each I. C. S. Course is a gateway to a profitable, exciting field. Each is authoritative, practical, easy to understand.

The time for action is *now*. Remember, Veteran Training is a limited offer. For most Veterans, July 25, 1951, is the deadline. The time to get started is now! Mark and mail the coupon today! It brings full details on how to enroll.



## INTERNATIONAL CORRESPONDENCE SCHOOLS



BOX 5650-K, SCRANTON 9, PENNA.

Without cost or obligation, please send me full particulars about the course BEFORE which I have marked X;

- |  |   |   |  |
|--|---|---|--|
| <p><b>Air Conditioning and Plumbing Courses</b></p> <ul style="list-style-type: none"> <li><input type="checkbox"/> Air Conditioning</li> <li><input type="checkbox"/> Heating</li> <li><input type="checkbox"/> Refrigeration</li> </ul> <p><b>Chemistry Courses</b></p> <ul style="list-style-type: none"> <li><input type="checkbox"/> Chemical Engineering</li> <li><input type="checkbox"/> Chemistry, Analytical</li> <li><input type="checkbox"/> Chemistry, Industrial</li> <li><input type="checkbox"/> Chemistry, Mfg. Iron &amp; Steel</li> <li><input type="checkbox"/> Petroleum Refining</li> <li><input type="checkbox"/> Pulp and Paper Making</li> </ul> <p><b>Civil Engineering, Architectural and Mining Courses</b></p> <ul style="list-style-type: none"> <li><input type="checkbox"/> Architecture</li> <li><input type="checkbox"/> Architectural Drafting</li> <li><input type="checkbox"/> Bridge and Building Foreman</li> <li><input type="checkbox"/> Building Estimating</li> <li><input type="checkbox"/> Civil Engineering</li> <li><input type="checkbox"/> Coal Mining</li> <li><input type="checkbox"/> Contracting and Building</li> <li><input type="checkbox"/> Highway Engineering</li> <li><input type="checkbox"/> Lumber Dealer</li> <li><input type="checkbox"/> Reading Structural Blueprints</li> <li><input type="checkbox"/> Sanitary Engineering</li> <li><input type="checkbox"/> Structural Drafting</li> </ul> | <ul style="list-style-type: none"> <li><input type="checkbox"/> Plumbing</li> <li><input type="checkbox"/> Steam Fitting</li> <li><input type="checkbox"/> Electronics</li> <li><input type="checkbox"/> Practical Telephony</li> <li><input type="checkbox"/> Radio, General</li> <li><input type="checkbox"/> Radio Operating</li> <li><input type="checkbox"/> Radio Servicing</li> <li><input type="checkbox"/> Telegraph Engineering</li> </ul> <p><b>Electrical Courses</b></p> <ul style="list-style-type: none"> <li><input type="checkbox"/> Electrical Drafting</li> <li><input type="checkbox"/> Electrical Engineering</li> <li><input type="checkbox"/> Electric Light and Power</li> <li><input type="checkbox"/> Lighting Technician</li> <li><input type="checkbox"/> Practical Electrician</li> </ul> <p><b>Internal Combustion Engines Courses</b></p> <ul style="list-style-type: none"> <li><input type="checkbox"/> Auto Technician</li> <li><input type="checkbox"/> Diesel-Electric</li> <li><input type="checkbox"/> Diesel Engines</li> </ul> <p><b>Mechanical Courses</b></p> <ul style="list-style-type: none"> <li><input type="checkbox"/> Aeronautical Engineer's, Jr.</li> <li><input type="checkbox"/> Aircraft Drafting</li> <li><input type="checkbox"/> Forging</li> <li><input type="checkbox"/> Heat Treatment of Metals</li> <li><input type="checkbox"/> Industrial Engineering</li> </ul> | <ul style="list-style-type: none"> <li><input type="checkbox"/> Structural Engineering</li> <li><input type="checkbox"/> Surveying and Mapping</li> </ul> <p><b>Communications Courses</b></p> <ul style="list-style-type: none"> <li><input type="checkbox"/> Aviation</li> <li><input type="checkbox"/> Gas Engines</li> <li><input type="checkbox"/> Flight Engineer</li> <li><input type="checkbox"/> Foundry Work</li> </ul> <p><b>Structural Engineering</b></p> <ul style="list-style-type: none"> <li><input type="checkbox"/> Machine Shop</li> <li><input type="checkbox"/> Mechanical Drafting</li> <li><input type="checkbox"/> Mechanical Engineering</li> <li><input type="checkbox"/> Mold-Loft Work</li> <li><input type="checkbox"/> Patternmaking—Wood, Metal</li> <li><input type="checkbox"/> Reading Shop Blueprints</li> <li><input type="checkbox"/> Sheet-Metal Drafting</li> <li><input type="checkbox"/> Sheet-Metal Worker</li> <li><input type="checkbox"/> Ship Drafting</li> <li><input type="checkbox"/> Tool Designing</li> <li><input type="checkbox"/> Welding Engineering</li> <li><input type="checkbox"/> Welding—Gas and Electric</li> </ul> <p><b>Railroad Courses</b></p> <ul style="list-style-type: none"> <li><input type="checkbox"/> Air Brake</li> <li><input type="checkbox"/> Diesel Locomotive</li> <li><input type="checkbox"/> Locomotive Engineer</li> <li><input type="checkbox"/> Locomotive Fireman</li> <li><input type="checkbox"/> Locomotive Machinist</li> <li><input type="checkbox"/> Railroad Section Foreman</li> </ul> <p><b>Steam Engineering Courses</b></p> <ul style="list-style-type: none"> <li><input type="checkbox"/> Boilermaking</li> <li><input type="checkbox"/> Combustion Engineering</li> <li><input type="checkbox"/> Engine Running</li> <li><input type="checkbox"/> Marine Engineering</li> <li><input type="checkbox"/> Steam Electric</li> </ul> | <ul style="list-style-type: none"> <li><input type="checkbox"/> Industrial Metallurgy</li> <li><input type="checkbox"/> Mechanical Drafting</li> <li><input type="checkbox"/> Mechanical Engineering</li> <li><input type="checkbox"/> Mold-Loft Work</li> <li><input type="checkbox"/> Patternmaking—Wood, Metal</li> <li><input type="checkbox"/> Reading Shop Blueprints</li> <li><input type="checkbox"/> Sheet-Metal Drafting</li> <li><input type="checkbox"/> Sheet-Metal Worker</li> <li><input type="checkbox"/> Ship Drafting</li> <li><input type="checkbox"/> Tool Designing</li> <li><input type="checkbox"/> Welding Engineering</li> <li><input type="checkbox"/> Welding—Gas and Electric</li> <li><input type="checkbox"/> Car Inspector</li> </ul> <p><b>Textile Courses</b></p> <ul style="list-style-type: none"> <li><input type="checkbox"/> Cotton Manufacturing</li> <li><input type="checkbox"/> Loom Fixing</li> <li><input type="checkbox"/> Textile Designing</li> <li><input type="checkbox"/> Woolen Manufacturing</li> <li><input type="checkbox"/> Rayon Weaving</li> </ul> <p><b>Business and Academic Courses</b></p> <ul style="list-style-type: none"> <li><input type="checkbox"/> Accounting</li> <li><input type="checkbox"/> Bookkeeping</li> <li><input type="checkbox"/> Business Administration</li> <li><input type="checkbox"/> Business Correspondence</li> <li><input type="checkbox"/> Certified Public Accounting</li> <li><input type="checkbox"/> Commercial</li> <li><input type="checkbox"/> Cost Accounting</li> <li><input type="checkbox"/> Federal Tax</li> <li><input type="checkbox"/> Foremanship</li> <li><input type="checkbox"/> Good English</li> <li><input type="checkbox"/> Higher Mathematics</li> <li><input type="checkbox"/> Motor Traffic</li> <li><input type="checkbox"/> Retailing</li> <li><input type="checkbox"/> Retail Store Management</li> <li><input type="checkbox"/> Salesmanship</li> <li><input type="checkbox"/> Sign Lettering</li> <li><input type="checkbox"/> Spanish</li> <li><input type="checkbox"/> Advertising</li> <li><input type="checkbox"/> Commercial Art</li> <li><input type="checkbox"/> Commercial</li> <li><input type="checkbox"/> First Year College</li> <li><input type="checkbox"/> Franch</li> <li><input type="checkbox"/> High School</li> <li><input type="checkbox"/> Postal Civil Service</li> <li><input type="checkbox"/> Secretarial</li> <li><input type="checkbox"/> Stenography</li> <li><input type="checkbox"/> Traffic Management</li> </ul> |
|--|---|---|--|

Name \_\_\_\_\_ Age \_\_\_\_\_ Home Address \_\_\_\_\_

City \_\_\_\_\_ State \_\_\_\_\_ Working Hours \_\_\_\_\_ A.M. to \_\_\_\_\_ P.M.

Present Position \_\_\_\_\_ Employed by \_\_\_\_\_

Length of Service in World War II \_\_\_\_\_

Special tuition rates to members of the Armed Forces. Enrollment under G.I. Bill and P.L. 16 approved for World War II Veterans. Canadian residents send coupon to International Correspondence Schools Canadian, Ltd., Montreal, Canada.

# PATENT PROTECTION FOR INVENTORS

A patent is a valuable right. On the basis of a constitutional provision Congress has established a system under which inventors may secure the exclusive right to prevent the unauthorized use, manufacture and sale of their inventions for periods of seventeen years. The inventor secures this protection by obtaining a patent.

Unless an inventor is thoroughly familiar with such matters, he is advised to employ a competent registered patent attorney, as the value of patents depends largely upon the skillful preparation of the specification and claims.

We recommend that you authorize us to conduct a search through the United States patents pertinent to your invention and to submit a report setting forth our opinion with respect to its patentability.

This firm is registered to practice before the U. S. Patent Office and is available to assist inventors in the preparation and prosecution of their cases. Detailed information and the preliminary steps to take to obtain patent protection will be furnished upon request. *Form below for mailing convenience.*

**VICTOR J. EVANS & CO. • *Merlin M. Evans***  
REGISTERED PATENT ATTORNEY  
430-D MERLIN BUILDING, WASHINGTON 6, D. C.

**VICTOR J. EVANS & CO. • *Merlin M. Evans***  
*Registered Patent Attorney*  
430-D Merlin Building, Washington 6, D. C.

*Please send me without obligation a copy of your booklet "Patent Protection For Inventors" together with your convenient "Evidence of Invention" form.*

Name.....

Address.....

City and State.....

PATENTS

TRADEMARKS

COPYRIGHTS

POPULAR MECHANICS

# Choose one of these 2 GREAT FIELDS

- Get Ready QUICK at COYNE!

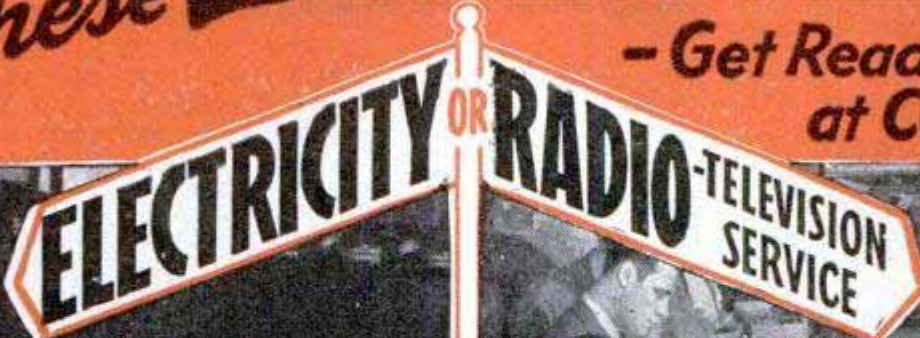

This big fire-proof building is occupied entirely by Coyne.

Prepare for Success Quickly... in the

## GREAT SHOPS OF COYNE

Conditions today are different. Many "one-operation" jobs that pay well will not last. Plan for steady pay and advancement by training NOW. Come to the great shops of COYNE in Chicago, for "all-around" training in Electricity or Radio-Television—the 2 great opportunity fields.

### NOT "HOME-STUDY" COURSES

Our famous "Learn-by-Doing" method gives you practical experience on a massive outlay of equipment. Not by correspondence, but actual shop work plus necessary theory. You are trained right here in the great Coyne shops that has been training men and young men for over 50 years.

### ELECTRICITY RADIO-TELEVISION SERVICE

**INCLUDING INDUSTRIAL ELECTRONICS**  
Big future in Power Plant Work, Motors, Armature Winding, Home and Factory Wiring, Appliances, Refrigeration, Maintenance, Illumination, etc. Electricians are in demand everywhere—lifetime job service to Coyne graduates. Send for BIG FREE BOOK.

A great field now, even greater growth ahead. Here at COYNE you're trained for Construction, Testing, Trouble-Shooting on Radio, Public Address, Sound Picture Units. Training includes FM, Television Servicing, etc. Our training is quick, easy, practical. Many Coyne trained men own well-paying radio businesses of their own.

**LARGEST, OLDEST, BEST EQUIPPED SCHOOL OF ITS KIND IN THE U.S.**

Pick Field You Like  
—Mail Coupon for  
**Big FREE Book**



Whether you prefer Electricity, or Radio, train on actual equipment, at Coyne. We have a big, fully illustrated book on each course, and we'll send you the one you want, without obligation. Mail coupon — TODAY.



### ELECTRIC REFRIGERATION COYNE

Added training in Electrical Refrigeration can now be included.

G. I. APPROVED

NON-VETERANS who are short of cash can finance most of their tuition and pay in easy monthly payments after graduation. Many earn while learning.

B. W. COOKE, President



## COYNE ELECTRICAL AND RADIO SCHOOL

500 So. Paulina Street, Dept. 49-72H, CHICAGO 12, ILL.

B. W. COOKE, President  
COYNE ELECTRICAL AND RADIO SCHOOL  
500 S. Paulina St., Dept. 49-72H, Chicago 12, Ill.

Send me your BIG FREE BOOK — for the course checked below. This does not obligate me and no salesman will call.

ELECTRICITY  RADIO-TELEVISION

NAME.....

ADDRESS.....

CITY..... STATE.....

# Learn this Profitable Profession



**IN 90 DAYS AT HOME**

## Money-Making Career Open to Men and Women, 18 to 50

Hundreds of men and women between 18 and 50 make \$10 to \$20 in a single day giving scientific Swedish Massage and Hydro-Therapy treatments. There is big demand from doctors, hospitals, sanatoriums and clubs. Graduates earn large full time incomes from these or in private practice in their own offices. Others make good money from home treatments given in spare time. Learn this interesting, money-making profession in your own home, through our home study course. Same instructors as in our nationally known resident school. You can win independence and prepare for future security by qualifying for your Diploma. Course can be completed in 3 to 4 months. Many earn while they learn. Begin your training at once.



### Anatomy Charts & Booklet FREE

Enroll now and we will include, at no extra cost, many needed supplies. Fit yourself to help meet growing demand for Scientific Swedish Massage. Send the coupon at once for complete details. Anatomy Charts and 32-Page Illustrated Booklet, FREE, postpaid.

**THE COLLEGE OF SWEDISH MASSAGE**  
Dept. 964D, 41 E. Pearson, Chicago 11, Illinois

Please send me FREE and postpaid, Anatomy Charts, 32-page Booklet and complete details on Home Training.

Name \_\_\_\_\_ Age \_\_\_\_\_

Address \_\_\_\_\_

City \_\_\_\_\_ State \_\_\_\_\_

## AUDELS Carpenters and Builders Guides 4 vols. \$6

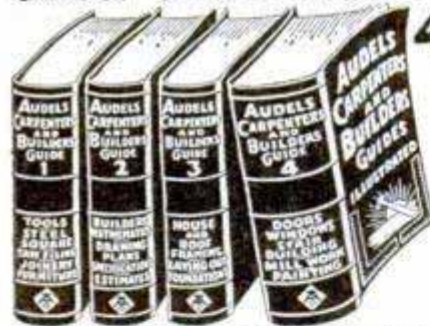

**Inside Trade Information** for Carpenters, Builders, Joiners, Building Mechanics and all Woodworkers. These Guides give you the short-cut instructions that you want—including new methods, ideas, solutions, plans, systems and money saving suggestions. An easy progressive course for the apprentice and student. A practical daily helper and Quick Reference for the master worker. Carpenters everywhere are using these Guides as a Helping Hand to Easier Work, Better Work and Better Pay. To get this assistance for yourself, simply fill in and mail the FREE COUPON below.

How to use the steel square—How to file and set saws—How to build furniture—How to use a mitre box—How to use the chalk line—How to use rules and scales—How to make joints—Carpenters arithmetic—Solving mensuration problems—Estimating strength of timbers—How to set girders and sills—How to frame houses and roofs—How to estimate costs—How to build houses, barns, garages, bungalows, etc.—How to read and draw plans—Drawing up specifications—How to excavate—How to use settings 12, 13 and 17 on the steel square—How to build hoists and scaffolds—skylights—How to build stairs—How to put on interior trim—How to hang doors—How to lay floor—How to paint



**AUDEL, Publishers, 49 W. 23rd St., New York 10, N. Y.**  
Mail Audels Carpenters and Builders Guides, 4 vols., on 7 days free trial. If OK I will remit \$1 in 7 days and \$1 monthly until \$6 is paid. Otherwise I will return them. No obligation unless I am satisfied.

Name \_\_\_\_\_

Address \_\_\_\_\_

Occupation \_\_\_\_\_

Employed by \_\_\_\_\_ PM

## Famous BAILEY TECHNICAL SCHOOLS

OFFER THE FOLLOWING COURSES:  
**PRACTICAL DIESEL ENGINEERING**  
**REFRIGERATION - AIR CONDITIONING**  
**COMMERCIAL ELECTRICITY**  
**RADIO - TELEVISION MECHANICS**

Your future success depends largely on the reputation of the school you attend. Don't take chances! Train at America's foremost school of mechanical specialization. Bailey is recognized and approved by industry. Bailey graduates get the top pay jobs! G.I. Approved. Send for FREE Catalog.

**BAILEY TECHNICAL SCHOOLS**  
1655 So. Grand Blvd., St. Louis, Mo.

## LEARN TO WRITE a Good Hand!

**FOR BUSINESS AND SOCIAL SUCCESS!**  
Easy to improve your handwriting at home quickly with my new instruction books just off the press. Master all the secrets of better penmanship. Simple and easy, fully illustrated, highly endorsed. Begin today. Write for:  New Free Book, "How to Become a Good Penman," or check books wanted, \$1.00 each.  Business Writing  Artistic Writing  Card Writing  Engraving, Alphabets  Bird and Design Flourishing  Complete Set \$4.50  Enclose 10c for your name beautifully written and special penpoint for shaded writing.  
S. A. Ziller, President, **TAMBLYN SCHOOL OF PENMANSHIP**  
441 Ridge Bldg. In Business Over 52 Years Kansas City, Mo., U.S.A.

## LEARN MEAT CUTTING At Home - In Spare Time

Get into the vital meat industry. Concise, practical Home Training based on 25 years proven instruction methods used at National's famous resident school. Prepares you for bigger pay as Meat Cutter, Supervisor, market manager or more money in your own store. Go as rapidly as your spare time permits. Diploma. Start NOW to turn your spare hours into money. Send for FREE bulletin today. No obligation.  
**NATIONAL SCHOOL OF MEAT CUTTING, INC., Div. U-104, Toledo 4, Ohio**

### How to Make Money with Simple Cartoons

A book everyone who likes to draw should have. It is free; no obligation. Simply address **FREE BOOK**

**CARTOONISTS' EXCHANGE**  
Dept. 94-D Pleasant Hill, Ohio

## RADIO ENGINEERING.

Broadcasting, Television, FM, Servicing, Electronics, Aviation, Marine & Police Radio taught thoroughly. Engineering course equivalent to 3 years' college radio work. Approved Veteran Training. Catalog free.  
**VALPARAISO TECHNICAL INSTITUTE, Dept. D, Valparaiso, Ind.**

## LEARN WATCH REPAIRING

**AT HOME.** By our modern and original system of instruction you can learn every part of the **WATCH REPAIRING TRADE AT HOME.** Prepare yourself for a well-paying position or start in business after completing our course of instruction. Good watch repairers are in demand and generally earn very good salaries. For particulars apply to the **Wisconsin School of Watch Repairing** 759 North Milwaukee St., Milwaukee 2, Wis.

### Learn BAKING At Home

Baking is one of America's high industries in wages. Nearly depression-proof. Thorough basic home course lays sound foundation. If you have aptitude, write for **FREE BOOKLET, "Opportunities in Commercial Baking."**  
National Baking School, 1315 Mich. Ave., Dept. 1354, Chicago 5



# WHICH OF THESE *Opportunities* INTERESTS *You*. MOST?

Accounting  
Air Conditioning  
Architecture & Building  
Automotive Engineering  
Aviation—Practical  
Aviation Drafting & Design  
Better Foremanship  
Bookkeeping  
Business Management

Contracting  
Diesel Engineering  
Drafting & Design  
Electrical Engineering  
Electricity—Practical  
Electronics, Industrial  
High School Courses  
Machine Shop Operations  
Mechanical Engineering

Plastics Engineering  
Plumbing—Practical  
Private Secretary  
Radio Operating & Servicing  
Railway Training  
Refrigeration  
Sheet Metal Pattern Drafting  
Shop Management  
Tool Making

## THINK! LOOK FORWARD!

Business is making big, new plans

Men and Women are preparing for the future

### WHAT ARE YOU DOING ABOUT YOUR TOMORROWS?

● *Today*, choose the job you want—and prepare for it. Or if you are already engaged in the work you like best, start training *now* for quicker promotion. Acquire the knowledge that will help you to get ahead faster, make more money and have greater security.

Invest part of your spare time in more rapid progress. Start training now, in spare time in your own home. Be ready to grasp your opportunity and step out ahead of those who lack the ability you have attained.

American School, founded in 1897 as an educational institution *not for profit*, can help you to reach your goal just as it has helped others during the past fifty-two years. Give serious thought to the list above. Pick one or more subjects that interest you. Then check the coupon at right, add your name and address and mail it at once. The school will send you details on its training plan and outline of study prepared by specialists. There is no charge, no obligation, so send the coupon immediately.

**HOME - STUDY TRAINING SINCE 1897**

**Take This First Easy Step**

**CHECK, CLIP AND MAIL COUPON NOW**

**AMERICAN SCHOOL, Dept. G445, Drexel at 58th, Chicago 37, Ill.**  
Without obligation, Please send FREE and postpaid, bulletin and details of the Subject checked.

- |  |  |  |
|--|--|--|
| <input type="checkbox"/> PLASTICS ENG'R            | <input type="checkbox"/> Accounting            | <input type="checkbox"/> Drafting and Design for Men and Women |
| <input type="checkbox"/> Refrigeration             | <input type="checkbox"/> Electrical Engr.      | <input type="checkbox"/> Radio                                 |
| <input type="checkbox"/> Architecture and Building | <input type="checkbox"/> Electricity-Pract.    | <input type="checkbox"/> High School                           |
| <input type="checkbox"/> Contracting               | <input type="checkbox"/> Electronics, Industr. | <input type="checkbox"/> Air Conditioning                      |
| <input type="checkbox"/> Practical Plumbing        | <input type="checkbox"/> Bookkeeping           | <input type="checkbox"/> Mechanical Eng.                       |
| <input type="checkbox"/> Automotive Engineering    | <input type="checkbox"/> Private Secretary     | <input type="checkbox"/> Shop Management                       |
| <input type="checkbox"/> Aviation Drafting         | <input type="checkbox"/> Diesel Engineering    | <input type="checkbox"/> Tool Making                           |
| <input type="checkbox"/> Aviation                  | <input type="checkbox"/> Sheet Metal           | <input type="checkbox"/> Better Foremanship                    |
| <input type="checkbox"/> Business Mgmt             | <input type="checkbox"/> Pattern Drafting      | <input type="checkbox"/> Machine Shop Operations               |
| <input type="checkbox"/> Railway Training          |  |  |

Name..... Occupation.....

Address..... Age.....

City..... State.....

PRACTICAL, EFFECTIVE

**AMERICAN SCHOOL**

Dept. G445, Drexel at 58th Street, Chicago 37

YOU  
can  
acquire

## LAW NIGHTS AT HOME! L. B. DEGREE

LaSalle's famous Law Library—used as reference in many Law libraries and Law offices—has enabled thousands to master Law surprisingly fast, in spare hours at home, for business and professional advancement.

These 14 remarkable volumes, compiled by leading professors and lawyers, cover the whole basic field of Law in condensed, orderly, simplified manner.

You advance rapidly with this great library, plus special lectures furnished. We guide you step-by-step with personalized Problem Method of instruction . . . you learn by doing—handling legal problems—not by memorizing rules.

Send for two FREE 48-page booklets, "Law Training for Leadership," and "Evidence," answering questions about Law and its value to you, and telling how LaSalle Law graduates are winning rapid advancement in business and public life. Mail coupon below. No obligation.

### LA SALLE EXTENSION UNIVERSITY

A Correspondence Institution

417 S. Dearborn St. Dept. 464-L Chicago 5, ILL.

Send me your two FREE booklets described above, without obligation.

Name \_\_\_\_\_ Age \_\_\_\_\_

Street \_\_\_\_\_

City, Zone & State \_\_\_\_\_

# INVENTORS

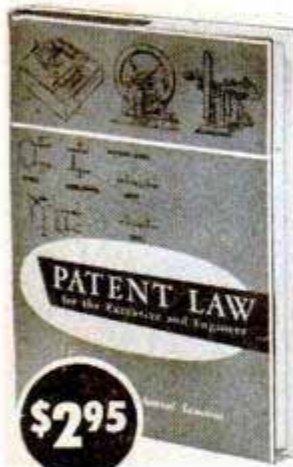

NO PATENT PROTECTION . . . NO PROFITS. Authoritative book on patent law, already bought by thousands of INVENTORS, ENGINEERS & EXECUTIVES will pay for itself . . . You CAN'T AFFORD TO BE WITHOUT IT. Learn simply and easily how protected inventions can make money for you; how to deal with your attorney . . . A MUST FOR INVENTORS, MECHANICS, ENGINEERS, who have money making patentable ideas . . . Easy to read and understand, only \$2.95. FREE: for cash or money order with your order, we will send a set of 8 1/2 x 11 invention records. Check or money order only.

RESEARCH PRESS, 137 N. Perry St., Dayton 2, Ohio  
Send me "Patent Law for the Executive and Engineer."  
Check or Money Order enclosed (You pay postage and send FREE complete set of Invention Records).  
Five days approval. I'll remit \$2.95 plus postage or return the book in five days.

Name \_\_\_\_\_ Title \_\_\_\_\_

Address \_\_\_\_\_

City \_\_\_\_\_ Zone \_\_\_\_\_ State \_\_\_\_\_ PM 10



## Learn WOOD PRODUCTION ENGINEERING

GET THIS FREE BOOK Today

It tells you how you can learn to become a successful WOOD PRODUCTION ENGINEER . . . by the Klok Home Study Correspondence Method . . . or by studying here in Grand Rapids in our Resident School . . . Training in WOOD PRODUCTION ENGINEERING offers you great opportunities . . . either to get a top position or to operate your own plant successfully.

The Klok Course teaches you SKETCHING, ROD-MAKING, DETAILING, STOCK BILLING, TIME STUDY, COST and MANAGEMENT.

WRITE FOR FREE BOOK TODAY! State preference whether Home Study or Resident course, with name, age, occupation and if veteran.

**KLOK INSTITUTE**  
LOUIS ST., N.W.  
GRAND RAPIDS, MICHIGAN



## RAISE HAMSTERS

The new wonder animals from Syria. Often called Toy Bears. Delightful pets. Everyone wants them. Laboratories need thousands. Clean, odorless. Raise anywhere. A profitable and interesting hobby or business. We furnish breeding stock with manual of instructions.

Write today for free illustrated literature.  
GULFHAMSTERY, 1536 BASIL, MOBILE, ALA.

## HYDROPONICS

Grow out-of-season vegetables, rare flowers or house plants by hydroponics WITHOUT SOIL!



Fascinating hobby or profitable business in your home; minimum space needed for big returns. Easy, clean, pleasant way to grow any plant indoors or out, year-round. Send postcard for FREE book showing how others are succeeding.

CHAPMAN-GILBERT, 824 W. IVY, SAN DIEGO, CALIF.

## SADDLE HORSES

LEARN HORSE TRAINING AND MANAGEMENT

SUBSCRIBE FOR The "EXPERT HORSEMAN"

ONLY \$1.00 PER YEAR



FREE BOOK—You will also receive a booklet that tells how you can learn to Break Colts, Gait Show Horses, Train Rodeo, Stock, and Race Horses, Break Bad Habits, Handle any horse, Train Circus Trick Horses

ANIMAL LOVERS ASSOCIATION  
BOX KA-111 TARZANA, CALIFORNIA

## EASY TO LEARN CODE

Learn or increase speed with an Instructograph—the Code Teacher that takes the place of an operator-instructor and enables anyone to master code without further assistance. Available tapes from beginners alphabet to typical messages on all subjects. Speed range 5 to 40 WPM. Always ready—no QRM. Thousands have "acquired the code" with the Instructograph System. Write today for convenient rental and purchase plans.



INSTRUCTOGRAPH COMPANY  
4701-V Sheridan Road, Chicago 40, Illinois

## Have an OFFICE of YOUR OWN!

LEARN NEW PROFITABLE PROFESSION At Home in 60 Days, Men & Women, 18 to 70!

Be Your Own Boss and the Boss of Others. Be Respected. Meet Interesting People.

Earnings of men and women in this profession run as high as \$5,000-\$15,000 yearly. Others make good money in spare time. Little money needed to start. A business where your earnings begin sooner. Easy to learn. No selling or goods to buy. No experience necessary. A depression-proof business. A course of action to guide you step by step as you earn. All 53 lessons sent at once to use as operating manuals. Easy terms. Diploma. Money-back agreement. Write for FREE BULLETIN.



FRANKLIN CREDIT SCHOOL  
Dept. 75-D ROANOKE 7, VIRGINIA

BY MAIL in Easy Lessons

*Don't miss the chance of a lifetime!*

# TELEVISION

**Radio - Electronics ..**  
**OFFER YOU A PROFITABLE FUTURE!**



OSCILLOSCOPE

Get the Facts About Our

## GREATEST OFFER in 17 YEARS

Here's good news . . . big news . . . our BIGGEST NEWS in 17 years. The equipment pictured at the right gives a partial idea of D.T.I.'s remarkable new combination of shop-method, home-training aids.

Now you can use and keep ALL of this equipment — PLUS other major training aids — to prepare you at home for a grand future in the fast-moving field of TELEVISION . . . RADIO . . . ELECTRONICS.

SEND FOR **FREE** BOOKLET

Mail the coupon today for our big, new 48-page OPPORTUNITY GUIDE BOOK. See how D.T.I.'s amazing, newer, training method helps you get started toward a GOOD JOB or your OWN BUSINESS in one of America's most promising, thrilling fields . . . that includes Television . . . F.M., Train, 2-Way Taxi, Aviation, and Broadcast Radio . . . Industrial Electronics . . . and other fast-developing branches.

In addition to well-illustrated lessons, you receive 16 shipments of Radio-Electronic parts from which you work over 300 instructive projects — including the building of (1) a commercial-type CATHODE RAY OSCILLOSCOPE that helps you get practical Television circuit training, (2) a double-range R-F SIGNAL GENERATOR, (3) a jewel-bearing MULTI-METER and (4) a quality 6-tube SUPERHET RADIO. You keep all of this equipment.

**YOU BUILD and KEEP THIS EQUIPMENT**  
**Work over 300 Home Experiments**

### EMPLOYMENT SERVICE

When you complete your training, our effective Employment Service is available to you without extra cost, to help you get started.

MULTI-METER

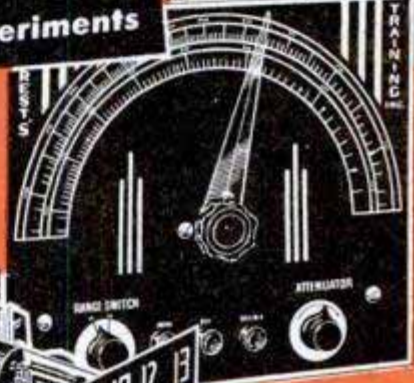

R-F SIGNAL GENERATOR



6-TUBE RECEIVER

**You also use HOME MOVIES**

**. . . a D. T. I. Exclusive!**  
 D.T.I. alone includes the use of modern, visual training aid . . . MOVIES . . . to help you learn faster, easier at home. You see electrons on the march and other fascinating "hidden action" — a remarkable home training advantage that speeds your progress.



### You May Choose to Train in Our MODERN CHICAGO LABORATORIES

Train quickly, using a wide variety of commercial equipment. D. T. I.'s new labs are among the finest of their kind. Ample instructors . . . every major training advantage. Write for details!

## MAIL THIS OPPORTUNITY COUPON NOW!

DeForest's Training, Inc.  
 2533 N. Ashland Ave., Dept. PM-F4  
 Chicago 14, Illinois

Send me **FREE** your 48-page OPPORTUNITY GUIDE BOOK showing how I may make my start in Television — Radio — Electronics.

Name \_\_\_\_\_ Age \_\_\_\_\_  
 Street \_\_\_\_\_ Apt. \_\_\_\_\_  
 City \_\_\_\_\_ Zone \_\_\_\_\_ State \_\_\_\_\_

**DeFOREST'S TRAINING, INC.**  
**CHICAGO, ILLINOIS**

Affiliated with the De Vry Corporation  
 Builders of Electronic and Movie Equipment

# Learn JEWELRY MAKING WATCHMAKING ENGRAVING

TRADES WITH  
GREATER SECURITY



Above Average Pay. Trained Men Always in Demand.  
Day and Night Classes. Enroll any Time. Write Today  
for Free Catalog and Information.

Approved for G.I. Training

**KANSAS CITY SCHOOL OF WATCHMAKING**  
America's Most Progressive Horological School  
617-621 Wyandotte St. Kansas City 6, Mo.

## 9 BIG BUILDING BOOKS

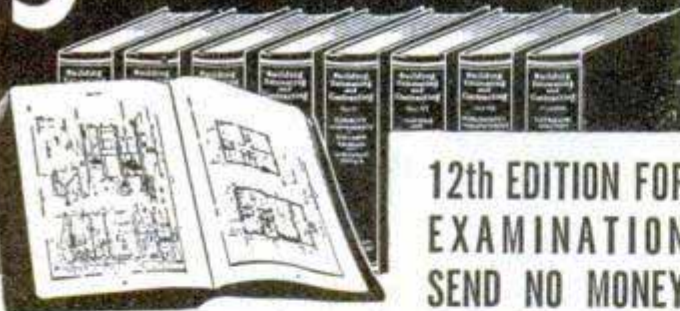

12th EDITION FOR  
EXAMINATION  
SEND NO MONEY

Learn to draw plans, estimate, be a live-wire builder, do remodeling, contracting. These 9 practical, profusely illustrated books cover subjects that will help you to get more work and make more money. Masonry, concrete forms, carpentry, steel square, roof framing, construction, plumbing, heating, painting, decorating and many other subjects. More than 4000 pages—2750 illustrations.

**BETTER JOBS — BETTER PAY** UP-TO-DATE EDITION  
A nationwide building boom is in full swing and trained men are needed. Big opportunities are always for MEN WHO KNOW HOW. These books supply quick, easily understood training and handy, permanent reference information that helps solve building problems. These books are the most up-to-date and complete we have ever published on these many subjects.

**Coupon Brings Nine Big Books for Examination**

**AMERICAN TECHNICAL SOCIETY**—Publishers since 1898  
Dept. G419 Drexel at 58th Street Chicago 37, Ill.

You may ship me the Up-to-Date edition of your nine big books, "Building, Estimating and Contracting," without any obligation to buy. I will pay the delivery charges only, and if fully satisfied in ten days, I will send you \$2.00, and after that only \$3.00 a month, until the total price of only \$34.80 is paid. I am not obligated in any way unless I keep the books.

Name \_\_\_\_\_  
Address \_\_\_\_\_  
City \_\_\_\_\_ State \_\_\_\_\_

Please attach a letter stating your age, occupation, employer's name and address, and name and address of at least one business man as a reference. Men in service, also please give home address.

## SUCCEED IN THE POULTRY BUSINESS!



Poultry is providing many trained men and women with a good, comfortable living, either part or full time. You, too, can enjoy country life, home-grown food, increased income, if you have the specialized knowledge that is so important.

For 28 years our Home Study Course has been helping thousands to greater success. Proper knowledge and "Know How" mean extra income from the start. Don't delay—write today for prospectus describing courses, methods, opportunities, service.

**NATIONAL POULTRY INSTITUTE**  
DEPT. 50 — ADAMS CENTER, N. Y.

## Be an INVESTIGATOR

**JAMES S. BOLAN, FORMER POLICE COMMISSIONER OF NEW YORK CITY** offers MEN & WOMEN an attractive opportunity to prepare for a future in *Investigation & Criminology* by comprehensive Home Study Course. Free placement service assists graduates to obtain jobs. APPROVED UNDER G. I. BILL OF RIGHTS.  
Write for Free Booklet PM

THE **BOLAN ACADEMY, INC.**  
EMPIRE STATE BLDG., NEW YORK 1, N. Y.

## Easy, Easy Money!

Nothing to buy. We supply FREE SAMPLE, solid brass front door name plate; beautifully engraved; bright lasting finish. Sells on sight. Every home buys. Show sample. Take order. Collect \$1 deposit. Keep it. Mail order to us. We deliver and collect \$2.50 balance. Make \$25, \$50 and more every week, spare time. Write NOW for FREE sample and simple selling help hints.

Dept. 180, NATIONAL ENGRAVERS  
214 SUMMER STREET, BOSTON 10, MASS.

## THERE'S MONEY IN CARTOONS!

**RAYE BURNS** will teach you HOW TO CREATE ORIGINAL CARTOONS at home that you may SELL! Course contains 26 lessons and over 600 illustrations. All for Only... **\$2.85**  
Send name and address for free details.

**RAYE BURNS SCHOOL, Dept. M, Box 3583, Cleveland, Ohio**

## APTITUDE TESTS

discover the kind of work or studies best for your success! You get a personal report—a guide for life—more happiness—more prosperity. For men, women, boys and girls. Write for complete facts.

**VOCATIONAL COUNSELING INSTITUTE**  
956 Maccabees Bldg., Detroit 2, Michigan

## Command Bigger Money!

# STUDY LAW

STUDY AT HOME for BUSINESS SUCCESS and LARGER PERSONAL EARNINGS. 40 years expert instruction — over 114,000 students enrolled. LL.B. Degree awarded. All text material furnished. Easy payment plan. Send now for FREE BOOK — "Law and Executive Guidance." It explains the course — how you may enroll and the many ways you can profit from Law Study. Write TODAY to:

**AMERICAN EXTENSION SCHOOL OF LAW**  
Dept. 13-PM, 646 N. Michigan Ave., Chicago 11, Ill.

GET INTO

# DIESEL-AUTO

## MECHANICS *Master All Phases*

**JOBS LIKE THESE ARE AVAILABLE TO TRAINED MECHANICS. CHOOSE THE FIELD YOU LIKE BEST**

### Get Complete Training

Diesel Fuel Injection  
 Automotive Motor Tune-up  
 Diesel Engine Rebuilding  
 General Garage Mechanic  
 Agricultural Implements  
 Auto Engine Rebuilding  
 Auto Elec. Service  
 Public Utilities  
 Parts Dealers  
 Bus & Truck Lines  
 Industrial Maintenance  
 Contracting & Excavating  
 Business of Your Own  
 AND MANY other similar openings.

As a National Schools graduate, you are trained for ALL opportunities in the Diesel & Auto Industries

### EARN WHILE YOU LEARN

With our practical Master Shop-Method Home Training, you study at home in your spare time. You receive Spare Time Work Lessons, which show you how to earn while you Learn . . . for extra money and experience. You Learn by DOING.

### TOOLS AND EQUIPMENT

To make your training complete, we give you selected mechanic's tools and equipment, illustrated below, including all-metal toolbox — as a regular part of your instruction.



### Shop-Method Home Training by an Established Resident School Prepares you for Many Good Jobs

Opportunity is everywhere for the trained Diesel-Auto Mechanic. Highways throng with cars, busses, trucks, tractors. Garages and Service Stations are kept busy. Factories, ships, farms, railroads, general industry, are dependent upon engine power. Here's a dynamic, fast-growing field that needs trained men who know ALL phases: installation, operation, maintenance and repair. Now—National Schools offers you a practical, all-embracing Diesel-Auto Mechanic's Course, including all of these advantages:

### Complete training, covering—Diesels, High Speed and Heavy Duty; Semi-Diesels, Gasoline and Special Fuel Engines AND Allied Mechanics.

- Basic Lesson Texts
- Diesel Installation
- Operation - Maintenance
- Diesel Chart Manual
- Spare Time Lessons
- Engine Service Manuals
- Engine Repair
- Drive Systems
- Diesel Electric Power
- Thermodynamics

### TOOLS AND EQUIPMENT

#### INVESTIGATE

Secure Full Information

**NEW, ILLUSTRATED BOOK & SAMPLE LESSON SHOW HOW WE TRAIN YOU . . . SEND FOR THEM TODAY!**



**NO COST  
NO OBLIGATION**

**APPROVED FOR VETERANS**  
Check coupon below

## NATIONAL SCHOOLS

LOS ANGELES 37, CALIF. • EST. 1905



### FIND OUT NOW... MAIL COUPON TODAY

NATIONAL SCHOOLS, DEPT. PM-D4  
4000 South Figueroa Street  
Los Angeles 37, California

(Mail in envelope or paste on penny postcard)

Mail me FREE the book, YOUR FUTURE IN DIESEL-AUTO MECHANICS, together with the Sample Lesson. I understand I may keep and use the information with no obligation.

Name \_\_\_\_\_ Age \_\_\_\_\_

Address \_\_\_\_\_

City \_\_\_\_\_ Zone \_\_\_\_\_ State \_\_\_\_\_

Check here if Veteran of World War II

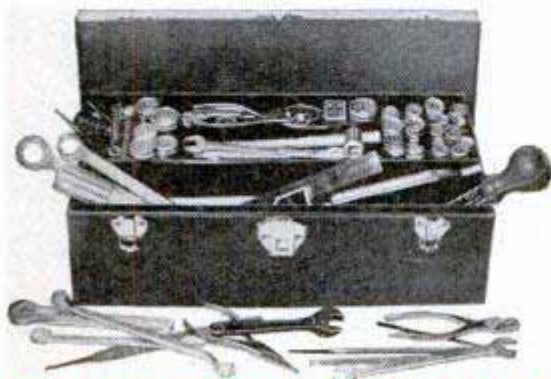

**WE GIVE YOU TOOLS OF YOUR TRADE**

**Train Now in Spare Hours at Home  
for a Better Job at Better Pay in...**

# REFRIGERATION and AIR CONDITIONING



1. **FIRST:** You get vital basic knowledge at home—during spare hours. Train as fast or as leisurely as you like.

2. **THEN:** You come to ITI's giant shops in Chicago—for a Full Four Weeks of practical instruction and actual work on newest, most modern equipment.

## **RICH Rewards for the Trained Man**

Now is the time to lay your plans for a better job at better pay! Get the facts about your future in the amazingly **FAST GROWING** field of Refrigeration, Air Conditioning and Heating! Men who know how to install, repair, rebuild and maintain this equipment are going ahead **FAST!** But many more fine jobs are open **NOW** in this rapidly expanding industry in both the home and commercial equipment fields. Experts say the opportunities are almost unlimited... **BUT ONLY PROPERLY TRAINED MEN CAN QUALIFY FOR THE BETTER PAYING JOBS!**

Investigate the Industrial Training Institute's 2-Way Course in Refrigeration, Air Conditioning AND Heating. In a few months this training gives you solid, practical, down-to-earth knowledge and experience you need. You don't need any special schooling or experience to master the ITI course. It's so simple, easy, and practical that you can finish your Training in a short few months' time. And after completing your Training ITI's wonderful job placement service is available to you without extra cost!

### **TRAINING MEN FOR INDUSTRY SINCE 1916!**

ITI Training is backed by more than 30 years of success and experience. We have given training to over 400,000 men since 1916. Today thousands of ITI graduates hold down top paying jobs. ITI occupies five large buildings, with over \$500,000.00 invested in shops and training facilities. Instruction staff of more than 100 men.

### **VETERANS!**

ITI residence training is fully approved under the G I Bill of Rights. Check coupon for special veterans' bulletin.

## **THIS BIG BOOK FREE!**

Find out about ITI Training. See for yourself how easy and simple it is to start at home, in your spare time, and prepare yourself for a fine job with a real future. It's all in ITI's fascinating, illustrated **FREE** book, "Your Future in Refrigeration & Air Conditioning." Just fill out and mail the coupon below **NOW!** Take this first step toward success **TODAY!**

**INDUSTRIAL TRAINING INSTITUTE**  
Dept. S-1  
2150 Lawrence Avenue, Chicago 25, Ill.



**INDUSTRIAL TRAINING INSTITUTE**  
2150 Lawrence Avenue  
Dept. S-1, Chicago 25, Ill.

Please send me **FREE** the ITI book, "Your Future in Refrigeration and Air Conditioning" and information about the opportunities for trained men in this fast growing field. I understand I'm under no obligation.

Name \_\_\_\_\_ Age \_\_\_\_\_  
Address \_\_\_\_\_  
City \_\_\_\_\_ Zone \_\_\_\_\_ State \_\_\_\_\_  
Are You A Veteran? \_\_\_\_\_

**SAY YOU SAW IT IN POPULAR MECHANICS**

# LEARN TELEVISION Radio ELECTRONICS



**Get a Good Pay Job - or  
Start Your Own Business**

Want to make **more** money? Want to be your **own** boss - have your own, money-making business - with your future **assured**? Then learn Radio and Television with my proven two-way method (lesson instruction plus actual practice) that can help you get into this great and growing business **quicker**. You learn by doing, right in your home in spare time. During your training you get 10 big kits of radio parts with which you perform hundreds of tests and experiments, build scores of circuits and testers to help you learn faster, more thoroughly.

Since 1929 I have been training men all over the world for success in radio, television and electronics. To learn how I can help **you** too, take the first step **now** by sending for my big 56-page illustrated book that tells how you may cash in on radio and television's big opportunities. My book is **Free** but it may mean your future success. Send for it today.

VETERANS! Approved for G. I. Training Under Public Laws 16 and 346

**C. H. MANSFIELD, President, Dept. A-16**  
**Hollywood Radio and Television Institute**  
810 West 6th Street, Los Angeles 14  
California, U. S. A.

**FREE**



**SEND for THIS BOOK**

VETERANS: Advise if eligible for G. I. Training

## **WATCHMAKING**

### **JEWELRY ENGRAVING AND REPAIR**

Enter this high-paying, time-honored profession, or prepare for a business of your own. Watchmakers in great demand. More jobs than qualified workers. Study under expert instructors in a long-established, nationally recognized school. Receive recognized diploma and certificate. Placement service. Approved under G. I. Bill. Write for **FREE** booklet.



**The Baronian School, Inc.**

2116 WALNUT ST. (DEPT. C) PHILA. 3, PA.



## **Become An Artist!**

**CASH IN ON BIG ART MARKET!**  
LEARN Cartooning, Commercial Art, Lettering, Showcard Writing, Photo Coloring, etc., **QUICKLY** with our **NEW, EASY METHODS.**

**Interesting Catalog FREE**

NATIONAL ARTISTS BUREAU  
P. O. Box 4248 Dallas 8, Texas

### **New 1949**

## **PLASTICS SUPPLIES CATALOG**

Just off press. Full details on Plexiglas, Lucite, rods, sheets, tubes, Acetates, cements, dyes, buffs, molding sets, tools, carving kits, accessories. Everything in plastics. Gives prices, sizes, colors, etc. Price 10c, stamps or coin, with ad for catalog.

**PLASTICS MFG. & SUPPLY CORP.**

DEPT. PM-4 • 4707 EUCLID • CLEVELAND 3, OHIO

## **High School at Home**

### **Many Finish in 2 Years**

No classes. No time wasted going to and from school. Progress as fast as your time and abilities permit. Standard H. S. texts supplied. Thousands enroll each year in this 52-year-old school. Send for **FREE** descriptive booklet.

**AMERICAN SCHOOL, Dept. H445**  
Drexel at 58th St., Chicago 37, Ill.

Without obligation, please send **FREE** descriptive booklet.

Name \_\_\_\_\_

Address \_\_\_\_\_

# They Never Knew It Was SO EASY To Play

**Thousands Now Play Popular Songs  
Who Didn't Know a Note of Music Before**

**You, too, can learn your favorite  
instrument at home, without  
a teacher, this quick,  
easy, money-saving way**

**T**HINK of the fun YOU are missing! The popularity, friendship, good times! Why? Because you think it's *hard* to learn music. You have an idea that it's a slow, tedious task, with lots of boring drills and exercises.

That's not the twentieth-century way! Surely you've heard the news! How people all over the world have learned to play by a method so simple a child can understand it—so fascinating that it's like playing a game. Imagine! You learn without a teacher—in your spare time at home—at a cost of only a few cents a day! You learn by the famous print-and-picture method—every position, every move before your eyes in big, clear illustrations. You **CAN'T** go wrong! And best of all, you start playing real tunes almost at once, from the very first lesson.

No needless, old-fashioned "scales" and exercises. No confused, perplexing study. You learn to play by playing. It's thrilling, exciting, inspiring! No wonder hundreds of thousands of people have taken up music this easy way. No wonder enthusiastic letters like those reproduced here pour in from all over the world.

Sound interesting? Well, just name the instrument you'd like to play and we'll prove you **CAN!** (Instruments supplied when needed. Cash or Credit.) Mail the coupon or write. Do it now! 51st year.

**U. S. SCHOOL OF MUSIC  
74 Brunswick Bldg.  
New York 10, N. Y.**



**Learned Quickly at Home.** "I didn't dream I could actually learn to play without a teacher. Now when I play for people they hardly believe that I learned to play so well in so short a time." \*H. C. S., Calif.

Music is the magic key to friendship, fun, romance. The person who can play a musical instrument is always sure of a welcome. Why not let music open up a new world for you. Thousands have discovered unexpected pleasure and profit in music, thanks to the unique method that makes it amazingly easy to learn.

**Send for FREE Booklet and  
Print and Picture Sample**

See for yourself how this wonderful self-instruction method works. Sit down, in the privacy of your own home, with the interesting illustrated booklet, "How to Learn Music at Home." No salesman will call—decide for yourself whether you want to play this easy way.



**Invited to Parties.** "Before I took your course I didn't know one note of music. Then three months later I started to play for dances. I've been invited to many parties. The course is easy and interesting." \*R. M., Vancouver, B. C.

**Well Worth Money.** "The course is fully self explanatory. When one is finished with it there is little one need learn. It is well worth the money and I fully believe you have the finest course on the market today." \*R. E. G., Clarksburg, W. Va.

**Surprised Friends.** "People who hear me play don't understand how I do it. They ask if I haven't had lessons from a teacher. To their surprise they find I haven't. I'm glad to be a student of your School." \*M. H., Athol, Kans.

**U. S. SCHOOL OF MUSIC  
74 Brunswick Bldg., New York 10, N. Y.**

I am interested in music study, particularly in the instrument indicated below. Please send me your free booklet, "How to Learn Music at Home" and the free Print and Picture Sample.

Piano  
Guitar  
Hawaiian Guitar  
Violin  
Piano Accordion  
Saxophone  
Trumpet, Cornet

Reed Organ  
Tenor Banjo  
Ukulele  
Clarinet  
Trombone  
Flute  
Piccolo

Modern  
Elementary  
Harmony  
Mandolin  
Practical Finger  
Control

Mr. \_\_\_\_\_ Have You  
Miss \_\_\_\_\_ This Instru.?  
Mrs. \_\_\_\_\_ (PLEASE PRINT)

Address \_\_\_\_\_

City \_\_\_\_\_ State \_\_\_\_\_

Note: If you are under 16 yrs. of age, parent must sign coupon.

SAVE 2c—Stick coupon on penny postcard.

# Learn A Trade NOW! PRACTICAL SHOP TRAINING!

## In Our Chicago Shops

- |   |  |
|---|--|
| <input type="checkbox"/> AUTO MECHANICS   | <input type="checkbox"/> WELDING—ARC and GAS |
| <input type="checkbox"/> DIESEL MECHANICS | <input type="checkbox"/> MACHINIST           |
| <input type="checkbox"/> REFRIGERATION    | <input type="checkbox"/> PIANO TUNING        |
| <input type="checkbox"/> BODY-FENDER      |  |

Above Approved For G. I.'s and Civilians  
One of America's Leading Practical Schools  
7 Floors of Fully Equipped Shops  
Over 48,000 Successful Graduates  
Expert Individual Instruction  
Learn by Doing—Low Living Expense  
Established 1902—Day and Evening Classes

## Also the following Home Study Courses

- |                                  |  |                                 |
|----------------------------------|--|---------------------------------|
| <input type="checkbox"/> PLASTIC | <input type="checkbox"/> REFRIGERATION | <input type="checkbox"/> DIESEL |
|----------------------------------|--|---------------------------------|

—CALL IN PERSON OR MAIL THIS AD TO—

## GREER SHOP TRAINING

(Desk 10) 460 South State St., Chicago 5, Ill.

Please send without obligation free information regarding trade checked above. (Specify whether you are a Veteran  or Civilian )

Name \_\_\_\_\_ Age \_\_\_\_\_  
Address \_\_\_\_\_  
City \_\_\_\_\_ State \_\_\_\_\_

## New Advertising Machine



## Prints & Illustrates 1¢ Post Cards

**FREE** Learn how thousands of business men, in every line, are boosting sales in spite of conditions—with 1¢ messages—printed and illustrated in a few minutes on gov't post cards—with amazing new patented **CARDMASTER**. Your "today's" ideas, read by your prospects next morning. Not a toy, but a sturdy advertising machine, built to last for years. Low price, sold direct. Guaranteed for five years. Send name today.

**SEND NAME** We'll send **FREE** illustrated book of money-making **IDEAS** for your business and complete, unique advertising plans. **RUSH YOUR NAME TODAY.**

**CARDMASTER COMPANY**  
4546 RAVENSWOOD, Dept. 134, CHICAGO 40, ILL.

## MONEY for MEN ALL FREE

THE PLASTEX Industry needs manufacturers on small scale and for big production of Lamp and Clock Stands, Art Goods and Novelties in Plastex and Marble imitation. Experience unnecessary. 1/2¢ material makes regular 10¢ store sellers. Rubber moulds furnished for speed production. Small investment brings good returns. Big chain store orders now being placed. Ambitious men have chance for real prosperity. Our Free booklet will interest and benefit you.

PLASTEX INDUSTRIES, Dept. A  
3400 Third Ave. New York 56, N. Y.



## LEARN MEAT CUTTING

through actual practice. Profitable Meat Cutting and Successful Meat Merchandising taught easily, quickly. **LEARN BY DOING** at Toledo in just six short weeks under actual market conditions. For beginners or men with experience. All subjects taught thoroughly and completely. Diploma, Job help. Get store of own. People must eat. School in operation over 25 years. Approved for GI training. Send today for **FREE** illustrated catalog. No obligation.

**NATIONAL SCHOOL OF MEAT CUTTING, Dept. 50-L, Toledo 4, Ohio**

## LAW FREE BOOK

Your **FREE** copy of "The Law-Trained Man" shows how to gain prestige and greater earnings through Blackstone home law study. All instruction material furnished including 18-volume Law Library written by 65 well-known law authorities. Lawyers, judges among our graduates. LL.B. degree. Low cost; easy terms. Write today.

**BLACKSTONE COLLEGE OF LAW** 225 N. Michigan Ave.  
Dept. 54, Chicago 1, Ill.  
A Correspondence Institution Founded in 1890

## HAUCK FLAME GUN KILLS WEEDS

**KILL WEEDS**, crab grass, Canada thistle—stalks, seeds and roots. Destroy brush, caterpillar nests, diseased trees, grasshoppers, chinch bugs, etc. Clear irrigation ditches, split rocks, burn tree stumps. Sterilize poultry houses, kennels, barns. Use as portable home forge. Melt ice, thaw pipes. Safe, inexpensive. Burns only 6¢ kerosene, 94% air! Thousands satisfied users. 7 models. Write for **FREE CATALOG**.

**HAUCK MFG. CO., 76 Tenth St., Brooklyn 15, N.Y.**

## STAMMER? GET THIS FREE BOOK!

This new 128-page book, "Stammering, Its Cause and Correction," describes the Bogue Unit Method for scientific correction of stammering and stuttering—successful for 48 years. **Benj. N. Bogue, Dept. 4914, Circle Tower, Indianapolis 4, Ind.**



## AUTO BOOKS ON APPROVAL



**SEND NO MONEY.** Just mail the coupon for a complete set of 4 Big, Thick Auto Books. 20th Edition. Over 2700 Pages! Whether you are a mechanic or helper, expert or apprentice, auto owner or driver, take immediate advantage of this **FREE EXAMINATION OFFER**.

### MAKE GOOD MONEY NOW HOLD A PERMANENT JOB

America wants its automobiles kept in good repair. Men with "know how" are in demand, at big pay. These books will help you get and hold an important job, or give you a chance to go into business for yourself now or later. Any man who half tries to improve himself can learn auto servicing and repairing by this quick reference method. Use the **JIFFY INDEX** to find easily understood answer to any auto problem. These wonder books prepared by eleven of America's great automobile engineers. Many hundreds of valuable illustrations. Send the coupon **TODAY**.

A year's consulting privileges with our engineers now given with these books without extra charge.  
**Publishers Since 1898**

**CAN YOU FIX IT?**  
These wonder books tell step by step **HOW** to make difficult repairs and adjustments, how to keep a car at maximum efficiency, including latest improvements in car design and operation. Engine troubles and how to correct them well covered.

**4 BIG, THICK VOLUMES**  
Over 2700 pages, 2000 illustrations, wiring diagrams, etc. Beautiful modernistic, washable cloth binding.

**AMERICAN TECHNICAL SOCIETY, Dept. A419**  
Drexel Ave. at 58th St., Chicago 37, Ill.

I would like to examine your 4-Volume Set of Auto Books. I will pay the delivery charges only, but if I choose I may return them express collect. If after 10 days' use I prefer to keep them, I will send you \$2 and pay the balance at the rate of only \$3 a month until \$24.80 has been paid. Include consulting service as offered above.

Name \_\_\_\_\_  
Address \_\_\_\_\_  
City \_\_\_\_\_ State \_\_\_\_\_

Please attach letter stating age, occupation, employer's name and address and name and address of at least one business man as reference. Men in service, also please give home address.





You receive all parts, including tubes, for building this fine, modern Superheterodyne Receiver. This and other valuable standard equipment becomes your property.

# Learn RADIO

## TELEVISION, ELECTRONICS

by  
**SHOP METHOD HOME TRAINING**

Let **NATIONAL SCHOOLS**, of Los Angeles, a practical Technical Resident Trade School for almost 50 years, train you for today's unlimited opportunities in Radio

these two **FREE** books will tell you how



### Good Jobs Await the Trained Radio Technician

You are needed in the great, modern Radio, Television and Electronics industry! Trained Radio technicians are in constant and growing demand at excellent pay—in Broadcasting, Communications, Television, Radar, Research Laboratories, Home Radio Service, etc. National Schools Master Shop Method Home Study Course, with newly added lessons and equipment, can train you in your spare time, *right in your own home*, for these exciting opportunities. Our method has been proved by the remarkable success of National Schools-trained men all over the world.

### You Learn by Building Equipment with Standard Radio Parts We Send You

Your National Schools Course includes not only basic theory, but practical training as well — *you learn by doing*. We send you complete standard equipment of professional quality for building various experimental and test units. You advance step by step until you are able to build the modern superheterodyne receiver shown above, which is yours to keep and enjoy. You perform more than 100 experiments—build many types of circuits, signal generator, low power radio transmitter, audio oscillator, and other units. The Free Books shown above tell you more about it—send for them today!



### **NOW!** NEW PROFESSIONAL MULTITESTER INCLUDED



This versatile testing instrument is portable and complete with test leads. Simple to operate, accurate and dependable. You will be able to quickly locate trouble and adjust the most delicate circuits. You can use the Multitester at home or on service calls. It is designed to measure AC and DC volts, current, resistance and decibels. You will be proud to own and use this valuable professional instrument.

**GET THE DETAILS—SEND THE COUPON** ▶

### LESSONS AND INSTRUCTION MATERIAL ARE UP-TO-DATE, PRACTICAL, INTERESTING

National Schools Master Shop Method Home Training gives you basic and advanced instruction in all phases of Radio, Television and Electronics. Each lesson is made easy to understand by numerous illustrations and diagrams. All instruction material has been developed and tested in our own shops and laboratories, under the supervision of our own engineers and instructors. A free sample lesson is yours upon request — use the coupon below.

#### You Get This and Other Valuable Information in the Free Sample Lesson:

1. Basic Receiver Circuits and How They are Used.
2. Construction of the Antenna Circuit.
3. How Energy is Picked Up by the Aerial.
4. How Signal Currents are Converted into Sound.
5. How the Tuning Condenser Operates.
6. How the R-F Transformer Handles the signal, and other data, with diagrams and illustrations.

Both Resident and Home Study Courses Offered

**APPROVED FOR VETERANS**  
CHECK COUPON

### NATIONAL SCHOOLS

LOS ANGELES 37, CALIF. • EST. 1905



#### MAIL OPPORTUNITY COUPON FOR QUICK ACTION

National Schools, Dept. PM-R4  
4000 South Figueroa Street  
Los Angeles 37, California

(Mail in envelope or paste on penny postcard.)

Mail me **FREE** the book "Your Future in Radio" and a sample lesson of your course. I understand no salesman will call on me.

NAME \_\_\_\_\_ AGE \_\_\_\_\_

ADDRESS \_\_\_\_\_

CITY \_\_\_\_\_ ZONE \_\_\_\_\_ STATE \_\_\_\_\_

Check here if veteran of World War II

# MAKE BIG MONEY FAST



**STEVINSON TRAINED  
AUTO, ELECTRICAL, and  
REFRIGERATION EXPERTS  
GET TOP MONEY**

**Approved for Civilian and Veterans Training**  
The steady work, backed by proved time-saving methods of Stevinson training and experience has won approval from civilians and veterans alike. If you are a qualified G. I., don't delay a day. Write today. Approved under laws 346 and 16.

## EARN WHILE YOU LEARN

No wasted time. Be an expert in latest modern methods . . . you work with most advanced new equipment. We help you arrange part-time work . . . help you get best jobs or set up your own business on graduating. Don't limit yourself. Get on the quick road to success with a solid Stevinson foundation. 27 years of successful training.

**STEVINSON TRAINING**

## GET FULL FACTS FREE. MAIL COUPON NOW!

**Stevinson Auto & Electrical School,  
Dept. PMA, 2008 Main St., Kansas City 8, Mo.**

Common sense tells me the practical 27 years success of Stevinson classroom-shop training means faster earning of big money for me. Send me full facts on the training courses I have checked, at no cost or obligation.

- Auto                       Air Conditioning  
 Refrigeration             Electrical Appliance  
 Auto Body & Fender Rebuilding

Name \_\_\_\_\_  
Street \_\_\_\_\_  
Town \_\_\_\_\_ State \_\_\_\_\_

# PRACTICAL AUTO INFORMATION

**Keeps Cars Rolling by Making Repairs  
and Adjustments Easy!**

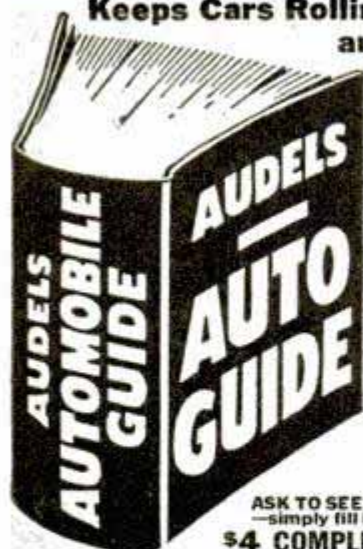

**AUDELS AUTO GUIDE**  
For Every Mechanic, Driver, Owner and Repair Shop.

**Sent on 7 Days Approval**  
Shows How to Tune Up—Keep Brakes Safe—Batteries Powerful—Tire Mileage Up—Save Gas—Lubricate Correctly.

**ANSWERS YOUR QUESTIONS**  
Contains all you need to know about 1—Construction, 2—Operation, 3—Service, 4—Repair of Modern Motor Cars, Trucks, Buses & Diesel Engines in every detail.

**NEW FLUID DRIVE TREATED**  
Easy to understand—1540 Pages, 1540 Illustrations. Gives definite directions on How to handle service jobs.

**ASK TO SEE IT—Get this information for yourself—simply fill in and mail coupon today.**

**\$4 COMPLETE • PAY ONLY \$1 A MO.**

**AUDEL, Publishers, 49 West 23rd St., New York**  
Mail AUDELS AUTOMOBILE GUIDE (\$4) for free examination. If O. K., I will send you \$1 in 7 days; then remit \$1 monthly until \$4 is paid. Otherwise, I will return book promptly.

Name \_\_\_\_\_  
Address \_\_\_\_\_  
Occupation \_\_\_\_\_  
Employed by \_\_\_\_\_ PM



**FIND OUT FREE—HAVE YOU  
GOT WHAT IT TAKES...**

**to be a FINGER PRINT EXPERT  
or TRAINED INVESTIGATOR?**

Send for free IAS Qualification Questionnaire. If in our opinion your answers indicate that you "have what it takes," then you will receive **absolutely free** the famous "Blue Book of Crime" . . . plus full details on how to train at home in Crime Detection and Finger Printing! IAS graduates are key men in over 800 Police Bureaus. See if YOU can train for this exciting, steady, "good pay" work! No obligation. No salesman will call. Write today, stating age.

**WRITE  
TODAY**

**INSTITUTE OF APPLIED SCIENCE**  
1920 Sunnyside Ave., Dept. X-1354, Chicago 40, Ill.

## ENGINEERING DEGREE IN 27 MONTHS

**INDIANA  
TECHNICAL  
COLLEGE**

Aeronautical, Chemical, Civil, Electrical, Mechanical, and Radio Engineering (inc. television). Drafting, 1-yr. Gov't approved for G.I.'s. Low rate. Earn board. Large industrial center. Students from 48 states, 18 countries. Demand for graduates. Enter June, September, December, March. Catalog.

549 E. Washington Blvd., Ft. Wayne 2, Ind.

## Learn PHOTOGRAPHY

Win success in photography by spare time Home Study or at our famous Resident School in the heart of New York. Commercial, Advertising, Portrait, Color, etc. 39th year. Write today!

**NEW YORK INSTITUTE OF PHOTOGRAPHY**

Dept. "49", 10 W. 33 St., New York 1, N. Y.

## WATCH REPAIRING

Be a Master Watchmaker! Graduates earn big money—many in business for themselves. The famous Sweazey System of Instruction teaches you quickly and easily. Our 41st year.

Write today for free information.

**CHICAGO SCHOOL OF WATCHMAKING**  
Dept. 149, 1608 Milwaukee Ave. Chicago 47, Ill.



**RE-STRING RACKETS  
AT HOME—EARN MONEY**

**EASY—PLEASANT—PROFITABLE**  
**FREE** Write for 1949 Catalog and Instruction Sheet NOW.

W. A. BICKEL & CO., 803 S. Boulevard, Dept. F-52, Oak Park, Ill.

**Say You Saw It in Popular Mechanics**

## BE A SUPERVISOR

**FRANKLIN TECHNICAL INSTITUTE  
HELPS YOUNG PEOPLE GET AHEAD**



● Specialized technical training opens wide the door to well-paid supervisory jobs in industry. 50,000 young men and women from many states have graduated from this Boston school and found good jobs in engineering and technical fields.

Practical two-year day courses in industrial electricity and electronics, industrial chemistry, mechanical and machine design, structural design and architectural drafting, automotive service and management, electric wiring and maintenance. Also preparatory and evening classes. Approved for veterans. 41st year. Write for catalog.

**FRANKLIN TECHNICAL INSTITUTE**  
43 BERKELEY STREET, BOSTON 16, MASS.

POPULAR MECHANICS

# draw me!

## \$1000.00

### In Valuable Prizes

SCHOLARSHIPS AND CASH  
TO AMATEUR ARTISTS

1st, 2nd and 3rd prizes . . . COMPLETE  
ART COURSES . . . including Drawing  
Outfits (value of each course \$240.00);  
4th, \$100.00; 5th, \$50.00; 6th, \$30.00  
and 10 prizes, \$10.00 each.



● *Copy the girl and try for a prize!*

Splendid opportunities now for *trained*  
artists in all fields. Find out how much  
ability you really have. Mail this coupon  
with your drawing.

#### Contest Rules

You must be amateur. Our  
students not eligible. Make  
copy of girl 5 ins. high.  
Pencil or pen only. Omit  
lettering. All drawings  
must be received by April  
30, 1949. None returned.  
Winners notified. If de-  
sired, send stamped, self-  
addressed envelope for list  
of winners.

#### ART INSTRUCTION, INC.

Dept. 4139C • 500 South Fourth Street, Minneapolis 15, Minn.

● Please enter my drawing (attached) in your \$1,000.00 April contest.

(Please Print)

Name \_\_\_\_\_ Age \_\_\_\_\_

Address \_\_\_\_\_

City \_\_\_\_\_ Zone \_\_\_\_\_ County \_\_\_\_\_

State \_\_\_\_\_ Occupation \_\_\_\_\_

# OPPORTUNITIES AHEAD

## For Men Who are Trained in AUTO BODY & FENDER WORK

Men 18 to 60. Want a future with good pay, perhaps a business of your own later? If you are mechanically inclined, start now to learn to become an auto body mechanic and fender repair man. This fast growing field has great possibilities for trained men with experience. U. E. I. spare time, home-study training combined with actual shop practice gives you sound, basic knowledge of latest, best methods so you may get the experience which may bring you big pay. Capable instructors supervise your studies and actual practice. Course includes acetylene welding, spray painting, use of hand and power tools, etc.

### THOROUGH, RELIABLE TRAINING

U. E. I. has trained men for new opportunity fields since 1927 and many students are now making good. Auto body and fender repairing is one of the best profit-makers in any garage or service station. Little capital required. . . . placement service, or we will show you how to start your own shop. Get the facts FREE, without obligation. Write today.

**Write for Facts**

## UTILITIES ENGINEERING INSTITUTE

AUTO-CRAFTS DIVISION

2523 Sheffield Ave., Dept. XC-1, Chicago 14, Ill.

Gentlemen:—YES! I want to get into profitable Auto Body and Fender Repair Work. Please send me FREE FACTS at once.

Name \_\_\_\_\_ Age \_\_\_\_\_

Address \_\_\_\_\_

City \_\_\_\_\_ Zone or County \_\_\_\_\_ State \_\_\_\_\_

Check here for Special Information if under 17.

## HIGH PAY JOBS

### FOR MEN WHO QUALIFY IN DIESEL



**ASSURE YOUR FUTURE.** Steady, big pay jobs await men qualified in Diesel, Tractor and Heavy Equipment. Can you take advantage of Diesel job and advancement opportunities in this fast-growing field?

### COMPLETE DIESEL COURSE AVAILABLE.

If you are ambitious and want to get ahead in this lucrative field, you'll want to know about the complete training in Diesel provided by Interstate. Trains you at home in spare time. Does not interfere with your present job. Covers all phases of operation. Up to the minute. Revised regularly to cover new developments. Free placement advisory service.

#### YOU OWE IT TO YOURSELF

to investigate I.T.S. home Diesel training. Thousands of students agree it has helped them to better jobs.. better pay. It can do the same for you!

#### SEND FOR FREE BOOK TODAY!

We'll gladly send you our big 24-page book "Getting Ahead In Diesel" FREE! Paste coupon on penny card and mail to

INTERSTATE TRAINING SERVICE  
4035 N. E. Sandy, Portland 13, Oregon

Please see that I receive FREE BOOK "Getting Ahead In Diesel":

Name \_\_\_\_\_ Age \_\_\_\_\_

Address \_\_\_\_\_

City \_\_\_\_\_ Zone \_\_\_\_\_ State \_\_\_\_\_ (D-3)

SAY YOU SAW IT IN POPULAR MECHANICS

## PRINT YOUR OWN POST CARDS

COMPLETE OUTFIT

only \$7.50

Amazing results in sales, inquiries and contacts . . . saves time and money . . . very easy to use GEM STENCIL DUPLICATOR is ideal for Advertising, Announcements, Notices, Labels, Forms, Price Lists—hundreds of uses for every type of business and organization. Comes complete with all supplies, instructions and 60-page Book of Ideas.

**FREE TRIAL OFFER:** Try it before you buy it! Write and a GEM OUTFIT will be sent you postpaid. After 10 days, send only \$7.50 or return the GEM, no questions asked. The GEM must sell itself: you be the judge.

BOND EQUIPMENT CO. • Dept. 135  
6633 Enright • St. Louis 5, Mo.

SEND NO MONEY • FREE TRIAL OFFER



## Learn to Write at Home in Spare Time

You are often judged by your handwriting. Why write a poor hand when it's so easy to become a Good Penman? Hundreds have become Expert Penmen at home in spare moments by my Simplified Method, who never thought before they could learn. Regardless of how you Now write, You, too can learn Expert Penmanship at home in spare moments. Write for Complete Information and my FREE BOOK, "How to Become an Expert Penman," which shows what others have accomplished by taking my Courses. If you wish, enclose 10c for Special Penpoint and your name with a flourished bird written on a card. Write TODAY.

D. M. Tevis, Box 25K, Chillicothe, Mo.

## WOULD \$400 PER MONTH



### INTEREST YOU?

It is easily possible to earn \$400 to \$500 a month raising ANGORA RABBITS. No experience required. Wool brings \$9 lb. Plenty markets. WRITE TODAY for FREE INFORMATION, PRICES & WHERE to SELL.

WHITE'S RABBITRY  
NEWARK 10, OHIO



## SENDING-RECEIVING SPEED

Learn to send and receive Radio Code with greater speed. Stop nervous tension. Have confidence. Be proficient. Same system used by radiotelegraph specialists. Thousands of operators needed. Rush name for FREE book.

CANDLER SYSTEM CO.

Dept. 5-D, Box 928, Denver 1, Colo., U. S. A.

## LEARN MONEY-MAKING CARTOONING

IN SPARE TIME — by Easy Picture Chart Method Same Simplified Method that has helped train creators of "Terry & Pirates," "Freckles," "Out Our Way," "Winnie Winkle," "Reg'lar Fellers," "Strange As It Seems," "The Neighbors," and many others. Earn while learning. Send 10c for Picture Chart (to test your ability), and full details. (State age.)

THE LANDON SCHOOL, 4904 Cleve. Transit Bldg., Cleveland, O.



## COVERALLS

SURPLUS STOCK FROM MIDWEST SUPPLY FIRM!

WHAT A BARGAIN! These sturdy coveralls though used, have been sterilized, laundered and pressed. Perfect condition. Choice of Blue or Tan. Send name, address, chest measurement and color desired. Pay postman plus postage or send cash and we ship prepaid.

WORK PANTS Only 99c pr.

Send waist and leg measure. Blue or Tan.

WORK SHIRTS Only 69c ea.

Send neck size. Blue or Tan.



Only \$1.49

(Pants and shirts sterilized, laundered, pressed.)

MILCO SALES, Dept. M-981

9350 ROSELAWN • DETROIT 4, MICHIGAN

POPULAR MECHANICS



# GET INTO DRAFTING

The Draftsman Plays a most Important Part in INDUSTRY

## DRAWING OUTFIT INCLUDED with Drafting courses

All the tools you need including folding drawing table. With them you can put your ideas on paper quickly and with accuracy. With training you are all set to master Drafting in months, — not years — at home.

### Learn in Spare Time—At Home!

(or at the College in Chicago)

A few hours of pleasant home study every week — that's all. With Chicago Tech's help, you train yourself step by step. This tested method — developed over 44 years of C.T.C. progress — prepares men for good positions in industry.



Practically everything that's built or manufactured these days is constructed from blue print drawings prepared by the draftsman. He is the KEY man in industry. No new machines can be built, no bridges erected, no buildings constructed until the draftsman has completed his work.

Drafting is clean, interesting, professional-type work. The draftsman is paid well to start. And he has real opportunities for advancement to high-pay jobs in Engineering. The tremendous production programs ahead in industry will require more draftsmen than ever before.

Send today for free information. See what this training has done for others, what it can do for you. Simply MAIL COUPON TODAY in an envelope or use a penny postcard.

**CHICAGO TECHNICAL COLLEGE**  
D-212 Tech Building, 2000 South Michigan Ave.  
Chicago 16, Illinois

## MAIL COUPON NOW

Chicago Technical College  
D-212 Tech Bldg., 2000 So. Michigan Ave.  
Chicago 16, Illinois

Mail me FREE Drafting Lesson with information about big opportunities in DRAFTING and how I can train at home.

- Architectural Drafting       Electrical Drafting  
 Machine Drafting          Structural Drafting  
 Builders' Course

Name \_\_\_\_\_ Age \_\_\_\_\_  
Address \_\_\_\_\_  
City \_\_\_\_\_ Zone \_\_\_\_\_ State \_\_\_\_\_

## BE A NOTARY PUBLIC

For effortless lifetime income. You notarize only legal papers with your signature and official seal, as a public notary, collect and keep the fees. No training needed, no course to study. Like compound interest, money intake grows as your official capacity becomes known. Income modest but steady, never-ending, like paid-up annuity. If you qualify as to character and age, old legal-supply firm, 22 cities, will see you appointed by governor and equip you for \$25. Every business person, steno, accountant should be a notary. Apply . . .

STATIONERS EXCHANGE, BOERNE 34, TEXAS

## SHORTHAND in 6 Weeks at Home

Famous Speedwriting system. No signs; no symbols; no machines; uses ABC's. Easy to learn; easy to write and transcribe. Fast preparation for a job. Surprisingly low cost. 100,000 taught by mail. Used in leading offices and Civil Service. Write for free booklet. SPEEDWRITING, Dept. 1504-9, 55 W. 42 St., New York 18

## Tells How You Can Learn to MOUNT BIRDS!

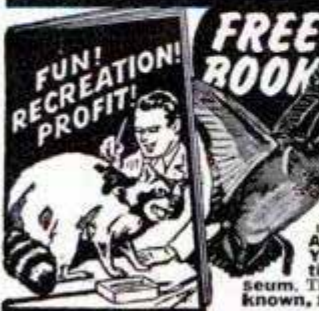

### Learn At Home

Men, Boys, Hunters, Fishermen, mount and save your lovely wild-game trophies. Be a Taxidermist. Mount Birds, Animals, Heads, Fish, Tan skins. YOU learn easily, quickly in spare time. Have a grand home-museum. The finest and the greatest hobby known, for sportsmen. Fun, real profits.

## FREE BOOK

Yes, FREE. Beautiful strange, valuable Book, telling all about Taxidermy. Contains over 100 beautiful game-pictures. And it's yours FREE, if you rush your request. You can mount all kinds of wild-game, and common specimens too. We can positively TEACH YOU. So GRASP this opportunity. RUSH letter or postal for this amazing FREE BOOK. Don't delay. State your AGE. N. W. SCHOOL OF TAXIDERMY, 2564 Elwood Bldg., Omaha 2, Neb.



## START AS HIGH AS \$3,351.00 YEAR

Many Early Examinations Expected. Prepare NOW! Veterans Get Special Preference! 40-Page Civil Service Book FREE

Mail Coupon Today SURE

Franklin Institute  
Dept. N85  
Rochester 4, N. Y.

(Not Government Controlled)

Gentlemen: Rush to me, FREE of charge, list of U. S. government big pay jobs. Send FREE 40-page book describing salaries, vacations, hours, work, etc. Tell me how to qualify for one of these jobs.

★ Name \_\_\_\_\_  
Address \_\_\_\_\_ Vet? \_\_\_\_\_

For Greater Income

# LEARN A TRADE



- ✓ Auto Mechanics
- ✓ Body-Fender Repair
- ✓ Diesel Engines
- ✓ Building Construction

- ✓ Refrigeration Air Conditioning
- ✓ Electricity Electronics
- ✓ Radio Servicing
- ✓ Television
- ✓ Drafting

The years ahead are going to be big. Grow with them. Prepare now to get into a great, growing industry. Train with C.T.I. — a Nationally Known School. Get the benefits of our efficient Placement Service whether you want a better job or business of your own. You can come directly to our big, well equipped shops, located only a block from the shores of Lake Michigan — or you can begin your training at home by C.T.I.'s SHOP-PROVED HOME TRAINING METHODS. Fill out coupon — mail it today for big, illustrated FREE booklet.

## FILL OUT · CUT OUT · MAIL TODAY!

### FACTS FREE FOR MEN WHO WANT TO GET AHEAD

COMMERCIAL TRADES INSTITUTE, Dept. E2-4  
1400 W. Greenleaf, Chicago 26, Ill.

Send free illustrated Brochures and other information about the field I have checked below.

- |  |                                      |   |
|--|--------------------------------------|---|
| <input type="checkbox"/> Body and Fender Repairing | <input type="checkbox"/> Radio       | <input type="checkbox"/> Building                           |
| <input type="checkbox"/> Automotive Mechanics      | <input type="checkbox"/> Television  | <input type="checkbox"/> Drafting                           |
| <input type="checkbox"/> Diesel Mechanics          | <input type="checkbox"/> Electricity | <input type="checkbox"/> Refrigeration and Air Conditioning |

Name \_\_\_\_\_

Address \_\_\_\_\_

City \_\_\_\_\_ State \_\_\_\_\_

Veteran       Non-Veteran



## VETERANS!

VETERANS — Just mail coupon we will handle all details.  
NON-VETERANS — Don't let the lack of ready cash prevent you from taking this training now. Investigate our Low Easy-Payment Plan and our Pay-After-Graduation Plan.



### Commercial Trades Institute

Dept. E2-4  
1400 W. GREENLEAF  
CHICAGO 26, ILL.

## LEARN

# AVIATION

AN ESSENTIAL INDUSTRY IN PEACE OR WAR  
MAXIMUM TRAINING IN MINIMUM TIME

for 19 years Cal-Aero Technical Institute has specialized in....

## ✓ AERONAUTICAL ENGINEERING

2 year course — kept abreast of new research and scientific development.

## ✓ MASTER AVIATION MECHANICS

1 year course — C. A. A. approved for Airplane and Engine License.

Modern "live" training equipment, including helicopters, jets, rockets, wind tunnel... Classes start monthly — Room and board available on our airport... Cal-Aero Tech Training is carefully designed for just one thing — TO MAKE MORE MONEY FOR YOU. More than 7000 successful graduates in addition to 26,000 pilots and 7500 mechanics trained for Army & Navy Air Forces, prove that our career training is unsurpassed.

APPROVED FOR VETERANS



GRAND CENTRAL AIR TERMINAL  
GLENDALE 1, CALIFORNIA  
LOS ANGELES COUNTY

## MAIL THIS COUPON TODAY!

Please send full information on Aviation Training FREE—without obligation.

Name \_\_\_\_\_ Birth Date \_\_\_\_\_

Street \_\_\_\_\_ Zone \_\_\_\_\_

City \_\_\_\_\_ State \_\_\_\_\_

CHECK ONE     VETERAN     NON-VETERAN    PM-4



## There's No "Mystery" in Watchmaking! YOU CAN LEARN THIS PROFITABLE SKILL!

For 300 years, watchmakers' skills have been closely-guarded secrets. Now, you can learn skilled watchmaking in scenic, mile-high Denver. I'll give you everything in practical benchwork from half-spring manipulation to position adjustment. Nationally accredited, veteran approved. Write Orville R. Hagans for information, no obligation. No salesman will call. FREE BOOKLET.

AMERICAN ACADEMY INC.  
SCHOOL OF HOROLOGY  
1549 Lawrence St., Dept. H, Denver 2, Colo.



## Bar Bells

Buy Direct From Factory

Write for free booklet  
and price list

\$8.95 up

INDEPENDENT IRON WORKS  
2416 East 23rd Street, Dept. B  
Los Angeles 11, Calif.



## BUILD YOUR OWN ENLARGER

Enjoy Photography's most fascinating hobby at a fraction of usual cost. With simple step-by-step instructions and diagrams plus a screwdriver and pliers you assemble your own Enlarger and Save! Get all features of more expensive Enlargers: precision machined aluminum alloy castings. 90° tilt for wall projection of prints, spherical aluminum lamphouse, helical rack and pinion focusing with extra large knobs, unconditional guarantee. For 35mm to 2 1/4x3 1/4 negatives. Time payment plan.

Write Today for Free Illustrated Folder  
CALIFORNIA TECHNICAL PRODUCTS CO.  
448 S. Hill, Dept. M-4, Los Angeles 13, Calif.

Say You Saw It in Popular Mechanics

## Learn PHOTOGRAPHY at Home

Splendid opportunities. Prepare in spare time. Practical basic training. Long-established school. Send for free book, "Opportunities in Photography." No obligation.

American School of Photography, 1315 S. Michigan Ave., Dept. 1354, Chicago 5, Ill.

# Now YOU Can Lick Any AUTO REPAIR JOB!

IN LESS TIME—WITH LESS WORK



**FREE  
7-DAY OFFER**

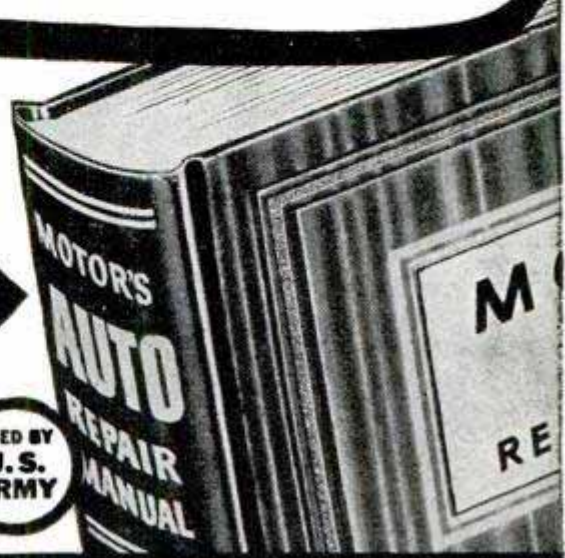

**MoToR's New Auto REPAIR MANUAL** shows you how to service and repair ANY part of ANY car!

No auto repair job is too tough when you've got MoToR's AUTO REPAIR MANUAL! YOU can repair anything from carburetor to rear end—quickly, easily, right! Just look up make, model, and the job in the quick index—and go to it! Clear, illustrated instructions lead you step by step.

To make such an amazing book possible, the engineer-editors of MoToR Magazine collected and "broke down" over 150 official factory shop manuals for you, spotted all the vital repair information you need, dove-tailed it all together into ONE handy, easy-to-understand book.

### No Other Manual Like It!

This BIG book—764 pages, 8½x11 inches, bound in sturdy fabric—brings you nearly 200,000 service, repair, adjustment, replacement, tune-up facts on every car built from 1935 to 1948! More than 1700 cut-away photos, diagrams,

drawings show you exactly WHAT to do and HOW to do it! Used by the U. S. Army, trade and technical schools everywhere, thousands of auto servicemen.

Now YOU—without cost—can see for yourself what a wonderbook MoToR's Auto Repair Manual really is. TRY it—FREE for 7 days! Learn first-hand how it can pay for itself the first few times you use it.

## SEND NO MONEY 7-Day Free Examination

Just mail coupon below—without money! When the postman brings your book, pay him nothing. First make it show you what it's got! Unless you agree this is the greatest time-saver and work-saver you've ever seen—return book in 7 days and pay nothing. Mail coupon today! Address: MoToR Book Department, Desk 14, 250 West 55 Street, New York 19, N. Y.

USED BY  
U.S.  
ARMY

### Clear, Pictured Facts on Every Job on Every Car Built Since 1935!

Nearly 200,000 service and repair facts on all these makes:

American	Ford	Nash
Bantam	Frazer	Oldsmobile
Auburn	Graham	Packard
Austin	Hudson	Pierce
Buick	Kaiser	Arrow
Cadillac	Hupmobile	Plymouth
Chevrolet	Kaiser	Pontiac
Chrysler	Lafayette	Reo
Cord	La Salle	Studebaker
Crosley	Lincoln	Terraplane
De Soto	Lincoln	Willys
Dodge	Zephyr	
	Mercury	

Over 700 big pages; including 70 pages of carburetor text, charts, illustrations, covering all models. Over 200 charts, tables; Tune-up Chart; Valve Measurements; Compression Pressure; Torque Wrench Reading; Starting Motor; Engine Clearances; Generator; Body Service; Dash Gauges; Brake Specifications; Front End Measurements, etc.; Engines; Electric, Fuel, Cooling, Lubricating Systems; Transmissions; Universals; Front Ends; Wheels; Rear Ends, etc.

### Same FREE 7-Day Offer Applies on MoToR's TRUCK REPAIR MANUAL

For mechanics, truck specialists, service stations, fleet owners. Covers EVERY job on EVERY truck made since 1936! 1400 pictures, 952 pages, 300,000 facts. Used by Armed Forces. Warranted to contain every essential fact you need to know. Sturdy binding, size 8½x11.

Covers all types Gasoline En-

gines; Diesels and Hesselmanns. Fuel Systems, Governors, Lubrication Systems, Ignition Systems, Starters, Generators, Clutches, Transmissions, Axles, Torque Dividers, Transfer Cases, Brakes, Steering, etc., etc.

ALSO SERVICES buses, farm and industrial tractors, contractor and road building equipment, stationary power machinery, etc. (on all parts described in Manual). Offered on same FREE 7-Day examination as Auto Repair Manual. Check box in coupon at right.



**MoToR** Published by MoToR, The Leading Automotive Business Magazine. MoToR's manuals assure high standards of repair work.

### MAIL COUPON NOW FOR 7-DAY FREE TRIAL

MoToR Book Dept., Desk 14, 250 West 55 Street, New York 19, N. Y. Rush to me at once: (check box opposite book you want)

MoToR's AUTO REPAIR MANUAL. If O.K. I will remit \$1 in 7 days, (plus 35c delivery charge), then \$2 monthly for 2 months, and a final payment of 95c one month later. Otherwise I will return book postpaid in 7 days. (Foreign price, remit \$8 cash with order.)

MoToR's TRUCK REPAIR MANUAL. (Described at left) If O.K. I will remit \$2 in 7 days, and \$2 monthly for 3 months, plus 35c delivery charge with final payment. Otherwise I will return book postpaid in 7 days. (Foreign price, remit \$10 cash with order.)

Print Name \_\_\_\_\_ Age \_\_\_\_\_

Print Address \_\_\_\_\_

City \_\_\_\_\_ Zone No. \_\_\_\_\_

State \_\_\_\_\_ (if any) \_\_\_\_\_

Occupation \_\_\_\_\_

Check box and SAVE 35c delivery charge by enclosing WITH COUPON entire payment of \$5.95 for Auto Repair Manual (or \$8.00 for Truck Repair Manual). Same 7-day return privilege applies.

# Don't Envy The PLUMBER-Be One

## Make \$15 to \$50 a Day

Every skilled workman will tell you Plumbers have the best of it. WINTER and SUMMER the Plumber is busy at top wages. No skilled Plumber is ever out of a job. Compare his opportunities with any trade. To the man with know how, Plumbing means profit. Investigate Universal Plumbing School. Not a "war born school," but a plumbing school developed and operated by plumbers since 1923.



The Plumber Protects The Health of the Nation

### Own Your Own BUSINESS

Have your own business and big profits with little other than training and a kit of tools.

### JOURNEYMAN Gets Good Salary

Master Plumbers own their own shop. A Journeyman works for a Master. With this training journey-men can depend on high wages.

G. I. Approved. Established 1923

### UNIVERSAL PLUMBING SCHOOL

877 Holmes Street

Kansas City, Mo.

### BE A PLUMBER IN JUST 32 WEEKS

#### Learn With Tools—Not Books

No need ever serve an apprenticeship. Don't envy the plumbers big profits—enjoy them. Learn every trick of the trade—Leadwork—Blueprint for plan reading, etc. under Licensed Master Plumbers.

#### Over 7,000 Successful Plumbers Recommend This School

This system has made more than 7,000 plumbers. Investigate our past performance. If you like to work with tools this is your opportunity. Become a Plumber in America's largest and only school devoted exclusively to plumbing. Write today for FREE information.

# INVENTORS

When you are satisfied that you have invented a matter of value—write me, without obligation, for full information as to what steps you should take to secure a Patent.

The usual first step is to have a search of the prior U. S. Patents conducted, so that I can report to you on the question of Patentability.

### PATRICK D. BEAVERS

(Formerly RANDOLPH & BEAVERS)

Registered Patent Attorney

934 Columbian Building Washington 1, D. C.

PATRICK D. BEAVERS, Registered Patent Atty.  
934 Columbian Bldg., Washington 1, D. C.

Please send me full information on how to secure Patent Protection and Trademark Registration.

Name \_\_\_\_\_

Street \_\_\_\_\_

City \_\_\_\_\_ State \_\_\_\_\_



## REFRIGERATION and AIR CONDITIONING

Look Into This

### BIG PAY TRADE — Don't say,

"I never had a chance!" These big opportunity trades need trained men! Now by the proven, practical U.E.I. training plan you can prepare in spare time to break into the profitable servicing and installing fields. Actual shop practice included.

The facts are FREE. Write for them today.

UTILITIES ENGINEERING INSTITUTE (Founded 1927)  
2525 SHEFFIELD AVE., DEPT. C-1 CHICAGO 14, ILLINOIS

## TRI-STATE COLLEGE

### B. S. DEGREE IN 27 MONTHS

66th Year.

Students from all over the world.

ENGINEERING — Courses in Civil, Electrical, Mechanical, Chemical, Aeronautical and Radio (including Television). Also Bus. Admin., Acc't. and Sec. Science. Low living costs. Modern cafeteria on campus. Graduates in demand. Enter June, Sept., Jan., March. Write for Catalog. 449 College Avenue, Angola, Indiana.

# PATENTS

## AND TRADE MARKS

### C. A. SNOW & CO.

REGISTERED PATENT ATTORNEYS

WRITE FOR INFORMATION TO

428 SNOW BUILDING, WASHINGTON 1, D. C.

# INVENTORS

Whether an invention is patentable can be substantially determined by a search of the U. S. Patent records. Without obligation, write for information explaining the steps you should take to secure a patent.

### JOHN N. RANDOLPH

Registered Patent Attorney

201 Columbian Building, Washington 1, D. C.

## PATENTS PATENT LAWYER

TRADE MARKS ASSOCIATE EXAMINER

**Gustave Miller** U. S. PATENT OFFICE 1922-1929

49PM WARNER BLDG. REGISTERED PATENT ATTORNEY

WASHINGTON 4, D. C. Send for Form "INVENTOR'S RECORD"

# INVENTING

**—FOR PROFIT!** If you have an inventive turn of mind, write for free 28-page booklet explaining how the Institute of American Inventors is helping inventors pre-test the profit possibilities of proposed devices to fill today's unprecedented demand for useful new inventions.

### INSTITUTE OF AMERICAN INVENTORS

Dept. 4, 1926 Eye St., NW, Washington 6, D. C.

## PATENTS

"Proof of Invention" Folder mailed without obligation.

**E. E. VROOMAN, Registered Patent Atty.**

505 McKim Building, Washington 5, D. C.

# INVENTORS

IF YOU WISH TO PROTECT YOUR INVENTION, You should take steps to protect it by a U. S. Patent. Write me for "Record of Invention" form.

### CARL MILLER REGISTERED PATENT ATTORNEY

Woolworth Bldg., 35th Floor, Dept. 49-A, New York City  
Please send me "Record of Invention" form.

NAME \_\_\_\_\_

ADDRESS \_\_\_\_\_



**\$200 GROSS IN MY  
FIRST WEEK!**

**FREE BOOK! MAIL COUPON**



**Some Make More, Some  
Less . . . Start This Busi-  
ness for YOUR OWN**

Would YOU like to own a permanent, year-round business in which it is possible to take in as much as \$200 gross the first week, as did L. A. Eagles? R. E. Traynor says, "I made \$62 gross in one day." R. R. Newlin reports, "I have averaged \$173 gross per week." Others report gross from \$100 per week to \$12,000 per year.

Surely YOU will want to investigate a golden opportunity like that. You need not have any special skill or experience, but if you are ambitious, honest and courteous, we will help you to start and succeed in YOUR OWN money-making business where net profits are high.

**No Shop Necessary**

Our Electric Rug Washer cleans rugs and carpets like new right on the customer's floor. This quick, thorough and highly efficient method removes dirt and grime, thus restoring the natural, fresh beauty of floor coverings. Anyone can run it. Rugs and carpets are not harmed.

There are hundreds of possible customers in YOUR vicinity. Most of them have several rugs needing regular cleaning. To get a quick start,

**VON SCHRADER MFG. CO.**  
A491, Racine, Wis.

Send at once (no obligation) your FREE booklet containing information about your Electric Rug Washer and how I can own my own permanent, profitable business.

Name \_\_\_\_\_  
Address \_\_\_\_\_  
City \_\_\_\_\_ (Zone) \_\_\_\_\_ State \_\_\_\_\_

shampoo a few rugs or carpets. These customers tell their friends and soon you should have an independent, prosperous business, and you should be able to keep it growing. Send the coupon RIGHT NOW for booklet that explains everything.

**Every Machine Guaranteed  
and Easy to Own**

You take no risk. These wonderful, fully guaranteed machines have been used and endorsed by largest hotels, railroads—also used by U. S. Government. Many individuals have built up successful businesses that made big profits. Mail the coupon TODAY and we will send complete information, including how to start and succeed in YOUR business without a large investment. Don't delay your BIG opportunity. Send the coupon AT ONCE.



**MAIL COUPON TO VON SCHRADER MFG. CO., A491, RACINE, WIS.**

**HOW TO BE SUCCESSFUL IN THE FAST GROWING PLASTICS INDUSTRY**



**LEARN at HOME in Spare Time -**

Consider the important Plastics field for your future career. More products are being manufactured from plastics than ever before—making more opportunities for trained men and women. Mail the coupon below for illustrated literature which shows the many uses of plastics and what trained men must know to succeed in the Plastics Industry.

**You Get 7 BIG Plastic Material KITS** with your course and can make these and many other attractive, useful articles while learning.



**STUDY AT HOME OR COME TO CALIFORNIA**

Take famous Plastics Institute home training or come to Los Angeles for practical work in modern laboratories and shops. Students from foreign countries and many states now attending.

**SEND FOR FREE CATALOG TODAY**

**START YOUR TRAINING NOW—mail coupon and get started on the road to success in the great and growing field of Plastics.**

**PLASTICS INDUSTRIES TECHNICAL INSTITUTE**  
Dept. PM 4-9, 1601 S. Western Ave., Los Angeles 6, Calif.

Gentlemen: Please send me free literature and information on job opportunities. I am interested in Home Training  attending school in Los Angeles

Name \_\_\_\_\_ Age \_\_\_\_\_  
Street \_\_\_\_\_ Zone \_\_\_\_\_  
City \_\_\_\_\_ State \_\_\_\_\_  
Veteran \_\_\_\_\_ Non-Veteran \_\_\_\_\_

**PLASTICS INDUSTRIES  
TECHNICAL INSTITUTE**

Approved for Veterans • Available for Non-Veterans



## HIGH PAY • SECURITY When You LEARN A TRADE

Get ready for a well-paid, lifetime job or a business of your own in one of these FIVE ESSENTIAL TRADES. Complete training under expert instructors with practical experience prepares you to step into a good paying job with a future and security.

**ELECTRICITY:** Basic electricity, Residential and Industrial Wiring and Appliance Repair.

**PLUMBING:** Every phase — pipe cutting and threading to complete installations, blue print reading.

**AUTOMOTIVE & TRACTOR:** Engine overhaul, Transmissions, Carburetion, Generator-Ignition Systems, Tune Up.

**DRAFTING:** College level training in general Machine and Architectural Drafting

**SHOE REPAIRING:** Complete practical training includes reconditioning and rebuilding.

Approved For Veteran's Training

## NATIONAL TRADE SCHOOL

2610 Grand • Kansas City 8, Mo.

Without obligation to me please send full information on the course checked.

.....Automotive and Tractor Technician .. Drafting

.....Plumbing .....Electricity .....Shoe Repairing

Name.....Age.....

Address.....

City.....State.....

Veteran?.....

## TUBE GIVEN WITH EVERY TIRE



"VETS" TAKE 10% DISCOUNT  
OUR GUARANTEE  
OUR TIRES must make good  
or WE WILL  
NEEDLESS TO PAY MORE  
RISKY TO PAY LESS  
OUR LONG EXPERIENCE  
INSURES YOUR SAFETY

You get what we advertise  
Highest Quality Lowest Prices

HIGH ORIGINAL TREADS Slightly Used  
BUY IN CONFIDENCE safe dependable selected POPULAR  
BRANDS—Guaranteed to give A-1 SERVICE. Do not confuse  
these tires with re-caps or re-treads.

SELECTED for TOUGHEST JOBS Not just good... THE BEST  
These are genuine Values! One Trial will CONVINCE YOU

### TOPS IN VALUE TOPS IN SAFETY

600-16 .. \$5.32	650-16 .. 5.32	700-16 .. 6.32
650-15 .. 5.02	700-15 .. 5.32	750-16 .. 7.92

World's Best Truck Tire Values Top Service Minimum Prices

600-20(6) .. \$8.72	750-20(10) .. 10.22	1100-20(12) .. 16.42
650-20(6) .. 8.72	825-20(10) .. 14.92	1100-22(12) .. 18.22
700-20(8) .. 10.32	900-20(10) .. 15.42	32x6(8) .. 9.82
750-20(8) .. 9.22	1000-20(12) .. 16.22	32x6(10) .. 11.82

750-20 MILITARY 8 PLY REGULAR \$8.62—SUPER \$11.92

900-16 MILITARY 8 PLY REGULAR \$7.22—SUPER \$9.22

ONE QUALITY THE BEST AVAILABLE

### HERE'S MAXIMUM QUALITY IN THESE O. K. SAFE TIRES

600-16 .. \$3.62	650-16 .. \$3.92	700-16 .. \$4.62
650-15 .. 3.92	700-15 .. 4.02	750-16 .. 5.92

600-20(6) .. \$8.02	750-20(10) .. \$9.22	1100-20(12) .. 13.92
650-20(6) .. 7.72	825-20(10) .. 11.22	1100-22(12) .. 16.92
700-20(8) .. 9.32	900-20(10) .. 11.92	32x6(8) .. 9.22
750-20(8) .. 8.22	1000-20(12) .. 12.92	32x6(10) .. 11.22

### OUR SPECIALTY—TIRES FOR SCHOOL BUSES AND AMBULANCES

Thousands of Tires Shipped to Satisfied Customers Through-out  
United States and Many Distant Points. Please Note: We've made  
Thousands of Friends by giving a Tube with Passenger and Truck Tires.  
MAIL ORDERS given Personal Attention — Send This Ad with Check  
or Money Order. Dep't. 2

STANDARD 834 N. Broad St., Phila. 30, Pa.

SAY YOU SAW IT IN POPULAR MECHANICS

# K-R-O KILLS RATS

• K-R-O BIS-KITS are ready-made, easy to use; containing *fortified red squill*, they're safer around livestock, pets, and poultry. K-R-O POWDER is 100% *fortified red squill*; economical to use in badly infested areas when mixed with natural baits. BIS-KITS, 35c and \$1.00; POWDER, 75c at drug, seed, and feed stores. Money-back guarantee. The K-R-O Company, Springfield, Ohio.



## BEAUTIFY YOUR GARDEN

### Build This Authentic Dutch Windmill

Wings turn on a roller bearing arrangement. The entire turret turns keeping the wings in the wind at all times. Mill stands approximately 40" high. Fully detailed and dimensioned plans **ONLY \$0.75** and instructions for this model **ONLY \$13.75** Complete Kit, consisting of all parts neatly cut to perfect fit, plans and instructions **ONLY \$13.75**

Send 10c for Catalog Illustrating Over 100 Fine Projects.

CRAFTSMAN'S MODEL COMPANY, Dept. P 3  
2030 N. 41st STREET MILWAUKEE 8, WIS.



## ITALIAN ACCORDIONS

Hand Made. Very Best. Lowest Prices. Buy Direct from Factory Representative and Save Money. Send Name and Address for FREE catalog.

ITALIAN ACCORDION MFG. CO.  
7600 Cottage Grove Ave., Dept. PM4, Chicago, Ill.

## Learn RADIO-TELEVISION

### In Your Own HOME WORKSHOP

Build interesting Radio Circuits, acquire real experience, do scores of practical experiments — all through RTA's complete balanced training plus 10 BIG KITS of parts which RTA GIVES YOU! Get finest instruction direct from Hollywood, nerve-center of broadcasting, television and radio activities.

FREE BOOK  
Send postal for complete details plus FREE BOOK "How to Make Good in Radio-Television."

RADIO TRAINING ASSOCIATION OF AMERICA  
5620 Hollywood Blvd. Dept. 4-PM Hollywood 28, Calif.

## Learn CARTOONING

HAVE FUN! MAKE MONEY! Cash in on your sense of humor at HOME—BY MAIL. No experience needed to start. Write today for FREE TRIAL LESSON and full particulars.

MOON Gag Cartoon School, Dept. A, Fall Creek, Wis.



### MINIATURE ELECTRIC PARTS

50 KINDS. Make electric train gadgets, telegraph sets, signals, invent. Learn electric circuits. Catalog and lighting kit contains lamp, socket assembly, wire switches, rivets, battery case, clamps, instructions, 25c. ELECTRIC GAME CO., SECOND ST., HOLYOKE, MASS.

## make MONEY CASTING AT HOME



Make your own rubber molds quickly, cheaply with X.L. RUBBER. Cast thousands of perfect figurines, book ends, plaques, ornaments, ash trays, etc. GREAT PROFITS!

Write for NEW Catalog.  
X.L. Rubber, Pts. \$2.00; Qts. \$3.50; Gallons \$8.95; Models and enough rubber for 3 molds \$1.00 plus postage.

PLASTIC ARTS STUDIO Route 2 • Dept. 2 • Muncie Ind.

**DO ANY JOB .. EASIER .. QUICKER**  
**MAKE MORE MONEY** *in the*  
**BIG OPPORTUNITY**  
**FIELDS**

**Here's the Help You Need**  
**For Best Paying Jobs**  
**Right NOW!**

**FREE TRIAL**  
**IN YOUR OWN HOME**

**Used by Army, Navy, Other Government**  
**Depts., 200 Schools and Industrial Firms.**

**SEND NO MONEY**  
 Select the Books  
**YOU Need Now!**  
 We Ship **C.O.D.**  
 Anywhere in U. S.  
 and Will Refund  
 Amount Paid if  
 Not Satisfactory.

Do it now! Get the better pay that goes to men with specialized knowledge. Get into one of these big opportunity fields. Big money and many other advantages await you if you prepare now. Here is the help you need—**EASY—QUICK—AT LOW COST.** Thousands of men have already used these famous books. Beginners and experienced men alike have doubled and tripled their earnings with this help. You too, can now get the special knowledge you need for top pay, better jobs, or a business of your own. This is your **GOLDEN OPPORTUNITY.**

**AIR CONDITIONING**

Big air conditioning boom is Nation-wide and bigger than ever. Alive with new opportunities! Get this non-technical book by international authority and be ready for your share of millions to be spent. Covers whole field. 450 pages. Illustrated. \$4.00.

**SHEET METAL LAYOUT**

Makes sheet metal layout work so simple that anyone can learn. Get this new instructor and get into the easiest, cleanest and best paying part of all sheet metal work. 143 jobs worked out in drawings and carefully explained. Gives standard for all sheet metal fittings. \$3.50.

**BAILEY'S HANDBOOK**

World famous handbook of universal questions and answers for Stationary, Marine and DIESEL engineers and firemen. Prepares for any license examination in installation, maintenance and operation of Diesel and steam plants. Pocket size, \$2.00.

**MODERN WELDING**

Newest book on all types of welding and heat treatment of metals. Written by recognized specialists in training men for production jobs. 430 Pages, 277 illus. Practical and Non-Technical. Covers everything you need to know. \$4.00.

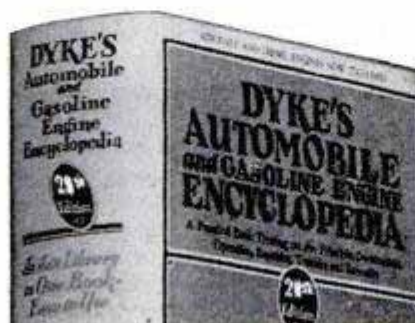

**1948**  
**21st**  
 EDITION  
 Leading  
 Auto  
 Book  
 for Over  
 32 Years

**World's GREATEST AUTO BOOK**

**New Material, Specifications,**  
**1947 Cars, 1948 Trucks, Busses,**  
**Tractors, Diesels**

Now with millions of cars needing repairs and thousands of men needed to do the work, you need the famous DYKE Auto Book more than ever before. New 21st Edition covers all principles, construction, repair, adjustments, testing, troubles and remedies. Over a half million copies of 20 editions of Dyke's have been sold. Buick Dynaflo, Farm and Outboard Motors and new electrical systems now covered. World's biggest book value. Only \$7.50.

This big book, a complete auto library in one volume, has 1483 pages—4600 illustrations and diagrams—weighs 6 lbs.—equal to 4 ordinary books.



**The Easy Way to a**  
**Profitable Business**  
**Of Your Own!**

Owners will spend big money to keep their good older cars looking like the new ones coming out. This is a practical money-making guide, ideal for shop owners and every man who wants a share of the millions to be spent in keeping old cars looking new. Tells how to get a good job or start business of your own with small capital. Covers everything including tools, methods and materials. Only book of its kind. 325 pages, 232 illustrations. \$3.50.

**HOUSE WIRING — NEW EDITION**

Get this new sixth edition of this standard and practical electrical wiring book. It gives complete practical instruction on every phase of house wiring in one handy volume. Goes further than most books on subject. Handbook style. Gives National Electric Code. 400 pages, 669 illustrations. Electrical work will reach a new high with millions of new homes to be built. Get started now. \$3.00.

**CARBURETORS — Dyke**

The standard guide in the best paying auto work for a generation. It has helped thousands of men make money. New edition covers engine tune-up, compression, ignition, carburetion, fuel pump valves, etc. Use this book to specialize in this big field. 244 pages, 549 illustrations. \$3.50.

Mail Coupon to **GOODHEART-WILCOX CO., Dept. 14, 1321 S. Michigan Ave., Chicago**



**20 Million Refrigerators**  
**Need Service and**  
**Repairs**

**REFRIGERATION—Book of the Hour!**

**Biggest Opportunity in Many Years!**

**LATEST PRINTING — ALMOST 1000 PAGES**

**408 Pictures—17 Diagrams in Colors Makes All Refrigerator Service Maintenance, Repairs Simple as A. B. C.**

Thousands of Refrigerators need repairs! Owners will pay big for competent service which will be needed more and more. Get **MODERN GAS AND ELECTRIC REFRIGERATION**, the non-technical guide to all types of refrigerators and get your share of this new profit. Get a job or start your own service business. This book will help you make money anywhere. It is the recognized standard book on the subject. Price \$5.00.

**SEND NO MONEY! Mail Coupon**

**GOODHEART-WILCOX CO.,**

**1321 S. Michigan Ave., Dept. 14, Chicago 5, Ill.**

Send books checked, C.O.D. I will pay postman, plus few cents charges. If not satisfactory I will return books in 5 days and you will refund money paid. (Outside U.S. or possessions remit with order.)

- |   |        |   |        |
|---|--------|---|--------|
| <input type="checkbox"/> Gas & Electric Refrigeration ..... | \$5.00 | <input type="checkbox"/> Air Conditioning .....       | \$4.00 |
| <input type="checkbox"/> Dyke's Auto Book .....             | \$7.50 | <input type="checkbox"/> Engineers Handbook .....     | \$2.00 |
| <input type="checkbox"/> Dyke's Carburetor Book .....       | \$3.50 | <input type="checkbox"/> Body and Fender Repair ..... | \$3.50 |
| <input type="checkbox"/> Modern Welding .....               | \$4.00 | <input type="checkbox"/> Shop Math. (2 vols.) .....   | \$3.00 |
| <input type="checkbox"/> Airplane Welding .....             | \$3.50 | <input type="checkbox"/> House Wiring .....           | \$3.00 |
| <input type="checkbox"/> Sheet Metal Layout .....           | \$3.50 | <input type="checkbox"/> A.C. Power Wiring .....      | \$4.00 |
|   |        | <input type="checkbox"/> D.C. Power Wiring .....      | \$4.00 |

If remittance accompanies order we will pay all postage charges under same return privilege.

Name \_\_\_\_\_

Address \_\_\_\_\_

City \_\_\_\_\_ State \_\_\_\_\_

# GROBAN'S - WAR SURPLUS BARGAINS

SHOP BY MAIL and SAVE  
Better buys - Satisfaction guaranteed

Brand New GENERAL ELECTRIC

8" Sealed Beam

## FLOODLIGHTS

300 Watts, 110 Volts, A.C. - D.C.

Has countless uses for:

- Homes
- Garages
- Workshops
- Driveways
- Outdoor advertising
- Displays
- Beach lighting
- Private air ports
- Photography

Wherever you need flood-lighting!

Bought by the U. S. Army for signal use. This is the greatest surplus bargain ever offered.

Lens, reflector and electrode vacuum sealed in one dust-proof, air tight unit. 300 Watts, 110 Volts. Weighs only 2½ lbs. List price \$10.50.



A TREMENDOUS VALUE for . . . **\$2.75** ea. postpaid

12 or more . . . . . **\$2.50** ea. postpaid

## Hand Hydraulic Pump

Brand New

Used for hydraulic jacks, presses, hoists and other hydraulic applications. For operating hydraulic cylinders to pump oil or hydraulic fluid under pressure. Hand pump has built-in check valve and is capable of delivering 1000 lbs. of pressure. Has alloy aluminum housing. Dimen.: 8" long x 3½" high x 2¾" wide. Ship wt. 3 lbs. A \$45.00 value . . . . . Now **\$8.95** postpaid



Outstanding Surplus Value!

BRAND NEW - GUARANTEED

## GRINDING WHEEL KITS

HUNDREDS OF ASSORTED ITEMS - A \$50 VALUE



FOR CUTTING, SHAPING, GRINDING, & POLISHING WOOD, METAL OR PLASTIC.

While supply still lasts, only

**\$8.95** Per Complete Kit

F.O.B. Chicago SET INCLUDES OVER 300 ITEMS

- 25 Grinding and cut-off wheels, sizes 1 to 5 inches, ½ to ¾ hole
- 6 Cut-off Wheels on ½" mandr'l.
- 3 Steel cutters 1½"
- 5 Steel cutters 3/32"
- 1 Steel circular saw mounted on mandrel
- 1 Drum sander ½" mounted on 3/32" mandrel
- 1 One inch buff on ½" mandrel
- 2 Leather wheels
- 1 Roughing stone
- 3 Honing stones 2 Felt bobs
- 10 Sanding rolls
- 5 Sanding sleeves
- 1 One inch felt wheel on ½" mandrel
- 1 7/8" rubber wheel on ½" mandrel
- 2 High speed rotary files ¼" shank
- 100 ¾" cloth butterfly abrasive discs
- 1 Box paper discs-100
- 1 Rag wheel-4 inch
- 10 Mounted stones-3/32", ¼", ½"
- 1 One inch wire wheel 5/8" hole, brass center

In sturdy compact container 13¼ x 9¼ x 2½", weight 8½ pounds; with installed rack for all drills.

- 1 4" Wire brush
- 1 Bristle brush 3", 5/8" hole, brass center

I enclose \$8.95  Check  M. O.  Send C. O. D.

Name \_\_\_\_\_  
Address \_\_\_\_\_

## SCOOP!

Brand New

## High Volume

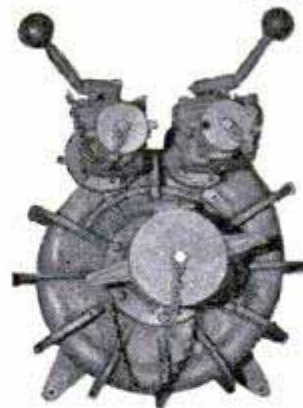

## CENTRIFUGAL PUMP

FOR FIRE PROTECTION, IRRIGATION, DE-WATERING, INDUSTRIAL USES, FARM USES, ETC.

PUMPS RATED 500 GALLONS PER MINUTE AT 275 FT. HEAD PRESSURE

Equipped with 1½" diameter straight splined shaft for direct coupling drive; 4½" threaded suction intake; two—2½" threaded discharge outlets; Hale Pump Co. Model CF volute type; use any 4 or 6 cylinder gas engine or couple directly to front of truck or auto; or use 25 H.P. electric motor; dimensions 21" x 24" x 28". Complete with full accessory kit including suction and pressure gauges, priming equipment, and instruction book. Ship. wt. 415 lbs. . . . . **\$149.50**

Gov't. acquisition cost \$425.00

NOW

**\$149.50**  
F.O.B. Chicago

ALL-PURPOSE

## WATER PUMP

Mfd. by PACKARD MOTOR CAR CO.

Ready for use on any pumping need

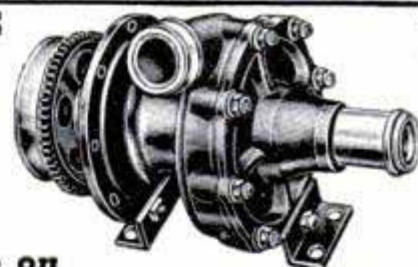

Brand New

## Belt Driven - Centrifugal Pump

- Use it for: DRAINING BASEMENTS
- HOME WATER SYSTEMS
- FIRE PROTECTION
- PRESSURE BOOSTER
- IRRIGATION
- DRAINING PONDS, TANKS, etc.
- SPRINKLING SYSTEMS
- STOCK WATERING
- INDUSTRIAL PUMPING

An extraordinary value for all types of intermittent or continuous pumping in the home . . . farm . . . factory. Built to exact specifications of Packard Motor Car Co. for use in Rolls-Royce Merlin Aircraft Engines. May be run with electric motor, gas engine or power take-off on tractor. Delivers up to 25 gallons a minute with ¼ H.P. motor; 80 gal. a min. with one H.P. motor. Will deliver up to 44 ft. head or 25 ft. suction. Use 1" outlet hose; 1" or 1½" inlet hose (recommended).

COMPLETE ENGINEERING REPORTS AND OPERATING INSTRUCTIONS FREE WITH PUMP

Has cast aluminum housing, accurately machined 5" bronze impeller; 3½" V belt pulley and mounting brackets. Shaft rotates on ball bearing; has grease gun fitting.

**\$21.50**

Complete with pulley and mounting brackets, ready for use.

Original cost approx. \$88.00. Shipping weight 10 lbs. A REAL BUY.

F.O.B. Chicago

WRITE FOR OUR FREE CATALOG!

ORDER DIRECT FROM AD  
Send payment or purchase order today  
SATISFACTION GUARANTEED

## GROBAN SUPPLY CO.

1507 SOUTH MICHIGAN AVE.

Chicago 5, Ill. Dept. PM-4

# GROBAN'S—WAR SURPLUS BARGAINS

SHOP BY MAIL and SAVE  
Better buys • Satisfaction guaranteed

## MINIATURE High Speed ELECTRIC MOTOR

IDEAL FOR MODEL BUILDERS, MODEL RAILROADERS, EXPERIMENTERS, HOBBYISTS. AC or DC. Reversible, speed may be regulated by varying voltage. Has miniature Klaxon thermostat switch. All connections are external and accessible. Has 3 mounting feet for easy installation. Double-end ball bearing supported shaft with small gear on one end. Die-cast housing with laminated field. Overall Dimen.: 3 1/4" long x 2 3/8" wide x 1 3/8" high. Net wt. 12 oz. A \$22.00 value.



Brand New

**\$2.95** postpaid



## Vickers MF9 Hydraulic PUMP or MOTOR

complete with mounting kit ready to install

\$75.00 value

**\$19.90** POSTPAID

Pump is compact, powerful, rated 1,000 P.S.I., .507 cu. in. per revolution, 8 gal. per min. at 3750 RPM. Change rotation by reversing flow. Delivers up to 6 H.P. Requires 1/3 to 6 H.P. to drive directly or by pulley. BRAND NEW.

Mounting kit has been especially designed to provide maximum utility and ease of mounting MF Series Vickers Pumps. Brackets are constructed of heavy steel plate; shaft is made of 1/2" steel with one end splined to fit pump; other end of shaft has machined flat for mounting a standard pulley with 1/2" hole. Shaft runs in oilite bronze bearings.

Pump only ..... \$14.95 postpaid

Mounting kit only ..... \$ 4.95 postpaid

Both as complete unit ..... \$19.90 postpaid

## Hydraulic Pressure Gauge

BRAND NEW

Ideal for high pressure hydraulic systems, adjusting pressure, relief valves, etc.

Range, 0 to 2000 P.S.I. Black plastic case 2 3/4" square, 1 3/4" deep. Black instrument face with white pointer and numerals. Worth many times this low price of ..... postpaid

**\$2.95**



ADJUSTABLE RELIEF VALVE... \$2.95 postpaid

FREE: New, 20-page illustrated Hydraulic Manual featuring diagrams, photographs and instructions—FREE with each hydraulic order.

## Self-Priming Bronze Pump

Positive Pumping Pressure

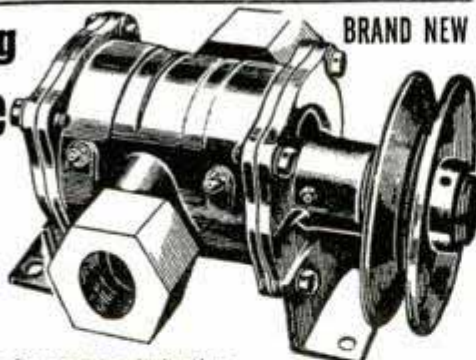

BRAND NEW

Perfect for draining basements, irrigation, fire fighting, sprinkling, pressure booster, insecticide and other spraying, fuel transfer, stock watering, industrial pumping, deep well jet pumping and home water systems. Rated 25 ft. suction and 150 ft. head pressure at 80 gallons. Use from 1/2 to 5 H.P. motor.

Mfd. by the Pump Division Eaton Mfg. Co.

Complete engineering report and instructions FREE with pump

Supplied with mounting brackets and 5" V belt pulley, ready for instant use. Standard 1 1/2" pipe thread inlet and outlet. Dimensions: 9 1/2" x 7 1/4" x 4 1/4". Ship. wt. 18 lbs. A \$142.00 value....

**\$32.50**

F.O.B. Chicago

## Brand New Air or Oil HYDRAULICS



Use hydraulics on arbor presses, hydraulic presses, hay lifts, manure loaders, lift trucks—push or pull, lift or turn, press or squeeze, open or close, lift or lower—and other hydraulic and industrial applications. Use with either air or oil . . . of finest precision workmanship.



1. Double action, 1" bore, 3" stroke, will lift 770 lbs. in 1/10 of a second using MF Pump. All steel barrel. Ideal for controls, door openers, positioning, etc. An \$18.00 value. . . . postpaid **\$4.95**
2. Double action, 1 1/2" bore, 5" stroke, will lift 1760 lbs. in one second with Vickers MF9 Pump. Wt. 3 lbs. A \$35.00 value. . . . . postpaid **\$8.95**
3. Double action, 1 1/2" bore, 9" stroke, will lift 1760 lbs. in one second with Vickers MF9 Pump. Wt. 4 lbs. A \$45.00 value. . . . . postpaid **\$10.95**
4. Use these cylinders on farm trucks, bulldozers, hay lifts, manure loaders, etc. Double action, 1 1/2" bore, 27" stroke. (Will lift 1760 lbs. in 2 seconds with Vickers Pump.) Wt. 8 lbs. A \$55.00 hydraulic cylinder value for only. . . . postpaid **\$12.95**
5. Double action, 2 3/8" bore, 8" stroke. (Will lift 4400 lbs. in one second with Vickers Pump.) Will withstand 1500 P.S.I. against wall. Wt. 7 lbs. A \$65.00 value. . . . . postpaid **\$14.50**
6. Double action 2 3/8" bore, 5" stroke, two-way solid 3/8" alloy steel shaft will lift 4400 lbs. in one second with Vickers Pump.) A \$73.00 value. . . . . postpaid **\$16.50**
7. Double action, 3" bore, 10 1/2" stroke. All steel hydraulic cylinder, will lift up to 12,000 lbs. (7000 lbs. in 3 seconds with Vickers Pump.) Complete with fittings. Wt. 12 lbs. A \$78.00 value. . . . . postpaid **\$19.50**
8. Double action, 3 1/2" bore, 11" stroke. (Will lift 9600 lbs. in 7 seconds using Vickers MF9 Pump.) Complete with fittings. Wt. 15 lbs. A \$92.00 value. . . . . postpaid **\$22.50**
9. Double action, 3" bore, 23" stroke, hydraulic cylinder will lift 7070 lbs. in 5 1/2 seconds using MF9 Hydraulic Pump. Especially suited for farm and construction machinery. Clevis mounting for easy use. Wt. 22 lbs. A \$145.00 value. F.O.B. Chicago **\$27.50**

Fittings available for above cylinders.

## Hydraulic Control Valves

Brand New



1. Four-way action control valve for use with 1. double action hydraulic cylinder, may be used with 1500 P.S.I. hydraulic system to open and close hydraulic cylinders. Brand new. Ship. wt. 4 lbs. A \$38.00 value. . . . . postpaid **\$7.95**
2. Four-way control valve for use with two hydraulic double action cylinders. Each cylinder may be operated independently of the other or in conjunction with the other. Oil may be locked in any of the cylinders to hold the piston at any required position. Brand New. Ship. Wt. 6 lbs. A \$60.00 Value. . . . . postpaid **\$10.95**
3. A two cylinder double action valve with a unique arrangement, allowing the operator to raise both cylinders simultaneously, to lower them simultaneously or to raise one and lower the other at any predetermined rate and speed. Brand New. Ship. Wt. 8 lbs. A \$75.00 value. . . . . postpaid **\$14.95**

## Brand New Double-Action Pneumatic — Hydraulic

# PRESS

\$300.00 value offered at a fraction of original cost

Using air or oil, this device is ideal as a punch press, vise, arbor press, etc. An excellent tool for industrial and shop use.

Use 150 lbs. of air pressure or 250 lbs. of oil pressure. Cushioned double action "Logan" Model AC ram, 6" bore and 6" stroke. Capable of up to 4200 lbs. of pressure using air. Has 3" throat. Lubricated gibs provide perfect alignment. Has adjustable work space. Hardened alloy steel piston rod 1" diameter. Frame constructed of cast steel with 3/4" base plate. Manufactured by Sipp-Eastwood Co. Unit is 49" high. Base is 9 1/2" wide by 18" deep. Wt. approx. 300 lbs. AN OUTSTANDING BUY at....

**\$79.50**

F.O.B. Chicago



WRITE FOR OUR FREE CATALOG!

ORDER DIRECT FROM AD  
Send payment or purchase order today  
SATISFACTION GUARANTEED

# GROBAN SUPPLY CO.

1507 SOUTH MICHIGAN AVE.

Chicago 5, Ill. Dept. PM-4

Complete blueprints of this RICHardson refreshment stand available for construction.



## Go in Business

WITH THIS REAL MONEY MAKER

Open your own roadside stand! It's a profitable enterprise requiring little investment. And your investment is protected by the exclusive RICHardson Root Beer franchise. Many veterans and other progressive business men are making hundreds of dollars a week with the RICHardson refreshment stand... and they are having fun, too.

SEND FOR FREE BOOKLET



Free booklet shows layout drawings and gives full details on basic stand and plans for later expansion into a larger stand. Write for your copy today.

RICHardson Corporation  
Dept. P-4, Rochester 3, N.Y.

## EARN MORE MONEY IN ELECTRICITY!

with APPLIED PRACTICAL ELECTRICITY

Coyne's new set helps men get ahead in Electricity. This great Set gives you complete, A to Z know-how. It's all explained in easy-to-follow language, hundreds of charts, examples, pictures. Covers practically all branches of electricity including appliance repairing; AC and DC equipment; electrical refrigeration; industrial electronics and much more. Brings you 10,500 electrical facts; 3,400 subjects; hundreds of wiring diagrams, tables, formulae, shortcut methods. Written and proved in the Coyne shops—backed by 50 years experience in electrical training that has put hundreds of electricians on the road to top earnings. APPLIED PRACTICAL ELECTRICITY IS THE MOST COMPLETE ELECTRICAL SET IN AMERICA.



Sent on FREE TRIAL

USE SET FREE FOR 7 DAYS!

You have to SEE these books to know how much they'll help you. See them FREE! Just fill out coupon below and mail it in. SEND NO MONEY. Examine the set for 7 days AT OUR RISK!

150 SHOP PRINTS BOOK FREE—FOR PROMPT ACTION



Act promptly and we will include FREE, our valuable new book "150 Shop Prints and How to Read Them." If you return the set at our expense in 7 days, you owe nothing. To keep Set, send either \$23.75 in cash or \$3.00 after 7 days and \$3.00 per month until \$25.50 is paid. Either way, you keep the 150 Shop Prints Book. It's yours FREE! Coupon below is just a request to see APPLIED ELECTRICITY Set and to get FREE Shop Prints Book for doing so. Mail coupon AT ONCE!

FREE TRIAL COUPON—MAIL NOW!

Educational Book Publishing Division,  
COYNE ELECTRICAL & RADIO SCHOOL,  
500 S. Paulina St., Dept. 49-R6, Chicago 12, Ill.  
YES! Send Coyne's new, 8 volume Set, "Applied Practical Electricity" to me, postpaid, for 7 days FREE TRIAL per your offer. Include, FREE of charge, your 150 Shop Prints Book.

Name \_\_\_\_\_ Age \_\_\_\_\_  
Address \_\_\_\_\_  
Town \_\_\_\_\_ Zone \_\_\_\_\_ State \_\_\_\_\_

# STUDY AT HOME

With An Educational Institution

Men with specialized training win higher positions, insure larger earnings, and are bigger successes in business and public life. Opportunities NOW greater than ever before. Send for our Catalog.

## ARTS and SCIENCES

Courses in Philosophy; Education; Letters; Public Health; Medical Jurisprudence; Psychology; Sociology; Physics; Chemistry; Plastics; Geology; Political Science; Theology; Business and Commerce; Accounting; Mathematics; Statistics; Agriculture.

## ENGINEERING

Courses in Electrical, Civil Mechanical, Drafting, Architectural, Steam, Aeronautical, Radio, Structural, Mining, Industrial, Petroleum, Marine, Chemical, Diesel, Automobile, Refrigeration, and Air Conditioning Engineering.

## LAW

Complete Professional Law Course includes 18 Hornbook Series college grade textbooks. Courses also in Commercial Law, Patent Law and Medical Jurisprudence.

McKinley-Roosevelt Incorporated, 4610-K, Sheridan Rd., Chicago 40, Ill.



## WORLD'S LOWEST PRICED ADDING MACHINE

IDEAL FOR BUSINESS AND PERSONAL USE—GUARANTEED ACCURATE. Not a toy. Operates with only a finger flick. Adds, subtracts, multiplies, divides. Counts up to one billion. Pays for itself over and over. Ideal Gift—for Business, Income Tax and School use. MONEY BACK GUARANTEE. Send name and address. Pay postman only \$2.95 plus postage. (Send full cash if outside U.S.) Beautiful rich-looking Leatherette Case included at no extra cost. Money back in 10 days if not delighted. AGENTS WANTED. CALCULATOR MACHINE CO., (Mfrs.) Dept. 213, P.O. Box 248 Glenview, Illinois

## POCKET RUBBER STAMP



Any three line rubber stamp in Bakelite pocket case. One unit. Holder and Pad. 2 1/2" long. Weighs 1 oz. Holder lifts

out of pad for instant use. Fits into pocket or purse. Use for: Shopping, Billing, Endorsement, Return Address. Send check or Money Order for \$1.79 Post Paid. No C. O. D.'s. Dept. PM-4 Republic Specialties Service, 88 Murray St., N.Y. 7, N.Y.

\$1.79 Post Paid



## E-Z SHINE Shoe Holder

For shining all shoes. Guaranteed. Our famous self-polishing shoe cloth 10c ea. additional.

WITH CHECK OR MONEY ORDER. (C. O. D.'s EXTRA) WAYNE MFG. CO., Dept. PM, WAYNE 7, PA.

# DO YOU WAKE UP STIFF?



When muscles are stiff and sore from unusual exercise or strain, use HEET®, the liniment that's strong yet does not burn the skin. Wonderful relief from muscular soreness comes as comforting HEET quickly starts to penetrate. Just brush it on with the applicator. HEET starts at once to ease muscular pain and keeps on working for hours. Ask your druggist for HEET liniment.

# Amazing NEW TOY GUN

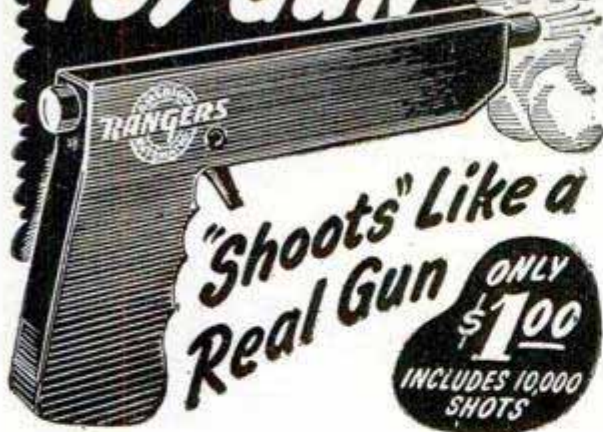

## COMPLETELY SAFE

Here is the gun that will thrill every boy. When you pull the trigger, it cracks out like a real gun and smoke puffs out of the muzzle. The American Rangers Automatic is a quick acting, repeating pistol that never misses. It shoots 60 to 75 shots without re-loading. Looks like a real gun. Absolutely SAFE. Contains no explosives. Each gun comes boxed with 10,000 shots of smoke powder or enough ammunition to last a full year. This smoke powder is harmless. Will not hurt the eyes and may even be eaten. Only \$1.00 each or 3 guns for \$2.00. Only limited quantity available. Write for yours NOW.

### SEND NO MONEY

#### Try 10 Days - At Our Risk

Just send name and address. On arrival deposit only \$1.00 plus C.O.D. postage for one gun or \$2.00 plus C.O.D. postage for three guns. If not completely satisfied return and your money refunded. Save money. If you send cash with order, we pay postage. Write TODAY. No foreign orders accepted.

**SPECIALTIES MFG. CO., Dept. 508**

1367 N. Sedgwick Chicago 10, Ill.

## FREE BOOK Tells How to Build Own Home and SAVE

Big 22-page book, tells how you can get in on America's gigantic building boom, as a well paid building tradesman or by going into the building business for yourself. Book explains all about unusual practical course in home building methods; how to build your own home at savings of thousands of dollars; how to build for others. No experience needed. Course includes complete PLANS and SPECIFICATIONS for modern six-room Dutch Colonial house. Available to veterans under G.I. Bill. Nominal cost to others on easy monthly payments. House plans alone worth twice price of complete course. Send card for Free illustrated book, "Your Future in the Building Business." Write today:



**COMMERCIAL TRADES INSTITUTE, Dept. D2-4**

1400 Greenleaf Avenue Chicago 26, Illinois

## TELEVISION Self Starting ELECTRIC CLOCKS

The Modern Way To Tell The Exact Time  
HOUR - MINUTE - SECOND - at a glance

DIRECT READING  
**NUMECHRON**  
Electric Clocks  
All 110 Volts, 60 cycles. AC.

**Price \$8.95**

OTHER MODELS up to \$14.95

5 1/2 in. long, 3 3/4 in. high, 3 3/4 in. deep. Shipping Weight 2 1/2 lbs.  
Deposit or payment in full with order. We pay freight.



STARLET  
Model #200  
Walnut (In Plastic)

**DIRECT SALES 921-PM- W. 17th St. Kansas City, Mo.**

"The finest precision writing instrument of its kind in the world"



If you want speed, rugged dependability and the finest typing features... you'll find the Smith-Corona better than any other portable. Ask your dealer. Ask him also about his easy payment terms.

# Smith-Corona

PORTABLE TYPEWRITER

## SALESMEN!

10-Second  
Demonstration  
Nets You  
**\$9.95**



Yes - Storekeepers now "Write with Light" - wipe off and write new sign - all in 10 seconds. Fastest seller in years. 10-second demonstration pays you \$9.95 cash in advance. Orders pour in HAND-OVER-FIST. Get started in your territory while "LITE WRITER" is brand new and hot as a pistol.

*Litewriter* "MAGIC CRAYON"  
MAKES SIGNS THAT GLOW LIKE BRILLIANT NEON!

Merchants everywhere - in small town and big city - all stare with amazement at this newest of all Fluorescent Sensations! They write on glass with "MAGIC CRAYON" - and Presto! - before their very eyes - there's a 5-color Advertising Message that glows like a brilliant Neon Sign!

**FREE!** Complete Sales Kit. Send name on penny postcard NOW for Big FREE Sales Kit and Free offer of Sample Demonstrator. No cost now or ever. Rush postcard now.

**MAXILUME CO., 125 W. Hubbard St. DEPT. L-84 CHICAGO 10, ILLINOIS**

SAY YOU SAW IT IN POPULAR MECHANICS

# KNOW ELECTRICITY AS THE EXPERTS KNOW IT... and get an expert's pay

EVERYWHERE the Croft Library is acknowledged as the standard—the leader—the last word in practical electrical education. It is more than a set of books. It is a complete Home-Study Course, capable of equipping any ambitious man for success in the electrical field. Thousands have used the Croft books to step up to better positions. The books are capable of solving easily and quickly problems which rise up to puzzle you in the day's work. They are accurate—thorough—fascinating—practical.



## The Croft Library of Practical Electricity

The Croft Library is a complete electrical educator. It is founded on practice—on 20 years of shirt-sleeve experience—on work as it is actually done. It is jammed from cover to cover with the kind of hard-headed facts you want. Written so that the beginner can easily understand it, yet so sound, so thorough, that it is the daily guide of 50,000 highly paid electrical workers and engineers. Croft tells you the things you need to know about motors, generators, armatures, commutators, transformers, circuits, switchboards, distribution systems—electrical machinery of every type—wiring for light and power—wiring of finished buildings—underwriters and municipal requirements—illumination in its every phase—the most improved methods of lighting lamps—and lamp effects, etc.—how to do a complete job, from planning it, to completion.

### No money down — easy payments

Fill in and mail the coupon attached and we will send you the entire set of seven volumes for ten days' examination on approval. We take all the risk—you assume no obligation. If you decide to keep the books, send \$3.50 in ten days and the balance at the rate of \$4.00 a month. Send the coupon NOW and see the books for yourself.

McGraw-Hill Book Co., 330 W. 42nd St., New York 18, N. Y.  
Send me for ten days' examination on approval the Croft Library of Practical Electricity, 7 vols. If satisfactory I will send you \$3.50 in 10 days and \$4.00 monthly until the price of \$19.50 is paid. If not wanted, I will return the books postpaid.

Name \_\_\_\_\_  
Home Address \_\_\_\_\_  
City and State \_\_\_\_\_  
Company \_\_\_\_\_  
Position \_\_\_\_\_ PM-4-49

# OPPORTUNITY KNOCKS



## GOOD JOBS With the RAILROADS

"No other major industry offers more varied opportunities... more security... or better general pay than the nation's railroads."

**INSURE YOUR FUTURE NOW** by training for an essential job in an essential industry. Investigate our 6-month training course today. Prepares you for jobs at \$240.00 per month and up as Operator-Agents.

**OVER 600 GRADUATES PLACED** with 28 railroads in 38 states. Typing, Telegraphy, Station Accounting, Train Orders, R. R. Rules, day and night classes. Mail the coupon now. Approved For Veterans.

**Railroad Communications Training School**  
104 East 8th, Dept. P. M., Kansas City, Mo.

Please send complete information on your school.

Name \_\_\_\_\_ Age \_\_\_\_\_  
Address \_\_\_\_\_  
Town \_\_\_\_\_ State \_\_\_\_\_

# REVOLUTION IN SHAVING!



You can't beat a *blade* for real luxury shaving. Slip in favorite *safety* blade—the Collins Vibrator *moves* it automatically! Scientific! Effortless! No more "half-shaving," no more scraping! Here at last is real clean shaving. **SHAVES WET! USES SAFETY BLADES! WATERPROOF!** If dealer not supplied, send \$9.95 to Collins Vibrator, 1802 N. Charles St., Baltimore 1, Md. Sent postpaid. Satisfaction guaranteed.

## COLLINS "Powerized Shaving" VIBRAZOR

# STUTTERING

## CORRECT IT AT HOME!

Easy step-by-step lesson method helps overcome stuttering. Successful with adults and children for many years. Write for FREE, helpful, easy-to-understand Chart and literature that shows cause of stuttering and how it may be corrected at home. Sent in Plain Wrapper. Valuable FREE information for Parents of stutters too. No obligation.

**FREE CHART and LITERATURE**

THE ATHENEUM, Dept. 10-D, 1714 Chestnut, St. Louis 3, Mo.

## MAKE UP TO \$5.00 AN HOUR IN YOUR OWN BIG-PROFIT BUSINESS!

National Organization teaches, helps, supplies everything — for establishing Rug, Upholstery, etc. Cleaning Business. Do work in customers' homes, buildings—new, easy way. Only a few dollars needed to start. Big, year-around demand everywhere. Write for FREE details! AMERICLEAN CO., INC.; 211 North 7th St.; Dept. G-23; St. Louis 1, Mo.



## SAVES YOU MANY DOLLARS ON ELECTRONICS, TV, RADIO & TOOLS

A penny postcard will bring you the 1949 Lafayette-Concord catalog, pages and pages of the finest equipment at amazing low prices. Use it to order everything you need, and pocket the difference. It's FREE!

Write to LAFAYETTE-CONCORD, Dept. LD-9  
100 Sixth Ave. 901 W. Jackson Blvd. 265 Peachtree St.  
New York 13 Chicago 7 Atlanta 3

# BE A DETECTIVE

WORK HOME or TRAVEL. Experience unnecessary. DETECTIVE Particulars FREE. Write to GEO. P. M. WAGNER, 125 W. 86th St., N. Y.

## LEARN WATCHMAKING JEWELRY REPAIRING

Start your training now for a better paying job or your own profitable business. Intensive practical training by experienced craftsman. Write for free catalog.

SCIENTIFIC SCHOOL OF WATCHMAKING, DEPT. PM-4  
3923 SAN FERNANDO ROAD GLENDALE 4, CALIFORNIA



# FREE! SAMPLE!

that GLOWS IN THE DARK!

## AN EASY WAY TO MAKE BIG MONEY

Be the first to sell sensational luminous house numbers, light switch plates, wall protectors, cord pulls, novelties, etc. Also luminous pictures, statues, decals, and a host of religious, nursery and other objects THAT GLOW IN THE DARK. Sell on sight. Get into this new and growing industry. ENORMOUS DEMAND... NO COMPETITION... BIG PROFITS. Represent a large manufacturer, established over 35 years. Write AT ONCE for liberal MONEY-MAKING offer and free sample to show you how they GLOW IN THE DARK.

Madison Mills, 303 Fourth Ave., Dept. S-4. New York 10, N.Y.



# PAINT YOUR CAR

2 FULL COATS for ONLY \$2.95  
ONE QUART DOES ENTIRE JOB

on any other Metal or Wood Surface

WITH **WYPE** TRADE MARK REG.

NO SPRAYING · NO MASKING · NO BRUSHING

AMAZING NEW BRUSHLESS  
**AUTO ENAMEL**  
You **JUST WIPE ON**  
with a **POWDER PUFF**  
instead of Brushing or Spraying



ANYONE CAN DO BEAUTIFUL JOB

Get Beautiful Mirror-Like Finish  
that Looks Like Spray Job!

Dries Dust Free One Hour · No Streaks or Lapmarks

No previous car-painting experience necessary. You get a beautiful high-gloss finish that gives you an expensive finish such as is sprayed on by Professional Auto Painters. With WYPE you need **NO BRUSH, NO SPRAY, NO MASKING!** Just **WIPE ON** with Powder Puff — which we furnish at no extra charge. You get a brilliant, glossy finish that is truly "factory-like." No streaks. No lap-marks. Guaranteed for TWO years not to crack, peel, chip or fade, if simple directions are followed. Takes about one hour to apply. Dries dust-free in an hour. WYPE comes in most popular shades. Goes over any other color, lacquer or enamel.

**NO OTHER PRODUCT Gives You This Protection**

**2-YEAR GUARANTEE**

We Guarantee WYPE against cracking, peeling, fading or chipping for two years after application, if applied according to directions furnished. Your money cheerfully refunded if WYPE does not live up to this Guarantee.

COPYRIGHT, WYPE CORP.

**Hundreds of other uses for WYPE!**



**Paint Anything At Home**

Repaint outdoor & indoor furniture, bicycles, hardware, damaged white enamel stoves, refrigerators, etc., and any other article of steel or wood.



The **ONLY** **Brushless Enamel CERTIFIED**



by U.S. Testing Co., Inc. **WORLD-FAMOUS**

**APPLY in ONE HOUR - DRIES to GLISTENING PROFESSIONAL FINISH**

WYPE is a new Miracle Enamel for Autos. It is NOT a wax or polish but a hard high lustre ENAMEL finish! With WYPE, ANYONE can do a beautiful job! Order a quart to paint your car or to get started in this BIG-MONEY Business!

**NO STREAKS OR LAPMARKS LOOKS LIKE SPRAY JOB**

**DEALERS & JOBBERS WANTED Write Today**

**MOST POPULAR COLORS**  
Black Brewster (dark) Green  
Brown Jewel (light) Green  
Red Washington (dark) Blue  
Grey Monticello (light) Blue  
White Sun Beige (light) Tan

**\$2.95 PER QUART**

75¢ a Pint—2 pints Do a 2-Tone Job

SEE YOUR DEALER or ORDER DIRECT SEND NO MONEY - Get WYPE Today!

Your dealer can't supply you, just send us postcard. We'll ship C.O.D. Just pay mailman for Wype, plus postal charges. Or send remittance with order and WE pay postage.

Some of the **FAMOUS DEPARTMENT STORES** that Sell WYPE

**VISIT or PHONE THE STORE IN YOUR CITY...** You live in one of the cities shown here, it will be more convenient to buy from your favorite department store. Ask your dealer! Leading merchants and gas stations everywhere sell WYPE.

Akron: M. O'Neil Co.; Baltimore: May Co.; Boston: Jordan Marsh Co.; Buffalo, N. Y.: J. N. Adam & Co.; Chicago: Goldblatt's 15 Dept. Stores (Goldblatt's, also, at Joliet, Ill.; Hammond, Gary & South Bend, Ind.); Cincinnati: Fair Store Co.; Cleveland: May Co.; Columbus, O.: F. & R. Lazarus Co.; Dallas: Sanger Bros., Inc.; Denver: May Co.; Detroit: People's Outfitting Co.; Ft. Worth: W. C. Stripling Co.; Grand Rapids, Mich.: Herpolzheimer Co.; Hackensack, N. J.: Packard-Bamberger Co.; Houston: Foley's; Indianapolis: Wm. H. Block Co.; Kansas City, Mo.: Jones Store Co.; Los Angeles: May Co.; Louisville: Kaufmann-Straus Co.; Memphis: B. Lowenstein & Bros.; Milwaukee: Ed. Schuster & Co., Inc.; Minneapolis: Donaldson's; New Orleans: Maison Blanche Co.; Newark, N. J.: Bamberger's; New York: Gimbel's; Omaha: J. L. Brandeis & Sons; Philadelphia: Lit Brothers; Pittsburgh: Kaufmann's; Portland, Ore.: Meier & Frank; Providence, R. I.: The Shepard Co.; Richmond, Va.: Miller & Rhoads, Inc.; Rochester, N. Y.: Sibley; Lindsay & Curr; St. Louis: Famous-Barr Co.; St. Paul, Minn.: The Golden Rule; San Antonio: Joske's of Texas; San Diego: Whitney's; San Francisco: Hale Bros. (Also Hale Bros., Oakland and San Jose); Seattle: The Bon Marche; Spokane: Spokane Dry Goods Co.; Syracuse, N. Y.: Dey Bros. & Co.; Toledo: Lion Dry Goods Co.; Warren, O.: Griswold's; Washington, D. C.: Lansburgh & Bro.; Youngstown, O.: Strouss-Hirschberg Co.

**WYPE CORP. Dept. 16-D 2214 DOLMAN ST. ST. LOUIS 4, MO.**

CREI Prepares Young Men for Professional Careers with *Industry-Recognized* Training in a minimum of time

## RADIO - ELECTRONICS TELEVISION ENGINEERING

Graduates of CREI residence school are preferred by industry because of their *training* and *ability*. This recognition is the reason that CREI men quickly find good jobs. With 22 years of practical teaching experience in these highly technical fields, CREI offers an outstanding faculty, modern and complete laboratories, shops and equipment. New students are accepted twice monthly and each may advance as rapidly as he is capable. The basic course with one specialized course requires an average of 20 months to complete. CREI is recognized as one of the country's leading technical institutes. Its work is of college level. It prepares the young man for a good job in industry in a minimum of time.



Approved for Veteran's Training

### CAPITOL RADIO ENGINEERING INSTITUTE

An Accredited Technical Institute Founded in 1927

**Mail coupon for Free Catalog**

Capitol Radio Engineering Institute, Dept. 174A  
16th & Park Road, N.W., Washington 10, D. C.  
Please send me your illustrated catalog and complete details.

Name \_\_\_\_\_ Age \_\_\_\_\_  
Street \_\_\_\_\_  
City \_\_\_\_\_ Zone \_\_\_\_\_ State \_\_\_\_\_  
 I am entitled to training under G.I. Bill.

# \$5000.

of Old Line Legal Reserve  
**LIFE INSURANCE**

FOR ONLY **\$4.50** A MONTH\*

AT AGE 21 (other ages in proportion)

\*One Half Permanent Rate in effect 5th year

Or you can buy as little as \$1500 of this unique protection at only 90c per \$1000. Policy offers all Standard Provisions under rigid N. Y. State Insurance Laws.

For 42 years POSTAL has sold life insurance by mail and over the counter; has satisfied policyholders in every state; has over \$14,000,000 in assets and has paid out over \$62,000,000 in benefits. All Standard Policies, men or women, ages 10-60 at low cost.

DIVIDENDS, payable annually, further reduce the low cost of your insurance. Send coupon for further details and rates. Life Insurance is vital!

#### GET THE FACTS BY MAIL

POSTAL LIFE INSURANCE COMPANY  
511 Fifth Avenue, New York 17, N. Y.—Dept. M-871  
Mail me without obligation complete information about your low cost "Modified 4 Policy" at my age.  
Name \_\_\_\_\_  
Occupation \_\_\_\_\_ Date of Birth \_\_\_\_\_  
Address \_\_\_\_\_

## BIG MONEY! SECURE FUTURE!

LEARN WATCH REPAIRING AT HOME



With our **ENLARGED Self Training Kit** START NOW in this uncrowded field! EASY to learn! Earn while you learn! Even as a sideline you can make \$50 and up each week.—Our **PRACTICAL SELF TRAINING KIT** contains: REAL PROFESSIONAL TOOLS (Loupe, 3-4 power; Complete Set of 6 Special assorted Screw Drivers; Tweezers AA; Plastic Material Tray; Case Opener & Knife) and **COMPLETE BOOK** on Modern Watch Repairing. Fully illustrated, easy to understand, shows every step in repair, adjustment and use of tools. Only... **\$6.95** Post Paid  
(If C.O.D., plus charges.) Money Back Guarantee.  
If ordered separately; book \$3.25; set of tools, \$4.25.

**MODERN TECHNICAL SUPPLY CO.**  
Dept. MMC, 55 W. 42nd Street, New York 18, N. Y.

New Complete Catalog on all Modern Precision Tools, Materials & Books with clear Descriptions & over 600 Illustrations for Watch-Clockmakers, Jewelers, Tool-Instrument Makers, Handicrafters. Useful for years because catalog entitles you to future supplements. SEND 50c for catalog — FREE with KIT

## WANT MORE MONEY? A BETTER JOB? LEARN SALESMANSHIP

Trained salesmen are in demand. Learn salesmanship at home, in spare time by a modern, proven home study course. Low cost. Plan now for a top pay job and a secure future in this interesting profession. Send for free details, NOW.

**CARTER EXTENSION UNIVERSITY**

2371 Chestnut Street San Francisco 23, Calif.



## LEARN AERONAUTICAL ENGINEERING

Aircraft and Engine Mechanics (A & E)

Train at the Flying Wing school—New classes starting soon. Write for illustrated catalog.

*Northrop Aeronautical Institute*

APPROVED FOR VETERANS DIVISION OF NORTHROP AIRCRAFT, INC.  
1527 E. Broadway, Hawthorne, Los Angeles County, California



### CLUB PINS AND GUARDS

Latin, Spanish, Hi-Y, Tri-Y, G. A. A., etc.

**J. A. MEYERS & CO., Inc. Dept. K**  
1031 W. 7th St., Los Angeles 14, Calif.

## RAISE REAL CHINCHILLAS

(not rabbits)

Matched breeding stock — Little space needed  
**PROFITABLE — GENTLE — HARDY**

Write for free information . . . or  
History and Handbook \$2.50

**ALLIED DISTRIBUTORS, Dept. A, Gardena, Calif.**

## Become a Doctor of PSYCHOLOGY

Win the degree of Ps.D. Teach the secret of contentment, happiness. Solve mental worries. Experience the revelation of truth. Chartered college. Individual help. Write for FREE book. **COLLEGE OF UNIVERSAL TRUTH, 5153-B North Clark St., Chicago.**

ORIGINALLY \$30 to \$55 **MEN'S FULLY GUARANTEED NEW 15-JEWEL WRIST WATCH \$13.95 PLUS TAX**

Sacrificed because they're post-war surplus

**WATER REPELLENT SHOCK PROTECTED**

1 year written guarantee

Luminous dial . . . sweep second hand Super-accurate . . . imported Swiss precision movement and case. You get them now for a small fraction of original prices. Don't delay! Order now . . . while they last. Send only \$1 down payment with order. Pay balance to postman on arrival, plus postage. Or we pay postage if you enclose \$13.95 plus \$1.39 Fed. Tax. Handsome expansion band included with prepaid order. Money back in 5 days if not delighted. Order now.



**MARYLAND DISTRIBUTORS, Dept. 276**  
501 E. Baltimore St. Baltimore 2, Md.

# Learn ENGINEERING DRAFTING...BUILDING in Chicago, Industrial Hub

Approved for  
G.I. Training

Time-Saving  
Courses

Day & Evening  
Classes

Get your training at **Chicago Tech** in the Nation's industrial center. Chicago provides unequaled opportunities for part-time employment while training and for permanent positions upon graduation. Many other cultural and recreational advantages described in Catalog—sent Free!

Chicago Tech, founded 45 years ago, has trained thousands of men now occupying important places in industry the world over. Training combines theory and practice in 1 year, 2 year, and 3 year (Degree) courses. Saving in time means earlier graduation — and consequently earlier employment.

Terms start January, April, July and October. Get information now to arrange for early admission and accommodations.

**CHICAGO  
TECHNICAL COLLEGE**  
D-83 Tech Bldg.  
2000 So. Michigan Ave.  
Chicago 16, Ill.



## MAIL COUPON TODAY

**CHICAGO TECHNICAL COLLEGE**  
D-83 Tech Bldg., 2000 So. Michigan Ave.  
Chicago 16, Ill.

Please send me without obligation free booklet on Time-Saving Technical Training.

Name \_\_\_\_\_ Age \_\_\_\_\_

Address \_\_\_\_\_

City \_\_\_\_\_ Zone \_\_\_\_\_ State \_\_\_\_\_

1 YEAR • 2 YEAR  
3 YEAR COURSES

**BUILDING  
DRAFTING  
ENGINEERING  
AIR CONDITIONING  
REFRIGERATION  
ELECTRICITY  
RADIO**



**We Include This BIG KIT  
of APPLIANCE TOOLS  
At No Extra Cost!**

With the tools and testers we send, you can actually start making money before your course is finished. With your first set of lessons we show you easy jobs you can do in your spare time. And remember—only one good repair job will pay for the cost of the entire course. Our lessons are not only practical but understandable and easy to grasp. You'll enjoy every minute of them—just as you'll enjoy this work when you get into it. Let's talk it over by mail. There's a lot more we want to tell you—including our assistance in helping you start your own business—and line up customers.

**Like To Work With Your Hands?  
Then Get Into**

## **ELECTRIC APPLIANCE Repair & Service**

Recent University Discoveries prove that one of three major classifications of men are only thoroughly happy when working with their hands. Nature intended A BIG GROUP of men to be the builders, artists, sculptors, surgeons, fixers and servicers of life. If you are in this group — not completely happy in your present work — seeking increased income, and handy with tools — **SOME SOUND ADVICE:** Get into electrical appliance service and repair. This great growing field gets better every day as more homes are wired for electricity.

**OPEN YOUR OWN SHOP  
Be Independent**

Our practical, thorough course teaches you this interesting good paying business **AT HOME — DURING YOUR SPARE TIME.** A Grade School Education is all you need. You can start small—in your basement or garage—with the tools we send you and **GROW AS BIG AS YOU LIKE** without fear of losing your job if a depression comes. Or, you can take a well-paid job for there is a big need for service men in this active field!

**LEARN  
AT HOME**

*In Spare Time*  
**How To Repair  
Washing Machines  
Vacuum Cleaners  
Electric Ranges  
Lamps, Motors,  
Irons, etc.  
REFRIGERATION  
and  
House Wiring**



**PACIFIC TRAINING SCHOOL — Dept. P-94**  
7217 So. Broadway, Los Angeles 3, Calif.

Please send me your **FREE BOOKLET** on:

Elec. Appliance Servicing  Refrig. Home Course  
 Refrig. Shop Course in L.A.  I am W. War II Vet.

NAME \_\_\_\_\_ AGE \_\_\_\_\_

ADDRESS \_\_\_\_\_

CITY \_\_\_\_\_ STATE \_\_\_\_\_

**MAIL COUPON for FREE BOOKLET**

Give Your Car the Style and Beauty  
of the 49's

WITH  
**Cadillac**  
TYPE



**WHEEL COVERS**

**SPECIAL DIRECT-FROM-FACTORY-TO-YOU OFFER**  
SET OF 4 ONLY \$14.95



**AVAILABLE IN ALL MODELS** 15" and 16" Wheels 1937 to 1949

Now you can make your car a style leader just like the newest '49 models with these beautiful Cadillac-Type Wheel Covers. No matter how old your car is these precision-built, triple chrome plated Wheel Covers will dress it up so much you'll be amazed. Not just wheel rims, not just hub caps, but complete Wheel Covers that snap on so easily you can put all four on your car in one minute. Have handsome three-color emblem. Fit almost any make. Guaranteed against rattle, vibration and rust. Last the life of your car. You've admired similar wheel covers on the new Cadillacs, now give your car the same class and distinction by ordering Cadillac-Type Wheel Covers TODAY, on this Special Direct-From-Factory-to-You Offer.

**SEND NO MONEY**  
10 Day Trial Inspection

**CHECK THESE FEATURES**

- Triple Chrome Plated
- Snap on Quickly
- Guaranteed against Rattle, Vibration and Rust
- Top-Quality Workmanship

**ORDER TODAY!** On arrival pay postman only \$14.95, C.O.D. postage, and 50c to help cover packing and shipping costs. See what they do for your car. Then if not delighted return in 10 days for \$14.95 back. Send \$15.45 (money order or check) with order and we pay postage. Be sure to state

MAKE \_\_\_\_\_ MODEL \_\_\_\_\_ YEAR \_\_\_\_\_

Write NOW to:

**LONDO COMPANY, Dept. 49-D**

2445 East 85th Street

Chicago 17, Illinois

**YOU CAN BE AN All Around HE-MAN**

JOWETT INSTITUTE, Dept. PM-94, 230 Fifth Avenue, New York City

All 5 famous courses by George F. Jowett, world's greatest body builder in 1 complete muscle building volume (valued at \$5 each) now only 25c. Packed with How-to-do-it pictures. 1. How to Mold a Mighty Arm. 2. Mighty Chest. 3. Mighty Back. 4. Mighty Grip. 5. Mighty Legs. Free strong men photo book. Quick results or money back! Send 25c, name, address, age.

**25c**

SAY YOU SAW IT IN POPULAR MECHANICS

**FREE BOOK TELLS HOW TO BE AN...**

*Accountant  
Salesman  
Secretary  
Stenographer*

**SECURED FUTURE... FREE EMPLOYMENT SERVICE**

Enter one of the "substantial earnings" fields through Hill's "Success Plan" training. A lifetime opportunity to join thousands of successful graduates in positions secured through our nation-wide employment service. No matter where you live, what you are doing now, Hill's can train you by study at home or in the resident school. Big Free book shows you the way to substantial earnings and an assured future. G. I. Approved.

Hill's Extension School & Business University  
Dept. PM-49, 619 W. Main St., Oklahoma City 2, Okla.  
Please send your free book, "Through Hill's to Success."

NAME \_\_\_\_\_  
ADDRESS \_\_\_\_\_  
CITY \_\_\_\_\_ STATE \_\_\_\_\_

Check here if eligible under G.I. Bill.  
Please check course and training plan preferred.

Course \_\_\_\_\_  Resident  Home Study

**EASY-TO-USE COUPON TODAY**

**WANT TO Write Stories**

**FREE LESSON** Articles Mysteries? shows how you learn at home



The demand for writers is creating great new opportunities for people with an urge to write. It's not as hard to succeed as you may imagine. Most famous authors come from ordinary walks of life. At home, you too may learn fiction writing, the best basis for all fields—short stories, features, articles, technical, mechanical and business items. Palmer Institute's Home Study Training (Established 1917) is endorsed by Rupert Hughes, Gertrude Atherton, Keith Monroe, and other famous authors and by scores of successful graduates. Complete instruction material and professional coaching to develop your own style. FREE book and lesson show how you may enjoy an ideal part time or full time career. Write today (no salesman will call). Veterans: advise us if you are eligible for G.I. Training.

**PALMER Institute of Authorship • Est. 1917**  
Approved for Veterans 1680 NO. SYCAMORE, Dept. T-49  
HOLLYWOOD 28, CALIFORNIA

**RUPTURED?**

**Get Relief This Proven Way**

Why try to worry along with trusses that gouge your flesh—press heavily on hips and spine—enlarge opening—fail to hold rupture? You need the Cluthe. No leg-straps or cutting belts. Automatic adjustable pad holds at real opening—follows every body movement with instant increased support in case of strain. Cannot slip whether at work or play. Light. Waterproof. Can be worn in bath. Send for amazing FREE book, "Advice To Ruptured," and details of liberal truthful 60-day trial offer. Also endorsements from grateful users in your neighborhood. Write:

**CLUTHE SONS, Dept. 31, Bloomfield, New Jersey**

**SUCTION SPONGE**



**AUTO WASHER**

Slide across surface and presto! New "Suction" Auto Washer shampoos cars like magic. Dust, dirt, grease, grime disappear in jiffy. Automobiles gleam like a mirror.

**SAMPLES FOR AGENTS**

Sample offer sent immediately to all who send name at once. A penny postal will do. Send No Money — JUST YOUR NAME.

**KRISTEE CO., 677 Bar St., Akron, O.**

**LEARN MOVIE PROJECTION THEATRE MANAGEMENT**



The Motion Picture Theatre Business offers big opportunities for trained men. Get into a fascinating field with a promising future. Train at home in spare time. Free Catalog. Established 20 years.

**THEATRE SCHOOL, 370 Washington St., Elmira, New York**

**OWN Your Own Business**

**Lifetime Income**

Clean and Mothproof rugs and upholstery "in the home" or public buildings. Start full or part time. Gross profits up to \$15 and \$20 a day on EACH of your service men. Easy to learn . . . quickly established.



**DURACLEAN** cleans by absorption! No scrubbing, soaking or shrinkage. Dirt and grease vanish . . . matted pile rises . . . colors revive. Furnishings used again same day.

**DURAPROOF** resists moths and carpet beetles. Your service backed by a National Money Back 4 Year Warranty.

We furnish enough material to return your total investment. EASY TERMS. Territories limited. Send for FREE booklet . . . full details.

**Duraclean Co. 16-4 Pl. Deerfield, Ill.**

# AT LAST... AN AMAZING NEW Underground Sprinkler System EVERY HOME-OWNER CAN AFFORD!

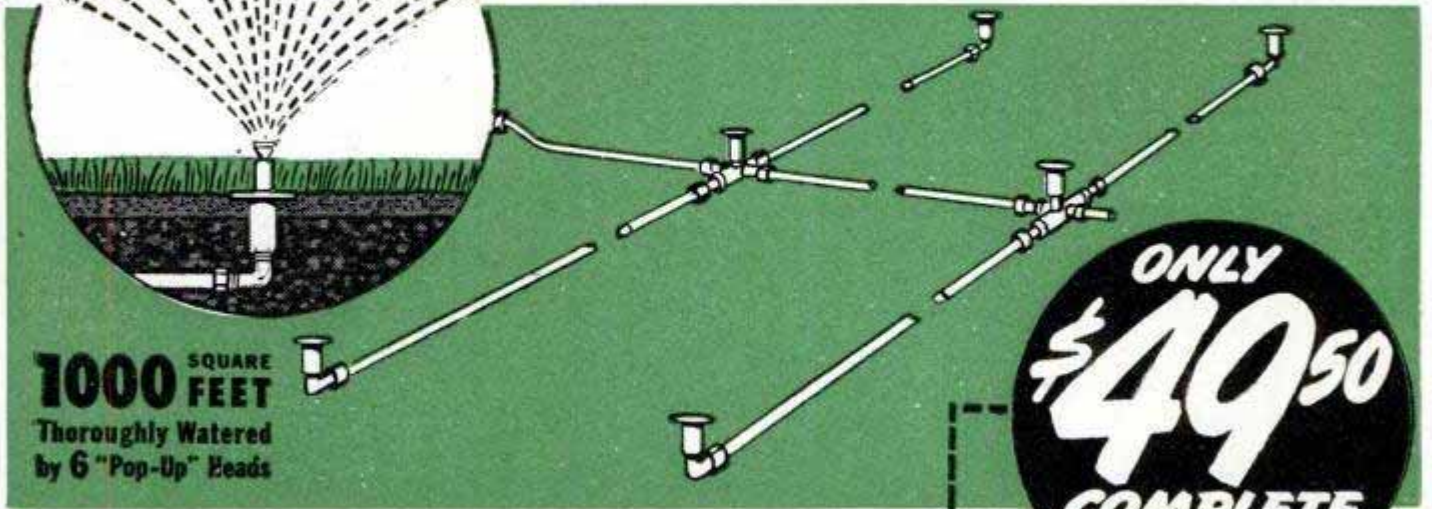

**1000 SQUARE FEET**  
Thoroughly Watered  
by 6 "Pop-Up" Heads

**ONLY \$49.50**  
**COMPLETE**  
NO EXTRAS TO BUY!

## INSTALL IT *Yourself* in One Evening WITHOUT DAMAGE TO LAWN OR GARDEN

Now... your lawn or garden can be sprinkled like a million dollar estate. Even the man whose "fingers are all thumbs" can install EVERSPRAY in a few hours. No special tools needed. No pipe to buy. No pipe fitting to cause trouble. No plumbers to pay. No complicated blueprints or instruction sheets to befuddle you. Simple, A.B.C. diagram makes everything easy with just a small monkey wrench.

**A Life-Time Installation**  
Once your EVERSPRAY is in place, it's there forever. No upkeep. No repairs. No draining. No inspection. It's in for keeps—always ready to give you trouble-free service year after year after year. Yet a home "renter" can take it up—and with him, when

### BE A USER-AGENT GET YOURS FREE!

The very moment your EVERSPRAY is sprinkling, friends & neighbors will want to know where they can get one too! Just send us their orders on our User-Agent Plan and quickly get back in profits three to four times the cost of your own Everspray. Check coupon if you're interested in our Plan.

he moves. No wonder owners by the thousands are rushing to install EVERSPRAY. It means *no more* wet clothes or muddy feet, *no more* hours wasted in sprinkling—*no more* neglected, burned out grass for want of time—*no more* wet puddles or dry spots once this amazing EVERSPRAY is installed.

**All Solid Brass and Copper**  
*Nothing to Rust, Rot, or to Wear Out*  
Every inch of the tubing that goes into an EVERSPRAY Underground Sprinkler System is made of *solid copper!* Every single fitting and connection is made of *solid brass!* The fittings are *machined* to assure perfect fit and prevent leakage. No part can rust! There are no rubber gaskets to rot or disintegrate.

Only EVERSPRAY gives you all of these exclusive features



### QUICK! EASY!

After you install your new EVERSPRAY, fold down the sod that was folded back, and the keenest eye can't see where you made the narrow, shallow trench that holds your "million-dollar estate" Sprinkler System.

### AMAZING "POP-UP" HEAD

Nothing else like it. Out of sight at sod level when not in use. Run lawn mower or roller right over them. Rake can't break or damage them. Children can not temper with recessed spray heads. Feet can't trip over them. Yet they pop up above grass level when water is turned on—and drop back when water pressure stops.

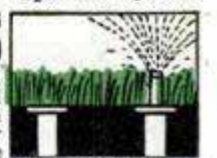

**From Mist to Rain**  
Patents applied for. Instant fingertip adjustment on EACH head gives any spray from fine mist to heavy rain.

### Automatic Drain Valve

Positively "freeze-proof". Entire system drains automatically **AFTER EVERY USE!** Nothing to worry about when zero weather comes. Nothing to get out of order or cause trouble. No blowing or draining... No repair or maintenance expense.

### SALESMEN WANTED

Salesmen, Distributors and Crew Managers wanted to call on home owners, hardware stores, department stores, and other retail outlets. Biggest summer seller ever invented. Make tremendous profits between now and July. Rush name air mail or telegraph for complete facts, discounts, commissions, demonstrator offer, and details of spectacular, sure-fire "JACK POT" Pyramid selling plan.

### MONEY-BACK GUARANTEE

We unconditionally guarantee the Everspray Underground Sprinkler System. This guarantee is made by one of the largest fabricators of copper and brass products in the world. If Everspray is not exactly as described in this advertisement or in our printed literature, the Entire System may be returned to us within 10 days after purchase and the purchase price will be refunded promptly and in full. You may buy direct from this advertisement with perfect confidence. ● If you don't order now, at least get all the facts. Send name on coupon for a beautiful folder containing pictures and descriptions of Everspray. It is FREE—no charge at any time. Send name today and be first in the neighborhood to enjoy Everspray.

**Everspray Products Co., Dept. 24**

A Division of Everhot Products Co.  
2001 W. Carroll Ave., Chicago 12, Illinois

**Everspray Products Co., Dept. 24**  
2001 W. Carroll Ave., Chicago 12, Ill.

Rush complete facts all FREE on EVERSPRAY Sprinkler. Square checked below shows Underground plan in which I'm interested.

- For my own use    As a User-Agent    As a salesman  
 I am enclosing \$49.50. Rush a complete EVERSPRAY Sprinkler System under your Money-Back Guarantee.

Name.....

Address.....

City..... Zone..... State.....

# NOW EASY TO START A Big Business ON A SMALL INVESTMENT



## WARNER SUCCESS PLAN Gives exact instructions showing you

- How to start in spare time
- How to use home as headquarters
- How to bring in the business
- How to do real METALIZING in genuine GOLD, SILVER, or BRONZE, by the easy Warner Method
- How to start without risking your job
- How to pyramid your profits
- How to be sure of steady, big income.

Don't turn this page until you've given serious thought to your future. In the uncertain years ahead, the men who own their businesses are the ones who will be happiest. A small start now easily can lead you to complete independence, freedom from time clocks, freedom from fear of lay-offs, freedom from the limits of a pay check.

Now, while you can do it without risk—now is the time to investigate the exceptional opportunity offered you by the Warner Success Plan. Looking into the market, checking up on the possibilities for big sales and big profits will not cost you anything. Isn't this the time to lay the foundation for a future of complete independence—a life of happiness—a steady, dependable income?

### METALIZING BABY SHOES AND OTHER KEEPSAKES

offers an exciting new opportunity to men or couples who want personal independence

If you'd like the feeling of being boss instead of being bossed—the Baby Shoe business is made to order for you. Just think of the appeal. A mother's love for her child—her desire to preserve forever the tiny shoes in which her baby took its first toddling steps. No wonder orders come easy and fast. No wonder profits are big. Then think of the future. Fifteen Million babies in the last five years—three million last year—millions more next year. As long as babies are born, this business will prosper—in good times or bad. Think of the fun. Every job is different, interesting. And when you deliver a job and collect the money, you get a tremendous glow of satisfaction out of the mother's happy exclamations over your work. There's not another business I know of that offers you such big rewards in cash, in security, in a future, in independence that can be started on such a shoestring. You'll be glad you saw this ad—IF YOU SEND THE FREE COUPON.



## READ THE ENTIRE PLAN

### 7 DAYS AT MY RISK

#### DON'T SEND A PENNY . . . Just Send Your Name

This is one of the most fascinating businesses you can imagine. There are 15 MILLION pair of baby shoes waiting right now to be METALIZED. The opportunities are unlimited. The future is very big. And it's a business in which the whole family can have fun helping. A perfect business for man and wife to start—or for two partners. And I want you to read the whole Plan at my risk. Don't spend a cent unless you go ahead.

I want every serious minded man to let me show what I've done in our own shops here in Chicago—reveal the exact facts about the profits to be made and the way to make them. I don't want you to spend a cent for supplies until you've studied the facts, talked them over with the family, and satisfied yourself that this is the ONE BIG OPPORTUNITY FOR YOU. That's why I allow you to read all trade secrets contained in the Warner Success Plan at My Risk. If you don't go ahead, you don't pay a cent.



## You Have Nothing to Lose

### ALL FACTS FREE! MAIL!

Raymond E. Brandell, Mgr., Warner Electric Co.,  
1512 Jarvis Ave., Dept. 34, Chicago 26, Ill.

As long as it doesn't cost me a cent, I'm willing to read the facts, investigate, and then give you my decision. Send the facts by next mail. No cost to me now or at any other time.

NAME \_\_\_\_\_

ADDRESS \_\_\_\_\_

CITY \_\_\_\_\_ Zone \_\_\_\_\_ STATE \_\_\_\_\_



### \$5.00 AN HOUR

Yes, it's possible for one man to turn out enough work to make \$5.00 an hour for his time. Think of how that pyramids when a partner or the whole family works.

#### Old Established Firm Backs You Up

The Warner Electric Company just celebrated its 26th year of success. You get a Real Start when you "join up with Warner"—you get real Guidance to Success.

Warner Electric Co., Dept. 34  
1512 Jarvis Ave., CHICAGO 26, ILL.

### WE SUPPLY EVERYTHING

You don't have to go "hunting" when Warner is behind you. We supply all materials, all mounts, chemicals, and metals. And you get the low prices made possible by our big quantity purchases and our own manufacture. You send for just what you need—and never have any big investment tied up in stock.

**WORLD'S  
BEST  
WANT AD  
MEDIUM**

# CLASSIFIED Advertisements



Advertisements in this section 75 cents per word, each insertion, minimum 10 words, payable in advance  
To be inserted under proper classification, copy must be in our office the 22nd of the  
second month preceding date of issue

F. W. Johnson, Manager, Classified Advertising

Popular Mechanics Magazine, 200 East Ontario Street, Chicago 11, Illinois

## 1166

## CLASSIFIED ADVERTISEMENTS

## 1166

## OPPORTUNITIES FOR YOU

### AUTOMOBILES, MIDGET CARS

**"SPEED & Mileage"** Manual—(New, revised!) Easily obtain greater speed, mileage, racing performance from any automobile! Famous authentic book shows soup up methods; speed tuning; mileage secrets; speed equipment plans; "customizing ideas!" 125 illustrations—Complete instructions on building inexpensive power equipment! Economizers! Superchargers! Manifolds! "Water Injectors!" Mufflers, fast conversions, "hot rods," custom sports cars! All about engines, "economy tuning," restyling, compression, fuels, cams, "racing tricks!" Latest "Hollywood stylizing!" Streamlining! Sport changes! Simple conversions! Plus California roadster plans! Parts lists! Speed catalogues! "Beautiful pictorial supplement!" Folios! Photographs! Working diagrams! Complete data! Everything \$1.98. Almqvist Engineering, Milford 73, Pennsylvania.

**MOTORIZED Vehicle manual.** Build three wheel scooters, racers, conversions, water injections, trailers, unicycle, etc. \$1.00. Illustrated circular—dime. Craftsmann Books, Box 1153, Milwaukee 1, Wisconsin.

**RACING Car performance** from your Plymouth, Dodge, DeSoto, Chrysler, Hudson, Studebaker, Chevrolet, Ford. Expert tells how to get that extra power acceleration, speed, efficiency, from your stock car. Learn how winning drivers rebuild engines for fast roadsters, hotrods, racers. Information on water injection, ignition, timing, gas saving, lubricating formulas, etc. Save up to thirty percent on parts, accessories, speed equipment. Complete instructions together with three months consultation service only \$2.00. Automotive Engineering Co., Dept. A-E, 2839 35th Street, Sacramento 17, California.

**"SUPERCHARGER"** Airfeed needle—Increases speed, power, pep! Starting! 10% more mileage guaranteed! Free trial! Quickly replaces idling jet. Specify car. \$1.50 (Eight's take 2, six's 1). Almqvist Engineering, Milford 73, Pennsylvania.

**NEW "1949" Crosleys**—"Come, get 'em." Free: Bus ticket, anywhere in U.S.A. to Marion, with each Crosley. Advise body model, color desired. Sedan \$998. Station wagon \$1031. Walraven Motors, Marion, Ohio. Phone 2761.

**CALIFORNIA Custom accessory headquarters.** Buy direct from original designers and save. Solid hood sides, lowering kits, grille panels, fender skirts, dual pipes, speed equipment, chrome motor accessories. New 1949 catalogue just out. 32 illustrated pages, jam-packed with California accessories, 25c. Eastern Auto Supply, 3319W South Grand, Los Angeles 7, California.

**SPEED Equipment bargains!** "California" mufflers \$4.50, duals \$17.50, racing heads \$29.00, dual manifolds \$9.95, water injectors \$4.95, chrome echo cans \$1.65, supercharger stacks \$2.98, lowering kits \$2.95, chrome fender trim 90c, others. Illustrated "Handbook-Catalog" 25c. Almqvist Engineering, Milford 73, Pennsylvania.

**"WATER Injection."** Save gasoline. Free descriptive, illustrated information. Neher Industries, La Verne, California.

**SEE Our ad under motorscooters** for new and used midget car bargains. Midget Motors Directory, Athens, Ohio.

**1949 CUSTOMIZING Manual**—Shows how to easily make your car look beautifully custom! Latest restyling, streamlining, customizing methods! Hollywood sport changes! Fast model conversions! Scores of photographs, illustrations, drawings! "Hop-up" specifications. Complete restyling information. (Including custom car catalog and amateurs "idea starter" kit). Everything \$2. Almqvist Engineering, Milford 73, Pennsylvania.

**DUALTONE Crystalline packed California mufflers** all automobiles; fender skirts \$15.65; long shackles \$1.95; lowering blocks all automobiles. Other special prices quoted free on items of interest. Catalogue 20c; Streamlining Manual with catalogue \$2.00. Dualtone Mufflers, 2636C India Street, San Diego 1, California.

**"HOLLYWOOD" Motorboat tone mufflers**—All cars \$4.85. Satisfaction guaranteed! Almqvist Engineering, Milford 73, Pennsylvania.

**NEW Sensational seat cover.** Mono, 6545 Santa Monica Blvd., Hollywood, California.

**"HOTROD Handbook"**—Just published! Latest speed data for all cars! Shows how to easily construct your own speed equipment—Build 145 m.p.h. racers! California roadsters! Sports cars! Fast street, track conversions! Illustrates "Hollywood customizing!" Body restyling! Motor rebuilding! Tuning! Streamlining! Gives "speed tricks," fuel formulas, mileage information, "conversion plans." Covers channeling, multiple carburetion, ignition, ratios, porting, balancing, trials. Latest California methods! Equipment! Hot rod plans. Working drawings! Photographs! Charts! Graphs! Terrific book \$2. Speed Publications, Drawer 716, Port Jervis 1, New York.

**CLYMER'S New steam traction engine album.** 160 large pages. Just out. 470 photographs, charts, drawings, early advertisements U. S. and foreign makes steam engines and threshing equipment. 105 different makes steam engines shown. See Case, Advance, Reeves, Rumley, Avery, Westinghouse, others, from 1855 to 1929. Unique, historical, educational book of real Americana. Postpaid \$2.50. DeLuxe edition fabric-bound \$3.50. Clymer, Dept. A-ST, 1268 So. Alvarado, Los Angeles 6, Calif.

**TIRE Mileage boosted;** all pressures. Engineered economy. Free literature. Alto, 2319A Walnut, Texarkana, Texas.

**NEW Clymer books.** How to build racing car \$2.00. Hot rod pictorial \$1.50. New Number 5 scrapbook old cars \$2.00. Service manuals Model A Ford \$1.00. Model "T" \$1.50. New Ford owner's handbook complete service data 1932 to 1949 models \$1.50. 1948 Indianapolis year book \$1.50. Gasoline saver guide \$1.50. Saga roaring road, early auto racing book \$2.00. Reprint catalogs, new Volkswagen \$1.00. Alfa-Romeo \$1.00. Isotta-Fraschini \$1.00. Duesenberg \$1.00. Doble Steamer \$1.00. Metz Friction Drive \$1.00. Publisher Clymer, 1268 So. Alvarado, Los Angeles 6, Calif.

**CHEVROLET Speed Manual** for Chevrolet owners desiring real hotrod performance from their 1937 to 1949 Chevrolets. Filled with photographs, complete information, proven methods. How to make your road car capable of 100 mph plus! How to build Chevrolet hotrod engines for road, track, or marine use. California Bill, Box L-1, Eaglerock, Los Angeles 41, Calif.

**RACE Car photos,** 1000 different, catalogue. Sample 25c. Smith, 17 Watson St., Paterson, New Jersey.

**We Sell direct to customers** over 200 speed equipment parts manufactured by us. Ford A-B-V8-6-4- (Ferguson), Studebaker Champion, Chevrolets and Willys. Cylinder heads, dual intake manifolds, lymite flywheels, oversize valves, compound springs, camshafts and other supplies. Complete engines ready for race for cars, boats and midgets. \$1.00 to cover illustrated literature and price sheet. R & R Mig. Co., Robert M. Roof, Box 546, Anderson, Indiana.

**CUSTOMIZE Your car!** Authentic California restyling plans galore! Working sketches, specific model changes. Comprehensive; complete! 130 photographs! Largest, finest or refund! Includes accessory catalog! \$2 postpaid. Post Publications, Box 723-ME, Arcadia, California.

**PHOTOGRAPHS,** World's finest automobiles. List, sample, 10c. Box 1028, Minneapolis, Minnesota.

**STOP-LIGHT Flasher \$3.00.** Radio Roy, Box 2225, Portland 14, Oregon.

**FORD Speed Manual** just off the press! Guaranteed finest speed manual you can buy! This book contains the information you need to hotrod any Ford V-8, Mercury, Ford Six, Model A, Lincoln-Zephyr. Filled with photographs, cutaway drawings by Medley explaining installation of hydraulic brakes on any year Ford. How to install V-8 engine in Model A. All expert, proven data which you can use! California Bill, Box L-1, Eaglerock, Los Angeles 41, Calif.

**CARBURETION** For car owners. New simplified illustrated pamphlet shows the way to better mileage, performance. Stop stalling, flooding with simple home adjustments. \$1.00. Carburetor Specialist, 501 N. Parramore St., Orlando, Fla.

**MAKE Your car go!** Hot-Rod Manual \$1.50. Speed parts list 25c. Hot-Rod, Box 9626PM, Hollywood 27, Calif.

**AUTOMOBILE Racing book,** fifth edition, well illustrated. Instructions on building bodies, frames, engines. Ford A and B conversions. Plans. AAA rules, specifications. Roadster racing. Indianapolis cars. \$1.00 postpaid, \$1.30 C.O.D. Ray Kuns, Dept. 47, Madisonville, Cincinnati 27, Ohio.

**FROM Speedway to roadway!** Track-proved hi-speed heads and manifolds now available for your passenger car! No special tools needed! Increase horsepower 25%! Astounding getaway! Free illustrated catalog. Speedsport, 6215AA Diversey, Chicago 39.

**AUTOMOBILE Racing, Sixth Edition.** 100 illustrations. Working drawings with building instructions for Ford-60 midget, California roadster, Offenhauser racer. Details on racer parts. Sample entrance blank. World's record 158.5 m.p.h. rear engine four-wheel drive car. Interesting information for fans, drivers, mechanics. \$2.00 postpaid; \$2.25 c.o.d. Ray Kuns, Department 63, Cincinnati 27, Ohio.

### AUTO SUPPLIES AND EQUIPMENT

**WELDING Blocks,** bodies—Repairing fenders easy with Hobart Welders. Adds \$\$\$ to profits. Low cost. Free catalog. Write Hobartweld, Box M-492, Troy, Ohio.

**PISTON Rings**—All sizes, oversizes, odd sizes. Individually engineered sets for every motor and motor condition by outstanding proving ground research group. Northwestern Auto Supply, 750 Division, Grand Rapids, Mich.

**OIL Filter** that cools oil. Remarkably efficient. \$8.60. Write for folder. Stone-wall Company, Dept. M, 2005 Cedar St., Alhambra, California.

**KAISER-FRAZER** Genuine factory parts mailed c.o.d. Special discount to dealers. All orders shipped same day. Write, wire Albany Park Motors, Inc., Parts Division, 2747 Lawrence Ave., Chicago 25, Ill.

**FENDER Skirts** all makes and models from 1935 to 1949. Made of heavy gauge steel. \$16.95 per pair, \$5.00 deposit. Balance on delivery. Dealers wanted. Ace Auto Products, Box 366A, Huntington Park, Calif.

**AUTOMOBILE Glass!** Direct savings! Write requirements. Cooper's, 3135 Lawrence, Chicago 25.

**SEND 10c** For valuable book "How to Operate a Profitable Welding Business." Regular 75c value. Hobartweld, Box M-493, Troy, Ohio.

**"AIRFLOW Needles."** Save gasoline. Write for free trial! Give make car and carburetor. Neher Industries, La Verne, California.

**"SMITHYS Mufflers"** for all cars. Free list. Bucks Auto Parts, 1296H, Merced, Calif.

**NEW Grilles** for all cars. Wagner Grille Co., Route 2, Bernville, Penna.

**SOLID-BRASS** Auto bells. Two loud chimes. Plunger operated. \$8.50. Bermuda Auto Bells, D-24, 16 Concord St., West Hartford 7, Conn.

**PISTONS**—American and foreign makes. Racing types made. Free price sheet. Meryman Co., Lawndale, PM2, California.

**MOTORISTS** Save gasoline by Vacuumating overrich mixtures. Fits all cars. For free particulars write Vacuumatic, Dept. 1495, Wauwatosa, Wis.

**SAVE Gas!** Instant starting. Lektron atomic coil booster. Only \$2.00. Money-back guarantee. Specify car. Electronic Industries, Cleveland 11, Ohio.

**HYDRAULIC Brakes** Ford Model "A," all V-8's. Modernize your old Ford. Specify model. E-Z installation. Complete kit new units replacing mechanical type. \$85. Clymer, Dept. A-HB, 1268 So. Alvarado, Los Angeles 6, Calif.

**SAFEGUARD** Your car against theft with new innerlocking device. Complete details, \$1.00. Roy Johnson, 457 Oliver St., San Pedro, Calif.

**YOUR Car** runs saw, generator, concrete mixer, \$6.50. Illustrated circular. Vise Brake Co., Omaha 5, Nebraska.

**SPEEDOMETER** Repair or exchange, \$7.50. Guaranteed. Give car model and year. Send to Speedometer Service, 917 Ogden Avenue, Downers Grove, Illinois.

**MAGNETIC Plug** removes abrasive steel grit from crankcase. Only 75c. Specify car. Free literature. Jacques, Rumson, N. J.

**WIZCURBS** Easily installed on front and rear fenders warn driver of curbs before damage to tires and fenders. Pair \$1.00 postpaid. Ferco Mfg. Co., Vineland, New Jersey.

**AUTO Parts** for all cars, transmissions, motors, differentials, fenders, carburetors. Security Auto Parts, 1923-PM Grace, Chicago 13

**CHEVROLET** Parts. Scarce motor, body, sheet metal parts. Grossman Chevrolet, Minneapolis, Minnesota.

**HARD-TO-GET** Auto body parts. We supply. Miller Auto Parts Service, 192 N. Clark Street, Chicago.

**BUICK** Parts. We stock a complete line of new Buick parts and engines. Same day service on orders and inquiries. We ship anywhere. Write today. Robertson Buick Co., 1001 S. Wabash, Chicago 5, Ill.

**BRUSH** Plating outfits connect to a battery. No tanks or shop required. Free particulars. Gunmetal Co., Avenue J, Decatur, Illinois.

**AUTO Parts.** Buy direct. Get dealers' prices. Represent us in your territory. Write requirements. Specify car make. Mechanics Auto Parts, Factory Warehouse, 3807-PM N. Ashland, Chicago 13.

## AUTO TRAILERS

**BLUEPRINTS,** Manuals to build trailers 12 to 30 ft. Streamliner manual \$1.00. Circular illustrating eight designs 20c. Craftsmann Books, Box 1153, Milwaukee 1, Wisconsin.

**ACTUAL** Photographs and plans for practical 12' camp and travel trailer \$1.00 plus Trailer Planner's Guide. Ed. Christensen, Box 687, Thief River Falls, Minn.

**BUILD** Your own trailer! Save money! Have every feature you want! Plans for house, sport, camp and utility trailers. Catalog describing 9 models 10c. 15c in Canada and overseas. Jim Dandy, Box 125-A, Wausau, Wisconsin.

## MOTORCYCLES, BICYCLES, MOTORSCOOTERS AND SUPPLIES

**NEW Bicycles** \$29.95. Wholesale. Retail. Bulletin 10c. Century Cycle, 3447 Lawrence, Chicago.

**BICYCLE** Supplies—Wholesale, retail list 10c Universal, 4713 Virginia, St. Louis, Missouri.

**BICYCLE** Repairing made easy. Illustrated "Bicycle Repair Manual" \$1.00. Klausner Cycles, Shelbyville, Illinois.

**INDIAN** Motorcycle \$35; Harley \$45; Briggs motorbike \$25; Cushman motor-scooter \$9, three wheeled motorscooter \$16.50; Springcycle \$10, midget car \$15, less motors. Briggs motor \$2.50. New motorbike conversions \$5. Four balloon tires for motorscooters or midget cars \$3. Mail order only. Over 5000 tires in stock. Plenty new midget cars, motorscooters, engines, automatic clutches, transmissions, etc., in stock at factory prices. Send 25c for Big War-Bargain catalogue Number 30 just out listing these and almost 400 other bargains. (35c by first class mail.) Midget Motors Directory, Athens, Ohio.

**4 CYCLE** Gasoline engines,  $\frac{3}{4}$  to 2 h.p. \$20 up. Free circular. Bob's, Box 229, Cherokee, Iowa.

**WHEELS**—Semi-pneumatic tires,  $\frac{3}{4}$ " roller bearings, 1.75 x 8, \$3.00; 1.75 x 16, \$3.50. Tyke Byke, 211 Harbor Road, Southport, Connecticut.

**JET** Propelled bicycle. Assemble your own. Photo and instructions \$1.00. Rush order. Maupin, Tipp City 5, Ohio.

**REVOLUTIONARY** New Weber high compression aluminum cylinder heads for Whizzer motorbikes and Cushman motorscooters. Increased power, greater economy, eliminates gasket troubles. Whizzer head \$5.95; Cushman head \$6.95. C.O.D. or cash with order. Dept. 4-49. Weber Tool Co., 4200 Whiteside, Los Angeles 33, California.

**AIRCOOLED** Engines. State needs. Enclose postpaid reply. Kenny's, Annandale, Minn.

**EXCHANGE** Your hard buddy seat for soft riding. \$10.00 up. Allen, 106 Brook St., Elgin, Ill.

**WHIZZER** Bike-motor \$25.00; Cushman motorscooter \$15.00; midget racer \$40.00; Shaw bicycle-motor \$15.00; Harley-Davidson motorcycle \$15.00; Smith motor-wheel \$25.00; Good motorscooter (twist grip) \$22.50. Rush 25c for new catalog #13 listing many other amazing bargains in motorscooters, used motors, midget cars, parts, wheels, etc. Gail, 538 Erie, Toledo, Ohio.

**HARLEY-DAVIDSON** Parts, accessories, batteries, and tires. 24 hour service. Authorized factory dealer. Philadelphia Harley-Davidson Company, 857 North Broad Street, Philadelphia 23, Penna.

**INDIAN** And Harley parts catalog 25c. Pistons, motor parts, batteries, tires, chrome accessories. Bootz, 1700 East University, Des Moines 16, Iowa.

**MOTORBIKE** Outfit \$5.00; midget car (complete) \$35.00; Indian motorcycle \$30.00; Cushman motorscooter (complete with extra tire) \$20.00; 1946 Whizzer \$35.00; other motorscooters \$10.00 up; motors \$3.00 up. Send 25c for new catalog #942 listing many other sensational bargains in used motors, motorscooters, motorcycles, parts, etc. Associated, Box 1764-CS, Toledo, Ohio.

**MOTORSCOOTERS.** New design. 6 big features. Literature 10c. Rollaway Motors, Lancaster, N. H.

**MOTORCYCLE** News, monthly. Yearly subscription \$1.00. Latest worldwide information. Sample 15c. Motorcycle News, 5424-A Sawyer, Chicago 25.

**RECONDITIONED** Motorcycles and motors. Chromium accessories. Complete stock Indian parts. Expert rebuilding. Fast service. Indian Motorcycle Sales, Kansas City 1, Mo.

**COMPLETE** One Stop Harley Davidson Sales Service, 813 Ohio Street, Wichita Falls, Texas.

**HARLEY-DAVIDSON** Parts, accessories, oil, expert service. Tires all sizes. Rebuilt 45" motors. Send \$2.25 for Army 45 Motorcycle Manual. 25c for accessory catalog and bulletins. Knuth's (Harley-Davidson Dealers), 2491 Fondulac, Milwaukee, Wis.

**WHEELS!** Build wagons, scooters, mowers, trailers, wheelbarrows, grocery carts, baby carts, play pens, baby carriages. 4" to 16". Free list. Trulsen Mfg. Co., 811 E. 31. Kansas City, Mo.

**TIRES** And industrial wheels, suitable for scooters, wheelbarrows, farm equipment, etc. All sizes. Bicycles and accessories. Largest assortment in America. Send dime for list. Cycle Transport Company, 1241 So. Michigan Ave., Chicago 5, Illinois.

## AVIATION

**BUILD** And fly Primary Glider. Folder 25c. Glider club plan 15c. No stamps. Dept. A, McFarland Aircraft Co., Greenville, Ohio.

**JET** Engine: Build the miniature M.E.W. 601, requires only hand tools; Construction plans \$1.00; parts available. Send 10c for illustrated literature and parts list. Minnesota Engine Works, Dept. PM, 387 University Ave., St. Paul 3, Minnesota.

**FAMOUS** "Zweng Texts" with examinations: Mechanic's Ratings \$3.00; Flight Engineer \$4.00. Pan American Navigation Service, 12021-6 Ventura Blvd., North Hollywood, Calif.

**PROPELLERS**—2-3 Blade for sleds, air-drive boats. Catalog. Standard Aero Craft, Box 387, Ft. Worth, Texas.

**LIGHTPLANE** Manuals, blueprints. Circular illustrating designs, motors 20c. Craftsmann Books, Box 1153, Milwaukee 1, Wis.

## BATTERIES, GENERATORS

**GENUINE** Edison alkaline batteries. Lifetime. Unconditionally guaranteed. Free literature. See-Jay Company, 321 Yonkers Avenue, Yonkers, N. Y.

**EDISON** Non-Acid lifetime storage batteries for home lighting, motors, industrial uses, radios, etc. Free interesting literature. Hawley Smith Co., Croton Falls 1, N. Y.

**KOHLER** Automatic lighting plants. Direct or alternating. 800-10,000 watts. See-Jay Company, 321 Yonkers Ave., Yonkers, N. Y.

## ELECTRICAL SUPPLIES

**LAMPS**—Build own originals. parts wholesale, any amounts. Catalogue 10c. Brown Lamp Co., Box 501, Wellston, St. Louis 12, Mo.

**SHELL** Lamp equipment catalog free. Shell House, Box 1685-D, Miami 35, Florida.

**BUY** Lamp parts wholesale. Parts you need for building, repairing, or assembling. Save money on large or small orders. New catalog for 10c. Gearon Company, Dept. 300-B, 427 South Desplaines, Chicago, Illinois.

**ELECTRIC** Watthour meters; single phase, reconditioned, calibrated. \$3.00 each f.o.b. Boston or \$4.50 delivered. Melvin Pierce, #900 Statler Blvd., Boston, Massachusetts.

**WATTHOUR** Meters. Reconditioned, guaranteed. Ideal for cabins, trailers, shops, \$2.95. T. Price, 310-14th, Raymond, Wash.

**LIGHTING** Plant: Portable, compact in 800 or 1000 watts, 110 volts, single phase, a.c. current (same as house current) direct driven by latest designed 2.5 h.p. or 3 h.p. air cooled engine. Write for details. General Merchandising and Equipment Co., Dept. 2, Box 18, Sharon, Penna.

**OIL** Lamps—Instructions for electrifying, restoring. Also 44 page illustrated catalog, all parts 10c. Gyro Lamps, 5402P N. Clark, Chicago 40.

**250,000 VOLT** Generator! 7-inch sparks, two foot coil. Spectacular scientific demonstrations. Complete, 15-min. assembly, \$7.50 postpaid. 500,000 volt model, \$12.00. Connell Radio Supply, Nashville, Indiana.

**WATTHOUR** Meters, reconditioned, calibrated, guaranteed, complete stock, all types and sizes, \$2.75 up, write for list. Maspenco Electric Light Co., 44 Starr Lane, Jamaica Plain, Mass.



**ELECTRIC Pencil:** Engraves all metals \$1.25. Beyer Mfg., 10511-H Springfield, Chicago 43.

**NEW Motors,** General Electric, 1/2 \$12.50, others to 1 horsepower. Free literature. Plenge, 114 Elliot Place, Bronx 52, New York.

**POCKET Tester**—Check voltage from 100 to 550 a.c. or d.c., polarity, continuity, fuses. Only 95c postpaid. Regency Sales Co., 5316 So. Justine St., Chicago 9, Ill.

### WELDING, SOLDERING, PLATING

**ACETYLENE** Welding outfits, new, \$54.50; arcwelders \$46.50. Eagle Welding, Dept. PM, 5085 Broadway, Chicago 40, Ill.

**WELDING** Schooling pays. G.I. approved. Best equipped in U.S. Free catalog. Write Hobart Welding School, Box M-495, Troy, Ohio.

**NEW** And used professional welding equipment, gas or electric, also repairing. Welding Headquarters, 2425 Milwaukee Ave., Chicago 47, Ill.

**"BUILD-UR-OWN"** Welder and a.c. power plant. Weld—Run tools, lights, motors—anywhere. Your engine plus Hobart generator saves \$350. Free instruction book. Write Hobartweld, Box M-494, Troy, Ohio.

**PLATING** Equipment, supplies and chemicals for copper, gold, silver, etc. Ramyr platers; 10, 30, 50, 100 amp. Complete silver plating assembly, includes rectifier, tank, anodes, solutions, etc. Full price \$109.50. Complete bronze baby shoe plating assembly \$97.50. Instructions free. Send for list. Hollywood Bronze Supply, Plating Div., 1770 N. Vermont, Hollywood 27, Calif.

**TYPEWRITER** \$40. Electric welder cheap. Trowbridge, 653 W. 81st, Chicago 20.

**P-1 GENERATOR** Owners: make yourself a better welder using our reactor and resistance coil unit; complete with plug-in panel, cables, ground clamp, electrode holder, and our patent applied-for fingertip control system. \$51 postpaid. Free literature. Thorndyke Manufacturing, Pipestone, Minnesota.

**ARC Welder,** 110 volt. Build it yourself. No transformer to burn out. Welds 1/2" steel. Will use 5/32" rod. Very inexpensive. Send \$1.00 for full information to H. E. Younger, R.R. #8, North Kansas City 16, Missouri.

**OXY-ACETYLENE** "Demurrage-free" Linde cylinders, Purox apparatus, Oxweld supplies, Metalmaster outfits, Miller electric hobby welders, approved fire extinguishers. Free literature. A-A Welding Supply Company, Dept. A, 9228 So. Ada St., Chicago 20, Ill.

**RADIATOR** Repairing, cleaning, re-coring. Our instructions tell how, how to equip a small shop at low cost, where to buy. Radiator Book, McBain, Michigan.

**WELDER!** New portable Champion Special transformer welder; 110/120 volts a.c. develops to 75 amps.; 9 heat stages. Welds, brazes, solders, cuts all metals. Easy to use. Simple instructions. Special flame weld torch free. Splendid for shop, farm, home repairs. Saves hundreds of dollars yearly. Only \$27.50. Also heavier models. 10 day free trial. Magic Welder Co., 239 MP Canal St., New York, N. Y.

**WELDERS** 110v. Welds 1/2" steel \$32.50. Morris Welding Service, 1850A State, Schenectady 4, N. Y.

**BUY** Direct from factory. Welding outfit, \$48.36. Soldering outfits \$7.76 to \$10.16 complete prepaid. Box 331, Hamilton, Ohio.

**OWN** Mirror shop. Resilver mirrors. Glass sign making. Electroplating. Supply prices. John Sprinkle, V55, Marion, Indiana.

**RECTIFIERS:** Ramyr Selenium platers, 10, 30, 50, 100 amp. sizes. Immediate shipment. Complete line of bronze baby shoe mounts. Write for list. Hollywood Bronze Supply, 1770 N. Vermont, Hollywood 27, Calif.

### MACHINERY, TOOLS, SUPPLIES

**THE Woodpeeler**—Peels any post cheaper, faster, cleaner. Capacity about 50 posts per hour. Write for illustrated literature and prices. The Woodpeeler, Box 330, Lake City, Florida.

**"TIRES"**—Save 1/3. New, rugged all purpose airplane tires, 10 inches to 56 inches high. Complete wheel assemblies attach easily to your axles. Free details. Write card today. Airplane Tire Co., Box 1201A, Tulare 2, California.

**YOUR Own** machine shop will save time and money on your repairs. Your neighbors work will pay you \$2-\$3 per hour. Our surplus machines are accurate, low-priced and delivered at once. Screw-cutting engine lathes \$150 and up. Powerful upright drill presses from \$110. Milling machines \$150, some higher. Shapers, welders, band saws, grinders. Our guarantee; satisfaction or your money back. Conversion Parts Co., 278 Adams Street, Boston 22, Mass. U.S.A.

**ATTENTION:** Marvelous, economical concrete block machines. Standard sizes. Low prices. \$39.50. Free catalog. Concrete Machine Company, 5466 Gravois, St. Louis 16, Mo.

**COMPACT** Amerline beam compass has self-contained scale giving rapid and accurate settings for circles up to 12 feet in diameter. \$3.00, postpaid. United Industries, Box 449, Madison 1, Wisconsin.

**DAYTON** 1/4" Electric drill with geared Jacobs chuck. Husky 115 volt a.c.-d.c. motor. List price \$21.95. Our price, \$18.50 postpaid. Satisfaction guaranteed. Ever-Cool Electric Co., Box 167, Rocky Ford, Colorado.

**FIRE** Extinguishers, 15-lb. C-0-2, \$42.50. Domonkos, 98-A4 Vermont, Newark 6, N. J.

**DRILL** Grinder for twist drills, \$2.95. See ad on page 276

**BUILD** Your own lawn mower sharpener, excellent investment. Plans, equipment. Mowerman, Hayward 5, Wis.

**DRAFTING** Instruments; new; used; famous makes; guaranteed; inexpensive. Free list. Southside, 210 E. 39th, Kansas City 2, Mo.

**BENCH** Power tools, motors, supplies. Wholesale prices. Homecrafters Co-operative, Grand Rapids 6, Mich.

**BAND** Saw—Special \$14.95. Ideal for hobbyists and home workshop. Free circular. Woodcraft Tools, Inc., 147 E. Lake, Minneapolis, Minn.

**EZ** Drill grinder—Pat. No. 2,411,609. Sharpens twist drills to factory precision in 30 seconds. Made of cold rolled steel. Aluminum protractor. Production or home workshop. \$2.80. EZ Mfg. Company, 4406 San Fernando Road, Glendale 4, Calif.

**GAGE** Your grinding of twist drills, hand or machine ground, for clearance and both cutting angles simultaneously. Really a positive gage for better drill efficiency. 1/16" to 3/4" size, 75c postpaid. Tingle Industries, 8731 Orangelawn, Detroit 4, Mich.

**CHUCKS,** (Genuine Westcott) Independent, Universal; threaded 1 1/2"-8 for South Bend, Atlas, Logan, Clausing, Craftsman lathes. Other chucks to 16". Top value. Tell us type and size chuck you want, make of your lathe and spindle nose dimensions so we can submit definite quotation and free literature. No obligation. Westcott Chuck Company, 3600 Walnut, Oneida, N. Y.

**A.C. Welders,** power mowers. Wholesale, retail. Holgerson's Service, Canton, Kans.

**PRECISION** Tools, used; micrometers, verniers, gauges, dials, etc., bought, sold, exchanged. Free list. Precision Exchange, 30 Church Street, New York 7, N. Y.

**HOME** Lathe owners—Build your own attachments. Send for picture, sample of work and list of blueprints. Cut gears, ratchets, etc. Make neat screws easy way. The Home Shop, 415 Raymond Ave., Glendale 1, Calif.

### BOATS, OUTBOARD MOTORS

**SAVE** 2/3 Cost. Build your own boat with our ready cut parts by the Welch System. No experience necessary. Rowboats to cruisers. Illustrated catalog 25c. Midwest Boat Company, Menomonee Falls, Wisconsin.

**BUILD** 8 Ft. dinghy, kit complete with all hardware, marine plywood, \$45. Free literature. Ideal, 19A West 19 Street, New York 11, N. Y.

**BOAT** Plans: Over 300 designs easy-to-build outboards, sailboats, runabouts, cruisers, etc. Get free catalog now. Motor Boating, 572C Madison Avenue, New York 22, N. Y.

**OUTBOARD** Motor parts, new and used, all makes. We can save you money. Write for price quotation. Cylinders rebored. Oversize pistons and rings for all makes, regardless of age. Outboard Motor Mart, Inc., 309-B Atlantic Ave., Boston 10, Mass.

**11 FOOT** Sailing pram, complete building plans, February price 40c. Catalog boatbuilding plans 10c. The Rudder, 15 Murray St., New York 7.

**SPECIAL** Price \$89.50, complete marine conversions for Ford V8. Illustrations free. Also conversions and accessories for all Ford and Jeep engines. Complete catalog 25c. Arthur Gershel, 51 Chambers St., New York City.

**P38 BELLY** Tank boat plans, complete instructions \$1.00. Details free. Buck's Auto Wrecking, 1635 T, Merced, Calif.

**KNOCK** Down boat kits. Outboards, inboards, sail, racing, molded shapes. Easy to assemble, enjoyable, minimum cost. Illustrated catalog 25c. Brooks Boat Company, Carrollton P4, Michigan.

**BOAT** Plans, kits—Hardware, conversions, plywood. See Marine Mart display ad page 279.

**OAK** Lumber finished to size for boat building. Waterproof plywood, marine finishes, supplies, books, plans. Send 10c for details and price lists. Trans-Marco Corporation, Mount Vernon, N. Y.

**SPORTSMEN!** Make Kayak from economical, easy-construction kit! Literature. Dedham Kayaks, Dedham, Mass.

**GOOD** Used marine engines. Bargain catalog free. Lind Supply Company, Coldwater, Michigan.

**BOAT** Plans: Wood; steel. Book, "Modern Designs for Boats and Yachts." \$1.00. John B. Clark, Yacht Designer, 329 Kenmore Drive, Bay Village, Ohio.

**STEERING** Wheels, windshield brackets, from \$6.95. Modern fittings, lowest prices, also complete pre-cut plywood boats. Bargains galore. Folder 10c. Marine, Box 681, Mendota, Minnesota.

**BUILD** Marine motors, Ford or Jeep. Federal Marine Motors, 9011 Cottage Grove, Chicago 19, Ill.

**NEW.** Used, rebuilt marine motors. Marine conversions, fittings. Free catalog. Stokes Marine Supply, Dept. 24, Coldwater, Michigan.

**BOATS** And all about them. How to select, build, repair and operate. For 40 years the leading practical boating magazine. Half price trial subscription. 12 issues for \$1.00. Motor Boat, 62 Gold Street, New York 7.

**OUTBOARD** Motors—Good values, used motors. Also used parts for most makes and models. Crandall-Hicks Co., 911 Commonwealth, Boston, Mass.

**MARINE** Conversions for Ford and Jeep engines. Catalog 10c. Lehman Manufacturing Company, Department D, Newark 2, New Jersey.

**COMPLETE** Constructional details on seventeen low-cost boats—power, sail, row. Designed for home builder with limited tools, no experience and little money to spend \$1.25. Popular Mechanics Press, (C-43), 200 E. Ontario, Chicago.

### ENGINES, MOTORS, DYNAMOS

**HOTTEST** Surplus list in the country. Electronics, hydraulics, aircraft, gadgets. Dick Rose, Everett, Wash.

**WELDERS** For all requirements. Free catalog. Write Hobartweld, Box M-496, Troy, Ohio.

**MOTORS**—1/2 H.P., 3450 r.p.m., \$17.50. 1 h.p., \$28. 1/2 h.p., 1750 r.p.m., \$18.50. Roberts, 7232 Madison, Forest Park 3, Ill.

**WELDING** Generators, 150 ampere \$47.50. 1/2 horse, 1750 r.p.m. motors \$19.75. 3/4 horse, 3450 r.p.m. \$22.50. Compressors \$17.50. Butler, 1885 Milwaukee, Chicago.

**ELECTRICAL** Repair men, send for literature on Motor Winding tester and a.c. motor winder. Motor Industries, Quincy, Illinois.

**MOTORS!** 1/2 H.P. D.C. converted to A.C. All new. High speed 110 volt, 25 or 60 cycle, ball bearing motors. Actual value about \$75.00. Now \$15.00 each or 3 for \$40.00. Countless uses for home mechanics. Can be used in any position. Order today! Immediate delivery! No c.o.d. orders. "Amazing Bachman's," 27 Herman Street, Rochester 5, New York.

**WINDING** Data, listing 225 motors, single and three phase, \$1.00. Motor Data Co., Box 7631, Kansas City 3, Mo.

### ATHLETIC EQUIPMENT, BODY BUILDING COURSES

**ACROBATS!** Strength, health. Free booklet. Write! Ea. Knoff, Pewaukee, Wisconsin.

**BARBELLS,** Dumbbells, \$8.95 up. Send stamp. Jackson Barbells, Springfield, N. J.

BIG Bargains, 12 courses \$1.00. News 10c. Sid's System, Southgate, California.

BARBELLS, Exercise equipment. Courses. Free booklet. Good Barbell Co., Reading, Penna.

DEADLY Judo—Fiercest fighting technique. Trick knockouts. (200 photographs, plus illustrations.) Expert instructions, three volumes. Complete \$2.25. Variety House, Box 46-B, Wall Station, New York 5.

### SPORTING GOODS, GUNS, FISHING TACKLE, ARCHERY, TRAPPING

FREE Bargain catalog! Write Klein's Sporting Goods, Department C, Chicago 6.

TEN Catfish baits. Easily prepared 50c. Kerby, Box 1, Lexington, Kentucky.

BARGAINS in popular and unusual fishing specialties. Write for free catalogue. Hobby Specialty Company, 912 Francis Palms Building, Detroit 1, Michigan.

FISHERMEN—Custom tied spider flies, 3 for \$1.00. Wm. Heldt, Hartford, Mich.

SEND Today for free information on my new fly-fishing system. Robert Snyder, Old Forge 2, New York.

FREE, New spring catalog of guns, fishing tackle, athletic goods, camping equipment, cameras, western goods. Write Andy Anderson's Sporting Goods Co., 120 W. Grand, Oklahoma City, Okla.

STRIKING Bag \$5.00. Footballs, basketballs, factory prices. Leather. Guaranteed, official. Catalogue. Apco, 131 Genesee, Utica, N. Y.

GOLFERS—Handmade woods; factory prices. Satisfaction guaranteed. Write Ed Gordon, Box 628, Oak Park, Ill.

MUSTAD Key brand fish hooks for amateur fly tyers—Strong, flexible, needle sharp, Norwegian made hooks. Up-eyed and down-eyed patterns. Write for free catalog. Aeroplane Spinner Mfg. Co., 748H Lincoln St., Denver, Colo.

180 PAGES Antique and modern pistol, sword, etc. values, 50c. Robert Abels, A860 Lexington Ave., New York 21.

MINNOW Traps, sportsmen's size \$2; professional's \$3. Professional's frog trap \$5. Traperafters; 1936 Delancey St., Philadelphia, Penna.

BOWS, Arrows. Quality archery equipment. Popular prices. Catalog 10c. Illustrated archery instruction book 50c. Archery, 617-K So. State, Chicago 5.

STOP Digging worms. Use secret spray. Pick them up one minute later. Formula \$1.00. Satisfaction guaranteed. American Angler, Box 301, Ballston Spa, N. Y.

BASEBALL Uniforms: Team mgrs., buy direct and save. These big league cut, large roomy uniforms are quality tailored of sturdy, Cricket cloth. \$11.95 value—our price \$6.95. Jr. league size \$5.75. 10 letters sewn on free. Write for illustrated catalog and fabric samples. Equal savings on all other baseball equipment. Bacharach Rasin Co., Dept. 43, 14 N. Howard St., Baltimore 1, Md.

AMAZING New telescopic casting rod. 5 feet. Parts slide into handle 11 inches. Fits your pocket. Literature free. Rice & Rice, Box 566A, Muskegon, Mich.

5000 BARGAINS. Firearms, binoculars, war relics. Catalog 40c. Smith Firearms, Rummene, New Jersey.

AMMUNITION—175 Sizes in stock. American, foreign. Dime for list. Central Sports, Delphos 5, Ohio.

SHOTGUNS—Richardson R-5, single barrel, 37 inches long. Weight, 5 $\frac{3}{4}$  lbs. Price, \$14.95 each. Cameo, 432 West 42d, New York.

SEND 10c For list 100 used guns. Frayseth's, Willmar, Minn.

PISTOLS, Revolvers, rifles, shotguns, ammunition. List 25c. Frank Farish, Vicksburg, Mississippi.

SURPLUS Camping supplies. Bargains. Free catalog. R. McManus, Cuttingsville 4, Vt.

SHOTGUNS, Rifles, revolvers, over 500 modern, obsolete. Also cartridges, list 10c coin. Ed Howe, 52 Main, Coopers Falls, Maine.

### TAXIDERMISTRY

"MODERN Taxidermist Magazine." Greenfield Center, N. Y. Devoted exclusively to taxidermy. Two sample copies 25c.

### BINOCULARS, TELESCOPES, MICROSCOPES, MAGNIFIERS

BINOCULARS—New light weight French 8x30 with case—\$39.75 tax included. Satisfaction guaranteed. Nu-Designs, Kalamazoo 26, Mich.

BINOCULARS—Sold. New and used. Also repairing. Write P. C. Meichsner Co., Inc., 93 Federal St., Boston, Mass.

NEW Rifle scopes, mounts, binoculars. Latest model Weaver K4 (coated) \$36.50, J4 \$23.50. Binoculars, new coated 6 x 30 M3 army \$43.50 plus tax. Bargain list all makes. Stan Wentling, Palmyra, Penna.

"TERRIFIC" Bargains—Government surplus telescopes, binoculars. Send \$1.00 for 10 piece hobbyist lens set. Contains magnifying and reducing lenses. Send stamp for "bargain" list. P. Jaegers, 93-08 95th Ave., Ozone Park 16, N. Y.

FAMOUS Bausch & Lomb rectangular magnifying and reading glass, 3 $\frac{3}{8}$ " x 2" lens. 9" focus. Handsome plastic handle. Overall 7 $\frac{3}{4}$ ". Gift boxed. \$3.75 postpaid. Guaranteed. Order now! Jarlan Company, 5 Beekman, New York 7.

NEW Binoculars, limited offer, Zeiss type 6 x 25—\$23.35; 8 x 30—\$30.00; 7 x 50—\$40.00 with case, straps, plus 20% tax. Money back guarantee. Bushnell Importers, 672 S. Lafayette Park, Los Angeles 5.

BINOCULARS, Telescopes, watches, guns. Buy, sell, trade. Schweer's, Donnellson, Iowa.

REFLECTING Telescopes, 60X, completely assembled \$25.00. Guaranteed observatory clearness. Free information. Skyscope, 475 Fifth Avenue, New York 17.

POWERFUL Astronomical telescopes easily made. Perfect lenses and instructions; 100X \$3.00, 100X and 200X \$4.00, 100X, 200X and 400X \$6.00. Clear vision, full power guaranteed. Instructions alone 10c. Suffolk Science Service, Manorville, N. Y.

ASTRONOMICAL Telescopes, binoculars, microscopes; bought, sold, repaired. Books. Lists 10c. Rasmussen-Reece, Amsterdam, N. Y.

TELESCOPES, Binoculars, microscopes, big bargain catalog free. Brownscope Company, 24 West 45th Street, New York.

GIANT Astronomical telescope 100 diameters magnification, with tripod. Full power, clear vision. \$15.00. Suffolk Science Service, Manorville, N. Y.

### DOGS, PETS, BIRDS, RABBITS

RAISE Guinea pigs. Make money at home. Booklet free. Taylor, Box 426A, Hapeville, Georgia.

\$3000 YEARLY Raising Angoras. Circular free. Vaughn's Rabbitry, Otley, Iowa.

\$400 MONTHLY. Raising Angora rabbits. Wool \$9 pound. Plenty markets. Details free. White's Rabbitry, Newark, Ohio.

RAISE Rabbits. Market provided. Illustrated booklet, 25c; with hutch plans, \$1.00. Hansen's Rabbit Institute, 1347 Miller Ave., Salt Lake City 6, Utah.

\$300 MONTHLY Raising Angoras for our market. Particulars free. Associated Breeders, 610 Marshall, St. Paul, Minn.

GRINSTEAD'S Famous Angoras! Giant Chinchillas! World's most profitable rabbits. Finest pedigree, heavy-producing, prize-winners. Literature free. Grinsteeds, Edwardsville, Illinois.

BEAUTIFUL Great Danes—Loving companion, guard. Sidney Baucom, Salt Lake City, Utah.

RAISE Rabbits. Four pound fryers in eight weeks. Ready market for meat, fur, wool. Illustrated book, describing leading breeds, housing, breeding, feeding, marketing. By America's largest Rabbit Association, 12 AR&CBA Building, Pittsburgh 17, Penna.

BEAUTIFUL Pure white pedigree police puppies. Ansonia Kennels, Mose, N. Dak.

\$1.00 FOR Booklet "Canary, Its Care, Breeding and Training," and three copies cage-bird magazine. American Canary, 2839PM N. Halsted, Chicago 14, Ill.

RAISING "Hamsters is profitable." Information. Pem's Hamstery, 3010-10th Ave., No., St. Petersburg 6, Fla.

SEE Gulf Hamstery ad on page 24. Shows picture of Hamster.

RAISE Chinchilla rabbits. Year-round money-makers from furs, meat, breeders. Experience unnecessary. Write today. Wilow Farm, Sellersville 15, Penna.

HOHL'S Hamsters. Clean, odorless pets, \$4.50 pair. Literature, picture free. Lab. stock, 317 Mt. Vernon Rd., Newark, Ohio.

MINK Raising information free. Complete. Lake Superior Mink Farm, Superior, EE1, Wisconsin.

INCREASE Your income by raising domestic rabbits. Small space needed. Ready market for delicious meat, fur and wool. Largest magazine in the industry tells you how. \$1.50 per year. Sample 15 cents. No stamps. Small Stock Magazine, Lamoni 20, Iowa.

\$3000 YEARLY Raising Angora rabbits. We buy your output. Contract particulars free. Kise's Enterprises, St. Paul 8, Minn.

MAKE Money raising bees: Send for How To Succeed With Bees, 96-page book by experts. Contains 190 tested plans, guaranteed to help you or your money back, only \$1.00. Popular Mechanics Press, 200 East Ontario Street, Chicago 11, Illinois.

### PLANTS, SEEDS, NURSERY AND GARDEN SUPPLIES

GLADIOLUS, List, 100 varieties, new rare, novelties. Robinsons, Sebastopol, California.

FREE Chrysanthemum catalog—25 hardy chrysanthemum plants. Five different colors. Unlabeled. Only \$2.00 postpaid. Wisheart Nursery, Dept. 14-2, Frankfort, Ohio.

GINSENG, Goldenseal. Hundred seeds \$1.50; thousand \$5. Dozen plants \$1.50; hundred \$9. Growing-selling instructions included. F. M. Collins, Viola, Iowa.

RAISE Your own trees and shrubs from seed for shade, windbreak, erosion control, etc. Write for free planting guide and price list. Woodlot Seed Co., Norway 4, Michigan.

### FARMS, FARM LANDS, REAL ESTATE

BIG Free spring catalog of farm bargains, many states, some equipped, many illustrated. Write today! United Farm Agency, 1408-PM Consumers Bldg., Chicago 4, Ill.

JUST Out Strout's Red Farm Catalog! Spring-summer time and money-saver—Free! Describes 2790 bargain properties, 35 states coast-to-coast. Write today for your free copy! Strout Realty, 255-P 4th Ave., New York 10, N. Y. 20 W. 9th St., Kansas City 6, Mo. 453 S. Spring, Los Angeles 13, Calif.

\$5.00 MONTHLY Buys 40 acres, near town; price \$200.00. Free list. Box 425-P, Carthage, Mo.

CANADIAN Tax sale lands for two dollars an acre and up. Small monthly payments. Farms, timber, hunting and fishing camps, minerals. Limited number of properties. Write at once for free catalogue. Tax Sale Service, Room 105, 120 Bloor St., West, Toronto 5, Canada.

GOVERNMENT Lands \$2.00 acre up. Information all states twenty-five cents. National Tax Service, 901-A Majestic Bldg., Detroit.

BIG Lists farms, ranches, water frontage properties. Free descriptive folders, prices. Splendid opportunities, Washington, Idaho, Montana, Dakotas, Upper Michigan, Wisconsin, Central Corn Belt. Information regarding Columbia and Missouri River Basin irrigation projects. L. H. Robbins, Milwaukee Railroad, 736K Union Station, Chicago 6, Illinois.

GOOD Farms—Ranches, Washington, Minnesota, Montana, Idaho, Oregon, North Dakota. Dependable crops, favorable climate. Write for literature, lists describing typical farm opportunities. Specify which state. J. W. Haw, 119 Northern Pacific Railway, St. Paul 1, Minn.

OZARK Magazine, Eureka Springs 11, Arkansas. For homeseekers, tourists. Year, \$1.50.

SOLD For taxes. Calif., Oregon, Washington timber, grazing, ranch and mining lands. 25c to \$3 acre min. bid. 10c (coin) brings circulars, photos, maps. Pacific Lands, Box 2350-PM, Hollywood, Calif.

LOTS \$300—Convenient payments. California's finest garden section. On Morro Bay's scenic shores. Wonderful fishing, hunting, boating, bathing. Fertile soil, softest water, temperate climate, congenial community. Free literature. Richard Otto, Department M, San Luis Obispo, California.

OZARK Lands for all purposes. Actual river frontages, 5 acres \$90.00 and upwards. Free list and literature. Hubbard, 424-I Minnesota Ave., Kansas City 4, Kansas.

## POULTRY, FARM SUPPLIES

**RAISE** Fryers new easy way. One man home plant earns \$500 monthly. Circular free. Poultrymans Institute, 1046-A So. Olive, Los Angeles 15, Calif.

**GROW** "Chicken of tomorrow" today with chicks from Pilch's famous Old Hen Breeders. You, too, will like Pilch's chicks because so many other people do. Reds, Rocks, Crosses, Sex-Links, White Rocks, Hamps, started chicks, and capons. Write for valuable 1949 calendar. Pilch's Chicks, Box M, Thompsonville, Conn.

**PIPE**—Rustproof, inexpensive. Free details. Sprinklet, Box 1462, Amarillo, Tex.

**\$6.95 BUYS** Smith money-maker chicks. Assortments. Purebreds. Bloodtested. Pedigree-sired sexed pullets, males, too. 100% live delivery. Catalog free. Smith Chickeries, Box 262-32, Mexico, Missouri.

**BABY** Chicks, champion mated. 52 varieties, 6 hybrids, licensed inspected, bloodtested. Rush postal, large colored book free, low prices. Berry's Farm, Route 12, Clarinda, Iowa.

**FREE** Information on how you can make up to \$5,000.00 raising broilers and fryers the newest way in your backyard or in your farm buildings. Write National Broiler Institute, Dept. 3, Versailles, Missouri.

**EARN \$4 To \$12** hourly. Chick sexing, culling and caponizing. G.I. approved. Pilch's School, Box PM, Thompsonville, Connecticut.

**KNOW** How to raise poultry for profit. Read Northeastern Poultryman. Every issue packed with helpful hints and practical suggestions. Latest articles on breeding, feeding and management. Subscribe now. 1 year 65c. 2 years one dollar, foreign subscriptions \$1.00 a year. Northeastern Poultryman, Dept. P.M., 376 Boylston St., Boston 16, Mass.

**RAISE** Turkeys the new way. Write for free information explaining how to make up to \$3000.00 in your own backyard. Address National Turkey Institute, Dept. 3, Columbus, Kansas.

## PROFITABLE OCCUPATIONS

**INEXPENSIVE** Manual teaches air conditioning. Write. Don Nelson, Warner Robins, Georgia.

**EXTRA** Money at home? Gold, silver, aluminum. Ring casting instructions 25c. Lauckner, Box 574-A, Great Falls, Mont.

**LOCKSMITHING** Secrets! Key fitting, lock repairing, opening; prices, sources. Illustrated book \$1.00. Wexler, 7 West 36, New York City.

**SENSATIONAL!** It's easy to earn big money with your own profitable business. Earn \$10.00 to \$50.00 a day. Make lamps at home. General illustrated course teaches you quickly. Course and wholesale supply catalog only \$2.00. Gearon Company, Dept. 200-B4, 27 South Desplaines, Chicago, Illinois.

**WOULD** You pay 3%—first \$350 made? Color-illustrated book "505 Odd, Successful Enterprises" free! Work home. Expect something odd! Pacific, Oceanside, Calif.

**YOU** Can make real money raising Golden Hamsters. New tiny animal. Easily raised at home. Write for details. Hudson Hamstery, Newfoundland 1, N. J.

**FOREIGN** Employment? Latest bulletin, overseas directory and application forms: \$1.00. (C.O.D. \$1.32.) Foreign Service Institute, P.O.B. 3934, Miami, Fla.

**START** Gun rebluing business, full or spare time work. Every gun owner a prospect. Directions \$1.00. R. Meininger, Gunsmith, Doylestown, Penna.

**PLATING**—Brush and electro, \$1.00. Formulas, instructions. C. Stratton, Electro Plater, 432 Pearl St., Lancaster, Penna.

**PIANO** Tuning for everyone \$1. Lessons and charts. Oscar Fyiling Laurel, Oroville, Calif.

**WANTED**—Purchasing agents. No money or experience required. Write Dept. C, Purchasing Manager, 2719 Lawrence, Chicago, Ill.

**PROFITABLE** Business making and building with easy-laying interlocking building blocks. Rex Products, Dept. 10, Piqua, Ohio.

**CONSTRUCTION** Report—Send \$1.00 for world wide job project listings. Up-to-minute-facts for construction men. Global Reports, P.O. Box 883-DX, Hollywood 28, Calif.

**TYPISTS**—Profitable business at home. Complete copyrighted information, 50c. Gaunt, 3521-A Broadway, Chicago 13, Ill.

**ELECTRIFY** And convert sewing machines. Easy, profitable. Inquire Ray's Distributors, Dept. PM, 107 Ray St., Mishawaka, Ind.

**"EVERYBODY** Likes candy." Learn to make in a professional manner. (Our 39th year.) Ragsdale Candies, D6, East Orange, New Jersey.

**EXCELLENT** Profits. Make, sell holiday flowers, novelties. Literature free. Velya Artcrafts, 324-M East 14, New York 3, N. Y.

**"FROG-RAISING"**—New book explains everything! Marlboro, 1035 Marlborough, Detroit 15, Michigan.

**BE** The Popular Mechanics representative in your neighborhood and earn big profits in your spare time. Write Popular Mechanics Magazine, Room 408M, 200 E. Ontario St., Chicago, Ill.

**\$46 FROM** Square foot plywood; jigsaw necessary. Write, Woodarts, P-38, Bridgewater, Mass.

**OWN** Mirror shop. Resilver mirrors. Glass sign making. Electroplating. Supply prices. John Sprinkle, V50, Marion, Ind.

**\$40.00 WEEKLY** Made growing mushrooms, fresh, dried. Dominion patent 331583. Free spawn. North American, 169P Yonge, Toronto, Canada.

**INTERESTED** In Latin American and foreign employment? \$1.00 brings Foreign Service Directory listing exporters and importers, oil, construction, mining, aviation companies. Hot tips for applications. Global Reports, Box 883-M, Hollywood 28, Calif.

**ALASKA**—The Last Frontier offers unlimited opportunities, \$1 brings government map and directory listing firms in fishing, construction, mining, aviation, fish and game rules, homestead data. Alaska Opportunist, Box 883-M, Hollywood 28, Calif.

## BOOKS, PERIODICALS, PICTURES, POSTCARDS

**QUICK** Profits taking magazine subscriptions, handling greeting cards. Casell Publishers Service, Westfield, New Jersey.

**NATIONAL** Geographic Magazine, 1888-1948, any issue. Periodical Service, Dept. PM, Swarthmore, Penna.

**FREE**—Description "How to become a successful stamp dealer" by Fairbrook, Long Beach, N. Y., 764 Lincoln.

**ADVENTURE!** Thrills! Action! Famous British monthly Wide World Magazine crammed full thrilling real life stories, actual true experiences all parts world. A vividly illustrated man's magazine, internationally famous over fifty years. Mailed direct from London for a whole year—12 big issues. Send only \$3 to George Newnes Ltd., (WW, 8), 342 Madison Avenue, New York 17.

**MAPS**, World globes, atlases—Free catalog. Belanger's, 51-P Talcott Ave., Rockville, Conn.

**SAVE** Money. Fix your own refrigerator. Get free details. Warco, 2689U Coolidge, Oakland 1, Calif.

**BOOK** Bargain! 10 pocket-size books, \$1. Good as new. Mystery, romance, western. Send dollar, we pay postage. Bookman, 319 N. Robinson, Oklahoma City, Oklahoma.

**BACK** Number magazines, used books. Reasonable. Reedmore, 240 East 9th, New York, N. Y.

**SEND 8** Pocket books, \$1.00. Receive 9. Perillo, Pearl River, N. Y.

**"HOW** To develop an alarm-clock mind." Unique methods revealed! Instruction folio. 25c. Catalog of unusual books included. Power Publisher, 790-N Broad St., Newark 2, N. J.

**FREE** List. Interesting, entertaining and instructive books. Laramie Sales, 4800 S. Laramie Ave., Chicago 38, Ill.

**BOOKFINDERS!** (Scarce, out-of-print, unusual books). Quickly supplied. Send wants. Clifton, Box 1377-PM, Beverly Hills, Calif.

**HOME** Craft course series, 26 books step by step, simple, easy to follow instructions—Profusely illustrated—many designs—some in full color. Write, Mrs. C. Naaman Keyser, Plymouth Meeting, Penna.

**SELF-EXPLAINING** Bible: Illustrated circular free. Box 446-P, Minneapolis, Minn.

**BOOKHUNTERS!** All subjects. Send wants! Jaher Book Service, 620-P East 178 Street, New York 57.

## GAMES, ENTERTAINMENT

**FACE** Masks—Life-like. Latex rubber as monkeys, witches, clowns, devils, fat men, baby faces, etc. Slips easily over head. \$2.50 each. Also, rubber vegetables, fruits, etc. Cameo, 432 West 42nd, New York.

## MAGIC TRICKS, PUZZLES, JOKER NOVELTIES

**MY** Free illustrated circular of 50 tricks. A. G. Steen, c/o Jones-Tuttle Road, Route 1, Plainfield, New Jersey.

**BE** A magician. Large professional magic catalog of latest tricks, 35c. Ireland, C-109 North Dearborn, Chicago 2.

**SEND 25** Cents for lists and best pocket trick in years. Egyptian ring trick requires no skill, a knockout. Eureka Magix Shop, Somerville, N. J.

**FREE** Deck trick cards with catalogs 25c. 12-PM Churchlane, Philadelphia.

**MADDENING** New puzzles, just like a pocket-size pin-ball machine. 3c stamp brings catalogue. Joseph W. Druke Co., Box 127, Grand Rapids 6, Mich.

**MAGIC** Tricks, jokes, books, cards, etc. List 10c. Behnke Sales, 5721 Leland, Chicago 30, Ill.

**MAGICIAN'S** Trick wand (Vanishes handkerchief!) Free with catalog 25c. Box 4228-PM, Philadelphia.

**CAN** You tell (without knowing beforehand) anyone's age or cash in pocket? 20c tells how. Never fails. Robt. A. Lees, 6217 West Wisconsin Avenue, Milwaukee 13, Wis.

**FREE**—Four professional magician's tricks, dollar value. 25c with catalog. Steiner's, 316 East 61, New York 21, N. Y.

**FOUR** Special card illusions 50c. Card Magic, 47 Glen, Holyoke, Mass.

**MAGIC** Tricks catalog 10c. "Marean" Magic Shop, 551H, Hopewell, Virginia.

**SCHOOLBOYS**, Sell "Secret Envelopes," 150% profit. Sample free! Stampico, Detroit 4, Mich.

**JOKERS** Novelties. Handshakers, squirters, whoopee cushions, table jokes. 5c brings catalog. Jokertrix, Box 274, Dallas, Texas.

**LARGE** 160 Page catalog, just published, 35c. We have supplied the best tricks to beginners and professionals for 38 years. Chicago Magic Company, 2300-K No. Mason Avenue, Chicago 39.

**SEND** No money. Jiffy coin trick free with Doty's exploding pencil \$1.50 c.o.d. Taulton, 1925 Shaftesbury, Dayton 6, Ohio.

**FREE** Catalog magic tricks, jokes, novelties. Laramie Sales, 4800 So. Laramie Ave., Chicago, Ill.

**MAGIC** Tricks, puzzles, books, cards, punch boards. Catalog 15c. Specialty, Box 671, St. Louis 1, Mo.

**LARGE** Catalogue of the best magic for professionals and amateurs. Send 35c. Mazda Magic Co., 1135 Westgate Ave., Oak Park, Ill.

**16** CARD Tricks and catalog 25c. Sterling Magic, Royal Oak, Mich.

**ENTERTAIN**, Mystify! 96 page catalog magic, joke and party goods, 25c. Riley-Borin, P-7909 Rhodes, Chicago 19.

**400-PAGE** Catalogue of 2000 tricks, pocket, parlor, stage. World's finest magic. Send \$1.00 for catalogue (refund first \$5.00 order). Kanter's, M-1311 Walnut, Philadelphia 7.

**DOLLAR** Magic set free with mammoth catalog 25c. "Mysto," 4462-PM Germantown, Philadelphia.

**"VENTRILLO."** Professional voice throwing instrument and "unusual" catalog 25c. POB-971, Philadelphia.

**SNEEZING**, Itching, powders. Eighteen other tricks free with joker's catalog 25c. 2404-N Fifteenth, Philadelphia.

**PROFESSIONAL** Catalog. 124 pages, 25c. Williams, 900 Plymouth, Ellwood City, Penna.

**VENTRILLOQUISM** Taught. 3c stamp brings particulars. Smith, 801 Bigelow, Peoria 5, Ill.

**WORLD'S** Largest professional magic shop, keeps you in touch with latest tricks. To receive mailings, send 50c for new catalog. Holden's, M220 West 42nd St., New York.

**LEARN** Magic, ventriloquism, mind-reading. Write for particulars. Quackenbus, Big Flats, N. Y.

## STAMP COLLECTING

FREE Stamp catalog! New, different, saves you money on stamps, albums, packets. Ewing, 109 N. Dearborn, Chicago 2.

FREE Copy interesting stamp collectors newspaper. Southern Philatelist, Miami 42, Florida.

55 DIFFERENT United States—5c. 8 different U. S. cacheted first day covers \$1.00. Approvals. Utechts, 1143G North Keeler, Chicago 51.

66 DIFFERENT Stamps, including U. S. battleships 6c. World wide approvals. Telic-Arts, Devon, Conn.

STAMPS 100 Years old. Every collector should have at least a few stamps nearly 100 years old. Although hard to get, we offer a wonderful selection of ten old 19th century foreign stamps and also the blue re-issue of the 100 year old first U. S. stamp, the famous 5c Franklin. All for only 10c. Kindly state whether approvals shall consist of U. S. or foreign stamps or both. Globus Stamp Company, 268 Fourth Avenue, Dept. 212, New York 10, N. Y.

MOZAMBIQUE, Triangulars, unused. Set 10c with approvals. Vargo Stamps, 6044 South Fairfield, Chicago 29, Illinois.

FREE! 10 Mint stamps! Approvals. Wonder Stamps, 3401-B, Council Bluffs, Iowa.

U. S. Illustrated price list 10c. Lush, 12863A Caldwell, Detroit 12, Mich.

SEVEN Mint pictorial sets 20c. Approvals, lists. Klondike, Harrisburg, Illinois.

MIXTURES. Worldwide. 1,500, \$1.00. Missions Outlet. Reverend Marshall, Paterson 1, New Jersey.

COMPLETE Outfit 3c; stamps cataloging over \$1, plus hinges, gauge, book for 100 stamps. Approvals, Moulblow, 740 Hagney, Bronx 56.

NEWFOUNDLAND 75 Unsorted 25c, 350 for \$1.00. Real value. Mayfair, Regal Rd., Toronto 10, Canada.

FREE Choice stamps. Approvals. Ren Stamp Co., 11407 Kinsman, Cleveland 4, Ohio.

LARGEST Diamond, tiniest triangle, etc., 3c. Pettibone, 411 S. Washington, Moorestown, N. J.

STAMP Buyers' Guide plus 50 different Hungary for 10c. Stampguide, Box 1649F, Oakland 4, California.

VICTORY Packet free—Includes stamps from Tanganyika, British Cayman Islands, animal, scarce babyhead, Coronation, early Victorian, airmail, map stamps. Including big illustrated catalogue. Send 5c for postage. Gray Stamp Company, Dept. PM, Toronto, Canada.

FREE—Famous Americans set, plus Flag Set, plus the National Parks Set, plus the Presidential Set to the \$5. A total of 90 stamps absolutely free to customers for our unsurpassed U. S. or foreign selections. Send 3c postage for 15 of the above mentioned stamps and full particulars. Triboro Stamp Company, 145 Nassau St., Dept. 104, New York.

GERMAN Price list sent free. Robert Barricklow, St. Clairsville, Ohio.

25 DIFFERENT India—3c with approvals. Premiums with purchases. Brandwein Stamp Co., Box 92-H, Bayonne, N. J.

UNITED States Collection. 100 different commemorative Columbians, flags, famous Americans only \$1.00. 150 different foreign \$1.00. Approvals on request. Cameron Stamp Co., Box 116, Verona, N. J.

GIFT—Three U. S. centenary San Marino to approval applicants. Deane Stamps, Box 87, Miami 35, Florida.

1862 PRINCE Edward Islands—Just 3c with approvals. Viking, 130-Z Clinton St., Brooklyn, N. Y.

MEXICO—15 Different 10c. Ezquerro 10, La Paz, Baja California, Mexico.

FREE \$1—\$2—\$5 United States stamps to applicants. U. S. approvals. Metropolitan, 140-B Nassau, New York 7.

SURPRISE Packet. Sets from Egypt, Australia, Albania, Finland Red Cross, New Zealand, Southern Rhodesia bicolored, commemoratives, pictorials, 5c with approvals. Else, 126 Eagle Street, Brooklyn, New York.

FREE. Irish commemorative collection, many colorful issues. Approvals sent. Raymax, 123-Z William St., New York City 7.

FREE! United States stamps nearly 100 years old to applicants. U. S. approvals. Wakonda, 140-G Nassau, New York 7.

GOYA Nude (2) 5c. Approvals, Han-nay's, 310 Quail, Albany 3, N. Y.

1/2c UP U. S. or foreign approvals by countries. Free lists. Hurt & Fosse, Blue Ridge, Virginia.

FREE! Mint United States, Armenia, South America, Russia packet, approvals. Greenwood, 263 Meridian, Miami Beach, Florida.

SCOOP! Sensational \$1.00 packet 25c to approval applicants. Newhouse of Stamps, Box 222, Mineola, N. Y.

GREAT "\$5.00 Catalog price for 10c" offer! (1) Big collection of 112 all different genuine stamps from Africa, South America, South Sea Islands, etc. Includes airmails, triangle and animal stamps; many others. (2) Four scarce unused United States, catalog price 40c. (3) Fine packet 25 different British Colonies—Burma, Hong Kong, Solomon Islands, etc. (4) U. S. \$5.00 high value. Total catalog price over \$5.00! Everything (all four items) for only 10c. Also approvals. Big lists of other bargains given. Crystal Stamp Co., Littleton 16, N. H.

FREE—Description "How to become a successful stamp dealer" by Fairbrook, Long Beach, N. Y., 764 Lincoln.

FREE—Treasure collection. Over 200 colorful Malaya, Wurttemberg, etc. Foreign approvals. National, Box 326A, Passaic, N. J.

200 DIFFERENT Stamps 3c to approval buyers. Littleton Stamp Co., Littleton 91, New Hampshire.

AROUND The world—30 different countries; Basutoland, Nyassaland, Tangier, Cyprus, St. Helena, 10c with approvals. Excello Stamps, P.O. Box #95, Hackensack, N. J.

WOW! \$10.00 Worth of fun 10c! What a treasure hunt! Big package 500 foreign stamps, including airmails, pictorials and others from the world over; stamps worth up to 25c each. This offer sent for 10c to approval applicants only. Jamestown Stamp Co., Dept. 22, Jamestown, New York.

FREE! Volcano pictorial! Mozambique! Burmesel! Nigeria! Approvals. Keating, 637-P Bergen, Jersey City, New Jersey.

SELECTED U. S. mint Roosevelt and flag sets. Both only \$1.00. Approvals. Quinn, 570, Madison 1, Wis.

CANADA Peace set 10c with attractive approvals. Rheauem, 8949 Routhier, Montreal 12, Canada.

FREE \$6.00 Scott's International Junior Album to approval customers. Hal Buck, Box 1287, Stockton, California.

FREE, 12 Different U. S., approvals accompany. Village Stamps, 90-39P 214 St., Queens Village 8, N. Y.

FIFTY Stamps from 50 nations, 10c. Garrow, Montevista, Chula Vista 4, California.

FREE! Two large colorful sets. (Contains 18 stamps.) Bargain approvals included. "PG," 195 Park, Lewiston, Maine.

FRENCH Colony packet, \$1.00, \$2.00, \$5.00 U. S. free with approvals. Hiaheah Stamps, Box 3441, Miami 22, Florida.

GENUINE "Goya Nude" set (catalogs 55c) 10c. Approvals. Royal Stamp Company, Tamaqua, Penna.

UNITED States Unused. Complete set 13 flag stamps plus 5c China commemorative only \$1.00. Fine approvals. Willett Stamps, Box 507, Port Chester, N. Y.

10 ASSORTED U. S. Commemorative stamps 15c. Five U. S. Air Mail 15c. Both 25c. Ideal Stamp, Box 179, Park Ridge, Ill.

50 DIFFERENT United States 10c. Price list free. Seidenberg, Cassopolis, Mich.

PHILIPPINES Honors General MacArthur, complete commemorative issue free to sincere approval customers. William Deems, Ravenswood, West Virginia.

TRANSPARENT Scale 2 1/2" x 8". Punched for all U. S. stamps. Make own pages. Perforation gauge, \$1.00. R. Ball, Wilmot Road, Scarsdale, N. Y.

COLORFUL Croatian Legion issue (4) complete 3c with approvals. George Richie, 840 Oak, Alameda, California.

100 DIFFERENT 10c. Price list free. Robert Ewing, Wapakoneta, Ohio.

QUALITY U. S. old and new mixture, 2 lbs. \$1.50; 5 lbs. \$3.00; 10 lbs. \$5.75. Halay, 132S West 63rd, New York 23.

FREE! China navigation issue with foreign approvals. Modern Stampco, Box 12, Wakefield Station, N. Y.

3000 U. S. Bargains. Price list free. Stone, Box 52-P, Dorchester 24, Mass.

THESE Are them! Unusual penny approvals. Roscoe Stamp, 1321 Roscoe, Chicago 13.

ROOSEVELT! New issue. Ecuador, three mint stamps. Special! 10c to approval applicants. GeeKay, 13 Overlea Ave., Baltimore 6, Md.

PENNY Postcard brings you approvals. Textstamp, Box 29, Beaumont, Texas.

FREE—Complete China "Great Wall" airmail set. Approvals. Sanders, 6126-B Carpenter, North Hollywood, Calif.

GIVEAWAY! 155 Different—30 countries, 10c. Approvals. Brooks, 2352B East 23rd Street, Brooklyn 29, New York.

50 DIFF. France, only 5c to new approval applicants. Bert Soika, Box 146M, Jackson Heights, N. Y.

DESIRABLE Approvals for junior collectors. Phoenix, 120 West 44th Street, New York 19, N. Y.

THOUSANDS! 1c Up! Quality approvals. Grabin, Box 1111, Sioux City 6, Iowa.

115 DIFFERENT, Hitlers, Roosevelt, Vatican, Liberia, etc. 25c. Buckley, 208 Ludlow Bldg., Dayton 2, Ohio.

100 U. S. Commemoratives, airs, etc., 10c; 300-25c. Box 457, Newark 1, New Jersey.

FREE! Tiny Chinese "midget" war set. Approvals. Seminole, Leeds, Alabama.

FREE! Complete Balkan aviation set with approvals. Beaman, Leeds, Alabama.

"HOW To become a stamp dealer." Complete instructions \$1.00. Nelson Exchange, Box 346-M, Rye, N. Y.

FREE! United States price list. 50 different U. S. 10c. Arthur Terreson, Box 479, Bellmore, N. Y.

10,000 PENNY Approvals waiting for you. Many from exotic countries, pictorials, airmails, new issues. Tilbury, Box 862, Newark 1, N. J.

UNITED States approvals complete coverage, fine quality, attractive prices. Seminole Stamps, Box 1138-P, Coral Gables, Florida.

IT'S Possible that you may be able to exchange your valuable duplicates thru this club. Particulars for stamp. McPherson's Stamp Exchange, Branch, Mich.

"GOLD Nugget approvals"—Nothing like them! Worldwide coverage. Write today! 8000 satisfied customers. Established 1921. Kessel's, Box 127A, Folsom, Calif.

FREE 5c Worth your choice from approvals with each 25c purchase. Holmes, 628-D Connally Drive, East Point, Ga.

IRISH Convent mixture, 2500, and 6000 British. The lot \$2.00. Catalogue free. Price Company, Killogrange, Dublin, Ireland.

A WORLD Of stamps for 10c. 19th century U.S., pictorials, air mails, British Colonies, etc., to new approval applicants; also a fine approval selection included. Send 10c today to Cosmopolitan Stamp Co., 1457 Broadway, New York City.

GERMANY (Greater) 500 diff. \$2.00. Masser, 322 E. 9th St., Brooklyn 18, N. Y.

FREE—Illustrated bargain lists. Albums, packets, supplies, special offers. Littleton Stamp Co., Box 51, Littleton, N. H.

100 DIFFERENT With approvals. Jacobson, 59 Nagle Ave., New York 34, N. Y.

75% DISCOUNT Off Scott's catalogue. Mostly 19th century British and Europe. H. Codwise, Box 5, Melrose Highlands, Mass.

SURPRISE Packet—25 stamps from different countries, 5c with approvals. Glassman, 3009-P Belle Plaine, Chicago 18, Ill.

FREE—Illustrated U. S. catalog. Olive Stamps, 315 Pierce, San Antonio 8, Texas.

100 ALL Different from China! Includes airmails! High values! Mint sets! Others! Only 10c to approval applicants. Star Stamp Company, Jamestown, New York.

FREE Nicaragua Roosevelt, illustrated bargain list. Imperial, Box 1491, Tampa, Florida.

FREE U. S. foreign price lists. Schneid-er, Jr., Route 3, McHenry, Illinois.

ILLUSTRATED Stamp magazine, 26 weeks 25c. Stamp Journal, Kalamazoo, Michigan.

FREE With approvals. British, Spanish, French Colonies, Vatican, Hitler heads, and airmail packet. Pan-American Stamp Co., Box 145, New York 33, N. Y.

UNITED States commemorative collection. Thirty-three different unused, Columbians to 1943 commemoratives only. Price \$1.00. Request approvals. "Stamps," Albany 1, New York.

**FREE!** U. S. monthly lists, fine stamps! Zole, 43-A Rinewalt, Buffalo 21, N. Y.

**\$1.00, \$2.00, \$5.00 U. S. Free.** Approval applicants. Flamingo, Box 4038, Miami 38, Florida.

**FREE!** Asia, Africa, Europe packet. Approvals. Standard, Box 43, West Farms, New York 60, New York.

**\$3.00 CATALOGUE Value**—Airmails, etc. 10c when requesting approvals. Florida Stamp Company, Box 807, Miami 10, Fla.

**CARLINS Approval Service,** Box 307, Fresno, California. 50 different stamps 5c to new customers.

**"MAN Size"** United States approvals! Illustrated catalog! Sullivan, Endicott Arcade, St. Paul 1, Minn.

**STAMPS** Of the United States, Canada, Newfoundland, worldwide upon request. Dan Hayden, Box 703, Bloomington, Ill.

**FRENCH Colonies,** 50 colorful, large pictorials, 10c only with approvals. Fields, 939 E. 85, Cleveland 6, Ohio.

**FLAG Stamp free** with U. S. approvals. Venigman, 1933 Patterson, Chicago.

**FREE Illustrated list.** Elbe dealer. "Treasure Hunt" penny approvals on request. Reed Company, Box 980, Chicago 90, Illinois.

**50,000 STAMP Grabbags** 25c each. Anderson, 630 Bingham 1, Reading, Penna.

**WORLDWIDE Different.** 200, 25c; 500, 50c; 1000, \$1.25; 2000, \$3.00, 5000, \$15.00. Beacon Sales, Maynard 2, Mass.

**15,000 DIFFERENT Stamps** 2c each! Gordon Davison, Box 1019B, Manchester, N. H.

**U. S. Price list.** Send postage. State Stamp Service, 1225 Park Building, Pittsburgh 22, Penna.

**200 DIFFERENT** Including Roosevelt triangle, 5c to approval applicants. M. Avalon Stamp Company, Springfield, Mass.

**50 DIFFERENT Stamps,** triangle, airmails, etc., 5c with approvals. Carlton's, 10243 Silverton, Tujunga, California.

**307 ALL Different 10c.** You will find scores of new varieties here for your collection! Big and little stamps, bisected stamp, commemoratives, triangles, high values! Bicolored beauties! Strange countries! Every stamp is different. All for only 10c to approval applicants. Write today and receive special Ionian Island stamp extra. Garcelon Stamp Company, Box 400, Calais, Maine.

**300 DIFFERENT** Given free with approvals. Postage 3c. Windsor Stamps, 1435 East 67th Place, Chicago 37.

**128-PAGE** United States catalog—1000 illustrations, 10c. Harris & Co., 202 Transit Bldg., Boston.

**FREE!** Crystal-mount samples! Har-risco, 202 Transit Bldg., Boston.

**BINGO!** Jackpot collection! Triangles, snaps, animals, midgets. All for 5c to approval applicants only. Southwest Stamps, Box 117, Long Beach 1, California.

**200 BRITISH** Empire stamps; only 3c. Kenmore Stamp Co., Arlington 74c. Massachusetts.

**FREE—Illustrated catalog!** Kenmore Stamp Co., Arlington 74c, Massachusetts.

**YOU'LL Like** our American and British Colonial approvals. Write now. Chesapeake Stamps, 748 Overbrook, Baltimore 12, Maryland.

**FREE U. S. price list,** postage 3c. Mark Hanna, 335 5th Ave., Pittsburgh 22, Penna.

**WORLD—500 Diff.** 50c, 1000 \$1.25, 75 Canada 25c, approvals, lists. Victoria Stamp Co., London 4, Canada.

**WORLD'S Largest stamp** (7½x14 inches). A real curiosity! Retail for 50c, only 3c to approval applicants. Tatham Stamp Co., Springfield 30, Mass.

**FREE!** 100 Worldwide different stamps to approval buyers. Big U.S. and illustrated bargain lists sent with approvals. Bookman, Maplewood, N. J.

**STAMP Collections** wanted. Complete collections, duplicate lots, surplus stock, mint and used. Prefer trade for printing or other items, buy outright if priced right. What have you, what's wanted? Vanroy Shirk, Lebanon, Penna.

**DEALERS—Wholesale list.** Postage 3c. Frank, 5031 Queensberry, Baltimore 15, Md.

**OLD Scarce U. S. seconds** on approval. Slightly defective, bargain prices. Her-nfeld, Clintonhill Station, Newark 8, N. J.

**POUND Stamps** containing thousands \$1.00. Longacre Shop, 108 West 42nd, New York 18.

**"BERLIN" Bears,** complete set of eight and 100 different stamps only 10c to approval applicants. Reich Stamp Co., 4647 Kenmore, Chicago 40, Ill., Dept. M11.

**ZOWIE-E!** A barrel of fun for only a dime. 500 United States stamps—absolutely unpicked and unsorted—just as received from church missions. Many varieties, including large commemoratives, airmails, high denominations up to \$5.00! Stamp-dom's biggest package of fun—and you might find something really valuable! Price only 10c to serious approval service applicants. Money back if not delighted. Illustrated bargain lists with each order. Mystic Stamp Company, Dept. 80, Camden, New York.

**25 ALL Different stamps** 10c. Tunis, Wakeman Ave., Newark 4, New Jersey.

**NICARAGUA "Tin Pan Alley"** diamond, Ecuador showing George Washington, and American flag in natural colors. Fezzan, Trieste, "American Army" stamp, first U. S. commemorative, \$100.00 Shanghai, Corsica, Anzac, Antique, others. All 5c. Approvals, Capital Stamp Co., Dept. 2, Little Rock, Ark.

### COINS, TOKENS, CURRENCY

**60 COINS** And bills, \$1.00. 100 bills, \$1.00. 35 coins, \$1.00. Oddehon, Box 482, St. Louis, Mo.

**1949 PRICE List** of U. S. coins 15c. 44 pages. James Randall, 116 South Michigan Ave., Chicago 3, Illinois.

**OLD Money** wanted. Will pay fifty dollars for nickel of 1913 with Liberty head (no buffalo). We pay cash premiums for all rare coins. Send 4c for large coin folder. May mean much profit to you. Numismatic Co., Dept. 20, Fort Worth, Texas.

**SEND Dime** for sales list No. 16. Acorn Stamp & Coin Co., Box 53, So. Norwalk, Conn.

**U. S. Coins** bought. Illustrated folder 15c. Hutchinson's, 3463 "I" Street, Philadelphia 34, Penna.

**FREE Foreign coin** and banknote with huge price list 10c. Tousseau Coin Co., 109 So. Mathilda Ave., Sunnyvale, Calif.

**BARGAINS—3-legged Buffalo Nickel** \$1.25. 1932-D Quarter \$1.00. 1932-S Quarter \$1.00. Large \$1.00 Bill \$1.60; Large \$2.00 Bill \$3.40. 4 Whitman Folders \$1.00; Handbook 75c; 254 page Guidebook \$1.50; New Type Folder \$1.00. Large Retail Catalogue 10c. Bebe Coin Company, 1180 East 63rd, Chicago 37, Illinois.

**KNOW** The true value of old money. Highest prices paid. Our complete buying-selling catalogue send 25c. Worthycoin Corporation, 294 Washington, (D-109), Boston, Mass.

**UNCIRCULATED** Foreign coin included with huge bargain list 10c. Many specials. 4 Whitman folders \$1.00. Little, 337 North Menard, Chicago 44.

**18 DIFF.** Coins 50c, free lists. Approvals upon application. Bishop, Box 2201, Kansas City, Mo.

**COINS** Wanted. Write for list. Elsholz, Box 9014-M, Pittsburgh 24, Penna.

**GET Profit** and pleasure in collecting old coins. Send 10c for 56 page illustrated coin catalog. You'll be delighted with it. Send for it now. B. Max Mehl, 370 Mehl Bldg., Fort Worth, Texas. Largest rare coin establishment in U. S. Established 49 years.

**FREE!** Foreign coin, banknote and coin collectors illustrated catalog to approval service applicants. Send 3c postage. Tatham Coinco, Springfield 30, Mass.

**4-IN-1 Special \$1.00** bargain offer: (1) United States 1893 Columbian world's fair half dollar; (2) album for holding coins; (3) large 56 page coin catalog; (4) genuine wooden nickel. Yes! All four items for only \$1.00. Order today. Money back if not pleased. Ben's Coin Company, 72 W. Washington, Chicago 2, Illinois.

**COINS** Wanted, will pay up to \$2000 for certain coins. Send 25c for catalogue. Burton's, 111 So. Third, Columbus, Ohio.

**COMMEMORATIVE ½.** Oregon, Texas, Kentucky, Cleveland, Long Island, \$2.00 ea. Illustrated catalogue 25c. Norman Shultz, Salt Lake 9, Utah.

### PRECIOUS STONES, MINERALS

**ZIRCONS,** Sapphires, rubies, others. Direct importation guarantees best quality; lowest prices. 3 sparkling, polished zircons totaling over 2 carats \$4.00. Catalogue 10c. Imhusex, Box 232, White Plains N. Y. Agents wanted.

**GEMSTONES,** Rough, polished. Mineral specimens. Every variety, lowest prices. List free. Plummer's, 2177 Bacon, San Diego 7, California.

**"GENUINE!"** Deep red Arizona rubies (garnets). Send quarter for packet. Bit-ner's, Box 2651, Phoenix, Arizona.

**METAL Detectors.** The very latest circuit. Free literature. Hedden Metal Detectors, 3329 Liberty Avenue, Pittsburgh 1, Penna.

### HOBBIES AND COLLECTIONS

**UNUSED Matchbook covers—100** different \$1.00. Catalog 10c. Charles Edelman, 1311C East 84, Cleveland 3, Ohio.

**POSTCARDS** Your hobby? Samples, lists, dime. Wilkins, 417 Hill, London 13, Canada.

**INVENTING** Can be an interesting and profitable hobby. Write for complete particulars. Institute of American Inventors, Dept. 40-E, 1926-Eye St. N. W., Washington 6, D. C.

**50 DIFFERENT Army** embroidered patches \$1. Other bargains. Insignia Mart, 703A Broadway, New York 3, N. Y.

**BOOKS—All Kinds—Homecraft,** Radio, Plastics, Boat Building, Photography, Model Building. Catalog free. Popular Mechanics Press, 200 E. Ontario St., Chicago 11, Ill.

### CAMERAS, PHOTO SUPPLIES

**BASS Says:** Bargaining 257 ready and waiting for you. The book which tells all. The finest in new and used camera equipment, a veritable encyclopedia. Write, phone or call the sign of the old "Horse Trader." 39th year of satisfaction or your money back dealing. Bass buys, sells and trades. Bass Camera Company, Dept. AG, 179 W. Madison St., Chicago 2.

**BARGAINS.** Roll film, 4x5 portrait pan, 1948 date, 2 dozen \$1.75, popular sizes 19c each. 35mm. film, 36 exposure, not reloads. Weston 80, 3 for \$1.00. Surplus contact paper assorted sizes 50c gross. Professional type pan heads \$2.27. G.I. developer, film or paper 28c gallon, 6 for \$1.39. O. D. Kodachrome Bantam 828 75c, 3¼x4¼ Kodachrome, six sheets \$1.75, processing included. Kodacolor 1948 dates 116 and 616, \$1.69, 120-\$1.29. Minimum order \$2.00, include postage. Equipment bought, sold, traded. Lists free. Mogull's, 68 W. 48th St., New York.

**ONE 8 Exposure** film developed and printed only 30c. Ness Studio, Wells, Minnesota.

**HOW** To sell your photographs! Get the latest, up-to-the-minute photo market data by subscribing to "Photo-Market-Facts." Written in fast moving, news-letter style, issued bi-monthly, this publication gives you a comprehensive analysis of selected markets in different fields every issue. It takes the guess work out of print selling. It cuts down rejections by showing how to rifle your work to the right market. Only \$1 a year. Order now and increase your photo sales. Photo Market Facts, IPGA, Dept. PM-2, 509 Fifth Avenue, New York City 1.

**TRANSPARO—Frame** for four color films. With this new light-pick frame you can now use color transparencies like regular pictures. No electric cords, no light globes to heat and fade your picture. Any style frame. Free illustrated circular. Transparo Frame Co., P.O. 1084, Seattle, Wash.

**PHOTOCOPY** Anything, papers, books. No darkroom. 8½ x 11" complete, \$6.95. Fotoflek, 4801 Yarmouth, Cincinnati 29, Ohio.

**HIGHEST** Prices paid for still, movie cameras, projectors. Ace Camera Exchange, 136 East 58th Street, New York P-22, N. Y.

**200X TELEPHOTO** Camera easily made. Trifling cost. Telephoto lens and instructions \$3.00. Instructions alone 10c. Suffolk Science Service, Box 208, Manorville, N. Y.

**FREE!** 124-Page illustrated revised 1949 photo catalog, send 3c stamp. Bloom's Camera Center, Inc., 1657-PM Main, Springfield, Mass.

**OPERATE** Your own photographic business. Details free! Peace Products Co., Dept. 801, 152 West 42nd St., New York City.

**TELESCOPES—Make** them yourself. Real fun. It's easy with our plans. Booklet giving various plans only 25c. Ask for Booklet No. 20. Popular Mechanics Press, 200 East Ontario St., Chicago 11, Illinois.

## PHOTO FINISHING

**PRINTS** Streaked with light? Camera needs new bellows. Installed \$2.75 up. Guaranteed repairing on all makes of cameras. Write for estimate on repairs needed. Willman Camera Service, 3222 N. 21 Place, Phoenix 2, Arizona.

**BARGAINS**—24 Prints from roll 45c; 16, 30c. 3 rolls finished. 48 prints plus new roll, \$1.00. Reprints 2½c. Four 8x10s \$1.00. Dodge, Albany 17, Wisconsin.

**PORTRAIT** Quality 5x7 enlargements 15c. 2 for 25c. NuTone Fotos, Box 228, Pottstown, Penna.

**PORTRAITS** —Hand-painted, natural color, to 8" x 10", 1. Sural Photos, 3300 Beach, Chicago 51, Ill.

**FOUR** Photos your favorite stars with eight exposure roll developed—16 prints 35c. Free enlargement coupons. Hollytints, P-1350 Hollywood, California.

**JUMBO** Or photo pack prints, 8 exp. roll 35c. 16 exp. roll 65c. NuTone Fotos, Box 228, Pottstown, Penna.

**FOTOSTAMPS** Personalize you! Free samples. Astro Service, P.O. Box 750, Boston 2, Mass.

**ENJOY** The real thrill of picture taking by making sure your films are developed right and printed right. We guarantee finest quality developing and printing in newest continuous strip process. 8 exposure roll only 35c. 12 to 16 exposures; 50c. Hitone, Box 2426A, East Cleveland 8, Ohio.

**35MM.** Rolls developed—Enlarged 3½x5 prints, 36 exposures \$1.00, 20 exposures 65c. 8 exposure rolls developed, printed oversize 30c, 12 exposures 45c, 16 exposures 55c. MacDonald's Photos, Box 228-J, Congress Park, Illinois.

**THIS** Ad plus 35c gives you 16 jumbo, oversize, enlarged prints from any roll developed. Enlargement coupon free. Skrudland, 6444-R Diversey, Chicago.

**STAMP-SIZE** Photographs made from your photo or snapshot. Small, 10 for 30c, 20 for 50c, 25 for \$1.00. Large, 5 for 30c, 10 for 50c, 25 for \$1.00. Photo returned unharmed. Prompt service. Agents wanted. Details sent with first order of 30c or over. H. & M. Photo Service, Box PM 525, Chicago 90, Illinois.

**8 EXPOSURE** Film developed, super-gloss print each good negative 30c. Parkway, Box 6068, Jackson 9, Mississippi.

**TWO** Beautiful prints from each picture on roll 30c. Twenty-eight years of satisfied customers. Quick service. Lens Photos, Dept. J4, Janesville, Wisconsin.

**YOU** Can develop your own negatives now. No darkroom needed with new daylight loading developing tank. Foolproof, economical, speedy. Free details. Bruce Enterprises, Box 255, North Hollywood, Calif.

**35MM.** Films developed each exposure enlarged to 3¼ x 4½ deekle-edge lifetime enlargements. Finest quality. Satisfaction guaranteed. 36 ex. \$1.25. 20 ex. 75c. Free mailers. May's Studios, Dept. K-49, La Crosse, Wis.

**ENLARGEMENTS.** Any size, life size, room size. Murals made from your own pictures or choose from ours. Studio Photo Service, 521 No. La Cienega Blvd., Hollywood 36, Calif.

**OVERNIGHT** Quality service, films developed 8 oversize glossy prints 30 cents, twelve 45c, sixteen 60c. Write for mailers. Southeastern Snapshot Finishers, Box 4996, Atlanta, Georgia.

**BEAUTIFUL** Enlargement from each picture on roll 30c. Cut Rate Photos, Dept. B4, Janesville, Wis.

**FREE** Price list on quality developing, printing, enlarging. Write for it today. Bryan's Photo Shop, Dept. M, Panama City, Florida.

**FILMS** Developed and enlarged double size. 8 exposures only 30 cents. 12 exposures 45 cents. 16 exposures 60 cents. Prompt service. Mailing envelopes on request. Real Fotos, P.O. Box 172, Station B, Brooklyn, N. Y.

**EXPERT** Finishing. Roll developed and 8 prints 30c. Rancho Photo, Dept. P, Ontario, Calif.

**8 BEAUTIFUL** Double size pictures and roll developed 30c. 8 hour service. Free mailers. Pacific Photo Service, Box 666, San Francisco, Calif.

**2 BEAUTIFUL** Hi-Gloss prints each good negative and enlarging coupon with each 8 exposure roll developed 28c. Free mailers. Owlphoto Co., Weatherford, Oklahoma.

**8 PRINTS** All enlarged to nearly post-card size from your roll or negatives 25c; 16-50c. (Trial offer). Willard Studios, Box 3535A, Cleveland, Ohio.

## MOTION PICTURES AND SOUND EQUIPMENT

**BARGAINS!** Guaranteed, reconditioned 16mm. sound projectors. Robert Salmon, 3558 So. 11th East, Salt Lake City, Utah.

**RIN, Tin, Tin**—"Silver Trail," 6 reels, James Oliver Curwood story, 16mm. s.o.f. New optical reduction prints, \$85.00. Trades accepted. Film lists free. Mogull's, 68 W. 48th St., New York.

**FREE** Movie list. Superior Film Service, Box 713, Troy, N. Y.

**NEW 16MM.** sound musicals produced by Universal Pictures. List for stamp. Adair Company, 6926 Roosevelt, Oak Park 9, Illinois.

**BARGAINS 16MM.** sound film, miscellaneous, "as is," one cent per foot. Sound features from \$42.50, shorts from \$2.50. 1600' reels \$1.00, storage cans, take two 1600' reels 95c. Wire belts 49c. Minimum order \$2.00, include postage. Films, equipment, bought, sold, exchanged. Bargain lists free. Mogull's, 68 W. 48th St., New York.

**SAVE 50%** On movies. Free circulars, sample film. Fromaders, Davenport 4, Iowa.

**DOCUMENTARY** Film "Come Again," two reels, 16mm. s.o.f., new prints \$12.50. Film, equipment, bought, sold, traded. Lists free. Mogull's, 68 W. 48th St., New York.

**8-16MM.** Films, free listing. De Photo, 648 Helen, Detroit 7, Michigan.

**SOUND** Projectors, 16mm., 35mm. from \$127.50. Bargain prices on screens, reels, cans, amplifiers, speakers, microphones, splicers, processing equipment, lenses, cameras. All types, equipment bought, sold, traded. Bargain lists free. Mogull's, 68 W. 48th St., New York.

**FREE** Movie list. Superior Film Service, Box 713, Troy, N. Y.

**GUARANTEED** Fresh anti-halo outdoor movie film! Weston 12! Daylight loading! Processing free! Three spools double 8 mm. \$3.45! Six single 8 mm. for Univex. \$4.60! Postpaid! Catalog. Filmcraft, 47th Holly, Kansas City 2, Missouri.

**"THE World's Greatest Passion Play."** 8mm. 16mm. and 35mm. Specify silent or sound. Rent or purchase. Hemenway Film Co., 33-F Melrose St., Boston 16, Mass.

**GET** Lifelike prints from your 8 or 16 mm. movie frames, color or black and white, with the new sensational Cine enlarger. Frames can be copied onto roll of 620 film. Simple, economical. Complete \$18.95. Send 3c for illustrated folder. Zenith Film & Supply Co., Dept. C, Box 114, Brooklyn 16, N. Y.

**BETTER** Quality 16mm. sound films. Waverly, 5707 So. Christiana, Chicago 29.

**CLEARANCE 16MM.** sound projectors \$155 up, sound films, equipment, silent films. Write promptly for free listing. Harris, 303 West 42nd Street, New York 18.

**16MM.** Silent projector converted to sound, \$69.95. Do it yourself. Simple to attach. Takes sound right off film through your radio or amplifier. Not a gadget but a permanent engineered sound head and radio film adapter for your 16mm. silent projector. Approved and recommended by sound engineers—Send for large illustrated folder or order, giving make and model of your projector. Enclose \$69.95 for complete sound head, adapter, attachments, instructions and everything you need. Apex Video Co., 813-C Central, Balboa, Calif.

**EXCLUSIVE**—Select movies. Viewers, unique film-strips, projectors, screens. Free catalog. Home Pix, 1674 Broadway, New York 19.

**ELECTRIC** Movie cameras. 16mm. Army GSAP, original condition, value \$200, complete with f3.5 lens—new \$32.50; used \$19.50. Accessories available for home conversion. Free details! Completely converted Lektro 16mm., ready-to-operate \$49.50, guaranteed. Magazine film for same \$3.50 includes processing. Thousands of camera, projector and photo equipment specials—write for Special Bargain Listings. Photo-shop, Room 204-P, 18 East 42nd St., New York City.

**KODAK** Super-X movie film—surplus but tested and guaranteed "good as gold!" 16mm. 100-ft. \$3.95; 50-ft. magazine \$3.50; 8mm. double 25-ft. \$1.65. Processing included. Stock up! Photoshop, Room 205P, 18 East 42nd St., New York City.

**BARGAINS** In good used 16mm. sound films. Complete one reel subjects often available at \$2.95. List for stamp. Blackhawk Films, Davenport, Iowa.

**EXCITING** Films. Thrill your audiences with unusual movies. For "Glamorous Exciting Stars" (state 8-16mm.) send only \$1.00 to Exciting Films, 2431 Hyperion, Hollywood, California.

**MOVIE** Film at tremendous savings! Kodak Super-X gov't. stock—tested, guaranteed. 16mm., 100-ft. \$2.95; 50-ft. magazine \$2.50; double 8mm., 25-ft. \$1.65; Super XX-50c addl. each roll. Free processing. Photo Surplus Sales, Box 11P, 12 Duane St., New York City.

**KODACHROME** Duplicating. 35mm. slides; 20c each. 3 or more same slide 15c each. Glass-mounted 10c each. Minimum \$1.00. Color slides and film strips from original art work; 35mm. reductions from larger transparencies. Movie film duplicating—black-and-white or color. Fast service—write for prices! Photoshop, Room 101-A, 18 East 42nd St., New York City.

**TITLE** Making, free booklet. Westwood Company, 635 Victoria Street, San Francisco, California.

**SEND** Ten cents for lists 8mm. and 16mm. motion pictures. Prices reasonable. Film Classic Exchange, Fredonia, N. Y.

**GUARANTEED** Fresh 8mm. color, indoor and outdoor types. \$3.80 per 25' spool, 3 spools \$11.00. Filmcraft, 47th Holly, Kansas City 2, Mo.

**I BUY, Exchange, swap** movies. What have you? What do you want? Lowest exchange rates in world. Catalogue \$1.00. Refundable. Harvey Iris, Box 539, Brockton, Mass.

**MOVIE** Films—16mm. and 35mm. sound and silent pictures, projectors, lists free. Simpson Films, 155 High, Dayton, Ohio.

**NEW 16MM.** sound projectors. Free lists. Cine Service, Box 582, Ithaca, N. Y.

**16 AND 35MM.** films, projectors (sound). Savarese, Woodcliff Lake, N. J.

**16MM.** Magazines—Eastman Super X, guaranteed, \$2.50 each postpaid. Free processing. Buy 5 get 1 free. Ask for catalog. Superior Bulk Film Co., 103-A So. Wells St., Chicago 6, Ill.

**8MM.** Sound projectors for the price of the average silent projectors. Write Standard Sales, Box 7525, North Kansas City Missouri.

**BRAND** New 16mm. sound projectors \$129.50. Send 10c for photographic catalog. Sterling's, 679 Northampton, Easton, Pennsylvania.

**LOWEST** Prices, raw film 8mm.-16mm. Free list. MK Photo, 451 Continental, Detroit 14, Michigan.

**BASS** Says: 39 years of leadership guarantees satisfaction. Finest cine equipment, 8mm., 16mm., and 35mm., silent and sound. Write the old "Horse Trader." Satisfaction or your money back always! Bass Camera Company, Dept. A, 179 W. Madison St., Chicago 2.

**WE** Buy, sell, rent, exchange home movies. Details for dime. Midland, Box 429, Oak Park 4, Ill.

**8-16MM.** Silent-sound films. Complete rental library. All latest subjects. Free catalogue, (sample film 10c). Garden Film 317 West 50th, New York 19.

**LEARN** Professional motion picture technique at home. Approved for veteran training under G.I. Bill. Free catalog. Motion Picture Institute, Birmingham 4, Mich.

**LEARN** Movie projection, management. Free catalog. Theatre Institute, Elmira, N. Y.

## MUSIC AND MUSICAL INSTRUMENTS

**SWISS** Musical units \$3. Music Boxes, 131 West 42nd, New York 18.

**FREE** Phonograph record; with first order. Send 10c for Famous Record Catalog. Mallorc, Room 42, 570 N. Gay St., Baltimore 2, Md.

**YOUR** Poems set to music, recorded by professional artists. Send poems or write. Free booklet, attractive offer. Song Service, 331-C West 46th, New York.

**SONGWRITERS** Publishing, printing service. Stuckmann Music Press, 4737 Broadway, Chicago 40.

**SENSATIONAL** Composing offer. Terry, 709½-PM North Broadway, Oklahoma City 2.

**ELECTRIC** Hawaiian guitar at tremendous savings. For student or professional. Melcor eye beam string pickup. \$50.00 value, only \$23.95. 25% with order, balance c.o.d. Trusound Inc., 630 W. Randolph, Chicago 6.

1949 ACCORDIONS — Wholesale. Free catalog. American Accordion Center, 5329 Belmont, Chicago.

EXTRA Special! 1000 names, addresses songwriters, \$1.00. Popular Advertising Company, Box 927, Atlanta, Georgia.

SONGWRITERS Attention! The amazing demand for phonograph records, accelerated by countless juke-boxes, warrants your immediate investigation. We are offering new writers the rare opportunity of having celebrated "hit" composer furnish music on reduced percentage basis for any likely poems received this month. Phonograph records are outselling piano copies 5 to 1. Recola Records, Hollywood 28, Calif.

SONGWRITERS! Outstanding, ethical offer. Hibbler, C5, 2157 N. Avers, Chicago.

SONGWRITERS-Publication collaboration. Newark Publishers, G.P.O. Box 1226, Syracuse, N. Y.

MUSIC Arranged, songs printed. Frank Wildt, Music Publisher, Lancaster, Penna.

STREAMLINE Accordions below wholesale. Circular. Metro, 44 North Albany, Chicago.

POEMS Wanted for musical setting. Send poems for free examination. Hamann Service, 614 Manhattan Building, Milwaukee, Wisconsin.

AMPLIFY Your accordion with our new mike \$22.50. Sounds like organ. Installed in minute. Use any amplifier. Amplifier and mike \$72.50. Write Del Principe, 307 So. Wabash Ave., Chicago.

POEMS Wanted to be set to music. Free examination. Send poems. McNeil, Master of Music, 510-PM S. Alexandria, Los Angeles, California.

SONGWRITERS: Send poems for free examination and outstanding offer. United Music Service, 150, Salem, Indiana.

WRITE Songs. Big money and reputation. Write for information. J. Gordon (Pub. Co.), 201 N. Hoyne Ave., Chicago.

ACCORDIONS—Guitars, trumpets and all musical instruments, new and used. Direct from national distributors, cash and terms. Save money. Del Principe, 307 So. Wabash Ave., Chicago.

## RADIOS, SUPPLIES, INSTRUCTION

FREE Morse code lesson. Complete course \$1.00. Dept. M, Otto Luther, New Preston, Conn.

FIX Any radio. Amazing new instrument locates radio troubles double quick. Simple instructions show you how. Thousands now in use. Free—write today for 28-page illustrated technical manual, "The Inside Story." Feiler Engineering Company, Dept. 4PM9, 945 George St., Chicago, Illinois.

MAKE "Loudest" crystal radio. Instructions, loudest crystal, catalog: 25c. Amorose, Route Four, Richmond, Virginia.

TELEVISION Antenna installation instructions \$1. Decx, 329 Muskoka, Grosse Pointe 30, Mich.

WIRE Kits—100 feet insulated radio hook-up and instrument wire in 10 assorted colors for amateurs, experimenters, repairmen, \$1.25. Wirecraft, Box 347, West Brookfield, Mass.

27 YEARS Of experience radio repairing. Simplified system. No calculations. [No formulas. Total price \$2.00 postpaid or c.o.d. Moneyback guarantee. Ross Radio, 114615 Grandriver, Detroit 27, Mich.

TELEVISION—Bright and clear. Adjust present aerial. Build low-cost precision antennae. Instructions, charts, diagrams, dimensions, plans. Free—Television stations, kilowatts, tower heights. Propson Company, Lumberton, N. J.

STANDARD Brands—Radios, television, appliances. Big discounts. Wilson, 1416 Villet, Milwaukee 5, Wisconsin.

FREE Radio and television catalog! Money saving prices on radios, hard-to-get-parts, record changers, wire and disc recorders, amplifier systems, tubes, books, amateur and test equipment. Write today! Radiocentric Equipment Co., Dept. 2012, 170 Nassau Street, New York 7, N. Y.

FM On old radios! Free data! Topical Empire, 1527 Highland, Box 42 A, Louisville 4, Ky.

TELEVISION, Radio, tubes, parts. Send for free bargain list. Hallmark, 592B Communipaw Ave., Jersey City, New Jersey.

MAKE Simple, tubeless, batteryless, distance-getting crystal radios. Crystal and illustrated instructions 25c postpaid. Allen, 427-P, Clinton, Missouri.

HEADPHONES. Guaranteed U. S. Signal Corps used double headsets with adjustable leather headbands and black bakelite earphones. Reg. \$3.00. Special now \$1.49. Allen Radio, Dept. HPM, Clinton, Missouri.

## BUSINESS OPPORTUNITIES

START Profitable mailorder business at home. Everything furnished. Details 10c. Suproco, Ogema, Wisconsin.

\$400 MONTHLY. Raising Angora rabbits. Wool \$9 pound. Plenty markets. Details free. White's Rabbitry, Newark, Ohio.

NOVEL Action jigsaw toy. Winter, 4200 Harford Terrace, Baltimore 14, Maryland.

UNPAINTED Figurines, plaques, statues, etc. List. Dept. P, Valents, Perry, New York.

\$50 WEEKLY Income on \$10 investment. Details free. Wilsons, Stanton, Calif.

"DOLLARS In Your Mail From Women." New. Different. Send quarter, refundable, today. Grant Lovell, 2166 South Shore, Erie 2, Pennsylvania.

OPERATE Profitable mail order business. For details write Kurt Service, 3325-P West 52 Street, Cleveland 2, Ohio.

CASH For your idea, 280 manufacturers need inventions, patented or unpatented. List free. Invention Bureau, 208M Clinton, Oak Park, Illinois.

MONEY From your drill press. Details free. McMenamin, Clementon 3, N. J.

MAKE Money making new greaseless doughnuts at home on electric machine. Wholesale to grocers, drug stores, cafes, hamburger shops. Send for free recipes and plans. M. Ray Company, 3605 South 15 Ave., Minneapolis 7, Minnesota.

MAKE Money at home. Experience not essential. Literature free. Paul Reed, 5132 Greer Ave., St. Louis 15-A, Mo.

FIGURINES. Gift ornaments. Unpainted, many to choose from. Start a profitable business—Hobby. Free catalog and information. Suiter Art Industries, 314 Westport, Kansas City, Mo.

BE Independent—Operate America's lowest price penny vending machine. Big profits. Immediate shipments. Write for bulletin and prices. Fielding Mfg. Co., Desk 49, Jackson, Mich.

BIG Money. Spare or full time in your home. No selling! Spray new miracle finishes, plush and suede on signs, radios, automobiles, figurines, lamps, toys, etc. Our business is booming—new easy Flok-Kraft methods—material costs few pennies, you get dollars. Free samples, complete powerful money making plan free. Write now! Coast, 1505-C West Manchester, Los Angeles 44.

EXCEPTIONAL Money making opportunity for live-wire distributor. Dealer's county franchise now available for fast selling low-priced fire extinguisher and alarm. Made of glass, modern as tomorrow. Tremendous market. Big profit. Write for full information. Autofyrstop Co., Dept. E-4, 2035 Washington Avenue, Philadelphia 46, Penna.

EARTHWORM Breeding. Valuable bulletins on successful methods mailed free. Earthmaster Publications, Dept. 14, Sun Valley, Calif.

"THIS Is it!"—Learn sewing machine repairing, plus profitable installing our motor kits, etc. Write Taylor Service Co., Hamilton 3C, Ohio.

START Your own business on our capital. Always your own boss. Hundreds average \$6,000 to \$25,000 annual sales year after year. We supply stocks, equipment on credit. 200 home necessities. Selling experience unnecessary to start. Wonderful opportunity to own pleasant, profitable business backed by world-wide industry. Write Rawleigh's, Dept. D-U-PPM, Freeport, Ill.

LIQUID Marble—Colorful, glossy! Molded, brushed, sprayed! Cast novelties, statuary, colored tiles. Flexible molds, composition floors. Particulars free. Marbleizing Service, Edwardsville, Illinois.

FOR An extremely profitable lifetime business operate a collection agency-credit bureau. Easily learned. Free folder. Cole & Associates, Syracuse 2, New York.

TRADE And class magazines. Keep posted. Latest single copies. Over 1000 covering every trade, business and interest. Price list free. Commercial Engraving Publishing Co., 34C North Ritter, Indianapolis 19, Indiana.

LIQUID Rubber, make flexible molds. Free sample. Chaney, 1130 E. 16th St., Jacksonville 6, Fla.

OPPORTUNITIES Galore, start mail order business at home, get booklet, "How To Build Your Own Mail Order Business." 25c. Satisfaction guaranteed, or get free details of other books, plans. Gold Seal Mail Order Service, 509-C S. Harris St., South Bend 19, Ind.

RECAST Old batteries into new. Latest achievements. Battery Laboratories, Minneapolis.

SELECTED Collection proven money making plans. Home-mail order. 6th edition. Particulars free. Flasco Sales, 2505VA 150 Street, Flushing, New York.

ELECTROPLATING Instructions, and formulas for brass, copper, cadmium, chromium, nickel, gold and silver plating. All for 25c. M. Hyde, Box 2099, Station V, Los Angeles 3, California.

DOUBLE Your money back if not more than pleased with "Opportunities Preferred"—the big 8 1/2 x 11 slick paper Magazine jam packed with ideas for operating a profitable "mail order" business. Latest issue 25c. Griffin & Company, 756 Broadway, Everett 49, Mass.

UNLIMITED Profits from used fluorescent tubes. Thousands available—no overhead. Free details. Welday, Box 61, Seville, Ohio.

MAKE Cash profits operating home mail-order business. Sparetime. Amazing plan and eye-opening information that will surprise you, 10c. Newberrys, 254 Williams, Citronelle, Ala.

FREE Book of "372 Unusual Worldwide Business Adventures!" Australia, Africa, South America, New Zealand! \$800 month reported (exceptional). Work delightful enterprises home. Prepare for surprise! Publishers-B, Carlsbad, Calif.

"SPECIALTY Manufacturing." Big money business. Start on small capital with dependable formulas. Send for free interesting booklet. Howard Robinson, Ph. G., 1300-A South Ohio Street, Sedalia, Mo.

PERFUME—Make it yourself. Learn how free. Profitable sparetime, home business. Men and women write "International." 6347 Parnell, PM-4, Chicago 21, Illinois.

WOULD You pay 3%—first \$350 made? Color-illustrated book "505 Odd, Successful Enterprises" free! Work home. Expect something odd! Pacific, Oceanside, Calif.

BRONZING Baby shoes is big business—Start your own business for \$4.95. Includes materials and instructions, no equipment required. Metaloids, Box 2095, Wichita, Kans.

BRONZED Baby shoes mountings, metals, plastics, onyx. Free catalogue. Wholesale, Box 2095, Wichita, Kans.

OUTSTANDING Soaps, waxes. Private label. Information free. Meyers, 717 So. 16, Ft. Dodge, Iowa.

MANUFACTURE At home and sell fast selling DDT household insect spray, for flies, mosquitoes, ants, silverfish, roaches, etc., clean fragrant. Easy, quick profits, small investment. Formula, complete instructions, supply sources, all necessary information, ten dollars. See-Tee-Are Products, 2219 Danville Street, Hopewell, Virginia.

VENETIAN Blinds! Profitable business opportunity! Small capital! Illustrated construction plans, instructions, supply sources. Remit \$1.00. Hunter, 2172 Green, Cleveland 21, Ohio.

1000% PROFIT Selling snake orchids. Devour live insects. Enterprises-L, Toronto 12, Canada.

HALF Million articles wholesale. Directory 25c. Publishers, Box 1302-P4, Detroit 31.

START Home manufacturing business making Cleaning Compounds, Soaps, Insecticides, Cosmetics, Polishes, Food Flavors. No machinery. Literature free. Kemix, Park Ridge, Ill.

EARN At home. Spare or full time. Preserve baby shoes. Few cents for supplies completes many dollars in finished work. Every parent a buyer. Send \$1 for simple, easy-to-use instructions and formulas. Order now! Baby Bride, Dept. 6, 3807 Benefit St., Baltimore 24, Md.

SELL By mail! Ideas galore! Join Mail Selling Opportunities Club! Details free! K. Wehner, Box 142-A, Roxbury 19, Mass.

RUBACREAM! Best bet for better molds! Free sample convinces! Castcraft Studios, 2027-P Fulton St., Brooklyn 33, N. Y.

"HOW To start your own magazine." 10c. Raymond Rigor, Box 125, Columbus, Indiana.

HOME Workers. Hand-spin Angora wool into yarn. Either sex. House of Angora. PM. Springfield, Illinois.

START Profitable mail order business. Literature free. Paul Kelch, Box 133-A, Bloomfield, N. J.

MAKE Money at home like I do! Free details. Dueffy, Covington, Ky.

FREE Literature describing money-making inspirations. Bonheim, 610 W. 204 St., New York 34, N. Y.

"WATERLESS Hand cleaner." Make, sell. No machinery. Build profitable business. Formula \$1.00. "Wax-o-Glass" cleans glass; polishes metals. Formula \$1.00. "Wipe-on auto paint" formula \$1.00. Metalizing baby shoes, complete process \$1.00. All four formulas only \$3.00. Satisfaction guaranteed. Ideal Formula Service, Park Ridge 5, Illinois.

NEW Lawn mower sharpeners. Details for stamp. Anton Wellert, 142 Gaylord Street, Binghamton, N. Y.

GET It for them wholesale. Be community buyer nationally advertised merchandise; radios, appliances, etc. \$5,000 year possible. Easy, fascinating new business. Stamp for literature. Cox, Saugus 10, Mass.

200 NEW Money making plans, tips, ideas for increasing your income. Folio free. Reynard Pub., Smithfield 3, Ohio.

PROFITABLE Mail order plans, details free. Alfred Haseman, Beecher, Ill.

MAKE Mail profits, your own mail order business, faster, surer, more dependably. Ask for proof now. Amity Co., New Canaan 2, Conn.

SALESMEN, Dealers, distributors: Every office buys new device. Quick demonstration conveniences. Sells \$24.50. You profit \$12.55. Exclusive territories. Geo. Wentz, San Marcos 5, Tex.

IGWT, Hot Springs, New Mexico, wants hundreds small manufacturers to make simple new screw-in fluorescent lamp bulb. License 6c per lamp. Big allowances to new companies in the field. U. S. patent 2,459,633.

"JUDS Mail Order Chats"—Tips, timely topics. Brings results, low cost, something different. F. Dupont, 1916 Kenneth, Arnold, Penna.

PIANO Tuning, repairing taught by mail. Finest concert system. Uncrowded field. Write Piano Technician, 708 Rawlings, Carbondale, Ill.

START Home business—Part or full time. Easy process velvetizes interiors, signs, novelties, radios, lamps at low cost. Plan, process and big trial package, 25c. Sparks, 1135 Queen Anne, Los Angeles 6.

AGENTS—Sell novelty and specialty items. Small investment, large profits. Send for price list. Kennedy Sales Company, Box 178, Richmond, Va.

MAIL Order success even for beginners. Details free. Condello, Box 443, Fords, N. J.

MAKE Tough plastic 1c pound. Makes durable floors, walls, mantels, roofs. 101 uses. Build attractive home yourself. Material cost \$150 room. Bays Laboratory, Oklahoma City 9.

OPERATE Your own mail order business. Six great books; 317 exciting pages, 220 new plans, many ideas, schemes. \$2.00 also c.o.d. Nichols Service, 4716 N. Winthrop, Chicago 40.

MOLD Plastics, plasters, compositions. Simplified, inexpensive methods. Unusually profitable. Literature free. Plastics Digest, 2925-R Michigan, Kansas City 3, Mo.

MAKE Rubber stamps, metalize baby shoes, repair dolls, silver mirrors, make plaster novelties. Catalogue of "30 ideas" free! Universal, Box 1076-A, Peoria, Ill.

OWN Your mail order business. No investment. Omaha Envelope Service, 4721-H California, Omaha 3, Nebr.

FACTORY Branch manager. Power mowers; \$79.50 up. Established line. Write fully. Rotacut, M-2004, Excelsior Springs, Mo.

MAILING Postcards selling repeat merchandise is profitable. Everything supplied. Details free. Gordan Publishers, Box 23, Pawtucket, R. I.

SAWDUST. Turn it into cash. Six methods. Instructions 25c. Charles, 12-BV, Norwood, Ohio.

START Your own business on credit. Always your own boss. 1554 dealers, sold \$5,000 to \$26,500 in 1948; their average \$6,742. We supply stocks, equipment on credit. 200 home necessities. Sales experience not needed to start. Wonderful opportunity to own pleasant, profitable business backed by world-wide industry. Write Rawleigh Co., Dept. D-U-PPM, Freeport, Ill.

METALLIZE Baby shoes. Excellent profits. New system assures success. Free details. Treasures Forever, 89 Henry Ave., Lynn, Mass.

EXPORT-IMPORT. Represent manufacturers! Conduct two-way profit, barter exchange business without capital. Buy-sell abroad, make huge profits. Uncrowded fields, unlimited opportunities. Learn at home in spare time. No previous experience necessary. Send \$1 for two 1949 bulletins, supplying hundreds business connections. Money refunded if unsatisfied. International Trade Promotion, 246-P, Fifth Ave., New York 1.

MEN—With cars \$100.00, \$200.00 weekly; full, part time; experience unnecessary. Write Plastic Products, 3151-2 Southport, Chicago.

27 WAYS To make money with sawdust. Big demand. Complete formulas and plans mailed postpaid for one dollar. Alfred Kay, 1123 Buchanan Street N.W., Washington 11, D. C.

"KNOW-HOW" From reliable government bulletins. "Truth About Mailorder," 25c, refundable. Coleman, Box 4006-K, Bay Pines, Florida.

RED Hot home mail manufacturing business opportunity. Everything furnished! 300% profit! Facts free. Bridges, 286-A Third Avenue, New York 10, N. Y.

MAIL Business opportunities—New plans; Proven propositions. "What to sell" service. Different! Profitable! Write: Smith, Box 2592-J, Hines, Illinois.

CALIFORNIA Almanac and state fact book, 568 pages profitable information, facts, figures, data. 42 maps, 36 charts, 390 tables, 93 special articles, \$1.50 postpaid, free circular. Sunland Stationers, Box 218, Sunland, Calif.

OPERATE Your own photographic business. Sales terrific! Cameras, projectors, enlargers, darkroom equipment, accessories, etc. Free details. Peace Products Co., Dept. 701, 152 West 42nd St., New York City.

FIRST Steps in Mail Order tells how to start a mail order business the right way. Will save you hundreds of dollars in costly mistakes. Send 25c for this 35-page book now. Ralph A. Long, 208 West Broad St., Tamaqua 2, Penna.

LEARN The three keys to success. (1) Choosing the right products. (2) Sources of supplies. (3) How, where and when to advertise. Free particulars. Business Plans Foundation, Box 56, Madison Square Sta., New York 10.

"ELECTROPLATING Know-How"—Get the professional know-how of modern electroplating, fascinating money making field, simply and quickly! Write for free illustrated booklet. Joseph B. Kushner, Electroplating Engineer, Stroudsburg 40, Penna.

HOUSE Paint—Wholesale \$2.70 gallon. Agents wanted. Free advertising offer. Certified Products, 812E 38th, Louisville, Ky.

EARN \$50.00 Or more weekly operating nut and gum vending machines in your spare time. Details free. Danco Coin Machine Co., Dept. PM, 1304 E. Baltimore St., Baltimore 31, Maryland.

MAIL Order News (55th year) brings you the mail order ideas you're looking for. Copy 25c. Clarence Woodfall, R.3, Charleston, Ill.

TWISTEE Balloons make animals, no glue, twelve balloon package 25c, sells 75c. Hottest balloon number for buyers. Plenty other items. Ellswood Balloons, LaJunta, Colorado.

NATURAL Molding Latex. Extra thick. Free sample. W. Wooley, 115-A Donald, Peoria, Ill.

MAKE Hollywood style marble-glazed cement pottery, birdbaths. Home-shop. Benches, fountains, stucco-rock walls, garden ornaments; chemically colored. Dime brings sample, amazing pictures. Hollywood Cementcraft, 8527-R Wonderland, Hollywood 46, California.

\$100 WORTH Of orders at a cost of \$4. "How." Send for details. Murphy, Box 522, Gary, Indiana.

OWN—Operate ball gum, nut, cigarette vending machines. Amazing profits, no selling. Write for free details. Cameo Vending, Dept. P, 432 West 42nd, New York.

1001 MONEYMAKING Ideas! Free details. Neuway Institute, Box 5463-M, Chicago 80.

SPECIAL Rubber for making molds. Literature and sample free. Universal, Box 1076-A, Peoria, Ill.

METAL Mountings for bronze baby shoes. Urbans, 2806 Holliday, Wichita Falls, Texas.

WHERE To buy 800,000 articles wholesale. Details free. Schibani, Box 1576-A, Birmingham 1, Alabama.

"HOW To start a successful mail order business." The guide to sound, profitable mail merchandising. 25c. Manhattan House, 126-B Lexington, New York 16, N. Y.

MECHANICALLY Inclined? Resurface butcher blocks. Lifetime business. Roy Crawford, Keyport, New Jersey.

DOLLARS In personalized baby record books. Sell by mail. Use same literature we do. No-Co-Ro, Oakland 6, California.

PLASTERCRAFT Supplies. Rubber molds, natural liquid rubber, rayon and cellophane flock finishes, etc. Illustrated catalog and "Plastercraft" course free on request. Blue Rapids Supply, Blue Rapids, Kansas.

LEARN Piano tuning at home in thirty days. Unlimited income. Sound recordings, electric record player, tools and instructions furnished. Write Capitol City Tuning School, Department PM, 211 East Michigan, Lansing, Michigan.

MAIL-ORDER Opportunities. Details free. Isbell, Suite 619-PM, 216 West Jackson, Chicago 6, Ill.

FOOT-PAL Sales-dealers', large repeat commissions. Free particulars. Brown Co., Box 126, Salt Lake City 8, Utah.

PACKAGED Offer gives all help needed to start you in mail order. Details free. Terwilliger, 303 PS Chestnut Street, E. Bound Brook, New Jersey.

MAKE Money spare or full time, casting metal toys and novelties. Latest scale model autos, original ashtrays, savings banks, water pistols, etc. Enormous wholesale and chain store demand keeps manufacturers busy. No experience or special place necessary. Write for details and illustrations of patterns needed. Metal Cast Products Co., Dept. A, 1696 Boston Road, New York 60, N. Y.

VENDING Machines earn big money! An investment as low as \$10.50 will start you in this fascinating, profitable business that can lead you to the road of success and independence. Routes can be established and operated in either full or spare time with no experience needed. Write for full details and our free catalog illustrating our nut, candy, gum and stamp vendors; also pin ball machines, music boxes, etc. Write immediately to Parkway Machine Corporation, Dept. 7, 623 W. North Avenue, Baltimore 17, Maryland.

BABY Shoe plating for the trade only. 5 day service. Beautiful samples always available. Thoro Plate Co., 6260 Romaine St., Hollywood 38, Calif.

SCIENCE Of memory simplified. Free booklet "Memory Development." Memorology Club, 2016 Sunnyside Ave., Chicago 25, Ill.

NOW Available! 1949 edition of Official Concessionaire's Guidebook. Jam-packed with money-making ideas, games, formulas, equipment for concessions, roadside stands, carnivals, medicine business, etc. Buyers guide. Send \$1.00 today for copy. Concessionaire's Guidebook, Box 133B Sta. B., Toledo 6, Ohio.

YOUR Own profitable home business. Preserve live flowers to last forever. New simple discovery. Enormous demand all year 'round. Tremendous profits! Light fascinating work. Send \$2.00 for working equipment, instructions, and valuable sales plans. Satisfaction guaranteed or money promptly refunded. Alfred Hermansen, 210 Fifth Ave., Suite 1102A, New York 10, N. Y.

POPCORN Equipment, potato chip outfits. Long Eakins Company, 4960 Hi Street, Springfield 99, Ohio.

NO Selling, operate vendors, amazing profits, details free. Silver-King, Suite B, 622 Diversey, Chicago 14, Ill.

HOME Business making statuettes, plaques, artificial marble, rubber molds. Metalizing baby shoes. Silvering mirrors. Formulas. Folder free. Creative, 236-L, Winnetka, Illinois.



**RAISE** Ginseng. Roots bring \$10.00 and. Circular free. Fezler Seed Co., Atchogue, N. Y.

**ANNOUNCING** Home study course in commercial baking. Practical basic training. Good field for those with aptitude. early depression proof. Send for free booklet. "Opportunities in Baking Industry." National Baking School, 1315 Michigan Ave., Dept. 3438, Chicago 5, Ill.

**MAKE** Money addressing envelopes. Our instructions reveal how. Glen Glenway, 13 Euclid, Cleveland 3, Ohio.

**I MAKE** Big money in the mail-order business. You can do the same at home with copyrighted system. Write me. I'll tell you how. F. Little, R.D. #1, Glenaw, Penna.

**ENVELOPES** Addressed accurately, reasonably. Fast service. We have capable addressers in your city. Glenway System, 13-Y Euclid, Cleveland 3, Ohio.

**READ "Advance"**—The voice of mail order. Offers money-making opportunities, sources of supply, personal guidance, etc. Issued monthly. Sample copy 25c. early subscription \$2.00. Advance Publishing Company, 313 East 21st Street, Suite 450, New York 10, N. Y.

**A BUSINESS** In your own home! Our chemicals, plus free water and cheap grocery store materials can bring you over \$500 monthly earnings. Plans and formulas free. Chemica Division, 1269 S. Horton, Los Angeles 6.

**A FACTORY** In your home garage! Fig. and sales rights, mechanics' waterless hand cleaner, \$500-\$800 monthly. No special equipment necessary. Formula rec. Western Aircraft Mfg., Dept. D, Los Angeles 6, Calif.

**BUY** The new Concession popcorn machine. Biggest low priced popper on market. \$100 puts you in business, complete. Also caramel corn, candy tross, candy pullers, kettles, heating equipment. Write for new catalog. Concession, Dept. A, Toledo 6, Ohio.

**LEARN** Piano tuning, repairing, at home. Tremendous field! Piano parts, tools furnished. Established 1935. Empire School of Piano Tuning, 606-B East University Ave., Champaign, Ill.

**UNPAINTED** Bookends, plaques, statues, figurines. List. Haverly Products, 219 8th Ave., Altoona, Penna.

**HOW** And where to obtain capital, small and large loans. Free particulars. Star Service, Wapakoneta, Ohio.

**OWN** Mirror shop. Resilver mirrors. Glass sign making. Electroplating. Supply prices. John Sprinkle, V60, Marion, Indiana.

**BRONZED** Baby shoe mountings and supplies. All metal bronze bookends, picture frames, ash trays, etc. Onyx ash trays, desk sets, plaques. Hardening solution, 30-amp. plating rectifiers with overstat control, \$85.00. Geared motors or agitation \$20.00. Lead lined tanks. Write for list. Hollywood Bronze Supply, 770 N. Vermont, Hollywood 27, Calif.

**QUICK** Money. "Repairing car batteries." At home! Easy too! Battery man, Grand Junction, Colorado.

**\$46 FROM** Square foot plywood. Jigsaw necessary. Write, Woodarts, X-38, Bridgewater, Mass.

**OPERATE** Profitable mail order business. Write Walter Service, 4159-A East 12th, Cleveland 5, Ohio.

**COLORGLAZED** Concrete pottery made without molds. Patented method. Cemetery products, novelties, tiles. Basement leak-sealing. Money-making projects. Booklet, details free. Men only. National Potteries company, Grand Rapids, Minnesota.

**START** Mailorder bookshop—Everything furnished. 25c brings booklet, samples, exciting ideas. General Publications, Ossining, N. Y.

**\$25 WEEKLY** Working two hours daily. No canvassing. No manufacturing. Lycke, Box 2471, Cleveland 12, Ohio.

**137 WAYS** To make money, in home or office, business of your own. Full particulars free. Elite Co., 220 Grand St., New York 13.

**BRUSH** Plating outfits connect to a battery. No tanks necessary. Good paying business at home plating autoparts, bathroom fixtures, bicycles, reflectors, silvering mirrors. No shop or experience required. Outfits furnished. Free booklet. Sunmetal Co., Ave. H, Decatur, Ill.

**EARN** \$200 Weekly installing new amazing "Styron" plastic wall tile in homes, offices. Easily applied. Tile your own kitchen, bathroom, too. Instructions, everything furnished. Literature free. J. S. Tile Co., 30 W. Washington St., Chicago 2, Ill.

**CO-PUBLISH** and advertise in The Central Mail Advertiser. Sample copy for stamp. Low rates. Large circulation. Bagby Printing Co., Georgetown, Ohio.

**MAIL** Order opportunities. Full or spare time. Hundreds of chances. No charge. Postal brings copy. Blackstone Press, Somerville, New Jersey.

**START** Home plaster novelty business. Amazing course tells how. Literature free. Kemo-Courses, Dept. A, 4862 Catalpa, Chicago 30, Ill.

**COPUBLISH** Leading m.o. paper. Latest copy Mail Sale Advertiser and proposition, dime. Vanroy W. Shirk, Lebanon, Penna.

**START** Plating business at home. Amazing profits. Make own outfit. Inexpensive. Illustrated instruction booklet 25c. Popular Mechanics Press, (C-43), 200 E. Ontario, Chicago.

### MONEYMAKING OPPORTUNITIES

**PROFITABLE** Articles made cheaply. Orenstein, 1653 East 9th, Brooklyn 23, N. Y.

**DEPRESSION** Insurance. Business of your own. Postal brings free information. Pru-Ex, 1010 Watauga, Kingsport, Tennessee.

**BE** Independent in a local or mail order business. T. Ryan, 1218 East 21 St., Oakland 6, Calif.

**WIN** Cash, cars in prize contests! Write for copy filled with current contests, winning hints and tips. Send only 25c. Wright Contest Digest, Dept. 17-D, P.O. Box 2266, St. Louis 9, Missouri.

**EARN** Money by mail! Two plans, "picture postcards," "big mails." Only 25c coin. Jos. Banas, 116 Clover St., Syracuse 4, N. Y.

**GOOD** Money cleaning clocks, watches. It's easy. Write: Brownie, Arvada, Wyo.

**\$4.00 PROFIT** Every sale. Columbia Bookkeeping Systems, 319 Dell, Pittsburgh 16, Penna.

**WIN** Contest prizes regularly! Others do! 10c brings latest issue "Contest Flyer," other revealing information. Lawrence, 687 Morgan, Camden 4, N. J.

**FREE** Book "372 Unusual Worldwide Business Adventures!" Successful! Australia, Africa, South America, New Zealand! Not hokum! Work home. "Different" plans. Prepare for surprise! Publishers-C, Carlsbad, Calif.

**WOULD** You pay 3%—first \$350 made? Color-illustrated book "505 Odd Successful Enterprises" free! Proven! Work home. Expect something odd! Pacific, Oceanside, Calif.

**SUCCESS** Even for beginners in postwar proven mail order methods. Details free. Write H. R. Hansen, 5 West 137th St., New York 30, N. Y.

**THOUSANDS** Articles wholesale. "Supply Source Directory" 10c. Ideal Service, Park Ridge 40, Illinois.

**MING** Trees, ready to assemble. Complete kit supplied \$5.95. P.O. Box 329, Sparks, Nevada.

**ASSEMBLE** Belts, no tools! Big profits. Sample 50c, eight assorted \$3.75. Artnic Leather, 411 Joseph Ave., Rochester 5, N. Y.

**15 MINUTES** Masters sign and advertising lettering; sign-painters secrets; cartooning book. All three \$1. Free circular. Abenterprises, Box 875-M, Peoria, Illinois.

**100% PROFIT** In spare time. No experience necessary. Details free. House and Home Post, 1216 Park Row Bldg., New York City 7, N. Y.

**START** Your own business for \$4.95. Price includes all materials and instructions. No equipment required. Particulars free. Metaloids, Box 2095, Wichita, Kans.

**INVESTIGATE** Mail order opportunities. Details free. Moy's, 517-7th S.W., Washington 4, D. C.

**BUILD** Rowboats in spare time. Little cost and effort. Sell at large profit or use for rental business. Professionally-built solid oak frame with brass screws. Complete, simple specifications for planing, flooring, finishing. Frame guarantees correct shape, balance, performance. Takes up to 8 h.p. motor. The 14-ft. frame shipped assembled \$39.50, ready for assembly \$29.50 f.o.b. Finished would sell for \$125 to \$150. H. C. Sweet Co., 12083 Woodbine, Detroit, Mich.

**BUILD** With concrete blocks: Walls, garages, houses. Professional Instructions \$1.00. "Blockmasons," 1256 Amanda, San Bernardino, Calif.

**EARN** Money evenings, copying and duplicating comic cartoons for advertisers. Adservice, Argyle 1, Wisconsin.

**HELICOPTER**, 14" Rotors, rubber motor, \$3.00 dozen, \$1.00 two samples. Heliotoy, R. 8, Dallas 11.

**CANDLE** Making—Profitable! Fascinating! Write Robins, 46 Sylvan Lake, Mundein, Illinois.

**LEARN** Professional candy making, easy method, free details. Philip Pate, Kissimmee, Florida.

**TIN** Cans. Turn them into cash. Nine methods. Instructions 50c. Charles, 12-BW, Norwood, Ohio.

**START** Home business in spare time. Make extra money. Experience unnecessary. Free literature. Personal Counseling, Box 1411, St. Petersburg, Fla.

**MAKE** Big money handling popular, fast-selling books from your own home by mail. Everything furnished! Unusual opportunity! No experience needed. Details free. Write: National, Box 88-L, Dorchester 22, Mass.

**MAKE** Extra dollars in your own back yard! Real opportunities, fully outlined. Rush name. Pickett's, 62-A Sanders Drive, Florence, Kentucky.

**HAVE** Home candy kitchen business—Good earnings! Full, spare time. Big demand! Get professional instructions. Write: Etterman, 1991-CC, Muskegon, Michigan.

**SURE** Money maker. Costs you 10c to 20c to make lawn chairs from vines. Send m.o. or check for full instructions and plans, \$2.00 or miniature sample, \$5.00. Write: Dewey Morgan, Box 15, Washington, N. J.

**MEN—Women**—"Most everybody likes candy." Learn to make in a professional manner. (Our 39th year.) Ragsdale Candies, D4, East Orange, New Jersey.

**MAKE** \$100 Per week or more in a full or spare time baby shoe metalizing business of your own. Write now for free literature on this easy to learn highly profitable business. Joseph B. Kushner, Metal Finishing Engineer, Stroudsburg 23M, Penna.

**MONEY** Making projects for your own business. Folder of ten for a quarter. Challenge, 87 Somerset, Springfield 8, Mass.

**DEALERS** Wanted! Sell new merchandise item by mail, from home. Everything furnished! Novelty Products, 1200-B Goldsboro, Sanford, N. C.

**BABY** Shoes preserved. Formulas, instructions, \$1.00. Novelty Bronzing, Box 56, Hyde Park 36, Mass.

**UNPAINTED** Plaster ornaments, easily decorated. Firestone's thick, white, natural-latex Loxite for rubber molds. Midwest Novelty Manufacturers, 524-A East Park, Anaconda, Montana.

**I MADE** \$1000 From 1000 tomato plants. Instructions, \$1.00 (refundable). Alfred Dinsmore, Marlborough, Mass.

**READ** Progressive Mailtrade, the magazine that tells how to make money by mail. Dime brings sample and special offer. Progressive Mailtrade, Box 357, Sheboygan, Wisconsin.

**PROFIT** With Larson Leathercraft. Belts, purses, 100 other ideas. Largest supply in U. S. Catalog 10c. Larson, Dept. C, 824 S. Tripp, Chicago 24.

**WIN** Contest money. General Contest Bulletin gives hundreds of tips. Lists current contests and rules. Sample 25c. General Contests, 1609½ East 5th, Duluth, Minn.

**ANALYZE** Handwriting for profit! Complete outfit \$1.00. Graphologists, POB-971, Philadelphia.

**EARN** Money at home! Thousands do! "Home Worker Magazine" tells how. Sample, 25c. Sizemore, Box 7, 4917 Kostner, Chicago 30, Ill.

**RESILVER** Mirrors at home. Formula 25c. Ideal Service, Park Ridge 6, Illinois.

**PRIZE** Contest bulletin gives various contests now operating, and valuable hints. 3c stamp. National Contest Bulletin, Box 2685P, Miami, Florida.

**PUBLISH** Your own magazine. Handmade 52 page format, well edited, illustrated. Cost low as \$1.00 month. Brings you prestige, profits. 25c brings sample. details. National. Ord. Nebr.

## FORMULAS, PLANS, ETC.

10,000 FORMULAS And trade secrets. Free literature. Stillman, 555 Kingston Ave., Brooklyn 3, N. Y.

HOT Tamale. Making for profit. Particulars. Box 384, Altus, Okla.

MAKE—Sell cleaners, soaps, polishes, flavors, cosmetics. No machinery. Formula literature free. Kemico, Park Ridge 16, Illinois.

FORMULAS For nearly everything. Catalog free. Write Creative, Winnetka, Ill.

PRODUCTS Analyzed. Duplicated. Improved. Formulas. Consulting Scientific Company, Swarthmore, Pennsylvania.

\$1.00 GETS You 21 money-making popcorn, candy apple formulas. We supply equipment. Concession Supply Company, Dept. A, Station "B," Toledo, Ohio.

TESTED Formulas. Interesting descriptive booklet free. Pont, Box 635-PM, Terre Haute, Indiana.

REAL Manufacturing formulas. Lists free. Cummings, Chemist, Gordon Ave., Syracuse 4, N. Y.

## PLASTICS

GLASSY-CAST: New and finest liquid plastic on the market. Cold set. 15 to 30 minutes for finished product. Free instructions. Easy to make novelties, toys, jewelry, machinery parts, etc. \$2.50 per qt. Elasto-Mold: Flexible, transparent, permanent production molds made in 20 minutes. Free details and samples on request. Also quality rubber latex. Wholesale prices. Plastic Service, 294 Washington St., Dept. PM4, Boston 8, Mass.

NEW Liquid plastic. Clear, colors. Cast without heat. Embed flowers, insects, coins. Saw, drill, carve. Fascinating, profitable. Use home tools. Send only 25c for exciting new home project manual showing how to get started. Castolite, Dept. D-101, Box 391, Woodstock, Ill.

LUCITE, Plexiglas—Any size sheets masked. Square foot cost 1/16" 96c; 1/8" \$1.25; 5/16" \$1.52; 3/4" \$1.80; up to 1 1/2" available. Colors add 10%. Include 10% postage. Almac Plastics, 230 Fifth Avenue, New York 1, N. Y.

CORK In sheets, framed bulletin boards. Postcard brings prices. Radigan, 9758 So. Harding, Chicago 42, Ill.

INTERNAL Carving color work kits only \$2.00. Plastic cold and hot dip dyes for all type plastics. Concentrated plastic cleaner. Also internal carving colors, cements, fillers, boosters, reducers. Order kit today. Free leaflet. Egyptian Dyes and Chemical Corp., 947 North Avenue, Dept. P.M.-4, Chicago, Ill.

AMAZING Liquid plastic. Beautiful results in half hour. Clear, colors. Embed photographs, coins, keepsakes, etc. Complete hobby kit \$3.25. Kristalon Plastics, Dept. P5, Box 29, Wilmette, Illinois.

LIFELIKE Roses expertly carved and tinted in flawless Lucite! Create personalized impressive jewelry gifts in few minutes. Special introductory offer \$1.00 postpaid. Longly & Blyden Mfg. Co., Box 991, Spokane 4, Wash.

COLORS Plastic catalog of finished masterpieces, carving instructions, supplies. You produce professional jewelry and gifts. Profitable line. For hobbyists, schools, dealers, salesmen. Only 25c. Ladies attention: Glitter birds of Paradise, pins and earrings. 50c nets you \$10.50. Hurry! Plastic Mart, 2443 East 14th Street, Oakland, California.

"CHEMIGLAS"—Inexpensive, water-clear casting resin. Pamphlet, 25c. Technicraft, 1156 Commonwealth, Boston 34, Mass.

BARGAINS In plastics. Lucite, Plexiglas, Catalin. Many colors and sizes. Details free. George Plastics, 6938A George St., Chicago 34, Ill.

PLASTIC, Sheets, rods, tubes, etc. Free list. Plastic Supply Co., 2901 N. Grand Blvd., St. Louis 7, Mo.

PLASTIC Materials and supplies for your hobby or business. Catalog and internal carving instructions free. Art Plastics of Calif., 8125 East 14th Street, Oakland 3, Calif.

INTERNAL Carved roses, orchids, swans, goldfish, butterflies, etc. Jewelry and gifts. Crystal Floral Novelty Co., Bound Brook, New Jersey.

PLASTICS—Supplies, findings, shells. Illustrated fabricating manual, bargain catalog. 10c. Gem-O-Lite, Box 686F, North Hollywood, Calif.

PLEXIGLAS—12" x 12" Masked sheets. 1/16"—\$1.00. 1/8"—\$1.25. 3/16"—\$1.55. 1/4"—\$1.85. Include 10% postage. Dyes, rods, tubes, luminous powders, carving blanks, drills, jewelry findings. Free catalogue. Craft Plastics, Somerville, New Jersey.

## CHEMISTRY

NEW Catalog: Chemistry, mineralogy, biology. 10c. Tracey Laboratories, Evanston, Illinois.

MAKE Chemistry your hobby. Fascinating, educational, recreational, vocational. Large general catalogue chemicals and apparatus 15c. Microscopic stain catalogue 20c. Both 25c. National Scientific Company, (Est. 1916), 2204 W. North Ave., Chicago 47, Ill.

COMPLETE Supply catalog, 10c. Pilgrim Chemical, 348-AB Edith, Salt Lake City 4, Utah.

NEW Used catalog 5c. Atlantic Laboratory Supply Co., 21 Wenham, Boston, Mass.

NEW Laboratory supply catalog of chemicals and apparatus. Contains many thousands of items with illustrations. Send 25c. Standard Science Supply Company, 1232 N. Paulina St., Chicago 22, Ill.

CHEMICALS And apparatus for industrial, analytical, and private laboratories. Catalog 15c. Dept. M-50, Biological Supply Co., 1176 Mt. Hope Ave., Rochester, N. Y.

NEW Idea chemical and apparatus outfits for home experimenting. Photo-Scales, semi-professional microscopes and biological supplies. Specializing in chemicals and laboratory supplies in small quantities. Send 15c for catalog. Established 1931. John H. Winn, 124A West 23 St., New York, N. Y.

HANDBOOK For chemical experimenters, illustrated, hundreds of experiments, 50c. Experiment booklet 15c. Supply catalog 5c. Reading Scientific Company, Reading, Penna.

## HELP WANTED

QUALITY Paint manufacturer wants representation on commission basis. Time and territory your own. Scott-Leed Paint & Varnish Co., 2948 E. 81st, Cleveland, Ohio.

BOYS Wanted. Over \$2.00 hour! Sell name plates for front doors. Free sample. Write Dept. 47, National Engravers, 214 Summer, Boston, Mass.

## AGENTS WANTED

AT Last! Something new and sensational in everyday cards. Gorgeous satin and velour designs. Get orders fast. Big profits. Imprinted stationery. Floral charmettes, napkins, 25 assortments for all occasions, retail 60c to \$1. Samples on approval. Puro Co., 2801 Locust, Dept. 940-D, St. Louis 3, Mo.

MEN And women to sell house to house famous Nu-Plak Products, wall plaque sets and bronzed baby shoes. Good deal. Send for box assorted samples, \$4.00. Write Marlins, Inc., 4630 Broadway, Chicago 40, Illinois.

BIGGER Income for you! Sell popular priced quality shirts direct. Big advance commissions. Bonus. Steady repeats. Permanent, profitable business opportunity. Also profit-making companion line. Write today. Free outfit. Bostonian Mfg. Co., Dept. 13, Boston, Mass.

MAKE Quick cash! Sell friends newest nylon hosiery, lingerie, blouses. Free displays. Complete line greeting cards. All-occasion samples on approval. Free stationery samples. Special outfit offers. Wear Wright, 1709 Arch St., Dept. B, Philadelphia, Pennsylvania.

BIG Cash profits to 100% yours. Sell friends thrilling greeting card values. Complete line everyday, religious, birthday, gift wrappings, stationery. Experience unnecessary. Request samples personal imprinted stationery and irresistible deluxe all-occasion assortment on approval. Special offers. Holiday Card, 463 Congress St., Dept. E, Portland, Maine.

\$1 STARTS You in business. Sell lined ties, 100% wool interlining. Costs you only \$7 per dozen, you make \$5.00 dozen. Send \$1.00 for special introductory offer two ties. Catalog complete line free. Phillip's Neckwear, 20 West 22nd St., Dept. K-34, New York 10.

PROFITS. Big demand and repeat orders selling rubber mats for home or auto. Free sales plan, Mitchell, Dept. PM4, 2140A San Fernando Road, Los Angeles 41.

EASY Cash for you selling new amazing plastic greeting cards. Also everyday pert 'n pretty, deluxe gift wrappings. Big demand. Profits to 100%. Free samples giant value personalized stationery napkins, coasters, matches, keepsake notes. Senrab Co., 212 W. Washington St., Syracuse, N. Y.

AMAZING Offer—\$50 is yours for selling only 100 boxes entirely different, new deluxe all-occasion cards. Patented feature television card included. Each box sells for \$1.00, your profit 50c. Surprises items. It costs nothing to try. Write today for samples. Cheerful Card Co., 625 White Plains, N. Y.

BE Independent! Be successful! Sell complete family line quality shoes. Popular prices. \$1.00-\$3.00 advance commissions. Bonus. Amazing features. 70 styles. Experience unnecessary. Free outfit. Moench Shoes, 10B, Boston, Mass.

\$100 WEEKLY—New complete, modern plastic line. Tablecloths, etc.—over 2 items. Every home prospect. 100% profit. Free samples. Carwell, 330C So. Wells Chicago 6.

EVERYDAY Cards. Earn \$5.00 with every ten \$1.00 boxes of everyday cards you sell. Also new plastic cards, personalized stationery, note paper and wrappings. Send for samples today. Howard P. Ellis, Dept. PM-4, Pitman, N. J.

AGENTS Make big money selling plastic tablecloths, U. S. patented plastic aprons, magic combination of purse and shopping bag. Also other items. Sells overnight. Samples free. Schneider Product Co., 83 Atlantic Ave., Revere, Mass.

NYLON Uniforms, immediate delivery immediate profits. Sell to doctors, dentists, nurses, waitresses, beauticians, housewives. Free sales kit. Superior Fabrics, Dept. P4, 3936 Market, Philadelphia 4, Penna.

LOOK Here! Wanted—Men and women to start in business on credit. Sell some 200 farm-home products. Thousands of dealers now make quick sales, big profits. For particulars write Rawleigh's, Dept. D-192-PPM, Freeport, Ill.

A DRESS For you with every 3 you order for yourself and family. Amazing new plan. Everything free. Harford Frocks, Dept. C-9128, Cincinnati, Ohio.

PLASTIC Tablecloth covers, curtains, drapes, baby pants, bowl covers and other plastic articles selling like wildfire! Make big money now! Free details. Write L & M Co., Dept. 58-D, 510 St. Charles, St. Louis, Mo.

MEN'S Outdoor wear. Year-round line. Terrific values. Big profits. Sure selling plan. Free catalog. Spruce Apparel, 4 West 33rd Street, New York 1, N. Y.

POCKET Pal: Replaces pocket knives. New, safe, beautiful. Always razor sharp. 50c seller. 321% profit. \$15.00 up dealer. Agents, salesmen, distributors. Sample elaborate sales kit 25c. Nelson Company, Moore Bldg., St. Paul 2, Minn.

NEW "Sponge" cleaning-cloth. Clean cars in jiffy. Lightning seller. Automobiles gleam like mirror. Samples sent on trial. Kristee 118, Akron, Ohio.

SELL New orchid everyday, birthday greeting cards. Big profits. Free particulars. Write Spooner Greetings, 115 Chauncy, Boston, Mass.

DIAMONTINR Rings sell themselves. Huge profits. Write Earles, Box 27-D, Flint, Michigan.

\$1.00 TO \$3.00 Profit every home with refrigerator, \$10.00 to \$30.00 daily. Really fast seller. Absolutely new, no competition. Blakesley, 3413A Lawnview, Corpus Christi, Texas.

BUY Thousands of nationally advertised products direct from manufacturers. Write for "Buy Direct and Save." Consumer Assn., 218-F Investment Bldg., Pittsburgh 22, Penna.

FREE Samples. Big profits showing amazing glow-in-the-dark specialties. House numbers, pictures, plastic novelties, religious and nursery objects, etc. Large manufacturer. Madison Mills, 303 Fourth Ave., New York 10, N. Y.

SUDSY Auto wash sells to service stations, auto dealers, fleet truck operators, etc. Quick selling highly profitable line. Several exclusive territories open. Six envelopes, each enough for one car wash and details for 9c in stamps. C. H. Berry Mfg. Co., 2509 So. 3rd St., St. Louis 4, Mo.

AMAZING New car wax gives sparkling showroom finish in minutes. 350% profit for producers who introduce this lightning seller. Rush name for free sample. Her sick, 1451-P North Cicero, Chicago 51, Ill.

**FREE Nylons given if Kendex hosiery runs or snags!** World's only women's hosiery sold with written guarantee amazing everybody. Mere words could not express unbelievable money-making opportunity. Fantastic earnings become reality. Armstrong earned \$202 in 9 days. Watkins sent 92 orders in one day. Imagine replacing hosiery free regardless of cause—whether use or abuse! Truly sales dynamite for terrific profits. Even if you never sold before, three magic words: "Guaranteed Against Everything" will open doors for you—make women listen and pour money in your pocket. Complete line from sheerest to service (15-20-30-40-60 denier) all lengths 28 to 35 inches—latest colors—seamed full fashioned and seamless. No competition because Kendex guaranteed nylons not sold in stores. Also complete line men's hosiery actually guaranteed for one full year! Nothing like this anywhere. Includes rayon, nylon, lisle, wool, cotton, mixtures, etc. All styles, patterns, colors, prices to please everybody. Thousands shipped daily. 100,000 pairs constantly in stock for fast delivery. Over 30 years in business. You need no money or experience. Nothing to pay now or later. Show free outfits. Write orders. We deliver and collect. Big advance cash plus huge bonus. Earn money spare or full time—exclusively or side line. No restrictions. Become manager—appoint others to sell for you—earn steady income on their sales. Complete money-making outfits including salesbooks in color, samples of hosiery materials, etc. furnished free and prepaid. Simply mail name and address to: Kendex Company, Babylon 43, N. Y.

**MAKE** More money selling personal initialed individualized belts, buckles, cap badges, western buckles, tie holders, name plates, 2000 emblems to choose. Big profits, whole or part time. Write today special outfit offer. Hook-Fast Specialties, Box 1425, Dept. 6, Providence, R. I.

**NEW** Products needed everywhere. Precision build Addomatic adding machine \$21.75. Jewelry crafted stainless steel tableware \$8.95. Unusual quality, big profits, repeats. Artcraft Specialty, Westmont, Illinois.

**ELIMINATES** Mudd. Window Wizard mechanically cleans glass surfaces in seconds. Quick profits. Sample \$1.00. Wizard Mfg. Co., 8529 E. Boyne St., Downey, Calif.

**SANITARY** Automatic toothpick dispenser for homes, restaurants, etc. Agents big commission. Write Sanipik Distributors, 601 So. Vermont, Los Angeles 5, Calif.

**POCKET** Plastic calendar cards and novelties. Write for particulars and samples. Webber Co., 2248 Belmont, Chicago, Ill.

**SKYROCKET** Your profits! Now! Just released! Modern Wonder Book of Knowledge. 52 books in one giant volume. Lavishly illustrated. Everybody prospect. Cash daily. Early birds' harvest. Hurry for details! Universal House, 1020-F Arch, Philadelphia, Penna.

**SEWING** Machine electrification kit. Nationally advertised. Has Good House-keeping Guaranty Seal. Can be demonstrated and sold in 5 minutes. Make at least \$5 per sale. For complete details write today to Brownell Distributors, Inc., Dept. PM, 308 Canal St., New York 13, N. Y.

**AGENTS** Make big money selling "Ear-Buds," the perfume earring sensation. New designs, particulars free. Minot, Inc., Box 77, Dorchester 22, Massachusetts.

**AGENTS**—Unbelievable, until you have tried this self selling foot bath powder. 98% people need it. 50% profits. Excellent repeater. Rush name for free sample. Saari, 1916 Sheffield, Chicago 14.

**GUARANTEED** Swiss watches, jewelry, \$2.95-\$20.00; collect advance commission; balance c.o.d. Brooklins, B-1975AD, Little Rock, Ark.

**\$4.00 AN** Hour selling KP (air flow) carburetor valves. Saves gas; improves performance. All motorists prospects. Guaranteed sample \$1.00. Details 1st class for stamp. Box 94, Englewood, Colorado.

**MUSIC** Greeting cards. All occasions. Dorby Music Cards, P.O. Box 738, Morristown, New Jersey.

**CONVINCE** Yourself how profitable it is selling revolutionary window advertising units to storekeepers. Send \$2.50 p.p. for trial kit and instructions, or c.o.d. plus charges. Duston Co., 55 E. Washington, Chicago, Ill.

**FAST** Profits selling In-Door Swings, \$2.95. Mothers love it. Turns doorway into indoor playground. No bolts, screws, nails. Write for information. Doorway Swings, 319 N. Robinson, Oklahoma City, Okla.

**I'LL Put a "shoe store business" in your pocket!** Nation's leader trains you to make big money! Fit men, women. Free sample outfit—Write today! Consolidated Shoe System, Dept. S-315, Chippewa Falls, Wis.

**CLEAN-O-WAX**—Sell the new product of our time. Cleans, polishes, waxes, one operation. Saves 50% labor. Retail \$1.00 will send two full size cans for \$1.00 with sales proposition. Charter Oak Company, 256 Cedar Blvd., Pittsburgh 16, Penna.

**EXCELLENT** Sideline, good profits with new, guaranteed product, tested by U.S. government. Absolute necessity for bakeries, restaurants, hotels, homes, farmers. Beats competition, steady repeater. Gart, 6118-P Laurel Hill, Woodside, N. Y.

**EARN** Big money year 'round. Be a one-person-department-store. Take orders for shirts, ties, hosiery, lingerie. Household linens, etc. For information, Corporative Merchandisers, Dept. PM-13, 547 Broadway, New York City 12.

**NEW!** Sell internally carved costume jewelry. Dept. D-35, Astoria Products, 631 3rd Ave., New York City.

**UP TO \$30.00** a day as sideline! Sensational new proposition for homes and businesses. Limited exclusive territories still available. Send 3c stamp to National Key Insurance Co., Room 900-14, 30 West Washington, Chicago, Ill.

**\$6.00 HOURLY** Showing Firestone Velon handbag—opens into large shopping bag. Fastest seller in America. Women buy several for gifts. Commissions advanced daily. Sample furnished. LeNard, 179-C, West Washington, Chicago 2.

**HOTTEST** 39c item on the market. Write National Sale & Service, Greenville, Penna.

**BE** Renewal headquarters for all magazines. Handle everything at home. Big profits. No experience. No capital needed. Free catalog tells how. Write McGregor Magazine Agency, Dept. 129, Mount Morris, Ill.

**AMAZING** New non-electrical burglar alarm for windows, or doors of homes, stores, offices, etc. Millions of prospects. Sells on sight. 100% profit. Easy sales. Tremendous opportunity. Retail at \$2.25. Write immediately. Robertson Company, 228 N. LaSalle, Chicago 1, Ill.

**FREE** Water and our concentrates, make flavors, lotions, shampoos, 125 products, labels, bottles supplied. Qualco, E20030 Russell, Detroit.

**BIG Money**—Fast! Sell quality plastic tablecloths (from \$4.00 dozen), curtains, aprons, etc. Factory prices. Free samples! Durever, 282-C Albany Ave., Brooklyn 13, N. Y.

**MEXICAN** Feather pictures. Unusual novelty. \$1.00 (stamps) brings \$2.00 worth samples, details. Refunded if unsatisfied. Aztec Art-P, Apartado 762, Mexico City.

**BOYS!** Earn big money and bonuses easy selling brass name plates for neighbor's doors. Write Hubstamp, 357-A Congress, Boston, Mass.

**AGENTS:** Stamping names on pocket-key protectors. Sample check with your name, address, 25c. Stamping outfits, Emblem checks, check-fobs, name plates. Hart Mfg. Co., 303 Degraw St., Brooklyn, N. Y.

**PHOTO**—Salesmen-agents. Sell beautiful hand-colored plastic enlargements. Collect deposit, we deliver. Profitable sideline. Send card, for free sample kit. Novel Portrait Co., 3343 North Ave., Chicago, Ill.

**INFORMATION**—Wholesale supply sources. Moneymaking plans. Increase your income! Write Reynard Service, Smithfield 3, Ohio.

**SELL** By mail books, novelties, bargains! Ready made circular service! Large profits! Catalog free! Elfco, 432 North Wells, Chicago 10.

**SCHOOL** Seniors—Earn 40% commission selling classmates America's most beautiful graduation name cards. Largest selection. Out-sells all others. Free sample kit. Printercraft, Dept. M, 1425 E. Elm St., Scranton 5, Penna.

**BIG** Money selling cast iron and aluminum cooking utensils direct to consumer, exclusive designs. Free illustrations. Jones Machine & Foundry Co., Chattanooga 2, Tenn.

**MAGIC** Cleaner—Laundry soap deal. Hotter than a firecracker. Big profits. Sample free. Bestco, 4642 No. Central, Chicago.

**GOLD** Lacquered window sign letters. Large sizes penny each. New foils. Absolutely beautiful. Free samples. Atlas, 544 W. 79th, Chicago 20.

**EXCELLENT** Sideline for printing and advertising salesmen. Decalomania name plates in small quantities. Great demand. Also, make money with our line of automobile initials and sign letters. Free samples. "Ralco" XL-Roxbury, Boston 19, Mass.

**AGENTS**—300% Profit selling genuine gold window letters; stores and offices. Free samples. Metallic Letter Co., 438-B North Clark, Chicago.

### HIGH-GRADE SALESMEN

**SELL** Ultra-blue stock signs to stores. 1000 slogans, comedy, general, religious. "7x11" cost 6c, sells 35c. Make money. 15 samples ultra-blue signs "7x11" \$1.00 postpaid. Lowy, 8 West Broadway, Dept. 458, New York City 70.

**ADVERTISING** Book matches—Cash in on big demand; sell union label matches. Cuts for all businesses and political parties. Free powerhouse selling kit, low prices, protection guaranteed on repeat orders. Cash commissions. Superior Match Co., Dept. M-39, 7530 Greenwood, Chicago.

**SALESMEN**, 100% Profits selling fine aged imported briar pipes. Free details. Union Distributing Company, 210 5th Ave., Suite 1102, New York City 10.

**SALESMEN**, Earn \$100 weekly, selling only six pair shoes daily. Commission and bonus. Wide variety for men, women, children. No investment. Experience unnecessary. Tanners Shoes, 410, Boston, Mass.

**BIG** Money selling fluorescent lighting fixtures for manufacturer in your territory. Complete line. Latest designs. Low prices. Free outfit. National Lighting, PM, 4221 Harrison, Chicago.

**SALESMEN** Earn \$100 per week up calling on stores and individuals. Selling ventilating equipment. Everyone a prospect. Write for free 30 page catalog and plans. No investment required. Appliance Distributing Company, 163 Walton St., Atlanta, Ga. Dept. M8.

**FANS**, Fans—Salesmen making \$50 to \$100 per day selling our electric fans, sump pumps and printed self sticking advertising tape. Write to Universal Fan Co., Inc., Peru, Indiana.

**SALESMEN**—Put yourself in line for big money, real future. Keep stores supplied with 5c-10c to 1c counter goods. Nationally advertised merchandise. Top profits for you, merchants. Liberal deals boost sales. Sideline or full time. World's Products, Dept. 10-R, Spencer, Ind.

**TREMENDOUS** Earnings showing revolutionary new business need. Business and professional men buy on sight. Free facts. Slocumb's Service, 215 Clisby Place, Macon 3, Georgia.

**SENSATIONAL** Commissions selling 15 color sport shirts, pajamas, nylon lingerie. Free portfolio. Jarod Manufacturing Corporation, Rockville Centre 1, New York.

**EARN** Big money fast! Sell finest-quality advertising work uniforms to garages, factories, filling stations, etc. Free selling kit. Topps, Dept. PM-449, Rochester, Ind.

**MAKE** \$200 Weekly and over taking orders outstanding quality metallized baby shoes. Free starting outfit. Marson's Bronze Art, 1059 Lewis, Long Beach 13, Calif.

**STOP!** Want to make money all year round selling a complete line, uniform trousers, shirts, caps, ties, badges, 2000 emblems, personal initialed buckles, belts, and hundreds of other easy-to-sell items? Sales kit furnished. Please write today. Hook-Fast Company, Box 480PM, Roanoke, Va.

**"BAGS"** Cups, napkins, etc. Buy here cheap! Big profits selling from car or truck to grocers, restaurants. Wholesale catalogue. "American Paper Company," Washington 2-C, D. C.

**POPCORN** Machines, all electric units, peanut roasters, caramelpcorn, heating appliances. Northside Sales, Indianola, Iowa.

**NEW** Jobs open in selling! Send name, address for five free issues of Opportunity Magazine's money-making guide, listing hundreds of companies who'll pay you well, full or part-time. No experience needed. Opportunity, 28 E. Jackson, Dept. 17, Chicago 4, Ill.

**BIG** Money taking orders. Shirts, ties, sox, pants, jackets, sweaters, shoes, uniforms, etc. Sales equipment free. Experience unnecessary. Nimrod, 4922-AN Lincoln, Chicago.

## EDUCATIONAL AND INSTRUCTION

**LEARN Diesel mechanics for higher pay.** Actual shop training in our up to date Chicago shops. Approved for veterans and civilians. Established 1902. Free information. Greer Shop Training, Desk 10-C, 460 South State Street, Chicago 5, Illinois.

**MEDICAL Laboratory technicians in great demand.** We train you in your own home. Catalogue free. Imperial Technical Institute, Box 973-J, Austin, Texas.

**WIN A well-paid job in travel—step into a new world of glamorous opportunity!** Today more Americans are "going places" than ever before in history. As a result—the hotel and institutional field is surging ahead to new prosperity. Successful Lewis graduates are "making good" everywhere in luxurious hotels, fashionable resorts, smart restaurants, and clubs. Free book explains how to qualify at home for a well-paid position in this ever-growing business where you are not dropped because you are over 40—shows how you are registered free of extra cost in the Lewis National Placement Service. Course approved for veterans training. Write today. Room PD-395, Lewis Hotel Training School, Washington 7, D. C. (Now in its 33rd year.)

**LEARN Auctioneering by mail.** Twenty copyrighted lessons and recordings. Sample lesson sent free. Diploma. Nelson Auction School, Renville, Minn.

**"HOW To Break and Train Horses"—A book every farmer and horseman should have.** It is free, no obligation. Simply address, Beery School of Horsemanship, Dept. 1104, Pleasant Hill, Ohio.

**EXPORT!** Learn at home from established world trader. Big paying positions. Your own profitable world-wide business by mail order without capital; or travel abroad. Experience unnecessary. Free booklet. Mellinger, 104W, Los Angeles 24, Calif.

**BE A real estate broker through home study or classroom instruction.** Write for free book. Approved for veterans. Weaver School of Real Estate, 15 E. Pershing Rd., Box CP-4, Kansas City 8, Mo.

**PLY Trade for Christ.** Write Divine Word Missionary Brothers, Conesus, New York.

**USED Correspondence courses and educational books bought, sold, rented, catalogue free.** Educational Exchange, Summer-ville, Ga.

**EARN High wages.** Learn body and fender by actual work in our up to date Chicago shops. Approved for veterans and civilians. Established 1902. Free information. Greer Shop Training, Desk 10-C, 460 South State Street, Chicago 5, Illinois.

**NOW You can learn the slide rule under an experienced teacher.** Previous knowledge of mathematics not necessary. Satisfaction or refund. Tech. Teacher, P.O. Box 1195-C, Jacksonville, Florida.

**OIL Painting courses.** Simplified home study. Beginners, artists, seaside vacation pupils. Technocratic School of Color, Box PM, York Harbor, Maine.

**HOW To get what you want with a winning personality,** revealed in our easy home-study plan. Results first lesson. Write today for free lecture and full details. No obligation. Personal Psychology, Inc., 1003 Washington Bldg., Louisville 2, Ky.

**BIBLE Course free.** Write: Victory Service, Dept. 449PM, Emmaus, Penna.

**WANTED.** Art courses. International and other good used correspondence courses. Bought, Sold, Rented. Baker, 5509-B Winthrop, Chicago 40.

**DENTAL Technician's practice kit.** Artificial teeth, plastic, etc. Instructions included. Grant Laboratory, S-219 W. 7th, Los Angeles, Calif.

**LAW Home-study (LL.B. degree) on 150-lesson, three-year, college course.** First lesson, \$1.00. Osborne University, San Bernardino, California.

**ENGRAVING And designing.** \$1.00 starts you on first lesson. Renzelman, 510 Seybold Building, Miami 36, Florida.

**MAGICIANS School.** Licensed, first of its kind. Approved for veterans. Free particulars. Dept. ME449, Chavez College of Magic, 729 West Ninth Street, Los Angeles 15, California.

**MAKE Up to \$30-\$40 week as a trained practical nurse!** Learn quickly at home. Booklet free. Chicago School of Nursing, Dept. M-4, Chicago.

**PHOTOGRAPHIC Mind.** Amaze, earn, learn! Facts, figures, names stick like burrs with Supermemory. Write Thor Books, M4, Box 1210, Chicago.

**LEARN Spanish quickly, easily.** Simplified lessons. Details free. Personal Counseling, Box 1411, St. Petersburg, Fla.

**NOW You can have an office.** Many earn up to \$5,000-\$15,000 annually in the collection business. Learn by home study course, experience unnecessary. Write for free bulletin. No obligation. Franklin Credit School, Dept. 228-D, Roanoke 7, Virginia.

**ADVERTISING—You can shortcut experience with my practical advertising formulas.** There's big money in advertising. First lesson and information free. The Ad-Man, 817 17th St., Room 331, Denver 2, Colo.

**\$100.00 WEEKLY.** Servicing, repairing radiators. Home study, Radiatorman, Hayward, Wis.

**HOME Bible course.** Simple, helpful, instructive. Total cost \$4.00 includes textbooks, stationery, examinations, certificate. \$1.00 starts you, or simply request prospectus. The Bible Study School, 378 Van Houten Street, Paterson 1, N. J.

**BE A mathematical wizard.** Add columns instantly. Free details. Vanderdrift, 517 Lincoln Place, Orange 2, New Jersey.

**PIANO Tuning pays.** Learn this profitable profession at home. Our Tunometer and mechanical aids make learning easy. No knowledge music necessary. Diploma granted. Largest and oldest school—50th year. G.I. approved. Write for booklet. Niles Bryant School, 78 Bryant Bldg., Washington 16, D. C.

**INVESTIGATOR Training.** Phillips Secret Service, 1917B North Kenneth, Chicago 39, Illinois.

**BOOKKEEPERS!** Increase your earnings! Operate your own simplified "Dollar-A-Week" bookkeeping and tax service. Full or spare time. Details free. No obligation. Ellis, Box 200, Cedar Grove, North Carolina.

**SCIENCE Of memory simplified.** Free booklet "Memory Development." Memorology Club, 2016 Sunnyside Ave., Chicago 25, Ill.

**USED Correspondence courses and books bought, sold, rented and exchanged.** Catalogue free. Lee Mountain, Pisgah, Alabama.

**LEARN Photo-engraving at home or in oldest, largest school in America.** Work for newspaper or establish own profitable business. New Tasope Photo-Engraving equipment available soon. Write for information. Veterans ask about G.I. training. The Aurora School of Photo-Engraving, Tasope Bldg., Aurora, Mo.

**SECRET Investigation.** Experience unnecessary. Investigators particulars free. George Wagner, M 125 West 86th, New York.

**LINGUAPHONE Makes languages easy.** At home learn to speak Spanish, Portuguese, Italian, French, German, Russian, by quick, easy Linguaphone Conversational Method. Save time, work, money. Linguaphone correspondence courses are available to veterans under G.I. bill of rights. Send for free book. State if G.I. Linguaphone Institute, 83 RCA Bldg., New York, 20, N. Y.

## PLAYS, STORIES, MANUSCRIPTS

**I WANT New writers to cash checks offered daily.** The easiest way to write for pay. No previous experience necessary. Free details. Saunders M. Cummings, 468-11 Independence Bldg., Colorado Springs, Colo.

## BUSINESS SERVICE

**HOLLYWOOD Remail service, or what?** Everson, Box 133, Los Angeles 25, Calif.

**CHICAGO Mail address.** Receiving, forwarding. Strictly confidential. Send \$1 monthly. Faultless, P3439 Michigan, Chicago 16.

**FLORIDA Mailing address.** Letters received, forwarded. Three postcards 25c. Personal Counseling, Box 1411, St. Petersburg, Fla.

**INCORPORATE Your business,** free details. Tax Research Bureau, Inc., Delaware Trust Building, Wilmington, Delaware.

## SPECIAL SERVICES

**ADDRESSING.** Typing, sealing, stamping, folding, mailing, etc. Done quickly, neatly. Price list sent on request. Clark Letter Shop, 801 W. Fulton St., Grand Rapids 4, Michigan.

**REFRIGERATION Questions answered.** 25c per group. Warco, 2689W Coolidge, Oakland 1, Calif.

**WORKING And detail drawings made.** Engineering services. Send sketch or specifications for estimate. Engineer Associates, Dept. A, 155 Cobb Ave., Decatur, Ill.

**AUTHORS.** Attention! Do you have stories you would like a movie company to accept? If so, have them typed, send to me together with \$10 for each story. I will correct it, including any necessary re-typing, then send to any company whose address you give me. Russell C. Hempstead, 10 Lincoln St., Oxford, Mich.

**WE Receive, remail letters;** \$3.00 monthly or 25c each. "Hawkins," 1300 Taylor, Washington, D. C.

**TREASURES In your closet!** Do you have worthless bank books, insurance policies or stock certificates in some forgotten drawer? They may be worth a fortune! Let us investigate for you. Write today. National Evaluators, P.O. Box 5852, Cleveland 1, Ohio.

## INFORMATION

**FOREIGN Employment for you.** Excellent permanent job opportunities for U. S. citizens. Wages at least 20% higher, less taxation, lower living costs. Improved social position. Transportation and housing furnished. Choice of climate and location. South and Central America, Far East, China, Alaska, Australia, New Zealand, Africa. Send \$1.00 for copyrighted digest showing oil, shipping, construction, mining, etc., companies working and hiring. Includes sample application letter, advice on wages, tips, etc. World Wide Company, Dept. PM-4, Madison 1, Wisconsin.

**RELIABLE Information,** facts, figures about California. Housing, working conditions, etc. \$1.00. Glen E. Middagh, 2378 Sutter St., San Francisco, Calif.

## CARTOONING, COMMERCIAL ART, SHOWCARD WRITING, SIGN PAINTING

**BE A showcard writer.** Learn at home in three weeks. Uncrowded. Big money field. Makes sales very first week. Write. R. J. Meisner, 1539 Wisconsin Ave., Dept. 12, Flint 6, Michigan.

**ANIMATED Cartooning.** Prepare for television. \$2.00 is all you pay for complete course. Cartoonimator, 5029 Illinois N.W., Washington 11, D. C.

**COMIC Pen and ink sketch made from your photograph.** Picture returned unharmed. State hobby or pastime. Send photo and \$1 to Baker Allmond, R-2, Windsor, Virginia.

**"HOW To Make Money With Simple Cartoons"—a book everyone who likes to draw should have.** It is free; no obligation. Simply address Cartoonists' Exchange, Dept. 94-C, Pleasant Hill, Ohio.

**CHALK Talk booklet,** \$1; plus cartoon course, chalk, paper. Studio, Box 114, Carlton Hill, N. J.

**SIGN Painting taught at home.** Test lesson free. Ben Kerns, Box 812-T, Greenville, S. C.

**9 ALPHABET 3 Numeral pattern sets and catalog,** \$1.00. Sign Letter Distributors, P.O. Box 101, Mineola, N. Y.

**EARN Money evenings,** copying and duplicating comic cartoons for advertisers. Adservice, Argyle 1-B, Wisconsin.

**LEARN Professional lettering in one week** by amazing new mechanical process. Complete instruction manual. 300 designs \$1.25. Major-Art System, 3510-D Palmer, Chicago 47.

**DRAFTING And artists' material catalogue,** thousands of items, 25c (deductible first \$2 order). Draftsmen's, 187 Madison, Chicago.

**NEW Style home study course in advertising art now ready.** Free portfolio "Your Career in Art." Applied Art Studio, 1662 Lincoln Avenue, Cleveland 7, Ohio.

**CHALK Talks.** Laugh producing program. \$1.00. Catalog 10c. Balda The Cartoonist, Oshkosh, Wisconsin.

## ADVERTISING AGENCIES, LETTER WRITERS, FOR ADVERTISERS

**ATTENTION.** Advertisers, mail order men. Now available—Choice Canadian mailing lists. Dominion wide. \$5.00 per 2000. Satisfaction guaranteed. Robert Kirkwood, 377 Dundas West, Toronto, Ontario, Canada.

**TEXAS—24 Words,** 50 weeklies, \$3.75. Pennebaker Adv. Service, Box 141, San Marcos, Texas.

**MAILING Lists** guaranteed, fresh names \$5.00 per thousand. Gonzalez, Bradbury Building, Los Angeles 13, California.

**BETTER Letters** produce better business. Write for our guaranteed \$1.00 trial offer. Ace Service, 20 East Jackson, Chicago 4.

**INCREASE Your mail order sales.** Sell to the farm market. Let us show you what others are doing. Free information. Farm Journal, 201 Farm Journal Building, Philadelphia 5, Penna.

**ADVERTISERS!** Reach nearly 18,000,000 readers. 25 Sunday national key newspapers, 18 words, \$51.50. "Terrific pullers." 20 popular newspapers, \$10.00. "Free booklet." Special—One inch display 2-821,198 circulation, \$48.30. Newmark's Advertising Agency, (Established 1893), 217-7th Ave., New York 11.

**ADVERTISE:** 24 Words, 40 newspapers \$3.50. Lists free. Advertising Bureau, 10511-C Springfield, Chicago 43.

**24 WORDS** in 50 weeklies, \$4.96. J. Darnell, 730 Hays, Jackson, Tennessee.

**ADS** Placed in out of town newspapers and magazines. Low rates. Catalogue free. Ideas that pay. Baker Advertising Agency, Successors Ankrum Agency, 189 W. Madison, Chicago 2.

**MAILING Lists,** certified, productive, inexpensive, \$5.00 1000. Homeworkers, agents, buyers, etc. Write Dixie Service, King, N. C.

### RUBBER STAMPS AND OFFICE SUPPLIES

**3 LINES,** Cushioned, indexed, 55c. Pads 35c. Printright, Wauwatosa, Wis.

**RUBBER Stamps.** Send for catalog. Excello, Box 500, Shreveport, Louisiana.

**3 LINES,** 50c. 125 Letterheads, 125 envelopes printed, \$1.98. 1949 catalogue. Johnson Press, Box 6-A, New York City 26.

### TYPEWRITERS, DUPLICATORS, OFFICE DEVICES

**STANDARD Typewriters** \$17.50; duplicators \$12.50; adders \$12.50. Nationwide service. Typewriters, 118 Spruce, Wichita, Kansas.

**REVOLUTIONARY** New addressing machine works without plates. Only \$30.47 postpaid, complete with supplies. Satisfaction guaranteed. Free folder. Time Saver Co., Dept. PM-D, 542 S. Dearborn St., Chicago 5, Ill.

**SELL** Addressing machine \$24.50. No plates. No stencils. Exclusive territory available. Mail Addresser, San Marcos 5, Texas.

**PRINT-O-MATIC** Selffeeding post card stencil printing duplicator \$13.50. All office machines. Supplies. Bargains. Type-write for free literature. Pittsburgh Typewriter Supply, 336-7 Fourth Avenue, Pittsburgh 22, Penna.

**RECONDITIONED** Typewriters, mimeograph, multigraph printing devices, appliances, supplies. Catalog. Dixiegraph Service, King, N. Carolina.

### PRINTING, MULTIGRAPHING, MIMEOGRAPHING, GUMMED LABELS

**BUSINESS,** Personal stationery, state requirements. Samples. Herbert Hudson, Centredale, R. I.

**PRINTING—\$1.00** Up. Professionally designed modern arrangements. Special types, rule, etc. M. R. Taylor, 262 E. 4th St., New York City 9.

**500 SHIPPING Labels** 2 1/4 x 2 3/4. \$1.25, 2 x 3 two color \$2.25. Myers Company, 1228 Adams, Owosso 1, Michigan.

**LOW Cost** business stationery. Samples. Crow, 533 18th St., Huntington 3, W. Va.

**BUSINESS,** Personal stationery. State requirements. Samples. Mero Products, 100 Morrison, Punxsutawney, Penna.

**PERSONAL** Postals. Handy, economical. Sample. Printing, Box 262, Easton, Penna.

**ADVERTISING** Postcard specialist! "Anything printed." Foster's, Box 2408, Oklahoma City 8, Okla.

**MIMEOGRAPHING** Experts. Samples free. Martin Mimeographing, 3212 Harper, Saint Louis, Missouri.

**1000 BUSINESS Cards** \$2.50 prepaid, samples free. Reliable Print Shop, 905 East Jefferson, Louisville 6, Ky.

**10 DUPLICATE Pads** (1,000 sheets) \$2.95—4"x7", your specifications. Smalley, 32 Wyoming, Tunkhannock, Penna.

**400 8 1/2 x 5 1/2 LETTERHEADS** \$1.35. Mango, 555-A South 20th, Newark 3, N.J.

**WATERMARKED Bond—5 1/2 x 8 1/2** statements, letterheads or invoices, 1000—\$3.75; 5000—\$10.00. Business cards, 1000—\$2.25. 25 years experience. Peters Associates, Troy, Ohio.

**MIMEOGRAPHING** 100 8 1/2 x 11 \$1.10. Additional hundreds 50c. Mimeographing, Madison, Tenn.

**BETTER Printing** at reasonable prices. Send requirements. Free samples sent upon request. Mills Burnham, Highland, No. Abington, Massachusetts.

**5000 6 x 9 CIRCULARS** \$16.00 Postpaid. Samples free. Journal Printing Co., Newark, Ark.

**SAVE Money** on your printing. Write today for new, low price list and offset ordering chart PM-1 free. We photograph your copy and reproduce it on white or colored paper. Advertisers Service Litho, 161 W. Harrison, Chicago 5, Illinois.

**SEND 10c** Now, for our 48 page 1949 price list—refunded first order. McCalk Press, 1326 South 27th, Omaha, Nebraska.

**500 3/4 x 2 1/4 FOUR Line** gummed stickers 35c; red border 50c. Moritz Printery, Saginaw, Mich.

**QUALITY Printing—Reasonable prices.** Fast service on catalogs, folders, publications. Write for prices. Bagby Printing Co., Georgetown, Ohio.

**MIMEOGRAPHING—Letters, pricelists, formulas, instructions.** Lowest prices. Lem's Letter Shop, 5710 Stanton, Detroit 8.

### PRINTING OUTFITS AND SUPPLIES

**PRINTING Presses, type, supplies.** Details free. Kelsey Presses, K-11, Meriden, Conn.

**MAKE Your own plastic printing cuts.** New Plexiplate Process. Plexiservice, Argyle 1, Wisconsin.

**HEMOCRAFT Presses, supplies.** Catalog 10c, refundable. Riegel, 1111 Harrison, Philadelphia 24, Penna.

**PRINTING Presses, type, supplies.** Lists 3c. Turnbaugh Service, Loysville, Penna.

**INEXPENSIVE** Home-made printing press. Details free. Novelty Shop, Downs-ville, Louisiana.

### PATENT ATTORNEYS

**INVENTORS—Patent laws** encourage the development of inventions. The Rules of Practice of the U. S. Patent Office advises—unless an inventor is familiar with such matters—that he employ a competent registered attorney or registered agent, as the value of patents depends largely upon the skillful preparation of the specifications and claims. Write for further particulars as to patent protection and procedure and "Invention Record" form at once. No obligation. McMorror, Berman & Davidson, Registered Patent Attorneys, 1345 Victor Building, Washington 1, D. C.

**INVENTORS—Learn how** to protect your invention. Unless the inventor is familiar with patent matters, he should engage a competent registered attorney or agent to represent him. We are registered to practise before the U. S. Patent Office and prepared to serve you in handling your patent matters. "Patent Guide for the Inventor" containing detailed information concerning patent protection and procedure with "Record of Invention" form will be forwarded to you upon request—without obligation. Clarence A. O'Brien & Harvey Jacobson, Registered Patent Attorneys, 91B-D District National Building, Washington, D. C.

**INVENTORS—If you consider** your invention to be something of importance, you may take steps to protect it with a U. S. patent which gives you the right to exclude others from making, using and selling your invention as claimed. "Patent Protection for Inventors" booklet outlining steps to take to secure patent protection will be mailed promptly without obligation. Victor J. Evans & Co., Merlin M. Evans, Registered Patent Attorney, 431-D Merlin Building, Washington 6, D. C.

**PATENTS, Trademarks, health registrations** in Mexico and Latin America. Free particulars immediately. International Patent Bureau, Mexico, D.F., Apartado 10727.

**CANADA—Ramsay Company** Registered, 273 Bank Street, Ottawa, Canada.

**PATENTS—Trade marks.** Gustave Miller, Registered Patent Attorney, 49-A Warner Building, Washington 4, D. C. Patent Lawyer.

**PATENTS, Trade marks.** Sanders, 6430 Evans, Chicago. Registered U. S. Patent Office.

**PATENTS, "Proof of Invention"** folder mailed without obligation. E. E. Vrooman, Registered Patent Attorney, 505 McKim Building, Washington 5, D. C.

**INVENTORS:** When you are satisfied that you have invented something of value write me, without obligation, for information as to what steps you should take to secure a patent. Write Patrick D. Beavers (Formerly Randolph & Beavers) Registered Patent Atty., 935 Columbian Bldg., Washington 1, D. C.

**C. A. SNOW & Co.—M-427,** Snow Building, Washington 1, D. C. Registered Patent Attorneys. Write for information.

**PATENTS—Trace marks.** Irving L. McCathran, 315 McLachlen Bldg., Washington 1, D. C. Registered Patent Attorney.

**INVENTORS:** For "Record of Invention" form, contact Carl Miller, Registered Patent Attorney, Woolworth Building, New York.

**INVENTORS:** Without obligation, write for information explaining the steps you should take to secure a patent. John N. Randolph, Registered Patent Attorney, 203 Columbian Bldg., Washington 1, D. C.

**"INVENTOR'S Guide"** free on request. Frank Lederimann, Registered Patent Attorney, 154 Nassau St., New York 7, N. Y.

**INVENTORS:** Write for free brochure "Evidence of Invention." Labiner, World Building, New York 7.

**PATENT Practice** before U. S. Patent Office. Validity and infringement investigations and opinions. Booklet and form "Evidence of Conception" forwarded upon request. Lancaster, Allwine & Rommel, Registered Patent Attorneys, Suite 411, 815-15th Street, N.W., Washington 5, D. C.

### FOR INVENTORS

**INVENTORS:** Learn how to protect your invention. Unless the inventor is familiar with patent matters, he should engage a competent registered patent attorney or agent to represent him. We are registered to practise before the U. S. Patent Office and prepared to serve you in handling your patent matters. "Patent Guide for the Inventor" containing detailed information concerning patent protection and procedure with "Record of Invention" form will be forwarded to you upon request—without obligation. Clarence A. O'Brien & Harvey Jacobson, Registered Patent Attorneys, 91A-D District National Building, Washington, D. C.

**FINANCIAL Aid** for invention development. TNB, Box 1434, Amarillo, Texas.

**CASH** For your idea. 280 manufacturers need inventions, patented or unpatented. List free. Invention Bureau, 208M Clinton, Oak Park, Illinois.

**INVENTORS—Patent laws** encourage the development of inventions. The Rules of Practice of the U. S. Patent Office advises—unless an inventor is familiar with such matters—that he employ a competent registered attorney or registered agent, as the value of patents depends largely upon the skillful preparation of the specifications and claims. Write for further particulars as to patent protection and procedure and "Invention Record" form at once. No obligation. McMorror, Berman & Davidson, Registered Patent Attorneys, 1344 Victor Building, Washington 1, D. C.

**INVENTORS—This firm** is registered to practise before the U. S. Patent Office and is available to assist inventors in the preparation and prosecution of their cases. "Patent Protection for Inventors" booklet containing detailed information and steps to take toward patent protection will be sent upon request. No obligation. Victor J. Evans & Co., 432-D Merlin Building, Washington 6, D. C.

**AMATEUR Inventors.** Your ideas may make your fortune. Suggestions to help capitalize on them \$1.00. Stevens, S & S, Loma, Montana.

**PATENT Searches** \$5.00. Includes patent copies. 48 hour service. Free protection forms. Patent Service Institute, 945-A Pennsylvania Ave., Washington 4, D. C.

**DRAWINGS, Blueprints.** Send sketch for estimate. Hull, 7829 Euclid, Cleveland 3, Ohio.

**INVENTORS' Primer** answers every question. Only \$1.00 postpaid. Adam Fisher Co., 61 Enright, St. Louis 8, Mo.

**PATENT Searches** \$5.00. Reports air-mailed within 4 days. Invention protection forms free. Write Miss Ann Hastings, Patent Searcher, P.O. Box 176, Washington 4, D. C.

**PROMPT Patent office search.** Analysis your invention for technical, commercial merit. Both \$5.00. Invention protection forms free. Industrial Patent Reports. Box 1081, Massachusetts Ave. and North Capitol, Washington 13, D. C.

**PATENT Searches \$5.00.** Reports airmailed within 4 days. Invention protection forms free. Write Patent Research Engineering, 318 Evans Building, Washington 5, D. C.

**PATENT Searches \$5.00.** Reports airmailed within 4 days. Invention protection forms free. Write Raymond L. Smith, Patent Searcher, 410 Bond Building, Washington 5, D. C.

**INVENTORS.** For "Record of Invention" form, contact Carl Miller, Registered Patent Attorney, Woolworth Building, New York.

**INVENTORS—Possibly I can help you.** Many years experience. Charles A. Scott, 773PM Garson Avenue, Rochester 9, N. Y.

**PATENTED, Unpatented inventions promoted.** M. Joyce Humphries, 1424 Landtitle, Philadelphia 10, Penna.

**INVENTORS:** The usual first step is to have a search of the U. S. Patents conducted, so I can report on patentability. Write, without obligation, Patrick D. Beavers (Formerly Randolph & Beavers), Registered Patent Atty., 936 Columbian Bldg., Washington 1, D. C.

**INVENTORS:** If you have an invention for sale, patented or unpatented, write Institute of American Inventors, Dept. 40A, 1926 Eye St. N.W., Washington 6, D. C.

**"INVENTOR'S Guide"** free on request. Frank Ledermann, Registered Patent Attorney, 154 Nassau St., New York 7, N. Y.

**INVENTORS:** Without obligation, write for information explaining the steps you should take to secure a patent on your invention. John N. Randolph, Registered Patent Attorney, 202 Columbian Bldg., Washington 1, D. C.

### INVENTIONS WANTED

**CASH** For your idea. 280 manufacturers need inventions, patented or unpatented. List free. Invention Bureau, 208M Clinton, Oak Park, Illinois.

**PATENTS** Practical chain or dept. store items purchased outright or royalty. Charles Harris, 90 No. Washington St., Boston, Mass.

**PRODUCTS** Research foundation—Selects new products, ideas, inventions for exploitation. Is yours available? Write: Dep't. B, Box 2106, San Francisco 26, Calif.

**EARN** Up to \$2,000 year, inventing simple items. Special cash markets. Hendrickson, Argyle 1, Wisconsin.

**PATENTS** Wanted—Will buy outright or royalty. Roxy Co., 3312 Lincoln, Chicago 13, Illinois.

**THERE** Are 10,000 manufacturers in Chicago. I can assist you to sell your patent. Write Ingles, 15 W. Ontario, Chicago.

**INVENTIONS** Wanted. Patented or pending only. Inventors' Exchange-B, Hartford 1, Conn.

**HIGHEST** Royalties—Cash. Official U. S. I. R. C. certification. Request free Booklet "M". Universal Marketing Co., 354 South Spring St., Los Angeles 13, Calif.

**INVENTORS:** Hundreds of manufacturers have requested our assistance in locating marketable new products. Complete information, free. Institute of American Inventors, Dept. 40-D, 1926-Eye St. N.W., Washington 6, D. C.

### PATENTS FOR SALE

**NEW** Toy novelties or practical items wanted, royalty basis or bought outright. Gumpertz, 1 W. 30th Street, New York 1.

**OUTRIGHT** Or royalty. Electric vacuum automatic scrubber. H. Prillwitz, Waupaca, Wis.

**ANCHORING** Device for tools using wooden handles, especially hammers. Patent pending. Edward Pillschafske, 508 So. 7th St., Springfield, Ill.

**POR** Sale or royalty. Patented transmission shock absorber. Carl Gulbrandsen, 2985 N.W. 51 Terrace, Miami, Fla.

**GARAGE** Door holder, 2388490. Outright or royalty. J. E. Jimsey, Route 1, Houston, Arkansas.

**OUTRIGHT** Or royalty, sensational beam-compass, plastic or metal. G. F. Zumbuhl, 151 Brompton, San Francisco 12.

**PATENT** Pending. Electric shavers, A.C.-D.C. Snapon ammeter. Descriptive drawings. Wilfred Whitton, 40 Guam Road, Bldg. 81, San Francisco, Calif.

**INVENTORS:** Test the commercial value of your patented or unpatented inventions, quickly and inexpensively. Write for free information. Institute of American Inventors, Dept. 40-B, 1926-Eye St. N.W., Washington 6, D. C.

### MANUFACTURING

**SMALL** Lot manufacturing. Aluminum castings; stampings; screw machine; plastics; models. J and M Company, Burlington, Kentucky.

**MODELS**—Small lot manufacturing. Metals, plastics, etc. Milburn, Burlington, Kentucky.

**MODELS.** Tools, dies, experimental work; large and small lot manufacturing. Van-Ess Specialties Company, 212 W. 14th Street, Covington, Ky.

### MODELS, MODEL SUPPLIES

**LOCOMOTIVE.** Equipped for steam performance. Detailed miniature replica. All mechanical and boiler features. Engine size 18 $\frac{1}{2}$ " long. Tender, 10 $\frac{1}{4}$ " long. 2 and  $\frac{1}{8}$ " rail gauge. Hand built. Not built from kit. Buchanan, 229 West Chestnut, Kingston, New York.

**DOWMETAL** Magnesium for all model makers. Rod, bar, sheet and scale structural shapes. The Craftsmiths, 15427 Robson, Detroit 27, Michigan.

**RAILROADERS**—50c Gets 1949 catalog reference manual. State O or HO gauge. Walthers, 247 Erie, Milwaukee 2, Wis.

**STEAM** Marine engines, 2 cylinder V-type precision machined. Bronze construction, with built in speed control. Free literature. Model Marine Engine Wks., Box 326, Evanston, Ill.

**BRASS** Gears and model supplies for the inventors. Send 10c for catalog. Pierce Model Works, Tinley Park, Ill.

**BUILD** Historic ship models, complete kits 39c to \$9.00. Catalog 10c. Ideal Models, 19 West 18th, New York 11, N. Y.

**SHIP** Models—Kits, fittings, plans, books, engines. Illustrated catalog 25c. James Bliss & Co., Inc., 220 State Street, Boston, Mass.

**SHIP** And yacht model fittings; blueprints. Send 25c for illustrated catalog No. 21—listing hundreds of items. A. J. Fisher, 1002-1 Etowah Ave., Royal Oak, Mich.

**MINIATURE** Steam locomotives,  $\frac{1}{4}$ ",  $\frac{1}{8}$ ",  $\frac{3}{16}$ " scales. Castings, parts, rail, steam fittings! Thorough drawings with instructions. Catalog 25c. Little Engines, Wilmington, Calif.

**SHIP** Models and yacht supplies complete. Large 64 page catalogue 30c. Bill Wild's, 510 East 11 St., New York City 9.

**LANDLOCKED** Sailors! Here's a beautiful, richly illustrated, fully descriptive catalogue of famous model ships—whalers, slavers, corvettes, etc., authentic in every detail. Send for it today. Only 25c. Halesite Yacht Service, Inc., Halesite, Huntington, N. Y.

### HOME CRAFTSMEN

**CELLULOID**—New, beautiful selection. Mottles, opaques, onyx, pearls. Used by ring makers everywhere. One pound assortment pieces approximately 30 sq. in. each. Price \$1.00. Please add 10c for postage. Craft Service, 337 University Avenue, Rochester 7, New York.

**90 ALL** New, full size lawn ornament and novelty patterns, up to 20" high. Only \$1.00. Mastercraft 4M2, 7041 Olcott, Chicago 31, Illinois.

**"KLONDIKE"** Jewelry findings—Bracelets, pins, earrings, chains, rings, stones, clips and other jewelry parts. Sample pound \$2.00, five pounds \$7.50. Imported cut stones; for rings, jewelry, novelties, etc. All shapes, colors, sizes. Sample 100 stones assorted, \$1.50 lot. Thousand lots \$5.00. Imported beads, all colors, sizes, sample pound \$1.00, five-pound lots, \$4.00. Prepaid only. Merchandise Distributing, Dept. 1, 19 E. 16th Street, New York 3.

**NEW** 1949 illustrated catalogue. 84 pages showing thousands of items for the leather crafter. Leathers, copper, tools, supplies, designs, patterns, books, and ready cut projects. Send 10c today to cover handling charges. Russo Handicraft Supplies, 245 South Spring Street, Dept. PM4, Los Angeles, California.

**LAWN** Ornaments. Ready cut patterns, full size. 20 assorted \$1.00 postpaid. Lincoln Craft Studio, Farmington, Conn.

**BEAUTIFUL** 9 x 12 Inlay picture kit, ready for assembly, complete with cement, frame etc. \$2.50. Veneer cement, no press needed, \$1.50 pint. Woodcraft, 1024 17th Street, Denver, Colorado.

**LEATHERCRAFT.** Monthly price list guarantees best prices. Catalog free upon request. Tandy Leather Company, Dept. PM-49, P.O. Box 397, Tulsa 1, Oklahoma.

**CHILDRENS** Outdoor playthings—Full size patterns. Complete instructions, 9 foot high, two swings, trapeze and ladder. 50c coin. Wood Products, Grundy Center, Iowa.

**EMBOSS** Pure tin foil, the easy metal to rise. Looks like silver. Beautiful artistic decorative. Two polished faces. For sale to any place of U.S.A. and Latin-America. Prices and sizes on request. John Pascual, San Leonardo 82, Habana, Cuba.

**HANDY** Small parts cabinet. Free folder. Metalart Co., Box 261, Lawndale, California.

**HOME** Bars. 25 designs built-in, portable, cellarettes, \$1.00. Craftplans, 7241-P Madison, Kansas City, Mo.

**SAVE** Thousands building your own home. Practical 47-lesson home-study course explains home-building A to Z. Includes plans and specifications for 6-room house. Others using with great success. Big 22-page book sent free. Commercial Trades Institute, Dept. DC2-5, 1400 Greenleaf Ave., Chicago 26, Ill.

**YARD-PORCH** Chair project. Parts ready for assembly. Also cabinet lumber and veneer deals. Sedlo Company, P.O. Box 7161, New Orleans, La.

**FREE** Catalog. Complete line of supplies. Lucite, plexiglas, shells and jewelry findings. Plastic Land, 1210 Spruce Street, Philadelphia, Pennsylvania.

**CORNER** China cabinets. Patterns, instructions for three designs. \$2.00. Woodcraft Products, Waterloo, Indiana.

**CRAFT** Supplies—Leather, metal, plastics, tools, free catalog. Kale Crafts, 2250 Milwaukee, Chicago 47, Illinois.

**MAKE** Lovely lamps from wood, big profits, 5 plans dollar. Childers Woodcraft, Dublin, Texas.

**LUMBER** Cut to order. Oak, cedar, walnut. Samples six kinds woods \$1.00. Jason Lyon, 368 E. Rock St., Harrisonburg, Va.

**"PACKAGED** Projects" for the home craftsman. 40 projects in kit form. Send \$1.00 for catalog plus booklet, "Woodworking Fundamentals." Marine Mart, Buffalo 7-X, New York.

**CATALOG:** Booklet, hobbycraft hints 10c. Leisure Hour Products, 416 Rose, West Hazleton 2, Penna.

**LEATHERCRAFTERS:** Free! 3 sheets new designs with latest catalog. Enclose 25c handling charge. Leather Specialties, 358 E. Broadway, Long Beach 2, California.

**MONEY** Making toy rubber band guns, prints \$1.00. Lightfoot, 912 South Veitch, Arlington, Va.

**JEWELRY** Findings, rhinestones, pearls, sequins, cameos. J & M Novelties, Box 464P, Griffith, Ind.

**SPECIAL** 77 Full sized patterns. Lawn ornaments, toys and novelties \$1.00. Modern Woodcrafts, Saginaw, Michigan.

**TROPICAL** Wood for sculpturing and carving. Lignum-vitae, Buttonwood, Madiera, etc. For information write B. Lurie, Box 892, Coral Gables, Fla.

**SHELLS,** Plastics, findings. Lowest prices. Free catalog. Frances Jones, Box 251, Sarasota, Fla.

**TURN** Your workshop into cash. Send postcard for catalog of modern saleable projects. Craftplans, 7241-P Madison, Kansas City 5, Mo.

**SCRAP** Leather, assorted colors. Six pounds for \$1.00 prepaid. Box 397, Tulsa, Oklahoma.

**LEATHERCRAFT** Lacing, bargains! Francis Byrd, 3406 Montrose Ave., Richmond, Virginia.

**LEATHERCRAFTERS:** Belt kits, projects, leather, supplies. Free catalog. Art Leather, 411 Joseph Ave., Rochester 5, N.Y.

**BANDSAW,** Jigsaw owners, let your machine bring extra profits, fun. Free details. Nu-Art, 33 Rosemont, Weymouth 91, Massachusetts.

**MAKE** Your own jewelry! All types of findings, metal and plastic; cameos, beads, shell kits, illustrated catalog, 20c. Hobby Art, P.O.B. 276, Dept. 7, New York 18, N. Y.

**50 PATTERNS** Toy furniture, action toys, etc. \$1.00. Continental Homecrafters, 907 Birch, Eau Claire 3, Wisconsin.

**CATALOG:** Patterns plywood novelty furniture, lawn ornaments, letters, numerals, plaques, frames, silhouettes, weathervanes, toys. Decal transfers. Over 100 other items. 200 articles illustrated. 25c, refunded first order. (No stamps please). Wo-Met Shop, Box 167, Ashburn, Georgia.

**LEATHER,** Retail, mail orders, catalog, tools, lacing, supplies. National Handicraft Co., 30 Frankfort St., New York City 7.

**KNOCKDOWN** Cedar chests. Lumber and veneers. Free price list. Giles & Kendall Company, Huntsville, Ala.

**LEATHERCRAFT!** Complete stocks of leathers, tools, supplies. Immediate shipment. Free catalog. Kit Kraft, 3203 W. Washington Blvd., Los Angeles 16, California.

**COPPER** And brass materials. Complete line for craftsmen and workshops. Catalog A free. Groundmaster Company, Boulder, Colorado.

**SPECIAL Offer:** 80 full size toy, novelty, and lawn ornament patterns only \$1.00 postpaid. Lynds, Box 193D, Medway, Mass.

### MAKE IT YOURSELF

**GARDEN Tractor**—Efficient, inexpensive. No auto-parts or machining. Plans \$3.50. C.O.D.'s encouraged. Satisfaction assured. Clearprint Plans (independent), Box 265-J, Muskegon, Michigan.

**MAKE Flint** arrow heads Indian method. How \$1.00. Colloro, 1610-B Rocker, Everett, Wash.

**DIVING Helmet** built from scrap materials. Easy to build. Plans and instructions \$1.00. Rehe, 401 E. 71st St., Chicago 19, Illinois.

**BUILD Your own garden tractor.** Save at least one-half. We supply every part. Partly assembled, easy to finish and paint. 2½ h.p. Clinton engine. Every part positively brand new. Exactly same as we furnished large manufacturer, who sold many hundreds. Money refunded if not as represented. Price \$140.00 f.o.b. Benton, Penna. One-half with order, balance c.o.d. Red Rock Machine Company, Benton 2, Penna.

**DESCRIPTIVE Plans** of easy blueprints for home owners, farmers, 25c. Details free. Dealers wanted. Edman, Box 307T, New York 19.

**AMAZING Home air conditioning unit.** Easy to construct, inexpensive, guaranteed efficient. Complete plans \$1.00. Ever-Cool Electric Co., Box 167, Rocky Ford, Colorado.

**BALL Bearing arbors, pillow blocks, other tools, free catalog, return mail.** Hawthorne Tool Co., Otsego, Michigan.

**FLUORESCENT Circline fixture.** We supply all parts, G. E. bulb, complete instructions for assembly and installation. \$6.75 postpaid. B. Herman, 125 E. 168, New York 52, N. Y.

**GRANDFATHER Clock** easily built. Big savings. See ad on page 276.

**"CONCRETE Block Homes."** 32 page booklet on how to build. \$1.00. H. C. Lightfoot, Civil Engineer, Richboro 1, Penna.

**BUILD Concrete blockmaker.** Inexpensive. Practical. Vibrator or hand. Write. Clyde Lee, Mountain View—A, Oklahoma.

**MAKE Your own handy lightweight concrete blocks** quickly with new blockmaker. Circular stamp. Manual 25c. Peerless, New Lenox, Illinois.

**BUILD Your own light or heavy duty garden tractor** Send postcard for free information on plans, easy instructions. Ellsworth Tractor Co., Dept. A, Camp-tonville, California.

**SOLAR Water heater systems** efficient any locality. Standard materials, low cost and easily built. Free facts. Solar Water Company, Box 175, Coral Gables, Florida.

### PLANS AND BLUEPRINTS

**IMPROVEMENT** For your septic tank. Patented system, dispels odors, use less drain-field. Specifications and drawings by registered professional engineer. \$2.00. De Haviland, Mundelein, Illinois.

**BUILD Quickchange gear box** without castings for \$10.00. Craftsman, Atlas, adaptable other lathes. Complete drawings \$4.50. Stevens, 2604 Military, Los Angeles 34.

### WATCHES, OLD GOLD, JEWELRY

**WATCHMAKERS' Journal** contains helpful hints on watch repairing. New improved issue 20c copy. Dean Co., 116-K Nassau St., New York 7, N. Y.

**WATCHES Wholesale**—\$14.50 up. Men's chronograph 17J—\$23.50. Free catalog. Nu-Designs, Kalamazoo 26, Mich.

**DIAMOND**—A man's stylish 14K gold setting is studied with scintillating diamond of approx. ½ carat. Banner value at \$200.00. The Roundtree Agency, 529 Elliott St., River Rouge, Mich.

**MONEY**—Highest cash paid for old jewelry. Any condition. Satisfaction guaranteed. Free information. International Metals, 4954 North Christiana, Chicago 25, Ill.

**STUN Your friends** with genuine, sparkling, brilliant-white zircons. Cut, polished, mounted just like diamonds. Amazing diamond-like appearance. Top-quality. Hard for even experts to tell the difference. Beautiful settings 14K gold. Over 100 gorgeous latest-style rings to choose from. Attractive low prices. Send for big free catalog. U. S. Zircon Syndicate, 139 N. Clark, Dept. 34, Chicago 2.

**WHOLESALE Watch repairing.** Request price list. Vaughn and Therrell, 1734 Main St., Columbia, South Carolina.

**HIGHEST Prices** paid for old gold, silver, platinum, diamonds, watches, gold teeth, old jewelry. Send now. Cash immediately. Goods returned if offer is not satisfactory. United Smelting Works, (The Old Reliable), 39-B South State, Chicago 3.

**GEMS, Precious and semi-precious,** all genuine, from world wide sources. Deal direct, no overhead, save money. Catalog 10c. Hill Co., Route 7, Salem, Oregon.

**HIGHEST Cash** for old, broken jewelry. Mail gold teeth, watches, rings, silverware, diamonds, spectacles. Satisfaction guaranteed. Free information. Rose Smelting Co., 29-A East Madison, Chicago.

### TOBACCO, SMOKERS' SUPPLIES

**PIPES Semifinished**—Finest imported briar, \$1.25. Merely sand, polish. Car-nauba wax, briar blocks, stems, bands, factory rejects. Free literature. Carva-pipe, 2829-G Dixie, Hamilton, Ohio.

**CIGARETTES**—Popular brands \$1.50 per carton postpaid. West of Mississippi add 8c per carton. Min. order 3 cartons. Send check or money order. King Co., Box 569D, Dover, Del.

**CIGARETTES** \$1.50 Carton postpaid, \$1.53, 5th zone up. Cigarette Sales, 1122 E. 31st, Kansas City, Mo.

### SURVEYING INSTRUMENTS

**GUARANTEED Factory rebuilt** transits and levels, sale, or rent, with purchase option. We will repair, trade or buy old instruments. Write for list M-49. Warren-Knight Co. (Manufacturers of Surveying Instruments), 136 North 12th St., Philadelphia 7, Penna.

### RAZORS, BLADES, SHARPENING

**100 QUALITY Double edge** razor blades \$1. Sensational savings! Sweeney, 6906 66th Place, Brooklyn 27, New York.

**100 SURGICAL Steel blades** for Gillette razors, \$1. Tomkins Brothers, 106 Fulton Street, New York 7, New York.

**100 NEW Razor blades, free gift, \$1.** Weiss, 3518 32nd Street, Union City, New Jersey.

**FREE Ball point pen** with each purchase of 100 super fine double-edged blue blades. \$1 complete! Post-paid. Money back guarantee. Berco Co., 246 5th Ave., New York 1, N. Y.

### FOR THE HOME

**WALLPAPER Removed** easily with new penetrating solution. Send \$1.00 for enough to make five gallons. P. McGuinn, Box 48, Oak Park, Ill.

### FOR SALE—MISCELLANEOUS

**TENTS, War surplus,** all sizes; cots, hammocks, camping equipment, canvas covers. Circular. Morsan, 10-19E 50th Avenue, Long Island City 1, New York.

**BARGAINS Galore**—Power lawn mowers, shop equipment, machinery, hand tools, million other surplus items. Atlas Equipment, 229B Southwest Blvd., Kansas City, Mo.

**PAINT**—House and barn paint for wagon jobbers, auctioneers and house to house men. White, gray, red, \$1.25 gallon; extra bright aluminum paint, \$1.45 gallon, all in 5-gallon cans. Gallon cans 10c higher. Will repeat. Chance to make big money. Mail check or money order for immediate shipment. Trading Post, 2104 Burlington, North Kansas City 16, Mo.

**WHIPPED Cream dispenser;** pint makes ½-gallon, for sundaes, \$17.50. Literature free. Domonkos, 98-A4 Vermont, Newark 6, N. J.

### WANTED—MISCELLANEOUS

**WE Have cash buyers and swappers** everywhere for anything. Big list 25c. Free details. Swappers' Guide, Box 415, Evansville, Indiana.

**ANYTHING Of value.** Robert, 207 North 5th Street, Springfield, Illinois.

**QUICKSILVER (Mercury)** urgently needed! Immediate payment. Wholesale Terminal, Norwood, Massachusetts.

### PERSONAL

**RECEIVE "Interesting Mails"**—25c keeps your name on mailing list for six months. Bentz, Jr., Chatawa 27, Mississippi.

**HAIR Falling?** Dandruff? Write. Elson, 137 Lewis St., Phillipsburg, N. J.

**BORROW By mail.** Loans \$50.00 to \$300.00 to employed men and women. Easy, quick. Completely private, confidential. No endorsers. Repay in convenient monthly payments. Details free in plain envelope. Write State Finance Co., 216 Savings & Loan Bldg., Dept. S-14K, Des Moines 8, Iowa.

**CIGARETTES.** Postcard brings confidential prices. Magills', Drawer 430-PM, Springfield, Missouri.

**SHAVING Miracle discovery!** Save about 9/10th of every shaving dollar for life, buy nothing, or double your dollar covering printing cost, back. Mr. Shay, 1132 West Kensington Road, Los Angeles 26, California.

**MEXICAN Mailing service.** Letters received, forwarded 20c. Photographic postcards 15c. Remailed free. Remit stamps, Tillotson, Apartado 1405, Guadalajara, Jalisco, Mexico.

**DANDRUFF? Dry, thinning hair?** Postcard brings authentic booklet. Regime Products, 9-P South Clinton, Chicago 6.

**MEXICAN Law.** General Practice Attorney, 1203 Arizona Street, El Paso, Texas.

**RONSON, Evans, Thorens, Packard** and all cigarette lighters repaired, refinished. Guaranteed service. Master Silverplaters, 2158 Gratiot, Detroit 7, Michigan.

**HOW You can find out!** Information discreetly developed, any matter, person, problem, anywhere. Personal-business assignments, representations undertaken. Nation-wide. Officially licensed, bonded service established 1922. Reasonable. Confidential. William Herman, 170 Broadway, New York.

### MISCELLANEOUS

**YOUR 20 Word inscription** expertly engraved on brass trophy plaque, 3" x 5", bowling, hunting, memorial, etc. \$2.00 postpaid. H. V. Ackerman, Malden on Hudson, N. Y.

**COLORED Glass tinsel,** light reflecting crystals and luminous powdered pigments. Combination trial offer and listing. \$1.00 prepaid. Glowelco, 475-MP Fifth Ave., New York 17.

**BIRD Baths, pots, urns, benches, pipe,** made at home! We sell forms. Concrete Machinery, Hickory 4, N. C.

**FOREIGN Travel stickers** for your luggage. 10 different interesting European hotel stickers \$1.00, 25 including South America \$2.00 or 60 different including air and steamship lines \$5.00. Juan Brodaty, Arenales 1947, Buenos Aires, Argentina.

**CARICATURES, 8 x 10, Professional.** Send photo or snapshot. Only \$2.00. Prompt return. Box 741, Rochester 4, New York.

**MAILING Lists** wanted. All types needed. Full coverage of America. State offers and prices in first contact. Any number considered. Review Service, Box #119, Dorchester, Ontario, Canada.

**BARGAIN Catalog.** 10c. Values galore. Tiptop, Box 9083 PM, Dallas, Texas.

**YOUR Name engraved on beautiful brass doorplate, 1 1/2" x 9". Postpaid \$1.00. H. V. Ackerman, Malden on Hudson, N. Y.**

**LEATHER Patches with your name, etc., stamped with 22K gold for your leather jacket. \$1.00 ppd. 1ne Imprint Co., Box 1773, Bremerton, Washington.**

**PAINTERS, Convert old gun to spray any ready mixed paint, without thinning. Complete plan, \$3.00. Mr. Harry Haisma, Wadsworth, Ill.**

**NEAT Neck shaves at home. Amazing new discovery guides razor for any style, any size neck. Absolute safety. Appliance plus complete directions only \$1.00 postpaid. Standard Guide Mfg., 716 W. Madison, Room 504, Chicago 6.**

**OUT OF print books found quickly. Send wants, no obligation, free catalog. Coast Booklanders, Box 8686, Los Angeles 46, California.**

**STARRETT 454A 10" height gauges with cases. New. \$34.50 cash prepaid. Lippincott Supply Company, 105 Lincoln Highway, Vallejo, California.**

**URANIUM Prospector's Handbook \$1. Non-technical. Craft-Connor Publishing Co., Dept. G, 601 S. Vermont, Los Angeles 5, Calif.**

**NEW! Amazing all-purpose mitt of sponge rubber! Nothing like it! Get several. Use as invigorating bath sponge—for washing dishes, windows, car, linoleum. Amazingly efficient, soft, flexible, durable. Pleasant to use. Protects hand; saves time, work. Only \$1.00 postpaid. Crum Creek Traders, Village Green, Wallingford, Penna.**

**GOOD Mailing lists. Many classifications. Write W. Nothern, Lake City, Arkansas.**

**SEPTIC Tank problems solved. "What to do." Booklet compiled from experience. Order now, \$1.00 per copy. Reuben Selfridge, Septic Tank Consultant, Dept. M, Clymer, N. Y.**

**FOAM Rubber. Thousands of uses. 1 x 16 x 75, \$8.50; 1 x 32 x 75, \$16.60; 2 x 32 x 75, \$21.00; 3 x 32 x 75, \$30.40; 4 x 27 x 74 1/2, \$44.95. Special sizes fabricated to order. No c.o.d.'s. United Foam Rubber, 233 Broadway, Oakland, Calif.**

**SWAP What you have for what you want. Machinery, boats, equipment, etc. Give description, condition, value and location. Swappers' Bureau, Box 5153, Jacksonville, Florida.**

**NEW Type insect destroyer. Electrical. Really amazing. Investigate. Wm. Moore, Grambling La.**

**PICTURE Frames, finished, unfinished. Descriptive circular free. Walker Frame Shop, Westport, Conn.**

**URANIUM Ore—1-pound sample \$5.00. Radioactive on Geiger Counter. Make many experiments. Compare it with other rocks and perhaps find uranium mine on your vacation. Uranium widely distributed from coast to coast. \$10,000 bonus offered by government for new discoveries outside Colorado plateau region. \$5.00 check or money order to: Colorado Uranium, Inc., Box B, Cortez, Colorado.**

**SCULPTOR: Will model dodads, gimmicks, plaques for plaster, pottery, etc. to your specifications. D. Nissen, Antioch, Illinois.**

**NECKTIE Exchange. Mail six neckties and \$1.00 cash, check, m.o. receive six beautifully reconditioned different neckties. Coupons for valuable free gift included. 159 North Wabash, Department C, Chicago 1, Illinois.**

**LAMP Manufacturer wishes to contact inventor with unusual idea for a table, floor or novelty lamp. Will buy outright or royalty basis. Reliable rated firm. Consider patented or unpatented idea. Interested in any item with appeal to Furniture trade. Send full information. Atlas Novelty Company of Chicago Inc., 167 N. Racine Ave., Chicago 7, Ill.**

**PANNING Gold—Free instruction booklet. Catalogue mining books; supplies. Old Prospector, B-236, Dutch Flat, Calif.**

**SEVEN Neckties cleaned \$1.00. Returned postpaid. Box 4411, Philadelphia 40, Penna.**

**TREASURE Finders! Goldak's 11 pound featherweight gold, silver and mineral locator. Guaranteed superior to any other device. Also Geiger counters for uranium prospectors. Free information. The Goldak Co., 1542 West Glenoaks Blvd., Glendale 1, Calif.**

**GIGANTIC Mails, magazines, listing 10c, three times, 25c, twelve times 50c. Waddell's, 341 East 76th, New York 21.**

**LETTERS Forwarded, confidential. 25c. A. Gilbert, 3519 Reta, Chicago 13, Illinois.**

**PROTECT Valuable photos—Frequently used printed matter. We'll enclose any size in electronically, edge-welded, transparent, plastic envelopes. Can't discolor or harm material. Wallet size only 25c. Send for circular and prices. Seal-view, R2, Lancaster, Penna.**

**SHIPPING Supplies—Free catalogue. Tags, labels, bags, cartons, sealers, etc. Fountainhead, 1049 Bluff, Beloit, Wisconsin.**

**100 MARKETS For homeworkers products! Wood, leather, metal, knit, etc. Bulletin \$1.00. Free literature. Research, 2409 12th Ave., Los Angeles 16, Calif.**

**70 BIBLE Lessons, 25c. Bulletin, Box 87, Cathedral Station, New York 25.**

**PAINT—Outside, Snow-White titanium lead and oil. Money-back guarantee not to peel, rub or wash off. \$2.25 gal. in 5-gal. cans. Sample can-50c. Snow-White Paint Co., 2545 Parkwood, Toledo, Ohio. 648 Hudson Street, New York.**

**\$10,000 OFFERED By U. S. government for each usable uranium find. Goldak now offers an ultra-sensitive Geiger Counter to prospectors of radioactive ore. For free bulletin, write The Goldak Co., Dept. M, 1542 W. Glenoaks, Glendale 1, Calif.**

**"RECEIVE Mail." Money-making offers, opportunities, catalogs. Name listed 10c. Ideal Service, Park Ridge 10, Ill.**

**TATTOOING Outfits, supplies. Illustrated list free. Zeis, 728 Lesley, Rockford, Illinois.**

**SQUARE Dance instructions. Calls, 25 sets, \$1.00. Rayburne, Eureka Springs, Arkansas.**

**MAKE Your own tractor, saw mill, home freezer, and scores of other farm devices. Amazing new book, "Popular Mechanics Farm Manual." 284 Pages packed with hundreds of illustrated plans and farm workshop ideas. Descriptive circular free. Popular Mechanics Press, Room 603, 200 East Ontario Street, Chicago 11, Illinois.**

**GEIGER Counters for finding uranium ores. Simple operation. Low prices. Interesting literature free. Fisher Research Laboratory, Inc., Palo Alto, California.**

**TREASURE Locators. New electronic lightweight M-Scope mineral and metal finders are now available for immediate shipment. Built for arctic-tropic use. Revolutionizes locating of minerals, gold, silver, metal objects. Unsurpassed efficiency, factory guaranteed. Low prices, time payment plan available. Send for free 16-page illustrated booklet. Fisher Research Laboratory, Inc., Palo Alto, California.**

**TATTOOING Machines, outfits. Free catalogue. Jensen, 120 West 83rd Street, Los Angeles 3.**

**NOW Ready: New, amazing Classified Advertising Record Book—prepared especially for classified advertisers. Here is a book that tells you instantly whether or not your advertising in any publication is paying you real results. You can tell immediately how many inquiries each publication produced—how much cash received from every ad. Spaces are provided for the name and address of the publication, date of issue, space used, rate, cost of ad, key number, etc. You have a complete record of each publication right before your eyes. Plenty of space to keep accurate record of 28 separate publications. You can have a copy by sending only 10c to cover postage and handling. Send for your copy now. W. F. Johnson, Classified Adv. Mgr., Popular Mechanics Magazine, 200 E. Ontario Street, Chicago 11, Illinois.**



## THE WORLD'S LARGEST WATCHMAKING SCHOOL GIVES YOU:

- G.I. APPROVED, NATIONALLY ACCREDITED COURSES
- MOST ABUNDANT WORKING AND TRAINING FACILITIES
- INDIVIDUAL INSTRUCTION BY EXPERIENCED FACULTY
- FREE PLACEMENT SERVICE FOR PART-TIME WORK AND HOUSING DURING TRAINING

- FREE EMPLOYMENT SERVICE UPON GRADUATION
- COMPLETE SET OF WATCHMAKER'S TOOLS TO VETERANS
- \$100 BONDED GUARANTEE OF PROFICIENCY TO PROSPECTIVE EMPLOYERS.

SEND FOR FREE 116-PAGE INFORMATION PACKET

**WESTERN PENNSYLVANIA HOROLOGICAL INSTITUTE, INC.**

DESK 40, 808 RIDGE AVENUE

PITTSBURGH 12, PA.

**LUMINOUS PAINT**  
GLOWS IN THE DARK!

**FOR SAFETY**  
**FOR MYSTERY**

NOW you can paint any article or part of an article Brilliant Green, Misty Violet, Bright Blue, Radiant Orange, Ruby Red, Golden Yellow and Orchid. Beautiful, standard colors by day that glow brilliantly at night! Thousands of uses! Liberal size can any color sent postpaid for only 89c. FREE illustrated catalog, luminous sample display cards show how RADI-GLOW paints can be used.

**CHEMICAL PRODUCTS COMPANY**  
1412 Great Northern Bldg.,  
Dept. 301, Chicago 4, Ill.

**89¢ PER CAN**

**SEND FOR FREE CATALOG!**

## WANTED JEWELRY

We buy old or broken jewelry. Highest cash prices paid immediately. Mail us gold teeth, watches, rings, diamonds, silverware, eyeglasses, old gold, silver, platinum, etc. Satisfaction guaranteed or your merchandise returned. Write for free information.

**ROSE SMELTING CO., 29-AA East Madison, Chicago 2, Ill.**

SAY YOU SAW IT IN POPULAR MECHANICS



## BIG PROFITS RESTRINGING RACKETS

**AT HOME! WRITE US!**

Earn big profits restringing tennis rackets at home. Easy work. Experience unnecessary. Save on your tennis, badminton, squash! Send for FREE CATALOG of Tennis Equipment—Hurry!

**H. E. Wills Co., 1047 W. 47th St. Dept. PM-49, Chicago, U. S. A.**

**Save On GUT!**  
—Buy Direct from Factory SILK!



**NEW FLUORESCENT FIXTURE**  
with **CIRCLINE LAMP!**



**GUARANTEED FOR 1 YEAR!**

A strikingly beautiful fixture in polished aluminum finish. Suitable for every room. Model C-32AP (illustrated), \$8.95. Model C-32S with etched glass shade, \$12. Sent **POSTPAID** anywhere in the U. S. upon receipt of cash order. C. O. D.'s sent F. O. B. factory.

Write for free literature on full line.  
**HANOVER**  
Box 186D **LIGHTING**  
Dept. ME, Hanover, Pa. **SALES**

**\$8.95**  
POST PAID

**THE GREATEST THING IN PLASTICS!**

**PLASTICAST**



**A NEW HOME INDUSTRY AND HOBBY!**

**PLASTICAST** is a transparent liquid plastic; can be poured into ANY kind of mold or container. Hardens in a few minutes into a transparent solid, clear-as-glass, tough as steel plastic! No tools machinery or skill required. **IDEAL** for imbedding pretty flowers, butterflies, photos, medals, souvenirs, biological specimens, etc. Makes a **PERMANENT** and **ATTRACTIVE** display. Make attractive jewelry, gems, lenses, knick-knacks, novelties. Easily cast into sheets, rods, blocks, ANY color, ANY shape! **EVERYTHING** furnished, including molds, for making about \$50.00 worth of unusual novelties! **PLASTICAST OUTFIT, Complete \$3.50 with 3 molds**.....

**PLASTIDUR . . . (LIQUID IVORY)**. Ideal for casting all **OPAQUE** articles. Hardens in a few minutes into an extremely hard **IVORY-like plastic!** May be dyed any color or cast into any shape. Works in **EVERY** type of mold! **Non-inflammable, waterproof, DURABLE**. Ideal for statuary, novelties, figurines, toys, gadgets, tools, knobs, bases . . . a million useful applications! Outfit comes complete with molds, dyes, accessories, instructions, etc. for making about \$100.00 worth of attractive jewelry, etc! **\$5.00**

**PLASTIDUR OUTFIT, Complete with 3 molds**.....  
➔ **BE A PLASTICS MANUFACTURER . . .** Sell your output on **CONTRACT** basis! We show you what to make and how. Our Casting Plastics are as easy to use as pouring water out of a glass!  
**TERMS:** We pay the postage (U.S.A. & Canada only) if full cash accompanies your order. C.O.D. accepted (U.S.A. only) if \$1.00 deposit is included for each item ordered. C.O.D. orders not postpaid.

**FREE** A very attractive and useful novelty made with one of our plastics given absolutely free with every one of our catalogs! Catalog lists many new materials for making **MOLDS** and **CASTINGS** with Liquid Plastics, Liquid Marble, Latex, Elastex, Castwood, Wax, Metals, Plaster, Shellcraft, Internal Carving, Molds, Moulage, etc. Price of catalog only 10c.  
**DEALERS: WRITE FOR ATTRACTIVE WHOLESALE PRICE LISTS**

**PLASTICAST CO. (Dept. C)**

4637 N. Kedzie Ave. Chicago 25, Illinois (Order by mail only)  
P. O. Box 987 Palo Alto, Calif.  
**CANADIAN CUSTOMERS**, please order directly from: Canadian Industrial Plastics, Ltd., 1058 1/2 Pender, West Vancouver, B. C.

**Say You Saw It in POPULAR MECHANICS**

**STEP OUT FOR EASIER WINDOW WORK**

WITH

**WINDOSTEP**



**Makes all outside window work easy & enjoyable!**

**SAVES TIME • SAVES MONEY SAVES LADDER-LIFTING!**

**HELPS YOU** Wash windows . . .

Hang screens, storm windows & awnings . . . Paint, putty & repair.

**IT'S STRONG . . .** Supports 1000 lbs.

**IT'S STURDY . . .** Has steel rail & wood platform.

**IT'S PORTABLE . . .** Easy to carry - Weighs 11 lbs.

**IT'S AUTOMATICALLY GRAVITY LOCKED** to window sill from inside. (It's installed from inside.)

**IT'S GUARANTEED**

Or Your Money Back! Low priced, only **\$9.85** Plus C.O.D. & P.P. or \$10.50 Prepaid. Add 50c west of Rockies. Dealer Inquiries Invited. Patent Pending

**MORRISON CRAFTERS INC.**  
711 Miami Street, Toledo 5, Ohio

**ORDER TODAY!**

**For Better Housekeeping, Your Home needs a WINDOSTEP!**

**EXPORT PAYS BIG**

Large World Trade firm offers men and women quick preparation for big pay positions or unlimited-profit businesses of their own. Mail order World-wide without capital, from home; or travel abroad. Represent manufacturers. Past experience not needed. Write today for **FREE BOOK**. State if veteran. Airmail reaches us over night. Mellinger Co., 1422-FA Westwood Blvd., Los Angeles 24, California

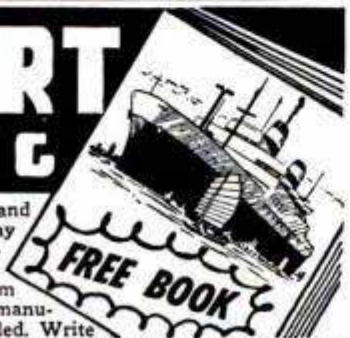

**REPAIR PARTS**

**Start Your Own Washing Machine Repair Business**

Immense field, excellent profits! Get our large complete wholesale catalogue showing thousands of repair parts illustrations: Singer rolls, V-belts, motors, gears, etc. Price \$1.75 per copy postpaid in U. S. Send check or money order today—price of catalogue refunded on first order.

Established 20 Years

**WESTERN APPLIANCE CO., Inc.**

350 Grand River Ave., Detroit 8, Mich.



**MAKE MORE MONEY**

**WRITE TODAY** for **FREE** package of colorful gift cards; and receive our fast selling assortment of Everyday cards on approval. **BIG PROFITS** selling our line of shopping and vanity bags, Mother Goose Pop-Ups & record, children's books, napkins, coasters, greeting cards, gift wraps, stationery. **Act now!** Get acquainted with our fast selling line. Organizations and Churches write for our special fund-raising plan.

**FANMOUR CORPORATION**

Department PM, 200 Fifth Avenue, New York 10, N.Y.

**SHOE REPAIR OFFERS BIG INCOME LEARN IN 12 WEEKS TIME**



You can own your own shop or earn big income as skilled shoe repairman. Growing demand everywhere at top wages for men who know how. We teach you quickly by actually working on shoes and modern machines. School open to all from 18 to 60 years of age. **FREE BIG 20 PAGE BOOK** explains everything. Send for your copy today.

**MODERN SHOE REBUILDING SCHOOL**

Approved for Vets Dept. PM  
Established 1927  
2937 Belmont Ave., Chicago, Ill. Rush Postcard Today  
806 So. Figueroa St., Los Angeles 14, Calif.



**E. J. SWEENEY**  
87,675 men have  
come to E. J.  
Sweeney Schools  
—WHY?



**DO  
IT  
NOW**

## Get Ready Quick for a TOP PAY JOB AUTO BODY, FENDER and PAINT MEN

Let me show you how to get ready—fast—for high pay and a steady job with a real future in auto body and fender work. My new Free literature tells how you can learn this specialized trade quickly and easily by the Sweeney System of Practical Experience. See actual photos of up-to-date modern equipment and big roomy shops. For a real opportunity to make good money, get in auto, body and fender work. Send for the facts today. 1054 Want Ads in newspapers in one state in one month alone show the amazing demand for trained men. Here is actual proof that there is opportunity for you today in this big field. Read the complete story on opportunities today in my Free literature. Mail a post card for yours today.

APPROVED FOR VETERANS TRAINING

**SWEENEY** AUTO SCHOOL, Inc.  
Dept. 24, 2901 East 14th St., Kansas City 1, Mo.

**FREE**

LITERATURE  
POSTPAID

MAIL COUPON FOR DETAILS

E. J. Sweeney, President  
Sweeney Auto School, Inc.  
Dept. 24, 2901 East 14th St.  
Kansas City 1, Mo.

Name \_\_\_\_\_

Address or RFD \_\_\_\_\_

City \_\_\_\_\_

State \_\_\_\_\_

Veteran

Non-Veteran

## I'll Give You Bulldog Courage in 48 Hours

Are you timid? Bashful? Self-conscious? Are you afraid of people? —afraid of superiors? Give me 48 hours and I'll give you BULLDOG COURAGE, I'll make you bristle with fighting Determination, or refund your money.

Thousands of men and women are being held back—made miserable—made unhappy. Why? Simply because of bashfulness—self-consciousness—fear of criticism—business worries—and dozens of other fears.

Yet fear is ABSOLUTELY UNNECESSARY. An amazing method has been discovered which banishes fear. No trouble! No inconvenience. No long waiting for results. This method is perfectly simple—perfectly natural—perfectly logical. It works almost instantly. Try it. You will be astonished! In just a few hours you may find yourself brimming over with splendid new courage—new daring—new self-confidence.



DAVID V. BUSH

**Only \$1**

David V. Bush gives you his secrets of real he-man courage in his famous book called "Spunk." It is one of the most startling books ever written. You can't read it without a quickening of your pulse—without a surge of red-blooded courage.

This book is declared to be the masterpiece of David V. Bush who has astounded throngs in America's greatest cities and shown thousands the way to health, prosperity and self-confidence. Write for this amazing book today. Send only \$1 in full payment. If you are not delighted, if your fears are not gone by the time you read this book, return the book within 5 days and your money will be instantly refunded.

INSPIRATIONAL PUBLISHING HOUSE, Dept. 24  
Mehoopany, Pa.

Name \_\_\_\_\_

Address \_\_\_\_\_

City \_\_\_\_\_

Zone \_\_\_\_\_

State \_\_\_\_\_

BE A **GOVERNMENT LICENSED**  
**AIRPLANE AND ENGINE MECHANIC**  
Train Now at **LINCOLN**



EARN BIG PAY IN  
**AVIATION**

Our new enlarged school now offers these courses:  
**MASTER AVIATION MECHANICS**, CAA Approved 1 Yr. Airplane & Engine Mechanics Course, **REFRESHER AIRPLANE & ENGINE MECHANICS**. Designed for veterans with aviation mechanics experience. Either course is available to veterans under the G. I. Bill of Rights. Write today for complete information.

**LINCOLN AVIATION INSTITUTE**

UNION AIR TERMINAL

DEPT. P-4

LINCOLN, NEBRASKA

## MODERNIZE YOUR KITCHEN

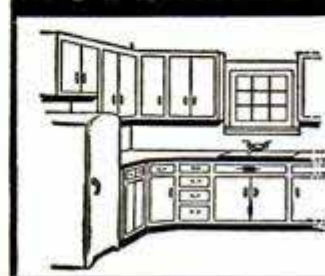

SAVE 2/3 THE COST!

New, illustrated manual shows every step in easy-to-understand charts and directions. How to modernize for yourself and get "professional" results at 1/3 the cost. Includes free design for your kitchen, plus net factory costs on knock-down cabinet fronts and other items. Have fun modernizing your own kitchen and save 2/3. Mail \$1.00 for complete kit to—

**THOMBERT CO.**  
NEWTON 1, IOWA

## RUPTURE!

An amazing Air-Cushion Invention allows body freedom at work or play. Light, neat, cool, sanitary. Durable, cheap. Day and night protection helps Nature support weakened muscles gently but surely. No risk. Sent on Trial! Write NOW for free Booklet and Proof of Results. All correspondence confidential.



Brooks Company, 161-D State St., Marshall, Mich.

## ELECTRICAL TRAINING

Intensive 32 weeks' residence course in fundamentals of industrial electrical engineering, including radio, electronics. Prepares for technician, engineering aides. Approved for veteran training. 56th year. Enter April 4, September 6. Catalog.

**BLISS ELECTRICAL SCHOOL**  
7630 TAKOMA AVENUE  
WASHINGTON 12, D. C.



## TYPEWRITERS!

For Sale At Big Savings

ALL MAKES — REBUILT LIKE NEW

For School, Business or Home Use

Write for Information

**M. & M. TYPEWRITER CO.**  
84 W. Washington St. Chicago, Ill.

SAVE UP TO  
**50%**  
AND MORE

SEND FOR  
**FREE**  
Diamond Catalog

All diamonds reset in new mountings.

Sold with iron clad  
money-back  
guarantee



Approx. 1/2 Ct.  
**\$95** incl tax  
\$200 Value

**The BERMAN**  
Company—DIAMOND BROKERS  
Dept. P, Berman Bldg., Baltimore 1, Md.

**BERMAN'S**  
Illustrated Catalog  
**OUT OF PAWN**  
**GENUINE**  
**DIAMONDS**  
Outstanding values  
from \$10 to \$5000

## MORE PERSONAL ATTENTION

WHEN YOU LEARN

# WATCHMAKING JEWELRY REPAIR ENGRAVING ...THE THACKER WAY!

Students learn FAST when Instructors offer personal attention. Our Master Course prepares you for all

branches of the Jewelry Trade. High percentage of graduates placed. Housing available. (Schools in Warren, O., and Pittsburgh, Pa.) G.I. Approved. Catalog FREE.

**A. W. THACKER ACADEMY FOR JEWELERS**

Dept. P • 423 Federal St. • Pittsburgh 12, Penna.

## WANTED TO BUY



Will pay cash prices for automobile catalogs, instruction books, sales leaflets, any years and models; also automobile magazines but *not* single ads clipped from regular magazines. Write, describing fully what you have to Museum, Dept. PM — 140 W. Ontario St., Chicago, Ill.

8x30 FINE QUALITY—BRAND NEW

## FRENCH Imported BINOCULARS

Get real *close-up* with these precision-built Binoculars. They're 8-power! Colmont Optics. Central focusing. Complete with carrying case. Made for and guaranteed by Haber & Fink.

A REAL BARGAIN AT...

**29<sup>50</sup>**

FOB our store plus 20% Fed. Tax

Mail orders filled

HABER & FINK, Inc., Dept. P. M., 12 Warren St., New York 7, N. Y.

## PLOWS CLEAN THROUGH

### 3 DAYS' BEARD!

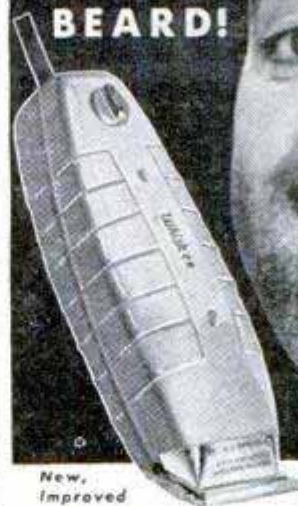

New, Improved

# WhiskER

ELECTRIC SHAVER

... the Shaver That Shaves Any Beard

ONLY \$12.95

Here's a precision made, close-cutting electric shaver at a pleasing price. The WhiskER, utilizing a long tested hair-clipper principle, shaves *any* beard... even 3 days' growth... effortlessly, quickly and cleanly. It's built to last... has no gears, brushes, bearings. Powerful, magnetic-type motor for 110 v., 60 cycle AC, is quiet operating. No radio interference. If your Barber, Beautician, or Dealer does not yet have the WhiskER, use coupon to order. Money back if not delighted after 5 day trial.

ELECTRO TOOL CORP., DEPT. 529-D, RACINE, WISCONSIN

## If Your Dealer Cannot Supply You MAIL THIS COUPON

ELECTRO TOOL CORP.

Dept. 529-D, Racine, Wis.

I enclose (check, money order) for \$12.95, for which please send me a WhiskER Shaver *postpaid*.

Name \_\_\_\_\_

Address \_\_\_\_\_

City \_\_\_\_\_ State \_\_\_\_\_

## Sensational New Electric **1** WELDER **2** CUTTER!



WELDER UNIT



CUTTER UNIT

Uses 110-115 AC or DC • INSTRUCTIONS INCLUDED  
WELD - BRAZE - CUT - MELT - SOLDER - HEAT TREAT

The WELDRITE combination—tested and proven by countless commercial and amateur users, is now offered direct to you at the amazingly low price of only \$12.00. No Gas—No Gauges—No Spark Lighter needed. Always ready for immediate use—Just plug WELDRITE into 110-115 AC or DC outlet. Uses standard welding and brazing materials available at all welding supply stores. WELDRITE furnished complete with Converter Unit, #1 Single Holder with attached Alligator clip, for welding metal up to 3/16" thickness, using up to 3/32" rod, and #2 Double Holder with Copper Coated Dual Carbon Electrodes for Cutting, Brazing, Heat Treating, Soldering, etc. Starting welding materials and instructions included.

Ideal for home workshop. Invaluable for body

and fender shops, garages, repair and machine shops, manufacturers, etc.

**SEND NO MONEY!** 10 DAY TRIAL OFFER

Order your WELDRITE Electric WELDER-CUTTER C.O.D. today. Pay postman \$12 plus postage charges (wt. 4 lbs.) or send \$12 and we pay postage. Either way, if not satisfied, return WELDRITE in 10 days, and money will be refunded. WELDER HOOD—Approved lens found in hoods costing to \$10—only \$3.95. Calif. orders add 2 1/2% tax. **FREE FOLDER**

**CALIFORNIA TECHNICAL PRODUCTS CO.**

448 So. Hill St., Los Angeles 13, Calif. Dept. A-4

**BOTH only \$12**  
LOWEST PRICE IN HISTORY!

Plastic Coasters  
and Tiles

## EMBED REAL FLOWERS in NEW Magic PLASTIC

Now, create many unusual things like the distinctive pansy coaster shown—made by embedding real pansies in Castolite—the "magic" liquid plastic that "pours cold like honey... sets like glass"... at room temperature. Comes crystal clear or may be dyed for brilliant color effects. Embed other flowers, too, also coins, butterflies, medals, favorite photos, etc. Make really different jewelry, candlesticks, picture frames for gifts or to sell.

### POUR GORGEOUS BOOKENDS

Castolite makes it easy to cast exquisite bookends like the one shown. Make copy duplicates of hundreds of art objects, figurines, etc. No special training needed. With new, easy-to-use Castomold you make your own molds in minutes. Use only home utensils. Follow simple step-by-step method. New pleasure, fine profits are possible.

MASTER KIT \$7.75 Postpaid.

SPECIAL KIT \$3.95 Postpaid.

At your dealer. If he can't supply you, send check or money order, or send 25c for exciting new Castolite Instruction Manual packed with 62 actual pictures showing how to get started immediately. Write today.

THE CASTOLITE CO.  
Dept. D-1  
Woodstock, Ill.



# RUPTURE

RELIEF...OR YOUR MONEY BACK

Web Truss... improved design for natural relief at a reasonable price. Reputable surgical manufacturer, years in business, offers folder if you write now. Money Back Absolutely Guaranteed If Relief Not Satisfactory.

WEB TRUSS CO. Dept. M-42 Hagerstown, Md.

## AMAZING NEW \$1.25 BOOK SHOWS HOW TO BUY GOOD CARS CHEAPLY

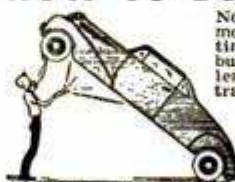

Now you can easily pick out a good car and save money in doing it. Book exposes the 36 tricks sometimes used to defraud car buyers. Shows how to avoid buying disguised taxis, patched-up wrecks, costly lemons. Gives 50 easy car tests. Covers fair prices, trade-ins, financing, insurance, repair, operating costs, etc. "How To Be An Expert Car Buyer" is packed full of authoritative money-saving inside information. Just one fact can save you \$100. Acclaimed by experts! R. Schmunk, Pres. AAA: "your valuable book should prevent most people from falling into the most obvious mistakes."

96pp Illus. Only \$1.25; COD \$1.50. You'll agree it's priceless. Buy now at Macys, Marshall Field, Gimbels, bookstores, Sears Catalog or: Cummings Enterprises, Publr.—Keystone State Bldg., Phila. 7Q, Pa.



## BARBELLS

Save Money—Buy the finest barbell equipment direct from our foundry—No other company can match our low price or value!

Send to-day for our FREE Barbell Catalog

BUR BARBELL CO.

Lyndhurst 16, New Jersey

95 lb.  
SET  
\$10.80  
Extra plates  
10c lb.



## FOR PROFIT & PLEASURE

### IN COPPER TOOLING & ETCHING

No Experience needed—start at once. BIG MONEY waiting in COPPER ART field. Plaques, Bowls, Trays, Gifts, Souvenirs of all kinds. Start on the road to success NOW! Here is an opportunity to get started in your own Big Paying Business—FREE DETAILS don't wait—WRITE NOW!

HOLLYWOOD COPPER ART—Dept. PM-4  
4257 Beverly Blvd., Los Angeles 4, Calif.

## New...Self-Contained SPRAY GUN

No Hose! No Tanks! No Pumps!  
No Motor!

It's true! A high-pressure spray gun as self-contained, as compact and portable, as a flashlight! Uses no current. Pressure comes from inexpensive CO2 cartridge. A cartridge sprays 10 to 20 oz. of liquid (depending on viscosity). Use gun for paints, liquid insecticides, oils, etc. For home, farm, workshop, garden, garage. Comes with 3 cartridges. Fully guaranteed. The Becker Spray Gun is shipped postpaid for only \$18.50; or send only \$2—we'll ship C.O.D., you pay postman balance plus postage. Extra cartridges, 10 for \$1, postpaid.



\$18.50

(With 3 cartridges)  
POSTPAID

SULLIVAN-BECKER CO., Dept. 119-D, KENOSHA, WIS.

ONLY ... RELEASED BY GOVERNMENT

90c PLUS 10c  
HANDLING  
CHARGE

Famous LEATHER  
MILITARY CASE

becomes smart peace-time

## GADGET BOX

The Hit  
of the hour FOR MEN and WOMEN

Ideal for small tools, elec. razor, toilet kit, ski-wax, hunting, fishing, photo equip. Would cost at least \$3.50 retail. Limited Gov. surplus.

ORDER NOW—SPECIAL: 6 BOXES \$5



TOP GRADE  
COWHIDE  
SIZE:

2 1/8" x 3 1/2" x 5 1/4"

JUST SLIP  
\$1.00  
INTO AN  
ENVELOPE  
AND MAIL

RENA SALES CO., 12800 Plymouth Road,  
Detroit 27, Mich. Dept. P.M.  
Send me \_\_\_\_\_ Gadget Box(s) Enclose find \$1.00  
(90c plus 10c postage) for each box ordered. You  
agree that I may return item and have the price  
refunded if not satisfied.  
Name \_\_\_\_\_  
Address \_\_\_\_\_  
City \_\_\_\_\_ Zone \_\_\_\_\_ State \_\_\_\_\_

## LOCKSMITHING & Key Making



PRACTICAL UP-TO-DATE COURSE—ONLY \$3.95

Easy-to-learn modern information for self-instruction. How to work on locks, de-code, make master-keys, repair, install, service, etc. For every handyman, home owner, carpenter, mechanic, service station operator, fix-it shop, hardware dealer, gunsmith. 53 plain illustrated lessons. FULL PRICE ONLY \$3.95. SEND NO MONEY. We'll ship postpaid. Satisfaction guaranteed or refund. NELSON-HALL CO., 1139 S. Wabash Ave., Dept. D-2, Chicago 5, Ill.



**BE FAIR TO YOUR HAIR** Want better looking hair? Embarrassed by falling dandruff, itching scalp? Get the new VITABRUSH, the electric-automatic brush with built-in brush head motor... gives scalp and hair an invigorating "workout" in just 3 minutes. Cleans scalp, stimulates blood supply, distributes the natural oils. Fun to use—relaxing. Write for satisfaction-guaranteed offer—today. Hershey Mfg. Co., 3767 Field Bldg., Chicago 3.

# \$3900 BUYS ALL MATERIALS FOR THIS LOVELY 5 RM HOME

**You build it yourself  
at less than half price**

This is made possible by *New Isometric Plans* that show clearly our Revolutionary Method of home construction. *You yourself* can now build an \$8,000 house for less than \$4,000. This amazing money-saving idea is made surprisingly plain in our New Plan Book, "HOMES YOU CAN BUILD YOURSELF." It is our supreme accomplishment after 29 years of service to home builders. Energetic men everywhere are now building this simplified way.

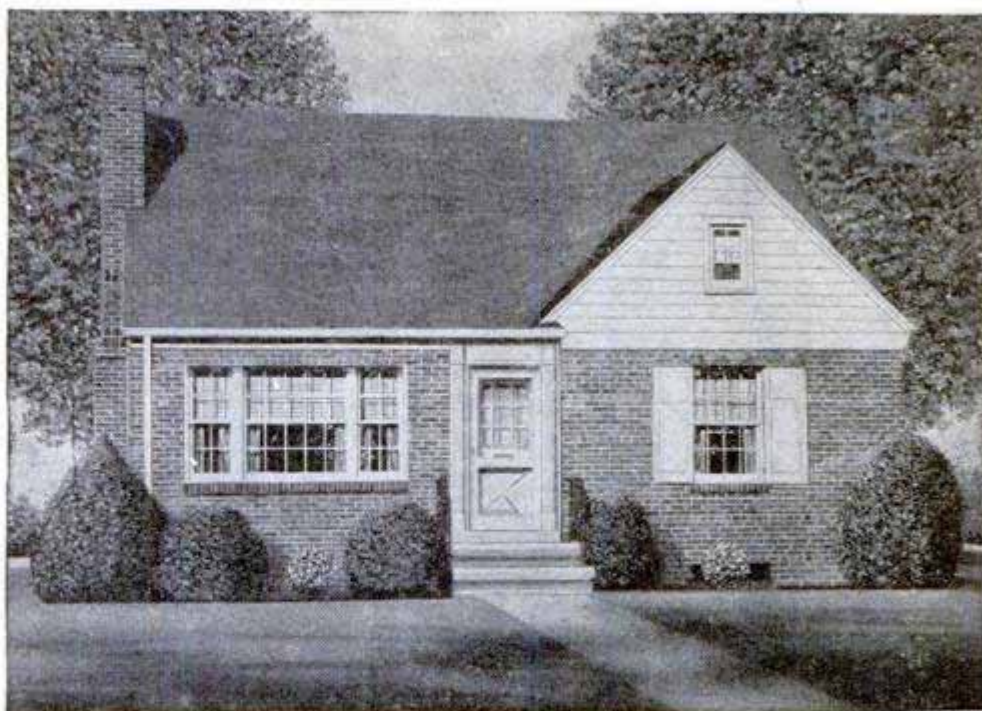

Send today 25c coin to cover plan book and mailing charges. Your money back quick if it isn't the greatest money-saving construction idea advanced in our time. All plan books and plans by mail only.

**STANDARD HOMES COMPANY** COLORADO BUILDING PM • WASHINGTON 5, D. C.

*"If you can pay rent, you can own a home"*

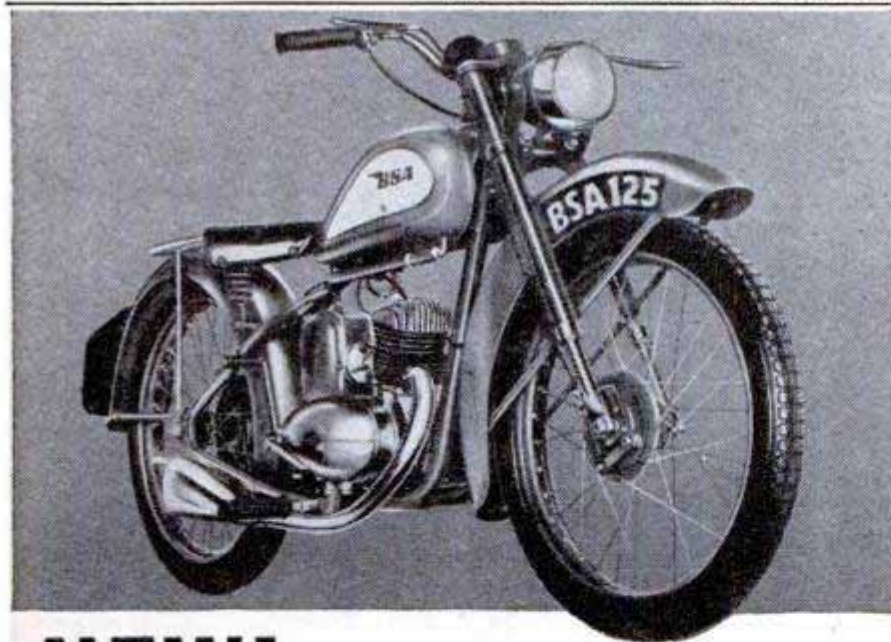

**NEW! Low-priced, lightweight**

**BSA BANTAM 125**

This outstanding lightweight looks and performs like many far bigger and heavier models —yet it consumes less gas than any other motorcycle you've known...and it's built to rigid specifications for years of reliability!

## 7 Amazing Features

- Telescopic Forks—just like the big jobs!
- Hand-operated clutch, smooth, silent and hard-wearing!
- Foot-operated Gear-shift—the easiest and safest way to change gear!
- New Right-hand AMAL Twist-Grip throttle—for instant and swift acceleration!
- Full-balanced mudguards—real weather protection!
- 15% lighter than others. Weighs only 150 lbs.
- Designed and produced in its entirety by world-famous B. S. A.-Sunbeam!

## COUPON TEAR IT OUT NOW!

Please rush me at once full details of the new B. S. A. 125 Lightweight Motorcycle. Also send literature describing the other nine larger models which comprise the B. S. A.-Sunbeam range.

M-1

Name \_\_\_\_\_

Address \_\_\_\_\_

State \_\_\_\_\_

**RICH CHILD CYCLE CO., INC.**  
SOLE IMPORTERS

22 East 29th Street, New York 16, N. Y.  
and 2510 West Slauson Avenue,  
Los Angeles 43, California

**HERE'S A NEW AND VITAL BUSINESS!**

**LEARN ELECTRICAL EQUIPMENT SERVICING**

**OFFERS BIG MONEY — INDEPENDENCE**

Learn in spare time at home. **NEW Shop Method Training System.** Work as many hours as you wish — the Electrical Equipment Technician is his own boss. It is not unusual for a technician to charge on the basis of \$5.00 to \$6.00 an hour! Command big wages.

**NO PREVIOUS EXPERIENCE NEEDED**

We furnish everything! Tool kits, training kits, including the famous Christy trouble-detecting **ELECTRONIC KIT.** Plus illustrated instructions written in simple, easy-to-understand language, check full of photographs and drawings. Shows you how to repair factory and household electrical units. Power machinery, refrigerators, washing machines, vacuum cleaners, irons, etc. Gives you a working knowledge of electricity, house wiring, motor winding, welding, nickel plating, etc. Shows how to build power tools you need, how to solicit business and what to charge. Many report paying for their entire course, tools, etc. on earnings made at home while learning!

**FREE BOOK SENT TO YOU**

Send your name for **FREE** booklet on Electrical Equipment Servicing and instructions for paying us later from your **EARNINGS WHILE LEARNING!** **CHRISTY TRADES SCHOOL, Dept. D-6803, 2835 N. Central Ave., Chicago 34, Ill.**

**JEEP PARTS**  
*The King of Jeeps*

**WORLD'S MOST COMPLETE STOCKS**

- MOTOR PARTS • CLUTCH PARTS
- ELECTRICAL SYSTEM PARTS
- WATER PUMPS • SHOCK ABSORBERS
- COMPLETE TRANSFER CASES
- COMPLETE TRANSMISSIONS
- FRONT AXLE ASSEMBLIES
- REAR AXLE ASSEMBLIES
- TIMKEN BEARINGS for JEEPS
- STEERING ASSEMBLIES

**BRAND NEW BELL CRANKS**  
Part No. A1211—GPW3131

**Free Catalog and Prices on Request. Write for your Special needs. Export Inquiries Invited**

**World's Largest Stock of Jeep Parts!**

**KING of JEEPS**  
1608 S. WABASH AVE. • CHICAGO  
—AMERICA'S FIRST JEEP DISTRIBUTOR—

**BERG TRUCK & PARTS CO.**

**HIGH POWER TELESCOPE**

**60 POWER—ALUMINUM TUBES—LENGTH OPEN 33" CLOSED 11"—ADJUSTABLE 15X - 30X - 60X — \$4.50**  
**NEW!** 3 different magnifications by simple adjustment of the eyepiece. 15 power for ultra-bright images with 30 and 60 power for extra long range. Guaranteed to bring distant objects, people, sports events, ships, moon, stars, etc., 60 times as close. Most powerful for anywhere near the money.



All 5 tubes made of strong but lightweight aluminum. 4 precision optical glass lenses. When collapsed it is used as a powerful compound microscope. Directions included. Money back guarantee. With genuine leather carrying case, only \$4.50. We pay the postage. Immediate delivery.

**BROWSCOPE CO.** -Dept. 4M, 24 W. 45th St. NEW YORK 19, N. Y.

**IMPROVE YOUR PLAYING**



**PIANISTS**—Send for **FREE** Booklet showing how you may greatly improve your technique, accuracy, memorizing, sight-reading and playing thru Mental-Muscular Coordination. Quick results. Practice effort minimized. Used by famous pianists, organists, teachers and students. No obligation.

**BROADWELL STUDIOS, DEPT. 159D, COVINA, CALIF.**

**HAMSTERS** LET THE PROLIFIC GOLD-EN SYRIAN HAMSTER earn you a steady income. Tremendous laboratory and pet market; 1000's needed. No experience required. Can be easily raised anywhere. Clean, odorless. Send 25c for illustrated "Hamster Handbook" or \$5.00 for pair and Handbook. F.O.B. Mobile, Ala.

**Azalea City Hamstery, 1412 East Linwood Drive, Dept. F, Mobile 18, Alabama**



**THIS RING IS A BEAUTY for only \$4.95**  
**Massive, 12K Gold-Filled, with 3 BIG, FLASHING IMITATION DIAMONDS**  
Replica of a \$1000 ring. Center stone ruby colored if desired. **SEND NO MONEY!** Send size or string. Pay postman on arrival plus 20% tax. Money back if not delighted.  
**CHARM JEWELRY CO., Dept. R-73**  
294 Washington St. Boston, Mass.

**FIBRE ARMS AND LEGS!**  
Light, correctly fitted, strong and comfortable. Natural appearance. Braces for all deformities. Scientific design. Fair Terms.

**BUCHSTEIN-MEDCALF** 223 S. 6th St., Minneapolis, Minn.

**RUPTURE RELIEF**

Advanced method. No leg straps, no elastic, no steel. Entirely different. Guaranteed. Write:  
**SMITH MANUFACTURING COMPANY**  
DEPT. PM PRESTON, ONT., CAN.



**SMALL 6 VOLT D.C. MOTOR**

Ideally suited for Buffers, Grinders, Fans, home-built gadgets and small vehicles. Hobbyists, Mechanics; here is the small high powered unit that fits your specific need! 6 volt D.C 3500 R.P.M.

**\$2.95 each \$2.50 in lots of 10 or more**

**Now You Can Own An ELECTRIC HAWAIIAN GUITAR AT A BELOW COST SAVINGS!**

An excellent instrument for student or professional. Plastic black finish, 31" long. Melior Eye Beam String Pickup, smooth volume and tone controls. You, too, can strum luring melodies like the pros!

**A \$50.00 VALUE!**



**SENSATIONALLY PRICED AT ONLY \$23.95**

25% with order, balance C.O.D. Write for descriptive catalog  
**MORT'S RADIO SHACK, INC. OF CHICAGO** 630 W. Randolph St. Dept. P.M., Chicago 6, Ill.

# DRAW for MONEY... Be an ARTIST!



**Trained Artists are Capable of Earning \$65, \$80 and MORE a WEEK!**

YOU CAN learn to draw at home in your spare time the well-known WSA way, COMMERCIAL ART, DESIGNING, CARTOONING all in ONE complete course. No previous Art experience necessary—we teach you step-by-step. Prepare for a fascinating hobby or profitable career. For 35 years WSA graduates have been making good—WHY NOT YOU?



**VETERANS! WSA Approved for Training Under G. I. Bill.** Write for FREE BOOK, "Art for Pleasure and Profit," fully describes course, our method of instruction and commercial opportunities for you. TWO ART OUTFITS included with training.

**MAIL COUPON TODAY FOR DETAILS.**

Washington School of Art, Studio 124R  
1115—15th St., N.W., Washington 5, D. C.

Please send me full information and your Free Book, "Art for Pleasure and Profit."

Name \_\_\_\_\_ Age \_\_\_\_\_

Street \_\_\_\_\_

City \_\_\_\_\_ Zone \_\_\_\_\_ State \_\_\_\_\_

I am entitled to training under "G.I." Bill

## PORTABLE ELECTRIC REFRIGERATORS

### Specifications

- Weight 60 Lbs. • Outside Dim's. 14" x 16" x 22" • 2" Insulation.
- Approx. 1.2 Cu. Ft. • Porcelain Inside • Grey Wrinkled Fin.

A lucky buy enables us to sell these Portable Electric Refrigerators Completely Reconditioned for the astounding full price of \$57.50 F.O.B. Lansing, Mich.



Operates on 6 volt D.C.  
110 Volts A.C.

**A LIMITED NUMBER ONLY**  
**To be sold as Purchased**  
**First come First served**

Car Owners    Veterinarians  
Boat Owners    Experimenters  
Sportsman      Airplanes

**Not for home or office use.**

**EASILY SERVICED**

**INDUSTRIAL METAL PRODUCTS CORP.**

Lansing 1, Mich., Box 156

## 500 p. Catalog, 7,000 Novelties 10c

**Roto Picture Section, 3,500 Illustrations, Beautiful 6-Color Cover**

Novelties, gadgets, gifts, funmakers from all over world. Carnival, circus, world's fair & science exhibit rolled into one. Covers hobbies, useful gadgets, timesavers & ALL novelties. Money-makers, money-savers. Live monkeys, shrunken skulls.



- |         |            |               |                 |                   |                     |                         |
|---------|------------|---------------|-----------------|-------------------|---------------------|-------------------------|
| Boats   | Jewelry    | Telescopes    | Field Glasses   | Fortune Tellers   | Electric Shockers   | Smoker's Novelties      |
| Rings   | Hobbies    | Funmakers     | Money Savers    | Symbol Jewelry    | Imported Articles   | Home Printing Sets      |
| Tools   | Gadgets    | Slide Rules   | Curious Seeds   | Office Novelties  | Radios & Supplies   | Engines — Motors        |
| Games   | Billfolds  | Barometers    | Makeup Goods    | Lucky Novelties   | Sweater Emblems     | Musical Instruments     |
| Knives  | Cameras    | Chameleons    | Banks & Vaults  | Occult Novelties  | Projectors & Film   | Live Animals & Pets     |
| Models  | Airplanes  | Microscopes   | Rubber Stamps   | Indian Novelties  | Western Novelties   | Auto & Bike Accessories |
| Turtles | Disguises  | Home Tools    | Sporting Goods  | Fishing Novelties | Scientific Supplies | 1000 Fascinating Books  |
| Stamps  | Exercisers | Magic Tricks  | Artist Supplies | Hula Hula Skirts  | Religious Novelties | Many, Many Other Things |
| Puzzles | Magnifiers | Electric Eyes | Novelty Checks  |                   |                     |                         |

**10c**  
Kits Wigs Pipes  
Guns Jokes Locks

**Collier's, Tide, Coronet, New Yorker Write About This Amazing "World's Greatest" Catalog**

25,000,000 orders in 35 years—our record. A catalog, but most wonderful book you've ever seen! Costs us 75c per copy to get out. Complete paper cover edition, 10c; De Luxe hard bound library edition, 25c. Sent Air Mail for \$1.00. (Stamps accepted.) One per customer. **JOHNSON SMITH & COMPANY** DEPT. C-28 **DETROIT 7, MICHIGAN**

## NEON SIGN SCHOOL

**G. I. APPROVED**

Learn Neon. Interesting, clean work, BIG PAY—\$1.50 to \$2.00 an hour to start. Our 12½ week Job-Practice Course gives you practical training in Glass Blowing, Neon Tube Bending, Color Gassing, other branches. No home study. No text books. No mathematics. FREE FOLDER explains. Write today.

**ACME NEON INSTITUTE, Dept. DD-3**  
330 South Paulina St. Chicago 12, Ill.

**LEARN IN 12½ WEEKS**

**Make BIG MONEY!**



**SPARE OR FULL TIME**  
**RIGHT IN YOUR OWN HOME**  
**Have Your Own Successful Business**

Yes, lush fields of profit are waiting to be tapped in this new field. New MIRACLE finish gives a velvety, luxurious surface to radios, lamps, toys, signs, store displays, figurines — Makes old objects beautiful and salable — Makes new things worth much more. Learn in a few days — start earning BIG MONEY — up to \$500 or \$1000 per month full time — \$75 per week spare time. Everything furnished — including complete simple-to-understand instructions on this NEW method that is EASY to learn. Send NO MONEY — a post card will do — it's too good to miss! Write now for details, FREE sample of FLOK-KRAFT covered material, hundreds of useful and profitable IDEAS. Do it NOW!



**Have Your Own Lasting, Successful Business— Be Your Own Boss— Huge Demand**

**FREE!!!**  
**DETAILS**

**COAST INDUSTRIES**  
Department PM-4  
1507 W. Manchester Avenue  
Los Angeles 44, Calif.



Name \_\_\_\_\_  
Address \_\_\_\_\_  
City \_\_\_\_\_  
Zone \_\_\_\_\_ State \_\_\_\_\_

**COAST INDUSTRIES, Dept. PM-4, 1507 W. Manchester Avenue, Los Angeles 44, Calif.**

**SEND COUPON TODAY!**

# LINGUAPHONE



is your *Passport*  
to the World

In your own home, alone or in a group, you can now learn to speak

**SPANISH • PORTUGUESE  
FRENCH • RUSSIAN  
ITALIAN • GERMAN**

or any of 23 other languages by the world-famous

## LINGUAPHONE Conversational METHOD

You learn the new language by listening to voices of native teachers. It is amazingly simple; thousands have succeeded. Educators hail Linguaphone as a notable advance in simplifying the mastery of languages. That is why so many Linguaphone Sets are used in schools, colleges, universities, as an aid to fluent speaking.

### Fun and Profit

Taking up a language by Linguaphone is actually a pleasure and entertainment. Every difficulty has been foreseen and removed. You begin to speak the new language so quickly that you not only amaze your friends but derive personal pleasure from your new accomplishment. Tens of thousands have proved this for themselves.

Available to Veterans under  
**G I BILL OF RIGHTS**

SEND FOR FREE BOOK

**LINGUAPHONE INSTITUTE**  
98 RCA BUILDING, NEW YORK 20, N. Y.

**LINGUAPHONE INSTITUTE**  
98 RCA Bldg., New York 20, N. Y.

Send me the FREE Linguaphone Book.

I am , am not  a World War II Veteran

I want to learn.....language.

Name .....

Address..... City.....



**YOU  
can  
draw!**

**AMAZING NEW HOLLYWOOD PLAN**  
Yes, YOU can draw **GIRLS, CARS, FRIENDS** and even **MAGAZINE COVERS**. It's so simple, no matter what your age. Many artists make more than \$150.00 per week in advertising and cartoons. Be your own boss, draw for money *anywhere*. Our Commercial Artists will teach you the secrets from **HOLLYWOOD**. Drawing materials furnished. Be a success. Write **NOW** for free details

## HOLLYWOOD SCHOOL OF ART

6533 Hollywood Blvd. Age.....  
Hollywood 28, Calif.  
Name.....  
Address.....  
City..... Zone..... State.....

# POCKET ALARM WATCH



**RADIUM HANDS & DIAL, IMPORTED SWISS MVM'T.**

Here's a Guaranteed accurate Time Piece that sounds off to your appointments, useful on week-ends, Vacations or to get you off to work on time. No bigger than an ordinary Pocket watch. Back opens to stand like a clock. A very good time keeper with clear bell alarm. In white metal. . . . Sorry no POST PD, C.O.D.s. Send check or money order. **Incl. Fed. Tax \$13.95**

**RICHARDS QUALITY PRODUCTS DEPT. P-1, P. O. BOX 139 NEW YORK 32, N. Y.**

## CORRESPONDENCE COURSES IN RADIO and ELECTRICAL ENGINEERING

Tuition  
**\$25**

**ELECTRICAL ENGINEERING.** Get good grasp of wide electrical field. Modern. Very understandable. Theory made easy.  
**RADIO ENGINEERING.** Extra fine course in radio, public address, photo-electric work. Trains you to be super-service man, real vacuum tube technician. Tuition ONLY \$25, either course. Deferred payment plan. Servicemen needed badly.  
**FREE** Electronic Kit given to students enrolling by June 1st. Write for free copies of school catalogs, student magazines, etc.  
**LINCOLN ENGINEERING SCHOOL, Box 931-P124, Lincoln, Nebr.**



## Genuine Trico VACUUM HORN

Loud, distinctive note carries 1/2 mile! Mounts under car hood. Reserve tank & all fittings at fraction of air horn cost. \$22.50 postpaid \$2.50 deposit on COD's. Woodward & Perry, 539 Turk, San Francisco 2



## POPULAR MECHANICS Outdoor Sports Manual!

All sportsmen, attention! Here are 156 pages of helpful hints for the Hunter, Fisherman, Trapper, Camper, Archer, and Boatman. How to make your own decoys, reconition your fishing rod, outwit the fur bearers, make an insect and vermin proof tent, shoot a modern crossbow, and service your outboard motor. These and a pack bag full of other articles for outdoor men. Your News Dealer has it in the 60c paper edition and we can supply the beautifully bound \$2.00 library edition.

**Popular Mechanics Press**  
200 E. ONTARIO ST. CHICAGO 11

## Say You Saw It in POPULAR MECHANICS

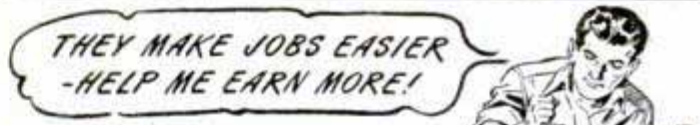

**SAVE MONEY ON  
Popular Mechanics  
SHOP NOTES  
for a limited time!**

**3** Latest Volumes **Only \$1.98** Postpaid



Now you can get three of Popular Mechanics famous, practical and helpful year books for the price of two. Every man who uses tools needs Shop Notes—packed with hundreds of ideas and kinks for machinists, auto workers, sheet metal men, painters, carpenters, plumbers, electricians, home repairers, home craftsmen and others. Every page of every volume is filled with money-saving and money-making facts for both professional and amateur mechanics, that you can use every day.

Start your Shop Notes Library now while our limited supply of the three latest volumes lasts. Rush coupon today with \$1.98 for 1948 and 1949 volumes and we will include 1947 FREE. Send only \$1.98 for all three volumes.

**688 PAGES  
OVER 2000  
Illustrations**  
Written in Popular Mechanics' famous style—Easy to Read—Easy to Understand—Easy to Use.

**POPULAR MECHANICS PRESS, Dept. 400, 200 E. Ontario St., Chicago 11**  
Rush Shop Notes volumes as checked. Remittance enclosed for \$.....

Special Offer: 1949-1948 and 1947 volumes—\$1.98  
 1949 Volume—\$1.00  
 1948 Volume—\$1.00  
 1947 Volume—60c

Name.....  
Address.....  
City..... Zone..... State.....



# LOOK! NEW 1950 ELECTROCAR with 3 real speed shifts

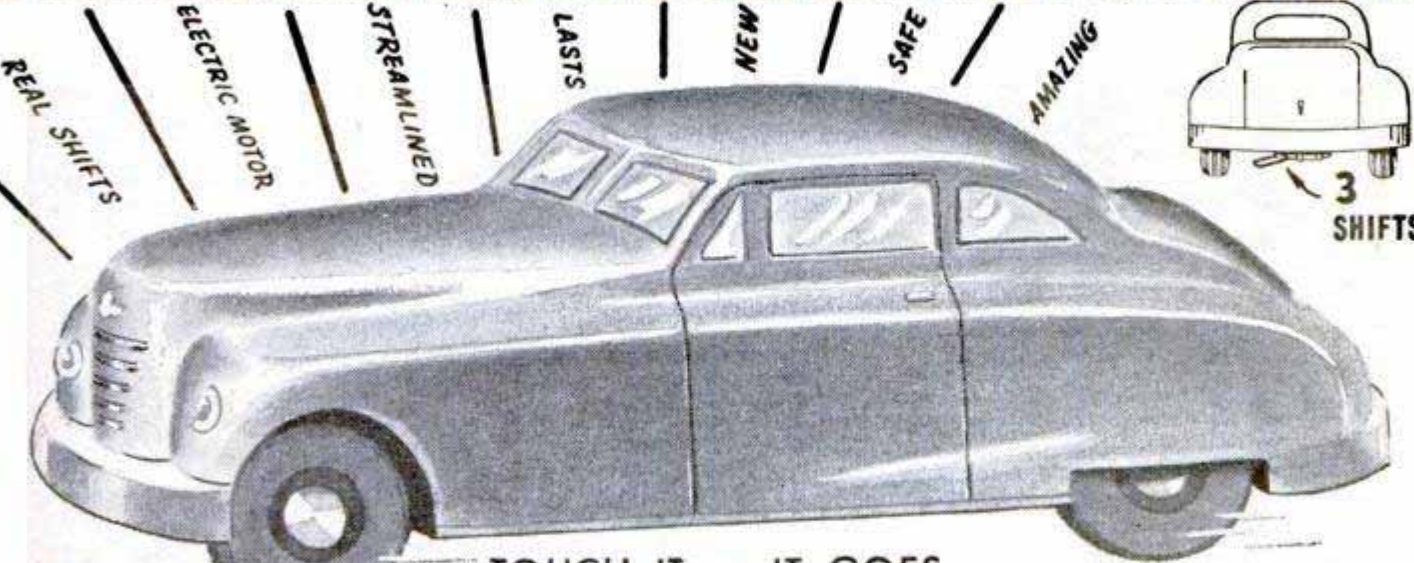

**LOW**  
**SECOND**  
**HIGH**  
**REVERSE**

**TOUCH IT - IT GOES THE OTHER WAY!**

Here is the sensationally new scale-model car that captivates every child (and mommy and daddy, too.) One flick of the magic gear lever and off it goes — in low, second, high — or reverse. Runs for hours. Driven by an electric motor, powered by two flashlight batteries — safe, economical — easily replaced. Over 10 inches long — comes completely assembled with batteries, headlights, balloon-type rubber tires — in shiny red durable plastic body. Lasts forever. RUSH ORDER TODAY!  
SEND NO MONEY (C.O.D. you pay postage Remit with order, we pay postage.)

Imagine  
only **298**  
Complete

**ELECTROCAR CO. 59 East 8th St. N. Y. 3 Dept. 95**

## GENUINE GOATSKIN A-2 FLIGHT JACKET

Brand New. Sizes 36-46. Were \$21.95. Now.....

**\$14.95**

## SUNGLASSES



WITH CASE **\$2.38**



Men's and Women's. Sweat Bar, 4 Base Ground and Polished Lenses. Send for FREE Catalogue

Orders sent postpaid. Sorry no C.O.D.'s Satisfaction or money-back CONSUMER'S CLOTHING CO. Inc., Box P, 26 Greene St., New York 13, N. Y.

## BE A POPULAR GUY



with a **RISEING TIE**

### GIRLS GO INTO HYSTERICS

as your tie goes up and down. Your friends will be held spellbound and remain fascinated for hours. A simple adjustment makes your tie rise and fall at will. This adjustment can be made in a few seconds on any tie. No hands, no bulbs used. Take a deep breath and say "ah" and you are a popular guy. No one can discover the secret of the rising tie. Free Catalog of 25 amazing tricks included with every order. **\$100** post paid or C.O.D. plus postage. World's Largest Magic Shop, Dept. PM-2 741 Eighth Ave., New York 19, N. Y.

# FREE

Send today for this big book of values in **TELEVISION**

**RADIO, ELECTRONIC, INDUSTRIAL, SOUND & AMATEUR EQUIPMENT**



## NEW 1949 NEWARK CATALOG

No matter how tiny the part, how tremendous the system... it's listed in this mammoth catalog... over 20,000 items including everything in Standard Brand equipment! The most complete essential reference book for pros, hams, hobbyists, novices, oldtimers... everyone interested in TV, radio and sound equipment!

**24-HR. MAIL ORDER SERVICE ONE YEAR TO PAY**

148 pages packed with pictures, charts, and vital information **KITS! SETS! PARTS! ACCESSORIES!**

**3 GREAT STORES!**  
115 West 45th Street and Downtown at 212 Fulton Street **NEW YORK**

323 W. Madison Street **CHICAGO**



Newark Electric Co. 242 W. 55th St., NYC

**MAIL COUPON NOW!** Dept. D14 Please send FREE Newark Catalog to:

NAME \_\_\_\_\_

ADDRESS \_\_\_\_\_

CITY \_\_\_\_\_ STATE \_\_\_\_\_



# LEARN

## THE PRINCIPLES OF ELECTRIC MOTORS

### ASSEMBLE YOUR OWN

#### FOR GRINDER - BUFFER - JIG SAW MODEL POWER-SHOE SHINER

NOT A TOY — but a powerful 1/10 HP, 1700 RPM shaded-pole motor (intermittent duty rating.) For ordinary 110 volt, 60 cycle current.

Complete instruction book tells how to assemble and what makes it run! Profusely illustrated with photos and diagrams—make it fun to learn by doing!

SO EASY a 14 year-old boy can do it—so good that electrical engineers use it for demonstrations. Wonderful DAD-and-SON project. Only tools you need are hammer, screwdriver, file, pliers and knife. NO SOLDERING.

FIBERGLAS insulation, Chrysler OILITE bearings, ALUMINUM end bells. Designed and made by former member of university engineering faculty.

SO NEW your dealer may not have it. If not, ORDER BY MAIL. If you wish, SEND NO MONEY.

Complete kit, including instruction book..... **\$8.95**  
 Instruction book (price refunded when you order motor)..... **25c**

**GUARANTEE** If you are not completely satisfied with your In-Struction-Duction motor kit, return it unused within 10 days for refund of your \$8.95. You're the judge!

**HAGEDORN ENGINEERING CO.** Box M-49 Woodland Park, Colorado

Send me the In-Struction-Duction Motor Kit COD. I will pay the postman \$8.95 plus postage.

I enclose \$8.95. Ship my In-Struction-Duction Motor Kit postpaid.

Send me the instruction book. I enclose 25c coin.

Name \_\_\_\_\_

Address \_\_\_\_\_

City \_\_\_\_\_ Zone \_\_\_\_\_ State \_\_\_\_\_

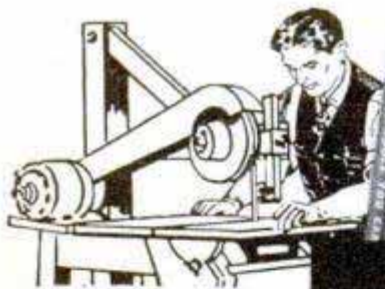

# 40 NEW EDITION

## Power Tools

### YOU CAN MAKE

## TURN WOOD, SCRAP AND WASTE INTO PRACTICAL POWER SHOP TOOLS

Don't limit your workshop fun to use of hand tools. Get the new edition of "Forty Power Tools You Can Make" with many new tools, and make your own power machines. Step up your fun and production. Do a better job with power tools. Make them yourself from wood and old discarded materials at small cost.

This book gives every detail in plain language you can understand and follow. Hundreds of pictures and plans show every step to follow. Mail coupon with \$1.50 today. Even though you have the old edition get this new book with 20 new tools. Money back if not satisfied.

# 40 Power Tools

## You Can Make at Little or No Cost

### Some of the 40 Tools You Can Make

- |                                |                           |
|--------------------------------|---------------------------|
| Table Saw with Tilting Arbor   | Wood Lathe                |
| Saw Sander Unit                | Power Hack Saw            |
| Drill Press from pipe fittings | Double Duty Sander        |
| Bending Brake                  | Jig Saws                  |
| Thickness Planer               | Band Saws                 |
|                                | 40 Different Tools in All |

**POPULAR MECHANICS PRESS, Dept. 4000**  
 200 E. Ontario St., Chicago 11

Send the new edition of "Forty Power Tools You Can Make."

Remittance for \$1.50 enclosed.

Name \_\_\_\_\_

Address \_\_\_\_\_

City \_\_\_\_\_ Zone \_\_\_\_\_ State \_\_\_\_\_

# BUILD THIS HOUSE Yourself

## The Famous Popular Mechanics House

The picture below is from an actual photograph of the Build-It-Yourself House with breezeway and garage, as built by Jack Brownson, 23-year-old veteran, in Aurora, Illinois.



Designed by Popular Mechanics and Famous Architects. Every Detail Simplified and Explained. No Previous Experience Needed!

Can you use everyday tools as well as the average Popular Mechanics reader? Then you, too, can easily build this modern house in any of its five designs, doing every part of the job yourself. The new Popular Mechanics Book, "Your Home—How to Build It Yourself" will show you how.

### Space for Living and Family Growth

This beautiful, modern house is 1½ stories, with basement, living room, kitchen, dining nook, two bedrooms, bath, plenty of closets and space for two additional bedrooms on second floor. The house itself is 35' 9"x28' 11"; breezeway 20' 10"x8'; garage 20' 10"x12'.

### The House That Has Everything

Designed for easy construction and the most living space for the least cost, the Build-It-Yourself House is also most attractive and suitable for any community and most income groups. The basic plan is adaptable to four other exterior designs.

### Get Book and Plans Now—Build When You Can

You may never have thought about actually building a house yourself, but now that building restrictions have been lifted, it is easier than you think. So order book and plans today. Even if you engage a contractor to build for you, you will need the plans. And you certainly will want the book which can easily save you hundreds of dollars, whether you build this or any other house.

## Mail Coupon for New Book and Plans!

Build It Yourself or Have It Built — Save Hundreds of Dollars!

### PLANS YOU CAN READ AND FOLLOW

Plans consist of ten working-size blueprints — floor plans, elevations, construction notes, framing, joints, lumber and mill list, specifications, plumbing and wiring diagrams. Every measurement is marked — every detail made clear as ABC. Book has 100 pages — three-fifths are photographs and drawings. Some sections in colors, showing just how your house will look when finished.

**BIG BOOK**  
 8½x11 inches



## MAIL COUPON FOR BOOK AND PLANS

**POPULAR MECHANICS PRESS**  
 200 E. Ontario St., Chicago 11

I enclose \$\_\_\_\_\_. Send me the items checked at once.

- Your Home and How to Build It Yourself..... \$ 3.00
- Complete set of plans for Popular Mechanics Home.. 12.50
- Book and plans at reduced price..... 14.00
- Duplicate sets of plans..... 5.00

Name \_\_\_\_\_

Address \_\_\_\_\_

City \_\_\_\_\_ Zone \_\_\_\_\_ State \_\_\_\_\_

**CASTING NOVELTIES FOR MONEY**

**NOW BE IN BUSINESS FOR YOURSELF**  
**THIS BOOK TELLS ALL!**

**Exciting New Book tells you how to make Big Money in your own business**

"Casting Novelties for Money" reveals plans and ideas that can make your future sound and secure. No experience, special skill or education necessary. Work spare time or full time . . . even in your own home. Book just bulging with money-making ideas. You'll especially want to read the special chapter about the amazing new material . . . Floc-Rite. It is the new material with 1001 uses that produces colorful finishes that look like Plush, Velvet, Velour and Suede . . . on almost any surface. Also includes a full page of color samples which allows you to see and actually feel this amazing new material. Price of "Casting Novelties for Money" is \$1.00. If not more than completely satisfied, return book in one week and your money will be promptly refunded. Send check, cash or money order now . . . or write for FREE information giving further details.

**BING PRODUCTS, Dept. PM46, 88 Broad St., Boston, Mass.**

# WORK GLOVES



Riegel makes the right glove for every job.

Riegel Textile Corp.  
 342 Madison Avenue  
 New York 17, N. Y.

"THIS TRADE MARK IS YOUR GUARANTEE OF VALUE"

# REAL ESTATE BE A BROKER

**PAYS BIG! SEND FOR FREE, BIG, ILLUSTRATED CATALOG NOW!** No obligation. Graduates report making substantial incomes. Start and run your own business quickly. Men, women of all ages, learn easily. Course covers Sales, Property Management, Appraising, Loans, Mortgages, and related subjects. **STUDY AT HOME** or in our classrooms in big cities. Diploma awarded. G.L. approved. Nationally known.

**WEAVER SCHOOL OF REAL ESTATE (Est. 1936)**  
 15 E. Pershing Road Dept. NT-4, Kansas City, Mo.

**FREE BOOK TELLS HOW**

**TAKE ORDERS**

## ... For NATIONALLY ADVERTISED APPLIANCES, TABLEWARE AND JEWELRY Make 25% Profit on Every Sale

Easy way to make extra money in spare time. Friends and neighbors glad to order from you because every item is Nationally Advertised by "BIG NAME" Companies under a Money Back Guarantee.

Send name today on a penny postcard for big, illustrated catalog that shows scores of highest quality Electric Irons, Toasters, Vacuum Cleaners, Washers, Grills, Clocks, Radios, etc. . . . all at standard retail prices. Catalog also shows newest designs in Silver Tableware, Costume Jewelry—other high-styled Jewelry set with Diamonds and other Pre-

cious Stones. You make 25% Profit (one fourth) on every order and fill all your own needs at low, wholesale prices. Don't wait. Start earning and saving money now. Send name on postcard to

**MAXILUME Company**  
 125 West Hubbard Street  
 Dept. A-84, Chicago 10, Illinois



## New! A COMPLETE FOTOLITE OUTFIT IN A COMPACT CARRY-ALL CASE

only \$10.95 Complete



**No Experience Needed to take Fine Pictures INDOORS with New ACME-LITEPAK No. 1**

NOW, take professional quality pictures indoors . . . the easy way . . . the sure way. Simple instructions show you exactly how. New fine quality ACME-LITEPAK No. 1 includes all lighting equipment you need—for color or black and white pictures. Here's what you get: 1. Strong, luggage-type carry-all container with plastic handle; 2. Two reflectors for #2 floods; 3. One reflector for #1 flood; 4. Three spring handclamps with "no-droop" fittings; 5. 15 ft. 3-way extension cord and switch; 6. Compartment for 3 stands which can be added later; 7. Four tested lighting plans. Measures only 20"x15"x12". Weighs 13 lbs.

**ORDER BY MAIL—SEND THIS COUPON NOW!**

ACME-LITE MFG. CO., 401 N. Wood St., Chicago 22, Illinois

Send me ACME-LITEPAK No. 1 at once. Enclosed is \$10.95 plus postage (shipping weight 13 lbs.) I may return the LITEPAK in 5 days for full refund if not satisfactory.

Name \_\_\_\_\_

Address \_\_\_\_\_

City \_\_\_\_\_ Zone \_\_\_\_\_ State \_\_\_\_\_

**FREE!**  
 Send Your Name for Our Big, Illustrated Catalog



# SAVE 2/3 Build Own ATTIC OR WINDOW FAN

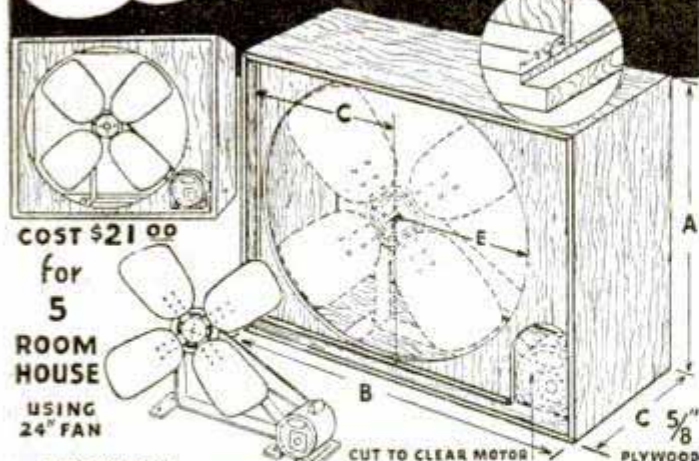

**COST \$21.00**  
for  
**5 ROOM HOUSE**  
USING  
**24" FAN**

ASSEMBLY	Size Fan	Dim -A-	Dim -B-	Dim -C-	Dim -E-	Price
Torington Precision Balanced Steel Blade Rigid Welded Construction. Adjustable motor mount. Correct pulley ratio to 1750 RPM Motor.	20"	22"	29 1/2"	11"	10 1/2"	\$19.50
	24"	26"	32 3/4"	13"	12 1/2"	\$21.00
	26"	28"	34 1/4"	14"	13 1/2"	\$22.00
	28"	30"	35 1/2"	15"	14 1/2"	\$24.50
	30"	32"	37 1/2"	16"	15 1/2"	\$27.50
	36"	38"	41 3/8"	19"	18 1/2"	\$29.95
	42" FAN					\$34.95
	48" FAN					\$39.95

Thousands in use. The assembly takes guesswork from your completed fan. Assembly comes complete with blade, pulleys, etc., all parts excepting motor and easily made wood box. Only work is to box assembly for attic or window, mount motor with 4 bolts and you'll have an efficient, sturdy, healthful, cooling fan. Order Model M-2 of size fan wanted. Send check, cash or money order plus \$2 for express and packing charges. For C.O.D. shipment send \$5 deposit. Satisfaction guaranteed or money back. (Special prices for quantities.)

**TROUSDALE MFG. CO., 266 Madison, Memphis, Tenn.**

## IT'S GUARANTEED A FULL YEAR

### Fine, 7-jewel Swiss wrist watch

Yes, this deluxe watch has 7 jewels of precious rubies, for time-keeping accuracy. Made by skilled Swiss craftsmen, and so good that a printed one-year guarantee is included. Glow-at-night dial, sweep-second hand to 1/5 sec.; pigskin strap; timed and tested movement. Hugged 3-piece case in mirror chrome. Packed in handsome presentation box at no extra cost.



Send no money—wear on 10-day trial  
Pay postman \$9.95, plus tax and COD postage . . . or send check for total \$10.94, and we pay all postage. Wear it 10 days; return for refund if you're not delighted.

**ONLY \$9.95**  
plus tax

**SWISS WATCH, 211 Paramount Bldg. (Dept. 904-C), Atlanta, Ga.**

# FALSE TEETH FIT TIGHT



**FOR LIFE OF PLATE With One Application or YOUR MONEY BACK**  
Professionally Developed  
Amazing

## LINO-DENT

**REAL COMFORT INSTANTLY FOR ALL PLATE WEARERS . . . No fuss or bother — looseness and slipping vanish — gum soreness heals and disappears — forever.**

**Not Messy — Not Sticky**  
Not a paste or powder but an amazing development in field of plastics. The same material modern dentures are made of. That's why we can guarantee perfect plate comfort permanently with one application.

Absolutely Safe Pure, non-toxic, non-irritating, harmless, odorless, tasteless, pleasant. Needs no heat. Easy to use!  
Money back guarantee  
**SEND NO MONEY**—Full size package only \$1.25 plus postage. Specify upper or lower. Both \$2.25 plus postage C.O.D. Enclose payment and save postage.

**LINO-DENT, Inc. (Dept. C-3) 1199 BROADWAY NEW YORK 1, N. Y.**

## CARBURETOR TOO RICH MAKES MOTORIST TOO POOR



Car owners who are wasting money and not getting proper gas mileage due to over-rich mixtures will be pleased to learn how to save gasoline by **VACU-MATING** over-rich mixtures. **VACU-MATIC** fits all cars, trucks and tractors. It is automatic and operates on the supercharge principle. Easily installed in a few minutes.

**SALESMEN WANTED!** Big Profits!  
Send name, address on penny postcard for free particulars and how to get yours for introducing.

**VACU-MATIC CO., 1434-1498 W. State St., WAUWATOSA, WIS.**

## COMMERCIAL TRADES' GRADUATES GET THE BETTER JOBS

**PRACTICAL SHOP TRAINING IN AIR CONDITIONING — REFRIGERATION ELECTRICITY MAJOR APPLIANCES SERVICE, MAINTENANCE & INSTALLATION**  
Write for Catalog PM4

**COMMERCIAL TRADES INSTITUTE**  
200 SOUTH 20TH ST. BIRMINGHAM, ALA.  
Member: Southern Association of Private Trade Schools  
An approved school to TRAIN Veterans & Non-Veterans

## BIG MONEY IN NEW SYSTEM OF HEATING

Learn about new system of heating WITHOUT FUEL. (Reverse cycle of refrigeration.) Wonderful opportunity to be miles ahead of others . . . IF YOU ACT NOW . . . Get the FACTS . . . They are FREE . . . No obligation.  
**PRACTICAL TRADES INSTITUTE, INC.**  
25 University Ave. S.E., Dept. P-4, Minneapolis 14, Minn. Write Today

**SAY YOU SAW IT IN POPULAR MECHANICS**

# FOOD DISTRIBUTORS

Exclusive distributorship on 20 cent food item, netting you up to \$7.20 a gross. Magnificently **CELLOPHANED** in yellow, purple and red. Displayed in super display boxes of 48 each. Cuts food cost. Sell 50 gross weekly. Free samples and details air mailed 18 cents postage. Regular mail 9 cents. Stamps O.K.

**FLAVOR-TITE FOODS • 1967 West Slauson Avenue • Los Angeles 44, Calif.**

**CALIFORNIA**

Distributor Inquiries Invited

# CURB-L-ARMS

**PROTECTS FENDERS — HUB CAPS — WHITEWALL TIRES!**

- SIMPLIFIES PARKING FOR EVERY MOTORIST.
- ROAD STATIC DISCHARGED TO GROUND.
- EASILY ATTACHED TO FRONT AND REAR FENDERS WITH SCREW DRIVER.

CURB-L-ARMS warn motorist when nearing curb and other unseen objects. Resonant warning sounds prevent costly damage to fenders, hub caps and white wall tires, simplifies parking. Antenna is made of high carbon, heat-treated steel, chrome-plated to automotive specifications—extends below fender level to reach low and high curbs. Needed on and fits all cars, old and new. **NO ELECTRICAL CONNECTION.**

FULLY GUARANTEED—Money refunded if not satisfied. See local dealer or order direct. To order, write your name and address in margin.

**AECO PRODUCTS DEPT. PM-4 Beverly Hills, Calif.**

U. S. Pat. No. 2464365

**BE SURE — GET THE ORIGINAL CURB-L-ARMS**

\$100 worth of protection for ONLY **\$125** Set of 2 Postpaid

# ELECTRIFY your SEWING MACHINE

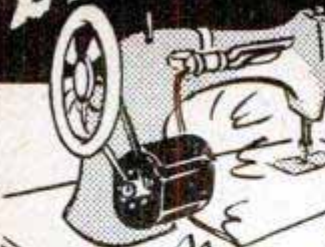

COMPLETE KIT ONLY  
**\$14.95**

90 DAY GUARANTEE

Now, make mother's or wife's sewing a pleasure. Easy to install. Fits ALL machines.

- Motor & Bracket
- AC-DC 60c. 115v.
- PULLEY & BELT
- 7 Speed Foot Control
- Cord Set
- Complete Instructions

SEND NO MONEY, pay postman plus C.O.D. or enclose money order and we will pay postage. MONEY BACK after five days if not completely satisfied. Shipping Wt. 6 lbs. State whether wheel on your machine turns towards or away from you.

2-TONE LUGGAGE CARRYING CASE \$9.95  
Specify base width, length and make of your machine. Wt. 11 lbs.



**FREE** CHROME plated SEWLITE as (illus.) plus an extra long wearing rubber belt.

**CONTINENTAL SALES COMPANY**  
Dept. PM1, 235 E. 59 St. New York 22, N. Y.

## WAR SURPLUS BARGAINS

**\$500,000.00 INVENTORY for QUICK LIQUIDATION**

Surplus items—hundreds of them for home, shop, factory, farm and outdoor use. New items, used items, reconditioned items—all at tremendous savings—all priced for quick sale.

**Page After Page of Values**

This big catalog shows page after page of amazing money saving values. Write for your copy today. Send 10c to cover postage, mailing, etc. Write today!

**10c**

**STARK'S** Dept. PM42 509 So. STATE STREET CHICAGO 5, ILLINOIS

## ELECTRICIANS' SCHOOL

HOUSE AND COMMERCIAL WIRING • MOTOR REPAIR AND REWINDING • ELECTRIC REFRIGERATION

Approved for Veterans Training

**PENNSYLVANIA INSTITUTE SCHOOL OF ELECTRICITY**  
42nd and SPRUCE STS. PHILADELPHIA 4, PENNA.

## SEND FOR THESE AUTOMATIC SHUT-OFFS FOR WATER HEATERS • INCINERATORS • WATER SOFTENERS

FULL MONEY BACK GUARANTEE on these automatic shut-offs which eliminate return trips to the basement! Installed in a few minutes with ordinary tools. Comes with simple, complete instructions. Order direct from factory.

Get **ERIE TIME-O-GAS** for your water heater or incinerator. To operate, set knob to burn for 2 to 5.5 minutes. **ERIE TIME-O-GAS** shuts off gas automatically! Works on manufactured, natural, mixed gas. Use with or without pilot. Pilot lighter included **FREE** with each unit.

Get **ERIE TIME-O-FLOW** for your water softener. Just set it for proper flushing time, after regenerating. **ERIE TIME-O-FLOW** shuts off rinse water automatically!

Send only **\$8.95** for postpaid **ERIE TIME-O-GAS**; **\$14.95** for **ERIE TIME-O-FLOW**; or C.O.D. plus postage; or write for **FREE** information. (Specify if **ERIE** TIME-O-GAS is for heater or incinerator).

**ERIE MFG. CO., Dept. P-6 — 300 N. 8th St., Milwaukee 3, Wis.**

# PLAN YOUR FUTURE NOW!

**Permanently Metalized Baby Shoes**

## YOU CAN START YOUR OWN BUSINESS

### AT HOME • SPARE TIME • FULL TIME

**LARGEST NUMBER OF SUCCESSFUL BUSINESS MEN**  
Our course has the largest number of successful business men in this field today. All are men and women who acted and are making money.

**MAKE \$5.00 PER HOUR.** Now is the time to cash in on this big-paying, easy-to-operate, year-round business. You need no experience. With actual illustrations and step-by-step instructions YOU can start to earn money immediately—up to \$50.00 to \$75.00 per week spare time—up to \$500 and more per month full time. In a few hours you can make more than most people make working an entire week.

- **THIS COURSE IS GUARANTEED.**
  - **Money-Back Guarantee**
  - **Most Successful Name in Metallizing**
  - **Big Income**
  - **Huge Demand**
  - **Sales Plans**
  - **Future Security**
  - **Your Own Business**
- IMMEDIATE RESULTS**—This tested and proved method shows you complete details so that you may start at once metallizing baby shoes with *real* Gold, Silver, Bronze, Pearl and Glass. They will last for ever and ever retaining every priceless detail of natural shoes. Five million new customers waiting to buy every year.
- BEGIN AT HOME**—Don't pass up this golden opportunity to start your own business on a shoe string. **ACT NOW!** We will send you full details absolutely free.

**USE THIS COUPON**

**SAMPLE SHOES!**

**INCLUDED WITH COURSE AT NO EXTRA COST**—2 actual metalized baby shoes guaranteed most attractive on market or PAIR OF YOUR OWN BABY SHOES METALIZED IF YOU PREFER

**Rush me FREE full particulars at once**

NAME \_\_\_\_\_

ADDRESS \_\_\_\_\_

CITY \_\_\_\_\_ Zone \_\_\_\_\_ STATE \_\_\_\_\_

# TOOLS

## 1000's OF SURPLUS VALUES



**SCREW PITCH GAGES**  
Lufkin, #73D, 28 pitch, New only, \$1.85. Starrett's Best, 27 pitch, #155. New. \$3.00 list for \$1.95.



**TORQUE WRENCH**  
25 lb., 3/8's drive, Sturtevant. Finest steel, Floating Handle, Brand New \$17.50 Value, only \$2.45.



**DeVILBISS ENGINE CLEANER**  
GDZ-510, complete with hose. Ideal for cleaning grease, cosmoline, etc., from motors, engines & machinery. \$12.00 value for only \$6.95.



**AIR HAMMERS**  
Chicago 3X and Cleveland E2 & E3, Pistol Grip. Used. Cost government \$55.00. Your cost, only \$6.95. Includes one set and spring. Extra sets, 35c.



**RIGID SCREW EXTRACTOR SETS**  
For screws 1/4" to 1/2" inclusive. Drills, drill guides, extractors & turnuts. 21 precision pieces and case. Brand new. \$12.00 value, \$6.95.



**STUD PULLERS**  
Wedge type like Plomb, 1/4 to 3/8 capacity. 1/2" drive. New. \$3.00 value for only \$1.15.

ALSO MANY OTHER SIMILAR TOOL VALUES!

Postage prepaid in U.S.A. with full remittance. Otherwise 25% with order. Balance, including postage, C.O.D.

### MAIN SUPPLY STORE

521 MAIN STREET • KANSAS CITY 6, MO

**U. S. Army Air Force Type**  
**SUN GLASSES**

**BEST BUY UNDER THE SUN!**



Men's and Women's sizes

Genuine Leatherette Case included

FORMERLY \$8.50 VALUE

Super-Sensationally Priced at only ... **\$1.88** postpaid

- ★ Cool green meniscus curved, polished lenses.
- ★ Gold Plated adjustable frames
- ★ Perloid Sweat-bar and Nose-pads
- ★ Reinforcing bar for greater durability
- ★ Lenses meet specification of U. S. Gov't. Bureau of Standards.

**LIFETIME GUARANTEE**

At any time during the life of these sun glasses we will fix them for a nominal service charge of 50 cents.

Absolute Satisfaction guaranteed or money cheerfully refunded.

**MAIL THIS COUPON TODAY!**

CHICAGO GOGGLE SALES CO., Dept. 100  
1148-1160 W. Chicago Ave., Chicago 22, Ill.

Please send me .... Men's .... Women's Sun Glasses.

Send C. O. D.  
 Enclosed find \$..... Mail Postpaid.

Name.....  
Address.....  
Town..... State.....

Catalog FREE

# BINOCULARS



7x50  
\$44  
Ht. 7 in.  
Wt. 37 oz.

7x50 MILITARY IND. FOC. \$44 Coated \$54  
6x30 GERMAN FEATHERWEIGHT CENT. FOC. \$37.50  
BROWNSCOPE 8x32 CENT. FOC. COATED \$39.50

Add 20% Fed. Tax

Leather Cases—We Pay Postage—Money Back Guarantee

**BROWNSCOPE CO.** Dept. 4M, 24 West 45 St. New York 19, N. Y.



# CERAMICS

We teach you how to make beautiful pottery and ceramic ware, for your own enjoyment, for home decoration or as a profitable source of income! Making pottery and ceramics at home is EXTREMELY EASY, fascinating, and enjoyable work that ANYONE can do. Send 10c for CERAMICS CATALOG and details of our free instruction plan. If you are interested in PLASTIC send 15c for big plastics catalog and attractive plastic cameo at no extra cost.

**PLASTICAST COMPANY, Dept. 7**  
4637 N. Kedzie Avenue Chicago 25, Illinois (Order by Mail Only) P.O. Box 987 Palo Alto, Calif.

## MONEY and FUN MAKING JEWELRY and SELLING

(1) **MAKING:** Complete starting kit contains enough gold filled, plated and silver material to make more than a dozen jewelry items such as Necklaces, Pendants, Bracelets, Earrings both pierced and unpierced, etc.; also all necessary tools, illustrated instructions and sales plan. All this only \$12, cash or C.O.D.  
(2) **SELLING:** Start a costume jewelry route in your town or neighborhood! Sell earrings, rings, bracelets, necklaces, tie chains, etc. Samples and sales plans only \$5, cash or C.O.D. (Samples will retail for over \$10.)

ROBINSON'S JEWELRY, Dept. 1, 610 Main St., Oregon City, Oregon

## ARTISTS MAKE MONEY

Do you like to draw? Send name, address, age and occupation for FREE ART TEST, to find out your ability.

**ART INSTRUCTION, Inc.**  
4139 ART INSTRUCTION BLDG., MINNEAPOLIS 15, MINN.

**TRAINED MEN GET THE BETTER JOBS**  
**PRACTICAL SHOP TRAINING**  
in AUTOMOTIVE MECHANICS  
BODY and FENDER REBUILDING  
If interested write for catalog or wire  
**ATLANTA MOTIVE TRADES INSTITUTE**  
Dept. P, 254 IVY St., N.E., Atlanta, Georgia  
Member of the Southern Association of Private Trade Schools  
Veterans ask about G I Training

**Learn TELEVISION-ELECTRONICS RADIO**  
Train at Home—Get Big Kits of Radio Parts!  
2 Big Books FREE Prepare now in spare time. Practical instruction. Approved for Veterans. Write for details and 2 Radio Books—ALL FREE! Rush name today!  
**SPRAYBERRY ACADEMY OF RADIO**  
Dept. 10-Q, 20 N. Wacker Drive, Chicago 6, Illinois

**Toolmaking Pays Drafting BIG**  
You can train at Allied's Big Shops or Study at Home under Allied's Supervised Home Plan  
Key Positions Open in Industry

- MACHINIST TRADE
- TOOL & DIE MAKING
- DRAFTING—ALL BRANCHES
- TOOL & DIE DESIGNING
- PRODUCT DESIGN & ILLUSTRATION

Established in 1928  
FULLY APPROVED  
Nationally Known, Endorsed by Industry  
Write For Catalog—A 1c Postcard will do  
**ALLIED SCHOOL OF MECHANICAL TRADES**  
1338-1340-1342 So. Michigan Ave.  
424 Allied Bldg. Chicago 5, Ill.

# CLOSE-OUT SURPLUS BARGAINS!

SAVE UP TO **90%**

Lenox Deluxe or Supreme Pure Brier. All styles. Given with order a \$1 Seal Tile Leather Pouch. Originally sold for \$3.50 ea. Close out

**PIPES 2 for \$1.00**

## MARGO LIGHTER

Attractive case. Wind-proof. Mfg. Lifetime Guarantee. Order now.

(Reg. \$3.50) **ONLY 69¢**



its unbelievable, but its **TRUE!**



**JACK BENNY & FIBBER MCGEE**  
**EDDIE CANTOR**

Burns & Allen, Jimmie Durante, Amos & Andy, Charlie McCarthy. 8 sides-10" records, gorgeous albums. Reg. \$10. Miracle Value

**RECORD ALBUMS! ONLY 2.95**

## BILLFOLDS!



While they last! Values to \$10. Finest Morocco, Goat or Calf Skin. Zipper leaves. Transparent compartments. It's wonderful for only

**1.95**

## GUARANTEED ONE YEAR BY MFG.

### SWISS WATCH (ARMY TYPE)

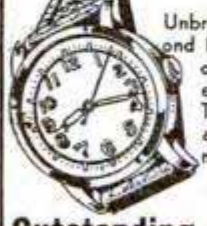

Unbreakable crystal. Sweep second hand. Radium dial. Chrome or Stainless steel case. Leather or metal stretch band. Tremendous value. Originally sold to \$19.95. Buy now — only

**6.95**

Outstanding Value!

plus 67c tax

### DE LUXE SHEFFIELD CHRONOGRAPH WRIST WATCH



Has everything—plus new low price. It's a timekeeper, stop watch, measures distance, speed of planes, cars, horses, etc. Sweep second hand, chrome case, unbreakable crystal, precision Swiss movement. Sold to \$29.95.

**9.75**

Plus 97c tax

## WORK SOX

Get them while they last. Durable cotton. All sizes. Good lengths. Many colors. \$2.50 Value. Look!

**6 pr. ONLY 1.15**

## RAZOR BLADES

Year's supply. 100 blades. Over 25 pls. Extra thin. Values to 25c pt. Given with order 50c Sharpener. Only

**1.00**

## GARDEN HOSE



### PLASTIC

1/3 weight of ordinary hose. Won't mildew or rot. Crack-proof. Resists oil. Top pressure. 2 year warranty. Don't pass this buy. Regular \$12.95.

(50 ft.) **6.99 ONLY**

### HONE STONE SET

Terrific! Reg. \$1.65 set. Includes Big Ben Stone (75c), Razor Stone (50c), Knife Stone (15c) & Oil (25c). Complete set only

**35¢**

### TOBACCO POUCH

Genuine Leather. Zipper and Pipe holder compartment. Reg. \$2.

Only

**29¢**



### RIFLE

Your kid will love it. Rifle type pop-gun with string tied cork. HARMLESS. He'll be the leader of his gang.

Regular \$2.00. Only

**65¢**

## GUARANTEED PENS



**98¢**

Onyx type finish. Heavy base. Home or office use. Regular \$3.00. Desk Pen Sets. Lifetime guarantee.



Penman Fountain Pens. Write right! Price right! Factory guarantee. Regular \$1.35. Imaginal Only

**35¢**

### LADIES RAINCOATS

Sensational value. Reg. \$10. Plastic with belt and hood. Styled in all colors. Small, Med.-Lg.

**1.98!**

## JUNIOR GENIUS ELECTRIC MOTOR KIT



Educational. Entertaining. Anyone can make an electric motor—guaranteed to work. Complete directions. Assemble in 2 hours. Unique. One of the best on the market. Only

**1.00**

### LAMP WIRE (ROYAL ELECTRIC)

Nylon Covered. For any electrical use. Buy of a lifetime! Any length. Only



**3¢ PER FOOT**

### ORDER BY MAIL AND SAVE

Send Cash, Check, M. O. (Postage Prepaid) or C.O.D. All merchandise is brand new. Money-Back Guarantee. Write for free catalog.

## WAYNE SALES CO.

423 AMERICAN AVE. LONG BEACH 12, CALIF.

## Now you can coat anything with LIQUID STAINLESS STEEL

IN SPARKLING, IRIDESCENT COLORS. APPLIED LIKE PAINT  
• CHEMICAL-PROOF, WATERPROOF, PERMANENT

By a new process, pure Stainless Steel has been incorporated with a new, tough, waterproof and chemicalproof plastic so that it can actually be applied like paint to practically any surface—quick-drying, beautiful and as near to a permanent protective coating as modern science can give you!

### PURE STAINLESS STEEL — APPLIED WITH A BRUSH

- "LIQUID STAINLESS STEEL" can be brushed or sprayed on wood, metal, plaster, brick, concrete or composition. "Metalize" ANYTHING with a paint-brush—painted or unpainted furniture, novelties, metal or wood cabinets, sinks, bathrooms, floors, surfaces exposed to salt or fresh water, interior or exterior—you can build of ANY material and give it a STEEL surface with "LIQUID STAINLESS STEEL"—the most durable and beautiful of all metals. Available in either the Natural color of Stainless Steel, or beautiful, sparkling iridescent metallic colors: Burgundy, Gold, Jade or Blue.
- PRICES: Quart \$3.95, Natural, \$4.30 for colors; Gallon, \$12.00 in Natural, \$12.95 for colors, all postpaid anywhere in U. S.

At dealers, or order direct (Dealers', Jobbers' inquiries invited).

**THE LOCKREY COMPANY** Plastics Division COLLEGE POINT 6, N. Y.

### ALSO ELECTRIAID CHARTS FOR ELECTRICAL ENGINEERS

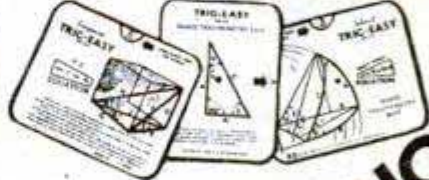

COMPLETE SET 3 CHARTS & ILLUSTRATED INSTRUCTIONS & TABLES, 168 PAGES  
ALL POCKET SIZE;  
POSTPAID  
**\$2.00**

# EASY TRIGONOMETRY CHARTS

AN EASY METHOD TO SOLVE PLANE, SPHERICAL & COMPOUND ANGLES, THOUSANDS USED BY TOOL MAKERS, DRAFTSMEN, STUDENTS, MACHINISTS, A PROVEN PRODUCT, STILL SOLD AS A TOOL TO THE MAN WHO WANTS TO MAKE THINGS ACCURATELY. SEND FOR YOUR SET NOW. MONEY BACK GUARANTEE. FREE CIRCULAR "TRIGONOMETRY" AT WORKY-ON REQUEST.

E.H.NEEDHAM DEPT. 51 CULVER CITY, CAL.

## USE TRIG-EASY

Sensational NEW 1949

# MIDWEST RADIOS with

**DUAL-SPEED RECORD PLAYER**  
**EASY TERMS**

Powerful 5 Wave Band Series

**16 AM-FM CHASSIS**

SEPARATE CHASSIS OR COMPLETE CONSOLES AVAILABLE

## SYMPHONY GRAND AM-FM RADIO-PHONOGRAPH



**30 DAYS TRIAL**



A magnificent instrument. Offers Series 16 Radio chassis, Dual-Speed Phonograph, Television Audio Switch-Over. Other console and table models available with Series 16, 12, or 8 chassis.

...also the **NEW MIDWEST TELEVISION** with **BIG 75 Square Inch Picture**  
Write for **FREE Folder**

Buy Direct From **FACTORY** and **SAVE**

Write in Name and Address (Please Print) on Coupon or by Postcard.

**MIDWEST RADIO & TELEVISION CORP.**  
Dept. 259, 909 Broadway, Cincinnati 2, Ohio

- Please send **RADIO** Catalog
- Please send **TELEVISION** Folder

**SEND THIS COUPON TODAY**

NAME \_\_\_\_\_  
ADDRESS \_\_\_\_\_  
CITY \_\_\_\_\_ ZONE \_\_\_\_\_ STATE \_\_\_\_\_

Say You Saw It in **POPULAR MECHANICS**



## "GET ON" Uncle Sam's PAYROLL

**START as high as \$3,351 Year**  
**Prepare NOW For Next Examinations**  
20,000 appointments each month

Hundreds of Jobs to be filled at big pay. Veterans get preference. Qualify now. Mail coupon today—**SURE**

**FRANKLIN INSTITUTE**  
(Not Gov't Controlled)  
Dept. N86, Rochester 4, N. Y.  
Rush to me entirely free of charge 40-page book with: (1) A full description of U. S. Government Jobs; (2) A list of U. S. Government Jobs; (3) Tell me how to qualify for one of these jobs.

Name \_\_\_\_\_  
Address \_\_\_\_\_ Vet? \_\_\_\_\_

# PAY RAISING—EXTRA MONEY BOOKS

Use these books to prepare for a better job—bigger pay—to start a profitable spare time or full time business of your own, improve your home, start a hobby. Popular Mechanics specializes in supplying outstanding self-help books on many subjects. Send for our FREE catalog.

- Outdoor Sports Manual**  
Hunters, Fishermen, Trappers, Campers, Archers, Boatmen. here is your book!...\$2.00
- Shop Notes Library**  
3 Vols. — 1949, 48, 47, 44, (No. Dup. Mat.)...\$2.48
- Painting, Furniture Finishing and Repairing**...\$1.50
- Rewinding and Servicing Electric Motors (No. 75)**... 25c
- Photo Handbook**  
An entirely new and different book from our Popular Photo Guide. It's a complete guide to better pictures and dark-room technique, and features dozens of handy gadgets you can make yourself...\$2.00
- High School Self Taught**  
Covers 25 subjects with study guide and self-testing quizzes. Completely revised and enlarged edition, 1280 pages, 300 illustrations, ...\$3.95
- Garden Book**  
Build own trellises, lawn furniture, fireplaces, ornaments, etc. ....\$1.25
- Diving, Cutting and Welding in Underwater Salvage Operations**  
Only book of its kind ..\$2.00
- Picture Framing**  
Modern methods for making and painting picture frames. Fully illustrated, ...\$2.75
- If You Want to Write You Can Write!** Learn through actual examples ...\$1.75
- A-B-C Shorthand**  
This easy to learn system can be mastered in 12 easy lessons ...\$1.00
- Modern Illustration**  
A practical art course covering all branches of commercial drawing, painting and methods of reproduction ...\$3.00
- 210 Deluxe Small Homes**...\$1.00
- Into the Freezer and Out**  
A complete handbook on the home freezing of foods. \$2.50
- Concrete Handbook**  
New book on using concrete around home, garden, farm ...\$1.50
- Zero Storage in Your Home**  
How to prepare, store and freeze food properly...\$2.50
- This Way Up**  
The successful philosophy of practical business men \$2.00
- Welding, Brazing and Soldering**  
How to build own equipment and how to use it effectively ...\$1.25
- Modern Refrigeration**  
Electric, Gas. Be service expert ...\$5.00
- Dyke's Auto Ency.** (includes Diesels, airplane engines) New 20th Ed. World's greatest book for mechanics \$7.00
- Household Mechanics**  
The "fix-it" book to end all "fix-it" books. Covers electric appliances, painting, carpentry, etc. ....\$2.75
- Oil Burner Handbook**...\$2.50
- Build Your Own Boat**  
Describes 17 popular boats—rowboats, sailboats, plywood outboard, etc. 192 pages \$1.50
- House Wiring (No. 89)**... 25c
- Turn Scrap Into Money**  
Convert old auto generators into motors, welders, etc. ....\$1.00
- Popular Mechanics Farm Manual**  
Packed with practical ideas and usable information that can easily be worth hundreds of dollars to every farm family and to homeowners everywhere. Send for free descriptive folder giving complete contents! ...\$3.00
- Woodworking for Every-body**...\$2.75
- Sheet Metal Work**...\$3.00
- Tool and Saw Sharpening (No. 92)**... 25c
- Forging Practice**.....\$1.50
- Action Toys (No. 66)**  
Plans for 21 easy-to-make toys ..... 25c
- Foundry Work**.....\$2.25
- Pattern Making**  
Wood, metal.....\$2.25
- Forty Power Tools**  
Build own saw, drill, lathe, sander, etc., from scraps—save money.....\$1.50
- Carpentry**.....\$2.50
- The Young Craftsman**  
Over 450 things boys can make.....\$1.50
- Five Acres and Independence**  
How to make money on small farm.....\$2.50
- Your Home and How to Build It Yourself**  
Step by step construction of the famous POPULAR MECHANICS house. Wonderfully illustrated.....\$3.00
- Drake's Householders Cyclopaedia**  
This is the time to save money on those necessary home repair jobs—Repairing, Remodeling, Carpentry, Painting, Decorating, Plumbing, Heating, Electric Wiring and Appliance Repairs, Furniture Repairs—This new book covers them all.....\$5.00
- Motorist's Handbook**  
Popular Mechanics scores again. A 160 page guide to automotive happiness...\$2.00
- Knots, Ties and Splices**  
For everyone who uses rope...\$1.25
- What to Make for Children**  
Junior tough on toys? Build him playthings that will last...\$2.00
- LeJay Manual of Homemade Electric Equipment**  
How to construct 100 items that are scarce and valuable...\$1.50
- How to Estimate for the Building Trades** Material and labor costs for masonry, plumbing, electricity, carpentry, heating, hardware, painting, etc. 629 pp.....\$5.50
- Rabbits for Food and Fur**...\$2.50
- Tool Making**.....\$4.00
- Tool Design**.....\$4.50
- Plumbing Installation & Repair**.....\$2.00
- Ropp's Calculator**... 75c
- Slide Rule Simplified**... \$2.75
- Drake's Refrigeration Service Manual**.....\$2.00
- Primer for Home Builders**  
All the information you need to know in building a house...\$2.50
- How to Read Aircraft Blueprints**...\$4.40
- America's Best Low Cost Homes**  
125 popular practical designs.....\$1.00
- Toys You Can Make of Wood**...\$2.50
- A.B.C. of Poultry Raising** \$2.50
- Ice Cream for Small Plants**  
Some technical formulas for ice cream, ices and frozen desserts on a commercial scale.....\$2.50
- Furniture Joinery**.....\$2.00
- Essentials of Upholstery**...\$3.25
- Radio Physics Course**  
A thorough training in radio fundamentals.....\$5.00
- Modern Home Medical Advisor**  
How to recognize diseases, practice proper hygiene, and know what to do in medical emergencies. 900 pages, 136 illustrations.....\$2.49

## MAIL THIS COUPON TODAY

Check the books you want, write your name and address below, and mail this advertisement with money order or check. Outside U. S. A. include 15% additional for shipping charges. Books selected will be mailed promptly on our "money back if you're not entirely satisfied" guarantee.

Name \_\_\_\_\_  
Address \_\_\_\_\_  
City \_\_\_\_\_ State \_\_\_\_\_

Mail to **POPULAR MECHANICS PRESS**  
Dept. 700—200 East Ontario St., Chicago 11, Ill.



# 25,000 MPH

The speed at which a rocket must attain in order to leave the Earth's gravitational pull. This and many other interesting facts supplied with scale Model of the V-2 Rocket. Have fun, or experiment seriously with a Rocket that works like the real thing. Zooms over 200 feet into the air. Get in on the ground floor and learn the secrets behind interplanetary space flights now.

ZOOMS OVER  
200 FEET  
INTO THE  
AIR

Can be  
used over  
and over  
again

## V-2 ROCKET

For only \$2.95 your rocket comes equipped ready to fly with special launching stand and full instructions on how to make your rocket zoom over 200 feet into the sky.

When payment is sent with order, we pay postage. Or send no money, sent C.O.D. \$3.50. Write Dept. M-4.

\$2.95

**WALSH PRODUCTS, INC.**

209 N. MAPLE AVENUE, EAST ORANGE, N. J.

## New Quick-Selling CELL-U-MOP...

DOES THE WORK OF  
6 TOOLS IN 1  
Holds 20 times its  
weight in water



Hands  
Never  
Touch  
The  
Water  
..  
Can Be  
Put In  
Boiling  
Water

others make  
**BIG MONEY**

"Enclosed find 56 orders representing 9 1/2 hours work on Monday and Tuesday." "Enclosed are 12 orders secured after supper this p.m."

**Housewives Pleased**  
Everyone that sees this outstanding CELL-U-MOP immediately want one... That's the reason our distributors are so successful... For MOPPING, WAXING, WALLS, WINDOWS, AUTOS and CLEANING RUGS. Sells quick to Taverns, Clubs, Hotels, Hospitals, Stores, Restaurants, Homes, etc. Drain Bracket squeezes out water thoroughly. Write for FREE particulars

CELL-U-MOP CO., Dept. P-4 FREEPORT, ILL.

## Boy! What a Picture!

And boy, what a book is Popular Mechanics new PHOTO HANDBOOK. Gives you the big three of superior photography:

1. The secret of taking better shots.
2. The technique of clearer developing.
3. The way to build better photo equipment.

Be an expert! Have fun! Save money!  
Paper covered edition on all newsstands... 60c  
Order colorfully bound library volume from  
**POPULAR MECHANICS PRESS... \$2.00**  
200 E. ONTARIO ST. CHICAGO 11

## Happy Highways Ahead!

With Popular Mechanics new **MOTORIST'S HANDBOOK**. 160 pages of authoritative advice to keep your car rolling smartly—longer. Brakes, body, spark plugs, battery, starter—every automotive part is covered in this up-to-the-minute manual of year 'round driving pleasure.

Your news dealer has the 60c paper edition.  
Order the clothbound \$2.00 volume from  
**POPULAR MECHANICS PRESS**  
200 E. ONTARIO ST. CHICAGO 11

# SPEEDEX GARDEN TRACTORS

Model C Including \$155.00  
Cultivator

**BIG BOY 6 H.P. \$285.00**

With Cultivator

Built For

- SMALL FARMS
- GARDENS
- GREEN HOUSES
- TRUCK GARDENS
- ORCHARDS

Just Drop Us A Penny Post-card For Your FREE Catalog



ALL  
PRICES  
F.O.B.  
RAVENNA

P-249-7A

**SPEEDEX  
GARDEN TRACTOR CO.**  
Post Office Box 216-D1, RAVENNA, OHIO

5821 1st AVE. S. • SEATTLE 8, WASH.

BEFORE BUYING ANY TIRE — CONSIDER YOUR FAMILY'S SAFETY — NOT JUST PRICE • BEST BRANDS, INCLUDING

GOOD YEAR Firestone

Goodrich U. S. ROYAL

SLIGHTLY WORN HIGH TREAD TIRES. NO RECAPS OR REBUILTS  
→ VETS TAKE 10% DISCOUNT. YOU CERTAINLY DESERVE IT ←  
FREE BUTYL TUBE 14 MONTH GUAR. BOND

600-16	\$4.40	550-17	\$5.75	600-20	\$8.95	34x7	\$10.95
650-16	\$4.40	525-18	\$5.75	700-20	\$9.95	825-20	\$11.95
650-15	\$4.30	700-16	\$5.00	32x6 (8)	\$9.95	900-20	\$12.50
700-15	\$4.50	750-16	\$6.00	32x6 (10)	\$10.50	1000-20	\$12.50

You've Never Seen Tires Like These Factory Adjusted  
"ALL-PURPOSE" CAR & TRUCK TIRES "TRIPLE-A" "TOP GRADE"  
GOLDEN-RULE GUAR. 24 MOS. AGAINST ANYTHING!  
600-16 \$5.50 525-18 \$6.75 600-20 \$9.95 32x6 (10) \$11.95  
650-16 5.50 550-17 8.00 650-20 10.25 825-20 15.45  
650-15 5.50 700-16 6.50 700-20 10.95 900-20 15.45  
700-15 6.50 750-16 6.50 32x6 (8) 10.95 1000-20 16.45  
600-16(6) 7.00 650-16(6) 7.00 750-20 11.00 34-7 13.00

We've Shipped Tires to Canada, Italy, Puerto Rico, Alaska  
Our Tires Used on School Buses and Ambulances  
**750-20 MILITARY Fits 32 x 6 700-20**  
8-ply Top Grade (Were \$9.75) \$9 Guar. 12 Mos.  
Premium Grade (Were \$18) \$13 Guar. 26 Mos.  
900-16 'A' \$7.75 900-16 'AA' \$10.75

Send check or money order & this ad for rush shipment. We won't ship a tire that WE wouldn't use. Blatt Bros. have personally Machine-pinpoint-inspected 1/2 million tires. Please depend on us.  
**BLATT** GIRARD AVE. TO LANCASTER AVE., DEPT. P.M.  
BLATT BLDG., PHILADELPHIA 31, PA.

Of course he rates high—he's got **P.A.\***



NEW HUMIDOR TOP  
Locks out air—seals  
in freshness... flavor

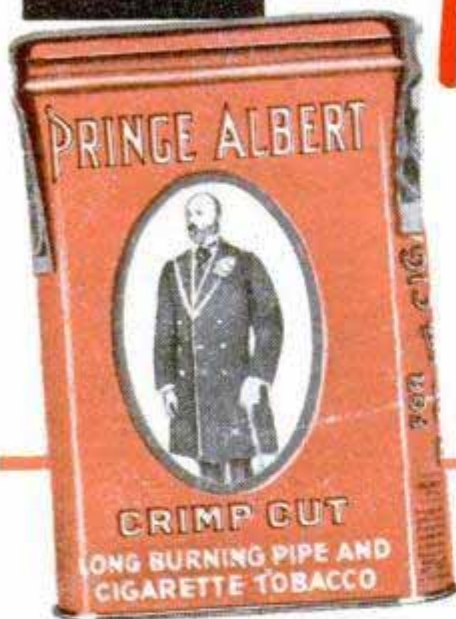

R. J. Reynolds  
Tobacco Co.,  
Winston-Salem,  
N. C.

**P.A.\*** means **P**ipe **A**ppeal  
The man with a pipe has an extra appeal to the ladies. Fill that pipe with Prince Albert for real smoking joy and comfort!

**P.A.\*** means **P**rince **A**lbert

● There are lots of reasons why Prince Albert is known as the National Joy Smoke! P.A.'s choice, crimp cut tobacco is rich-tasting... and tongue-easy. Specially treated to insure against tongue bite! Get Prince Albert in the handy pocket tin or the convenient pound size. It's America's largest-selling smoking tobacco!

"FOR CIGARETTE 'MAKIN'S',  
P.A. SURE RATES HIGH WITH ME!"

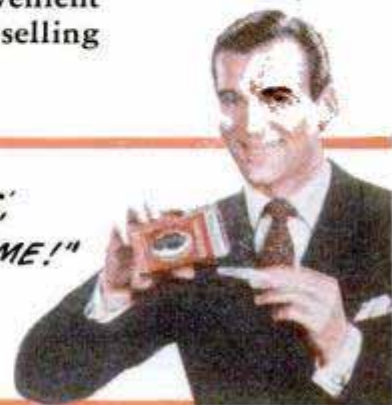

**The National Joy Smoke**

# POPULAR APRIL 1949 MECHANICS

WRITTEN SO YOU CAN UNDERSTAND IT  
VOL. 91 NO. 4

## we built a cabin for \$300



Photos by John Hobbs

"It gave me real pleasure to straddle a hefty log and square it into a corner post with a sharp adz"

**By Norman E. Chaplin**

**T**HE CABIN cost us less than \$300. Double that amount and convert it into a year-'round cottage. When we started to build there were innumerable obstacles to overcome, but having considerably more courage and energy than money, we got what we wanted and boast of our success.

The main obstacle was the lack of material and our lack of a GI priority. At the present time, the obstacle would be the high cost. Both problems may be solved

similarly, depending upon the intensity of the urge that drives one into action. If you are not afraid of hard work, if you can hit a nail on the head, keep to a straight line with a saw, and know how to use a square and level, and if you have the will to keep on the job until it is completed, such a house is yours.

There are several points I wish to stress. The first is a never-say-die attitude.

Second, the cottage, though small and

"We painted our cabin white. Seven storm windows in our living room give us a view that can't be beat"

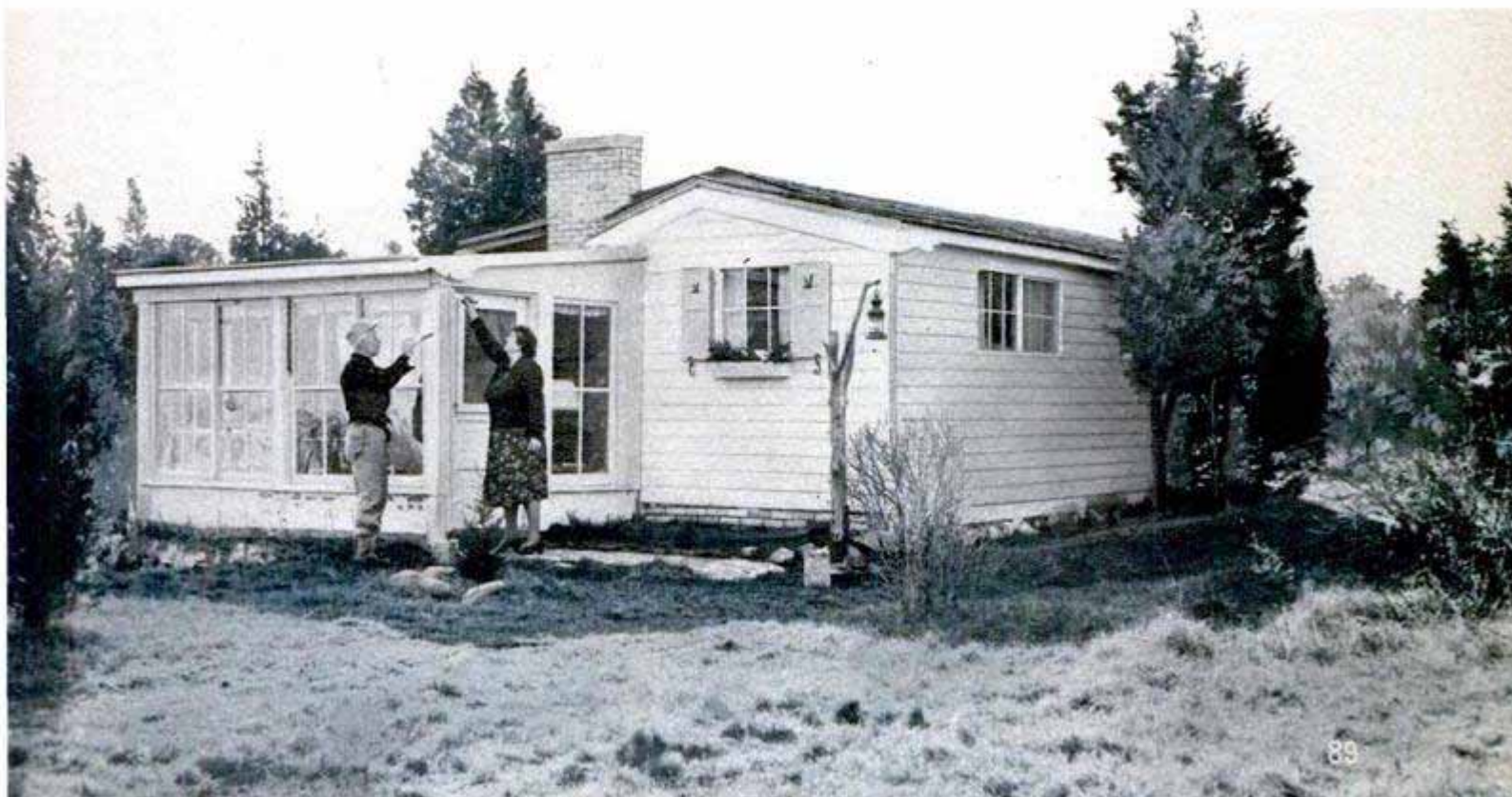

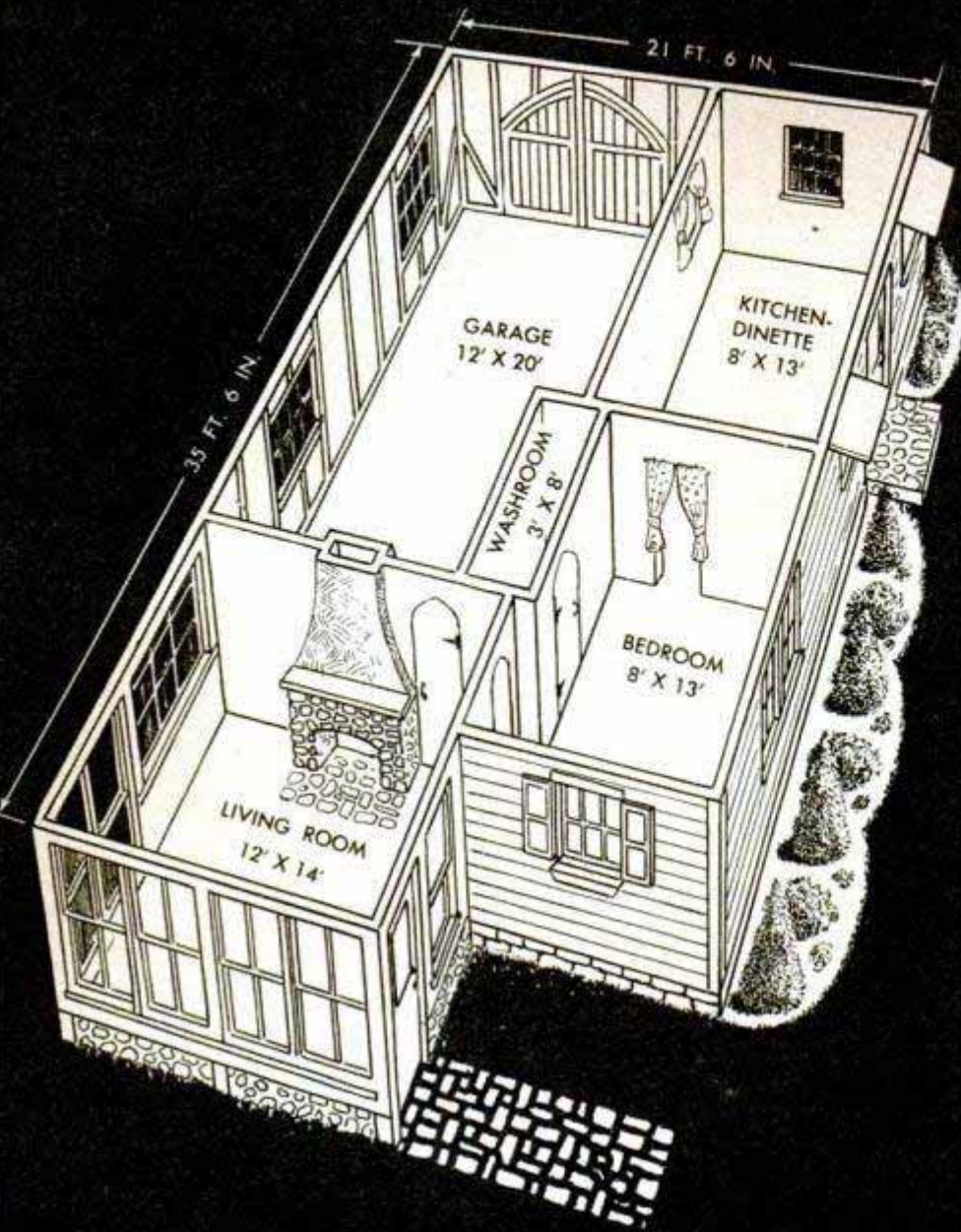

"We first built up the kitchen-dinette, bedroom and garage. A garage was a necessity, for we needed storage room for boats and tools. Later we added the living room and washroom. Below, when the cabin was almost finished I nailed up another new summer home, this one for our friends, the birds!"

built by amateurs at a minimum cost, need not be cheap or shacklike in appearance. Our \$300 cabin does not suffer in comparison with the \$7000 house next door, because we planned to make every feature the best possible before we dug the first hole. And this without an architect. Decide what you want in your house and then study magazine and newspaper plans. They may show pretentious or humble homes. Good ideas are everywhere.

We thought first of building a four-room cottage until we learned of the scarcity of building materials. The only builder considering the job gave us a figure of \$4000 for a summer cabin. This estimate, so far beyond what we had anticipated, tended to crystallize our independence. From then on we were concerned with the problems of a builder as well as an owner.

The plans were cut to three rooms and bath. A garage was included, for we needed a place for boats, tools, wood and the odds and ends that accumulate around a cabin. Planning means more than arranging floor space. The land, the morning sun, the sunsets, the summer breezes, the winter storms,

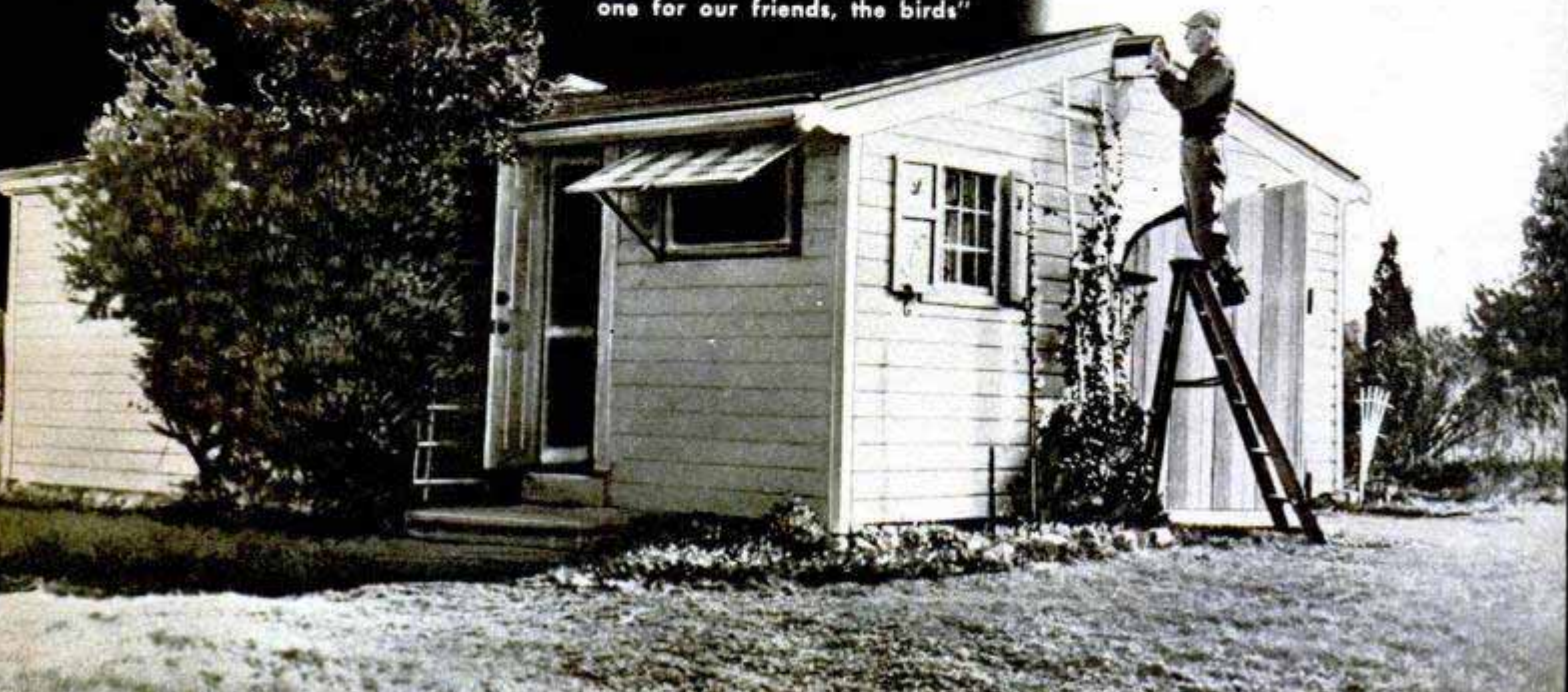

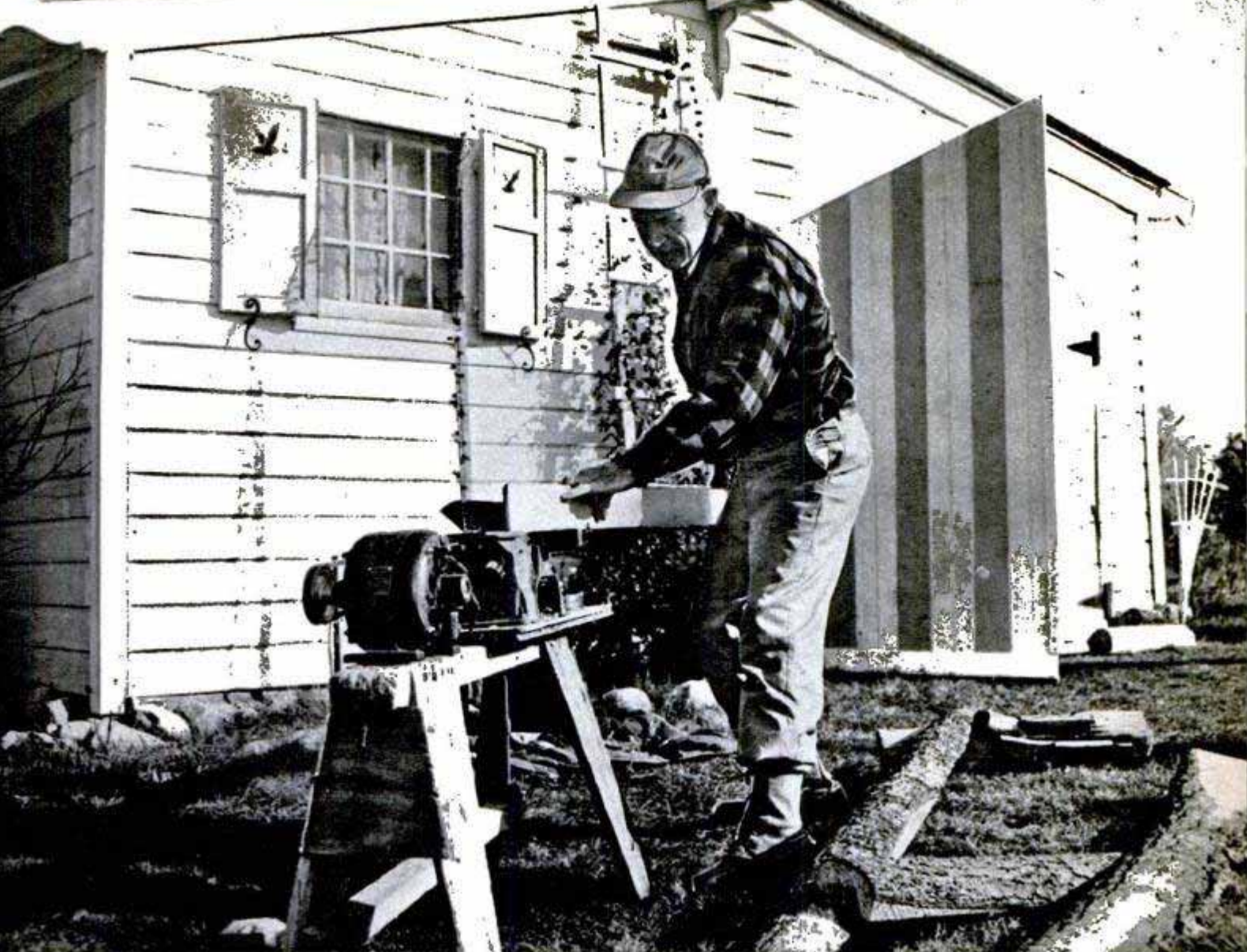

**"For trim I used pine slabs costing a dollar a trailer load, cutting and planing them into lumber myself"**

trees already available for landscaping, the best view of the ocean—these points and more were discussed and decisions made. The cabin, in spite of its simplicity, must be original in design, attractive and quaint. This is an important resolve. Do not build a "haphazard" cottage. The thoughtful touches that change a shack into a charming cottage cost little money. The effort and time spent on such touches produce results that are incalculable.

The cottage was placed close to the ground, closed in underneath with field stones laid in cement, which made a tight and attractive "cellar" wall. The stones were available without cost—found in the gutters of our newly laid streets and in stone walls placed at our disposal by interested friends. The cost of the cement was insignificant. The cottage itself is low-studded and rambling. The street wall is almost 50 percent garage door. When painting this, we experimented in order to unify the house and garage. We painted stripes of yellow and white on the doors, the rest of the building white: Over the doors hangs a birdhouse occupied each

spring by a family of wrens. Yellow shutters decorated with hand-painted ducks and held back with black S-hinges, and yellow flower boxes frame the 6 and 12-light windows. There are trellises on each side of the garage doors for honeysuckle and clematis.

The upper two panels of the kitchen door have the appearance of bull's-eye glass (done with paints), another touch of the unusual. At the same door a trellis, covered with morning-glories, hides the water pipes and drain.

When we were ready to build, no new lumber could be found. Secondhand lumber, high-priced and poor in quality, was ruled out. We searched for a building, which we ourselves might raze, and found a surprisingly large assortment—ex-service stations, roadside stands and old farm sheds. Many were low in price provided we did the moving. We finally purchased a collapsed summer cabin made of siding. For \$50 we acquired the cabin and such standing timber as we might need to replace sills and plate.

We sawed the walls of the cabin into

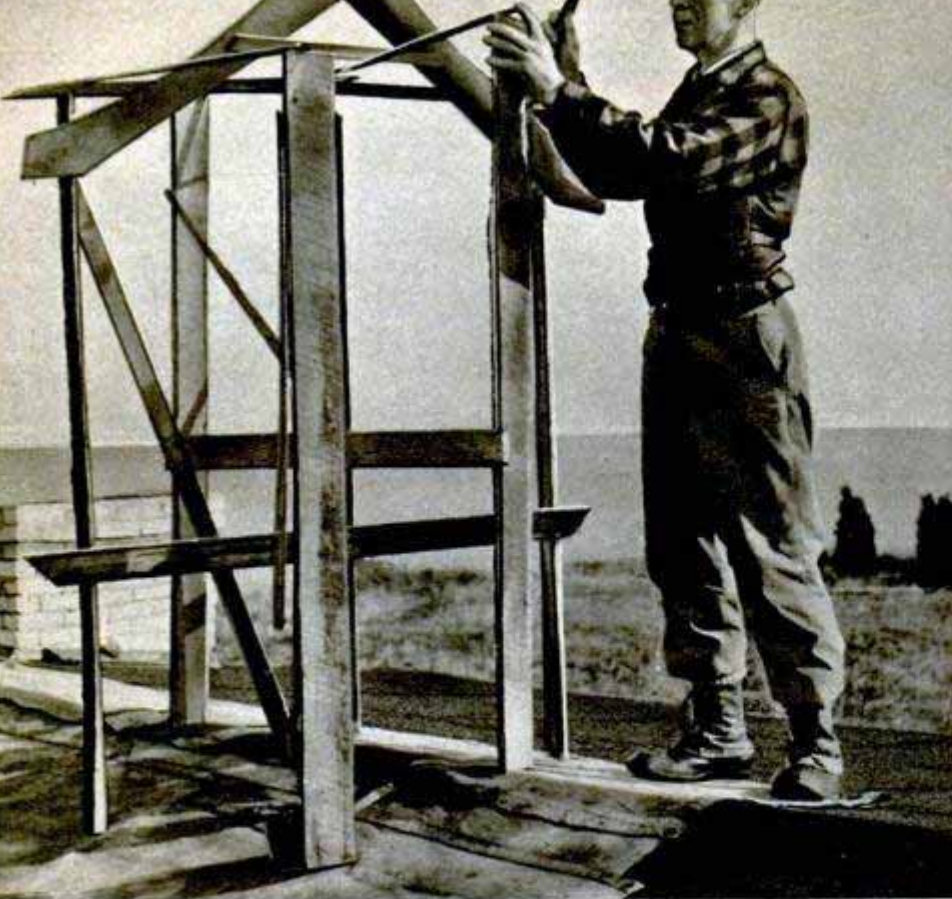

"Our cabin will never be finished, it seems. Now, I'm dummies up a glassed-in cupola that will give us a towering view of the sea"

4-by-8-foot sections—the largest size that would fit on our homemade trailer—and carted them to our own land, a beautiful spot overlooking the ocean near Plymouth, Mass. It was hard work and occupied all our spare time that first fall. Our determination never faltered, although we were sorely tried at times. There was an evening drive, after an all-day struggle with wrecking bars, saws and hammers, when the smell of burning rubber warned me of trouble. A few minutes later a trailer tire blew out. In order to mend the tube and shoe, every stick of lumber on the trailer had to be removed, piled at the side of the road and later repacked, this

time so none of the timbers could rub against the revolving wheel and thus burn another hole in the tire.

Pulling up floor boards with a nail remover to preserve as far as possible the utility of all lumber was slow work, but satisfactory. My wife removed the nails which my tool had lifted from the framing, and later she marked the sections to facilitate the reassembling on the homesite. Our floor plan had to be adapted to the lumber available without sacrificing "class and distinction." At long last we dumped our heterogeneous assortment of materials on the chosen land.

When we finally took stock we realized that there was not enough good material to establish the old cabin on the new site because of rot and wreckage. So we obtained more lumber, not from lumberyards, but from the woods where hurricane logs were still available.

This meant carting them on our trailer to a mill and having them cut into one-inch boards and some two-by-fours. Then we cut oak logs for sills and corner posts, and some cedar for posts. At last we were ready to start building.

Cedar posts, free for the chopping and lasting a lifetime, became our foundation. Challenged now by the builder's estimate, we determined to go ahead on the principle that no money would be spent unless absolutely necessary. We intended to prove that determination could overcome all difficulties, even financial ones.

To save a tree and still keep within the building restrictions, we had some difficulty in placing the cottage just where we

wanted it. But at last the first holes were dug and the posts for kitchen and bedroom were embedded in concrete. Several months later, when we were ready to add on the garage, we had to kindle bonfires to thaw out the frozen ground. The sills came next. Although several sizable timbers had been salvaged from the old cabin, we

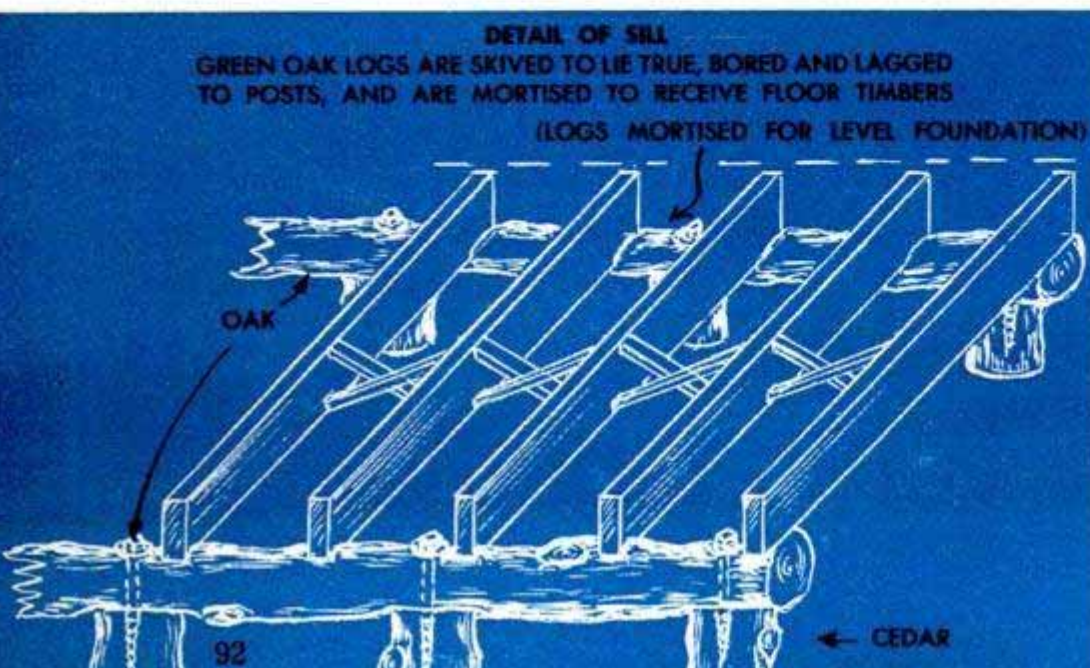



"Our total wiring costs were \$18, including an old ship's lantern I electrified and hung outside on a cedar post"



"One end of our living room is completely enclosed with glass. We poured a smooth concrete floor and marked it off like a compass card. At the opposite end is our sure-drawing fireplace with back and arch made of brick. We laid up a facing with field stones"

decided that green oak would make a more lasting framework. We used six eight-inch logs, squared into shape with an adz. I had always wanted to try my hand with an adz, and the money spent on this good tool was never regretted. There is no greater satisfaction than to straddle a hefty log and with judicious strokes, square the timber. Seasoned oak is granitelike in hardness, but the green oak was fashioned into sills and girders without too great effort.

Because of the windy location, I took the precaution of boring the sills and fastening them to the corner posts with lag screws and bolts. No hurricane would lift my cabin from its foundation! The erection of the wall sections came next. We used four-by-fours for corner posts. Maneuvering to maintain the original contour, I patched and rebuilt the framing, making doubly sure of the strength of every timber and joist. The day we raised our first corner post and fitted to it, at right angles, two wall sections of the kitchen, the rain came down in torrents. We had both looked forward to this

(Continued to page 258)



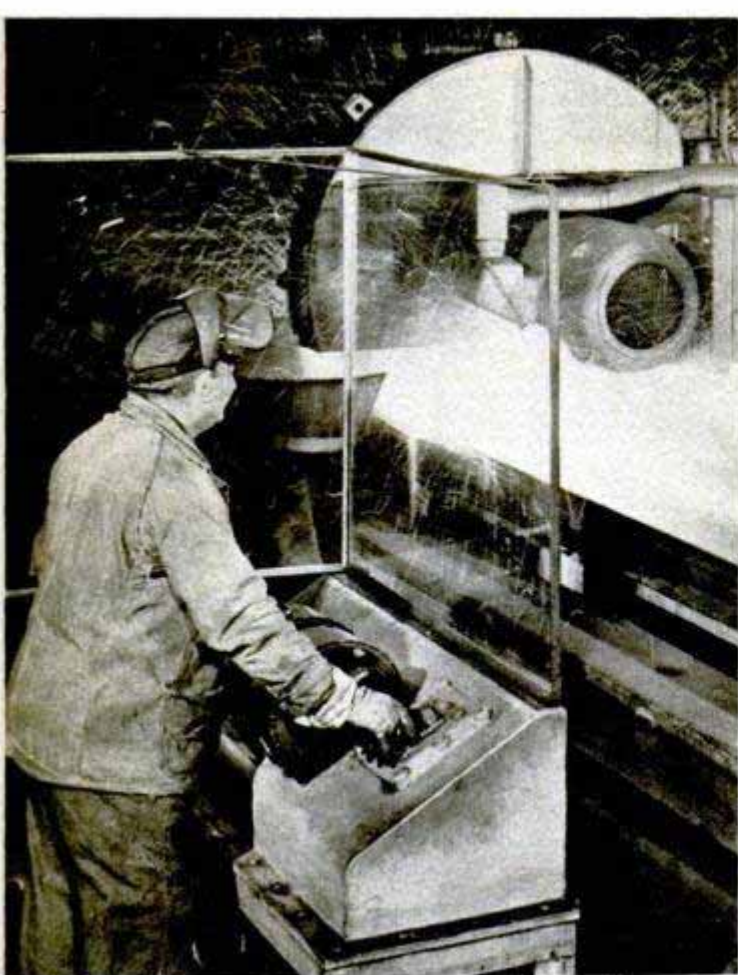

### High-Speed Saw Blade Melts Steel As It Cuts

Heavy sections of structural steel are cut at a rate of 13 feet a minute by a 60-inch saw blade that literally melts away the steel. When the blade, the teeth of which travel faster than 320 miles an hour, makes contact with the tough steel, friction generates heat more rapidly than the material can absorb it. This intense heat melts the surface and the saw teeth carry it away. The operator controls the saw remotely from behind a transparent plastic shield.



### Ultrasonic Therapy

Sounds 20 times higher than the top frequency that humans can hear are being tested in therapy treatments for several physical ailments. The sounds are in the ultrasonic region, 143 times higher than the top note of a piano. Dr. G. J. Thiessen of the National Research Council, Ottawa, Can., has developed a therapy instrument that pipes the sounds through a flexible cable and applies them to the affected body area. An electronic generator produces a 600,000-cycle note which is carried to a ground-quartz crystal. It is the crystal which vibrates and is applied to the patient. Although the tests have been inconclusive as yet, ultrasonic therapy shows promise of effectively treating several ailments including asthma, sinus, neuralgia, sciatica, lumbago and sprains.

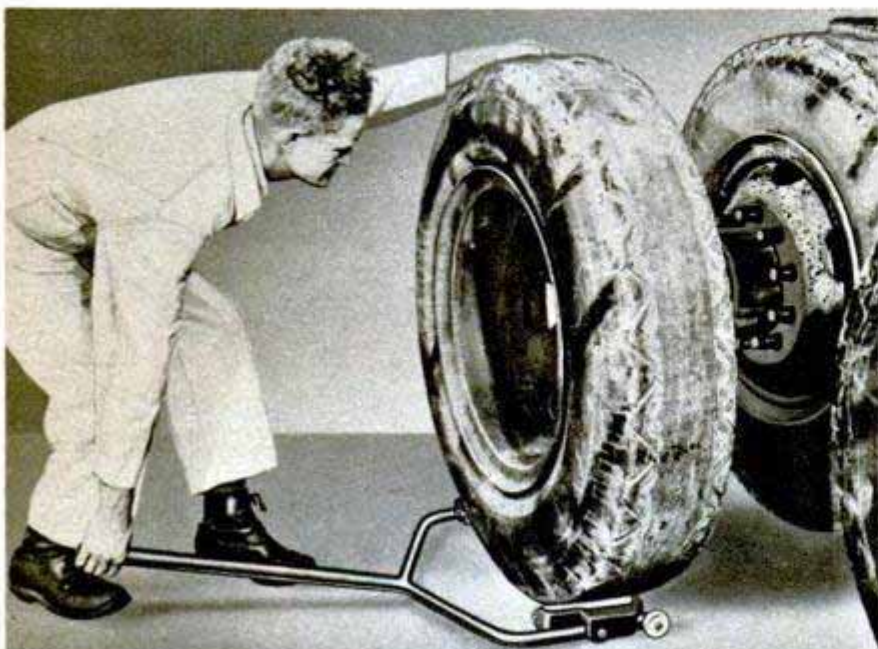

### Lifter Handles Truck Tires

One man can easily lift a heavy truck tire and roll it into position with the aid of a lever tool equipped with casters. The tool has two arms with a wheel on each arm. Parallel with the arms are two rollers mounted on swivel brackets. The lifter is shoved under the tire and the handle elevated. The brackets swing so that the lift is always straight up and there is no tendency for the tire to slip off. After the wheel has been rolled into position it is rotated until it is aligned with the wheel studs. The lifter handles any tire from 6.00-16 to 11.00-22 with a maximum lifting effort of only 25 pounds.





### Homemade Automobile Has Engine in Middle

Built by a South Carolina mechanic in his spare time, an unusual looking automobile has its engine in the middle. He originally intended to make the car a rear-engine model, but was unable to get the proper parts and had to place the engine just ahead of the rear axle. Because of the central location of the engine, which is connected to the differential by a 17-inch drive shaft, there is no room for a rear seat. A large luggage area is provided behind the engine compartment. The car goes from 20 to 24 miles on a gallon and cruises at 55 miles an hour.

### Back-Seat Clothes Rack for Car Doesn't Obstruct Driver's Vision

Without obstructing the driver's view to the rear, a clamp-on clothes rack for automobiles holds six or more suits. No screws are used to install the rack. It clamps to the window frames on each side of the rear seat. A turnbuckle in the center of the rack adjusts it to the proper width. The rod can also be used to suspend a baby basket or hammock. To remove the rack, you merely loosen the turnbuckle.

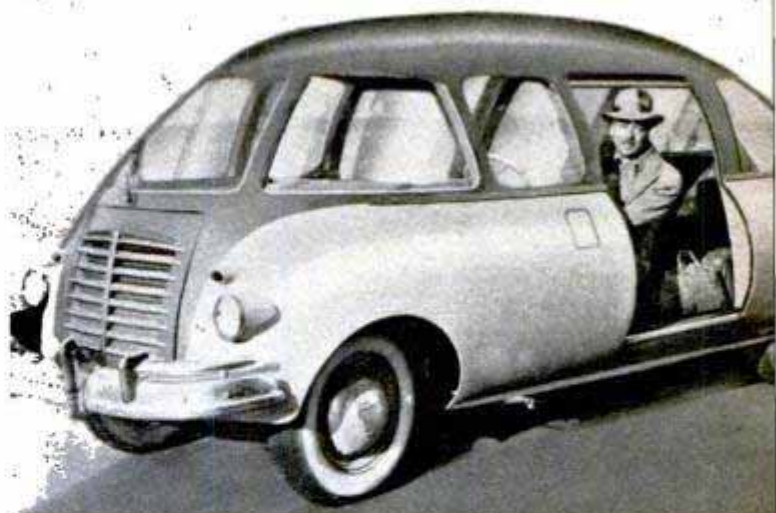
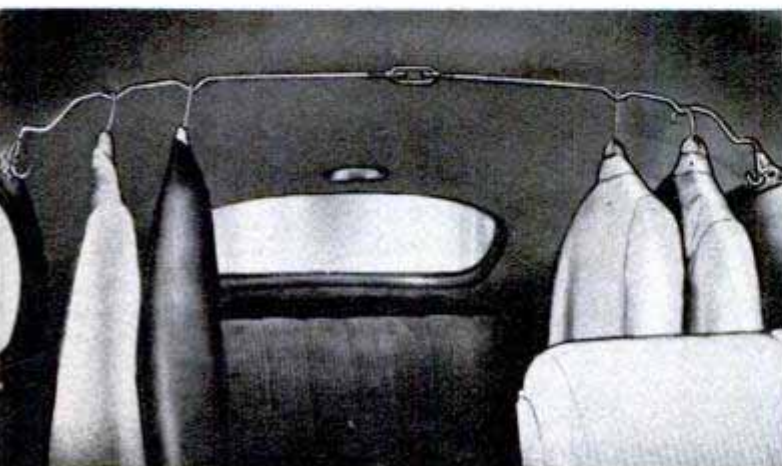

### Jeep Becomes Streamlined Sedan

Push-button doors and windows are featured on a completely streamlined jeep made by an Army officer on duty in Japan. Using the jeep chassis, Major Donald C. Surles of Cisco, Tex., built himself the ultramodern vehicle at a cost of \$2000. The original power plant is used. The doors slide upward into the roof when a button is pushed.

### Sugar-Beet Harvester

Up to six tons of sugar beets an hour are harvested by a tractor-drawn machine that does everything from topping and cleaning the beets to loading them in a truck. After being cleaned, the topped beets are carried up an elevator and dropped on a sorting belt. Two men, standing on the machine, sort the beets from clods and trash, dropping them into a trailer cart that has its own elevating chain for unloading the crop into a truck. Once removed from the soil, the beets never touch the ground.



# Rolling Out Man-Made Lumber

COMPRESSED sawdust board is being made by a British firm in continuous lengths and at one third the usual cost of manufacturing artificial lumber. The experimental English plant will be replaced this fall by a full-size one turning out board approximately four feet wide and  $\frac{1}{8}$  to  $\frac{3}{4}$  inch thick. Sawdust and resin are fed into a hopper, mixed and heated by high-frequency radio waves. It is then bonded by a pressure of 250 pounds to the square inch, at a temperature kept at 175 degrees Centigrade by infrared heat. Corrugated metal grooves the board to permit the escape of air bubbles when a final outer layer of paper or veneer is applied.

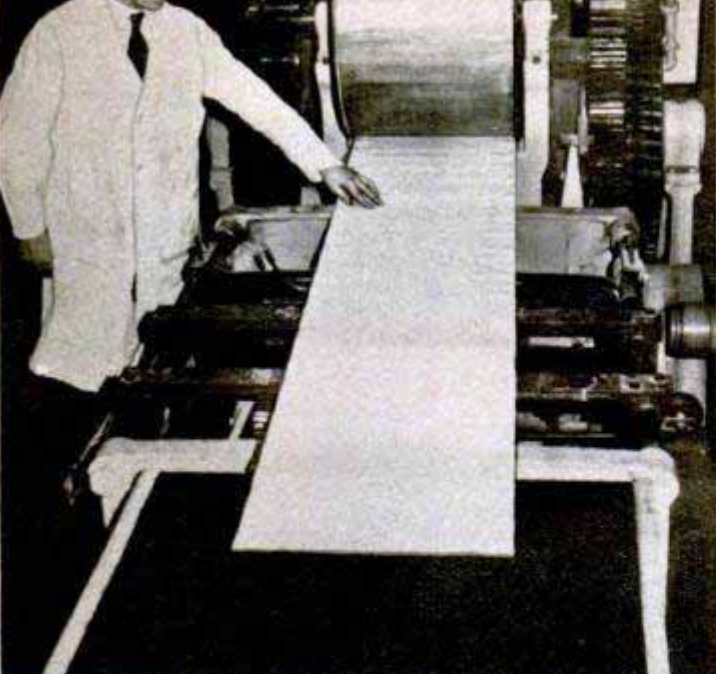

Artificially made lumber rolls out on the metal cutting table at speed of 8 to 10 feet per minute

Radio waves generated by apparatus in foreground heat sawdust-and-resin mixture prior to the bonding  
British Information Service photo

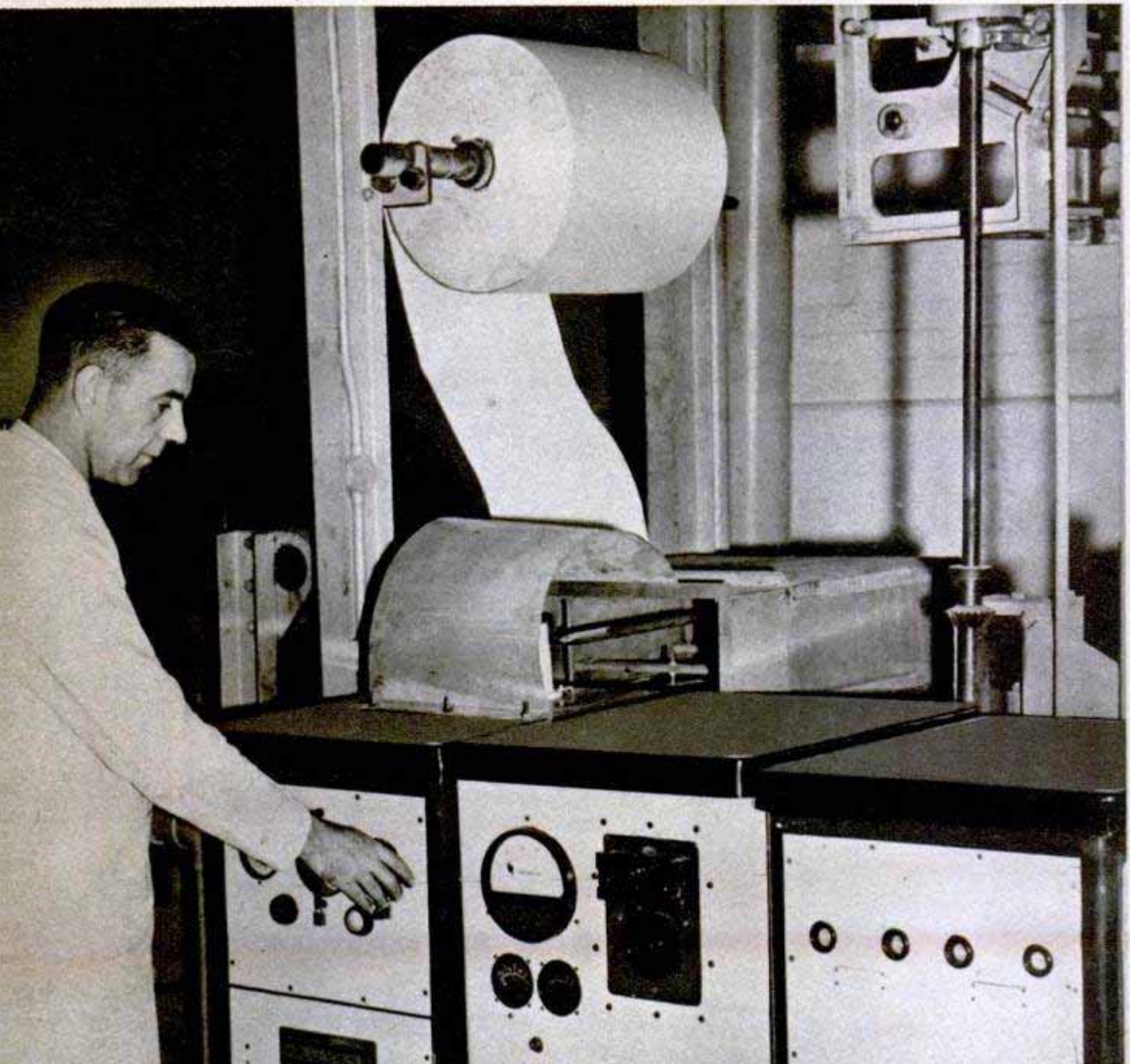

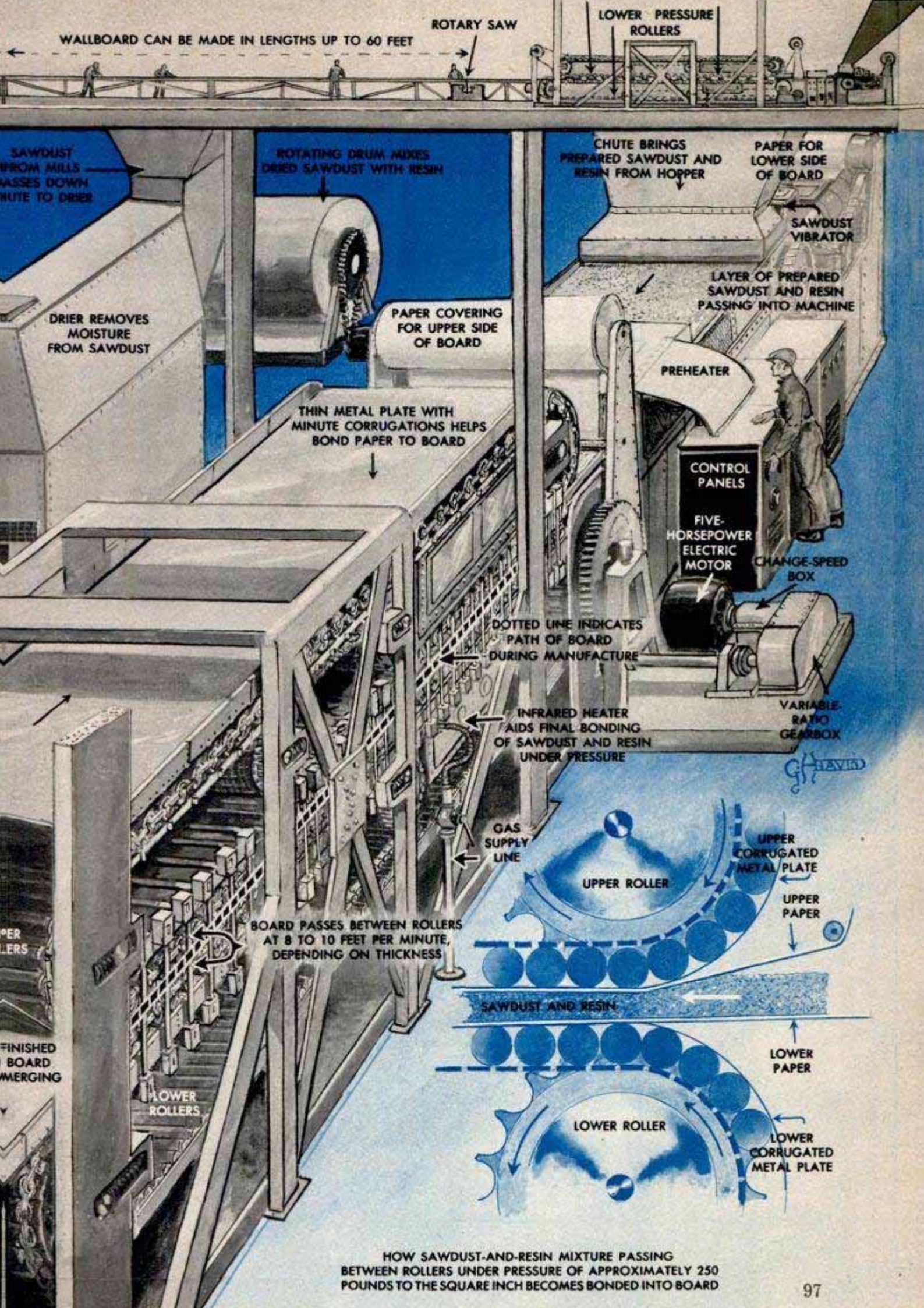



After landing on a nearby lake, fire fighters hike overland with their equipment to scene of the fire



Forest fire rolls through timber near Lady Evelyn, Ont. Plane bearing the firemen wings in for a landing

## ***Flying Fire Fighters***



↑ Fire pump is set up to carry water from the nearest stream. Seaplanes carry all the equipment as well as the fire fighters. Below, portable equipment is loaded aboard one of the planes for quick trip above forest

The whine of a plane engine has replaced the sound of a fire siren in northern Ontario. Fire fighters wing their way above the tall forests in seaplanes, land on one of the countless lakes or rivers that dot the province and hike the short distance to the fire scene. Time is vital in fighting forest fires—if a fire gets out of control it may rage across hundreds of miles of fine timber. Thirty pilots and 25 air engineers operate the 30 planes of the fire-fighting service, taking off from 23 bases strategically located across northern Ontario. The service patrols more than 360,000 square miles of terrain. The planes also are used for detection of fires as a supplement to observers in lookout towers. The Ontario service is one of the largest aerial fire-fighting services in the world and is credited with saving thousands of acres of forest each year by fast transportation of men and equipment to the scene of a fire.





## Precision-Casting Process Based on Wartime Technique

Using a technique developed in wartime when airplane supercharger buckets were precision-cast, Allis-Chalmers is now eliminating many machining operations by casting small, but intricate, parts for its products. These parts are cast so precisely that, although they were formerly machined, no machining is necessary. The process is based on the "lost wax" technique. Wax patterns are produced by injecting melted wax into metal dies. The wax pattern is removed and a refractory material poured around it and allowed to harden. Then the wax is melted and drained from the mold. Molten metal is poured into the cavity from which the wax was removed. After cooling for about five hours, the castings are knocked loose by an air hammer.



Top, left, injection molding of wax patterns. Dies are clamped in press and wax pumped in through flexible hose. Right, the molten metal is poured into molds. Above, final inspection of the castings. Parts on table are some produced by new process

## "Shrinking" Truck Dumps Load

Loads are carried down between the wheels in a rear-dump wagon called the Tournarocker. Though only 6½ feet high, it has a capacity of 16½ yards or 16 tons. Dumping is done by locking brakes on the rear wheels at the edge of the dump and raising the bowl by an electric motor and cable attached to the rear end of the bowl. This pulls the prime mover back towards the rear wheels, tips the bowl and dumps the load. It has an over-all length of about 26 feet and a 90-degree turning radius.



**B**ACK IN 1849 a lot of people acted in peculiar ways all on account of gold. They sold their homes and made for the prairies, the desert and the high mountains. It was California or bust. Some of them found gold. Others found nothing but black sand in their gold pans. But they kept coming, kept digging, kept chasing the golden rainbow.

A hundred years later, Lloyd D. Sweet of Watsonville, Calif., is hunting for gold, too. But it's an easy-going job to him. Gold is his hobby. If he garners any of the yellow stuff from his mine, he's happy about it. If he doesn't, he isn't bothered much. The reason is that his gold mine is near his summer home and his favorite recreation area. It is about halfway between the historic old mining towns of Downieville and Sierra City.

To reach Sweet's mine, you cross the North Yuga River on a "Flying Dutchman." That's a little wooden seat strung by a pulley on a cable. You pull yourself across stream with a rope. Nearby, among a formation of boulder deposits is the mine. There's a slit dug out of the rocks and built up with smaller stones. The sluice box is set in there. It's a wooden flume with burlap and cleats fastened along the bottom to catch gold washed down from his placer diggings.

# Hobby: Mining Gold

**Story and Photos by  
Harry De Lasaux**

Sweet's cabin is out of sight from the river level, a few hundred feet uphill. In order to build the cabin, Sweet—and Mrs. Sweet—had to clear brush and make a trail. The trail followed an old mining ditch used in the Gold Rush. It led from a nearby creek, a roaring little stream full of deep pools and brilliant falls. Sweet was asked how he secured the land.

"It's government land," he explained. "The country in the national forest areas is available for leasing provided you establish a mining claim. My first discovery of gold here netted me \$15 worth. I mined one nugget shaped like a thumb that was worth \$5. My claim includes the creek, so I'm always sure of plenty of water."

As the project developed, Sweet's talent as a mining engineer unfolded, too. He dug a ditch a quarter of a mile long upstream, dropping it down

To hurry gold production, Lloyd Sweet uses a fire hose on his water system to wash down the higher gravel banks

POPULAR MECHANICS



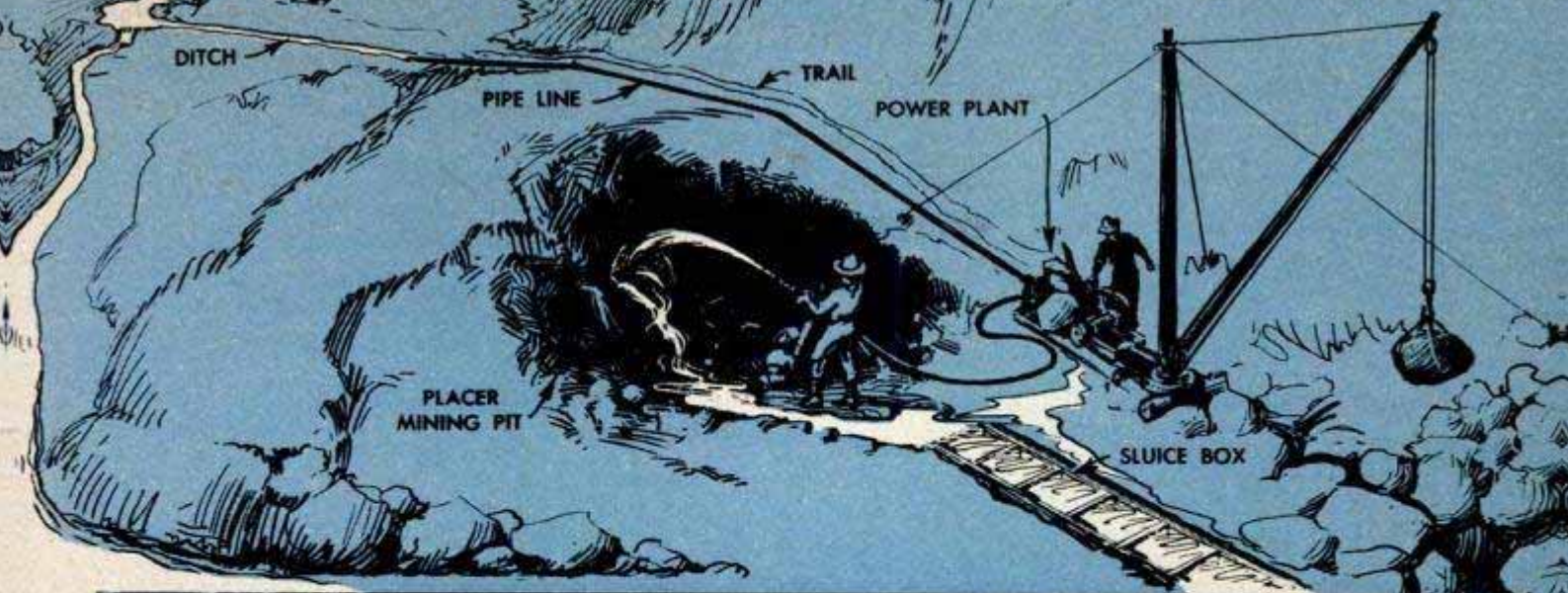

Top, sketch shows over-all plan of Sweet's homemade gold mine. Above, winch-and-gear system was built around old Chevrolet transmission. Below, water wheel is turned by gravity-flow stream piped from creek



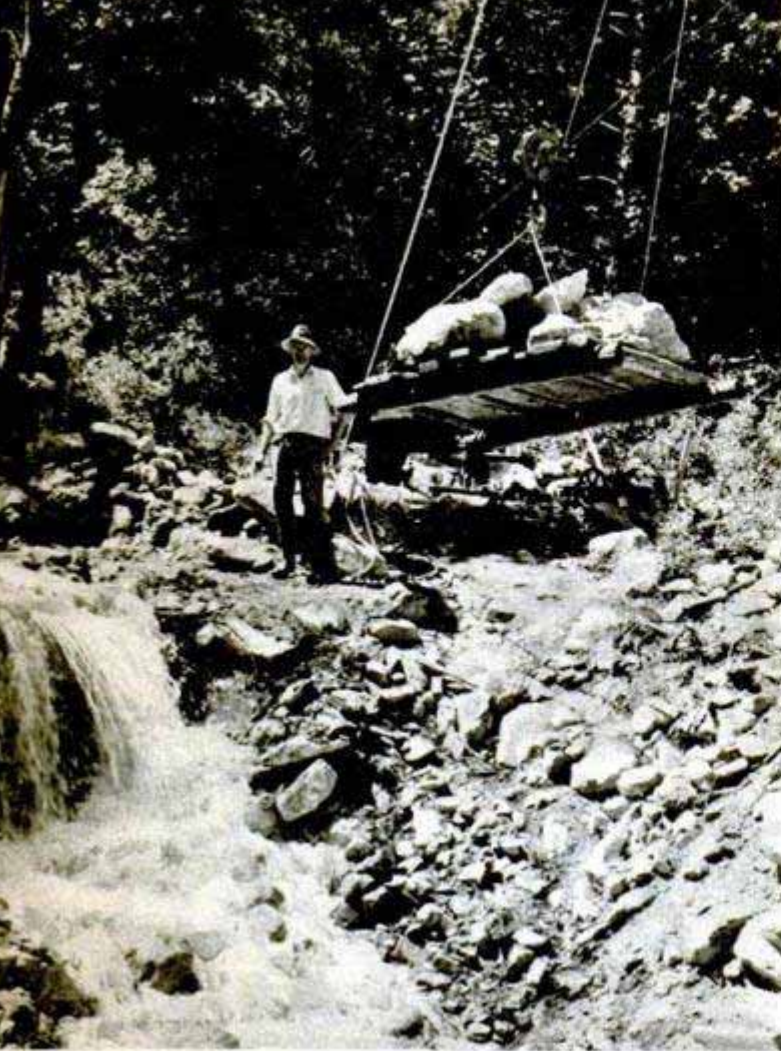

Jib crane operated by water-power system can lift a ton of boulders out of the diggings. Below, sluice box, lined on bottom with burlap and cleats, catches the gold as rushing waters wash the metal into it



gradually to the river to secure a good gravity flow. This ditch supplied water to wash down the gold-bearing earth and gravels through the sluice box.

Next, he had to have some sort of device to lift out the boulders so he could free the earth and gravel. The Sweets laid a quarter of a mile of three-inch iron pipe along the line of the ditch. This was to supply the water power for his proposed water wheel.

First, he built a Pelton water wheel. It was simply an iron plate, circular in shape, to which were bolted metal cups. He balanced not only the water wheel, but all fast-turning parts. Next, he set the water wheel in a heavy box frame to catch the water flowing from the three-inch pipe. For his cable drum and gear-reduction system, he went to the junk yard and bought an old Chevrolet transmission, from which he took the gearshift and gearbox. He then attached the winch to the power system, rigged up a jib crane and he was ready to move boulders out of the diggings.

When the ditch from up above is wide open, a flood of water rushes down over his diggings and washes sand and gravel through the sluice box. Occasionally, he stops it long enough to get down in the pit and clean out the boulders.

Just to hurry up the gold-washing process, he also has rigged up a fire hose, and in spare moments he washes down the higher areas of the gravel bank with it.

When visitors ask if he really gets any gold, he produces a piepan with gold concentrates in it. Swirling water around and around in the piepan, he gives it a quick flip like the sourdough miners used to. Instantly, through the layer of black sand in the bottom, there appear several good-sized nuggets.

Sweet also has built a home power plant. A three-inch pipe supplies water power for a second water wheel connected to a generator from an old locomotive. With a hiss and a roar the thing starts up, and in a few seconds the lights go on, the radio works and Mrs. Sweet can start ironing clothes with an electric iron.

Mr. Sweet is in business at Watsonville, a thriving farming town along the California coast a few hours' drive below San Francisco. He's in a position to make frequent trips throughout the year to the Sweet diggings along Sierra County's North Yuba River. It's the land of the '49ers, and the history of the country he enjoys is rich with Gold Rush excitement and drama. Also, the people of that mountain region are friendly and helpful. One old prospector taught him several profitable tricks of gold mining—even showed him how to retort his gold from the quicksilver by using a large raw potato!



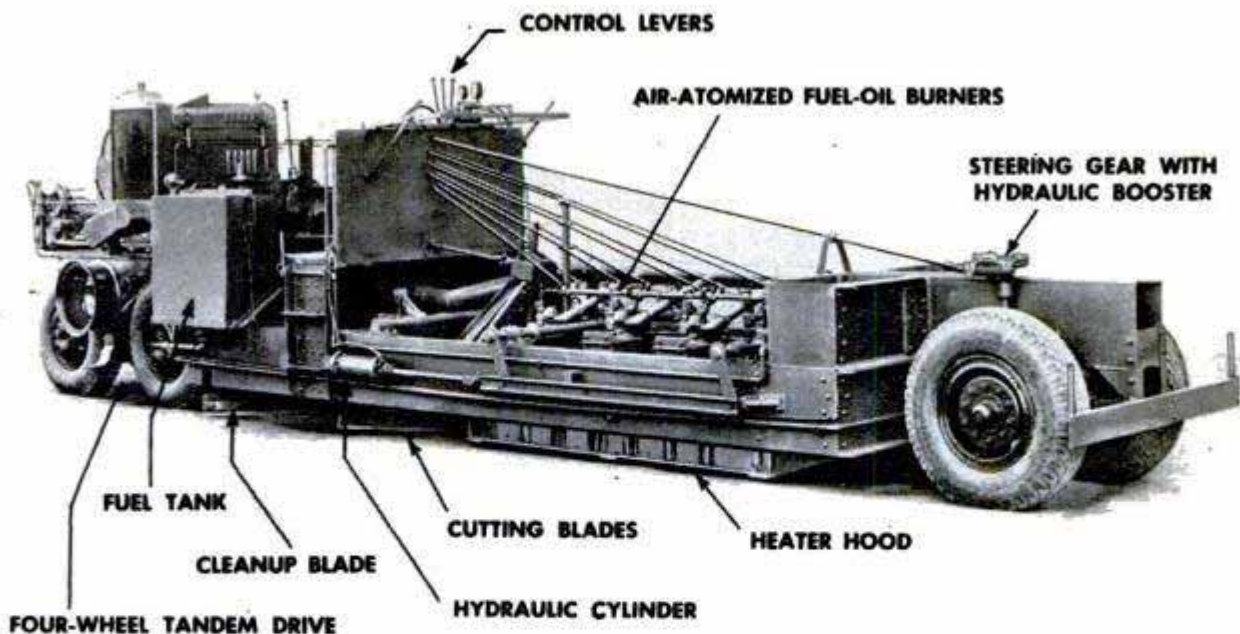

## Street Planer

Rough asphalt streets are planed smooth by a long vehicle that softens the surface with heat. Fuel-oil burners throw intense heat on the asphalt and, as the machine moves forward, the planing blade scrapes off the high spots, leaving the surface free of corrugations. The rear wheels are within the blade width, riding on planed surface. Under good conditions the planer can smooth 30,000 square yards of pavement per day.

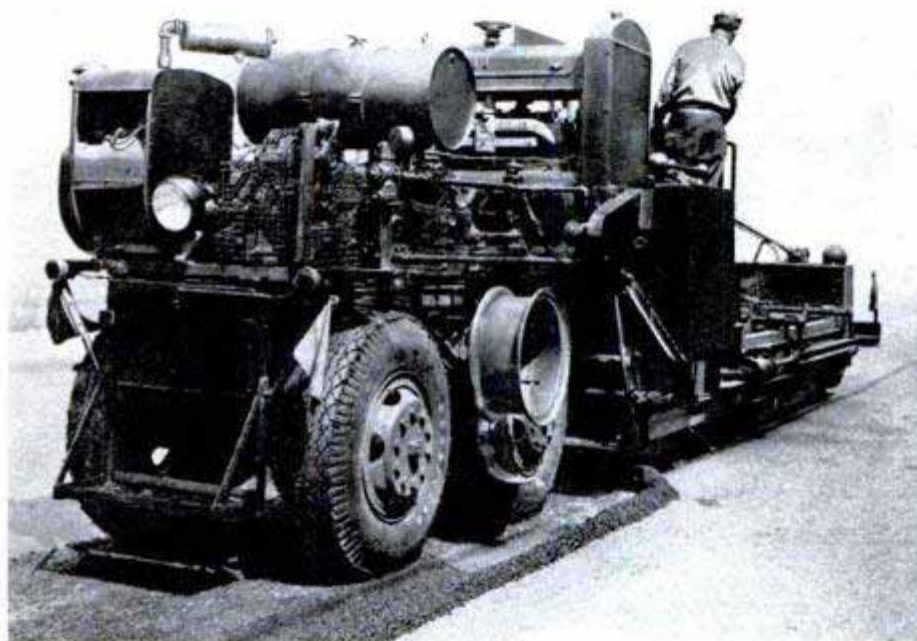

## Cranes Lift House And Carry It Away

When W. L. Lipscomb of Victoria, Tex., wanted to remove the second floor of a building and convert it into a separate cottage, he decided the easiest way would be to pick it up and carry it to the new location. He did just that with the aid of two mobile cranes. Not a piece of furniture was disturbed or a single dish broken as the two cranes, working as a team, lifted the upper floor off the building and carried it safely to its new foundation.

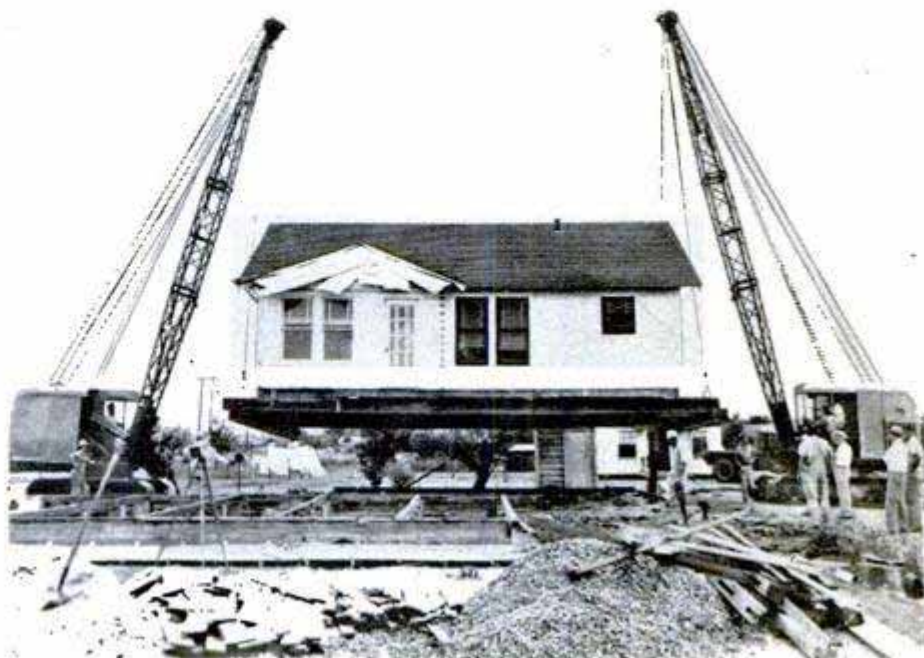

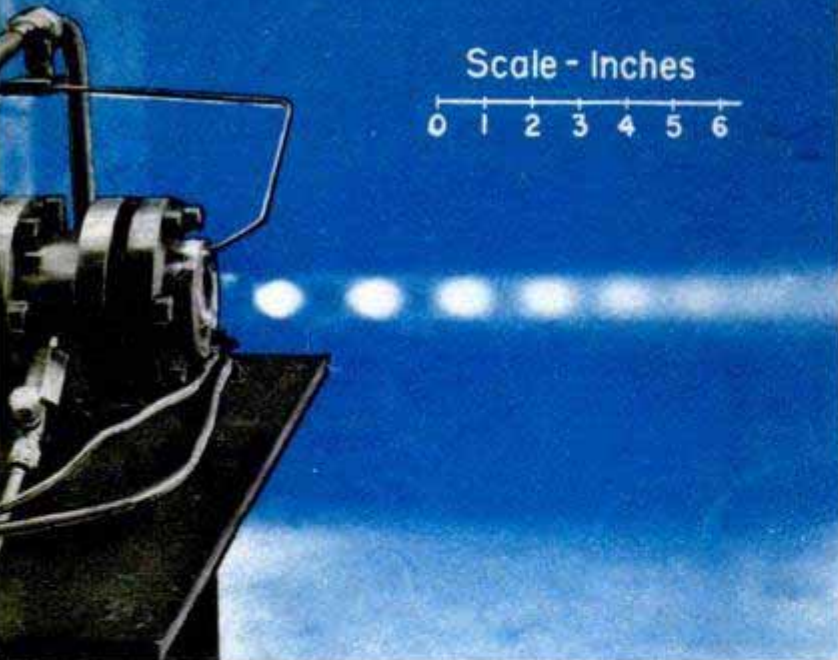

Scale - Inches  
0 1 2 3 4 5 6



**TRIPS TO THE MOON** in rockets are forecast by experiments with a liquid-hydrogen-powered test motor that blasts gases from its exhaust jet at 15,000 miles an hour. No larger than a man's fist, the rocket motor, above, produces a greater thrust than a small airplane engine. White spots in exhaust stream of rocket motor are shock waves through which the gases pass as they are decelerated by the atmosphere. Top, right, the scientists at Ohio State University observe the motor's performance from a control booth outside the test pit. The glass in the observation window is four inches thick. Tests show that liquid hydrogen, used in combination with liquid oxygen, will provide enough energy to overcome the gravitational pull of the earth



**TWIN BOOMS** and an extra-thick narrow wing distinguish the Anderson Greenwood 14, a two-place pusher plane nearing completion of flight tests. It cruises 110 miles an hour and has a range above 400 miles. A horizontal tail is above the propeller slipstream

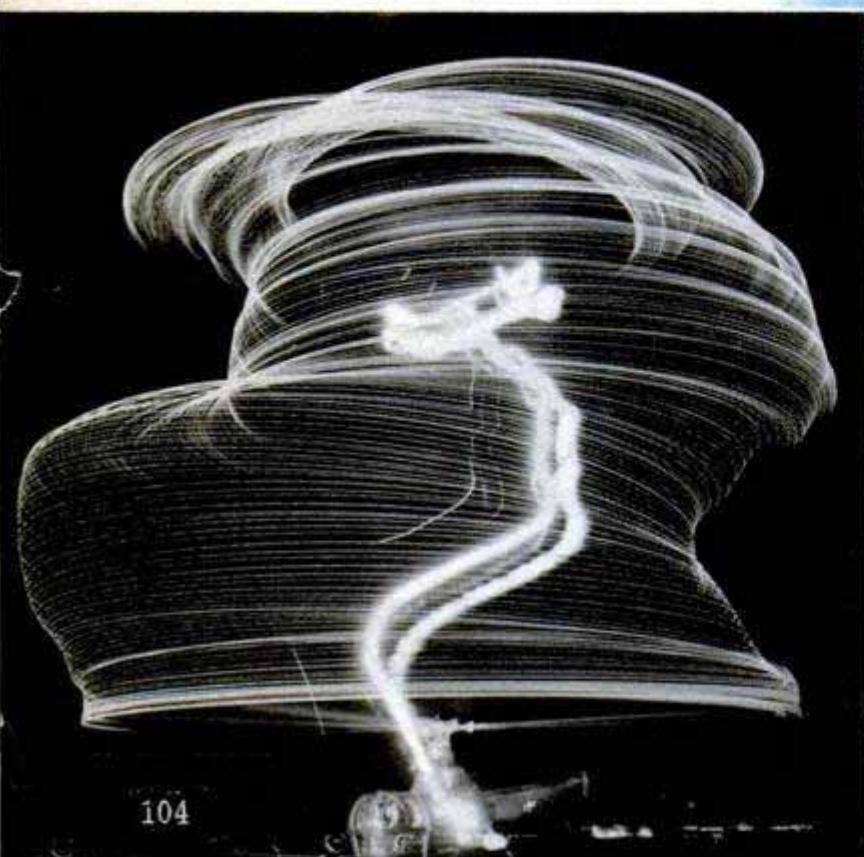

**WHIRLING PATTERNS** are traced in the night sky by lights on rotor-blade tips and fuselage of a helicopter undergoing tests by the U. S. Navy for rescue roles. Its position can be accurately pin-pointed even in the poorest visibility. Initial flight trials were made at Anacostia Air Station in Washington, D. C.

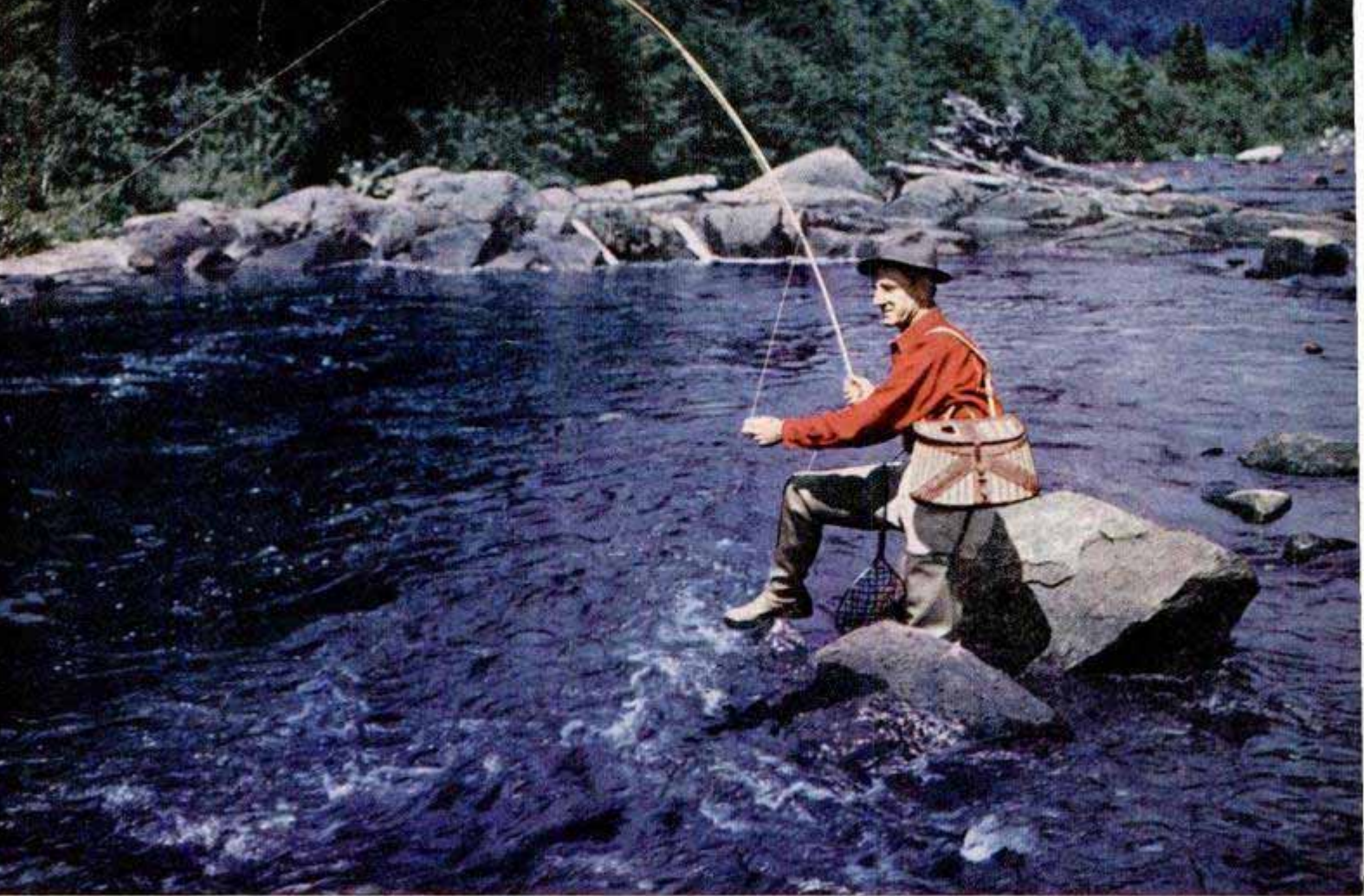

Photo by Kretschmer-FPG

# How to Tempt a Fish

## PART I

## FLY CASTING

**T**HIS IS A STORY of just average fishermen who, because of their choice of proper flies and fly-rod equipment, their knowledge of where to go and what times of day and evening to fish, must hide behind trees when tying flies to their leaders.

Because catching trout, bass, pike, pan fish, walleyes, salmon, landlocked salmon, bonefish, snook, tarpon, jack crevalle and sea trout with fly-fishing gear is so much fun and fly casting is so easy to learn, this sport is gaining tremendously in popularity throughout the sports world.

With about half an hour of coaching, you can learn enough about fly casting to catch numerous species of fresh and salt-water game fish, but it will take many years of conversing with the expert anglers before you will be able to talk like they do. It takes years of rubbing elbows with them at their clubs and in their streams to understand their "fly talk" — but you don't need this until later in life when sittin' beats wadin'.

What counts most is

that electric thrill that goes up the rod, through the palm of your hand, up your arm and into your heart when a fish is on your fly. And another important factor is that friendly feeling you build up inside for those with whom you fish.

There are millions of fishermen who prefer catching fish with a fly rod because it's the sporty way. The purist casts nothing but a dry fly that floats on the surface of the water. Next comes the angler who first tries it dry, then wet to get the big ones that are deeper during the middle of the day, and then dry again for the evening fishing. Third in line is the guy who mostly has in mind that he does not want to visit the commercial fish market on his way home. He goes to the stream, lake or bay fully equipped with dry and wet flies, streamers, nymphs, cork-bodied bugs, spinners, midget spoons, tiny plugs and worms.

In public life he is the same fellow who wears both belt and suspenders, but he usually comes home with fish

By Joe Godfrey, Jr.

International authority on fishing, founder and Executive Secretary of The Sportsman's Club of America, founder of The Fishing Hall of Fame and author of several well-known books on fishing

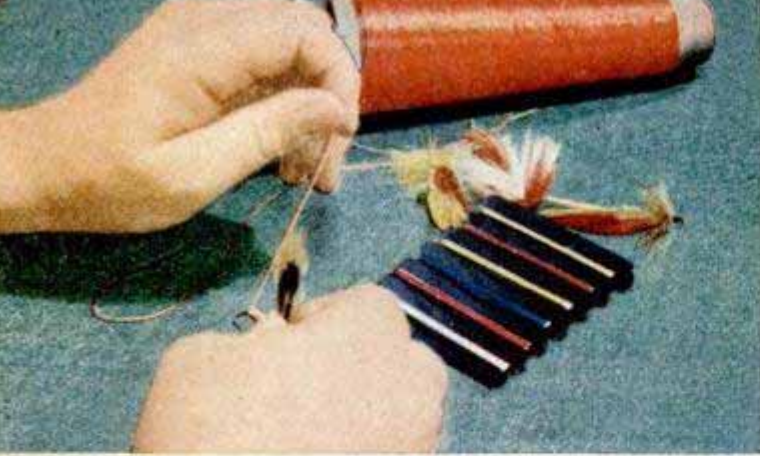

Thread that glistens in ultraviolet light now is used to tie flies that glow even on the cloudiest of days

for the table while some of the others can only say, "The big one got away."

There are many ways of catching fish such as guddling, chumming, soaking and trolley fishing, but here is a list of the highest-approved methods: 1—Dry-fly fishing. 2—Wet-fly fishing. 3—Spinner fishing. 4—Spinning. 5—Bait casting. 6—Trolling with artificials. 7—Trolling with bait. 8—Bobber fishing with bait. 9—Set-line fishing. 10—Net fishing.

You may catch more fish if you reverse

**FLIES FOR RAINBOW TROUT:** 1—Hair Professor. 2—Lachmann's Refracto Giant May Fly. 3—Edson Light Tiger. 4—Stroud's Silversides. 5—Ambrose Special. 6—Michigan Night Caddis. 7—Black Ghost Streamer. 8—Cains River Scotch Lassie.

the above list, but it won't be as much fun. The sport of fly fishing has in its fold at least two kinds of persons: The serious-minded angler who insists that he did not "catch" an Atlantic salmon, but rather he "killed" it, and he will further tell you why he used a No. 1 Jock Scott fly and on what the salmon were "feeding"; and the average or absent-minded fisherman who "caught" a salmon on something he thinks was a Dusty Miller fly, but he doesn't remember why he selected it or what size it was, and he doesn't care much what the fish were "eating" at the time. He does remember having a heap of fun taking this fish.

If in your travels you hear anglers telling of their catches (pardon the word "catch" instead of "kill," but these fish were thrown back) and if some of the stories sound exaggerated, go along with these fishermen as though you believed their yarns—provided you reserve your stories for last.

Truth is something more or less unknown in fishing circles because who wants to listen to a little-fish story?

But what part of this fishing business is truthful and where do we draw the line? Well, here it is, and you can count on this information just as you can be sure that fresh-caught walleye is good eating.

It is true that fish grow a lot faster after they are taken from the water. It is not true that fishing is a delusion entirely surrounded by liars in old clothes. It is true

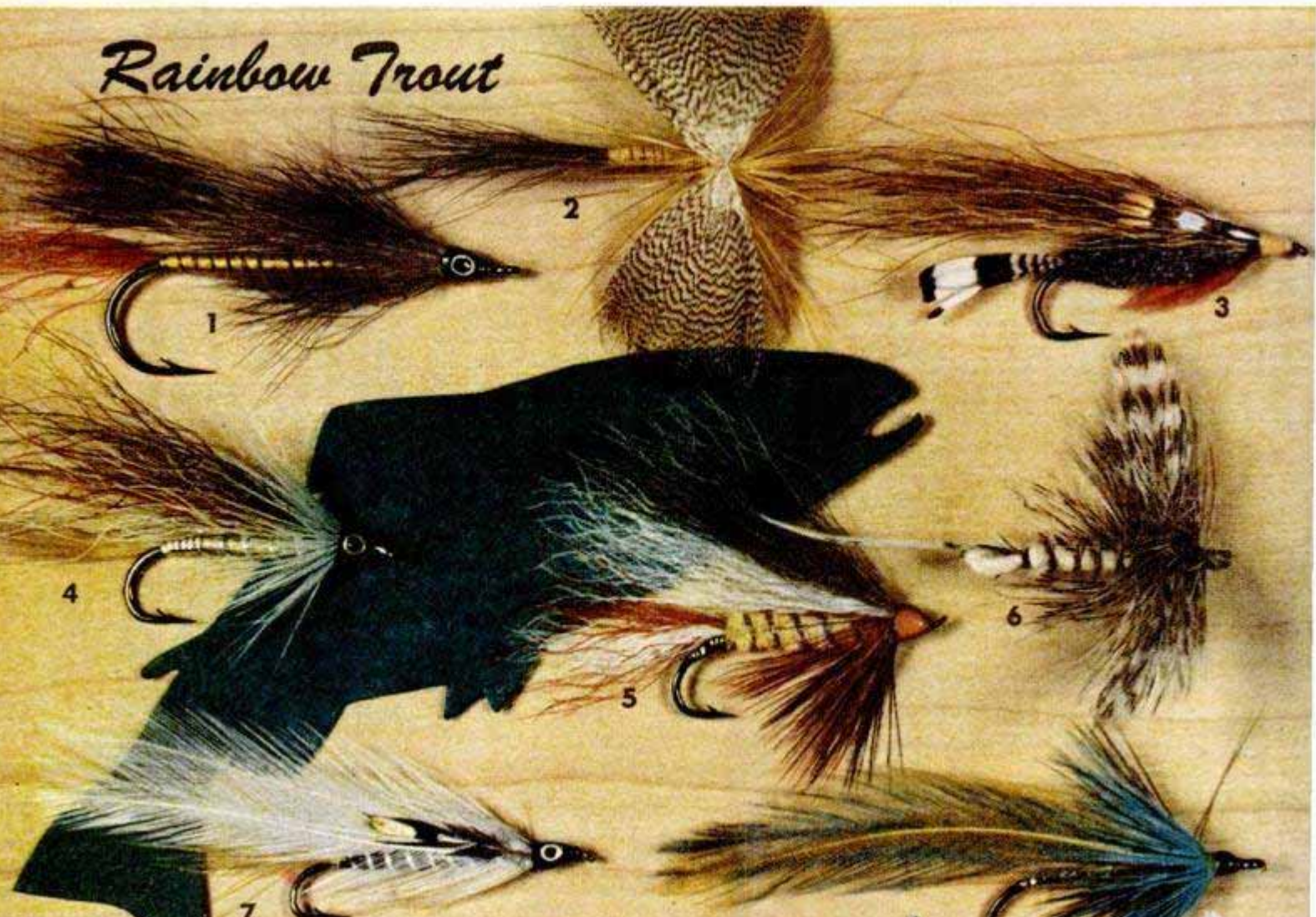

that fishing is a disease for which there is no cure. It is true that opening day is the time when an avalanche of anglers crowds our streams in search of a few scared trout.

It is true that a creel is a wicker basket in which the fly angler carries a fly book, lunch, raincoat, solunar tables, fishing calendar, fish finder, can of worms and one small trout. It is true that a guide is a conservationist in disguise. It is not true that he takes you where they were biting good "last week," that he encourages you to return "next week" when the water will be "lower," "higher," "clearer," "muddier."

It is not true that boots are what you wear to carry large quantities of water and are guaranteed to keep your feet warmer in summer and colder in winter. It is not true that flies are feather or bucktail imitations of nothing ever seen before. It is true that they are the favorite food of moths and are tied especially for decorating fishermen's hats. It is true that plugs are imitations of bees, beetles, birds, bananas, cigars and hula dancers. It is true that "rod" is the name for a fishing pole costing over five dollars. It is said, too, that fly rods are sold by weight—the lighter the rod, the heavier the price. It is true that the worm is greatly scorned in fishing circles but is secretly used by most trout fishermen.

Sir Izaak Walton is the patron saint of the angler. His great contribution to angling

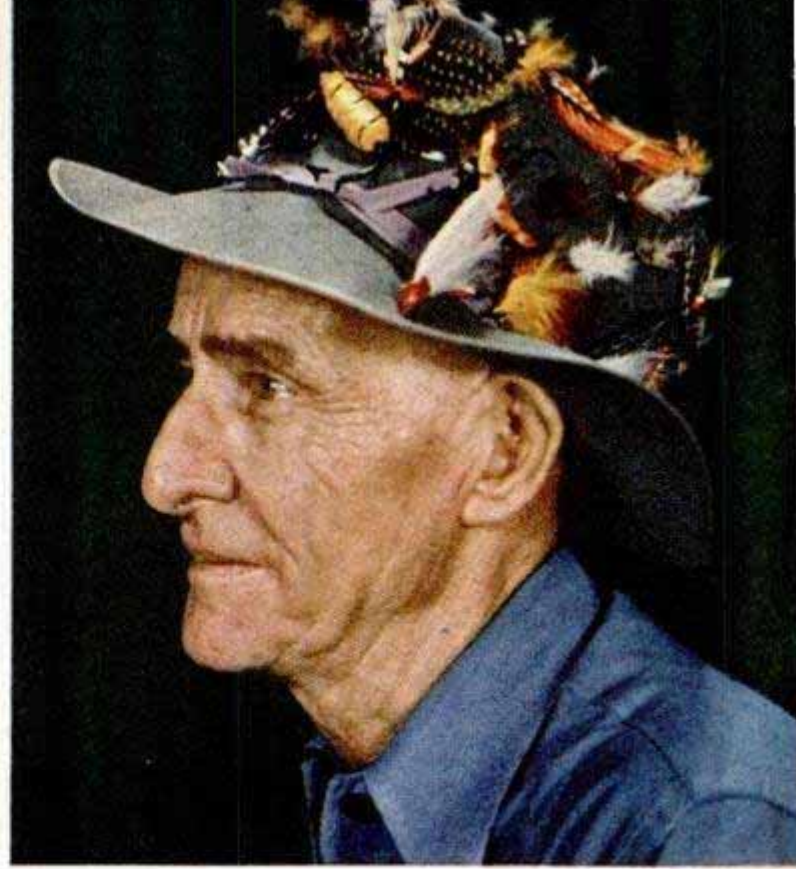

Old-time angler will swear his luck is best when he wears his battered fishing hat. Favorite flies are hooked in the crown, ready for use on the big ones

**FLIES FOR ATLANTIC SALMON:** 9—Jock Scott. 10—Green Highlander. 11—Pink Lady. 12—Cinnamon Sedge. 13—Brass Hat. 14—Thunder and Lightning. 15—Cahill. 16—Silver Doctor.



# Smallmouth Bass

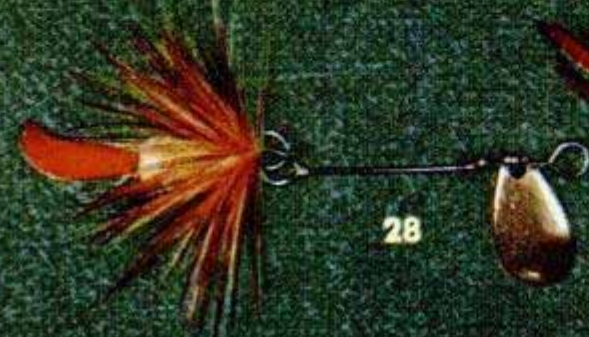

← **FLIES FOR SMALLMOUTH BASS:** 17—Red Hopper. 18—Bumble Minnow Gray Yellow. 19—Weber's Whiskerbug. 20—Black and White Bass Houn. 21—Kade's Red and Yellow Ozark. 22—Weber's HOB Streamer. 23—Bill Blade's Streamer. 24—Green Cork Popping Bug. 25—Red Optic Fly. 26—Blade's Hair Hopper. 27—Red and Black Wing Spinner. 28—Parmachene Belle Prescott Spinner. 29—Red and Yellow Mystery Bug.

was his famous book, "The Compleat Angler," first published in 1653. Since that date there have been published some 300 different editions of this work.

In his time there were some good fly casters and excellent fly fishing in England, but since then angling methods both abroad and here have improved so tremendously that today we are faced with the problem of supplying enough fish. There are better-designed fly rods to go with the improved techniques for dry-fly fishing, wet-fly fishing, bass-bug casting and salt-water fly casting. Let's compare. Sir Izaak Walton was content to fish in the streams of the British Isles. Lee Wulff fishes for Atlantic salmon in the waters of Newfoundland, New Brunswick and Nova Scotia, then goes in for giant-tuna fishing in Nova Scotia, then flies his Cub plane to fish for bonefish on the flats of the Florida Keys. He uses the same fly-rod equipment for bonefish that he does for Atlantic salmon, except in the North he uses his own flies called White Wulff and Gray Wulff, but in Florida he uses a fly that looks like a shrimp, tied by Homer Rhode, famous bonefish guide in Miami. Wulff compares the two as follows: "My reactions were geared to the fight of an Atlantic salmon, generally considered top

**FLIES FOR BROOK TROUT:** 30—Kade's Michigan Hopper. 31—Smedley's Own. 32—Dark Cahill. 33—AK Royal. 34—Cole's Choice. 35—Kade's Woody Royal. 36—AK Gray. 37—Ginger Quill. 38—Brown Wing Royal. 39—Yellow Kade. 40—Yellow Sally. 41—AK Black. 42—Leather Brown. 43—Upstream Wet Cole Fly. 44—Black Prince Streamer. 45—Quill Gordon. 46—Cow Dung. 47—Wisconsin Royal Coachman. 48—Rube Wood Wet. 49—Bucktail Royal Coachman. 50—Salyer's Stone Fly Gray. 51—McGinty Nymph. 52—Bergman's Caddis Grub. 53—Stroud's Carrot Nymph.

APRIL 1949



*Brook Trout*



Judicious fisherman will choose a fly that most resembles what the fish are feeding on at that moment

**FLIES FOR CRAPPIE:** 54—Yellow Bee Trout Bug. 55—Gray Drake. 56—Bluegill Pup. 57—Silver Doctor Polar Bear Fly. 58—Lachmann's Special Gold. 59—Ozark Red and White Bucktail. 60—Antoine's Favorite Hair Wing Fly. 61—Weber's Shinerakle. 62—Playfair Parmachene Belle. 63—Agar Cork Frog. 64—Jeff's Rubber Frog. 65—Schumann's Water Cricket. 66—Plastic Hopper. 67—Rubber Crab.

**FLIES FOR TARPON:** (opposite page): 68—Durham Ranger Silver. 69—Yellow Bead Eye. 70—Black and White Tandem Streamer. 71—Red and Yellow Ozark. 72—White Polar and Orange Streamer.

fish in fresh waters. While I could let a salmon take line out between my fingers without having the braided nylon burn me, the speed of the bonefish was much greater. After burning my fingers on that first bonefish run, I let the click act as a brake and watched my fly line melt off the reel arbor. I'm not going to give up Atlantic salmon fishing, but every winter or spring from now on I'll spend some time in the warm salt shallows after bonefish with my fly-casting outfit."

The type of outfit you select for fly fishing is entirely dependent upon the kind of fishing you plan to do. Salmon outfits are bigger, can be used for bonefishing and are good even in the taking of tarpon and sailfish if you are careful. The rod for dry-fly and wet-fly fishing for trout and bass should be 8 or 8½ feet long, with enough stiffness in the body of the rod to give sufficient striking power, but the action of the rod should permit a delicate presentation of the fly.

The fly reel may be simple, single action with a permanent click, with weight enough to balance the rod properly and capacity enough to hold the fly line. The average rule is: The weight of the reel, line and filler and the fly should be about 1½ times the weight of the rod. Automatic reels have become popular because with this reel, slack line, stripped off by hand, can be quickly spooled back on the reel by





pressing the lever with the little finger. When a fish strikes, you can quickly retrieve your loose line and concentrate on playing the fish. There are several semi-automatics that give you finger-tip control.

The fly line is important in casting. In bait casting you depend upon the weight of the lure to get distance, but in fly casting the weight of the line takes out the fly. Here again we have it all over Sir Izaak Walton because we have learned a lot about line finishes, line materials and line tapers. It is possible for the beginner today to step up and cast a fly that goes out like a bullet. Level lines (diameter is uniform throughout its length) are for fly fishing with spinners and live bait. Tapered lines are for longer casts.

Regarding line sizes, just remember that size C line measures .050 inch—subtract or add .005 for each size smaller or larger.

Although there are dozens of good torpedo lines, Marvin Hedge, famous distance caster, developed a seven-taper line that he can throw, without a rod, farther than most anglers can cast a line with the aid of their own fly rods.

When going fly fishing we are often asked three questions: 1—When is the best time to go fly fishing? 2—When should you cast upstream or down? 3—What flies should we select?

Conditions such as muddy waters from heavy rains, falling barometer, moon in the

wrong phase, water temperature too warm are exceptions, but generally speaking the best time to go fishing is whenever you can get away when the season is open, when there is a run on or when the stream is having a hatch of insects. The best hour for brook-trout fishing is in the evening, also for about three hours after sunrise. For rainbows, the evening again and all through the day is generally good. Brown trout bite best at night and are good feeders in early evening. Cutthroats and Dolly Vardens, it seems, are always hungry.

In casting, try to drop your fly in the placid waters of pools or overhanging embankments near swift-running water. Often you can get a strike in quiet waters when the fish won't bite in rapids.

Generally, the quiet waters require you to fish upstream and fast waters make it necessary to fish downstream, but there is more to it, of course. In the East, where streams are more heavily fished, you will find anglers fishing upstream; the same is true in Wisconsin or wherever the fish are shy. In the Western streams, there are more fish and you can fish up or down, depending upon the speed of the current. Edward R. Hewitt, the old master and inventor of the spider fly, finds a real slick piece of water before he tosses his famous spider—upstream. If there is a trout nearby, there is an explosion and the trout is hooked.

In our country, the best way to find out

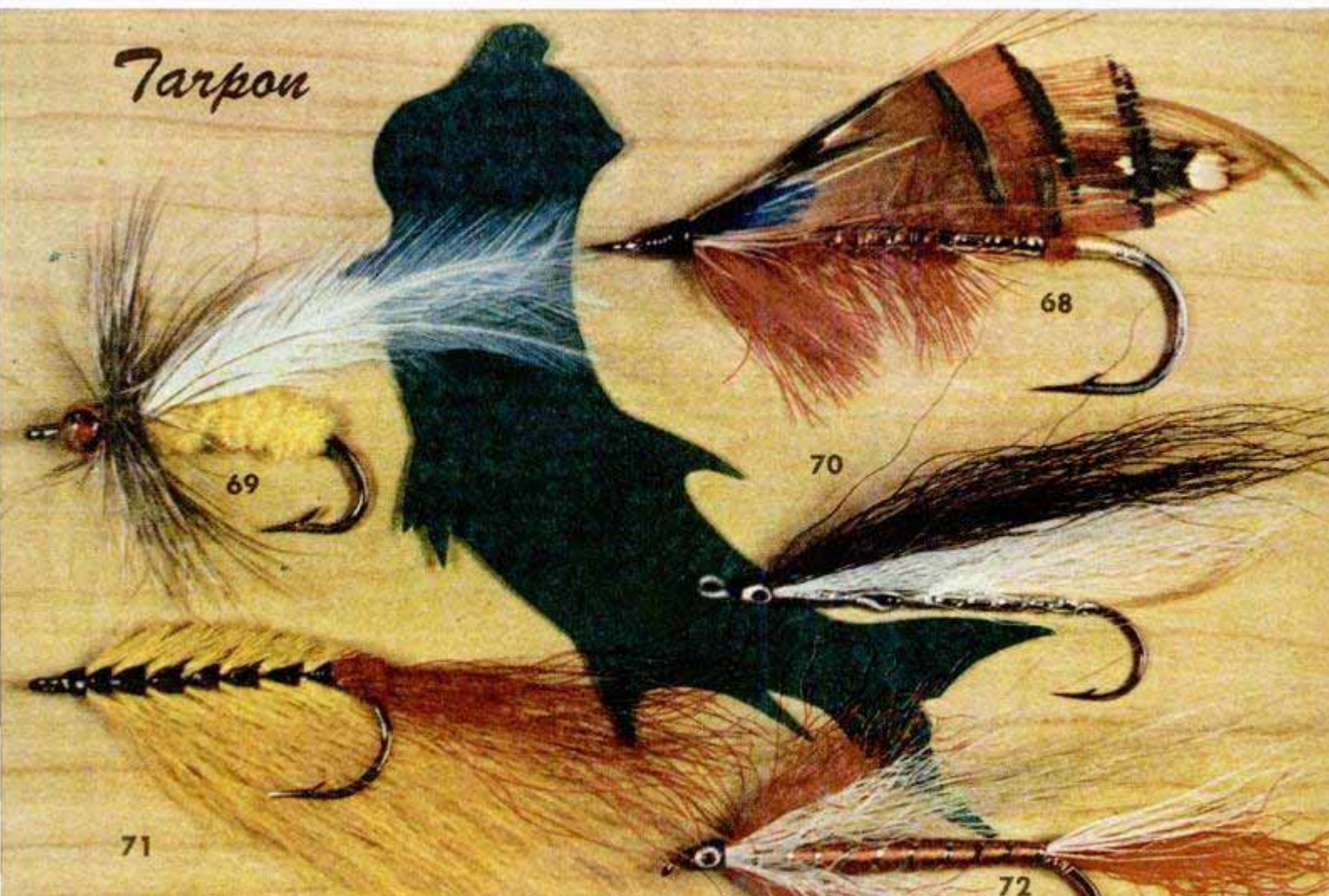

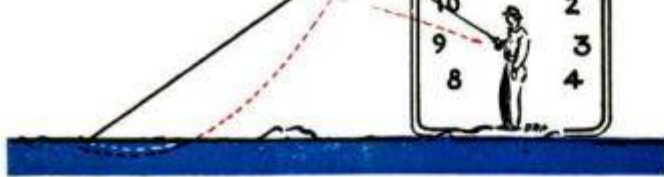

These five "clock" sketches show how to cast with a fly rod. Above, at beginning of cast, lift the rod slightly to 10 o'clock to gain tension for pickup

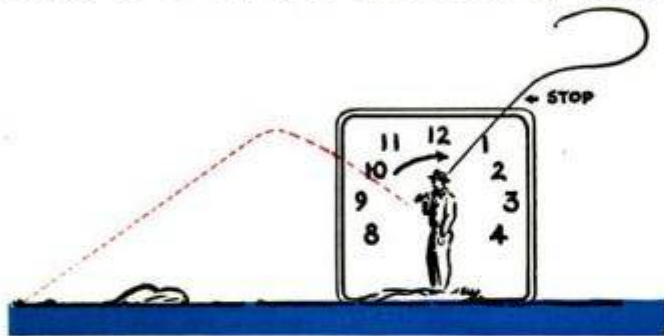

During the pickup, snap the rod tip sharply upward from 10 to 1 o'clock, using a brisk upswing of the forearm without moving the upper arm or shoulder

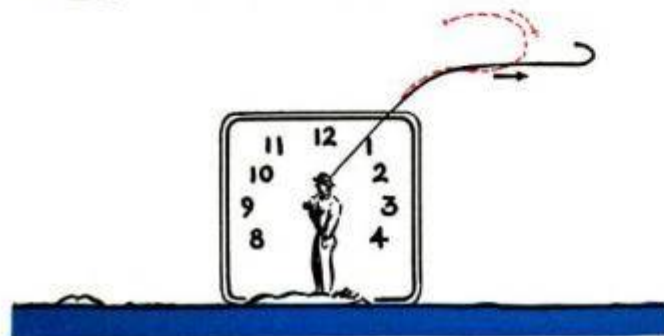

After this back cast, pause for a moment while line continues to move and whips out behind you. This will clear the line and prepare it for forward cast

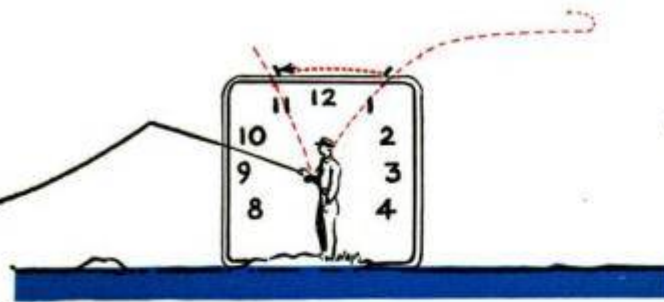

To cast the line forward again, drive the rod tip forward but not downward, stopping at 9:30 o'clock. Apply power to your cast between 1 and 11 o'clock

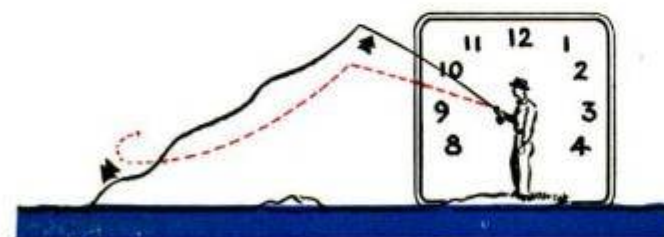

In laying the fly, aim three feet above the water target. As the line is about to reach the limit of the cast, raise rod tip slightly so fly hits water first

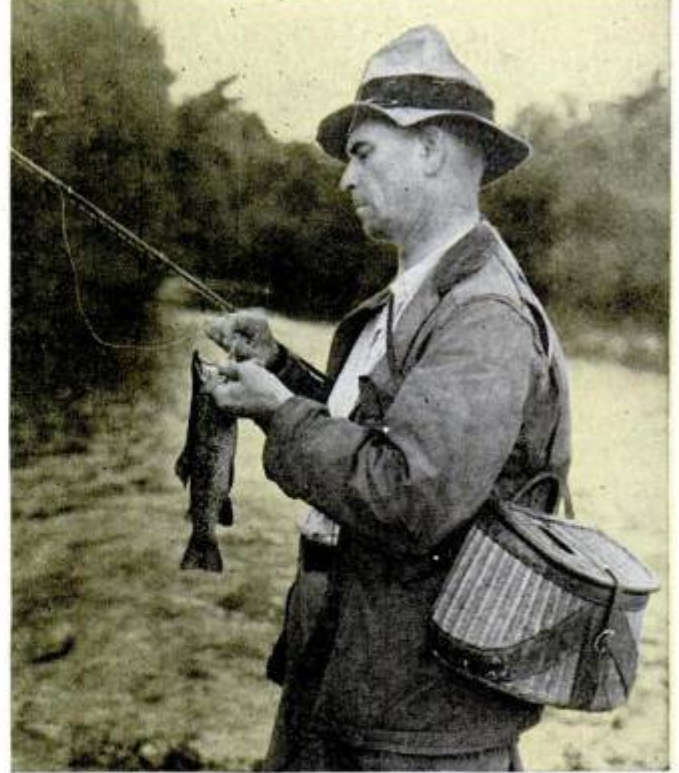

Most anglers try to appear nonchalant after landing a fighting game fish, but the thrill grows along with the fish as the story is told during winter evenings

the best flies is to ask an angler who has previously fished the waters. Every angler has a pet list of his own. Our most popular fly patterns today are: Royal Coachman, Ginger Quill, Brown Hackle, Parmachene Belle, McGinty, Queen of the Waters, Black Gnat, Gray Hackle, Coachman, Professor.

Most fly fishermen on dark days select darker-colored flies because really all the fish sees is the silhouette, and the surface of the water takes on a silvery color, thus bright flies will not be seen as well. Black Grats, Black Hackle and Black Prince are popular. Bright flies on bright days are always good for rainbows. When going for steelheads, select flies that sink swiftly, preferably flies that have lead or copper-wrapped bodies because these fish are usually well beneath the surface. Spinners are often used, but these drag along the bottom and you are easily hung on a rock, whereas a weighted fly bumps along more on the bottom.

Hook sizes that get the most fish are 10 to 16, but when fishing in streams above 5000 feet you must use smaller flies, usually from 14 to 20 because the natural hatches above this sea-level measurement—drakes and stone flies—are tiny. In the streams of California, Montana, Wyoming and Idaho the anglers prefer sizes 16 or 18. Anglers who want bigger trout often use size 10 flies.

Early season anglers are the ones who must be most particular that their dry fly imitates the natural insect. The hatches

(Continued to page 246)

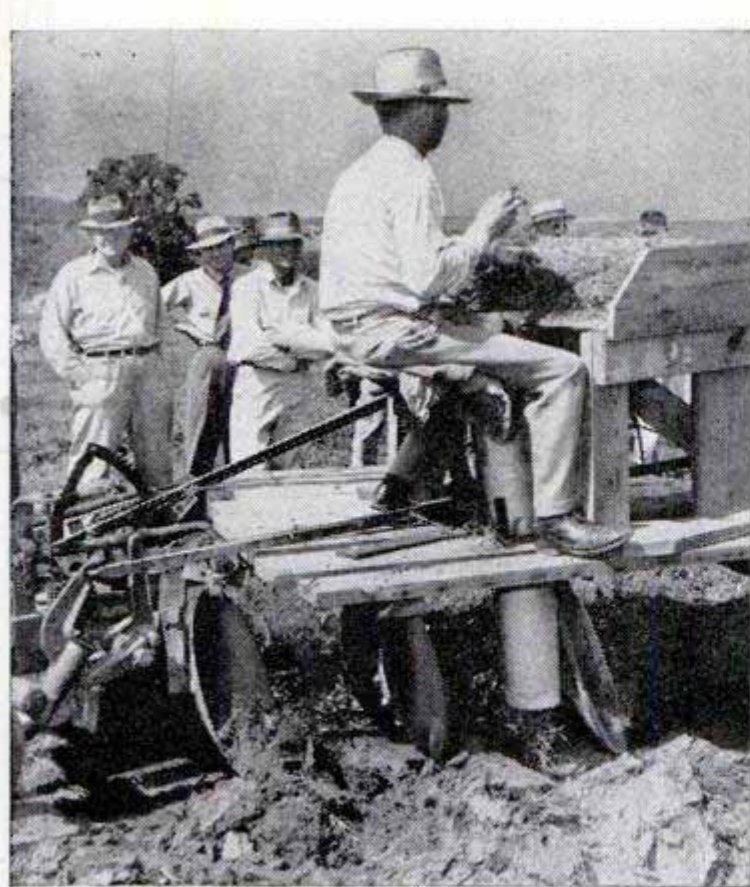

### Bermuda Grass Roots Planter

Bermuda grass roots are planted three times faster than usual by a device that plows, plants and covers in a single operation. It was adapted from a disk plow by Curtis Floyd, agricultural agent of Coal County, Okla. The roots are dropped through a pipe in moist soil behind the lead disk and immediately covered by the second and third disks. It puts roots three or four inches deep to insure better growth.

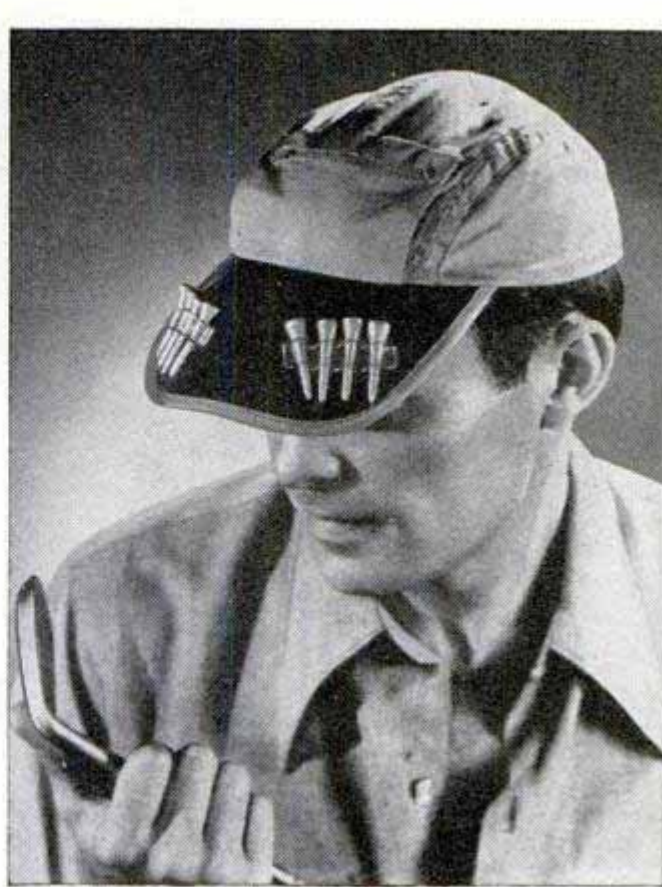

### Sports Caps With Pockets

Sports caps are now double-purpose—they not only keep the sun off your head and shade your eyes, but they also serve as convenient pockets for small items that are a nuisance when you're not wearing a coat. One model has a plastic visor with loops for golf tees or fishing flies. A zipper pocket on the front of the crown is a handy place to carry tickets or locker keys when on the beach or golf course.

### Infrared Rays Erase Disks For Reuse on Recorder

Sound grooves on plastic dictating disks are erased by heat and infrared rays in a machine about the size of a portable radio. Formerly the disks, made of Vinylite, could be used only once. The machine makes it possible to use the disks at least 25 times. The operator places the recorded disk on a spindle in the machine, presses a button and the recording spins inside a bath of heat and infrared rays. Centrifugal force on the heated plastic erases both sides of the disk simultaneously. The plastic by nature tends to return to its original molded form upon the application of heat. In less than a minute the lid opens automatically and the disk is ready for reuse. The erasing machines are leased to users of large quanti-



ties of disks on a 15 and 30-day basis; others can accumulate disks and have them erased at service centers.

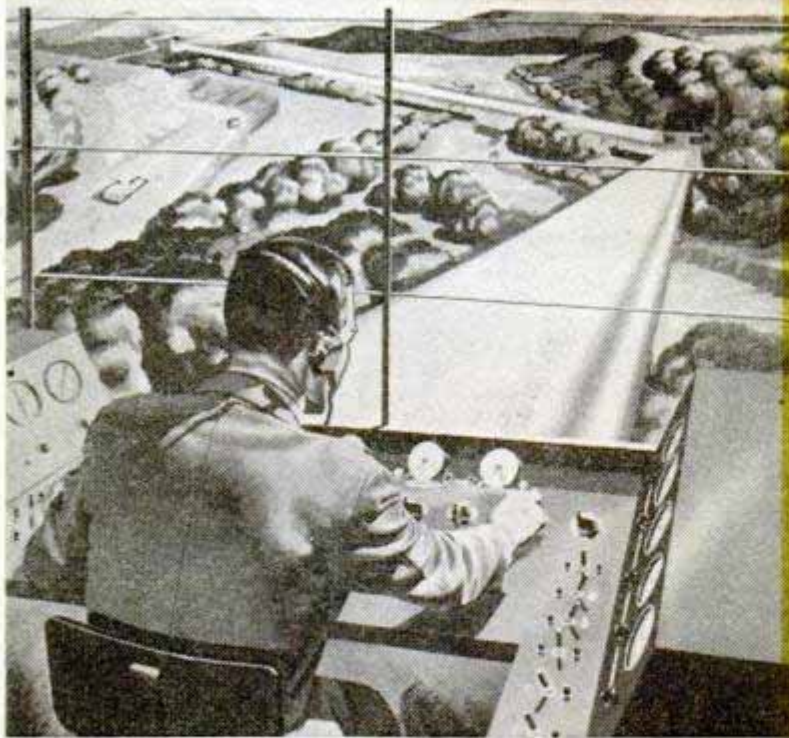

Above, one of five control towers. Below, cutaway of the tube shows how materials are transferred from one belt to the next

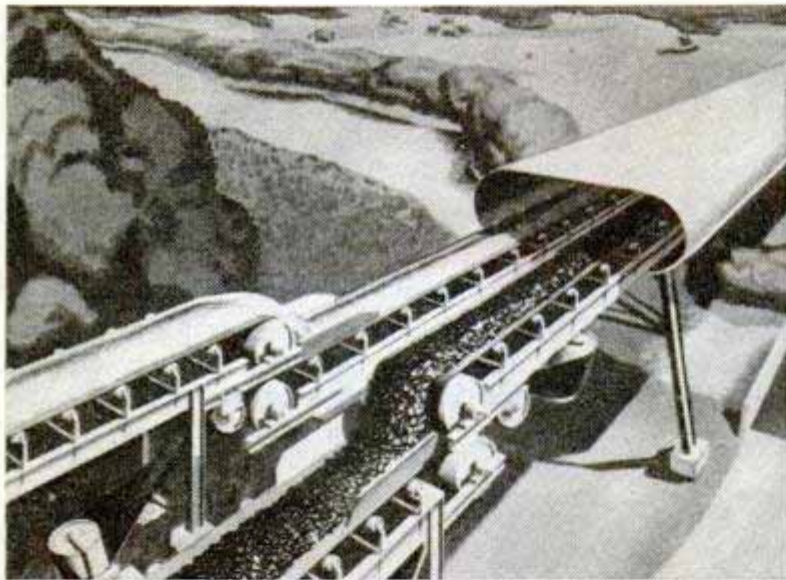

Below, elevated on steel supports, the two-way conveyor will not interfere with highway traffic. The twin belts, enclosed in a metal tube, will have a capacity of 52 million tons yearly

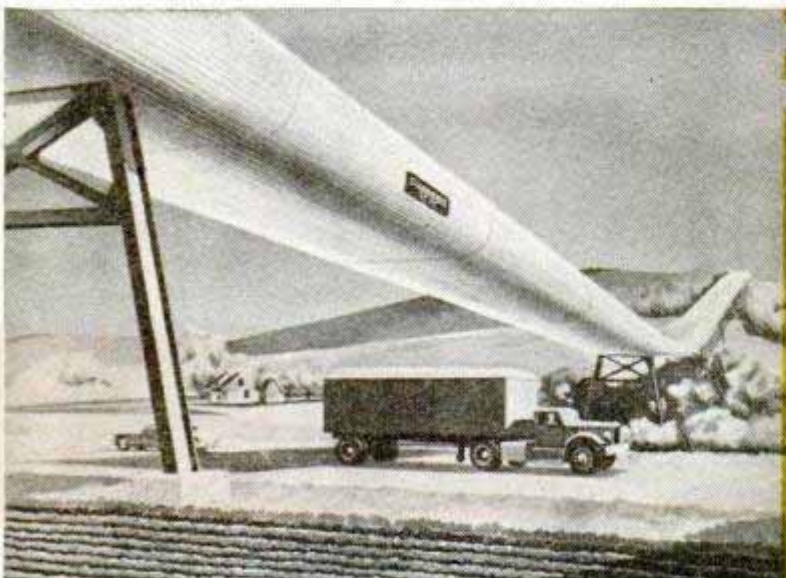

# 130-Mile Belt to Carry Coal and Ore

Snaking through rolling Ohio, twin "rivers" of rubber, flowing in two directions, may be a preview of future railroads

**T**WIN "RIVERS" that flow uphill and down may be the railroad of tomorrow, if plans for an endless-belt conveyor between Lake Erie and the Ohio River live up to expectations.

The main line of the system, designed to haul millions of tons of coal and ore annually, will be a two-way belt extending 103 miles from Lorain on Lake Erie to the Ohio River near East Liverpool. Spur lines to Youngstown and Cleveland will bring the total up to 130 miles. To move its capacity of 52 million tons a year, the belts will roll 20 hours a day and 300 days a year, saving an estimated 20 to 45 million dollars annually in railroad freight charges.

Mounted on steel supports, the two-way belts will travel in a giant metal tube, flattened on top

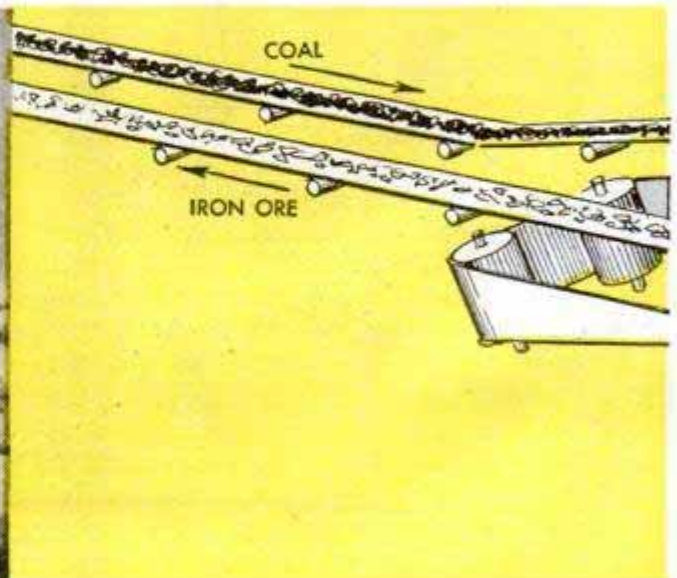

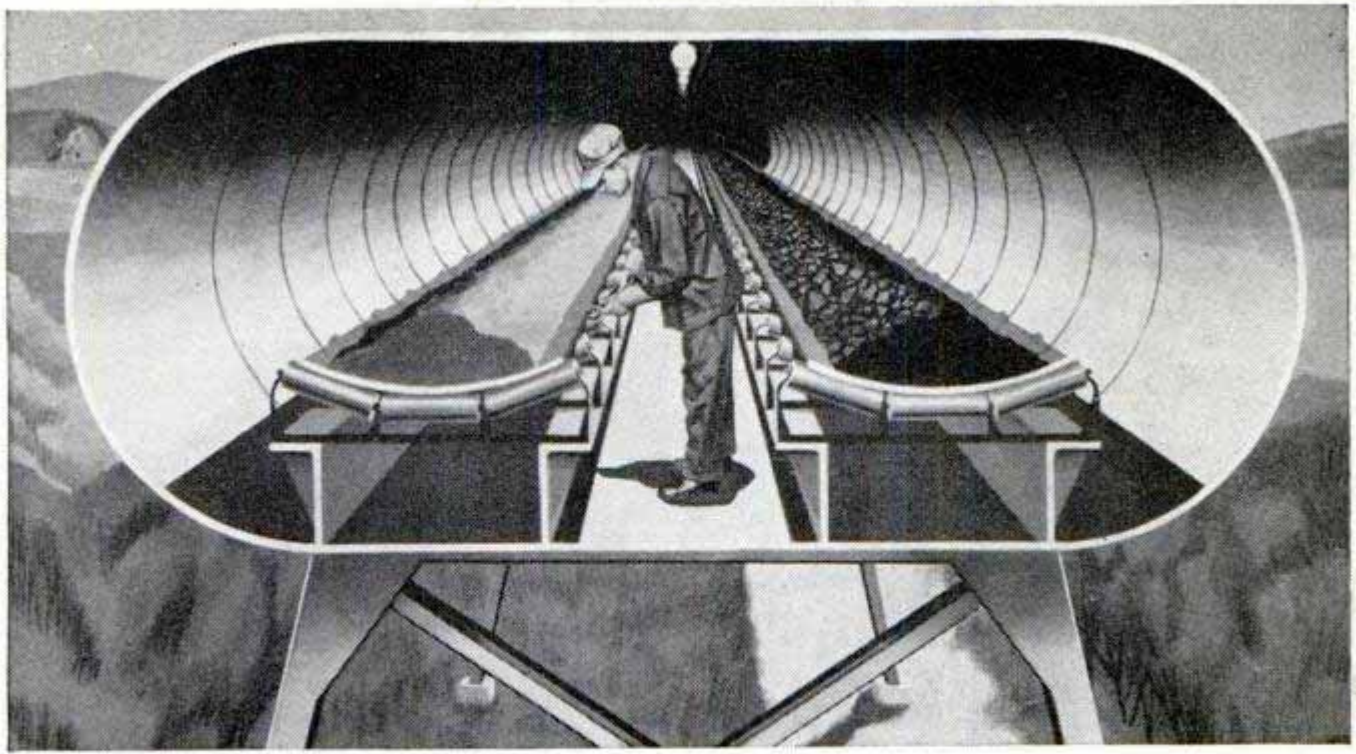

Above, conveyor tube has a catwalk for maintenance men. Below, the belt system will run between Lake Erie and the Ohio River

and bottom. To cover the 103 miles from river to lake, 172 belts will be used. Some belts will be over a mile long. A "switchback" pulley system enables the belts to carry loads in either direction.

Coal will move northward in a continuous stream at about 6.8 miles an hour, arriving at the lake at a rate of 3400 tons an hour. The southbound ore belt will, of course, move at the same speed, but, because ore is heavier than coal, its delivery rate will be 5400 tons an hour.

Belt widths vary, with 72 inches on the south end of the main line, 60 inches farther north and 42 inches on the spurs. The electrically operated belts will be push-button controlled with electric-eye "watchmen" to stop the entire system if trouble develops.



Drawing illustrates the ingenious pulley system by which the conveyor belts are made to reverse themselves so that they will carry material either way

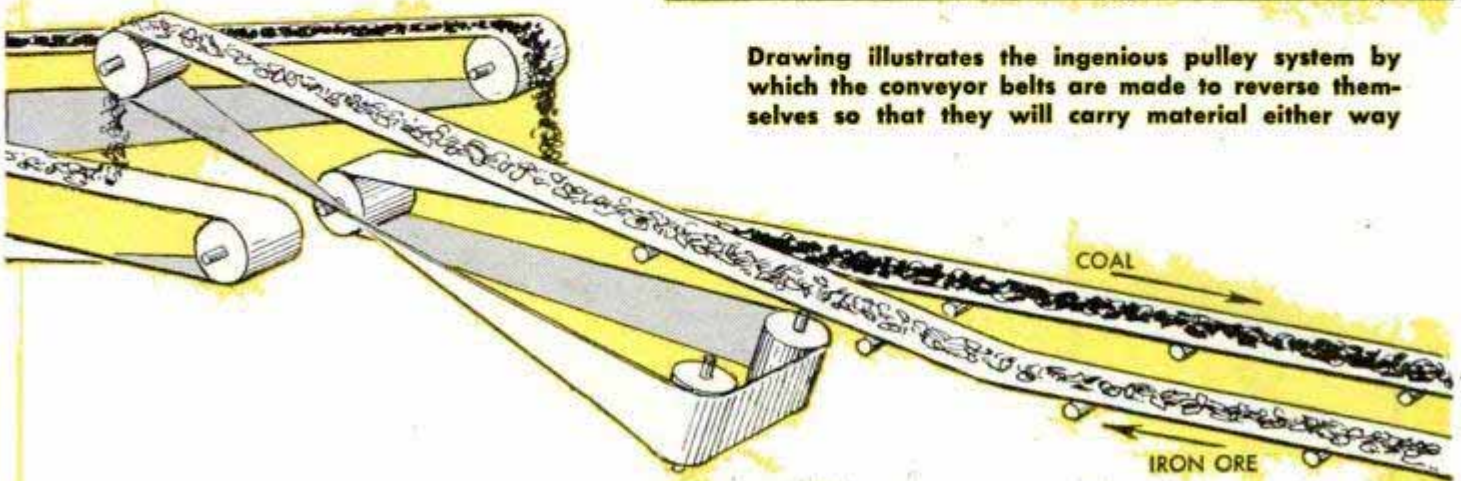

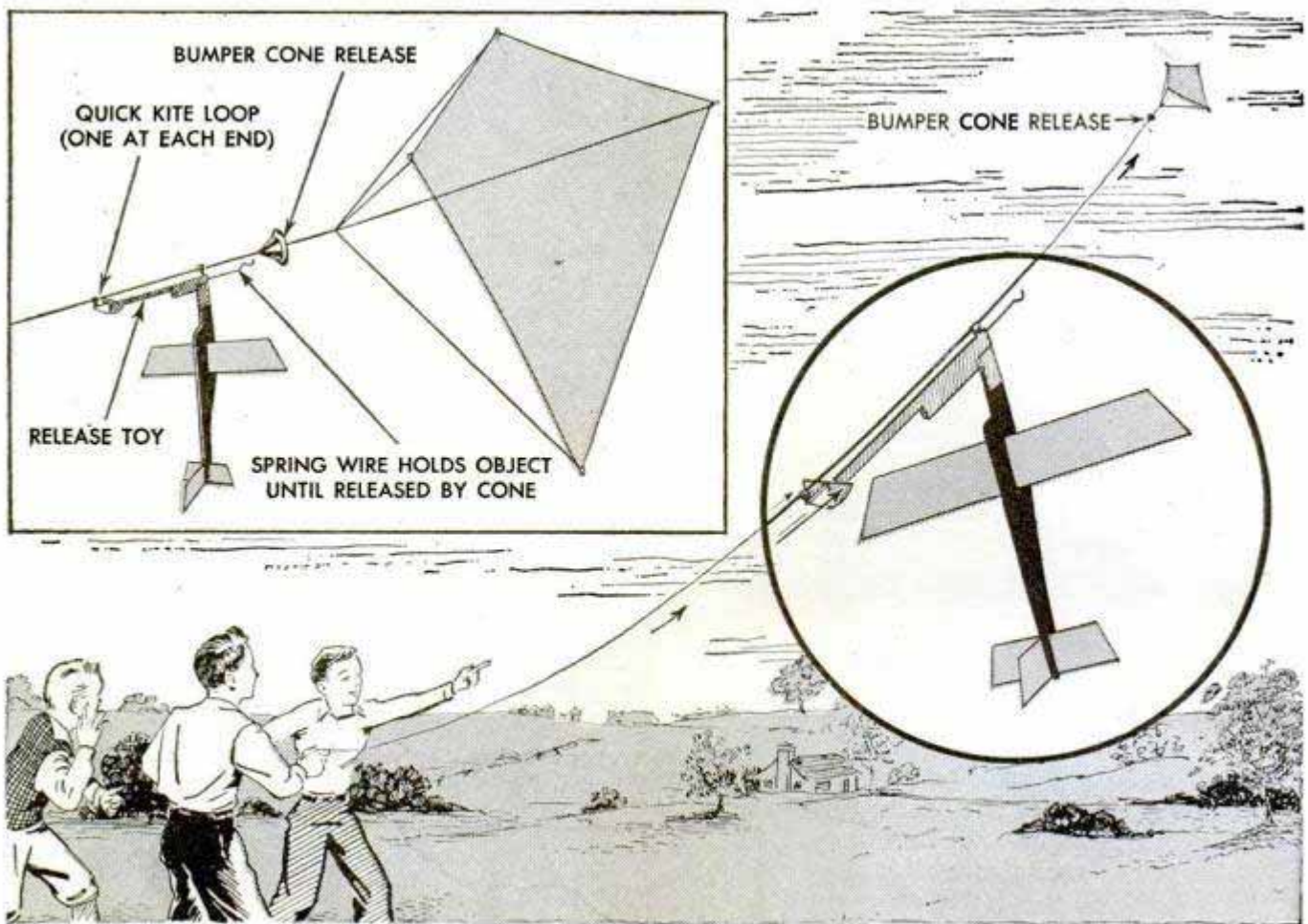

## Kite-String "Carrier" Frees Planes at 3000 Feet

Model planes, small parachutes and other lightweight objects descend from as high as 3000 feet after release from a toy carrier that rides up an ordinary kite string. Wind blowing against a cone at the rear pushes the device up the string. Objects hitched

to a spring wire at the front are released when it hits a bumper cone tied below the kite. The carrier returns down the string by its own weight. It takes about four minutes to go up 1500 feet and a minute to slide back.

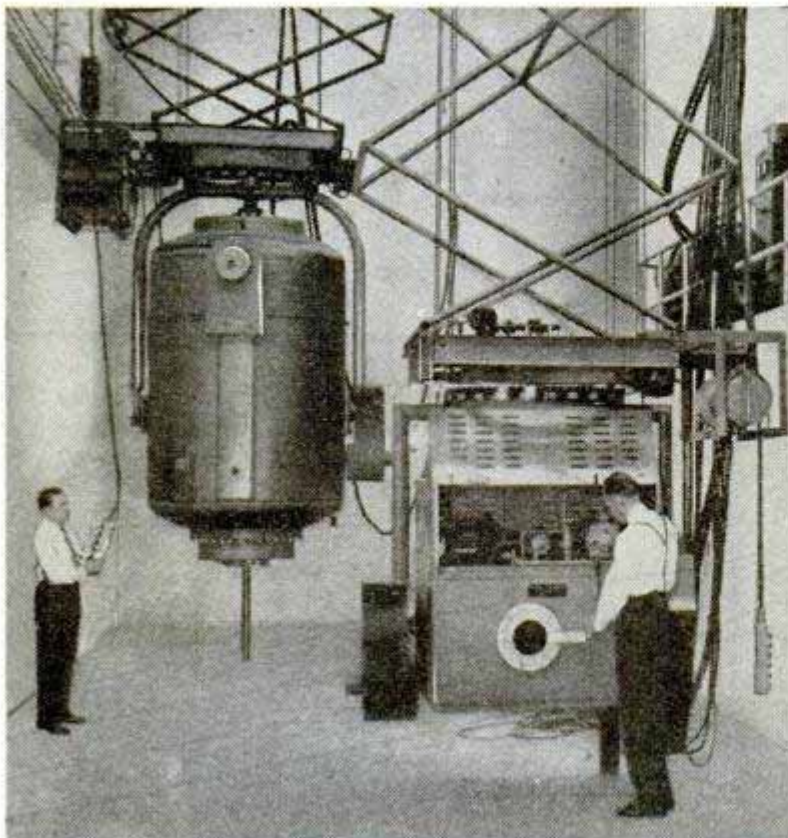

## Mobile Betatron

Capable of being aimed in any direction, a 10-million-volt X-ray generator is powerful enough to send its rays through 16 inches of steel. The powerful generator, said to be the world's first mobile betatron, is installed at the Naval Ordnance Laboratory, White Oak, Md., and will be used to study the complex internal assemblies of mines, torpedoes and other Naval ordnance. Compactly housed in a steel casing, the betatron weighs about 5500 pounds and can be moved around with a crane. It is housed in a special building surrounded by concrete walls three feet thick to protect personnel.

Ⓛ Glass insulators on telegraph poles are being replaced by an unbreakable rubber type that is much smaller and weighs about one tenth as much.

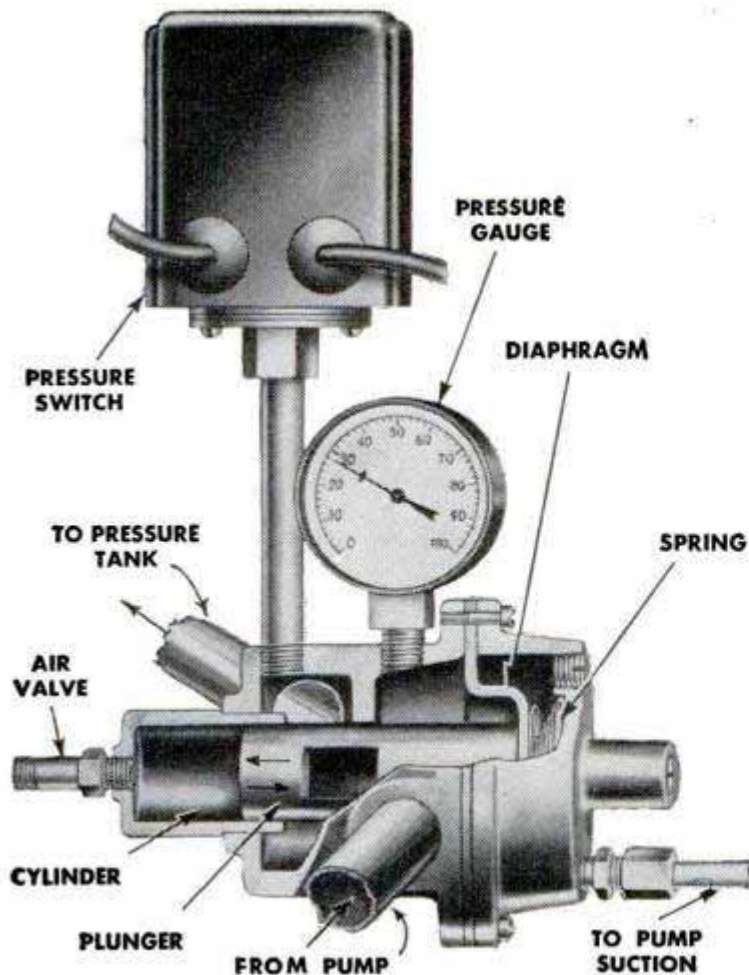

### Valve Meters Air Into Water Tank

Air is injected into the pressure tank of a water system by a metering valve to keep the system from being "waterlogged." Each time the pump starts, the valve injects air into the tank, maintaining an air cushion above the water. The automatic valve is installed between the pump and tank. When the pump starts, the pressure, acting on a diaphragm, moves a plunger out of a cylinder, sucking in air. When pumping stops, the piston is driven back by a spring, forcing the air into the valve from which it enters the tank when pumping is resumed.



### Disk Holds 30 Minutes of Dictation

Seven-inch disks, recorded on a new dictation machine, are so light they can be mailed for three cents, yet hold 30 minutes of dictation. The seven-inch Vinylite records are slipped into the machine from the side and are positioned automatically. To prevent "dry runs," a warning light blinks if no disk is in the recorder or if the cover is not down. A locating pointer enables the operator to find his place quickly on the record, should he remove it before the full time is used. A companion machine for the secretary plays the recording.

### Reel Indicates Water Depth

Fishermen can tell the exact depth of the water with a pocket reel that measures up to 100 feet. To check the lake bottom, the angler releases a brake screw on the reel which allows a weighted line to drop through the water. When the weight hits the bottom, he reads the depth in coded markings on the water-resistant line. He then reels in the line and resets the brake screw. The reel permits the angler to chart his favorite fishing spot so it can be located at any time. The line is coded at one-foot intervals for easy reading.

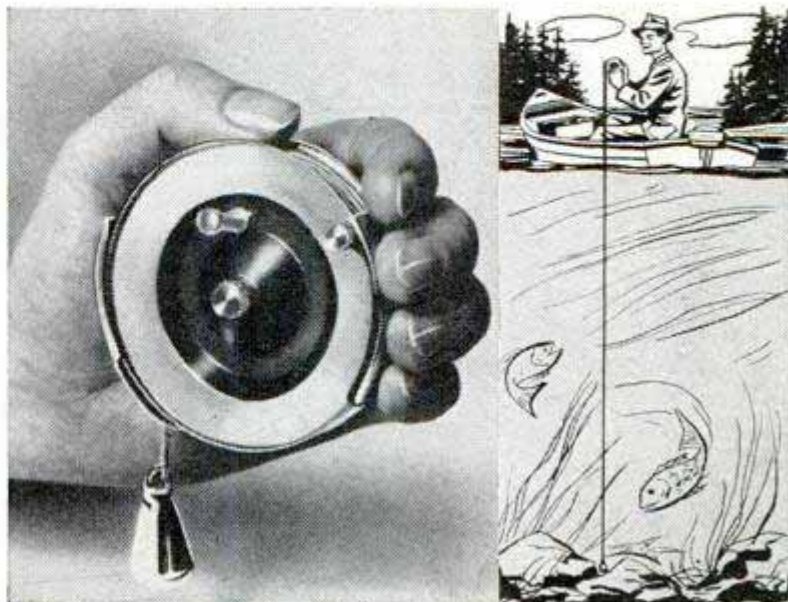

# Chrysler Family Debut



The new Plymouth is wider on the inside and narrower over-all—leaving room to spare getting into garage

**By Wayne Whittaker**

**WHEN THE TOP BRASS** of the Chrysler Corporation planned its strategy for 1949, they made a 90-million-dollar bet.

They wagered that handsome outlay for retooling on their belief that the American motorist is tired of having his hat knocked off every time he gets in or out of a car; that he would welcome a car with detachable fenders in preference to a fancy repair bill every time a panel-side automobile comes limping home with a bashed fender; that he'd like easy access to the wheels instead of having to unbutton skirts of metal to get at a flat tire.

So they embodied those features in the whole Chrysler family—Chrysler, DeSoto, Dodge and Plymouth—as they planned the

cars that would celebrate the silver anniversary this year of the first Chrysler automobile.

The stylists were sure that the public is more concerned with headroom than with a low, super-swanky silhouette parked at the curb; that people like larger doors which open all the way and stay open for easy entrance and exit, and a reduced over-all exterior width. Despite the fact that every car in the line has wider seats than ever, the outside widths have been reduced from  $1\frac{3}{4}$  to  $3\frac{3}{4}$  inches. The height of all new models has been lowered by  $1\frac{5}{8}$  to  $2\frac{1}{4}$  inches.

One question is always asked about every new car on automobile row. Does it look like the other postwar cars? The an-



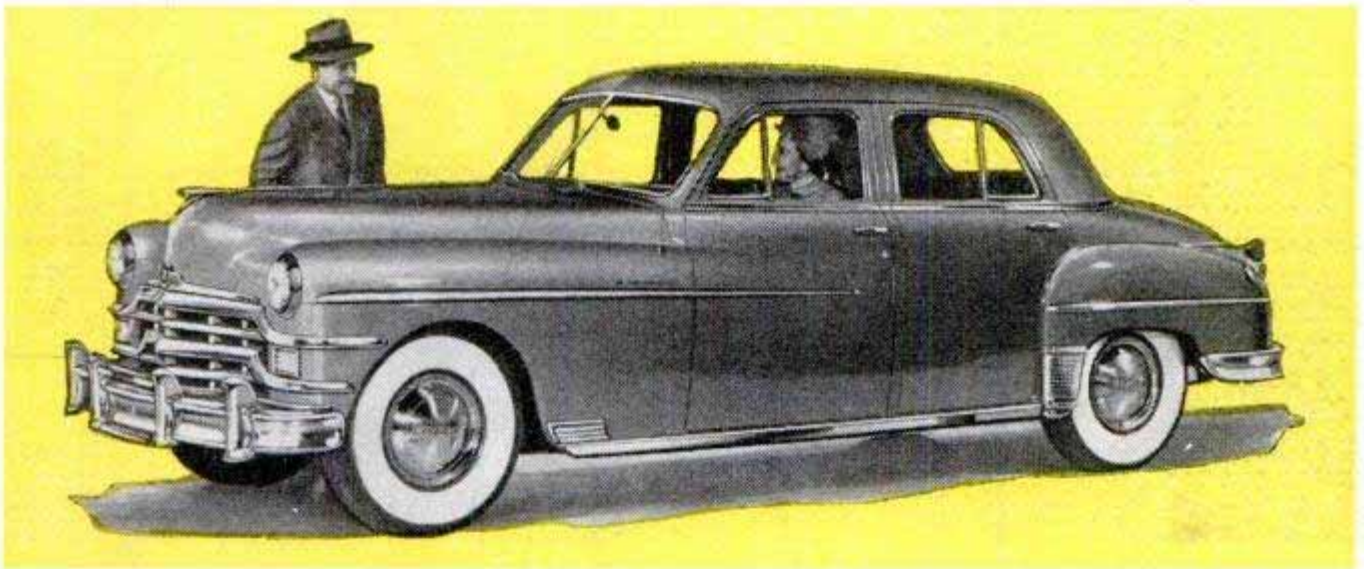
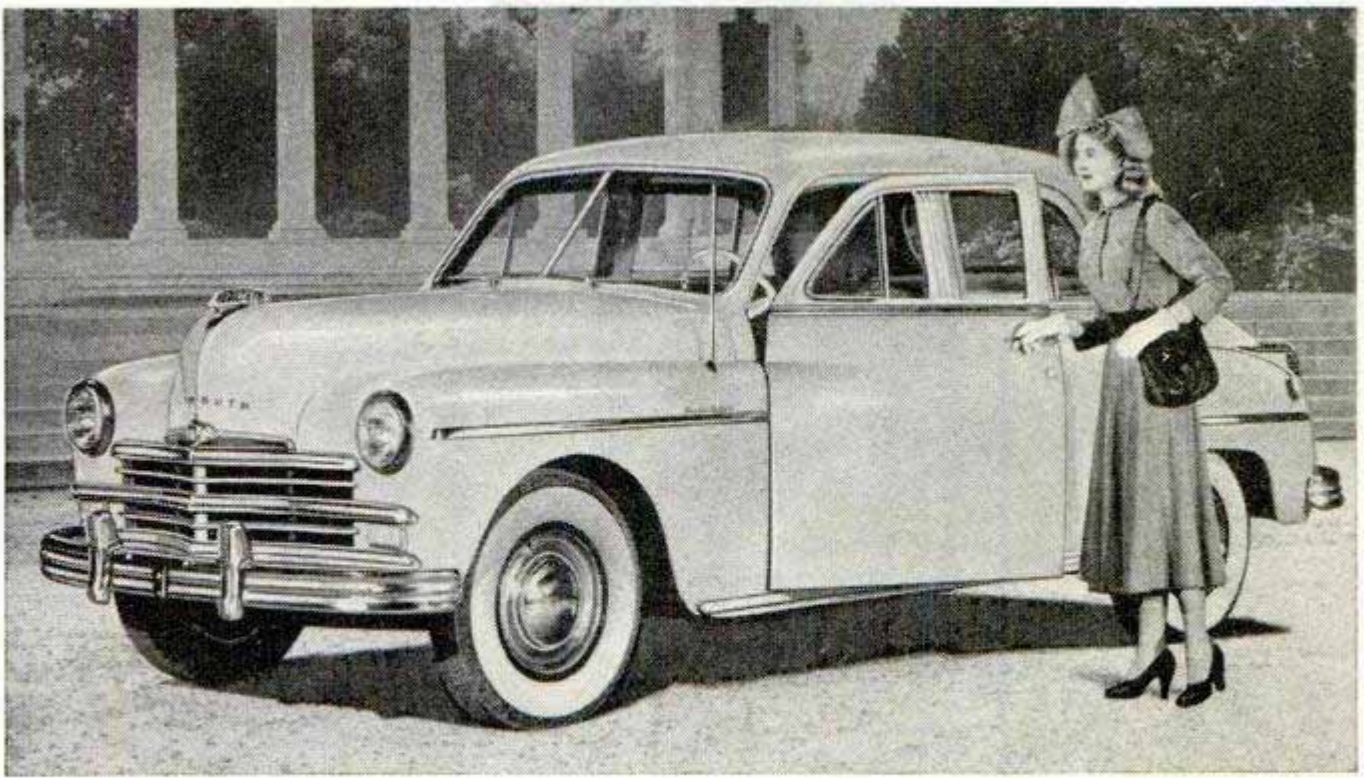

Top, 1949 Plymouth four-door sedan shows conservative styling. Below it is the Chrysler Windsor four-door

swer, as a glance at these pages will show, is: No, they look like conservative Chrysler-line cars rather than copies of their competitors. Perhaps there's a slight hint of Studebaker in the shape of top and rear deck, but the over-all design is distinctively Chrysler's own.

When K. T. Keller, president of Chrysler Corporation, was asked what he considered to be the outstanding feature of the new line, he said:

"We had to make up our minds what course to take in developing these new cars. It wasn't so much that we wanted everything on them to be new—although there are many improvements. The engines, for example, all have higher compression ratios. As far as design goes we wanted to build an outstanding car, a car that is easy to get into and get out of, that is easy to

garage, to handle in traffic or when parking. The outsides of our new cars are actually sculptured around conditions prescribed for the inside."

Despite the detachable fenders, exposed wheels and generous headroom, the '49 Chrysler line follows the straight-line styling trend and increased visibility introduced after the war. The corporation engineers and styling experts, of course, have had the advantage of studying the acceptance of many postwar innovations pioneered by others. At one time the embryo '49 Chrysler line was fenderless but this was changed after a careful sampling of public opinion.

Among the big news items in the Chrysler family debut are Plymouths and Dodges with reduced wheelbase in addition to the regular lines. The small Plymouth has a

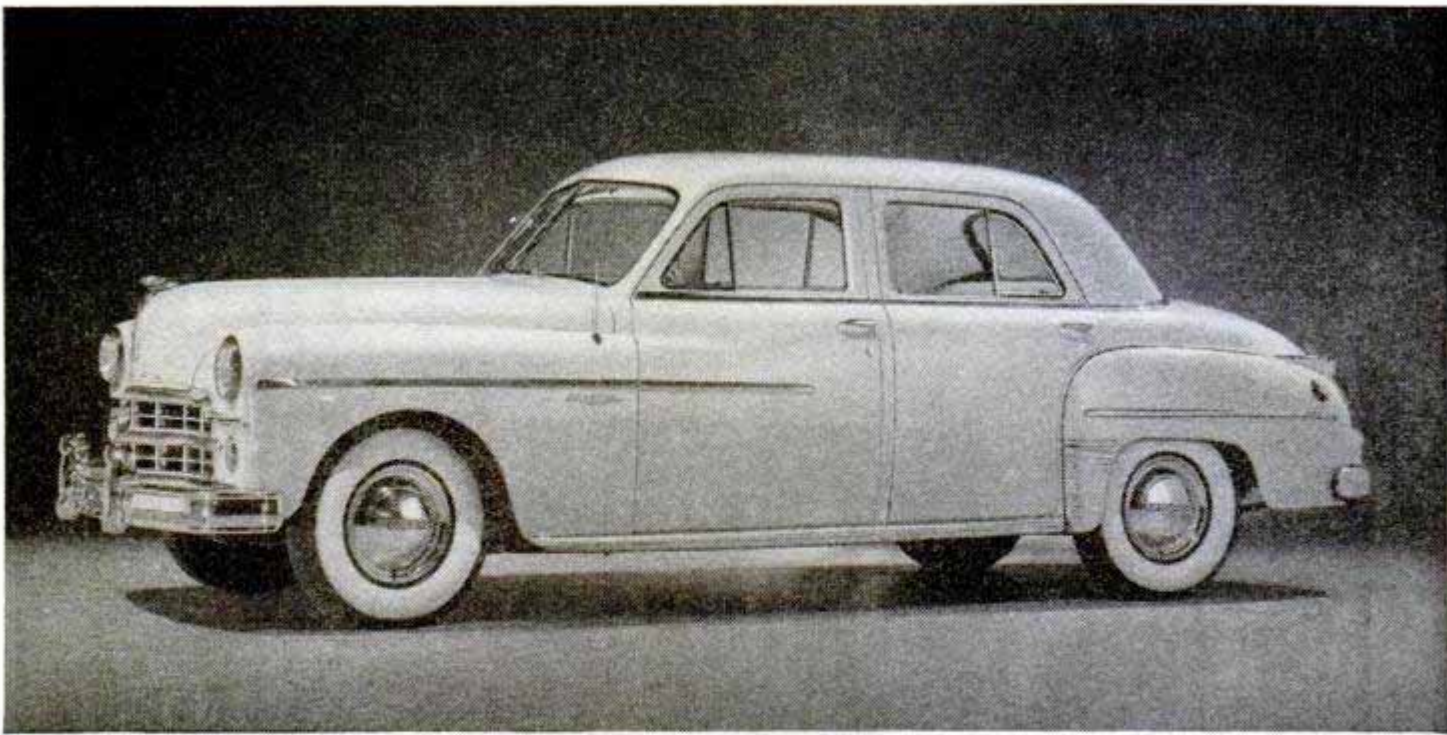

The Dodge Coronet four-door shows postwar styling but—look at those detachable fenders, front and rear

111-inch wheelbase compared with 118½ inches on the regular model; the small Dodge has a wheelbase of only 115 inches, compared with the regular's 123½ inches. The small Plymouths include a car new to the line—the Suburban, an all-steel station wagon which will be priced below the regular station wagon.

The small Dodge line will be known as the Wayfarer. It includes a real sensation and innovation which already has the brass hats of the motor industry shaking their heads. This is a "stripped" convertible or three-passenger one-seat roadster, a sleek automobile which probably will create a furor among the youth of the nation. It has no side windows like ordinary convertibles, but uses plastic side curtains (Paging Grandpa!) which are stored in a compartment back of the seat. The car has no horn or backup light, no clock, no interior frills of any kind. The canvas top is manually operated. The rear luggage compartment appears large enough to hold two or three trunks. The industry is not so much concerned about the smart appearance of the car as it is about rumors concerning the low price for which the roadster will sell. The car will be unveiled officially sometime next month.

The new Plymouth (bread-and-butter car of the Chrysler family which sold at the rate of 375,373 cars last year compared with 232,863 for Dodge, 118,951 for Chrysler and 90,223 for DeSoto) has been completely redesigned and streamlined. You have to look closely to make sure that those fenders really are detachable.

The Plymouth engine has been boosted in horsepower from 95 to 97. Performance

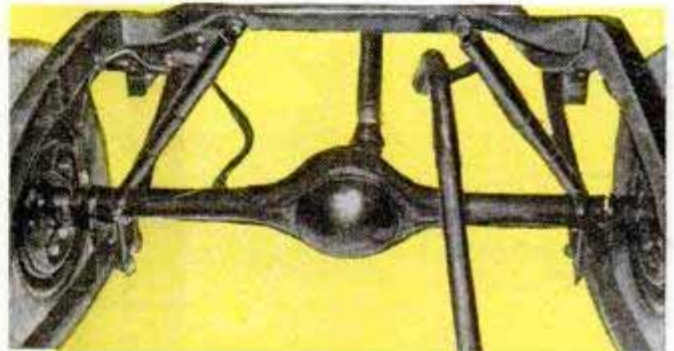

Airplane-type rear shock absorbers are mounted on all Chrysler line '49 cars in diagonal fashion to help eliminate sidesway. They are shown here on the Dodge. Below, no fender panels cover rear wheels



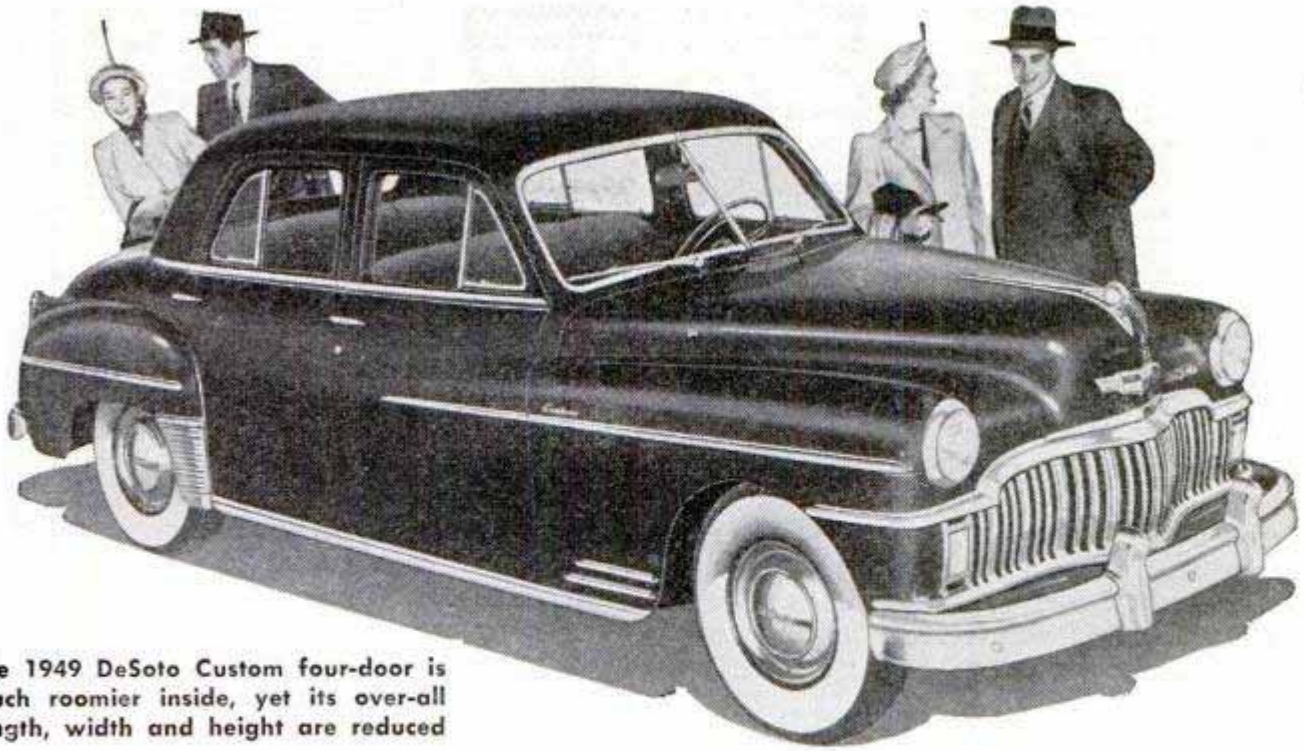

The 1949 DeSoto Custom four-door is much roomier inside, yet its over-all length, width and height are reduced

has been improved with a new cylinder head which increases compression ratio from 6.6 to 1 to 7 to 1. A new chrome-plated compression piston ring reduces cylinder wear and provides greater protection during the breaking-in period. Quicker warm-up and faster throttle response are two of the advantages of a new intake manifold.

When you step into the '49 Plymouth you are first impressed with the amount of head and leg room, both back and front seats, and the excellent visibility. The windshield

is 37 percent bigger than in previous models and the rear window is 35.4 percent larger. The seats are much wider—an increase to 56 inches in the front and to 57 inches in the rear. This is something of a design feat when you consider that the over-all width of the cars has been decreased by more than an inch.

The regular Plymouth line has a 118-inch wheelbase (an increase of one inch over the '48) with six models: a club coupe and a four-door sedan in the Deluxe series and

This picture proves that Plymouth fenders, like the other cars of the Chrysler line, are really detachable

A rack and spring hold the bumper jack in place beside the spare tire and prevent it from rattling

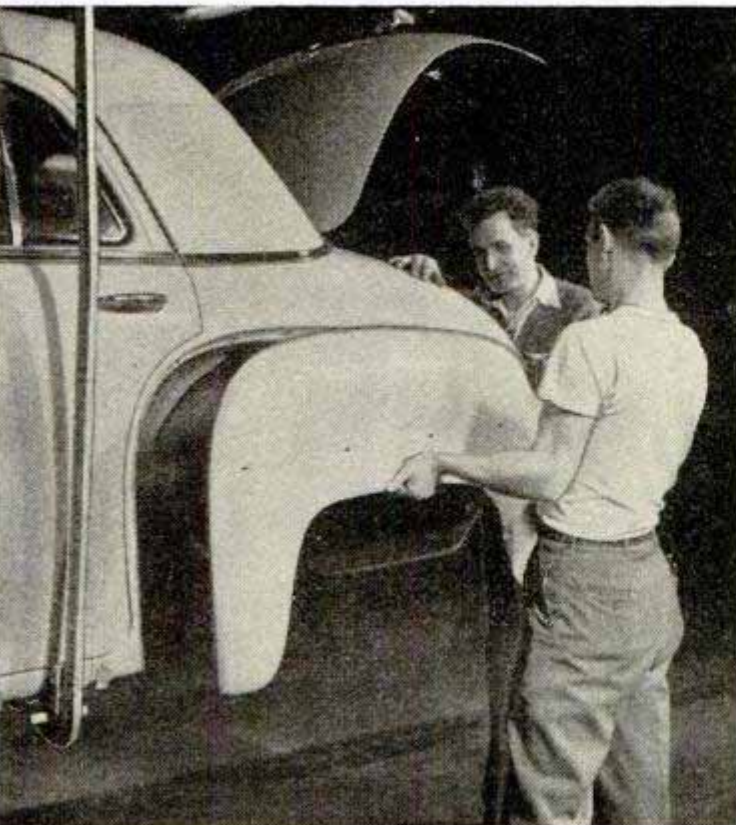

a Special Deluxe club coupe, four-door sedan, convertible coupe and station wagon. The three models with the new 111-inch wheelbase are the two-door sedan, a three-passenger coupe and the Suburban.

The Plymouths have "smooth riding" diagonally mounted shock absorbers which allow greater road clearance and reduce sidesway. A new automatic electric choke, of the same type used on other Chrysler-line cars, has been added. Among the innovations of primary interest to the driver is the combination ignition and starter switch which eliminates the starter button. The car starts by turning the ignition key slightly beyond the "ignition on" position. When released, the key automatically returns to "ignition on." Aside from the convenience to the driver, this starter makes it impossible for children to move a car which has been left in gear by pushing the starter button.

Other new items include a vent-window lock designed to reduce theft of articles from parked cars, a heavily armored ignition cable to reduce theft, bull's-eye lens in the center of the sealed-beam headlights to increase light output, hard-to-break plastic lenses in the stop, tail and parking lights, an enclosed circuit breaker which eliminates the need for replacing lighting-system fuses, and a rattleproof rack for the bumper jack.

The corporation's No. 2 seller, the Dodge, is being built in three lines of passenger cars with 11 body styles, two wheelbases and an improved 7-to-1 compression engine. The new cars are shorter in over-all length, narrower in exterior width and lower in height. However, the Coronet and

Meadowbrook models (regular line) have a wheelbase of 123½ inches, an increase of four inches. This increase results in better cradling of the passengers between the axles and a smoother ride. All of the cars have much less overhang in both front and rear which makes parking easier and provides better road clearance on driveways with steep grades. Over-all length of the regular line is 203⅝ inches.

The higher compression Dodge engine has a new cylinder head. Other engineering advances include improved carburetor, intake manifold, camshaft and fuel pump. The intake manifold gives a better distribution of the fuel-air mixture to the cylinders and its shorter riser produces more rapid response to acceleration. The new camshaft with quick-lift, short-duration valve timing affords improved performance through a large part of the speed range. Filter, gasket and sediment bowl have been eliminated on the fuel pump and an air dome provided on the suction side. Another engine improvement is a protective coating on cylinder walls which prevents scuffing or scoring during the break-in period.

A new Gyro-Matic transmission, available as extra equipment on the Coronet, frees the driver from shifting gears. The driver starts the car with the gearshift in "high" position and presses down on the accelerator. When sufficient forward speed is attained, the accelerator is released and the Gyro-Matic shifts automatically into "high." For extra power in passing, the accelerator is pushed to the floor to shift automatically into a lower gear.

The Dodge interiors are comfortable and quietly luxurious. The front seats are six

**The roomy 1949 Plymouth station wagon has varnished wood trim and it can carry nine passengers with ease**



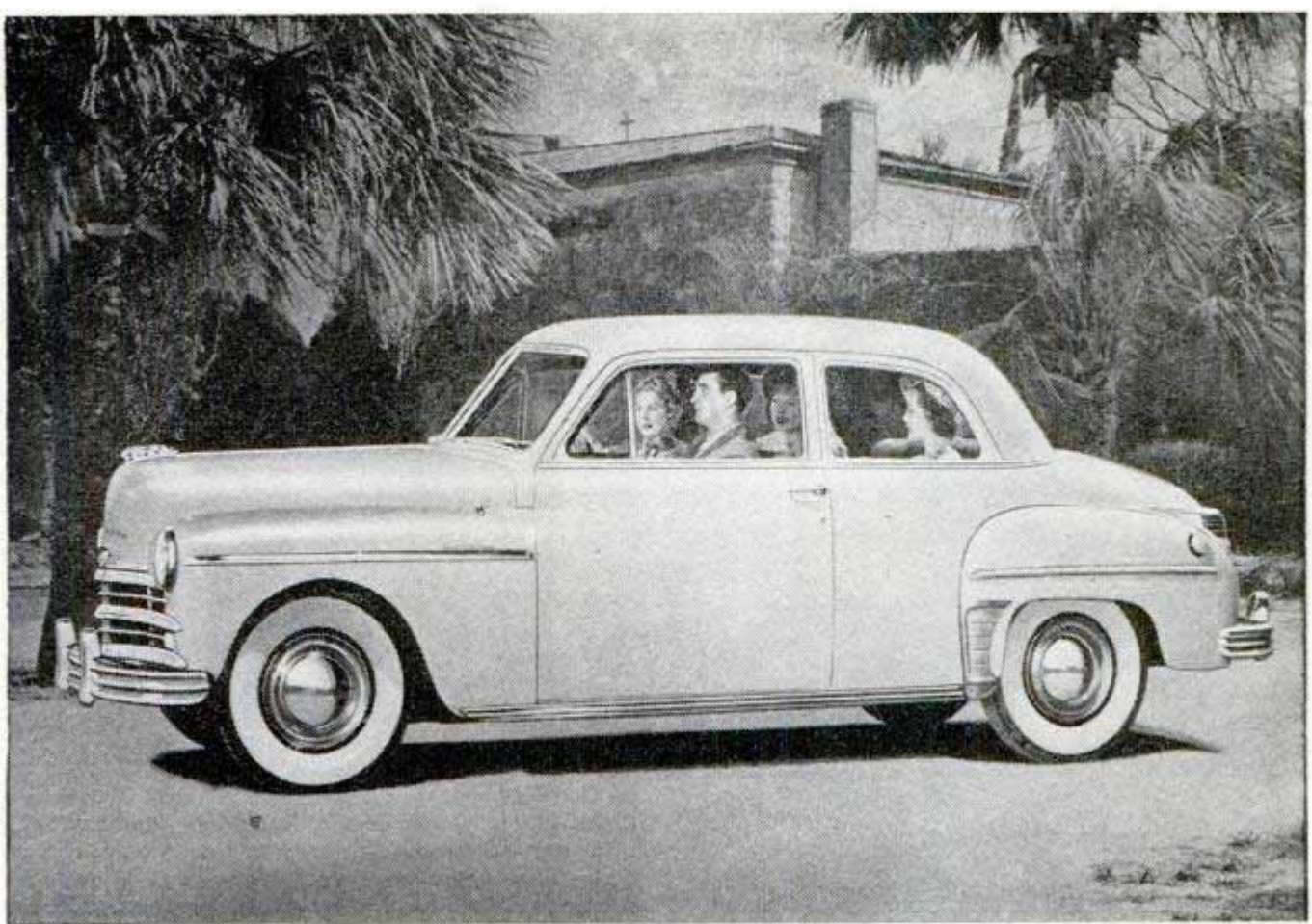

inches wider and the rear seats nearly eight inches wider than the '48s. The instrument panel has been moved four inches forward to increase interior length for more leg room; headroom has been increased to 37 inches for both front and back seats. The Dodge "knee level" seats have a height of  $15\frac{1}{8}$  inches in front and  $15\frac{1}{2}$  inches for the rear seat. The windshield area has been increased 24 percent and the larger rear window minimizes any blind spots. The doors open almost all the way and stay open when you are getting in or out.

The instrument panels have been completely restyled with the gauges centered in front of the driver and recessed to avoid confusing light reflections. Rotary switches replace the push-pull type formerly used. Many of the innovations already mentioned on the Plymouth, such as the new ignition switch, tamperproof vent-window lock, bull's-eye lens in the headlights and plastic lenses in the tail and stop lights, are to be found on the Dodge.

The Coronet and Meadowbrook lines include three four-door sedan models, a club coupe, convertible, eight-passenger sedan and a station wagon. The small-wheelbase Wayfarer line will include a two-door sedan and a three-passenger coupe in addition to the roadster.

The six 1949 Chrysler lines, to be known as Silver Anniversary models, are the six-cylinder Royal and Windsor series with

(Continued to page 270)

**Plymouth Special Deluxe club coupe shows shortening of over-all length by less overhang in front and rear**

**Headroom in the new Plymouth back seat? Plenty of it for a lady with a tall hat, and room to spare**



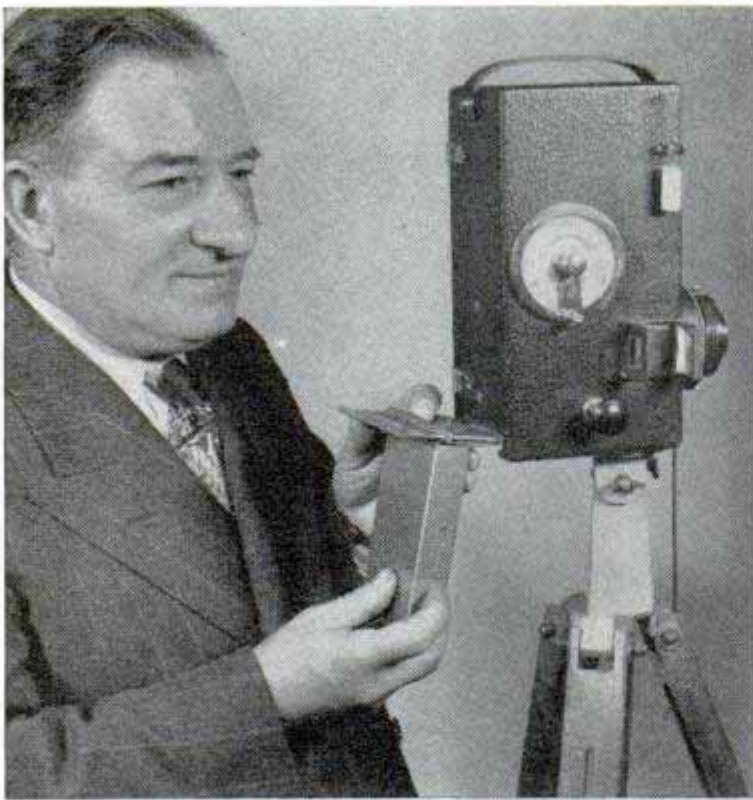

## Two-Minute Camera

Photographs taken with a direct-positive camera are processed right on the spot, in bright sunlight or shade, and completed within two minutes after the exposure. The camera, designed for sidewalk photographers and others who want prints to be ready almost immediately, is loaded with a magazine containing enough paper-film to make 50 exposures at a cost of less than two cents each. After the exposure is made, the photographer turns a crank, moving the paper down into a lightproof box fastened to the underside of the camera. A built-in knife cuts the photo from the roll. The box, with the paper-film inside, is removed from the camera and dipped in a developer. Baffles in the bottom of the box allow the solution to enter, but prevent entry of light. The print is then removed from the box and rinsed, bleached and redeveloped in daylight. The photos are permanent and dry in a few seconds.

Right, box of paper-film is loaded in camera. Left, after exposure, photo drops into this lightproof box which is removed for developing, below. Processing solutions enter box through baffle system in bottom

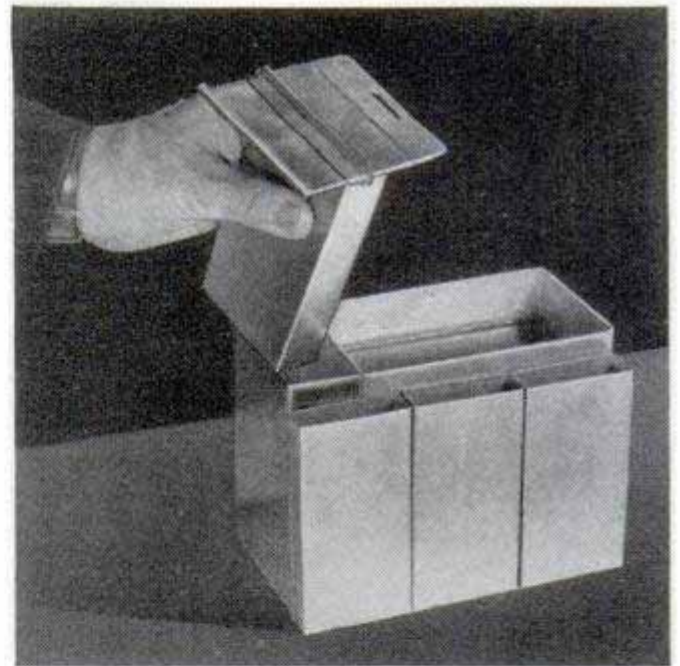

## "Gun" Saw Cuts Rubber or Steel

Anything from rubber to stainless steel can be cut through by a new electric gun-type saw. Its blade speed is variable and stroke length adjustable up to two inches, depending on material being cut and its thickness. A supporting handle that swivels 360 degrees and locks in any position eases arm fatigue. Guides for blade widths from a half inch to one inch also serve as gun sights in following a line. The saw can be driven by an electric drill, an air drill or a flexible shaft.

## "Bed" for Pilot Lessens Fatigue

Flying fatigue and the threat of "blackout" are reduced to new lows by a prone-position pilot bed being tested at the U. S. Air Force Aeromedical Laboratory. Basically a nylon netting supported over curved sides to make it fit body contours, the bed has enabled pilots to withstand up to 12 Gs (force of gravitational pull). Seated conventionally, a pilot can tolerate only about five Gs. Experimenters have used the pilot bed for eight hours continuously without experiencing discomfort. The prone position also requires less space for the cockpit and permits development of planes with slimmer silhouettes. Supports for the abdomen and head are adjustable. The arms rest in movable pans padded with foam rubber as the pilot operates special handgrip controls. A leg board gives each limb its own support, preventing pressure on the inside of the knees. The test bed is in the nose of a B-17 and another is to be put in the forward part of an F-80 jet plane. Both aircraft permit conventionally seated pilots to take over controls in emergencies.

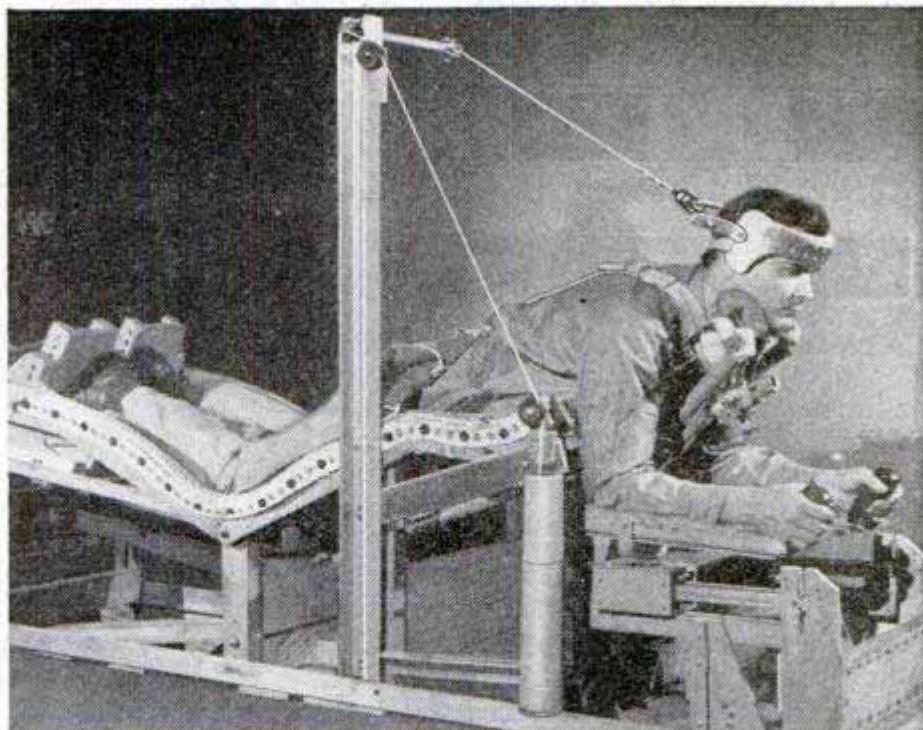

Air Materiel Command photos

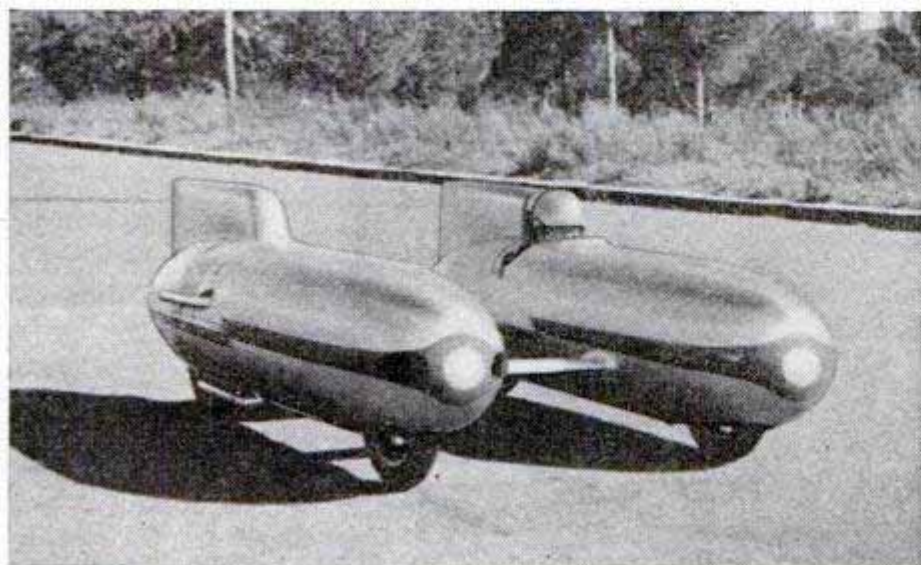
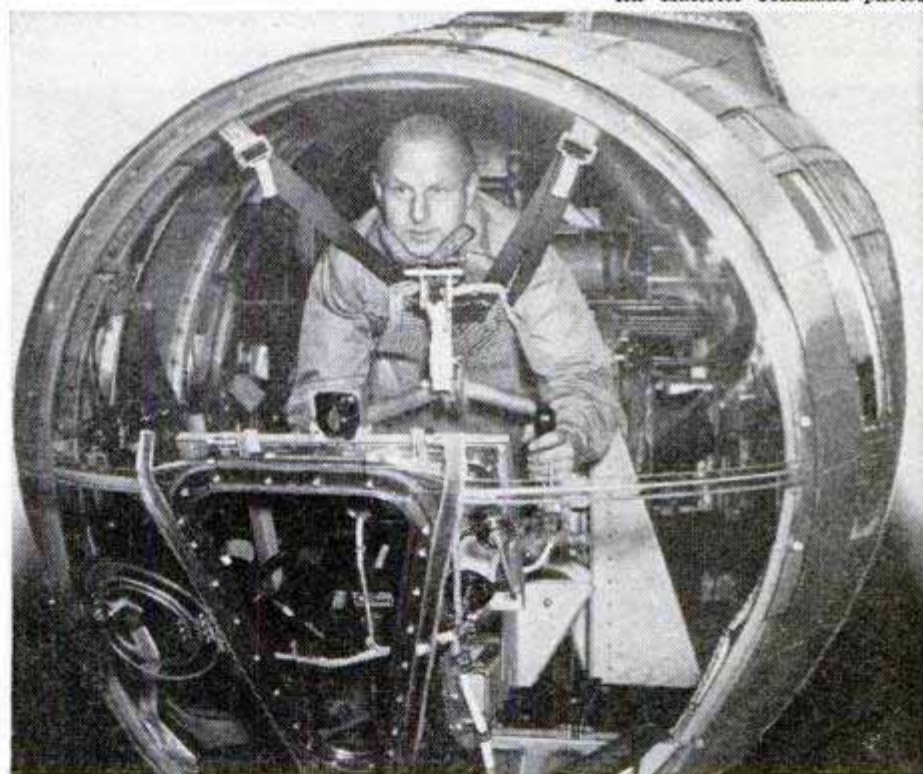

## Twin-Torpedo Racer

Capable of speeds well over 100 miles an hour, an Italian racing car looks more like a pair of wheeled torpedoes than a motor vehicle. The driver sits in one torpedo while the power plant, a 500-cubic-centimeter motorcycle engine, is in the other. The car covered one mile at an average of 79.9 miles an hour from a standstill; 126.4 miles an hour with a flying start.

# HARBOR SWEEP.....

**E**ARLY this year a strange vessel with twin hulls began house-cleaning operations in New York harbor. Her job is to collect and remove driftwood and floating debris which would soon stop traffic if not cleared away.

The new Driftmaster, 100 feet long and 36 feet wide and powered by two diesel engines, is the first vessel ever built specifically for this purpose. She was designed by U. S. Army Engineers, who have the job of keeping waterways clear for commerce.

Spaced 20 feet apart, each of the pontoonlike hulls is but eight feet wide, allowing water to flow freely in a channel through the center of the vessel. Engine room, crew quarters and control bridge are mounted on a superstructure joining

the hulls some feet above the water line.

Two nets of steel chain links hang in the well between the hulls. They are dipped alternately into the water flowing between the hulls to scoop up drift when the vessel is under way. Each net is 20 feet square.

When floating debris is sighted, the front edge of one of the nets is lowered about three feet below the surface of the water. A steel bar at the front edge of the net travels in tracks along the sides of the wells. The vessel drives forward and drift flows between the hulls and into the net.

The back end of the net is kept about six feet above the water. To prevent log jams, crew members armed with long pikes work from small steel bridges or walkways joining the hulls. By pushing timbers into parallel piles as they float to rest against the back of the net, about five cords of wood can be picked up in each net.

When one net is full, it is hauled up clear of the water to keep from being a drag and slowing the boat down, and the second net is lowered into working position.

When both nets are full, the Driftmaster, running at about eight miles an hour, carries her load to two incinerator barges anchored in the Upper Bay near Robbins Reef. Using the boom located about midships, the nets are picked up one at a time and the contents dumped on the barges. One of the barges is concrete, the other steel.

Although all of this drift material is pretty thoroughly waterlogged, much of it is also coated with oil, and in time it all burns up.

Drift starts accumulating up around the Great Lakes and Lake Champlain, and in all the little streams which flow into the Hudson. It consists of rotting piers, doors, ladders, packing cases, wire-rope reels, chicken coops, pieces of pianos, fences,

From control bridge straddling twin hulls of U. S. Army's Driftmaster, Capt. William P. Hocking operates levers that raise and lower drift nets





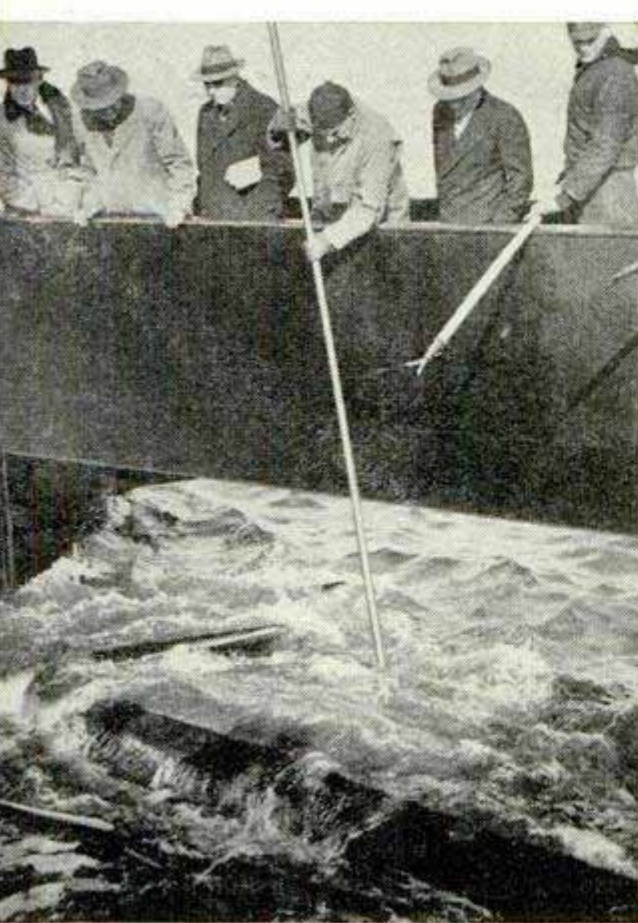

Reporters on trial run watch crewmen, upper left, guiding driftwood between hulls. Right, front view of vessel

railroad ties, telegraph poles—the list could go on forever.

Drift shifts from one side of the harbor to the other in a few hours, depending on the tides and the weather. Small launches scout out large patches and report their location by radiophone to the Driftmaster. After coming all the way down the Hudson, drift eventually meets the Atlantic Ocean, at which point it often forms into a long line, or streak, a mile or more in length.

In the course of a year, some 3000 cords of driftwood are picked up in New York harbor.

Steel-chain drift nets, right, seen looking forward from the bridge. Below, boom raises and positions nets singly, dumping them on an incinerator barge

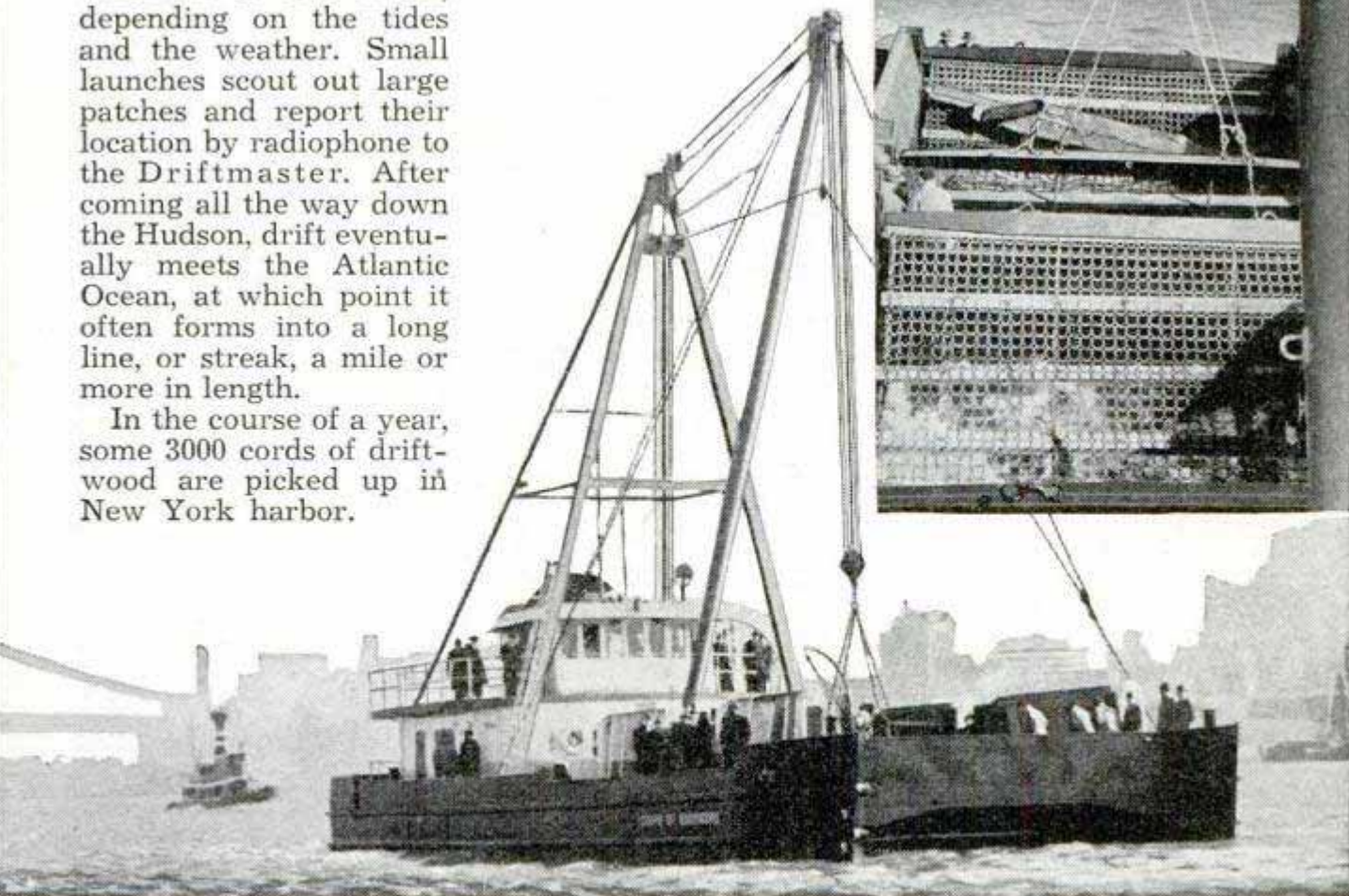
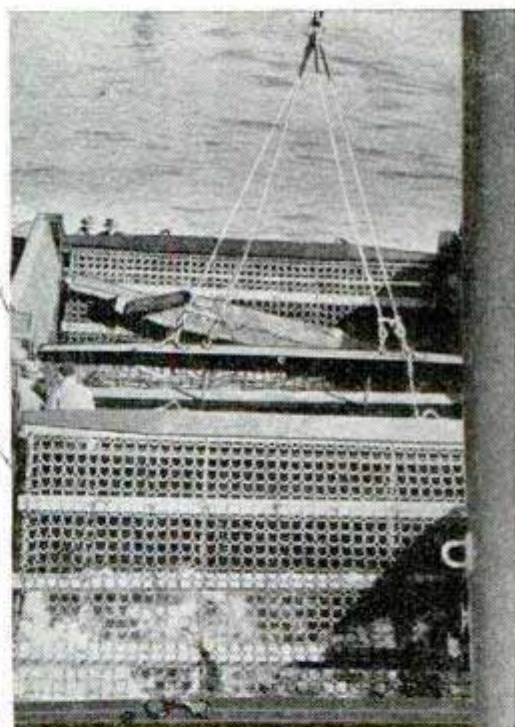



U.S. Navy photo

## Mauler Flies Record Weight

Grossing over 25,000 pounds, a Martin Mauler dive-torpedo bomber became the heaviest single-engine plane ever flown. Both its gross weight and 9000-pound pay-

load were much greater than that of a 21-passenger airliner. The record flight was made with complete armament—12 five-inch rockets, three 2200-pound torpedoes and four 20-mm. cannon. A one-man plane, it is being used experimentally on carriers.

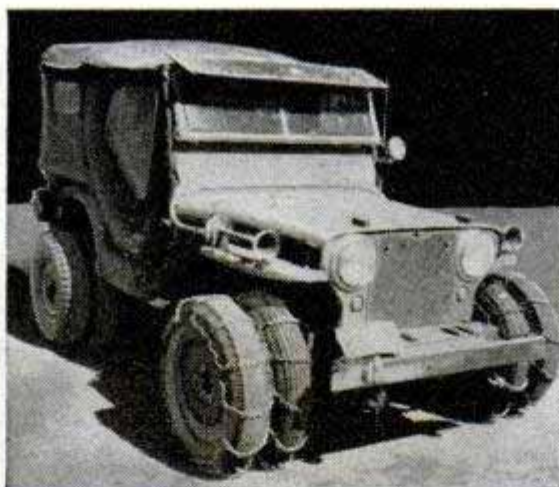

Left, bolts and spacers in place ready for extra wheel. Right, maximum traction is provided with duals on all wheels and tires at low pressure

## Jeep Adaptor Kit Adds Extra Wheels

Front and rear wheels of a jeep can be made dual for added traction with an adaptor kit consisting of extension bolts and spacers. It takes only a few minutes to mount the extra wheel. You replace the wheel nuts with extension bolts, insert spacers between bolts and slide the extra wheel in place. Chains can be used on one or both wheels.

## Auto-Dashboard Fence Holds Cigarettes Upright

Held in place by two rubber suction cups, a metal fence keeps your pipe, cigarettes and other small items on top of the dashboard where you can easily reach them. A holder inside the fence is shaped to hold a package of cigarettes in an upright position. The fence is made of highly polished chrome steel.

☐ White portland cement concrete floors are used in aircraft plants to reflect light on the under parts of equipment on which mechanics are working.

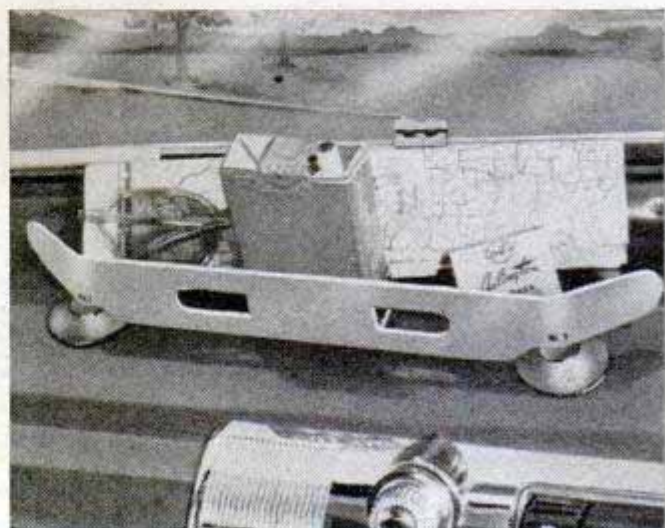



## Perch on Auto Door Keeps Pet Off Laps

Dogs have a car seat all their own in a pet perch designed to keep Rover off the passengers' laps. The seat, made of pressed wood, is a semicircle 20 inches in diameter. It has a protective railing for the pet and is padded along one side to protect the car's finish. The perch hooks into the window slot, giving the pet a commanding view of the scenery and plenty of fresh air to prevent him from becoming car sick.

## Remote Control for Tractor

Operating a pull-type, 16-foot hillside combine is normally a two-man job, one man to run the combine and the other to drive the tractor. Richard Johnson of Condon, Ore., does both jobs with the aid of a remote-control apparatus that enables him to drive the tractor right from the combine platform. Compressed air from a small compressor driven by the fan belt does the physical work of shifting and steering as electric air valves are opened and closed by switches on the combine control panel. An electric cord connects the control panel with the tractor. The labor-saving remote-control system has been used for drilling, weeding, spring tothing and road grading as well as combining.

Right, Johnson shifts and steers his tractor right from the combine platform with the switches on the control panel. Below, there's no driver sitting on the seat of this tractor as it pulls the combine. Below, right, close-up of the remote-control system

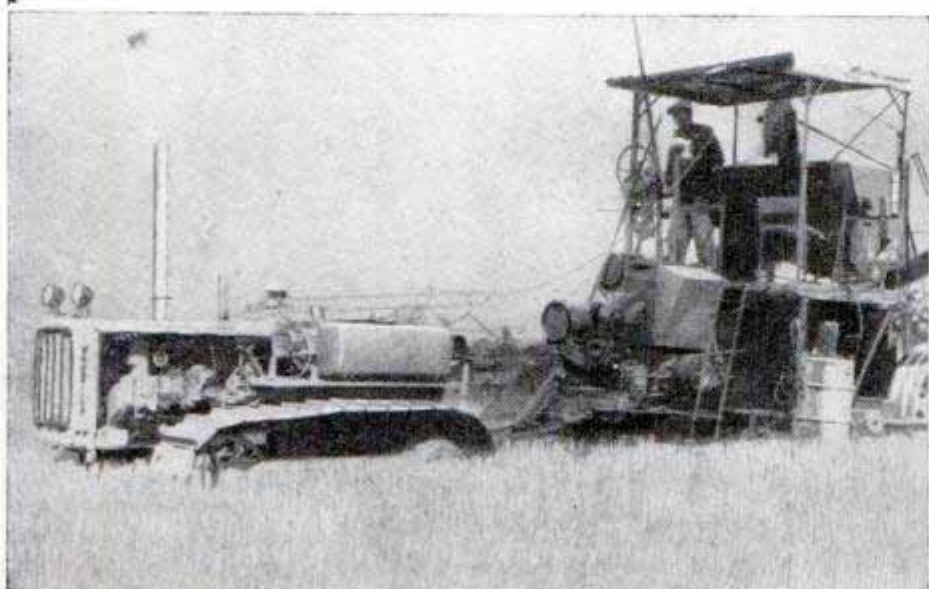

# moving day for the PARABEAVERS

By Thomas E. Stimson, Jr.



**T**HIS BEAVER is a smart one," John Ryneanson decided. "I'll tear down part of his dam and put the trap near the break. That way, he'll get caught when he swims over to repair the damage."

John was inspecting a new beaver pond on a small mountain stream near the old ghost town of Idaho City, 40 miles from Boise. The pond was beginning to flood a dirt road alongside the watercourse. At this location the beaver was a nuisance and had to be removed.

Ryneanson kicked a hole through the top of the dam with his boot and water began pouring through the break. Into the pool behind the dam he lowered a live trap, a wire-mesh contrivance that opens out flat. When tripped, it springs together like a suitcase, imprisoning the animal inside.

The trapper placed a couple of branches on each side of the trap to form barricades. These would force the beaver to detour across the top of the trap when he came over to repair the leak.

Here's the distinguished fellow who builds dams and fur coats. Note the handlike forefeet, the webbed hind feet and the two long teeth that can fell a tree

Popped into this crate, the beaver will be released by parachute. Rubber strips automatically open box

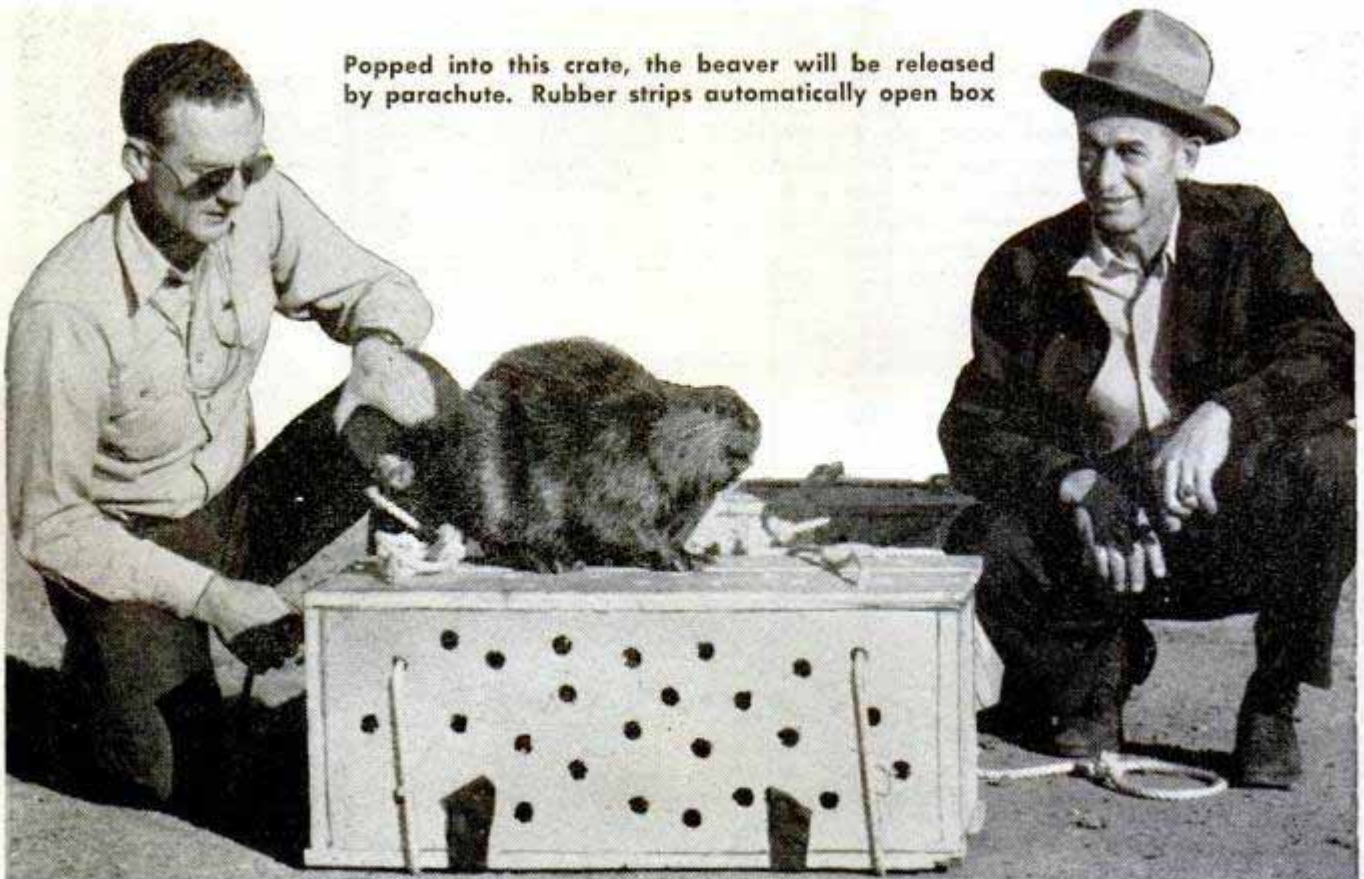

Rynearson would visit the trap again at dawn and, if he found the beaver inside, he would carry it by truck to an airstrip down near Boise where a plane would be waiting for a load of animal passengers. Before lunch time the beaver would have an airplane ride. He'd be tossed out of the plane by parachute, would walk away from the self-opening container when the parachute touched ground and would be making himself at home on a stream several hundred miles away from where he had been caught, in an area where he couldn't cause trouble.

Meanwhile Rynearson investigated another complaint. A farmer in the lowlands reported that the animals were continually damming his main

**Right, crated animals drift down toward an unpopulated stream. Below, that black spot on the parachute is the beaver, already bound for the nearest water hole**

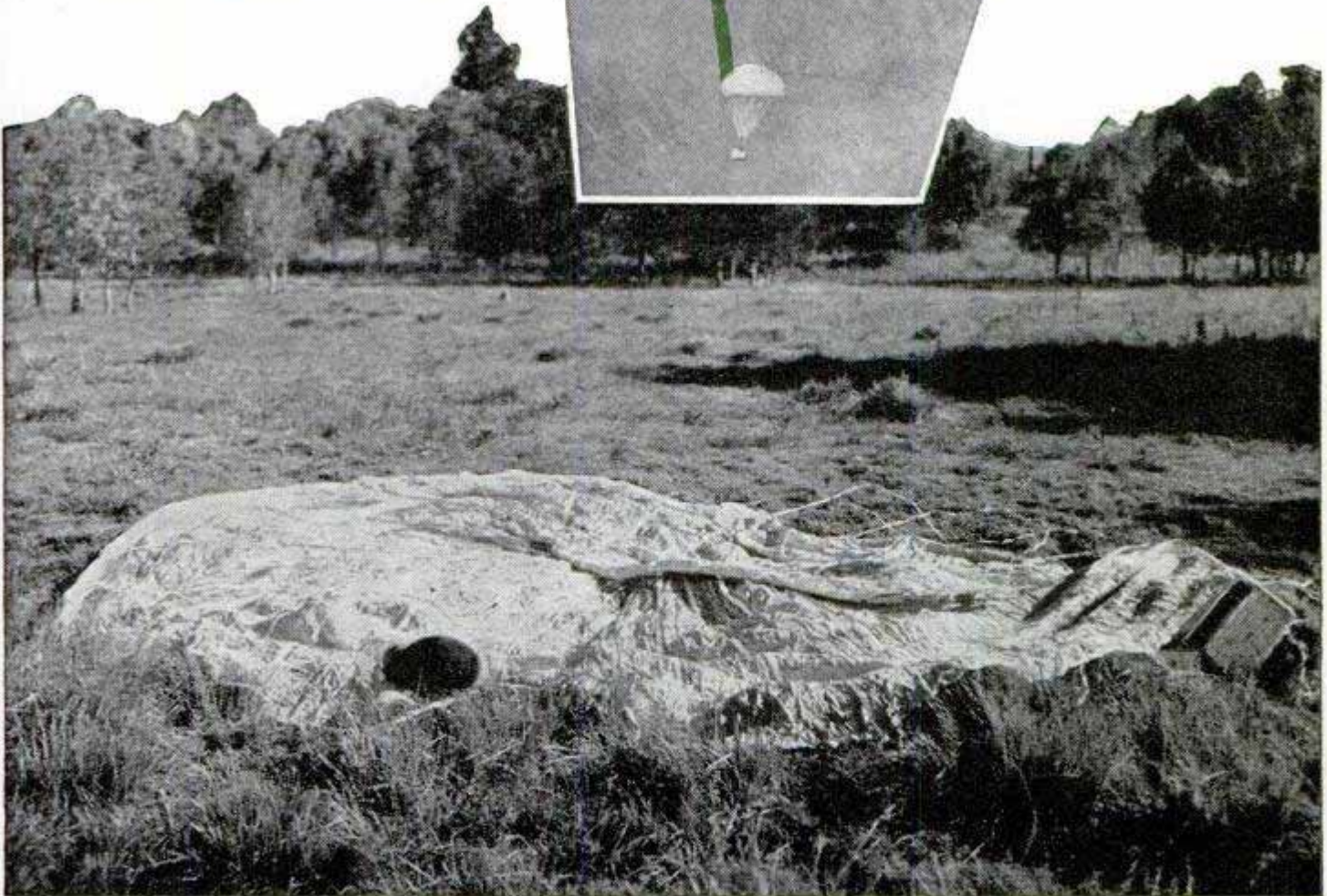
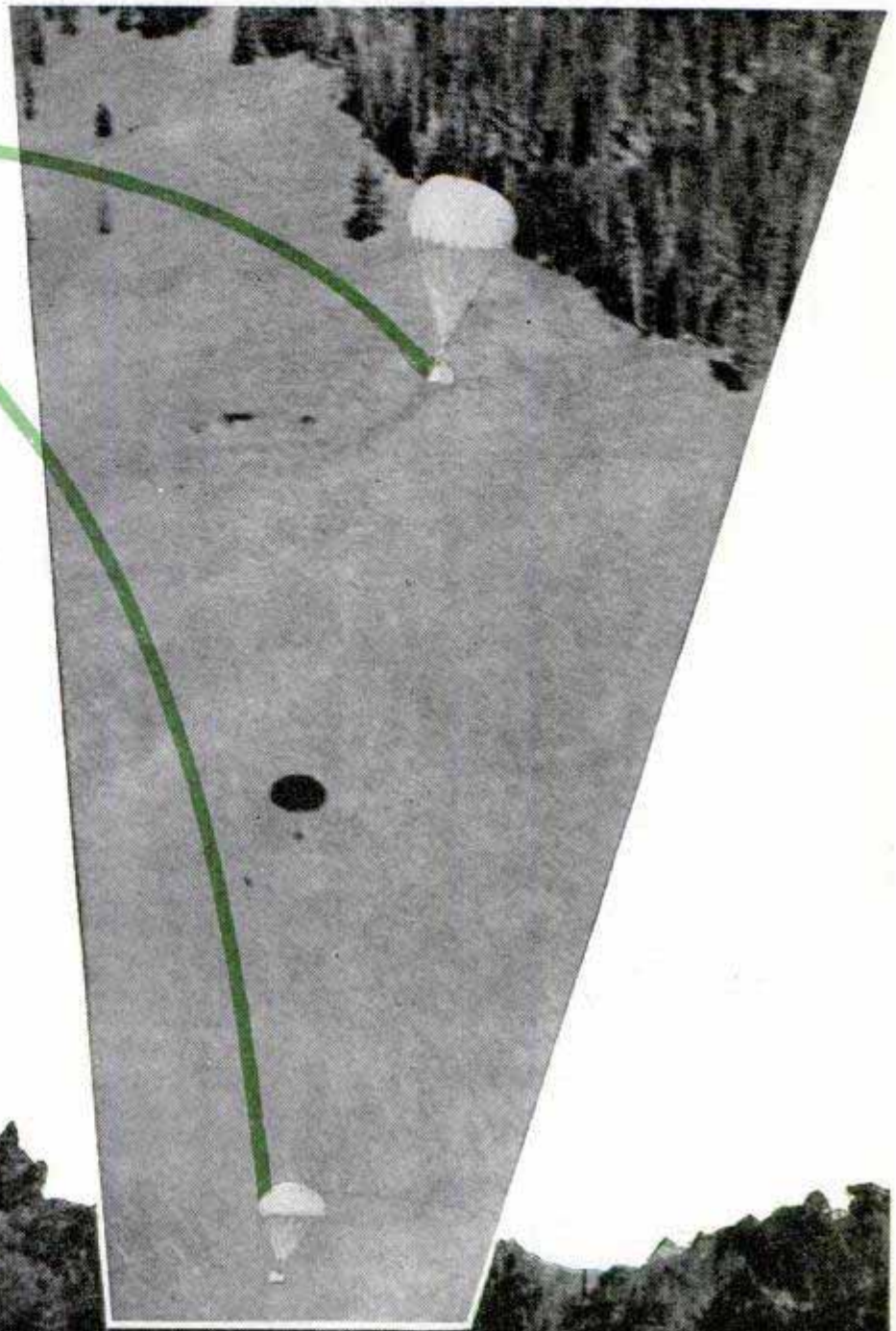

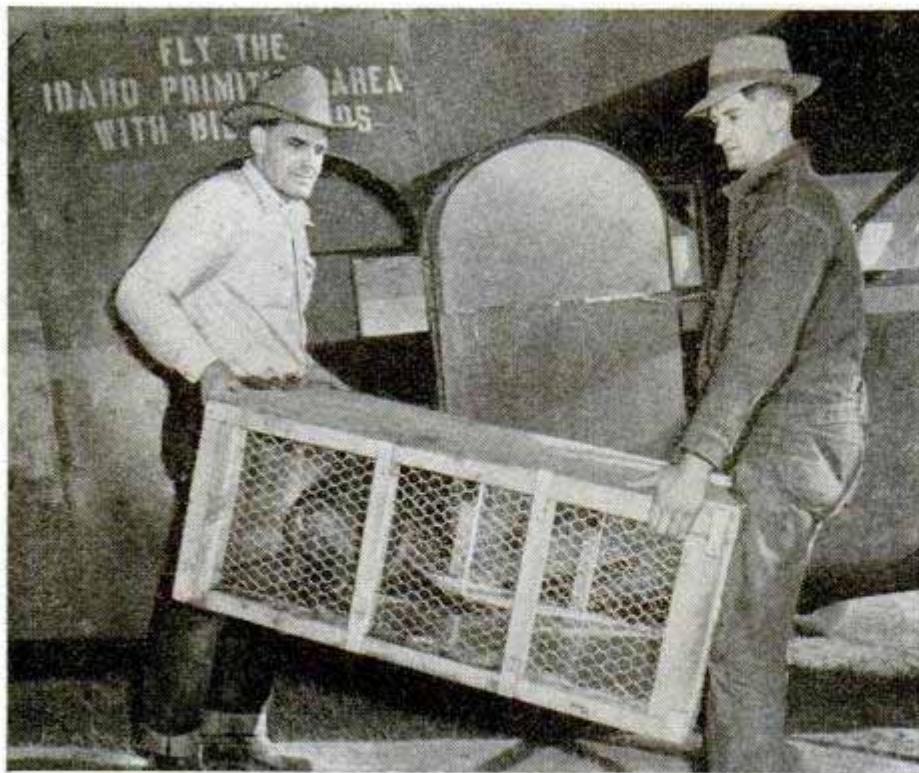

Aboard a transport plane goes a crated beaver for a trip to the mountains. This one will be hauled a few miles by truck after the airplane ride

irrigation ditch and cutting off his water. The farmer would tear down the dam in the morning and the beavers would build it up again overnight. The beavers and the farmer had been battling for a week.

Beavers can be great nuisances when they settle in an agricultural area. Part of a caretaker-trapper's job in Idaho is to remove them from locations in which they are doing damage. Rynearson is a pro-

essional trapper and also is one of the men designated as caretakers of the state's beaver population. Once there were almost 60 million beavers in the country; then they were trapped almost to extinction. They have brown glossy fur and are one of the most valuable of fur-bearing animals. It was the quest for beaver that first led explorers into many parts of the West, and some of the big fortunes of the times were founded on the beaver fur trade.

Forty or fifty years ago no more than a few thousand of the animals remained, tucked away in scattered mountain retreats. Stringent laws were passed to protect them and gradually the beaver population has been built up. Today, they are flourishing all the way from Maine to Washington and down through the Rockies, other large mountain ranges and along numerous river systems. The recent history of the beaver is an outstanding example of how conservation can be made to work.

Beavers are actually rodents, the largest of the several hundred rodents of North



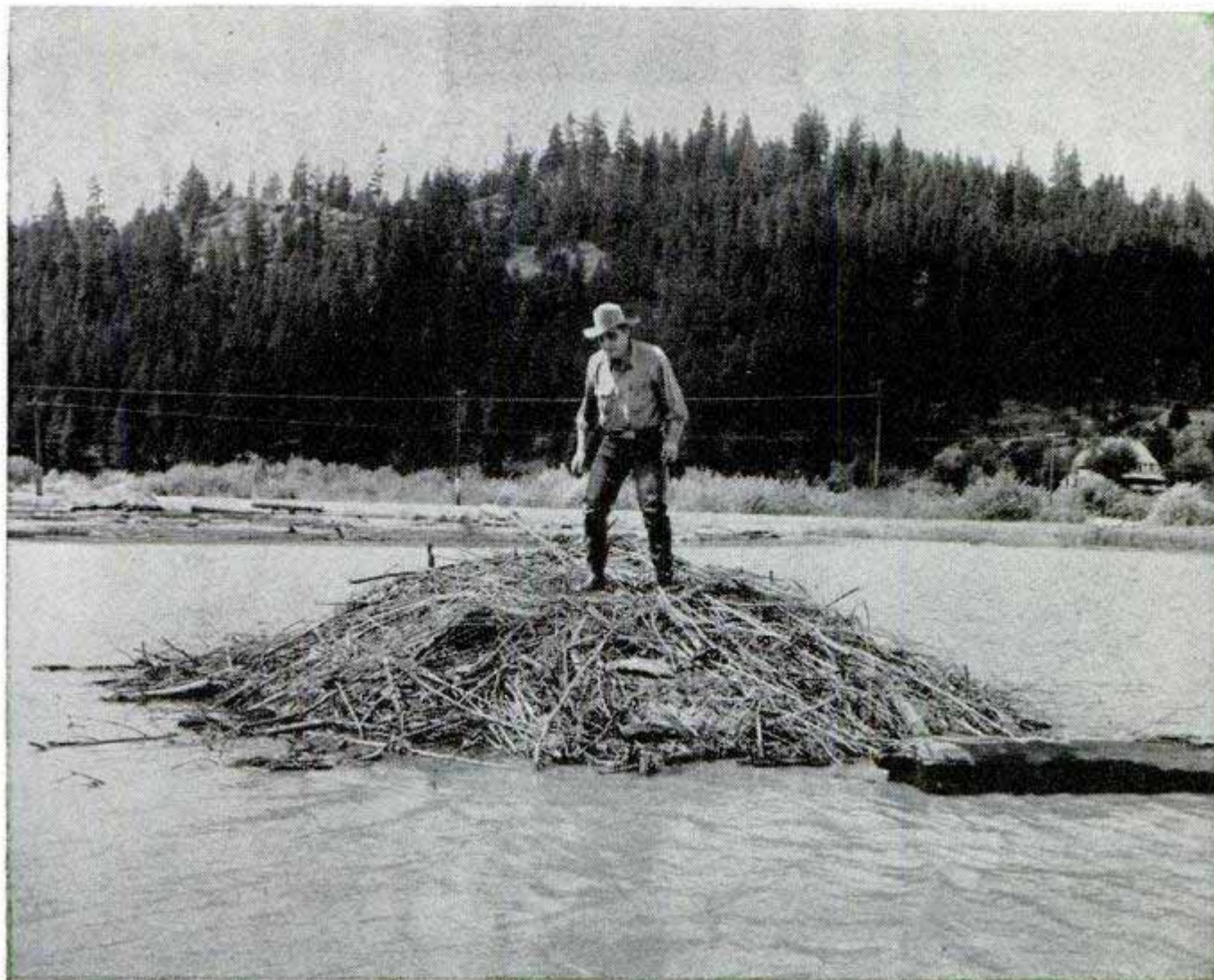

America. They average 25 to 30 pounds and large specimens may weigh as much as 50 or 60 pounds. They are amphibious and will die if kept away from the water. The animals have forefeet that resemble tiny hands and hind feet that are webbed. Their broad flat tails are used as props when sitting up, as rudders when swimming and for slapping the surface of the water to produce a danger signal. Their principal food is the bark of willow, aspen and similar trees. The animals cut wood with two long teeth that are constantly growing.

The first thing beavers do when they migrate to a new location or are planted on a stream is to build a dam. They want a personal pool of quiet water in which they can play and on which they can build a house that will protect them from predators and from winter's cold. In the muddy bottom of the pool they anchor hundreds of fresh branches as a food supply for winter. After they eat the bark they will use the sticks to build up or repair their dam.

The dam itself is a well-engineered and solidly built barrier that withstands winter ice and spring freshets. Often it contains a big tree that the animals fell in place, or it may include several logs they cut to size and float or push to the location. Twigs, sticks, branches and even stones are

**In taking a beaver census a trapper jumps up and down on a large house. The animals are frightened out and the trapper counts them as they swim away**

**Food sticks from which the bark has been eaten indicate that beavers are living along this stream**



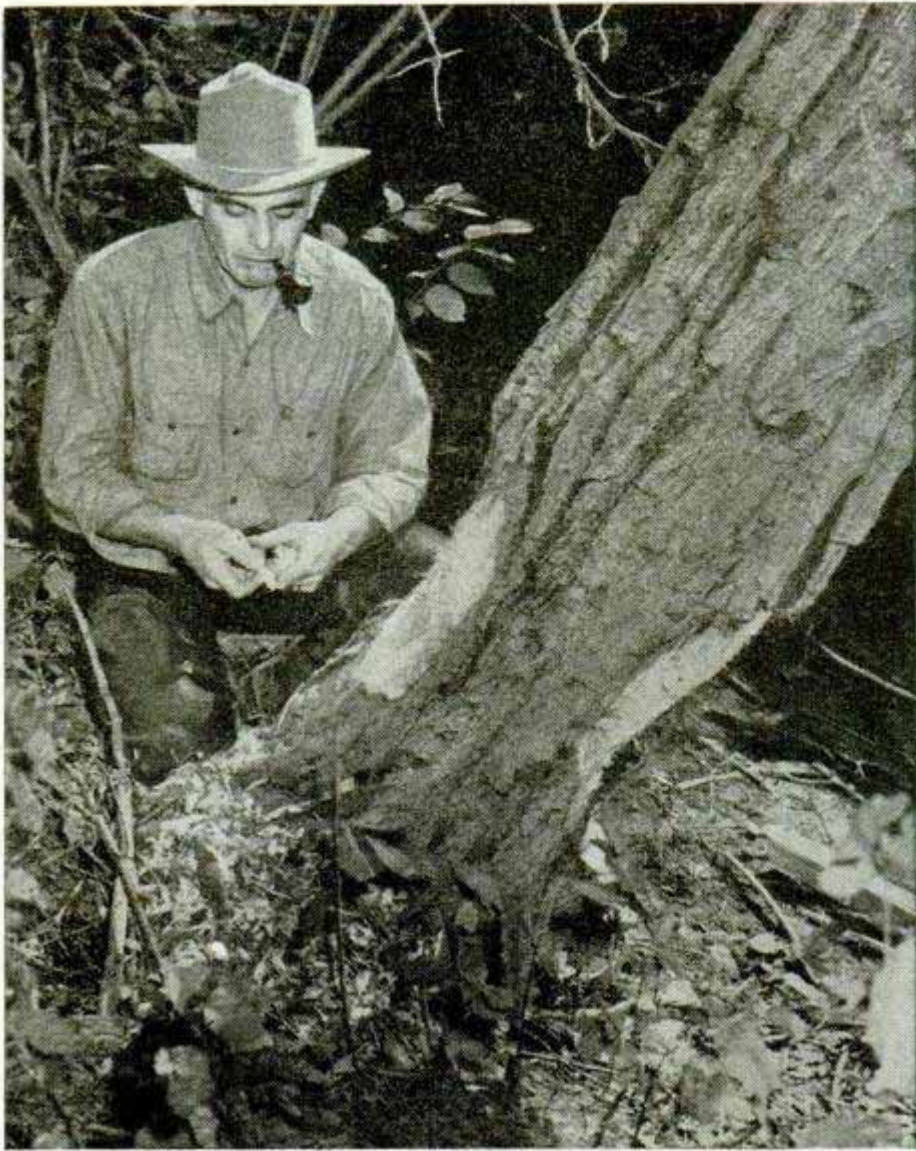

Caretaker-trapper estimates the size of new beaver on a mountain stream by measuring the size of the chips the animal cuts from a tree. Below, girl stretches skins on metal hoops. Traders prefer round-shaped pelts

packed into the interstices. Sometimes mud is carried up from the bottom to help fill the cracks. On a large stream a family of beavers has been known to build a dam that is a quarter of a mile long and up to four or five feet in height.

Their house is attached to the dam or a bank or sometimes is built as an island, composed of twigs, stones and mud. The foundation is built up to water level so that the animals have a dry floor under a domed roof. A large interior may measure 10 feet across. Usually, there are two underwater entrances. Their house makes a permanent abode for generations and is repaired every fall with more sticks and mud to insulate it against the weather.

Beaver dams are natural conservation devices. The dams hold back water and silt, stabilize stream flow and stimulate the growth of trees and bushes. Generally speaking, all kinds of wildlife

(Continued to page 266)

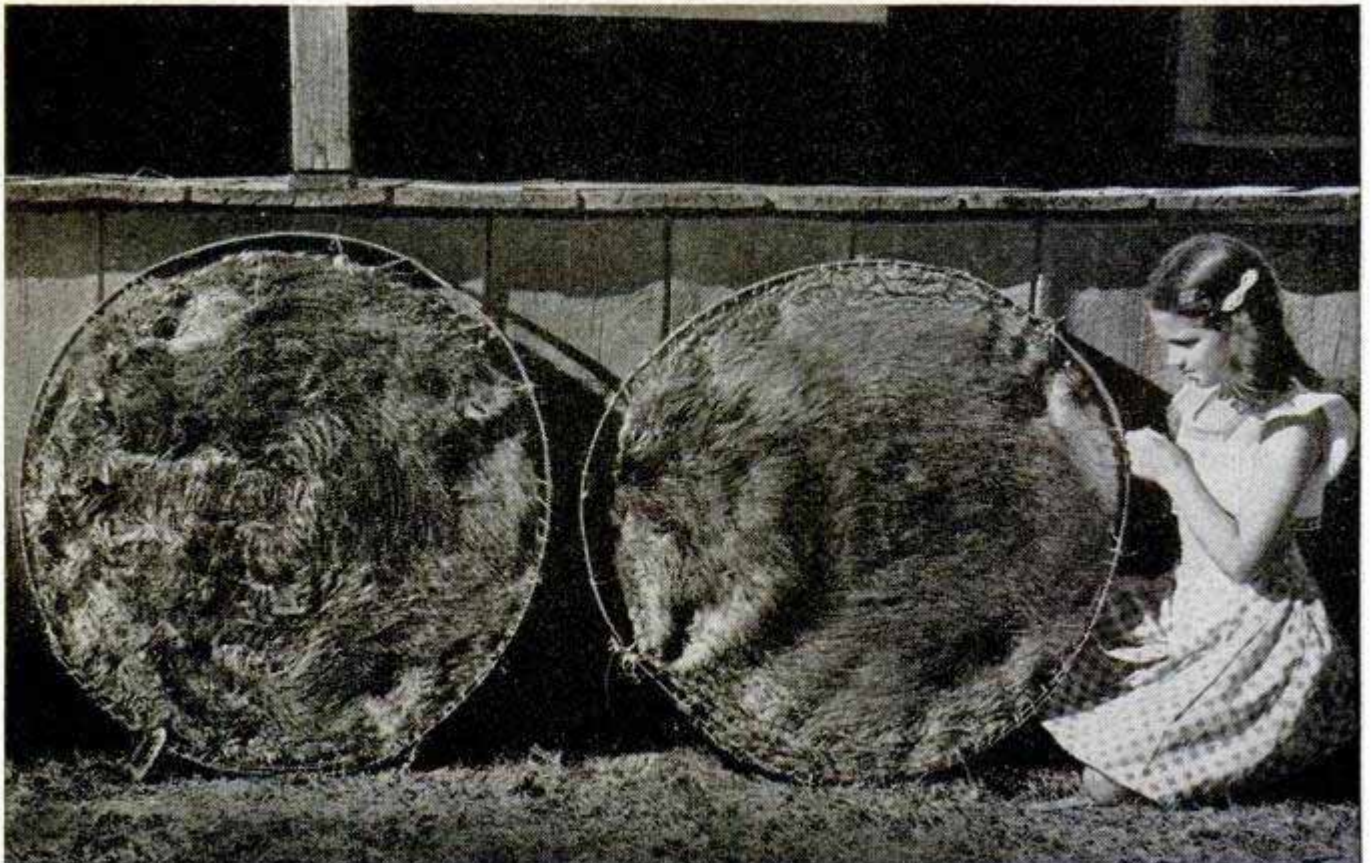



## Scooter-Car Seats Two

Fuel bills are low in a midget car which travels 60 to 75 miles on a gallon of gas and uses only a couple of ounces of oil a week. The open-air car has a five-horsepower motor that is started with a rope. Seating two, it scoots along at 40 miles an hour. Two other models will be available soon. One will have an enclosed body, battery, generator and starter and will be powered by a 7½-horsepower motor. The other will have a half body from the driver's seat forward.



## Electric Stapling Machine Fastens 30 Sheets a Stroke

Operating without levers, an electric stapling machine fastens up to 30 sheets when paper or other material touches its concealed control. Each stapling stroke is automatically adjusted to the thickness of the insert. It can also be used for saddle-stitching small booklets. To keep track of production and to warn an operator when to reload, a counter registers the number of staples used up to 999.

## Terraced Garden Grows Strawberries

You'll make economical use of your garden area with a pyramid bed especially designed for growing strawberries, but also suitable for flower gardens. The bed consists of five aluminum bands, each five inches wide but of varying lengths. These bands hold the soil mixture and permit the planting of 75 strawberry plants in a six-foot circle. A core of sharp sand in the center carries water down to all sections.

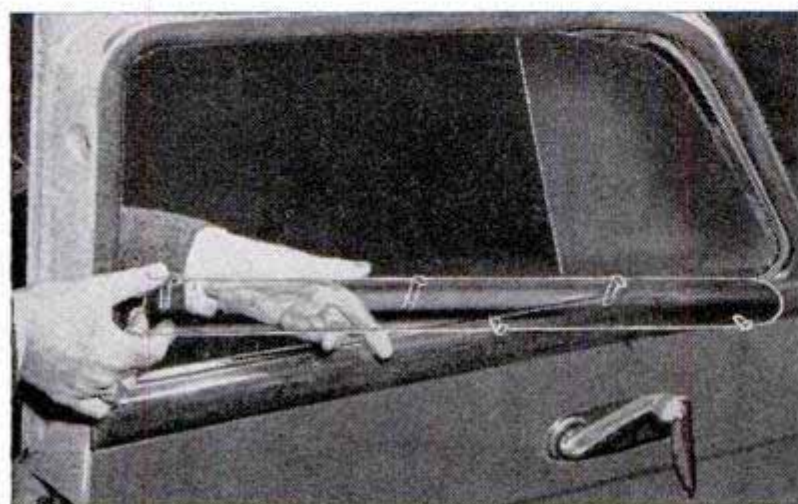
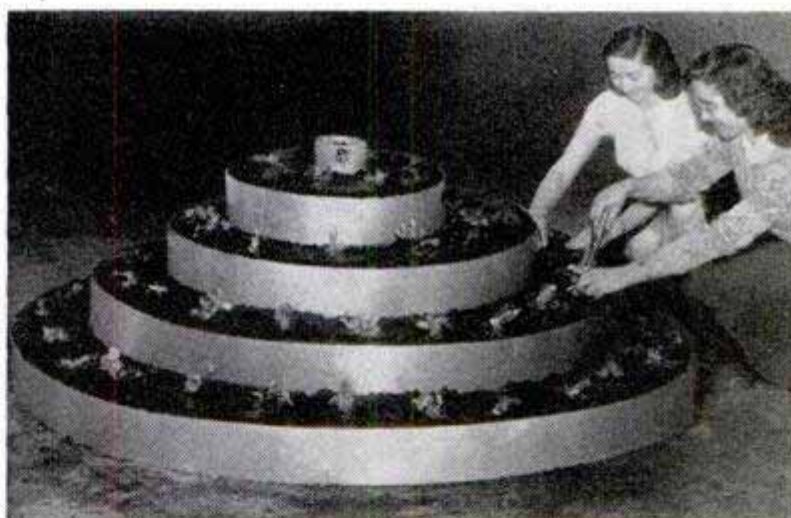

## Molding Protects Car Finish

Car-window molding, usually painted in an ornate wood-grain design, is protected from scratches by lengths of plastic that fit snugly over the sills. The plastic is held in place by wire spring clips. The molding completely covers the inner section of the window sill.

☞ Providing greater safety through increased visibility, the 1949 cars have 30 percent more glass area than prewar models.

By Chet Beer

Los Angeles Professional

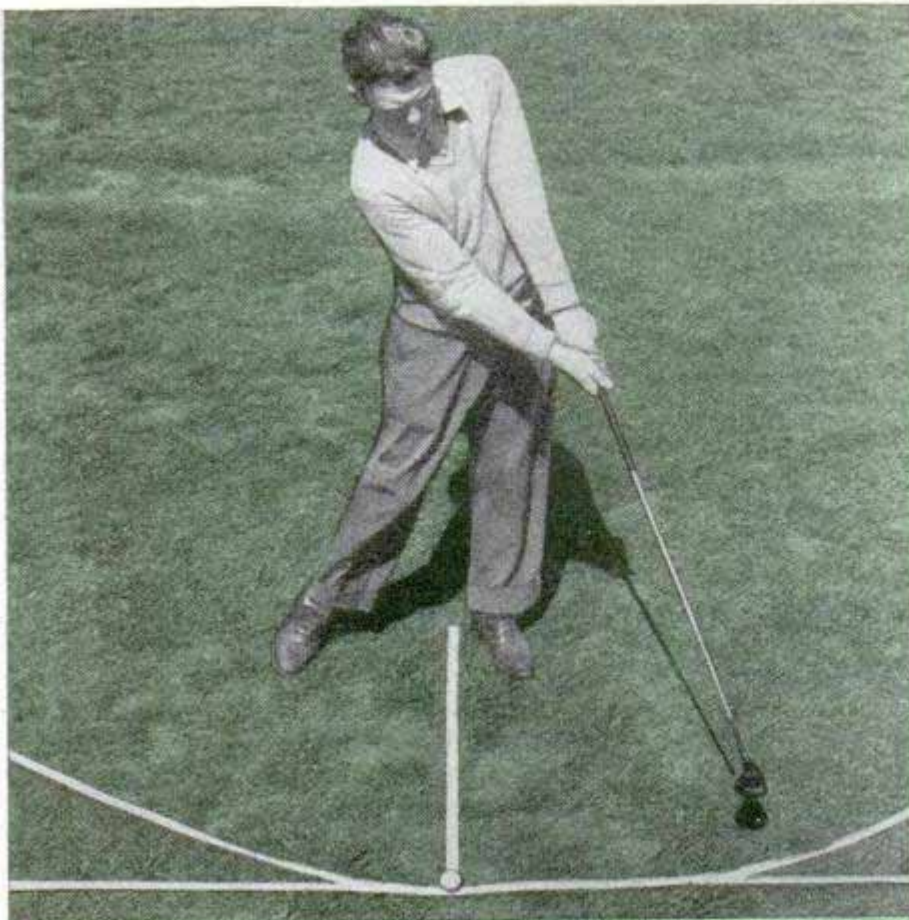

## Swing Like A Gate

With "gate" swing, curved line shows where club head rides along briefly behind ball on straight line of flight path, adding extra yards to drive

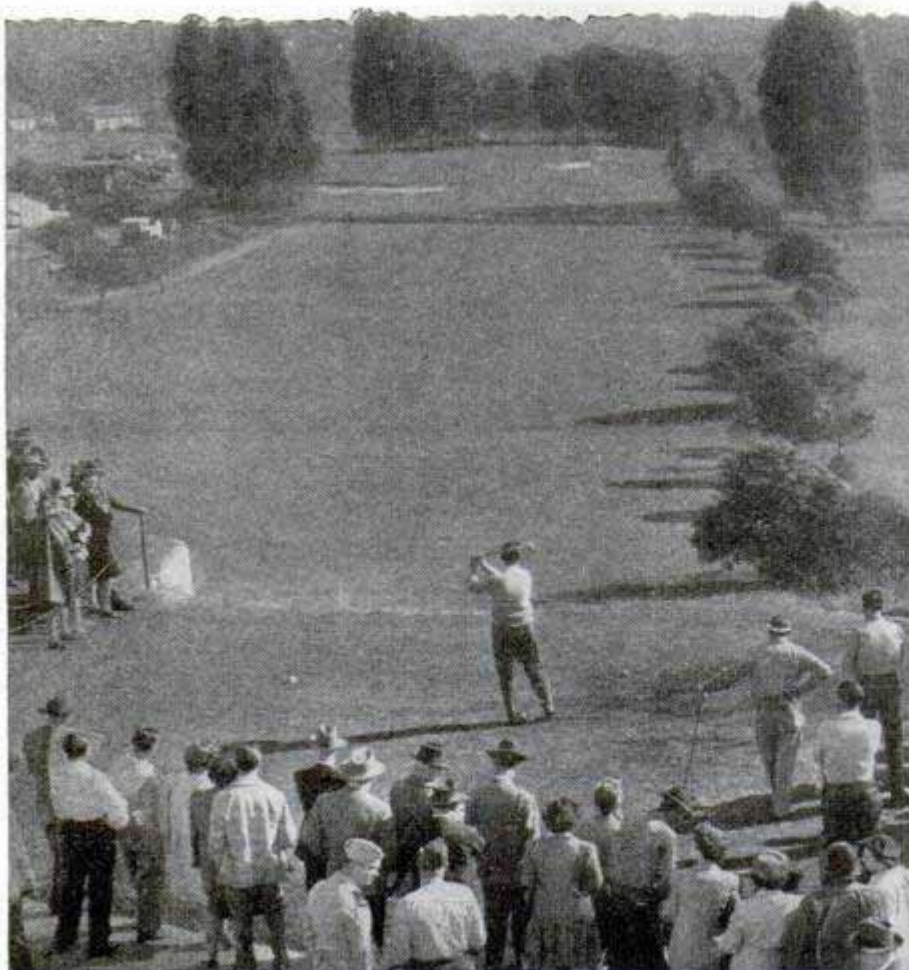

A GOOD GOLF SWING is an extremely simple mechanical action like the opening and closing of a garden gate.

A gate is built to swing back to its original position after being swung open and that's what you are trying to do when you swing a golf club.

Some players don't seem to understand that. They try to adapt golf to their own muscular habits instead of training their muscles to conform to a mechanical swing.

An easy way to learn the swing that I teach in individual lessons and in class instruction is to divide it into four parts or numbers. Each part is simple to learn and when performed correctly you are bound to get a good clean hit.

Part one is to hold the club in the left hand and take your position preliminary to swinging at the ball. With palm outstretched, curve the fingers of your left hand around the shaft and then lay your palm across the top of the shaft so that your thumb lies flat against it, just to the right of its center line. This may feel like an awkward grip until you become used to it, but there's an advantage in holding the club this way; it helps force your left arm into an extended position.

Holding the club, extend your left arm so that the club head is just behind the ball. Stand with your feet as far apart as the width of your shoulders, with the ball in line with your left heel. Your

After ball is hit, professional Chet Beer continues his swing until both hands are again shoulder high. Both wrists are relaxed at the completion of the stroke

knees are bent slightly to eliminate tension and your body is inclined forward slightly from the hips. The club and your left arm form a straight line.

Part two of this lesson is to reach down with your right hand and place it on the shaft just forward of your left hand, palm down, with the right little finger overlapping the left forefinger and with the right thumb lying along the shaft just to the left of the shaft's center line.

Reaching out to grip a club in this way forces your right shoulder down and causes you to flex your right knee a bit more. Your left shoulder is high and your left side is extended, as they should be all through the swing.

You are now in the basic position, ready to swing in imitation of the garden gate. Your head and your left foot are to serve as the hinges, and your extended left arm and the club are to act as the gate itself.

The third step is to turn your right hip away from the ball, allowing your left heel to rise, and thus rotating your body to the right on its own axis. Raise your arms to the right at the same time, shoulder high, and then allow the left wrist to "break" or cock so that the club continues swinging until it is pointed toward your objective.

Your position at the top of the backswing is this: Your head has moved as little as possible and your eyes are still fixed on the ball. Your shoulders have turned so that they face away from the line of flight. Your left arm, still extended, is holding the club horizontally and parallel with the line of flight, behind your head.

Try this demonstration: Addressing the ball just as if you planned to swing and hit it, raise your arms

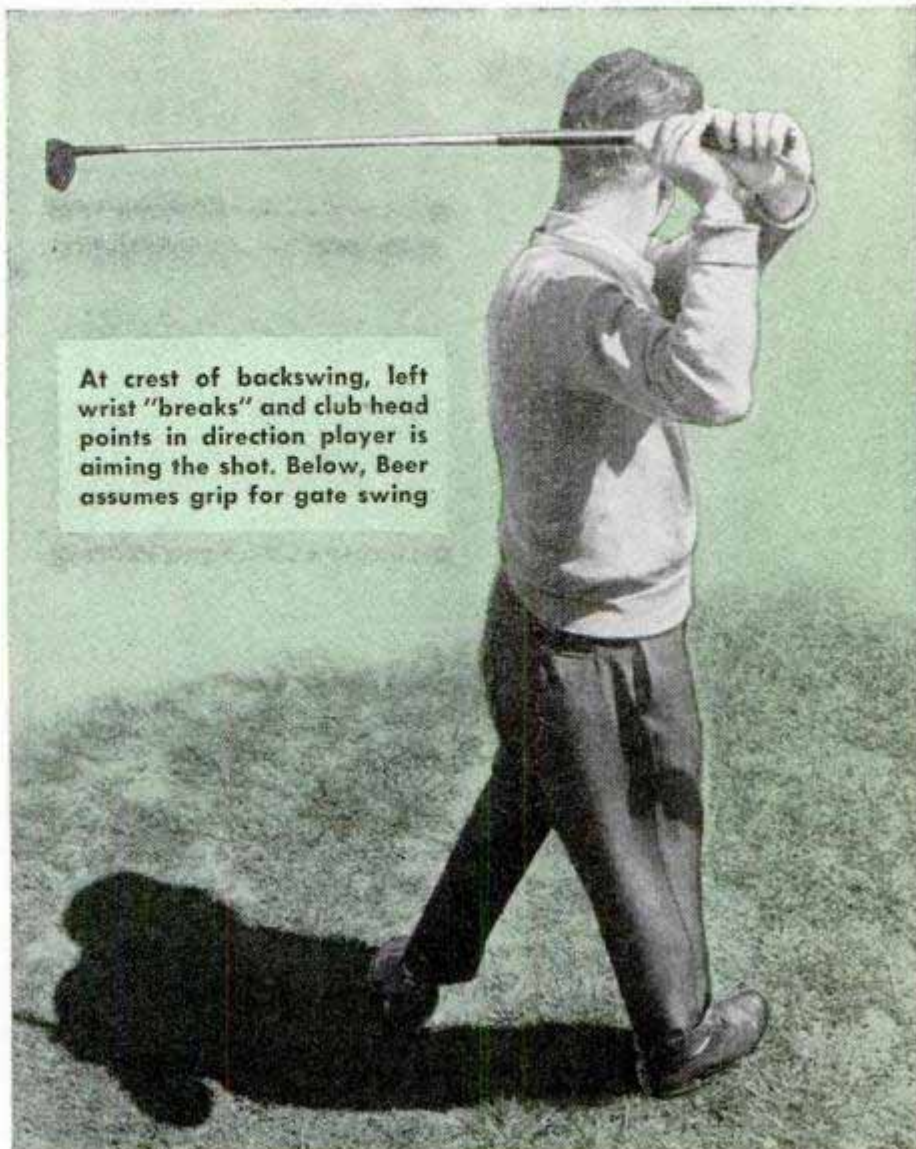

At crest of backswing, left wrist "breaks" and club head points in direction player is aiming the shot. Below, Beer assumes grip for gate swing



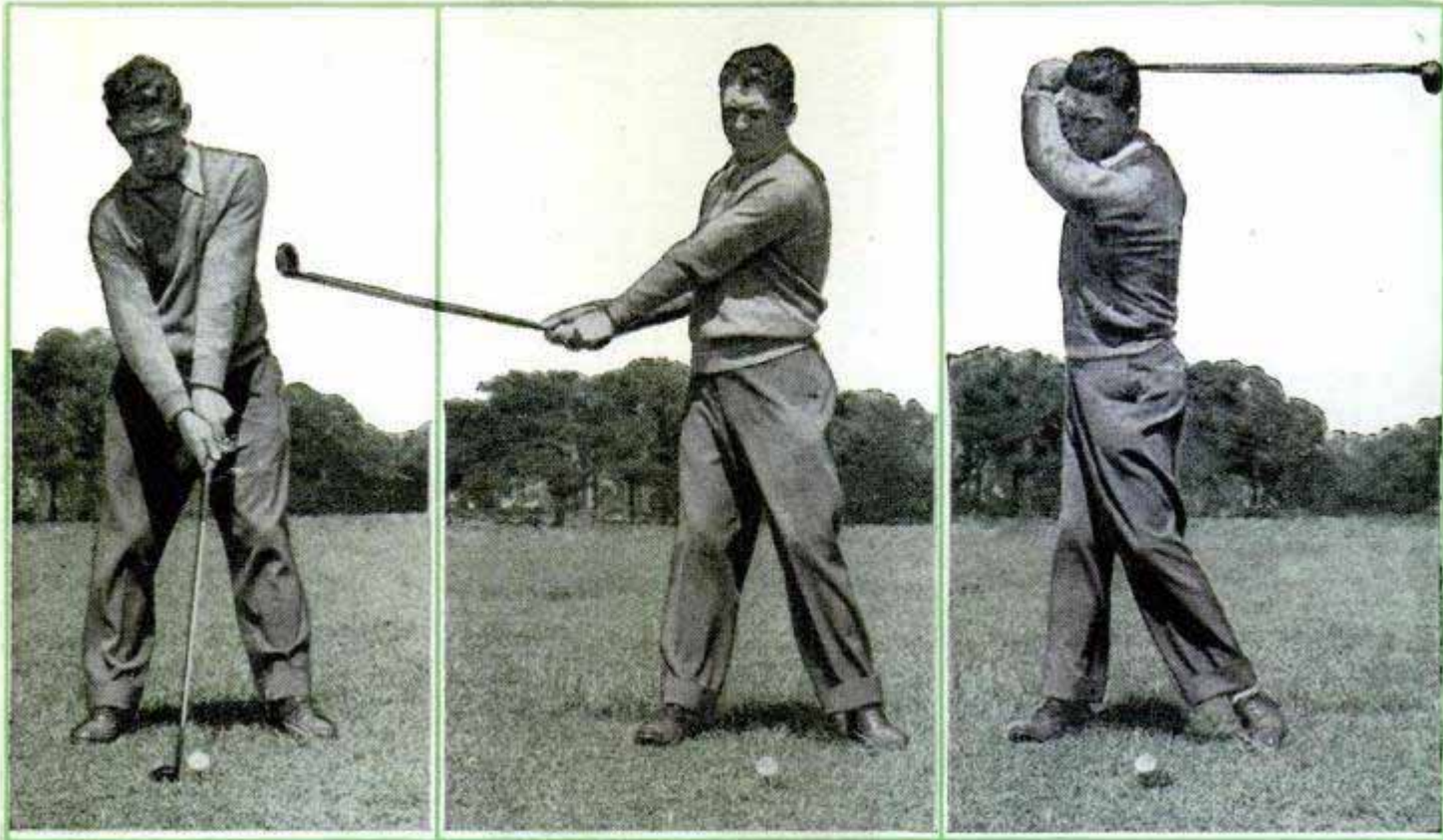

At start of swing, left, club is straight extension of left arm. As the club is brought back, center, golfer turns right hip away and lifts left heel. At backswing's highest point, right, club shaft is parallel with line of flight

straight out in front of you and cock both wrists so that the club head swings back over your head. Then rotate your body to the right, coming up on your left toe. Try your usual backswing and then this demonstration exercise a few times alternately, trying to achieve the demonstration position in your swing.

Step four is to swing down at the ball, hit it, and follow through. This whole forward swing must be done in a precise way. First, straighten your left wrist so that the club is swung up from its horizontal position behind your head and once more becomes an extension of your left arm.

With your body still in its turned position, sweep your arms down at the ball. Swing your arms down, not out. You must deliberately refrain from rotating your

body back to its original position during the downswing. Your arms automatically take care of that action.

During the downswing, your right elbow comes in against your body, forcing your body to the left in a lateral movement. This in turn pushes your left heel down to the ground again. Thus, at the moment of impact you are in the same position from which you started your backswing. Left arm, club and club head are all lined up with the ball. The lateral movement of your body now permits the club head to "ride" the ball for a short distance, tremendously increasing its flight.

Your swing doesn't end when the ball is hit. Continue to swing, with the club extended, until your hands are shoulder high once more. Then, let your wrists relax so

Before putting, golfer studies curved path the ball must follow toward cup to counteract slight dip in green

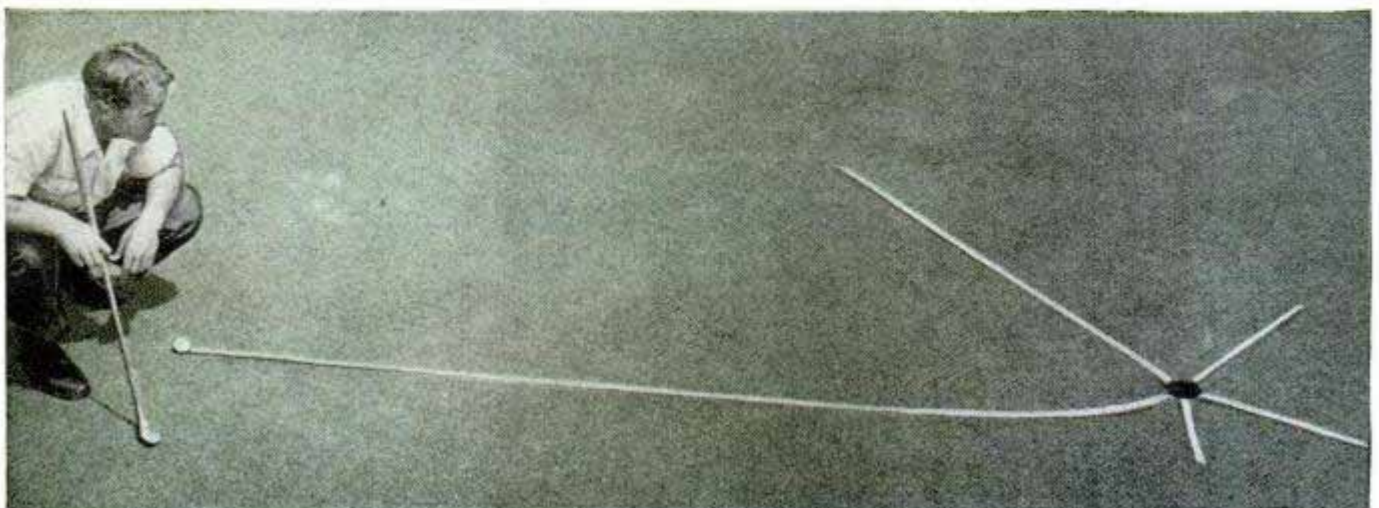

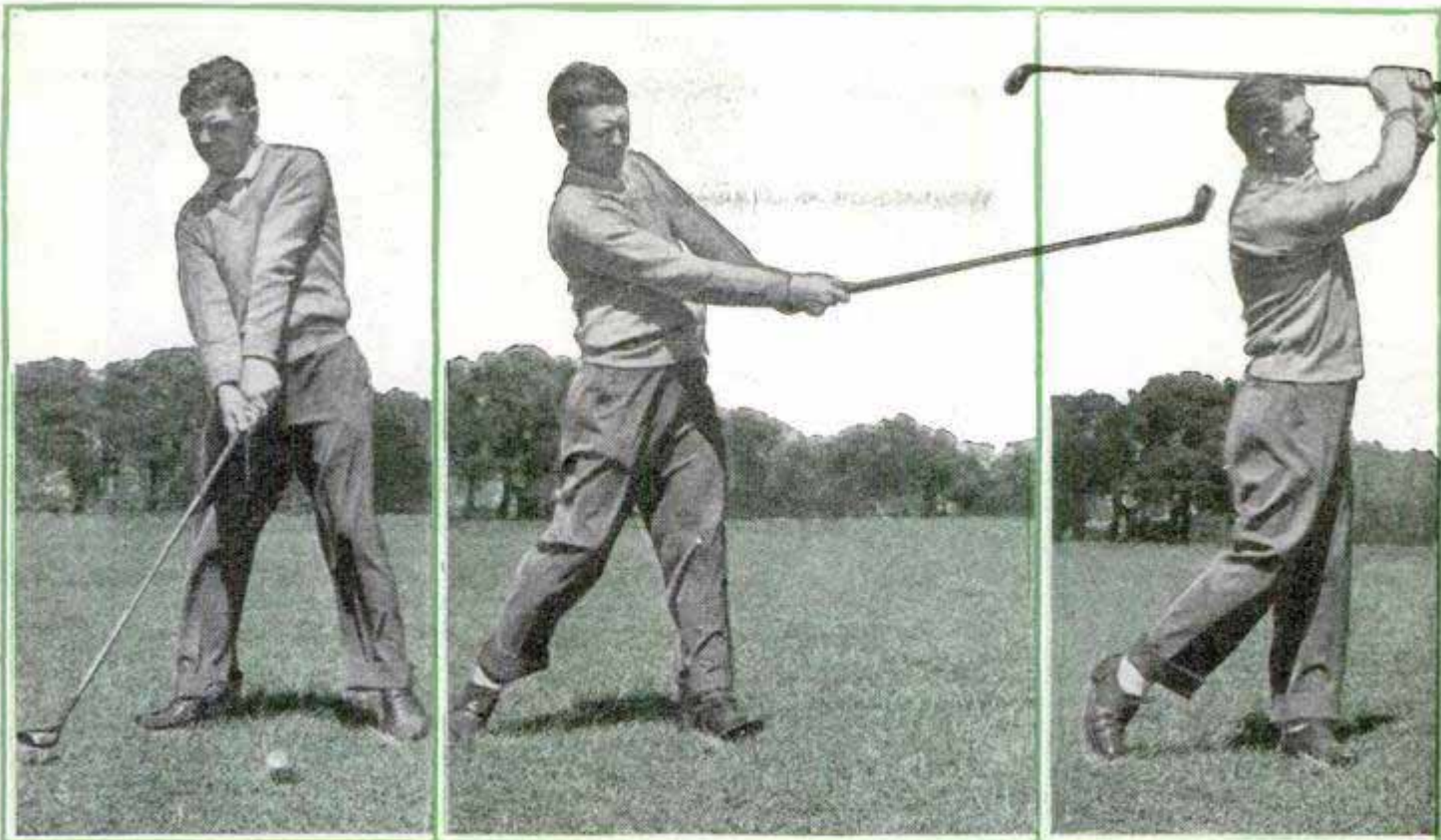

**Downswing, left, is made with arms alone. Center, the swing slows down after—not before—ball is struck**

**When follow-through is completed, the player's position is reverse of that at top of backswing**

that the club head swings over your shoulder, horizontal and parallel once more with the line of flight. This follow-through allows you to hit the ball when the club head is traveling its fastest and gives your arms space in which to slow down.

The swing I've described produces a hard-hit ball that has a long flight. The ball starts out low and climbs away from you in a straight, flat trajectory. It has considerable roll after landing.

This full swing should be used for all tee shots and for all long fairway shots. Short iron shots to the green are played with the same stroke, except that your body need not be turned as much away from the ball, and the backswing and follow-through are shortened.

If you have a chance to watch professionals in a championship match, you may think at first that each one has a style of swinging that is all his own, unlike most of his competitors. But on analyzing their swings you will realize that each is using the basic swing that I've described, modified some by his own characteristics.

Practice will develop this swing until it becomes natural to you, and a public driving range is a good place for practice. On the driving range, too, you can overcome any faults that you may have.

But don't try to figure out what you did wrong if you fail to hit the ball cleanly. Simply go back over the four parts of the swing I've described, perform each part as it has been told here, and try again.

**Playing medium irons calls for less extreme body turning and arm raising than in hitting woods for distance**

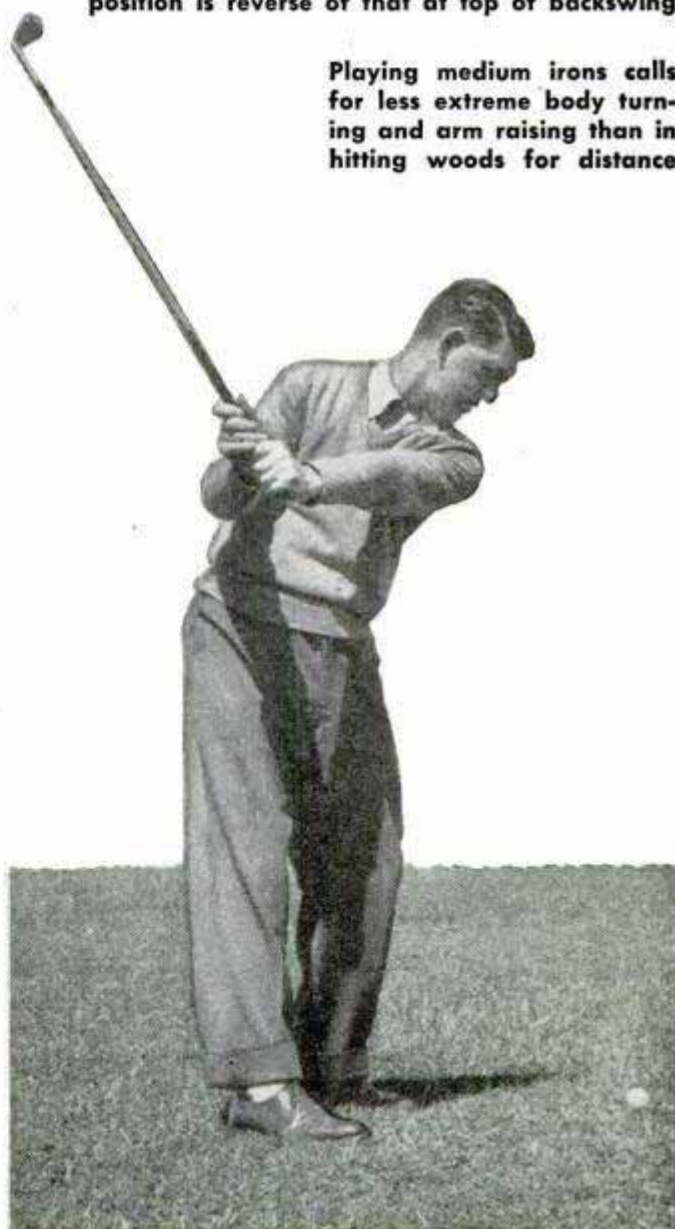



### Shoulder Holder Steadies Camera

Camera movement during exposures is cut to a minimum by a shoulder support that adjusts to hold the camera at either waist or eye level. The shelf on which the camera is mounted folds back into the frame for compact storage. Two shoulder clips fit over the shoulders, leaving the photographer's hands free and yet holding the camera securely.

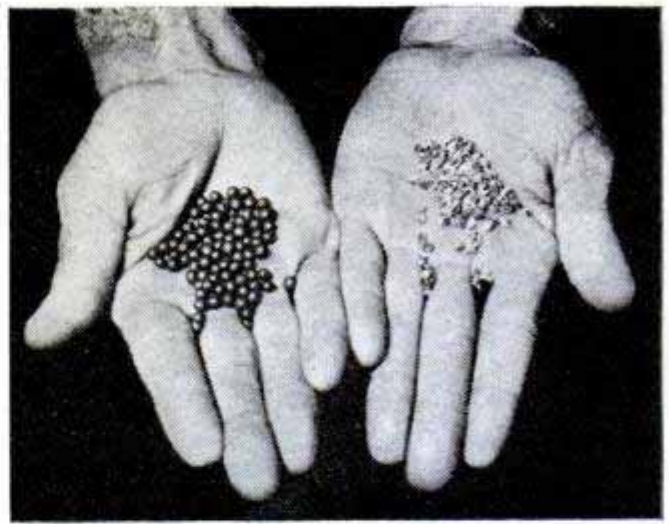

These are sugar-beet seeds. At right, their natural size; at left, the same seeds after being pelleted

### Seed Pellets Eliminate Thinning

Seed pellets make life easier for the home gardener by virtually eliminating the backbreaking chores of thinning and transplanting fragile seedlings. When coated to form pellets of pea size, such tiny seeds as carrots can be planted one at a time, properly spaced for sturdy plants. Used commercially for several years, the seed pellets are now available for home gardens. Seeds are coated with a mixture of soluble materials containing fungicides, insecticides, fertilizer and hormones, plus inert ingredients to add bulk. The coating also protects the seed, making it possible to plant in the open two or three weeks earlier than usual.



### High-Speed Wood Bit

High-speed boring in either soft or hard wood is done with a flat bit that bores in any direction, regardless of grain or knots. Designed for use with power drills, the bit has a long pilot that will start holes at angles as small as 45 degrees. Chips unload

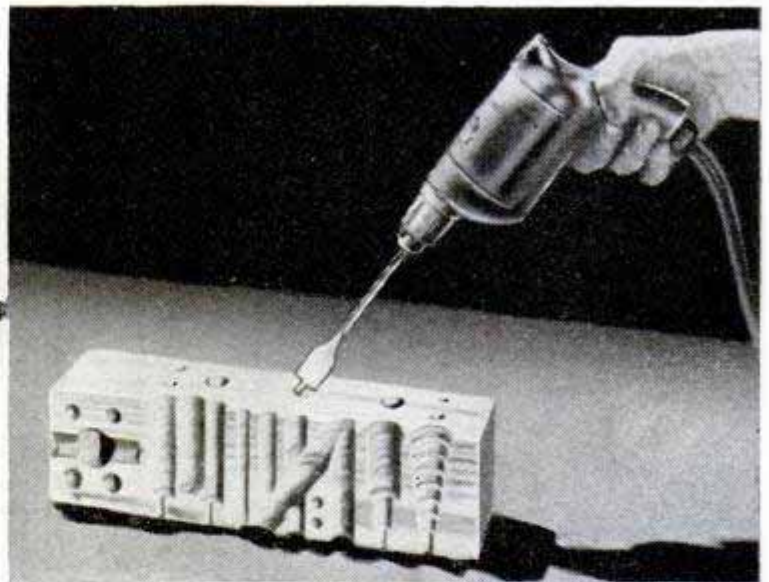

continuously without clogging the bit, which operates best at speeds of 750 to 3500 revolutions per minute. The bit can be sharpened quickly with a regular flat file and drills through Masonite, Bakelite and Lucite without chipping. A standard set contains six bits from  $\frac{3}{8}$  to 1 inch and one countersink, all having  $\frac{1}{4}$ -inch shanks.

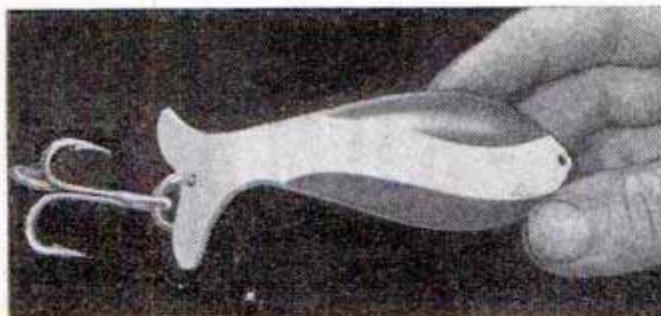

ROLL OF SPOON

REVERSE ROLL

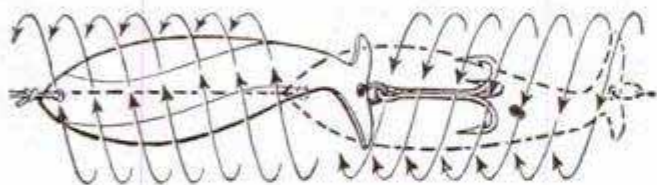

### Nontwist Reversing Lure

Twisted fishline is avoided with a spoon lure which reverses itself as it travels through the water with a flash-roll action. After five to seven rolls, pressure on the curved tail causes the lure to reverse its direction of roll. Various retrieving speeds may be used without loss of action. The lure is available in three sizes and several different color schemes.

### Valve Cap Has Built-In Tire Gauge

Checking tire pressures takes only a few seconds when your tires are equipped with individual pressure gauges that take the place of the regular valve caps. You simply press down a plunger on the gauge and, if your tire pressure is all right, a red bubble appears in a plastic window. If no bubble appears, your tire needs more air. The gauges are available for all standard tire pressures used on cars, tractors, motorcycles, trucks and aircraft.

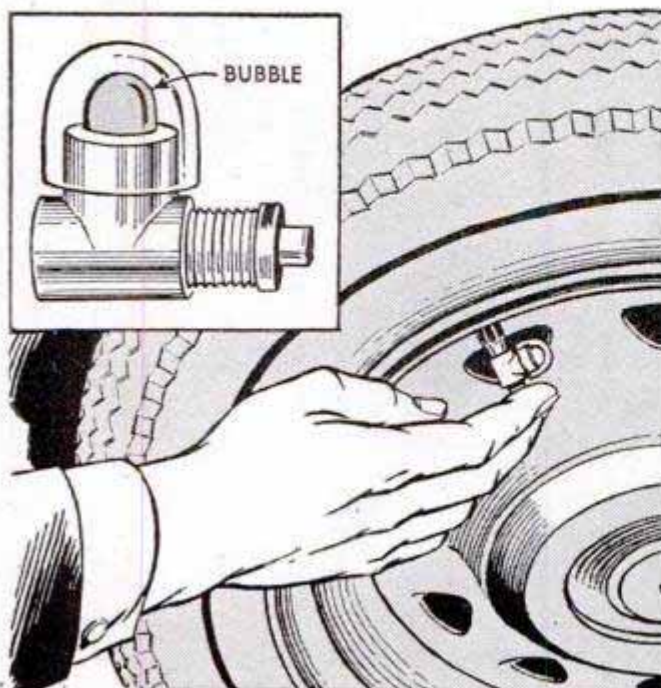

### Dispenser Applies Cement To Dry-Wall Sealing Tape

Tape for sealing the joints in dry walls goes on up to five times faster when the workman uses a tape and cement dispenser. The new machine, weighing only eight pounds when fully loaded, applies cement to the tape as it is fed from the applicator. The amount of cement used can be controlled. A built-in device cuts the tape at the desired length.

### Ruler Fits Notebook Rings

Designed for carrying in ring-binder notebooks, a transparent ruler, made of Vinylite plastic, is easily removed or inserted without opening the rings. The ring slots are punched to fit either two or three-ring notebooks. The ruler is suitable for both pencil and ink ruling on either flat or curved surfaces.

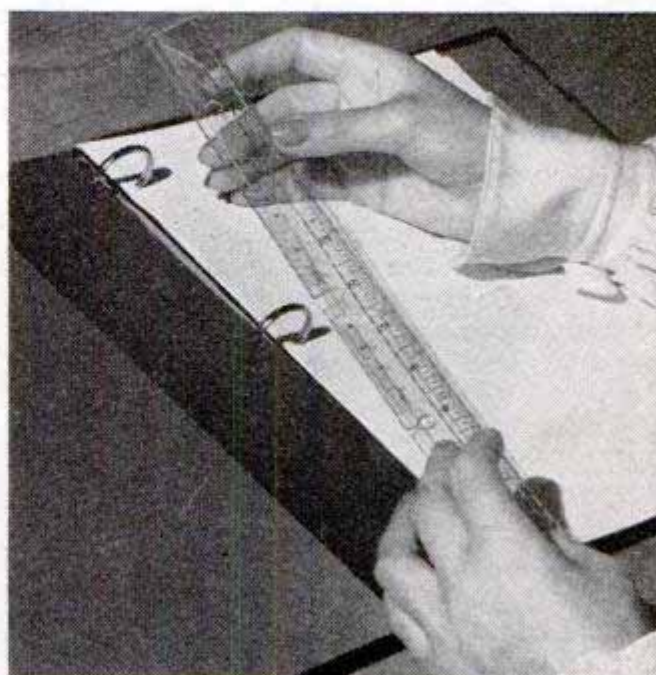

# PAINT-BOMBING

**T**O THE PILOT of a low-flying airplane, one tree in a forest looks pretty much like another. Normally, this isn't much cause for concern, but when the pilot is flying a DDT-spraying mission over thousands of acres of trees he wants to know when to start and when to stop.

By paint-bombing treetops, workers in the U. S. Bureau of Entomology provide pilots with easy-to-see markers on each corner of the tract to be sprayed. This technique, worked out by Walter J. Buckhorn of the Portland, Ore., branch of the bureau, brings the maritime line-throwing gun into landlubber service. It involves shooting a line over the treetop, hoisting a paint bomb to the top and exploding it, showering the upper crown with brilliant paint visible to the airman for miles.

When Buckhorn was given the job of marking 12 test plots of 360 acres each in an Oregon forest, he thought there must be some quick way to outline the infested areas for the pilots. He decided upon the line-throwing gun used by Coastguardsmen. The gun he uses is an 1873 model Army Springfield, .45-.70-caliber, with about half the barrel sawed off. Instead of a bullet, the charge fires a six-ounce brass projectile that is about a foot long. Loaded through the muzzle, the projectile has an eye in one end to which is tied the end of a roll of twine. When the projectile is fired, it yanks a "tail" of twine out of a canister clamped to the muzzle.

By trial and error, Buckhorn perfected the paint bomb he needed. He took an ice-cream container of waxed paper and filled it with paint. In the paint he placed a quarter of a stick of dynamite, capped and wired. The detonation wires come out through a hole in the lid.

With this equipment, painting the treetop is simple. Buckhorn, standing about 150 feet from the tree, fires the

projectile over the treetop. On the opposite side of the tree, an assistant picks up the end of the line and pulls the paint bomb, which Buckhorn has tied to his end of the twine, up to the top of the tree. By manipulating the detonation wires as the bomb is hauled upward, Buckhorn keeps it from tangling in the limbs.

Once the bomb is at the top, he touches off the explosive with a battery. The explosion sprays paint around in a thick cloud, coating the foliage.

The DDT spray over the 12 test plots was so successful in insect control that plans are being made for spraying 1¼ million acres of forest lands.

Buckhorn's paint-bombing technique is expected to be a big help in other work as well. Already, plans are being made to use it to guide pilots who make aerial surveys and photographic maps of forest lands.

Buckhorn aims his line-throwing rifle. Canister contains a roll of twine. Insert shows a paint bomb with its explosive

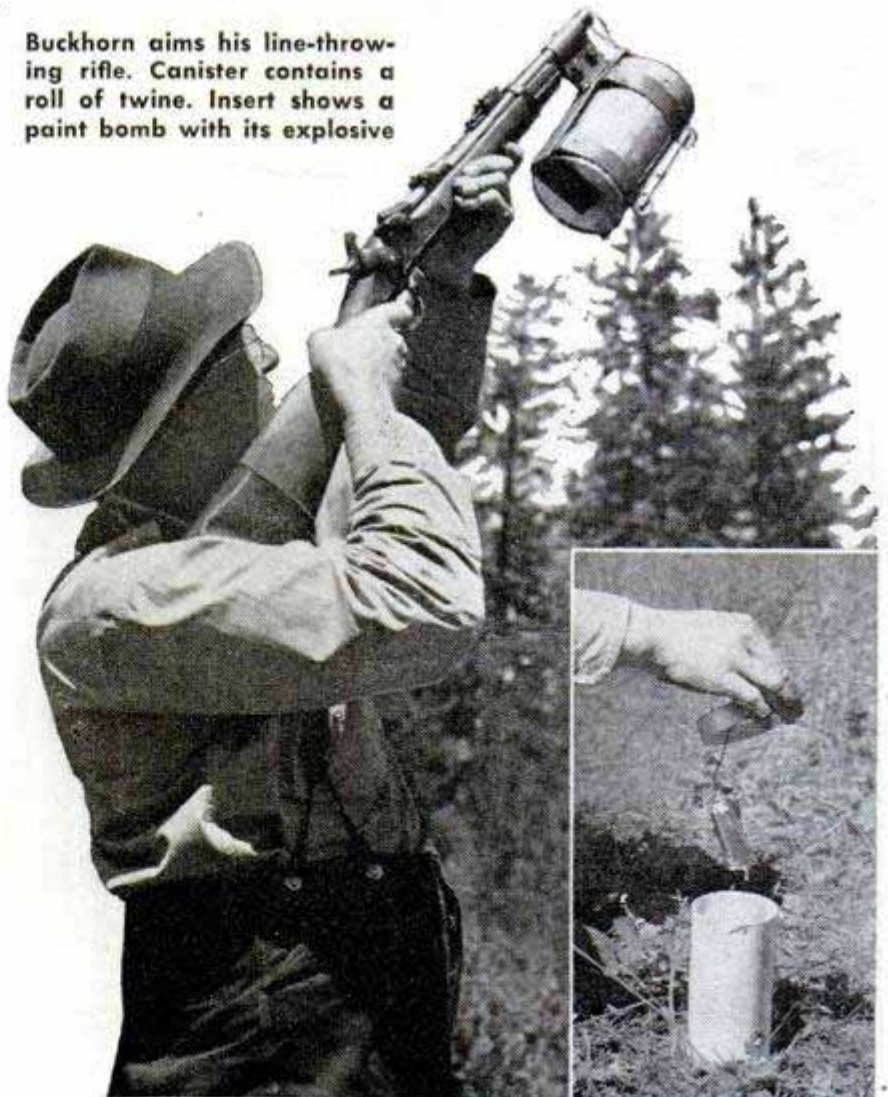



# TREETOPS



Left, after the line is fired over the treetop, the paint bomb is tied to one end and hoisted to peak of tree as shown here. Detonation wires run from bomb to ground. Above, paint bomb is exploded in crown of tall Ponderosa pine. Note the paint cloud around treetop. Below, guided by painted treetops, helicopter sprays forest



U. S. Bureau of Entomology photo

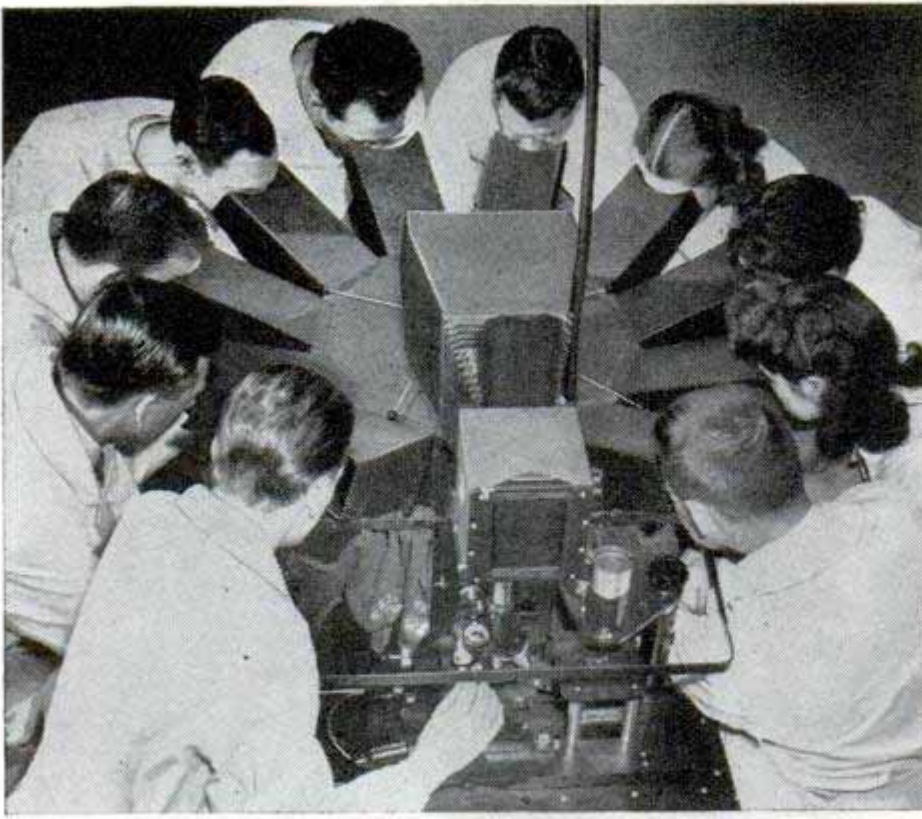

## Group Microscope Has 10 Eyepieces

As many as 10 doctors and technicians can study a slide simultaneously under a multiviewer microscope that projects the image on individual viewing screens. The 10 eyepieces are arranged in a circle around the machine. The doctors can call attention to any portion of the slide by means of convenient control handles that move a small pointer across the screens. The instrument can also be used to project the slide on a wall screen. Used for group instruction in the study of tumor tissues, the instrument costs \$2500.

## Rolling Luggage

Luggage equipped with a "retractable landing gear" can be rolled instead of carried. Two miniature wheels pivot out of one end of the wardrobe case, and a handle can be pulled from the opposite end. The suitcase then can be wheeled around like a pushcart. If the traveler has more luggage to manage, he can pull two extension arms out of the bottom of the case and pile the extra pieces on top of the rolling wardrobe unit.

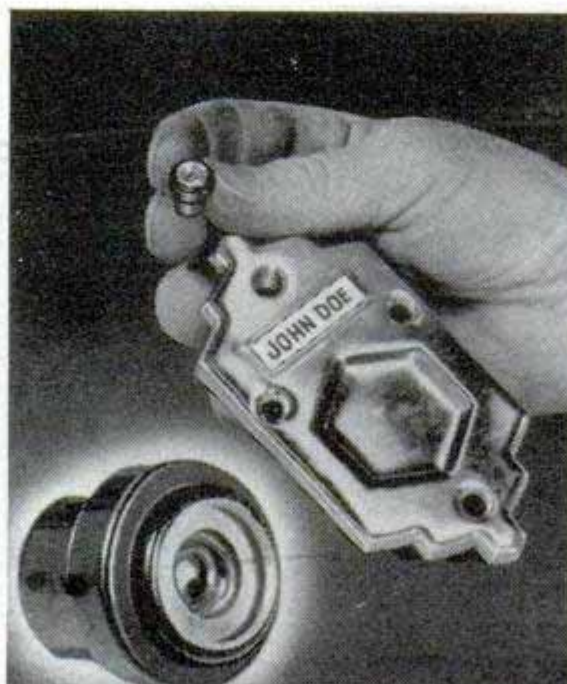
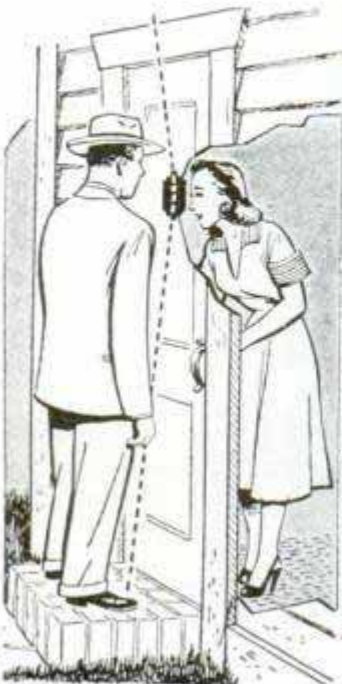
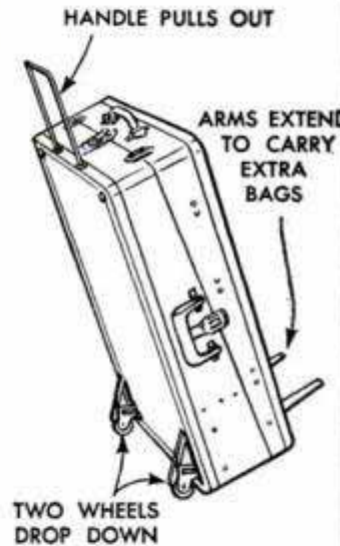

## Tiny Lens in Door "Inspects" Visitors

Through a wide-angle lens installed in a peep hole in the door, homeowners can see visitors from head to toe before the door is opened. The lens, only a fraction of an inch in diameter, is secured by a brass, chrome or bronze plate.

☐ The manufacture of portland cement involves such diverse equipment as a 600-ton kiln and a balance sensitive enough to weigh the dust from a butterfly wing.



# Iron Strike in Labrador

Deep in the northland, along the Labrador-Quebec border, lies one of this continent's richest iron-ore deposits. Map, below, shows the location. Left, modern prospectors use pneumatic drills in search for valuable ore

By James Montagnes

**T**WELVE years ago, Mathiau Andre, an Indian trapper, strolled into Seven Islands, Que., carrying some "pretty rocks" he had found while setting a trap line near the Quebec-Labrador border. His pretty rocks turned out to be extremely high-grade iron ore. Taken back into the unexplored wilderness by airplane, he pointed out that spot where he had picked up the rocks. Subsequent drilling has shown that he discovered what may be the biggest iron strike of the century.

Today, the area from the St. Lawrence River north to Ungava Bay seems destined to be the Mesabi of tomorrow. Prospectors, geologists, financiers and laborers are becoming acquainted with this desolate part of Canada, which a few years ago was unexplored wilderness.

Planes fly into the area from Seven Islands every day and plans are being made to construct a railroad into the iron-ore country. The center of activity is Burnt Creek, a

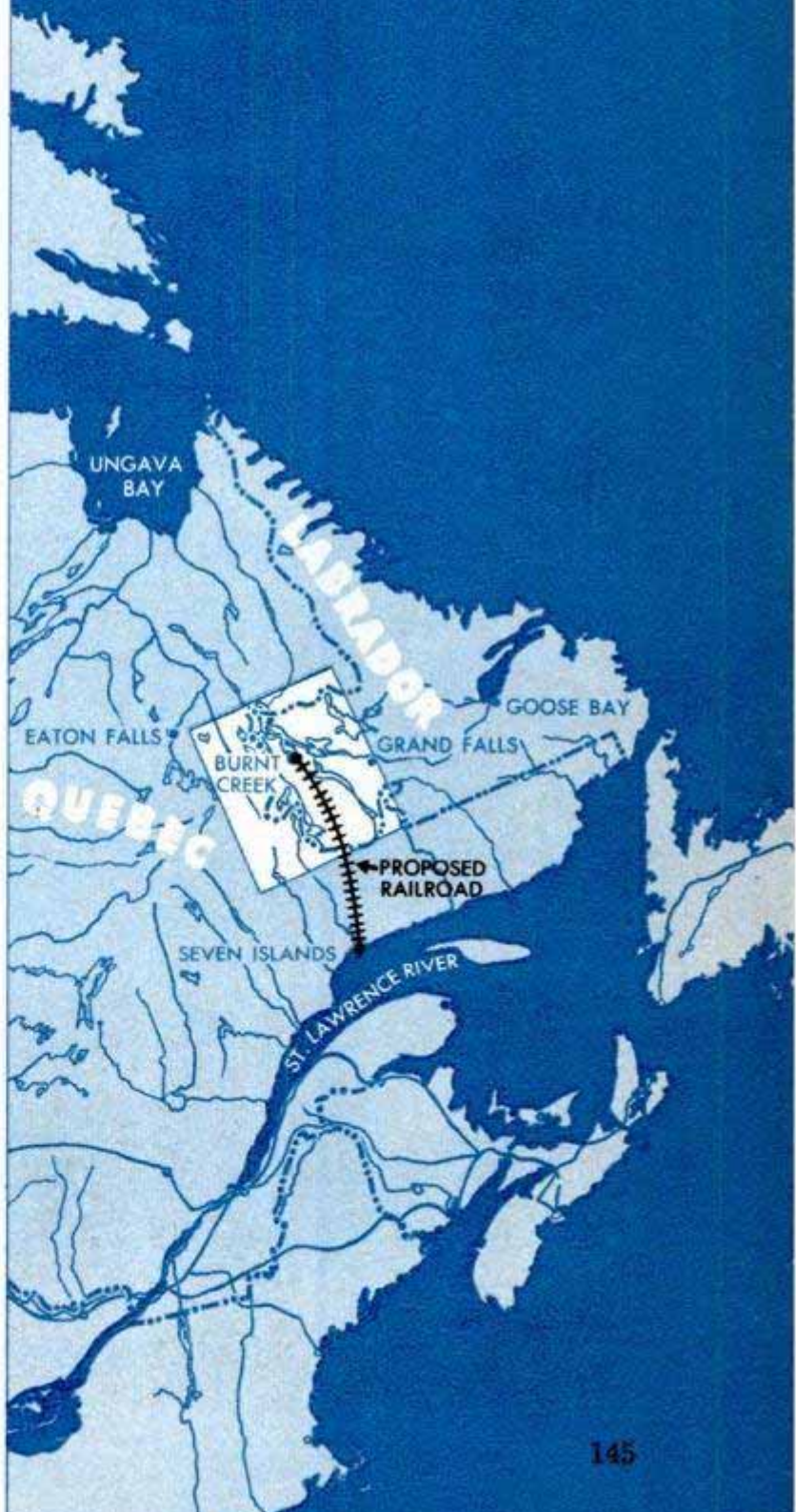

small mining community of 215 population. This primitive settlement, reminiscent of the gold-rush days, is sitting on one of the richest deposits of iron ore ever discovered. A test drilling located ore only two feet below the surface and was still bringing up good ore when drilling was stopped at 367 feet!

Distance was the main factor in starting a mining development in the Labrador area—distance from the nearest center of civilization, from transportation and sources of power to operate the mining equipment. By air it is close to 400 miles northeast of Quebec City to Seven Islands, a small settlement and fur post on the St. Lawrence River. There is no railway; you go by air or boat to get to Seven Islands. From a base there, air services have been flying in men and supplies to the new iron-ore fields 317 miles farther north.

This iron find in northern Quebec and Labrador is important to the North American economy. It means an ample supply of rich ore for the steel mills of the Great Lakes region and possibly new steel mills on the Atlantic seaboard and throughout eastern Canada. This is important in view of the signs of depletion of the best ore areas in the Minnesota iron ranges. Ore will be shipped from the Labrador area by train to Seven Islands and from there will go by steamer either to Great Lakes or

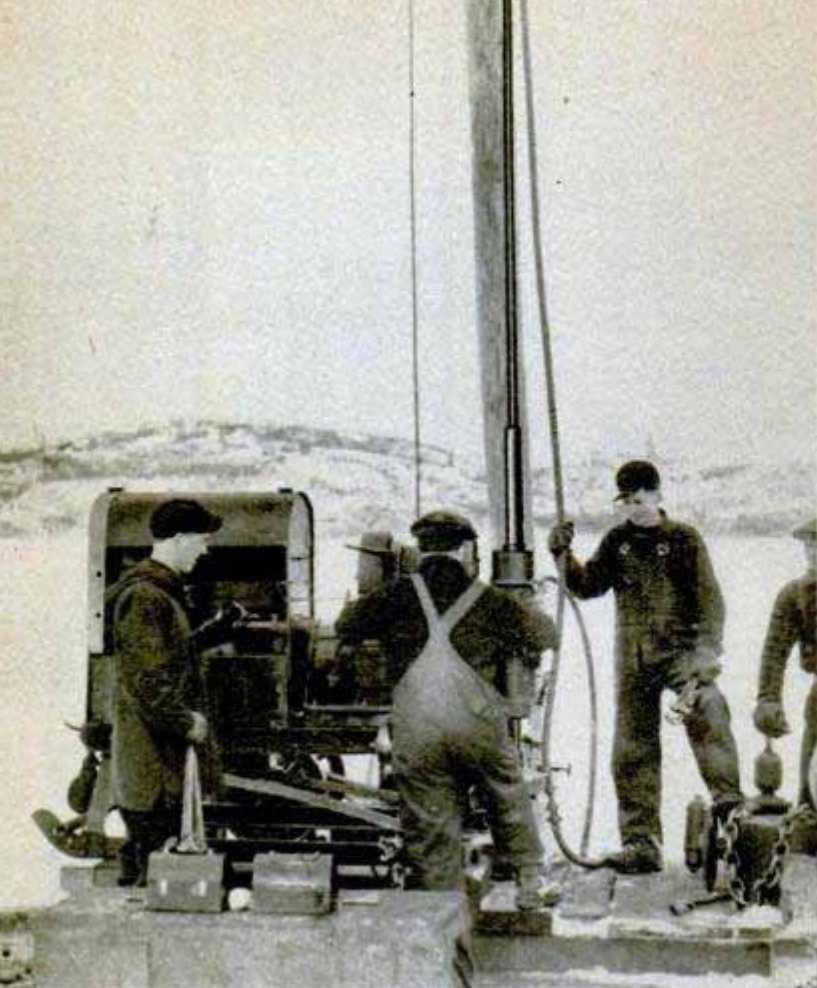

Diamond-drill crew in northern Canada hauls a core sample of iron ore out of the ground. Below, only 70 miles from the Quebec-Labrador deposits, Eaton Falls is expected to be used to produce electricity

Copyright Photographic Survey Co. Ltd.



Atlantic seaboard steel mills. It is expected that there will be sufficient iron ore in the Labrador region to stimulate completion of the St. Lawrence Seaway, to make for more economical shipment of iron ore by the largest lake freighters direct from Seven Islands to the steel mills of the Great Lakes.

The iron-ore development in this new frontier region is not a pipe dream, for the companies exploring and planning development there have already spent millions on exploration and plan to spend many more. They include some of the biggest mining interests in the United States and Canada, in many cases Canadian gold-mining interests working closely with iron interests from the United States. Long-term exploration concessions have been granted some of the firms by the governments of Quebec and Newfoundland, the latter having jurisdiction over Labrador.

In the major iron-ore development, a large Canadian gold-mining company and a major United States steel company have joined forces to map out 300 million tons of iron ore, enough to keep mining going for at least 30 years. They have been drilling and working in that area since the end of the war. Their search has succeeded to the point where they are now seeing their

minimum ore fields prospected. The railroad they plan to build will run from Seven Islands, on the St. Lawrence River, north into the development. A charter for the railway has been obtained and it is to be started by 1950. The development covers a concession of almost 24,000 square miles, most of it in Labrador.

So far, all transportation into the iron-ore site has been by air. By river, with many portages, it would take too long. By air, the trip can be made in less than two hours. Everything has been flown in, from men to bulldozers to make rough roads in the rocky country. All food comes in by air. Diamond drills, materials for houses, materials to set up chemical-analysis laboratories, ore dump carts and trucks, machinery of all kinds have all been flown in by contract air-freight service and by a subsidiary air-transport company of the mining interests. Even the airports and landing strips had to be built for summer operations after the first supply planes came in during the winter to land on the snow of northern lakes.

When the mining operations actually start, electric power will be developed for the mines from the numerous fast-flowing rivers of the hilly area. The main iron-ore "find" to date is not too far from Grand

**Burnt Creek camp is the center of the exploration activities in the Quebec-Labrador iron-ore development**

Copyright Photographic Survey Co. Ltd.



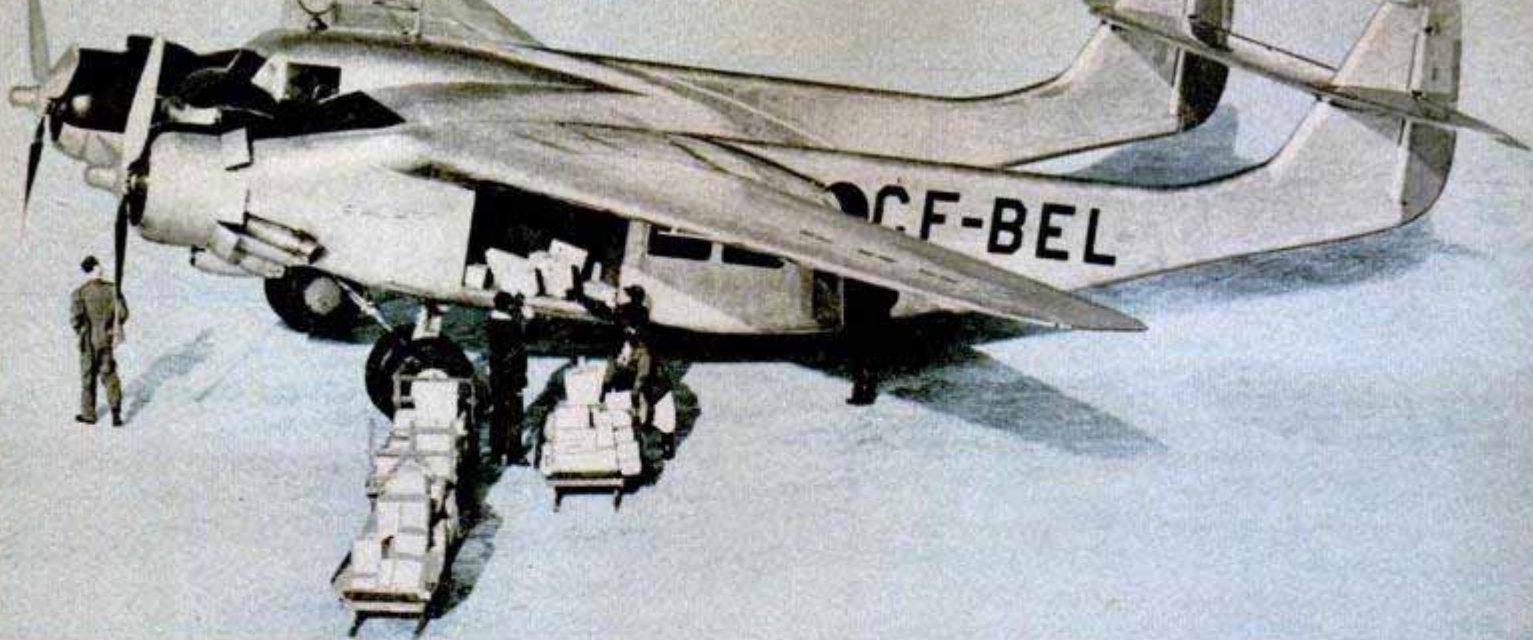

All supplies are flown into the Burnt Creek camp. This Burnelli transport is being loaded at Seven Islands

Falls on the Hamilton River. A series of falls on the river drops it 800 feet in a short distance, biggest drop being 302 feet. This is considerably more than the drop of Niagara Falls. Another important source of power will be at Eaton Falls, about 70 miles northwest of the site.

As in other parts of northern Canada, electric power will be generated in the northland of Quebec and Labrador long before there are any towns or cities in that area. The power will be used by the mines and as the mines grow, the towns and cities will come to the frontier.

As an example of what this new iron-ore development means to northern Canada, it is but necessary to look at similar devel-

opments in other parts of the northland. In northern Manitoba, for instance, a copper mine in the bush, 400 miles north of Winnipeg, has become a thriving town of over 5000 people in a matter of two decades. The town has all the modern conveniences of any other town its size, only there are no roads out of the town for a drive; the roads lead only into the bush. Much farther north, gold finds on Great Slave Lake have brought into being the town of Yellowknife, largest community in Canada's vast Northwest Territories. Similarly, mining operations in Labrador will see new towns spring up in what is today only wilderness, largely unexplored, and inhabited only by a few Indian trappers and Eskimos.

In the barren surroundings of desolate northern Canada, drillers hunt for the red metal

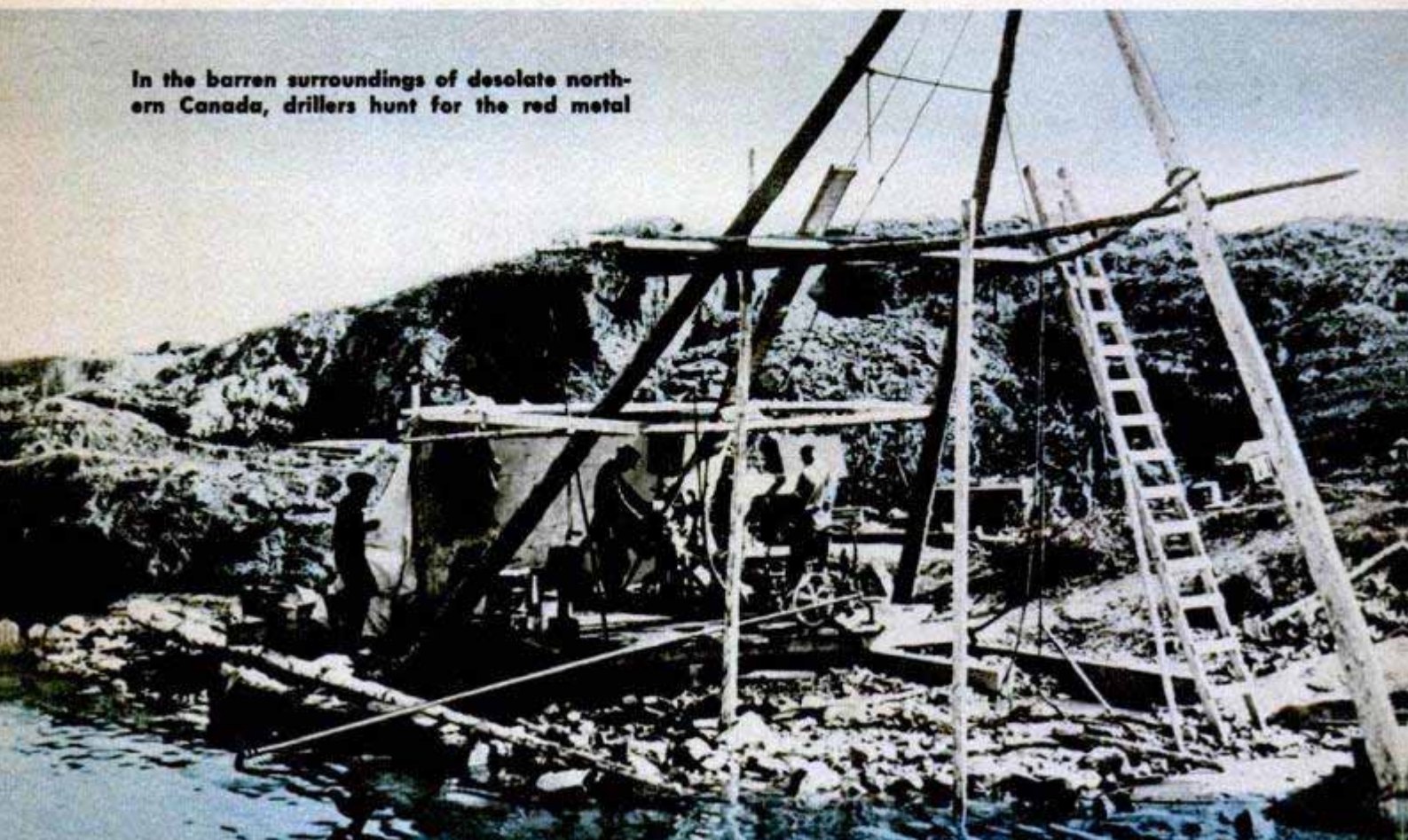

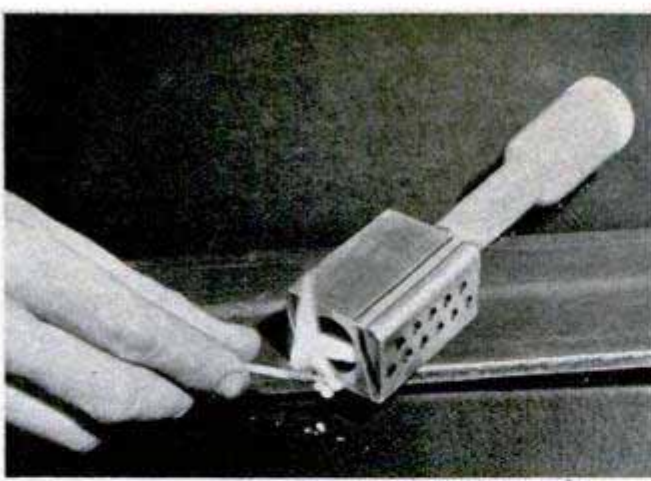

### Waxing Iron for Skis

Skis can be waxed without thawing them when a small self-heating iron is used. The iron holds a supply of heating disks. When the skis are to be waxed, one of the disks is placed in an opening in the iron and ignited with a match. In about two minutes the aluminum iron is hot and wax is held against it until melted wax runs down a groove and onto the ski. The skier then moves the iron over the ski to spread the wax. A curved edge of the iron rubs wax into the ski groove.

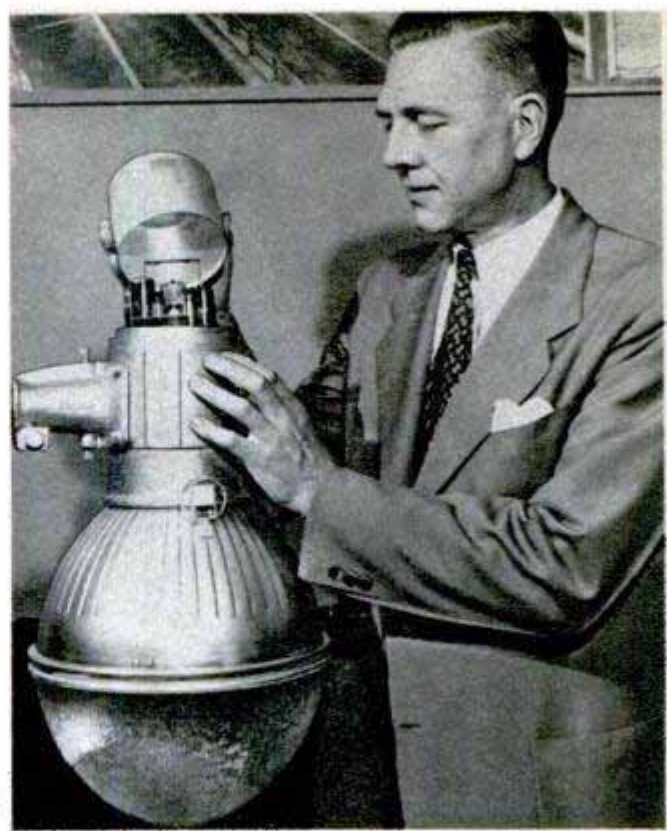

### Electric-Eye Street Lights Turn Themselves On and Off

When it gets dark enough to make vision hazy, individual street lights can now turn themselves on with an electronic eye that "sees" dusk and dawn approaching. The electronic control, small enough to be mounted in the top of each lamp housing, has a peephole through which the outside light is measured by a phototube. As light intensity in the immediate area drops low enough to make artificial lighting desirable, the light goes on. When dawn brightens the area, it goes off. Most control units used today turn entire circuits of lights on or off at a predetermined time regardless of light conditions.



### Crank-Up Garden Umbrella

Opening a new garden umbrella and tilting it into the sun is as easy as turning two cranks. The cranks are located on the support pole just above table-top level. One of them tilts the umbrella and the other raises or lowers it. A transparent waterproof covering protects the umbrella during rainy weather. The umbrellas are available in seven and eight-foot sizes in a large selection of colors and in solid or striped patterns.

☐ In soil-conservation projects, the Department of Agriculture has planted 33,650 miles of field windbreaks in the West.

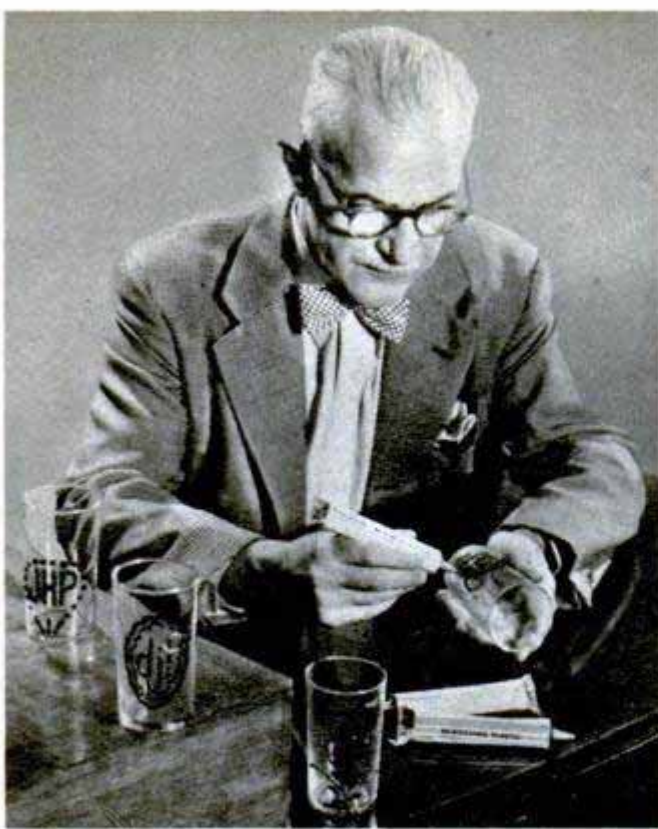

### Embossing Plastic

If you're artistically inclined, you'll enjoy working with a plastic that is squeezed from a tube to emboss everything from gift packages to drinking glasses. The plastic comes in several colors and adheres to cloth and leather as well as to smoother surfaces. When applied to any hard surface, such as glass or china, it can be removed easily if desired.

### Internal Pipe Wrench

Fittings that break off inside pipes are easily removed with an internal pipe wrench that is turned with a monkey wrench. The tool has only one moving part, a knurled cam that slips into gripping position inside the pipe. It is available in four standard pipe sizes.

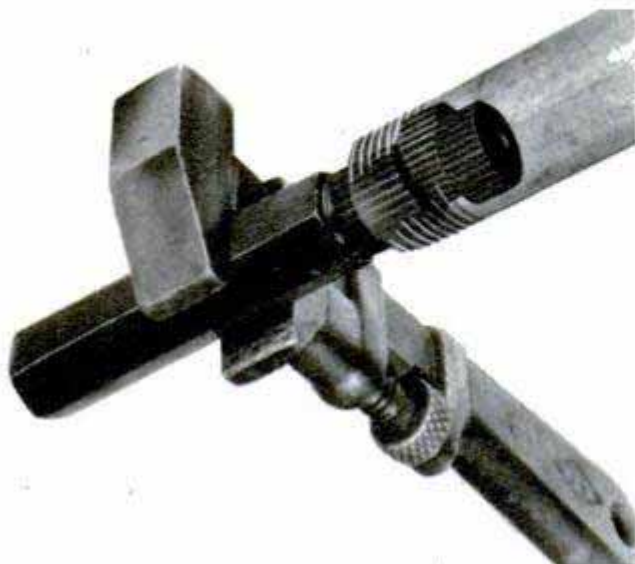

### Lacquer-Deposit Calculator

Lacquer deposits on engine pistons are measured quickly with a high-voltage instrument. One terminal is attached to the piston and the other to the deposit. The instrument then measures the amount of voltage required to burn through the lacquer. Since it takes a known amount of voltage to penetrate a given lacquer deposit, the thickness of the deposit can be calculated. The instrument eliminates the former technique of removing the deposits by hand and then weighing them.

### Magnet Holds Soap High and Dry

Suspended by a magnetic holder, a bar of soap remains dry and handy for instant use. A magnet, mounted in a wall bracket, attracts a steel ball that is attached to the soap by a notched stem. When the soap has to be replaced, you remove the steel ball and insert it in a new bar.





Refrigerator inspector peers through a quartz-glass viewer to check the metal hood that will encase the mechanism. Casing is filled with hydrogen. Bubbles will appear if there are leaks. The quartz viewer cuts murkiness of the water, making it possible to see the smallest bubbles



## getting the cold facts

Before a refrigerator reaches a corner of the kitchen it passes through a series of exacting tests to check its efficiency. It must pass leak and noise tests, temperature tests and durability checks under the critical eyes of men and instruments. Inspectors also learn much from refrigerating units that have been in operation for years. At right are shown two such units, one operating constantly for 25 years, the other 28 years. Note the frost that has built up around the freezing compartments. As individual parts break down, they are replaced during "off" cycle of the mechanism. Below, black-light beam is thrown on a compressor to spot possible oil leaks. Oil appears as white spot under the rays

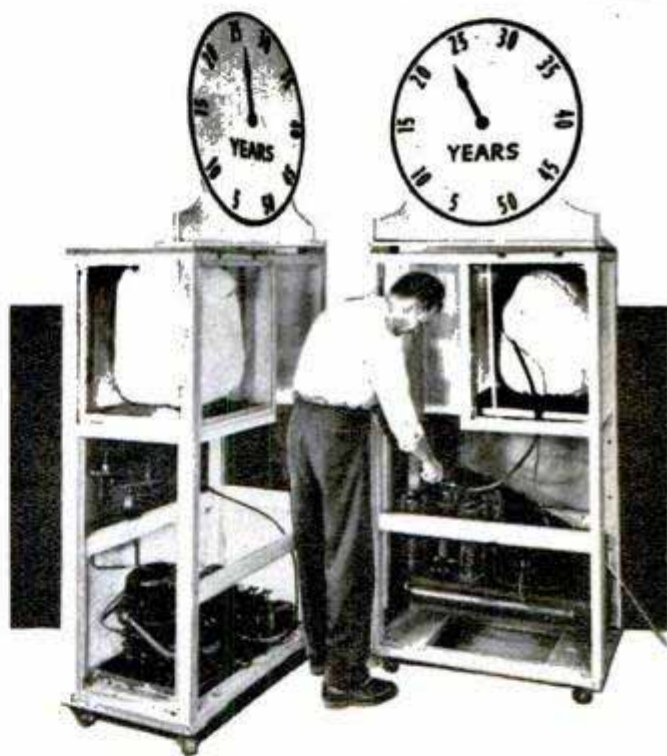

↓ Crystal microphone is held against the mechanism to determine the amount of noise the unit produces  
Frigidaire photos





**COOLING UNIT** will make your bedroom or trailer comfortable during the hot nights this summer. It mounts outside the window and disperses 800 cubic feet of filtered, washed and cooled air per minute

**TAPER LIGHTER**, below right, is a long mechanical match with which you can light gas heaters and burners easily. The striking unit slides up the tube to ignite the wick. It uses cigarette-lighter fluid

**BATHTUB HEADREST** makes reading or just plain relaxing in the tub a comfortable pastime. Suction cup holds it firmly against the sloping end of the tub. The headrest is cushioned with sponge rubber



**ICE BALLS** instead of cubes are the newest idea for cooling drinks. They're frozen in rubber trays that release one at a time when pressed on the back

## WHAT'S NEW *For Your Home*

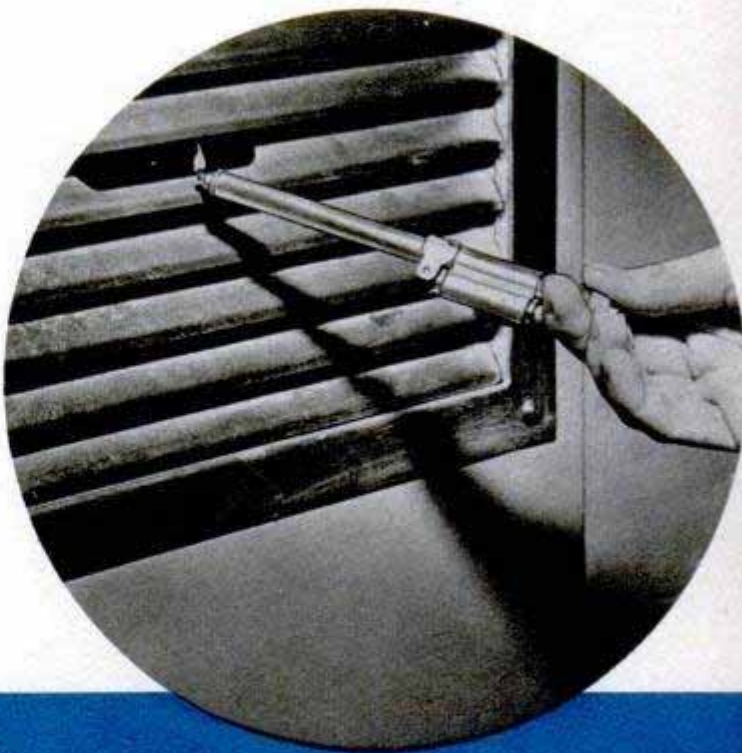

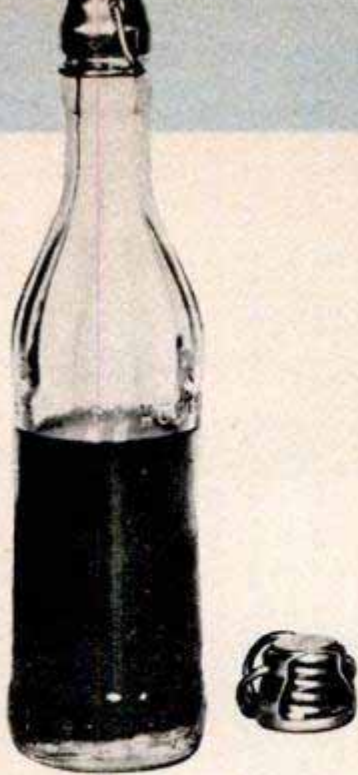

**BOTTLE RESEALER** locks in the carbonation of soft drinks. A safety valve releases any pressure above 45 pounds to prevent explosion if heated or shaken



**CHILD EATS** eagerly when he "shares" his food with plastic puppy that sits beside bowl, top right. But food falls back into bowl so child gets all of it

**FLOWER PLANTER**, right, has an attractive loop fence around the leakproof container. You hang the planter on wall by placing loops over nails or hooks

**PUSH-BUTTON COOKING** is here with an electric range, lower right, controlled by buttons that glow with colors which show the heat intensity being used

**NEEDLE THREADER** and knife are both part of a handy thimble. Thumb pressure slides the knife out for cutting. Wire loop pulls thread through the eye

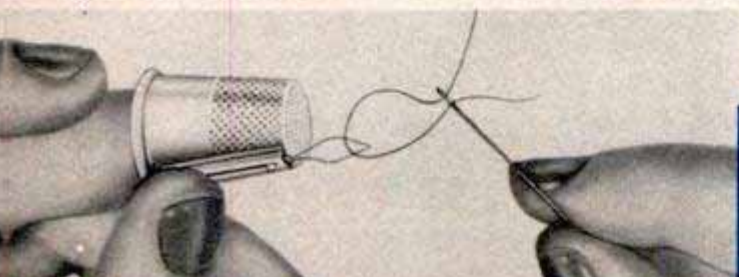
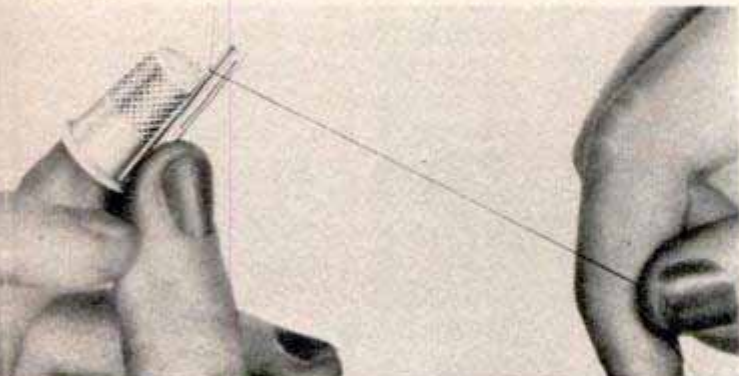
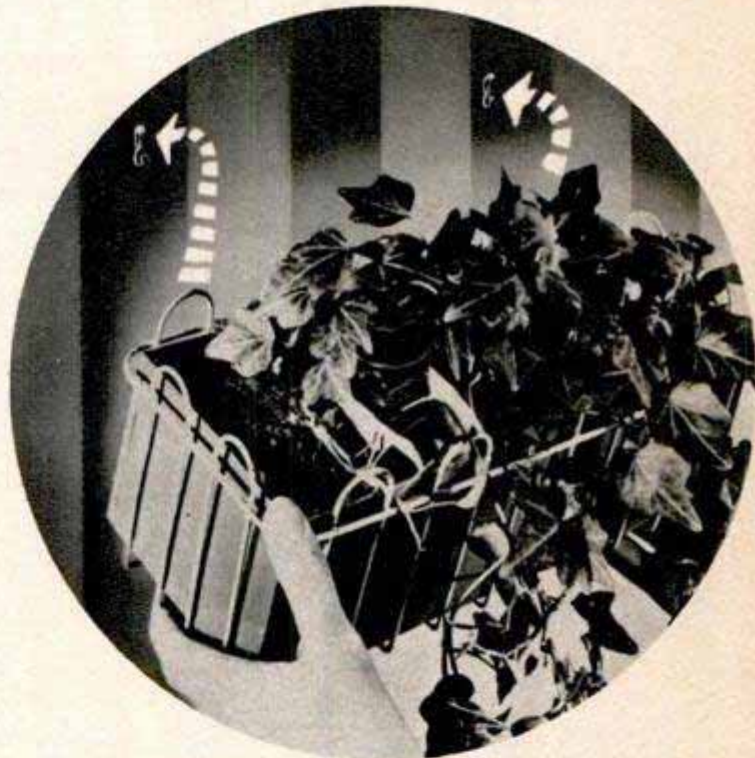



## Ambulance With Wings

Standing by on airfields throughout Saskatchewan, Can., are plane ambulances, ready to fly anywhere on the prairies to pick up medical patients who must be rushed to a hospital. The ambulance service is operated by the government and may be called into action by any doctor or responsible citizen. The plane closest to the patient then is dispatched and makes a landing on any reasonably level field in the vicinity. A nurse accompanies each air ambulance. The patient is carried on a stretcher which is loaded through a wide cargo door and secured to the cabin floor. The interior also has three seats for the nurse and relatives of the patient. If



Top, left, local doctor and farmer wave flying ambulance in for landing. Top, patient on stretcher is hoisted through wide door. Above, winged ambulances always stand ready for emergencies

required, a second stretcher can be substituted for two of the seats and a third patient can be carried on a mattress on the floor. Skis are used instead of wheels on the landing gear throughout the winter.



## Auto Tray

Eating in an automobile is a pleasure instead of a juggling act with an aluminum tray that attaches to front or rear-seat backs. A simple ratchet setting adjusts for either seat and rubber-sleeved arms protect the seat covering and hold the tray firmly. The tray was designed chiefly for drive-in eating places, but it can be used on outings and for travelers who like to eat in their cars.

☞ Tides flowing over the earth produce a friction which is slowing its rotation at a rate that will make the day a second longer in 100,000 years.



Ring of flame leaps up around the veteran oil truck. Crewmen of the new airport crash truck, upper right, watch fire spread

## BLANKET OF FOAM SAVES TRUCK

For five years fire engineers have been trying to burn up an old oil truck, but each year a blanket of foam foils the flames. Recently, during the demonstration of a new 12-ton airport crash truck, the oil truck and the surrounding area were doused with 200 gallons of high-octane gas and fuel oil. When the fuel was ignited, fire and smoke obscured the truck. Then fire-protection engineers smothered the flames with a blanket of carbon-dioxide gas and foam. Multijet nozzles deliver the gas at a rate of 800 pounds a minute and the foam at 2400 gallons a minute. Within 45 seconds, the fire was out and the truck was intact without even a flat tire.



With black smoke swirling around truck, crew unrolls equipment. Below, left, after 30 seconds of action, a fire-smothering fog hides truck. Below, fire out, the truck is plastered with foam



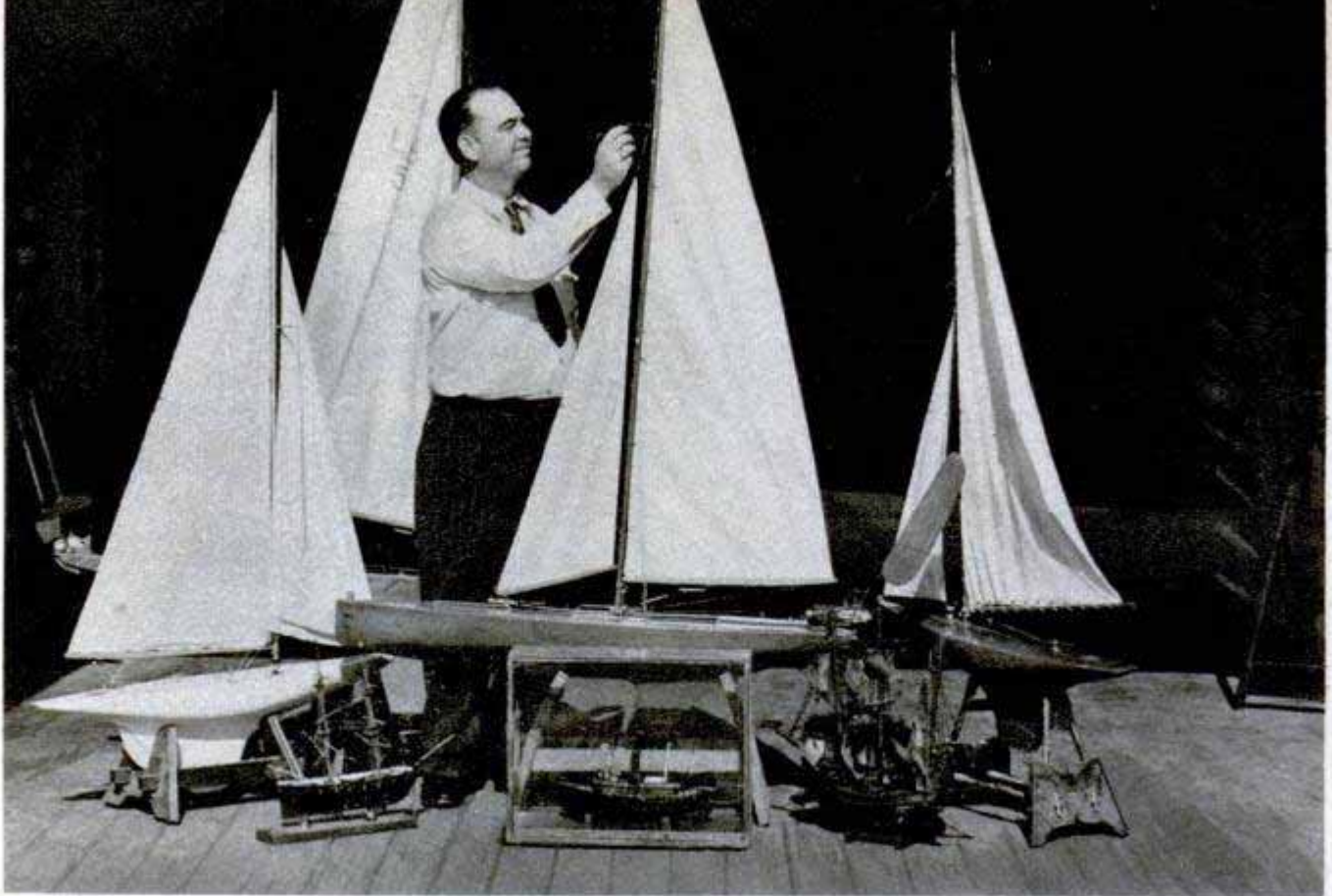

Roberts rigs model sailing boats which will appear full size on world's screens through Hollywood magic

## Hollywood Boatman

By Andrew Hamilton

**W**HO IN ALL Hollywood knows more about boats, rigging and equipment than any other one man?

You'll be wrong if you name Charles Laughton because he played Captain Bligh in "Mutiny on the Bounty." You'll score a clean miss if you pick John Ford, Victor Fleming or Tay Garnett, all of whom have directed many sea pictures.

The man you should choose is Benton Roberts, a 46-year-old industrial engineer, musician and graduate of Penn State. He has supplied boats and nautical equipment for more than 1800 Hollywood epics since 1931—approximately 100 pictures a year. What started as a sideline, today provides Roberts with a profitable livelihood for himself and a crew of three to nine men.

"People find it hard to believe that approximately 100 motion pictures containing boat scenes are made each year," Roberts says. "But it's true. Of course, some have boat scenes that are short and unimportant, but others like 'Captains Courageous,' 'Mrs. Miniver' or 'Mr. Peabody and the Mermaid' require weeks of shooting."

If the script calls for a Venetian gondola, Roberts has one that he can truck over to

the studio right away. If a director needs a couple of English longboats, he yells to an assistant who telephones Roberts. If it's a West Indies houseboat that's required—complete with pigs inside and chickens hanging from wire baskets over the gunwales—Roberts can supply it.

Over the past 18 years he has built up a fleet of more than 60 boats of all kinds, shapes and vintages. These range from a sleek, \$20,000 Chris-Craft (which has appeared in more than 50 films) to a crude South American mahogany dugout. In between are dories, dinghies, African war canoes, cabin cruisers, Eskimo kayaks, sampans, English punts, American racing shells, yachts and French longboats. Roberts calls them "character boats." The term is used in the same way that a certain type of actor is called a "character actor."

During World War II the Office of Strategic Services thought so highly of Roberts' collection they bought four of his Philippine-type native canoes. The OSS didn't say what would be done with them. Roberts didn't ask. But a \$600 check was promptly signed and the OSS whisked the canoes away. More than three years later they

were returned. Roberts has reason to believe that they were placed aboard U. S. submarines, taken into the Philippines and used for supersecret intelligence work.

As an engineering student at Penn State, Roberts had no intention whatever of winding up in the boat-brokerage business. But after graduation he came to California and took a job in the engineering department at Hal Roach studios. For several years he was a technician for "Our Gang" comedies. He built such trick props as an automobile that looked like a submarine and an old jalopy that fell apart like the one-hoss shay.

Then came sound motion pictures and the depression. Roberts took a job as pro-

prietor of the West Basin Yacht anchorage in the Los Angeles harbor.

One day M-G-M telephoned and said they needed a couple of yachts for a picture they were making — "Fast Life," starring William Haines. It was easy for Roberts to arrange a deal with the depression-hit yacht owners whose boats were tied up in his anchorage. M-G-M paid them a rental fee; they turned it over to Roberts.

"That was the start of it all," he says. "I worked several pictures for M-G-M. They recommended me to other studios. I've been busy ever since."

As additional orders came in Roberts began to purchase more boats and equipment. He plowed the profits right back into the

Much of Roberts' know-how went into building of the brig, *Pilgrim*, for the movie "Two Years Before the Mast"

Paramount Pictures photo

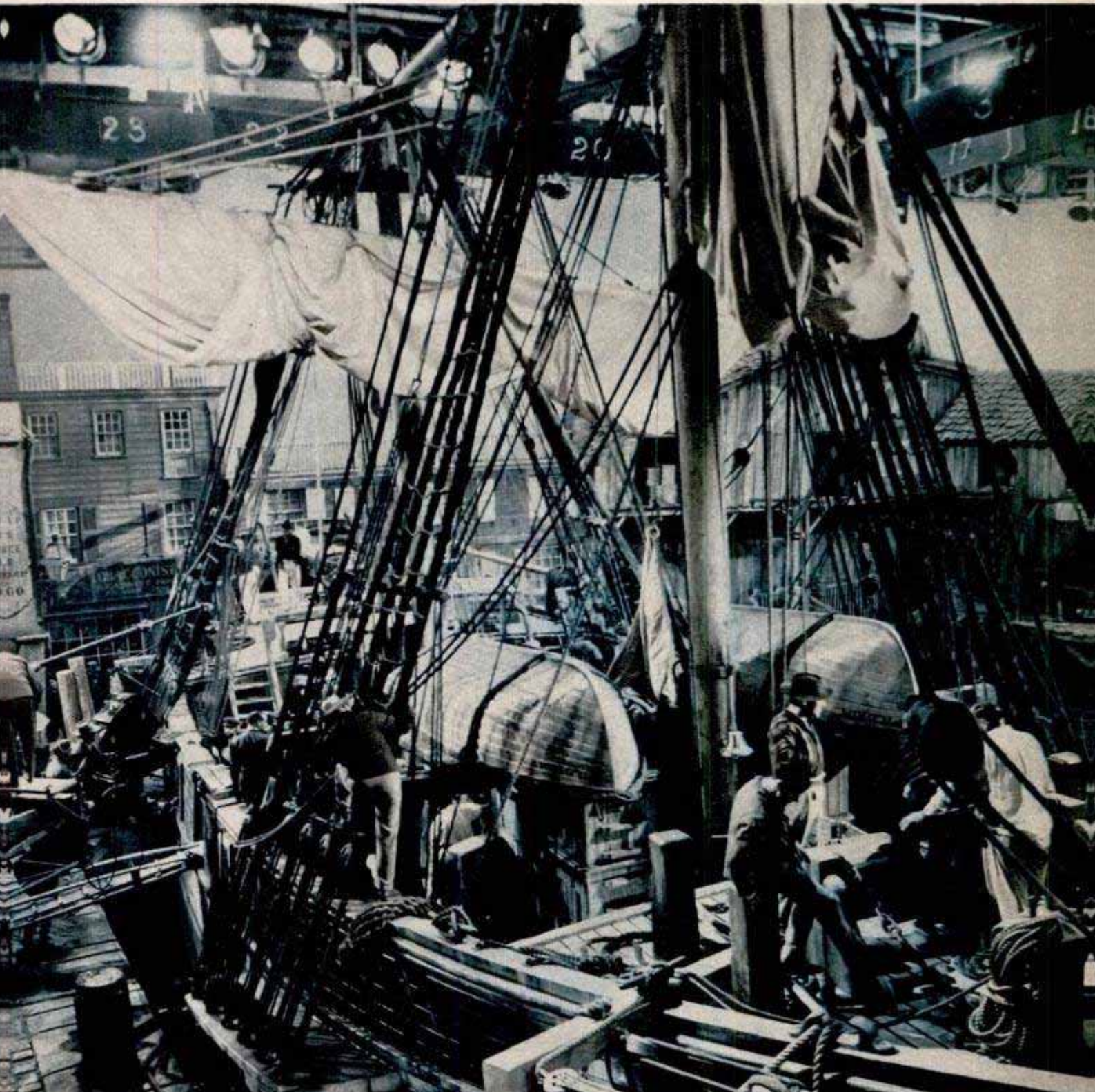

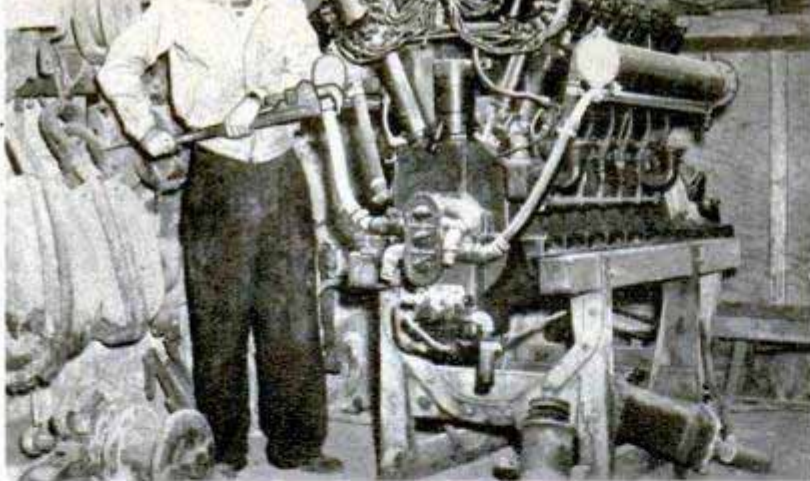

Assistant works on Roberts' 1918 Liberty engine, used when the movie script calls for shot of prohibition-days rum-runner engine.  
 ↓ Director of a motion picture may need an armada of small boats, so Roberts keeps several outboard motors on hand at all times



Roberts furnished sloop for movie "Lydia." Water in immediate background is real, breakwater is artificial

business. By 1943 he had collected so much stuff that he had to move from the West Basin in the Los Angeles harbor to Lake Machado, a small, marshy lake about half a mile inland.

There he built a combination warehouse, boathouse, repair shop and dock in which to keep his boats and equipment. On the ground floor he stores his most valuable boats. The loft is chock-full of rigging, sail and hardware. On the basement level, which opens toward the lake, is the outboard-motor shop.

His headquarters is practically a nautical museum. All three floors of the 40 by 100-foot building are overflowing with equipment of many types: lanterns, anchors, oarlocks, oars, boarding ladders, rope fenders, fishing gear, cargo nets, gaffs, binnacles, cork floats, dip nets, fishing jackets, boots, cargo lights, wheels, and capstans — almost anything imaginable that could be connected with boats or the sea.

How much is all this worth?

Roberts takes a long look around: "I dunno. Maybe \$100,000—maybe more."

Not long ago the director of the Harvard Museum was in

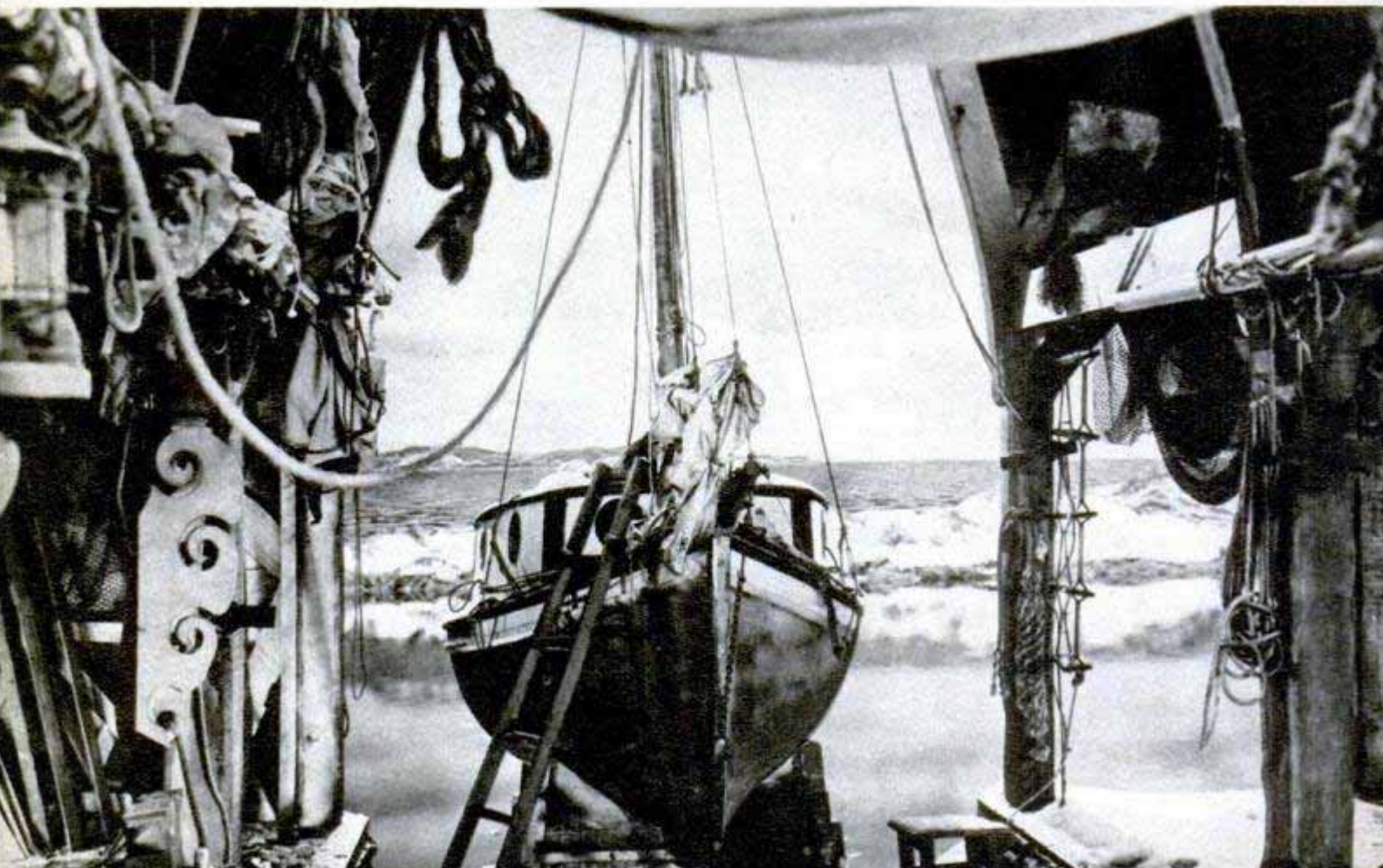



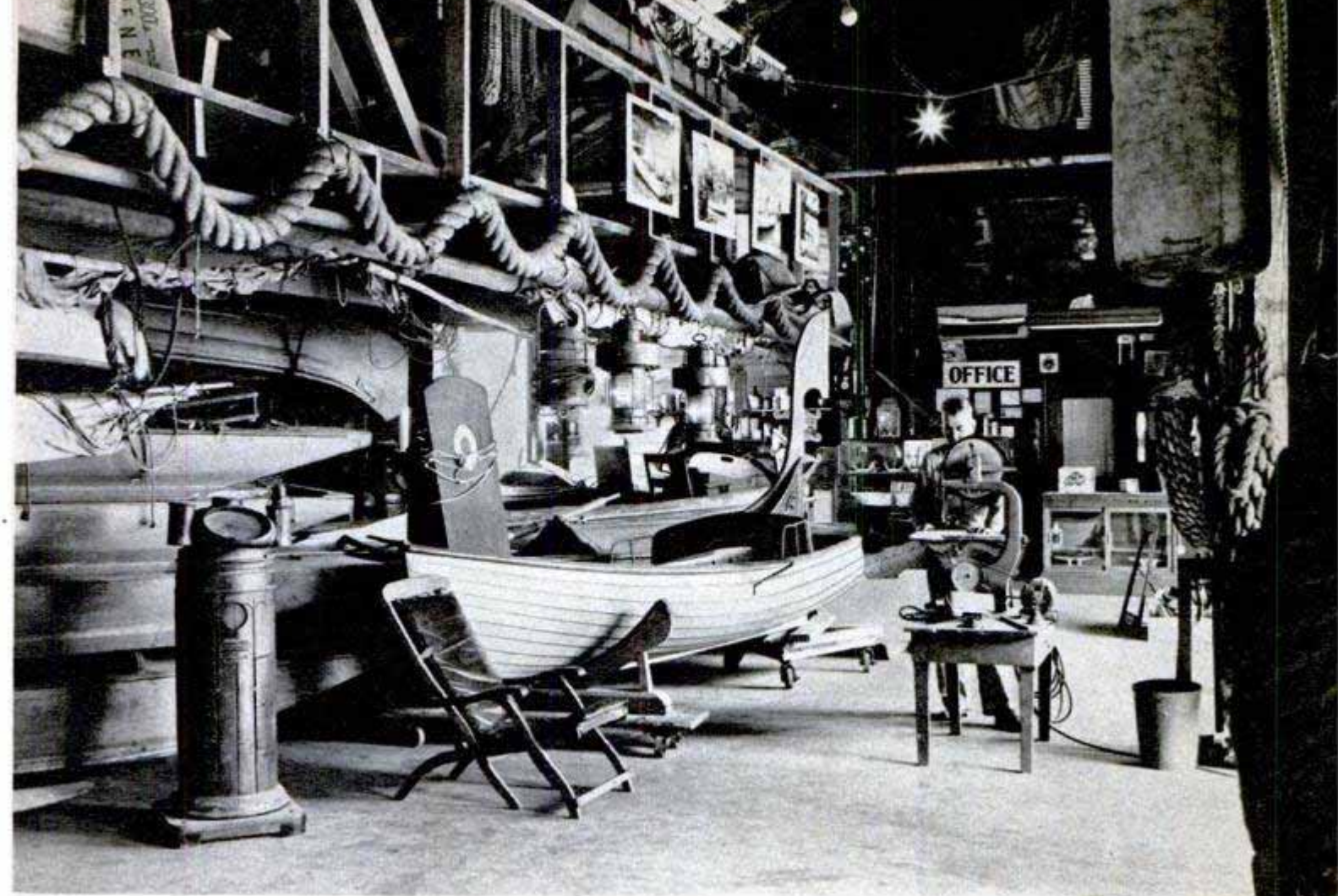

southern California. He heard through a friend that Roberts had "quite a collection of boats." He was interested because the Harvard Museum also collects boats of historical interest. But when he saw Roberts' extensive array, he shook his head enviously. "Harvard doesn't have anything like this."

Roberts works on a businesslike basis when he is dealing with Hollywood studios. He never sells, always rents. His terms are 10 percent of the value the first week, 5 percent per week thereafter. Charges range from \$45 a day for a speedboat to 25 cents a week for a life preserver.

"Actually, I try to save the studios money," Roberts says. "I know it is easy to cut budgets on an expensive picture by red-penciling the boat sequences. If I can show a director how to save money shooting a scene, he'll want to work with me next time."

Roberts' boats are used both inside the Hollywood studios

About \$100,000 worth of boats, engines, rigging and other nautical equipment is stored in Roberts' three-story boathouse. Below, war-heads for native canoes are spruced up with a new coat of paint

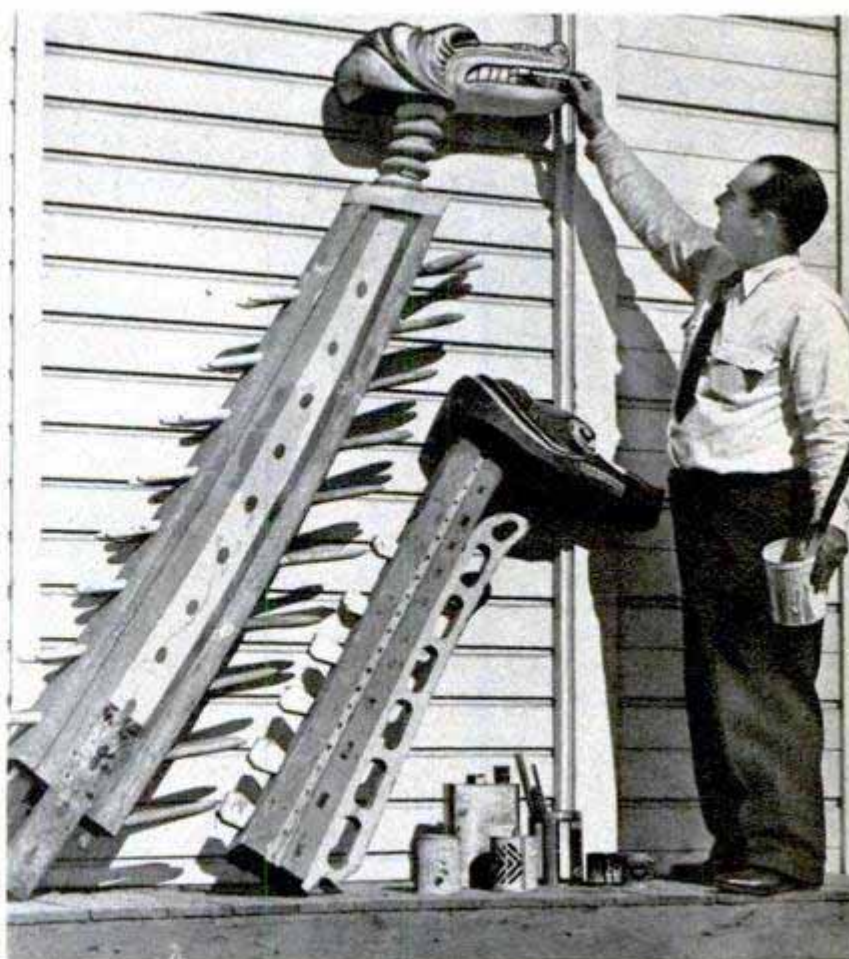

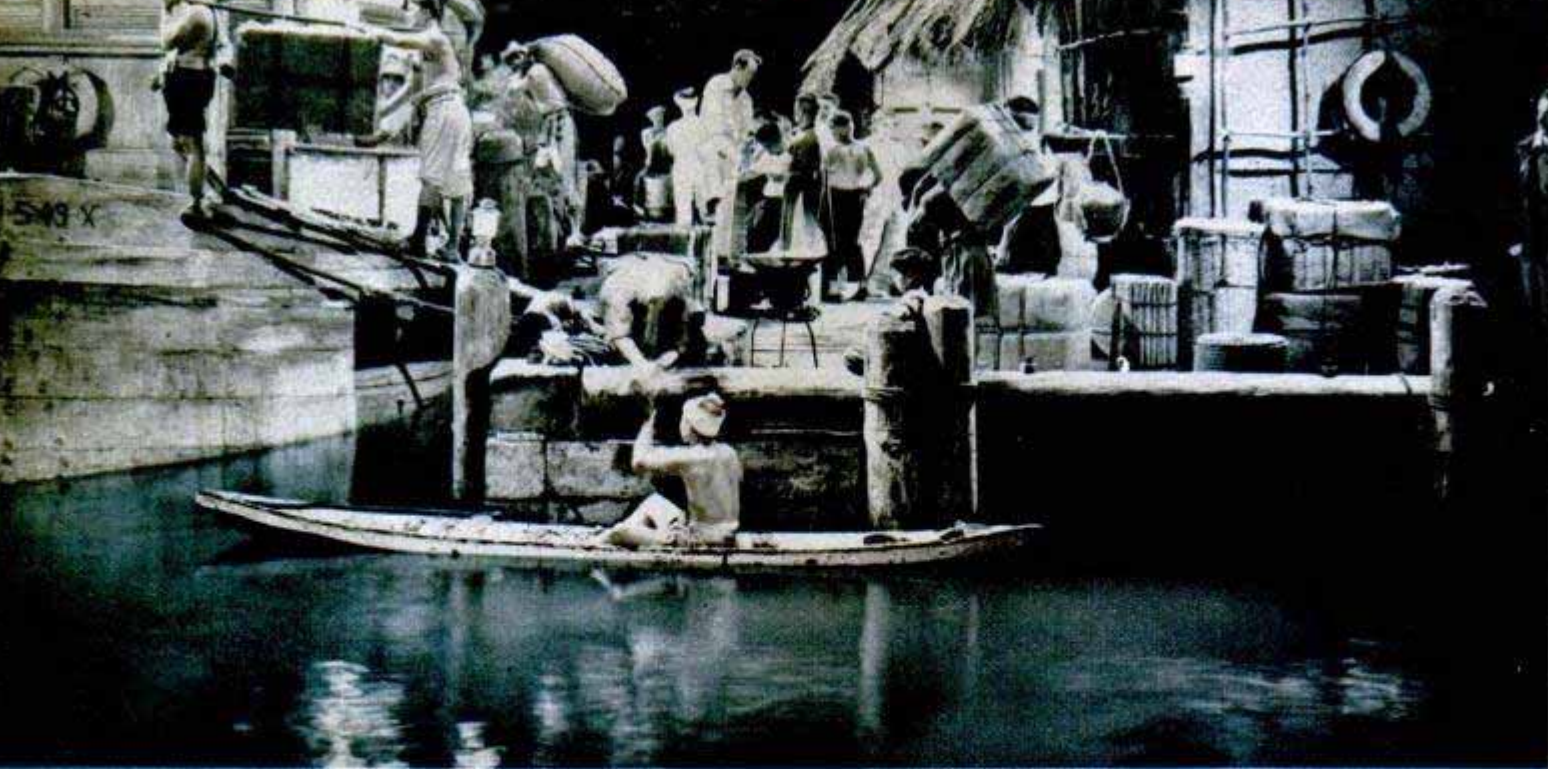

Paramount Pictures photo

For the picture "Saigon" Roberts furnished small native canoes, lanterns, life preservers and coiled rope

and on outdoor locations. Where only a close-up of the actors or the boats is required, shots are taken in studio "tanks" (small, artificial ponds) or "process shots" (against a screen that depicts an open sea, a roaring river or a South Sea dock). But where more of the background is required, Roberts' boats may be trucked to an appropriate outdoor setting. His craft have been shipped as far away as Maine, Canada, Louisiana and Mexico.

Roberts' biggest picture was "Captains Courageous," but his toughest was "Mrs. Miniver."

When the Grand Banks scene in "Captains Courageous," starring Spencer Tracy, was shot off Huntington Beach in southern California, it was a three-week job. Roberts rounded up 100 dories and 14 yachts, repainted or covered the superstructures with black paper so they would resemble fishing schooners.

"Much of that picture was shot on location," he says. "The expense of the rented yachts was terrific. We began shooting early in the morning and continued until late at night. Early one morning a blow came up and all 100 dories broke loose and were scattered along the southern California coast. That's one reason boat scenes are expensive!"

Here's what made "Mrs. Miniver" the toughest picture: M-G-M telephoned one afternoon at 4:00 p.m. and requested Roberts to have 50 boats at the Culver City studio by 6:00 a.m. the next morning. This was during the war, when transportation and gasoline were severely rationed.

Bets were wagered at the studios that

"this was one job Roberts couldn't pull off." But he is a resourceful individual with many friends. The boats were on the set at the appointed time and the shooting went off on schedule. In the script it was only a four-line scene, but it's the one that most people remember from that picture—the evacuation of Dunkirk. Roberts staged it for \$56 under his \$13,000 budget.

A good measure of Roberts' success is due to the fact that he can convert his 60 boats into several thousand different types by altering the sails, changing types of

(Continued to page 254)

Roberts, leaning over the bow, helps M-G-M camera-man rig camera for a low-angle shot just above water



## Machine Shop Unfolds From Truck

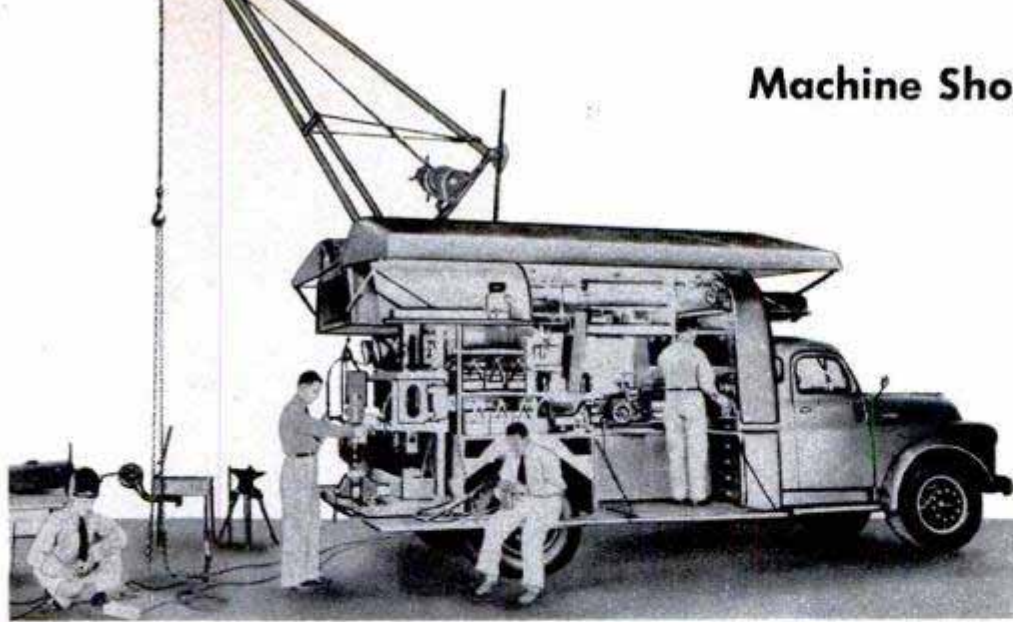

Equipped with all major machine and welding tools, a shop mounted on a truck body can cover on-the-job repairs over a large territory. Sides and catwalks fold out from the welded steel body to give protection to the crew in any kind of weather. A drill press, vise and electric grinder are located at the rear. Welding equipment, a lathe, an arbor-press frame and a 50-ton hydraulic jack are built into the truck. Above the shop is a swinging crane with a one-ton hoist. Optional equipment includes a carpenter's kit, blacksmith tools with a forge and anvil, and general shop tools. City electric lines can supply the power or it can be obtained from the truck engine through a power take-off. The engine also provides d.c. for welding.



Top, left, swinging crane with a one-ton hoist can be raised above the mobile shop to handle heavy equipment. Top, workman can stand on catwalk, protected from sun and rain by raised sides. Above, shop folds into a fast-moving truck between jobs

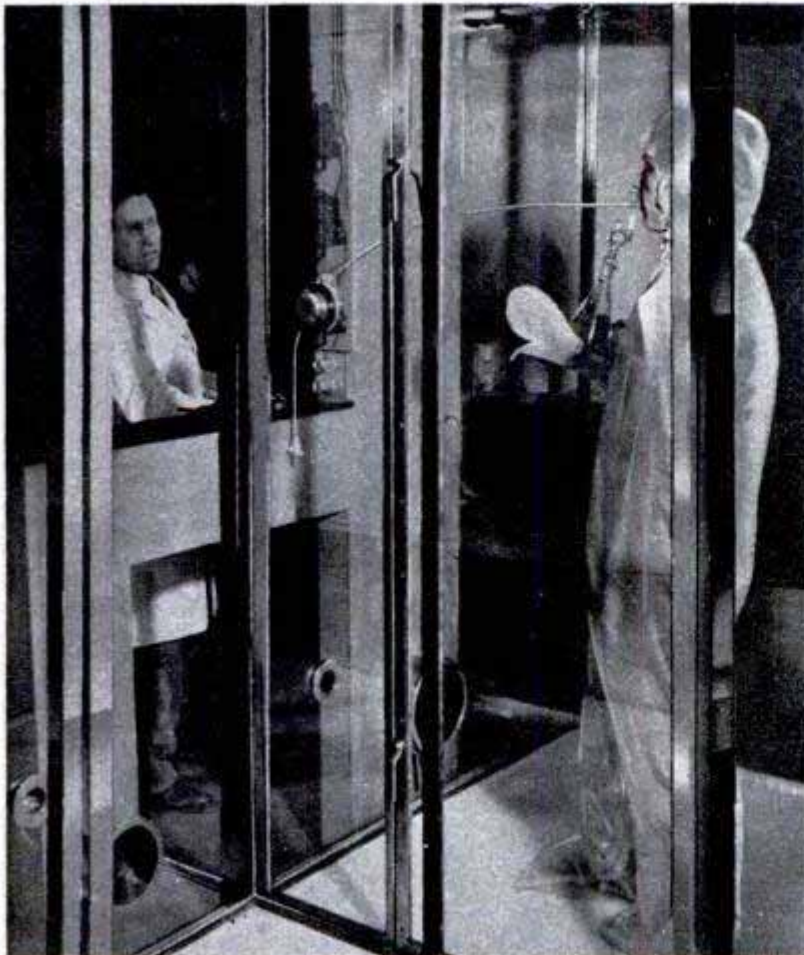

## "Odorproof" Glass Cage Tests Sense of Smell

Smells are studied scientifically in a "smellproof" glass cage at Cornell University. The cage is used in research aimed at uncovering the mysteries of the human olfactory system. The subject must bathe in a detergent, deodorize his nose and throat passages and put on an impervious, Fiberglas suit before being tested. He breathes isolated odors from a glass vial and exhales through a glass tube which pipes his breath into testing instruments. The research is expected to have immediate practical application in the air-conditioning field.

☐ American fur trappers and fur farmers produce about 30 million pelts a year, of which about 5 million are obtained from animals raised in captivity.



WHEN HIS SHIRTS wear out, Harrison Elliott doesn't discard them—to him they have a worthwhile future as raw material for his handmade paper. The New York hobbyist has a papermaking workshop in his home where he produces a variety of beautiful paper that is prized by collectors. Although he prefers to use new cotton and linen fabrics, Elliott has produced excel-

lent paper of unusual textures and colors from his castoff shirts and other garments. Since he is connected with the paper business professionally, his hobby is a sort of postman's holiday to him. However, as shown on the following pages, Elliott likes nothing better than to spend an evening in his home workshop producing fine papers of his own design and manufacture.



Elliott starts the process of converting a castoff shirt into fine paper by cutting the garment into many small pieces. The sharp blade of this cutter speeds the task. The buttons were removed earlier



Rags are placed in this tub where the motor-driven beater converts them into a fibrous mass. It takes several hours to complete the process. Elliott is examining the pulp which is still in threaded state

Beater roll with cover removed to show stainless-steel blades, which revolve against the corrugated bedplate, pounding the pieces of cloth into a pulp

Thoroughly beaten, the pulp is placed in a vat and stirred. Then this mold is lowered into the mixture and lifted out, covered with a thick sheet of pulp

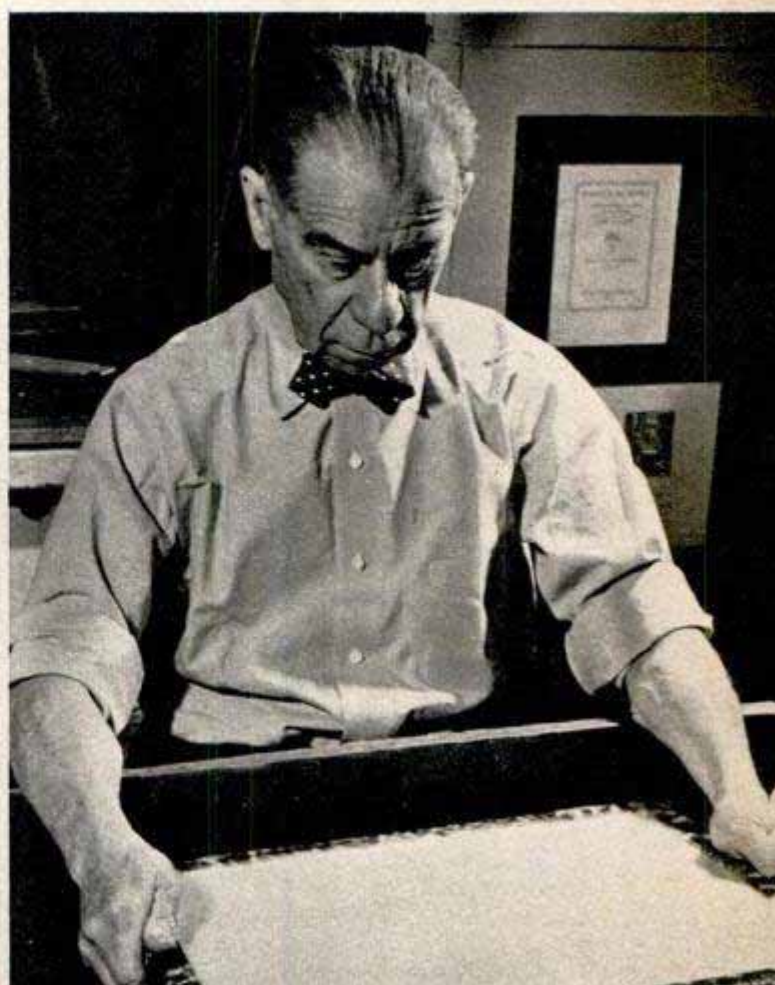



Elliott inspects the watermark design on the screen of a hand mold. The design is formed with fine wire

When pulp is removed from mold it looks like this. Design of the watermark shows up clearly in photo

This step, known as couching, consists of tipping the mold upside down, depositing the pulp on felt





Elliott produces many unusual papers. To make this sheet, he embedded leaves in the pulp during molding

After pulp sheets have been couched, they are placed under a hand press to remove moisture. Press is also used when the paper sheets, after sizing and drying, are squeezed between metal to produce smooth finish

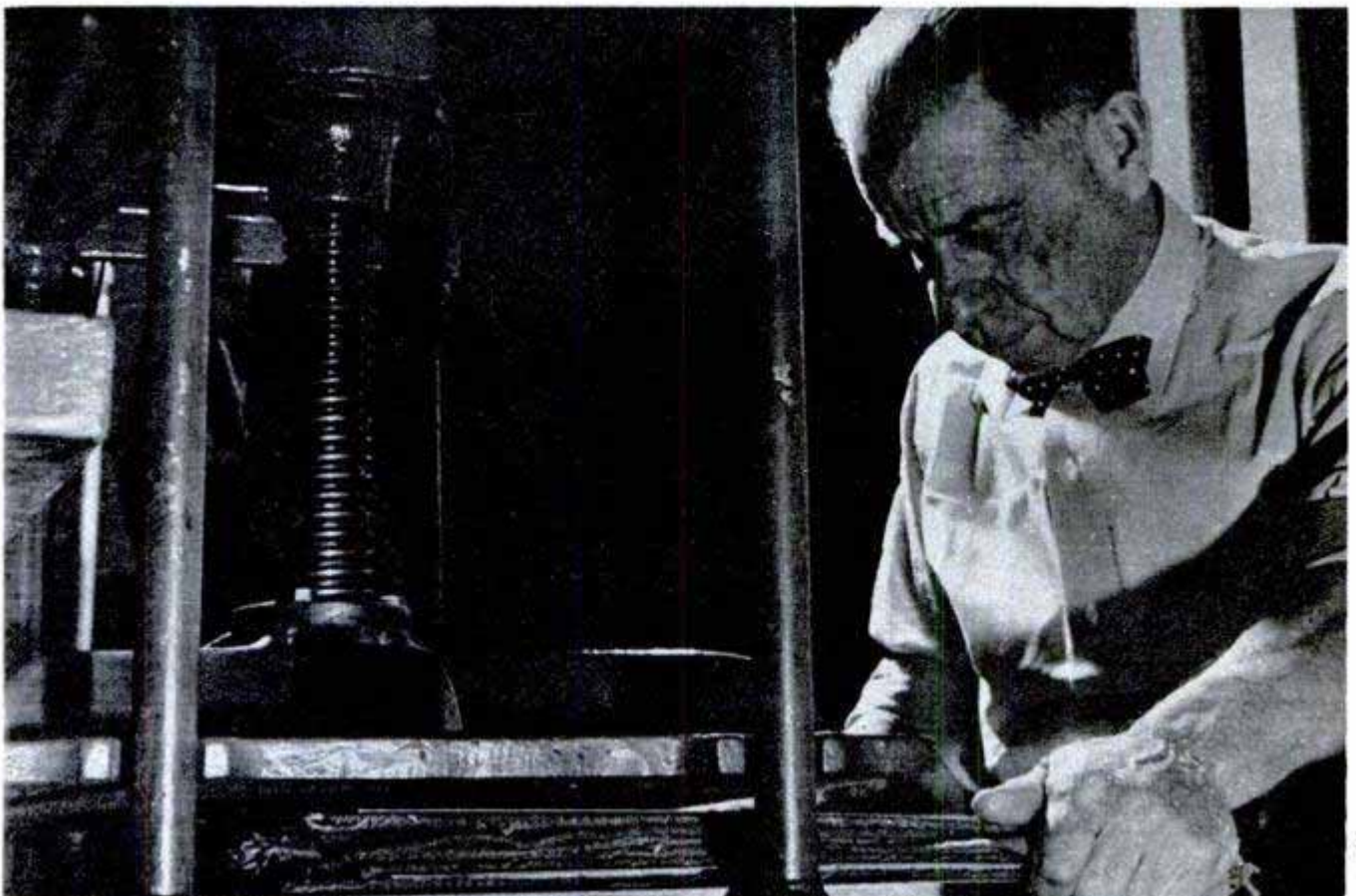

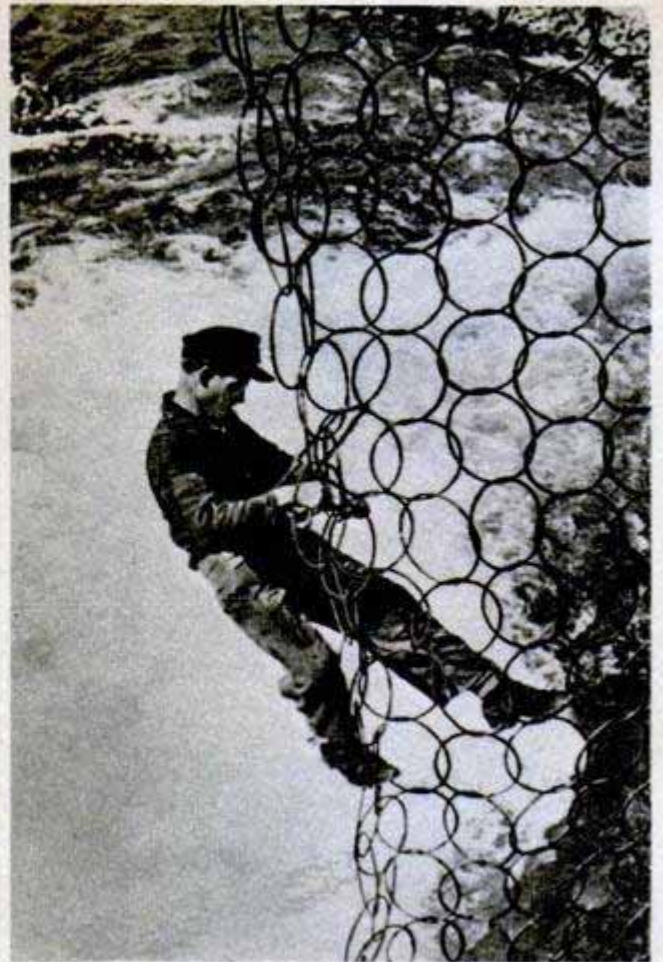

**TAKING DOWN THE SCREENS** is a risky operation when there are 250 tons of them suspended high above a roaring river. But to a former German parachutist who has the job, it is just a way to earn a living. The heavy screen, consisting of large steel rings linked together, was stretched along the top of a big dam in Westphalia, Germany, to protect the hydroelectric installation from destruction by Allied bombs. When bombs fell into the screen, they would explode before striking the retaining wall. Because of the steel shortage in Germany, the 250 tons of screen had to be dismantled. The former soldier doesn't seem to mind his unenviable task of scaling the nets and attaching draglines with which the screens are pulled down

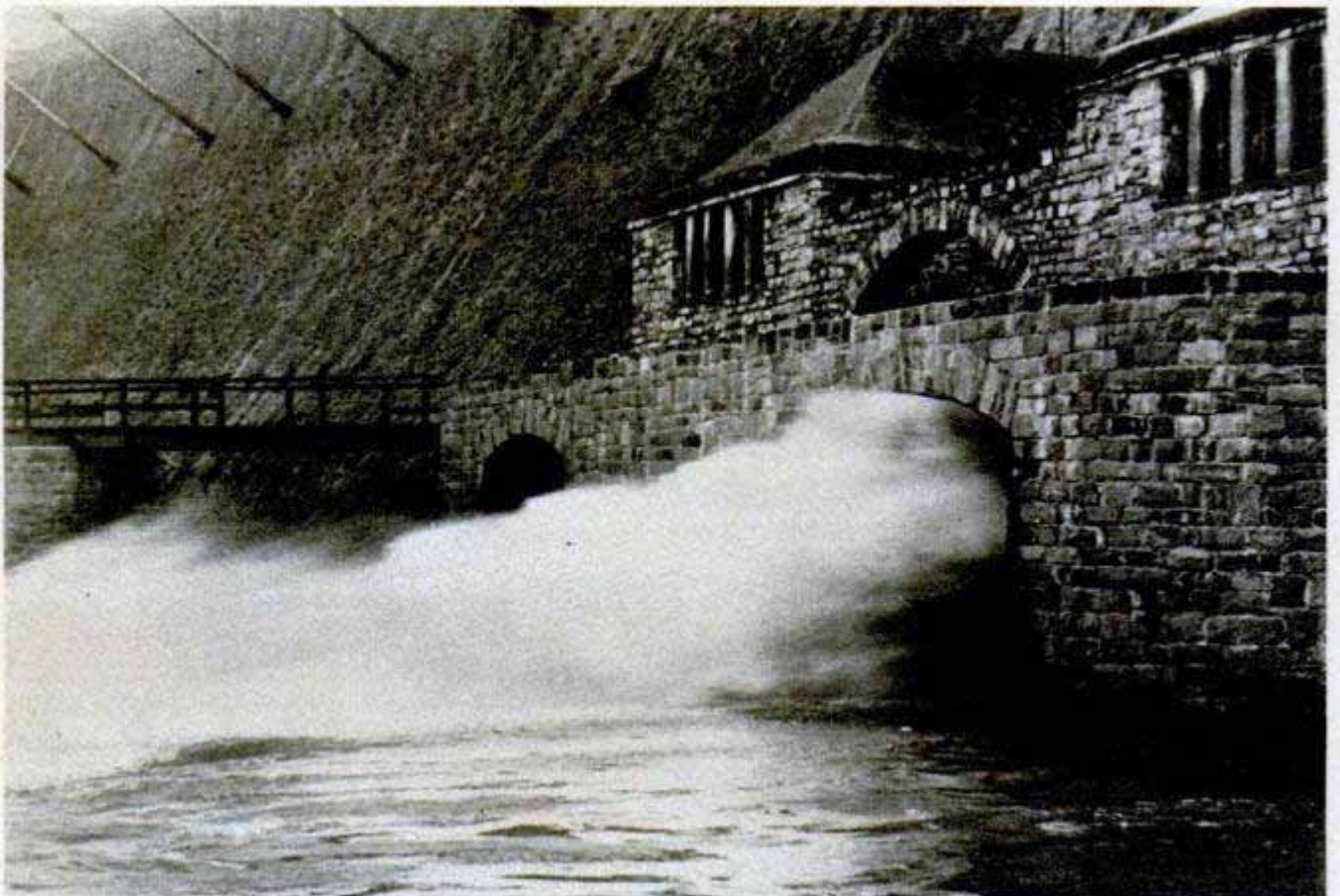



## Picnic Lunch Box Serves as a Table

Picnickers can carry their own table with them in the form of a handsome carrying case that opens to form a sturdy table on which to serve the lunch. Packed for travel, the case holds two large vacuum bottles, eight plastic cups and two metal sandwich boxes. Four hinged legs for supporting the table fold inside the case, which is covered with a durable canvas duck.



## River "Paddle Boat"

Paddling 45 miles a day along the river is not hard work for John Stemle of Jasper, Ind. He does it frequently in a single-seated paddle boat he built for less than \$60. The paddle wheels, each two feet in diameter, are made of welding rods and fitted with small blades. Fenders keep the water from splashing into the canvas-covered craft. He cranks the paddle wheels by hand with an old bicycle frame mounted upside down in the cockpit.



## Portable Saw Cuts Tile

All types of ceramic tile may be cut on the job with a portable tile-cutting machine that employs a high-speed diamond-faced saw with a peripheral speed of 7000 feet per minute. The motor and saw are on an overhead swing-type mount that facilitates control. All moving parts are above the work and chips and dust are washed away by the stream of water that serves as coolant for the saw blade. Jigs for holding various odd shapes of tile are provided and the machine may be adjusted for any desired cutting angle. The tile cutter weighs 80 pounds and may be used for cutting cemented pieces, optical glass and similar refractories.

¶ Instruments capable of measuring deflections as small as 1/1,000,000 inch are used by engineers in testing concrete pavements.

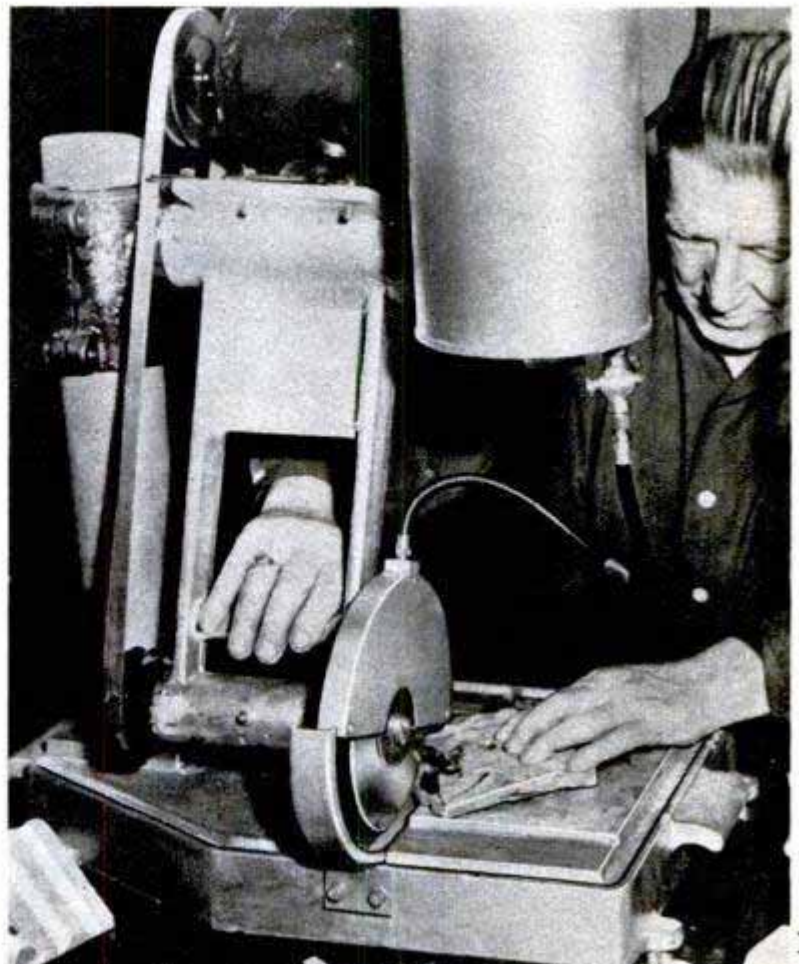

# Hen Tracks on Sound

Artist in sound uses only brush, pen and ink, spacing the dabs and marks by a guide chart under the film

He converts music into photographic terms. The white lines fanned out on black cards make a musical scale



WITH ONLY a strip of celluloid and a brush, Norman McLaren can create jazz music, the sound of a galloping horse, a burp or any other strange noise. McLaren is the one-man producer of the National Film Board at Ottawa, Canada's capital.

As McLaren puts it, he "makes hen tracks on sound tracks" or draws his sounds directly on movie film. The usual procedure in making a sound track is to pick up the sound through a microphone, then convert it into light and dark areas along the edge of the film. When run through a projector, this optical track is reconverted into sound through an amplifying system.

McLaren's method short circuits all these stages. All he does is make little black dabs with a pen or brush on the film. But they aren't just random dabs of ink—they must follow a special pattern and fit into a space less than  $\frac{1}{4}$  inch wide. If the sounds are to be loud he draws them with heavy strokes; if he wants them softer he reduces their size. All the dabs and wiggles must follow a mathematically precise pattern. To produce middle C, for example, he must make about 11 dabs for each picture along the film.

He also is experimenting with sound drawn on cardboard and later photo-

graphed on the edge of the film. In this method, the wave forms can be drawn as large as desired and reduced to the proper width when photographed. This makes it possible to build up complex sound patterns, thereby giving greater flexibility to hand-drawn sounds.

When he is making a musical track, he translates each musical note into photographic jargon on what he calls a "dope-sheet." The pitch, value, time and strength of the notes are converted into a table of technical terms.

McLaren's sound tracks are used with movie cartoons and other short subjects with such good results that the sound often steals attention from the picture itself. One film is a Baron Munchausen fantasy which depicts an upside-down world with upside-down sound. The hand-drawn sound is crammed on the film with fantastic results. Among his other numbers are a Bach rendition that sounds as if it were played on a buzz saw and "Pop Goes the Weasel" on an electric organ.

The artist's idea is not to copy existing sounds but to make new sounds which can't be obtained in any other way. Most of his sound tracks are, as he puts it, "a symphony of burps and rude noises" which produce hilarious results.

# Tracks

McLaren paints a scale on card. Each wavy strip is a different note but has the same tonal quality

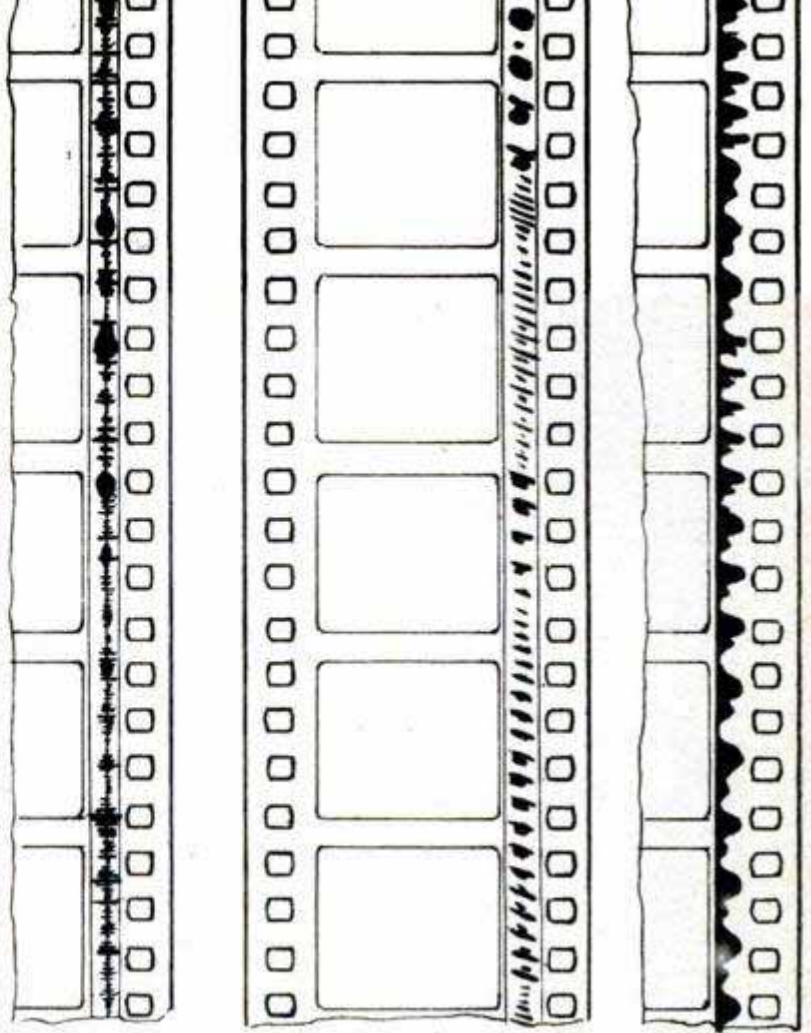

↑ Left strip is conventional track, other two are hand-drawn. Below, animation camera shoots sound on a card





### Self-Righting Life Jacket

Unconscious victims of sea disasters can't float face down in the water when they wear a self-righting life jacket developed in England. A gas cylinder inflates



the jacket and the air pocket supports the wearer face up on the surface. The jacket can be slipped on and inflated in less than 10 seconds. A canvas handle on top of the jacket permits rescuers to lift an unconscious survivor from the water.

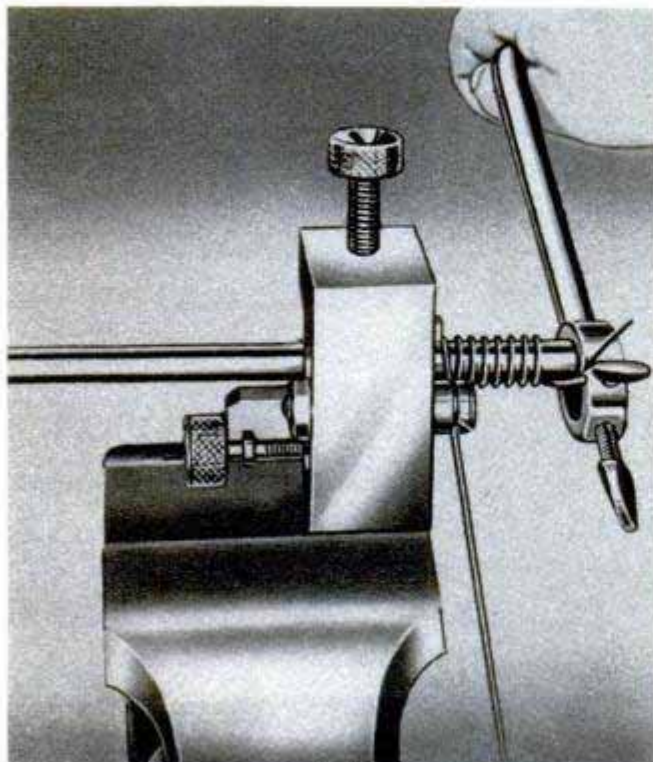

### Spring Winder

Springs of any size up to one inch can be turned out with a winder that is held in a vise. The winder, which can be operated by an inexperienced worker, uses wire up to  $\frac{1}{8}$  inch in diameter, and winds springs to any length and pitch. Turning a crank winds the spring to the desired size. The winder is part of a kit which also includes five mandrels and six coils of spring wire in various diameters.

### Air Vent for Hot-Water Heating

Venting air from hot-water heating systems is completely automatic with a new valve that requires none of the preliminary soaking needed with previous types. It can be used on both forced-circulation and gravity-circulation systems, either new or existing. A selector screw, easily adjusted, provides an automatic air eliminator, manual shutoff or manual venting.



### Radio on Farm Tractor Is Shockproof

Farmers can now hear their favorite news broadcasts, weather reports and other radio programs as they operate their tractors in the field. Designed especially for mounting on farm tractors, the new radio is waterproof and shockproof. It has six tubes and a telescoping antenna.



### Garage Lift-Post Jack Rolls to Job

Two small wheels on the base permit a new lift-post jack to be wheeled to the proper position. Designed for garages, the jack has a short handle so that it can be used in confined places. It lifts at the bumper or bumper bracket and can be manipulated from a standing position. When a car has been lifted, the complete wheel is exposed to permit quick changing of tires, inspecting brakes or packing wheel bearings.

### Feeder Tees Balls For Golf Practice

Golf balls are automatically teed up for practice shots by a machine installed on practice driving ranges. The golfer deposits his bucket of balls in a cylindrical container. Each time he presses a lever with his golf club, a ball rolls down a wire track and comes to rest on a rubber tee. When the lever is released, the track springs up, away from the ball.

Arm swings upright when ball rests atop tee. Inset shows how ball rolls down track to the tee

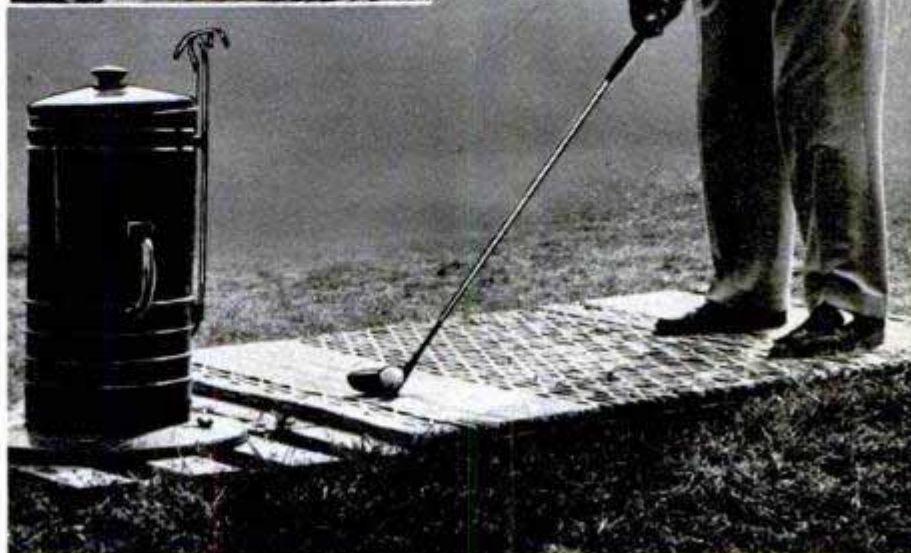

For information concerning sources of supply for commercial products described in this issue, turn to the WHERE-TO-BUY-IT INDEX (page 8), listing manufacturers' names and addresses

Slow horses have won at Aintree, but none without greatness of heart and endurance can meet the challenge of the fences and brooks that have tested the Grand National winners since 1837



A field of jumpers clears Becher's Brook which has taken a heavy toll of Aintree aspirants in the Grand National Steeplechase race

## Steeplechase Supreme

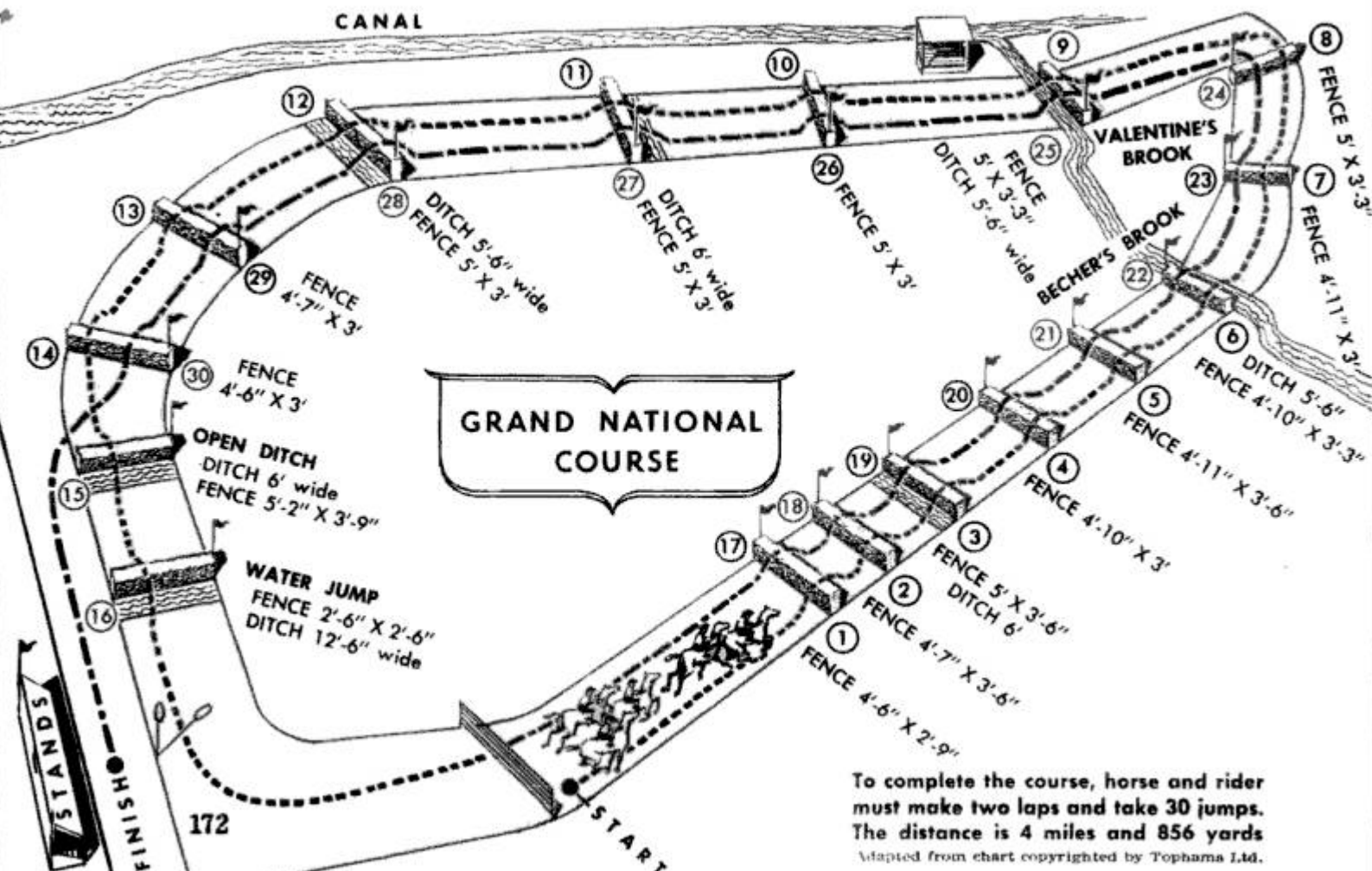

To complete the course, horse and rider must make two laps and take 30 jumps. The distance is 4 miles and 856 yards. Adapted from chart copyrighted by Tophams Ltd.

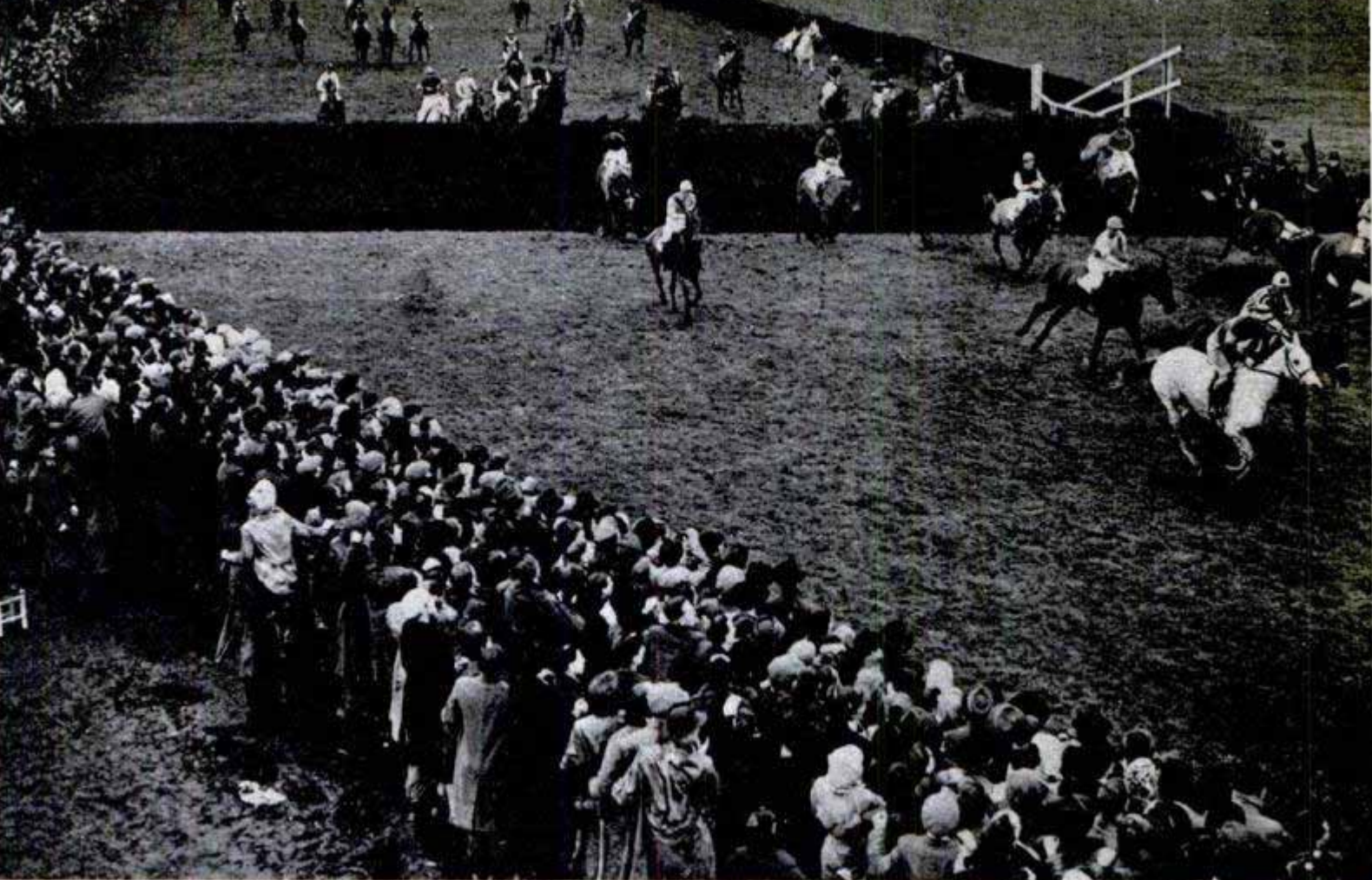

Crowd gathers along rail at deadly Becher's Brook. Horses must clear brook 5½ feet wide beneath fence

**S**PILLS AND THRILLS by the thousand have lured steeplechase fans from all over the world to the Grand National Steeplechase Course at Aintree, England. Owners of stout-hearted jumpers have traveled halfway around the globe with their entries in the slim hope they had a winner. One New Zealand horse, Moifaa, actually swam part way to England to enter and win the race. The ship on which Moifaa was being transported was wrecked off the coast and he swam ashore. That was back in 1904.

Moifaa was said to be one of the ugliest and ungainliest of horses ever to win the race. Beauty doesn't count at Aintree when the chips are down and the fences and water jumps on the second lap seem to get taller and wider. That is when horse and rider, plagued by fatigue and riderless mounts, must call upon hidden sources of endurance and courage. Some Aintree winners like Golden Miller have been real beauties and models of grace as they took the

jumps, but many have been plodders. What every Grand National winner has had to have is the heart of a champion.

Twice around this gruelling course equals 4 miles and 856 yards. There are 16 jumps on the triangular course and all except two are taken twice. The most famous of the jumps—which trainers and owners of steeplechase entries mention only in whispers—are Becher's Brook, Valentine's Brook and Canal Turn (No. 8 on the map on the opposite page).

Another thrilling moment at Becher's Brook as a favorite takes the jump





There are plenty of spills and broken bones at Aintree. On second lap, riderless horses add to the hazards

Aintree, a suburb of Liverpool Port in Lancashire, has seen this race run every year since 1839 except for three years in World War I and five years in World War II. The Grand National really started in 1837 over a course at Maghull but it was not until 1843 that the race was handicapped. From four starters in the first race — an all-time low — to a record of 57 in 1947, the Grand National has shown a preponderance of British winners. However, Battleship, an American horse and the son of Man o' War, won in 1938 in 9 minutes 29 $\frac{1}{2}$  seconds. That was within the six fastest times ever recorded for the course. Golden Miller made the fastest time in 1934, finishing in 9 minutes 20 $\frac{1}{2}$  seconds, carrying a rider who weighed 170 pounds.

The race is run in March each year, getting off amid great excitement to a straight 471 yards to the first fence. This is made of

close-packed gorse to a height of 4 feet 6 inches and is 2 feet 9 inches thick. A second similar fence an inch higher and 9 inches thicker follows. Then comes a fence of spruce 5 feet high and 3 feet 6 inches wide with a 6-foot ditch on the take-off side 2 feet 6 inches deep with a guard rail 1 foot 6 inches high in front of the ditch.

These jumps and the three succeeding are on the long straight course to Becher's Brook. Here many a man has seen his chance of winning vanish with his stake money. Becher's is made of fir to a height of 4 feet 10 inches and is 3 feet 3 inches wide. It looks innocent enough until half-way over. Then the jockey sees a ribbon of water on the far side stretching 5 feet 6 inches farther on. This is a natural brook running into a nearby canal.

There are more legends centered around Becher's Brook than any other part of

The Water Jump is 15 feet over-all. Among these entries finishing first lap are two horses without riders







An American entry (with 100-to-1 odds) clears Aintree hurdle

the course. Steeplechase followers like to tell about the great horse, Sprig, who cleared not only the fence and brook but also two fallen horses. This carried Sprig to victory and racing immortality in 1927. Sprig had competed twice before in the race as is often the case with winners.

Once over Becher's, the course bears left over another fir fence to Canal Turn at which a spruce fence 5 feet by 3 feet 3 inches leads immediately to another acute turn to the left. This brings the field to Valentine's Brook, actually a second crossing of Becher's near its junction with the canal. Although it is two inches higher than Becher's, it cannot claim as many victims.

It was at Valentine's Brook that fiery Easter Hero, known as "the greatest horse that never won the Grand National," met his doom. The cheers of the crowd followed this magnificent horse as he led from the very start of the race in 1929. But after he cleared Valentine's it was apparent that something had gone wrong. Later, in the paddock, after Gregalach had won, it was discovered that Easter Hero had spread one of his light racing shoes and could hardly walk. This horse was owned by an American, Jock Whitney.

After Valentine's comes a succession of easier jumps until the rider comes to Open Ditch. This has a fence of spruce prefaced by a 6-foot ditch that is banked by an 18-inch guard rail. The next one, Water Jump, which is 15 feet wide over-all with a thorn fence of spruce, ends the first lap. The second lap omits Open Ditch and Water Jump. Dodging around Open Ditch, the final stretch of 494 yards leads past the grandstand and tests the tired horses to find a winner.

During the 112-year history of the Grand National only 11 mares have been winners and only two four-year-olds. The three leaders are usually in the seven-year-old class. Since 1900 some 30 of the winners have been bred in Ireland, which leads envious trainers to remark that these horses have "the luck of the Irish" with them. This was true in 1928 when Tipperary Tim, who wasn't considered to be in the running, splashed through mud and rain to win. Only one other horse, Billy Barton, finished that day.

The key to success at Aintree seems to be good muscles, a fighting heart and a bit of Irish luck.

Tired horses on second lap are shown taking Becher's Brook. Sometimes only a few horses finish the race



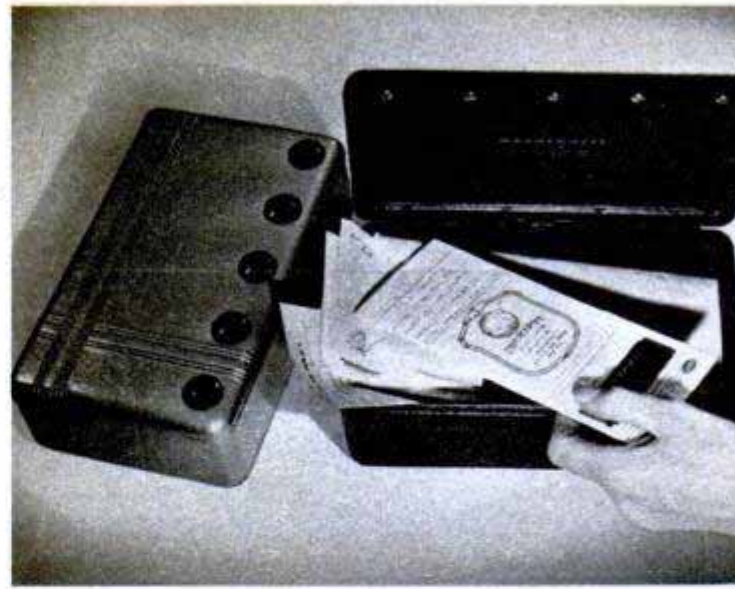

### Hobbyist Carves Monkeys From Peach Stones

Using only a pocketknife for a tool, Captain Adrien Joly of a police and fire station in St. Jerome, Que., Can., carves monkeys from peach stones. The figures follow outline of the stones and show the monkey curled up, complete with eyes, ears, hands, feet and ribs. Each figure requires about 36 hours to carve. The craftsman then fashions them into necklaces.

### Plane Pitches First Ball

Japanese high-school baseball teams started play in a tournament at Osaka with a ball dropped to the pitcher's mound from an American reconnaissance plane. It was then thrown by an American officer to a schoolboy catcher to formally open the competition. Donated by the American League of Professional Baseball Clubs, the ball had streamers attached for the drop.

Courtesy of The Osaka Asahi

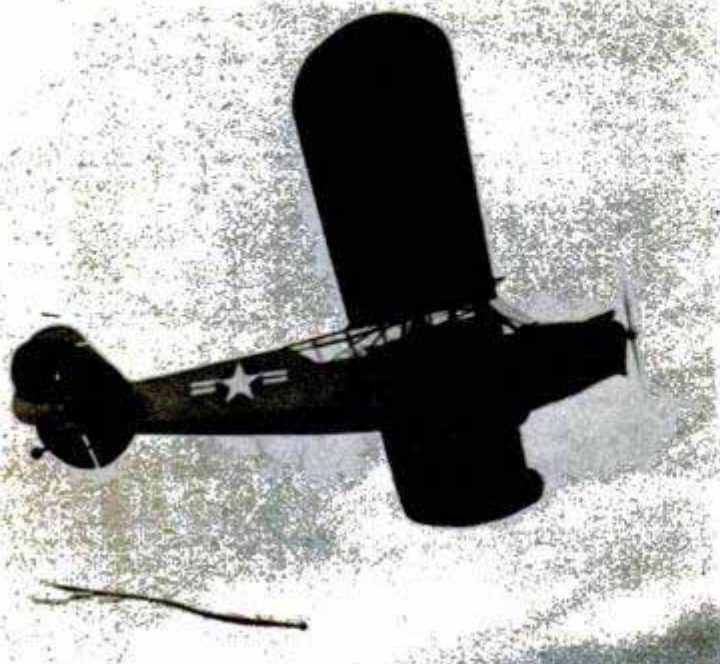

### Deposit Box Has Combination Lock

Complete privacy for your important papers is assured when you place them in an all-metal box that opens only when its five rotary locks are turned to the proper combination. Each of the locks is controlled by a plastic dial mounted along the front edge of the fire-resistant box. Small enough to be packed in your suitcase, the box keeps confidential papers and other valuables secure while you are traveling.

### Twin-Light Floodlight Unit

Using two photoflood lamps in a pair of 11-inch reflectors mounted on the ends of a bracket, a lighting unit for either movie or still cameras assures adequate illumination on moving subjects. As the photographer follows the subject with the camera, the lights do likewise. Light in weight, the unit has a convenient on-off switch just below the camera. It can be used with or without a tripod and it folds compactly for packing in a small carrying case.



## Variable-Pitch Prop Backs Up Boat

With a variable-pitch propeller for outboard motors the boatman can maneuver his craft in reverse, idle the motor in neutral or go forward at three different speeds. The propeller unit can be installed with a wrench and screwdriver. The controls are fastened directly under the gas tank.

All external parts of the propeller are made of aluminum alloy, with the bushings and drive shaft of stainless steel. If

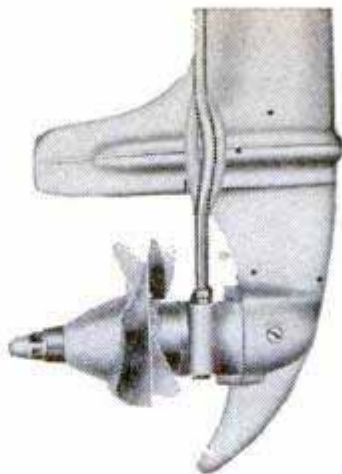

the control lever or rod is damaged accidentally, the propeller automatically moves into a forward driving position.

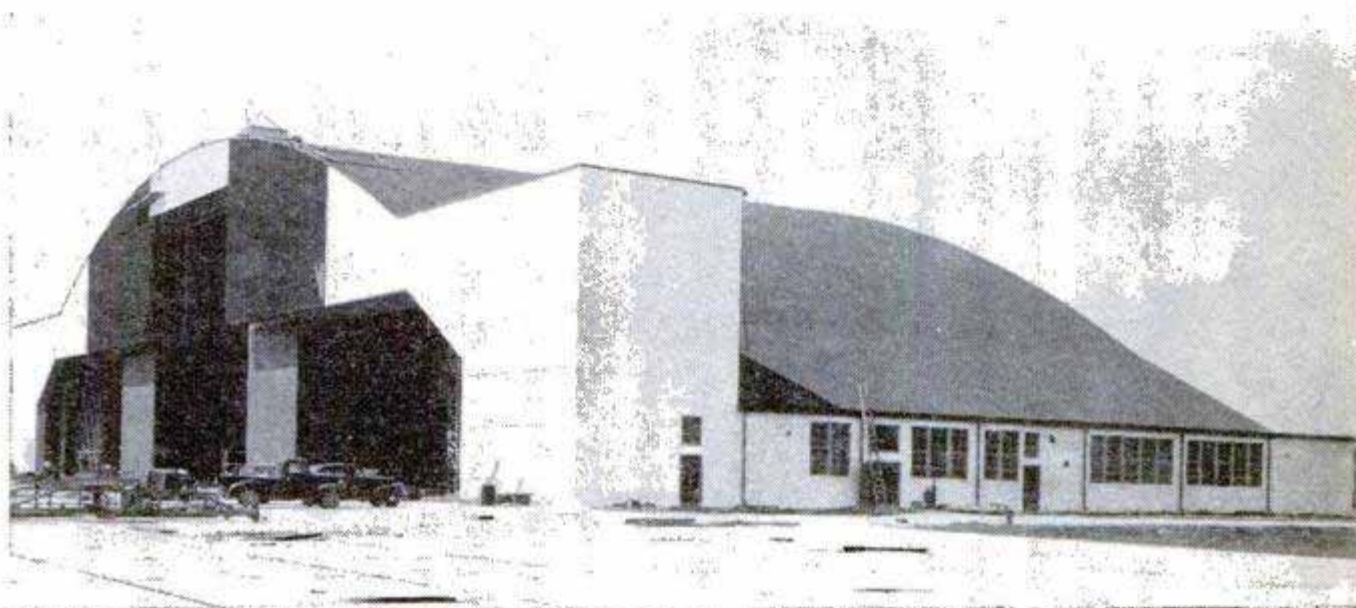

Official U. S. Navy photos

## Mesh-Wire "Cocoon" Shields Radar

Fine mesh wire covers the entire inside of the Navy's \$2,000,000 test hangar nearing completion at Patuxent River, Md. The fine wire screens out all electronic disturbances. The hangar will house the equipment for tests on radar and other electronic devices in aircraft. One of the largest shielded buildings ever constructed, it is 300 feet wide, 178 feet long and more than 67 feet high. A bay, 79 feet long and 35 feet high, will accommodate the nose of larger-type planes. Two layers of wire mesh have been laid in the concrete floor and bronze spring contacts join the shield at the door openings. Four miles of soldering were required

Fine mesh wire completely lining the interior will shield experiments within the Navy Air Test Center hangar from all electronic disturbances

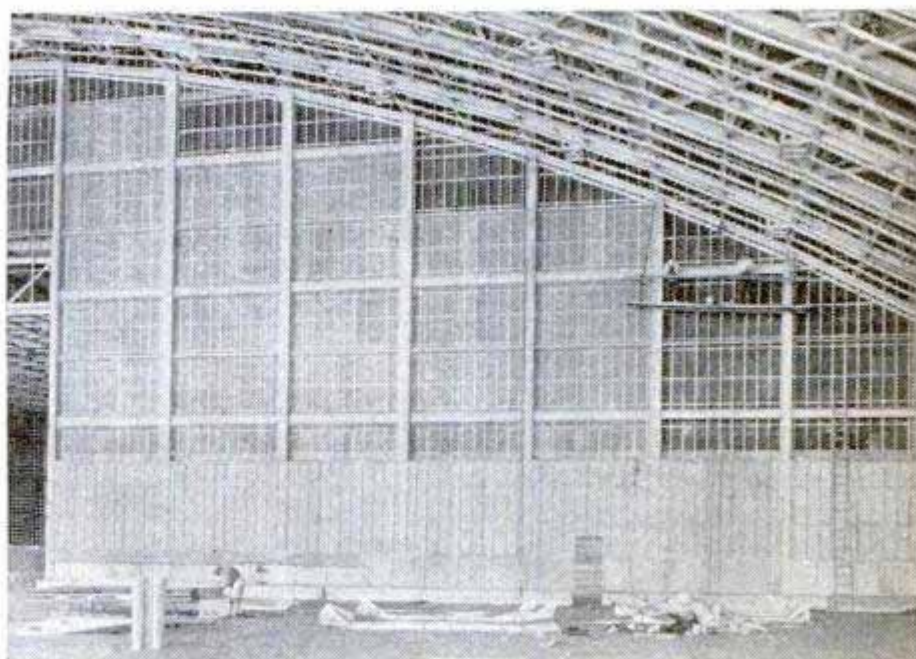

to bond all the joints in the covering. Mesh was used because it is cheaper and permits ventilation and light.

# SMOG SLEUTHS

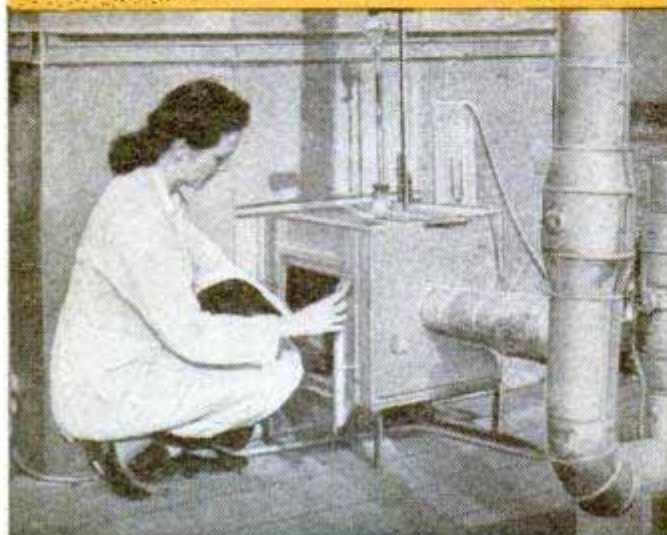

Above, attendant inspects box which generates test vapors that are blown into the smog chamber, below

EVERY DAY millions of tons of potentially deadly contaminants are poured into the air above our big cities and industrial areas. These lethal fumes are ordinarily carried off by the wind and harmlessly dissipated, but sometimes certain weather conditions combine to prevent their escape. The fumes may then descend in a poisonous cloud, causing acute discomfort and, in extreme cases, death. This is what happened at Donora, Pa., in October 1948, when a choking smog filled the narrow valley where the town is located, bringing death to 19 persons.

Smog has been hanging over industrial cities for years, but still nobody can say exactly what it is. Its name is a combination of the words "smoke" and "fog," but it is not that simple. There are as many theories about smog and what causes it as there are people studying the problem, but everyone agrees that something must be done about it, and soon.

Scientists of the Stanford Research Institute at Palo Alto, Calif., are trying to solve the mysteries of the smog which plagues Los Angeles, causing eye and throat irritation and reducing visibility.

Even though smog is visible, compounds which cause eye-smarting may be invisible and the amount of contaminating material

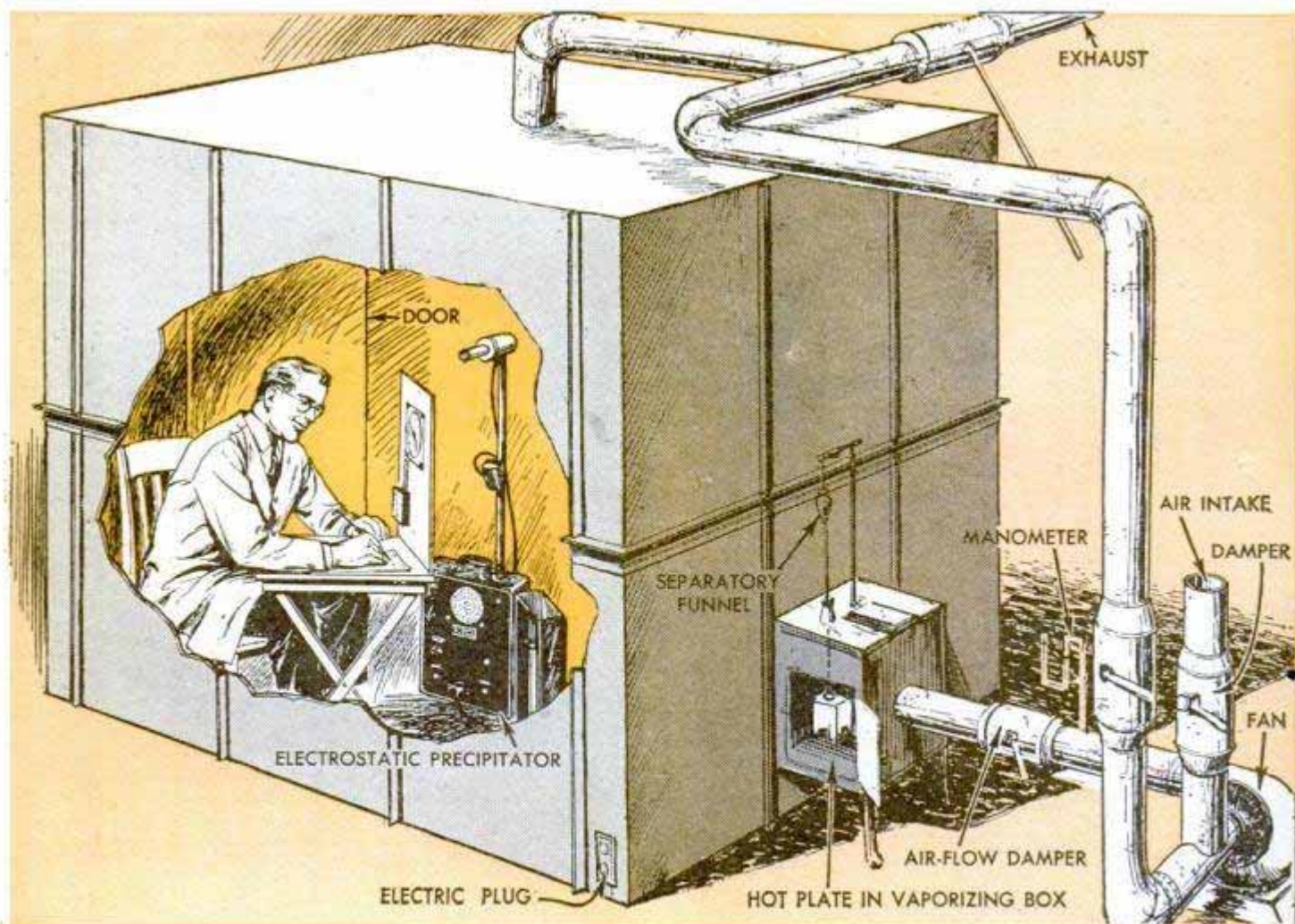



Fairchild Aerial Survey photo

**Air view of Los Angeles shows smog layer. Warm air mass above smog prevents it from rising and dispersing**

may be less than ten parts in a billion parts of air.

To bring smog into the laboratory where they could try out the suspected irritants on human "guinea pigs" under controlled conditions, the research-institute scientists developed the smog chamber.

It is a galvanized sheet-metal cubicle, big enough to walk around in, mounted on a movable platform so that it can be taken wherever the scientists want to make tests. One wall has an observation window and in the rear wall there is a small vaporization compartment where the smog is created. A blower sends it into the chamber where the subject records his reactions.

Technicians control the flow of smog through the chamber with dampers in the ducts leading into the chamber. Vapors in the chamber are picked up by an exhaust flue in the ceiling and either discharged or recirculated through a return duct.

Counting the blinks the eyes make when exposed to smog is a good way to measure the amount of eye irritation caused by smog. To measure blink rates, the scientists use goggles fitted with photoelectric cells. Smog vapors are fed into the air space between the goggles and the subject's eyes.

The photoelectric cells pick up the light reflected from the whites of the eyeballs and record each time this light is interrupted by a blink. By comparing the person's normal blink rate with his blink rate when the smog is irritating his eyes, researchers measure the effects of various irritants.

Chemical compounds such as sulphur dioxide, sulphur trioxide, formaldehyde, acrolein, oxides of nitrogen, hydrogen per-sulphide and elemental sulphur, which can cause eye and nose irritation, are being tested one at a time and in combination in the smog chamber.

Some of these chemicals already have bad reputations. In 1930, in the Meuse River Valley in Belgium, 68 persons were killed by a smog of industrial fumes which filled the valley. The victims died as a result of inhaling the deadly chemicals borne on minute fog droplets.

Dr. L. Dautrebande, Belgian scientist and authority on smog who did a great deal of research on the Meuse Valley disaster, is coming to the Stanford Research Institute to explore the possibility that the irritants in the Los Angeles smog are being carried by these minute liquid droplets.

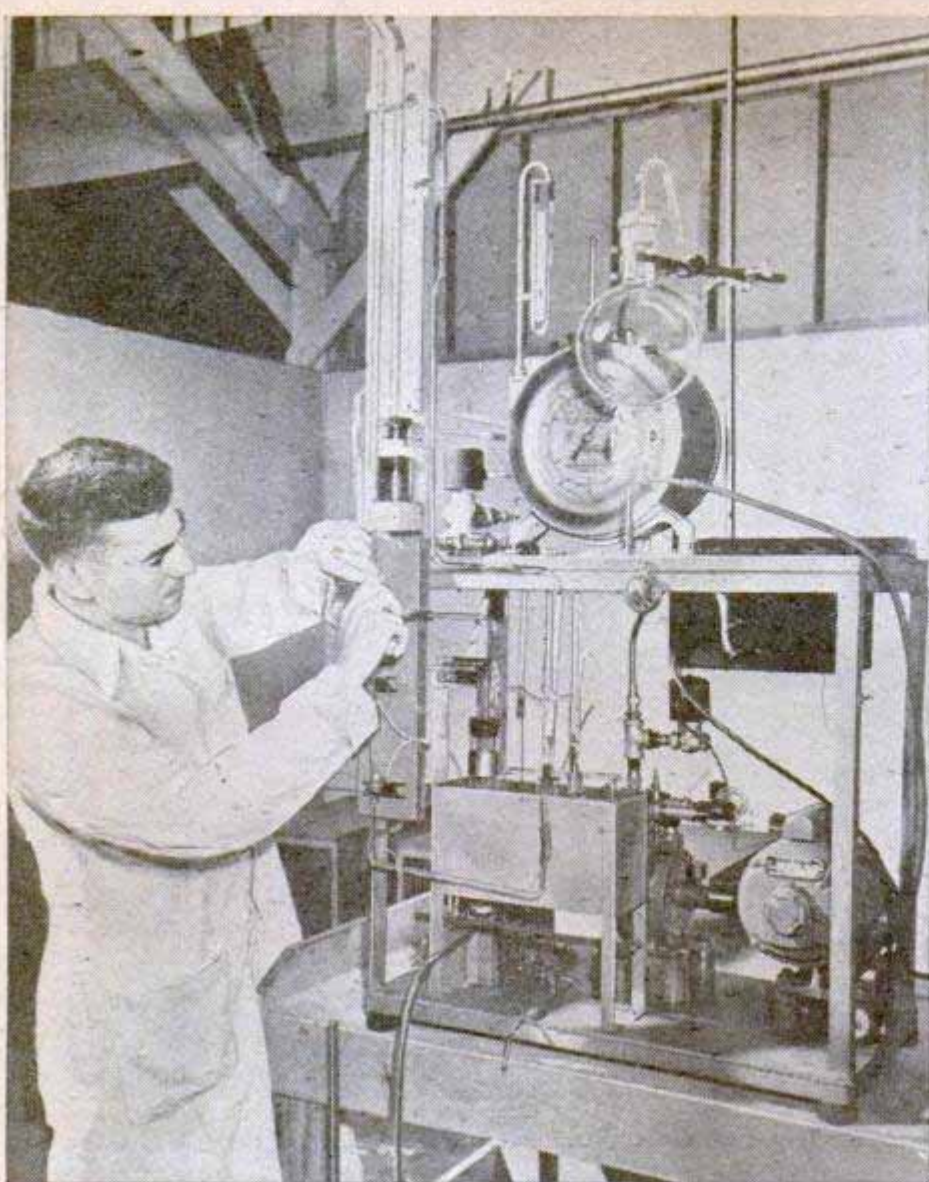

Spotting the irritants in the atmosphere calls for special instruments.

"If you squeeze all contaminating gases and moisture out of 200,000 cubic feet of Los Angeles air," explained one of the scientists, "you will have about one third of a barrel of water. In this quantity of water there will be dissolved perhaps twenty drops of contaminants, of which only a very small part may be the irritating or haze-producing materials we are looking for. The actual amount of contaminating material in 200,000 cubic feet of air may be so little that no method now exists to analyze it chemically. New methods must be invented."

An instrument to measure sulphur dioxide in the air looks like a Rube Goldberg invention with its maze of tubes, wires and tanks. It takes samples of the outside air and passes them through a tank

Above, complex apparatus measures tiny amounts of sulphur dioxide in the air. Below, transmissometer in box sends a beam of light into the large smog-filled pipe and measures the visibility loss caused by the vapor

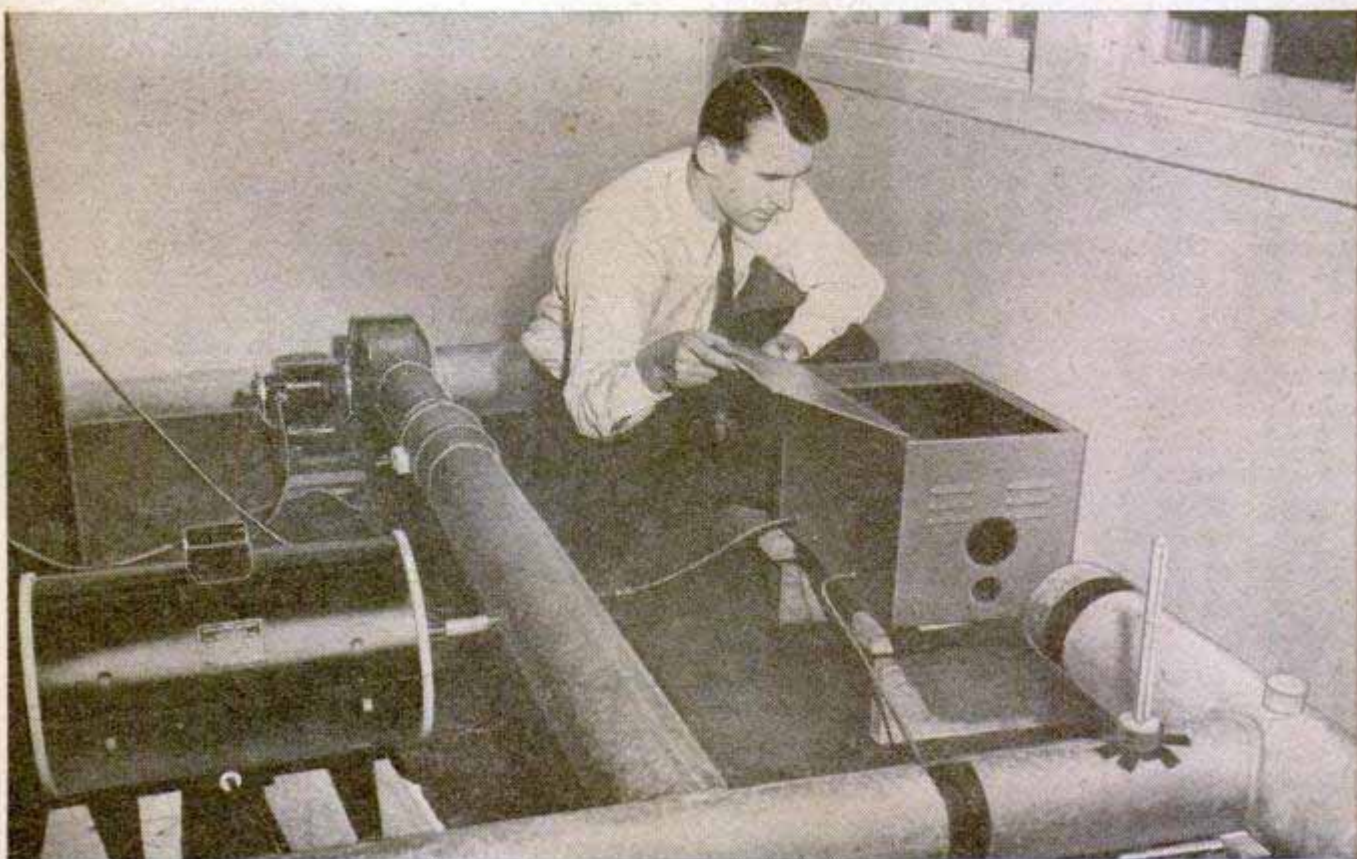

containing a solution of hydrogen peroxide.

If there is any sulphur dioxide in the sample, it is oxidized by the hydrogen peroxide to form sulphuric acid. Electrodes in the tank instantly record any change in the conductivity of the solution caused by the formation of sulphuric acid.

Another ingenious device for studying smog, the Venturi scrubber, uses a vacuum cleaner as its suction pump. Impurities in the air are literally scrubbed out as the outside atmosphere is sucked at a speed of over 200 miles per hour through the narrow neck of a Venturi tube. The high speed of the air as it rushes through the narrow opening of the tube causes it to mix violently with droplets of water being sprayed through the tube. Dust and other particles which are washed out are later removed from the water and tested to determine their nature.

Thousands of dollars are lost every year by airlines

(Continued to page 252)



Above, photoelectric cells measure the blink rate of the eyes as smog is forced inside goggles. Light, reflected by the whites of the eyes, actuates cells. Below, Venturi scrubber washes impurities from the air

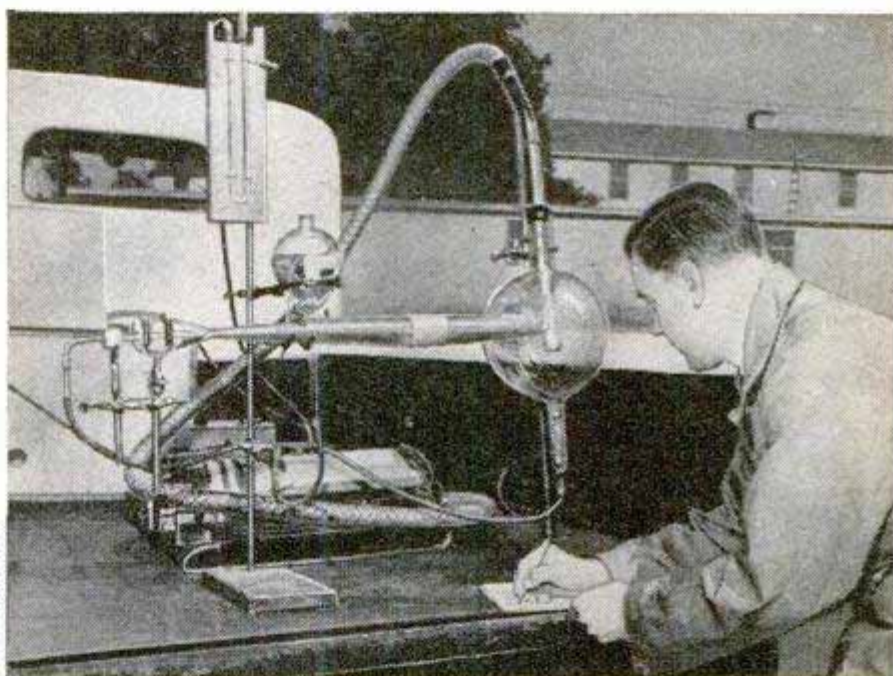

Portable test equipment is used to measure the amount of eye irritants in the air

# Mechanical Miners



Right, the 26-ton Colmol breaks up the coal with 10 rotating cutters. Below, demonstration of machine shows how coal is conveyed to rear



**M**ACHINES that dig coal faster than trucks can haul it away may soon be helping fill your coalbin. These mechanical miners are expected to make national coal production soar. Our best mines are now producing approximately 15 tons per man per day and our national average is 5 tons per man day.

With the new mining machines even the 15-ton rate will look skimpy. Eliminating the usual step-by-step mining sequence of cutting, drilling, blasting and loading, the new machines, in one continuous operation, roll up to the coal face, rip the coal from

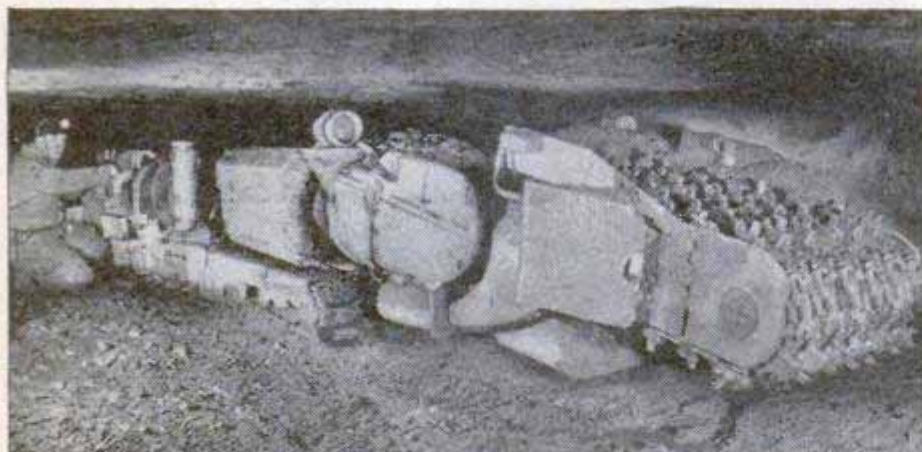

Below, the Joy Continuous Miner has its control panel about 14 feet behind the nose. Left, the Joy machine in operation underground. Notice its low profile

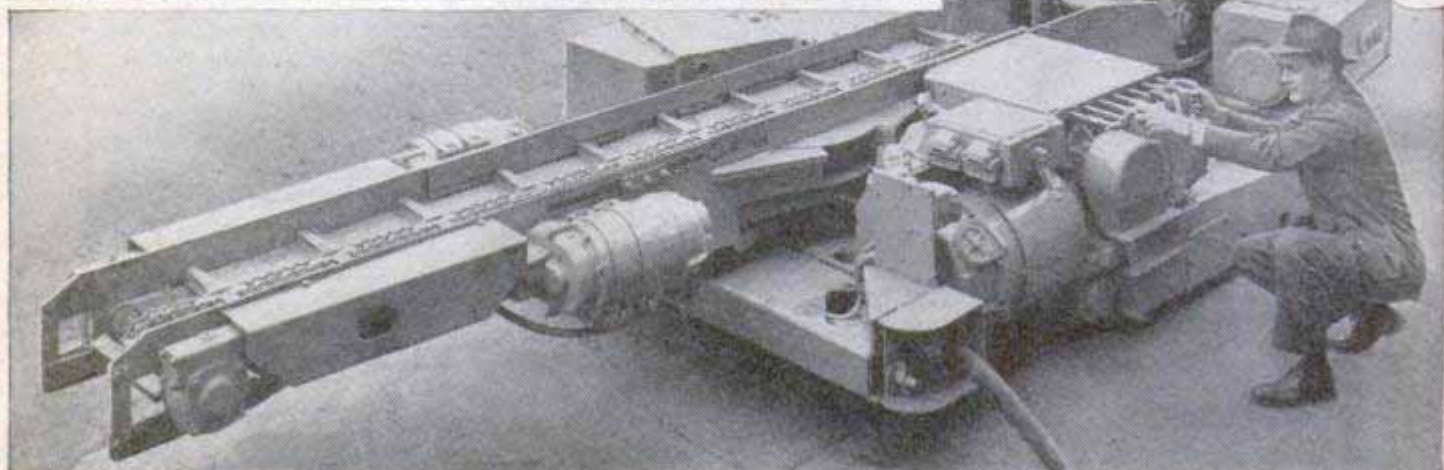



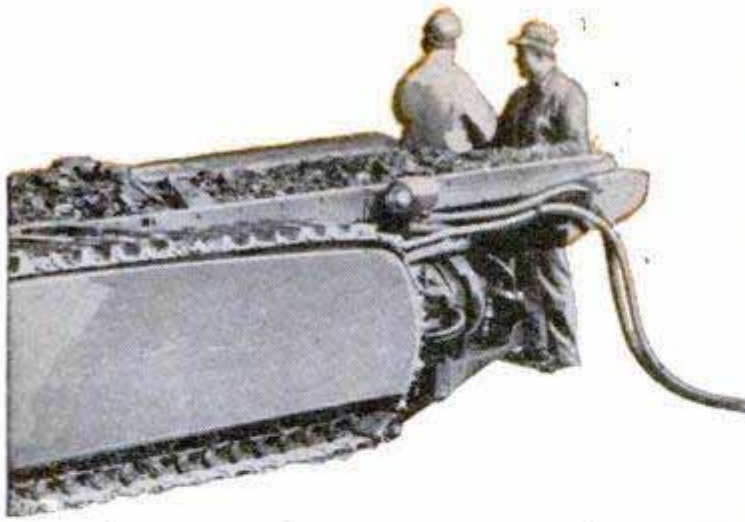

the seam and convey it into trucks at rates up to 100 tons per man day! Blasting and time-consuming drilling are eliminated.

Electrically driven, the machines move under their own power and resemble giant alligators as they "squirm" around obstacles and under low roofs.

The Colmol (pronounced "coal mole") has a rectangular cutting head that burrows into the seam with two rows of five rotating cutters. Teeth on the cutters rip the coal free from a face 9½ feet wide and 4 feet high, advancing 3 feet a minute under good conditions. Rotation of the cutters sweeps the coal onto a conveyor which carries it to the rear where it spills into trucks at a rate of three tons per minute. It takes only one man to run the powerful machine.

The second machine, the Joy Continuous Miner, has a capacity of two tons a minute. Its "snout" is a menacing looking affair with jagged teeth that scrape the coal loose and carry it back to a conveyor. Six rows of carbide mining bits, mounted on an endless-chain arrangement, move continuously around the snout, knocking the coal free. As the coal is ripped away, the operator raises the cutter head to cover the height of the seam. An intermediate conveyor moves the coal from the ripper snout to a rear conveyor that transports it to the trucks. Controls are located 14 feet behind the nose.

By eliminating all blasting, both machines increase safety and reduce the timbering required to support the roof. Water sprays wet the coal during cutting operations to reduce dust to a minimum, thus improving working conditions.

Both companies are cautious about claims for their new machines, but mine operators who will use them say that their new problem will be to keep the machines from burying themselves in the coal they have mined. They work so rapidly that it will take a conveyor-belt system to keep the coal moving to the surface.

## Cattle Feed From Cordwood

By Patrick G. Kellogg

PART OF THE nourishment in a beefsteak or glass of milk soon may come from a pile of sawdust.

Chemists at the U. S. Forest Products Laboratory, Madison, Wis., have perfected a process for converting wood waste into a molasses that can be used as cattle feed. In tests, beef cattle have fattened as fast with the molasses supplement as with corn, and dairy cows produced just as much milk.

The chemists extract blackstrap molasses from sawdust and other waste by cooking the waste with dilute sulphuric acid under pressure to produce sugar. Then they reduce the sugar to molasses by evaporation and distillation. The process yields 150 to 160 gallons of molasses for each ton of the wood waste.

Molasses can be extracted from almost any type of wood, although the yield depends upon the amount of cellulose available. Various forms of wood from sawdust to cordwood chunks have been used with almost equal success. Waste from turpentine-extraction plants produces almost as much molasses as other types.

Germany produced alcohol by a similar process during the war. Wood alcohol was essential to Germany's wartime industries and was used extensively as a fuel to power the V-2 jets.

The molasses-makers run cordwood chunks through a "hog" which chews them into slivers or chips. The splinters are blown into a storage bin until they are needed, then poured into a tall tank in batches of 300 to 400 pounds each. In the "digester" tank, the wood is cooked under high-pressure steam with sulphuric acid and water. The acid breaks down the large carbohydrate molecules into small sugar molecules. The solution then is neutralized with lime and filtered.

War-surplus distillation units at the laboratory condense the material, which is further thickened in a vacuum still. Even more purification produces a syrup or sugar that is fit for human consumption.

The process may be a tremendous help in reducing the critical food shortages in the world. Dr. Elwin E. Harris, specialist in charge of the experiments, estimates that wood wasted in finishing the floor of a small home could produce three tons of molasses.

Timberland owners are especially interested in the new process. Even the slashings and trimmings from a farmer's wood lot could be used as a source of molasses. Industrial glucose, now produced by the breakdown or hydrolysis of starch, also can be obtained by using the process.

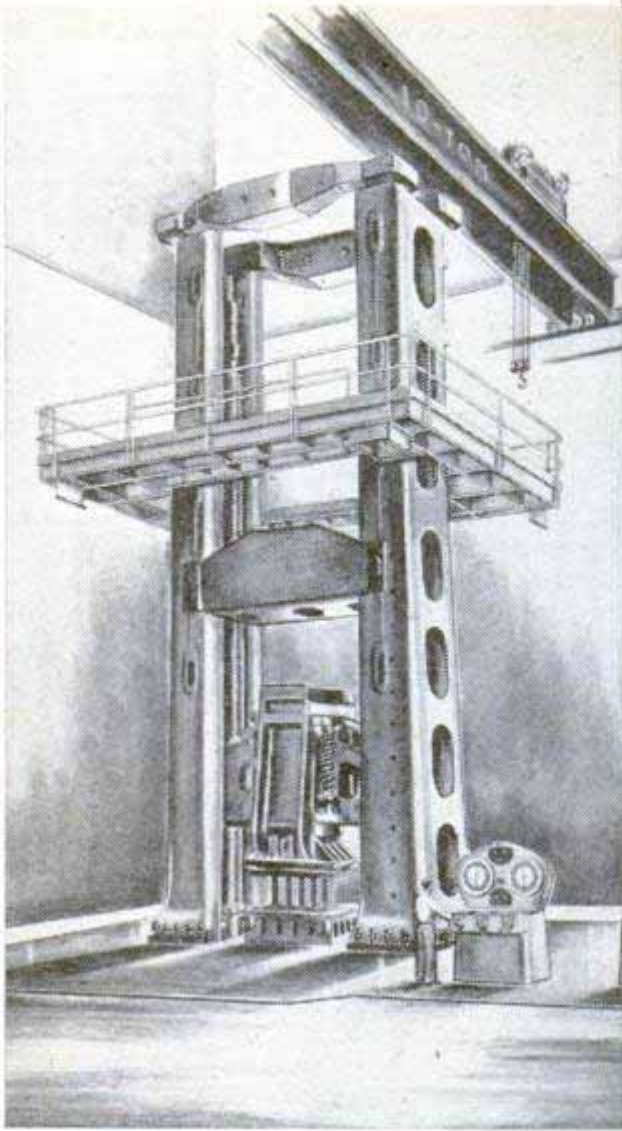

## World's Largest Testing Machine Has 5,000,000-Pound Capacity

Load capacities up to 5,000,000 pounds make a new testing machine at the Philadelphia Navy Yard the world's largest. Paradoxically, it will test the lightest aluminum and magnesium structures aeronautical engineers can design. Forty-seven feet high, the new machine handles specimens up to 30 feet high and 50 feet long in the 10 feet between its columns, and subjects them to high stresses in tension, compression and bending. A crosshead at the

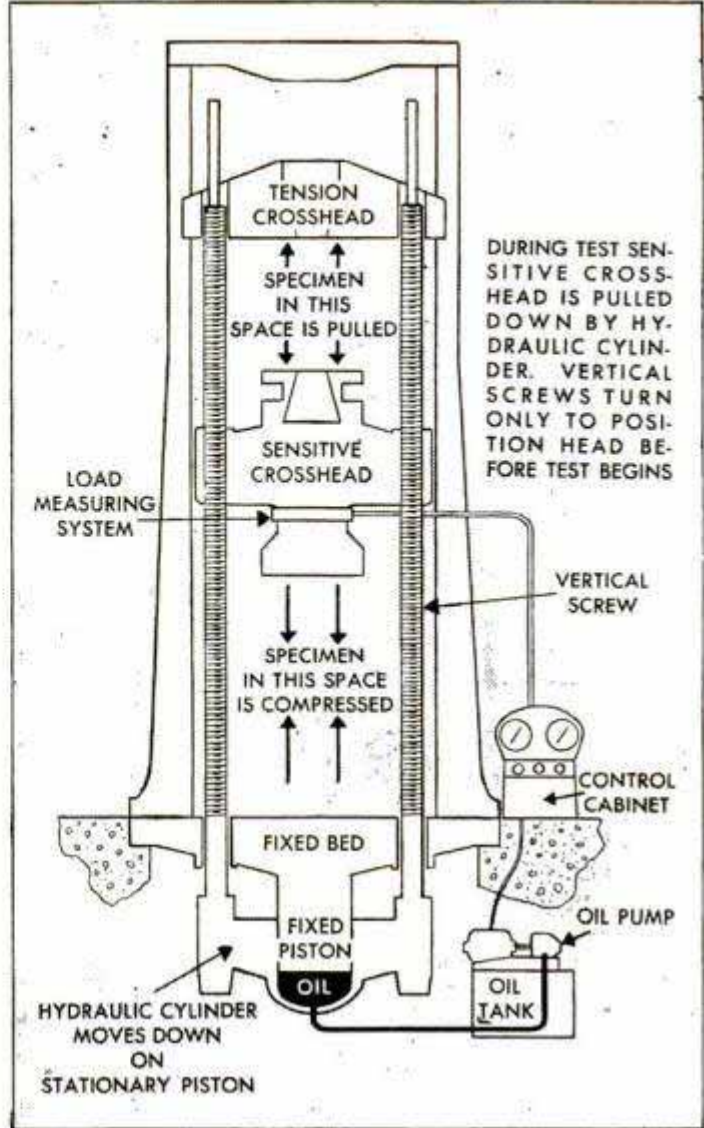

top and a bed at the base remain stationary, either tension or compression coming from downward movement of a 136,000-pound steel "sensitive" crosshead. Pacing disks provide constant rates of increasing load or strain. Loads are measured by the Emery cell, a shallow cylinder containing a loose-fitting piston and a metal diaphragm, so arranged that load on the specimen causes pressure change on a thin film of liquid trapped between the piston (and diaphragm) and the cylinder bottom. The ponderous machine registers load variations of as little as five pounds.

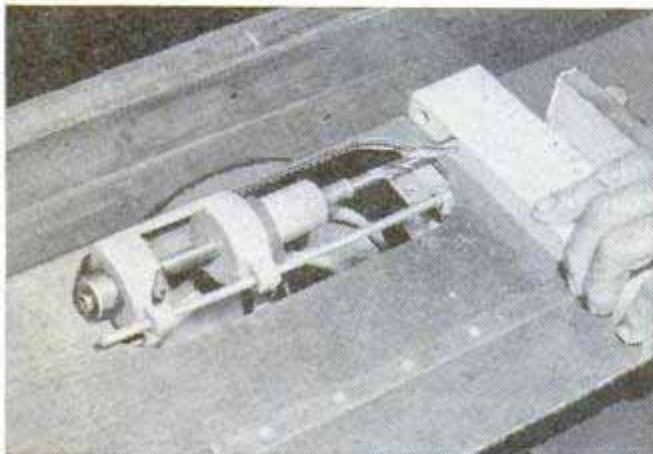

## Adapter Converts Table Saw Into Horizontal Drill

Almost any table saw can be converted into a horizontal drill by an adapter that is installed in a few minutes. The saw blade and the dust-chute cover are removed and the conversion unit mounted in place with the two screws that normally hold the cover. A V-belt driven by a pulley on the saw arbor supplies the power to the drill.

☛ On U. S. farms today there are 1,880,000 trucks and 4,860,000 pleasure cars.

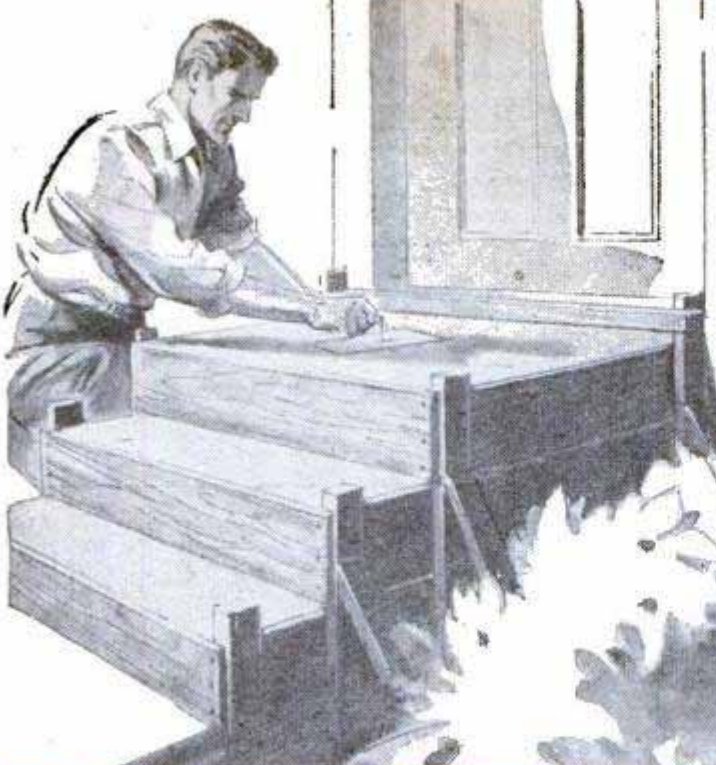

# the craftsman section

**CONCRETE STEPS** add much to a new home and help to modernize the appearance of an old one. See how you can build them yourself on page 205



**FINISHING FURNITURE** is an important step for the home craftsman. A story on page 198 gives the correct methods

**PORTABLE SAW TABLES** are handy in the crowded home shop or on the farm. An article on page 221 shows an unusual saw table of this type



**CAMERA REPAIRS** made periodically will assure your equipment being ready for that all-important picture. Refer to story on page 215



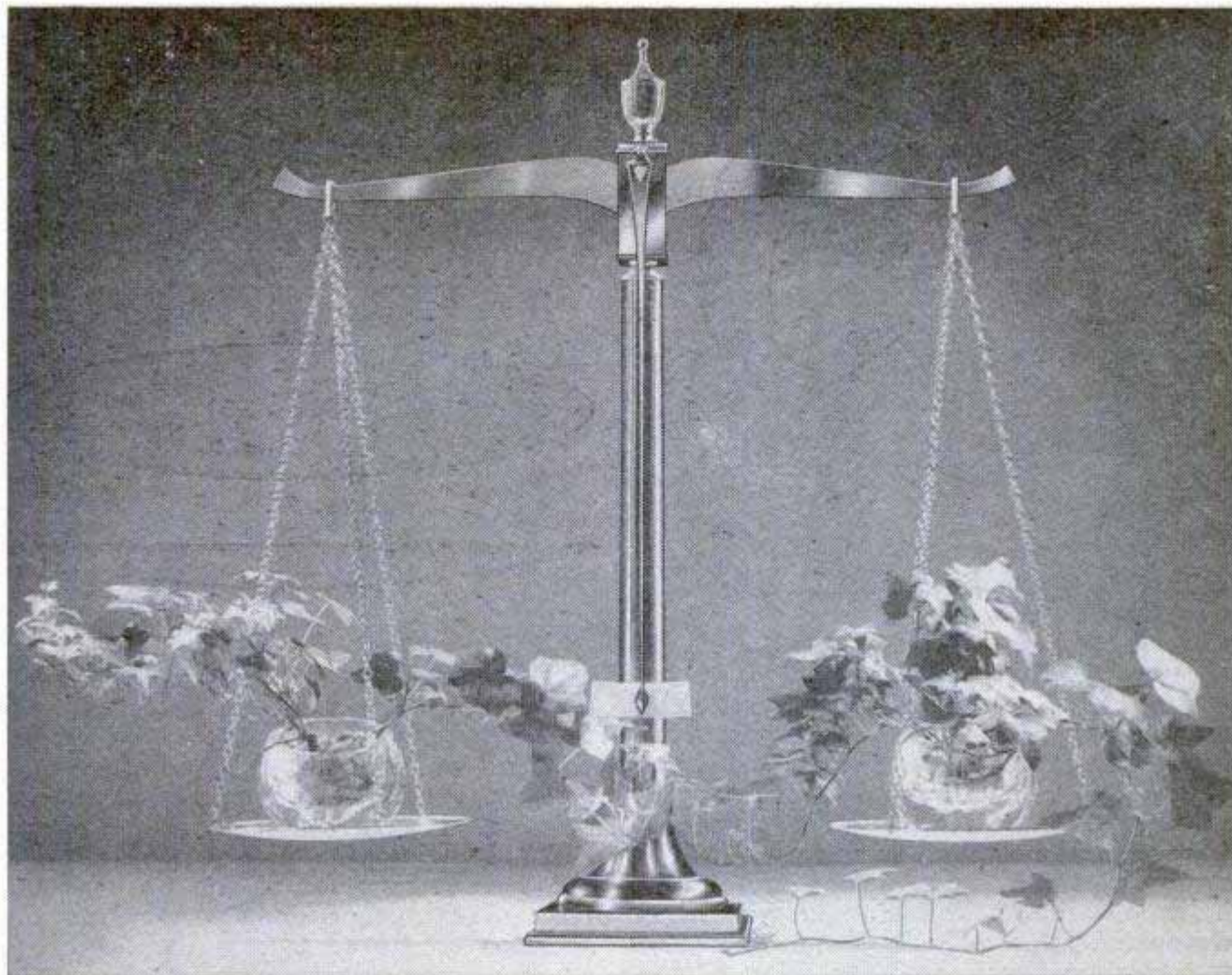

**By John B. Campbell**

**R**EMINISCENT of early counter scales, this smart-looking ivy balance in gleaming brass provides a distinctive and unusual table ornament. It's a lathe-and-drill-press project and especially aimed at the metalworker who takes pride in turning out an excellent piece of craftsmanship. With the exception of the steel knife edge and the ivory dial, all of the parts are made of brass, although the base and column can be of wood such as walnut, mahogany or ebony, varnished and hand rubbed.

Though the original was designed actually to serve as a balance, provision is made whereby the beam can be locked in a horizontal position to "balance" potted ivy. Details of the three parts comprising the base are shown in Fig. 2. These are drilled and tapped for bolting together with flat-headed machine screws, and the top piece of the stack is counterbored. Next, a flared member is turned which also is counterbored to fit over the shouldered projection of the piece beneath it. The upper end of the turning is turned down to fit inside a tubular post which is tapered from its full diameter at the bottom to  $\frac{7}{8}$  in. at the top. After this, a  $\frac{1}{64}$ -in. hole, counterbored for a 4-40 fillister-head ma-

chine screw, is drilled transversely through the post  $\frac{7}{8}$  in. up from the bottom.

Next, make the knife edge of stainless steel. This is sawed from  $\frac{1}{2}$ -in.-dia. stock and filed smooth to the dimensions given in Fig. 3. Both the locking pin and its ornamental knob, used to lock the crossbeam in a fixed position, are turned from brass. The clevis head and its component parts are detailed individually in the pull-apart view in Fig. 3, and shown assembled in the sectional view, Fig. 2. The two clevis members are fastened to the upper and lower rectangular plates with 4-40 flat-headed machine screws. The plates are first turned to a circular shape and then turned with a boss which is drilled and tapped. The upper plate is tapped to receive the threaded stud of the top ornament, while the lower plate is tapped to take the upper end of the threaded stud which ties the clevis, base and post assembly together. The stud consists of two lengths of rod threaded and soldered into a block as in Fig. 2.

A thin piece of ivory-colored plastic is used for the dial, Fig. 6. This is attached to the post by means of a brass support piece and a diamond-headed machine screw and nut, both being detailed in Fig. 6. The

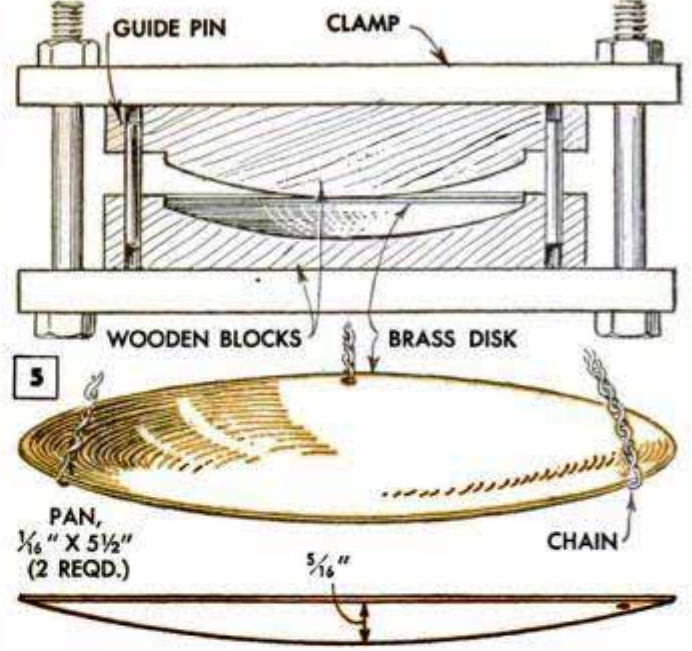
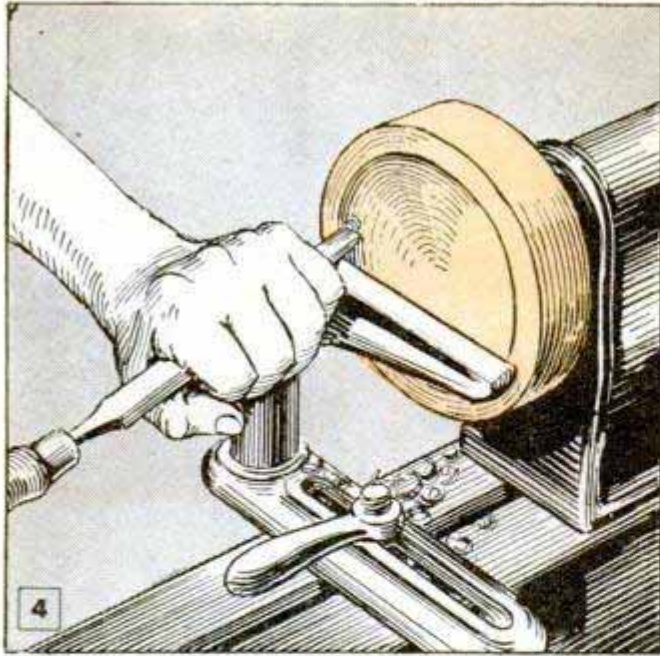

threaded portion of the screw should be long enough to enter the nut only halfway, the balance of the threads in the nut being taken up by a fillister-head screw from the back. The crossbeam is filed to the shape shown in Fig. 1 and then drilled and tapped, at the point indicated, for a 6-32 setscrew. Care should be taken to make the beam symmetrical and balance it accurately. To balance it, file out the triangular hole and clamp the knife edge in place. Then test the balance occasionally as filing of the beam progresses. Note that a hole made with a No. 55 drill is located at the apex of the triangular hole. This assures a firm grip on the flat surfaces of the knife edge when the setscrew is tightened. The triangular hole must be filed with care to

make sure that the knife edge, when clamped in place, assumes a true right angle with respect to the flat surface of the crossbeam. A  $\frac{3}{32}$ -in.-dia. pin having rounded and polished ends and of a length slightly less than the width of the space existing between the sides of the clevis, Fig. 1, is driven through a hole drilled in the crossbeam close to the apex of the triangular hole. This pin prevents the surfaces of the crossbeam from rubbing against the inside surfaces of the clevis. The crossbeam is positioned within the clevis and fastened to the knife edge by a setscrew from the top. Access to the setscrew is provided by the hole for the top ornament. Finally, the pointer, cut and filed according to Fig. 1, is attached to the projecting end of the knife edge with a setscrew. The two eyes from which the pans are suspended are filed from  $\frac{1}{8}$ -in.-thick brass to the dimensions in Fig. 3. Note that the inside top edge is filed to a blunt knife edge to engage the notches in the crossbeam. Three holes for attaching the chains supporting the pans are drilled in the lower edge of each eye.

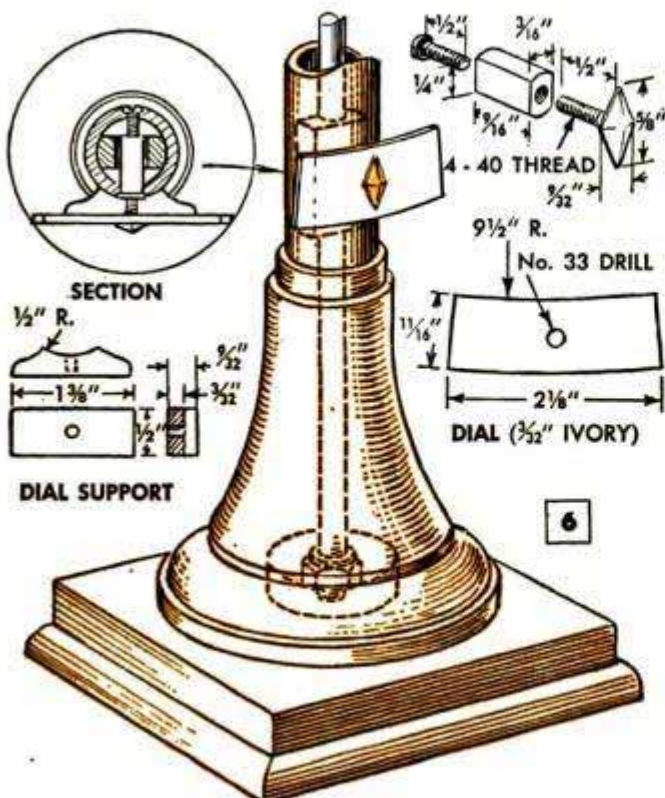

Spinning may be employed in dishing the pans, or the dishing can be done in a press like the one detailed in Fig. 5. Two wooden blocks, one being turned concave, Fig. 4, and the other convex, serve as dies between which brass disks are placed and clamped to dish them. Finishing consists of buffing each part individually and then coating it with clear lacquer to prevent tarnishing. If desired, an attractive "graining" can be applied to the clevis parts before they are lacquered. This is done by rubbing them back and forth on a sheet of fine emery cloth placed on a flat surface. The parts are held against a guide strip while rubbing so that the graining will be parallel with the edges of the parts.

# Appropriate Book Ends for the Home Workshop

What could be more appropriate to hold your craft books in the workshop than these novel book ends? Although appearing to be piercing the books, the handsaw actually is in two parts and, to further typify a workshop hobby, the bases of the book ends are made to represent carpenter's squares. If an old handsaw is not available, make the saw blade from sheet metal and the handle from hardwood which matches the veneer on the bases. Note that tabs on the ends of the blade sections are glued in slots cut in the base uprights. A better bond is had if the gluing surface of the blade is roughened before the glue is applied. The base of each book end consists of two pine blocks covered with a dark veneer, preferably walnut or mahogany. Glue and nail the blocks together and apply the veneer over the entire surface except the bottom, which is covered with felt. Reproduce graduations on the edges of the bases by inlaying them with strips of light-colored wood.

Axel E. Ogren, Chicago.

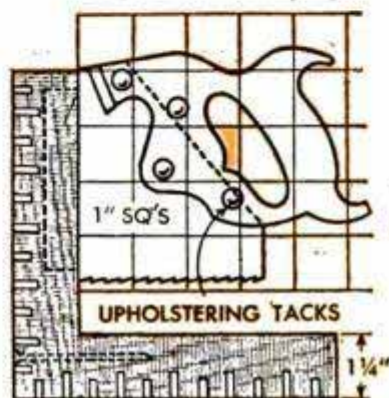
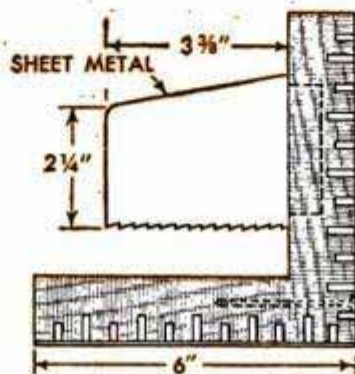
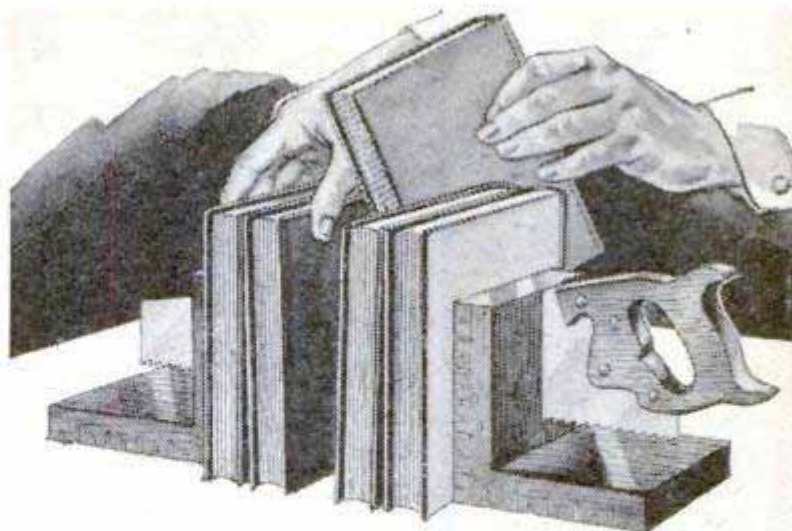

## Plywood Backing Aids Cutting Plastic With Magnetic Scrollsaw

To simplify cutting sheet plastic with a magnetic scrollsaw, one craftsman adds rigidity to the sheet by clamping it to a plywood backing. This reduces vibration of the plastic, makes the work easier, and lessens the possibility of breaking the sheet.

If the protective paper has been removed from the plastic, the pattern can be drawn directly on the backing. Small pieces of plastic can be similarly jigsawed by securing them temporarily to the backing with mucilage or water-soluble glue.

## *It's Coming Next Month-*

### POPULAR MECHANICS MASONRY HOME

#### *Our Answer to Your Housing Problem*

● The less expensive sequel to our *Build-It-Yourself Frame House*, it is a cozy home of five large rooms—living room, two bedrooms, bathroom, cabinet kitchen and utility room—approximately 674 square feet of comfortable living space. And it is all yours, complete with laundry and heating plant, for less than \$3650 if you build it yourself. Anyone who can mix mortar and cement can build the house. Carpentry consists mainly of putting on a simple hip roof. Insulated floors are poured concrete, exterior walls are concrete blocks stuccoed outside, and partition walls are tile. Walls in all rooms are furred out and plastered. In the descriptive story next month, see how easily anyone can build this beautiful, lasting home.

# Solving

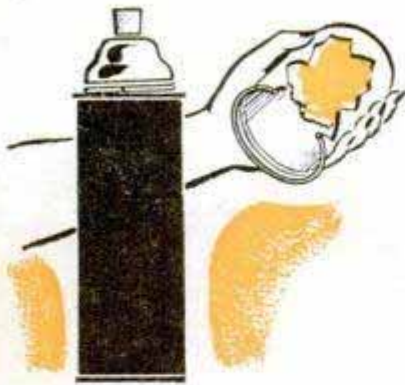

Placing a wadded napkin in a Thermos-bottle cover keeps the cork from working loose. When the cover is tightened, pressure of the napkin holds the cork securely in place

Made of aluminum tubing, this piecrust vent produces a crust unmarred, except for a hole in the center. Half of the tubing is cut in four parts bent outward



Plastic shower-curtain hooks provide attractive hangers for pot holders. The rustproof hooks come in bright colors and allow the pot holders to be hung easily from either a screw hook or a nail

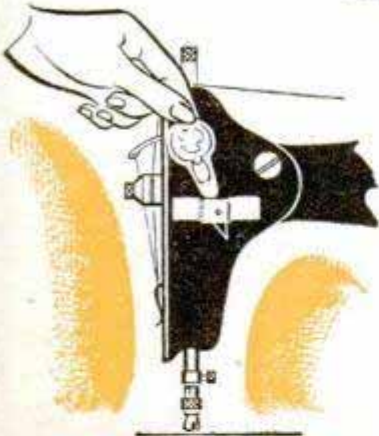

To keep a needle threader handy, store it in a holder made by attaching an adhesive bandage to the sewing machine. Slip threader under gauze portion of bandage



Lubricating zippers that have a tendency to stick is done simply by rubbing the teeth with wax. Occasionally lubricated in this way, the zippers will function smoothly



# Home Problems



If you do not have a glass funnel when pouring corrosive liquids into a small-necked bottle, the rubber cap from an extension-cord plug provides a good substitute in a pinch



The glass shades of hurricane lamps will stay clean and retain their sparkle longer if they are wiped with alcohol. Wash the shades as usual and wipe with an alcohol-moistened cloth

In many cases, applying vinegar to the joint of a broken chair rung or slat will loosen the glue sufficiently to permit easy removal of the part. Apply the vinegar with a small oilcan and allow to stand for a few hours. Repeat application if necessary



When power fails, an emergency lamp can be improvised by floating a thin piece of cork, which holds a string wick, in a glass filled with salad oil



A wire coat hanger forms a neat trellis for a potted vine. The hanger is bent into a figure eight and the hook is straightened and inserted in the dirt

## Air-Rifle Target Held on Tree With Auto-Tire Section

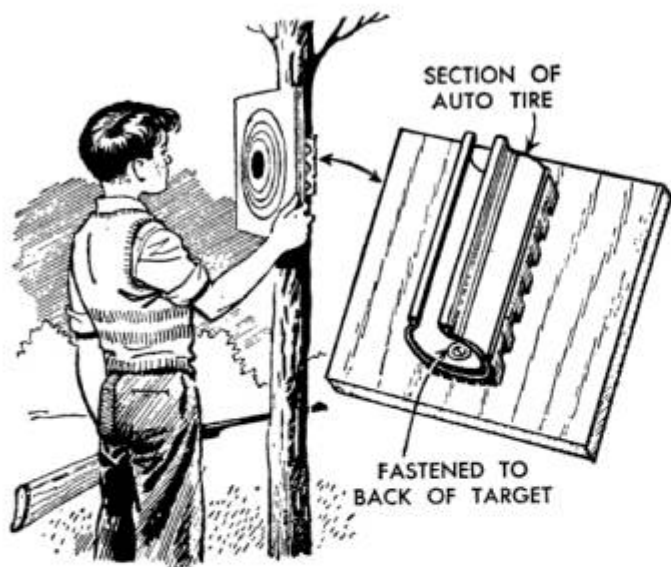

Fastening a section of old auto tire to the back of an air-rifle target permits clamping it to a slender tree or fence post. The tire section should be attached with screws and washers so it will not pull loose from the target when the latter is taken down.

## Easily Made Calculating Scale Speeds Figuring Dimensions

To save time when working with fractional dimensions, I made this handy calculator which is ideal for simple multiplication and division. The upper half of the calculator is 12 in. long and marked off in  $\frac{1}{16}$ -in. divisions. The lower half, also 12 in. long, is marked directly under the upper half but into 24 major divisions. Each major division has eight minor divisions located to coincide with those on the upper scale. In this way, any reading on the lower scale

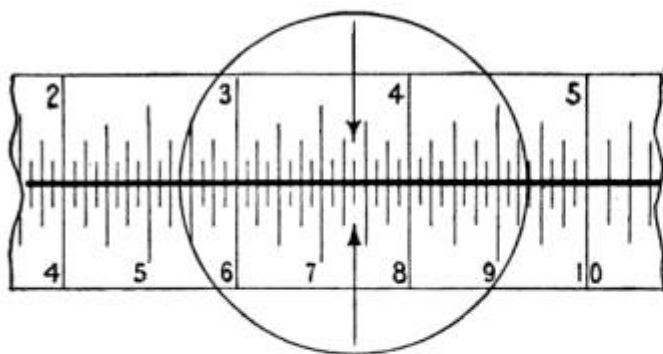

is exactly double the opposite figure on the upper scale. To multiply a dimension by two locate the dimension on the upper scale and read the answer directly below it on the lower scale. An example is given in the drawing. Any figure from zero to six can be multiplied by four by doubling it, as above, locating this result on the upper scale and then reading the final answer directly below it. The reverse procedure, of

course, is used for division, the original figure being located on the lower scale, and the answer read on the upper scale.

Harry M. Suttle, Sacramento, Calif.

## Plastic Insert for Jigsaw Table

If the metal insert in a jigsaw table is replaced with one of clear plastic, the lower chuck can be seen easily, permitting quick changing of the saw blades.

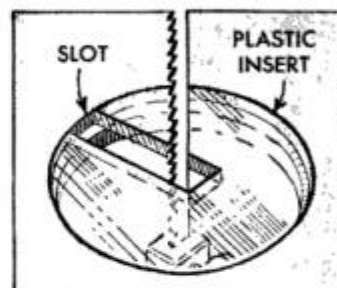

## Rubber Bands of Different Sizes Cut From Inner Tube

Rubber bands of varying sizes can be cut from sheet rubber or an inner tube by using this novel method. First cut a section from the inner tube and then split it along the seam. Now fold the piece double and cut slits in the crease, their location being determined by the size and thickness of the rubber bands required. Using the slits for a guide, cut out the rubber bands as shown in the drawing. Tinner's snips are excellent for cutting the inner tube, although a pair of inexpensive shears will do the job satisfactorily.

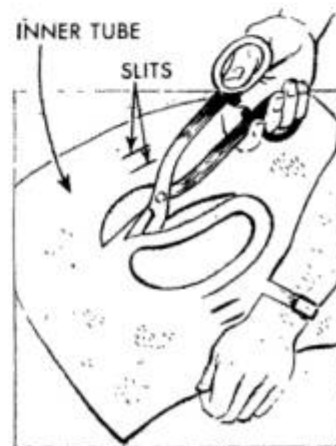

H. I. Hawxhurst, Sierra Madre, Calif.

## Cloth Cover Protects Seedlings

Sturdy covers to protect tender plants from the direct rays of the sun can be made by tacking strips of cotton cloth to wooden hoops. If the ends of the hoops are pressed well into the ground, there is little danger of the covers being blown away. Any number of strips can be sewed together to make the cover as long as desired, and extra hoops should be used at intervals to reinforce the covers along their length. If preferred, metal hoops can be used and the cloth sewed to them.

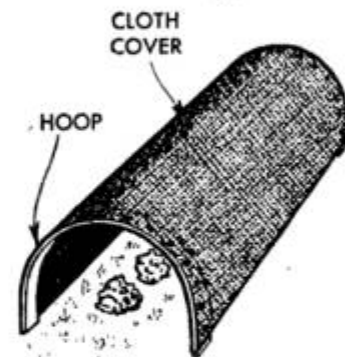

# Folding Towel Rack for Kitchen or Bathroom

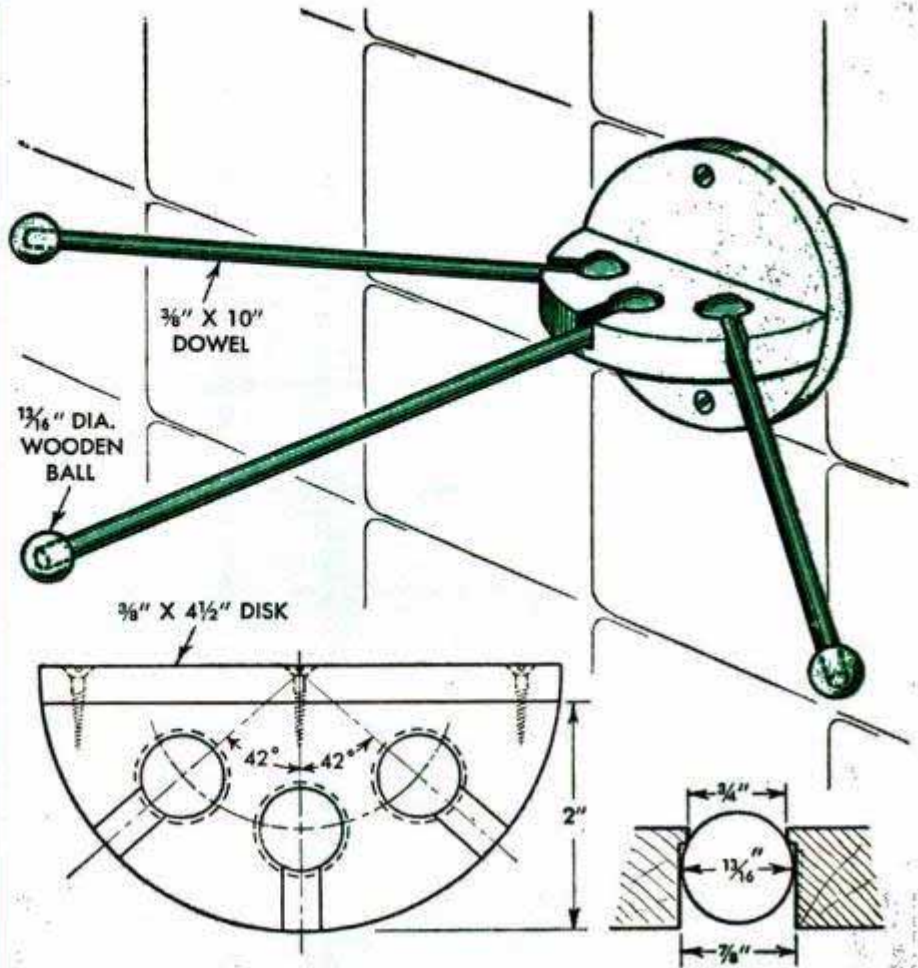
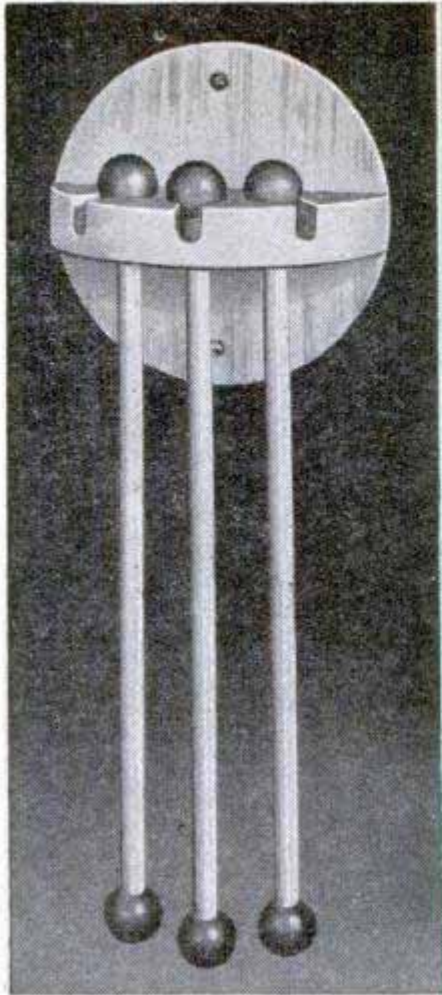

If you want something different in a towel rack, here's an exceptionally neat one that retracts against the wall. Lengths of birch dowel form the arms and balls turned from walnut are glued over the ends. Holes in the wall bracket must be counterbored carefully, as the counterbores serve as stops for the ball ends of the arms. To fold the rack, simply lift each arm and release it. The arm then falls to the vertical position as in the photo. Reverse the movement to bring the arms to the horizontal, or open, position

## 100 W.P. Combination Drier and Utility Shelf Installed in Waste Corner Space

Damp dishcloths and towels or an occasional piece of clothing can be dried out of sight, and the kitchen kept neat as a pin, if this combination drying rack and utility shelf is installed in space that otherwise would be wasted. Although the original unit was made to fit between a kitchen range and an adjacent wall, a similar rack can be fitted between cabinets or in any unoccupied corner. The drying rack consists of two plywood panels separated by lengths of dowel and bottom braces. Note that a window-shade spring is fastened to the back of the rack and the front panel covering the framework. This causes the rack, which is held closed with a cabinet-door catch, to spring open as soon as the catch is released. For smooth operation, the

rack rides on dowel rollers. These revolve on pins made by driving nails into the ends of the dowels and filing off the heads. The plywood utility shelf can be covered with linoleum or hardboard. However, if you wish to set hot pots and pans on the shelf, cover it with sheet aluminum. If the installation is made next to an uninsulated range, be sure to mount a piece of asbestos between the drier and the range.

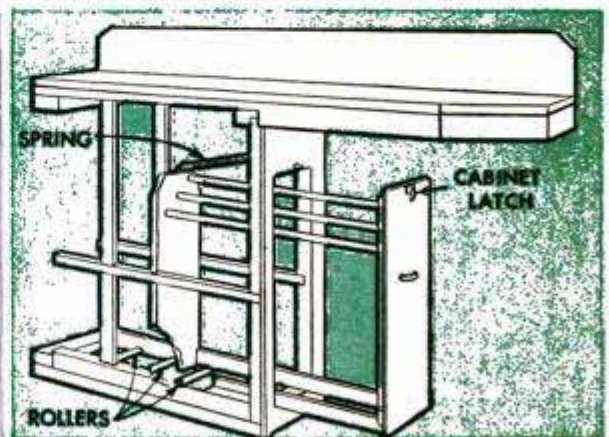

# ATTRACTIVE ENTRANCE

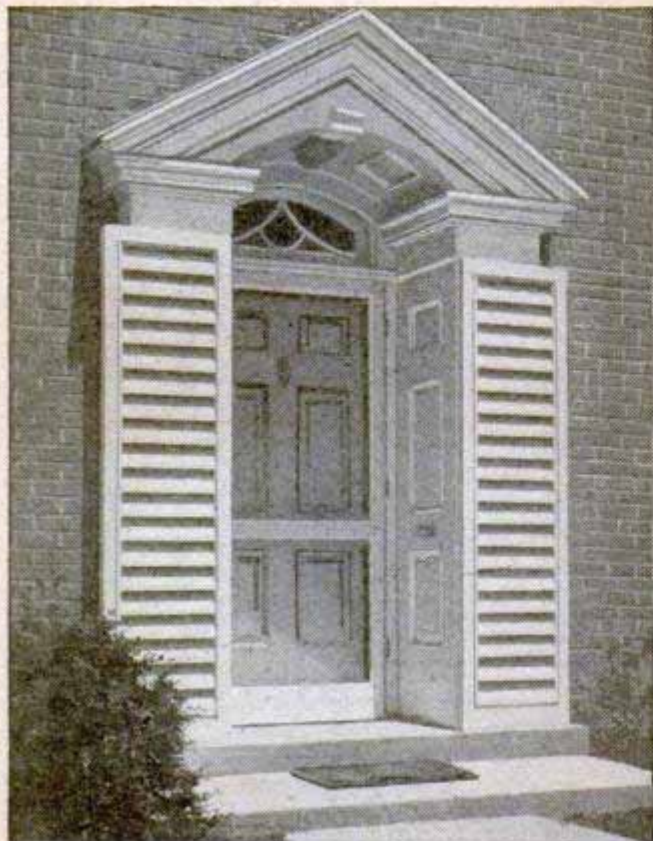

Flanking shutters with deep louvers lend the only modern touch to this fine doorway of colonial styling. A simple arched pediment and paneled wings recess the six-paneled door back from the wall line. Hand-wrought hardware completes the period detail.

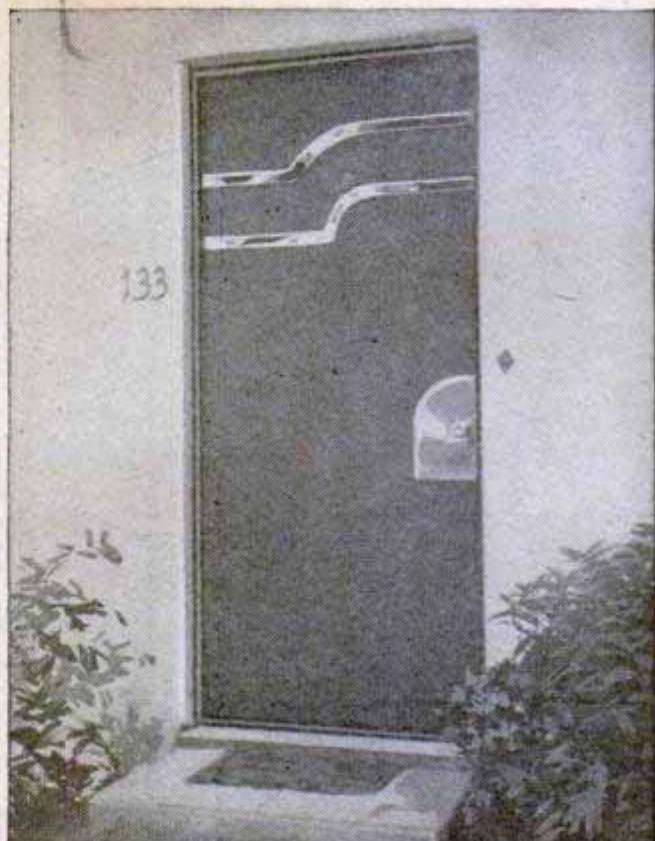

Definitely modern in design, this door is especially suited to the low-line architecture of small homes. Curved strips of polished chrome break the flat plane of the flush door in its recessed frame. A wide, curved lockplate adds a modern ornamentation.

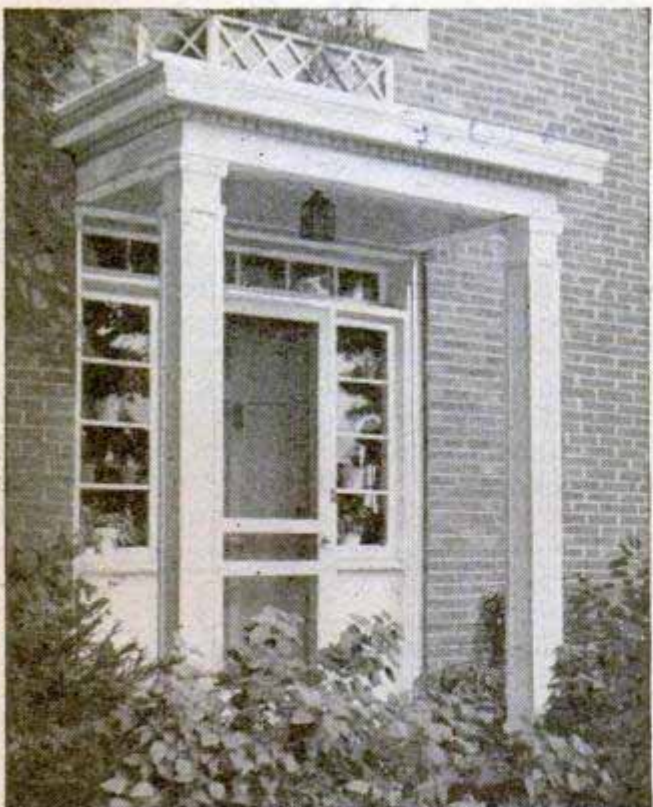

An ornate post-supported canopy shelters this glass-paneled doorway which is installed on the wall line. A wide transom is designed to balance height and width nicely. Shelves behind the glass panels provide space for a display of ceramics or potted plants.

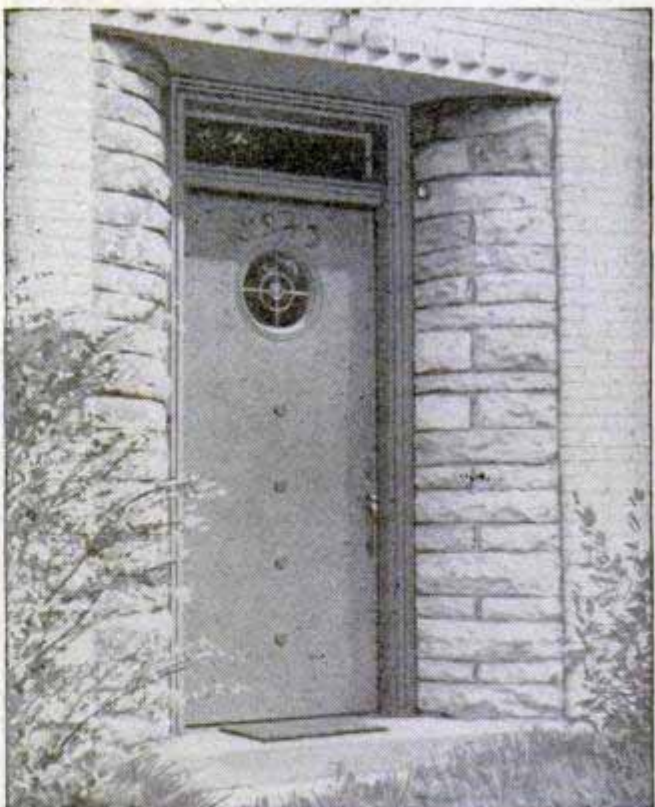

Modified modern design is suited to large homes or small ones of either new or old architectural lines. This doorway is readily worked into modernizing and remodeling plans. The plain recess is flanked with coved stonework and curves smoothly into wall line.

# DOORS

By Bob Hurst

**S**TYLED to the architecture of the home, front doorways are the final finishing detail. In selecting the type of door, whether it be for new construction or for use in remodeling an older home, careful consideration should be given to exposure, distance between windows on the same wall, size of windows and the height of the doorsill above grade. Recessing the door into the wall, as in several of the designs shown, helps to protect it from weathering. Where the door is framed on the wall line, a canopy gives the same protection and generally adds an attractive detail as well. Recessed doorways of colonial design are best suited to large homes of traditional architecture. New homes with low roof lines call for doorways of modified modern design and construction.

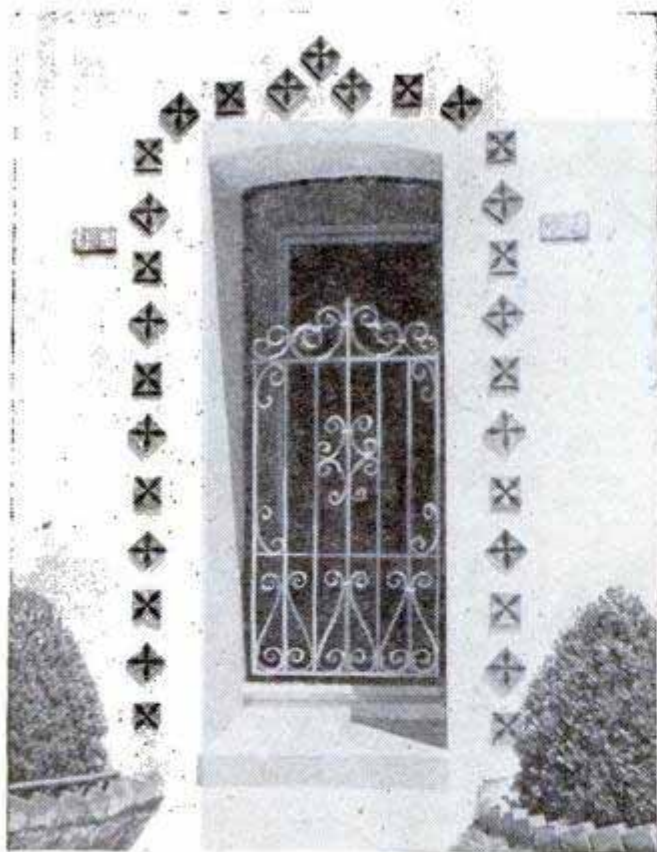
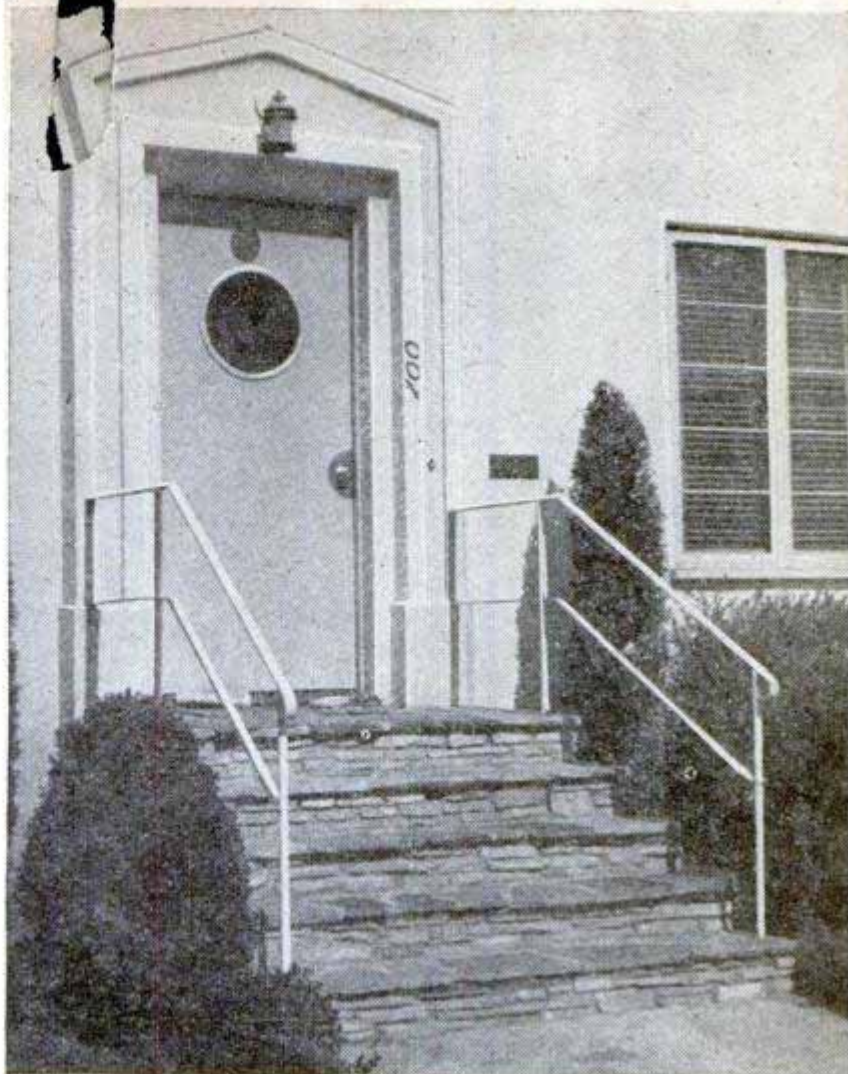

Guarded by heavy ornamental-iron grille and framed by colored glazed tiles set in the masonry wall, this deeply recessed doorway is easily adapted to the modernized types of Spanish architecture. It appears at its best when installed at grade level

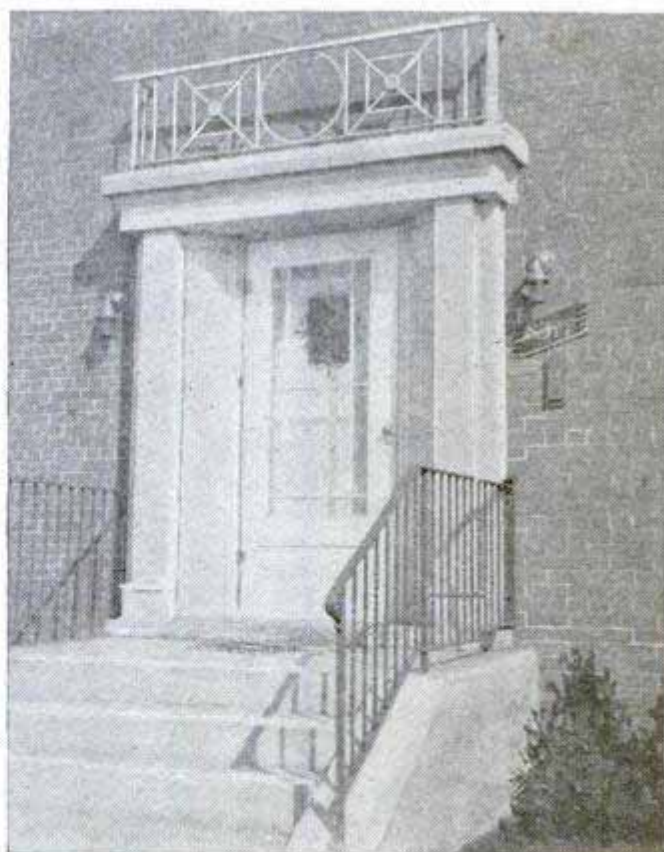

Plain straight lines of massive woodwork, flared side panels and an ornamental-iron pediment rail characterize this doorway. Note the similarity between it and a later type shown in photo at upper right. Both are suited to large two-story homes

## Concrete Cover for Shallow Well Cuts Cost by Saving Tile

W. T. M. Concrete

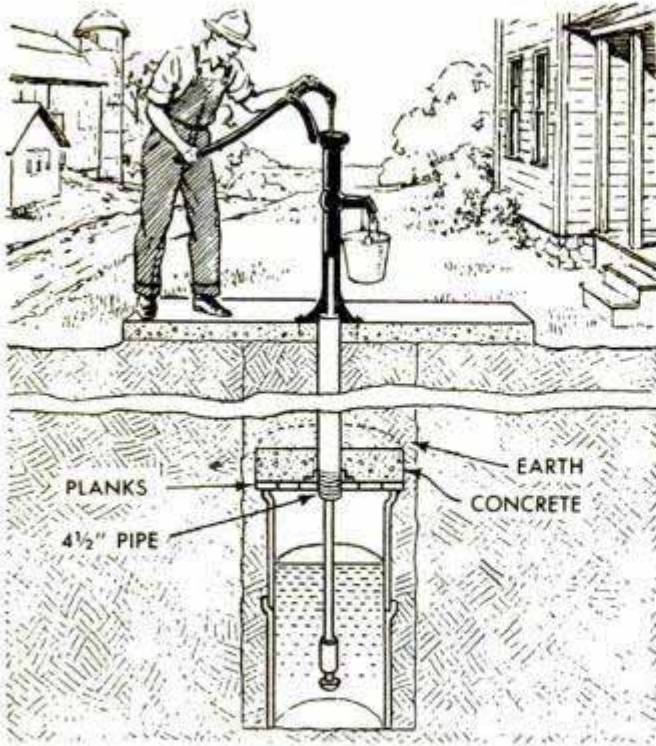

When digging a shallow well, you can save the cost of several tiles by installing a concrete cover just over the water level and running a length of 4½-in. pipe up to the pump. You probably can obtain a length of used pipe at a junk yard. Build a platform of planks over the rim of the last tile required, leaving an opening in its center for the pipe. Fasten a flange over the opening in the platform and, after threading the lower end of the pipe, turn the pipe into the flange. Then, temporarily supporting the top of the pipe with 2 x 4s, pour an 8-in. layer of concrete over the platform. After the concrete hardens, fill the rest of the wellhole with earth and complete installation of the pump.

Alex Owen, Schenectady, N. Y.

## Paint Can From Cream Carton

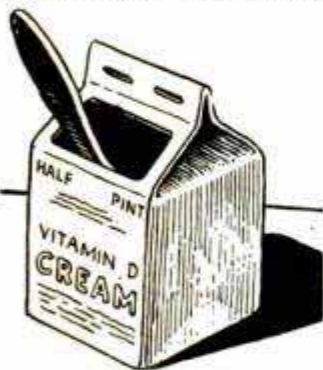

If you are unable to find a can for a small amount of paint, a cream carton will serve the purpose. Just enlarge the pouring spout in the top and wash and dry the inside of the carton.

## Trolling With Outboard Motor

To troll at very low speeds with an outboard motorboat, use a motor with full reverse and operate the boat stern-first.

The drag of the transom will maintain as low a speed as you wish. Be sure to stay away from shoal water, as the motor cannot be tilted in this reversed position.

## Scribing Parallel Lines on Cylinder

Sometimes, when working with wood or metal, it is necessary to scribe a line on a cylinder parallel with its axis. This can be done easily by using a length of angle iron as a straightedge. The angle iron naturally assumes a position parallel with the axis and is not likely to slip.

John M. Avery, Delhi, N. Y.



## Blotter Removes Decals

A wet blotter placed over a decal on a painted surface will loosen it sufficiently to permit removal with a dull knife without marring the finish. The blotter should remain over the decal for a couple of hours.

A. E. Fenn, Chicago.

## Burned-Out Fluorescent Tubes Form Novel Porch Trellis

Instead of discarding burned-out fluorescent tubes, you can use them to make an attractive trellis for the porch or terrace. A window box serves as a base, and a vertical member at each end of the box supports the tubes as shown in the detail.

H. T. Gunderman, New York City.



DO NOT USE

# LAMPS FANTASTIC

By Norbert Engels

IT IS FANTASTIC to think that lamps like these bring fancy prices in expensive shops, but even more so when you realize that they are made from old pewter jugs and pitchers, ornamental tobacco cans and painted glassware which, in many cases, are simply tossed out. There's practically no limit to what can be used for the lamp bases. It's a case of giving your imagination free rein. Combined with standard fittings or ones salvaged from old lamps, the parts required cost practically nothing. The examples given here show what can be done. The smart copper lamp shown below at the left was made from a 1-gal. oil measure, polished and lacquered and wired for a socket. The base for the nautical lamp shown below at the right is made from a decorative tobacco can and odd parts of several old lamps.

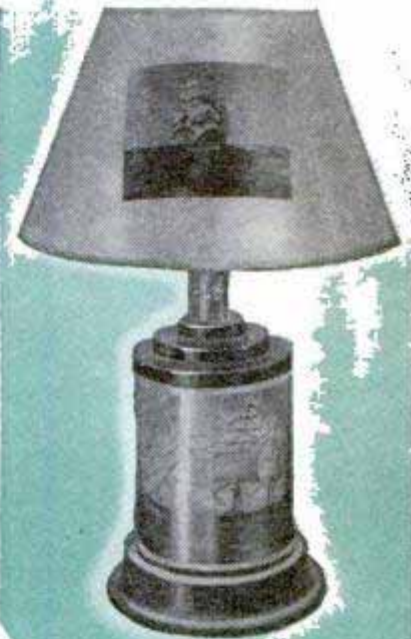
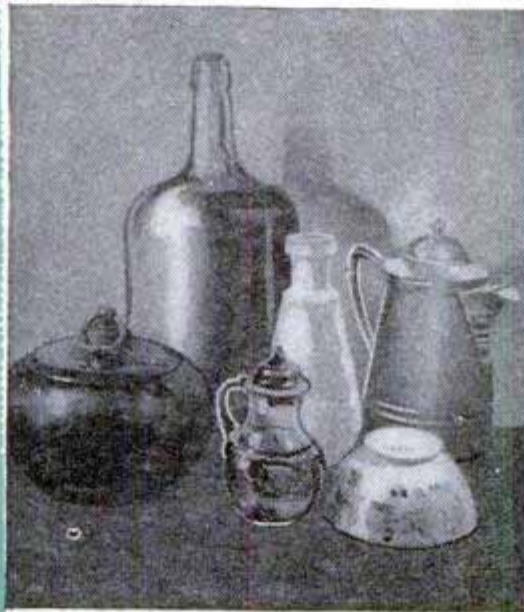

Above, left, a decorative candy can used for the base of this lamp is fitted with a socket fixture taken from an old lamp. The end of the fixture is attached to a wood block fastened to the bottom of the can. Above, right, shows an old-fashioned oil lamp that has been converted to an electric one by replacing the wick unit with a standard socket assembly

*Furniture you can Build p 150*

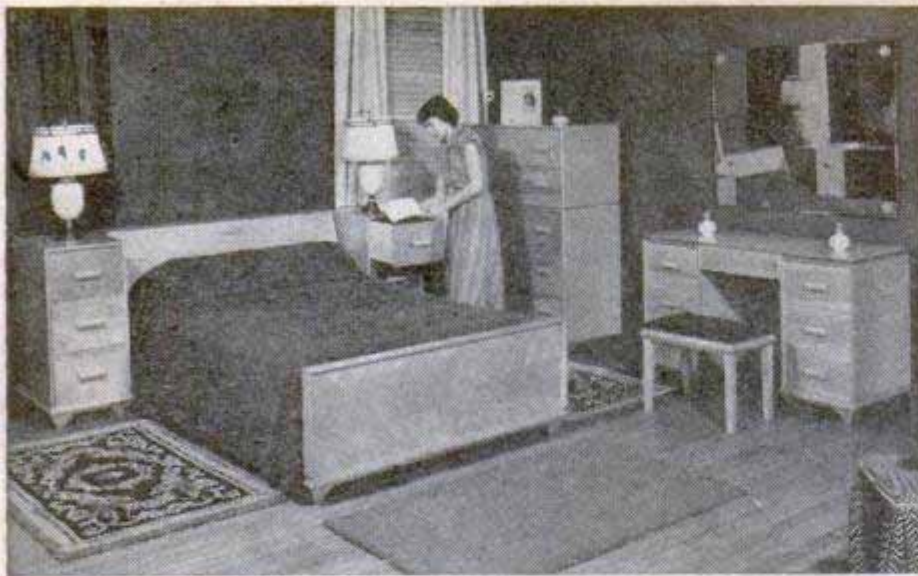

When building new furniture or restoring old pieces, each step of the finishing process, from bleaching and filling to varnishing or lacquering, is of the utmost importance. Perfection, of course, comes only with practice, but the following information will get you off to a good start

### Part III

**A**FTER COMPLETING the bedroom furniture described in the previous two issues, it's time for the all-important job of finishing it, because right here you can either flatter or ruin the appearance of the furniture.

No doubt, you have built the furniture of a wood suitable to take the particular finish desired, whether it be harvest wheat or heather mahogany, ambered walnut or limed oak. Naturally, the kind of wood used is a determining factor as, for instance, one cannot expect to obtain a limed-oak finish on birch. The finishing schedules presented below give a condensed procedure to follow in producing

## *Furniture for Filling, Staining*

a number of the popular, modern finishes, but, if the final results are to compare with finishes seen on store furniture, the finishing operation demands the same careful attention that you put into the cabinet work. Brushes and materials, as well as the room where the work is done, must be clean. Finishing should not be attempted in a cold room and the materials should not be cold. These precautions are important.

**Sanding:** Perhaps the most important

### FINISHING SCHEDULES

FINISH	APPLICATION
Ambered walnut	Bleach. Stain with amber stain. Apply sealer coat of thin lacquer. Fill with natural filler. Finish with clear lacquer.
Old-World walnut	Bleach. Seal. Fill with natural filler lightly tinted with burnt umber. Seal. Shade with brown wiping stain. Finish with clear lacquer.
Honeytone maple or birch	Tone with blond toner, using 1 part white lacquer to 4 parts clear, flat lacquer. Finish with water-white lacquer.
Pickled pine	Bleach. Stain with gray stain for pine. Finish with water-white lacquer or clear varnish.
Limed oak	Bleach. Seal. Fill pores with white paste wood filler. Finish with water-white lacquer.
Harvest-wheat mahogany	Bleaching will give required wheat color. Fill with natural filler lightly tinted with raw-sienna color in oil. Finish with lacquer.
Tweed mahogany	Bleach. Seal. Fill pores with red paste wood filler. Finish with water-white lacquer or clear varnish.
Heather mahogany	Bleach. Seal. Fill pores with white paste wood filler. Finish with water-white lacquer or clear varnish.



step in producing a beautiful, flawless finish is the sanding of the wood. Application of any number of finishing coats will not compensate for a careless job of sanding, but only tends to emphasize defects. Power sanders of the oscillating or belt types take the work out of sanding; however, if these are not available, you can do a satisfactory job of sanding by hand, wrapping the paper around a flat, felt-covered block and working with progressively finer grades of garnet paper from medium down to 5-0 grade.

**Bleaching:** Practically all of the

## *Your Bedroom and Varnishing*

so-called blond finishes are produced by first bleaching the wood to remove its natural color. This is done to obtain such popular mahogany finishes as harvest wheat, heather and tweed, and limed oak, and ambered walnut. Mahogany, when bleached and filled with white filler, is known as heather mahogany. When filled with red filler (natural filler with red oil



Above, a piano or draftsman's stool provides an excellent turntable when spraying lacquer on the smaller units. Below, a power sander makes play of sanding the broad, flat surfaces, but care must be used to avoid cutting through the top veneer

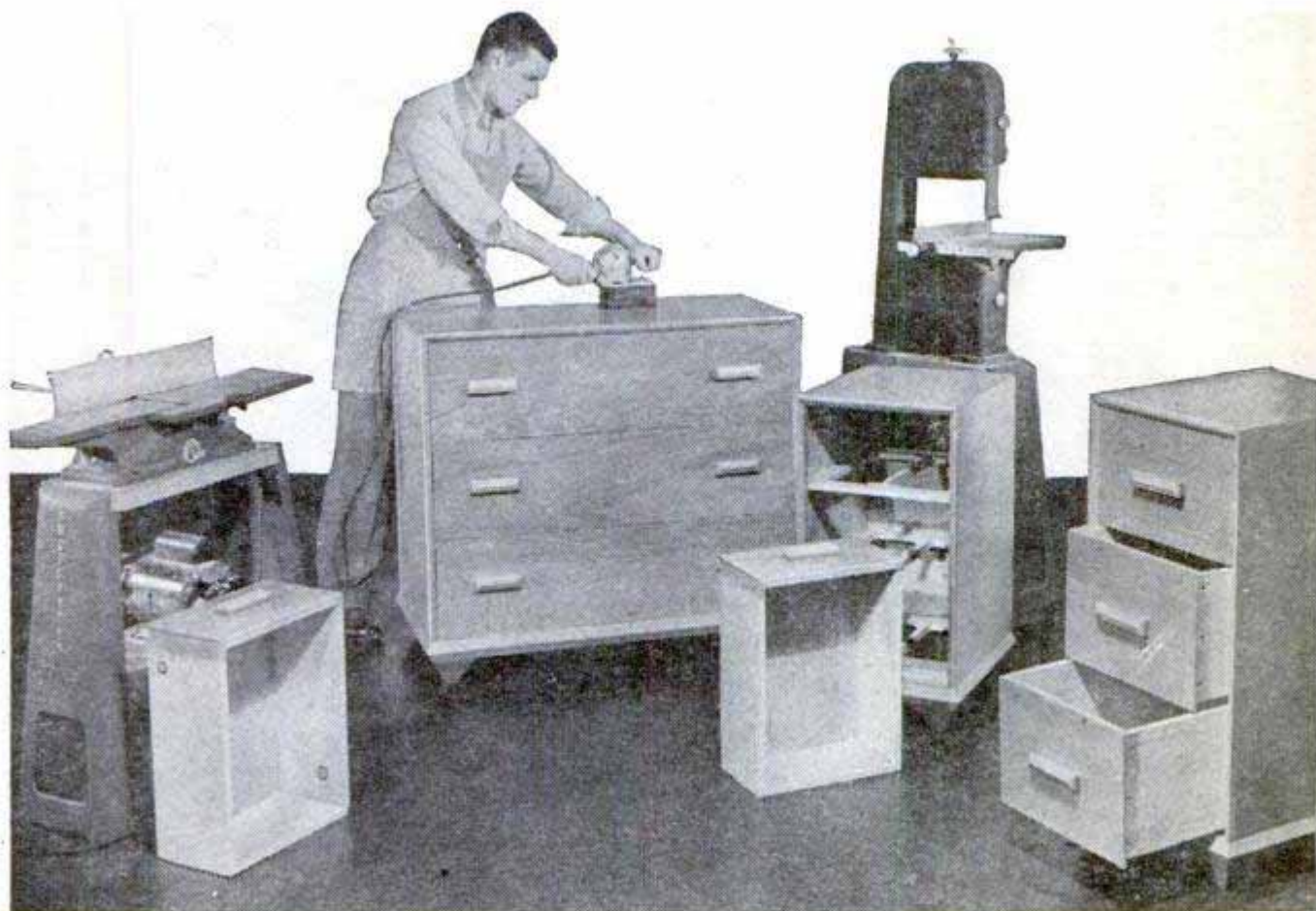



ing, so that they will sink into the pores. The filler is applied liberally in the direction of the grain, preferably with a short-bristled brush. Do not cover more than 6 or 8 sq. ft. of surface at one time or you will get ahead of the wiping and cleaning-up operations that follow. As soon as the filler flattens, it is wiped off. This is done by wiping across the grain with a coarse cloth such as burlap, or excelsior, using a circular motion. This is followed by cross-wiping with a fine material called tow, commonly used for upholstering purposes. This second wiping cuts the surplus filler flush with the surface of the wood. A third cross-wiping with a soft cloth wrapped around a felt block is excellent practice. A second application of filler, somewhat thinner than the first, is sometimes required when filling mahogany or other wood having a very open grain. This is determined by noting whether the pores are completely filled. Finally, the work is wiped lightly with the grain, using a soft cloth. This serves to remove any traces of filler missed in the towing-off operation. The filler should be allowed to dry 24 to 48 hrs. and then sanded very lightly with 5-0 wet-or-dry garnet paper.

M. T. CAMPBELL CO.  
703 E. 19TH ST.  
KANSAS CITY, MO.

In bleaching the wood to produce any of the popular blond finishes, the chemical solution is swabbed on the work with a rubber sponge. As the bleach is corrosive, wear rubber gloves

color added), it is called tweed, because of its pleasing pink tone. Bleached and filled with natural filler, it's called harvest-wheat mahogany. After bleaching, almost any color desired can be had by giving the wood a coat of diluted stain.

Bleaching is done with a commercial chemical solution consisting of two separate solutions which are mixed together and used immediately. As all bleaching solutions are highly corrosive, they should be handled carefully and applied with rubber gloves. Use a sponge to swab the solution on the wood and see that you wet the entire surface evenly. One application of bleach is usually sufficient although, in any case, it is good practice to make a test on a wood sample. Let the bleach stand and dry for 48 hrs.

**Filling:** Open-grained woods, such as oak, walnut, mahogany, etc., must be filled, that is, the pores of the surface and end grain must be packed level with a prepared paste filler. Fillers are available for either lacquer or varnish finishes and require cutting with benzine or turpentine to the consistency of thick cream before apply-

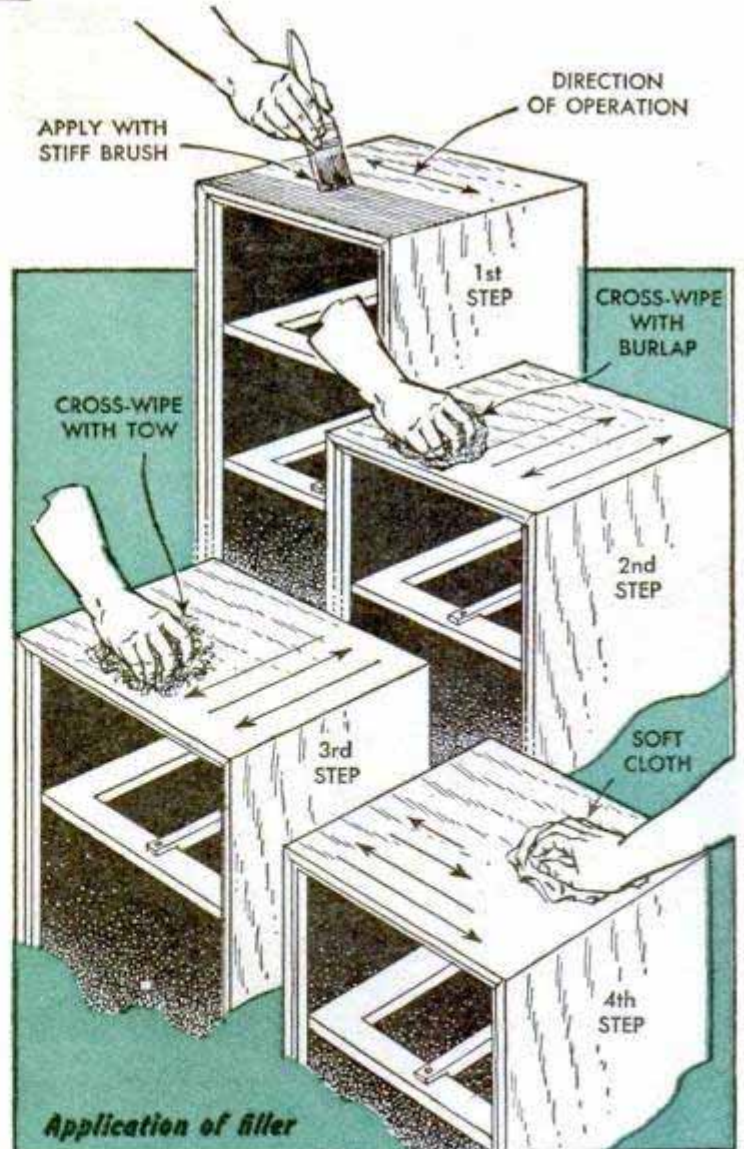

**Toning:** Toning is not successful on dark wood such as walnut, but very much so on naturally light-colored woods such as birch and maple. Toning, to some extent, takes the place of the bleaching process and is accomplished by spraying the bare wood with a semitransparent undercoat to lighten the wood. Toning is recommended for all extremely light finishes, as it does not obscure the grain, being almost as clear as water. Toner is made by adding white lacquer, 1 part, to clear flat lacquer, 4 or 5 parts. In the case of oak and mahogany, the toner should be made with tan-colored lacquer instead of white.

**Sealing:** Whether or not the bleached wood has been toned or stained, the surface must be sealed with a wash coat of shellac or lacquer before the work is filled. The wash sealer is made by cutting 1 part of clear shellac or lacquer with 6 parts of thinner. This coat is sanded lightly when dry, and then, after the grain is filled, a second sealer coat is applied. This is likewise sanded when dry, and followed with a coat of varnish or lacquer sealer. The latter coat, which fills any tiny open pores remaining, also is sanded. From here on, varnish or lacquer coats are applied, using a rubbed-effect or full-gloss type.

### Improved Pendant Switch

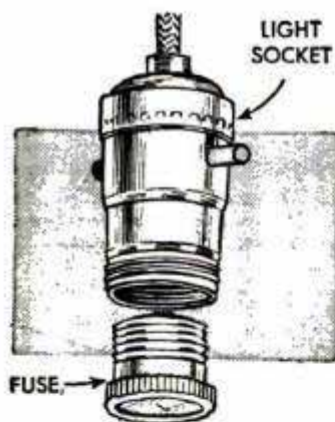

If the pendant switch on your kitchen or bathroom ceiling light breaks, here is a substitute that will serve the purpose until a new pendant switch is obtainable. Remove the broken switch and wire a push-button lamp socket in its place. Then,

turn a 15-amp. fuse into the socket to complete the circuit, and the socket will operate in the same way as a switch.

### Tools Held on Stepladder Top By Length of Wire Solder

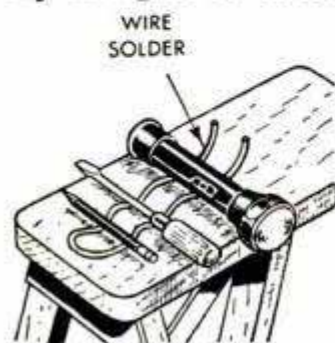

Especially handy when making overhead electrical repairs, a length of wire solder, doubled and crimped as shown, will prevent small tools from rolling off a stepladder.

### Coffee Can Serves as Camp Stove



For camping, picnics or long motor trips, an old coffee can provides a cookstove that heats for almost half an hour without refueling. Fill the can two thirds full of sand and punch ventholes around its side just above the level of the sand. Then pour about two thirds cup of gasoline or fuel oil over the sand. *Caution:* Do not pour gasoline or oil over hot sand. Allow the sand to cool for at least five minutes before refueling the stove.

Arthur F. McConnell, Kansas City, Mo.

### Thin-Wall Tubing Sawed Quickly

To saw thin-wall tubing quickly and easily, fit two blades into the hacksaw, staggering the teeth. The latter is done by elongating one hole in each blade with a rattail file, the elongated holes being made at opposite ends of the blades. The staggering prevents the teeth

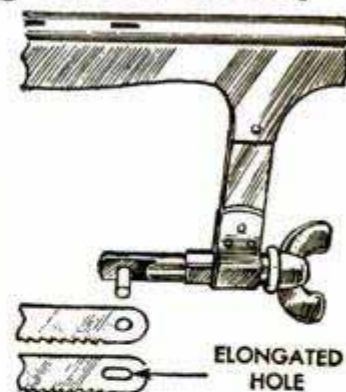

from hooking on the edge of the thin metal and permits the blades to cut like a file. In addition, if one of the blades is reversed, the saw will cut on both strokes, speeding the job considerably.

☐ A heavy steel spring used directly above a small boat anchor will act as a shock absorber during rough weather and thus help prevent the anchor from dragging.

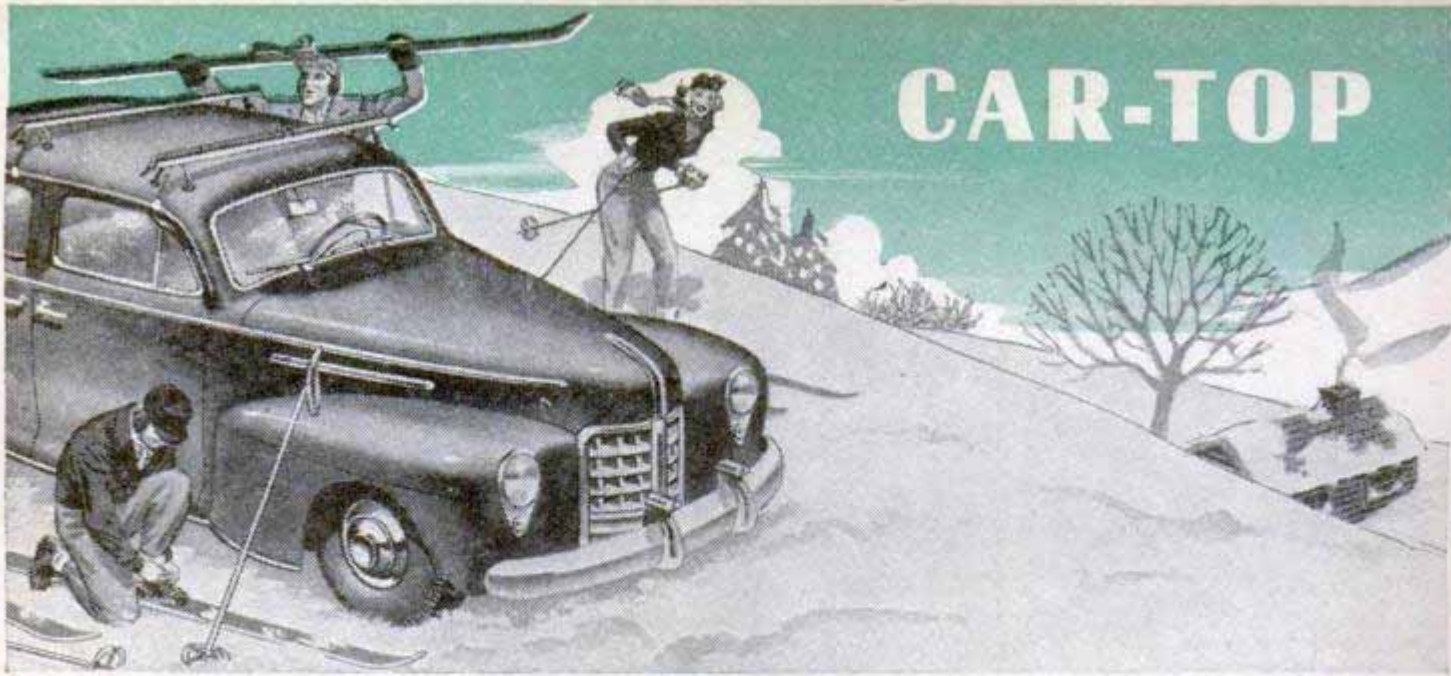

# CAR-TOP

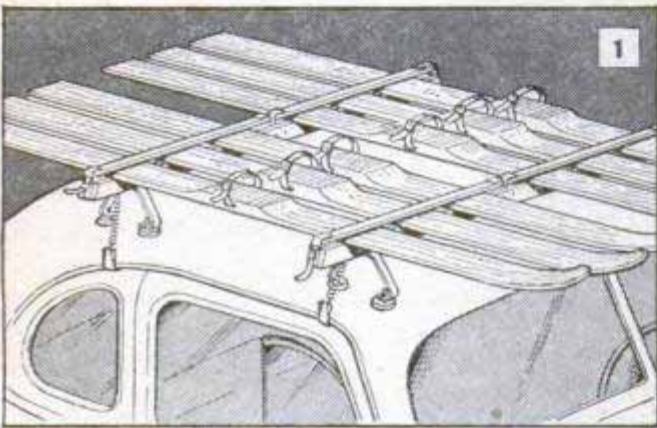

By Thomas E. Riley

**T**HIS DUAL-PURPOSE ski rack not only solves the transport problem for skiers, it serves equally well as a car-top canoe rack during the summer sport season. No extra parts are necessary to adapt it to either use. It consists of two laminated wooden frames resting on padded brackets, the frames being attached to the car top with spring-tensioned hooks shaped like gutters, the frames

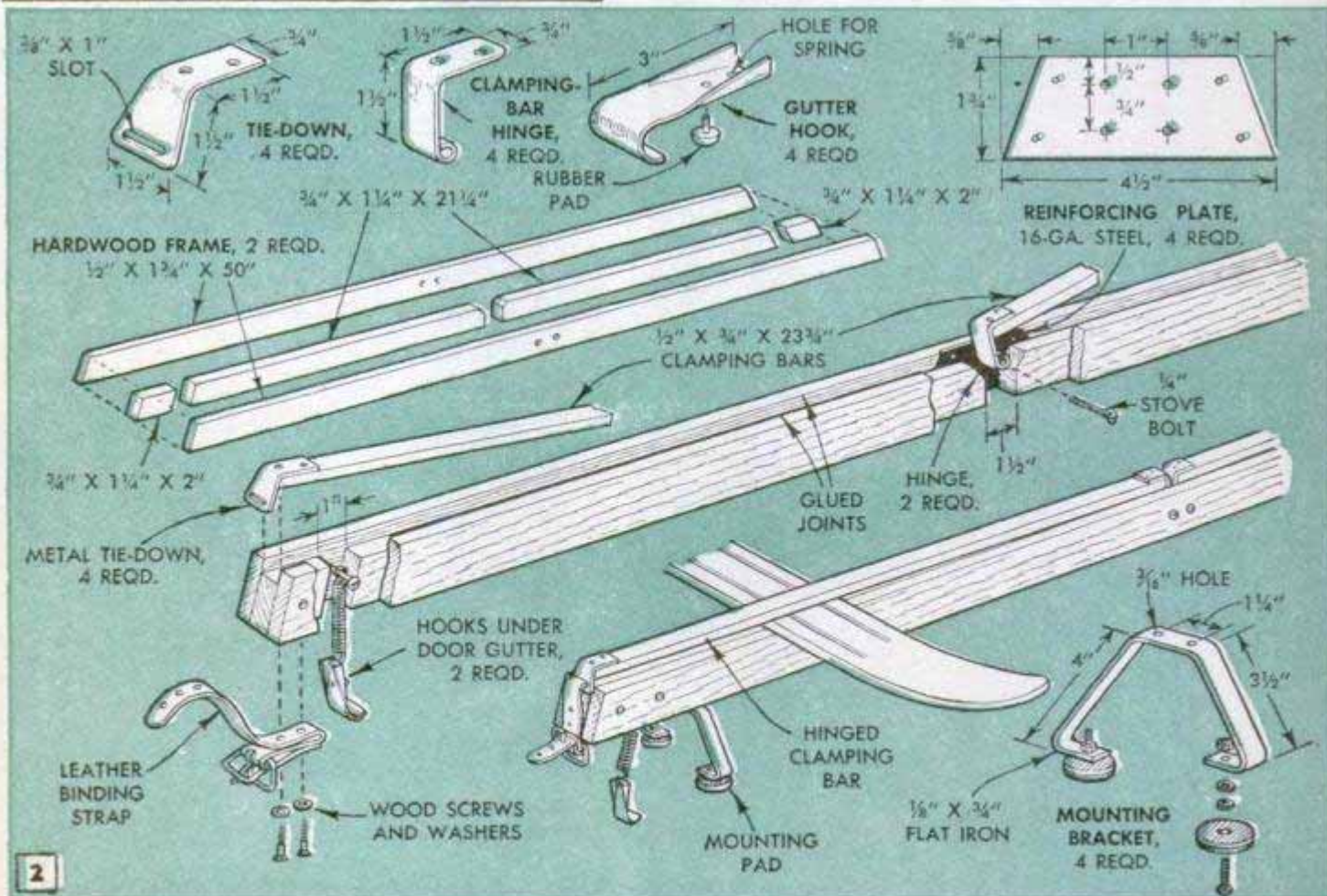

# SKI RACK



Fig. 1. Each wooden frame is assembled from six pieces of choice straight-grained spruce or birch, cut to the shape and general dimensions given in the details in Fig. 2. The outer members of each frame are reinforced with sheet-metal plates screwed to the inner face. After the plates are fastened in place, two pairs of holes are drilled through each plate and the wood to which it is joined. The location of these holes is shown in the upper right-hand detail in Fig. 2. Spaced as indicated, they provide dual settings for the clamping-bar hinge pins. Use waterproof glue when assembling the frames. Hard maple is the best wood for the clamping bars. Special hinges for the bars are made by reshaping two pairs of 6-in. strap hinges. These are bent to an L-shape as detailed in Fig. 2. Outer ends of the clamping bars are fitted with slotted metal tie-downs through which the free ends of the binding straps are passed. The tie-downs are bent to a 60-deg. angle and the ends of the clamping bars are sawed to the same angle to provide additional support. Bend the mounting brackets to the approximate shape shown in the lower right-hand detail, Fig. 2, and fit them with rubber suction cups or rubber pads. To use the rack as a canoe rack, withdraw the clamping-bar hinge pins, lower the clamping bars into the grooves in the tops of the frames and insert the hinge pins in the lower holes in the reinforcing plates.

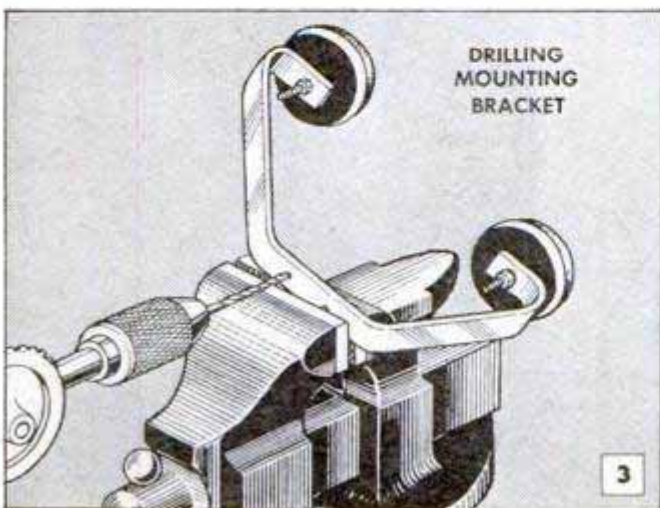

## Combination Dibble and Marker Spaces Plants Uniformly

From an old shovel handle and a couple of wooden strips you can make an adjustable dibble that will enable you to space seedlings uniformly when transplanting them. Just point the lower end of the handle and insert it through a hole drilled near one end of a wooden block of the desired length. Brace the outer end of the block and drive a screw into the edge of the block to engage the handle. A short dowel serves as a marker and three or four holes in the block permit the marker to be adjusted for spacing the plants.

Marion L. Rhodes, Knightstown, Ind.

## Controlling Flush-Tank Ball Valve

If the lift wires of the ball valve in a flush tank are wired together, overflowing of a toilet bowl is stopped by a quick twist of the flushing handle. In addition to permitting emergency seating of the valve without raising the tank cover, this positive control allows the bowl to be completely filled without overflowing. In many cases, filling the bowl will permit freeing a clogged drain by water pressure alone.



Roy G. Loughary, Portland, Ore.

## Staples Hold Sign Cloth Taut And Are Easy to Remove



When lettering large cloth signs, one artist found that office staples were better than thumbtacks to hold the cloth stretched tautly. To remove the staples rapidly, a length of stout fishline is placed under them as they are driven. A quick jerk on the line will then pull out the staples.

G. E. Hendrickson, Argyle, Wis.

## Weatherproofing Summer Cottages

Loose-fitting window frames and cracks in the siding and floors of summer cottages can be made windproof and weatherproof by using boat-calking compound to seal the openings. The compound can be applied with a calking gun, a knife, or, in an emergency, with a thin, flat stick that is somewhat pliable.

## Lacing Tip for Leather Thong Fashioned From Tin Can

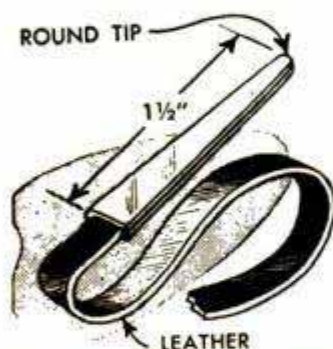

Using a piece of metal cut from a tin can, this leather-lacing needle is made in a jiffy and costs absolutely nothing. After cutting a piece  $1\frac{1}{2}$  in. square from the side of a tin can, bend the metal

double and flatten the bend with a hammer. Then trim the edges of the metal to shape with tinner's snips. Finally, file the edges smooth and round the tip. To attach the needle to the end of the lace, pry the metal edges apart with a knife, insert the lace and squeeze the needle together with a pair of

pliers. If necessary, tap lightly with a hammer to tighten the grip and use a razor blade to trim excess lacing from the edges of the needle.—Gerald W. Hall, Mentor-on-the-Lake, Ohio.

## Lacquer Protects Drawings

To keep plans and working drawings from tearing easily, one craftsman glues them to pieces of cheesecloth and coats them with clear shellac or lacquer.

Neal Houlahen, Glenshaw, Pa.

## Ornamenting Driveway Gateposts

Discarded lamp housings from older types of cars make novel ornaments for the tops of driveway gateposts. Each housing is painted as desired and its rim embedded in a coating of mortar on top of the post. — Willard Midby, Billings, Mont.

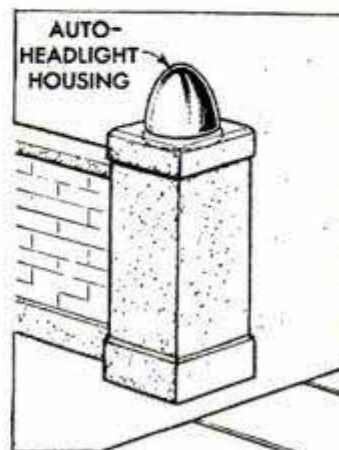

## Home-Workshop Arbor Press Utilizes Bottle Capper

By fitting a bottle capper with an adjustable table, one home craftsman made a handy arbor press for light work. He used a piece of 3-in. angle iron for the table, drilling and tapping it for two bolts. Then, he drilled a series of corresponding holes along the front of the T-shaped upright of the bottle capper to permit fastening the table at several different heights.

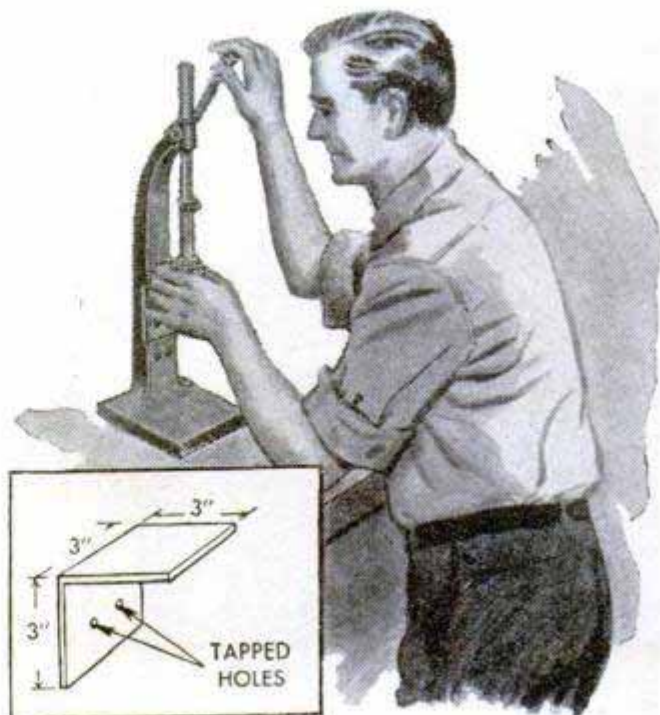

# STEPS IN CONCRETE

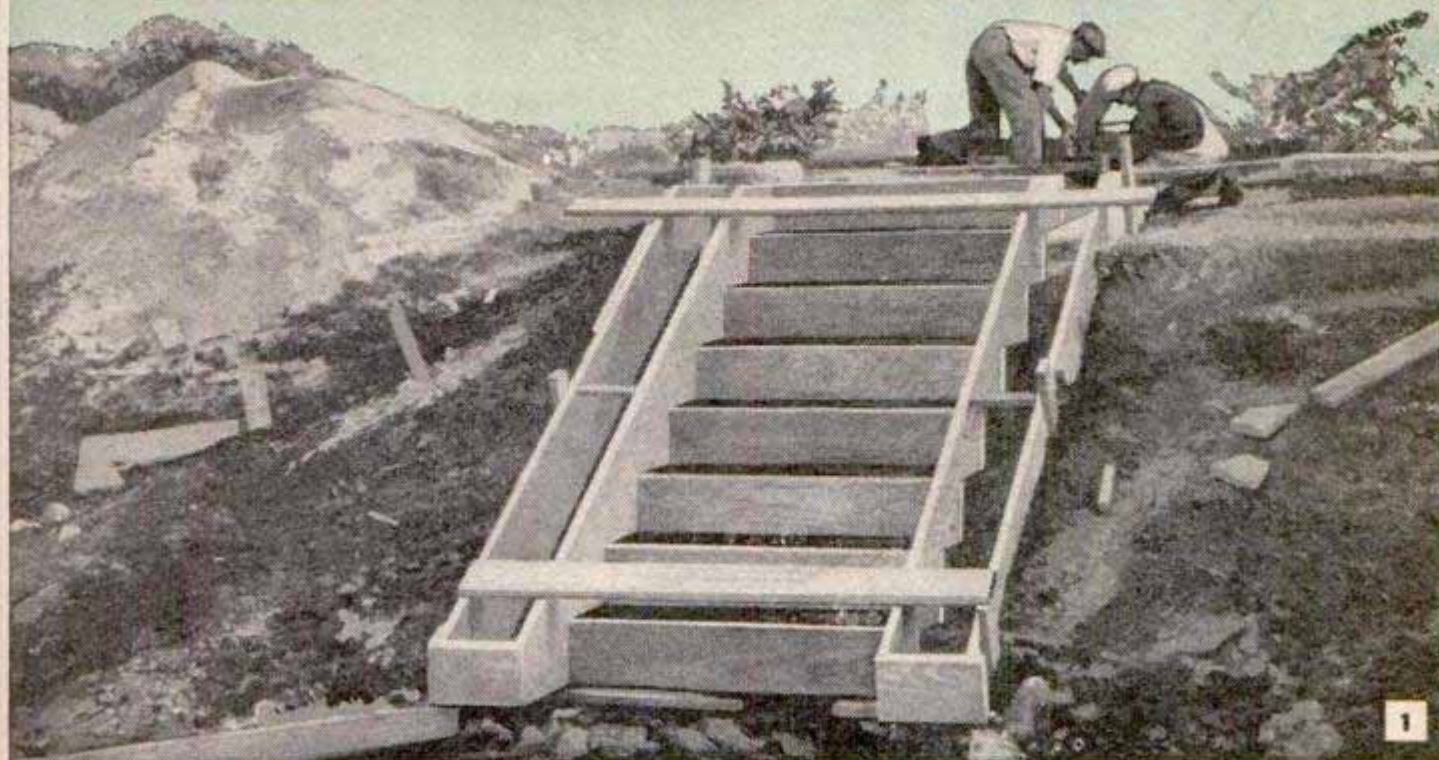

Photos courtesy Portland Cement Association

By Thomas Trail

**C**AST-CONCRETE steps add measurable values to any home, and welcome savings in first cost can be had by doing the whole job yourself, from setting the wooden forms to mixing and pouring the concrete. Only the simplest hand tools, such as a hammer, saw, and a good level, are needed for building the necessary forms, and the lumber and materials are available from any building-materials dealer.

The first step in setting the forms is preparing the ground over which the steps are to be cast. If the soil is well-drained and contains gravel and sand in relatively small amounts, about all that is necessary is to level and tamp the area thoroughly to compact the soil. On the other hand, if the soil is a heavy, tight clay through which drainage of surface water is slow in wet seasons, it will be necessary to excavate to a depth of 6 to 8 in. below grade and put in a tamped-gravel fill. Thorough tamping of the fill is of the first importance. Make a tamper by cutting an 18-in. length from a 6 x 8-in. timber and nail a 36-in. strip to each side to provide handles. Go over the whole area of the gravel fill with the tamper several times in order to compact the fill uniformly. Cinders should never be used as a fill under a heavy concrete casting as they disintegrate in time.

Fig. 1 pictures the form required to produce the type of terrace steps shown

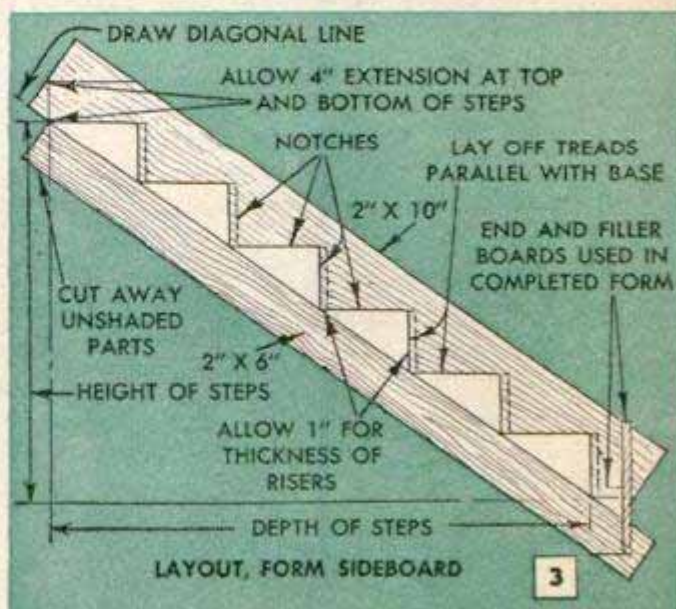
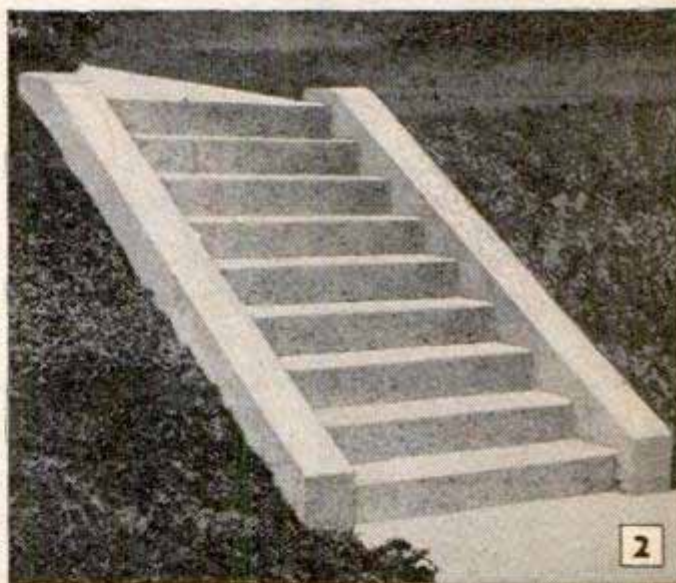

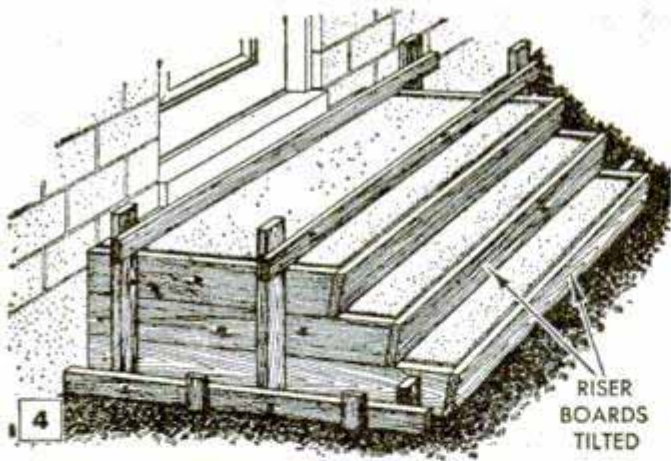

In this form, the riser boards are inclined at an angle of 5 deg. The purpose of this is to add to tread width without increasing the over-all dimensions

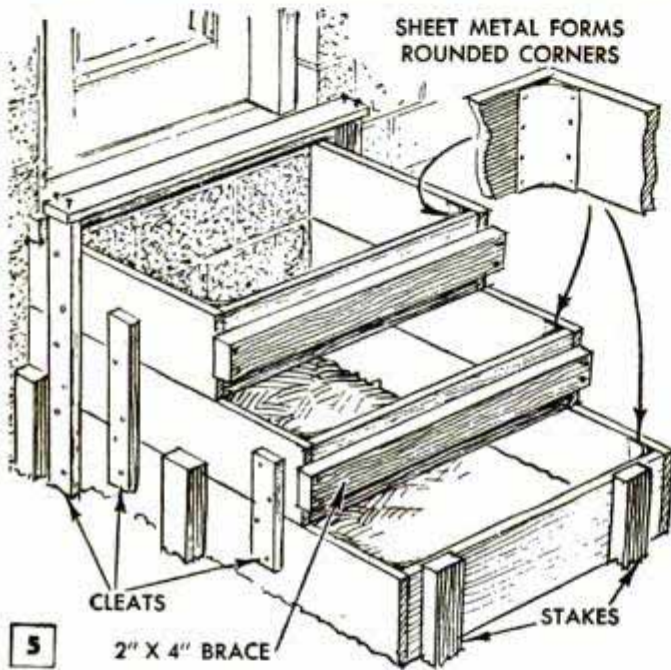

Braces, or stiffeners, usually are required to prevent springing of the riser boards under pressure of freshly poured concrete. Tie strips hold sides

in Fig. 2. Fig. 3 shows the method of laying out and cutting the form sideboards. Compare this with the simpler forms detailed in Figs. 4, 5 and 6. The form detailed in Fig. 6 gives the type of steps pictured in Fig. 8. To cover a given ground area, both types of forms require about the same amount of material per single step but the construction differs in some details. Note in Fig. 4 that the riser boards are inclined at an angle of about 5 deg. The purpose of this is to add to the actual tread width without increasing the over-all dimensions of the form. The inclination of the risers gives more toe room. In making this type of form, the risers should never be inclined more than 5 deg. The form in Fig. 4 is constructed for casting the steps, or stoop, considerably wider than the entrance doorframe. The smaller form in Fig. 5 has been made the width of the doorframe. In some types of stoops, this width may be necessary or desirable, but the general practice is to set the form to give a width that will extend from 6 to 18 in. on each side of the doorframe. This width allows plenty of room for installing an ornamental iron railing.

Lumber used for the forms should be smooth on one side and free from knot-holes. In addition to adequate staking, the boards should be well supported with braces and stiffeners to prevent bending under pressure when the concrete is poured. This is especially important where the width of the steps makes it necessary to use long riser boards. Braces, or stiffeners, of 2 x 4-in. stock should be nailed across the outer faces of all 3/4-in. riser boards more than 30 in. long and also across the face of 2-in. riser boards more



than 60 in. long. These braces or stiffeners, are shown in place in Figs. 5 and 6. When staking the first, or lower step form, use at least two stakes, Fig. 5, against the first riser board if it is 30 in. or less in length. If more, use three or four stakes. Tack the stakes to the board from the outside by driving the nails only part way in. The sideboards of forms like those in Figs. 5 and 6 are held together by means of cleats, at least two being required on each side, in addition to two or more stakes driven into the ground.

In Fig. 4, a somewhat different method of cleating and staking the sides of the form is shown. Here, the three sideboards are nailed to two 2 x 4-in. stakes previously located and driven at each side of the form. After plumbing the assembled sideboards, tie strips are nailed to the projecting ends of the stakes to keep the form from spreading under pressure of the freshly poured concrete. Then a narrow board is tacked to the stakes at each side of the form and additional short stakes are driven outside this board as shown. In this way, the end members of a wide form cannot shift during the pouring. The 2 x 4-in. braces, Fig. 5, have been omitted from the form in Fig. 4 to show better the angle of the riser boards.

When concrete side walls are cast integrally with the steps, Figs. 1 and 2, each step is reinforced with a 1/2-in. steel reinforcing bar which is placed in the step as the concrete is poured. The bar should be cut to such length that it extends beyond the ends of the step a distance equal to about half the thickness of the side walls. These bars prevent the side walls from cracking away from the steps.

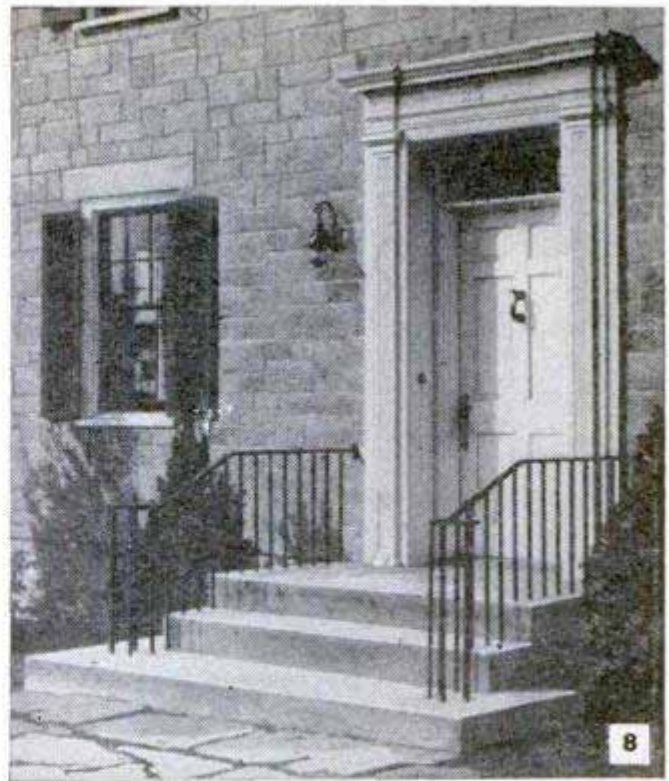

Figs. 7 and 9 detail methods of setting forms for basement stairs. Where the stair well is already formed with concrete walls, the stair forms are simply riser boards spaced, plumbed and wedged between the walls. The earth fill is tamped to a uniform slope. When the steps are wider than normal, it is necessary to fit side planks and vertical cleats so that the riser boards may be supported by horizontal braces which are wedged against the side planks, as in Fig. 9. Be careful in laying out and setting forms for basement stairs to keep the tread-to-riser proportions within the accepted comfort range, as in the right-hand details of Fig. 9. These dimensions

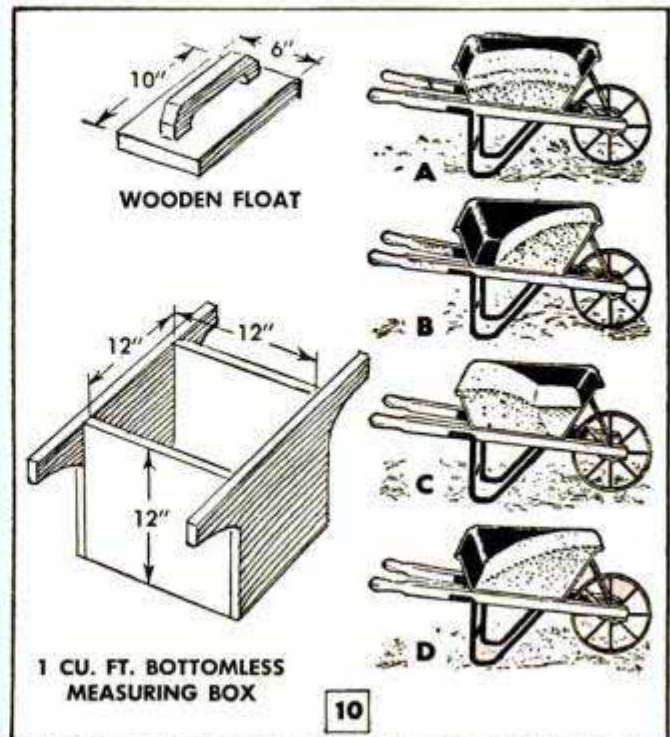
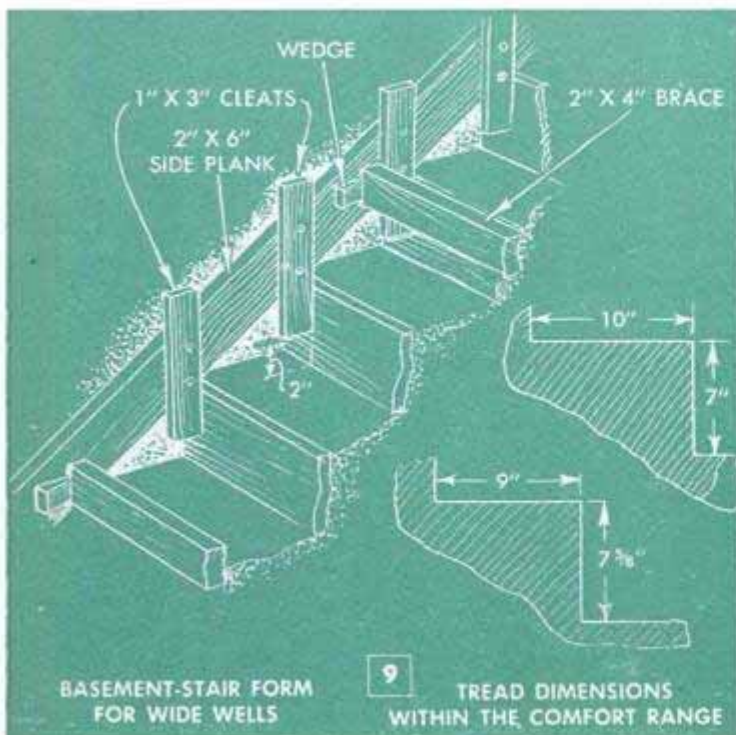

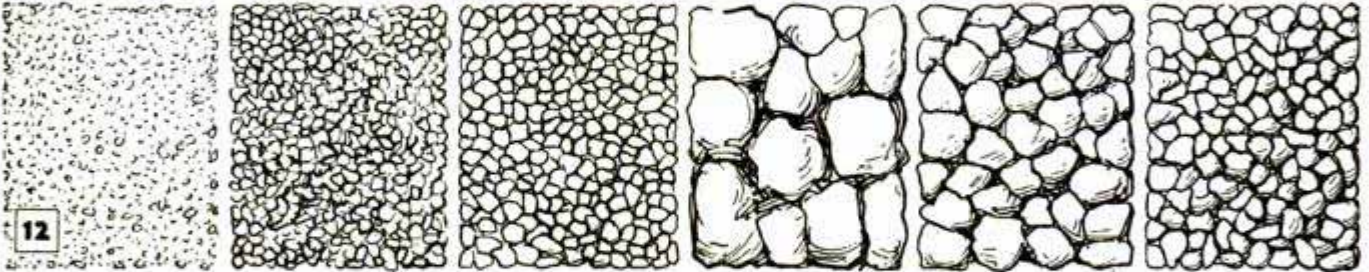

Clean, sharp sand of the quality used for concrete work should have fine, medium and large particles mixed in about equal proportions for the best results

The largest pebbles of the gravel should not exceed 1½ in. in size. Concrete mix should contain very nearly equal quantities of large, medium and fine pebbles

**13 HOW TO FIGURE CUBIC VOLUME OF STEPS**

Example: Six steps 36 in. wide, 7-in. riser and 10-in. tread, with 8-in. side walls.

7 X 10 = 70 sq. in.  
70 X 36 = 2520 cu. in.  
2520 X 6 = 15,120 cu. in.

7 X 10 = 70 sq. in.  
70 ÷ 2 = 35 sq. in.  
35 X 36 = 1260 cu. in.  
1260 X 6 = 7560 cu. in.

4 X 7 = 28 sq. in.  
28 X 36 = 1008 cu. in.

10 X 12 = 120 sq. in.  
120 ÷ 2 = 60 sq. in.  
60 X 8 = 480 cu. in.

1½ X 15 = 22½ sq. in.  
22½ ÷ 2 = 11¼ sq. in.  
11¼ X 8 = 90 cu. in.

66 X 15 = 990 sq. in.  
990 X 8 = 7920 cu. in.

4 X 16 = 64 sq. in.  
64 ÷ 2 = 32 sq. in.  
32 X 8 = 256 cu. in.

5 X 15 = 75 sq. in.  
75 ÷ 2 = 37½ sq. in.  
37½ X 8 = 300 cu. in.

15,120 cu. in.  
7,560 cu. in.  
1,008 cu. in.

23,688 cu. in. Steps  
18,092 cu. in. (9046 X 2)

41,780 cu. in. Volume

480 cu. in.  
90 cu. in.  
7920 cu. in.  
256 cu. in.  
300 cu. in.

9046 cu. in. One side wall

Total volume in cu. ins. 41,780 ÷ 1728 (cubic ins. per one cu. ft.) = 24 cu. ft., approx.

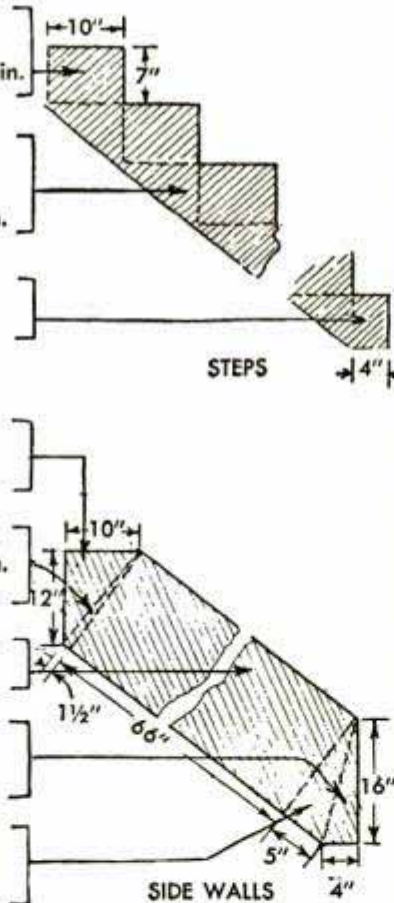

also apply when building forms for other types of steps.

On small jobs, concrete may be mixed by hand methods but, where several yards are required for a single pouring, it is better to rent a mixer or purchase concrete ready-mixed to specifications. In hand-mixing, make a bottomless box, Fig. 10, for measuring the amounts of gravel, sand and cement. The box holds 1 cu. ft. of dry material if made according to the dimensions. One good way of mixing is to shovel the measured materials into a wheelbarrow. Mix the dry materials as in steps A and B, Fig. 10. Add the proper amount of clean water, step C, and mix thoroughly, step D. Once the pouring is begun, continue until the job is finished. As soon as pouring is finished, level the concrete flush with the top of the forms with a wooden float, Fig. 10. Wait until the concrete stiffens slightly before troweling. Edges of the treads and other parts of the concrete work are rounded by running an edging tool along the top edges of the forms. Cover the concrete with wet sacks or straw and keep the covering damp for several days after pouring to aid in proper curing.

The largest size of gravel used in the concrete mix for pouring the average entrance steps should not exceed 2 in. in diameter, Fig. 11. Smaller average sizes are better. The average proportions of the sand and gravel sizes are shown in Fig. 12. The table, Fig. 13, shows how to estimate in detail the amount of concrete required for steps and side walls. If the aggregate (sand and gravel) is only slightly damp, use 5½ gal. of water per sack of cement when mixing. If the aggregate is quite wet, use only 4 to 4½ gal. of water per sack. Use of the correct amount of water is important.

Attractive in its simplicity, this combination birdbath and feeder will be a great favorite with your feathered friends. The unit is suspended from a tree limb with wire or chain and the bath features running water which drips from an overhead outlet. Water is piped to the bath by means of a length of copper tubing stapled to the tree trunk and along the underside of the limb. The lower end of the tubing is connected to the water line as shown, the valve being adjusted for a steady drip. A metal pan for the bath and two cups, one for feed and the other for suet, are set in a circular plywood platform. A hole for an overflow is drilled through the side of the pan just under the platform, and the suet cup is fitted with a skewer to hold the suet cake in place. Another novel feature of this unit is an offset perch made from two pieces of stiff wire and a length of dowel. This is soldered to the end of the copper tubing to permit the birds to catch the water as it drips from the outlet. The copper tubing is painted to match the bark of the tree, and

## Running Water Piped Up Tree Trunk Supplies Hanging Birdbath and Feeder

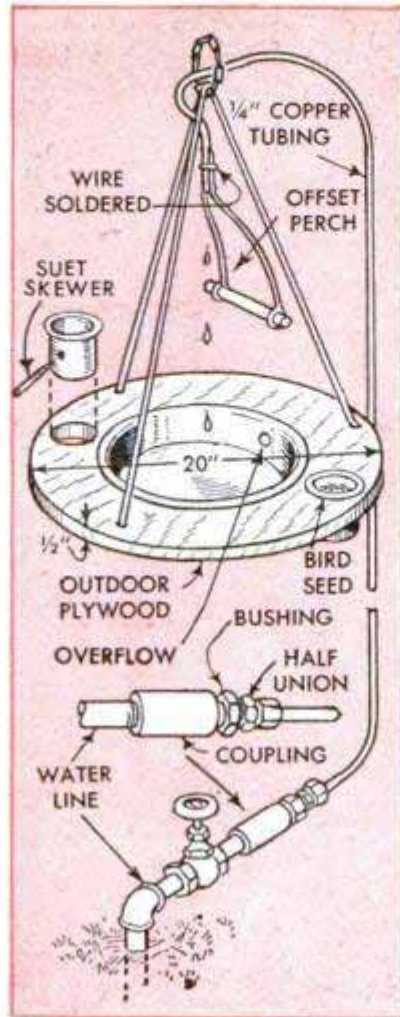

the undersides of the platform, pan and cups are painted the same shade except in a mottled effect to blend with the tree foliage.—Hi Sibley, Nuevo, Calif.

## Convenient Car-Top Carrier for Long Fish Pole Clamps to Drip Molding

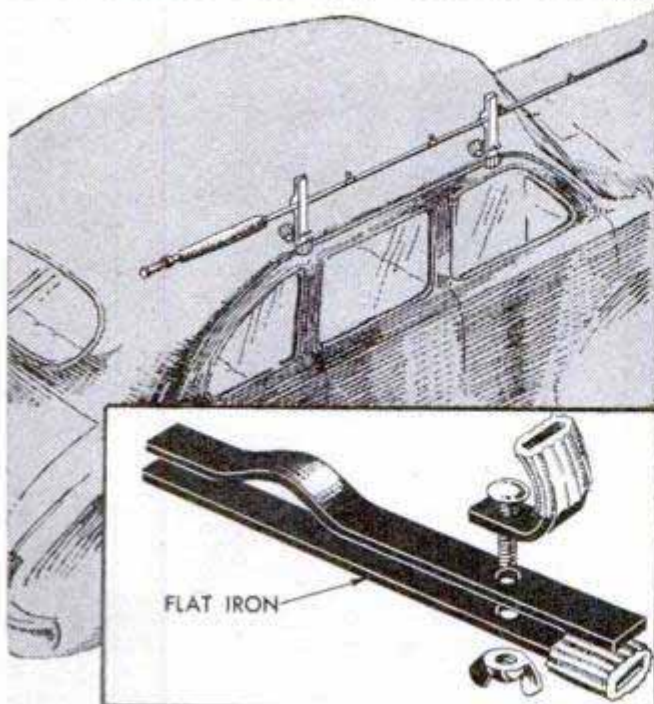

As my favorite fish pole is too long to be carried inside my car, I made this handy car-top carrier for the pole. It consists of two flat-iron holders, tightened with wing nuts, which clamp to the drip molding of the car. Pieces of rubber tubing pressed over the ends of the holders protect the car finish from being marred by the metal.

Claude W. Clifford, Portland, Ore.

## Ignition Contacts on Model Airplane Provided by Dress Snaps

Ignition systems of gas-model airplanes are not likely to fail because of broken contacts if ordinary dress snaps are soldered to the terminals and to the ends of the leads. In addition, use of the snaps permits the wiring to be disconnected quickly for replacing the various parts.

Fred M. Bowles, Annapolis, Md.

# THIS TOY "STEAM SHOVEL"

YOUNG engineers will have hours of fun with this sturdy model of a full-size steam shovel. It is realistic in design and principle of operation, and the cab and crane mounted on a truck chassis have a swivel base which permits swinging in a complete circle. Two hand cranks, one on each side of the cab, operate the shovel. The bottom of the shovel is hinged, and the load is dumped by pulling a trip cord extending back to the cab. Sand or loose soil is easily scooped from one spot and dumped in another or into a toy truck. Size of excavation is limited only by the swing of the crane and travel of the shovel beam.

The crane, Fig. 1, consists of two parallel members with spacer blocks, sheaves, and a roller between them. Note that the lower sheave has a double groove, a screw eye guiding the cord in one of the grooves. The

shovel beam has two slots, one for the roller of the crane and the other for the lifting cord. For durability, the shovel is made of sheet metal. Three teeth ground to flat, sharp points are soldered to the cutting edge of the shovel as shown in Fig. 2. Details of the latch are given in the lower left-hand detail. The truck chassis and cab are made of wood to the dimensions indicated in the side, top, and end views of Fig. 3, and are assembled as in Fig. 2. The rear wall of the cab is made of 1-in. stock planed to a curve and the roof is sheet metal. Four dual wheels are used on the rear of the truck chassis and two single-tired wheels on the front. These are turned to the dimensions given in the sectional view, Fig. 2, and drilled for a tight fit on the  $\frac{3}{16}$ -in. axle. Use hardwood, such as maple, for both the front and rear wheels. The winches

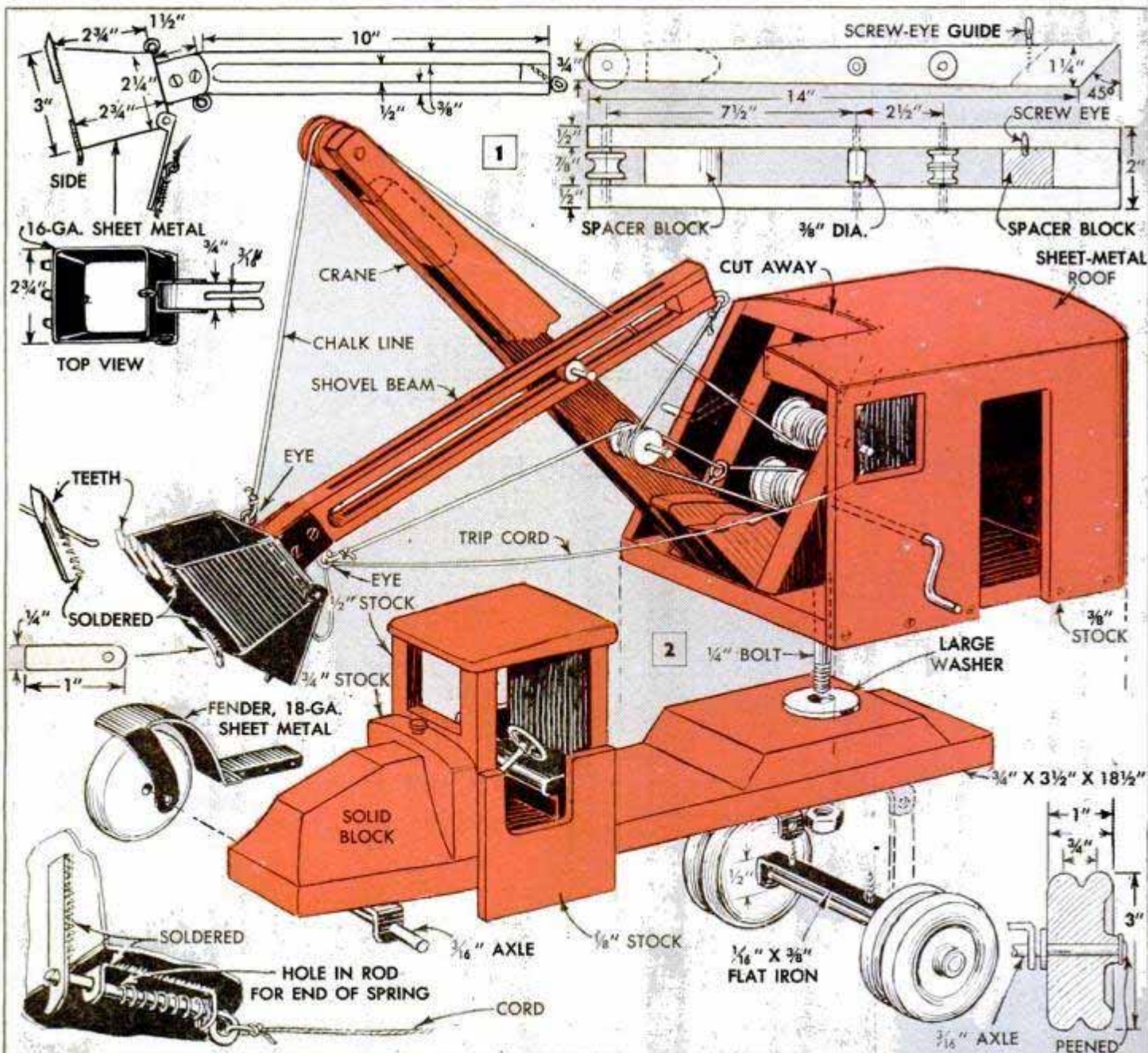

# REALLY DIGS

are wooden spools pinned to  $\frac{3}{16}$ -in. shafts bent to form crank handles. The upper winch raises and lowers the shovel while the lower winch moves the shovel back and forth. Controlling cords are arranged as shown in Fig. 2. After assembling, sandpaper all wooden parts to get a smooth surface over which to apply paint. The shovel, tires, cab roof and front fenders are painted black and all other parts a bright red or yellow. Use a durable, outdoor enamel for the final coat as the finish will get hard usage.

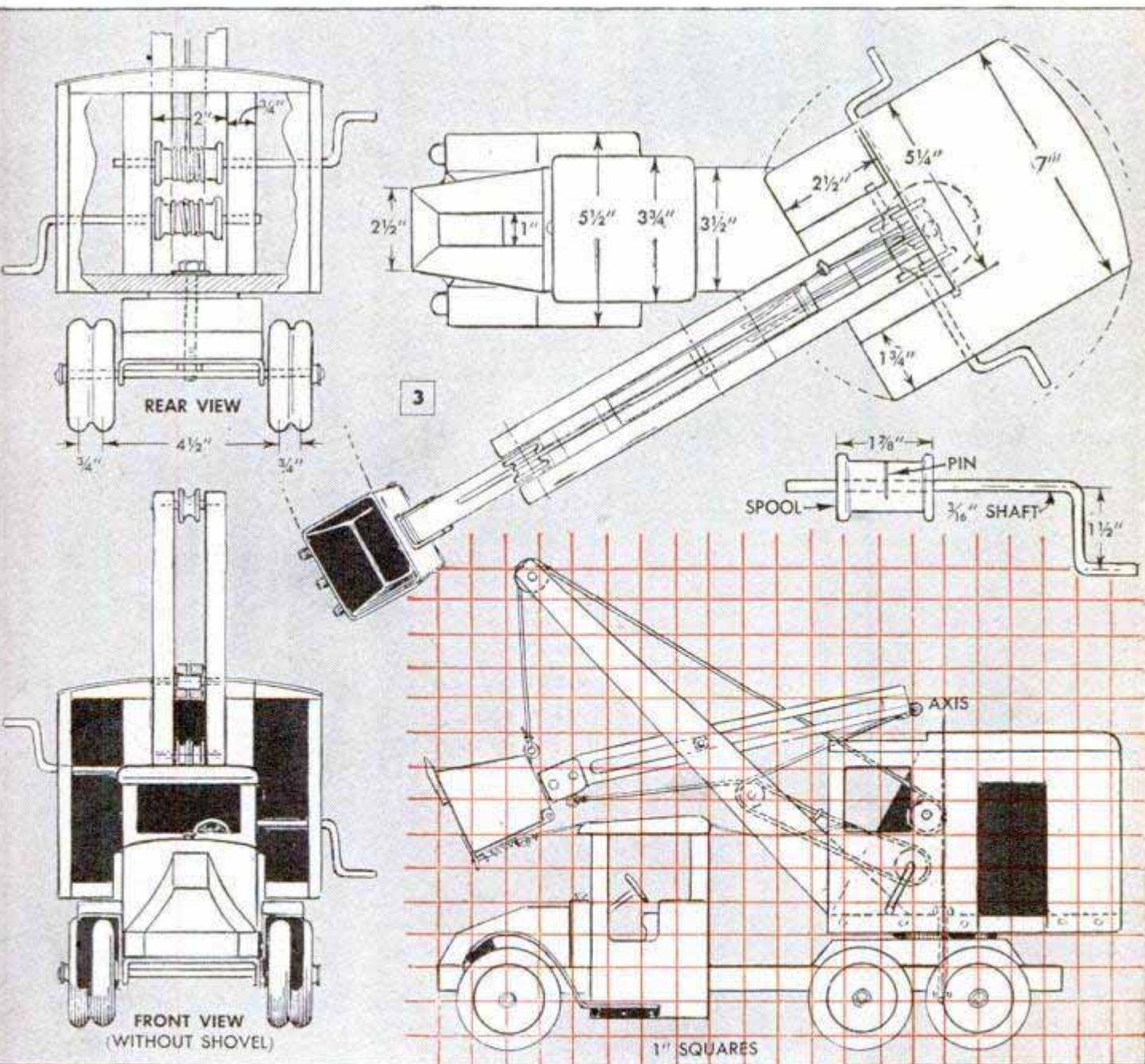

## Flower Trellis From Porch Gate Is Set Up in a Jiffy



If you have an old porch gate, it will provide an attractive flower trellis that can be folded and stored during the winter. Just extend the gate to the desired height and attach it with screws to a post or the side of a building so it is easily removed. If set up against a building, use wooden spacers to hold it away from the siding.

Byron L. Troyer, La Fontaine, Ind.

## Record Album Holds Saw Blades For Convenient Storage

Circular-saw blades are stored conveniently and safely by inserting them in the envelopes of a phonograph-record album.



If each envelope is labeled according to the type of blade it contains, blade selection can be made quickly.

Benj. Nielsen, Aurora, Neb.

## Dog Tethered to Swivel Post

Ideal for tethering a dog in the back yard, this swivel post is easily moved and the swivel prevents the dog from wrapping the tether around the stake. The stake is merely a length of pipe or rod pointed at one end for driving into the ground. A piece of thin iron rod, bent to shape and welded to a short length of pipe, is placed over the stake to provide the swivel. A washer under the swivel keeps it from working into the ground, and the top of the stake is peened over to prevent the swivel from slipping off. The swivel pipe should be large enough to rotate freely on the stake.

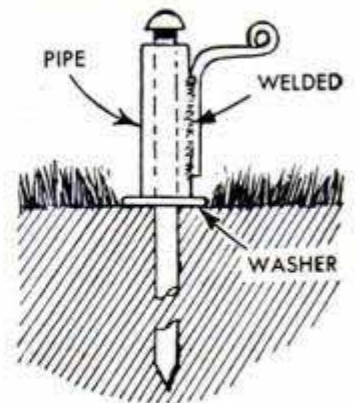

100 W.P.

## Round-Cornered Wooden Boxes

When making wooden boxes, such as flower boxes, that must present a good appearance, use pieces of quarter round to provide neat-looking rounded corners. Try to use quarter round of the same thickness as the sides of the box and, if necessary, reinforce the inside of the corner with sheet metal.

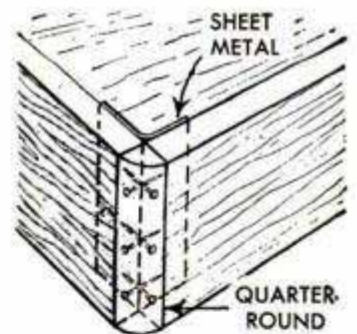

Herbert E. Fey, New Braunfels, Tex.

## Rubber Tubing on Tip of File Provides Finger Grip

A small section of heavy rubber tubing or hose pressed over the tip of a file provides a comfortable finger grip. This is especially useful to protect the fingers when filing for a long period of time. Use hose or tubing of a size that fits tightly over the tip of the file.

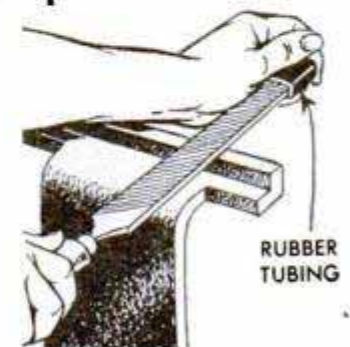

Clifford T. Bower, Decatur, Pa.

# Alsatian Chairs

THESE continental chairs with their widely splayed legs and attractive, carved backs are worthy projects for the home craftsman and provide distinctive pieces for a hall or dining room. Although each chair back appears difficult to make, actually it is fairly simple because the design first is cut through by scrollsawing. Either of the back designs is cut from a single panel, and the scrolled section finished in low relief with a chisel, veining tool and sandpaper. The seat is mounted on two cleats bored approximately 15 deg. from the vertical for insertion of the legs. The top ends of the legs are saw-cut to receive a wedge driven at right angles to the grain of the cleat. The top edges of the seat are rounded and, by using material 1 5/8 in. thick, the seat can be hollowed to form a concave section for greater comfort. In assembling, the back is fastened to the cleats with angle brackets which are recessed flush. Either antique or natural finish, waxed and rubbed to a soft luster, is suitable for this type of chair.

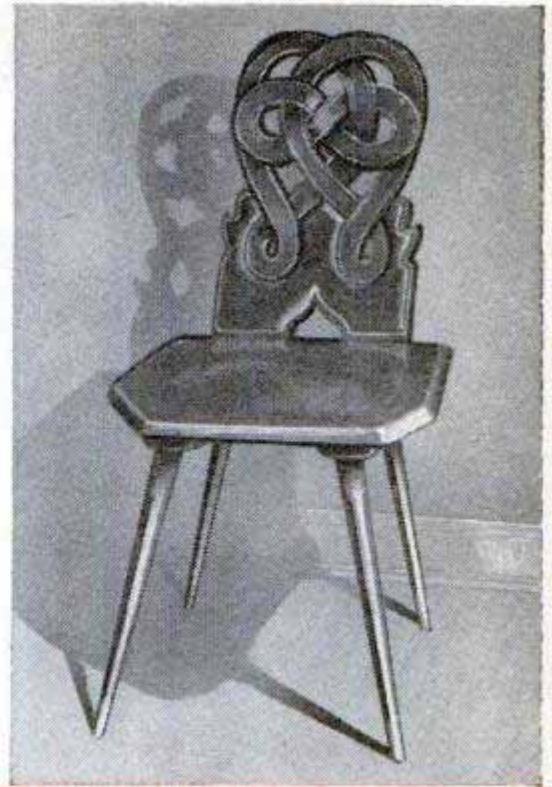

Furniture you can Build p 120

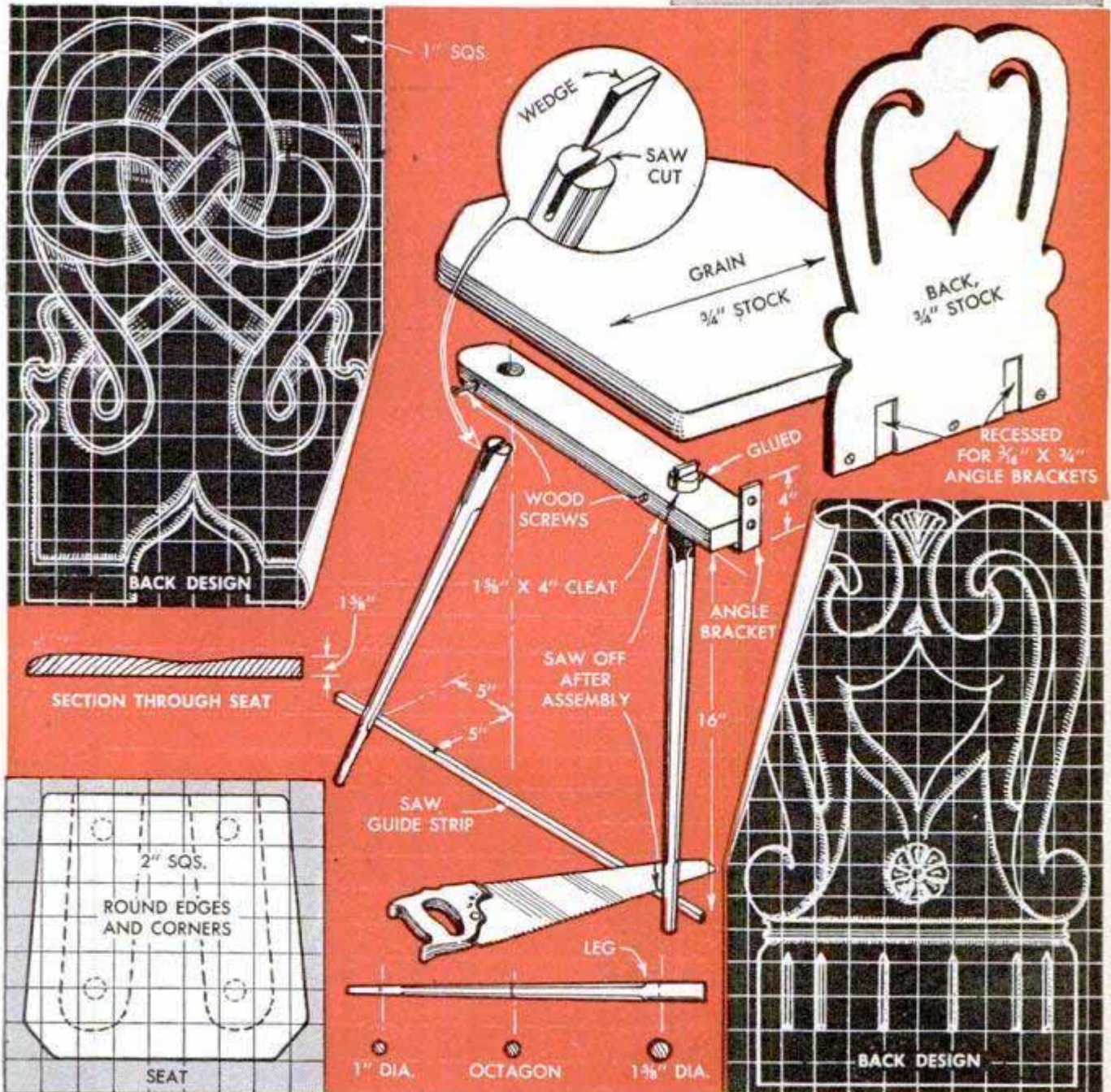



### Nonsplash Water Test Tank Checks Outboard Motors

An empty 55-gal. oil drum provides an ideal tank for testing outboard motors in water and, if the top of the drum is cut out to form a flap, water will not splash out of the tank when the motor is operated at high speeds. When laying out the top of the drum for cutting, draw a straight line, 16 in. long, 10 in. in from the rim, centering it on the drum top. Then, at each end of this line draw a perpendicular line back to the rim. Using a cold chisel, cut out the top along the perpendiculars and along the rim. Then bend the resulting flap downward to form the opening.—Ed Packer, Chicago.

### Pulley Cuts Glazing Putty

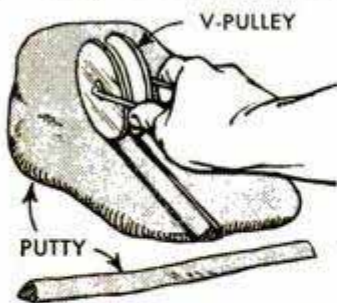

Glazing a window is done more quickly by an amateur if a small V-pulley is used to cut the putty into strips of the proper shape. An ordinary clothes-line pulley is the right size for the job. The putty is spread on a board with a rolling pin to the required thickness and cut as needed. The strips fit almost perfectly, requiring only slight pressure with a putty knife to press them in place.—Jeff Sterns, New Bedford, Mass.

Prevent breaking the agate guides of a fishing rod by inserting small corks in them before putting the rod in its case.

### Tap Serves as Center Punch

Instead of discarding a worn or damaged tap, save it and use it as a center punch. As most small taps have a pointed tip, they can be used without grinding, but, if desired, an extra-sharp point can be ground on the end of the tap since the metal is extremely hard.

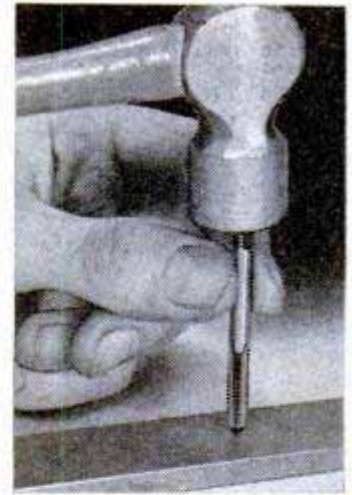

### Name Plate on Rural Mailbox Is Lettered With Thumbtacks

One farmer made a novel and easily read name plate for his mailbox by pressing thumbtacks into a piece of wood. After the wood is cut to shape and painted, the letters are roughly sketched on it. Then, the thumbtacks are pressed into the wood to form the letters. The wood, of course, should be painted dark to contrast with the heads of the tacks.

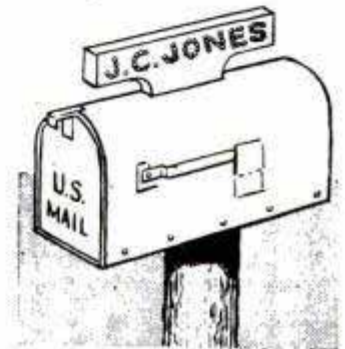

### Torch for Lighting Campfires Contained in Lipstick Holder

Just the thing for lighting campfires without wasting matches, this little torch contained in a lipstick holder is easily carried in a pocket. In addition, the cap of the holder keeps the wick dry even in the wettest weather. Either shape a candle to fit or wrap paper or tape around the holder to cover the slot and fill it with melted wax. Insert a wick in the wax before it has had time to harden.

Elmer A. Anderson, Prairie du Sac, Wis.

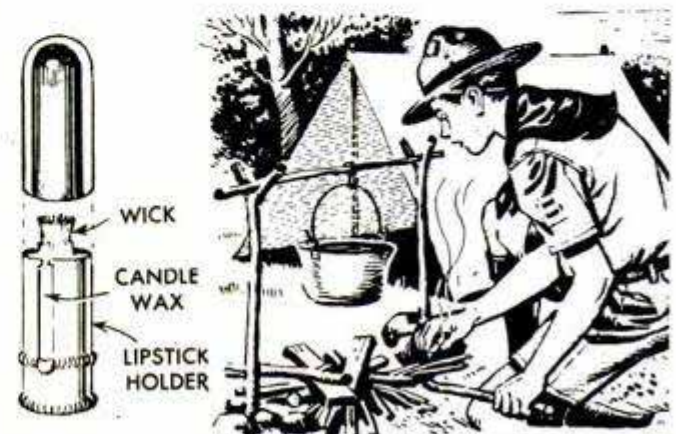



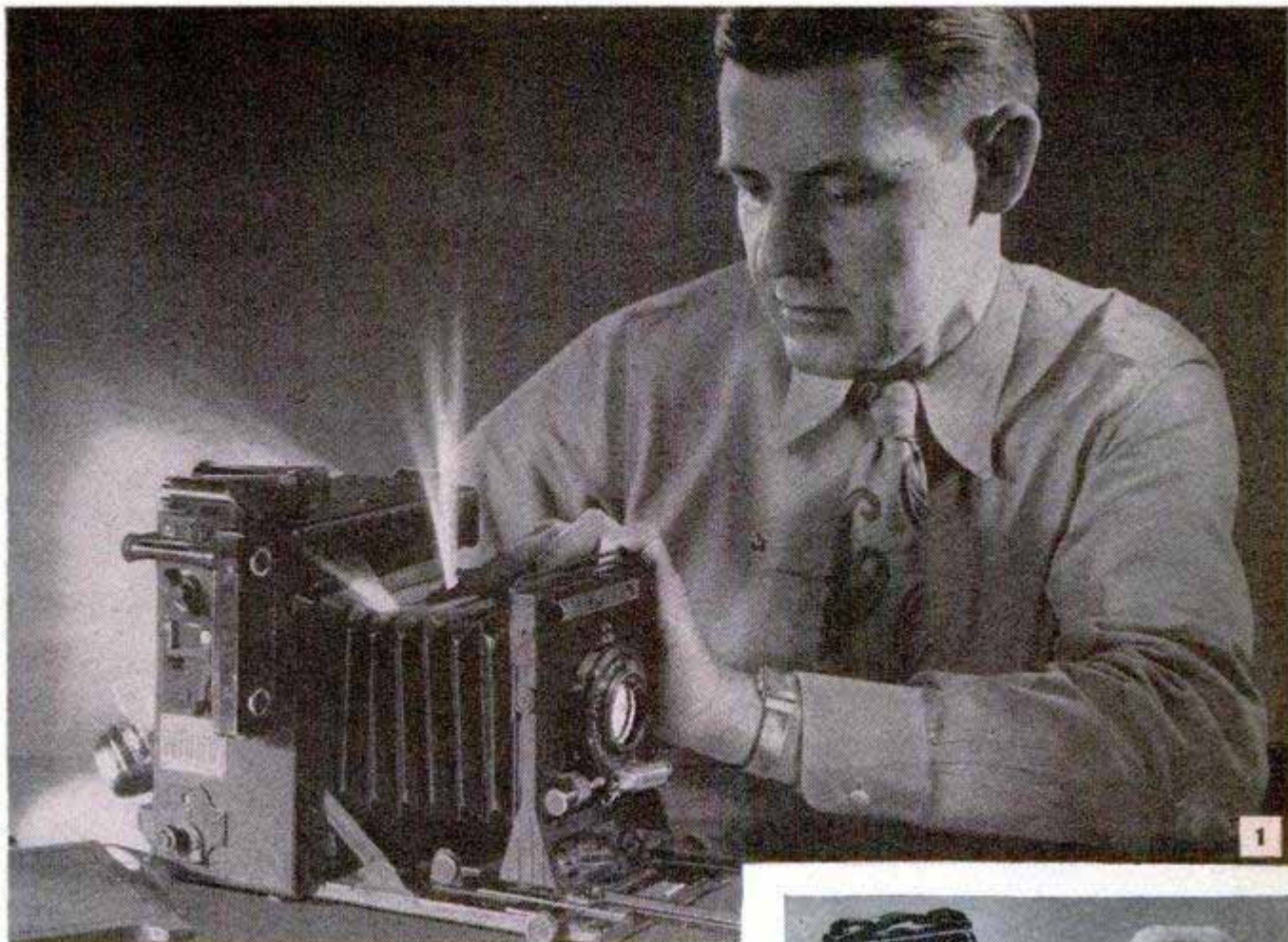

*Close-ups on*  
**CAMERA CARE**

By Richard W. Emery

EVERY photo fan dreams of that once-in-a-life-time shot. Getting it for the album calls for quick action and a camera and accessories in top-notch working condition. Some camera parts, such as the lens mechanism and the focal-plane shutter, are made with watchlike precision and their performance is affected by dust, dampness and extremes of heat and cold. Low temperatures tend to slow down the exposure speeds of between-the-lens shutters and also shutters of the curtain, or focal-plane, type. Fine dust works its way into the shutter mechanism in time and affects reliable operation. Dampness (condensation) has a slow, corrosive action on metal parts, especially near the seashore. However, good outdoor pictures are wherever you find them and frequently the exposure must be made in adverse weather conditions.

To protect the lens from damage during outdoor work under difficult conditions, keep it covered with a lens cap at all times when not in use. If the camera gets wet in a rainstorm, wipe all the parts as dry as possible and leave it open in a protected place until thoroughly dry. If you must leave the

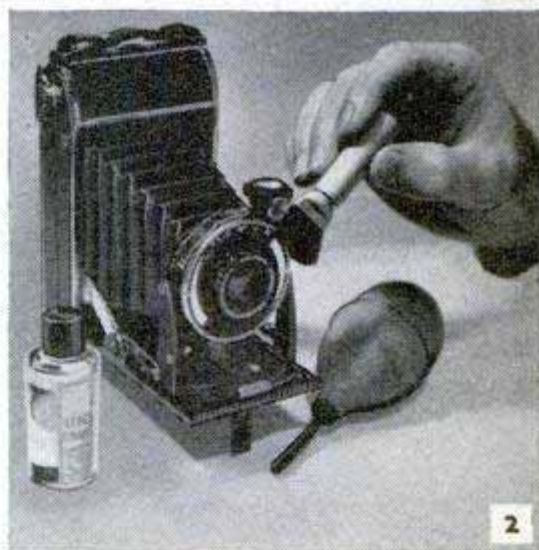

To clean a camera, first loosen dust with a soft brush as above. Then blow off dust and lint with a syringe as shown below



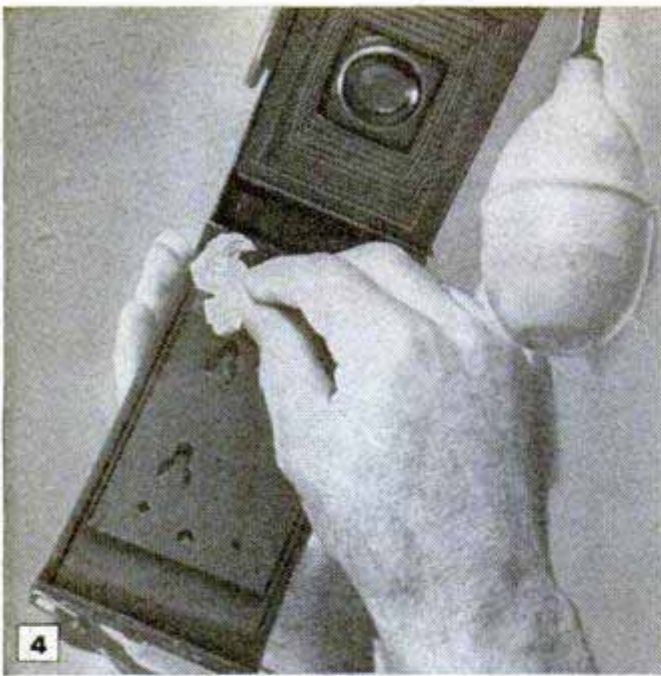

**4** For cleaning interior surfaces of cameras, use lens-cleaning tissue dampened with carbon tetrachloride

camera in a car parked in the sun during a hot day, wrap the camera in a coat or blanket to protect it from the extreme heat. When outdoors, the photographer should acquire the habit of carrying the camera either by the handle or hand strap or in a carrying case, rather than carrying it loosely in the hand as it may be dropped and damaged. Small cameras of the candid type should always be carried in a heavy leather case provided with a neck strap. After purchasing a camera, carefully study the manufacturer's instructions for its care and use. Mechanical misuse should be avoided, especially when operating the newer types of shutters. As an example, never cock a Compur shutter when it is

**A light leak in the bellows can be temporarily repaired by covering the hole with black gummed tape**

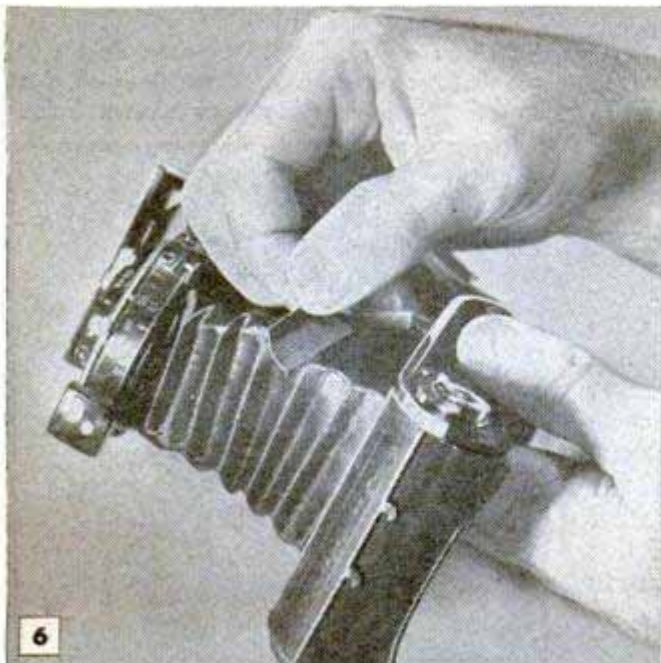

**6**

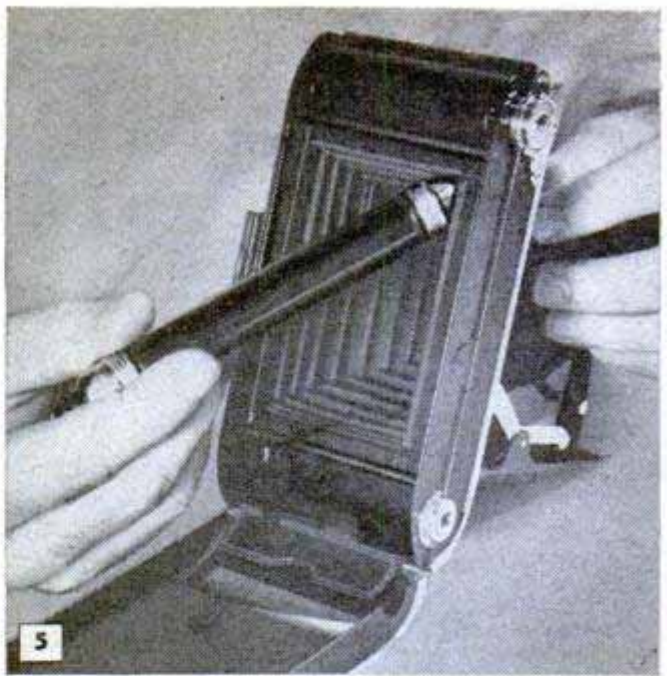

**5** To locate a light leak, press a flashlight against inside corners of bellows and inspect outer surface

set for time or bulb exposure and avoid changing from a fast shutter setting to the time or bulb setting when the shutter is cocked. Cover the lens and release the shutter before changing the setting. Avoid touching the surface of the lens with your fingers, as this may leave a smudge or a fingerprint that will spoil a good picture.

Periodic cleaning and inspection assure reliable performance. A thorough dusting of all the parts is the first step. For dusting, use a soft camel's-hair brush especially made for the purpose, Fig. 2. With this brush, you can get into the difficult corners both inside and outside. After loosening the dust with the brush, blow it clear with a rubber syringe as in Fig. 3. Don't

**After pressing tape down smoothly around the hole, crease it to conform to accordion folds of bellows**

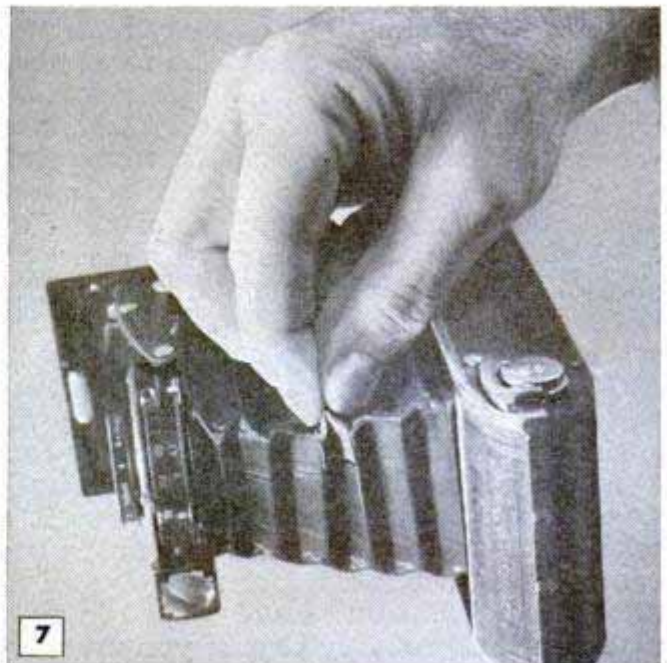

**7**



**8**  
Torn covering can be replaced with household cement. First coat both surfaces, then press them together

blow the dust away with the breath as this deposits moisture on the metal parts. The focusing racks and pinions on both folding cameras and view cameras should get special attention, as dust and abrasive grit tend to collect on these parts. The best cleaner is a small cloth swab dipped in carbon tetrachloride. Apply this liquid cleaner freely to flush away dirt and grit. In some cases, it will be necessary to dismantle parts of the camera in order to get at the racks. For drying and polishing interior metal surfaces, use a lens-cleaning tissue as in Fig. 4.

If the camera is of the extension-bellows type and has had considerable use, the bellows should be fully extended occasionally

Brushing the lens before polishing it will remove dust particles which may otherwise act as an abrasive

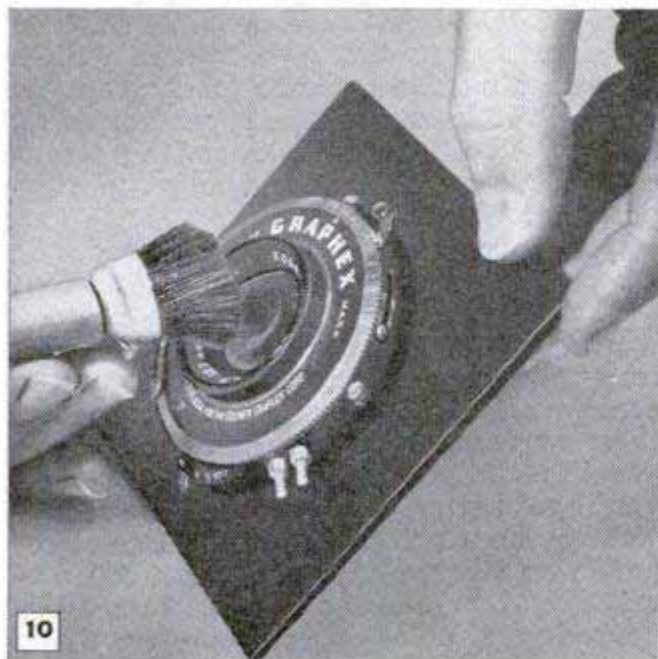

**10**



**9**  
Leather dressing will make a worn camera look new. Use cream type which contains preservative and dye

and closely examined for light leaks. Proceed as in Figs. 1 and 5. The room should be darkened so that tell-tale pinpoints of light will be revealed by a careful exploration with a small flashlight. Usually light leaks first show up in the accordion folds of the bellows. Small leaks can be repaired temporarily by covering with black masking tape as in Figs. 6 and 7. Place a finger inside the bellows and flatten the fold so that the tape will adhere over the whole area. Then crease the tape as in Fig. 7, so that it conforms to the fold of the bellows. A somewhat better repair can be made in most cases by applying the tape to the inside of the bellows fold, but this procedure takes much more time and care. Don't rely

After brushing, place a drop of lens-cleaning fluid on center of the lens. Then polish with lens tissue

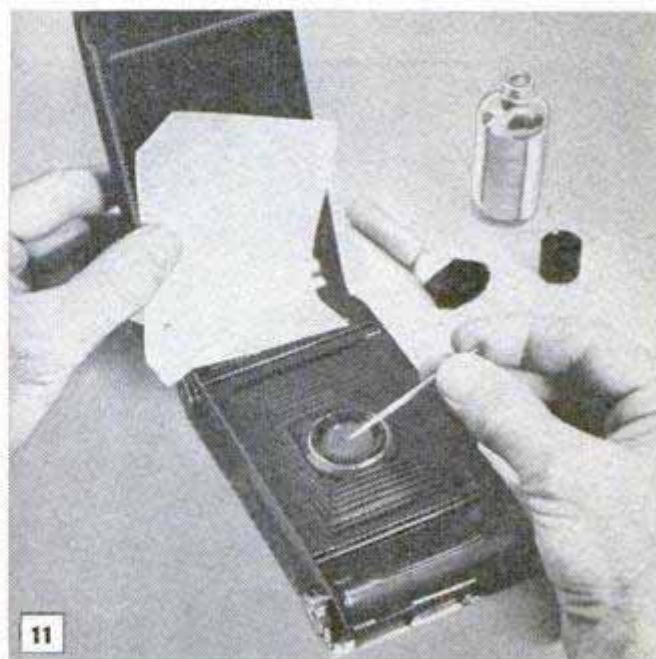

**11**



**12** To polish the lens surface inside the camera, remove or open the camera back and compress the bellows



**13** For a smooth sliding action, rub paraffin on sliding surfaces of film holders, above, and tripod, below

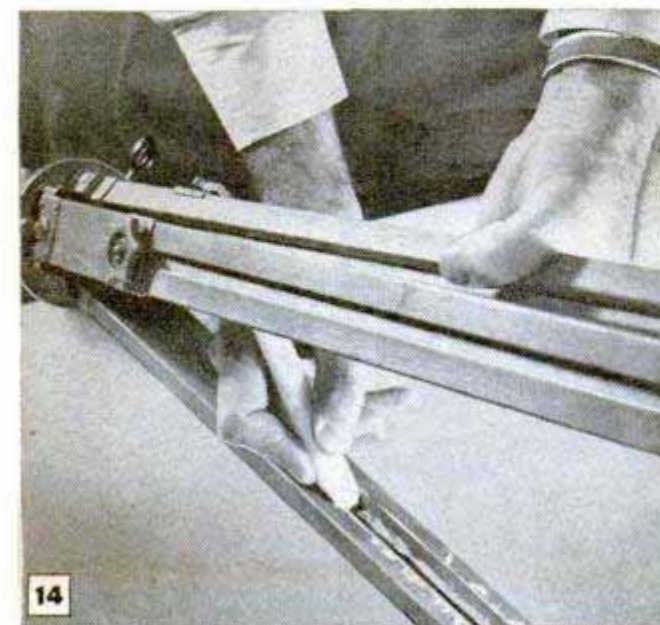

**14**



**15**

**15** Reflectors can be kept clean and bright with carbon tetrachloride. Polish the surface with a soft cloth

on taping a bellows that is torn or badly worn. Get a new bellows.

In time, hard knocks and general outdoor wear cause scuffs and tears in the covering of the camera box, or case. The covering will probably be loosened at its edges. Coat the underside of the loosened edges with a quick-setting household cement as in Fig. 8. If the area to be re-cemented is fairly large, coat both surfaces with cement and then hold them tightly in contact for a few seconds. A good leather dressing, applied according to the manufacturer's directions, can make a weather-worn camera look like new. Use a dressing of the type containing both a preservative and dye. Apply with a soft cloth as in Fig. 9 and polish until dry.

Be especially careful when cleaning a lens to avoid scratching the soft glass. Brush away any fine dust particles with a soft camel's-hair brush as in Fig. 10, then polish with lens tissue dampened with a lens-cleaning fluid. Some photographers place a single drop of the special cleaning fluid in the center of the lens with a toothpick as in Fig. 11. Clean and polish both exposed surfaces of the lens, Fig. 12.

Camera accessories made of wood and having sliding surfaces such as those on the cut-film holder, Fig. 13, and the folding tripod, Fig. 14, will continue to work smoothly if the sliding surfaces are coated occasionally with paraffin. After coating these surfaces, brush away all the excess paraffin. If you have flash equipment, you'll get better pictures when the reflectors are kept bright and clean. Use silver polish on silver-plated reflectors. All others should be cleaned with carbon tetrachloride and polished with a soft cloth. If the cleaning fluid is kept in a bottle spray-

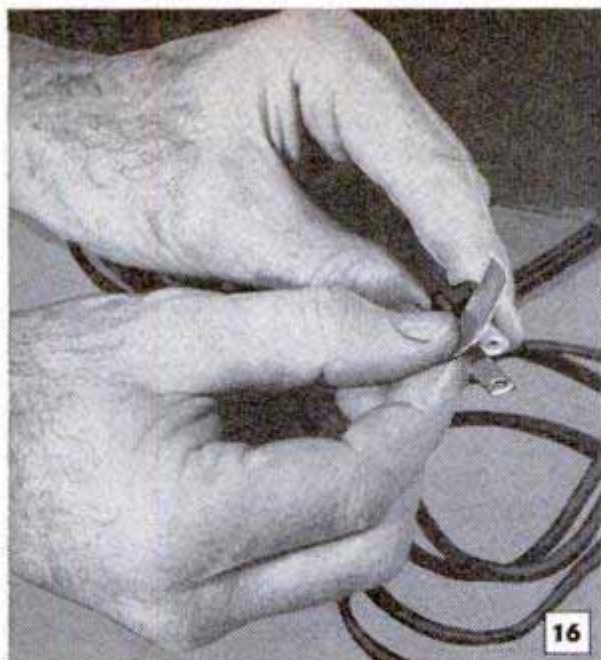

**Electric terminals of flash equipment should be kept clean by burnishing with emery cloth**

er, as in Fig. 15, the job is done quickly and easily. The electrical terminals of the flash system require periodic attention. Clean the corrosion off copper terminals with a fine polishing rouge or a fine emery cloth as in Fig. 16. Silver-plated terminals should be cleaned with a soft cloth dampened with carbon tetrachloride. When flash equipment is stored for any length of time, remove the batteries from their container and loop or coil the electrical cords so they do not become permanently kinked. The best protection for a camera in a sudden rainstorm is a waterproof bag of oiled silk or plastic, Fig. 17. For the greatest protec-



**A weatherproof bag tailored to fit the camera and flash gun will afford protection from dust and driving rain**

tion from dampness and dust, either when the camera is in storage or in intermittent use, the bag should be sewed with folded waterproof seams and provided with a handy drawstring which tightly closes the open end of the bag. Whether you buy or make a bag it should cover completely both camera and flash gun.

## **Plywood Case Protects Wide-Angle Lens From Dust and Damage**

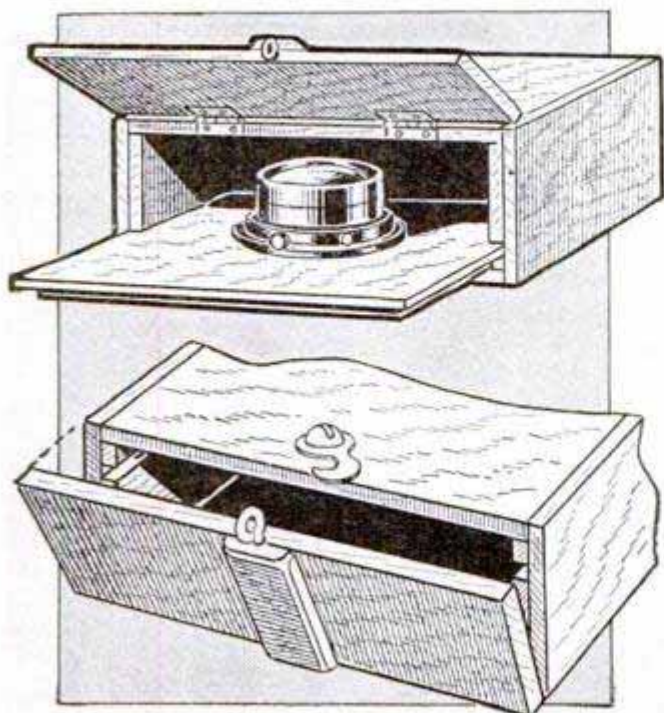

Having added a wide-angle lens to my camera equipment, I was faced with the problem of protecting it from dust and damage while carrying it in my camera case. I solved the problem by making a separate case for it from  $\frac{1}{8}$ -in. plywood. The lens is held snugly by sliding the lens board in a groove in each side of the case. These grooves should be waxed so the lens board slides smoothly. Two thicknesses of plywood are used for each side of the case. The inner piece is of two parts which are glued to the outer piece to form the groove. The front of the case is fitted with a cover attached with small brass hinges and held in the closed position with a flat, brass S-hook and a brass screw eye. Although I finished the case by merely applying a couple of coats of wax to the wood, it can be stained and varnished or painted to match the camera case.

Walter Fischman, Philadelphia, Pa.

## Condition of Flash Bulb Checked With Neon Test Light

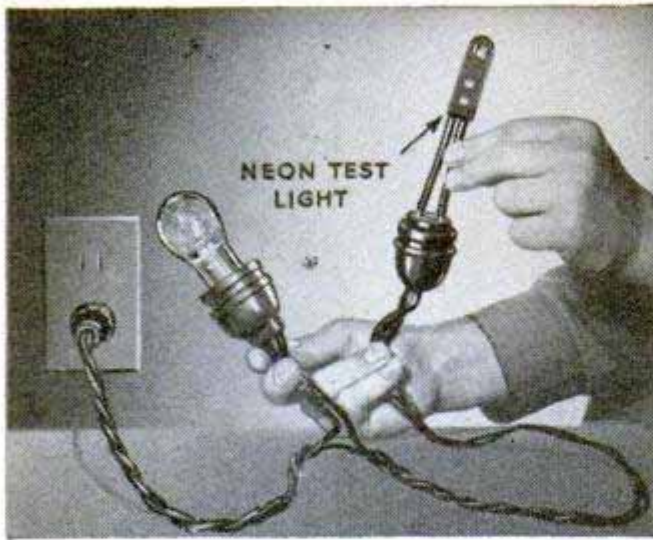

A small neon test light connected in series with a photoflash bulb will check the condition of the bulb without damaging it. When the tester circuit is plugged into the 110-volt line, the neon light will glow if the flash bulb is in good condition.

## Opening Developer Containers



Photographic chemicals packaged in containers fitted with metal covers are easier to open with a lift-type can opener than by cutting off the tops with a knife. The can opener does the job more quickly and is safer to use.

## Reminder for Darkroom Clock

When working with fine-grain developers which require comparatively long processing time, it is easy to forget the exact time the film should be removed from the solution unless an automatic timer is used. To eliminate guesswork when using a clock for timing, fasten a reminder hand to the face of the clock. It is simply a round cardboard backing to which a movable cardboard indicator is attached with a brass paper fastener. The backing is attached to the center of the clock-face with cellulose tape and the hand

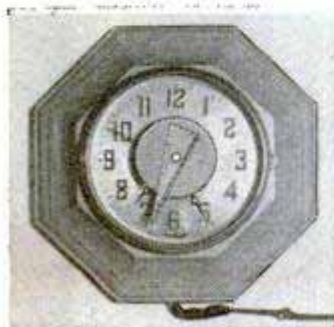

is moved to the predetermined time. When the minute hand of the clock is directly under the indicator hand, it is time to remove the film. The reminder can be used similarly when fixing or washing.

## Glass Rod Is Substitute Funnel

If a plastic or glass funnel is not at hand for transferring photo solutions from one container to another, try using a glass stirring rod as shown. The liquid will follow the rod into the container. If a stirring rod is not available, a rod-type thermometer may be used. In addition to the convenience of using a glass rod when a clean funnel is not handy, the rod is much easier to wash thoroughly than a funnel, thus avoiding contamination.



## Alcohol Dries Sponges Quickly

In order to speed drying his sponges before packing them, one traveling photographer wrings out as much of the water as possible and then soaks the sponges in alcohol. Wrung out again, the sponges are soon dry enough to pack as the alcohol evaporates much more rapidly than water.

R. F. Donovan, Jersey City, N. J.



## Tips of Tripod Legs Painted White To Minimize Accidents

To help prevent accidental tripping over the legs of a tripod, apply a coat of white paint to the rubber tips so they can be easily seen. White tire paint will provide a long-lasting coating. — Kenneth Murray, Colon, Mich.





# Portable

## Bench-Saw Cabinet

BY ADDING portability to a motor-driven bench saw, this wheelbarrow-type cabinet greatly increases its usefulness, especially in small home workshops where floor space is limited, or on a farm where it is sometimes more convenient to take the saw to the work. When long boards are to be ripped or crosscut, for example, the saw is easily moved so that the work will clear obstacles. In addition, the cabinet permits the saw and a supply of hand tools to be transported conveniently in a light truck or trailer.

Fig. 1 gives the over-all dimensions and Fig. 2 shows how the cabinet is assembled. Side panels of  $\frac{1}{2}$ -in. plywood are screwed to the inside face of the 2 x 3-in. frames. Drawer runners

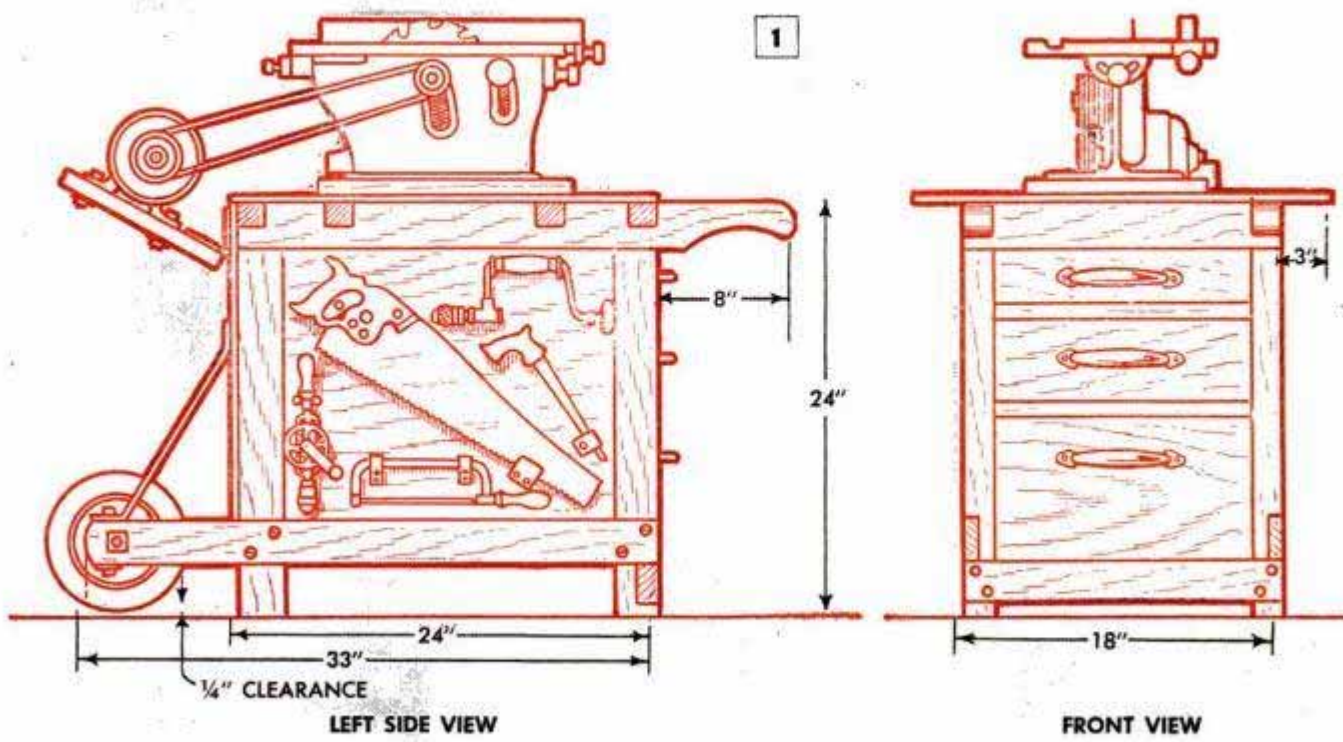
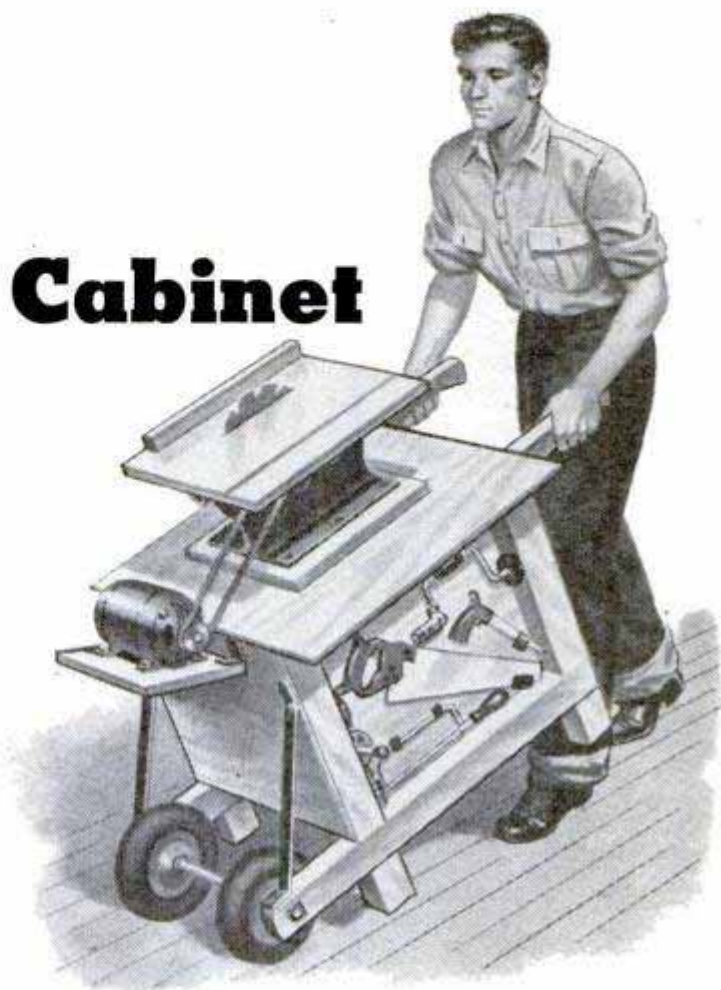

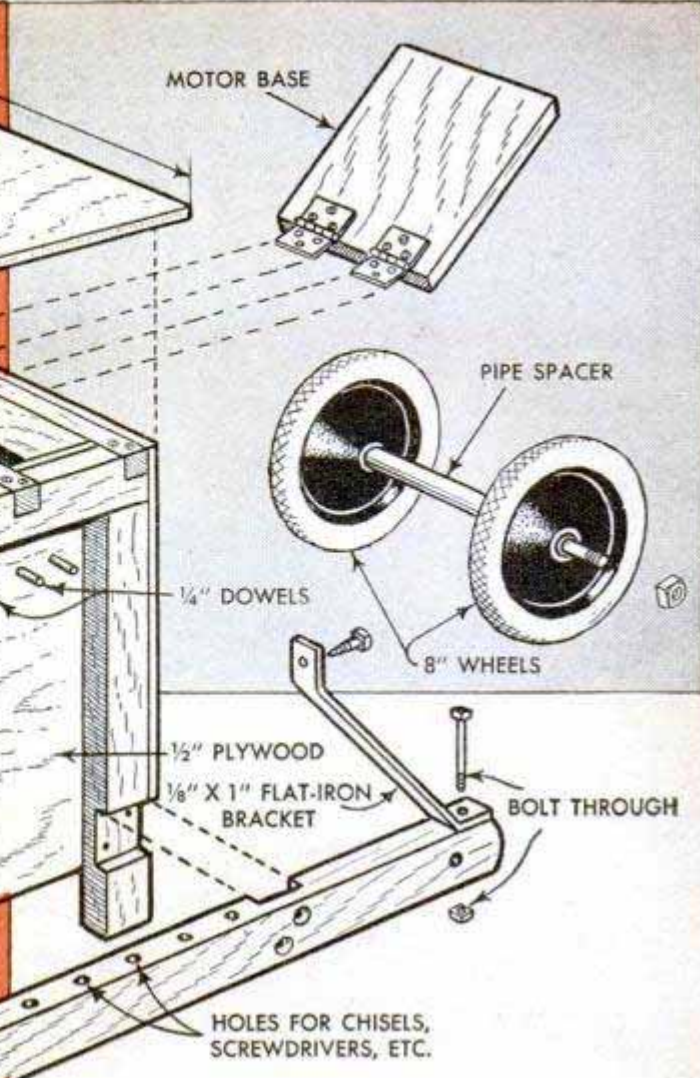
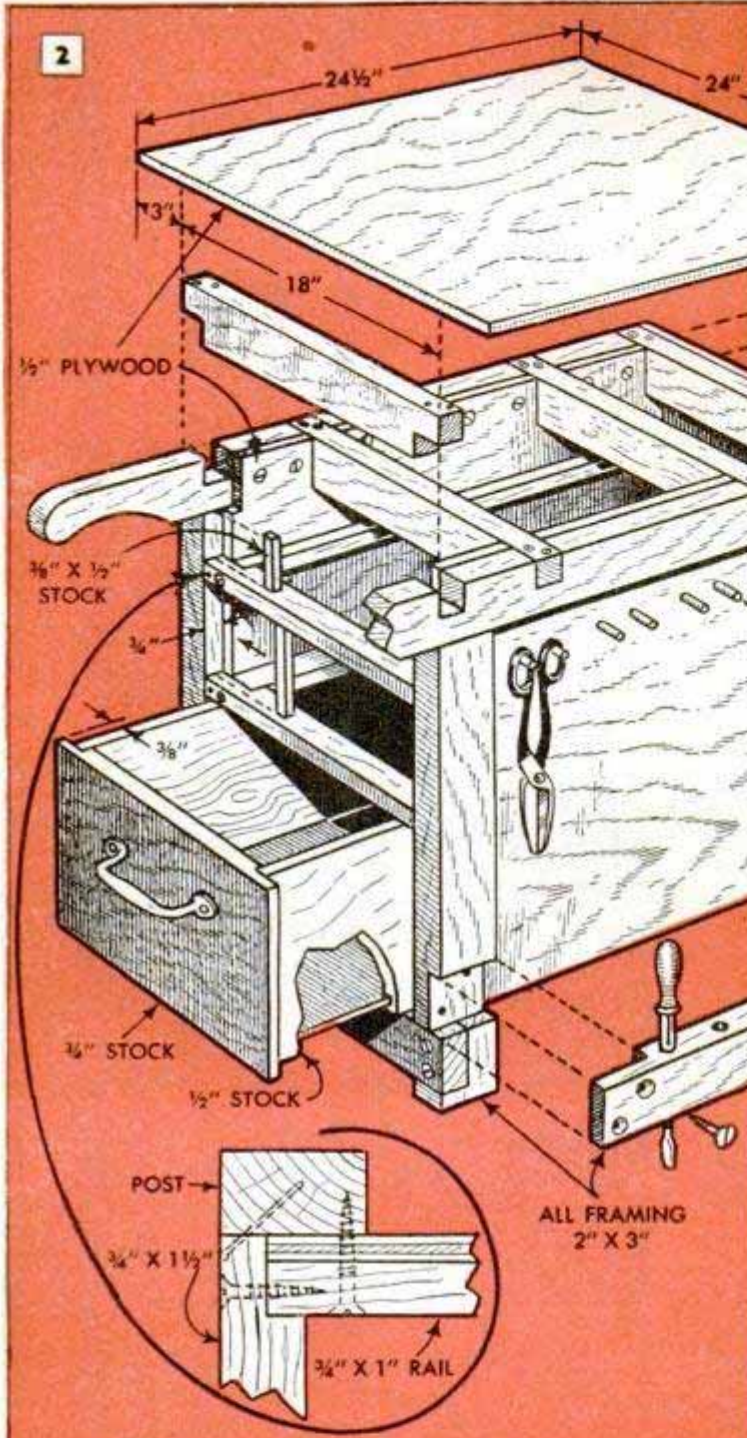

are fastened to the panels and then the two frames are joined by cross members, which are half-lapped and screwed to the corner posts. Note that the upper and lower horizontal members of the side frames extend at the top to serve as handles and at the bottom, in the opposite direction, to form the wheel fork. Next, drawer rails and guides are fitted and the three drawers are made, following the type of construction detailed in Fig. 2. Drawer bottoms can be of 1/4-in. plywood unless the bottom is to support a heavy weight. If this is the case, use 1/2-in. plywood. The bottoms fit in grooves cut in the drawer sides and fronts, and ends of the drawer backs fit in dados cut in the sides. The wheel fork is strengthened with flat-iron brackets attached with bolts and screws as in Fig. 2. The 8-in. wheels are mounted on a single shaft with a pipe spacer between them. Threaded ends of the shaft pass through holes drilled in the frame members which form the wheel fork, and nuts turned on the threaded axle ends hold it in place. The plywood back is attached to the corner posts with screws and the

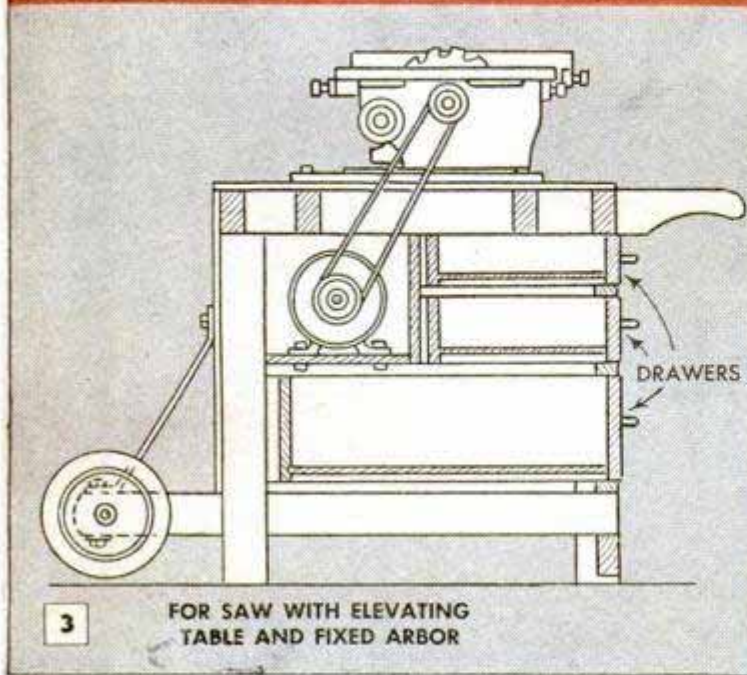



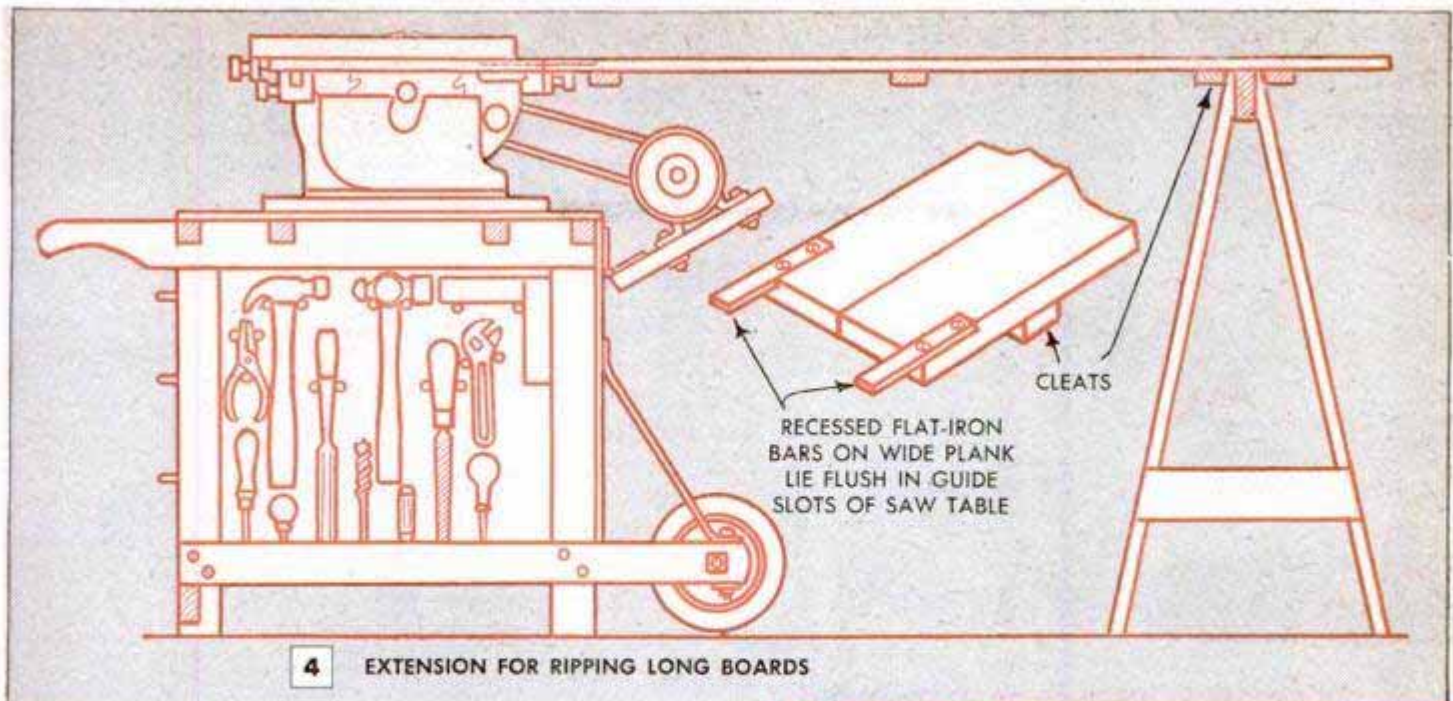

plywood top is supported by cross members half-lapped into the horizontal members of the side frames. The recessed side panels provide space for storage of hand tools to meet ordinary needs.

If the bench saw is of the type in which the arbor raises and lowers, a hinged motor base, Fig. 1, is necessary to equalize belt tension. For saws with a fixed arbor and an elevating-type table, the motor may be located inside the cabinet on a fixed base as in Fig. 3. Where the motor is mounted in this way, the upper drawers are shortened to allow space for the motor and drive belt. If the base of the saw provides only for bottom discharge of the sawdust, the top drawer can be used as a receptacle. In this case, it may be necessary to provide a sheet-metal deflector at the back of the drawer compartment to prevent sawdust from dropping into the lower drawers.

When the saw must be used for ripping extra-long boards, an extension table, Fig. 4, comes in handy. This consists of two boards glued together or cleated edge-to-edge to attain the required width. The outer end of the extension table is supported on a sawhorse of the correct height to hold it level with the top of the saw

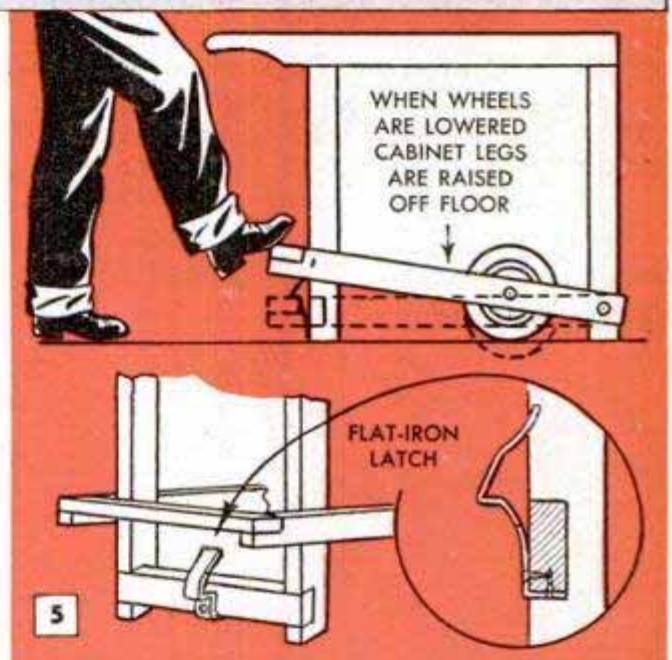

table. The opposite end of the extension is held flush with the edge of the saw table by two flat-iron bars recessed into the ends of the boards as in the detail, Fig. 4. The sectional size of the bars permits them to fit flush in the guide slots of the saw table. An alternate method of fitting the wheels is shown in Fig. 5. In this design, the wheels must be placed close to the balancing point.

## Accuracy of Carpenter's Level Easily Checked on Any Flat Surface

Because of the waste of time and money an inaccurate carpenter's level can cause, I always check the settings of a newly purchased level before using it on a job of any consequence. Naturally, the best way to do this is simply to lay the tool on a surface that is known to be level. However, the tool can be checked almost as easily on a surface that is not absolutely level. After selecting a flat, firm surface, I place the

tool on it and note exactly where the bubble settles in the level glass. Then, turning the tool end-for-end, I carefully take another reading. If the two readings are exactly the same, the tool is set accurately, but, if the readings vary, the level glass requires a corresponding adjustment. To check the setting of the plumb glass, I follow the same procedure, using a vertical surface.

Andrew Vena, Philadelphia, Pa.

## Metal "Bridge" Locks File Drawer In Large Drafting Table

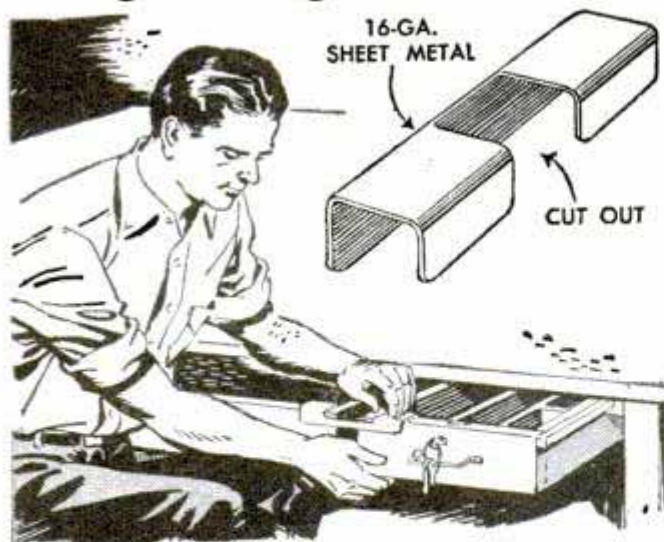

As my drafting table is equipped with a lock on the right-hand drawer but none on the long file drawer, I made a sheet-metal bridge to hook over the two drawers. With the bridge in place, locking the right-hand drawer locks the file drawer also.

L. E. Reichenbaugh, Tulsa, Okla.

## Sash Balance Weights Sheet Metal When Soldering Seam

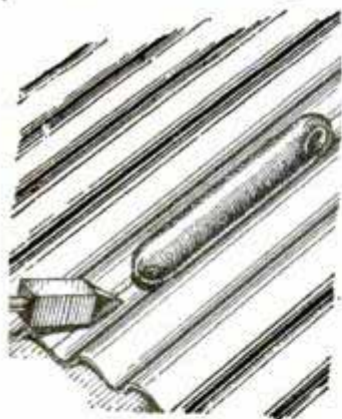

To facilitate holding two pieces of corrugated metal while soldering them together, lap the seam and weight it with a sash balance laid in the groove formed by the corrugations. Slide it along as work progresses.

## Checking Cylinder Wear

A piston ring and a feeler gauge are the only tools required to get a reasonably accurate check of cylinder wear on your car. As the ridge at the top of the cylinder does not wear, place the ring inside the cylinder at this point and measure the gap with the feeler gauge. Then move the ring

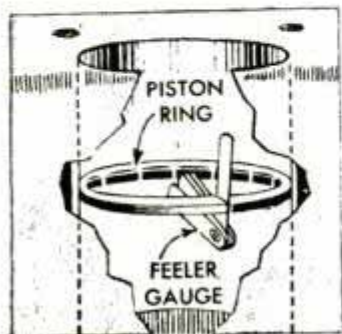

down about 2 in. and again measure the gap. One third of the difference between these two figures is the approximate amount of wear in thousandths of an inch. If you want to be extremely accu-

rate, divide by 3.1416. To check the wear in the lower part of the cylinder, repeat the procedure 2 in. up from the bottom. However, the wear at this point likely will be considerably less than the wear at the upper part of the cylinder.

## Sickle Sections Mounted on Hoe Adapt It for Rocky Soil

Unusually rocky soil is much easier to work if two sickle sections are riveted to the hoe. If equipment is available, welding the sections results in a more sturdy garden tool.



## Oiling Ball-Valve Fittings

When oiling ball-valve fittings, the ball has a tendency to restrict the flow of oil from the can spout. To avoid this, use a nail or a piece of stiff wire to depress the valve and apply the oil to the nail. It will run down the nail to the fitting. This method, of course, also can be used to oil other hard-to-reach places of a similar nature.



## Tether Attached to Long Pole Does Not Wrap Around Post

If an animal is tethered to a post for grazing, the tether can be kept from wrapping around the post by fastening it to a long pole as shown. The pole is pulled around the post by the animal and the full length of the tether is utilized.

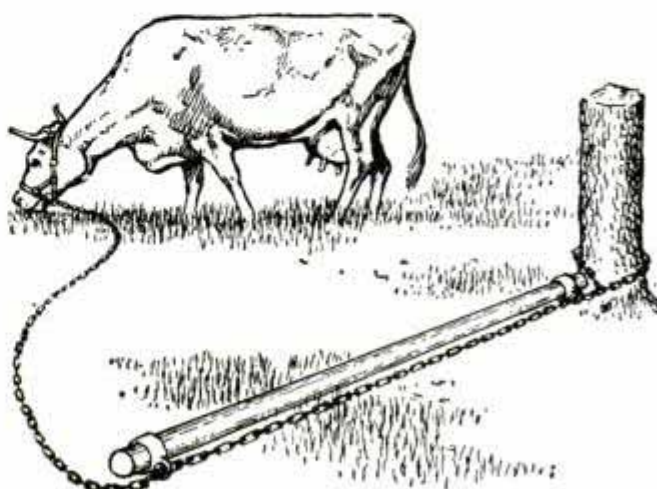

# AUTO-BRAKE SERVICING

By Phil Ruskin

MODERN car-braking systems have been so simplified and standardized in construction that any car owner who likes to tinker can easily make ordinary repairs and adjustments himself. A simple adjustment of one or more of the four braking units, Fig. 1, renewal of shoes, adding fluid or bleeding air out of the system are usually all that is necessary. The most common symptoms of defects in the system are brakes that squeal on application, a "soft" pedal or a pedal that requires pumping in order to make a quick stop. Operation of the hydraulic service brake is quite simple and the parts are easily reached for servicing. When the brake pedal is depressed, a piston in the main, or master, cylinder, Fig. 7, exerts pressure on the fluid in the brake lines. This transfers an equalized pressure to pistons in each of the wheel cylinders, Figs. 3, 5 and 6. Each wheel cylinder contains two pistons, the purpose of the two being to distribute hydraulic pressure equally to the two brake shoes in each braking unit. As the pedal is released, the pressure is relieved and the brake-shoe retracting springs release the shoes from contact with the brake drums and, at the same time, force the pistons of the wheel cylinder inward. This movement forces fluid out of the cylinders and back into the brake lines.

Before servicing the brakes, check the

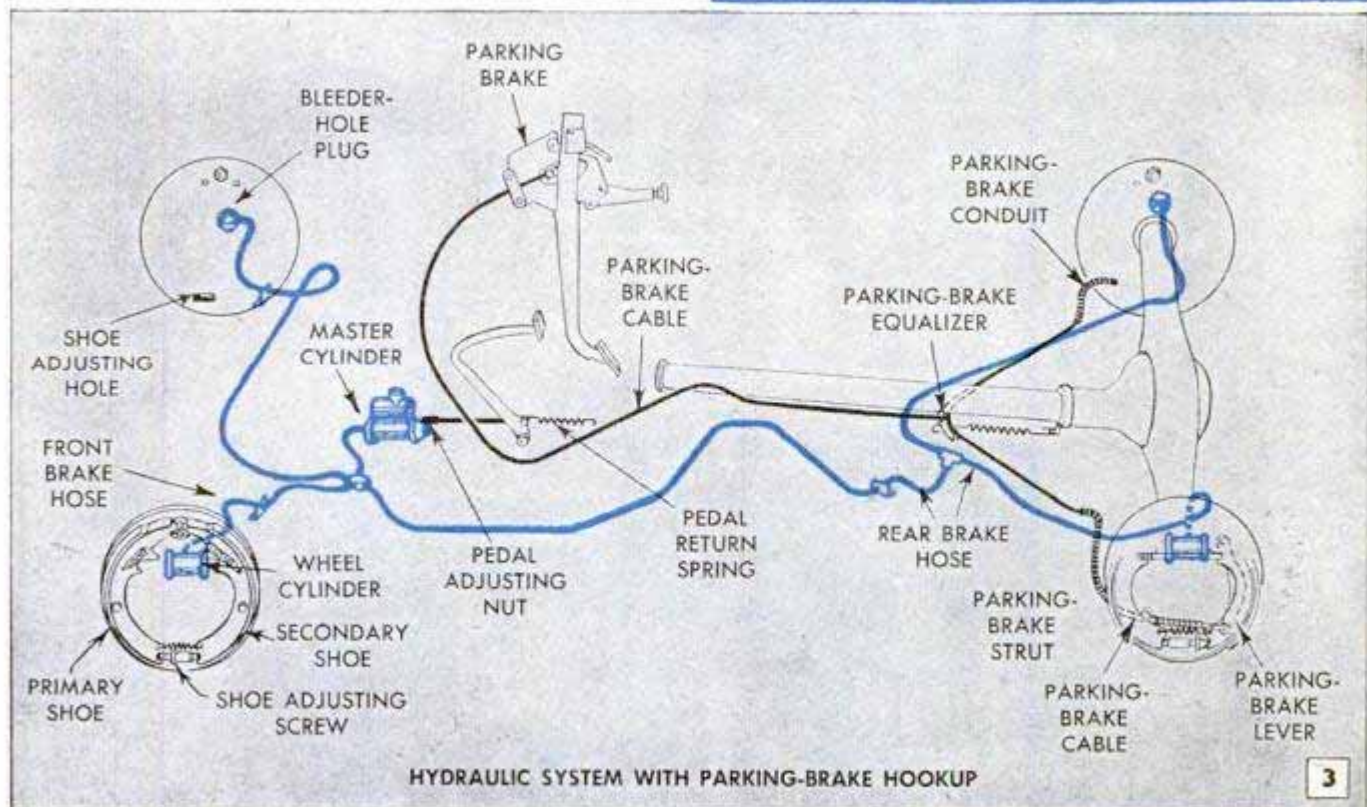
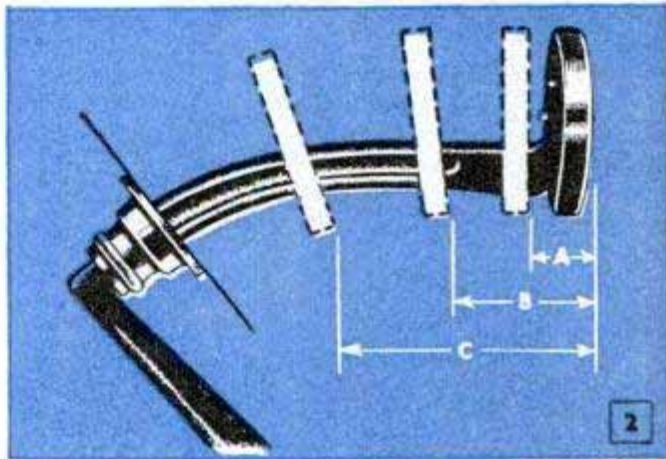
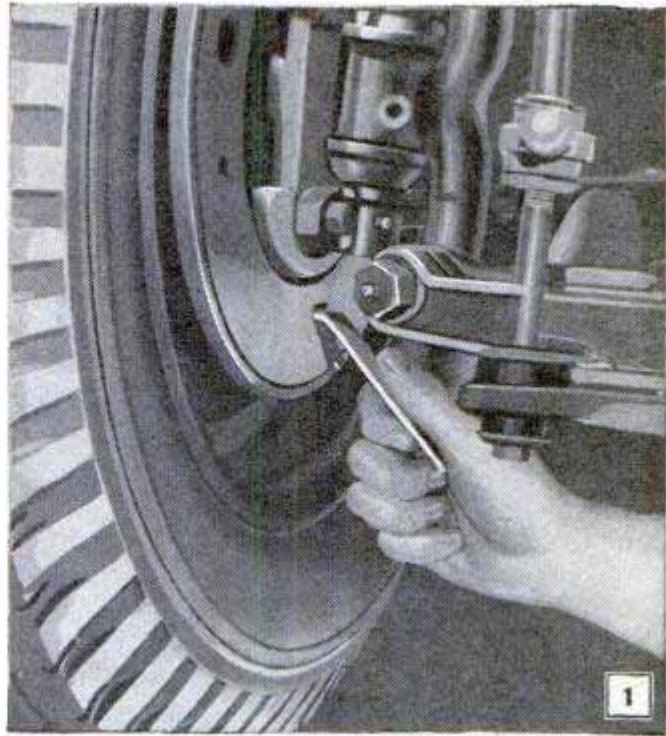

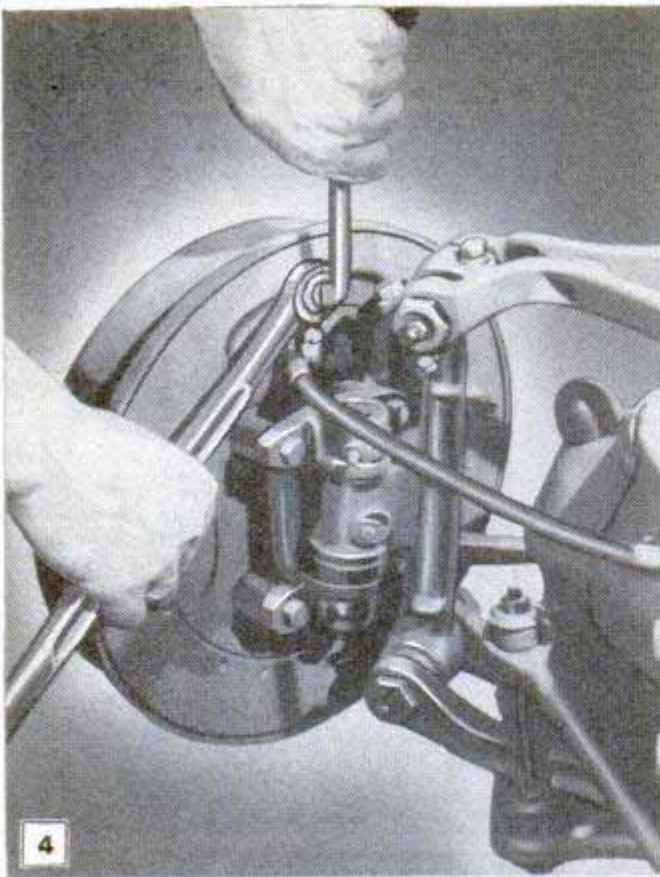

When new brake shoes are installed at the time of servicing, it's necessary to adjust anchor bolts. Although methods vary with different makes of brakes, the method shown above is typical of regular procedure

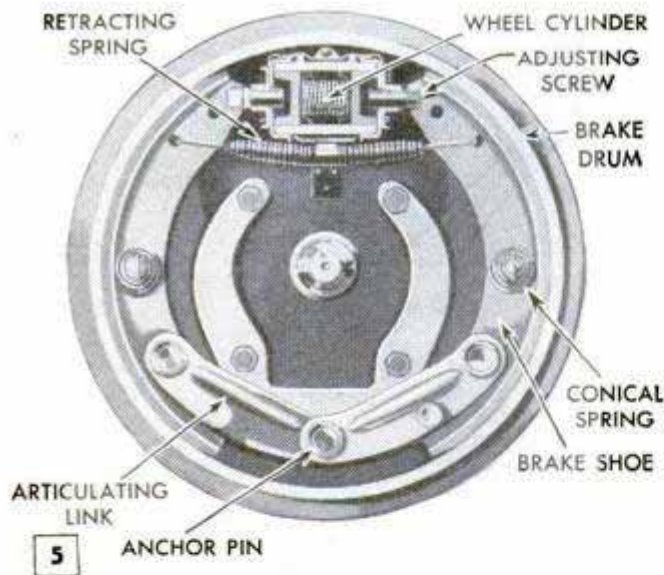

Sectional view, above, shows the hydraulic wheel cylinder and other parts of the brake unit. Below is a pull-apart view of the wheel cylinder, showing the various parts. Shown at the right is the master cylinder

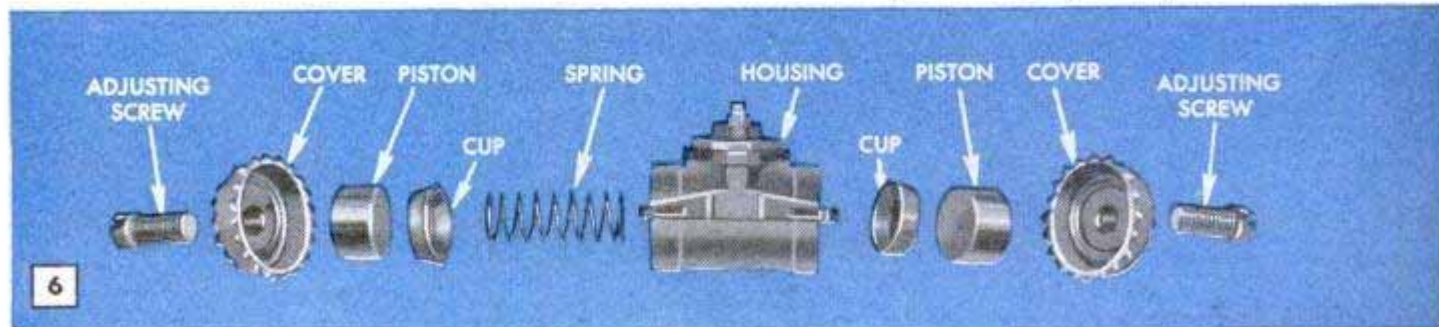

pedal for free movement and toeboard clearance. There should be from  $\frac{1}{4}$  to  $\frac{1}{2}$  in. of free movement, A in Fig. 2. Full braking pressure should be available between the positions B and C. A soft, spongy pedal can mean that there is air or gas in the system or insufficient fluid. Check the fluid level in the master cylinder, add fluid if necessary and then, before bleeding the system, examine the lines carefully for leaks. In bleeding the system to remove air, it is a common rule that the longest pipe line should be bled first. Remove the bleeder valve screw, Figs. 8, 9 and 10. Then attach the bleeder drain, Fig. 8, being careful to keep the end of the bleeder drain hose below the level of fluid in the jar. Unscrew the bleeder valve one-half to three-quarters turn, depress the foot pedal by hand and then allow it to return slowly. Air in the system will show as bubbles on the surface of the fluid in the glass jar. Continue movement of the pedal until bubbles cease to appear. Then tighten the bleeder valve, remove the drain hose and replace and tighten the screw at the bleeder valve.

To adjust the brake shoes, jack up the car and block the axles so that the wheels can be turned freely. Disconnect emergency-brake pull rods and remove the adjusting-hole covers from the flange plates. On one common type of brake, these holes are located at the bottom of the flange plate as in Fig. 1. Insert a flat tool or a screwdriver in the hole. The end of the tool should engage the lugs on the adjusting cover or star wheel. Lift up on

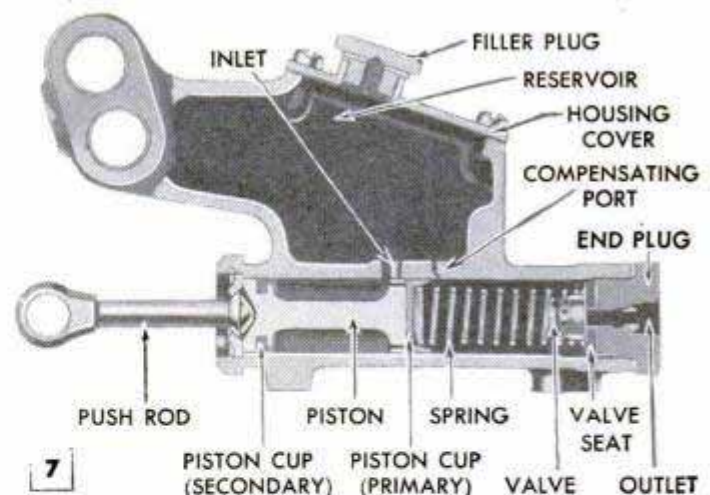

the adjusting tool to turn the star wheel to the right. Continue the adjustment on both star wheels until the brake shoes drag slightly when the road wheel is turned. Then back off the star wheel the required number of notches to give the brakes the proper running clearance. The service manual gives the proper number of notches to back the adjusting mechanism to get the correct clearance. The emergency or parking brake should be adjusted each time the service brakes are adjusted and, on some cars, it is necessary to adjust the parking brake before backing off the star wheels in the rear brakes. When new brake shoes have been installed at the time of servicing the brakes, it will be necessary to adjust all anchor bolts, Figs. 4 and 10. Although the methods will vary with different cars and makes of brakes, Fig. 4 shows the typical procedure in making this adjustment. After servicing the brakes, be sure that there is sufficient brake fluid in the master cylinder. The recommendations generally specify that it should be nearly full. Use only the brake fluid specified by the manufacturer of the car. On some late-model postwar cars, the brakes are of the self-centering, self-adjusting type. Under normal wear, this brake will not require servicing until replacement of the brake shoes is necessary. The brake automatically adjusts itself to compensate for each .005 in. of wear on the linings, keeping the running clearance always approximately the same.

To check performance of the brakes under the average driving conditions, road-test the car after the servicing has been completed. On dry, smooth concrete, the brakes should stop the car easily within a distance of 30 ft. at a speed of 20 m.p.h., Fig. 11, assuming, of course, that the tires are in good condition and have sufficient tread to grip the surface of the road effectively. This is a fair measure of brake efficiency but it is well to remember that other mechanical defects will affect good braking. Incorrect wheel alignment and wheels out of balance, worn tires, underinflation or overinflation of the tires, and worn wheel bearings are defects to look for if carefully serviced brakes do not give good performance under test.

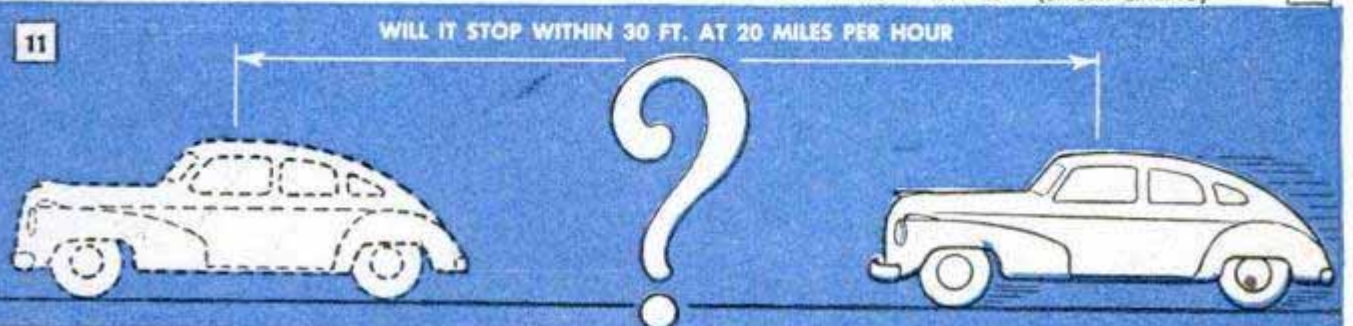
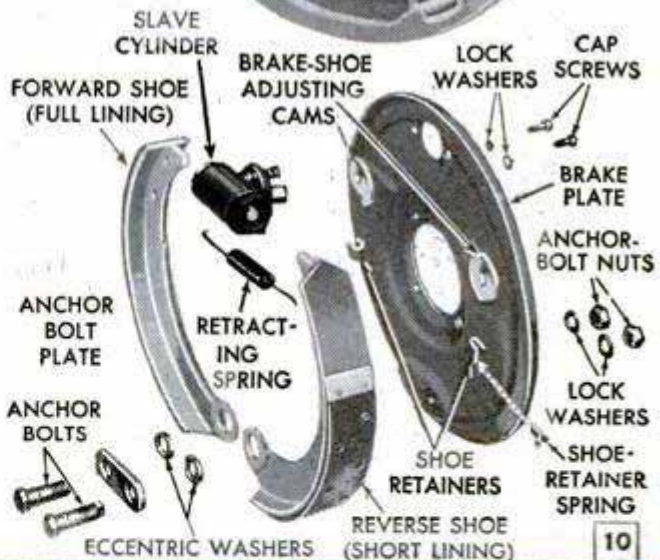
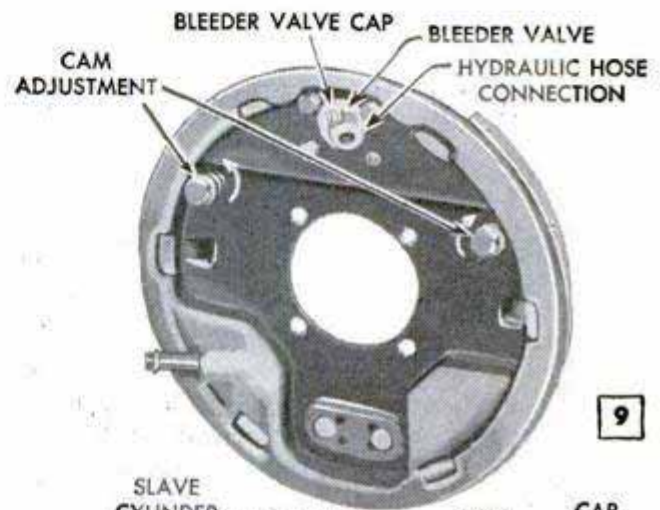

## Levels Attached to Yardstick Aid Sign Painter

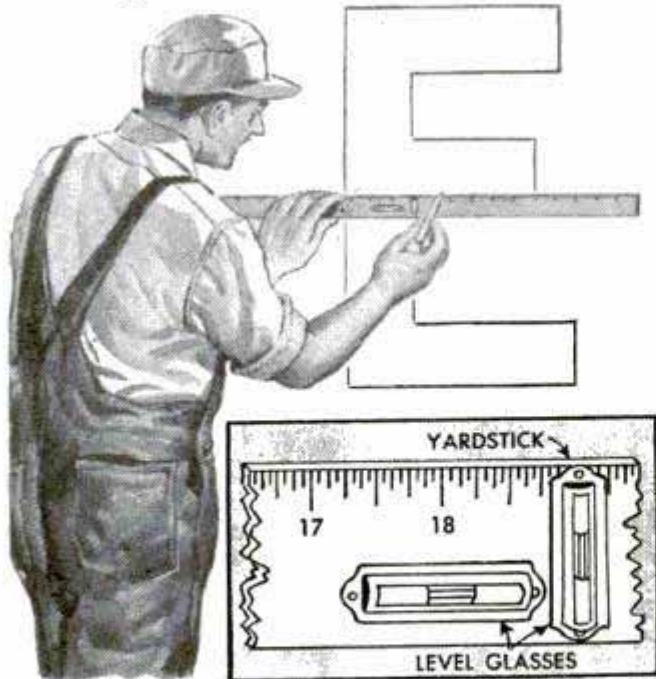

Two level glasses mounted at the approximate center of a yardstick save considerable time when sign painting. The level for horizontal lines must, of course, be attached exactly parallel with the edge of the yardstick, while the level for vertical lines must be exactly 90 deg. to the edge.—Bryant H. Neill, Waco, Tex.

## Modeling Clay Cleans Pencil

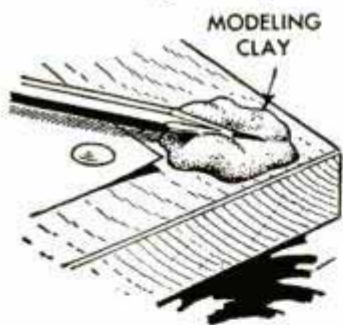

A small wad of modeling clay kept at one corner of a drawing board provides a handy means of cleaning newly sharpened pencils and removing partially dried ink from pens. The clay will

last for some time, as the soiled portion can be worked into the wad. The clay, of course, will stay in place on the board.

## Watertight Expansion Joint

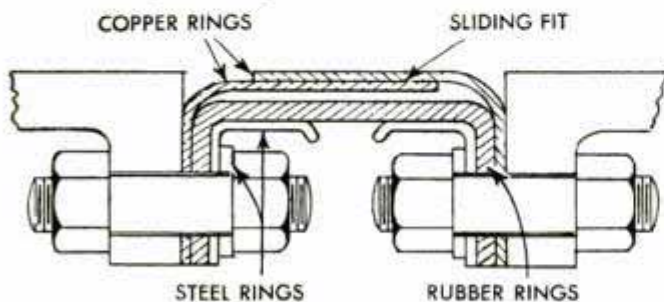

For long runs of pipe that are subjected to temperature extremes, this watertight joint allows for expansion and still with-

stands considerable pressure. Telescoping copper rings give lateral strength to the joint and a rubber ring makes it watertight. The latter should be replaced by a ring of synthetic material in cases where rubber is likely to deteriorate.

## Tire Section Provides Tag Rack

Use a section cut from the side of an old auto tire to clamp job tags to a convenient spot on the shop wall. The section should include the rim and a portion of the tread. If the rim part of the tire section is nailed or screwed tightly to the wall, there will be sufficient clamping action to hold either a few or a number of tags securely in place.

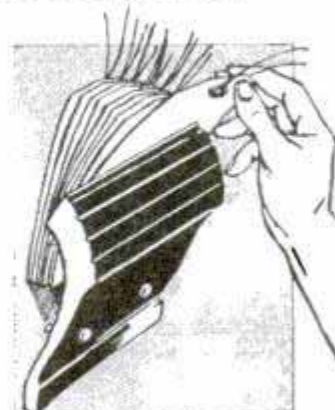

## Eraser Starts Nut in Recess

If a nut must be started on a bolt, the end of which is in a recess thus making it impossible to use the fingers, a pencil fitted with an eraser will do the trick. Just taper the eraser so its end will fit into the nut, twist the nut onto it, and start the nut on the bolt.



## Roosting on Fountain Discouraged By Suspended Barrel Hoop

Poultry are discouraged from roosting on the top of a drinking fountain if a barrel hoop is suspended directly over it. Three wires tied to the end of the main wire are used to keep the hoop horizontal and these are made as short as possible so the hoop will tip easily when a chicken attempts to roost on it. The hoop is centered and hung an inch or two above the fountain.



# Combination Sweeper-Sifter for Poultry Yards

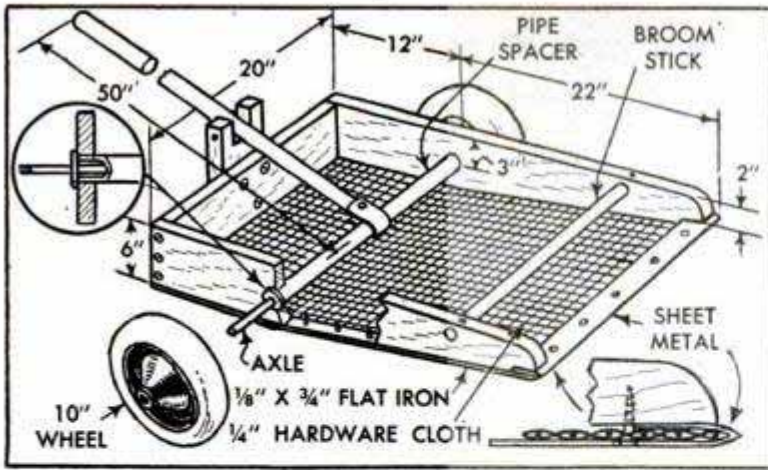

Cleaning poultry yards is done in a jiffy with this combination sweeper and sifter. Pushed along to gather litter and droppings, the sweeper is shaken occasionally to sift the load of dirt and sand. Except for the wheels and hardware cloth, the sweeper can be made from scrap materials



## Concrete Feed Troughs Are Made Easily by Molding in Earth Forms

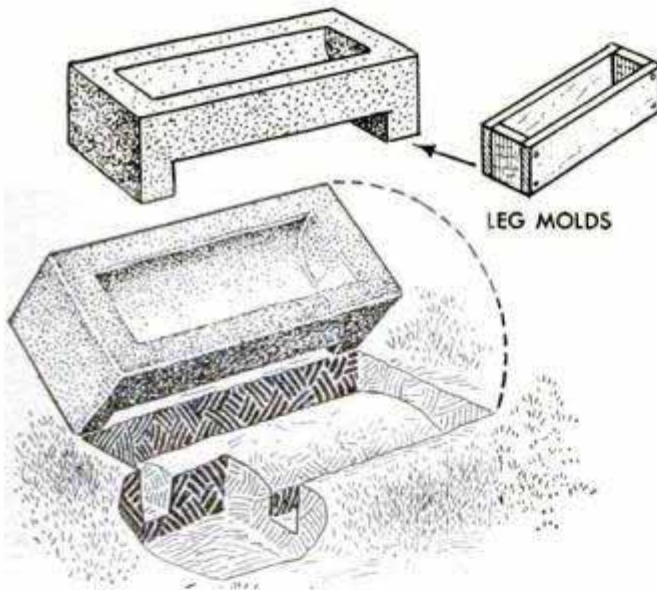

Needing several small feed troughs, I decided to cast them from concrete poured in forms dug in the ground, thus saving the expense of wooden forms. The form is dug as shown in the drawing, and the dirt is dampened and smoothed with a trowel. If the ground is dry, it must be thoroughly moistened before the concrete is poured to prevent the water in the concrete from being absorbed too rapidly. The trough is reinforced with chicken wire or iron rods, and wooden molds, which are placed on the bottom of the trough while the concrete is still wet, are used to cast the legs. After pouring is completed, the unit should be covered with damp straw and the concrete allowed to cure for several days.

Charles E. Mason, California, Mo.

W.T.M. Concrete

## Graduated Jig Permits Quick Setup to Bandsaw Circles of Various Sizes

A few minutes spent in making this graduated jig will save considerable time when setting up circle-cutting jobs on the bandsaw. The plywood base is drilled near one end for a dowel pivot and slotted, as shown, for several circle diameters. To use, just insert the saw blade in the proper slot and clamp the base to the table. — Graham Cheek, Asheboro, N. C.

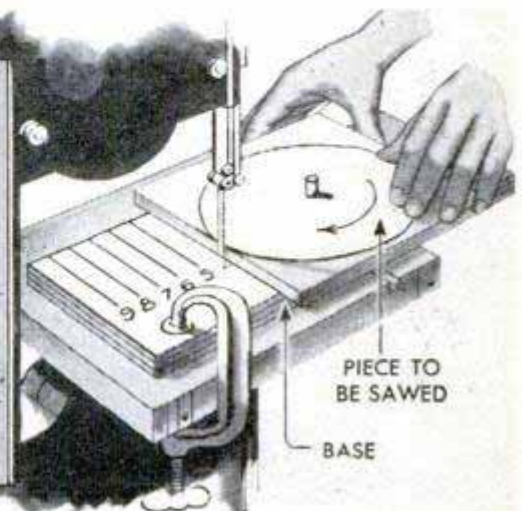
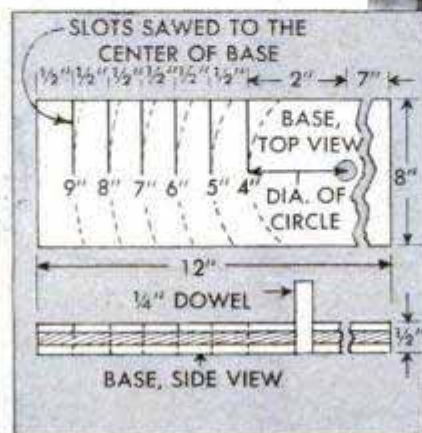

# Tool up with a FLEXIBLE SHAFT

By Sam Brown

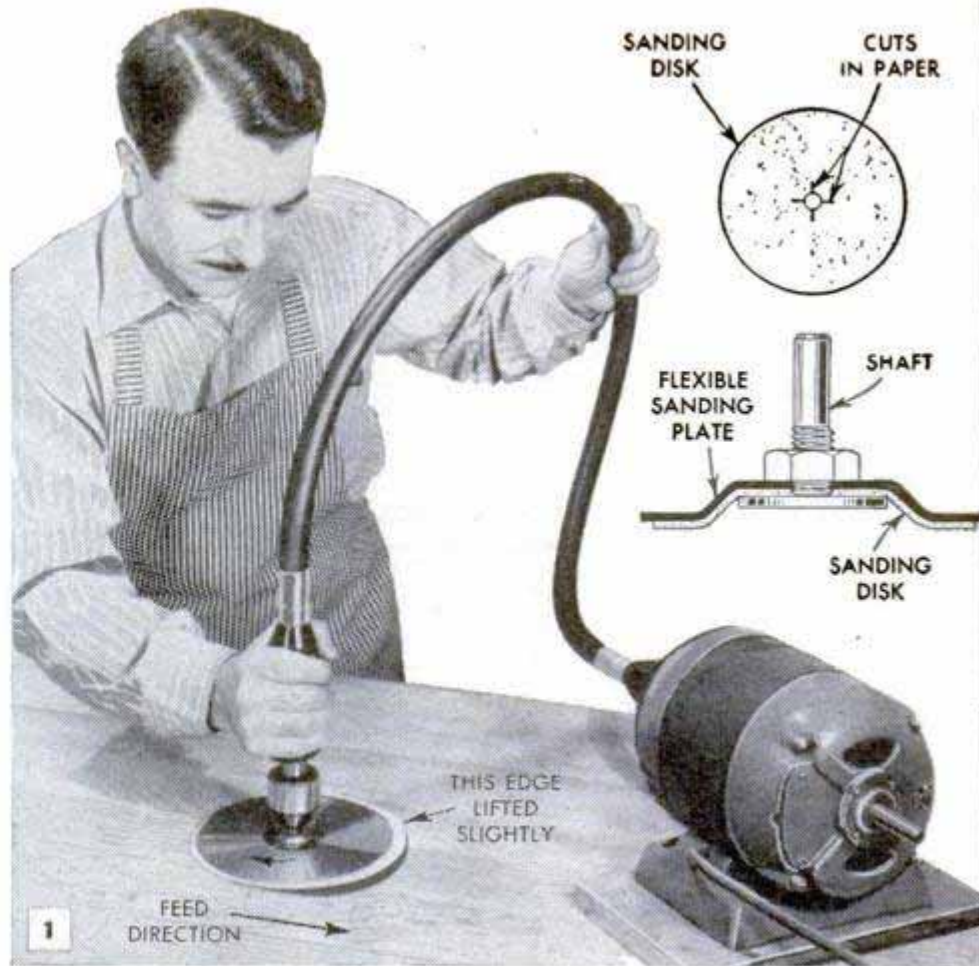

**A FLEXIBLE SHAFT** combines both the power and uses of many different tools in a handy portable unit. With it, you can carve, drill, sand, rout, buff, wire-brush, saw, polish and grind simply by using the necessary accessories on the projecting end of the shaft at the handpiece, Figs. 2 to 4 and 7 to 9 inclusive. Large flexible shafts are widely used in industry for such heavy operations as removing rust and scale, grinding welds, polishing large surfaces of metal and snagging castings.

Flexible shafts usually are rated large or small according to the size of the shaft, or core, as it is called. A large flexible shaft is one having a core  $\frac{5}{16}$  in. in diameter or larger, while a small shaft is one having a  $\frac{1}{8}$  to  $\frac{1}{4}$ -in. core. The large shafts will transmit power for the heaviest work that can be done with hand-held tools, and small shafts are especially suited to use with tiny rotary files, grinding wheels and polishers, which must be rotated at extremely high speeds. The small shafts are quite flexible and will operate efficiently when curved to a comparatively short radius.

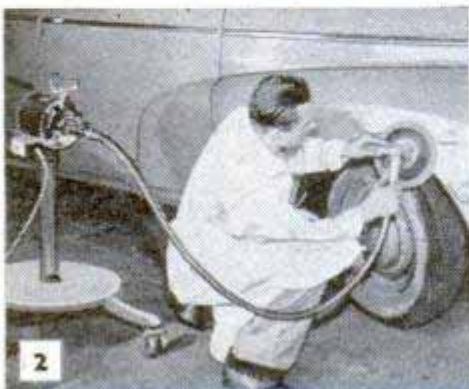

2 SANDING



3 GRINDING



4 POLISHING



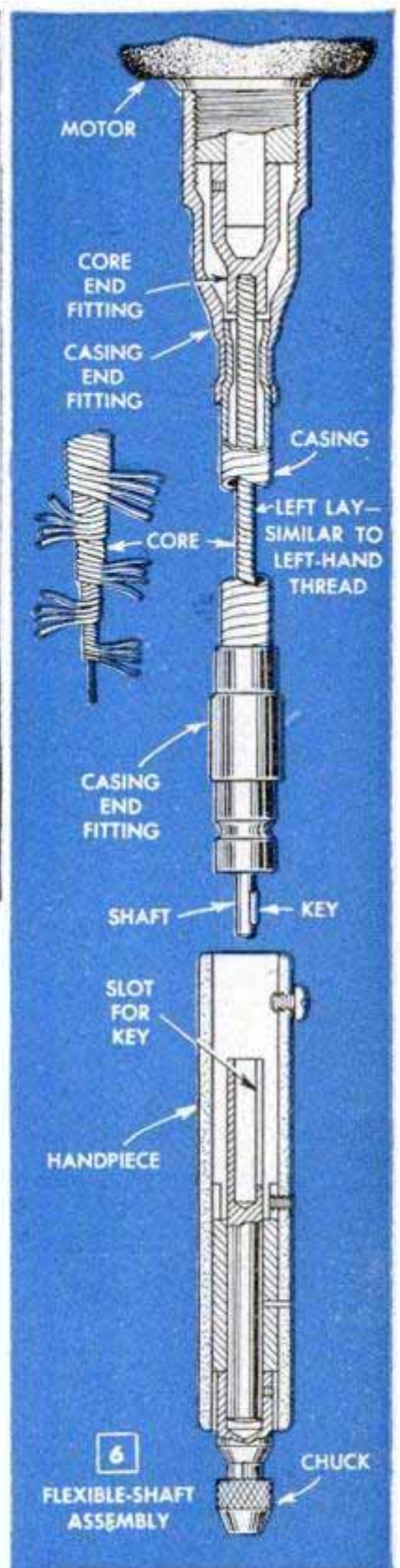
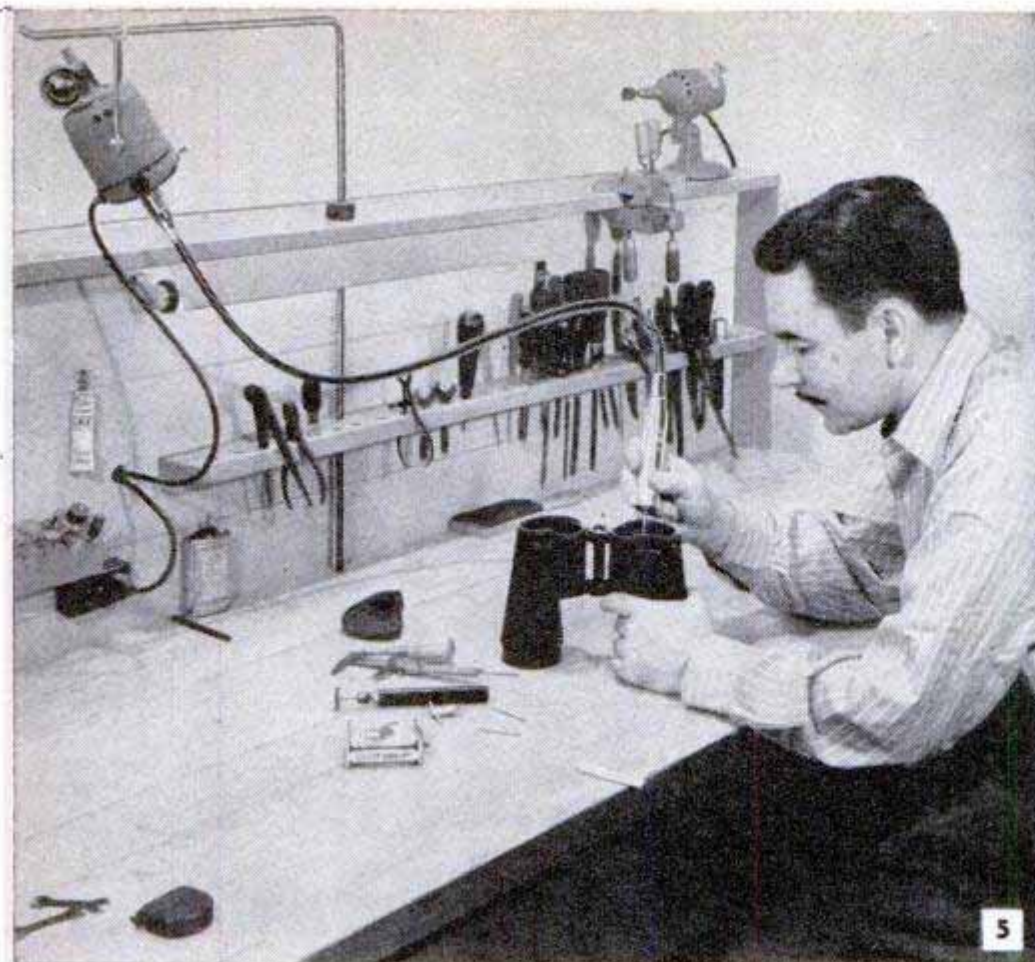

A flexible shaft consists of a stationary casing and a core, which rotates inside the casing. The core, in both the large and small sizes, is a precision-built unit consisting of layers of spring-steel piano wire wound to produce an alternating right and left-hand pitch, as in Fig. 6. The pitch of the outside layer determines the direction in which the shaft should be rotated. Most shafts are left pitch and should be operated in a clockwise direction, as this movement tends to tighten the outer winding of wire. Clockwise direction of rotation is common to lathes, drill presses and also to most types of motors. It is possible to reverse the direction of rotation of the shaft where the work load will at no time exceed half the power rating.

Although some casings consist only of a continuous spring-steel strip wound spirally with interlocking edges, most of the better-quality shafts are fitted with casings of braided wire and molded rubber or fabric coverings which give somewhat greater flexibility and ease of handling. Small shafts designed for high speeds often have a spiral inner liner which fits loosely over the core and has the effect

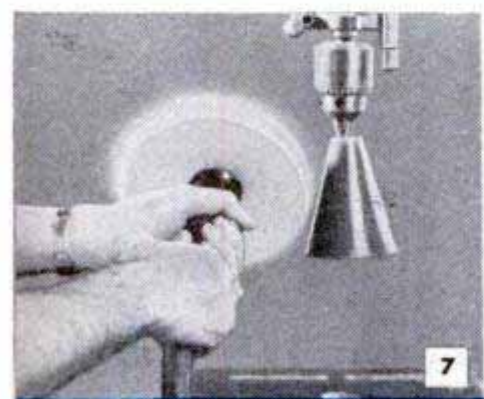

**BUFFING**



**DRILLING**



**CARVING**

① CORE DIAMETER	② HP. AT 1750 R.P.M.	③ MAXIMUM SPEED	④ MINIMUM RADIUS	⑤ LARGEST GRINDING WHEEL	⑥ DEFLECTION PER FT. OF LENGTH	SPECIFIC USES
$\frac{3}{16}$ "	1/100	25,000 R.P.M.	4"	$\frac{1}{2}$ " DIA.	100°	VERY DELICATE WORK ONLY —LIMITED USES
$\frac{1}{8}$ "	1/18	18,000 R.P.M.	5"	1" DIA.	70°	ALL KINDS OF CRAFTWORK WHERE FLEXIBILITY AND CONTROL ARE MORE IMPOR- TANT THAN POWER
$\frac{3}{16}$ "	1/10	12,000 R.P.M.	6"	2" DIA.	40°	
$\frac{1}{4}$ "	1/6	8,000 R.P.M.	6"	3" DIA.	30°	LIGHT DUTY CONTINUOUS BUFFING, POLISHING AND GRINDING. SINGLE OR MULTIPLE-SPEED UNITS
$\frac{3}{16}$ "	1/4	7,000 R.P.M.	7"	3 $\frac{1}{2}$ " DIA.	22°	
$\frac{3}{8}$ "	1/3	6,000 R.P.M.	8"	4" DIA.	18°	USUALLY 4-SPEED UNITS. USED FOR ALL KINDS OF MEDIUM TO HEAVY SANDING, GRINDING, ETC., PREFERABLY AT A FIXED LOCATION
$\frac{7}{16}$ "	1/2	5,000 R.P.M.	10"	5" DIA.	15°	
$\frac{1}{2}$ "	3/4	4,200 R.P.M.	10"	6" DIA.	11°	

① General average values — cores of the same dia. may vary in construction so that values given are only an all-around average.

② This column lists largest motor generally used. Safety factor is about 4. Motor power can be increased proportionately with increase in shaft speed. Example,  $\frac{1}{4}$ -in. core can handle 1/6 hp. at 1750 r.p.m., or 1/3 hp. at 3600 r.p.m.

③ Main consideration is the prevention of shaft overheating which occurs if shaft runs much over 500 surface feet per minute. Most shafts under  $\frac{1}{4}$ -in. dia. are powered with universal motors and will run much slower than "no load" speed of motor.

④ Values given are normal for good power transmission but shafts can be worked at sharper curves for occasional work.

⑤ These diameters are based on what the shaft will stand and also on how fast any grinding wheel can be operated with safety. Wire brushes, buffs and sanding disks can be larger.

⑥ This column shows deflection or "windup" of shaft under full load. A  $\frac{1}{8}$ -in. shaft, for example, will deflect 70 deg. per foot. If the shaft is 3 ft. long, total deflection will be 210 deg. or a little over  $\frac{1}{2}$  of a full turn.

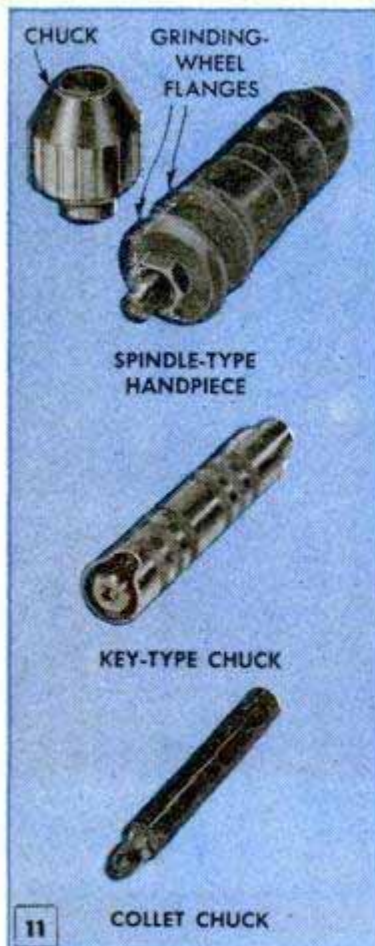

of reducing friction. Connecting members of the shaft are press-fitted into the casing and are designed to permit coupling directly to the motor at one end and to the handpiece at the other. When the shaft is operated straight or nearly so, Fig. 12, the end of the core extends only slightly. Fig. 13 shows how the core extends when the shaft is flexed. One end of the core is fixed in the connector and the other end is splined or keyed to the connector to permit movement in and out when the shaft is operated on a comparatively short radius. On some shafts, this movement is taken up at the motor end, the handpiece end being fixed. Shafts of this type can be attached directly to a motor shaft, Fig. 1, or to a drill press, Fig. 18. When connected to the drill press, as in Fig. 18, it should be kept in mind that the torque of the drill-press spindle far exceeds the load limit of the shaft.

Simplified data on the common sizes of flexible shafts is given in the table, Fig. 10. The data given is not exact but is average for all shafts. If you want a shaft for light craftwork, such as modelmaking, the  $\frac{1}{8}$  to  $\frac{3}{16}$ -in. core size is a good selection. For heavy grinding, buffing, and wire-brushing, the  $\frac{3}{8}$ -in. core is sufficiently strong to take the torque of motors up to  $\frac{1}{2}$  hp. For the small shaft, the handiest length is 3 to 3 $\frac{1}{2}$  ft. and the large shaft should be 5 to 6 ft. long. Such shafts are available as motor-and-shaft units with variable speeds, and also for direct attachment to motors, or any spindle of proper size and speed.

The business end of the flexible shaft is the handpiece and, in the larger units, many different types of handpieces are



12

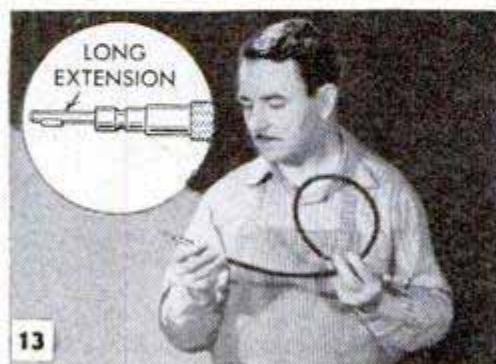

13

available. The straight, spindle-type handpiece, Fig. 11, usually is supplied with the large shaft. Flanges for this handpiece permit mounting accessories which have a center hole and can be held between the flanges. A hand-closing chuck having a threaded shank, which can be screwed onto the handpiece spindle, is useful for holding drills and any other tools having shanks of a diameter within the capacity of the chuck. Grinding wheels should not exceed the diameter given in the table, but such accessories as cloth buffs and sanding disks can exceed the grinding-wheel diameters by as much as 25 percent. A common handpiece supplied with the small shafts is either a collet chuck or a chuck tightened by means of a special key or spanner-type wrench, Fig. 11. These usually have a capacity of  $\frac{3}{32}$  or  $\frac{1}{8}$  in., adapters being available for holding the in-between sizes. Such chucks are ideally suited to driving mounted grinding wheels, wire brushes and small rotary files. The key-type chuck is available in either sleeve-bearing or ball-bearing construction, but collet chucks usually are supplied only with sleeve bearings. Right-angle handpieces are supplied for use with the heavy shafts. Figs. 2 and 4 show this type of handpiece in use.

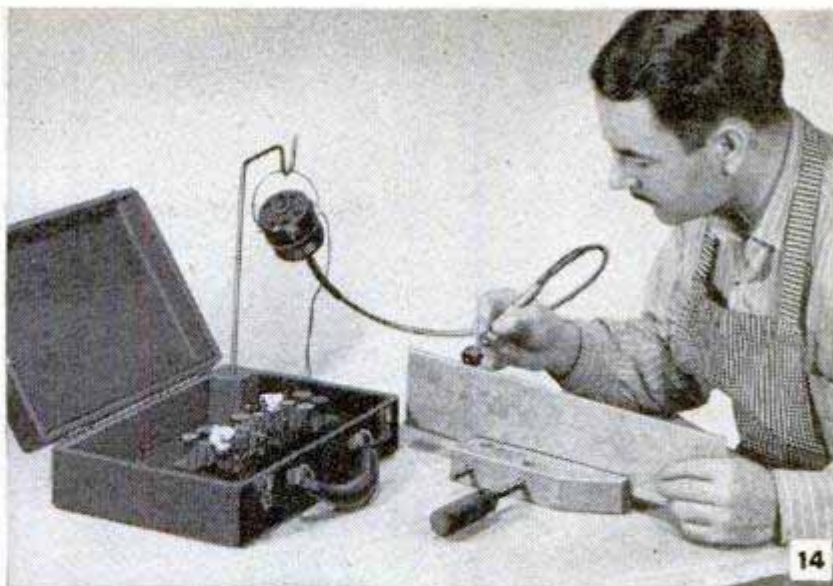

14

## MOTOR MOUNTS

Motors for powering small flexible shafts should be supported with a swivel joint for ease in manipulation. Fig. 14 shows a motor hanging from a vertical arm which is held by a toolbox. For portability, the motor can be carried on a shoulder strap as in Fig. 15. Benchwork requires that motor be supported overhead. See Fig. 16



15

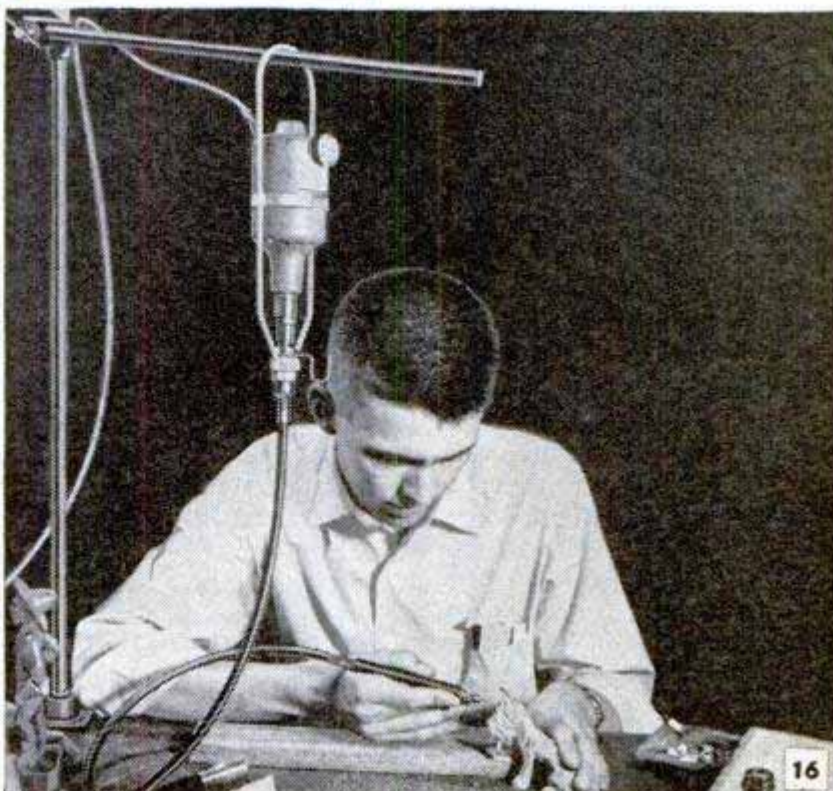

16

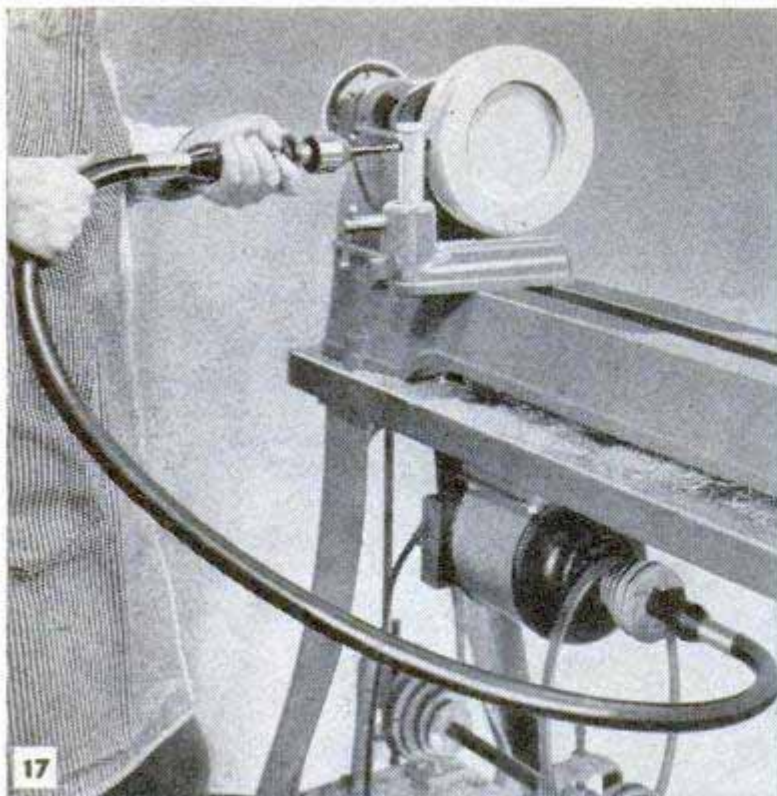

17



18

Power take-off for driving flexible shaft can be made from drill-press spindle, as above, or from lathe motor, as at the left



19

Core of shaft is cleaned and lubricated at regular intervals

Proper installation of the flexible-shaft unit is necessary if you are to get the most out of this versatile tool. One of the handiest arrangements for using a small shaft-and-motor unit is that in Fig. 5. On such units, the motor is provided with a bail or hook so it can be hung at some point above the work. In this case, a swinging arm mounted on the bench tool panel makes it possible to use the shaft unit at any point on the bench top. Other applications, using the same motor unit, are shown in Figs. 14, 15 and 16. Similar units are available with larger shafts and motors. The larger units also are supplied with a special floor stand as in Figs. 2 and 3. On these units, the motor base swivels, permitting the unit to follow the movements of the operator without undue flexing of the shaft. In small commercial shops and home workshops, the larger shafts can be set up as in Fig. 1, the motor being bolted to a wooden base.

The same type of shaft as that in Fig. 1 is shown in a somewhat different adaptation in Fig. 17 where it is being driven by the lathe motor and is used to drill index holes in a wood turning. In the setup shown in Fig. 1, maximum freedom of movement is obtained with the end of the motor shaft toward the operator, a trick to remember when operating a flexible shaft with the motor mounted on a stationary base. Disk-sanding is done with a special flexible disk constructed as shown in the details in Fig. 1. The abrasive disk usually is not attached to the backing disk with adhesive but is held in place by a recessed flange. In operating a disk of this type on large flat surfaces, make a one-way stroke with the leading edge of the disk lifted slightly as shown. In this way, the trailing edge will not leave scratches on the work. A lamb's-wool bonnet for polishing can be fitted over this type of disk.

Flexible shafts used intermittently need little servicing, except that care should be taken to make sure that the shaft does not run without lubricant. Dismantle the shaft at regular intervals and clean all the parts with a solvent as in Fig. 19. When assembling after cleaning, renew the lubricant with the grade specified by the manufacturer. Ball-bearing handpieces usually are provided with separate oilholes having ball closures. These handpieces should be lubricated at regular intervals with a medium machine oil or any special lubricant specified by the manufacturer.

(Certain photos courtesy R. G. Haskins Co., Delta Mfg. Co., Freedom Electric Co., and The Dumore Co.)

# Increasing Range of Lathe Milling Attachment

Easy to make and simple to use, this handy adapter considerably increases the usefulness of a lathe milling attachment. The base of the adapter is clamped in the milling-attachment vise, and work that is irregularly shaped or too large for the vise is mounted on a faceplate screwed on the adapter stub. For milling round work, the faceplate is replaced with a four-jaw chuck. All parts of the adapter are made of cold-rolled steel. One half of the stub is threaded the same as the lathe spindle, and the unthreaded portion is a force fit in a slightly undersize hole drilled through the base. A registering hole is drilled through both stub and base for a  $\frac{3}{16}$ -in. steel pin which holds the stub in place. A piece of  $\frac{1}{2}$ -in. square stock, drilled and tapped for a setscrew, is mounted on the face of the block as shown in the detail. Note that the three holes drilled in this piece are counterbored for fillister-head screws. The setscrew, of course, is turned through the piece of square stock and against the hub of the chuck or faceplate to lock it on the stub.

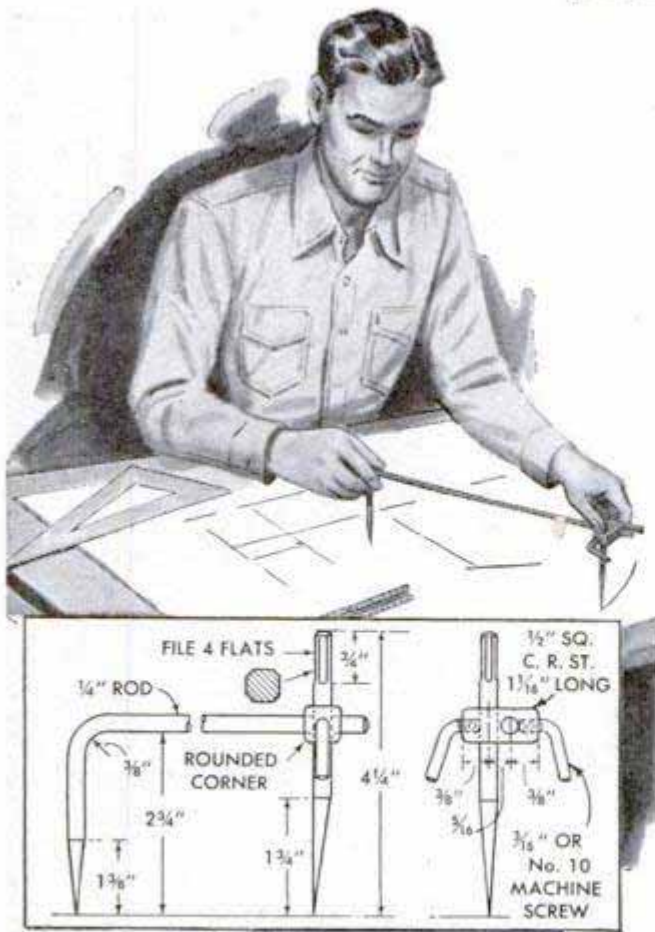
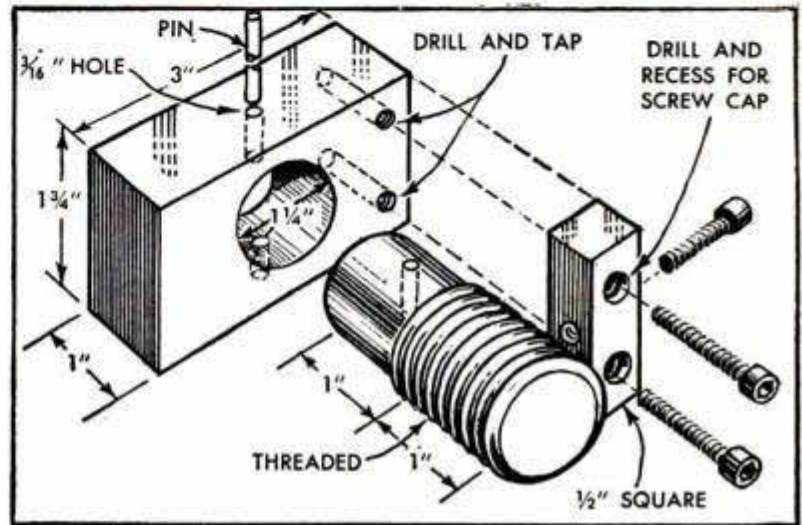
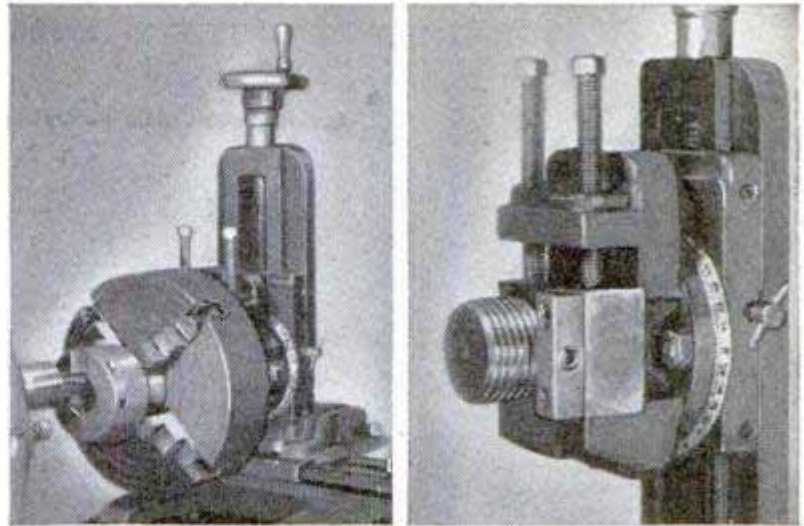

## Trammels Made From Drill Rod Also Used as Beam Compass

Made primarily from drill rod, this set of trammels is inexpensive and, by replacing the adjustable scriber with a pencil, it doubles as a beam compass. The beam and pivot point are made in one piece, one end of the rod being bent 90 deg. and pointed as shown. The adjustable point, or scriber, fits in a sliding head made of  $\frac{1}{2}$ -in. bar stock. Flats are filed on four sides of the upper part of the adjustable point to aid in turning it for the proper setting, and the tip of the point is bent to align with one side. Note that the locking screws for the adjustable point and the sliding head are bent from machine screws. In use, the sliding head is locked at the approximate setting. Then, the eccentric point is turned to the exact setting and also locked in place. To make accurate settings easier when using the tool as a beam compass, the upper part of the pencil can be filed at an angle so that the point is eccentric.

Earl R. Goddard, Denver, Colo.

☞ Pour paraffin over unused paint remaining in a can and it will not harden.

## Homemade Car-Parts Washer Agitated by Compressed Air

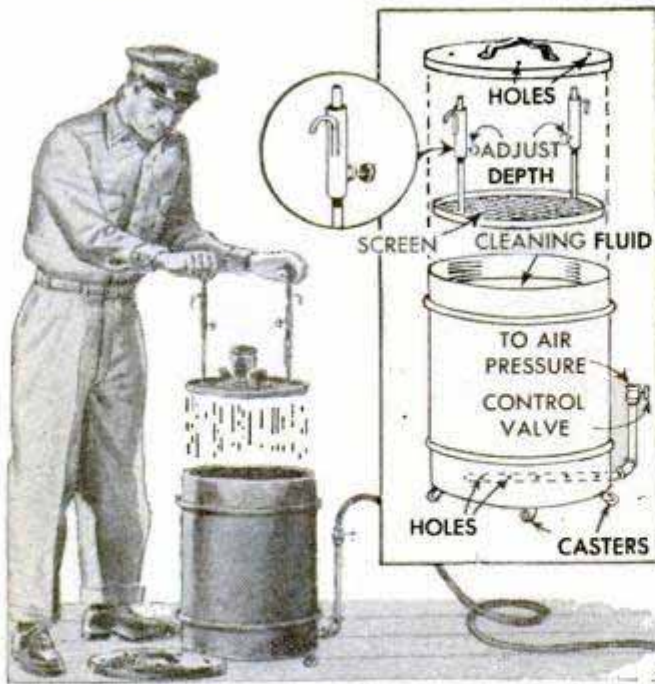

One mechanic uses a homemade washer agitated with compressed air to wash car parts quickly and thoroughly. The washer consists of an old oil drum, a tight-fitting cover, an adjustable parts rack and a length of pipe inserted at the bottom of the drum for an air intake. A series of holes is drilled along the portion of the pipe inside the drum, and the outer end is fitted with an air-hose connection and a control valve. The parts rack is simply a metal frame covered with screen wire. Two pieces of rod are welded vertically to the frame, sleeves being slipped over the rod and tightened with setscrews to permit adjusting the rack for depth. Note that holes are drilled through the cover to allow the air to escape and that casters are welded to the bottom of the drum to make it portable. Be sure that the cover is tightly in place before turning on the air pressure full force.

Elmer Vandrey, Truman, Minn.

## U.I. '51 Grain Sacks Stenciled Easily



A hoop of stiff wire inserted in a grain sack will stretch the sack taut for easy stenciling. The hoop can be made from a wire clothes hanger.

## Antifreeze Drained Without Loss

Clamping a length of hose to the radiator drain cock permits draining antifreeze into a gallon jug or other container without losing a single drop. In addition, this pre-

vents splashing the underside of the car and the garage floor. Clamp the hose to the drain cock by twisting a piece of wire around it.—T. A. Thom, Knoxville, Iowa.

## Sunken Nail Keg Holds Pail To Feed Young Calf

Instead of taking time to hold the feed pail when feeding a young calf, one farmer sets the pail in an empty nail keg which is partially embedded in the ground. Earth is shoveled into the keg to help anchor it. Of course, it is necessary to embed the keg at such



a depth that the rim supports the pail at the proper height for feeding. Mounted in this way, it is difficult for the calf to overturn the pail and spill the feed.

## Half Gate in Farm Fence U.I. '51 Ideal for Occasional Use

When farm lots are fenced with boards, narrow swinging gates are a convenience in passing from one lot to another. If infrequent use does not warrant the time and expense of installing full-size gates, a half gate will be found handy. This is easy to make and costs practically nothing. Just install a couple of boards vertically in the fence and saw off the upper boards between them. Then make a half gate from these short pieces and hinge it to one of the uprights.

Marion L. Rhodes, Knightstown, Ind.



## Portable Civilian Transceiver

**R**ADIO TRANSCEIVERS for public use between homes, automobiles, offices, manufacturing plants, farms, and many other person-to-person radio-telephone applications are now claimed to be in pilot-plant production according to one manufacturer who has received F.C.C. approval. The portable battery-operated combination transmitter and receiver is to be used on the 465-mc. band allocated for civilian use, when licensing is authorized.

The compact unit is about one fourth the size of the famous wartime walkie-talkie and is the result of two years of research and engineering in which many new techniques, including the use of "printed" silver-on-ceramic circuits, and subminiature tubes played an important part. In order to qualify for the F.C.C. approval, experimental units have been given exhaustive field tests by the manufacturer. These tests have been made between auto and home, home and office, boats and shore, planes and ground, and from person-to-person on city streets. It is also claimed that they have been tested for practical push-button operation in the field between hunters, mountain climbers, farmhouse and field, and by surveyors. This pioneer manufacturer predicts that this type of personal two-way radio will become a standard means of eyewitness reporting of sports and news events to radio and television audiences and to newspapers.

Two transceivers of the type shown in photos A and B are required for person-to-person air contact. In actual operation, the unit is held in the position shown in photo A. It weighs only 11 ounces, including the small folding antenna, and it is housed in a tiny case measuring  $1\frac{1}{4} \times 2\frac{7}{8} \times 6$  in. This pocket-size radio station includes all necessary equipment except a tiny headphone and the necessary batteries, which are carried in a separate case about the size of a miniature camera. Photos B and C show the ultracompact construction made possible by the subminiature tubes and "printed" circuit. This model 100-B citizens' transceiver is for Class-B stations only, operating on 465 megacycles, tolerance 0.4; input of 3 watts; emission, A-3 with 30 percent maximum modulation. The transmitting section uses a Sylvania 6K4 subminiature oscillator, and the receiver is a super-regenerative type using three Sylvania 1V5 subminiature tubes. Two of these tiny tubes are shown mounted on one of the ceramic panels in photo C. The total weight of the station equipment, including batteries, is  $2\frac{1}{2}$  pounds. The practical range is about two miles, depending upon the terrain.

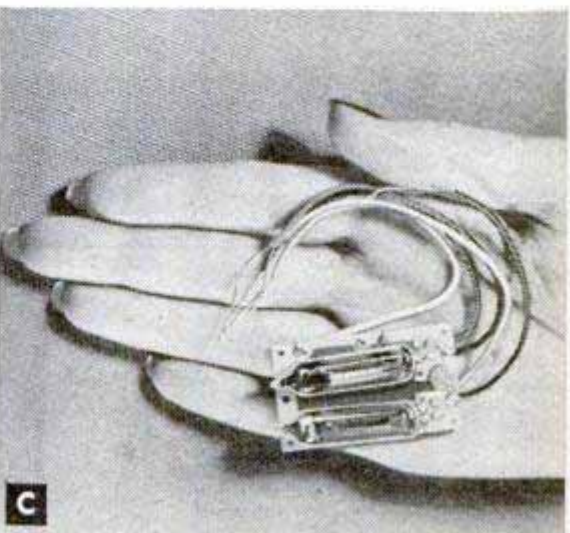

# LOW-COST 2-TUBE PROGRESSIVE

By S. A. Johnson

**T**HIS EXTREMELY SIMPLE and highly efficient two-tube receiver will be of interest not only to the builders of Unit No. 1, the one-tube set that appeared in the January issue, but also to anyone who wants an inexpensive, easy-to-build, broadcast-band receiver that will operate a loudspeaker to good room volume. Since this second model has a built-in power supply, it eliminates the 45-volt B-battery used in the previous set, and operates directly from your 110-volt a.c. supply line. It employs all of the same parts except the switch on volume control R5, which is changed to a single-pole, single-throw type. Therefore, the beginners who built Unit No. 1 can build this more powerful set with a minimum of expense and trouble, as only a few parts are added.

A type 6AK6 miniature power-pentode tube is now employed as a power amplifier for the output of the original 6J6 twin-triode tube; all of the excellent performance of the one-tube set is retained, with the added advantages of loudspeaker volume and all-electric operation. Both set No. 1 and set No. 2 are complete, individual units and need not be built progressively unless desired. Those who built the first set are advised to remove all wiring, except the tube-filament circuit, from the chassis base and completely rewire the circuit for this new 2-tube loudspeaker model.

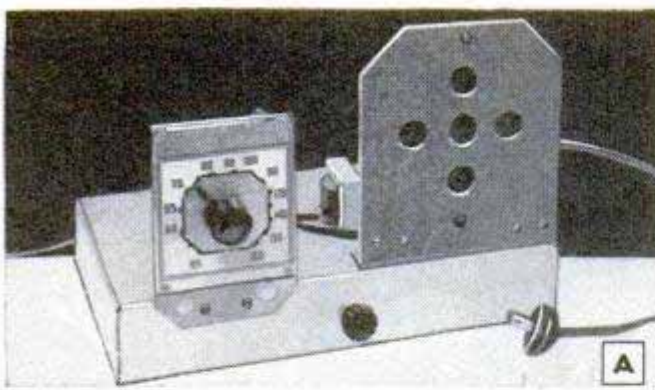

A

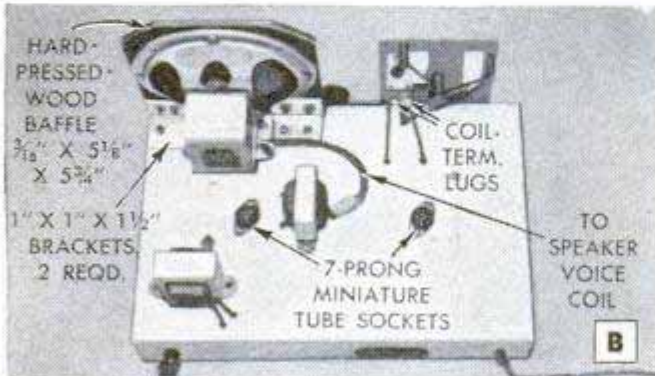

B

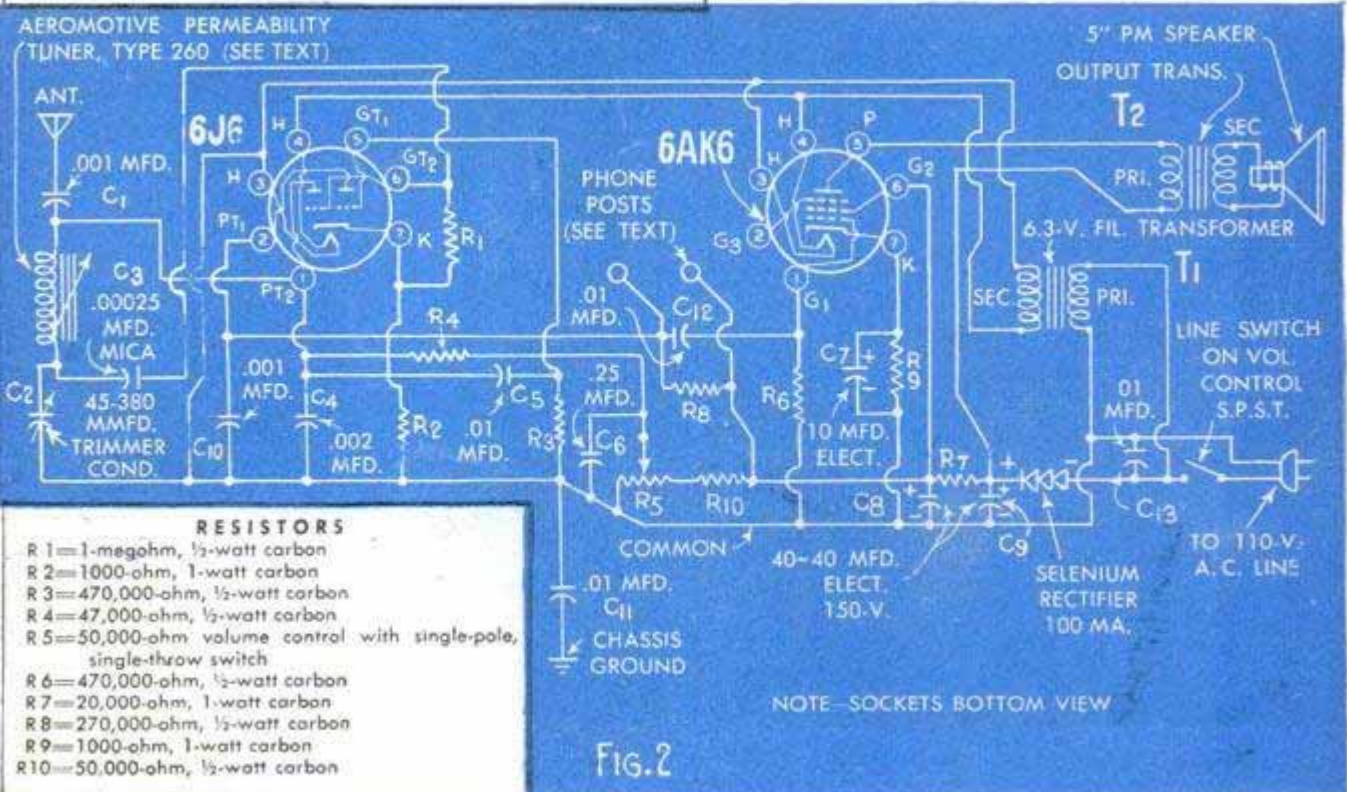
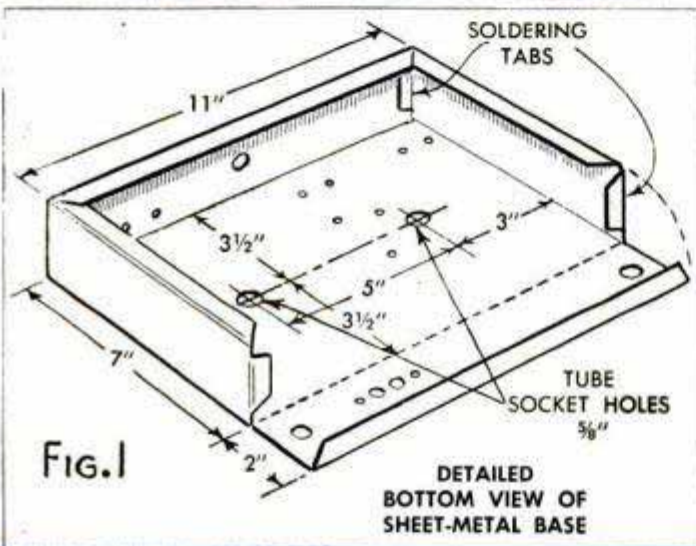





# SIGHT AND SOUND TODAY

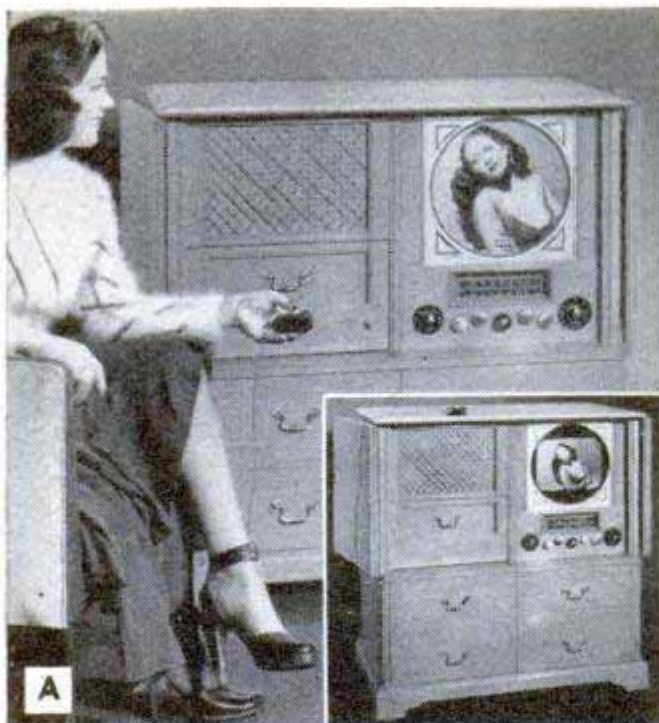

A—Either conventional rectangular TV pictures or circular enlargements from about the center of the regular picture are now available on the same viewing tube in this Garod television receiver. The inset photo shows the conventional picture, which the young lady can change at will by means of the push-button remote-control switch she holds in her hand. The switch is connected to a 15-ft. cord and provides close-ups of faces or specific events in the scenes. This Tele-Zoom feature is claimed not to distort the image. The operator can change back at will to the conventional-size picture whenever crowd action or an entire scene is preferable for viewing

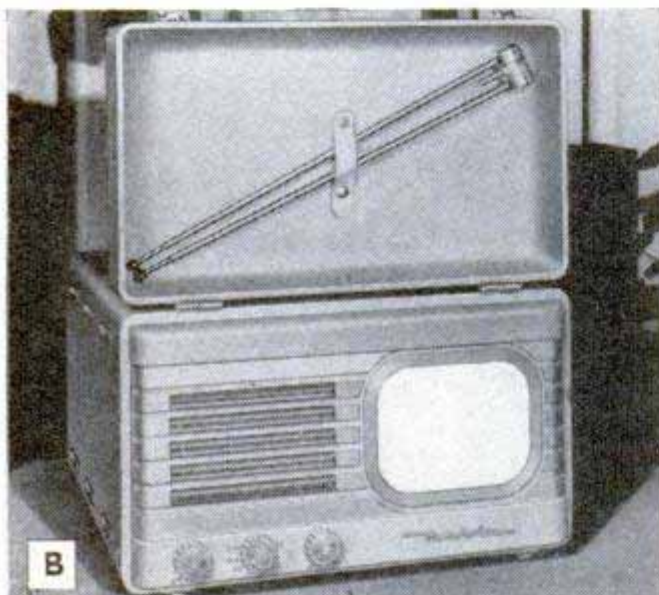

B—Completely portable, this television receiver includes an adjustable portable-type antenna that straps inside the lid of the case when not in use. The set employs a 7-in. picture tube and can be used wherever alternating current and TV broadcasting are available. It is built on the same chassis as the table-model Motorola VT71 and features the same simplified controls. C—This shows the portable TV set ready for use with the adjustable antenna inserted in its socket. The antenna snaps into place and may be rotated for peak performance. With antenna, set weighs 33 pounds. Case cover is leatherette

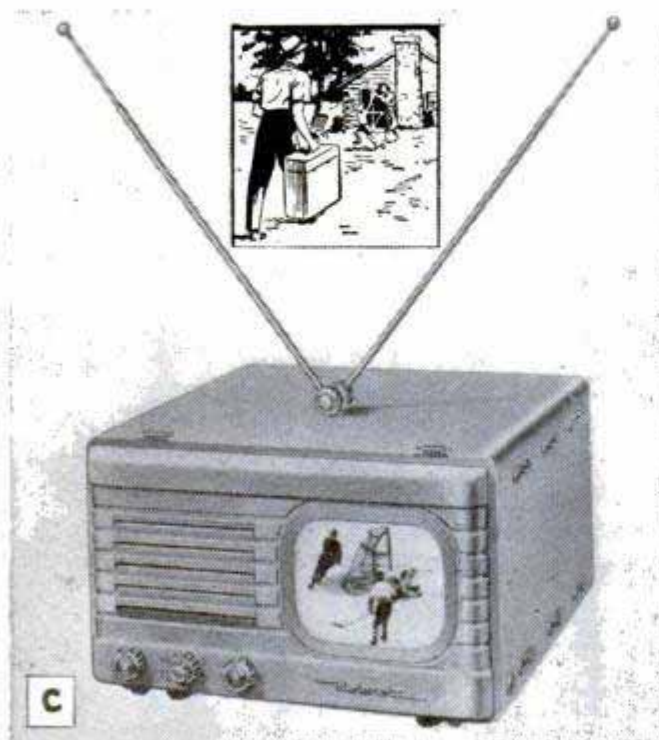

D—New type of record and automatic record player recently introduced by RCA plays a single-size disk about 7 in. in diameter for all classifications of recorded music, popular, classical, folk and children's material. Operation at 45 r.p.m. provides up to 5 minutes and 15 seconds of playing time on each side or up to 42 minutes when eight records are stacked on the automatic record player. Record-changer mechanism is claimed to be unusually fast and to eliminate 75 percent of the problems encountered in the conventional changers. The outstanding feature is the large, 1½-in., plastic-capped center spindle which houses the noiseless trigger-fast drop mechanism



# See the image $2\frac{1}{2}$ times as Bright

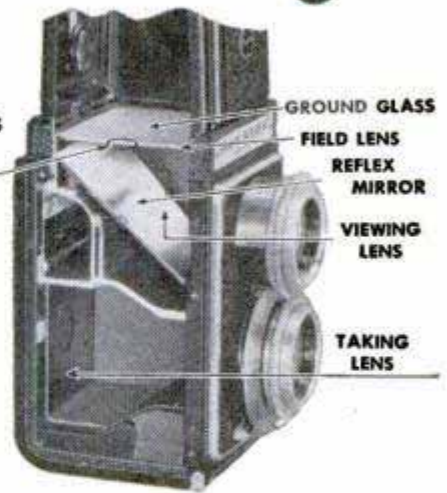
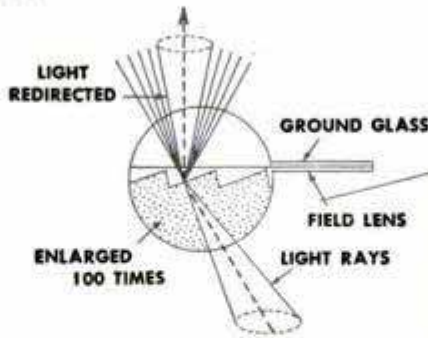

BRIGHT TO THE EDGES

**SPARKLING BRIGHT** describes the image you see in the finder of the new Kodak Reflex II Camera. Sharper focusing, edge-to-edge composing are made possible with the new Kodak Ektalite Field Lens beneath the ground-glass screen (see diagram above). Microscopic lens grooves redirect stray light rays—give you an image  $2\frac{1}{2}$  times as bright overall, 10 times as bright at corners, as with the usual ground-glass finder.

And of course you get all these Kodak *plus features*—Lumenized twin lenses, four-element Kodak Anastar  $f/3.5$ 's . . . fast-action  $1/300$ -second flash shutter . . . new automatic film stop.

Seeing is believing—so inspect the new Kodak Reflex II Camera at your nearest dealer's. The camera with case, \$135 plus tax.

## The NEW Kodak Reflex II Camera

Flashholder, \$9.50 plus tax.  
New two-piece field case comes with camera.

"Kodak" is a trade-mark.



(Prices subject to change without notice)

# Kodak

EASTMAN KODAK COMPANY, ROCHESTER 4, N. Y.

# Gear Shift Control

The *Johnson Way!*



Johnson engineers have been designing, testing, and developing this great motor for years. It has been *completely engineered for gear shift control* with automatic speed limitation in neutral and reverse—exhaust diversion in reverse—reverse lock (prevents tilting)—and shock-absorbing rubber-floated propeller.

But there's much more! Separate, Mile-Master Fuel Tank, for *hours* of cruising without refueling. "Hold-your-hat" acceleration. *Slow* trolling speed (in a 10.0 h. p.\* motor!). 40 great features. And Johnson **DEPENDability!** Look for your Johnson dealer's name under "Outboard Motors" in classified phone book.



\*10.0 OBC Certified brake H.P. at 1000 r. p. m.

## JOHNSON SEA-HORSES for **DEPENDability**

### FREE HANDY CHART

Write for 1949 Sea-Horse Handy Chart. Illustrates, charts the QD and the 4 other great Johnsons for '49. All features fully described.

JOHNSON MOTORS,  
400 Pershing Road, Waukegan, Illinois  
Johnson Motors of Canada, Peterboro, Canada



## Beginner's Set—Unit No. 2

(Continued from page 239)

available from all parts houses for about \$1.00. The dimensions are, of course, the same as for the previous set. Those who wish to make their own base can omit the ends, turned-over edges, and tabs. The base may be made of .055-in.-thick aluminum or any suitable sheet metal that can be bent to shape between two blocks of wood clamped in a vise. Drill all holes indicated in Fig. 1; the holes for the miniature tube sockets are  $\frac{5}{8}$  in. in diameter. Small drill holes may be reamed out to this size with a tapered reamer, or a Greenlee chassis punch may be used.

Photos A, B, C, D and E show various views of the completed set; if you did not build Unit No. 1, you should study these photos carefully and note how the various

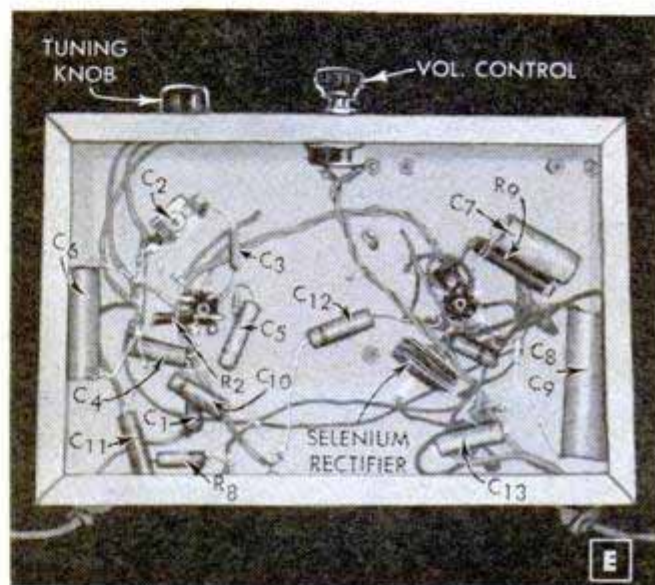

parts are mounted on the chassis base. The schematic circuit diagram appears in Fig. 2 and the pictorial wiring diagram is given in Fig. 3. Please note that this pictorial wiring diagram shows a bottom view of the chassis base. The miniature tube sockets should be mounted so that the blank terminal space is in the position shown. Use No. 20 insulated hookup wire for the circuit and make all soldered connections with rosin-core wire solder. The selenium rectifier is made self-supporting on the terminal strip by soldering its positive terminal directly to one of the insulated lugs on the terminal strip as shown in Fig. 3; it must clear the metal base. When wiring the circuit, check each lead carefully with both the pictorial and schematic wiring diagrams and mark out each lead on Fig. 3 with a colored pencil when it is completed. The use of tie-point strips having insulated terminal lugs simplifies circuit wiring. They enable the builder to use shorter

(Continued to page 244)

# New Eagle-Picher Decorator Paints simplify all home decorating!



**10 HARMONIZING COLORS!**

**HARMONIZE with each other!**

**BLEND with any color scheme!**

**SIMPLIFY color selection!**

**3 exactly matching finishes**



for walls, ceilings



for kitchens, bathrooms



for woodwork, cabinets

Eagle-Picher colors were selected by interior decorators because they harmonize completely with each other—blend perfectly with all colors in furniture, drapes, rugs—and are by far the most popular with discriminating homeowners.

With them you can work decorating miracles. You'll get professional effects, easily, because you're sure of a unified, harmonious color scheme, and you get exactly matching flat walls and glossy woodwork. They're easy to apply, too... cover almost any surface in one coat and may be washed because they're genuine oil paints.

Eagle-Picher paint for an average-sized room will cost you less than five dollars! Ask your dealer!

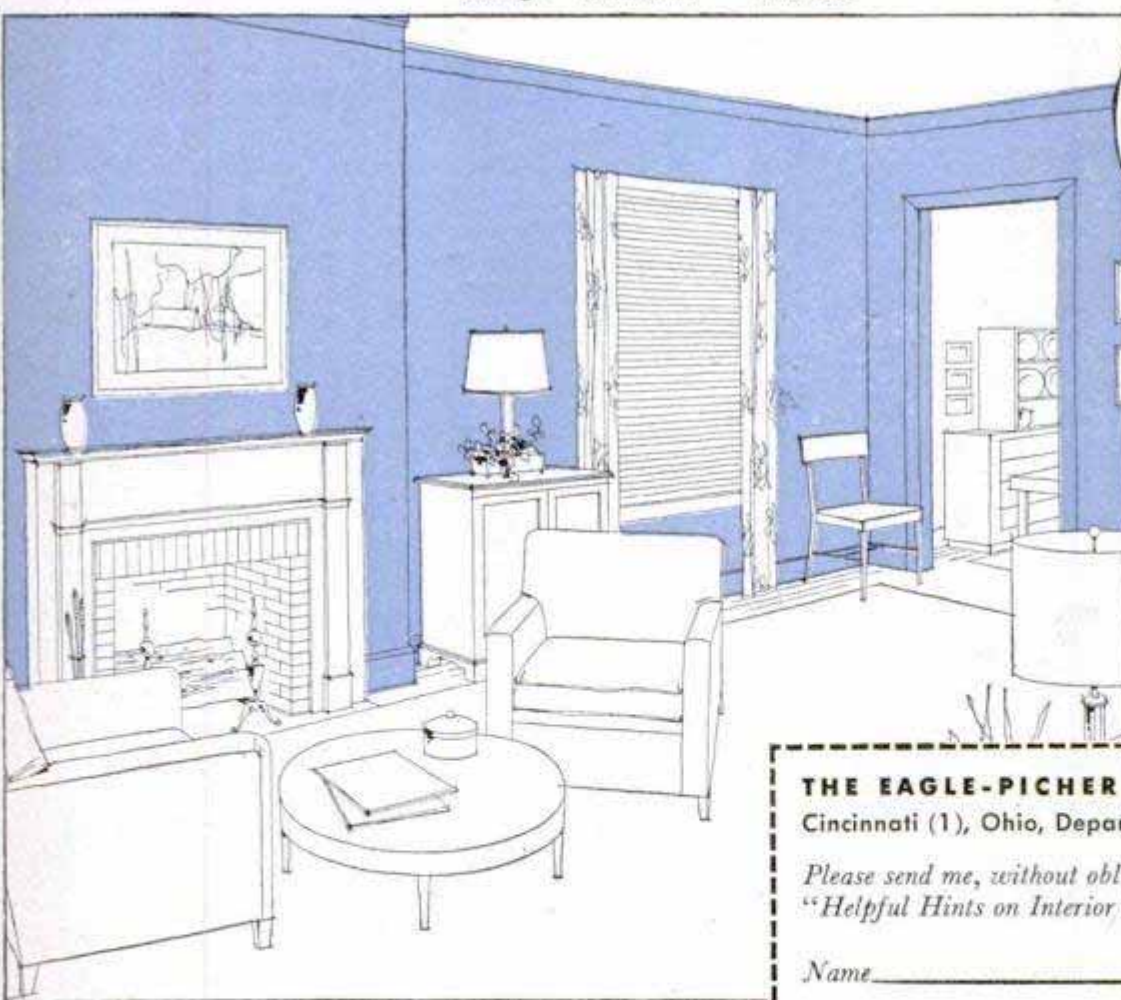

**PROVE IT YOURSELF!  
TRY YOUR  
FURNITURE COLORS  
IN THIS ROOM!**

Get out the crayons! See how this one shade of Decorator Paint—matched as closely as printing inks will permit—harmonizes with your color scheme.

Makers of Eagle White Lead Since 1843



**THE EAGLE-PICHER COMPANY**  
Cincinnati (1), Ohio, Department PM-49

Please send me, without obligation, your booklet, "Helpful Hints on Interior Painting."

Name \_\_\_\_\_

Address \_\_\_\_\_

City \_\_\_\_\_ Zone \_\_\_\_\_ State \_\_\_\_\_

The color in this illustration is Potters Blue. Other colors available in harmonizing Eagle-Picher Decorator Paints are: Roman Ivory · Twilight Gray · Desert Sand · Dresden Blue · Dusty Rose · Harvest Peach · Lettuce Green · Daffodil · Elfyn Green.

# WHEN IT'S A PLUMB YOU CAN BE SURE



It's As Perfect  
As A Tool Can Be

Your tasks will be easier, you'll do jobs better when you use a Plumb. Plumb Ball Pein Hammers, for example, are toughened to stand heavy work. The weight is centered behind the striking face to add force to the blow. Cone-shaped pein spreads rivets instead of mashing them. Tested hickory handles are shaped to lessen fatigue. Like all Plumb Tools they are balanced to make hard jobs easy —to do work faster.

Fayette R. Plumb, Inc., Phila. 37, Pa.

*The red handle and the black head  
—exclusively Plumb*

# PLUMB

HAMMERS • HATCHETS • AXES • FILES

leads and to make a neater wiring job. The various fixed resistors and condensers are self-supporting by means of their "pig-tailed" wire connections. Use care in soldering leads to the terminals of the small tube sockets.

The 5-in. permanent-magnet (PM) speaker is mounted on a  $\frac{3}{16}$  x  $5\frac{1}{8}$  x  $5\frac{3}{4}$ -in. hard-pressed-wood baffle, which in turn is mounted on the chassis by means of two metal angle brackets. First of all, five  $\frac{3}{4}$ -in. holes are drilled in the baffle, as shown in photo A, to act as the speaker grille. These holes are then backed with a piece of grille cloth which is glued in position before the speaker is mounted.

When the set is completely wired and the tubes are inserted in their respective sockets, plug in the power cord and rotate the volume control so that the switch is in the "on" position. Thanks to the selenium rectifier, the set warms up very quickly. As soon as the brief warm up is completed, you should be able to hear some "whistles" as you rotate the tuning-dial knob. "Backing off" the volume control brings in clearly the station you want to hear and eliminates the whistle. There is a certain knack in tuning a set of this type but you can learn it in a very few minutes by experimenting. As in the case of the one-tube set, a short, indoor antenna will give the best selectivity, but a long, outdoor antenna will provide stronger signals. Use the antenna that gives best results in your location. Once you have tuned in a station that you can identify and for which you know the frequency, set the dial pointer to that frequency. Then adjust trimmer condenser C2 under the base with a small screwdriver so that the dial pointer will always indicate that station. Always be careful not to turn the dial pointer past the scale limits. You will find that the position of the power plug in the wall sockets has a noticeable effect on hum level. Try reversing the plug in the wall socket if hum seems excessive. No external ground is used with this receiver; the set receives the effect of a ground through its connection with the power line. The headphone jacks on the rear of the chassis are retained in this new set for those who want to listen to programs with headphones after others have gone to bed. Simply plug the headphone-cord tips into the jacks and remove the 6AK6 tube. Removing the tube silences the loudspeaker; the remaining 6J6 tube gives excellent headphone volume. Detailed student material list R-376 for this low-cost progressive set Unit No. 2 is available from Popular Mechanics Radio and Electronics department upon receipt of ordinary letter postage.

# More Facts about the NEW FORD "FEEL"

When you drive this great '49 Ford, you sense in an instant the new Ford "Feel"—a feeling of effortless control, relaxing comfort and reassuring security—a feeling of eager and flexible response.

And one of the big reasons back of this new Ford "Feel" is . . .

## "Equa-Poise"

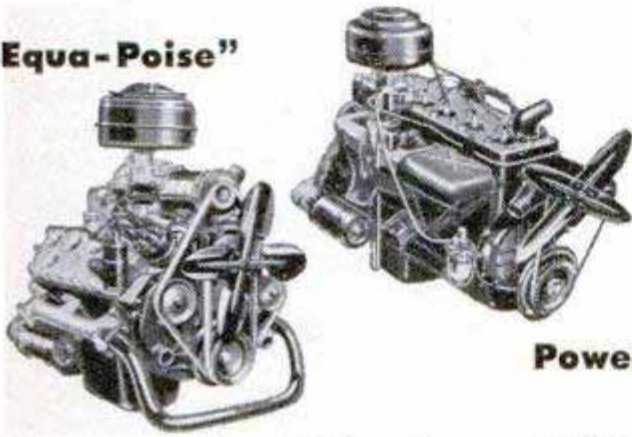

**Power!**

Take your choice of either the new 100 h.p. V-8 or the 95 h.p. Six and get smooth,

brilliant performance. Both engines are "Equa-Poise" mounted. Both incorporate a number of advancements in basic design—both are truly *new*. New "Equa-Flo" Cooling System, "Deep-Breath" Manifolding, "Power-Dome" Combustion Chambers and improved lubrication all contribute to Ford's feeling of responsiveness.

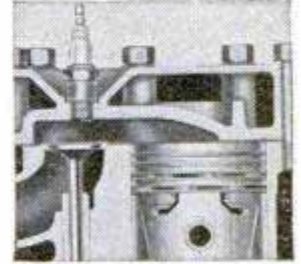

Ford "Power-Dome" Combustion Chamber

Ford offers new economy, too; up to 10% savings in gas—up to 25% with Ford's smooth new automatic Overdrive, optional at extra cost.

And remember, only Ford in its field gives you this power choice of new V-8 or new Six!

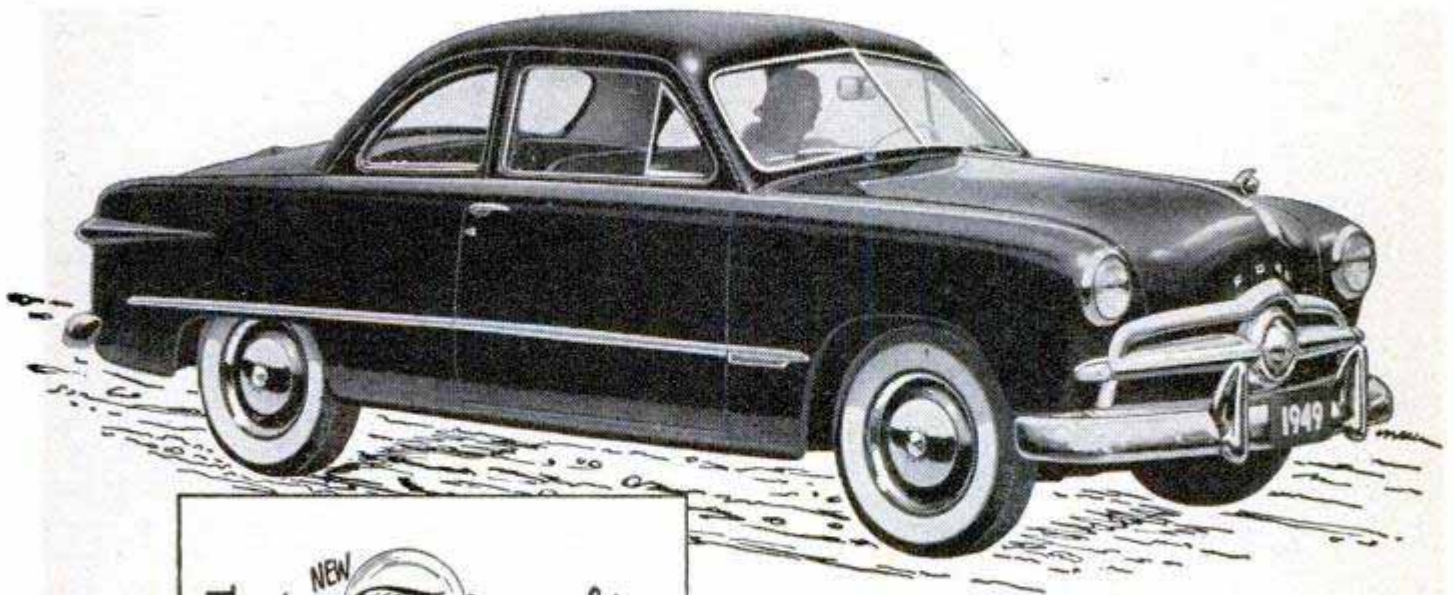

There's a <sup>NEW</sup> Ford in your future

Drive a FORD and FEEL the difference!

# MOTORISTS WISE SIMONIZ

T.M. REG. U.S. PAT. OFF.

MAKES CARS STAY BEAUTIFUL

*Better than 10  
'Here-Today...  
Gone-Tomorrow'  
Polishings!*



## Simonizing saves you time as it saves the finish!

Don't waste your time with 'temporary polishings'! Simonizing gives long lasting beauty...protects the finish and keeps colors from fading. Do as millions of motorists...Simoniz your car. It's easy to do yourself.

THE SIMONIZ COMPANY, CHICAGO 16, ILL.



Use Simoniz Kleener (liquid or paste) to clean finish. Then Simoniz for lasting beauty. Sold everywhere!

## How to Tempt a Fish

(Continued from page 112)

are most numerous in May and June. Later in the year, when the fish are feeding on grasshoppers and other bugs, the trout are not so fussy about what they take.

A few years ago, John Alden Knight came forth with his much-respected theory that fish feed during certain periods. Charts in his book tell you when during the day you should fish. These time charts are called the Solunar Tables.

No one has yet developed a successful fish call like a duck call or a moose call, but Frank Steel now has an instrument called the "Fish Finder" that makes fishing sound easy. He is the present world-record holder for Chinook salmon, with an 83-pounder which he caught in 1910 in the Umpqua River. He is the former national fly-casting champion, so he backs up this new instrument with many years of experience in fishing.

He says, "You've got to find the fish before you can catch them, so I have developed a dependable way of locating bass, trout, walleyes, northern pike, muskies and pan fish. I found the favorite water temperatures of all the common freshwater game fish. All smallmouth bass like 67 degrees, and they like it the same across the continent. When the surface water is 60 degrees you will find the smallmouth bass 5 to 10 feet deep, so you must fish for them at that depth. The fish finder gives you a water thermometer and the necessary fish charts for each fish."

Now for another tip on what's really hot in fly fishing. A tough, waterproof thread has been developed that reacts under light in the ultraviolet spectrum. Bathing suits made of the material can be seen at a distance of two miles, and have made quite a hit with some of the more attractive mermaids. Now the material is being used to tie flies that may catch all the trout and bass that swim. At dawn or dusk, in smog or on the cloudiest days, the flies glow as if they're alive and are said to be four times as bright as conventional flies.

Elmer Maywald of Oak Park, Ill., an expert angler and conservation-minded sportsman, last year fished in some of the better streams of British Columbia, Washington, Oregon, Idaho, Montana and Wyoming with his latest fly creation made from the feathers of a horned owl. It took more trout than anything else in his fly box. His hope is that every fly tier will use horned-owl feathers because the more horned owls that are destroyed the better will be the quail and duck shooting. In tying this fly

(Continued to page 252)



# Why General Electric headlamps give more light

—now 12% more light on the road... and they do not grow dim



**1. TODAY'S GENERAL ELECTRIC "ALL-GLASS" sealed beam Headlamp** is a rugged, one-piece bulb that gives you more light than ever. These pictures show why.

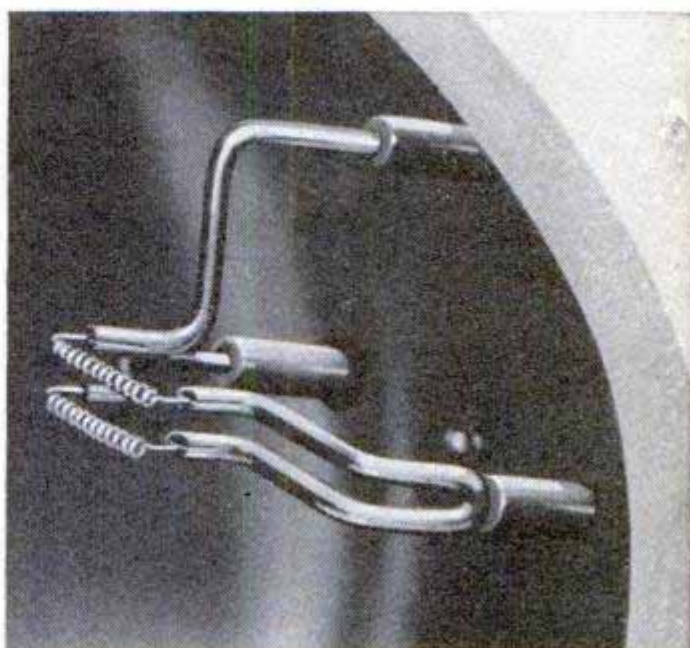

**2. BIG, IMPROVED FILAMENTS** give 12% more light on the road for driving, 16% more light for passing. And they won't shake loose on bumpy roads.

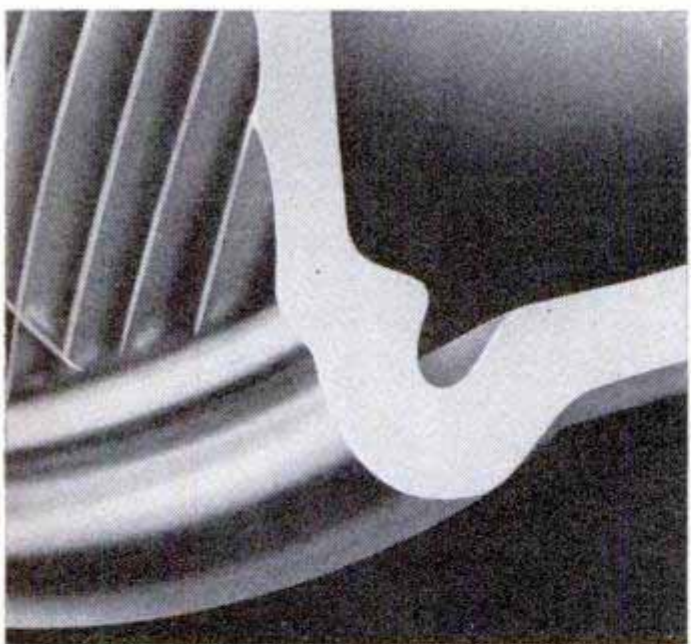

**3. THE ONE-PIECE, all-glass construction** keeps out all light dimming dirt and moisture. The average General Electric headlamp gives 99% of original light output even at the end of its life. *It does not grow dim!*

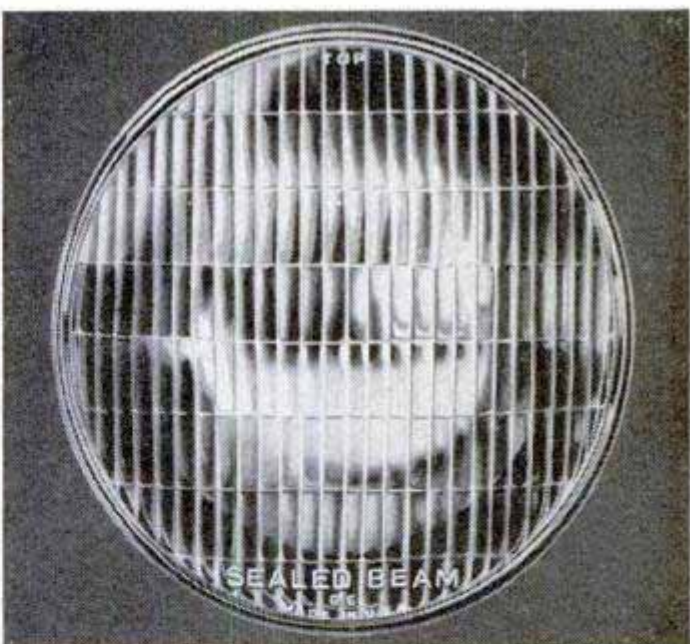

**4. THE LENS** is rugged hard glass, precision made to put maximum light on the road. Be sure to have your car lights checked next time you leave your car for service. And when you need replacements, make sure you insist on General Electric!

*You can put your confidence in—*

**GENERAL**  **ELECTRIC**

# Clinic



## for Homemakers

As a service to our readers in solving the hundreds of problems pertaining to a home—inside or out—the editors of *Popular Mechanics* invite you to present your problems to The Clinic Editor for help and advice. Address your questions to The Clinic Editor, *Popular Mechanics Magazine*, 200 East Ontario Street, Chicago 11, Ill.



**"Why do it the hard way?  
Get an Actionrod!"**

You'll get more wallop with Actionrod's live action.

Here's the rugged steel rod that's delicately balanced, responsive to the touch. Years of experience in tapering and tempering steel give Actionrod a "custom-built" feel just as comfortable as your old fishing hat.

If you want quality you can *feel*—as well as *see*—it's Actionrod for you. Your favorite sports store has it.

**ORCHARD INDUSTRIES, INCORPORATED**  
Detroit 5, Michigan

Complete  
price  
range



Wedge-Type  
Reel Lock



Owner's Name  
On Handle

**ACTIONGLAS**—Orchard's great new development in glass rods. Available in bait casting and fly rods. \$25 to \$35.

# Actionrod

**"SOLID STEEL  
WITH LIVE ACTION"**

### Refinishing Leather Upholstery

**Q**—I have a large leather-upholstered chair. The upholstery is rather worn at the corners of the cushion and on the tops of the armrests. There are a few small cracks at these points but they do not seem to go clear through the leather. Is there any way of refinishing leather upholstery to make it look like new?  
D.A.—Richmond, Va.

**A**—If you are sure that your chair is upholstered in genuine leather and not the so-called imitation leather or other types of leather substitute, then the question of whether or not it can be successfully refinished depends almost entirely on the extent and nature of the wear or other defects. Special enamels and dyes are available in a wide range of colors and are easy to apply by following the manufacturers' directions. The colored enamels are more or less opaque and are quite effective in hiding ordinary defects. The dyes color the material without entirely hiding the characteristic texture and graining of the leather. It is very important that all surfaces of the upholstery be thoroughly cleaned before either of these refinishing materials is applied.

### Fireplace Smokes

**Q**—Recently I moved into an old house having a large stone fireplace in the living room. This fireplace smokes badly when either wood or coal is burned. The flue seems to be clear of obstructions. Fireplace opening is about 36 in. high. What could be the cause of this trouble?  
B.G.—Portland, Me.

**A**—When you say the fireplace "smokes badly" we assume you mean that it smokes continuously and not just intermittently or when the fire is first lighted. Two quite common causes are suggested by your description. The first is that the flue is too small in sectional area. It should be not less than one tenth the area of the fireplace opening. A square flue generally seems to give better results than a rectangular one. The other possibility is that the wind shelf either is not properly located or constructed, or it is filled to the outside edge with an accumulation of fine ash, soot and very likely bits of mortar that have fallen from above. The purpose of the wind shelf, of course, is to prevent back draft. If it is covered with debris



(Continued to page 250)

Amazing new LUMITE screening

# STAINPROOF

*Because it's Rustproof!*

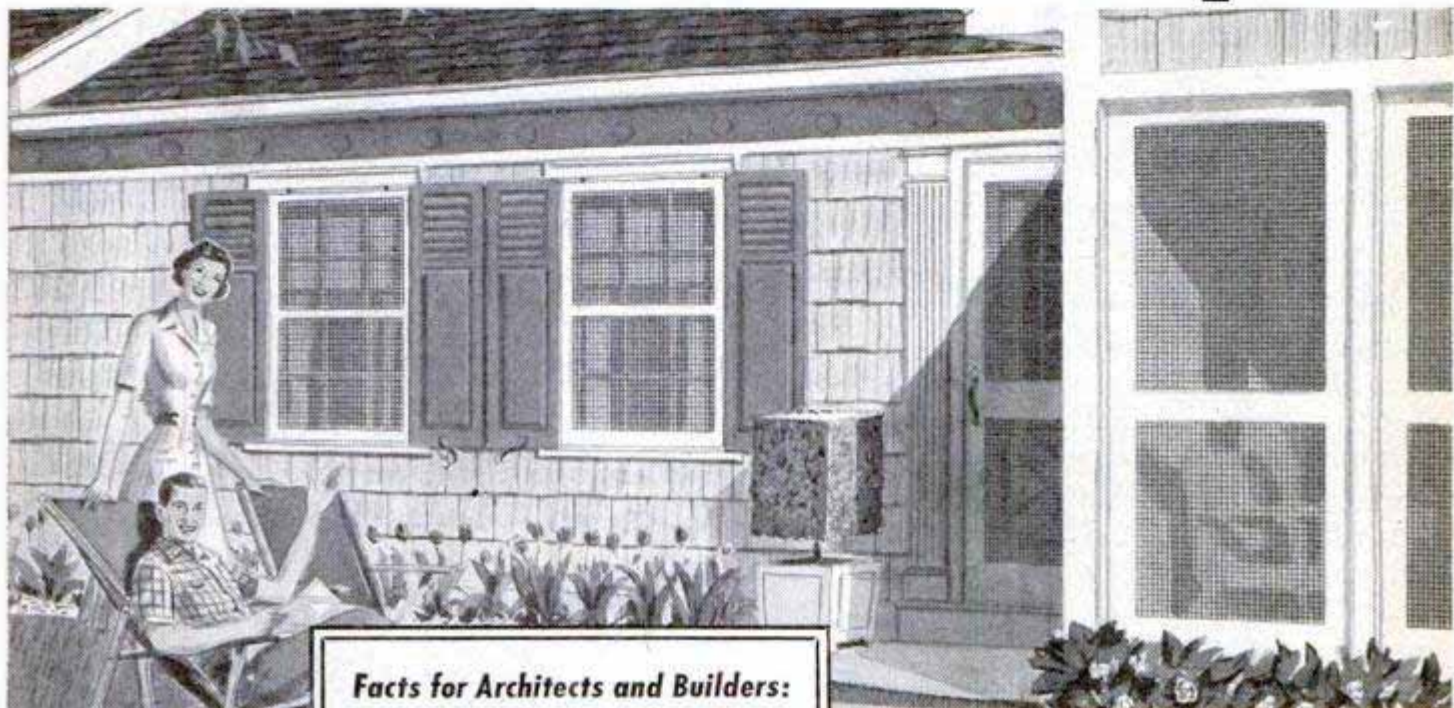

LONGER-  
LASTING

CAN'T  
STAIN YOUR  
HOUSE!

CAN'T  
RUST OR  
CORRODE

#### Facts for Architects and Builders:

**Effect of acids, alkalis and solvents**—Essentially none.

**Effect of age**—Independent scientific tests indicate that LUMITE is more durable than any other type of screen cloth under all climatic conditions that might normally be encountered.

**Non-inflammable**—Will not support flame . . . is self-extinguishing. Melting point, 340°F.

**Tensile strength**—Up to 40,000 lbs. per square inch.

**Impact strength**—Greater than conventional screening.

**Installation**—Cut with ordinary scissors. Fold cut edges under one-half inch. Tack or staple the screening smoothly and evenly every 1½". Because of inherent characteristics LUMITE will gradually draw itself into a snug, firm fit. For correct methods of machine framing, consult LUMITE engineers.

Imagine a screening that can be GUARANTEED never to rust, rot, corrode or stain your house—yet costs only 11½-12¢ per square foot. That's LUMITE!

Imagine a plastic so strong that it actually has greater impact strength than any other type of screening. That's LUMITE!

Imagine a screening that never needs painting to protect it from rust or corrosion. That's LUMITE!

Imagine a screening that is so easy to handle anyone can frame it—no special tools needed—will never sag or bulge when properly framed. That's LUMITE!

For your new home or to replace old screens, order LUMITE from your hardware, lumber or building supply dealer.

Write for information and free sample to Dept. PM-2, LUMITE DIVISION, Chicopee Manufacturing Corporation, 47 Worth Street, New York 13, N. Y.

\*Registered Trade-mark

**INSIST ON RUSTPROOF SCREENING**

# LUMITE

woven saran screening



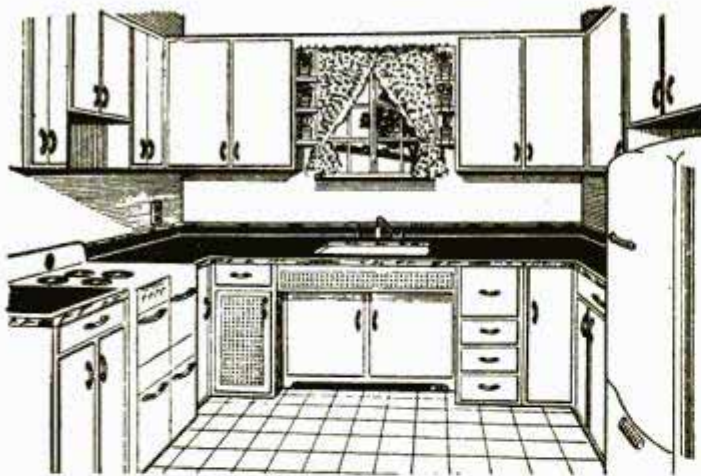

## MODERNIZE YOUR OWN KITCHEN EASILY—INEXPENSIVELY

with EASI-BILD\* "Build It Yourself" cabinets

The Easi-Bild Pattern Method takes the mystery out of making modern, professional looking base and wall cabinets. Tells what materials to buy...when and where to use each...specifies the right Casco Glue.

Includes complete assembly illustrations and step-by-step directions. FULL SIZE CABINET CONSTRUCTION PATTERNS make *entire* kitchen modernization an easy job!

\*Copr. 1949, Easi-Bild Pattern Co.

### Follow These Directions. Solve All Your Gluing Problems:



For boats, outdoor furniture, sports equipment—joints that must withstand outdoor exposure—**CASCOPHEN** (Resorcin Resin Glue). The first completely durable glue available to home-craftsmen.



For furniture, toys, heavy-duty home repairs—use **CASCAMITE** (Urea Resin Glue) where you want a light-colored or mold-proof glue line. Use **CASCO** (Casein Glue) for loose-fitting joints, general heavy-duty jobs. Both easily mixed in cold water.



SEND COUPON FOR CABINET PATTERN TO:

Casco Pattern Dept. PM-49  
P. O. Box 215, Pleasantville, N. Y.  
Enclosed is \$.....for material checked below:  
( ) Kitchen Wall and Base Cabinet, Pattern No. 201—\$1.00.  
( ) 32-page Pattern Book illustrating 94 pattern projects—20c.

Name \_\_\_\_\_

Address \_\_\_\_\_

City \_\_\_\_\_ Zone \_\_\_\_\_ State \_\_\_\_\_

**THE BORDEN CO. • CHEMICAL DIVISION**  
Makers of Casco Glues

or is too narrow, it could be the cause of an almost continuous back draft, forcing smoke and gases into the room. A thorough cleaning of the flue and wind shelf, and the installation of a damper, if there is none, might help to correct your trouble. However, if the flue is too small or the wind shelf too narrow, rebuilding is the only sure solution.

### Refinishing Ornamental Iron

Q—The ornamental-iron railing on my front stoop is rusty in spots and the paint is scaling off on the lower portions, exposing the metal to the weather. Can I refinish these railings myself in a dull black like the original finish? F.M.—Toronto, Ont., Can.



A—Yes, the actual refinishing is quite simple, the main problem being the thorough removal of the rust and scale. A stiff wire brush is quite effective for brushing off the rust and scale but you may have to use a coarse file to bare the metal on some parts of the railing. After a thorough wire-brushing, clean off all dust and loose material so that it will not be picked up by the brush and spread with the paint. As soon as the work has been cleaned, it should be immediately coated with a protective primer before the bare metal is exposed to moisture. Either a brushing red lead or tinner's red lead makes a good metal primer. Be sure to allow the primer plenty of time to dry thoroughly, and then apply a coat of flat-black paint. This dries without any sheen or gloss and makes a very attractive, durable finish.

### Cleaning Shellacked Floors

Q—My hardwood floors are shellacked and waxed. Now the finish has gotten grimy and dull. I have been told to use a dry-cleaning fluid to remove the old wax and grime, rather than a washing solution. Is this correct? R.M.—Kansas City, Mo.



A—Yes, insofar as the superiority of the cleaning fluid over washing-powder solution as a cleaner is concerned. However, we cannot recommend the use of cleaning fluid in any room in the house as the fire and health hazards are too great, even with all doors and windows open. Water in the washing solution may turn the shellac white on any areas where the wax film is worn off. With ordinary precautions, turpentine can be used safely to remove the old wax. Have the doors and windows open when applying the turpentine and for some hours after to allow the fumes to pass out. Embedded grime not removed along with the old wax can be removed with a household paint cleaner before refinishing the floor.

### Repairing Chairs That Squeak

Q—I have several older-type dining chairs with hardwood frames and backs. The joints of all the wooden parts are loose and squeak annoyingly when the chairs are in use. How can I tighten these loose joints—should I take each chair apart and reglue the joints, or is there a simpler method? Would I have to use clamps? R.R.—Denver, Colo.

A—The best method, of course, is to disassemble the chairs completely, clean all the old glue out of the joints and reglue, clamping the joints under pressure until the glue is dry. Use care when taking the chairs apart so as not to split the wood. Frequently, the parts of older chairs were joined with dowels and special care must be taken not to break these. To reassemble each chair as a unit, you will need at least four bar clamps. On some chairs, six bar clamps will be needed. Otherwise the chair must be joined in sections, allowing the glue to dry each time.

# HERE'S HOW TO END

*Oil Waste*



*Gas Waste*



*and Failing Power*

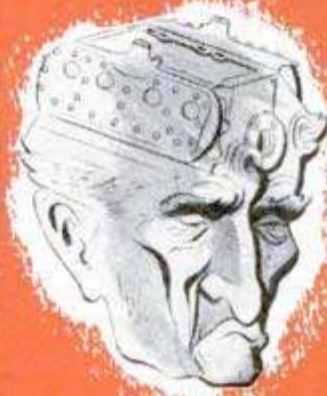

## **Our Challenge**

There are thousands of designs of piston rings made by 77 manufacturers—BUT this Sealed Power MD-50 Steel Oil Ring has exclusive advantages possessed by no other. Drop us a postal for positive proof of sheer mechanical superiority!

## **SEALED POWER PISTON RINGS**

**Save Oil! Save Gas! Seal Power!**

Make your car, truck or tractor deliver 1949 pep and 1949 fuel and oil economy, no matter when it was built! This sensational 4-piece Sealed Power Piston Ring ends oil and gas waste, seals power in the engine and gives you the old-time pick-up and quick starting you used to be so proud of! This is the only ring with the exclusive Sealed Power Full-Flow

Spring—praised by car owners and mechanics all over America. Ask your Sealed Power Franchised Dealer to tell you the whole story!

*Mail a postal card today for proof to back up our challenge. At the same time we'll send you our new illustrated booklet on 7 ways to save oil. It's free and may save you real money. Sealed Power Corp., Dept. G-4, Muskegon, Michigan.*

There is a Sealed Power Set specifically engineered for your car, truck or tractor—whatever the make, model, or condition!



**Sealed Power**  
**PISTON RINGS**  
BEST IN NEW CARS! BEST IN OLD CARS!

# Which of these 3 POWER TOOL KITS Do You Want?



- A high-power, professional machine!
- And ALL these selected accessories!

Choice of three kits, each with just the right equipment you need for your particular jobs. These kits assure the best work and the most work from the rugged GUILD Sander-Polisher. This many-purpose Guild Tool has an extra-sturdy  $\frac{3}{8}$ " spindle . . . 100% more power . . . covers 52% more working area. Avoids stalling . . . outlasts machines of similar size. Guaranteed.

1. **SHOP KIT** (illus.)—For homecraft and light industrial use. Sands, grinds, wire brushes, drills, mixes, cuts, buffs, polishes, etc. Includes bench stand and metal case. . . . Only \$69.50
2. **HOME KIT**—Polishes floors, furniture, cars, silverware; sharpens tools, knives. Sands wood, buffs, wire brushes, etc. Includes bench stand and metal case. Only \$59.50
3. **PAINTERS KIT**—Does heavy and light sanding, removes paint, wire brushes, mixes paint, cuts light metal, cleans up tile, etc. Includes metal case. Only \$59.50

A REAL BUY! At leading hardware and mill supply dealers, or write . . .

**PORTER-CABLE Machine Co.**  
1984 No. Salina St. Syracuse, New York  
Mfgs. of GUILD and SPEEDMATIC Electric Tools

he uses the feathers off the shanks of the feet for the body, and the hackle comes from the face of the bird.

What looks most important to the fish is the fly. It takes a good fly, properly presented, to get the best out of fly fishing. Fly tying is not just a fad of fishermen; it's a hobby that has lured doctors, presidents, baseball players, lawyers and industrialists away from their work. Every American town in a trout-fishing area possesses a fly tier or two and the big cities are crowded with them. In fact, the bug that bites the fly tier produces a fever every bit as serious as the disease that strikes millions of fishermen as soon as the season opens.

(To be continued)

## Smog Sleuths

(Continued from page 181)

operating in Los Angeles because of canceled flights due to smogged-in airports. To find out what smog does to visibility, the technicians built a transmissometer.

Patterned after one developed by Dr. N. E. Bradbury of Stanford University, it consists of a photoelectric cell mounted in a box along with a light which sends out a beam that is reflected back with a mirror to strike the photocell. The photoelectric cell registers the amount of light cut off by foreign particles in the air and gives an exact measure of visibility.

A perforated disk whirling in front of the bulb in the transmissometer chops the light beam into 1050 flashes per second so that the photoelectric-cell amplifier, tuned to pick up only this frequency, does not register any other light.

When the transmissometer is used in the laboratory, the light beam is directed through a 40-foot tube containing test-smog vapors. By testing separately each element of the smog, the scientists can find out how much each contributes to reduced visibility.

"From what we have found out about smog so far, we know that the conditions which cause smog are the same almost everywhere it occurs," stated one of the scientists.

"First, there must be a heavily industrialized area to provide the necessary smoke and fumes. Then, a meteorological "roof" or inversion layer must be present to prevent the smoke and fumes from escaping, and the wind must be stagnant, or nearly so, to keep the air from circulating and blowing the smog away."

Los Angeles makes a good smog laboratory because it has a large industrial area

(Continued to page 254)

# Don't let a rusty radiator take you for a costly ride

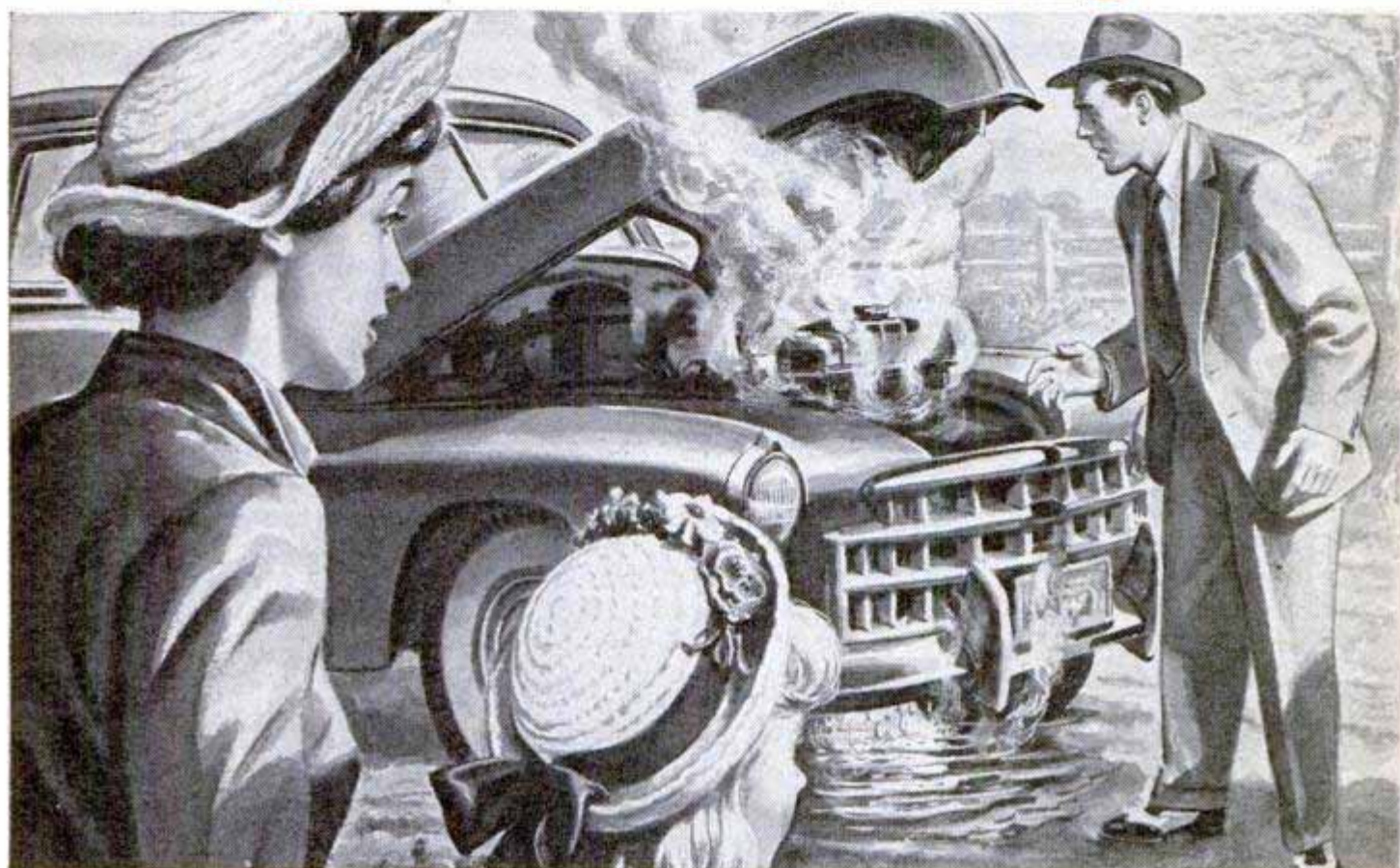

*Clean out rust with*

## **DU PONT COOLING SYSTEM CLEANSER**

Get rid of winter's accumulation of rust, scale and scum . . . avoid damage caused by overheating. Just pour a can of DU PONT CLEANSER into your radiator, run the engine 30 minutes or more, and drain. It dissolves rust—cleans thoroughly—improves the engine performance. It's safe, sure and easy to use.

*Keep out rust with*

## **DU PONT ACID AND RUST INHIBITOR**

After cleaning out the radiator, you can keep it free from rust all season by pouring in a can of DU PONT ACID AND RUST INHIBITOR. It retards rust formation, and keeps out acid, too.

*Avoid radiator leaks with*

## **DU PONT COOLING SYSTEM SEALER**

You can stop leaks quickly and securely—and help to prevent radiator leaks in the future—by pouring in DU PONT COOLING SYSTEM SEALER. It will not clog the radiator or harm hose or metal parts.



**Rust-clogged  
radiators cause  
overheating,  
trouble and expense**



REG. U.S. PAT. OFF.

Better Things for Better Living  
... Through Chemistry

What a difference a  
real hand sander  
makes!

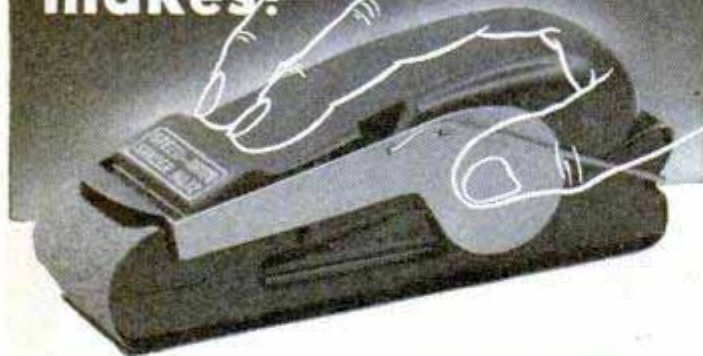

## The *NEW* SPEED-GRITS\* SANDER

A real professional-looking finish in a fraction of the required time by the old-fashioned wooden block. Fast on the flats and in the curves and corners too. That's the story of the new SPEED-GRITS Sander, the tool that handles like a plane.

It's light in weight but strongly built and it grips the sandpaper like a bulldog so it can't slip, loosen, snag or tear.

Best news of all is the low price. In two sizes—large size, with sanding area of 7" x 2", is priced at only \$1.25. Slightly smaller size costs \$1.00. Ask to see the handy SPEED-GRITS Sander at your local hardware store. You ought to have one in your shop.

\* Reg. Pending.



The SPEED-GRITS Sander loads like a camera—only faster and easier. You can unclamp it for loading and clamp it tight again in a jiffy.



The Mark of Quality in Abrasives

**BEHR-MANNING**  
NORTON abrasives TROY, N.Y.

and all the meteorological conditions necessary for smog formation. Los Angeles County is rimmed on three sides by high mountains and is located directly beneath the lower lip of a huge tilted saucer of air extending out over the Pacific Ocean to the Hawaiian Islands.

Whirling in a huge clockwise circle, this high-pressure system pours a cascade of warm air down on the California coast. Often 20 to 30 degrees warmer, the air forms a ceiling directly over the Los Angeles basin, floating above the cool air which fills the basin.

Contaminated air from the city below is unable to rise through this inversion layer which hovers between 1000 and 3000 feet above the ground. The natural haze of dust, salt particles and water droplets which collects at this layer is increased by man-made smoke and fumes, spreading a blanket of smog over the city. When the smog reaches ground level, eyes begin to smart and noses and throats burn.

The Stanford Research Institute scientists are working to perfect a smog-forecasting technique. With the help of a 36-foot chart on which they plotted two years of weather data from Los Angeles, they computed the Stanford Research Institute Smog Index. In its present state of development, the smog index helps meteorologists predict smog two days in advance with fair accuracy.

Forecasting smog is important because it will then be possible to limit the amount of smoke and fumes poured into the air when smog is expected. This knowledge may prevent a recurrence of the tragedies which struck the Meuse Valley and Donora.

## Hollywood Boatman

(Continued from page 160)

oarlocks, building a false cabin and adding figureheads.

He recalls one picture where a Hollywood flunky ordered a particular type of boat. Roberts knew it wasn't the right kind. He tried to say so, but the obnoxious underling insisted, "That's what the head man ordered and that's what he'll get."

Roberts shrugged his shoulders and delivered the boat. As soon as the director saw it he threw up his hands. "Utterly impossible!" he moaned. "It hides all the actors. We need a speed boat, not a cabin cruiser. How long will it take us to get a speed boat up here?"

"Give me a carpenter and I'll have one for you in about five minutes," Roberts said. He and the carpenter went to work, loosened a dozen screws and lifted the

(Continued to page 256)



# Success from the start!

*Sets New Performance Standard*

*Amazing Resistor does it!*



## Here's what it does

A SMOOTHER ENGINE IDLE—WIDER SPARK GAP HELPS ELIMINATE OCCASIONAL MISSING.

IMPROVED GASOLINE ECONOMY—PERMITS BURNING OF LEANER MIXTURES AND REDUCES MISFIRING.

INCREASED ELECTRODE LIFE—UP TO 200% AND MORE.

IMPROVED RADIO RECEPTION—REDUCES SPARK PLUG INTERFERENCE WITH RADIO, RADAR AND TELEVISION.\*

\*Within 35 mv/m from 540 kc. to 150 mc. at 50 ft.  
Auto-Lite Spark Plugs—Patented U.S.A.

## NEW AUTO-LITE

# Resistor SPARK PLUGS

### Acclaimed by car owners coast-to-coast

SO REAL are the operating advantages of this scientific Auto-Lite development that car owners everywhere are replacing their regular type spark plugs with Auto-Lite Resistors.

Departments and taxi companies tell us of their enthusiasm for the smoother idle and improved gasoline economy experienced.

Car dealers, service station operators, garage men, Police

See your Auto-Lite Dealer today for a complete new set of Auto-Lite Resistor Spark Plugs.

Toronto, Ont. **THE ELECTRIC AUTO-LITE COMPANY** Toledo 1, Ohio

BECAUSE OF ITS LOW RATE OF ELECTRODE EROSION, THE NEW AUTO-LITE RESISTOR SPARK PLUG PERMITS WIDER INITIAL GAP SETTINGS AND MAKES THESE ADVANTAGES POSSIBLE.

# AUTO-LITE Resistor SPARK PLUGS

See the new

**LUFKIN**

## Chrome Clad Micrometer

with non-glare satin finish



NOW  
AT YOUR  
DEALERS!

### See these 7 superior features

1. Heavy chrome plating with non-glare satin finish which makes readings easier than ever before in bright or poor light. Markings stand out sharp and bold against the satin finish. It is rust and wear resistant.
2. Hardened ground thread.
3. One-Piece Spindle.
4. Easy Adjustment.
5. Cutaway Frame.
6. Rapid Reading (Each Thousandth Numbered).
7. Micro-Lap Mirror-Like Finish on Anvil and Spindle Ends.

*Here's a real ally for the precision worker to whom accuracy is a "must." Ask your dealer to show you this improved tool.*

**LUFKIN**

PRECISION TOOLS • TAPES AND RULES  
THE LUFKIN RULE COMPANY  
Saginaw, Michigan

cabin off. The result, an open-cockpit speedboat, which the director had wanted all the time.

With a little ingenuity, a boat used in one film can be remodeled to fit an entirely different type of picture. The French boats used in "Frenchman's Creek" became English longboats for "That Hamilton Woman." A sloop that appeared in "Lydia" can be changed into a day cruiser, a cabin cruiser, a yacht tender or a motor sailer.

Roberts keeps in touch with several salvage outfits on the West Coast. When they come across something of interest, they ring him on the telephone. He is a voluminous reader of magazines and books—always on the hunt for photos and descriptions of historical or foreign boats.

When he can't buy exactly what he wants, he builds it himself. His Venetian gondola, his English punts and several of his native war canoes are examples. He uses modern boatbuilding techniques and his products are always much stronger and more waterproof than the originals—at the same time duplicating in exact detail the lines and ornamentation.

A film company on location in Canada once took some scenes featuring an 18-foot sailboat. Back in Hollywood, it was decided that some additional close-ups had to be taken. It was cheaper to hire Roberts' skill than to transport the film company all the way back to Canada. Working from only a photograph, he constructed an exact duplicate of the sailboat.

On one of his salvaging expeditions Roberts acquired a model of the War of 1812 sailing ship, Peary. He had no particular use for it then, but put it away on the theory that it might come in handy some day. In the picture, "The Beginning or the End," he was called upon to furnish President Franklin D. Roosevelt's study. While doing research for this task, he ran across an item which said that F.D.R. had been given a model of the Peary in 1934. Roberts was delighted to use his own model in the motion-picture reproduction of the wartime President's desk.

Because his boats are bread and butter to him, and because he's often the only man on a set who knows how to handle them, Roberts holds a card in the Screen Actors' Guild and appears in many boat scenes. He's a stocky little guy with a dapper mustache and a twinkle in his eyes. He may be the skipper of a yacht, the driver of a speedboat or the boatswain of the admiral's gig.

Take a good look the next time you witness a sea picture at the movies. You may be able to pick out Benton Roberts, the Hollywood boatman.

# The "9 lives" of a cat by Bers

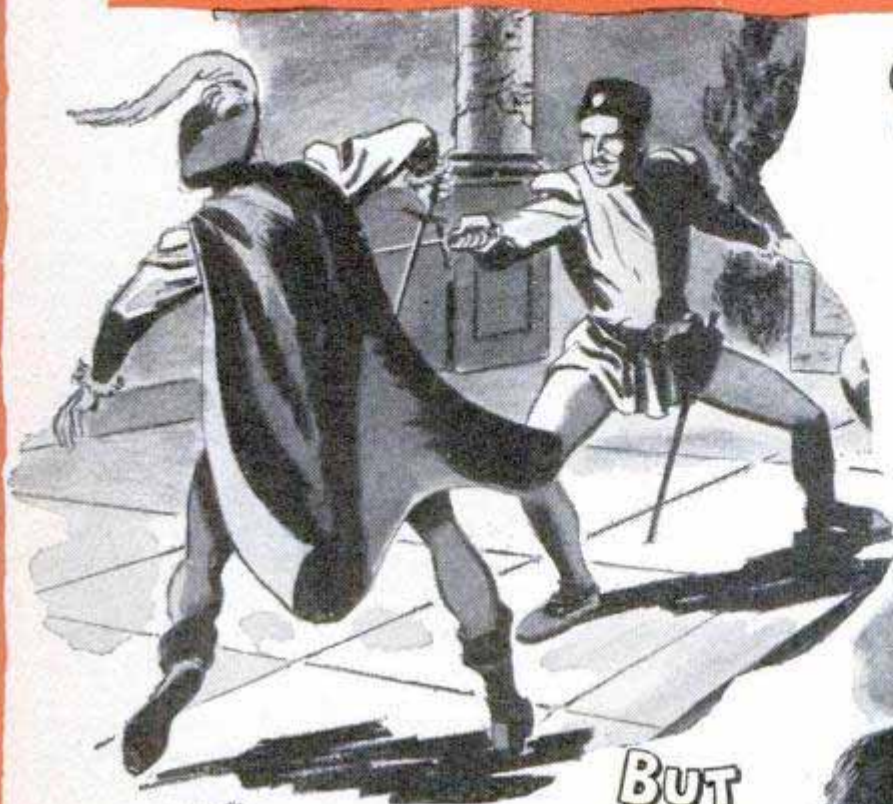

## SHAKESPEARE

MENTIONS THE "NINE LIVES" OF A CAT IN "ROMEO AND JULIET"

TYBALT: "WHAT WOULDST THOU HAVE WITH ME?"

MERCUTIO: "GOOD KING OF CATS, NOTHING BUT ONE OF YOUR NINE LIVES"



## BUT

EVEN TWO THOUSAND YEARS BEFORE SHAKESPEARE, A WRITER OF FABLES IN INDIA SAID ABOUT CATS, "IT HAS BEEN THE PROVIDENCE OF NATURE TO GIVE THIS CREATURE NINE LIVES INSTEAD OF ONE."



THE ORIGIN OF THE SAYING IS THE CAT'S ABILITY TO "BOUNCE BACK." HE'S TOUGH AND HARD TO LICK. "EVEREADY" BATTERIES HAVE THE SAME SORT OF "BOUNCE BACK." THEY RECOVER POWER BETWEEN USES... **LAST LONGER!** THAT'S WHY THEY'RE CALLED THE BATTERIES WITH "NINE LIVES."

## EVEREADY

BRAND

THE FLASHLIGHT BATTERY WITH "NINE LIVES"

recovers power between uses!



"Eveready," "Nine Lives," and the cat symbol are trade-marks of  
**NATIONAL CARBON COMPANY, INC.**  
30 East 42nd Street, New York 17, N. Y.  
Unit of Union Carbide  and Carbon Corporation

**Flavor**  
makes all the difference  
in the world!

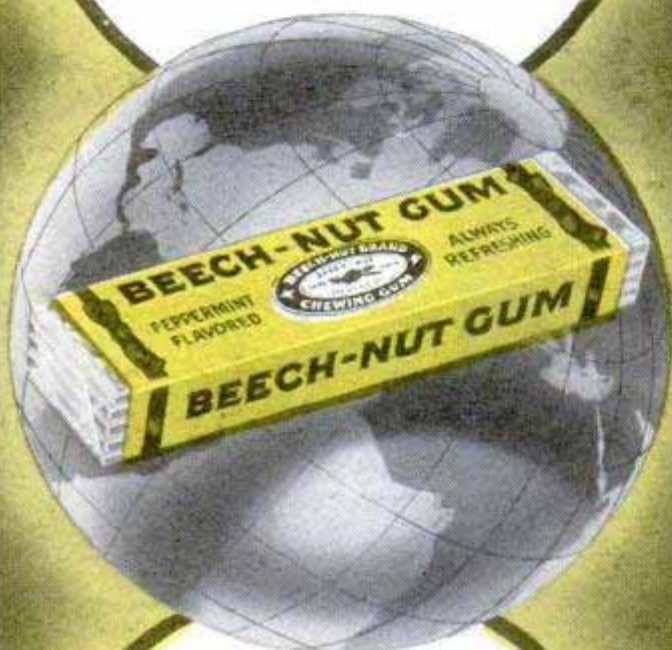

And there's one thing you  
can always depend upon...  
the consistently high qual-  
ity and fine flavor of

**Beech-Nut  
GUM**

*It's "Always Refreshing"*

## We Built a Cabin for \$300

(Continued from page 93)

adventure for so long, had done so many back-breaking jobs for just this moment, that we refused to be thwarted by the rain that lashed in from the ocean. As soon as the two sections were braced, I tossed a tarpaulin over the top. Then we sought partial protection from the storm, glorying that the roof of our cottage—in part—was over our heads at last.

The old window frames, minus glass and weak in structure, were taken home and glazed, reinforced, puttied and painted during the winter. The two doors, splintered and much the worse for wear, were rebuilt and made ready at home for re-hanging in the spring.

As with all the lumber we had salvaged, the floor and roof boards demanded careful sorting. Roof covering seemed a hopeless problem until I came across a builder who had an odd lot of asphalt shingles that he was willing to sell for a nominal amount. They covered one side of the roof. Over the garage, and later over the living room, we used a good grade of roofing paper that has withstood two winters.

Two layers of flooring were out of the question. Over the one floor we laid building paper and linoleum, which gives us a neat and tight floor. As soon as each wall was erected, my wife puttied and painted, filling cracks and holes. This "face lifting" has given the cabin an atmosphere of sanitation and beauty. Outside, the woodwork is white with yellow trim; inside, each room is finished in some pastel shade. The ceilings are white.

Critics might remark that I did not build the cabin according to conventional methods. Under the circumstances, the method I used—putting together the walls and then the roof—was most satisfactory. During the first winter, when we kept at the job every week end, we set up a wood stove in the kitchen with a stovepipe protruding through the window opening. It was crude, but we never suffered from the cold.

We were well satisfied with our first year's progress, for now we had a kitchen, bedroom and large garage. We started the second year with a summer of loafing, swimming, boating and fishing between bouts of work.

This year we confined our activities to the utilities—plumbing, heating and lighting. Our first move was for a better method of heating. A chimney and fireplace were in order. We also wanted a living room. And we built in a toilet, since town water now was available.

(Continued to page 260)

DEPENDABLE

# CHAMPION

SPARK PLUGS

## ← America's Favorite

The spark of good-fellowship flashes nowhere more brilliantly than on American highways—in the hearts of the men who drive our trucks. Courteous, skillful, responsible, they are a class of men whose opinions on spark plugs can be highly regarded. Independent surveys taken among them show that they prefer and use Champion Spark Plugs in vast majority, because they represent the ultimate in quality, value, performance and dependability. Champion Spark Plug Company, Toledo 1, Ohio.

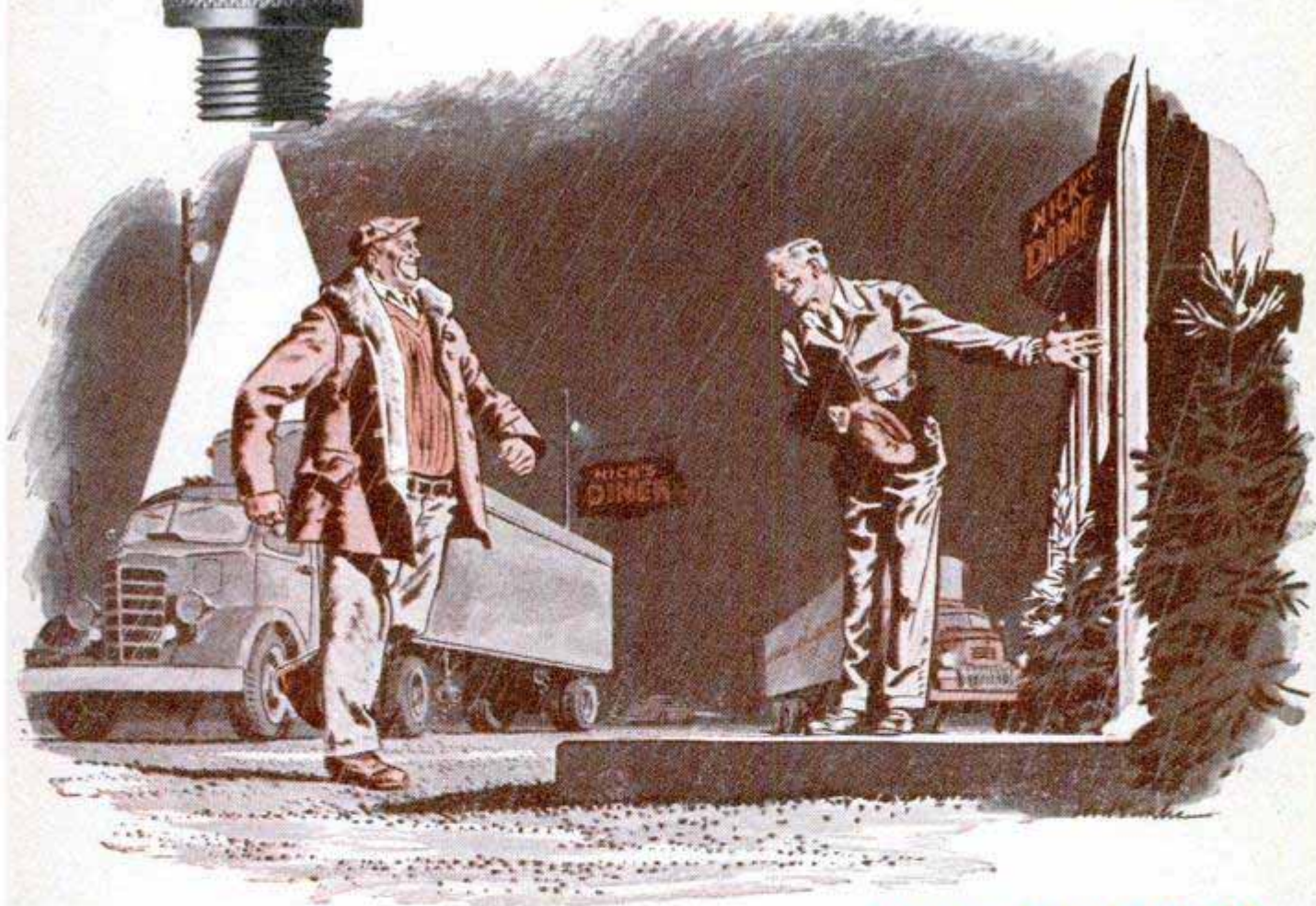

*FOLLOW THE EXPERTS*

**DEMAND DEPENDABLE CHAMPIONS**  
FOR YOUR CAR

Listen to the CHAMPION ROLL CALL . . . Harry Wismer's fast sportscast every Friday night, over the ABC network

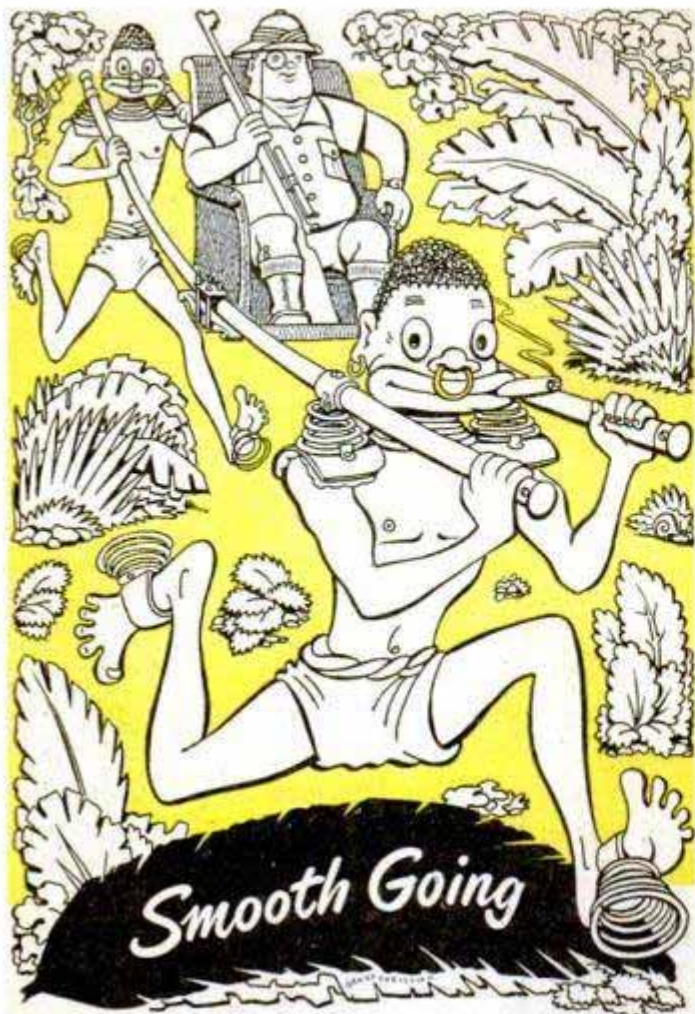

*-or double-your-money-back!*

You'll feel the difference in your car the first time you drive—after a Casite treatment. You'll have new, snappy pick-up, more power, smooth going.

Casite treatment is simple, quick, sure. Casite gets rid of winter's sludge, gum and goo . . . cleans your engine . . . leaves it free and lively. Casite gives extra protection by improving lubrication, thus cutting repair bills. No matter what kind of motor oil used, Casite gets it around quickly and into the tight spots.

Get a Casite treatment today—from your garage, service station, car or implement dealer.

**THE CASITE CORP. • HASTINGS, MICHIGAN**  
Casite Division, Hastings Ltd., Toronto

75¢ A PINT  
95¢  
In Canada

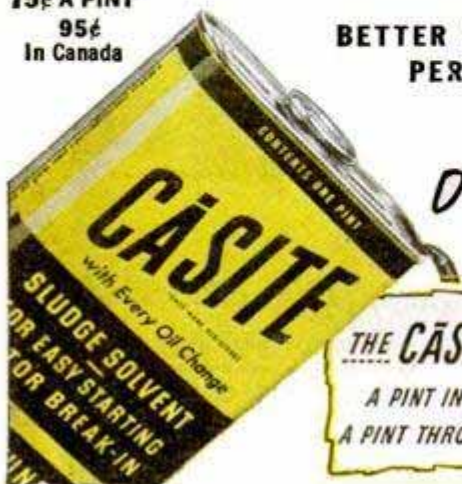

**BETTER AND SMOOTHER  
PERFORMANCE  
OR**

*Double-Your  
Money Back*

**THE CASITE TREATMENT**

A PINT IN THE CRANKCASE  
A PINT THROUGH THE AIR INTAKE

Months before, we had laid the chimney foundation so that the back wall of the chimney would be a part of the garage rear wall. The wall was completed with odd pieces of siding and a small door as passageway from the garage through the living room (porch) to the beach path. Fortunately white brick, cement and flue lining were plentiful and inexpensive. Many of the stones in the foundation and face of the chimney and hearth came from the beach and highways. Total cost of chimney and fireplace, including damper, lead and hard brick, was not over \$35.

The fireplace was faced with field stones, some of them brought to us by an interested friend from his own stone wall. We enjoyed putting them in place a few at a time, building up the pillars and arch like a jigsaw puzzle. Every stone belonged somewhere. We played along until we found that place. How did I know about building chimneys and fireplaces? Years before, a mason built my first fireplace. It smoked like Vesuvius. So I made a point of learning from a more capable mason all the tricks of the trade. The first fireplace I built worked, and so have the several I've laid up since. Bricklaying is play. Even my wife took to this job and turned out excellent work. Because we once more were out of lumber, we decided to build the living room of bricks. My wife laid up most of the bricks that went into outer walls while I was framing the roof.

To return to the fireplace. Hard brick for back and arch; for the hearth, flat stones from the beach laid in a bed of mortar and pointed up with a straight mixture of cement to which yellow ochre for coloring had been added. Above the mantel, where the chimney bricks were exposed, a stronger mix of cement and sand was used. I fashioned the mortar with a trowel to resemble Spanish stucco. On the garage side, a rough mix of sand and cement was wiped over the bricks to seal every possible crevice and guard against fire.

For the mantelpiece I adzed a wide oak log and pinned it to some base pieces mortared into the fireplace, leaving the wooden knobs of the pins sticking up slightly, like old ship trunnions. The fireplace solved our heat problem. A hole was left on the garage side, into which we have inserted a pipe for the wood stove which we use when we need extra heat. Were we to use the cabin in extremely cold weather, we would set up a coal stove from which we would run pipes to the other rooms.

Plumbing problems could not be solved without the expenditure of real money, we

(Continued to page 262)

# WE MAKE \$1000 IN 30 DAYS



"WE HAVE a BELSAW we got in 1940. It has been a wonderful mill, and it has made us lots and lots of money. My son and I work this mill alone and we can, believe it or not, make \$1000 in 30 days and do it easy."

F. W. Siegenthaler, Clatskanie, Oregon

## BELSAW PUT ME IN BUSINESS

"I own this 200 acre farm which has about 3½ million feet of 2nd growth fir. My son owns the BELSAW mill. Never in my whole life was I ever so well satisfied, contented and happy as I am now with his BELSAW mill. It has made him lots of money. If the Lord is willing and with His protection I feel it will make him plenty more. We are alone and do not hire any outside help. My son is the foreman and I am the crew."

Give yourself this steady, year around income. You don't need a crew . . . a tractor or old engine furnishes power for your BELSAW. With its mechanical feed, a BELSAW is easy to operate . . . beginners get excellent results right away.



### READ HOW BELSAWYERS TURN TREES into BIG PROFITS

Mr. Siegenthaler's experience is only ONE of thousands of examples how BELSAWS build big-money businesses. For example, Mr. Robert Ashton, Eagle River, Wisconsin, bought his BELSAW two years ago and began manufacturing crates for Universal Gas Ranges and other industrial users. He reports his sales have totaled thousands of dollars, and expects to greatly increase his volume this year. Mr. Wolfgram, Wabeno, Wisconsin, also reports unusually big profits with his BELSAW, turning out 12,000 feet of box stock a day. He also makes 1,500 boats a year. "It's easy with a BELSAW," E. C. Eddy, Mio, Michigan, writes. "With Mrs. Eddy as sawyer, we turn out 3,500 feet of cabin siding a day. Last year we turned down \$150,000 worth of business."

Whether you make lumber for your own use, or for sale, BELSAW gives you both profits and savings! Operate in your spare time, or on a full time basis. Put a portable BELSAW to work for you in your "off" farming season. Start economically . . . grow fast. You can start with only \$62.50 down payment and turn out valuable lumber for your own use . . . supply local retail yards . . . produce every kind of building material . . . do "custom sawing" for your neighbors and others. There's never a slow season for profits, and you'll have plenty of customers waiting for BELSAW products. Find out about BELSAW Portable Sawmills TODAY.

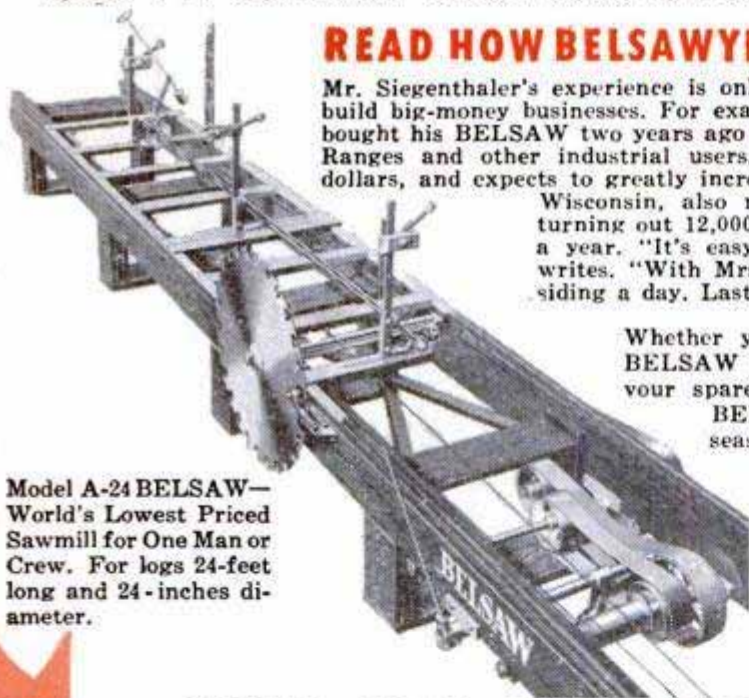

Model A-24 BELSAW—  
World's Lowest Priced  
Sawmill for One Man or  
Crew. For logs 24-feet  
long and 24-inches di-  
ameter.

## SEND FOR THIS FREE BOOK Today!

BELSAW MACHINERY CO 811-Q Field Bldg., Kansas City 2, Mo.

Please send me your FREE BOOK, HOW TO MAKE LUMBER

Name .....

Street or RFD .....

Town ..... State .....

# BELSAW MACHINERY CO

315 Westport Road

Kansas City 2, Mo.

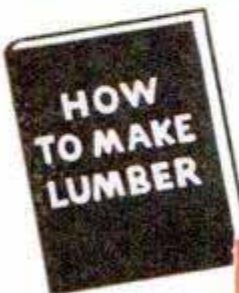

thought, until we discovered that the plumbing-supply houses couldn't supply us because there was still no open market for the non-GI. Once more we were on the hunt, and found at low cost a hopper and box, old-fashioned but in good condition; we also found second-hand iron and brass piping, and at long last, the necessary fixtures to complete the installation, along with a secondhand bathroom sink. An iron kitchen sink, apparently useless with rust, was salvaged from the original cabin. This was scoured, given three coats of enamel and placed in a framework of shelves and cabinets. The shelves, covered with linoleum and edged with chromium, make a modern and sanitary ensemble. An old faucet, chromium-plated at a cost of 75 cents, completes the up-to-date kitchen.

Our only labor bill, paid to two chaps who dug the ditch for water pipes, the foundation for the porch and the cesspool, was \$25. The cesspool was built of white brick—an experiment on my part since cesspool bricks were too expensive and chipped stone not available. I left spaces between the bricks, shaping the walls inward to a three-foot opening with a cover of concrete, an iron ring in the center. On top, to camouflage the cesspool, stands a birdbath made of concrete.

Now for our living room (or glassed-in

porch). Very little of our lumber was left, nor could we buy any. After some maneuvering, we finally acquired what is the most attractive room in the cabin. A 12-by-14-foot foundation was dug, a one-foot concrete wall was poured along the outer sides, and then the area was filled with gravel and stone and covered with a three-inch concrete floor, marked off in the four compass directions. In the center is a three-foot circle on which we will paint a compass card. We used oak for plate and corner posts, which we covered with wire lath and stuccoed inside and out. Seven four-light storm windows were inserted through which we obtain a view of the ocean and islands second to none. The small wall space is brick, laid by my wife and painted cream inside, white outside.

The walls of the toilet are covered with Rocklath and washable paper. An outside faucet serves bathers and gardener.

Wiring the house was perhaps the quickest job. The electric company attended to all outside work except placing the outlet box in combination with the switch box and the rigid conduit outside. The meter box was furnished free. The task of running the three wires through the weather head into the conduit and to the switch box was simple. Checking the neutral service

(Continued to page 264)

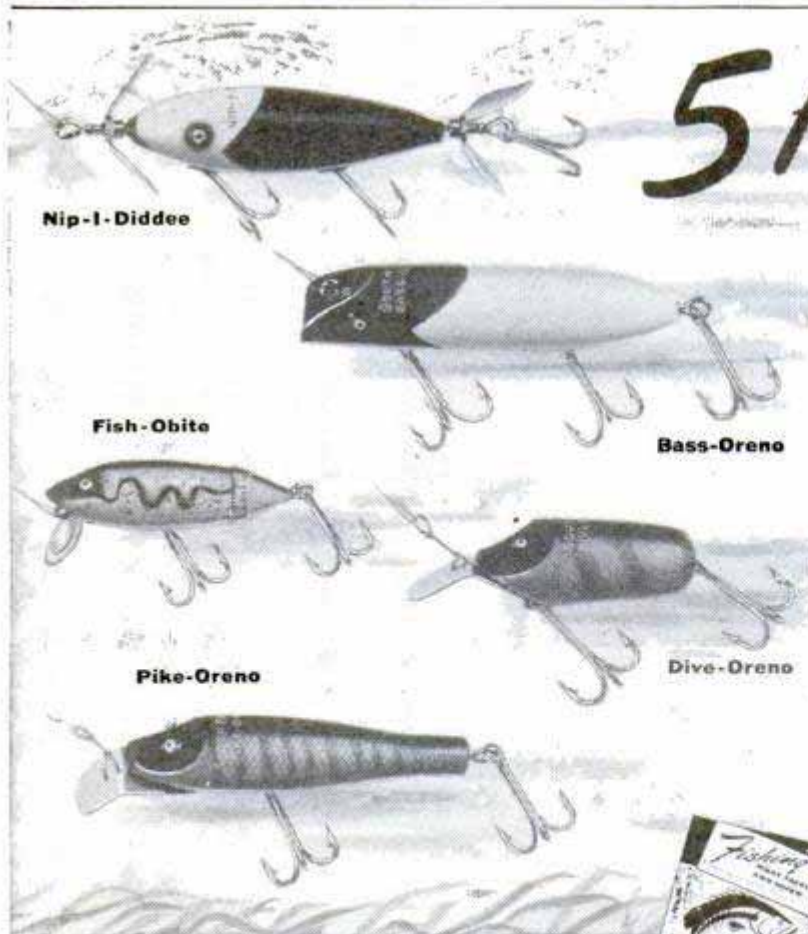

## 5 Fish Foolin' Baits

It's their tantalizing action—their lifelike finish that fools the big boys. For fish you can brag about, get these 5 baits.

**No. 910 Nip-I-Diddee**—new, semi-weedless, surface bait—effective action. **\$1.25.**

**No. 973 Bass-Oreno**—world's greatest and most imitated fish-getter. **\$1.10.**

**No. 952 Dive-Oreno**—deep diving, fast-action bait that goes down and gets 'em. **\$1.25.**

**No. 1991 Fish-Obite**—insured to catch fish, casts and trolls perfectly. **\$1.25.**

**No. 956 Pike-Oreno**—travels deep with irresistible wiggling minnow action. **\$1.25.**



**Perfectoreno Reels**—no backlashes. **\$10 up.**

**Black-Oreno**—line you can trust. 50 yds. **\$1.20 up.**

**Excel-Oreno**—finest of fly lines. **\$1.85 up.**



### FREE! New Book on Fishing

Every fisherman needs "Fishing: What Tackle and When." 76 pages of fishing hints, tackle, etc. Write for it now! **FREE.** South Bend Bait Co., 891 High St., South Bend 23, Ind.

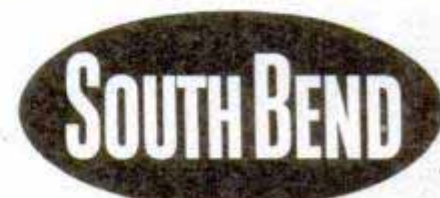

A Name  
Famous  
in Fishing



# Snap-on's Famous Ferret Set



Rugged tools . . . twice as strong as you would expect such slim, streamlined handles and thin-walled sockets to be.

*"The Choice of Better Mechanics"*

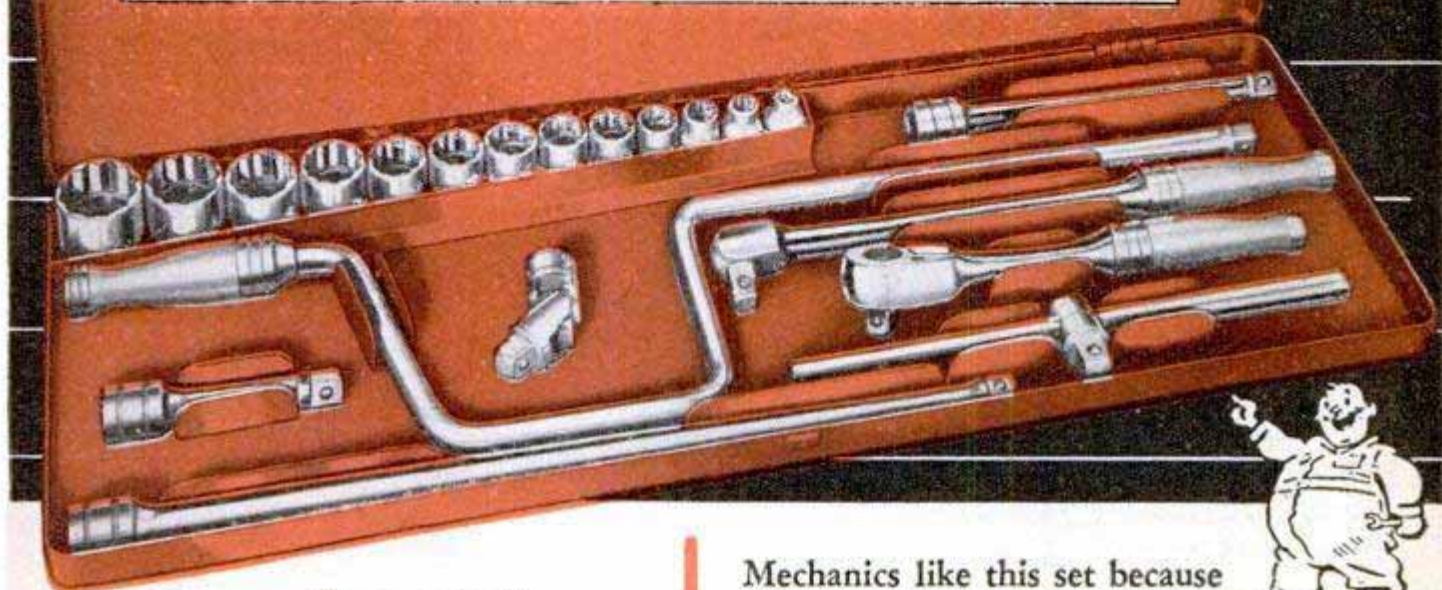

## Present Owners: Supplement your basic set with these Special Ferret tools . . .

### CLUTCH-TYPE SCREW DRIVER



Handles clutch-type (figure 8) head screws. Built short for easy operation in close quarters.

### RATCHET ADAPTOR



Converts any combination of Ferret handle, extension and socket into a reverse action ratcheting tool.

### PLASTIC GRIP HANDLE



A shockproof, plastic handle, 5 1/8" long that is ideal for electric work. Makes your Ferret Set more useful.

### DOUBLE HEX FLEXOCKETS



Saves a lot of tough work fumbling for hard to get at studs and bolts. Eight sizes: 1/8" to 3/4".

**FERRET FLEXTENSION** — A flexible steel cable extension connects handle and socket to work around corners and over obstructions.



### EXTRA LONG FERRET SPEEDER

36 1/2" long, 27" shank. Radius of sweep is 3 1/4". "Palm-Grip" handle rotates to provide easy operation.



Mechanics like this set because it is way over par in performance . . . the tools are strong and easily adaptable to a variety of jobs.

They squeeze into tight places and get those hard-to-reach nuts and bolts that defy the ordinary type wrench. Recently designed by Snap-on engineers, they have the new features that make fast, easy work of the tough jobs.

**INCLUDED IN THE SET:** 1/4" and 5/16" single broached sockets; 11 double broached sockets from 3/8" to 7/8"; a speeder wrench, sliding tee, 8" reversible ratchet, nut spinner and universal joint, plus a 3", 6" and 12" extension. All complete in a metal box for only **\$27.65**

**SNAP-ON TOOLS CORPORATION**  
8062-D 28th Avenue, Kenosha, Wisconsin

- Enclosed find  check  Money Order or  Company Purchase Order for the \$27.65 Snap-on Ferret Set.  
 Please send illustrated brochure describing 109 individual Ferret units.

Name.....  
Address.....  
City.....State.....



This glorified magnet is the stator from a Hoover Motor. It is electrically annealed after punching, then dipped in high-grade varnish and baked under infrared lamps on a continuous conveyor.



## WIRY

The good looks of the component parts of Hoover Motors show the fine workmanship built into them—precision-wound coils, miles of wire dedicated to smooth, cool, dependable performance in continuous operation. Made by the makers of the world-famous Hoover Cleaner. Order today from your nearest dealer for immediate delivery.



## HOOVER MOTORS

Made in capacities of  $\frac{1}{4}$  to  $1\frac{1}{2}$  H.P.  
The Hoover Company  
Electric Motor Division, North Canton, Ohio

wire and seeing that the entrance setup was well grounded were important jobs. B.X. was difficult to obtain, but I hunted until I found enough for my requirements. We installed outlets for refrigerator, stove, toaster, iron and various lamps. There are two outlets in the bedroom and several in the living room. The only fixed light is in the bathroom where we also have a plug for razor and heater. The garage has several wall plugs. At the end of the flagstone walk from porch door to path is an odd-shaped cedar post on which hangs an electrified ship's lantern. Total cost—\$18.

Another important suggestion is this—use pine slabs. One trailer load, costing one dollar, has been used for boarding-in eaves, for corner trim, casings around windows, trellises and moldings. Cut and planed with power tools, the wood finishes satisfactorily and is a tremendous saving over the cost of finished lumber bought from a dealer. Many of our finishing touches, such as the birdhouse, window boxes and trellises were made with wood that might have been used for firewood.

Soon we will install a cupola—a six-sided, glassed-in enclosure on the roof, from which we can scan the entire horizon. This latest venture illustrates why our method of building is so intriguing. There's always something more to plan and build.

It has taken us two years of week ends to complete the cabin as is. We now have forgotten the back-breaking jobs and are proud to share our beauty spot with our friends. Perhaps if we built now we would not be forced to tear down an old structure to obtain our lumber. It still would be a definite method of saving a great deal of money.

But this project has not saved us money alone. It has made possible a cabin which we could not have had otherwise. It has given health and strength to both of us. True, we were dead tired at the close of each working day, but when I look around at men of my age (soon leaving the fifties behind) and realize how "soft" many of them are, I am thankful that my impulse is to work.

There is, most of all, the joy of accomplishment, the pride in seeing a dream come true through one's own efforts. And the thrill of each accomplishment is repeated again and again, until the cottage becomes more precious to its owner than the castle of a king.

☐ Almost 24,000,000 tons of concrete—about the amount required for a four-lane highway connecting Chicago and Mexico City—were used in the construction of Grand Coulee Dam.

*Friendship and Fun*

GO TOGETHER ON A  
**HARLEY-DAVIDSON**  
with the new **HYDRA-GLIDE FORK**



"It's always fair weather when good friends get together"... on their Harley-Davidsons! And you're always headin' for fun... when you hit the thrill-trail to exciting race meets, hillclimbs and endurance runs, to delightful sightseeing trips and gypsy tours. No sport in the world is like motorcycling, no pleasure like riding a super-smooth, powerful Harley-Davidson... champion of motorcycles! Owning your own is easier than you think. See your dealer today. Mail the coupon now.



**HARLEY-DAVIDSON MOTOR COMPANY**  
Dept. P, Milwaukee 1, Wisconsin

Send free copy of *ENTHUSIAST* magazine, filled with motorcycle action pictures and stories; also literature on latest models.

Name.....

Street or R.F.D.....

City.....Zone.....State.....

(Continued from page 134)



and to Restore

**CAR PERFORMANCE**

**OIL-CONTROL STARTS HERE**

**TO STOP OIL-PUMPING REPLACE WORN ENGINE CONNECTING ROD BEARINGS**

Don't let your blood pressure go up when car performance goes down. It's easy to correct the trouble where it starts! Engine connecting rod and crankshaft bearings control oil flow for correct engine lubrication. When worn they let excess oil reach combustion chambers. It burns to carbon on piston rings, pistons, spark plugs and valves, stealing power—and performance goes up in exhaust smoke. To put oil back to its job of lubrication and put new power, pep and economy in the engine, replace with Federal-Mogul Oil-Control Bearings. Ask your mechanic!



**FEDERAL-MOGUL SERVICE**

(Division of Federal-Mogul Corporation)

**COLDWATER, MICHIGAN**

**CONTROL OIL-PUMPING  
WHERE IT STARTS—WITH**

**FEDERAL-MOGUL**

**OIL CONTROL BEARINGS**

1899 • 50 YEARS' CONTINUOUS BEARING EXPERIENCE • 1949

tend to increase along streams that contain beavers. Brooks that would dry up in the summer often flow all year around because of percolation from the dammed waters. Wells that go dry in the summer hold water all through the year when beavers are planted on adjacent streams.

The trouble is that a beaver sometimes selects a dam site that happens to be on a farmer's land and the farmer has decided for himself just where he wants the water level of his stream. He doesn't want a dam placed where its pool will flood his meadows or turn a dirt road into a morass. Nor does he care to have beavers whittle off all his fence posts close to the ground, as has happened. He doesn't want them prowling into his orchard to cut down valuable fruit trees which they seem to fancy.

A beaver-conservation program that pleases everyone is difficult to plan but after some trials and errors the Idaho State Fish and Game Commission has developed a program that works very well. Early in the century very few beavers were left in Idaho; now the state has a beaver population estimated at around 90,000.

The program is administered by John W. Smith, state fur supervisor, and consists of an allotment system by which a number of carefully selected trappers are allowed to take nominal numbers of skins every year in return for caring for the beavers in their districts. The purpose of the plan is to build up the population to its greatest practical size, estimated at 200,000, and at the same time to contribute fur to the market.

Most of the men chosen as beaver caretaker-trappers are professional trappers who are especially licensed by the state. Each is allotted a beaver district that consists of a natural watershed or a portion of one, amounting to several hundred or several thousand square miles. Part of the caretaker's duty is to live-trap beavers on the streams that have the greatest population and to transplant them on other streams in his area. Too, he takes care of all complaints by removing animals that are doing damage in rural sections. In return, he is allowed to trap for himself a number of beavers during the winter months when the fur is prime. The number runs from less than 100 to possibly more than 150 skins, depending on the local population and its rate of increase.

The skins are auctioned off by the state and the proceeds are divided 75 percent to the trapper and 25 percent to the state. Prices may average more than \$30 per skin

(Continued to page 269)

**CRAFTSMEN  
RECOGNIZE  
QUALITY**

*by these fine features in a*

**HACKSAW**

**BALANCED**  
for more efficient sawing...less worker fatigue.

**RUST RESISTANT**  
Nickel plating resists corrosion...adds eye-appeal.

**UNBREAKABLE**  
Neoprene handle with non-slip grip, moulded to frame, high dielectric value.

**RUGGED**  
construction of heavy-gauge steel.

**DESIGNED**  
to provide extra strength at points of stress.

**TOUGH**  
Pin Posts are machined from bar stock.

**STRONG**  
Tension Screw, die threaded from bar stock.

**RIGID**  
construction assures perfect alignment of blades. Straighter cuts...less blade breakage!

**No. 1049**  
is the catalog number of this fine hacksaw.

**EVERYBODY  
RECOGNIZES  
QUALITY**

*by this Trade-mark*

**CRESCENT TOOLS**



*Sign of the Artisan  
Symbol of Excellence*

"Crescent" is our trade-mark, registered in the United States and abroad, for wrenches and other tools. Sold by leading distributors and retailers everywhere and made only by **CRESCENT TOOL COMPANY, JAMESTOWN, NEW YORK**

# SHOPSMITH IS

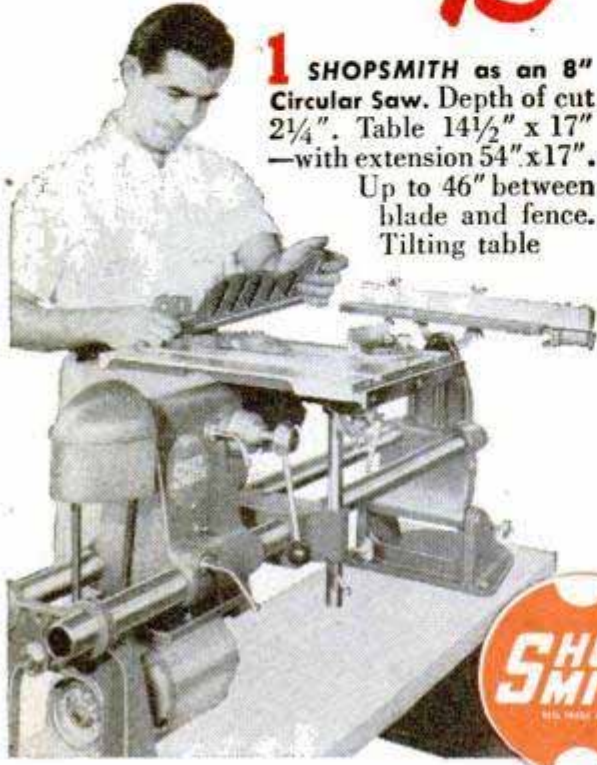

**1 SHOPS MITH as an 8" Circular Saw.** Depth of cut 2 1/4". Table 14 1/2" x 17" —with extension 54" x 17". Up to 46" between blade and fence. Tilting table



In 60" x 18" space **SHOPSMITH** is a complete power-tool shop —run by one motor

In less than a minute **SHOPSMITH** converts from any one to any other of the five basic power tools shown here. In each position it has greater work capacity than comparable single-purpose tools. (**SHOPSMITH** converts also to buffer, grinder, router, drum sander, shaper, mortiser, etc.) **SHOPSMITH** is precision-engineered, ruggedly built — weighs 200 lbs. You can set up a **SHOPSMITH** in any corner of your basement or garage. See demonstration at any Montgomery Ward store, or your leading hardware or department store. Or mail coupon below for name and address of nearest dealer.

FIVE TOOL UNIT  
COMPLETE ONLY

**\$159.50**

with 1/2 h.p.  
ball bearing motor  
**\$195.50**

#### MAGNA ENGINEERING CORPORATION

465 California Street — Dept. 84B  
San Francisco 4, California

Please send descriptive folder on **SHOPSMITH** and name of nearest dealer

Name \_\_\_\_\_

Address \_\_\_\_\_ City \_\_\_\_\_ Zone \_\_\_\_\_ State \_\_\_\_\_

**2 SHOPS MITH as a Vertical Drill Press.** Drills to center of 15-inch circle. 27-inch maximum distance from table to chuck, 4 1/4-inch feed

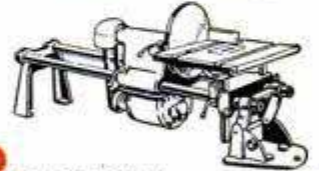

**3 SHOPS MITH as a 12" Disc Sander.** Adjustable mitre gauge. 14 1/2" x 17" table tilts to 45 degrees. Discs can be removed and replaced in seconds

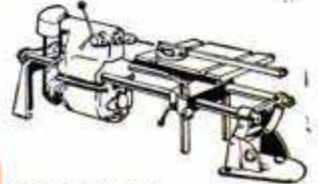

**4 SHOPS MITH as a Horizontal Drill Press.** Brand-new in the power tool field! Provides accurate drilling for doweling. No limit on length of work



**5 SHOPS MITH as a 34" Wood Lathe.** (34" between centers) with a 15-inch swing. Quill feed 4 1/4 inches. Tool rest always slides parallel to ways

# BIG- CAPACITY TOOLS IN ONE

and a caretaker-trapper often receives several thousand dollars as his share.

Each trapper captures and turns over to the state a number of beavers amounting to 10 percent of the number he is permitted to trap for the market. These animals are then transplanted to unpopulated mountain streams in Idaho's primitive areas.

In past years the state commission used trucks and pack animals for transplanting the beavers but on long trips the animals often perished because they were kept away from water for too long. Now, a journey of any distance is performed by airplane. It's cheaper and more reliable.

Dropping the beavers by parachute is a new experiment and more than 35 of the animals have been dropped successfully to date. It's a tricky operation and it takes a skilled mountain pilot to pick out the stream that has been selected for the drop and to get down to within a couple hundred feet of the ground, the altitude at which the drops are made. The wind must be gauged just right so that the parachute and its burden won't drift into trees. Usually, the chute lands within a hundred feet or so of the stream. A male and female are planted close together on the same stream so that a new colony may be started.

The drop box is hinged at the bottom like a clamshell and is tied with a piece of

weak string. Two lengths of inner-tube rubber are stretched across the bottom and are secured to the sides, tending to make the box break its string and fly open. This can't happen as long as the parachute supports its weight but once the box touches the ground its sides open up and the beaver walks out, heading instinctively for the nearest water.

No one except caretaker-trappers may take beaver in Idaho. Other states have tried open seasons but usually trappers and hunters have depleted the population almost to zero in a single season. Stringent controls have had to be reapplied.

California has been trying a controlled open season in which trappers who have obtained permits are allowed to take pelts in special control areas that contain an oversupply of animals. Once California had so many beavers that fur brigades from the Hudson's Bay Company traveled south to capture them; now the state's population is not more than several thousand.

Each state is doing all that it can to restore the animals to numbers that will permit the taking of some fur and that at the same time will make beavers an important factor in erosion control. Once threatened with extinction, the valuable animals are regaining their original place in the wild-life population.

## "You're Sure to Have MORE FUN with a Coleman Along" — Says Andy Devine

"I like plenty of good food wherever I go, and I get it quick with my Coleman Folding Camp Stove without any waiting, fuss, muss or bother. I just set it up and start cooking, and in no time I have the kind of food that satisfies a big outdoor appetite."



Andy Devine can currently be seen in the Republic Picture, "The Last Bandit."

### **Coleman** Folding CAMP STOVE

Lights instantly. Cooks like a city gas range. Makes and burns its own gas from gasoline. Folds up, carries like a suitcase. Ask your dealer for a demonstration.

Prices as low as \$9.95 in U. S. A.



### **Coleman** Floodlight LANTERN

Adds more hours of fun to each day. Floodlights 100-ft. area. Storm-proof. Safe. Durable. Prices as low as \$9.95 in U. S. A. Ask your dealer for demonstration.



The Coleman Company, Inc.  
Wichita 1, Kansas

The Coleman Company, Inc.  
Dept. 216-PM, Wichita 1, Kansas

Please send me FREE booklet on the Coleman Folding Camp Stove and other Coleman Appliances.

Name \_\_\_\_\_

Address \_\_\_\_\_

City \_\_\_\_\_ State \_\_\_\_\_

# BACK AGAIN!

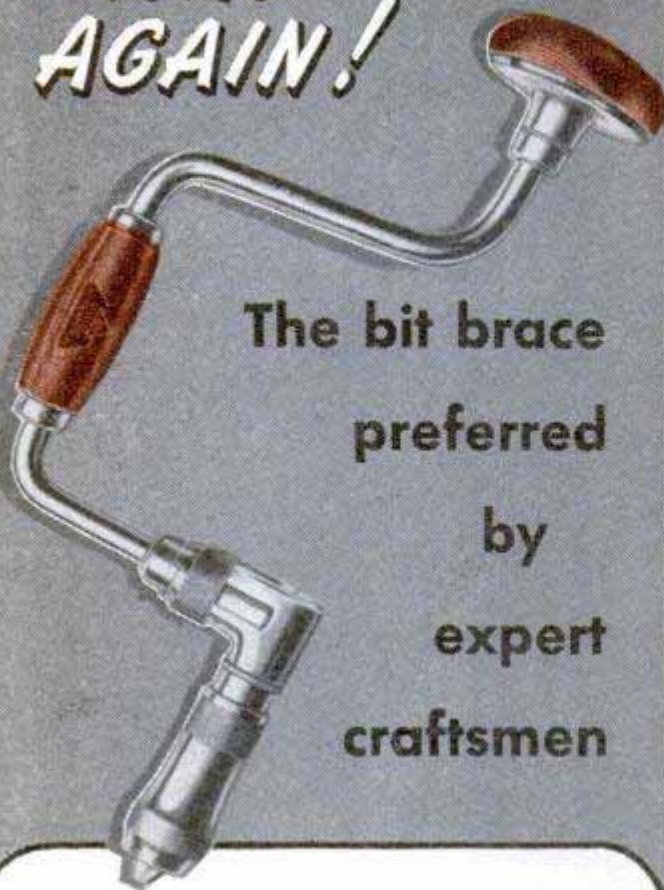

The bit brace  
preferred  
by  
expert  
craftsmen

When a hand tool becomes so well known that craftsmen call it by number, you can be sure it's a tool of unusual quality. That's why expert carpenters and cabinet-makers everywhere are welcoming the return of the No. 32 Millers Falls bit brace.

Yes, No. 32 is back again — with its fine construction, highly polished buffed nickel finish, tropical hardwood sweep handle and head. No. 32 is the country's standard 10-inch quality brace.

Find out what we mean. Ask your hardware dealer to show you the No. 32 bit brace. At the same time see some of the other Millers Falls quality tools, Millers Falls Company, Greenfield, Mass.

**MILLERS FALLS  
TOOLS**

SINCE  
1868

## Chrysler Family Debut

(Continued from page 123)

five body types, the eight-cylinder Saratoga (two body types), New Yorker (four), Town and Country (two), and Crown Imperial (two). New to the line this year is a Royal station wagon which seats nine passengers and has removable intermediate and rear seats.

The wheelbase of the Royal and Windsor series has been increased four inches from 121½ inches to 125½ inches. At the same time the over-all length has been reduced from 208<sup>9</sup>/<sub>32</sub> inches to 203<sup>15</sup>/<sub>16</sub> inches. On the Saratoga and New Yorker models the wheelbase has been lengthened from 127½ inches to 131½ inches and the over-all length reduced from 214<sup>9</sup>/<sub>32</sub> to 210 inches. The Royal and Windsor models are 2<sup>3</sup>/<sub>32</sub> inches lower, standing at 65¾ inches, and the big eights stand 66 inches high, a reduction of about two inches.

In regard to over-all width, the Royals and Windsors are 4<sup>5</sup>/<sub>16</sub> inches narrower, being reduced from 77¾ inches to 73<sup>1</sup>/<sub>16</sub> inches. Despite this, as in the other cars of the company line, the interior is more spacious. On the four-door sedan, the front seat cushion is six inches wider, increasing from 52 to 58 inches, and the rear seat has been widened from 51 to 58 inches. The New Yorker and Saratoga models have been narrowed by 3<sup>1</sup>/<sub>16</sub> inches and at the same time the front seat is six inches wider and the rear seat seven inches wider.

Windshield area of the new Chryslers has been increased from 687 to 851½ square inches. The rear window also has been enlarged.

Compression ratio has been boosted on both the six and the eight-cylinder engines. On the sixes (Royal and Windsor) the ratio has been increased from 6.7 to 1 to 7 to 1, and on the eights from 6.7 to 1 to 7.25 to 1. Engineers report an accompanying increase in better performance and gasoline economy. The electrical and ignition system has been made more durable and weatherproof as a result of Chrysler's experience in building combat vehicles during the war. All models are equipped with weatherproof spark-plug covers. A new air cleaner and higher-capacity fuel pump are designed for improved engine performance.

The Chrysler instrument panel has been completely restyled and front-seat passengers have plenty of space between them and the right-hand side of the panel. The panel itself is narrower than in the past and concave in shape. Also, the heater installation is under the hood. All of the

(Continued to page 272)



# The AMAZING TOOL of 1000 USES

## NEW HOME-UTILITY 5" SANDER-POLISHER

for **SANDING • GRINDING • RUBBING • WAXING**  
**CLEANING • DRILLING • BUFFING • POLISHING**  
**BURNISHING • SHARPENING • WIRE BRUSHING**



As a  
Sander

As a  
Polisher

### PRICED for EVERY HOME

*Only*  
**\$29<sup>95</sup> For**

- 5" Electric Sander-Polisher
- 5" Moulded Rubber Pad
- 3 "Open Grain" Sanding Discs  
(coarse, medium, fine)
- Lambswool Polishing Bonnet
- 7 oz. can of Home-Utility Electric Wax

This great new Home-Utility 5" Sander-Polisher is the most versatile workshop tool you've ever seen! It drives a whole raft of attachments. You'll figure out new uses every time you work with it. And it's quality-built by BLACK & DECKER, famous maker of outstanding electric tools for over 38 years!

See demonstration of HOME-UTILITY Sander-Polisher today at your hardware, electrical or implement dealer.

# ELECTRIC HOME-UTILITY TOOLS

Products of BLACK & DECKER Mfg. Co.  
Dept. H4M, Towson 4, Maryland



REMOVING PAINT



POLISHING CAR



WAXING FURNITURE



DRILLING METAL



SHARPENING CUTLERY



REMOVING RUST

### NEW DISC SANDING TABLE



Most revolutionary attachment ever offered for small portable electric tools. Sands difficult bevels, ends of wood, plastics, etc. With mitre gage, material can be sanded to any angle. Sharpens edged tools, chisels, etc.

Only \$8.25

for Sanding Table—Metal Plate—Disc  
Cement—Mitre Gage—3 "Open  
Grain" Discs

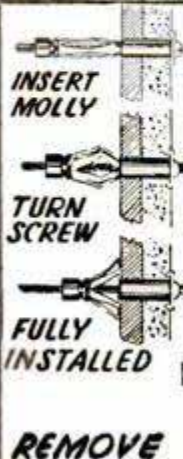

INSERT MOLLY

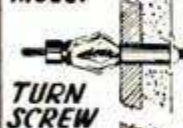

TURN SCREW



FULLY INSTALLED



REMOVE SCREW

WITH MOLLY YOU CAN FASTEN ANYTHING and do it quickly, neatly and safely. MOLLY will hold fixtures securely to floors, ceilings or any hollow wall construction... Simple to install, all you need is a screw driver. Sold by leading hardware stores everywhere.

Write for Free Descriptive Folder



PLACE FIXTURE

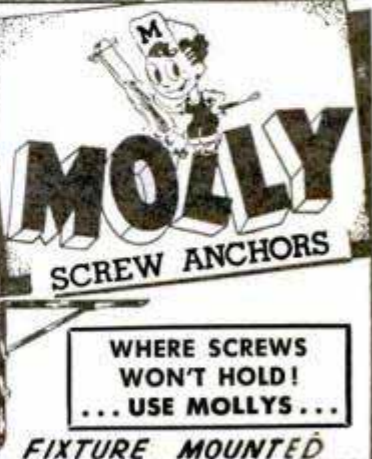

WHERE SCREWS  
WON'T HOLD!  
... USE MOLLYS ...

FIXTURE MOUNTED

MOLLY CORPORATION

522 COURT ST.

READING, PA.

## REQUIRED READING FOR HOME CRAFTSMEN

**FREE!**

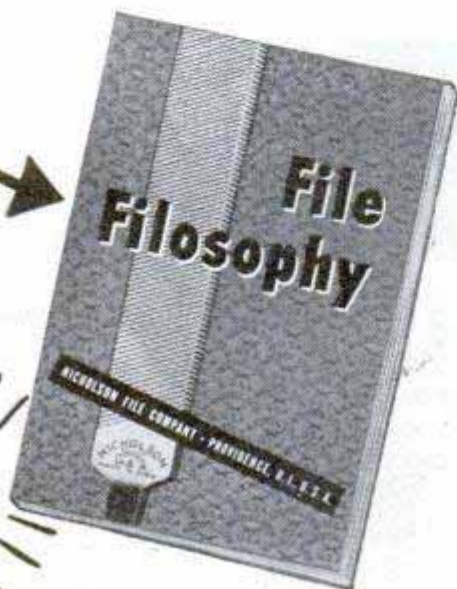

It's yours for the asking—  
a fact-packed, 48-page handbook on  
the kinds, care and use of files.

Learn how to pick *The right file  
for the job*; how to improve your  
filing technique; how to sharpen hand-  
saws, circular saws, crosscuts, tools  
and implements.

Illustrations galore! Up-to-the-minute  
facts about the latest developments in  
files and filing techniques.

Send for your **FREE** copy of "File  
Philosophy" today. Simply write to:

**NICHOLSON**  
U.S.A.

**NICHOLSON FILE COMPANY**  
22 Acorn St., Providence 1, R. I.  
(In Canada, Port Hope, Ont.)



**NICHOLSON**  
**FILES** FOR EVERY PURPOSE

instruments are grouped in a semicircular "safety eye" housing directly over the steering column and to the right a leather-covered safety cushion of sponge rubber extends to the door. This affords protection to front-seat passengers, particularly children, in case of a sudden stop.

The Chrysler's Prestomatic Fluid-Drive transmission has been simplified as to the hydraulic and electrical parts in an effort to minimize mechanical and control difficulties. New gearshift-control-lever lengths and more rigid connecting links make the shifting easier and quieter.

All the innovations of the Plymouth and Dodge cars, such as the new ignition switch, diagonally mounted shock absorbers and coated cylinder walls are found in the Chryslers. All Chryslers are now given an application of undercoating at the factory.

The 1949 DeSoto conforms with the other products of the company line in conservative beauty, excellent visibility, increased wheelbase (from 121½ to 125½ inches), reduced over-all length, much wider seats and slightly narrower exterior width, detachable fenders, wrap-around bumpers and lower silhouette. The engine has an increased compression ratio and slightly boosted horsepower.

The new DeSoto is a comfortable car with "chair high" seats to let the driver and passengers take advantage of the better visibility. The steering wheel has been placed so that shorter drivers may see over it easily and long-legged drivers will not bump their knees into it. Tip-Toe hydraulic shift and Fluid Drive are retained in the '49 DeSoto. All of the mechanical improvements on the other Chrysler Corporation cars, from new ignition system to nonsway shock absorbers, are incorporated in the new DeSoto.

The Custom line includes a four-door sedan, club coupe, convertible, Suburban and eight-passenger sedan. The Deluxe line has a four-door sedan, club coupe, station wagon and a Carry-All sedan. The latter has a rear seat that can be quickly folded flush with the floor to provide extra luggage space.

### Light "Watchman"

For persons who want their homes lighted evenings when they are out, there is a new miniature electronic control that switches lights on and off at preset times. It can be plugged into any electrical outlet. The device can also be used to control lighting in stores, dark hallways, garages and poultry sheds.

You get more capacity

Model 40A

with a  
**DELTA MILWAUKEE**

**Multiplex Radial-Arm Saw**

**Cuts time and costs for:**  
 • Contractors • Lumber Yards  
 • Cabinet Shops • Sash and Door Plants • Pattern Shops  
 • Shipping Departments • Farms • Schools • Maintenance Departments • Others

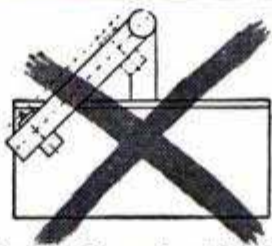

**The Old, Conventional Principle—** This shows how conventional radial-arm saws pivot from the column. They have practically no mitering capacity at 45°, not much usable capacity at 30°, and almost none beyond 45° on left-hand miters.

**The Modern Delta Multiplex principle —** This shows how center-pivoted saw arm permits Delta Multiplex to be set quickly to cut any miter — right- or left-hand — at full capacity up to 90°. The saw rotates through 360°. Permits unlimited number of saw positions, greater capacity and ease of operation.

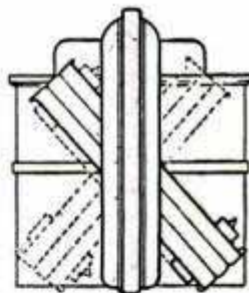

**One Multiplex does all this — and more!**



- ✓ Cutting arm rotates 360° — you get an unlimited number of saw positions!
- ✓ You get 100% mitering capacity — you can cut full-length miters, both right-hand and left-hand — from 0° to 90°!

Your nearby Delta distributor has a complete line of Multiplex models with motors ranging from 1/2 H. P. to 10 H. P. and rip capacities from 2" to 6". Inspect them there. See for yourself the Delta Multiplex features that assure you of safety, speed, convenience, capacity, and economy. And ask about buying on easy credit terms. Look for the

name of your Delta distributor under "Tools" in the classified section of your telephone directory. *Send coupon for free bulletins!*

**Model 20A—Bench model.** An exceptionally low-cost portable machine. Can be carried easily in the back of your car. Has a rip capacity up to 2". A favorite of builders, for cutting interior trim. With 1/2 H.P. Single Phase 110 Volt Motor. **\$195.00\***

F.O.B. Norwalk, Ohio

**Model 40A—Floor model with cabinet base.** Two men can carry it. Has a rip capacity up to 3 1/4". Widely used for cutting foundation forms, sheathing, roofing, cabinets, doors, frames, drawers, sills, stair treads, etc. With 1 1/2 H.P. Single Phase or 3 Phase Motor. **\$385.00\***

F.O.B. Norwalk, Ohio

\*Prices subject to change without notice

**TEAR OUT COUPON AND MAIL TODAY!**

**DELTA MANUFACTURING DIVISION**  
 Rockwell Manufacturing Company  
 580D E. Vienna Ave., Milwaukee 1, Wis.

Send me free bulletin describing the complete line of Delta Multiplex Radial-Arm Saws.

Name.....

Title.....

Company.....

Address.....

City..... State.....

HM-67

# Everything in Radio at Lowest Prices!

## FREE

Send for  
**ALLIED'S**  
180 Page  
Catalog



**BUILDER'S KITS  
TELEVISION SETS  
HI-FIDELITY SOUND  
AMATEUR GEAR  
THOUSANDS OF PARTS  
TUBES, TOOLS, TESTERS  
BOOKS & DIAGRAMS**

Everything for  
Servicemen, Engineers,  
Experimenters, Builders,  
Soundmen, Amateurs



## Radio's Leading Buying Guide

Get ALLIED'S 1949 Catalog —biggest and most complete in Radio. Get *everything* you need from the world's largest stocks of top-quality equipment—at down-to-earth money-saving prices. Have the advantages of speedy reliable shipment, expert personal help, and complete satisfaction on every purchase. Get more for your money at ALLIED—Radio's Largest Supply House. Send today for your FREE ALLIED Catalog—the preferred Buying Guide to *everything* in radio and electronic equipment.

## ALLIED RADIO

ALLIED RADIO CORP.,  
833 W. Jackson Blvd., Dept. 5-D-9  
Chicago 7, Illinois

FREE

Send FREE 1949 ALLIED Catalog.

Name.....

Address.....

City.....Zone.....State.....

# Clean-up Time

... for car cooling systems, too!

Avoid engine overheating on hot summer days

with *Warner* care



**WARNER RADIATOR CLEANER**—Thoroughly cleans cooling system of rust, oil-muck and grease. Harmless to metals, hose and car finish.

**WARNER COOLING SYSTEM PROTECTOR**—Prevents rust and corrosion—keeps cooling system clean for maximum efficiency.

"Just Shake . . . Pour . . . and Fret No More!"  
See your service man or do it yourself.

Warner-Patterson Company, 920 S. Michigan Ave., Chicago 5

make your own *Gems* **29.50**  
F.O.B.

All necessary lapidary equipment is furnished, including a super-charged diamond blade for sawing, and all wheels for grinding, shaping and polishing; also complete instructions. The complete equipment as shown, less motor and belt, for only \$29.50, f.o.b., Burlington, Wisconsin. Write today for information and literature.

**B & I MANUFACTURING CO.**  
Dept. S Burlington, Wis.

**DRAINS CELLARS, WASH TRAYS  
CIRCULATES OIL**

Pumps 1800 GPH 300 gal.  
30' high, use 1/8 to 1/2 HP **\$6.50**  
motor. Will not clog.

Postpaid if cash with order.  
(Add 50c for west of the Mississippi.)  
Thousands in use since 1936

**LABAWCO PUMPS, BELLE MEAD 7, N. J.**

**FULLSIZE, CUT-TO-SHAPE BOAT PATTERNS**  
and specifications. Designed by Naval Architect. Cruisers, runabouts, sloops, outboards, sailing canoe, etc. Low prices. Send 10c (coin) for illustrated catalog. SPECIAL: Send \$1.00 for "HOW TO BUILD BOATS" book, postpaid. PolyWog Houseboat Plans, \$10. Cleveland Boat Blueprint Co. Dept. 666, Cleveland 13, Ohio

**SAVE OVER 50%!**

**BRAND NEW, COMPLETE EQUIPMENT**

**WELDING TORCHES**  
Smith's Type #2, \$9.75  
complete with 4 tips & wrench, canvas kit . . . Post Paid

Rego Heavy Duty, \$16.50  
complete with 5 tips, wrench, instructions . . . Post Paid

**CUTTING TORCHES**  
National #400, with 4 tips, wrench, instructions . . . Post Paid

**Harris Oxy. & Acet. REGULATORS**  
Complete with 2 gauges \$22.50 each on both units . . . Post Paid

All merchandise Guaranteed as represented or money refunded. Send check or money order. No C.O.D.

**F & M SALES, 1515 Germantown Ave., Phila. 22, Pa.**



# New SpeedWay COMBO KIT

## \$29.50

at your local hardware  
and electric stores.

### Every home needs these basic tools!

Not only the home craftsman, model maker and mechanic, but everyone with a home, a car or a hobby needs a SpeedWay Combo Kit.

Here are the basic power tools needed wherever things are made, installed or repaired: No. 69 SpeedWay 1/4" Drill, with attachments for sanding and polishing

A No. 129 SpeedWay Hand Grinder, that takes all arbor-mounted grinding wheels, rotary files, cutters and brushes, and accessories as shown (left)

With this kit you can drill holes up to 1/4" diameter, can grind, cut and shape steel, brass, wood, plastics, bone, etc. Tedious jobs like sand-papering, polishing and filing, scraping off rust, etc., actually become fun.

Designed and built by SpeedWay—manufacturers of quality power tools for over 40 years. These are not toys but capable electric tools with lots of power and correct operating speeds.

Sold by all leading hardware, electric, tool and department stores. (Ask for a demonstration.)

Write for FREE descriptive circular and the name of your nearest dealer.

## Speedway Manufacturing Co.

1863 So. 52nd Avenue  
CICERO, ILLINOIS



Powerful 1/4" Capacity Electric Drill—drills holes in steel or wood. Quality drill bit included.



with adapter, rubber backer, and abrasive discs, it makes a portable power sander. (Adapter backer and 10 assorted abrasive discs included)



with the slip-on lamb's wool bonnet, it is a portable power-driven polisher or buffer.



Snapped in the chromium plated Speed Stand, it becomes a horizontal drill stand, bench sander or polishing head.



High-Speed Hand Grinder (20,000 R P M)—For all mounted cutting burrs (for cutting steel wood bone plastics), grinding stones, brushes and abrasive discs. Seven assorted accessories plus 1/8" and 3/32" collets included.



Instruction Manuals—easy-to-follow guides to year 'round fun and useful pleasure with your Combo-Kit.

Note: The tools in the Combo-Kit operate on either 110-120 V AC or DC current

**SpeedWay** "Blue Line Tools"

No. 209 DRILL STAND (ONLY) \$12.95	No. 89 1/2" HAND DRILL \$29.95	No. 89 J 1/2" HAND DRILL \$34.95	No. 117 BENCH GRINDER \$14.95	No. 128 BENCH GRINDER \$29.95	G-A-KIT \$13.95	No. 69 1/4" DRILL \$11.80	No. 129 HAND GRINDER \$8.25	No. 229 STAND (ONLY) \$5.25
------------------------------------	--------------------------------	----------------------------------	-------------------------------	-------------------------------	-----------------	---------------------------	-----------------------------	-----------------------------



## Do an hour's painting in minutes!

**GIVES SMOOTH, PROFESSIONAL FINISH**

Once you paint the Speedy Sprayer way you'll never be happy wielding a brush! For Speedy Sprayer is designed to make painting actually *fun*. Merely pull the trigger—and your most troublesome paint jobs are done *in minutes* instead of hours! Inside and outside of your house, basement walls, furniture, screens, radiators, auto—they're all easy with Speedy Sprayers. Ask your hardware, paint, lumber or auto supply dealer. If he hasn't Speedy Sprayer, he can get it for you.



*Pays for itself on your first big job!*

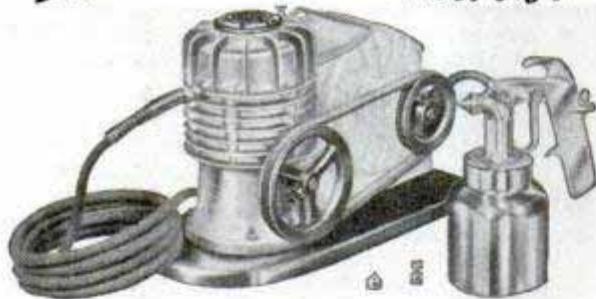

### **SPEEDY SPRAYER 890**

Sturdy—dependable—portable! Delivers clean, oil-free air at 2 cu. ft. per min. at 30-40 lbs. pressure. Operated by any 1/4 h.p. motor. Never needs oiling. Outfit with gun, less motor. **\$29.95**



### **SPEEDY SPRAYER 444**

Double capacity. No job too big! Delivers 4 cu. feet of clean, oil-free air at 40 lbs. pressure. Operated by 1/2 h.p. motor or gas engine. Outfit with gun, less motor. **\$54.50**

**W. R. BROWN CORPORATION • CHICAGO 39, ILL.**

*Specialists in Portable Sprayers for Over 20 Years!*

**FREE!**

W. R. BROWN CORPORATION  
5717 Armitage Ave., Chicago 39, Ill.  
Please send me your Free Booklet "How to Spray." Also literature.

Name.....

Address.....

City..... State.....

*Low-Priced*  
**ROTARY TILLER**

**Unsurpassed  
for Tilling  
and Cultivating**



The Mulsifier Soil Tiller! Makes it easy to work 1 to 20 acres of common crops. Pulverizes the soil as fine as if it were plowed, disked and harrowed. Spreads fertilizer as it tills. Ideal for cultivating. Has adequate power for all workable soils. Travels at speeds up to 2 1/2 miles per hour. Nothing to do but guide it. Compact—can be carried in trunk of car. Completely equipped—no extras to buy. Sells at a fraction of the price of a tractor. Send postcard for circular.

**MULSIFIER CORPORATION**

7758 HAMILTON, DETROIT 2, MICH.

\*Trade Mark Reg. U. S. Pat. Office

*Free  
CIRCULAR*

*Mulsifier*  
**ROTARY SOIL TILLER**

**SHARPEN IT YOURSELF!**

Save money, get a \$100 better job for only \$1

Any man handy with tools can use this remarkable sharpener! Attaches in place of stationary lawnmower blade, grinds rotary blades to keen edge and perfect alignment with stationary blade! Results absolutely guaranteed or money back. Complete instructions included. Sizes 12 to 18 inches. Be sure to send size wanted with check or money order for \$1 to:

**PEERLESS LAWNMOWER SHARPENER, Dept. PM-4**  
217 Guilford Avenue, Collingswood, N. J.



**NONE BETTER!**

**SUPER DRILL GRINDER**



Sharpens round shank drills from 3/32" to 1/2" in diameter, up to 6" long. Grinds old drills like new in 4 different point angles, using hand or power grinding wheels. Money-back guarantee.

Price only \$2.95

At Dealers or Postpaid

**CRANDALL MFG. CO.** 1512 W. Slauson, Dept. FA-40, Los Angeles 44, Calif.



**BUILD FINE GRANDFATHER CLOCK NOW**

The simple sensible Red-i-Kut way as thousands have—**SAVE HALF. SHOP TESTED PLANS "SPIRIT OF THE CENTURY"** Narrow waist 83" tall or stately **"SPIRIT OF AMERICA"** straight side model with pictures. **EASY-TO-FOLLOW PLANS**, tell all—plus **BROCHURE** of heavy brass weight Westminster, tube chime, movements, dials, solid mahogany case kits. Send \$1.00 today—Both Plans \$1.50 NOW. **KUEMPEL CHIME CLOCK CO.**, 23 Kuempel Bldg., Minneapolis 16, Minn.

**FASTEST PLANER in the WORLD**  
at this Low Price... **\$215.00**

**BELSAW Multi-Duty Planer**

Speed up production! Increase your profits! BELSAW power self-feeds at 24 feet per



● LARGER CAPACITY ● FASTER OUTPUT ● KNIFE SHARPENING ATTACHMENT  
**BELSAW MACHINERY CO.**

minute... The lowest-priced surfacer that will handle 12x6 in. stock. Planes green or dry sawed lumber into smooth, worked forms. Three high-speed steel knives make 42 cuts per inch. Multi-duty BELSAW takes inexpensive attachments for all planing mill operations—Jointing, Rabbeting, Grooving, Matching. BELSAW is the **only** 12 in. planer providing **attachments for jointing and grinding its own knives**. Start planning NOW for BIGGER VALUE and BETTER PERFORMANCE, with BELSAW. Write for FREE specifications, illustrations and low prices. **B1016 Field Bldg., 315 Westport Rd., Kansas City, Mo.**

*Replace with a*  
**DELCO BATTERY**  
*for GOOD SERVICE*  
*for a LONG TIME*



DELCO BATTERIES FOR PASSENGER CARS, TRUCKS, BUSES AND TRACTORS ARE SOLD BY DELCO BATTERY DEALERS EVERYWHERE

**DELCO-REMY** *WHEREVER WHEELS TURN OR PROPELLERS SPIN*

# HOW TO BE SURE OF QUALITY When Buying WHEELS—

**Buy**

The farm and industrial puncture-proof rubber tire wheels approved by the engineering departments and used on portable equipment for farm and industry built by the leading manufacturers in America: GLEASON FARM and INDUSTRIAL WHEELS. Steel discs electrically welded, ball bearings for easier rolling, fit standard 1/2" or 3/8" axles and equipped with semi-pneumatic rubber tires for smoothest rolling.

**Buy**

GLEASON FARM and INDUSTRIAL WHEELS from your hardware store, get the added protection of his reputation! Best of all because he buys in quantity, and absorbs all the freight costs, you get finer wheels at a lower delivered cost, as well as prompt delivery out of stock. Tell him what you need and you'll get exactly what you want, 12 models to choose from, mounting brackets, axles and casters too!



## LOOK FOR THIS FARM & INDUSTRIAL WHEEL DISPLAY

Pick the wheels you need from this action display, spin them on the axle, see how easy and smoothly they roll. Inspect the wheels you are buying. The leading hardware store in your community features this display of GLEASON FARM and INDUSTRIAL WHEELS, low in price, but best in quality.

**GLEASON CORPORATION**  
534 NORTH NINTH STREET  
MILWAUKEE 3, WISCONSIN

# Mows and Trims Lawns



In One Simple Easy Operation  
8 1/4 Lbs.



Save Time and Labor with a

## MONTAMOWER

New model. New type metal handle has special device to adjust cutting height. Drive shaft now mounted on free rolling, factory lubricated, sealed ball bearings. No tired backs or aching arms. 8 1/4 lbs. live precision made mechanism that first gathers, then cuts smoothly a clean 16" swath through grass, dandelions, spike grass, lawn weeds. No noise or clatter. As modern and efficient as your electric razor. Cuts right up to walls, fences, trees or posts; leaves no fringes to be trimmed by hand. Cutters self-sharpening. Built to last many years. Many thousands in use. Sold direct from factory for 26 years. Costs little. Write at once for trial on your own lawn "approval offer," guarantee information and literature.

### MONTAMOWER DISTRIBUTING CO.

94 Keeler Bldg.

GRAND RAPIDS 2, MICHIGAN

## BUMPER RE-NU

Renew bumpers yourself in a few minutes with our chrome-lak finish. This amazing, revolutionary discovery is a result of many years of laboratory research. No electricity—no special equipment needed. A child can do a perfect job. This is not a paint, not a polish, but an entirely new application. Creates a durable finish which can be used on hundreds of different surfaces. Sold with money back guarantee. Receive your Bumper Re-Nu by return mail by sending \$1 today to:

JACK ERMAN, BOX 147, HAMTRAMCK 12, MICHIGAN

\$1 <sup>post</sup> <sub>pd.</sub>

## SHARPEN CIRCULAR SAWS LIKE AN EXPERT



Precision file circular saws in your own workshop. No experience necessary. Adjustable to any pitch or angle. Gets hollow-ground, cross-cut or combination saw blades true and sharp. Fits 6" to 12" blades with 1/2, 3/8, 3/4 or 13/16" centers. Complete with file, instructions, 4-different size mandrels. Money Back Guarantee. \$6.95 postpaid — check or money order. \$1 dep. on C.O.D.'s. Profit maker for fix-it shops. FREE ILLUSTRATED FOLDER! Order Today! Hardware dealers — send for prices.

\$6.95

SURE-SHARP MFG. CO., Dept. M-49, P. O. Box 24, Santa Ana, Calif.

**ENSHRINE THEIR MEMORIES WITH U.S. MONUMENTS**

There is none better. Our free catalog is ready for you. Write today. A-18, U. S. Marble & Granite Co., Oneco, Fla.

Erected. Freight paid.

## READY CUT HOMES

**Order Now**

Homes \$1835.00 and up, freight paid. Orders filled in order received. Save up to \$1000 on modern production method homes. Much more compared with builders' prices. Anyone can assemble. Complete, plans furnished, hardware, roofing, glass, nails, etc. for full color catalog showing 37 modern low-priced homes and floor plans. Complete low cost building plans ready for filing. Sold separately if desired.

Dept. PM-49  
**INTERNATIONAL MILL & TIMBER CO.**  
Bay City, Mich. **35c**

NEW COLOR CATALOG FOR ONLY





**RAMYR SELENIUM PLATERS**  
10 amps to 250 amps.  
Model Shown, 10 amps . . . \$39.95



Descriptive literature  
and wholesale prices  
on request.

Your inquiries  
invited.

Our engineering  
service is at your  
disposal at all times  
without charge.



**"Tops" IN MOUNTINGS, EQUIPMENT  
and SUPPLIES for the  
BRONZED BABY SHOE INDUSTRY**

Bases of Unbreakable Metal--Also of Onyx or Marble

Complete Shop Assemblies—any capacity from 10 to 500 pairs  
weekly. Priced \$97.50 to \$3,500.

99 times out of 100 when your plating isn't right...it's your  
solution that's wrong.

**ANALYZING KIT**

Complete with simple instructions \$17.95.  
Will pay for itself many times over.

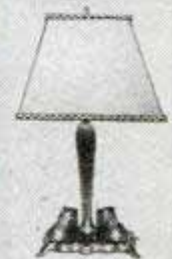

*World's Oldest and Largest*  
**HOLLYWOOD BRONZE SUPPLY**

Headquarters: 1770 N. Vermont Ave., Hollywood 27, California



Never Bind Tapered Ferrule

Tip Locking Screw

Screw Locks  
Reel Seat

Superb action and "feel" of the Heddon Pal Rod is the result of its exclusive, patented tapered construction as shown below. This perfect weight distribution provides longer life, exquisite action and casting power that greatly improves your ability to cast and catch more fish. Buy a Heddon Pal Rod. Note the difference. Write for catalog.

**Heddon**  
**"PAL" ROD**

Models—\$12.50, \$17.50, \$25  
Lengths—4½, 5, 5½ feet  
Actions—extra light, light,  
medium and stiff

James Heddon's Sons  
Dowagiac, Mich.



Thick Wall at Butt End

Perfect Weight Distribution

Thin Wall at Tip

**Save BUILD YOUR OWN BOAT**  
BIG SAVINGS AWAIT THE HOME BUILDER  
THRU MARINE MART'S MAIL ORDER SERVICE

**World Famous "PACKAGED BOAT" Kits**  
18 models—outstanding design—8-18 ft.—dinghies to runabouts—inboard—outboard—sail. \$34.50 up. Finest kits available. Easy home assembly. All parts pre-cut, frames pre-assembled. Send 25c (coin) for "Packaged Boat" literature or, send \$1.00 for literature plus booklet, "Plywood Boats."

**BOAT PLANS—PATTERNS—100 DESIGNS**  
100 modern designs by Deed, Lord, Crandall, etc. Planked, steel, plywood—all types—6 to 35 ft. Detailed blueprints, full size paper patterns available.

Send 35c (coin) for Catalog, or send \$1.00 for Catalog plus booklet, "Boat Building."

**MARINE MART—DEPT. 24—BUFFALO 7, N. Y.**

**MARINE PLYWOOD**

Plywood . . . fir, hardwood. Also boat building lumber. Stock list 10c (coin). Send 50c (coin) for stock list and booklet, "Plywood Hints."

**MARINE HARDWARE**

Complete stock of fittings, accessories. 15,000 items. Prompt delivery. Send \$1.00 for 250-page, illustrated catalog.

**CONVERSIONS**

Vee- and Stern-drives; reduction and reverse gears; kits, engines, accessories. Catalog 50c (coin). With booklet, "Conversion Hints," \$1.00.

FOR SUCCESS IN  
GOOD MEASURE  
INSIST ON A

# Royal Eagle Rule

A good rule to go BUY. Seasoned hard maple for extra strength. Riveted strike-plate joints cannot slip or stretch. At better dealers everywhere.

RIVETED STRIKE  
PLATE JOINTS



ONLY ON EAGLE RULES

EAGLE RULE MFG. CORP.  
NEW YORK 59, N. Y.

## New ARMY MINE DETECTOR

An/PRS-1 is a portable device for detecting metallic and non metallic objects. Metals, Buried Cables and sewer Tile.

No C.O.D.  
Our Special Price **\$26.40** with battery  
\$17.50 without battery

By lengthening dipole rods operator will be able to increase the depth sensitivity. This unit comes complete with spare tubes, antenna dipole and reflector, and instructions manual, in wooden chest 9½" height x 28¼" length x 15½" depth. Weight in operation is only 22 lbs. LESS Batteries. Power supply: Three 45 volt and one 6 volt batteries. Uses standard batteries. Original COST \$285.00. Shipping weight appr. 80 lbs. F.O.B. New York. No C.O.D.'s. Send Order to:



**COLUMBO TRADING CO., INC.**

304 CANAL ST. DEPT. PM NEW YORK 13, N. Y.

## 30 Early American Designs

New designs . . . Early American pieces adapted to modern living . . . in 2 series, A and B. Each packet contains 15 sheets, 8½ x 11", with photos and working drawings. Easy to make practical gifts . . . cricket, napkin holder, candle stand, etc. Each packet 25c postpaid. Send for both packets, Stanley Tools, 149 Elm St., New Britain, Conn.

25c



**STANLEY**

Reg. U.S. Pat. Off.

THE TOOL BOX OF THE WORLD

## Build YOUR OWN BOAT



Complete parts cut to exact size—ready to assemble. Marine waterproof plywood, rustproof oarlocks. Ideal for car top. Also models with laminated frames; mahogany decked runabouts. Build for sale at attractive profit. Exclusive franchise to local builders. Send 10 cents (dime) for illustrated literature.

\$39<sup>50</sup> and up

**OZARKA**

649 WASHINGTON AVE.  
WOODSTOCK, ILL.

## BRUSH PLATING OUTFITS

• for re-plating articles in the home and shop. No tanks necessary. Free particulars. •  
**GUNMETAL CO., AVE. M, DECATUR, ILLINOIS**

## Command Bigger Money!

# STUDY LAW

STUDY AT HOME for BUSINESS SUCCESS and LARGER PERSONAL EARNINGS. 40 years expert instruction — over 114,000 students enrolled. LL.B. Degree awarded. All text material furnished. Easy payment plan. Send now for FREE BOOK — "Law and Executive Guidance." It explains the course — how you may enroll and the many ways you can profit from Law Study. Write TODAY to:

**AMERICAN EXTENSION SCHOOL OF LAW**  
Dept. 13-PM, 646 N. Michigan Ave., Chicago 11, Ill.



best known

name in power-lawn-mowers

for thirty years

"MOTO-MOWER"

Why push a hand mower when you can drive a "Moto-Mower" . . . builders of quality power mowers for thirty years . . . write for literature and the name of the nearest dealer . . . a MOTO-MOWER is worth insisting upon.

The . . . sizes 20" to 71".  
**MOTO-MOWER**  
4615 Woodward, DETROIT 1  
... since 1919 *Company*

# King Midget



- HOME ASSEMBLED
- MASS PRODUCED
- LOW-COST AUTOMOBILE

Drive this car for as low as 50c per week. Up to 90 miles per gallon, 45 to 50 m.p.h.

Large enough for a husky six footer. A pleasure to assemble. Just bolt together our precision built parts. Get the facts. Send 25c for detailed circular with large photo, 3 view drawings, price of all parts. Better still, send \$1 (refunded first order) for this plus actual assembly book with 42 photos, drawings; blueprints of snow and ice conversions, etc.

**WORLD'S LOWEST PRICED CAR**

MIDGET MOTORS MFG. CO., Athens 1, Ohio

## BUILD YOUR POWER TOOLS

WITH POLY BALL BEARING ARBORS  
**HEAVY DUTY GRINDER**

3/4" x 17 1/2" precision spindle, self-lubricating ball bearings, heavy casting, V belt, 3 step pulley driven through rear or base.

ONLY **\$18.25**



Model D-12 Pictured

**FREE!** Write for POLY illustrated literature.

Ship. wt. 13 pounds



C4-1/2 Pictured

**POLY BALL BEARING ARBORS**  
 C4-1/2 x 12 1/2 spindle, housing 2x8, \$7.95 pp.  
 C5-5/8 x 12 1/2 spindle, housing 2x8, \$8.45 pp.  
 C6-3/4 x 12 1/2 spindle, housing 2 1/4 x 8, \$9.45 pp.  
 D8-1 x 17 1/2 spindle, housing 2 5/8 x 11, \$18.75 pp.

SHAPER ARBORS—Free literature on request.

POLY PRODUCTS, 2032-A E. Walnut, Pasadena 8, Calif.

## NEWEST OTTAWA LOG SAW

**SELF-PROPELLED — MOVES ANYWHERE on OWN POWER**

World's fastest Log Saw. Powerful 6 H-P air-cooled motor. Attachments for sawing down trees, buzzing limbs, post hole digging and pulley for belt jobs. Big demand for wood, pulp, posts. Make big money sawing wood this easy way. Low factory-to-user prices. Nothing like it. **FREE details.**

OTTAWA MFG. CO., 7-927 Pine St., Ottawa, Kansas



## ENJOY Your Car to the FULLEST

Other instruments in your car give assurance that most everything is in order. But what about directions? It's real driving pleasure to know you're headed right, always, with a **HULL AUTO-MOBILE COMPASS**. Beaconlite illuminated \$5.95. Streamline standard, \$3.95. At your dealer's. Write for literature.

HULL MFG. CO., P. O. Box 246-D4, Warren, Ohio



## Do YOU make this mistake in PAINTING?

Failure to prepare the surface before repainting often results in an unsatisfactory job. Dirt, grease, and wax should be removed . . . Glossy varnish or enamel should be dulled, to prevent the new finish from "crawling" or pulling away.

**WIL-BOND**—an easy-to-use liquid—does a complete job of preparing any type of surface. Easily applied with a rag. Eliminates sanding . . . Eliminates messy washing down with soap and water. *Cleans, dulls, and bonds in one operation!* Sets up a slight "tack" which causes the new finish to spread easily, cover evenly, bond perfectly.

Write for leaflet on **WIL-BOND**. Sold by paint and hardware stores.

**WIL-BOND**

Wilson-Imperial Company, 119 Chestnut Street, Newark 5, N. J.



# Free...



YOUR 1949

## PHOTOGRAPHIC CATALOG

OVER 1000 ILLUSTRATIONS—descriptions and prices of more than 1700 pieces of photographic equipment are included in Montgomery Ward's big, new Photographic Catalog.

**THE NEWEST IN STILL CAMERAS**—the sensational new Land camera that gives you a finished print just 60 seconds after you snap the shutter! The new Bell & Howell Foton automatic 35 mm. (takes up to six pictures a second); the new low-priced Bolsey miniature with twin lens reflex focusing; and many others.

**THE LATEST IN MOVIE CAMERAS**—the new Cine Kodak Special II (approaches the capacity of professional movie cameras), the new De Jur 8 mm. with Fade-Matic control, plus Wards new complete line of sound equipment.

**NEW ACCESSORIES**—the latest still projectors, new enlargers, and lighting equipment. In this section you'll find everything to help you get the most from your photographic hobby.

**EDITORIALS ON PHOTOGRAPHY**—valuable information on developing, printing, enlarging and movie making, plus many other useful tips.

Convenient monthly payments if you wish!

## MONTGOMERY WARD

Chicago • Albany • Baltimore • Denver  
 Ft. Worth • Kansas City • Oakland  
 Portland, Ore. • St. Paul

Clip and Mail this Coupon Now!

MONTGOMERY WARD, Dept. PM-49  
 Please send me the new 1949 Photographic Catalog as soon as printed (about May 1).

Name \_\_\_\_\_  
 (PRINT plainly)  
 Street Address \_\_\_\_\_  
 or Box \_\_\_\_\_  
 Postoffice \_\_\_\_\_ State \_\_\_\_\_

# Complete Ignition System Tester

Record  
Low Price

Absolutely  
Brand New!  
WORTH \$75

**FREE!**

12 page operating manual—profusely illustrated—if you order today!



FOR MECHANICS

AUTO HOBBYISTS

PILOTS

RADIO HAMS

FARMERS

BOAT ENTHUSIASTS

TELEPHONE MEN

FOR GARAGES

Self-contained trouble shooter for testing generators, starters, relays, regulators, storage batteries, field rheostats in any gasoline engine—automobile—truck—tractor—marine or airplane. Also tests AF and RF radio and telephone circuits.

- Voltage regulator switch for 6 or 12 volts.
- Exclusive meter polarity control adjusts for Positive or Negative ground.
- Special test selector—5 independent test circuits.
- 4-bank calibrated echelon meter.
- Tests both Volt and Ampere variance.
- Steel grey metal carrying case with handles.

A sensational buy

**SEND NO MONEY**

Just drop us a card saying you want your tester on 10-day free trial. When it arrives, pay the postman

**\$24.95**

plus postage. Money with order brings tester *postage-free*. If not completely satisfied—return your tester within 10 days and receive your money back in full.

**SHENKO SALES**

2115 S. HIGH ST.  
COLUMBUS 7, OHIO

Say You Saw It in Popular Mechanics

**MYSTERIOUS DEVICE WELDS BRAZES**  
**ANYONE CAN OPERATE** **SOLDERS & CUTS**

ONLY \$9.95

**FOUR-WAY WELDER**

This newly invented **FOUR-WAY PORTABLE ELECTRIC WELDER** will do brazing, soldering, welding and cutting on brass, bronze, iron, steel, cast iron and other metals. It's easy to use. **WORKS INSTANTLY** off any properly wired 110 VOLT A.C. OR D.C. LINE. Does a thousand and one professional type repair jobs. **SAVES TIME AND MONEY** on auto, home appliance, farm and shop repairs. It's indispensable for maintenance men, farmers, repair shops, engineers, tin smiths, home and auto owners, bicycle and fix-it shops, etc. The **FOUR-WAY** COMES COMPLETE WITH ALL SUPPLIES READY TO OPERATE including simplified instructions. IT'S FULLY GUARANTEED. Order one today for 10 DAY TRIAL or write for FREE particulars. **FOUR-WAY WELDER CO., Dept. PMD-49**  
3160 North Clark St., Chicago 14, Illinois

# MAKE YOUR OWN!

WITH

## Griffin READYCUT LEATHER PROJECTS

Over 100 KITS in every kind of Tooling and Carving Leather, accurately cut, all parts included. Only Top Grade Leathers used. You do the choosing. You do the tooling, carving, stamping, the punching and assembling



SEND FOR COMPLETE CATALOG Please send 10c to cover mailing.

SINCE 1924

OUT OF THE WEST, THE HOME OF LEATHER CARVING  
**Griffin Craft Supplies**

5515-A GROVE STREET  
OAKLAND 9, CALIFORNIA

**EVERYTHING FOR THE LEATHER WORKER**

Largest, most complete stock of *Leathercraft Tools and Accessories* in U.S.A.



**HIDES AND SKINS** of Craft Leathers of every kind if you prefer to cut your own.

## 30" SHEET METAL BRAKE

Forms angles, channels, vees, flanges, locks, zees. Handles 26 gage sheet steel, heavier gages of aluminum, copper, plastic, etc. Portable. Can be held in a bench vise, or bolted down. All steel. Wt. 40 lbs. Shipped exp. collect.



- 12" BRAKE.** Fits in vise to form difficult and compound bends, up to 20 gage steel 12" wide, \$12.50 PP.
- WISE IRON BENDER.** Forms rings, hooks, eyelets, etc. in 1/2" round or square; 1/4" up to 2" wide in bar iron. Price \$10.00 PP.
- SHEET METAL PLIERS.** 2 1/2" wide, \$2.00; 5", \$3.50.

Immediate delivery. Order direct, cash or C.O.D., or send for folder.

**WISE BRAKE MFG. CO.**

1116 SO. 27th ST. DEPT. P4 OMAHA 5, NEBR.



## BARGAINS FROM WORLD WAR II

Thousands of Bargains in Military, Outdoor and Sport Goods for Hunter, Farmer, Scout. Write for FREE 32-page CATALOG OF BARGAINS.

A and N SUPPLY CO.

4720 Lester St. Richmond 15, Va.

## SPECIAL OFFER!

LOCK-STITCH SEWING AWL

**\$1.**

Postpaid

Famous, patented lock-stitch sewing awl complete with needles, waxed thread and direction folder. Hundred uses—sewing, repairing leather goods, canvas, belting, harness, saddles, gun cases, awnings, golf bags. Extra needles and thread available. Satisfaction guaranteed or money back. Send currency, check or money order. **Yates Mfg. Co., 611-H Main St., Lake Geneva, Wisconsin**

## TOOL AND DIE DESIGN



FREE COPY of our catalog explains comprehensive 12 month course in tool or die design. Expertly planned curriculum. Highly individualized instruction. Housing, employment problems aided.

Write today for complete information.

TECHNICAL EDUCATION, INC. (Acme School)

Dept. PM, 2804 Belmont Chicago

## POWER MOWERS

Only \$59.50  
Originally \$99.50

**Streamlined — Powerful**

Complete with Maytag twin-cylinder motor—17 1/2" rotary tool-steel, fully guarded blades—cast aluminum body. Cuts grass and weeds, wet or dry, forward or backward. Eliminates trimming, raking—chops grass into fine mulch. Send check with order, or specify C.O.D. or Sight Draft B/L.



**EQUIPMENT DISTRIBUTING CO.**

1106 South Kirkwood Road St. Louis County 22, Mo.

Witte  
Diselectric  
Model LDREA.  
7.5 KVA-AC.



Reliable power  
for a few cents  
an hour!  
**WITTE**  
DIESELECTRIC PLANTS

A Witte Diselectric Plant starts and operates on low cost fuel oil. It eliminates the risk and additional cost of gasoline, reducing fuel costs in some instances by as much as 50%. The Witte pre-combustion chamber assures full fuel combustion, giving maximum power from every dollar you spend for fuel.

The Witte Diselectric is famous for trouble-free performance under strenuous operating conditions. Sturdy Witte construction practically eliminates maintenance problems.

WHAT SIZE DO YOU NEED? Witte Diselectric Plants range from 3 to 10 KVA-AC; from 2.5 to 8 KW-DC. See your Witte dealer, or write for free illustrated literature.



**WITTE ENGINE WORKS**  
1610 Oakland Ave., Kansas City 3, Missouri  
Division of Oil Well Supply Company

**UNITED STATES STEEL**

**DUAL CROSS and ROTARY FEED**

**PALMGREN** ROTARY, INDEX, MILLING TABLE No. 83

Has 8" table, 360° movement and 4" cross feed travel. Adjusting wheels and dials graduated in degrees and thousands. Slotted for bolting to table. No. 83 Priced \$49.50. No. 82 without rotary feed \$39.75. Write for Circular No. 10  
**CHICAGO TOOL and ENGINEERING CO.**  
8365 South Chicago Ave., Chicago 17, Ill.



**\$10,000 REWARD**

Earn the government bonus by locating  
Radio-Active Ores with the

**P.R.I. GEIGER COUNTER**

Weight about 2 lbs. Price only \$75.00 complete.  
Enclose check to save C.O.D. charges.

**PRECISION RADIATION INSTRUMENTS, INC.**  
1101-P N. Paulina St. Chicago 22, Ill.

**MODERNIZE Your Refrigerator**  
with DEFROST-O-MATIC

Automatically defrosts refrigerator each night while you sleep. Simply hang on wall and plug in refrigerator. Set once and forget. Saves electricity—Prolongs refrigerator life. Frozen foods unaffected. Years of dependable service. 110 Volt 60 cycle AC. SEND NO MONEY: Pay postman \$9.95 plus postage. Or send M. O. and we pay postage. Money back guarantee.

**MODERN EQUIP. CO.,** Lohrville 1, Iowa, U. S. A.



**Thompson**  
**BEATS**  
the World  
on **BOATS**



**Better Built  
Lower Prices**

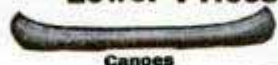

Canoes

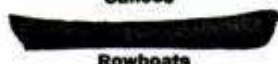

Rowboats



Outboards

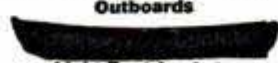

Light Boat for Auto

**Safe Boats With Full Length Spray Rails**  
Keep passengers perfectly dry—even at high speeds. Catalog also shows two new models of "Take-Along" Boats. Two big factories—save you freight.  
**CATALOG FREE**  
Write for your copy. State kind of boat in which you are interested.  
**THOMPSON BROS. BOAT MFG. CO. (151)**  
213 Ann St. (Write to either place)  
PESHIGO, WIS. 113 Elm St. CORTLAND, N.Y.

**INSTANTLY CONVERTS  
LINEAR FEET  
TO BOARD FEET**

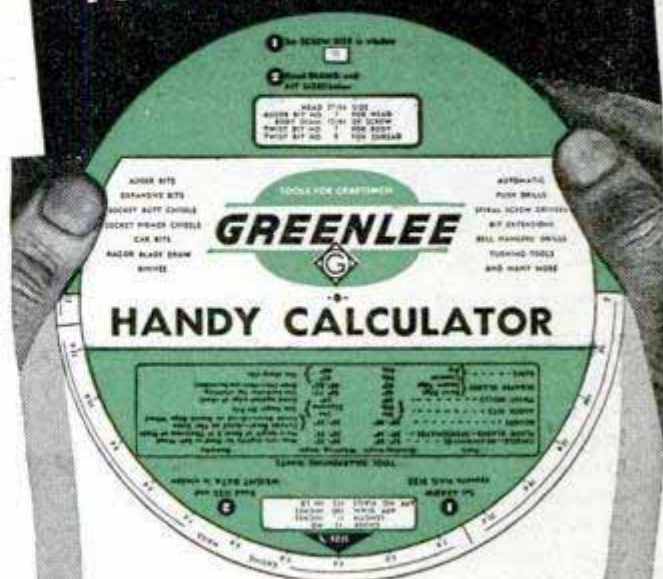

Solves many other  
woodworking problems  
in seconds  
only **10¢**

Easy to use. Fast . . . simply set dial of GREENLEE Handy Calculator to get measurements; slope per foot in degrees; comparative hardness, weights and workability of various woods; bit sizes; nail specifications; tool sharpening hints. 6" diameter heavy varnished cardboard. Special offer by maker of famous GREENLEE tools. Send 10¢ to Greenlee Tool Co., 2104 Columbia Avenue, Rockford, Illinois.

TOOLS FOR CRAFTSMEN

**GREENLEE**



**SAY YOU SAW IT IN POPULAR MECHANICS**

**Protect Property...Loved Ones!**  
Automatic Fire Protection in Your Home  
with **RED COMET** Extinguishers



- INEXPENSIVE
- ALWAYS EFFECTIVE
- EASILY INSTALLED
- AUTOMATIC

Every home workshop contains fire hazards. Now you can provide 24-hour protection for your property and loved ones with famous Red Comet Automatic Fire Extinguishers on guard. This unique device functions automatically without human aid. When fire starts, Red Comets go into action instantly. A heat-sensitive thermostatic fuse releases a spray of powerful Red Comet fluid which forms a smothering blanket of fog and quickly snuffs out fire. Rigid factory tests assure positive operation. Manufactured since 1931. There are more than one million Red Comets in use in homes, factories and stores all over the world.

Don't gamble your life and property. Be protected with Red Comets.

Available in two sizes—Standard model protects up to 175 cubic feet; Senior size, up to 350 cubic feet. Standard model, as illustrated, priced at \$6.45.

Write for free literature or send check or money order to:



## RED COMET, INC.

175 R. C. Building Littleton, Colorado

**SALESMEN!!** Operate your own business. Sell Red Comets! Needed in every home, store, farm. Many fine territories open. Write for details today!

## Always Handy AT NITE

Carry this BUDDY lantern anywhere—in glove compartment, tool chest, drawer, pocket or purse. Compact, sturdy, lots of light! Switch glows in dark. At hardware, sport, electric stores. Uses 2 standard 1 1/4" flash-light cells. Less bat. **\$1.75**



DELTA ELECTRIC CO., MARION, IND.

**Delta BUDDY** ELECTRIC LANTERN

## Make Ur Own POWER LAWN MOWER

Just add Engine or Motor

- Lightweight "easy to operate."
- Cast aluminum base with 18" Rotary Blade (Hardened Steel).
- Ball-bearing rubber tired wheels.

Now is the time to install your own gasoline or electric motor on a well built new aluminum chassis. Will accommodate up to 2 hp engines or 1/2 hp motor.

WE can also furnish gasoline and electric power mowers at big savings. Inquiries invited.

PRICE F.O.B., K.C., MISSOURI  
SEND CHECK OR M.O. NO COD'S

**ATLAS EQUIPMENT CO.**

229 S.W. BLVD. Dept. P.M. KANSAS CITY, MO.



## ACE LATHE TOOL SET



Be permanently tooled-up for every operation on your Metal Cutting Lathe

The ACE Set is complete—there's nothing more to buy. Drop forged by the manufacturers of cutting tools used by 96 per cent of the plants and shops in industry they are correctly designed, are of special steel, are finely finished, are stronger—will last a lifetime. You can cut easier, faster and more accurately with ACE TOOLS. At your Hardware Store—

**ARMSTRONG BROS. TOOL CO.**

"The Tool Holder People"

5268 W. Armstrong Ave., Chicago 30, U.S.A.

- 3 Turning Tools, 2 Cutting-off Tools, Knurling Tool, Boring Tool, Threading Tool, High Speed Steel Cutters and Blades, and 2 Wrenches in Fitted Steel Case.

## MARCOT KEY MACHINE

Immediate Delivery



MARCOT No. 8 KEY MACHINE, mounted on Cabinet, less motor, \$ 95.00  
Auto Code Book and Auto Depth Keys . . . . . 12.50  
100 Dz. Popular Cylinder Key Blanks . . . . . 60.00  
Set—Key File, Follow-Through Rods, Lock Picks, Bit Key Gauge, Thimble, Pins, Springs . . . . . 10.50  
"Locksmith Trade Books" . . . . . 6.75  
How to Open Locks without Keys or Picks; Secret of Locksmithing; How to Make Keys by the Impression Method; Master Key Systems. TOTAL COST . . . . . \$184.75

**A. J. MARCOTTE CO.,** 1200 N. Kedzie Ave. Dept. PM, Chicago 51, Ill.

## LAWN ORNAMENT-NOVELTY PATTERNS

28 Lawn Ornament Patterns, 25c. Other patterns; 15-20" high; Dutch Girl, Dutch Boy, Pirate, Bull Terrier, Mexican Girl, Mexican Boy, Dwarf, Penguin, Flower Girl, 10c each. 25 Novelty Patterns, 30c. All 62 Full Size Patterns, \$1.00 Postpaid. Strother Pattern Service, Dept. AY-8, Box 128, Belington, W. Va.

Say You Saw It in Popular Mechanics

## STOP TAPPET NOISE!

Install **ADJUSTABLE TAPPETS**

for **FORD and MERCURY V-8's (85-100 HP)**



Johnson Adjustable Tappets guarantee better engine performance! Over 2,000,000 of these popular tappets are giving quiet, trouble-free service.

Simple and easy to install during valve grinding jobs.

Nothing complicated . . . no extra labor involved.

ASK YOUR SERVICE MAN OR NEAREST AUTOMOTIVE JOBBER TODAY

**JOHNSON PRODUCTS INC.** Muskegon, Michigan



SANDING

The only attachment for angle-head electric drilling.

POLISHING

**This Spring make your car, floors, woodwork, furniture gleam like new with BULL BUFFER!**

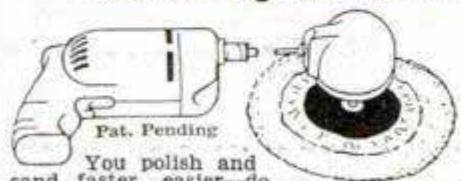

Pat. Pending  
You polish and sand faster, easier—do beautiful, professional work—with this amazing attachment for your electric drill. (You can also drill up to 1/2" with your 1/4" drill and at right angles never before possible!) Bull Buffer more than pays for itself the very first time you make your car, floors, woodwork, furniture gleam like new. It's built of lifetime materials and guaranteed. Thousands and thousands of satisfied users. At your dealer or send cash, check or money order for your Bull Buffer, complete as pictured. Only

**\$9.95**

1. Fits any chuck on an electric drill or flexible shaft—no extra power unit to buy!
2. Only Bull Buffer has gear reduction—the power to do any job without injury to your electric drill!
3. Only Bull Buffer has swivel action—turns in complete circle when drill is stationary!
4. Only Bull Buffer has angle head for electric drill—gets to all hard-to-reach surfaces, curved or flat!
5. Only Bull Buffer has 3 speeds\* — "same as," 1/2-speed, or twice speed of your drill!

\*See description under photo of Bull Buffer kit.

**BERTRAM N. ENGINEERING CO.**  
3121 MAIN ST. DEALERS WRITE FOR NAME OF NEAREST WHOLESALER KANSAS CITY, MO.



Bull Buffer comes complete with sheepskin bonnet and two sanding discs, only \$9.95. Bull Buffer alone cuts drill speed 1/2; for direct drive (or "same as") drill speed, order Adapter A with Bull Buffer; for twice drill speed, order Adapter B.

**ORDER THESE ACCESSORIES FOR YOUR BULL BUFFER**

1 1/2" Jacobs No. 6425 key chuck: with Bull Buffer, increases 1/4" drill to 1/2" capacity — reduces speed, increases power .....	\$5.00
Extra sanding discs (000-00-0-1-2 1/2-3-4) each .....	.10
2 1/2" cup wire brush for removing paint, rust, scale, etc. ....	1.75
Extra sheepskin bonnet .....	1.25
Adapter A—for direct drive at "same as" drill speed .....	1.00
Adapter B Set—for sanding at twice drill speed .....	2.00
Bull Buffer car cleaner .....	.50
Bull Buffer car polish .....	1.00

**QUALITY TILTING TABLE SAW**

TABLE INCLUDING EXTENSION 18" x 14"

**\$24.95**

Complete as shown  
F.O.B.  
Royersford, Pa.



IMMEDIATE DELIVERY

Send for catalogue showing complete line of Tilting Table and Tilting Arbor Saws, from \$24.95 to \$87.50  
**AMERICAN MACHINE & TOOL CO., Inc.**  
ROYERSFORD, PA. DEPT. 111



**Powell SETS THE PACE**

DEALER INQUIRIES INVITED

- 7 H.P. Motorcycle-type Engine
- Solid steel frame
- Faster pick-up than a car
- Highway cruising speed of 45 miles per hour
- Automatic clutch
- Chrome-plated fenders, handlebars, and sport muffler —looks like a custom job
- Smooth, simplified control
- Costs no more than ordinary scooters

**Powell MANUFACTURING COMPANY** DEPT. PM449 COMPTON, CALIF.

Write for FREE FOLDER and address of nearest dealer

**M-SCOPE TREASURE -MINERAL LOCATORS**

WRITE FOR FREE, ILLUSTRATED 16-PAGE BOOKLET

M-SCOPE TREASURE-MINERAL LOCATORS. Low priced, unsurpassed efficiency, lightweight models. Factory guaranteed. Immediate shipment. Credit plan available. Write for free 16-page booklet. GEIGER COUNTERS for finding Uranium ores. Several models. Simple operation. Low priced. Immediate shipment. Interesting free literature.



URANIUM

**FISHER RESEARCH LAB., INC., PALO ALTO, CALIF.**

GOLD

New 1949 Model



Turn your Spare Time  
into **CASH**

with the **FOLEY  
LAWN MOWER  
SHARPENER**



Why don't you get into this steady repeat cash business? Start in spare time in garage or basement. The Foley sharpens all sizes and types of mowers in 15 or 20 minutes (with handles on). Prices run from \$1.50 to \$2.00 for hand mowers, and from \$5.00 to \$8.00 for power mowers. This is the way to make money!

The Foley Electrakeen System is the same as used by lawn mower factories—it sharpens all reel blades and cutter bar in ONE operation. It turns out perfect work that pleases your customers and brings them back. Every lawn mower needs sharpening at least once or twice a season. No experience needed with a Foley—and it puts a perfect cutting edge on any reel blade mower two to three times faster than any other method.

**SHARPENS  
1,000 MOWERS  
PER SEASON**

"I have sharpened over 10,000 mowers in my Foley Lawn Mower Sharpener in the last 10 years — only repairs needed were new belts." — Charles H. Smith, Calif.

**MADE \$582.00  
IN ONE MONTH**

"My lowest month sharpening lawn mowers was \$80.00 and highest \$582.00. Naturally my best months are in the Summer." — W. W. Loud, Okla.

**PAID ITS COST  
IN 30 DAYS**

"The Foley Lawn Mower Sharpener paid its cost the first 30 days after installing. It's O.K. in every way," says M. H. Engler, Mo.

**Low Prices, Less than \$50 Starts You**

Start your business on payment plan if you wish — less than \$50 will put a new 1949 model Foley Lawn Mower Sharpener in your hands ready to go. 99c out of each dollar you take in is profit. FREE PLAN shows how to start — mail coupon today!



**Send for FREE PLAN**

FOLEY MFG. CO., 407-9 Foley Bldg., Minneapolis 18, Minn.  
Send FREE PLAN on the Foley Lawn Mower Sharpening business.

Name \_\_\_\_\_  
Address \_\_\_\_\_

Do it  
**Faster**  
and  
**Easier**  
with  
the

WRITE FOR FREE CATALOG — shows attachments that save time and money!



**PAGE  
Garden Tractor**

New 1949 line with extra features! Riding and walking models, 1½ to 5 HP. Complete gear drive, no cheap belts or chains. Large tires—high clearance—easy to handle—power turn. Low factory prices—\$188 to \$436 with cultivator. Get benefits of 24 years of garden tractor experience!

**PAGE DAIRY and FARM EQUIPMENT**  
1904 S. 81st STREET • MILWAUKEE 14, WIS.

**NU-WAY HEAVY DUTY CUTTING UNIT**  
with Timken Roller Bearings

PRICE  
**\$16.50**  
WHY PAY MORE



Build your own rotary type lawn or weed cutter. Take the hard work out of weed cutting. Build yourself an up-to-date weed and lawn mower with the Nu-Way heavy duty unit.

Write for Free Circular—We Supply Cutting Unit Complete  
**TRACTOR-LITE MFG. CO., Spirit Lake, Iowa**

**NEW 1949 CATALOG**

**48 PAGES OF REAL VALUES**

for the home workshop—hobbyists—woodworking equipment—sprayers—welding outfits—tools—motors—hundreds of other items.

Make this interesting catalogue your shopping guide. Send 10c to cover handling and mailing—TODAY.

**MIDWEST SALES CO. 2533 C INDIANA  
KANSAS CITY, MO.**

**MAGNETS** OF ALL TYPES—10c UP  
AMAZINGLY POWERFUL!!  
4 oz. Alnico Magnet, lifts 10 lbs.  
\$1.10. Our Leader, 15 oz. Magnet,  
lifts 40 lbs. \$2.50. New alloy—will not  
weaken! Useful for lifting valuables from tanks,  
lakes, or rivers easily! 7 small magnets \$1.10 with  
list of many shop and home uses. Satisfaction guaranteed.  
R. EYRICH, 2566 N. 49TH ST., MILWAUKEE 10, WIS.

**A 10-Ton Press  
at Low Cost**

Pressing, separating, bending, and straightening jobs in your shop are easy with this press. Ten-ton capacity provides ample pressure. Adjustable table takes work up to 18 inches wide and 11½ inches high. Send for free bulletin showing press and wide variety of accessories.

UT-10A Press f.o.b. factory \$36.00

**DAKE ENGINE COMPANY**  
624 Seventh Street, Grand Haven, Michigan





# WAR SURPLUS

V  
A  
L  
U  
E  
S

## ARMY SLEEPING BAG

Genuine Army surplus. 100% wool. 30" zipper. Reissue—guaranteed like new. Complete with water repellent cover. **3.95**  
Add 25c for mailing.



## AIR CORPS TYPE SUNGLASSES

Brand new. 4 base optically ground lens. 24 karat gold plated frame. Pearlloid brow rest. Complete with case. **1.88**  
Add 10c for mailing.



## OFFICER'S PINKS

Brand new. Fine quality officer's elastic trousers. Sizes 29 thru 42. Reg. \$17.95 value. **11.50**  
Add 25c for mailing.



## ARMY PUP TENT

Genuine Army surplus. Full size. Reissue—guaranteed perfect condition. Complete with poles and pins. **3.95**  
Add 35c for mailing.



## NAVY T-SHIRT

Brand new. First quality. Snowy white, soft fine knit cotton. Sizes small, med., large. **4 for \$2**  
Add 15c for mailing.



## NAVY KNIFE

Brand new. Tempered steel 5 1/4" "Parkerized" blade. Complete with sheath. **98c**  
Add 10c for mailing.



SEND FOR FREE CATALOG

MONEY BACK GUARANTEE

## NATIONAL JOBBING CO.

BOX 1485 Dept. N-4 Omaha, Nebr.

## LOOK! FIN-DER SAX-SLING

NEVER SLIP OR KINK  
HIGH SPEED ADJUSTING  
BALLBEARING

AT ALL GOOD DEALERS OR ORDER DIRECT

\$7.00  
FIN-DER 1251 • 4th Avenue, San Diego 1, Calif.

NEW!

## "YANKEE" ANGLE VISES

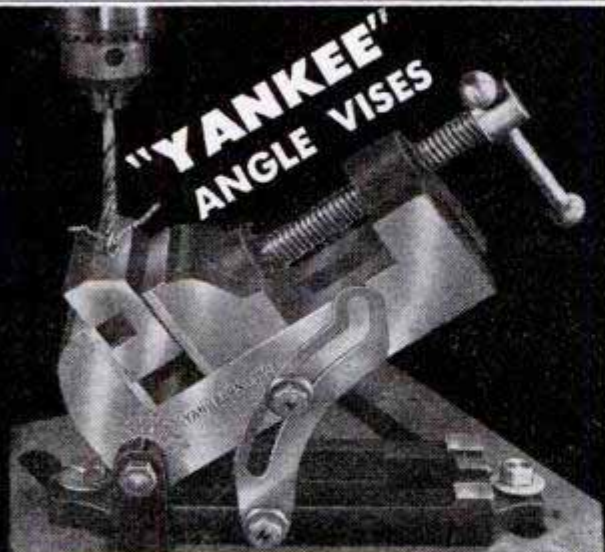

**1-minute angle set-ups!** Tilt it for the angle and lock it. You're set up for any operation, machine or bench. Two sizes, 2" and 2 3/4" jaws, with or without swivel base. Write for Vise

Folder and "Yankee" Tool Book. **YANKEE TOOLS NOW PART OF STANLEY**  
THE TOOL BOX OF THE WORLD  
NORTH BROS. MFG. CO.  
Philadelphia 33, Pa.

# 7 TOOLS IN 1

- Mortises
- Taps
- Sands
- Shapes
- Drills
- Carves
- Routs

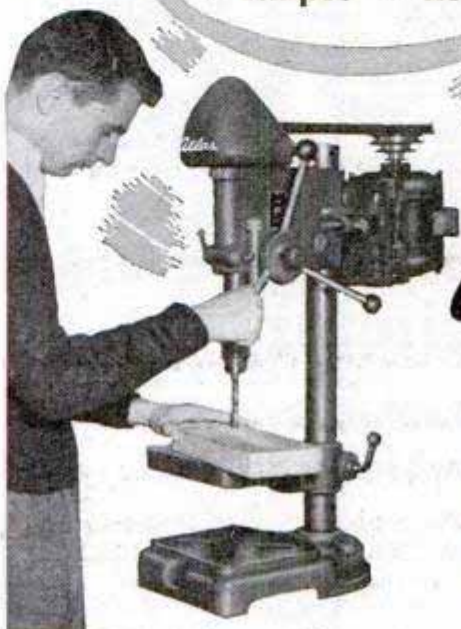

WITH **Atlas**

**12 3/4"**

BALL BEARING

**DRILL PRESS**

**\$64.50**

F.O.B. Kalamazoo, less motor

You get yourself a whole shop full of tools for money-saving work around your home when you install an Atlas drill press and accessories. Mortise and tenon joints for tables, chairs, doors, screens, cabinets... fluting, reeding, inlaying... precision drilling and tapping for making and repairing home equipment... the jobs are almost endless that this one fine tool will do. The Atlas 54 has ball bearing "floating drive" for smooth running and lasting accuracy. Send coupon for full details.



## Atlas 8" TILT/ARBOR SAW

Work stays flat, saw tilts for angle cuts. Safe, sure. Cuts to 2 3/8" deep. 3 table sizes to 22"x45 1/2".  
Send for Catalog.

FREE CATALOG!

Please send your latest catalog

- DRILL PRESSES
- TILT/ARBOR SAWS

Name \_\_\_\_\_  
Address \_\_\_\_\_  
City, State \_\_\_\_\_

**ATLAS PRESS COMPANY**  
443 N. Pitcher St., Kalamazoo, Mich.



**MATCHED PRECISION TOOLS FOR WOODWORKING AND METALWORKING**

SAY YOU SAW IT IN POPULAR MECHANICS



5 Kinds of Work with 1 Tool

1. Handgrinding
2. Bench-grinding
3. Lathe-grinding
4. Flexible-shaft
5. Sanding-Polishing

# DUMORE

## Duplex Handgrinder

**A versatile tool with plenty of power — to do your work faster and easier**

You can see by these pictures why home-workshop fans say, "The Dumore Duplex is the handgrinder to buy!" *It's a real tool* — rugged and powerful. And it's built to do everything from delicate carving in plastic and wood to tough clean-up jobs on hard weld-metal!

Just think of the advantages of these features:

1. A full 1/14 hp Dumore motor for no-stall power.
2. An extra-capacity chuck for 1/4", 1/8" and 3/32" tools.
3. Attachments that convert it instantly to Flexible Shaft Tool, Bench Grinder, Toolpost Grinder, Sander-Polisher.

It is almost impossible to list all of the hundreds of jobs you can do with this fine Dumore tool in any workshop. We hear of new ones every day from enthusiastic, satisfied users. And every job is done faster, easier, and *better* — thanks to the Duplex. Enjoy working with a tool that adds so much more fun to your hobby. Get a Duplex today.

Tear out this coupon and mail today

— for complete information on the Dumore Duplex Grinder, Flexible-shaft attachment, Handy-Sandy, Bench Stand, and Toolpost Bracket.

The Dumore Company, Dept. D-51, Racine, Wisconsin

Please send me the items checked:

Duplex Deluxe Kit with 27 accessories. \$27.50 enclosed

Duplex Standard Kit with 9 accessories. \$19.75 enclosed

Shipping Charges C.O.D. on all items

Complete information on the Duplex Grinder and all accessories.

Name.....

Address.....

City..... (.....) State.....

H-24

## FINE TOOLS NEED FINE OIL!

**3-IN-ONE OIL**

• Lubricates

• Prevents Rust

• Cleans • Polishes

SOLD EVERYWHERE

## 3-IN-ONE Oil

## Sand Casting — Forging — Heat Treating — Case Hardening

# BRONZE FOUNDRY



In your own workshop allows you to design and build your own GASOLINE ENGINES, STEAM ENGINES, STATUARY, ART OBJECTS, SPECIAL TOOLS, NEW INVENTIONS, ETC. You can also make forgings and case harden steel. Your shop is not complete without a FOUNDRYETTE. Three sizes are available capable of making bronze castings of 1 1/2, 3 and 6 pounds weight, aluminum, copper, brass, etc., \$22.50, \$29.50, \$42.00 f.o.b. Kansas City. Domestic gas supply and 110 volt AC or DC energy required for operation. Write for circular.

**KANSAS CITY SPECIALTIES CO.**  
Box 6022, Dept. P-3 Kansas City, Mo.

## SAVE ON TOOLS

## MECHANICS NET PRICES

Send 25c in stamps for "Illustrated Catalog." Hundreds of Nationally Known, NEW & GUARANTEED Hand & Specialty Tools at Mechanics NET prices. Guaranteed by manufacturers. NOT War Surplus.

**GIZMO TOOL CO.** BOX 656-B SAN FRANCISCO 2, CALIF.

## AMAZING MYSTERY BUTTON



Startles Everybody. With this Electronic Button you can make your own Telephone — Amplifier — Detectophone. Attach this button to piece of cardboard — transmit conversation to another room. Music also transmitted to distant places. Most interesting electrical apparatus ever discovered. Enables you to perform hundreds of experiments. So tiny it can be concealed in dozens of places. A Pre-War Product. Electronic Button including 5000 word instruction booklet with 50 illustrated experiments, postpaid, only..... **\$1.00**

Electronic Products Company, Saint Charles 7, Ill.

**NOW** YOU CAN EARN UP TO **\$6.00** PER HR.

in your own WEAVING BUSINESS!

Amazing All Weave Electric Loom weaves rugs, draperies, textiles in hundreds of colors and patterns. Produces up to 40 feet of 42-inch material per hour. Ideal business for physically handicapped.

Entirely automatic... easy to operate... no experience necessary... free instruction booklet... working materials easily obtained. Uses 110 volt A.C. power. (Special voltage or gasoline motors supplied at extra cost.)

The All Weave Electric is a full size loom, capable of heavy-duty, production-line work, yet reasonably priced. Write for descriptive folder TODAY! Dept. P.

**ALL WEAVE LOOM CORP.** 9128 St. Charles Rock Rd. Saint Louis 14, Missouri

# Stucco Spraying Earns High Incomes

It's today's biggest business opportunity in the building field. High returns from a low investment. Easy, fascinating work. Large waiting market because Colorcrete is applied over all kinds of old and new masonry surfaces — exterior and interior.



## Beautifies and Protects All Types of Buildings

Pneumatic pressure sprays plastic-like Colorcrete to give enduring beauty and water-resistant values. Range of 30 gleaming colors; many textures. Easy to wash. Smartly modern. Write or wire today for Opportunity Portfolio.

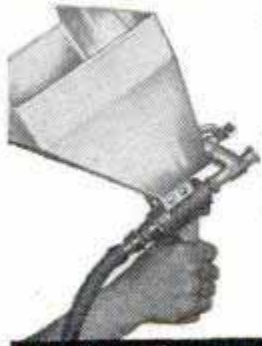

**COLORCRETE** COLORCRETE INDUSTRIES, INC.  
570 OTTAWA AVE., HOLLAND, MICH.

## MACHINE SHOP EQUIPMENT



The 1949 edition of the famous Center Tool Co. Catalog is now ready! Every workshop owner should have a copy. 240 pages full of illustrations, descriptions, and prices of the latest tools made by best known manufacturers in U. S. You pay the cost of printing—50c. **We refund your 50c with your first order of \$10.00 or more.** Prompt delivery on most tools. Send check or money order today!

CENTER TOOL CO., 153 Centre Street, Dept. C, New York 13

## FREE PLANS POWER MOWER KITS FREE PLANS

Have one of the finest mowers money can buy. Write for FREE PLANS and PARTS LIST showing you how to SAVE up to 75% by assembling Triangle's POWER MOWERS.

3 Wheel Model

### SPECIAL FACTORY PRICES

Kits, Parts, Engines, Wheels, Etc. Also complete TRIANGLE MOWERS ready to mow, at Low Factory Prices. 3 and 4 wheel models.

4 Wheel Model

SAVE your back. Assemble or build your own 3 or 4 wheel power mower with our precision made kits and parts. Write today for full facts. Free Plans, Parts List, Low Factory Prices. DEALERS INVITED.

TRIANGLE MANUFACTURING CO., Dept. M-2, Box 185, Fort Scott, Kans.

## EXTRA PROFITS FOR SAW SHOPS WITH BEMACO RAPID SAW SET

IT'S AUTOMATIC Sets hand saw teeth in 60 seconds—Approx. 400 band saw teeth. 4½ to 12 points with one adjustment. Hammer and anvil action does precision job. Every tooth alike—no breakage.

IMMEDIATE DELIVERY

WRITE TODAY



**BEAVER MFG. CO.**

802-C South Isis Avenue, Inglewood, California

Save **\$300.00** to **\$500.00**  
by building your own  
**arc welder**



HOBART D.C. welding generator in 150—200—300 ampere sizes.

Here's how you can do it with one of these HOBART units.

1. Select the generator best fitted for your work. 2. Decide between portable and stationary. 3. Connect your own gas engine or power source.

**Go after those BIG PAY jobs.** No need waiting to own a complete factory built outfit. Let HOBART help you get started now with profitable arc welding, by building your own.

**Start your own business** or use arc welding in your present work. It's easy. Connect a full capacity HOBART welding generator to electric motor or power shaft for shop work—or mount it on truck or trailer with gasoline engine for welding anywhere, independent of power lines.

**No limit to possibilities and uses** Do arc welding of highest quality on all kinds of work. Manufacturing, maintenance, repair. Generators with auxiliary power operate tools, appliances, lights and earn extra money for you.

**It will pay you to investigate** the complete line of A.C. and D.C. HOBART arc welders. Built for every need. Mail the coupon today for more information.

HOBART BROTHERS COMPANY  
Box M-49, Troy, Ohio, U.S.A.

**HOBART**

ONE OF THE WORLD'S LARGEST BUILDERS OF  
**ARC WELDERS**



HOBART D.C. welding generator with 1 or 3 KW aux. D.C. power.



HOBART A.C. welding generator with 5 or 8 KW aux. A.C. power.



HOBART A.C. transformer type welder is one of many other types built.

Quick, thorough training for you in arc welding.

The HOBART Trade School offers complete or partial courses. Check coupon



HOBART Electrodes for better, faster welding.

Clip this coupon NOW!

HOBART BROTHERS CO., Box M-49, Troy, Ohio

Please send data on items checked:

- Generators only to "Build Your Own" For:  D.C. Welding Only,  D.C. Weld—D.C. Power,  A.C. Weld—A.C. Power,  A.C. Transformer Type Welders,  Other Hobart Welders,  Hobart Trade School,  Hobart Electrodes.

NAME \_\_\_\_\_

ADDRESS \_\_\_\_\_

Free!  
Vest Pocket Guide to Better Welding



## Thousands of Parts **TRUCKS** For Military

We have for immediate delivery genuine parts for all makes and models, 4x2 - 4x4 - 6x4 and 6x6. All models from 1/4 ton to 20 tons. All makes: Auto-car, Biederman, Brockway, Chevrolet, Diamond T, Dodge, Federal, Ford, GMC, International, Mack, Oshkosh, Reo, Studebaker, White, Willys and Jeeps. We have parts lists available on some models. Write stating model of Truck.



### JEEP TOPS and CURTAINS

(Weatherizing Kit), complete top with back curtain and side curtains with zip-in-doors. 5 windows. Waterproof O.D. color. Shipping weight 40 lbs. Wonderful value. FOB, K.C. **\$39.50**

### TRAILER AXLE

Heavy duty trailer axle suitable for many types of trailer construction. Also excellent for building of heavy farm trailers and wagons. It is a 15,000 lb. capacity square type straight trailer axle complete with Timken roller bearings, hubs, and 6 hole 750 x 20 Budd Wheels. Without brakes. Axle is 2 1/2 inches square and 70 inches between wheel mounting flanges. Std. width. AN EXCELLENT BUY. **With Single Wheels. \$59.50 With Dual Wheels. \$69.50**

**WINCH CABLE** — New with hook. 300 ft. length. **\$37.50**

**Steel Wire Rope TRUCK TOW CABLE** 5/8" diameter. 15 ft. overall length. Loop on each end. Shipping weight 14 lbs. Price, **\$3.00**

**TOW CABLE** — 15 ft. long. 1/4" thick. Steel with clevis and eye. Every motorist should have for emergencies. Shipping weight 2 1/2 lbs. Each. **\$1.50**

**UTILITY GAS TANK** 6 Quarts—New Surplus. Cylindrical 5 1/2" diameter, 15 1/2" length. Brackets for mounting in horizontal position. Complete with Filler cap in center, drain plug in bottom and pet-cock on end. Ideal fuel tank for small gas engines, stoves, etc. **\$1.50**

All prices quoted good 30 days FOB, Kansas City. 25% deposit required on COD orders.

**American AUTO PARTS CO.**  
1830 LOCUST — DEPT. PM  
KANSAS CITY, MISSOURI.

## One Swipe of NEW PLASTIC Makes these LEATHER and LEATHERETTE Items LIKE NEW

Get Into A Money Making Business

Make like new, worn, scuffed or faded leather and artificial leather equipment. Either your own to renew, recolor and beautify, or cafe, restaurant and hotel equipment as a business. Single stroke with a brush renews. Does not crack, peel or scuff. Resists acid, alcohol, caustics and weather. All colors. Mail coupon for free sample.

**FREE Sample SHOWS EFFECT**

**\$50 to \$500 Profit On One Job Possible**

Let me show you how, as I have shown others. Get your own exclusive territory while available. Mail coupon today. I'll do the rest. — Jack Edwards, Sales Mgr.

**LEATHER-NEW PRODUCTS, 6082 Sunneslope, Kansas City, Mo.** Send me without obligation a sample of Leather-New coated material so I can inspect it.

Name \_\_\_\_\_  
Address \_\_\_\_\_  
City \_\_\_\_\_ State \_\_\_\_\_



**STRIPE WITH PAINT EASY AS USING A PENCIL**

## PAINTERS' STRIPING TOOL

NOW you can do your own expert striping on furniture, bikes, model planes, bulletins, autos, toys, signs, linoleum, wall board... make plain walls look like tile! It's easy to paint straight, curved, circular, even parallel lines with any color. Handiest paint tool in your workshop! Type "M" Master Painters' Striping Tool complete with tip for 1/16" stripe, \$1.00. Tool with choice of 1/64", 1/32", 3/64", 5/64", 3/32", 1/8" tip—\$1.50... all tips 75c ea. Tool with complete set of 7 tips \$5.00. (COD's postage collect.) WENDELL MFG. CO., 4234-B Lincoln Ave., Chicago 18, Ill.

**A TOOL... NOT A BRUSH**



Dealers Write Today!

**\$1.00 POST PAID**

## New MILLING ATTACHMENT



**SIZES FOR 8" to 16" METAL LATHES** Build it yourself from our sets of semi-machined castings and save \$8. Can be finished on your lathe alone. Complete drawings and instructions furnished with castings.

Mill keyways, slots, splines, dovetails, flutes for reamers, special cutters. Produce gears, ratchets, racks; bore, face, etc. with this precision attachment.

**FREE** Illustrated folder and price list of castings, milling cutters, etc. Write today. Mention your lathe.

**HURON MACHINE AND TOOL CO.**  
YALE 4, MICHIGAN

## HOT WATER in a JIFFY!

**Pocket-Size ELECTRIC WATER HEATER Boils Faster than Gas**

Place heater in water, plug in electric socket. Boiling water in a "jiffy". Order now! Pay postman or send \$2.95 to Starr Mfg. 3521 Wesleyan Drive, Toledo, Ohio.



**\$2.95**

## AIR RIFLES **BENJAMIN** AIR PISTOLS

**PIONEERS - LEADERS** SEND FOR FREE FOLDER OF LATEST MODELS TODAY If you want a REAL GUN for PRACTICAL USE inside or outdoors get a SAFE - CLEAN - ECONOMICAL - BENJAMIN with Adjustable Power and Amazing Accuracy. For BEST RESULTS use BENJAMIN H-C PELLETS. WRITE AT ONCE, BENJAMIN AIR RIFLE CO., 812 MARION ST., ST. LOUIS 4, MO.

## D.C. ARC WELDER

200 Amperes Continuous Duty

Easily mounted on tractor or elsewhere. Welding range 0-250 amperes by dial type control. Includes proper pulley for your application. Six months guarantee, with money-back 10-day trial period. (A \$300 value) at less than half. Write today for Catalog.

Or, **25c** for PLAN send "Build Your Own Welder from Surplus Aircraft Generator" and we'll include free literature and catalog.



**LEJAY MFG. CO.**  
847 LeJay Bldg., Minneapolis 8, Minn.



**BUY DIRECT AND SAVE!**

**FACTORY to YOU**  
at WAY BELOW RETAIL

Get **GAYLARK**

DeLuxe **SEAT COVERS**

**ACTUALLY THE VERY SAME MATERIAL USED IN COVERS SELLING UP TO \$25!**

You've never seen seat covers like these before—NOW offered to you at tremendous savings. Cheerful patterns that brighten up your car—cover up worn upholstery—protect new upholstery. GAYLARK'S new Seat Covers are TOPS in quality, smart styling, and value. Stunning new *Uniblend* plaids compliment your car interior. Just the handsome touch YOUR car needs!

Every GAYLARK Seat Cover is designed for maximum service, with double stitched seams for greater strength. Easy to install too! On-in-a-jiffy with elasticized slip-over sides that give a snug, smooth fit. Here's VALUE for you! So buy direct from GAYLARK—and YOU pocket the difference.



**CHECK THESE IMPORTANT ADVANTAGES**

- ✓ Sturdy Construction
- ✓ Up-to-the-minute Styling
- ✓ Full Protection for Front and Rear of Seat
- ✓ Washable Plastic Coated Fibre
- ✓ Colorful "Uniblend" Plaid
- ✓ Double Stitching Throughout
- ✓ Trimmed with Richly Grained Leatherette
- ✓ Perfect, Glove-like Fit
- ✓ Genuine DuPont Coloring
- ✓ Money Saving

**\$3.98** for 3-passenger solid back coupe, or rear seat of coach or sedan.  
**FRONT SEAT COVER \$4.98**  
**\$8.95** complete set of covers for sedan or coach.

**WE HAVE COVERS TO FIT EVERY POPULAR MAKE OF CAR—NEW OR OLD MODELS**

**EASY TO INSTALL—**

**on all types and makes of cars!**

Be sure to specify which type covers you wish when you order. Note styles illustrated below:

1. Solid back for 4-door sedan front or rear. Rear for coach or coupe.
2. Divided back, solid seat for front coupe or coach.
3. Individual seats or bucket type for divided back and seat.

**GAYLARK PRODUCTS** 615 N. Aberdeen, Chicago 22, Ill.

**MONEY-BACK GUARANTEE**

Like thousands of others, you will be completely satisfied with GAYLARK Seat Covers. If not—your money will be cheerfully refunded, at once.



**BUY DIRECT AND SAVE BY MAIL**

**SEND NO MONEY**

**GAYLARK PRODUCTS, Dept. C1**  
615 N. Aberdeen, Chicago 22, Ill.

Gentlemen: Rush Gaylark Seat Covers on 5-day money-back guarantee

- Complete front and back covers \$8.95     Front seat cover only \$4.98  
 3-pass. divided back coupe \$4.98 My car is a 19..... Make.....  
 3-pass. solid back coupe or rear seat of coach or sedan \$3.98  
 Type 1     Type 2     Type 3     2-door     4-door  
 Rush postpaid—\$.....enclosed.     Send C.O.D. plus postage.

Name.....  
(please print)

Address.....

City..... Zone..... State.....

- Please include one pair Fibre Door Protectors to match, at \$1.00 per set  
 Wedge cushion to match, \$1.00

# Provides PRECISION CONTROL..

because  
**FOREDOM #99**  
**FLEXIBLE SHAFT**  
MACHINE with  
**PENCIL-SIZE**  
HANDPIECE..

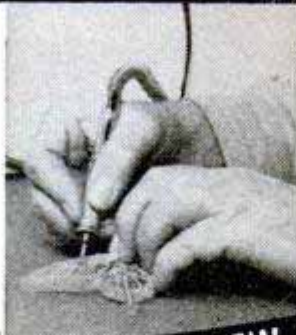

**KEEPS YOUR WORK WELL IN VIEW**

35"  
FLEXIBLE  
SHAFT  
•  
**\$15<sup>95</sup>**  
COMPLETE  
WITH  
MOTOR

**GRIND - POLISH - SAW - SAND -  
ETCH - ENGRAVE - ROUT - CARVE -  
MILL - CLEAN**

**Use on all metals, wood, plastics,  
glass, leather, linoleum, etc.**

REMEMBER that in the precision-made FOREDOM you get MORE POWER—LONGER MOTOR LIFE because MOTOR IS NOT DWARFED TO FIT HAND. DOES HUNDREDS OF JOBS WITH MARVELOUS EASE because pencil-size handpiece gets into hard-to-reach places—provides positive, easy, precision control.

Profit by experience of many thousands of Foredom users—over a quarter century experience stands behind the product. Other heavier-duty models at proportionately reasonable prices. No. 25 Accessory Set (a truly versatile assortment) \$5.50 extra. Also No. 999 Kit, comprises No. 99 Machine, illustrated, and set of 12 accessories, all in wooden case for only \$19.95. 6-step Foot Rheostat \$4.85. Over 70,000 Foredoms in use.

AND HERE'S ANOTHER AMAZING FOREDOM PRODUCT



← YOUR MOTOR  
**Foredom PRESTO-FLEX**  
with PENCIL-SIZE Handpiece **\$5.95**

Now turn your old motor, drill press, or electric drill into a Flexible Shaft Tool. Simply attach to your electric drill, drill press or motor. Presto—a flexible shaft machine! Off again in a jiffy! Pencil-size handpiece gives you finger-tip control. Gets into tight places you can't reach with any other tool. Handy 35" overall length. And—only \$5.95 complete! Not to be confused with inferior imitations. Precision made, backed by 1/4 century experience in this field. All parts replaceable. Order NOW. If ordered for use on motor, specify motor shaft diameter and add 50c for coupling. (Available for 1/4", 5/16", 3/8", and 1/2" shafts.) No. 50 Accessory Set available \$1.50 extra. Order TODAY.

## FOREDOM ELECTRIC CO., Dept. A-1116 Mail Coupon

27 Park Place, New York 7, N. Y.

Now

Please send me FOREDOMS checked below on 10-day trial.  
 Presto-Flex Tool (\$5.95)       No. 50 Accessory Set (\$1.50)  
 Motor Coupling (50c)       No. 25 Accessory Set (\$5.50)  
 Specify motor shaft diameter \_\_\_\_\_  
 No. 99 Machine (\$15.95)       Foot Rheostat (\$4.85)  
 No. 999 Kit (\$19.95)       Free Catalog

Send C.O.D. plus postage. I will pay postman.  
 I enclose payment. Send postpaid.  
 (Money back either way if not delighted)

Name \_\_\_\_\_  
 Address \_\_\_\_\_  
 City \_\_\_\_\_ Zone \_\_\_\_\_ State \_\_\_\_\_



**BUILD A MODEL OCEAN  
LINER THAT ACTUALLY RUNS**  
"24" QUEEN ELIZABETH"

Complete Kit with electric motor, propeller, universal, shafting, plans and instructions. Easy to build, fun to operate... **\$4.95**  
 Buy at your dealer or order direct.  
**SCIENTIFIC MODEL AIRPLANE CO.**  
 214 Market St. Newark 2, N. J.

**BINOCULARS, 6 x 30 Universal, used, good condition, with case. \$85 Value.. \$42.50**  
**BINOCULARS, U. S. Navy 7 x 50, used, good cond., with case. \$180 Value..... \$95.00**  
**BINOCULAR CASES, 6 x 30, two grades, leather, new..... \$5.00 and \$7.50**  
**7 x 50 Leather BINOCULAR CASE, new. \$15 Value..... \$7.50**  
**TELESCOPES, U. S. Navy, 16 power, with case. Val. \$125..... \$29.50**  
**5 Power Ranger TELESCOPES..... \$2.00**  
**Engineers Metal Army Type SIGHTING LEVELS, New..... \$2.00**  
**SURPLUS GOVT. TRIPODS for Level, Transit, Cameras, etc. Used. Good Condition. \$5.95**  
**NEW TRIPODS for Transits, Levels, etc. Value \$75.00. Special..... \$13.50**  
**TRANSFORMERS, Western Electric, 5 volt to 650, New..... \$4.95**      **CANVAS SAFETY BELTS, Metal Snaps, New, \$3.00 Val..... 75c**

Many unadvertised specials. What do you Need?  
 Send 25c for our New Gun and Sporting Goods Catalog — with Annual Gun Digest, both for \$1.50.

## Public Sport Shops

11 S. 16th St., Phila. 2, Pa. No COD'S

## BRASS NAME PLATES OR KEY TAGS



(INDIVIDUAL STAMPING)  
**40c each—3 for \$1.00**

Half actual size  
**QUANTITY PRICE — SAME STAMPING**  
**8 for \$2. - 15 for \$3. - 25 for \$4. - 50 for \$6.**  
 LARGER QUANTITIES ON REQUEST  
**TAGCO, BOX 38X, WINGDALE, N. Y. STAMPING EQUIPMENT**

## DRILL PRESS CLAMP

**FITS ANY DRILL PRESS with 7/16", or wider, slot**

**HOLDS ALL SHAPES**

If your dealer hasn't it send price direct.

**DODD PRODUCTS INC.**

405 Atkins Ave. Lancaster, Pa.



ONLY  
**\$2<sup>95</sup>**

## TRY A Dry Lube!!

NEOLUBE contains colloidal graphite. Apply like paint to wood, metal, glass, rubber, plastics. Dries rapidly. Adheres firmly. Does not brush off. The films formed are lubricating, conductive and opaque. Home craftsmen, sportsmen and hobbyists use NEOLUBE for chain drives, hinge pins, sticking windows, working models, electrical contacts, toys; on delicate mechanisms or engine bearings; on threaded parts for easy disassembly, on reels, guns and autos. Hundreds of uses for the tinkerer or skilled mechanic. Literature on request. Send \$1.00 for 2 oz. bottle. Postage paid in U.S.A. for cash with order.

**HURON INDUSTRIES, P. O. BOX 557, PORT HURON 3, MICHIGAN**

Say You Saw It in Popular Mechanics

## LEARN WELDING AT HOME

60 LBS. OF READY MADE PARTS **Only \$24.95**

## BUILD YOUR OWN HEAVY DUTY WELDER

SAVE!  
 Buy Only NECESSARY PARTS

Heavy Duty transformer coils ready wound. Laminations ready cut. Five heat stages. Easy to assemble... no special tools needed. With only a few hours practice you can do skilled welding on steel, cast-iron and other metals. Illustrated instruction manual included. Sold on 30-day unconditional Money-Back Guarantee.

**FREE: WRITE TODAY FOR FULLY ILLUSTRATED PAMPHLET P-4.**

**ATOMIC ARC WELDER CO.**  
 1037 So. 19th St. OMAHA, NEBR.

Gives 100% penetration. Welds are stronger than original metal. Operates on 110 or 220 AC.

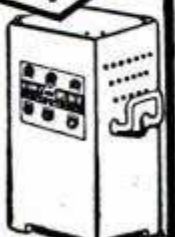

# "ROYAL" ROTARY MOWER

IT'S NEW! IT'S PERFECT! IT'S TRULY A BEAUTIFUL ECONOMICAL MOWER—THE MOST PRACTICAL EVER MADE

Have a Beautiful Lawn • Mosquito Free Surroundings  
Cuts with a SMOOTH FINISH through any LAWN, Spike Grass, Dandelions and High Weeds. Easy to Adjust Cutting Height. Clippings are Scattered Evenly. NO NEED for RAKING or after

"Precision Built" to Last a Life Time



TRIMMING. SOLD Direct to YOU, at FACTORY PRICES. Light Weight (only 34 lbs.) Royal Mower for Either Gasoline or Electric Motor — 20 Inch Cut—Without Engine. . . . . \$5000

OUR DEPENDABLE GASOLINE ENGINE, 2 H. P. 4 Cycle AIR COOLED. Light Weight 30 lb. Quick Easy Starting at any Temperature. No Vibration. Best Engine Ever Made. . . . . \$5550

SAVE MONEY: ROYAL MOWER and Gasoline Engine, Complete as Shown only. . . . . \$10000

ALL PRICES F.O.B. ROYAL OAK, MICH. Prompt Shipment. Order Today. If you Prefer Send Check or Money Order for \$20.00. We Ship C.O.D. for Balance.

Absolute Money Back Guarantee

## ROYAL OAK LAWN MOWER SHOP

Dept. A—Box 48

ROYAL OAK, MICHIGAN

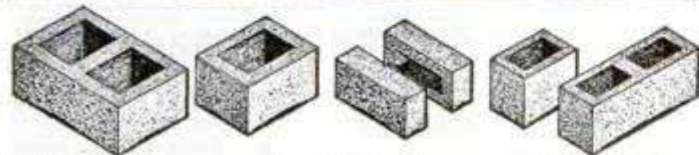

## Make Concrete Blocks and Bricks

New superior method makes square, true, easy-to-lay units which will pass any building code. Small investment, high production, big profits. One \$30.00 machine will make four 5"x8"x12" blocks per minute—1000 per day. Pays for itself in a few days. Sell blocks or save 2/3 building cost by making and laying your own.

POST CARD BRINGS FREE FOLDER

Economy Manufacturing Company  
Dept. P Stone Mountain, Georgia

FENDER SKIRTS . . . . . \$17.20 PER PAIR

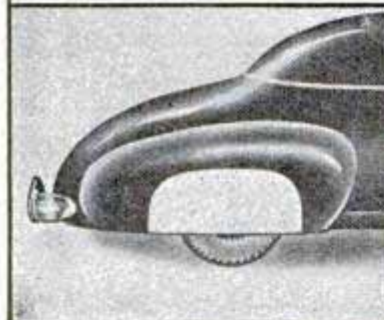

For Ford, Chev., Merc., Plym., DeSoto, Chry., Dodge, Kaiser-Frazer and Buick. Beautify your car—bring out the flowing lines inherently designed there. Sparkling beauty you'll like. Constructed of heavy gauge body steel, finished in prime, perfect fit.

SANDEE MUFFLER CO  
Box 296, La Tijera Sta.  
Los Angeles 43, Calif

Gentlemen Please send me one set of Sandee Fender Skirts to fit my . . . . . (year and make of car)  
 Check for \$17.20 enclosed  
 Ship C.O.D.

## OWN A Printing Business

Cards, Tickets, Stationery, etc. Good profit in spare time. PRINT YOUR OWN greeting cards, movie titles, church work, etc. Save money. Easy rules supplied. Raised printing like engraving too. Have home shop. Sold direct from factory only. Pays for itself in short time. Write for free catalog of outfits, and all details. KELSEY PRESSES, 0-37, MERIDEN, CONNECTICUT

## DIRECT OIL BURNERS Complete With 3 Electric Controls



Coordinated Air Tabulator and air deflector. New Heavy Duty Blast Tube. 1 to 4 gal. capacity. Easy servicing. Quiet operation. Immediate delivery. Specify nozzle size and gallonage. Complete with thermostat and all electric controls. The Most Efficient Burner Built.

Regular Price \$189.00

Our Price \$89.50

FITS ANY TYPE FURNACE

In ordering Burners Specify number of rooms to be heated.

We Also Handle Tanks In All Sizes

WRITE FOR PRICES

If you send check or money order we will pay the Freight.

DIRECT SALES, 921-PM- W. 17th St., Kansas City, Mo.

DINGHIES,  
CANOES,  
AUTO-TOP BOATS



FISHING AND FAMILY BOATS

# EVINRUDE POWERS THEM ALL!

RUNABOUTS  
AND SPEEDSTERS



CRUISERS AND HOUSEBOATS

CHOOSE EVINRUDE—for finer performance on any boat! Choose from the line that's really complete . . . "singles"—"twins"—and thrilling four-cylinder models . . . 1.5 to 50 certified horsepower . . . a motor that's right for every type of hull! Only Evinrude gives you the revolutionary FISHERMAN DRIVE that lets you power over snags, rocks, shoals—through reeds and thick weed beds—"wherever there's water to float your boat." SEE YOUR EVINRUDE DEALER! Look for his name under "Outboard Motors" in the yellow pages of your phone book. Catalog FREE . . . write today. EVINRUDE MOTORS, 4289 N. 27th St., Milwaukee 9, Wis.



In Canada: Evinrude Motors, Peterboro, Ontario.

# EVINRUDE

FIRST IN OUTBOARDS • 40th YEAR

SEE WHAT YOU CAN DO WITH

# TOUCH-PLATE

REMOTE CONTROL UNIT

- EASIER TO INSTALL than a doorbell . . . complete instructions with each unit.
- EXTREME CONVENIENCE with extra switches controlling 110 volt yard, garage, porch, shop, etc. lights from many locations by remote control. (24 volt Touch Plate circuit)
- LOW COST because switch runs are inexpensive low voltage wire with switches wired in parallel.
- NO-SHOCK SAFETY of low voltage switch circuit even in damp locations.

JUST TOUCH YOUR LIGHTS ON



**\$12.50** Complete



Model 2500

Die cast box with 24 volt transformer and impulse type relay factory wired for simple installation.



TOUCH-PLATES

Model 1400A  
Modern design, momentary contact 24 volt switch.

**90c** Each

OTHER MONEY-SAVING TOUCH-PLATE PRODUCTS

RELAY Model 1550

Solenoid operated impulse type connection silver contact magnetic switch. Rating 5 Amp 125 V.A.C. . . . Coil 24 volt.

**\$3.80**  
Each



GANG BOX Model 1610

For centralized mounting of up to six relays for silent operation.

**\$6.80**  
Each



TRANSFORMER Model 78K1

115 V.A.C Primary 24 V.A.C Secondary with mounting plate to fit standard 4 sq. outlet box. Built-in bi-metal circuit breaker protects transformer in case of shorts, etc.

**\$5.60**  
Each

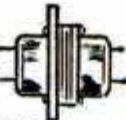

CONVERTER Model 17C

Converts 24 V.A.C to 24 V.D.C for intermittent duty. Can be used with 78K1 transformer to operate any 24 V.D.C relay. Built-in bi-metal circuit breaker protects converter in case of shorts, etc.

**\$5.80**  
Each



WRITE FOR COMPLETE INFORMATION

Ship to \_\_\_\_\_  
Address \_\_\_\_\_  
City \_\_\_\_\_ State \_\_\_\_\_  
Quantity \_\_\_\_\_ Item \_\_\_\_\_ Price \_\_\_\_\_

DEALERS WANTED

Check enclosed  Ship C.O.D.  (25% deposit required with all C.O.D. orders)

TOUCH-PLATE CO., INC.

P. O. Box No. 1811, Long Beach, Calif.

## MECHANICS-ATTENTION!

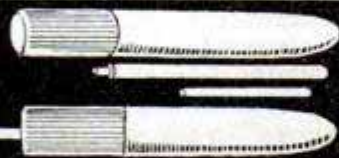

Tool and Die Makers, Mechanics of all types welcome the W-O-I 'Little Giant Magnet.' Its a convenient pocket-size instrument containing a powerful little Magnet with detachable steel picks for extracting steel chips from drill holes, retrieving steel parts from hard-to-reach crevices, and similar uses.

### W-O-I Nail Magnet Nail Sets

Used by thousands of Metal Lathers for starting stub nails into hard concrete, and by carpenters, plumbers, carpet layers and others, for driving tacks, brads—etc., into hard surfaces. 6" Long—"Light As A Feather—Strong As An Ox."

**W-O-I Nail Set \$2.00, W-O-I Little Giant Magnet \$1.55**  
post paid upon receipt of Check or Money Order.

GUARANTEED SATISFACTION

**W-O-I PRODUCTS** 1434 CARMEN AVE. CHICAGO 40, ILL.

## GOVERNMENT SURPLUS! WORLD'S LOWEST PRICE

### PHOTO FLASH EQUIPMENT



COMES COMPLETE WITH  
**4** EDGERTON  
FLASH TUBES  
& REFLECTORS



EASY TO  
CONVERT INTO  
A 2-WAY PHOTO  
FLASH UNIT  
OPERATES ON 110V. AC & 12V. BATTERY

Brand new at a fraction of original cost. Contains finest component parts available. All necessary parts and complete instructions included. After conversion, works on 110V AC or 12V battery by a flick of a switch.

**\$68.**  
WRITE FOR MORE DETAILED INFORMATION. IMMEDIATE DELIVERY COMPLETE  
CINEX, INC., 165 W. 46th St., N. Y. 19, N. Y., Dept. PM-4

## MAKE MONEY MAKING DOUGHNUTS

Make new greaseless doughnuts at home on electric machine. Sell for cash to grocers, cafes, drug stores, etc. No exp. nec. Good profits. Small investment. Send for free recipes and plans.

MART RAY CO. • 3605 S. 15 Ave. • Minneapolis 7, Minn.

**2270° F** **\$3.15**

### VOLCANO GAS TORCH

No Compressed Air

For use by Manufacturers, Hobbyists, Dentists, Jewelers, Laboratories, and Garages. For brazing with silver, soft soldering, bending light metal and glass tubes, and many other uses. Burns regular house gas (manufactured gas only). Sample of silver and flux furnished with torch. Send check or money order. Guaranteed.

## MILLER METAL PRODUCTS CO.

P. O. Box 4026 • ROANOKE, VIRGINIA

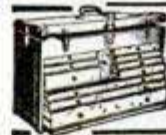

### GERSTNER Tool Chests

represent unusual values. There is a size for the tools of every Machinist and Toolmaker. Free catalog.

### GERSTNER TOOL CHESTS

449 Columbia St. Dayton 7, Ohio

## Free Booklet on FLEX-O-SHAFT

illustrating this all-purpose power machine with hand-piece that handles as easily as a pen. Motor with switch, foot-operated rheostat, and 66 accessories at special low price. Write

FLEX-O-SHAFT SALES CO.

Dept. C

Prairieview, Illinois.

Say You Saw It in Popular Mechanics

## ELECTRICITY Anywhere

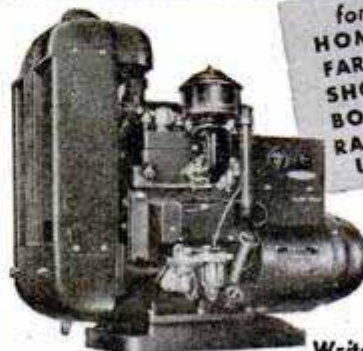

for  
HOMES  
FARMS  
SHOPS  
BOATS  
RADIO  
USE

Onan gasoline-engine-driven Electric Plants supply reliable, economical electric service for any use Portable, stationary or stand-by models. Water or air-cooled, compact and rugged.

A.C.: 350 to 35,000 watts in all standard voltages and frequencies. D.C.: 600 to 10,000 watts, 115 and 230 volts. BATTERY CHARGERS: 500 to 3,500 watts; 6, 12, 24, 32 volts.

Write for folder

### D. W. ONAN & SONS INC.

5820 Royalston Ave., Minneapolis 5, Minn.





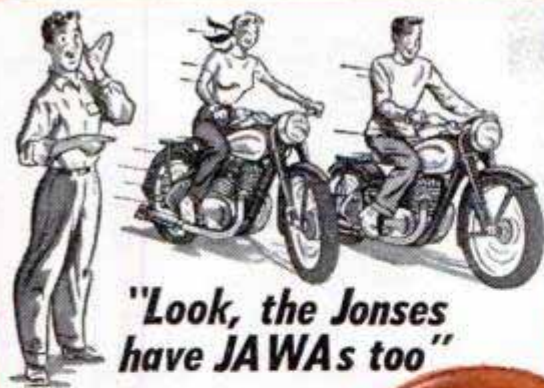

**"Look, the Joneses have JAWAs too"**

From coast to coast Jawa owners are telling us of the pleasure and service they are enjoying. Yes, the Jawa is a new kind of motorcycle . . . designed for comfortable, sensible transportation with all the z-z-zip of a jet.

See your Jawa dealer today and try it out yourself. You'll agree, too, "it's a honey of a motorcycle".

Franchise Dealerships available. Write today for details.



**the most talked about motorcycle in America**

*the Jawa 250*



**The greatest value in Motorcycles**

• No bounce or jar on any road • Soft Braking • Front & rear Tele-Float Spring Suspension • Automatic Clutching • Four-Speed foot gear shift • Constant mesh transmission • 95 miles per gallon. More exciting features in a Jawa than in any other motorcycle . . . at a price that makes it your **OUTSTANDING** motorcycle buy! At your Jawa Dealer or write to

**JAWA MOTORCYCLE CO.**

DIVISION OF INDUSTRIAL OPERATIONS, INC.

2432 Grand Concourse, New York 57, N. Y.

**EARN A STEADY INCOME**

*Sharpen*  
**CIRCULAR SAWS**



Thousands of Circular saws need sharpening every month.

Improved Acme Circular Saw Sharpener sharpens saws 6" to 60" Rip, Cross-cut, Combination, Dado, even planer knives. Easy to operate, accurate—fast—safe. Bevels 45°, Gums, Joints. • You can profit with this machine.

Write for details.

**BURR MFG. CO.**

8933 VENICE BOULEVARD  
LOS ANGELES 34, CALIFORNIA

**EASIER GARDEN and LAWN SPRINKLING**  
with New **WATER BOY ROLLAWAY**  
**HOSE REEL**

Basket reel in basement protects hose from damage or theft, keeps it ready for instant, easy action, winter and summer. No hose to carry, unwind or connect. Keeps your hose out of sight — yet easy to use—easy to put away. For details and low price, write Dept. A.

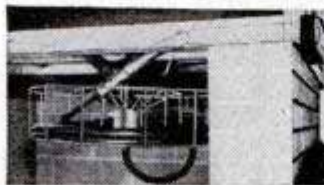

**THE ZIERDEN CO.**

3811 S. KINNICKINNIC AVE. • MILWAUKEE 7, WISCONSIN

**Learn A Trade NOW!**  
**PRACTICAL**  
**SHOP TRAINING!**

**In Our Chicago Shops**

- |   |  |
|---|--|
| <input type="checkbox"/> AUTO MECHANICS   | <input type="checkbox"/> WELDING—ARC and GAS |
| <input type="checkbox"/> DIESEL MECHANICS | <input type="checkbox"/> MACHINIST           |
| <input type="checkbox"/> REFRIGERATION    | <input type="checkbox"/> PIANO TUNING        |
| <input type="checkbox"/> BODY-FENDER      |  |

Above Approved For G. I.'s and Civilians  
One of America's Leading Practical Schools  
7 Floors of Fully Equipped Shops  
Over 48,000 Successful Graduates  
Expert Individual Instruction  
Learn by Doing—Low Living Expense  
Established 1902—Day and Evening Classes

**Also the following Home Study Courses**

- |                                  |  |                                 |
|----------------------------------|--|---------------------------------|
| <input type="checkbox"/> PLASTIC | <input type="checkbox"/> REFRIGERATION | <input type="checkbox"/> DIESEL |
|----------------------------------|--|---------------------------------|

— CALL IN PERSON OR MAIL THIS AD TO —

**GREER SHOP TRAINING**

(Desk 10) 460 South State St., Chicago 5, Ill.

Please send without obligation free information regarding trade checked above. (Specify whether you are a Veteran  or Civilian )

Name \_\_\_\_\_ Age \_\_\_\_\_

Address \_\_\_\_\_

City \_\_\_\_\_ State \_\_\_\_\_

SAY YOU SAW IT IN POPULAR MECHANICS

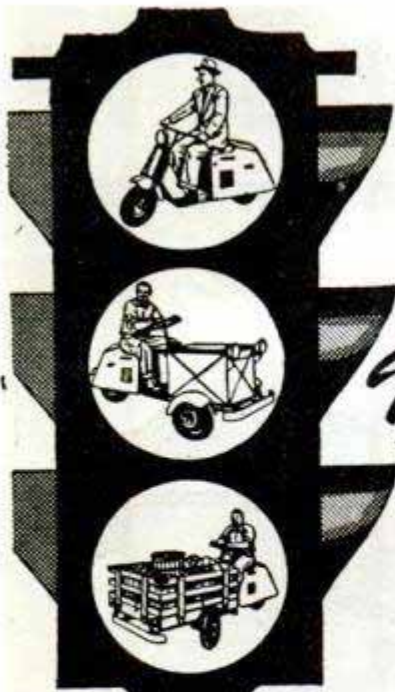

**TRAFFIC TESTED**

and  
*Proved*

**7 TIMES SAFER**

Get up to 75 mi. per gal. You won't be a "Traffic Turtle" with a Cushman Motor Scooter! Get away quickly! Move through traffic with ease and comfort. And parking problems disappear . . . just a few reasons why Cushman is your best buy, your safest investment in low cost transportation. See your dealer for demonstration or write Dept. PM-39

**Cushman** THE PIONEER MOTOR SCOOTER  
**CUSHMAN MOTOR WORKS Inc.**  
LINCOLN NEBRASKA U.S.A.

DEALER INQUIRIES INVITED

**Pick up DOLLARS off the floor!**

Start your own floor finishing business . . . big profits—no overhead—small investment



Yes, YOU can make real money—and put the profits in your own pocket! Now's the time to cash in on new housing and construction. No experience needed. Our booklet instructs you completely in setting up, operating and selling your services. Get started now!

**MAIL TODAY**

**HOLT MANUFACTURING CO.**  
651 20th Street, Oakland 12, Calif.

Gentlemen: I enclose 25¢ in coin or stamps for your complete booklet: "How to Make Money in the Floor Business." I understand there is no further obligation.

NAME \_\_\_\_\_  
ADDRESS \_\_\_\_\_  
CITY \_\_\_\_\_ STATE \_\_\_\_\_

SAY YOU SAW IT IN POPULAR MECHANICS

**GIVES YOU 2 DRILLS IN 1**



Converts any 1/4 inch Electric Drill to 1/2 inch capacity. Reduction gears reduce speed 5 to 1, the average speed of 1/2 inch Drill thereby increasing power.

Jobbers write Price **\$11.95** for proposition

M.O. or check with order

**G. M. CO. MANUFACTURING, INC.**  
1308 43rd Avenue  
Long Island City 1, New York

**WOODWORKERS . . . Get this!**  
CONSTANTINE MASTER MANUAL

Get the Most Fun From Your Hobby

Indispensable to woodworkers. Newest, biggest edition, more pages, more color, helpful how-to-do-it articles, pre-war and new items, more bargains. Send 25¢ today and we will include **FREE! FULL YRS. SUBSCRIPTION** to Chips and Chats, published bi-monthly. Keeps you up-to-date on everything in woodworking, offers big money-saving bargains. Send now.

**ALBERT CONSTANTINE & SON, Inc.**  
791-L East 135th Street, New York 54, N. Y.



Your Dealer Has C-THRU Drawing Supplies

RULERS - TRIANGLES - SLIDE RULES - CURVES - STENCILS - PROTRACTORS - T-SQUARES

**C-THRU Ruler Co.**  
WINDSOR STREET, HARTFORD, CONN., U.S.A.



**OTTAWA Tiller & Mower**

Patents Pending



New Tiller and Mower with 2 H. P. "Red Seal Continental Motor." Two speeds and free wheeling. Does most any kind of mowing. Cuts close to trees and fences. Attachments for soil tilling, etc. Thousands in use. Sold direct to user. Now in our 45th year. FREE details. Low price.

**OTTAWA MFG. CO., 4-927 Lawn Ave., Ottawa, Kansas**

**POWER HACKSAW \$47.25**

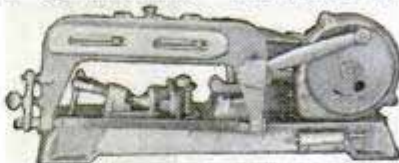

LESS MOTOR  
F. O. B. Benton Harbor

No other saw like it. Rugged cast iron construction. Bronze bearings. Quick action vise—jaws swivel to 45°. Draw cut. Automatic shut-off switch. Capacity 4" x 4".

Send for full details and name of nearest dealer.

**EXCEL MACHINE TOOLS BENTON HARBOR, MICHIGAN**

**REAL DIESEL ENGINE**

**\$2.95**

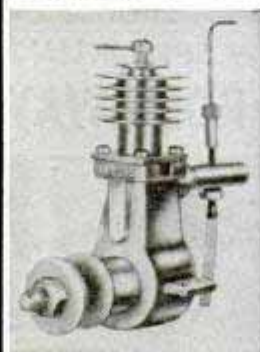

WE'RE CRAZY, they tell us, giving away a real diesel engine, complete with cylinder and piston, carburetor, crankshaft and connecting rod. All parts completely machined, ready for easy assembly. **ONLY \$2.95.** How do we do it? We're selling thousands of **DEEZILS**. So production's up; costs tumble down. **DEEZIL** is a precision engine. Actually runs at 7500 RPM. Produces 1/7 HP. Ideal for planes, boats, midget cars. Send \$2.95 plus 25¢ postage today.

**GOTHAM HOBBY CORP.**

107 East 126th Street New York 35, N. Y. Dept. "P"

# Build This Beautiful "CUBSTER" BODY

Fits Over Our Model "D" Chassis  
(Write for Descriptive Circular)

(Low Cost) **BODY**  
With Our **BODY KIT**



- NO METAL FORMING
  - NO SPECIAL TOOLS
  - BALL BEARING STEEL WHEELS •
- 118" Long  
12"x21 1/2" Ball Bearing Heavy Steel Wheels with Gates 225 lb. Load Semi-Pneumatic Tire, For 1/2" or 5/8" Axles.

Two for Only ..... \$10.50  
Four for Only ..... \$21.00  
25% DEPOSIT ON C.O.D. ORDERS.

ORDER NOW

Add 10% for prepaid Shipment in U.S.A. 32 other sizes and type wheels in stock. Descriptive Circulars and Lists of our products will be mailed promptly if you enclose 10c in your letter.

OSBORN WHEEL CO., 115 So. Main St., Dept. P-4, Doylestown, Penn.

## POWERFUL!

### ECONOMY TRACTOR



Lightweight, Low-priced, Big capacity for all jobs, Ideal for small acreage, Implementation attachments available. Write Dept. M-4

Tractor Features: Adjustable Tread, High Clearance, 7 H.P. Air Cooled Engine, Automatic Clutch, Differential and Transmission.

ENGINEERING PRODUCTS CO. 915 Niagara Court Waukesha, Wis.

## LEATHERCRAFT FOR FUN FOR PROFIT

Make your own Leather Novelties, Belts, Bags, etc., in spare time. A hobby you will love. Complete kits and equipment for tooling, carving and embossing at very low cost. Send 15c for catalog describing tools, leather and instructions. Your 15c refunded on 1st order.

JONAS HANDICRAFT CO. (Dept. M.), 32 Frankford St., New York 7, N. Y.

## URAC "185" NOW AVAILABLE... IN SMALL CONTAINERS



Best bonding agent for gluing structures: furniture, toys, plastic table tops, phenolic and melamine laminates, masonite, ETC. . . . Easy to mix, easy to use. Water Resistant. Rot proof, Stain proof. Fla. \$1.50; Qts. \$2.25; Gal. \$5.50 and 5-gal. \$23.75 including hardener.

Send Payment and Save postage and C.O.D. FEES.

\*TRADE NAME REGISTERED BY AMERICAN CYANAMID CO., MFR.

THE NELSON COMPANY  
IRON MOUNTAIN - MICHIGAN

## BUILD YOUR OWN TRAILER

with NATIONAL'S Easy-to-Read PLANS

Here it is! Your own full size house on wheels . . . or if you prefer, a sleek sports trailer that will add new thrills to your vacation. Easy to read, easy to follow instructions and a complete "cost of materials" with every plan.

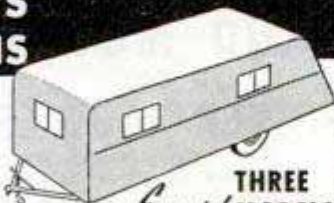

ORDER ALL THREE GET ONE FREE!

Set of 3... \$2

FREE!

Big illustrated parts Catalog with Any Order!

- THREE Smart MODELS
- Model 27 27-foot Luxury Liner, 35' rooms, toilet. Sleeps 6. \$100
  - Model 20 20-foot Cabin Trailer, 5' tops for looks. Sleeps 4. \$70
  - Model 10 Sports Trailer for hunting, fishing, Sleeps 2. \$50

NATIONAL TRAILER STORES

Dept. PM-Box 2353 Terminal Annex • Los Angeles 54, Calif.

# POWER KING SPEED TEAM FOR FINE WOODWORKING



## 12" BAND SAW

Massive, quality construction! 122 lbs. of stability, precision engineered for lasting accuracy. Ball bearings. Cuts to 6 1/4" deep. 14"x14" ground table, tilts 45°.

## BELT and DISC SANDER



10" disc, 4" belt. Sands almost every shape. Spindles run on ball bearings. Table tilts. Belt can also be used in vertical position.

Porch, lawn and household furniture, valances, window boxes, toys, games — the list is almost endless of the ways you can save money with these fast, accurate Power King tools in your workshop.

The Power King band saw gives you unusual capacity for all types of bandsawing. The big belt and disc sander sands any width boards, angles, curves. Both tools are made by Atlas to industrial quality standards. Send coupon or postcard for new 36-page catalog.

NEW FREE CATALOG

MAIL THIS COUPON TODAY

Name \_\_\_\_\_  
Address \_\_\_\_\_  
City, State \_\_\_\_\_



ATLAS PRESS CO.

435 N. Pitcher St., Kalamazoo, Mich.



MATCHED PRECISION TOOLS FOR WOODWORKING AND METALWORKING

**DRILL** SOLID CONCRETE  
COMMON BRICK  
SANDSTONE, ETC.

**1 INCH  
IN 29 SECONDS with  
Hammerin' Hank**

The Sensational New Rotary-Impact Attachment that gives Hammer Action to an ordinary electric drill!

Slip "Hammerin' Hank" into the chuck — turn the switch — WHAM! WHAM! WHAM! — a hammer blow every time the bit turns a half revolution. No need anymore to pass up tough masonry jobs because you don't own a pneumatic! Fits all makes 3/8" or 1/2" chucks; takes 3/8" or 1/2" bits. Bites through super-fast, super-clean with as little as 10 lbs. thrust. A real triumph of invention — amazingly low priced!

**TESTED!**

Drilled an inch in concrete block in 29 seconds!  
Drilled 1000 holes without appreciable loss of speed or dulling of bit.  
Beat "standard" drills 4 to 1 in speed, 100 to 1 in efficiency!  
Actually lengthens bit life immeasurably.

If dealer can't supply, send \$9.95 direct for postpaid rush shipment. Satisfaction guaranteed.

**CRANDALL-YORK, INC., UNION CITY, PENNA.**

**3 Darra-James**  
BASIC HOME SHOP TOOLS

8" TILTING ARBOR SAW  
12" DRILL PRESS  
4 1/2" JOINTER

Three of the World's  
Finest Power Tools  
(NOT a combination!)

All 3 For  
**\$164.50\***

For details write  
DEPT. M-3  
**TOOLKRAFT CORP.**  
WATERBURY 91, CONN.



\*Prices subject to change without notice.

M-3

Name \_\_\_\_\_  
Address \_\_\_\_\_



**ZIPSCOOT \$49.75**

America's Outstanding Scooter Value!  
This smart looking speedster is easily and quickly assembled from our factory finished kits. Uses standard gasoline motor. Speeds up to 30 miles per hour. 100 miles per gallon of gas. Send 25 cents for assembly information, drawings, and illustrations. Kits available for immediate shipment.

Zipscot Company, Toledo 6, Ohio



**STURDY ALL STEEL CABINET**



EACH DRAWER 7 x 12 x 2" DEEP  
Made of 20 gauge paint lock steel genuine Hammeroid exterior finish. Ideal for small parts, tool, or hobby shop. Drawers are drawn from one piece of steel with smooth rounded corners. Price only \$14.85. Send cash, check or M.O. for \$14.85. Postpaid delivery. **SAVE BUY DIRECT FROM MANUFACTURER.**

VENDORLATOR MFG. CO., 4000 Railroad Ave., Fresno, Calif.

**LIQUID MARBLE**

COMPOSITION FLOORS  
FLEXIBLE MOLDS

Mold, Brush, Trowel, Spray It!  
Mold Novelties, Statuary, Art Goods in Flexible Plastic Molds; 5c material makes \$1 seller. Make Marbleized floors, Tile Walls. Colorful, glossy, amazing! Easily learned; start in garage or basement. Particulars free. **MARBLEIZING SERVICE, Dept. 10-F, Edwardsville, Ill.**

**\$4.95 REAL ENGINE VALUE**

A miniature gas engine that really operates.

Thousands of Buzz "B" gasoline engines have been sold at twice the price. Now is your chance to buy a real 1/6 H.P. gas engine for only \$4.95. Turns up over 8,000 r.p.m. For Boats, planes, midget cars, etc. Guaranteed and ready to run. Includes Champion spark plug and tank. Send only \$1.00, engine shipped collect for balance, same day.

WRITE FOR FREE CATALOG OR SEND 10c FOR NEW MAMMOTH ILLUSTRATED CATALOG OF THOUSANDS OF HOBBY ITEMS.

America's Hobby Center, Inc., Dept. B-49, 156 West 22nd St., N. Y. 11

**LUMBER**

A Board or a Carload

TOP GRADE KILN DRIED

BIG NEW 144 PAGE CATALOG

UNEQUALED BARGAINS

WALNUT, MAHOG., CHERRY, MAPLE, WH. HARD AND SOFT, POPLAR, PL-QTR., AROMATIC RED CEDAR

OF HARD TO FIND WOODWORK ITEMS, HARDWARE AND SUPPLIES, the finest craftsmen catalog Harold Hunt ever published—32 rare and fancy woods in natural colors — also in color. 49 matched veneer designs, multi-colored bindings, inlays, overlays, scroll patterns, etc. Only 15c, rebated on first order.

**CRAFTSMAN WOOD SERVICE CO.**  
2729 S. Mary St. Dept. A-4 Chicago 8, Ill.

**BURIED TREASURE, MINERALS  
AMAZING NEW GOLDAK LOCATORS**

**SENSATIONAL NEW MODEL!**  
ONLY 11 pounds weight! One hand operation! Money-Back Guarantee of Superiority. Write for full details.

**THE GOLDAK CO.**  
1542 WEST GLENOAKS BLVD.  
GLENDALE 1, CALIFORNIA

World's largest maker of fine locators.



**Takes Less Than 3 Hours to Convert  
HAND MOWERS  
to  
POWER MOWERS**

Handy-Dandy Lawn Mower Kit fits any hand mower from the 16 to the 20 inch size. Kits furnished separately or with power units.

**Available.**

Kits available for Power Products, Maytag, Lauson, Briggs Stratton, Clinton, other small gas engines or electric motors. In stock 3/4 or 1 1/2 h.p. Lauson engine and 19" heavy duty Pennsylvania Mowers.

**DEALERS WANTED**

**LE CLAIRE MANUFACTURING CO., LE CLAIRE, IOWA**  
DEPT. P.M. 151

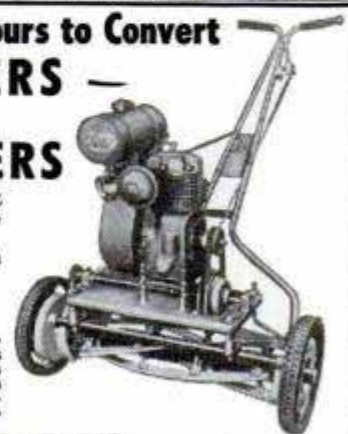



# MAIL ORDER



## HALES FIRE PUMP



For fire depts., factories, forest fire protection, etc. 600 gal. per min. Can be operated with 4 or 6 cylinder gas engine. 4 1/2" intake . . . 2—2" outlets . . . 265 ft. head at 120 lbs. pressure. Passed by National Board of Fire Underwriters.

**\$149.50**  
NEW, Stock #407 . . .

## PLASTIC HOSE

Good for water, oil, air, etc. Will stand 75 lbs. pressure. Available in 100 ft. lengths.

1/2", (your choice)	3/16", (your choice)	1/4", (your choice)	9/16", (your choice)	5/8", (your choice)	per foot..	4c
5/16", (your choice)	3/2", (your choice)	13/8", (your choice)	1", (your choice)	1 1/8", (your choice)	per foot..	8c

### Automatic



## AIR COMPRESSOR

Complete. Piston type with 10 gal. tank, 1/2 HP capacitor type, AC, 110-220 volt 60 cycle motor. V-belt drive. Will develop 75 lb. pressure—approx. 2 cu. ft. Brand new

**\$79.50**  
(Stock #340) . . . only  
**Assemble yourself and save \$10.**  
ABOVE tank with legs and saddle. . . . . **\$11.95**  
AS ABOVE—1/2 HP motor, 2 cyl. Westinghouse compressor. 3 CFM at 75 lbs. . . . . **\$109.50**

### Portable

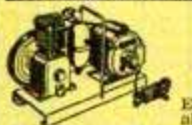

## AIR COMPRESSOR

Electric motor driven, portable spray painting unit for jobs requiring a larger quantity of material. Piston type, single cyl. air compressor has 2" bore by 1 3/4" stroke. 2.86 CFM. Max. working pressure 40 lbs. Mounted on base. Equipped with safety valve & drain cock. 1/2 HP capacitor type motor, 110 volt AC, with cord and plug. 20 ft. air hose and fittings. Ship. wt. 45 lbs. Brand new. (Stock #348) . . . . . only

## Electric Rubber Cable (ALL NEW) CORD SETS



Extension cords, 100 ft. heavy duty. Plug, socket and guard. Number 16 wire. Worth at least \$10.  
OUR PRICE. . . . . **\$5.95**  
(Stock #310)  
Same as above—50 ft. length. (Stock #311) . . . . . **\$4.25**

## HEAVY DUTY ELECTRIC CABLE

3 wire #10 Super Cable, Stock #408  
100 ft. . . . . **\$22.00** 250 ft. . . . . **\$48.00**  
4 conductor neoprene covered #18 stranded tinned copper wire (two blacks & two whites). Run in parallel gives you #16 gauge. Lugs furnished for parallel run. Water & oil resistant. (Stock #346).  
100 ft. 250 ft. 500 ft. 1320 ft. reel  
**\$4.25 \$10.00 \$19.00 \$36.00**

150 ft. reels, 3 wire #6 with 4, 60 amp Crouse & Hines connectors—2 male & 2 female. Perfect for welders, hay loaders, saws, electric ranges, etc. List price **\$6500** \$190. per reel. OUR PRICE. . . . . (Stock #313)



## LARGE WATER TANK

Backyard swimming pool or water storage tank. Made of heavy rubberized fabric, with outlet on bottom. Diameter 12 ft. Height 5 ft. Holds 3000 gal. Complete with cover, stays and guide lines. Cost Gov't. approx. **\$7950** \$350. OUR PRICE. . . . . Due to cost of handling send full amount with order.

# BARGAINS



War Surplus and Other Items



## HORNS and HOWLERS



Motor driven (not a vibrator). Heavy duty with great power and long life. Adjustable for high, medium or low tone. 110 volt AC current. Weather proof. For alarm or signal horn on boats, school yards, factories, etc. List price \$47.00. OUR PRICE, **\$9.45** new. . . . . Stock #302

## BALL BEARING ARBORS



Grinding and saw arbor, has 1/2" double end shaft, 1 1/2" long with 2" center pulley. New Departure double roll ball bearings. Right and left hand thread. Self aligning Dodge pillow block. 10,000 RPM. Bearings alone list at \$10. Complete arbor new. **\$4.95** (Stock #305) . . . . . only  
HI-SPEED GRINDER (not pictured). Has 2 step pulley driven thru rear or base. **\$10.95** (Stock #328) . . . . .

## SPECIALS!

### Power Hand Saw



Electric hand saw, AC-DC, 115 volt, 60 cycles. Speed: 3600 RPM. 6" blade. Automatic safety guard. Base adjustable for depth of cut. Blower clears sawdust. Brand new and packed in steel carrying case. Mfg. by Cummins. **\$68.00** Stock #410. Only . . . . .

## STAINLESS STEEL TABLE TOPS



22" W x 37" L x 3/4" thick. Polished top, bottom dull with hardwood veneer between. Stock #411. **\$2.95** New only . . . . .

## CLUTCH



for motor-scooters, motor-bikes, lawn mowers, etc.

Mercury centrifugal clutch for use with any small gas engine. 3" "A" belt pulley, 3/8" bore. Brand new only. (Stock #400) . . . . . **\$9.95**



## MARINE FLOAT

Made of heavy rubberized fabric. 1/2" rope encircles raft passing through deer rings as handles. Original cost \$525. Can be used as swimming pool, dock, diving raft, etc. Will support 4 tons! Cannot tip. Stock #412

6' W x 20' L. **\$59.50** 6' W x 25' L. **\$69.50**

Due to cost of handling, send full amount with order on this item.



## AC ARMY LIGHT PLANTS

300 Watt, 110-220 volt AC, 60 cycle light plant powered by 1 1/4 HP gas engine, direct drive. Mounted on base. **\$99.50** Stock #409 . . . . .

New 750 watt 110 volt 60 cy. light plant with Briggs-Stratton model AP gas engine. (Stock #315) . . . . . **\$149.50**

New 1000 watt 110 volt 60 cy. light plant with Briggs-Stratton model BP gas engine. (Stock #316) . . . . . **\$179.50**

New 2500 watt 110 volt 60 cy. light plant Briggs-Stratton model Z 6 HP gas engine. Used, like new . . . . . **\$225.00**

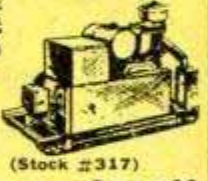

New . . . . . **\$265.00**  
Add \$10 for tools and spare parts.

Rebuilt 5000 watt 110 volt 60 cy. light plant with automatic remote control. Powered by Jeep 4 cyl. gas engine. Rebuilt like new and guaranteed. (Stock #318) . . . . . **\$625.00**

7,500 watt, 110 volt AC light plant powered by VE-4 Waukesha 4 cyl gas engine. Continental or Hollinsworth generator. Remote control starting with 100 ft. starting cable, and 100 ft. of 3 wire #6 cable. Complete switch board. Used, like new and guaranteed. (Stock #347) . . . . . **\$675.00**

Add \$65.00 for transformer to make plant 3 phase 220 volt.  
10,000 watt 110 and 220 volt 60 cy. light plant with automatic remote control. Powered by Jeep 4 cyl. gas engine. Rebuilt like new and guaranteed. (Stock #319) . . . . . **\$900.00**

## PORTABLE DC LIGHT PLANT

3000 watt 110 volt DC powered by new 6 HP Briggs-Stratton model ZEP gas engine. Rebuilt generator. Generator alone lists at \$243.00. Has volt meter, rheostat, 4 female plugs, and ball bearing 2.75 x 10 rubber wheels. Guaranteed. (Stock #320) . . . . . only **\$185.00**

## GENERATORS

AC—750 watt 110 volt 60 cycle with voltmeter, rheostat, 3/4" shaft. Dimensions: 9"H x 12"W x 13"L. Wt. 52 lbs. Shielded to prevent radio interference. Mfg. by Eacor. \$125.00 value. **\$69.50** OUR PRICE, new (Stock #322)



AC 1000 watt — **\$79.50** (Stock #403) . . . . .

DC-300 watt. 12 volt, 2900 RPM. Heavy duty, with current cut-out relay, high and low switch, 30 amp. meter. Can be bought less shaft and base to be used direct mounted to Briggs-Stratton 1 HP engine. NEW (Stock #323) . . . . . **\$7.00**

Complete with base, shaft and bearing. (Stock #324) . . . . . **\$15.95**

## KITCHEN EXHAUST FAN



For kitchens, attics, basements, etc. 8" ball bearing fan Mfg. by Robbins & Meyers. Can be run vertically or horizontally. 110 volt AC 60 cycle motor with plug and cord. New in original box. Stock #401 . . . . . only **\$11.95**

## HALF TON WAGON



Heavy duty wagon with plate aluminum body 24" x 42". Stock #332 Completely assembled **\$42.50**

# ALL ITEMS GUARANTEED AS REPRESENTED C & H ELECTRIC Co.

434 W. JUNEAU AVE. MILWAUKEE 3, WISCONSIN

All prices F.O.B. Milwaukee. 25% deposit required on all C.O.D. orders. No C.O.D.'s under \$10.00. Use stock number when ordering. Many other bargain items not listed—write for our free circulars.

# Time to "Spring-Clean" your Oil filter



**WINTER DRIVING GUMS UP YOUR ENGINE...** dangerously clogs up your oil filter.



**LOOK AT THAT MUCK...** an oil filter element loaded to capacity with sludge, grit.



**TO HELP AVOID COSTLY ENGINE REPAIRS...** install a clean, new "Purolator" Refill.



**TROUBLE-FREE MILES AHEAD...** "Purolator" traps all the abrasives, all the sludge.

Make the Spring changeover complete... new oil and a clean oil filter. Install a new Purolator Micronic Refill. Purolator, remember, is the filter that traps all the engine-wrecking sludge and abrasives.

Purolator Refills fit all oil filters. \$1.38 to \$2.50, depending on make of car; installed in a few minutes. If your car is not equipped with an oil filter, put in a Purolator. \$6.50 up, also depending on make of car.

**Purolator**  
**MICRONIC OIL FILTER**  
... the oil filter that traps all the abrasives, all the sludge.

## Do a Better Job WITH ONE OF THESE EMPIRE LEVELS

**EMPIRE TORPEDO LEVEL**  
Smallest, most handy and accurate Level made. "Cigar-shaped"—no sharp corners to tear pocket. Aluminum stock. Only 3 oz. wgt. 9" long. Has Level, Plumb, 45° Vials.  
No. 26 ..... \$2.00



**ALUMINUM LEVEL — No. 151**  
Cast and Machined, a Beautiful Tool, with Patented, Removable Level and Vial.  
With 2 Plumb, 2 Levels, 2 — 45° Vials. 18"..... \$6.40  
24"..... \$6.80 28"..... \$7.80  
Order **EMPIRE LEVELS** from your local dealer.  
Write direct for literature.

## EMPIRE LEVEL MFG. CO. BOX 97, DEPT. P-251 MILWAUKEE 13, WISCONSIN

## SCREWY-MIX BARGAINS

- 1-Assorted machine screws, sheet metal screws and bolts, sizes 2-56 to 3/8-24, various type heads, 3 LBS. \$1.15-5 LBS. \$1.50.
  - 2-Mixed Steel Rivets 1/16 to 1/4 dia. Flat and Round Heads, Various lengths—five pounds \$1.00.
  - 3-Mixed Aluminum Rivets—50c LB. Mixed Cotter pins 35c LB.
  - 4-Mixed lock and flat washers 30c LB. Mixed Nuts 50c LB.
- Add 5c per LB. for parcelpost on Screwy-mix.

BEARINGS	Bore	O.D.	Type	Price
			Ball	15c
	5/32"	5/8"	Ball	15c
	3/16"	1/2"	Needle	15c
	1/4"	5/8"	Ball	22c
	1/4"	3/4"	Ball	22c
	1"	1 1/4"	Needle	28c
	5/8"	1 3/8"	Ball	40c

Minimum order bearings \$1.00 add 10c postage.

**JAY-CEE SALES CO., 4554 Grand River Ave., Detroit 8, Mich.**

**Chromesides** bring your car UP TO DATE

Dressy chrome plated wheel rims snap on instantly under regular hub caps. Specify make and year. Set of 4 special at...

**WOODWARD & PERRY 1275**  
539 Turk, San Francisco 2

## BARGAIN!

**HIGH SPEED ROTARY FILES**

Set of 5 Assorted	.....	\$ 2.00
" " 10 "	.....	3.75
" " 20 "	.....	7.25
" " 30 "	.....	10.00

1/4" shank



**SID TOOL CO., 183 Grand St., N. Y., N. Y.**

## Power Lawn Mower Bargain of the Year

- Save up to \$80.00 if you act Quickly
- ROTARY POWER MOWER**—New—Nationally Advertised 20" Swath—2 H.P. Engine—Light Weight. Former list price—\$149.50. **\$99.50**  
Our Bargain price.....
  - REEL TYPE POWER MOWER**—Nationally Advertised 20" Swath—1 1/2 H.P. Engine—Fully rebuilt. Former list price—\$159.50. **\$74.95**  
Our Bargain price.....
  - ROTARY ELECTRIC HEDGE TRIMMER**—New. 10" dia. blade—Complete with motor and cord. Former list price—\$24.95. **\$12.95**  
Our Bargain price.....

Limited Quantity—Price subject to prior sales. Terms—25% with order—balance C.O.D. Or inclose check or money order.

**MOW-MASTER SALES**  
BOX 203 KANSAS CITY, MO.



# OWN A FAMOUS MOTO-TOOL

The "Pocket-Size Machine Shop"

**HIGH-SPEED STEEL CUTTERS  
- AT NO EXTRA COST**

No modern home workshop is completely equipped without MOTO-TOOL . . . the correctly balanced motor-in-hand tool. It grinds, drills, routs, carves, polishes . . . without vibration. Higher speed does work better, faster, on practically any material. MOTO-TOOL Kit No. 2 includes high-speed-steel cutters for longer life, better work. MOTO-TOOL is backed by over 12 years of industrial use . . . packs years of pleasure. Due to wide popularity and increased production, Dremel's pre-war prices still prevail!



MOTO-TOOL No. 2  
With Emery Point  
**\$16.50**

**MOTO-TOOL KIT No. 2**  
With 23 Accessories  
(High-Speed Steel Cutters, Grinding Wheels, Polishing Accessories)

**\$23.50**



### NEW DRILL PRESS

This 12" high precision drill press is ideal for model making, wood carving, routing, etc. Utilizes No. 2 Moto-Tool. Only \$9.95 (Less Moto-Tool).



### Look For These Moto-Tool Features

Approximately 27,000 R.P.M. plus dynamically balanced armature provides vibrationless finger-tip control. Moto-Tool has oilless, sealed bearings • Patented automatic chuck lock pin • Over-size armature shaft—hardened, ground, polished • 110 Volt, AC-DC motor • Sliding snap-type switch • Cord protector • Shockproof bakelite housing • Dust-filtered air-cooling system • Weighs only 13 oz.

**MONEY-BACK GUARANTEE:** Buy Dremel Moto-Tools from your dealer. If he cannot supply you, order direct on 5-day trial, money-back guarantee. Shipped postpaid for payment in full (Send check or money order); or, send only \$2 now and pay postman balance plus postage upon delivery. Catalog of Dremel Tools and Accessories FREE.

**DREMEL MFG. CO. • Dept. T119-D • Racine, Wis.**

## THOUSANDS BUILD



# U-MAK-IT BOATS

**START NOW!**

**EASY TO ASSEMBLE KITS**  
NO EXPERIENCE NECESSARY  
Everything Complete in Kit.  
Quality Material. Simple as ABC instructions. Immediate Delivery.  
Save Money, Big Value, Sturdy

**ROWBOATS, KAYAKS, DINGHIES, INBOARDS, OUTBOARDS, RUNABOUTS, CABIN CRUISERS**

SEND 25¢ (COIN) FOR CATALOGS  
Colorful Illustrations show all '49 Models, 8 to 23 Ft., and Construction Details.

**U-MAK-IT PRODUCTS**  
MARINE DIVISION  
Formerly Kayak Boat Co.  
703P- WHITTIER ST., N. Y. 59, N. Y.

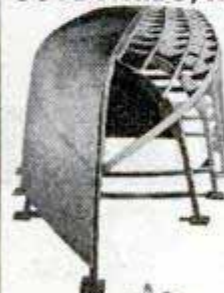

## NEW Electric SANDER



Only  
**\$14.85**  
POSTPAID

### AMAZING Patented MOTO-SANDER AND POLISHER

Say "Good-bye" to Hand Sanding & Polishing! Let speedy "Moto-Sander" do the work while you just guide it. Ideal for light sanding jobs. Use Moto-Sander for finishing, refinishing, redecorating. Quickly and smoothly sands furniture, walls, woodwork, wall board, plaster joints; boats, workshop projects, etc. Straight-line action (non-rotary) will not burn or scratch surface. Use Moto-Sander also for fast, effortless polishing of furniture, refrigerator cabinets, automobiles, other waxed surfaces. There are dozens of time and money-saving uses in every shop and home for this inexpensive machine. Moto-Sander is the lightest, most practical electric sander on the market. Delivers 7,200 strokes a minute . . . works into those hard-to-get-at places . . . weighs only 2 1/2 lbs. Furnished complete with 6 sheets assorted grade Garnet Paper for sanding, plus felt pad and sheepskin for wax polishing. Operates on 110-120 V., 60 cycle A.C. Thousands of satisfied users.



EASY FOR AWKWARD PLACES



SANDS FLAT SURFACES EVENLY



GETS INTO TIGHT CORNERS



ROUNDS CORNERS LIKE MAGIC

### USE MOTO-SANDER AROUND THE HOUSE

- Sand Furniture and Bookcases
- Sand Stairways, Doors, Woodwork
- Sand Walls before painting
- Polish the Family Car
- Polish Pianos and Cedar Chests
- Polish Waxed Furniture

**MONEY-BACK GUARANTEE:** Buy Moto-Sander from your dealer. If he cannot supply you send only \$14.85 (check or money order) and we will ship postpaid; or, send only \$2 now, and pay postman balance plus postage upon delivery. Your MONEY-BACK if not delighted after 5 days' trial.

**DREMEL MANUFACTURING CO.**  
DEPT. SP119-D • RACINE, WIS.



## New IMPROVED Electric MOTO-SAW

ONLY \$5.85  
(with 3 Saw Blades) Postpaid

**SAFE AS A HAND SAW  
JUST GUIDE IT!**

The versatile Moto-Saw is as safe as a hand saw. A touch of the trigger switch sets it going . . . releasing stops it instantly.



**SAWS TO CENTER OF 19" WIDTHS**  
No Limit to Length of Stock it Will Cut  
**THOUSANDS OF SATISFIED USERS**

### AVERAGE CUTTING SPEED ONE FOOT PER MINUTE

Moto-Saw works more like magic than any tool you ever saw! Takes no effort to run . . . no perceptible pressure to feed . . . only a trifle heavier than a hand scroll saw, and better balanced in your hand. Runs 7,200 strokes a minute . . . leaves no rough edges . . . easily cuts intricate scroll designs in medium hard wood up to 3/4" thick. Blade holder faces blade 4 ways . . . permits sawing sideways as well as forward and backward. Sturdily constructed . . . only two moving parts . . . never needs oiling . . . requires no bench room or floor space. Operated on alternating current. Thousands of satisfied users.

**MONEY-BACK GUARANTEE:** Buy Moto-Saw from your dealer. If he cannot supply you, send only \$5.85 for Moto-Saw and 3 blades, postpaid; or, send only \$1.00 now, and pay postman balance plus postage upon delivery. MONEY-BACK if not delighted after 5 days' trial.

**DREMEL MFG. CO. • Dept. S119-D • Racine, Wis.**

# PROFITS AND SPEED

## THE MODERN LAWN MOWER SHARPENER

PRICE  
**\$241.50**  
LESS  
MOTOR

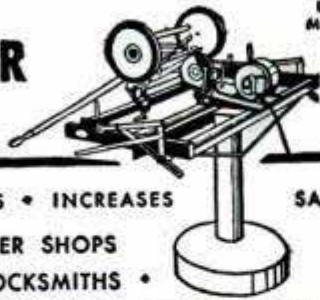

INCREASES PROFITS • INCREASES SALES!  
FOR LAWN MOWER SHOPS  
FIXIT SHOPS • LOCKSMITHS •  
HARDWARE STORES • GOLF COURSES • SCHOOLS  
PARKS • PLAYGROUNDS • INSTITUTIONS •  
CEMETERIES • AND ALERT INDIVIDUALS!

*Sharpens All Reel Type Mowers • Hand, Power or  
Gang • 10 to 20 Minutes • No Dismantling  
No Extra Attachments Needed*

All reel type mowers, from 5-inch edgers to 36-inch power mowers, are quickly sharpened to extreme ends of both left and right twist reel blades. Handle, wheels, roller and motor remain in place when sharpening is in process. Bed knife is sharpened in same brackets that hold mower in grinding position. No extra attachments required. One lever puts mower or bed knife in grinding position. 100% steel construction. Grinding head rides on five ball bearing races. Small, compact, easy to operate. Sharpens wood chisels, joiner knives and planer blades without extra attachments.

**ORDER NOW**  
Immediate Delivery

Skate Sharpener Attachment Available  
Send For Free Bulletin No. 10B

**MODERN MFG. CO.** 160 N. FAIR OAKS AVE.  
PASADENA, CALIFORNIA

## Choice of Professionals...

### WISS

These famous snips easily cut 18 gauge. M3 cuts curves and circles as well as straight... ideal for the home workshop. \$4.25. Rubber grips recommended, 60¢ extra.

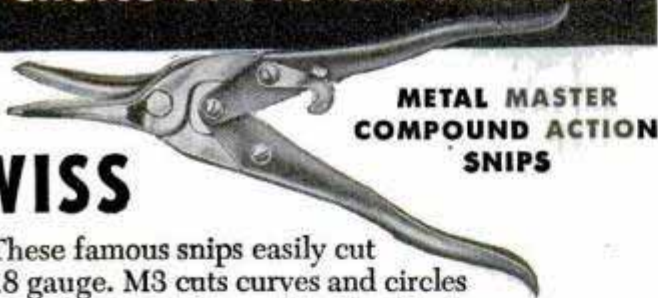

**METAL MASTER  
COMPOUND ACTION  
SNIPS**

### WISS

**HY-POWER PRUNERS**  
#908-8"

Finest pruners you can buy... and easiest cutting. Test before buying. They cut instantly... with less pressure... leave a clean "unchewed" clip. Anvil type blade stays keen and sharp indefinitely. \$2.50.

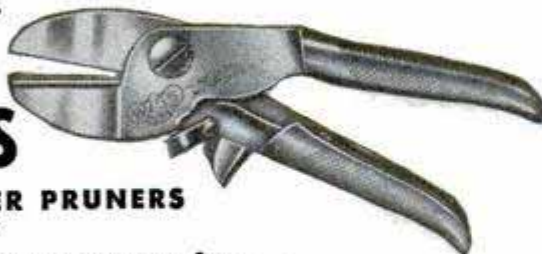

*Prices slightly higher in Denver and west.*

Quality for more than a Century  
**J. WISS & SONS CO.**  
Newark 7, N. J.

See You Saw It in Popular Mechanics

## JONES Model 48 POLISHER 3 TOOLS IN 1

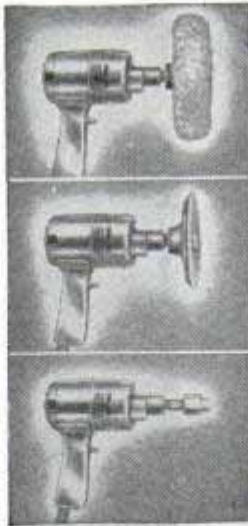

For **POLISHING...SANDING...DRILLING**  
For Simonizing the family car—  
**BUFFING—POLISHING** (furniture),  
metal, wood, plastics, and other  
hard surfaces.  
For **SANDING** woodwork and  
other materials, removing  
paint, etc.  
For **DRILLING** anything—with  
the Jacob's 1/4" chuck attachment.

Write for Bulletin

**JONES MOTROLA CORP.**  
STAMFORD, CONN.

## AMAZING NEW SAFE JIG SAW READY!

At last—a revolutionary, new electric jig saw small children may use, yet powerful enough to be the basic tool in Dad's workshop. Make "Standing Photo Silhouettes" of favorite snap shots... fancy what-nots, toys, for fun and profit! Just plug in! No motor to buy—no oiling. Thousands sold. Use in livingroom, apartments, etc. Patented. Nothing else like it. Mail postal NOW for illustrated, Free Circular, low price!

Dealers Write!

**FREE  
Circular!**



**SYNCR0**

**SYNCR0 CORPORATION, Dept. H-49, Rochester, Mich.**

## RELIABLE LOW COST FOOT-SWITCH



FREE—folder showing uses of Smith-Switch in workshop, office, plant.

Famous Smith-Switch frees both hands for work at machine. Gives instant control of drill press, power saw, etc., etc. Furnished complete with cord and plug. No soldering or wiring. Heavy duty tungsten points, bronze spring. Just \$3.00 postpaid or send \$1.00 for C.O.D. plus fee. (Foreign \$4.00). Money back guar.

*In Calif. include 3 1/2% Sales Tax*

**NATHAN R. SMITH MFG. CO.** 105 D Pasadena Ave.  
South Pasadena, Calif.

## Save Money—Make Money with LARSON Leathercraft

For gifts or for sale—make easy-to-assemble leather items. Complete stock leathers, tools, accessories.

Send ten cents for new catalog of 101 money-making ideas.

**J. C. LARSON CO.** 824 S. Tripp Ave.  
Chicago 24, Illinois

## OUTSIDE WHITE PAINT \$2.65 gal.

made with Titanium—pure Linseed Oil—pure White Lead

**Red Barn Paint \$2.35 gal. Aluminum Paint \$3.45 gal.**

**Factory To You Prices on:** Paint—Varnishes—Enamels—Roof Coatings—Caulking and Glazing Compound—Shellac—Putty.

Write for free price list and color card.

Send check or money order to:

**SCOTT-LEED PAINT & VARNISH CO.**

2948 E. 81st

Cleveland, Ohio

## FORMING WITHOUT DIES

### with DI-ACRO BENDER

Many small parts can be rapidly formed without dies, to accuracy of .001" with DI-ACRO "Die-Less Duplicating" Machines—Benders, Brakes, Shears, Rod Parters, Notchers, Punches. Save die expense and time delay. For experimental work, samples, models, etc., as well as regular production runs. Write for "Die-Less Duplicating" circular.



**O'NEIL-IRWIN MFG. CO.** 341 8th AVE.  
LAKE CITY, MINN.



FROM TROLLING SPEED  
TO FULL THROTTLE  
IN AS LITTLE AS 3 SECONDS\*

NEW *Martin* MOTORS  
acclaimed:

"Best Outboards Ever Built!"

NOW, MORE THAN EVER BEFORE,  
THE NEW STANDARD OF PERFORMANCE

Expect much . . . and get more . . . from amazing MARTIN OUTBOARD MOTORS! Thrill to unexcelled outboard motor performance . . . speed . . . beauty . . . flexibility . . . endurance! Once you MAN-A-MARTIN . . . you'll enjoy outboard motoring at its best. Only MARTIN has mechanically controlled intake poppet valves for perfect fuel control at all speeds . . . full 360 degree power head swivel . . . simplified, synchronized throttle and spark controls . . . streamlined, leak-proof filler cap . . . vertical stern adjustment . . . more horsepower per pound of motor weight . . . plus many other outstanding features. Every MARTIN MOTOR is "Performance Tested" by experts before it leaves the factory, your assurance of highest quality and workmanship. See the entire MARTIN line—3 sizes—at your dealers today!

Write for FREE illustrated booklet on Martin Motors, plus "Tips For Tops In Outboard Motoring". Address: Martin Motors, Dept. PM-496, Eau Claire, Wis.

MARTIN MOTORS are priced from \$119.95



*Martin*  
OUTBOARD  
MOTORS

\*MARTIN  
"60"  
Alternate  
Firing Twin  
7.2 H.P.  
Approx. 44 lbs.,  
Certified at  
4,000 R.P.M.

MARTIN MOTORS, DIVISION, NATIONAL PRESSURE COOKER COMPANY, Eau Claire, Wis.  
Canadian Sales by: Martin Motors,  
Division, National Pressure Cooker Co. (Canada) Ltd., Wallaceburg, Ont.

## SURPLUS BRAND NEW AIR COMPRESSORS

for Garage - Shop - Factory - Farm or Home  
Height 9" - Weight 7 1/2 lbs. Uses 1/4 HP Motor

A sturdy, well built air compressor of steel and die cast metal constructed to give satisfactory and lasting service. 20-30 lbs. continuous pressure. Higher pressure for intermittent service. Formerly sold for \$14.50. (Spray gun and hose also available, write for prices.)

COMPRESSOR CORPORATION OF AMERICA  
St. Joseph, Mich.

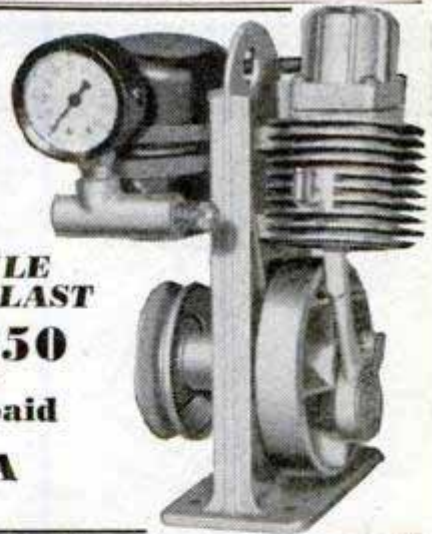

WHILE  
THEY LAST  
\$8.50  
Prepaid

## THE NEW CASCO Electromatic Power-Tool-Kit

SPEEDY MORE THAN  
20,000 R.P.M.  
SMOOTH OPERATION AT  
HIGH SPEED  
STREAMLINED

Chrome plated finger grip—With unbreakable plastic case. For Greater Durability.

The Greatest Value Ever offered in the power Tool Field.  
Operated on AC or DC Current  
**\$14.95**

THE CASCO TOOL with 50 Accessories **\$19.95**

**DIRECT SALES**

921-PM. W. 17th St.  
Kansas City, Mo.



## Hydraulic SPEED REDUCER of many uses Variable Speeds and INSTANT REVERSE

Zero to 600 or 700 R.P.M.

For LATHES, REAMERS, TRANSMISSION, MIDDLET CARS, MILLING MACHINE, TABLE, SHAPER, THREAD MILLING FIXTURES, HOME MADE WOOD WORKING LATHE, EXHAUST FAN, PUMP, HOIST, GENERATOR, OVERHEAD TROLLEY, PRODUCTION BELT, OPENING and CLOSING DOORS, and MANY OTHER USES. Industrial or Home Use. Cost Government \$300.00. High Quality Precision Workmanship. Case measures 7 1/2" Long, 7" High, 6 1/2" Wide. Input and Output Shafts 3/8" diameter. Beautiful Red Chackle Finish Case.

If C.O.D. is requested a 10% Deposit must accompany order and we ship F.O.B. Chicago.

OUTPUT TORQUE ADJUSTMENT ZERO TO 100 INCH POUNDS

FINGER TIP CONTROL

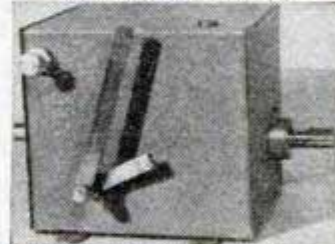

Shipping Wght. 25 pounds

Only **\$54.50** PREPAID  
2 quarts oil included FREE

1 1/2" -8 thread Lathe Chuck Adapter, \$3 extra

DIRZIUS MACHINE SHOP A, 1423-25 So. 52nd Ave., CICERO 50, ILL.

\*\*\*\*\*

# Power YOUR BOAT

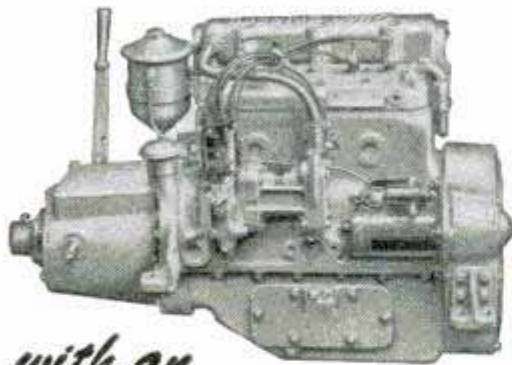

## with an ATLAS "SKIPPER"

There is such a definite relationship between hull and horsepower and boat speed, that you ought to determine just what you want in an engine, before you get too far along with hull plans or construction. Here is a compact 55 H.P. heavy duty gasoline engine, made by one of America's foremost builders of Marine Diesel engines. With direct drive, it weighs under 500 pounds. Its heavy flywheel cushions power impulses and provides that smooth operation that delights every yachtsman. We make this one size and type only, because it is ideal for the requirements of so many sportsmen, fishermen, lake and river boatmen. For pleasure craft or small commercial vessels, investigate "The Skipper." Write for complete specifications and prices.

**ATLAS IMPERIAL DIESEL ENGINE CO.**  
1000 - 19th Ave. Oakland, California, U.S.A.  
Branches in Principal Ports

## UNIVERSAL HAND DRILL



**REACHES SPOTS  
NO OTHER DRILL  
CAN REACH**

Patented adjustable hand drill has chuck that can be positioned at any angle over a range of 270° to permit drilling into close corners by just a twist of a thumb screw. Capacity up to 1/4".

Shipped anywhere in the U.S.A. postpaid

**A  
MARVELOUS  
BUY at  
\$3.00**

NO C.O.D.'s NO STAMPS PLEASE PRINT

Samor Engineering Co., Dept. PM, 37-25 33rd St., Long Island City 1, N. Y.

Enclosed find \$..... Send me..... Universal Hand Drills.

Name.....

Address.....

SAY YOU SAW IT IN POPULAR MECHANICS

**NOW YOU TOO CAN BUILD  
15 RADIOS**

COMPLETE KIT \$14.75



**Absolutely No Knowledge  
of Radio Necessary**

**You Need NO Additional Parts**

**The PROGRESSIVE RADIO KIT**

is THE ONLY COMPLETE KIT. Contains everything you need. Instruction Book, Metal Chassis, Tubes, Condensers, Resistors and all Radio parts.

The 36-Page Book written by Expert Radio

Instructors teaches you to build radios in a Professional Manner.

You start with a 1-tube receiver. Before you are done with this

kit, you will have built 11 Receivers, 1 Public Address System

and 3 Transmitters. **SPECIAL FREE OFFER!**

Electrical and Radio Tester sent absolutely FREE with each Progressive

Radio Kit. PLUS FREE membership in Progressive Radio

Club. Entitles you to free expert advice and consultation service

with licensed radio technicians.

Write for further information, or ORDER your KIT **\$14.75**

Now! ONLY.....

Postage prepaid with check or money order

(Postage not prepaid with C.O.D. orders)

**PROGRESSIVE ELECTRONICS CO., Dept. PM-23**

497 Union Avenue Brooklyn 11, N. Y.

## "THE KEY TO METAL BUMPING"



Complete course in famous Fairmount method of body and fender repair. Step by step procedure from damage analysis to metal finishing. Over 100 illustrations. Send \$1.00 to

**MANZEL, INC., 315 Babcock St., Buffalo 10, N. Y.**

## THE TX-8 GEIGER COUNTER



The latest, lightest and most sensitive device ever developed for locating all radioactive mineral deposits. Simple to operate. Estimates quality and quantity of ore discovered. Write immediately for details and prices...

**OMAHA SCIENTIFIC SUPPLY CO.**  
DEPT. N, 3623 LAKE ST., OMAHA 4, NEBR.

## Your YOUNGSTER WILL LOVE IT!



Give your youngster the joy-ride of a lifetime! TRACTALL looks just like a man-size Tractor. It's the perfect gift for boys, girls, up to 12 years old. Pedal-driven. Sold direct from factory. Write for Literature and FREE trial offer.

INLAND MFG. CORP., Dept. PM-4, 164 Ellcott St., Buffalo 3, N. Y.

## OTTAWA Buzz Master

A faster brush cutter and wood sawing machine. Propels itself while cutting saplings and brush. 7 H-P motor. Many outstanding and exclusive features. Available attachments: sickle bar, rotary tiller, sprayer, air compressor, snow plow and pulley for belt work. Thousands in use. Send for FREE booklet.



**OTTAWA MFG. CO., 1-927 Brush Ave., Ottawa, Kansas**



**OUTBOARDS NOW SOLD  
FACTORY-TO-YOU!**

**SAVE UP TO 37 1/2% ON  
THESE FINE MOTORS**



**\$49.50**

Model A-1 at left weighs only 17 lbs. — 1.7 H. P. — O.B.C. certified. 1949 list price \$79.50. You save \$30. 12 month guarantee. All models reduced up to 10.5 H. P. New sales policy brings you pre-war prices!

**FREE FOLDER  
SHOWING ALL MODELS**

**MUNCIE GEAR WORKS**  
DEPT. M4 MUNCIE, IND  
POPULAR MECHANICS

GET THIS USEFUL . . .

**"Teddy" KIT**

for  
**SANDING!  
POLISHING!  
GRINDING!**

FITS  
ANY  
ELECTRIC  
DRILL

Has over 1000 uses — polishing furniture, autos, etc., waxing, sanding and refinishing wood and metal, smoothing welds, etc.

6" heavy flexible rubber disc, bends into curved surfaces. 6 heavy backed, garnet sanding discs, of ass't grits, superior lambs wool bonnet. Disc and bonnet are attached in a jiffy without cementing. A handy kit to own.

**OTHER KIT SIZES**

3 1/2" . . . . . \$1.50    5" . . . . . \$2.85  
4" . . . . . \$1.75    7" . . . . . \$4.00

**MONEY BACK GUARANTEE**

See your nearest dealer or order direct enclosing check or money order.

**FRED V. FOWLER CO.**

137 FEDERAL ST., BOSTON 14, MASS.



**NOW ONLY  
\$3 25**

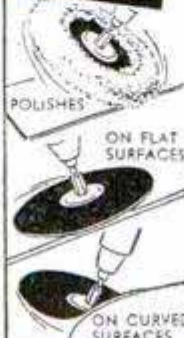

The "New Look" in Masonry is **STREAMLINED**

**\$336<sup>34</sup>**

\*National Average May vary according to locality

**Buys ALL the  
Dunstone for  
the "AMERICANA"**



The "Americana" is 37' x 24', with 936 square feet of area. Yet the average price of the Dunstone to build all-masonry cavity walls is only \$336.34. The same square-foot economy applies to any kind of building — residential, commercial or industrial — of any size or design — anywhere.

**Beauty • Long Life • Safety**

Dunstone has much more than price alone. It has the beauty of streamlined proportioning, and the eye-appeal of a wide color range. It has the endurance and weather-defying qualities of masonry at its best. And it stands for fire-proof, termite-proof construction.

**DUNSTONE** America's Finest Masonry

Dunstone is a super-brick—a full 16" long. Square and true in all dimensions. Reduces mortar joints. Has the symmetry demanded by modern styling. All these values for a lower-than lumber price!

Dunstone's low price is made possible by local manufacturing, using local labor and local materials, in a country-wide chain of local plants. Write for book "Tomorrow's Silhouettes" and name of plant nearest you.

**W. E. DUNN MFG. CO.**

610 W. 24th Street

Holland, Mich.

**You Can Be the Local  
Manufacturer**



The manufacture of Dunstone is an outstanding opportunity for men of vision and alertness looking for a local manufacturing business allied with the great building industry. We supply all plant equipment necessary. Provide you with complete manufacturing data. Back you with liberal sales and advertising assistance. Write for informative book "Blueprints for Profit."

**BUILD YOUR OWN  
POWER LAWN MOWER**

**WHY BREAK YOUR BACK  
MOWING FIELD OR LAWN?**

WRITE  
FOR  
**FREE**  
LITERATURE  
The Rite-Way  
Mower  
Attachment  
Ball Bearing



**SAVE MONEY  
SAVE TIME**  
Now anyone  
can save time  
and effort mowing field or lawn by building  
their own whirl type power mower. Build  
according to your own ideas and needs at small  
cost. Cut close to fences, walks, buildings,  
etc. Build in short time with parts and in-  
structions we furnish. Save hours of time  
and back breaking labor. Write today for  
FREE information.



IT'S FUN TO BUILD

**T & H MFG. CO., Dept. MP3  
811 E. 31, Kan. City 3, Mo.**

**6 in 1  
UTILITY SET  
FOR ONLY \$1.45  
POST PAID**

**Money Refunded If Not Satisfied!**

6 IN 1 UTILITY SET HAS 1000 USES. All four screw drivers fit into the handle to form a handy precision set for all your repairs. Handle rust-proofed, hardened alloy. Screw driver blades hardened steel. Hammer head nickel plated.

EVERYBODY'S FAVORITE. This marvelous utility set is handy in the kitchen. It's easy now to fix things around the house and you will also want one of these utility sets to keep in the glove compartment of the car.

JUNIOR CAN BE HIS OWN MECHANIC. He will learn the value of tools and manual training with his 6 in 1 Utility Set. Get an extra one for Junior, too!

Send check, M. O., or cash with order

**GUARANTEE**—We guarantee the 6 in 1 utility set to be as represented in this ad. If not completely satisfied return to us within ten days for full refund.

**NATION WIDE PRODUCTS CO.  
4432 N. MOZART STREET • CHICAGO 25, ILL.**



**EARN BIG MONEY**  
AND BE YOUR OWN BOSS  
*Sharpening Lawn Mowers*

**Build a Business of Your Own With  
A UNIVERSAL GRINDER**

In your own garage or basement, and earn \$25.00 a day or more. Mr. Hardy writes, "I am doing a fine business with the UNIVERSAL GRINDER. One customer sends another. I spent 40c for a newspaper ad and have done nearly \$500.00 worth of business." Mr. Helmeck of Canada writes, "We sharpened 750 mowers last year and are 1056 on this year's run. The Universal surely makes satisfied customers." Mr. Barton of California says, "The lawn mower business, with the Universal Grinder, has been a gold mine these last two years."



**A Complete Single Unit • No Attachments Necessary**  
• Precision-Built • Simple to Operate • Sharpens Reel Blades at Proper Angle • Grinds a Keen Cutting Edge Full Length of Blade

Only on the UNIVERSAL GRINDER can the inside face and edge of the stationary blade, as well as the reel blades, be ground to proper clearance

**ALL IN ONE SET-UP**

WITHOUT REMOVING ANY BLADE FROM THE MOWER

Write for **FREE Folder today!**

Rogers Mfg. Co., Dept. M-49, Lindsey, Ohio

**ACCURATE and TOUGH is the MASTER**

**TUFBOY! BUY ONE NOW!**

Mechanics and craftsmen will welcome the Master Tufboy's accuracy and rugged construction. Its blade, of the finest tempered spring steel, has clearly etched graduations and its case is made of the toughest chrome-plated zinc alloy which will withstand the roughest kind of treatment. You will find the Master Tufboy at your local hardware or building supply dealer or if you prefer, use the coupon below.

**MASTER**

REG. U.S. PAT. OFF.

WOOD AND STEEL TAPE RULES

PM-4

Master Rule Mfg. Co., Inc.  
201 Main Street, White Plains, N. Y.

Gentlemen:  
I enclose  \$1.35 for the 6 ft. Tufboy  
I enclose  \$1.65 for the 8 ft. Tufboy

Name.....  
Address.....  
City.....State.....

**\$11 WAR SURPLUS SAVING**

**20 PIECE 1/2" DRIVE SOCKET SET** **\$8.99** PREPAID  
Regular \$20.00 Set For..

- Universal Socket
- Speed Handle
- Break-Over & 10" extension

Order COD, or save postage and COD charges by mailing check, cash or M.O. No stamps please.  
Write for free catalogue today.

**E. J. BUCHANAN, Distributor**  
2016 S. QUANNAH TULSA, OKLA.

**PLYWOOD BOAT KITS**  
**\$67.50**  
(Freight included)

Build the 12 ft. V-Bottom "Sportsman" as shown. Ready-cut kits include all hardware, paint, etc. Send for free folder on all models as low as \$29.95, freight included.

**TAFT MARINE WOODCRAFT**  
Dept. "R," 636 39th Ave. N.E. Minneapolis 21, Minn.

**ALASKA WONDERLAND**  
"Guide to Alaska," 208 pages, color illustrated, tells of this booming country. Interesting information on principal cities, climate, transportation, industries, wild life, opportunities, etc. Price \$1.50 Post Paid-\$1.64 in California. Send M.O. or check—C.O.D.'s accepted.  
**K & K PUBLICATIONS** 4854 LANKERSHIM BLVD. - DEPT. M NORTH HOLLYWOOD, CALIFORNIA

**BARGAINS!**  
Newest Hohner accordions, also slightly used models at savings of \$100 or more. Limited stock, so write today for catalog M. Harmonicas, too.  
**JORGENSEN BROTHERS**  
RACINE, WISCONSIN

**GENUINE DIAMOND SCRIBER!**

Writes on glass, metals, plastics. Hex. Aluminum 6". Money back guarantee. Agent inquiries invited.  
**\$2.00** Postpaid  
**CLIPPER DIAMOND TOOL CO., INC.** 21-B W. 46 ST., N. Y. 19

**OIL TANKS GASOLINE**

525 Gal. round 42" x 86", 12 gauge, 3 opening. F.O.B. South Bend, Ind. ....	\$7000
1065 Gal. over or under ground, 12 gauge, 3 opening 46" x 148". F.O.B. South Bend, Ind. ....	\$11000
275 Gal. oval 14 gauge, basement, 26" x 46" x 60" with leg lugs. F.O.B., K. C., Mo., or Tulsa, Okla. ....	\$4250
275 Gal. farm tank, standard openings, oval. F.O.B., K. C., Mo., or Tulsa, Okla. ....	\$4250
275 Gal. farm tank standard openings, complete with 6 ft. stand, hose nozzle, gauge, valves, etc. F.O.B., Tulsa, Okla. ....	\$8000
300 Gal. farm Tank 14 gauge round. F.O.B., Tulsa, Okla. ....	\$4500
300 Gal. farm Tank 14 gauge complete with stand hose, nozzle valves, gauge, etc. F.O.B., Warren, Ohio. ....	\$9000
300 Gal. Septic Tanks 14 gauge. F.O.B., K. C., Mo. ....	\$6000
500 Gal. Septic Tanks 14 gauge. F.O.B., K. C., Mo. ....	\$7000

Deposit or payment in full with order.

**DIRECT SALES** 921-PM- W. 17th ST. KANSAS CITY, MO.  
POPULAR MECHANICS

# WAR Surplus

## AND OTHER Startling BARGAINS.

**BRAND NEW**  
**Khaki SUN TAN SHIRTS & PANTS**  
 BRAND NEW! Pants made of 1/2 oz. and shirts of 6 oz. mercerized khaki santon (well) materials. Well tailored. Add 10¢ per garment postage.

**SHIRTS 26<sup>9</sup> PANTS 34<sup>4</sup>**  
 14 to 17 29 to 42

### SENSATIONAL VALUE!



**Aviator style SUN GLASSES**  
 Precision made 34 K GOLD PLATED METAL FRAME. 4 base curve. Ophthalmic ground. Pearl lens. SHUTS OUT 90% OF THE ULTRA VIOLET RAY. We sold them at \$5.00. Add 10¢ postage and handling.

**233**

### 50 FT. HANK NYLON

**59¢ PARACHUTE CORD**

New, 1/2 inch diameter. Ideal for clothes lines and venetian blind and drapery cords. 550 lbs. tensile strength. Add 2¢ postage.

### O.D. wool serge SHIRTS-PANTS

Used but in excellent condition, perfect. They have been designated for RE-ISSUE BY THE GOV'T. Pure wool serge. Less than the price of the cheapest overall. Add 8¢ per garment for postage.

**SHIRTS 25<sup>9</sup> PANTS 27<sup>9</sup>**  
 13 to 15 27 to 33

### NAVY STYLE T-SHIRTS



Brand new. Size: small, medium and large. White only. Fine long staple combed cotton yarn. Add 2¢ per garment postage.

**55¢**

### 50% Wool SOCKS

Men's med. light-weight. Khaki and natural colors. Excellent value. Add 2¢ post. per garment.

**39c 10 PR. \$3.80**

### Surplus DUST MASKS

**33¢**

Brand new. For paint or insect spraying. For millers and farmers. Perfect dust protection. Add 5¢ postage.

**SEND FOR FREE**

### U.S. NAVY WORK JACKETS

3 Heavy Suspenders  
 Four Pockets  
 Good Work

**169**

Made of 8 oz. green herringbone twill. Tailored to Navy specifications. Ideal utility and work jackets. Add 10¢ per garment postage.

### WAR Surplus CIRCULAR

OVER 150 OUTSTANDING WAR SURPLUS BARGAINS—also many other special offers.

### Greatest Watch Value!

in U.S.A!  
**17-JEWEL Military Style**



Think of it! Here is a genuine 17-jewel wrist watch with a GUARANTEED SWISS MOVEMENT. WATER & DUST REPELLANT. SHOCKPROOF. ANTI-MAGNETIC. RADJUM DIAL and SWEEP SECOND HAND. Set in a genuine stainless steel case with a fine leather strap. Save at least \$15.00. If you don't think this the greatest value in the U.S., return it for refund.

**1995 PLUS 10% FED. TAX**

### ARMY STYLE 688 COMBAT BOOTS



NEW. For sportsmen and outdoor wear. 10" high. Reversed uppers, full oak leather sole, with composition outer sole. Add 27¢ post.

**6 TO 12**

### NAVY STYLE FIELD SHOES



Rugged and comfortable. Reversed uppers. Full oak leather sole, composition outer sole. Sizes 6 to 12. E & EE. Add 22¢ post.

**499**

GT012

### OFFICER STYLE OXFORDS



Best quality uppers. Good-wear welt. Top grade oak leather sole. Sizes 6 to 12. O & E. Add 20¢ post.

**695**

\*BROWN \*BLACK

### O. D. WOOL MUMMY TYPE SLEEPING BAGS

BRAND NEW. Made of fine quality water-repellent poplin material. Unlined, full zipper front, 2 slash pockets. WORTH TWICE OUR PRICE. Add 10¢ postage.

**299**

Now only

**3.88**

### DOWN and FEATHER FILLED MUMMY TYPE SLEEPING BAGS

BRAND NEW. Water repellent poplin outside. Complete with carrying bag. Down and chicken feather filled. Full size. Add 35¢ post.

**13.99**

### WOOL LINED KHAKI PANTS \$2.88

Used, perfect. Regular \$12.00 value. Khaki (chize) outside, all wool kersey lining. Sizes 28 to 34. Add 15¢ post.

### 63% WOOL CUSHION FOOT SOX

Ideal for outdoor wear, gym sox, etc. Khaki and white. Exceptional value. Add 3¢ post.

**49c 10 PR. \$4.80**

### ORDER BY MAIL

Please send remittance with order. Add postage. Absolute satisfaction or your money back.

**Send today!**

## SIoux FALLS SURPLUS STORE

SIoux FALLS, S. D.

# ALL STEEL MULTI DRAWERS for the HOME WORKSHOP

**TWO SIZES • LOW PRICE**

**M1010** (small drawer unit)—5" front to back, 2 3/4" wide, 2 1/4" deep—40¢ each. Accommodates 3 drawer dividers—2 for 5¢—Part No. M1011.

**M1212** (large drawer unit)—11 1/8" front to back, 3 1/2" wide, 3" deep—\$1.29 each. Accommodates 5 drawer dividers—5¢ each—Part No. M1213.

The kind of cabinet you have always wanted, now available through radio shops, hardware stores, automotive supply stores or for name of nearest supplier write direct to

**MULTI DRAWER**

## THE CININNATI VENTILATING CO.

INCORPORATED  
 COVINGTON, KENTUCKY

## GOVT. COST \$87.25

# JAEGER CHRONOMETRIC TACHOMETER

U. S. NAVY SURPLUS — ACCURACY — PRECISION — GUARANTEED

For PRECISION timing of all rotating mechanisms. Incomparable GUARANTEED ACCURACY of 1/10 of 1%. An RPM counter and surface speed indicator combined with chronometric operation which AUTOMATICALLY computes period of test in EXACTLY 6 SECONDS. No stop watch or personal equation necessary. UNSURPASSED for cameras, projectors, generators, motors, sanders, turbines, saws, shafts, looms, fans, lathes, etc. Packed in plush-lined, simulated leather case. UNCONDITIONALLY GUARANTEED subject to your inspection and approval. Manufactured by JAEGER and TOTCO, leaders in field of exacting measuring devices.

**NOW \$19.75**

**All prices F.O.B. No. Hollywood — 20% deposit with C.O.D.**

### 115 V REVERSIBLE DIEHL MOTOR



3450 RPM — 60 cycle — 1/40 HP—Single or 3 phase (specify choice), balanced bearings, cost Govt. \$41.50.

**\$6.95**

### 56 TO 1 PRECISION GEAR BOX



Manufactured by Western Gear Works. Spline shafts. Terrific torque. U.S. Navy Surplus. Brand new. Cost Govt. \$125.00.

**\$4.95**

## Semlers' ASSOCIATED SURPLUS CO.

10838 VENTURA BOULEVARD • NO. HOLLYWOOD, CALIF.

# Mow 'Em Down with PRONTO POWER LAWN MOWER

Give your lawn the new  
look with Pronto

After 4 years production a proven, well engineered, original, safe, lifetime, quick action, easy handling, economical, most simple and practical of all power lawn mowers.

Pronto first with quiet enclosed spiral gear 4 ball bearing drive. No troublesome belts, pulleys, chains, sprockets, friction wheels or inefficient cutter revolving at engine speed.

Four 10 inch ball bearing (sealed) rubber tired wheels.

Pronto design 20 inch blade whirling type with removable safety type manganese steel cutter tips (new set postpaid \$1.00).

Cutter arm readily adjustable any height from ground to suit operator, and will cut grass as close as any mower. Pronto cutter assembly has highest cutter torque for horse power of any mower known, and up to three times more cutting power at blade than other mowers.

Pronto base is cast of light strong Aircraft metal. Axles extend entirely through base for strength. Steel handles are adjustable for height and position.

Our long experience and know how in the whirling blade mower field qualifies us to offer the Pronto as a satisfactory mower, proved by hundreds of satisfied users for every type and condition of grass as well as weeds, long and short, light and heavy, also uneven, rough and terraced lawns. Cutter blade trims to within 1/2 inch of any desired object, therefore ideal for cutting around trees, shrubbery, walks, fences, etc.

Briggs and Stratton or Clinton 4 cycle gasoline Engines are used on the Pronto mower as both Engines are well known for their reliability and easy starting, as well as nation wide service facilities.

**COMPLETE MOWER \$89.50**

MOWER LESS ENGINE, OTHERWISE COMPLETE..... **\$54.50**



## GEAR DRIVE CUTTER ASSEMBLY

For those who desire to construct their own mower, or want a replacement cutter assembly, we furnish the complete gear driven cutter assembly as used on Pronto mowers, with flexible connection to Engine shaft, (give diameter of Engine shaft when ordering) and 20 inch blade with safety cutter tips complete as shown for..... **\$22.50**

All prices FOB factory, check or money order in full with order, no COD's, all orders filled in rotation as received by us. We have one price to all, and no dealers or agents.

**PRONTO MOWERS  
OLDSMAR, FLORIDA**

## SAVE MONEY · BUILD YOUR OWN

Swing-Up Garage Door or  
Complete Garage and Tool House



Easi-Bild\* Patterns are easy to use

Anyone can build this attractive one-car garage and tool house or make a modern one-piece door. No special tools or skill required. It's easy to build and easy to install with Stanley Swing-Up Garage Door Equipment. You'll be amazed to see how this door operates. Just turn the handle and watch it float upwards as easily as a feather in a breeze.

Easi-Bild Patterns take all the mystery out of building—provide complete list of materials needed, step-by-step direction. Garage measures 13 x 20 ft. Doors can be built using pattern No. 86, 8 ft. x 7 ft. or up to 16 ft. wide.

Save Money Have Fun Build it Yourself!



Send for your Easi-Bild Patterns now:

Easi-Bild Pattern Co., Dept. PM, Pleasantville, N. Y.

Enclosed is \$..... for the following Easi-Bild Patterns:

- ( ) No. 86 Swing-Up Garage Door  
( ) No. 113 Garage & Tool House

Name.....

Address.....

City..... Zone..... State.....

\*Copyright 1949, Easi-Bild Pattern Company



**NEW  
FREE  
FISHING  
CATALOG**

Now Ready - Write  
Today For Your Copy!

HUNDREDS OF VALUES LIKE THESE:

- \$2.50 Thrifty Level Wind Casting Reel.....\$1.89**  
**\$1.85 Jointed Cane Pole, brass ferrules, 3-pc. 12' \$1.39**  
**\$1.35 Nylon Casting Line. 15 lb. test. 50 yd......85**  
**\$1.55 Nylon Casting Line. 20 lb. test. 50 yd.....\$1.00**

Order these items—cash or C. O. D.

**GATEWAY SPORTING GOODS CO.  
1319 Main St. Kansas City 6, Mo.**

## HOW TO CUT RAFTERS

New vest pocket book gives lengths, side cuts, plumb cuts, deductions. For all rafters for any building from one inch to forty feet wide. Gives numbers to cut on square. Also degrees for same cuts for Radial Saws. All standard pitches from 1/4 to 3/4. Just open book to pitch page and there are your lengths, side cuts, etc. Anyone who knows what a jack rafter is can frame a roof if he has this great book. Price \$1.50 prepaid. Builders' Topics, Dept. M, Lock Box 828, Seattle, Washington. CARPENTERS, PLUMBERS, PLASTERERS, ELECTRICIANS, ETC., subscribe for Builders' Topics, the monthly magazine for HE-MAN CONSTRUCTION WORKERS. Only \$2.00 per year. Sample copies 25c.

DESK MODEL

TELEPHONES

WALL MODEL



**\$17.95 for 2** OF EITHER MODEL

Telephones are complete with power, wire, hook-up instructions etc. Any number of telephones can be connected in circuit. Common talking, common ringing. Simple installation, absolutely no technical knowledge required. 25% deposit with order, balance C.O.D., F.O.B. Brooklyn, FREE: Fine Descriptive Folder.



Eastern Telephone Co., Dept. PR-2, 320 18th St., Brooklyn 15, N. Y. 50th 8-5161

## STANDARD GARDEN AND SMALL FARM TRACTORS

Plow  
Seed  
Cultivate  
Mow Hay  
and Lawns

Powerful Gas Tractors for Small Farms, Gardeners, Florists, Nurseries, Fruit Growers, Poultrymen.

**1 & 2 Cylinders**

High Wheels, Rubber or Steel Tires, Walk or Ride.

Do Belt Work — Free Catalog

**STANDARD ENGINE CO.  
MINNEAPOLIS, MINN.  
3221 Como Avenue**



**NEW YORK, N. Y.  
517 West 26th Street**

## FREE CATALOG! Electric motors and AIR COMPRESSORS at Wholesale Prices

MASTERAIRE COMPRESSOR CO. 3 Hamilton St., Newark 2, N. J.



**Shoot anywhere with a  
CROSMAN**

With your Crosman you do more shooting. Crosman controllable power gives you America's most versatile gun... for light game hunting and indoor or outdoor target shooting... at short or long range. Perfect for range in cellar or garage. No noise, No flash or recoil. No powder reek. No license required. Many models in rifles and pistols. .177 and .22 caliber. Low cost ammunition. At hardware and sporting goods dealers. Send for illustrated literature.

**CROSMAN ARMS COMPANY, INC.  
3 HENRIETTA STREET · ROCHESTER 7, NEW YORK**

# A TOOLSHOP IN YOUR HAND



**There's Only One Genuine Handee**  
First tool of its kind—today's finest. Smooth, steady power at your fingertips. Easy to handle. Make ship, plane and train models, bookends, costume jewelry. Grinds, drills, polishes, routs, carves, sands, saws, engraves on metal, wood, plastic, glass, leather, etc. 25,000 r.p.m. AC or DC. Wt. 12 oz. With 7 accessories \$20.50. In case with 40 accessories \$27.50. At stores or sent postpaid. A fine gift for a friend or yourself. CHICAGO WHEEL & MFG. CO., 1101 W. Monroe St., Dept. PM, Chicago 7, Ill. Free 52-page manual.

**HANDEE TOOL OF 1001 USES**

## "SIG-NA-LITE" FOR CARS WITH OVERDRIVE

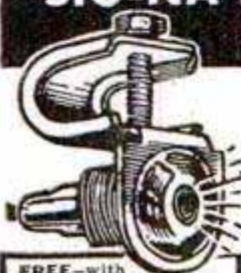

**FITS ALL CARS FROM 1940 THRU 1949**

With SIG-NA-LITE you get utmost benefit from your overdrive. **AUTOMATICALLY FLASHES GREEN LIGHT THE INSTANT CAR IS READY FOR OVERDRIVE.** Eliminates guesswork or forgetting. Saves gas and oil. Reduces engine wear. Anyone can install in 5 minutes. Beautifies dash. Chrome finished with green jewel. Complete with fittings and instructions. Send check or Money Order to

**\$2** Post Paid In USA

**C. D. HILL PRODUCTS, Dept. PM4  
5227 Parker Ave., Chicago 39, Ill.**

FREE—with SIG-NA-LITE, Folder on "How to Get the Most From Your Overdrive"

does your car  
*faint* in traffic?

**REPLACE YOUR TIRED OLD FUEL PUMP**

with a

**STEWART-WARNER**

*Electric*

**FUEL PUMP!**



**Save yourself** the trouble, embarrassment and expense of a car that won't start instantly, stalls in traffic or sputters and dies at every stop. Stewart-Warner's *Electric Fuel Pump* feeds a steady, even flow of fuel to your engine the second you turn on the ignition!

**Save your battery** with quick starts in any weather! Cut troublesome vapor lock and dangerous fuel pump failures, too! This sturdy, dependable *Electric Fuel Pump* can be quickly installed on any make of car or truck, in single or double units.

Your local Ignition and Carburetor Shop or Service Garage can replace your old mechanical fuel pump. Write for free illustrated booklet.

**STEWART-WARNER CORPORATION**  
1801 Diversey Parkway • Chicago 14, Illinois

IMMEDIATE DELIVERY



Dealer Inquiries Invited

EASY TERMS

**FASTER IN TRAFFIC THAN A CAR**

at a fraction of the cost!

**AUTOMOTIVE**

**SALSBURY**

**SEE AND DRIVE THE MOST COMPLETELY  
AUTOMATIC VEHICLE EVER BUILT**

Write for free folder and dealer's name

**SALSBURY MOTORS, Dept. PM4**

Division of Wayne Manufacturing Company  
Pomona, California

WRITE FOR YOUR **FREE** COPY OF THE NEW  
**KRW HYDRAULIC PRESS BOOK**

Describes all manner of Production and Shop Work on KRW Hydraulic and Bench Type Presses. 32 pages illustrating the new KRW Hand-operated, Electric-operated and Air-operated Hydraulic Presses. 25 to 100-ton capacities.

Write for your copy today.



**K. R. WILSON, DEPT. 17, 215 MAIN ST., BUFFALO 3, N. Y.**

WE FURNISH ALL MACHINED METAL PARTS, EVERY SCREW, NUT, BOLT, WASHER, AND COMPLETE PLANS FOR THIS...

## BIG 10" POWER SAW



**\$9.95**  
LESS GUARD AND WOOD

POST PAID ANYWHERE IN U.S.A.



FULL \$9.95 REFUND IF NOT SATISFIED WITHIN 10 DAYS

ASSEMBLE IT YOURSELF WITH SIMPLE HOUSEHOLD TOOLS!

TABLE 24" x 20" • TILTS TO 45°  
CUTS 0" TO 3/4" DEEP • TAKES 10" BLADE

COMPLETE PLANS (WITHOUT PARTS) 10c

AMERICAN MACHINE & TOOL CO., Inc.

DEPT. 44, ROYERSFORD, PA.

## STOP SANDING BY HAND! use the new SAND-O-FLEX on curved and irregular surfaces

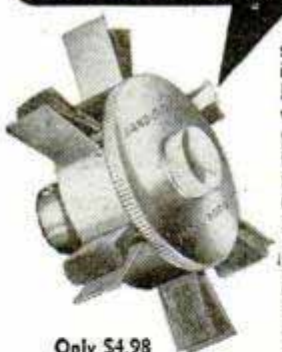

Use Sand-O-Flex on contoured and flat surfaces alike. This low-cost sander reaches into recesses, around intricate curves, and handles all those tedious finishing jobs that were formerly done only by hand. Fasten it to your motor shaft or any of your present stationary or portable power tools. The ideal sander for a hundred home uses. Finishes any material—woods, metals, compositions. Satin finishes stainless steel!

Sand-O-Flex consists of 6 abrasive strips backed by 6 separate brushes in a light-weight aluminum body. When rotated at usual motor speed the brushes "cushion" the abrasive cloth and mold it to the work shape. Abrasive unwinds as ends are worn. All parts are replaceable. Refill abrasive cartridges 3/4" wide, available in coarse, medium and fine for wood and metalworking. Fits 1/2" or 5/8" shafts. Adapters furnished on request.

Only \$4.98  
The most versatile sander ever made!  
Money-Back Guarantee

Use it on a



PORTABLE DRILL

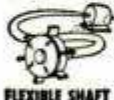

FLEXIBLE SHAFT



DRILL PRESS

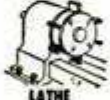

LATHE



MOTOR SHAFT

Over a quarter million Sand-O-Flex wheels are in use today! Imagine! Only \$4.98 fully assembled, complete with one refill cartridge. Instruction sheet included. Attractively boxed. Fully guaranteed. If not more than satisfied, return within 30 days and your money will be promptly refunded. Enclose check or money order with coupon, below, or send \$1 deposit and pay balance on delivery. State shaft size. MAIL COUPON TODAY!

L. P. ENTERPRISES, DEPT. P-1, 424 S. BEVERLY DR., BEVERLY HILLS, CALIF.

Enclosed \$4.98 for Sand-O-Flex, postpaid.

Enclosed \$1.00, send Sand-O-Flex C.O.D. plus postage.

For 1/2" Shaft  
 For 5/8" Shaft

(PRINT NAME AND ADDRESS PLAINLY IN MARGIN)

## LAWN MOWER SHARPENER



Lawn mower sharpening at low cost!

**\$42.50**

less motor.

turn spare time into dollars

Order direct from  
**QUAD CITY PRODUCTS**  
Company, Inc.

Box 42, Rock Island, Ill.



## JIG SAW ATTACHMENT

Fits Any Drill Press!

Heavy duty tool is precision built with bronze and ball bearings. Hermetically sealed. Not a toy. Cuts plastic, light metals or wood up to 2" Rips to any length.

NO MOTOR TO BUY!

**NOW ONLY \$12.50**

Shipped prepaid. Send check, money order or C.O.D.

Dealers Write for Circular

LA MONTE • BOX 61, BELFLOWER, CALIF.

## RACING CAR EQUIPMENT FOR ALL CARS!

Engines, Racing Heads, Manifolds, Carburetors, Mufflers, etc. Speed Instructions and literature \$1.00—refunded first order.

LEE MOTORCRAFT CO.

1412 Great Northern Bldg.

Chicago, Ill.

## Superette Dual Vacuum Auto Horns

The Voice of Authority on The Highway



One blast and those "road hogs" really move over. Superette Horns compare favorably to air horns costing \$75 to \$100. Can

be installed under hood or on front fender. Beautiful lacquer finish. Operates from intake manifold of your car. No tank needed. Cost is only \$8.95 complete with all necessary fittings, control valve and simple installation instructions. Send check or money order today or order C.O.D. • • Adds much to your car.

THE PROTECTUROD COMPANY, Dept. 353  
4033 Windsor Road, Youngstown 7, Ohio



## ORR MAGIC ARC IRRIGATOR

Adjustable, oscillating type sprinkler with adjustable spray. Covers complete area up to 40 ft. radius, 80 ft. diameter at normal water pressure. Can be permanent installation or portable. No springs, nothing to corrode or clog. Guaranteed. Full instructions with each unit ordered. \$6.00 prepaid. C.O.D. You pay postage.

APEX MFG. LABORATORIES

P. O. BOX 283

SO. PASADENA, CALIF.

## Build Your Own BICYCLE TRAILER or UTILITY CART



Enjoy camping trips, make extra money running errands. Will carry up to 200 pounds. Handy cart around home. Change bicycle hitch to cart handle in second. Kit of complete parts, including special hitch to bicycle with body and tongue metal parts already shaped.

COMPLETE PARTS for only \$7.95

FOR UTILITY CART HANDLE with easy attachable joint, \$1.85 add

Full instructions how to build. Easy and enjoyable. If not completely satisfied return in five days for refund. You pay return post charges. Send cash or money order to Dept. T-4 or write for free literature.

WHIPPLE MFG. CO., Inc.

SPIRIT LAKE, IOWA



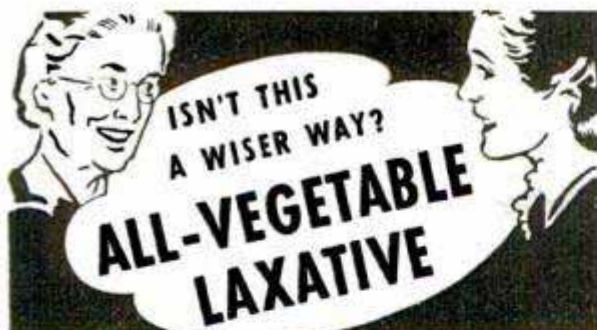

**NATURE'S REMEDY (NR) TABLETS**  
 —A purely vegetable laxative to relieve constipation without the usual griping, sickening, perturbing sensations, and does not cause a rash. Try NR—you will see the difference. Uncoated or candy coated—their action is dependable, thorough, yet gentle as millions of NR's have proved. Get a 25c box and use as directed.

**Nature's Remedy**  
**NR TO-NIGHT** TOMORROW ALRIGHT

**FUSSY STOMACH?**  
 RELIEF FOR ACID  
 INDIGESTION,  
 GAS AND  
 HEARTBURN



**LATHE CUTTER BIT GRINDING GAUGE**  
 For checking clearance and rake angles.  
**50c** SOUTH BEND LATHE WORKS  
 postpaid 455H E. MADISON ST., SOUTH BEND 22, IND.



**NOW ANY CAR CAN HAVE THE LUXURY APPEARANCE THAT TURBO TUBES PROVIDE . . . EASILY INSTALLED . . . RUST-PROOF**

Be the first in your neighborhood to display this sporty equipment on your car—it's going to be all the rage this year! Made to original equipment specifications, these beautiful Turbo Tubes are brass with copper, nickel and chrome applied—they won't rust! Black baked enamel center plates attach them easily to any curved surface. Money-back guarantee.



**SEND \$3.95 TODAY FOR SET OF 6 TURBO TUBES SENT POSTPAID IN U.S.A.**

Send check or money order. Sorry, no C.O.D.'s. The gleaming beauty of our Turbo Tubes is shown in actual illustration at left. Easily installed on any car.

**LEA ASSOCIATES, 1061 Covington Drive, Detroit 4, Mich.**

**new low-priced electric paint sprayer**



Only **\$12.95** Complete



**BURGESS vibro-sprayer**  
 Pat. Applied For  
 Just Plug Into Any 110 Volt A.C. Socket and Spray

for utility painting of tables—chairs—screens—floors—clothes hampers—car fenders—toys

**Built-In-Head Motor and Compressor Unit**



Now! An electric sprayer as easy to handle as a brush—and twice as fast! Sprays household enamel, lacquer, varnish, shellac, light oils and insecticides. No extras to buy! 25 oz. jar. 8 ft. cord. Mail the coupon for full information.



**BURGESS BATTERY COMPANY, Handicraft Division**  
 151 Rand Road, Lake Zurich, Illinois

Please send **FREE** 12-page instruction booklet and illustrated circular in color describing the New Burgess Vibro-Sprayer.

Your Name \_\_\_\_\_  
 Street Address \_\_\_\_\_  
 City \_\_\_\_\_ Zone \_\_\_\_\_ State \_\_\_\_\_

**CASH IN ON THE BUILDING BOOM!**

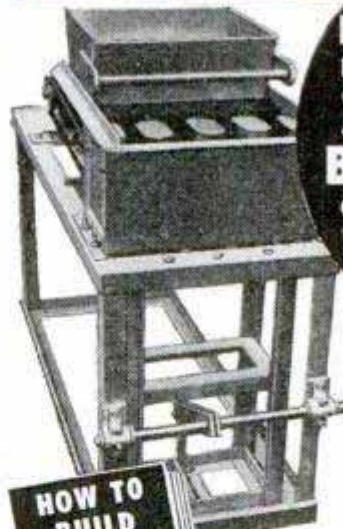

**MAKE BUILDING BLOCKS RIGHT IN YOUR OWN BACKYARD AMAZING GENERAL BLOCK MACHINE**

CAPACITY 1000 BLOCKS PER DAY  
**\$199** LESS MOTOR F.O.B. PLANT  
 ONLY SHIPPING WEIGHT 400 lbs.

Cinder and Concrete Blocks in big demand. Sell all you produce, to contractors and builder supply yards, at 15c to 25c each. Easy to start your own profitable business.

GENERAL BLOCK MACHINE can be operated indoors or out, in floor space 9 ft. x 10 ft. All steel construction. Vibrator mounted in sealed ball bearings. Simple to run. Powered by 1/2 H.P. electric motor or 1 H.P. gas engine. Produces up to 1,000 8x8x16 blocks in 8 hour day. Superior 3 care type, meeting all building code requirements. Produces 4x8x16, 8x8x16, 17x8x16 blocks. Material for blocks, cinders, cement and sand, obtainable anywhere. Full instructions and mixing formulas with each machine. Immediate Delivery. Mail coupon at once for full details, sent free without obligation.

**HOW TO BUILD YOUR OWN CONCRETE BLOCK HOME**  
 Only 1 Prepaid

Wonderful book written and illustrated by our staff of experts.

**GENERAL ENGINES CO.**  
 DEPT. EP — DREXEL BLDG., PHILADELPHIA 6, PA.

Shows you 8 ways to save money and how to make and lay blocks, laying out building lines, mixing your own concrete, building steps, porches and concrete floors, includes floor plans for 6 beautiful easy to construct concrete block bungalows. Mail coupon at once with \$1.  
 Name \_\_\_\_\_  
 Address \_\_\_\_\_  
 City \_\_\_\_\_ Zone \_\_\_\_\_ State \_\_\_\_\_



## CROSLLEY Announces big NEW models!

They're here—five new Crosley style leaders! New Crosley Sedan Deluxe is bigger! It's the latest word in American design. New speed-line styling, rich interior, choice fabrics. Seats 4 with ample luggage room. Crosley—the world's biggest-selling Station Wagon—has larger, longer body lines. All steel. No increase in price. New Crosley Convertible gets admiring glances wherever it goes. And smart Crosley trucks save money by the mile.

That's not all. Today's Crosley engine gives you even more power, even better hill climbing—even greater economy—35 to 50 miles on a gallon of regular gasoline. Smart enough for small incomes, inexpensive enough for high income tax brackets! Crosley gives you more for your money. Prices range downward from the Station Wagon at only \$929 F.O.B., Marion, Indiana.

**CROSLLEY**  
a FINE car

See all five models at your dealer's. Or write for free catalog—Crosley Motors, 2530-HD Spring Grove Ave., Cincinnati 14, Ohio.



SAY YOU SAW IT IN POPULAR MECHANICS

HYDRAULIC—PNEUMATIC

### ACTUATING CYLINDER

WITH ATTACHED HIGH PRESSURE SWIVEL CONNECTOR  
PUSH AND PULL

Raise, lower machinery, garage doors, dump trucks, bulldozer blades, shovels, other uses. Brand new, war surplus, genuine Bendix Aviation part #402985; double action, 4" bore, 1 1/2" stroke, 31" long; 100-2000 p.s.i.; shipp. wgt. 50 lbs. Only \$24.50 F.O.B. Chicago area. Gov. cost \$268; a top value! a powerful worker. Don't delay. Order today! Each. (Quantity buyers, dealers, write for special discount.)

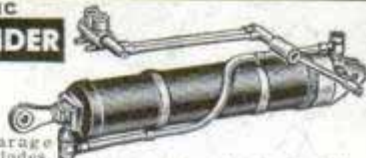

ONLY \$24.50



### ALLIS-CHALMERS POWER TAKEOFF

FOR HD-7 CATERPILLAR TRACTOR  
Genuine Allis-Chalmers part #047842; fits any HD-7 Caterpillar tractor. War surplus, brand new; complete with gear shift, forward, neutral, reverse. A remarkable value, worth \$225. Now only \$52.50 each. F.O.B. Chicago area. Sh. wgt. 150 lbs. It's tops in versatile, portable power. Order now. Each. (Quantity buyers, dealers, write for special discount.)

Special discount in lots of 4. Dealers please write. Send Check or Money Order, 25% with C.O.D.'s. Full Satisfaction Guaranteed.

ONLY \$52.50

STAHLER DISTRIBUTORS, PM-4, 810 Michigan, Evanston, Ill.

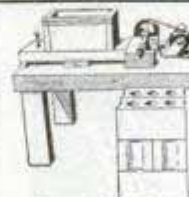

### BUILD YOUR OWN CONCRETE BLOCK MACHINE

The simple machine shown here can be built at home for approx. \$10 (excluding motor). It will make a standard size block in 20 seconds, or several hundred blocks in an 8 hour day. No extra forms needed for mass production. Mold box or form remains on machine. Only block needs be handled. Make \$250 per month selling blocks; or build your house, shop, or garage saving 2/3 the cost by making blocks and laying up your own walls. Also plans for hand operated block machine, and hand or power driven mixers. Send dime for further information.

CLYDE LEE, Dept. A-1, Mountain View, Okla., U.S.A.

### SAVE 1/3! POWERBIKE

DIRECT FROM FACTORY TO YOU

Nationally known—Makes your bike a speedy streamlined Powerbike at new low cost. Ideal for work and play! Write for FREE LITERATURE!



### SAGINAW PRODUCTS CORP.

108 RIVER ST., SAGINAW, MICHIGAN

WRITE NOW FOR FREE CATALOG NO. MA



FOSTER MFG. CO., 247 DELAWARE AVE., BUFFALO 2, N. Y.

## Complete MODEL FLYING OUTFIT! only \$6.95

Here's your chance to buy, at a ridiculously low price, a complete model plane outfit. The plane is rugged (all metal), with wings, tail & fuselage finished and colored, ready to assemble with landing gear, wheels and everything you need to fly it!



HERE IS WHAT YOU GET:

Herkiser CO2 engine, ready-to-run • Prefabricated and colored plane, ready to assemble and fly • CO2 Capsule holder • CO2 Capsules for power • Correct propeller • Engine instructions • Landing gear flight log • Insignia • etc., etc.



Entire Outfit  
\$6.95

Fly the latest in model airplanes, powered by CO2 capsules—the same capsules that charge home soda bottles. No gasoline, oil or smelly exhaust fumes. There's nothing like the thrill of CO2 flying. You don't need such space for free-flights (100 ft. square on calm days).

Send remittance in full or send \$1.00. We will ship same day, balance C.O.D. Large illustrated 2-color Hobby Catalog only 10¢ Dept. BF-49

AMERICA'S HOBBY CENTER Inc.

156 West 22 Street, New York 11

## FILL IT UP... ROLL IT ON T-ROL PAINT ROLLER

Fountain Type

349  
Postpaid  
in U.S.A.



EARL W. MILLER CO. Dept. PM  
12027 Hamilton Detroit 3, Mich.  
Enclosed  Check  Money Order for  
\$\_\_\_\_\_ Ship \_\_\_\_\_ T-Rol Paint Rollers  
(QUANTITY)

at \$3.49 each, postpaid to:

NAME \_\_\_\_\_

ADDRESS \_\_\_\_\_

CITY \_\_\_\_\_ STATE \_\_\_\_\_

No C.O.D.'s—Money Back Guarantee

The miraculous, economical T-ROL applies any oil-base paint or enamel, evenly, without brush or lap marks, on any smooth surface.



NO DIP! NO DRIP!

EARL W. MILLER CO., 12027 Hamilton, Detroit 3, Mich.



**SURPRISE VALUE**  
 100 Pieces for **\$1.00**  
 Electric Grinders  
 A Bagful of  
 Bargains at  
 Post Paid in U.S.A.  
 Grinding Wheels, Cut-off Wheels,  
 Sanding Discs, Mounted Stones,  
 Sharpening and Honing Stones,  
 Rotary Cutting Burs, Abrasive  
 Cartridges, and many other items. Rush check or Money Order.



**18 ROTARY CUTTERS**  
**\$5.85**  
 Value \$13.50  
 Post Paid in U.S.A.

Assorted sizes cutter on 1/8" or 3/32" shank. Will fit all hand grinders. Ideal for cutting wood, metal, or plastic. Brand new.



**2 CIRCULAR SAWS**  
 AT A RECORD BREAKING  
 PRICE—BOTH AT ONLY **\$1.50**  
 1" diameter saws on 1/2" Mandrels. For cutting wood, plastic, or soft metals. Order at once! Send Check or Money Order for this big bargain.  
 Post Paid in U.S.A.

SCHUPACK SUPPLY CO., 7331 Cottage Grove, Dept. M4, Chicago 19, Ill.

**AMES UNIVERSAL DIAL INDICATOR SETS**  
**NEW SURPLUS**

OUR PRICE **\$15.00**  
 Reg. sold for **\$23.00**

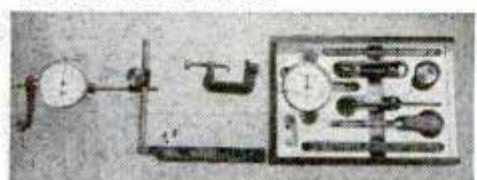

You get a complete set including Dial Gage with hole Attachment, Bar with Upright, Clamp sliding swivel, Dial holding rod and three contact points. Hole attachment also, can be adjusted to almost any position, and used in places inaccessible to ordinary indicators. All this along with a beautiful box for only \$15.00.

Write today before limited supply of these AMES KITS are exhausted.

**VETERAN TOOL AND SUPPLY CO.**  
 88 Baxter Street New York 13, N. Y.

**AGENTS 300% Profit SIGN LETTERS**

For Store Fronts and Office Windows. Anyone can put them on. Free Samples. Liberal Offer to General Agents.

METALLIC LETTER CO., 430 N. Clark, Chicago 10

**STOP**  
**CHANGING MOTOR OIL—**  
**KEEP IT CLEAN INSTEAD!**  
 with  
**RECLAIMO**



The Famous HEATED Oil RE-REFINING Filter!

Continuously cleans and RE-REFINES motor oil as you drive (by utilizing motor heat)—keeps oil in high grade lubricating quality at all times—reduces motor wear to a minimum! Proves conclusively that "Oil Does Not Wear Out Mechanically" as stated by U. S. Bureau of Standards, (Bulletin 86).

- REMOVES SOLIDS (by filtration)
- REMOVES WATER (by distillation)
- PREVENTS Excess Fuel Dilution
- PREVENTS Acid and Sludge Formation

Stable Viscosity ELIMINATES All Oil Changes  
**CAR • TRUCK • TRACTOR OWNERS!**

You'll want to know more about Reclamo's Oil, Motor and Money-Saving Features. FREE 40-PAGE BOOK "OIL FACTS" gives you the complete "Reclamo" story plus details about our New 90-Day No Risk-No Cost TRIAL OFFER! WRITE for YOUR COPY TODAY!

**NEW ADDED FEATURE!**  
 Gas - Moisture Vapor Injector  
 Increases Mileage with Smoother Performance



**RECLAIMO MFG. CO.**  
 5083 Elston Ave., Dept. 92, Chicago 30, Ill. (DEALERS WANTED)

*Make \$20 to \$30 a Week*  
**EXTRA MONEY**



**MACHINE SAW FILING**  
**PAYS UP to \$2 or \$3 an HOUR**

With the high prices of food, clothing and everything else, just think what you could do with extra money every week! Turn your spare time into CASH—sharpening saws with a Foley Automatic Saw Filer pays up to \$2 or \$3 an hour. You will find you can make \$20 to \$30 a week in your spare time as a starter.

You can work in your basement or garage—no experience necessary. "The first saw I sharpened with my Foley Filer came out 100%"—writes Clarence E. Parsons. No canvassing—"I advertised in our local paper and got in 93 saws"—says M. L. Thompson. The Foley is the only machine with which you can file all hand saws, also band saws and cross-cut circular saws.

**SEND FOR FREE BOOK**  
**"INDEPENDENCE AFTER 40"!**

Shows how you can get business from home owners, farmers, carpenters, schools, factories, etc. With a small investment, no overhead, no stock of goods to carry, you can get right into a cash business—and possibly later on develop into a full-time repair shop. Send coupon today for Free Book.

"Each saw I filed got me six more and business has been picking up that way since a year ago. If it keeps up I will have to buy another Foley Saw Filer." — William C. Baldwin

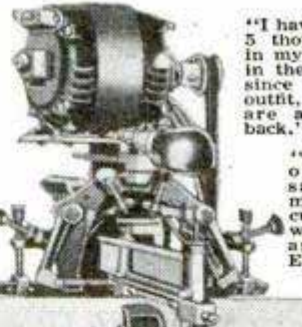

"I have done 4 or 5 thousand saws in my spare time in the 4 1/2 years since I got the outfit, and they are all coming back."—Len Grego

"Have filed over 2200 saws in 18 months. One customer always brings another." — E. A. Fink

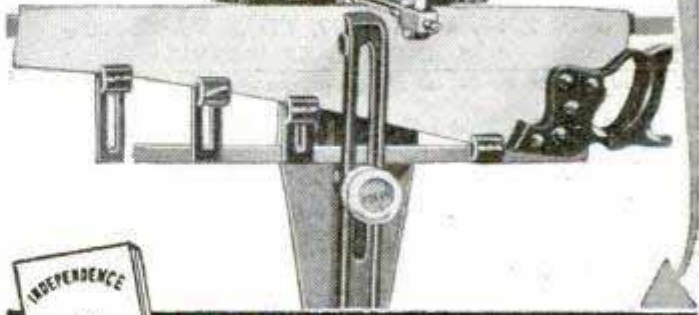

**SEND COUPON FOR FREE BOOK**

**FOLEY MFG. CO.**  
 416-9 Foley Bldg., Minneapolis 18, Minnesota  
 Send FREE BOOK—"Independence After 40."

Name \_\_\_\_\_  
 Address \_\_\_\_\_

# ASSEMBLE YOUR OWN TRAILER

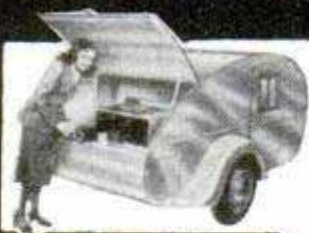

**CUB SPORTSTER**

**SAVE UP TO 50%**

Enjoy the luxury of owning one of these sturdy, streamlined trailers. Save up to half the normal cost by assembling it yourself. For practically material costs alone, you can buy the full-size CUB SPORTSTER or CUB SR. trailer in construction kit form.

In only a few hours, using a screwdriver, hammer and wrench, either trailer can be

easily assembled. Precision cut, factory-finished panels and sub-assemblies are guaranteed to fit.

Both trailers have sleeping room for two adults and two children, thus they can pay for themselves during one vacation. Many Cub trailer owners make extra money by renting their trailers for week-end and vacation trips!

The CUB SPORTSTER has a rugged all metal body and all steel frame that weighs only 450 lbs. It is 12' 7" long, 6' wide, 5' in height and it adds only 75 lbs. tongue weight to your car. The CUB SPORTSTER kit includes a galley, ice box, wheels, fenders and all parts except tires and tubes.

Only **279.50** plus F.O.B. Los Angeles tax

The CUB SENIOR can't be matched in either price or quality. A walk-in trailer, it has plenty of room for everything in pre-assembled cupboards, drawers and a spacious closet. Built-in dinette bed, sink, ice box and two fold-away tables give you all the comforts of home. The CUB SENIOR is 10' long (8' body length), 6' 4" wide and 6' 9" in height. It has an all steel frame and all parts are included except tires and tubes.

Only **395.00** plus F.O.B. Los Angeles tax

(C.O.D. shipment will be made on either trailer if at least \$50.00 deposit accompanies order.)

Write today for FREE illustrated folder.

Dealer inquiries are invited

**National Trailer Stores**

BOX 2353, DEPT. M-49, TERMINAL ANNEX,  
LOS ANGELES, CALIFORNIA

MAIL THIS FOR

**New Catalog**

of Attachments and  
Accessories for Lathes



**SOUTH BEND LATHE WORKS**  
455A E. Madison St., South Bend 22, Indiana

Name \_\_\_\_\_

Street \_\_\_\_\_

City \_\_\_\_\_ State \_\_\_\_\_

## 2 SURPLUS VALUES!



### SET OF 3 OFFSET SCREWDRIVER SETS SIMPLE - LIGHT - STRONG

Quickest, easiest way to start, tighten, or remove screws in close quarters. Adaptable to both finger and lever turning. Knurled head for finger turning to engage or remove free screws, hex-wrench handle engages bit in 6 positions for leverage in securely setting or removing stubborn screws. Just what you need for those hard-to-get-at screws. Each set \$1.00 Post-paid in handy holder package. Set of 3 paid **Also available in Phillips bits at 10c extra.**

### NEW U. S. NAVY PRECISION

### ENGINEERS GAGES

Specially designed for machinists and engineers who want a compact set of gages. Consists of taper gage with 3/8" rule on reverse side, wire gage with decimal equivalents on reverse side, 9 thickness gage leaves from .002 to 1/16". Overall length is only **\$200** Post-4 3/4". List price \$5.00. .... post

Send check, money order or cash. No COD's. Satisfaction guaranteed.

### HARDWARE SUPPLY CO.

495 Atlantic Ave. Boston, Mass.

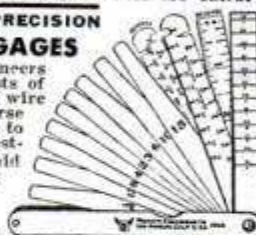

## M-6 COMPASS

Precision compass by "Sherrill". Easy to compensate, equipped with nite lite, excellent for planes, cars, boats, trucks, etc. Easily mounted. Instruction manual and calculator included. **\$25.00 value.**

**\$5.95** prepaid

## FREE CATALOG

Over 250 Surplus Bargains

**WRITE TODAY!**

**FISLER SALES CO.** DEPT. PM-11  
723 WALNUT ST. KANSAS CITY 6, MO.

Mechanics! Repairmen! Hobbyists!

## 10 DRAWER All-Steel CABINETS

12 section steel drawers with adjustable dividers. Size 16 1/4" wide x 8" high x 10" deep—drawers 1 3/4" deep with card holders. All electric welded in brown hammerloid finish.

At your dealers or write direct

**MODEL BOX and CABINET COMPANY**  
205 WEST WACKER DRIVE CHICAGO 6, ILLINOIS



**\$11.75**

## WHEELS - WHEELS

- 5" disc wheel, 5/8" tire, 5/16 or 3/8" sleeve ..... \$0.30
- 6" disc wheel, 5/8" tire, 5/16 or 3/8" sleeve ..... \$0.35
- 7" disc wheel, molded tire, 3/8" sleeve ..... \$0.45
- 8" disc wheel, 1 1/8" tire, 1/2" sleeve ..... \$0.70
- 7" disc wheel, 1" tire, 1/2" ball bearing ..... \$0.80
- 8" disc wheel, 1 1/8" tire, 1 1/2" ball bearing ..... \$1.00
- 10" disc wheel, 1.75 semi-pneumatic tire, 1 1/2" B.B. .... \$1.50
- 10" cast alum. wheel, 2 3/4" semi-pneumatic tire, 5/8" ball bearing ..... \$4.50
- Hub caps for 5", 6", 7" wheels. .... 3c each Plus postage

**UNITED WHEEL STAMPING CO., Dept. PM-4**  
2756 W. 115th St. Chicago 43, Ill.

## SAVE UP TO \$30

OFF LIST PRICE - ON BRAND NEW

## GASOLINE ENGINES

at the lowest prices we have ever offered

**Briggs & Stratton, Clinton, Lauson**

1 1/2 - 2 1/2 - 3 1/2 H.P.

Write for illustrated circular and details on special

**FREE OFFER**

**BENJAMIN'S FOR MOTORS**

2122 Mill Ave.

Brooklyn 10, New York

**MAIL ORDERS U.S. ARMY SURPLUS**



**SAVE \$6 ON THIS \$8.95 Value BOOTS \$2.95**  
 Ideal all-weather work, sport and outdoor shoe.  
 Leather uppers—rubber bottom.

- Flexible double chrome, tanned, tough wearing leather uppers!
- Leak-proof gusset tongue!
- Non-skid heavy duty rubber soles.

10" 12" Tops  
 Reconditioned. Look Like New.  
 Shpg. Wght. 5 LBS.

**NEW! MECHANIC'S TROUBLE LAMPS — 50 FOOT CORD!**



- 50 feet of Heavy Duty Rubber Coated Cord.
- Sturdy Switch built into handle.
- Rugged, shockproof Rubber Handle.
- 2 extra Plug-ins built into handle.
- Heavy duty steel wire guard.
- Removable Reflector Shield.

**\$4.50 VALUE! Complete \$2.95**  
 Shpg. Wght. 2 Lbs. 10 Ozs.

**TARPS 100% WATERPROOF, FIRE, MILDEW RESISTANT MULTIPLE SEAMS, GROMMETS ALL AROUND.**

9x12, \$7.56	6x7, \$2.95	16x16, \$17.92
Shipping weight 20 Lbs.	Shipping weight 7 Lbs.	Shipping weight 50 Lbs.

Send for Free Catalog. AMAZING VALUES!

**UNIVERSAL ENTERPRISES**

Dept. P.M. 946 S. Main St. Los Angeles 15, Calif.  
 All Prices f.o.b. Los Angeles  
 1/3 deposit on C.O.D.'s—Pay by money order or check

**WHAM-O SPORTSMAN\*** \$1.00 Postpaid

Powerful—New—Accurate  
 Kills Rabbits, Squirrels, Etc.  
 Routs Pests

Rivals Archery!  
 Fast Becoming a Major Sport.  
 Handy - Silent - Inexpensive. Easy to use.  
 Complete with 40 pellets and extra rubber straps.  
 WHAM-O MFG. CO., Box G 92, South Pasadena, Calif.  
 \*Professional model used by members Nat'l Slingshot Assoc.

For Finest Performance Use SHOPMASTER TOOLS

**SHOPMASTER INC.**

1214 THIRD ST. S., MINNEAPOLIS 15, MINN.

Get This Now!

**SPRAY PAINTING**

New Book Makes Money Saves Money



**COMPLETE INSTRUCTION FOR PROFESSIONAL USE AND 'ROUND-THE-HOUSE JOBS — INCLUDES AUTO PAINTING AND REFINISHING**

Get this new 1948 spray painting book to help you on the job or for better and time-saving paint work around the home and car. Thoroughly practical—covers every phase of spray painting technique. Tells what paint or other finish to use, how to mix colors, how to make perfect jobs, easy, quick.

New edition has over 160 pages. Cloth binding. Illustrated. Send \$2.00 for postpaid delivery or we will send C.O.D. Money back if not satisfied.

**FREDERICK J. DRAKE & CO.**

317 GREEN BAY ROAD DEPT. 14 WILMETTE, ILL.

**NOW AVAILABLE with Depth of Cut and Bevel Cut Adjustment**



**COMPLETE \$61.95**  
 F. O. B. Chicago

**THE MODEL 60 Mall Saw**  
 REG. U.S. PAT. OFF.

Do a complete job with the Model 60 MallSaw —use the new attachment and the Model 60 for making compound angle cuts on hip rafters and bridging or use the depth adjustment for scoring or cutting. The saw will crosscut, rip or angle cut rough or dressed lumber, cut metals, cut and score tile, concrete and other aggregate compositions.

No. 30487 Depth of Cut and Bevel Cut Adjustment—easily attached, allows cuts to 1-31/32" on 90 degree angle cuts . . . 1-11/32" on 45 degree bevel cuts . . . minimum cuts of 5/16" at 90 degrees or 1/4" at 45 degrees . . . can be purchased as an attachment for your Model 60 Saw . . . \$7.00  
 Model 60 MallSaw — 2" capacity with 6" blade . . . \$54.95

Other MallSaws Available to 4-1/2" Capacity.

Ask Your Dealer or Write Power Tool Division for FREE Literature.

**MALL TOOL COMPANY**

ESTABLISHED 1921

7805 S. Chicago Avenue Chicago 19, Ill.

# ELECTRIFY your SEWING MACHINE

REPLACEMENT OR REFUND OF MONEY  
 Guaranteed by Good Housekeeping  
 IF NOT AS ADVERTISED THEREIN

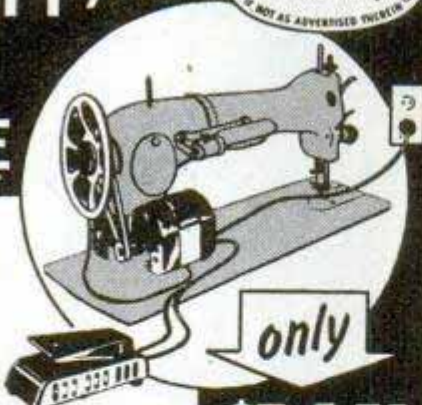

Ideal gift for Mother, Wife, Sister

**NEW Improved Brownell**

## SEWING MACHINE MOTOR KIT

- EASILY ATTACHED IN SECONDS!
- ANYONE CAN DO IT!
- COMES FULLY WIRED & CONNECTED!
- 1 YEAR GUARANTEE ON ALL PARTS!

YOU GET ALL THIS! Powerful Universal AC-DC motor, rheostat that holds to any desired speed, steel pulley, rubber belt, extension cord with plug and double socket, mounting bracket, simple instruction sheet. All parts brand new.

GIFT LAMP, TOO! U. L. Approved sew machine electric lamp, \$2.75 value, given with each order at no extra charge.

only \$16<sup>75</sup>

COMPLETE WITH GIFT SEW LIGHT ILLUSTRATED

ANY MAKE, no matter how old, converted to modern electric machine.

### FREE 10-Day Trial Offer Coupon

**BROWNELL DISTRIBUTORS, INC., Dept. 34**  
 308 Canal St., New York 13, N. Y.

Rush me your sewing machine motor kit at \$16.75 complete with gift lamp. Make of my machine is.....

Handwheel turns  toward me  away from me.

Send postpaid. I enclose \$.....

Send C.O.D. I'll pay postman \$16.75 plus C.O.D. fee.

Name .....

Address .....

City..... Zone..... State.....

If not fully satisfied, I may return kit in 10 days for refund.

To introduce "Flywheel-Action":

## FREE TRIAL 95¢ GOLF BALL

with factory-direct order! **6 for \$3.50** Postpaid



Here's why American's exclusive "Flywheel-Action" golf balls give you 14.9% more spin:

Other golf balls have weight concentrated near the liquid center.



American "Flywheel-Action" golf balls have weight distributed farther away from the liquid center. That's why you get longer flight, more "bite," and truer putting, with American "Flywheel-Action."

SEND COUPON TODAY!

Order 6 top quality, new, 95¢ "Flywheel-Action" High-Speed balls at 58<sup>1</sup>/<sub>2</sub>¢ each. We ship 7—your order of 6 plus free "Sampler." You get American's finest 95¢ Tournament balls at 50¢ each.

**OUR GUARANTEE:** Give your free Sampler "the works" in actual play. If you're not convinced it's the sweetest-playing golf ball you've ever used, regardless of price, return all 7 balls for full refund. American Golf Ball Mfg. Co., 8629 W. 3rd St., Los Angeles 36, Calif.

American Golf Ball Mfg. Co. PM  
 8629 W. 3rd St., Los Angeles 36, Calif.  
 Send six 95¢ Golf Balls, & free Sampler.

\$3.50 Check or Money  Send C.O.D. (Postage extra)

Order enclosed.  Send C.O.D. (Postage extra)

Name.....

Address.....

City..... State.....

# SOCKET SET



\$20.00 VALUE — PRICE \$9.50

Our purchase of over 200,000 wrenches as unused U. S. Air Force surplus makes this low price possible. All sockets are 12 point and plated. All tools are NEW. They are well-known popular standard makes such as Plomb, Snap-On, etc. Set consists of 22 pieces, 1/2" and 3/8" drive. Shipping weight 10 pounds. This is what you get.

- 1—5/16" Socket
- 1—3/8" Socket
- 1—1/2" Socket
- 1—9/16" Socket
- 1—5/8" Socket
- 1—11/16" Socket
- 1—3/4" Socket

- 1—13/16" Socket
- 1—7/8" Socket
- 1—15/16" Socket
- 1—1" Socket
- 1—1-1/16" Socket
- 1—1-1/8" Socket
- 2—Bar Handles

- 1—2" Extension
- 1—4" Extension
- 1—18" Extension
- 1—T Handle
- 1—1-1/2" Flex Handle
- 1—3/8" Speed Handle
- 1—1/2" Speed Handle

All sets shipped via parcel post same day we receive order. Money Order or Check, 25% Dep. on C.O.D.'s. Prices F.O.B. Fresno.

## ARMY SURPLUS SALES

1820 TULARE ST.

OF FRESNO

FRESNO, CALIF.

# GIGANTIC LIQUIDATION

AN BOLTS, AN NUTS, SCREWS  
 CLEVIS PINS, DZUZ FASTENERS,  
 CLAMPS & HARDWARE

SEND FOR FREE LIST OF HARDWARE

THE MART, 11 E. Harrison St., Chicago

# DRESS UP YOUR STOVE

## STOVALL LAMPS

Fits most makes of Gas or Electric Stoves

- Illuminates Brightly Entire Stove Top
- Attractively designed and finished in White Enamel and Chrome Trim
- Mark Timer can be set for any time to 1 hr. and rings alarm
- Permit setting stoves flush to wall
- Comes with keyholes in back to fasten to wall



The complete Stovall Lamp Unit includes—The mark Times—Condiment set and tray—Turn knob socket for up to 60 Watt bulb. 6 ft. of approved rubber cord, and plug cap. Clamp for fastening onto back splash of stove. Overall width 14", Height above back splash 9". Mounting clamp has wing nut set screw allowing 1" minimum opening.

Deposit or payment in full with order. We pay Freight.

**\$9.95** Each

**DIRECT SALES** 921-PM-W. 17th KANSAS CITY, MO.

# Flip-Tight SANDER

26 sq. in. of Sanding Surface

Its New! its Different

Double-action mechanism draws Emery Cloth drum-tight and solidly secures it... in one motion! Hard Maple block fits the hand-shaped for extra sanding surface.



**\$1.50**

NO C.O.D. ORDERS with 7 Ft. extra Emery Cloth Money Refunded if not satisfied

Order from

**HAYS HAND SANDER**  
 Dept. CH, Davenport, Iowa.

### WIPE IT ON ENAMEL

Choice of 5 Colors & Black  
Amazing new enamel can be applied with a cloth, pad or powder puff. No skill needed. Flows out smooth as glass. Dries quickly to a porcelain-like, durable glass finish.

**\$5.95 Value** Quart can covers most cars. **Quart Can \$2.95**



### AUTO BODY SOLDER

Smooth working putty like filler. Hides dents and holes in auto bodies. Applied with putty knife. Dries to metallic hardness with no shrinkage.

**PINT CAN \$1.50**

### Our Finest Precision REBUILT MOTOR BLOCK ASSEMBLIES

Sold Outright or Exchange

Rebuilt by skilled mechanics. Assembly has Waterfall Block with New Pistons, Pins, Rings, Bearings, Crankshaft, all new hardware. Guaranteed 90 Days Allowance on Old Motor.

Up shop at contract price. No extra charge for installation. No need to remove both of auto's cylinders. Save money if you're not sure you'll need it. We'll refund difference when we receive your motor.

**\$5.00 Crating Charge**

BUICK	Quart.	Exch.
34-47 8 cyl.	\$209.00	\$165.00
CHEVROLET	Quart.	Exch.
29-47 6 cyl.	115.00	95.00
CHRYSLER	Quart.	Exch.
34-47 6 cyl.	157.00	132.00
35-47 8 cyl.	209.00	165.00
DE SOTO	Quart.	Exch.
34-47 6 cyl.	157.00	132.00
DODGE—3 1/2" bore	Quart.	Exch.
33-47 6 cyl.	150.00	120.00
3 1/2" bore	Quart.	Exch.
34-47 6 cyl.	157.00	132.00
FORD	Quart.	Exch.
28-31 4 cyl.	107.00	87.00
32-34 V8	129.00	109.00
35-47 V8	149.00	109.00
37-39 60 HP	154.00	109.00
MERCURY	Quart.	Exch.
37-47 V8	149.00	109.00

### \$150.00 Value 2 Wheel TRAILERS

1800 LBS. CAPACITY

Dimensions of body 76" long, 40" wide, 12" deep. Made of sturdy hardwood, 1/2" reinforced. Will carry heavy loads and withstand plenty of abuse. Complete with 16" wheels, 1/2" axles, 1/2" springs. 6.00x16 high tread used tires, 17", 18", 19", 20" or 21".

Complete with Coupling

NOTE! HEAVY CAR SUB FRAME AND 2 SPRINGS

wheels and tires if specified. With low bar and hitch. The unit is composed of perfect used chassis complete with 2 springs. New hardwood box painted red.

COMPLETE with TIRES & TUBES. **\$85.00**

Shipped F.O.B. Chicago.....

### USED Pass. Car TIRES

75-90% Original Tread

35 X 1 1/2 } \$4.95 ea.  
400 X 1 1/2 }  
450 X 1 1/2 }

Three listed below have a continuous tread design. Tread depth will vary. Repairs are guaranteed for the life of the tire. Specify exact size when ordering.

Size	Star	Price
32x5.50x17	700x15	6.95
32x5.50x18	700x16	6.95
47x5.50x19	700x17	6.95
47x5.50x20	700x18	6.95
47x5.50x21	700x19	6.95
47x5.50x22	700x20	6.95
47x5.50x23	700x21	6.95
47x5.50x24	700x22	6.95
47x5.50x25	700x23	6.95

### AUTO-SERV Kleenex Dispenser

Simple to Install Under Glass Compartment of the Car for Ready Service

AUTO-SERV provides Kleenex Tissues for driver and passenger. Carries a full packer without over-crowding glove compartment. Postpaid \$2.50

### JEEP FRONT FLOOR MATS

With Full Bars For all Jeeps. **\$3.95**

Send 25% Cash With All Orders, Balance C.O.D.

### J.C. WHITNEY & Co.

1919 Archer Ave. Chicago 16, Ill.

### FENDER SKIRTS

All metal in prime finish. Rubber leading to prevent rattling.

MC131-N **\$12.95** Per Pair

No more to worry about. Make best model of 201

### GUTTED MUFFLERS FOR ALL CARS

Gives that Motorboat Tone

Universal type fits all cars. **\$4.95**

### DUAL MUFFLERS 17.95

1935-48 Ford V8  
1939-48 Mercury

Increases power. Reduces back pressure. Complete.

### NEW CONVERTIBLE TOPS

100% Waterproof, Weatherized Material. Not Affected by Snow or Rain. Choice of Black or Tan. \$50.00 to \$130.00. Values As Low As **\$24.95**

"ZIPPER TYPE" REAR CURTAIN

Each top packed with steel springs and contains all needed hardware and fittings. Drivers in front compartment. New front bar, better fasteners and quality, laboratory tested material for better than the standard. All tops have zip up front, heavy canvas, plastic most resistant. Tops are securely attached with steel bars and secured for durability.

2 Pass. Ford A 28-31 Roadster & Coupes..... \$24.95  
2 Pass. Ford 33-39 Roadster & Coupes..... 29.50  
Ford 39-39 Roadster & Coupes..... 42.00  
5 & 6 Pass. Ford 36-49 & Mercury 35-39 Coupes..... 33.75  
2 & 4 Pass. Ply. Chev. De Soto & Dodge 40-48 Coupes..... 35.45  
2 & 4 Pass. Chev. Buick Olds. Pont. & Cad. Coupes..... 37.45  
4 & 5 & 6 Pass. Chev. Buick Olds. Pont. & Cad. 39-48 Coupes..... 34.50  
5 & 6 Pass. La Salle 36-40; Hudson & Terra. 36-47 Cops. 39.95  
5 & 6 Pass. Nash 37-41; Packard 36-45; Stude. 1948 Cops. 43.75

NOTE: SPECIFY COLOR WANTED ALSO MODEL OR SERIES, BODY STYLES, YEAR AND MAKE WHEN ORDERING.

### Hi-Speed Equipment FOR ALL CARS

HI-COMPRESSION HEADS  
SINGLE & DUAL MANIFOLDS  
HI-SPEED CAMSHAFTS

More Pick-up—You're down in a flash. No fuel waste—Every drop of fuel used. Extra horse power—Faster passing. More mileage per gallon. Better performance at all speeds.

FOR ALL CARS

### MAKE ANY CUT WITH THESE NEW WOODSHAPERS for YOUR CIRCLE SAW or DRILL PRESS!



**MODEL #60**—Originally designed for heavy industrial use, now priced for home workshop. Can be attached directly in chuck of your drill press. Exclusive pilot bearing (see illustration) eliminates side thrust, chatter and vibration—assures smooth cutting action. Blades can't come out—set screws hold them securely. Complete, with YOUR CHOICE OF ANY 6 PAIR DOUBLE-GROUND BLADES SHOWN BELOW, only \$12.95.

**MODEL #50**—Same as Model #60 but without exclusive pilot bearing. Designed for intermittent shaping; over 100 different shapes can be cut. Complete, with ANY 6 BLADES OF YOUR CHOICE SHOWN BELOW, only \$8.95.

All Aladdin tools are guaranteed. Postage prepaid with all cash orders. C. O. D. plus postage. GET YOUR ORDER IN TODAY.

**ALADDIN MFG. CO., INC.**  
3121 Main Street Kansas City, Missouri  
Dealers Write Today



**MODEL SA-10**—Heavy-duty, industrial-type shaper of solid steel, now priced in home workshop range. Absolutely safe—blades locked in position with screws all the way through. In ordering, state diameter of shaft. Complete WITH ANY 6 PAIR OF READY-GROUND BLADES SHOWN BELOW, only \$14.95.

**ALADDIN WOODSHAPING BLADES**  
Specify by number the blades you want. Additional blades \$1.50 each, \$3.00 per set.

No. 510	No. 511	No. 512	No. 513	No. 514	No. 515
CHISEL POINT	FLATTEN BLADE	FLATTEN & POINTED	FLATTEN & BEVELLED	FLATTENED	ROUNDED
No. 516	No. 517	No. 518	No. 519	No. 520	No. 521
FLAT POINT	FLATTEN & POINTED	FLATTEN & POINTED	FLATTEN & POINTED	FLATTEN & POINTED	FLATTEN & POINTED



**BASS IS BEST WEJUNS**  
LEISURE COMFORT



**BASS IS BEST QUAIL HUNTERS**  
FIELD and STREAM



**BASS IS BEST SKI BOOTS**  
EXTRA CONTROL



**BASS IS BEST SPORTCASINS**  
GOOD GOLF STRATEGY

**G. H. BASS & CO.**  
60 MAIN STREET  
WILTON, MAINE

### ONLY \$9.75 POST PAID

### JET PERFORMANCE FOR YOUR CAR WITH VAPOJET

VAPOJET gives your car super aircraft power and performance. VAPOJET users report 25% more mileage from regular gas. A double saving! Eliminates carbon, vaporlock and overheating. Complete kit permits easy installation—fits all cars. Order today—\$9.75 complete, postage prepaid. \$1.00 deposit on C.O.D.—your check or money order in full saves postage. You take no chances—satisfaction guaranteed or money back! Specify car, year, number of cylinders. MAIL COUPON NOW!

**VAPOJET MANUFACTURING COMPANY**  
11424-N BIONA DRIVE LOS ANGELES 34, CALIF.

—ORDER TODAY—  
Gentlemen: Please rush me \_\_\_\_\_ Vapojet units, complete with necessary linkage, instructions, etc. Enclosed is my check (or money order) in amount of \$ \_\_\_\_\_  
Car \_\_\_\_\_ No. of cyl. \_\_\_\_\_ Year \_\_\_\_\_  
NAME \_\_\_\_\_  
STREET \_\_\_\_\_  
CITY \_\_\_\_\_ STATE \_\_\_\_\_

# THE BIGGEST SURPLUS BARGAINS IN YEARS

**ELECTRIC MOTOR 1/2 H.P. 27 V.D.C. R.P.M. 4000 No. 750.** FOR INTERMITTENT OR CONTINUOUS DUTY. 5/8" SHAFT. VARIABLE SPEED MOTOR. Can be adapted to 110 V.A.C. or R.E.A line by rearranging armature brush leads. UNUSED. \$550 Instructions incl.

**VICKERS, HYDRAULIC PUMP.** Use it for any type liquid pumping job. Rated 1000 P.S.I. .410 cu. in. per rev. 375 gal. per Hour at 3750 R.P.M. Self priming. S.U.d. thread. 3/4" intake and discharge ports, 5/8" splined shaft. JUST ADD PULLEY and power and you're ready to go. Original Eq. cost \$100.00. S. Wt. 7 lbs. BRAND NEW. Diagrams & \$1250 data incl. Price.

BRAND new Check & Relief Valve Adjustable \$250 for any pressure postpaid

**BRAND NEW HYDRAULIC CONTROL VALVES.** Four way control for use with two hydraulic double action cylinders. Each cylinder may be operated, independently of the other or in conjunction with the other. Oil may be locked in any of the cylinders to hold the piston at any required position. Brand New \$60.00 \$995 value postpaid

**2. A TWO CYLINDER DOUBLE ACTION VALVE,** with a unique arrangement allowing the operator to raise both cylinders simultaneously, to lower them simultaneously, or to raise one and lower the other at any predetermined rate and speed. \$1250 Brand new a \$75.00 value postpaid

**3. SWIVEL CONNECTION VALVE.** Consists of a stationary and movable section. The stationary section is mounted solidly on machine & connected with piping. Flexible connections are then connected to the movable section & carried to any movable part of the machine. For carrying oils, liquids. For FARMS, Ranch & Shop. Diagram & Instruction Inc. Brand new. Price \$550 postpaid

**THOMPSON BOOSTER PUMP. GREATEST PUMP VALUE IN YEARS.** Use them for Homes, Farms, Ranch or shop. Motor Driven centrifugal pump will empty 50 gal. drum of water in approx. 20 min. Runs on 24V. D.C./ \$750 A.C. NEW.

**LUBE PUMP BRAND NEW.** Precision Gear Impeller Pump pumps Liquid up to 3 gal. per minute. Pressure up to 200 lbs. per sq. in. For high vacuum, air pressure, Hydraulic units, etc. S.t.d. 1 1/2" threaded & keyed shaft. Instruction \$395 Inc. \$35.00 value. Ship. wt. 4 lbs. Price.

**SENSATIONAL FASCINATING MYSTERIOUS SEL-SYN.** Two or more connected together work perfectly on 110 V. A.C. For weather vanes, rotating directional antennas or controlling distance operation. Complete with diagram and instructions (wt. 3 1/2 lbs) PER PAIR. \$350

**VALUABLE GEARS BARGAINS. SPEED REDUCER 10-1 or 5-1 ratio, 90 degree angle. Shaft Driven. 1 1/2" spline. Shaft with 3 mounting holes 5/16". Only \$450**

**DYNAMOTORS ALL BRAND NEW, G.E. Input 27 V. D.C. .485 KVA, Output 115 V. A.C. \$450 Wt. 16 lbs. ea.**

**DYN. New, Model #23350.** Input 27 V. D.C. Output 285 V. D.C. Wt. 3 1/2 lbs. Ea. \$135

**NEW CUNO OIL FILTER.** Aircraft type keeps oil clean without cartridge replacement. For all AUTOS, TRUCKS and TRACTORS. Install at home in a few minutes. STOP CHANGING MOTOR OIL. Instructions \$495 incl. Ea.

Send check or Money order. No c.o.d.'s. Prices f.o.b. K.C. except when marked postpaid.

**GENERAL SALVAGE COMPANY**  
Dept. 17, 2922 E. 27th St. Kansas City, Mo.

# MASTER HOBBY ARBOR TOOL KIT AT THE GIVE-AWAY PRICE \$5.95

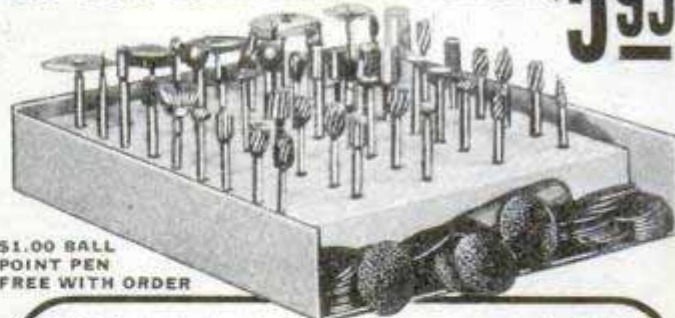

\$1.00 BALL POINT PEN FREE WITH ORDER

3/32nd 1/8 shanks—the best gift you can give to the hobby worker. We give you saws, drills, routers, carvers, emery disks, polishing compound, reamers, barers, shapers, stone polishers, stone points, grinding points. Over 150 pieces that we went out and priced in other stores for over \$20.00 for half of what we sell for \$5.95. After receiving set, if you don't think it is worth at least \$20.00, send it back. Your money refunded.

Send C. O. D., check, cash or money order.

**GENERAL AIRE CO.**

447 W. NORRIS ST. • Dept. PM • PHILA. 22, PA.

## BUILD YOUR OWN AIR COMPRESSOR

At A Fraction of Usual Cost!

Yes, from surplus and junk parts you can easily build a compressor—100 lbs. or more capacity. Every home workshop, radio shop, etc. needs compressed air to clean machinery, spray paint, etc. Send \$1.00 for simple, step-by-step illustrated instructions plus other helpful data.

**G & S SHOPS**

Hobby Dept. PM-4

356 W. 74th St. Chicago 21, Ill.

★ SAVE TIME and MONEY with the **MARCLIFF Saw ARBOR**



GUARANTEED ACCURACY

Built for service. Inner collar assembled to shaft. Then faced after assembly to INSURE ACCURACY. Bearing spots ground to .003. Fabricated from Stainless Steel tubing. Top quality bearings for smooth operation. Available in 1/2" or 3/4" Shaft size. Saw Housing 8" overall length 1 1/2" Pulley and 1 1/2"

MARCLIFF MFG. CO., Hudsonville, Michigan

DEALERS WANTED

SEND \$7.20 Check or Money Order Shipped prepaid

## Rebuilt GENERATORS

Chevrolet—Ford—Plymouth exchange price \$6.95 guaranteed

F.O.B. Chi. Generators rebuilt by factory-trained experts. Also hard-to-get parts for every car. STARTERS, TRANSMISSIONS and rear ends at tremendous savings.

**WORLD AUTO PARTS CO.**  
2200 N. Ashland Chicago 14, Ill.

ORDER from one of the nation's largest replacement dealers

## Carry Your Heat From Room To Room

Nationally Advertised **ELECTRESTEEM**

Office—Workshop—Garage—Store—Home—Any Room with Electrical Outlet \$3735 each

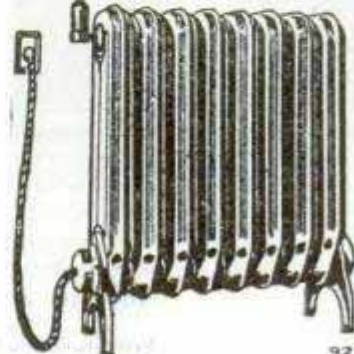

To have steam heat from any electrical outlet is unusual—but to have portable steam heat is indeed remarkable. Electresteem Radiators, 20 1/4" high, 23 1/4" long and weighing only 39 lbs., can easily be carried to any room where heat is required. Takes the place of oil or small coal heaters. Beautifully Finished—Operates on Any Current. Low Cost Operation—Will Heat the Average Room.

We can also use **Dealers** If you send check or money order we will pay the freight.

**DIRECT SALES**

921-PM-W, 17th St., Kansas City, Mo.

# PRECISION BUILT Barron DRILL PRESS TOOLS!

**15** Essential workshop operations now accomplished on any drill press with famous Barron Tools and Accessories... Planing, mortising, rabbeting, shaping, surface sanding, polishing, tenoning, grooving, routing, drum sanding, beading, paneling, veining, edging, molding, dovetailing, etc.

**FREE! Workshop Guide**

Including a complete catalog of time-proved, precision built Barron Workshop Tools. Convert ANY drill press into your most versatile, low cost power tool.

FULL 10 DAY MONEY BACK GUARANTEE

**BARRON TOOL CO., INC.**  
669 ARCHITECTS BLDG. DETROIT 1, MICH.

 \$750

Drill Press Planer \$595

 Rotary Surface Sander \$900

 Safety Shaper Cutter and Blades Set of 6 Hi-Speed Router Bits \$950





## Loose Bathroom Fixtures Just Need SMOOTH-ON

Hooks, cup holders, shelf brackets, towel racks, soap dishes and other fixtures stay in place when you use Smooth-On No. 1 Iron Cement. You apply it to screws or bolts and into the screw or bolt holes. The fixture stays tight, because Smooth-On expands a little as it sets. Get a 1/4-oz., 7-oz. or 1-lb. size of Smooth-On No. 1 and keep it handy, not only for tightening loose parts and fixtures, but to stop leaks and seal cracks. If your hardware store hasn't Smooth-On, write us.

### FREE Repair Ideas

Send for YOUR free copy of the 40-page Smooth-On Handbook of time-saving, money-saving repairs you can make in the home, on the car. Just mail us a postcard. SMOOTH-ON MFG. CO., Dept. 37D 570 Communipaw Ave., Jersey City 4, N. J.

Do it with  
**SMOOTH-ON**  
THE IRON CEMENT OF 1000 USES



## SAVE 25% ON QUALITY BALL-BEARING WHEELS!

This spring, save when you build or repair garden carts, kiddie velocipedes, laundry carts, wheelbarrows—anything that rolls on rubber! Bilt-Rite wheels are semi-pneumatic, ball-bearing, red wheels, guaranteed top quality. Compare Bilt-Rite's quality and price—then order today.



#### REPLACEMENT WHEELS FOR HOME USE

(For 1/2 inch Axles)

6 x 1.00.....\$1.30 10 x 1.75 in...\$2.15

8 x 1.75..... 1.80 10 x 2.00 in... 2.45

#### INDUSTRIAL WHEEL FOR HEAVY LOADS

(For 5/8 in. axle)

10 x 2.75 in.....Only, \$4.65!

**Bilt-Rite Guarantee**  
No better wheels are made regardless of price; 10 day return privilege.

If size you need isn't listed, write for Folio A

ORDER TODAY—Send cash, check, or M.O.—Pay postage on arrival.

**BILT-RITE WHEEL COMPANY**

520 EAST MISSOURI AVE. KANSAS CITY 6, MISSOURI

## THEY THOUGHT HULA POPPER ... JUST ANOTHER PRETTY BAIT



"On a recent fishing trip, we each purchased a Hula Popper . . . thinking it just another pretty bait to adorn our tackle boxes. We did, however, give them a good try and the results of two days' use is reflected in this photograph of the Black Bass caught in Southeast Volusia County, Florida" . . . Hugh K. Pierson, Mrs. Pierson, New Smyrna Beach, Fla., and Marvin Mann, Manteo, N. C., shown (left to right) in this order in the illustration above.

Write for Free 1949 Catalog

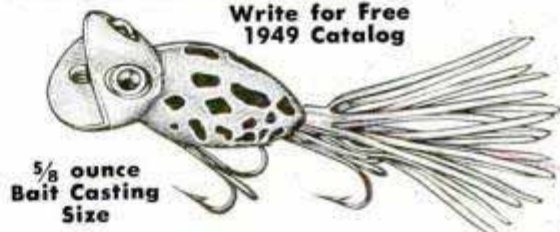

5/8 ounce Bait Casting Size

5/8 oz. Bait Casting Size . . . \$1.21 ea.

Extra Quick-Change Hula Skirts (small) . . . 17c ea.  
Colors: Red Head, Frog, Black, Yellow, Pearl, and Luminous

Hula Popper floats. You can make it pop, plunk, twitch or jerk, at will. When at rest, Hula Skirt goes into action. Makes Bass fighting mad.

1/16 oz. Fly Rod Hula Popper . . . 75c ea.

Hula Popper—T. M. Reg. U. S. Pat. Office

A-449-18

**FRED ARBOGAST & CO., INC.**

1654 W. NORTH ST., AKRON 3, OHIO

## PORTER MUFFLERS INCREASE

## SPEED POWER MILEAGE

REDUCES BACK PRESSURE UP TO 50%

TWIN SETS FOR FORD AND MERCURY STATION WAGON STACKS

### DUAL-TONE & MELLOW-TONE

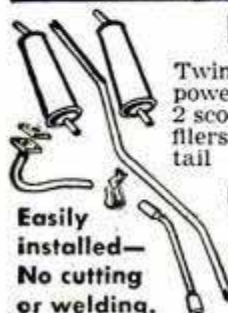

Twin exhaust for pep and power. Sets complete include 2 scoop design, thru type mufflers with left side head and tail pipes and all brackets.

Ford and Mercury 1935 to 1948 complete **\$17.50**

FREE illustrated catalog with diagrams

Finest mufflers made. Heavy 16 gauge steel casing, shredded steel packed. Cannot blow out or burn out. Lifetime Guarantee.

Complete sets, 1935 to 1948—\$23.00 1949 Ford & Merc.—\$25.00

Write name & address plainly in the margin



Heavy chrome finish . . . Specify year and model, also RIGHT or LEFT . . . Ford and Mercury, '42 thru '48, with brackets—**\$14.95** each Porter Mufflers for all cars. "Steel Pack"—Lifetime Guarantee. Free Folders and Price List . . . All prices quoted F.O.B. Hollywood, California.

**PORTER MUFFLER CO., INC.**  
5401 Sunset Blvd., Hollywood 27, Calif.

**DON'T LET MR. FISH  
GIVE YOU THE LAUGH**

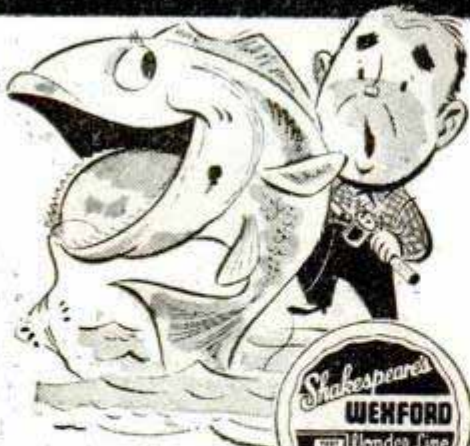

*Shakespeare*

**WEXFORD**  
A WONDER LINE

**WEARS UP TO  
3 TIMES LONGER  
AVERAGES 7 TIMES  
MORE WATER-RESISTANT!**

Mr. Fish won't give you the laugh if you use the fishermen's favorite, Shakespeare WEXFORD Wonder Line. That's because it wears up to 3 times longer than any of 10 leading lines tested. This is a fact, based on independent laboratory tests.

WEXFORD averages 7 TIMES MORE WATER-RESISTANT too, assuring you smoother, more accurate casting, extra enjoyment every hour of every fishing trip.

Ask for WEXFORD in the blue and red box at your sports store. **FREE 1949 TACKLE BOOK** and Fishing Calendar. Newest in Tackle, Fishing Tips. Write Shakespeare Co., Dept. PM4, Kalamazoo 2, Mich.

*Shakespeare*

**FINE FISHING TACKLE**

HONOR BUILT FOR OVER 50 YEARS

SAY YOU SAW IT IN POPULAR MECHANICS

**3, 4, & 5 HORSEPOWER**

**RED GARDEN TRACTOR**

**E** PLOW, DISC, HARROW, CULTIVATE and PLOW SNOW 3-4-5 H.P. Easy to Operate • Economical

NO BELTS • NO CHAINS  
POWER TURNING

BUY DIRECT  
from FACTORY  
at FACTORY  
DISCOUNT  
write for  
BIG, FREE  
CATALOG



RED-E  
TRACTOR CO.

Does Over  
30 Jobs

Thousands  
of Satisfied  
Users

All-Gear Drive  
in Oil Filled  
Grit-Proof  
Housing

Adjustable  
Handles to Fit  
Your Grip

**All Tractors  
Guaranteed**

RED E TRACTOR CO., Box 234, Richfield, Wisconsin  
Please Send Me 32-page FREE Catalog.

NAME \_\_\_\_\_

ADDRESS \_\_\_\_\_

**HARGRAVE**

No. 22  
**IMPROVED  
SAW VISE**



Clamps on any board or bench  
Constructed for long satisfactory service, this Vise holds the saw between a strong steel channel section and eccentric rod. Fibre insert resists oil and grease. Is securely riveted to channel section, affords double grip on saw, eliminating chatter. Standard saw set can be used with this vise. Filing space 10 3/4" long.

At Hardware and Mill  
Supply Dealers Everywhere.

Write for Catalog of  
Complete line.

1954 Waverly Ave.  
Cincinnati 12, Ohio

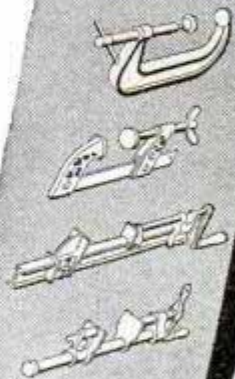

*The* **CINCINNATI TOOL Co.**



**\$2.95**  
EACH

**NOW! FILE YOUR  
OWN SAWS**

Do expert saw filing at home. Precision filing easy without experience. Two simple adjustments. Keeps any hand saw extra sharp and true-cutting. Complete with file. Money back guarantee. Cash with order, prepaid. (COD postage extra.) Order today.

**THE SPEED CORP., Dept. PM1**  
2025 N. E. Sandy, Portland 12, Oregon

**THEY'RE SUPER SCOPES!**



36" 17 POWER

Extends to 36 inches. Precision and Polished Lenses. Ideal for Studying Stars, Plane Spotting, etc. Satisfaction Guaranteed or Money Refunded. Send Check or Money Order to.....

**\$2.95**  
Post Paid

**CRITERION CO., Dept. PM4**

438 Asylum St.

Hartford 3, Conn.

**Build your own JET ENGINE!**



SEND  
NO  
MONEY

Order these plans today

1. JET PROPELLED BICYCLE. Assemble your own. Photo and instructions \$1.00.
2. HOW TO MAKE EXPERIMENTAL JET ENGINES. Seven sheets drawings with information and instructions \$2.95.
3. BOTH OF ABOVE in one order \$3.75. SEND NO MONEY. Order both at once \$3.75 C.O.D. in USA plus e.o.d. postage. Send check or Money Order and we pay postage. Get other information too. Rush Order.

**J. HOUSTON MAUPIN, Dept. 55, Tipp City, Ohio**



**New Precision Bilt MICROMETERS**

Chrome finished nationally known makes. Gives a lifetime of accurate detailed service.

- |   |        |             |        |
|---|--------|-------------|--------|
| 1" Central                                  | \$3.50 | 4" Starrett | \$6.50 |
| 1" Central, Tubular (also ideal for tubing) | \$3.75 | 5" Slocumb  | \$7.50 |
| 1" Slocumb                                  | \$4.25 | 6" Central  | \$7.50 |
| 2" Central                                  | \$4.95 | 6" Slocumb  | \$8.50 |
|   |        | 7" Slocumb  | \$9.50 |

Plus 25c handling and mailing



**COMPRESSOR**

Aircraft—G. E. 1/3 hp., 27 volt, 7 Amp. Can be converted to 110 V. w/transformer. Used for spraying, etc.

**\$19.95**

Limited Quantity. Price FOB, Kansas City, Mo. No COD's. Write for our new Catalog.

**A to Z Steel Letter  
PUNCH  
SETS**



- |       |        |
|-------|--------|
| 1/4"  | \$4.95 |
| 3/8"  | \$5.95 |
| 1/16" | \$2.50 |

Plus 25c handling and mailing

**ATLAS EQUIPMENT & SALVAGE CO.**

229 S. W. Blvd.

Dept. PM3

Kansas City, Mo.

# COMPLETE LOCKSMITH SHOP *only*

ALL NEW MERCHANDISE!  
POPULAR STANDARD EQUIPMENT

**\$149.00**

**START YOUR SHOP NOW!**

*At Home, Garage, Basement, or rent a small store, or add a key department to your present business.*

- A. 1 Champion Precision Key Machine.
- B. { 1,000 Popular Key Blanks.
- { 1 Key Board with Key Hooks.
- C. 4 Popular Locksmith Books.
- D. 2 Locksmith's Warding Files.
- E. 1 Set Lock Picks in Case.
- F. Big Assortment Parts and Tools.



**ALL FOR ONLY \$149.00. EASILY WORTH \$175.00!**

*Slightly higher out of U.S.A. 25% deposit on C.O.D. orders. Start making money at once! Order your outfit today! Complete satisfaction guaranteed! Write for FREE catalog today!*

REPAIR SHOP SERVICE • Box 264M • SKOKIE, ILL.

# DAISY AIR RIFLE

**\$2.59**

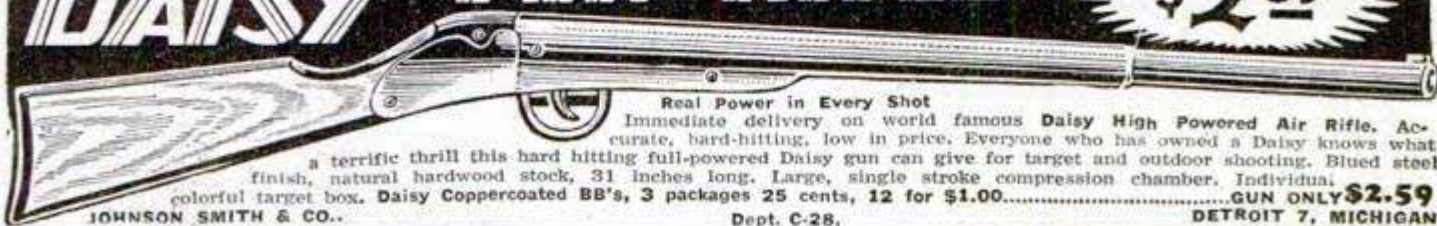

**Real Power in Every Shot**

Immediate delivery on world famous Daisy High Powered Air Rifle. Accurate, hard-hitting, low in price. Everyone who has owned a Daisy knows what a terrific thrill this hard hitting full-powered Daisy gun can give for target and outdoor shooting. Blued steel finish, natural hardwood stock, 31 inches long. Large, single stroke compression chamber. Individual colorful target box. Daisy Coppercoated BB's, 3 packages 25 cents, 12 for \$1.00.....**GUN ONLY \$2.59**

JOHNSON SMITH & CO.

Dept. C-28,

DETROIT 7, MICHIGAN

**AT LAST  
AGAIN AVAILABLE**

## THE AMAZING *Electric* TOY AUTO

**NO WINDING  
RUNS  
FOR HOURS**



A Collectors Item!

A scale model car, packed with fun and instructive play—Put it in gear and away it goes—in low, second, high. Touch it, and it goes in reverse. Driven by the exclusive VIBRO-ROLL MOTOR, powered by two flashlight batteries easily replaced after many hours of running. Safe, economical, 10" long, broad, low and handsome. Lasts indefinitely. Send your order today. \$2.98 complete. Postage paid—C.O.D., you pay postage.

**\$2.98**

ALL ELECTRIC PRODUCTS CO. 173-G Northfield Ave., Pittsburgh 4, Pa.

## New MASTER ADDRESSER

**PAYS FOR ITSELF IN 2 OR 3 MAILINGS!  
AMAZING LOW COST!**



Imprints addresses on envelopes, cards, etc. Ideal for businesses, churches, lodges, unions, etc. Handles any size list. Fast, easy to operate. Compact. Machine \$24.50. With all supplies for 500 names, tax paid, \$30.47. PREPAID. FREE literature. Write today or save time by sending remittance with name and address. Satisfaction guaranteed.

**DONALD F. ROSSIN CO.**  
216-X SO. FOURTH ST.  
MINNEAPOLIS, MINN.



## Sensational TWIN CARBURETION

**POWER • SPEED • ECONOMY**

Amazing Mani-Daptor Unit allows twin carburetors on any car. Steps up motor efficiency approx. 20%. Firing order at no time affected by fadeouts—yet saves gas. More high gear driving. Faster pickup, more economy with a Mani-Daptor. Precision-built aluminum polished unit will last for years. Comes complete with necessary linkage, easy-to-follow instructions. ORDER YOURS TODAY!

For 8-cyl **\$26.50** Chrome **\$1.25** ea.  
cars Stacks  
For 6-cyl **\$32.00** Finned **\$2.00** ea.  
cars Stacks

Free Illus. Stacks and carburetors are not included in price of unit. Cash, check or money order. C.O.D.'s o.k.  
**L. B. BACKUS MFG. COMPANY**  
P. O. Box 97-M Inglewood, Calif.

*The New Improved  
All-Purpose*

## DYNAMIC Super Charged ARC WELDER

Industrial Transformer Type

**IDEAL FOR AUTO HOME APPLIANCE AND FARM IMPLEMENT REPAIRS**

WORKS ON IRON, STEEL and other metals. Does work you'd expect from a larger costlier machine. Portable, easily carried. OPERATES from any properly wired 110 Volt Line. Also available for 220 volt current at slight additional cost

**IT WELDS • IT BRAZES • IT SOLDERS**

EASY TO OPERATE TRANSFORMER TYPE WELDER. If inexperienced you can learn to do professional work by following the SIMPLIFIED WELDING and OPERATING INSTRUCTIONS FURNISHED—comes complete ready to operate with helmet, rods, cable, instructions. SAVE TIME and MONEY—Do your own welding. Just a few repair jobs will pay for this machine. A practical and profitable machine tool for any workshop. Make money doing repair work for others. Write today for full particulars.

DYNAMIC WELDER CO., Dept. 49-T, 15 E. 23rd St., Chicago 16, Ill.

**ONLY \$28.50 COMPLETE**



**SPECIAL GIFT OFFER! ARC TORCH WORTH \$6.80 YOURS at NO EXTRA COST!**

**TWIN CARBON TORCH** (illustrated) for use with DYNAMIC is unsurpassed for brazing, soldering, pre-heating and cutting iron, steel, brass, bronze and other metals. With it you greatly increase profitable uses of your welder. Does work of oxy-acetylene torch. Comes complete with instructions, carbons and cables. For LIMITED TIME ONLY we are giving a

Twin Carbon Electric Arc Torch worth \$6.80 with every DYNAMIC WELDER. Act now to get this valuable premium at the single low price of welder alone.

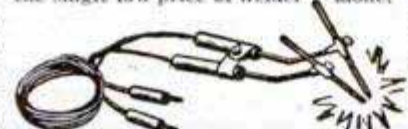

**Mail Coupon FOR FREE FACTS**

**10-DAY TRIAL OFFER**

DYNAMIC WELDER CO., Dept. 49-T, 15 E. 23rd St., Chicago 16, Ill. Send me FREE details of your ELECTRIC Arc Torch Gift Offer and Dynamic Welder 10-Day TRIAL OFFER.

NAME \_\_\_\_\_  
ADDRESS \_\_\_\_\_  
CITY \_\_\_\_\_ ZONE \_\_\_\_\_ STATE \_\_\_\_\_



**YOU'LL ENJOY  
GARDENING  
WITH THE  
NEW**

**BOLENS HUSKI HANDI-HO**

This single wheel garden tractor speeds up your lawn and garden work, and gives you better results. There's plenty of work drive in its one horsepower engine — even for plowing snow in winter. And it's so well balanced, so simple to control with easy-action steering and handlebar turning grips for clutch and throttle, that any member of your family can use it. When you see how this low-priced power tool makes your garden more productive and your lawn more beautiful, you'll wish you could have had it years ago!

Get the complete details from your BOLENS HUSKI dealer, or write direct for circulars.



**BOLENS PRODUCTS DIVISION**  
Food Machinery and Chemical Corporation  
265-4 Park Street, Port Washington, Wisconsin

Better performance, better price . . . your best buy is BOLENS

## NEW DIRECT FLAME SOLDERING OUTFIT

**RANSOME  
NO. "99"**



*Operates on Bottled Gas*  
**Complete Unit \$32.25, Exp. prepaid**

Ransome "99" soldering outfit will permit you to do twice the work with half the effort. Torch operates on butane or propane (bottled gas). Lights with a match and stays lighted. No time lost refuelling, generating, pumping pressure, or reheating work. Torch weight only 12 oz. Is 14" long. 2½ gallon cylinder of fuel lasts 200 hours. Burns without smoke, soot, or odor. Ideal for home craftsmen, electricians, plumbers, sheet metal workers, radio repair men.

Ransome "99" Outfit consists of: Torch with choice of A, B, or C Tips; 2½ gallon ICC approved cylinder; gas regulating valve; 10' high pressure hose. \$32.25, express prepaid. Have your oil company fill cylinder and you are ready to go to work. Torch only with A, B, or C tip \$9.00, postpaid. Extra tips A, B, or C \$4.50 each. Tip D is \$8.00. Torch with all 4 tips \$26.00, postpaid.

To avoid time lapse for personal checks to clear, remit by bank draft, cashier's check, or money order.



**RANSOME COMPANY**  
4032 HOLLIS STREET EMERYVILLE, CALIFORNIA

## PRESSURE PRINCESS

*Makes every job EASIER*

**YOU** have never seen a single cylinder portable air compressor that packs so much power as this one. Built by the makers of the famous 4 cylinder Pressure Queen, the Princess will do any job, from inflating tires to painting buildings. Compact, simple and rugged, it will last your lifetime and pay for itself over and over again.



Powered by electric motor or gas engine.

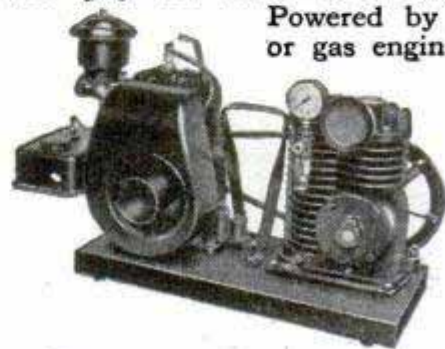

*Write for  
Literature  
and Prices*

### THE CAMPBELL-HAUSFELD CO.

1046 Railroad Avenue

Harrison, Ohio

### BUILD YOUR OWN <sup>Five</sup> <sup>Second</sup> AUTO BED



Complete step-by-step plans, and photographs make it easy. Utilize present car seats. Changes from driving position to bed in FIVE SECONDS. No pins, bolts or blocks. Over 5,000 in use. State year, make and model. No hardware supplied. Cash, Check or money order. Only \$3.50 per set. **Top Shops, Garages—Make Money** Start a new sideline. Make Auto Beds. Big profit item. Write for prices on complete set of plans and photos for all makes and models.

AUTO BED SHOP, Dept. PM-4, 4554 Eagle Rock Blvd., Los Angeles 41, Calif.

### BUILD HEAVY DUTY MACHINES



**SAVE UP TO 90%**— You can build, using our practical, easy-to-read plans, all kinds of machines, for home, farm or shop — scooters, portable sawmills, metal working machines, concrete machinery of all kinds, printing equipment, woodworking machines, midget autos, dish washers, farm equipment, freezers, tractors.

**FREE CATALOG HANDBOOK**  
183 SETS OF PLANS  
VALUABLE INFORMATION

**NICHOLS EQUIPMENT COMPANY**  
D-2110 PURVIS, MISS.



### SURPLUS HYDRAULIC PUMP

Genuine Vickers constant displacement high pressure pump. Use it for any type of liquid pumping job. Will pump 400 gal. per hour at 3750 R.P.M. Precision piston type design provides 1000 lbs. per square inch pressure. Self priming. Standard thread ¾ inch intake and discharge ports. With ¾ inch splined shaft — just add pulley and power and you're ready to go.

**HAS HUNDREDS OF USES**

These pumps are brand new. Original acquisition cost approx. \$100.00. Can also be used as hydraulic motor; for rams, opening doors, hydraulic lifts, etc.— also for any liquid transporting job. War surplus, but brand new. Shp. wt. 7 lbs. Will include at no extra charge an hydraulic control valve and ship postpaid when remittance accompanies order. (Control valve, only \$1.95.) Satisfaction guaranteed. Rush your order today.

**\$9.95**

### SURPLUS AIRCRAFT COMBUSTION HEATER

15,000 BTU, fuel vapor type heater utilizing air ram for greatest efficiency. Size 23" x 7" x 3". Complete with stainless steel heat exchanger, fuel filter, solenoid valve, metering device, 24V firing unit, relief valve, diaphragm switch, etc. Instruction booklet furnished. Shipped in original factory box, total weight 30 lbs. Now selling at only . . . **\$1295**

**F.O.B. HOUSTON. SEND CHECK OR MONEY ORDER**  
**SOUTHWEST AERO SUPPLY** DEPT. PM4, DRAWER 488  
SOUTH HOUSTON, TEXAS



"SAVE IT AND  
FIX IT"

# FIXES

FURNITURE, DISHES, TOYS  
BOOKS AND GLASSWARE

It's transparent, waterproof,  
flexible and durable.  
Get a tube  
today.



## DUOCO CEMENT

REG. U. S. PAT. OFF.

# The LAWNHAVER

SELF-PROPELLED

MAKES MOWING AS EASY AS  
WALKING EMPTY-HANDED



3/4 HP—\$125  
1 1/2 HP—\$139.50

Yes, the 3rd wheel drive does away with all controls. Start the LAWN-SHAVER, cut your lawn—to stop or turn around lift 3rd wheel from ground by raising the handle with fingertip ease (its perfect balance makes this simple). Trims flush with obstacles, can be operated in spots where no other power mower can go. Vertical height adjustment 1/2" to 3 1/4". Chain driven wheel and reel. Heavy duty solid steel construction. 4 cycle gas engine.

See Your Local Dealer or  
Order Today on Coupon Below

SEND FOR  
FREE BOOKLET

SOUTHERN METAL  
STAMPING CO., Inc.  
1111 S. Liberty St.,  
New Orleans, La.

Enclosed find check \_\_\_\_\_ money order \_\_\_\_\_ in the amount of  
\$ \_\_\_\_\_ for \_\_\_\_\_ LAWNHAVER. Please send to . . .  
NAME \_\_\_\_\_  
ADDRESS \_\_\_\_\_

## Sensational Bargains: LOWEST PRICES! All Items Guaranteed As Represented

**BACKGEAR MOTOR**  
90 RPM 110V. 60 cycle, A.C. slow speed motor. All brass construction. Sturdy gears & bearings. Drives window displays, toys & useful experimental work. 6"x2 1/2", 5/32" shaft. Pulley FREE. \$3.50 ea. Postpaid. In lots of 6 ONLY \$2.95 each.

**1000 Ft. BLOWER WITH 1/6 H.P. MOTOR**  
1000 cubic feet free air per minute for cooling, heating, drying, blowing, ventilating, air conditioning, dust collecting, etc. 1/6 H.P., 110 volt, 60 cycle, 1750 RPM, A.C. Motor, No. B-54, List Price \$65.00. **OUR SPECIAL \$45.00** Fob. Chgo.

**MOTORS:** Westinghouse, Leland, G.E. & others. 1/2 H.P. AC-110-220, 60 cycle 1750 RPM. Like new—Totally enclosed 50° C—Fully Guaranteed . . . ONLY \$19.75 Fob Chgo.  
NEW G.E. Capacitor Type, 110 V—60 cyc—3450 RPM, 1/2 H.P., ONLY \$23.50 Fob Chgo.  
NEW G.E. Capacitor Type, 220 V—60 cyc—3450 RPM, 1/2 H.P., ONLY \$21.00 Fob. Chgo.

**GENERAL ELECTRIC AMPLIDYNE MOTOR GENERATOR No. 5AN3INJ18A**

An all purpose machine adaptable to many uses. Double ball bearing, can be mounted in any position. Brand New, in original factory cartons, original cost \$140.00. Use as 24/32 volt D.C. Motor, pulls over 1 1/2 H.P.; or 0/60 volt D.C. generator; or belt driven will deliver 30/40 amps., for charging auto batteries. Amplidyne only . . . **SPECIAL \$5.95** Fob. Chgo.  
You can make simple changes in connections (no winding necessary) and make a 110 volt, AC/DC, 10,000 RPM, 1/2 H.P. motor for grinding, polishing, routing, sanding, shaping or sawing wood. Amplidyne complete with shaft extension and instructions for reconnecting . . . **SPECIAL \$7.95** Fob. Chgo.

Write for our Illustrated Price List on Other Bargains and SAVE MONEY—

C. MARSHALL SALES, 3546 W. Fullerton Ave., Dept. P-4, CHICAGO 47, ILL. • RUSH ORDER TODAY

## BARGAIN! ELECTRICAL & MECHANICAL EQUIPMENT BARGAIN!

**TESTED FEATURES**  
1/3 H.P. General Electric motor, 115 volts, 60 cycles, AC; runs on regular house current. Stainless steel shafts. Aluminum base and stand. Completely screened at intake to prevent clogging. Pumps over 2,000 gallons per hour. Equipped with "Nee" ball bearings. Pump is three feet high. Cutler-Hammer float operated switch, starts and stops automatically.  
Our Regular Price \$69  
NOW **\$39.50**  
F.O.B. N.Y.C.  
Same as above, made entirely of copper & bronze, equipped with 1/4 H.P. Ohio Motor with over-load protection... **\$49.50**

**300-Gal. HEAVY DUTY RECIRCULATING PUMP**  
For pools, cellars, evaporative coolers, bilges and 1001 other uses. Supreme's outstanding heavy duty unit will deliver 300 gal. p.h. at 6 ft. head. Completely enclosed 1/30 H.P. 110-V. 60-cycle motor with self-oiling long life feature. Non-corrosive shaft and bronze pump 10 1/2" high, 3/4" I.P.T. also in 6 volts DC for bilge pump.  
**\$19.50**  
Same as above with automatic cutoff, requires no attention . . . **\$25.00**  
Also all sizes & types motors in stock for all purposes.

**ELECTRIFY YOUR SEWING MACHINE**  
Simple to attach and operate  
This supreme set consists of AC-DC 115-v 60 cy., double shaft motor, foot control, rheostat, bracket, belt, pulley mounting screws, PLUS a FREE complete sewing light.  
**\$15.50**  
Cash or C.O.D. 20% Dep. on orders.  
**CANAL ELECTRIC CO.**  
310 CANAL ST., DEPT. PM4  
NEW YORK 13, N. Y.  
ALL PRICES FOB. NYC

# HANDY ELECTRIC HOME PAINT SPRAYER

**NO BRUSH!  
NO BACKACHE!**



**10 DAYS  
FREE TRIAL**

Weights  
only 2½ lbs.

Why wear yourself out using old-fashioned brushes? **VIBRA-SPRAYER** quickly, evenly sprays glossy enamels, lacquers, insecticides satin-smooth. All-in-one instrument requires no compressor, motor or accessories. Piston activated, housed in sturdy plastic. Weighs only 2½ lbs., uses standard replaceable mason jar for paint container. Spray volume is adjustable, fingertip control. AC-110 volts.

## FOR PAINTING, SPRAYING, DISINFECTING

Get professional results painting furniture, metal cans, partitions, concrete, brickwork, rough wood, boats, wagons, screens, cabinets, venetian blinds, metal equipment, etc.

### Send NO MONEY — 10 Days' Trial

We guarantee that **VIBRA-SPRAYER** will apply paint smoothly, quickly, easily—or return it within 10 days for full purchase price refund. Only \$12.95 C.O.D. plus delivery, or send full payment now and we pay delivery. Order NOW from

**FOSTER PRODUCTS, Inc., Dept. 5G37**  
179 WOOSTER ST. NEW YORK 12, N. Y.

## LOOK FOR THE NAME

**Buckeye** when you buy a

## LAWN MOWER

Built by a factory noted for quality lawn mowers since 1880, the long experience behind **BUCKEYE** mowers assures you complete satisfaction with their fine, practical, labor saving performance. Streamlined design; light, strong, durable. Reasonably priced; recommended by reliable dealers. Send for free booklet describing the popular self propelled **BUCKEYE** Power King and the easy-to-push **BUCKEYE** hand mowers.

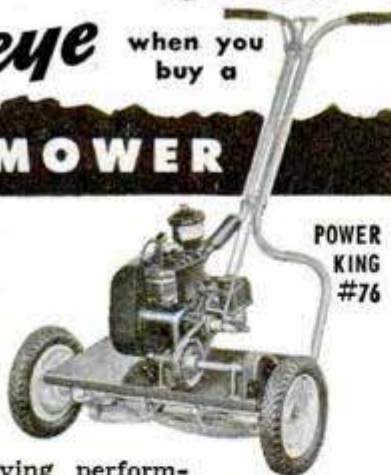

POWER KING #76

HAND AND POWER LAWN MOWERS

**MAST-FOOS MFG. CO., Dept. PM-49, Springfield, O.**

You may send descriptions of **BUCKEYE** Lawn Mowers, also name of your nearest dealer.

Name \_\_\_\_\_  
Address \_\_\_\_\_  
City \_\_\_\_\_ State \_\_\_\_\_

# WAR SURPLUS BARGAINS

"THE BOTTOM OF THE SURPLUS BARREL IS IN SIGHT"



**COMPLETE GENERATOR SET.** Includes Aviation type generator (Type L3, 28 Volt, 25 Amp. rotation CW, 2500 RPM) measures 12 x 5 inches, weighs 24 lbs. Outfit also includes famous Carbon Pile type voltage regulator (AN3080-1) with mounting base for same. Holds voltage within given operating range at varied generator speeds. Complete set, generator, regulator and base (all like new) now offered at approx. 10% of AAF acquisition cost. Complete set only \$24.50. Generator only (shp. wgt. approx. 35 lbs.) only **\$17.50**

## PORTABLE FOOD WARMER KIT



Used by AAF for warming liquids, food, etc. Operates on 110 V. AC or 28 V. DC. Keeps foods hot for hours. Case measures 11 x 17 x 17 in. Equipment includes 6 4½ in. stainless steel cups with lids, 4 stainless food trays or plates with lids, 6 each knives, forks, spoons, 1 water container, plugs, etc. Use at home, on boats, planes, etc. to warm canned goods, etc. and to keep them warm. May be packed with dry ice to keep things cold. Use also on hunting and fishing trips, picnics, etc. Shp. wgt. approx. 35 lbs. Complete, only **\$19.95**

## LIGHT PLANT "HOMELITE" PORTABLE

A complete, self powered portable light plant of 14 V. DC; 1000 watts. Powered by approx. 3 H.P., air cooled gas engine. Complete with meter, etc. Mounted on pneumatic tired wheels and dolly. Crated and guaranteed like new. (Shp. wgt. approx. 115 lbs.) Each only **\$74.50**

## NAVIGATOR'S CELESTIAL SEXTANT

Link A-12 type, good serviceable condition; in carrying case, instructions, navigation study book (AAF), etc. (Shp. wgt. 9 lbs.) Reduced to less than 10% of AAF cost. Now only **\$14.95**

## AUTOMATIC RADIO DIRECTION FINDER

Bendix, type SCR269G (AAF), receiver type 433G. The famous ADF set used to guide vessels and aircraft throughout the world (simplest form of navigation known to man). Turn set on, tune to station you wish to navigate to (frequency 200—1750 KC, includes marine beacons, aircraft beacons with weather, all broadcast stations); then "follow the electronic needle into port." This set is complete in every detail with all components needed. Installed it weighs 85 lbs. Reception is wide, tone clear. Operates from 24-32VDC aircraft or boat power. Sets are perfect but used, bench checked and operated prior to shipment. Complete with full instruction booklet, diagrams, not wired up to plugs (wire not furnished). Now selling at 5% of cost. (Shp. wgt. approx. 100 lbs.) Reduced **\$124.50** to only.....

**AERO MAGNETIC COMPASS.** Panel mounting type, made by Pioneer. Original cost approx. \$75.00. New, reduced to only **\$5.95**

**AIR COOLED AIRPLANE ENGINE.** 6 cyl. in-line inverted, Ranger Mfg.: 175 H. P., net weight approx. 375 lbs. Engines are new, in factory box with tools, two magnetos, (no carburetors) etc. Total shp. wgt. approx. 750 lbs. Original cost over \$3000. To close out **\$295.00** balance of stock, reduced from \$495 to.....

Send check or money order. All F.O.B. Houston. Can ship mail, express or freight, transportation charges collect. Order today while these bargains are available.

**AERO PARTS SUPPLY, Dept. PM4**  
MUNICIPAL AIRPORT HOUSTON 17, TEXAS

## Say You Saw It in POPULAR MECHANICS

# YODER SUPER GOOSE HORN



for  
**AUTOMOBILES**

ONLY  
**\$3.95**  
postpaid  
Fair Traded

Beautiful...New...Unusual  
Gives the new model car  
that Different Look. Gives

the timid old car that Bold Look.  
Clear tone commands attention. Horn is 12" long with a 3½" Bell. Fits all cars. Lasting chrome finish. Fits on car door. Simple to install. No holes to drill.

**YODER MANUFACTURING CO.**  
2401-21X E. 103rd Street, Los Angeles 2, California

# New Shasta Engine POWERED WATER PUMP



HERE is a gasoline engine driven 1 HP water pump suitable for wells to 200' deep. Capacities to 3000 GPH. Pressures to 40#. Designed for installation beyond the electric lines, on farms, ranches, suburban homes, mountain cabins. Should electric power finally become available, unscrew 4 bolts and remove engine and we can supply a standard electric motor to install in its place. Engine runs 3450 rpm, same as electric motor. Pump can be easily disconnected from well and stored during winter months if desirable.



The shallow well model, suitable for lifts to 22', \$190 freight prepaid. Deep well model good for 140' lifts \$210 freight prepaid. Two-stage deep well pump for lifts to 200' costs \$231 freight prepaid. Immediate shipment on receipt of bank drafts or money orders. Additional information will be mailed you on request.

**SHASTA PUMP COMPANY**  
681 HEGENBERGER ROAD  
OAKLAND, CALIFORNIA

TURBINES • CENTRIFUGALS • EJECTORS

**Now CHEAP OIL BURNER**  
FOR HEATING AND COOKING STOVES-FURNACES  
HEAT YOUR HOME, COOK YOUR MEALS  
WITH CHEAP FURNACE OIL

**NO MORE SHOVELING COAL OR ASHES.** Sensational Fuelizer Starter Vaporizing System turns Cheap No. 1 Furnace Oil, also Range, Heater, Tractor Distillate, Kerosene and like oils into oil heat—one of the quickest, hottest fires known. **LIFETIME GUARANTEE. \$1.00 Bonus Offer for Testing.** We will let you try it in your own stove or furnace for one month. Get yours for introducing. Big profits QUICK. Be first. Send in your name today for details and cash in on the tremendous demand for this Amazing Invention.

**NORTHWEST MFG. CO., 634-D, Mitchell, S. Dak.**



What makes the difference?

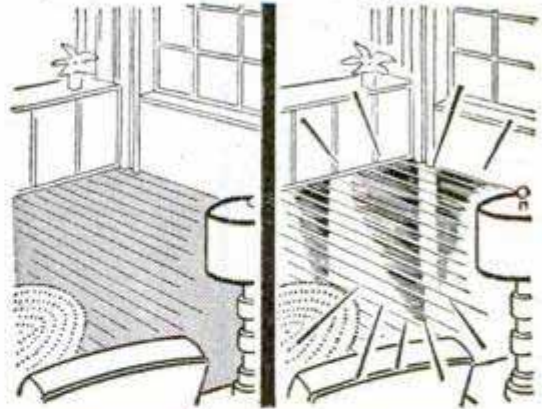

## LIN-X CLEAR-GLOSS VARNISH

Yes, and what a difference! That clear, tough, long-lasting coat of Lin-x Clear-Gloss Varnish protects and beautifies floors, woodwork, furniture, printed linoleum, boats, countless other surfaces—resists boiling water, sizzling cooking greases, alcoholic beverages. *And so EASY to use—just brush it on!*



At your paint, hardware and department store!



Distributed by  
Acme White Lead & Color Works, Detroit • The Lowe Brothers Co., Dayton • John Lucas & Co., Inc., Philadelphia • The Martin-Senour Co., Chicago  
Rogers Paint Products, Inc., Detroit • The Sherwin-Williams Co., Cleveland

Model 500 for Home Workshops  
or the Master Craftsman



From drill press to vertical miller in one minute

## Mastercraft ROTARY TABLE

Drills in a dead straight line or on a radius—cuts male or female slides on any form—cuts flats, hex or squares—cuts keyways, special shapes, splines and innumerable other forms. **ADJUSTABLE DIALS** read in thousandths—**ROTARY TABLE** graduated in 360 degrees; is 7" square and travels 4 1/2" in either direction—**QUICK ACTING Swivel Vise** jaws positively lock regular or irregular shapes up to 4 3/4". **ADAPTABLE TO ANY DRILL PRESS.**

**\$37.50** prepaid

**F & M SALES, INCORPORATED**  
1054-58 Cahuenga Boulevard • Hollywood 38, California

FOR ALL MAKES AND MODELS



ORDER NOW!

### DOUGLASS Steel-Pack MUFFLERS

Performance that excels • Stamina that endures  
Rugged construction. Steel tubing. Straight-thru-design. Solid tube with steel packing. "Throbbing Deep Tone." Complete for Easy Installation. Satisfaction Guaranteed

32-40 FORD V-8	\$5.96	29-48 CHEVROLET	\$5.96
41-49 FORD V-8	6.85	31-41 PLYMOUTH	5.96
39-49 MERCURY	6.85	42-48 PLYMOUTH	6.85
35-49 FORD & MERCURY DUAL SETS			\$23.00
49 FORD & MERCURY DUAL SETS			25.00

Specify Year and model • Enclose Money Order or Check with Order.  
DEPT. M-4



1949  
COMPLETE  
RACING  
EQUIPMENT  
CATALOG  
25c

WRITE  
RACING EQUIPMENT DIVISION

DOUGLASS MUFFLER MANUFACTURING COMPANY - 1916 W. VALLEY BLVD. - ALHAMBRA, CALIF.

# BETTER CONTROL<sup>SM</sup> of Growing Conditions



\*Available Plant Food • Soil Moisture • Soil Aeration  
• Insect and Pest Control • Soil Temperature

## With a SEAMAN ROTARY TILLER!

A SEAMAN ROTARY TILLER means better and lower cost seedbeds . . . better control over vital growing factors. Many Seaman users report increased crop yields (often 35% or more).

HERE IS WHAT HAPPENS: The power-driven Tiller tines break up clods and aerate the pulverized ground . . . which helps warm up the soil, hastening seed germination and promoting earlier maturity. Some users increase aeration by tilling with hood up, also helping to control weeds and insects.

The pulverizing action also creates more capillary paths for water to follow. You lose less water and nutrients through erosion, evaporation, and leaching.

Fertilizer is mixed throughout the topsoil depth for quicker and more effective decomposition.

Power take-off and motorized units (gas or diesel) . . . 3 to 7 ft. tillage widths. Write for Bulletin NST and see your Seaman dealer.

**SEAMAN MOTORS, Inc.**  
364 N. 25th Street, Milwaukee 3, Wis.

Modernizing?  
Remodeling? Use..  
**CHROMTRIM**  
"Trim-it-Yourself"  
METAL MOULDINGS

You'll find hundreds of uses for this handy metal trim around your home. Kitchen, bathroom, stairs or attic can be streamlined in a jiffy. Chromtrim comes in convenient 6' lengths, 8 shapes, all ready to tack on.

Chromtrim is easy to cut — Economical to use — Bends simply to any shape.

Send 10¢ for "Trim Ideas"—16 pages brimming with Chromtrim projects, ideas, and directions for use.

R. D. Werner Co., 295 Fifth Ave., N. Y. 16

Enclosed is 10¢ for CHROMTRIM "Trim Ideas" booklet PM-4.

Name \_\_\_\_\_

Address \_\_\_\_\_

City \_\_\_\_\_ Zone \_\_\_\_\_ State \_\_\_\_\_

**R. D. WERNER CO., INC.**

295 Fifth Avenue, New York 16, N. Y.

# GEARED TOOLS FOR THIS ATOMIC AGE

.. Are Saving USERS \$s—Energy  
Making **BIG MONEY** for AGENTS..  
.. Eifel-Line Super-Tools

with the Amazing 4X, EXPANDO-Jaw



The NEW '4X' Jaw

Above Composite Cut shows 2 Positions.  
• The Exclusive Parallel EXPANSION-Grip has countless new uses.

• A 3-Jaw, 7" Plierenck KIT and  
• 8 1/2" KITS with 3 to 8 Jaws, etc.: Universal, Pipe, Wire; for a Million Sizes 0", 1 3/4", and

• GIANT Univ. '4X' and Pipe Jaws (Range 1" to 3")  
• Tub'g Ctr., Grip-Clamp, etc. 1-Oz. to 1-TON grips! Do Thousands of Jobs, Quicker, Better and Easier.

• 8 1/2" Items FIT EIFEL-GEARED Plierencks. '33 and later. Sold SINGLY or in ANY Combination.



GET the Most Amazing Gripping-tool Facts Ever

MAIL this COUPON TODAY . . .

on a Postcard will do . . .

Print your Address . . . Get FREE

1) The 115-Picture MANUAL—M,

2) The 120-Picture CATALOG—C,

. . . With OFFER as marked—

PART-TIME AGENT  USER

FULL-TIME DISTRIBUTOR

**AMERICAN PLIERENCK CORP<sup>N</sup>**

4611 N. RAVENSWOOD AVE., CHICAGO 40, ILL., DEPT. PM94



3) Also FREE (in U.S.A.) this 3/4", 6-Edge, End-and-Angle Screwdriver, etc. . . often more Valuable, Useful than a Pocketknife!

## NEWEST B-M POWER MOWER

For Modern Lawn Care

Low Factory Price  
• Fully Guaranteed  
• Some Dealerships Available



Newest addition to our family of fine power lawn mowers. Light, 3-wheel, rotary blade mower. Lifetime construction. Powerful 1 1/2 h.p. 4-cycle engine. Self-propelled and other models available, including build-it-yourself Kit.

B-M MOWER CO., Box 66-PM, Blue Mound, Kans.

## NEW BAND SAW RIPPING FENCE



Fits all band and jig saw tables from 7" to 15". All metal construction, 10-day money-back guarantee. Send name and address for C.O.D. or send \$1.98 now, and we ship prepaid. Dealer inquiries invited.

WASCO MFG. CO., Box 111, Blue Island, Ill.

## WAR SURPLUS BARGAINS

• **POWER PLANTS.** 110-volt, 60 cycle, 3,000 watt. Remote switch electric self-starter. Fine instrument control panel, Army's finest plants. Full maintenance-operation instructions. Ideal for farmers, sportsmen, contractors. New condition. Cost Gov't. \$74. Sale price—\$345.00. Also lower priced plants. Freight prepaid. (Write for details this marvelous plant)

• **MARINE ENGINES.** New single cylinder Briggs U. S. Falcon, 3.5 h.p. air cooled, flame arrester, thrust bearing, shaft coupler. Ideal for fishing boats. Also excellent for farm or industrial uses. Used for garden tractors, weed sprayers, elevators, pumps, scooters, saws, etc. Complete instructions. Standard price \$130.00. Prepaid price only \$89.90. Same engine with Utility Clutch. \$99.90

• **BRIGGS 6.5 H.P. ENGINE.** Model ZZ. Nearly new & excellent. Useful tractors, grain elevators, weed & paint sprayers, pumps, scooters, saws. Cost \$130. Our freight paid price. . . . . \$86.90

• **PRESSURE AIR UNIT AND SPRAYER.** Portable wheeled Briggs-N 1 1/2 h.p. engine driven unit. Bendix 2-cylinder compressor. Gauge, regulator, valves, hose—complete. Excellent for painting, weed or insect spraying, tire pumping, cleaning and greasing equipment, etc. Hundreds uses—our most popular item! Cost \$259. Special Freight Prepaid . . . . . \$99.50

• **ROTARY GEAR PUMPS.** Precision unit. New condition. High vacuum and pressure. Dozens of pumping uses on farm and in business—also pumps high vacuum. Full instructions. Cost \$36.50. Prepaid price . . . . . \$3.95

**MISCELLANEOUS BARGAIN ITEMS**  
• 6 ton winches. . . . . \$110.50  
• Hyd. pumps. . . . . \$7.90  
• Flexible power shaft. . . . . 98c  
• Wheatstone bridges. . . . . \$59.50  
• Many other values

• Desk phone & ringer. \$4.99  
• Vacuum pumps. . . . . \$5.60  
• 110 v. 60 c. Selsyns. \$4.99 pr.  
• Utility engine or motor clutch. Max. cap. 6.5 h.p. at \$13.95

We pay freight or postage all items. We accept personal checks. Order direct from ad or write for bargain cut. Our references—17 year's business in Lincoln and the Nat'l Bank of Com.

LECO ENGINEERING CO. LINCOLN, NEBR.



**MAKE EXTRA MONEY**  
In Your Spare Time

# SHARPEN LAWNMOWERS

Start a profitable business of your own. Earn up to \$5.00 an hour sharpening lawnmowers in your basement or garage. Just place lawnmower in the IDEAL Lawnmower Sharpener and make a few simple adjustments. In a few minutes you have a smooth-running, perfect-cutting mower. No experience needed. WRITE TODAY FOR FULL INFORMATION on how to get started.

GRINDS ALL MAKES OF LAWNMOWERS  
BACKED BY 50 YEARS OF  
ENGINEERING

EXPERIENCE

SHARPENS SPEEDILY,

ACCURATELY . . .

ORDER NOW

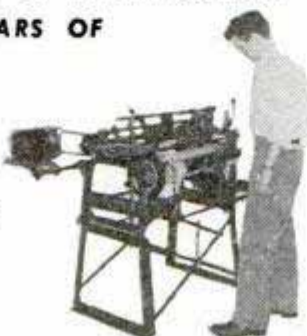

## THE FATE-ROOT-HEATH CO.

DEPT. D-3

PLYMOUTH, OHIO

Send for this FREE  
DIESEL BOOKLET



See how the economy and long life of a

# Sheppard

# DIESEL

reduces power costs  
by at least 75%!

Send for this new Sheppard Diesel booklet. It tells the complete Sheppard story of simplified fuel injection . . . full diesel operation on any 1 of 15 different fuels . . . 3 to 5 times longer engine life. Send for your free copy today.



**Sheppard Diesels**  
Hanover 4, Pa.

DEALERS—Send for details on profitable Sheppard franchise.

5.4 H.P. AIRCOOLED single cylinder power unit. Others up to 100 H.P. Generating sets from 2 to 36 K.W.

STATIONARY • AUTOMOTIVE • MARINE

DIESEL'S THE POWER... *Sheppard's* THE DIESEL

## BUILD YOUR OWN TILTING ARBOR SAW!

Exclusive GIL-BILT Build-It-Yourself Features

SAVE  
**\$50**  
OR MORE

- No machining—build easily with hand tools only
- No blueprint reading—step-by-step pictorial plans, full scale patterns, actual photographs
- Sturdy wood, aluminum, and steel construction
- Capacity and performance of commercial saws selling for \$60 and up

### GIL-BILT 10-INCH TILTING ARBOR SAW



- 27x28 in. table, 13½ in. capacity in front of blade
  - 10 in. blade cuts ¾ in. deep, tilts full 45 degrees
  - Floor model, 34" high table always stays level
  - New Departure ball bearing arbor, ¾" precision shaft turned down for ½" bore blades, alum. housing, shipped ready to run
  - Jackscrew and 4½ in. dia. handwheel lowers and raises blade
  - Cast aluminum miter gauge and self-aligning rip fence guide
- Gil-Bilt Metal Parts Kit includes Plans, Ball Bearing Arbor, Miter Gauge and Bar, Rip Fence Guide, Machined Lock Knobs, Jackscrew Mechanism and Handwheel, and All Other Metal Parts (less blade)..... \$20.95  
Same Kit with 10" comb. blade..... 25.90  
Same Kit with 8" comb. blade..... 24.90

### GIL-BILT 8-INCH TILTING TABLE SAW

- 21x27 in. table tilts full 45 degrees, 13 in. capacity in front of blade
- 8 in. blade cuts from 0 to 2½ inches
- New Departure ball bearing arbor, ¾" precision shaft turned down for ½" bore blades, alum. housing, ready to run
- Cast aluminum miter gauge and self-aligning rip fence guide (same as above)



GIL-BILT Metal Parts Kit includes Plans, Ball Bearing Arbor, Miter Gauge and Bar, Rip Fence Guide, Machined Lock Knobs, Tilt Support Segments, and All Other Metal Parts (less blade)..... \$15.95  
Same Kit with 8" Combination Blade..... 19.90



### GIL-BILT 12-INCH BAND SAW

- Cuts to center of 24 in. circle
- Handles stock up to 6 in. thick
- Fully enclosed mechanism for utmost safety
- Wheels turn on heavy ¾ in. shafts, four Oilite bronze bearings
- 18x18 in. table tilts 45 degrees
- Upper wheel tension and tilt mechanism of cast aluminum; completely assembled
- Two blade guides, each has ball thrust bearing, self-lub bronze jaws
- Rubber tired wheels. Choice of cast alum. or make-your-own wood wheels on metal hubs
- Uses standard 78 in. blades up to ¾ in. wide

GIL-BILT Metal Parts Kit includes Plans, rubber tires, 3/16" blade, hubs for wood wheels, bearings, shafts, tilt mechanism, guides, tilt support segments, and all other metal parts..... \$16.95  
Same kit with two ready-to-install 12" cast aluminum wheels 20.95

NO DEALERS — ONE LOW PRICE! Prices include postage up to 600 miles. Send cash, check or money order for complete kit, or send \$1.00 for each set of Step-by-Step Plans and Order Kit later less cost of Plans. Plans sent postpaid anywhere in the world.

### GILLIOM POWER TOOLS

P. O. Box 1-PD, Lambert Field, St. Louis 21, Missouri

COMPLETE  
PLANS  
only  
**\$1.00**  
EACH

# SANDEE

Mufflers—All Ford, Chev., Ply..... \$4.45  
All Buick, Pont., Olds., Chrys.,  
Dodge, Hudson, K.F., Pack., etc..... \$5.45  
V-8 and Merc. Duals  
(32-49 incl.)  
**\$15.95**



DURABILITY

**SPORTONE**  
MUFFLERS  
(Pats. Pend.)

Beautiful  
SANDEE  
Fender Skirts  
**\$16.95**

A SANDEE Sportone will outlast two ordinary mufflers and give More Power! More Speed! More Mileage!—plus a tone quality unsurpassed.

Please ship (item): \_\_\_\_\_ Price \_\_\_\_\_  
Car and Year \_\_\_\_\_ Name \_\_\_\_\_  
Address \_\_\_\_\_

SANDEE MUFFLER CO. 5643 Corryne Pl. Culver City, Calif.

# WAR SURPLUS AND OTHER BARGAINS

## Aero-Torch

THE OUTSTANDING OFFER OF THE YEAR FOR MECHANICS OR HOBBYISTS!

For HEATING  
BURNING  
SOLDERING  
or BRAZING

*New!*

A compact versatile torch for electricians, plumbers, painters, auto mechanics, dental technicians, jewelers, neon glass formers, plastic workers and radio repair men. Burns propane or butane for 13 continuous hours at cost of only 3c. No moving parts to get out of order. Burns in any position with non-varying flame at approx. temp. of 3660°. No hose connections to get in way. Always ready for use! Built to withstand 2800 lbs. p.s.i. 2 1/4" diameter, 10 1/2" long. Complete wgt., only 2 lbs! **AN AMAZING VALUE . . .**

Only **\$13.95** each



### CHICAGO PNEUMATIC TOOLS AND OTHER MFR'S.

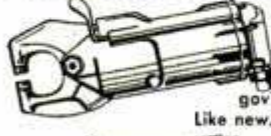

**Squeeze Riveter with Alligator Yoke**

For all types of metal and auto body work. Purchased from an active gov't. tool crib. Original cost about \$80.00. Like new. Weight 4 lbs. . . . . Each **\$12.95.**



**C-Type Yoke Riveter Compression Squeeze Type**

Like new. Wgt. 5 lbs. . . . . Each **\$12.95.**



**Thor Pistol Grip Riveter & Chipping Hammer**

Ideal for fender, brake lining, concrete breaking work. Like new. Six rivet sets and bucking bar included, making a complete combination. Wgt. 9 lbs. . . . . Each **\$6.95.**

**CAMPERS' SPECIAL**  
Fancy briar pipes from Quarter Master Corps. Assorted shapes and sizes. All popular makes. Set of 7 . . . **\$3.50**

**MICROMETERS**  
Chrome plated, precision engineered and carefully tooled to give long life. All new. 0-1" cap. **\$2.25**  
1-2" capacity . . . . . ea. **\$3.50**  
2-3" capacity . . . . . ea. **\$5.50**

**COMBINATION OFFER!**

### CLECO GUN with



**10 Cleco skin clamps, 10 #30 high speed drills, 100 Dupont exploding, self-bucking rivets, asst. sizes.**

The Cleco gun is ideal for template work, sheet metal layout, etc. to eliminate use of sheet metal screws — saves thousands of man-hours. Will hold tolerances! Rivets easily exploded by soldering iron. Valuable item — no shop or hobbyist should be without one! Shipping wgt. 2 lbs.

**ALL FOR . . . . . \$4.75**

Send check, money order or cash. 25% deposit required on C.O.D. orders. All prices F.O.B. Culver City, Calif.

**AIRBORNE SALES CO., INC.** DEPT. PM 4-9  
CULVER CITY, CALIF.

**SAY YOU SAW IT IN POPULAR MECHANICS**

## BURN WATER IN YOUR CAR!

**GET MORE SPEED POWER MILEAGE HOW?**

The **Octagane Water Injector**

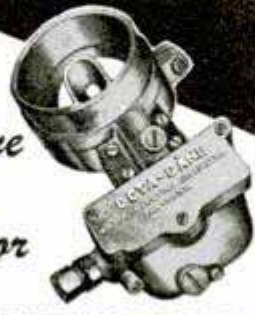

JUST SEND US A POST CARD FOR FREE INFORMATION ON WATER INJECTION—BUT DO IT TODAY!

**COMMONWEALTH CARBURETOR CORPORATION**  
DIV. 16-B, BERKELEY 2, CALIFORNIA  
*Dealers' Inquiries Invited*

# SAVE ALMOST 50%

Regular Price

**\$4.95**

NOW ONLY

**\$2.95** f.o.b. Balto.



## 18 Pc. Ratchet Socket Wrench Set

Complete range of 14 socket wrenches 3/16" to 15/16". Two offset handles. Ratchet wrench and plug adapter. Bright plated tools in heavy metal case. Add 30c postage for each set ordered. Order now.

## TCX-52 MARVEL SCHEBLER CARBURETOR

Can Be Used on Gasoline Engines Up to 20 H.P.

1/2" Venturi throat—13/16" throttle opening. Main nozzle .08" ID. Bronze body, brass float chamber, 1/8" IPT gas inlet, needle valve, mounting studs 1-13/16" between centers. **\$2.95**  
Sturdily built. Export packed. . . . .



**ABELL DISTRIBUTING CO., Dept. 36**  
5 E. BIDDLE ST. BALTIMORE 2, MD.

## This Machine Should Cost \$69.95

### 5 POWER TOOLS in ONE

Drill press pulls 1/4" drill in steel; saw takes 8" blade; lathes 10" swing, 30" centers; sander 8"; emery wheel 3". Handles big, heavy work — tools easily interchangeable — uses 1/4 to 1/2 H.P. motor. Factory-to-you price only \$39.95 complete. Send \$18.00 (balance COD) on 10-day FREE trial, money-back guarantee, or write today for FREE catalog.



EMRICK, INC., 1734 Clinton, Kalamazoo, Michigan

**See it - Use it!**  
**FREE TRIAL - 10 DAYS**

## HEAVY CAST ALUMINUM BLOWER ONLY \$10

**SINGLE EXHAUST BLOWER DELIVERS APP. 100 CU. FT. AIR PER MINUTE.** For Workshops, Labs, Kitchens, Cellars, Electronic Tube cooling or any use where airblowers are needed. Install it yourself with any household tools. 110 V., A.C., 50-60 cycles. Cont. duty motor.

**DOUBLE EXHAUST BLOWER.** 2 heavy cast alum. housings. Double intake and exhaust. **\$15.** Shipped Parcel Post. Pay slight charge on arrival. Send check, M.O. Money-Back Guar. Free Lit.

**UNIVERSAL YONKERS CORP.**  
137 Alexander St. (M-4) Yonkers 2, N. Y.

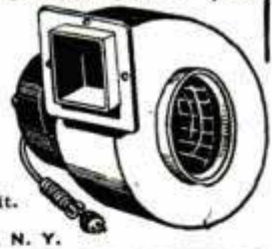

### PISTON TYPE COMPRESSOR



## EASY PROFIT IN PAINT SPRAYING

Paints walls, ceilings, screens, furniture and machinery faster, better. All complete as shown less motor. Carry anywhere. Fully guaranteed. Could be used with 1/4 H.P. motor or less. Price **\$35.00** less motor F.O.B. Chicago. \$5.00 deposit balance C.O.D. or see your dealer. With motor \$53.00.

**IDEAL AUTOMATIC PUMP CO., Dept. P.M. 8**  
801 W. Washington Blvd. Chicago 7, Ill.

## MARINE ENGINES

Kermath manufactures the widest range of marine engines. From the tiny 5 H.P. one lugger to the 550 H.P. Vee 12, Kermath can power your boat correctly. The new Screwball engines will save you more money and space than can any other. If you need 5, 10, 25, 50, 100 or 140 H.P. better get the dope on the Kermath Screwballs.

**KERMATH MANUFACTURING CO., 5862 Commonwealth, Detroit 8, Mich.**

## Portable, Compact - 110 volt Lighting Plant Carry It To . . . The Job!

Will develop 800 watts 110 volts, single phase AC current (similar to house current).

America's most modern single cylinder air-cooled 2.5 to 3 H.P. engine with the latest engineering features, such as an aluminum alloy rod, no bearing failures, and ball bearing mains, etc. This unit is outstanding competitive in its field and economical to operate. Will burn low test or kerosene fuel with slight change at a small additional cost.



**GENERAL MDSE. & EQUIPMENT CO.**  
DEPT. 1 - BOX 18, SHARON, PA. PHONE: 21181

# GREATEST IDEA YET IN POWER TOOLS!

for WOOD • LEATHER  
FIBRE • GLASS  
METAL • PLASTICS

It drills! It polishes!  
It saws! It etches!  
It carves! It grinds!  
It sands! It buffs!  
It sharpens! It cuts!

## CASCO'S NEW 40-Pc. TOOL'N'RAK



Hangs up—every tool ready to use...takes the clutter off your workbench! A super-sensational value!

Built of enduring solid hardwoods, Casco's new TOOL'N' RAK keeps 40 precision accessories and Casco Power Tool fingertip handy! Precision-built 27,000 RPM fractional HP motor, AC-DC. Exclusive Casco pencil-grip! Radio static suppressor! 36-page Project Book FREE!

Get yours now, at Department, Hardware, Auto Supply, Appliance, and Jewelry stores...all 40 pieces complete..... **\$17.95**

**CASCO** CASCO PRODUCTS CORP.  
BRIDGEPORT 2, CONN.

## Supreme HOMESHOP BAND and CIRCULAR SAWS



**HAIRLINE CONTROL • LESS RESHARPENING  
FASTER, SMOOTHER CUTTING • LONGER LIFE**  
NOW—for your home shop! Famous SUPREME Band and Circular Saws nationally used by industry—now available in the SUPREME HOMESHOP Line to fit any size or make of home power tool! Special Nickel Alloy Steel. Free from kinks and other imperfections. SUPREME HOMESHOP SAWS are precision-engineered for highest cutting efficiency under heaviest punishment. End saw troubles, cut costs, speed your best work.

**SUPREME BAND SAWS**  
6' 6" — \$1.00    7' 9-1/2" — \$1.10    9' 6-3/4" — \$1.30  
in any of the following widths: 1/8, 3/16, 1/4, 3/8".  
8" Flat-Ground Combination Circular Saw — \$3.65  
**IMMEDIATE DELIVERY — ALL STANDARD SIZES**

**ACT TODAY! ORDER DIRECT, stating Size, Make and Model. Or at your dealer. Write for Free Illustrated Circular.**

**THE SAW & KNIFE SPECIALTY CO.**  
6526 CARNEGIE AVENUE • CLEVELAND 3, OHIO

## Finer Trailer Living

Greater comfort with exclusive new "Heat Saver" . . . Finer interiors . . . Outstanding quality produced by exclusive machine methods . . . Three year warranty . . . Yet, Schult costs no more than an ordinary trailer.



### Write FOR FREE BOOK

Describes exclusive "Heat Saver," the greatest contribution to trailer living in years . . . details of kitchens, closets, bedrooms and floor plans of newly styled, moderately-priced, easy-trailing Schult models.



SCHULT CORP., Dept. 3204, Elkhart, Ind.  
In Canada: John Inglis Co., Ltd., Toronto

**SCHULT** Trailer Coaches  
Member T.C.M.A.

## PERFORMANCE COUNTS in SMALL TRACTORS!



SEE THE POWERFUL  
5-H. P. GRAVELY—  
the world's finest, yet most moderately priced Garden Tractor. Complete line of exclusively designed power tools for every Garden, Lawn and Field job.

## GRAVELY TRACTOR

FIELD-TESTED FOR 27 YEARS

**MAIL NOW! FOR NEW FREE BOOKLET!**

GRAVELY MOTOR PLOW & CULTIVATOR CO  
BOX 463                      DUNBAR, W. VA.

NAME \_\_\_\_\_

ADDRESS \_\_\_\_\_

TOWN \_\_\_\_\_ STATE \_\_\_\_\_

**SOLVING YOUR LAWN & GARDEN PROBLEMS**

multiply the value of all your workshop tools with  
**DESMOND-SIMPLEX**  
 enclosed screw—steel slide  
**VICES**

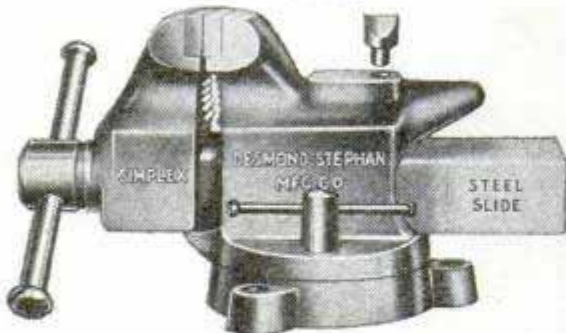

Best low priced quality vise made. Steel Screw enclosed in steel slide for protection. Swivel base for extra convenience. Handle ends tapered, won't pinch fingers. Pipe jaws part of vise, can't get lost. Replaceable hardened steel jaw inserts fit snugly on heavy shoulder, withstand heaviest blows. Hardened steel cutoff tool on anvil. Get a Desmond-Simplex Vise from your hardware dealer, or write direct for valuable folder.

**The Desmond-Stephan Mfg. Co.**

Walnut Street, Urbana, Ohio

Send me descriptive folder and prices on Desmond Vises: Basic workshop tools.

NAME \_\_\_\_\_  
 STREET \_\_\_\_\_  
 CITY \_\_\_\_\_ STATE \_\_\_\_\_



**AMAZING NEW**  
**Warren**  
**DADO SAWING WASHERS MAKE ALL THESE CUTS ON YOUR SAW!**

Smooth, accurate grooves—12 widths, any angle. No chatter, no burning, chewing, or sanding! Just dial desired width with Micro-matic adjustment! 5 sizes fit any saw arbor— $\frac{1}{2}$ ",  $\frac{3}{8}$ ",  $\frac{1}{2}$ ", 1", 1 $\frac{1}{2}$ ". See your dealer or use coupon below! Satisfaction guaranteed.

**DEALERS, ORDER DIRECT!**

**WARREN WASHERS CO., DEPT. 24**  
 70 Medbury Ave., Detroit 2, Michigan

Enclosed \$4.95 for one set of Warren Washers, postpaid. My arbor size is \_\_\_\_\_

NAME \_\_\_\_\_  
 ADDRESS \_\_\_\_\_  
 CITY \_\_\_\_\_ STATE \_\_\_\_\_



\$4.95 set  
 pat. pend.

**Keep Brushes like New**

**BEFORE** **AFTER**

5c  
 10c  
 25c

**DICA DOO PAINT BRUSH BATH**  
*Cleans and Restores PAINT BRUSHES*

At Paint, Hardware, Dept., and 5 & 10c Stores  
 Patent Cereals Co. Geneva, N. Y.

**SUPER JET**  
**MINIATURE BLOWTORCH**

NO PRE-HEATING REQUIRED—STARTS IMMEDIATELY  
 You can use this amazing new tool for soldering, brazing, melting glass, plastic polishing. Take it on camping trips. Its 2000° F. flame will light even the wettest wood in an instant. Complete with 2 hour supply Super Jet Tablet Fuel. Money back guarantee if not completely satisfied.

**\$1.35** Post Paid

**GADGET MART** 538 Madison Ave. Dept. PM 1  
 New York 22, N. Y. "Home of Mail Order Gadgets."

**DUST-O-VAC** the Dust & Chip Collector  
 for Home Workshops, Industry & All Machines

DUST-O-VAC collects and bags wood and plastic chips, wood and metal dust, wood shavings. Free Bag

Attaches to circular saw, planer, band saw, grinder, belt or disc sander, shaper, drill press with shaper or sander attachment, spindle shaper, wood lathe or jig saw. 110 A.C., D.C. Free Ill.

**\$19.95** Free Ship. east of Miss. West of Miss., add \$1. Check. M.O.

**UNIVERSAL YONKERS CORP., 137 Alexander St., M-4, Yonkers 2, N. Y.**

**WAR SURPLUS BARGAINS**

**WAR SURPLUS BARGAINS**

**\$500,000.00 INVENTORY for QUICK LIQUIDATION**

Surplus items—hundreds of them for home, shop, factory, farm and outdoor use. New items, used items, reconditioned items—all at tremendous savings—all priced for quick sale.

**Page After Page of Values**

This big catalog shows page after page of amazing money saving values. Write for your copy today. Send 10c to cover postage, mailing, etc. Write today!

SEND TODAY FOR YOUR COPY **10c**

**STARK'S** Dept. PM4 509 So. STATE STREET CHICAGO 5, ILLINOIS

# "Wellworth" Sensational Offer! WESTINGHOUSE AIR COMPRESSOR

plus pressure tank, pop valve,  
gauge for tank, air regulator &  
gauge, filter, 20 ft. air hose,  
check valve & air chuck

10 items  
All For **\$37.50**

**IDEAL FOR HOME-FARM-FACTORY**

Wherever compressed air is needed

A fortunate purchase from the government enables us to offer you this amazing buy at a small fraction of its original cost. All brand new. You get the WESTINGHOUSE COMPRESSOR and all of the accessories shown for only \$37.50. Shipping wt. 50 lbs. Designed for automotive truck or tractor mounting. Can be run off fan belt or power takeoff, or mounted horizontally. Comes with automatic clutch. Can be installed for use on farm trucks, jeeps, tractors, tire or garage service trucks, contractor or road building machinery, pneumatic devices, etc. Can be operated with 1/2 H.P. or more electric motor or equivalent portable gas engine.

Compressor separately, \$22.50

Equipment Less Compressor \$19.50

## THE COMPRESSOR

Piston Type, 2-cylinder, 2 inch bore, 1 1/2" Stroke Ball Bearing, AUTOMATIC CLUTCH, OIL FREE AIR, 3.27 c.f.m. at 600 R.P.M. 6.54 at 1200. Suggested operating pressure 75 P.S.I. DIMENSIONS: 9" wide, 11 7/8" high, 6 3/8" deep. Wt. 23 lbs.

## AIR TANK

Stainless steel, size 12" x 24" with 2 quarter inch openings. Suitable for 150 lb. pressure. Equipped with gauge to show tank pressure, air regulator & gauge to regulate pressure, safety valve, oil and water trap.

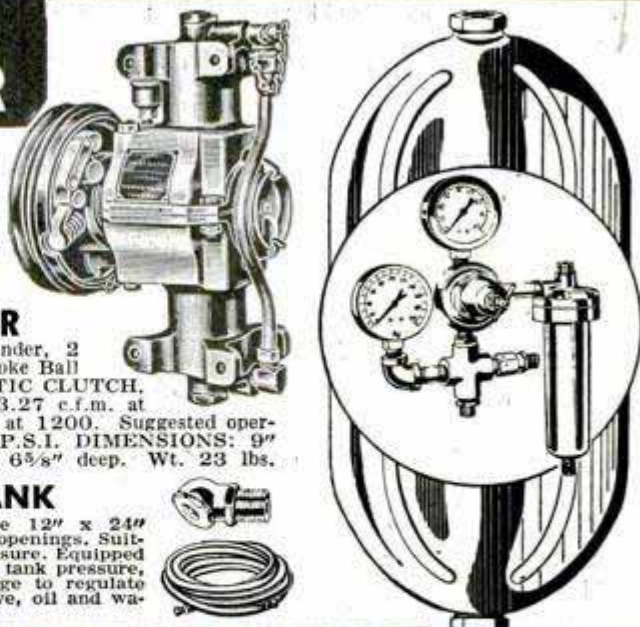

# AMAZING "Wellworth" COMPRESSOR DEAL

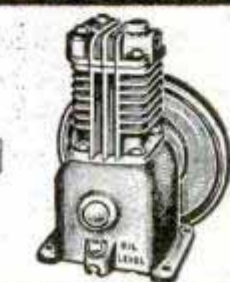
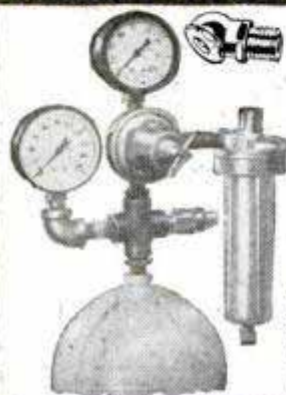

Compressor only—\$17.95  
Spray Gun and Hose—\$10.45—  
Wt. 5 lbs.  
Tank and accessories as shown  
above—\$14.50. Wt. 7 lbs.  
Adjustable 1/4" Pop Valve—\$1.50  
2 1/2" Air Gauge—\$1.75

**Air Compressor:** Piston type, size 2 x 1 3/4", both valves in head, bronze bearings, splash lubrication, "V" Belt drive. Intake muffler and cleaner. Capacity 2.8 c.f.m. at 100 lbs. continuous pressure or 150 lbs. intermittent, with 1/2 HP motor. Can be used with 1/4 HP or 1/3 HP at lower speed. Wt. 14 lbs. Operating instructions furnished.

**Air Tank and Accessories:** Stainless steel, 6" x 24" with gauge and safety valve, air regulator gauge and filter, drain cock, hose connection. Suitable for 100 lb. pressure.

## SENSATIONAL OFFER!

Complete outfit consists of compressor, pressure spray gun with 2 nozzles, pop valve, 20 ft. hose, air tank and accessories as described, air chuck. Complete for only

**\$37.50**

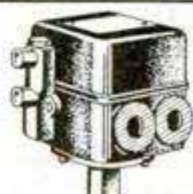

## AUTOMATIC PRESSURE SWITCH WITH UNLOADER

Double pole, with 2 way release valve. Set at 125 to 150 lbs. pressure. For use on compressor units 1/4 to 3 H.P. Pressure range 20 to 200 lbs. Weight 4 lbs. ONLY **\$10.25**

## PORTABLE SPRAY OUTFIT

1/3 H.P.  
ELECTRIC  
MOTOR  
DRIVEN  
•  
Complete  
With Base

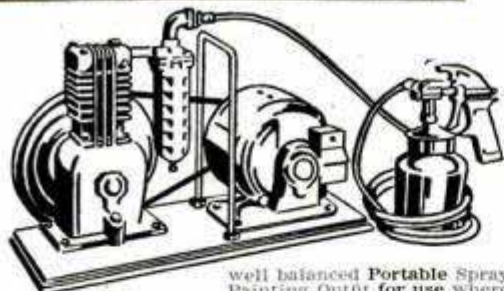

Well balanced Portable Spray Painting Outfit for use where painting job requires a larger quantity of material. Sprays all types of average viscosity paints, enamels, lacquers, varnishes, etc. Piston type, single cylinder air compressor has 2 in. bore by 1 3/4 in. stroke. Displacement 2.80 C.F.M.; maximum working pressure 40 lbs. Mounted on sturdy wood base with rubber feet attached. Pulsation chamber is equipped with safety valve, drain cock. 1/3 H.P. G-E motor, 110-volt AC, with cord and plug; 20 ft. air hose and fittings. Spray Gun is pressure feed type, internal atomizing, with one quart metal cup. Fan and round spray nozzle furnished. Shipping Wt. 50 lbs.

Price only  
**\$49.95**

## AUTOMATIC COMPRESSOR UNIT

1/3 H.P. heavy duty capacitor motor AC 110/220 volt 60 cycle, 2 x 1 3/4 inch piston type compressor, splash feed lubrication, 12 x 24 inch tank, automatic pressure switch, pressure range 100 to 125 lbs., check valve, safety valve, air regulator with gauge and filter, 20 ft. air hose with air chuck for inflating tires. V. belt drive. Shipping wt. 90 lbs.

SAVE  
**\$50.00**

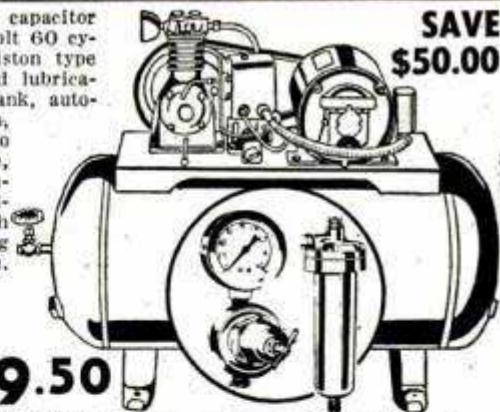

Special Price  
ONLY **\$79.50**

Same unit as above with 1/2 H.P. motor, furnished with 13" x 24" tank. Shipping wt. 125 lbs.

PRICE **\$98.50**

## PNEUMATIC AIR TOOLS

Riveting and chipping hammers for many uses: riveting, chipping, hammering, auto body work, concrete breaking, etc.; used, guaranteed like new.



### CHICAGO PNEUMATIC RIVETER & CHIPPING HAMMER

CP4X Pistol grip handle with air control. Takes up to 3/16" rivet. Weight 6 lbs. List price \$73.00.

Special Price **\$12.95** Same as above, brand new **\$19.50** Size CP3 Takes 5/32" Rivet **\$8.95**

### Chicago Pneumatic Lever Type AIR DRILL



With 1/4" Jacob Chuck. Wt. 2 lbs. List price \$55.00 Only **\$15.00**



Ingersoll Rand AIR DRILL  
With 1/4" Jacob Chuck. Wt. 2 lbs. List price \$55.00 Only **\$15.00**

### A.V.C. 11 INGERSOLL RAND



Push button, takes 5/32" rivet. Wt. 3 lbs. List price \$65.00. Only **\$8.95**



A.V.C. 10 Ingersoll Rand CHIPPING HAMMER  
Takes 1/8" rivet. Wt. 3 lbs. List price \$80.00. Only **\$8.95**

### POP TYPE VALVES

150 lbs. pressure. Has a close range of closing after pop-off pressure is reached. 1/4" pipe thread

Only **\$1.50**



"Wellworth" AIR CHECK VALVES  
Dash Pot. Quiet Operating.  
1/4" ..... \$2.75  
3/8" ..... 3.25  
1/2" ..... 4.50  
3/4" ..... 9.50  
1" ..... 12.50

Price f.o.b. Chicago. Immediate delivery. All items sold on money back guarantee. Send check or money order today. Write for free folder.

## WELLWORTH TRADING CO.

Merged with C & M Equipment Co.  
1831 S. STATE ST., DEPT. D-4, CHICAGO 16, ILL.

**She's some SMOOTHIE!**  
(YOUR CAR, THAT IS)

when equipped with

**ADVANCE DEEP TONE MUFFLERS**  
(SINGLE STRAIGHT-THRU OR DUAL SET)  
Rich, low, mellow tone. Also greater power, speed, and economy result from reduced back pressure. Rugged steel tube, blow-out proof. Simple to install. No welding. Dual set comes complete with rubber mounted clamps, fittings.

**ADVANCE FENDER SKIRTS**  
Heavy duty steel skirts to beautify, streamline. Tight fit, no rattle, easy to install, prime painted.

**KI-YI AND RAZZ HORNS**  
Get these novelty horns for laughs.

MAIL COUPON BELOW



**ADVANCE MUFFLERS** Dept. PM 4-9  
6800 S. VERMONT AVE., LOS ANGELES 44, CALIF.

Send check, money order, or we will mail C.O.D. You pay postage upon receipt.

<input type="checkbox"/> Dual Muffler Set (Ford, Mercury only) .. \$20.00	<input type="checkbox"/> Single Muffler (other makes) .. \$5.50	<input type="checkbox"/> Fender skirts, pr. \$16.95
<input type="checkbox"/> Single Muffler (Ford, Chev., Plym.)... 4.86	<input type="checkbox"/> 2 1/2" Chrome tail pipe tips .. 1.75	<input type="checkbox"/> Ki-Yi Horn, each 3.25
<input type="checkbox"/> Send free catalog showing complete line.		<input type="checkbox"/> Razz Horn, each 3.25

Car make \_\_\_\_\_ Year \_\_\_\_\_ Model \_\_\_\_\_  
Name \_\_\_\_\_  
Address \_\_\_\_\_ City \_\_\_\_\_ State \_\_\_\_\_

**Be Your Own Boss**



**T**here's a great feeling to being in something for yourself, where all the profits go into your own pocket. American floor sanders make it possible for you to realize this ambition without special schooling or a big investment. Begin small and work up to as large an enterprise as you desire... It all depends on your ambition to get ahead. Ask for "tell-all" booklet entitled "Opportunities in Floor Surfacing". Use coupon and enclose 25 cents in coin or stamps to cover handling.

**AMERICAN FLOOR SURFACING MACHINE CO.**

535 So. St. Clair St. • Toledo 3, Ohio  
Gentlemen:  
Enclosed find 25c in stamps or coin for booklet "Opportunities in Floor Surfacing," telling me how I can start my own floor sanding business.

Name \_\_\_\_\_  
Street \_\_\_\_\_  
City \_\_\_\_\_ State \_\_\_\_\_

SAY YOU SAW IT IN POPULAR MECHANICS

**Bready**

**SPEEDS GARDENING**  
**MAKES THE TOUGH**  
**JOBS E-A-S-Y!**



- Low in cost
- Economical to run
- 1 1/2 and 2 1/2 H.P. models

Bready Garden Tractor plows, discs, harrows, seeds, cultivates. Powerful, easy-to-guide. Implements attached in a jiffy. Lawn mower, cutter bar, snow plow, other handy attachments make Bready your year 'round handy man!

**WRITE TODAY for free booklet!**

**The Bready Tractor & Implement Co.**

BOX 230 SOLON, OHIO

**METALS**

sold in small quantities for the home workshop. Steel, Brass, Copper, Aluminum, etc. In Bars, Shapes, Tubes and Sheets. Write for free price list.

**CASHMETALS CO., 2720 California Ave., Pittsburgh 12, Pa.**

**SPEED AND POWER HANDBOOK**



Very latest methods! Build your own Dual Manifolds, Superchargers, Water Injectors, Hi-Compression Heads, Fuel Saving Devices—easily. **SAVE MANY DOLLARS!** Get racing speed, acceleration, dynamic power increases from any automobile! Build fast Stock Cars! California Roadsters! Hotrods! Get Construction Diagrams! Ingenious Formulas! Speed Secrets! Conversion Ideas! Also "Economy Information"—Mileage Tricks! Tuning Techniques! Picture Catalogues. Plans! Including "California Restyling Ideas"—Glossy photographs! Drawings! Plexi-Pops! Channeling! Model Revising! Streamlining! Customizing!—\$1.98 complete. Newhouse Automotive Industries, 5941-84 Hereford, Los Angeles 22, Calif.

**GENUINE ALUMINUM STEP LADDERS**

Save—direct from manufacturer to you! New patented safety features provide extra years of efficient, safe use. All sizes. Write for FREE catalog.

**MORTON METAL PRODUCTS CO., 3517 Gratiot St., St. Louis 3, Mo.**

**ALL-PURPOSE BLOWERS**  
FOR HOME, DARKROOM, PROJECTORS, RADIO, ETC.



A guaranteed, superior surplus item of over 1000 uses: cooling closets, burning coal or wood, exhausting compartments, and others. **Two Models both brand new:** #A—for 115V, 400 cps AC, turns 6700 rpm (circuit for 110V, 60 cps on request), Mfd. by Westinghouse, Size: 5 1/2 x 4 x 1/4, Wt. 2 1/4 lbs. \$2.95 FOB Chicago. #B—for 115V, 60 cps AC, turns 6500 rpm, Mfd. by F. R. Smith & Co. Size: 5 x 4 3/4 x 1/4, Wt. 3 lbs. \$5.95 FOB.

**THE MART, 11 E. HARRISON, CHICAGO**

*A Thousand and One Ideas You Can Use on the Farm!*



**POPULAR MECHANICS FARM MANUAL**

Use it to Step up Farm Efficiency — Increase Production — Improve Farm Appearance — Save Time, Labor, Money!



**A Must for Every Farm Family! Saves Money for City Homeowners Too!**

Here is the experience of hundreds of successful farm operators brought together in one handy, easy-to-read, easy-to-use, working handbook by the editors of Popular Mechanics. It is brimful of short cuts, labor-saving ideas, ingenious apparatus and methods that will simplify the day's work and lighten some of the more tedious chores, make money and save money for you.

**HELPS IN THE FIELD — IN THE BARN — IN THE HOME**

Every department of the farm is covered in the Farm Manual. Every member of the family will find in it something that he or she can use to tremendous advantage in farm operation, maintenance and improvement, from the building and care of equipment to painting the farm home and fast freezing fruits and vegetables. It covers farm buildings, the farmhouse and other homes and is of interest equally to the woman looking for home improvement, beauty and convenience and the man striving for easier and more profitable operation.

**ORDER TODAY — FOR YOURSELF — FOR A GIFT**

Use the coupon below. Mail it today. Book will be sent at once, postpaid if you include payment with your order. If you don't think the Farm Manual is worth even more than you paid for it after five days' use, send it back by mail and your money will be refunded. This may be the best investment you ever made. Rush coupon today.

**284 FACT-PACKED PAGES**

**Hundreds of Illustrations**

Popular Mechanics Farm Manual is packed with practical ideas and usable information that can easily be worth hundreds of dollars to farm families and homeowners everywhere.

**Farm Machinery and Implements**  
How to make and get the most out of farm implements.

**Farm Workshop Equipment and Repairs**  
Ideas that can save hundreds of dollars.

**Poultry and Livestock**  
How to build equipment, gadgets, etc. Care of farm animals and poultry.

**Vegetable Storage—Processing**  
Winter storage, home freezing tips, make your own freezer.

**Farm Home Improvement**  
Fencing, repairing electrical appliances, plumbing, electrical wiring, saving coal, painting, curing leaky basements, hanging wall paper, making garden tools, garages, working with concrete, painting, etc.

**Farm Hints and Kinks**  
Forty pages of illustrated, practical ideas, short cuts, etc., that will save time, labor and money.

**SURPLUS BARGAINS ASSEMBLE YOUR OWN BINOCULARS!**

Complete Optics! Complete Metal Parts! Save More Than 1/2 Regular Cost



**GOVERNMENT'S 7X 50 BINOCULARS**

We supply full instructions  
**METAL PARTS**—Set includes all Metal Parts—completely finished—for assembly of 7 X 50 Binoculars. No machining required. A sturdy Binocular carrying Case is optional with each set of Metal Parts.  
Stock # 842-H ..... \$39.40  
Postpaid, plus \$4.80 for Case—Total ..... \$44.20  
**OPTICS**—Set includes all Lenses and Prisms you need for assembling

7 X 50 Binoculars. These are in excellent condition—perfect or near-perfect—and have new low reflection coating.  
Stock # 5102-H ..... \$25.00 Postpaid

(These are standard American made parts . not Jap, French or German.)  
**NOTICE!** If you buy both Binocular Optics and Binocular Metal Parts, add 20% Federal Excise Tax to above prices.

**ARMY'S 6 X 30 BINOCULARS**—We have complete Optics and Metal Parts. Write for Catalog H.

**SLIDE PROJECTOR SETS**—Consist of all unmounted lenses you need to make the following size projectors:

Stock # 4038-H—2 1/4"x2 1/4" ..... \$3.35 Postpaid  
Stock # 4039-H—2 1/2"x3 1/2" ..... \$3.35 Postpaid  
Stock # 4029-H—35 mm. .... \$2.85 Postpaid

**MOUNTED ANASTIGMAT LENSES**—Use for Projectors, Enlargers, Copying Cameras. Complete with Shutter and Diaphragm. Value about \$20. An excellent buy. **WE WILL INCLUDE FREE ILLUSTRATED BOOKLET on HOW TO MAKE YOUR OWN ENLARGER.**  
Stock # 8004-H Speed f/7.7, focal length approx. 127 mm. Suitable for pictures, negatives, positives up to 3 1/2"x4 1/4". \$7.50 Postpaid  
Stock # 8006-H Speed of f/7.7, focal length approx. 100 mm. Suitable for pictures, etc. up to 2 1/4"x3 1/4". \$8.50 Postpaid  
Stock # 8007-H—Speed of f/6.3, focal length approx. 100 mm. .... \$9.50 Postpaid

We have literally millions of war surplus lenses and prisms for sale at 10c and up. Write for Catalog "H"—Sent Free!

**Satisfaction Guaranteed Order by Stock No. EDMUND SALVAGE COMPANY P. O. AUDUBON, NEW JERSEY**

**MAIL COUPON • Money Back if Not Satisfied**

POPULAR MECHANICS PRESS, Dept. 665  
200 East Ontario St., Chicago 11, Ill.

Send \_\_\_\_\_ copies of the Farm Manual at once.  
 Remittance (\$3.00 each) enclosed. Send postpaid. Add 15% if outside U.S.A.  
 Send C.O.D. (\$3.00 each) plus delivery charges. U.S.A. only.  
 If sent as a gift to another, send name and address on separate sheet.

Name \_\_\_\_\_  
Address \_\_\_\_\_  
City \_\_\_\_\_ Zone or Route \_\_\_\_\_ State \_\_\_\_\_



**GANGWAY! I'M DOING 50!**

**Incorporates some scientific principle used on aircraft air-speed indicators!**

**Amazing New AIR-FLIGHT BICYCLE SPEEDOMETER**  
Patents Applied For

for **BICYCLES SCOOTERS TRICYCLES MOTOR SCOOTERS etc!**

No gears, no cables, no complicated mechanism . . . Just snap it on your handlebars . . . and go! Large, easily-read dial gives accurate speeds up to 50 miles per hour. Not a toy . . . a precision instrument at a fantastically low price.

**39c**

Get yours today! Complete At Bicycle, Toy, Variety, Chain and Dept. Stores

PRODUCT OF INSTRUMENT DIVISION  
**KNICKERBOCKER PLASTIC CO., INC.**  
4101 San Fernando Road, Glendale 4, California

# A DOUBLE PAGE OF PALLEY VALUES!!!

IN MANY ITEMS WE HAVE THE WORLD'S LARGEST SUPPLY

**HERE THEY ARE! THOSE TERRIFIC MIX VALUES**

**GADGET MIX**  
Especially prepared for the HOBBYIST. Rivets, Spacers, Bolts, Screws, Nuts, Gears, etc. A gold mine. #106. **\$1.19**

**BEARING MIX**  
Needle, Ball & Roller Bearings in excellent assortment. Sizes from 1/8" to 1". One of our "BEST SELLERS". 15 BEARINGS. #170 for ONLY **\$2.95**

**HINGE MIX**  
12 pairs of strap and butt Hinges, Glass 1" x 1" to 1 1/2" x 4" in length to 8" strap. #170E. A \$3.00 Value FOR ONLY **\$1.09**

**ABRASIVE AND GRINDING WHEEL MIX**  
50 Pieces including honing stone, pencil rolls, wheels, abrasive sheets, etc. A really sharp value. #170AG. **99c**

**SPRING MIX**  
Torsion, Compression & Tension Springs, steel, brass. A treasure here for emergency. #205. 2 LBS. for ONLY **89c**

**COMBO-MIX**  
Comb. of all above, all in one pkg. Sent. At special introductory price. **\$5.79**

**FILE MIX**  
Ten Assorted Files of 6", 8", 10", 12". Includes 3 Vixens, ball rounds, bastards, mills, etc. in seconds and used but in good condition. 1 Vixen alone worth our price for the entire mix. **99c**

**LENS MIX**  
THE PHOTOGRAPHERS FRIEND  
10 pieces of precision finished lenses, and first surface mirrors, including the following:  
A 51 mm dia. double lens, A 85 mm dia. lens with speed fig. a complete set of 3 lenses, one double convex, two objective plano-convex, each having a 1 1/2" focal length, one 3 1/2" dia. plano-convex lens with a 3" focal length.  
Also 3 double sided first surface mirrors totaling 37 square inches, worth \$10.00.  
Make your own projector, portrait and enlarging lens magnifiers, photo spots, etc. You'll bring to your friends about this one for ONLY **\$5.49**

**PULLEY MIX**  
You'll want this one around. 10 micarta and metal pulleys ranging from 1" to 5" with ball and one piece bearings. These are aircraft pulleys, the best made with hundreds of uses. A WONDERFUL BUY @ **\$2.95**

**SWITCH MIX**  
New 12 assorted types of Aircraft Switches. Including double & single throws, double & single poles & multiples. Voltage ratings from 5 to 20 amps. 125 Volts A. C., 35 amps. 24 Volts D. C.  
1001 uses in Auto, Truck, Tractor, Jeep, Shop, Radio, etc. **\$2.95**

**REAMER MIX**  
168-reamer Assortment: Special Taper line finish Reamers - High Speed Steel. Slightly used but in excellent condition. Ten assorted sizes ranging from .186 x .165 and 244 x .215 to .425 x .385 and .432 x .403. One alone worth our selling price of ten. For set of ten Reamers **\$4.49**

**COUNTERSINK MIX**  
#168A - Countersink Assortment! Excellent condition - High Speed Steel. Assortment of ten 100" and 110" with pilot sizes ranging from 3/32" to 3/16". For Ten **\$2.69**

**DEAD LINE FLASH!** Just Purchased \$600,000 Inventory of New Cutting Tools. Taps, Drills, Milling Cutters, Metal Saws. TREMENDOUS SAVINGS! WRITE FOR LIST

**DOUBLE CASTER UNIT**  
2 Needle bearded 6" Casters joined as a unit on a 7 1/2" x 8" rubber protected steel face plate. The unit is 9" high and will completely swivel. Ball bearings in swivel entirely enclosed and protected. Bolts Furnished. If you have to move heavy machinery or rigs these are just the unit. At a Fraction of its cost. Unit **\$9.85**

**AIRCRAFT INSTRUMENT MIX - 12 different new or good used cond**

Fuel Air Ratio Right and Left Indicator Oil Pressure Gauge  
Air Speed Indicator Flap Position Indicator Liquidometer  
Manifold Press Indicator A-8 or A-9 Oxy. Reglats. Engine Gauge Unit (Fuel & Oil Pressure cyl. hd. temp.)  
Autumn Ind. & Transmitter Landing Instruction

These Instruments contain sensitive meter movements. Miniature gyros, jewels and ball bearings, gears, valves . . . a treasure trove of fine parts. **\$16.95**

APPROXIMATELY \$2000 GOVERNMENT COST FOR ONLY

**CHEMISTRY SET REEL COUNTER AND CONTROL BOX**

Made for Chemical Warfare Division for testing water, etc. Complete set with chemicals, test tubes, full instructions. Packed in attractive lucite box with covers and dividers. 15 Pieces. **\$1.39** Set

Counts 0 to 999, each drive advances figures one numeral. Manual single pole, double throw switch has neutral position and serves to reel forward and reverse, with red jewel instrument light to indicate winding operation. Reset dial to turn counter back to 0. Assembled in compact 2"x2 1/2"x5 1/2" box. **\$2.69** Each

**LOADING SWITCH MC 432** Containing many electronic parts including 5 position multiple switch, 4 micro adjustment rheostats, fixed resistors, etc. A profitable investment @ **69c** Old Reliable for the AAF.

**BOAT FENDER**  
21" long 5" dia. Protection against docks for small boats. \$6.50 Value. Only **\$1.95**

**EX-1 - HYDRAULIC MASTER & SLAVE UNIT**  
Extractor Controls. Eliminate complicated rod linkage for throttle control on boats, gasoline engines, etc. These two units connected with 1/4" tubing and filled with oil serves as a precision 1 - 1 ratio 90° throw control with a minimum of effort. Combination Master and Slave **\$15.95**

**AIR CO OXYGEN REGULATOR** Latest design, sturdy, lightweight - dual gauge regulator unit. Gauge range from 0-220 P. S. I. regulated pressure 0-3000 P. S. I. bottle pressure. Designed for safety factor of 2400 P. S. I. Fits all standard Oxygen high pressure bottles, used in welding, torch cutting, Oxygen breathing. Compare this value anywhere **\$12.50**

#155 VICTOR CUTTING TORCH Type #408SS. Used but in gd. cond. **\$15.75**

**MECHANIC'S MONKEY WRENCH**  
Adjustable 4" Jaw opening. Drop forge Auto. type. Cad. 89c These Prices Plated Blk. 79c for Themselves

**NEW PEXTO PLIERS**  
Side cutting beveled head a \$3.50 Value Only **\$1.79**

**METAL SNIPS** Compound action. Hard steel blades. Expansion spring. Locking device. Right Hand and Left Hand **\$2.59**

**BC 306-A NEW SIGNAL CORPS TUNING UNIT**  
In heavy aluminum case with black crackle finish 15" x 10" x 8". Valve variable dial knob, calibration 0-100, with locking assembly. Switch - 5 position with knob. 6 1/2" diam. coil with three other inside, and movable induction tuning coil. WORTH MANY TIMES MORE **\$1.89** ea.

**HS 33 NEW LOW IMPEDANCE RADIO HEADSET**  
The latest and most improved style, currently in use in aircraft. New. Packed in original box. Leather head band, sponge rubber ear pads. Includes COIL and JACK **\$3.25**

High to Low Impedance Adapter **35c** ea.

**HEADSET HS-30-U** Two Magnetic Type receivers in wear-resistant brass case. Soft rubber inserts in each receiver to fit into wearers' ears. Flexible steel head band. Ideal for communications, divers, workers in noisy compartments, etc. NEW! **\$1.59**

**1574 PORCH LIGHT SET**  
w/ illuminated house Number Decals. All for only **\$1.49**

**VINYLITE TUBING**  
Capable of insulating up to 5000 volts. This Plastic tubing used for protecting wire, decorative purposes, water or other fluid hose. Price per ft.

1"	Black, Clear, Red	.15
1 1/2"	Clear, Red	.12
2"	Grey, White	.12
3/16"	White	.02
3/16"	Clear	.02

No Sale Under \$1.00  
Above sizes are only a sample of the stock we carry, should you desire other sizes or types please send us your inquiry.

**WIRE AT REAL VALUES!**

3/16" dia.	3 strand, treated jute	.02 ft.
3/16" dia.	3 strand, jute	.07 ft.
3/16" dia.	3 strand, sisal	.08 ft.
3/16" dia.	3 strand, sisal	.08 ft.

**TANK** Capacity 21.7 gallons. Aluminum 4 threaded ports. Filler Capacity. Size 7" x 28" x 28". Ideal for Water or Gas Tank on Auto, Boat, Truck, Tractor, Etc. New. #126 **\$5.29**

**PNEUMATIC AND AIR TOOLS**  
10,000 in various popular makes, sizes, types. Cleco, Aro, Ingersoll Rand, Chicago, Pneumatic, Buckeye, etc.

**RIVET** #180  
#181 Pistol  
#186 Squeezer

**GUNS**  
Pistol & Goose-neck Type  
101 Uses. Chipmunk Branding cement and auto body work.

Chicago Pneumatic, Cleco, Ingersoll Rand Makes. E3, E2, 3X, 2X, OY \$55 Value **\$8.95** \$30 Value **\$15.95**

**PNEUMATIC ALLIGATOR SQUEEZER** #186 **\$15.95**

**AIR DRILLS OR MOTOR SPECIAL**  
with 1/4" JCB Chuck

**THOR #210R Model 4526 REVERSIBLE AIR DRILL**  
000 R.P.M. Xint. for Tapping **\$19.95**

**PNEUMATIC ANGLE DRILL**  
With Terry Adapter ea. Send for Catalogue and List of Other Sizes, Types of Pneumatic Tools. **\$12.50**

**Here's a Real "Lite Special"**  
Farm, Auto, New U. S. Navy Portable Pistol Grip. Sealed Beam, 12v. Search Spot or Emergency. Light - featherweight Gov. Cost our price \$35.00 **\$1.95**

3 Extra filters - Red, Green & Amber **93c** Set

**NEW FLEXIBLE GOOSENECK LAMP**  
110 V. A. C. 13 ft. wire with socket switch and plug. In mounting bracket suitable for home or workshop. Wire alone worth our price of **99c** each.

**NAVY BATTLE LANTERN**  
ATTN. SPORTSMEN, OUTDOOR WORKERS! THIS IS A MUST FOR YOU!  
This powerful battle tested lantern complete with 3 standard 1 1/2" volt dry cell batteries. One of the finest hand portable signaling and lighting units drives a terrific beam. Size 6" x 7" x 4" with a 4" dia. reflector. Comp. Only **\$3.29**

**PIANO HINGE**

Overall Width	Length	Price
1 1/4" (1/2" side)	72" alum.	\$1.00 ea.
2" (1" side)	72" alum.	\$1.19 ea.
1 1/2" (1/2" side)	57" cad. steel	.75 ea.
3/2" (1 1/2" side)	33" steel	\$1.00 ea.

**AIRCRAFT CABLE**  
Alloyed steel, rust resistant, 3/16" dia. 18 ft. long, with turnbuckle ends. **99c** ea.

On reels in any length

1/16"	3c ft.	3/16"	6c ft.
3/32"	4c ft.	1/4"	8c ft.
1/8"	4 1/2c ft.	9/32"	9c ft.
5/32"	5c ft.	1/2"	12c ft.

**RUBBER GOODS**  
NEOPRENE SHEET RUBBER

Thickness	approx. width	Price per sq. ft.
#325 .020"	1/64"	36" .75
#328 .032"	1/32"	22" \$1.39
#329 .125"	1/8"	46" \$4.75

Item #329 laminated rubber sheet with cloth casing. Flexible but very fine for heavy work. Rubberized Hosp. or Bed Sheets. 54" x 72". \$10.00 Value Only **\$2.29**

**ELECTRIC SOLDERING IRON**

#198 110 Volt A. C. Vulcan **\$8.50** Value

#198 200 Watt **\$3.95**  
#198A 100 Watt **\$2.95**



# SAVE up to 85% in WAR SURPLUS at GADGETEER'S HEAVEN

### New Hydraulic Cylinders, Valves, Pumps, Fittings, Hose and Tanks

51 SIZES AND TYPES. WORLD'S LARGEST SUPPLY 1001 Labor Saving Adaptations for Pulling, Pushing, Lifting Operations. Finest Precision workmanship and materials. Liquid and or Air Operation, developing terrific power. 20,000 Available. Write for Catalogue Priced to sell at 15% Gvt. Cost

### PUMPS, New Hydraulic, Vacuum, Air P-1 HYDRAULIC PESCO TYPE

Positive displacement gear type. Capacity: 1 gal. per minute, at 1500 R. P. M. at 1500 P. S. I. Operating speed: 3700 R. P. M. intermittent maximum 4500 R. P. M. Rotation: either direction with slight adjustments. \$9.49

800 GPH at 30 PSL can also be used as hydraulic for 4 GPM at 400 PSL or for Vacuum drawing 15 in. mer. at \$6.29 ea. 1500 R. P. M.

### VALUABLE GEARS BARGAINS!

#111 8 to 1 ratio, spindle drive #110 \$2.98  
6 to 1 with screw shaft #111 \$4.98  
85 to 1 (can be used for radio, antenna, etc.) #112 \$3.95  
#113 10:1 gear ratio \$3.95

### DC GENERATOR 140 AMP NEW

Direct Current Generator. Especially suited for adaptation to homemade welding unit. A last moving item at \$17.95

### P-1 GENERATOR 200 AMP \$22.50 ea.

T-1 GENERATOR 12 V., 25 Amps at 1800 to 4200 R.P.M. Trucks Aircraft, Radio, A Real Value \$13.95

### D. C. METERS

AMMETERS 0 - 30 \$4.25  
0 - 120 \$3.95  
0 - 240 \$4.95  
0 - 300 \$4.95  
0 - 600 \$4.95  
0 - 1200 \$4.95  
0 - 2400 \$4.95  
0 - 3000 \$4.95  
0 - 6000 \$4.95  
0 - 12000 \$4.95

### WINCH HOISTS

Thousands of satisfied users. Hundreds have written, the most wonderful tool in the world.

### No. 100 WINCH HOIST

Cap. 2500 lbs. with 24:1 ratio controlled bronze worm gear. 1 1/2" alloyed steel cable with hook, two speed handle. Ideal for Garage, Trucking, Mach. Shops, Boat Bldrs., etc. A \$100 Value \$15.99

### OXFORD BR. & TOOL SCRAPERS

Complete set of 4 tools packed in Giltwood Wood Case.

1 ea. 8", 10", 12", 14" half round Scraper.  
1 - 6" Three square Scraper.  
1 - 12" Double end Scraper.  
Made of Finest Tool Steel, Forged, Tempered, and Hollow Ground. At the Unheard of Price for Entire Set of Only \$2.49

### PLASTIC PARALLEL STRAIGHT EDGE

with knobs and rubber pads for use alongside on each section. A must for inspectors, mechanics, draftsmen, and engineers... You've never seen 'em 'em. 97¢

### GAS ENGINES HERE'S A TERRIFIC VALUE PARADE IN CHEAP POWER.

#### 10 H. P. CONTINENTAL GAS ENGINE

4 cylinder, Magneto Spark, built in Gas Tank. Water Cooled with Radiator. Complete with Tachometer and mounted on heavy steel frame for portability. A very smooth running job. Used but in guaranteed condition. Above engine used to drive pump described and priced below \$175.00

### WATER PUMP WIP-1

100 Gallons per Minute. 75 ft. head pressure, with 2" standard pipe ports. \$159.00  
PUMP SOLD SEPARATELY OR PUMP AND GAS ENGINE SOLD TOGETHER AS ONE UNIT \$325.00

### Genuine Red Seal 4 Cycle Air Cooled L head 2 H.P. CONTINENTAL GAS ENGINE

standard equipment inc. Mesh type air cleaner, flywheel, magneto, boat type carburetor, blower housing, muffler, fuel tank, fuel filter with shut off valve, starter pulley, etc. The ideal power package for light tractors, lighting plants, compressors, boats, lawn mowers, etc. And cast your eyes at this price \$47.95

### New BRIGGS & STRATTON MODEL "A" GAS ENGINE

Rating 2.10 H.P. 4 cycle, single cylinder. Complete in original Factory Crates. A \$102 Value for Only \$64.95

### W-1B LARGE HEAVY STEEL FILTERING TANK

30" dia. x 4' high. Complete with 2 large line filters, line pressure. Gauges, 5-way diverter valve (washing, filtering, filtering to waste, shut, by pass). Chlorination control panel with gauges, pressure regulating valve and tanks. 2" standard pipe plumbing throughout. \$229.00

### Sperry Aircraft Directional GYRO COMPASS

Precision made for sensitive direction 360° swing calibrated in 1/10 degree (6 min) Luminous dial. Built in 3 volt instrument light and and bank indicator 4 1/2" cube metal box with 3" dia. face. Operates on Vacuum. Ideal for cars, light planes or boats. Can be used in autos and boats by attaching one tube to intake manifold. Complete with caging and reset knob. Re-insure. Good Condition ONLY \$4.49

### High Pressure Oxygen Bottle

New. Will hold up to 3,000 lbs. PSL with CO2 used as fire inflator or fire extinguisher, with oxygen for sick room or deep-water diving, etc. Completely equipped with brass valve, 3/8" hose. Dial gauge, & canvas bag. \$2.29

### NEW ADJUSTABLE TAP WRENCHES

Jaws are made of tool steel, hardened and tempered. Won't break or get out of line.

#7 THREADWELL Cap. 1/4" to 1 1/2" \$2.49  
#8 VERMONT Cap. 1/4" to 1 1/2" \$3.49  
#24 GREENFIELD Cap. 1 1/2" to 4" Length 72" \$6.49

### Selsyn Mr. Transformers

For Remote Control G. E. Model 21.1G. 1 57.5 volts. 400 cycle \$514  
Can be used on 110 volt. Pr. Cost \$60.00 - Our Price \$3.95

### MICARTA TUBE

Ideal for Insulating or Bushing Stock. 3/8" x 1/4" wall x 1' O. D. Original use was for trailing antenna - F 10. Use for tow rack, seawater displays, shifting spacers, bearings, etc. In original crates. 59¢ ea.

### S & K ROLL-A-WAY TOOL CARRIER

Not Tunny, but made of heavy gauge red crackle finish steel. 32"x27"x19". With 1 dividing drawer, 1 drawer with clamp-on rack for tools. Locks on upper drawer and pull out lid for locking lower chamber with drawer. Rubber Wheel Ball Bearing Swivel Castors with 2 Extra Portable Tool Trays. We have 80 of 'em now, but they won't last long at COMPLETE UNIT \$32.95

### AIR COMPRESSOR

Thousands now in use for spraying, inflating, tractors, trucks, garage, laboratory, air tools, industrial use, etc. Lightweight but powerful, can be run by 1/2 H. P. Motor or Gas Engine. Operates in either Direction or rotation. Gives approximately 2.27 CFM at 600 RPM, 6.54 CFM displacement at 1200 RPM. Has 2 inch bore, 1 1/2 inch stroke. Suggested pressure 75 P.S.I. Size 9" x 12" x 16 1/2". Weight approximately 23 pounds. AT THIS NEW LOW PRICE \$23.95  
Motors, Tanks, Fittings to Adapt this Unit also Avble.

### POWER UNIT

The Complete Model G&R 12-24, 100 Cooling of a Single Cylinder, Air Cooled, Four-Cycle, Briggs-Stratton Gasoline Engine, Type-Stroke Cylinder, Air Cooled, L-Head, Four-Cycle, 6 H. P. Bore 3", Stroke, 3 1/2". Governed for Speed Between 2500 - 3200 R. P. M.  
Directly Connected to a Direct Current Generator of 2000 Watts, Rating 26.5 Volts, 100 Amps, to form an Integrated Unit. Fuel Container 1 1/2 Gallons.  
The Engine and Generator are Mounted on Four Shock Absorbing Rubber Motor Mounts Attached to a Channel Iron Base. 4 Wheel for Mobility can be used as Lighting Plant or Power Supply. A TERRIFIC VALUE!  
THE BUY OF THE CENTURY... ONLY \$79.89

### Electronic Transmissn. Gear Train

GT-1 Containing approx. 50 Bronze Spur & Pinion Gears ranging from 3/8" to 4" dia., 5 sets of 7 cluster gears, 2 complete worm & worm gear drive sets, 40 N. D. ball bearings from 1/2" to 1 1/2" dia, watch springs, bushings, posts, face plates, housings, Micro Switches, 2 miniature, controlled clutches, etc. 19 lbs. of Pleasure and profit. \$8.49  
A Tremendous Gadget Misc. Only Gears in above train are all in multiple size and sequence with identical tooth ratio giving hundreds of ideal gear reduction combinations.

### NEW PRESSURE TANKS

Stainless Steel - Shatter Proof, Seamless, 10,000 available in 8 different sizes, 1001 uses.

12" x 24 inches - 2100 Cu. in. capacity \$4.75  
18" x 24 inches - 3600 Cu. in. capacity \$5.49  
24" x 24 inches - 5400 Cu. in. capacity \$6.95  
30" x 24 inches - 8100 Cu. in. capacity \$8.49

### GEAR BOXES

VTG-1-50", 1 1/2 to 1 bevel gear reduction, 1/2" dia. with lever control for engaging & disengaging positive clutch, dust proof housing, pre-lubricated bearings, size 7"x8". A lifetime value. \$3.95  
VTG-2-30" bevel gear reduction 18 to 1, 1 1/2" x 4 square. Final take-off 4 1/2" dia. 26 tooth, 3/4" diam. spur gear with lever control for engaging and disengaging positive clutch, dust proof housing, pre-lubricated bearings, size 12"x8". Only Both above gear boxes can be used with above Transmission. \$6.49

### FIRE EXTINGUISHER

Kiddle Lee Col Type, Built to Gov't spec, wirebound, shatterproof Heavy Case. Fully recharged, 3 1/2" lb. - 2 1/2" x 4" Trigger control with horn 4TB type. \$15 Value \$13.25  
#601A \$11.75  
2 lb. Col type \$23 Value \$20.75  
10 lb. Charged with horn Col \$85 Value \$25.75  
#603 15 lb. Break Disc type New \$60A \$75 Value \$29.75  
#605 11 lb. Wheel Control \$20 \$32.95  
15 lb. Squares trip. New \$20C \$85 Value \$39.95

### New Electric Motors

#500 new 1/4 H.P. 27 Volt D. C. 24 Volt A. C. This motor can be readily adapted to 110 A. C. by the simple method of rearranging armature brush leads. We furnish free diagram of instructions with each order. A Sensational Value \$5.95

### U. S. ELECTRICAL 28V MOTOR

1/2 H.P. 8403 R.P.M. 16.5 Amps. Continuous Duty \$5.49 ea.

### BATTERIES

NEW! FULL STRENGTH FOR PORTABLE RADIOS, SIGNAL LAMPS, BOATS, ELECTRIC TRAINS, ETC.

#516 9 Volt 8" x 6 x 4 in. .3 run 24 or 27 Volt motor... 79¢ ea.

### Westerhouse AIR COMPRESSOR

Thousands now in use for spraying, inflating, tractors, trucks, garage, laboratory, air tools, industrial use, etc. Lightweight but powerful, can be run by 1/2 H. P. Motor or Gas Engine. Operates in either Direction or rotation. Gives approximately 2.27 CFM at 600 RPM, 6.54 CFM displacement at 1200 RPM. Has 2 inch bore, 1 1/2 inch stroke. Suggested pressure 75 P.S.I. Size 9" x 12" x 16 1/2". Weight approximately 23 pounds. AT THIS NEW LOW PRICE \$23.95  
Motors, Tanks, Fittings to Adapt this Unit also Avble.

### POWER UNIT

The Complete Model G&R 12-24, 100 Cooling of a Single Cylinder, Air Cooled, Four-Cycle, Briggs-Stratton Gasoline Engine, Type-Stroke Cylinder, Air Cooled, L-Head, Four-Cycle, 6 H. P. Bore 3", Stroke, 3 1/2". Governed for Speed Between 2500 - 3200 R. P. M.  
Directly Connected to a Direct Current Generator of 2000 Watts, Rating 26.5 Volts, 100 Amps, to form an Integrated Unit. Fuel Container 1 1/2 Gallons.  
The Engine and Generator are Mounted on Four Shock Absorbing Rubber Motor Mounts Attached to a Channel Iron Base. 4 Wheel for Mobility can be used as Lighting Plant or Power Supply. A TERRIFIC VALUE!  
THE BUY OF THE CENTURY... ONLY \$79.89

### Electronic Transmissn. Gear Train

GT-1 Containing approx. 50 Bronze Spur & Pinion Gears ranging from 3/8" to 4" dia., 5 sets of 7 cluster gears, 2 complete worm & worm gear drive sets, 40 N. D. ball bearings from 1/2" to 1 1/2" dia, watch springs, bushings, posts, face plates, housings, Micro Switches, 2 miniature, controlled clutches, etc. 19 lbs. of Pleasure and profit. \$8.49  
A Tremendous Gadget Misc. Only Gears in above train are all in multiple size and sequence with identical tooth ratio giving hundreds of ideal gear reduction combinations.

### Vickers Hydrlic Transmission

VT-1 Self contained, 2 H. P. constant torque of all speeds with variable volume reversible, piston pump (controlled by outside lever) supplying piston hydraulic motor. Automatic pressure, dash pot for smooth control. Power output R. P. M. -O to 1/2 input R. P. M. in both directions. Input R. P. M. 1800 continuous 4000 intermittent. Dash pot can be removed for greater R. P. M. Ideal for Lathes, Duplicator Setup on Mills, Conveyors, Small Cars, Drives, Gearing, Etc. COST GOVERNMENT APP. \$400.00 You'll Chortle when you get it for ONLY \$19.50  
Various units, Gear Trains, Power Take-Offs, Detrives Applicable to a multitude of adaptations, also Available.

### NEW PRESSURE TANKS

Stainless Steel - Shatter Proof, Seamless, 10,000 available in 8 different sizes, 1001 uses.

12" x 24 inches - 2100 Cu. in. capacity \$4.75  
18" x 24 inches - 3600 Cu. in. capacity \$5.49  
24" x 24 inches - 5400 Cu. in. capacity \$6.95  
30" x 24 inches - 8100 Cu. in. capacity \$8.49

### GEAR BOXES

VTG-1-50", 1 1/2 to 1 bevel gear reduction, 1/2" dia. with lever control for engaging & disengaging positive clutch, dust proof housing, pre-lubricated bearings, size 7"x8". A lifetime value. \$3.95  
VTG-2-30" bevel gear reduction 18 to 1, 1 1/2" x 4 square. Final take-off 4 1/2" dia. 26 tooth, 3/4" diam. spur gear with lever control for engaging and disengaging positive clutch, dust proof housing, pre-lubricated bearings, size 12"x8". Only Both above gear boxes can be used with above Transmission. \$6.49

### FIRE EXTINGUISHER

Kiddle Lee Col Type, Built to Gov't spec, wirebound, shatterproof Heavy Case. Fully recharged, 3 1/2" lb. - 2 1/2" x 4" Trigger control with horn 4TB type. \$15 Value \$13.25  
#601A \$11.75  
2 lb. Col type \$23 Value \$20.75  
10 lb. Charged with horn Col \$85 Value \$25.75  
#603 15 lb. Break Disc type New \$60A \$75 Value \$29.75  
#605 11 lb. Wheel Control \$20 \$32.95  
15 lb. Squares trip. New \$20C \$85 Value \$39.95

### CARBON TETRACHLORIDE (Red)

The Best Cleaner you ever saw for parts and machinery. Also Fire Extinguisher fluid. In One Gallon Cans \$1.59 Gal.

### GREENLEE - HAND TUBE BENDER

Designed for fast, free action, in bending steel, copper, brass, alum. tubing. Fits in std. vise up to 180 degree bend, makes smooth, small radius bends, free of kinks, scratches, etc. Available in the following sizes:  
1/4" @ \$4.50, 5/16" @ \$4.95, 3/8" @ \$6.95  
1/2" @ \$8.25, 3/4" @ \$9.75, 1" @ \$11.25  
Comp. Set of 6 Benders \$43.95

Order Direct From This Ad. All Sales Final. All Prices F.O.B. Los Angeles. Pay by M. O. or Cx. P.O.'s Accepted, from D & B Rtd. Firms. 1/3 Dep. with C.O.D. Now available New 1949 Edition, 90 Page Freely Illustrated Catalogue Containing Many Valuable information tables, Computations, Data, Etc. Send 25c to cover handling, Mailing, Etc.



**Time Payments**—Now you can buy any South Bend machine tool with 25% down payment and balance in twelve monthly installments. Small financing charge.



**Send Coupon** at once for the catalog(s) you want—or contact our local distributor. He is listed under "Machinery" or "Machine Tools" in your classified telephone directory.

## SOUTH BEND LATHE WORKS

455 East Madison Street, South Bend 22, Indiana

Please send the catalog(s) checked:

- |                                      |                                       |   |
|--------------------------------------|---------------------------------------|---|
| <input type="checkbox"/> Catalog 9-F | <input type="checkbox"/> Catalog 73   | <input type="checkbox"/> Catalog 400              |
| <input type="checkbox"/> Catalog 22  | <input type="checkbox"/> Catalog 77-U | <input type="checkbox"/> Time Payment Information |

NAME \_\_\_\_\_

STREET \_\_\_\_\_

CITY \_\_\_\_\_ STATE \_\_\_\_\_

## NEW SOUTH BEND LATHE CATALOGS

**CATALOG 9-F** describes 9" Quick Change Gear, Plain Change Gear and Toolroom Lathes; Precision Turret Lathes with 1/2" collet capacity—9" swing; Attachments, Accessories, and Tools for 9" lathes.

**CATALOG 22** describes South Bend Lathes with 9", 10", 13", 14 1/2", 16", and 16/24" swings; Precision Turret Lathes; Drill Presses; Shaper; Attachments, Accessories and Tools. Prices are shown.

**CATALOG 73** describes the new 13" and 14 1/2" Quick Change Gear and Toolroom Lathes with 1" maximum collet capacity; their Attachments, Accessories, Tools.

**CATALOG 77-U** describes Attachments, Accessories and Tools for all sizes and types of South Bend Lathes. Many adaptable to other makes of lathes.

**CATALOG 400** describes the new 14" Drill Presses—bench and floor models.

**WRITE FOR ONE TODAY**

Save Time, Work, Money, Make Extra Profits  
with **SHAW**

**"DU-ALL" and "PEPPY-PAL" TRACTORS**



and By  
**YEARS**  
Manufacturing  
"W-HOW"

WALKING MODELS 1½ to 5 H. P.



**PLOW**



**CULTIVATE**



**MOW**

and Dozens of Other Jobs

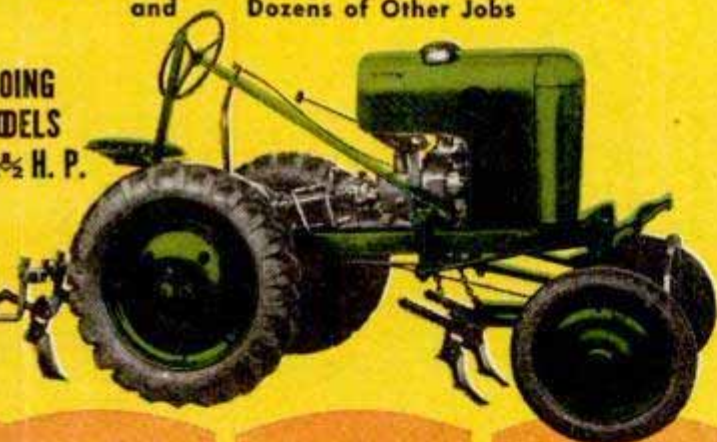

ING  
DELS  
½ H. P.

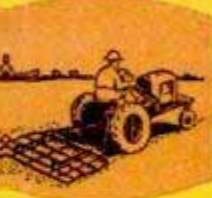

**HARROW**



**BULLDOZE, SNOWPLOW**



**RAKE**

and Many Other Jobs — Winter and Summer

**DO DOZENS OF JOBS QUICKLY AND EASILY WITH JUST ONE TRACTOR!**

Shaw tractors are always ready to plow, cultivate, bulldoze, harrow, mow, haul, rake, seed, spray, disc, saw and do scores of other jobs on a minute's notice. A child can operate these amazing machines and the low-cost Jiffy Hitch attachments are quick and easy to change.

**IDEAL TRACTOR FOR GARDENS, SMALL FARMS**

If you're gardening, farming, maintaining a golf course, chick hatchery, orchard, estate, cabin camp, truck farm, park, etc., you need a Shaw Du-All or Peppy-Pal. You'll get more jobs done, at lower cost, in a fraction of the time. You'll get top-quality work out of these dependable, efficient Shaw tractors.

**SOON PAYS FOR ITSELF—CHEAP TO OPERATE**

The remarkably low initial cost of Shaw tractors and attachments plus the low operating costs (only a few cents an hour) makes Shaw the buy of the year. It will soon pay for itself in time and labor-saving plus helping make extra profits for the man who job-contracts or likes to earn spare-time money.

**ECONOMICAL TO BUY—TOP QUALITY MATERIALS**

From big heavy duty tires to the smallest engine pin you receive only first quality materials—carefully and sturdily constructed, thoroughly inspected and tested for longer service and low maintenance. Precision engineering and efficient power utilization assure top performance on the toughest job.

**FULL GUARANTEE—PROMPT SHIPMENT**

Every Shaw tractor carries a full year's guarantee against any defect in workmanship or material. Check the many features of Shaw tractors—many different models ranging from 1½ to 12½ horsepower, variable speeds, power turn, forward and reverse, Timken roller bearings, Ross steering device and scores of other important features. Mail the coupon below, select and order your Shaw tractor for early delivery.

**SAW WOOD  
DO ALL KINDS OF BELT JOBS**

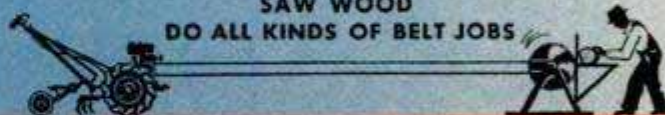

**LOW FACTORY PRICES**

modern factory and streamlined production methods assure you substantial savings. Compare the price and the value—you'll agree that Shaw gives you more for your money.

**FREE!** NEW ILLUSTRATED "ACTION-PICTURE" BULLETIN AND PRICE LIST

**ACT NOW - SEND NO MONEY**  
Mail Coupon for FREE Booklet and Price List

**SHAW MANUFACTURING CO.**  
4504 Front Street, Galesburg, Kansas, or  
668G North 4th Street, Columbus, Ohio

Please send me Free Booklet and price list.

Name .....

Address .....

# WILLIE MOSCONI

World's Pocket Billiard Champion, 1947 and 1948, holds pocket billiards high-run record of 309 balls in succession and match single game record of 127. Mosconi also rates as a 3-cushion expert.



# WILLIE HOPPE

A champion since '06, the veteran Willie Hoppe has held every title in carom billiards. After 44 years of competition, he's still world's 3-cushion champion.

WHEN THE "BOY WONDER" MEETS THE "OLD MASTER" OF THE CUE...IT'S

## CAMELS for MILDNESS!

MY BRAND, TOO,  
WILLIE HOPPE—THE  
30-DAY MILDNESS  
TEST WON ME  
OVER TO CAMELS  
FOR KEEPS!



30 DAYS?...I'VE  
SMOKED CAMELS  
FOR 20 YEARS. I  
KNOW THEY'RE MILD,  
AND CAMELS ALWAYS  
TASTE GREAT!



In a recent test  
of hundreds of people  
who smoked only  
Camels for 30 days,  
noted throat special-  
ists, making weekly ex-  
aminations, reported

**NOT ONE SINGLE  
CASE OF THROAT  
IRRITATION  
due to smoking  
CAMELS!**



● Millions of smokers have been enjoying Camel mildness for years, but if you haven't yet discovered the cool, cool mildness and rich, full flavor of Camel's choice tobaccos... make the Camel mildness test in your own "T-Zone" (T for Taste and T for Throat).

*Money-Back Guarantee!* Try Camels and test them as you smoke them. If, at any time, you are not convinced that Camels are the mildest cigarette you ever smoked, return the package with the unused Camels and we will refund its full purchase price, plus postage. (Signed) R. J. Reynolds Tobacco Company, Winston-Salem, North Carolina.