

ANC



POPULAR MECHANICS

MAGAZINE

WRITTEN SO YOU CAN UNDERSTAND IT

REG'D. TRADE MARK, GREAT BRITAIN, NO. 410426

REG. U.S. PAT. OFF.



ICE - WATER "SCOOT"

Page 112

SPEEDEX

BIG BOY AND MODEL C GARDEN TRACTORS

SPEED WORK • SAVE MONEY

LOW PRICES

ONLY \$155⁰⁰

MODEL C WITH CULTIVATOR

Big Boy

6 HP — \$285.00

WITH CULTIVATOR

Write today for complete
information. Use a penny
postcard.



SPEEDEX
Has many
outstanding features. Our
illustrated circular will tell
all about them. Canadian
inquiries invited.

P 149-10

ALL PRICES F.O.B. RAVENNA

SPEEDEX GARDEN TRACTOR CO.

5821 1st AVE. SO.
SEATTLE 8, WASH.

← ADDRESS OFFICE NEAREST YOU →

Post Office Box 216
RAVENNA, OHIO



1. MORE MILES! After 26,007 miles of hard service, this B. F. Goodrich Silvertown still has "plenty of good tread left", writes Dr. H. C. Baumann of Pottstown, Pa. The BFG tread lasts longer because it's wider, more level. Greater contact with road surface means slower wear.



2. MORE COMFORT! "Truly remarkable service", writes W. T. Sherin of Greenwich, N. Y., who has driven his BFG tires 43,519 miles. That remarkable service includes more comfort, proved by riding tests that show BFG tires give a smoother ride than other regular tires.



3. MORE SAFETY! T. F. Clifford, Westfield, Mass., has driven 44,000 safe miles on stronger, bruise-resisting B. F. Goodrich tires. You get more with BFG tires because research—now backed by industry's greatest Research Center—keeps them ahead of the times.

Users get more miles because Research Keeps

B.F. Goodrich

First in Rubber



B. F. G. MUD-SNOW
Best traction

B. F. G. SILVERTOWN
Lowest cost per mile

B. F. G. EXTRA-CUSHION
Easiest riding

PREMIUM SILVERTOWN
Highest quality



This One





“Talking” pegs...
and Talking people

THERE ARE 10,000 pegs in this machine, representing 10,000 subscribers in a crossbar telephone exchange—the latest switching system which handles dial calls with split-second swiftness.

The pegs represent many types of telephone users—two-minute talkers and ten-minute talkers . . . people who dial accurately . . . those who make a false start or two. They are starting a journey through a unique machine which analyzes the performance of dial equipment in a typical central office.

But while an actual crossbar exchange connects your call in a matter of seconds, this counterpart moves far more slowly. It gives the Bell Laboratories engineers who built it time to observe what happens to

each call—where bottlenecks develop, which parts are overworked or underworked, which of the circuits are most used.

In a manual exchange, the number of operators may be changed to meet different traffic conditions. In crossbar, all switching is done by complex electro-mechanical devices, permanently built in. This machine shows how many devices of each kind there must be in a new exchange to give you the best of service with a minimum of expensive equipment.

This traffic-study machine is one of the many ingenious research tools devised by the Laboratories as part of its continuing job—finding new ways to give you better and better telephone service.



BELL TELEPHONE LABORATORIES

Exploring and Inventing, Devising and Perfecting, for Continued Improvements and Economies in Telephone Service

Popular Mechanics Magazine

Registered in U. S. Patent Office and Canada

H. H. WINDSOR, Founder

H. H. WINDSOR, JR., Editor and Publisher



this month's cover

VERY SPORTY LOOKING, that strange amphibious craft portrayed in beautiful northwoods surroundings on our cover. Actually, it isn't for fun. It's a business coupe for travel on lake ice or open water. To get better acquainted with it, try hunting game out of season along the Canadian shore of Georgian Bay, or go stealing timber from some private Ontario woodland. You'd find yourself a fugitive from the "Scoot," which has as its sole reason for existence the chasing of poachers for the Ontario government. Conceived and built by Ontario forestry men, the craft is unique and alone in the world. Only one has been built; but if we know our family of readers, a lot of homespun copies of the Scoot will be speeding over frozen landscapes next winter. Roswell Brown was the cover artist. Story of the Scoot appears on page 112.

Published monthly by POPULAR MECHANICS COMPANY, 200 East Ontario Street, Chicago 11, Ill. H. H. Windsor, Jr., president; Paul H. Dunakin, vice president and general manager; D. F. Windsor, vice president and secretary-treasurer; William Harrison Fettridge, vice president and assistant to the publisher; Clover L. Perkins, advertising manager; Alan M. Devoe, circulation manager. Single copy in the United States and Canada, 35 cents; subscription rates in United States and possessions, Canada, Philippines and countries of the Pan-American Postal Union, 1 year, \$3.50; 2 years, \$6.00; 3 years \$8.00. To all other countries add \$1.00 a year

over United States prices for overseas postage. If you plan to move, notify us at least 30 days in advance so you will not miss an issue. Give both old and new addresses. Entered as Second Class Matter, September 15, 1903, at the Post Office at Chicago, Illinois, under Act of March 3, 1879. Entered as Second Class Matter at Post Office Dept., Canada. Copyright 1949 by Popular Mechanics Company. Copyright under International Copyright Union. Copyright in France. All rights reserved under Pan-American Copyright Union. Printed in the United States of America.

Volume 91 MARCH 1949 Number 3

Managing Editor.....Roderick M. Grant
 Assistant Managing Editor.....Wayne Whittaker
 Shop Notes and Crafts Editor.....James R. Ward
 Radio-Television, Electronics Editor.....Frank L. Brittin
 Associate Editor, Aviation.....Aubrey O. Cookman, Jr.
 Associate Editor.....Clifford B. Hicks
 Eastern Editor.....Bill Reiche
 Western Editor.....Thomas E. Stimson, Jr.
 Art Director.....Frank Beatty

Assistant Editors
 Donald R. Brooks Dorothy E. Hoffmann Arthur R. Railton

Assistant Editors, Shop Notes and Crafts
 W. Clyde Lamme Wayne C. Lecky Frank N. Stephany A. E. Youngquist

In This Issue

The Navy Explores the Air Waves - -	89
Tips From the Camp Cook - - -	100
They Must Land Safely - - -	104
Where Fishing is Rugged - - -	114
Want to Buy Some Rain? - - -	130
Small Cars for Britons - - -	138
Prehistoric Crop - - -	141
Backstage Miracle Makers - - -	152
Brains That Click - - -	162
They Hunt Wood - - -	169
Science Hits the Bull's-Eye - - -	174

For the Craftsman

Hammer 'em in Copper - - -	182
Furniture for Your Bedroom—Part II -	189
Use Cleaning Fluids Safely - - -	198
Leathercraft - - -	203
Make Your Rowboat Shipshape - -	210
Let the Shot Light Itself - - -	216
Lathe Sanders - - -	221
Two Farm Sprayers - - -	226
Radio-Television, Electronics - - -	237
Clinic for Homemakers - - -	248

Other items, and manufacturers of available products described, are listed on pages 8 and 10

FREE TRAINING in **Auto Mechanics Plus good pay while learning**

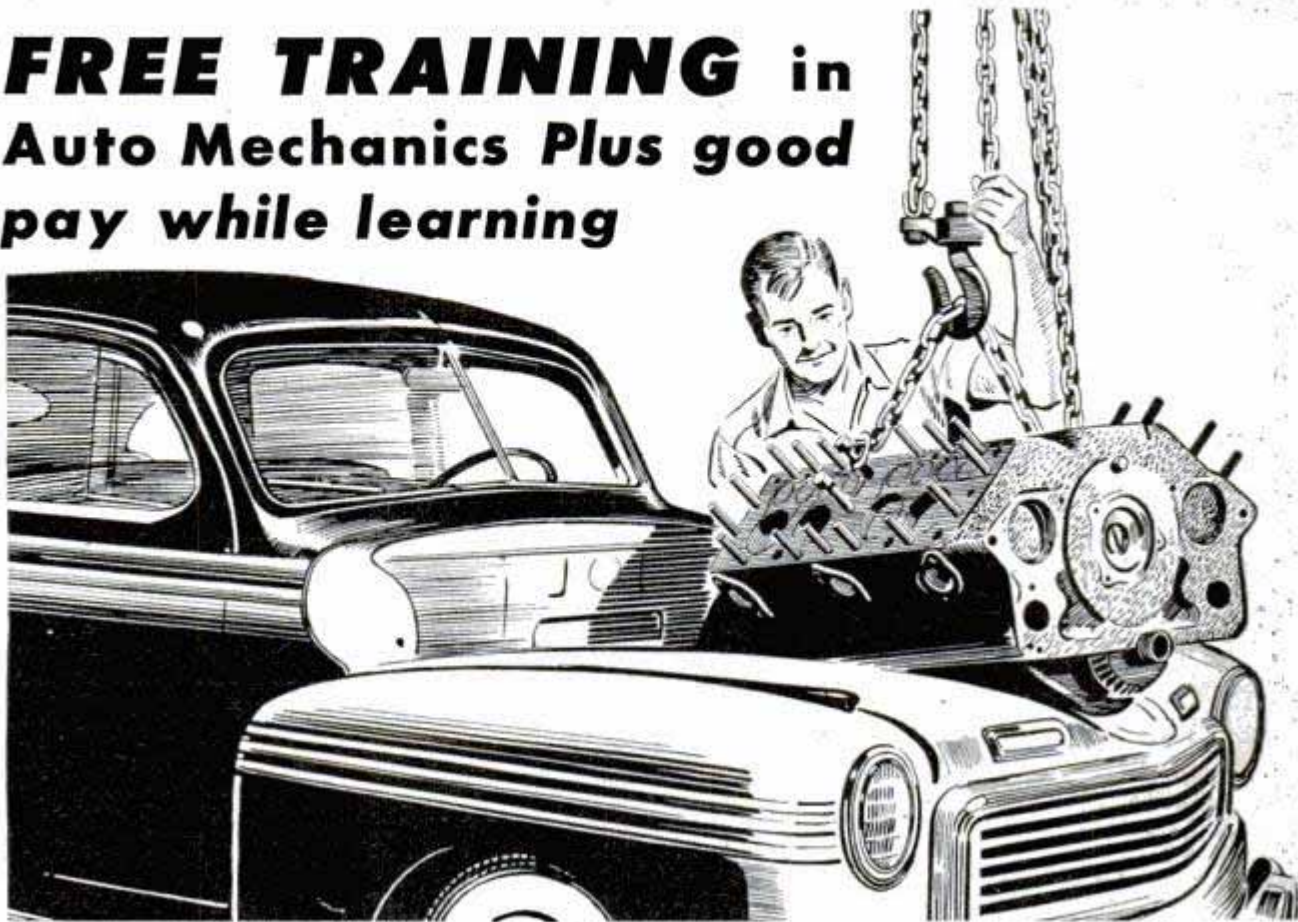

Become a first-class automotive mechanic and you're set for life... sure of a good job or able to run a shop of your own. Here's your chance to learn this valuable trade and the training won't cost you a penny. In addition, you'll get good pay while learning.

The United States Army is offering this outstanding opportunity to a limited number of young men who have high school diplomas, or state certificates to show equivalent education. Under the new Army plan, you can sign up for the automotive school and be *sure* of enrollment immediately after basic training.

In the Army trade schools you'll be taught by experts, with equipment that

is the very latest in the automotive field. These schools are the finest in the world. So good that many colleges and trade schools give credit for work done in them.

Your pay starts immediately. You'll get \$75 a month, plus free food and housing... free clothing and equipment... free medical and dental care... free retirement plan... low-cost insurance. In all, the pay is equal to \$211.50 in civilian life.

You owe it to your future to get details on this opportunity today.

You can get the facts, without obligation, at the nearest U. S. Army Recruiting station.

INTERESTED IN SOME OTHER TRADE?

Automotive Mechanics is only one of more than 60 U. S. Army trade schools open to qualified young men. Ask your Recruiting Officer about any trade in which you are interested. Chances are he can offer you what you want.



**PEACE IS AMERICA'S
MOST IMPORTANT BUSINESS**

The new peacetime Army and Air force offer young men...

- ★ WIDEST CHOICE OF CAREER JOBS
- ★ BEST OPPORTUNITY FOR ADVANCEMENT
- ★ UNUSUAL RETIREMENT BENEFITS

U.S. ARMY and U.S. AIR FORCE
RECRUITING SERVICE



Mercury, "messenger of the gods," was slow compared with Ultrafax—which moves at the speed of light.

This messenger delivers a million words a minute

Recently, at the Library of Congress, a distinguished audience saw documents flashed across Washington by a new means of communication . . . and reproduced *in facsimile*.

This was Ultrafax in action—a super-fast television communications system developed at RCA Laboratories. Reproductions of *any* mail—personal, business, or military . . . including police descriptions, fingerprints, bank drafts—can travel at 186,000 miles a second!

Material to be sent is placed before an RCA "flying spot" scanner, and transmitted by ultra-high frequency radio signals. Miles away, the pictures appear on a picture tube and are photographed. By a new photographic process, negatives are ready for printing or projection in 40 seconds.

Eventually, when Ultrafax comes into commercial use, a complete Sunday paper, every word, every picture . . . may cross America in 60 seconds.

Science at work . . .

Ultrafax is but *one* of scores of major achievements pioneered at RCA Laboratories. This leadership in science and engineering adds *value beyond price* to any product or service of RCA and RCA Victor.

Examples of the newest developments in radio, television, and electronics may be seen in action at RCA Exhibition Hall, 36 West 49th Street, N. Y. Admission is free. Radio Corporation of America, Radio City, N. Y. 20.



RADIO CORPORATION of AMERICA

World Leader in Radio — First in Television

the JOLLY TAR

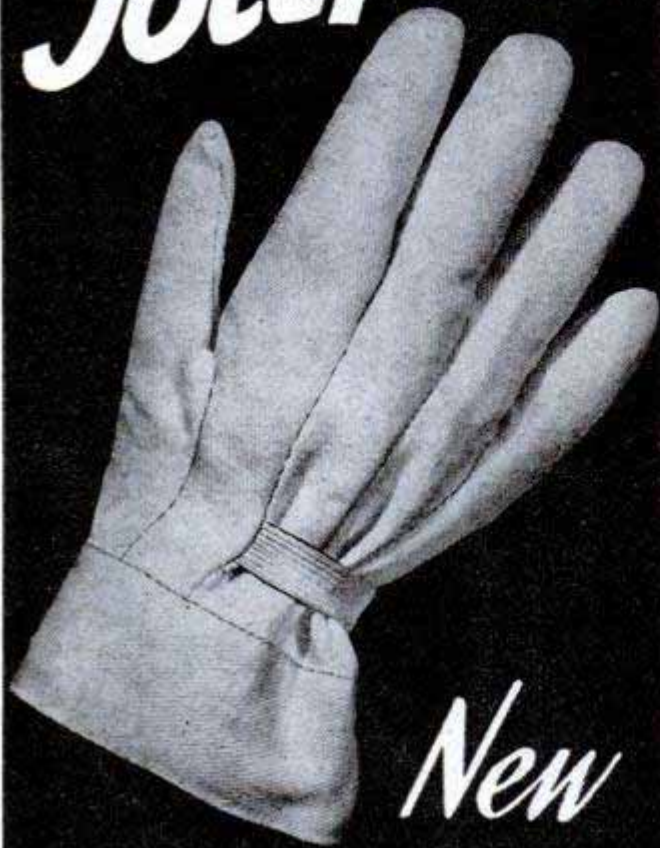

New

RIEDEL WORK GLOVE
for Home · Farm · Industry
Men's and Ladies' Sizes

For greater comfort when you work...and for lots of extra wear...try Riegel's new "JOLLY TAR" Work Glove. Elastic back strap keeps glove on comfortably...permits circulation of air so hands won't become sweaty. Made of special flannel-backed canvas, soft finish inside, with safety cuff for greater protection.

OTHER STYLES FOR EVERY NEED

canvas, jersey, leather...knit wrist, band top, gauntlet...double palm, reversible, quilted. Ask for the Riegel brand wherever work gloves are sold. Free catalog if requested on business letterhead.

Riegel Textile Corp.

342 Madison Avenue
New York 17, N. Y.



"THIS TRADE MARK IS YOUR GUARANTEE OF VALUE"

In this corner: **THE EDITORS**



THE BOSS spotted a headline in the paper: Operation Hole-in-the-Ice. There ought to be a story for us. Next Wednesday a few hundred hardy fishermen would start chopping holes through 40 inches of ice on the bleak surface of Great Slave Lake, 800 miles north of the Canada-United States border, to haul up whitefish and lake trout.

Anybody want to go up there and get the story and pictures for us? We cast around for one willing and capable, and found him in the person of Harry Rowed, Canadian photographer and writer. He caught a plane north from Edmonton about the time he meant to hang up his sock for Santa, spent the holidays in the land of quick-freeze and came back with a whale of a story, which please sit by the fire and read. It begins on page 114.

Mr. Rowed wrote us glowingly about the wonderful break in the weather. It really warmed up for him.

"I was comparatively lucky," he said. "Just three or four days before I arrived they recorded temperatures below —60. Was out on the ice one day at 40 below, but had more grief trying to keep the camera warm than I did myself. Fortunately, I had winterized the cameras about a month ago. Daylight is a pretty slim quantity this time of year... however, we had plenty of low sun for shadow effects, even at high noon!"

The fisher folk who swarm out across Caribou Bay with their dog teams every winter are a rugged and interesting lot... some of them Ukrainians, like Bill Workun, former Canadian paratrooper, and John Kashak; or Irish, like Bill O'Connor, Cree Indians like Leonard Cardinal and Frank Ladoucuer whose lead dog pulled him dripping from a break in the ice. Our own favorite is pretty Edna Powder, who helps her father, brother and sisters pack whitefish. You'll meet her on page 121. Agree?

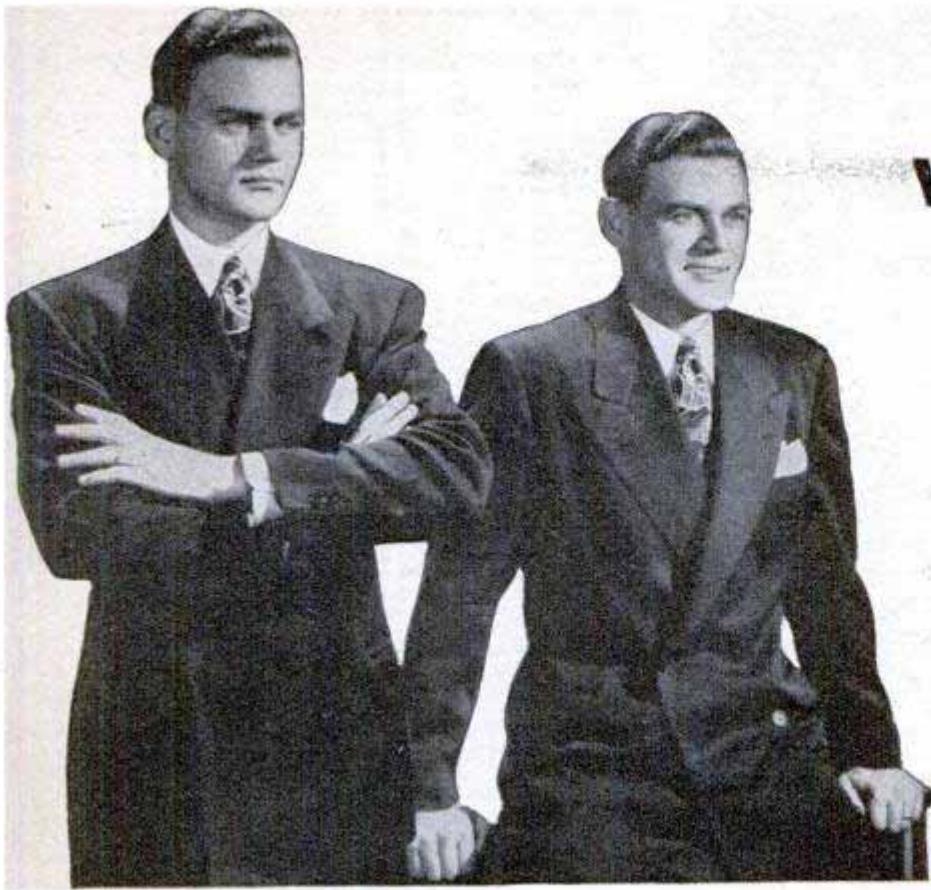

If YOU were Boss would YOU promote "YOU"?

Business is always willing to pay the man who knows—and pay him well. The man who is ready and will-

Be honest now—

suppose that a better job had opened up in your company—carrying with it promotion and more money—could you qualify?

If you were boss, would you select "YOU" for that better job?

Consider before you answer.

First of all, could you *fill* the job? Has your experience fitted you for the step forward—have you been preparing for promotion apart from experience gained on the job?

Or have you just been filling a niche, doing daily tasks well but making no real and intelligent effort to learn and qualify for the job ahead so that if an opening should occur you would be ready to fill it?

The man who gets real promotion is the one who makes his own breaks—the man who slaves in the ordinary job at low pay just wishes and dreams of promotion and more money. Which are you?

ing to take responsibilities—and capable of directing the efforts of other men is a valuable asset to any business organization. He never wants for a good job and above average earnings. He gets ahead.

We have helped thousands of men achieve promotion and more money—success sometimes beyond their dreams—a success that was started by a coupon similar to the one below.

Get out of that rut—don't be satisfied with a mediocre job at small pay—be a success in business—this coupon may be your first step.

Mail the coupon and we'll include "Ten Years' Promotion in One"—a book which has helped many men. Do it today—tomorrow never comes for the man who consistently puts things off.

LASALLE EXTENSION UNIVERSITY A Correspondence Institution

Dept. 364-R, 417 S. Dearborn, Chicago 5, Ill.

Please send me your free 48-page booklet telling how I can succeed in the field I have checked below—plus "Ten Years' Promotion in One" without obligation.

- | | |
|--|--|
| <input type="checkbox"/> Higher Accountancy | <input type="checkbox"/> Traffic Management |
| <input type="checkbox"/> C.P.A. Coaching | <input type="checkbox"/> Foremanship |
| <input type="checkbox"/> Bookkeeping | <input type="checkbox"/> Industrial Management |
| <input type="checkbox"/> Law: LL.B. Degree | <input type="checkbox"/> Stenotypy |
| <input type="checkbox"/> Business Management | <input type="checkbox"/> (Machine Shorthand) |
| <input type="checkbox"/> Salesmanship | |

Name..... Age.....

Address.....

City, Zone, State.....

LASALLE EXTENSION UNIVERSITY
A Correspondence Institution
Dept. 364R Chicago 5, Illinois

Because **PYROIL** gives oil the property of clinging to cylinder walls . . .

- it *prevents battery drain due to "dry starts."
- it *prevents scoring of cylinder walls.
- it *prevents corrosion and rust when automobile is not in use.

* it is Pyroil

Ask your gas station attendant to add PYROIL and add miles to your car.

PYROIL for Aircraft Engines

Use Aircraft Pyroil B for lubricating oil, Aircraft Pyroil A for gasoline.

GIVEN! An attractive Pyroil metal savings bank — takes coins up to 50¢ pieces — is yours for the asking — sent postage paid.



Manufactured and Guaranteed by Pyroil Company, 89 Pyroil Bldg., La Crosse, Wisconsin.

Canadian Distributors: Central Purchasing Agencies, Ltd., Toronto, Ontario

PYROIL COMPANY

89 Pyroil Bldg., La Crosse, Wisconsin

I want my car to last and run properly. Please tell me more about Pyroil and how it can accomplish this for me.

Name _____

Address _____

City or Town _____ State _____



WHERE-TO-BUY-IT INDEX

Source of supply appears after items commercially available

AUTOMOTIVE

"Tattooing" tires (Goodyear Tire & Rubber Co., Akron 16, Ohio)	110
Nonslip car jack (Triangle Jack, Inc., 1208 S. Washington St., Wichita, Kans.)	122
Insulation spray for ignition wires (Zaco Laboratories, 1360 W. 9th St., Cleveland 13, Ohio)	122
1949 Pontiac (Pontiac Motor Division, 196 Oakland Ave., Pontiac, Mich.)	123
Playboy station wagon (Playboy Motor Car Corp., 2450 Kenmore Ave., Tonawanda, N. Y.)	125
Vitalizer keeps battery strong (General Electric Co., Schenectady 5, N. Y.)	128
Road lamp flashes warning (Weiser-Hill Manufacturing Co., 2020 Mahoning Road, Canton, Ohio)	129
Road sander for cars (Highway Safety Appliances, Inc., 1381 Marshall Ave., St. Paul, Minn.)	129
Aluminum car	134
Window folds as top lowers (Pittsburgh Plate Glass Co., 632 Duquesne Way, Pittsburgh 22, Pa.)	135
Gasoline-tank lock (Steele Manufacturing Co., 445 Winchester Ave., Ashland, Ky.)	140
Removable truck fender (Diamond T Motor Car Co., 4401 W. 26th St., Chicago 23)	140
Platform in car serves as desk or playpen (Linne Products Co., 1819 Stanford St., Santa Monica, Calif.)	140
Three-wheel car (Tri-Wheel Motor Corp., Oxford, N. C.)	147
Ignition tester (F & B Manufacturing Co., 4248 W. Chicago Ave., Chicago 51)	150
Flameproof oil lasts life of car	173
Hydraulic bumper jack (Vulcan Mfg. Co., Inc., Winona, Minn.)	180

AVIATION

Pilot clips wings flying through wall	110
High-speed trainer	110
Pilotless target flies 220 m.p.h.	111
Wind-tunnel superspeeds	137
"Flying Easter egg" helicopter	161
High-speed patrol plane (Consolidated-Vultee Aircraft Corp., San Diego 12, Calif.)	161
Giant fuel tank for B-36	180

FARM

Lightweight sprayer (John Bean Division, Food Machinery Corp., Lansing 4, Mich.)	151
Gas covers protect plants (Frost Shield Plant Cover Co., Box 943, Austin, Tex.)	173
"Jackknife" harrow	180

FISHING

Fish caught at 16,000-foot depth	150
Lure has concealed hooks (Ecksi-Lure Mfg. Co., 2928 Empire Ave., Burbank, Calif.)	178
Plug retriever (Kin Day Manufacturing Co., Bristol, Tenn.)	178
Personal bait bucket (Inland Marine Co., 7817 Grove Ave., Webster Groves 19, Mo.)	178
Metal claw takes place of landing net (International Metal Products Co., 3110 Park Ave., St. Louis 4, Mo.)	178
Magnetic fly box (Charles F. Orvis Co., Manchester, Vt.)	178

HOUSE AND HOME

Automatic refrigerator defroster (Automatic Controls Corp., Wolverine Bldg., Ann Arbor, Mich.)	122
Padlock-bolt secures door hasp (Master Lock Co., Milwaukee 10, Wis.)	122
Fire alarm (Therm-O-Larm Corp., 3133 Fairfax Road, Cleveland 18, Ohio)	135
Sprinkler-sprayer (Broadmoor Industries, Inc., 1040 W. Fort St., Detroit 26, Mich.)	135
Gooseneck lamp (Edgewood Furniture Co., 208 E. 27th St., New York City 16)	158
Glass weather stripping (Malanco, Inc., 14410 South Western, Blue Island, Ill.)	158
Ball-bearing glider for windows (East Side Tool and Die Works, Portland, Ore.)	158
Plastic coating for imitation leather (Leather-New Products, 701 Land Bank Bldg., Kansas City, Mo.)	159
Glowing house number (Sues-Francis Mfg. Co., 1050 Florida Ave., Akron 14, Ohio)	159
Fiberglass curtains (Owens-Corning Fiberglass Corp., 1823 Nicholas Bldg., Toledo 1, Ohio)	159
Stove-top water coil (Miracoil Corp., 140 Pearsall Ave., Jersey City 5, N. J.)	159
House within a house	168
Gauge for oil drum (Hinman Mfg. Co., Tallahassee, Fla.)	179

INDUSTRY

Lightweight panels (The Glenn L. Martin Co., Baltimore 3, Md.)	98
Trimmer slices canal	99
Radial diesel (Nordberg Mfg. Co., Milwaukee 7, Wis.)	128
Atom-smasher in can	137
Synthetic mica (Owens-Corning Fiberglass Corp., 1833 Nicholas Bldg., Toledo 1, Ohio)	151
Scientists study "world's best fire"	157
"Jellied" gas kindles boilers	173
Tractor-tire tester	173

PHOTOGRAPHY

Meter for color photographers (Photo Research Corp., 5454 Harold Way, Los Angeles 27, Calif.)	94
Cameras to fight heart disease	134
Photographing magnetism	147
Static snaps picture	151

(Continued to page 10)

F. & C. HUMACHER CAR, 535 MANHATTAN AVE., N. Y. CITY

there's a TIME LIMIT on veteran training



Training under the G.I. Bill is a *limited offer*. You must enroll within four years after your discharge or before July 25, 1951 — whichever is later. Plan to take full advantage of the benefits to which you are entitled under the law. **START NOW.**

YOU MAY CHOOSE I. C. S. TRAINING

More veterans study with International Correspondence Schools than with any other school. Send *today* for full information on practical, authoritative I. C. S. training!

INTERNATIONAL CORRESPONDENCE SCHOOLS



BOX 5647-K, SCRANTON 9, PENNA.

Without cost or obligation, please send me full particulars about the course BEFORE which I have marked X:

- | | | | |
|--|--|---|--|
| <p>Business and Academic Courses</p> <ul style="list-style-type: none"> <input type="checkbox"/> Accounting <input type="checkbox"/> Bookkeeping <input type="checkbox"/> Business Administration <input type="checkbox"/> Business Correspondence <input type="checkbox"/> Certified Public Accounting <input type="checkbox"/> Commercial <input type="checkbox"/> Commercial Art <input type="checkbox"/> Cost Accounting <input type="checkbox"/> Federal Tax <input type="checkbox"/> First Year College <input type="checkbox"/> Foremanship <input type="checkbox"/> Good English <input type="checkbox"/> Higher Mathematics <input type="checkbox"/> Motor Traffic <input type="checkbox"/> Retailing <input type="checkbox"/> Salesmanship <input type="checkbox"/> Sign Lettering <input type="checkbox"/> Spanish <input type="checkbox"/> Traffic Management <input type="checkbox"/> Air Conditioning and Plumbing Courses <input type="checkbox"/> Air Conditioning <input type="checkbox"/> Heating <input type="checkbox"/> Refrigeration | <p><input type="checkbox"/> Advertising</p> <p>Chemistry Courses</p> <ul style="list-style-type: none"> <input type="checkbox"/> Chemical Engineering <input type="checkbox"/> Chemistry, Analytical <input type="checkbox"/> Chemistry, Industrial <input type="checkbox"/> Chemistry, Mfg. Iron & Steel <input type="checkbox"/> Petroleum Refining <input type="checkbox"/> Pulp and Paper Making <input type="checkbox"/> Civil Engineering, Architectural and Mining Courses <input type="checkbox"/> Architecture <input type="checkbox"/> Architectural Drafting <input type="checkbox"/> Building Estimating <input type="checkbox"/> Civil Engineering <input type="checkbox"/> Contracting and Building <input type="checkbox"/> Highway Engineering <input type="checkbox"/> Lumber Dealer <input type="checkbox"/> Reading Structural Blueprints <input type="checkbox"/> Sanitary Engineering <input type="checkbox"/> Structural Drafting <input type="checkbox"/> Structural Engineering <input type="checkbox"/> Surveying and Mapping <input type="checkbox"/> Communications Courses <input type="checkbox"/> Electronics <input type="checkbox"/> Practical Telephony <input type="checkbox"/> Radio, General <input type="checkbox"/> Radio Servicing | <p><input type="checkbox"/> Telegraph Engineering</p> <p>Electrical Courses</p> <ul style="list-style-type: none"> <input type="checkbox"/> Electrical Drafting <input type="checkbox"/> Electrical Engineering <input type="checkbox"/> Electric Light and Power <input type="checkbox"/> Lighting Technician <input type="checkbox"/> Practical Electrician <input type="checkbox"/> Power House Electric <input type="checkbox"/> Ship Electrician <input type="checkbox"/> Internal Combustion Engines Courses <input type="checkbox"/> Auto Technician <input type="checkbox"/> Diesel-Electric <input type="checkbox"/> Diesel Engines <input type="checkbox"/> Aeronautical Engineer's, Jr. <input type="checkbox"/> Aircraft Drafting <input type="checkbox"/> Forging <input type="checkbox"/> Heat Treatment of Metals <input type="checkbox"/> Industrial Engineering <input type="checkbox"/> Industrial Metallurgy <input type="checkbox"/> Machine Shop <input type="checkbox"/> Machine Shop Inspection <input type="checkbox"/> Mechanical Drafting <input type="checkbox"/> Mechanical Engineering | <p><input type="checkbox"/> Mold-Loft Work</p> <p>Electrical Courses</p> <ul style="list-style-type: none"> <input type="checkbox"/> Patterning—Wood, Metal <input type="checkbox"/> Reading Shop Blueprints <input type="checkbox"/> Sheet-Metal Drafting <input type="checkbox"/> Sheet-Metal Worker <input type="checkbox"/> Ship Drafting <input type="checkbox"/> Tool Designing <input type="checkbox"/> Welding Engineering <input type="checkbox"/> Welding—Gas and Electric <input type="checkbox"/> Railroad Courses <input type="checkbox"/> Air Brake <input type="checkbox"/> Diesel Locomotive <input type="checkbox"/> Locomotive Engineer <input type="checkbox"/> Locomotive Fireman <input type="checkbox"/> Locomotive Machinist <input type="checkbox"/> Railroad Section Foreman <input type="checkbox"/> Steam Engineering Courses <input type="checkbox"/> Boilermaking <input type="checkbox"/> Combustion Engineering <input type="checkbox"/> Engine Running <input type="checkbox"/> Marine Engineering <input type="checkbox"/> Steam Electric <input type="checkbox"/> Textile Courses <input type="checkbox"/> Cotton Manufacturing <input type="checkbox"/> Rayon Weaving <input type="checkbox"/> Woolen Manufacturing |
|--|--|---|--|

Name _____ Age _____ Home Address _____

City _____ State _____ Working Hours _____ A.M. to _____ P.M.

Present Position _____ Employed by _____

Length of Service in World War II _____

Special tuition rates to members of the Armed Forces. Enrollment under G.I. Bill and P.L. 16 approved for World War II Veterans. Canadian residents send coupon to International Correspondence Schools Canadian, Ltd., Montreal, Canada.

(Continued from page 8)

TOOLS

Snap nut for sheet-metal screws (Prestole Corp., 3159 Bellevue Road, Toledo 6, Ohio).....146
 Miniature metal-turning lathe (Small Machines, Inc., West Los Angeles, Calif.).....147
 Self-locking shingle nails (Elastic Stop Nut Corp. of America, Union, N. J.).....168
 Pneumatic spade (LeRoi Company, 1706 South 68th St., Milwaukee 14, Wis.).....172
 Frame guides file for saw sharpening (J. W. Coghlan, 1912 E. 3rd St., Pueblo, Colo.).....179

MISCELLANEOUS

Plastic kit (Pittsburgh Fabric Products Co., 4756 Penn Ave., Pittsburgh 6, Pa.).....94
 Water babies.....95
 Playing tag with lobsters.....96
 Sensitive instrument detects lead in air (E. I. DuPont de Nemours & Co., Inc., Wilmington 98, Del.).....98
 "Scoot" chases poachers on ice and water.....112
 Power wheel for bikes (Power Wheel, Inc., 11 S. La Salle St., Chicago 2).....123
 Timesavers for the blind.....124
 Atomic clock.....125
 Ben Franklin, Junior.....126
 Cigarette lighter has visible fuel supply (Ritepoint Co., 4350 South Kingshighway Blvd., St. Louis 9, Mo.).....128
 Photocells take "census" of trees.....136
 Collapsible "lung".....146
 Shotgun fires .22 scatter shells (P. S. Industries, Wellington, Ohio).....146
 Beauty shop in a bucket.....148
 Machine for baling moss.....150
 Sit-down exerciser (The Exerciser Co., Canon City, Colo.).....157
 Ranch patrol craft.....157
 Sensitive ammeter.....160
 Youths build railway.....160
 Toy rocket plane (Johnson Manufacturing Co., 1338 W. Garvey Ave., Monterey Park, Calif.).....160
 Nonblotting drafting pen (Keuffel & Esser Co., 303 Adams St., Hoboken, N. J.).....161
 Hydraulic lifter for invalids (Porto-Lift Manufacturing Co., 1410 N. Larch St., Lansing 5, Mich.).....172
 Radio guides "TNT" ships.....172
 Midget sub.....179

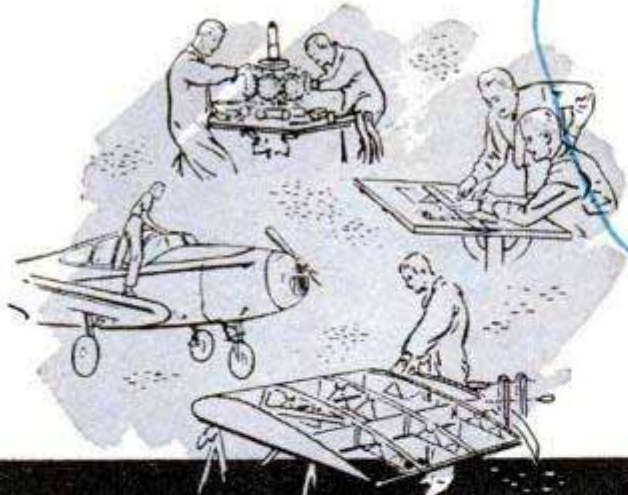

HERE IS YOUR JOB in AVIATION

We have hundreds of urgent requests for Embry-Riddle ground and flight graduates -- many times the graduates we had available could have been placed in the last 3 months. Never has there been such opportunity for you in aviation. Begin your career now. A few short months at Embry-Riddle and you're ready for a good job with best pay.

EMBRY-RIDDLE OFFERS **INDUSTRY NEEDS**

Complete training in minimum time for A&E Mechanics and all fundamental flight, specialist and technical positions • Modern airline-size hangars, classrooms, shops and airplanes • Experience gained over a quarter-century of aviation training • Living facilities on the airport.

Mechanics, technicians, specialists, engineers, pilots -- many, many more men than all aviation schools together can supply. The shortage of trained personnel is becoming more acute. Get in on the ground floor... Embry-Riddle students are spoken for well ahead of graduation. Don't delay. Write for proof of job opportunities TODAY. Begin your aviation career at Embry-Riddle NOW.



**AUTHORIZED
G. I.
TRAINING**

Dean of Enrollments - Dept. 99
Embry-Riddle School of Aviation
Miami 30, Florida

Please Print

NAME _____
 ADDRESS _____
 City _____
 State _____ Age _____

I am interested in ...

A.&E. Mechanic
 Commercial Pilot
 Engineering
 A.&E. Combined with Commercial Pilot
 Flying Mechanic
 Drafting & Design

Check One Veteran Non-Veteran

TRAIN IN MIAMI -- AIR CAPITAL OF THE WORLD

Craftsman and Shop Notes Index

AUTOMOTIVE

Improvised wooden gauge checks wheel toe-in.....207
 Battery-cable insulation protected with section of hose.....209
 Determining oil-gauge location by exhaust-pipe position.....232
 Trailer hitch folds under car when not in use.....233
 Valve springs cause tappet noise if installed upside down.....236

FARM

Sliding door on rabbit hutch provided by extension screen.....188
 Covered wagon pulled by oxen forms novel rural mailbox.....194
 Light auger raises unbroken soil sample.....223
 Tire provides marking guide when "topping" fence posts.....224
 Farm push truck.....225
 Discarded pans utilized as poultry watering dish.....233

HOUSE AND HOME

Ice-cream mix frozen quickly by using home freezer.....184
 Kerosene torch aids lighting furnace.....185
 Bowl cover catches crumbs.....185
 Solving home problems.....186
 Cork disks serve as feet for trinket boxes.....188
 Use cleaning fluids safely.....198
 Shutters made from scrap wood enhance plain windows.....200
 It's easy to make your own window screens.....201
 Paste application removes stains from wallpaper.....202
 Permanent solar awnings of cedar slats.....207
 Milk can provides foot scraper when cut out for shoes.....236

LAWN AND GARDEN

Birdhouse constructed from nail keg.....185
 New design gives back-yard incinerators a lift.....195
 Corncobs impaled on rake teeth mark garden seed rows.....202
 Young trees protected by guards cut from garden hose.....213
 Wood ashes rid tree of borers.....214
 Spacer and aligning jig aids building picket fence.....214
 Hollow concrete blocks form strawberry wall.....215

MACHINES

Slanting improves cutting action of jigsaw blade.....188
 Saw-blade guide kept from slipping.....196
 Grinder doubles as disk sander.....200
 Bandsaw tires dressed quickly with sanding block.....215
 Lathe sanders.....221
 Splicing broken V-belt.....224
 Metal collar adapts boring bar for internal threading.....224
 Drip oiler lubricates steady rest.....232

NOVELTIES

Outdoor chess played on "flagstone" board.....195
 Get on with your spring plowing.....197
 Trinket chest.....208
 Aluminum humidor holds king-size cigarettes.....213
 Cotter pins form photo stand.....214

OFFICE, SHOP AND STORE

Magnet holds spring for cutting.....184
 Adhesive tape holds small parts.....200
 Substitute thread-cutting oil.....222

(Continued to page 42)

AUDELS CARPENTERS & BUILDERS GUIDES—(4 Book Set).....\$6

A practical illustrated trade assistant on modern construction for carpenters, joiners, builders, mechanics and all woodworkers. 4 vols., 1600 pages, 3700 illustrations. Fully indexed, flexible covers. Each volume sold separately \$1.50 a vol.

AUDELS PLUMBERS & STEAMFITTERS GUIDES—(4 Book Set).....\$6

A Practical Trade Assistant & Ready Reference. Explains in plain language & by clear illustrations, diagrams, charts, graphs, pictures principles of modern plumbing practice including Marine Pipe Fitting and Air Conditioning. 4 Vols.—1670 Pages—3642 Diagrams & Illustrations. Each Vol. Sold Separately \$1.50 a Vol.

AUDELS OIL BURNER GUIDE.....\$1

384 Pages Covering Installation, Servicing & Repairs All Types Domestic & Industrial Burners. Illustrated. Highly Endorsed.

AUDELS HOUSE HEATING GUIDE.....\$4

1000 Pages Covering Working Principles, Installation, Service of All Modern House Heating, Ventilating & Air Conditioning Systems. Explains New Radiant Heating. Fully Illustrated & Indexed.

AUDELS REFRIGERATION & AIR CONDITIONING GUIDE.....\$4

New from Cover to Cover—1280 Pages, Fully Illus. Covering basic principles, servicing, operation & repair of household, commercial & industrial refrigeration & air conditioning. A gold mine of essential important facts for engineers, servicemen, users.

AUDELS SHEETMETAL WORKERS HANDY BOOK.....\$1

Practical inside information. Fundamentals of Sheet Metal Work. 388 pages. Illustrated. 11 sections. Clearly written. Essential & important facts, figures, pointers in everyday language. Ref. Index.

AUDELS SHEETMETAL PATTERN LAYOUTS.....\$4

Developed by Experts for Sheet Metal Workers, Layout Men & Mechanics. A Practical Encyclopedia in 10 Sections, size 7 x 10 x 2—1125 Pages—350 Layouts—1600 Illustrations. 1001 Key Facts. Fully indexed for ready reference in answering your layout problems. Covers all phases of sheet metal work including Pattern Cutting, Pattern Development & Shop Procedure.

AUDELS BLUE PRINT READING.....\$2

For Mechanics & Builders. Covers all types of blue print reading including ship & airplane. 416 pages, fully illustrated.

AUDELS MATHEMATICS & CALCULATIONS FOR MECHANICS \$2

Mathematics for home study or reference. 700 pages, 550 illus. Practical mathematics from beginning. How to figure correctly. Easy, correct methods covering complete review. Illus. & Indexed.

AUDELS AUTOMOBILE GUIDE.....\$4

A practical quick ready reference book for auto mechanics, service men, operators & owners. Explains theory, construction & servicing of modern motor cars, trucks, buses & auto type Diesel engines. 1700 pages, fully illustrated. 55 chapters. Indexed. A standard book for mechanics. New Hydraulic drive covered.

AUDELS DIESEL ENGINE MANUAL....\$2

A practical, concise treatise with questions and answers on the theory, operation and maintenance of modern diesel engines. Over 400 pages, fully illus. All details plainly brought out, this book is of extreme value to engineers, operators & students.

AUDELS WELDERS GUIDE.....\$1

A concise, practical text on operation & maintenance of all welding machines for all mechanics. Over 400 pages, illustrated. Covers all methods of electric and acetylene welding including airplane work.

AUDELS MACHINIST & TOOLMAKERS HANDY BOOK.....\$4

Covers modern machine shop practice in all its branches. Tells how to set up & operate lathes, screw and milling machines, shapers, drill presses & all other machine & hand tools. 1600 pages, fully illustrated. Indexed. 5 sections. 1—Modern Machine Shop Practice. 2—Blue Print Reading & How to Draw. 3—Calculations & Mathematics for Machinists. 4—Shop Physics. 5—How to Use the Slide Rule. 60 chapters. Easy to read and understand. A shop companion that answers your questions.

AUDELS ELECTRIC MOTOR GUIDE \$4

Practical Information Covering Construction, Control, Maintenance & Wiring Hookups of All Types Electric Motors also Armature Winding. 1000 Pages Fully Illustrated & Indexed.

AUDELS ELEC. WIRING DIAGRAMS \$1

210 Pages. Illustrated. Gives practical facts on wiring of electrical apparatus. It shows clearly how to wire apparatus for practically all fields of electricity. Each diagram is complete & self-explanatory. Highly Endorsed Pocket Companion.

AUDELS PRACTICAL ELECTRICITY \$4

A key to a practical understanding of Electricity. For maintenance engineers, electricians & all electrical workers. 1440 Pages, 2600 illus. Covers important electrical information in handy form—including wiring for Light & Power. Indexed.

AUDELS RADIOMANS GUIDE.....\$4

A key to the practical understanding of radio including Frequency Modulation, Television, etc., Aircraft & Marine Radio. For radio engineers, servicemen, amateurs. 914 Pages, 633 Illustrations & Diagrams. Photos. Review Questions & Answers, Reference Index.

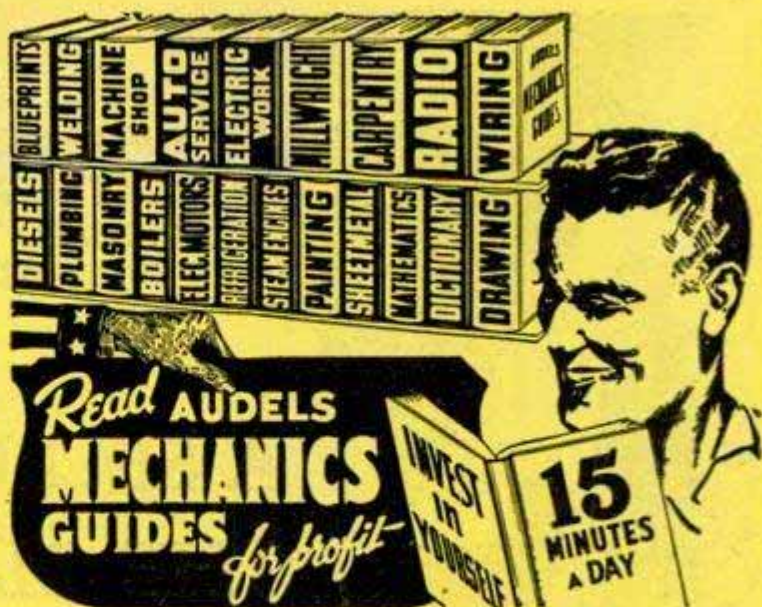

AN AUDEL GUIDE IS A GOOD FRIEND!
Step Up Your Own Skill with the Practical Facts and Figures of Your Trade. Save time and money with right methods, short cuts, labor saving ideas. CHECK NOW! You can look over any Audel Guide in your home. Start the Easy Payments if satisfied.

CUT HERE MAIL ORDER

AUDEL, Publishers, 49 W. 23 St., New York 10, N. Y.

Please mail me for 7 days' free examination the books marked (X) below. I agree to mail \$1 in 7 days on each book or set ordered, and to further mail \$1 a month on each book or set ordered until I have paid the purchase price. If I am not satisfied with Guides I will return them.

- AUTOMOBILE GUIDE, 1700 Pages 54
- DIESEL ENGINE MANUAL, 400 Pages 2
- WELDERS GUIDE, 400 Pages 1
- CARPENTERS & Builders Guides (4 Book Set) 6
- PLUMBERS & Steamfitters Guides (4 Book Set) 6
- MASONS and Builders Guides (4 Book Set) 6
- BLUE PRINT READING, 416 Pages 2
- MASTER PAINTER & Decorator, 320 Pages 2
- GARDENERS & GROWERS GUIDES (4 Book Set) 6
- OIL BURNER GUIDE, 384 Pages 1
- HOUSE HEATING GUIDE, 1000 Pages 4
- REFRIGERATION & Air Conditioning Guide, 1280 Pages 4
- SHEET METAL WORKERS Handy Book, 388 Pages 1
- SHEET METAL PATTERN LAYOUTS, 1100 Pages 4
- AIRCRAFT WORKER, 240 Pages 1
- MECHANICAL DRAWING GUIDE, 160 Pages 1
- MECHANICAL DRAWING & DESIGN, 480 Pages 2
- MATHEMATICS and CALCULATIONS, 700 Pages 2
- MECHANICAL DICTIONARY, 968 Pages 4
- MACHINISTS & Toolmakers Handy Book, 1600 Pages 4
- MILLWRIGHTS & Mechanics Guide, 1200 Pages 4
- POWER PLANT ENGINEERS GUIDE, 1500 Pages 4
- ENGINEERS & FIREMANS EXAMINATIONS, 528 Pages 1
- PUMPS, HYDRAULICS & Air Compressors, 1658 Pages 4
- MARINE ENGINEERS Handy Book, 1280 Pages 4
- ENGINEERS and Mechanics Guides (8 Book Set) 12
- Answers on Practical ENGINEERING, 254 Pages 1
- ELECTRIC WIRING DIAGRAMS, 210 Pages 1
- ELECTRICIANS EXAMINATIONS, 250 Pages 1
- ELECTRIC DICTIONARY, 9000 Terms 2
- ELECTRIC MOTOR GUIDE, 1000 Pages 4
- PRACTICAL ELECTRICITY Handy Book, 1440 Pages 4
- ELECTRICAL POWER CALCULATIONS, 425 Pages 2
- RADIOMANS GUIDE, 914 Pages 4
- ELECTRONIC DEVICES, 216 Pages 2
- NEW ELECTRIC LIBRARY, 7000 Pages (12 Book Set) 18

Vols. I, II, III, IV, V, VI, VII, VIII, IX, X, XI, XII—\$1.50 Each

Name _____

Address _____

Occupation _____

Employed by _____

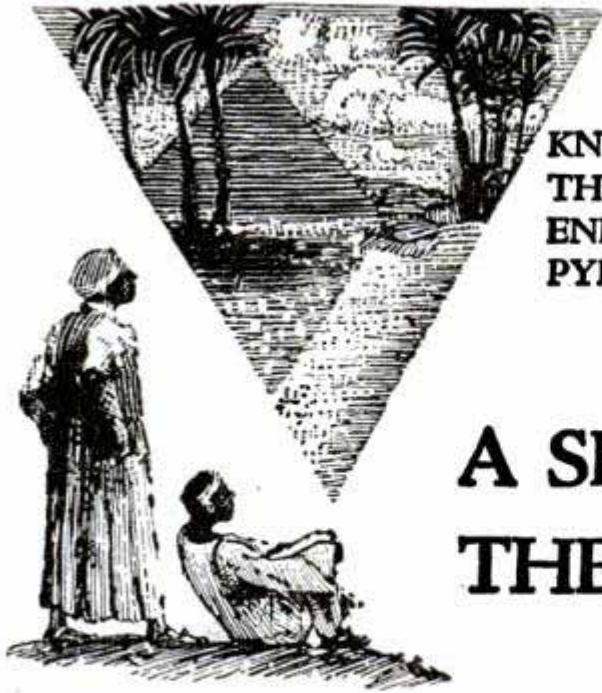

**KNOWLEDGE
THAT HAS
ENDURED WITH THE
PYRAMIDS**

A SECRET METHOD FOR THE MASTERY OF LIFE

WHENCE came the knowledge that built the Pyramids and the mighty Temples of the Pharaohs? Civilization began in the Nile Valley centuries ago. Where did its first builders acquire their astounding wisdom that started man on his upward climb? Beginning with naught they overcame nature's forces and gave the world its first sciences and arts. Did their knowledge come from a race now submerged beneath the sea, or were they touched with Infinite inspiration? From what concealed source came the wisdom that produced such characters as Amenhotep IV, Leonardo da Vinci, Isaac Newton, and a host of others? Today it is known that they discovered and learned to interpret certain *Secret Methods* for the development of their inner power of mind. They learned to command the inner forces within their own beings, and to master life. This secret art of living has been preserved and handed down throughout the ages. Today it is extended to those who dare to use its profound principles to meet and solve the problems of life in these complex times.

This Sealed Book—FREE

Has life brought you that personal satisfaction, the sense of achievement and happiness that you desire? If not, it is your duty to yourself to learn about this rational method of applying natural laws for the mastery of life. To the thoughtful person it is obvious that everyone cannot be entrusted with an intimate knowledge of the mysteries of life, for everyone is not capable of properly using it. But if you are one of those possessed of a true desire to forge ahead and wish to make use of the subtle influences of life, the Rosicrucians (not a religious organization) will send you *A Sealed Book* of explanation without obligation. This *Sealed Book* tells how you, in the privacy of your own home, without interference with your personal affairs or manner of living, may receive these secret teachings. Not weird or strange practices, but a rational application of the basic laws of life. Use the coupon, and obtain your complimentary copy.

The ROSICRUCIANS

SAN JOSE

(AMORC)

CALIFORNIA



AMENHOTEP IV
Founder of Egypt's
Mystery Schools

*Use this
coupon for
FREE
copy of book*

SCRIBE L. R. G.
The Rosicrucians (AMORC)
San Jose, California

Please send free copy of *Sealed Book*, which I shall read as directed.

NAME _____

ADDRESS _____

CITY _____

I WILL SEND YOU BOTH FREE

64 PAGE BOOK

See how I give you practical experience building Radio circuits at home with BIG KITS OF PARTS I SEND. Illustrated book shows how you make extra money fixing Radios in spare time while still learn-

ing. Read letters from men I trained, telling what they are doing, earning. See the kind of fascinating jobs Radio, Television, Electronics offer. FREE with coupon below!

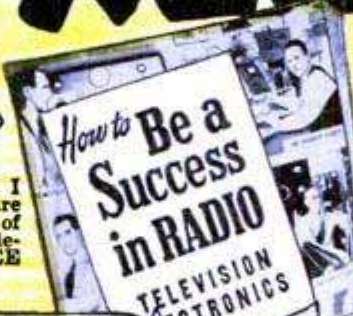

ACTUAL RADIO LESSON

Same coupon entitles you to FREE lesson, "Getting Acquainted With Receiver Servicing." Discloses short-cuts Radio Repairmen use. Tells how

"superhet" circuits work, three reasons why tubes fail, locating defects, repairing loudspeaker. Over 80 pictures, diagrams. FREE! Send coupon now.

GETTING ACQUAINTED WITH RECEIVER SERVICING

See for yourself how I train you at home to BE A RADIO-TELEVISION TECHNICIAN

Want a good-pay job in the fast-growing RADIO-TELEVISION Industry? Want a money-making Radio-Television shop of your own? Here's your opportunity. I've trained hundreds of men to be Radio Technicians—MEN WITH NO PREVIOUS EXPERIENCE. My tested and proved train-at-home method makes learning easy. You learn Radio-Television principles from illustrated lessons. You get practical experience building, testing, experimenting with MANY KITS OF PARTS I send. All equipment yours to keep.

Make EXTRA MONEY In Spare Time

The day you enroll, I start sending SPECIAL BOOKLETS that show you how to make \$5, \$10 a week EXTRA MONEY fixing neighbors' Radios in spare time. From here it's a short step to your own shop, or a good-pay Radio-Television servicing job. Or get into Police, Aviation, Marine Radio, Broadcasting, Radio Manufacturing or Public Address work. And think of the present and future opportunities in the booming Television Industry.

See What N. R. I. Can Do For You

Act now! Send for my DOUBLE FREE OFFER. Coupon entitles you to actual lesson, "GETTING ACQUAINTED WITH RECEIVER SERVICING," absolutely free. Over 80 pictures and diagrams! You also get my 64-page book, "HOW TO BE A SUCCESS IN RADIO AND TELEVISION—ELECTRONICS." Tells how quickly, easily you can get started. Send coupon in envelope or paste on penny postal. J. E. SMITH, President, Dept. 9CP, National Radio Institute, Pioneer Home Study Radio School, Washington 9, D. C.

You Build This MODERN RADIO with Parts I Send

Complete, powerful Superheterodyne Radio Receiver brings in local and distant stations. N. R. I. gives you everything . . . speaker, tube, chassis, transformer, sockets, loop antenna, and all other Radio parts you need to build set.

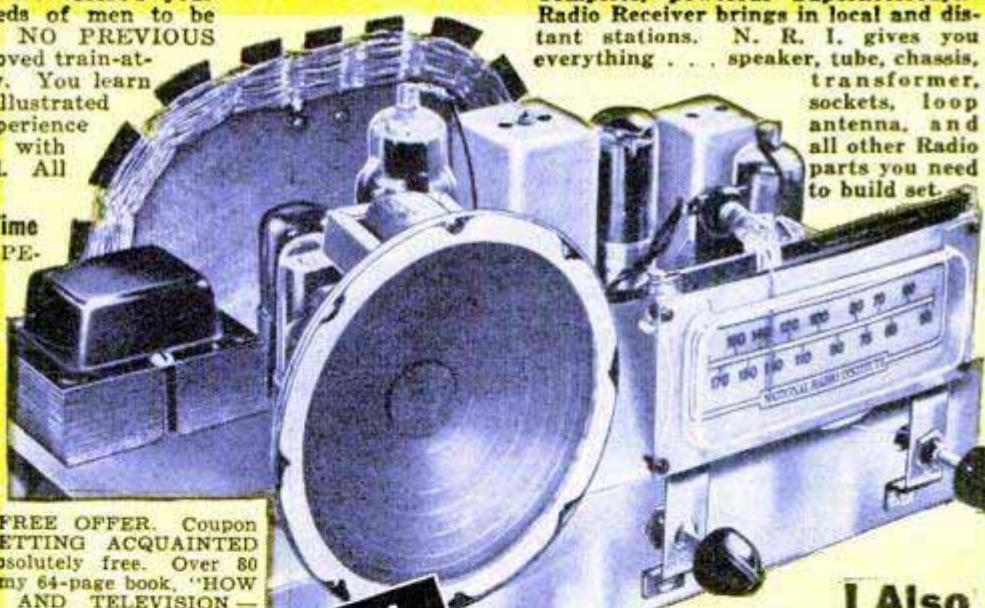

MAIL NOW

I Also Send You Many Other RADIO KITS

I TRAINED THESE MEN

Has Own Radio Business
"Now have two Radio shops, servicing about 200 sets a month. Highly successful our first full year." — ARLEY STUDYVIN, DeSoto, Missouri.

Extra Cash In Spare Time
"Earned enough spare time cash to pay for my Course by time I graduated. N. R. I. training is tops!" — ALEXANDER KISH, Carteret, New Jersey.

Actual Lesson and 64 Page Book FREE

MR. J. E. SMITH, Pres., Dept. 9CP National Radio Institute, Washington 9, D. C.

Mail me FREE Sample Lesson and 64-page book about how to win success in Radio and Television—Electronics. (No salesman will call. Please write plainly.)

NAME..... AGE.....
 ADDRESS.....
 CITY..... ZONE..... STATE.....
 Check If Veteran Approved For Training Under G. I. Bill

MY COURSE INCLUDES **TELEVISION**

Learn this Profitable Profession



IN 90 DAYS AT HOME

Money-Making Career Open to Men and Women, 18 to 50

Hundreds of men and women between 18 and 50 make \$10 to \$20 in a single day giving scientific Swedish Massage and Hydro-Therapy treatments. There is big demand from doctors, hospitals, sanatoriums and clubs. Graduates earn large full time incomes from these or in private practice in their own offices. Others make good money from home treatments given in spare time. Learn this interesting, money-making profession in your own home, through our home study course. Same instructors as in our nationally known resident school. You can win independence and prepare for future security by qualifying for your Diploma. Course can be completed in 3 to 4 months. Many earn while they learn. Begin your training at once.



Anatomy Charts & Booklet FREE

Enroll now and we will include, at no extra cost, many needed supplies. Fit yourself to help meet growing demand for Scientific Swedish Massage. Send the coupon at once for complete details. Anatomy Charts and 32-Page Illustrated Booklet, FREE, postpaid.

THE COLLEGE OF SWEDISH MASSAGE
Dept. 964-C, 41 E. Pearson, Chicago 11, Illinois

Please send me FREE and postpaid, Anatomy Charts, 32-page Booklet and complete details on Home Training.

Name _____ Age _____

Address _____

City _____ State _____

NEW ELECTRIC LIBRARY

\$1.50 A VOLUME

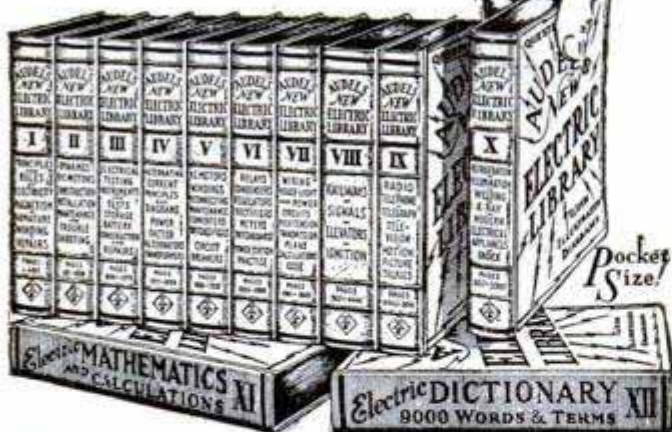

WHAT EVERY ELECTRICIAN WANTS TO KNOW!

Is easily found in AUDEL'S NEW ELECTRIC LIBRARY. Electricity made simple as ABC. Up-to-date, trade dope for the expert and ALL electrical workers. Questions, answers, diagrams, calculations, underwriter's code, design, construction, operation and maintenance of modern electrical machines and appliances FULLY COVERED.

All available at small cost, easy terms. BOOK-A-MONTH service puts this NEW information in your hands for 6c a day. You can start your subscription with any volume. Write TODAY for electric Folder and FREE TRIAL offer.

THEO. AUDEL & CO., 49 W. 23rd St., New York City

Mail Vol. I, Electric Library on 7 days' free trial. If O. K. I will remit \$1.50; otherwise I will return it. I also request you to mail one book each month on same terms. No obligation unless I am satisfied.

Name _____

Address _____

Occupation _____ P.M.

Famous BAILEY TECHNICAL SCHOOLS

OFFER THE FOLLOWING COURSES:
PRACTICAL DIESEL ENGINEERING
REFRIGERATION-AIR CONDITIONING
COMMERCIAL ELECTRICITY
RADIO-TELEVISION MECHANICS

Your future success depends largely on the reputation of the school you attend. Don't take chances! Train at America's foremost school of mechanical specialization. Bailey is recognized and approved by industry. Bailey graduates get the top pay jobs! G.I. Approved. Send for FREE Catalog.

BAILEY TECHNICAL SCHOOLS
1655 So. Grand Blvd., St. Louis, Mo.

An ASSURED FUTURE for You Learn Profitable WATCH REPAIRING

BIG MONEY WHILE LEARNING
Study at Home — or at Our Accredited School
Complete Home Correspondence Course or G. I. Approved Residence School Plan. Also, Post-Graduate Plan at school for correspondence students.

Write Today for COMPLETE DETAILS to
American Institute of Specialized Watch Repair
Dept. No. 100 270-76 East Building Grand Rapids, Michigan

Bar Bells

Buy Direct From Factory **\$8.95** up
Write for free booklet and price list
INDEPENDENT IRON WORKS
2416 East 23rd Street, Dept. B
Los Angeles 11, Calif.

ARTISTS MAKE MONEY

Do you like to draw? Send name, address, age and occupation for FREE ART TEST, to find out your ability.

ART INSTRUCTION, Inc.
3139 ART INSTRUCTION BLDG., MINNEAPOLIS 15, MINN.

SAY YOU SAW IT IN POPULAR MECHANICS

CIGARETTES

ALL POPULAR BRANDS - LUCKIES - CAMELS - CHESTERFIELDS
OLD GOLD - PHILLIP MORRIS - RALEIGHS. AS LOW AS
\$1.52 Per Carton

ORDERS SHIPPED IMMEDIATELY — FRESH STOCK DAILY

WE PAY PARCEL POST

50 Cartons — \$1.52 Each \$76.00
25 Cartons — \$1.53 Each \$38.25
10 Cartons — \$1.57 Each \$15.70

5 Cartons — \$1.59 Each \$7.95

GUM All Brands — 20 Pkgs. 85c with cigarette order. Send check or money order.
DIRECT SALES 921 W. 17th St. Kansas City, Mo. **\$1.52 Per Carton**



INVENTORS



Learn how to protect your invention. The U. S. Patent Laws provide that any new and useful art, machine, article of manufacture, or composition of matter, or any new and useful improvement thereof, may be patented if the act of invention is involved. Therefore, every inventor with a valuable invention should take advantage of the Patent Laws and proceed for patent protection in order to safeguard his rights.

A patent gives the inventor the exclusive right to prevent others from making, using, or selling the invention claimed in the patent for a period of seventeen years.

The Patent Laws were enacted for the benefit of the inventor to give him protection for the features of his invention which are patentable. These features must be properly and concisely set forth and claimed in a formal application for patent, in order to comply with the requirements of the Patent Laws. For that reason, unless the inventor is familiar with patent matters, he should engage a competent registered patent attorney or agent to represent him. We are registered to practice before the U. S. Patent Office and are prepared to serve you in the handling of your patent matters.

A specially prepared booklet entitled "Patent Guide for the Inventor", containing detailed information with respect to patent protection and procedure, together with a "Record of Invention" form will be promptly forwarded to you without obligation upon request.

CLARENCE A. O'BRIEN & HARVEY JACOBSON

Registered Patent Attorneys

91-C DISTRICT NATIONAL BUILDING • WASHINGTON 5, D. C.

Patents
Trademarks
Copyrights

CLARENCE A. O'BRIEN & HARVEY JACOBSON
Registered Patent Attorneys
91-C District National Bldg., Washington 5, D. C.
Please send me copy of "Patent Guide for the Inventor" and also
"Record of Invention" form. This request does not obligate me.

Name _____

Address _____

City _____ State _____

(Please write or print plainly.)

HOW TO MAKE MONEY
in
RADIO
ELECTRONICS
TELEVISION

HOW TO READ
RADIO DIAGRAMS
AND SYMBOLS

SPRAYBERRY
F. L. B.S.E. '14

SPRAYBERRY
ACADEMY
OF RADIO

GET THESE 2 BIG BOOKS

FREE.

IF YOU
WANT TO LEARN

RADIO!

I Train You RIGHT by Sending You 8 BIG KITS of Radio Equipment including A POWERFUL 6 TUBE SUPERHET RECEIVER and 16 RANGE TEST METER!

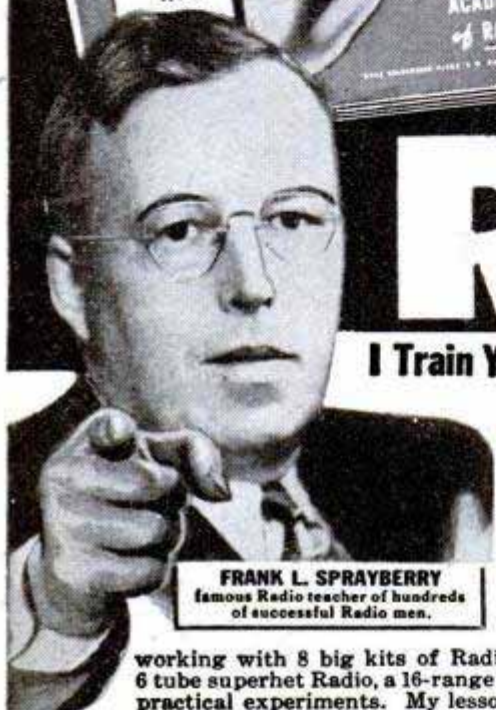

FRANK L. SPRAYBERRY
famous Radio teacher of hundreds
of successful Radio men.

working with 8 big kits of Radio parts I supply. You build a powerful 6 tube superhet Radio, a 16-range test meter, perform over 175 interesting, practical experiments. My lessons are easy and interesting. . . you need

no previous experience in Radio. My famous *Business Builders* help you earn EXTRA CASH getting and doing neighborhood Radio Service jobs while learning. You couldn't pick a better time to get into Radio. Good Radio Service and Repair Shops are needed everywhere as millions of new sets are in use. Trained men are wanted for opportunities in Police, Aviation and Marine Radio, F.M., Standard Broadcasting and Television. Mail coupon today for my FREE Books.

LEARN HOW TO BUILD-TEST-REPAIR RADIOS By Working with YOUR HANDS!

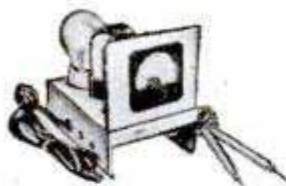

I give you a fine, moving coil type Meter—with parts for a complete analyzer and Circuit Continuity Tester. "Trouble-shoot" with professional accuracy.

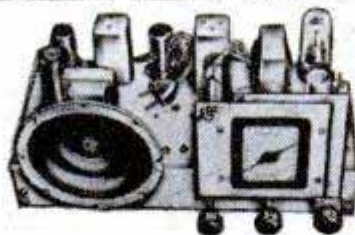

You really learn Radio the PRACTICAL way . . . when you build this big, powerful 6-tube Superhet Radio from parts I send you.

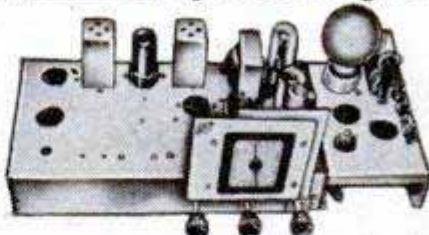

You don't have to buy expensive ready-made equipment. You get valuable experience building this Signal Generator and Multi-purpose Tester.

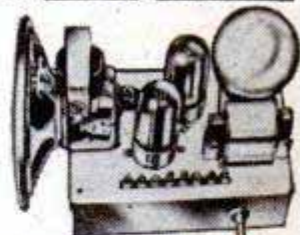

You construct this rectifier, filter, resistor and condenser tester, and really get on the Practical end of Radio.

LOW COST RADIO TRAINING STUDY AT HOME IN SPARE HOURS

RUSH COUPON Today!

SPRAYBERRY ACADEMY OF RADIO, Dept. 10-P
Sprayberry Building, Pueblo, Colorado, or
20 N. Wacker Drive, Chicago 6, Illinois
Please rush my FREE copies of "How to Make Money
In Radio, Electronics and Television" and "How to Read
Radio Diagrams and Symbols." No Salesman will call.

Name _____ Age _____

Address _____

City and Zone _____ State _____

CHECK HERE IF A VETERAN
(Mail in an Envelope or Paste on Penny Postcard)

Easy monthly payments, if desired. Everything you need is furnished—nothing else to buy. The equipment I send you is yours "for keeps"—to use in your business or job. I have trained hundreds of successful Radio men—and I can help you, too. Get the facts about Sprayberry Training—it's your first step to success, security and a bigger income. Fill out and mail coupon today. I'll rush my 2 Free books to you by return mail.

VETERANS: Approved for G. I. Training under Public Laws 16 and 346.

SPRAYBERRY ACADEMY OF RADIO

Dept. 10-P

Sprayberry Building, Pueblo, Colorado, or
20 N. Wacker Drive, Chicago 6, Illinois



Trained Radio men can step into their own profitable Radio Service Shop

NOW!

**TWO LOCATIONS
To Serve You Better!**

Mail Coupon to Location
Nearest Your Home

INVENTORS

Patent laws encourage the development of inventions.

We recommend that an inventor employ a registered Patent Attorney or agent, if the inventor is not familiar with patent matters. This is because the value of a patent depends largely upon the skillful preparation of the specification and claims in the patent application.

The firm of McMorrow, Berman and Davidson is registered to practice before the United States Patent Office. Additionally it engages patent attorneys able to readily understand inventors' disclosures, to advise concerning patentability, and to prepare appropriate specifications and claims.

If an inventor believes he has an invention, a search of the most pertinent prior U. S. patents should be made and a report obtained relative to its patentability. Where such report indicates that the invention appears patentable, in order to secure protection, diligence should be exercised in making application for a patent.

Send for a copy of Patent Booklet entitled "How To Protect Your Invention." This booklet contains information on patent protection and procedure. You will also receive an "Invention Record" blank. This will be promptly forwarded to you upon request—no obligation.

McMORROW, BERMAN & DAVIDSON

Registered Patent Attorneys

PATENTS • TRADE MARKS • COPYRIGHTS

135-X VICTOR BUILDING, WASHINGTON 1, D. C.

McMORROW, BERMAN & DAVIDSON

Registered Patent Attorneys

135-X Victor Building, Washington 1, D. C.

Send me your Patent Booklet, "How To Protect Your Invention", and also "Invention Record" form at once. I understand this request does not obligate me.

Name.....

Address.....

City.....

(WRITE OR PRINT NAME CLEARLY)

How to Make YOUR Body Bring You

FAME

Instead of SHAME!

Will You Let Me Prove I Can Make You a New Man?

I KNOW what it means to have a body that people pity! I was once a skinny, 97-lb. weakling—such a poor specimen that I was constantly self-conscious, embarrassed. But later I discovered the secret that turned me into the holder of the title, "The World's Most Perfectly Developed Man." I'd like to prove that the same system can make a NEW MAN of YOU!

7 DAY TRIAL OFFER

I don't say I can do all this for you in 7 days. But I DO want to prove I can show you enough results in even THAT short time to convince you that my system of "Dynamic Tension" will give you the kind of body you have always longed to have!

Do you want powerful shoulders—a fine, deep chest—biceps like iron—arms and legs rippling with strength—a stomach ridged with sinewy muscle—a build to be proud of? Then let me prove that "Dynamic Tension" is what you need.

FREE BOOK It costs only a stamp—or a postcard—to mail coupon below. I'll send my new, free book, "Everlasting Health and Strength." It tells about my "Dynamic Tension" method; shows, from actual photos, how I have developed my pupils—explains about my 7 DAY TRIAL OFFER. Charles Atlas, Dept. 8Q, 115 East 23rd St., New York, N. Y.



Charles Atlas

This is an actual snapshot taken at the beach.



Mail
Coupon
Now for
FREE Book

CHARLES ATLAS, Dept. 8Q,
115 East 23rd Street, New York, N. Y.

I want the proof that "DYNAMIC TENSION" will help make a new man of me—give me a healthy, husky body and big muscle development. Send me your free book, "Everlasting Health and Strength."

Name _____ Age _____
(Please print or write plainly)
Address _____
City _____ State _____

Command Bigger Money! STUDY LAW

STUDY AT HOME for BUSINESS SUCCESS and LARGER PERSONAL EARNINGS. 40 years expert instruction—over 114,000 students enrolled. LL.B. Degree awarded. All text material furnished. Easy payment plan. Send now for FREE BOOK—"Law and Executive Guidance." It explains the course—how you may enroll and the many ways you can profit from Law Study. Write TODAY to:

AMERICAN EXTENSION SCHOOL OF LAW
Dept. 12-PM, 646 N. Michigan Ave., Chicago 11, Ill.



RAISE HAMSTERS

The new wonder animals from Syria. Often called Toy Bears. Delightful pets. Everyone wants them. Laboratories need thousands. Clean, odorless. Raise anywhere. A profitable and interesting hobby or business. We furnish breeding stock with manual of instructions.

Write today for free illustrated literature.

GULF HAMSTERY, 1536 BASIL, MOBILE, ALA.

REAL ESTATE

BE A BROKER

PAYS BIG! SEND FOR FREE, BIG, ILLUSTRATED CATALOG NOW! No obligation. Graduates report making substantial incomes. Start and run your own business quickly. Men, women of all ages, learn easily. Course covers Sales, Property Management, Appraising, Loans, Mortgages, and related subjects. STUDY AT HOME or in our classrooms in big cities. Diploma awarded. G.I. approved. Nationally known.

WEAVER SCHOOL OF REAL ESTATE (Est. 1936)
15 E. Pershing Road Dept. PM-3, Kansas City, Mo.

FREE BOOK TELLS HOW

SADDLE HORSES

LEARN HORSE TRAINING AND MANAGEMENT

SUBSCRIBE FOR

The "EXPERT HORSEMAN"

ONLY \$1.00 YEAR



FREE BOOK—You will also receive a booklet that tells how you can learn to Break Colts, Gait Show Horses, Train Rodeo, Stock, and Race Horses, Break Bad Habits, Handle any horse, Train Circus Trick Horses

ANIMAL LOVERS ASSOCIATION
BOX KA-111 TARZANA, CALIFORNIA

LEARN MONEY-MAKING CARTOONING

IN SPARE TIME — by Easy Picture Chart Method

Same Simplified Method that has helped train creators of "Terry & Pirates," "Freckles," "Out Our Way," "Winnie Winkle," "Reg'lar Fellers," "Strange As It Seems," "The Neighbors," and many others. Earn while learning. Send 10c for Picture Chart (to test your ability), and full details. (State age.)

THE LONDON SCHOOL, 4903 Cleve. Transit Bldg., Cleveland, O.



Learn FINGERPRINTING AND IDENTIFICATION

IN-YOUR OWN HOME IN YOUR SPARE TIME

Specially prepared correspondence courses make it easy to learn this fascinating study essential in the field of CRIME DETECTION.

FREE Booklet

Under the Private Correspondence On Request School Law of Pennsylvania, Licensed by the Dept. of Public Instruction.

PENNA. INSTITUTE OF CRIMINOLOGY

Dr. W. Nisson Brenner, Director
DEPT. NO. 17
Extension Division
135 So. 2nd Street
Philadelphia 6, Pa.





You've got to compete with trained men!

The untrained man stands a slim chance today. Right now there are 14 million more highly skilled, experienced workers in the country than before the war.

Jam-packed schools and colleges are turning out record classes two and three times a year. The armed services continue to return thousands of technical experts to civilian life every month.

That's why it is so important that you get all the training you can—now, before "the squeeze" begins. Continue your formal

education if you can. If not, investigate the opportunities offered by I. C. S.

For more than 57 years, I. C. S. has been training those determined to make good regardless of the odds. Leaders in nearly every field of business and industry are counted among the men and women who have taken I. C. S. courses. Their records of success prove the worth of sound, practical I. C. S. training. Don't gamble with your future. It may be later than you think. Mark and mail the coupon today!

INTERNATIONAL CORRESPONDENCE SCHOOLS



BOX 5648-K, SCRANTON 9, PENNA.

Without cost or obligation, please send me full particulars about the course BEFORE which I have marked X:

- | | | | |
|--|---|--|---|
| <p>Air Conditioning and Plumbing Courses</p> <ul style="list-style-type: none"> <input type="checkbox"/> Air Conditioning <input type="checkbox"/> Heating <input type="checkbox"/> Refrigeration <p>Chemistry Courses</p> <ul style="list-style-type: none"> <input type="checkbox"/> Chemical Engineering <input type="checkbox"/> Chemistry, Analytical <input type="checkbox"/> Chemistry, Industrial <input type="checkbox"/> Chemistry, Mfg. Iron & Steel <input type="checkbox"/> Petroleum Refining <input type="checkbox"/> Pulp and Paper Making <p>Civil Engineering, Architectural and Mining Courses</p> <ul style="list-style-type: none"> <input type="checkbox"/> Architecture <input type="checkbox"/> Architectural Drafting <input type="checkbox"/> Bridge and Building Foreman <input type="checkbox"/> Building Estimating <input type="checkbox"/> Civil Engineering <input type="checkbox"/> Coal Mining <input type="checkbox"/> Contracting and Building <input type="checkbox"/> Highway Engineering <input type="checkbox"/> Lumber Dealer <input type="checkbox"/> Reading Structural Blueprints <input type="checkbox"/> Sanitary Engineering <input type="checkbox"/> Structural Drafting | <ul style="list-style-type: none"> <input type="checkbox"/> Plumbing <input type="checkbox"/> Steam Fitting <input type="checkbox"/> Plastics <p>Structural Engineering</p> <ul style="list-style-type: none"> <input type="checkbox"/> Structural Engineering <input type="checkbox"/> Surveying and Mapping <p>Communications Courses</p> <ul style="list-style-type: none"> <input type="checkbox"/> Electronics <input type="checkbox"/> Practical Telephony <input type="checkbox"/> Radio, General <input type="checkbox"/> Radio Operating <input type="checkbox"/> Radio Servicing <input type="checkbox"/> Telegraph Engineering <p>Electrical Courses</p> <ul style="list-style-type: none"> <input type="checkbox"/> Electrical Drafting <input type="checkbox"/> Electrical Engineering <input type="checkbox"/> Electric Light and Power <input type="checkbox"/> Lighting Technician <input type="checkbox"/> Practical Electrician <p>Internal Combustion Engines Courses</p> <ul style="list-style-type: none"> <input type="checkbox"/> Auto Technician <input type="checkbox"/> Diesel-Electric <input type="checkbox"/> Diesel Engines <input type="checkbox"/> Gas Engines <p>Mechanical Courses</p> <ul style="list-style-type: none"> <input type="checkbox"/> Aeronautical Engineer's, Jr. <input type="checkbox"/> Aircraft Drafting <input type="checkbox"/> Forging <input type="checkbox"/> Heat Treatment of Metals <input type="checkbox"/> Industrial Engineering | <ul style="list-style-type: none"> <input type="checkbox"/> Aviation <input type="checkbox"/> Gas Engines <input type="checkbox"/> Flight Engineer <input type="checkbox"/> Foundry Work <p>Industrial Metallurgy</p> <ul style="list-style-type: none"> <input type="checkbox"/> Machine Shop <input type="checkbox"/> Mechanical Drafting <input type="checkbox"/> Mechanical Engineering <input type="checkbox"/> Mold-Loft Work <input type="checkbox"/> Pattermaking—Wood, Metal <input type="checkbox"/> Reading Shop Blueprints <input type="checkbox"/> Sheet-Metal Drafting <input type="checkbox"/> Sheet-Metal Worker <input type="checkbox"/> Ship Drafting <input type="checkbox"/> Tool Designing <input type="checkbox"/> Welding Engineering <input type="checkbox"/> Welding—Gas and Electric <p>Railroad Courses</p> <ul style="list-style-type: none"> <input type="checkbox"/> Air Brake <input type="checkbox"/> Diesel Locomotive <input type="checkbox"/> Locomotive Engineer <input type="checkbox"/> Locomotive Fireman <input type="checkbox"/> Locomotive Machinist <input type="checkbox"/> Railroad Section Foreman <p>Steam Engineering Courses</p> <ul style="list-style-type: none"> <input type="checkbox"/> Boilermaking <input type="checkbox"/> Combustion Engineering <input type="checkbox"/> Engine Running <input type="checkbox"/> Marine Engineering <input type="checkbox"/> Steam Electric | <p>Textile Courses</p> <ul style="list-style-type: none"> <input type="checkbox"/> Cotton Manufacturing <input type="checkbox"/> Loom Fixing <input type="checkbox"/> Textile Designing <input type="checkbox"/> Woolen Manufacturing <input type="checkbox"/> Rayon Weaving <p>Business and Academic Courses</p> <ul style="list-style-type: none"> <input type="checkbox"/> Accounting <input type="checkbox"/> Bookkeeping <input type="checkbox"/> Business Administration <input type="checkbox"/> Business Correspondence <input type="checkbox"/> Certified Public Accounting <input type="checkbox"/> Commercial <input type="checkbox"/> Cost Accounting <input type="checkbox"/> Federal Tax <input type="checkbox"/> Foremanship <input type="checkbox"/> Good English <input type="checkbox"/> Higher Mathematics <input type="checkbox"/> Motor Traffic <input type="checkbox"/> Retailing <input type="checkbox"/> Retail Store Management <input type="checkbox"/> Salesmanship <input type="checkbox"/> Sign Lettering <input type="checkbox"/> Spanish <input type="checkbox"/> Advertising <input type="checkbox"/> Commercial Art <input type="checkbox"/> Commercial Art <input type="checkbox"/> First Year College <input type="checkbox"/> French <input type="checkbox"/> High School <input type="checkbox"/> Postal Civil Service <input type="checkbox"/> Secretarial <input type="checkbox"/> Stenography <input type="checkbox"/> Traffic Management |
|--|---|--|---|

Name _____ Age _____ Home Address _____

City _____ State _____ Working Hours _____ A.M. to _____ P.M.

Present Position _____ Employed by _____

Length of Service in World War II _____ Special tuition rates to members of the Armed Forces. Enrollment under G.I. Bill and P.L. 16 approved for World War II Veterans. Canadian residents send coupon to International Correspondence Schools Canadian, Ltd., Montreal, Canada.

I N V E N T O R S

A patent is a valuable right. On the basis of a constitutional provision Congress has established a system under which inventors may secure the exclusive right to prevent the unauthorized use, manufacture and sale of their inventions for periods of seventeen years. The inventor secures this protection by obtaining a patent.

*U*nless an inventor is thoroughly familiar with such matters, he is advised to employ a competent registered patent attorney, as the value of patents depends largely upon the skillful preparation of the specification and claims.

*W*e recommend that you authorize us to conduct a search through the United States patents pertinent to your invention and to submit a report setting forth our opinion with respect to its patentability.

*T*his firm is registered to practice before the U. S. Patent Office and is available to assist inventors in the preparation and prosecution of their cases. Detailed information and the preliminary steps to take to obtain patent protection will be furnished upon request. *Form below for mailing convenience.*

VICTOR J. EVANS & CO. • *Merlin M. Evans*
REGISTERED PATENT ATTORNEY
430-C MERLIN BUILDING, WASHINGTON 6, D. C.

<p>VICTOR J. EVANS & CO. • Merlin M. Evans <i>Registered Patent Attorney</i> 430-C Merlin Building, Washington 6, D. C.</p> <p><i>Please send me without obligation a copy of your booklet "Patent Protection For Inventors" together with your convenient "Evidence of Invention" form.</i></p> <p>Name.....</p> <p>Address.....</p> <p>City and State.....</p>
--

PATENTS

TRADEMARKS

COPYRIGHTS

LEARN

ELECTRICITY

ON REAL,
FULL SIZE EQUIPMENT
Train Quickly under Expert Instructors

IN THE GREAT SHOPS
OF COYNE

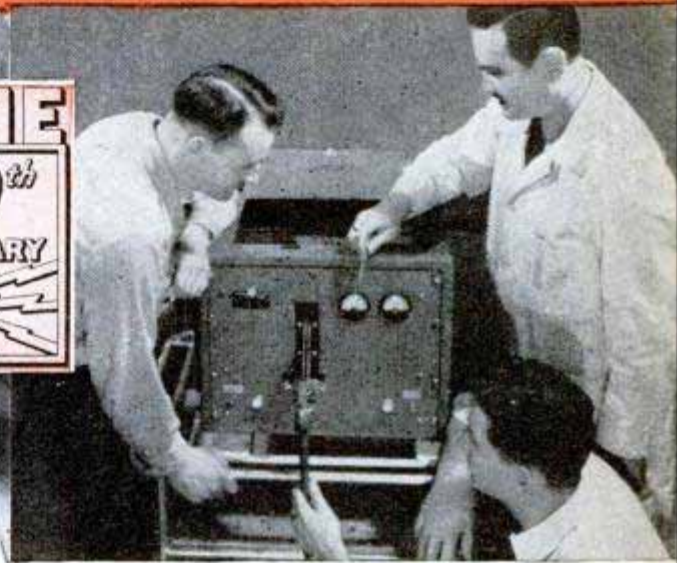

Why Spend Years Getting Ready?
Train Quickly at COYNE — Be Making
Real Money while Others Putter Along!

es, you can get ready for Good Pay
a Big Future in ELECTRICITY —
coming to COYNE in Chicago to
ain on actual equipment! Here you
ork on real motors, armatures, switch-
ards—do actual wiring and trouble-
ooting — get the "all-around" train-
g you need.
Not "Home-Study"
e do not teach by mail. All training is
ven in our Great Shops, plus necessary
eory. Expert instructors guide you.

No advanced education or previous ex-
perience needed.

**GI Approved — Finance Plan
for Non-Vets**

COYNE is authorized to train men
under the G. I. Bill. Non-veterans may
enroll now, pay most of tuition after
graduation. Special plan for men of
draft age. If you need part-time work to
help out with living expenses while at
Coayne, we'll help you get it.

FAMOUS "LEARN-BY-DOING" METHOD



1 You are TOLD the
how and why of
each job.

2 You're shown how
to do typical jobs by
trained instructors.

3 You DO EACH JOB
YOURSELF on real
equipment.

TRAIN FOR JOBS LIKE THESE
Light and Power Wiring . . . Power Plant Work . . .
Armature Winding . . . Substation Operator . . . Maintenance
Electrician . . . Electrical Testing . . . Signal Maintenance
. . . Industrial Electronics . . . Electric Refrigeration
and many others.

Mail for Big FREE BOOK

Come to COYNE during our 50th
Anniversary Year! Oldest, largest, best
equipped school of its kind in America.
BIG FREE BOOK tells all about
your future in Electricity and how
you can get ready quickly at
COYNE. Dozens of pictures. Rush
coupon today!
B. W. COOKE, Pres.
COYNE ELECTRICAL AND RADIO SCHOOL
500 S. Paulina St., Dept. 39-72, Chicago 12, Ill.



**RUSH THIS COUPON
NO SALESMAN WILL CALL**

B. W. COOKE, Pres.
COYNE ELECTRICAL AND RADIO SCHOOL,
500 S. Paulina St., Dept. 39-72, Chicago 12, Ill.

Send me your big FREE BOOK on ELECTRICITY
and Special plan for men of draft age. This does not
obligate me in any way and no salesman will call on me.

NAME.....

ADDRESS.....

CITY.....STATE.....

BE A WINNER AT ANYTHING YOU TACKLE WITH **PROGRESSIVE POWER** Now **ALL 5 FAMOUS JOWETT COURSES** in 1 Volume for only **25¢**

DARLING, THAT BULLY WON'T PICK ON YOU AGAIN.

WHAAM!

JOE YOUR NEW ENERGY AND APPEARANCE SURE DO A GOOD JOB YOU EARNED YOUR PROMOTION.

"The Jowett System is the greatest in the world!" says R. F. Kelly, Physical Director, Atlantic City



Let's Go, Pal! I'll prove I can make YOU an **"ALL-AROUND" HE-MAN**

FAST — OR NO COST! says George F. Jowett World's Greatest Body Builder

Enjoy My "Progressive Power" Strength Secrets! Give Me 10 Easy Minutes a Day — Without Strain! I'll teach you the "Progressive Power Method" through which I rebuilt myself from a physical wreck the doctors condemned to die at 35, to the holder of more strength records than any other living athlete or teacher! "Progressive Power" has proven its ability to build the strongest, handsomest men in the world. And I stand ready to show you on a money back basis—that no matter how flabby or puny you are I can do the same for you right in your own home. Let me prove I can add inches to your arms, broaden your shoulders, give you a man-sized chest, powerful legs and a Rock-like back—in fact, power pack your whole body so quickly it will amaze you! Yes, I'll jam you with power and confidence to master any situation—to win popularity—and to get ahead on the job! Through my proven secrets I bring to life new power in you inside and out, until YOU are fully satisfied you are the man you want to be.

PROVE IT TO YOURSELF IN ONE NIGHT

Send only 25c for my 5 easy-to-follow, picture-packed courses now in 1 complete volume "How to Become a Muscular He-Man." Try it for one night! Experience the thrilling strength that surges through your muscles.

George F. Jowett

Whom experts call "Champion of Champions"

- World's wrestling and weight lifting champ at 17 and 19.
- World's Strongest Arms.
- 4 times World's Perfect Body — plus other records.

10 DAY TRIAL!

Think of it—all five of these famous courses now in one picture-packed muscle-building volume for only 25c. If you don't actually FEEL results within ONE WEEK, send it back and your money will be promptly refunded! Photo Book of Famous Strong Men!

I am making a drive for thousands of new friends fast—REGARD-LESS OF COST!

SO GET NOW MY 5 Muscle Building COURSES (Valued at \$5 each)

All in 1 Great Complete Volume Packed With How-To-Do-It Pictures!

Now, this "get-acquainted," extremely low price of only 25c is your chance to build a body you'll be proud of! Follow Jowett's easy method of muscle building NOW!

For Only **25c**



FREE!

Photos that inspire you to might and muscle. Free with order.



George F. Jowett Champion of Champions

FREE GIFT COUPON!

Jowett Institute of Physical Culture DEPT. PM-93 230 Fifth Avenue, New York 1, N. Y.

Dear George:—Please send by return mail, prepaid, **FREE** Jowett's Photo Book of Strong Men, along with all 5 Muscle Building Courses. 1. Molding a Mighty Chest. 2. Molding a Mighty Arm. 3. Molding a Mighty Grip. 4. Molding a Mighty Back. 5. Molding Mighty Legs—Now all in One Volume "How to Become a Muscular He-Man." Enclosed find 25c. NO C.O.D.'S.

NAME _____ AGE _____
(Please Print Plainly, Include Zone Number)

ADDRESS _____

MAKE MORE MONEY THROUGH AUDIOMETRY

in spare time at home

Free literature tells how you can become expert in fitting of hearing aids in short time. Get into this well-paying uncrowded professional field. Complete course consists of General Physics, Anatomy, Physiology of the Human Ear, Psychology of Hearing, etc. together with Audiometry. Degree of Doctor of Audiometry conferred.

Write today for free literature.

ONLY SCHOOL OF ITS KIND

NATIONAL COLLEGE OF AUDIOMETRY
DEPT. PM-3 ANTIOCH, ILLINOIS

NEW! LOW COST! RESPIRATOR

Wear when sanding, grinding, paint spraying, sweeping, dusting, furnace cleaning, etc. Handy as a pair of glasses. Just keep mouth closed and breathe through nose is all you do to operate. Protects against nuisance dusts, lint, coal, cement, grain dust, hay fever pollen. Has 9 sq. in. filter. For EYE protection against paint spray, dusts, gases, fumes, smoke, order our Fog-Proof Rubber GOGGLES..... \$2.00 p.p.



Order Today \$1.00 POST PAID

JERRY BRYANT, Dept. PM 919 N. Michigan Ave. Chicago 11, Ill.

LEARN MEAT CUTTING At Home — In Spare Time



Get into the vital meat industry. Concise, practical Home Training based on 25 years proven instruction methods used at National's famous resident school. Prepares you for bigger pay as Meat Cutter, Supervisor, market manager or more money in your own store. Go as rapidly as your spare time permits. Diploma. Start NOW to turn your spare hours into money. Send for FREE bulletin today. No obligation.

National School of Meat Cutting, Inc., Div. U-103, Toledo 4, Ohio

"How to Make Money with Simple Cartoons"



A book everyone who likes to draw should have. It is free; no obligation. Simply address

FREE BOOK

CARTOONISTS' EXCHANGE
Dept. 93-D Pleasant Hill, Ohio

RADIO ENGINEERING. Broadcasting, Television, FM, Servicing, Electronics, Aviation, Marine & Police Radio taught thoroughly. Engineering course equivalent to 3 years' college radio work. Approved Veteran Training. Catalog free.

LEARN WATCH REPAIRING



AT HOME. By our modern and original system of instruction you can learn every part of the **WATCH REPAIRING TRADE AT HOME.** Prepare yourself for a well-paying position or start in business after completing our course of instruction. Good watch repairers are in demand and generally earn very good salaries. For particulars apply to the Wisconsin School of Watch Repairing 759 North Milwaukee St., Milwaukee 2, Wis.

Thrilling Work COLORING PHOTOS



Fascinating vocation learned at home by those with aptitude. Thrilling pastime. National method brings out life-like colors. Free booklet.

NATIONAL PHOTO COLORING SCHOOL
1315 S. Michigan, Dept. 1353, Chicago 9

WHICH OF THESE *Opportunities* INTERESTS *You* MOST?

Accounting
Air Conditioning
Architecture & Building
Automotive Engineering
Aviation—Practical
Aviation Drafting & Design
Better Foremanship
Bookkeeping
Business Management

Contracting
Diesel Engineering
Drafting & Design
Electrical Engineering
Electricity—Practical
Electronics, Industrial
High School Courses
Machine Shop Operations
Mechanical Engineering

Plastics Engineering
Plumbing—Practical
Private Secretary
Radio Operating & Servicing
Railway Training
Refrigeration
Sheet Metal Pattern Drafting
Shop Management
Tool Making

THINK! LOOK FORWARD!

Business is making big, new plans

Men and Women are preparing for the future

WHAT ARE YOU DOING ABOUT YOUR TOMORROWS?

● *Today*, choose the job you want—and prepare for it. Or if you are already engaged in the work you like best, start training *now* for quicker promotion. Acquire the knowledge that will help you to get ahead faster, make more money and have greater security.

Invest part of your spare time in more rapid progress. Start training now, in spare time in your own home. Be ready to grasp your opportunity and step out ahead of those who lack the ability you have attained.

American School, founded in 1897 as an educational institution *not for profit*, can help you to reach your goal just as it has helped others during the past fifty-two years. Give serious thought to the list above. Pick one or more subjects that interest you. Then check the coupon at right, add your name and address and mail it at once. The school will send you details on its training plan and outline of study prepared by specialists. There is no charge, no obligation, so send the coupon immediately.

PRACTICAL, EFFECTIVE HOME • STUDY TRAINING SINCE 1897

Take This First Easy Step

CHECK, CLIP AND MAIL COUPON NOW

AMERICAN SCHOOL, Dept. G345, Drexel at 58th, Chicago 37, Ill.

Without obligation, Please send FREE and postpaid, bulletin and details of the Subject checked.

- | | | |
|--|--|--|
| <input type="checkbox"/> PLASTICS ENG'R | <input type="checkbox"/> Accounting | <input type="checkbox"/> Drafting and Design for Men and Women |
| <input type="checkbox"/> Refrigeration | <input type="checkbox"/> Electrical Engr. | <input type="checkbox"/> Radio |
| <input type="checkbox"/> Architecture and Building | <input type="checkbox"/> Electricity-Pract. | <input type="checkbox"/> High School |
| <input type="checkbox"/> Contracting | <input type="checkbox"/> Electronics, Industr. | <input type="checkbox"/> Air Conditioning |
| <input type="checkbox"/> Practical Plumbing | <input type="checkbox"/> Bookkeeping | <input type="checkbox"/> Mechanical Eng. |
| <input type="checkbox"/> Automotive Engineering | <input type="checkbox"/> Private Secretary | <input type="checkbox"/> Shop Management |
| <input type="checkbox"/> Aviation Drafting | <input type="checkbox"/> Diesel Engineering | <input type="checkbox"/> Tool Making |
| <input type="checkbox"/> Aviation | <input type="checkbox"/> Sheet Metal | <input type="checkbox"/> Better Foremanship |
| <input type="checkbox"/> Business Mgmt | <input type="checkbox"/> Pattern Drafting | <input type="checkbox"/> Machine Shop Operations |
| <input type="checkbox"/> Railway Training | | |

Name..... Occupation.....

Address..... Age.....

City..... State.....

AMERICAN SCHOOL

Dept. G345, Drexel at 58th Street, Chicago 37

MEN-IF YOU VALUE Your Future- read this FREE BOOK

SEND
FOR IT
Today!



Tells You How to Win Bigger Pay and Real Security

This book is yours without a penny of cost. "Your Future in Refrigeration and Air Conditioning" tells you what's in store for you in this fast moving, big pay field. No obligation. We want you to have this big, fascinating book. We want you to have the opportunity to read it—and to decide for yourself whether this is the field for you. You'll see pages of interesting pictures showing men on-the-job in Refrigeration and Air Conditioning. You'll read all about the fine opportunities in this amazing industry. This can easily be the most important book you'll ever receive and read—because it concerns your own future! Refrigeration and Air Conditioning has plenty of room for trained men—to handle good paying jobs in the many branches of this great industry. Almost unlimited future for men who know this work. Now you may learn Refrigeration and Air Conditioning at home in spare time. No need to give up present job or income while preparing to step into a better job. Act now! Simply write your name and address on the coupon below and mail today. Get your free copy at once . . .

INDUSTRIAL TRAINING INSTITUTE

2150 Lawrence Avenue, Dept. R-1, Chicago 25, Ill.

MAIL COUPON NOW No Cost
No Obligation

Mr. C. H. Smith, President,
Industrial Training Institute, Dept. R-1
2150 Lawrence Avenue, Chicago 25, Illinois

Please send me a FREE COPY of "Your Opportunity in Refrigeration and Air Conditioning" by return mail.

Name _____
Address _____
City and Zone _____ State _____



Learn **WOOD PRODUCTION ENGINEERING**

GET THIS FREE BOOK
Today

It tells you how you can learn to become a successful **WOOD PRODUCTION ENGINEER** . . . by the Klok Home Study Correspondence Method . . . or by studying here in Grand Rapids in our Resident School . . . Training in **WOOD PRODUCTION ENGINEERING** offers you great opportunities . . . either to get a top position or to operate your own plant successfully.

The Klok Course teaches you **SKETCHING, ROD-MAKING, DETAILING, STOCK BILLING, TIME STUDY, COST and MANAGEMENT.**

WRITE FOR FREE BOOK TODAY! State preference whether Home Study or Resident course, with name, age, occupation and if veteran.

KLOK INSTITUTE
LOUIS ST., N.W.
GRAND RAPIDS, MICHIGAN



MONEY for MEN ALL DATA FREE

THE PLASTEX Industry needs manufacturers on small scale and for big production of Lamp and Clock Stands, Art Goods and Novelties in Plastex and Marble imitation. Experience unnecessary. 1/2c material makes regular 10c store sellers. Rubber moulds furnished for speed production. Small investment brings good returns. Big chain store orders now being placed. Ambitious men have chance for real prosperity. Our Free booklet will interest and benefit you.

PLASTEX INDUSTRIES, Dept. A
3400 Third Ave. New York 56, N. Y.

ANALYZE Handwriting

Uncrowded, fascinating field. Gratifying earnings reported by graduates in Employment, Credit, Social Service, Police and Entertainment fields. Others have developed profitable private practice, full or spare time, as Personal Problem and Vocational Counselors. Send for 3000 word **TEST LESSON** and Grapho Analyst **FREE.**

A. I. G. A. Inc.
Wilhoit Bldg., Dept. 120 Springfield, Mo.

Get this Great Catalog of MAGIC

Amazing tricks, mystifying and spooky stage and party illusions. Easy to do—no skill—perfect instructions. Fool your friends. Loads of fun. Add "life" to any party. 350 pages. 600 illustrations. Mail \$1.00 for catalog, credited on your first order for \$5.00 or more.

NATIONAL MAGIC COMPANY
119 S. State St., Dept. P-3
Chicago 3, Ill.

NEW YORK SCHOOL of MECHANICAL DENTISTRY

SINCE 1920—The outstanding Training Center for all phases of Dental Laboratory Technology. Licensed by New York and New Jersey States. Approved for Veterans G.I. BILL & P.L. 16. Visitors Welcome. Ask for Free Bulletin "P."

NEW YORK SCHOOL OF MECHANICAL DENTISTRY
America's Oldest School of Dental Technology
138 Washington St. NEWARK 2, NEW JERSEY
Also: 125 W. 31 Street NEW YORK 1, N. Y.
Immediate Enrollment — Day and Evening

PLAY THE ACCORDION IN FEW WEEKS

Thru Startling New "SEE—HEAR—and LEARN" method

Makes learning to play the accordion **SURER... FASTER... EASIER . . .** and it's great fun while learning.

Get all the thrilling details. Write to

O. PAGANI & BRO.
289 Bleecker St., New York 14, N. Y.

Don't miss the chance of a lifetime!

TELEVISION

Radio - Electronics ..

OFFER YOU A PROFITABLE FUTURE!

Get the Facts About Our

GREATEST OFFER in 17 YEARS

Here's good news . . . big news . . . our BIGGEST NEWS in 17 years. The equipment pictured at the right gives a partial idea of D.T.I.'s remarkable new combination of shop-method, home-training aids.

Now you can use and keep ALL of this equipment — PLUS other major training aids — to prepare you at home for a grand future in the fast-moving field of TELEVISION · RADIO · ELECTRONICS.

SEND FOR **FREE** BOOKLET

Mail the coupon today for our big, new 48-page OPPORTUNITY GUIDE BOOK. See how D.T.I.'s amazing, newer, training method helps you get started toward a GOOD JOB or your OWN BUSINESS in one of America's most promising, thrilling fields . . . that includes Television . . . F.M., Train, 2-Way Taxi, Aviation, and Broadcast Radio . . . Industrial Electronics . . . and other fast-developing branches.

In addition to well-illustrated lessons, you receive 16 shipments of Radio-Electronic parts from which you work over 300 instructive projects — including the building of (1) a commercial-type CATHODE RAY OSCILLOSCOPE that helps you get practical Television circuit training, (2) a double-range R-F SIGNAL GENERATOR, (3) a jewel-bearing MULTI-METER and (4) a quality 6-tube SUPERHET RADIO. You keep all of this equipment.

You also use HOME MOVIES

. . . a D. T. I. Exclusive!
D.T.I. alone includes the use of modern, visual training aid . . . MOVIES . . . to help you learn faster, easier at home. You see electrons on the march and other fascinating "hidden action" — a remarkable home training advantage that speeds your progress.



DeFOREST'S TRAINING, INC.
CHICAGO, ILLINOIS

Affiliated with the De Vry Corporation
Builders of Electronic and Movie Equipment

OSCILLOSCOPE

MULTI-METER

YOU BUILD and KEEP THIS EQUIPMENT
Work over 300 Home Experiments

EMPLOYMENT SERVICE

When you complete your training, our effective Employment Service is available to you without extra cost, to help you get started.

R-F SIGNAL GENERATOR

6-TUBE RECEIVER

You May Choose to Train in Our MODERN CHICAGO LABORATORIES

Train quickly, using a wide variety of commercial equipment. D. T. I.'s new labs are among the finest of their kind. Ample instructors . . . every major training advantage. Write for details!

MAIL THIS OPPORTUNITY COUPON NOW!

DeForest's Training, Inc.
2533 N. Ashland Ave., Dept. PM-F3
Chicago 14, Illinois

Send me **FREE** your 48-page OPPORTUNITY GUIDE BOOK showing how I may make my start in Television — Radio — Electronics.

Name _____ Age _____

Street _____ Apt. _____

City _____ Zone _____ State _____

Learn JEWELRY MAKING WATCHMAKING ENGRAVING

TRADES WITH
GREATER SECURITY



Above Average Pay. Trained Men Always in Demand.
Day and Night Classes. Enroll any Time. Write Today
for Free Catalog and Information.

Approved for G.I. Training

KANSAS CITY SCHOOL OF WATCHMAKING
America's Most Progressive Horological School
617-621 Wyandotte St. Kansas City 6, Mo.

AUDELS NEW MACHINISTS HANDYBOOK NOW READY!

Prepare!

A KEY TO SHOP PRACTICE
For Every Machinist, Tool-maker, Machine Operator, Draughtsman, Metal Worker, Mechanic or Student. Covers Shop Practice in All Branches.

A READY REFERENCE
Tells How to Operate and Set Up Lathes, Screw and Milling Machines, Shapers, Drill Presses and All Machine Tools.

5 PRACTICAL BOOKS IN ONE!
60 FULLY ILLUSTRATED CHAPTERS
Covering: 1—Modern Machine Shop Practice. 2—Blue Print Reading and How to Draw. 3—Calculations & Mathematics for Machinists. 4—Shop Physics. 5—How to Use Slide Rule.

Get This Information for Yourself. Mail Coupon Today. No Obligation Unless Satisfied. **ASK TO SEE IT.**

1600 PAGES FULLY ILLUSTRATED \$4 COMPLETE • PAY ONLY \$1 MO.

THEO. AUDEL & CO., 49 WEST 23rd STREET, NEW YORK
Mail AUDELS MACHINISTS & TOOLMAKERS HANDY BOOK. Price \$4 on 7 Days Free Trial. If O. K. I will remit \$1 in 7 days and \$1 monthly until \$4 is paid. Otherwise I will return it.

Name _____
Address _____
Occupation _____
Reference _____ PM



I HAVE SOMETHING VALUABLE TO GIVE YOU

I would like to send you my **PICTURE TOUR BOOK** absolutely **FREE** about one of America's largest and oldest Poultry Farm and Hatchery organizations.

My book is very complete and full of interesting and instructive color pictures. I know you'll enjoy and profit by reading it.

AMAZING POULTRY SECRETS

This book reveals many secrets you should know about profitable chicken raising, and especially **HYBRIDS** and **PURE BREDS**. It is **ABSOLUTELY FREE**. A postcard will bring it.

If you are interested in raising good chickens that make better profits and more pleasure write me **TODAY**.

MRS. HARRY HAM
ROUTE 56 ATCHISON, KANSAS

Have an OFFICE of YOUR OWN!

LEARN NEW PROFITABLE PROFESSION
At Home in 60 Days, Men & Women, 18 to 70!

Be Your Own Boss and the Boss of Others. Be Respected. Meet Interesting People.

Earnings of men and women in this profession run as high as \$5,000-\$15,000 yearly. Others make good money in spare time. Little money needed to start. A business where your earnings begin sooner. Easy to learn. No selling or goods to buy. No experience necessary. A depression-proof business. A course of action to guide you step by step as you earn. All 53 lessons sent at once to use as operating manuals. Easy terms. Diploma. Money-back agreement. Write for **FREE BULLETIN**.



FRANKLIN CREDIT SCHOOL
Dept. 75-C ROANOKE 7, VIRGINIA

BY MAIL in Easy Lessons

LEARN TO WRITE a Good Hand!

FOR BUSINESS AND SOCIAL SUCCESS!
Easy to improve your handwriting at home quickly with my new instruction books just off the press. Master all the secrets of better penmanship. Simple and easy, fully illustrated, highly endorsed. Begin today. Write for: New Free Book, "How to Become a Good Penman," or check books wanted, \$1.00 each. Business Writing Artistic Writing Card Writing Engrossing Alphabets Bird and Design Flourishing Complete Set \$4.50 Enclose 10c for your name beautifully written and special pinpoint for shaded writing.
S. A. Ziller, President, **TAMBLYN SCHOOL OF PENMANSHIP**
441 Ridge Bldg. In Business Over 52 Years Kansas City, Mo., U.S.A.

STAMMER? GET THIS FREE BOOK!

This new 128-page book, "Stammering, Its Cause and Correction," describes the Bogue Unit Method for scientific correction of stammering and stuttering—successful for 48 years. **Benj. N. Bogue**, Dept. 4914, Circle Tower, Indianapolis 4, Ind.

BECOME AN EXPERT DRAFTSMAN

You can qualify easily for splendid openings in Industry. The Triangle School, established 1943, is approved for Veterans and offers the training you need. (High School education required for entrance). Living quarters arranged.

Send for information.

TRIANGLE SCHOOL OF DRAFTING
DEPT. M—347 FIFTH AVE., PITTSBURGH, PA.

GET INTO

DIESEL-AUTO

MECHANICS *Master All Phases*

JOBS LIKE THESE ARE AVAILABLE TO TRAINED MECHANICS. CHOOSE THE FIELD YOU LIKE BEST

Get Complete Training

Diesel Fuel Injection
 Automotive Motor Tune-up
 Diesel Engine Rebuilding
 General Garage Mechanic
 Agricultural Implements
 Auto Engine Rebuilding
 Auto Elec. Service
 Public Utilities
 Parts Dealers
 Bus & Truck Lines
 Industrial Maintenance
 Contracting & Excavating
 Business of Your Own
 AND MANY other similar openings.

As a National Schools graduate, you are trained for ALL opportunities in the Diesel & Auto Industries

EARN WHILE YOU LEARN

With our practical Master Shop-Method Home Training, you study at home in your spare time. You receive Spare Time Work Lessons, which show you how to earn while you Learn . . . for extra money and experience. You Learn by DOING.

TOOLS AND EQUIPMENT

To make your training complete, we give you selected mechanic's tools and equipment, illustrated below, including all-metal toolbox—as a regular part of your instruction.

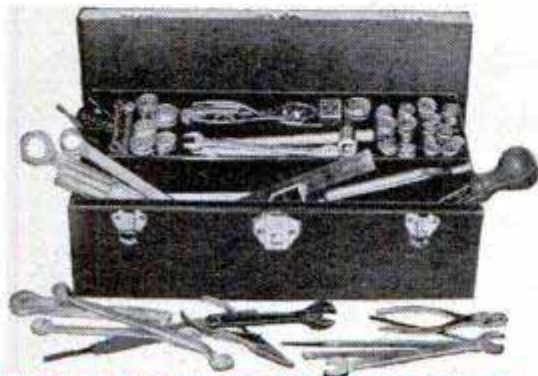

WE GIVE YOU TOOLS OF YOUR TRADE



Shop-Method Home Training by an Established Resident School Prepares you for Many Good Jobs

Opportunity is everywhere for the trained Diesel-Auto Mechanic. Highways throng with cars, busses, trucks, tractors. Garages and Service Stations are kept busy. Factories, ships, farms, railroads, general industry, are dependent upon engine power. Here's a dynamic, fast-growing field that needs trained men who know ALL phases: installation, operation, maintenance and repair. Now—National Schools offers you a practical, all-embracing Diesel-Auto Mechanic's Course, including all of these advantages:

Complete training, covering—Diesels, High Speed and Heavy Duty; Semi-Diesels, Gasoline and Special Fuel Engines AND Allied Mechanics.

- Basic Lesson Texts
- Diesel Installation
- Operation - Maintenance
- Diesel Chart Manual
- Spare Time Lessons
- Engine Service Manuals
- Engine Repair
- Drive Systems
- Diesel Electric Power
- Thermodynamics

TOOLS AND EQUIPMENT

INVESTIGATE
Secure Full Information

NEW, ILLUSTRATED BOOK & SAMPLE LESSON SHOW HOW WE TRAIN YOU . . . SEND FOR THEM TODAY!

**NO COST
NO OBLIGATION**

APPROVED FOR VETERANS

Check coupon below

NATIONAL SCHOOLS

LOS ANGELES 37, CALIF. • EST. 1905



FIND OUT NOW . . . MAIL COUPON TODAY

NATIONAL SCHOOLS, DEPT. PM-D3
4000 South Figueroa Street
Los Angeles 37, California

(Mail in envelope or paste on penny postcard)

Mail me FREE the book, YOUR FUTURE IN DIESEL-AUTO MECHANICS, together with the Sample Lesson. I understand I may keep and use the information with no obligation.

Name _____ Age _____

Address _____

City _____ Zone _____ State _____

Check here if Veteran of World War II

Be a RADIO TECHNICIAN!

TELEVISION - F.M. - ELECTRONICS INCLUDED



Get **PRACTICAL** Training in the

Great Shops of COYNE

BIG opportunities are waiting for men who know the *practical* and *technical* end of Radio and Television. That's what you get at COYNE—besides practical Shop training in F.M., Electronics and other branches of this giant field.

COYNE offers both a Practical Course and a Practical Technicians Course in the field of **RADIO and TELEVISION SERVICE**. Coupon brings details on both courses. Mail it today.

NOT A CORRESPONDENCE COURSE!



OLDEST, LARGEST, BEST EQUIPPED SCHOOL OF ITS KIND IN AMERICA



Established 1899—50th ANNIVERSARY YEAR. The better your training, the brighter your future. At Coyne you train on a vast outlay of real Radio and Television equipment. We don't teach by mail.

G.I. APPROVED... FINANCE PLAN FOR NON-VETERANS

Don't be held back by lack of cash. Start now, pay most of tuition later. Coupon brings special plan for men of draft age.

Send for BIG FREE BOOK

Dozens of big pictures, all the facts about COYNE Practical Course and Practical Technicians Course in Radio-Television. No obligation. No salesman will call. Rush coupon now!



COYNE B.W. COOKE, Pres.
ELECTRICAL & RADIO SCHOOL
500 S. Paulina, Dept. 39-3H, Chicago 12

FREE BOOK COUPON

B.W. COOKE, Pres.,
COYNE Electrical & Radio School
500 S. Paulina St., Dept. 39-3H, Chicago 12, Ill.

Send me FREE BOOK and information about your Practical Course and Practical Technicians Course in RADIO-TELEVISION. Also details of special plan for men of draft age.

NAME.....
ADDRESS.....
CITY..... STATE.....

SUCCEED IN THE POULTRY BUSINESS!



Poultry is providing many trained men and women with a good, comfortable living, either part or full time. You, too, can enjoy country life, home-grown food, increased income, if you have the specialized knowledge that is so important.

For 28 years our Home Study Course has been helping thousands to greater success. Proper knowledge and "Know How" mean extra income from the start. Don't delay—write today for prospectus describing courses, methods, opportunities, service.

NATIONAL POULTRY INSTITUTE
DEPT. 50 — ADAMS CENTER, N. Y.

There's No "Mystery" in Watchmaking! YOU CAN LEARN THIS PROFITABLE SKILL!



For 300 years, watchmakers' skills have been closely-guarded secrets. Now, you can learn skilled watchmaking in scenic, mile-high Denver. I'll give you everything in practical benchwork from hair-spring manipulation to position adjustment. Nationally accredited, veteran approved. Write Orville R. Harkins for information, no obligation. No salesman will call. **FREE BOOKLET.**

AMERICAN ACADEMY INC.
SCHOOL OF HOROLOGY
1549 Lawrence St., Dept. B, Denver 2, Colo.



Learn to Write at Home in spare time

Why write a poor hand? Be a Good Penman—Win Prestige, Success. Right in your own home, regardless of how you Now write, you can learn Expert Penmanship during your spare moments by my Simplified Method, that will enable you to attract attention and amaze your friends, and for your Social and Business Advancement. Investigate NOW! Write for Complete Information and my FREE BOOK, "How to Become an Expert Penman," which shows what others have accomplished by taking my Courses. If you wish, enclose 10c for Special Penpoint and your name with a flourished bird written on a card. Write TODAY.

T. M. TEVIS, BOX 25K, CHILLICOTHE, MO.

LAW FREE BOOK



Your FREE copy of "The Law-Trained Man" shows how to gain prestige and greater earnings through Blackstone home law study. All instruction material furnished including 18-volume Law Library written by 65 well-known law authorities. Lawyers, judges among our graduates. LL.B. degree. Low cost; easy terms. Write today.

BLACKSTONE COLLEGE OF LAW 225 N. Michigan Ave.
Dept. 53, Chicago 1, Ill.
A Correspondence Institution Founded in 1890



BE AN ARTIST

Send for interesting picture book "BUILDING A FUTURE"

Explains the unique position of the professional artist in American life. Gives examples of huge professional income. Tells definitely how YOU can acquire PROFESSIONAL skill—AND PROFESSIONAL INCOME—within one year—in spare time at home. No obligation. Book is free. Write name, address and age on penny postcard and mail TODAY to:

GRANT SCHOOL OF ART
Dept. 13, 225 N. Michigan Ave., Chicago 1, Ill.

Be an INVESTIGATOR

JAMES S. BOLAN, FORMER POLICE COMMISSIONER OF NEW YORK CITY offers MEN & WOMEN an attractive opportunity to prepare for a future in *Investigation & Criminology* by comprehensive Home Study Course. Free placement service assists graduates to obtain jobs. APPROVED UNDER G. I. BILL OF RIGHTS.

Write for Free Booklet PM.

THE BOLAN ACADEMY, INC.
EMPIRE STATE BLDG., NEW YORK 1, N. Y.



FREE
7-DAY TRIAL!

Return and Pay Nothing
If Not Completely Satisfied

MOTOR'S
AUTO
REPAIR
MANUAL

Now Any
AUTO REPAIR JOB

Can Be "Duck Soup" For You!



See How to Repair—Quickly and Easily—Any Car Built Since 1935! Over 200,000 Service and Repair Facts—More than 1700 "How-to-Do It" Photos, Drawings, Diagrams! Over 200 "Quick-Check" Tables! 700 Pages of Easy, Step-by-Step Instructions!

HERE'S the huge, illustrated "How-to-Do-It" volume you NEED to "whiz through" any service or repair job on any make or model car built from 1935 to 1948! Save work on those "ornery" jobs that can be such a "headache!" Make MORE money by doing more jobs in LESS time!

Whether you're a trained specialist or a beginner mechanic, you'll quickly get the "know-how" from MoToR's Auto Repair Manual. Just look up the make, model and job in the Instant-Reference Index. Then go to it! Easy step-by-step pictures make every operation "duck soup" for you!

LIKE 150 SHOP REPAIR MANUALS IN ONE!

Here, in detailed "Quick-Reference" tables and concise "How-to-Do-It" words and

pictures, are the official facts and instructions you MUST HAVE to tune up, service or repair any car! Priceless help that saves you "guess-work"—eliminates trial and error!

Factory engineers from every automobile plant in America worked out these time-saving standard procedures for their own motor car line. Now the editors of MoToR have gathered together this wealth of "Know-How" from over 150 Official Factory Shop Manuals, "boiled it down" into clear, readable terms in one handy, indexed book!

EVERYTHING YOU'LL NEED TO KNOW

MoToR's Manual takes nothing for granted. Starts at the very beginning; tells you how to identify all 653 car models. More than 1700 easy-to-follow Photos, Drawings, and Diagrams guide you step-by-step right through each operation. 700 big, readable pages are crammed with Factory Specifications and Adjustment Tables, Tune-Up Charts, Tables of Measurements and Clearances, Overhauling and Replacement facts, and Much MORE!

SEND NO MONEY

Just mail coupon! When the postman brings book, pay him nothing. First, make it show you what it's got! Unless you agree this is the greatest time-saver and work-saver you've ever seen—return book in 7 days and pay nothing. Mail coupon today! Address: MoToR Book Dept. Desk 13, 250 West 55th Street, New York 19, N. Y.

Published by MoToR, The Leading Automotive Business Magazine.

Used By
U. S. Army
and Navy

COVERS ANY CAR BUILT SINCE 1935!

Auburn Cadillac
Austin Chevrolet
Chrysler Buick
Cord Crosley
De Soto Dodge
Ford
Frazer
Graham
Hudson
Hupmobile
Kaiser
Lafayette
La Salle
Lincoln
Mercury
Oldsmobile
Nash
Packard
Pierce Arrow
Plymouth
Pontiac
Reo
Studebaker
Terraplane
Willlys

ABOVE: Showing operation of Buick Dyna-Flow — and, BELOW: How to adjust Ford Clutch. Every moving part is covered in simple words and BIG, CLEAR 8 1/2" x 11" Pictures.

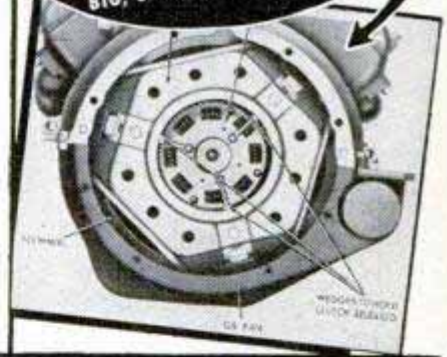

Just 2 of the Many Letters of Praise



"MoToR's Manual paid for itself on the first 2 jobs, and saved me valuable time eliminating guesswork." — W. SCHROP, Ohio



"Instructions so clear have no trouble learning anything about any car. Now working as mechanic in big plant." — SAM ORDONEZ, Cal.

Same FREE Offer on MoToR's TRUCK MANUAL

Covers EVERY job on EVERY truck made since 1936! 1400 pictures, 952 pages, 300,000 facts. All types Gasoline Engines, Truck Diesels, Hesselmanns, Fuel Systems, Governors, Lubrication, Ignition, Starters, Clutches, Axles, Brakes, etc., etc.

ALSO covers many buses, tractors, contractor and road building equipment, stationary power machinery. Check box in coupon.



MAIL COUPON NOW FOR 7-DAY FREE TRIAL

MoToR BOOK DEPARTMENT

Desk 13, 250 West 55th Street, New York 19, N. Y.

Flush to me at once: (Check box opposite book you want)

MoToR's AUTO REPAIR MANUAL. If O.K. I will remit \$1 in 7 days, (plus 25c delivery charge), then \$2 monthly for 2 months, and a final payment of 95c a month later. Otherwise I will return book postpaid in 7 days. (Foreign price, remit \$8 cash with order.)

MoToR's TRUCK REPAIR MANUAL. (Described at left.) If O.K. I will remit \$2 in 7 days, and \$2 monthly for 3 months, plus 25c delivery charge with final payment. Otherwise I will return book promptly. (Foreign price, remit \$10 cash with order.)

Print Name.....Age.....

Print Address.....

City & Zone No.....State.....

SAVE 35c delivery charge by enclosing WITH COUPON check or money order for full payment of \$5.95 for Auto Manual (or \$8.00 for Truck Manual). Same return-refund privilege applies.

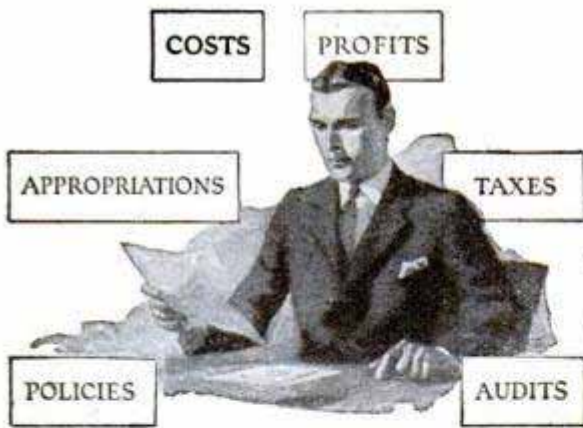

BECOME AN EXPERT ACCOUNTANT

The Profession That Pays

The demand for skilled accountants—men who really know their business—is increasing. National and state legislation is requiring of business much more in the way of Auditing, Cost Accounting, Business Law, Organization, Management, Finance. Men who prove their qualifications in this important field are promoted to responsible executive positions.

Send for Free Book—

"Accountancy, the Profession That Pays"

Why let the other fellow walk away with the better job, when through home-study you can equip yourself for a splendid future in this profitable profession?

Knowledge of bookkeeping unnecessary. We train you from ground up, or according to your individual needs. Low cost; easy terms.

Send for free 48-page book describing the LaSalle accountancy training and the opportunities in this highly profitable field—plus "Ten Years' Promotion in One," a book which has helped many men.

If you have the urge, the will to increase your income, mail the coupon NOW.

LASALLE EXTENSION UNIVERSITY

A CORRESPONDENCE INSTITUTION

417 S. Dearborn Street

Dept. 364-HR, Chicago 5, Ill.

Please send me "Accountancy, the Profession That Pays"—plus "Ten Years' Promotion in One"—without obligation.

- Higher Accountancy
- C.P.A. Coaching
- Bookkeeping
- Law: LL.B. Degree
- Business Management
- Salesmanship
- Traffic Management
- Foremanship
- Industrial Management
- Stenotypy (Machine Shorthand)



Name _____ Age _____

Address _____

City, Zone, State _____

APTITUDE TESTS

discover the kind of work or studies best for your success! You get a personal report—a guide for life—more happiness—more prosperity. For men, women, boys and girls. Write for complete facts.

VOCATIONAL COUNSELING INSTITUTE
956 Maccabees Bldg., Detroit 2, Michigan

Say You Saw It in Popular Mechanics

Learn to MOUNT BIRDS

Tan SKINS, make up FURS

Be a Taxidermist. Double your hunting fun. We teach you at Home. Mount Birds, Animals, Fish, Heads, common specimens. Fun and profits. Decorate home and den **MAKE MONEY**. Mount game, tan for others. Big profits in spare time. **WRITE TODAY.**

100 game pictures in **FREE BOOK**. Hunters, get your copy. It's **Now Free.** Send post card. State your **AGE.**

NORTHWESTERN SCHOOL OF TAXIDERMY
Dept. 2563 Omaha, Nebraska

PRINT YOUR OWN POST CARDS

COMPLETE OUTFIT only \$7.50



Amazing results in sales, inquiries and contacts... saves time and money... very easy to use GEM STENCIL DUPLICATOR is ideal for Advertising, Announcements, Notices, Labels, Forms, Price Lists—hundreds of uses for every type of business and organization. Comes complete with all supplies, instructions and 60-page Book of Ideas.

FREE TRIAL OFFER: Try it before you buy it! Write and a GEM OUTFIT will be sent you postpaid. After 10 days, send only \$7.50 or return the GEM, no questions asked. The GEM must sell itself; you be the judge.

BOND EQUIPMENT CO. • Dept. 135
• 6633 Enright • St. Louis 5, Mo.

SEND NO MONEY • FREE TRIAL OFFER



LEARN MEAT CUTTING

through actual practice. Profitable Meat Cutting and Successful Meat Merchandising taught easily, quickly. LEARN BY DOING at Toledo in just six short weeks under actual market conditions. For beginners or men with experience. All subjects taught thoroughly and completely. Diploma. Job help. Get store of own. People must eat. School in operation over 25 years. Approved for GI training. Send today for FREE illustrated catalog. No obligation.

NATIONAL SCHOOL OF MEAT CUTTING, Dept. 50-K, Toledo 4, Ohio

WHY DON'T YOU WRITE?

Writing short stories, articles on business, sports, homemaking, gardening, shop crafts, local and club activities, etc., will enable you to earn extra money. In your own home, on your own time, the New York Copy Desk Method teaches you how to write—the way newspaper men learn, by writing. Our unique "Writing Aptitude Test" tells whether you possess the fundamental qualities essential to successful writing. You'll enjoy this test. Write for it, without cost or obligation.

Veterans: This course approved for Veterans' Training.

NEWSPAPER INSTITUTE OF AMERICA
SUITE 5599-C, ONE PARK AVENUE, NEW YORK 16, N. Y.

Over \$2.00 Every Hour!

Sell name plates for front doors

FREE Sample, Write Dept. 179

National Engravers

214 Summer St.

Boston, Mass.

ENGINEERING DEGREE IN 27 MONTHS

INDIANA TECHNICAL COLLEGE

Aeronautical, Chemical, Civil, Electrical, Mechanical, and Radio Engineering (inc. television). Drafting, 1-yr. Gov't approved for G.I.'s. Low rate. Earn board. Large industrial center. Students from 48 states, 18 countries. Demand for graduates. Enter March, June, September, December. Catalog.

539 E. Washington Blvd., Ft. Wayne 2, Ind.

CHEMISTRY

LEARN AT HOME... Chemical knowledge is essential for thousands of good jobs in industry, business, science. IPC enables you to master practical chemistry. It's the ONLY home study chemistry course which enables you to learn by performing actual experiments—using chemicals and apparatus supplied with the course—in addition to your IPC textbook studies. Compares with recognized college courses in General Chemistry. Write today for free descriptive booklet.

INSTITUTE OF PRACTICAL CHEMISTRY
3 PROSPECT AVENUE, HAGERSTOWN, MD.



Learn RADIO

TELEVISION, ELECTRONICS
by
SHOP METHOD HOME TRAINING

Let NATIONAL SCHOOLS, of Los Angeles, a practical Technical Resident Trade School for almost 50 years, train you for today's unlimited opportunities in Radio

You receive all parts, including tubes, for building this fine, modern Superheterodyne Receiver. This and other valuable standard equipment becomes your property.

these two FREE books will tell you how



Good Jobs Await the Trained Radio Technician

You are needed in the great, modern Radio, Television and Electronics industry! Trained Radio technicians are in constant and growing demand at excellent pay—in Broadcasting, Communications, Television, Radar, Research Laboratories, Home Radio Service, etc. National Schools Master Shop Method Home Study Course, with newly added lessons and equipment, can train you in your spare time, *right in your own home*, for these exciting opportunities. Our method has been proved by the remarkable success of National Schools-trained men all over the world.

You Learn by Building Equipment with Standard Radio Parts We Send You

Your National Schools Course includes not only basic theory, but practical training as well—you learn by doing. We send you complete standard equipment of professional quality for building various experimental and test units. You advance step by step until you are able to build the modern superheterodyne receiver shown above, which is yours to keep and enjoy. You perform more than 100 experiments—build many types of circuits, signal generator, low power radio transmitter, audio oscillator, and other units. The Free Books shown above tell you more about it—send for them today!



NOW! NEW PROFESSIONAL MULTITESTER INCLUDED



This versatile testing instrument is portable and complete with test leads and batteries. Simple to operate, accurate and dependable. You will be able to quickly locate trouble and adjust the most delicate circuits. You can use the Multitester at home or on service calls. It is designed to measure AC and DC volts, current, resistance and decibels. You will be proud to own and use this valuable professional instrument.

GET THE DETAILS—SEND THE COUPON ▶

LESSONS AND INSTRUCTION MATERIAL ARE UP-TO-DATE, PRACTICAL, INTERESTING

National Schools Master Shop Method Home Training gives you basic and advanced instruction in all phases of Radio, Television and Electronics. Each lesson is made easy to understand by numerous illustrations and diagrams. All instruction material has been developed and tested in our own shops and laboratories, under the supervision of our own engineers and instructors. A free sample lesson is yours upon request—use the coupon below.

You Get This and Other Valuable Information in the Free Sample Lesson:

1. Basic Receiver Circuits and How They are Used.
2. Construction of the Antenna Circuit.
3. How Energy is Picked Up by the Aerial.
4. How Signal Currents are Converted into Sound.
5. How the Tuning Condenser Operates.
6. How the R-F Transformer Handles the signal, and other data, with diagrams and illustrations.

Both Resident and Home Study Courses Offered

APPROVED FOR VETERANS CHECK COUPON

NATIONAL SCHOOLS

LOS ANGELES 37, CALIF. • EST. 1905



MAIL OPPORTUNITY COUPON FOR QUICK ACTION

National Schools, Dept. PM-R3
4000 South Figueroa Street
Los Angeles 37, California

(Mail in envelope or paste on penny postcard.)

Mail me FREE the book "Your Future in Radio" and a sample lesson of your course. I understand no salesman will call on me.

NAME _____ AGE _____

ADDRESS _____

CITY _____ ZONE _____ STATE _____

Check here if veteran of World War II

THE GREATEST
THING

IN
PLASTICS!

PLASTICAST



A NEW HOME INDUSTRY AND HOBBY!

PLASTICAST is a transparent liquid plastic; can be poured into ANY kind of mold or container. Hardens in a few minutes into a transparent solid, clear-as-glass, tough as steel plastic! No tools machinery or skill required. IDEAL for imbedding pretty flowers, butterflies, photos, medals, souvenirs, biological specimens, etc. Makes a **PERMANENT AND ATTRACTIVE** display. Make attractive jewelry, gems, lenses, knick-knacks, novelties. Easily cast into sheets, rods, blocks, ANY color, ANY shape! **EVERYTHING** furnished, including molds, for making about \$50.00 worth of unusual novelties! **PLASTICAST OUTFIT, Complete \$3.50** with 3 molds.

PLASTIDUR . . . (LIQUID IVORY). Ideal for casting all OPAQUE articles. Hardens in a few minutes into an extremely hard IVORY-like plastic! May be dyed any color or cast into any shape. Works in **EVERY** type of mold! Non-inflammable, waterproof. DULtable. Ideal for statuary, novelties, figurines, toys, gadgets, tools, knobs, bases . . . a million useful applications! Outfit comes complete with molds, dyes, accessories, instructions, etc. for making about \$100.00 worth of attractive jewelry, etc! **PLASTIDUR OUTFIT, Complete with 3 molds \$5.00**

BE A PLASTICS MANUFACTURER . . . Sell your output on **CONTRACT** basis! We show you what to make and how. This offer open to **PLASTICAST** customers only.

Our Casting Plastics are as easy to use as pouring water out of a glass! **TERMS:** We pay the postage (U.S.A. & Canada only) if full cash accompanies your order. C.O.D. accepted (U.S.A. only) if \$1.00 deposit is included for each item ordered. C.O.D. orders not postpaid.

FREE

A very attractive and useful novelty made with one of our plastics given absolutely free with every one of our catalogs! Catalog lists many new materials for making **MOLDS** and **CASTINGS** with Liquid Plastics, Liquid Marble, Latex, Elastex, Castwood, Wax, Metals, Plaster, Shellcraft, Internal Carving, Molds, Moulage, etc. Price of catalog only 10c.

DEALERS: WRITE FOR ATTRACTIVE WHOLESALE PRICE LISTS

PLASTICAST CO. (Dept. C)

5961 Madison St. Chicago 44, Illinois (Order by mail only) P. O. Box 987 Palo Alto, Calif.

STRENGTHEN Your VOICE!

YES—you can now build yourself a powerful speaking and singing voice with this amazing new scientifically sound tested method. Self-training . . . no music or piano required. Results **GUARANTEED**. Just send your name for the sensational details. **FREE** chart of your vocal mechanism included!

PERFECT VOICE STUDIOS, Studio C-10, Kimball Hall Building, Chicago 4, Ill.

FREE BOOK
TELLS HOW
TO BE AN . . .

Accountant
Salesman
Secretary
Stenographer

SECURED FUTURE . . . FREE EMPLOYMENT SERVICE

Enter one of the "substantial earnings" fields through Hill's "Success Plan" training. A lifetime opportunity to join thousands of successful graduates in positions secured through our nation-wide employment service. No matter where you live, what you are doing now, Hill's can train you by study at home or in the resident school. Big Free book shows you the way to substantial earnings and an assured future. G. I. Approved.

Hill's Extension School & Business University
Dept. PM-39, 619 W. Main St., Oklahoma City 2, Okla.
Please send your free book, "Through Hill's to Success."

NAME _____
ADDRESS _____
CITY _____ STATE _____

Check here if eligible under G.I. Bill.

* Please check course and training plan preferred.

Course _____ Resident Home Study

EASY-TO-USE COUPON TODAY

CONFIDENTIAL LOAN SERVICE

Borrow \$50 to \$300⁰⁰

Need money? No matter where you live you can borrow **BY MAIL** \$50.00 to \$300.00 this easy quick confidential way.

BY MAIL

IT IS EASY TO BORROW BY MAIL!

Completely confidential and private **CONVENIENT MONTHLY PAYMENTS**

NO ENDORSERS NEEDED EMPLOYED MEN and women of good character can solve their money problems quickly and in privacy with loans **MADE BY MAIL**. No endorsers or co-signers. Your employer, relatives and friends will not know you are applying for a loan. Convenient monthly payments. Send us your name and address and we will mail application blank and complete details **FREE** in plain envelope. There is no obligation. Act now!

STATE FINANCE COMPANY

216 Savings & Loan Bldg., Dept. R107K, Des Moines 8, Iowa

WATCH REPAIRING

Be a Master Watchmaker! Graduates earn big money — many in business for themselves. The famous Sweazey System of Instruction teaches you quickly and easily. Our 41st year.

Write today for free information.

CHICAGO SCHOOL OF WATCHMAKING
Dept. 139, 1608 Milwaukee Ave. Chicago 47, Ill.

EASY TO LEARN CODE

Learn or increase speed with an Instructograph — the Code Teacher that takes the place of an operator-instructor and enables anyone to master code without further assistance. Available tapes from beginners alphabet to typical messages on all subjects. Speed range 5 to 40 WPM. Always ready—no QRM. Thousands have "acquired the code" with the Instructograph System. Write today for convenient rental and purchase plans.



INSTRUCTOGRAPH COMPANY

4701-V Sheridan Road, Chicago 40, Illinois

BE A NOTARY PUBLIC

Be a Notary Public. Largest legal supply house, 22 cities, guarantees your appointment by governor if you qualify, equips you completely for \$16.97. Respected public office. You certify legal papers, use official seal made with your name, collect fees. Easy. Notaries needed everywhere. Be one. Write—

STATIONERS EXCHANGE — BOERNE 33, TEXAS

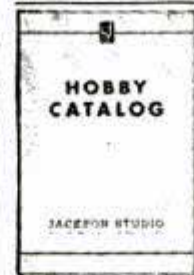

HOBBY CATALOG

NEW 1949 edition, 84 pages crammed with big selection of tools and materials for plastics, ceramics, hand power tools, plans, etc., etc. A gold mine of hard-to-find items such as foam rubber, kits, books and "How To" information. Every craftsman should have a copy. Send 25c now to

JACKSON, Dept. 76

5440 N. Shoreland Ave., Milwaukee 11, Wis.



RAISE Money Making CHINCHILLAS

Several females and a male start a large herd which will furnish you an income for years. Just a few feet of space are required. No experience needed. We furnish all instructions. Write world's largest breeder today for free details.

WILLOW BROOK FARM, R-36, Sellersville, Pa.



MAKE BIG MONEY Become An Artist!

CASH IN ON BIG ART MARKET! LEARN Cartooning, Commercial Art, Lettering, Showcard Writing, Photo Coloring, etc. **QUICKLY** with our **NEW, EASY METHODS.**

Interesting Catalog **FREE**

NATIONAL ARTISTS BUREAU
P. O. Box 4248 Dallas 8, Texas

Learn BAKING At Home

Baking is one of America's high industries in wages. Nearly depression-proof. Thorough basic home course lays sound foundation. If you have aptitude, write for **FREE BOOKLET**, "Opportunities in Commercial Baking." National Baking School, 1315 Mich. Ave., Dept. 1353, Chicago 5



Men... You Can Make \$150 a Week in Television!

To succeed, you need assemble and sell only 1 Transvision TV Kit a week*

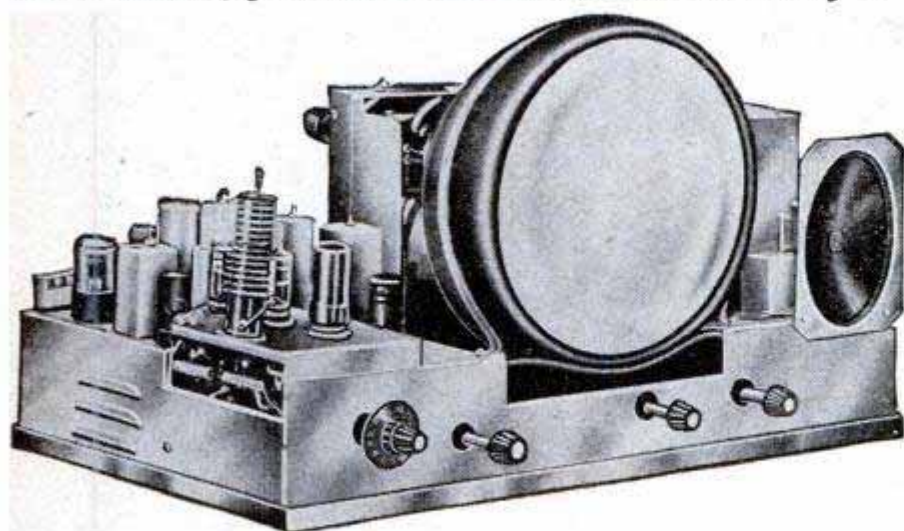

TRANSVISION

offers ambitious men an opportunity to get into Television now, and make big money.

Here's our 3-Point DEALER PLAN:

1. Sell high-quality television sets constructed by you from our TV kits, at competition-beating prices.
2. Feature our beautiful line of exclusive custom-built cabinets, designed and finished to your customers' specifications.
3. Make profits from resale of the nationally advertised Transvision line of TV Kits and Accessories.

*Dealer Folder No. D-1 shows how you can make \$150 a week. Write for it now.

New... Transvision 10" TV Kit (Model 10A)—a Sensational Value!

Gives Bright, Stable 52 Sq. In. Picture—Continuous Tuning
EASY TO ASSEMBLE — SAVES YOU 1/2 THE COST!

Want a television set for yourself? Want to assemble them for resale at a profit? The new Transvision Model 10A electromagnetic Television Kit (illustrated above) is ideal: Gives a bright, stable 52 sq. in. picture. Has 10" picture tube, and **CONTINUOUS TUNING** on all 12 channels. Its high sensitivity makes for improved long-distance reception; especially good on high channels. Comes complete with all-channel double-folded dipole antenna and 60 ft. of lead-in wire.

Transvision **MODEL 10A TV KIT**, less cabinet.....Net \$199.00
Transvision **MODEL 12A TV KIT**, same as above, but has a 12" picture tubeNet \$263.00

NEW STREAMLINED CABINETS for Transvision Model 10A or 12A TV Kit. Made of select grain walnut with beautiful rubbed finish. Fully drilled, ready for installation of assembled receiver.

Walnut Cabinet for **10A or 12A** (Specify).....Net \$44.95
Mahogany and Blonde slightly higher.

NO TECHNICAL KNOWLEDGE REQUIRED FOR ASSEMBLY!

Transvision's simple step-by-step Instruction Sheet makes assembling a Television Kit a pleasure. Each kit comes complete with all-channel double-folded dipole antenna and 60 ft. of lead-in wire.

Nothing else to buy!

FREE 162 p. Transvision TELEVISION COURSE with purchase of any Transvision TV Kit.

You don't need this course to assemble a Transvision TV Kit, because the job is easy enough and our instruction sheet is simple and clear. BUT, if you want a good introduction to television fundamentals as a basis for further study, the Transvision Television Home-Study Course is ideal. Remember, you pay nothing extra for this course. Ask your distributor.

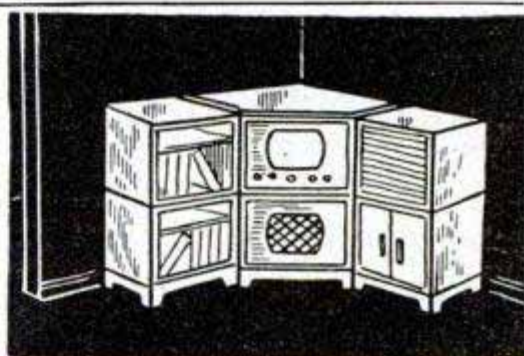

BUILD YOUR OWN CABINETS...

Low Cost... Big Value... Big Profits!

Build and sell beautiful Television Sets with Transvision's "MODULAR" CABINETS... supplied in knockdown, unpainted form. Easy to assemble.

Transvision's "MODULAR" Cabinets come in knockdown, unpainted units, offering an unlimited range of combinations, including even a bar. Finish them off to suit any living room, den, office, etc. The units are simple and practical in design, and require as little as 1/2 hour per unit for assembly.

Corner piece, shown above, has room for Television, Phono, Record Storage, and Open Book Case... COMPLETE Net \$84.00. For other units and prices, write for "Modular" Catalog.

All Transvision Prices are fair traded; subject to change without notice. Prices 5% higher west of the Mississippi.

TRANSVISION, INC., Dept. PM, NEW ROCHELLE, N. Y.

For FREE 20 p. TV BOOKLET, Dealer Folder D-1, and Catalog, See Your Distributor!

NEW YORK, N. Y.

FEDERATED PURCHASER
80 Park Place
PALLADIUM TELEVISION
CORP.
785 Third Ave.

BRONX, N. Y.

NATIONAL RADIO DIST.
899 Southern Blvd.

BROOKLYN, N. Y.

BENRAY DISTRIBUTING CO.
506 Coney Island Ave.

STATEN ISLAND, N. Y.

B. & D. DISTRIB. CO.
Staten Island 5

LONG ISLAND, N. Y.

ELECTRONIC SUPPLY CO.
40-14 Greenpoint Ave.
Long Island City, N. Y.
ISLAND RADIO DIST. CO.
412 Fulton Ave.
Hempstead, L. I., N. Y.

WESTCHESTER, N. Y.

RADIOMART
149 Riverdale Ave.
Yonkers, N. Y.

NEW JERSEY

NIDISCO JERSEY CITY
713 Newark Ave.
Jersey City, N. J.; also:—
Cliffside, Passaic, Trenton
VARIETY ELECTRIC CO.
601 Broad St.
Newark, N. J.

BOSTON, MASS.

TRANSVISION
OF NEW ENGLAND
1306 Boylston St.

PHILADELPHIA, PA.

TRANSVISION OF PHILA.
235 N. Broad St.

WASHINGTON, D. C.

STAR RADIO
409 11th St., N.W.

CHICAGO, ILL.

TRANSVISION OF CHICAGO
1002 S. Michigan Ave.

HOLLYWOOD, CALIF.

TRANSVISION OF CALIFORNIA
8572 Santa Monica Blvd.

How To Build Your Own Home!

and Save

Thousands of Dollars

FIGURE it yourself. Suppose a house costs \$9000. The contractor makes 20% and the architect 5%. That's \$2250 before you bat an eye. But you can use the C.T.I. method to do your own building and pay YOURSELF that money. Build a fine house, too. Look what Samos did! Can YOU do that? We think YOU CAN!



What Samos Did!

John Samos, Newport News, Va., writes: "I had planned to build a house, but was not qualified until I studied your course. Now I have completed my house and moved in. I saved considerable money and I know the house has been made with best materials. I intend to enter the building business next spring."

Money and Know-How

But you have two problems—money and know-how. As for the first, the Government now helps finance home building as never before. You can build with very little cash. Often cheaper than paying rent. About the second, that's where we come in. Today through the C.T.I. Home-Building Course of 47 simple, plain-as-day, home-training lessons you learn about modern home-building methods from A to Z. We show you exactly how a house is built—all about it from basement to roof.

Next, let's have an interview by mail. The facts are stated in a big, exciting, illustrated book. It's FREE. Before you do another thing, clip the coupon. It may bring the answer to a lot of hopes and dreams. Sign and mail TODAY.

Remodel, too

● Many students SAVE money and MAKE money almost from the start doing remodeling and repair jobs for themselves and others. Student Stanley Radwanski, Vincennes, Ind. writes: "I started the C.T.I. Building Course for my personal use. I planned on fixing my own home, the way I wanted it. But soon neighbors saw me and next thing I heard was, 'I have a job for you.' Now I'm getting more jobs than I can handle." We have helped many other men like Radwanski.

No Experience Needed!

● To put C.T.I. Home-Building methods to work, you need not be a building tradesman or mechanic. This course teaches METHODS. All about Planning, Estimating, Supervising, Sub-Contracting. Shows how every part of the Construction should be handled. A beginner can build his own house with this course. Or go into the building business. Get the Big FREE Book.

You Get Plans for THIS House

With the Course we send you complete, professional PLANS and SPECIFICATIONS for this beautiful six-room Dutch Colonial house. Handsome FREE Book explains these and many other facts. (Note: Besides Home-Building, C.T.I. has residence and home-study courses in other fine fields. Mail coupon for facts.)

**MAIL COUPON
FOR NEW
FREE BOOK**



COMMERCIAL TRADES INSTITUTE

1400 GREENLEAF AVENUE, DEPT. D2-3, CHICAGO 26, ILLINOIS

Send me information on the Course I have checked below:

- | | | |
|---|--|---|
| <input type="checkbox"/> HOME-BUILDING | <input type="checkbox"/> Electricity and Electronics | <input type="checkbox"/> Body and Fender Rebuilding |
| <input type="checkbox"/> Radio and Television | <input type="checkbox"/> Auto Mechanics | <input type="checkbox"/> Refrigeration |
| <input type="checkbox"/> Air Conditioning | <input type="checkbox"/> Mechanical Drafting | <input type="checkbox"/> Diesel Mechanics |

NAME _____ Vet Non-Vet

ADDRESS _____

CITY _____ ZONE _____ STATE _____



Learn ELECTRIC APPLIANCE

Service & Repair

AT HOME IN YOUR SPARE TIME

We teach you this interesting, good-paying business from A to Z—at home. Our practical, thorough, shop-method course qualifies you to take a job at once, or start in for yourself. A grade school education is all you need. This is an ideal time for men of all ages (up to 60) to get into this active, constantly expanding field, for every year sees millions of new homes wired for electricity . . . and multiple millions of new electric appliances produced. Everyone, literally, is a customer for the man who knows how to service and repair electric devices.

This business is particularly suited to the man who is handy with tools, and likes to keep busy with his hands . . . the men who are the makers, builders, and servicers of life. If you are not completely happy in your present work, there is a WIDE-OPEN OPPORTUNITY for you in this field . . . which is getting bigger and better every day.

YOU LEARN

How To Repair
Washing Machines
Vacuum Cleaners
Electric Ranges
Lamps, Motors,
Irons, etc.
REFRIGERATION
and
House Wiring

OPEN YOUR OWN SHOP Be Independent and Secure

No new-fangled machine can ever take your place in this work . . . as it calls for trained hands to service appliances — so your job is safe, even in a depression. If you open your own shop, you not only enjoy security and independence . . . and can have others work for you . . . it's just a step to a prosperous appliance business where the **BIG PROFITS LIE**. There's no satisfaction like being your own boss, and here's a real opportunity to make that a reality. Or, of course, you can take a well paid job in this active line, as trained men are needed. Remember, this is AN ELECTRICAL AGE. Getting into this field now is to ride the tide of progress.



This
ELECTRICAL
APPLIANCE
TESTER
and a
BIG KIT OF TOOLS
INCLUDED
at No Extra Cost!

Earn While You Learn

You can actually start earning before your course is finished with the Kit of Tools and Tester we send you. With your first set of lessons, we show you easy jobs that can be done in your spare time, at home. And remember — just one good repair job can pay for the complete cost of the course. A business can be started in your garage or basement — expanding from there, as you grow. Let's talk it over by mail.

Make it a point to get posted about our course by sending TODAY — without obligation — for our free booklet telling the entire story.

Send
for this
FREE
BOOKLET



No Salesman Will Call

MAIL COUPON TODAY

PACIFIC TRAINING SCHOOL — Dept. P-93
7217 So. Broadway, Los Angeles 3, Calif.

Please send me your FREE BOOKLET:
"Today's Big Opportunity — Appliance Servicing"

NAME _____ AGE _____

ADDRESS _____ ZONE _____

CITY _____ STATE _____

Please print plainly

AUDELS Carpenters and Builders Guides 4 vols. \$6



Inside Trade Information for Carpenters, Builders, Joiners, Building Mechanics and all Woodworkers. These Guides give you the short-cut instructions that you want—including new methods, ideas, solutions, plans, systems and money saving suggestions. An easy progressive course for the apprentice and student. A practical daily helper and Quick Reference for the master worker. Carpenters everywhere are using these Guides as a Helping Hand to Easier Work, Better Work and Better Pay. To get this assistance for yourself, simply fill in and mail the FREE COUPON below.

Inside Trade Information On:

How to use the steel square—How to file and set saws—How to build furniture—How to use a mitre box—How to use the chalk line—How to use rules and scales—How to make joints—Carpenters arithmetic—Solving mensuration problems—Estimating strength of timbers—How to set girders and sills—How to frame houses and roofs—How to estimate costs—How to build houses, barns, garages, bungalows, etc.—How to read and draw plans—Drawing up specifications—How to excavate—How to use settings 12, 13 and 17 on the steel square—How to build hoists and scaffolds—skylights—How to build stairs—How to put on interior trim—How to hang doors—How to lath—lay floors—How to paint



AUDEL, Publishers, 49 W. 23rd St., New York 10, N. Y. Mail Audels Carpenters and Builders Guides, 4 vols., on 7 days free trial. If OK I will remit \$1 in 7 days and \$1 monthly until \$6 is paid. Otherwise I will return them. No obligation unless I am satisfied.

Name _____

Address _____

Occupation _____

Employed by _____ PM

Do you want

- ..to go to College?
- ..or to enter a Profession?
- (Such as Accounting, Architecture, Nursing, Dentistry, Teaching, Social Work, Osteopathy, Beauty Culture, Optometry, Embalming, Chiropody, Law, Medicine, etc.)
- ..or get an Office Position?

To get anywhere, you practically **MUST** finish High School **FIRST**. You can complete our simplified High School Course in SPARE time at home, as **FAST** as your time and abilities permit. Equivalent to resident school work—prepares you for college, pre-professional examinations, business, industry. Standard texts furnished. Diploma. Credit for H. S. subjects already completed. Single subjects if desired. Low tuition, easy terms. American School, Chicago, est. 1897—endorsed by educators. Finish your high school education **NOW**. Write **TODAY!**

High School Course at Home Many Finish in 2 Years

American School, Dept. H345, Drexel Ave. at 58th St., Chicago 37, Ill. Gentlemen: Send me **FREE** information covering special training in subjects checked below. No obligation on my part.

- | | |
|--|--|
| <input type="checkbox"/> High School Course | <input type="checkbox"/> Diesel Engineering |
| <input type="checkbox"/> Architecture and Building | <input type="checkbox"/> Drafting and Design for Men & Women |
| <input type="checkbox"/> Automotive Engineering | <input type="checkbox"/> Plastics |
| <input type="checkbox"/> Business Management | <input type="checkbox"/> Private Secretary |
| <input type="checkbox"/> Electrical Engineering | <input type="checkbox"/> Mechanical Engineering |
| <input type="checkbox"/> Elec. and Gas Refrigeration | <input type="checkbox"/> Aviation |
| <input type="checkbox"/> Air Conditioning | <input type="checkbox"/> Salesmanship |
| <input type="checkbox"/> Railway Training | <input type="checkbox"/> Radio |
| <input type="checkbox"/> Electronics, Industrial | |

Name.....

Address.....

DON'T BE A JOB SLAVE! LEARN WATCH REPAIRING AT HOME



WITH OUR SELF TRAINING KIT

Get started NOW in this uncrowded field! EASY to learn! **BIG MONEY! SECURE FUTURE!** Earn while you learn! Even as a sideline you can make \$50 and up each week.—Our new **PRACTICAL SELF-TRAINING KIT** is all you need. Contains set of **PROFESSIONAL TOOLS:** (Loupe, 3-4 power; Complete set of 6 Special Screw Drivers—finest tempered steel blades; Tweezer AA; Plastic Material Tray) and **COMPLETE BOOK** on Modern Watch Repairing. Fully illustrated, easy to understand, shows every step in repair, adjustment and use of tools. Only \$6.45 Post Paid (If C.O.D., plus charges.) Money Back Guarantee. If ordered separately; book \$3.25; set of tools, \$3.50. Special **WATCH REPAIR DEP'T** for advanced jobs. Lowest prices. Send watch for free estimate.

MODERN TECHNICAL SUPPLY CO.

Dept. MMC, 55 W. 42nd Street, New York 18, N. Y.

Complete Precision Tool, Material & Book Catalog for Watch-Clockmakers, Jewelers, Tool-Instrument Makers, Handicrafters. Over 600 ILLUSTRATIONS. SEND 25c for catalog—FREE with order.

Save Money—Make Money with LARSON Leathercraft

For gifts or for sale—make easy-to-assemble leather items. Complete stock leathers, tools, accessories.

Send ten cents for new catalog of 101 money-making ideas.

J. C. LARSON CO. 824 S. Tripp Ave. Chicago 24, Illinois



AJAX AUSTRALORPS

Sensational WORLD CHAMPION LAYERS. Mature fast. Excellent rosters—capons. Massive size. Illinois-U.S. Approved—Fulorum controlled. Low farm prices. **PROFIT SHARING PLAN.** Catalog FREE. Write TODAY. **AJAX HATCHERY, BOX 432, QUINCY, ILLINOIS**

Learn PHOTOGRAPHY

Win success in photography by spare time Home Study or at our famous Resident School in the heart of New York. Commercial, Advertising, Portrait, Color, etc. 39th year. Write today!

NEW YORK INSTITUTE OF PHOTOGRAPHY

Dept. "49", 10 W. 33 St., New York 1, N. Y.

MAKE THIS SUIT YOURS NEW PLAN



EARN CASH SHOWING TO FRIENDS!

Write at once if you want this fine made-to-measure suit! You can get it by taking a few orders from friends, and earn up to \$10, \$12 in a day. Your bonus suit helps you take more orders with latest style, made-to-measure **guaranteed suits** at amazingly low prices. Also complete line of **Ladies' Tailored Suits**. No experience, no money needed. Write **TODAY** for **FREE SAMPLES**—telling about yourself—age, etc. No obligation! **PIONEER TAILORING CO.** Congress and Throop Streets, Dept. Q-1116, Chicago 7, Ill.



HAMSTERS!

Get the unique Golden Hamster today. Profitable, Prolific, Educational, friendly. 1000's needed by labs and pet shops. Raised anywhere. No experience required. Send 10c for literature or \$5 for pair and literature.

Azalea City Hamstery, 1412 East Linwood Dr., Dept. F, Mobile 18, Alabama

NOW YOU CAN EARN UP TO \$6.00 PER HR.

in your own WEAVING BUSINESS!



Amazing *All Weave Electric Loom* weaves rugs, draperies, textiles in hundreds of colors and patterns. Produces up to 40 feet of 42-inch material per hour. Ideal business for physically handicapped.

Entirely automatic... easy to operate... no experience necessary... free instruction booklet... working materials easily obtained. Uses 110 volt A.C. power. (Special voltage or gasoline motors supplied at extra cost.)

The All Weave Electric is a full size loom, capable of heavy-duty, production-line work, yet reasonably priced. Write for descriptive folder **TODAY!** Dept. P.

ALL WEAVE LOOM CORP. 9128 St. Charles Rock Rd. Saint Louis 14, Missouri

LOOKS EASY.. DOESN'T IT?

AND IT IS! Yet it's from the famous "Merry Widow" Waltz

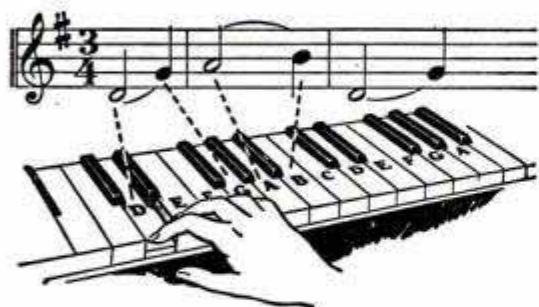

Look at the diagram. The first note on the music is "D." Following the dotted line to the keyboard you'll find "D" is the white key between the two black keys near the middle of the keyboard. From that you can locate the other notes. As you strike them on the piano you'll be playing the melody of the ever-popular "Merry Widow" Waltz. Simple, isn't it? Now read below how you can take lessons on any instrument and learn to play quickly and easily . . . at a surprisingly low cost.



HERE'S PROOF THAT you, too, can learn to play the piano or any other instrument!

• Don't let the mistaken idea that it's difficult to learn music deprive you of the pleasure of playing any longer. Learning to play is now actually as easy as A-B-C . . . thanks to the amazing new "Note-Finder."

This invention of the U. S. School of Music takes the mystery out of the piano keyboard, ends tedious scales and exercises, enables anyone to play a real tune almost from the start. You learn to play by playing. Soon you will be thrilled to find that you can pick up almost any piece and play it at sight. That applies to the piano, violin, guitar . . . any instrument you choose!

And remember you learn to play by actual notes—not "by ear" or some trick number system.

Takes Only Few Minutes a Day!

With this modern method you don't need any previous knowledge of music; you don't need to spend months on monotonous exercises. It's real fun to learn music this short-cut way, and it takes only a few minutes of your spare time. What's more, it costs just a few cents a day . . . and that includes everything.

But see for yourself! Simply send today for our free Print and Picture Sample. It will show you how you can quickly learn your favorite instrument. You will also receive a handsome booklet and details of the money-saving offer that enables you to learn music for but a few cents a day. Mail coupon today. Instruments supplied when needed, cash or credit. U. S. School of Music, 73 Brunswick Bldg., New York 10, N. Y. (Est. 1898).

HERE'S FURTHER PROOF!

Invited to Parties

"Before I took your course, I did not know one note of music. Then 3 months later I started to play for dances. I've been invited to many parties."

*R. M., Vancouver, B. C.



Plays From Start

"Your advertisements are true to the letter. I can actually play my favorite instrument even though I'm only at the beginning. How can I ever express my joyful gratitude."

*F. R. O., Illinois.

*Actual pupils' names on request. Pictures by professional models.

FREE! Print and Picture Sample

U. S. School of Music, 73 Brunswick Bldg., New York 10, N. Y. Please send me Free Booklet and Print and Picture Sample. I would like to play instrument checked below.

(Do you have instrument _____)

Piano	Accordion	Trumpet	Ukulele
Violin	Mandolin	Trombone	Clarinet
Guitar	Saxophone	Tenor Banjo	Other Instrument

Mr. _____

Miss _____

Mrs. _____ (PLEASE PRINT)

Street _____

City _____ State _____

Note! If you are under 16 yrs. of age parent must sign coupon.

Save 2c—Stick Coupon on penny postcard

No Shop
Needed

**Operate
YOUR OWN
Business**



Clean and Mothproof Rugs and Upholstery

• See our Service "ad" in March issue of McCall's •

Can you qualify? . . . If you are dependable, honest and willing to work, send for FREE Booklet explaining how you can become "your own boss" in a growing business of your own. You'll use proven successful methods of established DURACLEAN Dealers. Service rendered "in the home," offices and public buildings. Easy to learn. No experience necessary.

DURACLEAN cleans by absorption! No scrubbing. No soaking or shrinkage. Fabrics dry in just a few hours. Dirt, grease and many unsightly spots vanish as if by magic . . . colors revive. Upholstery and floor coverings last longer.

DURAPROOF kills moths and carpet beetles. Makes material resistant to both! Another year 'round service. DURAPROOF, to our knowledge, is the only moth proof service backed by a National Money Back, 4 YEAR WARRANTY.

These services are Nationally Advertised! Leading furniture and department stores recommend DURACLEAN Dealer's service. Almost every building in your territory houses a potential customer. Even auto dealers buy your service to revive upholstery in used cars. You get many voluntary and repeat orders.

Some dealers establish a shop or an office after business has grown. Others continue to operate from their own home. Profits up to \$15 and \$20 for a day's service on EACH of your service men.

Territories are limited! Write now for FREE Booklet explaining details of these Nationally Advertised services.

Duraclean Co., 16-3 Pl., Deerfield, Illinois

INVENTORS

When you are satisfied that you have invented a matter of value—write me, without obligation, for full information as to what steps you should take to secure a Patent.

The usual first step is to have a search of the prior U. S. Patents conducted, so that I can report to you on the question of Patentability.

PATRICK D. BEAVERS

(Formerly RANDOLPH & BEAVERS)

Registered Patent Attorney

934 Columbian Building Washington 1, D. C.

PATRICK D. BEAVERS, Registered Patent Atty.
934 Columbian Bldg., Washington 1, D. C.

Please send me full information on how to secure Patent Protection and Trademark Registration.

Name _____

Street _____

City _____ State _____

MORE PERSONAL ATTENTION

WHEN YOU LEARN

WATCHMAKING JEWELRY REPAIR ENGRAVING

...THE THACKER WAY!

Students learn FAST when Instructors offer personal attention. Our Master Course prepares you for all



branches of the Jewelry Trade. High percentage of graduates placed. Housing available. (Schools in Warren, O., and Pittsburgh, Pa.) G.I. Approved. Catalog FREE.

A. W. THACKER ACADEMY FOR JEWELERS

Dept. P • 423 Federal St. • Pittsburgh 12, Penna.

PATENTS
AND TRADE MARKS
C. A. SNOW & CO.
REGISTERED PATENT ATTORNEYS

WRITE FOR INFORMATION TO
428 SNOW BUILDING, WASHINGTON 1, D. C.

INVENTORS

Whether an invention is patentable can be substantially determined by a search of the U. S. Patent records. Without obligation, write for information explaining the steps you should take to secure a patent.

JOHN N. RANDOLPH

Registered Patent Attorney

201 Columbian Building, Washington 1, D. C.

PATENTS PATENT
LAWYER

TRADE MARKS
Gustave Miller
39PM WARNER BLDG.
WASHINGTON 4, D. C.

ASSOCIATE EXAMINER
U. S. PATENT OFFICE 1922-1929
REGISTERED PATENT ATTORNEY
Send for Form
"INVENTOR'S RECORD"

INVENTING

—FOR PROFIT! If you have an inventive turn of mind, write for free 28-page booklet explaining how the Institute of American Inventors is helping inventors pre-test the profit possibilities of proposed devices to fill today's unprecedented demand for useful new inventions.

INSTITUTE of AMERICAN INVENTORS

Dept. 4, 1926 Eye St., NW, Washington 6, D. C.

PATENTS "Proof of Invention"
Folder mailed without obligation.

E. E. VROOMAN, Registered Patent Atty.
505 McKim Building, Washington 5, D. C.

Say You Saw It in Popular Mechanics

INVENTORS

IF YOU WISH TO PROTECT YOUR INVENTION, You should take steps to protect it by a U. S. Patent. Write me for "Record of Invention" form.

CARL MILLER REGISTERED PATENT ATTORNEY

Woolworth Bldg., 35th Floor, Dept. 39-A, New York City
Please send me "Record of Invention" form.

NAME _____

ADDRESS _____



GET INTO DRAFTING

The Draftsman Plays a most Important Part in INDUSTRY

DRAWING OUTFIT INCLUDED with Drafting courses

All the tools you need including folding drawing table. With them you can put your ideas on paper quickly and with accuracy. With training you are all set to master Drafting in months, — not years — at home.

Learn in Spare Time—At Home!

(or at the College in Chicago)

A few hours of pleasant home study every week — that's all. With Chicago Tech's help, you train yourself step by step. This tested method — developed over 44 years of C.T.C. progress — prepares men for good positions in industry.



CHICAGO

TECHNICAL COLLEGE

C-212 Tech Building, 2000 South Michigan Ave.
Chicago 16, Illinois

Practically everything that's built or manufactured these days is constructed from blue print drawings prepared by the draftsman. He is the KEY man in industry. No new machines can be built, no bridges erected, no buildings constructed until the draftsman has completed his work.

Drafting is clean, interesting, professional-type work. The draftsman is paid well to start. And he has real opportunities for advancement to high-pay jobs in Engineering. The tremendous production programs ahead in industry will require more draftsmen than ever before.

Send today for free information. See what this training has done for others, what it can do for you. Simply MAIL COUPON TODAY in an envelope or use a penny postcard.

MAIL COUPON NOW

Chicago Technical College
C-212 Tech Bldg., 2000 So. Michigan Ave.
Chicago 16, Illinois

Mail me FREE Drafting Lesson with information about big opportunities in DRAFTING and how I can train at home.

- Architectural Drafting Electrical Drafting
 Machine Drafting Structural Drafting
 Builders' Course

Name _____ Age _____

Address _____

City _____ Zone _____ State _____

MOCK-UP FOR TWO FUTURES

This full-size wooden model of an airplane is taking shape under the hands of *Northrop* engineering students. The completed mock-up will be an exact likeness of a new type plane that may help mold the future of private flying. As a means of practical training in *Aeronautical Engineering* it helps mold the futures of hundreds of young men.

This mock-up is part of a typical *Northrop* training project. Students designed the airplane, prepared the working drawings, and built the mock-up to check on their design. They will make all the standard engineering tests, using the same methods as engineers in an actual aircraft engineering department.

This practical training prepares *Northrop* students to join the ranks of *Aeronautical Engineers* now designing the vast future of aviation. *Northrop* graduates are stepping directly into design, research, testing, aerodynamics, and power plant engineering... some are in such advanced work as guided missile design.

Northrop students know there is a big future in *Aeronautical Engineering*. It takes them only two short years to get ready. Send the coupon for full information.



The Airplane in the Making

Northrop aeronautical engineering students combined their ideas for the ideal private plane. A twin-boom pusher type, the propeller is placed between the two booms for safety from the whirling blades. The cabin arrangement permits pilot and passenger to step into the plane as easily as entering an auto.



Division of Northrop Aircraft, Inc. ★ James L. McKinley, Managing Director

1527 EAST BROADWAY, HAWTHORNE, LOS ANGELES COUNTY, CALIF.

APPROVED FOR VETERANS

NORTHROP AERONAUTICAL INSTITUTE
1527 East Broadway, Hawthorne, Los Angeles County, Calif.

Please send information on opportunities in Aeronautical Engineering, your catalog, and starting dates of classes. I am interested in:

- Aeronautical Engineering Aircraft & Engine Mechanics

Name _____ Age _____

Address _____

City _____ Zone _____ State _____

Check one: Veteran Non-Veteran

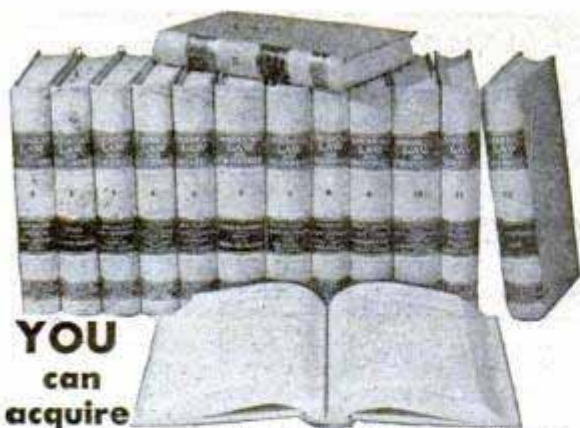

**YOU
can
acquire**

**LAW NIGHTS AT HOME!
L. L. B. DEGREE**

LaSalle's famous Law Library—used as reference in many Law libraries and Law offices—has enabled thousands to master Law surprisingly fast, in spare hours at home, for business and professional advancement.

These 14 remarkable volumes, compiled by leading professors and lawyers, cover the whole basic field of Law in condensed, orderly, simplified manner.

You advance rapidly with this great library, plus special lectures furnished. We guide you step-by-step with personalized Problem Method of instruction . . . you learn by doing—handling legal problems—not by memorizing rules.

Send for two FREE 48-page booklets, "Law Training for Leadership," and "Evidence," answering questions about Law and its value to you, and telling how LaSalle Law graduates are winning rapid advancement in business and public life. Mail coupon below. No obligation.

LA SALLE EXTENSION UNIVERSITY

A Correspondence Institution

417 S. Dearborn St. Dept. 364-L Chicago 5, ILL.

Send me your two FREE booklets described above, without obligation.

Name..... Age.....

Street.....

City, Zone & State.....

MAKE BIG MONEY IN SPARE TIME

Every Business and Profession uses

BUSINESS CARDS

WHITE, BUFF OR BLUE **2000 for \$345**

POSTPAID ANYWHERE IN U.S.A. COMMISSION \$100

TEAR-OFF CARDS

with beautiful leather pocket case

500 for \$345

Postpaid—Commission \$1
Raised letter printing
Extra fine quality



RAISED LETTER BUSINESS CARDS 1000 for \$345

POSTPAID—COMMISSION \$1
CHOICE OF BLACK OR BLUE INK
WRITE FOR FREE SALES OUTFIT!

QUALITY BUSINESS CARD CO.

Dep't. D, 118 N. Jefferson St., Chicago 3, Ill.

SAY YOU SAW IT IN POPULAR MECHANICS

WATCHMAKING

JEWELRY ENGRAVING AND REPAIR

Enter this high-paying, time-honored profession, or prepare for a business of your own. Watchmakers in great demand. More jobs than qualified workers. Study under expert instructors in a long-established, nationally recognized school. Receive recognized diploma and certificate. Placement service. Approved under G. I. Bill. Write for FREE booklet.



The Baronian School, Inc.

2116 WALNUT ST. (DEPT. C) PHILA. 3, PA.

Save Your Feet

Thousands relieved from pain walk freely with **HEEFNER ARCH SUPPORTS**



Write for Free Booklet

"FOOT FACTS"

HEEFNER ARCH SUPPORT CO., 671 Logan Bldg., Salem, Virginia

HYDROPONIC\$

Grow out-of-season vegetables, rare flowers or house plants by hydroponics **WITHOUT SOIL!**



Fascinating hobby or profitable business in your home; minimum space needed for big returns. Easy, clean, pleasant way to grow any plant indoors or out, year-round. Send postcard for FREE book showing how others are succeeding.

CHAPMAN-GILBERT, 824 W. IVY, SAN DIEGO, CALIF.

CHINCHILLA

CLEAN • GENTLE • HARDY
RAISE THEM FOR PROFIT—FREE INFORMATION—BREEDERS FOR SALE—SUPPLY & FEED CATALOG FREE... HISTORY & HANDBOOK—PRICE \$2.50.

NEED LITTLE SPACE
Write for facts to

ALLIED DISTRIBUTORS
GARDENA, CALIFORNIA

LEARN MOVIE PROJECTION THEATRE MANAGEMENT



The Motion Picture Theatre Business offers big opportunities for trained men. Get into a fascinating field with a promising future. Train at home in spare time. Free Catalog. Established 20 years.
THEATRE SCHOOL, 370 Washington St., Elmira, New York



AUTO WASHER

Your car sparkling clean—in a jiffy—magic "sponge" cleaning-cloth. Simply glide over car. PRESTO! Dust, grease, dirt, and grime disappear in a jiffy. Leaves finish clear, lustrous. Autos gleam like a mirror.

SAMPLES FOR AGENTS

Sample offer sent immediately to all who send name at once. Penny postal will do. Send no money—JUST YOUR NAME.
KRISTEE CO., 675 Bar St., Akron, Ohio

FENDER SKIRTS \$17.20 PER PAIR

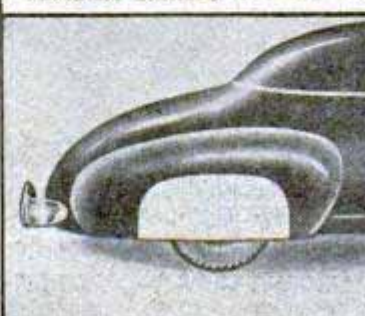

For Ford, Chev., Merc., Plymouth, DeSoto, Chrysler, Dodge, Kaiser-Frazer and Buick. Beautify your car—bring out the flowing lines inherently designed there. Sparkling beauty you'll like. Constructed of heavy gauge body steel, finished in prime, perfect fit.

SANDEE MUFELER CO
Box 296, La Tijera, Calif.
Los Angeles 43, Calif.

Gentlemen: Please send me one set of Sandee Fender Skirts to fit my (year and make of car)
 Check for \$17.20 enclosed
 Ship C.O.D.

WANTED MAN WITH CAR

No Time Like Now to Get In McNess Business

It's no trick to make good money when you use your car as a McNess "Store on Wheels." Farmers buy everything they can from McNess Men because McNess Products are tops in quality, represent extra values. Attractive business-getting prizes and premiums; also money-saving deals to customers make selling McNess daily necessities a snap.

We Supply Capital—Start Now!

There's no better work anywhere. Pays well, permanent, need no experience to start, and we supply capital to help you get started quick. You begin making money first day. Write at once for McNess Dealer Book. It's FREE. Tells all—no obligation. (1)

THE McNESS CO., 746 Adams St., Freeport, Ill.



Use Your
CAR
to Raise
Your
PAY

Guaranteed by mfr. for FULL YEAR

Handsome Swiss wrist watch...

Marvelous value in a good-looking watch, built by skilled Swiss craftsmen. So well-made that a printed one-year guarantee is given. Has sweep second hand, glow-at-night dial, rugged chrome case, unbreakable crystal. Timed and tested movement; leather strap.

Send no money—10 day trial
Pay postman \$6.95, plus tax and postage (or send check and we pay postage). Return in 10 days, if not delighted.

Swiss Watch Distr.

211 Paramount Bldg.
(Dept. 903C) Atlanta, Ga.



FOR BIG MEN ONLY!



SHOES
IN SIZES 10 to 16

We specialize in large sizes only—sizes 10 to 16; widths AAA to EEE. Wing Tips, Loafers, Moccasins, Hand Woven Oxfords, Dress Oxfords, High Dress Shoes, Work Shoes, Sox. Styling specially designed for large sizes. Satisfaction guaranteed. Sold by mail only. Write now for FREE Catalog.

Write

For

FREE

CATALOG

KING-SIZE Inc., 795, Brockton, Mass.

X.L. RUBBER MOLDS

will realize your great profits quickly!

WRITE FOR NEW FREE CATALOG

YOU can EASILY learn to cast thousands of perfect plaques, book ends, figurines, ash trays, etc. IT'S EASY, FUN, PROFITABLE! X.L. Rubber, Pts. \$2.00; Qts. \$3.50; Gallons \$8.95; Molds and enough rubber for 3 molds \$1.00—plus postage.



SEND
FOR
FREE
FACTS

GREAT PROFITS
MAKE YOUR OWN RUBBER MOLDS

PLASTIC ARTS STUDIO • Route 2 • Dept. 2 • Muncie, Ind.

LEARN AT HOME TO MOUNT BIRDS



Animals, Heads, Fishes, Pets; to TAN. Be a Taxidermist. Profit and FUN.

Hunters, save your valuable TROPHIES.

Mount ducks, squirrels, everything. Learn to TAN for leather and furs. Wonderful HOBBY Have a HOME MUSEUM.—BIG PROFITS mounting for others. INVESTIGATE NOW.

FREE BOOK With 100 fine game pictures. NOW absolutely FREE. Write TODAY.

Send Postal TODAY for FREE BOOK. State AGE. N.W. SCHOOL OF TAXIDERMY, Dept. 2503. Omaha, Neb.



SPECIALIZE



You can become a radio and television technician now!

A million new jobs — almost 4,000 a week — will be created in the television industry during the next five years according to estimates of industry leaders. Actually, during 1948, television grew faster than any other industry in the history of America.

Here is a real opportunity for you. Trained television technicians are in demand. By starting now, you can get in on the ground floor — grow as television grows.

To help supply this needed manpower, the Milwaukee School of Engineering has expanded its radio and television courses. Now you can get complete practical, technical training in the MSOE laboratories. This is not just a serviceman's course. It prepares you for a career in all of the technical phases of television and radio.

This special course prepares you for any of the following careers:

- | | |
|---|--|
| Television Serviceman | Radio and Television Tester |
| Radio Serviceman | Broadcast Radio-Operator |
| Radio and Television Retailer | Police, Taxi-Cab and Railroad Transmitter Operator |
| Supervisor in Radio and Television Assembly | Police, Taxi-Cab and Railroad Receiver Serviceman |

OTHER COURSES AVAILABLE

SERVICE	TECHNICIAN	PROFESSIONAL
6 to 12 Months	1 to 2 Years	3 Years
• Electricity	• Electrotechnics (Power)	• Electrical Engineering Bachelor of Science Degree
• Welding	• Radio and Television	Major in Electronics or Power
• Refrigeration	• Electronics	
• Heating	• Refrig., Heating and Air Cond.	

MILWAUKEE SCHOOL of ENGINEERING



A Technical Institute Founded 1903 by Oscar Werwath

MILWAUKEE SCHOOL OF ENGINEERING, Dept. PM349 N. Broadway and E. State, Milwaukee, Wis.

Without obligation send me free booklet "Career Building" and more details on course in Radio and Television or.....course.

Name.....Age.....

Address.....

City.....Zone.....State.....

SAY YOU SAW IT IN POPULAR MECHANICS

AVIATION

AN ESSENTIAL INDUSTRY IN PEACE OR WAR
MAXIMUM TRAINING IN MINIMUM TIME

for 19 years Cal-Aero Technical Institute has specialized in....

✓ AERONAUTICAL ENGINEERING

2 year course - kept abreast of new research and scientific development.

✓ MASTER AVIATION MECHANICS

1 year course - C. A. A. approved for Airplane and Engine License.

Modern "live" training equipment, including helicopters, jets, rockets, wind tunnel... Classes start monthly - Room and board available on our airport... Cal-Aero Tech Training is carefully designed for just one thing - **TO MAKE MORE MONEY FOR YOU.** More than 7000 successful graduates in addition to 26,000 pilots and 7500 mechanics trained for Army & Navy Air Forces, prove that our career training is unsurpassed. **APPROVED FOR VETERANS**



MAIL THIS COUPON TODAY!

Please send full information on Aviation Training FREE—without obligation.

Name _____ Birth Date _____

Street _____ Zone _____

City _____ State _____

CHECK ONE VETERAN NON-VETERAN PM-3

Helps to solve today's toughest CONSTRUCTION PROBLEMS

Here are the facts you need on every problem concerned with the design and construction of civil engineering structures. These books give you the most complete compilation of structural engineering data ever published—bring you genuinely professional information from records of actual practice. Written by 63 recognized engineering specialists, these six volumes are a complete reference on each aspect of structural engineering.



6 vols., 3763 pp., illus.
10 DAYS' FREE TRIAL

STRUCTURAL ENGINEERS' HANDBOOK LIBRARY

See coupon for Special Price and Terms

Covers the how and why of foundation and substructure design and construction, general theory of structural members and detailed design of such members—explains the principles of statics, reactions, moments and shears in beams and trusses, influence lines, methods of computing stresses in lateral trusses—gives details of design and construction of steel, timber and concrete structures, etc., etc.

McGraw-Hill Book Co., 330 W. 42 St., New York 18, N. Y.

Send me for ten days' free examination the Structural Engineers' Handbook Library. If satisfactory I will send you \$4.75 in 10 days and \$5.00 monthly until the price of \$29.75 is paid. If not wanted I will return books postpaid.

Name _____

Home Address _____

City _____ Zone _____ State _____

Company _____

Position _____ PM-3-49

(Continued from page 10)

Adjustable beam compass for rough layout.....223
 Glass plates hold notices on bulletin board.....224
 Large pipe cut squarely.....232
 Pie-plate stand for sign.....233
 Removing rust and restoring polished finish.....235
 Erasing hint helps typists.....236
 Adjustable shop shelves.....236

PHOTOGRAPHY

Rack for solutions permits easy temperature control.....220
 Label on double film holder describes contents.....220
 Flash gun indexed to aid positioning reflector.....220
 Obtaining better color balance in transparency projection.....220
 Protecting lenses from chipping.....220

RADIO-TELEVISION, ELECTRONICS

Keeping an eye on television.....237
 1949 "little giant" set for experimenters.....238
 More tubes in less space.....240

TOOLS

Extension aids driving nails in hard-to-reach places.....184
 Block clamps sandpaper securely.....188
 Weighted file handles.....188
 Angle slots in miter box laid out accurately.....188
 Level wired to straightedge permits easy handling.....194
 Tool for removing hands of clock.....196
 Sawing model-railroad tracks.....196
 C-clamps aid moving furniture.....196
 Straightedge for finishing sidewalk.....200
 Scissors sharpened expertly with homemade hand grinder.....202
 File tightened in wooden handle.....202
 Carbon from dry cell provides tip for soldering iron.....214
 Blacksmith's forge utilizes old vacuum-cleaner parts.....222
 Cork seals end of chuck.....224
 Set of punches for home shop made from drill rod.....232
 Bracket increases usefulness of portable drill.....234
 Hammer claws rounded to aid removal from pocket.....236

MISCELLANEOUS

Emergency eye shade fits glasses.....184
 Stored skis retain arch if clamped on ceiling joist.....184
 Silencing pounding of attic tank.....194
 Paintbrush suspended in solvent.....194
 Screen-wire "lath" backs patching.....200
 Radial model-airplane cowls.....207
 Low-cost spotlight for cabin cruiser.....209
 Paint preserved for future use.....213
 Pair of gloves kept together.....222
 Spring holds turn button snugly.....232

IMPORTANT NOTICE—It is the intention of this magazine to provide its readers with information regarding the latest developments in the mechanical arts. We take no responsibility as to whether the disclosures contained in our articles are covered by patents and advise readers to investigate this subject before making, using, or selling any of the products, machines, or processes described in order to avoid possible liability for patent infringements.

Outside Weather Controls Furnace

Installed on an outside wall, a new time switch takes the exterior temperature into consideration in regulating the heating system. Instead of setting the control for the time heating is to start, the owner sets it at the time the building is to be warm the following morning. The regulator then anticipates the heat requirements of the building, depending on the outside temperature, and turns on the heating system at the proper time during the night. During cold weather the heat is turned on much earlier than during warm weather. The regulator can be wired into the regular room thermostat circuit.

Liquid Stainless Steel

Applied like paint, a stainless-steel coating can be put on over wood or metal by anybody who can use a brush or spray. Microscopic flakes of stainless steel are mixed in a liquid plastic to provide the correct consistency for spreading. The plastic is waterproof, chemicalproof and fireproof, making the combination coating very durable. Quick drying, the coating can be used for decorative or protective purposes.

AT LAST... AN AMAZING NEW
Underground Sprinkler System
 EVERY HOME-OWNER CAN AFFORD!

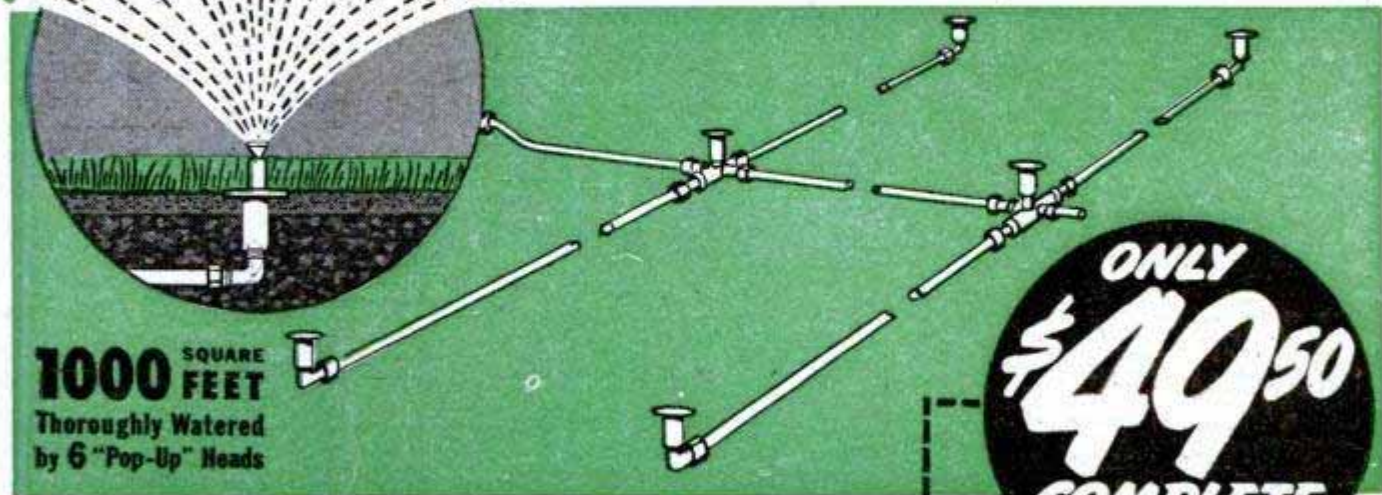

1000 SQUARE FEET
 Thoroughly Watered
 by 6 "Pop-Up" Heads

ONLY \$49.50
 COMPLETE
 NO EXTRAS TO BUY!

INSTALL IT Yourself in One Evening
 WITHOUT DAMAGE TO LAWN OR GARDEN

Now... your lawn or garden can be sprinkled like a million dollar estate. Even the man whose "fingers are all thumbs" can install EVERSPRAY in a few hours. No special tools needed. No pipe to buy. No pipe fitting to cause trouble. No plumbers to pay. No complicated blueprints or instruction sheets to befuddle you. Simple, A.B.C. diagram makes everything easy with just a small monkey wrench.

BE A USER-AGENT GET YOURS FREE!
 The very moment your EVERSPRAY is sprinkling, friends & neighbors will want to know where they can get one too! Just send us their orders on our User-Agent Plan and quickly get back in profits three to four times the cost of your own EverSpray. Check coupon if you're interested in our Plan.

he moves. No wonder owners by the thousands are rushing to install EVERSPRAY. It means *no more* wet clothes or muddy feet, *no more* hours wasted in sprinkling—*no more* neglected, burned out grass for want of time—*no more* wet puddles or dry spots once this amazing EVERSPRAY is installed.

A Life-Time Installation
 Once your EVERSPRAY is in place, it's there forever. No upkeep. No repairs. No draining. No inspection. It's in for keeps—always ready to give you trouble-free service year after year after year. Yet a home "renter" can take it up—and with him, when

All Solid Brass and Copper
Nothing to Rust, Rot, or to Wear Out
 Every inch of the tubing that goes into an EVERSPRAY Underground Sprinkler System is made of *solid copper!* Every single fitting and connection is made of *solid brass!* The fittings are *machined* to assure perfect fit and prevent leakage. No part can rust! There are no rubber gaskets to rot or disintegrate.

Only EVERSPRAY gives you all of these exclusive features

QUICK! EASY!
 After you install your new EVERSPRAY, fold down the sod that was folded back, and the keenest eye can't see where you made the narrow, shallow trench that holds your "million-dollar estate" Sprinkler System.

AMAZING "POP-UP" HEAD
 Nothing else like it. Out of sight at sod level when not in use. Run lawn mower or roller right over them. Rake can't break or damage them. Children can not temper with recessed spray heads. Feet can't trip over them. Yet they pop up above grass level when water is turned on—and drop back when water pressure stops.

From Mist to Rain
 Patents applied for. Instant fingertip adjustment on EACH head gives any spray from fine mist to heavy rain.

Automatic Drain Valve
 Positively "freeze-proof". Entire system drains automatically **AFTER EVERY USE!** Nothing to worry about when zero weather comes. Nothing to get out of order or cause trouble. No blowing or draining... No repair or maintenance expense.

SALESMEN WANTED
 Salesmen, Distributors and Crew Managers wanted to call on home owners, hardware stores, department stores, and other retail outlets. Biggest summer seller ever invented. Make tremendous profits between now and July. Rush name air mail or telegraph for complete facts, discounts, commissions, demonstrator offer, and details of spectacular, sure-fire "JACK POT" Pyramid selling plan.

MONEY-BACK GUARANTEE
 We unconditionally guarantee the EverSpray Underground Sprinkler System. This guarantee is made by one of the largest fabricators of copper and brass products in the world. If EverSpray is not exactly as described in this advertisement or in our printed literature, the Entire System may be returned to us within 10 days after purchase and the purchase price will be refunded promptly and in full. You may buy direct from this advertisement with perfect confidence. ● If you don't order now, at least get **all** the facts. Send name on coupon for a beautiful folder containing pictures and descriptions of EverSpray. It is **FREE**—no charge at any time. Send name today and be first in the neighborhood to enjoy EverSpray.
Everspray Products Co., Dept. 23
 A Division of Everhot Products Co.
 2001 W. Carroll Ave., Chicago 12, Illinois

Everspray Products Co., Dept. 23
 2001 W. Carroll Ave., Chicago 12, Ill.

Rush complete facts all **FREE** on EVERSPRAY Sprinkler. Square checked below shows Underground plan in which I'm interested.

For my own use As a User-Agent As a salesman
 I am enclosing \$49.50. Rush a complete EVERSPRAY Sprinkler System under your Money-Back Guarantee.

Name _____
 Address _____
 City _____ Zone _____ State _____

MAKE BIG MONEY FAST



STEVINSON TRAINED AUTO, ELECTRICAL, and REFRIGERATION EXPERTS GET TOP MONEY

STEVINSON TRAINING

Approved for Civilian and Veterans Training
 The steady work, backed by proved time-saving methods of Stevinson training and experience has won approval from civilians and veterans alike. If you are a qualified G I, don't delay a day. Write today. Approved under laws 346 and 16.

EARN WHILE YOU LEARN
 No wasted time. Be an expert in latest modern methods . . . you work with most advanced new equipment. We help you arrange part-time work . . . help you get best jobs or set up your own business on graduating. Don't limit yourself. Get on the quick road to success with a solid Stevinson foundation. 27 years of successful training.

GET FULL FACTS FREE. MAIL COUPON NOW!

Stevinson Auto & Electrical School, Dept. PM, 2008 Main St., Kansas City 8, Mo.
 Common sense tells me the practical 27 years success of Stevinson classroom-shop training means faster earning of big money for me. Send me full facts on the training courses I have checked, at no cost or obligation.

Auto Air Conditioning
 Refrigeration Electrical Appliance
 Auto Body & Fender Rebuilding

Name _____
 Street _____
 Town _____ State _____

THERE'S MONEY IN CARTOONS!

RAYE BURNS will teach you HOW to CREATE ORIGINAL CARTOONS at home that you may SELL! Course contains 26 lessons and over 600 illustrations. All for Only... **\$2.85**

Send name and address for free details.

RAYE BURNS SCHOOL, Dept. M, Box 3583, Cleveland, Ohio

BE A DETECTIVE
 WORK HOME or TRAVEL. Experience unnecessary.
DETECTIVE Particulars FREE. Write to
GEO. P. M. WAGNER, 125 W. 86th St., N. Y.

BLISS Electrical Training

ELECTRICAL SCHOOL

Intensive 32 weeks' residence course in fundamentals of industrial electrical engineering, including radio and electronics. Extensive laboratory, shop work, drafting. Prepares for electrical technician and engineering aides in communications, power, manufacturing, business machines, sales, service. 56th year. Classes begin April 4, Sept. 6. Catalog. 7628 TAKOMA AVENUE WASHINGTON 12, D. C.



THE WORLD'S LARGEST WATCHMAKING SCHOOL GIVES YOU:

- G.I. APPROVED, NATIONALLY ACCREDITED COURSES • MOST ABUNDANT WORKING AND TRAINING FACILITIES • INDIVIDUAL INSTRUCTION BY EXPERIENCED FACULTY
- FREE PLACEMENT SERVICE FOR PART-TIME WORK AND HOUSING DURING TRAINING
- FREE EMPLOYMENT SERVICE UPON GRADUATION • COMPLETE SET OF WATCHMAKER'S TOOLS TO VETERANS • \$100 BONDED GUARANTEE OF PROFICIENCY TO PROSPECTIVE EMPLOYERS.

SEND FOR FREE 116-PAGE INFORMATION PACKET

WESTERN PENNSYLVANIA HOROLOGICAL INSTITUTE, INC.
 DESK 40, 808 RIDGE AVENUE PITTSBURGH 12, PA.

Earn BIG MONEY Full or Part Time

Nationally-known and recognized Mechanical Trades School offering Resident Courses under the G. I. Bill and Correspondence Courses on easy monthly payment plan, desires permanent services of a capable, energetic Sales Representative in your locality.

Work is that of enrolling men for highly-approved and recommended training in Air Conditioning-Refrigeration, Commercial Electricity, Diesel, and Radio-Television. A position of dignity, offering top earnings (up to \$12,000 a year) and splendid opportunities for advancement. Make security and high earnings yours through good times or bad. No prior sales experience necessary if you are intelligent, aggressive and a hard worker. Our thorough training and fine cooperation assures your success from start.

Men with successful experience in the sale of Educational Courses, or men otherwise qualified, have opportunity to become District Managers with live, well-established, highly-rated, growing concern. Write giving full particulars regarding yourself. Confidential.

BAILEY TECHNICAL SCHOOLS
 1651 S. Grand Blvd., Dept. PM 1, St. Louis, Mo.



"DIPPY WET"

THE MAGIC DRINKIN' BIRD in the Gilded Cage!

Just touch him and he drinks and drinks! Magic because there are no springs, no wires and no gadgets . . . he's a scientific drinker! His round black eyes and bright coloring make him a family favorite . . . Complete with green metal cage and drinkin' cup.

\$1.95

SEND NO MONEY—Just send your name and address, pay postman \$1.95 upon delivery plus delivery charges or remit \$1.98 and we pay postage. Order Today! (Special Price to dealers.)

NOVELTY MART, 59 East 8th St., New York 3, N. Y., Dept. 33

CORRESPONDENCE COURSES IN RADIO and ELECTRICAL ENGINEERING

ELECTRICAL ENGINEERING. Get good grasp of wide electrical field. Modern. Very understandable. Theory made easy.

RADIO ENGINEERING. Extra fine course in radio, public address, photo-electric work. Train you to be super-service man, real vacuum tube technician. Tuition ONLY \$25, either course. Deferred payment plan. Servicemen needed badly.

FREE Electronic Kit given to students enrolling by Apr. 15. Write for free copies of school catalogs, student magazines, etc.

LINCOLN ENGINEERING SCHOOL, Box 931-P123, Lincoln, Nebr.

FREE MRS. BERRY'S POULTRY BOOK

BABYCHICKS or STARTED, Champion-Mated, Licensed-Inspected, B.W.D. TESTED, 52 BREEDS, 6 HYBRIDS. Sexed or straight. Mature fowls, Hatching Eggs and Remedies. **LOW PRICES.** The ORIGINAL Berry's Farm—over 50 years' service. **LARGE BEAUTIFUL BOOK FREE.** Stamps appreciated.

BERRY POULTRY FARM, Ex. 29, CLARINDA, IOWA

LEARN TELEVISION Radio ELECTRONICS



**Get a Good Pay Job - or
Start Your Own Business**

Want to make more money? Want to be your own boss - have your own money-making business - with your future assured? Then learn Radio and Television with my proven two-way method (lesson instruction plus actual practice) that can help you get into this great and growing business quicker. You learn by doing, right in your home in spare time. During your training you get 10 big kits of radio parts with which you perform hundreds of tests and experiments, build scores of circuits and testers to help you learn faster, more thoroughly.

Since 1929 I have been training men all over the world for success in radio, television and electronics. To learn how I can help you too, take the first step now by sending for my big 56-page illustrated book that tells how you may cash in on radio and television's big opportunities. My book is Free but it may mean your future success. Send for it today.

VETERANS! Approved for G. I. Training Under Public Laws 16 and 346

C. H. MANSFIELD, President, Dept. A-15
Hollywood Radio and Television Institute
810 West 6th Street, Los Angeles 14
California, U. S. A.



SEND FOR THIS BOOK
VETERANS! Advise if eligible for G. I. Training



Free Catalog Just Off the Press

Fully illustrated, 88 pages, showing special footwear and clothing and forty-eight other leather and canvas specialties of our own manufacture.

L. L. Bean, Inc.
Dept. P
Freeport Maine
Mfrs. Fishing and Camping
Specialties

WATCH REPAIRING \$\$\$ LEARN AT HOME \$\$\$

Watchmakers make big money. Many needed. We train you thoroughly at home in spare time. Personal training under experts. No previous experience necessary. Tools and 15-jewel watch part of course. Ten easy lessons. Write today for free literature.

ILLINOIS SCHOOL OF WATCH REPAIRING
2870 ELSTON AVE., DEPT. PM-3, CHICAGO 18, ILLINOIS

SAY YOU SAW IT IN POPULAR MECHANICS

MAKE CRIME YOUR BUSINESS

ON THE SIDE OF THE LAW!
Help fight crime! . . . Earn steady good pay as a Finger Print Expert or Investigator. I.A.S. trains you—by easy, low-cost home study lessons. Learn this exciting work in spare time. Write for full details now!

OVER 800 POLICE BUREAUS...
Employ I.A.S.-trained men . . . proof of what I.A.S. can do. Write today (state age) for details. No obligation. No salesmen will call.

INSTITUTE OF APPLIED SCIENCE
Dept. 1353, 1920 Sunnyside Avenue
Chicago 40, Illinois

WORK FOR THE

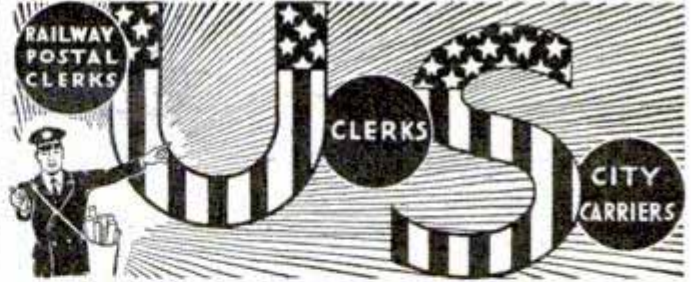

GOVERNMENT

**Start as high as \$3,351
A YEAR**

(Veterans Get Special Preference)

Get Ready Now for Next Examinations

City Mail Carriers, Post Office Clerks

Clerks and Carriers now get \$2,550 the first year of regular employment and automatically increase \$100 a year to \$3,550. Open to Men—Women 18 to 50. Clerks and Carriers can be promoted to other postal positions paying as high as \$7,550.00.

Railway Postal Clerks

Railway Postal Clerks get \$2,750 the first year of regular employment, being paid on the first and fifteenth of each month. (\$114.60 each pay day.) Their pay is automatically increased yearly to \$3,850 and \$4,050 in large organizations. Advance may be had to Chief Clerk at \$5,850 a year. Male Veterans only.

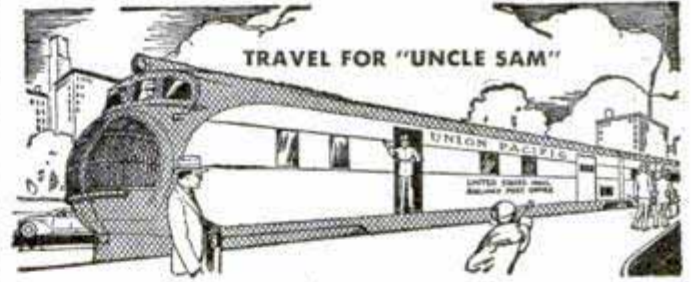

3 Days On—3 Days Off—Full Pay

Railway Postal Clerks on long runs usually work 3 days and have 3 days off duty or in the same proportion. During this off duty their pay continues just as though they were working. They travel on a pass when on business. When they grow old, they are retired with a pension.

Many Other Positions

Many other positions are obtainable. Rural Carriers—Stenographers—Typists—Patrol Inspectors—Assistant Statistical Clerks—etc. Those wishing these positions should qualify at once.

Get Free List of Positions

Fill out the following coupon. Tear it off and mail it today—NOW, at once.
Although not government controlled, this can result in your getting a big paid government job.

FRANKLIN INSTITUTE, Dept. M85, Rochester 4, N. Y.

Rush to me, entirely free of charge (1) a full description of U. S. Government Jobs; (2) Free copy of illustrated 40-page book, "How to Get a U. S. Government Job" with (3) List of U. S. Government Jobs; (4) Tell me how to qualify for one of these jobs.

Name _____

Address _____ Veteran? _____

Use This Coupon Before You Mislaid It. Write or Print Plainly.

Complete blueprints of this RICHardson refreshment stand available for construction.



Go in Business

WITH THIS REAL MONEY MAKER

Open your own roadside stand! It's a profitable enterprise requiring little investment. And your investment is protected by the exclusive RICHardson Root Beer franchise. Many veterans and other progressive business men are making hundreds of dollars a week with the RICHardson refreshment stand... and they are having fun, too.

SEND FOR FREE BOOKLET!



Free booklet shows layout drawings and gives full details on basic stand and plans for later expansion into a larger stand. Write for your copy today.

RICHardson Corporation
Dept. P-3, Rochester 3, N.Y.

Don't Envy The PLUMBER - Be One

Make \$15 to \$50 a Day

Every skilled workman will tell you Plumbers have the best of it. WINTER and SUMMER the Plumber is busy at top wages. No skilled Plumber is ever out of a job. Compare his opportunities with any trade. To the man with know how, Plumbing means profit. Investigate Universal Plumbing School. Not a "war born School," but a plumbing school developed and operated by plumbers since 1923.



Own Your Own BUSINESS

Have your own business and big profits with little other than training and a kit of tools.

JOURNEYMAN Gets Good Salary

Master Plumbers own their own shop. A Journeyman works for a Master. With this training journeymen can depend on high wages.

G. I. Approved. Established 1923

UNIVERSAL PLUMBING SCHOOL

877 Holmes Street

Kansas City, Mo.

BE A PLUMBER IN JUST 32 WEEKS

Learn With Tools—Not Books

No need ever serve an apprenticeship. Don't envy the plumbers big profits—enjoy them. Learn every trick of the trade—Leadwork—Blueprint for plan reading, etc. under Licensed Master Plumbers.

Over 7,000 Successful Plumbers Recommend This School

This system has made more than 7,000 plumbers. Investigate our past performance. If you like to work with tools this is your opportunity. Become a Plumber in America's largest and only school devoted exclusively to plumbing. Write today for FREE information.

GENUINE DIAMONDS

SAVE UP TO 50% AND MORE



SEND FOR **FREE** Diamond Catalog

BERMAN'S
Illustrated
Catalog
OUT OF PAWN
GENUINE
DIAMONDS

VALUES FROM \$10 TO \$10,000

All Diamonds Reset in new Mountings
IRON CLAD
Money-Back Guarantee

The BERMAN Corp.
DIAMOND BROKERS

America's Great Diamond Values

DEPT. P BERMAN BLDG., BALTO. 1, MD.

CARBURETOR TOO RICH MAKES MOTORIST TOO POOR



Car owners who are wasting money and not getting proper gas mileage due to over-rich mixtures will be pleased to learn how to save gasoline by VACU-MATING over-rich mixtures. VACU-MATIC fits all cars, trucks and tractors. It is automatic and operates on the supercharge principle. Easily installed in a few minutes.

SALESMEN WANTED! Big Profits!

Send name, address on penny postcard for free particulars and how to get yours for introducing.

VACU-MATIC CO., 7617-1479 W. State St., WAUWATOSA, WIS.



SPORTSMEN! GIANT SPOOL Now Yours On SPECIAL INTRODUCTORY OFFER

DIRECT-TO-YOU FROM MILL Only \$1.69

MEN! Here's your chance to get this amazing strong, almost unbreakable DuPont NYLON thread for sewing leather and canvas, salt water fishing, net mending, bamboo rod wrapping. Used by Air Force on parachutes. SEND NO MONEY. Just name and address. Specify black or white thread. On arrival pay postman \$1.69 plus

C.O.D. postage. Test for 10 days. If not delighted, return for money back. Limited offer. Order TODAY. 2 Spools... \$3.29. LEEWARD PRODUCTS, Dept. F-49C, 189 W. Madison, Chicago 2, Ill.

SHOE REPAIR OFFERS BIG INCOME LEARN IN 12 WEEKS TIME

You can own your own shop or earn big income as skilled shoe repairman. Growing demand everywhere at top wages for men who know how. We teach you quickly by actually working on shoes and modern machines. School open to all from 18 to 60 years of age. FREE BIG 20 PAGE BOOK explains everything. Send for your copy today.

MODERN SHOE REBUILDING SCHOOL

Approved for Vets Established 1927 Dept. PM
2937 Belmont Ave., Chicago, Ill. Rush Postcard Today
806 So. Figueroa St., Los Angeles 14, Calif.

BUILD SOLID WOOD SCALE MODEL

Wm. Galloway Train



• Realistic StromBecker model of first freight train in U. S. Length 14 1/2", height 3 1/2". Kit complete with ready-shaped parts for easy assembly, \$1.00... Other StromBecker Kits: Piper Cub Supercruiser, 50¢; Submarine Nautilus, 35¢; Rock Island Rocket Streamliner, \$1.50; many more. Ideal for display on mantle, desk, or in collector's group.

AT YOUR TOY OR HOBBY DEALER
Send for free Catalog describing models.

StromBecker

STROMBECKER-BECKER MFG. CO., Dept. PM-3, Moline, Ill.

\$200 GROSS IN MY FIRST WEEK!

Some Make More, Some Less... Start This Business for **YOUR OWN**



Would YOU like to own a permanent, year-round business in which it is possible to take in as much as \$200 gross the first week, as did L. A. Eagles? R. E. Traynor says, "I made \$62 gross in one day." R. R. Newlin reports, "I have averaged \$173 gross per week." Others report gross from \$100 per week to \$12,000 per year.

Surely YOU will want to investigate a golden opportunity like that. You need not have any special skill or experience, but if you are ambitious, honest and courteous, we will help you to start and succeed in YOUR OWN money-making business where net profits are high.

No Shop Necessary

Our Electric Rug Washer cleans rugs and carpets like new right on the customer's floor. This quick, thorough and highly efficient method removes dirt and grime, thus restoring the natural, fresh beauty of floor coverings. Anyone can run it. Rugs and carpets are not harmed.

There are hundreds of possible customers in YOUR vicinity. Most of them have several rugs needing regular cleaning. To get a quick start,

FREE BOOK! MAIL COUPON

VON SCHRADER MFG. CO.
A391, Racine, Wis.

Send at once (no obligation) your FREE booklet containing information about your Electric Rug Washer and how I can own my own permanent, profitable business.

Name _____

Address _____

City _____ (Zone) _____ State _____

shampoo a few rugs or carpets. These customers tell their friends and soon you should have an independent, prosperous business, and you should be able to keep it growing. Send the coupon RIGHT NOW for booklet that explains everything.

Every Machine Guaranteed and Easy to Own

You take no risk. These wonderful, fully guaranteed machines have been used and endorsed by largest hotels, railroads—also used by U. S. Government. Many individuals have built up successful businesses that made big profits. Mail the coupon TODAY and we will send complete information, including how to start and succeed in YOUR business without a large investment. Don't delay your BIG opportunity. Send the coupon AT ONCE.



MAIL COUPON TO

VON SCHRADER MFG. CO., A391, RACINE, WIS.

Learn ENGINEERING DRAFTING...BUILDING in Chicago, Industrial Hub

Approved for G.I. Training

Time-Saving Courses

Day & Evening Classes

Get your training at Chicago Tech in the Nation's industrial center. Chicago provides unequalled opportunities for part-time employment while training and for permanent positions upon graduation. Many other cultural and recreational advantages described in Catalog—sent Free!

Chicago Tech, founded 45 years ago, has trained thousands of men now occupying important places in industry the world over. Training combines theory and practice in 1 year, 2 year, and 3 year (Degree) courses. Saving in time means earlier graduation — and consequently earlier employment.

Terms start January, April, July and October. Get information now to arrange for early admission and accommodations.

CHICAGO TECHNICAL COLLEGE
C-83 Tech Bldg.
2000 So. Michigan Ave.
Chicago 16, Ill.



MAIL COUPON TODAY

CHICAGO TECHNICAL COLLEGE
C-83 Tech Bldg., 2000 So. Michigan Ave.
Chicago 16, Ill.

Please send me without obligation free booklet on Time-Saving Technical Training.

Name _____ Age _____

Address _____

City _____ Zone _____ State _____

- 1 YEAR • 2 YEAR
- 3 YEAR COURSES
- BUILDING
- DRAFTING
- ENGINEERING
- AIR CONDITIONING
- REFRIGERATION
- ELECTRICITY
- RADIO

9 BIG BUILDING BOOKS

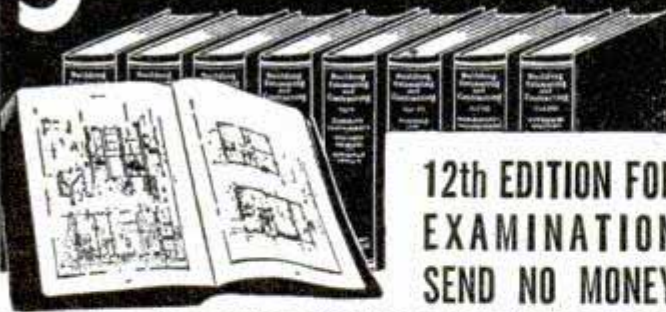

12th EDITION FOR EXAMINATION SEND NO MONEY

Learn to draw plans, estimate, be a live-wire builder, do remodeling, contracting. These 9 practical, profusely illustrated books cover subjects that will help you to get more work and make more money. Masonry, concrete forms, carpentry, steel square, roof framing, construction, plumbing, heating, painting, decorating and many other subjects. More than 4000 pages—2750 illustrations.

BETTER JOBS — BETTER PAY

A nationwide building boom is in full swing and trained men are needed. Big opportunities are always for MEN WHO KNOW HOW. These books supply quick, easily understood training and handy, permanent reference information that helps solve building problems.

UP-TO-DATE EDITION

These books are the most up-to-date and complete we have ever published on these many subjects.

Coupon Brings Nine Big Books for Examination

AMERICAN TECHNICAL SOCIETY—Publishers since 1898
Dept. G319 Drexel at 58th Street Chicago 37, Ill.

You may ship me the Up-to-Date edition of your nine big books, "Building, Estimating and Contracting," without any obligation to buy. I will pay the delivery charges only, and if fully satisfied in ten days, I will send you \$2.00, and after that only \$3.00 a month, until the total price of only \$34.80 is paid. I am not obligated in any way unless I keep the books.

Name _____
Address _____
City _____ State _____

Please attach a letter stating your age, occupation, employer's name and address, and name and address of at least one business man as a reference. Men in service, also please give home address.

Learn A Trade NOW! PRACTICAL SHOP TRAINING!

In Our Chicago Shops

- | | |
|---|--|
| <input type="checkbox"/> AUTO MECHANICS | <input type="checkbox"/> WELDING—ARC and GAS |
| <input type="checkbox"/> DIESEL MECHANICS | <input type="checkbox"/> MACHINIST |
| <input type="checkbox"/> REFRIGERATION | <input type="checkbox"/> PIANO TUNING |
| <input type="checkbox"/> BODY-FENDER | |

Above Approved For G. I.'s and Civilians
One of America's Leading Practical Schools
7 Floors of Fully Equipped Shops
Over 48,000 Successful Graduates
Expert Individual Instruction
Learn by Doing—Low Living Expense
Established 1902—Day and Evening Classes

Also the following Home Study Courses

- | | | |
|----------------------------------|--|---------------------------------|
| <input type="checkbox"/> PLASTIC | <input type="checkbox"/> REFRIGERATION | <input type="checkbox"/> DIESEL |
|----------------------------------|--|---------------------------------|

—CALL IN PERSON OR MAIL THIS AD TO—

GREER SHOP TRAINING

(Desk 10) 460 South State St., Chicago 5, Ill.

Please send without obligation free information regarding trade checked above. (Specify whether you are a Veteran or Civilian)

Name _____ Age _____
Address _____
City _____ State _____

Want to Write

Short Stories, Mysteries, Articles?

Free Book Tells How You Learn at Home

The demand for writers is creating great new opportunities for people with an urge to write. It's not as hard to succeed as you may imagine. Most famous authors come from ordinary walks of life. At home, you too may learn fiction writing, the best basis for all fields—short stories, features, articles, technical, mechanical and business items. Palmer Institute's Home Study Training (Established 1917) is endorsed by Rupert Hughes, Gertrude Atherton, Keith Monroe, and other famous authors and by scores of successful graduates. Complete instruction material and professional coaching to develop your own style. FREE book tells how you may enjoy an ideal part time or full time career. Write today (no salesman will call). Veterans: advise us if you are eligible for G.I. Training.

APPROVED FOR VETERANS

PALMER INSTITUTE OF AUTHORSHIP • Desk T-39
1680 N. Sycamore • Hollywood 28, Calif.

Learn RADIO-TELEVISION

In Your Own HOME WORKSHOP

Build interesting Radio Circuits, acquire real experience, do scores of practical experiments—all through RTA's complete balanced training plus 10 BIG KITS of parts which RTA GIVES YOU! Get finest instruction direct from Hollywood, the nerve-center of broadcasting, television and radio activities.

FREE BOOK
Send postal for complete details plus FREE BOOK "How to Make Good in Radio-Television."

RADIO TRAINING ASSOCIATION OF AMERICA
5620 Hollywood Blvd. Dept. 3-PM Hollywood 28, Calif.

ELECTRICIANS' SCHOOL

HOUSE AND COMMERCIAL WIRING • MOTOR REPAIR
AND REWINDING • ELECTRIC REFRIGERATION

Approved for Veterans Training

PENNSYLVANIA INSTITUTE SCHOOL OF ELECTRICITY

42nd and SPRUCE STS. PHILADELPHIA 4, PENNA.



NEW! SUPER GADGET

NAUTICAL ANCHOR BOTTLE OPENER and KEY CHAIN

Novel, Unique and Patented. Die cast bronze, chromium finish. Guaranteed to please. Sent post-paid \$1 (bill).

P. O. BOX 766 P & W CO., Dept. M SAN FRANCISCO, CALIF.



LABORATORY TECHNICIAN

BE A LABORATORY SPECIALIST: complete course. Big demand from hospitals, doctors, clinics. We teach all branches of medical laboratory work, including Medical and Dental X-Ray.

Approved by American College of Medical Technologists
Co-educational Free Placement Bureau
Free Catalog

Accredited for "veteran" training
CHICAGO COLLEGE OF LABORATORY TECHNIQUE
Dept. P.M., 431 S. Wabash Ave. Chicago 5, Illinois

Say You Saw It in Popular Mechanics

NOW YOU TOO CAN BUILD 15 RADIOS



Absolutely No Knowledge of Radio Necessary

You Need NO Additional Parts

The PROGRESSIVE RADIO KIT

is THE ONLY COMPLETE KIT. Contains everything you need. Instruction Book, Metal Chassis, Tubes, Condensers, Resistors and all Radio parts.

The 36-Page Book written by Expert Radio Instructors teaches you to build radios in a Professional Manner. You start with a 1-tube receiver. Before you are done with this kit, you will have built 11 Receivers, 1 Public Address System and 3 Transmitters. **SPECIAL FREE OFFER!**

Electrical and Radio Tester sent absolutely FREE with each Progressive Radio Kit. PLUS FREE membership in Progressive Radio Club. Entitles you to free expert advice and consultation service with licensed radio technicians.

Write for further information, or ORDER your KIT \$14.75 NOW! ONLY.....

Postage prepaid with check or money order (Postage not prepaid with C.O.D. orders)

PROGRESSIVE ELECTRONICS CO., Dept. PM-20
497 Union Avenue Brooklyn 11, N. Y.

THESE 5 TRADES ASSURE YOU

HIGH PAY • Future Security

- **PLUMBING** Every phase of plumbing: Pipe-Cutting and Threading, Lead-Wiping, Rough-in Projects on Installations, Completed Installations of entire plumbing systems, Blueprint reading, Estimating.
- **DRAFTING** College-level courses in General Machine and Architectural Drafting, with fundamentals in Drafting Mathematics—all under graduate engineers.
- **SHOE REPAIRING** From simplest repairs on boots and shoes to the finest details of reconditioning and rebuilding, under expert craftsmen.
- **ELECTRICAL** Technical and shop training include Basic Electricity, Residential Wiring, Industrial Wiring, General Testing and Trouble Shooting, and Appliance Repair.
- **AUTOMOTIVE & TRACTOR** Applied training on latest model automobiles and tractors, including engine overhaul, transmission and differentials, carburetion, generator and ignition systems, engine tune up, Hydramatic and Vacamatic Transmissions, and general service.

"There's Always a Demand for the Man who KNOWS!"

CHOOSE ONE OF THESE 5 LEADING TRADES

Get Out of that Rut... Be a Skilled Tradesman! Have a Lifetime Career... Own Your Own Business and Be Secure in Your Old Age.

NOW while Enrollment is still open, send for FREE information.

THE 5 DIVISIONS OF

NATIONAL TRADE SCHOOL

2610 Grand Ave., Kansas City 8, Mo.

- Plumbing Drafting
 Shoe Repairing Electrical
 Automotive & Tractor

NAME _____

ADDRESS _____

CITY _____

STATE _____

VETERAN _____

OCCUPATION _____

Choose One of these 5 Essential Trades

Our complete courses of thorough training prepare you to go right into the field as a Qualified Tradesman at High Pay in only 34 weeks (39 in Shoe Repair). All courses under especially trained instructors with practical experience. 6 Hour Classes 5 Days a Week. Our Employment Department helps you.

VETERANS "Approved for veterans' training by the State Department of Education under Public Law 346."
 "Approved for veterans' training by the Veterans' Administration under Law 16."

Send Coupon for Free Information Now

Draw me!

COPY THIS GIRL AND TRY FOR A

Free \$240 Art Course

5 PRIZES! 5 Complete Art Courses, including Drawing Outfits! Each Course Valued at \$240

EXTRA! Whether you win or not, the contest judges will write you... if they feel you can develop your talent profitably. Our famous home-study course makes your own room an extension of one of the world's largest art schools. 34 years experience in turning out successful, money-making graduates. Splendid opportunities now for trained artists in all fields. Find out how much ability you really have. Take this Drawing Test FREE. Mail this coupon with your drawing.

RULES. You must be amateur. Make copy of girl 5 ins. high. Pencil or pen only. Omit lettering. All drawings must be received by March 31, 1949. None returned. Winners notified. If desired, send stamped, self-addressed envelope for list of winners.



ART INSTRUCTION, INC.

Dept. 3139-C, 500 S. Fourth St., Minneapolis 15, Minnesota

Please enter my drawing, (attached) in your FREE \$240 ART COURSE CONTEST for March.

(PLEASE PRINT)

Name _____ Age _____

Address _____

City _____ Zone _____ State _____

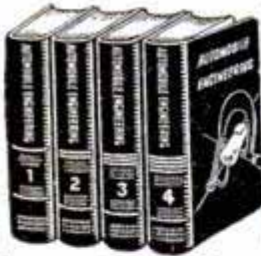

AUTO

BOOKS ON APPROVAL



SEND NO MONEY. Just mail the coupon for a complete set of 4 Big, Thick Auto Books. 20th Edition. Over 2700 Pages! Whether you are a mechanic or helper, expert or apprentice, auto owner or driver, take immediate advantage of this **FREE EXAMINATION OFFER.**

MAKE GOOD MONEY NOW HOLD A PERMANENT JOB

America wants its automobiles kept in good repair. Men with "know how" are in demand, at big pay. These books will help you get and hold an important job, or give you a chance to go into business for yourself now or later. Any man who half tries to improve himself can learn auto servicing and repairing by this quick reference method. Use the **JIFFY INDEX** to find easily understood answer to any auto problem. These wonder books prepared by eleven of America's great automobile engineers. Many hundreds of valuable illustrations. Send the coupon **TODAY.**

A year's consulting privileges with our engineers now given with these books without extra charge.

Publishers Since 1898

CAN YOU FIX IT?

These wonder books tell step by step **HOW** to make difficult repairs and adjustments, how to keep a car at maximum efficiency, including latest improvements in car design and operation. Engine troubles and how to correct them well covered.

4 BIG, THICK VOLUMES

Over 2700 pages, 2000 illustrations, wiring diagrams, etc. Beautiful modernistic, washable cloth binding.

AMERICAN TECHNICAL SOCIETY, Dept. A319
Drexel Ave. at 58th St., Chicago 37, Ill.

I would like to examine your 4-Volume Set of Auto Books. I will pay the delivery charges only, but if I choose I may return them express collect. If after 10 days' use I prefer to keep them, I will send you \$2 and pay the balance at the rate of only \$3 a month until \$24.80 has been paid. Include consulting service as offered above.

Name _____
Address _____
City _____ State _____

Please attach letter stating age, occupation, employer's name and address and name and address of at least one business man as reference. Men in service, also please give home address.

SAY YOU SAW IT IN POPULAR MECHANICS

STUDY AT HOME

With An Educational Institution

Men with specialized training win higher positions, insure larger earnings, and are bigger successes in business and public life. Opportunities **NOW** greater than ever before. Send for our Catalog.

ARTS and SCIENCES

Courses in Philosophy; Education; Letters; Public Health; Medical Jurisprudence; Psychology; Sociology; Physics; Chemistry; Plastics; Geology; Political Science; Theology; Business and Commerce; Accounting; Mathematics; Statistics; Agriculture.

ENGINEERING

Courses in Electrical, Civil Mechanical, Drafting, Architectural, Steam, Aeronautical, Radio, Structural, Mining, Industrial, Petroleum, Marine, Chemical, Diesel, Automobile, Refrigeration, and Air Conditioning Engineering.

LAW

Complete Professional Law Course includes 18 Hornbook Series college grade textbooks. Courses also in Commercial Law, Patent Law and Medical Jurisprudence:

McKinley-Roosevelt Incorporated, 4810-K, Sheridan Rd., Chicago 40, Ill.

LEARN WATCHMAKING JEWELRY REPAIRING

Start your training now for a better paying job or your own profitable business. Intensive practical training by experienced craftsman. Write for free catalog.

SCIENTIFIC SCHOOL OF WATCHMAKING, DEPT. PM-3
3923 SAN FERNANDO ROAD GLENDALE 4, CALIFORNIA



AJAX LIGHT BRAHMAS

WONDERLAY STRAIN Egg-show winners. Gigantic size. Quick growing. Heavy layers. Exceptional capons. Illinois-U. S. Approved-Pullorum Controlled. Thousands hatching weekly. Low farm prices. Catalog **FREE.** Write **TODAY.**
AJAX HATCHERY, BOX 434, QUINCY, ILLINOIS

PRACTICAL MATHEMATICS 4 BOOKS IN ONE! SAVE HALF PRICE!

Easy self-instruction in 25 branches by college experts—all in one volume! Helps you qualify for a better job. 1280 pages, 600 illustrations. Sent for free trial. Only \$1.00 down, \$1.00 a month; total \$4.95 plus postage. (Cash price \$5.00 postpaid) 160-page Logarithm book free with order. National Educational Alliance, Inc., Dept. 563, 37 West 47th St., New York 19, N. Y.

For Greater Income

LEARN A TRADE



- ✓ Auto Mechanics
- ✓ Body-Fender Repair
- ✓ Diesel Engines
- ✓ Building Construction
- ✓ Refrigeration Air Conditioning
- ✓ Electricity Electronics
- ✓ Radio Servicing
- ✓ Television
- ✓ Drafting

The years ahead are going to be big. Grow with them. Prepare now to get into a great, growing industry. Train with C.T.I.—a Nationally Known School. Get the benefits of our efficient Placement Service whether you want a better job or business of your own. You can come directly to our big, well equipped shops, located only a block from the shores of Lake Michigan—or you can begin your training at home by C.T.I.'s **SHOP-PROVED HOME TRAINING METHODS.** Fill out coupon—mail it today for big, illustrated **FREE** booklet.

FILL OUT · CUT OUT · MAIL TODAY!

FACTS FREE FOR MEN WHO WANT TO GET AHEAD

COMMERCIAL TRADES INSTITUTE, Dept. E2-3
1400 W. Greenleaf, Chicago 26, Ill.

Send free illustrated Brochures and other information about the field I have checked below.

- | | | |
|--|--------------------------------------|---|
| <input type="checkbox"/> Body and Fender Repairing | <input type="checkbox"/> Radio | <input type="checkbox"/> Building |
| <input type="checkbox"/> Automotive Mechanics | <input type="checkbox"/> Television | <input type="checkbox"/> Drafting |
| <input type="checkbox"/> Diesel Mechanics | <input type="checkbox"/> Electricity | <input type="checkbox"/> Refrigeration and Air Conditioning |

Name _____

Address _____

City _____ State _____

Veteran Non-Veteran



VETERANS!

C.T.I. courses are approved under the G.I. Bill. Just Mail Coupon, we will handle all details. (Low tuition, easy terms if you are not a veteran.)



Commercial Trades Institute

Dept. E2-3
1400 W. GREENLEAF
CHICAGO 26, ILL.

Plastic Coasters
and Tiles

EMBED REAL FLOWERS in NEW Magic PLASTIC

Now, create many unusual things like the distinctive pansy coaster shown—made by embedding real pansies in Castolite—the "magic" liquid plastic that "pours cold like honey . . . sets like glass" . . . at room temperature. Comes crystal clear or may be dyed for brilliant color effects. Embed other flowers, too, also coins, butterflies, medals, favorite photos, etc. Make really different jewelry, candlesticks, picture frames for gifts or to sell.

POUR GORGEOUS BOOKENDS

Castolite makes it easy to cast exquisite bookends like the one shown. Make copy duplicates of hundreds of art objects, figurines, etc. No special training needed. With new, easy-to-use Castomold you make your own molds in minutes. Use only home utensils. Follow simple step-by-step method. New pleasure, fine profits are possible.

MASTER KIT \$7.75 Postpaid.

SPECIAL KIT \$3.95 Postpaid.

At your dealer. If he can't supply you, send check or money order, or send 25c for exciting new Castolite Instruction Manual packed with 62 actual pictures showing how to get started immediately. Write today.

THE CASTOLITE CO.
Dept. C-1, Box 391
Woodstock, Ill.



Put your future
in your own hands

BE AN ARTIST

Here's the Amazing
Way We Teach You
Step-by-Step to Draw
At Home in Spare Time

Draw for money. Prepare yourself now for a fascinating, pleasant and profitable Art career. COMMERCIAL ART, DESIGNING, CARTOONING—all in one complete home study course. No previous art experience necessary. We teach you step-by-step and prepare you for good art jobs in advertising, newspaper and magazine publishing, department stores, printers, engravers, or in art studios, etc. You can become your own boss. For 35 years our graduates have been "making good"—WHY NOT YOU?

Trained Artists Are Capable of Earning
\$65, \$80 and MORE a WEEK

Write for FREE BOOK, "Art for Pleasure & Profit"—tells about our course, instruction service, material furnished, what our graduates say, and commercial opportunities for you. TWO ART OUTFITS and other features included with training.

Veterans! Course "G.I." Approved

FREE BOOK gives details!



Washington School of Art, Studio 123R
1115—15th St., N.W., Washington 5, D. C.

Please send me full information and your Free Book, "Art for Pleasure and Profit."

Name _____ AGE _____

Street _____

City _____ Zone _____ State _____

I am entitled to training under the GI Bill

CODE SPEED SHORT CUT

Be an expert. Learn to be a Telegraph or Radio Operator. Qualify for amateur or commercial license. Intensely interesting work—good pay. Learn at home or wherever you are, quickly, easily with the famous Candler Speed System. Book of particulars Free.

CANDLER SYSTEM CO., Dept. 5-C, Box 928, Denver 1, Colo., U.S.A.

EARN MONEY servicing STOVES and ranges. Set control accurately and rapidly. OVEN PYROMETER shows heat without opening oven door. Satisfaction guaranteed. \$2100 anteed. 3" scale. 0-750°F. Complete
ASSEMBLY PRODUCTS, INC. Chagrin Falls, Ohio

SAY YOU SAW IT IN POPULAR MECHANICS

AGENTS! Westinghouse

Gives Fluorescent Sales a Tremendous
Upward Spurt With New Circl-Arc Lamps

RUSH NAME for
FREE Selling
Outfit



One of many fast selling combinations of straight and half circle tubes.

BRAND new—Cash in quick and big on tremendous demand for Fluorescent Fixtures with the sensational new WESTINGHOUSE Circl-Arc Lamp. Half circles of brilliant, economical, beautiful Fluorescent Light. Nothing like them ever shown before. Old-style straight tube fluorescents can be bought anywhere, but you'll be FIRST with WESTINGHOUSE Circl-Arc—the biggest lighting scoop in history. New buyers—new profits waiting everywhere!

FREE Send Name on Penny Post Card for Complete Selling Outfit showing more than 100 Different Fixtures. Rush name today—have profits next week.

MAXILUME CO.

125 W. Hubbard St., Dept. 83, Chicago 10, Illinois

SCORES OF NEW MODERN
DESIGNS SELL ON SIGHT



NOW AT MY RISK!

I want you to read the
WARNER SUCCESS PLAN



It shows you how to... **METALIZE BABY SHOES** AND OTHER KEEPSAKES

- how you can start in spare time with your home as headquarters.
- how to build—step by step—to big profits and personal independence.

This is the famous Warner Success Plan—the Plan for Personal Success in your own fascinating business that many men, married couples credit with freeing them from the limits of a pay check and from the drudgery of a time clock.

It gives the exact step by step instructions for starting a business in spare time—without risking the job or steady pay. It shows with pictures, photographs, and drawings exactly how to Metalize Baby Shoes and other keepsakes. It shows how to get the orders coming in—how to expand—how to get others working for you—how to be SURE of at least twice your present pay before you give up your job for a life of personal independence.

15 Million Prospects

There are 15 MILLION pair of Baby Shoes in the country right now ready to be Metalized. Last year alone, more than THREE MILLION more babies were born.

There's not one of these mothers who doesn't want her baby's first shoes preserved forever. The Business is tremendous... and never ending.

The Warner Success Plan shows you how to turn this exciting opportunity into cash. Shows exactly how to prepare the shoes, how to put on them a coating of genuine gold, silver, or bronze metal by simple Warner Electroplating process. Shows how to get the business coming in, how to start in spare time, how to pyramid profits. Shows you how the whole family can have fun while building for an independent future. My own Shop here in Chicago does a Big Business by the very secrets I will now unfold to you.

Read The True Facts

Don't say "Yes" now. You must have ALL THE FACTS. Then decide. First, I want you to read the entire Plan—at my risk. After investigating—after discussing it with your family—then and only then do you decide whether to use the plan and make the small investment necessary to start.

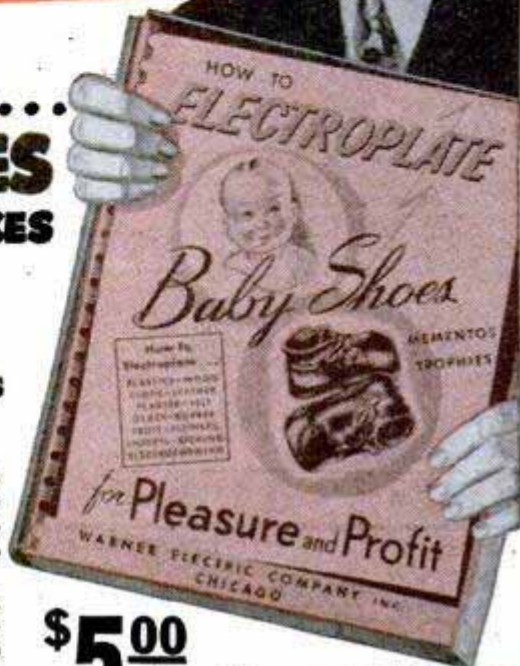

\$5⁰⁰ An Hour PROFIT

Yes, even in spare time it is possible for a man to finish enough work to pay \$5.00 an hour for his time. Think what this can pyramid into when the family helps.

3c MAY START A FORTUNE

Today I want you to do only one thing. Send the coupon. Let me give you all the facts. Remember, what I send you does not cost you a cent beyond the postage you put on your letter to me. With an opportunity like this, a man who has a serious interest in his future MUST investigate. MAIL THE COUPON TODAY and see for yourself why so many families have called the WARNER SUCCESS PLAN a "godsend".

**DON'T SEND A PENNY
JUST MAIL THIS COUPON TODAY!**

Raymond E. Brandell, Mgr., WARNER ELECTRIC CO.
1512 Jarvis Ave., Dept. 33, Chicago 26, Ill.

As long as it doesn't cost me a cent, I'm willing to read the facts, investigate, then give you my decision. Send the facts by next mail. No cost to me now or at any other time.

NAME _____

ADDRESS _____

CITY _____ Zone _____ STATE _____

MAKE 12 TIMES YOUR MATERIAL COSTS

Remember, the Warner Process is not a cheap imitation "PAINT" process. It is the genuine METALIZING through real Electroplating. And in spite of being the best, your materials cost so little that your profits are 12 Times your material cost. Then, when mothers order the shoes mounted as book-ends, as pictures, as ash-trays or pen sets, you make the BIG EXTRA PROFITS on the beautiful mounts.

WARNER-ELECTRIC CO.
1512 Jarvis Avenue
DEPT. 33
Chicago 26, Illinois



WE SUPPLY ALL MATERIALS

You don't have to go "hunting" when Warner is behind you. We supply all materials, all mounts, chemicals, and metals. And you get the low prices made possible by our big quantity purchases and our own manufacture. You send for just what you need and never have any big investment tied up in stock.

**WORLD'S
BEST
WANT AD
MEDIUM**

CLASSIFIED Advertisements



Advertisements in this section 75 cents per word, each insertion, minimum 10 words, payable in advance
To be inserted under proper classification, copy must be in our office the 22nd of the
second month preceding date of issue

F. W. Johnson, Manager, Classified Advertising
Popular Mechanics Magazine, 200 East Ontario Street, Chicago 11, Illinois

1194

**CLASSIFIED
ADVERTISEMENTS**

1194

**OPPORTUNITIES
FOR YOU**

AUTOMOBILES, MIDGET CARS

WE Sell direct to customers over 200 speed equipment parts manufactured by us. Ford A-B- V8-6-4- (Ferguson), Studebaker Champion, Chevrolets and Willys. Cylinder heads, dual intake manifolds, lynch flywheels, oversize valves, compound springs, camshafts and other supplies. Complete engines ready for race for cars, boats and midgets. \$1.00 to cover illustrated literature and price sheet. R & R Mig. Co., Robert M. Roof, Box 546, Anderson, Indiana.

"SPEED And Power" Handbook—Very latest methods! Build your own dual manifolds, "superchargers," water injectors, hi-compression heads, fuel saving devices—easily. Save many dollars! Get racing speed, acceleration, dynamic power increases from any automobile! Build fast stock cars! California roadsters! Hotrods! Get ingenious formulas! Speed secrets! Illustrations! Conversion ideas! Also "Economy Information"—mileage tricks! Tuning techniques! Picture catalogues. Including "California Restyling Ideas"—glossy photographs! Drawings! Model revising! Customizing! Streamlining! \$1.98 complete. Newhouse Automotive Industries, 5941-B2 Hereford, Los Angeles 22.

CUSTOMIZE Your car! Authentic California restyling plans galore! Working sketches, specific model changes. Comprehensive! complete! 130 photographs! Largest, finest or refund! Includes accessory catalog! \$2 postpaid. Post Publications, Box 723-ME, Arcadia, California.

MODEL "A" and "T" Ford book. 572 pages, complete information repairing, maintenance, servicing both models and Fordson tractor. \$3.50. Model "A" book only \$1.00 postpaid. Clymer, Dept. A-ATA, 1268 So. Alvarado, Los Angeles 6, Calif.

CALIFORNIA Custom styling headquarters. Buy direct from original designers and save. Solid hood sides, lowering kits, grille panels, fender skirts, dual pipes, speed equipment, chrome motor accessories. 24 page picture catalogue with scores of beautifying accessories—25c. Eastern Auto Supply, 3319A South Grand, Los Angeles 7, California.

PHOTOGRAPHS, World's finest automobiles. List, sample, 10c. Box 1028, Minneapolis, Minnesota.

HIGH Compression heads. V-8. More speed, acceleration, power. Offenhauser or Edlebrock \$75.00 complete set. Dual manifolds complete with throttle kit, fuel lines. Edlebrock \$49.00, Offenhauser \$55.00. Give make, model V-8. Catalog 10c. Clymer, Dept. A-33, 1268 So. Alvarado, Los Angeles 6, Calif.

RACE Car photos, 1000 different, catalog. Sample 25c. Smith, 17 Watson St., Paterson, New Jersey.

SEE—Our ad under motorscooters for midget car bargains. Midget Motors Directory, Athens, Ohio.

CLYMER'S 1948 Indianapolis race year book. Complete information, 100 photographs, charts, drawings, cartoons. \$1.50. DeLuxe Fabrikoid bound \$2.50 postpaid. Clymer, Dept. A-548, 1268 So. Alvarado, Los Angeles 6, Calif.

"SUPERCHARGER" Needle valve—Increases speed, power, pep! Starting! 10% more mileage guaranteed! Free trial! Quickly replaces idling jet. Specify car. \$1.50. (Eights take 2, sixes 1). Almqvist Engineering, Milford 58, Pennsylvania.

"VAPO-STEAMATIC" Water injection. Easily built (almost no cost). Finest automatic "moist-humidity" system. Engineering triumph—up to ten more miles per gallon! Tremendously increases horsepower! Eliminates ping, carbon, overheating. Reduces wear—lengthens engine life! Copyrighted "Installation Handbook"—including completely illustrated plans, diagrams, instructions. \$1.00 postpaid. Newhouse Automotive Industries, 5941-B1 Hereford, Los Angeles 22.

STOP-LIGHT Flasher \$3.00. Radio Roy, Box 2225, Portland 14, Oregon.

HOW To build racing car book. New revised, complete mechanical data, big cars, midgets, hotrods. 50 photos, drawings, charts. \$2.00 postpaid. Clymer, Dept. A-NRB, 1268 So. Alvarado, Los Angeles 6, Calif.

INTERESTED In automobiles? Send for free sample copy. Franson's Weekly Motor News, Box 254, Eugene, Oregon.

"SPEED & Mileage" manual—(new, revised!) Easily obtain greater speed, mileage, racing performance from any automobile! Famous original book shows soup up methods; speed tuning; mileage secrets; speed equipment plans; "customizing ideas"! Photographs! Complete instructions on building inexpensive power equipment! Economizers! Superchargers! Manifolds! "Water injectors"! Mufflers! Fast conversions! "Hot rods"! Custom sports cars! All about engines, "Economy Tuning," compression, fuels, trials, "racing tricks"! Latest "Hollywood stylizing"! Streamlining! Sport changes! Simple conversions! California roadster plans! Parts lists! Speed catalogues! "Beautiful pictorial supplement"! Folios! 125 illustrations! Working diagrams! Complete data! Everything \$1.98. Almqvist Engineering, Milford 58, Pennsylvania.

POUNDEN-GERDE V8 Magnetos for racing and industry. \$100.00. Photo 25c. Pounden, 336 West F Street, San Diego.

FORD Speed Manual just off the press! Guaranteed finest speed manual you can buy! This book contains the information you need to hotrod any Ford V-8, Mercury, Ford Six, Model A, Lincoln-Zephyr. Filled with photographs. Cutaway drawings by Medley explaining installation of hydraulic brakes on any year Ford. How to install V-8 engine in Model A. All expert, proven data which you can use! California Bill, Box L-1, Eaglerock, Los Angeles 41, Calif.

STEAM Automobile books. Clymer's Steam Scrapbook 224 pages, 100 steam cars illustrated, described, \$2.00. Modern Steam Car Book. Original catalog reprints. Stanley, White, Doble \$1.00 each postpaid. Specify title wanted. Clymer, Dept. A-SS, 1268 So. Alvarado, Los Angeles 6, Calif.

CARBURETION For car owners. New simplified illustrated pamphlet shows the way to better mileage, performance. Stop stalling, flooding with simple home adjustments. \$1.00. Carburetor Specialist, 501 N. Parramore St., Orlando, Fla.

FORD Owners and mechanics, we supply several simple replacement parts making Ford and Mercury brakes free floating, super powerful with soft pedal; eliminating squeal, chatter and groan—\$4.25-\$6.90. Expanders stopping piston slap and oil trouble—35c. All models. 1928-1948. Easily installed by yourself. Write for details. Super Brake-Floater Company, 4022 West Lake Street, Chicago 24, Illinois.

FAMOUS Car catalog reprints. 1949 Alfa-Romeo, 1949 German Volkswagen, 1949 Italian Maserati racing and new sport car, 1949 rear-engined Isotta-Fraschini V-8, Rolls-Royce "Silver Wraith," Duesenberg supercharged, Mercedes-Benz, Miller race cars, Cord, Rayfield Cyclecar, V-8 Chevrolet, Stanley Steamer, Doble Steamer, 1916 Metz friction driven, 1912 Ford. Specify catalog desired. \$1.00 each postpaid. Clymer, Dept. A-3X, 1268 So. Alvarado, Los Angeles 6, Calif.

CHEVROLET Speed Manual for Chevrolet owners desiring real hotrod performance from their 1937 to 1948 Chevrolets. Filled with photographs, complete information, proven methods. How to make your road car capable of 100 mph plus! How to build Chevrolet hotrod engines for road, track, or marine use. California Bill, Box L-1, Eaglerock, Los Angeles 41, Calif.

CLYMER'S Test reports on post-war Kaiser-Frazer, Studebaker, 1949 Ford, 1949 Mercury, gives impartial, uncensored report 3000-mile economy, speed, record tests. Part-by-part equipment analysis. 3000 owner tabulations in each book. 200 owner letters. Good, bad comments about each make, no punches pulled. Learn the truth. Specify make car interested in. \$1.50 postpaid. Clymer, Dept. A-TR, 1268 So. Alvarado, Los Angeles 6, Calif.

1949 CUSTOMIZING Manual—Shows how to easily make your car look beautifully custom! Latest restyling, streamlining, customizing methods! Hollywood sport changes! Fast model conversions! Scores of photographs, illustrations, drawings! "Hop-up" specifications. Complete restyling information. (Including custom car catalog and amateur's "Idea Starter" kit.) Everything \$2. Almqvist Engineering, Milford 58, Pennsylvania.

CLYMER Crash helmet. Finest model with visor \$25.00. Catalog free. Clymer, Dept. A-CH, 1268 So. Alvarado, Los Angeles 6, Calif.

SPEED Equipment bargains! "California" mufflers \$4.50, duals \$17.50, racing heads \$29.00, dual manifolds \$9.95, water injectors \$4.95, chrome echo cans \$1.65, supercharger stacks \$2.98, lowering kits \$2.95, chrome strips 90c, others! Illustrated "Handbook-Catalog" 25c. Almqvist Engineering, Milford 58, Pennsylvania.

CLYMERTONE, Twin muffler sets, beautiful sound, complete with necessary welded pipes, E-Z installation. Ford V-8, \$20.00. Chevrolet set with split manifolds, \$37.50. Specify car model. Clymer, Dept. A-34, 1268 So. Alvarado, Los Angeles 6, Calif.

MAKE Your car go! Hot-Rod Manual \$1.50. Speed parts list 25c. Hot-Rod, Box 9626PM, Hollywood 27, Calif.

OUTBOARD Motorboating Handbook. 252 pages. 89 charts, drawings. Complete service information every make outboard. Greatest outboard book ever. Just published. \$3.50 postpaid. Clymer, Dept. A-OM, 1268 So. Alvarado, Los Angeles 6, Calif.

AUTOMOBILE Racing book, fifth edition, well illustrated. Instructions on building bodies, frames, engines. Ford A and B conversions. Plans. AAA rules, specifications. Roadster racing. Indianapolis cars. \$1.00 postpaid. \$1.30 C.O.D. Ray Kuns, Dept. 47, Madisonville, Cincinnati 27, Ohio.

INTERCHANGEABLE Parts book. New book tells every automobile part that interchanges with others. Same parts many times vary 100% in price. This book enables garages, mechanics, dealers, owners to buy under cheapest listing. Tremendous savings for users. \$15.50 postpaid. Clymer, Dept. A-IP, 1268 So. Alvarado, Los Angeles 6, Calif.

DUALTONE Crystalline packed California mufflers for all automobiles. Large chrome tailpipe extensions. Chromed carburetors, fuel pumps, long shackles, dual manifolds, hi-compression heads, flywheels, camshafts, fender skirts, plexitops. Send 20c illustrated catalogue, deduct from first order. Streamlining Manual \$2.00. Dualtone Mufflers, 2636C India Street, San Diego 1, Calif.

FROM Speedway to roadway! Track-proved hi-speed heads and manifolds now available for your passenger car! No special tools needed! Increase horsepower 25%! Astounding getaway! Free illustrated catalog. Speedsport, 6215AA Diversey, Chicago 39.

NEW Hot rod book. Revised 1946-47-48 cars. 125 photographs, descriptions, California Dry Lake speed records. \$1.50 postpaid. Clymer, Dept. A-3NV, 1268 So. Alvarado, Los Angeles 6, Calif.

AUTOMOBILE Racing, Sixth Edition. 100 illustrations. Working drawings with building-instructions for Ford-60 midget, California roadster, Offenhauser racer. Details on racer parts. Sample entrance blank. World's record 158.5 m.p.h. rear engine four-wheel drive car. Interesting information for fans, drivers, mechanics. \$2.00 postpaid; \$2.25 c.o.d. Ray Kuns, Department 63, Cincinnati 27, Ohio.

AUTO SUPPLIES AND EQUIPMENT

SPEEDOMETER Repair or exchange, \$7.50. Guaranteed. Give car model and year. Send to Speedometer Service, 917 Ogden Avenue, Downers Grove, Illinois.

MAGNETIC Plug removes abrasive steel grit from crankcase. Only 75c. Specify car. Free literature. Jacques, Rumson, N. J.

WIZCURBS Easily installed on front and rear fenders warn driver of curbs before damage to tires and fenders. Pair \$1.00 postpaid. Ferco Mfg. Co., Vineland, New Jersey.

AUTOMOBILE Shatterproof glass! Direct factory savings! Write requirements. Cooper's, 3135 Lawrence, Chicago 25.

PATENTED—Lachapelle's motor and motor fuel treatment gives more miles per gallon, more miles per motor. 100,000 miles treatment for \$3.00 postpaid. Ferns Products, 8120 Walnut Dr., Los Angeles 1, Calif.

"SMOKO" Generates fantastic smoke screens! Free information! Smoko Engineering Company, Huntington 4, Indiana.

SAF-T-CAR-BLOCK. New sensational invention prevent slipping or rolling when used with bumper jack. Never wears out. Never fails. Safety necessity. \$2.50. Agents wanted. Morgan Research Company, Box 239, Marietta, Ohio.

MOTORISTS Save gasoline by Vacuumating overrich mixtures. Fits all cars. For free particulars write Vacuumatic, Dept. 1476, Wauwatosa, Wis.

POWER-TONE Mufflers for that power plus tone. Dual sets complete \$22.00 and \$23.00. Singles for all cars. Also new power dual intake manifold for Ford and Mercury. Many other items. Dealer inquiries invited. Power Engineering, Dept. PM-3, 4506-R Delmar, St. Louis, Mo.

HOLLYWOOD "Razz" horn. Humorous efficient signal with a smile. \$3.50. Ki-Yi barking dog horn \$3.50. Cadet Vacuum twin air horns, spun brass, chrome finish. Complete \$29.75 postpaid. E-Z installation any car. Clymer, Dept. A-KY, 1268 So. Alvarado, Los Angeles 6, Calif.

AMAZING Discovery prevents battery terminal corrosion. Saves batteries and cables. Install Armor Discs, 35c. K-L Supply, Grand Island, New York.

"AIRFLOW Needles." Save gasoline. Write for free trial! Neher Industries, LaVerne, Calif.

SAVE Gas. Instant starting with "Lek-tro" spark intensifier. Guaranteed. Only \$2.00. Specify car. Electronic Industries, Cleveland 11, Ohio.

SOLID Brass, two musical chimes. Foot operated. \$8.50. Bermuda Auto Bells, Dept. 23, 16 Concord St., West Hartford 7, Conn.

SMITHYS Mufflers for all cars. Free list. Bucks Auto Parts, 1296H, Merced 7, Calif.

NEED GI truck parts? We have all the parts for GI, GMC, Dodge, Chevrolet, Studebaker, Jeep, etc. At the best prices. Max Auto Parts, Dept. A, 531 Marietta St., Atlanta, Ga.

WELDING Bodies, blocks, repairing fenders, bumpers—easy with Hobart Welders. Low cost, adds dollars to your profits. Catalog free. Write Hobartweld, Box M-392, Troy, Ohio.

AUTO Parts for all cars, transmissions, motors, differentials, fenders, carburetors. Security Auto Parts, 1923-PM Grace, Chicago 13.

CHEVROLET Parts. Scarce motor, body, sheet metal parts. Grossman Chevrolet, Minneapolis, Minnesota.

HARD-TO-GET Auto body parts. We supply. Miller Auto Parts Service, 192 N. Clark Street, Chicago.

TIRE Mileage boosted. All pressures. Engineered economy. Free literature. Alto, 2319 Walnut, Texarkana, Texas.

PISTONS—American and foreign makes. M. Merryman Co., Lawndale, Calif.

BUICK Parts. We stock a complete line of new Buick parts and engines. Same day service on orders and inquiries. We ship anywhere. Write today. Robertson Buick Co., 1001 S. Wabash, Chicago 5, Ill.

"BUILD-UR-OWN" Welder. Portable. Hobart Welder plus auto engine saves \$350. Free instruction book. Write Hobartweld, Box M-393, Troy, Ohio.

AIR Horns—"Strombos" most powerful of all signals. Complete passenger car kits; all cars. Models available for boats, trucks, buses, and diesel locomotives. For the "right of way" right away! Buy Strombos. Illustrated bulletins on request. Strombos Company, 4525 Twelfth, Detroit 8, Michigan.

NEW And used automobile and truck parts. Lowest prices. Complete stock. Prompt reply. Babbitt Auto Parts, 2833 W. Chicago Ave., Chicago 22.

BRUSH Plating outfits connect to a battery. No tanks or shop required. Free particulars. Gunmetal Co., Avenue J, Decatur, Illinois.

AUTO Parts. Buy direct. Get dealers' prices. Represent us in your territory. Write requirements. Specify car make. Mechanics Auto Parts, Factory Warehouse, 3807-PM N. Ashland, Chicago 13.

AUTO TRAILERS

ACTUAL Photographs and plans for practical 12' camp and travel trailer \$1.00 plus Trailer Planner's Guide. Ed. Christensen, Box 687, Thief River Falls, Minn.

GENERAL Steel Products Corporation will license manufacturers and fabricators the rights in all states to manufacture and distribute to dealers, the new patented design "Nelson" utility safety trailer, 2908 Washington Ave., Santa Monica, California.

BUILD Your own trailer! Save money! Have every feature you want! Plans for house, sport, camp and utility trailers. Catalog describing 9 models 10c. 15c in Canada and overseas. Jim Dandy, Box 125-A, Wausau, Wisconsin.

MOTORCYCLES, BICYCLES, MOTORSCOOTERS AND SUPPLIES

CUSHMAN Motorscooter \$8, midget car \$25, motorbike \$10 less motors; motors \$3 up; Harley engine \$5; motorbike conversions \$5; midget racer and parts \$40. Winter special: Four balloon tires for motorscooters or midget cars \$3. Mailorder only. Over 6000 tires in stock. Plenty brand new Regal motorscooters less motors \$37.50, plenty new midget cars, engines, automatic clutches, transmissions etc., in stock at factory prices. Send 25c for Big War-Bargain Catalogue Number 29 just out listing these and almost 400 other bargains. (35c by first class mail). Midget Motors Directory, Athens, Ohio.

REVOLUTIONARY New Weber high-compression aluminum cylinder heads for Whizzer motorbikes and Cushman motorscooters. Increased power, greater economy, eliminates gasket troubles. Whizzer head \$5.95; Cushman head \$6.95. C.O.D. or cash with order. Dept. 1-49, Weber Tool Co., 4200 Whiteside, Los Angeles 33, California.

NEW Bicycles \$29.95. Wholesale. Retail. Bulletin 10c. Century Cycle, 3447 Lawrence, Chicago.

MOTORCYCLE Pistons and parts. New used. Harley, Indian, Henderson, Super-X. List 10c. Ballak, 811 N. 9th, St. Louis 1, Mo.

AIRCOOLED Engines, new or used, bought and sold. Details dime. Kenny's, Annandale, Minnesota.

DRI-SEAT. All weather, plastic bike saddle cover, fits all bikes. Red, blue 25c. Main Supply, Fairfield, Illinois.

GENUINE Motorcycle jackets of "super tough" black horsehide; zippers on sleeves and pockets; epaulets, nickel snap fasteners; adjustable waistbelt. Send your money, today. Jacket, postpaid, \$21.00. Devjackets, P. O. Box 3342, St. Paul 1, Minn.

EXCHANGE Your hard buddy seat for solid riding comfort. Allen, 106 Brook St., Elgin, Ill.

MOTOR Scooters, bicycle engines. 120 miles gallon. Dime for catalog. Clymer, Desk A-35, 1268 So. Alvarado, Los Angeles 6, Calif.

JET Propelled bicycle. Assemble your own. Photo and instructions \$1.00. Rush order. Maupin, Tipp City 5, Ohio.

HARLEY-DAVIDSON Parts, accessories, batteries, and tires. 24 hour service. Authorized factory dealer. Philadelphia Harley-Davidson Company, 857 North Broad Street, Philadelphia 23, Penna.

MOTORCYCLE Books. Complete servicing information all American motorcycles \$1.50. Triumph, Ariel, B.S.A., Norton, Villiers, \$1.50 each. Modern Motorcycle Mechanics large book all foreign, American makes \$3.95. How Obtain Speed \$1.50. How to Manage Motorcycles \$1.50. Catalog free. Clymer, Dept. A-MC, 1268 So. Alvarado, Los Angeles 6, Calif.

MOTORIZED Vehicle manual. Build scooters, midgets, conversion, water injections, trailer, air-cooling Ford motor, etc. \$1.00. Craftsmann Books, Box 1153, Milwaukee, Wis.

CUSHMAN Scooter \$35. Briggs motor \$18. Maytag motor \$15. Many more bargains in the Exchange Bulletin. Send 25c in coin, 35c first class mail. Behnk's, Dept. B, 5721 Leland, Chicago 30, Ill.

HIGHLY Polished motorcycle lapel pins. Harley, Indian, Norton, B.S.A., Sunbeam, Ariel, Triumph, Velocette. 75c each. Tie clasps \$1.00. Specify make wanted. Catalog free. Clymer, Dept. A-LP, 1268 So. Alvarado, Los Angeles 6, Calif.

WHIZZER Bike-motor \$25.00; Cushman motorscooter \$15.00; midget racer \$40.00; Shaw bicycle-motor \$15.00; Harley-Davidson motorcycle \$15.00; Smith motor-wheel \$25.00; Good motorscooter (twist grip) \$22.50. Rush 25c for new catalog #13 listing many other amazing bargains in motorscooters, used motors, midget cars, parts, wheels, etc. Gall, 538 Erie, Toledo, Ohio.

INDIAN And Harley parts catalog 25c. Pistons, motor parts, batteries, tires, chrome accessories. Bootz, 1700 East University, Des Moines 16, Iowa.

MOTORBIKE Outfit \$5.00; midget car (complete) \$35.00; Indian motorcycle \$30.00; Cushman motorscooter (complete with extra tire) \$20.00; 1946 Whizzer \$35.00; other motorscooters \$10.00 up; motors \$3.00 up. Send 25c for new catalog #942 listing many other sensational bargains in used motors, motorscooters, motorcycles, parts, etc. Associated, Box 1764-CS, Toledo, Ohio.

BICYCLE Supplies. Wholesale, retail list 10c. Universal, 4713 Virginia, St. Louis, Missouri.

MOTORSCOOTERS, New design, 6 big features. Literature 10c. Rollaway Motors, Lancaster, N. H.

MOTORCYCLE News, monthly. Yearly subscription \$1.00. Latest worldwide information. Sample 15c. Motorcycle News, 5424-A Sawyer, Chicago 25.

RECONDITIONED Motorcycles and motors. Chromium accessories. Complete stock Indian parts. Expert rebuilding. Fast service. Indian Motorcycle Sales, Kansas City 1, Mo.

COMPLETE One Stop Harley Davidson Sales Service, 813 Ohio Street, Wichita Falls, Texas.

HARLEY-DAVIDSON Parts, accessories, oil, expert service. Tires all sizes. Rebuilt 45" motors. Send \$2.25 for Army 45 Motorcycle Manual. 25c for accessory catalog and bulletins. Knuth's (Harley-Davidson Dealers), 2491 Fondulac, Milwaukee, Wis.

WHEELS! Build wagons, scooters, mowers, trailers, wheelbarrows, grocery carts, baby carts, play pens, baby carriages. 4" to 18". Free list. Trulsen Mfg. Co., 811 E. 31, Kansas City, Mo.

TIRES And industrial wheels, suitable for scooters, wheelbarrows, farm equipment, etc. All sizes. Bicycles and accessories. Largest assortment in America. Send dime for list. Cycle Transport Company, 1241 So. Michigan Ave., Chicago 5, Illinois.

AVIATION

DURALIUM SnowPlane skis—12"x96"—\$180.00. Complete fittings. Call Air, Afton, Wyoming.

PROPELLERS, Plans, for ice-snow sleds, air boats. Catalog 10c. Banks-Maxwell, Ft. Worth, Texas.

PROPELLERS—2-3 Blade for sleds, air-drive boats. Catalog. Standard Aero Craft, Box 387, Ft. Worth, Texas.

LIGHTPLANE Manuals, blueprints. Circular illustrating designs, motors 20c. Craftsman Books, Box 1153, Milwaukee 1, Wis.

BATTERIES, GENERATORS

SULPHATION Cause of 90% battery trouble. "Battery Magic" dissolves, prevents sulphation. Freezeproof. Harmless. Guaranteed! \$1 postpaid package treats 3 cell battery. Battery Magic, 225-A South 10th St., Minneapolis 1, Minnesota.

EDISON Non-Acid lifetime storage batteries for home lighting, motors, industrial uses, radios, etc. Free interesting literature. Hawley Smith Co., Croton Falls 1, N. Y.

ELECTRICAL SUPPLIES

LAMPS—If you build or repair and have had trouble getting parts, your search is ended! Speedy 24-hour service from most complete stock in country. Illustrated catalog 10c. Dealer—Send business card for quantity discount. Gyro Lamps, 54-02P Clark, Chicago 40.

ELECTRIC Pencil: Engraves all metals \$1.25. Beyer Mfg., 10511-H Springfield, Chicago 43.

LAMPS—Build own originals. Parts wholesale, any amounts. Catalogue 10c. Brown Lamp Co., Box 501, Wellston, St. Louis 12, Mo.

NEW Motors, General Electric, 1/2 \$12.50, others to 1 horsepower. Free literature. Plenge, 114 Elliot Place, Bronx 52, New York.

AMAZING Kit 300 different group connections 1-2-3 phase. Complete \$3.00. Motor Service, 262A Paterson Ave., Hasbrouck Heights, New Jersey.

FREE Catalog—Motors, welders, welding supplies, generators, home freezers, many other electrical bargains. LeJay Company, Minneapolis, Minnesota.

ELECTRICAL Supplies, lighting fixtures, lamp parts, wholesale prices, any amount, from manufacturer. Catalog 10c. Fidelity, Dept. "B," Box 368, Miami 3, Fla.

POCKET Tester—Check voltage from 100 to 550 a.c. or d.c., polarity, continuity, uses. Only 95c postpaid. Regency Sales Co., 5316 So. Justine St., Chicago 9, Ill.

BUY Lamp parts wholesale. Parts you need for building, repairing, or assembling. Save money on large or small orders. New catalog for 10c. Gearon Company, Dept. 300-B, 27 South Desplaines, Chicago, Illinois.

MAGNETS, Two Alnico (V) rods, booklet, circulars—25c. Terry Sales Company, Box 1014, Toledo 1, Ohio.

WELDING, SOLDERING, PLATING

ARC Welder, 110 volt. Build it yourself. No transformer to burn out. Welds 1/2" steel. Will use 5/32" rod. Very inexpensive. Send \$1.00 for full information to H. E. Younger, R.R. #8, North Kansas City 16, Missouri.

WELDING Outfits, new, popular brand, \$44.95 complete. Includes torch, tips, regulators, hose, goggles, lighter. General, 2106 N. Broadway, St. Louis, Mo.

"BUILD-UR-OWN Portable arc welder. Save \$350. Easy with Hobart generator plus auto engine. Free instruction book. Write Hobartweld, Box M-394, Troy, Ohio.

BUILD Your own d.c. arc welder. Up to 300 amperes. New design, made from surplus materials and aircraft generators supplied by us. Plans only 35c, including new catalog. LeJay Mfg. Co., 847 LeJay Bldg., Minneapolis 8, Minnesota.

ELECTROPLATING Units—Complete sets. Copper, nickel, cadmium \$1.50, silver \$2.00, gold \$4.50. Write for free literature. Regency Sales Co., 5316 So. Justine St., Chicago 9, Ill.

WELDING Schooling pays. GI approved. Finest equipped in U. S. Free catalog. Write Hobart Welding School, Box M-396, Troy, Ohio.

WELDERS For all requirements. Free catalog. Write Hobartweld, Box M-395, Troy, Ohio.

ONLY \$9.95—Newly invented four-way welder does brazing, soldering, welding and cutting. It's easily operated from any properly wired 110 volt a.c. or d.c. line. Saves time, money on auto, home appliance, farm and shop repairs. All supplies furnished including simplified instructions. Fully guaranteed. Order one today for 10 day trial or write for free particulars. Four-Way Welder Co., 3180 North Clark Street, Dept. PMC39, Chicago 14, Illinois.

OXY-ACETYLENE "Demurrage-free" Linde cylinders, Purox apparatus, Oxweld supplies, Metallmaster outfits, Miller electric hobby welders, approved fire extinguishers. Free literature. A-A Welding Supply Company, Dept. A, 9228 So. Ada St., Chicago 20, Ill.

RADIATOR Repairing, cleaning, re-coring. Our instructions tell how, how to equip a small shop at low cost, where to buy. Radiator Book, McBain, Michigan.

WELDER! New portable Champion Special transformer welder; 110/120 volts a.c. develops to 75 amps.; 9 heat stages. Welds, brazes, solders, cuts all metals. Easy to use. Simple instructions. Special flame weld torch free. Splendid for shop, farm, home repairs. Saves hundreds of dollars yearly. Only \$27.50. Also heavier models. 10 day free trial. Magic Welder Co., 239 MP Canal St., New York, N. Y.

WELDERS 110v. Welds 1/2" steel \$32.50. Morris Welding Service, 1850A State, Schenectady 4, N. Y.

BUY Direct from factory. Welding outfit, \$48.36. Soldering outfits \$7.76 to \$10.16 complete prepaid. Box 331, Hamilton, Ohio.

OWN Mirror shop. Resilver mirrors. Glass sign making. Electroplating. Supply prices. John Sprinkle, V55, Marion, Indiana.

RECTIFIERS; Ramy Selenium platers, 10, 30, 50, 100 amp. sizes. Immediate shipment. Complete line of bronze baby shoe mounts. Write for list. Hollywood Bronze Supply, 1770 N. Vermont, Hollywood 27, Calif.

MACHINERY, TOOLS, SUPPLIES

CHUCKS, (Genuine Westcott) Independent, Universal; threaded 1 1/2"-8 for South Bend, Atlas, Logan, Clausing, Craftsman lathes. Other chucks to 16". Top value. Tell us type and size chuck you want, make of your lathe and spindle nose dimensions so we can submit definite quotation and free literature. No obligation. Westcott Chuck Company, 3600 Walnut, Oneida, N. Y.

POWER Tools. Build your own with Lewis Castings. Save up to 80%! Complete castings, materials and blueprints supplied for 23 woodworking and metal-working tools. 32 page catalog 10c. Lewis Machine Tool Co., 3217 Union Pacific Avenue, Dept. M, Los Angeles 23, Calif.

ALL Sizes, types, descriptions of bolts, nuts and screws for industry, home and farm. In stock or machined to order. Specialists. Moran Standard Parts Co., 10305 Dequindre St., Detroit 12, Mich.

BAND-SAW For home workshop—Hobbyists. Special \$14.95. Equals high priced band saw. Circular free. Woodcraft Tools, Inc., 147 E. Lake, Minneapolis, Minn.

FIRE Extinguishers, C-O-2, \$3.82 up. Domonkos, 98-A3 Vermont, Newark 6, N. J. Agents wanted.

REAMERS Ground, 10c blade, plus postage. Frazer, Box 801, Santa Rosa, Calif.

POWER Tools, equipment wholesale prices. Free bulletin. Homcrafters Co-operative, Grand Rapids 6, Michigan.

BACK Geared metal and wood cutting 12" band saw, 6" jointer, ball bearing, 47" long. Ball bearing spindle shaper, 15" x 20" table, 8" tilting table, ball bearing, bench saw. Lowest priced line of high grade tools on market. Free catalog. Dealers wanted. Backus Machine Co., Boyd, Wisconsin.

SURPLUS Machinery, tools, etc. Rush name. Wayne Engineering, Elkins 1, W. Va.

A.C. Welders, power mowers. Wholesale, retail. Holgerson's Service, Canton, Kans.

ASSORTED To your order! Nuts, bolts, screws, etc. for every need. Rush postal, free bargain catalog. Scientific Assortments, 4554 Maplewood, Chicago 25, Ill.

PRECISION Tools, used: micrometers, verniers, gauges, dials, etc. bought sold, exchanged. Free list. Precision Exchange, 30 Church Street, New York 7, N. Y.

GAS Drive arc welders, "Build-ur-own" portable. Get profitable jobs anywhere. Save \$350 with Hobart generator plus auto engine. Free instruction book. Write Hobartweld, Box M-397, Troy, Ohio.

DADO Cutters for your saw machine. Do grooving, rabbeting, tenoning. Free circulars. Advance Mfg. Co., 2129 East Lake Street, Minneapolis 7, Minnesota.

"TIRES"—Save 1/3. New, rugged all purpose airplane tires, 10 inches to 56 inches high. Complete wheel assemblies attach easily to your axles. Free details. Write card today. Airplane Tire Co., Box 1201A, Tulare 1, California.

"LARGER Drill attachment." Drill to 1/2" with 1/4" electric drills. One and two speeds. \$7.50 and \$10.75. Literature. Palmer, 12 E. Holly, Pasadena 1, Calif.

DRILL Grinder for twist drills, \$2.95. See ad on page 283.

BENCH Saws, popular 8" size for home craftsmen, \$17.50. A. S. H., 2651 Cleveland, Westlawn, Penna.

CONCRETE Block machines from \$39.50. Catalog free. Concrete Machine Company, 5466 Gravois, St. Louis 16, Missouri.

HOME Lathe owners—Build your own attachments. Send for picture, sample of work and list of blueprints. Cut gears, ratchets, etc. Make neat screws easy way. The Home Shop, 415 Raymond Ave., Glendale 1, Calif.

BOOKS—All Kinds—Homecraft, Radio, Plastics, Boat Building, Photography, Model Building. Catalog free. Popular Mechanics Press, 200 E. Ontario St., Chicago 11, Ill.

BOATS, OUTBOARD MOTORS

SPORTSMEN! Make Kayak from economical, easy-construction kit! Literature. Dedham Kayaks, Dedham, Mass.

GOOD Used marine engines. Bargain catalog free. Lind Supply Company, Coldwater, Michigan.

NEPTUNE Outboard motors. Wholesale prices all sizes. Outboard Sales, 820 Dryades St., New Orleans, Louisiana.

KNOCK Down boat kits. Outboards, inboards, sail, racing, molded shapes. Easy to assemble, enjoyable, minimum cost. Illustrated catalog 25c. Brooks Boat Company, Carrollton P3, Michigan.

BUILD Flashlight battery powered model boat. Powerful motor, shaft, propeller, boat plans, \$2.50. Free details. Montague Electric, R-1, Montague, Michigan.

WANT Outboard motor 10 to 24 horsepower. Wesley Allen, Windsor, Mo.

BOAT Plans, kits—Hardware, conversions, plywood. See Marine Mart display ad page 297.

BOAT Plans: Wood; steel. Book, "Modern Designs for Boats and Yachts." \$1.00. John B. Clark, Yacht Designer, 329 Kenmore Drive, Bay Village, Ohio.

STEERING Wheels, windshield brackets, from \$6.95. Modern fittings, lowest prices, also complete pre-cut plywood boats. Bargains-galore. Folder 10c. Marine, Box 681, Mendota, Minnesota.

BUILD Marine motors, Ford or Jeep. Federal Marine Motors, 9011 Cottage Grove, Chicago 19, Ill.

P-38 BELLY Tanks. New, steel, 10 foot or 6 foot size, \$9.95. Anzio Boat Company, 89H, Merced 9, Calif.

TWENTY Plywood boat plans \$1.00. Catalog boat building plans 10c. The Rudder, 15 Murray Street, New York 7.

NEW, Used, rebuilt marine motors. Marine conversions, fittings. Free catalog. Stokes Marine Supply, Dept. 24, Coldwater, Michigan.

BOATS And all about them. How to select, build, repair and operate. For 40 years the leading practical boating magazine. Half price trial subscription, 12 issues for \$1.00. Motor Boat, 62 Gold Street, New York 7.

BUILD Your own boat by the Welch System, ready cut parts. No experience necessary. Save 2/3 cost. Rowboats to cruisers. Illustrated catalog 25c. Midwest Boat Company, Menomonee Falls, Wis.

OUTBOARD Motors—Good values, used motors. Also used parts for most makes and models. Crandall-Hicks Co., 911 Commonwealth, Boston, Mass.

MARINE Conversions for Ford and Jeep engines. Catalog 10c. Lehman Manufacturing Company, Department D, Newark 2, New Jersey.

COMPLETE Constructional details on seventeen low-cost boats—power, sail, row. Designed for home builder with limited tools, no experience and little money to spend \$1.25. Popular Mechanics Press, (C-43), 200 E. Ontario, Chicago.

ENGINES, MOTORS, DYNAMOS

CLOSE-OUT Sale. Less than factory cost. Nationally advertised new 1 h.p. gasoline engines. Never unpacked. Regular \$59.95 value for \$27.50 f.o.b. Motorize your lawn-mower, saw, pump jack, garden spray, etc., at low cost. Limited supply. Send cash, money order or c.o.d. Box 61, Acton, Ind.

ELECTRICAL Repair men, send for literature on Motor Winding tester and a.c. motor winder. Motor Industries, Quincy, Illinois.

FOR Sale. 5 Diesel-powered d.c. generating units powered by 6-cylinder General Motors 90 h.p. motors driving 60 kilowatt, 3 phase, 220-volt generating units. Originally made for U. S. navy with heat exchangers instead of radiators. Have had little use as standby emergency equipment. Original investment \$6,000 each. Send offers to Paul H. Dunakin, General Manager, Popular Mechanics Company, 200 E. Ontario, Chicago.

WELDING Generators, 150 ampere \$47.50. $\frac{1}{2}$ horse, 1750 r.p.m. motors \$19.75. $\frac{3}{4}$ horse, 3450 r.p.m. \$22.50. Compressors \$17.50. Butler, 1885 Milwaukee, Chicago.

MOTORS! $\frac{1}{2}$ H.P. D.C. converted to A.C. All new. High speed 110 volt, 25 or 60 cycle, ball bearing motors. Actual value about \$75.00. Now \$15.00 each or 3 for \$40.00. Countless uses for home mechanics. Can be used in any position. Order today! Immediate delivery! No c.o.d. orders. "Amazing Bachman's," 27 Herman Street, Rochester 5, New York.

WINDING Data, listing 225 motors, single and three phase, \$1.00. Motor Data Co., Box 7631, Kansas City 3, Mo.

ATHLETIC EQUIPMENT, BODY BUILDING COURSES

BIG Bargains, 12 courses \$1.00. News 10c. Sid's System, Southgate, California.

BARBELLS—Finest quality \$8.98 and up. Free catalog. Lurie Barbell Co., 1729-M Rockaway Parkway, Brooklyn, N. Y.

BARBELLS, Exercise equipment. Courses. Free booklet. Good Barbell Co., Reading, Penna.

DEADLY Judo—Fiercest fighting technique. Trick knockouts. (200 photographs, plus illustrations.) Expert instructions, three volumes. Complete \$2.25. Variety House, Box 46-B, Wall Station, New York 5.

SPORTING GOODS, GUNS, FISHING TACKLE, ARCHERY, TRAPPING

AMAZING New telescopic casting rod. 5 feet. Parts slide into handle 11 inches. Fits your pocket. Literature free. Rice & Rice, Box 566A, Muskegon, Mich.

ARROW Kit to make 12 arrows—contains cedar shafts, target points, nocks, feathers, glue. Boxed \$2.25 in U.S.A. Fisher-Smith Archery, 710 E. Mulberry, Bryan, Ohio.

SEND A dime for "flashy" trout, perch or crappie spinner and catalog. Murray's, Auburn, Maine.

NYLON Fishing lines, braided, 200' 20 lb. test \$1.00; 175' 35 lb. test \$1.00. Longer lengths available. Macmillan, Pleasant Valley, N. Y.

JOINTED Cane fishing pole \$1.95. Many fishing items. Dealer discounts. Bob Pace, Combs, Ark.

ARCHERY Catalog 50c. Finished equipment or materials to make your own. Gassman's, 1724 Fredericksburg Road, PM, San Antonio, Texas.

MOSSBERG Bolt, 22 repeater \$28.60; Taylor barometers \$10.00; surplus sextants \$12.50; binoculars (new) 7 x 50 \$67.50; dealers wanted. (Free catalog). Pan American Navigation Service, 12021-6 Ventura Blvd., North Hollywood, Calif.

5000 BARGAINS, Firearms, binoculars, war relics. Catalog 40c. Smith Firearms, Runnemed, New Jersey.

FIREARMS—Ammunition. Complete list postpaid 25c. Frank Parish, Vicksburg, Miss.

AMMUNITION—175 Sizes in stock. American, foreign. Dime for list. Central Sports, Delphos 5, Ohio.

ANGLERS' Almanac tells you when, where, how. Answers more questions on fishing than any other book. Only \$1 at your dealer or Anglers' Almanac, Dept. CC-16, 350 Broadway, New York 13, N. Y.

BASEBALL Uniforms: Team mgrs., buy direct and save. These big league cut, large roomy uniforms are quality tailored of sturdy, Cricket cloth. \$11.95 value—our price \$6.95. Jr. league size \$5.75. 10 letters sewn on free. Write for illustrated catalog and fabric samples. Equal savings on all other baseball equipment. Bacharach-Rasin Co., Dept. 33, 14 N. Howard St., Baltimore 1, Md.

FLYTYING Materials. Free catalog. Cunningham, P44, Sunnyside P.O., Long Island City 4, N. Y.

SHOTGUNS—Richardson R-5, single barrel, 37 inches long. Weight, 5 $\frac{3}{4}$ lbs. Price, \$14.95 each. Cameo, 432 West 42d, New York.

NEW Rifle scopes, mounts, binoculars. Weaver K4 \$36.50, J4 \$23.50. Binoculars—New 6x30 M3 army coated \$43.50 plus tax. Bargain list. Stan Wentling, Palmyra, Penna.

SEND 10c For list 100 used guns. Frayseth's, Willmar, Minn.

PISTOLS, Revolvers, rifles, shotguns, ammunition. List 25c. Frank Parish, Vicksburg, Mississippi.

SPORTSMEN, Get our new 1949 catalog. 32 pages packed with sporting goods. Send 25c, which we refund on \$1.00 order. Midwest Sporting Goods, Palace Building, Minneapolis, Minn.

SURPLUS Camping supplies. Bargains. Free catalog. R. McManus, Cuttingsville 4, Vt.

SHOTGUNS, Rifles, revolvers, over 500 modern, obsolete. Also cartridges, list 10c coin. Ed Howe, 52 Main, Coopers Mills, Maine.

MOLDS For fishermen's sinkers, squids, and jigs. Sweet's Molds, Tonawanda, N. Y.

BINOCULARS, TELESCOPES, MICROSCOPES, MAGNIFIERS

NEW Lightweight binoculars. Coated optics! 6 x 30 U. S. army M3-\$48.95. 6 x 30 Bausch and Lomb, U. S. navy-\$65.00. 7 x 50 U. S. navy M32-\$78.00. 8 x 30 Carl Zeiss-\$98.00. Add 20% tax. Lifetime written guarantee. United, 7941 S. Halsted, Dept. ARC-1108, Chicago 20.

NEW Binoculars. Introductory offer Zeiss type 6x25-\$23.35; 8x30-\$30.00; 7x50-\$40.00 with case, straps. Money back guarantee. Bushnell Importers, 672 S. Lafayette Park, Los Angeles 5.

BINOCULARS, Telescopes, watches, guns. Buy, sell, trade. Schweer's, Donnellson, Iowa.

REFLECTING Telescopes, 60X, completely assembled \$25.00. Guaranteed observatory clearness. Free information. Skyscope, 475 Fifth Avenue, New York 17.

POWERFUL Astronomical telescopes easily made. Perfect lenses and instructions; 100X \$3.00, 100X and 200X \$4.00, 100X, 200X and 400X \$6.00. Clear vision, full power guaranteed. Instructions alone 10c. Suffolk Science Service, Manorville, N. Y.

ASTRONOMICAL Telescopes, binoculars, microscopes; bought, sold, repaired. Books. Lists 10c. Rasmussen-Reece, Amsterdam, N. Y.

TELESCOPES, Binoculars, microscopes, big bargain catalog free. Brownscope Company, 24 West 45th Street, New York.

GIANT Astronomical telescope 100 diameters magnification, with tripod. Full power, clear vision. \$15.00. Suffolk Science Service, Manorville, N. Y.

DOGS, PETS, BIRDS, RABBITS

BEAUTIFUL Collie puppies, males \$12, females \$8. Will ship c.o.d. Norbert Gonerling, R. 1, Kaukauna, Wis.

RAISE Giant Chinchilla rabbits. Tremendous profits from gorgeous furs, delicious meat. Ideal business. Chinchilla Rabbitry, Box 142, Fairmont 25, West Virginia.

RAISE Chinchilla rabbits. Year-round money-makers from furs, meat, breeders. Experience unnecessary. Write today. Willow Farm, Sellersville 15, Penna.

MAKE Extra cash. Raise Giant Chinchilla rabbits. Waters Rabbit Farm, Glennville, Ga.

\$3000 YEARLY Raising Angoras. Circular free. Vaughn's Rabbitry, Otley, Iowa.

\$400 MONTHLY Raising Angora rabbits. Wool \$9 pound. Plenty markets. Details free. White's Rabbitry, Newark, Ohio.

\$300 MONTHLY Raising Angoras for our market. Particulars free. Associated Breeders, 610 Marshall, St. Paul, Minn.

RAISE Rabbits. Market provided. Illustrated booklet, 25c; with hutch plans, \$1.00. Hansen's Rabbit Institute, 1347 Miller Ave., Salt Lake City 6, Utah.

HOHL'S Hamsters. Clean, odorless pets. \$4.50 pair. Literature, picture free. Lab. stock. 317 Mt. Vernon Rd., Newark, Ohio.

SEE Gulf Hamstery ad on page 18. Shows picture of Hamster.

RAISE Guinea pigs. Make money at home. Big demand. Booklet free. Taylor, Box 426A, Hapeville, Georgia.

ANGORAS, Giant Chinchillas, White Giants. World's most profitable rabbits. Finest pedigree, heavy-producing, prize-winners. Literature free. Grinsteads, Edwardsville, Illinois.

RAISING Rabbits, Cavies, Hamsters, Chinchillas is profitable. Big demand. Instruction book and magazine 25c. Book and magazine (monthly) one year, \$1. Small Stock Farmer, Fairlawn 2, New Jersey.

MINK Raising information free. Complete. Lake Superior Mink Farm, Superior, EEL, Wisconsin.

MINK Raising amazingly profitable. Free folder gives inside "secrets" on feed; care. Lawrence Moigard, Brigham City 12, Utah.

INCREASE Your income by raising domestic rabbits. Small space needed. Ready market for delicious meat, fur and wool. Largest magazine in the industry tells you how. \$1.50 per year. Sample 15 cents. No stamps. Small Stock Magazine, Lamoni 20, Iowa.

\$3000 YEARLY Raising Angora rabbits. We buy your output. Contract particulars free. Kise's Enterprises, St. Paul 8, Minn.

PLANTS, SEEDS, NURSERY AND GARDEN SUPPLIES

GINSENG, Goldenseal. Hundred seeds \$1.50; thousand \$5. Dozen plants \$1.50; hundred \$9. Growing-selling instructions included. F. M. Collins, Viola, Iowa.

CHRYSANTHEMUM Catalog free—All the better ones. Plenty bargain offers. Save. Send postal now. Wisehart Nursery, Dept. 14-1, Frankfort, Ohio.

RAISE Your own trees and shrubs from seed for shade, windbreak, erosion control, etc. Write for free planting guide and price list. Woodlot Seed Co., Norway 4, Michigan.

RAPE Seed, White Dutch and Alsike clover. North Idaho grown. Cheap prices, samples on request. Stellys Seed Cleaning, Gifford, Idaho.

FARMS, FARM LANDS, REAL ESTATE

\$5.00 MONTHLY Buys 40 acres near town; price \$200. Free list. Box 425-P, Carthage, Mo.

BIG Free spring catalog many states, some equipped, many illustrated. Write today! United Farm Agency, 1408-PM Consumers Bldg., Chicago 4, Ill.

CANADIAN Tax sale lands for two dollars an acre and up. Small monthly payments. Farms, timber, hunting and fishing camps, minerals. Limited number of properties. Write at once for free catalogue. Tax Sale Service, Room 105, 120 Bloor St., West, Toronto 5, Canada.

GOVERNMENT Lands \$2.00 acre up. Information all states twenty-five cents. National Tax Service, 901-A Majestic Bldg., Detroit.

STROUT'S Fall-Winter farm catalog—Free! Red cover. Chock-full of bargains coast-to-coast. Eppd. and uneqpd. farms, groves, retirement places, etc., etc. Write today for your free copy. Strout Realty, 255-P-4th Ave., New York 10, N. Y. 20 W. 9th St., Kansas City 6, Mo. 453 S. Spring, Los Angeles 13, Calif.

BIG Lists farms, ranches, water frontage properties. Free descriptive folders, prices. Splendid opportunities, Washington, Idaho, Montana, Dakotas, Upper Michigan, Wisconsin, Central Corn Belt. Information regarding Columbia and Missouri River Basin irrigation projects. L. H. Robbins, Milwaukee Railroad, 736K Union Station, Chicago 6, Illinois.

GOOD Farms—Ranches, Washington, Minnesota, Montana, Idaho, Oregon, North Dakota. Dependable crops, favorable climate. Write for literature, lists describing typical farm opportunities. Specify which state. J. W. Haw, 119 Northern Pacific Railway, St. Paul 1, Minn.

OZARK Magazine, Eureka Springs 11, Arkansas. For homeseekers, tourists. Year, \$1.50.

SOLD For taxes. Calif., Oregon, Washington timber, grazing, ranch and mining lands. 25c to \$3 acre min. bid. 10c (coin) brings circulars, photos, maps. Pacific Lands, Box 2350-PM, Hollywood, Calif.

LOTS \$300—Convenient payments. California's finest garden section. On Morro Bay's scenic shores. Wonderful fishing, hunting, boating, bathing. Fertile soil, softest water, temperate climate, congenial community. Free literature. Richard Otto, Department M, San Luis Obispo, California.

OSARK Lands for all purposes. Actual river frontages. 5 acres \$90.00 and upwards. Free list and literature. Hubbard, 424-I Minnesota Ave., Kansas City 4, Kansas.

POULTRY, FARM SUPPLIES

WHITE African guineas—Eggs, chicks, stock. Big profits. Illustrated catalogue free. Goshen Poultry Farm, Box A-24, Goshen, Indiana.

\$6.95 BUYS Smith money-maker chicks. Assortments. Purebreds. Bloodtested. Pedigree-sired sexed pullets, males, too. 100% live delivery. Catalog free. Smith Chickeries, Box 262-32, Mexico, Missouri.

RAISE Fryers new easy way. One man home plant earns \$500 monthly. Farm proven methods. Circular 10 free. Poultrymans Institute, 1046 So. Olive, Los Angeles 15, Calif.

BABY Chicks, champion mated. 52 varieties, 6 hybrids, licensed inspected, bloodtested. Rush postal, large colored book free, low prices. Berry's Farm, Route 12, Clarinda, Iowa.

FREE Information on how you can make up to \$5,000.00 raising broilers and fryers the newest way in your backyard or in your farm buildings. Write National Broiler Institute, Dept. 3, Versailles, Missouri.

YOU can make money from poultry this year! Future outlook excellent. Our experimental farm advice will help you. Subscribe today! \$1.00, two years. Poultry Tribune, Dept. 16, Mount Morris, Illinois.

EARN \$4 To \$12 hourly. Chick sexing, culling and caponizing. G.I. approved. Pilch's School, Box PM, Thompsonville, Connecticut.

KNOW How to raise poultry for profit. Read Northeastern Poultryman. Every issue packed with helpful hints and practical suggestions. Latest articles on breeding, feeding and management. Subscribe now. 1 year 65c. 2 years one dollar, foreign subscriptions \$1.00 a year. Northeastern Poultryman, Dept. P.M., 376 Boylston St., Boston 16, Mass.

RAISE Turkeys the new way. Write for free information explaining how to make up to \$3000.00 in your own backyard. Address National Turkey Institute, Dept. 3, Columbus, Kansas.

PROFITABLE OCCUPATIONS

YOU can make real money raising Golden Hamsters. New tiny animal. Easily raised at home. Write for details. Hudson Hamstery, R-1, Newfoundland 1, N. J.

WOULD You pay 3%—first \$350 made? Color-illustrated book "505 Odd, Successful Enterprises" free! Some offer occasional "day off." Work home. Expect something odd! Pacific, Oceanside, Calif.

WANTED—Purchasing agents. No money or experience required. Write Dept. C, Purchasing Manager, 2719 Lawrence, Chicago, Ill.

PROFITABLE Business making and building with easy-laying interlocking building blocks. Rex Products, Dept. 10, Piqua, Ohio.

GET Into photo offset printing. Big demand. uncrowded field. Learn at home. Build your own simple equipment. Write John L. Moon, Box 1775, Spokane, Wash.

LOCKSMITHING Secrets! Key fitting, lock repairing, opening; prices, sources. Illustrated book \$1.00. Wexler, 7 West 36, New York City.

FOREIGN Employment? Latest bulletin, overseas directory, application forms \$1.00. (c.o.d. \$1.32). Foreign Service Institute, POB 3934, Miami, Fla.

JUMBO Frog raising, profitable. Particulars 10c. Vol Brashears, Berryville, Ark.

CONSTRUCTION Report—Send \$1.00 for world wide job project listings. Up-to-minute-facts for construction men. Global Reports, P.O. Box 883-DX, Hollywood 28, Calif.

SOAP. Ten easy recipes \$1.00. Nunn, 659 E. Oxnard, California.

MUSHROOMS Grown, boxes, barrels, instructions 50c. Spawn \$1.00. Manureless process \$2.00. Gordons, 553 William, Winnipeg, Manitoba.

FREE Book "372 Unusual Worldwide Business Adventures!" Successful! Australia, Africa, South America, New Zealand! Work delightful, "different" plans home. Publishers-V, Carlsbad, Calif.

ELECTRIFY and convert sewing machines. Easy, profitable. Inquire Ray's Distributors, Dept. PM, 107 Ray St., Mishawaka, Ind.

\$100 MONTHLY Added income. 30 page factual booklet tells how. Send \$1.00 now. Refunded if not satisfied. Oxford Company, Drawer 929M, San Antonio 6, Texas.

"EVERYBODY Likes candy." Learn to make in a professional manner. (Our 39th year.) Ragsdale Candies, D6, East Orange, New Jersey.

TYPISTS—Profitable business at home. Complete copyrighted information, 50c. Gaunt, 3521-A Broadway, Chicago 13, Ill.

SENSATIONAL! It's easy to earn big money with your own profitable business. Earn \$10.00 to \$50.00 a day. Make lamps at home. General illustrated course teaches you quickly. Course and wholesale supply catalog only \$2.00. Gearon Company, Dept. 200-B, 27 South Desplaines, Chicago, Illinois.

MAKE Flexible molds! Cast plaques, novelties, bookends! Free sample! H. Tooker, Hamilton 9, Ohio.

EXCELLENT Profits. Make, sell holiday flowers, novelties. Literature free. Velya Artcrafts, 324-M East 14, New York 3, N. Y.

"FROG-RAISING"—New book explains everything! Marlboro, 1035 Marlborough, Detroit 15, Michigan.

BE The Popular Mechanics representative in your neighborhood and earn big profits in your spare time. Write Popular Mechanics Magazine, Room 408M, 200 E. Ontario St., Chicago, Ill.

\$46 FROM Square foot plywood; jigsaw necessary. Write, Woodarts, P-38, Bridgewater, Mass.

OWN Mirror shop. Resilver mirrors. Glass sign making. Electroplating. Supply prices. John Sprinkle, V50, Marion, Ind.

\$40.00 WEEKLY Made growing mushrooms, fresh, dried. Dominion patent 331583. Free spawn. North American, 169P Yonge, Toronto, Canada.

INTERESTED In Latin American and foreign employment? \$1.00 brings Foreign Service Directory listing exporters and importers, oil, construction, mining, aviation companies. Hot tips for applications. Global Reports, Box 883-M, Hollywood 28, Calif.

ALASKA—The Last Frontier offers unlimited opportunities, \$1 brings government map and directory listing firms in fishing, construction, mining, aviation, fish and game rules, homestead data. Alaska Opportunist, Box 883-M, Hollywood 28, Calif.

BOOKS, PERIODICALS, PICTURES, POSTCARDS

QUICK Profits taking magazine subscriptions, handling greeting cards. Cassell Publishers Service, Westfield, New Jersey.

NATIONAL Geographic Magazine, 1888-1948, any issue. Periodical Service, Dept. PM, Swarthmore, Penna.

FREE List. Interesting, entertaining and instructive books. Laramie Sales, 4800 S. Laramie Ave., Chicago 38, Ill.

REPUTATION Builder: "Clever Remarks and Replies" \$1.00. Edmund Bodlais, 1257 S. Burnside, Los Angeles 35, Calif.

WOULD You pay 3%—first \$350 made? Color-illustrated book "505 Odd Successful Enterprises" free! Expect something odd! Pacific-B, Oceanside, Calif.

BOOKS—Business, self-help, technical. Send for free list. The Book Nook, Candler, North Carolina.

MAPS, Atlases, globes. Free catalog. Belanger's, 51H Talcott Ave., Rockville, Conn.

STARTLING Revelations! Read "Prophetic Years 1947-1953." Free literature. Progress Company, 4033 Chownen, Minneapolis 10, Minn.

ART Anatomy, The Human Figure \$1.00. Free catalogue interesting books. A. Faller Company, 201 Dewey Street, Newark 8, New Jersey.

BOOKFINDERS! (Scarce, out-of-print, unusual books). Quickly supplied. Send wants. Clifton, Box 1377-PM, Beverly Hills, Calif.

EXCITING, Strange, unusual books. Send \$2.00 for sample book plus 25 page catalog and private collectors list. Rare Book Company, Dept. C, 1219 1/2 North LaBrea Ave., Hollywood 38, California.

HOME Craft course series, 26 books step by step, simple, easy to follow instructions—Profusely illustrated—many designs—some in full color. Write, Mrs. C. Naaman Keyser, Plymouth Meeting, Penna.

SELF-EXPLAINING Bible: Illustrated circular free. Box 446-F, Minneapolis, Minn.

BOOKHUNTERS! All subjects. Send wants! Jaher Book Service, 620-P East 178 Street, New York 57.

GAMES, ENTERTAINMENT

MIND-READING, Mental magic! Perform seemingly impossible feats. 10 secrets, \$1.00. R & E Magic Co., Box 1021, Worcester 1, Mass.

FACE Masks—Life-like. Latex rubber as monkeys, witches, clowns, devils, fat men, baby faces, etc. Slips easily over head. \$2.50 each. Also, rubber vegetables, fruits, etc. Cameo, 432 West 42nd, New York.

MAGIC TRICKS, PUZZLES, JOKER NOVELTIES

FREE: Mystifying "Magic Library" folio. Lynch, 402-10 Hazlett, Baltimore 29, Md.

AMAZING Parlor, stage trick: Liquid colored on command by remote control. Details free. Colonial Specialties, Box 2, Bullshead, Rochester, N. Y.

READ Sealed writing. Three different methods \$1.00 or 50 cents each. Welches, 333 W. Tipton St., Huntington, Indiana.

SEND No money. Jiffy coin trick free with Doty's exploding pencil \$1.50 c.o.d. Tauton, 1925 Shaftesbury, Dayton 6, Ohio.

FREE Catalog magic tricks, jokes, novelties. Laramie Sales, 4800 So. Laramie Ave., Chicago, Ill.

MAGIC Tricks, puzzles, books, cards, punch boards. Catalog 15c. Specialty, Box 671, St. Louis 1, Mo.

MAGICIANS School. Licensed, first of its kind. Approved for veterans. Free particulars. Chavez College of Magic, Dept. MM639, 729 West Ninth Street, Los Angeles 15, California.

LARGE 160 Page catalog, just published, 35c. We have supplied the best tricks to beginners and professionals for 38 years. Chicago Magic Company, 2300-F No. Mason Avenue, Chicago 39.

SUCKER Card trick. Hindu mystic trick, (cards included) 3 dimes. "Marean" Magic Shop, Hopewell, Virginia.

MONEY Mallet—Have fun producing money. Sure, simple. \$1.00 for mallet and instructions. Money back guarantee. OXO, Box 2, South Station, Yonkers 5, New York.

LARGE Catalogue of the best magic for professionals and amateurs. Send 35c. Mazda Magic Co., 1135 Westgate Ave., Oak Park, Ill.

16 CARD Tricks and catalog 25c. Sterling Magic, Royal Oak, Mich.

ENTERTAIN. Mystify! 96 page catalog magic, joke and party goods, 25c. Riley-Borin, P-7909 Rhodes, Chicago 19.

500 TRICKS. New 1949 edition. Send 10c for Douglas famous catalog showing best in good magic, lowest prices, fastest same-day service. 30 years in business. Douglas Magicland, Dept. 1, Dallas, Texas.

400-PAGE Catalogue of 2000 tricks, pocket, parlor, stage. World's finest magic. Send \$1.00 for catalogue (refunded first \$5.00 order). Kanter's, M-1311 Walnut, Philadelphia 7.

DOLLAR Magic set free with mammoth catalog 25c. "Mysto," 4462-PM Germantown, Philadelphia.

"VENTRILLO." Professional voice throwing instrument and "unusual" catalog 25c. POB-971, Philadelphia.

SNEEZING, Itching, powders. Eighteen other tricks free with Joker's catalog 25c. 2404-N Fifteenth, Philadelphia.

PROFESSIONAL Catalog. 124 pages, 25c. Williams, 900 Plymouth, Eilwood City, Penna.

VENTRILLOQUISM Taught. 3c stamp bring particulars. Smith, 801 Bigelow, Peoria 5, Ill.

WORLD'S Largest professional magic shop, keeps you in touch with latest tricks. To receive mailings, send 50c for new catalog. Holden's, M220 West 42nd St., New York.

LEARN Magic, ventriloquism, mind-reading. Write for particulars. Quackenbus, Big Flats, N. Y.

STAMP COLLECTING

FREE—Famous Americans set, plus Flag Set, plus the National Parks Set, plus the Presidential Set to the \$5. A total of 90 stamps absolutely free to customers for our unsurpassed U. S. or foreign selections. Send 3c postage for 15 of the above mentioned stamps and full particulars. Triboro Stamp Company, 145 Nassau St., Dept. 103, New York.

20 ASSORTED U. S. Commemorative stamps 20c. Five U. S. Air Mail 10c. Ideal Stamp, Box 179, Park Ridge, Ill.

FREE! Canadian sets, royal visit, George VI, George V, coronation, jubilee, others, to approval applicants. Ensign, Box 118-M, South Orange, N. J.

GIBRALTAR Packet free—Nice collection Gibraltar, New Zealand Centennial, British Uganda, French Colonials, early British Colonial, West Indies, South American, war stamps plus Philatopic Monthly Magazine. All for 5c postage. Empire Stamp Company, Dept. PM, Toronto 5, Canada.

35 DIFFERENT Greece or complete set "views," 10c. Approvals 1/2c up. Kingman, Highbridge Box 42, New York 52.

ABSOLUTELY Free—Gilbert, Ellice, Cook Islands, Tonga, Seychelles, Ascensions—free to approval applicants. Viking, 130-Z Clinton St., Brooklyn, N. Y.

FREE! United States price list, 50 different U. S. 10c. Arthur Terreson, Box 479, Bellmore, N. Y.

10,000 PENNY Approvals waiting for you. Many from exotic countries, pictorials, airmails, new issues. Tilbury, Box 862, Newark 1, N. J.

UNITED States approvals complete coverage, fine quality, attractive prices. Seminoles Stamps, Box 1138-P, Coral Gables, Florida.

IT'S Possible that you may be able to exchange your valuable duplicates thru this club. Particulars for stamp. McPherson's Stamp Exchange, Branch, Mich.

FREE! Mint United States, Armenia, South America, Russia packet, approvals. Greenwood, 263 Meridian, Miami Beach, Florida.

"GOLD Nugget approvals"—Nothing like them! Worldwide coverage. Write today! 8000 satisfied customers. Established 1921. Kessel's, Box 127A, Folsom, Calif.

FREE 5c Worth your choice from approvals with each 25c purchase. Holmes, 628-D Connally Drive, East Point, Ga.

1/2c UP U. S. or foreign approvals by countries. Hurt & Fosse, Blue Ridge, Virginia.

FREE—25 Cent value with first order general foreign and U. S. approvals. Best for less. Roger Gregg, Canastota, N. Y.

IRISH Convent mixture, 2500, and 6000 British. The lot \$2.00. Catalogue free. Price Company, Killgrange, Dublin, Ireland.

A WORLD Of stamps for 10c. 19th century U.S., pictorials, air mails, British Colonies, etc., to new approval applicants; also a fine approval selection included. Send 10c today to Cosmopolitan Stamp Co., 1457 Broadway, New York City.

FREE! Liberia triangle airmail set, approvals. Martin, Box 1128, Miami Beach, Florida.

GERMANY (Greater) 500 diff. \$2.00. Masser, 322 E. 9th St., Brooklyn 18, N. Y.

FREE—100 Old issues. Wurttemberg, British Colonies, etc. Request approvals. National, Box 42A, Passaic, N. J.

THESE Are them! Unusual penny approvals. Roscoe Stamp, 1321 Roscoe, Chicago 13.

GENUINE "Goya nude" set (catalogs 55c) 10c. Approvals. Royal Stamp Company, Tamaqua, Penna.

FREE—10 Japan war stamps. Approvals. Schroeder, 636 Charles, St. Paul 4, Minn.

FREE Copy new interesting stamp newspaper. Southern Philatelist, Miami 42, Florida.

1000 DIFFERENT Stamps \$1.20. approvals. Bob Stovall, 235 Cortland, Detroit 3, Mich.

CODFISH Special—Send 3c stamp for attractive mint stamp and special offer. Stampman Lindquist, Boonton, New Jersey.

FREE! 33 Haiti, Congo, Rhodesia, others. Approvals. Robert Keating, Box 267, Forest Hills, N. Y.

FREE, 12 Different U. S., approvals accompany. Village Stamps, 90-39F 214th St., Queens Village 8, N. Y.

FREE—Illustrated bargain lists. Albums, packets, supplies, special offers. Littleton Stamp Co., Box 51, Littleton, N. H.

15 DIFFERENT Victorials, approvals. Timber, 74 Wallace St., Maiden 48, Mass.

66 DIFFERENT Stamps, including U. S. battleships 6c. World wide approvals. Telic-Arts, Devon, Conn.

STAMP Buyers' Guide plus 100 different world-wide for 10c. Stampguide, Box 1649P, Oakland 4, California.

100 DIFFERENT With approvals. Jacobsen, 59 Nagle Ave., New York 34, N. Y.

FREE—Pictorial stamps to approval applicants. Dot's Stamp Exchange, P.O. Box 407, Montrose, Penna.

GRUESOME Murder set complete 3c. Approvals included. Eisenmac, 3518 Cummings, Cleveland 18, Ohio.

75% DISCOUNT Off Scott's catalogue. Mostly 19th century British and Europe. H. Codwise, Box 5, Melrose Highlands, Mass.

EXCHANGE Stamps universe. Particulars free. "Exchangers," Bry 126, Seine, France.

6 BEAUTIFUL Sets of stamps 10c. Approvals included. Ciula, P.O. Box 2511, Paterson, N. J.

EIGHT Bicolored French colonies free. Approval applicants. Everglades, 279 Northwest 57th St., Miami, Florida.

FREE—China Constitution issue with foreign approvals. Modern Stampco, Box 12, Wakefield Station, N. Y.

UNPICKED: 5000 U. S. \$2.00; 5000 foreign \$3.00; 1000 British Colonials \$2.00. Kuhn, 81-10 Broadway, Elmhurst, New York.

SURPRISE Packet—25 stamps from different countries, 5c with approvals. Glassman, 3009-P Belle Plaine, Chicago 18, Ill.

FREE—Illustrated U. S. catalog. Olive Stamps, 315 Pierce, San Antonio 8, Texas.

TROPICAL Beauty. Six beautiful mint pictorials from Somali Coast. Special! 7c to approval applicants. GeeKay, 13 Overlea Ave., Baltimore 6, Md.

UNITED States stamps—Approvals. Bargain prices. Metropolitan, 140-B Nassau, New York City 7.

UNITED States Commemorative mint plate blocks. Everglade 17c. Lists free. Seligman Stamps, 346 Lewis, Brooklyn 33, New York.

FRENCH Colony packet, \$1.00, \$2.00, \$5.00 U. S. free with approvals. Hialeah Stamps, Box 3441, Miami 22, Florida.

STAMP Magazine! Copy free! "Stamp Post," South Catalina, Pasadena, Calif.

FREE! Volcano pictorial! Mozambique! Burmese! Nigeria! Approvals. Keating, 637-P Bergen, Jersey City, New Jersey.

APPROVALS! Up to 60% discount! Bardsley, Arlington Ave., Roslyn, Penna.

100 ALL Different from China! Includes airmails! High values! Mint sets! Others! Only 10c to approval applicants. Star Stamp Company, Jamestown, New York.

FREE!—25 Different Romania to approval buyers. Wonder Stamps, 3401-B, Council Bluffs, Iowa.

BIGGER, Better, lower priced United States approvals. Box 488, Minneapolis.

FINE Approvals, fast, personal service. What countries do you prefer? I'll send their stamps. Skinner, 438 Locust, Long Beach 12, Calif.

TRANSPARENT "Stamp-a-Ranger" scale. Holes punched in groups for all U. S. stamps, make own album, \$1.00. R. Ball, Wilmot Rd., Scarsdale, N. Y.

FREE Nicaragua Roosevelt, illustrated bargain list. Imperial, Box 1491, Tampa, Florida.

SEND \$1 Bill for 125 perfect U. S. stamps, no two alike. Guaranteed over \$5 value. Decker, Box 524, Ferdinand, Florida.

200 DIFFERENT World-wide with approvals. Osborn, 1300 Summit, Cantonsville, Maryland.

BECOME Successful stamp dealer through our proven method. Details free. Largentiere Company, 6462 83rd Place, Forest Hills, New York.

POCKET Stamp wallet loaded with stamps cataloging over \$1, all for 3c with approvals. Moublow, 740 Hegney, Bronx 56.

LIBERIAN Triangulars, 10c with approvals. Vargo Stamps, 6044 South Fairfield, Chicago 29, Illinois.

6 IONIAN Island stamps. Approvals. WBS, Box 28, Wilkes-Barre, Penna.

GIFT Packet with introductory approvals. Surf Stamp Co., Box 2296, Miami Beach, Fla.

OPPORTUNITY! \$5.00 American stamp, Grenada, Korea, Saxony, Abyssinia, triangle and over 100 different others cataloging to 60c each. Everything 10c with approvals. Trader Horn Stamp Co., Department P, Ludington, Michigan.

Fiji Included! Stamps from 40 countries 10c. Elsea, Bowling Green, Ohio.

FREE! Fifty different worldwide. Approvals. Jack Dudak, 150-B-3, Streator, Illinois.

CURACAO Commemorative issue—plus 100 others—5c with foreign approvals. National, Box 42A, Passaic, N. J.

ZEPPELIN, German U Boat, Cyprus, Trinidad, Tobago, Uganda. All sent upon receipt of 10c. Approvals included. Thirco, 101 3rd Ave., Newark 4, N. J.

FREE U. S. foreign price lists. Schneider, Jr., Route 3, McHenry, Illinois.

ILLUSTRATED Stamp magazine, 26 weeks 25c. Stamp Journal, Kalamazoo, Michigan.

FREE With approvals. British, Spanish, French Colonies, Vatican, Hitler heads, and airmail packet. Pan-American Stamp Co., Box 145, New York 33, N. Y.

UNITED States commemorative collection. Thirty-three different unused, Columbians to 1943 commemoratives only. Price \$1.00. Request approvals. "Stamps," Albany 1, New York.

HI-IQ Hinges. New safety feature. Thousand 35c. Three boxes \$1. Stampade, 1219 Huron, Cleveland 15, Ohio.

FREE! U. S. monthly lists, fine stamps! Cole. 43-A Rinewalt, Buffalo 21, N. Y.

ATTRACTIVE United States approvals, low priced. Wakonda, 140-G Nassau, New York City 7.

SELECTED U. S. mint Roosevelt and flag sets. Both only \$1.00. Approvals. Quinn, 570, Madison 1, Wis.

\$1.00, \$2.00, \$5.00 U. S. Free. Approval applicants. Flamingo, Box 4038, Miami 38, Florida.

AROUND The world—30 different countries: Basutoland, Nyassaland, Tangier, Cyprus, St. Helena, 10c with approvals. Excello Stamps, P. O. Box #95, Hackensack, N. J.

GERMANY "War packet," assaultboats, warplanes, Hitlers; free to sincere approval customers. William Deems, Ravenswood, W. Va.

TANNAU Tauva "Wrestler" triangle 30 others all different only 5c with approvals. Ed Vidal, 3396 Altavista, Cincinnati 11, Ohio.

STAMPS For collectors. G. D. Ridings, Dept. D, Melvin Hill, N. C.

FREE Canada with approvals that satisfy. Rheume, 8949 Routhier, Montreal 12, Canada.

FREE! Asia, Africa, Europe packet. Approvals. Standard, Box 43, West Farms, New York 60, New York.

\$3.00 CATALOGUE Value—Airmails, etc. 10c when requesting approvals. Florida Stamp Company, Box 807, Miami 5, Fla.

CARLINS Approval Service, Box 307, Fresno, California. 50 different stamps 5c to new customers.

"MAN Size" United States approvals! Illustrated catalog! Sullivan, Endicott Arcade, St. Paul 1, Minn.

STAMPS Of the United States, Canada, Newfoundland, worldwide upon request. Dan Hayden, Box 703, Bloomington, Ill.

FRENCH Colonies, 50 colorful, large pictorials, 10c only with approvals. Fields, 1939 E. 85, Cleveland 6, Ohio.

FLAG Stamp free with U. S. approvals. Wenigman, 1933 Patterson, Chicago.

FREE Lists—Albums, packets, sets. H. Favill, Box 2005, Madison 5, Wis.

AMAZING "Queer Countries" packet—Free with approvals! Saxon, Walden, N. Y.

50 DIFFERENT United States 10c. Price-list free. Seidenberg, Eustis, Fla.

FREE Illustrated list. Elbe dealer. "Treasure Hunt" penny approvals on request. Reed Company, Box 980, Chicago 90, Illinois.

POSITIVELY Greatest free offer—Rare octagonal (eight sided) stamp, gorgeous diamond, giant triangle, also mammoth and midget stamps, total value \$2.00, all free to foreign approval buyers. Plus free, Scott's International \$6.00 album and latest Scott stamp catalogues. Odd Stamps, Santa Ana, California.

FREE! United States commemorative price list. Historical Stamp Co., 1280 Ocean Ave., Brooklyn 30, N. Y.

50,000 STAMP Grabbags 25c each. Anderson, 630 Bingham 1, Reading, Penna.

WORLDWIDE Different, 200, 25c; 500, 50c; 1000, \$1.25; 2000, \$3.00, 5000, \$15.00. Beacon Sales, Maynard 2, Mass.

15,000 DIFFERENT Stamps 2c each! Gordon Davison, Box 1019B, Manchester, N. H.

U. S. Price list. Send postage. State Stamp Service, 1225 Park Building, Pittsburgh 22, Penna.

200 DIFFERENT Including Roosevelt triangle, 5c to approval applicants. M. Avalon Stamp Company, Springfield, Mass.

50 DIFFERENT Stamps, triangle, airmails, etc., 5c with approvals. Carlton's, 10243 Silverton, Tujunga, California.

307 ALL Different 10c. You will find scores of new varieties here for your collection! Big and little stamps, bisected stamp, commemoratives, triangles, high values! Bicolored beauties! Strange countries! Every stamp is different. All for only 10c to approval applicants. Write today and receive special Ionian Island stamp extra. Garcelon Stamp Company, Box 400, Calais, Maine.

300 DIFFERENT Given free with approvals. Postage 3c. Windsor Stamps, 1435 East 67th Place, Chicago 37.

128-PAGE United States catalog—1000 illustrations, 10c. Harris & Co., 202 Transit Bldg., Boston.

FREE! Crystal-mount samples! Har-risco, 202 Transit Bldg., Boston.

GREAT "\$5.00 Catalog price for 10c" offer! (1) Big collection of 112 all different genuine stamps from Africa, South America, South Sea Islands, etc. Includes airmails, triangle and animal stamps; many others. (2) Four scarce unused United States, catalog price 40c. (3) Fine packet 25 different British Colonies—Burma, Hong Kong, Solomon Islands, etc. (4) U. S. \$5.00 high value. Total catalog price over \$5.00! Everything for only 10c to approval applicants! Big lists of other bargains given. Crystal Stamp Co., Littleton 16, N. H.

BINGO! Jackpot collection! Triangles, maps, animals, midgets. All for 5c to approval applicants only. Southwest Stamps, Box 117, Long Beach 1, California.

200 BRITISH Empire stamps; only 3c. Kenmore Stamp Co., Arlington 74c, Massachusetts.

FREE—Illustrated catalog! Kenmore Stamp Co., Arlington 74c, Massachusetts.

YOU'LL Like our American and British Colonial approvals. Write now. Chesapeake Stamps, 748 Overbrook, Baltimore 12, Maryland.

FREE. Irish commemorative collection, including rebellion issue with approvals. Raymax, 123-Z William St., New York City 7.

FREE U. S. price list, postage 3c. Mark Hanna, 335 5th Ave., Pittsburgh 22, Penna.

WORLD—500 Diff. 50c, 1000 \$1.25, 75 Canada 25c, approvals, lists. Victoria Stamp Co., London 4, Canada.

WORLD'S Largest stamp (7½x14 inches). A real curiosity! Retail for 50c, only 3c to approval applicants. Tatham Stamp Co., Springfield 30, Mass.

FREE! 100 Worldwide different stamps to approval buyers. Big U.S. and illustrated bargain lists sent with approvals. Bookman, Maplewood, N. J.

STAMP Collections wanted. Complete collections, duplicate lots, surplus stock, mint and used. Prefer trade for printing or other items, buy outright if priced right. What have you, what's wanted? Vanroy Shirk, Lebanon, Penna.

DEALERS—Wholesale list. Postage 3c. Frank, 5031 Queensberry, Baltimore 15, Md.

OLD Scarce U. S. seconds on approval. Slightly defective, bargain prices. Her-nfield, Clintonhill Station, Newark 8, N. J.

FOUND Stamps containing thousands \$1.00. Longacre Shop, 108 West 42nd, New York 18.

BERLIN Bears, complete set of eight and 100 different stamps only 10c to approval applicants. Reich Stamp Co., 4647 Kenmore, Chicago 40, Ill., Dept. M11.

ZOWIE-E! A barrel of fun for only a dime. 500 United States stamps—absolutely unpicked and unsorted—just as received from church missions. Many varieties, including large commemoratives, airmails, high denominations up to \$5.00! Stamp-dom's biggest package of fun—and you might find something really valuable! Price only 10c to serious approval service applicants. Money back if not delighted. Illustrated bargain lists with each order. Mystic Stamp Company, Dept. 80, Camden, New York.

25 ALL Different stamps 10c. Tunis, Wakeman Ave., Newark 4, New Jersey.

WOW! \$10.00 Worth of fun. Only 10c! What a treasure hunt! Big package 500 foreign stamps from foreign missions, other sources. Includes stamps from Africa, South America, Free French, Somali, Palestine, etc. Includes airmails, commemoratives and stamps worth up to 50c. This offer sent for 10c to approval applicants only. Jamestown Stamp Co., Dept. 22, Jamestown, N. Y.

NICARAGUA "Tin Pan Alley" diamond, Ecuador showing George Washington, and American flag in natural colors, Fezzan, Trieste, "American Army" stamp, first U. S. commemorative, \$100.00 Shanghai, Corsica, Anzac, Antique, others. All 5c. Approvals. Capital Stamp Co., Dept. 2, Little Rock, Ark.

COINS, TOKENS, CURRENCY

UNCIRCULATED Foreign coin included with huge bargain list 10c. Many specials. 4 Whitman folders \$1.00. Little, 337 North Menard, Chicago 44.

OLD Money wanted. Will pay \$100.00 for 1894 dime, S. mint. \$50.00 for 1913 Liberty head nickel (not buffalo). Big premium paid for all rare coins. Send 4c for large coin folder. May mean much profit to you. Numismatic Co., Dept. 20, Fort Worth, Texas.

FOREIGN Bills—10 different, 15c. Bills and coins, lists. Oliver Arnold, Macon, Mo.

RETAIL Coin price list for collectors 15c. 40 pages. James Randall, 115 South Michigan Avenue, Chicago 3, Illinois.

18 DIFF. Coins 50c, free lists. Approvals upon application. Bishop, Box 2201, Kansas City, Mo.

60 COINS And bills, \$1.00. 100 bills, \$1.00. 35 coins, \$1.00. Oddehon, Box 482, St. Louis, Mo.

FREE 1931D Lincoln cent, complete retail price lists. Reynolds Coins, Flint 3, Michigan.

BARGAIN! Rare collection contains United States half cent over 140 years old, large cent before 1857, Flying Eagle cent, 1859 cent, 1863 cent, 1890 cent, 1909 VDB cent, 1923-S cent, 2c piece, 3c silver, 3c nickel half dime, shield nickel, 1883 nickel, 1913 nickel, Liberty seated dime, Liberty seated quarter, Civil War cent, Jackson cent, Colonial coin before 1790, Confederate bill, fractional currency note, broken bank bill, old southern bill, foreign coin, foreign bill, ancient Roman coin over 1500 years old and our complete buying and selling catalogue all for \$5.00. Catalogue alone 25c. Worthycoin Corporation, 294 Washington, (D-106), Boston, Mass.

100 DIFFERENT Foreign coins \$3.95. 3-legged buffalo nickel \$1.25. 1932-D quarter \$1.00. 1932-S quarter \$1.00. 4 Whitman coin albums \$1.00, type album \$1.00, hand-book 75c, 255 page guidebook \$1.50. Big bargain catalogue. 15c. Bebee Coin Company, 1180 East 63rd, Chicago 37, Illinois.

COINS Wanted. Write for list. Elsholz, Box 9014-M, Pittsburgh 24, Penna.

GET Profit and pleasure in collecting old coins. Send 10c for 56 page illustrated coin catalog. You'll be delighted with it. Send for it now. B. Max Mehl, 370 Mehl Bldg., Fort Worth, Texas. Largest rare coin establishment in U. S. Established 49 years.

FREE! Foreign coin, banknote and coin collectors illustrated catalog to approval service applicants. Send 3c postage. Tatham Coinco, Springfield 30, Mass.

4-IN-1 Special \$1.00 bargain offer: (1) United States 1893 Columbian world's fair half dollar; (2) album for holding coins; (3) large 56 page coin catalog; (4) genuine wooden nickel. Yes! All four items for only \$1.00. Order today. Money back if not pleased. Ben's Coin Company, 72 W. Washington, Chicago 2, Illinois.

COINS Wanted, will pay up to \$2000 for certain coins. send 25c for catalogue. Burton's, 111 So. Third, Columbus, Ohio.

COMMEMORATIVE \$½, Oregon, Texas, Kentucky, Cleveland, Long Island, \$2.00 ea. Illustrated catalogue 25c. Norman Shultz, Salt Lake 9, Utah.

ANTIQUES, RELICS, INDIAN GOODS, CURIOS

10 ANCIENT Indian arrowheads \$1.00. List Free. Lear's, Kirby, Arkansas.

PRECIOUS STONES, MINERALS

ZIRCONS, Loose. Genuine Siam imports. Pure white. Special: 3 genuine zircons, from ½ kts. to 1½ kts., \$6.00 tax included. We can supply zircons in all sizes and mountings of all types. Send order or write for details today. B. Lowe, Holland Bldg., Dept. PM, St. Louis, Mo.

GEMSTONES, Rough, polished. Crystallized specimens. Every variety, lowest prices. List free. Plummer's, 5068 Brighton, San Diego 7, California.

METAL Detectors. The very latest circuit. Free literature. Hedden Metal Detectors, 3329 Liberty Avenue, Pittsburgh 1, Penna.

HOBBIES AND COLLECTIONS

WANTED Old cigarette cards. Write Charles Bray, East Bangor, Penna.

COLLECT Decorations, war medals, historical and profitable. Large sales list 20c. Decorations bought. Batson, 1344 Connecticut, Washington 6, D. C.

HANDY Small parts cabinet. Free folder. Metalart Co., Box 261, Lawndale, California.

POSTCARDS Your hobby? Samples, lists. dime. Wilkins, 417 Hill, London 13, Canada.

NEW—15 Different match covers 10c. Box 202, Rochester 1, N. Y.

UNPAINTED Figurines. Illustrated list free. Oman, 642 Broadway, St. Paul 1, Minn.

UNUSED Matchbook covers; 100 different \$1.00; free catalog. Charles Edelman, 1311C East 84, Cleveland 3, Ohio.

INVENTING Can be an interesting and profitable hobby. Write for complete particulars. Institute of American Inventors, Dept. 40-E, 1926-Eye St. N. W., Washington 6, D. C.

50 DIFFERENT Army embroidered patches \$1. Other bargains. Insignia Mart, 703A Broadway, New York 3, N. Y.

CAMERAS, PHOTO SUPPLIES

MAKE Money with your camera! Get editor's up-to-minute photo market data written in breezy news-letter style, by subscribing to "Photo Market Facts." Only \$1 for one year subscription (6 issues), you get analysis of markets in different fields. Eliminates guess work in photo selling. Cuts rejections by showing how to rifle your prints to the right market. Send your \$1 today. Photo Market Facts, IPGA, Dept. PM, 509 Fifth Avenue, New York City 17.

HYDROJET, Amazing washer for all size prints, \$3.95 postpaid. Postcard brings literature and bargain list of unusual photographic items. Post Sales Company, 169 Clinton Ave., Jersey City 4, N. J.

YOUR Camera can pay you big, handsome profits the year round. New, amazing plan. Nothing to buy. We supply everything. Details free. Wolff Enterprises, 4025-M Easton, St. Louis 13, Mo.

YOUR Prized negatives make prize winning photo enlargements with new Precision enlarger, only \$22.20 complete. Write Tam Products CM3, 3814 Wrightwood, Chicago 47, Ill.

BASS Says: Bargaingram 257 ready and waiting for you. The book which tells all. The finest in new and used camera equipment, a veritable encyclopedia. Write, phone or call the sign of the old "Horse Trader." 39th year of satisfaction or your money back dealing. Bass buys, sells and trades. Bass Camera Company, Dept. AG, 179 W. Madison St., Chicago 2.

FREE! 116-Page illustrated photographic catalog. send 3c stamp. Bloom's Camera Center, Inc., 1657-PM Main, Springfield, Mass.

PHOTOGRAPHY For pleasure or profit. Learn at home. Practical basic training. Long established school. Write for booklet. American School of Photography, 1315 Michigan, Dept. 3431, Chicago 5.

OIL Coloring photographs can be a fascinating hobby or profitable sideline for those with artistic talent. Learn at home. Easy simplified method. Send for free booklet. National Photo Coloring School, 1315 Michigan, Dept. 3431, Chicago 5, Ill.

PHOTOCOPY Anything—Papers, books. No darkroom. \$6.95 complete. Fotoflek, 4801 Yarmouth, Cincinnati 29, Ohio.

TELESCOPES—Make them yourself. Real fun. It's easy with our plans. Booklet giving various plans only 25c. Ask for Booklet No. 20. Popular Mechanics Press, 200 East Ontario St., Chicago 11, Illinois.

PHOTO FINISHING

ANY Size roll developed and 4x6 or 3 1/4 x 4 1/2 oversize glossy Velox prints: 8 exposure 35c, 12 exposure 55c, 16 exposure 70c. Clement Photo Service, 1318 W. Columbia Ave., Philadelphia 22, Penna.

ROLL Developed 16 prints 25c. 10 reprints 25c, 50—\$1.00. Dick's Photo, Louisville, Ky.

35 ENLARGED Reprints \$1.00. Macdonald's Photos, Box 228-J, Congress Park, Illinois.

ENLARGEMENTS, Process flexibility permits individual perfection; 5"x7" send negative, 15c; 8"x10", 25c. Brandt Photo, Box 222 G, Kenilworth, Illinois.

OVERNIGHT Quality service, films developed 8 oversize glossy prints 30 cents, twelve 45c, sixteen 60c. Write for mailers. Southeastern Snapshot Finishers, Box 4996, Atlanta, Georgia.

ANY 6 Or 8 exposure roll developed. 8 hobby prints (all enlarged) 35c in coin. Handy mailing envelopes. Valuable premiums. Jack Rabbit, Spartanburg, So. Car.

8 HOUR Service, Box 468, San Francisco. Your 8 exposure roll printed jumbo or regular size 30c; 12 exposures 35c; 16 exposures 50c; 36 exposures \$1.00. Reprints, jumbo or regular 3c. Regular prints deckled. Fine grain developing. Send for free mailers. Quality Photo Service, Box 468, San Francisco 1, Calif.

THIS Ad plus 35c gives you 16 jumbo, oversize, enlarged prints from any 8 exposure roll developed. Enlargement coupon free. Quality and quick service for 19 years. Skrudland, 6444-P Diversey, Chicago.

LIFETIME Prints, free samples. Swift Photo, Box 23, Springfield 2, Missouri.

PHOTOGRAPHY For pleasure or profit. Learn at home. Practical basic training. Long established school. Write for booklet. American School of Photography, 1315 Michigan, Dept. 3452, Chicago 5.

BEAUTIFUL Enlargement from each picture on roll 30c. Cut Rate Photos, Dept. B4, Janesville, Wis.

FREE Price list on quality developing, printing, enlarging. Write for it today. Bryan's Photo Shop, Dept. M, Panama City, Florida.

FILMS Developed and enlarged double size. 8 exposures only 30 cents. 12 exposures 45 cents. 16 exposures 60 cents. Prompt service. Mailing envelopes on request. Real Fotos, P.O. Box 172, Station B, Brooklyn, N. Y.

EXPERT Finishing. Roll developed and 8 prints 30c. Rancho Photo, Dept. P, Ontario, Calif.

TWO Beautiful prints from each picture on roll 30c. Twenty-seven years of satisfied customers. Quick service. Lens Photos, Dept. J4, Janesville, Wis.

8 BEAUTIFUL Double size pictures and roll developed 30c. 8 hour service. Free mailers. Pacific Photo Service, Box 666, San Francisco, Calif.

2 BEAUTIFUL Hi-Gloss prints each good negative and enlarging coupon with each 8 exposure roll developed 28c. Free mailers. Owlphoto Co., Weatherford, Oklahoma.

OVERSIZE Prints; overnight service; 35c. Films developed and 8 prints near postcard, only 35c. Electronic process, non-fade, glossy pictures. Write for free mailers. Peachtree Photo Finishers, Dept. PM, P.O. Box 4324, Atlanta, Georgia.

8 PRINTS All enlarged to nearly postcard size from your roll or negatives 25c; 16-50c. (Trial offer). Willard Studios, Box 3535A, Cleveland, Ohio.

MOTION PICTURES AND SOUND EQUIPMENT

PROCESS Your Ansco color movies! Complete equipment, chemicals, instructions, \$99.00. Laboratory equipment lists free. Mogul's, 68 West 48 St., New York.

CLOSING Out 1000 (16mm. musical) soundies. Reverse titles. \$2.50 each. Free list. Special quantity prices. Gaines, 639-M Addison, Chicago 13, Illinois.

TITLE Making, free booklet. Westwood Company, 635 Victoria Street, San Francisco, California.

BARGAINS In good used 16mm. sound films. Complete one reel subjects often available at \$2.95. List for stamp. Blackhawk Films, Davenport, Iowa.

SEND Ten cents for lists 8mm. and 16mm. motion pictures. Prices reasonable. Film Classic Exchange, Fredonia, N.Y.

GUARANTEED Fresh 8mm. color, indoor and outdoor types. \$3.80 per 25' spool, 3 spools \$11.00. Filmcraft, 47th Holly, Kansas City 2, Mo.

I BUY, Exchange, swap movies. What have you? What do you want? Lowest exchange rates in world. Catalogue \$1.00. Refundable. Harvey Iris, Box 539, Brockton, Mass.

YOU Develop it. Get a 33 ft. developing rack, safe light, all chemicals, trays and instructions for \$5.85. Fully guaranteed. Free circulars and film samples. Promader Genera, Davenport 4, Iowa.

MOVIE Films—16mm. and 35mm. sound and silent pictures, projectors, lists free. Simpson Films, 155 High, Dayton, Ohio.

FREE! 16MM. sound bargain list. Waverly, 5707 South Christiana, Chicago 29.

16MM. Sound, silent, oldtime movies. Dealers prices. Jubilee, 723 7th Ave., New York 19.

NEW 16MM. sound projectors. Free lists. Cine Service, Box 582, Ithaca, N. Y.

EXCLUSIVE, Select movies. Projectors, screens, viewers, films. Free catalog. Home Pix, 1674 Broadway, New York 19.

16 AND 35MM. films, projectors (sound). Savarese, Woodcliff Lake, N. J.

WORLD'S Best Passion Play, sound; silent, 16-35 mm. prints only. Bay State Film Co., 36-38 Melrose, Boston 16, Mass.

16MM. Magazines—Eastman Super X, guaranteed, \$2.50 each postpaid. Free processing. Buy 5 get 1 free. Ask for catalog. Superior Bulk Film Co., 103-A So. Wells St., Chicago 6, Ill.

EXCEPTIONAL Bargains 16mm. sound-silent equipment and films. Write promptly for free listing. Harris, 303 West 42nd Street, New York City 18.

FILM With or without processing. Free circulars and samples. Fromaders, Davenport 4, Iowa.

8MM. Projectors, economically priced. Write Becco, Box 875-A, Charleston, S. C.

85 KODACHROME Movies! War, atom bomb, travel, air, national parks. Catalog, 3c stamp. 2 scene "Waikiki" sample, \$1.00. Specify 8mm. or 16 mm. World in Color Productions, Elmira, N. Y.

8MM. Sound projectors for the price of the average silent projectors. Write Standard Sales, Box 7525, North Kansas City, Missouri.

BRAND New 16mm. sound projectors \$129.50. Send 10c for photographic catalog. Sterling's, 679 Northampton, Easton, Pennsylvania.

LOWEST Prices, raw film 8mm.-16mm. Free list. MK Photo, 451 Continental, Detroit 14, Michigan.

BASS Says: 39 years of leadership guarantees satisfaction. Finest cine equipment, 8mm., 16mm., and 35mm., silent and sound. Write the old "Horse Trader." Satisfaction or your money back always! Bass Camera Company, Dept. A, 179 W. Madison St., Chicago 2.

FREE. Movie catalog; samples 10c. Projectors, cameras, supplies. Goodwill Company, Jackson, Tennessee.

WE Buy, sell, rent, exchange home movies. Details for dime. Midland, Box 429, Oak Park 4, Ill.

RENT 16mm. sound films 50c reel. Large selection, free catalog. Film Service, 128 Chestnut St., Roselle Park, N. J.

GUARANTEED Fresh anti-halo outdoor movie film! Weston 12! Daylight loading! Processing free! Three spools double 8 mm. \$3.45! Six single 8 mm. for Univex, \$4.60! Postpaid! Catalog. Eso-S, 47th Holly, Kansas City 2, Missouri.

8-16MM. Silent-sound films. Complete rental library. All latest subjects. Free catalogue. (sample film 10c). Garden Film, 317 West 50th, New York 19.

LEARN Professional motion picture technique at home. Approved for veteran training under G.I. Bill. Free catalog. Motion Picture Institute, Birmingham 4, Mich.

LEARN Movie projection, management. Free catalog. Theatre Institute, Elmira, N. Y.

MUSIC AND MUSICAL INSTRUMENTS

1949 ACCORDIONS—Wholesale. Free catalog. American Accordion Center, 5329 Belmont, Chicago.

BARGAINS: Harmonicas, instruments. Catalog 25c. Musician's Shop, 2 E. Centre, Baltimore 2, Md.

SENSATIONAL Composing offer. Terry, 709 1/2 N. Broadway, Oklahoma City, Okla.

EXTRA Special! 1000 names, addresses songwriters, \$1.00. Popular Advertising Company, Box 927, Atlanta, Georgia.

SONG-POEMS, Titles wanted. Outstanding proposition. Send material today! Special Service, 2115-M Kenilworth, Berwyn, Illinois.

SONGWRITERS Attention! The amazing demand for phonograph records, accelerated by countless juke-boxes, warrants your immediate investigation. We are offering new writers the rare opportunity of having celebrated "hit" composer furnish music on reduced percentage basis for any likely poems received this month. Phonograph records are outselling piano copies 5 to 1. Recola Records, Hollywood 28, Calif.

POEMS Wanted for musical setting. Send poems for free examination. Five Star Music Masters, 630 Beacon Bldg., Boston, Mass.

FREE Phonograph record; with first order. Send 10c for Famous Record Catalog. Mallorc, Room 41, 570 N. Gay St., Baltimore 2, Md.

SONGWRITERS! Outstanding, ethical offer. Hibbler, C5, 2157 N. Avers, Chicago.

PHONOGRAPH Records cheap. Catalogue. Paramount, BM-313 East Market, Wilkes-Barre, Penna.

SONGWRITERS-Publication collaboration. Newart Publishers, G.P.O. Box 1226, Syracuse, N. Y.

MUSIC Arranged, songs printed. Frank Wildt, Music Publisher, Lancaster, Penna.

RECORDS: New hillbilly, popular, spirituals—39c. Free catalog. Mallorc, Room 6, 570 N. Gay St., Baltimore-2, Md.

YOUR Poems set to music, recorded by professional artists. Free booklet, attractive offer. Write: Song Service, 331-C West 46th, New York.

STREAMLINE Accordions below wholesale. Circular. Metro, 44 North Albany, Chicago.

POEMS Wanted for musical setting. Send poems for free examination. Hamann Service, 614 Manhattan Building, Milwaukee, Wisconsin.

AMPLIFY Your accordion with our new mike \$22.50. Sounds like organ. Installed in minute. Use any amplifier. Amplifier and mike \$72.50. Write Del Principe, 307 So. Wabash Ave., Chicago.

POEMS Wanted to be set to music. Free examination. Send poems. McNeil, Master of Music, 510-PM S. Alexandria, Los Angeles, California.

SONGWRITERS: Send poems for free examination and outstanding offer. United Music Service, 150, Salem, Indiana.

WRITE Songs. Big money and reputation. Write for information. J. Gordon Pub. Co., 201 N. Hoyne Ave., Chicago.

ACCORDIONS—Guitars, trumpets and all musical instruments, new and used. Direct from national distributors, cash and terms. Save money. Del Principe, 307 So. Wabash Ave., Chicago.

RADIOS, SUPPLIES, INSTRUCTION

RADIO Tubes—Dealers, wholesalers, manufacturers: Tubes at lowest possible prices. Fully guaranteed. Send for money saving list. Le-Hi Electrical Co., Dept. A, 660 Broadway, Newark 4, N. J.

27 YEARS Experience radio repairing. Simplified system. No calculations. No formulas. Total price \$2.00 postpaid or c.o.d. Ross Radio, 14615 Grandriver, Detroit 27, Mich.

TELEVISION—Sharp and clear. Adjust present aerial. Build low-cost precision antennae. Complete instructions, troubleshooting chart, diagrams, construction plans, dimensions, no mathematics. Prapson's, Lumberton, New Jersey.

BEGINNER'S Radio Repair Hints 25c. Guaranteed. Bruce, 7818-B Hampson, New Orleans 18, La.

FM On old radios! Free data! Topical Emprise, 1527 Highland, Box 42 A, Louisville 4, Ky.

TELEVISION, Radio, tubes, parts. Send for free bargain list. Hallmark, 592B Communipaw Ave., Jersey City, New Jersey.

RADIO Tubes and supplies: Spada Enterprises, 10C Lexington, Wethersfield 9, Conn.

MAKE Loudest crystal radios. Easiest instructions. Loudest Crystal: 25c. Amorse, Route Four, Richmond, Virginia.

RADIO Tubes, surplus radio equipment, bargains. Ask for list. Kay Electronics, Box 25, Hollis, New York.

24 **PAGES** Tested plans "18 long distance crystal sets," including 10c "Radio-bulldozer," unusual catalog—total 25c. Laboratories, 578-c, San Carlos, California.

BUY Everything at wholesale prices! Radio parts, equipment for the amateur, service man and experimenter. Lowest prices anywhere. Write Mid America, Dept. C-21, 2412 S. Michigan, Chicago 16, Ill.

RADIO—Television facts. Learn the direct way with knowledge that reveals secrets and truths of 20 years' practical experience. Every beginner and radio man can put this information to use. Details sent at once. Wilson Radio, 2463 N. 3rd, Milwaukee 12, Wisconsin.

MAKE Crystal radio "boosters." Ten times volume. Designs, instructions, catalog, 25c. Radio Leader, La Verne, Calif.

HEADPHONES. Guaranteed U. S. Signal Corps used double headsets with adjustable leather headbands and black bakelite earphones. Reg. \$3.00. Special now \$1.49. Allen Radio, Dept. HPM, Clinton, Missouri.

JOIN Xtal-X Crystal Set Club: Year's membership, literature, diagrams, 25c. Box 609, Torrance, Calif.

FIX Any radio. Amazing new instrument locates radio troubles double quick. Simple instructions show you how. Thousands now in use. Write today for free 28-page illustrated technical manual, "The Inside Story," Feiler Engineering Company, Dept. 1PM9, 945 George St., Chicago, Illinois.

MAKE Simple, tubeless, batteryless, distance-getting crystal radios. Crystal and illustrated instructions 25c postpaid. Allen, 427-F, Clinton, Missouri.

BUSINESS OPPORTUNITIES

SELL Costume jewelry and specialty items. \$2.00 will put you in business or send for details. Money refunded if not satisfied. Kennedy Sales Company, P. O. Box 178, Richmond, Virginia.

FIRST Steps in Mail Order tells how to start a mail order business the right way. Will save you hundreds of dollars in costly mistakes. Send 25c for this 35-page book now. Ralph A. Long, 208 West Broad St., Tamaca 2, Penna.

OPPORTUNITY Seekers, make more money by mail! Here's how you can start at small cost. Get these facts first. Free details Gold Seal Mail Order Service, 509 So. Harris St., South Bend 19, Ind.

VENETIAN Blinds! Profitable business opportunity! Small capital! Illustrated construction plan, instructions supply sources. Remit \$1.00. Hunter, 2172 Green, Cleveland 2, Ohio.

START Bottled natural gas business. New, amazing opportunity. Demand enormous. Pays big profits. Literature free. Enco Pasadena 16, California.

LEARN The three keys to success. (1) Choosing the right products. (2) Sources of supplies. (3) How, where and when to advertise. Free particulars. Business Plans Foundation, Box 56, Madison Square Sta., New York 10.

STRING Pearls, beads. Easy trade to learn. Do work for jewelers, department stores, friends, at home, or open your own shop. Poynter's, 310 13th St., Richmond, Calif.

"WATERLESS Hand Cleaner." Make, sell. No machinery. Build profitable business. Complete formula \$1.00. Ideal Service, Park Ridge 2, Illinois.

"ELECTROPLATING Know-How"—Get the professional know-how of modern electroplating, fascinating money making field, simply and quickly! Write for free illustrated booklet. Joseph B. Kushner, Electroplating Engineer, Stroudsburg 40, Penna.

FIREPROOF Mattresses, curtains, homes, almost anything. Earn big. Save big. Be independent. Eldorado Fireproofers, Lotus, California.

WANT Sound, profitable mail order business? Specialist, thirty years experience—unique success record—offers several tested, exclusive opportunities. Moderate capital. Free bulletin, details. Erol Slater, 707 South Hill, Los Angeles 14.

RAISE Earthworms commercially; illustrated system \$1. Literature. Stoner's, Chattanooga 4, Tennessee.

GLASY-CAST: New and finest liquid plastic on the market. Cold set. 15 to 30 minutes for finished product. Free instructions. Easy to make novelties, toys, jewelry, machinery parts, etc. \$2.50 per qt. Elasto-Mold: Flexible, transparent, permanent production molds made in 20 minutes. Free details and samples on request. Also quality rubber latex. Wholesale prices. Plastic Service, 294 Washington St., Room 813, Boston 5, Mass.

HARDWARE Dealers for Rotacut-Farmco power mowers. Complete line. Extra discount. Farm Products, M-2003, Excelsior Springs, Mo.

HOUSE Paint—Wholesale \$2.70 gallon. Agents wanted. Free advertising offer. Certified Products, 812E 38th, Louisville, Ky.

EARN \$50.00 Or more weekly operating nut and gum vending machines in your spare time. Details free. Danco Coin Machine Co., Dept. PM, 1304 E. Baltimore St., Baltimore 31, Maryland.

OPERATE Vending machines. Low investment. Long profits. Our booklet; "Dollars From Pennies" Free. T. O. Thomas Co., Paducah, Ky.

DISTRIBUTORS—Leather novelties, ideal sellers. Send \$10.00 for sample assortment. Supreme Leather Products, 78 Fifth Avenue, New York.

MAIL Order News (55th year) brings you the mail order ideas you're looking for. Copy 25c. Clarence Woodfall, R.3, Charleston, Ill.

TWISTEE Balloons make animals, no glue, twelve balloon package 25c, sells 75c. Hottest balloon number for buyers. Plenty other items. Ellswood Balloons, LaJunta, Colorado.

"THREE Way natural." 300% profit. It's new, convincing. Literature for stamp. Eleven winners. McCurdy, Box 1877, Miami, Fla.

SEND \$1.00 For information of business with unlimited possibilities. J. Benicewicz, 1212-150th St., East Chicago, Ind.

TRADE And class magazines. Keep posted. Latest single copies. Over 1000 covering every trade, business and interest. Price list free. Commercial Engraving Publishing Co., 34C North Ritter, Indianapolis 19, Indiana.

START Your own business on our capital. Always your own boss. Hundreds average \$6,000 to \$25,000 annual sales year after year. We supply stocks, equipment on credit. 200 home necessities. Selling experience unnecessary to start. Wonderful opportunity to own pleasant, profitable business backed by world-wide industry. Write Rawleigh's, Dept. C-U-PPM, Freeport, Ill.

BE Independent—Operate America's lowest price penny vending machine. Big profits. Immediate shipments. Write for bulletin and prices. Fielding Mfg. Co., Desk 39, Jackson, Mich.

"THIS Is it!"—Learn sewing machine repairing, plus profitable installing our motor kits, etc. Write Taylor Service Co., Hamilton 3B, Ohio.

EXCEPTIONAL Money making opportunity for live-wire distributor. Dealer's county franchise now available for fast selling low-priced fire extinguisher and alarm. Made of glass, modern as tomorrow. Tremendous market. Big profit. Write for full information. Autofirstop Co., Dept. E-3, 2035 Washington Avenue, Philadelphia 46, Penna.

BIG Money. Spare or full time in your home. No selling! Spray new miracle finishes, plush and suede on signs, radios, automobiles, figurines, lamps, toys, etc. Our business is booming—new easy Flok-Kraft methods—material costs few pennies, you get dollars. Free samples, complete powerful money making plan free. Write now! Coast, 1505-B West Manchester, Los Angeles 44.

BURGLAR Alarms now in demand. Installations made easy with new simplified parts. Free catalog. Bulldog, 1303 S. Broad Street, Philadelphia, Penna.

NATURAL Molding Latex. Extra thick. Free sample. W. Wooley, 115-A Donald, Peoria, Ill.

OWN—Operate ball gum, nut, cigarette vending machines. Amazing profits, no selling. Write for free details. Cameo Vending, Dept. P, 432 West 42nd, New York.

WOULD You pay 3%—first \$350 made? Color-illustrated book "505 Odd, Successful Enterprises" free! Some offer occasional "day off." Work home. Expect something odd! Pacific, Oceanside, Calif.

SELECTED Collection proven money making plans. Home-mail order. 6th edition. Particulars free. Flasco Sales, 2505VM 150 Street, Flushing, New York.

MAKE Hollywood style marble-glazed cement pottery, birdbaths. Home-shop. Benches, fountains, stucco-rock walls, garden ornaments; chemically colored. Dime brings sample, amazing pictures. Hollywood Cementcraft, 8527-R Wonderland, Hollywood 46, California.

FREE Course casting novelties. Big profits at home. Write Major Chemical Company, 131 Inman St., Cambridge 39, Mass.

ADVERTISING—Publishing business anywhere in United States. Details, sample copy, dime. Midwest Advertising Distributors, 325 Lincolnway West, South Bend 1, Indiana.

GOODYEAR Rubber—for molds, 75% solids Malaya rubber. Trial half pint \$1.00. Write Goodyear, Lake Geneva, Wis.

PROFITS From hand sculptured greeting cards. Book explains. \$1. Bibbs, 1924 Woodland, Kansas City 6, Mo.

MAKE Money at home like I do! Free details. Duffey, Covington, Ky.

\$100 WORTH Of orders at a cost of \$4. "How." Send for details. Murphy, Box 522, Gary, Indiana.

1001 MONEYMAKING Ideas! Free details. Newway Institute, Box 5463-M, Chicago 80.

BE Wealthy. Get business self-starters. Own self-paying homes. Midco, 67 S. Harris, Columbus 4, Ohio.

SPECIAL Rubber for making molds. Literature and sample free. Universal, Box 1076-A, Peoria, Ill.

\$400 MONTHLY. Raising Angora rabbits. Wool \$9 pound. Plenty markets. Details free. White's Rabbitry, Newark, Ohio.

FREE Booklet "How to Sell by Mail." Raymond Rigor, Box A-125, Columbus, Ind.

B A B Y Shoe mountings. Bookends, frames, etc. St. Albans Plating and Casting, 135-17 135 Ave., So. Ozone 20, N. Y.

METAL Mountings for bronze baby shoes. Urbans, 2806 Holliday, Wichita Falls, Texas.

WHERE To buy 800,000 articles wholesale. Details free. Schibani, Box 1576-A, Birmingham 1, Alabama.

MAIL Order opportunities galore. Literature 10c. Sanchez, Box 66, Chelsea Station, New York 11.

"HOW To start a successful mail order business." The guide to sound, profitable mail merchandising. 25c. Manhattan House, 126-B Lexington, New York 16, N.Y.

HALF Million articles wholesale. Directory 25c. Printers, Box 1302-P3, Detroit 31.

\$50 WEEKLY Income from \$10 investment. Particulars free. Wilsons, Stanton, Calif.

MAKE Money by mail—details. Gedgard, Box 798-F, New York 1, N. Y.

MAKE Rubber stamps, metalize baby shoes, repair dolls, silver mirrors, make plaster novelties. Catalogue of "30 ideas" free! Universal, Box 1076-A, Peoria, Ill.

IT'S New. \$1.00 brings you complete details. Guaranteed money maker. D. & S. Sales, R.F.D. #2, Hicksville, N.Y.

YOUR Home or garage has space needed for mfg. new mechanics hand cleaner. Each \$1.00 invested brings \$4.00. No machinery needed. Exclusive territory. Trade-mark and formulae free. Tiffany Products, 289 E. 6th, St. Paul, Minn.

1000% PROFITS Making 8 scarce materials for building boom. \$1.00. Enterprises, 157 Goldale, Toronto, Canada.

MECHANICALLY Inclined? Resurface butcher blocks. Lifetime business. Roy Crawford, Keyport, New Jersey.

MANUFACTURE At home and sell wonderful DDT household insect spray. Easy, quick profits, small investment. Formula, complete instructions ten dollars. See-Te-Are Products, 2219 Danville Street, Hopewell, Virginia.

IMMEDIATE Cash profits by mail. I'll show you how. Write me today. B. C. Fryer, Department A-3, Box 1895, Atlanta, Georgia.

RED Hot home mail manufacturing business opportunity. Everything furnished! 300% profit! Facts free. Bridges, 286-A Third Avenue, New York 10, N. Y.

\$5.00 PER Hour metalizing baby shoes. Original "go in business on a shoe string" success plan offers new way to big profits at home full or spare time. Complete details free. Send postcard now. Kiktavi Co., 211B W. Manchester, Los Angeles 44.

MAIL Business opportunities — New plans; proven propositions. "what to sell" service. Different! Profitable! Write: Smith, Box 2592-J, Hines, Illinois.

FREE Book "372 Unusual Worldwide Business Adventures"! "Different"! Pictures! Australia, Africa, South America, New Zealand! \$800 month reported (exceptional). Work delightful enterprises home. Prepare for surprise! Publishers-X, Carlsbad, Calif.

RUBBER Moulds, the new sensational liquid rubber for manufacturers of novelties, in plaster, plastic, and marbelizer material, (marbelizer hot pouring), send for sample. We make also rubber moulds to order, send your model for free estimation, work is guaranteed for fine details. Artilliano, Dept. P, 1080 N. Main St., Waterbury 12, Conn.

REUPHOLSTER Your own car or operate upholstery shop. Complete auto upholstery instruction manual \$2.00 money order c.o.d. First Upholstery Service, 3439 Michigan Ave., Chicago, Ill.

PROFITABLE Fast seller. 3-way sales plan. Flinson, Box 4333BC, Kansas City 1, Mo.

GET Hundreds money making deals, business ideas, plans and manufacturing. Amazing folio free. Austin Mail Service, 5538 Lexington, Chicago, Illinois.

DOLLARS In personalized baby record books. Sell by mail. Use same literature we do. No-Co-Ro, Oakland 6, California.

RUBBER—Molds, models, casting, finishing, metalizing materials. Wholesale catalog and sample. Stamp please. Plastic Products, 3151-3N Southport, Chicago.

RUBACREAM! Best bet for better molds! Free sample convinces! Castcraft Studios, 2027-P Fulton St., Brooklyn 33, N. Y.

SELL By mail! Ideas galore! Join Mail Selling Opportunities Club! Details free! J. Wehner, Box 142-A, Roxbury 19, Mass.

PLASTERCRAFT Supplies. Rubber molds, natural liquid rubber, rayon and cellophane flock finishes, etc. Illustrated catalog and "Plastercraft" course free on request. Blue Rapids Supply, Blue Rapids, Kansas.

MAIL Order opportunities. Read "Dollars and Sense." Copy 10c. Brown, Gracie Station, New York 28.

ELECTROPLATING Instructions and formulas for brass, copper, cadmium, chromium, nickel, gold and silver plating. All for 25c. M. Hyde, Box 2099-Station V, Los Angeles 3, California.

MAIL Order success even for beginners. Proven plan brings cash. Full or spare time. Details free. Condello, Box 443, Fords, N. J.

SHARPEN Saws, lawnmowers. We supply fast, dependable equipment. Write for folders. Ace Machinery Co., 309 Laurel, Modesto, Calif.

LEARN Piano tuning at home in thirty days. Unlimited income. Sound recordings, electric record player, tools and instructions furnished. Write Capitol City Tuning School, Department PM, 211 East Michigan, Lansing, Michigan.

PROFITABLE Home business. Valuable plans free! Levine's, 15-PM Boulevard Station, New York 59, N. Y.

GLUE. 25 Easy recipes \$1.00. Nunn, 659 E. Oxnard, California.

METALLIZE Baby shoes. Excellent profits. New system assures success. Free details. Treasures Forever, 89 Henry Ave., Lynn, Mass.

MAIL-ORDER Opportunities. Details free. Isbell, Suite 619-PM, 216 West Jackson, Chicago 6, Ill.

SAWDUST. Turn it into cash. Six methods. Instructions 25c. Charles, 12-BU, Norwood, Ohio.

MAKE Liquid marble, artificial marble flooring, flexible molds, statuary, art goods, novelties. Complete formulas, instructions \$1.00. Satisfaction guaranteed. Kemico, Park Ridge 5, Ill.

\$1 STARTS You in business. Sell new, sensational, key insurance for only \$1. Send \$1 for yours and profitable franchise. No other expense. Money refunded. National Key Insurance Co., 30 W. Washington St., Chicago, Ill.

MAKE Money making new greaseless doughnuts at home on electric machine. Wholesale to grocers, drug stores, cafes, hamburger shops. Send for free recipes and plans. M. Ray Company, 3605 South 15 Ave., Minneapolis 7, Minnesota.

FOOT-PAL Sales-dealers, large repeat commissions. Free particulars. Brown Co., Box 126, Salt Lake City 8, Utah.

SAVE Money. Get all bronze baby shoe supplies from one source. Prompt deliveries. Low costs. All types of mountings—book ends, ash trays, pen sets; plating compounds, equipment. Also complete course in electroplating baby shoes that shows easy way to start profitable business in spare time at home. Read details page 52 this magazine. Send name for free facts. Warner Electric Company, 1512 Jarvis Ave., Dept. C-33, Chicago 26, Ill.

PROFITABLE Mail order plans. Details dime. Alfred Haseman, Beecher, Ill.

BUSTER Speegel's "One year books." No. 1 "One year in a rural hardware" (successful \$6,300) 15 interesting pages. No theories, but facts and figures on actual operations. Ideal inventory, buying tips. Learn how the easy way. \$1.00 post-paid. Buster Speegel Publications, P.O. Box 2412, Orlando, Fla.

BE Independent! Send \$1.00 (refundable) for children's mechanical, educational book (patented) and information. Dyc, 1321 Arch Street, Philadelphia 7, Pennsylvania.

DOLLAR Brings 15 manufacturers names of any item. Wegner Supply, Randall, Iowa.

START Bottled natural gas business. New, amazing opportunity. Demand enormous. Pays big profits. Literature free. Enso, Pasadena 16, California.

LIQUID Marble—Colorful, glossy! Molded, brushed, sprayed! Cast novelties, statuary, colored tiles. Flexible molds. Composition floors. Particulars free. Marbleizing Service, Edwardsville, Illinois.

ESTABLISH A chemical specialty business. Descriptive literature 25c. Industrial Laboratory, Holland, Michigan.

MAKE Tough plastic 1c pound. Makes durable floors, walls, mantels, roofs. 101 uses. Build attractive home yourself. Material cost \$150 room. Bays Laboratories, Oklahoma City 9.

LIQUID Rubber, make flexible molds. Free sample. Chaney, 1130 E. 16th St., Jacksonville 6, Fla.

BRONZING Baby shoes is big business. Start your own business for \$4.95. Price includes all materials and instructions. No equipment required. Particulars free. Metaloids, Box 2095, Wichita, Kans.

METAL, Plastic, onyx, mountings for bronzed baby shoes, 20 styles. Hardening solution. Wholesale. Box 2095, Wichita, Kans.

MAKE Money from own home by mail selling office supplies. Tremendous demand. Snyder, 5-B Spring, Beachwood, New Jersey.

PACKAGED Offer gives all help needed to start you in mail order. Details free. Terwilliger, 303 PS Chestnut Street, E. Bound Brook, New Jersey.

INCOME From local information. Interesting. Sparetime. Neher Company, La Verne, Calif.

START Profitable mail order business. Literature free. Paul Keich, Box 133, Bloomfield, N. J.

WE Need more live-wire Rototiller dealers to handle the well known, nationally advertised Rototiller. This machine is a leader in its field. A demonstration usually means a sale. Occupies small floor space. Many owners say Rototiller pays for itself in one season. Big dealer profits on every machine plus profits on attachments. Small investment puts you into the Rototiller business. Why don't you, too, make big profits in '49 with Rototiller. Write or wire Frazer Farm Equipment Corp., York, Pennsylvania. A division of Graham-Paige Motors Corp.

START Home manufacturing business making Cleaning Compounds, Soaps, Insecticides, Cosmetics, Polishes, Food Flavors. No machinery. Literature free. Kemix, Park Ridge, Ill.

MAKE Money spare or full time, casting metal toys and novelties. Latest scale model autos, original ashtrays, savings banks, water pistols, etc. Enormous wholesale and chain store demand keeps manufacturers busy. No experience or special place necessary. Write for details and illustrations of patterns needed. Metal Cast Products Co., Dept. A, 1696 Boston Road, New York 60, N. Y.

VENDING Machines earn big money! An investment as low as \$10.50 will start you in this fascinating, profitable business that can lead you to the road of success and independence. Routes can be established and operated in either full or spare time with no experience needed. Write for full details and our free catalog illustrating our nut, candy, gum and stamp vendors; also pin ball machines, music boxes, etc. Write immediately to Parkway Machine Corporation, Dept. 7, 623 W. North Avenue, Baltimore 17, Maryland.

BIG Profits operating automatic shoe shine machines. Vassar, Cleveland 5, Ohio.

BLUEPRINTING — Thousands of small manufacturers, inventors, and sales organizations need local blueprint facilities. New direct process requires only inexpensive, easy-to-make equipment. Establish full or part time business in your community. Complete instructions \$1.00. Macy of Illinois, Distributors, 30 W. Washington, Chicago, Illinois.

BABY Shoe plating for the trade only. 5 day service. Beautiful samples always available. Thoro Plate Co., 6260 Romaine St., Hollywood 38, Calif.

SCIENCE Of memory simplified. Free booklet "Memory Development." Memorology Club, 2016 Sunnyside Ave., Chicago 25, Ill.

MAKE Flexible molds! Cast plaques, novelties, bookends! Free sample! H. Tooker, Hamilton 44, Ohio.

NOW Available! 1949 edition of Official Concessionaire's Guidebook. Jam-packed with money-making ideas, games, formulas, equipment for concessions, roadside stands, carnivals, medicine business, etc. Buyers guide. Send \$1.00 today for copy. Concessionaire's Guidebook, Box 133B Sta. B., Toledo 6, Ohio.

YOUR Own profitable home business. Preserve live flowers to last forever. New simple discovery. Enormous demand all year 'round. Tremendous profits! Light fascinating work. Send \$2.00 for working equipment, instructions, and valuable sales plans. Satisfaction guaranteed or money promptly refunded. Alfred Hermansen, 210 Fifth Ave., Suite 1102A, New York 10, N. Y.

BUY Nationally advertised merchandise for others; radios, appliances, etc. Low wholesale prices. Make commission each purchase. Up to \$5,000 year possible. Easy, fascinating new business. Free information. Cox, Saugus 10, Massachusetts.

POPCORN Equipment, potato chip outfits. Long Eakins Company, 4960 Hi Street, Springfield 99, Ohio.

BABY Shoe metalizing. Secrets never before revealed. Amazing offer. Schoettle, Friendship, Ohio.

NO Selling, operate vendors, amazing profits, details free. Silver-King, Suite B, 622 Diversey, Chicago 14, Ill.

HOME Business making statuettes, plaques, artificial marble, rubber molds. Metalizing baby shoes. Silvering mirrors. Formulas. Folder free. Creative, 236-L, Winnetka, Illinois.

RAISE Ginseng. Roots bring \$10.00 pound. Circular free. Fezler Seed Co., Patchogue, N. Y.

ANNOUNCING Home study course in commercial baking. Practical basic training. Good field for those with aptitude. Nearly depression proof. Send for free booklet, "Opportunities in Baking Industry." National Baking School, 1315 Michigan Ave., Dept. 3438, Chicago 5, Ill.

MAKE Money addressing envelopes. Our instructions reveal how. Glen Glenway, 5713 Euclid, Cleveland 3, Ohio.

I MAKE Big money in the mail-order business. You can do the same at home with copyrighted system. Write me. I'll tell you how. F. Little, R.D. #1, Glenshaw, Penna.

ENVELOPES Addressed accurately, reasonably. Fast service. We have capable addressers in your city. Glenway System, 5713-Y Euclid, Cleveland 3, Ohio.

READ "Advance"—The voice of mail order. Offers money-making opportunities, sources of supply, personal guidance, etc. Issued monthly. Sample copy 25c. Yearly subscription \$2.00. Advance Publishing Company, 313 East 21st Street, Suite 450, New York 10, N. Y.

A BUSINESS In your own home! Our chemicals, plus free water and cheap "grocery store" materials can bring you over \$500 monthly earnings. Plans and formulas free. Chemica Division, 1269 S. Norton, Los Angeles 6.

MAKE Money by mail. Howard, 1778A Hamburg St., Schenectady 4, N. Y.

A FACTORY In your home garage! Mfg. and sales rights, mechanics' water-less hand cleaner. \$500-\$800 monthly. No special equipment necessary. Formula free. Western Aircraft Mfg., Dept. D, Los Angeles 6, Calif.

BUY The new Concession popcorn machine. Biggest low priced popper on market. \$100 puts you in business, complete. Also caramel corn, candy toss, candy pullers, kettles, heating equipment. Write for new catalog. Concession, Dept. A, Toledo 6, Ohio.

LEARN Piano tuning, repairing, at home. Tremendous field! Piano parts, tools furnished. Established 1935. Empire School of Piano Tuning, 606-B East University Ave., Champaign, Ill.

UNPAINTED Bookends, plaques, statues, figurines. List. Haverty Products, 1219 8th Ave., Altoona, Penna.

HOW And where to obtain capital. Small and large loans. Free particulars. Star Service, Wapakoneta, Ohio.

OWN Mirror shop. Resilver mirrors. Glass sign making. Electroplating. Supply prices. John Sprinkle, V60, Marion, Indiana.

BRONZED Baby shoe mountings and supplies. All metal bronze bookends, picture frames, ash trays, etc. Onyx ash trays, desk sets, plaques. Hardening solution, 30-amp. plating rectifiers with powerstat control, \$85.00. Geared motors for agitation \$20.00. Lead lined tanks. Write for list. Hollywood Bronze Supply, 1770 N. Vermont, Hollywood 27, Calif.

QUICK Money. "Repairing car batteries." At home! Easy tool! Batteryman, Grand Junction, Colorado.

\$46 FROM Square foot plywood. Jigsaw necessary. Write, Woodarts, X-38, Bridgewater, Mass.

OPERATE Profitable mail order business. Write Walter Service, 4159-A East 112th, Cleveland 5, Ohio.

COLORGLAZED Concrete pottery made without molds. Patented method. Cemetery products, novelties, tiles. Basement leak-sealing. Money-making projects. Booklet, details free. Men only. National Potteries Company, Grand Rapids, Minnesota.

SPECIALTY Manufacturing, the big money business that can be operated anywhere. start on a very small capital; we supply dependable formulas and complete instructions; get interesting free booklet, "Money-making Opportunities in Specialty Manufacturing." Howard Robinson, Ph.G., 1300-A South Ohio Street, Sedalia, Mo.

START Mailorder bookshop—Everything furnished. 25c brings booklet, samples, exciting ideas. General Publications, Ossining, N. Y.

\$25 WEEKLY Working two hours daily. No canvassing. No manufacturing. Lycke, Box 2471, Cleveland 12, Ohio.

137 WAYS To make money, in home or office. business of your own. Full particulars free. Elite Co., 220 Grand St., New York 13.

MAILING Postcards selling repeat merchandise is profitable. Everything supplied. Details free. Gordan Publishers, Box 23, Pawtucket, R. I.

BRUSH Plating outfits connect to a battery. No tanks necessary. Good paying business at home plating autoparts, bathroom fixtures, bicycles, reflectors, silvering mirrors. No shop or experience required. Outfits furnished. Free booklet. Gunmetal Co., Ave. H, Decatur, Ill.

CO-PUBLISH And advertise in The Central Mail Advertiser. Sample copy for stamp. Low rates. Large circulation. Bagby Printing Co., Georgetown, Ohio.

MAIL Order opportunities. Full or spare time. Hundreds of chances. No charge. Postal brings copy. Blackstone Press, Somerville, New Jersey.

START Home plaster novelty business. Amazing course tells how. Literature free. Kemo-Courses, Dept. A, 4862 Catalpa, Chicago 30, Ill.

EARN \$200 Weekly installing new amazing "Styron" plastic wall tile in homes, offices. Easily applied. Tile your own kitchen, bathroom, too. Instructions, everything furnished. Literature free. U. S. Tile Co., 30 W. Washington St., Chicago 2, Ill.

COPUBLISH Leading m.o. paper. Latest copy Mail Sale Advertiser and proposition, dime. Vanroy W. Shirk, Lebanon, Penna.

START Plating business at home. Amazing profits. Make own outfit. Inexpensive. Illustrated instruction booklet 25c. Popular Mechanics Press, (C-43), 200 E. Ontario, Chicago.

MONEYMAKING OPPORTUNITIES

SURE Money maker. Costs you 10c to 20c to make lawn chairs from vines. Send m.o. or check for full instructions and plans, \$2.00 or miniature sample, \$5.00. Write: Dewey Morgan, Box 15, Washington, N. J.

HOUSEWARES Items. Sell on sight. Every home a prospect. Men, women, boys or girls—make big money with these hot sellers. Write for circulars. Kooper Kraft, Box 8-M, Terre Haute, Indiana.

EARN Up to 100% profit selling beautiful personalized matches, napkins, coasters, pencils, novelties. Request free samples. Lynne Novelty, 739A Riverside Ave., Elmira, N. Y.

FREE Literature on money making ideas. Write: Lighthouse, 1023-M Hamilton Street, Lockport, Illinois.

MEN—Women — "Most everybody likes candy." Learn to make in a professional manner. (Our 39th year.) Ragsdale Candies, D4, East Orange, New Jersey.

MAKE \$100 Per week or more in a full or spare time baby shoe metalizing business of your own. Write now for free literature on this easy to learn highly profitable business. Joseph B. Kushner, Metal Finishing Engineer, Stroudsburg 23M, Penna.

START Profitable air conditioning business. Don Nelson, Warner Robins 2, Georgia.

LEARN Profitable clock repairing. All types. Illustrated manual \$1. Thies, Publishers, Genoa 3, Illinois.

15 MINUTE Advertising and sign lettering course; sign painter's secrets; cartooning book; all three, \$1. Free circular. Abenterprises, Box 875-M, Peoria, Illinois.

BIG Money daily making beautiful leather link belts, no tools, materials furnished, you assemble by hand. D-E Products, Dept P1, 8 E. Huron St., Chicago 11, Ill.

MONEY Making projects for your own business. Folder of ten for a quarter. Challenge, 87 Somerset, Springfield 8, Mass.

INVESTIGATE Mail order opportunities. Write Moy's, 517-7th S.W., Washington 4, D. C.

WOULD You pay 3%—first \$350 made? Color-illustrated book "505 Odd Successful Enterprises" free! Proven! Work at home, office. Expect something odd! Pacific, Oceanside, Calif.

BIG Money making opportunities. Write Springer, 1126 E. Apache St., Phoenix, Arizona.

WIN Cash, cars in prize contests! Write for copy filled with current contests, winning hints and tips. Send only 25c. Wright Contest Digest, Dept. 17-C, P.O. Box 2266, St. Louis 9, Missouri.

SELL—Television, radios, appliances, bicycles, sporting goods, hardware. Wilson, 1416 Vliet, Milwaukee, Wisconsin.

CONCRETE Block molds, 8x16x4 \$6.70, others, literature free. Lehnert, Norwood 2, N.J.

START Home candy kitchen—Good earnings! Everyone likes candy. Learn professional methods. Etterman, 1991-B Lake Shore Drive, Muskegon, Michigan.

MAKE Big money handling popular, fast-selling books from your own home by mail. Everything furnished! Unusual opportunity! No experience needed. Details free. Write: National, Box 88-L, Dorchester 22, Mass.

DEALERS Wanted! Sell new merchandise item by mail, from home. Everything furnished! Novelty Products, 1200-B Goldsboro, Sanford, N. C.

MAKE Extra dollars in your own back yard! Real opportunities, fully outlined. Rush name. Pickett's, 62-A Sanders Drive, Florence, Kentucky.

FREE Book "372 Unusual Worldwide Business Adventures!" Successful! Australia, Africa, South America, New Zealand! Not hokum! Work home. "Different" plans. Prepare for surprise! Publishers-W, Carlsbad, Calif.

MAKE Extra money sparetime. Work at home. Literature free. Liebig Industries, Box 400M, Beaver Dam, Wisconsin.

BABY Shoes preserved. Formulas, instructions, \$1.00. Novelty Bronzing, Box 56, Hyde Park 36, Mass.

"DOLLARS In your mail from women." New. Different. Send quarter, refundable, today. Grant Lovell, 2166 South Shore, Erie, Pennsylvania.

GET "Dollars by mail." Postal brings details. Terrill, Bogard 2, Mo.

EARN Money evenings, copying and duplicating comic cartoons for advertisers. Adservice, Argyle 1, Wisconsin.

CHEMICAL Gardens. Eleven recipes \$1.00. Nunn, 659 E. Oxnard, California.

BIG Money—Sparetime. Make venetian blind repairs in your neighborhood. Send name and address. Americal, 2334 First Ave., New York City. No special tools needed.

FREE Mail of opportunities, profitable plans, samples. Dancer, Mansfield, Ohio.

MAKE Picture frames at home. Good as professionals. No machinery; very simple. Everything furnished. Amazing money-making opportunity. Read ad page 283 this issue. Futureframe, Box 829, Iowa City, Iowa.

THOUSANDS Articles wholesale. "Supply Source Directory" 10c. Ideal Service, Park Ridge 40, Illinois.

UNPAINTED Plaster ornaments, easily decorated. Firestone's thick, white, natural-latex Loxite for rubber molds. Midwest Novelty Manufacturers, 524-A East Park, Anaconda, Montana.

START Profitable mailorder business at home. Everything furnished. Complete information 10c. Suproco, Ogema, Wisconsin.

I MADE \$1000 From 1000 tomato plants. Instructions, \$1.00 (refundable). Alfred Dinsmore, Marlborough, Mass.

READ Progressive Mailtrade, the magazine that tells how to make money by mail. Dime brings sample and special offer. Progressive Mailtrade, Box 357, Sheboygan, Wisconsin.

PROFIT With Larson Leathercraft. Belts, purses, 100 other ideas. Largest supply in U. S. Catalog 10c. Larson, Dept. C, 824 S. Tripp, Chicago 24.

CANDY Manufacturing and marketing, complete course \$6.00, literature 10c. Philip Pate, Kissimmee 1, Florida.

INCREASE Your earnings: Local business opportunities; mail order information; wholesale supply sources; valuable money-making tips; information, free details, rush name. Wilkin Company, Hillsboro, Ohio.

WIN Contest money. General Contest Bulletin gives hundreds of tips. Lists current contests and rules. Sample 25c. General Contests, 1609 1/2 East 5th, Duluth, Minn.

ANALYZE Handwriting for profit! Complete outfit \$1.00. Graphologists, POB-971, Philadelphia.

UNPAINTED Figurines. Illustrated list free. Oman, 642 Broadway, St. Paul 1, Minn.

EARN Money at home! Thousands do! "Home Worker Magazine" tells how. Sample, 25c. Sizemore, Box 7, 4917 Kostner, Chicago 30, Ill.

RESILVER Mirrors at home. Formula 25c. Ideal Service, Park Ridge 6, Illinois.

PRIZE Contest bulletin gives various contests now operating, and valuable hints. 3c stamp. National Contest Bulletin, Box 2685P, Miami, Florida.

PUBLISH Your own magazine. Handsome 52 page format, well edited, illustrated. Cost low as \$1.00 month. Brings you prestige, profits. 25c brings sample, details. National, Ord, Nebr.

FORMULAS. PLANS. ETC.

WAX-O-GLASS; Cleans glass; polishes metals amazingly quick. Make it yourself. Formula \$1.00. Ideal Service, Park Ridge 3, Ill.

NEW Improved paint thinner. Powerfully sweet orange scented. Make at 1/2 the price of turpentine. Quart sample sent with formula. Price \$2.00. Steven J. Milan, Odorless Co., 107 Downs Ave., Binghamton, N. Y.

INVISIBLE Inks. Appear by chemicals. Ten recipes \$1.00. Nunn, 659 E. Oxnard, California.

21 MANUFACTURING Formulas. Cosmetics, shaving, cleaners. Supply directory. No machinery. \$1.00. Mark Moye, Windsor, Vermont.

10,000 FORMULAS And trade secrets. Free literature. Stillman, 555 Kingston Ave., Brooklyn 3, N. Y.

MAKE—Seal cleaners, soaps, polishes, flavors, cosmetics. No machinery. Formula literature free. Kemico, Park Ridge 16, Illinois.

PLANS—New patent sewage disposal system. Requires less drainage, build it yourself. Specifications and drawings by registered professional engineer. \$2.00. De Haviland, Mundelein, Illinois.

FORMULAS For nearly everything. Catalog free. Write Creative, Winnetka, Ill.

PRODUCTS Analyzed. Duplicated. Improved. Formulas. Consulting Scientific Company, Swarthmore, Pennsylvania.

\$1.00 GETS You 21 money-making popcorn, candy apple formulas. We supply equipment. Concession Supply Company, Dept. A, Station "B," Toledo, Ohio.

TESTED Formulas. Interesting descriptive booklet free. Pont, Box 635-PM, Terre Haute, Indiana.

REAL Manufacturing formulas. Lists free. Cummings, Chemist, Gordon Ave., Syracuse 4, N. Y.

PLASTICS

INTERNAL Carvers! Beautifully finished pin and earring blanks, \$1 sample set, includes findings, gift box. Many shapes, also cigarette boxes, coasters, paper weights and other beautiful gift items, ready for carving. Catalog, Jamer Corp., M-1, Manufacturer, 22 E. 21 St., New York 10.

DOUBLE Your income. Do highly skilled plastics work at home. New short training course—free materials during training. Old established plastics organization offers this opportunity, act now. Plastics Laboratories, 3324 Park Blvd., Oakland 10, Calif.

PLEXIGLAS, Lucite, acetate, sheets, rods, tubes, jewelry findings, craft supplies, over 1700 items. 25c which brings catalog internal carving folder, information on fabricating plastics, deducted from first order. Plastic Parts, Dept. H-2039, 1157 S. Kingshighway, St. Louis, Mo.

PLASTIC, Sheets, rods, tubes, etc. Free list. Plastic Supply Co., 2901 N. Grand Blvd., St. Louis 7, Mo.

MOLDS Made for Plasticor C-2, lowest prices. F. Giddings, 2544 Clarkson Street, Denver, Colorado.

PLASTIC Smoking set. Assemble yourself. \$3.00. Hanson Plastics, 7625 South Parkway, Chicago 19.

PERSONALIZE Your handicraft with cast plastic initials. Your three initials and other samples, three dimes. A. Dreher, 2232 Brockway, Cleveland 18, Ohio.

PLASTIC Materials and supplies for your hobby or business. Catalog and internal carving instructions free. Art Plastics of Calif., 8125 East 14th Street, Oakland 3, Calif.

AMAZING Liquid plastic pours cold, hardens in half hour. Clear, colors. Expensive equipment unnecessary. Embed photographs, coins, flowers, keepsakes. Complete kit only \$3.25. Kristalon Plastics, Dept. P-4, Box 29, Wilmette, Illinois.

MOLDEX! Molders best molding rubber. Pentucket Arts, Seabrook, New Hampshire.

LUCITE, Plexiglas. All size sheets. Cost square foot (12" x 12") 1/16" 96c; 1/8" \$1.25; 3/16" \$1.52; 1/4" \$1.80; colors add 10%. Include 10% postage. Almac Plastics, 230 Fifth Ave., New York 1, N. Y.

BEAUTIFUL Colored plastic catalog. Finished and unfinished items, instructions, and supplies 25c. Make gifts, jewelry, useful articles. Hobbyists, schools, salesmen, dealers, profitable line. Attention ladies: New glitter bird pins, you make them. 50c makes you \$15.00. Hurry. Plastic Mart, 2443 East 14th St., Oakland, California.

INTERNAL Carved roses, orchids, swans, goldfish, butterflies, etc. Jewelry and gifts. Crystal Floral Novelty Co., Bound Brook, New Jersey.

PLASTICS—Supplies, findings, shells. Illustrated fabricating manual, bargain catalog, 10c. Gem-O'-Lite, Box 686F, North Hollywood, Calif.

PLEXIGLAS—12" x 12" Masked sheets. 1/16"-\$1.00. 1/8"-\$1.25. 3/16"-\$1.55. 1/4"-\$1.85. Include 10% postage. Dyes, rods, tubes, luminous powders, carving blanks, drills, jewelry findings. Free catalogue. Craft Plastics, Somerville, New Jersey.

CHEMISTRY

NEW Laboratory supply catalog of chemicals and apparatus. Contains many thousands of items with illustrations. Send 25c. Standard Science Supply Company, 1232 N. Paulina St., Chicago 22, Ill.

NEW Catalog: Chemistry, mineralogy, physics, biology. 10c. Tracey Laboratories, Evanston, Illinois.

CHEMICALS And apparatus for industrial, analytical, and private laboratories. Catalog 15c. Dept. M-50, Biological Supply Co., 1176 Mt. Hope Ave., Rochester, 7, N. Y.

COMPLETE Supply catalog, 10c. Pili-grim Chemical, 348-RR Edith, Salt Lake City 4, Utah.

CHEMICALS, Glassware. Send 5c. Atlantic Laboratory Supply Co., 21 Wenham, Boston, Mass.

MAKE Chemistry your hobby. Fascinating, educational, recreational, vocational. Large general catalogue chemicals and apparatus 15c. Microscopic stain catalogue 20c. Both 25c. National Scientific Company (Est. 1916), 2204 W. North Ave., Chicago 47, Ill.

NEW Idea chemical and apparatus outfits for home experimenting. Photo-Scales, semi-professional microscopes and biological supplies. Specializing in chemicals and laboratory supplies in small quantities. Send 15c for catalog. Established 1931. John H. Winn, 124A West 23 St., New York, N. Y.

HANDBOOK For chemical experimenters, illustrated, hundreds of experiments, 50c. Experiment booklet 15c. Supply catalog 5c. Reading Scientific Company, Reading, Penna.

HELP WANTED

BOYS Wanted. Over \$2.00 hour! Sell name plates for front doors. Free sample. Write Dept. 46, National Engravers, 214 Summer, Boston, Mass.

AGENTS WANTED

WHOLESALE Article. 100% profit. Quick resales. Territory going fast. Know 20 years. Glenn Perkins, Byron, Mich.

AMAZING Offer—\$50 is yours for selling only 100 boxes entirely different, new deluxe all-occasion cards. Patented feature television card included. Each box sells for \$1.00, your profit 50c. Surprise items. It costs nothing to try. Write today for samples. Cheerful Card Co., 584, White Plains, N. Y.

NYLON Uniforms, immediate delivery, immediate profits. Sell to doctors, dentists, nurses, waitresses, beauticians, housewives. Free sales kit. Superior Fabrics, Dept. P3, 3936 Market, Philadelphia 4, Penna.

\$6.00 HOURLY Showing Firestone Velon handbag—opens into large shopping bag. Fastest seller in America. Women buy several for gifts. Commissions advanced daily. Sample furnished. LeNard, 179-C, West Washington, Chicago 2.

EXTRA Cash income. Sell friends new, different greeting card assortments, exclusive stationery unobtainable elsewhere. Profits to 100%. Bonus. Request free samples exclusive personalized stationery and all-occasion samples on approval. Regal Greetings, PM-6 Hazel Park, Mich.

HOTTEST 39c item on the market. Write National Sale & Service, Greenville, Penna.

GREETING Card money-makers. Birthday, Easter, motherday. Catalog free. Greenport Art Company, Dept. 938P, Brooklyn 15, New York.

BE Renewal headquarters for all magazines. Handle everything at home. Big profits. No experience. No capital needed. Free catalog tells how. Write McGregor Magazine Agency, Dept. 129, Mount Morris, Ill.

AT Last! Something new and sensational in everyday cards. Gorgeous satin and velour designs. Get orders fast. Big profits. Imprinted stationery. Floral charmettes, napkins. 25 assortments for all occasions, retail 60c to \$1. Samples on approval. Puro Co. 2801 Locust, Dept. 940-C, St. Louis 3, Mo.

AMAZING New non-electrical burglar alarm for windows, or doors of homes, stores, offices, etc. Millions of prospects. Sells on sight. 100% profit. Easy sales. Tremendous opportunity. Retail at \$2.25. Write immediately. Robertson Company, 228 N. LaSalle, Chicago 1, Ill.

LOOK! 10 Day free examination offer starts you in easy, profit-making, greeting card business. Profits to 100%. Bonus. Special offers. Request all occasion samples on approval for 10 day free examination and free name imprinted and floral stationery samples. New England Art Publishers, North Abington 102, Mass.

FREE Nylons given if Kendex hosiery runs or snags! World's only women's hosiery sold with written guarantee arising everybody. Mere words could not press unbelievable money-making opportunity. Fantastic earnings become reality. Armstrong earned \$202 in 9 days. Watkinson sent 92 orders in one day. Imagine replacing hosiery free regardless of cause—can whether use or abuse! Truly sales dynamite for terrific profits. Even if you never sold before, three magic words: "Guaranteed Against Everything" will open doors for you—make women listen and pour money in your pocket. Complete line from sheers to service (15-20-30-40-60 denier)—all lengths 28 to 35 inches—latest colors—seamed full fashioned and seamless. No competition because Kendex guaranteed nylons not sold in stores. Also complete line men's hosiery actually guaranteed for one full year! Nothing like this anywhere. Includes rayon, nylon, lisle, wool, cotton, mixtures, etc. All styles, patterns, colors, prices to please everybody. Thousands shipped daily, 100,000 pairs constantly in stock for fast delivery. Over 30 years in business. You need no money or experience. Nothing to pay now or later. Show free outfits. Write orders. We deliver and collect. Big advance cash plus huge bonus. Earn money spare or full time—exclusively or side line. No restrictions. Become manager—appoint others to sell for you—earn steady income on their sales. Complete money-making outfits including salesbooks in color, samples of hosiery materials, etc. furnished free and prepaid. Simply mail name and address to: Kendex Company, Babylon 32, N. Y.

HERE'S Easy extra money for you. Greeting cards, Masslinn napkins, towels, utility purse-shopping bag etc. Show new, largest, most beautiful greeting card line of all time; all-occasion, birthday cards, gift wraps, etc. New bonus plan earns you up to and over 100% profit. Name-imprinted and personal monogrammed stationery samples free. Write now. Dept. PM3, Pen-Brush, 139 Duane St., New York 13.

I'll Put a "shoe store business" in your pocket! Nation's leader trains you to make big money! Fit men, women. Free sample outfit. Write today! Consolidated Shoe System, Dept. S-314, Chippewa Falls, Wis.

SELL Ultra-blue stock signs to stores. 1000 slogans, comedy, general, religious. "7x11" cost 6c, sells 35c. Make money. 100 samples ultra-blue signs "7x11" \$1.00 postpaid. Lowy, 8 West Broadway, Dept. 452, New York City 70.

NEW Patented plastic sink rack, retails \$1.00. Active distributors protected. Sample \$1.00. Write wholesale prices. Savasink Company, 194 Hempstead Tpke, Franklin Square, N. Y.

EVERYDAY Cards. Earn \$5.00 with every ten \$1.00 boxes of everyday cards you sell. Also new plastic cards, personalized stationery, note paper and wrappings. Send for samples today. Howard P. Ellis, Dept. PM-3, Pitman, N. J.

FREE Water and our concentrates, make flavors, lotions, shampoos, 125 products, labels, bottles supplied. Qualco, E20030 Russell, Detroit.

MAKE \$50 Selling America's leading all occasion greeting card assortments. Samples on approval. Complete line fast money makers—gift wrappings, place cards. Free samples imprinted and monogram stationery. Write Lorain Art Studios, Dept. AO, Vermilion, Ohio.

MUSIC Greeting cards. All occasions. Dorby Music Cards, P.O. Box 738, Morristown, New Jersey.

BIG Money—Fast! Sell quality plastic tablecloths (from \$4.00 dozen), curtains, aprons, etc. Factory prices. Free samples! Durever, 282-C Albany Ave., Brooklyn 13, N. Y.

PLASTIC Tablecloth covers, curtains, drapes, baby pants, bowl covers and other plastic articles selling like wildfire! Make big money now! Free details. Write L & M Co., Dept. 58-C, 510 St. Charles, St. Louis, Mo.

SELLS Itself. Key chain miniature telescope attached, shows glamorous girls. Sample 35c, details free. Baldwin Specialty Co. 10217 Atlantic Blvd., South Gate, Calif.

LOOK Here! Wanted—Men and women to start in business on credit. Sell some 200 farm-home products. Thousands our dealers now make quick sales, big profits. For particulars write Rawleigh's, Dept. C-192-PPM, Freeport, Ill.

A DRESS For you with every 3 you order for yourself and family. Amazing new plan. Everything free. Harford Frocks, Dept. B-9128, Cincinnati, Ohio.

EARN Many dollars now with Thomas Terry's amazing new springtime and year end plans. Send today for two unusual assortments on approval and new free display folders. Write Thomas Terry Studios, 1 Union Ave., Westfield, Mass.

ABSOLUTELY Free! Big package actual sample fabrics and style presentation dresses, lingerie, hosiery, etc. Take orders. Commissions big. Send no money. Melville Co., Dept. 4776, Cincinnati, Ohio.

SCHOOL Seniors! Your postal will bring our wonder, Kwick-Sell cardalog of popular graduation name cards. Biggest profits! Only firm giving free souvenir chest and card case. Don't miss out! Hurry! Write post! Craftcards, Box 235 (L), Pittsburgh 30, Pennsylvania.

MAKE Money calling on friends. Show greeting card assortments—Birthday, get-well, others. Floral stationery. Gift wrappings. Experience unnecessary. Samples on approval. Wallace Brown, 225 Fifth Ave., Dept. F-4, New York 10.

POCKET Pal: Replaces pocket knives, new, safe, beautiful. Always razor sharp. 50c seller, 321% profit. \$15.00 or more daily. Agents, salesmen, distributors. Sample 10c. Nelson Mfg. Co., 222 W. Kellogg, St. Paul 2, Minn.

NEW "Sponge" dish cloth. Replaces messy dishrags. Banishes dishwashing drudgery. Lightning seller. Samples sent on trial. Kristee, 117, Akron, Ohio.

DE-ODORIZER—Refrigerator and ice-box unit. Sell finest, retails \$2.00, and profit 100 to 300%. Exclusive territory. Write L. A. Muffler, Continental Bldg., Los Angeles.

BUY Thousands of nationally advertised products direct from manufacturers. Write for "Buy Direct and Save." Consumers Assn., 218-F Investment Bldg., Pittsburgh 2, Penna.

SUCCESS Seekers. \$1.00-\$3.00 advance commissions plus cash bonus plan selling quality shoes direct. Amazing features. 70 styles entire family. Experience unnecessary. Free starting outfit. Moench Shoes, 10A, Boston, Mass.

NEWEST Money sensation. Sell hand tinted ties with personal initial. 100% profit. Experience unnecessary. Special offers. Write for free 20 page catalog complete line ties, mufflers. Philip's Neckwear, 20 West 22nd St., Dept. K-33, New York 10.

MEXICAN Feather pictures. Unusual novelty. \$1.00 (stamps) brings \$2.00 worth samples, details. Refunded if unsatisfied. Estec Art-P, Apartado 762, Mexico City.

BOYS! Earn big money and bonuses by selling brass name plates for neighbor's doors. Write Hubstamp, 357-A Congress, Boston, Mass.

MAKE Big money with the wonderful new "Pink Satin" Cream Shampoo! Sells hot! Sales repeat! Splendid money-maker for you! Rush name for interesting details, today. Demo Laboratories, Bogota, N. J.

MAKE Sensational profits! New, sell-on-right Plastic line: Tablecloths, aprons; many other splendid fast-selling items, novelties. Postal brings free details, special deals. Hurry! Royalty, Box 748-H, Passaic, N. J.

WOULD You pay 3% first \$350 made? Color-illustrated book "505 Odd Successful Enterprises" free! Expect something odd! Pacific-A, Oceanside, Calif.

AGENTS We have a "natural" for big profit and quick sales. Millions sold annually. Write, Star Company, Wholesalers, Geneva, Ill.

OVER 100 "Automatic fire extinguisher" experienced dealers have changed to Red Ball Inc. since Oct. 25. There is a reason. Make us prove it. Write Box 1655, Salt Lake City, Utah.

300% PROFITS Selling genuine, guaranteed, "NuSilver Polish and Silvering Liquid." Apply with cloth. Stores, offices, homes. NuProcess Products, Aurora, Ill.

SENSATIONAL Sales everywhere with the brand new "Ace-Hi" Game. Complete demonstrating sample \$1.00. Retail \$1.95. Leitner Company, 4031 N. Paulina, Chicago 13.

BIG Profits. Luminous car monograms. Sample stamp. Brooks, B120M, Arkansaw, Wis.

EARN Big money year 'round. Be a one-person-department-store. Take orders for shirts, ties, hosiery, lingerie. Household linens, etc. For information, Corporate Merchandisers, Dept. PM-12, 547 Broadway, New York City 12.

PRIVATE Label product—Crystals, shampoo, disinfectants, etc. Dieter Products, 1021 Chestnut Street, Reading 5, Penna.

GREETING Cards, gift wrappings, novelties. Personalized Paper Products, 4154g Fifth Street, Philadelphia 40.

GET Into business free. Write Sliwa Bros., 889 Seneca, Buffalo 10, N. Y.

BIG Profits, quick sales—50,000,000 prospects. "Ear-Buds," latest earring sensation. Custom made, particulars free, sample pair \$1.68. Minot Company, Box 77, 22 Minot, Dorchester 22, Massachusetts.

BIG Profits. Sell outstanding enlargements. Richphoto, 215 W. 98th, New York 25.

DO You want \$50? Show lovely greeting cards, stationery, wrappings, napkins—to friends, neighbors, co-workers. \$50 profit on 100, \$1 boxes. Free literature shows beginners easy way to make money. Approval sample. Torres Co., 373 Fulton St., Brooklyn 1, N. Y.

AGENTS, Quantity users! Big 48 page catalog of rubber stamps and marking devices sent for dime. (Refunded first order). Miles Specialist, Kokomo 1, Indiana.

OWN Your own business. Sell men's neckwear, spare or full time. Small investment—big profits. Free catalogue. Radio City Neckwear, Dept. M. 112 W. 50th, New York City.

PARACHUTE (Nylon). Three amazing toys in one. Dollar value. Sells 59c. Costs 30c. BK Jobbers, 728 Cherry, Toledo, Ohio.

AGENTS: Stamping names on pocket-key protectors. Sample check with your name, address, 25c. Stamping outfits, Emblem checks, check-fobs, name plates. Hart Mfg. Co., 303 Degraw St., Brooklyn, N. Y.

PHOTO-Salesmen-agents. Sell beautiful hand-colored plastic enlargements. Collect deposit, we deliver. Profitable sideline. Send card, for free sample kit. Novel Portrait Co., 3343 North Ave., Chicago, Ill.

MAKE More money selling personal initialed individualized belts, buckles, cap badges, tie holders, name plates. 2,000 emblems to choose. Big profits, whole or part time. Write today; special outfit offer. Hookfast Specialties, Box 1425, Dept. 6, Providence, Rhode Island.

FREE Samples. Big profits showing amazing glow-in-the-dark specialties. House numbers, pictures, plastic novelties, religious and nursery objects, etc. Large manufacturer. Madison Mills, 303 Fourth Ave., New York, N. Y.

HOTTEST Seller of all time. Details free. C & C Sales, Box 1046P, Chicago 90, Ill.

INFORMATION — Wholesale supply sources. Moneymaking plans. Increase your income! Write Reynard Service, Smithfield 3, Ohio.

FAST Money! Take orders for new sensationally different picture enlargements. No competition. Everybody buys. Gotham Products, Box 5427 M, Philadelphia 43, Penna.

SELL By mail books, novelties, bargains! Ready made circular service! Large profits! Catalog free! Elco, 432 North Wells, Chicago 10.

SCHOOL Seniors—Earn 40% commission selling classmates America's most beautiful graduation name cards. Largest selection. Outsell all others. Free sample kit. Printercraft, Dept. M, 1425 E. Elm St., Scranton 5, Penna.

BIG Money selling cast iron and aluminum cooking utensils direct to consumer, exclusive designs. Free illustrations. Jones Machine & Foundry Co., Chattanooga 2, Tenn.

EXCELLENT Sideline for printing and advertising salesmen. Decalcomania name plates in small quantities. Great demand. Also, make money with our line of automobile initials and sign letters. Free samples. "Ralco" XL-Roxbury, Boston 19, Mass.

AGENTS—300% Profit selling genuine gold window letters; stores and offices. Free samples. Metallic Letter Co., 438-B North Clark, Chicago.

HIGH-GRADE SALESMEN

SALESMEN, Distributors, jobbers, handle fast selling line, costume jewelry. Direct from factory. Large earnings. Packerling Co., 180 N. Main, Attleboro, Mass.

31-MAN Power sales proposition—New patented tool multiplies man's strength 31 times. 2-minute demonstration sells 1 to dozens to retail outlets, railroads, transports, public works, shops, factories, electricians, police, highway depts., farmers. Every auto, bus, truck or street car should have one. Light, compact, low priced. Look at earnings one month—Ruffo, \$1880; Maurice, \$4,500; McElhane, \$450; Brown, \$556, spare time. Grab your territory now or wish you had. Palcosteel Co., Ltd., Massena 11, N. Y.

SELL Calendars now. Be the first in your district. Good sideline or full time. Every business wants them. Few calendar salesmen are on the road now which means more sales for you. Fleming Calendar Co., 6539 Cottage Grove, Chicago 37.

FOR Tremendous profits—Sell Kory perfume pen. Contains year's supply of finest perfume. Necessity for every woman, girl. Write immediately for details. Brand-Nu, 425 Fifth Ave., New York.

80c PROFIT On every dollar. Scientifically engineered automotive carburetor item. Every owner a prospect, 3 minute sales easy. Guaranteed sample \$1.00. Details 1st class for stamp. Box 94, Englewood, Colorado.

SALESMEN, Earn \$100.00 weekly, selling only six pair shoes daily. Commission and bonus. Wide variety for men, women, children. No investment. Experience unnecessary. Tanners Shoes, 410, Boston, Mass.

FANS—Fans. Salesmen making \$50.00 to \$100.00 per day selling our electric fans, sump pumps and printed self sticking advertising tape. Write Universal Fan Co., Inc., Peru, Indiana.

SALESMEN Earn \$100.00 per week up calling on stores and individuals. Year round sales. Everyone a prospect. Write for free 30 page catalog and plans. No investment required. Appliance Distributing Company, Inc., Dept. M8, 163 Walton St., N. W. Atlanta, Georgia.

STOP! Want to make money all year round selling a complete line, uniform trousers, shirts, caps, ties, badges, 2000 emblems, personal initialed buckles, belts, and hundreds of other easy-to-sell items? Sales kit furnished. Please write today. Hook-Fast Company, Box 480PM, Roanoke, Va.

"BAGS," Cups, napkins, etc. Buy here cheap! Big profits selling from car or truck to grocers, restaurants. Wholesale catalogue. "American Paper Company," Washington 2-C, D. C.

EXCLUSIVE Agency—Brush attachment for painting window sash. Sell to retailers. Large profits. 50c for sample. Tru-Trim Products, Dept. M, Hammondsport, N. Y.

SALESMEN—Put yourself in line for big money and real future. Keep stores supplied with 5c-10c counter goods. Nationally advertised merchandise. Top profits for you and merchants. Liberal deals boost sales. Sideline or full time. World's Products, Dept. 10-P, Spencer, Ind.

SALESMEN, Agents, distributors. Sell specialty items. Cigarette lighters, flashlights, ball point pens, all complete with key chains. Send \$2.00 for samples. Kennedy Sales Company, Box 178, Richmond, Va.

BRUSH And mop salespeople—Sell our improved 1949 model cellulose sponge mop with rubber window wiper, direct to homes. Earnings up to \$25.00 daily. No stock to carry. No delivering. We ship direct to customers. c.o.d. Write National Brush & Broom Co., Dept. PM-2, Valparaiso, Indiana.

RAY-PRUF Sunglasses — High quality line. Fast sellers, large profits. Write Sterling Optical Co., 150 South St., Newark, N. J.

hundreds of companies. No if pay you well, full or part-time. No experience needed. Opportunity, 28 E. Jackson, Dept. 17, Chicago 4, Ill.

QUICK Sure money. Selling Annie Blain flavors. Highland Park 1, New Jersey.

BIG Money selling tooth powder. Write today. James Walker, 633 Plymouth Ct., Chicago, Ill., Dept. 3.

BIG Money taking orders. Shirts, ties, socks, pants, jackets, sweaters, shoes, uniforms, etc. Sales equipment free. Experience unnecessary. Nimrod, 4922-AN Lincoln, Chicago.

EDUCATIONAL AND INSTRUCTION

\$100.00 WEEKLY. Servicing, repairing radiators. Home study, Radiatorman, Hayward, Wis.

LEARN Graphic arts in a few months, earn good wages. Hand composition, monotype, etc. Free bulletin. Graphic Arts Technical School, 1104 Currie, Minneapolis 3, Minn.

BE A real estate broker through home study or classroom instruction. Write for free book. Approved for veterans. Weaver School of Real Estate, 15 E. Pershing Rd., Box CP-3, Kansas City 8, Mo.

MANAGERS Wanted everywhere. You can qualify. Casson's inspiring practical course "Efficient Management" in 198 page book makes managers increase profits in stores, businesses and factories. Send \$3 today for third enlarged edition and receive free 3000 word lesson: "Become irresistible in life and business." When not delighted return book within week but keep lesson and your \$3 flies back. Educational Publishing Institute, 5643 Lami-rada, Room 105, Los Angeles 38, Calif.

IF You'd like a profitable office business, operate a collection agency. Our inexpensive short course quickly qualifies you. Write Cole & Associates, Syracuse 2, New York.

EXPORT! Learn at home from established world trader. Big paying positions. Your own profitable world-wide business by mail order without capital; or travel abroad. Experience unnecessary. Free booklet. Mellinger, 103W, Los Angeles 24, Calif.

MAKE Up to \$30-\$40 week as a trained practical nurse! Learn quickly at home. Booklet free. Chicago School of Nursing, Dept. M-3, Chicago.

"HOW To Break and Train Horses"—A book every farmer and horseman should have. It is free, no obligation. Simply address, Beery School of Horsemanship, Dept. 1103, Pleasant Hill, Ohio.

STUTTERING Corrected at home. Free literature. Athenium, PM-31, 1714 Chestnut, St. Louis 3, Mo.

HOME Bible course. Simple, helpful, instructive. Total cost \$4.00 includes textbooks, stationery, examinations, certificate. \$1.00 starts you, or simply request prospectus. The Bible Study School, 378 Van Houten Street, Paterson 1, N. J.

WANT U. S. gov't. job? Big pay—Security. Men-women earn more. Qualify now for exams. Free 40-page book, sample tests. Write Franklin Institute, Dept. M24, Rochester, N. Y.

BECOME A Doctor of Psychology or Metaphysics. Teach secret of contentment, happiness. Win degree of Ps.D. or MsD. Solve mental worries. Free book. College of Universal Truth, 5153-C North Clark, Chicago.

WOULD You pay 3%, first \$350 made? Color-illustrated book "505 Odd Successful Enterprises" free! Expect something odd! Pacific-E, Oceanide, Calif.

PHOTOGRAPHIC Mind! Amaze, earn, learn! Facts, figures, names stick like burrs with Supermemory. Write Thor Books, M3, Box 1210, Chicago.

LEARN Tile setting at home in 2 to 4 weeks. Full price \$12.50. Zaludek, P.O. Box 6961, Los Angeles 22, California.

NEW Correspondence courses. 500 subjects. Complete, \$9.95. Write DeVoto Schools, 35 Vicente, San Francisco 16, Calif.

SHELL Wonders catalog free. Shell House, Box 1685-C, Miami 35, Florida.

pay for course after securing position. Write, Free School, Kokomo 3, Indiana.

LEARN Mechanical dentistry: World-wide opportunities. Start own business. Resident school gives practical instruction at the bench. G.I.-approved. Housing available. Write for folder PM. Franklin Schools, 719 Liberty, Pittsburgh 22, Penna.

LEARN Auctioneering by mail. Sample lesson free. Nelson Auction School, Ren-ville, Minnesota.

BE A mathematical wizard. Add columns instantly. Free details. Vanderdrift, 517 Lincoln Place, Orange 2, New Jersey.

PIANO Tuning pays. Learn this profitable profession at home. Our Tonometer and mechanical aids make learning easy. No knowledge music necessary. Diploma granted. Largest and oldest school—50th year. G.I. approved. Write for booklet. Niles Bryant School, 78 Bryant Bldg., Washington 16, D.C.

INVESTIGATOR Training. Phillips Secret Service, 1917B North Kenneth, Chicago 39, Illinois.

BOOKKEEPERS! Increase your earnings! Operate your own simplified "Dollar-A-Week" bookkeeping and tax service. Full or spare time. Details free. No obligation. Ellis, Box 200, Cedar Grove, North Carolina.

SCIENCE Of memory simplified. Free booklet "Memory Development." Memorology Club, 2016 Sunnyside Ave., Chicago 25, Ill.

BOOKKEEPING Easily learned! Rapid, simplified instruction. Introductory lesson 35c—15 lesson course, \$5.00. B. Buchalter, 1280 Ocean Ave., Brooklyn 30, N. Y.

DENTAL Technician's practice kit. Artificial teeth, plastic, etc. Free instructions with kit. Grant Laboratory, S-219 W. 7th, Los Angeles, Calif.

MEDICAL Laboratory technicians in great demand. We train you in your own home, in your spare time. Also home study course in general chemistry. Free catalogue. Imperial Technical Institute, Box 973-J, Austin, Texas.

USED Correspondence courses and books bought, sold, rented and exchanged. Catalog free. Lee Mountain, Pisgah, Alabama.

LEARN Photo-engraving at home or in oldest, largest school in America. Work for newspaper or establish own profitable business. New Tasope Photo-Engraving equipment available soon. Write for information. Veterans ask about G.I. training. The Aurora School of Photo-Engraving, Tasope Bldg., Aurora, Mo.

SECRET Investigation. Experience unnecessary. Investigators particulars free. George Wagner, M 125 West 86th, New York.

LINGUAPHONE Makes languages easy. At home learn to speak Spanish, Portuguese, Italian, French, German, Russian, by quick, easy Linguaphone Conversational Method. Save time, work, money. Linguaphone correspondence courses are available to veterans under G.I. bill of rights. Send for free book. State if G.I. Linguaphone Institute, 83 RCA Bldg., New York, 20, N. Y.

EARN Extra pay the easy way. Write confession and love stories that sell at highest rates. Beginning study material sent on 20-day free trial. Croydon Institute, 1545 North Larrabee, Chicago 10.

PLAYS, STORIES, MANUSCRIPTS

SPECIALIZED Revision, rewriting, typing, expert preparation of short stories and novels for marketing. Tinney, 3111 Arizona, Dallas, Texas.

I WANT New writers to cash hundreds of checks for \$1 to \$100, offered each month. The easiest way to write for pay. No previous experience necessary. Send for free details. No obligation. Saunders M. Cummings, 468-M Independence Bldg., Colorado Springs, Colo.

BUSINESS SERVICE

VERMONT Postmark: 25c each. "Peters," South Hero, Vermont.

CAPITALIZE On Chicago loop address. Forwarding, various personalized services. Business Service Bureau, 430 S. Wabash Ave., Chicago 5, Ill.

CONSULTING Engineering—Mechanical or electrical. \$4.00 per hour. Strictest confidence. Send us your problems. Dup Engineering Service, 5665 La Jolla Blvd., La Jolla, Calif.

COMING To California? All questions the west coast answered for \$1.00. Write The Question Box, 1322 South Bronson, Los Angeles 6, Calif.

WE Receive, remail letters; \$3. monthly or 25c each. "Hawkins," 13 Taylor, Washington, D. C.

TREASURES In your closet! Do you have worthless bank books, insurance policies or stock certificates in some forgotten drawer? They may be worth a fortune! Let us investigate for you. Write today. National Evaluators, P.O. Box 5852, Cleveland 1, Ohio.

INFORMATION

FOREIGN Employment for you. Excellent permanent job opportunities for U. S. citizens. Wages at least 20% higher, less taxation, lower living costs. Improved social position. Transportation and housing furnished. Choice of climate and location. South and Central America, Far East, China, Alaska, Africa. Send \$1.00 for copyrighted Digest showing oil, shipping construction, mining, etc. Companies working and hiring. Includes sample application letter, advice on wages, tips, etc. World Wide Company, Dept. PM-3, Madison 1, Wis.

CALIFORNIA. Dependable facts and figures about jobs, housing, merchandise. \$1.00. M. Pomeroy, 11926-PM Wilshire, Los Angeles 25.

RESEARCH Library congress. Any subject \$1. Literature free. F. A. Harris, 4496 Brookland Station, Washington, D. C.

PICTURE Puzzle fans—Win big! Learn the tricks of the picture puzzle makers. Now you can solve those tie breakers and win big cash prizes. For you to a fortune, send 50 cents today for "crets of the Picture Puzzle," Box Philadelphia 5, Penna.

CARTOONING, COMMERCIAL SHOWCARD WRITING, SIGN PAINTING

"COMIC Pen and ink sketch" from your photograph. Picture returned unharmed. State hobby. Send photo \$1.00 to Jack Miller, 421 East W. Canton, Illinois.

"HOW To Make Money With Cartoons"—a book everyone who like draw should have. It is free; no obligation. Simply address Cartoonists' change, Dept. 93-C, Pleasant Hill, Calif.

FIGURE Drawings by French Lalire. Over hundred female poses, details, \$1.00. Art Headquarters, 1 Avenue North, St. Petersburg, Fla.

FAMOUS \$75 Lockwood art collection \$6 postpaid. Other smash bargains. Catalog 10c. Art Book Arnold 5-C, Missouri.

BECOME Professional lettering. Easy with guaranteed master lettering. \$8.50. Major-Art System, 3510-C P. Chicago 47.

COMIC Pen and ink sketch made your photograph. Picture returned unharmed. State hobby or pastime. photo and \$1 to Baker H. Allmond, R. Box 49, Windsor, Virginia.

LEARN Showcard writing at home in spare time. Fascinating, profitable. Free information. Sherwood Publishing Co., Irvington 11-9, N. J.

BECOME A sign painter, start earning quickly. Signways, Knox, Indiana.

LEARN Sign painting. Wonderful trade. Big money. New method for teaching beginners. Price \$5.00. Free particulars. Haines System, Sabina, Ohio.

BE A showcard writer. Learn at home in three weeks. Uncrowded. Big money field. Make sales very first week. Write: R. J. Meisner, 1539 Wisconsin Avenue, Dept. 12, Flint 6, Mich.

SIGN Painting taught at home. Test lesson free. Ben Kerns Studios, Box 812, Greenville, S. C.

CARTOONIST'S Magazine, 25c. Lessons, hints, Cartoonist Hartman, 2776 California Ct., Lincoln 8, Nebraska.

NEW Style home study course in advertising art now ready. Free portfolio "Your Career in Art." Applied Art Studio, 1662 Lincoln Avenue, Cleveland 7, Ohio.

CHALK Talks. Laugh producing program, \$1.00. Catalog 10c. Balda The Cartoonist, Oshkosh, Wisconsin.

ADVERTISING AGENCIES, LETTER WRITERS, FOR ADVERTISERS

ADVERTISERS! Reach nearly 18,000,000 readers. 25 Sunday national key newspapers, 18 words, \$51.50. "Terrific pullers." 20 popular newspapers, \$10.00. "Free booklet." Special—One inch display 2-821,198 circulation, \$48.30. Newmark's Advertising Agency, (Established 1893), 217-7th Ave., New York 11.

ADVERTISE: 24 Words, 40 newspapers \$3.50. Lists free. Advertising Bureau, 10511-C Springfield, Chicago 43.

EXPERIENCE Pays! Highly resultful "know-how" methods. Direct mail, mail-order, campaigns. What's your problem? Finkle, 257 South Spring, Los Angeles 12.

FREE! 1949 Advertisers Rate and Data Directory. 52 pages! E. H. Brown Advertising Agency, 20 N. Wacker, Chicago 6.

24 WORDS in 50 weeklies, \$4.96. J. Darnell, 730 Hays, Jackson, Tennessee.

ADS Placed in out of town newspapers and magazines. Low rates. Catalogue free. Ideas that pay. Baker Advertising Agency, Successors Ankrum Agency, 189 W. Madison, Chicago 2.

MAILING Lists, certified, productive, inexpensive, \$5.00 1000. Homeworkers, agents, buyers, etc. Write Dixie Service, King, N. C.

RUBBER STAMPS AND OFFICE SUPPLIES

PICTORIAL Rubber stamps, 5 different samples 25c. Stampco, Detroit 4, Mich.

3 LINES, 50c. 125 Letterheads, 125 envelopes printed, \$1.98. 1949 catalogue. Johnson Press, Box 6-A, New York City 26.

3 LINES 45c: cushioned, indexed 55c; pads 35c. Stampright, Wauwatosa, Wis.

LINE 20c; 2-35c; 3-50c. Stamp Works, Auburn, Nebraska.

TYPEWRITERS, DUPLICATORS, OFFICE DEVICES

4 TYPEWRITER Ribbons, good quality, \$1.75 postpaid. Jobar, 833M East 217th Street, Bronx 67, N. Y.

REVOLUTIONARY New addresser, No plates, \$32.50 complete. Cunningham, 1463 E. 50th, Chicago.

ADDRESSING Machine complete with supplies \$32.50. Samples and folder free. Mail Addresser, San Marcos, Texas.

STANDARD Typewriters \$17.50; duplicators \$12.50; adders \$12.50; nationwide shipper. "Typewriters," 118 Spruce, Wichita, Kansas.

TYPEWRITER \$30.00, Electric welder cheap. Trowbridge, 653 W. 81st, Chicago 20.

RECONDITIONED Typewriters, mimeograph, multigraph printing devices, appliances, supplies. Catalog. Dixiegraph Service, King, N. Carolina.

PRINT-O-MATIC Mimeographing post card typeless stencil duplicator printer \$13.50. Office duplicators—Hilcos, Speedo-prints. Typewriters, portable adding machines, addresserettes, automatic envelope sealers. All office machines. Duplicator supplies. Literature free. Pittsburgh Typewriter Supply, 336-4 Fourth Avenue, Pittsburgh 22, Penna.

PRINTING, MULTIGRAPHING, MIMEOGRAPHING, GUMMED LABELS

SAVE Money on your printing. Write for low price list and chart. We photograph and reproduce your copy on white or colored paper. Our art dept. will help with your advertising folders, catalogs, forms, etc. Direct mail sales our specialty. Winchester Printing Co., Grand Rapids, Michigan.

50 8 1/2 x 11 Hammermill letterheads with 50 envelopes \$1.00 postpaid. Benneville, Box 1931, Pittsburgh 30, Penna.

400 8 1/2 x 5 1/2 LETTERHEADS \$1.35. Mango, 555-A South 20th, Newark 3, N.J.

1,000 BLOTTERS, \$2.75; Cards, \$2.25; samples. Box 174, Niagara Falls, New York.

GUMMED Tape printed. List price. Excel, Box 14, Northfield, Ohio.

MIMEOGRAPHING 100 8 1/2 x 11 \$1.10. Additional hundreds 50c. Mimeographing, Madison, Tenn.

BUSINESS, Personal stationery. State requirements. Samples. Mero Products, 100 Morrison, Punxsutawney, Penna.

BETTER Printing at reasonable prices. Send requirements. Free samples sent upon request. Mills Burnham, Highland, No. Abington, Massachusetts.

GUMMED Labels, stationery. List free. Reed, Box PM-135, Spiro, Okla.

5000 6 x 9 CIRCULARS \$16.00 Postpaid. Samples free. Journal Printing Co., Newark, Ark.

100 8 1/2 x 11 HAMMERMILL Letterheads and 100 envelopes \$1.98. Herbert Hudson, 261 Woonasquatucket, Centredale, R. I.

100 ENVELOPES Printed, 2-colors \$1.00. Samples. Box 523, Rochester 2, N. Y.

BETTER Grade printing reasonable. Estimates on anything. Economic Press, Leonia, N. J.

1000 BUSINESS Cards, \$2.50 prepaid. Samples free. Reliable Print Shop, 905 East Jefferson, Louisville 6, Ky.

SAVE Money on your printing. Write today for new, low price list and offset ordering chart PM-1 free. We photograph your copy and reproduce it on white or colored paper. Advertisers Service Litho, 161 W. Harrison, Chicago 5, Illinois.

SEND 10c Now, for our 48 page 1949 price list—refund first order. McCall Press, 1326 South 27th, Omaha, Nebraska.

500 3/4 x 2 1/4 FOUR Line gummed stickers 35c; red border 50c. Moritz Printery, Saginaw, Mich.

QUALITY Printing—Reasonable prices. Fast service on catalogs, folders, publications. Write for prices. Bagby Printing Co., Georgetown, Ohio.

MIMEOGRAPHING—Letters, pricelists, formulas, instructions. Lowest prices. Lem's Letter Shop, 5710 Stanton, Detroit 8.

PRINTING OUTFITS AND SUPPLIES

PRINTING Presses, type, supplies. Send stamp for details or dime for complete illustrated printer's supply book and samples. Kelsey Corp., J-11, Meriden, Conn.

MAKE Your own plastic printing cuts. New plexiplat process. Plexiservice, Argyle 1, Wisconsin.

HOMECRAFT Presses, supplies. Catalog 10c, refundable. Riegel, 1111 Harrison, Philadelphia 24, Penna.

PRINTING Presses, type, supplies. Lists 3c. Turnbaugh Service, Loysville, Penna.

INEXPENSIVE Home-made printing press. Details free. Novelty Shop, Downsville, Louisiana.

PATENT ATTORNEYS

PATENTS, Trade marks. Sanders, 6430 Evans, Chicago. Registered U. S. Patent Office.

PATENTS—Trade marks. Gustave Miller, Registered Patent Attorney, 39-A Warner Building, Washington 4, D. C. Patent Lawyer.

PATENTS. "Proof of Invention" folder mailed without obligation. E. E. Vrooman, Registered Patent Attorney, 505 McKim Building, Washington 5, D. C.

INVENTORS—Patent laws encourage the development of inventions. The Rules of Practice of the U. S. Patent Office advises—unless an inventor is familiar with such matters—that he employ a competent registered attorney or registered agent, as the value of patents depends largely upon the skillful preparation of the specifications and claims. Write for further particulars as to patent protection and procedure and "Invention Record" form at once. No obligation. McMorrow, Berman & Davidson, Registered Patent Attorneys, 1343 Victor Building, Washington 1, D. C.

PATENTS, Trademarks, salubridad registrations in Mexico and Latin America. Free particulars immediately. International Patent Bureau, Apartado 10727, Mexico, D.F.

INVENTORS—If you consider your invention to be something of importance, you may take steps to protect it with a U. S. patent which gives you the right to exclude others from making, using and selling your invention as claimed. "Patent Protection for Inventors" booklet outlining steps to take to secure patent protection will be mailed promptly without obligation. Victor J. Evans & Co., Merlin M. Evans, Registered Patent Attorney, 431-C Merlin Building, Washington 6, D. C.

INVENTORS: When you are satisfied that you have invented something of value write me, without obligation, for information as to what steps you should take to secure a patent. Write Patrick D. Beavers (Formerly Randolph & Beavers) Registered Patent Atty., 935 Columbian Bldg., Washington 1, D. C.

C. A. SNOW & Co.—M-427, Snow Building, Washington 1, D. C. Registered Patent Attorneys. Write for information.

PATENTS—Trade marks. Irving L. McCathran, 315 McLachlen Bldg., Washington 1, D. C. Registered Patent Attorney.

INVENTORS: Learn how to protect your invention. Unless the inventor is familiar with patent matters, he should engage a competent registered patent attorney or agent to represent him. We are registered to practise before the U.S. Patent Office and prepared to serve you in handling your patent matters. "Patent Guide for the Inventor" containing detailed information concerning patent protection and procedure with "Record of Invention" form will be forwarded to you upon request—without obligation. Clarence O. O'Brien & Harvey Jacobson, Registered Patent Attorneys, 918-A District National Building, Washington, D. C.

INVENTORS. For "Record of Invention" form, contact Carl Miller, Registered Patent Attorney, Woolworth Building, New York.

INVENTORS: Without obligation, write for information explaining the steps you should take to secure a patent. John N. Randolph, Registered Patent Attorney, 303 Columbian Bldg., Washington 1, D. C.

"**INVENTOR'S** Guide" free on request. Frank Ledermann, Registered Patent Attorney, 154 Nassau St., New York 7, N. Y.

INVENTORS: Write for free brochure "Evidence of Invention." Labiner, World Building, New York 7.

PATENT Practice before U. S. Patent Office. Validity and infringement investigations and opinions. Booklet and form "Evidence of Conception" forwarded upon request. Lancaster, Allwine & Rommel, Registered Patent Attorneys, Suite 411, 815-15th Street, N.W., Washington 5, D. C.

FOR INVENTORS

INVENTORS—This firm is registered to practice before the U. S. Patent Office and is available to assist inventors in the preparation and prosecution of their cases. "Patent Protection for Inventors" booklet containing detailed information and steps to take toward patent protection will be sent upon request. No obligation. Victor J. Evans & Co., 432-C Merlino Building, Washington 6, D. C.

INVENTORS—Patent laws encourage the development of inventions. The Rules of Practice of the U. S. Patent Office advises—unless an inventor is familiar with such matters—that he employ a competent registered attorney or registered agent, as the value of patents depends largely upon the skillful preparation of the specifications and claims. Write for further particulars as to patent protection and procedure and "Invention Record" form at once. No obligation. McMorrow, Berman & Davidson, Registered Patent Attorneys, 1342 Victor Building, Washington 1, D. C.

PATENT Searches \$5.00; also electronic and engineering searches. Immediate attention. Request free protection form. Patent Service, 703 Albee Bldg., Washington 5, D. C.

INVENTORS' Technical assistance. Graduate engineer—can offer years of scientific design experience. Write for free discussion of your problem. No obligation. Clifford Hill, 210 Fifth Avenue, Suite 1102, New York City 10.

INVENTORS! Have you good, patentable ideas? Write Patent Agent Metzler, 11 West 42nd, New York.

PATENT Searches \$5.00. Reports air-mailed within 4 days. Invention protection forms free. Write Patent Research Engineering, 318 Evans Building, Washington 5, D. C.

PATENT Searches \$5.00. Reports air-mailed within 4 days. Invention protection forms free. Write Miss Ann Hastings, Patent Searcher, P.O. Box 176, Washington 4, D. C.

PATENT Searches \$5.00. Reports air-mailed within 4 days. Invention protection forms free. Write Raymond L. Smith, Patent Searcher, 410 Bond Building, Washington 5, D. C.

DRAWINGS. Blueprints—Send sketch for estimate. Hull, 7829 Euclid, Cleveland 3, Ohio.

READ Inventor-Gadeteer magazine—Latest world's inventive news, photos, stories. Interesting, instructive, helpful. Three months' trial subscription 50c; sample 25c. Inventor-Gadeteer Pub. Co., Los Angeles 13, Calif.

INVENTORS. For "Record of Invention" form, contact Carl Miller, Registered Patent Attorney, Woolworth Building, New York.

INVENTORS—Possibly I can help you. Many years experience. Charles A. Scott, 773PM Garson Avenue, Rochester 9, N. Y.

DEVELOP Your ideas now. Free booklet. Eto Development Company, Long Island City 1.

PATENTED. Unpatented inventions promoted. M. Joyce Humphries, 1424 Land-tite, Philadelphia 10, Penna.

INVENTORS: The usual first step is to have a search of the U. S. Patents conducted, so I can report on patentability. Write, without obligation. Patrick D. Beavers (Formerly Randolph & Beavers), Registered Patent Atty., 936 Columbian Bldg., Washington 1, D. C.

INVENTORS: If you have an invention for sale, patented or unpatented, write Institute of American Inventors, Dept. 40A, 1926 Eye St. N.W., Washington 6, D. C.

INVENTORS: Learn how to protect your invention. Unless the inventor is familiar with patent matters, he should engage a competent registered patent attorney or agent to represent him. We are registered to practise before the U.S. Patent Office and prepared to serve you in handling your patent matters. "Patent Guide for the Inventor" containing detailed information concerning patent protection and procedure with "Record of Invention" form will be forwarded to you upon request—without obligation. Clarence A. O'Brien & Harvey Jacobson, Registered Patent Attorneys, 91A-A District National Building, Washington, D. C.

INVENTORS' Financial assistance. Investment Development Company, Box 1462, Amarillo, Texas.

"**INVENTOR'S** Guide" free on request. Frank Ledermann, Registered Patent Attorney, 154 Nassau St., New York 7, N. Y.

INVENTORS: Without obligation, write for information explaining the steps you should take to secure a patent on your invention. John N. Randolph, Registered Patent Attorney, 202 Columbian Bldg., Washington 1, D. C.

INVENTIONS WANTED

ESTABLISHED, Reliable manufacturer seeks new games for home playing. Must be simple, have action, in popular price range. Write us what you have. Confidential. Write care of F. A. Huettner, 976 Kent Avenue, Brooklyn 5, N. Y.

THERE Are 10,000 manufacturers in Chicago. I can assist you to sell your patent. Write Ingles, 15 W. Ontario, Chicago.

CASH—Royalty. We manufacture, nationally advertise inventions. Fast action! Federal Identification Co., Robert Burbridge, Pres., 1713-35 West Grand Ave., Oklahoma City 6, Okla.

EARN Up to \$2,000 year, inventing simple items. Special cash markets. Hendrickson, Argyle 1, Wisconsin.

IDEAS For plastic articles and toys: If you have any ideas or inventions, patented or unpatented, concerning new plastic toys or practical household articles that you think good enough for production, please contact us in reference to producing them on a royalty payment basis. If your idea is not practical for our type of manufacturing it will be returned to you. No cost or charge is involved on your behalf. Commonwealth Plastics Corp., Leominster, Mass.

INVENTIONS Wanted. Patented or pending only. Inventors' Exchange-B, Hartford 1, Conn.

HIGHEST Royalties — Cash. Official U. S. I. R. C. certification. Request free Booklet "M", Universal Marketing Co., 354 South Spring St., Los Angeles 13, Calif.

INVENTORS: Hundreds of manufacturers have requested our assistance in locating marketable new products. Complete information, free. Institute of American Inventors, Dept. 40-D, 1926-Eye St. N.W., Washington 6, D. C.

PATENTS FOR SALE

PATENT Pending. Electric shavers, A.C.-D.C. Snapon ammeter. Descriptive drawings. Wilfred Whitton, 40 Guam Road, Bldg. 81, San Francisco, Calif.

INVENTORS: Test the commercial value of your patented or unpatented inventions, quickly and inexpensively. Write for free information, Institute of American Inventors, Dept. 40-B, 1926-Eye St. N.W., Washington 6, D. C.

MANUFACTURING

SMALL Lot manufacturing. Aluminum castings; stampings; screw machine; plastics; models. J and M Company, Burlington, Kentucky.

PLASTIC Or metal parts. Small lot manufacturing. Drawings made. Reasonable. R. L. Christian Co., P.O. Box 39, Stratford, Conn.

PRECISION Dies, gears, parts, inventions, manufacturing. Baum's Metal Specialties, Kansas City, Mo.

CUSTOM Built moulds for plastics, aluminum. Send blueprints. Unamit Mould & Machine Company, Bunker Hill, Ill.

MODELS — Small lot manufacturing. Metals, plastics, etc. Milburn, Burlington, Kentucky.

MODELS. Tools, dies, experimental work; large and small lot manufacturing. Van-Ess Specialties Company, 212 W. 14th Street, Covington, Ky.

MODELS, MODEL SUPPLIES

RAILROADERS—50c Gets 1949 catalog reference manual. State O or HO gauge. Walthers, 247 Erie, Milwaukee 2, Wis.

SHIPMODEL Kits and fittings of highest quality. Send 15c for 1949 catalog. Model Shipways, Folio 60, 476 Main Street, Fort Lee, New Jersey.

STEAM Marine engines, 2 cylinder V-type precision machined. Bronze construction, with built in speed control. Free literature. Model Marine Engine Wks., Box 326, Evanston, Ill.

MINIJET Engine kit now \$9.95 pp. U.S.A. Assemble real pulse-jet at home. Send m.o. today. No c.o.d.'s. Minijet Motors Sales Company, Box 406, Pasadena, California.

BRASS Gears and model supplies for the inventors. Send 10c for catalog. Pierce Model Works, Tinley Park, Ill.

BUILD Flashlight battery powered boat. Powerful motor, shaft, propeller, boat plans, \$2.50 postpaid. Free literature. Montague Electric, Montague, Michigan.

STEAM Engine castings. Circular 10c. Anton Bohaboy, 2297 Price, Rahway, N. J.

"**JETEX**"—It's new! It's unique! It's thrilling! The fastest small jet engine ever made. Interchangeable for model planes, boats, autos—simple, inexpensive to operate. \$4.95 postpaid. Includes fuel supply. Scoop your crowd! 15c for booklet; order today! Telasco Ltd., 11 West 42 St., New York 18.

DOWMETAL Magnesium for all model makers. Rod, bar, sheet and scale structural shapes. The Craftsmiths, 15427 Robson, Detroit 27, Michigan.

BROWNING Machine gun kit, 40 machined parts \$1.00. Vancraft, 17792 Northrop, Detroit 19, Michigan.

MODEL Railroad on a table top. Have fun building America's smallest railroad models. Scale 1/10"-1 ft. Operate electrically on TT gauge (15/32") track. Build from kits or buy ready-to-run. Big variety streamliners, diesels, steam locos, freight and passenger cars. Complete set, engine, 3 cars, 10 1/2 ft. track only \$29.95. Send 20c for big new 1949 catalog. H. P. Products, Dept. PM, Hartford City, Indiana.

BUILD Historic ship models, complete kits 39c to \$9.00. Catalog 10c. Ideal Models, 19 West 18th, New York 11, N. Y.

SHIP Models — Kits, fittings, plans, books, engines. Illustrated catalog 25c. James Bliss & Co., Inc., 220 State Street, Boston, Mass.

SHIP And yacht model fittings; blueprints. Send 25c for illustrated catalog No. 21—listing hundreds of items. A. J. Fisher, 1002-1 Etowah Ave., Royal Oak, Mich.

LARGE Illustrated catalog Lionel trains and accessories, 10c. Bens Hobby Shop, 72 West Washington, Chicago 2.

MINIATURE Steam locomotives, 1/4", 1/2", 3/4" scales. Castings, parts, rail, steam fittings! Thorough drawings with instructions. Catalog 25c. Little Engines, Wilmington, Calif.

SHIP Models and yacht supplies complete. Large 64 page catalogue 30c. Bill Wild's, 510 East 11 St., New York City 9.

LANDLOCKED Sailors! Here's a beautiful, richly illustrated, fully descriptive catalogue of famous model ships—whalers, slavers, corvettes, etc., authentic in every detail. Send for it today. Only 25c. Halesite Yacht Service, Inc., Halesite, Huntington, N. Y.

KEEP In touch with the activities of the British modelmaking fraternity. Send a dollar bill for year's subscription (4 issues) Modelcraft Magazine and list. 77 Grosvenor Road, London, S. W. 1.

HOME CRAFTSMEN

LEATHERCRAFTERS! First time offered! Approximately 15 sq. ft. of leather remnants. Many large pieces absolutely guaranteed for useful handicraft items including pigskin, cowhide, and unusual leathers all for \$2.98 postpaid. Send check or money order for exciting selection to D-E Products, Dept. PM-1, 8 E. Huron St., Chicago 11, Ill. Free special listing of remnant bargains.

MAKE Your own "Hercules" belts! Complete kit includes finest calfskin links, tongue and metal buckle. Simple instructions enclosed. Send \$1.00, we ship prepaid. Arokraft, Dept. M, 32 W. Randolph, Chicago 1.

LUMBER Cut to order. Oak, cedar, walnut. Samples six kinds woods \$1.00. Jason Lyon, 368 E. Rock St., Harrisonburg, Va.

"**PACKAGED** Projects" for the home craftsman. 40 projects in kit form. Send \$1.00 for catalog plus booklet, "Woodworking Fundamentals." Marine Mart, Buffalo 7-X, New York.

CATALOG: Booklet, hobbycraft hints 10c. Leisure Hour Products, 416 Rose, West Hazleton 2, Penna.

LEATHERCRAFTERS: Free! 3 sheets new designs with latest catalog. Enclose 25c handling charge. Leather Specialties, 358 E. Broadway, Long Beach 2, California.

JEWELRY Findings, shellcraft, misc. supplies. Low prices. Catalog 5c refundable. Hobbycraft Supply, 208 N. Wells, Chicago 6.

MING Trees, build your own, complete kit supplied \$5.95 postpaid. P.O. Box 329, Sparks, Nevada.

LAWN Chairs, garden figures, furniture, novelties, toys, etc. 68 popular plans with full size patterns, \$1.00. Mastercraft 3M, 7041 Olcott, Chicago 31, Illinois.

LAWN Ornaments. Ready cut patterns, full size. 20 assorted \$1.00 postpaid. Lincoln Craft Studio, Farmington, Conn.

LEATHERCRAFTERS! Free catalog! Leather, tools, supplies. Rosenblum Leather, 518 N. 8th, Sheboygan, Wis.

PORCELAIN Figurine profit. Outfit \$5. Miracle glass eraser, \$1 ppd. Anell, Box 762, B. F. Sta., Washington 4, D.C.

MONEY Making toy rubber band guns, prints \$1.00. Lightfoot, 912 South Veitch, Arlington, Va.

JEWELRY Findings, rhinestones, pearls, sequins, cameos, J & M Novelties, Box 464P, Griffith, Ind.

SPECIAL 77 Full sized patterns. Lawn ornaments, toys and novelties \$1.00. Modern Woodcrafts, Saginaw, Michigan.

SHELLCRAFT! Make beautiful seashell jewelry. Income or hobby! Large illustrated catalog! Supplies, instructions, 10c postage. (Buy direct from manufacturer.) Pace's, Box 279M, Bradenton, Florida.

USE Your own hand drill to make holes in glass, china, crockery, etc. No tools to buy. Dollar bill brings simple instructions. Wiggs, 207 South 13th, Lawton, Okla.

CRAFT Supplies—Leather, metal, plastic, tools. Free catalog. Kale Crafts, 2250 Milwaukee, Chicago 47, Illinois.

ETCHING Glass recipe \$1.00. Eleven chemical garden recipes \$1.00. Nunn, 659 E. Oxnard, California.

TROPICAL Wood for sculpturing and carving. Lignum-vitae, Buttonwood, Madiera, etc. For information write B. Lurie, Box 892, Coral Gables, Fla.

SHELLS, Plastics, findings. Lowest prices. Free catalog. Frances Jones, Box 251, Sarasota, Fla.

TURN Your workshop into cash. Send postcard for catalog of modern saleable projects. Craftplans, 7241-P Madison, Kansas City 5, Mo.

WINTER Shop project deals. Designs and materials for lamps, tables, etc. Veneers. Sedlo Company, P.O. Box 7161, New Orleans, La.

"KLONDIKE" Jewelry findings—bracelets, pins, earrings, chains, rings, stones, clips and other jewelry parts. Easy to assemble. Sample pound \$2.00, five pounds \$7.50. Imported cut stones. For rings, jewelry, novelties, etc. All shapes, colors, sizes. Sample 100 stones assorted, \$1.50 lot. Thousand lots, \$5.00. Imported beads, all colors, sizes, sample pound \$1.00, five-pound lots, \$4.00. Prepaid only. Merchandise Distributing, Dept. 1, 19 E. 16th Street, New York 3.

SCRAP Leather, assorted colors. Six pounds for \$1.00 prepaid. Box 397, Tulsa, Oklahoma.

LEATHERCRAFT Lacing, bargains! Francis Byrd, 3406 Montrose Ave., Richmond, Virginia.

LEATHERCRAFTERS: Belt kits, projects, leather, supplies. Free catalog. Art Leather, 411 Joseph Ave., Rochester 5, N.Y.

BANDSAW, Jigsaw owners, let your machine bring extra profits, fun. Free details. Nu-Art, 33 Rosemont, Weymouth 91, Massachusetts.

MAKE Your own jewelry! All types of findings, metal and plastic; cameos, beads, shell kits, illustrated catalog, 20c. Hobby Art, P.O.B. 276, Dept. 7, New York 18, N. Y.

50 PATTERNS Toy furniture, action toys, etc., \$1.00. Continental Homecrafters, 907 Birch, Eau Claire 3, Wisconsin.

CATALOG: Patterns plywood novelty furniture, lawn ornaments, letters, numerals, plaques, frames, silhouettes, weathervanes, toys. Decal transfers. Over 100 other items, 200 articles illustrated. 25c. refunded first order. (No stamps please). Wo-Met Shop, Box 167, Ashburn, Georgia.

LEATHER, Retail, mail orders, catalog, tools, lacing, supplies. National Handicraft Co., 30 Frankfort St., New York City 7.

PLASTIC Jewelry supplies. Free catalog. J & M Novelties, Box 464P, Griffith, Indiana.

KNOCKDOWN Cedar chests. Lumber and veneers. Free price list. Giles & Kendall Company, Huntsville, Ala.

LEATHERCRAFT! Complete stocks of leathers, tools, supplies. Immediate shipment. Free catalog. Kit Kraft, 3203 W. Washington Blvd., Los Angeles 16, California.

CERAMIC Jewelry supplies, bar pins, ear screws, for ceramic and woodworkers; also glass and seashell assemblers. Free catalog. Philadelphia Badge Co., Dept. B-1, 1007 Filbert St., Philadelphia, Penna.

COPPER And brass materials. Complete line for craftsmen and workshops. Catalog A free. Groundmaster Company, Boulder, Colorado.

SPECIAL Offer: 80 full size toy, novelty, and lawn ornament patterns only \$1.00 postpaid. Lynds, Box 193D, Medway, Mass.

MAKE IT YOURSELF

GARDEN Tractor—Efficient, inexpensive. No auto-parts or machining. Plans \$3.50. C.O.D.'s encouraged. Satisfaction assured. Clearprint Plans, Box 265, Muskegon, Michigan.

TINKERING With and building things catalog handbook 25c. Details free. Agents wanted. Edman, 307J, Radio City Station, New York 19.

BUILD Your own power lawn mower from our kit of parts. Any or all parts furnished including engine and plans. Prompt delivery on complete B-M mowers. Free literature. B-M Mower Company, Box 66-PM, Blue Mound, Kansas.

"CONCRETE Block Homes," 32 page booklet on how to build. \$1.00. H. C. Lightfoot, Civil Engineer, Richboro 1, Penna.

INVISIBLE Inks. Nineteen recipes \$1.00. Nunn, 659 E. Oxnard, California.

GRANDFATHER Clock easily built. Big savings. See ad page 283.

CARDBOARD Sign letter patterns. Prices for stamp. Oscar, Box 3319, Corpus Christi, Texas.

BUILD Concrete blockmaker. Inexpensive. Practical. Vibrator or hand. Write. Clyde Lee, Mountain View—A, Oklahoma.

STREAMLINED, Built-in kitchen cabinets to fit any kitchen. Complete, easy to understand detailed plans and specifications showing "professional" construction methods. All for \$1.00. Thombert Co., Box 447 M. Newton, Iowa.

MAKE Your own handy lightweight concrete blocks quickly with new blockmaker. Circular stamp. Manual 25c. Peerless, New Lenox, Illinois.

BUILD Your own light or heavy duty garden tractor Send postcard for free information on plans, easy instructions. Ellsworth Tractor Co., Dept. A, Camp-tonville, California.

SOLAR Water heater systems efficient any locality. Standard materials, low cost and easily built. Free facts. Solar Water Company, Box 175, Coral Gables, Florida.

PLANS AND BLUEPRINTS

BUILD Quickchange gear box without castings for \$10.00. Craftsman, Atlas, adaptable other lathes. Complete drawings \$4.50. Stevens, 2604 Military, Los Angeles 34.

WATCHES, OLD GOLD, JEWELRY

EXPERT Jewelry repairs. Rings, watches, setting, stones replaced, crystals fitted, etc. Lowest prices, prompt service, written guarantee. We buy old gold, platinum, diamonds. Send jewelry insured mail for free estimate. Star Jewelry Manufacturing Company, 1 North Eutaw Street, Baltimore 1, Maryland.

EXPERT Watch repairing. 6 months written guarantee by master watchmakers. All makes repaired. Reasonable prices. Send watch insured mail for free estimate. No obligation. Bonded Watch Repair Company, Dept. 20, 219 W. Chicago Ave., Chicago 10, Ill.

WHOLESALE Watch repairing. Request price list. Vaughn and Therrell, 1734 Main St., Columbia, South Carolina.

GUARANTEED Watch repairing. Lowest prices. Write for free particulars. Three Vets Watch Repair Service, 31A N. Gore Ave., St. Louis 19, Mo.

WATCH And Clockmakers Handbook—Britten \$5.79. Most complete on the subject. Free catalog. Engineer's Book Service, 19 W. 44th St., New York City 18.

WATCHMAKERS' Tools, supplies, sold—bought. Catalogue! Bengal Company, Culver City, California.

GOLD \$35.00 Ounce—Mail old gold teeth, jewelry, watches, diamonds—receive cash by return mail. Satisfaction guaranteed. Free information. Dr. Weisberg's Gold Refining Company, 1500-Q Hennepin, Minneapolis, Minn.

HIGHEST Prices paid for old gold, silver, platinum, diamonds, watches, gold teeth, old jewelry. Send now. Cash immediately. Goods returned if offer is not satisfactory. United Smelting Works, (The Old Reliable), 39-B South State, Chicago 3.

GEMS, Precious and semi-precious, all genuine. From world wide sources. Deal direct, no overhead, save money. Catalog 10c. Hill Co., Route 7, Salem, Oregon.

HIGHEST Cash for old, broken jewelry. Mail gold teeth, watches, rings, silverware, diamonds, spectacles. Satisfaction guaranteed. Free information. Rose Smelting Co., 29-A East Madison, Chicago.

TOBACCO, SMOKERS' SUPPLIES

PIPES Semifinished — Finest imported briar \$1.25. Merely sand, polish. Carnau-ba wax. Briar blocks, bits. Free literature. Carvapipe, 2829-G, Hamilton, Ohio.

SMOKERS! Trial box fifty, mild hand made cigars; \$2.00 postpaid! Samples. Do-Remi 136-B Reservoir, Providence 7, Rhode Island.

CIGARETTE Smokers, your dollar gadget, magnetic. Morgan Edwards, 4268 Shenandoah, St. Louis 10, Mo.

SMOKING Pipes repaired: Stems \$1.00, silver bands \$1.00, renovate 75c: Meer-schaum repairs appraised. Prepay and save c.o.d. charges. The Humidor, 8129 Euclid, Cleveland 3, Ohio.

BRIAR Pipe, leather pouch, tobacco, cleaners, wind lighter, complete \$1.75. Stamps accepted. Lylie Company, Security Warehouse, Minneapolis, Minn.

CIGARETTES—Popular brands; minimum 3 cartons. Price \$1.50 per carton; postpaid. Add 3c per carton for west of the Mississippi. Send check or money order. King Co., Box 569-D, Dover, Delaware.

RAZORS, BLADES, SHARPENING

DOUBLE-EDGE Razor blades, extra sharp. 50-\$1.00. Franklin Underwood, Har-wich, Mass.

100 DOUBLE-EDGE Blades, watch spring steel, \$1.00, postpaid. Abbe (Blades), 190 West Burnside Ave., Bronx 53, N. Y.

100 SURGICAL Steel blades for Gillette razors, \$1. Tomkins Brothers, 105 Fulton Street, New York 7, New York.

FOR THE HOME

SENSATIONAL Fruit juicer \$1.20 post-paid. Salvatori, 2327 Third, Riverside, Ill.

WALLPAPER Removed easily with new penetrating solution. Send \$1.00 for enough to make five gallons. P. McGuinn, Box 48, Oak Park, Ill.

CESSPOOL Sense. Free copy on request. Septic Bend Co., Rockland, Mass.

FOR SALE—MISCELLANEOUS

WATTHOUR Meters. Reconditioned, guaranteed. Ideal for cabins, trailers, shops. \$2.95. T. Price, 310-14th, Raymond, Wash.

FOR Sale—Leatherette remnants, many sizes, colors. Get acquainted. 20 lbs. \$6.00. Leatherette shopping bags 89c. 200 shells assorted \$6.00. Orville Wisehart, Shirley, Ind.

ATLAS 6-Inch lathe and equipment. Used once. \$270 value. Make offer. H. C. Belding, St. Charles, Mo.

WHIPPED Cream dispenser. Pint makes 1/2-gallon for cream. \$15. Literature free. Domanos, 98-A3 Vermont, Newark 6, N. J.

WAR Surplus clothing. Men's, women's. Amazing bargains! Free catalogue. N. Y. Clothing Co., 2079A Second Ave., New York 29.

DECAL Letters and numbers. Black 1 1/4 in. high. For roadside signs, mail boxes, trucks, station wagons, house numbers, office doors, etc. Easy to apply, neat. Send \$1 for 20. Extras 5c. Willits & Redding Co., Dept. 17, 514 W. Sedgwick St., Philadelphia 19, Penna.

WAR Surplus tents all sizes, paints, camping equipment, cots, canvas covers. Morsan, 10-17C 50th Ave., Long Island City 1, New York.

WHOLESALE—8 Million DuPont nylon hose, 3 pairs. \$2.00 postpaid. Ready. Sibert Associates, Box 1242, Chattanooga, Tennessee.

WAR Surplus, aircraft items, shop equipment, machinery and a million other items. Free catalog. Atlas Equipment, 229 Southwest Blvd., Kansas City 8, Mo.

WANTED—MISCELLANEOUS

MANUFACTURERS, Wholesalers of consumer merchandise. Your catalogs, sales proposition invited. The Universal Line, Orange 1, Massachusetts.

I HAVE Cash buyers for anything. Free particulars. Toole, Box 415, Evansville, Indiana.

ANYTHING Of value. Robert, 207 North 5th Street, Springfield, Illinois.

QUICKSILVER (Mercury) urgently needed! Immediate payment. Wholesale Terminal, Norwood, Massachusetts.

PERSONAL

BORROW By mail. Loans \$50.00 to \$300.00 to employed men and women. Easy, quick. Completely private, confidential. No endorsers. Repay in convenient monthly payments. Details free in plain envelope. Write State Finance Co., 216 Savings & Loan Bldg., Dept. R-14K, Des Moines 8, Iowa.

EXCHANGE Neckties! Mail six neckties and \$1.00. Receive six different ties. Box 565, Woodcliff Lake, N. J.

STUTTERING Corrected at home. Lesson technique successful with adults and children for many years. Send for free literature. The Athenium, PM-22, 1714 Chestnut, St. Louis 3, Mo.

RONSON, Evans, Thorens, Packard and all cigarette lighters repaired, refinished. Guaranteed service. Master Silverplaters, 2158 Gratiot, Detroit 7, Michigan.

GLOBAL Remailing service. Free particulars. Travelpost, Box 5453, Tucson, Arizona.

FAMOUS Brooklyn postmark! Letters forwarded. 25c each. Victors, 93 Hart St., Brooklyn 6, N. Y.

HAND Guide! Positively guides hand until you learn to write correctly. Write, Ozment, 9, St. Louis, Mo.

STATIONERY—Your favorite sport illustrated. \$1.25 postpaid. Novelprint, 18 Central Street, Windsor, Vermont.

PHOTO Stamps, 100 for \$2.00. Real photographs in stamp form. Send snapshot or negative to Sharpless Photos, 1544 E. 65th Street, Chicago 37P, Ill.

RECEIVE "Interesting Mails"—25c keeps your name on mailing list for six months. Bentz, Jr., Chatawa 3, Mississippi.

WHAT Does your last name mean? Complete report on meaning, 25c coin. (Print name plainly). Surname Research Company, 104-A North Pear Street, Olympia, Wash.

MEXICAN Mailing service. Letters received, forwarded 20c. Photographic postcards 15c. Retailed free. Remit stamps. Tillotson. Apartado 1405, Guadalajara, Jalisco, Mexico.

DANDRUFF? Scalp trouble? If externally caused write for booklet. Regime Products, 9-P South Clinton, Chicago 6.

MEXICAN Law. General practice attorney. 1203 Arizona Street, El Paso, Texas.

SEND Six ties and \$1.00. Receive six different ties. Box 204, Greencastle, Indiana.

FOOT Sufferers get instant relief with a pair of soft sponge rubber arch supports. Send \$1.00 to Cadwallader, 311 Crosby Bldg., Buffalo 2, N. Y.

HOW You can find out! Information discreetly developed, any matter, person, problem, anywhere. Personal-business assignments, representations undertaken. Nation-wide. Officially licensed, bonded service established 1922. Reasonable. Confidential. William Herman, 170 Broadway, New York.

HAIR Falling? Dandruff? Write Trichologist, 137 Lewis St., Phillipsburg, N. J.

MISCELLANEOUS

SHIPPING Supplies—Free catalogue. Tags, labels, bags, cartons, sealers, etc. Fountainhead, 1049 Bluff, Beloit, Wisconsin.

UNPAINTED Figurines, plaques, statues, etc. List. Valents, Perry, New York.

100 MARKETS For homeworkers products! Wood, leather, metal, knit, etc. Bulletin \$1.00. Free literature. Research, 2409 12th Ave., Los Angeles 16, Calif.

NEW All purpose plastic metal mender for home, farm and auto. Tested and proved. 1½ lb. can only \$1.25 postpaid. Charles Doettrel, 306 Maple, Buffalo 4, N. Y.

UNPAINTED Plaster figures, figurines, plaques and etc. Large selection. Also novelglaze paints. "Gives chinalike effect without firing." Send 10c for catalog. Novel, Inc., Sparta, Wisconsin.

HOLD-ALL Clamp. Holds flashlight any position. Projects light where needed. Illustrated circular free. Valentine, Wellsville, Mo.

PAINT—Outside, Snow-White titanium lead and oil. Money-back guarantee not to peel, rub or wash off. \$2.25 gal. in 5-gal. cans. Sample can-50c. Snow-White Paint Co., 2545 Parkwood, Toledo, Ohio. 648 Hudson Street, New York.

ATTENTION Salesmen: For practical household advertising specialties, side line or full time job. Well-known line by a long established manufacturer. Write for details on open protected territories. Patent Novelty Co., Dept. PM, Fulton, Illinois.

YOUR Name or initials beautifully imprinted on 50 book matches for \$1.35 postpaid. Imprints, 424 Hepburn, Milton, Penna.

24 KARAT Gold framed porcelain miniatures made from any photo. Send for prices. Robert Daly, Studio M-3, 203 W. 69 St., Box 91, New York 23.

FOOL Friends. Send letters from Miami Beach. Inclose your letter stamped and 25c. \$5.00 monthly service. Jacob Helfer, Dania, Florida.

PERSONALIZE Stationery, etc. Lifetime engraving embosser. Free sample. Aabalon's, New York 18.

"THIS Is It!" Learn sewing machine repairing, plus profitable installing our motor kits, etc. Write, Taylor Service Co., Hamilton 6B, Ohio.

70 BIBLE Lessons, 25c. Bulletin, Box 87, Cathedral Station, New York 25.

QUIXSTIX Repairs furniture nicks, dents, gouges; \$1.00 postpaid, Doane, Box 282, Salem, Mass.

PANNING Gold—Free instruction booklet. Catalogue mining books; supplies. Old Prospector, B-230, Dutch Flat, Calif.

WOULD You pay 3% first \$350 made? Color-illustrated book "505 Odd Successful Enterprises" free! Expect something odd! Pacific-S, Oceanside, Calif.

NEW! The super-gadget of the year. Die cast bronze, chromium finished. Nautical, guaranteed usable every day of the year. \$1 (bill) postpaid. P. & W. Co., P.O. Box 766, San Francisco, Calif.

FIRE Extinguisher, quick and effective. A real economical emergency weapon against fires. \$2.00 postpaid. Be protected! Fires give no warning! Postcard brings free information. Ray Sales, 1334 Downing Place, N.E., Washington 18, D. C.

EXCEPTIONAL Value men's, boys' leather belts 65c. Caspy, 239 Dumont Ave., Brooklyn 12, New York.

\$10,000 OFFERED By U. S. government for each usable uranium find. Goldak now offers an ultra-sensitive Geiger Counter to prospectors of radioactive ore. For free bulletin, write The Goldak Co., Dept. M, 1542 W. Glenoaks, Glendale 1, Calif.

SAVE Up to 75%. Watches, clothing, sporting goods, novelties, etc. Amazing bargain catalog. 25c (refunded first order). Tip Top, Box 9083PM, Dallas, Texas.

OUT Of print books found quickly. Send wants, no obligation, free catalog. Coast Bookfinders, Box 8686, Los Angeles 46, California.

BOOKS—All Kinds—Homecraft, Radio, Plastics, Boat Building, Photography, Model Building. Catalog free. Popular Mechanics Press, 200 E. Ontario St., Chicago 11, Ill.

URANIUM Prospector's handbook. \$10.-000 bonus. Mail \$1 to Craft-Connor Publishing Co., 601 S. Vermont Ave., Los Angeles, Calif.

LUMINOUS Reflective paints glow day and night. New angle money maker! Numerous samples 25c. Write today! Research, 1842-PM Byron, Chicago 13.

TIE Exchange. Mail six neckties and \$1.00 receive six different beautifully reconditioned neckties. Coupons for 24K gold-plated free gift included. Department C, 159 N. Wabash, Chicago 1, Illinois.

NEW 1949 Book listing 1000 free articles for post card request. Book \$1. Particulars free. National Advertisers, B552, Memphis, Tenn.

KEEP Your septic tank clean by keeping the bacteria alive; one year supply \$1.00. Box 155, LeRoy, Illinois.

"RECEIVE Mail," Moneymaking offers, opportunities, catalogs. Name listed 10c. Ideal Service, Park Ridge 10, Ill.

TATTOOING Outfits, supplies. Illustrated list free. Zeis, 728 Lesley, Rockford, Illinois.

AMAZING Non-metallic magnetic discs float in air. Set of 3-35c. 3 sets \$1.00 postpaid. Discs, 3104 West Vliet, Milwaukee 8, Wis.

ORANGES, Red grapefruit, Tree-ripened, my orchard. McCants, Weslaco, Tex.

SQUARE Dance instructions. Calls, 25 sets. \$1.00. Rayburne, Eureka Springs, Arkansas.

YOUR Name engraved on beautiful brass plate 1½"x9". Postpaid \$1.00. H. V. Ackerman, Malden on Hudson, N. Y.

MAKE Your own tractor, saw mill, home freezer, and scores of other farm devices. Amazing new book, "Popular Mechanics Farm Manual." 284 Pages packed with hundreds of illustrated plans and farm workshop ideas. Descriptive circular free. Popular Mechanics Press, Room 603, 200 East Ontario Street, Chicago 11, Illinois.

GEIGER Counters for finding uranium ores. Simple operation. Low prices. Interesting literature free. Fisher Research Laboratory, Inc., Palo Alto, California.

LUMINOUS Powdered pigments. Trial offer and listing. \$1.00 prepaid. Glowelico, 475-MP Fifth Ave., New York 17.

TREASURE Locators. New electronic lightweight M-Scope mineral and metal finders are now available for immediate shipment. Built for arctic-tropic use. Revolutionizes locating of minerals, gold, silver, metal objects. Unsurpassed efficiency, factory guaranteed. Low prices, time payment plan available. Send for free 16-page illustrated booklet. Fisher Research Laboratory, Inc., Palo Alto, California.

TATTOOING Machines, outfits. Free catalogue. Jensen, 120 West 83rd Street, Los Angeles 3.

MEDICAL Laboratory technicians in great demand. We train you in your own home, in your spare time. Also home study course in general chemistry. Free catalogue. Imperial Technical Institute, Box 973-J, Austin, Texas.

NOW Ready: New, amazing Classified Advertising Record Book—prepared especially for classified advertisers. Here is a book that tells you instantly whether or not your advertising in any publication is paying you real results. You can tell immediately how many inquiries each publication produced—how much cash received from every ad. Spaces are provided for the name and address of the publication, date of issue, space used, rate, cost of ad, key number, etc. You have a complete record of each publication right before your eyes. Plenty of space to keep accurate record of 28 separate publications. You can have a copy by sending only 10c to cover postage and handling. Send for your copy now. W. F. Johnson, Classified Adv. Mgr., Popular Mechanics Magazine, 200 E. Ontario Street, Chicago 11, Illinois.



AMAZING BURGLAR ALARM GUARANTEED TO STOP THIEVES

FOR CARS • HOMES • FARM BUILDINGS

A South Dakota manufacturer has discovered an easy way to protect cars, homes, farm buildings from Burglars, sneak and chicken thieves. The manufacturer is so sold on his sensational DEVIL DOG Burglar Alarm that he is willing to let you try it for ten days and will offer you \$1.00 for testing it. New sales plan promises big money to hustlers. Be first to get your DEVIL DOG Burglar Alarm for introducing in your territory. CASH-IN on the tremendous demand this device will create. Shipped prepaid from factory on ten year guarantee. Rush name and address for details to

NORTHWEST ELECTRIC CO., Dept. C-303, Pukwana, S. Dak.

CREI Prepares Young Men for Professional Careers with
Industry-Recognized training in a minimum of time

RADIO-ELECTRONICS-TELEVISION ENGINEERING

GRADUATES of the Capitol Radio Engineering Institute residence school are preferred by industry because of their *training* and *ability*. This recognition is the reason that CREI men quickly find good jobs in radio-electronics-television engineering and technical fields.

With 22 years of practical teaching experience in these highly technical fields, CREI offers an outstanding faculty, modern and complete laboratories, shops and equipment.

New students are accepted twice monthly and each may advance as rapidly as he is capable. The basic

course with one specialized course requires an average of 20 months to complete, depending on the ability of the individual student.

CREI is recognized as one of the country's leading technical institutes. Its work is of college level. It prepares the young man for a good job in industry in a minimum of time.

Approved for
 Veterans' Training



CAPITOL RADIO ENGINEERING INSTITUTE
 An Accredited Technical Institute Founded in 1927
 Dept. 173A, 16th and Park Rd., N.W., Washington 10, D.C.

MAIL COUPON FOR FREE CATALOG

Capitol Radio Engineering Institute, Dept. 173A
 16th and Park Rd., N. W., Washington 10, D. C.

Please send me your illustrated catalog and complete details.

Name _____ Age _____

Street _____

City _____ Zone _____ State _____

I am entitled to training under G.I. Bill.

BURN WATER IN YOUR CAR!

The new OCTA-GANE Water Injector is designed to give your car premium performance from low grade fuels. In addition it will measurably increase power and mileage completely eliminate engine "ping" or "knock" and keep your engine internally clean.

The OCTA-GANE is a well constructed unit, engineered to last for the life of your car. It comes complete with a stainless steel tank and all necessary fittings and brackets for mounting. Installation is a simple matter of a few minutes. A one year guarantee comes with each OCTA-GANE.

The OCTA-GANE is priced at only \$24.95 delivered and we urge you to take advantage of the special coupon at right to give your car a new lease on life.

We will be pleased to send you full descriptive literature at your request.

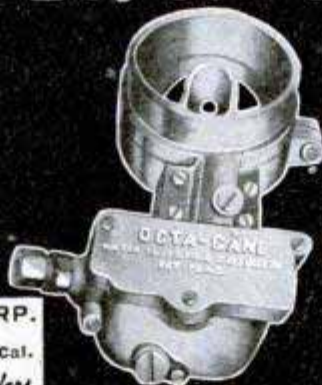

COMMONWEALTH CARBURETOR CORP.
 SUCCESSORS TO CONTINENTAL CARBURETOR CO
 Div. 15-B, 1478 University Avenue, Berkeley, Cal.
 Inquiries invited from established automotive dealers.

COMMONWEALTH CARBURETOR CORP.
 Div. 15-B, 1478 University Avenue, Berkeley, Cal.

SIRS: PLEASE SHIP TO ME IMMEDIATELY ONE COMPLETE OCTA-GANE WATER INJECTOR UNDER THE PLAN CHECKED BELOW

- \$1.00 ENCLOSED. PAY POSTMAN BALANCE C.O.D.
 \$24.95 ENCLOSED. SHIP FULLY PREPAID.

(PLEASE PRINT PLAINLY)

NAME: _____

STREET: _____

CITY: _____ STATE: _____

MAKE & YEAR OF CAR: _____

MODEL: _____ NUMBER OF CYLINDERS: _____

RHEUMATISM HIGH BLOOD PRESSURE

ARTHRITIS - NEURITIS - SCIATICA

Enjoy a vacation in Florida's health-giving sunshine while you receive our marvelous scientific treatment.

Thousands have found relief after other treatments have failed! Write for FREE literature A today.

LOFFLER CHIROPRACTIC CLINIC JACKSONVILLE 5, FLA.



NEW! FOR PROFIT & PLEASURE

IN COPPER TOOLING & ETCHING

No Experience needed - start at once. BIG MONEY waiting in COPPER ART field. Plaques, Bowls, Trays, Gifts, Souvenirs of all kinds. Start on the road to success NOW! Here is an opportunity to get started in your own Big Paying Business - FREE DETAILS don't wait - WRITE NOW!

HOLLYWOOD COPPER ART - Dept. PM-3
 7266 Sunset Blvd., Hollywood 46, Calif.

DO IT AT HOME



**\$64.40 PROFIT
 IN 4 HOURS**

That's Pollack's **FIRST DAY** Record with **ROTO-CLEAN** - Amazing New Non-Electric Whirling Glass Cleaner

I've been in Direct Selling a long time. In my day, I've run across some terrific money-makers. But believe me, for quick and spectacular and steady profits, I've never seen the equal of ROTO-CLEAN! Pollack worked just 4 Hours and made \$64.40 profit for himself.

ROTO-CLEAN is the non-electric glass cleaner that works on an amazing new principle. Just press a glass over the brush and it **WHIRLS!** Bartenders, tavern owners, soda fountain and restaurant operators grab on sight. Because ROTO-CLEAN actually cleans glasses

cleaner - cleans them quicker and easier than many electric glass cleaners costing ten times as much.

I'm not trying to sell you a bill of goods. In this ad, I'm not trying to sell you anything. All I want you to do is let me send you the facts so you can see for yourself. To prove I mean business, I even send real salesmen a sample ROTO-CLEAN without a penny of cost, as explained in my Special Offer to new men.

Don't send a cent. But rush the coupon. This simple step may give you the biggest, quickest cash clean-up of your life. Mail coupon now to

L. B. Patterson,
 MAXILUME CO., Dept. X-83,
 125 W. Hubbard St., Chicago 10, Ill.

L. B. Patterson, Maxilume Co., Dept. X-83
 125 W. Hubbard St., Chicago 10, Illinois
 Rush complete information about ROTO-CLEAN and FREE SAMPLE Offer to new men.

Name _____

Address _____

City _____ Zone _____ State _____

FREE
 Demonstrator
 Offer, Mail
 Coupon



BUDGET-SAVING HAIR CLIPPER



THE VERSATILE

Cadet (R)

ELECTRIC HAIR CLIPPER

Put the practical "Cadet" Electric Hair Clipper to work . . . saves time and money for the whole family! You'll find this strong, yet inexpensive electric hair clipper mighty handy for removing superfluous hair, too. Special-design blade for clean, close cutting. Operates on 110 V., 60 cycle A.C. Fully approved by Underwriters' Laboratories. Only \$9.95 at drug, department, hardware and electric appliance stores. If your dealer cannot supply you, order direct from factory. Send check or money order. 5-DAY MONEY-BACK GUARANTEE.

ELECTRO TOOL CORPORATION

DEPT. C529-C • RACINE, WISCONSIN

INVENTORS

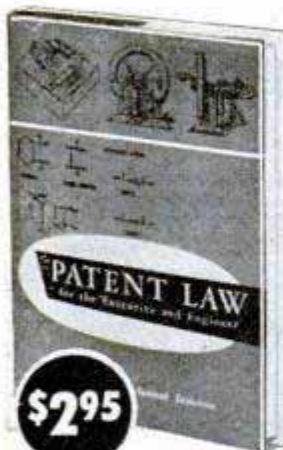

NO PATENT PROTECTION . . . NO PROFITS. Authoritative book on patent law, already bought by thousands of **INVENTORS, ENGINEERS & EXECUTIVES** will pay for itself . . . **YOU CAN'T AFFORD TO BE WITHOUT IT.** Learn simply and easily how protected inventions can make money for you; how to deal with your attorney . . . **A MUST FOR INVENTORS, MECHANICS, ENGINEERS,** who have money making patentable ideas . . . Easy to read and understand, only \$2.95. **FREE:** for cash or money order with your order, we will send a set of 8½x11 invention records. Check or money order only.

RESEARCH PRESS, 138 N. Perry St., Dayton 2, Ohio
 Send me "Patent Law for the Executive and Engineer."
 — Check or Money Order enclosed (You pay postage and send FREE complete set of Invention Records).
 — Five days approval. I'll remit \$2.95 plus postage or return the book in five days.

Name _____ Title _____
 Address _____
 City _____ Zone _____ State _____ PM10

AUTHENTIC MODEL KITS



Stage Coach Kit \$150
 Plus 15c postage
Covered Wagon Kit \$150
 Plus 15c postage
Army Truck Kit \$100
 Plus 15c postage
ALL 3 for Only \$375
 Plus 25c postage

Pleasant leisure hours spent in building these realistic miniature replicas pay off in satisfaction and the pride of displaying your craftsmanship. Wells Fargo Stage Coach revives memories of the Old West; Conestoga Covered Wagon just like the Pioneers'; 2½ ton Army Cargo Truck is backbone of U. S. Army combat supply service. Covered Wagon and Stage Coach ½" scale; Army Truck ¼" scale. You'll enjoy working with precision parts, die-cut from white pine and plywood, for simple, accurate assembly; free-rolling wheels, real metal fittings, formed ribs, leather springs, etc., full size plans.

HOLLYWOOD MODELS POST OFFICE BOX 389
 BURBANK, CALIFORNIA



Pants Prices DOWN!
SAVE \$4.55
\$12.50 VALUE, Only \$7.95

Genuine Gabardine Dress Trousers. Finest virgin wool and fine-spun rayon blended. Twill weave resists wrinkles, holds crease, gives amazing wear. Expert fashion tailored for perfect fit. Zipper front. Roomy pockets. Blue, Tan, Sand, Lt. or Dk. Brown, Blue-Gray. Waist sizes: 28-38 pleated, 28-50 plain.
SEND ONLY \$1 with name, waist size, 1st and 2d color selection. Pay postman balance or send full price, save postage. Money back if not pleased.
 More sales people wanted. Order a pair—get big profit offer.
LINCOLN TAILORS • Dept. PM-3 • Lincoln, Nebr.

REAL ESTATE

BE A BROKER

PAYS BIG! SEND FOR FREE, BIG, ILLUSTRATED CATALOG NOW! No obligation. Graduates report making substantial incomes. Start and run your own business quickly. Men, women of all ages, learn easily. Course covers Sales, Property Management, Appraising, Loans, Mortgages, and related subjects. **STUDY AT HOME** or in our classrooms in big cities. Diploma awarded, G.I. approved. Nationally known.
WEAVER SCHOOL OF REAL ESTATE (Est. 1936)
 15 E. Pershing Road Dept. NT-3 Kansas City, Mo.

FREE BOOK TELLS HOW



CERAMICS

We teach you how to make beautiful pottery and ceramic ware, for your own enjoyment, for home decoration or as a profitable source of income! Making pottery and ceramics at home is **EXTREMELY EASY, fascinating, and enjoyable work** that ANYONE can do. Send 10c for CERAMICS CATALOG and details of our free instruction plan. If you are interested in PLASTICS send 10c for big plastics catalog and attractive plastic cameo at no extra cost.
PLASTICAST COMPANY, Dept. 7
 4637 N. Kedzie Avenue Chicago 25, Illinois (Order by Mail Only) P.O. Box 987 Palo Alto, Calif.

WOULD YOU SPEND 50c TO LEARN DAN LURIE MUSCLE BUILDING SECRETS



Dan Lurie, "America's Most Muscular Man" tells all in one complete easy-to-follow book — **75 HOW-TO-DO-IT PICTURES**—Plus 4—11"x22" illustrated wall charts only 50c postpaid. (No stamps please.) This is the same guaranteed method that champions throughout the world use. Dan Lurie says—"Either I show you (without the bunk and baloney) how to turn your flesh into power-packed, useful muscles or back goes your 50c." Can you afford NOT to start today? Send to Dan Lurie, Personal, Dept. 159C, 1729 Rockaway Parkway, Brooklyn 12, N. Y.

DAN LURIE
 4 time winner

"America's most muscular man"

DO ANY JOB.. EASIER.. QUICKER
MAKE MORE MONEY in the
BIG OPPORTUNITY
FIELDS

Here's the Help You Need
For Best Paying Jobs
Right NOW!

FREE TRIAL
IN YOUR OWN HOME

Used by Army, Navy, Other Government
 Depts., 200 Schools and Industrial Firms.

SEND NO MONEY
 Select the Books
 YOU Need Now!
 We Ship C.O.D.
 Anywhere in U. S.
 and Will Refund
 Amount Paid if
 Not Satisfactory.

Do it now! Get the better pay that goes to men with specialized knowledge. Get into one of these big opportunity fields. Big money and many other advantages await you if you prepare now. Here is the help you need—EASY—QUICK—AT LOW COST. Thousands of men have already used these famous books. Beginners and experienced men alike have doubled and tripled their earnings with this help. You too, can now get the special knowledge you need for top pay, better jobs, or a business of your own. This is your GOLDEN OPPORTUNITY.

AIR CONDITIONING

Big air conditioning boom is Nation-wide and bigger than ever. Alive with new opportunities! Get this non-technical book by international authority and be ready for your share of millions to be spent. Covers whole field. 450 pages. Illustrated. \$4.00.

SHEET METAL LAYOUT

Makes sheet metal layout work so simple that anyone can learn. Get this new instructor and get into the easiest, cleanest and best paying part of all sheet metal work. 143 jobs worked out in drawings and carefully explained. Gives standard for all sheet metal fittings. \$3.50.

BAILEY'S HANDBOOK

World famous handbook of universal questions and answers for Stationary, Marine and DIESEL engineers and firemen. Prepares for any license examination in installation, maintenance and operation of Diesel and steam plants. Pocket size. \$2.00.

MODERN WELDING

Newest book on all types of welding and heat treatment of metals. Written by recognized specialists in training men for production jobs. 430 Pages, 277 illus. Practical and Non-Technical. Covers everything you need to know. \$4.00.

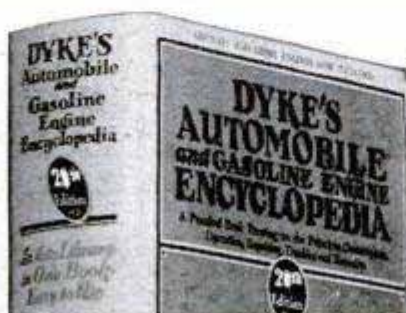

1948
21st
 EDITION
 Leading
 Auto
 Book
 for Over
 32 Years

World's Greatest AUTO BOOK

**New Material, Specifications,
 1947 Cars, 1948 Trucks, Busses,
 Tractors, Diesels**

Now with millions of cars needing repairs and thousands of men needed to do the work, you need the famous DYKE Auto Book more than ever before. New 21st Edition covers all principles, construction, repair, adjustments, testing, troubles and remedies. Over a half million copies of 20 editions of Dyke's have been sold. Buick Dynaflo, Farm and Outboard Motors and new electrical systems now covered. World's biggest book value. Only \$7.00.

This big book, a complete auto library in one volume, has 1483 pages—4600 illustrations and diagrams—weighs 6 lbs.—equal to 4 ordinary books.



**The Easy Way to a
 Profitable Business
 Of Your Own!**

Owners will spend big money to keep their good older cars looking like the new ones coming out. This is a practical money-making guide, ideal for shop owners and every man who wants a share of the millions to be spent in keeping old cars looking new. Tells how to get a good job or start business of your own with small capital. Covers everything including tools, methods and materials. Only book of its kind. 325 pages, 232 illustrations. \$3.50.

HOUSE WIRING — NEW EDITION

Get this new sixth edition of this standard and practical electrical wiring book. It gives complete practical instruction on every phase of house wiring in one handy volume. Goes further than most books on subject. Handbook style. Gives National Electric Code. 400 pages, 669 illustrations. Electrical work will reach a new high with millions of new homes to be built. Get started now. \$3.00.

CARBURETORS — Dyke

The standard guide in the best paying auto work for a generation. It has helped thousands of men make money. New edition covers engine tune-up, compression, ignition, carburetion, fuel pump valves, etc. Use this book to specialize in this big field. 244 pages, 549 illustrations. \$3.50.

Mail Coupon to GOODHEART-WILLCOX CO., Dept. 13, 1321 S. Michigan Ave., Chicago



**20 Million Refrigerators
 Need Service and
 Repairs**

REFRIGERATION—Book of the Hour!

Biggest Opportunity in Many Years!

LATEST PRINTING — ALMOST 1000 PAGES

408 Pictures—17 Diagrams in Colors Makes All Refrigerator Service Maintenance, Repairs Simple as A. B. C.

Thousands of Refrigerators need repairs! Owners will pay big for competent service which will be needed more and more. Get MODERN GAS AND ELECTRIC REFRIGERATION, the non-technical guide to all types of refrigerators and get your share of this new profit. Get a job or start your own service business. This book will help you make money anywhere. It is the recognized standard book on the subject. Price \$5.00.

SEND NO MONEY! Mail Coupon

GOODHEART-WILLCOX CO.,
 1321 S. Michigan Ave., Dept. 13, Chicago 5, Ill.

Send books checked, C.O.D. I will pay postman, plus few cents charges. If not satisfactory I will return books in 5 days and you will refund money paid. (Outside U.S. or possessions remit with order.)

- Gas & Electric Refrigeration \$5.00
- Dyke's Auto Book \$7.00
- Dyke's Carburetor Book . \$3.50
- Modern Welding \$4.00
- Airplane Welding \$3.50
- Sheet Metal Layout \$3.50
- Air Conditioning \$4.00
- Engineers Handbook . . . \$2.00
- Body and Fender Repair . \$3.50
- Shop Math. (2 vols.) . . . \$3.00
- House Wiring \$3.00
- A.C. Power Wiring \$4.00
- D.C. Power Wiring \$4.00

If remittance accompanies order we will pay all postage charges under same return privilege.

Name _____
 Address _____
 City _____ State _____

BE AN AUTO MACHINIST

Get Ready for
**GOOD PAY,
STEADY JOB**
Quickly



FREE BOOK
Tells Why Now's The
Time to get Your
**PRACTICAL
TRAINING**

Make more money in AutoMechanics when you specialize. Free Booklet tells how specialized training helps you get ahead.

AUTO MACHINIST
Student in engine rebuilding learning to operate a crankshaft grinder. Specialized training puts you in line for better jobs and higher pay.

ENGINE REBUILDING or GENERAL AUTO MECHANICS

Get ready for a good paying job in either of these big fields. Get PRACTICAL EXPERIENCE while you learn. See pictures of modern shops and up-to-date equipment in Free Booklet. Learn machine shop, auto electricity, carburetion, troubleshooting, motor tune-up, transmissions, many other jobs. Send for booklet today.

VETERANS American Trade School is G. I. Approved. Please state if veteran.

WRITE TODAY FOR
FREE BOOKLET

AMERICAN TRADE SCHOOL
2417 McGee, Kansas City, Mo.

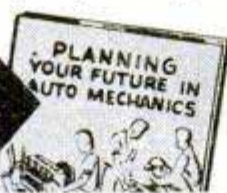

STUDY AVIATION

BUILD YOUR FUTURE
IN THE *Fastest
Growing* INDUSTRY...

SUCCESS IS *Speedier*, TOO...



Increase your earnings. Train for a successful career at this internationally-famous aeronautical school. Government Approved and industry recognized. You learn on "live" aircraft—the same type you will work on after graduation.

Complete, thorough courses in Engineering, Flight, Mechanics, Radio and Electronics, Meteorology, Airport Management and Operations, Instruments, Link Trainer and Parachutes.

Spartan's 21 years of experience is your assurance of getting the greatest amount of training in the shortest possible time.

Investigate the many opportunities and the training required.

SPARTAN
SCHOOL OF AERONAUTICS
TULSA, OKLAHOMA

MAIL COUPON TODAY

Spartan School of Aeronautics
Tulsa, Oklahoma Dept. PM-39
Please send me complete information on: Course _____
Name _____ Age _____
Street _____
City _____ State _____



Jig Saw Patterns

Big Bargain Packet

62 SQUARE FEET—Full Size!

50 AMAZING PROJECTS —
ONLY \$3.00 Complete

Every pattern full size ready to paste on wood and cut out. No tracing, no graph square enlarging. It's the new, simplified way of making projects in half the time it took you before.

Packet contains Dutch Windmill Ivy Bracket plus 49 other exciting things to make. Cradle, Waddling Box, Pot Holder, Snack Tray, Wall Plaques, Elephant Shelf, Bunny Cart, Beverage Server, Costume Jewelry, Seaboard Bracket, Bird Garden Cutouts, Airy Wall Shelves, Scottie House Marker, Whisk Broom Holder, Oval Mirror Bracket, Tooth Brush Holder, Wind-Operated "Dog Chases Cat," Stairway to Stars, Lotus Flower Bracket, Swan Plant Bracket, Wall Plaques, many other profitable patterns.

Amazing value. Worth \$10. Send \$3.00 now, or we send COD if you pay postage. HURRY! Order Jig Saw Packet No. 2 now from

Craftsman Pattern Club

117-M2 Worth St.,
New York 13, N. Y.

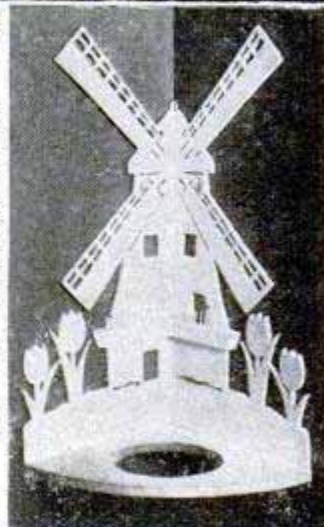

SHORTHAND in 6 Weeks at Home

Famous Speedwriting system. No signs; no symbols; no machines; use ABC's. Easy to learn; easy to write and transcribe. Fast preparation for a job. Surprisingly low cost, 100,000 taught by mail. Used in leading offices and Civil Service. Write for free booklet to:

Speedwriting
Dept. 1503-9, 55 W. 42 St., New York 18

POCKET-MITE PORTABLE

PACKS AMAZING POWER!
Tiny enough to easily slip into pocket and featuring hearing-aid midget tubes and new long-life midget batteries all contained within beautiful plastic case. No ground or outside antenna needed for strong reception within 50 miles radius. Stations over 2,000 miles distance received with plug-in antenna. Complete set of finished midget parts including tubes and beginners picture diagram direct from lab to you. Ready to wire as shown. Only \$6.99 P.P. Foreign orders \$8.00 U.S. Cash.



ELECTRONIC RESEARCH LABS., Dept. A
1216 PARK ROW BLDG. NEW YORK CITY 7

"LEARN-BY-DOING" ELECTRICITY

NATION'S LARGEST EXCLUSIVE ELECTRICAL SCHOOL

G.I. APPROVED Get actual experience in great shops of M.T.I. Learn all phases Practical Electricity; Housewiring, Motors, Const., Maintenance, etc. Living arrangements, Part-time jobs, etc.

Send coupon TODAY.

MICHIGAN TECHNICAL INSTITUTE Veteran
2281 W. Fort St., Detroit, Mich., Dept. PM-3
Name _____
Street _____
City _____ State _____

GLASY-CAST New Liquid Plastic Cold-Set



15 TO 30 MINUTES FOR A FINISHED PRODUCT

No heat, or machinery required. Crystal clear, brilliant gloss in natural state. Colored pigments or dyes may be added for solid or transparent effect.

GLASY-CAST can be poured in flexible or rigid molds, including rubber, Plaster of Paris, Elastomeric vinyl molds, and even certain types of wax molds. Glasy-Cast is a real money-making material and requires no experience.

MAKE BIG PROFITS with GLASY-CAST manufacturing novelties, toys, jewelry, etc. EMBED FLOWERS, COINS, biological specimens, and many other items in clear solid Glasy-Cast. Make your own Christmas gifts.

FREE INSTRUCTIONS WITH EACH ORDER OF **GLASY-CAST**

SMALL QUANTITIES AT WHOLESALE PRICES.

1 quart. \$2.50, 1 gallon. \$9.50.
5 gallon lots. \$8 per gallon
Prices FOB Boston.

ELASTO-MOLD. A NEW FLEXIBLE mold material makes permanent production molds in a few minutes at low cost. No shrinkage. Practically 100% efficient for use in casting Glasy-Cast as well as any other plastic material.

Hundreds of castings can be made from Elasto-Molds, Instructions with each order. Prices on request.

WE ALSO SELL GENUINE LIQUID RUBBER at \$5.50 per gallon. FOB Boston. Write for free sample of Elasto-Mold and Glasy-Cast casting. Money Back Guarantee if not satisfied.

PLASTIC SERVICE, Dept. M-6
294 Washington Street, Rm. 813, Boston 8, Mass.

locksmithing and key making

PRACTICAL UP-TO-DATE COURSE

How to pick locks, de-code, make master-keys, install, service, etc. New, self-instruction lessons for every handyman, home-owner, carpenter, mechanic, service station operator, fix-it shop, hardware dealer, gunsmith, cycle shop. Good steady money-making trade!

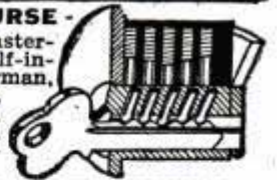

53 EASY ILLUSTRATED LESSONS
Full price only \$3.95, nothing more to pay. Satisfaction or your money back. Fill in coupon at bottom of page and mail today.
NELSON-HALL CO.
1139 S. Wabash Ave. Chicago 5, Ill.

watch and clock repairing



LEARN AT HOME—IN YOUR SPARE TIME
Prepare now for a happy future of prosperity, security. Fascinating high-grade occupation for men of almost any age or physical condition. You can earn while you learn.

PRACTICAL COURSE IN HOROLOGY How-to-do-it lessons for beginners as well as those already in the trade. Thorough self-instruction training in American and Swiss watches, clocks, contains a wealth of helpful photos, drawings, diagrams, charts, etc. Only \$4.95 for everything, complete. Satisfaction or refund guaranteed. Mail no-risk coupon below.

practical RADIO servicing

SELF-INSTRUCTION COURSE Teaches you the practical side of radio . . . repair, adjustment, operation, alteration, trouble-shooting. No previous knowledge necessary. Prepare to set up a shop of your own—or train for the big industrial electronics field. Simplified lessons, including mathematics, review questions, problems, answers. Up-to-date! Only \$3.95, complete. Money-back guarantee. Use coupon below.



REAL ESTATE BUSINESS

The foundation of all wealth is land! Train yourself for a career in this booming profession. Here is the information you need on how to get started and how to get ahead in real estate. Includes instructions in appraisals, valuations, management, investments, practical real estate operating, low cost housing, the law on real estate transactions including legal forms, etc., salesmanship, and many other subjects a successful real estate man must know. Strictly up-to-date. Complete, only \$6.95. Money-back guarantee. Use No-Risk coupon below.

Short-Cut Mathematics COMBINED WITH Practical Mechanics Simplified

Be a "master mind." Learn how to juggle figures, do baffling tricks with numbers. Add long columns of figures this lightning-quick, short-cut way. Multiply 4 figures by 4 figures without old-fashioned multiplication. Here are speedy, simplified systems used by stage "wizards," expert accountants, engineers. Only \$1.49. Course includes illustrations, problems, answers. Mail coupon below!

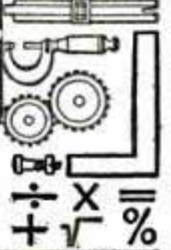

COMPLETE BLUEPRINT READING COURSE

Interesting, simplified self-instruction lessons for builders, mechanics, electricians, plumbers, welders, carpenters, automotive & aviation workers, etc. 24 volumes include over 600 actual blueprints, diagrams, other instructive step-by-step pictures. Unusual bargain for any practical man. Complete, only \$6.95, postpaid. Satisfaction or refund. Coupon below.

BUILD IT YOURSELF

Be a practical handyman. Save time and money with these professional Tricks-of-the-Trade. Carpentry made easy! New self-instruction course in one handy volume, complete with full page photographs, diagrams, etc. Teaches woodworking, painting & decorating, upholstering, power tools, cabinet making, etc. Full price only \$1.98. Money-back Guarantee. Mail coupon today!



Mail This No-Risk Coupon—Quick Action!

NELSON-HALL Co., 1139 S. Wabash Ave., Dept. C-2, Chicago 5, Ill.

Please rush me the items I am checking below. It is understood that if I am not 100% satisfied I will send the material back within 10 days and you will make full immediate refund, without question or quibble.

- Watch & Clock Repairing \$4.95
- Locksmithing & Key Making 3.95
- Practical Radio Servicing 3.95
- Real Estate Business 6.95
- Short-Cut Mathematics 1.49
- Blueprint Reading Course 6.95
- Build It Yourself 1.98
- Apartment House Management 5.95
- Jewelers' Encyclopedia 1.69
- How to Sell Life Insurance 6.95
- Complete Shorthand Course 4.95

I enclose \$ in full payment. Ship postpaid.
 Ship COD for \$ plus postage and COD charges.

Name

Address

WAR SURPLUS BARGAINS

10c

\$500,000.00 INVENTORY FOR QUICK LIQUIDATION

Surplus items—hundreds of them for home, shop, factory, farm and outdoor use. New items, used items, reconditioned items—all at tremendous savings—all priced for quick sale.

Page After Page of Values

This big catalog shows page after page of amazing money saving values. Write for your copy today. Send 10c to cover postage, mailing, etc. Write today!

SEND TODAY FOR YOUR COPY

STARK'S Dept. PM3 509 So. STATE STREET CHICAGO 5, ILLINOIS

DRAFTING is always the BIG PAY FIELD

Get Started Now! I Will Train You at Home Until You Get a Good Pay Job

Get a better job with more pay and pleasant working conditions. Get into Drafting—where all products start—where the Draftsman is the key man—where promotions to tool designer—industrial and product design—engineers—rate the very top pay. I will train you at home until you get a good pay job and give you real experience on the same kind of jobs you will do with the best paying firms. I furnish instruments and all equipment when you start. Write today for vital facts and FREE book. Give age.

ENGINEER DOBE

DIVISION 13 LIBERTYVILLE, ILL.

TOOLS DRAFTING TABLE and Complete Outfit Sent When You Start!



DIESEL is Going Places Come Along!

Yes, Diesel is a trade with a future. Look at the way trains, busses, boats, trucks, factories... everywhere... are changing to Diesel Power. It is going to take man power to keep the engines going. That means a great demand and great opportunities for the Diesel-trained man! That man can be YOU, if you are an average, ambitious, mechanically-inclined man.

KEEP YOUR JOB—LEARN AT HOME!

You don't have to give up your present job to learn Diesel. With U. E. I. training, you get complete fundamentals in practical, easy-to-understand home-study lessons. Includes operation, fuel systems, repairs, auxiliary equipment, etc. You may also get practical training in our modern, well-equipped shops. Experienced Diesel men show you short-cut methods, help you learn faster. High school diploma not necessary. Our 22nd year.

Success Demands Action, Act Now!

If you want to go places with DIESEL, act promptly. Fill out and mail coupon below for all the facts. No obligation. Do it AT ONCE!

Utilities Engineering Institute

Diesel Division, 2521 Sheffield Avenue
Dept. DC-1, CHICAGO 14, ILLINOIS

UTILITIES ENGINEERING INSTITUTE

Diesel Division, 2521 Sheffield Ave.
Dept. DC-1, Chicago 14, Illinois

YOU BET, I want to go places with Diesel! Rush FREE FACTS on U. E. I. training and Diesel opportunities.

NAME _____ AGE _____

ADDRESS _____

ZONE OR COUNTY STATE

Check here for special information if you are under 17.

Mail Coupon
Today for
**FREE
FACTS**

MASONS



& BUILDERS GUIDES

Inside Trade Information for Bricklayers, Cement Workers, Plasterers, Tile & Stone Setters.

Covering:—
BRICK LAYING
tools, materials,
bonding mortars,

designs, setting Frames, Foundations, Arches, Chimneys and Repairing old brick work. **GLASS BRICK and TILE SETTING**, hollow tile, walls, roofing. Placing re-inforced work, stucco, water-proofing, Plastering in all its branches, wall board. Stone Masonry, Mosaic and Steel Construction. **INCLUDING CONCRETE MIXING—CONCRETE BLOCK CONSTRUCTION**

1100 Pages, 2067 illustrations, Handy Size. **HIGHLY ENDORSED. ASK TO SEE THEM! TO GET THIS ASSISTANCE FOR YOURSELF FILL IN AND**

MAIL ORDER

AUDEL, Publishers, 49 W. 23rd St., New York 10, N. Y. Mail Audels Masons and Builders Guides, 4 vols. on 7 days' free trial. If O.K. I will remit \$1 in 7 days and \$1 monthly until \$6 is paid. Otherwise I will return them. No obligation unless I am satisfied.

Name _____

Address _____

Occupation _____

Employed by _____ PM

"MAGIC ARM" FLUORESCENT LAMP...
at Sensational **BARGAIN PRICES!** Twist it! Turn it! Bend it! For light where you need it.

One tube A.C. \$12.95
One tube D.C. 15.75
Two tubes A.C. 15.75

"Magic-arm" permits easy adjustment of light to any direction. 2 bolts clamp base firmly to any surface up to 3/8" thick. Bolts removable for screw fastening. Streamlined design in brown finish. All parts guaranteed 1 year. Underwriter Laboratories approved. A must for use in the Home, Workshop, Office, Laboratory or Industry. Uses 15 watt tubes (not incl.) price per tube 67c. Send check with order & we pay postage. Also sent C.O.D.

★ **PROVEN PRODUCTS** ★ Send for Catalog of electrical bargains.
351 W. 52nd St., New York City 19

ATTIC FAN KITS

SAVE \$100.00 UP. Make your own fan for any HOME or BUSINESS. Complete kit contains propeller, bronze bearings, collars, steel shaft, correct size pulleys, belt, bolts, nuts and installation drawings. New G. E. and Westinghouse motors, 110 V., 60 Cy., A.C., F.O.B. Atlanta, Georgia. Send 25¢ on C.O.D.'s. MOTORS AND KITS CAN BE PURCHASED SEPARATELY.

Fan Kit	With Motor	C.F.M.	Motor Size - Price	Without Motor
30"	\$37.62	7,200	1/4 HP \$11.30	\$26.32
36"	39.68	10,250	1/4 HP 11.30	28.38
42"	41.97	12,500	1/3 HP 11.75	30.22
48"	67.40	16,000	1/2 HP 32.65	34.75

ELECTRIC FAN & EQUIPMENT CO.
BOX 17—STATION E ATLANTA, GA.

PLASTICATED "GI" CLOTHS

WATERPROOF, LIGHTWEIGHT, 8 X 10 foot, 1001 uses as painter's dropcloth, lawn, furniture, machinery, merchandise cover, beach blanket, or shelter. Many uses camping, fishing, or picnic trips. Send \$1.25, and we will ship one cloth prepaid—

SAX-ON • Dept. M-3 • 3840 Fullerton • Chicago 47, Ill.

HARD-TO-BREAK
Plastic **FLEX-IT** 6 Ft. Rule
7—Reasons why it is UNEQUALLED—7

1. Withstands abusive treatment; no cross grain
2. Graduations & numerals are burnt in plastic
3. Will not absorb moisture
4. Withstand all normal temperatures
5. Will not stretch or shrink
6. Accuracy maintained at all times
7. Excellent insulator

Mfg. in white & yellow with black figures

FLEX-IT RULE CO. \$1.00
Box 121 Elyria, Ohio Postpaid

Learn PHOTOGRAPHY at Home

Splendid opportunities. Prepare in spare time. Practical basic training. Long-established school. Send for free book, "Opportunities in Photography." No obligation. American School of Photography, 1315 S. Michigan Ave., Dept. 1353, Chicago 5, Ill.

START PROFITABLE BUSINESS

Figurines, Gift Ornaments, Unpainted. Many to choose from. Easy to do—a hobby that pays off. Free catalog and information. SUITER ART INDUSTRIES, 314 Westport, Kansas City, Mo.

NEW Pocket MICROSCOPE

3 different magnifications, 20, 40, and 60 power, instantly, at the flick of a finger. Ring type fine focusing control.



High accuracy—for use in factory, show-room, field. Requires no slides, no pre-arranged conditions, no special light source. A compound microscope with precision ground and polished lenses, hard-coated to admit more light, reduce glare and eliminate reflection. Full, flat field of vision. 5 1/4" long (closed), weight 3 oz. Lifetime baked enamel and triple-chrome plated finish. Handsome case included. **\$14.50** POSTPAID

SCHOENIG & CO., Inc.
Dept. 3PM 9 Rockefeller Plaza New York 20, N. Y.



OUR GUARANTEE
Our tires must make GOOD or WE WILL
NEEDLESS TO PAY MORE
RISKY TO PAY LESS
Send this ad with order
TUBE GIVEN WITH EVERY TIRE
You Get What We Advertise
Highest Quality—Lowest Prices
Slightly Used
HIGH ORIGINAL TREADS

BUY IN CONFIDENCE safe
dependable POPULAR BRANDS
POSITIVELY NOT RE-CAPS

These are genuine Values!
One Trial will CONVINCE YOU

600-16 .. \$4.30	700-15 .. \$4.10
650-15 .. 4.10	700-16 .. 4.85
650-16 .. 4.30	750-16 .. 5.85

SELECTED O.K. for TOUGHEST JOBS
Not just good . . . THE BEST
TOPS IN VALUE TOPS IN SAFETY

600-16 \$5.40	700-15 \$5.40
650-15 5.00	700-16 6.40
650-16 5.40	750-16 7.00

World's Best Truck Tire Values
Top Service Minimum Prices

600-20 \$8.00	750-20(10) 10.95
650-20(6) 8.00	825-20 12.75
700-20(8) 8.95	900-20 12.75
32x6(8) 10.50	1000-20 13.75
32x6(10) 12.25	1100-20 14.75
750-20(8) 10.50	1100-22 16.75

750-20 MILITARY 8 PLY \$10.75
900-16 MILITARY 8 PLY \$7.50
ONE QUALITY THE BEST AVAILABLE

Thousands of tires shipped to satisfied customers.
We've made thousands of friends. MAIL ORDERS
given personal Attention. Send money order or check.
Dep't. 2

STANDARD
834 N. Broad St. Phila. 30. Pa.

ARE YOU *NATURALLY* INVENTIVE?

"Cash In" On Your Natural Talent
By Learning WHAT To Invent—
2100 Inventions Needed Now!

TURN your talents into CASH! Invent the *simple*
things that people need and want!

The Kiddie Kar brought its inventor a cool MILLION dollars. A 70-year old grandmother made \$350,000 on an overall buckle. Others became independently wealthy by "dreaming up" the rubber pencil tip, the ordinary paper clip, the hair-pin, etc. YOU can cash in, too—if you concentrate your talent on the inventions that are really NEEDED!

The EASY Way to Get Started



\$250,000

\$135,000

Don't waste time and brain-work on something nobody wants! Find out WHAT to invent. A valuable book by Raymond F. Yates, noted science editor and inventor, lists and describes over 2100 PRACTICAL, money-making ideas that are crying aloud to be invented!

These 2100 ideas are the things most needed and surest to make money. They are listed under 34 different headings for quick reference: Electrical, Radio, Automotive, Agricultural, Building, Household, Clothing, Toys, Time-Savers, etc.

This book ALSO tells how to think inventively; how to PROTECT your ideas; how to develop an invention STEP-BY-STEP, etc.



\$100,000

\$1,000,000

SEND NO MONEY FREE 5-DAY EXAMINATION

Would YOU like a slice of the \$280,000,000 that American inventors get each year in royalties? Get started now! Just mail the coupon and get "2100 Needed Inventions," by Raymond F. Yates, for 5 days' FREE trial. If, even in that short time, you are not convinced this book can help you make money—just return it and owe nothing. Otherwise, send only \$2.50, plus few cents postage, as payment in full.

Any one of the 2100 ideas in this book can bring somebody a fortune. Maybe it can be YOU! Mail the coupon and get this book on FREE TRIAL at once! Wilfred Funk, Inc., Dept. T493, 227 East 44th Street, New York 17, N. Y.

WILFRED FUNK, Inc., Publishers, Dept. T493
227 East 44 Street, New York 17, N. Y.

Please send me 2100 NEEDED INVENTIONS for FREE EXAMINATION. If I keep the book I will send you \$2.50 plus few cents actual postage. Otherwise I will return it within 5 days, without further obligation.

Name _____
Address _____
City _____ Zone No. _____ State _____
(if any)

Check here if enclosing \$2.50 WITH this coupon, and we will pay all postage charges. Same 5-day return privilege, for full refund, applies. (Canadian Orders—25c extra for carrying charges. Only U. S. currency accepted.)

Gadgeteer's Corner U.S. SURPLUS

ELBOW TELESCOPE
3 X, field view 13°, 20 min. Achromatic, color-corrected. Can be converted to a "center-scope" for drill press, jig and tool work. Lens suitable for photography and microscopes. Govt. cost approx. \$1.50..... **\$4.95**

JEEP CAN SPOUT
Complete with flexible nozzle, brass screen filter! Can be used in any gas or oil can with 2 1/4" opening. **2 FOR \$1**
Minimum quantity, 2

GENUINE LEATHER CASE
5" x 2" x 3 1/2" with leather strap. Perfect for small tools, camera accessories, etc. Brand new, only..... **\$1.00**

RUBBER BALLOONS
Air Corps, target type balloon. Inflates up to 45". **\$1.00**

COMPLETE CAMPERS KIT
Everything you need incl. canteen and cover, cup, knife, fork, spoon, wrist compass, G.I. can opener, water purifying tablets, pistol belt, goggles, and field bag..... **\$4.95**

3X GUN SIGHT
Precision optical instrument: powerful achromatic color corrected lens; waterproof shockproof. All bronze and brass body. Long distance observation. 22 1/2" long. Gov't cost approx. \$175. **\$4.95**

SURPLUS DISTRIBUTORS
924-B N. Plankinton Ave.
Milwaukee 3, Wisconsin
All orders shipped FOB Milwaukee, postage collect. Send money order or check. On C.O.D. orders, enclose 20% deposit, balance plus postage on arrival. Money cheerfully refunded if not satisfied.



HERE'S A NEW AND VITAL BUSINESS!

LEARN ELECTRICAL EQUIPMENT SERVICING

OFFERS BIG MONEY — INDEPENDENCE

Learn in spare time at home. **NEW Shop Method Training System.** Work as many hours as you wish — the Electrical Equipment Technician is his own boss. It is not unusual for a technician to charge on the basis of \$5.00 to \$6.00 an hour! Command big wages.

NO PREVIOUS EXPERIENCE NEEDED

We furnish everything! Tool kits, training kits, including the famous Christy trouble-detecting **ELECTRONIC KIT.** Plus illustrated instructions written in simple, easy-to-understand language, check full of photographs and drawings. Shows you how to repair factory and household electrical units. Power machinery, refrigerators, washing machines, vacuum cleaners, irons, etc. Gives you a working knowledge of electricity, house wiring, motor winding, welding, nickel plating, etc. Shows how to build power tools you need, how to solicit business and what to charge. Many report paying for their entire course, tools, etc. on earnings made at home while learning!

FREE BOOK SENT TO YOU

Send your name for **FREE** booklet on Electrical Equipment Servicing and instructions for paying us later from your **EARNINGS WHILE LEARNING!**

CHRISTY TRADES SCHOOL

DEPT. D-6703 2835 N. CENTRAL AVE., CHICAGO 34, ILL.

\$5000.
of Old Line Legal Reserve
LIFE INSURANCE
FOR ONLY **\$4.50** A MONTH*
AT AGE 21 (other ages in proportion)

*One Half Permanent Rate in effect 5th year

Or you can buy as little as \$1500 of this unique protection at only 90c per \$1000. Policy offers all Standard Provisions under rigid N. Y. State Insurance Laws.

For 42 years **POSTAL** has sold life insurance by mail and over the counter; has satisfied policyholders in every state; has over \$14,000,000 in assets and has paid out over \$62,000,000 in benefits. All Standard Policies, men or women, ages 10-60 at low cost.

DIVIDENDS, payable annually, further reduce the low cost of your insurance. Send coupon for further details and rates. Life Insurance is vital!

—GET THE FACTS BY MAIL—

POSTAL LIFE INSURANCE COMPANY
511 Fifth Avenue, New York 17, N. Y.—Dept. M-864
Mail me without obligation complete information about your low cost "Modified 4 Policy" at my age.

Name _____
Occupation _____ Date of Birth _____
Address _____



NOW! You'll be SAFER DRIVING IN HEAVIEST RAINS WITH WINGFLEX ON VENTILATOR WINDOWS

Amazing new **WINGFLEX** lets you drive in greater safety with ventilator wings open...in stormiest weather! Shield drains off rain flowing down windows...protects upholstery and clothing from water dripping in. Circulating air relieves musty odors, stuffiness inside car...prevents windshield "fog"...reduces risk of accidents. Snap-clamp secures to bottom of ventilators, rubber seal prevents leaks. Made of chrome plated steel. Fits all cars except new Studebaker. \$1.95 pr. ppd. Send check or M.O. C.O.D.'s plus postage.

WINGFLEX drains off rain flowing down open ventilators. Keeps water from dripping in. Lets musty odors out. Prevents windshield "fog".

Fits All Cars Except new Stude

\$1.95 PR. POSTPAID

PRODUCT CO., Dept. PM-2
705 Olive, St. Louis 1, Mo.

NEW FLUORESCENT FIXTURE with GE CIRCLINE LAMP!



GUARANTEED FOR 1 YEAR!

A strikingly beautiful fixture in polished aluminum finish. Suitable for every room. Model C-32AP (illustrated), \$8.95. Model C-32S with etched glass shade, \$12. Sent **POSTPAID** anywhere in the U. S. upon receipt of cash order. C. O. D.'s sent P. O. B. factory. Write for free literature on full line.

HANOVER
Box 186D LIGHTING SALES
Dept. SC, Hanover, Pa.

\$8.95
POST PAID

TOOL AND DIE DESIGN

FREE COPY of our catalog explains comprehensive 12 month course in tool or die design. Expertly planned curriculum. Highly individualized instruction. Housing, employment problems added. Write today for complete information.

TECHNICAL EDUCATION, INC. (Acme School) Chicago
Dept. PM, 2804 Belmont

KEEP OFF

NEW PLAN CATALOG

Send postcard today for **FREE** catalog of up-to-the-minute workshop projects—home bars, poker table, kitchen cabinets, workbenches, outdoor fireplaces, power tools, novelties, things to make for children, etc.

CRAFTPLANS, 7241 Madison, Dept. P-140, Kansas City 5, Mo.



CARTOONING

HAVE FUN! MAKE MONEY! Cash in on your sense of humor **AT HOME—BY MAIL.** No experience needed to start. Write today for **FREE TRIAL LESSON** and full particulars.

MOON Gag Cartoon School, Dept. M, Fall Creek, Wis.



Toolmaking PAYS Drafting BIG

You can train at **Allied's Big Shops** or Study at Home under **Allied's Supervised Home Plan**

Key Positions Open in Industry

- MACHINIST TRADE
- TOOL & DIE MAKING
- DRAFTING—ALL BRANCHES
- TOOL & DIE DESIGNING
- PRODUCT DESIGN & ILLUSTRATION

Established in 1928

FULLY APPROVED

Nationally Known, Endorsed by Industry

Write For Catalog—A 1c Postcard will do

ALLIED SCHOOL OF MECHANICAL TRADES
1338-1340-1342 So. Michigan Ave.
423 Allied Bldg. Chicago 5, Ill.

EVERY HOME NEEDS A WindoStep

For All Outside Window Work, Upstairs and Down! Wash, Paint, Putty. Hang Screens and Awnings. Use with Combination Storm Sash.

★ WindoStep* saves time, effort, strength. Eliminates use of ladders etc. Light, strong, 1000-lb. test.

★ Steel railing, substantial floor. Rubber protectors.

★ Easily adjusted to any wall thickness. Gravity-locked to sill from inside.

Can't be unhooked while in use. Guaranteed. Pat. Pend.

★ \$9.85 C.O.D. plus fee. \$10.50 postpaid. Add \$.50 west of Rockies. Free folder.

Territories open. *T.M.

Morrison Crafters, Inc.
709 Miami St., Toledo 5, O.



MAKE MONEY IN LANDSCAPING

Thorough training by Internationally known Landscape Architect to start your own business, improve your home or advance in this well paid field. Many Opportunities. Approved for Veterans. Send for FREE BOOK.

NATIONAL LANDSCAPE INSTITUTE
Dept. P-3, 310 So. Robertson Los Angeles 36, Calif.



This machine will make BIG PROFITS FOR YOU

Own your own big profit business!

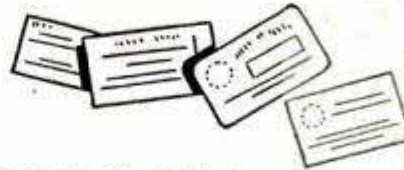

It seals—it moisture-proofs—it weatherproofs—it's tamperproof.

Be the first one in town to plastisize-protect snapshots—identification, Social Security, Credit Cards—valuable papers—badges, etc. Plastisizing with an Everseal Press is the perfect protection.



Every drug store, photo shop, hotel, restaurant, club, factory, church, school—plenty of local businesses right in your home town—can sell for you.

Everyone, men, women and children, who carries any identification, photos, Social Security or Credit Card is a potential customer.

Here is an opportunity you can't afford to miss. A guaranteed Studebaker-Everseal Press, ready to operate, supplies to produce \$500.00 worth of merchandise, complete operating instructions, instructions on how to set up your own business, samples.

Now is the time for you to get started! Don't delay! Write today for complete information on how you can start your own big profit business.

EVERSEAL SALES CORP.

Dept. PM3, 8039 EXCHANGE AVENUE, CHICAGO 17, ILLINOIS

SAY YOU SAW IT IN POPULAR MECHANICS

NEW...SENSATIONAL PLASTIC COATING... 1001 USES

PROTECTS SURFACES — PRESERVES FINISH
SAVES WORK AND MONEY

Krylon, the new all-purpose, protective coating, can be wiped, brushed or sprayed on all objects. It's water repellent, flexible, transparent, durable, dries in minutes. Krylon wraps in plastic—prevents rusting of tools and machinery, tarnishing of brass, chrome or silver. Preserves woodwork, furniture or

leather. Waterproofs wiring. Available in 12 oz. automatic spray can . . . \$2.95, or in 2-in-1 utility package of Krylon plastic coating and Krylon solvent cleaner . . . \$1.69. At better stores everywhere, or write direct. Cash or money orders only. Postage prepaid. Foster & Kester Co., Inc., Philadelphia 32, Pa.



WANT A GOVERNMENT JOB?

START AS HIGH AS \$3,351

Many Permanent Appointments Being Made

VETERANS GET SPECIAL PREFERENCE

Many Government Jobs.
City and Rural Carriers—
Postoffice Clerks—Liquor
Inspectors—Meat Inspectors
— Accountants — Ste-
nographers — Typists
—etc. Prepare now for
next Examinations.

FRANKLIN INSTITUTE,
Dept. M86, Rochester 4, N. Y.
(Not Government Controlled)

Sirs: Rush to me, without charge, copy of 40-page book, "How to Get a U. S. Government Job," list of positions, and full particulars telling how to qualify for them.

NAME _____

ADDRESS _____

VET? _____



HIGH PAY JOBS FOR MEN WHO QUALIFY IN DIESEL



ASSURE YOUR FUTURE. Steady, big pay jobs await men qualified in Diesel, Tractor and Heavy Equipment. Can you take advantage of Diesel job and advancement opportunities in this fast-growing field?

COMPLETE DIESEL COURSE AVAILABLE. If you are ambitious and want to get ahead in this lucrative field, you'll want to know about the complete training in Diesel provided by Interstate. Trains you at home in spare time. Does not interfere with your present job. Covers all phases of operation. Up to the minute. Revised regularly to cover new developments. Free placement advisory service.



YOU OWE IT TO YOURSELF

to investigate I.T.S. home Diesel training. Thousands of students agree it has helped them to better jobs... better pay. It can do the same for you!

SEND FOR FREE BOOK TODAY!

We'll gladly send you our big 24-page book "Getting Ahead In Diesel" FREE! Paste coupon on penny card and mail to

INTERSTATE TRAINING SERVICE
4035 N. E. Sandy, Portland 13, Oregon

Please see that I receive FREE BOOK "Getting Ahead In Diesel":

Name _____ Age _____

Address _____

City _____ Zone _____ State _____ (3)

5 BRAND NEW NOVELTIES FOR \$1
Now you can preview the latest novelty creations months in advance. One dollar brings you FIVE new novel gifts—one each month for five whole months! Get the most fascinating and interesting novelties long before they are available locally! Send \$1.00 today to:
THE NOVELTY OF THE MONTH CLUB
131-W West 42nd St. New York City 18

Model 500 for Home Workshops or the Master Craftsman



From drill press to vertical miller in one minute

Mastercraft ROTARY TABLE

Drills in a dead straight line or on a radius—cuts male or female slides on any form—cuts flats, hex or squares—cuts keyways, special shapes, splines and innumerable other forms. ADJUSTABLE DIALS read in thousandths—ROTARY TABLE graduated in 360 degrees; is 7" square and travels 4½" in either direction—QUICK ACTING Swivel Vise jaws positively lock regular or irregular shapes up to 4¾". ADAPTABLE TO ANY DRILL PRESS.

\$37.50 prepaid

F & M SALES, INCORPORATED
1054-56 Cahuenga Boulevard • Hollywood 38, California

QUALITY TILTING TABLE SAW

TABLE INCLUDING EXTENSION 18" x 14"

\$24.95

Complete as shown
F.O.B.
Royersford, Pa.



Send for catalogue showing complete line of Tilting Table and Tilting Arbor Saws, from \$24.95 to \$87.50
AMERICAN MACHINE & TOOL CO., Inc.
ROYERSFORD, PA. DEPT. 111

IMMEDIATE
DELIVERY



TIRES with a GENUINE MONEY BACK GUARANTEE!

You get what you order or your MONEY BACK if returned to us prepaid within 5 days! Over 1 million tires shipped from this factory all over the world.
High Original Treads, Slightly Worn, 98% Non-Skid Double Service Premium Tires
6.00-16 \$5.47 4.75-19 \$5.47 6.00-16 \$6.27
6.50-16 5.97 5.25-18 5.47
7.00-16 6.47 4.50-21 5.47
6.50-15 5.97 7.00-15 6.47
Send Check or M.O. to Dept. A
INDIANA RUBBER CO., 4041 Ridge Ave., Phila. 29, Pa.



NEW 15-JEWEL MEN'S WATCHES

Waterproof! Sweep second hand, stainless steel back, radium dial glows in dark. Genuine Swiss movement, guaranteed timekeeper, leather strap. 25% with order—balance C.O.D. Wholesale Only!
\$8.95 ea.
3 watches minimum
Also ELGIN, BULOVA, GRUEN, BENRUS, WALTHAM watches rebuilt & Guaranteed like new. Write for catalog.

JOSEPH BROS. 59 E. MADISON ST. DEPT. M-3, CHICAGO 3, ILL.

LIQUID MARBLE COMPOSITION FLOORS

Flexible Molds, Statu- ary, Art Goods in Flex- ible Plastic Molds; Ge- material makes \$1 seller. Make Marbleized floors, Tile Walls. Colorful, glossy, amazing! Easily learned; start in garage or basement. Particulars free.
MARBLEIZING SERVICE, Dept. 10-F, Edwardsville, Ill.

LEATHERCRAFT FOR FUN FOR PROFIT

Make your own Leather Novelties, Belts, Bags, etc., in spare time. A hobby you will love. Complete kits and equipment for tooling, carving and embossing at very low cost. Send for FREE catalog describing tools, leather and instructions.

JONAS HANDICRAFT CO. (Dept. M-2), 32 Frankford St., N. Y. 7, N. Y.

Say You Saw It in Popular Mechanics

RUPTURE Troubles ENDED

Advanced method. No leg straps, no elastic, no steel. Entirely different. Guaranteed. Write:
SMITH MANUFACTURING COMPANY
DEPT. PM PRESTON, ONT., CAN.

HELPFUL BOOKS

Send post card asking for FREE catalog
Popular Mechanics Press, 200 E. Ontario, Dept. 601, Chicago 11

**LOW
FACTORY
PRICES!**

... on the Sensationally **NEW 1949**

MIDWEST RADIOS

NOW Available with New Automatic

DUAL-SPEED RECORD PLAYER

For Playing Both Standard and LP (Long Playing) Records

30 DAYS TRIAL

**NEW
SERIES 16
SUPER DE LUXE
AM-FM
CHASSIS**

**14 1/2" PANASONIC
SPEAKER**

**5
WAVE
BANDS**

**EASY
TERMS**

58

**OUTSTANDING
FEATURES**

Including the
Exclusive Midwest
FLASH-O-MATIC
Volume and Band Indication
TELEVISION
Audio Switch-Over
FIDEL-A-STAT
Color-Ray Tone Selection
TRI-MAGNADYNE
Coil System
... Plus NO-DRIFT FM
and many other features

COMPLETE WITH FRONT PANEL—READY TO INSTALL!

Here is the last word in radio engineering . . . a powerful, world-ranging, magnificently-toned radio that is unsurpassed for performance, selectivity, sensitivity, and advanced engineering features. Uses these latest-type tubes, rectifier and tuning indicator: three 7A7, three 7A4, two 7C5, one 7A6, one 7Q7, one 6BA6, one 6BE6, one 6C4, one 6AL5, one 5U4, one 6U5. Comes complete with satin stripe copper finish front panel attached, Magna-Tenna Loop Aerial and giant 14 1/2" Electro-Dynamic Panasonic Speaker. Requires only a few minutes to install, plug in and play.

AVAILABLE in Separate CHASSIS or Complete Consoles Like this

Beautiful **SYMPHONY GRAND
AM-FM RADIO PHONOGRAPH**

with **NEW DUAL-SPEED
Automatic RECORD PLAYER**

For Both **STANDARD and LP RECORDS**



A Magnificent musical instrument and a masterpiece of cabinet design. Uses Series 16 Super DeLux AM-FM Chassis. Giant 14 1/2" Panasonic Speaker; Tri-Magnadyne Coil System; Built-in Loop Antenna. Other luxurious console and table model cabinets available with Series 16, 12 and 8 chassis—on Easy Terms and 30 Days Free Trial.

Rush for Free Catalog!

Send This Coupon Today—Write in Name and Address (Please Print) on Coupon or 1c Postcard

MIDWEST RADIO & TELEVISION CORP.

Dept. 258, 909 Broadway, Cincinnati 2, Ohio

Please send me your new FREE 1949 Catalog.

NAME _____

ADDRESS _____

CITY _____

ZONE _____

STATE _____

BUY DIRECT FROM FACTORY and SAVE!

MIDWEST RADIO & TELEVISION CORP.

Dept. 258

909 Broadway,

CINCINNATI 2, OHIO

PRACTICAL AUTO INFORMATION

Keeps Cars Rolling by Making Repairs
and Adjustments Easy!

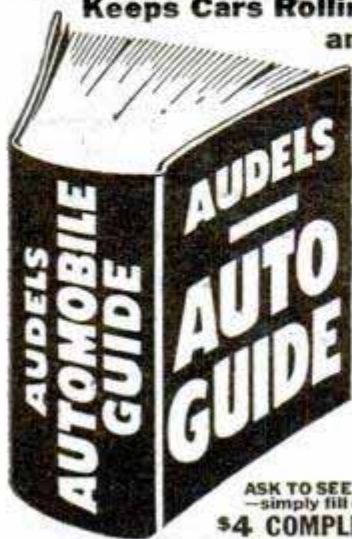

AUDELS AUTO GUIDE
For Every Mechanic, Driver,
Owner and Repair Shop.

Sent on 7 Days Approval
Shows How to Tune Up—Keep
Brakes Safe—Batteries Power-
ful—Tire Mileage Up—Save
Gas—Lubricate Correctly.

ANSWERS YOUR QUESTIONS
Contains all you need to know
about 1—Construction,
2—Operation, 3—Service,
4—Repair of Modern Motor
Cars, Trucks, Buses & Diesel
Engines in every detail.

NEW FLUID DRIVE TREATED
Easy to understand—
1540 Pages, 1540 Illustrations.
Gives definite directions on
How to handle service jobs.

ASK TO SEE IT—Get this information for yourself
—simply fill in and mail coupon today.
\$4 COMPLETE • PAY ONLY \$1 A MO.

AUDEL, Publishers, 49 West 23rd St., New York
Mail AUDELS AUTOMOBILE GUIDE (\$4) for free examination. If O. K., I
will send you \$1 in 7 days; then remit \$1 monthly until \$4 is paid.
Otherwise, I will return book promptly.

Name _____
Address _____
Occupation _____
Employed by _____ P.M.

Can a Man MY Age Become a Hotel Executive

Even Though He Has No Previous Hotel
Experience?

Would you like to step into a well-paid position as Hotel, Restaurant,
Inn, or Club Manager, Purchasing Agent, Social Director, Assistant
Manager? Would you like to be able to look forward happily to the
future? The success of Lewis graduates from 18 to 50 PROVES you
can—though you never had a minute's experience in hotel work.



**Nelson Davis, Newspaper Route Man,
Now Assistant Manager, Knew Nothing
about Hotel Work.**

"I had nothing to look forward to but hard, monotonous
work, long hours, poor pay. Then I answered a Lewis
advertisement and shortly afterwards enrolled. Soon
after graduation, the Lewis School placed me in a fine
Pennsylvania hotel. Later the manager asked me to go
to Miami to take a similar position. Now Assistant
Manager. Lewis training did it all."

Step Into a Well-Paid Hotel Position
FREE Book Gives Fascinating Facts

The Lewis School's FREE Book, "Your Big Opportunity," explains how
you can qualify for a well-paid position at home, in leisure time. It
tells how you are registered FREE of extra cost in the Lewis National
Placement Service; shows how you can be a Lewis Certified Employee
—certified to "make good" when placed in a position. Mail the
coupon NOW!

Course approved for Veterans' Training.

Lewis Hotel Training School
Room PC-324, Washington 7, D. C.

33 SUCCESSFUL
YEARS

Send me the Free Book, "Your Big Opportunity," without
obligation. I wish to know how to qualify for a well-paid position
at home, in my leisure time.

Name _____

Address _____

City _____ Zone _____ State _____

Check here if eligible under G.I. Bill of Rights.

Handy Mail Order List

Little Library of Useful INFORMATION

5 for \$1.00
12 for \$2.00
25¢ Each

Here at amazingly low cost is the practical
help and information you have always wanted.
Articles in previous issues of Popular
Mechanics have been classified according to sub-
ject and are now available in these handy
reprint booklets.

How to Use Measuring Tools—
Micrometers, Calipers, etc.—
106.

Power Driven Saws—74.
Drill Presses, Grinders, Etc.—79.
Wood, Metal Turning—Lathes—81.
Filing Machine, Hack Saw, Cutoff
Wheel, Shaper—82.

Lathe Tools You Can Make—101.
Workbenches—Tool Cabinets—47.
Spray Painting—94.

From Pattern to Casting—91.
Tool and Saw Sharpening—92.
Sharpening Drills, Wood Bits—
90.

Successful Wood Turning—32.
How to Read Blueprint—71.
Metal Turning Lathe Kinks—99.
Operating a Metal Lathe—100.
Heat Treating, Hardening—102.
Working With Glass—103.

Servicing Elec. Motors—75.
Electromagnets & Solenoids—44.
Transformer Construction—41.
The Boy Electrician—43.

Soldering and Brazing—17.
Arc and Spot Welders—5.
Electroplating With Nickel, Chro-
mium, Cadmium, Etc.—86.

Plating Leather, Wood, etc.—87.
Lower Your Fuel Costs—31.
Curing Leaky Basements—45.
Fitting Home Game Room—55.
Indoor & Outdoor Fireplaces—88.
Backyard Gardening—39.

Lawn and Garden Novelties—72.
Trellises, Pergolas, Fences—76.
Lawn and Garden Furniture—77.
Playground Equipment—73.

How to Use Your Drill Press—125.
Making Serving Trays—53.
Knots and Ropework—105.

Sanders—80.
House Wiring—89.
Hanging Wallpaper
—38.

Built-in Fixtures—78.
Bird Houses—7.
Magazine Racks—49.
Clock Cases—50.
Book Ends—52.

Small Tables—54.
Smoking Stands—56.
Desks—58.
Book Cases—59.

Action Toys—86.
High Flying Kites
—67.
Telescopes—20.
Metal Craft—28.
Small Looms—37.

Gem Cutting—42.
Photo Enlargers—1.
Photo Kinks—98.
Cleaning Formulas
—11.
Taxidermy—9.
Photo Lighting—119.
Training Dogs—35.
Small Furnaces—36.

Working With Plastics—61
Simple Home Improvements—104
Ridding Home of Insect Pests—107
Children's Room Furniture—51.
Jigsawed Novelties—57.

Doll House & Doll Furniture—60.
25 Shelves You Can Make—64.
Novelties Turned on Lathe—62.
Inlay Pictures—Veneering—63.
Wood, Soap Carving—65.
Windmills & Weathervanes—68.
Lamps from Wood, Metal—69.
Rustic Furniture—18.
Wood Finishing—40.

How to Fix Electrical
Appliances—111
Painting Your House—117
Build Your Own Relays—123
Rowboats, Small Dinghy—83.
Small Sail Boats—84.

Two Outboard Runabouts—85.
Build Own Canoe, Kayak—30.
Build Class-E Ice Yacht—22.
Auto Kinks, Shortcuts—10.
Lawn and Garden Equip-
ment—124

Motor-Driven Midget Cars—34.
Stop Auto Elect. Troubles—95.
Photo Printers and Dryers—25.
Photo Darkroom Equipment—96.
Trick and Table Top Photos—97.
Home Movie Equipment—118

Poultry Houses—108.
Guns and Decoys—109.
Re-Silvering Mirrors—70.
Chemical Experiments—93.
Log Cabins, Tourist Houses—14.
Using Basic Tools—120

Farm and Garden Tractors—8.
Building Extra Attic Rooms—23.
Attractive Basement Rooms—24.

Check Titles Wanted, Clip, Mail with Remittance to

POPULAR MECHANICS PRESS, Dept. 635, 200 E. Ontario, Chicago 11

FREE

Send today
for this big book of values in
TELEVISION

**RADIO, ELECTRONIC, INDUSTRIAL,
SOUND & AMATEUR EQUIPMENT**

**NEW 1949
NEWARK CATALOG**

No matter how tiny the part, how tremendous the system... it's listed in this mammoth catalog... over 20,000 items including everything in Standard Brand equipment! The most complete essential reference book for pros, hams, hobbyists, novices, oldtimers... everyone interested in TV, radio and sound equipment!

**24-HR. MAIL ORDER SERVICE
ONE YEAR TO PAY**



Newark Electric Co.
242 W. 55th St., NYC

MAIL | Dept. C14 Please send FREE Newark Catalog to:
COUPON | NAME _____
NOW! | ADDRESS _____
| CITY _____ STATE _____



148 pages packed
with pictures, charts,
and vital information

**KITS! SETS! PARTS!
ACCESSORIES!**

3 GREAT STORES!

115 West 45th Street
and Downtown at
212 Fulton Street
NEW YORK

323 W. Madison Street
CHICAGO

Now Quick-Selling CELL-U-MOP...

DOES THE WORK OF
6 TOOLS IN 1
Holds 20 times its
weight in water

others make
BIG MONEY

"Enclosed find 56 orders representing 9 1/2 hours work on Monday and Tuesday." "Enclosed are 12 orders secured after supper this p.m."



Hands
Never
Touch
The
Water
..
Can Be
Put In
Boiling
Water

Housewives Pleased
Everyone that sees this outstanding CELL-U-MOP immediately want one... That's the reason our distributors are so successful... For MOPPING, WAXING, WALLS, WINDOWS, AUTOS and CLEANING RUGS. Sells quick to Taverns, Clubs, Hotels, Hospitals, Stores, Restaurants, Homes, etc. Drain Bracket squeezes out water thoroughly. Write for FREE particulars

CLOSED CELL-U-MOP CO., Dept. P-3 FREEPORT, ILL.

PLAN
YOUR
FUTURE
NOW!



Permanently
Metalized
Baby
Shoes

**YOU CAN START
YOUR OWN BUSINESS**

AT HOME • SPARE TIME • FULL TIME

**LARGEST NUMBER
OF SUCCESSFUL
BUSINESS MEN**

Our course has the largest number of successful business men in this field today. All are men and women who acted and are making money.

Now is the time to cash in on this big-paying, easy-to-operate, year-round business and you need no experience. MATERIALS COST YOU ONLY 5c— YOU GET \$6.00! With actual illustrations and step-by-step instructions. YOU can start earning money in only one week—up to \$50 to \$75 per week spare time—up to \$1000 per month full time—\$5.00 and more per hour possible. Working only a few hours you can make more money than most people make working an entire week.

THIS COURSE IS
GUARANTEED.

- Money-Back Guarantee
- Most Successful Name in Metallizing
- Big Income
- Huge Demand
- Sales Plans
- Future Security
- Your Own Business

IMMEDIATE RESULTS—This tested and proved method shows you complete details so that you may start at once metallizing baby shoes with real Gold, Silver, Bronze, Pearl and Glass. They will last for ever and ever retaining every priceless detail of natural shoes. Five million new customers waiting to buy every year.

BEGIN AT HOME—Don't pass up this golden opportunity to start your own business on a shoe string. ACT NOW! We will send you full details absolutely free.



USE
THIS
COUPON

FREE!!

Course includes FREE—2 actual metallized baby shoes guaranteed most attractive on market or PAIR OF YOUR OWN baby shoes metallized if you prefer.

SEND
NO
MONEY

KIKTAVI
Company Dept. PM-3
2111 W Manchester
Los Angeles 44, California

Rush me FREE full particulars at once

NAME _____

ADDRESS _____

CITY _____ Zone _____ STATE _____

SAY YOU SAW IT IN POPULAR MECHANICS

BROADCASTS to Your Own Radio NO WIRES or Hookups

COMPLETE MINIATURE TRANSMITTING STATION. Electronic wonder—MICRO-VOX. Beams voice right thru ether... to any RADIO WITHIN 75 FEET tuned to MICRO-VOX. Amazing precision instrument. NOT JUST A MICROPHONE. SELF-CONTAINED. Portable. Transmitter—Tube & Batteries. CLEAR, LIFE-LIKE fidelity. EASY TO OPERATE. HUNDREDS OF USES with your Radio—Inter-Com! Public Address! "Baby Listening" Nurse! Pleasure! Parties! Meetings! Gags! Sing, play instruments, produce sound effects, shows. Practice public speaking, make records.

FREE 24-HR. TRIAL! Send no money. \$6.95 C.O.D., plus charges. Or remit \$7—no pay postage. Test MICRO-VOX 24 hours! If not delighted, money refunded. ORDER NOW.

MICRO-VOX, Inc., Dept. 43, 130 N. Wells St., Chicago 6, Ill.



\$6.95 Complete

12 Months Driving For \$7.95
New Saw Tooth Tread Design—New Tire Guarantee
SPECIAL INTRODUCTORY BARGAIN
600-16 and 550-16 — \$7.95 two for \$14.75
650-16 and 700-15 — 8.95 two for 15.75

Send this ad with orders. Mail orders rushed on receipt of check or money order for the size desired. Add State sales tax where necessary.
MASON TIRE SALES, 14018 Beech Ave., Cleveland 11, Ohio

**RE-STRING RACKETS
AT HOME—EARN MONEY**
EASY — PLEASANT — PROFITABLE
Write for 1949 Catalog and FREE Instruction Sheet NOW.
W. A. BICKEL & CO., 803 S. Boulevard, Dept. F-52, Oak Park, Ill.

BIG MONEY IN NEW SYSTEM OF HEATING From AIR, WATER and EARTH
Learn about new system of heating WITHOUT FUEL. (Reverse cycle of refrigeration.) Wonderful opportunity to be miles ahead of others... IF YOU ACT NOW... Get the FACTS... They are FREE... No obligation.
PRACTICAL TRADES INSTITUTE, INC.
25 University Ave. S.E., Dept. P-3, Minneapolis 14, Minn. Write Today

STOP WATCH
Genuine Swiss. Push Button
CHRONOGRAPH
This is the 4 in 1 Precision Swiss-Built Watch of Unvarying Accuracy
\$7.95
plus 10% tax

The perfect timepiece for track and field sports, engineering, photography, race horse clocking; for mechanics, students, measures distance—time to 1/75 second, radio. A rugged everyday wristwatch for active men. Send money order, check for \$7.95 plus 10% tax or \$8.74, or we mail COD (you pay postage). Order NOW from

- Chrome Case
- Rugged Shock Resistant
- Sweep Second Hand
- Radium Dial
- Unbreakable Crystal
- Genuine Leather Strap
- Written Guarantee with each watch

Unconditional Guarantee. Money back in 10 days for any reason whatever.

OPAL JEWELRY, 224 Washington St., N. Y. C. 7

LINGUAPHONE



is your *Passport*
to the World

In your own home, alone or in a group, you can now learn to speak

**SPANISH • PORTUGUESE
FRENCH • RUSSIAN
ITALIAN • GERMAN**

or any of 23 other languages by the world-famous

LINGUAPHONE Conversational METHOD

You learn the new language by listening to voices of native teachers. It is amazingly simple; thousands have succeeded. Educators hail Linguaphone as a notable advance in simplifying the mastery of languages. That is why so many Linguaphone Sets are used in schools, colleges, universities, as an aid to fluent speaking.

**Available to Veterans under
G I BILL OF RIGHTS**

SEND FOR FREE BOOK
LINGUAPHONE INSTITUTE
98 RCA BUILDING, NEW YORK 20, N. Y.

LINGUAPHONE INSTITUTE
98 RCA Bldg., New York 20, N. Y.
Send me the FREE Linguaphone Book.
I am , am not a World War II Veteran
I want to learn.....language.
Name
Address..... City.....

SAY YOU SAW IT IN POPULAR MECHANICS

AMAZING New INVENTION...

**Saves TIME
AND STEPS!**
For Busy People

(see Write-up Page 240
February issue Popular
Mechanics)

As if by some mysterious magic, RADI-OFF shuts off radio automatically as you lift receiver. Starts it promptly as receiver is replaced. Fits all cradle or upright phones. No special wiring needed—does not attach to phone. Will not alter or affect quality of reception. Can also be used to shut off electric irons, vacuum cleaners, mixers, etc. Only \$4.95 postpaid.



Like Magic!
**SILENCES
Your RADIO**
WHEN YOU
PHONE
**STARTS IT AGAIN
As Receiver
is Replaced!**

**AGENTS
WANTED!**

KENWORTH MFG. CO., Dept. PM-3 3455 N. Holton St.
Milwaukee 12, Wis.



CARTOONING

Taught by 9 Professionals

Here's a new idea in cartooning schools—45 Lessons created by NINE Famous Professionals: Boltinoff, Lariar, Nofziger, Roir, Ross, Roth, Salo, Schus and Wolfe. Over 2000 Instruction Drawings! Complete course includes: COMIC STRIPS • MAGAZINE CARTOONING • SPORT CARTOONS • POLITICALS • ANIMALS • ADVERTISING COMICS • BOOK ILLUSTRATION • CUTE GIRLS, etc.

Learn the modern way! Your homework personally criticized by all 9 famous teachers. Up to 2 years to finish. Approved as a Correspondence School under the laws of the State of New York. Approved for Veterans. For literature write to:

The PROFESSIONAL SCHOOL OF CARTOONING, Inc.
Dept. PM-2, 505 Fifth Avenue • New York 17, N. Y.

CIGARETTES

ALL POPULAR BRANDS \$1.57
Per Carton Postpaid

Minimum order 5 cartons—quantity discounts.

MIDWEST SALES CO. 2533 G Indiana
Kansas City, Mo.

NEON SIGN SCHOOL

G. I. APPROVED

Learn Neon. Interesting, clean work, BIG PAY—\$1.50 to \$2.00 an hour to start. Our 12½ week Job-Practice Course gives you practical training in Glass Blowing, Neon Tube Bending, Color Gassing, other branches. No home study. No text books. No mathematics. FREE FOLDER explains. Write today.

ACME NEON INSTITUTE, Dept. CC-3
330 South Paulina St. Chicago 12, Ill.

LEARN
IN 12½
WEEKS

GLOWS IN THE DARK

5



AN EASY WAY TO MAKE BIG MONEY

Be the first to sell sensational luminous house numbers, light switch plates, wall protectors, cord pulls, etc. Also luminous pictures, statues, decals, and a host of religious, nursery and other objects THAT GLOW IN THE DARK. Sell on sight. GET INTO THIS NEW AND GROWING INDUSTRY. ENORMOUS DEMAND... NO COMPETITION... BIG PROFITS. Represent a large manufacturer, established over 34 years. WRITE AT ONCE for liberal MONEY-MAKING offer and FREE SAMPLE to show you how they GLOW IN THE DARK.
MADISON MILLS, 303 Fourth Ave., Dept. R-4, New York 10, N. Y.

Write for **Free Sample!**

GENUINE SWISS
2-Push-Button
CHRONOGRAPH
WRIST WATCH



ONLY... \$6.95

A Sensationally low price for such a timepiece. A WRIST WATCH and STOP WATCH in one!

IT HAS EVERYTHING!

Note These Features...

- It's a TIMEKEEPER!
- It's a STOP WATCH!
- It MEASURES DISTANCE
- It MEASURES SPEED of Airplanes, Cars, Race Horses, etc.

It has Sweep Second Hand, Chrome Case, Artistic Workmanship.

EXPANSION BRACELET of matching stainless steel 49c additional.

SEND NO MONEY! Rush order today. Pay postman only \$6.95 plus 10% tax and postage. Satisfaction guaranteed or money refunded if returned within 10 days.

HARVEY SALES, Dept. 262
 4916 N. Albany Ave. Chicago 25, Ill.

40 POWER TELESCOPE
 Coated Lenses



- 40X—WONDERFUL for Astronomy
- 30X—SUPERS for Long Distances
- 20X—EXCELLENT Spotting Scope
- 10X—FINE for Close Study

FOUR TELESCOPES in One because of Adjustable Power Eyepiece. Precision American made Telescope. Magnesium-fluoride Hard Coated Lenses. Achromatic Objective lens 2 1/4" diameter. Length closed 9 1/2", open 27 1/2". Genuine **\$4250** postpaid. Leather covering. Weight 28 ozs.

DEALERS WRITE FOR PRICE
 "MILLIONS" OF LENSES, ETC. SEND STAMP FOR "BARGAIN LIST."
A. JAEGER'S 93-08P 95th AVE. OZONE PARK 16, N. Y.

New Advertising Machine



PRINTS and ILLUSTRATES
1¢ POST CARDS

Send Coupon

CARDMASTER CO., 4546 Ravenswood DEPT. 133, CHICAGO 40, ILL. FREE!
 Send FREE Illustrated Book* and complete, unique advertising plans and money making ideas for my business.

* Shows HOW thousands of business men in every line are boosting sales in spite of conditions with 1c messages printed and illustrated in few minutes on gov't post cards—with amazing, new, patented **CARDMASTER**. Your "today's" ideas, read by your prospects next morning. Not a toy, but a sturdy advertising machine built to last years. Sold direct at low price. Guaranteed five years. **SEND NAME TODAY. All FREE!**

NAME _____
 ADDRESS _____
 CITY _____ ZONE _____ STATE _____

Blue Print
for PROFIT

Here's Your Success Plan



a few cents worth of materials **BRINGS YOU DOLLARS!!**

Have Your Own Lasting, Successful Business—Be Your Own Boss—Help Fill Huge Demand ... No Experience Is Necessary

It covers

Rich profits are waiting to be tapped in this new field. New MIRACLE finish gives a velvety, luxurious surface to radios, lamps, toys, signs, store displays, figurines, auto dashboards, and hundreds of other items. Make old objects beautiful and saleable — make new things worth much more with this soft, rich covering that can be applied to any surface, even if old and worn.

START RIGHT AWAY

Yes, you can learn in a few days to start MAKING MONEY! Everything you need is furnished, including fully detailed, illustrated instructions that are complete and easy to understand. Every point is explained, to show you how to start on the road to big money, full or spare time, right in your own home.

EVERYTHING COMPLETE

In addition to full instructions, you get a complete set of materials that enables you to start at once. A few cents worth of materials can mean many dollars in return to you — you can earn up to \$500 or \$1,000 per month full time; up to \$75 per week spare time.

ACT NOW

Grasp this opportunity TODAY — start your own business. It's too good to miss! SEND NO MONEY — fill out the coupon and stick it on a post card or in an envelope and mail today for full details, FREE sample of FLOK-KRAFT covered material, and hundreds of useful and profitable IDEAS. Do it NOW — be first!

Covers Wood, Fabric, Metal, Glass, Plaster, Plastic or any Surface

SEND NO MONEY

COAST INDUSTRIES Dept. PM-3
 1509 West Manchester, Los Angeles 44, Calif.
 Please rush me all the details!

TOYS old or new

LAMPS take on a new distinctive beauty

JEWELRY BOXES give perfect protection

DISPLAY PIECES become unusually eye-appealing

CAR DASHBOARDS made soft as velvet



Get the **BIG MONEY** in **ELECTRICITY!**

USE THESE GREAT BOOKS FREE FOR 7 DAYS



APPLIED PRACTICAL ELECTRICITY

Coyne's new set helps men keep up with new developments to earn top pay in Electricity. These great books give you complete, A to Z, know-how, explained in easy-to-follow language, charts, examples and pictures. Covers practically all important branches of electricity including appliance repairing, AC and DC equipment, electrical refrigeration, automotive electricity, industrial electronics and much more. You get more than 11,500 important, useful electrical facts... over 3400 subjects... hundreds of diagrams, tables, formulae, short-cut methods. No matter what phase of electricity you want to know about—you'll find it clearly written in **APPLIED PRACTICAL ELECTRICITY**. Into these 8 great volumes, has gone 50 years of experience in electrical training which has put hundreds of electricians on the road to bigger pay opportunities.

5 to 1 GUARANTEE

Set must earn 5 times its cost or Coyne sends money back on its return at end of 1 year.

FREE TRIAL OFFER

We want you to prove to yourself that these books are all we say they are. So here's our amazing **FREE TRIAL** offer to you: fill out the coupon below and mail it in. **SEND NO MONEY.** We'll send the complete 8-volume set to you, postpaid. Use it **FREE** for 7 days and discover how **APPLIED PRACTICAL ELECTRICITY** can help you get ahead!

BOOK OF 150 SHOP PRINTS WHILE THEY LAST Free!

Here's a reward for you if you act promptly. With the 8 volume set we will include—absolutely **FREE** of charge—our big, practical book of "150 Shop Prints and How to Read Them." You may return the set at our expense within 7 days and you won't owe us a penny. If you keep the set, just send either \$23.75 cash or \$3 in 7 days and \$3 a month until \$25.00 is paid. Either way, the *Shop Prints* book is yours to keep as a **FREE** gift from Coyne! Coupon below is not an order, only a request to examine **APPLIED ELECTRICITY** and receive the **FREE** book. Fill out and mail the coupon **NOW!**



Educational Book Publishing Division
COYNE ELECTRICAL & RADIO SCHOOL
500 S. Paulina St., Dept. 39-R6, Chicago 12, Ill.

Educational Book Publishing Division
COYNE ELECTRICAL & RADIO SCHOOL
500 S. Paulina St., Dept. 39-R6, Chicago 12, Ill.

YES! Rush, postpaid, Coyne's new 8-volume set **APPLIED PRACTICAL ELECTRICITY**. I want to examine these books **FREE**, per your offer. Include book of 150 Shop Prints **FREE** for me to keep whether or not I keep the Set.

Name _____ Age _____
Address _____
Town _____ Zone _____ State _____
Where Employed _____

BE A POPULAR GUY



with a RISING TIE

Girls go into hysterics as your tie goes up and down. Your friends will be held spellbound and remain fascinated for hours. A simple adjustment makes your tie rise and fall at will. This adjustment can be made in a few seconds on any tie. No hands, no bulbs used. Take a deep breath and say "ah" and you are a popular guy. No one can discover the secret of the rising tie. **\$1.00** post paid or C.O.D. plus postage. Free Catalog of 25 amazing tricks included with every order. **MAGIC CENTER** World's Largest Magic Shop, Dept. PM-1 741 Eighth Ave., New York 19, N. Y.

Get This Now! SPRAY PAINTING New Book Makes Money Saves Money



COMPLETE INSTRUCTION FOR PROFESSIONAL USE AND 'ROUND-THE-HOUSE JOBS — INCLUDES AUTO PAINTING AND REFINISHING

Get this new 1948 spray painting book to help you on the job or for better and time-saving paint work around the home and car. Thoroughly practical—covers every phase of spray painting technique. Tells what paint or other finish to use, how to mix colors, how to make perfect jobs, easy, quick. New edition has over 160 pages. Cloth binding, illustrated. Send \$2.00 for postpaid delivery or we will send C.O.D. Money back if not satisfied.

FREDERICK J. DRAKE & CO.
117 GREEN BAY ROAD DEPT. 13 WILMETTE, ILL.

SPEED-MILEAGE MANUAL

EASILY OBTAIN GREATER SPEED, MILEAGE, RACING PERFORMANCE FROM ANY AUTOMOBILE! Famous New Book Shows Soup Up Methods; Speed Tuning; Mileage Secrets; Speed Equipment Plans; "Customizing Ideas!" Photographs! Complete Instructions on Building Inexpensive Power Equipment! Economizers! Superchargers! Manifolds! "Water Injectors!" Mufflers! How to build **FAST CONVERSIONS!** "HOT RODS!" **CUSTOM SPORTS CARS!** All About Engines, "Economy Tuning," Compression, Fuels, Trials, "Racing Tricks!" Latest "Hollywood Styling!" Streamlining! Sport Changes! Simple Conversions! California Roadster Plans! Parts Lists! Speed Catalogues! Folios! 125 Illustrations! Working Drawings! Complete data! PLUS "Beautiful Custom Car and Hot Rod Pictorial Supplement!"

ONLY \$1.98 POST PAID Satisfaction Guaranteed
ALMQUIST ENGINEERING
MILFORD 60, PENNSYLVANIA

How To Appear TALLER! INCHES



Wear Dr. Scholl's Height Elevators \$3.95 Pr.

Why feel inferior because you are short? Dr. Scholl's Height Elevators, improved invention, make you appear inches taller. Worn invisibly. Slip into your shoes like an insole. Transferable from one pair to another. No one knows what you wear. Very comfortable. Many regular users. Sold by shoe stores and Dr. Scholl's Foot Comfort Shops in principal cities.

SEND NO MONEY. If your dealer is not supplied with Dr. Scholl's Height Elevators, order from us direct, giving your height, shoe size and width. Pay mail man \$3.95, plus postage, or send check or currency and we will send prepaid. Money back if not satisfied.

DR. SCHOLL'S, INC., Dept. PM, Chicago, Ill.

BEFORE YOU BUY "ANY" TIRE—
CONSIDER YOUR FAMILY'S SAFETY — NOT JUST PRICE!
→ VETS TAKE 10% DISCOUNT. YOU CERTAINLY DESERVE IT ←
CHOOSE YOUR FAVORITE BRAND

GOOD YEAR  **Firestone** 
Goodrich  **U. S. ROYAL** 

AND MORE OF THE WORLD'S BEST BRANDS
SLIGHTLY WORN HIGH TREAD TIRES. NO RECAPS.
FREE BUTYL TUBE with all these **14 MONTH GUAR. BOND**
 AAI Tires

600-16 \$4.40	550-17 \$5.75	600-20 \$8.95	34x7 \$10.95
650-16 \$4.40	525-18 \$5.75	700-20 \$9.95	825-20 \$11.95
650-15 \$4.30	700-16 \$5.00	32x6 (8) \$9.95	900-20 \$12.50
700-15 \$4.50	750-16 \$6.00	32x6 (10) \$10.50	1000-20 \$12.50

"ALL-PURPOSE" CAR & TRUCK TIRES "TRIPLE-A" "TOP GRADE"

GOLDEN-RULE GUAR. 24 MOS. AGAINST ANYTHING!		"TRIPLE-A" "TOP GRADE"	
600-16 \$5.50	525-18 \$6.75	600-20 \$9.95	32x6 (10) \$11.95
650-16 5.50	550-17 8.00	650-20 10.25	825-20 15.45
650-15 5.50	700-16 6.50	700-20 10.95	900-20 15.45
700-15 6.50	750-16 6.50	32x6 (8) 10.95	1000-20 16.45

WHITEWALLS OR 6 PLY TIRES \$1 EXTRA **6-8-10-12-14 PLY**

We've Shipped Tires to Canada, Italy, Czechoslovakia, Alaska, Panama, Puerto Rico, Germany, and South America.

Our Tires Used on School Bus., and Ambulances

750-20 MILITARY Fits 32 x 6 700-20
 8-ply Top Grade (Were \$9.75) \$9 Guar. 12 Mos.
 Premium Grade (Were \$18) \$13 Guar. 26 Mos.
 900-16 'A' \$7.75 900-16 'AA' \$10.75

Send check or money order & this ad for rush shipment. We won't ship a tire that we wouldn't use. Blatt Bros. have personally pinpoint-inspected 1/2 million tires. Please depend on us.

BLATT GIRARD & LANCASTER AVE., DEPT. P.M.
 BLATT BLDG., PHILADELPHIA 31, PA.

Brand New TARPAULINS

9 oz. Water Repellent with grommets and tie ropes. These durable covers offered at ridiculously low prices.
 6'x9 1/2' ea. \$3.45 6 1/2'x13' ea. \$4.95
 Lots of 12, ea. \$3.25 Lots of 12, ea. \$4.65
WALL TENT 9'x9' waterproof canvas. front and back windows. 3'6" wall, open at **\$19.95** back. Ends 8' high. Only.

Prices FOB, K. C., Mo.
AMERICAN SUPPLY CO.
 329 W. 5TH ST. DEPT. P.M. KANSAS CITY, MO.

PLASTICS Material and supplies. Retail and wholesale. Beginner's outfit \$1.25. **FUN & PROFIT!** Get FREE Catalog.

PLASTIC LETTER INDUSTRIES
 DEPT. M 188 N. WELLS ST. CHICAGO 6

Say You Saw It in Popular Mechanics

WORLD'S LOWEST PRICED
ADDING MACHINE

VEST POCKET SIZE
IDEAL for BUSINESS & PERSONAL USE!

FREE TRIAL
ONLY \$2.95
 TOTAL COST
 SEND NO MONEY
FREE!!

Fits vest pocket or purse. Guaranteed accurate. Operated as easily, and as reliable, as machines costing many times as much. Not a toy. Precision made, very durable—guaranteed for life against defects in construction. You positively can't buy a calculator of equal quality for as little money. **ACCEPTED AS THE FINEST LOW PRICED CALCULATOR FOR OVER 35 YEARS!** Operates with a flick of your finger. Adds, subtracts, multiplies, divides—counts up to one billion. Pays for itself over and over in mistakes avoided, and time saved.

Each Baby Calculator in Beautiful, rich-looking Leatherette case—at no extra cost.



MAKES IDEAL GIFT
 Sold on a positive money back guarantee. Send only \$2.95. Calculator sent postpaid, or send name and address and pay postman \$2.95 plus postage. **MONEY BACK IN 10 DAYS IF NOT DELIGHTED!** (If outside U. S., send \$3.50.)

AGENTS WANTED
CALCULATOR MACHINE CO., (Mfrs.)
 Dept. 212, P. O. Box 248, Glenview, Illinois

WAR SURPLUS
OPTICAL BARGAINS

ASSEMBLE YOUR OWN BINOCULARS!

Save More Than 1/2 Regular Cost



GOVERNMENT'S 7X50 BINOCULARS

Complete Optics!
Complete Metal Parts!
 We supply full instructions

METAL PARTS—Set includes all Metal Parts completely finished—for assembly of 7 X 50 Binoculars. No machining required. A sturdy Binocular carrying Case is optional with each set of Metal Parts.
Stock #842-H \$39.40
Postpaid, plus \$4.80 for Case—Total \$44.20

OPTICS—Set includes all Lenses and Prisms you need for assembling 7 X 50 Binoculars. These are in excellent condition—perfect or near-perfect—and have new low reflection coating.
Stock #5102-H \$25.00 Postpaid
 (These are standard American made parts . . . not Jap, French or German.)

NOTICE! If you buy both Binocular Optics and Binocular Metal Parts, add 20% Federal Excise Tax to above prices.

ARMY'S 6x30 BINOCULARS

COMPLETE OPTICS & METAL PARTS—Model M-13A1, 6 X 30 Binoculars. (Waterproof Model). Everything you need—ready for assembly. When finished will look like a regular factory job costing \$102. to \$120. The Optics are new, in perfect or near-perfect condition. Have new low reflection coating. Metal Parts are new and perfect, all completely finished. No machining required. Complete assembly instructions included.
Stock #830-H \$40.00 Postpaid
plus \$8.00 tax—Total—\$48.00

20X PRISM SPOTTING SCOPE SET—Consists of all lenses and prisms (slightly chipped) you need to make a good, standard 20X Spotting Scope. Low reflection coated. 57 mm. dia. Achromatic objective. Some Metal Parts Included. We furnish Directions.
Stock #5145-H \$22.00 Postpaid
 (Also surplus Riflescopes — Write for Bulletin "H")

SLIDE PROJECTOR SETS—Consist of all unmounted lenses you need to make the following size projectors:
Stock #4038-H—2 1/4"x2 1/4" \$3.35 Postpaid
Stock #4039-H—2 1/2"x3 1/2" \$3.35 Postpaid
Stock #4029-H—35 mm. \$2.85 Postpaid

35MM KODACHROME PROJECTING LENS SET—Consists of a mounted projecting lens, heat absorbing glass, 2 condensing lenses.
Stock #4035-H \$4.85 Postpaid

MOUNTED ANASTIGMAT LENSES—Use for Projectors, Enlargers, Copying Cameras. Complete with Shutter and Diaphragm. Value about \$20. An excellent buy. **WE WILL INCLUDE FREE ILLUSTRATED BOOKLET on HOW TO MAKE YOUR OWN ENLARGER.**
Stock #8004-H Speed f/7.7, focal length approx. 127 mms. Suitable for pictures, negatives, positives up to 3 1/2"x4 1/4". **\$7.50 Postpaid**
Stock #8006-H Speed of f/7.7, focal length approx. 100 mms. Suitable for pictures, etc. up to 2 1/4"x3 1/4". **\$8.50 Postpaid**

We have literally millions of war surplus lenses and prisms for sale at 10c and up. Write for Catalog "H" — Sent Free!

Order by Stock No. Satisfaction Guaranteed
EDMUND SALVAGE COMPANY
 P. O. AUDUBON, NEW JERSEY

LEARN EXPORT

Buy and sell world-wide without capital. Travel abroad if desired. Export men and women in demand. Your own business — profits unlimited. Salaried jobs in many branches of Export-Import. Practical, low cost **WORLD TRADE COURSE** teaches you quickly at home in spare time. No previous special experience or schooling needed. World Trade Certificate awarded. Write today for **FREE BOOKLET**. No obligation. State if veteran. Air-mail reaches us overnight. **THE MELLINGER CO., Exporters-Importers, 1422-EN Westwood, Los Angeles 24, Calif.**



Perfect Circle *The Most Honored Name in Piston Rings*

Honored by America's foremost automotive engineers, who recently acclaimed Perfect Circle Piston Rings as best engineered—4 to 1.*

Honored by Doctors of Motors, America's expert mechanics, who actively express their piston ring preference by installing millions of Perfect Circles every year.

Honored by motor-wise car owners all over America, who in survey after survey have invariably named Perfect Circle their first choice by a wide margin.

Look for this sign (right). It identifies a place where your car will receive expert attention. Your local Doctor of Motors knows your car, knows the value of honest workmanship and reliable parts. He will install a set of Perfect Circle Piston Rings Custom Made for your car to restore power, save gas, stop oil burning.

Perfect Circle Corporation, Offices: Hagerstown, Indiana, and Toronto, Canada. Plants: Hagerstown, Richmond, New Castle, and Tipton, Indiana, and Toronto.

**In an independent survey just completed among automotive engineers—maintenance men, fleet operators and designers of new equipment—Perfect Circle was first choice as the best engineered piston ring—first by more than 4 to 1—and received more votes than ALL other brands combined!*

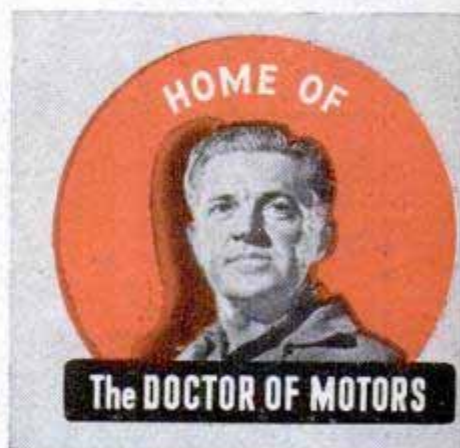



the navy explores the air waves

OUT ON THE END of Point Loma that overlooks San Diego Bay radio technicians are beaming microwaves straight up at the sky. At a nearby receiving apparatus they listen for the faint echoes that are reflected back to earth from turbulences and currents in the atmosphere.

In an adjoining field, other experts are performing similar experiments with SODAR, a sound apparatus that for some purposes is comparable to radio. Sharp explosions are created and the sound of the explosions is beamed upward by a parabolic reflector. Echoes reflected back from the air currents are recorded.

What is being sought is more knowledge about conditions in the troposphere that influence radar, television and other high-frequency radio signals.

In theory, these high frequencies are good for line-of-sight distances only and yet it sometimes happens that VHF and UHF signals are received at points hidden from the transmitter by mountains or by the earth's curvature. A temperature inversion in the atmosphere, for instance, may create a temporary channel along which the

Ionosphere echoes caused three dots (lower line) to be received at San Diego when one was sent from Washington



Overhead rack at right is used to support a number of receiving pickups for testing antennas. Transmitting antenna is placed on a turntable under the naval officer's right hand. Pickups show strength of the signal along the curve

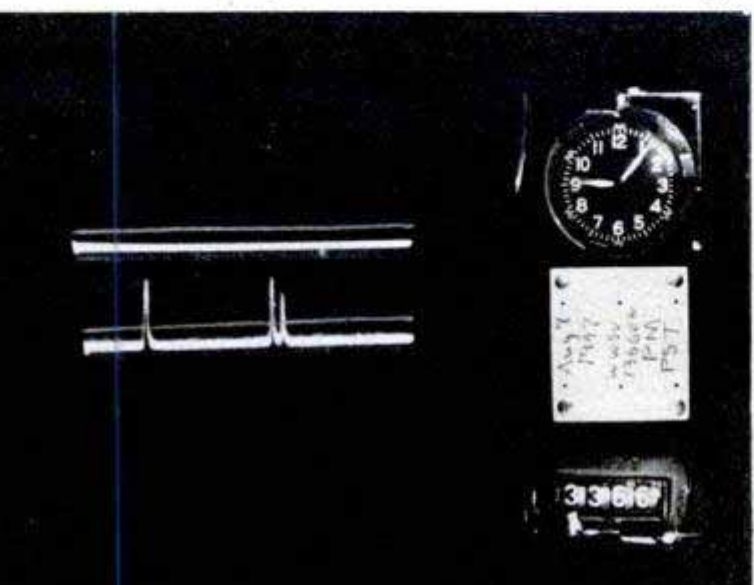

short waves can move parallel with the earth for greater than normal distances. The humidity gradient over the ocean can have a similar effect.

By probing the atmosphere with radio waves that are only one centimeter long, by studying the reflections from beamed explosions and by other research, the radio technicians soon may learn new facts that will help them to invent high-frequency radios of greater range, accuracy and reliability.

Radio atmospheric is one of numerous

projects underway at the U.S. Navy Electronics Laboratory, which has its headquarters in San Diego. NEL is one of the country's major research institutions and is directed by Capt. R. Bennett II, U.S.N. Joseph P. Maxfield, noted for his contributions to telephony and other subjects, is superintending scientist. The laboratory is operated by the Bureau of Ships and is engaged not only in research but also in development and "systems engineering" by which new ideas are converted into practical pieces of equipment for use by the fleet. About two thirds of the 1000 persons on the staff are research technicians or scientists.

Useful and versatile as radio is, it is not yet as perfect as the scientists would like to make it. They want, for example, a radar apparatus that would locate a distant target almost to within a matter of inches instead of the 100 feet or so that is acceptable now. Such highly accurate radio ranging would be valuable, among other uses, in selecting sites for offshore oil wells.

The engineers want to eliminate fading on long-range radio transmissions and they want to develop long-range radio circuits that can handle several thousand words a minute. They would like to transmit a dozen messages at once, on different frequencies, from a single antenna and they would like to hook a dozen receivers to a single antenna to receive the messages.

They want to find the best locations for

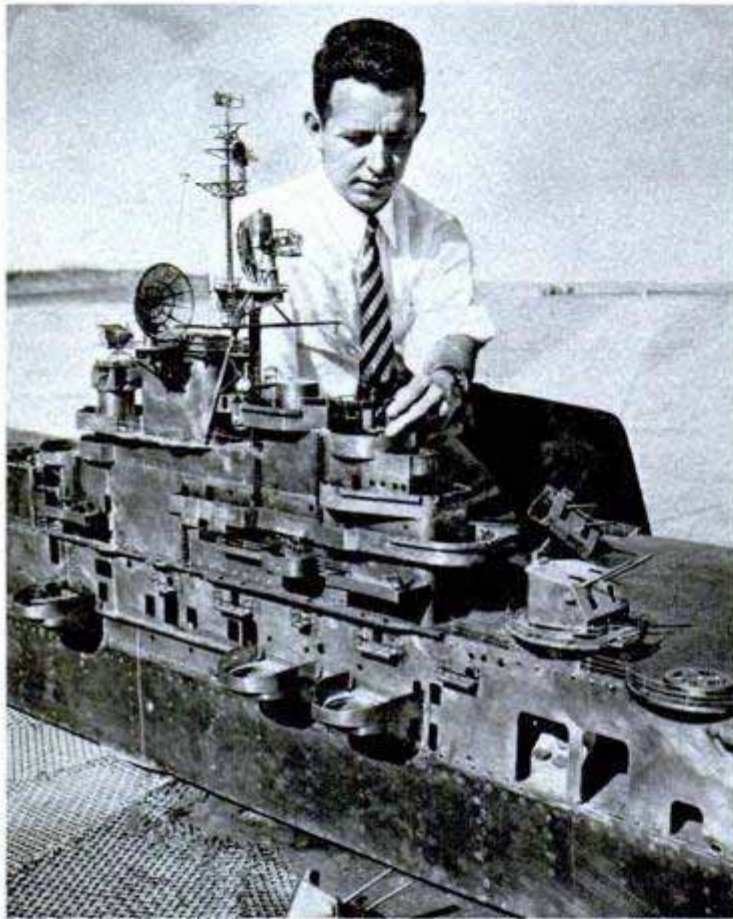

Left, turrets on scale-model ships are demountable and the guns can be pointed in various directions to test effect on communications. Below, technicians place the carrier's island in position for testing

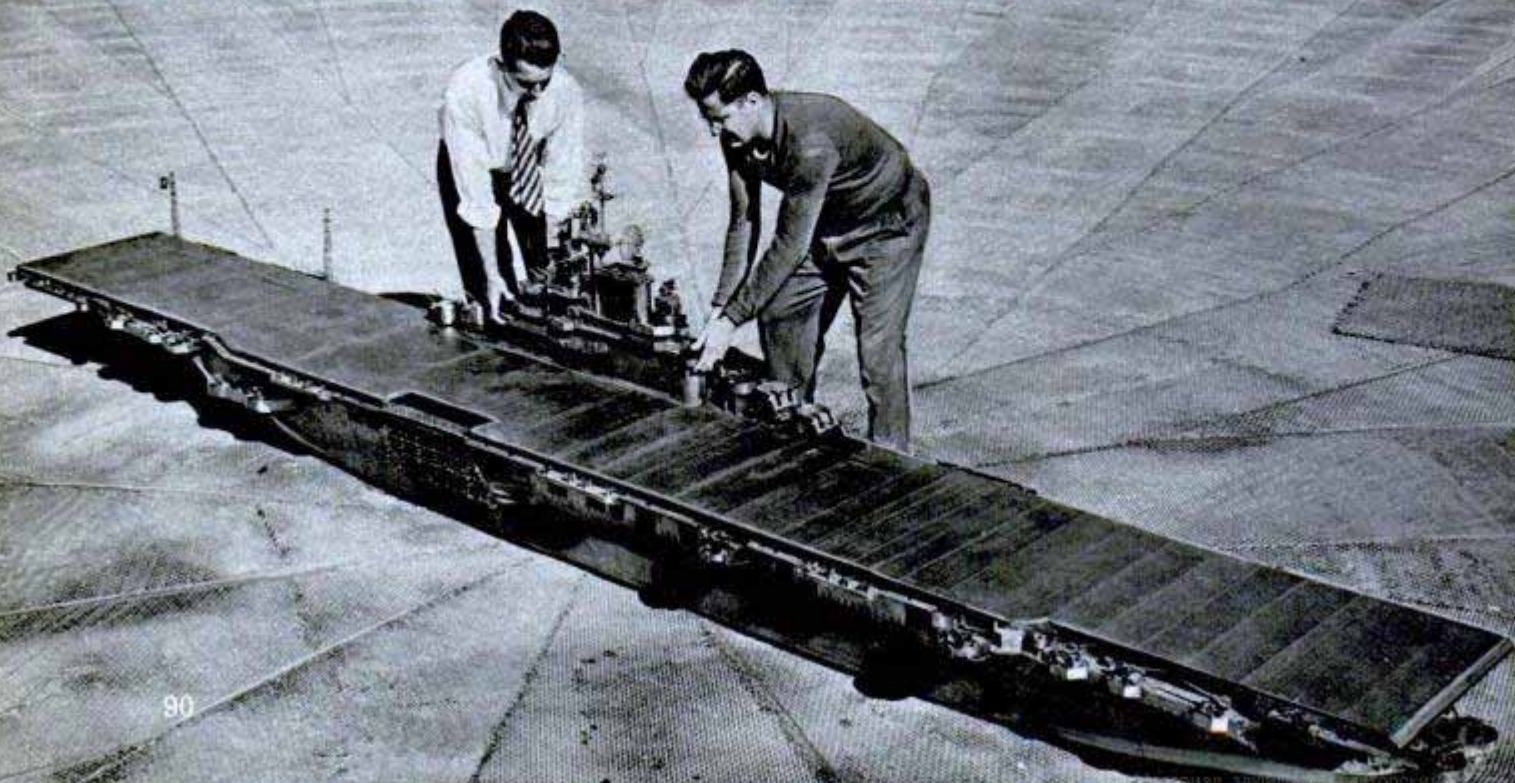

placing communication antennas on ships so that each antenna will be efficient at all points of the compass. A big aircraft carrier, as an example, may use 25 different communication circuits at one time and the traffic requires a forest of transmitting and receiving antennas. The efficiency of each is affected by the locations of the other antennas, by the size, shape and heading of the ship, and even by such protuberances as turrets and deck guns.

The result is that a certain antenna may have an effective range three times greater in one direction than in another. The pilot of an aircraft some distance away may find that his radio suddenly fades out completely when the surface ship makes a turn and blanks off the antenna behind its island. Ship-to-ship and ship-to-shore communications likewise are hampered. One of the tasks at NEL is to determine the best locations for antennas on existing ships and to determine the best electronic structural requirements for future vessels so as to provide nondirectional radiation patterns.

It's easiest to do this work with models instead of full-size ships. The laboratory builds its own models of brass, to $\frac{1}{24}$ or $\frac{1}{48}$ of full scale. A model of an Essex-class carrier is 18 feet long, $\frac{1}{48}$ the length of the ship itself. The model weighs 646 pounds and is complete down to the barrels of its anti-aircraft guns. Turrets can be rotated, gun barrels can be moved to different angles and the model's deck elevators raised or lowered. These details permit studying the effects that the masses of metal have on radio transmission.

NEL uses a scaled-down artificial "ocean" for testing its model ships. The ocean consists of wire mesh laid flat on the ground. It provides the same electronic effect as water. The model to be tested is placed on a turntable in the center of the artificial ocean and spun around, six times a minute, at the same time that the model transmits a radio signal from the antenna being tested. The signal is picked up by receiving antennas placed around the perimeter of the ocean and the varying strength of the signal is recorded on graph paper.



Explosions above reflector send sound waves into troposphere where they are reflected back to earth for study by scientists

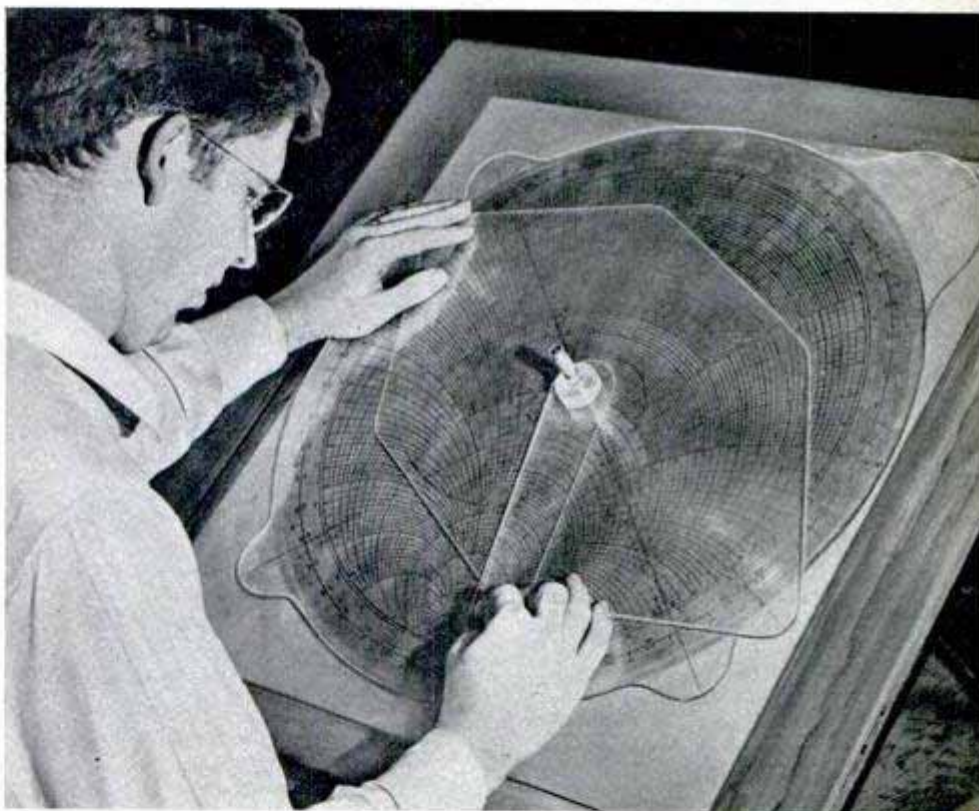

Above, this complex impedance chart is used in measuring the electrical characteristics of antenna designs. Below, worker adjusts a wave guide that emits radio waves which are beamed straight up by the parabolic reflector for the reflection tests



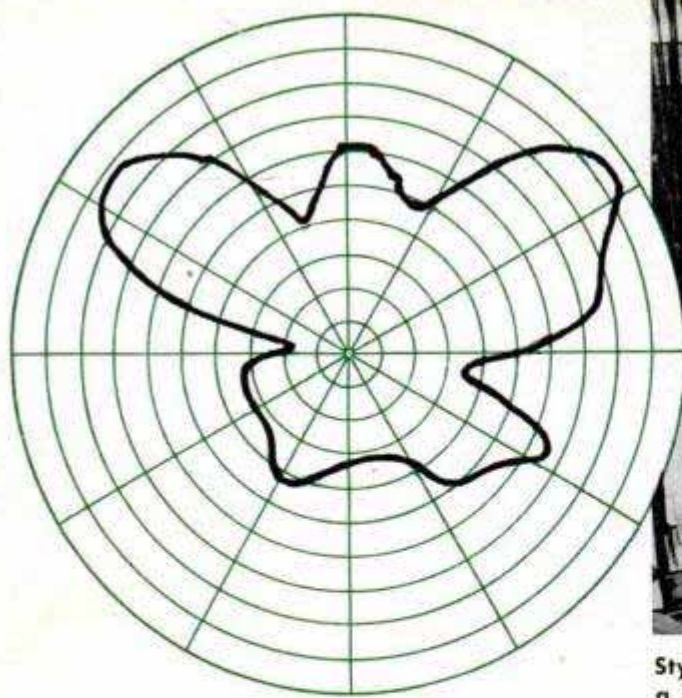

Stylus on swinging arm plots the all-around range of antennas on a 360-degree chart fastened to turntable. On the chart, shown at left, the masking effect of a ship's superstructure is very apparent

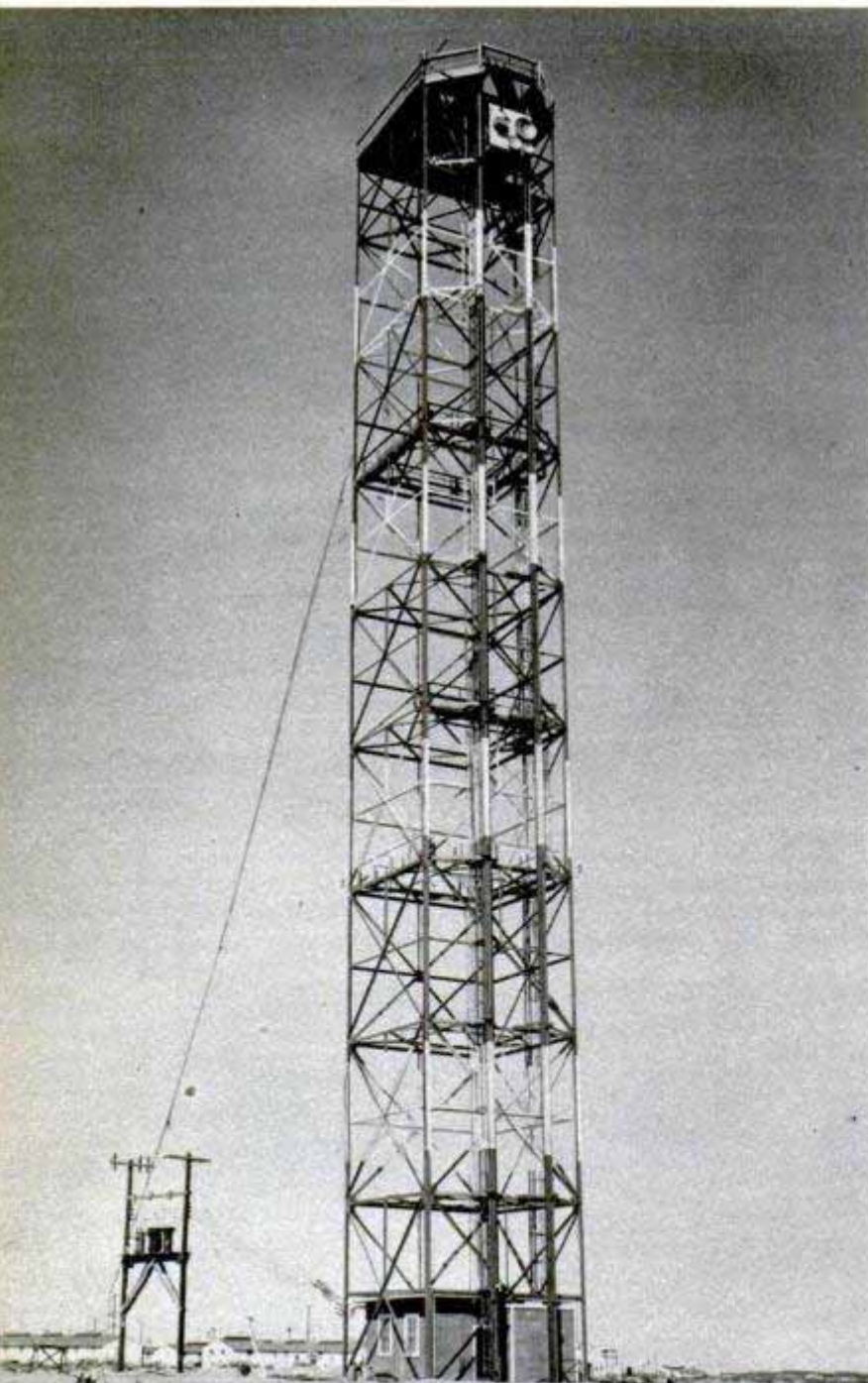

When two or more radio circuits can be handled by a single antenna simultaneously it will be possible to reduce the number of antennas on a ship or it will allow more traffic to be handled by the present number of antennas. This "multiplexing" of antennas is receiving considerable study and the indications are that by means of filters it will be possible to handle numerous circuits through one antenna without excessive energy losses.

Another important subject is the application of teletype and other land-line equipment to radio communication, particularly the adaptation of automatic high-speed equipment to long-range radio circuits. NEL has equipment that can transmit and receive several thousand words a minute in the laboratory, but so far the equipment is good for only 200 or 300 words a minute on the air.

The stumbling block is the so-called "multi-path delay phenomena." Portions of the transmitted energy are reflected from different layers of the ionosphere. At high speed the result is unintelligible gibberish. A dash becomes elongated, a dot is no longer a single dot. At slow speeds the human ear or an automatic machine finds nothing wrong with the reception but a high-speed machine that is timed in microseconds faithfully records every separate reflection of energy. So far the phenomena have limited reception to perhaps a tenth of the speed possible with present transmitting equipment.

Tower elevator lifts antennas and instruments to various heights for determining relationship between signal strength and atmospheric conditions

Allied with the above is the problem of fading, a condition ascribed to cancellations and phase interferences of the energy reflected from the ionosphere. NEL hopes to reduce fading from distant stations by the development of so-called diversity systems of antennas. The idea is that signal strength may increase on an antenna of a certain design just as it begins to fade away on an antenna of a different type.

These problems have to do with the medium frequencies. The very high frequencies are being investigated just as thoroughly. In one study, an airplane equipped with meteorological instruments plus a number of radio transmitters with wave lengths ranging from a few meters to a few centimeters is flown back and forth within sight of the laboratory. The plane transmits streams of signals to the ground while passing through various atmospheric conditions. Later the strength of the signals received at the laboratory is checked against the readings of the weather instruments on the plane.

Work that is even more precise is done at a location in Arizona where the clear, dry atmosphere is virtually the same day after day. Heat radiation from the ground produces a nightly temperature inversion at low levels and allows a close-up study of what this phenomenon does to radio waves. "Microscopic" measurements of atmospheric conditions and their effects on radio transmission are made by instruments that are carried up and down on elevators. Other information is obtained from instruments carried by a captive balloon that climbs 5000 feet above ground. Readings on the instruments are transmitted electrically to the ground by wires attached to the cable.

NEL handled the installation of the SOFAR network in the eastern Pacific that will be placed in operation late this year and by means of which it will be possible to pin-point the exact location of a ship or aircraft in distress. A four-pound depth charge is dropped overboard from the distressed vessel and the sound waves from the resulting underwater explosion are picked up at three SOFAR receiving stations, one in the Hawaiian Islands and two on the California coast. By triangulation of the directions from which the sounds are received, the point at which the explosion occurred is determined.

Some of the experiments at the laboratory are, for obvious reasons, highly secret, but it's no secret that the findings of these experts may mean better radio and television reception in the future.

Underwater explosions provide valuable information on behavior of sound waves in the sea

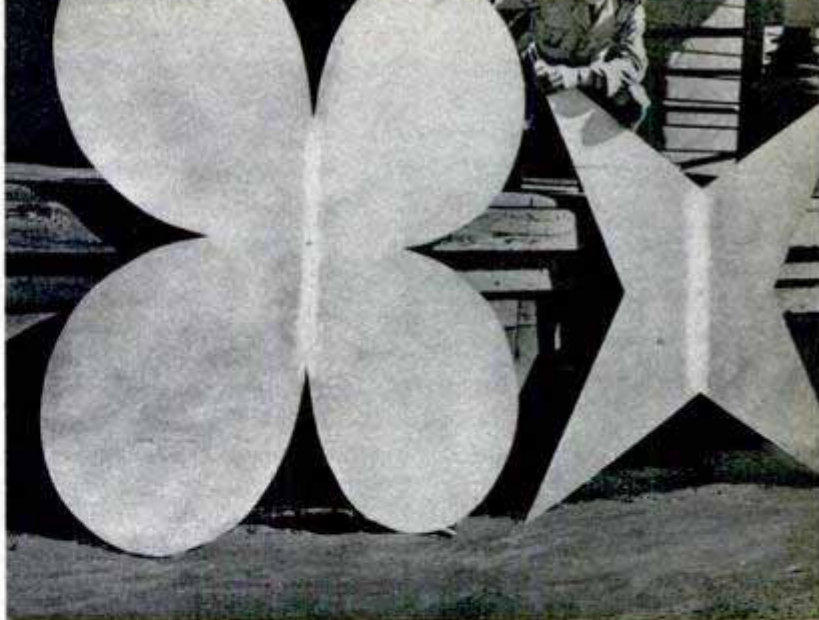

Above, these sheet-metal cutouts illustrate the two theories on the patterns formed by radio broadcasts which are transmitted from an antenna in the center

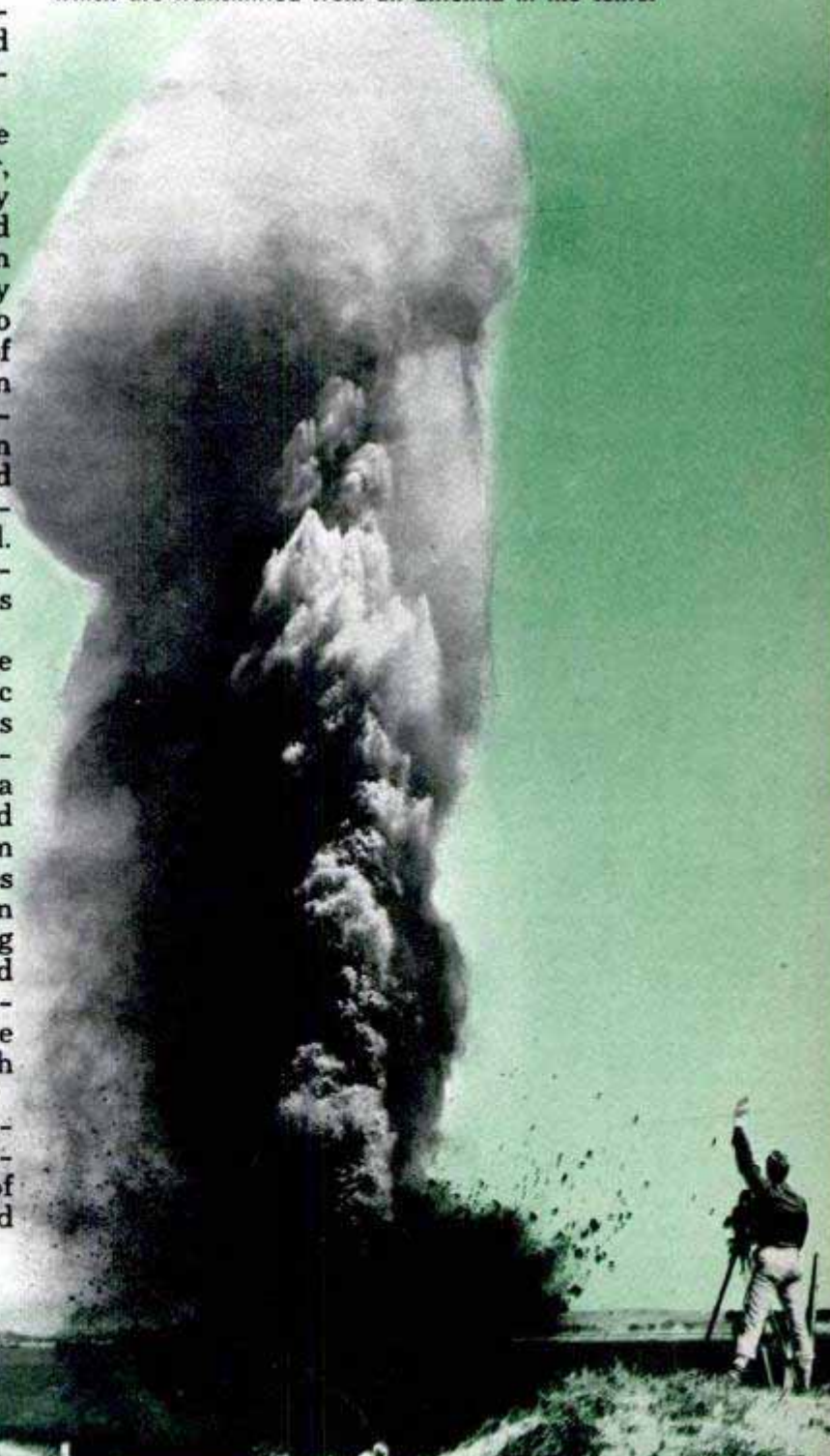



Kit With Molds Casts Plastic

Plastic toys and decorative objects can be cast at home with a kit that includes molds and all necessary materials. Two ½-pound bottles of liquid plastic are provided. The plastic is thermosetting and is cured by heat in a double boiler or an oven. Once hardened and cured, it retains its shape permanently. Objects such as photographs, insignia and real or artificial flowers can be embedded in the plastic, which is normally crystal clear but may be tinted if desired. The hardened objects can be sawed, machined, drilled, sanded and polished. Ordinary household items also can be used as molds.

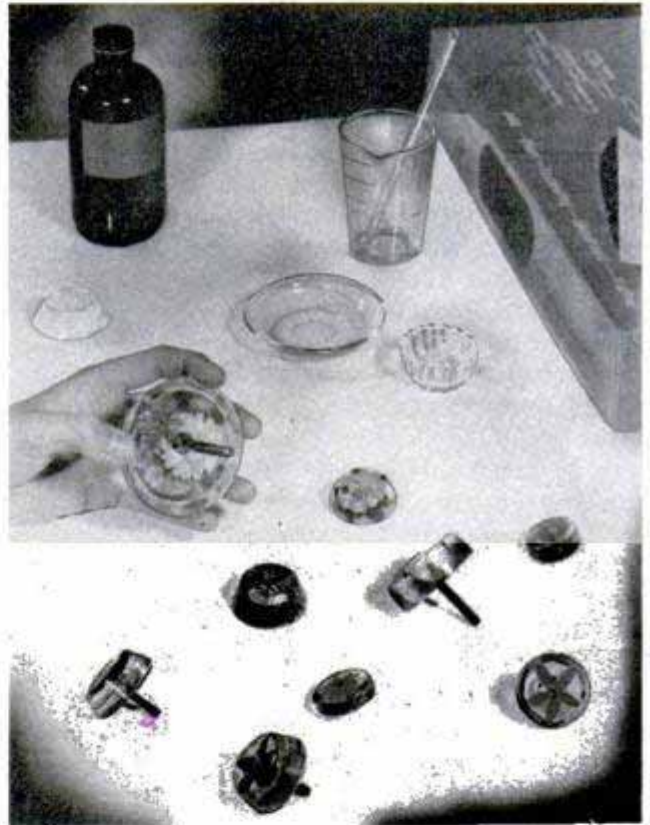

Meter for Color Photographers Measures Color Temperatures

← Color photographers can now determine the exact color of light with a new meter that measures color temperature in degrees Kelvin. The meter consists of an extra-sensitive photoelectric cell which measures incident light. It is aimed away from the subject and toward the camera. When the trigger is pulled, the meter registers color temperature within 100 degrees Kelvin. The photographer, knowing the temperature for which the film is balanced, then is able to select the proper correction filter to provide true color reproduction.

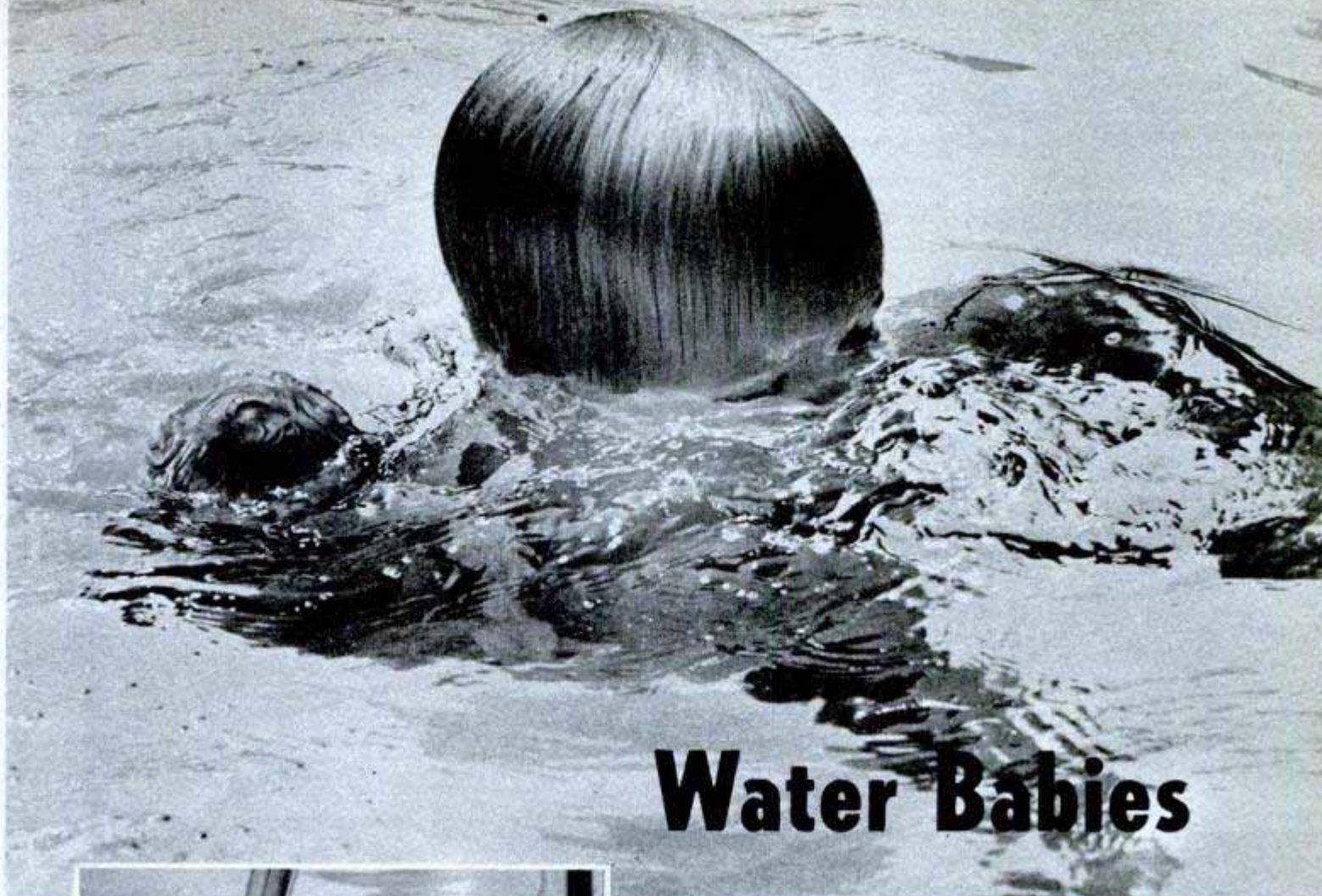

Water Babies



Swimming is child's play for this lad who learned to swim at nine months, two months before he could walk! Above, at 14 months, tiny swimmer "rescues" his favorite doll with all the skill of a lifeguard

Left, the youngster has more trouble climbing out of the pool than he has in the water. He's one of many Los Angeles children who learned to swim here

Below, Mrs. Crystal Scarborough, who has taught more than 5000 tiny youngsters to swim, gives student some pointers on diving. She believes babies should begin swimming lessons in the pool at three months

This 15-month-old girl demonstrates her strong leg action as she swims toward her instructor. The children swim with their eyes open and instinctively turn their heads for a gulp of air

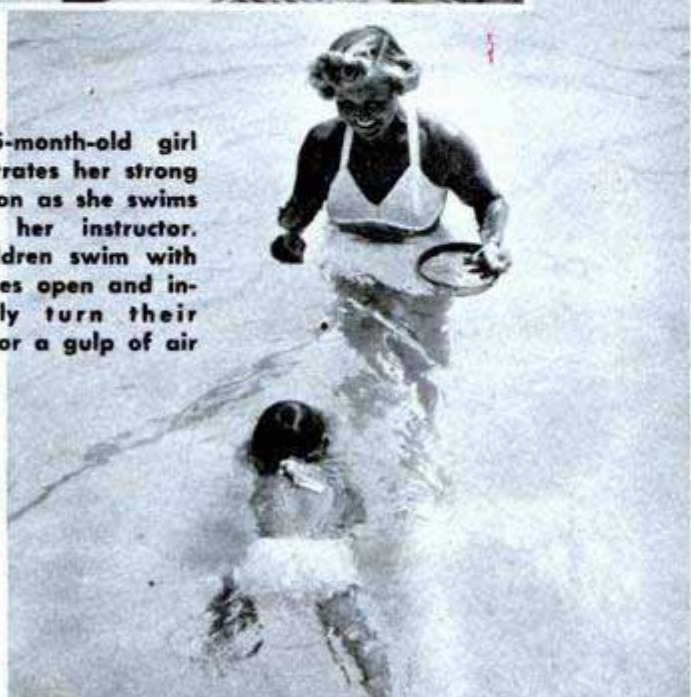

PLAYING TAG WITH LOBSTERS

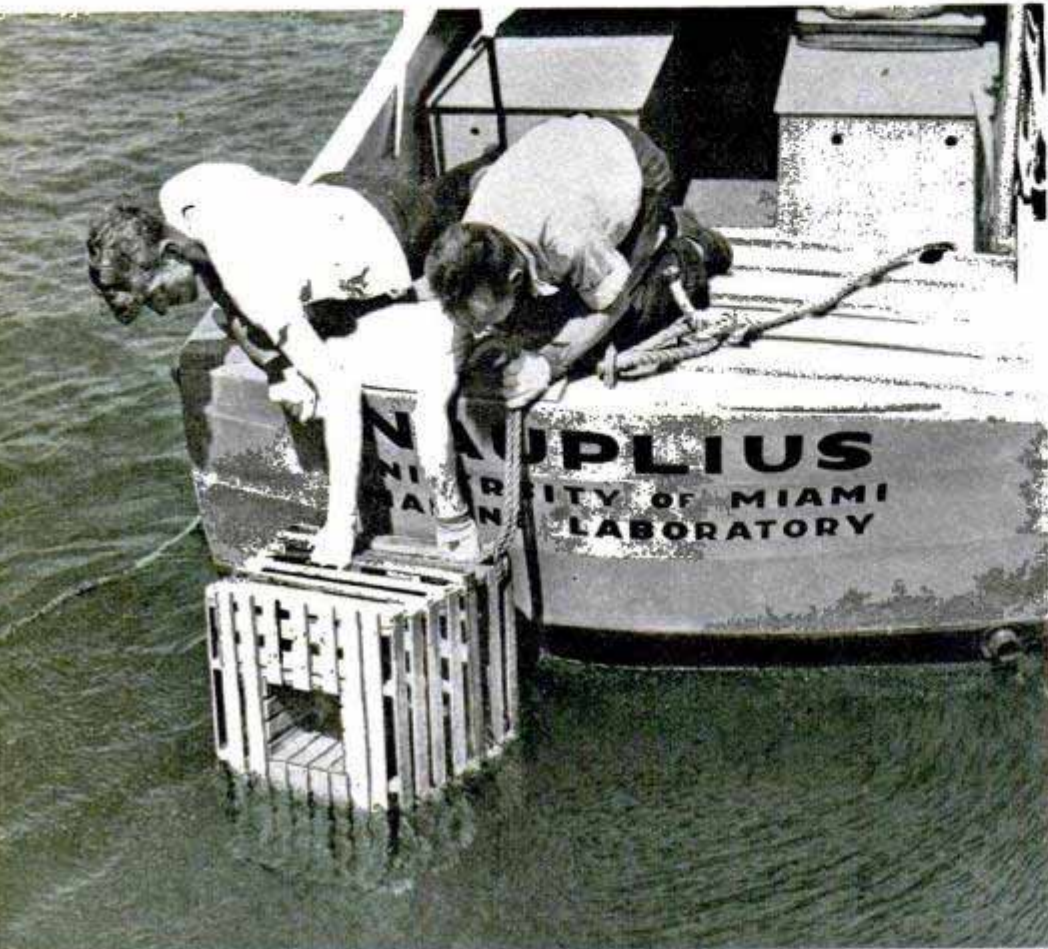

Above, thousands of lobsters, caught in traps like the one being raised here, have been tagged and released along the Florida coast. Funnel-like entrance to trap lets lobsters in, but prevents exit. Below, biologists unload the trap, placing the lobsters in a tank prior to tagging them



LOBSTERS along the coast of Florida are wearing "dog tags" to help scientists learn more about their private lives. The decreasing population of the spiny lobster, a clawless but valuable crustacean, threatens the livelihood of several hundred fishermen in the \$500,000 industry.

Before effective conservation laws could be written, more information on the extent of the lobsters' migrations, their rate of growth and their total population was needed. Scientists at the Marine Laboratory of the University of Miami knew they could get this information only by tagging the crustaceans.

But what kind of tag would be harmless to the lobster yet durable enough to stand perhaps years at the bottom of the sea? And how could it be attached to the lobster so as not to come off when the lobster shed its old shell during the seasonal molt?

Test lobsters living in laboratory tanks helped solve the problem. The answer was a thin plastic strip about two inches long and $\frac{3}{16}$ inch wide, pointed and barbed at one end. Laminated indelibly into the plastic are a record number and returning instructions.

In tagging a lobster, the barbed end is skillfully inserted between two shell segments of his tail, just to one side of the center line down his back in order to miss the intestinal tract, and thrust home into the muscle

By Verne O. Williams

leaving about 1/2 inch protruding.

The flexible plastic does not harm the lobsters. When the old shell slips off, the tag stays with the lobster and protrudes from the new shell. And the tags resist long immersion perfectly. One tag was even returned still legible after being boiled with the lobster and found at the dinner table!

When they return the tags, fishermen report when, where and by whom the lobster was caught. To encourage the return of tags, a \$1 reward is given. As the returns came in from Key West to Dania on the southeastern Florida coast, it was apparent to the scientists that the lobsters were more venturesome fellows than had been thought.

In a little over a year one marathon walker traveled a distance of 119 straight-line miles from the releasing point along the irregular coral reefs. In finding food and escaping enemies, the ugly creature probably traveled hundreds of extra miles on side trips. On a size basis this is roughly comparable to a man's hiking from Miami, Fla., to Juneau, Alaska, with side jaunts to New York and San Francisco.

Some of the lobsters, however, were recaptured in the same vicinity within a week or two. Others, like tourists, moved northward in summer and southward in winter. During the spring mating season they gathered in bunches on shoal banks.

The percentage of tagged fish caught in the various trapping areas is used to estimate the number of lobsters on the bottom. The data leads to the conclusion that heavy fishing has depleted certain areas.

"But it also shows migrating lobsters from virgin grounds will repopulate these depleted areas, saving the jobs of the fishermen, if proper conservation laws are enforced," says Dr. F. G. Walton Smith, laboratory director.

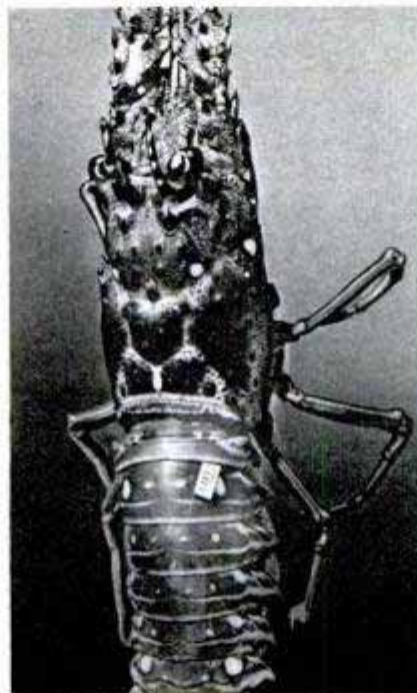

Top, left, tag is inserted between tail segments off the center line to avoid intestinal tract. Printed plastic tag is shown above

Left, numbered end of the tag extends outside shell so that it can be easily seen by fishermen who return it to the laboratory

Below, biologists measure lobsters prior to tagging and releasing them. When recaptured, the tagged lobsters are measured again



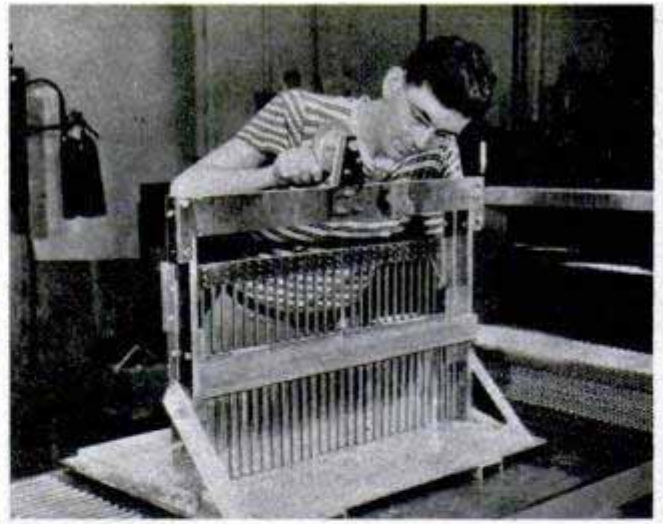

Above, left, long strips of the aluminum foil are corrugated by machine preparatory to assembling the panel. Right, several pieces of the corrugated foil are assembled for application of adhesive to form honeycomb

Below, left, bonded together by adhesive, the core sections are cut to size by this saw. Right, the completed honeycomb section is removed from the oven ready for use in building airplanes, furniture and auto bodies



Aluminum Foil Forms Core of Lightweight Panels

Aluminum foil such as is used in cigarette packages may not look very strong to you, but when properly fabricated it produces a lightweight panel strong enough to serve as flooring in your new home. The foil is corrugated and cemented between sheets of metal, wood or plastic in honeycomb fashion. This sandwich-like panel, a cross section of which resembles a beehive, is bonded together by a special adhesive to form an extremely strong unit. Previous honeycombing techniques have used kraft paper or linen, impregnated with a plastic,

but the aluminum-foil method produces a panel of equivalent strength that is unaffected by humidity, dryness or temperature. The new paneling has many applications. It may be used as walls or floors in the home or to make doors and furniture. Its light weight makes it ideal for aircraft and automobiles and it is already being used in the Martin 2-0-2 and 3-0-3 airplanes. There are 800 cells to the square foot and the material is so light that it will float even though 80 percent of the cells have been punctured.

Detector Uses Ultraviolet Rays to Measure Lead in Air

Designed for use in plants where the amount of lead in the air may reach toxic levels, a new instrument is so sensitive that it detects lead in amounts as low as one part in 20 million. This quantity is so minute that one BB shot ground into an extremely fine powder would have to be dispersed in 500,000 cubic feet of air to pro-

duce a similar contamination. The mobile instrument makes instantaneous and continuous readings. Air samples are passed through an electrical-spark discharge and the resultant light rays go through a photoelectric Geiger counter where the lead content is determined from the ultraviolet rays in the light.



Trimmer Slices a Canal

Moving ponderously along two rails more than 100 feet apart, a huge trimmer used on reclamation projects skims the surface off newly dug canals. The smoothed earth then is ready for the concrete lining. Weighing 120 tons, the trimmer is 38 feet across the base and 100 feet between the tips of the two arms. It follows the machines that make the rough excavation, moving along at a top speed of 42 inches per minute. Accurate trimming is important; if too much material is removed, more concrete lining will be required, and if not enough is removed the lining will be too thin. As the machine moves along the rails, 11 buckets on each side move upward, scooping out the earth and dumping it on conveyor belts which carry it to waiting trucks.

Skimming off earth's surface, trimmer dumps material at left

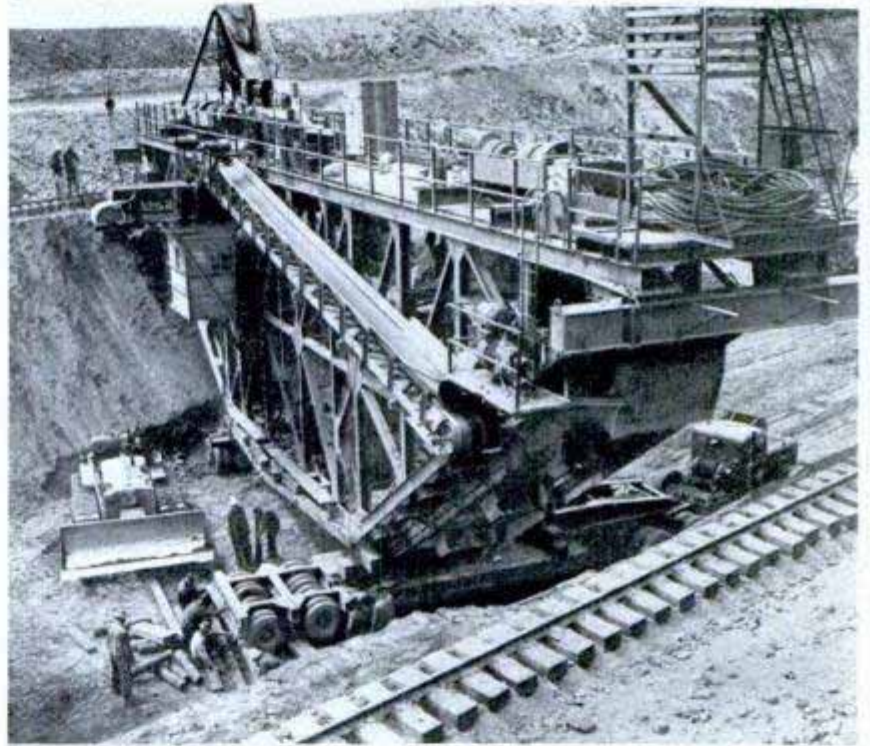

Bureau of Reclamation photos

Above, right, huge truck, dwarfed by trimmer, moves big machine into position. Below, left, buckets on an endless chain scoop up the rock and soil. Below, right, before trimming, air hammer smashes earth into solid mass

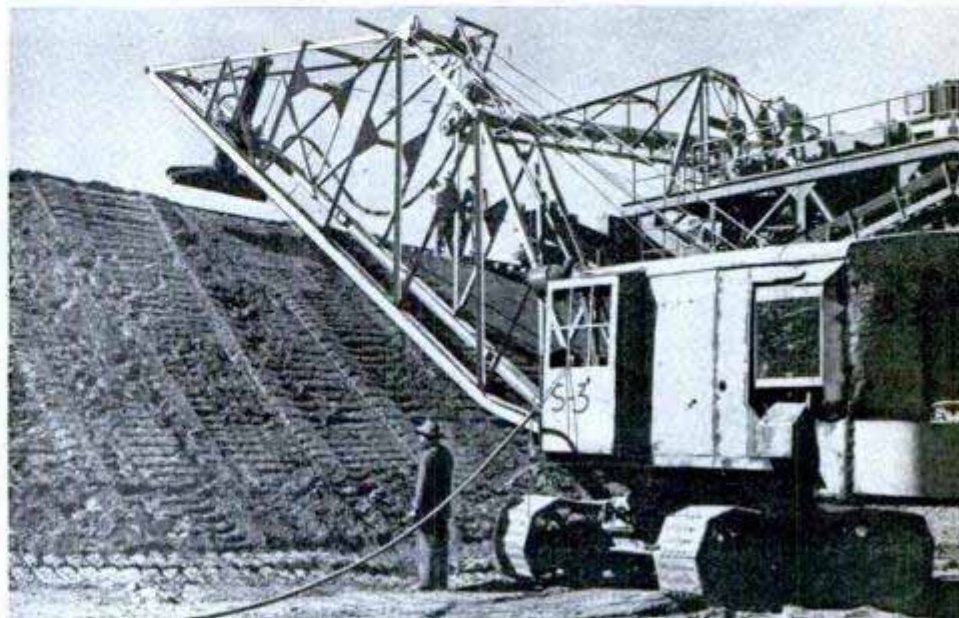

Tips from the

By Claude M. Kreider

GOOD FOOD, properly cooked and attractively served, can make any camping trip a whopping success. Tasty meals are possible only if they are carefully planned and cooked in an adequate camp kitchen. The camper's food usually is chosen from staples that are easy to carry. Here are some tips that may make your next expedition more enjoyable.

FOR THE AUTOMOBILE TRIP

With a reasonable amount of space for carrying the "kitchen," many persons simply raid their cupboards of a wide assortment of kettles, pots and pans. These are heavy, awkward to transport and usually fail in their purpose. And those shiny utensils which are the housewife's pride will come home battered and blackened. At the other extreme, the old-timer's dented coffee pot and heavy iron skillet, which he vows are enough utensils for anyone, are wholly inadequate for preparing good camp food. The solution is the nesting aluminum cook outfit. A six-person kit of this heavy-gauge material weighs only about 12 pounds. In its protective bag it is one compact unit about 12 by 14 inches in size—an entire kitchen.

These aluminum utensils, while light in weight, hold the heat well, an advantage in outdoor cooking where space over the fire is limited. A covered kettle or frying pan may thus be set aside for a moment and it will keep the food hot until time to serve it. The full kit contains four buckets or kettles having straight sides and removable bails. Each nests snugly inside the next larger and the largest kettle, of three-gallon capacity, holds the entire kit.



One camper angles for the evening meal while the other prepares the fire. This "stove" is simple but satisfactory for the deep woods. It consists of carefully leveled rocks to hold the frying pan and a green limb to support the kettles

Old favorite of the camper is a stack of golden flapjacks. A cast-aluminum frying pan turns them out in a hurry without constant greasing. All that's required is to touch a bacon rind to the bottom of the skillet before the batter is poured in



Camp Cook...

Photos by Ray Chapin

Inside the smaller kettle nest the eight-cup coffee pot and six soup bowls. And inside these fit the coffee cups, the only items of the kit not of aluminum. Here the ability of that material for holding heat might result in burned lips. If aluminum cups come with the complete kit, they should be discarded and replaced with those of white enamelware.

The heavy-gauge plates and the two 10-inch, cast-aluminum frying pans with detachable handles fit over the top of the assembled kettles along with the flat kettle lids. The largest kettle serves nicely for a water bucket or will hold a huge stew or "mulligan," the kind that is warmed up for another meal and gets better with each warming. The smaller kettles serve for boiling and stewing of vegetables, fruits and cereal. The frying pans are excellent for frying and serve for hot cakes without continued use of grease after a bacon rind has been touched to the surface of the pan.

The final essential items of this kit are two nesting milk pans for the washing of hands and dishes. These do not come with the kit as sold but may be purchased of either aluminum or "dairy tin" of a size to fit together and then over the bottom of the assembled outfit.

Sheet of heavy-gauge galvanized iron forms an excellent stove top, yet is not hard to pack in the kit



Experienced camper doesn't worry about the smoked-up exterior of his aluminum utensils but keeps the inside clean and bright

FOR THE "GO LIGHT" TRIP

Three or four persons on a short camping trip may, of course, dispense with those parts of the kit that are not needed. For a canoe or mountain pack trip, where weight and bulk are important, the two larger kettles might well be left out, and perhaps the wash pan, thus reducing the bulk considerably without destroying the efficiency of the outfit as a whole.

Even the back packer may choose his necessarily light cook kit from the assembly by taking only the smaller kettle, one frying pan and the coffee pot, plus the necessary plate and cup.

The knife-and-fork roll with a complete





Folding fire irons are staked in at an angle to hold the coffee pot at narrow end, kettles at the other

assortment of tableware, plus necessary "kitchen tools," while complete and compact for the more luxurious automobile trip, may also be reduced in size to fit any need and mode of transportation. With a loop in the roll for each item, the danger of losing or forgetting an important piece—perhaps the butcher knife or can opener—is minimized.

In mountain country, flat rocks can serve as a stove and at the same time they provide a convenient table top. Below, right, on an auto trip nothing can beat the folding gasoline stove for turning out a piping-hot meal

THE COOKING FIRE

The automobile camper will, of course, have his gasoline stove, of either two or three-burner size, and cook almost as comfortably as on the gas range at home. But the woods camper must depend on a wood fire, supporting his utensils with any means available. The simplest "stove" is perhaps a sheet of heavy-gauge galvanized iron about 12 by 30 inches in size. Being flat, it packs nicely and the weight is little. This is laid on large rocks and the fire built in a trench beneath.

Even less bulky is a pair of fire irons. These are made of one-inch angle iron, from 24 to 30 inches in length, with 12-inch folding legs of strap iron riveted loosely at the end of each bar. They are best used over a trench between large, flat-top rocks which will serve as a worktable and warming oven beside the fire. The legs, sharpened at the end, are driven into the ground, leaving the bars level at the proper height. These irons may also be used in a woods or desert country without the rocks and are perhaps the best solution for outdoor cooking where nature does not cooperate. They should always be placed at a tapering angle, with the wide end for the larger utensils, such as the frying pan, and the coffee pot at the narrow end.

In cooking over these irons the fire is kept blazing at one end for quick boiling, and the hot coals are raked down under the frying or grilling end where they won't produce flames and smoke to irritate the cook. The folding irons are easy to construct in the home workshop and their cost is small.

While some kind of a "stove," the sheet



of iron or the folding fire irons, can usually be carried, there may be times when you'll want to depend on the country alone. Then, flat boulders, carefully arranged, will do nicely for holding the cooking utensils. These will need careful bedding with the shovel for a level top and should be slanted as recommended for the fire irons. In a woods country, where green small growth is available, an ideal combination is the rock stove for slow frying, and the kettles and coffee pot suspended above a blaze on a cross stick laid in two crotched stakes driven well into the ground. These, of course, must be of green wood to resist the heat. Willow, alder, cottonwood, poplar and all the softwoods are good for this purpose. Resinous woods, such as pine and fir, are unsuitable.

Dry firewood is essential for good cooking. Any of the hardwoods is better than either soft or resinous wood. The experienced woods camper locates his camp only where there's good firewood. The small dead limbs of oak, ash, sycamore, maple and nearly all hardwoods are ideal for cooking. They need little chopping and produce great heat with a minimum of smoke. A dead log that is sound and dry also provides fine cooking wood but requires some strenuous work with a keen ax to provide both kindling and heavier lengths for a lasting fire.

Many of the dry softwoods and small dead limbs, which often may be knocked off the trunks of pine and fir trees, will serve for camp cooking when the hardwood is absent. The former provide a quick, hot fire which needs constant replenishing, and the small limbs of the conifers burn well, fortunately containing little resin or pitch. Conversely, a pitch-pine log furnishes fine kindling for starting the fire quickly on a cold morning or even in the rain. The splinters from such a log burn at the touch of a match, flaring up like torches.

Complete kitchen for the auto trip includes the cook kit and dish pans, cutlery roll, stove stand and stove



Compact camp kitchen provides most of the comforts of home. Note reflector oven in front of the fire

Complete kitchen for the auto trip includes the cook kit and dish pans, cutlery roll, stove stand and stove

The good woods cook checks carefully for his firewood supply before he camps for the night. And he sallies forth with a sharp ax, which he guards with jealous care, to provide an ample supply of good firewood even before he starts to unpack his "kitchen."

Finally, the cook assumes the essential duty of extinguishing the fire carefully and thoroughly when it is no longer needed. Forest authorities who know the ever-present danger of a forest fire advise: "Extinguish your fire with water, then cover it with dirt."

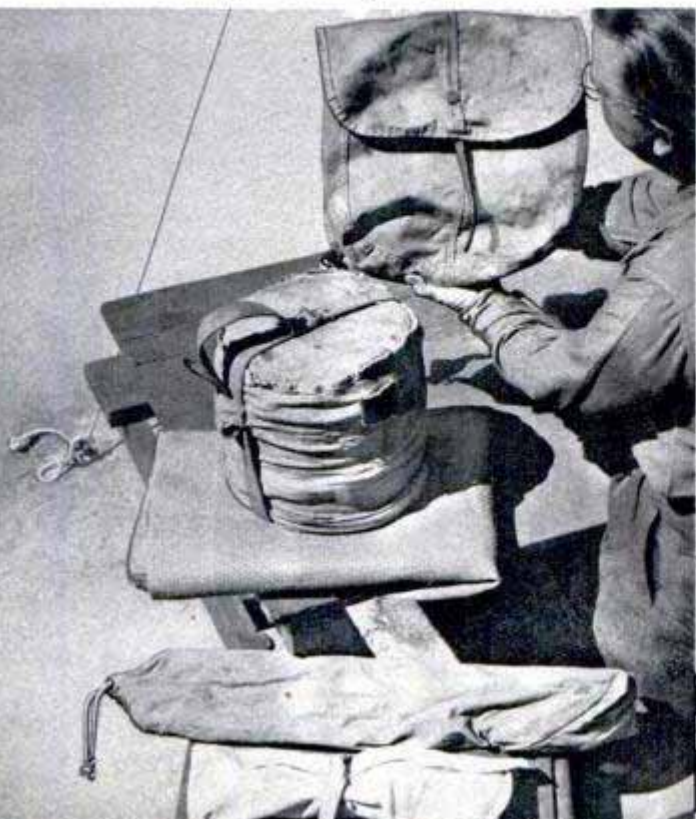

DOTTED LINE REPRESENTS
STRING OF APPROACH LAMPS

WHITE LINES SHOW LOCATION OF FIDO
LINES AT LOS ANGELES AIRPORT

MAIN RUNWAY

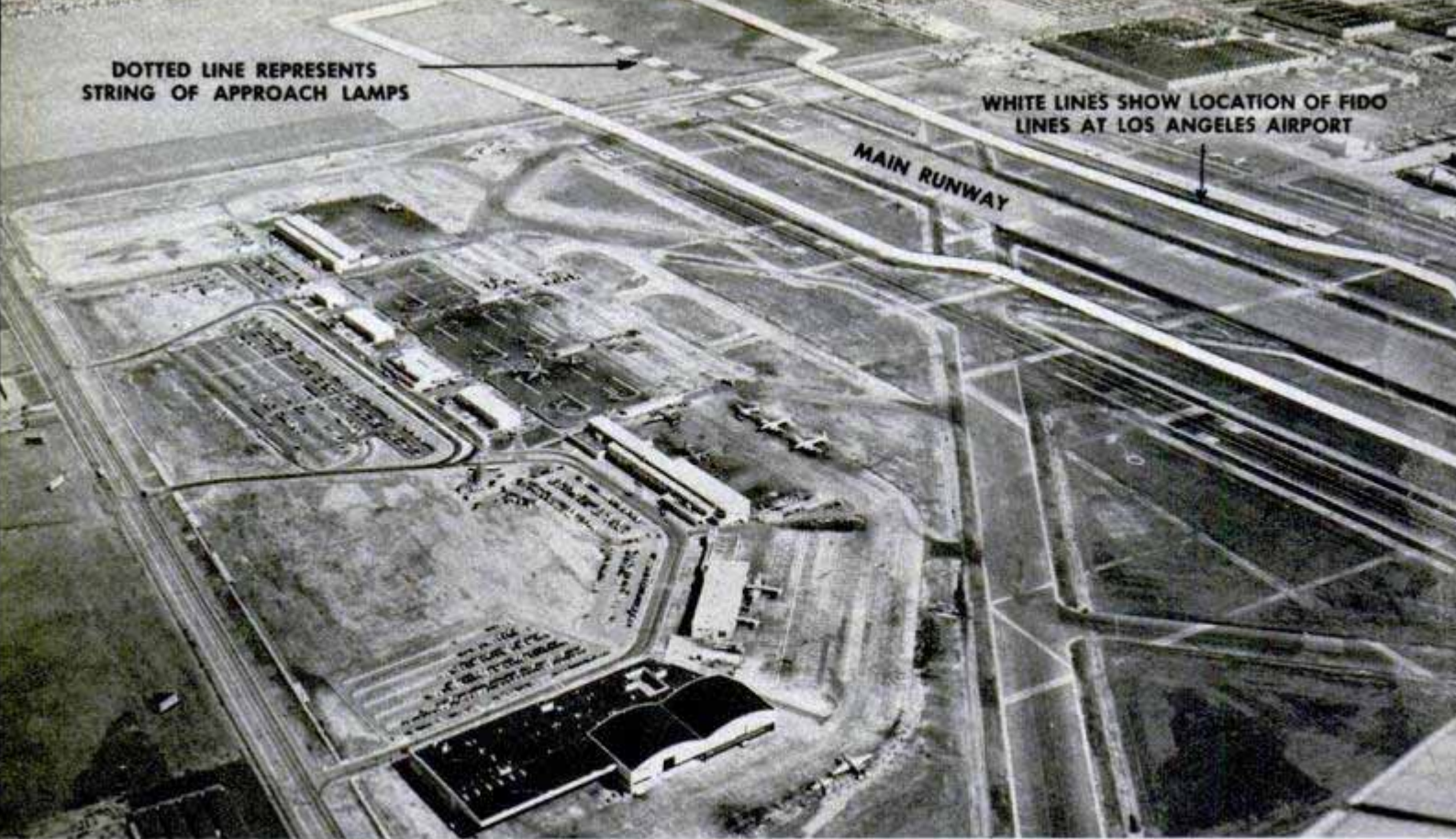

Fog burners at Los Angeles airport will create island of good visibility in worst weather

They must land safely

By Thomas E. Stimson, Jr.

AIR TRAVEL is safe enough, but is it dependable? Not always, disgruntled passengers say, and it won't be until planes are able to take off and land on schedule in spite of adverse weather.

Take the busy Los Angeles airport, handling five percent of the nation's total air traffic. Two hundred transport operations are scheduled in and out of Los Angeles every day, a volume that amounts to some 1,200,000 passengers a year.

Yet for more hours per year than airport officials like to admit, Los Angeles is shut down tight by ocean fog. Sometimes westbound transcontinental planes are held over at intermediate stops while the passengers fume. Then, likely as not, they are finally landed at alternate fields as far as 100 miles from their destination. A southbound passenger from San Francisco may spend as much travel time on the bus as he spends in the air.

To cure this, Los Angeles is installing an all-weather landing system that will permit all traffic to arrive or depart on schedule. Heart of the new landing system is a FIDO (the letters stand for "fog inten-

sive, dispersal of") installation that burns away the fog and makes the runway an island of good visibility, even in zero-zero conditions. FIDO was invented by Britain during the war and has since been considerably refined in this country.

The Los Angeles FIDO system is planned for completion this month and will consist of two lines of burners, one on each side of the main east-west runway. Each line will extend for 4000 feet along the runway and for 2000 feet into the approach zone. Six-foot flames from the oil burners, ignited electrically, will heat the air and dissipate fog sufficiently to provide a ceiling of more than 300 feet and a visibility of more than three quarters of a mile within two or three minutes after the system is turned on.

FIDO is costing \$820,000 and the airlines that use it will be charged from \$100 to \$400 per landing, depending on traffic density and the length of time of each burn. This is considerably less than the cost involved in landing at outlying fields and carrying

Painting at right visualizes fog burners in use. → Six-foot flames can heat air and dissipate fog fast enough to boost ceiling to 300 feet in three minutes



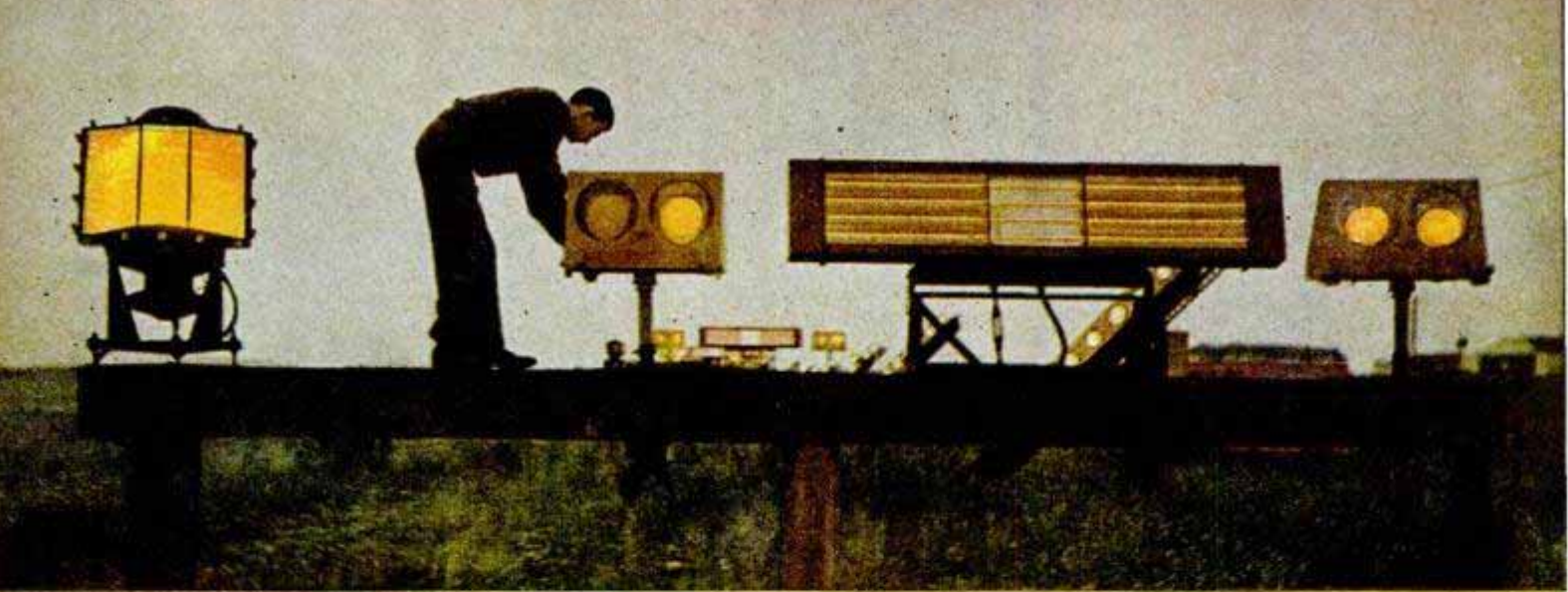

Amber-colored lights being tested along right side of approach corridor at Arcata, Calif., experimental station

passengers to their destination by bus.

All-weather landings at Los Angeles will depend on several types of aids, all coordinated into one system. An incoming pilot will let down through the overcast by means of standard radio procedure or ILS radio—or both. As he passes over the inner radio marker he will visually pick up the outer end of a string of powerful approach lights that lead directly to the landing runway.

Somewhere along this illuminated approach the pilot breaks into the area of

good visibility that was manufactured by FIDO. He continues on to the field and makes his landing in the normal manner, still in good visibility. During his approach the pilot is monitored by a GCA crew on the ground who will wave him off by radio if he appears to be deviating from the prescribed glide path.

All the system's components have been tested exhaustively at the Landing Aids Experiment Station at Arcata, Calif., where FIDO has been in use for years and where the modern high-pressure FIDO system

was developed. The early low-pressure systems used gasoline as fuel; today diesel oil or furnace oil is equally as good. The heavier fuels now used are completely atomized at the burners under a pressure of 1500 pounds per square inch.

The Arcata field has a reputation as the foggiest airport in the United States. Its system of landing aids, however, has enabled Southwest Airways to conduct on-schedule passenger transport operations in

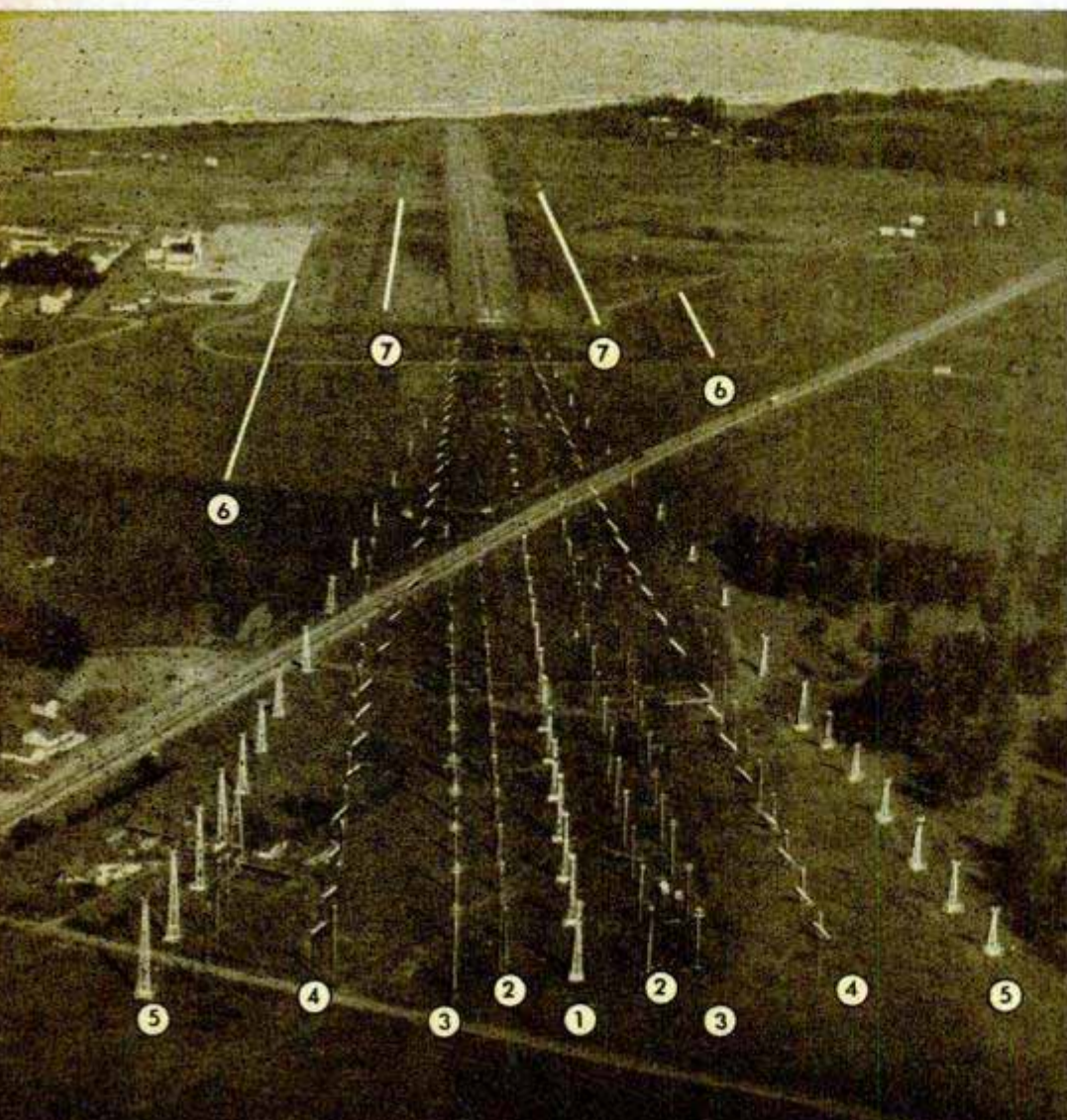

Man-made forest of metal towers spreads out below planes landing at Arcata. They are: (1) center lights, (2) AGA systems, (3) Bar-tow multi-row system, (4) slope-line lights, (5) experimental approach towers, (6-7) parallel FIDO burners

and out of Arcata since December, 1947, in spite of fogs so dense that automobile traffic on an adjacent highway often has to slow down to a crawl. From 400 to 700 passengers per month arrive at or depart from Arcata, a considerably higher volume of traffic than is considered normal for such an area, and that is attributed to the reliability of operations, rain or shine. Many landings from July to November are made with the assistance of FIDO.

The Landing Aids Experiment Station was instituted by the Navy during the war and its value as a research airport was so apparent that the station has been continued as a cooperative project. It is sponsored by the Navy, Air Force, Civil Aeronautics Administration, Air Line Pilots' Association and the Air Transport Association. Transocean Air Lines operates the field under contract and conducts the investigations desired.

To evaluate the different landing aids, Transocean staffed the field with a group of experts that includes Rolf Tingdale, station director; E. C. Marlin, operations manager; Dr. Maurice Garbell, technical consultant; James Davis, lighting engineer; R. J. McDonald, fog-dispersal engineer; Robert E. Fogle, electronics supervisor; Hugh Stocker, meteorologist; and Vance Gudmonson, flight-test supervisor.

The airport is closed to private flying but is used by Southwest and United Air Lines, with eight scheduled transport oper-

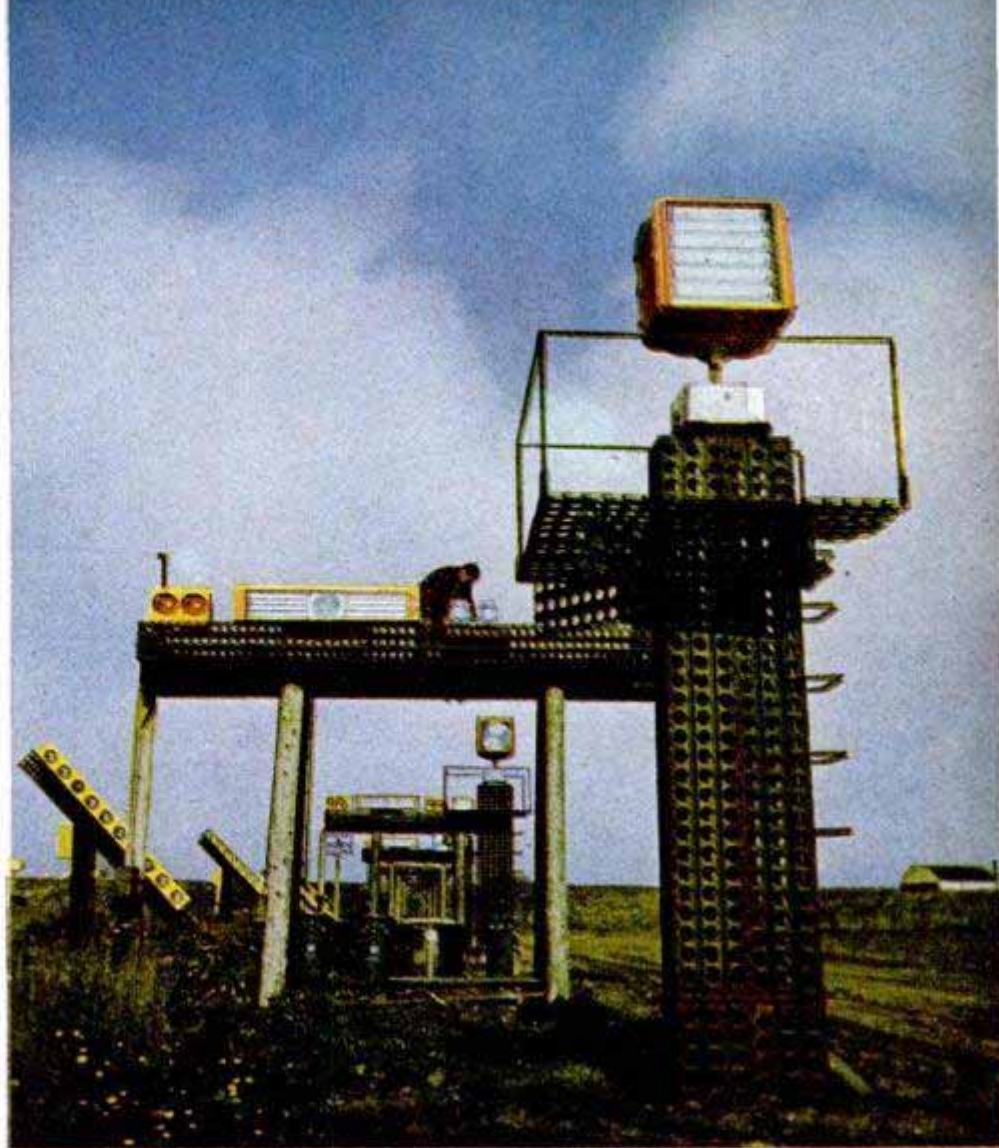

In foreground is one of 36 high-intensity red neon "blaze" approach units that emit light flashes of up to $3\frac{1}{3}$ billion candle power

ations a day. There are also numerous unscheduled test flights by the field staff whenever visibility approaches zero.

Transocean's test pilots use six aircraft that include a B-17 and a DC-3 and last year made more than 400 separate test flights under adverse weather conditions, principally for studying approach-light

Runway lights under test have "breakaway" joints flush with ground so they won't damage plane if struck

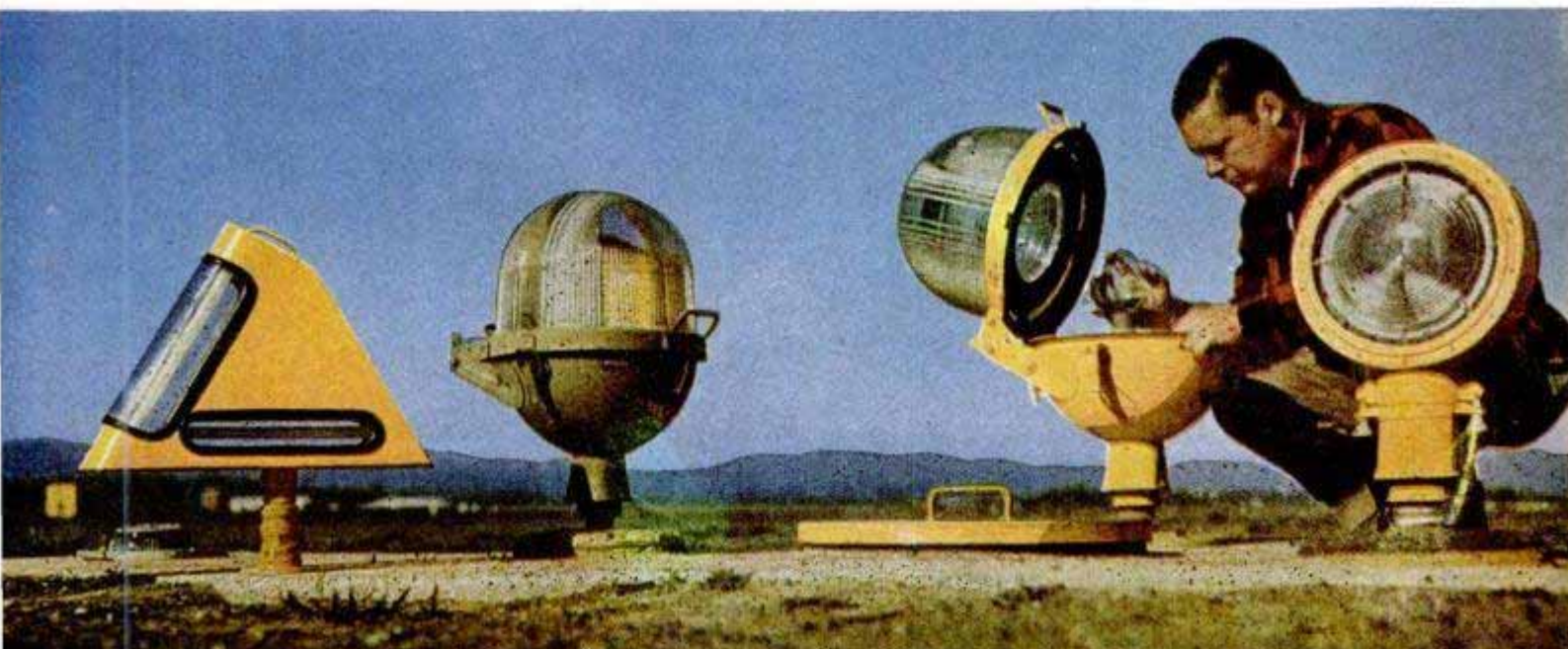

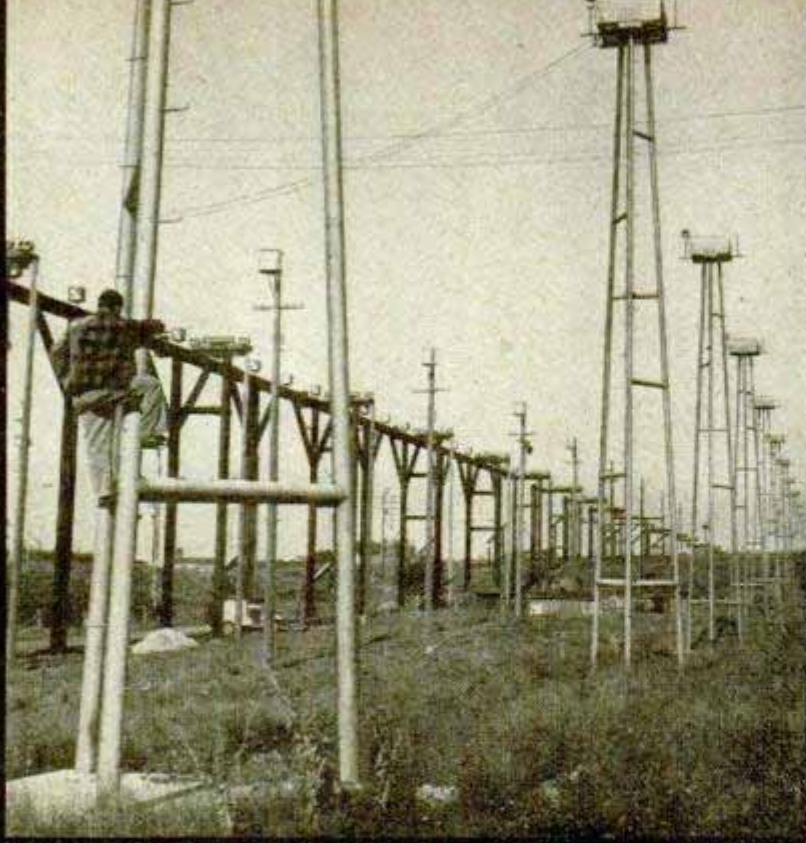

Network of towers brings the approach lights up to the level of runway. Towers on left were made from war-surplus landing mats

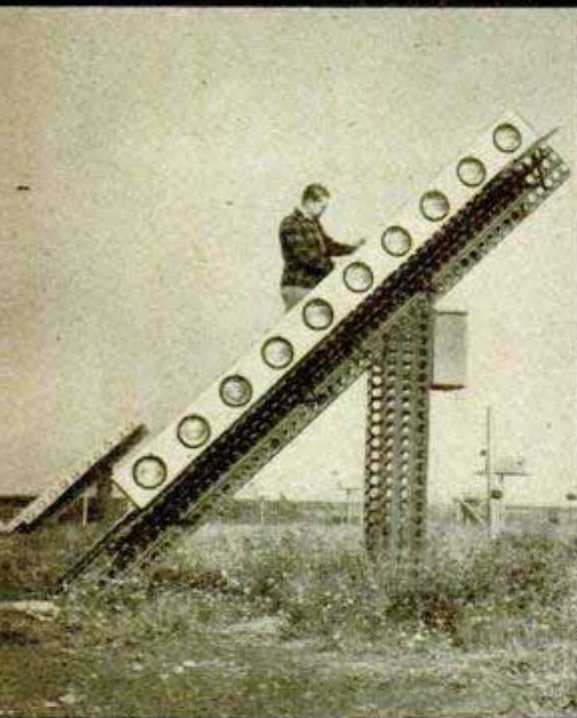

Each of the diagonal units of the slope-line lighting system pierces the sky with ten 500-watt landing lamps. Above right, diagrams show appearance of the slope lines to an incoming pilot when he is above, on and below the glide path

Right, scanning unit of ceilometer continuously reports the ceiling under clouds or fog by measuring the height of a light beam. It reports by radio to central recording machine



systems. All flights of this type are monitored by GCA and a permanent record made of the path of each. All radio conversations between the pilot, the tower, and GCA are recorded, and each aircraft carries a flight recorder that shows how closely the pilot followed his ILS readings.

Various FIDO systems, including 13 kinds of burners and various ignition devices, have been tested at LAES. Two sound systems intended to dissipate fog have been studied, as has a chemical spray intended for the same purpose.

One of the main projects at present is to evaluate the different approach-light systems. Six in all have been installed in the approach area, a zone some 600 feet wide and 3000 feet long. One is operated at a time and a test pilot makes use of it during an approach, then another system is turned on for the next approach. The entire experimental lighting system amounts to nearly 3000 powerful lamps and some 75 miles of wiring.

All lamps in the approach zone are at runway level. Since the field itself is at a higher elevation than is the ground in the approach zone, this has made it necessary to erect a forest of weird-appearing towers and standards to support the lamps. Many of the supports are fabricated from

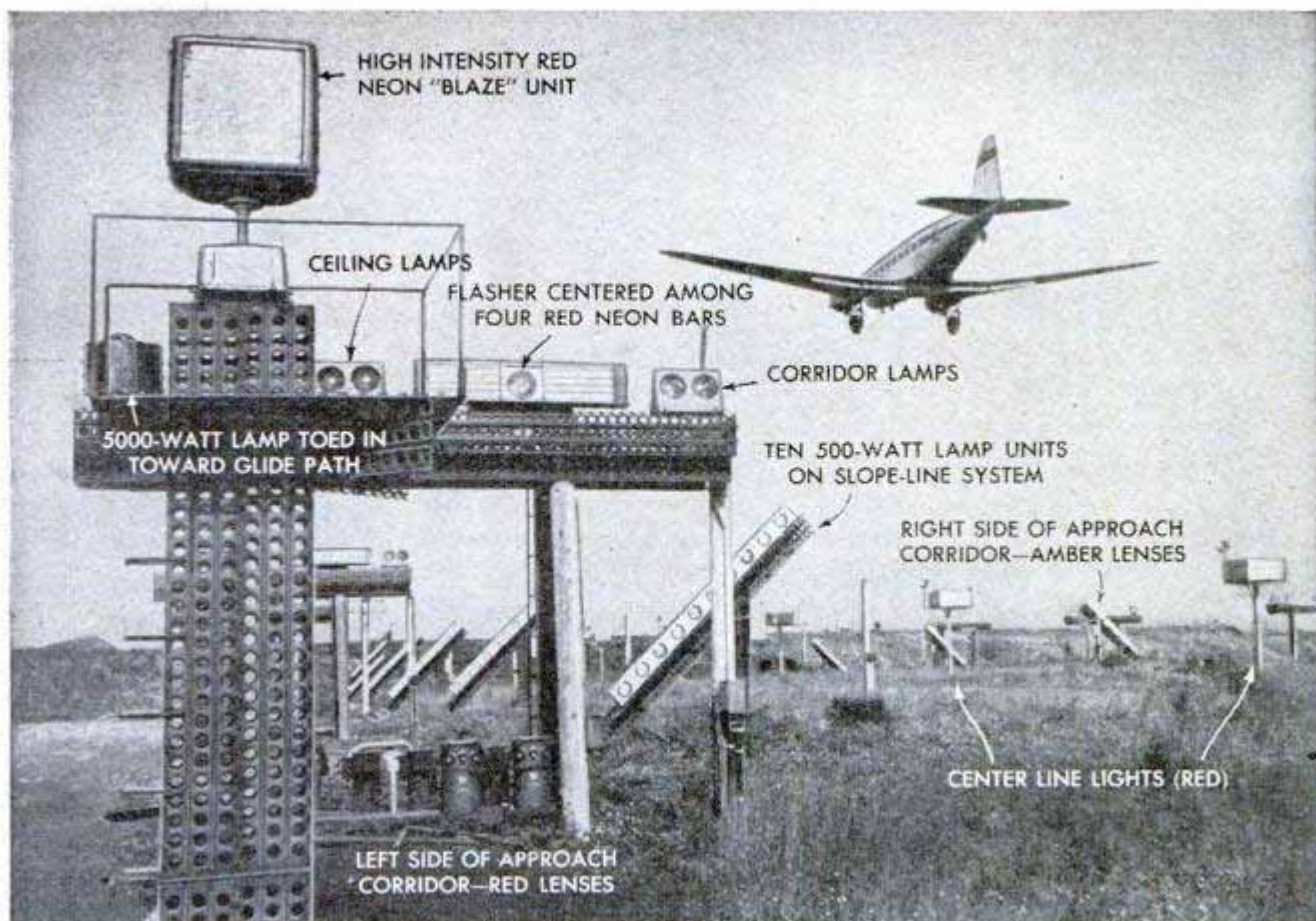

Airliner coming in for landing at Arcata, with approach-light test installations on supports in foreground

war-surplus metal landing-mat material and the towers range from 3 to 87 feet tall. So much electricity is required that the field has installed its own generator plant.

The newest system under test is a Westinghouse design that consists of 72 lighting units spaced in a straight line 100 feet to the left of the center line of the approach area. Every other lighting unit is a clear krypton high-speed flash of the condenser-

discharge type similar to the Strob lamps used by photographers. Each can produce a brilliant flash of up to $3\frac{1}{3}$ billion candle power that lasts for 17 microseconds.

The alternate units are high-intensity red neon "blaze" markers which can either be flashed in sequence with the krypton units at high candle power or burned steadily, alone, in good flying weather. The

(Continued to page 246)

Left, landings in fog and at night are under constant radar "eyes" of crews in GCA trailer. Right, all approach and runway-light systems are turned on and off, and their intensities varied, from panel in control tower





Above, Douglas Aircraft photo



Below, Beech Aircraft photo

High-Speed Trainer Has Engine at Rear

Student pilots get greater visibility with the engine-in-the-rear design of the new Douglas XT-30. A shaft under the cockpit floor drives the propeller. With length and wingspan approximately 36 feet, it has been designed to cruise at 190 miles an hour and operate as high as 30,000 feet. A smaller trainer, also developed for possible military use, the Beech Model 45 is an adaptation of the company's four-place Bonanza personal plane. In the trainer version, which costs less than wartime models to operate, a conventional tail replaces the "butterfly" tail.

New-design trainers, Douglas XT-30, top, and Beech Model 45

"Tattooing" Tires Increases Traction

Tires are given increased traction by a "tattooing" machine that roughens the tread with thousands of irregular-shaped holes. This is done, without removing the tires from the wheels, by spinning each tire on two rollers covered with minute steel points. Four tires are handled an hour.

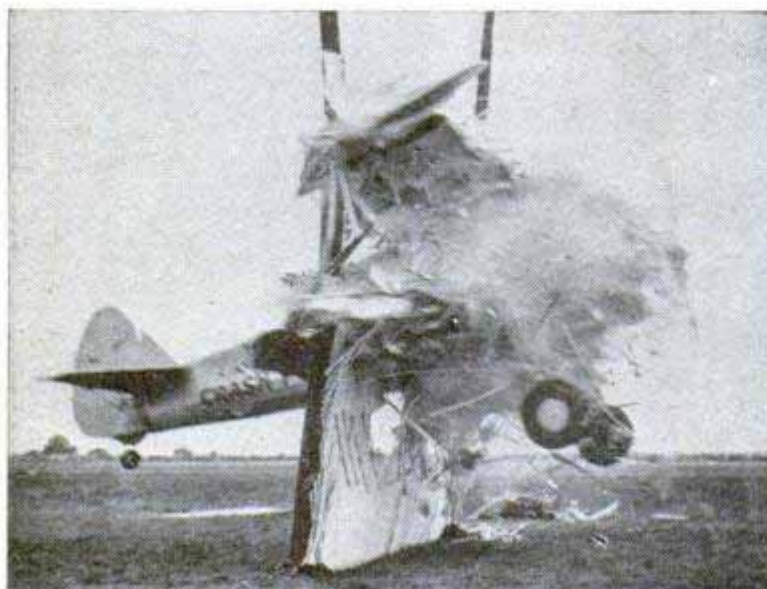
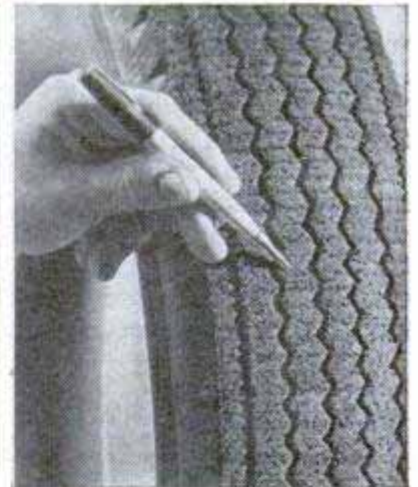

Pilot Clips Wings Flying Through Wall

Having his wings clipped is no new experience for Tommy Walker, who flies his light plane through a wooden wall as a feature of the Flying Tigers Air Show. The two uprights slice off the wing tips as the fuselage crashes through the wall. Walker, a former Flying Tiger, has successfully completed the stunt 16 times.

☐ American farmers have 3 million tractors that operate 15 million farm implements, an average of five tools for each tractor.

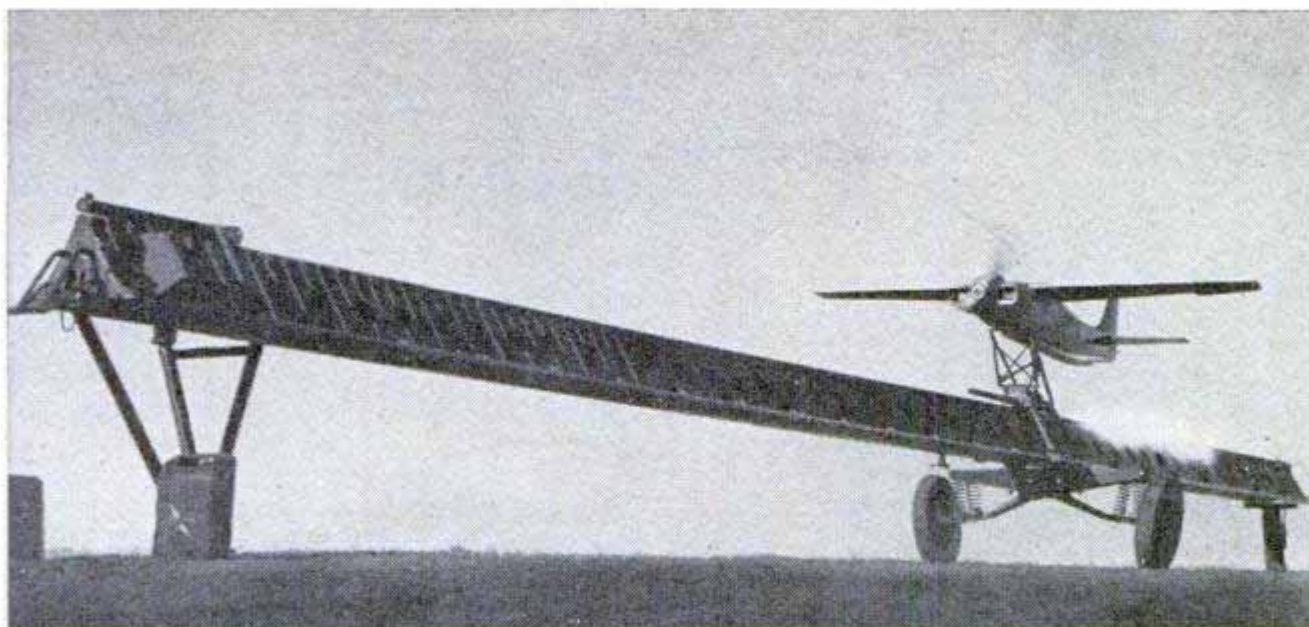

Air Materiel Command photos

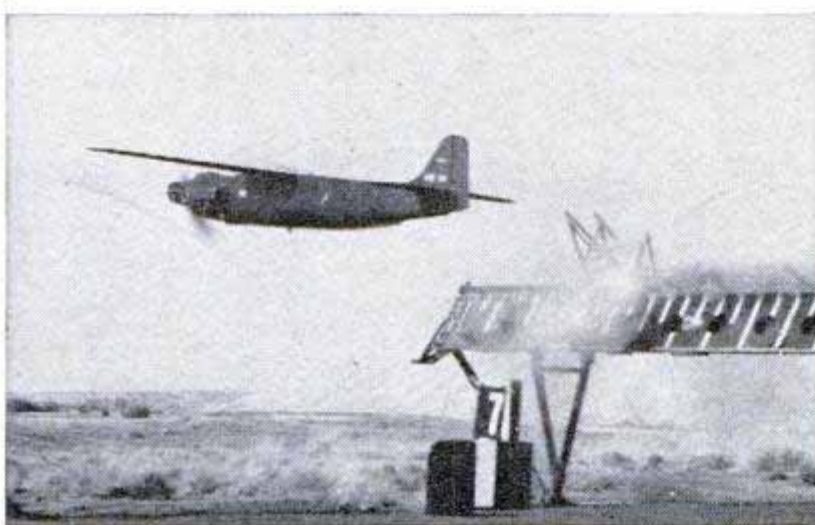

Rocket car speeds a pilotless target plane, above, on 60-foot-long take-off catapult. Left, at 80 miles an hour the car hits hydraulic snubbing device and plane shoots ahead into the air. Below, after flying at speeds as great as 220 miles an hour, parachute 32 feet wide is opened automatically or by control operator to float craft down to earth

PILOTLESS TARGET PLANE FLIES 220 M.P.H.

HOUR-LONG flights at 220 miles an hour are made by a remotely controlled target plane that can simulate all the maneuvers of a fighter aircraft. At 200 yards it resembles a normal-sized fighter 500 yards away. The OQ-19A will be used by the Air Force for aircraft, antiaircraft and flexible gunnery practice. It can be operated anywhere within line of sight. The 300-pound target, over 10 feet long and with a wingspan of 12 feet, is driven by a 60-horsepower engine. The 2½-foot-high fuselage is all metal. It is launched from a 60-foot catapult at 80 miles an hour by a rocket car, which is stopped within the last four feet by a hydraulic snubbing device and used again. Landing is accomplished by a 32-foot-wide parachute which is released by the control operator. Interruption of the carrier wave, either by direct-hit damage or short circuits in the wiring, also opens the parachute. Another automatic device frees the chute upon landing, preventing damage by the plane being pulled along the ground. An aluminum keel from the engine mount to the tail absorbs landing shocks. Twice as fast as any previous pilotless flying target, the OQ-19A can climb 2400 feet a minute from a sea-level take-off to its service ceiling of 20,000 feet.





"SCOOT"

Chases Poachers on Ice and Water

Airplane engine mounted on steel piping sends craft skimming across ice. Below, bow is covered with galvanized iron

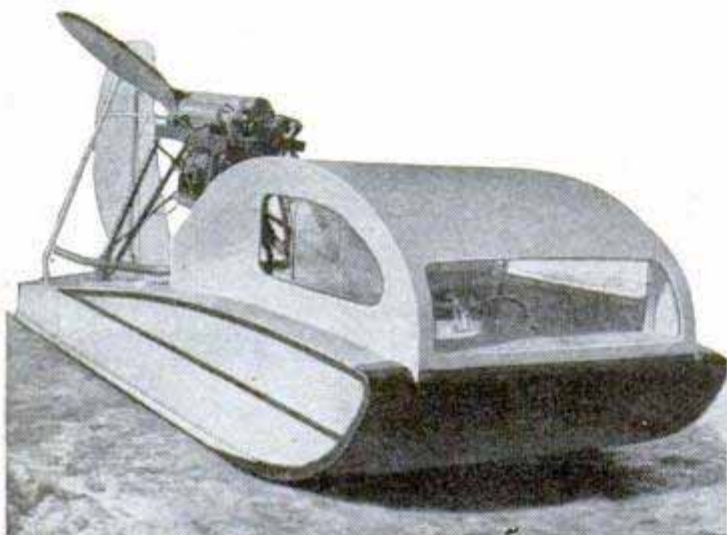

↓ Plywood skin is applied to the hull of the Scoot. Oak crossbeams and spruce stringers form strong frame for hull

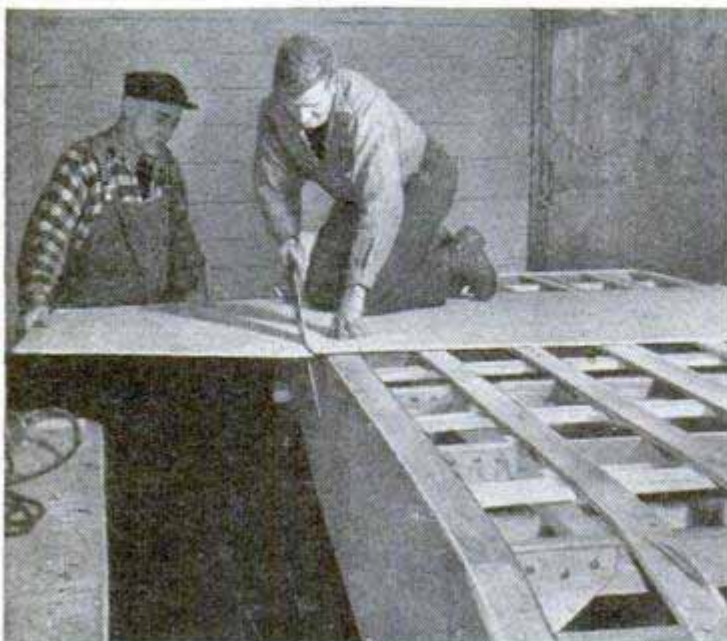

WINTER game poachers and timber pirates along the eastern shore of Georgian Bay, an arm of Lake Huron, dread the sound of an airplane-type motor. But retribution doesn't descend upon them from the skies. It skims along the bay in the Ontario Department of Lands and Forests' unique propeller-driven amphibian, appropriately called the "Scoot."

The shores of Muskoka and Parry Sound districts stretch 100 miles as the crow flies, but innumerable inlets and Georgian Bay's "30,000 Is-

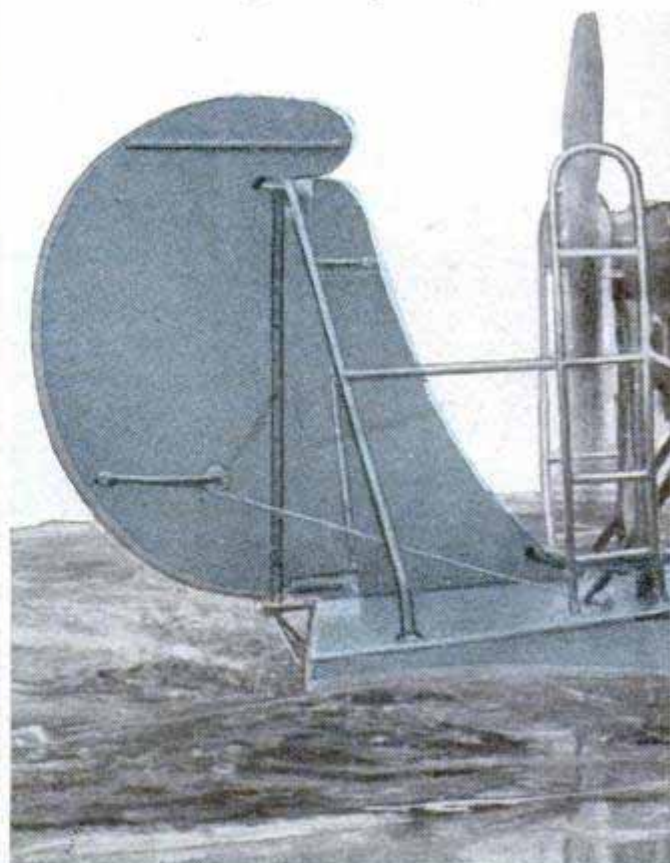

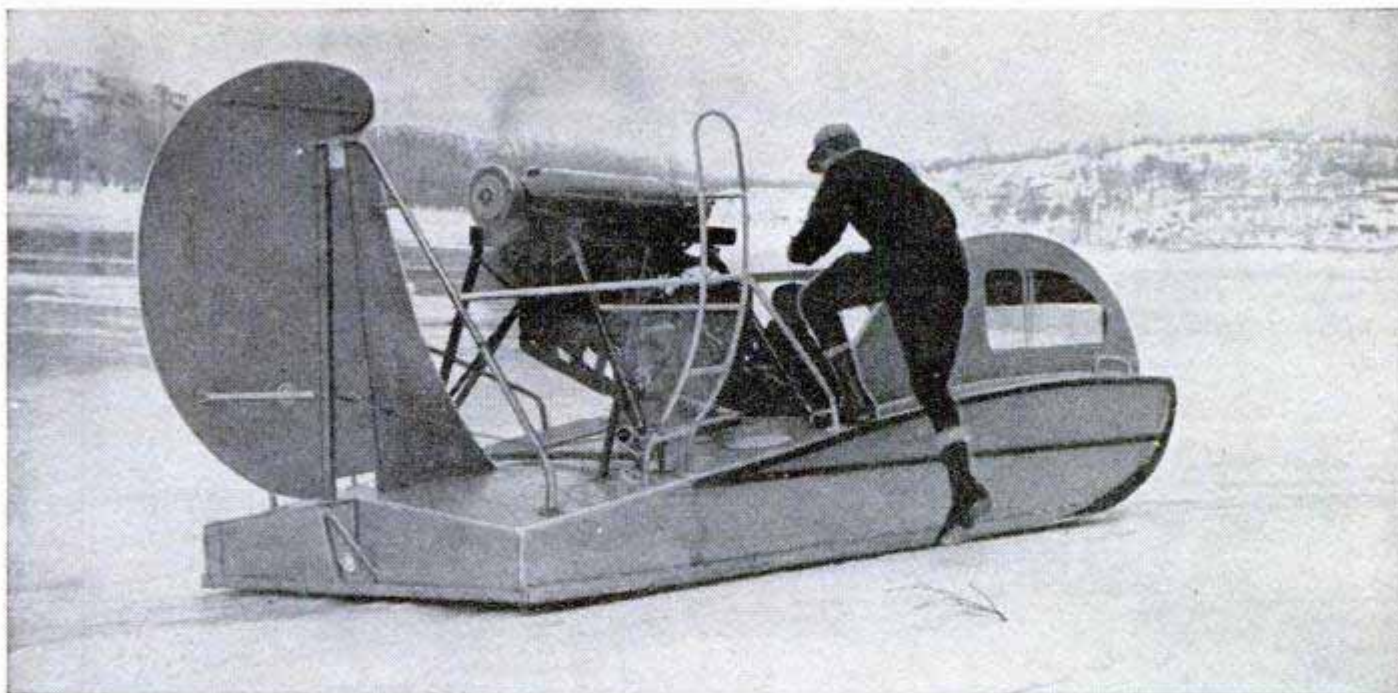

Novel craft skims along ice or snow at 35 miles an hour, swooping down on game poachers and timber pirates

lands" multiply the actual shore line many times. Summer resorts and camps dot the area, which includes a large provincial forest and several Indian reservations. In past winters, most of the shore line was inaccessible to regular patrols. A game warden or forest ranger might take days on snowshoes to reach the spot where an infraction was suspected. Even standard snowmobiles were helpless in the face of stretches of treacherous ice or open water.

But the Scoot pays little heed to such obstructions. Skimming along smooth ice at 35 miles per hour—higher speeds may be reached on good snow—it doesn't slacken speed when approaching open water. Its momentum causes it to plane lightly over the surface and the wave created at the bow cushions any shock which might

occur when the craft climbs back onto solid ice. The hull, made of oak cross-beams, and longitudinal stringers of spruce, withstands buffeting by rough ice and engine vibration. Sides, deck and cabin are of 1/4-inch plywood. Three layers of plywood form the bow halfway to the stern, with two layers for the balance of the bottom. The bottom and parts of the sides are also covered with three layers of 16-gauge galvanized iron. Welded steel piping forms a mount for the 134-horsepower Menasco aircraft engine. Aluminum piping is used for propeller guards and braces for the fin and rudder.

Already, it is reported, the regular patrols made possible by the Scoot have inspired several would-be lawbreakers to abandon their schemes.

Scoot approaches a layer of strong ice from the open water



By Harry Rowed

A SOUTHERN GI JOE, fresh from a frigid flight over the Canadian Arctic, had this reply to a reporter's query:

"The North? Boss, it ain't nothin' but miles and miles of nothin' but miles and miles!"

There is some basis in fact for his appraisal. A northland flight in winter unfolds hundreds of miles of wind-crusted barren lands, frozen muskeg, lakes and rivers. After hours of flying, the terrain seems limited only by the horizons. Most northerners will concur with the

Left, map of the Great Slave Lake region showing transportation facilities. Fish are hauled south to railhead at Grimshaw in insulated trucks. Below, a fisherman's caboose, 25 miles out on the windswept ice of Great Slave



WHERE FISHING IS RUGGED

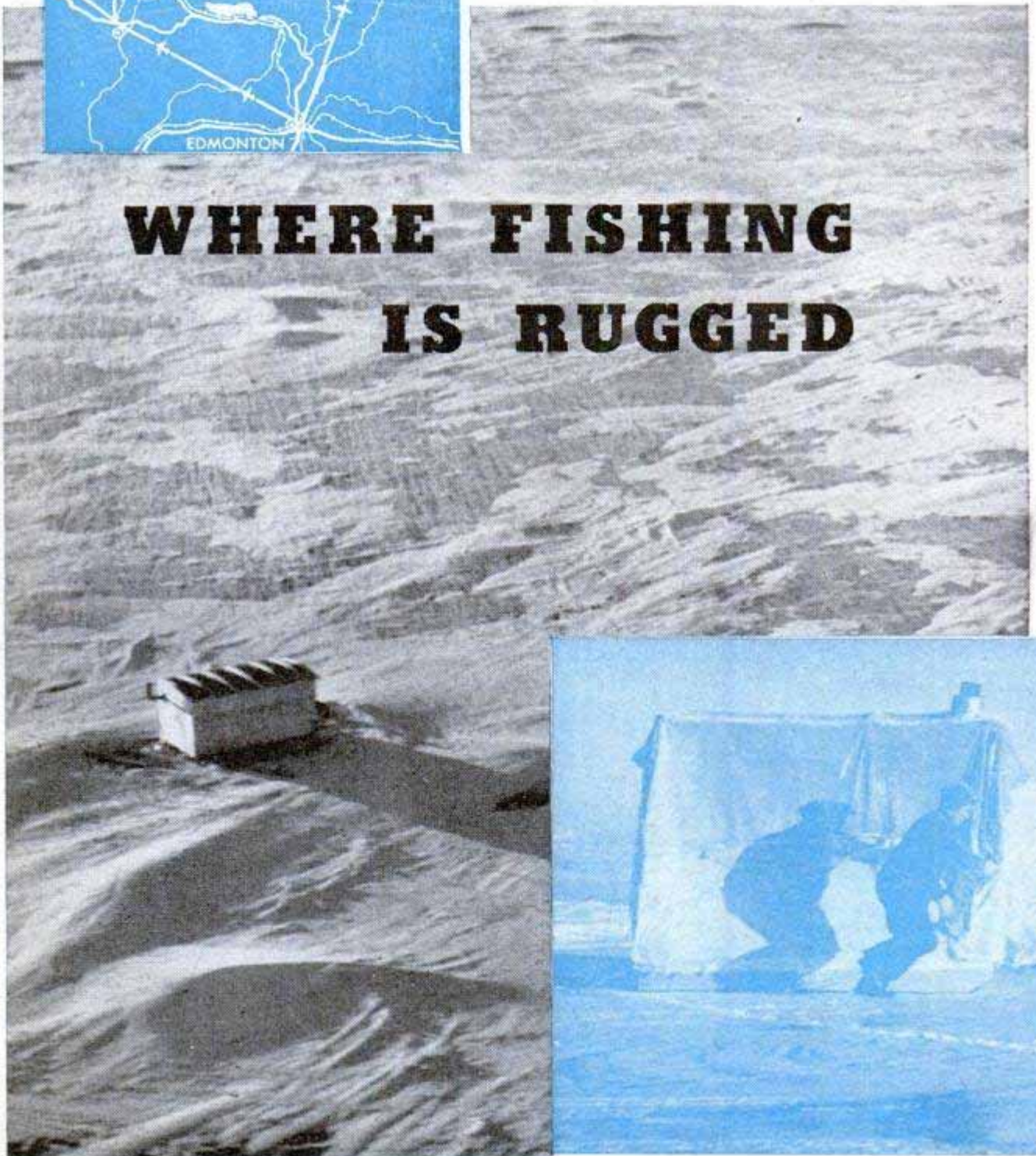

soldier, but with important reservations. There are literally miles and miles of miles and miles; there are also activity and industry and an acknowledged potential of greater wealth and significance.

Out of Canada's north-land recently have come reports of new discoveries in gold and base metals. The uranium deposits of Great Bear Lake became exciting news following release of the first atomic bombs. In the North, too, are other rich resources, not so sensational as the mineral finds, but adding materially to the stability of the far-flung regions.

Had the GI's aircraft dropped altitude over Great Slave Lake, he would have noticed dozens of small wooden buildings, some of them on the ice 25 miles offshore. Closer inspection would have revealed men busy nearby, dog teams mushing across the ice and snow, and snowmobiles scurrying between the camps and shore line. Even the air traffic he noted in the area probably was playing a vital role in the industry below.

The men scattered over the vast expanse were winter fishermen and the buildings their movable



Photos by Harry Rowed

As protection from the winds and extreme temperatures, some fishermen pitch small tents, like the one shown above, near their basin holes



Above, fish are hauled ashore in snowmobiles that speed across the ice at 45 miles an hour. Below, dog team pulls shelter to new fishing spot

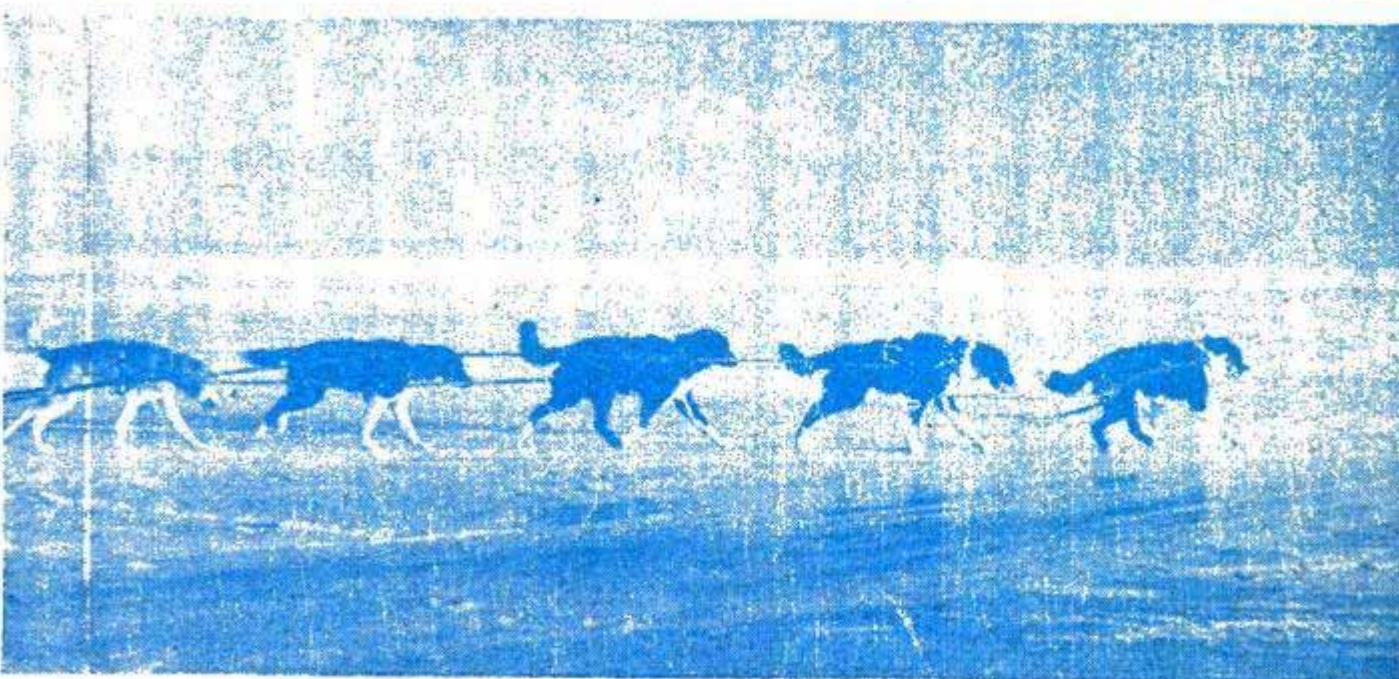



Days are short at Great Slave and the sun hugs the horizon. This fisherman is testing the ice adjacent to a new crack. Nobody walks around on ice after dark because of the possibility of falling into hidden crevices

Below, left, part of the long night is spent taking care of the tools. Fisherman sharpens the needle bar he uses to chop holes in ice. Right, Frank Ladouguer and the dog that saved his life when he fell in the lake





Left, dog's paw, cut on sharp ice, is treated by fishermen who look upon the animals as extremely valuable helpers. Right, the cold job of removing the fish from the nets must be done as soon as nets are pulled in

living quarters, skid-equipped cabooses. The dog teams sped freshly caught fish for cleaning and packing, or transported the men and their nets to new sites. Snowmobiles and aircraft were carrying on from there, rushing the fish to the settlement at Hay River for shipment by truck, and finally train, to markets in New York and Chicago.

Great Slave Lake spreads across 11,170 square miles in the Territories. It ranks twelfth in size in the world, fifth in North America, is 325 miles in length and boasts an average breadth of 50 miles. Depth, in places, is greater than 2000 feet. History dates it back to 1772 when Samuel Hearne discovered its existence. The name was derived from the Slave (Slavi) Indians who once dominated its shores.

The lake boomed into prominence in recent years with the finding of large gold deposits in the vicinity of Yellowknife. Since then, as a result of government surveys, the lake was opened for commercial fishing and first produced during the summer of 1945. This winter more than 600 fishermen daily "jiggered" their nets through basin holes in Great Slave's ice, seeking whitefish and trout to help fill the brisk demand from the U. S. and Canada.

Opening of the new highway spanning the north country between Grimshaw, Alta., and Hay River at Great Slave's southwest corner was mainly responsible for the unprecedented influx of fishermen from almost any part of western Canada

you'd care to name. The improvement in transportation, as the road brought a direct route to a railhead, brought visions of quick financial returns which were realized by many of the professional fishermen but lost to the bulk of the inexperienced "part timers" who flocked into Hay River. With a wary eye to conservation and prolongation of the industry, the Canadian government, at the beginning of the winter fishing season, set a limit of 1½ million pounds, the fishing to cease immediately when that figure was reached. In January, the authorities increased the quota to a new figure of 4 million pounds.

While the get-rich-quick aspect of the business is a falsity generally, there is no doubt that an experienced fisherman, given any kind of break in weather and locating the fish, can make an excellent livelihood over the winter. This is a worthwhile supplement to the more generous remuneration of summer fishing. But it is a rugged and hazardous life which demands tremendous resourcefulness and resistance to the spirit-breaking cold that sweeps in from the polar regions on Arctic winds. More than one embryo fisherman, probably wisely, headed back south early this year when Great Slave temperatures slipped down to 64 below zero.

Most hazards and hardships are directly connected with weather and ice conditions. With fluctuating temperatures, great cracks and pressure ridges appear without warning except the startling "gurrump," a

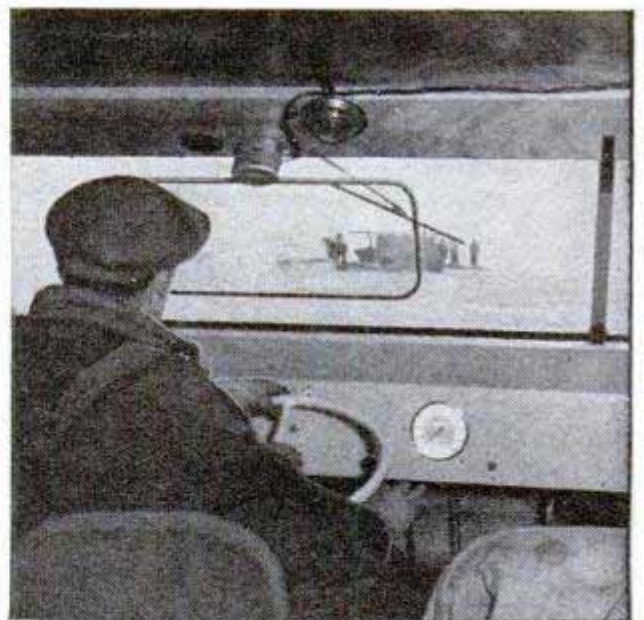
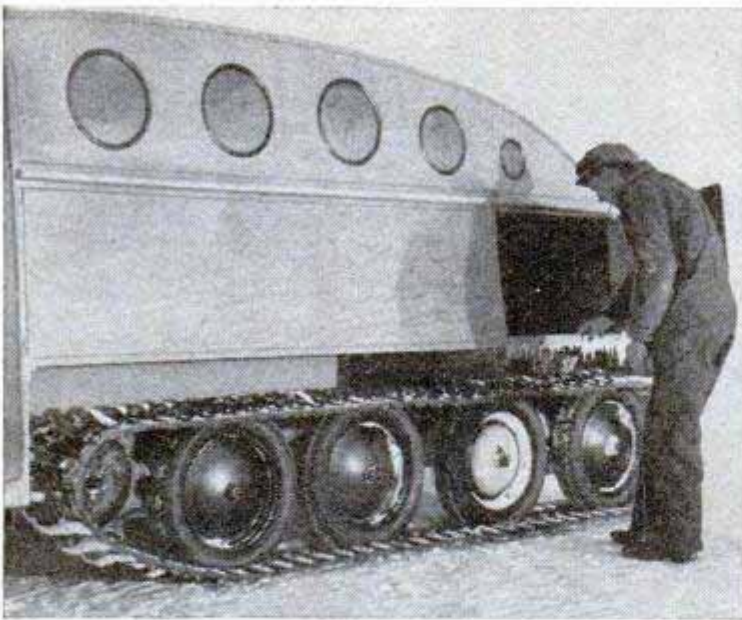

Top, left, rear-engine snowmobile is driven by rubber tread. Right, it is fairly comfortable inside the cab of the snowmobile as it nears a fishing camp on the ice. Above, frozen stiff, the fish are piled like sticks as pickup approaches

Below, jigger is lowered into water. At right, jigger pushes forward under ice as line is pulled. Net is attached to line and pulled through to another hole. Rock drags net to bottom

thunderous rumble that is altogether too familiar to the winter fisherman. A blizzard can follow before the surface refreezes solidly, completely obliterating the crack with snow. The danger is obvious.

Frank Ladoucier, husky Cree Indian who has been fishing on northern lakes almost as long as he can remember, was driving his dogs into the teeth of a Slave Lake wind. The low sun of midwinter brushed the horizon, silhouetting the drifting snow as far as Frank could squint in the direction where sky and ice met. His catch had been good. In another hour he and the dogs would be heading for the rewards of the day, warmth and food of the shore-line cabin for Frank, the usual meal of partially thawed fish for the dogs.

Suddenly, the lead dog swerved,

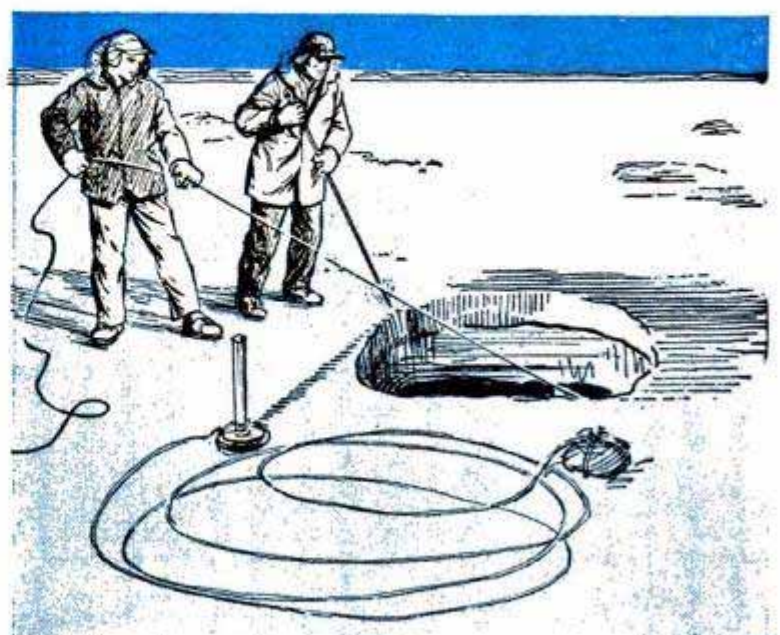

then burst into renewed speed. The latter act saved the lives of Frank and his team for the momentum carried the alert lead dog over the drifted snow blanketing a wide crack in the 40-inch ice. Frank and the remaining dogs were plunged into the icy waters, the man clinging perilously to the sled. Yipping in terror, the lead dog pulled away. The second dog caught his footing, then the third. Combined strengths yanked Frank to solid ice. Even then he was in grave danger. Before he reached the cabin his clothes were frozen so stiff he could hardly walk. His feet, face and hands were frostbitten.

Earlier in the season, uplake from Frank's fishing area, a group of fishermen was setting nets several miles from shore. The center of Great Slave still had open water but the fishermen were on thick ice and prospects were encouraging. Without warning, the ice to shoreward split open and moved away from the main body. The fishermen raced their dog teams in frantic effort to find an ice bridge or narrow section they could cross. In a matter of minutes they had become marooned on an ice floe which would break up with the first sign of wind. They were lucky. A passing airliner noticed their plight, radioed Hay River and circled the spot while canoes manned by Royal Canadian Mounted Police and natives rushed to the rescue.

The ice cracks and pressure ridges are



Heads of large trout are cut off so fish will fit inside standard boxes

unpredictable. In December of this season, a Hay River fisherman parked his truck near his caboose, about eight miles offshore. Next morning there was no sign of the truck, only unmistakable evidence that the ice had opened and swallowed it in 80 feet of water. An upheaval of the ice threw a disturbing surprise in the direction of Bill Workun, former Canadian paratrooper, who fished before the war and now is back in the business. Bill was just about to climb into his bunk when the caboose lurched, depositing him, dishes and everything not nailed down in an ungainly heap in the middle of the floor. Bill continued to the door to find a grandpappy pressure ridge parked near his steps. Another few feet would have brought the ridge, some of which erupt to a height of 20 feet or more,

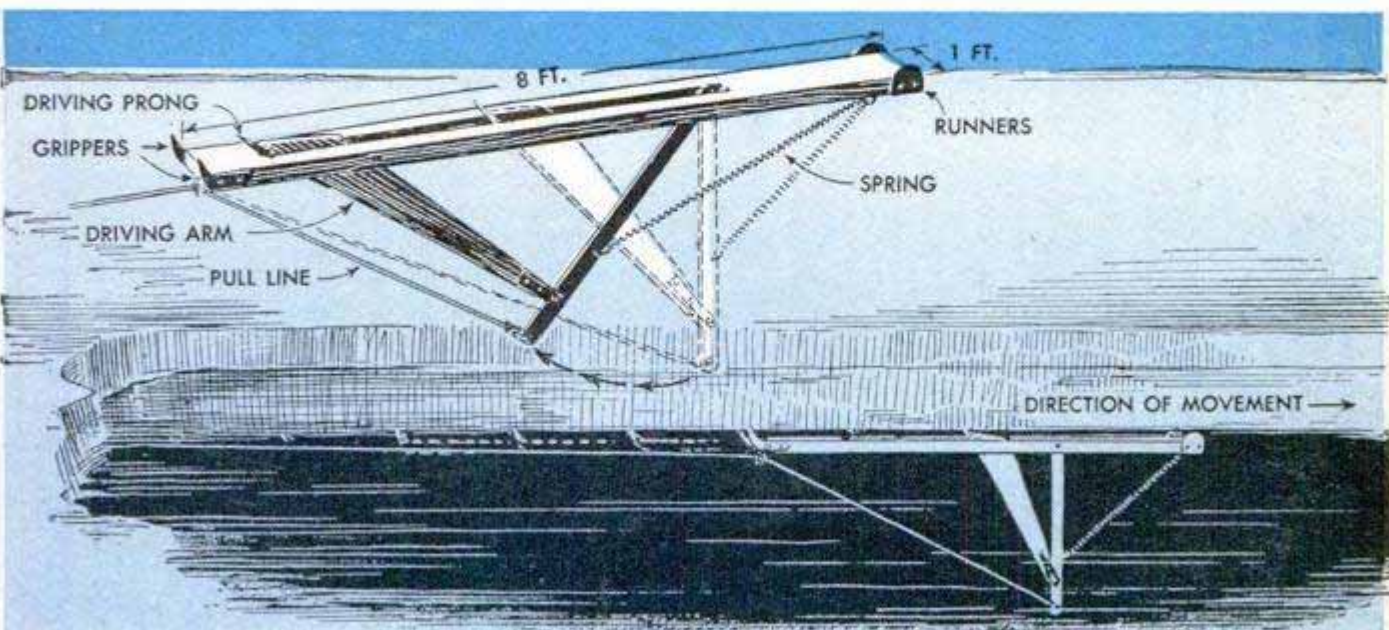



Plane hauls four tons of fish on each trip from fishing area to Hay River. It makes up to three trips daily

near enough to have turned Bill's caboose on its side, perhaps completely over.

Most of the original and basic mechanical features of the actual fishing operations are unchanged. In transportation there is another story. Progress of the McInnes Products Corporation of Edmonton

serves as illustration. McInnes, pioneer on Great Slave Lake, is one of the acknowledged "Big Four" operators in the region, the others including the Menzies Company, the Clarke Fisheries and Gateway.

McInnes' winter operations got underway in the '20s. Horses hauled frozen fish

Fish are cleaned as soon as net is hauled in. Some are then packed in cartons. Fisherman loads box of fish in snowmobile



from camps in Saskatchewan to the railroad, covering the distance over a system of relays on winter roads. Later, chartered aircraft entered the picture, transporting fresh fish to heated cars spotted for fast shipment south. In 1946, the company dipped into reserves for three Anson aircraft and a Douglas. The Douglas operated this winter at Great Slave Lake, lifting four tons of fresh or frozen fish per load from the McInnes main camp at Caribou Bay to Hay River. From Hay all companies run trucks to Grimshaw where the Northern Alberta Railway terminus is located.

In view of the quota basis for Great Slave, speed in handling is of primary importance. The fishing companies have been employing every means to get the fish off the ice quickly and en route to the markets. Most revolutionary machine at Slave is the Bombardier snowmobile, a Quebec-manufactured vehicle which has proved invaluable to the fishing industry on the big lake. Powered by a

Chrysler motor and utilizing rubber tread belts for drive, the plywood Bombardiers number nearly 20 at Hay River, speedily making the rounds of fishermen miles out on the lake. They are rated at 45 miles an hour with a 1200-pound payload of fish, will virtually triple that weight figure when the fish are hauled in a keen-runner sled rather than in the cargo compartment of the Bombardier itself. Used by all major companies, the Bombardier is rapidly replacing trucks as it is safer and greatly expedites gathering of the harvest.

The fishermen's tools of trade have not altered greatly over the years but two changes are noteworthy. Most important development has been introduction of the "jigger," an ingenious device which facilitates the setting of nets by pulling them under the ice by means of a running line. The wooden jiggers, eight feet long, are forced through the basin holes cut by the fishermen and the running line attached securely to a hinged arm in a slot in the jigger. When the running line is pulled, the jigger moves along under the ice. Release of the running line introduces action of a spring on the jigger which pulls back the driving arm. This arm, in swinging back, taps the ice with a pointed spike on its upper end. The tapping, easily audible to the fisherman even when the ice is several feet thick, enables him to follow the progress of the jigger and locate the point where the next basin hole should be cut. The jigger is lifted through the new hole and the running line detached.

Then the nets, which are weighted (usually with stones or leads) for lake-bottom fishing and also bear wooden floats to keep them erect, are tied to the line and pulled through under the ice.

When it is recalled that the former method of set-



Pretty Edna Powder, daughter of a fisherman, helps out with the packing

ting nets employed cumbersome poles, the jigger's usefulness to the industry can be appreciated. Now the fishermen set nets in gangs of 100 yards between basin holes and with much greater ease and assurance.

His other tools are simple but effective. For cutting the basin hole, the fisherman uses a needle bar. His ice chisel comes in handy for trimming the edges of the basin

(Continued to page 274)

At Hay River, fish are packed in ice inside wooden boxes for trip south





Coating on Ignition System Makes Engines Start Easier

Coating all wires and parts of the automobile ignition system with an insulating spray makes engines start easier and run better. When the liquid is sprayed on wiring, spark plugs, coil, condenser, and inside and outside of the distributor cap, it provides a moistureproof barrier. Packed under pressure, it is released from the can in a fine spray when the top valve is opened, coating the various ignition parts quickly and thoroughly.

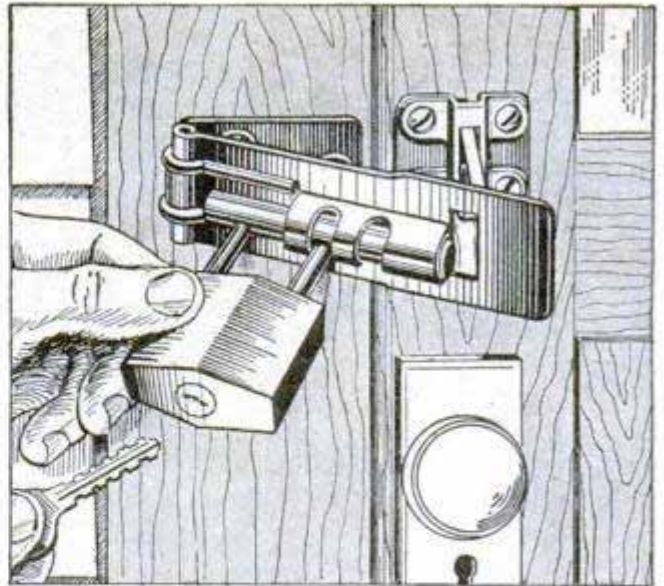

Padlock-Bolt Secures Door Hasp

Permanently attached to a sliding bolt, a padlock permits a hasp-type fastener to be securely locked. The user swings the hasp shut, slides the bolt into the eye and then pushes the padlock shut, which snaps one pin of the lock into a hole in the bolt. This prevents the bolt from being pushed back through the eye.

Automatic Refrigerator Defroster

Electric refrigerators are defrosted automatically every night by a clockwork mechanism that shuts off the current at a preset time and turns it back on when defrosting is completed. The device can be set to defrost the freezing unit at any time during the 24-hour period. Plugged into any outlet, the timer has a socket into which the refrigerator cord is plugged.

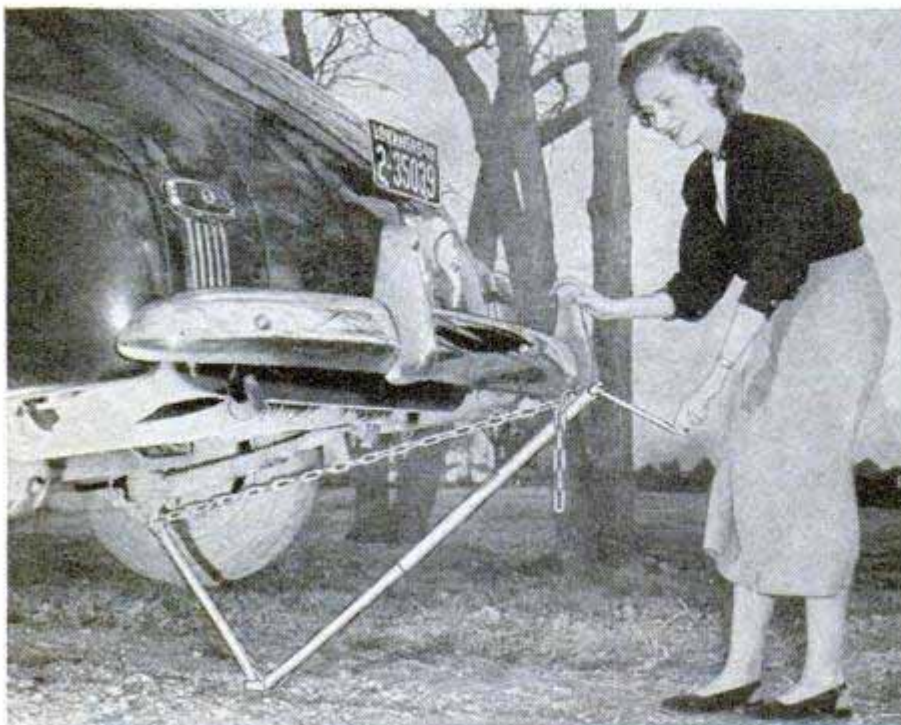

Car Jack Can't Slip Even on Incline

Even on a hill, you don't have to block the wheels when jacking up your car with a jack that combines the advantages of a bumper jack with those of an axle jack. The jack has two arms that pivot on the base plate and are connected at the other end by a chain. As you crank the jack, the outside arm lengthens, pulling the chain and raising the inside arm. There's no chance of the car falling off the jack because the chain acts as a cradle.



1949 Pontiacs Accent Roominess and Visibility

More space has been provided in 1949 Pontiac Chieftains and Streamliners by advancing the rear seat well ahead of the wheel housing. Moving the front seat four inches forward and the steering wheel two inches to the left gives the driver and those beside him more elbow room. In 10 types, the new bodies are 2½ inches lower, front and rear doors are respectively six and nine inches wider, and there is 38 percent more glass area, front and rear. Wheelbase has been standardized at 120 inches on all models. Last year's grille has been replaced by a single chrome bar, simulating a second bumper, spanning the entire front above 10 louvers. Both the Chieftain series, which replaces the Torpedo line, and the Streamliners will come with a 90-horsepower six-cylinder engine or a 104-horsepower eight. The starter button



and all operating controls are grouped around the steering column. Hydramatic drive, ordered by 75 percent of the 1948 Pontiac buyers, will continue to be available as optional equipment.



Power Wheel for Bikes

Instead of driving the rear wheel, a new power unit for bicycles provides a third wheel which is rotated by a gasoline engine. The unit can be attached to any make or style of bicycle. The gas control is attached to the handle bars, and power is transferred from the 1.3-horsepower engine to the third wheel through an automatic centrifugal clutch. The engine provides enough power to drive a bicycle about 100 miles on a gallon of gas.

☐ Some 21 million acres of desert land have been brought under irrigation by the U.S. Reclamation Service and private agencies.

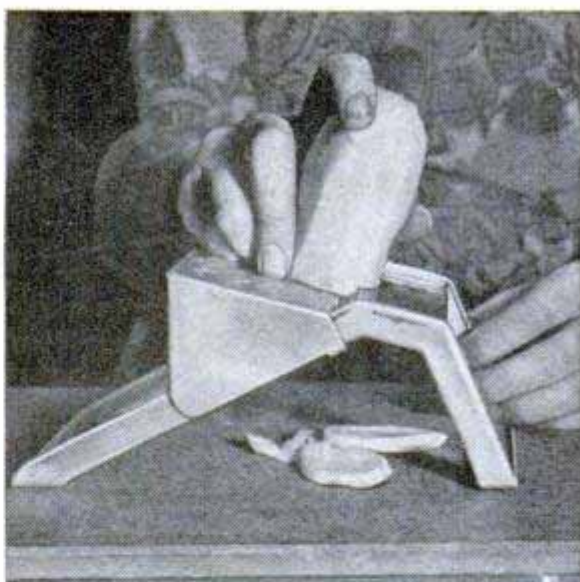
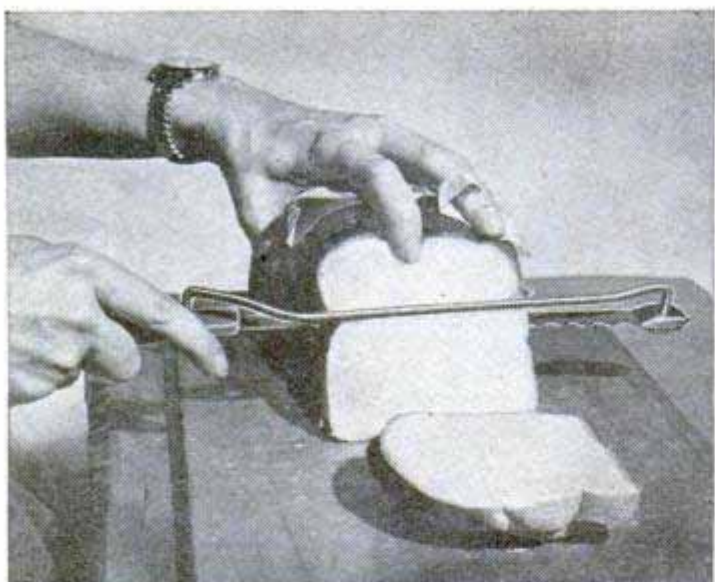

TIMESAVERS FOR THE BLIND

Kitchen and workshop chores are made simpler and safer with equipment specially designed by the American Foundation for the Blind. The foundation's technical research laboratory is devoted entirely to developing tools and gadgets that ease the problems of blindness. A bread slicer with an adjustable guide, above, cuts slices any thickness from a sliver to $\frac{1}{2}$ inch thick. For paring vegetables, there is a kitchen aid, upper right, on which desired thicknesses are preset by raising or lowering a platform on which a vegetable is moved toward cutting edge. A quick-heating soldering iron, right, helps the sightless technician locate his work carefully while the iron is cool. A pull of a trigger switch provides soldering heat in a few seconds. The iron cools by the time he is ready to make another connection. Precise work is possible with a saw holder, below, that can be adapted to ripping lengthy sections of wood and used with standard handsaws and some types of hacksaws. Items are sold at cost to the blind

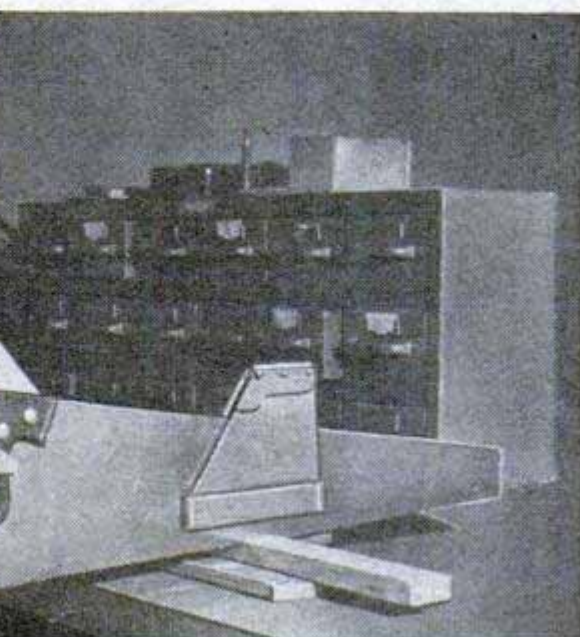
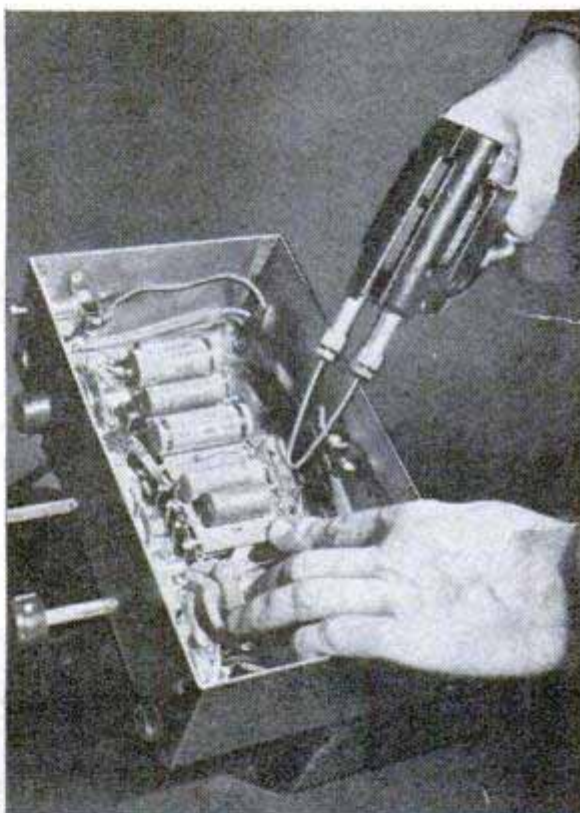

Clock Regulated by Vibrations of Molecules Keeps Perfect Time

So accurate that it will lose only one second in 300 years, an atomic clock developed at the Bureau of Standards is controlled by the constant, natural vibration of atoms in the ammonia molecule. The atomic timepiece is the first clock not dependent on astronomical observation.

Driven by a quartz-crystal oscillator, the clock is a complex electronic instrument. A low-frequency radio signal, generated by the crystal oscillator, is transformed into a very high frequency signal. This signal is then compared with the natural vibration frequency of the ammonia molecule, which oscillates or turns itself inside-out 24 billion times a second. When the two frequencies differ, an "error signal" adjusts the oscillator, bringing them into agreement. The natural frequency of the ammonia molecule being invariable, this continuous synchronization enables the clock to tick off seconds far more accurately than any other method.

Top, standing in front of the atomic clock are Dr. E. U. Condon, director of the Bureau of Standards, and Dr. Harold Lyons, inventor of the clock. Condon is holding a model of the ammonia molecule which furnishes invariable frequency for controlling the timepiece. Right, schematic drawing of ammonia molecule showing the way nitrogen nucleus oscillates above and below the plane of three hydrogen nuclei to control timepiece

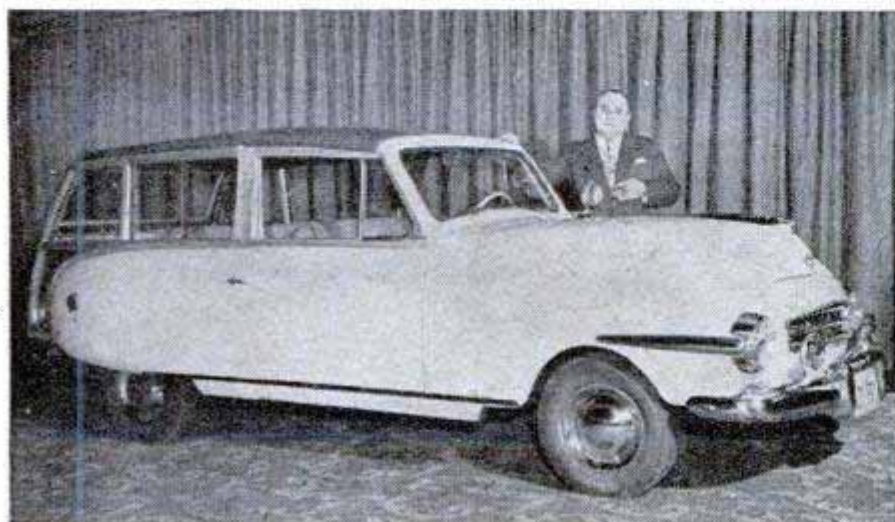
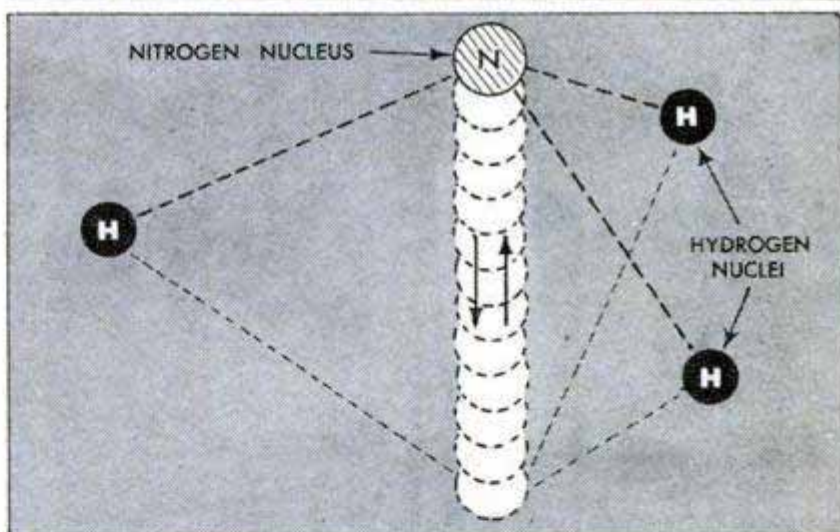
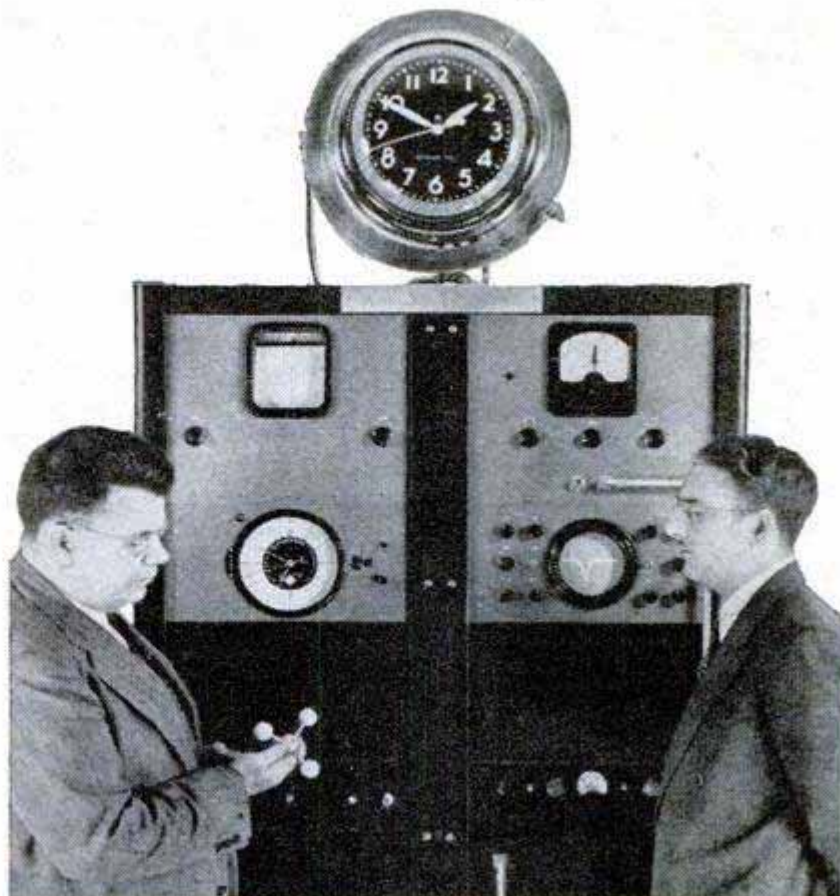

Playboy Station Wagon

Designed to sell for about \$1500, the Playboy station wagon is a bigger and heavier car than the convertible built by the Buffalo manufacturer. The station wagon has a 96-inch wheelbase, an over-all length of 163 inches and weighs 2350 pounds. It is 300 pounds heavier and 8 inches longer than the convertible. Both models will be powered by the same engine, an L-head, four-cylinder, 48-horsepower, water-cooled Hercules. Oil capacity is 4 quarts.

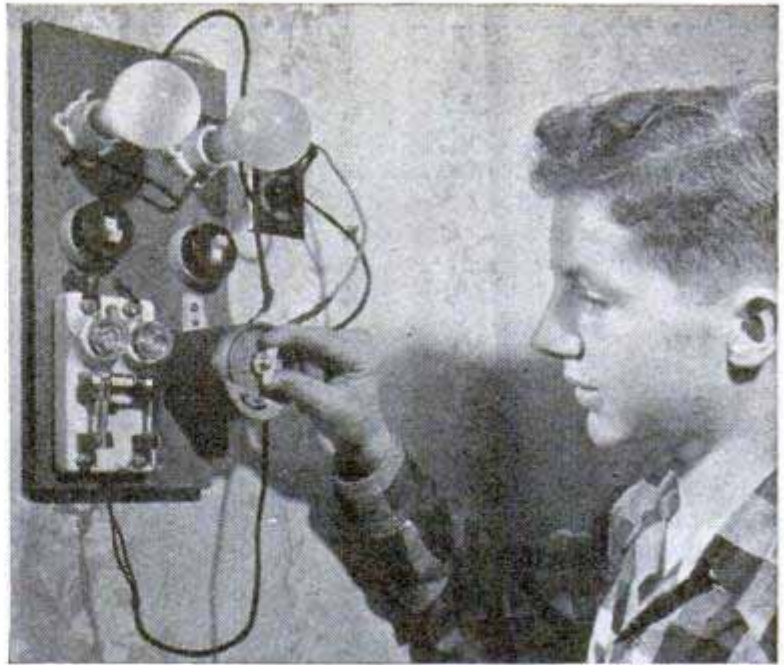

Westinghouse photos

Left, Jimmie tunes in a program on the radio he built from an old keg, a crystal, wires and earphones. He contrived the automatic timer, right, to turn on hen-house lights early to give chickens longer working day

Model electrified farm really works. Bulbs are from old pin-ball game

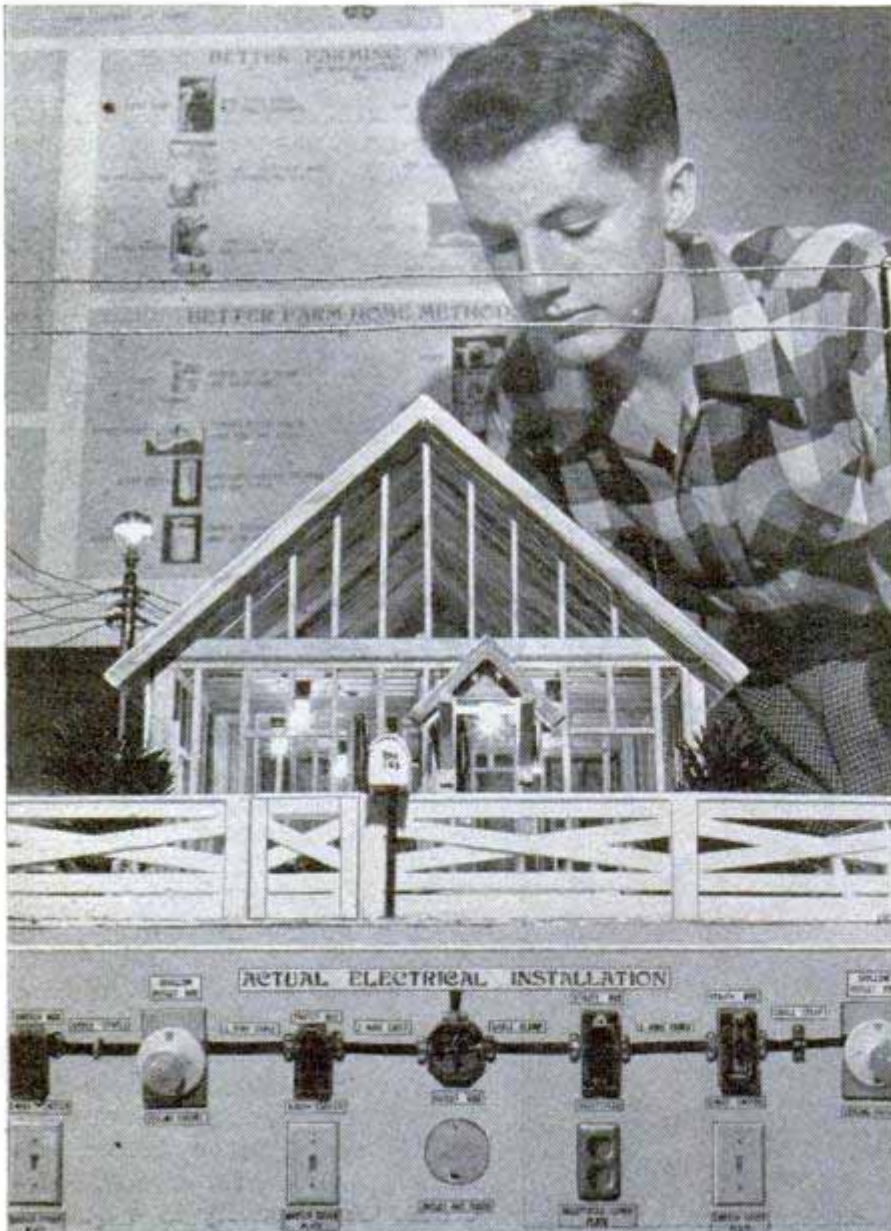

Ben Franklin, Junior

THAT OLD-TIME tinkerer, Ben Franklin, would find a kindred spirit in Jimmie Sutherland of Windsor, Mo., who can't resist electromagnets and earphones, bolts and wires. It's paid off for Jimmie, too—he recently won a Westinghouse scholarship for his feats of electrical wizardry on his father's farm. The lad's model farm with a wiring system that really works amazes even professional engineers. For his hen house Jimmie has worked out an automatic timer that snaps on the lights at 4:00 a.m. to lengthen the working day. Result—more eggs. He has electrified the milking job on the neighboring farm, built radios from fig barrels and now is installing an automatic door-opener for the hen house.

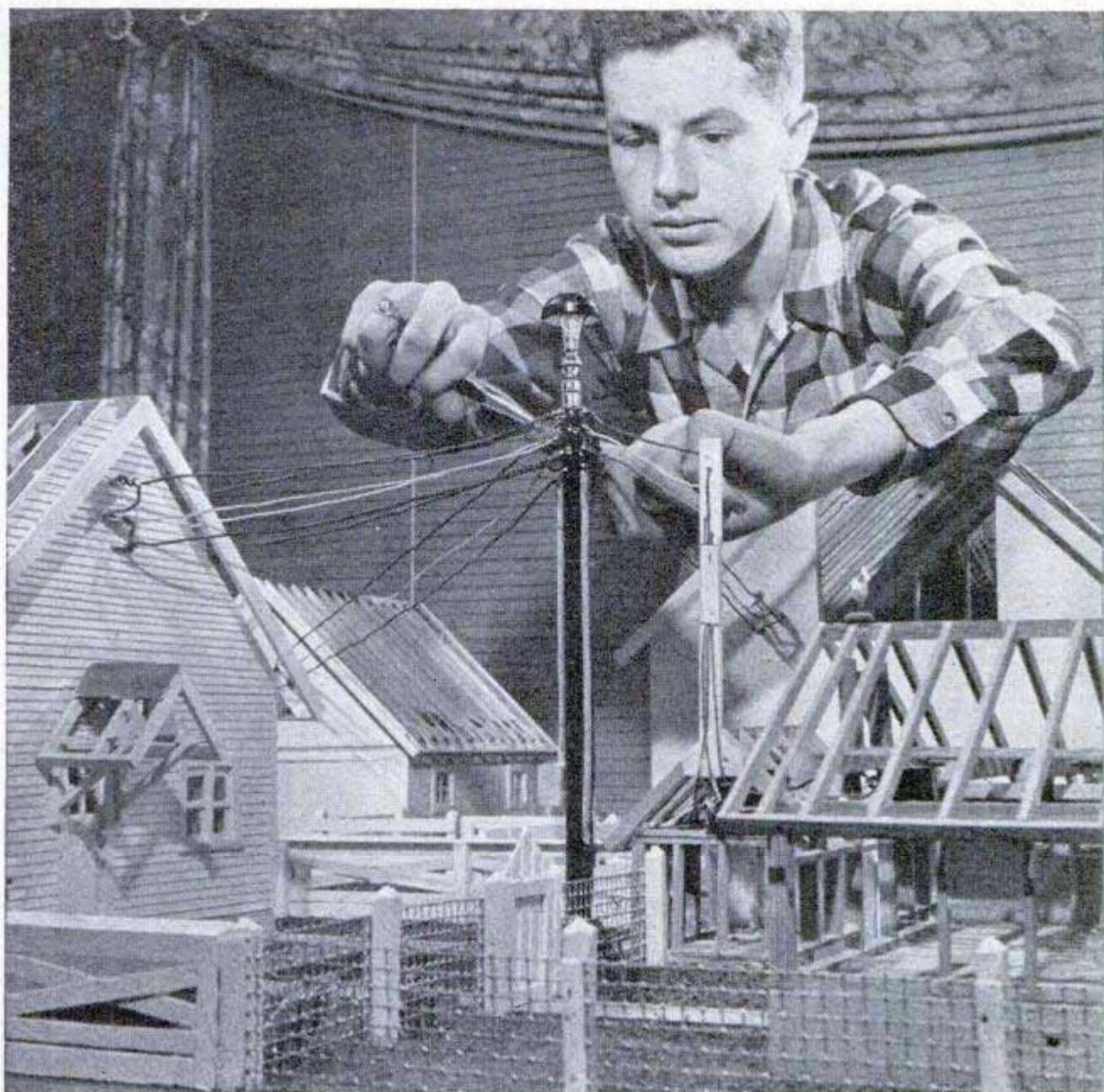

Young wizard completes center pole of his farm—his biggest wiring headache. The wooden farm buildings were fastened with glue that Jimmie made himself and put into old glue tubes, a neat trick if you can do it

Left, electromagnet holds pliers at right angle. The magnet, made of baling and doorbell wire, has 10 pounds' pull. Right, Jimmie tries to lick a current problem in automatic door opener he'll install in hen house



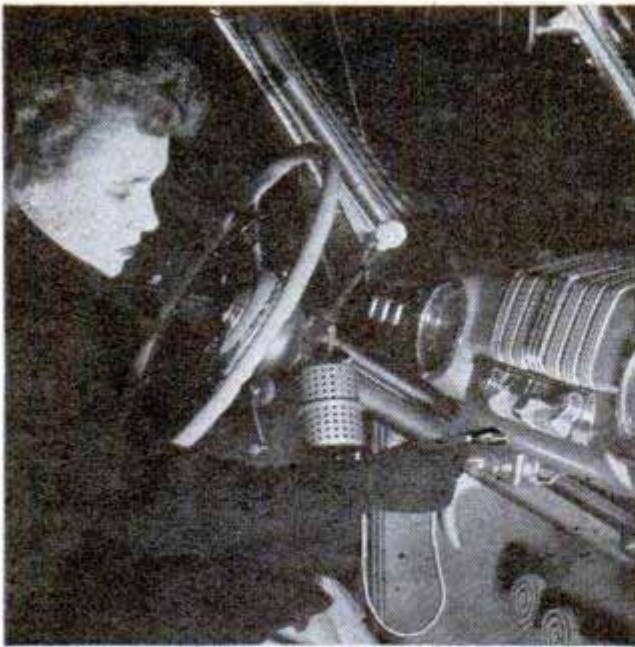

Vitalizer Keeps Battery Strong

Car batteries are kept at summertime operating conditions during cold weather by an electric vitalizer that supplies a slight current to the battery through the ignition system. This current, drawn from any 110-volt household outlet, maintains chemical activity in the battery so that its starting power is at summertime levels. A handy plug connects the device to the cigarette-lighter socket on the dash.

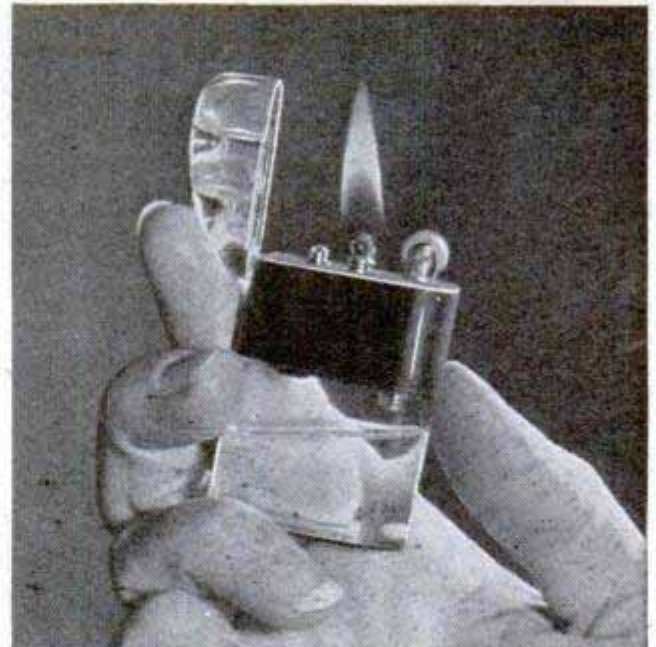

Plastic Base of Cigarette Lighter Lets You See When Fluid is Low

Your cigarette lighter won't run dry unexpectedly if it has a transparent fuel reservoir, enabling you to see when it needs refilling. The fluid is transferred from the reservoir to the wick chamber by means of a small valve near the spark wheel. Because the reservoir is sealed, the fluid cannot evaporate. The lighters come in four different colors.

Radial Diesel Engine Develops 1800 Horsepower

Developing 1800 horsepower, a radial diesel engine provides a heavy-duty power supply in a compact design that requires minimum headroom for servicing. The engine is a two-cycle type with 11 cylinders of 14-inch bore. Unit weight per horsepower is only about 39 pounds. Connecting

rods are attached to the crankpin in an unusual manner, which causes the pinions to "walk" around the master gear. Counterweights and a balanced design reduce vibration to a minimum. The engine can be used as a spark-fired engine when special cylinder heads are installed.

Left, over-all view of the radial diesel shows its compactness. Right, cutaway of the master-gear assembly

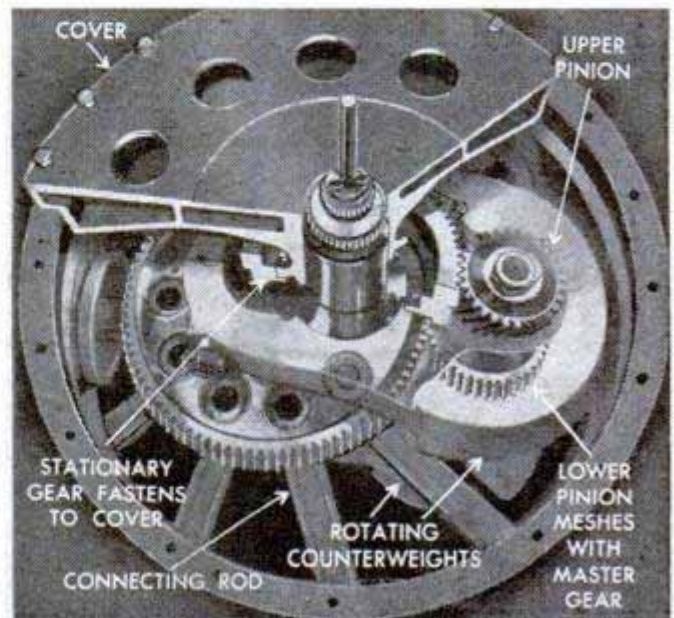
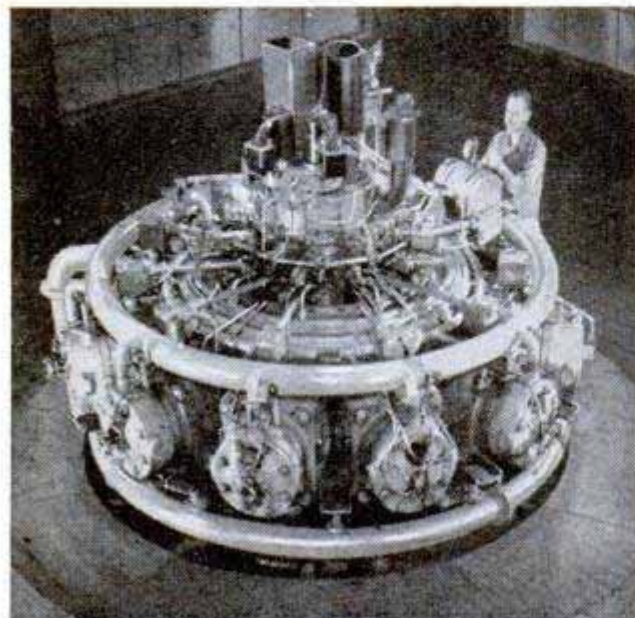

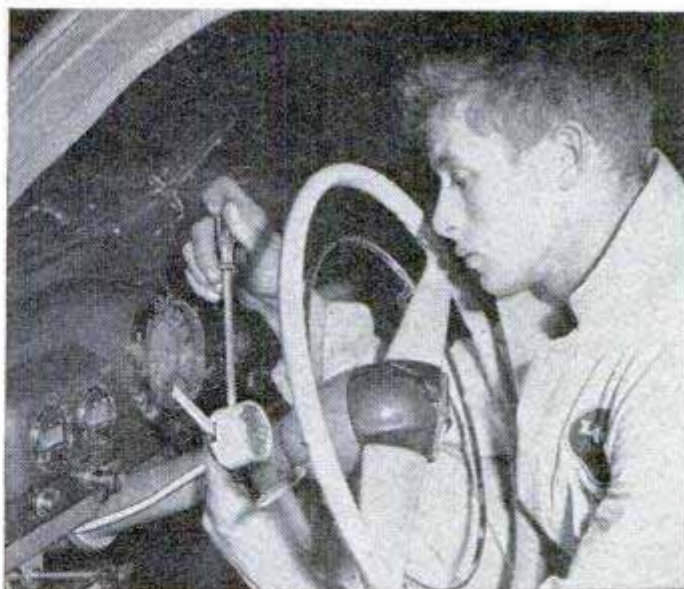

Dash-Controlled Car Sander Prevents Skids on Icy Roads

Winter driving is made safer by an automobile road sander that spreads a specially prepared grit in front of the rear wheels to provide traction on the slickest ice. A convenient switch on the steering column operates two solenoid valves, releasing the grit from hoppers permanently mounted in the rear trunk. Discharge tubes equipped with slushproof nozzles spread the grit directly in front of the wheels. Installation is easy. Only two holes have to be drilled in the trunk floor. The grit, which gives twice as much traction as sand, is sold in large cartridges that fit into the collar of the hoppers, thus eliminating the necessity of handling the material.

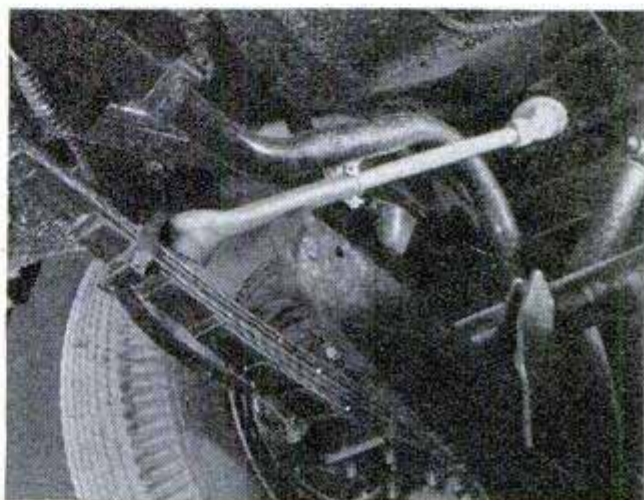

Mounted in the trunk, the two hoppers release grit in front of the rear wheels to stop skidding, top, left. Switch on steering column, top, controls flow of grit. Below, close-up of one of the discharge tubes



Road Lamp Flashes Warning

With a new trouble lamp, stalled motorists and truck drivers are assured of both a warning light and a beam to help them in making repairs. The red warning light is in the top of the lamp and the trouble light in the side. A switch permits five different combinations of the red flasher and trouble light. The lamp has a swivel base which can be adjusted to focus the trouble light. A 14-foot cord clips to the ammeter of any car or truck.

☐ Airline travel last year was twice as safe as in 1947, according to a Civil Aeronautics Administration report listing 109 fatalities in six accidents during 1948 compared with 219 deaths in eight accidents the year previous.

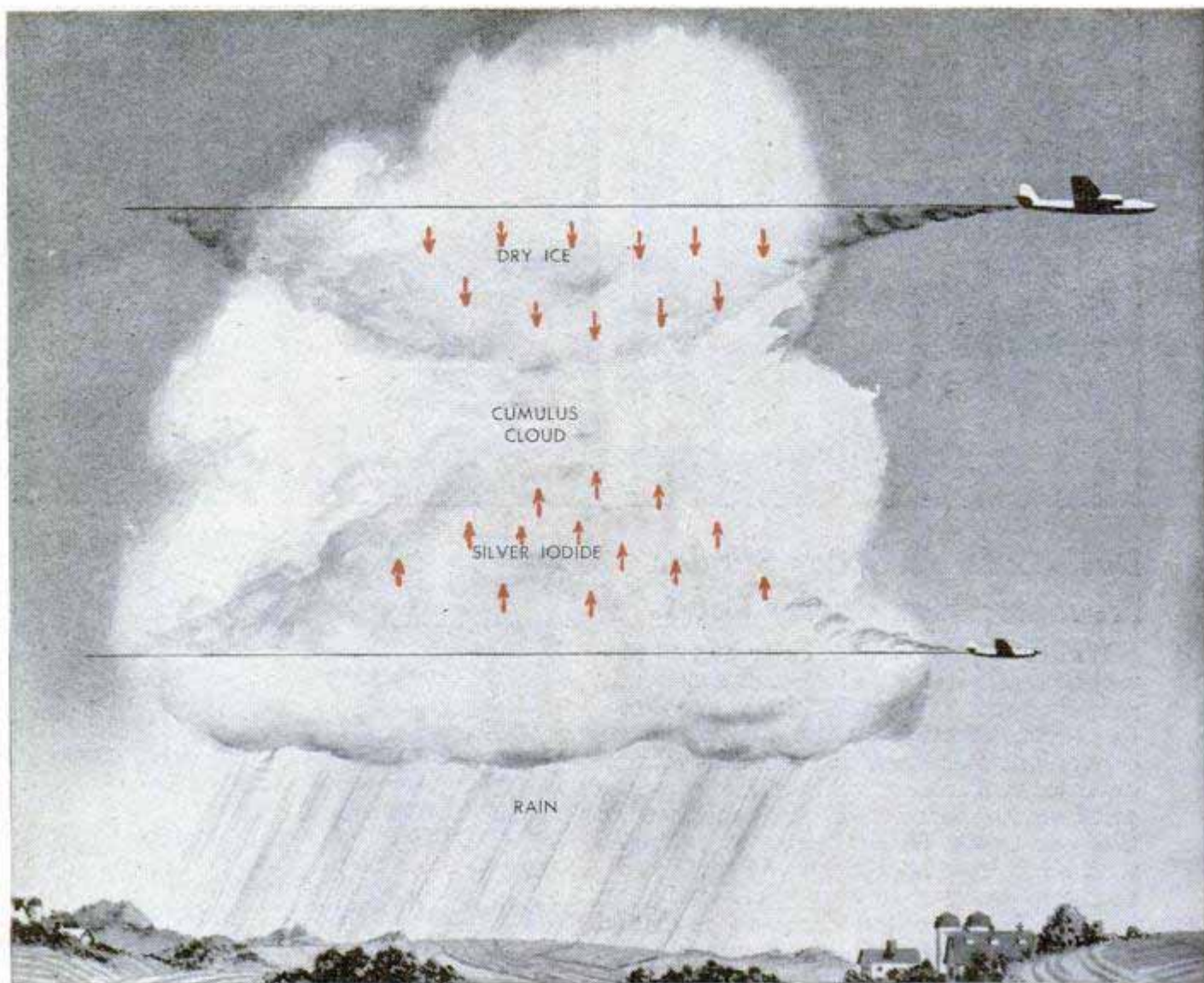

In double-seeding method, one plane dumps Dry Ice from above while another sends up silver iodide from below

Want to Buy Some Rain?

By Irving P. Krick

American Institute of Aerological Research

as told to

Thomas E. Stimson, Jr.



DR. KRICK, president of the American Institute of Aerological Research, for 17 years was head of the meteorology department of California Institute of Technology. Among other duties during the war he served as Chief of the Weather Information Section of the U. S. Strategic Air Forces. At present he operates a meteorological consulting service for clients throughout the United States

ARE MODERN rain-making techniques any good?

No! The Air Force and the Weather Bureau speak. The two agencies declare that they got negative results in numerous attempts to stimulate rainfall over an 8 by 20-mile test area in Ohio last year.

Yes! This is the equally positive answer by a number of other investigators.

The latest and perhaps most authoritative confirmation is supplied by a project conducted under the auspices of the Arizona Weather Research Foundation. The results indicate that during one month last summer, cloud-seeding operations over the Salt River, Verde River and Tonto Creek watersheds placed 12,000 acre-feet of water in storage in excess of the amount that would have been produced naturally by existing atmospheric conditions.

The difference between the Ohio and the

Arizona experiments seems to be that the Air Force-Weather Bureau effort was a study in which virtually every cloud that passed over the test area was seeded even though the clouds may not have been in the necessary physical state to yield moisture, while in Arizona only those situations were utilized in which it was thought more rain could be produced than would occur naturally.

Too, it is believed that the Ohio test area was chosen arbitrarily because of a pre-existent rain-gauge network on the ground, without determining beforehand whether the region was suitable for the experiment. Finally, the test area was too small for measuring the rainfall from clouds that passed down-wind from the seeded sector.

In spite of the pessimistic Ohio report and the uncertain results of amateur rain makers, the body of scientific evidence indicates that properly equipped and directed campaigns to increase rainfall can be economically successful in suitable areas. Fortunately, the areas most suited for the work seem to be the semiarid regions of the earth. Agriculture in those regions suffers unduly in periods of less-than-normal rainfall, a condition that may now be prevented or ameliorated.

The present understanding of how rainfall most often occurs is based on the Bergeron-Findeisen ice-crystal theory of precipitation. Generally speaking, clouds are formed when a mass of moist air is driven upward to an altitude at which temperatures below freezing exist. This



Inside this funnel-shaped chamber, twine impregnated with silver iodide is burned to send out clouds of particles that can grow into snowflakes. Below, a map of the seeded area shows how the location of intense rainfall corresponds to the up-wind location of seeding operations

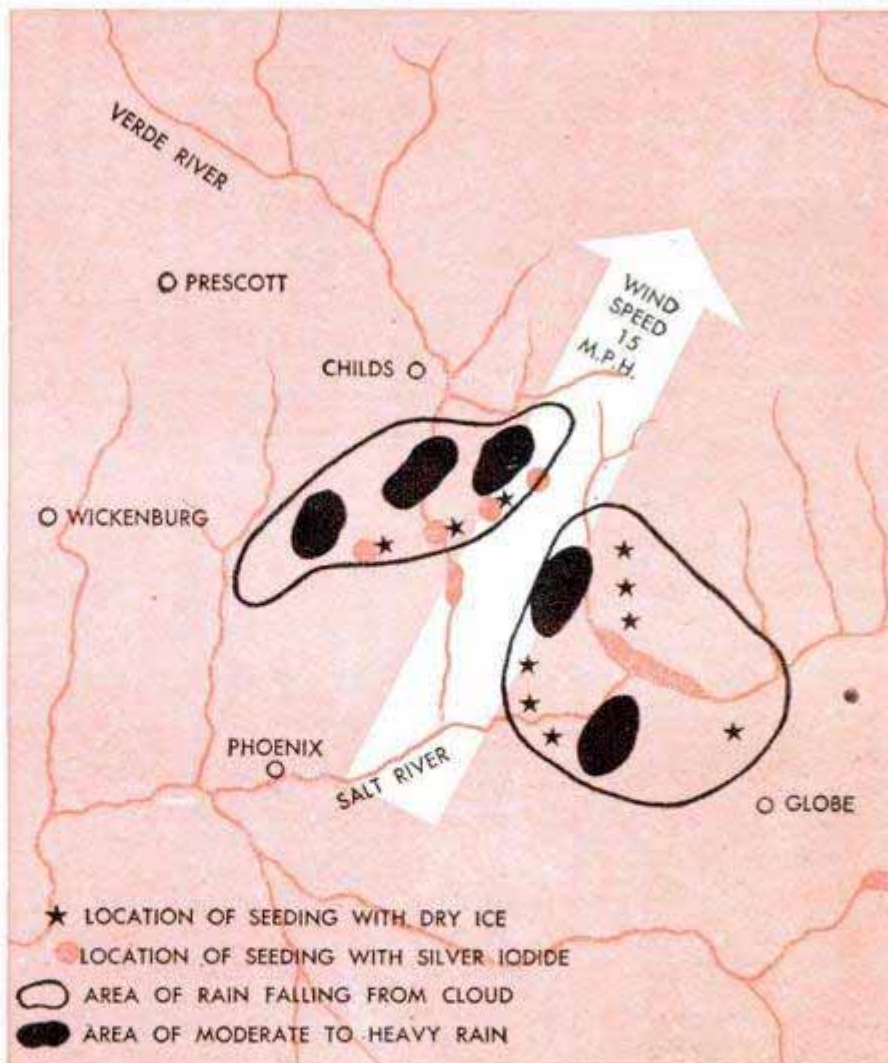

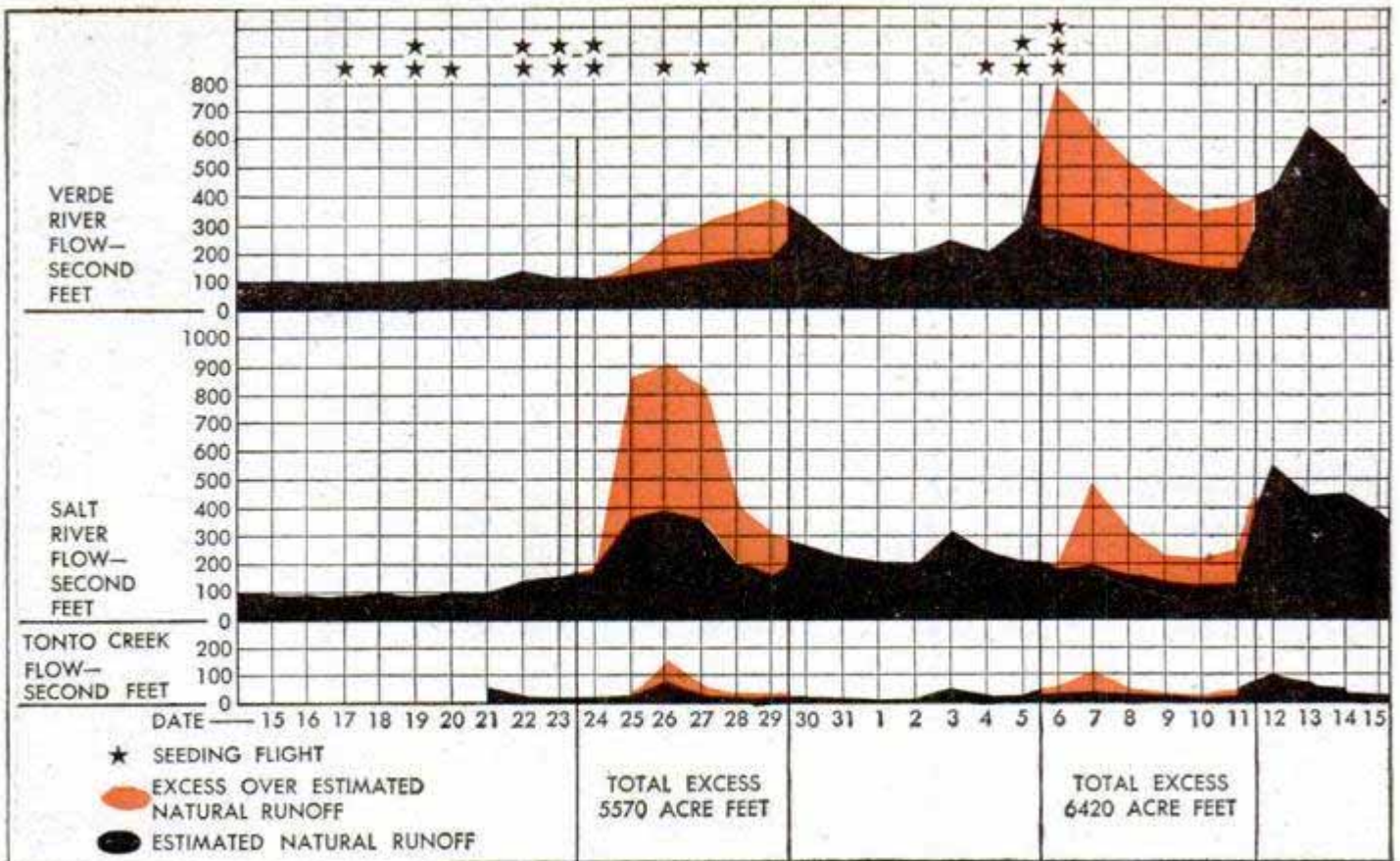

Red areas on graph show the estimated runoff produced by rain-making flights. Each star denotes a flight

can happen when a steady wind blows the air up the side of a mountain or up a sloping boundary surface between two dissimilar air currents in a storm area, or when the lower layers of an air mass become heated to such an extent that they are forced upward by adjacent cool-air bodies. These conditions cool the rising air and condensation takes place, creating a cloud.

When the temperature in the upper part of the cloud drops below freezing, some of the cloud droplets are changed to ice crys-

tals. Other droplets quickly freeze on these nuclei, which then grow to snowflake size and descend, turning into raindrops below the freezing level.

Modern attempts to bring on this condition artificially are based on experiments by General Electric investigators who produced miniature snowstorms in the laboratory by using Dry-Ice pellets to cool artificial clouds to temperatures at which ice crystals form spontaneously.

Later, the experimenters were able to

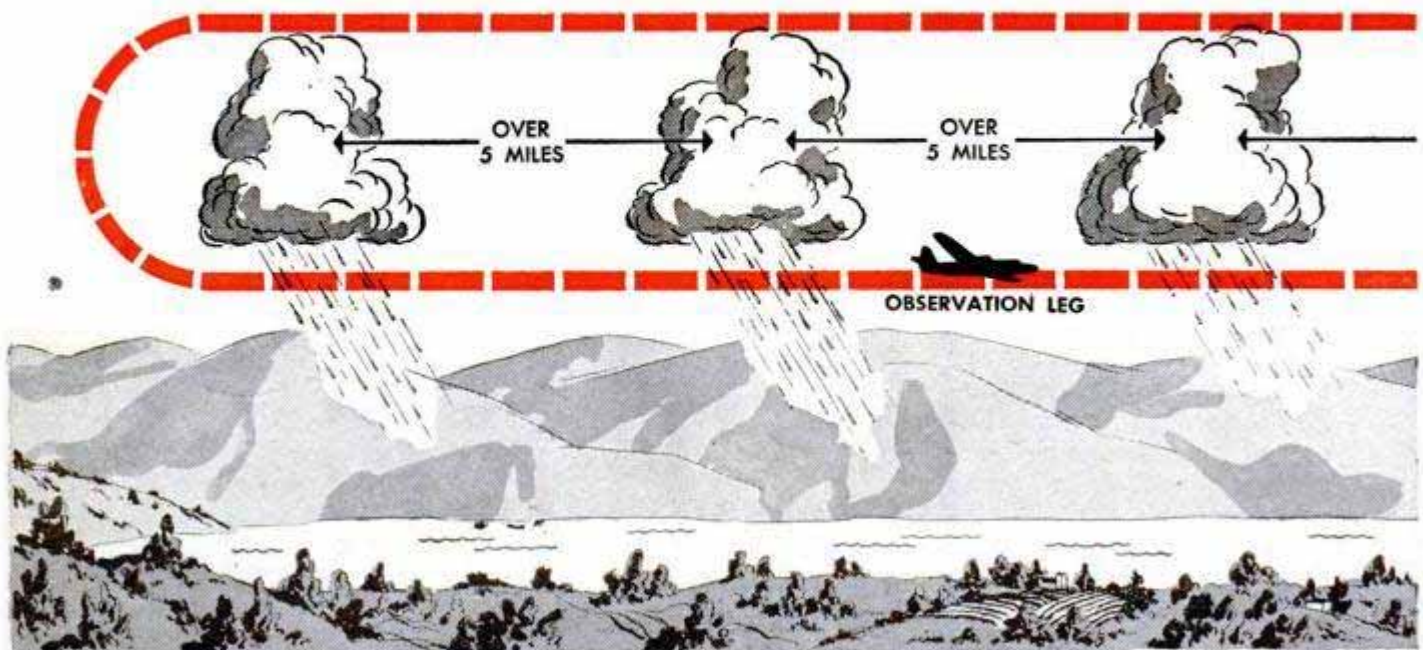



U. S. Air Force photo

Compartment behind pilot contains apparatus for dispensing clouds of silver-iodide particles. Above, right, Air Force poured Dry Ice from B-17 in Ohio experiments. Below, right, four switches operate silver-iodide dispenser

induce cloud droplets to coalesce into raindrops by introducing silver-iodide smoke into the cloud. Silver-iodide particles have a crystalline structure similar to that of ice crystals, and attract moisture. Additional experiments have tested the effectiveness of other condensation nuclei such as sprays of water, dusts and volcanic ash.

In transferring these techniques to Nature, it has been customary to seed clouds from above with Dry-Ice pellets or to release silver-iodide smoke into the clouds.

(Continued to page 266)



Plane seeds a line of thunderheads, then makes an observation run beneath clouds to determine results

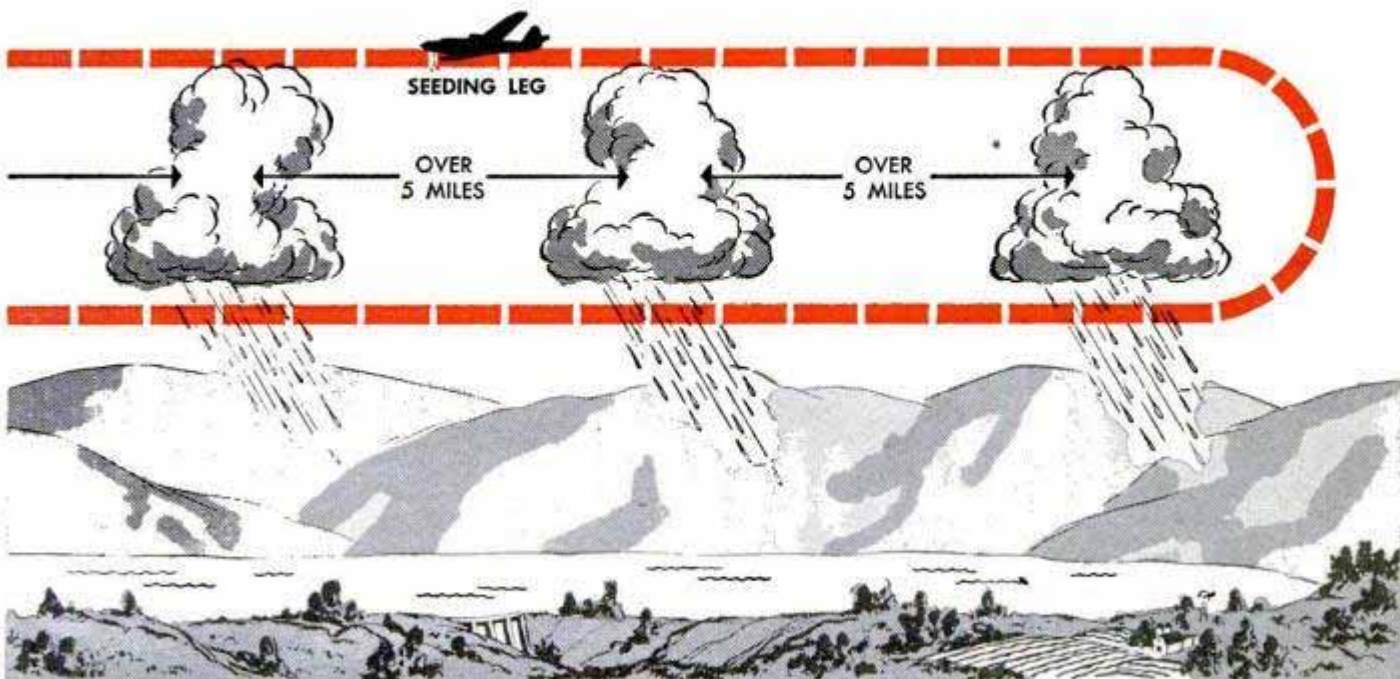

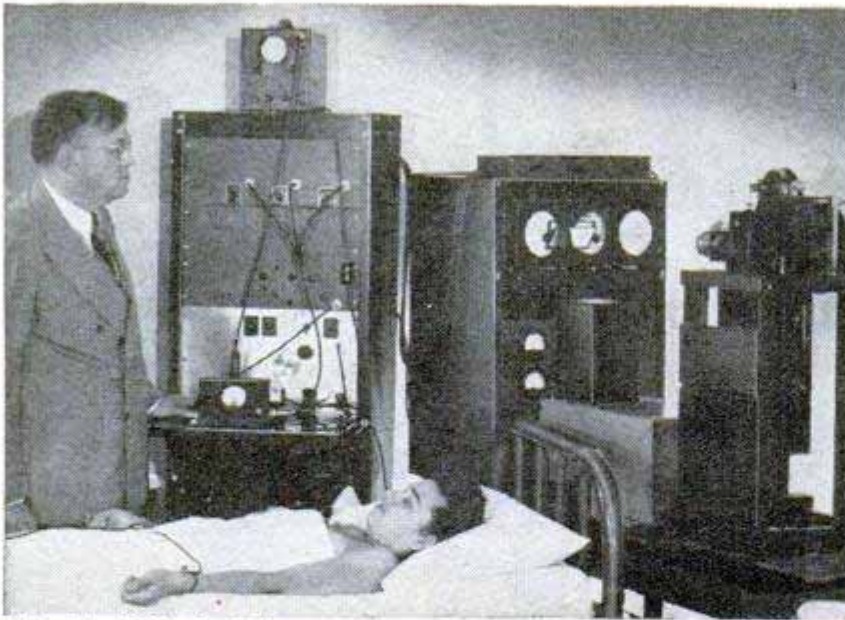

University of Nebraska photo

↑ Instrument picks up even the faintest sounds of human heart and records them on film. Above, right, film strips show differences between healthy heart and one with organic murmur. Right, camera photographs and prints electrocardiograph in four seconds

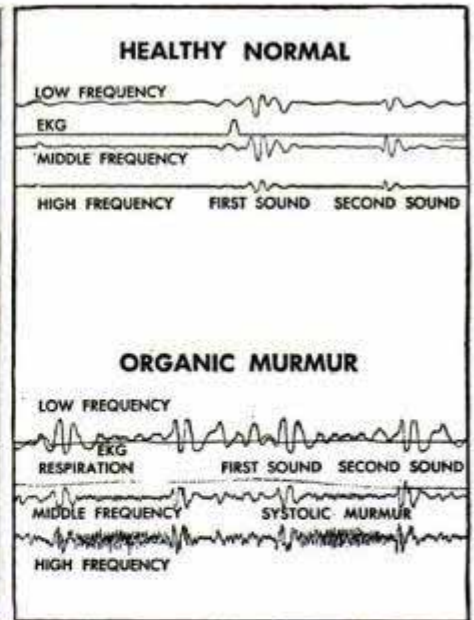

Cameras to Fight Heart Disease

Two cameras developed recently are expected to aid man's fight against heart disease. One records visibly the sounds made by the human heart—sounds that are too faint for a doctor's ear to detect. In using the instrument the doctor places a small microphone over the patient's heart. Sounds picked up by the microphone are amplified and then turned into light beams by cathode-ray tubes. A moving film records the track of the beams, producing a picture of the sound pattern of the patient's heart. The other camera is connected with an electrocardiograph and photographs the rise and fall in the electrical heart current. The action is recorded on film which is exposed, developed, fixed, washed and dried in four seconds, producing an immediate record for the patient's heart action.

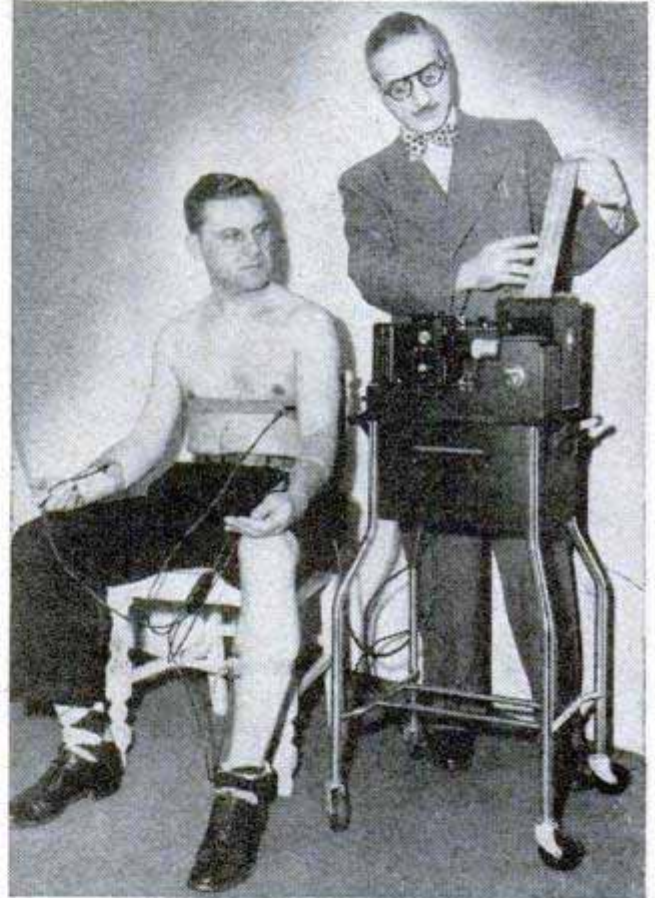

Aluminum Car

Constructed largely of aluminum, a new French car, the Gregoire, travels more than 100 miles an hour. The front-wheel-drive auto is powered by an 11-horsepower engine and travels 23 to 25 miles per gallon of gas. Each wheel, with tire, weighs only nine pounds. The car was shown recently as a feature of the Paris Automobile Exposition.

Sprinkler-Sprayer

By changing a control valve the homeowner can convert a new lawn sprayer into a sprinkler for hand use. For automatically soaking the lawn he pushes a spike, which supports the sprinkler, into the earth. When he wants to spray by hand, he moves the control valve and a fine spray shoots out the forward end of the sprinkler. The spray field is adjustable from 5 to 40 feet in radius. The sprayer is aluminum except for the brass fittings and the steel stake.

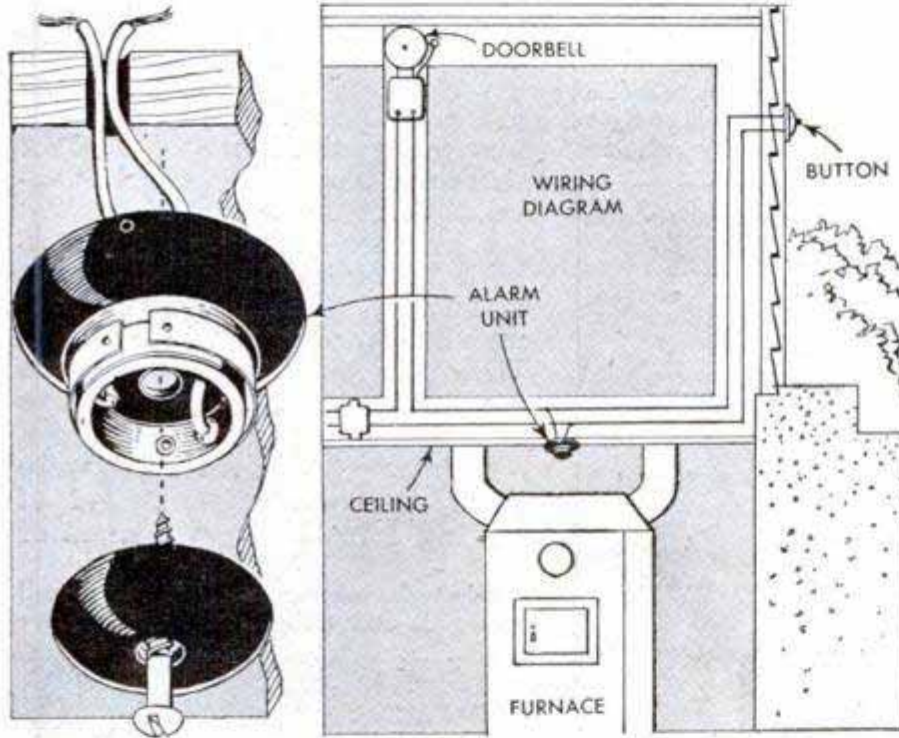
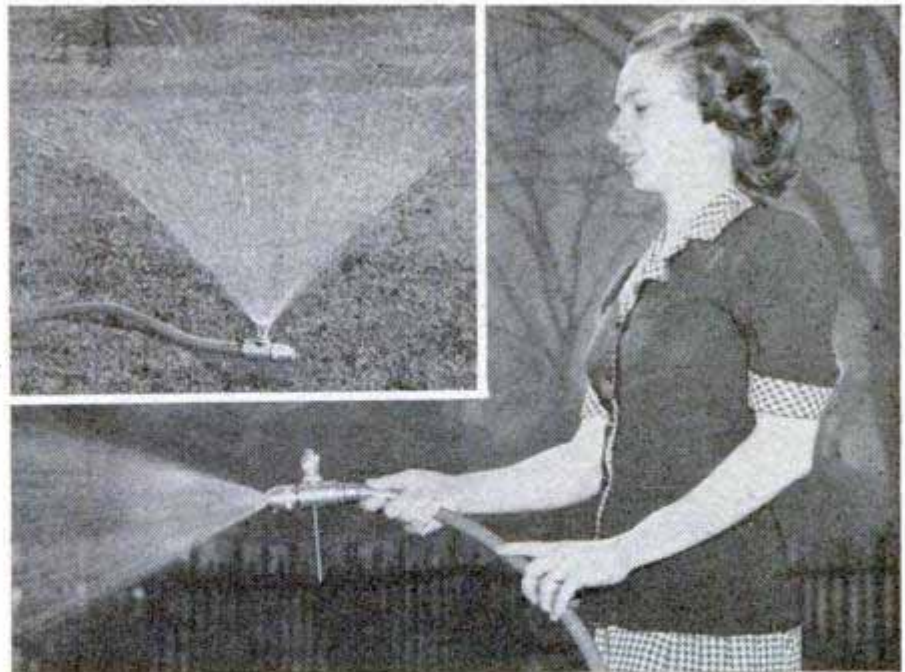

Doorbell Thermostat Makes Fire Alarm

When a small thermostat is connected on the same circuit with a doorbell, the latter serves as a fire alarm. The thermostat is fastened above the furnace, near a water heater or in any other area where there is danger of fire. If the temperature rises above 140 degrees, contact is made within the thermostat to sound the bell. Several thermostats can be connected in circuit with the same bell. The thermostat can be tested by holding a match near the unit or by pressing a contact.

Window Folds as Top Lowers

Folding glass permits the use of a full-size rear window on convertible automobile tops. The glass, formed of a special plate glass-plastic sandwich, folds in the center like an accordion on a narrow plastic joint when the top is lowered. It is used on the new Hudson.

☐ Pine pitch, used in the production of turpentine, rosin and other naval stores, is now being extracted from stumps of the western yellow pine, thus providing a valuable use for millions of these stumps available in the Northwest.



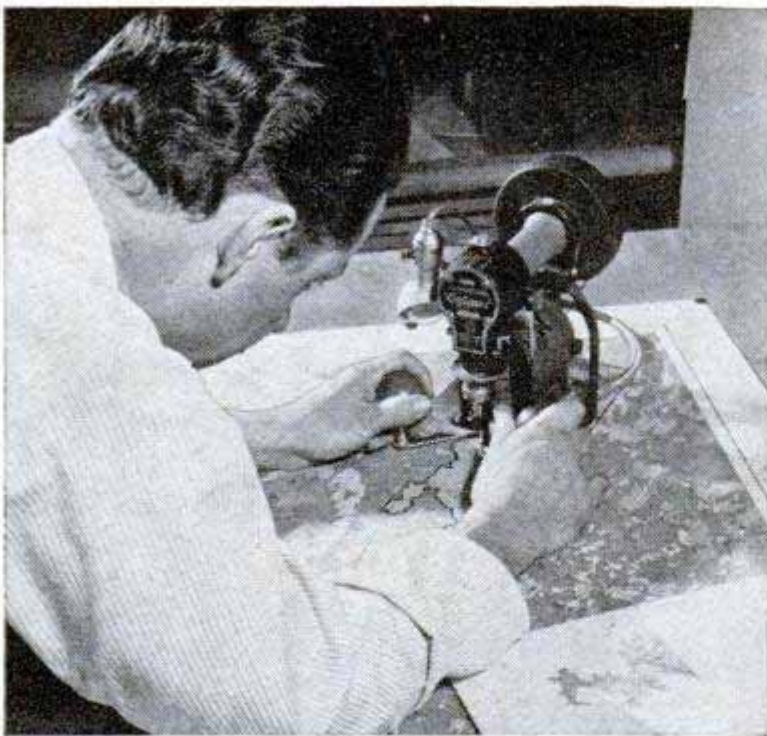

Above, Canadian forestry worker cuts out the portions of the map to be measured by the photoelectric planimeter. Below, an exploded drawing of the planimeter shows the bank of lights, the opal glass slide, the two photocells and the microammeter

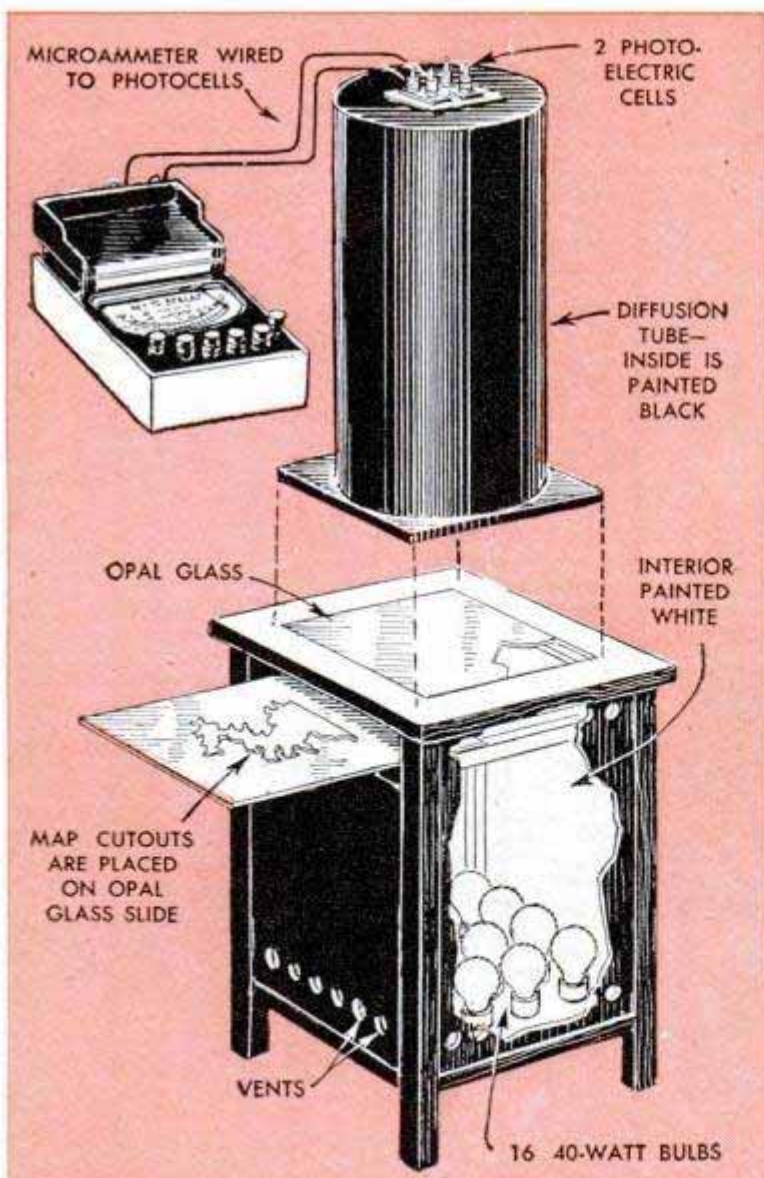

Photocells Take

LIKE ANY good businessman, a country has to take inventory of its resources. When these resources include millions of acres of trees, the problem of inventory is tremendous.

Forest survey maps, scaled one inch to the mile, are marked to show patches of hardwoods and softwoods, with an additional breakdown according to height, density and commercial value. Computing the acreage of each of these categories by usual methods involves hours of computation.

In the Dominion Forest Service of the Canadian Government, skilled map-measurers formerly spent hours hunched over the huge maps, measuring and computing the tree inventory.

But today, thanks to an ingenious machine called a photoelectric planimeter, the time required for this work has been cut by 75 percent. Until the new machine was put into use, technicians spent 23 hours computing the timber stands in an area of 135,000 acres on a map scaled one inch to the mile. With the planimeter, the same measurements are made in five hours—a saving of 18 hours.

Formerly, two methods were used. One method consisted of placing over the map a sheet of

Ready to be measured, a cutout is placed on a slide and pushed into the planimeter



"Census" of Trees

Cellophane covered with evenly spaced dots. Each dot represented one acre and by tediously counting the number of dots enclosed by the forested area the technician computed the approximate acreage. The second method, more accurate than the first, required a polar planimeter. By tracing the outline of each area with a stylus on the arm of the device, the map-measurer arrived at the number of acres enclosed by the outline. Because of the mathematical work involved in this method, serious errors often resulted.

There's no tedious computation with the photoelectric planimeter which is accurate to plus or minus one percent.

The new instrument measures the area of any opaque material placed on its glass slide simply by measuring the amount of light intercepted by the material. Two photoelectric cells are mounted on top of the planimeter and are wired to a sensitive microammeter. When any opaque material is placed between the lights and the photo-cells, some light is prevented from hitting the cells and the dial reading decreases proportionate to the size of the material.

The technicians paste the map on a sheet of cardboard and cut out the forested areas just as you would cut out a jigsaw puzzle. The irregular-shaped cutouts are placed on the opal glass slide and pushed into the machine. By reading the microammeter dial, the technician determines accurately and instantaneously the number of acres in the map section being measured.

Measuring forest areas on a map this size takes 23 hours when this polar-planimeter technique is used



Atom-Smasher in Can Detects Neutrons

Because neutrons are neutral and carry no electrical charge they cannot be detected directly by electrical means, but a neutron counter has been invented that is actually a miniature atom-smasher and it fits inside an ordinary tin can. Developed at Westinghouse, the counter consists of an electronic tube coated with a mixture containing a very small amount of uranium 235, the atomic-bomb ingredient. When neutrons strike this coating, uranium atoms are split, throwing off atomic fragments which are detected electrically. The tin can is lined with a two-inch wall of paraffin to slow down the speeding neutrons before they strike the electronic tube.

Five Times the Speed of Sound Is New Wind-Tunnel Record

Air speeds more than five times the speed of sound have been achieved in the captured and modernized German supersonic wind tunnels at the Naval Ordnance Laboratory, White Oak, Md. The new record is designated Mach number 5.18, or 5.18 times the speed of sound. The high speed was obtained at -377 degrees Fahrenheit and is the equivalent of a speed of 3960 miles an hour under normal temperatures at sea level. The record was attained in a 16-inch-square working section of the tunnels, captured by American forces at the conclusion of World War II. The high speeds are used to test air flow over projectiles fired from supersonic aircraft, or at such aircraft.





Small Cars For Britons

Morris Oxford (top) carries six passengers; below, smaller Morris Minor



AMERICAN designers of small cars are casting a sharp eye across the Atlantic at the new products turned out by veteran British builders of midget cars. The postwar British midgets, especially the popular Morris cars built at Oxford, stress increased visibility, a lower center of gravity and at the same time a high road clearance, definite curves in their designs and—surprise—rear fenders.

These midgets with British accents have the solid look of their big automotive brothers and the engineers have striven for big-car comfort and handling. All changes, however, were dictated by economy of maintenance and operation. With cruising speeds of about 50 miles per hour, the Morris Oxford sedan will travel 25 miles on a U. S. gallon of gasoline and the



This four-cylinder Morris Minor convertible carries four persons and travels 40 miles on a gallon of gas

smaller Morris Minor about 40 miles. The Morris has a quiet-running four-cylinder side-valve engine.

The British midgets are presented as "quality" cars with luxurious interior trimming in English leather. The bodies are sprayed with sound-insulating material, are rustproofed and the paint jobs are in varied colors. Gone is the separate chassis; the new Morris cars feature all-steel mono-construction of body shell. Gone, too, is the conventional front suspension. Torsion bars give efficient suspension at the least expenditure of weight and steel, according to the Nuffield Organization, builders of the Morris and known as the "General Motors of England." Rear suspension remains faithful to long semielliptics hung on oilless rubber bushings.

Lockheed hydraulic brakes are featured on all four wheels with the latest type double-leading shoes in the front drums. A separate parking brake operates through a quick-action pistol-grip lever to the rear wheels only. The transmission consists of a conventional four-speed gearbox. Synchromesh engagement of the upper three gears is used and larger models have finger-tip gearshifts under the steering wheel.

Other departures from tradition on the

new midgets include movable front seats, easily adjusted for tall or short drivers, a new steering system utilizing an ingenious rack-and-pinion arrangement to give an easy action, and a drive which made it possible to reduce the height of the transmission tunnel through the floor of the car. Another feature, which makes the cars ride smoother, is the positioning of the rear seat in front of the rear axle instead of over it and moving the engine slightly forward.

The Morris midgets are built in two models, the "big" six-passenger Oxford sedan and the small Minor. The Oxford has a wheelbase of 97 inches and an overall length of 166 inches compared with 86 and 147½ for the Minor. The 62-inch-high Oxford is four inches taller than the Minor. Widths are 64½ inches for the Oxford and 60 for the Minor. Tire sizes: 5.25 by 15, Oxford; 5.00 by 14, Minor. The latter is built as a sedan or convertible.

So-called luxury appointments are grouped instruments, easily read at night by soft-glow lighting, built-in defrosting and heating ducts under the instrument panel, pull-out ash trays, roomy glove compartment, alligator-style hood with a locking control on the dash, and a reasonably large luggage trunk at the rear.



DESK OR CHILD'S PLAYPEN, you can have your choice with a wide platform that fits in the back seat of a sedan or club coupe. Supported by two hangers that hook over the front seat, it can be raised or lowered. It can also be made wide enough to fill the complete width or narrow enough to leave room for a passenger

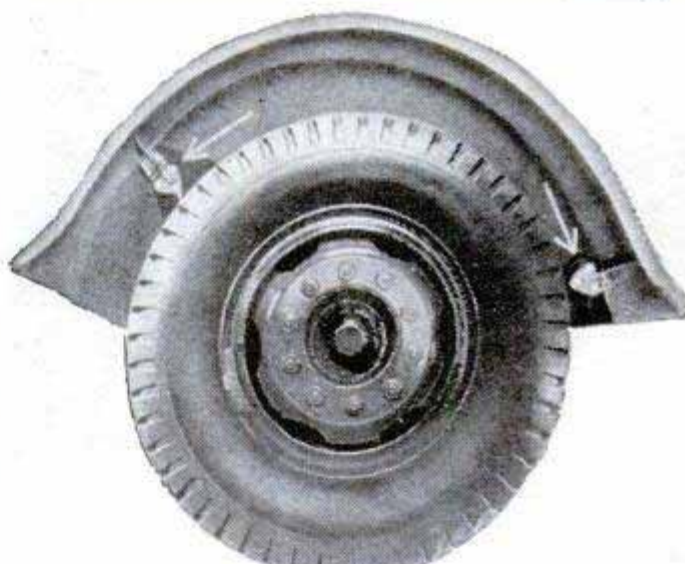
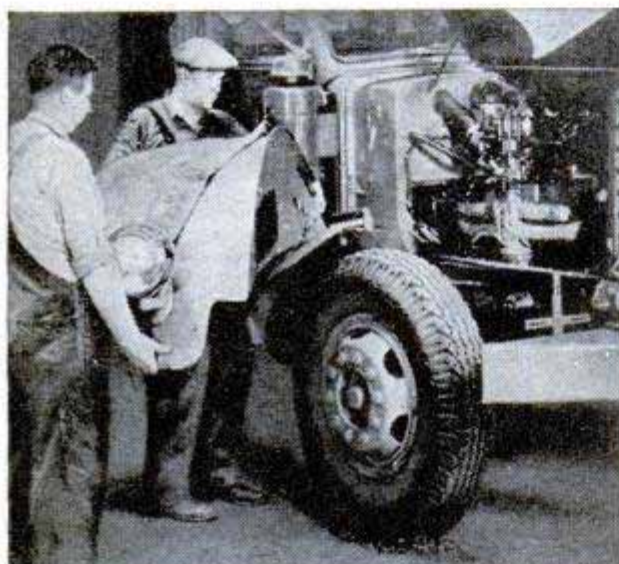

REMOVABLE TRUCK FENDER makes mechanics happy by uncovering the engine for easy accessibility during repairs. After disconnecting headlight wires at a junction box, the mechanic loosens the fender by removing three bolts at front, three at rear (see arrows). The fender assembly is then lifted off, exposing the engine

GASOLINE-TANK LOCK for cars having a hinged fender door is controlled by a button on the dash. No key is needed to lock or unlock the door. You push the door shut and it is locked. When you need gasoline, you press the dash button and an electrical circuit unlocks the door, which springs open automatically

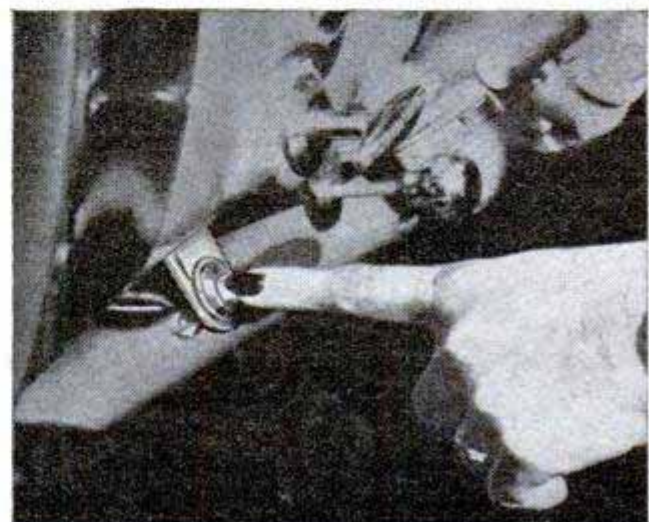
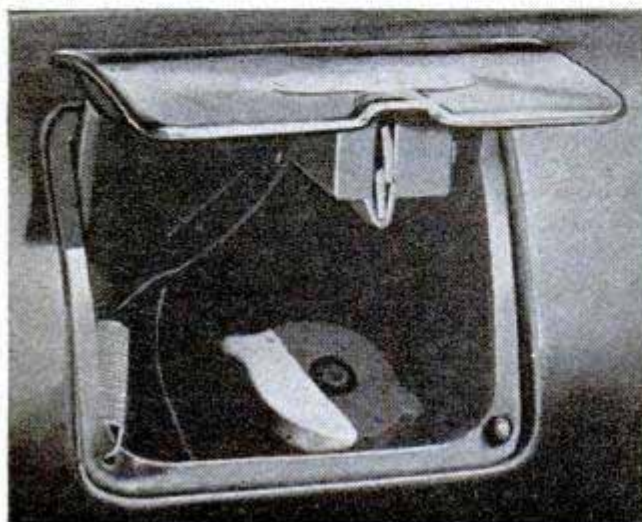

Our groves of redwoods aren't dying out, say the tree experts. These forest giants, some born more than 3000 years ago, are seeding new groves that will insure a ceaseless supply of valuable wood

Right, with the undercut completed, a lumberjack sights along his "gun sticks" to determine the direction the giant will fall after opposite side is sawed and wedged

Giant logs are moved easily by water. An artificial pond is maintained beside redwood sawmill

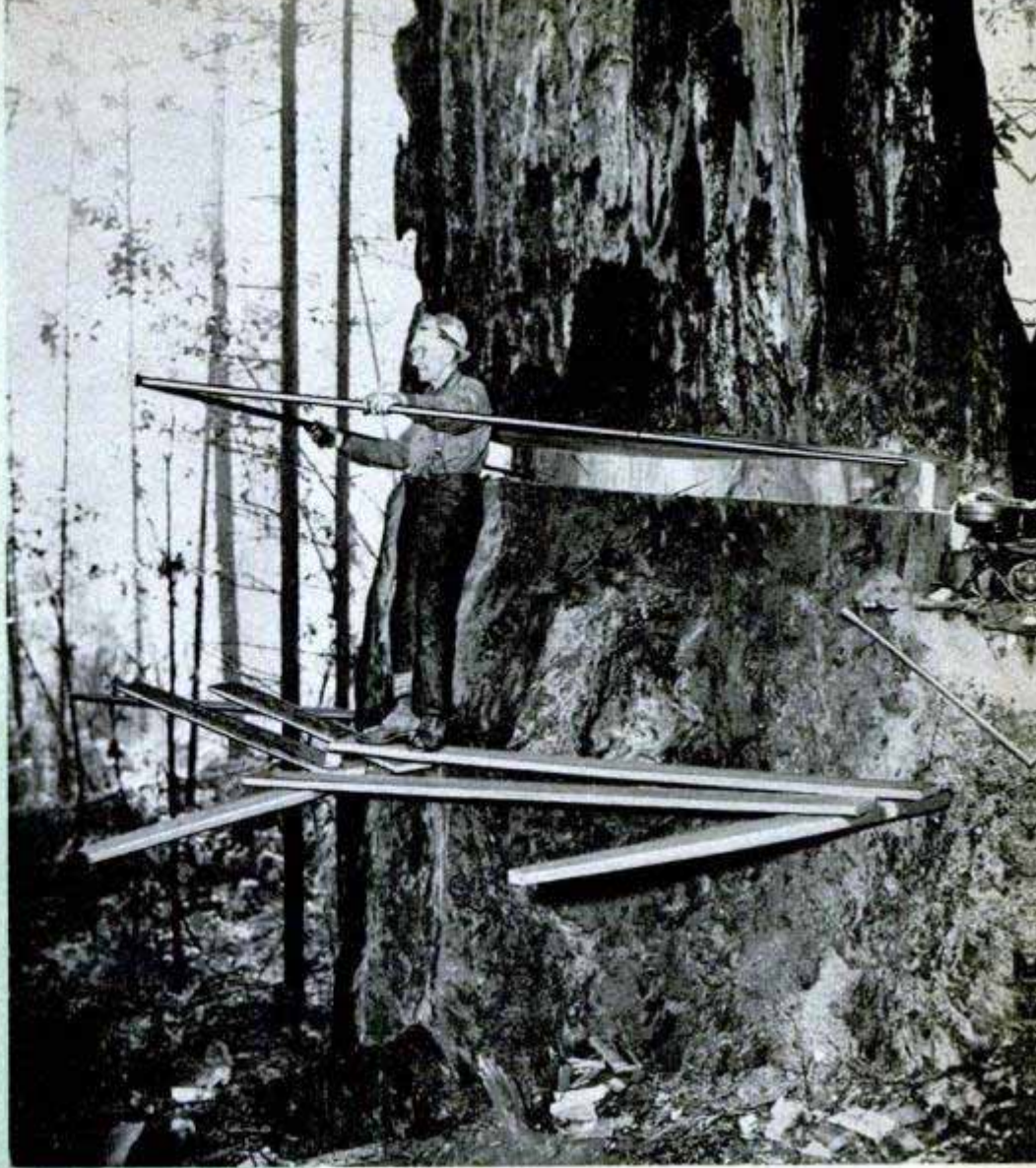

Prehistoric Crop



SOME OF California's redwood trees are so large that when one of them fell across a ravine it was used as an automobile bridge. Ranchers merely chopped a flat roadway along the trunk.

Many living redwoods have hollow bases, the result of forest fires, and it is not uncommon for a farmer to stable a horse in the woody cavern or use it for sheltering his wagon or truck. Such a room is called a "goosepen." Occasionally a woodsman boards up the entrance to a goosepen, fastens on a door and lives comfortably inside the tree.

The General Sherman tree is the largest living thing. Its base exceeds the width of many city streets. Its exact height is 272.4 feet, its diameter at the ground

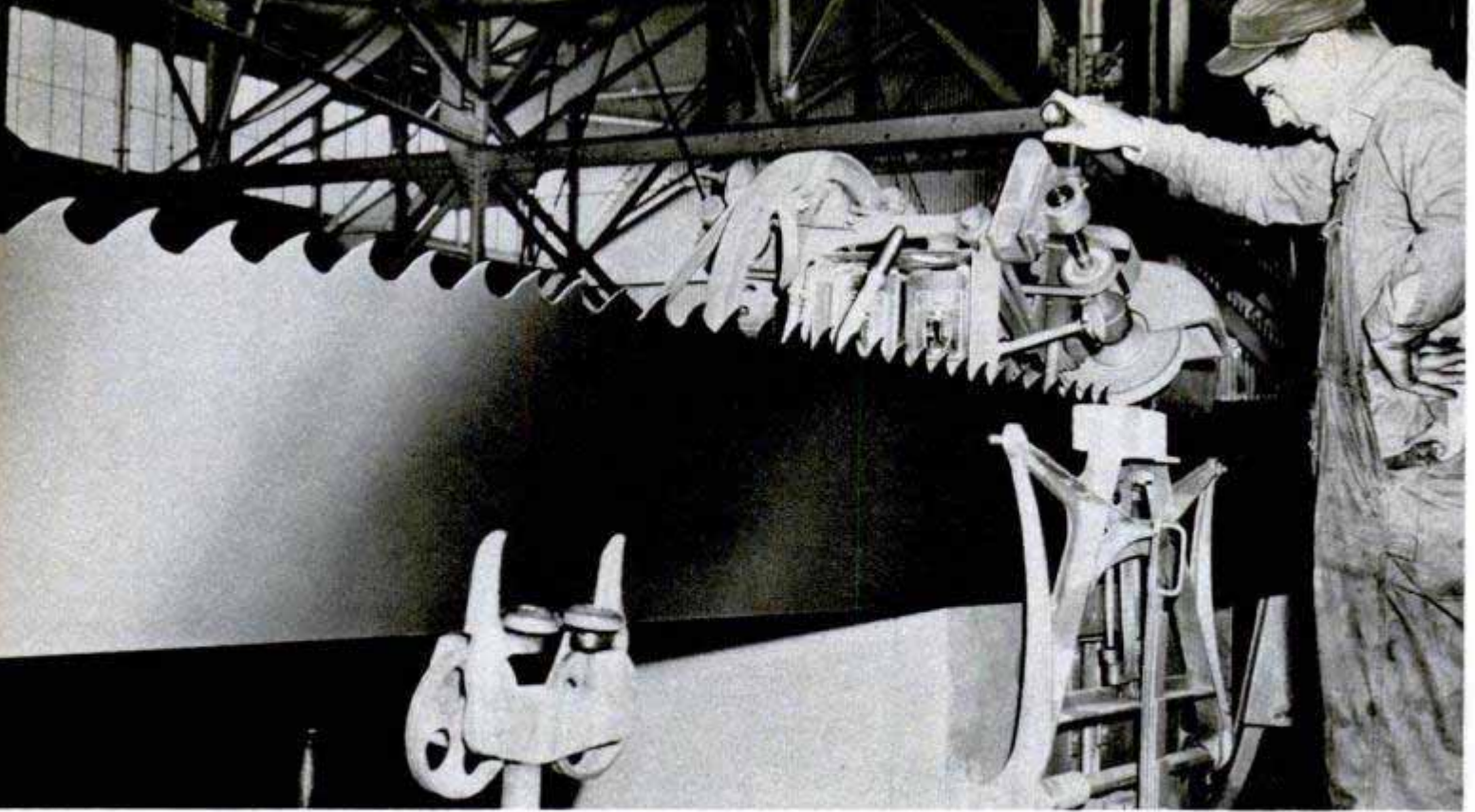

Bandsaw blade is a ribbon of steel more than a foot wide. This automatic machine sharpens the huge teeth

36.5 feet. One of its branches is 140 feet long and has a diameter of almost seven feet, large enough to make an impressive tree all by itself.

Years ago one man working with an ax required 4½ months to fell a large redwood, then spent most of the balance of the year splitting the wood into 4 by 5-inch fence posts seven feet long. He got 7700 posts without touching the knotty upper portion of the trunk.

Today, two men with a power saw that is operated by an attached gasoline engine can fell an average large redwood in half a day. Saw blades are as long as 14 feet. One of the lumberjacks often has to chop into the far side of the tree to keep the saw blade free. Explosives are sometimes used to split open the fallen trunks.

The General Sherman and some of its companions probably are close to 4000 years old, judging by counts of the annual rings of other big trees that are lying on the ground. No one knows the precise age of the General Sherman because no instrument built for coring into a tree is long enough to reach its center.

There are actually two types of California redwoods. The *Sequoia gigantea*, the

true "big tree," exists in scattered groves between the 4000 and 8000-foot levels on the west slope of the Sierra Nevada. Most of the groves now are inside Sequoia, Kings Canyon and Yosemite National Parks or are otherwise protected. Although cut extensively in the past, the *Sequoia gigantea's* soft, brittle wood was never of great commercial importance.

The so-called coast redwood, *Sequoia*

Seeds of the towering trees are about the size of a speck of sawdust. Here a sample is checked to discover the percentage of live seeds

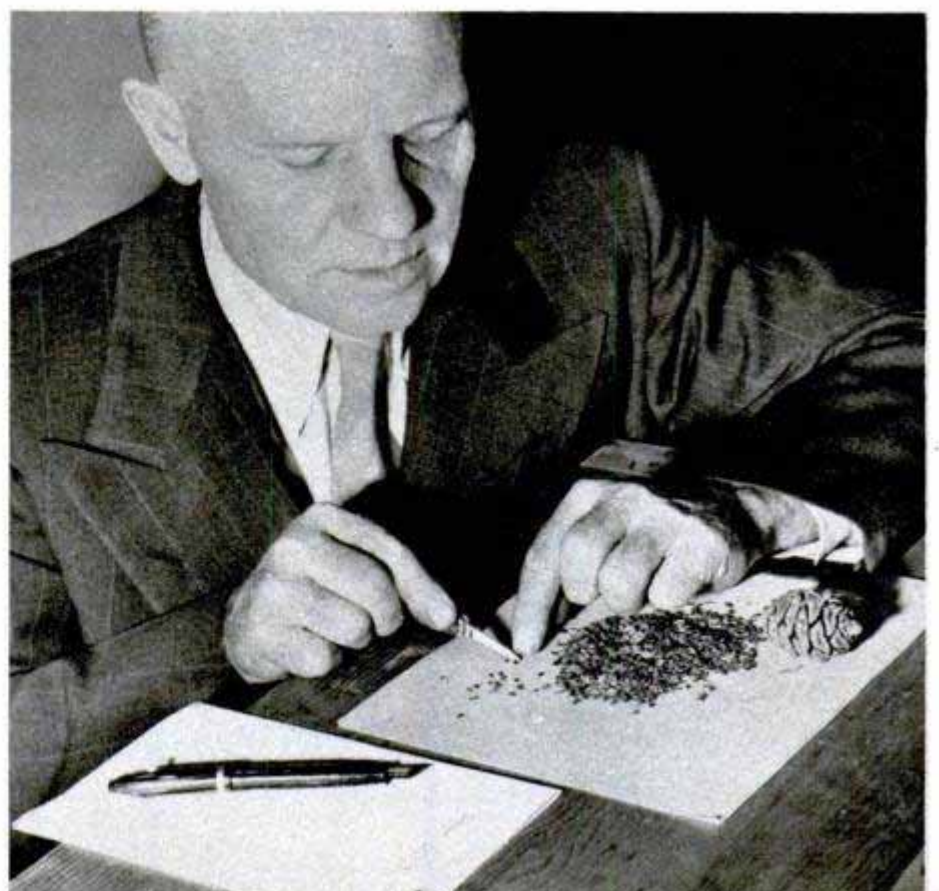

sempervirens, grows almost as large and frequently taller than its relative. Great forests of coast redwoods flourish in the fog belt that extends 30 miles wide from southern Oregon to south of San Francisco. Many of the best stands are preserved inside public parks. As commercial lumber, the coast redwood is extremely important. Its strong, dark, insect and rot-resistant wood is widely used as siding, framing, shingle and fence-post materials.

The general belief has been that the California redwoods are the dying survivors of an almost-extinct race, for fossils show that the genus *Sequoia* had almost worldwide distribution some 30 million years ago. It is understood now that the redwoods are hardy, flourishing species that probably will be with us forever. Both types have been planted extensively throughout the United States and abroad and it is almost safe to suggest that there are more healthy redwoods alive today than when the groves were discovered.

Fossil specimens of another *Sequoia*, the dawn redwood, have been found in many parts of the world and silviculturists have thought for a long time that the dawn redwood is one species that actually had become extinct. It is an interesting type because it is considered to be one of the ancestors of the coast redwood, though the number of their chromosomes differs widely.

Four years ago, however, a living dawn redwood tree was discovered in Szechuan Province, south of the Yangtze River in China, and since then several hundred specimens have been identified in the district. They are looked upon as true living fossils. The dawn redwood somewhat resembles a bald cypress and loses its leaves in the fall, unlike the other redwoods which are evergreens. Seeds of the dawn redwood

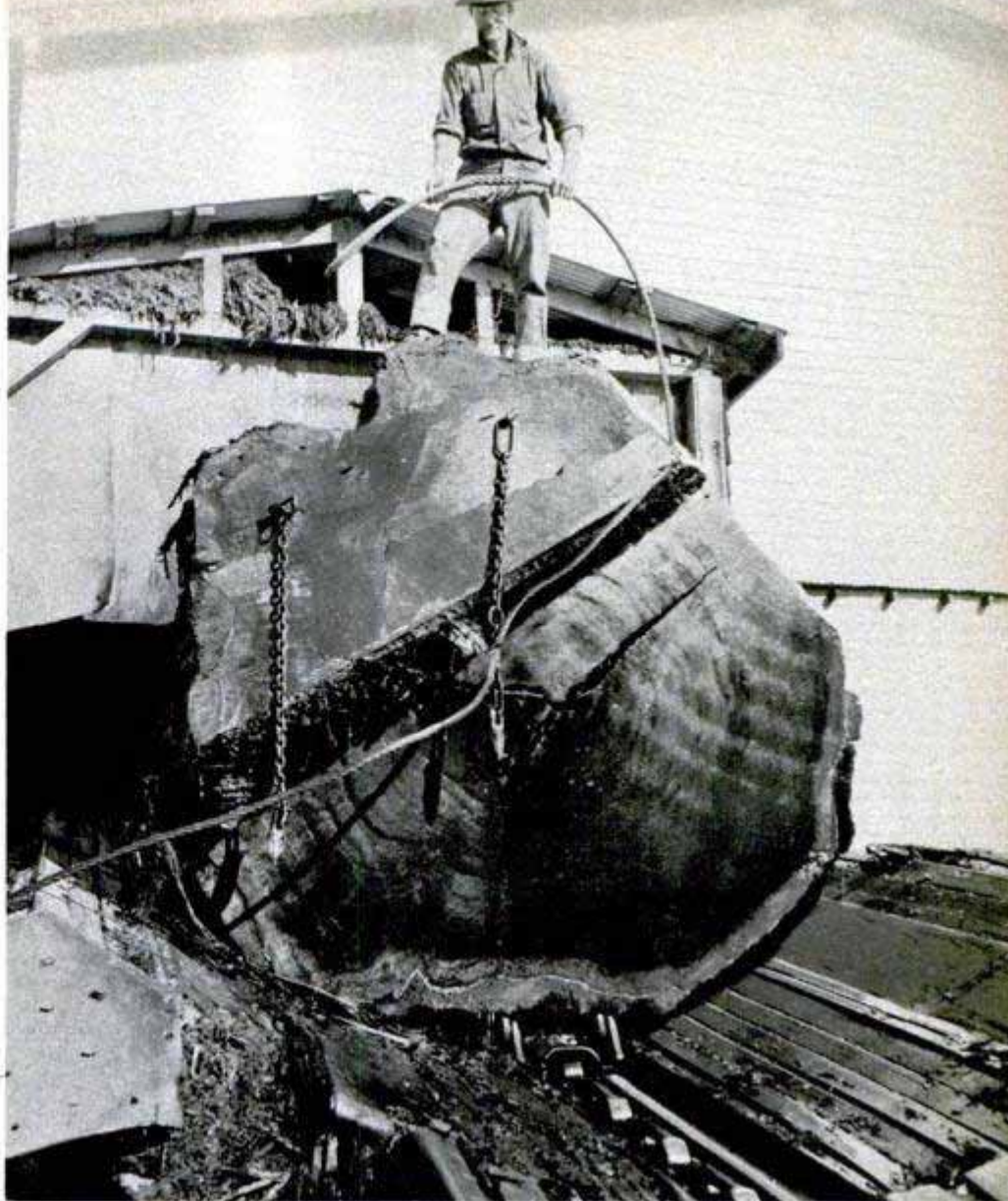

At the mill a giant log rides up a conveyor to a platform where the bark will be skinned off. Below, 3000 years from now this one-year-old seedling may still be alive. Under good conditions it will grow at a rate of two feet per year for a period of more than 70 years



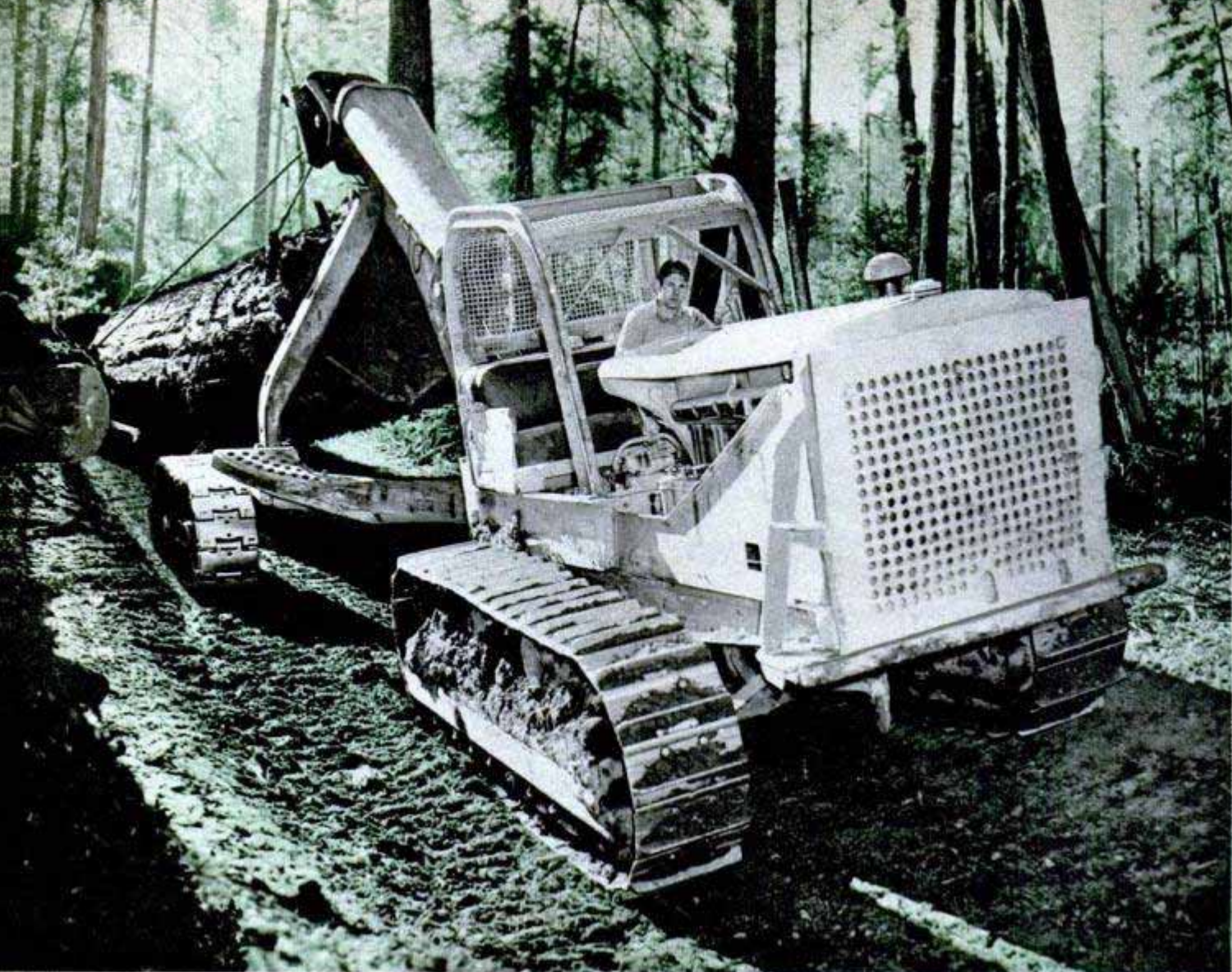

Hoist attachment for a tractor moves on its own tracks to pull redwood logs through the forest. Below, a two-year-old stands beside a redwood more than 2000 years old. Tunnel has not damaged trunk



are to be planted in California to determine whether the tree will grow there.

Much of what is known about the domestic redwoods has been learned from several experimental forest areas maintained by public and private agencies. For instance, at Whitaker Forest, adjacent to Sequoia National Park, Dr. Woodbridge Metcalf and members of the agricultural college of the University of California have made extensive studies of *Sequoia gigantea*. Whitaker Forest consists of 320 acres of densely timbered land that were deeded to the university in 1910 and have been used as a laboratory ever since. Many misconceptions about the big trees have been cleared up by the studies.

One of the reasons why the redwoods were thought to be dying out was that few, if any, seedlings and small trees were found growing under natural conditions. It is known now that *Sequoia gigantea* is virtually unsuccessful in reseeding itself because the forest floor is so littered with debris that seeds can't get a start, and there is not enough sunlight close to the ground for a young *Sequoia* to grow. For such huge trees, the seeds are incongruously small. They resemble tiny bits of sawdust and are so light that an average of 90,000

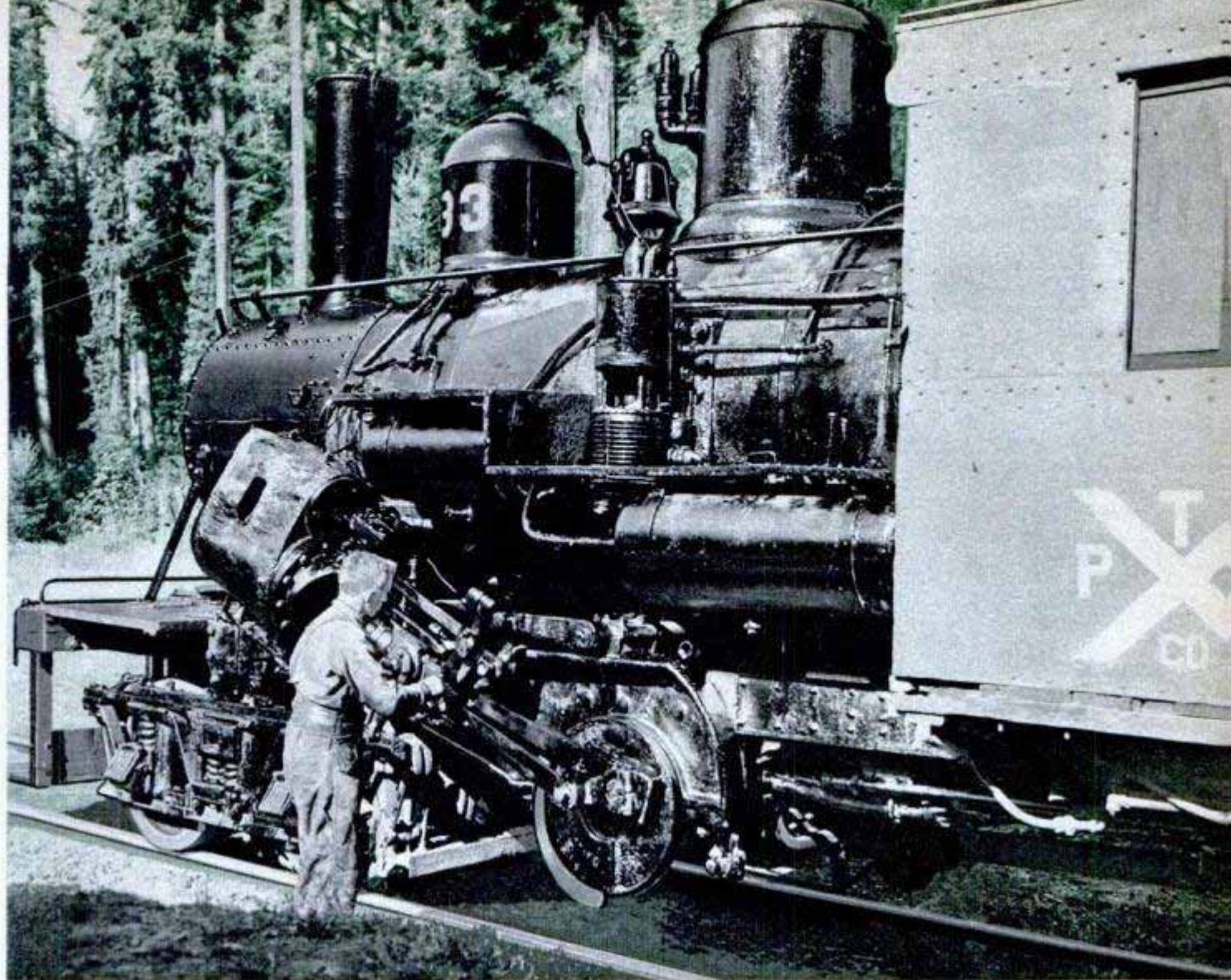

seeds are needed to make a pound.

At Whitaker Forest, however, and at other locations, it has been learned that when the seeds are deposited in a moist and slightly mineral soil and have plenty of room and some sunshine they grow faster and more thickly than almost any other tree. Young *Sequoias* under good conditions average a growth of two feet per year for more than 70 years.

The modern idea, demonstrated at Whitaker Forest among other places, is that selective logging of mature trees is a requisite of maintaining a perpetual forest, as this provides more light and also exposes more soil. Likewise, much of the new growth must be weeded out from time to time to make room for the rest. Fire prevention is important while the trees are young but after 40 years the thickness and relative fire-resistance of *Sequoia* bark enables that tree to survive fires that kill most other species.

Sequoia gigantea has been

(Continued to page 262)

Old-time standard-gauge locomotive still hauls big redwood logs down from the forests. Below, a docksaw churns the water as it cuts a floating log to the desired lengths. Some logs are so heavy they must be anchored to lighter logs or they sink



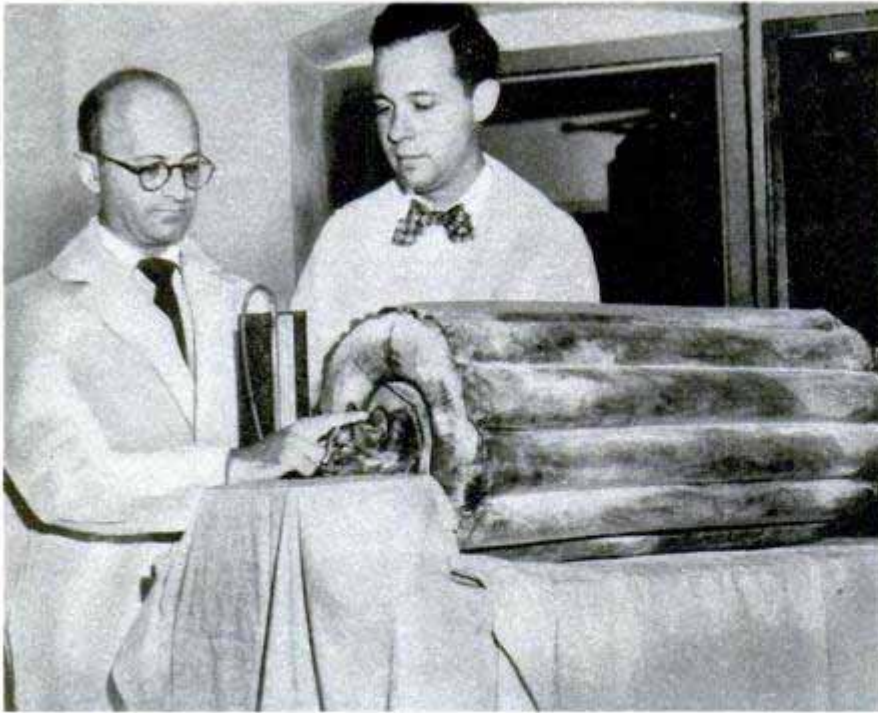

Collapsible "Lung" Has Cloth Walls

Two sheets of rubberized cloth with compressed air between them form the shell of a respirator developed at Yale University for possible low-cost mass production. The cloth "lung" is collapsible and a 32-inch-long model that tested satisfactorily weighs under two pounds. A plywood disk fitted with a sponge-rubber neckpiece seals one end of the inner cylinder and contains tubes to measure pressure and to permit evacuating air from the chamber.

Snap Nut for Sheet-Metal Screws Expands to Lock Pieces Together

Sheet-metal parts are fastened together tightly and quickly with the aid of a snap nut that fits Nos. 8 and 10 metal screws. The nuts are designed for mass production of sheet-metal assemblies, and can be anchored without access to the rear surface. The nut snaps into a $\frac{3}{32}$ -inch-square hole in panels .037 to .055-inch thick. After it is inserted, prongs snap out to hold it in place while the screw is tightened. As the screw is driven, the spring arms expand to lock the two sheet-metal parts together.

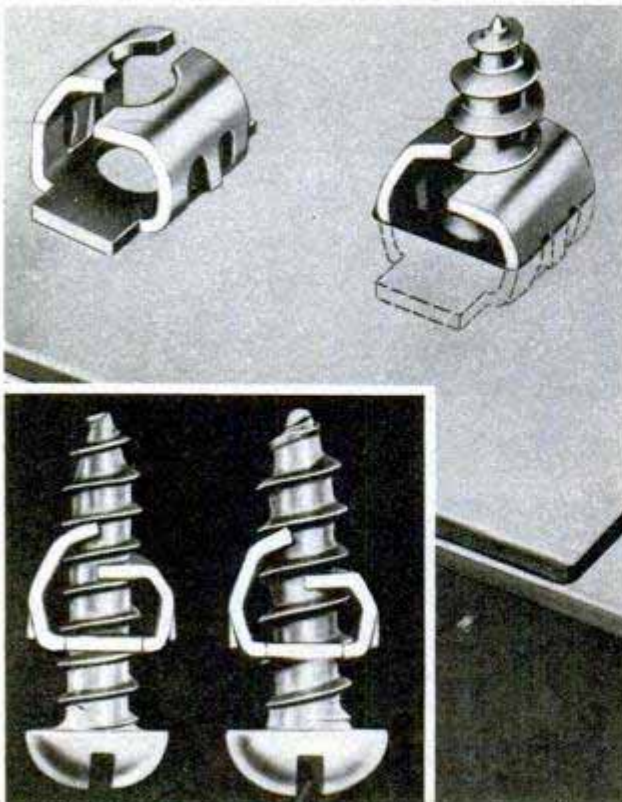

Shotgun Fires .22 Scatter Shells

Sportsmen can fire .22-caliber ammunition from a shotgun with an accessory that fits into the breech. The small attachment reduces the gauge of 12, 16 or 20-gauge shotguns, adapting them for short-range trapshooting. It gives a pattern of approximately 100 shot in a 15-inch circle at 30 feet with sufficient penetration to shatter small clay targets. Adaptable for use in single-barrel, double-barrel, over-and-under or pump gun, the accessory gives the sportsman four practice shots for the price of one shotgun shell.





Car Sheds Engine and Rear Axle

Designed for quick city delivery of light loads, a three-wheel car called the Thrif-T can change engines with ease. The entire power plant, a two-cylinder air-cooled engine located in the rear, is removed along with the rear axle and wheeled out from under the chassis frame for replacement of the unit or for major repairs. The compact engine is mounted in a cradle beneath a deck in the rear and is removed by disconnecting the rear springs and the front end of the cradle and accessories. This car carries a 500-pound pay load and has a top speed of about 40 miles per hour. It weighs only 900 pounds, has an 85-inch wheelbase and an over-all length of 126 inches. The Thrif-T is available in several models including a covered type with extra head-room suitable for florists or cleaners.

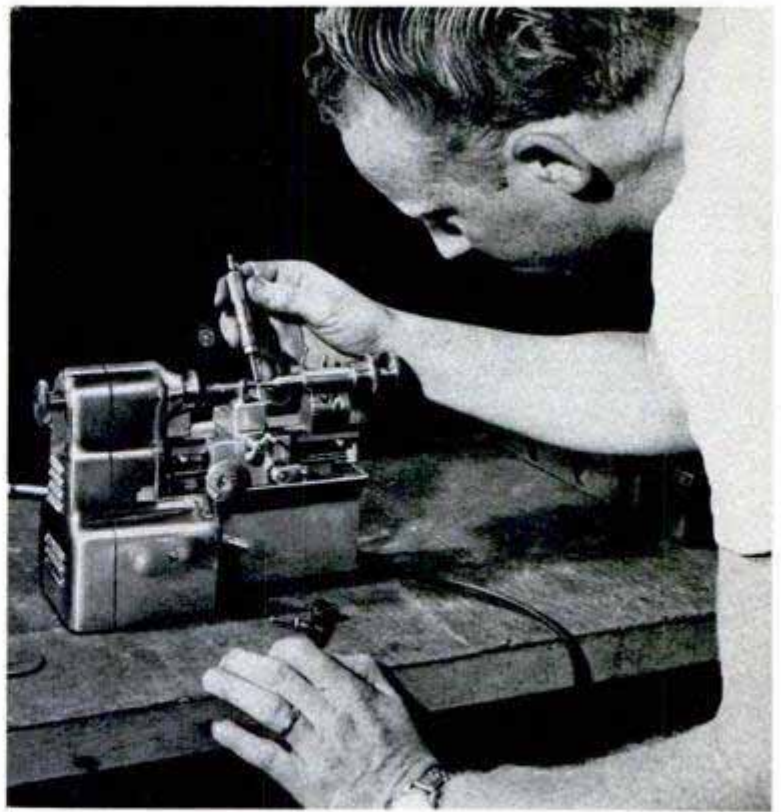

Miniature Metal-Turning Lathe Has Motor Mounted in Base

Extremely compact, a new metal-turning lathe for craftsmen and hobbyists combines standard lathe facilities with the highly specialized features of a jeweler's lathe. Only 10½ inches long, 7¼ inches high and less than 4 inches deep, the lathe includes a self-contained motor mounted in the base. It has a speed range of 100 to 3000 revolutions per minute.

Electronic Tube Permits Magnetism to Pose for Photographs

Magnetism can be photographed with the aid of an electronic tube which resembles a large radio tube. An electrical charge produces a ball-shaped bluish glow from the tube. When the tube is held near a

magnet, the glow follows the lines of force, producing a three-dimensional image of the magnetic field. These glow lines then can be photographed. The tube was developed at New York University.

Below, left, tube produces bluish glow. Right, photo shows how glow paths follow lines of magnetic force

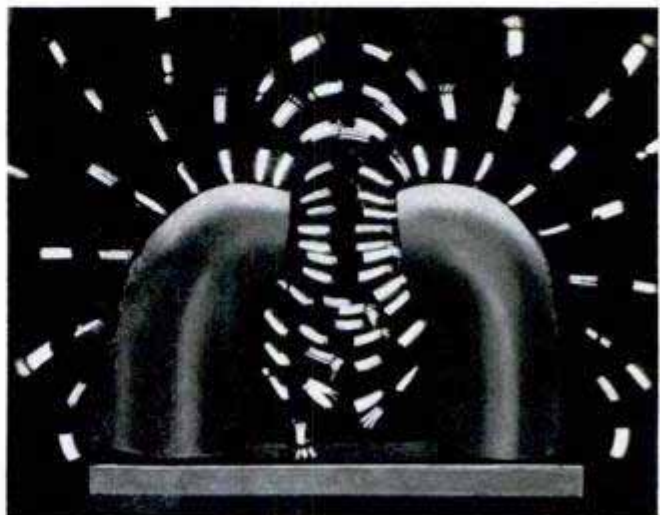



Pal, veteran parade horse, enjoys the fuss of getting ready for the big night. Below, groom lathers body after soaking mane. Left, squeegee is used after final rinse



BEAUTY SHOP in a BUCKET

Photos by
Richard W. Emery

After rinsing and bleaching, the mane is braided tightly while it is still damp. This "sets" the hair and when it is dry the mane is brushed out (below, right). This results in a beautiful fluff. The process is duplicated with the tail

WHEN CHIEF OF POLICE Al Slaight of Long Beach, Calif., and his famed mounted patrol appear on parade there are loud cheers from the onlookers. Behind the spick-and-span appearance of both horses and riders are hours of preparation.

Horses—even parade horses—like to roll in deep dust and sink their hoofs in mud when they are turned loose. Their manes and tails are magnets for burs, and stray whiskers have a way of growing in the wrong places.

The beauty shop for these sleek parade animals is a soapsuds bucket. On parade days Chief Slaight's horse, Pal, (pictured on these pages) is first corralled and then led to a sunny outdoor stall. A groom approaches with a bucket of suds. Pal, being a veteran, appears to wel-

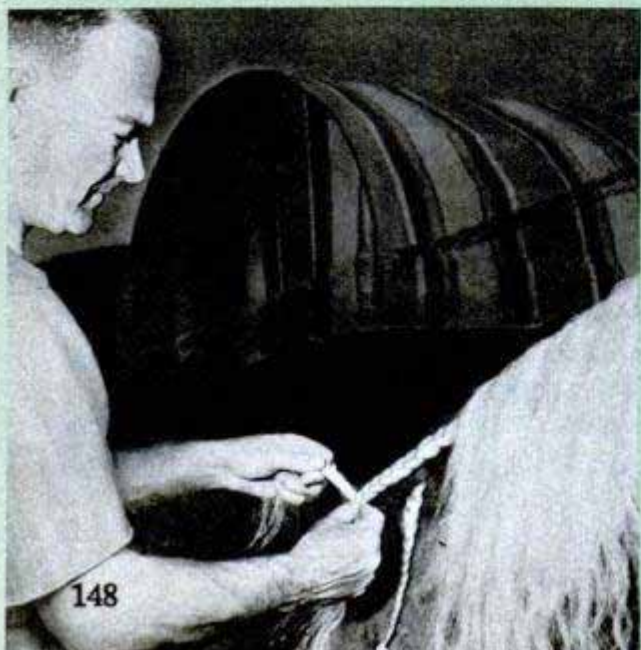

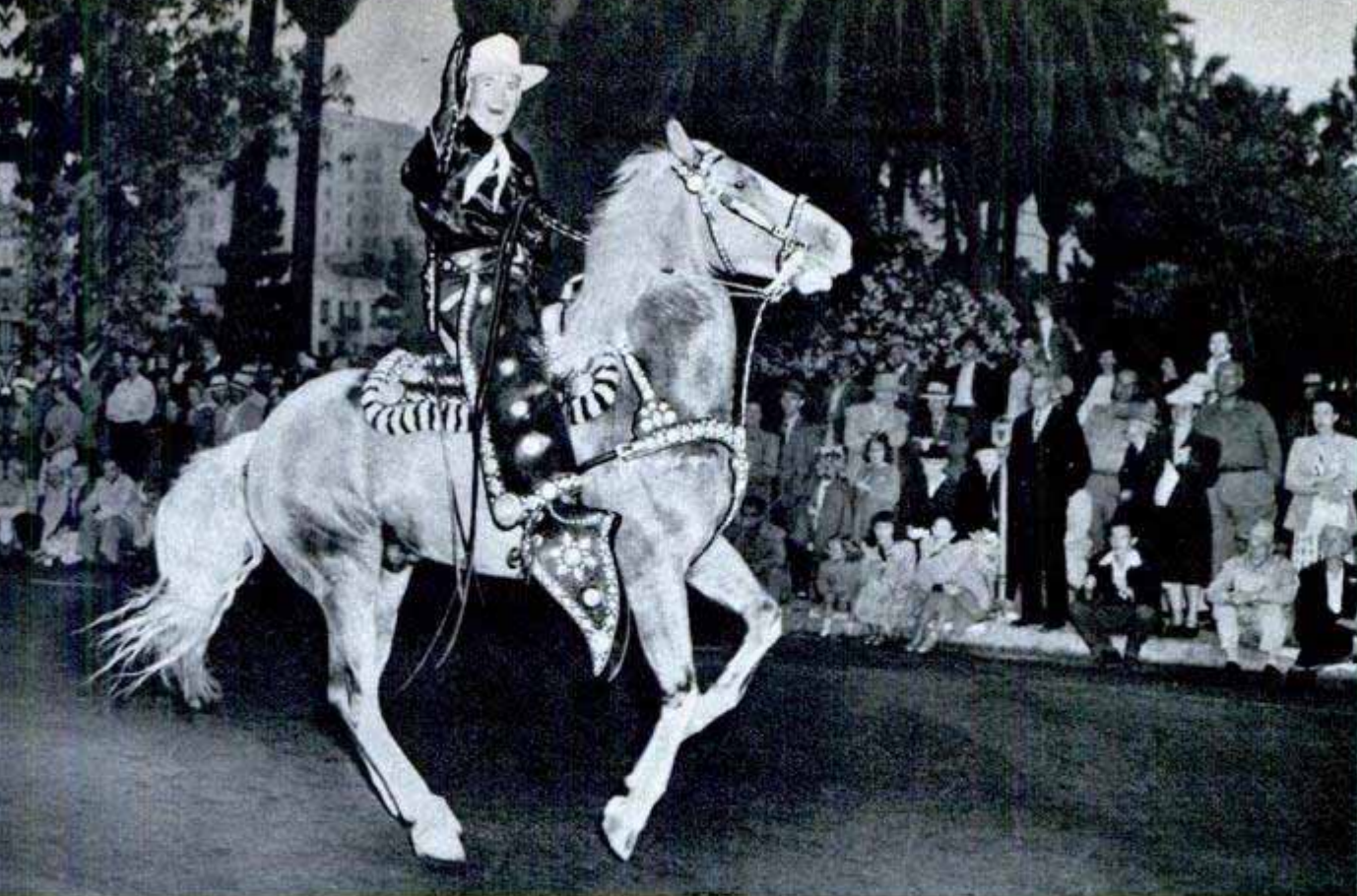

Pal looks as proud as his rider when Chief of Police Al Slaight of Long Beach heads the parade

come the cleaning operation. If he is really dirty with dust caked into his coat, the job calls for curry comb and brush before soapsuds.

Pal gets his mane and tail soaked with suds. The lather soaks in while the groom bathes the rest of the horse. After the mane and tail are scrubbed and rinsed, a bleach solution is used to remove any stains. For horses like Pal, with a blond mane, a bluing solution is used in the rinse.

After a final all-over rinse, Pal is squeegeed with a metal or wooden scraper. Then from nose to tail the horse gets a thorough rubdown with heavy towels. The mane and tail are braided tightly while the hair is damp. This results in a "set" which is brushed out to form a fine fluff. Clippers and scissors are used to trim around the hoofs and to cut away any stray whiskers. Hoofs must be scrubbed with a brush and given a coat of polish. The shoes of a parade horse must be in perfect condition to prevent slipping on hard-surfaced pavement.

Saddle, bridle and decorations must be cleaned and polished. This tedious job is done usually after the horse has been blanketed down and put in a stall with 18 inches of straw under him.

"A parade horse loves a parade," says Chief Slaight. "Pal really goes for that applause. He's a ham actor all the way through."



Pal holds still while his tail is scrubbed before bleaching. Below, polishing silver decorations and cleaning leather are also part of the job of making parade horse like Slaight's Pal look his best





Machine Squeezes Moss Into 40-Pound Bales

Bill Crane has devised a baling machine for moss he collects on islands off the coast of British Columbia and ships to nursery-men in Los Angeles. The moss is put in a

long box with plungers at either end forcing it into compact 40-pound bales, which are tied with wire. The moss is used to line hanging baskets and window boxes.



"Pistol" Fires Stroboscopic Light To Test Ignition Timing

Auto mechanics can make timing tests in broad daylight with a stroboscopic light similar to that used in high-speed photography. The light, made in the shape of a pistol, throws a blue-white beam more than 10 feet to "stop" the motion of the part being tested by lighting it once every revolution. It can be used at all engine speeds to synchronize and test ignition timing as well as to study the action of the governor and to determine whether there is excessive play in the distributor shaft.

Fish at 16,000-Foot Depth Caught by Research Anglers

Fish that live more than 16,000 feet beneath the surface of the ocean recently were caught during a cruise of the Swedish motorboat, Albatross, which made a research voyage around the world. A fish called the bathypterois was caught at that depth. A trawl made at a depth of 26,000 feet brought up no fish, but produced evidence of other life.

☐ When you shuffle a pack of cards and deal a single bridge hand, you have only one chance in 635,013,-559,600 of getting the perfect hand of 13 spades.

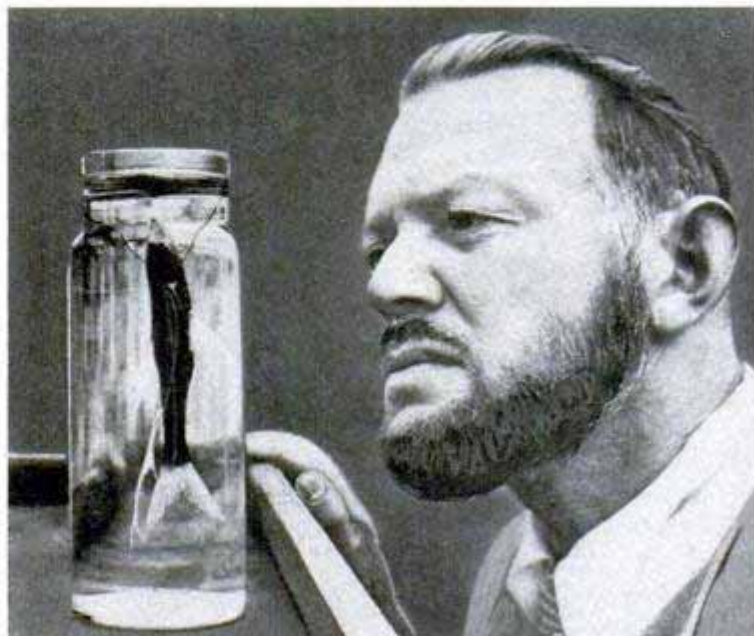

Static From Hair Combing Fires Photoflash Bulbs

Electricity that crackles when a girl combs her hair is powerful enough to fire photoflash bulbs. A General Electric photographer has attached a metallic collector rod to an ordinary comb, and then connected the rod to the electrodes of the high-speed bulbs. Each stroke of the comb through a girl's hair supplied 8000 volts of power, enough to flash the lamps and take the girl's picture. Engineers have determined that the crackle of a comb running through the hair represents 8000 to 10,000 volts of potential electricity. Static electricity that is generated when a person scuffs his feet across a rug will generate as much as 18,000 volts, according to the General Electric engineers.



Synthetic Mica Produced on Pilot-Plant Scale

Man-made mica with all the characteristics of natural mica is being produced on a pilot-plant scale in this country. Great quantities of mica are required for use in many types of electrical equipment, radio and radar. In the past, the principal supply has come from India and Brazil. Research

toward a synthetic mica was started by the Army and Navy during the war. The man-made substance has all the desirable characteristics of natural mica. The manufacture of synthetic mica may relieve the U. S. from dependence on foreign supplies—especially in times of crisis.

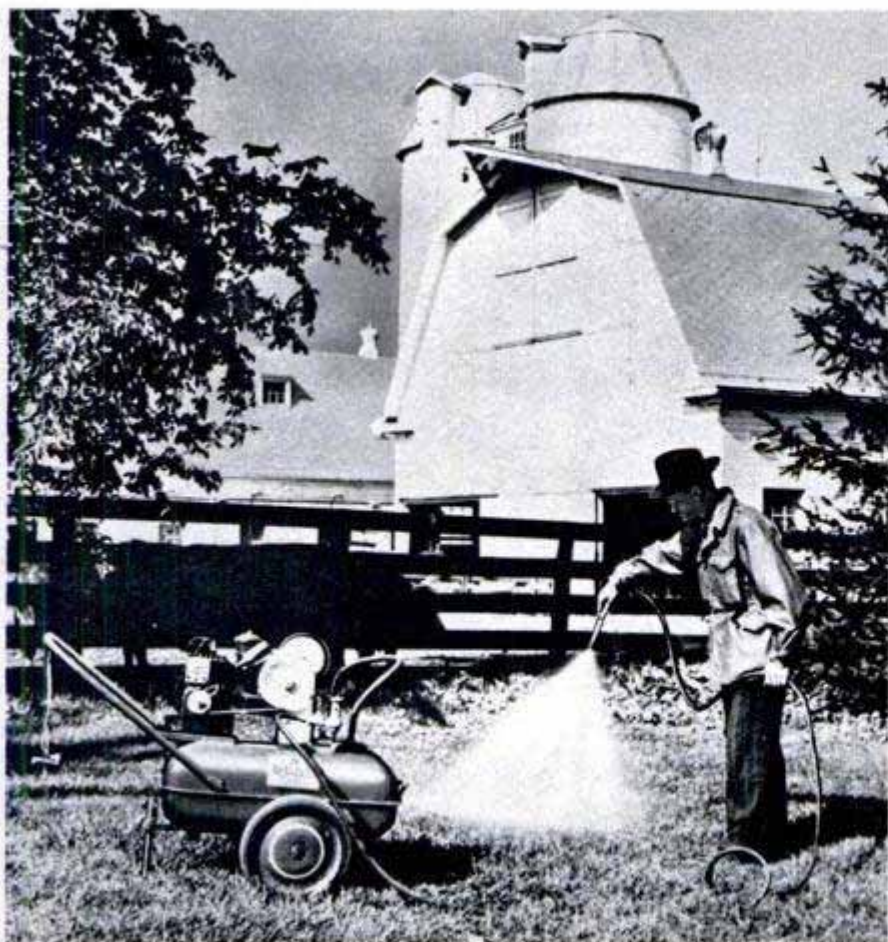

Lightweight Sprayer Has Variety of Uses

Everything from bugs to fires can be controlled by a portable sprayer that weighs only 118 pounds and is mounted on rubber tires. Powered by an electric motor or gasoline engine, the sprayer has a control valve that changes it from high to low pressure. As a high-pressure sprayer it can be used on tall trees and shrubbery. For spraying weed killer on lawns, low pressure is used. Pressure can be varied from 10 to 200 pounds. The tank holds 15 gallons.

Prehistoric Eskimos lived in houses using the ribs and jawbones of whales as timbers, excavations on Baffin Island have revealed.



Backstage Miracle Makers

Building battleships, palaces or the Gardens of Versailles is all in the day's work for scenery men at the St. Louis Municipal Opera Company's huge outdoor theater. Below is a replica of USS Nevada used in "Hit the Deck." Guns at left are inserted from rear

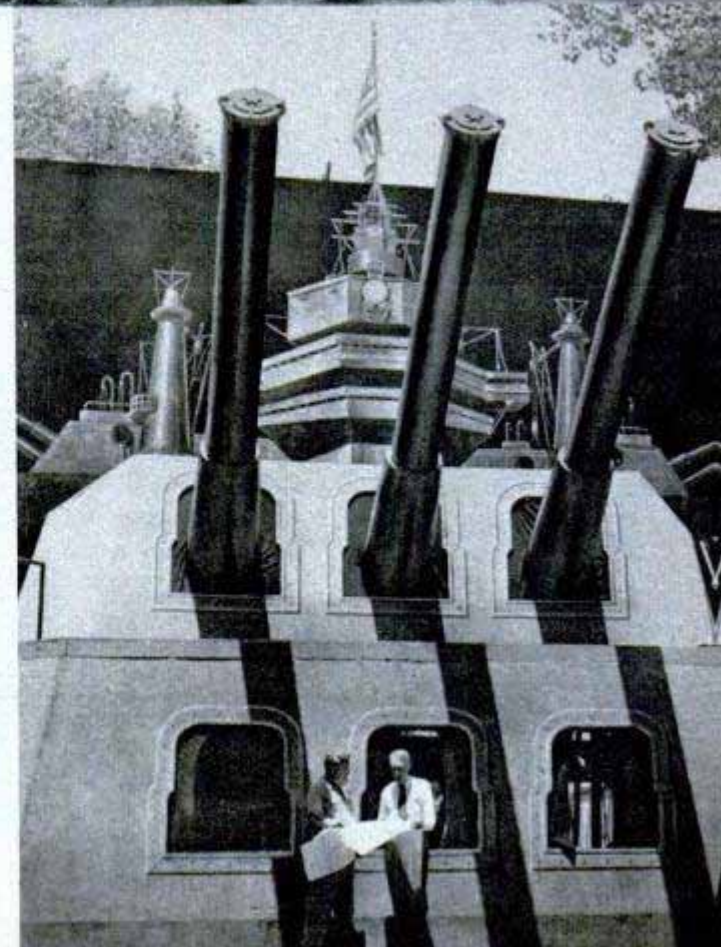
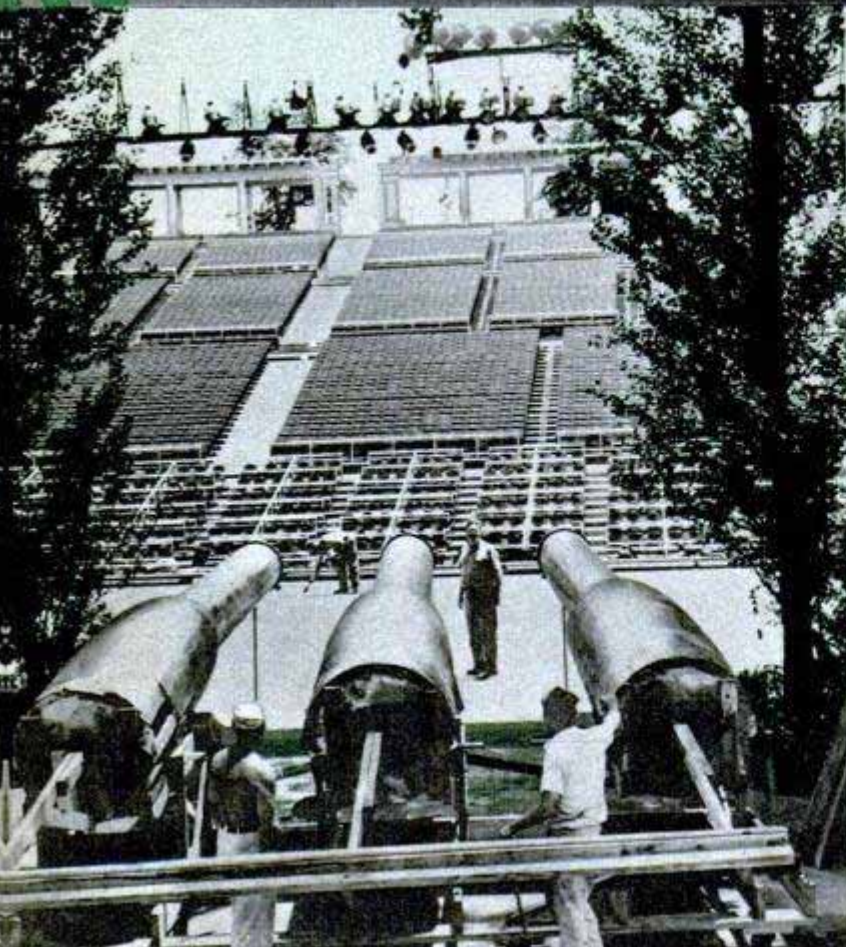



Long before show time a crowd of 12,000 gathers in St. Louis outdoor theater. Huge sets are at the right

By Wayne Whittaker

A PPLAUSE like the roar of seven seas from 12,000 persons in the big outdoor theater rises toward the night sky. It is the end of Scene One. The giant stage is blacked out and a curtain of light turned on the audience makes phantoms of the scene shifters. There is no other curtain in this theater with its auditorium built into a hillside and the stage framed by two great oaks. White pillars atop the hill give the place the grandeur of ancient Greece or Rome—but this million-dollar outdoor municipal theater happens to be the glory of modern St. Louis, Mo.

In the dim regions backstage, organized confusion reigns. Huge pieces of scenery that form a full-size water-front restaurant come apart and disappear into the shadows. Scores of performers scurry through the moving sets.

"Hey, grip!" barks a foreman at a stage-hand. "Give a hand with this battleship."

Out of darkness loom the bow and tur-

rets of the USS Nevada with its big guns protruding. The battleship unit is centered on stage and three more guns on a separate mount are pushed through the lower gun windows and raised menacingly. The stage flooring serves as the forward deck. Sailors swarm up the ship's ladders onto the sturdy upper deck and take their stations. The lights go on and the audience is looking down on the deck of one of the most realistic ships this side of the U. S. Navy.

The audience applauds politely at a setting which would bring down the house in New York, Chicago or Los Angeles. The reason is that St. Louis audiences are accustomed to stage settings on a scale found nowhere else in the world outside of the movie studios. The municipal theatergoers have seen the gardens and fountains of the Palace of Versailles, the exterior of a medieval inn with a frontage of 125 feet, a portable arched bridge that could hold 30 men, a full-size orchard of apple trees

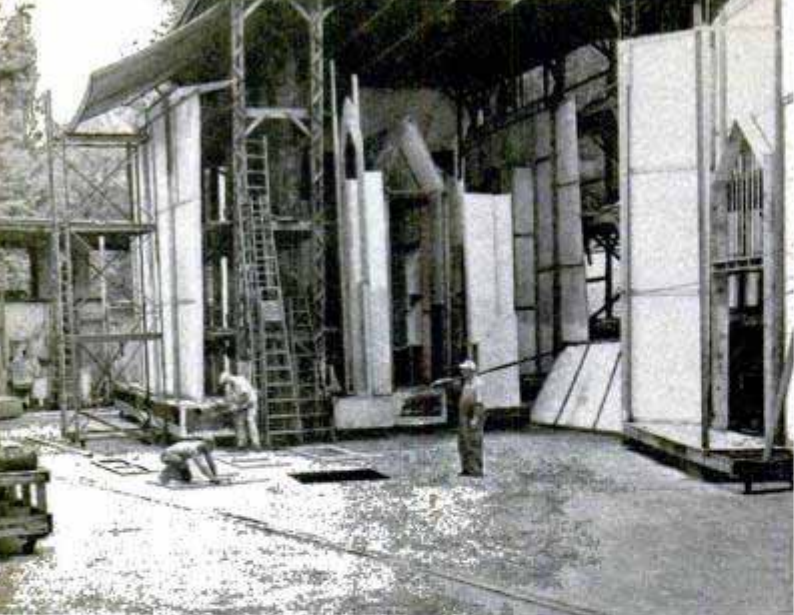

Except at show time building activity hums backstage where the sets are made. Night crews use spotlights

in bloom, a genuine outdoor fireworks display in a garden scene, castles and grand staircases galore, a four-story "living" tapestry in a French chateau, and scores of other breath-taking settings.

These backstage miracles are produced by a hard-working crew that operates around the clock. Most of the operettas play for only seven nights, which means that every week an entire setting of new scenery must be built. John Kennedy, productions manager, and Watson Barratt, art director, ignore what any script calls for in the way of settings. If, as in *Auld Lang Syne*, the script specifies a Scottish landscape, Barratt will toss in an arched bridge that can hold half the cast. If, as in the *Desert Song*, the script designates the set-

ting as a Persian garden, Barratt includes not one but three fountains in staggered formation extending downhill from a pergola. All the fountains are electrically operated. The pools about the fountains are watertight galvanized tubs with recirculating pumps attached. The beauty of the fountains is enhanced during the shows with colored lighting effects. The remotely controlled lights, big floodlamps, are installed in an arch which extends high above the front of the stage. Sound-amplification horns, also placed here, are connected with the row of microphones across the forward part of the stage. Lights and horns are serviced from a catwalk.

The stage proper is 125 feet wide and extends back to a maximum depth of 160 feet. A turntable at the front is 47 feet in diameter and makes a revolution in 90 seconds. The full stage depth includes a 70-foot ramp leading back to an old administration building, rehearsal stage and scenery storehouse. Under the ramp and below this rear backstage section flows the River des Peres. Years ago this stream occasionally overflowed into the actors' dressing tents. After a major engineering operation the river now makes an underground detour and today performers are safe far above it in a modern brick building with comfortable dressing rooms. The theater plant also includes three rehearsal stages, the newest being the same size as the stage proper.

The region backstage where the big sets are built, stored, torn apart and rebuilt is as interesting as anything presented to the

Giant stage is 125 feet wide and 50 feet deep to rear of turntable. The workman is painting scenery marker

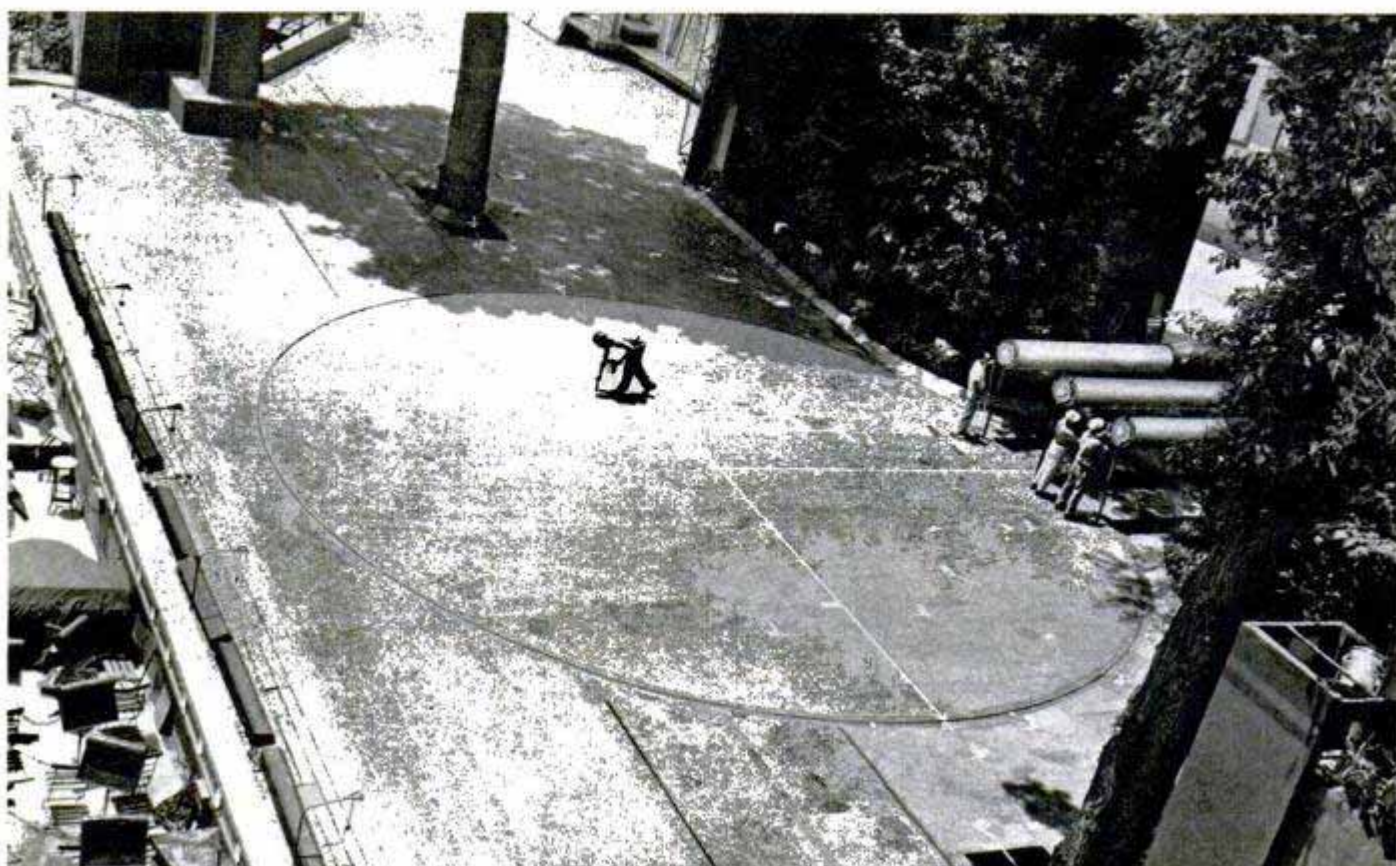

audience. A stroll through this beehive at any time of the day or night—except during show time when construction ceases—is done to the hum of power tools. The entire place is an outdoor workshop because the scenery is too huge to be made inside. Many sets are 30 feet high and 40 or 50 feet long. Fifty-five men work here in three shifts, in good weather and bad and under sunshine and floodlights. They include building crews, electricians, painters, property men and scene shifters.

The general backstage scene is like that of a Hollywood studio. Here is the front of an ancient inn with heavy wooden stairs leading up to a balcony. Over there is the setting for a saloon in Havana. The deck of a luxurious yacht with realistic portholes. The tower of a castle. A colonial facade—Greek temple or southern mansion?

Along the "paint bridge"—a three-story steel skeleton structure—painters are busy on various levels creating new pieces of scenery. Some are at work on the front of a "stone" inn and others on a series of 18-foot "statues." These statues are what the workmen call transparencies,

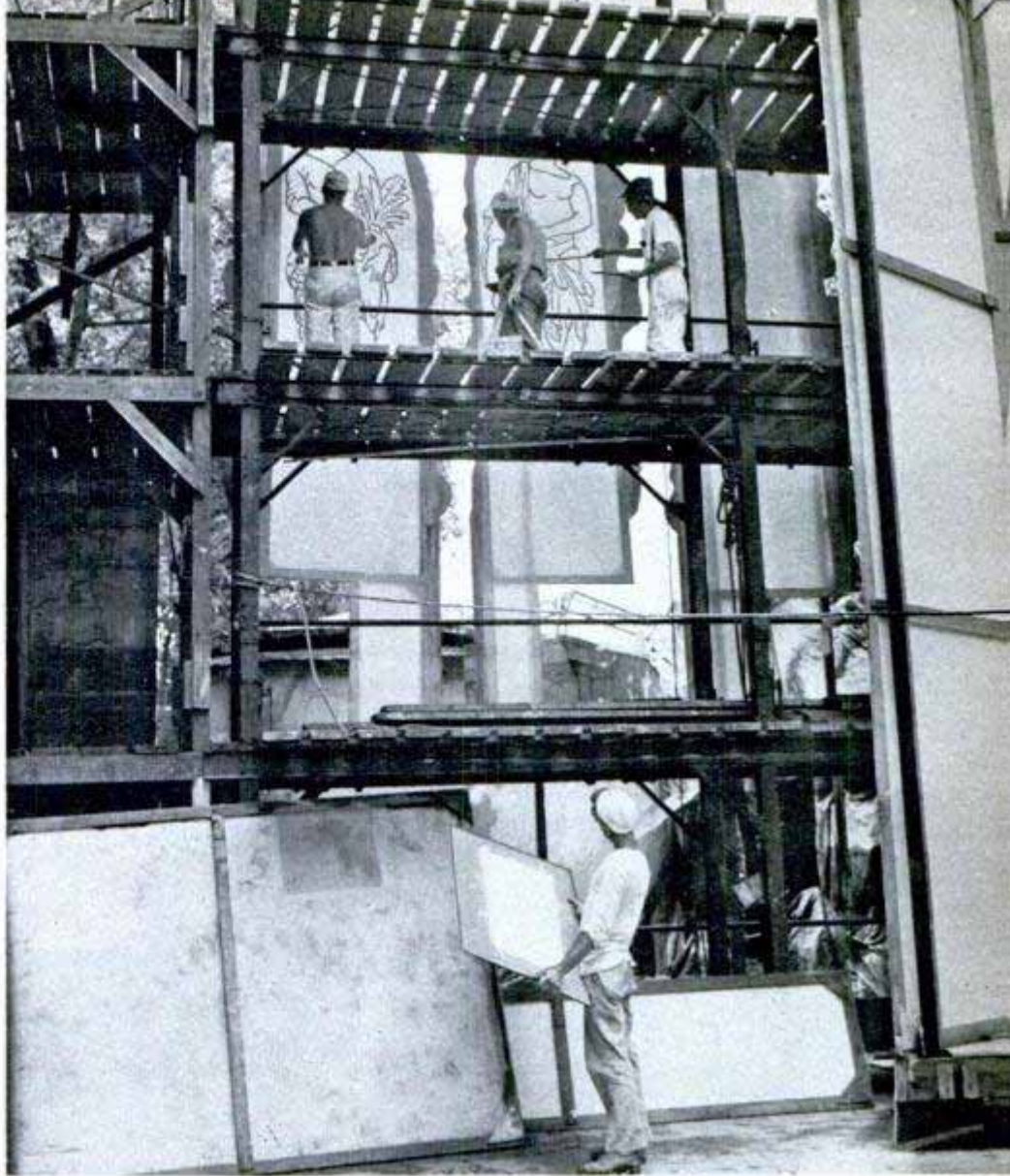

Photos by John Drew Atkin

The stage scenery is so big artists have to work on a three-story paint bridge. Here they are making transparencies (above and below at right) which will be lighted from behind. Below, left, Sydna Scott, the actress, inspects lightning rods on one of theater's twin oaks

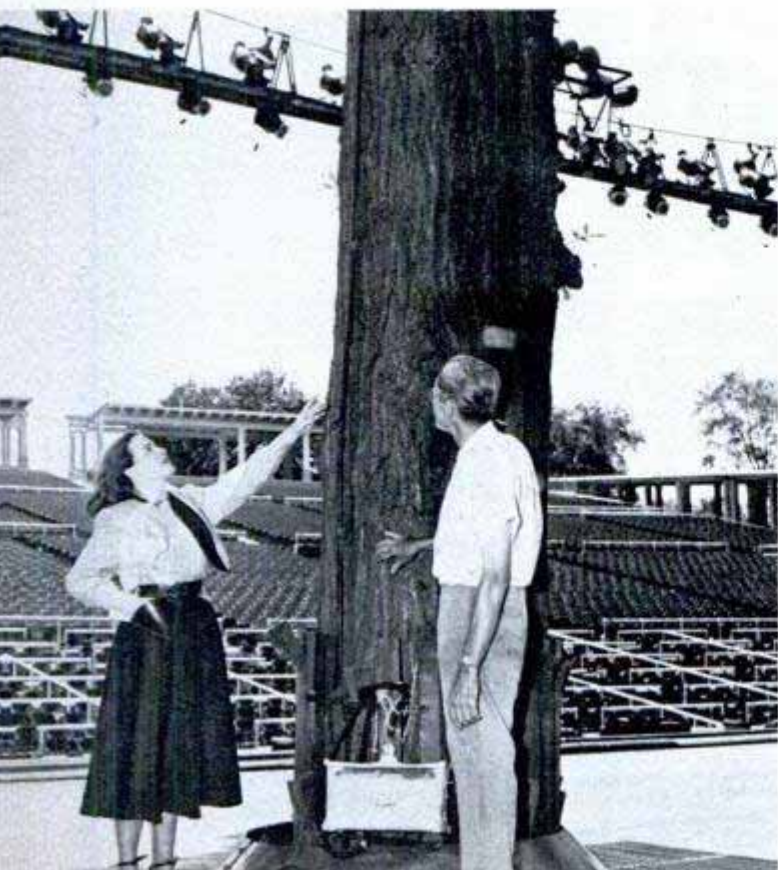



John Kennedy, New York producer, rehearses actress on unfinished set. Right, Louis Anweiler, electrician, studies his script while an assistant director at window gives cues at the rehearsal. Below, stage lights and amplifiers form big arch

used frequently and with good effect at the Municipal Opera. They are painted in such a way that illumination from the rear makes them stand out like real statues on the stage in garden scenes. The same system is used for chandeliers or windows covered with Venetian blinds.

When the plan for an outstanding piece of stage scenery, such as the battleship replica for *Hit the Deck*, leaves the worktable of Barratt it goes directly to John Steinigger, master mechanic. First, trucks are assembled to support the set. The low trucks roll on casters and are weighted by heavy railroad rails. Part of the battleship (turret and side guns) is painted on muslin stretched on a wood framework. Part is constructed of strong 2 by 4s and 2 by 8s. The big guns call for 2 by 4 centers surrounded by 1/4-inch strips wrapped in canvas and covered with oil paint to give them a metallic luster.

During the 12-week season, the construction crews use 36,000 feet of 1 by 12-inch boards, 60,000 feet of 1 by 3-inch battens, 26,400 feet of 2 by 4s and the same amount

(Continued to page 260)

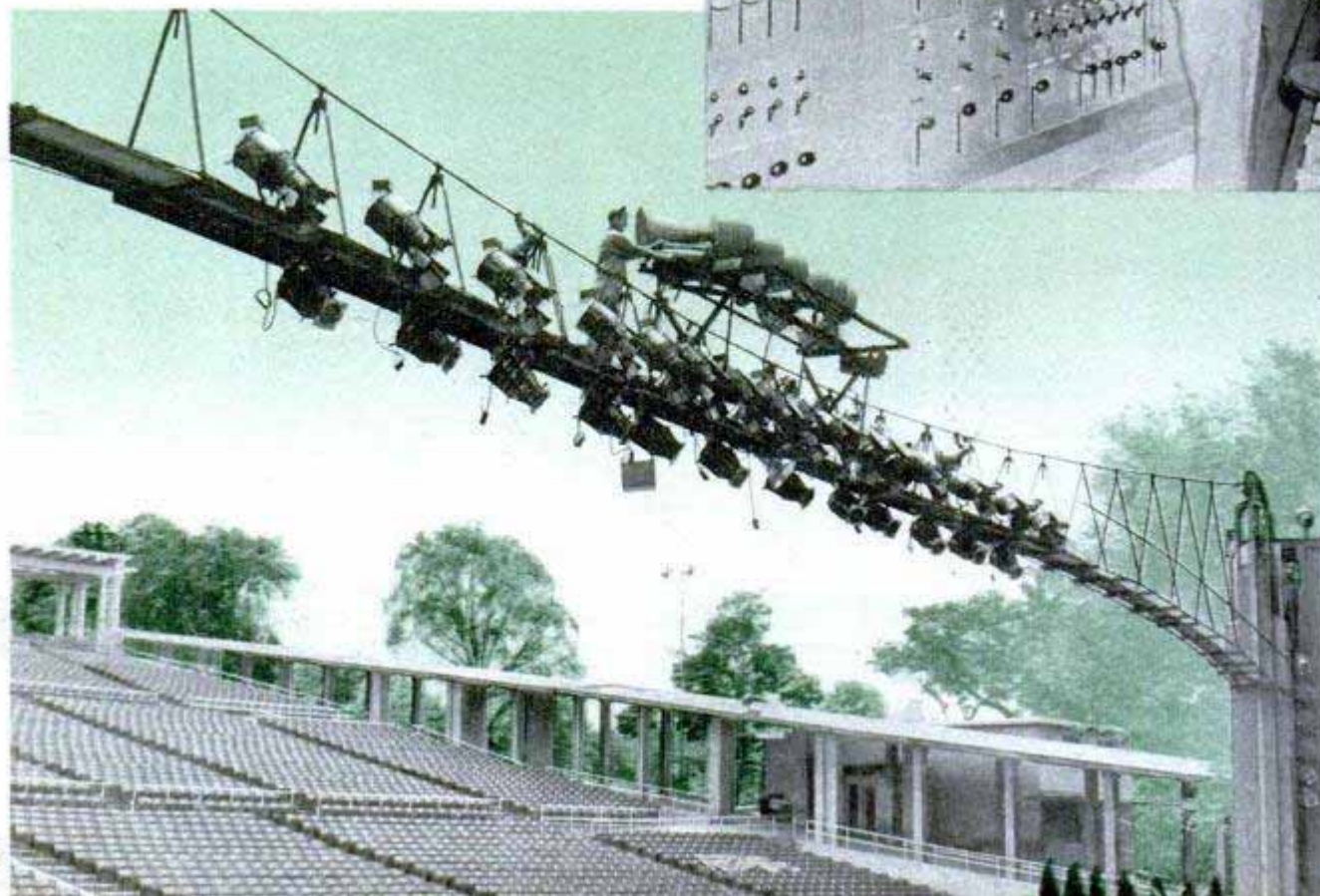
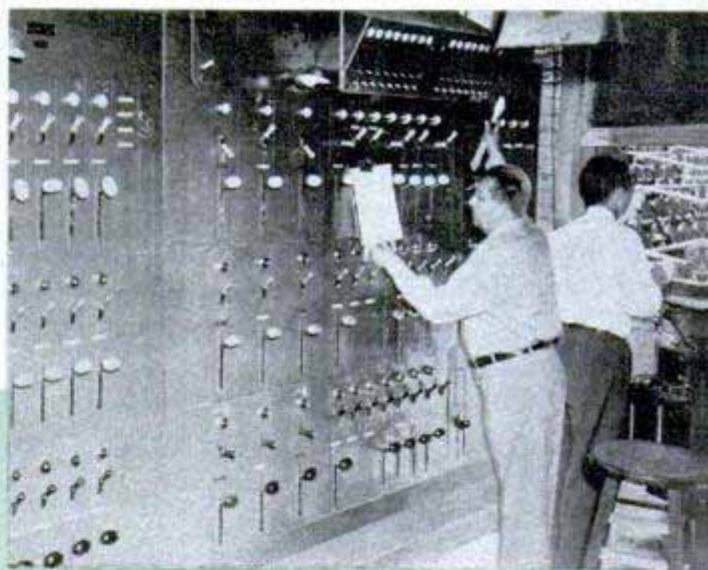

Ranch Patrol Craft For Snow or Water

Built to meet the changing weather conditions of Montana, a streamlined sled can be quickly converted for use on ice, snow or water. The craft was designed by Jack Coultas of Conner, Mont., to be used as a ski patrol craft on his ranch. Its versatility quickly became apparent and detachable ice runners and water floats were added. Mounted on skis for snow, the craft travels 45 miles an hour. On runners over clear ice it will make 90 miles an hour. As a water craft it draws only a few inches of water. The craft is made of spruce and aluminum framing covered with fabric. It is powered with a 35-horsepower light-plane engine and is steered by a rudder, using a modified stick control.

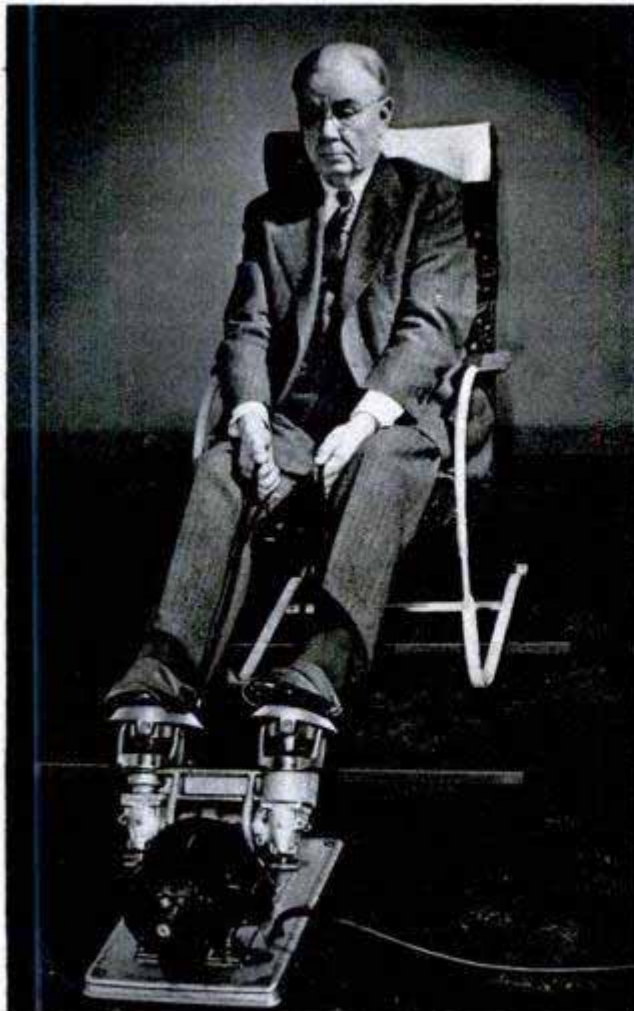
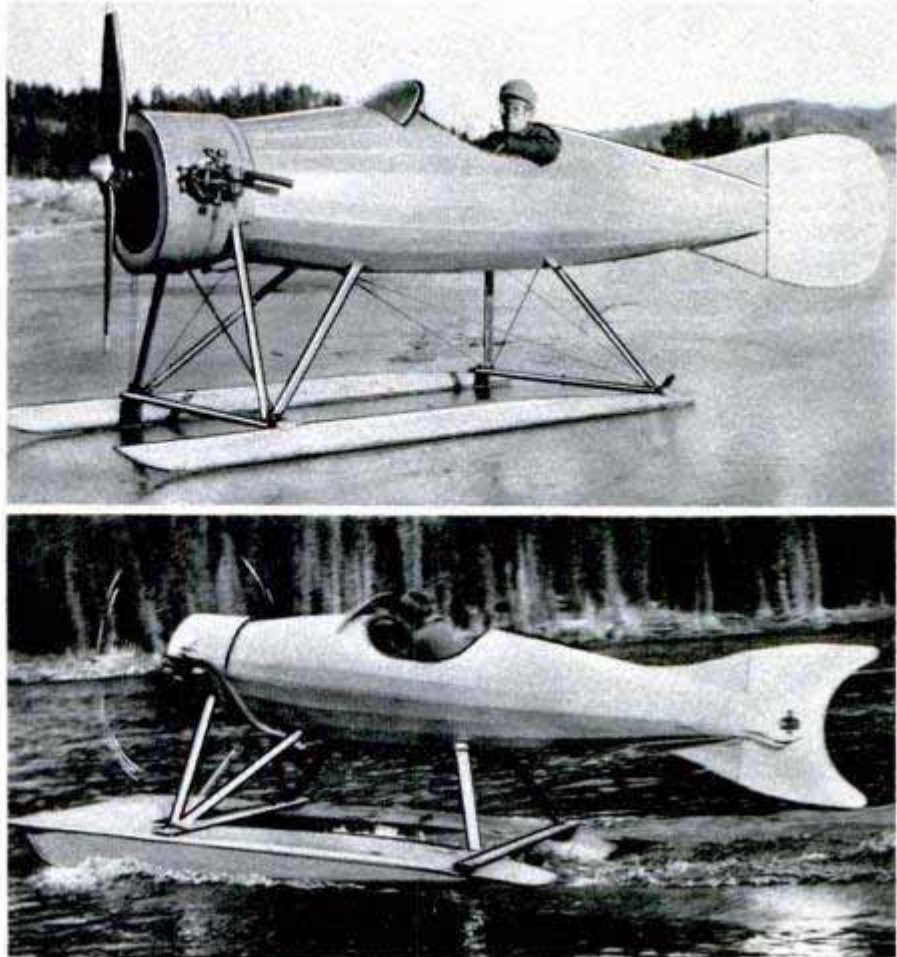

Sit-Down Exerciser

Many muscles of the body are exercised by a motor-driven exerciser that becomes more active as the pull on two hand straps is increased. The portable machine is powered by an electric motor. Two pedestals, attached by ball-and-socket joints to rotating spindles, have jackets for the feet. When the feet are placed in these jackets and the hand straps pulled, the machine exercises the feet and legs and the pull on the straps brings the arm and shoulder muscles into play.

Scientists Study "World's Best Fire"

How fast does fire burn? Westinghouse scientists hope to build the "world's best fire" while conducting research on the design of jet engines and gas turbines. Fire is being studied from four different approaches: How it burns under various conditions of pressure, temperature and fuel mixture; how air should be injected into the combustion chamber; how the chamber should be designed, and what kind of fuel nozzle will give the greatest efficiency. An oil atomizer developed in the research rips heavy fuel apart into microscopic droplets at the rate of 25 billion a second to increase the burning efficiency.



GOOSENECK LAMP can be used to shed either direct or indirect light. Flexible cable bends in any direction to focus the beam on the desired spot. Right, lamp slides into a bracket that is screwed to the wall. All parts, including shade, are made of brass

GLASS WEATHER STRIPPING, below, is punched into cracks around windows and doors with a knife. Made of fine glass fibers, the material keeps out water, heat, cold, dirt, soot and pests. It is impervious to moisture and won't rot. Cracks up to one inch in width can be plugged with the weather stripping

WHAT'S NEW *For Your Home*



↑ **BALL-BEARING GLIDER** for windows eliminates the need for sash balances. A strip of metal, punched at intervals, is installed in the side channels. Ball bearing mounted in the sash rolls up strip and can be seated in desired hole



↑ **PLASTIC COATING** for imitation leather, applied with a paintbrush, produces a gleaming surface that makes worn furniture look new again



↑ **GLOWING HOUSE NUMBER** has wires that attach to the terminals of the doorbell button, providing constant illumination. The cost of operating the numeral is less than two cents a month



FIBERGLAS CURTAINS need no ironing or stretching, can be washed by machine or hand, rehung while still damp

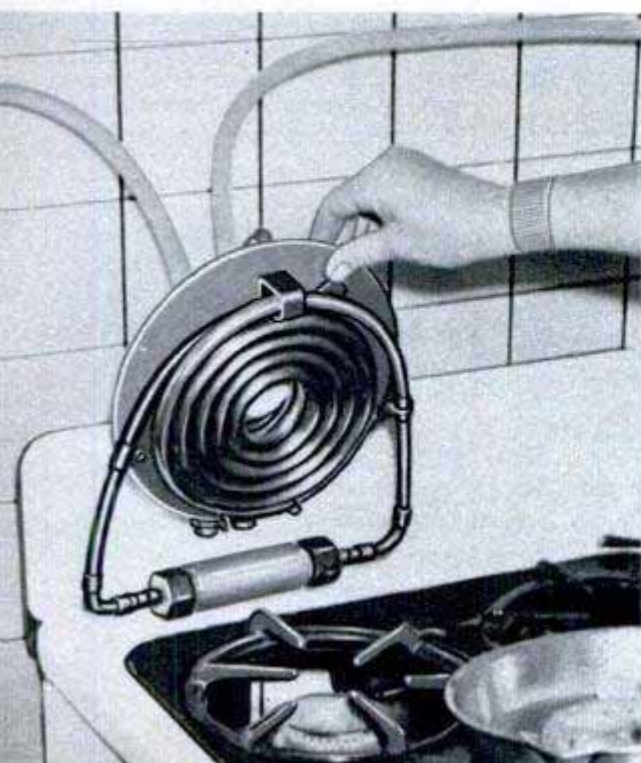

STOVE-TOP WATER COIL, below, heats water for bathing and dishwashing while meals are being cooked. Designed for boats, trailers and cabins, coil can be used on any stove burning gas, kerosene, gasoline or fuel oil. Below, left, coil swings back when burner is needed for cooking





Youths Build and Operate Mountain-Top Diesel Railroad

Boys and girls enrolled in the Pioneer Movement, a youth organization in Hungary, have built a railway and operate it with little help from adults. The railway is atop Mount Szechenyi, a wooded hill which overlooks Budapest and the Danube River.

Children who built and operate the project range in age from 12 to 14. The only adults on the line are the passengers and the engineers who drive the diesel engines. During the first week of operation 43,345 persons rode on the youth railroad.

Sensitive Ammeter Measures a Billionth of An Ampere

Electrical currents as minute as one billionth of an ampere are measured accurately by an ultrasensitive microammeter designed by the Radio Corporation of America. Battery operated, the portable meter will have wide application in the

fields of radioactivity, television and astronomy as well as other projects involving the measurement of faint electrical currents. A safety feature of the instrument makes it capable of withstanding overloads of 10,000 percent without damage.



Toy Rocket Plane Climbs 100 Feet

Fired from a rubber-band gun, a toy rocket plane of aluminum zooms 100 feet into the air and then floats slowly back to earth under its own parachute. The parachute, made of paper, is carried inside the fuselage. When the plane reaches the top of its flight, the hinged fuselage opens, releasing the parachute for the trip back to earth.

☐ Army C-rations, familiar to veterans, now come equipped with disposable plastic spoons that are sterilized and sealed in Cellophane wrappers.

High-Speed Patrol Plane

Two high-speed patrol planes designated the XP5Y-1, now under construction for the Navy, will be powered by four propeller-turbine engines. The engines develop at take-off more horsepower per pound of airplane than some modern fighter planes. The flying boats are designed for long-range day and night search of sea areas, for rescue operations and antisubmarine patrols. They have an especially high length-beam ratio which gives them excellent characteristics in the water. The first plane, under construction by Consolidated-Vultee, is expected to be flown early this year. The

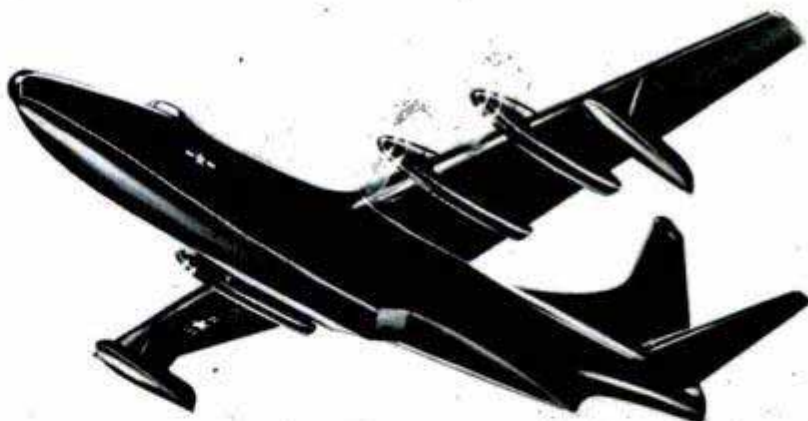

design was tested with a radio-controlled model, while a nonpowered catapult model was used to check landing characteristics.

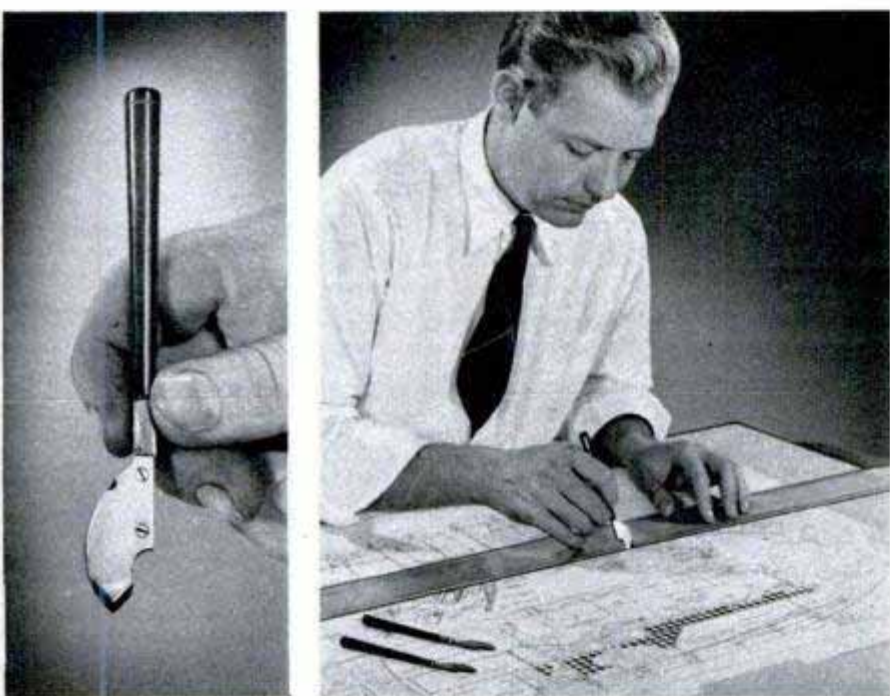

Nonblotting Drafting Pen Has Large Ink Capacity

Draftsmen can draw from five to eight times more lines between fillings with a drafting pen that has an extra-large ink capacity. The new pens come in three standard line widths. These precision-set line widths are .009 inch for center and dimension lines, .013 inch for section lines and .020 inch for outlines. Consisting of two parallel plates between which the ink is held by capillary attraction, the ink-filled pens can be laid on the work without blotting. The pens are easily cleaned by drawing a strip of paper between the plates.

Ailerons on Blade Tips Guide "Flying Easter Egg"

Ailerons on the rotor-blade tips control direction of a one-man helicopter built by Fred Landgraf of Los Angeles, Calif. Nicknamed the "flying Easter egg" because of its shape, the 850-pound craft has a retractable gear that can stand the shock of power-off emergency landings. An 85-horsepower engine turns its two overlapping, synchronized rotors at a top speed of 100 miles an hour.

Usefulness in business was the No. 1 reason given by 86 percent of the most active private pilots for flying, the results of a Civil Aeronautics Administration survey revealed.



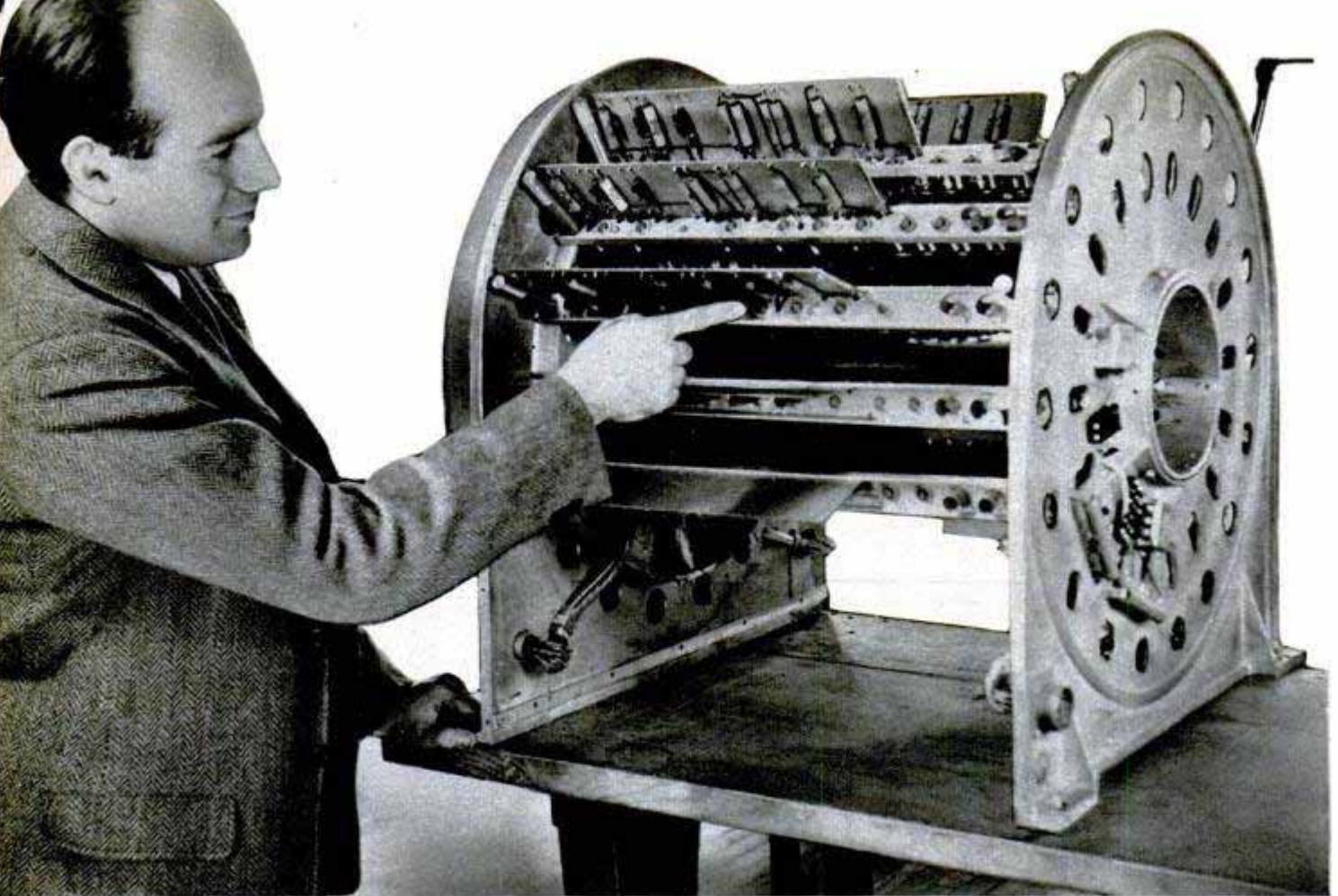

Eckert-Mauchly Computer Corp. photo

Eckert inspects ingenious memory units he devised for the computers. Pulses representing numbers flow into the mercury tubes. They are amplified and switched back and forth until needed, then pop up in the calculator

Brains that Click

By Andrew Hamilton

YOU KNOW HOW it is when you have some figuring to do—your income tax, plans for a new house, or perhaps next year's vacation. You work yourself into a frustrated frenzy and usually come up with several different answers. There's addition, subtraction, multiplication, division, fractions, percentages, square roots, decimals . . .

More than one weary pencil pusher has wished aloud: "Boy, if I only had a machine to do this!"

For 300 years scientists have been working on mechanical devices to take the drudgery out of mathematics. But it's only recently that they've come up with anything worth shouting about.

Today, in the mathematical and engineering laboratories of America's universities and research centers, giant robots are being built that can do complicated problems thousands of times faster than the human brain, store up long strings of figures in their "memories," flash red lights and ring bells when they get out of whack, and tackle problems so complex it staggers the imagination.

"Some of these machines are almost human," a mathematician said recently. "It gives you the creeps to think what they can do."

The high-speed calculators of science, however, don't remotely resemble the popular notion of a mechanical robot. Instead, they are huge mechanical and electronic machines that cost up to \$750,000, weigh as much as 100 tons, fill whole rooms and are equipped with thousands of vacuum tubes and millions of feet of wire. If you can imagine a Rube Goldberg combination radio-phonograph-telephone switchboard-organ console-typewriter-newspaper teletype-pin-ball machine, you will have a faint notion of a high-speed calculator's appearance.

These machines are unbelievably fast. An ordinary desk calculator will multiply two 10-digit numbers, such as 3,650,678,548 by 5,477,648,971 in about 10 seconds. A "thinking machine" will give you the multiplication in $\frac{3}{1000}$ second. Here's another example: About 400,000 customs declarations are made each month and it takes

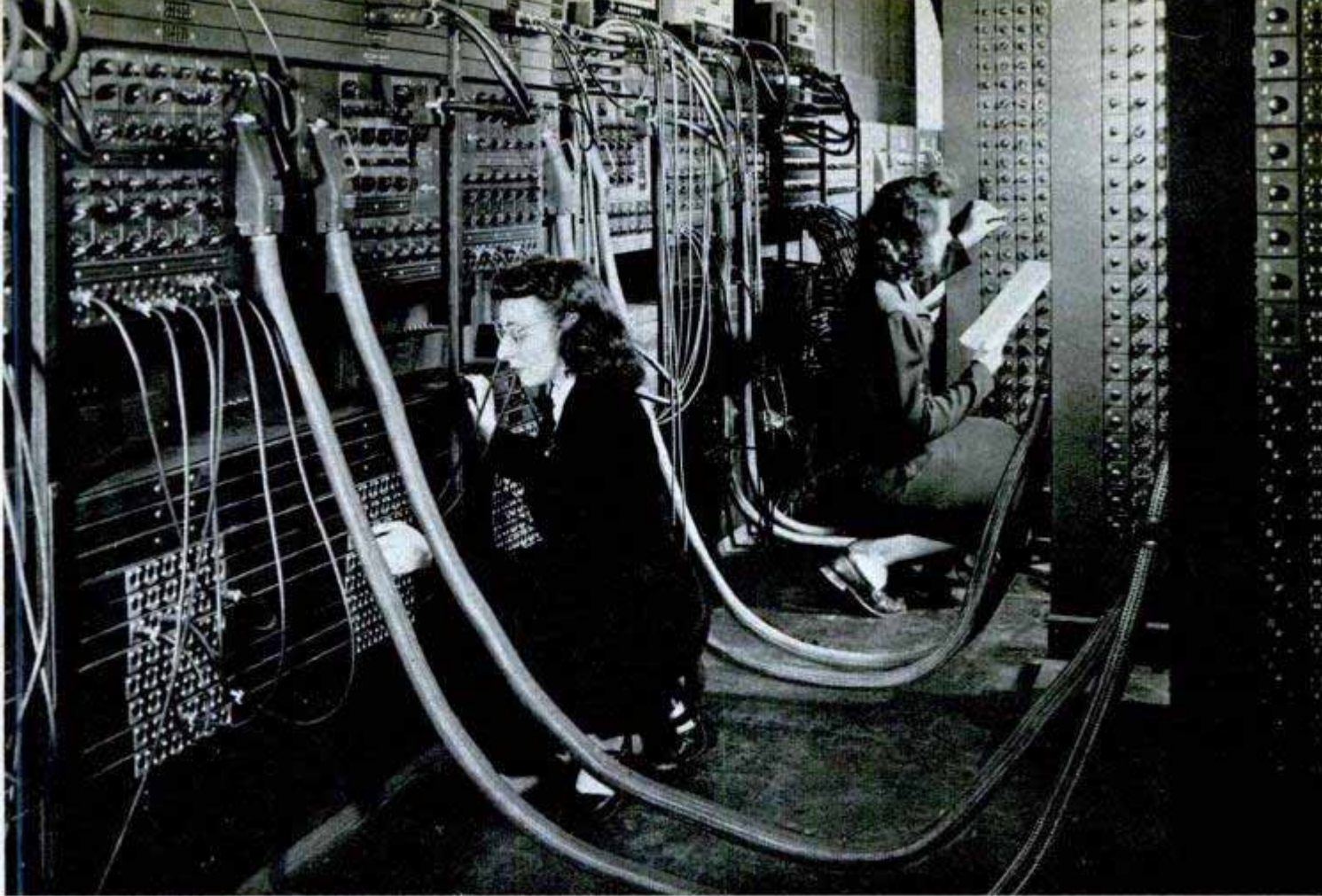

Army photo

At the Army's Ballistic Research Laboratory, digits in astronomical numbers are put through ENIAC which comes up with firing tables, solves other complicated problems. Above are table panels and switch assemblies

about 1800 man-hours to process them. A machine being built for the U. S. Bureau of the Census will do the job in approximately 36 hours.

The high-speed computers are at their best when handling problems that involve a number of "variables." For example, it might be easy to describe by ordinary mathematical methods a penny tossed into the air—how high it rose, how far away it fell, the arc it described, and the number of seconds before it reached the ground. But how do you describe a whole handful of coins, all spinning to various heights and dropping to the ground at various times? Those kinds of "variables," which are found in many scientific and business problems, are taken in stride by the computers.

The "memory units" of the high-speed calculators are ingenious devices. One type consists of a number of stainless-steel tanks of mercury equipped at each end with quartz crystals. When electrical impulses, representing

numbers, are fed into one end of the tank, the crystal changes them into sound waves. The waves travel through the mercury and emerge at the other end as electrical impulses again. After being amplified, they are fed back into the first crystal—thus

Differential analyzer at U. C. L. A. has gears and shafts instead of tubes, finds the answers by rearrangement of the individual parts

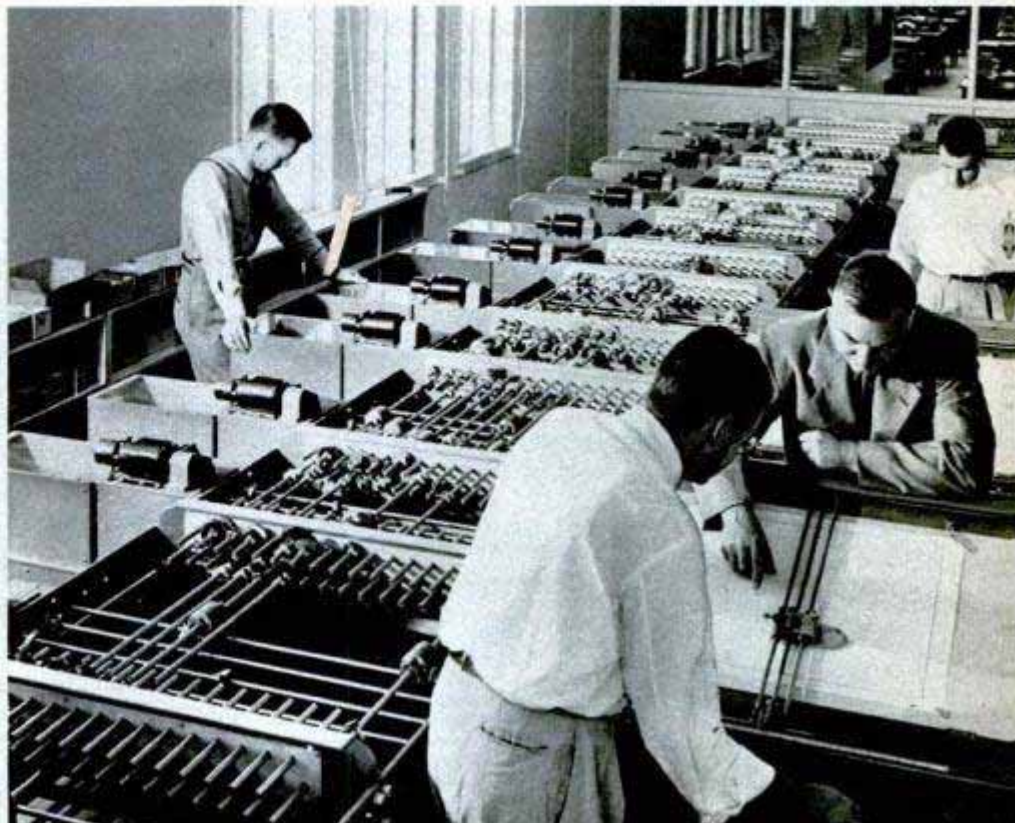

Photos on the three following pages show how an electronic calculator solves a problem. Here an operator punches holes in cards, each hole representing a number from zero to nine. Both numbers and instructions to the machine are recorded



moving in a continuous circuit until they are needed on a problem. Although moving at high speed, they are held separate by a central oscillator which keeps the digits in step and $1/4,000,000$ second apart.

In general, there are two principal types of high-speed calculators:

(1) *Analogue computers* arrive at their total by the use of some substitute for actual figures. A slide rule, for example, substitutes distances along its length for actual figures. It's difficult to get an accurate answer when adding 10 ohms to a previous total of 2,000,000 ohms. But there are many problems where an approximate

answer is as good as an accurate answer. And here the analogue computers shine.

(2) *Digital computers* arrive at their totals by counting. Man's 10 fingers comprised the first digital computer. Then came adding machines, which depend upon a series of wheels. And finally the giant calculators of today, which use electrical impulses.

On duty 24 hours a day, these jumbo-size machines are expected to open up vast new fields of knowledge. A scientist said recently: "So superior are they in efficiency and capacity that the mathematician whose domain at one time was merely that which

Prepared cards are dropped in a card reader, which senses the holes electrically and enters the numbers in memory units at the rate of 30,000 digits a minute. Machine then has necessary data to solve problem

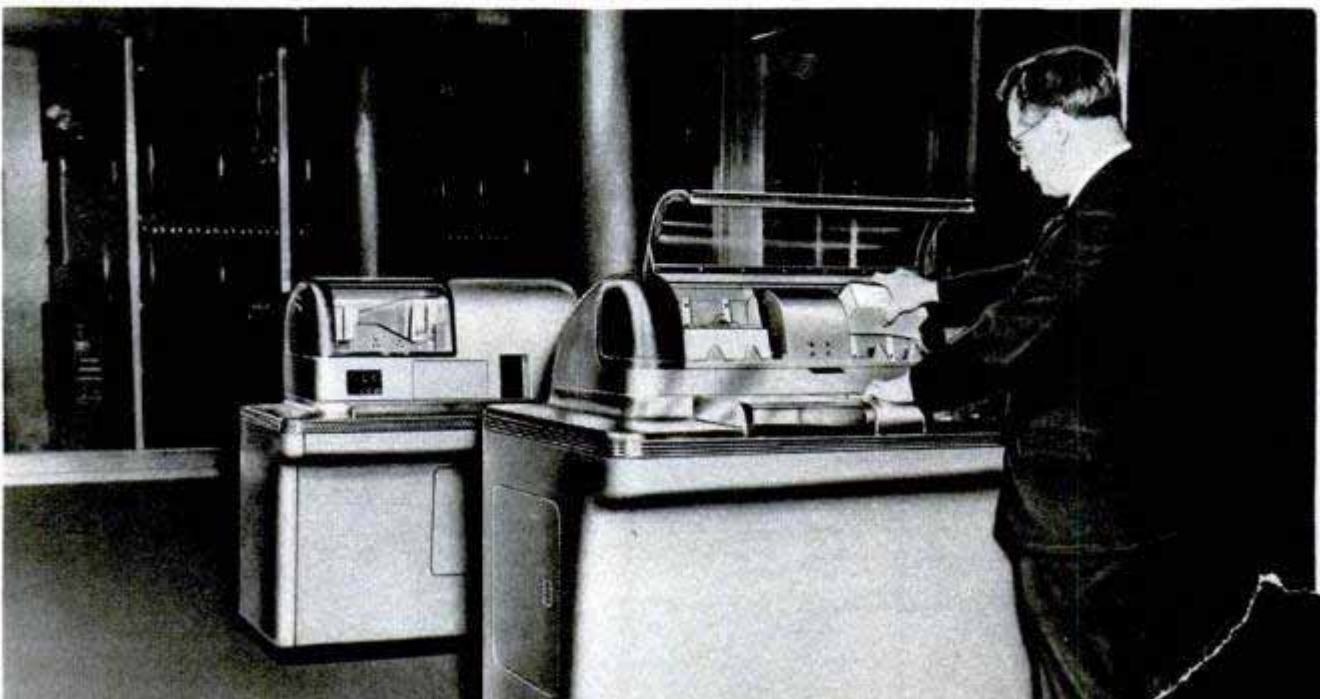

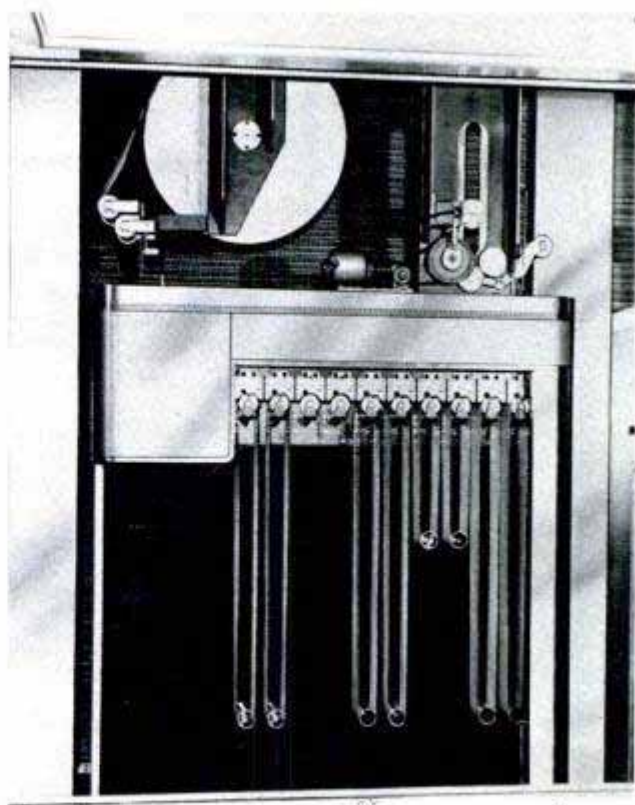

International Business Machines Corp. photos

↑ Information also can be fed into the machine by punched paper tapes. Punch automatically reads numbers from cards and records them on tape. Right, a memory unit punches intermediate results for use later

he could see from the crest of an anthill now commands everything he can see from a mountain top."

Every science known to man—from archeology to zoology—has developed vast amounts of sheer statistics that are useless unless properly interpreted. To speed up such routine brainwork and leave the best human minds free for creative thinking, this is the type of thing that the "thinking machines" will do:

Predict accurately how a rocket motor will work before it is built.

Digest the complicated statistics of the census or the national income tax.

Estimate the impact on the nose wheel of a plane landing at a force too dangerous for actual testing.

Predict the speed at which a gas turbine will vibrate according to its design.

The mathematical automatons probably will reduce the need to build more and more complicated and expensive wind tunnels, miniature water channels and other models designed to determine the characteristics of new planes, ships and harbor construction.

Although it's easy to think of these giant pieces of machinery as "mechanical brains" and "electronic brains," they are purely robots and not in any sense inde-

pendent thinkers. They don't formulate problems themselves—but only work them out after they have been instructed to do so by humans.

For example, oceanographers of the University of California are interested in plotting the bottom of the Pacific off San Diego. A great many soundings of the sea have been taken at different locations. But the

At all times the console control desk shows the operator the function that is in progress and the results being achieved

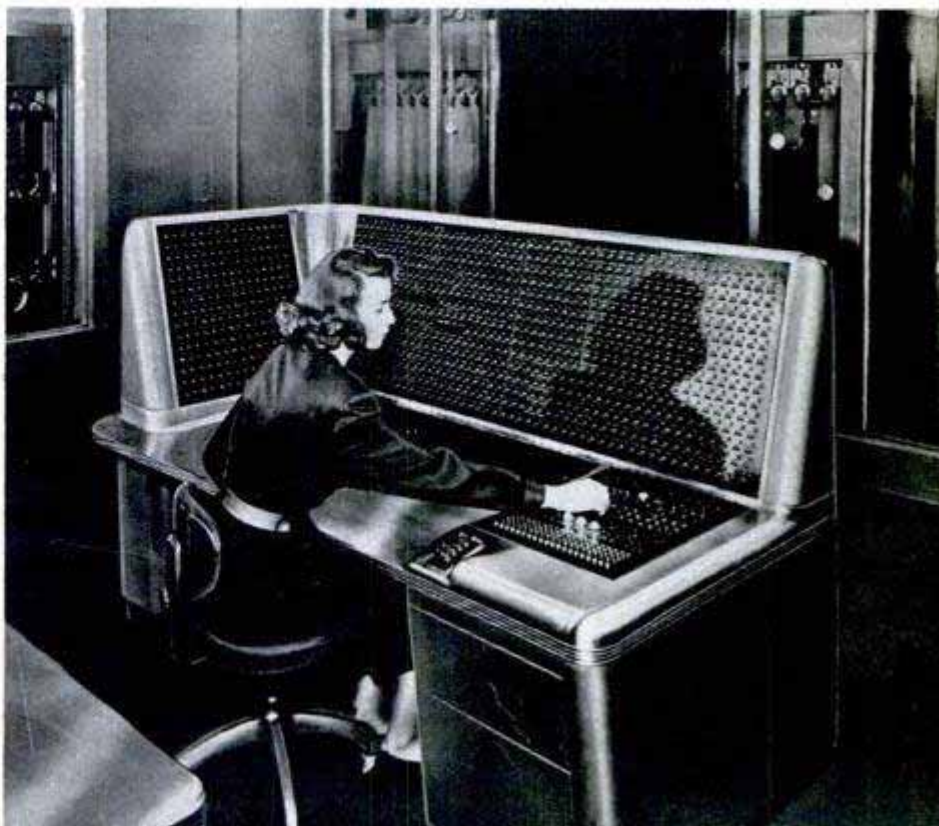



Printer publishes the running results at a rate of 24,000 digits a minute, permitting scientist to modify problem as he sees results

problem of joining these soundings into the most likely profile of the bottom is enough to discourage any mathematician.

Here's how a "thinking machine" will do it: Thousands of sounding figures (each identified by latitude and longitude) will be fed into a high-speed calculator on cards or a magnetic tape. After these figures have been fixed in the machine's "memory," the computer will be asked to calculate point after point. For each point it will be instructed to search the soundings in its memory and pick out all those, for example, within half a mile from the point in question. Then the machine will be asked to search the soundings again and select all within a mile radius. Giving these distant soundings somewhat less weight, the machine will average all the figures and come

has reached the stage of higher mathematics. Some of these formulas are so difficult that the weather forecasters can't work them out with the old pencil-and-paper methods until the weather has already passed over.

Army ballistics experts use the machines to work out the gasoline consumption of jet planes at various speeds and altitudes. The Navy employs them to compute range tables for new missiles. They can be used to measure the effect of a coal strike on the nation's economy, the long-range forecasting of earthquakes, the distribution of cosmic rays falling on the earth and many other scientific and social problems that never have been accurately solved.

Ever since Blaise Pascal, the French philosopher and mathematician, invented an "arithmetic machine" in 1647, scientists have been trying to devise computers to save wear and tear on human brains. Adding machines and I.B.M. punched-card machines are both fairly recent examples of this trend.

But it was not until the late 1930s and World War II that the real, giant-size "mechanical brains" and "electronic brains" appeared. As in the early days of the automobile industry, they assumed various sizes and shapes and were equipped with several types of motive power.

There are, for example, various types of differential analyzers, an electromechanical instrument composed of shafts,

When problem is solved, typewriter reads numbers from cards and prints them in form suitable for publication by offset printing
International Business Machines Corp. photo





Harvard University photo

Where does the next wire go? Jig used on Aiken Mark II calculator shows complicated wiring in each panel

gears and couplings. Most of these parts are removable, which permits them to be put together in the correct relationship to each other to solve individual problems. Raw materials are fed into the machine from graphs representing numerical values. As many parts revolve and change position, it draws the answer in graph form with a mechanical pen.

The differential analyzer has been used to determine the trajectory of guided missiles, the path of water particles around the wing of an airplane and the design of aircraft radar. Several universities, including Massachusetts Institute of Technology, University of California at Los Angeles and the University of Pennsylvania now possess differential analyzers.

The second kind of high-speed calculator

Technician arranges value tapes to feed problem into Mark II computer. Answer will come out in minutes

Navy photo

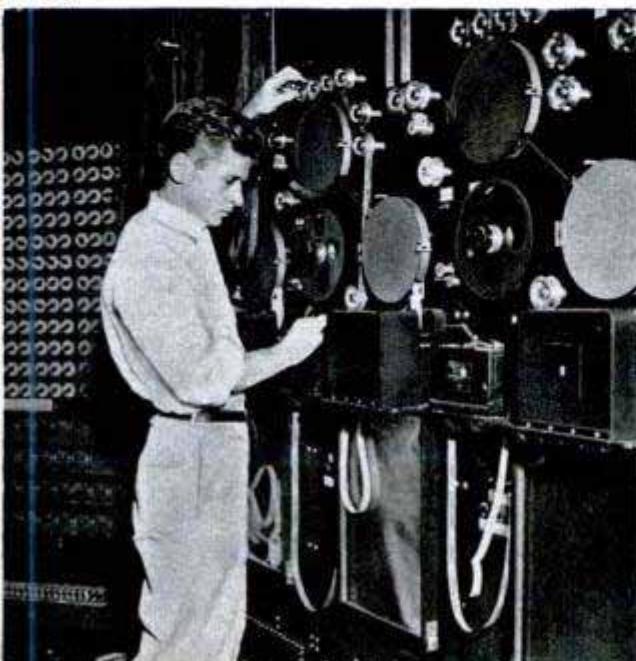

is the network analyzer, a type especially useful for problems of electrical production and transmission. It's possible to turn it into a miniature electric-power company, with portions representing generators, transmission lines and consumers. The effect of adding a new generating plant to the system can be calculated even before the plant is on the drawing boards.

A network analyzer can also be used to solve many kinds of mechanical problems. It can examine the designs for machinery and predict how much vibration can be expected. A special kind of network analyzer called a thermal analyzer can solve problems in heat flow—determine, for example, whether or not a certain kind of a machine-gun barrel will hold up. Firing rate, water

(Continued to page 256)

Like an old-time player piano, M.I.T.'s 100-ton calculator gets its instructions from punched paper roll

Massachusetts Institute of Technology photo





House Within a House

How can you build a house in bad weather without slowing down construction? This problem, which has baffled builders for centuries, has been solved by contractor Caesar Marconi of Chicago, who rolls a large Quonset building to the site and proceeds to build the house inside. Large rollers make it possible to move the building into position and then roll it away when the house has been completed. The building protects workmen and their materials from the rain, snow and the heat of the sun.

Top, portable Quonset building is rolled away after the house is completed. The building shelters workers from rain, snow and sun. Right, giant "hangar" is moved from site to site on large rollers

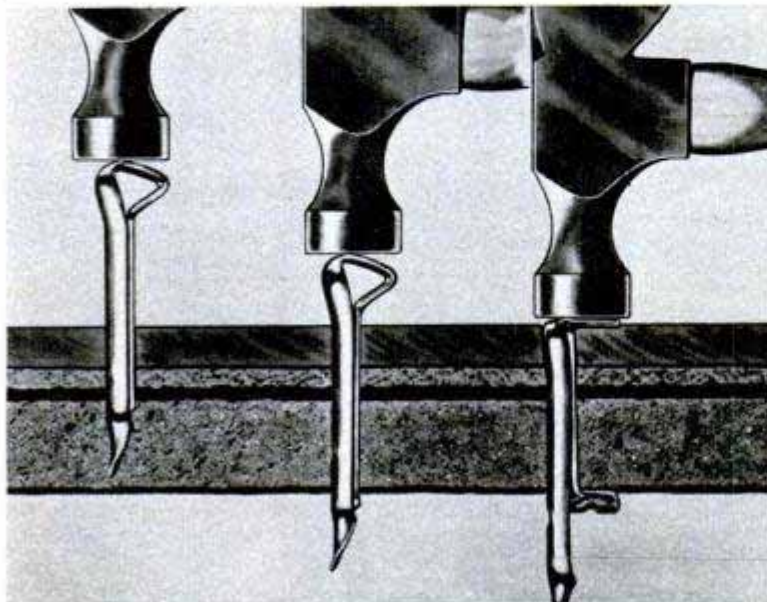
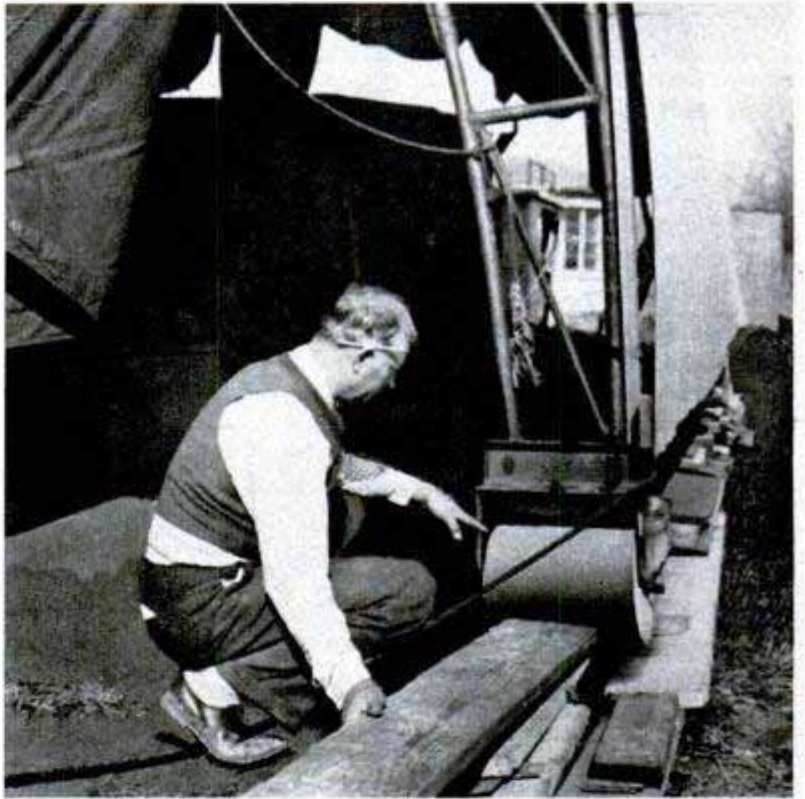

Self-Locking Shingle Nails Clinch Behind Sheathing

Self-locking nails clinch with the last blow of the hammer, making it possible to fasten shingles to low-cost gypsum sheathing. The nails are made with two legs, one nested inside the other. The head is in the shape of a triangular loop. When the loop is flattened by the hammer, the inner leg bends at a right angle to clinch behind the sheathing. The nails can be driven at any convenient point without locating studs. They are $1\frac{3}{4}$ inches long, made of low-carbon steel coated with zinc and count 200 pieces to the pound.

they hunt

WOOD

By Henry F. Unger

TURN Wilbur F. Opdyke loose in an unusual wooded area and you are virtually giving him a ticket to heaven. The Ohio hobbyist is one of the foremost wood collectors in the world and his filing cabinets containing about 2600 species of wood are proof of his gathering ability. However, there are about 100,000 different trees and woody plants in the world, each having a variety of color, grain and texture and Opdyke feels that he still has a long way to go to complete his collection.

President of the Wood Collectors Society, which has members in most states in this country and in more than 13 foreign countries, Opdyke isn't merely a mail-order collector. He makes periodic "hunting" trips when he hears of a tree or wood not included in his files. Recently, he had a field day in California, where he claims the wood collector has his greatest opportunity. While there, Opdyke loaded his car with roots of various trees and hauled them to his wood "laboratory" in Cleveland Heights, Ohio.

For years, hundreds of hobbyists scattered throughout the world were collecting various species of wood without any common system. Under Opdyke's direction, the Wood Collectors Society was formed in April 1947. Rules specify that pieces of wood to be used as specimens should measure $\frac{1}{2}$ by 3 by 6 inches. Opdyke has a special filing cabinet that he built to take these sample pieces. It has 43 drawers, each holding 50 pieces.

With this filing system, Opdyke now collects methodically. He checks through his file cards, on which are typed the common name, botanical name, the family, the key number and the location where the wood was found. He checks this data against the list of 100,000 species available in the world. Correspondence with foreign collectors produces missing species. Hearing of nearby "strikes," Opdyke hauls out his saw, gets permission from the owner and cuts down the small tree.

When he brings the specimen home or receives a rough sample through the mail, he hurries into his workshop. The wood is cut with a circular saw. Opdyke prefers



Wood collectors have to be agile at times. Here a man climbs a tree to get a leaf for aid in identification during a field trip through a Texas forest

to get several standard pieces from each sample. The extra pieces he trades with other collectors for specimens not in his collection. Once the pieces are cut to regulation size, Opdyke sands them, catalogues them, types out the required information, pastes it on each piece and files it.

Because of the completeness with which Opdyke catalogues his collection, the filing cabinets would serve as encyclopedias

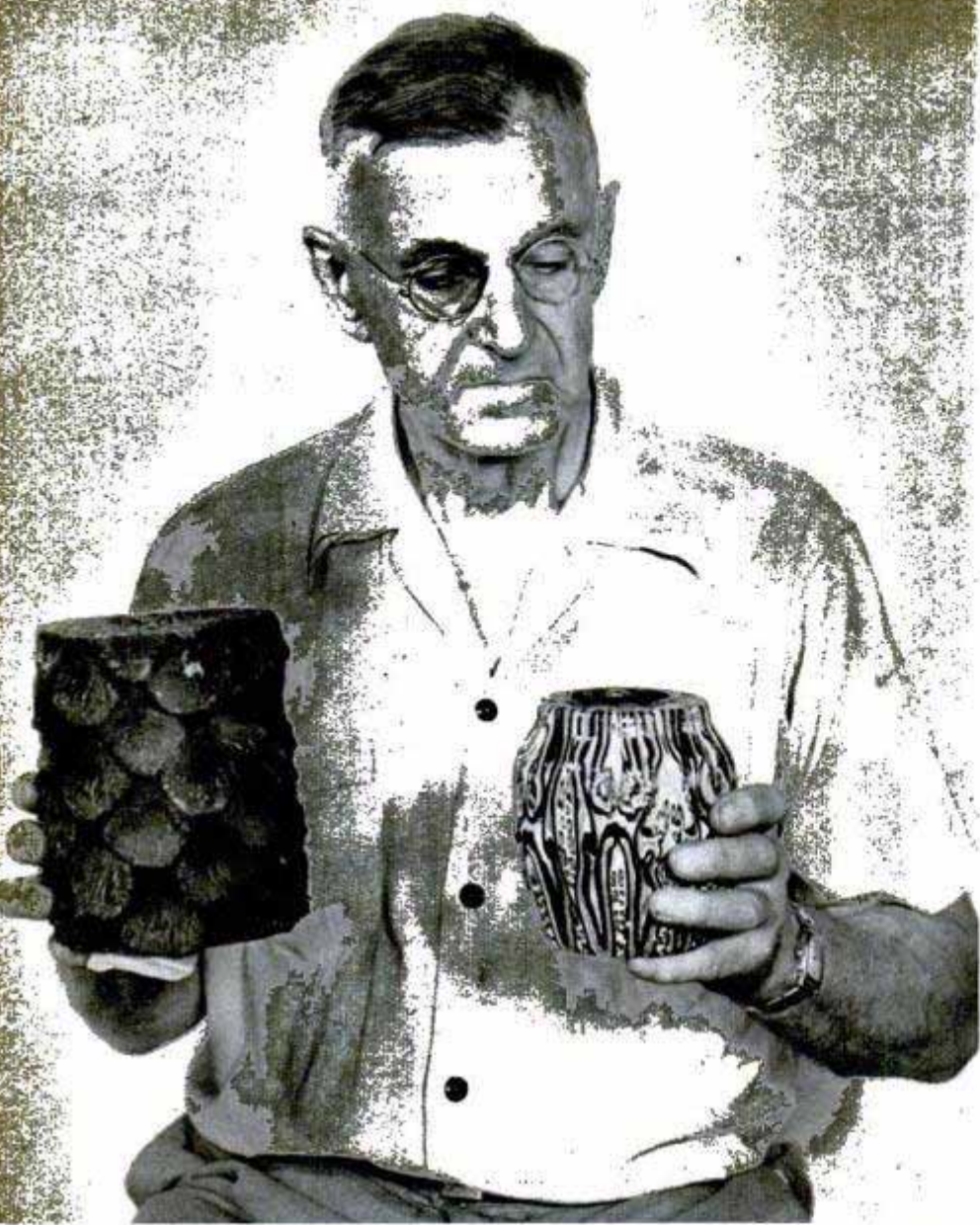

Not all his collection consists of neat blocks. Opdyke is holding two pieces of an unusual wood sent to him by a foreign collector. The wood is from a New Zealand tree fern. The piece at the left is in its natural state. At the right is a vase made of the same wood

on wood if necessary. Some of his woods, however, have more than scientific interest. One of his exhibits is a piece of the oak flooring that was laid in the White House.

Opdyke started his wood collection by accident. Illness forced him to retire from business. He occupied his time making inlaid table tops and trays of rare woods. When he finished this work, he found that he had 113 different types of wood. The collecting bug bit him right then. Today, the tropics and arctics, the forests and deserts of the world are all represented in his collection. He has the brilliant canary-yellow wood of *Mahonia haematocarpa* from Arizona, redwood from California, ebonies from Africa, heavy rosewood from Brazil, flinty yellow-heart satinwood from Santo Domingo, palms from the Canary Islands and a poisonous sumac from a swamp near Mentor, Ohio. To the wood collectors, wood means more than trees. They also collect specimens of woody plants, such as shrubs, vines and even grasses. Bamboo, for instance, is a grass. Boston ivy is classed as a plant, but Opdyke has a slab hewn from an ivy trunk three inches in diameter.



Three specimens of wood in the rough. Left, the ocotillo, which is a native of Arizona. Center, Jeffrey pine from California. Right, another one from California, this being greasewood-chamiso

When Opdyke first began collecting, he was eager to obtain only woods with pretty colors. Soon he found that there was interesting folklore connected with many of the woods he had gathered. For instance, he has a toothache-tree specimen, which is used in the South to "cure" a toothache. The taste of the wood is worse than the toothache. He has a sample from the manchineel, the poisonous tree growing in southern Florida. It poisons the surrounding air and causes skin irritation if a person passes close to it.

Another interesting specimen is a "pink-ivory" wood which comes from Africa. It is a sacred wood to the natives and the tribal chieftain is the only person who can possess it legally. If another native is found with a piece of the wood, he is quickly executed. Another unusual wood, that of the Ginkgo tree, is a veritable "living fossil." It was held sacred in the Orient for several thousand years. The *Leguminosae* or pea family has thousands of species. It is the second-largest family in the world with its 15,000 different species.

The heaviest wood in the Opdyke collection is the *lignum vitae* and the lightest is balsa. Rarities in the collection include lace barks from the East Indies and New Zealand. Opdyke has the upper parts for these woods, but has been unable to get a sample of the woody part. Also in the unusual category is the Vine of the Cross, a tiny wood from the Dominican Republic, which has a perfect Maltese cross in its center.

As a hobby that has the world as its playing field and yet can be started in your own back yard, wood collecting is becoming a favorite. And certainly there is very little financial investment required. Members of the society sell the sample pieces to each other for 25 cents each, regardless of their rarity. The society's constitution sets this price as the standard.



Above, Opdyke gets ready to cut up a piece of *Aralia*, an Ohio wood, into sample blocks. He cuts as many samples as he can from a single piece and sells or trades the extras with other collectors. Below, he removes a sample of Macassar ebony from his large filing cabinet





Pneumatic Spade

Even hard-packed clay can be dug easily with an air-operated spade that combines the features of a shovel with those of a pneumatic drill. Weighing only 18 pounds, the shovel is 19 inches long. A trigger control inside the D-type handle turns the air on and off. Oil from a reservoir in the handle is metered into the air stream and forced through the working parts to lubricate the mechanism as it is used.

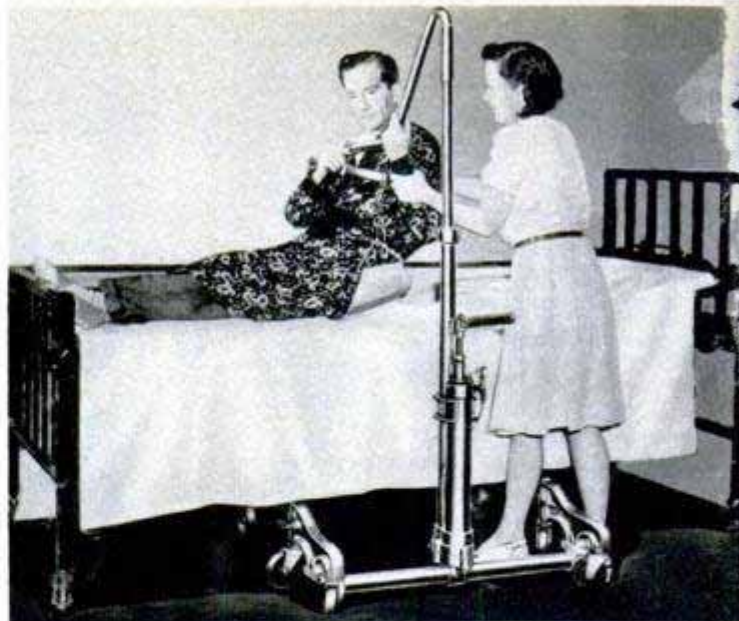

Hydraulic Lifter for Invalids

Invalids are lifted in and out of beds, chairs and automobiles by a hydraulic lifter designed for use in hospitals and homes. A canvas cradle, suspended from the lifting arm, is placed under the patient and he is raised when the pumping lever is operated. The lifter operates smoothly without strain on the patient or attendant and its legs fold inward for easy movement through narrow doors and hallways.



Radio Guides 'TNT' Ships To Blast Enemy Beach

Phantom ships, unmanned but carrying a load of high explosives, were guided ashore by radio to blast enemy beach defenses during the war, the Navy recently revealed. The ships were used only once—during the invasion of southern France—but were scheduled for use in the invasion of Japan. They varied from small sea sleds to cargo ships, PT boats, destroyer escorts and amphibian landing craft, all equipped with radio-control gear. The larger ships could carry up to 7000 tons of high explosives. Especially designed for the project were small craft driven through the water by a conventional propeller, but which could climb across the beach on tractor treads and sidle up to a beach defense position before the explosive was set off. Larger ships could have been equipped with television cameras to show the remote-control operator what lay in the path of the robot vessel.



Tractor-Tire Tester Checks Tread Design

Improved tread designs for tractor tires may result from tests with a special machine at the Department of Agriculture's proving grounds at Auburn, Ala. A tractor equipped with a single tire is mounted inside the framework of the power machine. It then is driven over a prepared soil bed while instruments measure the drawbar pull, traction and slippage of the tire. Each tire is tested with 12 different loads in three types of soil to approximate most field conditions. The purpose of the research is to design

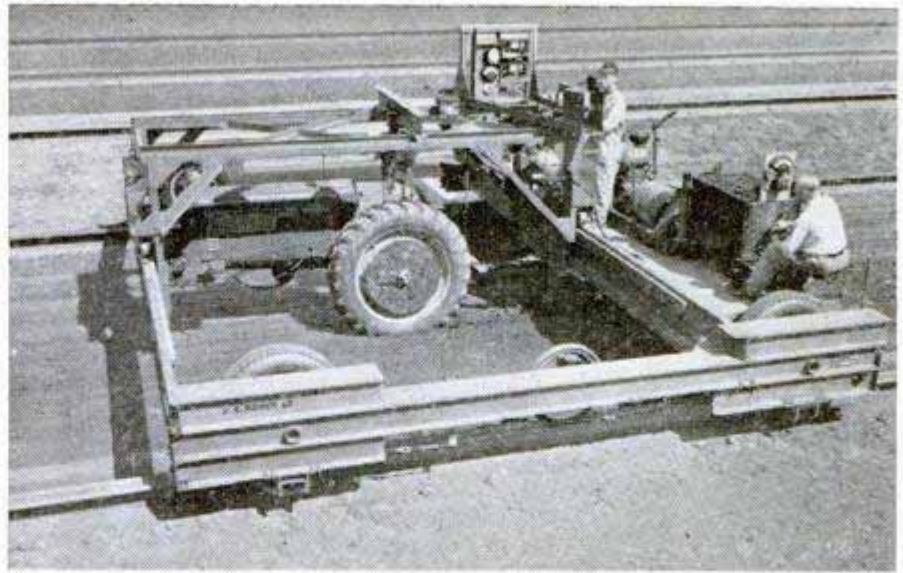

tractor-tire treads that will have greater traction with a corresponding saving in gasoline consumption.



War-Surplus Gas Covers Protect Plants From Frost

Plants are protected from frost by plastic covers that were issued to soldiers during the war as protection against gas attacks. The covers, which protect plants up to five feet tall, can also be used to isolate plants during spraying. When not in use, the covers fold into a small package.

Flame-Thrower's "Jelly" Used as Boiler Kindling

Fires in giant industrial boilers are started more quickly with thickened fuel, a wartime material used in flame throwers and incendiary bombs. The jellylike substance is made of diesel oil and aluminum soap. It brings boilers to full operating pressure in 30 minutes, compared with the eight hours usually required. Because it can be spread over the entire grate, the material shortens the time required to build up a fire.

One Filling of Flameproof Motor Oil Lasts Life of Car

Because it won't burn, a new lubricating oil perfected in England is said to enable automobiles to run for a lifetime on one filling of oil. By displacing the hydrogen in hydrocarbons, the base of all lubricants, with fluorine, the British scientists made the oil noninflammable. If the motorist uses an efficient oil filter, he will be assured of a constant supply of oil provided there

are no leaks in the lubricating system, the scientists claim. The flameproof nature of the oil also will reduce fire risks in aircraft and ships.

☐Forty-two percent of the cars and thirty-seven percent of the trucks in use today are over 10 years old, according to the Automobile Manufacturers Association.

science hits the bull's-eye



By Morris Chaklai and Allan Rechtschaffen



ROBIN HOOD may have been a whiz with the bow and arrow, but he would have a tough time competing with modern archers. Spark chronographs, synthetic materials, prismatic sights, electronic pictures, mathematical computations, and even psychological principles are helping produce scores that would have stumped not only Robin Hood but archers of a couple of decades ago.

Whereas a score of 500 in an American round (30 arrows each at 40, 50 and 60 yards) was enough to top a tournament 20 years ago, the archer of today must hit 700 or better out of a possible 810 to put a first-place trophy on his mantelpiece. Women are putting in unheard of scores and, for the first time in history, they are giving the men a run for their money.

But the scientific development of archery was long neglected. The bow and arrow, one of man's first inventions, provided him with a means of existence, enabled him to conquer new lands and determined in large measure the destiny of nations until a comparatively recent date. Yet the scientific sages ignored the improvement of man's earliest great weapon until 1929.

In that year, Dr. Clarence N. Hickman, now a physicist at the Bell Telephone Laboratories, published the first scientific paper on archery — "Velocity and Acceleration of Arrows." During the last two decades—a span infinitesimal in the vast history of archery—more has been done to improve the bow and arrow than

Dr. Clarence N. Hickman drawing his new center-shot flight bow. Note cutaway center part

Right, Doctor Hickman's prismatic sight, timer, arm guard. Plunger under timer on wrist is pushed up before each shot and clicks out after a few seconds — signal to shoot arrow

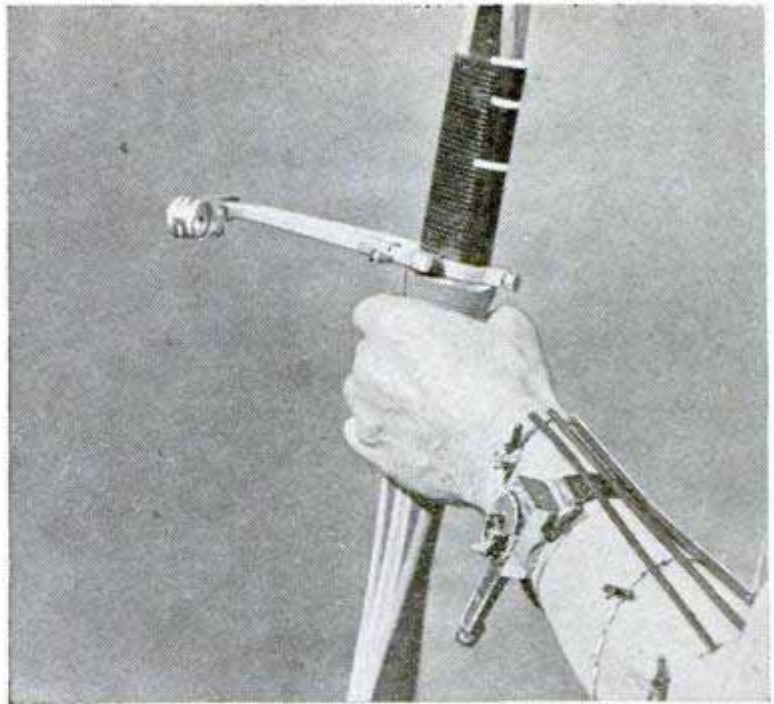

in the entire 50,000-year existence of the weapon.

Regarded as "the Father of Scientific Archery," Doctor Hickman's interest was derived from his grandfather, who learned to shoot from the Cherokee Indians. As a boy, Doctor Hickman hunted fish in Lizton, Ind., by shooting umbrella staves at them. He took up archery as a hobby and later, as a research physicist, became interested in the physical aspects of the sport.

Doctor Hickman's first experiment with the bow and arrow was prompted by the fact that he was not strong enough to pull a heavy bow. By measuring the force required to pull various bows, and by measuring the velocity of arrows shot from them, he found that the application of some reinforcing material on the back of the bow, the side away from the shooter, considerably enhanced the efficiency. Thus, by gluing some material like fiber on the back of the bow, the archer is able to shoot his arrow farther and faster without proportionately increasing the force required to draw the string.

In the course of these experiments, Doctor Hickman developed an automatic shooting machine which could release every arrow in exactly the same way, enabling him to get accurate results. This device was used in many subsequent experiments in studying arrow velocity. Even more important, he developed a spark chronograph for measuring the velocity of arrows. When Doctor Hickman was placed in charge of rocket development by the National Defense Research Committee in 1940, he made extensive use of a modified version of this chronograph in testing the velocity of rockets.

After proving the worth of reinforcing bows with some sort of backing, Doctor Hickman kept on the lookout for suitable backing materials. Rawhide had been used as a bow backing in ancient times,

Drawings below illustrate methods of aiming. Dashed line in top one shows trajectory of the arrow and the dotted line the line of sight to point of aim on ground

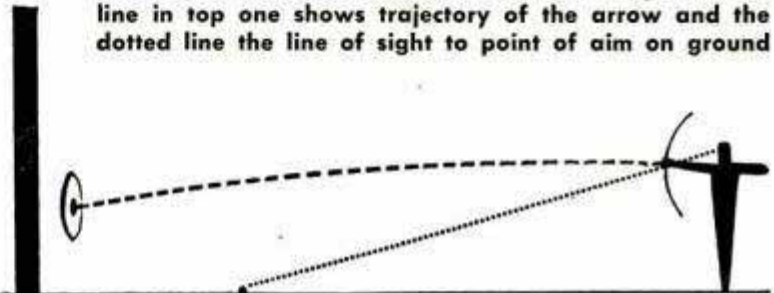

Here the bead of a mechanical sight is put in line with the target, but archer cannot see arrow when he shoots

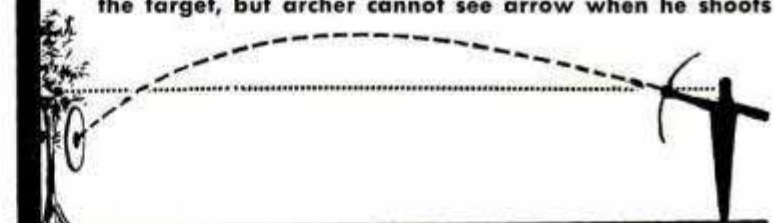

This is another example with different positioning of mechanical sight, but archer still can't see his arrow



With Doctor Hickman's double prismatic sight archer can see both the arrow tip and the target at the same time

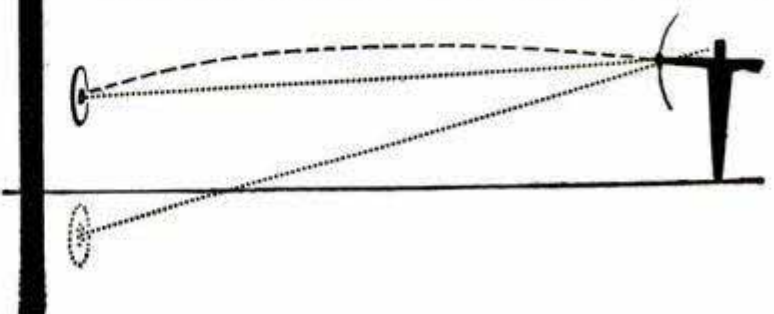



With 25-pound center-shot bow Doctor Hickman shot farther in 50-pound-class match than all but one contestant. Shooting close to center results in flatter trajectory since arrow loses no force in curving around the bow. Below, tournament gear includes aluminum arrows, range finders, sights

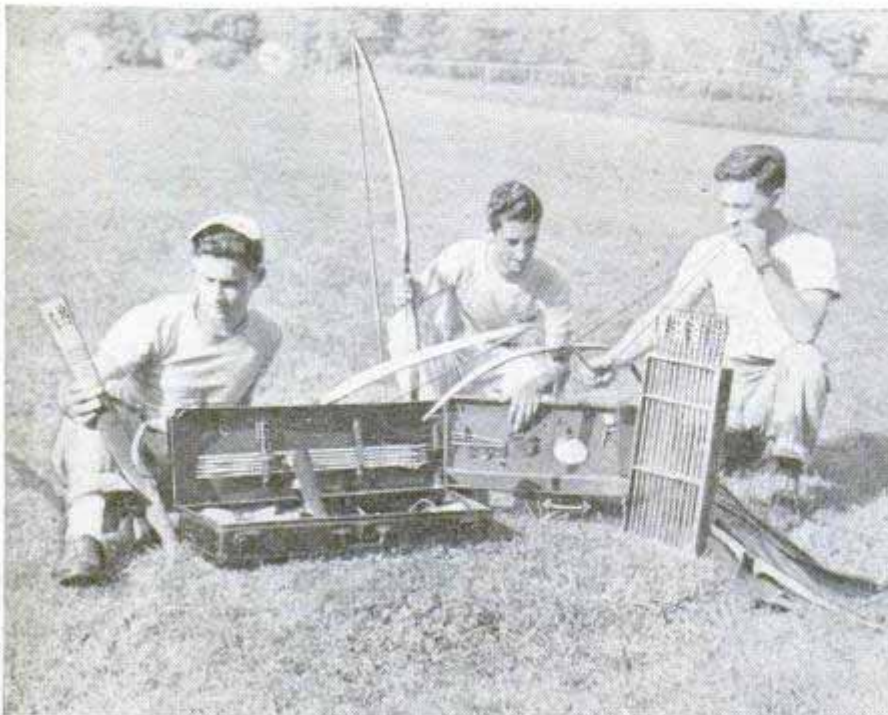

but as some experiments showed, unless it was applied just right, it actually lessened the efficiency of bows. In many cases, it only increased the strength required to draw the string without substantially increasing the distance or the speed with which the arrow traveled.

Doctor Hickman finally hit upon a new synthetic substance for bow-backing purposes, Celanese Fortisan. While working at his ballistics laboratory in Cumberland, Md., during the last war, he learned of a new secret fiber which was being used for parachute shrouds. He obtained samples of it and found that it was ideal for bow backings and bowstrings, since it was even stronger than nylon and three times as strong as silk, which he had been using previously.

Doctor Hickman searched for means of getting the bow to do more work and keeping the archer from becoming exhausted. For centuries weaker archers had been excluded from such aspects of the sport as flight shooting, which is shooting for distance. This was just a question of having enough strength to draw an 80 or 90-pound bow. Doctor Hickman delved into a mass of mathematical computations and experiments and emerged with the most efficient bow ever developed in the history of archery.

Sporting a radical new design, in addition to the most favorable features of the ancient weapons, the new bow is nearly 100 percent more efficient than most of those in use today. The proof is in Doctor Hickman's success in flight shooting.

Last year he entered the New Jersey State Flight Shooting Championships in the 50-pound class.



While most of the competitors took advantage of the maximum weight allowed, Doctor Hickman used his new bow, a 25-pounder. He came in second, shooting farther than many who were using bows twice as strong.

The new bow is a reflexed, recurved, bizarre-looking affair whose limbs are semicircles curving away from the archer when at rest, resembling a figure 3. When at full draw, the limbs straighten out and the string makes an angle of 90 degrees with the tips of each limb. This construction permits the use of short limbs with relatively long arrows, an ideal setup for gaining velocity and distance.

Although the bow is still in the experimental stage, preliminary results have been encouraging. It may be looked upon as an oddity by those who are used to the graceful curves produced by the traditional English longbow.

This will not be the first time Doctor Hickman's scientific evidence has bucked tradition. When the sporting scientist showed that a bow of rectangular cross section was more efficient and durable than one with a rounded belly, many tackle makers laughed and continued to round the inside of their bows. But the desire for greater accuracy finally won out.

One by one, tackle makers converted to flat-bellied bows. As Doctor Hickman pointed out, there

(Continued to page 252)

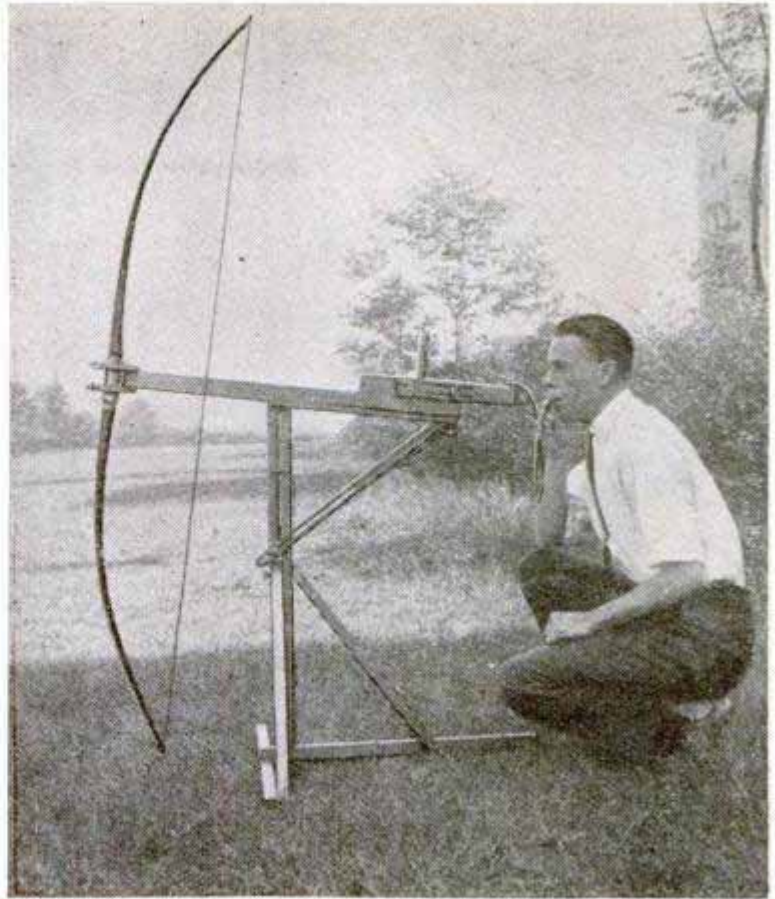

Top left, Doctor Hickman's center-shot bow (left) compared with orthodox English longbow. Above, his shooting machine, first used in 1929, measures velocity of arrows and marked the linking of technology and archery to improve this ancient sport

Doctor Hickman explains to Girl Scouts that it takes proper form as well as modern equipment to acquire archery skill

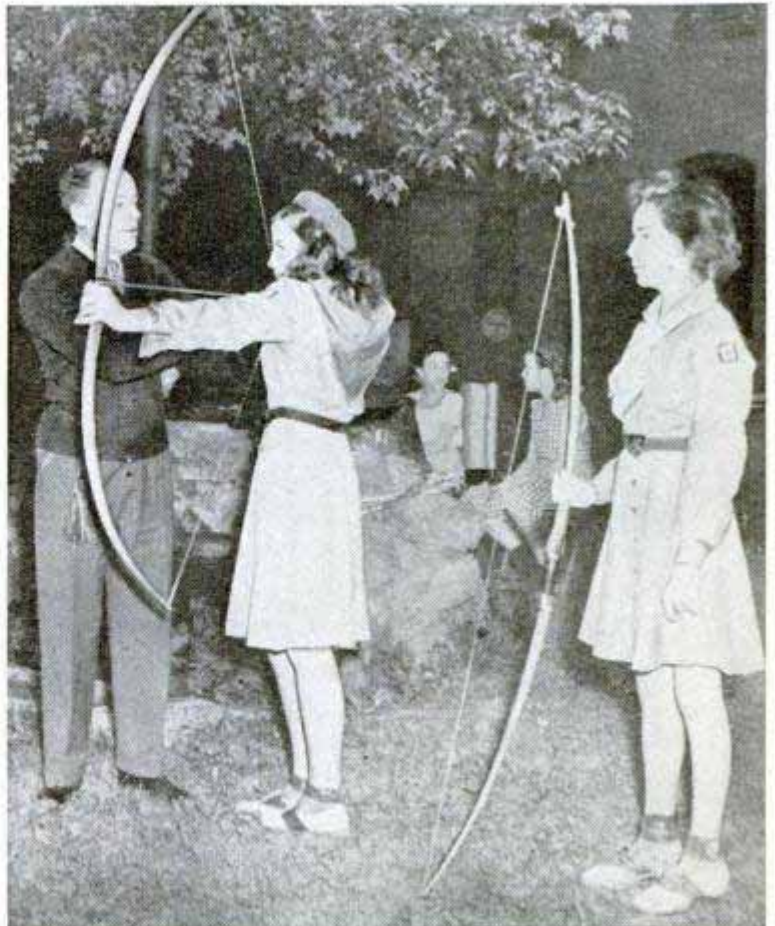



MAGNETIC FLY BOX holds fragile flies firmly without danger of crushing hackles or wings. Small permanent magnets grip the hooks, eliminating clips

New Angles for Anglers

METAL CLAW takes the place of the usual landing net. Pressure on the sliding handle closes the jaws of aluminum, locking the fish in an 800-pound grip

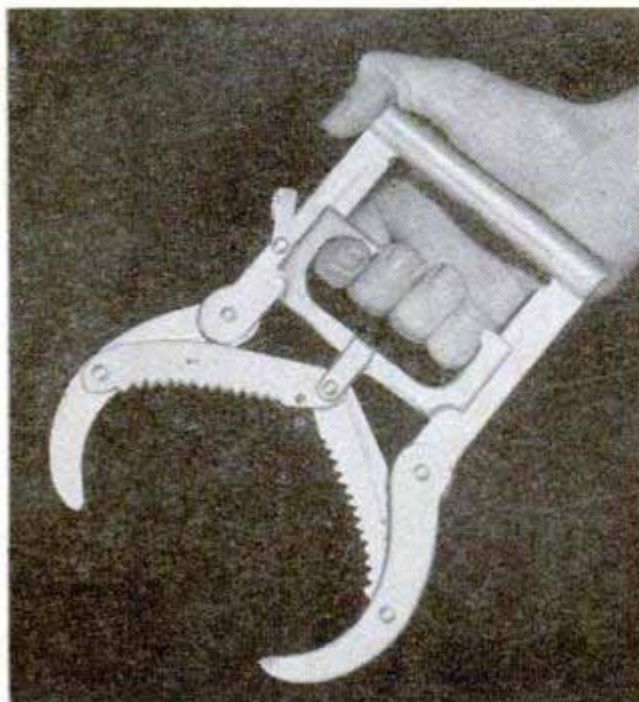

PERSONAL BAIT BUCKET floats alongside you as you wade, keeping your supply of minnows always handy. Tied to the belt by a short line, the bucket is kept afloat by a buoyancy chamber inside the lid

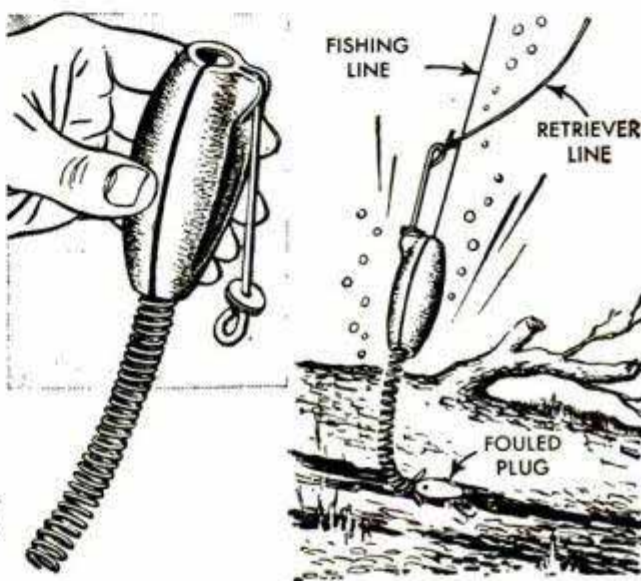

PLUG RETRIEVER consists of a heavy weight and a coiled spring. You slide it down the line and, by jerking it up and down, jostle the fouled plug free

CONCEALED HOOKS on this lure, below, make it virtually weedless. Two retractable hooks are held inside the lure by a spring during trolling. When a fish strikes, the pull on the line ejects the hooks

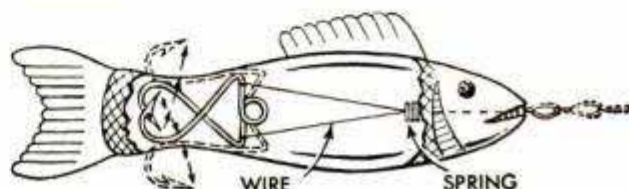

POPULAR MECHANICS

Midget Sub

Built from scrap found in a Hamburg, Germany, junkyard, a midget submarine is designed to move along the ocean bottom in search of ship wreckage. Peter Luetjens, a mechanic, built the craft and claims he can descend 300 yards and remain underwater four hours. The little craft must be towed by a surface vessel. Two searchlights capable of penetrating 20 yards at a depth of 70 yards provide light for the inventor's underwater excursions. The sub is divided into three compartments.

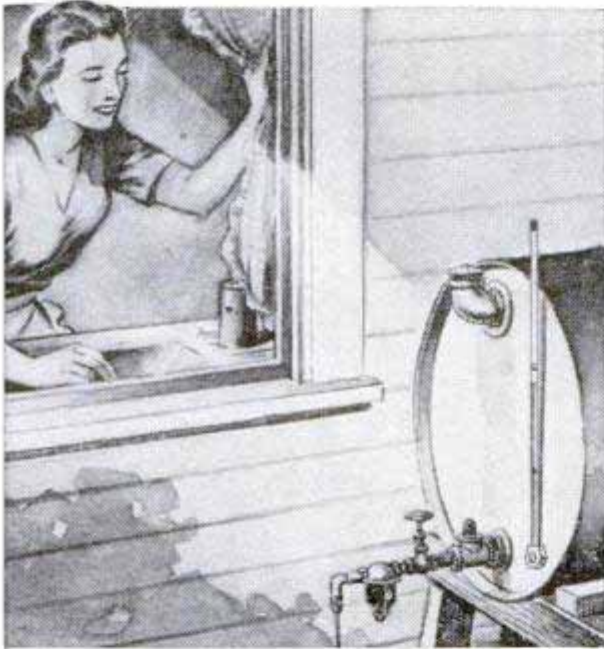
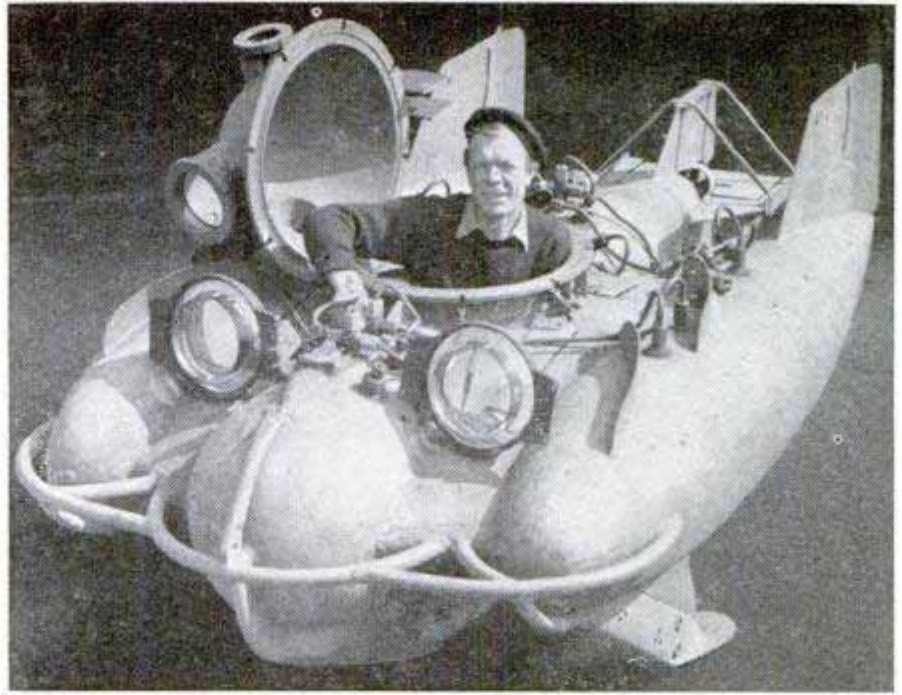

Gauge on Oil Drum Is Easy to Read

Installed with a hammer and screwdriver in less than a minute, a liquid level gauge for oil drums has no moving parts to get out of order or adjustment. Because of this it will give accurate readings for years without attention. The transparent tube is formed of unbreakable plastic and has an easy-to-read scale etched into it. One screw holds the gauge against the drum and neoprene washers prevent leaks.



Frame Guides File For Saw Sharpening

Even a novice can sharpen saws correctly with a portable frame that clamps to the workbench. The saw blade is held vertically in the base of the frame and the file is guided along a track at the correct angle to sharpen the teeth. A rectangular guide rod along the top of the device is notched on each side to control file movement for four different types of saws.

☐ The mass of the earth is 6,586,-000,000,000,000,000 (six sextillion, 586 quintillion) short tons, according to the General Electric Research Laboratory.

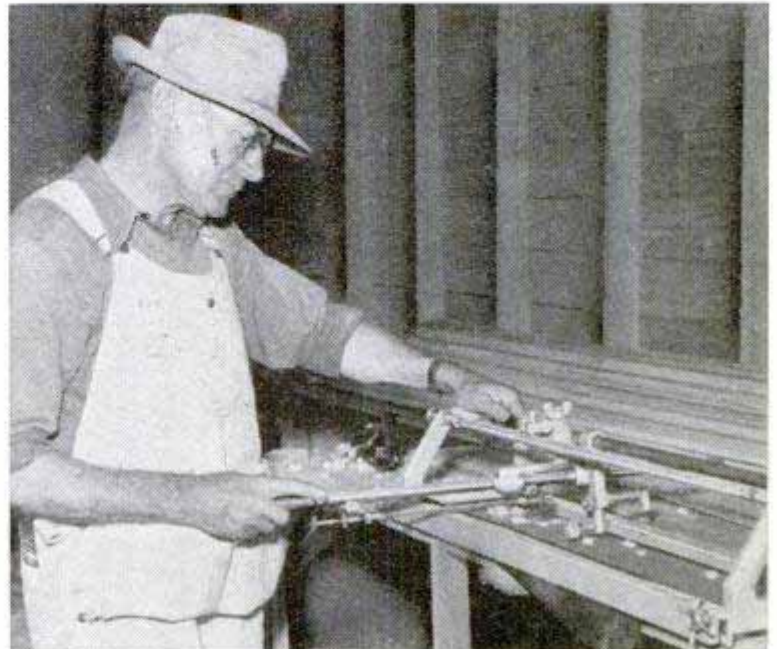



"Jackknife" Harrow Works Three Ways

Consisting of two sections joined by a giant hinge, a tractor-drawn implement serves as a bush-and-bog harrow, a cutting harrow or a pulverizing harrow. The back section, made up of plain disks, swings up over the front scalloped-disk section to add weight for use as a bush-and-bog harrow. With the rear section down, the implement becomes a pulverizing or cutting harrow.

Sleeve-Type Handle Raises Car Jack

Only a few pumps of the vertical handle of a hydraulic bumper jack are required to lift a car wheel off the ground. When the sleeve-type handle is rotated, the car lowers itself. The bumper hook is so designed that the jack can be used on any kind of car. A ball on the bottom fits into a socket in the base. The lifting range of the jack is 18 inches and its weight is 10 pounds.

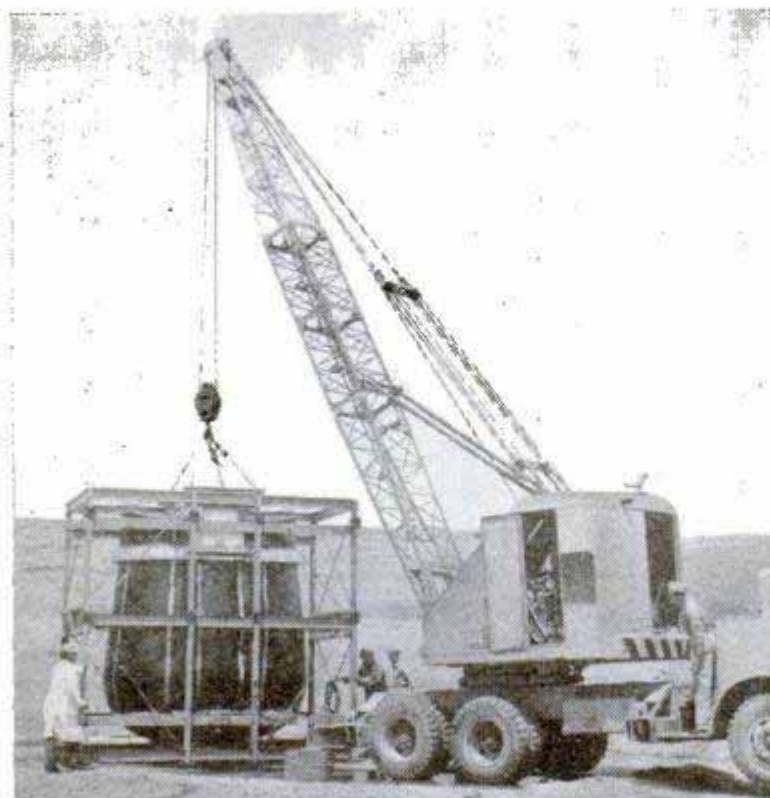
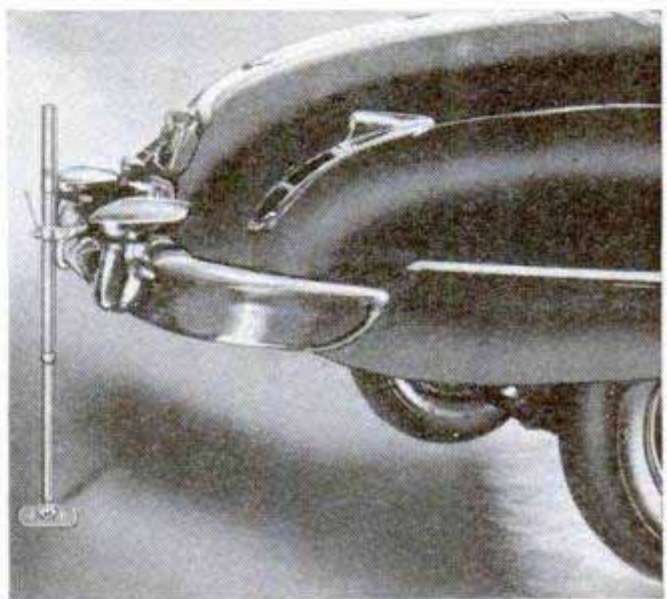
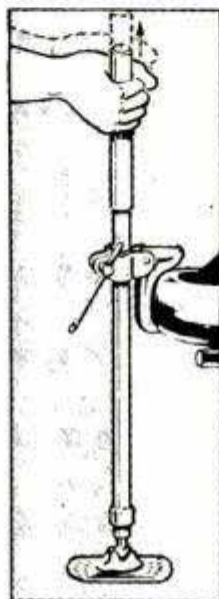

Giant Fuel Tank for B-36 Has 3000-Gallon Capacity

Big enough to serve as a filling-station storage tank, a giant airplane fuel tank for the Air Force's mammoth B-36 is so heavy it has to be moved around with a mobile crane. To protect the tank during shipment, a steel shipping crate is used. The 3000-gallon "fuel cell," which is self-sealing and will be carried in the plane's bomb bay, was designed and built by Firestone for Consolidated-Vultee's six-engine sky giant. It was recently tested for damage by gunfire at the Muroc Dry Lake firing range in California.

☐ Carrying only meteorological instruments, an Army Signal Corps balloon reached an altitude of 140,000 feet, setting a record for ascent into the stratosphere.

FARM SPRAYERS

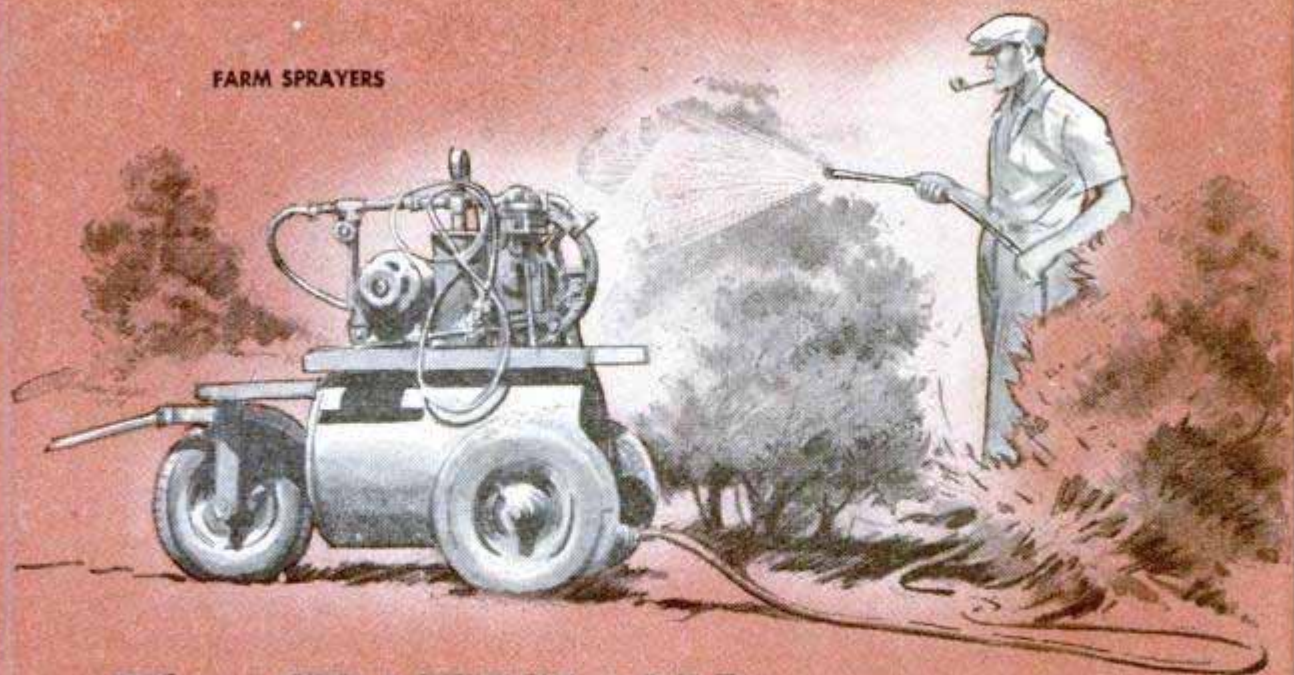

The CRAFTSMAN

★ Designed and built by practical farm craftsmen, the power sprayers pictured and detailed on page 226 cover just about all the requirements of both farmers and orchardists. One, a self-contained, electrically driven unit, is designed to handle any of the common materials which are sprayable, from insecticides to paint. The other, a heavy tractor-drawn unit, is made especially for field spraying in row crops, but it can be adapted to orchard spraying, weed killing and spraying ornamental trees.

★ One evening of pleasant home-shop work will give you an attractive finished project in hand-hammered metal. Although hammered craft pieces are almost unlimited in design possibilities, we have selected six patterns in hammered-copper ash trays, page 182, as being the easiest to finish in one short evening.

★ A wooden trinket chest, page 208, having a trick lid and a charred or sugi finish, offers the craftsman something new in woodworking.

★ Practical shop feature for the month, page 221, gives instructions for fitting a disk and drum sander to your wood lathe.

HAMMERED ASH TRAYS



LATHE SANDERS

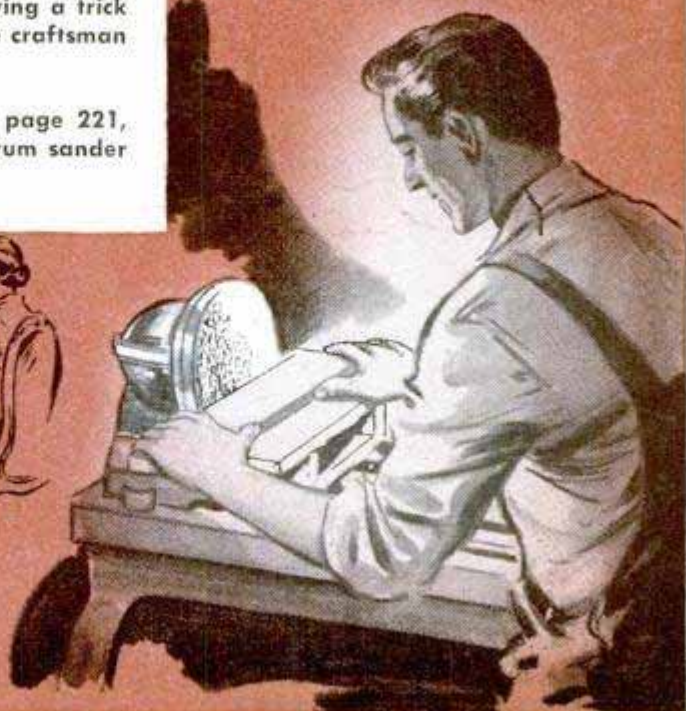

TRINKET CHEST

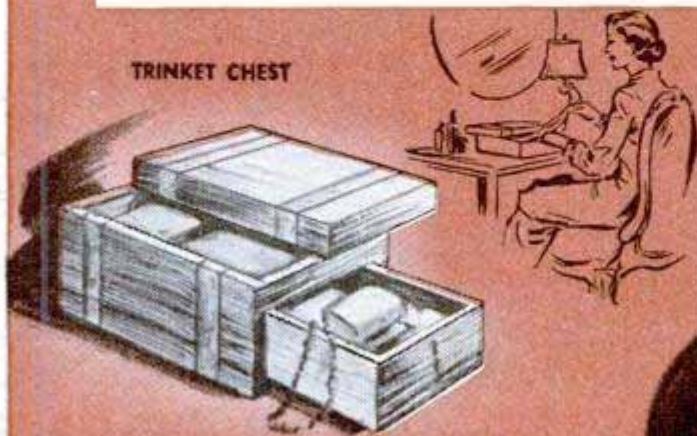

HAMMER 'em

By Ralph S. Wilkes

HAND-WROUGHT in copper and highly polished, these gleaming ash trays are smart accessories for a basement rumpus room. The series of eight progressive steps pictured on the opposite page show how a tray is made. The mold is made by recessing a hardwood block $\frac{3}{4}$ in. deep, and the tools required are improvised from a tack hammer, a nail set, a small cold chisel and a wooden mallet. Each of the six designs given below requires a piece of copper 6 in. square which is annealed by heating it until it is purple in color and then quenching immediately in water. This softens the metal and reduces the chances of tearing it when hammering. The annealing operation is done once or twice during the forming. The rounded nose of the tack hammer is used to iron out any wrinkles in the metal at the corners of recess.

Dishing is done with the rounded end of the wooden mallet by centering the metal over the mold and working in toward the center from the outer edge of the depression in the block. As the dishing progresses,

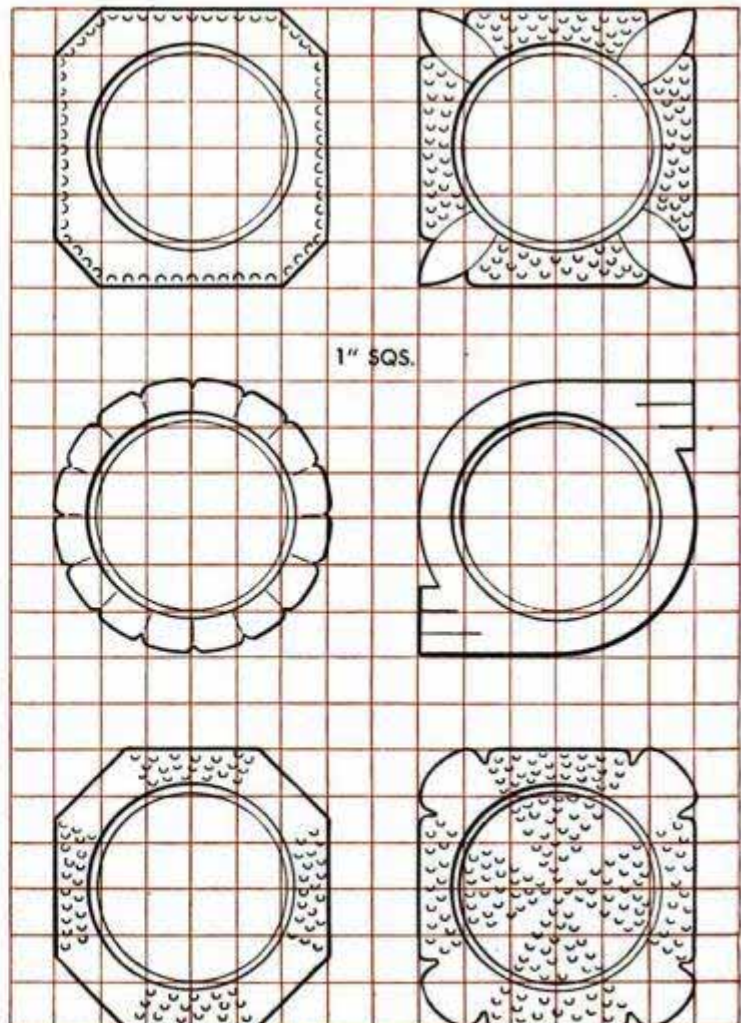
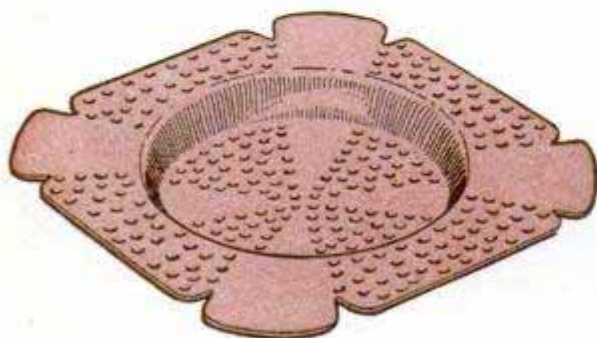
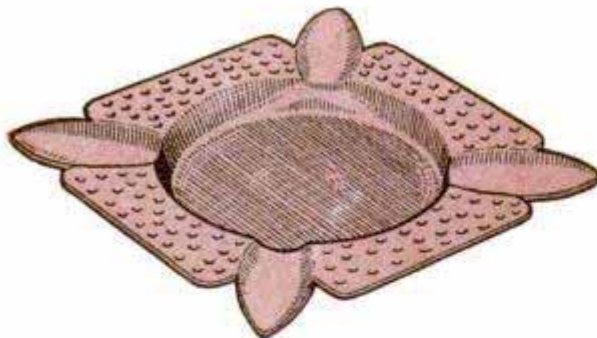
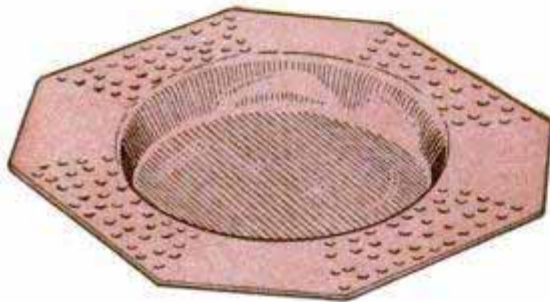
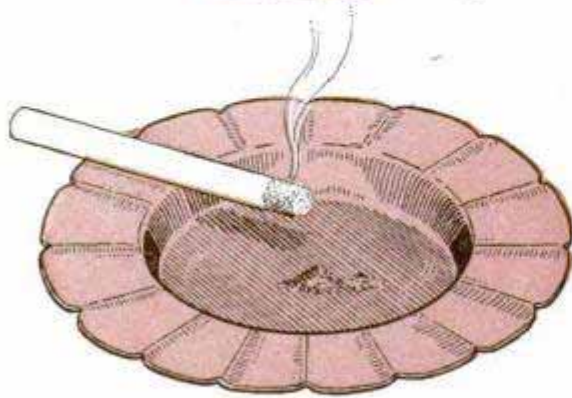
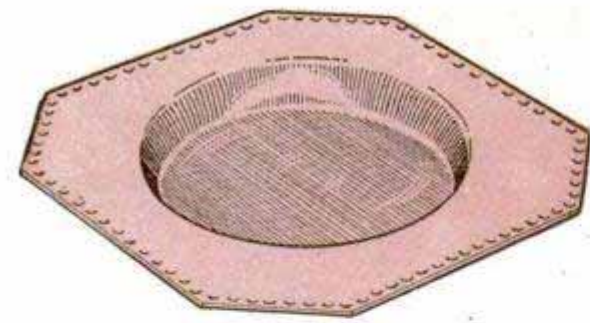

in COPPER

the metal will wrinkle at the rim. This is annealed and hammered flat with the smooth end of the mallet. When dished, the desired design is drawn on the rim of the tray with a pencil and cut with tinner's snips. The rough edges of the metal are smoothed with a fine file. The completed tray can be ornamented by engraving, peening or etching.

The trays can be finished in several ways. A satin finish is had by merely rubbing the metal with fine steel wool and a high polish can be obtained by buffing with jewelers' rouge. Another attractive finish is had by dipping the metal momentarily in a solution of nitric acid, one part, and water, four parts, and rinsing immediately in water. Care should be taken in handling the acid to avoid getting it on the hands or clothing. Whatever treatment is used, the finish should be protected from tarnishing by coating the metal with clear lacquer, applying it with a brush or spray gun.



1st—Anneal copper by heating, then quenching in water

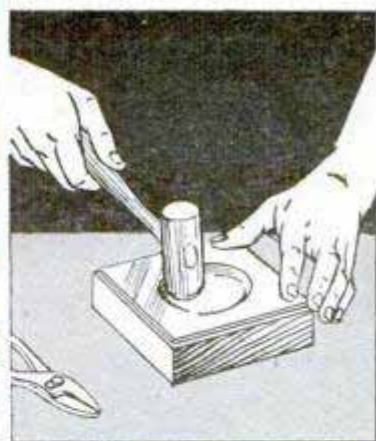

2nd—Dish metal by hammering into turned wooden mold

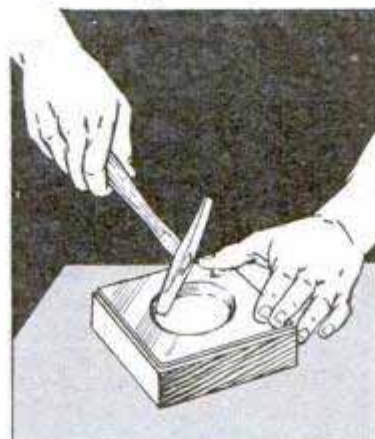

3rd—Use a tack hammer to iron out wrinkles in corners



4th—Mark rim design with a pencil, following patterns



5th—Snip off corners. Then smooth rough edges with file

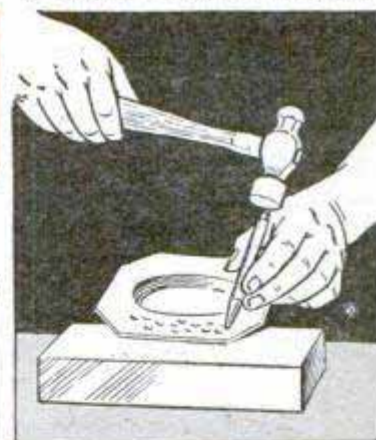

6th—Use rounded end of nail set for a peened effect

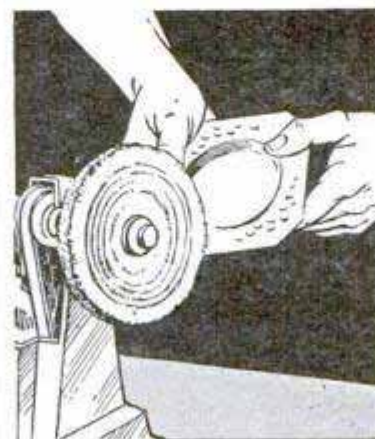

7th—Buff metal to obtain a bright finish by using rouge



8th—Prevent tarnishing by applying coat of clear lacquer

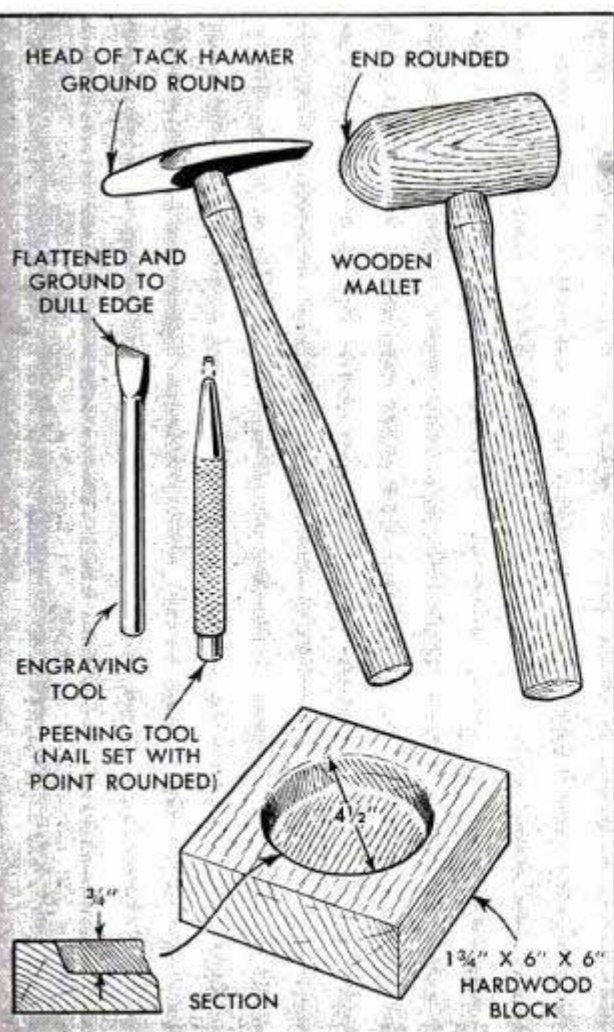



Ice-Cream Mix Frozen Quickly By Using Home Freezer

In making ice cream, the use of crushed ice and salt can be eliminated by suspending the ice-cream mix in a home freezer. Remove the ice container from an electric ice-cream freezer and fit the mixing unit into a wooden frame. Then, assemble the unit with the container in place, remove one of the covers from the home freezer and place the unit in the freezing compartment while mixing.—Thomas E. Stimson, Jr., Los Angeles, Calif.

Extension Aids Driving Nails In Hard-to-Reach Places

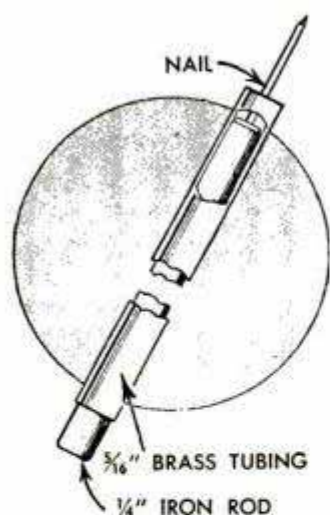

end. With the nail held in position by the tubing, the projecting end of the rod is hammered to drive the nail. If desired, the rod can be magnetized to hold the nail straight.—S. L. Tish, Bronx, N. Y.

☞ Plain vinegar will remove fish odor from your hands, pots and skillets.

Emergency Eye Shade Fits Glasses

Mislaying an eye shade necessary to your work is not serious as a substitute can be cut from paper. Cut out the shade as in photo and slip it over the frame of your glasses.



Magnet Holds Spring for Cutting

When cutting off the end of a coil spring with a cold chisel, the severed end can be kept from flying off by use of a strong horseshoe magnet. Lay the magnet on the anvil and rest the spring against it so that the ends of the magnet contact the spring on each side of the cold-chisel blade.—G. E. Hendrickson, Argyle, Wis.



Stored Skis Retain Proper Arch If Clamped on Ceiling Joist

Finding that one ski repeatedly lost its arch when the pair was stored in the usual manner, one man now stores his skis by fastening them to a basement ceiling joist. The ends of the skis are held to the side of the joist by simple clamps consisting of pieces of 1 x 2 screwed to the joist. A block of the necessary thickness placed under the skis retains the proper arch when the clamps are drawn tight.

H. E. Winchester, Salt Lake City, Utah.

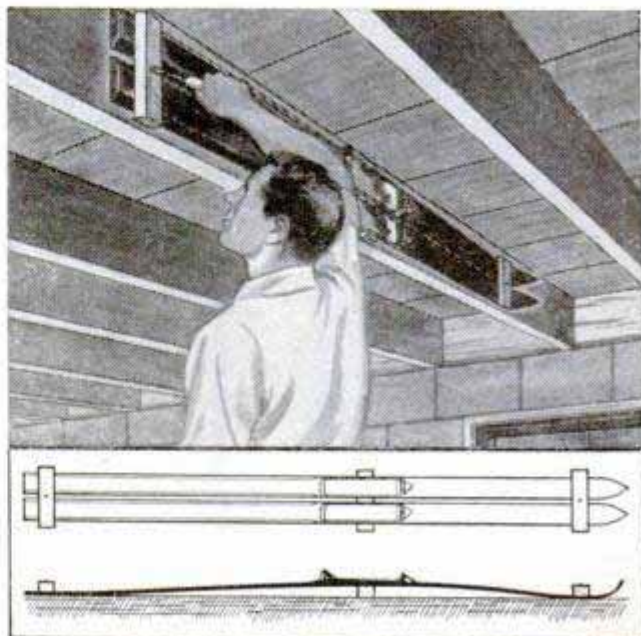

A nail keg or small barrel, cut in half and anchored to a wooden platform, makes an attractive birdhouse when mounted on a post in the back yard. The house has an unusual thatch roof which is made by tying bamboo rake teeth to a center pole and lacing a piece of wire through them to hold them against the rim of the keg. The roof pole is simply a piece of broomstick forced into an under-size hole drilled through the end of the keg. The platform or base of the house is made as shown in the lower detail and is fastened to the post with wooden braces. Flat-iron brackets or steel corner plates anchor the house to the base. Although the original birdhouse had only one opening, another opening or two can be added and the house partitioned, using plywood or hardboard panels.

Birdhouse Constructed From Nail Keg Has Appearance of Thatch-Roofed Hut

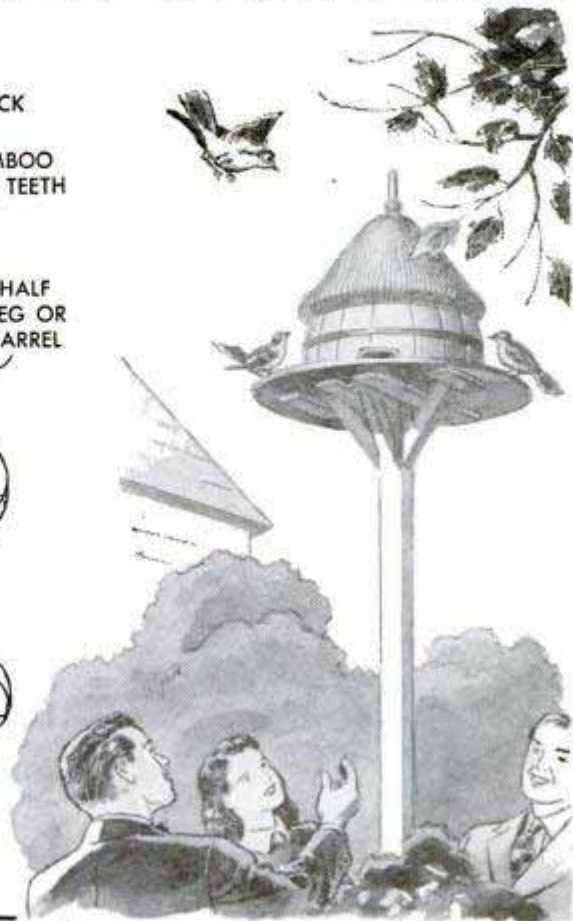
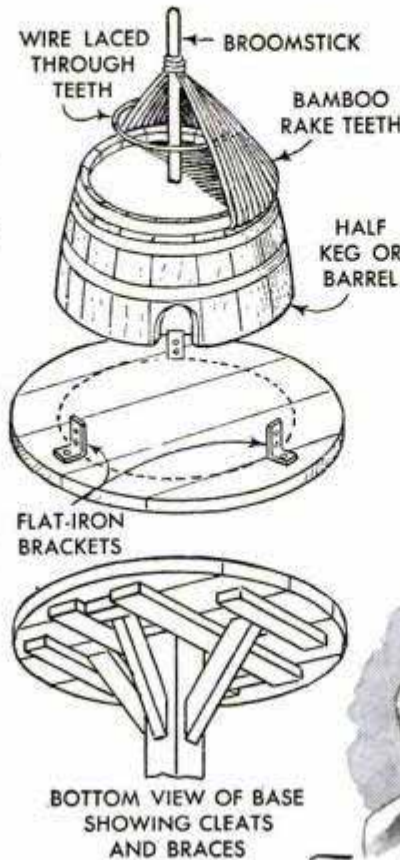

Kerosene Torch Aids Lighting Furnace Without Soiling Hands or Clothes

After you've placed kindling and fuel in the furnace there's the problem of lighting it without getting hands and arms smeared with greasy soot from the edges of the fire-door opening. That's where this long-handled kerosene torch comes in handy. It's simply a length of rod welded to a pipe cap, a piece of cloth being tied around the

end of the rod. The rest of the unit consists of two lengths of pipe welded to an iron base. One pipe contains kerosene and the other, a shorter one, is left empty to serve as a "snuffer" for putting out the lighted torch safely. When the torch is not in use, its cap is turned onto the threaded end of the longer pipe, thus preventing the kerosene from being spilled if the unit is knocked over. The level of kerosene should be high enough to keep the cloth saturated.

Jack Lee Thompson, Nocona, Tex.

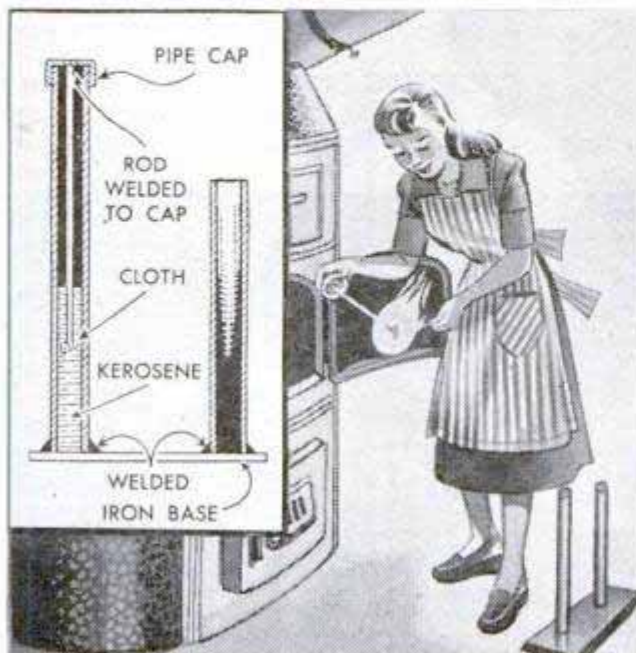

Bowl Cover Catches Crumbs

When grinding dried bread or crackers in a meat grinder, slip a plastic bowl cover over the end of the grinder to catch the crumbs. It will keep them from being scattered over the table top.



☐ Bread and other baked goods will remain fresh longer in camp if half a potato is placed in the bread container.



WAFFLES WON'T STICK to waffle-iron grids if the latter are cleaned by brushing with baking soda. Applying the soda with a stiff, wire-bristled brush will remove all the discoloration

WHEN MEASURING LIQUIDS of two or more kinds into a teaspoon with an eye dropper, both hands are left free if the handle of the spoon is propped between the tines of a fork

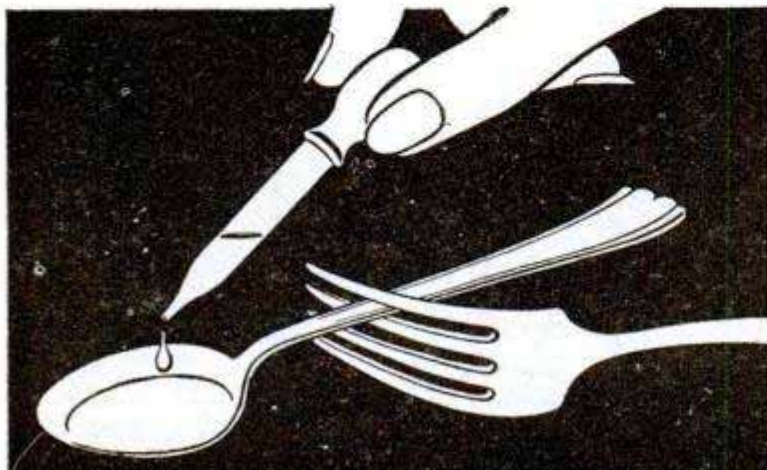

SOLVING

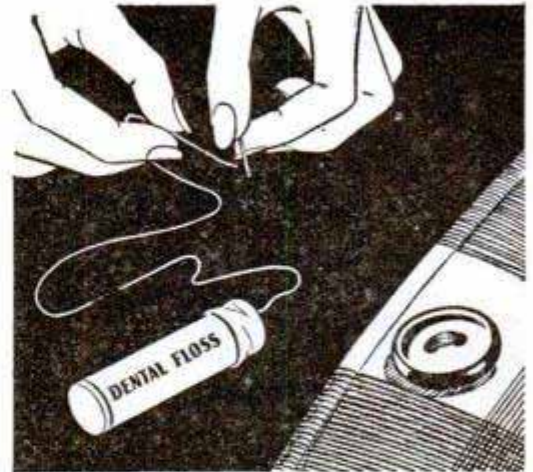

TO SEW BUTTONS on children's garments and men's work clothes use dental floss instead of ordinary thread. The dental floss is considerably stronger than thread and better able to withstand rough usage



DYEING CLOTHES is done more easily by using an old curling iron to stir and inspect the fabric. The spring action of the iron assures a firm grip which prevents dropping the cloth and splashing the dye

CLOTHESLINE PROPS are kept from sliding and falling by wrapping adhesive tape around the line at the sides of the props

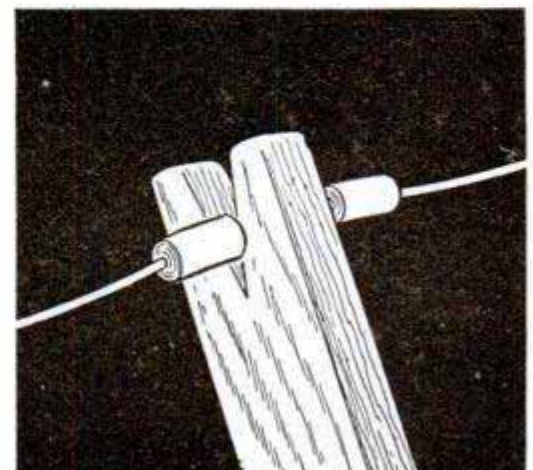

HOME PROBLEMS

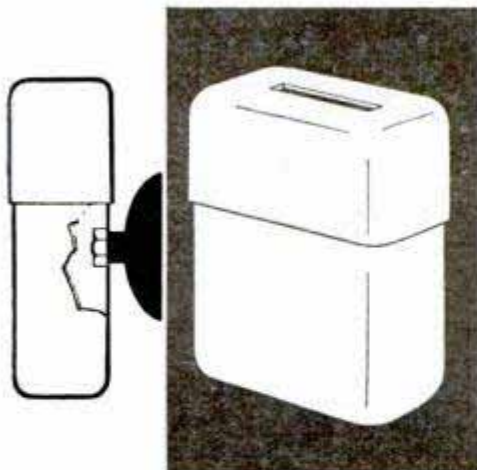

DISPOSAL OF USED RAZOR BLADES is no problem if they are placed in a metal or plastic cigarette case fastened to bathroom wall. Suction cup is bolted to side of case and the cover is slotted for blades

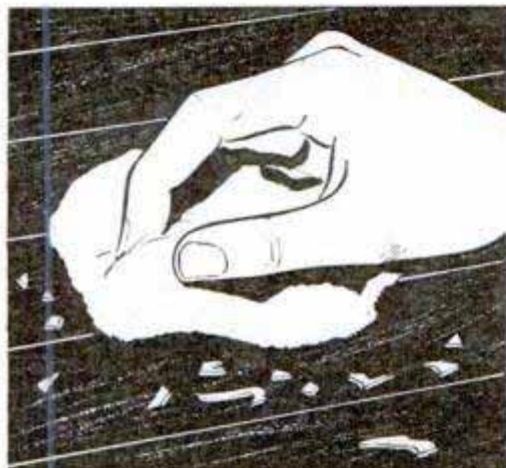

SLIVERS OF GLASS can be picked up from the floor or table top in a jiffy with a moistened wad of absorbent cotton. This will do a thorough job and considerably reduce the danger of injuring the fingers

WINDOWS LOCK AUTOMATICALLY when they are closed if the usual sash locks are replaced with cupboard-door catches

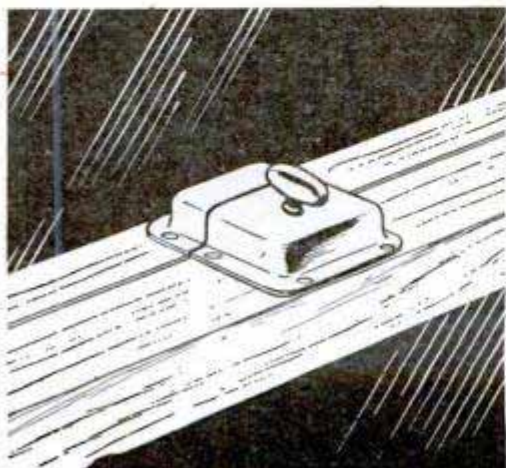

TROUSER RACK for closet door is provided by spring-type curtain rods. One end of each rod is held by a screw hook, and key ring attached to other end loops over a screw

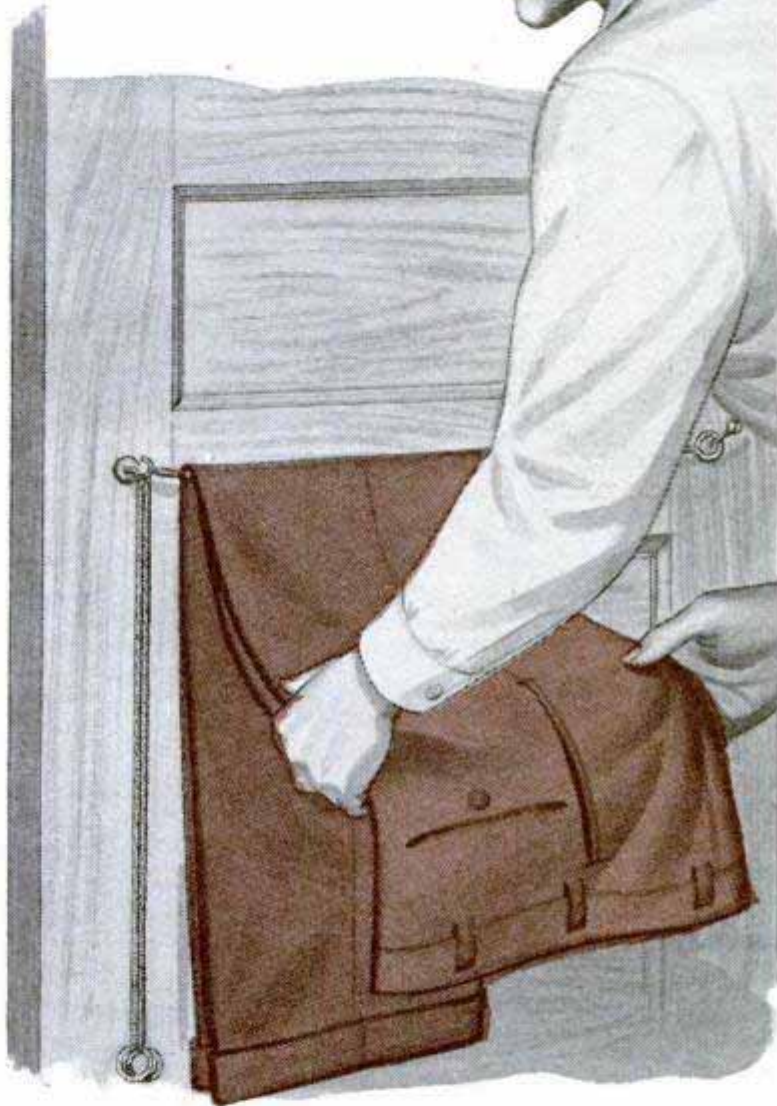

GLASS TOP FOR WINDOW SILL protects the finish from dampness caused by potted plants. Use a piece of ordinary window glass, cutting it to size and smoothing the edges with an oilstone



Sliding Door on Rabbit Hutch Provided by Extension Screen

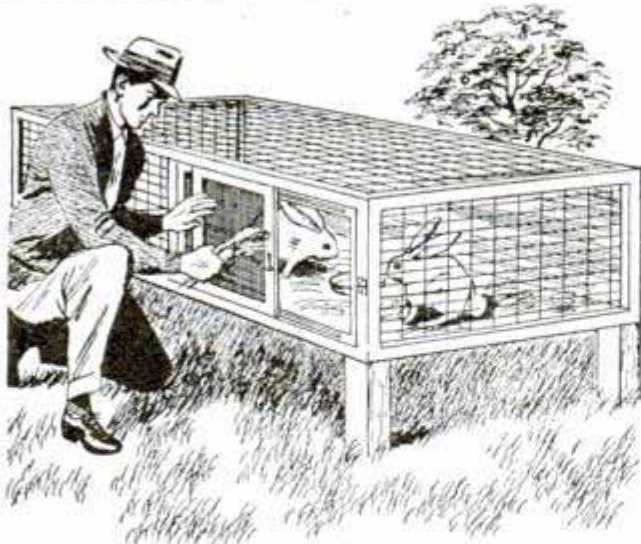

An extension screen of the type commonly used on house windows serves as an excellent sliding door for a rabbit hutch or small pet cage. It is easily opened or closed and can be fastened with a screen-door hook and eye.

W. S. Darling, Danbury, Conn.

Slanting Improves Cutting Action Of Jigsaw Blade

For cutting metal or hardwood, the performance of a jigsaw is improved by moving the blade slightly forward in the top chuck. In this way, the cutting action on the downward stroke is forward. On the upward stroke, the blade moves away from the work, eliminating the lifting action usually encountered. Slight adjustment of the blade probably will be necessary to obtain the best operation.

Richard Hanscom, Elmhurst, Ill.

Angle Slots in Miter Box Laid Out Accurately

When assembling a wooden miter box, you can make sure that the 45-deg.-angle slots are accurate by laying them out on the underside of the box. To do this, carefully mark an exact square on the bottom of the

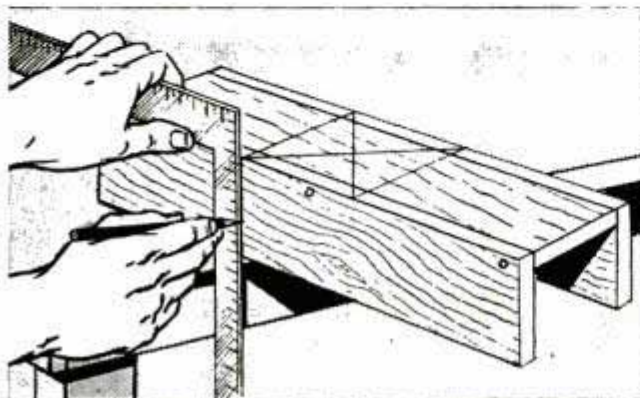

box, draw the diagonals, and extend them across the sides of the box to the top. Then, make the saw cuts in the usual way.

Michael Ligocki, Gary, Ind.

Block Clamps Sandpaper Securely

Instead of improvising a makeshift sanding block whenever one is needed, make one from a piece of hardwood fitted with a flat-iron clamp and keep it around the shop. Drill a hole through the center of the flat iron and bend it at right angles about $\frac{1}{4}$ in. from each end. Then fasten the clamp to the block with a round-headed screw so it grips the paper securely.

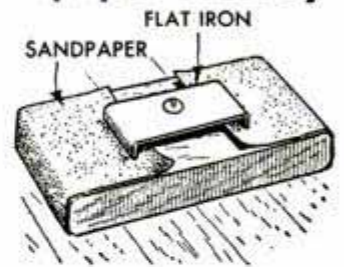

Arthur Trauffer, Council Bluffs, Iowa.

Weighted File Handles

Empty carbon-dioxide cartridges filled with lead provide heavy handles for small files. Should a file be dropped, the extra weight of the handle will cause it to fall handle-first, thus protecting the tool blade from damage. To make a handle of this type, grind off the end of a cartridge, as shown, and fill it with lead. After the lead hardens, drill an undersize hole for the file tang and press the tang into the hole.

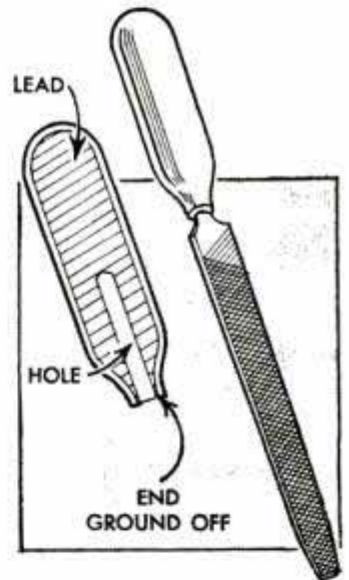

David Jenkins, Xenia, Ohio.

Cork Disks From Pop-Bottle Caps Serve as Feet for Trinket Boxes

Cork disks found in bottle caps are just the right size to make feet for jewelry and trinket boxes so they will not mar the tops of dressers. The cork disks are easily removed from the bottle caps with a knife blade and then they are glued to the bottoms of the boxes.

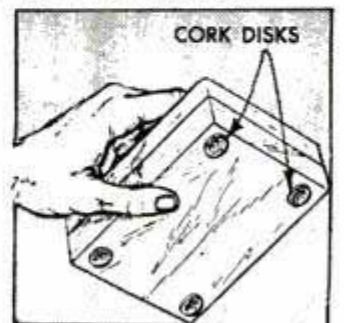

Frank Shore, New York City.



Furniture You Can Build p. 45

Furniture for Your Bedroom

**Part
Two**

WITH THE night stands, chests and vanity units completed as described in Part I, you can tackle the bed. In addition to its pleasing simplicity, it features a built-in storage compartment in the headboard for bedding and two roomy drawers for shoes. If twin beds are preferred to a full bed, the basic construction is the same. It would be merely a matter of making the bed narrower, installing only one drawer and eliminating the center partition in the storage compartment. Most of the bed is made of $\frac{1}{4}$ -in. plywood. On the original bed, the lid of the storage compartment was a $\frac{3}{4}$ -in.-plywood panel, but to save cost, this too can be of $\frac{1}{4}$ -in. material by gluing it to a half-lapped frame as shown in Figs. 13 and 14.

The bed footboard consists of a $\frac{1}{4}$ -in. plywood panel which is framed on three sides with a $\frac{3}{4}$ x 2-in. molding. The latter is chamfered and grooved

Right, a jointer plus a bench saw are the only power tools needed. Here, base molding is being run on jointer after being ripped on saw

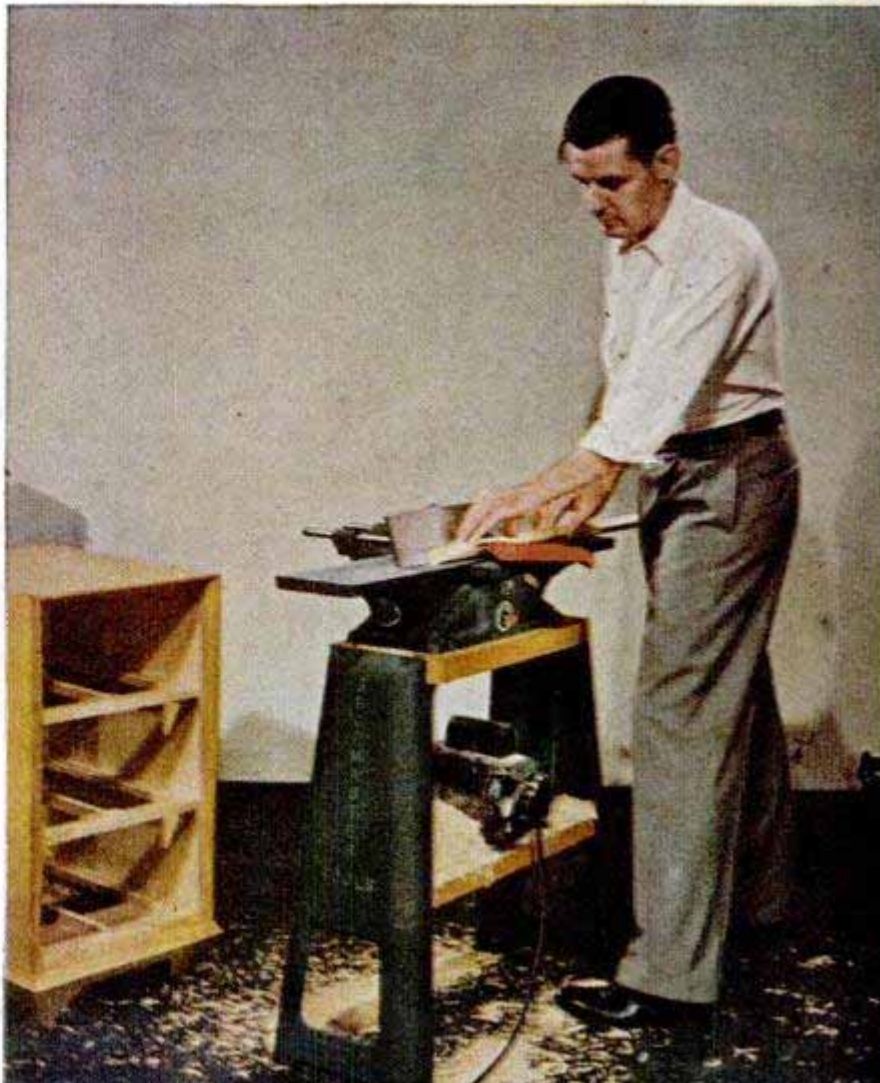



A roomy drawer opens at each end of the bed headboard to provide storage space for seasonal footwear. Being concealed when the headboard is flanked with night stands, the drawers also provide a safe place for personal papers and jewelry

Another feature of this headboard is a convenient built-in storage compartment for bedding. If you wish, the compartment can be lined with aromatic, red cedar to protect woolen blankets from moths. Open, the lid rests on the bed



$\frac{3}{8}$ in. deep on its inside face to fit over the edge of the plywood. The panel is faced across the bottom with a $\frac{3}{4} \times 1\frac{3}{4}$ -in. molding which matches the molding on the night stands, chests and other pieces. This molding is glued to the plywood so that it overlaps the bottom edge $\frac{1}{2}$ in., sectional detail Fig. 16, and then five rabbeted cleats, 6 in. long, are spaced along the inside and screwed to the molding. Note that the molding is mitered at the ends and returned at the corners for a distance of 4 in., Fig. 16. Note also that the lower ends of the grooved molding, which covers the edges of the plywood, are chamfered on two adjacent outside edges to fit flush with the bottom molding and the upper ends are mitered. The feet are made the same as detailed in Part I, except that here the shoulder must measure $1\frac{1}{4}$ in. long instead of 1 in. The feet are rabbeted on two adjacent sides and glued into the corners formed by the molding to bring them flush.

The headboard is built around a framework of scrap wood, Fig. 15. Start each end assembly with a $\frac{3}{4} \times 4 \times 11\frac{1}{2}$ -in. base piece and screw a $\frac{3}{4} \times 2\frac{1}{2} \times 15$ -in. upright piece to it, $\frac{1}{4}$ -in. in from the front edge. Note that the upper end of this piece is notched for a cross member. Another piece, $\frac{3}{4} \times 1\frac{1}{2} \times 30\frac{3}{4}$ in., is attached vertically to the base piece, $\frac{1}{4}$ in. in from the rear edge. This piece is joined to the front piece with a cross member located 10 in. up from the top surface of the base, forming the drawer opening. Both end assemblies of the framework are joined together as shown, fitting a $\frac{3}{4} \times 1$ -



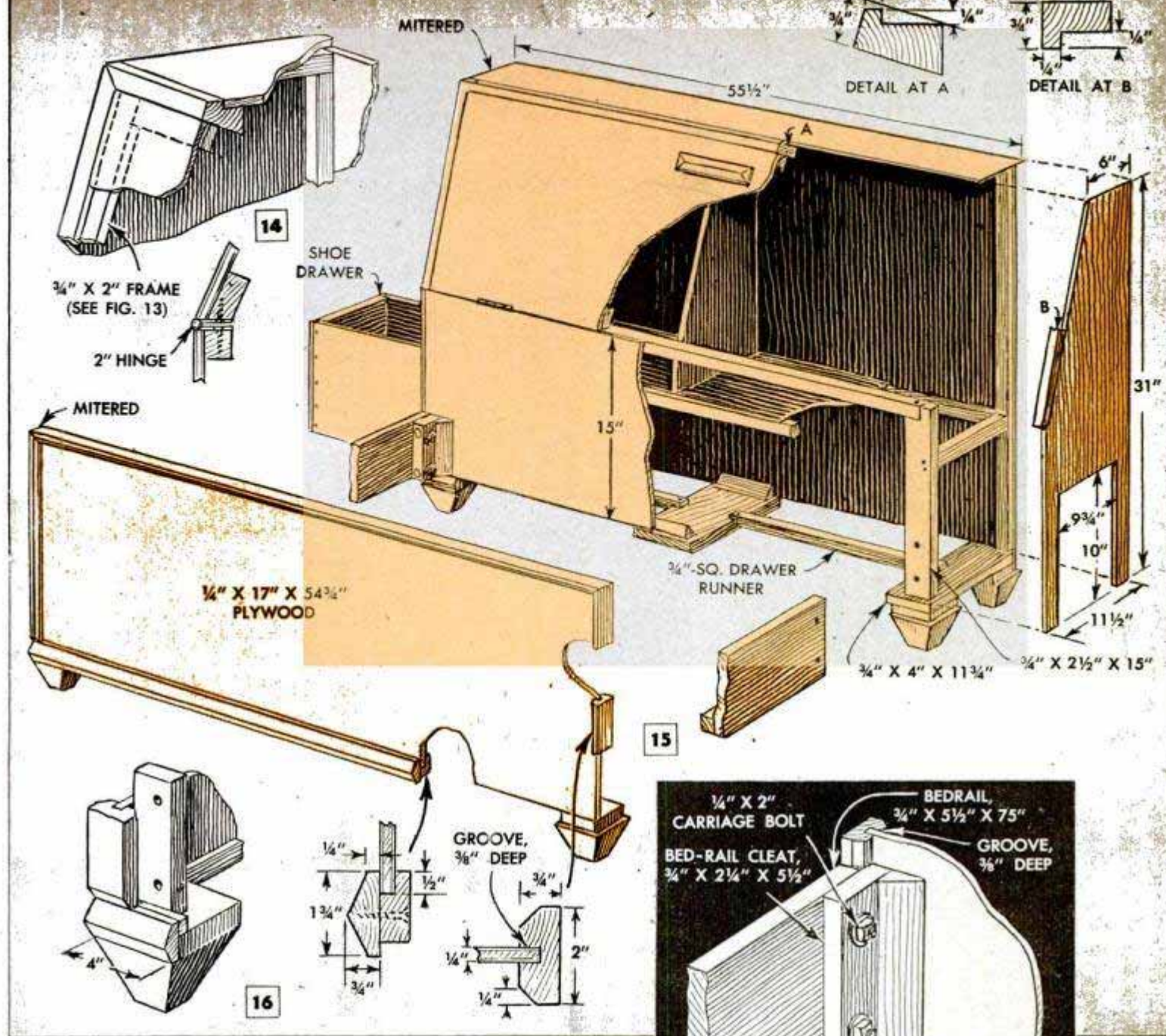

in. strip into the notched front uprights, another one below it at a point flush with the member at the top of the drawer opening and a third piece at the same height at the rear. These two latter strips form a ledge for the bottom of the compartment which is of plywood.

Now, cover the back of the framework. This requires a fir-plywood panel, 1/4 x 30 3/4 x 55 in., which is nailed and glued so that the edges are flush with the framework. Next, fit the front panel, cutting it 15 x 55 in. The plywood pieces covering the ends of the headboard taper to 6 in. at the top from a point 15 in. up from the bottom. These are made right and left hand, selecting the best face of the plywood for the outside, and mitered at the top. After the ends are glued in place, the drawer-runner assembly is installed. The runners are simply 3/4-in.-square strips, notched at each end to hook over the base pieces and a center piece fastened to the plywood with glue blocks.

Fit the panel forming the bottom of the bedding

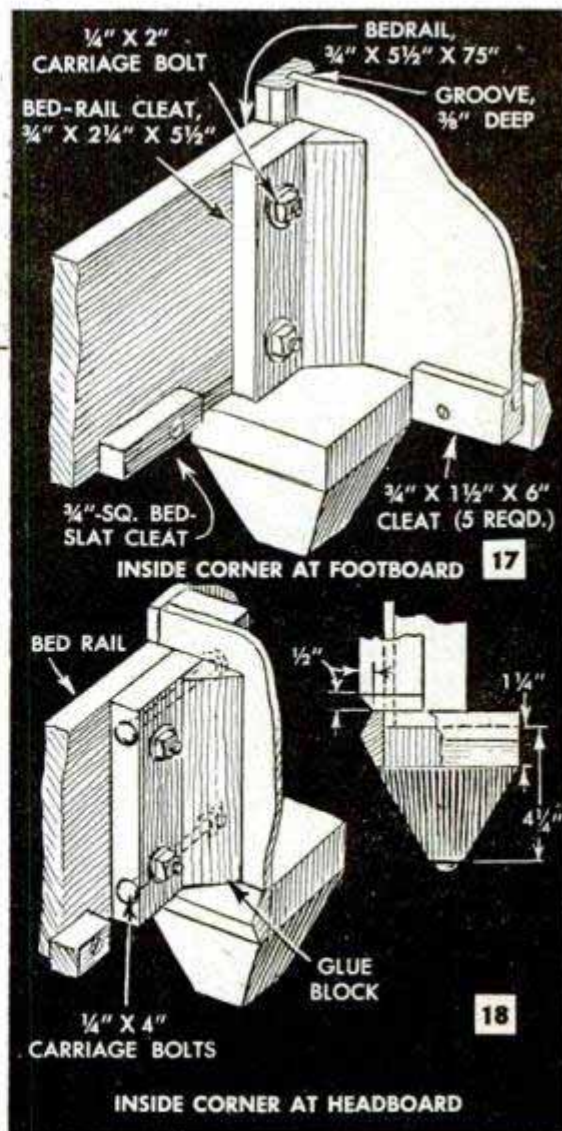

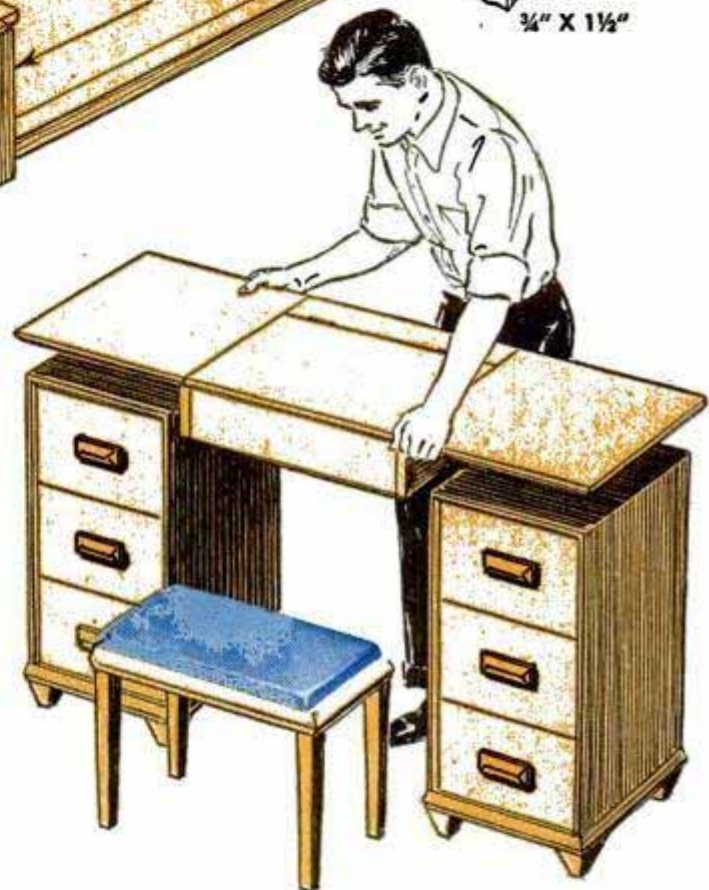
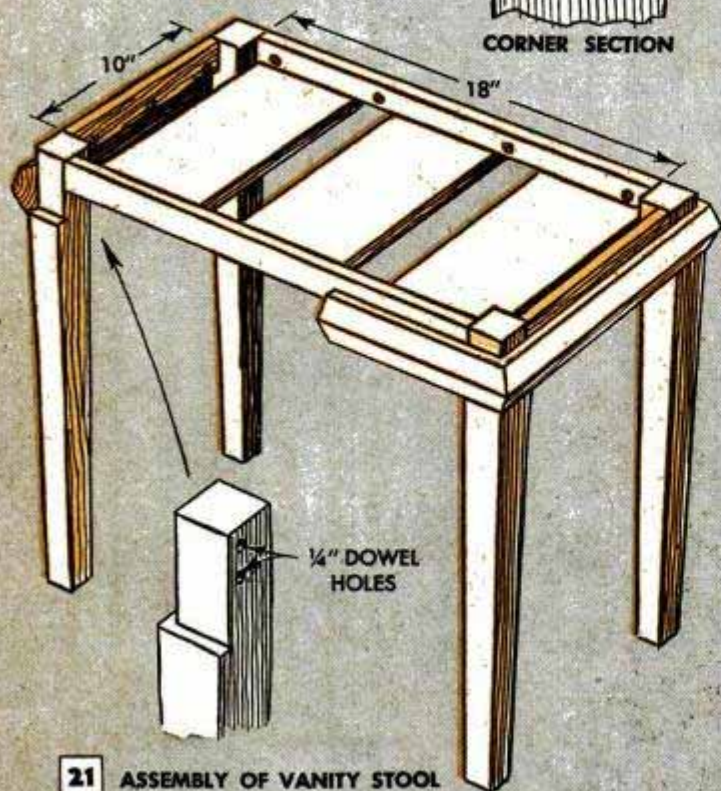
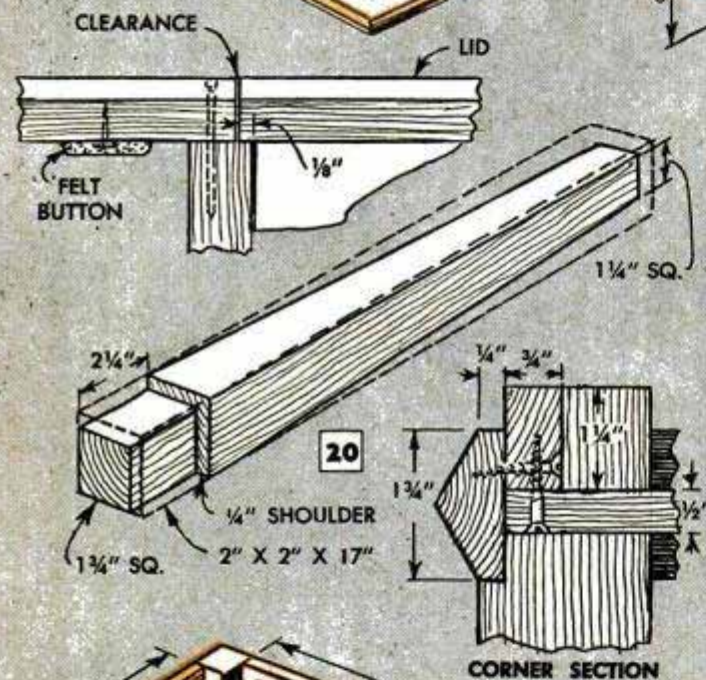
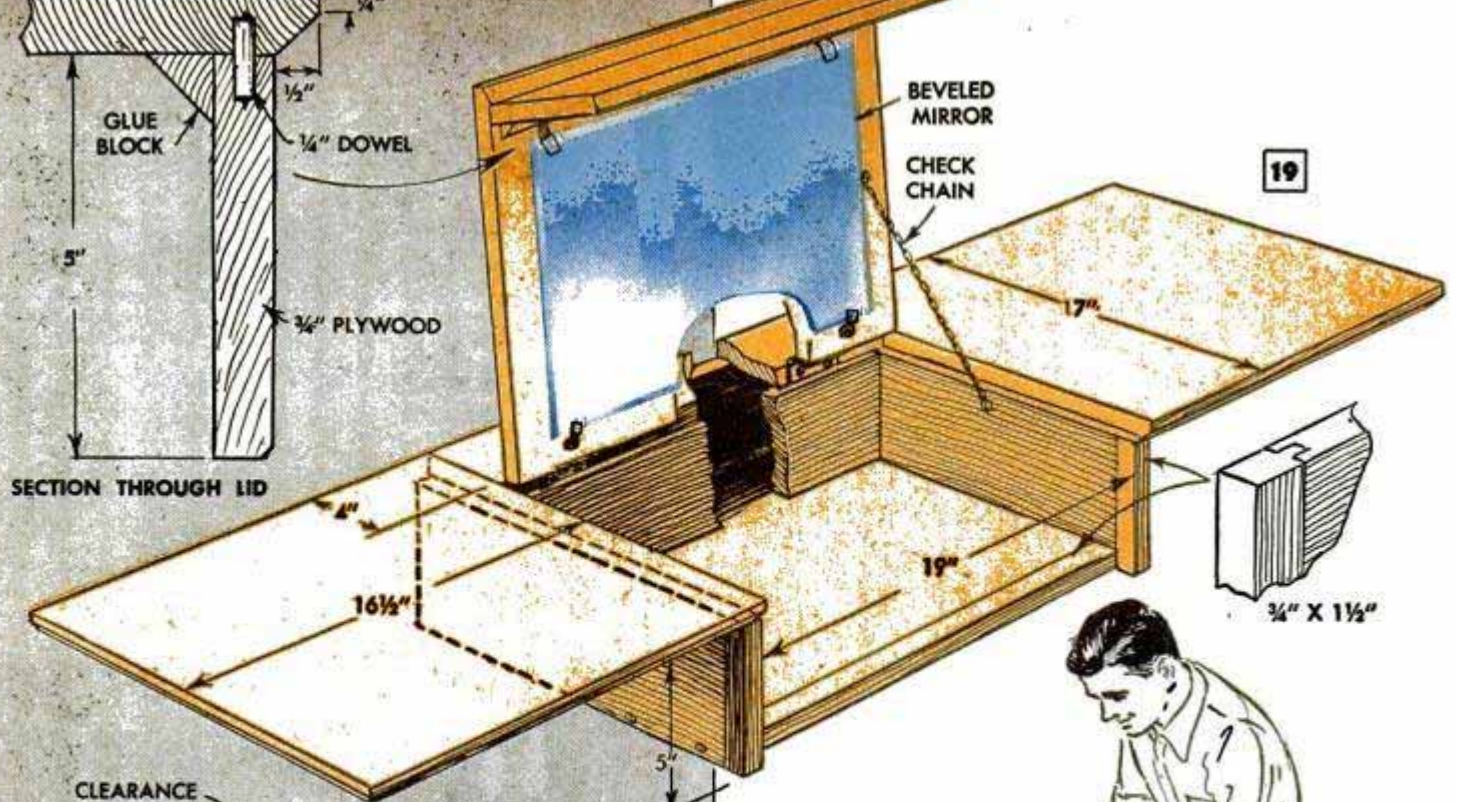

compartment next, and then add the top panel, mitering it to fit accurately with the mitered ends. The compartment partition, which gives support to the top, is notched at the front to fit around the framework strips. The exposed edges of the plywood framing the compartment are covered with a 3/4-in. rabbeted molding. The strips which cover the edges of the ends are cut as indicated in detail B, while the one that covers the edge across the top is cut as shown in detail A. The molding is mitered at the corners and glued and clamped to the plywood. A base molding, matching that used on the footboard, is fitted around the outside corners, gluing and clamping it to the edges of the base pieces of the framework.

21 ASSEMBLY OF VANITY STOOL

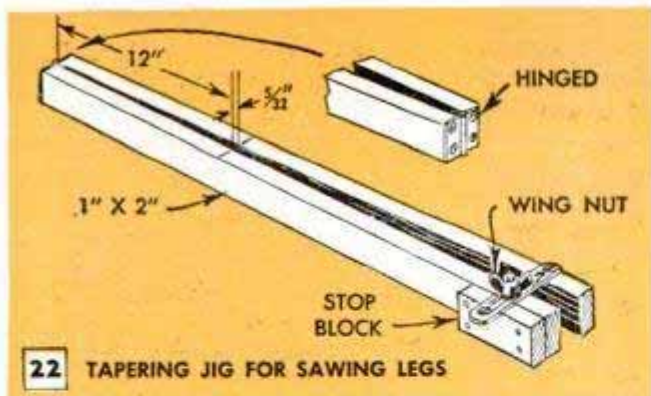

22 TAPERING JIG FOR SAWING LEGS

The compartment lid is hinged as shown in the sectional detail, Fig. 14, and drawers and handles are made as described in Part I. Bedrails are attached to the head and footboard as detailed in Figs. 17 and 18.

The separate top, Fig. 19, which merely rests on two base units to form a vanity, is made of $\frac{3}{4}$ -in. plywood and solid stock. The top requires a panel 17 x 52 $\frac{1}{2}$ in. Three edges are chamfered on the underside and then the panel is cut into four pieces. The cosmetic compartment is made like a box. The sides and back are screwed to a plywood bottom and a fourth piece is installed to support the narrow fill-in piece to which the lid is hinged. Note how end grain of the side and bottom members of the compartment is concealed with edging strips, tongued and grooved. The outboard panels are nailed and glued to the top edges of the compartment $\frac{1}{8}$ in. in from the inner faces to provide a shoulder for the lid. This is shown in the detail above Fig. 20. The front apron is attached to the lid with dowels and a triangular glue block is placed on the inside. The lid can be leaned against the wall when opened or a check chain can be used to hold it at the right angle.

Assembly of the vanity stool is detailed in Fig. 21. First make the legs by cutting a $\frac{1}{4}$ x 2 $\frac{1}{4}$ -in. rabbet on two adjacent faces of each one. The legs taper from 2 in. square at the shoulder to 1 $\frac{1}{4}$ in. square at the bottom, Fig. 20. Before tapering the legs, bore holes in adjacent inner faces as shown for doweling $\frac{3}{4}$ x 1 $\frac{1}{4}$ -in. rails flush with the face of the rabbets. A jig like the one shown in Fig. 22 may be used to rip the taper on each face, after which the cut is dressed smooth on a jointer. The corner-section detail at the right of Fig. 20 shows how a mitered face molding is attached to the rails with screws from the inside. A choice of two methods for upholstering the stool is given in Fig. 23. If tow or hair is used, the seat is supported by three $\frac{1}{2}$ -in. pieces spaced as in Fig. 21. If foam rubber is used, the bottom of the stool is covered with a piece of $\frac{1}{4}$ -in. plywood held by cleats screwed to the rails.

(Methods of finishing will be described in Part 3)

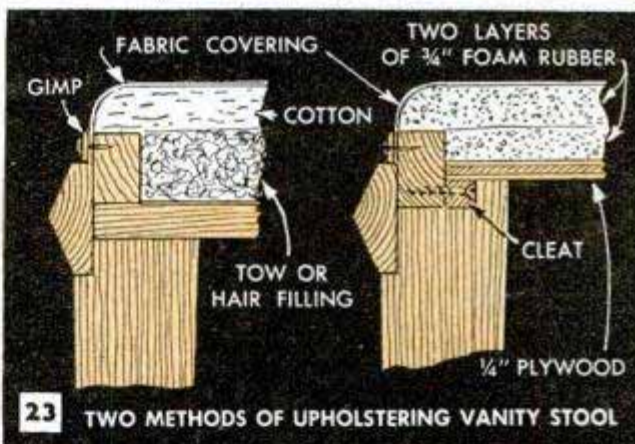

23 TWO METHODS OF UPHOLSTERING VANITY STOOL

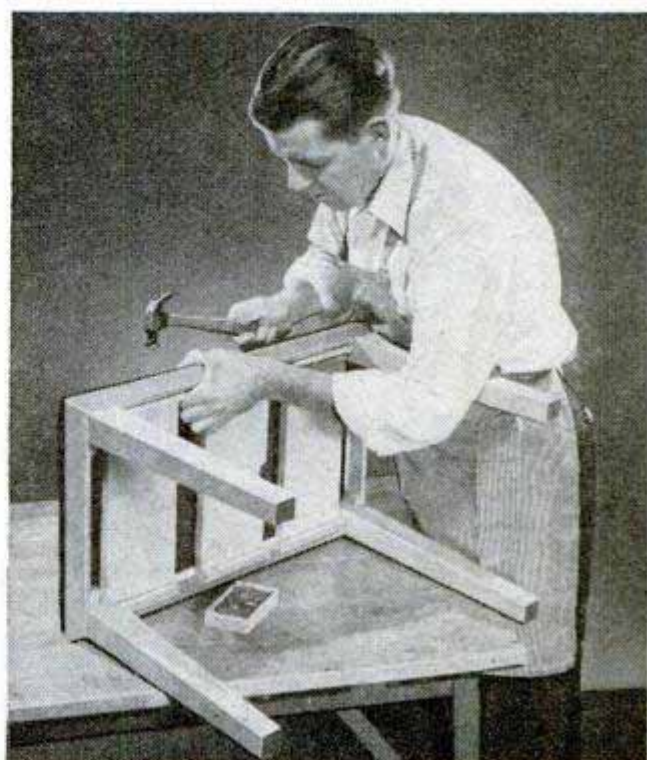

Covered Wagon Pulled by Oxen Forms Novel Rural Mailbox

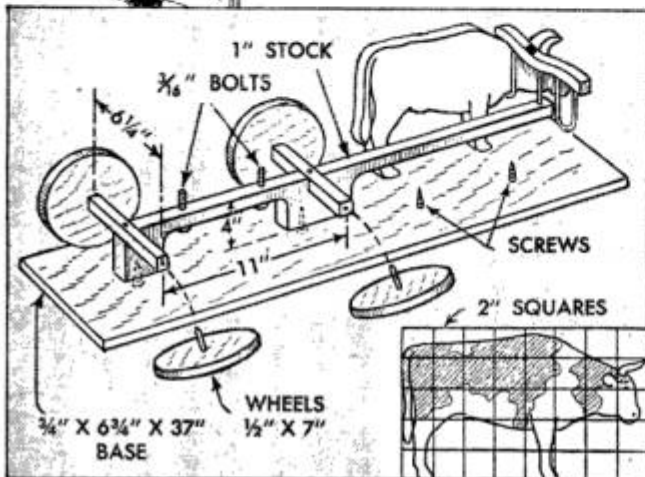

Should you want something unusual and yet simple in a rural mailbox, mount the box on four wooden wheels and "hitch" a team of oxen to it. Cut out the oxen according to the squared pattern and make the frame and wheels. Then fasten these parts to a wooden base and bolt the mailbox in place. After painting the unit as desired, attach it to the mailbox post.

E. W. Kessler, Hocomo, Mo.

Silencing Pounding of Attic Tank

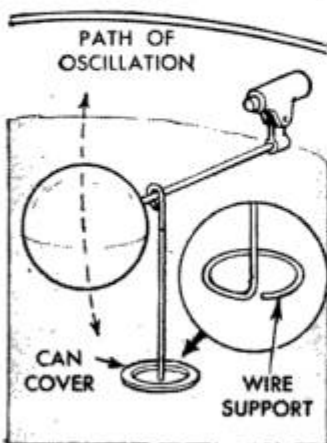

If your water is pumped to an attic tank which supplies pressure to the plumbing system, the noisy pounding of the intake valve usually is due to oscillation of the float. This can be eliminated by attaching a simple damper to the float. The damper is made by

bending a short length of brass or galvanized-iron wire, as shown, and inserting it through a hole punched in a can cover. The cover rests on the wire support and is free

to move upward only. In this way, the damper tends to retard upward motion of the float while it does not hinder downward motion. The resulting dampening action stops oscillation of the float before any sound can be emitted or damage done to the inlet valve.—A. Anderson, Nairobi, Kenya.

Paintbrush Suspended in Solvent

The bristles of a paintbrush stored in a can of turpentine or other thinner will remain in good condition for several days if the brush does not rest on the bottom of the can. A holder which allows the bristles to be immersed in the solvent without touching the bottom is made by nailing a split section of hose to a strip of wood or stirring paddle. The brush handle is inserted in the hose and the holder is placed in the can of thinner.

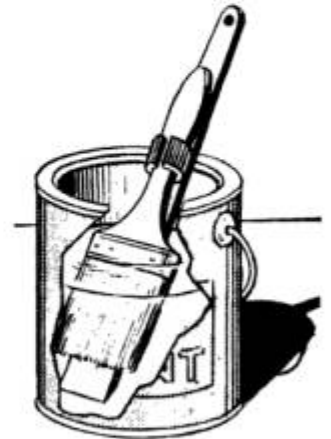

Level Wired to Straightedge Permits Easy Handling

When using a straightedge and a metal carpenter's level to plumb a doorframe or corner post, your hands will be left free to hold the straightedge if the level is wired to it. Notches in the straightedge permit the level to be wired temporarily to the opposite edge of the board.

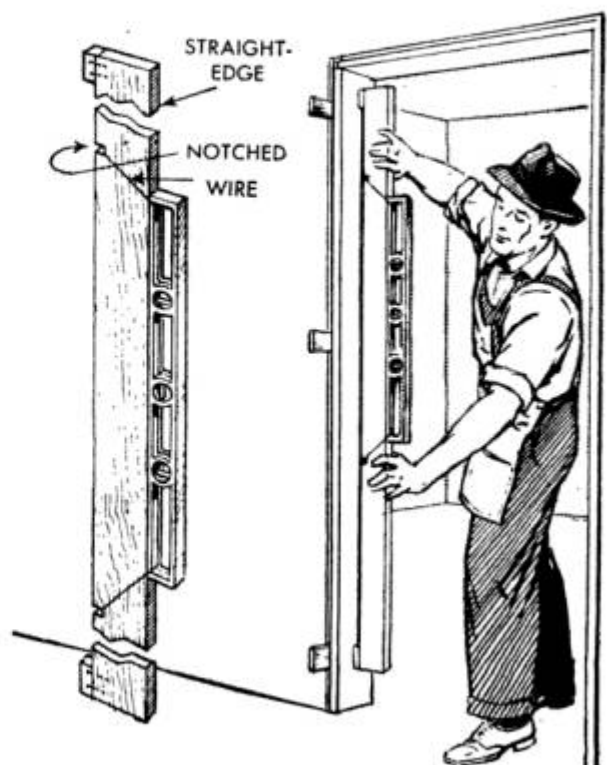

New Design Gives Back-Yard Incinerators a Lift

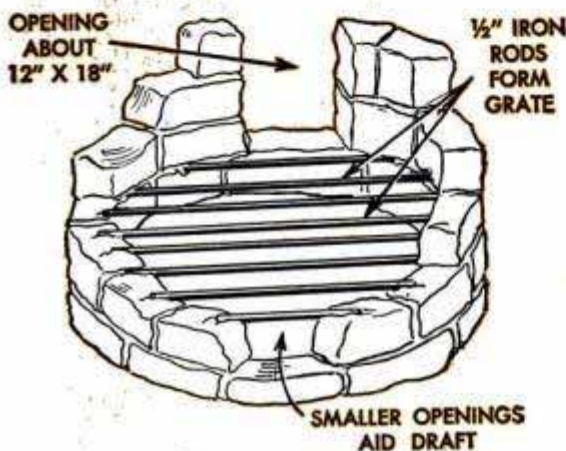

The average outdoor incinerator seldom amounts to more than a cylinder of fence wire or an old oil drum with the end knocked out. But one can be made to beautify a yard as shown in these two examples. The circular one resembles an outdoor fireplace, being made of stone laid in mortar and fitted with a grate and draft. The tall one, which looks like a miniature lighthouse, is open at the back and windows provide necessary draft

Outdoor Chess Played on "Flagstone" Board Adds Novelty to Game

The game of chess takes on a new twist and keeps players on their toes when played on a "flagstone" board with giant-size chessmen. A concrete terrace laid out in a checkerboard pattern serves as a playing board and chessmen are jigsawed and turned to represent as closely as possible the kings, bishops, queens, pawns, etc., of a regular chess set. The photo shows a chessboard composed of alternate squares of grass and concrete, each square being 18 in. in size. Where space is limited, 12-in. or even smaller squares will do. The squares are cast individually in forms and set nearly flush with the ground. By greasing the inside of the forms, the flagstones can be pushed out of them without sticking. Painting the concrete a brick-red color will give the chessboard an attractive appearance. The chessmen, of course, are painted contrasting colors.

Joseph S. Baer, San Diego, Calif.

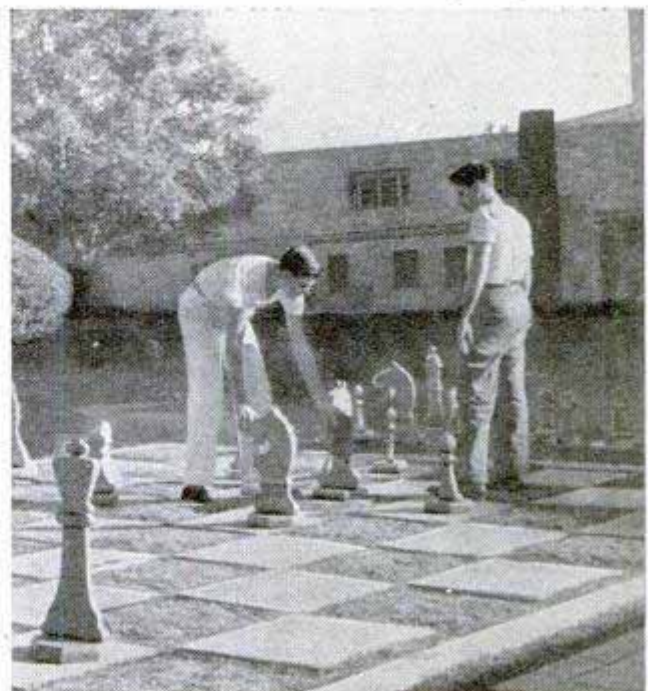

W.T.M. Concrete

Tool for Removing Hands of Clock Operates Similarly to Wheel Puller

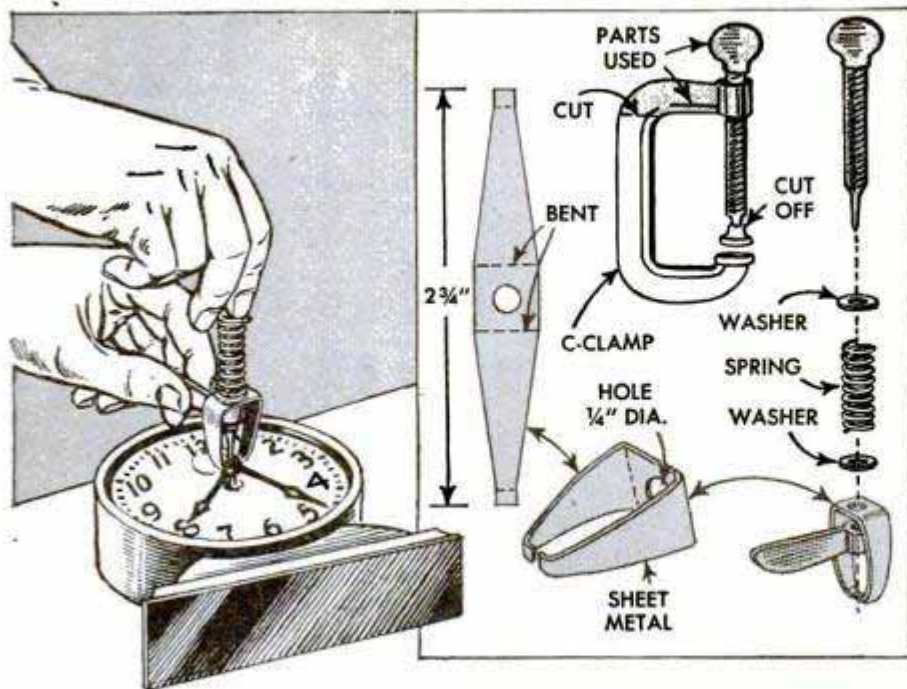

Working on the same principle as a wheel puller, this handy tool will remove even the most stubborn clock or gauge hands quickly and without damage. The handle-and-screw assembly is cut from a C-clamp, the screw being cut off and pointed as shown in the upper right-hand detail. Two washers and a compression spring placed over the screw hold a sheet-metal gripper tightly to the handle. To use the tool, slip the arms of the gripper over the clock hand and center the tip of the screw on the end of the shaft. Tighten the screw to force the gripper upward, pulling the hand from the shaft.

Saw-Blade Guide Kept From Slipping When Locking Screw Is Loosened

If the blade guide on a scrollsaw drops all the way down when the locking screw is loosened, this can be eliminated by fitting a short compression spring to the tip of the screw and, in some cases, to the extension rod also. The spring provides sufficient friction to keep the guide from slipping when the screw is loosened while still permitting the guide to be adjusted easily. A tenon slightly longer than the compressed spring should be filed on the end of the screw or rod. Then, when the screw is tightened, the spring will compress over the tenon, allowing the tip to make contact.

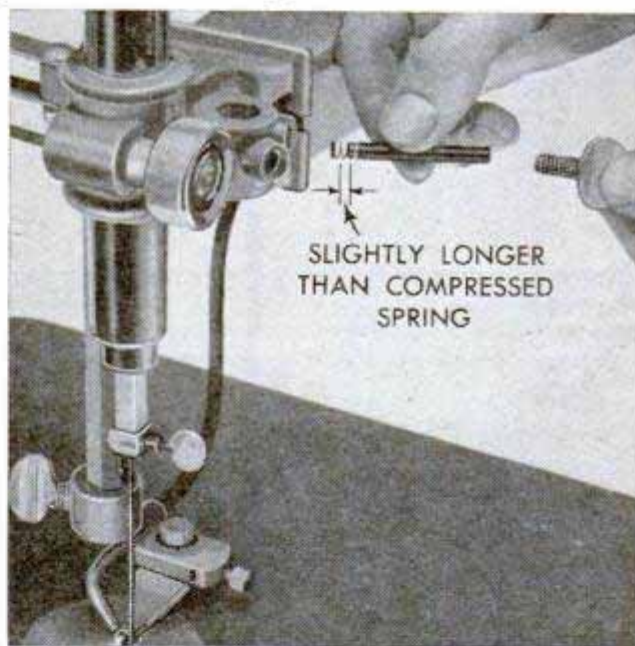

Sawing Model-Railroad Tracks

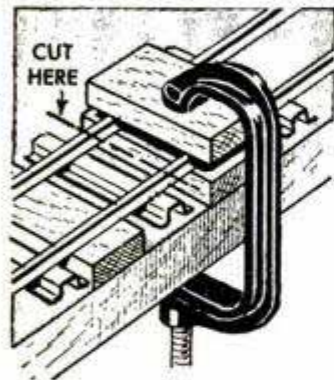

Cutting model-railroad track to fit a particular layout is simplified by placing the track on small blocks spaced between the ties and then clamping it to a workbench as shown. The wooden blocks under the rails keep the

ties from being crushed or bent by pressure of the C-clamp, and the cleat on top holds the rails firmly while they are being hacksawed. Note that the saw cut is made near the C-clamp, the free end of the track being held with the hand. Use a fine-toothed saw for the job, and file off any burrs.

C-Clamps Aid Moving Furniture

When a heavy desk or table must be moved single-handedly, the job is done more easily if casters welded to C-clamps are clamped to the legs at one end. With the casters in place, the other end of the piece is lifted and pushed as a wheelbarrow.

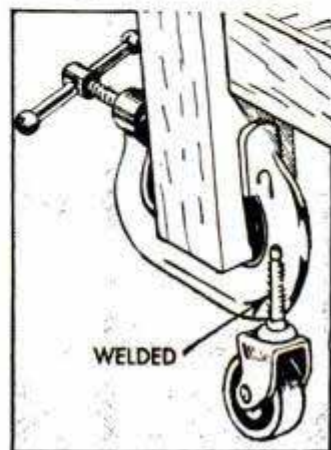

Get On With Your Spring Plowing

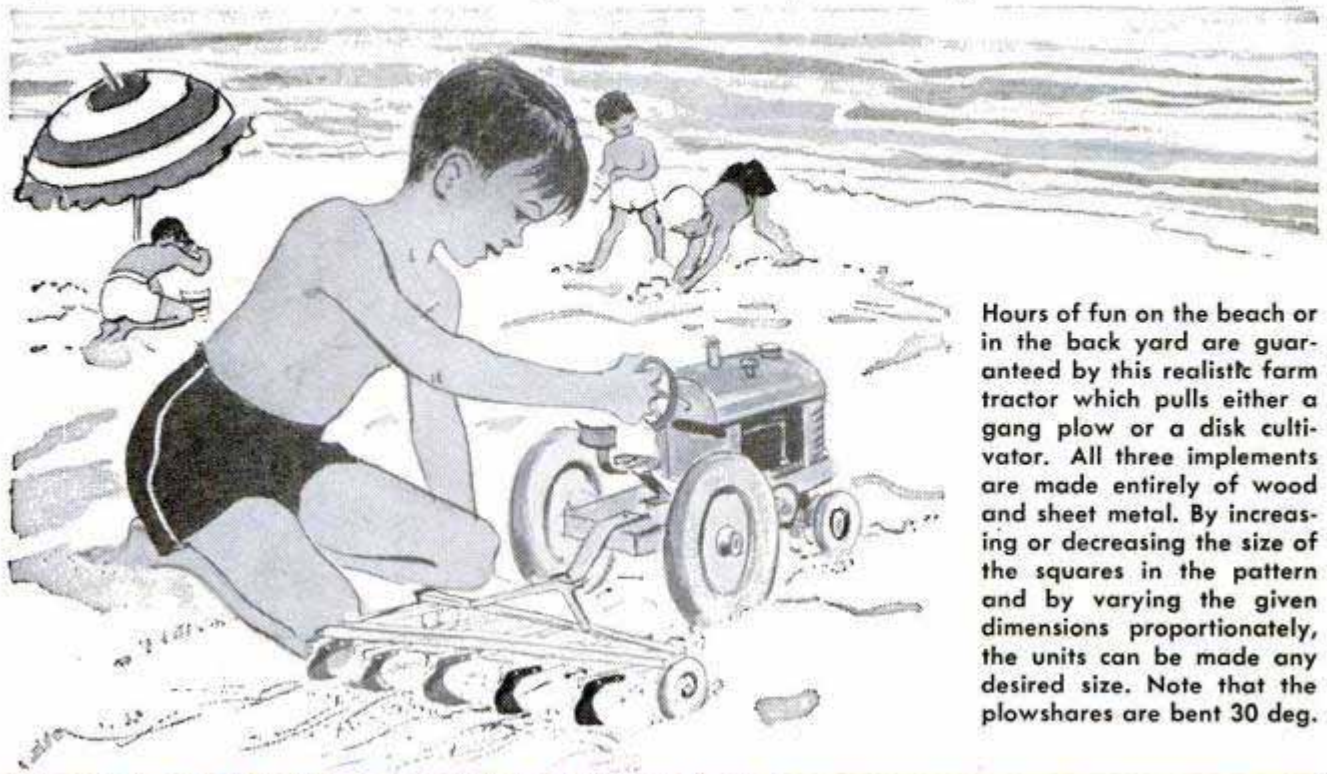

Hours of fun on the beach or in the back yard are guaranteed by this realistic farm tractor which pulls either a gang plow or a disk cultivator. All three implements are made entirely of wood and sheet metal. By increasing or decreasing the size of the squares in the pattern and by varying the given dimensions proportionately, the units can be made any desired size. Note that the plowshares are bent 30 deg.

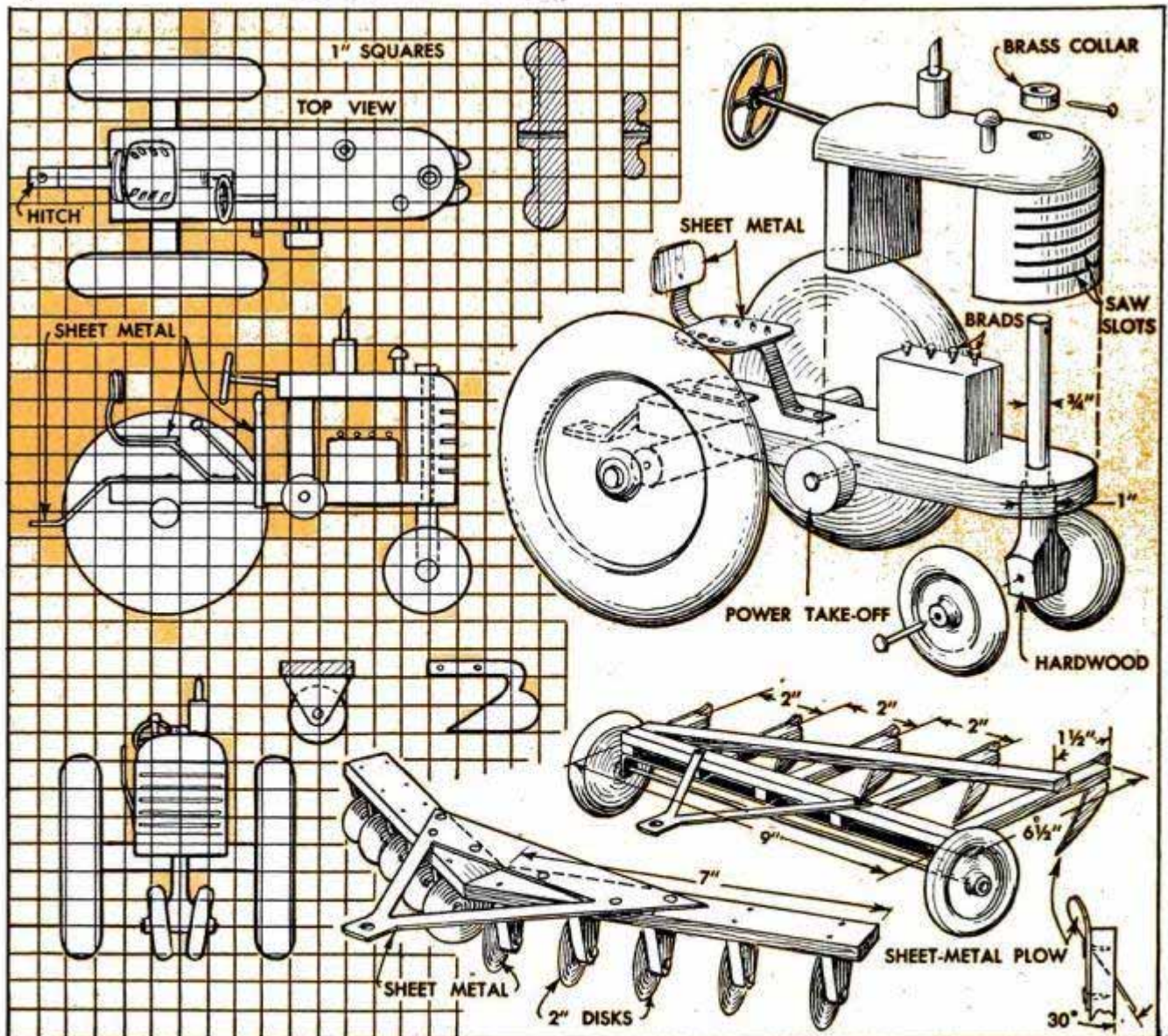

USE CLEANING FLUIDS SAFELY

Solvents capable of cleaning the finest of fabrics or greasiest machinery can be used safely if a few simple rules are followed



Large cleaning jobs, such as furniture upholstery, above, and clothing, below, should be done outdoors so that cleaning-fluid vapors will not be inhaled



NO ONE WOULD deliberately throw a stick of dynamite on a floor or point a loaded gun at his head; yet, in many homes, some cleaning fluids or solvents are handled in such a way that their vapors could become concentrated and be just as explosive. Most of these liquids are highly volatile and inflammable but they are perfectly safe to use if the vapors caused by evaporation of the liquid are carried into the open as fast as they form. The vapors of many of the solvents are also toxic and, if inhaled in sufficient amount, will cause illness. In industry, large quantities of solvents are used without accidents because suitable equipment and safety supervision make certain that the solvents are used in the correct manner. However, in the home, you can be your own safety supervisor by carefully following a few rules for the safe use of cleaning fluids.

Naphtha, benzene, gasoline, acetone and carbon tetrachloride are the commonly used solvents. From a safety standpoint, the most important property of a solvent is its volatility or the tendency of the solvent to evaporate, thus producing a vapor which escapes into the air. The vapors of many of the commonly used solvents, when mixed with the proper proportion of air, are readily ignited by a flame, spark or cigarette.

When cleaning clothing or furniture upholstery, the work should always be done outdoors, preferably on a breezy day so the vapors will be blown away. The mate-

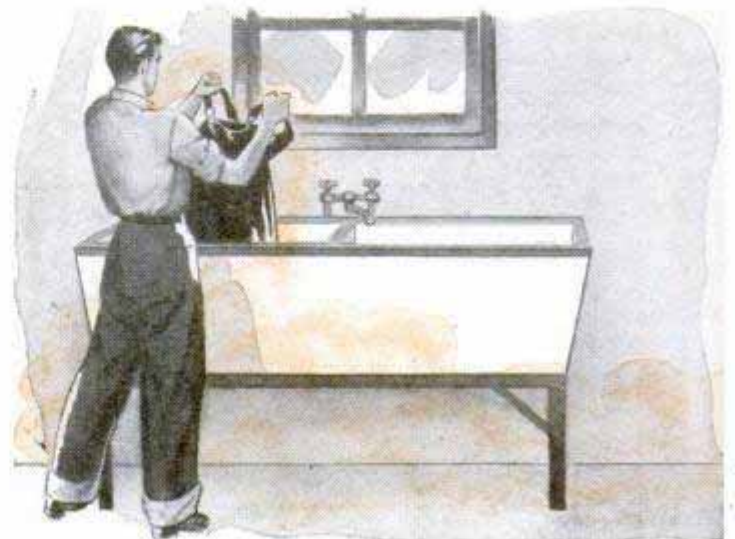

rial should never be rubbed together as is done when washing with soap and water. With some materials, this action may generate static electricity, resulting in a spark which would ignite the solvent. If dry cleaning is attempted in the basement laundry tub, remember that the solvent vapors can travel long distances along the floor, and might eventually reach a gas hot-water heater or furnace in sufficient concentration to start a fire which may flash back to the solvent in the laundry tub. Small cleaning jobs, such as removing spots from a tie or degreasing a piece of machinery, can be done indoors safely provided the work is done near an open window or door. Solvent-wet articles or rags should not be left to dry indoors unless there is adequate ventilation. If the solvent is spilled on the floor, it should be wiped up immediately and all windows and doors left open until the solvent vapor has dissipated completely.

When cleaning wall-to-wall carpeting or articles that cannot be moved outdoors, use one of the "high flash" petroleum solvents, commonly called "safety solvents" because they are not as easily ignited as the highly flammable naphtha or benzine. Certain solvents, such as carbon tetrachloride, are entirely nonflammable. However, adequate ventilation must be provided because the vapors of almost any solvent are toxic in varying degree when inhaled in large quantities. Solvent vapors may cause stomach distress, irritation of the eyes, nose and lungs, and dizziness. If the vapors are inhaled over a considerable period of time, they may act as an anesthetic, causing unconsciousness or even fatal illness.

Strict adherence to the instructions given on the label of the solvent and plenty of ventilation to carry off the dangerous solvent vapors will make these useful cleaners perfectly safe to use.

(Information courtesy Safety Research Institute)

Do not use cleaning fluid in an unventilated basement. Solvent vapors can travel long distances along the floor to a gas heater, starting a fire which may flash back to laundry tub

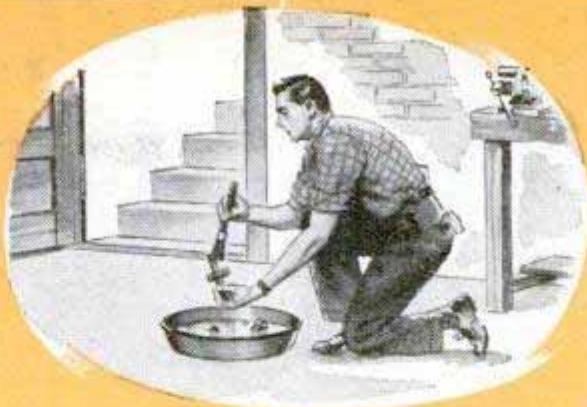

Cleaning small machinery parts can be safely done indoors, provided the windows and doors are open

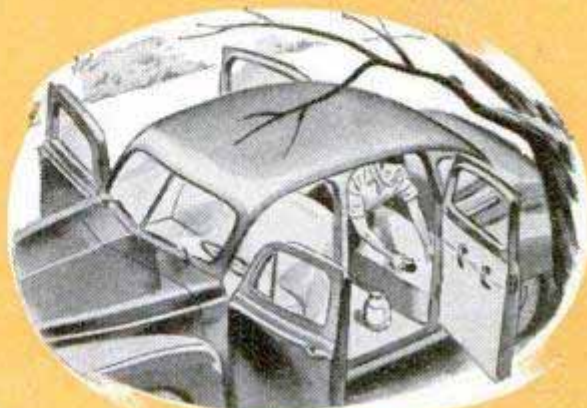

When cleaning automobile interiors with solvents, car should be parked outside with all doors open



Cleaning spots from rugs requires cross ventilation or a fan to carry off the dangerous fumes



Solvent-wet clothes should be hung outdoors until the cleaning-fluid odors are completely dissipated

Straightedge for Finishing Sidewalk Is Easy to Use and Saves Concrete

W.T.M. Concrete

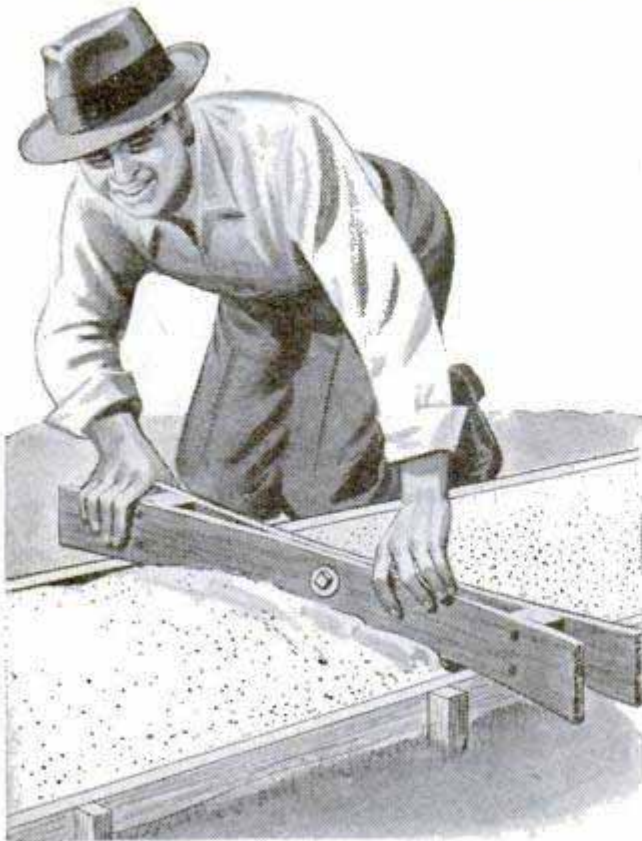

Two 1 x 4s bolted together at the center and blocked apart near the ends provide an easy-to-use straightedge for finishing sidewalks. The straightedge should be long enough to extend over the form boards at each side of the walk. The spread ends hold the straightedge upright, and the bowed portion tends to gather the concrete at the center of the walk, keeping it from being pushed out of the form.

Shutters Made From Scrap Wood Enhance Plain Windows

Enough lumber to make these attractive shutters probably can be found around the home. After the ends of the crosspieces are cut at 45-deg. angles, they are nailed to two vertical strips of 1 x 2-in. stock. The latter



should be positioned well in from the ends of the crosspieces so that a pleasing shadow line results. The finished shutters are painted a complementary color which, of course, is determined by the color of the roof and trim.—Bob Hurst, Chicago.

Grinder Doubles as Disk Sander

Fastening a sandpaper disk over the shaft of a grinder and against the face of one of the wheels permits the grinder to serve also as a disk sander. This setup is handy for sanding small wooden parts and shaping plastics. It does not interfere with the normal operation of the grinder.

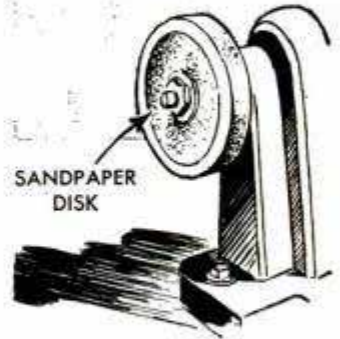

W. H. McClay, Pasadena, Calif.

Screen-Wire "Lath" Backs Patching

Having to fill a fairly large hole in a plasterboard partition, I found that a piece of screen wire makes an excellent backing for the patching plaster. I inserted a bolt through the center of a piece of wire cut slightly larger than the hole and then turned a nut on the end of the bolt. I pushed the screen wire through the hole and pulled on the bolt to hold the wire against the back of the plasterboard while I filled the hole. When the patching plaster set, I simply turned out the bolt and filled the bolt hole. Elliott Erickson, Harbert, Mich.

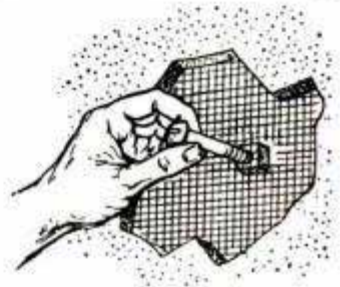

Adhesive Tape Holds Small Parts

When repairing clocks or electrical appliances where a number of small parts have to be removed, keep the parts in order by laying them on the adhesive side of a strip of tape. The adhesive will prevent the parts from rolling or being brushed aside accidentally and lost. Small pieces of tape across the ends of the strip will hold it flat.

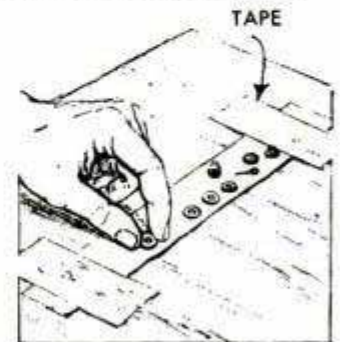

Benj. Nielsen, Aurora, Neb.

It's Easy To Make Your Own Window Screens

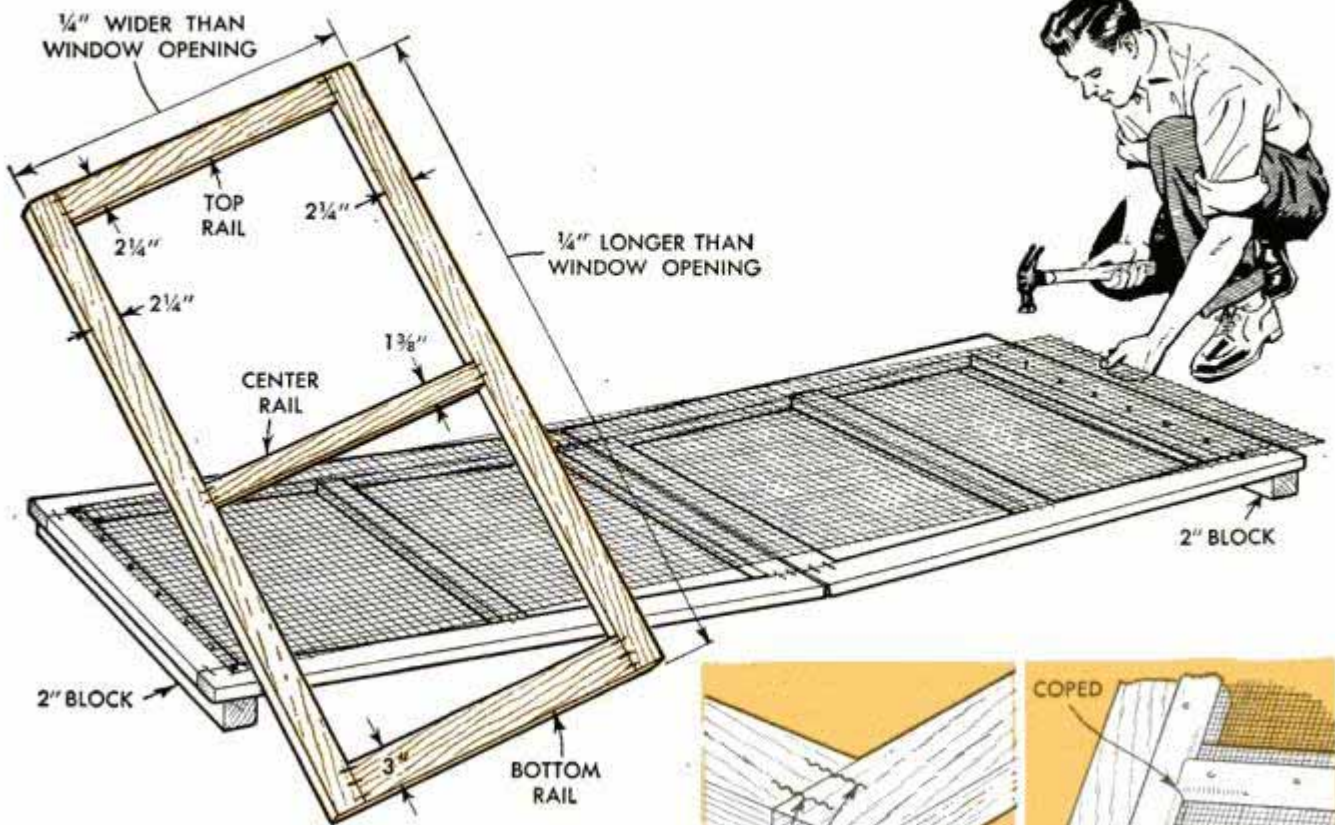

SOME OF YOUR window screens may need re-covering, others a new frame. Whatever is required, the work is not difficult for any homeowner to do himself. As for tools, a simple wooden miter box, a hammer and a chisel or sharp knife are all that is necessary. Clear white pine, 1 1/8 in. thick, is the best wood to use when a new frame is needed. It is stocked by most lumberyards. All pieces are cut so that the assembled frame will be about 1/4 in. larger over-all than the window. This makes it possible for the bottom to be planed at an angle to match the slant of the sill and also permits the rest of the frame to be fitted snugly.

Top, center and bottom rails of the frame are the same length. By using a miter box, it's easy to cut the ends squarely and, by providing a stop block, each piece can be cut to exactly the same length. If a long bar clamp is available, it can be used to hold the pieces in place for nailing. Corrugated fasteners or wiggle nails, 5/8 in. wide, are used to nail the joints, detail A. These are driven flush about 1/2 in. in from the edge and a nailset is used to drive them slightly below the surface to allow puttying over. Use three fasteners on each side of the bottom joints and two at all other joints. It's a good idea to coat all joints with paste white lead before assembling.

The screen wire should be about 1 in. wider than the inside measurement of the frame. To stretch it tautly, two frames are

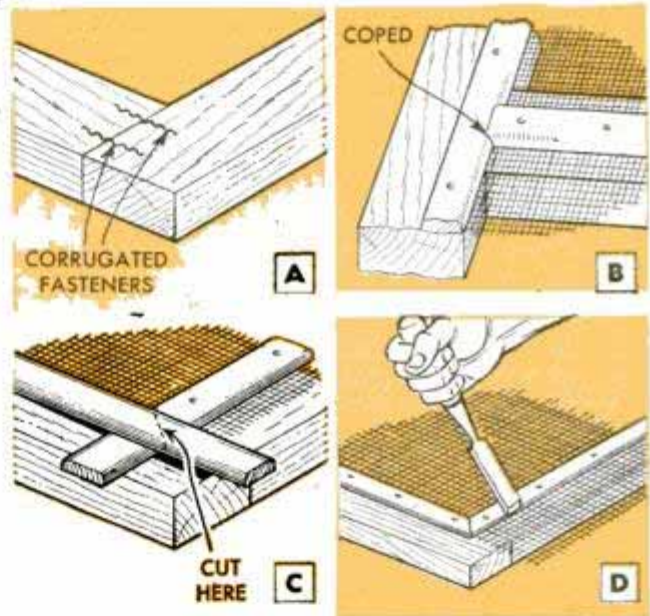

covered at one time. They are placed end-to-end and blocked up at the outer ends. The wire is tacked across the end of one frame and then pulled firmly and tacked across the end of the other frame. Use common carpet tacks or screen staples and space them about 3 in. apart. With this done, the blocks are removed and the tacking is completed with the frames flat on the floor, after which the frames are cut apart.

The edges of the screen wire are covered with stock screen molding. The molding is permitted to overlap at the corners and then a saw is run through both strips at a 45-deg. angle, as in detail C, resulting in a perfectly fitting joint. At the center rail, the molding is coped, or undercut, as in detail B. The job is completed by trimming off the excess wire at the ends, as in detail D, with the heel of a sharp chisel.

Joseph C. Stanko, Fair Haven, N. J.

Scissors Are Sharpened Expertly With This Homemade Hand Grinder

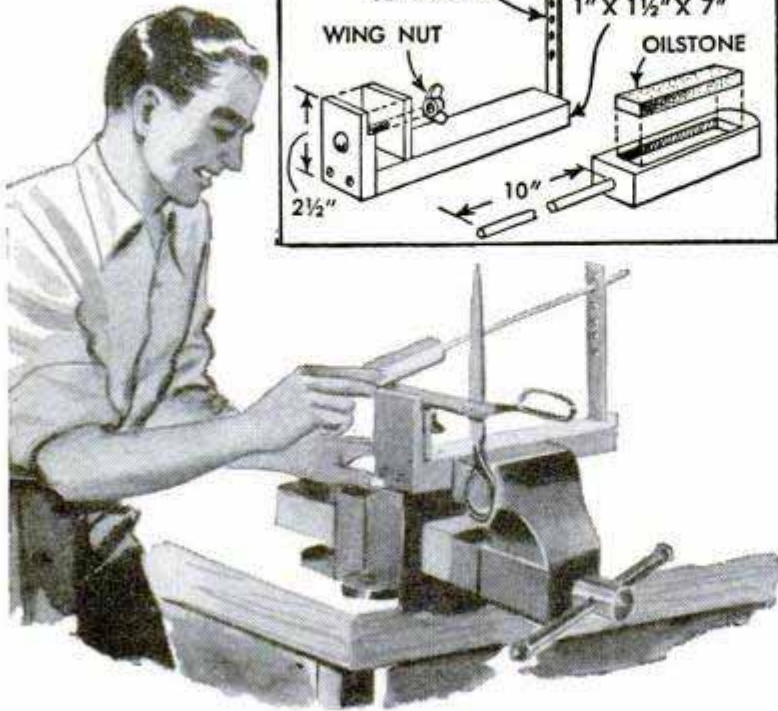

Designed and built by O. J. Potter of Bremerton, Wash., this easily made scissors-grinder permits sharpening the blades with a swinging motion which results in a smooth edge without burring or feathering. The jig is made as shown, a piece of flat iron drilled with a series of five or six equally spaced holes being screwed to the end of the wooden base. The spaced holes provide a means of changing the grinding angle to correspond to the bevel of the cutting edge. The grinder itself consists of an oilstone embedded in a wooden block and a length of rod which is a force fit in a hole drilled in the end of the block. When setting up for grinding, the arm is inserted through one of the holes in the upright and a check is made to see that the angle of the stone is the same as that of the beveled cutting edge of the scissors blade being sharpened.

Corncobs Impaled on Rake Teeth Mark Garden Seed Rows

To space seed rows in a small garden, just impale two corncobs on the teeth of a rake. Pulling the rake across the garden plot results in evenly spaced seed rows, their separation, of course, being determined by the spacing of the cobs on the rake teeth. If you want exact spacing of the rows, place one marker in the last row previously marked.



File Tightened in Wooden Handle

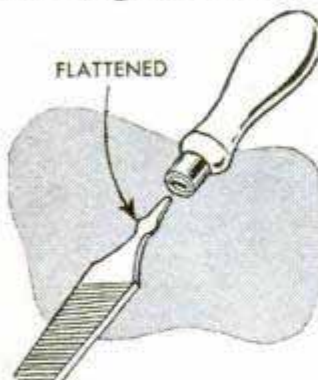

If a file works loose from a wooden handle, it can be replaced tightly by hammering a flat on the tang. To do this, first heat the tang and then flatten it slightly at a point that extends well within the handle.

Paste Application Removes Stains and Grease Smudges From Wallpaper

Grease smudges and fingerprint stains are quickly removed from wallpaper by an application of paste made by mixing carbon tetrachloride with fuller's earth. The paste is troweled over the stain and allowed to remain until it dries and turns a pale color. If traces of the spot are still visible when

the dried paste is dusted off, repetition of the process should completely remove them. If the spot covers a large area, clean only a small portion at a time. As the fumes of carbon tetrachloride are mildly toxic, keep the room well ventilated.

S. S. Palestrant, Bronx, N. Y.



LEATHERCRAFT

By Bruce Grant

ADAPTED from the ornate braiding adorning the sword belts of early Spanish conquistadores, these two examples of leatherwork, although seemingly complicated, actually are quite simple and fascinating to braid. The wrist-watch band, Fig. 1, and the belt, Fig. 2, which is of the same braid, only made wider, are but two of the many practical accessories to which this attractive braid is suited. In addition to the procedure given for braiding a strap or belt, instructions also explain how to braid a turk's-head knot and how to cover a buckle.

The wrist-watch band requires a piece of calfskin $\frac{5}{8}$ in. wide by $8\frac{1}{8}$ in. long, three yards of $\frac{1}{8}$ -in. beveled goatskin lacing and a buckle with a $\frac{5}{8}$ -in. opening. For tools, you'll need a knife, a thonging chisel, a leather punch, an awl or fid, a lacing needle and a tube of cellulose cement. The end of the lacing is skived, then inserted in the needle and held with a dab of cement. The calfskin strip is cut into five pieces as indicated in Fig. 3. The piece forming the strap end is rounded at one end, punched for the buckle tongue and perforated with four slits. The slits are made with a thonging chisel held at a 45-deg. angle, $\frac{1}{16}$ in. in from the end. The buckle

To braid a belt, you merely weave it twice as wide as the wrist-watch band, as the braiding is the same

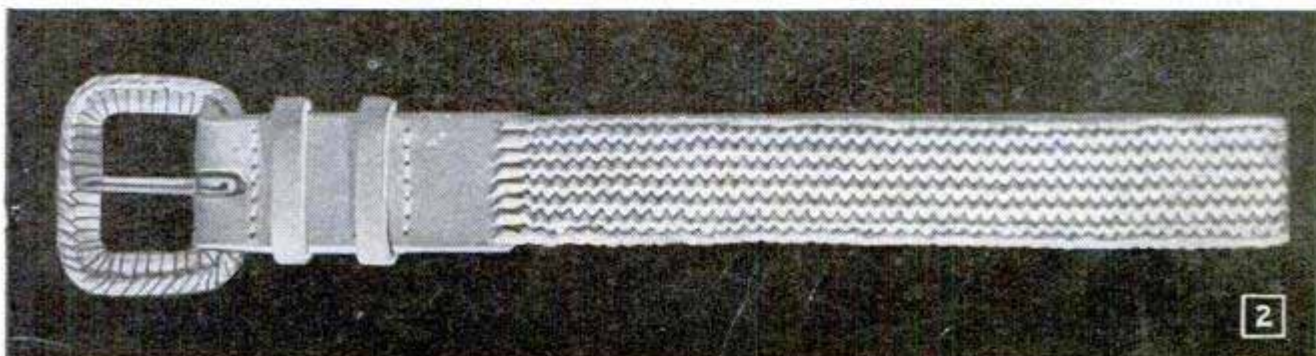

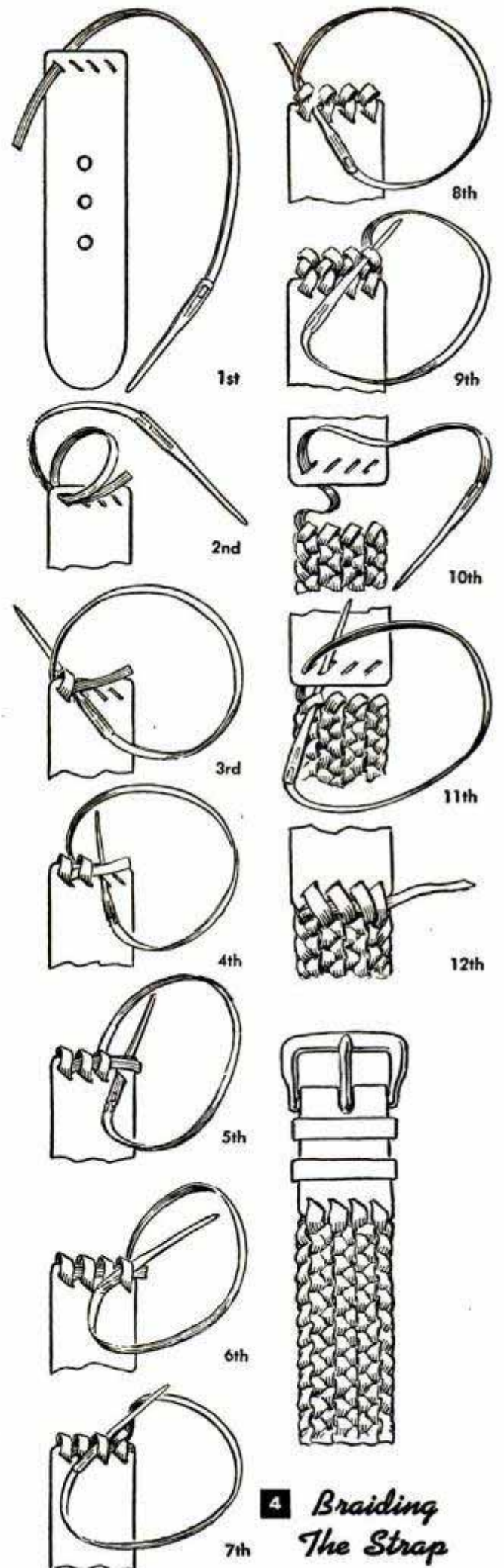
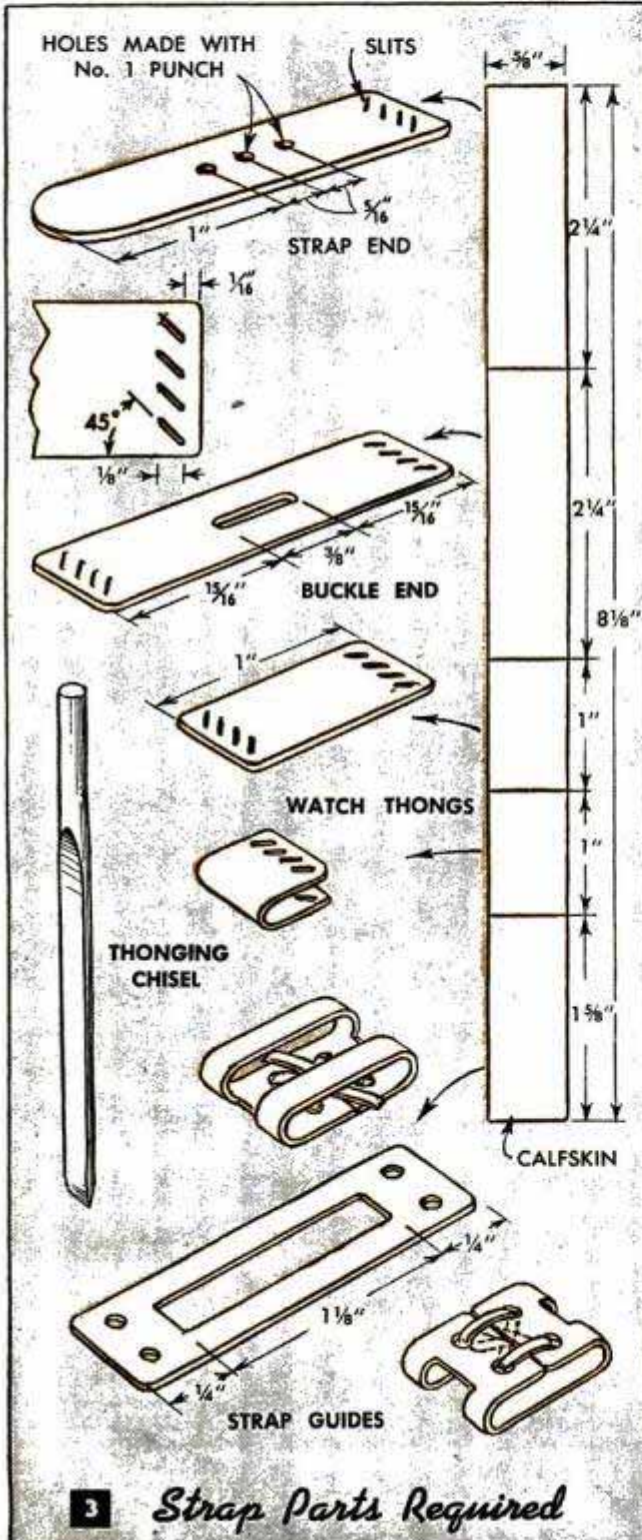

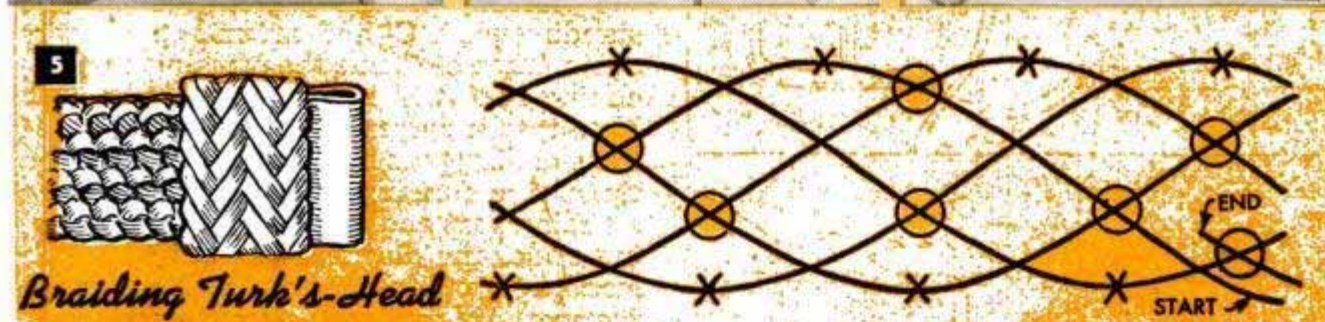
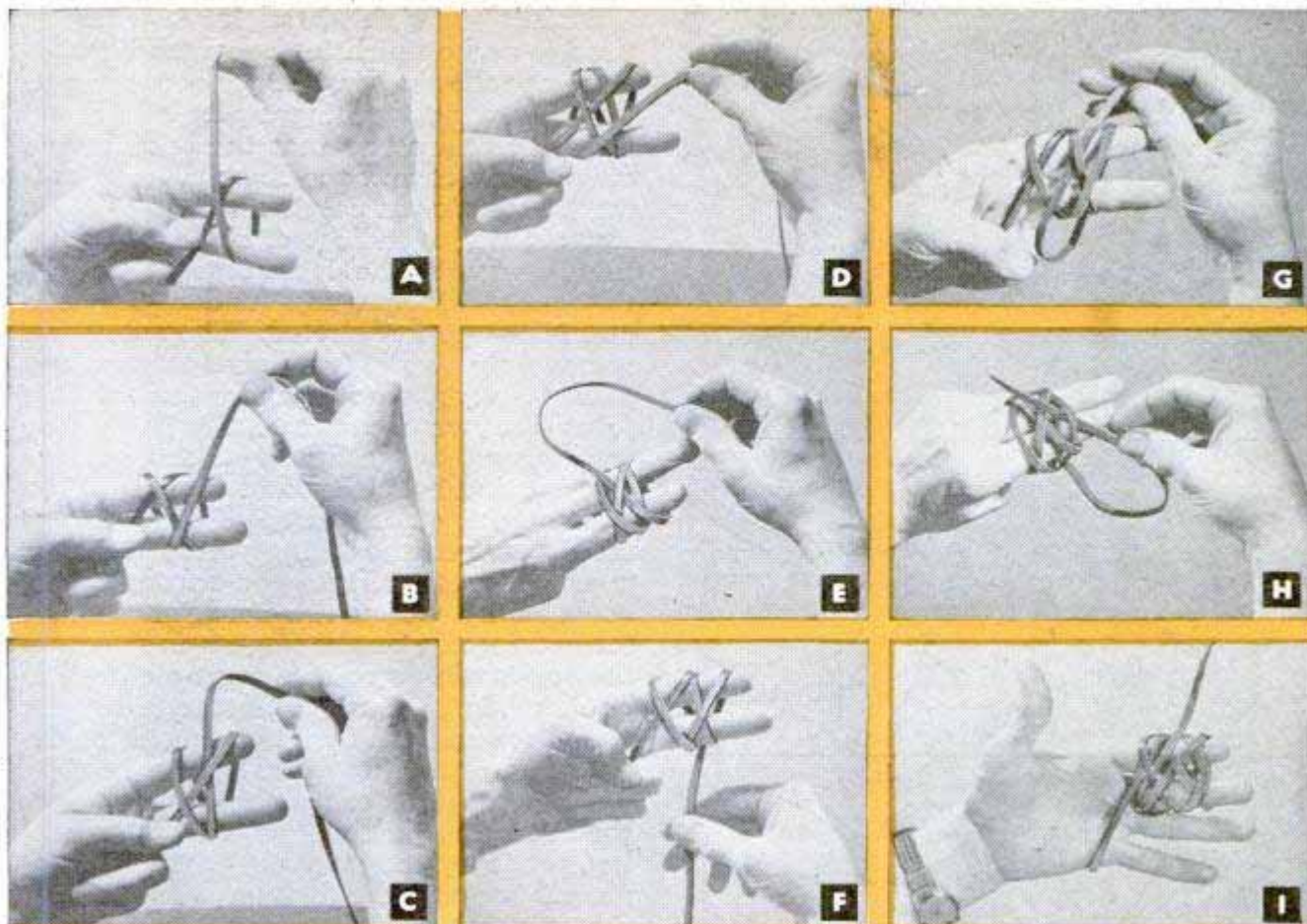

end, which is the same length as the strap end, has a slot cut in it. This is made by punching a hole at each end of the slot and removing the portion between the holes. Aligning slits in each end of the piece are punched at one time while the strip is folded, finish side out. The two pieces used for the thongs are punched in the same manner. The fifth piece is slotted and folded and the ends are laced together, as shown, to form strap guides.

To braid the wrist-watch band, take the strap end and start lacing through the slit at the extreme left as in Fig. 4, step 1. Draw the lacing or thong all the way through except for about an inch. Then come back around and go through the same slit again, step 2, drawing the lacing tight. Continuing, the needle is brought forward and pushed through the next slit, step 3, and drawn tight, the end of the thong being underneath. This is repeated as in steps 4 and 5 and then, being sure that the needle passes to the left of the working strand,

bring it to the front and through the right-hand loop, step 6. Pull it through and tighten and then proceed to come around again and pass through the second loop, step 7, pulling it tight. Keep going back and forth as in steps 8 and 9 until you have about twenty rows braided.

Now, take one of the watch-thong pieces and insert the needle through the left-hand slit as in step 10. Then pass the needle through the left-hand loop of the braiding and through the second slit as in step 11. Proceed in the same way, finishing by bringing the lacing under the loops as in step 12. Cut off the excess and secure the end with a dab of cement. The same procedure is followed in joining and braiding the other parts but, before attaching the braiding to the other thong, check to see if the band is the right size. In determining the size, remember that the braid when first woven stretches and, therefore, it should be made short enough so it will be fastened by the first hole in the strap.

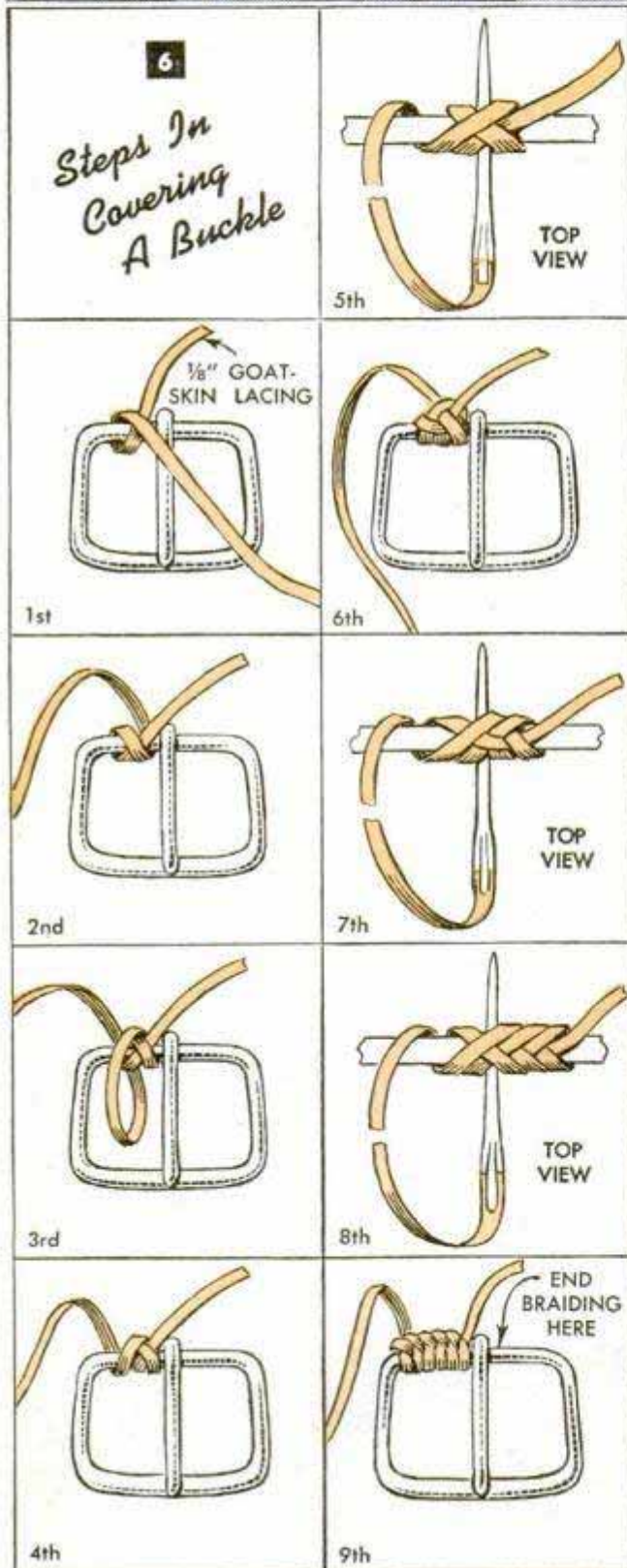
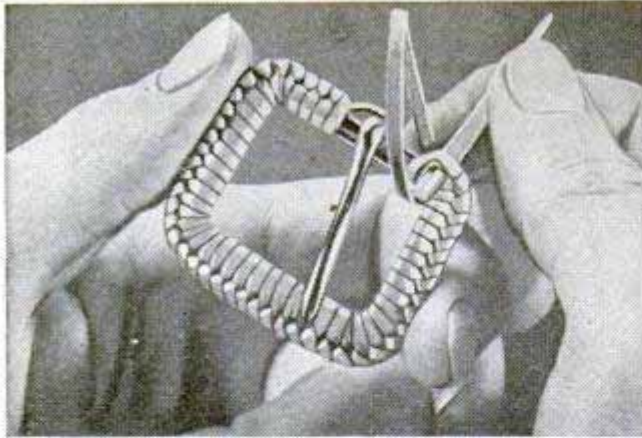

Braiding a turk's-head knot, which is used to add a finish to the watch band, is done as follows: First, make a paper pattern following the diagram in Fig. 5 and form it in a roll so that the ends of the diagram meet and the lines are continuous. Place pins at points marked X. Now, starting where indicated, begin following the lines with the lacing, going around the pins and passing under previous strands at points circled. When finished, remove the work from the pattern and place it over the strap where the braiding joins the watch thongs. Tighten the turk's-head by gradually taking up the slack, going over the knot several times. When tight, place a drop of cellulose cement between the lacing where the ends meet and cut it off. As you become adept at braiding the turk's-head, it can be formed rapidly on the fingers as shown in the series of progressive steps pictured in photos A to I inclusive. To start, wrap the lacing around the first two fingers of the left hand as in photo A. The part held by the left thumb is called the standing end, the other the working end. Pass the working part over the standing part and completely around the fingers as in B. Now the working part is passed beneath the standing part, C, and around the fingers again. Then continue the working part, inclining it to the extreme right, photo D. Note that it passes along the right side of the standing part but, when it reaches the tip of the forefinger, it passes over the standing part and along its left side, passing under the diagonal strand just as the standing part does, photo E. Now, bring the working part to the front once more, photo F. From this point on, the sequence will be over one strand and under one, leaving the lacing fairly loose, G. Working on the back of the hand, photo H, the lacing is passed under one of the scallops and over another. Finally, bring the working part alongside the standing part once more as in photo I.

Covering a belt buckle is shown in Fig. 6. Starting with a yard of $\frac{1}{8}$ -in. goatskin lacing, and holding the buckle with the heel upward, begin as in step 1. Then pass the lacing around and bring it to the front as in step 2. Go around again as in steps 3 and 4. Now, closely following the top view, step 5, open the lacing with an awl and insert the needle between the first and second strands, pulling the lacing tight, step 6. Repeat the same procedure, inserting the needle this time between the second and third strands, step 7. Continuing as in step 8, pass the lacing around the buckle, pulling each loop tight to produce the braid shown in step 9. The finished buckle is shown in the photo.

H K - 51

To keep the radiant heat of the sun out of my house during the summer and still take full advantage of its warmth during the winter months, I fitted my windows with solar awnings. Even on cold, overcast days, the awnings reflect a maximum amount of light into the rooms. Covering only the top halves of the windows, they are an attractive fixture on a home of modern design. The awnings consist of a series of 1/4 x 6-in. cedar slats long enough to extend 4 in. beyond the sides of the windows. The slats are mounted on strips of wood with angle brackets, and wooden blocks, along with another set of wooden strips, bring the awnings flush with the wall of the house. My home is located at 43-deg. north latitude, and I found that spacing the slats 5 in. apart keeps out the sun's rays from the middle of April to the latter part of August. The spacing, of

Permanent Solar Awnings of Cedar Slats Control Sun's Rays for Year-Round Comfort

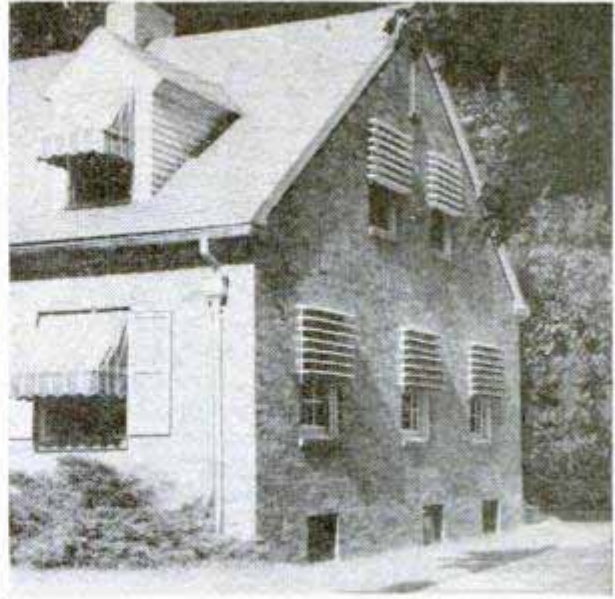
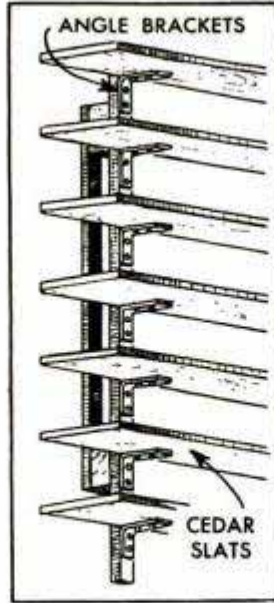

course, is determined by the latitude in which the awnings are to be used and, once this is done, further adjustment is unnecessary. If desired, the awnings can be attached with storm-sash hangers and removed for the winter.

Charles H. Spurway, East Lansing, Mich.

H K - 51 U.E.'51

This Improved Wooden Gauge Makes It Easy to Check Wheel Toe-In

Hesitating to take my car to a service station every time I went over a bad bump or hit a curb too hard while parking, I made this simple gauge for checking toe-in of the wheels. It has meant considerable savings in worn tires. I fastened a piece of wood, 6 ft. long, to two 8-in. legs and attached a base to one of the legs to hold the

gauge upright. Then, I drove a nail through the horizontal member near one end and fastened another nail near the other end of this piece with a rubber band to permit adjustment. To check toe-in with the gauge, I scribe a line on each tire with an ice pick or screwdriver by holding the tool against the tire while turning the wheel. The wheel, of course, must be jacked up and held steady while scribing the line. Next, I set the gauge against the back of the wheels with the fixed nail on the scribed line of one wheel and adjust the movable nail so it is exactly on the scribed line of the other wheel. Then, without moving the nail, I bring the gauge around to the front of the wheels and check the position of the scribed lines. If the lines indicate that the toe-in is more or less than that designated in the instruction manual for my car, I take the car to my mechanic and have him recheck the alignment and correct the trouble.

W. A. Leak, San Leandro, Calif.

H K - 51

Radial Model-Airplane Cows

Realistic radial cowls for solid-model airplanes are made from metal chair glides. Drill the center of the glide for the propeller shaft and air intakes, grind off the points and glue the glide to the nacelle.

Fred M. Bowles, Annapolis, Md.

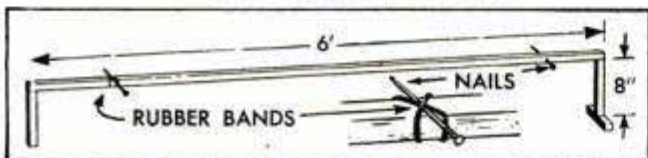

TRINKET CHEST

The trick lid on this attractive burnt-cypress trinket chest will foil tiny prying hands for, instead of opening in the conventional manner, the lid, being pivoted on parallel arms, must be pulled forward. The sugi or burnt-wood finish is produced by charring wood lightly and rubbing with suede-shoe brush to bring out grain in relief. A wash coat of thin, clear lacquer containing gilt is applied, then wiped off immediately

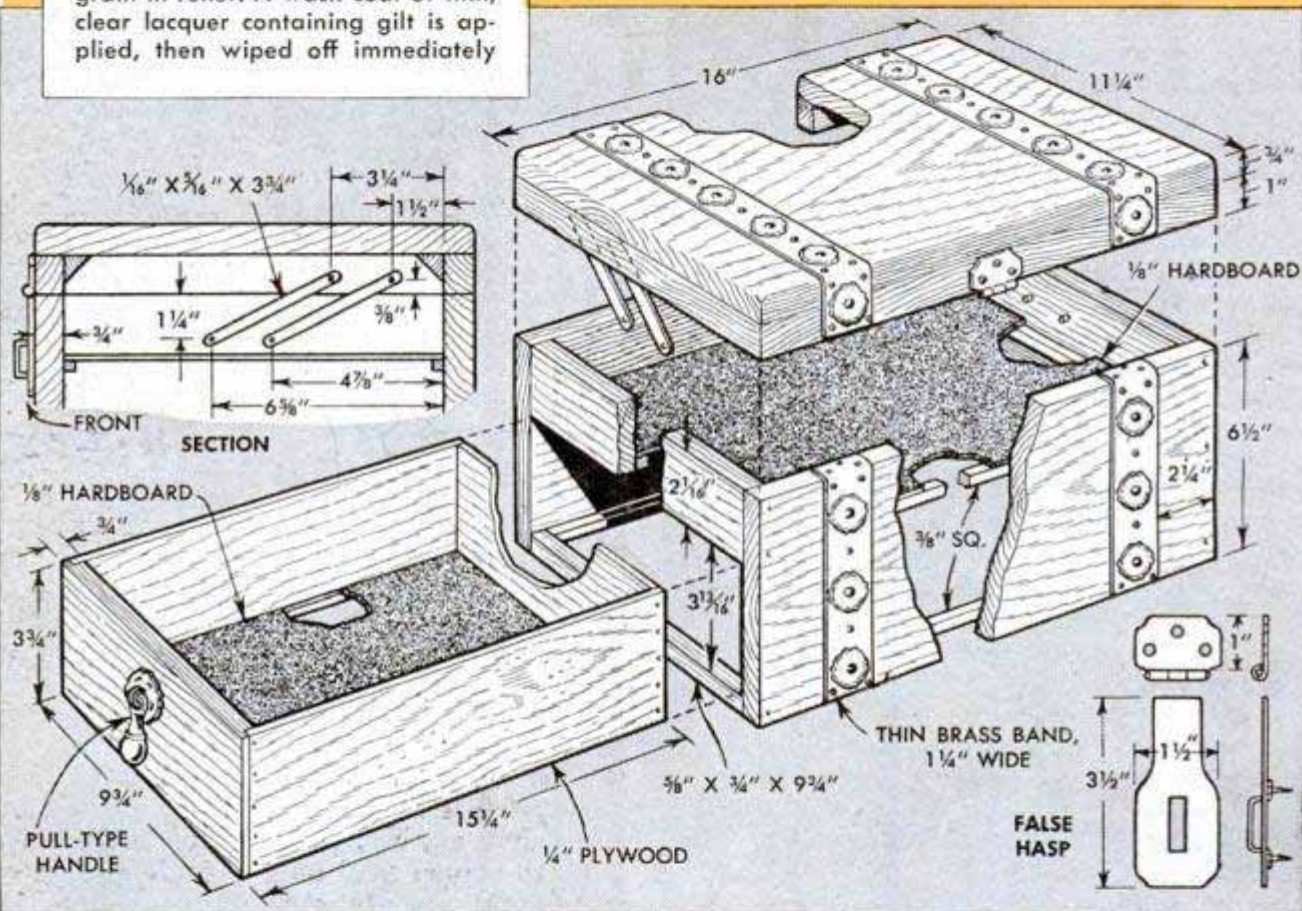
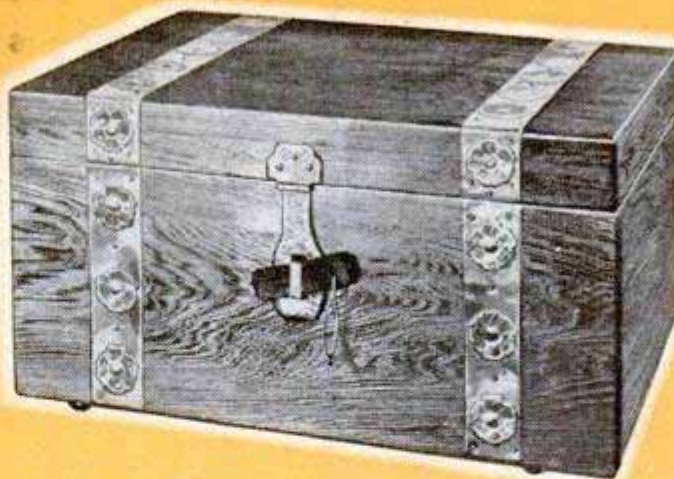

Sugi finish is produced by charring the cypress and then brushing with a fine-wire brush to raise grain

A two-piece dummy hasp parts when the lid is pulled forward and adds to the deception of how lid works

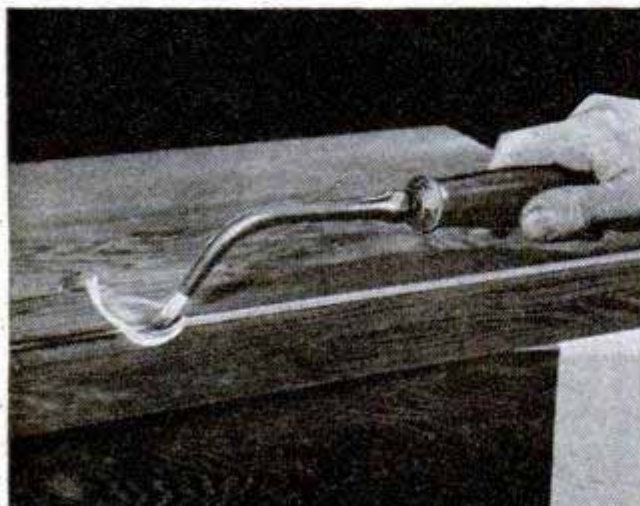

DESIRING a low-cost spotlight for my cabin cruiser, I made one from a sealed-beam car headlight of the bumper-mounted type. The unit is controlled remotely from inside the cabin and throws an elliptical spot a quarter of a mile or more, making it ideal for sighting buoys. The headlight is pivoted on its original mounting bracket which is cut and drilled to suit. The rest of the unit is made from brass pipe fittings, with the exception of a piece of 1/4-in. copper tubing used as an arm for controlling the light vertically. However, galvanized fittings will do if desired. The unit is attached to the cabin roof by means of a pipe flange through which a 4-in. length of pipe is turned. Note that the threads of the pipe are extended so it can be screwed into the flange to project below the cabin ceiling. Seam compound is applied liberally around the hole in the roof before the flange is screwed or bolted in place. The pipe caps attached to each end of this length of pipe are faced or filed flat and center-drilled to take a 1/2-in. pipe. The slotted 1/2-in. pipe for lateral control is polished smooth. The slot also is polished to allow the control arm to slide freely. A top bearing is provided by sweat-soldering a collar to the pipe just below the slot. Another collar, which is a slide fit on the pipe, is attached to its lower end with a setscrew and serves as a bottom bearing. The 12-in. length of 1/4-in. pipe which raises and lowers the control arm should be a sliding fit inside the 1/2-in. pipe and will require bushing. This can be done by spot-soldering shim stock to the inside of the 1/2-in. pipe at the bottom of the slot and at the lower end of the pipe. One end of the control arm is flattened and slotted and the other end is threaded to screw into a hole tapped in the 1/4-in. pipe. If equipment is available, these parts should be brazed together. Note how this arm is bent to permit raising the light. The mounting bracket of the lamp is attached to the 1/2-in. pipe with a brass pin and set of spacers, the latter taking up the difference between the spread of the bracket arms and the outside diameter of the pipe. The lens clamp of the

Low-Cost Spotlight for Cabin Cruiser Utilizes Sealed-Beam Auto Headlight

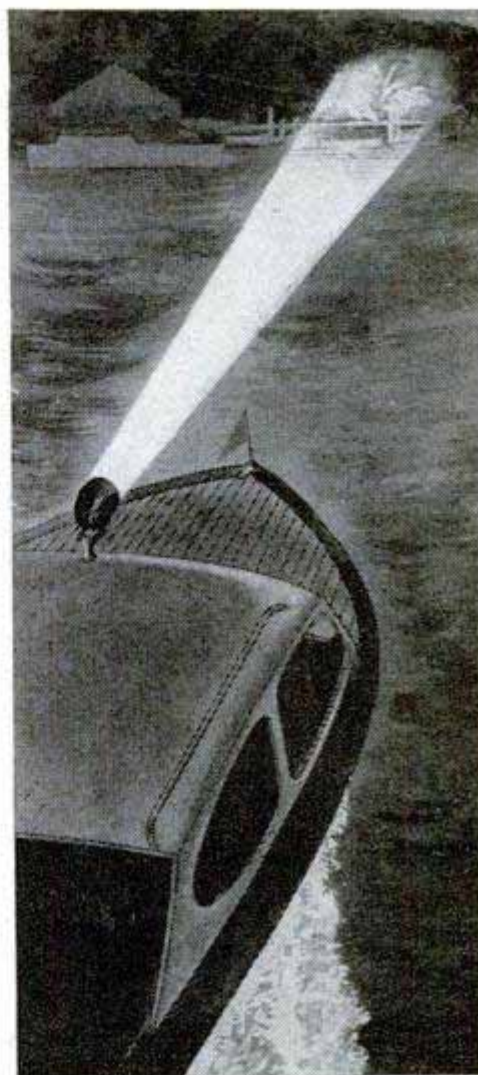
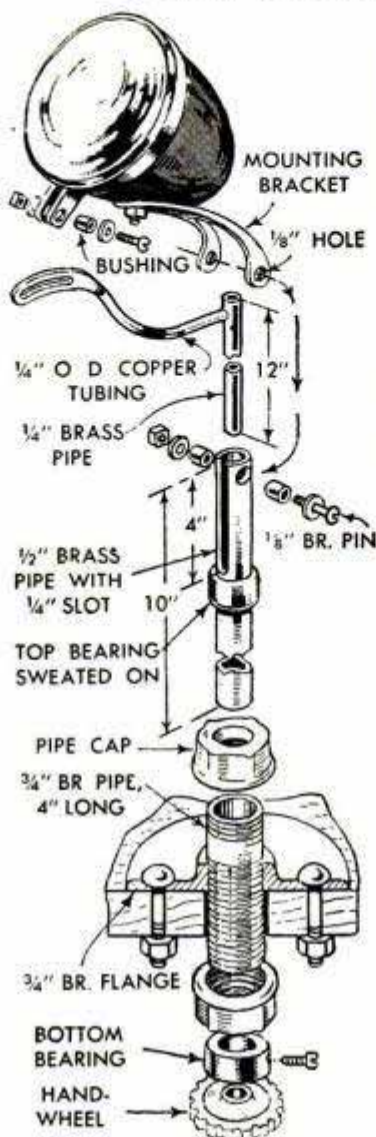

headlight is attached to the control arm with a bolt having a bushing which rides in the slot. After the unit is assembled, the bottom bearing is tightened so there is a slight drag when the spotlight is turned. Finally, a small handwheel is added to the lower end of the 1/4-in. pipe to manipulate the light. Wiring is done by bringing the wire down through the 1/4-in. pipe and connecting it through a switch on the light itself or on the light panel of the boat. The light is grounded to complete the circuit.

J. Wallace Millard, Amityville, L. I., N. Y.

Battery-Cable Insulation Protected With Section of Garden Hose

When battery cables come in contact with metal parts of a car, there is danger of the insulation wearing through, thus shorting the battery. As a safeguard, place a length of garden hose over the cable, leaving the terminals free. In this way, the hose must be worn through before the cable insulation is reached.—R. C. Zuiker, Chicago.



Make Your Rowboat Shipshape

By S. S. Palestrant



BY USING the ordinary "making ready" methods of the good boatman, a worn and leaky flat-bottom boat, or "sharpie" as it is sometimes called, can be made shipshape in a few hours' time. In general, the methods used will apply to any type of boat, flat, round or V-bottom, but just what you do depends primarily on the age and condition of the craft. A boat that is taken from the water and stored during each off season probably will require very little repair from year to year, but work boats used by trappers, hunters and others need frequent and thorough check-ups. Flat-bottom boats that are merely tied up when not in use become waterlogged, leaky and hard to handle. In time, either dry or wet rot or both will weaken the boat so that it is structurally unsafe.

If the condition of the boat indicates only the normal amount of wear and the paint is chalky, but not peeling or scaling to the bare wood at any point, then sandpapering and painting are all that is necessary to recondition it. However, scaling paint, damaged oarlock mounts or decks and the presence of dry rot in the bottom planks or the stem call for complete repair and refinishing. If this must be done, place the boat on sturdy sawhorses, as in Fig. 1, and remove the paint either by softening the film with a blowtorch, as in Figs. 2 and 4, or by use of a paint remover. With either method, use a scraper to remove all the loosened paint down to the bare wood. Check the side and bottom planks along the chine for dry rot by forcing

Defects due to rough usage and neglect can make a flat-bottom rowboat unseaworthy after only a few seasons. Here's the way a good boatman would proceed to fit out a boat as good as new

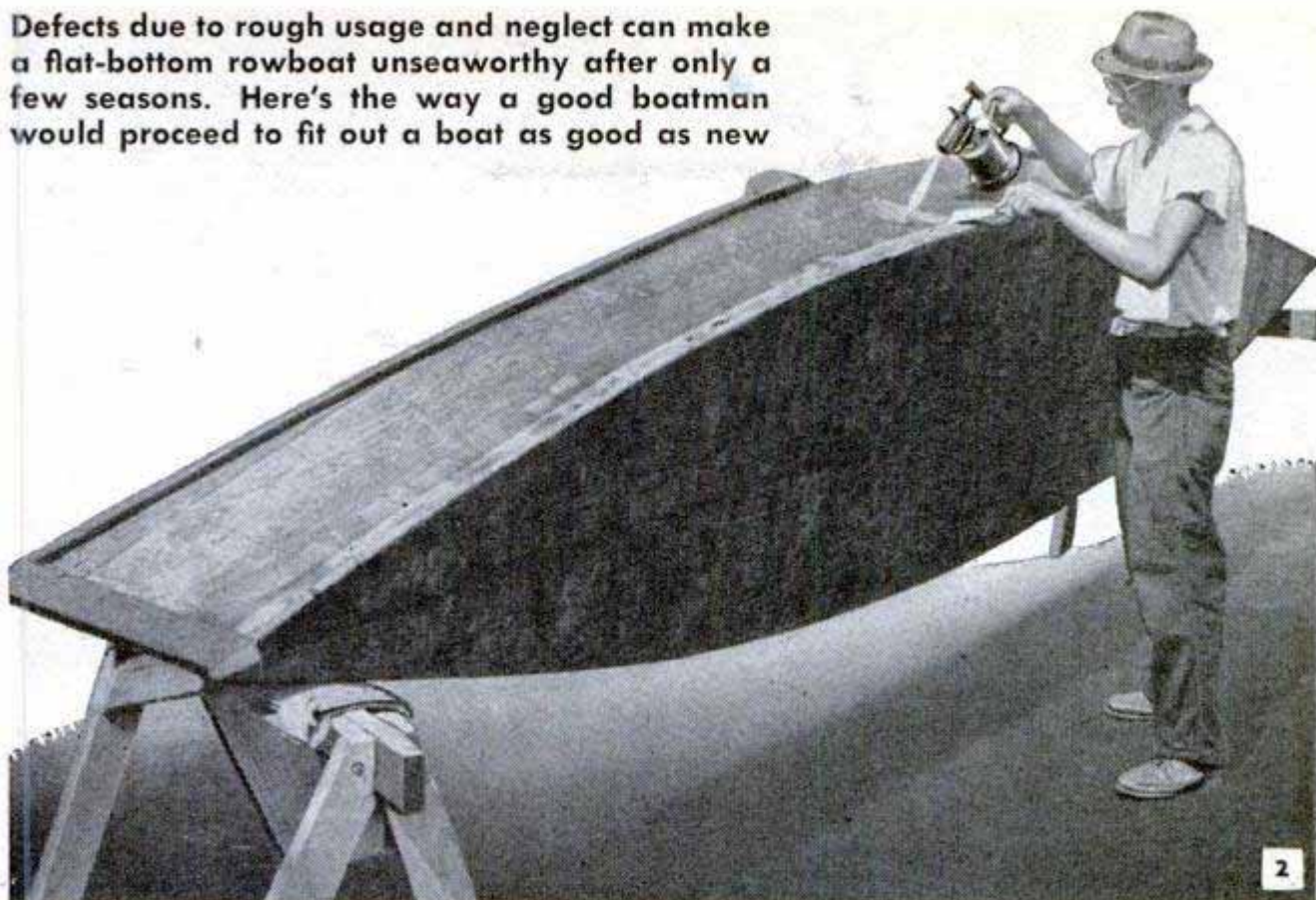

a knife blade into the wood. If any of the planks are soft they should be replaced. Often a new stem will be required because of dry rot or wet rot due to lack of ventilation under the deck. Two common methods of making a stem for a flat-bottom rowboat are shown in Fig. 3, details A, B and C. The one-piece stem, details A and B, made from selected oak, is the best although it is more difficult to make. The ends of the side planks are fitted into rabbets cut into the stem block at the correct angle, detail B. Then the projecting portion of the block is shaped to form a cutwater. This can be straight vertically or at an angle as desired. In the built-up stem, detail C, the rabbet is formed by joining two beveled blocks of different widths. The blocks are joined with heavy galvanized screws and marine glue, although waterproof cabinet glue also can be used. Use galvanized screws or bolts wherever it is necessary to employ metal fasteners. In replacing any parts, select sound, seasoned stock and be sure to duplicate the dimensions of the old part in all details in the new one.

Prepare the wood for the priming coat of paint with a thorough scraping and sanding. Renew the caulking in the bottom planks, Fig. 5, and replace the keel, detail D, Fig. 3. If necessary to replace any bottom planks, it is important that the grain run the same on all pieces, detail D, Fig. 6. Repair or replace the decks and oarlock mounts and also the rub rails, if necessary, Fig. 6, details A to D inclusive. Be sure that

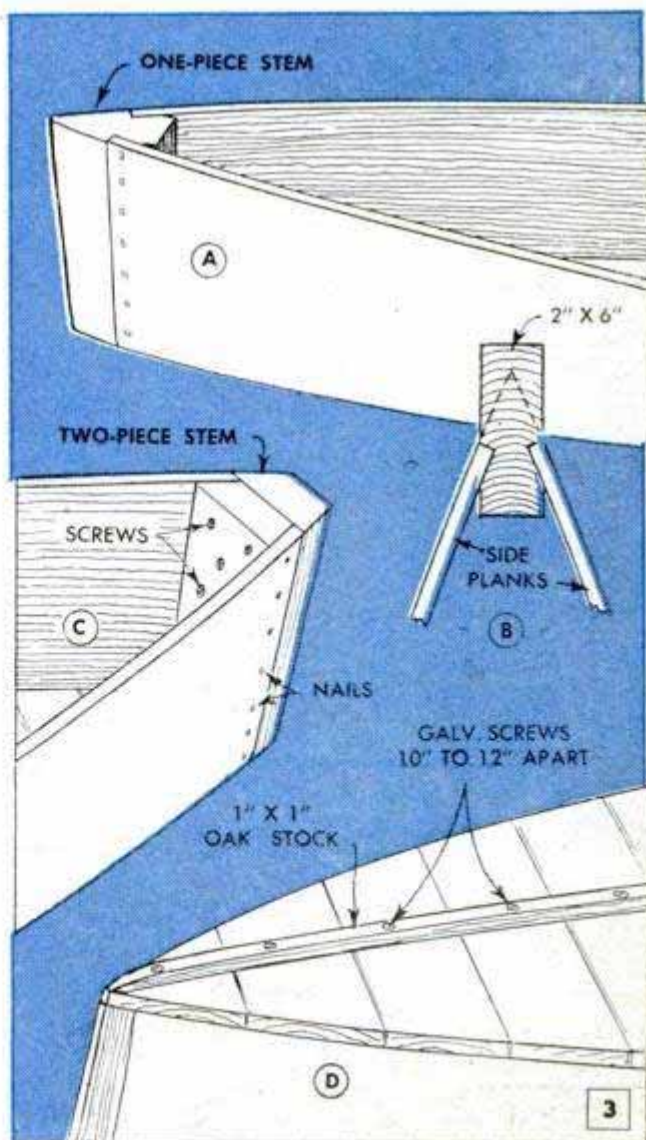



When refinishing, pay special attention to the inside of the boat. Damaged paint should be loosened with a blowtorch and scraped to expose bare wood



Recalcing periodically will assure a tight, dry boat and add greatly to the life of bottom planking. Important thing is to calk joints uniformly

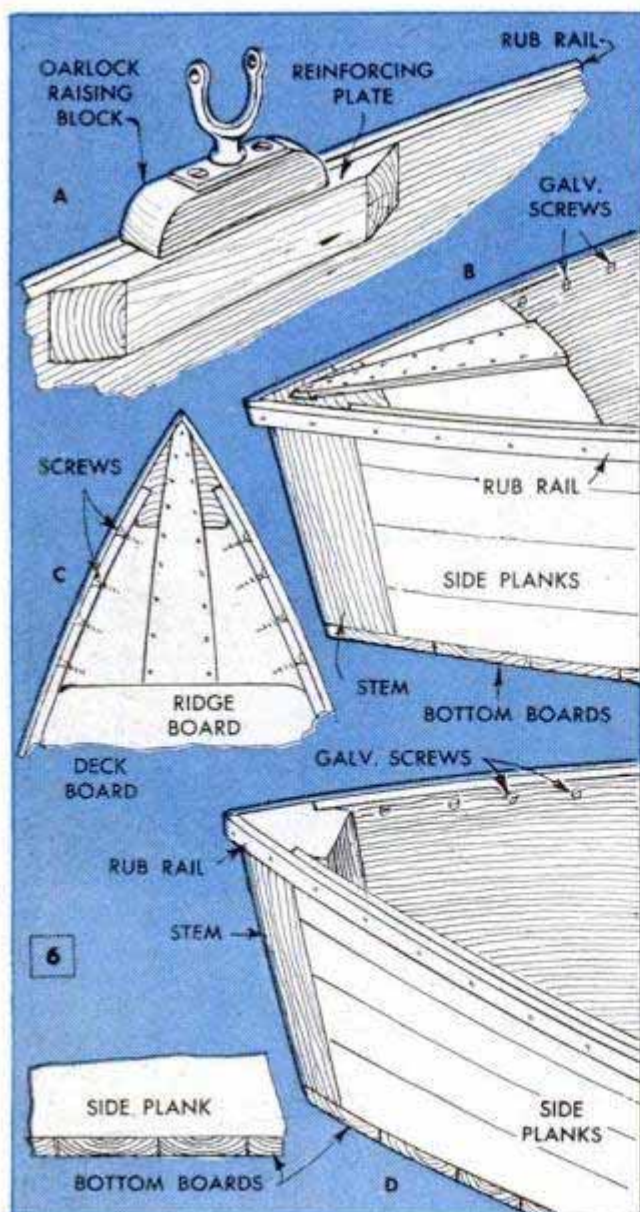

the wood is thoroughly dry before applying the first priming coat. In priming a boat, usually it is best to apply two or three thin priming coats with long intervals of drying between. Brush out the priming coats well to assure uniform coverage, and be especially particular to work the primer into all exposed end grain. Use a primer with a white-lead base. After priming, most boat refinishers go over the entire surface and fill all dents, nail holes and slight nicks either with a filler made from white-lead paste or a commercial seam sealer made for boat work. Then the surface is carefully sanded in preparation for the application of the finishing coats of full-bodied paint. The last priming coat must be thoroughly dry before applying the first finishing coat. When painting the bottom, or any part where paint must be brought up to an edge, draw the loaded brush off the edge, not against it. In this way you will avoid drips and sags in the paint film which result from careless application. The first finishing coat should be thinned with a reducer to an easy brushing consistency. The second finishing coat can be slightly heavier, perhaps, but avoid a heavy application. Two finish coats over a three-coat primer should be sufficient to produce a smooth, durable finish. If desired, a copper bottom paint can be applied instead of the lead-and-oil priming coat. The copper-base paint may be applied only to the bottom boards, or can be brought up the sides to the load waterline. In this case, the sides are primed and painted with a lead-and-oil paint from the waterline to the sheer line.

Aluminum Humidor Holds King-Size Cigarettes

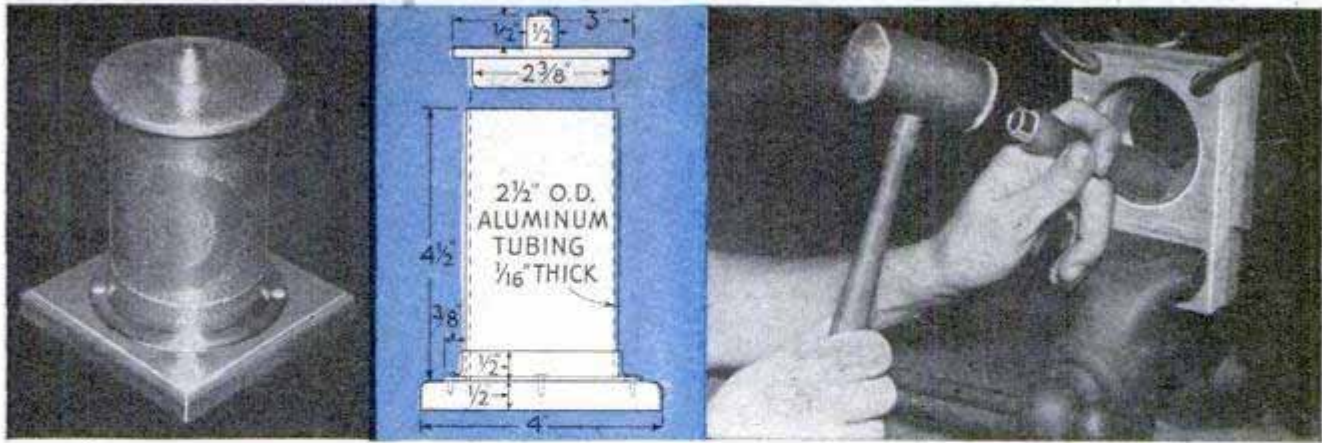

Although the body of this humidor is simply a piece of hammered aluminum tubing, the supporting base flange offers more of a challenge to the hand crafter's skill. The flange is formed by a hand-planishing operation, using a special jig made from two pieces of hardwood held in a vise as in the right-hand photo. After cutting the flange from soft aluminum to the inner and outer diameters, the resulting ring is centered in the jig and held securely with clamps. A hardwood file handle, used as in the photo, serves as a planishing tool. Work slowly and be careful to bend the flange uniformly to avoid tearing the edge of the metal. After forming, file the inner edge of the flange to a snug fit over the bottom of the tubing. Hand-hammering of the body is done with the tubing placed over a piece of pipe or a metalworker's bench stake. If you wish to decorate the hammered surface with your initial, lay out the outline of the letter with a pencil, and then carefully work around

it with a small ball-peen hammer. Hammer the metal top on an ordinary anvil or on a surface plate. Note that the cover is composed of three parts, a knob, or handle, a metal disk, and a bottom disk of hardwood which is an easy fit inside the humidor body. Both the handle and the bottom disk can be cut from hardwood, such as maple or boxwood. A small hole is drilled through the center of the metal disk, and the knob is joined to the bottom disk by a screw, preferably driven up from the bottom. This securely locks the three parts together. The base is made from the same wood as the knob so that the two parts match in color. Drill four equally spaced holes in the body flange and attach the flange to the wooden base with four aluminum rivets. File the ends of the rivets to a sharp point and drive them as nails. Polish the metal parts on a buffing wheel, being careful to remove all scratch marks, and then finish with a coat of metal lacquer.

R. J. DeCristoforo, New York City.

Trunks of Young Trees Protected by Guards Cut From Garden Hose

To protect the trunks of young trees from damage, I made effective guards from lengths of garden hose which were wrapped around the trunks. I cut the hose spirally by placing it in a wooden channel and then rotating it while sawing at a 45-deg. angle. No fastening is required, as the tension of the hose holds it firmly around the trunk.

Edward H. Stutz, Cleveland, Ohio.

Paint Preserved for Future Use

Prevent paint from hardening in the can after exposure to the air by pouring a thin layer of turpentine over the surface. Put a bit of the paint in the groove in the friction top of the can also, and then drive the cover down tightly. This seals the can and the paint will not skin over as so often happens if the can is not well sealed.

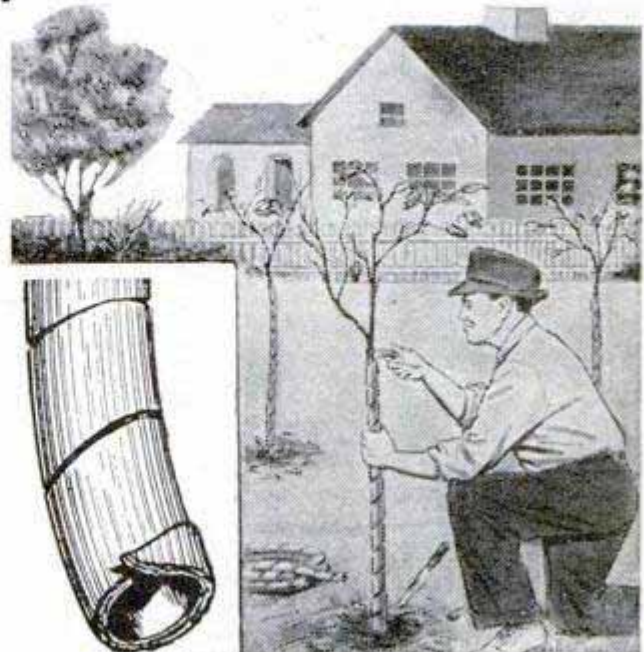

Carbon From Dry Cell Provides Tip For Homemade Soldering Iron

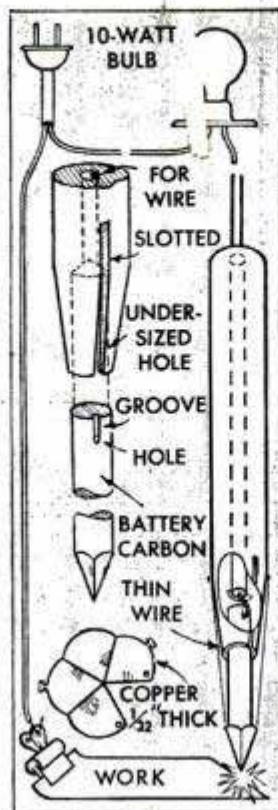

Utilizing the carbon core of a flashlight cell as a tip and a piece of broomstick as a handle, one homeowner made an electric soldering iron for his shop. The battery is baked in a hot oven for an hour so it will dry and harden. Then the carbon core is removed and filed to a four-sided point. After the broomstick handle is drilled, tapered and slotted as shown, the top end of the carbon is drilled and grooved to permit attaching the wire. One wire is secured to the carbon and connected to a 10-watt bulb which indicates when the iron is on. A paper clip on the end of the other wire is clamped to the work to complete the circuit. Note that a copper tip is cut out and fastened to the carbon with two lengths of thin wire, the latter being wound around small screws driven into the handle. The copper tip, of course, must be tinned, and it should be detached occasionally so the loose carbon underneath can be removed. To use the soldering iron, touch the tip to the work and draw it away slightly to form an arc which heats the tip. Do this frequently to keep the iron hot.

C. L. Meehan, Lakeview, Ont., Can.

Wood Ashes Rid Tree of Borers

My favorite method of ridding a tree of peach-tree borers and other destructive insects is to sprinkle large quantities of wood ashes around the base of the tree during the spring and fall. The worms and

insects that would otherwise infest the roots will not live in ashes. In addition, the ashes provide fertilizer for the tree. Ashes should not be placed close to the tree in dry summer months.

Ralph Underhill, Beebe, Ark.

Cotter Pins Form Photo Stand

A neat stand for a cardboard-framed photograph is made by slipping two cotter pins over its bottom edge. One arm of each pin is first bent outward, as shown, to support the photo upright.



Handy Spacer and Aligning Jig Aids Building Picket Fence

To speed the job of spacing and aligning the pickets when building a picket fence, one homeowner devised this wooden level and spacer. It is made from a board cut to the exact length of the pickets. A strip of wood is nailed to each end of the board and a screen-door handle is screwed to one face. Note that the ends of the board must be cut perfectly square so the crosspieces form right angles. The bottom crosspiece holds the picket to be nailed while the top crosspiece aligns it with the previously nailed picket.

Roger Bechard, Montreal, Que., Can.



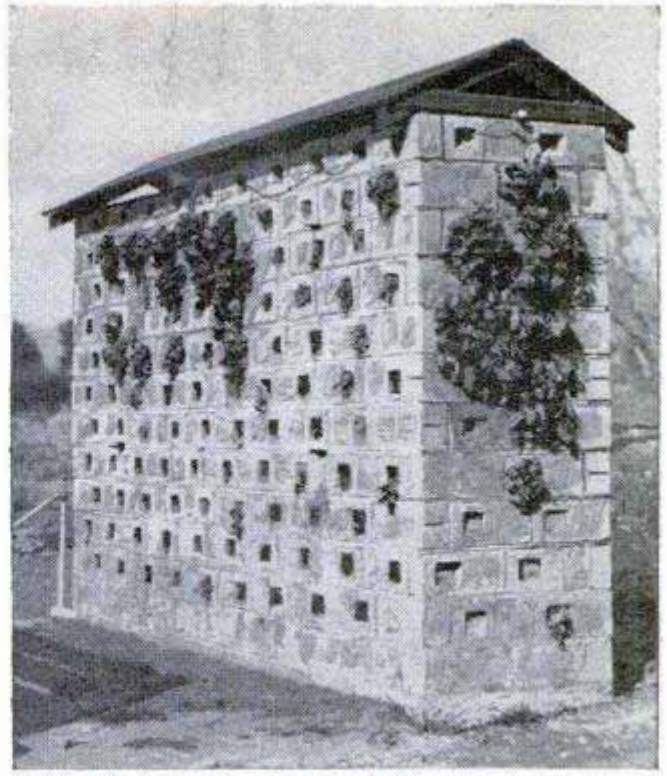
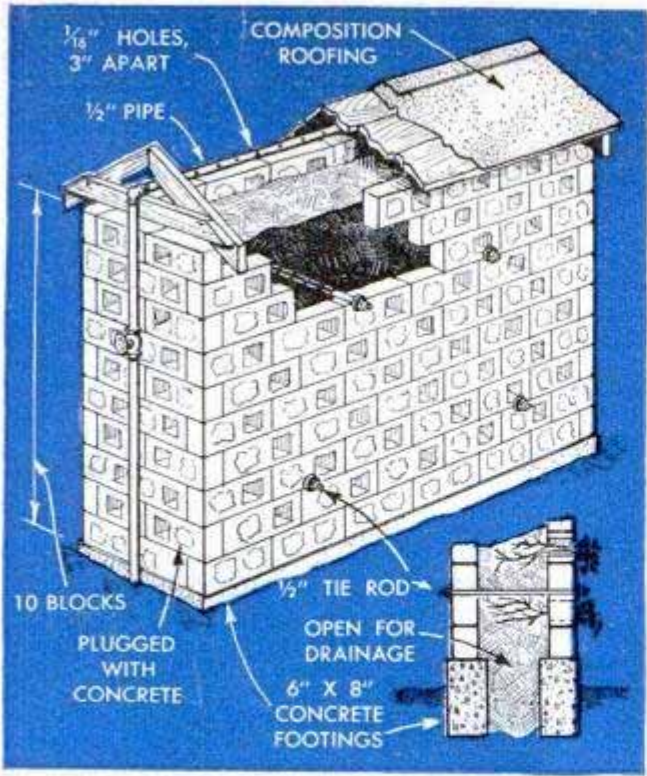

Hollow Concrete Blocks Form Strawberry Wall

Concrete blocks, of the hollow type, laid on edge on a concrete footing, form walls of this unique strawberry bed. One hole in each block is plugged with concrete and a strawberry plant is set in the other.

The plants are set after each course, or layer, of blocks is laid. For example, after laying a course of blocks, fill the enclosure to the level of the holes with a rich mixture of loam, compost and well-rotted manure. Then push the plants into the holes from the inside until the leaves are exposed to the sun on the outside of the wall. Care must be taken to soak and tamp each layer of soil to avoid loose soil settling away from the roots, thus causing them to dry out and

die. Tie rods are used to prevent the two long walls from bulging outward. After the top course is completed, a water pipe with $\frac{1}{16}$ -in. holes drilled 3 in. apart is installed lengthwise across the top as indicated. The flow of water should be directed straight down and regulated by a conveniently located valve. A roof, completely covering the top, will prevent excessive moisture during heavy rains. The structure should be positioned so the two long walls will benefit from the morning and afternoon sun, and should be located so it is not shaded at any time. By clipping the runners, most of the original plants can be made to bear fruit for several seasons.

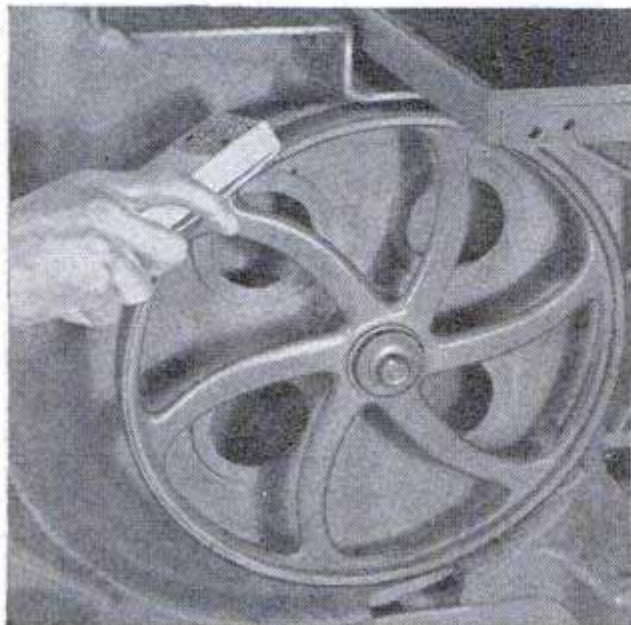

Bandsaw Tires Dressed Quickly With Sanding Block

When the tires of a bandsaw develop grooves as the result of long use, it is necessary to true them before the blade will again track properly. To do this quickly, tack a piece of coarse sandpaper around a wooden block. Then, remove the blade from the machine, turn on the power, and hold the sanding block squarely against the rubber tire on the lower wheel. After dressing the tire of this wheel, replace the blade, start the machine, and hold the block against the bottom of the upper tire.

☐ Faded wool rugs may be brightened by rubbing with a flannel dipped in warm water to which a little vinegar and common salt have been added. Dry in the open air.

Let the shot **LIGHT** *itself*

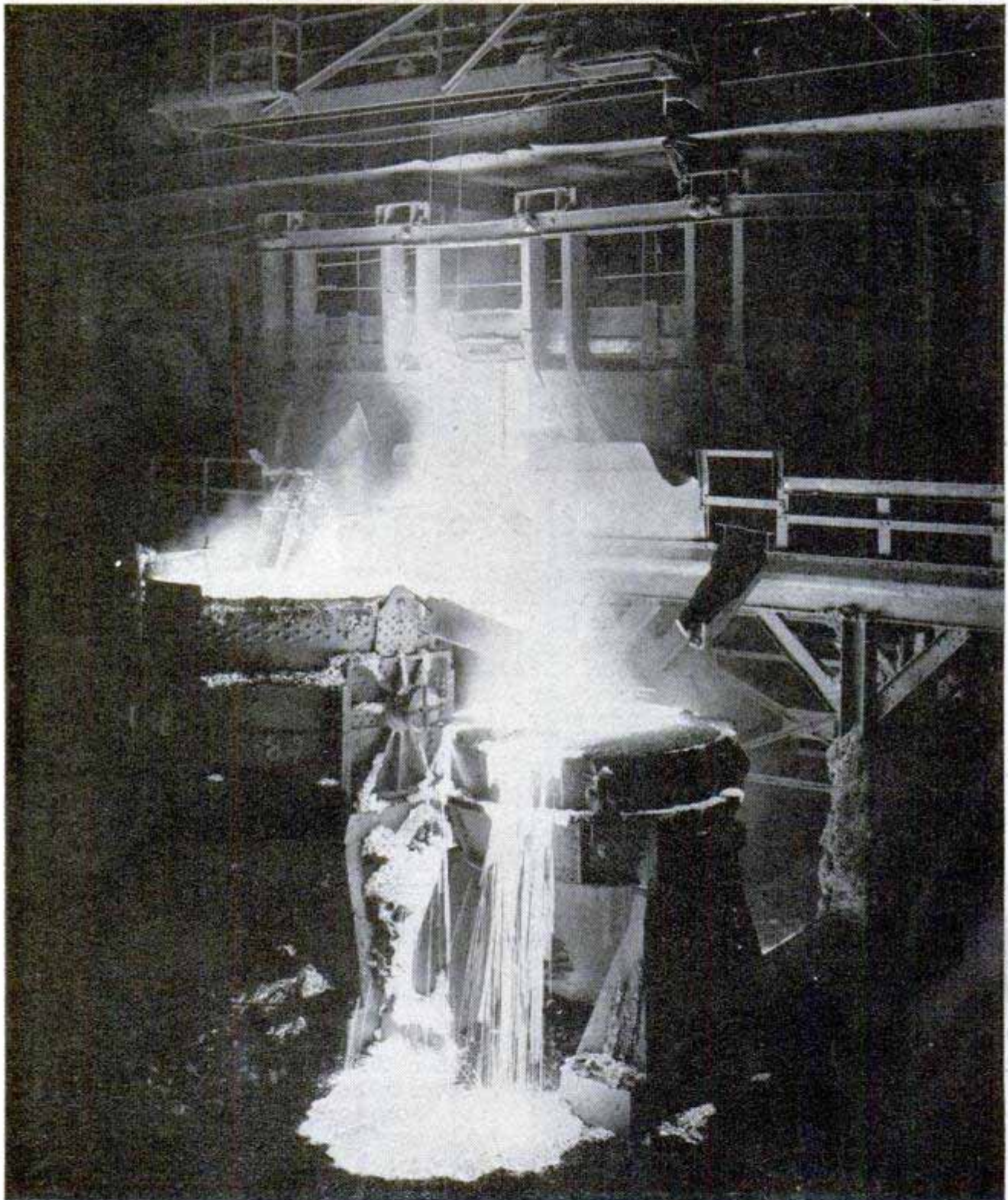

GOOD PICTURES of any subject result from a studied arrangement of background mass and correctly lighted foreground details. When shooting photos of industrial processes—men and machines at work—forceful presentation is achieved by simply utilizing bold contrasts of light and shadow. In many instances the picture is merely allowed to “build” itself on the background by means

By Fred G. Korth

of the radiated light from the materials in the object itself or by means of radiated light resulting from an operation or process. The photo directly above is a good example of this type of self-lighted shot. Here molten steel is being poured from an open-hearth furnace into a huge ladle, from which slag is overflowing onto the floor. The brilliant luminosity of the red-hot metal is the only source of

light. Radiated light has illuminated just enough of the background detail to fill in the story, thus definitely identifying the picture and at the same time lending its own dramatic emphasis. Note especially the location of the camera to take a three-quarter view which gives the proper angular perspective to the highlighted detail. Note also that the camera was placed above, rather than below, the center of interest. Shooting down on large objects has the effect of making them look smaller, brings all details into more natural size relationships and gives greater uniformity of emphasis to the composition.

The action photo at the right required only a single flash coming from the right to illuminate the machine, the operators and the work against a semidarkened background. The shot is taken approximately at eye level. Note that the flash was placed to illuminate the inside of the metal ring farthest from the camera and to high-light the edge

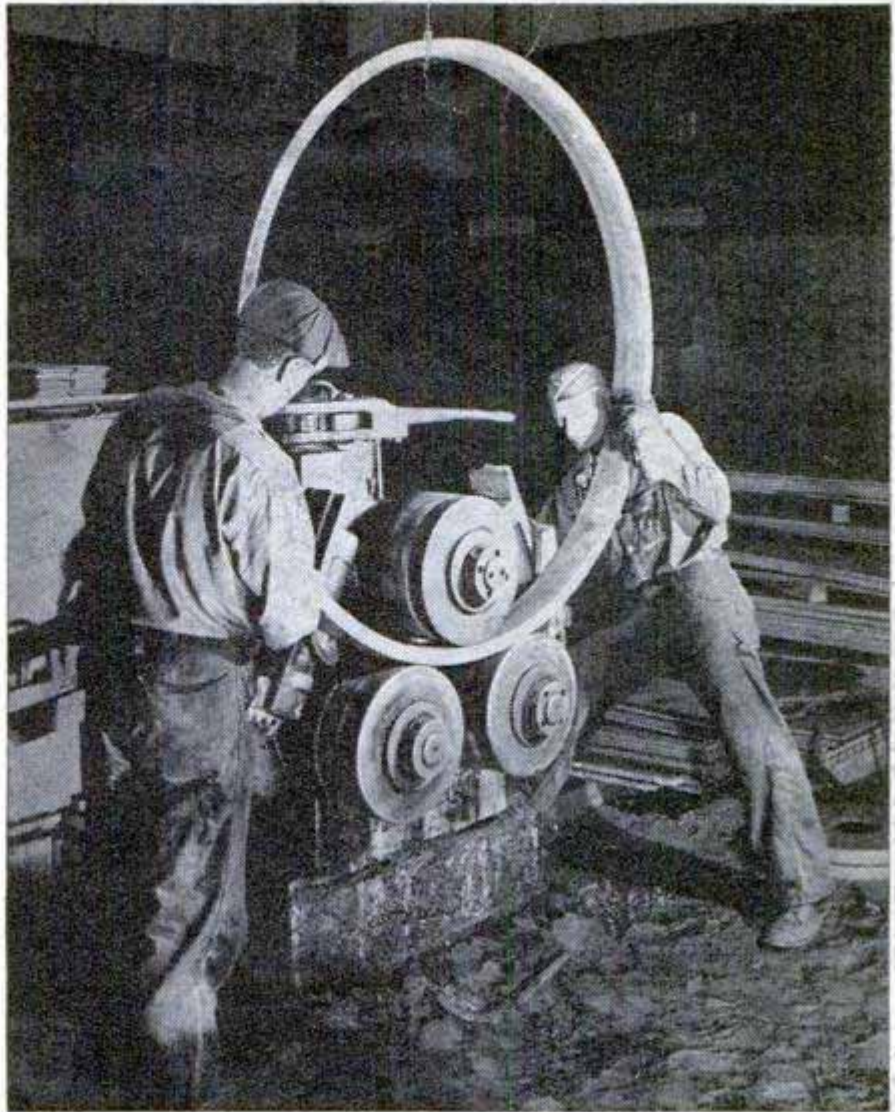

Above, a dramatic action shot with detail emphasized against a dark background by subdued flash lighting. Note that the flash is placed to light the inside of the ring farthest from the camera but only high-lights the edge nearest the camera. Below, a self-lighted shot of a large workroom



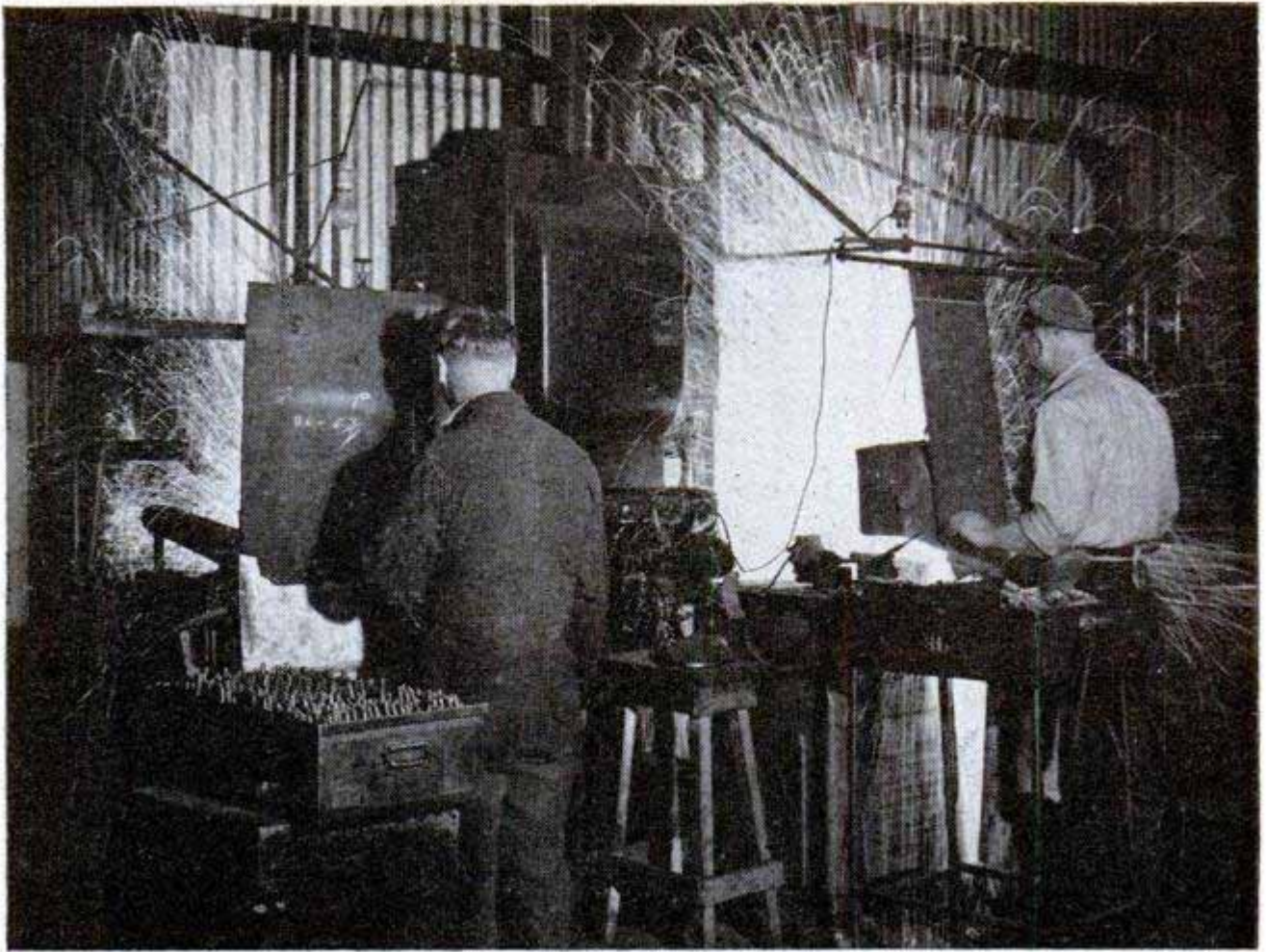

Above, the background is self-lighted by the welding operation while a single flash placed at a distance prevents loss of foreground detail. Below, a self-lighted shot in which only the tracery of the sparks from a welding operation is used to light the picture



brightly. Both the position of the camera and the location of the single flash achieve balance and the foreshortening of the three-quarter view dramatizes the action.

The lower photo on the preceding page presents another problem to the photographer. Obviously, it would be impossible to illuminate this large workroom and the scores of operators with photographic lighting. But by simply raising the fluorescent fixtures a few inches the shot was made to light itself even more effectively. Then a small lens stop and a half-second exposure on fast pan film did the trick. Again the shot is taken at approximately eye level with the camera "looking" straight down the line of workers at the left. This position of the camera gives one more of a feeling of action, of work being done in the room, for the eye is led directly down the line of busy workers at the right of the aisle immediately in front of the camera. Any other angle or elevation of the camera would have resulted in a flat, uninteresting shot with an unnatural foreshortening of objects and persons in the foreground and a loss of detail in the background.

The photos above and at the left are examples of photos that are allowed to develop their own action through the delicate tracery of innumerable sparks from welding operations. The picture at the left is wholly self-lighted, but in the shot above, a

single flash is placed at some distance to the right to illuminate softly the workers and their equipment. When picturing welding operations it is important that the exposure be long enough for the spark pattern to attain maximum brilliance on the film. Any other necessary lighting should be reduced to secondary power either by using the smallest flash bulb or floodlight, or by moving it some distance away from the action. These two pictures also emphasize the importance of camera angle. Put yourself in the position of the photographer for a moment and you can see that only slight changes in camera elevation and position will alter the pictorial values and change the composition by bringing unseen details into the field of the lens. Certain positions around the lower scene would soften the sharp outlines, change the spark pattern and perhaps even lose the picture story entirely. After a study of the two shots you can see that the photographer has chosen his vantage point with care and only after a detailed examination of the work being done at the scene. It is quite evident from both shots that the picture possibilities were carefully appraised from several angles before selecting the spot at which to set up the camera. Only careful positioning of the camera could catch the sharp silhouette in the photo at the left. Moving slightly to the left or right of the position from which the action was shot, or just a slight change in camera elevation, would lose most of the dramatic values of the whole composition.

All of the accompanying photos emphasize the importance of correctly evaluating the kind and nature of the background to be included in industrial pictures. As in the first photo discussed, background detail is in many instances essential to the composition. In self-lighted shots the background detail included is more or less controlled by the camera position and the amount of radiated light. In flash or floodlighted shots, the trick is to light the background in such a way that the background detail appears only in greatly subdued outline. The action shot of the two operators at the bending machine is a good example of carefully controlled background lighting. An exception is the action shot of the welders at the top of the preceding page. Here the background is self-lighted but the

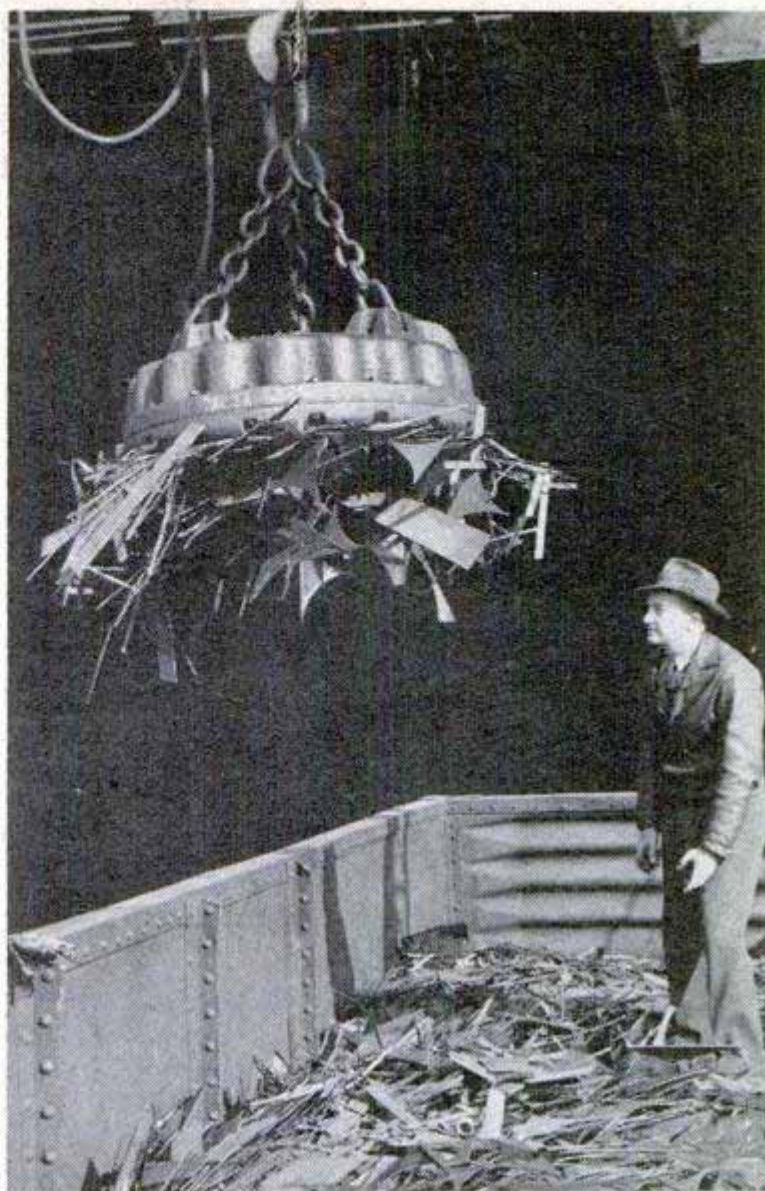

Only the sun was used to light this picture of the big magnet with its load of scrap metal being examined by the inspector

foreground is flash-lighted so that the necessary definition of foreground detail will not be lost in semidarkness.

Some industrial shots, however, tell the whole story without any lighted background props. The shot of the welder at the lower left on the preceding page and the photo directly above are good examples. Both are self-lighted, one by the glow of the welding operation, the other by the sun. In the photo above, the exposure was timed to catch the big magnet with its load of scrap metal in midair, and a careful study of the picture possibilities beforehand enabled the photographer to locate the camera so as to use the dark interior of an adjacent building as a background. Just enough of the loaded car was included to identify the picture as being that of an inspector examining the run of scrap material being unloaded at a foundry. This shot emphasizes the importance of making sure that objects in motion are in the correct position at the time of exposure.

Sink Rack for Developing Solutions Permits Easy Temperature Control

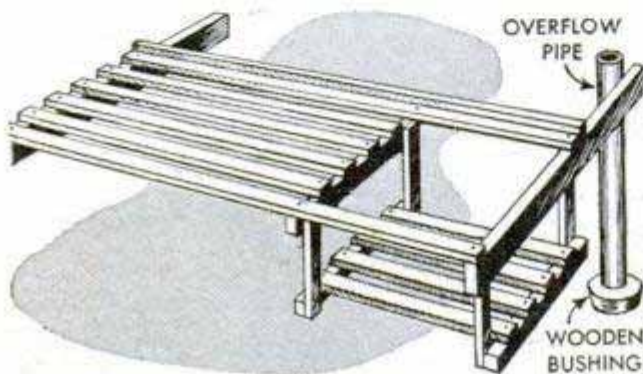
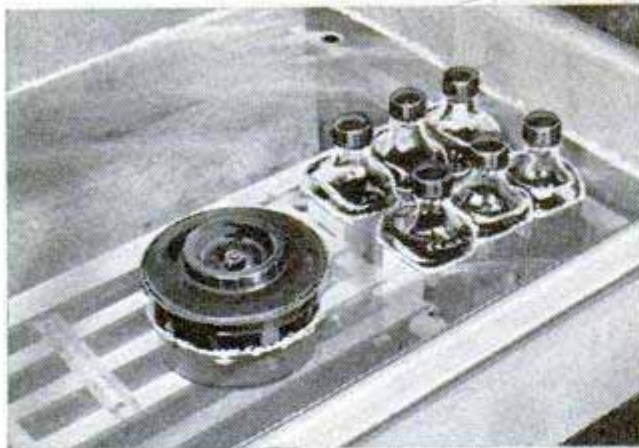

When developing color films, it is important to keep all solutions at the same specified temperature. This can be done easily by making a two-level rack similar to the one shown and wedging it inside the sink. An overflow pipe is fitted into the sink drain by means of a wooden bushing. A thermometer is laid on the rack and, as the volume of water involved is comparatively large, the temperature is kept constant simply by adding a little hot or cold water from time to time.

Willard Allphin, Danvers, Mass.

Label on Double Film Holder Describes Contents

As a reminder of the type of film loaded in double film holders, one photographer writes this information on a label glued to the edge of each holder. The labels are



made wide enough to permit noting the film on each side of the holder when it is loaded with two types. If the notation is made with a soft pencil, it can be erased easily.

Wayne A. Ward, Watertown, N. Y.

Battery Case of Flash Gun Indexed To Aid Positioning Reflector

If bulbs of more than one size are used in a flash gun, the reflector can be centered quickly by first marking the proper position for each type of bulb on the back of the battery case. To do this, insert bulbs of various sizes in the gun, centering the reflector for each size and filing a small groove in the battery case directly under the end of the reflector clamp. These grooves, of course, are later used to position the reflector and they are easily seen if filled with white paint.

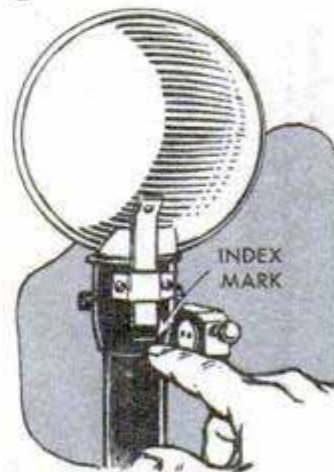

Obtaining Better Color Balance In Transparency Projection

Because of the fact that a color transparency usually is taken in daylight, the color balance of the projected image is improved by tinting the projector bulb a faint blue. A frosted bulb is tinted by dipping it in cellulose-acetate plastic dye until the desired shade is reached and then rinsing it in cold water. Be careful not to touch the bulb until it is dry as the dye softens the frosting. If the projector is equipped with a clear-glass bulb, the reflecting surfaces may be dyed a light blue. As an alternative, a thin sheet of clear plastic, tinted a light blue, may be mounted next to the diffusing screen.

Protecting Lenses From Chipping

Auxiliary lenses and unmounted color filters are less likely to be chipped if their edges are protected with a thick, resilient coating of fingernail polish. Cellulose cement also will serve the purpose. Apply the cement or polish carefully so it does not run onto the surface of the lens.



Rep. L.L.B. #14

SHOP NOTES

LATHE SANDERS

By Dick Hutchinson

DO YOU need disk and drum sanders to supplement your belt sander? They can be obtained inexpensively by simply turning a wooden drum to operate between your lathe centers, and a plywood disk to attach to the lathe faceplate or screw center. For the disk sander, you will need a simple table

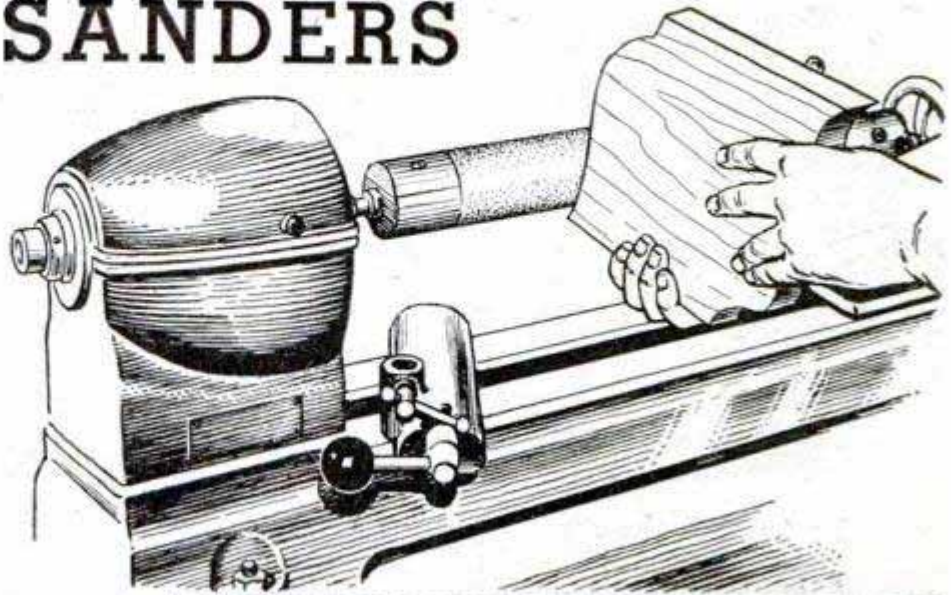

to fit on the lathe ways as in Fig. 3.

To make the drum sander, select two pieces of hardwood, one piece 1 in. thick and 3 in. wide, the other 2 in. thick and 3 in. wide. The drum can be any convenient length up to about 15 in. If it is made longer without increasing the diameter proportionately, there is a danger of whipping at high speeds. Glue the pieces together, as in Fig. 1, with a sheet of heavy paper between them. When the glue is dry, mark the center on each end; then mount in the lathe and turn to $2\frac{7}{8}$ in. in diameter. Drill and counterbore each part near the ends for a $\frac{1}{4}$ -in. stove bolt, and then separate the pieces by running a sharp knife blade along the joint. A piece of 1-in. cloth tape attached to one side of the drum over the joint makes a durable, continuous hinge. Cover the drum between the bolt holes with $\frac{1}{16}$ -in. felt, the edges of the felt meeting at the joint. Glue only the ends of the felt to the two parts of the drum, as in the lower detail, Fig. 1. When the hinged parts are drawn together with the bolts, the felt should be tight. Wrap sandpaper around the drum and insert its ends in the opening between the hinged parts. Then tighten the bolts. For best results, the drum should operate at a speed of about 2000 r.p.m. with a medium-grit sandpaper. Fig. 2 shows another

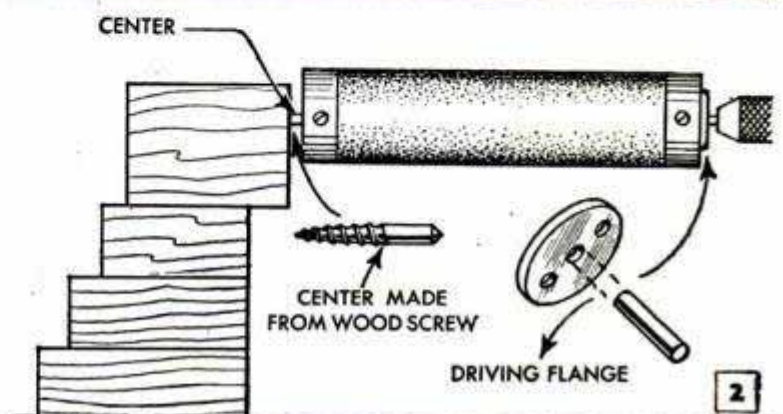
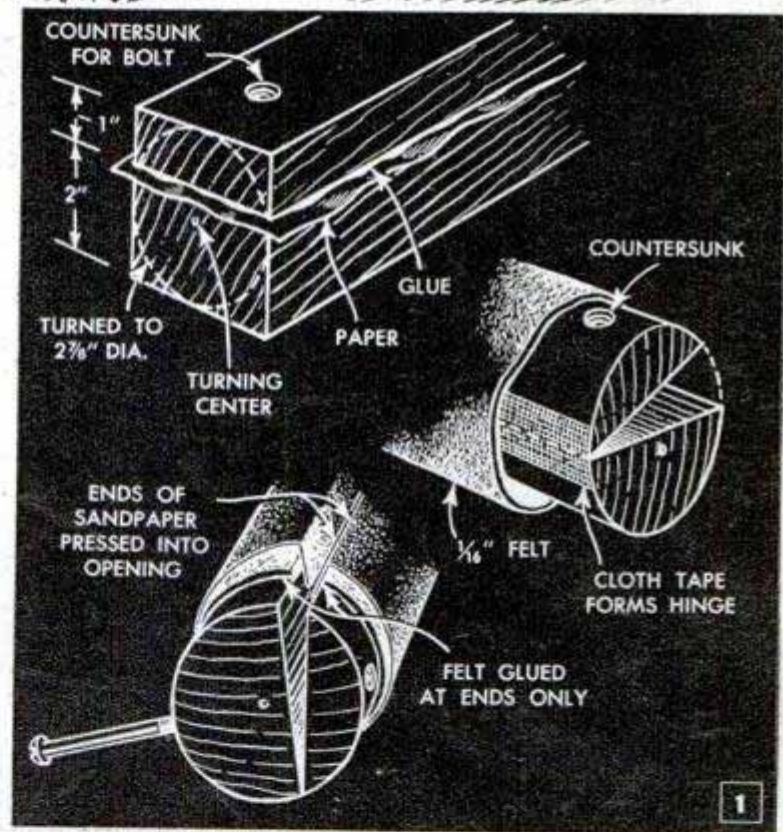

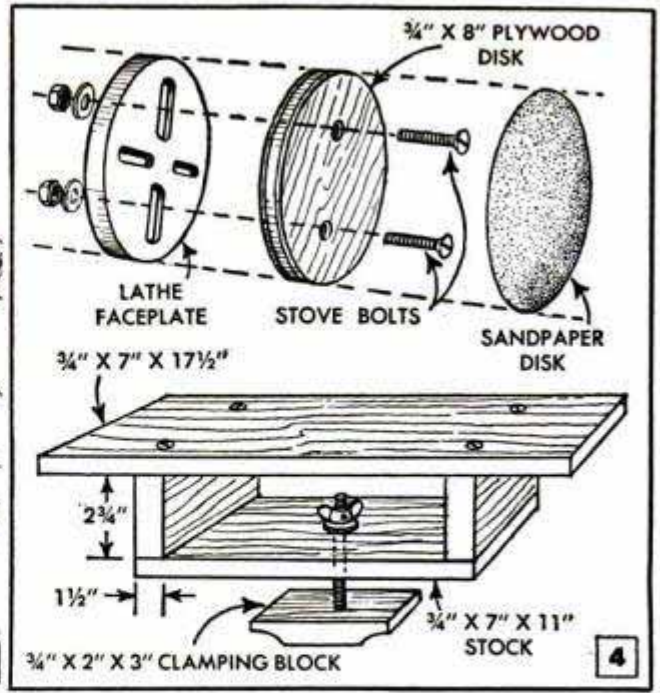
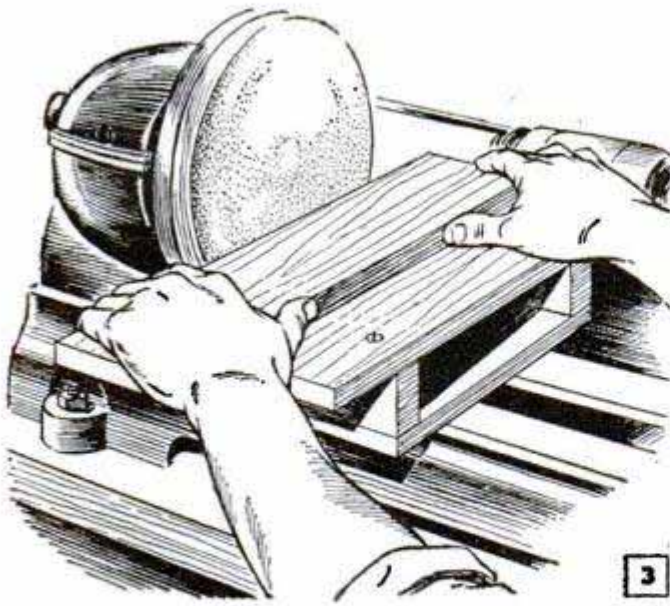

way of operating the same type of drum with an improvised tailstock, driving it with either a polishing head or a small grinder having a threaded spindle on which a drill chuck can be mounted. A driving flange is made by inserting a pin tightly in a small disk cut from $\frac{1}{8}$ -in. sheet metal, Fig. 2. The disk is screwed to the drum end.

Figs. 3 and 4 show how to make the sanding disk and a table which clamps to the lathe bed. When in position on the lathe bed, the top of the table should be about $\frac{1}{8}$ in. below the center of the disk. This distance is determined by the swing of your lathe. For average small work, a disk speed of 2000 r.p.m. is recommended.

Homemade Blacksmith's Forge Utilizes Old Vacuum-Cleaner Parts

By using the motor and fan assembly of a discarded vacuum cleaner as a blower, in addition to other odd parts, one blacksmith made himself a forge at little cost. The blower is connected to the air inlet and

fastened to one leg of the forge with a flat-iron bracket. The leg bolts are tightened with wing nuts to facilitate removal of the unit when electricity is not available. In this case, of course, a hand-operated blower must be used.

A. M. Morgan, Lafayette, Calif.



Pair of Gloves Kept Together

To prevent one of a pair of work gloves from being mislaid, use snap fasteners to hold the gloves together. This also permits hanging the gloves from a hook or nail.



Substitute Thread-Cutting Oil

If you have a rush job to do and run out of thread-cutting oil, any of the following common items may be substituted successfully: melted bacon fat, linseed oil, or turpentine. White-lead-and-oil paint also will serve the purpose, but it is messy to use and must be thoroughly cleaned off.

Howard D. Wildman, Schenectady, N. Y.

This Light Auger Raises Unbroken Soil Sample

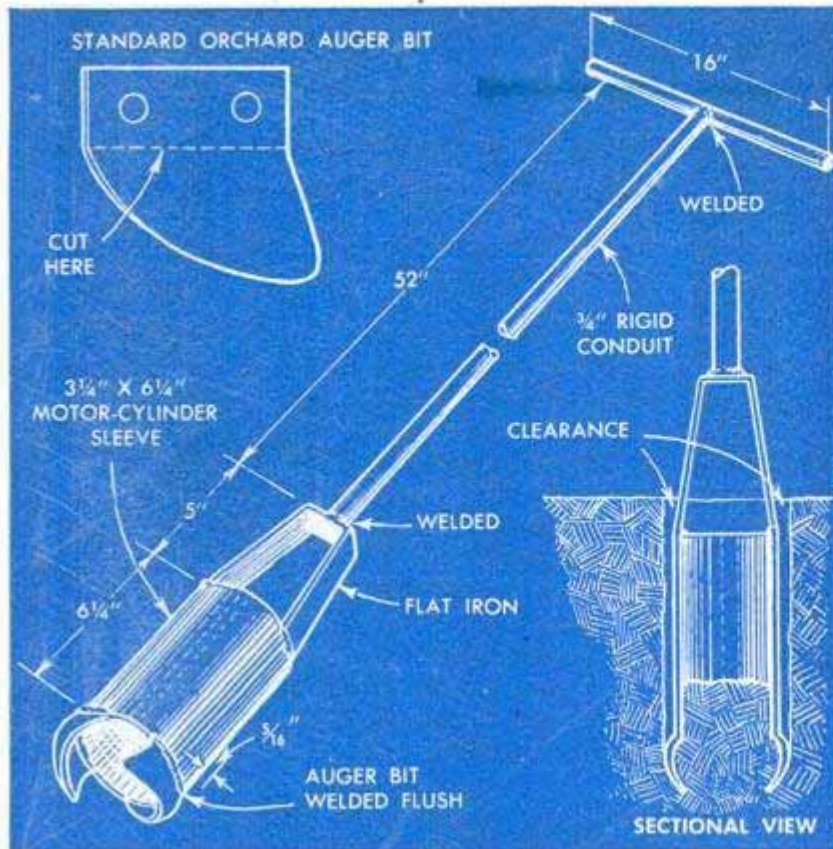

Sectional drawing above shows how the clearance between the soil and sleeve permits easy removal of the auger from fairly deep holes

Weighing only about 5 lbs., this hollow auger for taking soil samples can be turned into the ground with less than half the effort required when using the conventional sample auger. It works equally well in soils that are either dry and loose or tight and sticky, removing a core of unbroken earth which makes it possible for the surveyor to examine the soil structure as it actually occurs at the full depth of the auger's capacity. A removable cylinder sleeve from a tractor engine is used

for the body of the auger and the handle for turning and lifting is made from two pieces of electrical conduit welded as indicated above. The lower end of the handle is welded to an A-shape bracket, the free ends of which are welded to the top ends of the cylinder sleeve. Two standard 4-in. soil-auger bits are welded to the other end of the sleeve, the bits being positioned so that they cut a bore diameter slightly greater than the diameter of the sleeve.

W. L. Southworth, Portland, Ore.

Adjustable Beam Compass for Rough Layout and Blackboard Instruction

For rough layout in sign painting, window-display work and blackboard instruction, this adjustable beam compass is just the thing. The arm of the compass is a length of 1/4-in. rod threaded at one end. This end is turned into a tapped hole in the edge of a metal block, entering a larger hole drilled through the center of the block to take a piece of chalk or crayon. The other sliding end of the arm fits through a hole in a sliding pivot made from a short piece of rod, 1/2 in. or more in diameter. A blind hole is drilled in the bottom of the pivot for a pencil eraser, and a hole for a setscrew is drilled and tapped in the top of the pivot. Chalk is secured in the holder simply by turning the arm.

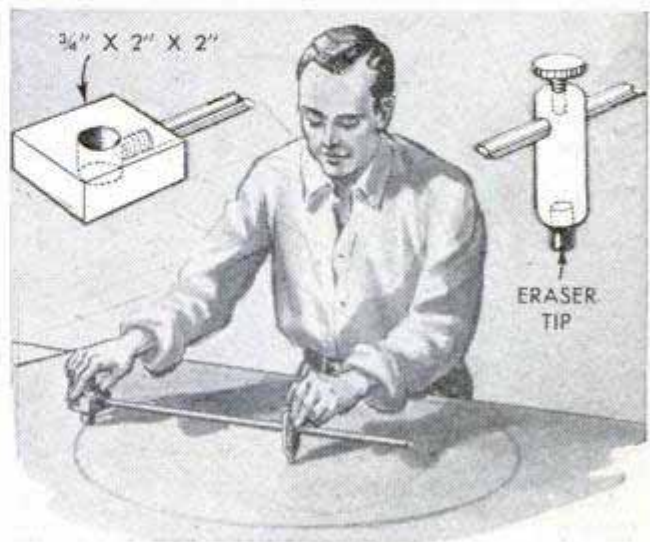

Glass Plates Hold Notices On Bulletin Board

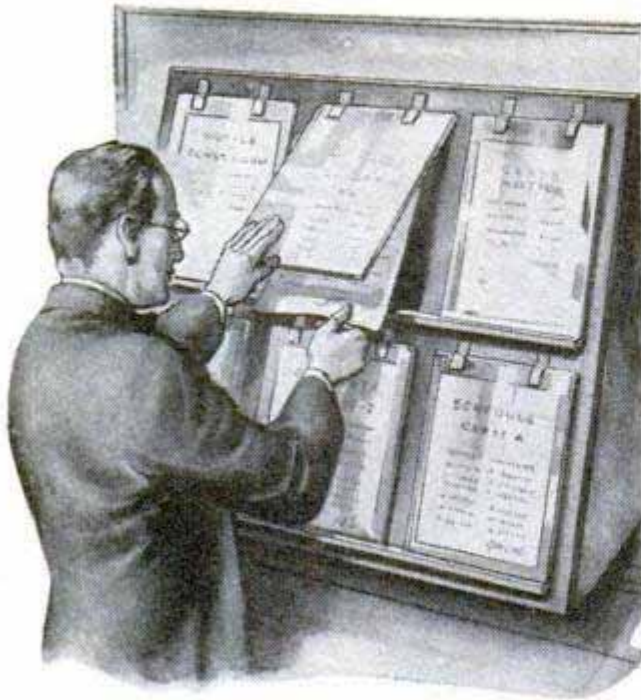

Notices can be posted on a school or factory bulletin board without the use of thumbtacks if they are held with hinged plates of glass or clear plastic. The covers also keep the notices from becoming soiled or torn. The bulletin board must be fastened to the wall in a sloping position so the covers, which are hinged with adhesive tape, rest on the face of the board. Cleats extending the full length of the board are nailed under the bottom edges of the plates to give them additional support.

Metal Collar Added to Boring Bar Adapts It for Internal Threading

Large internal-threading jobs which must be bolted to the lathe carriage can be done with an ordinary boring bar converted into an adjustable threading bar. The conversion is made by adding a steel collar to the

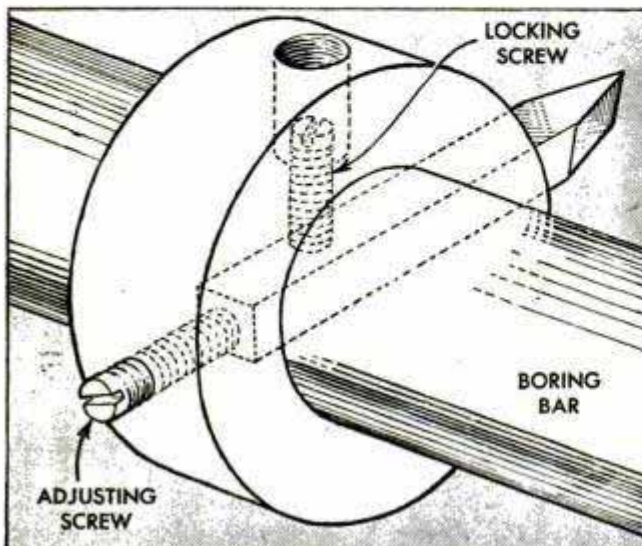

boring bar, the collar being drilled for the threading tool and also to permit access to the locking screw. Drill and tap a hole in the collar for a depth-adjusting screw.

H. Moore, Leeds, England.

Auto Tire Provides Marking Guide When "Topping" Fence Posts

When one farmer wants to saw the tops of a number of fence posts at an angle so that they will shed water, he uses a small section of discarded auto tire as a marking guide. The result is a neat-appearing row of uniformly cut posts. If a little oil is rubbed on the edge of the tire, it can be tacked temporarily to the post and used as a saw guide.

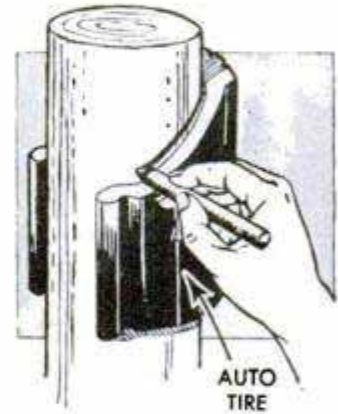

If a little oil is rubbed on the edge of the tire, it can be tacked temporarily to the post and used as a saw guide.

Splicing Broken V-Belt

Recently, while pouring steps to my front porch, the V-belt on the mixer broke. As we were working on a holiday, I was unable to purchase a new one. Since the job had to be completed, it was a case of making the old belt do. I simply half-lapped each end of the belt as shown, formed holes with an awl, and laced the ends together with wire. By blocking up the engine to compensate for the shorter belt, the splice held and the mixer ran satisfactorily until the job was finished.

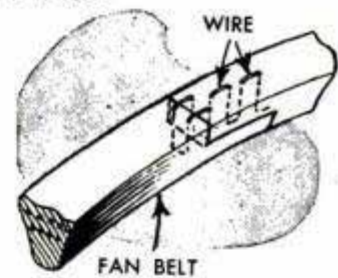

Herbert E. Fey, New Braunfels, Tex.

Cork Seals End of Chuck

The life of a drill-press chuck which is removed from the press when not in use is prolonged by inserting a cork stopper in the open end of the chuck. This prevents foreign matter and moisture from causing wear and rust on the working parts. The jaws of the chuck must be completely drawn in before inserting the cork.



FARM PUSH TRUCK

handles heavy loads

BUILT by Leonard Hammerschmidt, California poultry rancher, this labor-saving push truck can be used by farmers everywhere to simplify the handling of sacked feeds or small grains in the narrow feeding alleys of dairy barns, farrowing houses, and large granaries. A single caster wheel in front is controlled by a steering arm mounted on the rear panel of the platform body. Hardwood is used for the sills and cross members of the platform frame. The cross members are mortised the full thickness into the sills and fastened with bolts. The cross members are mortised the full thickness into the sills and fastened with bolts. The rear-axle brackets are each made from two pieces of angle iron and a sleeve welded together as in one of the details below. After assembling the wheels on the axle with a pipe spacer, the axle is welded to the sleeves at each end. To assemble the front caster, the fork is cut from a stock truck caster of the swiveling type and the ball-bearing swivel assembly is welded to a new and larger fork made from $\frac{3}{16}$ -in. sheet steel. Note that the swivel is located on the fork 2 in. off-center from the wheel axle. Before bolting the wheel assembly in place, an arm bent from flat iron is welded to one side of the fork and drilled at the outer end to take the steering rod. Angle-iron uprights are now bolted to the rear ends of the sills and braced as shown. The platform frame is then covered with 1 x 4 or 1 x 6-in. boards and spaced holes are drilled in the uprights for small screws used to attach the boards making up the back panel. The steering arm and handle are made from $\frac{1}{2}$ -in. rod and the parts are assembled as shown in the detail below.

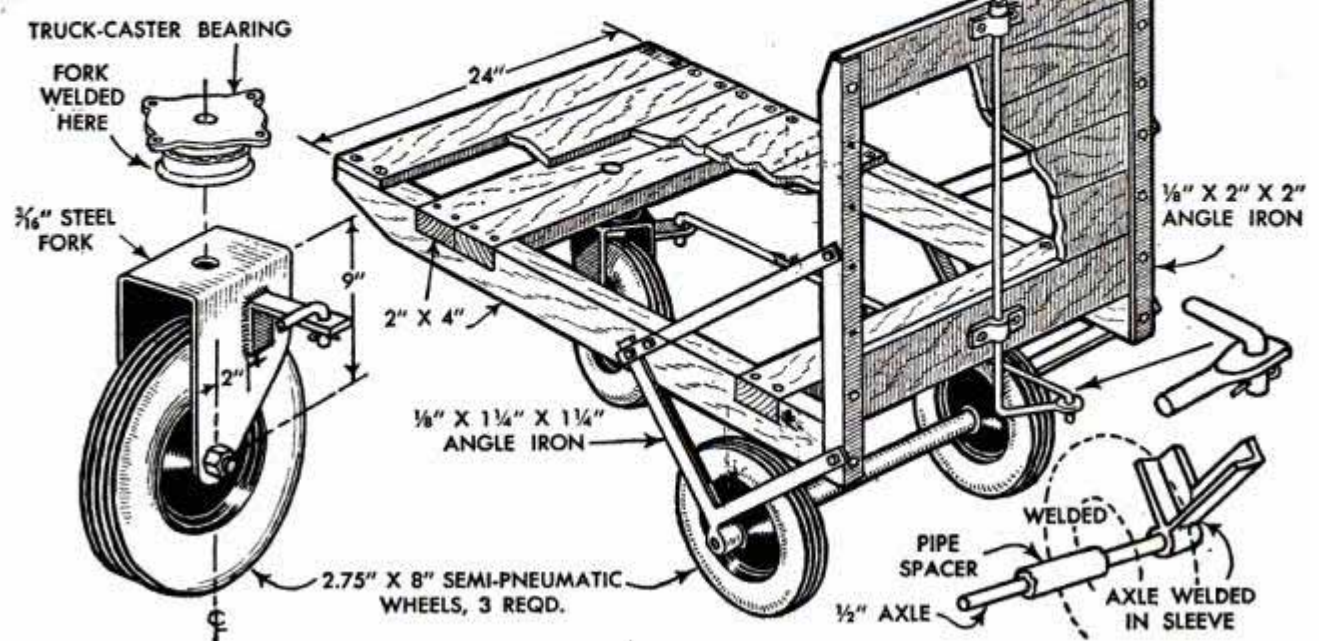
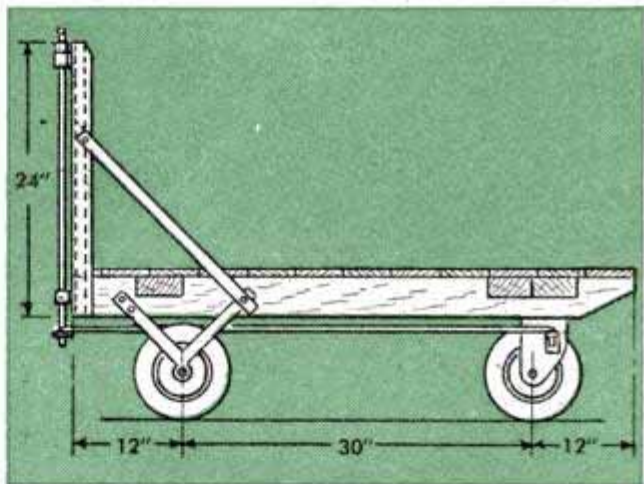

TWO FARM SPRAYERS

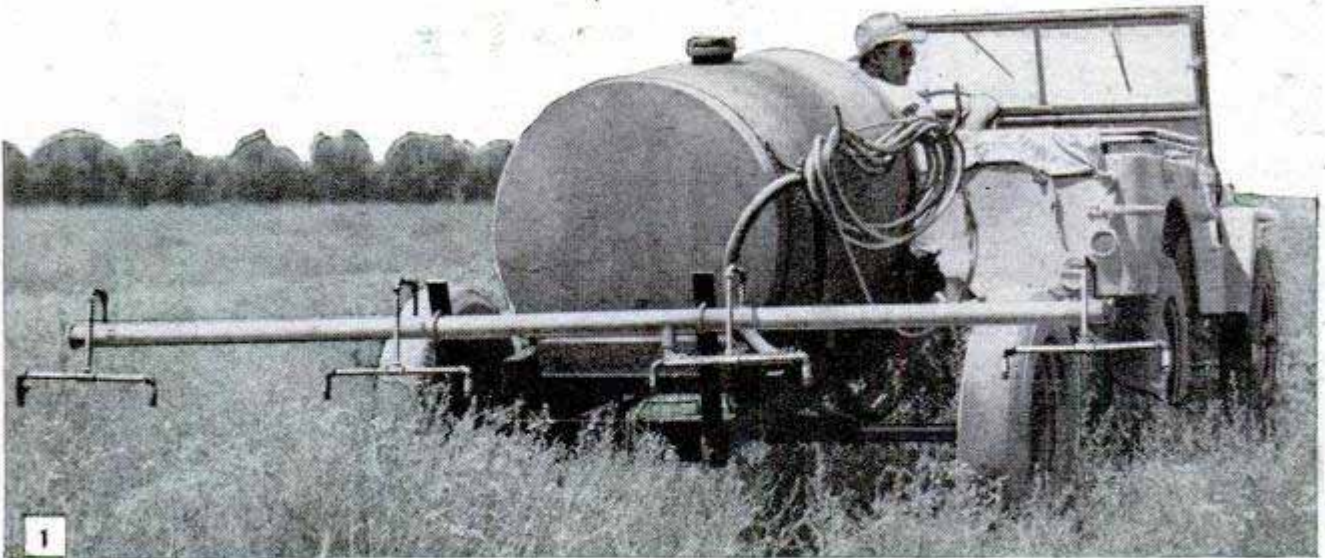

Here's the heavy field sprayer being pulled by a jeep and spraying plants in rows with the row-crop spray boom. Eight nozzles cover both sides of the plants. Other types of spray booms can be adapted to this unit

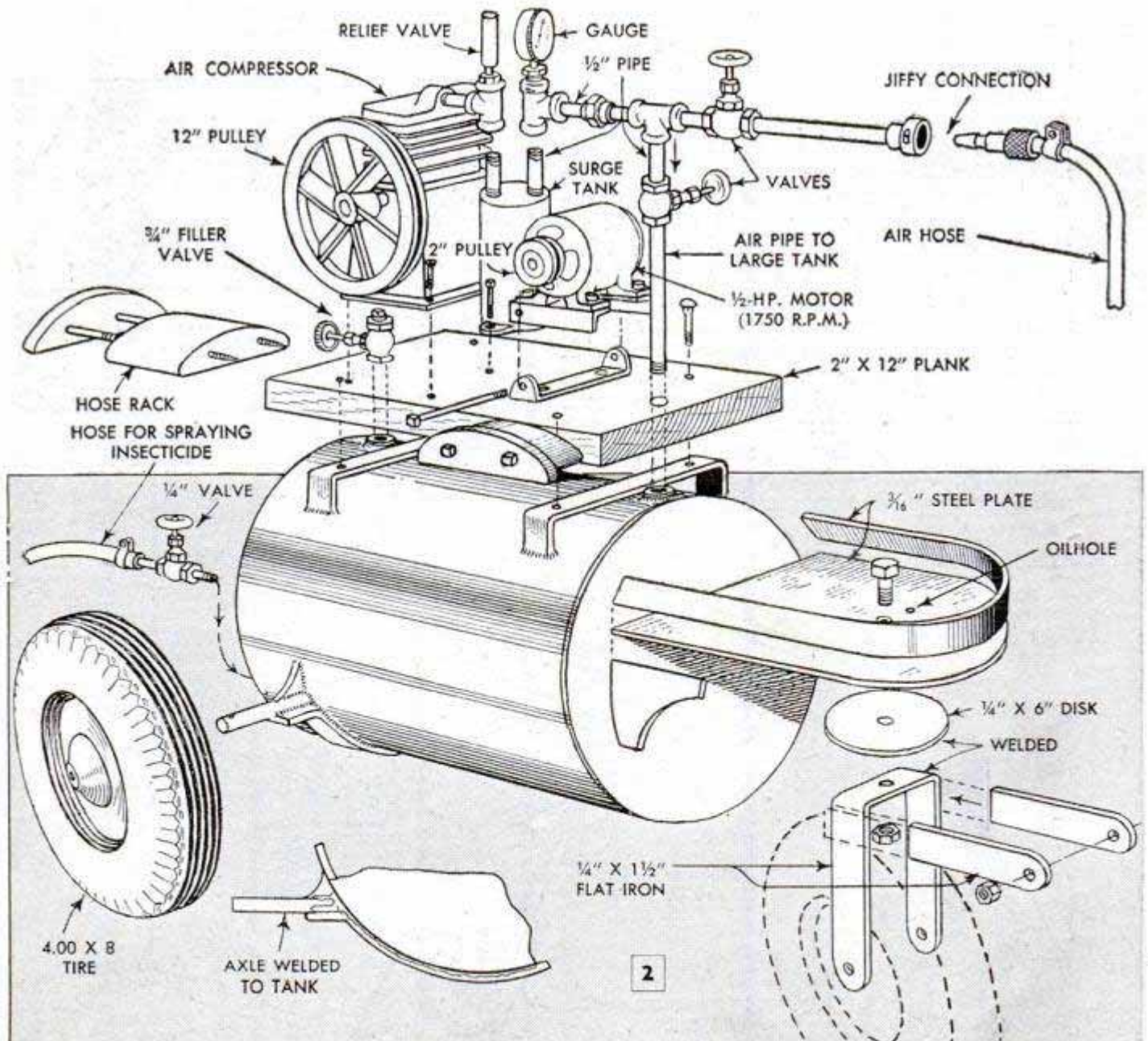

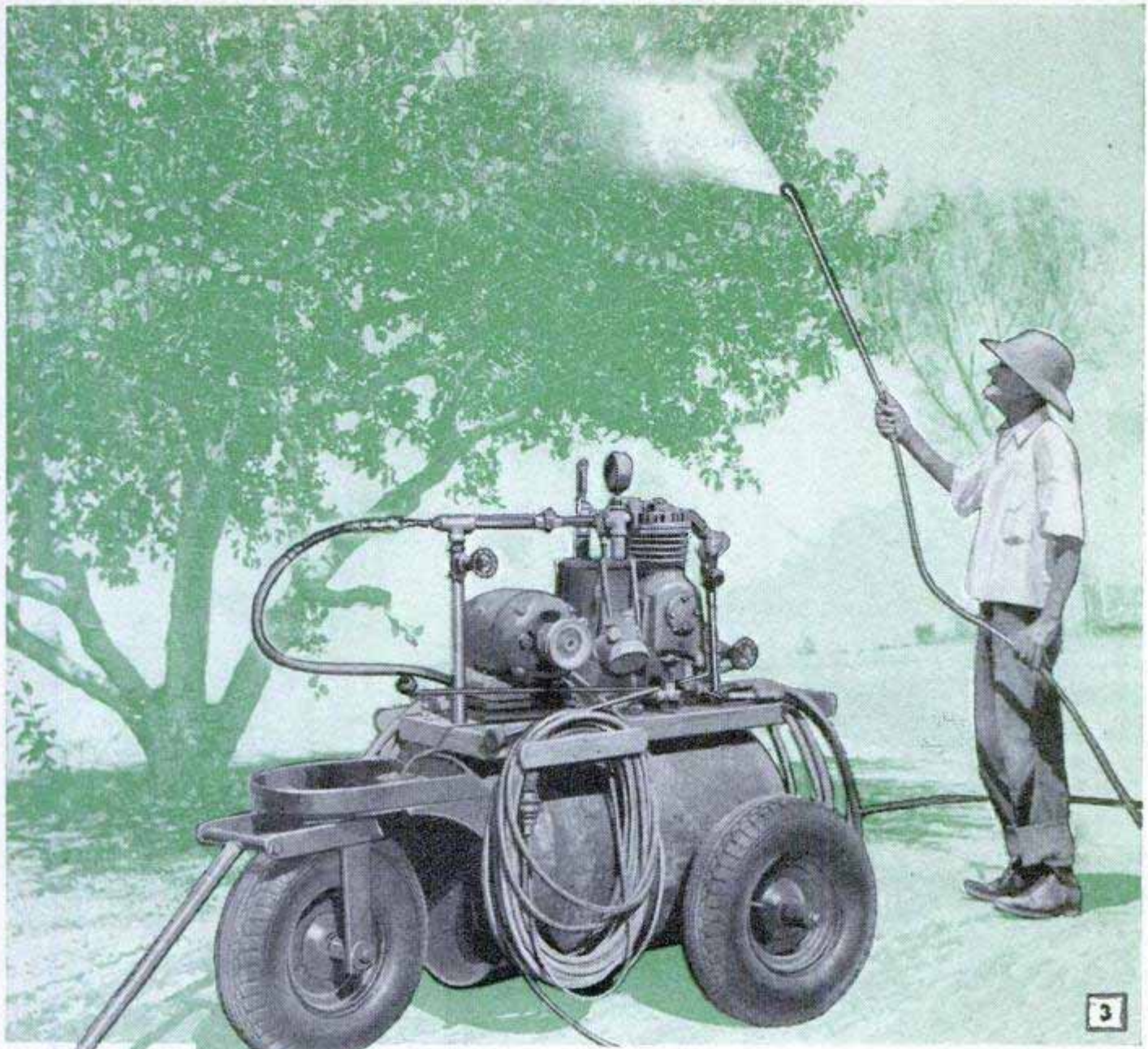

By Hi Sibley

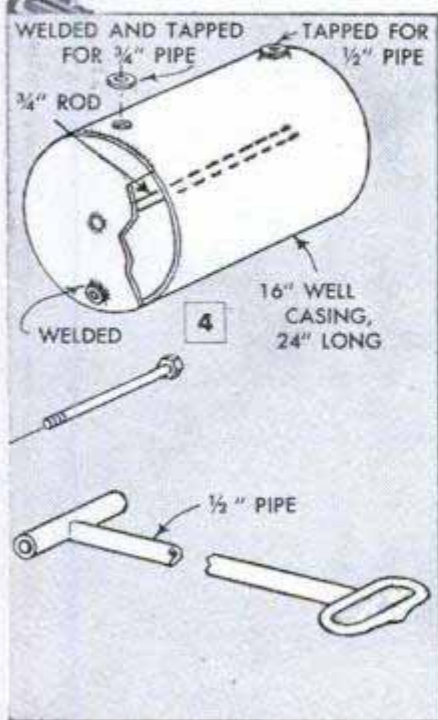

WITH THE EXCEPTION of such standard equipment as an electric motor, an engine, pumps, and, in one case, the tank, both of these handy power sprayers were built entirely in small farm shops. Each has been in service for more than two years. The electrically driven outfit shown in Fig. 3 was developed primarily for use in spraying insecticides in poultry houses, but has since been adapted to such varied jobs as spraying fruit trees and garden crops, spray painting and inflating tires. It is easily pulled about by hand, being mounted on a tricycle truck with large pneumatic-tired wheels.

Many of the parts can be assembled from materials you have at hand as slight variations in the specifications given for certain parts will not affect efficient operation. As an example, the pressure tank is made from a length of 16-in. steel well casing. Of course, a tank made from lighter-gauge metal would be just as suitable. The power unit is mounted on a plank bolted to the top of the tank, which forms the chassis. Arrangement of the various parts is shown in Figs. 2 and 3. The steel platform just above the front wheel holds a paint pail, spray gun, hose or other accessory. General dimensions of the unit are given in Fig. 5.

The tank, Fig. 4, is the first part to build. It is fitted with a

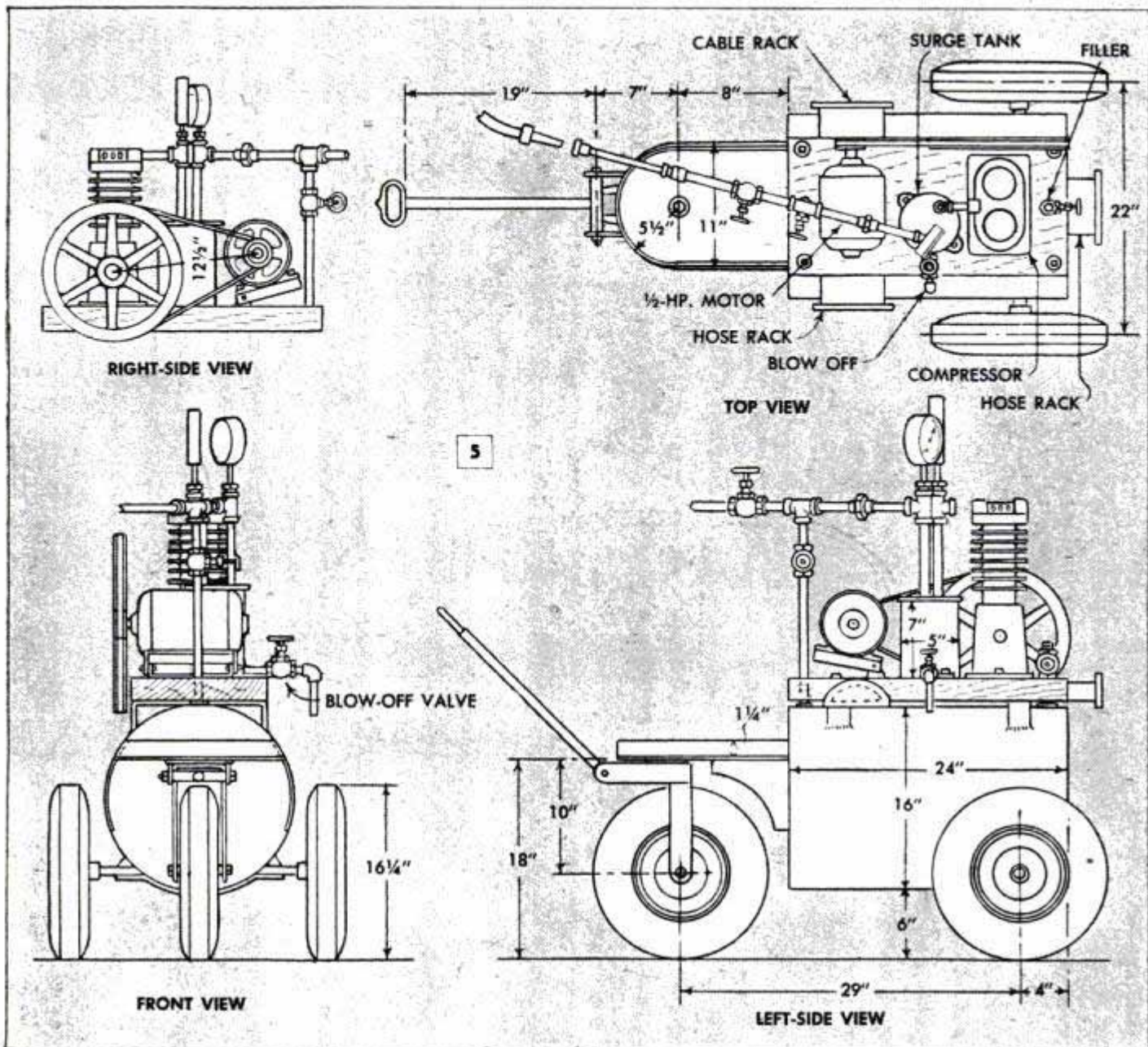

1/2 or 3/4-in. reinforcing rod that passes through the center and through steel disks, which are welded in the ends of the casing section that forms the body of the tank. This reinforcing rod is necessary to give sufficient strength, with a reasonable margin of safety, to withstand the high pressures developed. Next, weld on the front platform, which is simply a piece of sheet steel with one end cut on a 5 1/2-in. radius and a rim and supporting brackets welded to it. A hole for the kingbolt and one for an oilhole are drilled after the platform is welded in place on the tank. The stub axles for the rear wheels, Fig. 2, are welded to the tank and are reinforced with braces and a semicircular strap which passes under the tank and is welded there. After the front-wheel fork has been bent to shape, a 6-in. steel disk is welded to its top and two arms cut from flat iron are welded to the side members to complete the assembly. The handle is cut from 1/2-in. pipe with

a ring welded to one end for a convenient handhold. A pipe sleeve is welded to the other end of the handle to fit between the arms on the wheel fork, as shown in Fig. 2 and the top view, Fig. 5. Finally, drill holes in the tank for a filler tube, air supply and an outlet at the back near the bottom. Standard couplings are welded into the latter two holes.

The power plant should be assembled on the base before it is bolted to the tank. Note that the motor is mounted on a hinged base to maintain uniform belt tension. Use a 2-in. drive pulley on the motor and a 12-in. pulley on the compressor and drive with a standard 1/2-in. V-belt. Employ at 1/2-hp. 1750-r.p.m. motor, and a standard two-cylinder compressor. Air from the compressor passes into a surge chamber which cushions the impulses when using a paint spray gun or insecticide equipment. The surge chamber is made from a length of 5-in. pipe capped at

both ends and fitted with a valve at the bottom for blowing off condensation. Two bolt lugs are welded to the lower end. A pressure gauge is installed in the inlet pipe to the chamber and a poppet valve in the outlet pipe. When spraying insecticide, the valve is opened and air from the compressor passes directly into the tank, the liquid being discharged through a hose connected to the tank outlet. Wooden racks are fastened to the plank on both sides with lag screws to provide handy storage space for the motor cord and hose. Use industrial wheels with ball or roller-bearing hubs and 4.00 x 8-in. pneumatic tires.

The pump-type sprayer detailed in Figs. 6 to 11 inclusive and also shown in Fig. 1 is designed for spraying row crops in large fields. The tank has a capacity of 150 gals. of liquid spray solution and the engine and pump are mounted in front of the tank. Outlets from the pump provide for a hand nozzle attachment for weed killing, Fig. 10, and also for a pressure-hose connection to a row-crop boom mounted at the rear of the chassis. The tank is of standard manufacture and it will prove good economy to purchase it

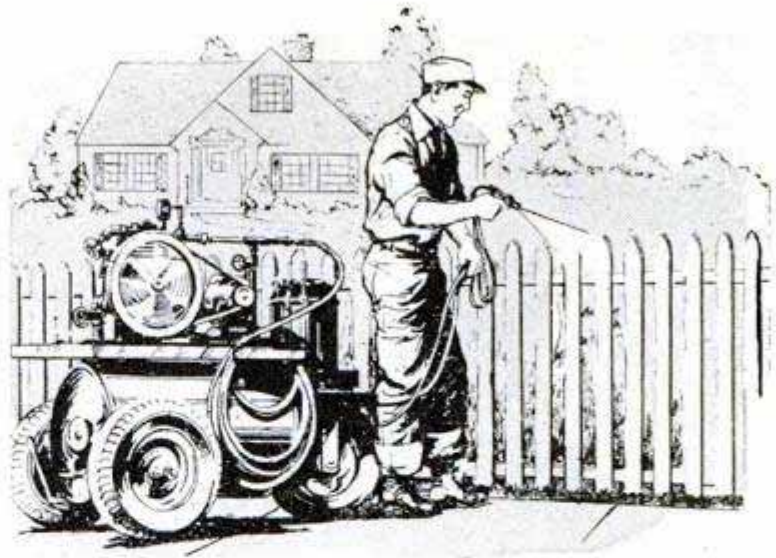

Electrically driven sprayer is fitted out as an all-around unit. It handles any ordinary sprayable liquid from insecticide to paint

outright rather than to attempt to make it in the average small shop. Side members of the chassis are steel I-beams, Fig. 9, and the drawbar is a length of 3-in. pipe with the outer end flattened over a heavy ring and welded. The axle was taken from a Star automobile, but a 1933 Ford or Chevrolet front axle will do as well. The steering knuckles are welded and the flat springs are used intact, except that the forward end of each is supported by a pin, without shackles, and the rear eye is cut

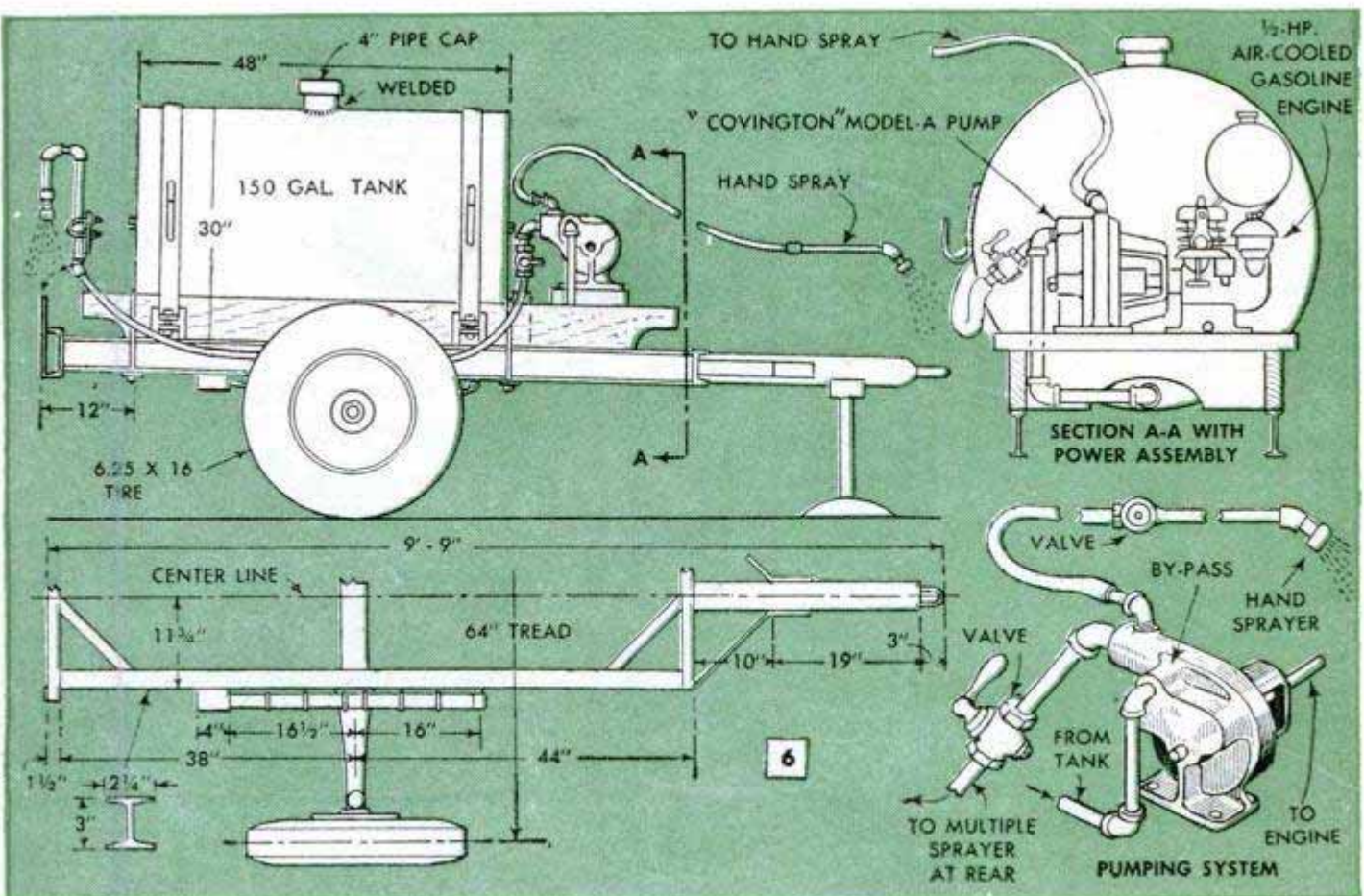

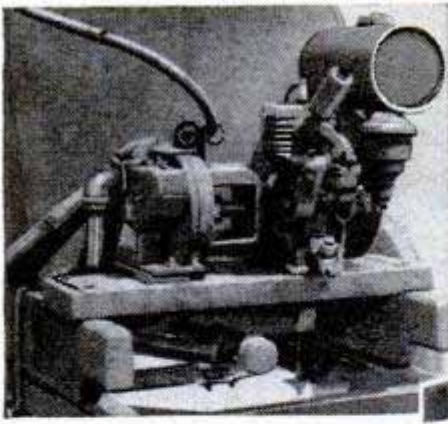

8

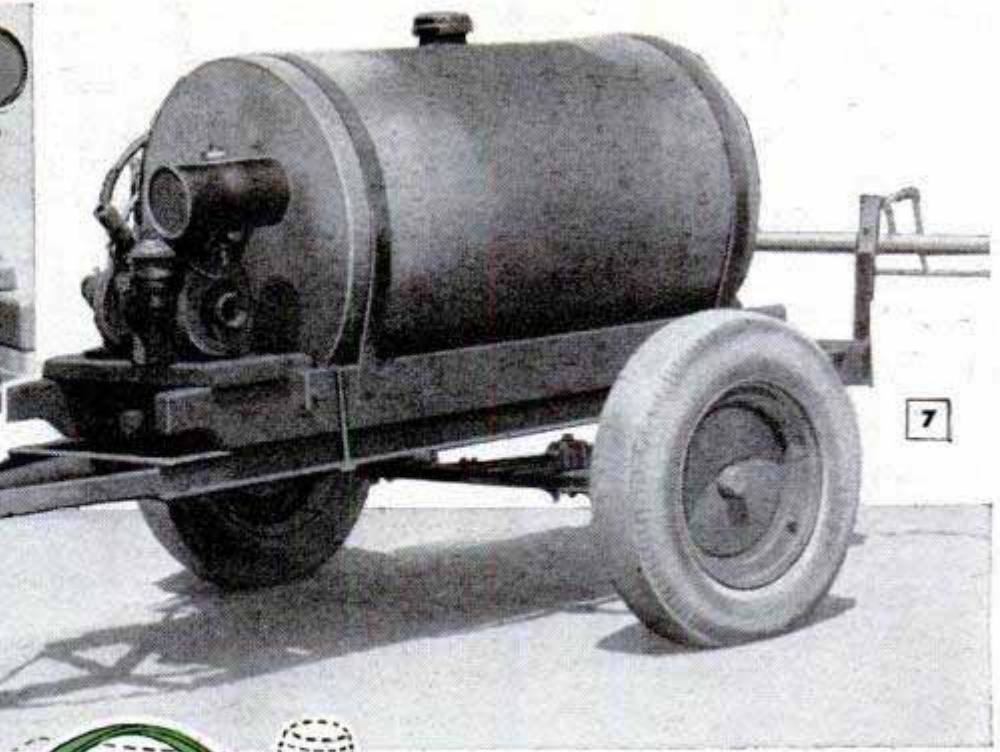

7

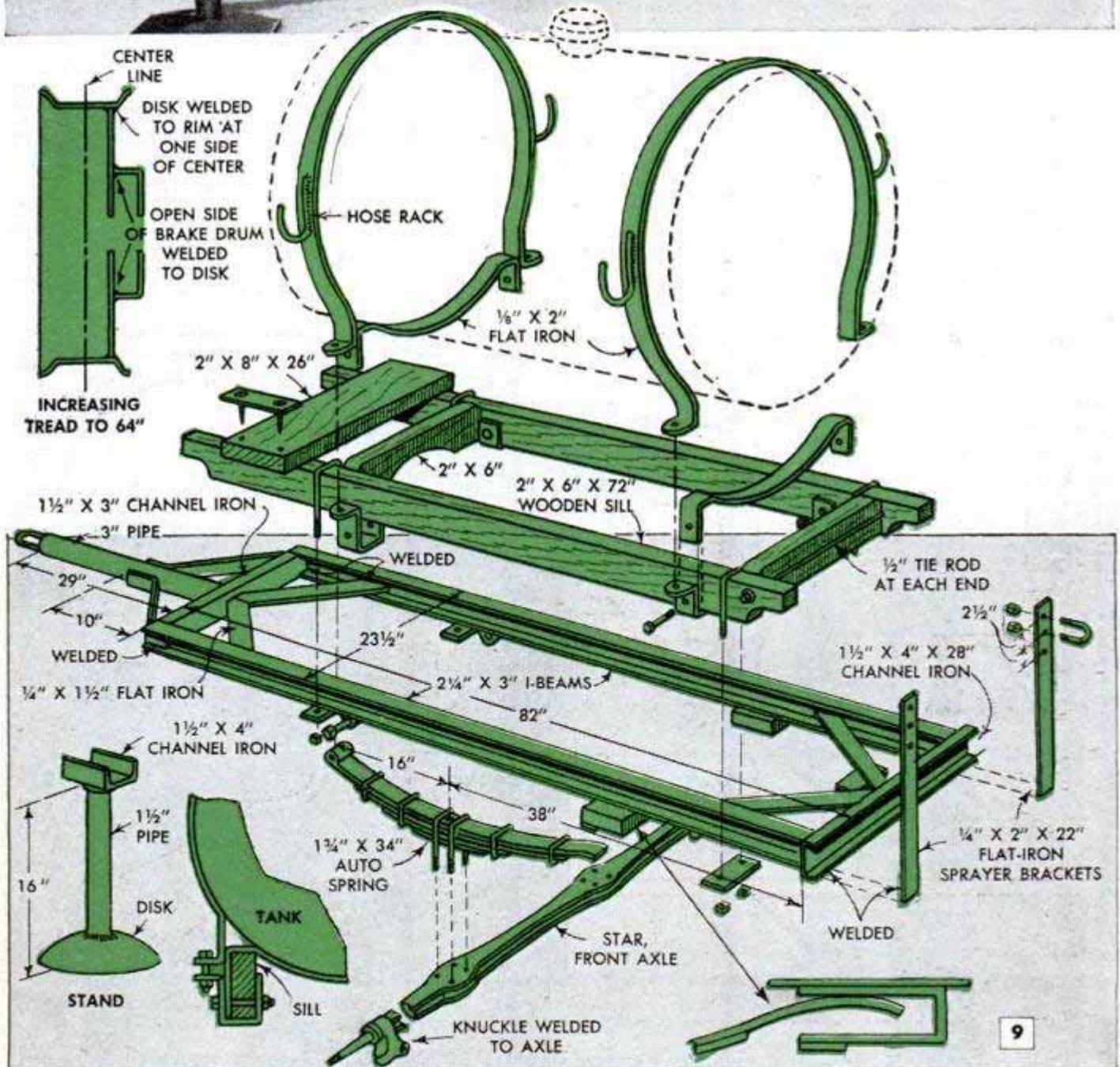

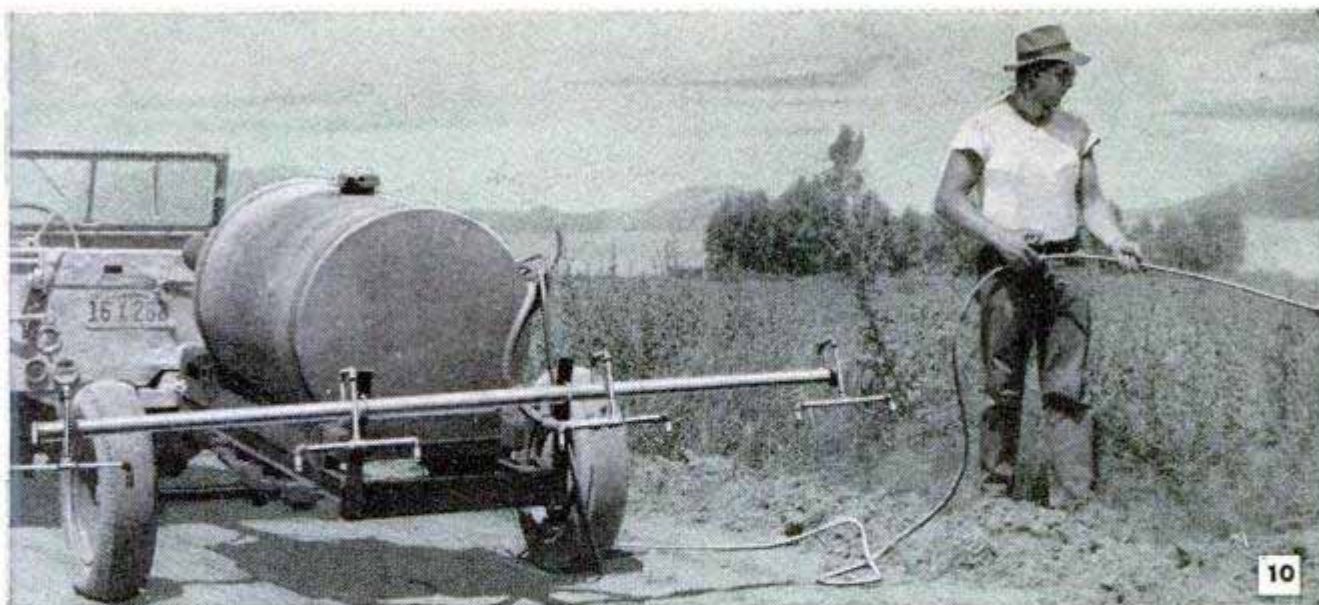

off and that end then rides in a box made by welding steel plates to the I-beam, as in Fig. 9. At the rear end of the chassis, two uprights are welded, each having a row of equally spaced holes to provide adjustment for the U-bolts holding the boom. A simple jack for supporting the drawbar is detailed in Fig. 9.

To widen the wheel tread sufficiently for average row-crop work, the wheels are altered, as in Fig. 9, by welding a standard wheel disk to the rim in an off-center position. A brake drum welded to the disk with the open side against the disk completes the change.

Fig. 9 also details the hardwood frame of the tank cradle. The sills are attached to the chassis with heavy U-bolts and the engine and pump are bolted to a heavy hardwood plank which extends across the front ends of the cradle frame. The plank is lag-screwed to the sills. Heavy tie rods

pass through the sills just outside each spreader member. Two-piece steel bands, or straps, bolted to S-brackets attached to the sills support the tank and prevent it from shifting when the trailer passes over rough ground. Hooks welded to the bands on each side provide racks for hose storage. A common type of row-crop boom with two nozzles above each crop row is detailed in Fig. 11. It is built from standard pipe and fittings and standard spray nozzles. When assembling, use pipe-thread compound in all joints and draw each joint tightly to prevent leakage under pressure. Some users, such as potato growers, require three nozzles to each crop row. In this type of boom, two nozzles are aimed upward and the third nozzle is aimed downward. While this type of spray boom could, of course, be made from pipe and fittings, it is a good investment to purchase the three-nozzle boom ready-made.

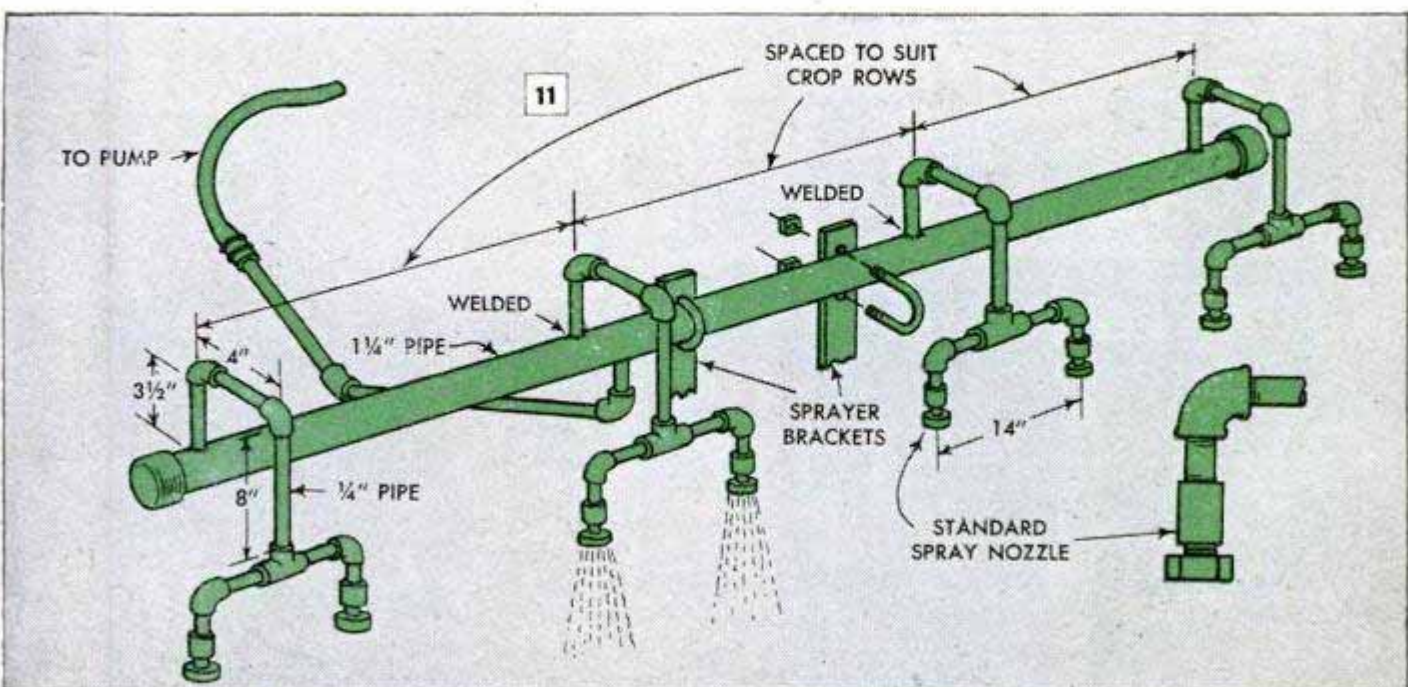

Determining Oil-Gauge Location By Exhaust-Pipe Position

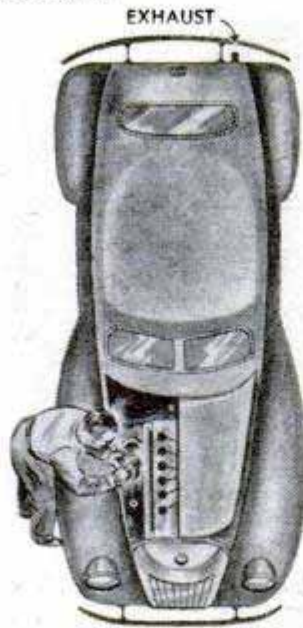

On cars having a single exhaust pipe, filling-station attendants can quickly determine the location of the dip-stick oil gauge. The gauge usually will be found on the side of the car opposite the exhaust. For example, if the exhaust is on the left-hand side of the car, the oil gauge is on the right-hand side.—Opie Read, Jr., Chicago.

Set of Punches for Home Shop Made From Drill Rod

An essential item for the amateur as well as the professional gunsmith, modelmaker or experimenter, this special set of punches is easily turned from drill rod. The set includes a prick punch, upper detail, a center

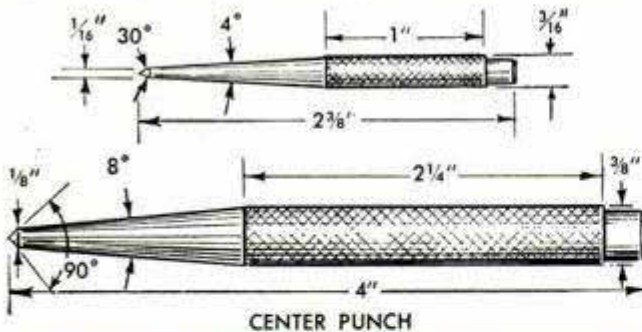

CENTER PUNCH

A	B	C	D	E	F
.060	1/4	3/16	1 1/2	1	1/8
.090	3/8	3/16	1 3/8	1	3/16
.120	1/2	1/4	1 3/4	1	3/16
.150	3/4	1/4	1 3/4	1	3/16
.180	3/4	1/4	2	1	3/16
.210	3/4	3/16	2 1/8	1	1/4
.240	1	3/16	2 1/4	1	1/4

ABOVE DIMENSIONS IN INCHES

punch and extra-small pin punches of various sizes as shown in the table. The points of the pin punches should be faced perfectly square and the heads should be rounded or chamfered. Be sure to leave a fillet where the punch and grip sections join, as a sharp shoulder at this point may develop cracks in the process of hardening. Temper the punches by heating to a dull, cherry red and quenching in water.

John L. Alden, Maplewood, N. J.

Drip Oiler Lubricates Steady Rest

For long-running jobs on his lathe, one machinist keeps the steady rest lubricated with a drip oiler fastened to the top of the rest. Pipe fittings and a length of tubing carry the lubricant to the work.—Harry H. Hohberger, Chicago.

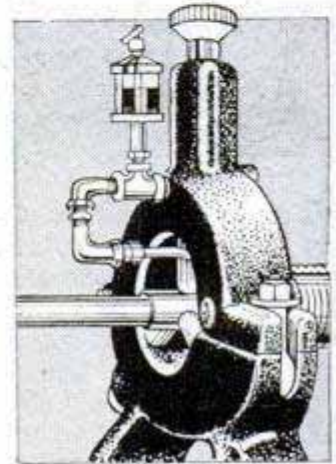

Large Pipe Cut Squarely

To cut large-diameter pipe squarely, mark it with soapstone using a piece of paper as a guide. The paper should have one perfectly straight edge and be long enough to overlap about 1/4 of its length when wrapped around the pipe. The overlap is required to align the edge of the paper.

John Krill, North Lima, Ohio.



Spring Holds Turn Button Snugly

When a wooden turn button on a door wears and becomes a loose fit on the nail, it will stay put in any position if a short spring is slipped over the nail before it is driven in place. A washer is used between the spring and turn button, and also between the nailhead and spring if the former is smaller in diameter than the spring.

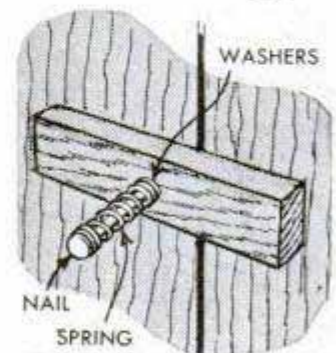

Trailer Hitch Folds Under Car When Not in Use

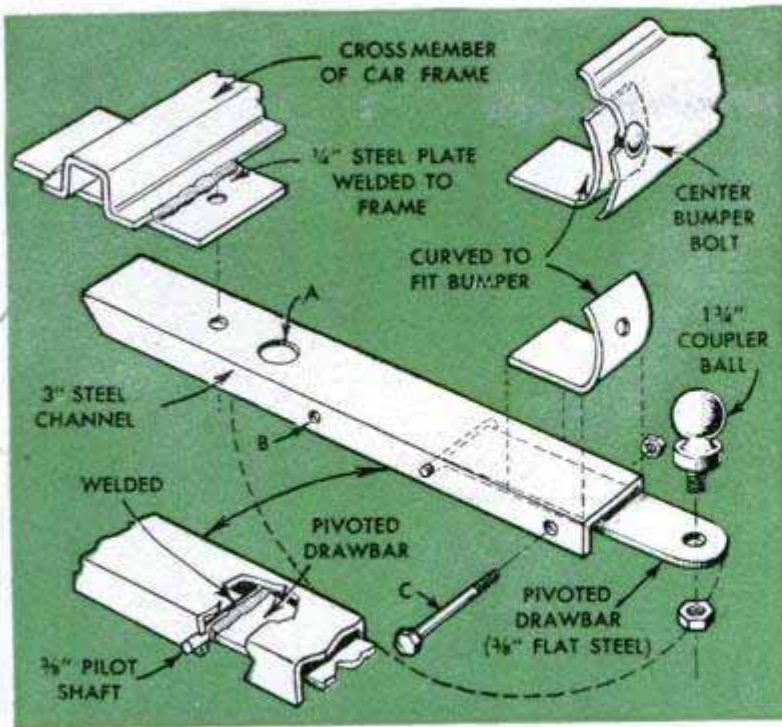

This trailer hitch is attached directly to a rear cross member of the car frame. The pivoted drawbar, which carries the coupler ball, folds back under the car when not in use, leaving the bumper clear. The main frame of the hitch is made from steel channel which extends from the car-frame member to a point flush with the rear bumper. The length of the channel frame will have to be determined by the distance from the car-frame member to the outer face of the bumper. As indicated in the de-

tail above, the large hole A provides an opening for the coupler-ball nut, allowing the pivoted drawbar to lie flat when in the folded position. To fold the drawbar, the bolt C is withdrawn, the bar folded back, and the bolt inserted in the hole B. Note that the holes for the bolt C are drilled in the legs of the channel in such a position that the bolt will pass under the folded drawbar. Use lock washers on all bolts to prevent the nuts from loosening.

Fred M. Sequin, Superior, Wis.

Discarded Metal Kitchen Pans Utilized as Poultry Watering Dish

If you have two fairly deep metal pans which are too battered for further use in the kitchen, they will make an excellent watering dish for the chickens. In one of the pans, cut four rectangular openings large enough for a chicken's head and neck.

Then, invert this pan over the other one and punch or drill holes through both rims on opposite sides of the pans. Rivet or wire the pans loosely together through one set of holes so that they will swing apart for filling or cleaning, and fasten the pans shut by inserting a nail through the other set of holes. Remember to bend over all edges of the cutouts or file them smooth.

Marion L. Rhodes, Knightstown, Ind.



Pie-Plate Stand for Sign

One baker displays small signs in his store window by mounting them on paper pie plates. The pie plate is turned upside down and the card is held in a slot cut across the bottom of the plate.



BRACKET INCREASES

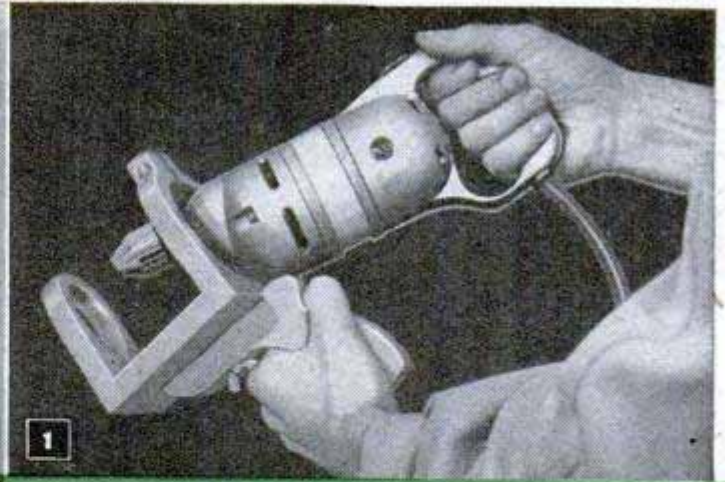

1

Above, the electric hand drill and bracket are assembled by inserting drill through holes in the bracket. Left, bracket fastened to adjustable arm of photo enlarger makes utility drill press. Balancing spring aids in manipulation

By M. G. Winterton

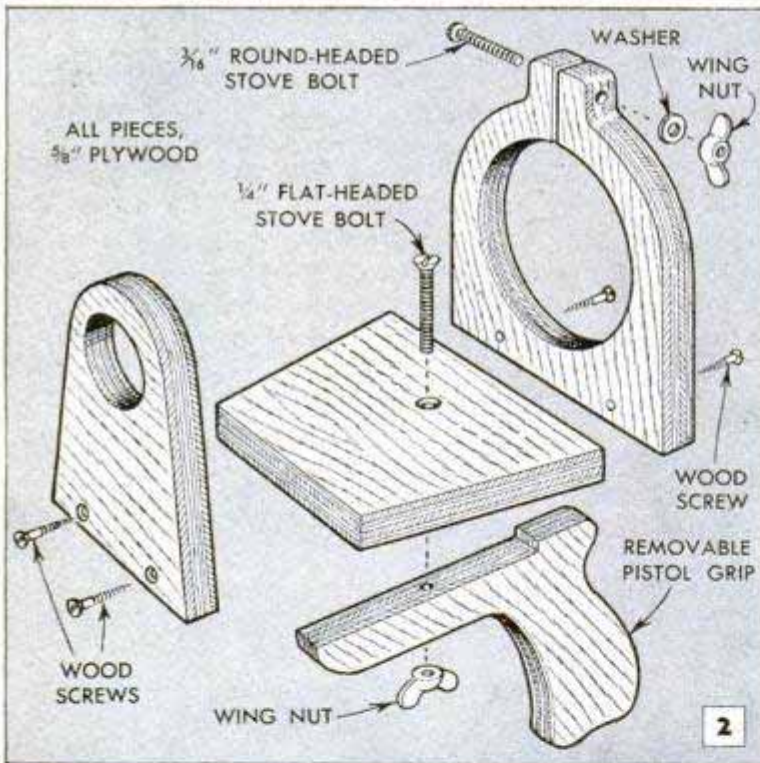

MANY attachments now available for small portable electric drills require the use of a stationary support for the drill so that the work can be held and guided with both hands. Figs. 1 to 3 inclusive and the photos on the next page show how a simple bracket for holding the drill in various work positions adds to the usefulness of this handy tool. The bracket consists of three parts, Fig. 2, with a pistol-grip piece added for two-handed operation of the drill in polishing or wire-brushing operations. Before sawing the opening in the clamping-bracket member, measure the diameter of the body of the drill just in front of the handle, then bandsaw or scrollsaw the opening slightly larger. Saw the outside to the contour given in Fig. 3 and split the

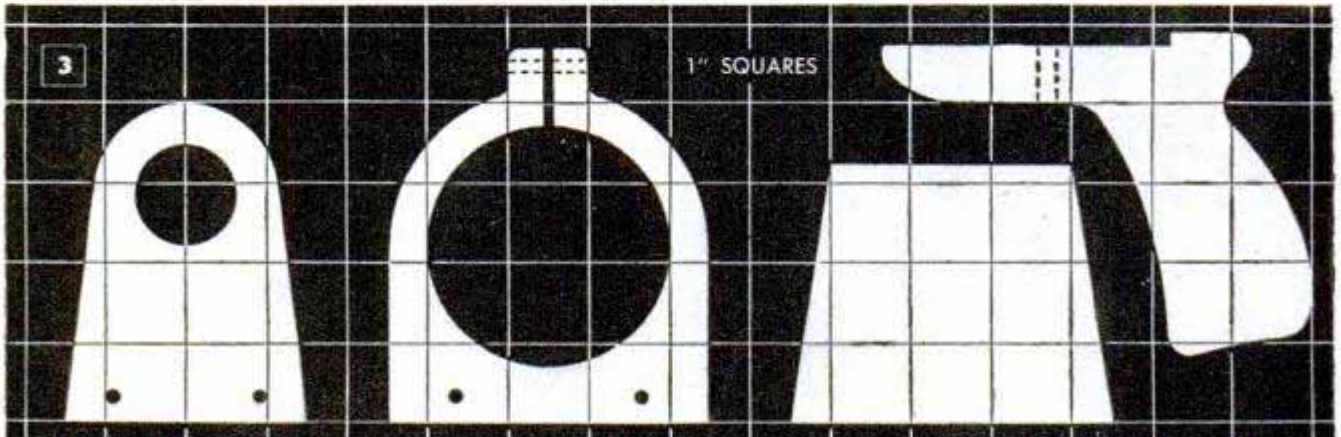

USEFULNESS OF PORTABLE DRILL

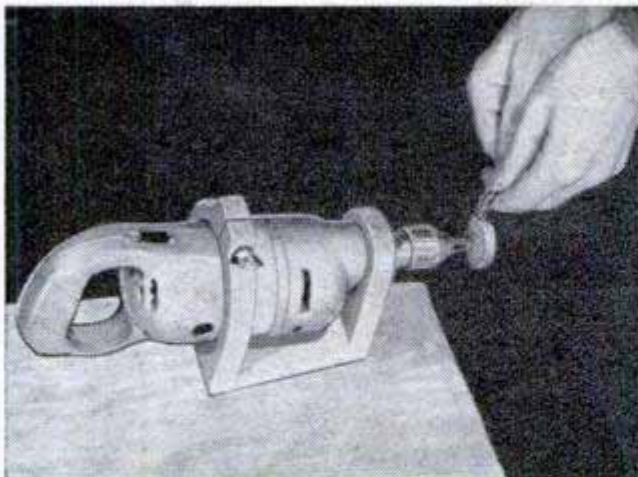

Above, with bracket handle removed, electric drill serves as portable bench grinder. Below, electric drill used as disk sander. Bracket mounted on adjustable arm of photo-enlarger stand can be set in horizontal or vertical position at any desired height

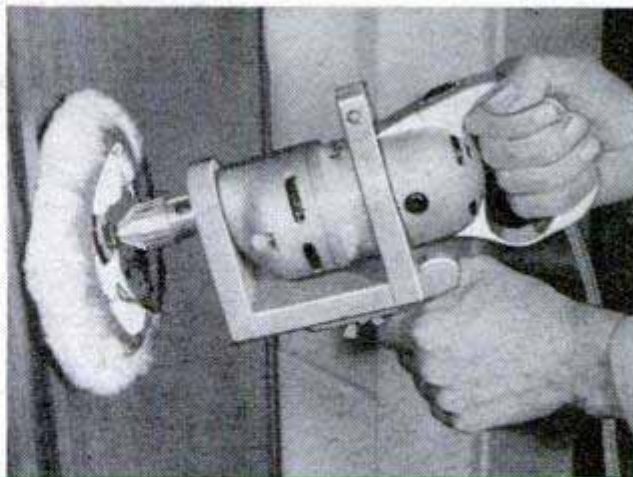

Above, bracket offers convenient two-hand control when using electric drill equipped with a buffer for polishing. Below, clamping the drill-bracket handle in bench vise will hold drill firmly when using rotary files or mounted abrasive wheels

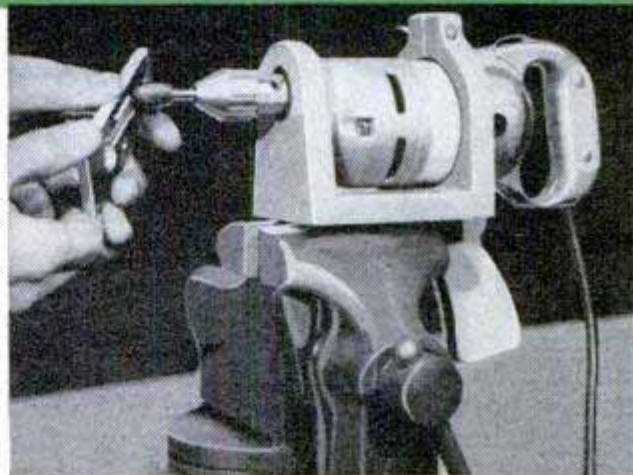
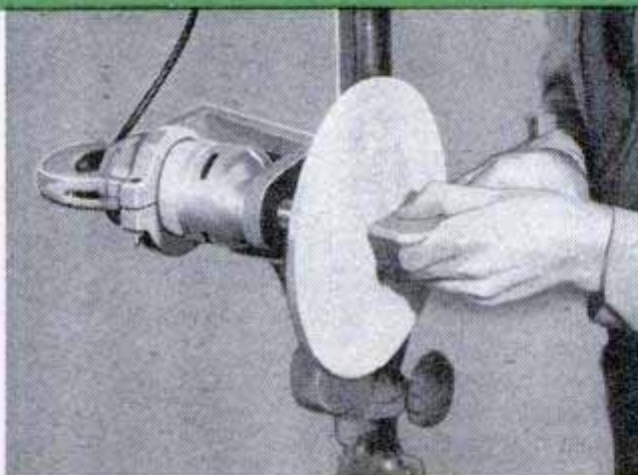

boss at the top with two side-by-side saw cuts. Drill the split boss for a $\frac{3}{16}$ -in. stove bolt. Then drill the clamping piece and screw it to the bottom piece. Insert the drill in the clamping piece, center it, and tighten the wing nut. Place the assembly on a level surface and bring up the other supporting member against the end of the chuck. Mark a pencil line on the wood around the end of the chuck. Locate the

center of the circular pencil mark. Then measure the diameter of the bearing housing just back of the chuck and drill a hole in the supporting member of the same diameter as the housing. Screw this member to the base piece to complete the bracket. The pistol-grip piece is made removable by attaching it with a stove bolt and wing nut. Photo at the left of Fig. 1 shows the bracket attached to a photo-enlarger arm.

Removing Rust From Metal Parts and Restoring Polished Finish

The finish of rusted tools and instruments is renewed by first immersing them in a saturated solution of stannous chloride to remove the rust. The tools are allowed to remain in the solution overnight and then rinsed with water. Next they are placed in a hot soda-soap bath and dried. After this, they are cleaned with alcohol and polished with a chalk-and-oil paste. A recent coating of rust can be removed from large items simply by rubbing the metal with a cork

soaked in light oil. This not only removes the rust but polishes the surface as well. If the metal has been rusted for a considerable length of time, it will be more difficult to clean. In this case, use a paste made by mixing equal parts of flowers of sulphur and fine tripoli with olive oil. A cork charged with the paste is rubbed vigorously over the rusted area. Stubborn rust spots are removed with an oil-charged cork dipped in emery dust.

Milk Can Provides Foot Scraper When Cut Out for Shoes

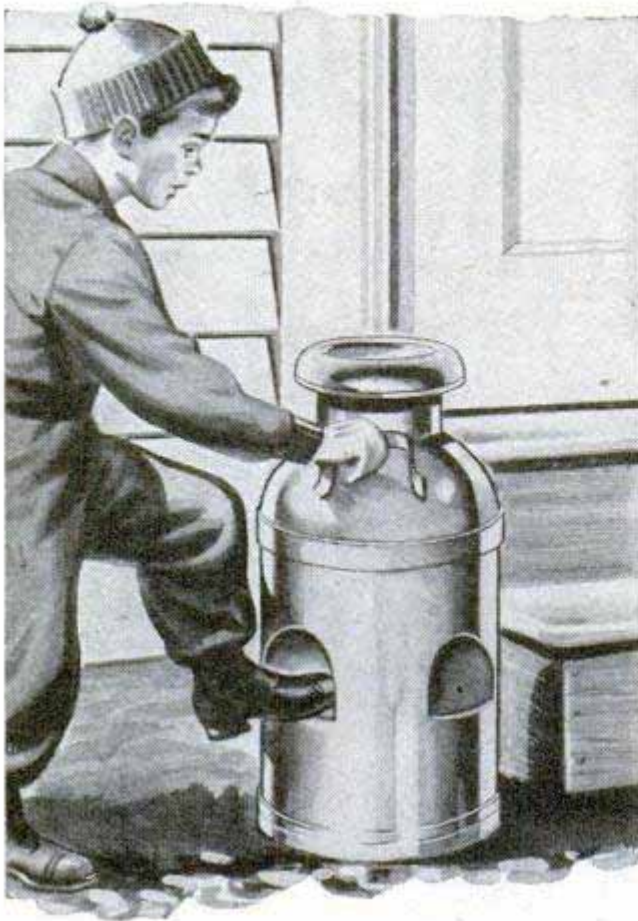

Made by cutting several holes in the side of an old milk can, this portable foot scraper can be set wherever needed. Another advantage particularly appreciated when using it at the doors of the house is that the mud collects inside the container. Unlike an ordinary shoe scraper, there is little danger of children falling on this one and injuring themselves.

Valve Springs Cause Tappet Noise If Installed Upside Down

Upside-down installation of valve springs on Chrysler cars may be the cause of tappet noise. Note in the detail that the end of the spring having the least amount of separation between the coils, A, should be on the top, and that the end having the

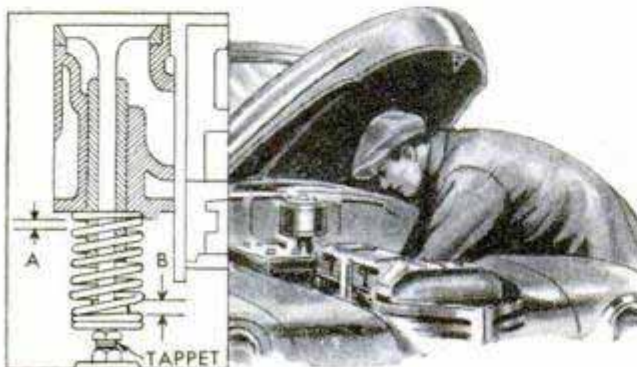

wider separation, B, should be at the tappet. Although the drawing is exaggerated, the difference can be seen by careful examination of the spring.

Corners of Hammer Claws Rounded To Aid Removal From Pocket

Carpenters who carry claw hammers in their hip pockets find that they are often difficult to remove. However, rounding the outside corners of the claws will not only make the hammer much easier to remove, but will minimize wear and tear on the pockets. Rounding the claws does not weaken them.

Roy C. Haynes, Sylacauga, Ala.

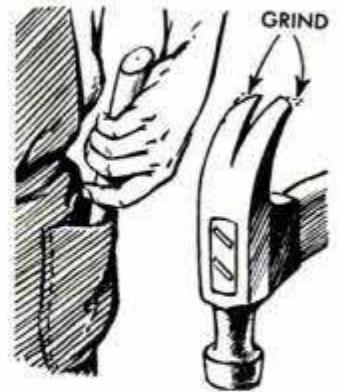

Adjustable Shop Shelves

When building shelves for use in the shop, nail strips of corrugated sheet metal to the inside surfaces of the uprights. The corrugations support the shelves and permit the spacing between them to be adjusted. If the ends of the shelves are rounded, they will fit snugly in the corrugations. Employing the same idea, built-in shelves are installed in the walls of a garage simply by nailing strips of the metal to the studding.

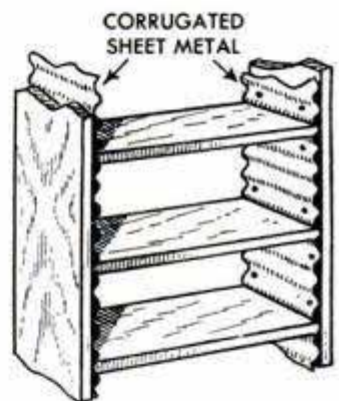

Erasing Hint Helps Typists

Before erasing on a typewriter, form the top of the paper into a shallow trough at back of the platen and turn the paper until the type to be erased is slightly toward the trough side and back of the top center of the platen. In this way, the eraser dust will collect in the trough and can be blown clear of the typewriter mechanism.

Henry Hanscom, Elmhurst, Ill.



RADIO *Television* ELECTRONICS

Keeping An Eye On Television

A—FM-AM radio-phonograph-television console set features the Zenith Giant Circle screen. The TV-receiver section employs 24 tubes plus 3 rectifiers. It is pretuned for all present channels and provision is made for a simple adjustment if needed to receive in ultra-high frequencies above 500 megacycles, if such TV frequencies are allocated

B—"Visible noise," the electronic interference that occasionally mars television-picture reception, has been greatly reduced by a new station selector, or tuning unit, in this RCA 22-tube table-model TV receiver. The engineering department is using several new circuit refinements, which include an additional tuned circuit and a special improved input system

C—Solving the problem of placing more television sets in homes and commercial establishments without buying complete receivers, this Olympic "duplicator" duplicates the image that is tuned in on the main TV set to which it is connected. Up to 12 units may be used. Automatic in operation, there are no controls except volume and the off-on switch

D—Electric rotator for FM or TV antennas operates in any weather and is connected to a plastic control box, located adjacent to the receiver. It may be installed on most TV and FM antennas. This Alliance Tenna-Rotor gives armchair control for the instant and correct "beaming" of the antenna to the exact compass point for best possible reception

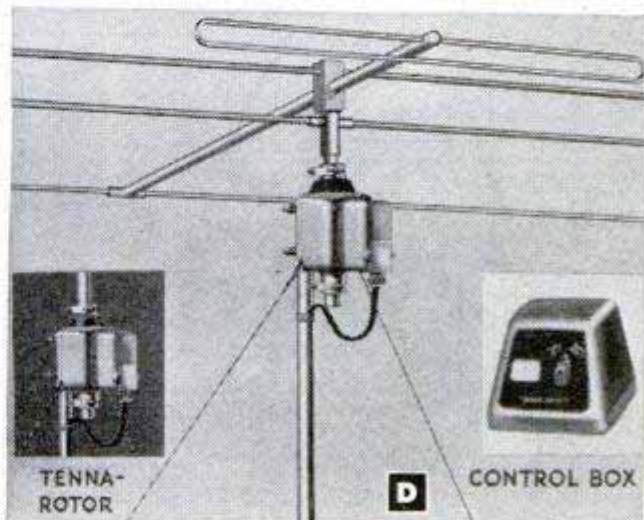
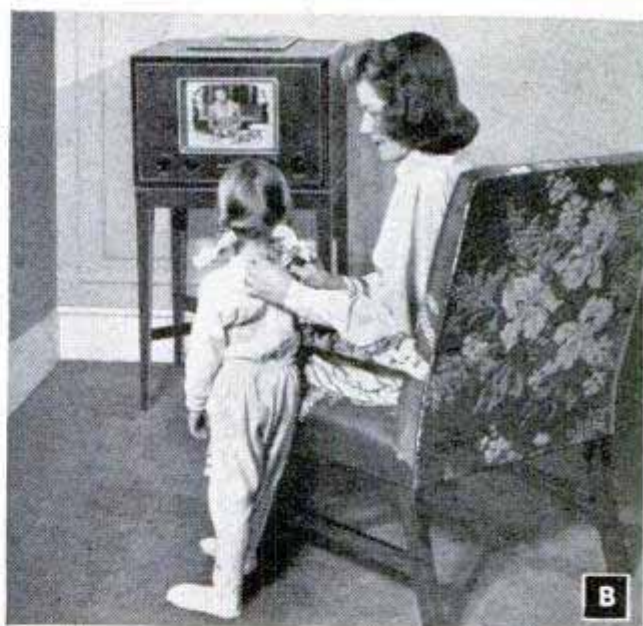

1949 "LITTLE GIANT" TRF

By Arthur I. Rattray



ALTHOUGH simple enough for the beginner, the unusual performance and flexibility of this 4-tube tuned-radio-frequency broadcast-band receiver will interest any experienced builder. This 1949 model of the popular annual student set costs much less to build than previous models. The set includes a phono-input jack and may be used as an amplifier for a record player. Furthermore, it makes an excellent AM tuner for a public-address system, or for use with any large audio amplifier and separate speaker. When tested in *Popular Mechanics* radio laboratory, the fidelity and sensitivity were highly satis-

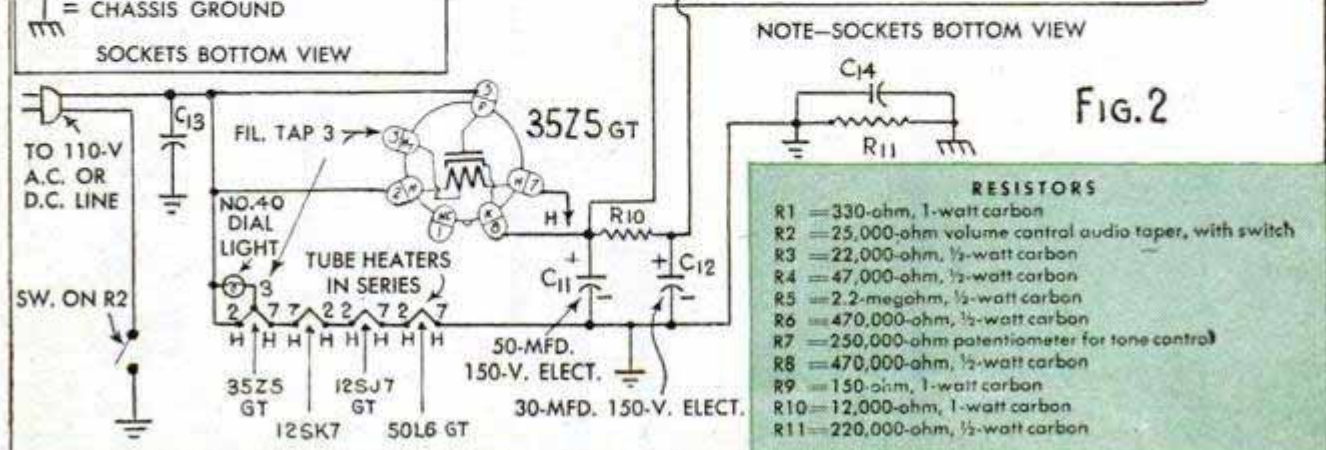
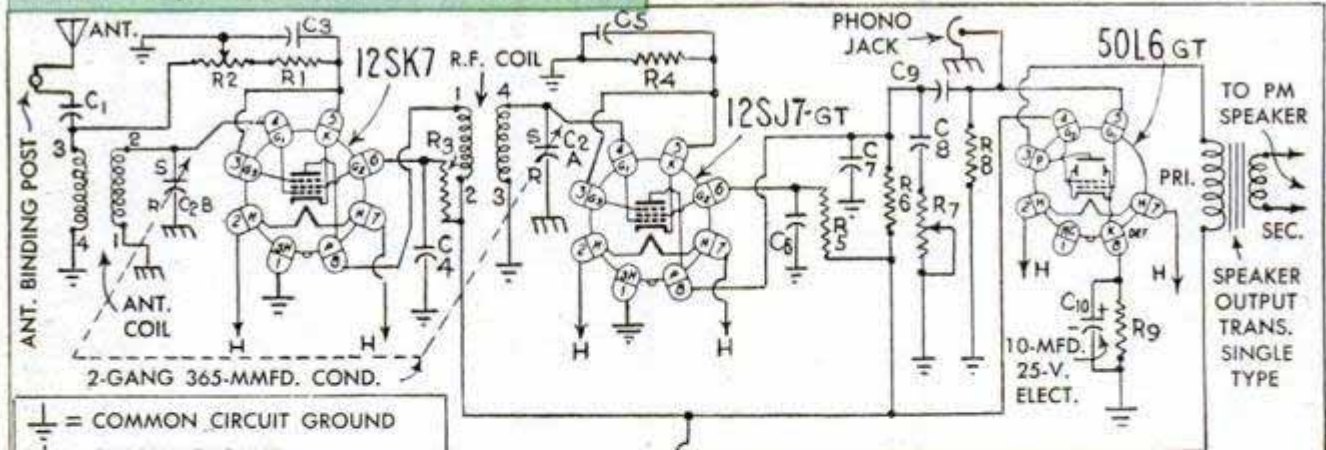
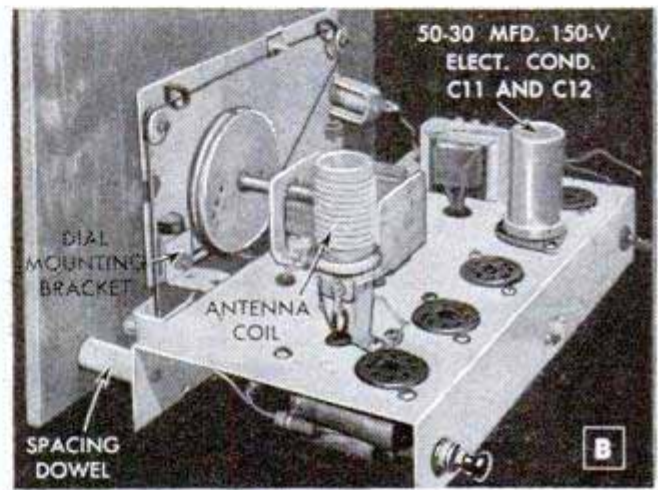
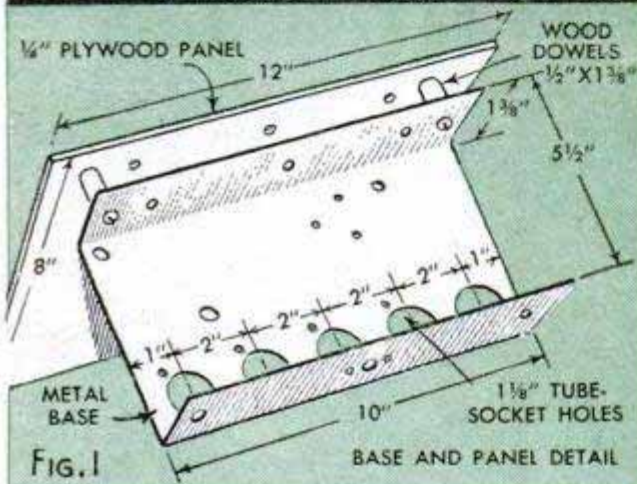
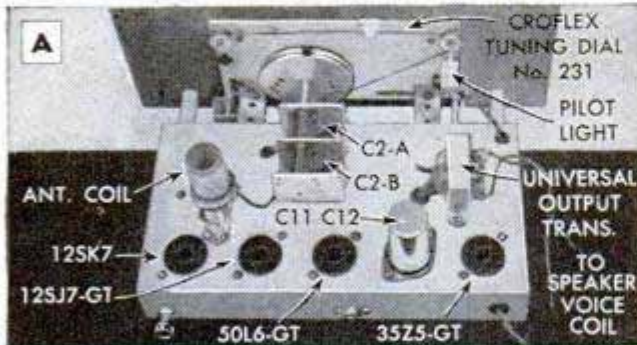

- NOTE—SOCKETS BOTTOM VIEW
- RESISTORS**
- R1 = 330-ohm, 1-watt carbon
 - R2 = 25,000-ohm volume control audio taper, with switch
 - R3 = 22,000-ohm, 1/2-watt carbon
 - R4 = 47,000-ohm, 1/2-watt carbon
 - R5 = 2.2-megohm, 1/2-watt carbon
 - R6 = 470,000-ohm, 1/2-watt carbon
 - R7 = 250,000-ohm potentiometer for tone control
 - R8 = 470,000-ohm, 1/2-watt carbon
 - R9 = 150-ohm, 1-watt carbon
 - R10 = 12,000-ohm, 1-watt carbon
 - R11 = 220,000-ohm, 1/2-watt carbon

More Tubes in Less Space

MINIATURE tubes make ultra-compact radio and television receivers possible. These tiny tubes weigh less than an ounce and range from 1 to $2\frac{1}{8}$ in. in height; they require one fourth the space of the tubes they are replacing. Besides their size and weight, miniature tubes have the advantage of shorter leads, which improves their performance by making them an immediate part of the circuit, according to GE engineers. They point out that the miniatures are valuable especially when used with high frequencies, such as are employed in FM and television. They require no Bakelite bases, and have fewer parts, making it possible to build them faster and more cheaply.

The miniature radio tube, displayed by the young lady in photo A, is contrasted with the conventional-size tube which it replaces. As these tubes are more fragile than the older types they must be handled with care, especially when inserting and removing them from their sockets. The pins are comparatively small and easily bent out of line. A metal pin straightener of the type shown in photo B costs only about 50 cents. The pins can be straightened by using a pair of tweezers, as illustrated in photo C, but this must be done very carefully, as the loss of just one tube would equal the cost of the straightener twice over. The straightener has fluted openings which permit the delicate pins to start easily. They are then forced into proper position.

If it is necessary to carry a set of these tubes to a service shop for testing, it is a good idea to bind the tubes together with adhesive tape, keeping the tips free, as indicated in photo D. The glass bulbs are drawn to fine tips which are easily broken if the tubes are carried loose in a bag. When inserting new tubes, seat them firmly in their sockets in the vertical position shown in photo E and be very careful not to damage the delicate prongs or tip. In photo F, an old-type tube socket is shown in comparison with the new one required for miniature tubes. These small sockets fit into $\frac{5}{8}$ -in. chassis holes; they simplify chassis construction for students and experimenters as small drill holes may be enlarged with a tapered reamer. A toy muffin tray makes a good safe holder for these tubes on the workbench, as illustrated in photo G. The entire set of tubes for one of the new table-model receivers is in the toy tray; all but one are miniatures. A selenium rectifier was employed in this set. The useful life of miniature tubes is comparable to that of the older types.

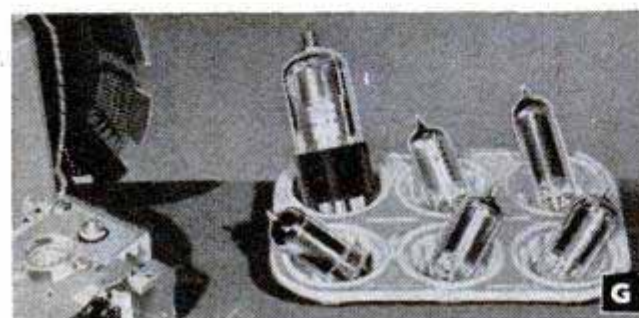
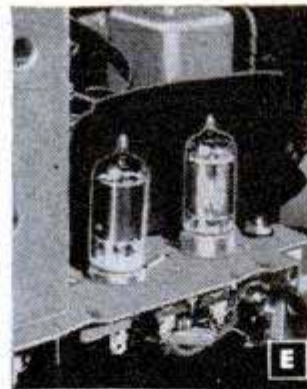
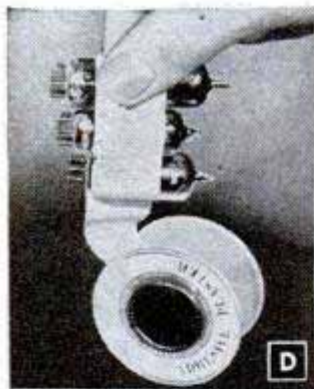

A
ROLL-FILM
CAMERA—



the Kodak Medalist II Camera has the accuracy and operating refinements of a precision miniature. Automatic film advance, shutter cocking, and double-exposure prevention . . . 9 speeds to 1/400.

S A
SHEET-
FILM
CAMERA—



with the Accessory Back it quickly converts to a film-pack, sheet-film, or plate camera with ground-glass and range-finder focusing. Now you can choose from the full range of Kodak Film emulsions.

S A
CLOSE-UP
AND
COPYING
CAMERA—

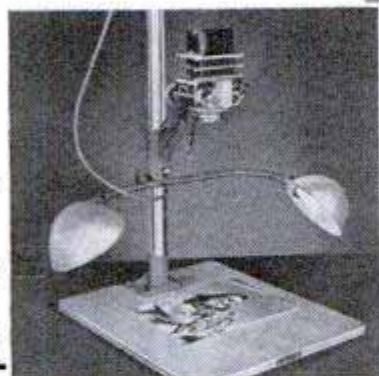

for use in combination with its accessory back and the Kodak Precision Enlarger Stand Assembly. Extension Units may be used singly or in combination for various magnifications.

3 Kinds of Camera



Kodak Medalist II

• Take a good look at this famous Kodak camera. It's designed for a wide variety of photographic jobs. The Kodak Ektar *f*/3.5 Lumenized Lens is the finest in the 2¼ x 3¼ field . . . takes superb black-and-white or full-color pictures. Flash Supermatic Shutter. Coupled range finder. Camera with field case, \$270 plus tax. Flash attachment, \$9.50 plus tax . . . *At your Kodak dealer's.*

**EASTMAN KODAK COMPANY
ROCHESTER 4, N. Y.**

(Prices subject to change without notice)

"Kodak" is a trade-mark

Kodak

1949 "Little Giant" TRF Dual-Purpose Set for Experimenters

(Continued from page 239)

is 1½ x 5 x 9½ in. These blank bases are available in either 20-ga. steel or in .005-in.-thick aluminum. The location of the parts on the chassis base is not critical but it is important that the tube sockets be mounted with the center keys in the posi-

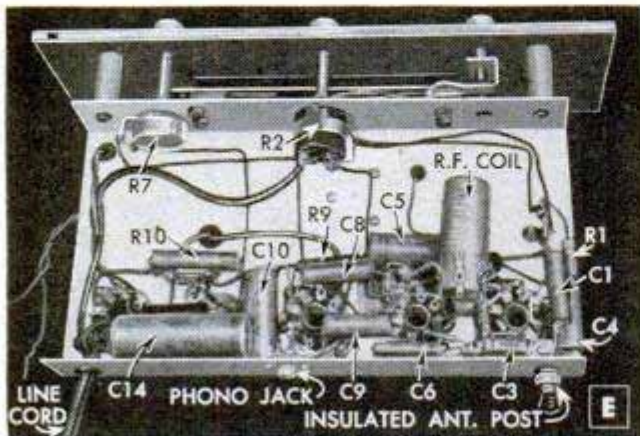

tion shown in the pictorial wiring diagram, Fig. 3. Photos A, B, C, D and E should be carefully studied before beginning construction. All parts are clearly identified in these photos and in the pictorial wiring diagram. Schematic circuit diagram, Fig. 2,

carries the same coil-terminal key numbers and both diagrams should be checked as the wiring progresses. Use rosin-core wire solder and make certain that all soldered connections are neat and both mechanically and electrically strong. Please note that the common circuit grounds and the actual chassis grounds are clearly indicated and must be made as shown. No common circuit-ground leads should touch the chassis. This entails a little extra wiring but it keeps the metal chassis from ever being "hot."

The antenna and R.F. coils are placed one below and the other on top of the chassis base and they are mounted at right angles to each other so that their corresponding fields will not cause oscillations. It will be noted that the antenna and the R.F. coil grid leads return to common ground while the variable-tuning condenser is to chassis ground; this also helps to prevent oscillations. If the Croflex tuning-dial assembly is not used, it will be necessary to mount the variable-tuning condenser on the chassis so that the substituted circular dial will be centered on the front panel. In this case, the small tuning knob shown in the model will not be used. Therefore, the volume control can be shifted to its position to keep all the controls

(Continued to page 244)

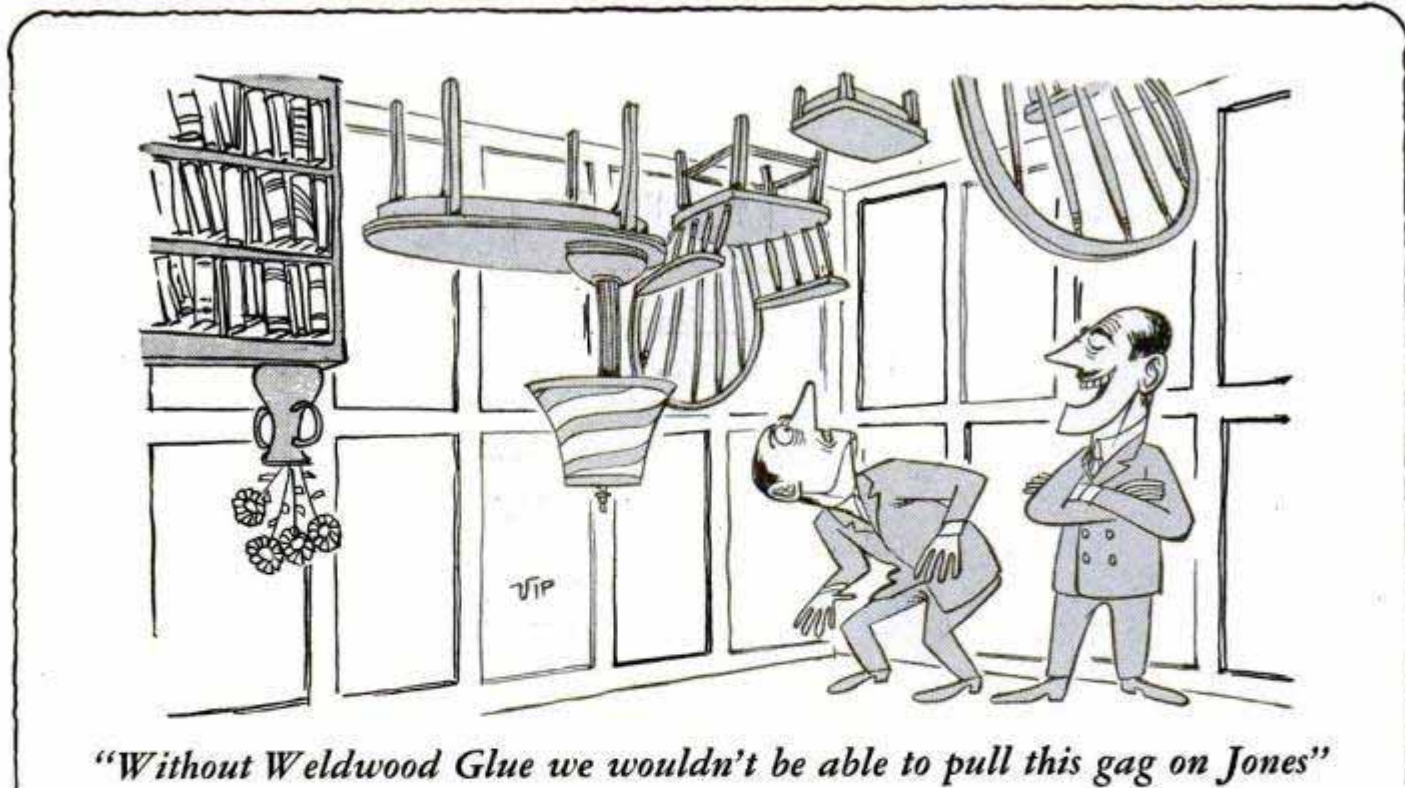

When you want a wood-to-wood bond that will really hold . . . remember Weldwood Glue. It's quick to mix . . . easy to use . . . tremendously strong . . . stain-free . . . rot-proof . . . and permanent. At hardware stores, lumber yards, chain stores, in 15¢, 35¢, 65¢, 95¢ and larger sizes.



WELDWOOD
PLASTIC RESIN GLUE

United States Plywood Corporation, New York 18, N. Y.

**NO OTHER SAW
HAS THESE
WANTED
FEATURES!**

**New! PERPETUALLY
GUARANTEED**

BALANSAW*

by **CUMMINS**

Model 606...6-inch. With Steel Case.

\$68

At Hardware, Electrical
and Mill Supply Dealers

BALANCE AT LAST!

**THE WEIGHT'S ON
THE WORK AND
YOU SEE WHERE YOU SAW**



**FOR BUILDERS...
FARM...FACTORY...
HOME SHOP.
TESTED, PROVED...
MOST PRACTICAL,
BETTER BUILT!**

YOURS FOR LIFE!

Your BALANSAW needs never be replaced; it is PERPETUALLY Guaranteed by Cummins, Precision Manufacturers since 1897.

Only BALANSAW combines the two features you want—*Balance* and *Visibility*. With Balansaw, the weight helps do the work instead of dragging on your wrist. And you sight this saw right on the line you're cutting; an internal blower clears the cut of sawdust. Users call it the world's sweetest operating saw, and so will you!

Finest Construction! **READ:** 6-in. combination blade, 1 7/8 in. in the wood. Blades for flooring and transite available. Steel base adjusts instantly for depth of cut. Die cast aluminum alloy frame. Automatic safety guard. Heavy duty switch. Precision alloy steel worm, navy bronze gear. Impeller-cooled. Anti-friction N.D. ball and roller bearings. 12-in. overall, wgt., 11 lbs. Try BALANSAW at dealer's or mail coupon. You'll agree it's the easiest, surest saw you ever used!

NOT THIS:



Unbalanced. Breaks Your Wrist.

NOT THIS:



Somewhat Balanced. But You Can't See What You're Doing.

INSTEAD:



Visibility and Balance.

EASY ON THE WRIST

**ALSO "C-LINE" DRILLS
PERPETUALLY GUARANTEED!**



No. 200 (1/2-in.) \$43.75
Jacobs Geared Chuck,
Standard Duty.



No. 130 (1/4-in.) \$20.95
Jacobs Geared Chuck,
Light Duty.

CUMMINS PORTABLE TOOLS DIV.
Cummins Business Machines Corp.
4742 No. Ravenswood Ave., Chicago 40, Ill. Dept. No. 1

Gentlemen: Without obligation please send me Cummins Balansaw and Drill Literature and nearest dealer's name.

Name.....

Address.....

City.....State.....



Full Line
of Standard
and Light
Duty Drills.

* Balansaw Trade Mark
Registered U.S. Patent Office

**NOW-IT'S EASY
TO KEEP TOOLS
FACTORY-SHARP!**



CRYSTOLON *the oil-filled bench stone*

Bring those dull tool edges back to life easily and quickly with a professional CRYSTOLON Combination bench stone. Both sides of this stone — coarse and fine — are ready for use from the start. The stone is already impregnated with a special oil so that when you slide that tool edge on a CRYSTOLON stone you can feel the smooth, even action of the uniformly sized abrasive grains — every grain cutting sharp and clean and quickly giving you that factory-sharp edge that every craftsman wants.

Drop in at your local hardware store — look over the CRYSTOLON counter display — select the size stone you want. Then see how quickly and easily you can put new life into that dull chisel or plane-blade and have edge-tools that are a pleasure to work with.

THE MARK OF QUALITY IN ABRASIVES



BEHR-MANNING
TROY, N. Y.

uniform on the 1/4-in. walnut-finished plywood front panel. The dial-light bracket and socket are supplied with the Croflex tuning-dial assembly; therefore, if this type of tuning dial is not used, it will be necessary to purchase a dial-light bracket with a screw-base socket and jewel and mount it on the plywood front panel at any convenient point. A good location would be at the upper left-hand corner when facing the panel. If the Croflex dial is used, the builder will find that complete assembly instructions come with it. The Meissner antenna and R.F. coils are provided with mounting brackets; when they are mounted in the positions indicated, their terminal-numbering arrangement is as shown in the pictorial wiring diagram, Fig. 3. These standard coils are highly efficient, easily available, and should be used. The antenna coil is No. 14-1010 and the R.F. coil is No. 14-1011. The universal speaker-output transformer is a Stancor No. A-3856; the speaker voice-coil connections are made to secondary terminals 2 and 5 as the 50L6 tube should have a load impedance of about 2000 ohms.

If oscillations occur on the high end of the band when lining up the set after it is completely wired, it may be necessary to remove the "gimmick," which is a single-turn wire connected to the primary and wound around the secondary of the antenna coil. Merely clip it off where it is connected to the primary. When aligning the set, adjust the trimmers on the side of the variable-tuning condenser C2-A and C2-B on a station at the high end of the broadcast band for maximum output. Then adjust them on some station at the low end of the band for maximum output. Again return to the high end to see if maximum output is still obtainable. If it is not, a medium between the high and low end of the band should be reached. Either an indoor or outdoor antenna may be used, depending upon the location. In localities where there are a number of powerful broadcasting stations, a 15 or 20-ft. indoor antenna may be used. For distant reception, a good outdoor antenna will give the best results. No external ground wire should be used on this a.c.-d.c. receiver.

If the set is to be used as a tuner in connection with a larger amplifier and speaker, turn the set volume control to maximum to keep hum level at the lowest possible point. Volume is then controlled at the larger amplifier in the usual manner. Remove the set speaker and replace it with an 8-ohm wire-wound resistor. Detailed student material list R-375 is available from Popular Mechanics Radio and Electronics department on receipt of ordinary letter postage.

AT LAST! OUTBOARDS THAT LET YOU

SHIFT

REVERSE · NEUTRAL · FORWARD
Just **SHIFT** the lever!



Scott-Atwater proudly presents complete new line of gear **SHIFT** motors that weigh only 1 3/4 lbs. more, cost only \$149.50 to \$199.50

Outboard owners have asked for it. Now Scott-Atwater has perfected it . . . a gear **SHIFT** outboard so simple, so sound, so foolproof you'll want it on sight. Easy to use . . . **SHIFT** the gear **SHIFT** to back up, stand still or go ahead (you can't clash gears). Easy to own . . . all three new **SHIFT** models priced under \$200. Easy to carry . . . the Scott-Atwater **SHIFT** adds only 1 3/4 pounds to motor weight. See the new **SHIFT** models at your Scott-Atwater dealer's soon. Then get ready to **SHIFT** . . . to Scott-Atwater!



FREE! NEW BOOK OF NAUTICAL KNOWLEDGE tells what every outboard skipper should know about navigation, safety and operating principles to improve your skill, and let you have more fun on the water. Write for your copy to Dept. PM-39, Scott-Atwater Mfg. Co., Minneapolis 13, Minn.

NOW ENJOY CRUISER CONTROL with SCOTT-ATWATER

SHIFT
...to warm up motor in neutral

SHIFT
...to back away from dock

SHIFT
...to make an "eggshell landing"

Enjoy these new features, too!

- Slip Clutch propeller protection
- Duo-Grip Carrying Handle
- Constant Pressure Water Pump

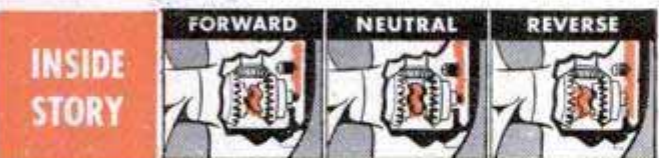

Driveshaft gear is always engaged with both forward and reverse gears. But neither is permanently engaged with propeller shaft. When you **SHIFT**, clutch dog moves. Its position determines whether forward or reverse gear is engaged. If neither is, you're in neutral.

SHIFT to Scott-Atwater

3 NEW GEAR **SHIFT** MODELS!

<p>4 H.P.* SINGLE 1-14 M.P.H. \$149⁵⁰</p>	<p>5 H.P.* TWIN 1-16 M.P.H. \$179⁵⁰</p>	<p>7 1/2 H.P.* TWIN 1-20 M.P.H. \$199⁵⁰</p>
---	---	---

*to be OBC Certified *to be OBC Certified *OBC Cert. @ 4200 RPM

For further information write Dept. PM39, Scott-Atwater Mfg. Co. Inc., Minneapolis 13, Minn.

They Must Land Safely

(Continued from page 109)

entire sequence of speed lamps flashes on and off every $\frac{3}{5}$ second.

Somewhat comparable is a Sylvania system that has a row of 23 high-intensity flashers, again of the condenser-discharge type. Each of these is centered on a background of four horizontal red neon bars. The units are spaced 100 feet apart, starting at the outer end of the approach zone. Close to the field they are replaced by twin rows of red neon bar units—without flashers—as a warning to the pilot that he is about to encounter the end of the runway. Each flasher produces approximately 10 million candle power for $\frac{1}{5000}$ second and the system operates in sequence, completing a cycle every $\frac{1}{2}$ second.

A third system, designed by American Gas Accumulator Company, has eighteen 5000-watt lamps spaced along each side of a 200-foot-wide approach corridor at 200-foot intervals. Right-hand lamps have amber lenses, those on the left are red and the beams are toed in toward the glide path.

A Bartow multi-row approach-light system has 154 units, each consisting of two 600-watt aircraft landing lamps spaced along the sides of the approach corridor, amber on the right and red on the left.

Except for the lamps closest to the field, each installation consists of double units. One pair of lamps is directed upward and the other pair points out along the approach. Elevation and toe-in angles of the units are adjustable from the tower to fit varying weather conditions.

Another system, the so-called "slope line," contains about 600 clear 600-watt aircraft landing lamps which are mounted in groups of 10 on a series of diagonal supports along each side of the approach corridor. The lights are aimed so that an approaching pilot who is on the proper glide path sees what appears to be two straight lines of lights converging toward the runway. If he is off the proper path the groups of lights break up into echelon patterns that tell the pilot the amount and direction of his error. If he is too high the groups of lights separate and appear to lay over instead of joining in a line, and if he is too low the groups stand up straight.

The simplest lighting system of all consists of a single line of thirty 500-watt on-course airway lamps, red in color, that leads along the center line of the approach area to the landing runway.

At present all of these approach-light systems are turned on or off manually at

(Continued to page 252)



Why Pay More and Get Less? Only the BULL BUFFER

Has everything you want in a polisher-sander!

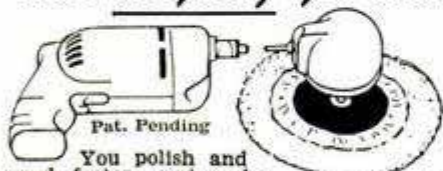

Pat. Pending
You polish and sand faster, easier—do beautiful, professional work—with this amazing attachment for your electric drill. (You can also drill up to $\frac{1}{2}$ " with your $\frac{1}{4}$ " drill and at right angles never before possible!) Bull Buffer more than pays for itself the very first time you make your car, floors, woodwork, furniture gleam like new. It's built of lifetime materials and guaranteed. Thousands and thousands of satisfied users. At your dealer or send cash, check or money order for your Bull Buffer, complete as pictured. Only

\$9.95

1. Fits any chuck on an electric drill or flexible shaft—no extra power unit to buy!
2. Only Bull Buffer has gear reduction—the power to do any job without injury to your electric drill!
3. Only Bull Buffer has swivel action—turns in complete circle when drill is stationary!
4. Only Bull Buffer has angle head for electric drill—gets to all hard-to-reach surfaces, curved or flat!
5. Only Bull Buffer has 3 speeds* — "same as," $\frac{1}{2}$ -speed, or twice speed of your drill!

*See description under photo of Bull Buffer kit.

BERTRAM M. ENGINEERING CO.
DEALERS WRITE FOR NAME OF NEAREST WHOLESALER
KANSAS CITY, MO.



Bull Buffer comes complete with sheepskin bonnet and two sanding discs, only \$9.95. Bull Buffer alone cuts drill speed $\frac{1}{2}$; for direct drive (or "same as") drill speed, order Adapter A with Bull Buffer; for twice drill speed, order Adapter B.

ORDER THESE ACCESSORIES FOR YOUR BULL BUFFER

1 $\frac{1}{2}$ " Jacobs No. 6425 key chuck: with Bull Buffer, increases $\frac{1}{4}$ " drill to $\frac{1}{2}$ " capacity — reduces speed, increases power.	\$5.00
Extra sanding discs (000-00-0-1-2 $\frac{1}{2}$ -3-4) each	.10
2 $\frac{1}{2}$ " cup wire brush for removing paint, rust, scale, etc.	1.75
Extra sheepskin bonnet	1.25
Adapter A—for direct drive at "same as" drill speed	1.00
Adapter B Set—for sanding at twice drill speed	2.00
Bull Buffer car cleaner	.50
Bull Buffer car polish	1.00

BANISH



Our Challenge

There are thousands of designs of piston rings made by 77 manufacturers—BUT this Sealed Power MD-50 Steel Oil Ring has exclusive advantages possessed by no other. Drop us a postal for positive proof of sheer mechanical superiority!

Oil Waste



Gas Waste



and Failing Power

SEALED POWER PISTON RINGS

Save Oil—Save Gas—Seal Power!

Enjoy 1949 power and 1949 economy in your car, truck or tractor, no matter what year it was built! This great Sealed Power Piston Ring ends oil and gas waste, gives you back the thrilling power you used to enjoy. It is the only ring with the Sealed Power Full-Flow Spring, praised by mechanics and car owners all over America! Ask your Sealed Power Dealer to tell you the whole story!

Mail a postal card today for proof to back up our challenge! At the same time we'll send you our new illustrated booklet on 7 ways to save oil. It's free and may save you real money. Sealed Power Corporation, Dept. G-3, Muskegon, Michigan.

Ask for Sealed Power Pistons, Cylinder Sleeves, Valves, Water Pumps and Chassis Parts

There is a Sealed Power Set specifically engineered for your car, truck or tractor—whatever the make, model or engine condition.



Sealed Power
PISTON RINGS
BEST IN NEW CARS! BEST IN OLD CARS!

...with the great-est of ease"

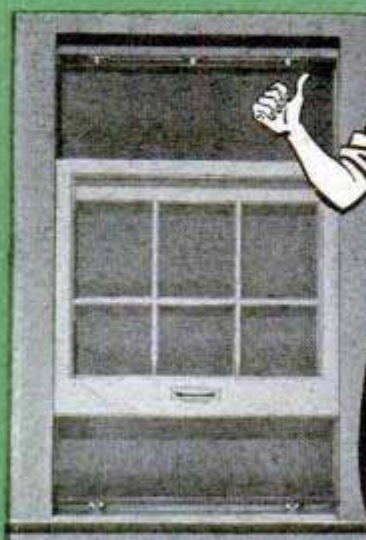

SCREEN YOUR HOME

with **DURALL**
ALUMINUM TENSION SCREENS



This spring leave ladder climbing to the daring young men who like to "float through the air." You can put up your Durall tension screens with the greatest of ease—from inside the house.

Simply install top bar and sill brackets and snap on the screen. There are no side frames to cut and fit!

Durall is all metal, yet flexible! You can roll it up for storage or leave it up all year—for window washing just release screen at bottom. It will never rust, stain, sag or require painting.

And what a bargain! You save up to dollars per screen on price alone!* See your dealer or send coupon for folder with complete details.

*The popular 28" x 54" size retails at only **\$4.35**

• A FULL-LENGTH SCREEN FOR DOUBLE-HUNG WINDOWS •

NEW YORK WIRE CLOTH CO., 445 Park Ave., New York 22, N. Y. PM-3
Please send full data on DURALL.

Name _____
Street Address _____
City _____ State _____

Clinic



for Homemakers

As a service to our readers in solving the hundreds of problems pertaining to a home—inside or out—the editors of *Popular Mechanics* invite you to present your problems to The Clinic Editor for help and advice. Address your questions to The Clinic Editor, *Popular Mechanics Magazine*, 200 East Ontario Street, Chicago 11, Ill.

Time for Pruning Shrubs

Q—What is the proper time for pruning both ornamental and flowering shrubs, spring, summer or fall?
W. R., Louisville, Ky.

A—In general, the shrubs that bloom during the early spring develop their flower buds during the previous season. If these shrubs are pruned while dormant, a large percentage of the flower buds will be removed and destroyed in pruning. If the shrub is being pruned to some definite shape, a heavy pruning at any one time may result in damage to growth. As a rule, the proper time to prune the early blooming shrubs is about two weeks after the flowers have fallen, when the plant is in full leaf. They then will develop blossom buds during the remainder of the growing season for the following year. On the other hand, most varieties of late blooming shrubs, those that bloom during the late spring and summer, develop the flower buds early in that same season. Such shrubs should be pruned in the early spring while still dormant and just before growth starts. Ordinarily, pruning has a three-fold purpose, the first being to remove excess plant parts to increase the size and number of blooms. The second is to trim and shape the shrub by pruning to make it strong structurally and to stop formation of sharp-angle crotches and overlapping branches. The third is to train the young plant from its earliest period of growth to form a definite and pleasing shape by careful pruning over a period of several growing seasons. The latter two are also reasons for training small ornamental trees.

Picture Spots Wall

Q—Recently, I moved several large pictures which had been hanging for some time in the same place. Dark spots of the exact size of the frames now appear on the wall. How can I remove these unsightly spots and prevent their recurrence?—B. T., San Francisco, Cal.



A—As a rule, it is rather difficult to remove the spot entirely by ordinary means without damaging the wall or covering, as some wall coverings fade less behind the picture. However, most of the soiling is due to a lack of air circulation, which allows dust to collect back of the frame. If the walls are painted with a washable oil paint, a household paint cleaner will remove the grime and dust, making the spot less noticeable. Clean papered

(Continued to page 250)

Facts about the NEW FORD "FEEL"

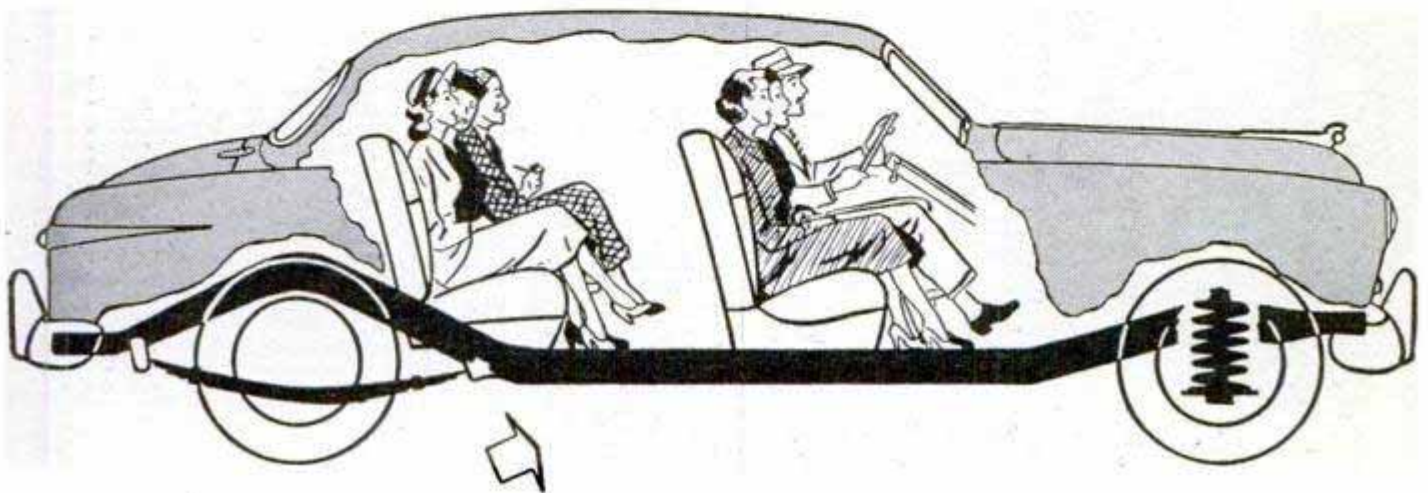

One of the most important things contributing to the New Ford "Feel" is the solid roadability and exceptional comfort of the "Mid Ship" Ride. Seats are scientifically positioned between the wheels to cradle the passengers luxuriously.

In addition, a completely new suspension system is part of the Ford "Feel" of cradled smoothness. The "Para-Flex" Rear Springs are extra-long semi-elliptic type. Impregnated inserts between tips of spring leaves, together with concentrated pressure-type rubber bushings at shackles and brackets, eliminate need for lubrication.

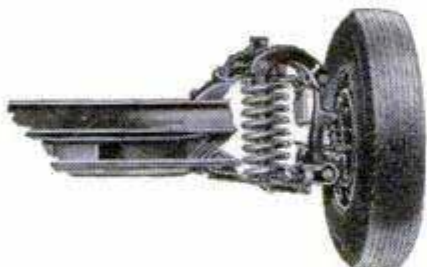
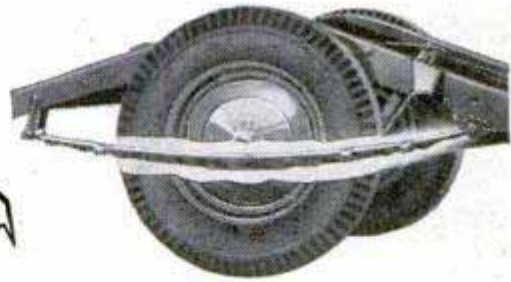

At the front are "Hydra-Coil" Springs in a swinging link independent suspension system. Double-acting hydraulic aircraft-type shock absorbers are mounted inside the coil springs. They can be easily removed and replaced without even jacking up the car. You'll feel the difference in the ride.

Add the new low center of gravity and the 59% more rigid body-chassis combination and you have, as a result, Ford's famed "Mid Ship" Ride . . . an outstanding part of the new Ford "Feel" everyone is talking about.

There's a ^{NEW} Ford in your future

For Cabinet Finishing

use PLASTIC WOOD



in your
HOME WORKSHOP!

If you'd like a satiny smooth, professional finish on your next cabinet job—use Plastic Wood! It's an ideal filler for cracks or rough grains, dries tight and hard, sands to a swell finish and takes paint, lacquer or varnish perfectly. Here's an extra hint—knot holes or gouges just disappear when this handiest filler is used! *Handles like putty—hardens into wood!*

... dozens of other uses

FOR FILLING ...

- Countersunk screws
- Chipped furniture
- Nail and screw holes

FOR REPAIRING ...

- Loose casters
- Broken balusters
- Broken furniture

- You'll want Plastic Wood SOLVENT, too. Get both at one time. It is made especially to control the consistency of Plastic Wood... useful also in removing dried Plastic Wood from tools and fingers.

T. M. Reg. U. S. Pat. Off.

At all Hardware,
Paint and 10c Stores

PLASTIC WOOD

Tube or Can

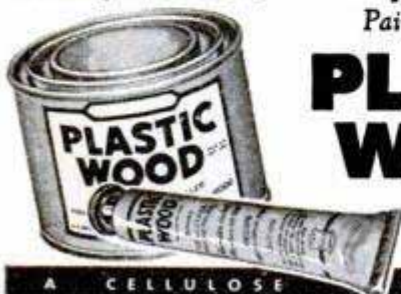

A CELLULOSE FIBRE FILLER

walls with a wallpaper cleaner. When hanging the pictures, drive a tack at each lower corner of the frame, letting the head project from $\frac{1}{8}$ to $\frac{1}{4}$ in. The tacks hold the picture away from the wall, permitting air to circulate freely and preventing the accumulation of dust.

Seeding Shaded Curb

Q—I have a wide, shaded curb sloping to the north and for the past two years I have tried unsuccessfully to get grass to grow there. The distance from sidewalk to curb is about 10 ft. and the whole shaded area slopes rather abruptly. What are your recommendations?

M.B., Detroit, Mich.



A—It is not always possible to maintain a permanent lawn under heavy shade, especially in the location you describe. Usually, only a small portion of the grass will survive from year to year. However, you can get fairly good results by seeding yearly with a mixture of grass seed prepared especially for shade. At the outset, the soil and seedbed are prepared as for a new seeding, but thereafter spot seeding of the area may suffice, at least for a few seasons. A continuous fertilization program is nearly always necessary in such locations, as the trees feed heavily on soil fertility throughout the growing season, thus robbing the grass of needed plant food. Keep the new seeding mowed regularly throughout the season but set the mower to cut at least $1\frac{1}{2}$ in. high; 2 in. is better if possible.

Paint Chips On Woodwork

Q—I have just finished enameling dark-stained woodwork and now the enamel is checking in places, exposing the dark finish underneath and making unsightly blemishes. I used one coat of flat paint and three of enamel. What is wrong?

A.R., Boston, Mass.



A—By "flat" paint we assume you mean an ordinary, interior wall paint, and also that you applied it over a glossy varnish finish on the woodwork. This is a common cause of the trouble you describe, as paint does not bond well to a high-gloss finish. As a rule, the best procedure in enameling such a surface is first to give it a thorough cleaning to remove finger marks and grime. Then go over the finish with a medium steel wool or sandpaper to cut the gloss. Apply two coats of prepared enamel undercoater and follow with one coat of enamel. In most cases, it's a good idea to sand the second coat of undercoater lightly. If the stain on the woodwork is a dark brown or if it contains red, use a spirit enamel instead of the undercoater. Then there will be no danger of the stain bleeding through the enamel finish.

Leveling Basement Floor

Q—My basement floor is in good condition. There are no cracks or breaks anywhere. However, the slope, or fall, to the two drains seems much more than necessary, being at least 6 in. and resulting in a depression in the floor with rather steep slopes around each drain. I have thought of leveling the floor and raising the drains to give a fall of about 1 in. or so, by simply filling the depressions with new concrete laid over the old. Would this be advisable?

S.M., Racine, Wis.

A—The floor could be leveled by first chipping the area about the drains to roughen the surface and then pouring new concrete. However, we could not fully recommend this procedure. It is better, we believe, to break up the old concrete around the drains, removing it entirely, back to the point where the floor is more nearly level.

Here's your **GO** sign to good times

HARLEY-DAVIDSON
with the new **HYDRA-GLIDE FORK**



Every bend in the road brings new fun and thrills . . . every highway leads to new adventures when you're riding a super-smooth Harley-Davidson in the world's greatest sport . . . motorcycling! There's no end to enjoyment, no lack of places to go and things to do. Delightful gypsy tours, exciting race meets, endurance runs and hillclimbs . . . sightseeing trips to scenic splendors and historic places all beckon you to happy days and endless good times. Owning a Harley-Davidson is easier than you think. See your dealer today, and mail the coupon now.



HARLEY-DAVIDSON MOTOR COMPANY
Dept. P, Milwaukee 1, Wisconsin

Send free copy of **ENTHUSIAST** magazine, filled with motorcycle action pictures and stories; also literature on latest models.

Name.....

Street or R.F.D.....

City.....Zone.....State.....

the tower. One of the projects at LAES is to devise an automatic control by means of which a selected lighting system will turn itself on or off and adjust its intensity according to the existing visibility. It would be governed by devices that measure visibility and ceiling. Six transmissometers installed at different locations around Arcata measure the visibility of the atmosphere and report their readings continuously by radio to one central recording device. Two ceilometers that constantly measure the height of the cloud ceiling above the field are also in use.

Also being studied at Arcata are runway-marker lights of new design, and means by which a pilot touching down can determine his location in reference to the total length of the runway. Still another problem concerns identification and illumination of taxi-ways. Other studies are projected for the future, the goal of the whole research program being to find the simplest and surest ways of helping aircraft take off or land at will, regardless of the weather.

Science Hits the Bull's-Eye

(Continued from page 177)

is twice as much stress produced in the compression of the round-bellied bow as

in the stretching of the back of the bow. This meant that too much tension was produced in the belly of a rounded bow which had less surface area to absorb the strain. This resulted in the weakening and misshaping of bows through long use when the overburdened wood fibers in the belly became crushed.

Doctor Hickman also has done considerable research on arrow construction. This has had widespread significance, not only in archery, but in the development of American rocket warfare, since many of his findings were used in the development of such weapons as bazookas, rockets fired from airplanes or ships, and rocket motors that are used to increase the penetrating power of bombs.

For his war work, Doctor Hickman received the Presidential Citation Medal for Merit from the Army and Navy. It is the highest award given to a civilian by the armed forces.

Archers have long known that the spine, or stiffness and resilience, of an arrow must be matched by the drawing force of a bow if the arrow is to fly straight. But they did not know why. By taking electronic pictures of arrows in flight, Doctor Hickman showed how this was tied in with the archer's "paradox."

(Continued to page 254)

Compare features when you buy a plane!

On any planing job, you want good control, a balanced, comfortable grip, perfect results. Professional woodworkers will tell you that you get all three in a Millers Falls plane — and they're *right!*

Only in Millers Falls planes will you find a three-point bearing lever cap, a solid tool-steel cutter, a perfectly-fitting cap . . . because they're Millers Falls *exclusives*. But more — find out how comfortable those hand-fitting solid rosewood knobs and handles are, how sensitive your cutter adjustments, side or depth.

Best of all, Millers Falls planes cost no more. See them at your hardware dealer's. Millers Falls Company, Greenfield, Mass.



The plane you need

Smooth planes — for finishing broad, flat surfaces or reaching into low spots.

Jack planes (illustrated) — for rough, heavy cuts and truing up of board edges.

Jointer planes — for final finishing, or dressing edges before joining.

Block planes — for cross-grain work.

(Many others for special work)



Millers Falls Tools

How amazing tube
discovery seals punctures
while you ride!

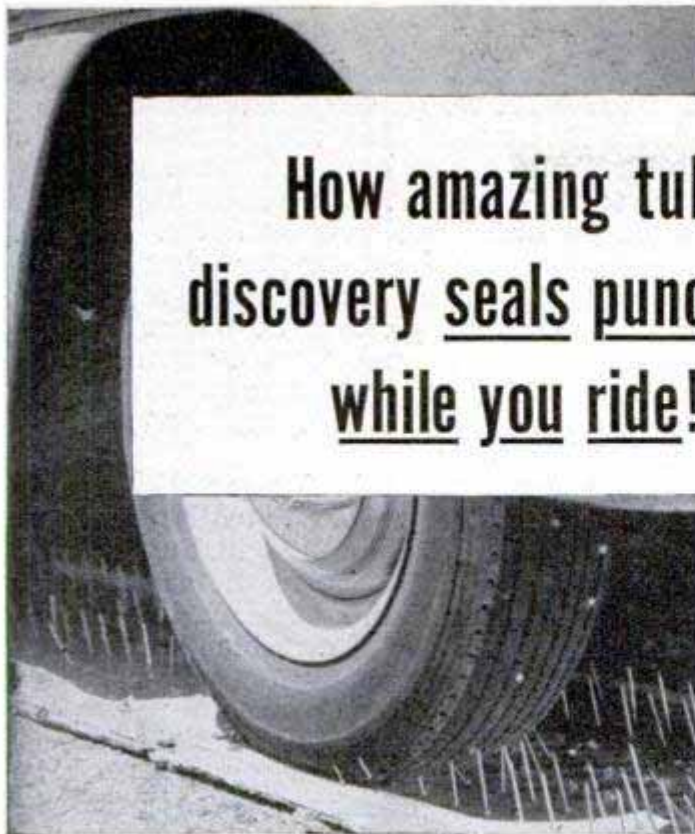

1. Sharp nails—*hundreds of them*—pierce deeply into this tire in grueling "Torture Test". What happens? Nothing! The tire does *not* go flat . . . the car keeps right on rolling!



2. For good measure, *more* nails are pounded into the tire and through the tube. *Still no flat!* The secret lies in the amazing Sealed-Air Tube with patented Bulkheads perfected by Seiberling.

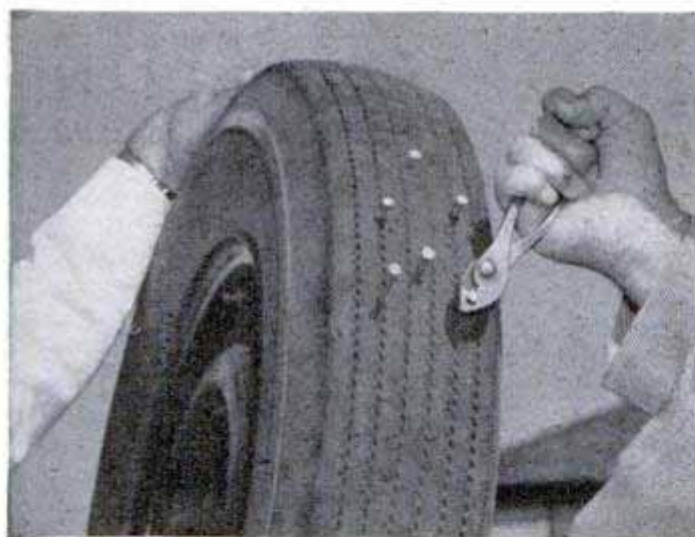

3. Here's how you "fix" a puncture when you have Seiberling Sealed-Air Tubes with patented Bulkheads. Just pull out the nail or other sharp object, and the tube seals itself *permanently!* No further repairs necessary!

How can this tube
outlast four tires
'WITHOUT GOING FLAT?'

How can this amazing Seiberling Sealed-Air Tube—the tube *no one* can imitate—actually outlast four tires, run as high as 300,000 miles—without even *one* flat? How can it save you many times its purchase price by eliminating the expense of tube repair bills and ruined tubes and tires? How can it make your driving immeasurably safer by protecting you from the dangers of sudden flats and blow-outs, and from the hazards of roadside tire changes? If you drive a car or truck, it will pay you many times over to fill in and mail the coupon below for the amazing story of what the Seiberling Sealed-Air tube can do for you.

SEIBERLING

Sealed-Air TUBES
WITH PATENTED BULKHEADS

FREE! Send coupon before you have another flat!

Learn more about the *only* tube built around the amazing Bulkheading principle. We'll send you, without obligation, our new book "10,189 PUNCTURES—AND NOT ONE FLAT!" Seiberling Rubber Company, Dept. P-1, Akron 9, Ohio.

Name.....

Address.....

City.....State.....

YOU'RE NEVER OUT OF WORK

when you have a
sideline business
to fall back on

- STEADY, PROFITABLE INCOME
- NO EXPERIENCE REQUIRED
- BE YOUR OWN BOSS



IN SPARE TIME — OR FULL TIME SHARPEN LAWNMOWERS on the IDEAL SHARPENER

YOU can put one of our IDEAL Lawnmower Sharpeners in your garage or basement and start a good paying business of your own—on the side—or full time—sharpening lawnmowers. In a short time your earnings will pay for the machine. From then on, everything you take in is "gravy."

Get started now! Early this spring and all summer, people in your neighborhood will keep bringing you mowers to sharpen. Just place the lawnmower in the IDEAL, make a few simple adjustments! The IDEAL does the rest. You collect the cash! Get the facts! Be first in your neighborhood!



Send for
FREE
booklet today!

THE FATE-ROOT-HEATH CO.
DEPT. D-3, PLYMOUTH, OHIO

For many years the paradox had played upon the imagination and curiosity of archers. From a first glance at the bow and arrow, it would seem that the arrow should fly far to the left, since it passes on the left side of the bow, while the string flies to the middle. This actually happens when the string is slowly let down.

In order to find out exactly what happened, Doctor Hickman developed a camera that would take pictures at the rate of 6000 frames a second. This camera was able to stop the flight of arrows and was soon adopted by the Army and Navy for filming projectiles.

The pictures taken by Doctor Hickman showed that the arrow actually bends around the bow and keeps oscillating in its flight. This not only solved the academic problem of the archer's paradox, but also showed why arrows of certain spine must be matched to different strength bows, lest a badly matched arrow assume a permanent warp or break due to its initial buckling from the force of the string.

Fortified with this knowledge, Doctor Hickman advocated shooting the arrow from a point nearer the center of the bow rather than from the side of the bow. This "center shot" bow eliminated the need for special considerations in matching arrows of correct spine.

The center-shot bow has the advantage that very light arrows may be shot with heavy bows, giving flatter trajectories than are possible with bows that force the arrow to bend around them.

Another of Doctor Hickman's inventions has solved the major problem in aiming. Experience has shown that the most comfortable and accurate shooting position is one in which the arrow is held by the fingers just beneath the chin. Since the eye is on a higher level than the arrow, the line of sight is downward from the eye to the arrowhead to some point on the ground before the target. This is known as the "point of aim" method of shooting. Here the archer sights at some small object which he places on the appropriate spot on the ground, and does not see the target in the act of shooting.

Many bowmen have tried to eliminate this bothersome practice by using mechanical sights. These consist of various appendages placed on the upper limb of the bow, allowing the line of vision to continue from the eye to the sight and on to the target. In this practice, however, the archer does not see the arrow and cannot check whether he has taken a full draw. To overcome this new handicap, some archers took to attaching mirrors to their bow limbs.

(Continued to page 256)

Here's Why

WHIZZER

Is America's Leading
Bike Motor

AIR COOLED MOTOR

4-cycle design, 2½
rugged h.p. Auto-
type carburetor gives
125 miles per gallon.
Speeds to 35 m.p.h.

TWIST-GRIP CONTROLS

Motorcycle type, for
safe, easy control
under all operating
conditions.

STREAMLINED GAS TANK

Holds 5 quarts. Made
of heavy gauge steel,
baked enamel finish.

STEEL CABLE BELT DRIVE

Notched V-belts are
reinforced with 5
high-flex steel cables,
give extra efficient
power transmission.

RUBBER MOTOR MOUNTS

Special three-point
suspension, mounted
in rubber, soaks up
vibration.

HOT-SPARK IGNITION

High tension mag-
neto, coil and con-
denser for quick
starting. No battery
required.

ALL-CHROME TRIM

Motor mounts, belt
guard and exhaust
pipe chrome plated
for extra beauty,
longer life.



FOR NEAREST WHIZZER DEALER, CALL
WESTERN UNION, ASK FOR OPERATOR 25

HEAVY-DUTY BIKE STAND

Adjustable, extra
heavy stand supplied
with every motor.

COMPLETE WITH ALL
NECESSARY ATTACHMENTS

\$109⁹⁷

Federal Tax Included,
F.O.B. Pontiac, Mich.

Fits any
man's balloon tire bike

PRECISION ENGINEERED

Cylinder micro-honed
to 5/10,000" toler-
ance. Drop forged
crankshaft, camshaft,
connecting rod.

FREE LITERATURE!

WHIZZER MOTOR COMPANY
350 South Sanford,
PONTIAC, MICHIGAN

Send me literature on the Whizzer Bike Motor

NAME _____

STREET _____

CITY _____ STATE _____

The NEW DUMORE Hobby-Flex

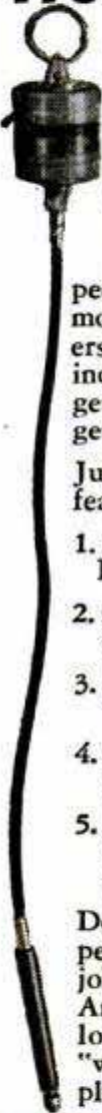

... a genuine Dumore flexible-shaft tool for faster, easier hobby-work

The new Hobby-Flex is "made to order" for you. And it's made by the same people who produce the famous Dumore precision grinders and flexible-shaft tools for industry. So you know you're getting the *finest* when you get a Hobby-Flex!

Just look at these special features:

1. A vibrationless 1/20 hp Dumore motor (15000 rpm).
2. A durable 36" flexible shaft; 8-foot cord.
3. A pen-size handpiece for "close control" on fine work.
4. A chuck that takes both 1/8" and 3/32" tools.
5. A handy hanger-ring to hold the motor on a hook or overhead pipe.

Doesn't that sound like the perfect tool for hundreds of jobs in any home workshop? And it is. That's why it belongs at the top of your "want" list. Send for complete information.



Sawing wood models



Grinding jewelry



Polishing plastic sculpture



Carving fine woods



Plastic carving



Filing and drilling metal models

But this only makes the bow cumbersome. Doctor Hickman solved both the problems of mechanical sights and point-of-aim shooting with one stroke. He invented a sight consisting of two prisms which bend the image of the target up to the eye. The archer then seemingly aims at the center of the target. Since the arrow actually rests on the arm of the sight, the archer lines up the point of his arrow, the cross hairs of his sight and the bull's-eye. Thus, he cannot pull his arrow back too far or too little.

Psychological, as well as mechanical, hindrances have plagued the archer. One of these is the habit of "freezing" before reaching the point of aim, a difficulty common also to riflemen. As many psychologists have pointed out, this is due to a subconscious fear that the shooter will release the arrow as soon as the tip of the arrow reaches the point of aim, thus deflecting the arrow in the direction the bow is moving.

To overcome this, Doctor Hickman uses a mechanical timer which he attaches to his wrist. He then proceeds to aim at his "point," and holds on it until the timer clicks. This has produced a conditioned reflex whereby he automatically releases when the timer clicks and not one second before. By developing this habit, he has eliminated the fear of losing the string too soon, permitting him to adjust freely on the point.

Doctor Hickman's home is an archer's paradise. In addition to a sizable collection of tackle, he has one of the largest private collections of archery books and prints in the world. And his box full of medals and trophies is a monument to his scientific achievements in archery.

Brains That Click

(Continued from page 167)

cooling and choice of metal for the barrel can be computed theoretically even before the gun is built. One of the best-known network analyzers is located at Illinois Institute of Technology.

The latest model "thinking machine" that scientists and mathematicians drool over is the electronic-type calculator. Such computers use vacuum tubes and literally figure with the speed of lightning, rather than by any ingenious system of wheels or gears. The Army, the Navy and the U. S. Bureau of Standards have spent several million dollars on such machines.

The Navy has sponsored the work of Dr. Howard Aiken at Harvard who has developed three calculators: Mark I, a mechanical type using counter wheels; Mark

(Continued to page 258)

Tear out this coupon and mail today!

- | | | |
|-----------|-----------|-------------|
| Sawing | Drilling | Burnishing |
| Grinding | Routing | Cleaning |
| Sanding | Finishing | Engraving |
| Polishing | Carving | Touching Up |
| Burring | Filing | Shaping |

N-23

The Dumore Company, Dept. C-51, Racine, Wisconsin

Please send me the items checked below:

No. 19-021 Hobby-Flex, consisting of motor, flexible-shaft, handpiece, and wrenches. \$21.50 enclosed.

No. 19-011 Deluxe Hobby-Flex, same as above, plus steel carrying case and 10 accessories. \$27.50 enclosed. (Cash or Money-order please. Shipping Charges C.O.D.)

Literature giving complete information.

Name _____

Address _____

City _____ State _____



Presenting

**THE NEW LUFKIN "CHROME CLAD"
MICROMETER—with Non-Glare Satin Finish**

7 SUPERIOR FEATURES

*"Chrome Clad", Non-Glare Satin Finish, Easy to Read, Rust and Wear Resistant • Hardened Ground Thread • Easy Adjustment • One Piece Spindle • Cutaway Frame • "Rapid Reading", (Each Thousandth Numbered) • Micro-Lapped Mirror-Like Finish on Anvil and Spindle Ends.

*Before releasing Lufkin Chrome Clad Micrometers to the public they were used for several years in our own plant on various types of rough and finished metal working production. All micrometers tested have retained their non-glare satin finish to our complete satisfaction.

Lufkin adds another important feature to the many which now distinguish its famous Micrometers,— "Chrome Clad", Non-Glare Satin Finish. Utilizing recent pacesetting developments in metal finishing, Lufkin now applies a heavy chrome plating to its micrometers. This finish possesses a non-glare quality

which makes reading easier than ever before. You get your reading at a glance in bright or poor light. Markings stand out sharp and bold against the satin finish. It is rust and wear resistant. Here's a real ally for the precision worker to whom accuracy is a "must". Ask your dealer to show you this improved precision tool.

PRECISION TOOLS **LUFKIN** TAPES • RULES

Accuracy of Measurement is the Key to Precision

THE LUFKIN RULE COMPANY • SAGINAW, MICHIGAN

Everything in Radio at Lowest Prices!

FREE

Send for
ALLIED'S
180 Page
Catalog



**BUILDER'S KITS
TELEVISION SETS
HI-FIDELITY SOUND
AMATEUR GEAR
THOUSANDS OF PARTS
TUBES, TOOLS, TESTERS
BOOKS & DIAGRAMS**

*Everything for
Servicemen, Engineers,
Experimenters, Builders,
Soundmen, Amateurs*

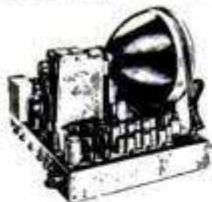

Radio's Leading Buying Guide

Get ALLIED'S 1949 Catalog—biggest and most complete in Radio. Get *everything* you need from the world's largest stocks of top-quality equipment—at down-to-earth money-saving prices. Have the advantages of speedy reliable shipment, expert personal help, and complete satisfaction on every purchase. Get more for your money at ALLIED—Radio's Largest Supply House. Send today for your **FREE ALLIED Catalog**—the preferred Buying Guide to *everything* in radio and electronic equipment.

ALLIED RADIO

ALLIED RADIO CORP.,
833 W. Jackson Blvd., Dept. 5-C-9
Chicago 7, Illinois

FREE

Send **FREE** 1949 ALLIED Catalog.

Name.....

Address.....

City..... Zone..... State.....



II, an electric-relay type which recently was moved to the U. S. Naval Proving Grounds, Dahlgren, Va.; and Mark III, a hush-hush electronic computer which has not yet been completed.

The Army has backed the scientific team of Dr. J. Presper Eckert, Jr., and Dr. John Mauchly, formerly of the University of Pennsylvania. They developed the ENIAC (Electronic Numerical Integrator and Calculator) which has been moved to the Army's Aberdeen Proving Grounds, Aberdeen, Md. The ENIAC is the only all-electronic computer in operation today. It is not a machine in the usual sense—the only moving parts are devices to feed numbers in and print numbers out.

Not long ago Eckert and Mauchly set up their own company in Philadelphia and are now working on the UNIVAC, the BINAC and other types of computers. The UNIVAC, the only large computer designed to manipulate alphabetic information, will soon be made available to business and industry. The BINAC, two models of which have been built, is a smaller, simpler and lower-priced calculator—almost a "pocket" edition—which is only five feet high, four feet long and one foot wide.

The Army is also financing the work of Dr. John von Neumann at the Institute for Advanced Study, Princeton, N. J. He's developing a calculator of an advanced type which, it is jokingly said, may be called the MANIAC (Mechanical and Numerical Integrator and Calculator).

The U. S. Bureau of Standards has a four-part program under way. In Washington, D. C., it is setting up a Computation Laboratory, a Statistical Engineering Laboratory and a Machine Development Laboratory. In Los Angeles it has organized an Institute for Numerical Analysis on the U.C.L.A. campus to serve Western research and industry.

Engineers and mathematicians are like airplane designers. Models in use are already long outmoded by those on the drawing boards. Where a calculator like the ENIAC today is equipped with 18,000 vacuum tubes and weighs 30 tons, computers in the future may have only 1000 vacuum tubes and perhaps weigh only 1½ tons.

Though never completely satisfied with performance, scientists get a happy gleam in their eyes when they contemplate the high-speed electronic calculating machines of today and the future.

One of them puts it this way: "Just one of these machines will do in a few hours what a human mathematician couldn't do with a million pencils in a hundred lifetimes."

IF YOUR ROLLING STOCK
DOES THIS... IT'S TIME
TO FIX THE SWITCH...

AND

IF YOUR CAR FEELS LIKE THIS...
IT'S TIME FOR MARFAK
CHASSIS LUBRICATION



THAT CUSHIONY FEELING LASTS LONGER WITH MARFAK!

When *Marfak* goes "on the job," you can forget about chassis lubrication for 1,000 miles and *more*. *Marfak* is tough and *longer-lasting*, specially compounded to fight friction and wear. The evidence is the "cushiony" driving ease you experience — right from one *Marfak* job to the next. Ask for *Marfak* Lubrication today at your neighborhood Texaco Dealer, *the best friend your car ever had*.



THE TEXAS COMPANY
TEXACO DEALERS IN ALL 48 STATES

Texaco Products are also distributed in Canada

TUNE IN... TEXACO STAR THEATER every Wednesday night starring Milton Berle. METROPOLITAN OPERA broadcasts every Saturday afternoon. See newspaper for time and station.

Evinrude gives you

*Tops in
fishin' fun*

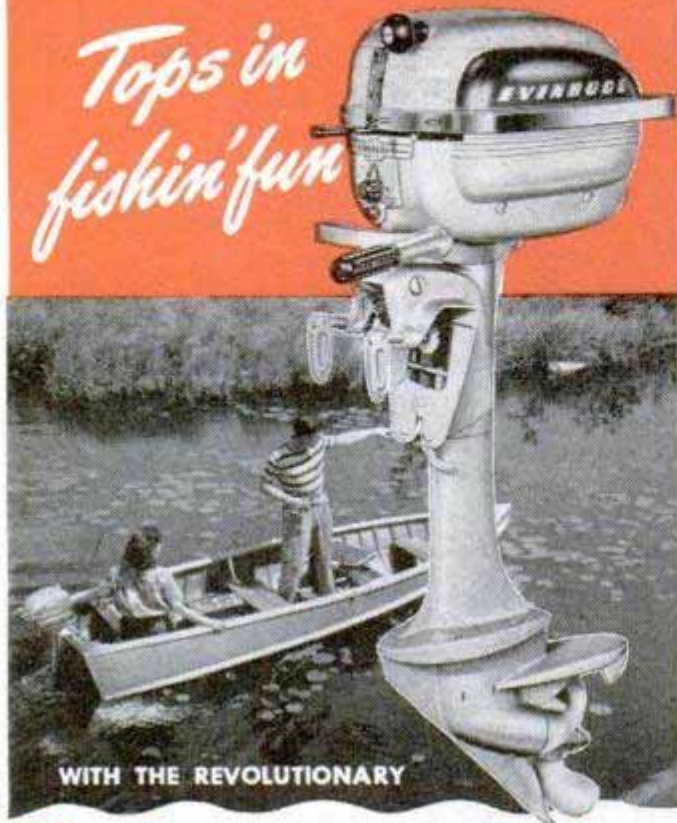

WITH THE REVOLUTIONARY

Fisherman Drive

... takes you anywhere there's water to float your boat!

Yes... with this patented Drive you can go "anywhere there's water to float your boat." And what a difference *that* makes to your boating and fishing fun! No longer need you dodge reeds and weed beds! Or hurriedly cut the power over shoals, snags, rocks! There's *nothing like it* for carefree boating in all waters!

SEE YOUR EVINRUDE DEALER... and see the complete line of 40th Anniversary models... 1.5 to 50 horsepower... *the right motor for every boat!* Look for your dealer's name under "Outboard Motors" in the yellow pages of your phone directory. For free catalog write EVINRUDE MOTORS, 4248 N. 27th St., Milwaukee 9, Wisconsin.



through weeds



over snags



over shoals



FREE Write for full-color catalog of complete line—gives helpful information on features, boats, speeds.

In Canada: Evinrude Motors, Peterboro, Ontario

EVINRUDE

FIRST IN OUTBOARDS • 40th YEAR

Backstage Miracle Makers

(Continued from page 156)

of 2 by 8s, 36,000 bolts of various sizes and hundreds of yards of muslin.

The muslin on which the scenes are painted is first given a coat of glue sizing. The artists use water-color paint which is sprayed with formaldehyde to keep it from running in case of rain. The finished sets must stand out in all weather, but the management fears wind more than rain. The big scenery pieces are like sails. When not on stage during a production every piece is tied down with ropes. If a storm threatens, the audience sees the ropes out front to guard against accidents.

"Our accidents ain't serious ones," chuckled one of the stagehands. "They're funny ones. Worst one lately was with a telephone. It rang good and loud. The actor went to answer it but there was no telephone to be found. Somebody forgot it. You should have heard the audience howl."

This story may be just one of the folk tales (usually false) which have grown up around the theater. Every stagehand, actor and technician will tell you that the two great burr oaks framing the stage and "hundreds" of years old are insured by Lloyds of London for "thousands." This is denied by Paul Beisman, manager of the theater, who has been associated with the Municipal Opera since it was founded.

"There's no denying those trees are priceless," he said. "All you have to do is witness one of the outdoor scenes at night when they are lighted to appreciate that. In fact, this spot was selected because those trees are there. They are probably the two most pampered trees in the U.S. Lightning rods reach into every branch; they are fed, fertilized, watered, patched, trimmed and cared for like a couple of prima donnas." He hesitated. "But insured by Lloyds of London? No. I keep denying that story but it makes no difference. Next year everybody will be saying the same thing."

Here are a few facts and figures about the St. Louis Municipal Opera: In the 30 years of its existence it has entertained more than 18,500,000 persons at 2254 performances of operettas, comic and light operas. The production cost (on a professional basis with leading New York producers, directors and principals) now totals \$600,000 a season. The company has never lost a penny and shows a small profit. The theater seats range in price from 30 cents to \$2.60. Every night there are 1500 free seats in the top section. This is

(Continued to page 262)

EVEREADY BRAND the battery

with 'NINE  LIVES'



Just as an active cat ...

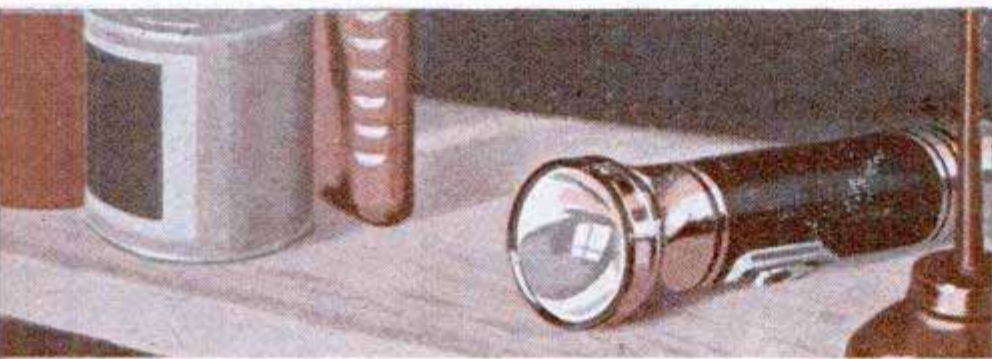

takes a cat nap and ...



bounces back with new pep... so "Eveready" batteries bounce back for extra life!



● Naturally, when you use your flashlight, you use up some of the power in the batteries. But "Eveready" batteries recover power between uses—thanks to a reaction of chemicals in the batteries. Yes, "Eveready" batteries *bounce back* for extra life! Insist on "Eveready" batteries for your flashlight—they're the largest-selling brand in the world!

The registered trade-mark "Eveready" distinguishes products of

NATIONAL CARBON COMPANY, INC.

30 East 42nd Street, New York 17, N. Y.

Unit of Union Carbide  and Carbon Corporation

because the theater is on city property and is itself actually owned by the taxpayers of St. Louis.

The success of the Municipal Opera has inspired other cities to build similar outdoor theaters: Dallas, Memphis, Louisville, Atlanta, Pittsburgh, Indianapolis and Los Angeles. Indoor civic theaters are found in Detroit and San Francisco.

Producer John Kennedy says that to succeed, every municipal theater must be self-supporting and not depend on a rich sponsor. The shows with their elaborate scenery must be so good that you can't keep the crowds away. That's true in St. Louis where theatergoers carry umbrellas to sit in the rain and where taxi drivers mention the "Muny Opera" with the same pride as they do the St. Louis Cardinals.

Prehistoric Crop

(Continued from page 145)

widely planted as an ornamental, and commercial plantings greatly extend its range and usefulness. For one thing, young *Sequoias* have ideal length and form for use as telephone poles. Deep ground frost and extreme dryness are the chief checks to its possible range.

The coast redwoods do not attain the

same bulk with maturity as do the *gigantea* but they frequently grow considerably taller. *Sempervirens* as tall as 350 feet or more have been measured. One huge tree alone may contain 360,000 board feet of lumber. In selected areas the trees run more than a million board feet of lumber to the acre.

Coast redwoods reproduce rapidly from seed although many people in the redwood country are ready to swear that the tree grows only from sprouts. This belief is due to the remarkable sprouting energy that the species exhibits. Practically every stump sends up a ring of new shoots from its root collar. Many newly cut logs also sprout if they are allowed to lie.

Bark-covered redwood logs that were used as columns for decorating the face of a wooden bank building a number of years ago destroyed their classic effect by sprouting their full length with new green growths. Logs used for building railroad trestles are apt to do likewise. Such sprouts usually die away after the first season but with sufficient moisture they send down their own root systems and develop into healthy trees.

The coast-redwood forests are yielding tremendous amounts of lumber and there has been considerable concern over this

(Continued to page 264)

BUY FARM and INDUSTRIAL WHEELS FROM YOUR HARDWARE STORE

Now you can get the same standard stock puncture-proof rubber tire wheels as used by leading manufacturers of portable farm and industrial equipment *right from your hardware dealer!* Ask for **GLEASON WHEELS.**

Quality — Service

You'll get the manufacturer's guarantee and your dealer's reputation back of every one of these ball bearing welded steel disc wheels, and there's no delay in delivery!

Engineered Wheels

Designed and built expressly for use on the finest portable equipment being made today.

Save ON DELIVERED COST

No extra freight or handling charges to pay, on Gleason Farm and Industrial Wheels; the wheels approved by the engineering departments of leading manufacturers.

Tire Dia.	Tread Width	List Price
6"	2"	\$4.00
8"	2½"	\$5.80
8"	1¾"	\$2.50
10"	1¾"	\$2.90
10"	2¾"	\$5.80
12"	1¾"	\$3.50

Check load capacities, axle sizes and hub widths with your hardware dealer before you buy.

GLEASON CORPORATION
534 NORTH NINTH STREET
MILWAUKEE 3, WISCONSIN

* AC's patented processes make Coralox the finest insulator in spark plug history. Improved electrical insulation, no matter how high the temperature. Better heat conduction. Maximum resistance to heat shock. Less fouling. Harder, stronger, longer-lived.



MORE NEW CARS AND TRUCKS
ARE EQUIPPED WITH AC SPARK PLUGS
THAN WITH ANY OTHER MAKE

can't miss ...

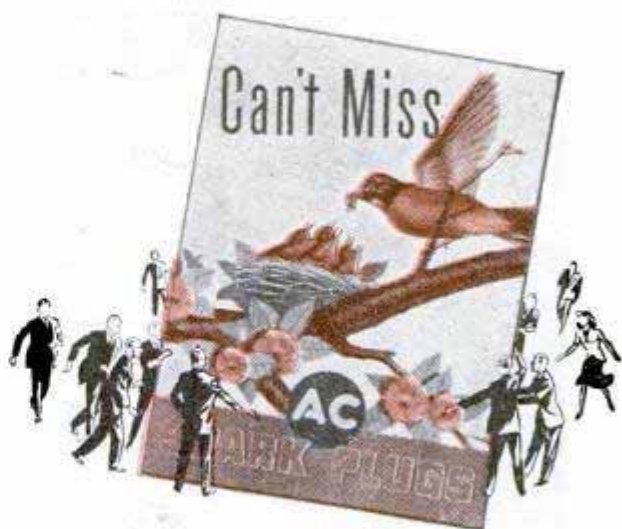

● Until you've actually tried AC Spark Plugs with patented CORALOX Insulator,* you can't imagine how much more zip and ginger they can give your engine. This remarkable insulator stays free from oxide coating longer.

Clean plugs don't misfire. That saves you gas—takes you farther on the balmy days that invite long drives.

AC's patented CORALOX Insulator means more engine power and getaway.

You "can't miss" if you insist that your car's spring tune-up includes a set of the spark plugs that "can't miss"—AC Spark Plugs with patented CORALOX Insulator.

AC
SPARK PLUGS

LOOK FOR  THIS SIGN

AC SPARK PLUG DIVISION • GENERAL MOTORS CORPORATION

MOTORISTS WISE SIMONIZ

T.M. REG. U.S. PAT. OFF.

MAKES CARS STAY BEAUTIFUL

*Better than 10
"Here-today...
Gone-tomorrow"
Polishings!*



Simonizing saves you time and effort . . . because it lasts longer!

Don't waste your time with 'temporary polishings'! Simonizing gives long lasting beauty...protects the finish and keeps colors from fading. Do as millions of motorists...Simoniz your car. It's easy to do yourself.

THE SIMONIZ COMPANY, CHICAGO 16, ILL.



Use Simoniz Kleener (liquid or paste) to clean finish. Then Simoniz for lasting beauty. Sold everywhere!

destruction of a great scenic asset. Aesthetically and commercially it is important that the forests continue to grow forever. The indications are now that this is going to be the case. Oddly enough the best results in maintaining the forests appear to come from controlling natural growth rather than producing seedlings in nurseries and setting them out.

Considerable work in reforestation has been done by the Pacific Lumber Company of Scotia, Calif., which, as the operator of the largest single redwood lumber plant, has a very real interest in never running out of raw material. The Pacific Lumber Company is processing 400,000 board feet of lumber in its plant every eight-hour day and it estimates that it will always have enough timber in reserve to stay in operation.

This conclusion is based on the fact that at present rates of cutting it has about a 30-year supply of virgin timber ahead of it, plus the fact that parts of its lands that were first logged in the '80s and '90s already are suitable for logging again.

Selective logging wasn't a formal procedure in the early days, as it is now, but the early loggers happened to leave enough mature seed trees and enough young growth on the slopes behind them to allow the forest to continue to grow. Removal of the biggest trees that had shaded and stunted the young growth permitted the immature trees to accelerate their own speed of growing.

Twenty years ago the Pacific Lumber Company went into the nursery business in a big way and grew thousands of hardy seedlings and set them out on cut-over land. The seedlings flourished but after a time it became apparent that just as much new lumber was being produced by natural processes on adjacent land as was being produced on the planted ground. Today, the company simply thins out the forest to obtain maximum growth from the trees that remain. That, plus leaving groups of mature seed trees here and there, is about all that is necessary.

There is no more waste in redwood lumbering than there is in the packing industry that proverbially uses everything except the squeal. Caskets, cigar boxes and other specialties, as well as general building lumber, are made out of the best wood. Short pieces that are left over are cut into shingles and lath. The shavings and sawdust that accumulate from the mill operations are pressed into logs suitable for burning in fireplaces.

Much of the thick fibrous bark is cut, shredded and processed into a fireproof

(Continued to page 266)

Success from the start!

Sets New Performance Standard

Amazing Resistor does it!



Here's what it does

A SMOOTHER ENGINE IDLE—WIDER SPARK GAP HELPS ELIMINATE OCCASIONAL MISSING.

IMPROVED GASOLINE ECONOMY—PERMITS BURNING OF LEANER MIXTURES AND REDUCES MISFIRING.

INCREASED ELECTRODE LIFE—UP TO 200% AND MORE.

IMPROVED RADIO RECEPTION—REDUCES SPARK PLUG INTERFERENCE WITH RADIO, RADAR AND TELEVISION.*

*Within 35 mv/m from 540 kc. to 150 mc. at 50 ft.
Auto-Lite Spark Plugs—Patented U.S.A.

NEW AUTO-LITE

Resistor SPARK PLUGS

Acclaimed by car owners coast-to-coast

SO REAL are the operating advantages of this scientific Auto-Lite development that car owners everywhere are replacing their regular type spark plugs with Auto-Lite Resistors.

Departments and taxi companies tell us of their enthusiasm for the smoother idle and improved gasoline economy experienced.

Car dealers, service station operators, garage men, Police

See your Auto-Lite Dealer today for a complete new set of Auto-Lite Resistor Spark Plugs.

Toronto, Ont. **THE ELECTRIC AUTO-LITE COMPANY** Toledo 1, Ohio

BECAUSE OF ITS LOW RATE OF ELECTRODE EROSION, THE NEW AUTO-LITE RESISTOR SPARK PLUG PERMITS WIDER INITIAL GAP SETTINGS AND MAKES THESE ADVANTAGES POSSIBLE.

AUTO-LITE *Resistor* SPARK PLUGS

THIS IS THE OUTBOARD MOTOR YOU'VE BEEN WAITING FOR



- Gear shift Control
- Calibrated Carburetor
- Ful-Vue Fuel Gauge
- Twin-Grip Hand-Holds
- Idle-Minder
- Synchro-Control
- Salt Water Protection
- Separate, Mile-Master Fuel Tank
- Vari-Volume Pump
- Lubri-Tite Seals
- Rubber-floated Propeller
- Perfected Alternate Firing Twin
- Flex-Mount Power Head
- 40 Great Features!



FREE HANDY CHART

Write for new 1949 Sea-Horse Handy Chart. Illustrates, charts the QD and the 4 other great Johnsons for '49. All features fully described. Write today. JOHNSON MOTORS, 400 Pershing Road, Waukegan, Ill. Johnson Motors of Canada, Peterboro, Canada

JOHNSON SEA-HORSES for DEPENDability

- MODEL HD—Small Alternate Firing Twin 2.5 H.P.*
- MODEL TD—Medium Alternate Firing Twin 5.0 H.P.*
- MODEL QD—Large Alternate Firing Twin with Gear-shift Control and Mile-Master Fuel Tank . 10.0 H.P.*
- MODEL SD—Super Alternate Firing Twin with Mile-Master Fuel Tank 16.0 H.P.*
- MODEL PO—Heavy Duty Opposed Twin 22.0 H.P.*



*All ratings are OBC Certified Brake H.P. at 1000 r.p.m.

material for insulation. The blanket industry uses some of the long strands of bark for mixing with wool. Dust from the shredded bark goes into paper roofing material and some of it is sold as a conditioner for heavy soils.

Some fiber becomes an ingredient in the material used in sealing oil wells, some refuse wood is exploded like puffed rice and becomes a constituent of various dark-colored plastic materials. The junk wood that is left over from all these operations is burned, but not because this is a convenient way to dispose of it. The wood is the necessary fuel that runs the boilers of the generating plant that produces the power by which the mill is operated.

Want to Buy Some Rain?

(Continued from page 133)

Often the latter is done immediately under a cloud where the strong natural updraft carries the vapor aloft.

Most investigators think that artificial nucleation is practical only when a cloud is in a state at which precipitation will occur anyway. The seeding simply provides a trigger action that starts or stimulates the natural process. Under proper conditions it is possible to develop considerably heavier rainfall than would occur otherwise. The extra yield depends more on the state of the atmosphere than on the amount of water in any single cloud.

Last year was a dry year in Arizona. Some rain could be expected from thunder clouds, but not enough to make up the deficiency, and the irrigators and other water users who draw upon the reservoirs behind Roosevelt and Bartlett dams wanted every extra drop they could get. Interested groups in the state created the Arizona Weather Research Foundation to test scientific rain-making techniques. The foundation in turn employed the Krick weather research staff in Pasadena, Calif., to determine whether summer weather over the watersheds behind the two reservoirs was suitable for seeding, to direct operations and to evaluate the results.

From a study of the very complete local upper-air meteorological records for a number of years it was apparent that air of suitable moisture content and physical structure quite frequently flowed over the watershed area. The freezing level in these air streams was at an altitude of around 15,000 feet. Artificial nucleation of cloud masses that extended above that level appeared feasible. Aircraft operated by the Precipitation Control Company of Phoenix

(Continued to page 268)

Steady work . . . big money with American



BE YOUR OWN BOSS!

Now's the time to step out of the "hourly wage class"—and make **BIG PAY EVERY DAY** in a business all your own! Here's how—start a floor surfacing business with an American! Hundreds of men are doing this and making \$35 to \$50 a day—you, too, can make big money!

There's plenty of floor surfacing work all the year 'round in today's booming building industry. Pleasant, indoor work . . . sand both new and old floors. Easy to operate an American Sander—no big overhead—no large investment—no special schooling. Decide now that you want to get ahead and be your own boss!

Send for "money-making" booklet entitled "Opportunities in Floor Surfacing"—use coupon and enclose 25c in coin or stamps to cover handling.

AMERICAN FLOOR MACHINES

The American Floor Surfacing Machine Co.
535 So. St. Clair St., Toledo 3, Ohio

Enclosed find 25c in stamps or coin for booklet "Opportunities in Floor Surfacing", telling me how I can start my own floor sanding business.



Send Coupon Today!

Name.....

Street.....

City..... State.....

ALL BROKE-WATER TO TAKE JITTERBUG!

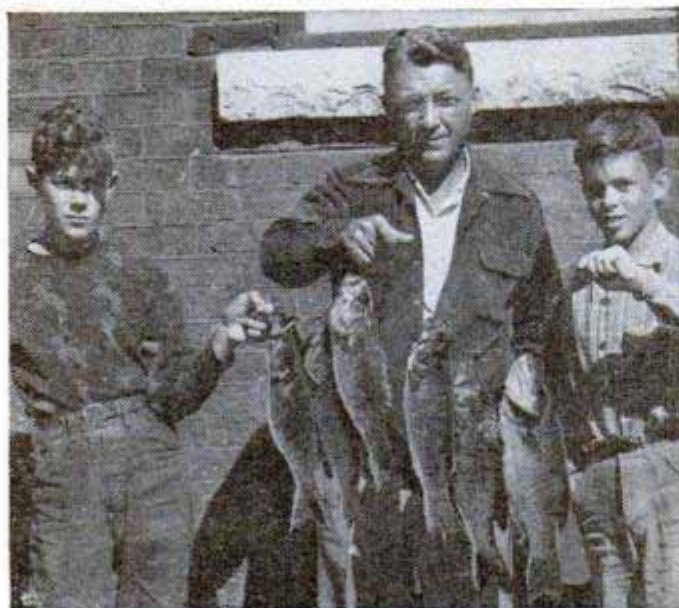

"Our Jitterbug took the limit, each day, at St. Potier Lake, near Whitefish," is the way T. B. Stonerock of Dayton, Ohio, describes this photograph showing his son, Tommy (right), and friend, Peter Farrell (left), with their catch of Smallmouth Bass . . . all weighing over 2 pounds. Mr. Stonerock, the boys and a Jitterbug have a date to fish St. Potier Lake again, next year.

WRITE FOR FREE
1949 CATALOG

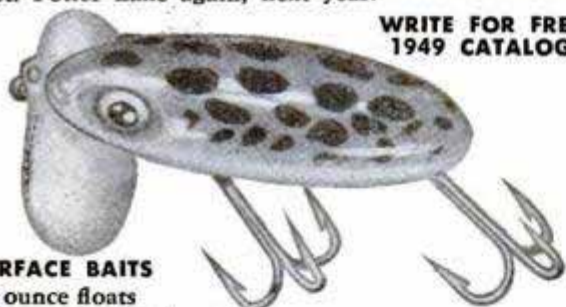

SURFACE BAITS

$\frac{3}{8}$ ounce floats

$\frac{3}{8}$ ounce sinks when at rest

Either size \$1.21 each

Colors: Red Head, Frog, Black, Yellow, Scale, Perch, Pearl, Luminous, Blue Head, Pearl Herringbone

Try the new $1\frac{1}{4}$ ounce Musky Jitterbug \$2.00 each
Jitterbug—T. M. Reg. U.S. Pat. Off. A-349-18

FRED ARBOGAST & CO., INC.

1633 W. North St., Akron 3, Ohio

and by Weath-Air, Inc., of Burbank, were used for the seeding flights.

Meteorologists in the Pasadena laboratories telegraphed a forecast for the watershed area to a staff flight-control meteorologist in Phoenix early each morning during July, August and September. If a forecast was favorable, the Phoenix meteorologist immediately alerted the pilots and informed them of the area in which seeding was to be done and the time at which it was to start. During the balance of the morning he conferred with the local U. S. Weather Bureau staff to modify the flight instructions if necessary.

Twenty-seven operational flights were made during the 90 days. On some occasions Dry Ice was employed, on others silver-iodide vapor was released, and on some days both agents were used to infect the clouds.

A war-surplus P-64, the "Barnestorm No. 3," specially rebuilt for the work by Precipitation Control Company, was used as the silver-iodide plane. The vaporizing apparatus consists of an electric arc through which silver-iodide crystals are passed. The vapor thus produced is ejected from the plane through 10 tubes spaced around the fuselage to provide maximum mixing with the slipstream air. The vapor may also be mixed with the water of combustion that condenses from the engine exhaust or it may be mixed with an atomized water spray that is ejected from the plane under high pressure.

C. S. Barnes, president of Precipitation Control, spent $3\frac{1}{2}$ years developing his present equipment and has flown numerous rain-making contracts. A typical operation consisted of a number of cloud-seeding flights over Bear Valley in the San Bernardino Mountains of southern California last spring during a period when the whole region was experiencing one of the worst droughts in its history. Bear Valley received from 90 to 180 percent of

(Continued to page 270)

U T I C A

UTICA TOOLS

For More Tool Mileage

TOOL No. 91
4", 6", 8", 10", 12"
Adjustable Steel Wrench

**SEE
YOUR
DEALER**

UTICA DROP FORGE & TOOL CORP.
UTICA 4, NEW YORK

Announcing **CHAMPION** V-Glow Plugs

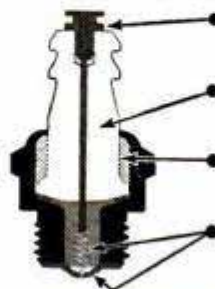

CHAMPION TERMINAL—assures better center electrode seal and provides sturdier electrical connection.

CHAMPION-CERAMIC INSULATORS—proved dependable in millions of Champion Spark Plugs.

CHAMPION SILLMENT SEAL—prevents excessive compression leakage between insulator and shell.

CHAMPION "THERM-O-FLEX" CONSTRUCTION—longer element life, more dependable performance.

Follow recommendations of plug types and fuels approved by engine manufacturer.

CHAMPION

SPARK PLUG COMPANY, TOLEDO 1, OHIO

DEPENDABLE

CHAMPION

SPARK PLUGS

America's Favorite! →

Quick starting and smooth, effortless engine performance on cold mornings are, in large measure, due to dependable spark plugs. In the opinion of most engine experts and motorists in general, no spark plug is more dependable than Champion—America's Favorite—because they represent the ultimate in quality, value, performance and dependability.

CHAMPION SPARK PLUG COMPANY, TOLEDO 1, OHIO

*FOLLOW THE EXPERTS
DEMAND NEW DEPENDABLE CHAMPIONS
FOR YOUR CAR*

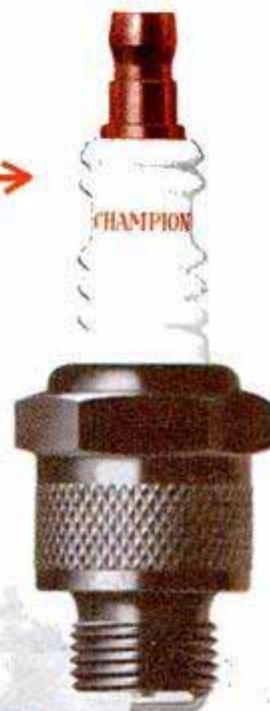

Listen to the CHAMPION ROLL CALL . . . Harry Wismer's fast sportscast every Friday night, over the ABC network

What makes the difference?

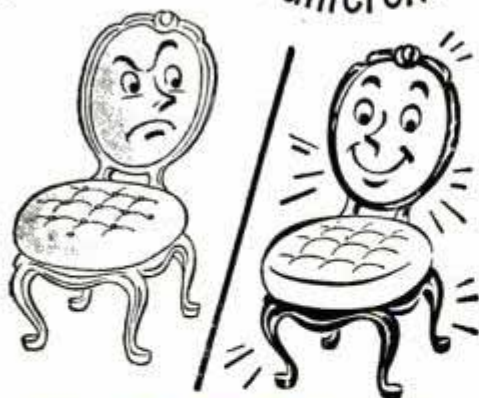

LIN-X

CLEAR-GLOSS VARNISH

Yes, and what a difference! That clear, tough, long-lasting coat of Lin-x Clear-Gloss Varnish protects and beautifies floors, woodwork, furniture, printed linoleum, boats, countless other surfaces—resists boiling water, sizzling cooking greases, alcoholic beverages. And so EASY to use—just brush it on!



At your paint, hardware and department store!



Distributed by

Acme White Lead & Color Works, Detroit • The Lowe Brothers Co., Dayton • John Lucas & Co., Inc., Philadelphia • The Martin-Senour Co., Chicago Rogers Paint Products, Inc., Detroit • The Sherwin-Williams Co., Cleveland



Larger, longer body lines, new luxury interior appointments. New highest compression (7.8 to 1) Crosley engine. More power—up to 50 miles on a gallon. Costs less than an 8-year-old, high up-keep used car! Prices range downward from the Station Wagon at only \$929 F. O. B. Marion, Indiana. Five beautiful new models.

CROSLLEY
a FINE car

For complete new catalog, write: Crosley Motors, Inc., 2530-HC Spring Grove Avenue, Cincinnati 14, Ohio.

its normal rain and snow during the time that Barnes operated, although in adjacent areas the precipitation averaged only 48 percent of normal.

Dry-Ice seeding for the Arizona experiment was done by Weath-Air's war-surplus B-25, now fitted with a Dry-Ice chute. The B-25 also carries a silver-iodide oxy-acetylene smoke generator that uses an open forced-draft combustion chamber, not employed in the Arizona tests.

At the end of the 90-day experimental period it was found that rainfall to the ground was started or increased locally on 66 percent of the flights. On 19 percent of the flights it was difficult to determine whether the observed rain had been artificially produced, and on 15 percent of the flights no rain was started.

In practically all cases where rain occurred either generally or in showers over the entire area, the heaviest rains were recorded directly below and down-wind of the points that were seeded.

A direct way of measuring the exact amount of rainfall that is artificially induced doesn't exist. Close approximations, however, can be obtained when records of past weather sequences and the resulting rainfalls are available.

This permits use of the analogue method of evaluation, a wartime-developed technique. Briefly, a particular weather sequence is compared with similar atmospheric situations that occurred in the past. Other things being equal, the past rainfall is a good indication of the amount that will occur again. Any extra amount that is recorded during and immediately after a seeding operation can be ascribed to artificial nucleation.

In evaluating the results of the Arizona experiments, measurements of the water that flowed into the reservoirs were compared with the inflows that should have resulted from the existing weather sequences. Records of past inflows, tied to past weather sequences, provided the basis for comparison. By this method it was found that, following a single six-day operational period, a surplus of 5570 acre-feet of water that may be ascribed to the seeding flights was put into storage. A detailed study for two six-day operational periods showed that in all some 12,000 extra acre-feet of water were impounded. These figures do not account for the additional water that fell on the surfaces of the reservoirs themselves and could not be measured by the flow meters at the intakes. Similar positive results were obtained subsequently in a single seeding

(Continued to page 272)

Piston rings
 need
 replacing
 too!

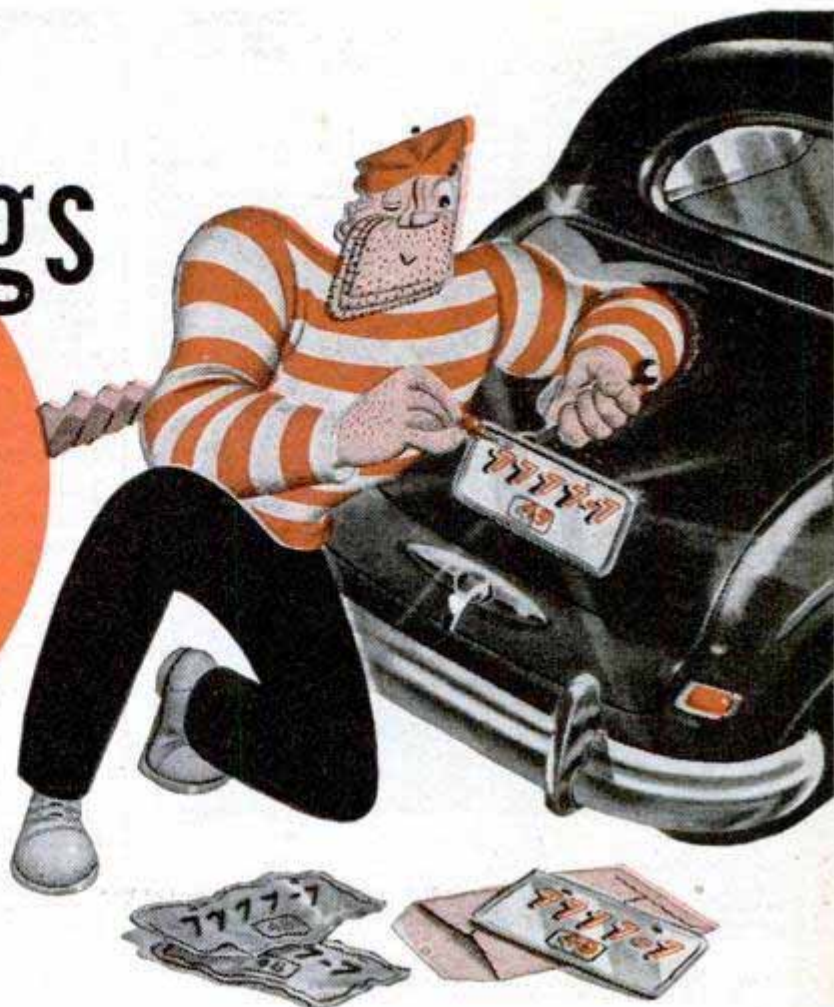

● Oil-pumping in your car flashes a warning that your piston rings are worn and should be replaced immediately.

Fortunately, replacing piston rings is a comparatively simple and inexpensive job.

And when you replace with Hastings Steel-Vent Piston Rings, you *stop* oil-pumping, *check* cylinder wear and *restore* performance.

It's the best money you can spend on your car.

HASTINGS - MANUFACTURING COMPANY • HASTINGS, MICHIGAN
 Hastings Ltd., Toronto

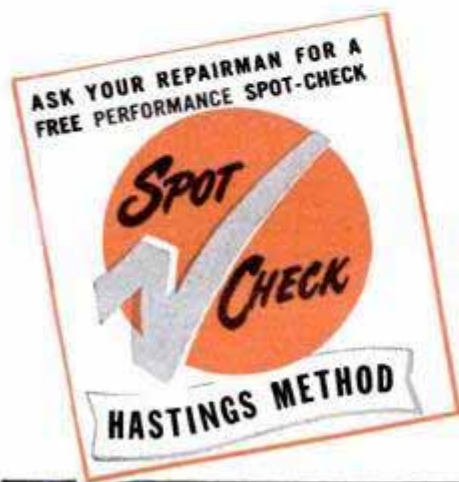

HASTINGS

STEEL-VENT PISTON RINGS

"TOUGH... BUT OH SO GENTLE"

TOUGH on oil-pumping — **GENTLE** on cylinder walls

LAST YEAR'S PROFIT
\$ 3,000!



with a

FOLEY SAW FILER

"Last year's profit amounted to \$3000. Not so bad for a one-man outfit" — from C. C. H., Penn. From Ohio J. B. W. wrote us—"I made \$765 last year filing saws, and it sure comes in handy. I do this work in my spare time." Men in communities of all sizes make up to \$2 or \$3 an hour with the Foley Saw Filer working full time or part time. That extra money comes in mighty handy in these days of high prices.

It's no trick to take care of the saw filing for your neighborhood hardware or lumber dealer — plus looking after the saws for farmers, townspeople, manual training departments and factories. The Foley files all hand saws, also band and cross-cut circular saws. It's a cash business, no canvassing, no eyestrain and no experience needed.

FREE BOOK Shows How to Start

INDEPENDENCE AFTER 40 shows just how you can start at home in your spare time — work in your basement or garage. It's an immediate cash business that can develop into a full-time repair shop.



Send for **FREE BOOK**

FOLEY MFG. CO., 316-9 Foley Bldg.
Minneapolis 18, Minn.

Send me free book "INDEPENDENCE AFTER 40."

Name _____

Address _____

flight that was conducted over the watershed of Lago Toronto, Chihuahua, Mexico, by the same team.

The objective of the Arizona campaign was to increase materially the amount of water in storage. The ability of seeding operations to produce heavy downpours that result in heavy runoffs to the reservoirs was well demonstrated. Although the rain-making efforts were conducted as a research project rather than a normal business operation, the extra water that was placed in storage was produced at a cost of between \$2.00 and \$2.50 per acre-foot, a price that is satisfactory from an economic standpoint.

It's doubtful that chance alone could be responsible for these heavy downpours of rain. Research and development work are being continued, in any event, for artificial nucleation apparently may provide the water in dry years to save crops and grow the grass that makes cattle fat.

Frostproof Hydrant

Weather is no problem with a frostproof hydrant that provides a flow of water even though it is frozen solid. Secret of the device is a pipe-inside-a-pipe. The inner pipe is a rubber lining that runs the length of the riser-spout from the valve, below the frost line, to the outlet. When the water is turned off, the rubber lining, that is installed under tension, contracts until it holds a column of water not much thicker than a pencil. This water is above the frost line and freezes. When the valve is opened, the pressure of the water system expands the rubber lining against the pipe, allowing water to flow past the ice and out the spout. The flowing water soon melts the ice, completely clearing the hydrant.

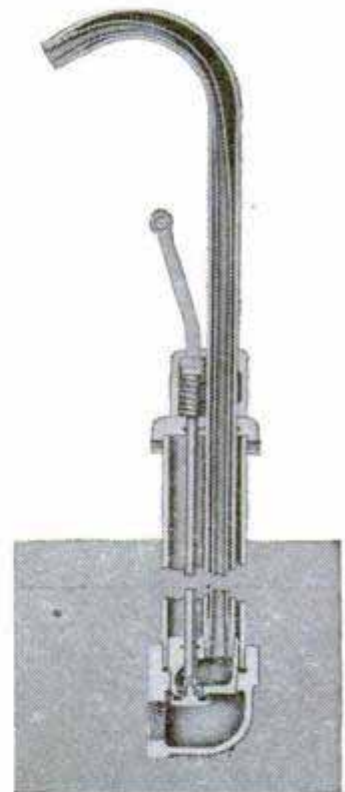

☐ New-model passenger cars require an average of 1000 pounds more steel per vehicle than those produced during the early 1930s.

No. 85
Utility Boat, \$1.00



No. 113
Garage & Tool House,
\$1.00

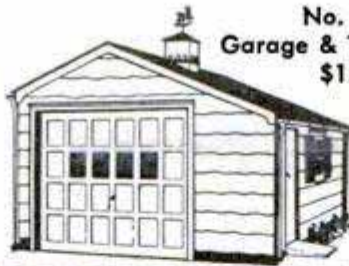

No. 80
Service Counter, \$0.60

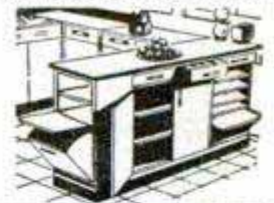

No. 75
Terrace Table,
\$0.35



MAKE YOUR OWN *and* SAVE WITH AN *Atlas* TILT/ARBOR SAW

No. 78
Garden Chaise, \$0.35



Thousands of American men are using their shops to save hundreds of dollars a year . . . building shelves, cupboards, cabinets, garages, furniture remodeling . . . beating high prices with their own skill and the new Atlas big-capacity quality tools. So can you. The 97 Easi-Bild patterns will help you get started. An Atlas 8" Tilt/Arbor saw should be your first shop power tool.

The Atlas 8" gives you so much more saw for your money it's hard to make comparisons. It has a tilting arbor — *table is always flat*. Cuts 2 3/8" deep. The table is *grey-iron — precision-ground*. It is 22" x 18" (22" x 35 1/2" with two extensions) and has 10 5/8" working surface ahead of blade — the capacity you'll want for big boards and panels. The new-type rip fence locks at *both ends* — releases instantly for easy positioning. Vernier control for fine adjustment. Blade height and angle controls work smoothly. Dust-sealed *ball bearings* assure long, smooth, accurate service.

See the saws at your Atlas dealers. Start saving money with your shop this month! Send the coupon today for full details about the tools you want.

\$89.75
F.O.B.
Kalamazoo
less motor
and
extensions.



Atlas TOOLS FOR YOUR SHOP

24" Jig Saw
6"-10" Lathes
Belt, Disc Sander
Spindle Shaper
Drill Presses
12" Wood Lathe

**SEND
THIS
COUPON**

ATLAS PRESS CO., 343 N. PITCHER ST., KALAMAZOO, MICH.

Send details on these Atlas Tools:

- 8" Saws Spindle Shaper Drill Press
 24" Jig Saw 10" Metal Lathe Belt & Disc Sander
 12" Wood Lathe

Cash Included for These Patterns

- No. 78 No. 113 No. 75 No. 80 No. 85

Send Complete Pattern Catalog

Name _____

Address _____

City, State _____



**MATCHED PRECISION TOOLS FOR
WOODWORKING AND METALWORKING**

Where Fishing Is Rugged

(Continued from page 121)

hole in order that the nets may be pulled or set smoothly, and he has an ordinary scoop shovel for clearing the hole of bro-



This wooden box contains 60 pounds of Great Slave Lake whitefish, carefully packed for the long trip

ken ice. Recently, the circular-type needle bar was replaced by a three-sided counterpart, more efficient than its predecessor.

For Great Slave fishing the law dictates that the gill nets used must have a mesh

of not less than 5½ inches. This regulation, obviously, is in the interests of conservation, limiting the size of the fish netted. While an undersized fish will slip through the mesh, the larger ones get hung up by the gills as they attempt to back out of the mesh.

For his \$10 license fee the fisherman may put out 1000 yards of gill net. In addition to his equipment, which he either rents or buys outright, the fisherman is responsible for his cabin or cabooses, his living expenses and, of course, the warm clothing necessary for the job. Each morning he totes along 10 to 15 pairs of woolen mitts, changing them as soon as they become wet. Parkas, with adequate hoods, are standard dress. For foot covering, the time-honored combination of Indian moccasins and low rubbers is most popular.

The fisherman usually teams up with one, two or three others as the operation is not an efficient one-man deal. They seldom work on a direct salary basis with the fish companies, preferring to gamble on the catch. On Great Slave this winter some crews of three were averaging 1000 pounds a day but many were far below that figure. Much depends on the experience of the fishermen and the locality.

As a rule, the fishermen operate on a

(Continued to page 276)



#411 South Bender

Presto-Lock offset handle locks reel and tip, aligns stainless steel guides and tip-top perfectly. Lengths 4'11" or 5½'. \$13.50. Solid and tubular steel rods, \$5.50 up.

THRILLING ROD ACTION

THE #411 SOUTH BENDER HAS IT!

Want a rod that lets you feel every leap and lunge of a fightin' fish? Then, try a No. 411 South Bender. The smooth, live-action of its 3½ ounce tip is the answer to sportier, thrill-packed fishin'.

The controlled flexibility of its solid alloy tip has just the right whip for perfect, effortless casting. You

haven't seen anything—or felt anything—in bait casting rods until you cast with a South Bender.

FREE!
New Book on Fishing
Every fisherman needs "Fishing—What Tackle and When." 76 pages of fishing hints, casting instructions, fish pictures, tackle. Write for it today!
SOUTH BEND BAIT CO.
891 HIGH STREET
SOUTH BEND 23, INDIANA



Perfectoreno Reels—no backlashes. \$10 — \$16.
Excel-Oreno Fly Line—the finest made. \$1.85 up.
Black-Oreno Line—Guaranteed. 50 yds. \$1.20 up.
Split Bamboo Fly Rods—14 models. \$15 — \$35.
Oren-O-Matic Fly Reels—automatic. \$10, \$10.50.

SOUTH BEND

A Name
Famous
in Fishing

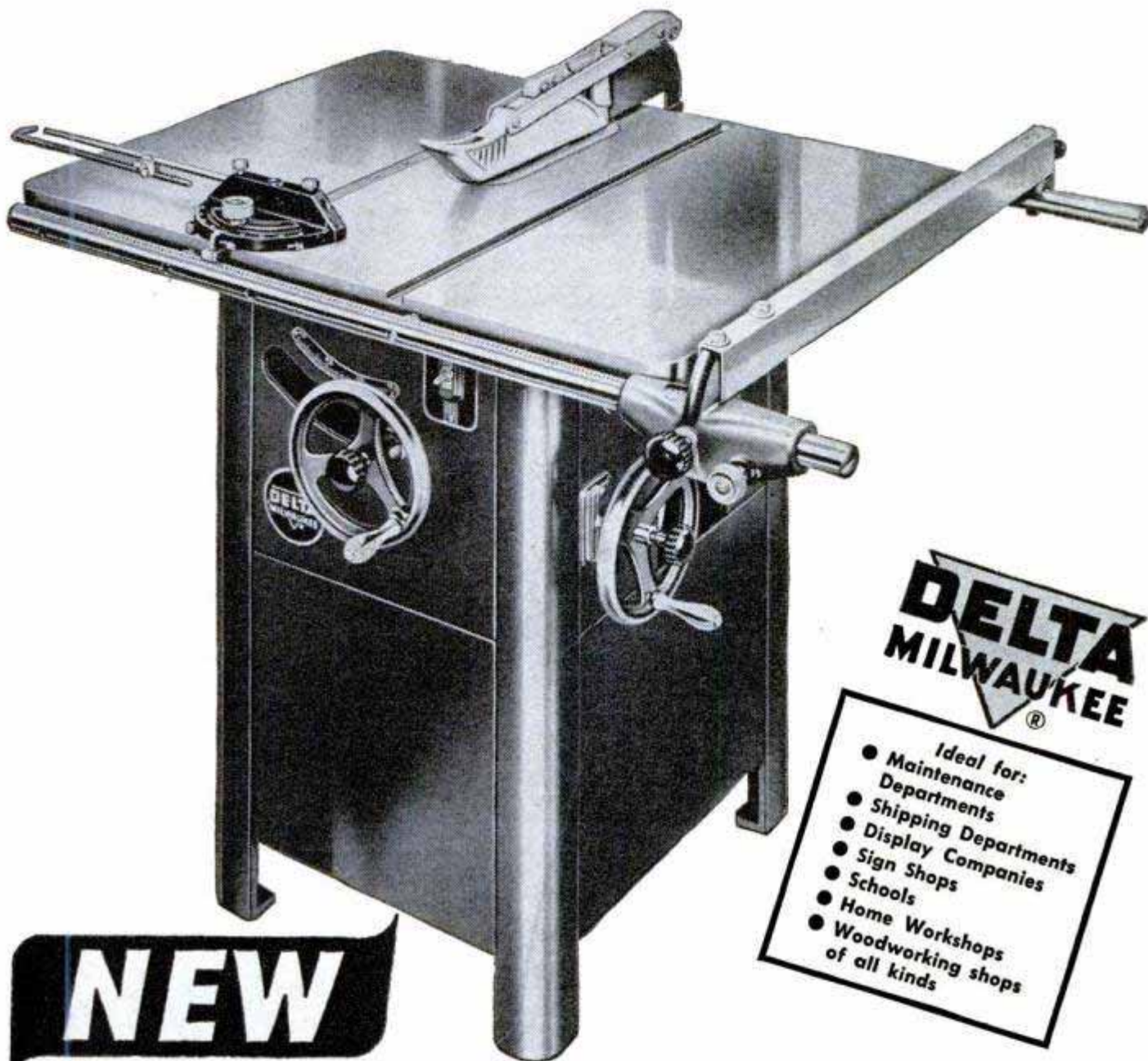

**DELTA
MILWAUKEE**

- Ideal for:*
- Maintenance Departments
 - Shipping Departments
 - Display Companies
 - Sign Shops
 - Schools
 - Home Workshops
 - Woodworking shops of all kinds

NEW

DELTA® 8" Tilting-Arbor Saw

**Does all circular-saw work . . .
quickly, easily, accurately**

A compact floor model — fits in small space. Takes maximum vertical cut of 2-5/16". Welded steel cabinet is of 18-gage metal. Big 25" x 33" cast-iron table — heavily ribbed for rigidity. 12" working surface in front of blade at maximum cut. Rip fence extends from front to back of table. Set-over feature of guide rails increases rip capacity at right of blade from 20" to 27". Convenient hand-wheel controls. Adjustable table insert. Auto-set miter gage. "Super-safe" saw guard. Universal motor bracket takes any frame motor. Price, \$149.50, without motor and switch—subject to change without notice.

Have your nearby Delta distributor show you this new Delta 8" Tilting-Arbor Saw. And have him tell you how you can get it on easy credit terms. See him now.

Look for the name of your Delta distributor under "Tools" in the classified section of your telephone directory.

Free Bulletin AD-455! Pictures and describes the new Delta 8" Tilting-Arbor Saw, feature by feature. Shows why Delta quality construction means longer saw life and greater operating satisfaction.

Also available without charge is Delta Catalog B-48—a handbook of woodworking machines. Request both, by coupon below.



TEAR OUT COUPON AND MAIL TODAY!

DELTA MANUFACTURING DIVISION
Rockwell Manufacturing Company
680C E. Vienna Avenue
Milwaukee 1, Wisconsin

Send me free copies of Bulletin AD-455 and Catalog B-48.

Name.....

Title.....

Company.....

Address.....

City..... State.....

HM-66

partnership basis, or one may be a "boss man" with a couple of hired hands who usually draw about \$150 monthly together with food and smokes and transportation to and from their homes, and who usually regard the job as an apprenticeship prior to going on their own. Occasionally, too, fishing turns into a family affair. Among the North's most consistent producers are the Powders at Caribou Bay. Robert, the father, and Rex, a young son, perform the arduous and more rigorous tasks of setting and pulling the nets while the girls of the family attend to the packing.

Together the crews live in the lake-shore cabins or in one of the cabooses far out on the lake. The cabooses are on skids and can be hauled by the Bombardiers whenever the fishermen decide to "follow" the fish which tend to migrate to deeper water as the weather becomes colder. Each day some or all of the nets are pulled and the fish removed. They are cleaned at once, the fisherman employing a round-tipped butcher-type knife which enables him to finish the operation in two adept strokes. The first slices open the fish, the second deftly gouges out all entrails. Fresh fish are packed in wooden boxes and iced down while the frozen product is often cartoned on the spot to be picked up later.

Whitefish and lake trout are the goal of all fishermen on Great Slave as remuneration varies according to the kind of catch as well as volume. Tentative prices to the fisherman, at the time of this writing, were 10 cents per pound for lake trout, medium-sized, and 8 cents for those described as "headless" because their heads must be cut off before they'll fit in the standard fish boxes. "Headless" indicates a larger and older fish, secondary in food value to the tender mediums. Whitefish, the bulk of the catch in Great Slave, was bringing eight cents a pound. A lower value was set on "connys," the inconnu, which is found in abundance in the Mackenzie River and many of its connecting lakes. The conny looks like an overgrown whitefish, also has some of the trout's characteristics, tips the scales to 40 pounds fairly consistently, but is not considered as delectable as the Slave's whites and trout, ranked among the world's finest table fish.

When next you sit down to a meal of Great Slave fish, dwell a moment on its story and the "miles and miles of nothing but miles and miles" from which it came. You might also save a thought for hardy northerners like Frank Ladoucier, Bill Workun and Indian families like the Powders who are braving the rigors of the sub-Arctic to set their nets.

GROBAN'S - WAR SURPLUS BARGAINS

Hand Hydraulic Pump

Brand New

Used for hydraulic jacks, presses, hoists and other hydraulic applications. For operating hydraulic cylinders to pump oil or hydraulic fluid under pressure. Hand pump has built-in check valve and is capable of delivering 1000 lbs. of pressure. Has alloy aluminum housing. Dimen.: 8" long x 3 1/2" high x 2 3/4" wide. Ship wt. 3 lbs. A \$45.00 value Now **\$8.95** postpaid



Self-Priming ELECTRIC PUMP

APPLICATIONS: oil burners, aquariums, fluid metering, fuel pump, tool post grinder, coolant pump, pressure lubricating pump, general industrial, etc.

MOTOR MFD. BY BLACK & DECKER; double ball bearing series wound, continuous duty, 1/30 H.P. electric motor, rated 12,000 R.P.M. Transformer included for use on 110 V AC current. Also applicable for 24-32 V DC.

PUMP MFD. BY WELDON TOOL CO. with standard 1/4" tubing ports; rated 2 G.P.H.; remove pump and use motor as high speed grinder.

OVERALL DIMENSIONS: 7 3/4" long x 3 1/4" wide x 3 1/4" high. Approx. wt. 5 lbs. \$51.00 value.



Compact - BRAND NEW

\$12.95 postpaid

SHOP BY MAIL and SAVE
Better buys • Satisfaction guaranteed

ALL-PURPOSE WATER PUMP

Mfd. by PACKARD MOTOR CAR CO.

Ready for use on any pumping need

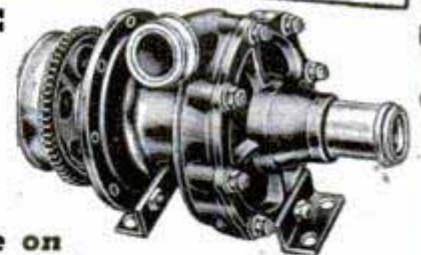

Brand New

Belt Driven - Centrifugal Pump

An extraordinary value for all types of intermittent or continuous pumping in the home, farm, or factory. Built to exact specifications of Packard Motor Car Co. for use in Rolls-Royce Merlin Aircraft Engines. May be run with electric motor, gas engine or power take-off on tractor. Delivers up to 25 gallons a minute with 1/4 H.P. motor; 80 gal. a min. with one H.P. motor. Will deliver up to 44 ft. head or 25 ft. suction. Use 1" outlet hose; 1" or 1 1/2" inlet hose (recommended).

COMPLETE ENGINEERING REPORTS AND OPERATING INSTRUCTIONS FREE WITH PUMP

Has cast aluminum housing, accurately machined 5" bronze impeller; 3 1/2" V belt pulley and mounting brackets. Shaft rotates on ball bearing; has grease gun fitting.

\$21.50

Original cost approx. \$88.00. Shipping weight 10 lbs. A REAL BUY.

F.O.B. Chicago

- Use it for: DRAINING BASEMENTS
- HOME WATER SYSTEMS
- FIRE PROTECTION
- PRESSURE BOOSTER
- IRRIGATION
- DRAINING PONDS, TANKS, etc.
- SPRINKLING SYSTEMS
- STOCK WATERING
- INDUSTRIAL PUMPING

Complete with pulley and mounting brackets, ready for use.

WRITE FOR OUR FREE CATALOG!

ORDER DIRECT FROM AD SATISFACTION GUARANTEED
Send payment or purchase order today

GROBAN SUPPLY CO.
1507 S. MICHIGAN AVE., Chicago 5, Dept. PM-3

GROBAN'S-WAR SURPLUS BARGAINS

SHOP BY MAIL and SAVE
Better buys • Satisfaction guaranteed

MINIATURE High Speed ELECTRIC MOTOR

IDEAL FOR MODEL BUILDERS, MODEL RAILROADERS, EXPERIMENTERS, HOBBYISTS. AC or DC. Reversible, speed may be regulated by varying voltage. Has miniature Kilixon thermostat switch. All connections are external and accessible. Has 3 mounting feet for easy installation. Double-end ball bearing supported shaft with small gear on one end. Die-cast housing with laminated field. Overall Dimen.: 3 1/4" long x 2 3/8" wide x 1 3/8" high. Net wt. 12 oz. A \$22.00 value.



Brand New
\$2.95 postpaid

AIR FORCE WOOD PROPELLER

Decorate your den, trophy room, office, clubroom with a BRAND NEW genuine Air Corps Propeller. Made of polished laminated hard wood, 6 ft. long. Ship. wt. 75 lbs. GOVT. ACQUISITION **\$12.95** TION COST \$112.00. NOW ONLY F.O.B. Chicago

Vickers MF9 Hydraulic PUMP or MOTOR

complete with mounting kit ready to install



\$75.00 value

\$19.90 POSTPAID

Pump is compact, powerful, rated 1,000 P.S.I., .507 cu. in. per revolution, 8 gal. per min. at 3750 RPM. Change rotation by reversing flow. Delivers up to 6 H.P. Requires 1/3 to 6 H.P. to drive directly or by pulley. BRAND NEW. Mounting kit has been especially designed to provide maximum utility and ease of mounting MF Series Vickers Pumps. Brackets are constructed of heavy steel plate; shaft is made of 1/2" steel with one end splined to fit pump; other end of shaft has machined flat for mounting a standard pulley with 1/2" hole. Shaft runs in oilite bronze bearings.

Pump only \$14.95 postpaid
Mounting kit only \$ 4.95 postpaid
Both as complete unit \$19.90 postpaid

Hydraulic Pressure Gauge

BRAND NEW

Ideal for high pressure hydraulic systems, adjusting pressure, relief valves, etc. Range 0 to 2000 P.S.I. Black plastic case 2 3/8" square, 1 3/4" deep. Black instrument face with white pointer and numerals. Worth many times this low price of postpaid **\$2.95**



ADJUSTABLE RELIEF VALVE . . . \$2.95 postpaid

FREE: New, 20-page illustrated Hydraulic Manual featuring diagrams, photographs and instructions—FREE with each hydraulic order.

Self-Priming BRONZE PUMP

BRAND NEW

Positive Pumping Pressure

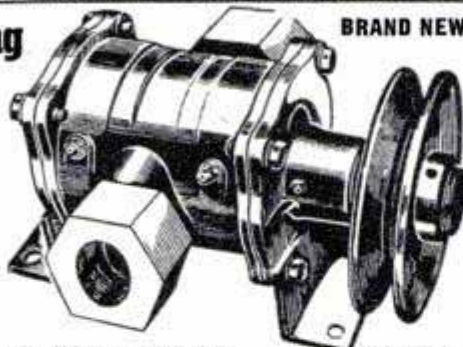

Perfect for draining basements, irrigation, fire fighting, sprinkling, pressure booster, insecticide and other spraying, fuel transfer, stock watering, industrial pumping, deep well jet pumping and home water systems. Rated 25 ft. suction and 150 ft. head pressure at 80 gallons. Use from 1/3 to 5 H.P. motor. Mfd. by the Pump Division Eaton Mfg. Co.

Complete engineering report and instructions FREE with pump

Supplied with mounting brackets and 3" V belt pulley, ready for instant use. Standard 1 1/2" pipe thread inlet and outlet. Dimensions: 9 1/2" x 7 3/4" x 4 1/4". Ship. wt. 18 lbs. A \$142.00 value.

\$32.50 F.O.B. Chicago

WRITE FOR OUR FREE CATALOG!

BRAND NEW Air or Oil HYDRAULICS

Use hydraulics on arbor presses, hydraulic presses, hay lifts, manure loaders, lift trucks—push or pull, tilt or turn, press or squeeze, open or close, lift or lower—and other hydraulic and industrial applications. Use with either air or oil . . . of finest precision workmanship.



1. Double action, 1 1/2" bore, 5" stroke, will lift 1760 lbs. in one second with Vickers MF9 Pump. Wt. 3 lbs. A \$35.00 value. postpaid **\$8.95**
2. Double action, 1 1/2" bore, 9" stroke, will lift 1760 lbs. in one second with Vickers MF9 Pump. Wt. 4 lbs. A \$45.00 value. postpaid **\$10.95**
3. Use these cylinders on farm trucks, bulldozers, hay lifts, manure loaders, etc. Double action, 1 1/2" bore, 27" stroke. (Will lift 1760 lbs. in 2 seconds with Vickers Pump.) Wt. 8 lbs. A \$55.00 hydraulic cylinder value for only. postpaid **\$12.95**
4. Double action, 2 3/8" bore, 8" stroke. (Will lift 4400 lbs. in one second with Vickers Pump.) Will withstand 1500 P.S.I. against wall. Wt. 7 lbs. A \$65.00 value. postpaid **\$14.50**
5. Double action 2 3/8" bore, 5" stroke, two-way solid 5/8" alloy steel shaft (will lift 4400 lbs. in one second with Vickers Pump). A \$73.00 value. postpaid **\$16.50**
6. Double action, 3" bore, 10 1/2" stroke. All steel hydraulic cylinder, will lift up to 12,000 lbs. (7000 lbs. in 3 seconds with Vickers Pump.) Complete with fittings. Wt. 12 lbs. A \$78.00 value. postpaid **\$19.50**
7. Double action, 3 1/2" bore, 11" stroke. (Will lift 9600 lbs. in 7 seconds using Vickers MF9 Pump.) Complete with fittings. Wt. 15 lbs. A \$92.00 value. postpaid **\$22.50**

Fittings available for above cylinders.

Hydraulic Control Valves Brand New



1. Four-way control valve with built-in relief valve, for use with double action hydraulic cylinder, may be used with 1500 P.S.I. hydraulic system to open and close hydraulic cylinders. Brand new. Ship. wt. 4 lbs. A \$38.00 value. postpaid **\$7.95**
2. Four-way control valve for use with two hydraulic double action cylinders. Each cylinder may be operated independently of the other or in conjunction with the other. Oil may be locked in any of the cylinders to hold the piston at any required position. Brand New. Ship. Wt. 6 lbs. A \$60.00 Value. postpaid **\$10.95**
3. A two cylinder double action valve with a unique arrangement, allowing the operator to raise both cylinders simultaneously, to lower them simultaneously or to raise one and lower the other at any predetermined rate and speed. Brand New. Ship. Wt. 8 lbs. A \$75.00 value. postpaid **\$14.95**

BRAND NEW

Vickers Heavy Duty HYDRAULIC PUMP



For tractors, bull-dozers, construction machinery, lift trucks, industrial applications, etc. Used on Ross carriers. Delivers 18 gal. per minute at 1000 P.S.I. at 1200 R.P.M. using 10 H.P. Has 1 1/2" intake; 1 1/4" outlet; threaded and keyed 3/4" shaft for direct or pulley drive. Wt. 40 lbs. Dimensions: 5 3/4" diameter, 7 1/2" high. Original value \$148.00. NOW **\$39.50** F.O.B. Chicago

Brand New Vickers Heavy Duty HYDRAULIC CONTROL VALVE

This Vickers heavy duty 4-way control valve, Part C-2330, is ideal for use with the Vickers Heavy Duty Pump for double action cylinders. Has built-in relief valve with 50 to 1000 lbs. per sq. in. overload adjustment; max. capacity 24 GPM; pressure inlet connection from pump 3/4" pipe thread; cylinder connections 3/4" pipe thread; discharge connection to tank 1 1/4" pipe thread; Over. dimen.: 8 3/8" W. x 10 7/8" L. x 7 5/8" H. Ship. wt. 54 lbs. ORIGINALLY COST MANY TIMES MORE. NOW **\$24.95** F.O.B. Chicago

ORDER DIRECT FROM AD
Send payment or purchase order today
SATISFACTION GUARANTEED

GROBAN SUPPLY CO.

1507 SOUTH MICHIGAN AVE.

Chicago 5, Ill. Dept. PM-3

CUSTOM BUILDERS

EQUIP YOUR RADIO CONSOLE WITH THIS Quality CHASSIS



NEW ESPEY MODEL 511 AM-FM CUSTOM BUILT

Install this High Fidelity Instrument in your old radio console and marvel at the difference.

- Here is a fine radio, in chassis form, to please the most discriminating music lover.
- Easy to install in any console cabinet old or new, the Espey 511 AM-FM radio chassis embodies the latest engineering refinements for lasting high quality at a price that defies competition.
- Features, 12 tubes plus rectifier and tuning indicator; drift compensated circuit for high frequency stability; tuned RF on AM and FM, high fidelity push-pull audio; 13 watts power output; wide range 12" PM speaker; smooth flywheel tuning; phono input provision; separate AM and FM antennas. Other models available including 25 watt output.

SATISFACTION GUARANTEED

Makers of fine radios since 1928.

Write for catalogue Ds containing complete specifications and the name of our nearest distributor.

ESPEY TEL. BUtterfield 8-2300
MANUFACTURING COMPANY, INC.
 528 EAST 72nd STREET, NEW YORK 21, N. Y.

Learn A Trade NOW!
PRACTICAL SHOP TRAINING!

In Our Chicago Shops

- | | |
|---|--|
| <input type="checkbox"/> AUTO MECHANICS | <input type="checkbox"/> WELDING—ARC and GAS |
| <input type="checkbox"/> DIESEL MECHANICS | <input type="checkbox"/> MACHINIST |
| <input type="checkbox"/> REFRIGERATION | <input type="checkbox"/> PIANO TUNING |
| <input type="checkbox"/> BODY-FENDER | |

Above Approved For G. I.'s and Civilians
 One of America's Leading Practical Schools
 7 Floors of Fully Equipped Shops
 Over 48,000 Successful Graduates
 Expert Individual Instruction
 Learn by Doing—Low Living Expense
 Established 1902—Day and Evening Classes

Also the following Home Study Courses

- | | | |
|----------------------------------|--|---------------------------------|
| <input type="checkbox"/> PLASTIC | <input type="checkbox"/> REFRIGERATION | <input type="checkbox"/> DIESEL |
|----------------------------------|--|---------------------------------|

— CALL IN PERSON OR MAIL THIS AD TO —

GREER SHOP TRAINING

(Desk 10) 460 South State St., Chicago 5, Ill.

Please send without obligation free information regarding trade checked above. (Specify whether you are a Veteran or Civilian)

Name _____ Age _____

Address _____

City _____ State _____

BACK ACHE?

SORE MUSCLES?



When muscles are stiff and sore from unusual exercise or strain, use HEET®, the liniment that's strong yet does not burn the skin. Wonderful relief from muscular soreness comes as comforting HEET quickly starts to penetrate. Just brush it on with the applicator. HEET starts at once to ease muscular pain and keeps on working for hours. Ask your druggist for HEET liniment.

TUBULAR STEEL AXLES \$6⁹⁵

BUILD YOUR OWN TRAILER OR UTILITY FARM WAGON

FORGED COUPLER BALLS
 2 in. dia.
90c
 incl. Nut and washer

58" tread width axle—1 ton capacity
 Fits Ford V8 or Plymouth wheels
 Higher tonnage axles and special tread widths available at reasonable prices. Axle also adaptable to Chevrolet wheels. Write for folder today. Send check or money order.
CARD BRINGS FREE FOLDER

C.A.R. PRODUCTS CORPORATION
 1811 6th St. Wyandotte, Mich.

Save Your Car and Your Temper WITH A HULL AUTOMOBILE COMPASS

Wrong turns mean lost miles, time and driving pleasure. Be right, every time, with a Hull Automobile Compass. Beaconlite illuminated, \$5.95. Streamline standard, \$3.95. At your dealer's. Write for literature.

HULL MFG. CO., P.O. Box 246-D3, Warren, Ohio



AMAZING SHAVE INVENTION!



VESTPOK is the perfect answer to between-shaves stubble trouble. Match book size. Needs no soap, mirror or electricity. Use any time, any place. Formerly nationally advertised at \$3. Now only \$1., with 10 blades of finest razor steel. Immediate shipment. Satisfaction guaranteed. Vestpok Division, Dept. V10, Ward Machine Co., Inc., Brockton 64, Mass. **\$1**



TYPEWRITERS!

For Sale At Big Savings
ALL MAKES — REBUILT LIKE NEW
 For School, Business or Home Use

Write for Information
M. & M. TYPEWRITER CO.
 84 W. Washington St. Chicago, Ill.

SAY YOU SAW IT IN POPULAR MECHANICS

New MIRACLE WALL CLEANER

Saves Costly Redecorating!
AMAZING INVENTION. Banishes old-style housecleaning mess and mud. No tacks—no sticky "dough"—no red, swollen bands. No more dangerous stepladders. Literally erases dirt like magic from walls, ceilings, window shades, upholstered furniture, etc. *Endadruducery!* **SAVES REDECORATING!**

SAMPLES FOR AGENTS Sample offer sent immediately to all who send name at once. A penny postal will do. **SEND NO MONEY—** just your name. **KRISTEE CO., 676 Bar Street, AKRON, OHIO.**

10 SHELF PLANS

NEW FULL SIZE

New, full size, easily built, beautiful wall shelf plans ready to trace on lumber, cut out and assemble. Corner and wall racks with 1 to 3 shelves. Stores charge about \$75.00 for these shelves. Make money selling them. Finest selection available. PLUS BONUS of 48 other novel cut-outs, Dutch Boys, Girls, Toys, etc., etc. PLUS FREE new 1949 Handicraft Catalog. Send only \$1 to



JACKSON, Dept. 66
5440 N. Shoreland Ave.
Milwaukee 11, Wis.

Sand Casting — Forging — Heat Treating — Case Hardening

BRONZE FOUNDRY



In your own workshop allows you to design and build your own GASOLINE ENGINES, STEAM ENGINES, STATUARY, ART OBJECTS, SPECIAL TOOLS, NEW INVENTIONS, ETC. You can also make forgings and case harden steel. Your shop is not complete without a FOUNDRYETTE. Three sizes are available capable of making bronze castings of 1½, 3 and 6 pounds weight, aluminum, copper, brass, etc., \$22.50, \$29.50, \$42.00 f.o.b. Kansas City. Domestic gas supply and 110 volt AC or DC energy required for operation. Write for circular.

KANSAS CITY SPECIALTIES CO.
Box 6022, Dept. P-2 Kansas City, Mo.

MACHINE SHOP EQUIPMENT



The 1949 edition of the famous Center Tool Co. Catalog is now ready! Every workshop owner should have a copy. 240 pages full of illustrations, descriptions, and prices of the latest tools made by best known manufacturers in U. S. You pay the cost of printing—50c. We refund your 50c with your first order of \$10.00 or more. Prompt delivery on most tools. Send check or money order today!

CENTER TOOL CO., 153 Centre Street, Dept. C, New York 13

BUILD YOUR OWN FAST FREEZER

PLANS \$1

It's easy to build this household appliance with LeJay Plans. Made from new or used parts. Save up to 50%. No expert knowledge needed. Plans show 6 sizes and are easy to follow. All details clearly explained. Enjoy making one of these freezers. Mail \$1 for set of plans and catalog. **LEJAY MFG. CO., 447 LeJay Bldg., Minneapolis 8, Minnesota**



SEND THIS ON 1c POST CARD FOR

FREE CATALOG

(NEW SPRING EDITION)

of Guns, Fishing Tackle, Athletic Goods, Camping Equipment, Cameras, Western Goods.



ANDY ANDERSON'S SPORTING GOODS CO.
120-124 West Grand - - - Oklahoma City, Oklahoma

Name PM-3
Address
City State

Get This VALUABLE BOOK of SHOP TRICKS!

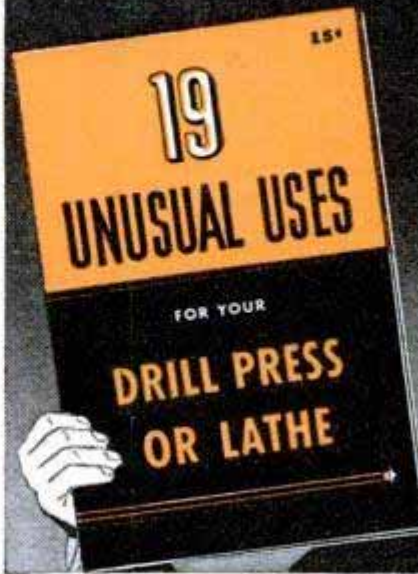

Thousands sold at 15¢... now it's yours for the cost of handling and mailing!

CONTAINS 19 EXTRA USES FOR YOUR LATHE AND DRILL PRESS . . . SHOP KINKS TO HELP YOU GET MORE AND BETTER WORK FROM THESE VERSATILE TOOLS

Just Mail Coupon and 10¢ . . .

Booklet Will Be Sent You By Return Mail

Be sure to see the new Jacobs Hand-Tite and Hex-Key Chucks. Both have the amazing new Rubber-Flex Collet that gives terrific gripping power, better accuracy, longer life. They'll put more work in your workshop. At your hardware dealer's.

IF IT'S A JACOBS... IT HOLDS



HEX-KEY CHUCK...fits drill press spindles — motor shafts — jack shafts. With Morse taper arbor, fits lathe headstock, tailstock. 4 models, capacities to ½"; fits ½" or ⅝" shafts.



HAND-TITE CHUCK . . . fits threaded spindle hand and power tools. . . used on polishing heads, bench grinders, flexible shafts, etc. 3 sizes . . . capacities to ½". Models to fit ⅜-24, ½-20 and ½-24 threaded spindles.

ONLY

Jacobs Chucks

Have The Rubber-Flex Collet
Its Parallel Bite Holds True and Tight

THE JACOBS MANUFACTURING COMPANY
150 Jacobs Road, Hartford 2, Conn.

Please rush my copy of "19 Unusual Uses For Your Drill Press And Lathe". I enclose 10¢ for handling.

Name
Street
City Zone State

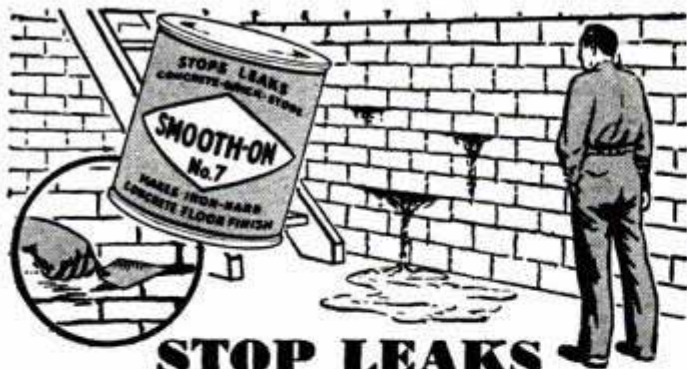

STOP LEAKS IN CELLAR WALLS

Do it with Smooth-On No. 7 Cement! Apply with trowel or stiff brush to leaky cracks, holes, porous spots, seams or other leaks in concrete, brick or stone walls and floors. The leaking will stop and Smooth-On will "stay put", for it expands slightly as it hardens. May be applied to wet or dry surfaces, indoors or outside. Use Smooth-On No. 7, too, to seal openings around pipes passing through walls. Buy Smooth-On No. 7 by name and number in 1-, 5-, 20- or 100-lb. size. If your hardware store hasn't it, write us.

FREE Leaflet and Handbook

We'll send you leaflet showing No. 7 uses, also the famous 40-page Smooth-On Repair Handbook describing other Smooth-On Cements and showing many helpful home repairs. 170 illustrations. Write today.

SMOOTH-ON MFG. CO., Dept. 37C
670 Communipaw Ave., Jersey City 4, N. J.



Do it with
SMOOTH-ON
NO. 7 CEMENT

Pick up **DOLLARS**
off the floor!

Start your own floor finishing business...
big profits—no overhead—small investment



Yes, YOU can make real money—and put the profits in your own pocket! Now's the time to cash in on new housing and construction. No experience needed. Our booklet instructs you completely in setting up, operating and selling your services. Get started now!

MAIL TODAY

HOLT MANUFACTURING CO.
651 20th Street, Oakland 12, Calif.

Gentlemen: I enclose 25¢ in coin or stamps for your complete booklet: "How to Make Money in the Floor Business." I understand there is no further obligation.

NAME _____

ADDRESS _____

CITY _____ STATE _____

ORIGINALLY \$30 to \$55 **MENS FULLY GUARANTEED NEW 15-JEWEL WRIST WATCH** 13.95 PLUS TAX

Sacrificed because they're post-war surplus
WATER REPELLENT—SHOCK PROTECTED
1 year written guarantee

Luminous dial... sweep second hand
Super-accurate... imported Swiss precision movement and case. You get them now for a small fraction of original prices. Don't delay! Order now... while they last. Send only \$1 down payment with order. Pay balance to postman on arrival, plus postage. Or we pay postage if you enclose \$13.95 plus \$1.39 Fed. Tax. Handsome expansion band included with prepaid order. Money back in 5 days if not delighted. Order now.



MARYLAND DISTRIBUTORS, Dept. 275
501 E. Baltimore St. Baltimore 2, Md.

OTTAWA Buzz Master



A faster brush cutter and wood sawing machine. Propels itself while cutting saplings and brush. 7 H-P motor. Many outstanding and exclusive features. Available attachments: sickle bar, rotary tiller, sprayer, air compressor, snow plow and pulley for belt work. Thousands in use. Send for FREE booklet.

OTTAWA MFG. CO., 1-927 Brush Ave., Ottawa, Kansas

HOT WATER in a JIFFY!

Pocket-Size **ELECTRIC WATER HEATER**
Boils Faster than Gas

Place heater in water, plug in electric socket. Boiling water in a "jiffy". Order now! Pay postman or send \$2.95 to Starr Mfg. 3521 Wesleyan Drive, Toledo, Ohio.



FURNACES FOR HOME AND SHOP



COAL—LP—GAS—OIL. Fittings, pipes and registers. Water heaters. Ranges and floor furnaces. BLOWERS with motors. Get the parts you need and modernize your own heating system. Wholesale & Retail. Lowest prices.

FREE BOOKLET

PEERLESS SALES & SUPPLY

4318 Sheridan Lincoln 6, Nebr.



ELECTRIC WELDER

AC or DC 110 Volts
Pre-war type—All metal—No chemical—5 year written guarantee. Welds 1/8" thick metal or money back. Repairs tanks, tools, fenders, machine parts, etc. Comes complete with rods, unit directions and eye shield.

\$645
COMPLETE

On C.O.D. mailing charges extra.
ESSAY MFG. CO., INC., Dept. P.M., Quincy 69, Mass.

GIVES YOU 2
DRILLS IN 1



Converts any 1/4 inch Electric Drill to 1/2 inch capacity. Reduction gears reduce speed 5 to 1, the average speed of 1/2 inch Drill thereby increasing power.

Jobbers write Price **\$1195**
for proposition

M.O. or check with order

G. M. CO. MANUFACTURING, INC.
1308 43rd Avenue
Long Island City 1, New York



RAMYR SELENIUM PLATERS
10 amps to 250 amps.
Model Shown, 10 amps ... \$39.95



**"Tops" IN MOUNTINGS, EQUIPMENT
and SUPPLIES for the
BRONZED BABY SHOE INDUSTRY**

Bases of Unbreakable Metal--Also of Onyx or Marble

Complete Shop Assemblies—any capacity from 10 to 500 pairs
weekly. Priced \$97.50 to \$3,500.

99 times out of 100 when your plating isn't right...it's your
solution that's wrong.

ANALYZING KIT

Complete with simple instructions \$17.95.
Will pay for itself many times over.



Descriptive literature
and wholesale prices
on request.

Your inquiries
invited.

Our engineering
service is at your
disposal at all times
without charge.

World's Oldest and Largest
HOLLYWOOD BRONZE SUPPLY

Headquarters: 1770 N. Vermont Ave., Hollywood 27, California



FEELS RIGHT...WORKS RIGHT!

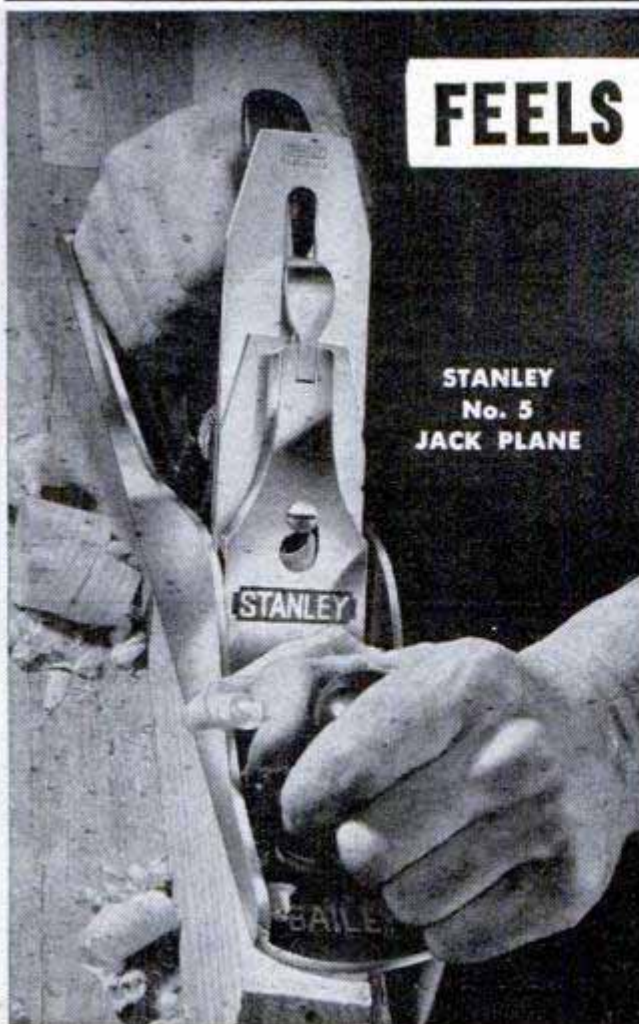

**STANLEY
No. 5
JACK PLANE**

The minute you grasp a Stanley Plane and ease the cutter into the wood, you feel the fitness of a fine tool . . . the skill of your hand and eye going right down to the face of the work. It's responsive! It's beautifully balanced! It's right in every detail, from the bevel of the cutter to the way the knob and handle fit into your hands. A lot more than good steel goes into a tool like that . . . the best ideas of generations of the best tool users. You can't get more than that in any tool: you always get a full measure of it in Stanley Tools.

Let this coupon bring you these two books

THE TOOL BOX OF THE WORLD

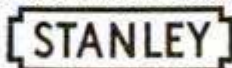

Reg. U.S. Pat. Off.

One is FREE! The other, the latest edition of a famous textbook for the home workshop, clothbound, fully illustrated, just \$1.00

— HARDWARE • HAND TOOLS • ELECTRIC TOOLS —

Stanley Tools, 139 Elm St., New Britain, Conn.

Please send by return mail:

FREE booklet: "The Joy of Accomplishment", 188-page book: "How to Work with Tools and Wood", \$1.00 enclosed.
(In Canada: Send order to Stanley Tool Co. of Canada, Ltd., Roxton Pond, Quebec.)

Name.....
Address.....
City..... State.....



"SAVE IT AND
FIX IT"

REPAIRS

CHINA, TOYS, FURNITURE
BOOKS AND LUGGAGE

It's transparent, waterproof,
flexible and durable.
Get a tube
today.



DUCO CEMENT

REG. U. S. PAT. OFF.



SWIVEL
JAW

NEW!

SEYMOUR SMITH
"Snap-Lock"
PLIER-WRENCH

3
NEW
Features

1. Swivel Jaw holds odd-shaped pieces.
2. Capacity Indicator pre-sets jaw spread.
3. Release unlocks jaws instantly by a touch of the finger.

Tremendous grip. Use as a plier or, when locked closed, for holding articles to be drilled, welded, ground, etc. 1000's of uses around home, farm, garage, shop. No. 2607, 7", \$1.75; No. 2610, 10", \$2.25. At your dealer or write direct. Free circular.

CAPACITY
INDICATOR



INSTANT
LOCK
RELEASE

SEYMOUR SMITH & SON, INC.
900M Main St., Oakville, Conn.



The Modern PLASTIC
for lasting Home Repairs

PERMANENTLY mends cracks or holes in wood, tile, stone or plaster. Sticks and stays put—Does not chip, shrink or fall out. Easy to use. Economical. Mold it, chisel it, polish or paint it. If unobtainable from your lumber, paint or hardware dealer, the big 4-lb. can will be sent you post-paid (in U.S.) for only \$1. Full money-back guarantee, order now.

DONALD DURHAM CO.
Box 804-O, Des Moines, Ia.

SHARPEN CIRCULAR SAWS LIKE AN EXPERT



With SURE-SHARP you can precision file circular saws in your own workshop. No experience necessary. Adjustable to any pitch or angle. Gets hollow-ground, cross-cut and combination saw blades true and sharp. Fits 6" to 12" circular saws with 1/2, 5/8, 3/4 or 13/16" centers. Complete with file, instructions, 4-different size mandrels. Money-back guarantee! Cash with order, \$6.95 postpaid. Hardware dealers inquiry invited.

SURE-SHARP MFG. CO., Box 24, Dept. 11, Santa Ana, Calif.

\$4.95 REAL ENGINE VALUE



A miniature gas engine that really operates. Thousands of Buzz "B" gasoline engines have been sold at twice the price. Now is your chance to buy a real 1/8 H.P. gas engine for only \$4.95. Turns up over 8,000 r.p.m. For boats, planes, midget cars, etc. Guaranteed and ready to run. Includes Champion spark plug and tank. Send only \$1.00, engine shipped collect for balance, same day.

WRITE FOR FREE CATALOG OR
SEND 10c FOR NEW MAMMOTH ILLUSTRATED
CATALOG OF THOUSANDS OF HOBBY ITEMS.

America's Hobby Center, Inc., Dept. B-39, 156 West 22nd St., N. Y. 11

DRILL PRESS CLAMP

FITS ANY DRILL PRESS
with 7/16", or wider, slot
HOLDS ALL SHAPES

If your dealer hasn't it send
price direct.

DODD PRODUCTS INC.

405 Atkins Ave. Lancaster, Pa.



ONLY
\$3.75

HAUCK FLAME GUN KILLS WEEDS



KILL WEEDS, crab grass, Canada thistle—stalks, seeds and roots. Destroy brush, caterpillar nests, diseased trees, grasshoppers, chinch bugs, etc. Clear irrigation ditches, split rocks, burn tree stumps. . . Sterilize poultry houses, kennels, barns. Use as portable home forge. Melt ice, thaw pipes. Safe, inexpensive. Burns only 6% kerosene, 94% air! Thousands satisfied users. 7 models. Write for FREE CATALOG.

HAUCK MFG. CO., 75 Teath St., Brooklyn 15, N.Y.

Say You Saw It in Popular Mechanics

Now CHEAP OIL BURNER FOR HEATING AND COOKING STOVES-FURNACES HEAT YOUR HOME, COOK YOUR MEALS WITH CHEAP FURNACE OIL

NO MORE SHOVELING COAL OR ASHES. Sensational Fuelizer Starter Vaporizing System turns Cheap No. 1 Furnace Oil, also Range, Heater, Tractor Distillate, Kerosene and like oils into oil heat—one of the quickest, hottest fires known. LIFETIME GUARANTEE. \$1.00 Bonus Offer for Testing. We will let you try it in your own stove or furnace for one month. Get yours for introducing. Big profits QUICK. Be first. Send in your name today for details and cash in on the tremendous demand for this Amazing Invention.

NORTHWEST MFG. CO., 634-C, Mitchell, S. Dak.

MAKE YOUR OWN!

WITH

Griffin READYCUT LEATHER PROJECTS

Over 100 KITS in every kind of Tooling and Carving Leather, accurately cut, all parts included. Only Top Grade Leathers used. You do the choosing. You do the tooling, carving, stamping, the punching and assembling



SEND FOR COMPLETE CATALOG Please send 10c to cover mailing.

SINCE 1924

OUT OF THE WEST, THE HOME OF LEATHER CARVING

Griffin Craft Supplies

5515-A GROVE STREET OAKLAND 9, CALIFORNIA

EVERYTHING FOR THE LEATHER WORKER

Largest, most complete stock of Leathercraft Tools and Accessories in U.S.A.



HIDES AND SKINS of Craft Leathers of every kind if you prefer to cut your own.

NONE BETTER! SUPER DRILL GRINDER



Sharpens round shank drills from 3/32" to 1/2" in diameter, up to 6" long. Grinds old drills like new in 4 different point angles, using hand or power grinding wheels. Money-back guarantee.

Price only \$2.95

At Dealers or Postpaid

1512 W. Slauson, Dept. FA-39, Los Angeles 44, Calif.

Make Your Own PICTURE FRAMES

(See Febr. Popular Mechanics Page 329). NOW anyone can easily and inexpensively MAKE YOUR OWN Picture Frames with our perfectly mitered and special adhesive treated moulding and our FUTURFRAME KIT. Four Metal Frames hold the moulding securely and absolutely square and in a few minutes you can insert the small brads in the holes drilled. Remove the Four Metal Frames and you have a Perfect Picture Frame. We can supply other sizes of moulding for FUTURFRAME KIT. Make Money... Making Frames... With This Kit. Kit COMPLETE \$100 With Moulding for One 8"x10" Picture ONLY... Post paid

FUTURFRAME, Box 829, Iowa City, Iowa • Order Yours Today

BUILD FINE GRANDFATHER CLOCK NOW

The simple sensible Red-i-Kut way as thousands have—SAVE HALF. SHOP TESTED PLANS "SPIRIT OF THE CENTURY" Narrow waist 83" tall or stately "SPIRIT OF AMERICA" straight side model with pictures. EASY-TO-FOLLOW PLANS tell all—plus BROCHURE of fine brass weight Westminster, tube chime, movements, dials and mahogany case kits. Send \$1.00 today—Both Plans \$1.50 NOW. KUEMPEL CHIME CLOCK CO., #2 Kuempel Bldg., Minneapolis 16, Minn.



Low-Priced ROTARY TILLER

Unsurpassed for Tilling and Cultivating

The Mulsifier Soil Tiller! Makes it easy to work 1 to 20 acres of common crops. Pulverizes the soil as fine as if it were plowed, disked and harrowed. Spreads fertilizer as it tills. Ideal for cultivating. Has adequate power for all workable soils. Travels at speeds up to 2 1/2 miles per hour. Nothing to do but guide it. Compact—can be carried in trunk of car. Completely equipped—no extras to buy. Sells at a fraction of the price of a tractor. Send postcard for circular.

MULSIFIER CORPORATION

7758 HAMILTON, DETROIT 2, MICH.

*Trade Mark Reg. U. S. Pat. Office



Mulsifier

ROTARY SOIL TILLER

MARCH 1949

own a profitable arc welding business

LOOK! YOU CAN "BUILD YOUR OWN"



HOBART can help you!

Arc Welder and power generator combinations



A.C. or D.C.

1.

A.C. welding-A.C. power generator only for "building your own" . . . or the complete gas engine powered unit at left.



3.

Gas Engine Driven DC Welder for repair and construction in the field.



4.

Transformer Type AC welders. Sizes 180 to 500 amp. for small or large shops.



5.

Electric Driven DC Welder for faster work on production and maintenance.



6.

DC Weld - AC Power Gas engine driven unit for welding, lights, tools, etc.



7.

DC Generator Only For "building your own" portable gas engine welder.



8.

DC Weld - DC Power Generator handles welding and tools with your engine.



9.

DC Weld - DC Power Gas engine driven welder with 1 or 3 KW aux. power.



Hobart Trade School Learn all types of welding at little cost. Enroll now.



Free! - arc welder's vest pocket guide Contains charts, symbols, and other useful data.

Hobart Brothers Co., Box M-39, Troy, Ohio, U.S.A.

HOBART "One of the world's largest builders of arc welders."

HOBART BROTHERS COMPANY, BOX M-39, TROY, OHIO

Without obligation send me complete information on the items I've checked by number.

1 2 3 4 5 6 7 8 9 Welding School Booklet
 Send me complete Arc Welder Catalog Vest Pocket Guide

Name _____

Address _____

SAY YOU SAW IT IN POPULAR MECHANICS



FASTER, EASIER GARDENING!
THERE'S NO TRICK TO IT WITH A

Bready



- Low in cost
- Economical to run
- 1½ and 2½ H.P. models

Even a child can guide a Bready through the toughest gardening jobs. Bready Garden Tractor plows, discs, harrows, seeds, cultivates. Lawn mower, snow plow, other attachments make Bready your year 'round handy man.

WRITE TODAY for free booklet!

The Bready Tractor & Implement Co.
BOX 230 SOLON, OHIO

BUILD IT, FIX IT WITH AMBROID

"IT STAYS STUCK!"



For a quick job with permanent results use multi purpose, fast drying Ambroid liquid cement. For home workshop, household or factory. A quality leader for 39 years. Ready-to-use Ambroid is waterproof, transparent, quick drying, extra strong, flexible, heat and corrosion resistant. For assembling, repairing or mending jobs, keep Ambroid handy. At your dealer's or send 25c for a big 2 oz. tube postpaid. Money back guarantee.

Also 50¢ 4-oz. tube. Pts., qts., gals., for industrial use.

AMBROID
INC. BOSTON, MASS.
EST. 1910
MADE IN U.S.A.

25c TUBE

AMBROID

303 Franklin St., Boston 10, Mass.

Say You Saw It in Popular Mechanics

NOW IT'S EASY TO REMOVE PAINT



Remove paint, varnish, enamel, lacquer, or shellac—without burning, without hard scraping! Wonder-paste does the trick quickly, easily. That's why painters have been using it for years. Simply apply Wonder-Paste directly over the old finish with a paint brush. Allow time for complete penetration—then slide off the soft, sludgy mass with a putty knife. Leaves no raised grain or scorched areas to be sanded. Write for Wonder-Paste Leaflet and ask for advice on your particular removing problem. Get Wonder-Paste from your paint or hardware store.

WONDER-PASTE
Wilson-Imperial Company, 119 Chestnut Street, Newark 5, N. J.

for **AMAZING** acceleration

DIXIE-WESTERN DUAL INTAKE MANIFOLDS for V-8 FORDS AND MERCURYS

\$1500 Gas Line and Throttle Kit \$2.50 extra

Chrome Plated Velocity Stocks — \$1.50 ea
By Test: Increased Acceleration by 26%
Increased Power and Speed by 11%

All DIXIE-WESTERN manifolds are brightly polished cast aluminum.

DIXIE-WESTERN MANIFOLD CO.
Box 364 • Los Angeles 43, California

Dual Intake Manifolds

Dealers Wanted

ONE-MAN SAWMILL LESS THAN \$225.00

Easy To Turn Trees Into Money



Makes lumber, ties, shingles, crates, lath, studding, siding.

Belsaw Models in 10 to 24 foot sawing lengths. MECHANICAL FEED, accurate set works and positive dogs. Use tractor or old auto engine for low cost power. Thousands used for commercial sawing. Pays for itself quickly. Send post card today for FREE booklet, "How To Make Lumber" and Catalog of Woodworking Equipment.

BELSAW MACHINERY CO., 811P Field Bldg.
315 Westport Road Kansas City 2, Mo.

AT LAST—Modeling in Leather

No tools needed! Pre-cut and shaped leather parts, when cemented, sanded, and colored, become authentic 3-dimensional solid genuine leather models. Send check or money order Today! Choose 3 Geese as wall ornaments or Duck or Dog on pen stand or ash tray. **3.00** prepaid

Leathersmiths' Inc Dept P 106 Water St N.Y. 5

MICROSCOPES SUPPLIES-ACCESSORIES & SCIENTIFIC INSTRUMENTS

BELL SPENCER NEW & USED LEITZ BOUGHT-SOLD-EXCHANGED-REPAIRED

Send for FREE LIST

NATIONAL SCIENTIFIC INSTRUMENT CO. 119 CHAMBERS ST. N.Y. 7

MEDICAL INDUSTRIAL AMATEUR

READY CUT HOMES

Order Now

Homes \$1835.00 and up, freight paid. Orders filled in order received. Save up to \$1000 on modern production method homes. Much more compared with builders' prices. Anyone can assemble with simple plans furnished. Complete, including paint, hardware, roofing, glass, nails, etc. Send 35c in coin for full color catalogue showing 57 modern low-priced homes and floor plans. Complete low cost building plans ready for filing. Sold separately if desired.

Dept. PM-39
INTERNATIONAL MILL & TIMBER CO.
Bay City, Mich. **35c**



NEW COLOR CATALOG FOR ONLY 35c



OWN A FAMOUS MOTO-TOOL

The "Pocket-Size Machine Shop"

HIGH-SPEED STEEL CUTTERS
— AT NO EXTRA COST

No modern home workshop is completely equipped without MOTO-TOOL. . . . the correctly balanced motor-in-hand tool. It grinds, drills, routs, carves, polishes . . . without vibration. Higher speed does work better, faster, on practically any material. MOTO-TOOL Kit No. 2 includes high-speed steel cutters for longer life, better work. MOTO-TOOL is backed by over 12 years of industrial use . . . packs years of pleasure. Due to wide popularity and increased production, Dremel's pre-war prices still prevail!



MOTO-TOOL No. 2
With Emery Point
\$16.50

MOTO-TOOL KIT No. 2
With 23 Accessories
(High-Speed Steel Cutters, Grinding Wheels, Polishing Accessories)

\$23.50



NEW DRILL PRESS

This 12" high precision drill press is ideal for model making, wood carving, routing, etc. Utilizes No. 2 Moto-Tool. Only \$9.95 (Less Moto-Tool).



Look For These Moto-Tool Features

Approximately 27,000 R.P.M. plus dynamically balanced armature provides vibrationless finger-tip control. Moto-Tool has oilless, sealed bearings • Patented automatic chuck lock pin • Over-size armature shaft—hardened, ground, polished • 110 Volt, AC-DC motor housing • Sliding snap-type switch • Cord protector • Shockproof bakelite housing • Dust-filtered air-cooling system • Weighs only 13 oz.

MONEY-BACK GUARANTEE: Buy Dremel Moto-Tools from your dealer. If he cannot supply you, order direct on 5-day trial, money-back guarantee. Shipped postpaid for payment in full (Send check or money order); or, send only \$2 now and pay postman balance plus postage upon delivery. Catalog of Dremel Tools and Accessories FREE.

DREMEL MFG. CO. • Dept. T119-C • Racine, Wis.



AMAZING Patented MOTO-SANDER AND POLISHER

Saves Time — Saves "Elbow Grease"

Here's a machine that takes the hard work out of two tough jobs . . . sanding and polishing. "Moto-Sander" is so easy to handle that a child can use it . . . so fool proof that, with it, even a novice can do a craftsmanlike job. Moto-Sander's fast, straight-line action (non-rotary) eliminates any possibility of wood burns or scratches. Does a magically smooth finishing job . . . gets into corners and places others can't reach. All you do is guide it! There are dozens of time and money-saving uses in every home and shop for this inexpensive machine. Use Moto-Sander to get smooth sanded finish on furniture, painted walls, boats, bird houses, scale models, etc. Use it also for speedy, effortless polishing of waxed furniture, automobiles and other surfaces—simply by removing sandpaper and clamping on polishing pad. Moto-Sander is the lightest, most practical electric sander on the market—the only one of its kind. Furnished with 6 assorted sheets Garnet paper for sanding . . . plus felt pad and sheepskin for wax polishing. Operates on alternating current. Thousands of satisfied users.

Only \$14.85
POSTPAID



EASY FOR AWKWARD PLACES



SANDS FLAT SURFACES EVENLY



GETS INTO TIGHT CORNERS



ROUNDS CORNERS LIKE MAGIC

USE MOTO-SANDER AROUND THE HOUSE

- Sand Furniture and Bookcases
- Sand Stairways, Doors, Woodwork
- Sand Walls before painting
- Polish the Family Car
- Polish Pianos and Cedar Chests
- Polish Waxed Furniture

MONEY-BACK GUARANTEE: Buy Moto-Sander from your dealer. If he cannot supply you send only \$14.85 (check or money order) and we will ship postpaid; or, send only \$2 now, and pay postman balance plus postage upon delivery. Your MONEY-BACK if not delighted after 5 days' trial.

DREMEL MANUFACTURING CO.
DEPT. SP119-C • RACINE, WIS.

THOUSANDS BUILD

U-MAK-IT BOATS

START NOW!

EASY TO ASSEMBLE KITS
NO EXPERIENCE NECESSARY
Everything Complete in Kit.
Quality Material. Simple as ABC instructions. Immediate Delivery.
Save Money, Big Value, Sturdy

ROWBOATS, KAYAKS, DINGHIES, INBOARDS, OUTBOARDS, RUNABOUTS, CABIN CRUISERS

SEND 25¢ (COIN) FOR CATALOGS

Colorful Illustrations show all '49 Models, 8 to 23 Ft., and Construction Details.

U-MAK-IT PRODUCTS

MARINE DIVISION
Formerly Kayak Boat Co.
703P- WHITTIER ST., N. Y. 59, N. Y.



New Improved Electric MOTO-SAW

ONLY \$5.85
(with 3 Saw Blades) Postpaid



SAFE AS A HAND SAW JUST GUIDE IT!

The versatile Moto-Saw is as safe as a hand saw. A touch of the trigger switch sets it going . . . releasing stops it instantly.



SAWS TO CENTER OF 19" WIDTHS

No Limit to Length of Stock it Will Cut
THOUSANDS OF SATISFIED USERS

AVERAGE CUTTING SPEED ONE FOOT PER MINUTE

Moto-Saw works more like magic than any tool you ever saw! Takes no effort to run . . . no perceptible pressure to feed . . . only a trifle heavier than a hand scroll saw, and better balanced in your hand. Runs 7,200 strokes a minute . . . leaves no rough edges . . . easily cuts intricate scroll designs in medium hard wood up to 3/4" thick. Blade holder faces blade 4 ways . . . permits sawing sideways as well as forward and backward. Sturdily constructed . . . only two moving parts . . . never needs oiling . . . requires no bench room or floor space. Operated on alternating current. Thousands of satisfied users.

MONEY-BACK GUARANTEE: Buy Moto-Saw from your dealer. If he cannot supply you, send only \$5.85 for Moto-Saw and 3 blades, postpaid; or, send only \$1.00 now, and pay postman balance plus postage upon delivery. MONEY-BACK if not delighted after 5 days' trial.

DREMEL MFG. CO. • Dept. S119-C • Racine, Wis.

HANDY 6 in 1 Home Tool

**THE BIGGEST VALUE
YOU EVER SAW
FOR \$1.00**

Satisfaction
guaranteed
or money back.

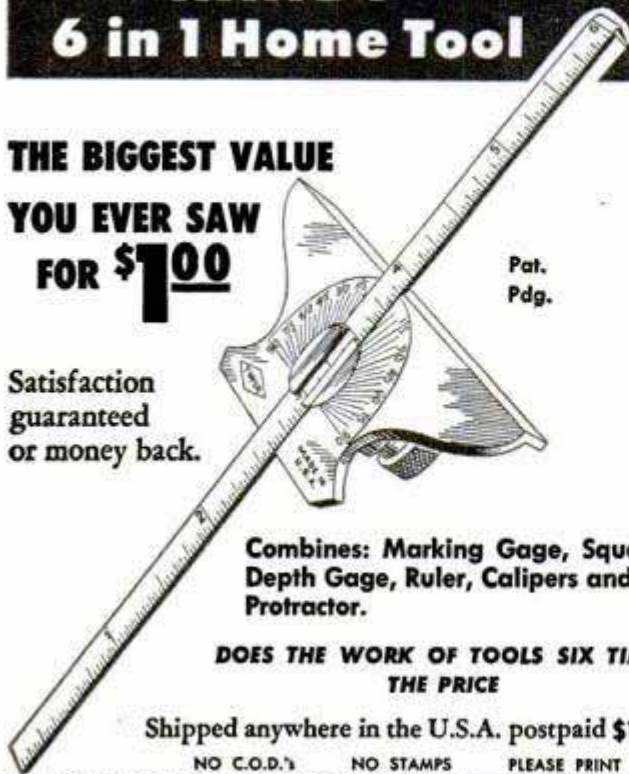

Pat.
Pdg.

**Combines: Marking Gage, Square,
Depth Gage, Ruler, Calipers and
Protractor.**

**DOES THE WORK OF TOOLS SIX TIMES
THE PRICE**

Shipped anywhere in the U.S.A. postpaid \$1.00

NO C.O.D.'s NO STAMPS PLEASE PRINT

Samor Engineering Co., Dept. PM, 37-25 33rd St., Long Island City 1, N. Y.

Enclosed find \$..... Send me..... Handy 6 in 1 Home Tools.

Name.....

Address.....

DIAL your SAW CUTS!



AMAZING NEW

Warren

**DADO SAWING WASHERS MAKE
ALL THESE CUTS ON YOUR SAW!**

Smooth, accurate grooves—12 widths, any angle. No chatter, no burning, chewing, or sanding! Just dial desired width with Micro-matic adjustment! 5 sizes fit any saw arbor— $\frac{1}{2}$ ", $\frac{3}{8}$ ", $\frac{1}{2}$ ", 1", 1 $\frac{1}{8}$ ". See your dealer or use coupon below! Satisfaction guaranteed.

DEALERS, ORDER DIRECT!

WARREN WASHERS CO., DEPT. 23
70 Medbury Ave., Detroit 2, Michigan

Enclosed \$4.95 for one set of Warren Washers,
postpaid. My arbor size is _____

NAME _____

ADDRESS _____

CITY _____ STATE _____

\$4.95
set

pat.
pend.

LOOK! DO FACTORY FINISH PAINTING WITH THIS AMAZING, ALL-ALUMINUM, LOW COST PAINT SPRAYING UNIT



**Factory Set—Easy to Operate
FOR PAINT, LACQUER,
STAIN AND WAX
Needs No Cleaning!**



Complete with
AIR COMPRESSOR
6 FT. THICK-WALL HOSE
2-6 OZ. CONTAINERS
WITH JET CAPS
LIFETIME
COLOR-DABBER HANDLE
FULL INSTRUCTIONS
WITH UNIT
A Cesco Product

Spray automobile fenders, furniture, woodwork, machinery, etc. 50 lb. pressure obtained with easy foot-operated compressor—needs pumping only at intervals to keep air supply constant. Containers may be refilled as often as required. Disposable spray jets. Perfect for home use or in automotive repair shops, woodworking shops, factories, boat yards, hobby shops, etc. Entire unit weighs only 3 lbs.

ALL FOR
\$9.95
POSTPAID

THE HOWARD COMPANY
Dept. 13 — 615 Davis St.
Evanston, Illinois

MONEY BACK GUARANTEE

BUILD DUTCH WINDMILLS Lighthouses, Lawn Figures, Lawn Chairs, Trellises, Etc., Beautify Your Garden

Model B-30 Windmill 24" high.
Wings operate farmer at bucksaw. Blueprint...50c
Model B-10 Windmill hexagon style, 40" high
overall. A beautiful model. Blueprint...75c
Model H-10 Lighthouse, 40" high. Blueprint...75c
Comfortable, Sturdy Cape Cod Lawn Chair.
Blueprint...50c
12 Artistic Trellises. Blueprint all 12 only...50c
Special All Blueprints mentioned above
for only \$2.50.



"Over 35,000 Satisfied Customers"
Send 10c for illustrated Catalog.
CRAFTSMAN'S MODEL CO.
Dept. P2
2030 N. 41st St. Milwaukee 8, Wis.

BUILD ARC WELDER FROM OLD
GENERATOR
For Light or Heavy Work. 75-200
amps. No previous experience
needed. Complete PLANS and
valuable Catalog 35c.
LEJAY MANUFACTURING CO.
1347 LeJay Bldg., Minneapolis 8, Minn.



STANDARD GARDEN AND SMALL FARM TRACTORS



RIDE-WALK Powerful Gas Tractors for
Small Farms, Gardeners,
Florists, Fruit Growers,
Poultrymen, Nurseries,
1 & 2 Cylinders
Rubber or Steel Tires.
High Wheels—Free Catalog

**Plow
Seed
Cultivate
Mow Haul
Belt Work**

STANDARD ENGINE COMPANY
MINNEAPOLIS, MINN. NEW YORK, N. Y.
3221 Como Avenue 617 West 26th Street

DUAL TAIL PIPE EXTENSION



Fits all cars — chrome plated
DEEP TONE
produced by 2 1/2 inch outlets
Postage free on prepaid orders
TRADE INQUIRIES INVITED

\$2.95

LYONS PRODUCTS COMPANY

PAT. PEND. 2426 So. LaBrea Ave., Dept. PM-3, Los Angeles 16, Calif.

FIRES SNUFFED OUT AUTOMATICALLY!

with Famous

RED COMET FIRE EXTINGUISHERS!

When fire starts Red Comets go into
action, release powerful spray, create a
blanket of fog which smothers fire—
without human aid! Can be mounted
in homes, shops, autos, boats—in any
enclosed space! Write for FREE LITERATURE today!



RED COMET, INCORPORATED

267 Red Comet Building • Littleton, Colorado
SALESMEN! Operate your own business—sell Red Comets!
Every home, farm, store a prospect. Territories open! Write!

Your weight does the work with a "YANKEE" QUICK-RETURN SPIRAL SCREW DRIVER

● Save your wrist: drive and draw screws faster. Just push on a "Yankee" 130A Spiral Driver. Your weight and the spiral turns the screw without blisters or fatigue. Quick-return spring in handle holds blade in slot and returns the handle after every stroke.

★
Write for the
"YANKEE"
Tool Book
.. FREE ..

"YANKEE" TOOLS
NOW PART OF
STANLEY
THE TOOL BOX
OF THE WORLD

**NORTH BROS.
MFG. CO.**
Philadelphia 33, Pa.

CUT YOUR SCORE WAY DOWN

With the "INLINE" METHOD
OF PUTTING
AND
APPROACHING

The Simple And Logical System That
Guarantees Stroke Reduction In The
Scoring Zone

By the Author of "GOLF AFTER FORTY"

COMPLETELY ILLUSTRATED
\$1.00 POSTPAID

HATTSTROM GOLF SPECIALTIES
1724 Sherman Ave. Evanston 1, Illinois

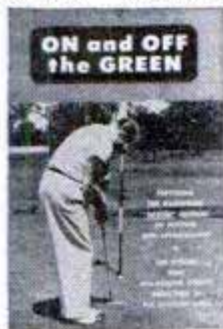

FULLSIZE, CUT-TO-SHAPE BOAT PATTERNS

and specifications. Designed by Naval Architect. Cruisers, runabouts, sloops, outboards, sailing canoe, etc. Low prices. Send 10c (coin) for illustrated catalog. SPECIAL: Send \$1.00 for "HOW TO BUILD BOATS" book, postpaid. PolyWog Houseboat Plans, \$10. Cleveland Boat Blueprint Co. Dept. 666, Cleveland 13, Ohio

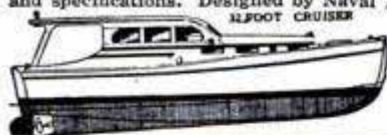

One Swipe of NEW PLASTIC Makes these LEATHER and LEATHERETTE Items LIKE NEW

Get Into A Money Making Business

Make like new, worn, scuffed or faded leather and artificial leather equipment. Either your own to renew, recolor and beautify, or cafe, restaurant and hotel equipment as a business. Single stroke with a brush renews. Does not crack, peel or scuff. Resists acid, alcohol, caustics and weather. All colors. Mail coupon for free sample.

FREE Sample SHOWS EFFECT



**\$50 to \$500 Profit
On One Job Possible**

Let me show you how, as I have shown others. Get your own exclusive territory while available. Mail coupon today, I'll do the rest. — Jack Edwards, Sales Mgr.

LEATHER-NEW PRODUCTS,
6082 Sunneslope, Kansas City, Mo.
Send me without obligation a sample of Leather-New coated material so I can inspect it.

Name

Address

City

State

NEW—IMPROVED ELECTRIC DRILL KIT

22 Pc. 1/4" Capacity

22 Ga. Steel Carrying Case — Size
3 1/4" x 5 3/4" x 10 1/2"

ONLY **\$19.95** Shipped Prepaid
in U.S.A.

FAIRCHILD 1/4" LIGHT-DUTY DRILL

New Streamlined Design, Fast, Modern Electric Drill Suitable for Hobbyist, Mechanic and Farmer. Fairchild universal type motor — housing made of 2 piece precision cast aluminum alloy — improved sturdy keyless 3 jaw chuck — Saw grip handle gives perfect balance and makes drilling easier. Lacquer sprayed with hard finish that will not peel. Factory Guaranteed for 90 days.

EXCEPTIONAL VALUE Eagle Electric DRILL KIT

Drill—Box and Drills same as above only box is heavy cardboard and has 4 less Drills, only **\$15.95**
LIMITED QUANTITY. SHIPPING CHARGES COLLECT.

CENTURY'S NEW WOOD BITS

SET W-5

Contains 5
Wood Bits with
1/4" round shank,
sizes 1/4", 5/16",
3/8", 7/16", and 1/2",
packed in cardboard box.



The only drills expressly made to drill holes up to 1/2" Dia. in wood with 1/4" electric drills.

Shipped Prepaid in
U.S.A.
set \$3.95

1/4" **BLACK & DECKER** We carry the 1/4" Home Utility Drill \$18.95 prepaid postage and the 1/2" Drill at \$35.95 shipped prepaid. We also carry B. & D. stands, kits and accessories.

HI-SPEED DRILL and WOOD BIT SET with TOOL BOX

ONLY **\$9.90** COMPLETE

Shipped Prepaid in U.S.A.

M-12 includes:
7 HI-SPEED TWIST DRILLS
Sizes 1/16" to 1/4"
Drill rack provides holes for 8 intermediate 64th sizes.
For Iron, Steel, Wood, Plastic, Etc.
5 WOOD BITS WITH 1/4" SHANK
Sizes 1/4" to 1/2"
For Use in Wood Only. Designed especially for use in 1/4" capacity portable electric drills.



ALL-METAL TOOL BOX
Compartment designed to hold all popular priced 1/4" electric drills.

AN EXCELLENT COMBINATION PACKAGE

We would like to suggest the M-12 Hi-Speed Drill and Wood Bit Set and Tool Box, the 1/4" Black & Decker Home Utility Drill, and the New 7" Flex-Sander and Polisher. ALL 3 FOR **\$33.33**
Shipped Prepaid in U.S.A.

New Prehler Improved 7" Flex Sander and Polisher

ONLY **\$4.95** COMPLETE

Shipped Prepaid in U.S.A.

BENDS POLISHES BUFFS
1/4" Shank for use in Lathes, Electric Drills, Drill Press, Flexible Shaft tools on AC or DC motors. We have tested many sanders, some cost more, some less, but consider, in our estimation, this 7" Flex-Sander and Polisher to be today's best value—The Electric Drill King.



New Surplus RUBBER GLOVES

Man's Size 14" Long. Good for use in Garages, Plating Shops—Removing Paint and Varnish, Cleaning, Etc. Shipping wt. 1 lb. Easily worth over \$1.00 a pair.

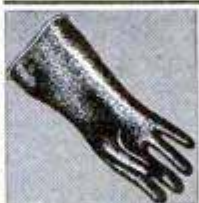

55c pair 2 pr. **\$1.00**
\$5.50 doz.
Shipped Collect

New 350 W., 110 V. A.C. Lighting Plant

Powered by a 1 1/2 H.P. Briggs & Stratton Gas Engine. All New. Limited quantity. This is a Government surplus item. Price is less than our replacement cost. **\$99.99**
Were \$179.50. NOW Collect

Complete Distributors of Electric Drills and Accessories
SORRY—NO C.O.D.'s ACCEPTED WITHOUT 25% DEPOSIT

MAIL ORDERS TO
THE ELECTRIC DRILL KING
Mail order Div. of Carl-Sons Best Hardware
1627-29 N. DAMEN AVE. CHICAGO 47, ILLINOIS

Color Film Users! BUY NO MORE COSTLY FILTERS!



... And still take perfect INDOOR flash-color pictures with NO exposure increase necessary!

Sounds unbelievable? Revolutionary JEN-DIP "RED LABEL" coats ordinary flash-bulbs AMBER, and instantly converts them to perfect spectral balance for ALL TUNGSTEN-TYPE color film!

Coats 300 bulbs

\$1.50 with Beaker

- NON-INFLAMMABLE!
- For use with any TUNGSTEN-TYPE color film.
- No Rinse—No Wipe
- Dries almost instantly!

This means you eliminate breakable, quick-fade filters; save money enough to buy extra color film and bulbs. And you'll get no more cold, bluish pictures!

Don't waste another exposure of expensive color film. Order Jen-Dip today by mail, and start saving money!

Send Check or Money Order, Please.

Write today for literature on other amazing Jen-made equipment.



JEN PRODUCTS SALES CO.

419 West 43rd Street, New York 18, N. Y.

**Now
for EVERY WORK SHOP!**

**NEW
Invention** **Electroplates
by BRUSH**



**Easy to Plate CHROMIUM
GOLD, SILVER, NICKEL, COPPER**

... For Pleasure and Profit!

If you have a workshop—at home or in business—you need this new Warner Electroplater. At the stroke of an electrified brush, you can electroplate models and projects—you can replate worn articles, faucets, tools, fixtures, silverware, etc. with a durable, sparkling coat of metal... Gold, Silver, Chromium, Nickel, Copper or Cadmium. Method is easy, simple, quick. Everything furnished—equipment complete, ready for use. *By doing a bit of work for others, your machine can pay for itself within a week.* So make your shop complete by getting a Warner Electroplater right away. Send today for FREE SAMPLE and illustrated literature. ACT AT ONCE! Mail Coupon.

**WARNER ELECTRIC CO., DEPT. A-3
1512 Jarvis Avenue, Chicago 26, Ill.**

FREE Details & Sample!

WARNER ELECTRIC CO., 1512 Jarvis Avenue, Chicago 26, Dept. A-3

Gentlemen: Send Free Sample and Details to:

Name _____

Address _____

City _____

State _____

**Thompson
BEATS
the World
on BOATS**



**Better Built
Lower Prices**



**Safe Boats With
Full Length Spray Rails**

Keep passengers perfectly dry—even at high speeds. Catalog also shows two new models of "Take-Along" Boats. Two big factories—save you freight.

CATALOG FREE
Write for your copy. State kind of boat in which you are interested.

THOMPSON BROS. BOAT MFG. CO. (151)
213 Ann St. PESHTIGO, WIS. Write to either place 113 Elm St. CORTLAND, N.Y.

ACE

LATHE TOOL SET



**Be permanently toolled-up
for every operation on
your Metal Cutting Lathe**

The ACE Set is complete—there's nothing more to buy. Drop forged by the manufacturers of cutting tools used by 96 per cent of the plants and shops in industry they are correctly designed, are of special steel, are finely finished, are stronger—will last a lifetime. You can cut easier, faster and more accurately with ACE TOOLS. At your Hardware Store—

ARMSTRONG BROS. TOOL CO.

"The Tool Holder People"

5268 W. Armstrong Ave., Chicago 30, U.S.A.

GENERAL PLASTICS

You can make attractive plastic articles for your own personal use as well as for gifts and sale by following Raymond Cherry's book "GENERAL PLASTICS." Revised 1948. Shows how to work plastics with hand tools and power tools, and how to do internal carving and dyeing. Designs and directions for 49 projects including letter openers, buttons, jewelry, lamps, tableware. One of the finest books published. At craft stores or direct. \$1.50 postpaid. Or sent C.O.D. plus postage. Order today. McKNIGHT and McKNIGHT, 138 Market St., Bloomington, Ill. Clip this.

AIR RIFLES BENJAMIN AIR PISTOLS
PIONEERS - LEADERS

SEND FOR FREE FOLDER OF LATEST MODELS TODAY
If you want a REAL GUN for PRACTICAL USE inside or outdoors get a SAFE - CLEAN - ECONOMICAL - BENJAMIN with Adjustable Power and Amazing Accuracy. For BEST RESULTS use BENJAMIN H-C PELLETS. WRITE AT ONCE. BENJAMIN AIR RIFLE CO., 812 MARION ST., ST. LOUIS 4, MO.

FIBRE ARMS AND LEGS!
Light, correctly fitted, strong and comfortable. Natural appearance. Braces for all deformities. Scientific design. Fair Terms.
BUCHSTEIN-MEDCALF 223 S. 6th St., Minneapolis, Minn.

RUPTURED?

Get Relief This Proven Way

Why try to worry along with trusses that gouge your flesh—press heavily on hips and spine—enlarge opening—fail to hold rupture? You need the Cluthe. No leg-straps or cutting belts. Automatic adjustable pad holds at real opening—follows every body movement with instant increased support in case of strain. Cannot slip whether at work or play. Light. Waterproof. Can be worn in bath. Send for amazing FREE book, "Advice To Ruptured," and details of liberal truthful 60-day trial offer. Also endorsements from grateful users in your neighborhood. Write:

CLUTHE SONS, Dept. 31, Bloomfield, New Jersey

HOOD & RADIATOR ORNAMENTS

• CHROME PLATED • UNIVERSAL FITS ALL CARS



FLYING SWAN 8" high, 6 1/4" long. Similar to Packard design. Ea. **\$4.95**

PANTHER 9 1/4" long, 5 1/4" high. Rich and massive looking. Ea. **\$2.95**

GREYHOUND 9 1/4" long, 3" high. Sleek streamlined popular model. Ea. **\$1.95**

BULL DOG 5" long, 3" high. Sporty, heavy model. Ea. **\$1.95**

Choice of 4 New Models

Latest 1949 NEW TRIM RINGS



MODERNIZES ANY CAR TO LOOK LIKE 1949 MODELS

Gleaming Chrome Plated. Universal Fits All Cars. Theftproof—Easy to Install—Fastens with small bolt on both sides of fenders or hood.

SET of 6, **\$4.95** only

SAVE on USED Pass. Car TIRES



75% to 90% Original Tread

Tires have small repairs and the repairs are GUARANTEED for the life of the tire.

Tires listed on right have a continuous tread design, tread depth will vary. Repairs are Guaranteed for the life of the tire. Specify exact size when ordering.

550 X 16	600 X 16	650 X 16	} \$4.95 ea.
525-550x17	525-550x18	475-500x19	
525-550x19	450-475-500x20	525-550-x20	
440-450-500x21	525-550x21		} 5.95 ea.
700x15	700x16	700x17	
700x17	700x18	700x19	} 6.95 ea.
750x15	750x16	750x17	
750x17			} 7.50 ea.

Also Truck Tires and Tubes in Stock — All Sizes.

550x16	600x17	} 3.95 ea.
600x15	600x18	
600x16	600x19	} 6.45 ea.
625-	600x20	
650x16	600x21	

J. C. WHITNEY & CO., HEADQUARTERS FOR Hi-Speed Equipment



FOR ALL CARS

More Pick-up — You're away in a flash. No fuel waste — Every drop of fuel used. Extra horsepower — faster passing. More mileage per gallon. Better performance at all speeds. Write for Catalog & Prices.

Our Finest Precision REBUILT MOTOR BLOCK ASSEMBLIES



Carries the Same 90 DAY GUARANTEE As a New Motor Assy.

Sold Outright or Exchange

Rebuilt by skilled mechanics. Assembly has Reborn Block with New Pistons, Pins, Rings, Reground Crankshaft, all New Bearings. Guaranteed 90 Days.

Allowance on Old Motor

We ship at outright price. Send your motor prepaid, must be suitable for rebuilding. Send in notarized bill of sale showing title number if any. We refund difference when we receive your motor.

BUICK	Outrt.	Exch.
34-47 8 cyl.	\$209.00	\$165.00
CHEVROLET	Outrt.	Exch.
29-47 6 cyl.	115.00	95.00
CHRYSLER	Outrt.	Exch.
34-47 6 cyl.	157.00	132.00
35-47 8 cyl.	209.00	165.00
DE SOTO	Outrt.	Exch.
34-47 6 cyl.	157.00	132.00
DODGE — 3 1/4" bore	Outrt.	Exch.
33-47 6 cyl.	150.00	120.00
3 3/8" bore	Outrt.	Exch.
34-47 6 cyl.	157.00	132.00
FORD	Outrt.	Exch.
28-31 4 cyl.	107.00	87.00
32-34 V8	129.00	109.00
35-47 V8	149.00	109.00
37-39 60 HP.	154.00	109.00
MERCURY	Outrt.	Exch.
39-47 V8	149.00	109.00

60 HP. JEEP Engines



Reconditioned, Tested and Guaranteed in perfect running order and ready to run. Every part is checked to be perfect and carries a 90 Day Guarantee same as a new engine.

COMPLETE with . . . Generator, Starter, Distributor, Coil, Fan and Fan Belt, Water Pump, Fuel Pump, Intake and Exhaust Manifolds, Carburetor, Oil Filter, Spark Plugs, Flywheel, Clutch and Pressure Plate, Wiring.

Outright, **\$179.50**

PG58R-003, Ea.

JEEP FRONT FLOOR MATS

Rubber with Felt **\$3.95**

Back. For all Jeeps. Ea.

NEW CONVERTIBLE TOPS

Choice of Black or Tan. All Tops Tailor Made for Easy Installation. As Low as **\$24.95**

Instructions for Simple Installation with Each Top



"ZIPPER TYPE" REAR CURTAIN

Each top packed complete and consists of main top, proper, rear curtain and all needed binding and fittings. (Glass is not supplied—use glass from top being replaced). Best quality, laboratory tested—equal to or better than the original. All metal parts are of heavy bright chrome plated rust resistant. Tops are heavily stitched with treated thread and sewed for durability and appearance.

Car	Year	Price	Car	Year	Price
BUICK	1936-48	\$41.75	Hudson also		
CADILLAC	1936-48	41.75	Terra to '38		
CHEVROLET	1936-48	39.50	HUDSON	1941-47	48.95
CHRYSLER	1935-38	33.00	LASALLE	1936-40	41.75
CHRYSLER	1940-48	39.50	MERCURY	1939-42	37.95
DE SOTO	1935-38	33.00	MERCURY	1946-49	39.95
DE SOTO	1940-48	39.50	NASH & LAFAYETTE	1937-41	39.95
DODGE	1935-38	33.00	OLDSMOBILE	1936-48	41.75
DODGE	1940-48	39.50	PACKARD	1936-48	45.95
FORD			PLYMOUTH	1935-39	33.00
1928-31 Roadster & Cpe.	24.95		PLYMOUTH	1940-48	39.50
1933-39 Rdstr. & 2 pas. Cpe.	33.00		PONTIAC	1936-48	41.75
1928-39 Phaet. & Sedan	42.95		STUDEBAKER 1948	44.15	
1936-42-5 Pas. Clb. Cpe.	37.95				
1946-48-6 Pas. Clb. Cpe.	39.95				

NOTE: Specify when ordered also Model or Series, Body Style, Year & Make when ordering.

"FULL VISION" REAR WINDOWS

Replaces rear curtain and gives 3 times more vision. Fits Chrysler Products, Ford and Mercury, General Motors cars 1946-49. Specify make, year and model. Shipped prepaid in U.S.A., only. **\$25.00** Each



Fender Skirts

For most makes of cars including '49 Ford & Mercury. Made of all metal, prime finish, with Rubber beading to prevent rattle. Easy to Install.

MC31N-9 **\$12.95**

Per Pair

Be sure to specify year, make and model of car.

GUTTED MUFFLERS FOR ALL CARS



Gives that Motorboat Tone

MD20N-210

Universal type to fit all cars. **\$4.95** ea.

Send 25% Cash With All Orders, Balance C.O.D.

J.C. WHITNEY & Co.

1919 Archer Ave. Chicago 16, Ill.

1935-48 FORD V8 & 1939-48 MERCURY

DUAL MUFFLERS

Increases power. Reduces back pressure. Saves gas.

MD20N-208—Complete Set **\$17.95**

PROVED!

— AND APPROVED

America's
LOWEST COST
Transportation

Cushman

MOTOR SCOOTER



GET UP TO
75 MILES PER GAL.

OWN IT! MAINTAIN IT!
OPERATE IT! ALL FOR LESS
THAN 1¢ A MILE

CUSHMAN MOTOR SCOOTERS are the world's best buy in low-cost transportation. Motor to work, to play, to market, to school—EVERYWHERE—quickly, conveniently, economically! No parking worries—no garage problem! No battery or radiator to maintain! No expensive upkeep or replacements! There's a CUSHMAN for every transportation need. Get the facts today. See your dealer or write Dept. PM-29.

DEALER INQUIRIES INVITED

CUSHMAN MOTOR WORKS, Inc
LINCOLN NEBRASKA USA

She's some **SMOOTHIE!**
(YOUR CAR, THAT IS)

when equipped with

ADVANCE DEEP TONE MUFFLERS
(SINGLE STRAIGHT-THRU OR DUAL SET)

Rich, low, mellow tone. Also greater power, speed, and economy result from reduced back pressure. Rugged steel tube, blow-out proof. Simple to install. No welding. Dual set comes complete with rubber mounted clamps, fittings.

ADVANCE FENDER SKIRTS
Heavy duty steel skirts to beautify, streamline. Tight fit, no rattle, easy to install, prime painted.

KI-YI AND RAZZ HORNS
Get these novelty horns for laughs.

MAIL COUPON BELOW



ADVANCE MUFFLERS Dept. PM 3-9
6800 S. VERMONT AVE., LOS ANGELES 44, CALIF.

Send check, money order, or we will mail C.O.D. You pay postage upon receipt.

<input type="checkbox"/> Dual Muffler Set (Ford, Mercury only) . . . \$20.00	<input type="checkbox"/> Single Muffler (other makes) \$5.50	<input type="checkbox"/> Fender skirts, pr. \$16.95
<input type="checkbox"/> Single Muffler (Ford, Chev., Plym.) . . . 4.86	<input type="checkbox"/> 2 1/2" Chrome tail pipe tips 1.75	<input type="checkbox"/> Ki-Yi Horn, each 3.25
<input type="checkbox"/> Send free catalog showing complete line.		<input type="checkbox"/> Razz Horn, each 3.25

Car make _____ Year _____ Model _____
Name _____
Address _____ City _____ State _____

BINOCULARS, 6 x 30 Universal, used, good condition, with case	\$42.50
BINOCULARS, U. S. Navy 7 x 50, used, good cond., with case	\$95.00
BINOCULAR CASES, 6 x 30, two grades, leather, new	\$5.00 and \$7.50
7 x 50 Leather BINOCULAR CASE, new	\$7.50
TELESCOPES, U. S. Navy, 16 power, with case. Val. \$125	\$29.50
5 Power Ranger TELESCOPES	\$2.00
SIGHTING LEVELS, New, Engineers Metal Army Type	\$2.00
SURPLUS GOVT. TRIPODS for Level, Transit, Cameras, etc. Used, Good Condition	\$5.95
NEW TRIPODS for Transits, Levels, etc. Value \$75.00. Special	\$13.50
TRANSFORMERS, Western Electric, 5 volt to 650, New	\$4.95
CANVAS SAFETY BELTS, Metal Snaps, New, \$3.00 Val.	75c

Many unadvertised specials. What do you Need?
4th Edition Annual Gun Digest, \$1.50.

Public Sport Shops

11 S. 16th St., Phila. 2, Pa. No COD'S

NOW! FILE YOUR OWN SAWS



Do expert saw filing at home. Precision filing easy without experience. Two simple adjustments. Keeps any hand saw extra sharp and true-cutting. Complete with file. Money back guarantee. Cash with order, prepaid. (COD postage extra.) Order today.

\$2.95 EACH

THE SPEED CORP., Dept. PM1
2025 N. E. Sandy, Portland 12, Oregon

GET THIS FINE SUIT NO MONEY TO PAY!

BIG CASH EARNINGS, TOO!

Big news! This fine tailored suit yours without paying one cent—and big cash earnings, too! It's easy! Just take a few orders. Earn up to \$10 in a day and get your own suit as extra bonus. Dozens of rich new fabrics, superbly tailored in latest styles, at low prices produce orders on sight. Money-back guarantee. **FREE SAMPLES!** Write today giving name, address, age, etc. for big complete outfit of actual samples and details of amazing new **BONUS SUIT** and money-making plan—**All Sent Free!** No experience. **SEND NO MONEY!** W. Z. GIBSON, Inc, 500 S. Throop, Dept. Q-516, Chicago 7, Ill.

LUMBER

A Board or a Carload

BIG NEW 144 PAGE CATALOG **UNEQUALLED BARGAINS**

OF HARD TO FIND WOODWORK ITEMS, HARDWARE AND SUPPLIES, the finest craftsman catalog Harold Hunt ever published—32 rare and fancy woods in natural colors—also in color, 43 matched veneer designs, multi-colored bindings, inlays, overlays, scroll patterns, etc.

CRAFTSMAN WOOD SERVICE CO.
2729 S. Mary St. Dept. A-3 Chicago 8, Ill.

TOP GRADE KILN DRIED WALNUT, MAHOG, CHERRY, MAPLE, WH. HARD AND SOFT, POPLAR, PL-QTR, OAK, AROMATIC RED CEDAR

MAGNETS

OF ALL TYPES—10c UP
AMAZINGLY POWERFUL!

4 oz. Alnico Magnet, lifts 10 lbs. \$1.10. Our Leader, 15 oz. Magnet, lifts 40 lbs. \$2.50. New alloy—will not weaken! Useful for lifting valuables from tanks, lakes, or rivers easily! 7 small magnets \$1.10 with list of many shop and home uses. Satisfaction guaranteed. R. EYRICH, 2566 N. 49TH ST., MILWAUKEE 10, WIS.

Say You Saw It in Popular Mechanics

2270° F  \$3.15

VOLCANO GAS TORCH

No Compressed Air

For use by Manufacturers, Hobbyists, Dentists, Jewelers, Laboratories, and Garages. For brazing with silver, soft soldering, bending light metal and glass tubes, and many other uses. Burns regular house gas (manufactured gas only). Sample of silver and flux furnished with torch. Send check or money order. Guaranteed.

MILLER METAL PRODUCTS CO.
P. O. Box 4026 • ROANOKE, VIRGINIA

PAINERS' STRIPING TOOL

A TOOL... NOT A BRUSH

NEW, IMPROVED

Modern—streamlined—fits the hand like a fountain pen! Easy to use as a pencil. Draws parallel lines—straight, curve or circular. Does expert job on autos, furniture, toys, bikes, model planes, signs, bulletins, linoleum. (Makes wall board look like tile.) Every painter and craftsman needs one! Type "M" MASTER Painters' Striping Tool complete with tip for 1/16" stripe, \$1.00. Tool with choice of 1/64", 1/32", 3/64", 5/64", 3/32", 1/8" tip—\$1.50... all tips 75c ea. Tool with complete set of 7 tips \$5.00. (COD's postage collect.) Paint dealers, write!

\$1.00 POST PAID

EASY AS USING A PENCIL!

WENDELL MFG. CO.
4234-B Lincoln Ave., Chicago 18, Illinois

New MILLING ATTACHMENT



SIZES FOR 8" to 16" METAL LATHES

Build it yourself from our sets of semi-machined castings and save \$8. Can be finished on your lathe alone. Complete drawings and instructions furnished with castings.

Mill keyways, slots, splines, dovetails, flutes for trimmers, special cutters. Produce gears, ratchets, racks; bore, face, etc. with this precision attachment.

FREE Illustrated folder and price list of castings, milling cutters, etc. Write today. Mention your lathe.

HURON MACHINE AND TOOL CO.
YALE 4, MICHIGAN



Ask Your Hardware Store for FULLER'S Unbreakable Amber Handle SCREW DRIVERS

America's most popular line of moderately-priced screw drivers! Wide range of sizes. FULLER TOOL CO., Inc. 911 Faile St. New York 59 World's largest makers of Amber-Handle Tools

ALL PURPOSE FOLDAWAY TABLE or BENCH LEGS

Make sturdy folding tables, benches or work horses with these steel channel, riveted folding legs. Black enameled and rubber tipped. 30" high for table tops 5.98 pr.; 24" high for benches or work horses 4.98 pr. Send for free circular.

THE DIAMOND MFG. CO.
1100 ALTAMONT AVE. SCHENECTADY 7, NEW YORK



\$4.98 (LEGS ONLY)

LATHE CUTTER BIT GRINDING GAUGE

50¢ postpaid For checking clearance and rake angles. SOUTH BEND LATHE WORKS 455H E. MADISON ST., SOUTH BEND 22, IND.

MUFFLERS

STEELS and ALUMINUMS with a motorboat tone

SINGLES, Chev., V-8, Plymouth, Steels \$5.50, Aluminum \$7.00. Chry., Olds., Buicks, etc., Steels \$7.50, Aluminum \$9.00. V-8 and MERCURY DUALS, Steel \$17.50, Aluminum \$21.00, '49 FORD DUALS, \$2.50 extra. Split Manifold Sets, Steels \$35.00, Aluminum \$45.00. Aluminums are guaranteed for life of your car.

DEALERS WANTED

SANDEE MUFFLER CO.
BOX 296 LA TIJ., LOS ANGELES 43, CALIF
2624 W. SLAUSON AVE., LOS ANGELES, CALIF.

EXCITING VALUES FROM LAFAYETTE-CONCORD

AMERICA'S GREATEST RADIO MAIL ORDER ORGANIZATION FOR 29 YEARS



SPECIAL ON PHONO-RADIO

worth 3 times this low, low price \$19.95

Never before have you seen a fine radio-phono combination at such an unheard of low price. You play up to 12" records... It's got the famous Alnico 5PM speaker and lots more you'd expect to find in sets 3 times the price. It's the buy of a lifetime. Complete with tubes. 1F417P, Shpg. wt. 15 lbs. \$19.95

NEW! DRAFTING MACHINE AN EXCEPTIONAL BUY!

Eliminates use of T-square, protractor, and triangles. Makes sharp, accurate drawings up to 16" x 22" Combination 90° angle, calibrated scale moves at any angle to any point on the masonite board. Includes 17 1/2 x 23 1/2 x 1/4" board, steel arms, fittings, rubber feet. No. 18N15092P. Shpg. wt. 8 lbs. \$63



FOR MECHANICS, DRAFTSMEN, DESIGNERS, INVENTORS, ETC.



NICEST IDEA OF THE YEAR BEDLAMP RADIO

FOR YOUR FAVORITE GAL

It's a beautifully-designed Bed Lamp & Radio combination. Enables her to read under light that's kind to her eyes—while she listens to her favorite band. Superhet circuit. Built in "air-magnet." Complete broadcast band coverage. AC or DC. Lamp has frosted lens for glareless light. Lamp and radio operated separately or together, as desired. Streamlined walnut bakelite. Brackets fit any type of bed. It's a \$29.95 value! \$21.95 No. 1-533P. Shpg. wt. 9 lbs.



MORE THAN A TOY A REAL 1-TUBE RADIO

Here's an honest-to-goodness 1 tube set that plays anywhere, anytime. Picks up stations within 100 miles. Built like a telephone, dials like a phone, plays like any real portable radio. Safe for the tiniest tot—no electrical connections. Private earphone prevents Mama and Papa from hounding in on Superman. No. 33F2454SP. Complete with tubes and batteries... \$4.75



100 WATT HEAVY-DUTY IRON



Now you can pick up a fine 100 watt Belden Iron, at nearly two-thirds off! Mfg. by Drake and Underwriter listed. Ideal for radios, switchboards and other "close quarter" work. Comes complete with 6 ft. cord, standard 3/8" tip. Thousands sold at \$6.75! No. 99N8000P. Shpg. wt. 3 lbs. \$2.69

SEND FOR THIS FREE 180 PAGE CATALOG

A penny postcard will bring you the big, money saving, 1949 Lafayette-Concord catalog. There are 180 pages crammed with the latest developments in TV, Ham, AM and FM radios, P.A., kits, tools, etc. Write today for your free catalog.

Order by mail, or stop in person at any one of our outlets:

- NEW YORK: 100 Sixth Avenue, 542 E. Fordham Rd., Bronx
- CHICAGO: 901 W. Jackson Blvd., 229 W. Madison St.
- ATLANTA: 245 Peachtree St.
- BOSTON: 110 Federal St.
- NEWARK: 24 Central Ave.

LAFAYETTE-CONCORD

LAFAYETTE-CONCORD, Dept. LC-9
100 Sixth Avenue, New York 13, N. Y.

On mail orders you will be charged a few cents extra for postage.

- Please send me free catalog No. 89
- Please fill the attached order

Name.....
Address.....
City..... Zone..... State.....

SAY YOU SAW IT IN POPULAR MECHANICS

Increase the CROP CAPACITY of Your Land with a SEAMAN ROTARY TILLER



The power-driven tines of the Seaman Rotary Tiller dig up the ground, break up clods and mix trash, cover crop, manure or other fertilizer evenly throughout the seedbed. This actually increases the crop capacity of the land because there is a better chance for effective decomposition of the plant-food elements . . . in quantities and places that will do the growing crop the most good for the longest time.

Write for Bulletin NST, describing and illustrating all models . . . both motorized and power take-off, 3 to 7 ft. tillage widths.

MAKES BETTER SEEDBEDS . . .

● Thoroughly "mixes-in" Cover and Fertilizer to provide better plant food balance.

● Breaks Up Clods. Tills soil fine, medium or coarse to fit your need.

● Conserves moisture, aerates soil, helps to control weeds and crop pests, hastens seed germination, helps get rid of plant-starving air pockets.

SEAMAN MOTORS, INC.

364 NO. 25TH ST., • MILWAUKEE 3, WISCONSIN

NOW ANYONE CAN PUTTY WINDOWS

with the

DUO-FAST PUTTY KNIFE

NEW EASY FAST

Does a perfect job. Packs—Shapes—Trims putty. Makes a hard job easy. Pays for itself on first window. Get yours, today! It will be your favorite tool!

See \$1.00

Your Hardware, Paint, Glass or Lumber Dealer—OR Order Direct. ONLY \$1.00 POSTPAID IN U.S.A.

Duo-Fast PUTTY KNIFE FASTENER CORP.
864 Fletcher Street, Chicago 14, Illinois

I am enclosing \$1.00 — please send me one Duo-Fast PUTTY KNIFE

NAME _____

ADDRESS _____

CITY _____ STATE _____

HOW TO CUT RAFTERS

New vest pocket book gives lengths, side cuts, plumb cuts, deductions. For all rafters for any building from one inch to forty feet wide. Gives numbers to cut on square. Also degree for same cuts for Radial Saws. All standard pitches from 1/8 to 5/8. Just open book to pitch page and there are your lengths, side cuts, etc. Anyone who knows what a jack rafter is can frame a roof if he has this great book. Price \$1.50 prepaid. Over 35,000 copies sold to date.



BUILDERS' TOPICS

THE CARPENTERS' MONTHLY MAGAZINE

The he-man construction workers' magazine. The finest technical magazine published for all building trade workers. Tells you how to build—how to frame roofs—how to do electrical work—how to do plumbing, painting and plastering. Contributors to the editorials are the largest lumber, building and allied trade associations in America. If you have not subscribed, do it today. Subscription rates \$2.00 per year, or 3 years for \$5.00.

FREE

WORKERS ATTENTION! Builders' Topics is a magazine you are sure to like because it's a technical uplift—a book in itself which will come to you every month for three years for only \$5.00. For a limited time only we will give you FREE a POCKET BOOK, "HOW TO CUT RAFTERS," WITH EACH 3 year SUBSCRIPTION.

BUILDERS' TOPICS P. O. Box 828
Seattle 11, Wash.
SAMPLE COPIES OF BUILDERS' TOPICS 25c



The NEWEST THING in VISORS

For the first time, a pair of smartly tailored side visors has been matched with a front visor . . . a really new look for your car.

FRONT VISORS
(fitting most cars)
\$24.95 (Full Chrome Brackets)
\$22.50 (Painted Brackets)

SIDE VISORS
(fitting any 4-door cars)
\$12.00 (PAIR)

Visors come to you with prime paint ready for color match with your car. If your Dealer cannot supply you, send check or money order for immediate direct factory shipment.

AIRITE MANUFACTURING COMPANY

5515 TELEGRAPH ROAD • TOLEDO 12, OHIO

TRUCK PARTS FOR MILITARY TRUCKS

We carry largest stock in midwest. All makes and models. LOWEST PRICES.

Write stating model to

WILENSKY AUTO PARTS CO.
1226 N. Washington Ave., Minneapolis, Minn.



ARC WELDING FOR PROFIT OR PLEASURE

60 LBS. OF READY MADE PARTS

Only \$24.95

BUILD YOUR OWN HEAVY DUTY WELDER

SAVE
Buy Only
NECESSARY
PARTS

All parts Ready-Made and easy to assemble. You can do all around welding on steel, cast iron and other metals after only a few hours practice. Illustrated instruction manual included. Sold on 30-Day Money-Back Guarantee!

FREE: Write today for fully illustrated Pamphlet P-3

ATOMIC ARC WELDER CO.
1037 So. 19th St. OMAHA, NEBR.

Gives 100% penetration. Welds are stronger than original metal. Operates on 110 or 220 AC.

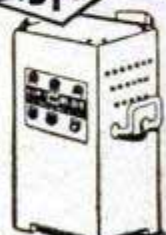

NOW YOU CAN BROADCAST!

ONLY THIS CIRCUIT PERMITTED WITHOUT A FEDERAL LICENSE

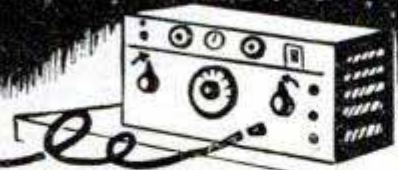

NOW YOU CAN BROADCAST! Exercise that long inhibited desire to get behind your own "mike" and get out on the ether! **NOW YOU CAN DO IT!**

NO LICENSE OR TEST OF ANY KIND REQUIRED! Use a microphone or key any place in the U.S.A. Make new friends by radio, enjoy **REAL BROADCASTING!** ONLY THE **DOUBLE C CIRCUIT PERMITTED UNDER THESE CONDITIONS**, a clever method of sine modulation.

Regardless what you have read or heard to the contrary, we **GUARANTEE THIS CIRCUIT MAY BE USED FOR AMATEUR BROADCASTING WITHOUT A LICENSE, OR MONEY REFUNDED IN FULL!** Send today for **BLUE PRINTS AND INSTRUCTIONS** how to build your transmitter and receiver. Full price for **BLUE PRINTS AND INSTRUCTIONS** only \$1.50 postpaid (orders East of Denver will be air-mailed).

Complete Kit of parts for building a 25-watt transmitter, including power supply (but not including tubes and microphone) \$29.75. **THIS IS NOT A TOY, NOT A GADGET, NOT A PHONOGRAPH ATTACHMENT, NOT AN INTER-COM . . . THIS IS REAL AMATEUR BROADCASTING!** Hurry . . . be the first in your community to be **ON THE AIR!** Send \$1.50 today for your **BLUE PRINT AND INSTRUCTIONS.**

PACIFIC ELECTRONICS
P. O. BOX 212 (DEPT. A) PALO ALTO, CALIF.



**BETTER WORK!
MORE PLEASURE!**
FROM
YOUR WORKSHOP

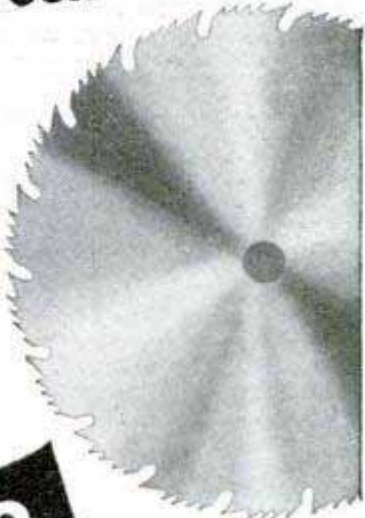

No. 37
Flat Ground Mitre

MECHANIC-KUT CIRCULAR SAWS

● For the fine craftsmanship that doubles the pleasure you get from your workshop, choose Atkins "Silver Steel" Mechanic-Kut Circular Saws. Made especially for home craftsmen, they have all the qualities that have made Atkins Circulars top favorites in large plants and shops the country over. Fast-cutting, razor-keen, beautifully accurate — with the edge-holding qualities and longer life that only the finest Atkins "Silver Steel" can give — there is no finer circular saw for the home workshop. Available in rip, cut-off or combination patterns, in 5 models, 6 to 10 inches diameter. Each individually packaged and furnished with one bushing.

ATKINS Mechanic-Kut Planer Knives. Companions in extra performance to Mechanic-Kut Circular Saws. A style and size for every home planing job.

When you buy saws or knives for your workshop, be sure of quality. Buy Atkins. See Your Dealer Soon.



E. C. ATKINS AND COMPANY
402 S. Illinois Street, Indianapolis 9, Ind.

Command Bigger Money! STUDY LAW

STUDY AT HOME for BUSINESS SUCCESS and LARGER PERSONAL EARNINGS. 40 years expert instruction — over 114,000 students enrolled. LL.B. Degree awarded. All text material furnished. Easy payment plan. Send now for **FREE BOOK** — "Law and Executive Guidance." It explains the course — how you may enroll and the many ways you can profit from Law Study. Write TODAY to:

AMERICAN EXTENSION SCHOOL OF LAW
Dept. 12-PM, 646 N. Michigan Ave., Chicago 11, Ill.

MARCOT KEY MACHINE



MARCOT No. 8 KEY MACHINE, mounted on Cabinet, less motor. \$ 95.00
Auto Code Book and Auto Depth Keys 12.50
100 Dz. Popular Cylinder Key Blanks 60.00
Set — Key File, Follow-Through Rods, Lock Picks, Bit Key Gauge, Thimble, Pins, Springs. 10.50
"Locksmith Trade Books" 6.75
How to Open Locks without Keys or Picks; Secret of Locksmithing; How to Make Keys by the Impression Method; Master Key Systems.
TOTAL COST \$184.75

A. J. MARCOTTE CO., 1200 N. Kedzie Ave. Dept. PM, Chicago 51, Ill.

LUMINOUS PAINT GLOWS IN THE DARK!



NOW you can paint any article or part of an article **Brilliant Green, Misty Violet, Bright Blue, Radiant Orange, Ruby Red, Golden Yellow and Orchid.** Beautiful, standard colors by day that glow brilliantly at night! Thousands of uses! Liberal size can any color sent postpaid for only 89c. **FREE** illustrated catalog, luminous sample display cards show how **RADI-GLOW** paints can be used.

CHEMICAL PRODUCTS COMPANY
1412 Great Northern Bldg., Dept. 201, Chicago 4, Ill.

89¢ PER CAN

SEND FOR FREE CATALOG!



Keep that
SHOWROOM SHINE

with this Wax-Treated
AUTO POLISHING CLOTH

You get 50 "dry washes" for 50c . . . with a Las-Stik Cleaning and Polishing Cloth—the heavy flannel, long-nap, super-soft, wax-treated cloth that absorbs all dust, picks up all road grime, yet never scratches, never stains. Keeps that slick new look on your car, leaves a real polish. Won't leave streaks or film, won't hurt the finest finish. Cleans as it polishes—one cloth can be used for months. The stitched edge and soft feel of this large, heavy-nap flannel cloth show its quality. Carries the guaranty seal of Good Housekeeping Institute. Comes in handy metal container for keeping cloth in glove compartment of car or on shelf in garage.

COMPANION CLOTH FOR FURNITURE—the modern substitute for the dust cloth—also sells for 50c.

Double Your Money Back if the Las-Stik Polishing Cloth does not live up to every claim we make for it!

At garages, service stations, auto supply stores. If your dealer can't supply you, send 50c to address below. Specify "Automobile" or "Furniture" Cloth (both for \$1.00).

LAS-STIK MFG. CO.

DEPARTMENT "C"
HAMILTON, OHIO

World-famous MYERS
WATER SYSTEMS

See how they're built!

There are five different types of Myers Water Systems, varying widely in design and construction to meet all needs most efficiently and economically. Free booklet shows all five types—simple, compact Myers designing, rugged in-built features, methods of operation—things you should know for proper selection of your water system. Mail coupon now.

Plunger
Type for
Shallow
Wells



Plunger
Type
for
Deep
Wells



Ejecto
Type for
both shallow
and deep
wells.



THE F. E. MYERS & BRO. CO.
Dept. N-101, Ashland, Ohio

Send your free Water System Book.

Name _____
Town _____
County _____ State _____

FREE BOOK



Drive this car for as low as 50c per week. Up to 90 miles per gallon. 45 to 50 m.p.h. Large enough for a husky six footer. A pleasure to assemble. Just bolt together our precision built parts. Get the facts. Send 25c for detailed circular with large photo, 4 view drawings, price of all parts. Better still, send \$1 (refunded first order) for this plus actual assembly book with 42 photos, drawings; blueprints of snow and ice conversions, etc.

WORLD'S LOWEST PRICED CAR

MIDGET MOTORS MFG. CO., Athens 1, Ohio

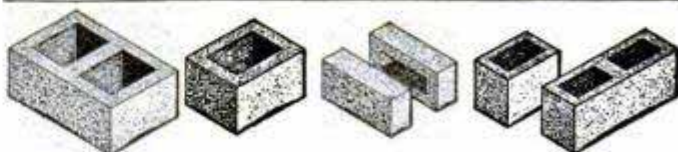

Make Concrete Blocks and Bricks

New superior method makes square, true, easy-to-lay units which will pass any building code. Small investment, high production, big profits. One \$30.00 machine will make four 5"x8"x12" blocks per minute—1000 per day. Pays for itself in a few days. Sell blocks or save 2/3 building cost by making and laying your own.

POST CARD BRINGS FREE FOLDER

Economy Manufacturing Company
Dept. P Stone Mountain, Georgia

NEW 30" SHEET METAL BRAKE

Forms angles, channels, vees, flanges, locks, zees. Handles 26 gage sheet steel, heavier gages of aluminum, copper, plastic, etc. Portable. Can be held in a bench vise, or bolted down. All steel. Wt. 40 lbs. Shipped exp. collect. **\$24.50**



12" BRAKE. Fits in vise to form difficult and compound bends, up to 20 gage steel 12" wide, \$12.50 PP.

18" CURVE FORMER. Handles 16 gage steel 2" to 30" dia., \$10.00 PP.

VISE IRON BENDER. Forms rings, hooks, eyelets, etc. in 1/2" round or square; 1/4" up to 2" wide in bar iron. Price \$10.00 PP.

SHEET METAL PLIERS. 2 1/2" wide, \$2.00; 5", \$3.50. Immediate delivery. Order direct, cash or C.O.D., or send for folder.

VISE BRAKE MFG. CO.

1116 SO. 27th ST.

DEPT. P3

OMAHA 5, NEBR.

ENSHRINE THEIR MEMORIES WITH U.S. MONUMENTS Erected. Freight paid.

There is none better. Our free catalog is ready for you. Write today. A-18, U. S. Marble & Granite Co., Oneco, Fla.

SAY YOU SAW IT IN POPULAR MECHANICS

FASTEST PLANER in the WORLD
at this Low Price... **\$215.00**

BELSAW Multi-Duty Planer

Speed up production! Increase your profits! BELSAW power self-feeds at 24 feet per minute. . . The lowest-priced surfacer that will handle 12 x 6 in. stock. Planes green or dry sawed lumber into smooth, worked forms. Three high-speed steel knives make 42 cuts per inch. Multi-duty BELSAW takes inexpensive attachments for all planing mill operations—Jointing, Rabbeting, Grooving, Matching. BELSAW is the **only** 12 in. planer providing **attachments for jointing and grinding its own knives.** Start planning NOW for BIGGER VALUE and BETTER PERFORMANCE, with BELSAW. Write for FREE specifications, illustrations and low prices.



● LARGER CAPACITY ● FASTER OUTPUT ● KNIFE SHARPENING ATTACHMENT
BELSAW MACHINERY CO. 81015 Field Bldg., 315 Westport Rd. Kansas City, Mo.

You Can Be the Local Manufacturer

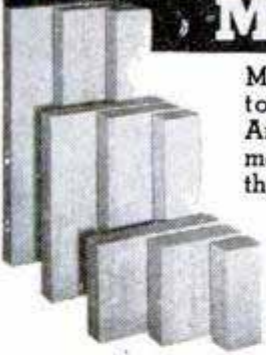

More local plants are badly needed to make Dunbrik-Dunstone — America's finest masonry. Smart—modern — colorful. Yet costs less than lumber. Millions used annually for homes, stores, factories, public buildings, etc.

Write for portfolio "Blueprints for Profit"



With Dunbrik-Dunstone you can ride the tide of the biggest building cycle in history. Local plant—local materials—local labor. Equipment costs moderate. Liberal sponsor co-operation. 100%—150% mark-up on basic costs. Write at once.

W. E. DUNN MFG. CO.
600 W. 24th St., Holland, Michigan

DUNBRIK DUNSTONE PLYWOOD BOAT KITS \$54.00

(Including Freight)



This READY-CUT 12 ft. fishing boat can be assembled in 8 hrs. without forms or special tools. Kits are complete including all hardware, paint, and etc. Send for free folder.

TAFT MARINE WOODCRAFT

Dept. K 636 39th Ave. N.E. Minneapolis 21, Minn.

FALSE TEETH KLUTCH holds them tighter

KLUTCH forms a comfort cushion; holds dental plates so much firmer and snugger that one can eat and talk with greater comfort and security; in many cases almost as well as with natural teeth. Klutch lessens the constant fear of a dropping, rocking, chafing plate. 25c and 50c at druggists . . . If your druggist hasn't it, don't waste money on substitutes, but send us 10c and we will mail you a generous trial box. © I. P. INC.

KLUTCH CO. Box 4993-C ELMIRA, N. Y.

Say You Saw It in Popular Mechanics

ELECTRICITY Anywhere

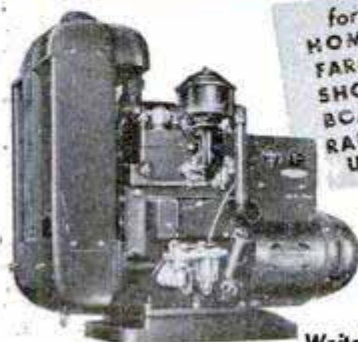

for HOMES FARMES SHOPS BOATS RADIO USE

● Onan gasoline-engine-driven Electric Plants supply reliable, economical electric service for any use. Portable, stationary or stand-by models. Water or air-cooled, compact and rugged.

A.C.: 350 to 35,000 watts in all standard voltages and frequencies. D.C.: 600 to 10,000 watts. 115 and 230 volts. BATTERY CHARGERS: 500 to 3,500 watts; 6, 12, 24, 32 volts.

Write for folder

D. W. ONAN & SONS INC.
5819 Royalston Ave., Minneapolis 5, Minn.



THERE ARE More Ways TO USE Mall Hobbyist Tools



Cutting Lumber



As a Table Saw

\$32.50
F. O. B. Chicago (Stand Only)



Cutting Concrete



Disc Sanding



As a Drill Press

\$17.50
F. O. B. Chicago (Stand Only)



Drilling Masonry

MODEL 60
2" Capacity
Mall Saw

This handy MallSaw cuts everything from wood to steel, scores aggregate compositions, grooves mortar joints, and, in addition, can be converted to:

- TABLE SAW
- BENCH GRINDER
- SHAPER
- DRUM SANDER
- WIRE BRUSH



No tool is more useful around home, farm or shop than the 3/8" MallDrill. It drills holes up to 5/8" in steel, masonry and other materials — and up to 1" in wood. Can be converted to:

- DRILL PRESS
- DISC SANDER
- METAL SHEARS
- HOLE SAW
- ROTARY FILE
- POLISHER
- SCREWDRIVER
- WOOD-TURNING

Write for FREE Booklet or visit your local Mall Dealer. He is listed in your Classified Telephone Directory.

MALL TOOL COMPANY
7805 SOUTH CHICAGO AVENUE • CHICAGO 19, ILL.

Amazing NEW TOY GUN



"Shoots" Like a Real Gun

ONLY \$1.00
INCLUDES 10,000 SHOTS

COMPLETELY SAFE

Here is the gun that will thrill every boy. When you pull the trigger, it cracks out like a real gun and smoke puffs out of the muzzle. The American Rangers Automatic is a quick acting, repeating pistol that never misses. It shoots 60 to 75 shots without re-loading. Looks like a real gun. Absolutely SAFE. Contains no explosives. Each gun comes boxed with 10,000 shots of smoke powder or enough ammunition to last a full year. This smoke powder is harmless. Will not hurt the eyes and may even be eaten. Only \$1.00 each or 3 guns for \$2.00. Only limited quantity available. Write for yours NOW.

SEND NO MONEY Try 10 Days - At Our Risk

Just send name and address. On arrival deposit only \$1.00 plus C.O.D. postage for one gun or \$2.00 plus C.O.D. postage for three guns. If not completely satisfied return and your money refunded. Save money. If you send cash with order, we pay postage. Write TODAY. No foreign orders accepted.

SPECIALTIES MFG. CO., Dept. 508
1367 N. Sedgwick Chicago 10, Ill.

Sharpens 1,000 MOWERS per Season



in spare time with the FOLEY

LAWN MOWER SHARPENER

"I have sharpened over 10,000 mowers in my Foley Lawn Mower Sharpener in the last 10 years - only repairs needed were new belts." - C.H.S., Calif. From R. R., Ill. - "The first month's business paid for my machine." The Foley sharpens all sizes and types of mowers in 15 or 20 minutes (with handles on). Prices run from \$1.50 to \$2.00 for hand mowers, and \$5.00 to \$8.00 for power mowers. This is the way to make money!

Low Prices, Less than \$50 Starts You

Start your business on payment plan if you wish - less than \$50 will put a new 1949 model Foley Lawn Mower Sharpener in your hands ready to go. 99¢ out of each dollar you take in is profit. FREE PLAN shows how to start - mail coupon today!

Send for FREE PLAN

FOLEY MFG. CO., 307-9 Foley Bldg., Minneapolis 18, Minn.
Send FREE PLAN on the Foley Lawn Mower Sharpening business.

Name _____
Address _____

Sensational New Electric

① WELDER ② CUTTER!



USES 110-115 AC or DC WELD - BRAZE - CUT - SOLDER - MELT - HEAT TREAT

BOTH only \$15

INSTRUCTIONS INCLUDED

The WELDRITE combination - tested and proven by countless commercial and amateur users, is now offered direct to you at the amazingly low price of only \$15.00. No Gas - No Gauges - No Spark Lighter needed. Always ready for immediate use - Just plug WELDRITE into 110-115 AC or DC outlet. Uses standard welding and brazing materials available at all welding supply stores. WELDRITE furnished complete with Converter Unit, #1 Single Holder with attached Alligator clip, for welding metal up to 3/16" thickness, using up to 3/32" rod, and #2 Double Holder with Copper Coated Dual Carbon Electrodes for Cutting, Brazing, Melting, Heat Treating, Soldering, etc. Starting welding materials and instructions included. Ideal for home workshop, invaluable for body and fender shops, garages, repair and machine shops, manufacturers, etc.

SEND NO MONEY! 10 DAY TRIAL OFFER. Order your WELDRITE Electric WELDER - CUTTER C. O. D. today. Pay postman \$15 plus postage charges (wt. 5 lbs.) or send \$15 and we will pay postage. Either way, if not satisfied, return WELDRITE in 10 days, and money will be refunded.

WELDER HOOD - Approved lens found in hoods costing to \$10 - only \$3.95. Free Folder on Request. California order please add 2 1/2% sales tax.

CALIFORNIA TECHNICAL PRODUCTS CO. 448 So. Hill St., Dept. A-3 Los Angeles 13, Calif.

make your own Gems 29.50 F.O.B.



All necessary lapidary equipment is furnished, including a super-charged diamond blade for sawing, and all wheels for grinding, shaping and polishing; also complete instructions. The complete equipment as shown, less motor and belt, for only \$29.50, f.o.b., Burlington, Wisconsin. Write today for information and literature.

B&I MANUFACTURING CO.
Dept. S Burlington, Wis.

New 1949 PLASTICS SUPPLIES CATALOG

Just off press. Full details on Plexiglas, Lucite, rods, sheets, tubes, Acetates, cements, dyes, buffs, molding sets, tools, carving kits, accessories. Everything in plastics. Gives prices, sizes, colors, etc. Price 10¢, stamps or coin, with ad for catalog.

PLASTICS MFG. & SUPPLY CORP.
DEPT. PM-3 • 4707 EUCLID • CLEVELAND 3, OHIO

OWN A Printing Business



Cards, Tickets, Stationery, etc. Good profit in spare time. PRINT YOUR OWN greeting cards, movie titles, church work, etc. Save money. Easy rules supplied. Raised printing like engraving too. Have home shop. Sold direct from factory only. Send dime for supply book, suggested outfits, all details and advice on your needs. No obligation. **KELSEY, INC. C-37, MERIDEN, CONN.**

Chuck Centers



For Turning, Grinding Centerless Work

Split precision bushings provide full bearing for **GREATER ACCURACY!!**

O, 1, 2, 3 M. T. Shanks

Set C-60 \$21.00 Includes 1 Chuck Center, 13 assorted bushings, popular sizes for armatures, in Steel Box. Delivered

See Your "KNOCK-OUT" Dealer or order DIRECT from

1150 1st Ave. S. E. **K. O. LEE CO.** Aberdeen, S. D.

THIS 5 ROOM ALADDIN \$1396 FREIGHT PAID

HOW TO BEAT THE BUILDING GAME

The Aladdin Read-Cut System of construction enables you to save 18% lumber waste and up to 30% labor costs, and guarantees you will receive the highest quality lumber and a COMPLETE house as specified, shipped anywhere, all in one shipment.



65 DESIGNS TO CHOOSE FROM—HERE'S WHAT YOU GET



You get all the lumber cut to fit by fast machinery production line methods—marked and numbered, ready to erect practically without the use of a saw; also siding, flooring, trim, all millwork, doors, windows, glass, hardware, nails, roofing, paint and complete drawings with instructions. During the past 40 years many Aladdin home buyers have erected their own homes.

IMMEDIATE DELIVERY SEND 25c FOR CATALOG T
THE ALADDIN CO. BAY CITY, MICHIGAN

IT'S NEW!

THE REVOLUTIONARY BOICE-CRANE FRICTION-MATIC WET TOOL GRINDER



\$16.50

F.O.B. Factory

Simplified Self-Adjusting Friction Roll Drive. No countershaft or extra belt • Peripheral Speed Remains Constant As Wheel Wears. Exclusive feature • No Water Thrown On Operator. Has "controlled-water action" • Permits Proper Pressure Control. Operator takes a comfortable standing position and works on top of the wheel • Larger Tool Rest (2½" x 5"). Perfect for long, slim knives, wide tools • Accurate Controls For Grinding Angles From Zero To 30°. First tool rest with adequate adjustment • 8" Diameter and 1½" Face Sandstone Wheel. 135 r.p.m. increasing as wheel wears to maintain peripheral speed of approximately 280 feet per minute • Gray Enamelled Steel Case. 16 gauge. Weight 14 lbs. net; 17 lbs. packed.

Order Today. Power Tool Dealers Everywhere. For literature write

BOICE-CRANE COMPANY • 943 CENTRAL AVENUE • TOLEDO 6, OHIO

THICKNESS PLANERS • SPINDLE SHAPERS • SAW-JOINTERS • LATHES • TILTING-ARBOR
SAWS • BELT SANDERS • SPINDLE SANDERS • BAND SAWS • JIG SAWS • DRILL PRESSES

Save

BUILD YOUR OWN BOAT

BIG SAVINGS AWAIT THE HOME BUILDER THRU MARINE MART'S MAIL ORDER SERVICE

World Famous "PACKAGED BOAT" Kits

18 models—outstanding design—8-18 ft.—dinghies to runabouts—inboard—outboard—sail. \$34.50 up. Finest kits available. Easy home assembly. All parts pre-cut, frames pre-assembled. Send 25c (coin) for "Packaged Boat" literature or, send \$1.00 for literature plus booklet, "Plywood Boats."

BOAT PLANS—PATTERNS—100 DESIGNS

100 modern designs by Deed, Lord, Crandall, etc. Planked, steel, plywood—all types—6 to 35 ft. Detailed blueprints, full size paper patterns available.

Send 35c (coin) for Catalog, or send \$1.00 for Catalog plus booklet, "Boat Building."

MARINE MART-DEPT. 24-BUFFALO 7, N. Y.

MARINE PLYWOOD

Plywood . . . fir, hardwood. Also boat building lumber. Stock list 10c (coin). Send 50c (coin) for stock list and booklet, "Plywood Hints."

MARINE HARDWARE

Complete stock of fittings, accessories. 15,000 items. Prompt delivery. Send \$1.00 for 250-page, illustrated catalog.

CONVERSIONS

Vee- and Stern-drives; reduction and reverse gears; kits, engines, accessories. Catalog, 50c (coin). With booklet, "Conversion Hints," \$1.00.

M-SCOPE TREASURE -MINERAL LOCATORS

WRITE FOR FREE, ILLUSTRATED 16-PAGE BOOKLET

M-SCOPE TREASURE-MINERAL LOCATORS. Low priced, unsurpassed efficiency, lightweight models. Factory guaranteed. Immediate shipment. Credit plan available. Write for free 16-page booklet.

GEIGER COUNTERS for finding Uranium ores. Several models, Simple operation. Low priced. Immediate shipment. Interesting free literature.



URANIUM

FISHER RESEARCH LAB., INC., PALO ALTO, CALIF.

GOLD

BUILD A PLAN and SAVE MONEY

NO TOOLS
EASY TO ASSEMBLE
USE OVER AND OVER AGAIN

SIMPLE DIRECTIONS
COLORFUL PLASTIC
PREVENT BUILDING MISTAKES

\$5.75

Make your "dreams" live by constructing a table size model of your Dream Home. It's so simple a child can do it. No tools—No fuss. Just follow the easy directions. Hundreds of floor plans can be created to fit your own taste.

Making changes on a scale model helps save expensive mistakes when you build your real home. Furniture cutouts to scale, enable you to plan your decorating scheme and electrical outlets.

FREE (with Set)—"How To Plan The Home You Want" 32 pages full of helpful home building hints.

Only \$5.75 Postpaid

Sorry No CODs. Add 2% Tax in N.Y.C. Money Back Guarantee If Returned Within 5 Days of Receipt.

BUILD-A-PLAN, INC., Dept. PM

1150 BROADWAY

NEW YORK 1, N. Y.



EASY PROFIT IN PAINT SPRAYING

Paints walls, ceilings, screens, furniture and machinery faster, better. All complete as shown less motor. Carry anywhere. Fully guaranteed. Could be used with 1/4 H.P. motor or less. Price \$35.00 less motor F.O.B. Chicago. \$5.00 deposit balance C.O.D. or see your dealer. With motor \$55.00.

IDEAL AUTOMATIC PUMP CO., Dept. P.M. 8
801 W. Washington Blvd. Chicago 7, Ill.

BLACK ORNAMENTAL HARDWARE BY STANLEY

Reg. U.S. Pat. Off.



FREE Idea Booklet shows where and how to use this attractive, new hardware. Styled from original Colonial and Early American pieces. 16 pages of helpful information. See your hardware dealer or use coupon below.

The Stanley Works, New Britain, Conn. Dept. PM

Please send me "Idea Booklet".

Name.....

Address.....



HARDWARE • HAND TOOLS • ELECTRIC TOOLS • STEEL STRAPPING

PRESTO! MASTER GLAZE

ANYONE CAN

LEAVES HARD GLASS-LIKE FINISH
EASY TO APPLY
PROTECTS THE SURFACE
NO SMEAR OR STREAKS AS WITH WAX
LASTS SIX MONTHS TO A YEAR

SEALS THE PORES OF THE SURFACE

WILL NOT FINGER-MARK

EASY TO KEEP CLEAN

NO OILY FILM AS WITH POLISH



SAVES YOU MONEY

Car Owners! Meet Master Glaze—the sensationally different luster for new and used cars! Not a wax—not an oil polish—not a paint!—nothing that "smears" over the surface.

MASTER GLAZE is a unique discovery—a creamy liquid—quick and easy to apply! Gives a hard, glass-like surface. Even gasoline cannot dull it! Lasts six months to a year! Amazing luster—beautiful, sparkling clean and brilliant! Doesn't finger-mark—doesn't smear! A match box full glazes an entire car. Seals the pores—protects! **NOTHING LIKE IT!**

FREE SAMPLE

Just send your name and address to

MASTER GLAZE CO., 7720-661 W. Harwood Ave., Milwaukee, Wis.



BUILD YOUR OWN ZEOLITE WATER SOFTENER

You can do it inexpensively with only a wrench and a little spare time. Famous Zeolite process softens water and removes all iron. Send \$1 for easy-to-follow directions and list of materials. (Materials available locally or from us.) Or inquire about factory-built LARCO Softeners \$45.75 up. **LAKE REGION MFG. CO., INC., 3920-A Lynn Ave., Minneapolis 16, Minn.**

WOODWORKERS... Get this

CONSTANTINE MASTER MANUAL

Get the Most Fun From Your Hobby Indispensable to woodworkers. Newest, biggest edition, more pages, more color, helpful how-to-do-it articles, pre-war and new items, more bargains. Send 25c today and we will include **FREE! FULL YRS. SUBSCRIPTION** to Chips and Chats, published bi-monthly. Keeps you up-to-date on everything in woodworking, offers big money-saving bargains. Send now.

ALBERT CONSTANTINE & SON, Inc.
791-K East 135th Street, New York 54, N. Y.



RACING CAR EQUIPMENT FOR ALL CARS

Engines, Racing Heads, Manifolds, Carburetors, Mufflers, etc. Speed Instructions and literature \$1.00—refunded first order.

LEE MOTORCRAFT CO.

1412 Great Northern Bldg.

Chicago, Ill.

AUTOMATIC RETOOTHER

MAKES NEW PROFITS

for HAND SAWS

Cuts new teeth in 50 seconds—any size 4 to 16 points. Old teeth fall off as chips. Easy to operate. A perfect job.

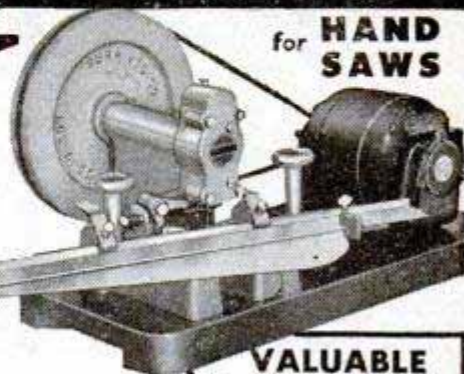

IMMEDIATE DELIVERY

BURR MFG. CO.
8933-AA VENICE BLVD.
LOS ANGELES 34, CALIFORNIA

VALUABLE BOOK

Order Burr's Blue Book of Coast to Coast prices for saw shop services. **25c**

NOW, YOU TOO CAN WELD!

IT'S EASY—WITH THE

HIGH IN PERFORMANCE
—LOW IN COST!

Complete
\$89.00



miller
"Hobby Arc"
HOME WELDER
110 VOLTS

Designed and built by the men who make the Miller industrial welders. Compact, light in weight, low in cost yet able to do a man sized welding job with electrodes up to 1/8". Operates on AC current on a 30 ampere fuse. Shipped complete with electrodes, electrode holder, helmet and cables.

TRY IT IN YOUR WORKSHOP

miller ELECTRIC MANUFACTURING CO.
APPLETON, WISCONSIN

SHARPEN IT YOURSELF!

Save money, get a \$1.00 better job for only

If you can adjust your lawnmower you can sharpen it—and perfectly. Peerless Sharpener attaches in place of stationary blade, grinds rotary blades to keen edge and perfect alignment with stationary blade. Results guaranteed or money refunded. Complete instructions included. Sizes 12 to 18 inches. Send check, M.O. or dollar bill, and size wanted to



PEERLESS LAWNMOWER SHARPENER
217 Guilford Avenue, Collingswood, N. J.

Build YOUR OWN BOAT



Complete parts cut to exact size—ready to assemble. Marine waterproof plywood, rustproof oarlocks. Ideal for car top. Also models with laminated frames; mahogany decked runabouts. Build for sale at attractive profit. Exclusive franchise to local builders. Send 10 cents (dime) for illustrated literature.

\$39.50 and up

OZARKA

639 WASHINGTON AVE.
WOODSTOCK, ILL.

HOW-TO-DO-IT WOODWORKING PLANS

FREE for the home carpenter. Now, by following these simplified blueprint plans, you can easily make attractive tables, chairs, shelves, bookcases, cabinets, etc. right in your own workshop.

You also get a full size bottle of Rogers "Gorilla Grip" Glue... the glue with a ton of strength in every drop... Tops for furniture repairs and construction.

Take advantage of this special offer... send 10c today to Rogers Isinglass & Glue Co., Gloucester, Mass.

The Glue With the Grip of a Gorilla!

ROGERS

the best LIQUID FISH GLUE
GLOUCESTER, MASS.



Provides PRECISION CONTROL..

because
FOREDOM #99
FLEXIBLE SHAFT
MACHINE with
PENCIL-SIZE
HANDPIECE..



KEEPS YOUR WORK WELL IN VIEW



35"
FLEXIBLE
SHAFT

\$15.95
COMPLETE
WITH
MOTOR

GRIND - POLISH - SAW - SAND -
ETCH - ENGRAVE - ROUT - CARVE -
MILL - CLEAN

Use on all metals, wood, plastics,
glass, leather, linoleum, etc.

REMEMBER that in the precision-made FOREDOM you get MORE POWER—LONGER MOTOR LIFE because MOTOR IS NOT DWARFED TO FIT HAND. DOES HUNDREDS OF JOBS WITH MARVELOUS EASE because pencil-size handpiece gets into hard-to-reach places—provides positive, easy, precision control.

Profit by experience of many thousands of Foredom users—over a quarter century experience stands behind the product. Other heavier-duty models at proportionately reasonable prices. No. 25 Accessory Set (a truly versatile assortment) \$5.50 extra. Also No. 999 Kit, comprises No. 99 Machine, illustrated, and set of 12 accessories, all in wooden case for only \$19.95. 6-step Foot Rheostat \$4.85. Over 70,000 Foredoms in use.

AND HERE'S ANOTHER AMAZING FOREDOM PRODUCT



YOUR MOTOR
Foredom PRESTO-FLEX
with PENCIL-SIZE Handpiece \$5.95

Now turn your old motor, drill press, or electric drill into a Flexible Shaft Tool. Simply attach to your electric drill, drill press or motor. Presto—a flexible shaft machine! Off again in a jiffy! Pencil-size handpiece gives you finger-tip control. Gets into tight places you can't reach with any other tool. Handy 35" overall length. And—only \$5.95 complete! Not to be confused with inferior imitations. Precision made, backed by 1/4 century experience in this field. All parts replaceable. Order NOW. If ordered for use on motor, specify motor shaft diameter and add 50c for coupling. (Available for 1/4", 3/16", 3/8", and 1/2" shafts.) No. 50 Accessory Set available \$1.50 extra. Order TODAY.

FOREDOM ELECTRIC CO., Dept. A-1115 Mail Coupon

27 Park Place, New York 7, N. Y.

Now

- Please send me FOREDOMS checked below on 10-day trial.
- | | |
|---|--|
| <input type="checkbox"/> Presto-Flex Tool (\$5.95) | <input type="checkbox"/> No. 25 Accessory Set (\$5.50) |
| <input type="checkbox"/> Motor Coupling (50c) | <input type="checkbox"/> Foot Rheostat (\$4.85) |
| <input type="checkbox"/> Specify motor shaft diameter _____ | <input type="checkbox"/> No. 50 Accessory Set (\$1.50) |
| <input type="checkbox"/> No. 99 Machine (\$15.95) | <input type="checkbox"/> Free Catalog |
| <input type="checkbox"/> No. 999 Kit (\$19.95) | <input type="checkbox"/> Send C.O.D. plus postage. I will pay postman. |
| | <input type="checkbox"/> I enclose payment. Send postpaid. |
- (Money back either way if not delighted)

Name _____
Address _____
City _____ Zone _____ State _____

SAY YOU SAW IT IN POPULAR MECHANICS

FISHERMEN!



Just the knife for you! Chrome plated blade with scaler, hook disgorger and cap lifter. 5" long closed... One of many CAMILLUS Knives at your local dealer's.

CAMILLUS
has the edge!

#5
K6-MILL-us

CAMILLUS CUTLERY COMPANY, N. Y. U. N. Y.

EARN BIG MONEY AND BE YOUR OWN BOSS Sharpening Lawn Mowers

Build a Business of Your Own With A UNIVERSAL GRINDER

In your own garage or basement, and earn \$25.00 a day or more. Mr. Hardy writes, "I am doing a fine business with the UNIVERSAL GRINDER. One customer sends another. I spent 40c for a newspaper ad and have done nearly \$500.00 worth of business." Mr. Helmeck of Canada writes, "We sharpened 750 mowers last year and are 1056 on this year's run. The Universal surely makes satisfied customers." Mr. Barton of California says, "The lawn mower business, with the Universal Grinder, has been a gold mine these last two years."



A Complete Single Unit • No Attachments Necessary
 • Precision-Built • Simple to Operate • Sharpens
 Reel Blades at Proper Angle • Grinds a Keen
 Cutting Edge Full Length of Blade

Only on the UNIVERSAL GRINDER can the inside face and edge of the stationary blade, as well as the reel blades, be ground to proper clearance

ALL IN ONE SET-UP

WITHOUT REMOVING ANY BLADE FROM THE MOWER

Write for FREE Folder today!

Rogers Mfg. Co., Dept. M-39, Lindsey, Ohio

Supreme HOMESHOP BAND and CIRCULAR SAWS



**HAIRLINE CONTROL • LESS RESHARPENING
FASTER, SMOOTHER CUTTING • LONGER LIFE**
 NOW—for your home shop! Famous SUPREME Band and Circular Saws nationally used by industry—now available in the SUPREME HOMESHOP Line to fit any size or make of home power tool! Special Nickel Alloy Steel. Free from kinks and other imperfections. SUPREME HOMESHOP SAWS are precision-engineered for highest cutting efficiency under heaviest punishment. End saw troubles, cut costs, speed your best work.

SUPREME BAND SAWS
 6' 6" — \$1.00 7' 9-1/2" — \$1.10 9' 6-3/4" — \$1.30
 in any of the following widths: 1/8, 3/16, 1/4, 3/8".
 8" Flat-Ground Combination Circular Saw — \$3.65

IMMEDIATE DELIVERY — ALL STANDARD SIZES
 ACT TODAY! ORDER DIRECT, stating Size, Make and Model. Or at your dealer. Write for Free Illustrated Circular.

THE SAW & KNIFE SPECIALTY CO.
 6526 CARNEGIE AVENUE • CLEVELAND 3, OHIO

ZIPSCOOT \$49.75

America's Outstanding Scooter Value!
 This smart looking speedster is easily and quickly assembled from our factory finished kits. Uses standard gasoline motor. Speeds up to 30 miles per hour. 100 miles per gallon of gas. Send 25 cents for assembly information, drawings, and illustrations. Kits available for immediate shipment.

Zipscoot Company, Toledo 6, Ohio

BUILD YOUR OWN BOAT—Only \$35

NEW Guaranteed Complete Kit

Write for FREE folders to Dept. P.M.

Includes all PRE-CUT Marine wood parts, screws, glue, hardware, building jig. Easy to build in few spare hours. Simple directions. Aircraft shell design gives amazingly tough 65 lb. V-bottom boat for hunters, fishermen, yachtsmen, boys 8 to 80. Converts to fast, stable sailer — any time with extra kit.

PRITCHARDSONS' • 2744 W. 37th PL. CHICAGO 32, ILL.

STATION WAGONS CABS

AND BODIES FOR ALL JEEPS — WOOD OR ALUMINUM

Cabs in kiln dried hardwoods, bodies of aluminum. Safety glass, finest hardware, locks, full opening rear door.

CABS \$144.50 Plus Tax

FOB Cleveland, Complete, semi-assembled. Full bodies slightly higher. Send 25% with order, balance COD.

STATION WAGONS, INC. (PM)
 6619 Euclid Avenue, Cleveland, O.

BRUSH PLATING OUTFITS

• for re-plating articles in the home and shop. No tanks necessary. Free particulars. •

GUNMETAL CO., AVE. M, DECATUR, ILLINOIS

RUPTURE!

An amazing Air-Cushion Invention allows body freedom at work or play. Light, neat, cool, sanitary. Durable, cheap. Day and night protection helps Nature support weakened muscles gently but surely. No risk. **Sent on Trial!** Write NOW for free Booklet and Proof of Results. All correspondence confidential.

Brooks Company, 161-D State St., Marshall, Mich.

ITALIAN ACCORDIONS

Hand Made. Very Best. Lowest Prices. Buy Direct from Factory Representative and Save Money. Send Name and Address for FREE catalog.

ITALIAN ACCORDION MFG. CO.
 7600 Cottage Grove Ave., Dept. PM3, Chicago, Ill.

WAKE UP YOUR Scalp

WITH THE NEW ELECTRIC-AUTOMATIC Vitabrush

BE FAIR TO YOUR HAIR Want better looking hair? Embarrassed by falling dandruff, itching scalp? Get the new VITABRUSH, the electric-automatic brush with built-in brush head motor... gives scalp and hair an invigorating "workout" in just 3 minutes. Cleans scalp, stimulates blood supply, distributes the natural oils. Fun to use—relaxing. Write for satisfaction-guaranteed offer—today.

Hershey Mfg. Co., 3714 Field Bldg., Chicago 3.

FREE parts catalog



Build Better Trailers
with Safety-Engineered

- ★ Torq-less Axles
- ★ Bull Dog Hitches
- ★ Parking Jacks

... Send for your copy TODAY!



HAMMER BLOW TOOL CO.
Dept. 131, Wausau, Wisconsin



WHEELS AT BARGAIN PRICES

- ... 4" wheel & tire, 5/16" sleeve bearing: \$0.45 ea.
- ... 5" wheel 5/8" solid tire 5/16" shaft hole 0.65 ea.
- ... 6" wheel 5/8" solid tire 5/16" shaft hole 0.75 ea.
- ... 7" wheel 3/4" solid tire 3/8" shaft hole 0.85 ea.
- ... 8" wheel 1" solid tire 1/2" sleeve bearing 1.25 ea.
- ... 8x2" wheel, semi-pneumatic tire 7/16" ball bearing 2.50 ea.
- ... 10x1.75 wheel semi-pneumatic tire 7/16" or 1/2" ball bearing 3.25 ea.
- ... 12x1.75 wheel semi-pneumatic tire 1/2" bronze bearing 3.50 ea.
- ... 10x2.50 wheel semi-pneumatic 1/2" ball bearing 4.50 ea.
- ... 6x2" wheel 5/8" ball bearing, solid tires 2.95 ea.

BUILD YOUR OWN—Wagons — Scooters — Soap Box Racers — Welding Carts — Baby Pens — Etc. To order above wheels write number wheels wanted in space provided, tear out and mail this ad with check or money order and your name and address. If other sizes are wanted write for FREE LIST.

TRULSON MFG. CO., 811 E. 31 St., Dept. WP-2, Kansas City, Mo.

NEWEST OTTAWA LOG SAW

SELF-PROPELLED — MOVES ANYWHERE on OWN POWER

World's fastest Log Saw. Powerful 6 H-P air-cooled motor. Attachments for sawing down trees, buzzing limbs, post hole digging and pulley for belt jobs. Big demand for wood, pulp, posts. Make big money sawing wood this easy way. Low factory-to-user prices. Nothing like it. **FREE** details.



OTTAWA MFG. CO., 7-927 Pine St., Ottawa, Kansas

BUILD YOUR OWN ENLARGER

Enjoy Photography's most fascinating hobby at a fraction of usual cost. With simple step-by-step instructions and diagrams plus a screwdriver and pliers you assemble your own Enlarger and Save! Get all features of more expensive Enlargers: precision machined aluminum alloy castings, 90° tilt for wall projection of prints, spherical aluminum lamphouse, helical rack and pinion focusing with extra large knobs, unconditional guarantee. For 35mm to 2 1/4 x 3 1/4 negatives. Time payment plan.

Write Today for Free Illustrated Folder
CALIFORNIA TECHNICAL PRODUCTS CO.
448 S. Hill, Dept. M-3, Los Angeles 13, Calif.

One Year Written Guarantee!
ARMY AIR CORPS 16 JEWEL

ELGIN

\$19.95



Made for Pilots and Navigators of the U. S. Army Air Forces. They had to be good. Sturdy 16 Jewel Elgin men's wrist watches. Shock resistant. Sweep second hand. Luminous hands and dial. Stainless steel back. Unbreakable crystal. Water repellent. Made by ELGIN one of America's outstanding watch manufacturers. Fully reconditioned. One year written guarantee sent with each watch. Supply limited! **SEND NO MONEY.** Simply pay postman \$19.95 plus 10% tax and postage on delivery. Cash orders sent postpaid. **UNITED PRODUCTS CO., 7941 S. Halsted, Dept. RES-1509, Chicago 20.**

Thousands of Parts For Military TRUCKS

We have for immediate delivery genuine parts for all makes and models, 4x2 - 4x4 - 6x4 and 6x6. All models from 1/2 ton to 20 tons. All makes: Autocar, Biederman, Brockway, Chevrolet, Diamond T, Dodge, Federal, Ford, GMC, International, Mack, Oshkosh, Reo, Studebaker, White, Willys and Jeeps. We have parts lists available on some models. Write stating model of Truck.



JEEP TOPS and CURTAINS

(Weatherizing Kit), complete top with back curtain and side curtains with zip-in-doors. 5 windows. Waterproof O.D. color. Shipping weight 40 lbs. Wonderful value. **FOB, K.C. \$34.50**

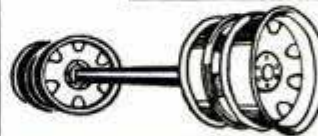

TRAILER AXLE

Heavy duty trailer axle suitable for many types of trailer construction. Also excellent for building of heavy farm trailers and wagons. It is a 15,000 lb. capacity square type straight trailer axle complete with Timken roller bearings, hubs, and 6 hole 750 x 20 Budd Wheels. Without brakes. Axle is 2 1/2 inches square and 70 inches between wheel mounting flanges. Std. width. **AN EXCELLENT BUY.**

With Single Wheels. \$59.50 With Dual Wheels. \$69.50

NEW POWER WINCHES

Govt. Surplus. All are Brand New and Suitable for front or rear mounting.

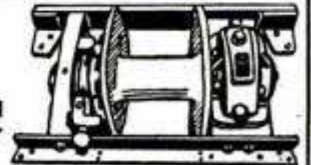

WINCH CABLE—With Chain and hook, 1/2" in diameter. 200 ft. length. **\$2500**

WINCH CABLE—New, with hook, 3/8" in diameter. 300 ft. length. **\$3750**

New **WINCH, GARWOOD OR HEIL**—15,000 lb. capacity. **\$1500**

GARWOOD WINCH—25,000 lb. capacity. **\$2000**

HYDRAULIC JACKS



Government Surplus, slightly used 5 ton Hydraulic Jacks of popular brands. Guaranteed serviceable, complete with handle. Shipping weight, 25 lbs. Each **\$7.95**

UTILITY GAS TANK

6 QUARTS—New Surplus. Cylindrical 5 1/2" diameter, 15 1/2" length. Brackets for mounting in horizontal position. Complete with Filler cap in center, drain plug in bottom and pet-cock on end. Ideal fuel tank for small gas engines, stoves, etc. **99c**

TOW CABLE—15 ft. long, 1/4" thick. Steel with clevis and eye. Every motorist should have for emergencies. Shipping weight 2 1/2 lbs. Each. **99c**

All prices quoted are FOB, Kansas City. 25% deposit required on COD orders.

American AUTO PARTS CO.
1830 LOCUST — DEPT. PM
KANSAS CITY, MISSOURI.



MUCH MORE SPEED FOR OUTBOARDS!



All tests conclusively prove that MICHIGAN'S newly developed "AQUA-JET" propellers provide more speed and better performance for the following motors: Mercury 7 1/2 and 10 H.P.; Champion 8; Scott-Atwater 7 1/2; Evinrude L-4; — on racing craft and runabouts. Write for prices. Other propellers for superior performance for practically every Outboard in every application. Write for catalog with recommendation charts. **MICHIGAN WHEEL CO., Grand Rapids 3, Mich.** World's largest manufacturers of motorboat propellers. Dealers everywhere.

PROFITS AND SPEED

THE MODERN LAWN MOWER SHARPENER

PRICE
\$241⁵⁰
LESS
MOTOR

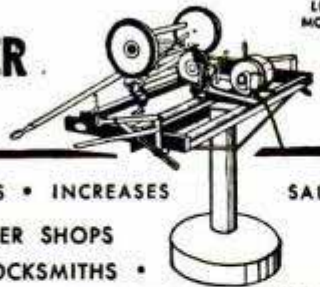

INCREASES PROFITS • INCREASES SALES!
FOR LAWN MOWER SHOPS
FIXIT SHOPS • LOCKSMITHS •
HARDWARE STORES • GOLF COURSES • SCHOOLS
PARKS • PLAYGROUNDS • INSTITUTIONS •
CEMETERIES • AND ALERT INDIVIDUALS!

Sharpens All Reel Type Mowers • Hand, Power or
Gang • 10 to 20 Minutes • No Dismantling
No Extra Attachments Needed

All reel type mowers, from 5-inch edgers to 36-inch power mowers, are quickly sharpened to extreme ends of both left and right twist reel blades. Handle, wheels, roller and motor remain in place when sharpening is in process. Bed knife is sharpened in same brackets that hold mower in grinding position. No extra attachments required. One lever puts mower or bed knife in grinding position. 100% steel construction. Grinding head rides on five ball bearing races. Small, compact, easy to operate. Sharpens wood chisels, joiner knives and planer blades without extra attachments.

ORDER NOW
Immediate
Delivery

Skate Sharpener Attachment Available
Send For Free Bulletin No. 10B

MODERN MFG. CO. 160 N. FAIR OAKS AVE.
PASADENA 1, CALIFORNIA

This Amazing Hand Tool Has Everybody Talking!



New
**WISE-GRIP
WRENCH**

And no wonder! You can search the world over and nowhere will you find a tool with the genuine usefulness of the New VISE-GRIP wrench. Does jobs impossible with any other tool.

- LOCKS with terrific grip.
- Adjusts to pliers action.
- Exclusive Involute Jaw Curve combined with Knurled Jaw Tips, Thin Nose and Wire Cutter makes this tool perform with real magic.

FINE ALLOY STEEL. NICKEL PLATED FINISH.

WITH Cutter	WITHOUT Cutter
No. 7W—7-in., \$2.25	No. 7C—7-in., \$1.85
No. 10W—10-in., \$2.50	No. 10C—10-in., \$2.25

If not at your dealers, order direct.
Postage paid if price accompanies order.

PETERSEN MFG. CO. • Dept. M3 • DeWitt, Nebr.

Ball-Bearing *SPEED WHEELS*



JUVENILE WHEELS

(No bearing, solid tires)

4".....45c 6".....65c
7".....75c

(Semi-pneumatic tire, ball bearing)

6x1.....1.65	8x2.....2.20
8x1.25.....1.85	10x1.25.....2.20
8x1.75.....1.95	10x1.75.....2.30
12x1.75.....3.45	

INDUSTRIAL WHEELS FOR HEAVY LOADS

6x2 Welded.....3.45	10x2.75 HC.....5.70
8x2 Bolted.....4.35	10x2.75 Prie.....7.00
8x1.....5.25	12x2.00.....6.90
8x2.00.....5.20	12x3.00.....10.60
8x2.50.....5.40	4.00x8-2.....14.70
10x2.00.....6.10	4.00x8-4.....15.85
16x4.00.....15.15	

DEALERS, JOBBERS,
AND MANUFACTURERS!
OUR NEW PRICES WILL
INTEREST YOU.

WRITE US NOW FOR COMPLETE
NEW CATALOG

Send check with order. No C.O.D.

JIM BROWN TOY COMPANY

1097 Home Ave.

Akron 10, Ohio

MILITARY TRUCK PARTS

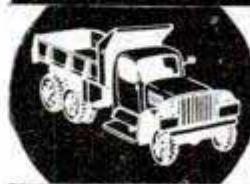

Every part for every G.I.
type vehicle from jeep to
20-ton prime mover 6x6
40% to 80% below list.

NORTHWESTERN AUTO PARTS CO.

834 NORTH SEVENTH ST. • MINNEAPOLIS 11, MINN.

MAKE MONEY MAKING DOUGHNUTS

Make new greaseless doughnuts at home on electric machine. Sell for cash to grocers, cafes, drug stores, etc. No exp. nec. Good profits. Small investment. Send for free recipes and plans.

MART RAY CO. • 3605 S. 15 Ave. • Minneapolis 7, Minn.

DRAINS CELLARS, WASH TRAYS CIRCULATES OIL



Pumps 1800 GPH 300 gal.
30' high, use 1/8 to 1/2 HP motor. Will not clog. **\$6⁵⁰**

Postpaid if cash with order.
(Add 50c for west of the Mississippi.)

Thousands in use since 1936

LABAWCO PUMPS, BELLE MEAD 7, N. J.

CRESCENT TOOLS

Give Wings to Work

ASK YOUR
HARDWARE
DEALER

AGENTS 300% Profit SIGN LETTERS

For Store Fronts and Office Windows. Anyone can put them on. Free Samples. Liberal Offer to General Agents.

METALLIC LETTER CO., 430 N. Clark, Chicago 10



GETTING BALD?

Doctor's Amazing Discovery for Hair and Scalp!

Why spend hundreds of dollars and time visiting fancy offices for treatment? • This discovery may be used in the privacy of your home—in a few minutes—only once each week—made from a specialist's prescription, it has been highly successful in stopping further loss of hair due to the most common cause—seborrheic dermatitis and associated dandruff! We do not claim infallibility. • Guaranteed refund if you are not delighted with a healthier head of hair! Mail your name and address only! When this remarkable formula preparation with easy to follow instructions is delivered to you pay postman only \$10 plus postage! This product is medically tested and proven! It is guaranteed to delight and surprise you! Baldness won't wait! Order now! Mail Orders to Dept. 8 NATIONAL SCALP RESEARCH, Box 186, Jersey City 3, N. J.

SEND
NO
MONEY

MAKE ANY CUT WITH THESE NEW WOODSHAPERS for YOUR CIRCLE SAW or DRILL PRESS!



MODEL #60—Originally designed for heavy industrial use, now priced for home workshop. Can be attached directly in chuck of your drill press. Exclusive pilot bearing (see illustration) eliminates side thrust, chatter and vibration—assures smooth cutting action. Blades can't come out—set screws hold them securely. Complete, with **YOUR CHOICE OF ANY 6 PAIR DOUBLE-GROUND BLADES SHOWN BELOW**, only \$12.95.

MODEL #50—Same as Model #60 but without exclusive pilot bearing. Designed for intermittent shaping; over 100 different shapes can be cut. Complete, with **ANY 6 BLADES OF YOUR CHOICE SHOWN BELOW**, only \$8.95.

All Aladdin tools are guaranteed. Postage prepaid with all cash orders. C. O. D. plus postage. **GET YOUR ORDER IN TODAY.**

ALADDIN MFG. CO., INC.

3121 Main Street

Kansas City, Missouri

Dealers Write Today



For Your Circle Saw

MODEL SA-10—Heavy-duty, industrial-type shaper of solid steel, now priced in home workshop range. Absolutely safe—blades locked in position with screws all the way through. In ordering, state diameter of shaft. Complete **WITH ANY 6 PAIR OF READY-GROUND BLADES SHOWN BELOW**, only \$14.95.

ALADDIN WOODSHAPING BLADES

Specify by number the blades you want. Additional blades \$1.50 each, \$3.00 per set.

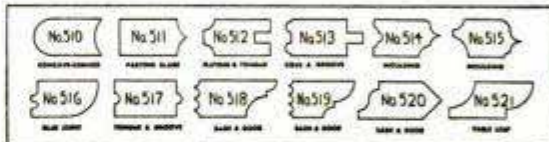

NAVY STYLE FIELD SHOES



NEW. Sturdy, long-wearing, comfortable. Reverse leather upper. Oak leather inner sole. Composition outsole, rubber heel.

4.99

Sizes 7 thru 12. plus 25c for mailing.

SHEEPLINED FLIGHT PANTS



Reissue, excellent condition. All leather. Sizes small, med., large.

3.98

plus 25c for mailing.

Money Back Guarantee

WAR SURPLUS VALUES

AVIATORS' JACKET

Brand new. Air Corps Type B-15. Fully alpaca lined, including sleeves. Zipper front. Large mouton fur collar. Sizes 34 thru 44.

12.44

PLUS 25c FOR MAILING



NAVY JACKET

Brand new. Navy N-1 Jacket. Fully alpaca lined. Zipper and button front. Sizes 36 thru 44.

12.44

PLUS 25c FOR MAILING

NATIONAL JOBBING CO.

BOX 1485 Dept. N-3 Omaha, Nebr.

OFFICERS' PINKS

Brand new. Fine quality officers' elastique trousers. Sizes 29 thru 42. Reg. \$17.95 value.

11.50

plus 25c for mailing.



SHEEPLINED JACKET

Air Corps Type B-3. Like new. All leather with full sheep lining and large sheepskin collar. Zipper front. Sizes 36, 38, 40, 42. Plus 25c for mailing.

14.95



Send for **FREE CATALOG**



WRITE FOR YOUR FREE COPY OF THE NEW KRW HYDRAULIC PRESS BOOK

Describes all manner of Production and Shop Work on KRW Hydraulic and Bench Type Presses. 32 pages illustrating the new KRW Hand-operated, Electric-operated and Air-operated Hydraulic Presses. 25 to 100-ton capacities.

Write for your copy today.



K. R. WILSON, DEPT. 17, 215 MAIN ST., BUFFALO 3, N. Y.

Lowest Priced Arc Welder

... gives World's Easiest Welding "LINCWELDER 180 AC"

NOW EVERYONE CAN:

- Repair broken steel and cast iron parts.
- Reclaim worn parts with hardsurfacing.
- Build all kinds of equipment.

See it... try it at your local Lincoln Welder. Get full details in Bulletin 370, or write The Lincoln Electric Company, Dept. 191, Cleveland 1, Ohio.

PRICE* **\$150.00**
FREIGHT PREPAID



Has the amazing Self-starting Arc

*Lowest priced 180 amp. arc welder. Built for 220 volt line only. Accessories as shown, \$19.00.

REASON IT OUT AND YOU'LL

PREFER

THIS



ALL-VEGETABLE LAXATIVE

NATURE'S REMEDY (NR) TABLETS
—A purely vegetable laxative to relieve constipation without the usual griping, sickening, perturbing sensations, and does not cause a rash. Try NR—you will see the difference. Uncoated or candy coated—their action is dependable, thorough, yet gentle as millions of NR's have proved. Get a 25c box and use as directed.

Nature's Remedy
NR TO-NIGHT TOMORROW ALRIGHT

FUSSY STOMACH?

RELIEF FOR ACID
INDIGESTION,
GAS AND
HEARTBURN



EAT LIKE CANDY
TUMS^{10c}
STOMACH DISTRESS
FOR THE TUMMY!

BUILD ARC WELDER PLANS 35c

We Show You How to build this new powerful welder without rewinding. For light or heavy work. Uses coils taken from old auto generators. Works on 110 or 220 volts A. C. Has 20 different heats. Send 35c for complete PLANS and valuable Catalog. Write today.
LEJAY MFG. CO., 3347 LeJay Bldg., Minneapolis 8, Minn.



BEFORE YOU BUY ANY SMALL TRACTOR



SEE THE POWERFUL
S-H.P. GRAVELY—

the world's finest, yet most moderately priced Garden Tractor. Complete line of exclusively designed power tools for every Garden, Lawn and Field job.

ONE TRACTOR DOES 17 JOBS!

GRAVELY TRACTOR

FIELD-TESTED FOR 27 YEARS

MAIL NOW! FOR NEW FREE BOOKLET!

GRAVELY MOTOR PLOW & CULTIVATOR CO.
BOX 363 DUNBAR, W. VA.

NAME _____
ADDRESS _____
TOWN _____ STATE _____

SOLVING YOUR LAWN & GARDEN PROBLEMS

Build your own SMITH Compressor

Operates spray guns, rock drills, tampers, paving breakers, sandblasting . . . Uses only 1 gallon of gas an hour!



Save Money—build your own Smith Air Compressor! Famous the world over! Capacity 60 cu. ft.; pressure up to 100 lbs. per sq. inch. Just order the Smith Compressor Head and Accessories with complete instructions for assembling. All you need is a Ford Motor and shop facilities. Head equipped with high speed compressor valves; automatic unloading and idling.

Write for complete information!

GORDON SMITH & COMPANY, Inc.
410 College Street • Bowling Green, Ky.

NU-WAY HEAVY DUTY CUTTING UNIT

with Timken Roller Bearings

PRICE

\$16.50

WHY PAY MORE



Build your own rotary type lawn or weed cutter. Take the hard work out of weed cutting. Build yourself an up-to-date weed and lawn mower with the Nu-Way heavy duty unit.

Write for Free Circular—We Supply Cutting Unit Complete
TRACTOR-LITE MFG. CO., Spirit Lake, Iowa

LOOK!

FIN-DER SAX-SLING

NEVER SLIP OR KINK
HIGH SPEED ADJUSTING
BALLBEARING

\$1.00

AT ALL GOOD DEALERS
OR ORDER DIRECT

FIN-DER 1251 - 4th Avenue, San Diego 1, Calif. **NEW!**

GERSTNER Tool Chests

for the good tools of Machinists and Toolmakers, are superior in every way. Free catalog.

GERSTNER TOOL CHESTS

449 Columbia St. Dayton 7, Ohio

POWER HACKSAW \$47.25

LESS MOTOR
F. O. B. Benton Harbor

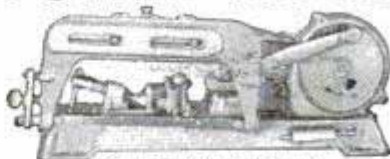

No other saw like it. Rugged cast iron construction. Bronze bearings. Quick action vise—jaws swivel to 45°. Draw cut. Automatic shut-off switch. Capacity 4" x 4".

Send for full details and name of nearest dealer.

EXCEL MACHINE TOOLS DEPT. PM-39 BENTON HARBOR, MICHIGAN

SAVES FUEL!

Thermostatic
RADIATOR VALVE . . .
Automatically

LETS YOU HEAT ANY ROOM INDIVIDUALLY AT THE MOST

COMFORTABLE TEMPERATURE.

Replaces ordinary air valves. Radiator heats only when temperature drops below valve setting and shuts off vent when setting is again reached. May be installed in one-pipe steam system.

\$4.95

prepaid



SEE YOUR LOCAL DEALER OR WRITE **HEAT-TIMER CORP., 160 Fifth Ave., N. Y. C.**

GET THIS USEFUL . . .

"Teddy" KIT

for
SANDING!
POLISHING!
GRINDING!

FITS
ANY
ELECTRIC
DRILL

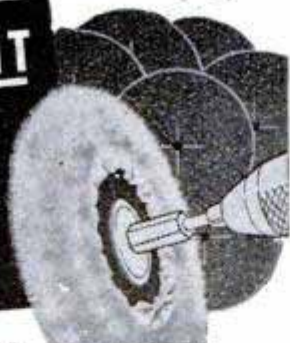

NOW ONLY
\$3 25

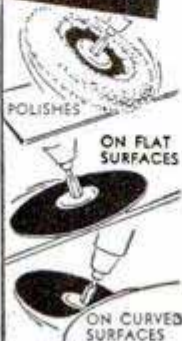

POLISHES

ON FLAT
SURFACES

ON CURVED
SURFACES

Has over 1000 uses — polishing furniture, autos, etc., waxing, sanding and refinishing wood and metal, smoothing welds, etc.

6" heavy flexible rubber disc, bends into curved surfaces. 6 heavy backed, garnet sanding discs, of ass't grits, superior lambs wool bonnet. Disc and bonnet are attached in a jiffy without cementing. A handy kit to own.

OTHER KIT SIZES

3 1/2" \$1.50 5" \$2.85
4" \$1.75 7" \$4.00

MONEY BACK GUARANTEE

See your nearest dealer or order direct enclosing check or money order.

FRED V. FOWLER CO.

137 FEDERAL ST., BOSTON 14, MASS.

GENUINE

DIAMOND SCRIBER!

\$2.00

Postpaid

Writes on glass, metals, plastics. Hex. aluminum 6". Money back. No C.O.D.'s; send cash, M.O., check.



CLIPPER DIAMOND TOOL CO., INC.

21-B W. 46 ST., N. Y. 19

SPEED AND POWER HANDBOOK



Very latest methods! Build your own Dual Manifolds, Superchargers, "Water Injectors," Hi-Compression Heads, Fuel Saving Devices—easily. **SAVE MANY DOLLARS!** Get racing speed, acceleration, dynamic power increases from any automobile! Build fast stock cars! California roadsters! Hotrods! Get ingenious formulas! Speed secrets! Illustrations! Conversion ideas!

Also "Economy Information"—Mileage tricks! Tuning techniques! Picture catalogues. Including "California Restyling Ideas"—Glossy photographs! Drawings! Model revising! Customizing! Streamlining! \$1.98 complete.

Newhouse Automotive Industries, 5941-B4 Hereford, Los Angeles 22, Calif.

BARGAINS FROM WORLD WAR II

Thousands of Bargains in Military, Outdoor & Sport Goods for Hunter, Farmer, Scout. Send 10c for NEW 32-page catalog, just issued, returned with first order.

A and N SUPPLY CO.

4720 LESTER ST. RICHMOND 15, VA.

REAL DIESEL ENGINE

\$2.95

WE'RE CRAZY, they tell us, giving away a real diesel engine, complete with cylinder and piston, carburetor, crankshaft and connecting rod. All parts completely machined, ready for easy assembly. **ONLY \$2.95.** How do we do it? We're selling thousands of **DEEZILS**. So production's up; costs tumble down. **DEEZIL** is a precision engine. Actually runs at 7500 RPM. Produces 1/7 HP.

Ideal for planes, boats, midget cars. Send \$2.95 plus 25c postage today.

GOTHAM HOBBY CORP.

107 East 126th Street New York 35, N. Y. Dept. "P"

PICK OUT THE MAN WHO FISHES WITH A Shakespeare WONDEREEL



Long Casts Without Backlash

3-WAY SPIN CONTROL the Secret

Yes, sir, the happy fisherman is the WONDEREEL fisherman, because he gets long, accurate casts without backlash or thumbing . . . thanks to:

One: oversize tail end bearing, *two:* adjustable head end spool cap, and *three:* lightweight spool for easy starting, quick stopping.

These patented Shakespeare 3-Way Spin Control features prevent backlash, because they won't let spool and line outrun bait. That's why beginners learn to cast with Wonder reel in 5 minutes, why even experts are switching to it. In 3 models at sports stores.

FREE 1949 TACKLE BOOK and Pocket Fishing Calendar. Newest in Reels, Rods, Lines, Accessories, Fishing Tips. Write Shakespeare Company, Dept. 83, Kalamazoo 2, Michigan.

Shakespeare

FINE FISHING TACKLE

HONOR BUILT FOR OVER 50 YEARS

MAIL THIS FOR

New Catalog

of Attachments and
Accessories for Lathes



SOUTH BEND LATHE WORKS

455A E. Madison St., South Bend 22, Indiana

Name _____

Street _____

City _____ State _____

Q. D. WOOL SHIRTS
13 to 15
269
PANTS
28 to 34
295



Perfect condition, designed for reissue. All have been cleaned and pressed by the Q. M. Corps. 100% all wool serge. Priced less than the cheapest work clothes. Add 12c postage per garment.

BRAND NEW KHAKI SHIRTS-PANTS
14 to 17
299
28 to 42
379

NEW. Neatly tailored of 8.2 chino khaki suntan material. Shirts have 2 button-down flap pockets, pants have cuffs. Add 10c postage per garment.

OFFICER STYLE OXFORDS
695



• BROWN
• BLACK

NEW. Finest quality uppers, best oak bend leather outer sole. Half leather lined. Add 20c post.

ORDER FROM THIS AD

BARGAINS

- 50% WOOL HOSE
NEW. Medium weight, rugged and warm. Post. 3c.
- 63% CUSHION FOOT HOSE
NEW. 63% wool, double sole. These are known as the desert sock. Khaki and white. Add 4c post. per pair.
- B-15 AVIATOR'S JACKET
Renders greatest warmth per oz. of weight. Mountain cloth outside, pile lined body and sleeves. Genuine mouton collar. 4 pockets—2 outside, 2 inside. Wool knit cuffs and waistband. Add 27c postage.

39c

49c

1288

WAR Surplus

And other outstanding bargains—Order from this ad. It offers Added savings.

NAVY STYLE FIELD SHOES
499



NEW. Rugged, comfortable. Reversed uppers, full oak leather inner sole, extra composition outer sole. Add 22c post.

PARA-TROOPER BOOTS
\$9.95 SIZES 6-12



10" high—Uppers Brown Elk, Good-year Welt, Oak Leather Sole, Extra Composition Tap Sole. Add 27c post.

NYLON PARACHUTE CORD
NEW. Ideal for clotheslines, 50 FT. drapery and venetian blind cords. 550 lbs. tensile strength, 3/16" diameter. Add 7c postage. **59c**

ARMY STYLE COMBAT BOOTS
688



NEW. For sportsmen and outdoor wear. 10" high. Reversed uppers, full oak leather sole, with composition outer sole. Add 27c post.

6 TO 12

NAVY T-SHIRTS WHITE



59c

NEW. Combed yarn, full cut. Small, medium, and large. 5c postage.

MAIL ORDERS . . .

Please send remittance with order. Include postage. Guaranteed Satisfaction.

SIoux FALLS SURPLUS STORE
SIoux FALLS, S.D. **SEND FOR FREE War Surplus CIRCULAR**

SAY YOU SAW IT IN POPULAR MECHANICS

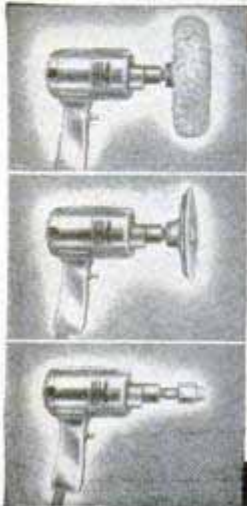

JONES Model 48 POLISHER
3 TOOLS IN 1

- For **POLISHING . . . SANDING . . . DRILLING**
- For Simonizing the family car—**BUFFING—POLISHING** (furniture), metal, wood, plastics, and other hard surfaces.
- For **SANDING** woodwork and other materials, removing paint, etc.
- For **DRILLING** anything—with the Jacob's 1/4" chuck attachment.

Write for Bulletin

JONES MOTROLA CORP.
STAMFORD, CONN.

"PRE-SEASON" OFFER
Make Ur Own Power
LAWN MOWER
Just add Engine or Motor

- Lightweight "easy to operate."
- Cast aluminum base with 18" Rotary Blade (Hardened Steel).
- Ball-bearing rubber tired wheels.



Now is the time to install your own gasoline or electric motor on a well built new aluminum chassis. Will accommodate up to 2 1/2 hp engines or 1/2 hp motor.

WE can also furnish gasoline and electric power mowers at big savings. Inquiries invited.

PRICE F.O.B., K.C., MISSOURI
SEND CHECK OR M.O. NO COD'S

ATLAS EQUIPMENT CO.

229 S.W. BLVD. Dept. P.M. KANSAS CITY, MO.



RULE-LEVEL

The amazing ruler with built-in levels. Ideal for mechanics, home workshops, all maintenance. Fine quality hard wood. 18 inch, 98c. 36 inch, \$1.50.

GEO. E. WATSON CO. DEPT. 3-P.
CHICAGO 1, ILLINOIS



ARC WELDER

A sturdy, compact, metal Arc Welding Outfit for light welding. For home workshops, mechanics, farmers, etc. Repairs toys, fenders and other steel or galvanized items, 16 ga. Everything you need—Welder, Helmet, Rods, Attachments, Instructions. Only \$5.95 postpaid, or C.O.D. plus few cents postage. Ten-day Trial Offer. Money back guarantee if not satisfied.

\$5.95
Complete

MINEX MFG. CO., 173 Debolt St., Newtown, Ohio

STURDY ALL STEEL CABINET



EACH DRAWER 7 x 12 x 2" DEEP
Made of 20 gauge paint lock steel genuine Hammerloid exterior finish. Ideal for small parts, tool, or hobby shop. Drawers are drawn from one piece of steel with smooth rounded corners. Price only \$14.85. Send cash, check or M.O. for postpaid delivery. **\$14.85** Post-paid

SAVE BUY DIRECT FROM MANUFACTURER.
VENDORLATOR MFG. CO., 4000 Railroad Ave., Fresno, Calif.

New BANDSAW
Unheard of value—Sturdy all metal 10-inch bandsaw, cuts wood, metal, etc. Compares with saws costing \$15 or more. Special introductory price for limited time only. **\$29.95**



FREE literature. Write today for details or save time by sending remittance with name and address. **SATISFACTION GUARANTEED.**
RAYMOND TOOLS CO.
1305-W Glenwood Ave. Minneapolis, Minnesota

BRIGGS-STRATTON ENGINES

1 1/2 HP MODEL N—GOVT. SURPLUS

In good operating condition with 30 day **\$39.50** written guarantee

PRICE FOB, K. C. NO COD'S

MIDWEST SALES CO.

2533 M. INDIANA
KANSAS CITY, MO.

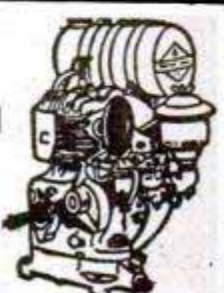

INSTANT STARTING TRUE PERFORMANCE LOW UPKEEP

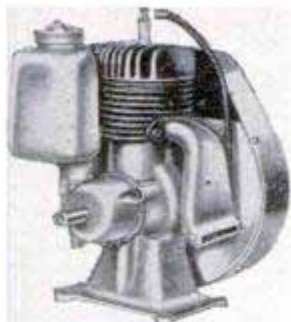

Use the EEMCO engine built by ERIE to be assured of freedom from irritating starting delays. Extra powerful high tension Alnico magneto—modern carburetor for smooth steady performance—no valves to grind or stick— $\frac{3}{4}$ H.P. at 2400 R.P.M.—only 18 lbs.—aluminum alloy construction. Ideal for lawnmowers, sprayers, pumps, portable tools, conveyors, blowers, bikes, scooters, inboards and many other uses.

\$54.50 F.O.B.

Add \$1.10 to price if governor is required. Order now for fast delivery. Send only 25% by check or money order—balance C.O.D.

If your dealer cannot supply you, order direct.

EEMCO ERIE ENGINE & MFG. CO.

DEPARTMENT 2C — ERIE, PENNSYLVANIA

FINEST SWEDISH PRECISION TOOL

6" VERNIER CALIPER



Graduated in thousandths for inside, outside, depth and thread measurements

ACCURACY GUARANTEED

\$18.75

C. O. Ds. \$5 Dep.

TRANSOCEAN TRADING COMPANY

DEPT. O, 532 N. LA BREA AVE., LOS ANGELES 36, CALIF.

BUILD HEAVY DUTY MACHINES

SAVE UP TO 90%— You can build, using our practical, easy-to-read plans, all kinds of machines, for home, farm or shop—scooters, portable sawmills, metal working machines, concrete machinery of all kinds, printing equipment, woodworking machines, midget autos, dish washers, farm equipment, freezers, tractors.

NICHOLS EQUIPMENT COMPANY

D2010 PURVIS, MISS.

FREE CATALOG HANDBOOK 183 SETS OF PLANS VALUABLE INFORMATION

HEAVY CAST ALUMINUM BLOWER ONLY \$11.25

SINGLE EXHAUST BLOWER DELIVERS APP. 100 CU. FT. AIR PER MINUTE. For Workshops, Labs, Kitchens, Cellars, Electronic Tube Cooling or any use where airblowers are needed. Install it yourself with any household tools. 110 V., A.C., 50-60 cycles. Cont. duty motor. **DOUBLE EXHAUST BLOWER.** 2 heavy cast alum. housings. Double intake and exhaust. **\$16.85.** Shipped Parcel Post. Pay slight charge on arrival.

Send check, M.O. Money-Back Guar. Free Lit. **UNIVERSAL YONKERS CORP.** 137 Alexander St. (M-3) Yonkers 2, N. Y.



HYDRAULIC-PNEUMATIC

ACTUATING CYLINDER

WITH ATTACHED HIGH PRESSURE SWIVEL CONNECTOR PUSH AND PULL



Raise, lower machinery, garage doors, dump trucks, bulldozer blades, shovels, other uses. Brand new, war surplus, genuine Bendix Aviation part #402685; double action, 4" bore, 18" stroke; 100-2000 p.s.i.; 3 1/2" cylinder; shipp. wgt. 50 lbs. Only \$24.50 F.O.B. Chicago area. Gov. cost \$200; a top value; a powerful worker. Don't delay. Order today! Each..... **\$24.50** (Quantity buyers, dealers, write for special discount.)

ALLIS-CHALMERS POWER TAKEOFF

FOR HD-7 CATERPILLAR TRACTOR

Genuine Allis-Chalmers part #047642, fits any HD-7 Caterpillar tractor. War surplus, brand new; complete with gear shift, forward, neutral, reverse. A remarkable value, worth \$225. Now only \$52.50 each, F.O.B. Chicago area. Sh. wgt. 150 lbs. It's tops in versatile, portable power. Order now. Each..... **\$52.50** Special discount in lots of 4. Dealers please write.

Send Check or Money Order, 25% with C.O.D's. Full Satisfaction Guaranteed.

STAHLER, DISTRIBUTORS, PM-3, 810 Michigan, Evanston, Ill.

POWER KING 4 1/2" JOINTER-PLANER

EASY, EXPERT WOODWORKING FOR YOU!



The smooth finish and tight joints that characterize professional woodworking can be yours at low cost with the Power King 4 1/2" Ball Bearing Jointer-Planer. It saves you time and work in planing, rabbeting, tonguing, beveling. Built extra heavy, with massive cast iron base and table—ground table top—tilting fence—3-blade steel cutter head—many other outstanding features. Made by the manufacturers of Atlas tools for industrial, commercial, and home shops. See it at your dealer's—buy it for professional results in your shop projects! \$44.75.

POWER KING 1 1/4" DRILL PRESS \$42.75

Another top tool value! Rugged, smooth, accurate. Drills wood, metals and plastics. Has low-cost accessories that help you get real "professional" results on such jobs as mortise and tenon joints, routing, shaping, sanding, carving, inlaying. Send coupon for complete information on this handy precision tool.

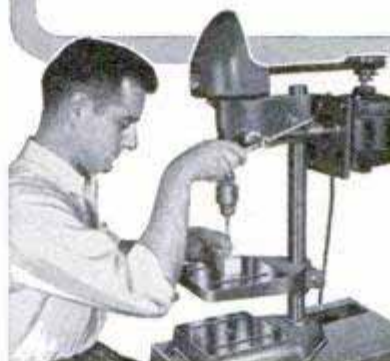

POWER KING 8" TILT/ARBOR SAWS \$61.75

All prices F.O.B. Kalamazoo, less motor. Subject to change without notice.



ATLAS PRESS COMPANY

335 N. Pitcher St., Kalamazoo, Michigan

MATCHED PRECISION TOOLS FOR WOODWORKING AND METALWORKING

SEND FOR FREE LITERATURE TODAY

ATLAS PRESS COMPANY
335 N. Pitcher St., Kalamazoo, Mich.
Please send new Power King catalog to:

Name _____
Address _____
City, State _____

25,000 MPH

The speed at which a rocket must attain in order to leave the Earth's gravitational pull. This and many other interesting facts supplied with scale Model of the V-2 Rocket. Have fun or experiment seriously with a Rocket that works like the real thing. Zooms over 200 feet into the air. Get in on the ground floor and learn the secrets behind inter-planetary space flights now.



Rocket being fired at Wendover Field.

V-2 ROCKET

For only \$2.95 your rocket comes equipped ready to fly with special launching stand and full instructions on how to make your rocket zoom over 200 feet into the sky.

When payment is sent with order, we pay postage. Or send no money, sent C.O.D. \$3.50. Write Dept. M-3.

Can be used over and over again

\$2.95

WALSH PRODUCTS, INC.
209 N. MAPLE AVENUE, EAST ORANGE, N. J.

Sharpen Saws Yourself With TREYCO FIXTURES

Saws require setting only once to 5 or 6 sharpenings. Assures faster, cleaner cuts. Furnished complete with saw set and all accessories for all saws. Save money and earn extra money by sharpening saws for yourself and others. Tool makers precision . . . low prices . . . order by model numbers below . . . send check or money order . . . money-back satisfaction guarantee . . . shipped prepaid.



Model No.	Saw Size	Price	Model No.	Price
280	7" - 8"	\$11.95	280W	\$5 extra for 2 grinding wheels
100	7" - 10"	\$14.95	100W	
120	7" - 12"	\$16.95	120W	

Also available Index Fingers for sharpening 1 1/2" - 7" diameter metal-working saws or saws for other materials for use on table top at \$3.50. Specify your grinding wheel hole size.

Quickly Easily PAYS for ITSELF

TREYCO PRODUCTS
264 HARTFORD AVENUE BUFFALO 17, N. Y.



Handy Flexible SHAFT

Converts any motor, drill press, electric drill, electric fan (10 inch or larger) into a handy rotary tool

ONLY \$2.95

OLD FAN MOTOR



VACUUM CLEANER MOTOR



Attach ROTA-SHAFT in a jiffy. Use for grinding, polishing, sharpening, cleaning, engraving, making tools, carving on metal, plastic, wood, glass. Convenient handpiece for easy handling . . . 40-inch overall length. Complete with buff and sanding disc ready to use in a drill press chuck. Order today!

SEND NO MONEY! Mail your order. Pay postman only \$2.95 plus postage on delivery. Try 10 days — if not delighted, return for money-back. For use on motor, add 35c for Special Coupling and state shaft diameter.

STRADER PRODUCTS CO.

DEPT. H-101
259 Strader Ave. Cincinnati 26, Ohio

EMERGENCY SUPPLY TANK



Fill at any gas station. 150 lbs. airs 5 flat tires. Inflates rubber boots. Use for touch-up spray jobs, tire service truck, air horns, dust out motors, machinery, etc. Shatterproof 12"x24" stainless steel tank with carry handle, check valve, two feet hose and tire filling chuck. Only \$7.95

Price FOB, K. C. No COD's

MIDWEST SALES CO. 2533 M INDIANA KANSAS CITY, MO.

New and Different Drum Sander



NO GLUED UP SLEEVES TO BUY. Cut sleeves from regular size sheets. Unique way of holding sleeve to drum. No wedge. Twist of key and sleeve is tight. SPONGE RUBBER backing. Use on drill press, small motor, electric drill taking 1/2" tool. Adapter and key included. Send check or money order.

DEALERS WANTED. 2 1/2" x 3" long \$2.95 Post-paid
Money back guarantee. 3" x 3" long \$3.50

Singly Specialty Co., Hendersonville, N. C.

Precision Double Action STEAM ENGINE \$6.25



Ready to run by steam, water or air pressure

Positive valve action. Brass valve and piston. Manifold exhaust chamber. Reversible by changing intake and exhaust lines. Fittings to attach small rubber hose from applied pressure. Can be used as air, water or oil pump on small applications. Self priming. Speed from 40 to 4000 R.P.M. 7" long, 2 3/8" high, Bore 7/16", Stroke 9/16". Flywheel 2 3/4" diameter. Send Money Order, Money or Certified Check. No personal checks.

PRUETT NOVELTY WORKS 1019 Covina Hills Rd. Covina, Calif.

PRECISION JEWELERS SCREW DRIVERS



Complete Set of 8 for Every "Hobbyist"

AT LAST— a complete set of precision screw drivers to meet the needs of every model builder. Not a miniature but the same type set used by U. S. Navy for precision instruments and watches during the war. Brass knurled tempered hexagon heads, finest tempered steel blades, sizes 2-D. Never before a set of this quality and price. Your satisfaction at such a low price. Money back if not satisfied. C.O.D. \$2.00 plus postage or send \$2.00 and we pay postage.

PINE WATCH CO., Rm. 40, 29 Eldridge St., New York 2, N. Y.

Have Fun and Make Money!

MENDELSON SPEEDGUN*

JUNIOR

for cameras with
synchronized or
non-synchronized shutters!

7⁵⁰ TO 9⁹⁵

Fed. Tax
included

Easy to
operate!



*Reg. U.S.
Pat. Off.

At all
photo
dealers!

Write for Mendelsohn Speedgun Jr. folder MSJ-6
"How to have fun and make money with your Speedgun Jr."

MENDELSON SPEEDGUN CO., INC.
463 Bloomfield Avenue, Bloomfield, N. J.

HIGH PRESSURE HYDRAULIC PUMP FOR HOME, SHOP AND FARM USE



Genuine Vickers constant displacement high pressure pump. Use it for any type of liquid pumping job. Will pump 400 gal. per hour at 3750 R.P.M. Precision piston type design provides 1000 lbs. per square inch pressure. Self priming. Standard thread 3/4 inch intake and discharge ports. With 3/8 inch splined shaft — just add pulley and power and you're ready to go.

HAS HUNDREDS OF USES

These pumps are brand new. Original acquisition cost approx. \$100.00. Can also be used as hydraulic motor; for rams, opening doors, hydraulic lifts, etc.—also for any liquid transporting job. War surplus, but brand new. Shp. wgt. 7 lbs. Will include at no extra charge an hydraulic control valve and ship postpaid when remittance accompanies order. (Control valve, only \$1.95.) Satisfaction guaranteed. Rush your order today.

\$9.95

**SOUTHWEST AERO SUPPLY DEPT. PM3, DRAWER 488
SOUTH HOUSTON, TEX.**

OTTAWA Tiller & Mower

Patents
Pending

New Tiller and Mower with 2 H.P. "Red Seal Continental Motor." Two speeds and free wheeling. Does most any kind of mowing. Cuts close to trees and fences.

Attachments for soil tilling, etc. Thousands in use. Sold direct to user. Now in our 45th year. FREE details. Low price.

Mows
40" Swath

OTTAWA MFG. CO., 4-927 Lawn Ave., Ottawa, Kansas

A MUST FOR MECHANICS



Assembly and repair work made easy with "HOLDIT" screw holding, screw driver. Simply set blade in screw slot and push to get secure attachment: YOU'VE PUT A HANDLE ON THE SCREW. Automatically resets. SATISFACTION GUARANTEED. See your tool dealer or send to factory. Sizes: 3" \$1.00, 6" \$1.15, 9" \$1.25. #4 Jr. For Small Screws, \$1.25. Send check or money order . . . sorry no COD's. DEALERS WANTED.

MINER CO., Box 235, San Lorenzo, Calif.

A REAL BARGAIN BUY!

for
OFFICE
HOME
FARM
SHOP

ONLY
\$2.00
COMPLETE KIT
Postpaid

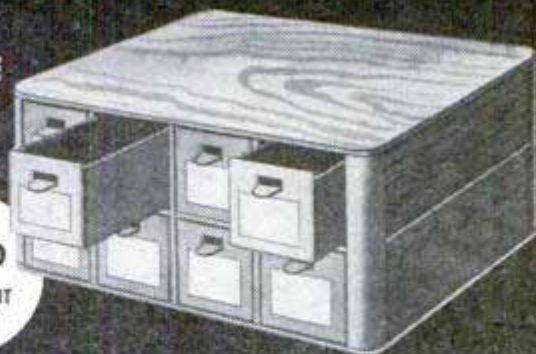

8 DRAWER UTILITY FILE ASSEMBLED IN A FEW MINUTES!

Perfect for nails, screws, nuts, bolts, washers,
model parts, buttons, all kinds of odds and ends.

Here's the handy file you've always wanted for those small, hard-to-find, easily lost articles. Made of sturdy, lasting laminated fibre board in attractive limed oak finish. Machine turned and grooved wood corner posts. Matching, 200 lb. strength, smooth-sliding drawers. Units may be combined to make larger cabinets. Comes in kit form, ready to assemble, complete with brads and labels. All you need is a hammer!

DRAWER SIZE
2" DEEP
2 1/8" WIDE
6 1/4" LONG

SEND FOR YOUR CABINET KIT TODAY!

CALUMET CONTAINER COMPANY

332 South Michigan Ave., Chicago 4, Ill.

Send me at once _____ cabinet kits @ \$2.00 ea. (No C.O.D.'s, please.)

Name _____

Address _____

City _____

Zone _____

State _____

CASH IN ON THE BUILDING BOOM!

MAKE

**BUILDING BLOCKS
RIGHT IN YOUR
OWN BACKYARD
AMAZING GENERAL
BLOCK MACHINE**

CAPACITY 1000 BLOCKS PER DAY

\$1.99 LESS MOTOR
ONLY F.O.B.
PLANT
SHIPPING WEIGHT
400 lbs.



Cinder and Concrete Blocks in big demand. Sell all you produce, to contractors and builder supply yards, at 15c to 25c each. Easy to start your own profitable business.

GENERAL BLOCK MACHINE can be operated indoors or out, in floor space 9 ft. x 10 ft. All steel construction. Vibrator mounted in sealed ball bearings. Simple to run. Powered by 1/2 H.P. electric motor or 1 H.P. gas engine. Produces up to 1,000 8x8x16 blocks in 8 hour day. Superior 3 care type, meeting all building code requirements. Produces 4x8x16, 8x8x16, 7 1/2x8x16 blocks. Material for blocks, cinders; cement; and sand; obtainable anywhere. Full instructions and mixing formulas with each machine. Immediate Delivery. Mail coupon at once for full details, sent free without obligation.

HOW TO
BUILD
YOUR OWN
CONCRETE
BLOCK
HOME
Only 1/2 Prepaid

Wonderful
book written
and illustrated
by our staff of
experts.

GENERAL ENGINES CO.

DEPT. MP — DREXEL BLDG., PHILADELPHIA 6, PA.

Shows you 8 ways to save money and how to make and lay blocks, laying out building lines, mixing your own concrete, building steps, porches and concrete floors, includes floor plans for 6 beautiful easy to construct concrete block bungalows. Mail coupon at once with \$1.

Name _____

Address _____

City _____ Zone _____ State _____

SANDING AND GRINDING CURVES

MADE EASY

AT ONE-TENTH THE COST!

SPINGRITS MAKE
OBSOLETE HARD-TO-GET,
COSTLY PREFORMED ABRASIVE SLEEVES

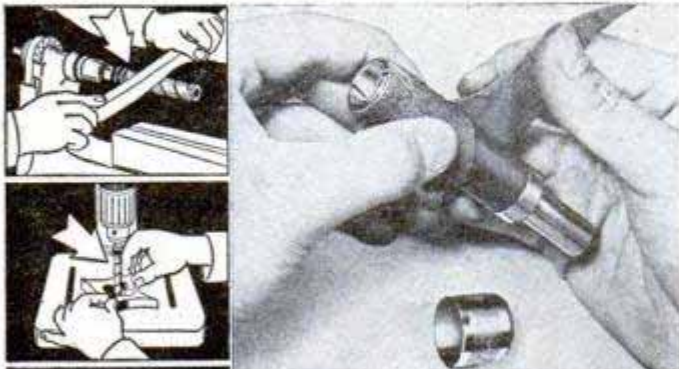

Inexpensive straight strips of abrasive in a wide range of grits are quickly spiral wrapped around SPINGRIT® SANDING SPINDLES and securely locked at both ends, making a fine precision tool which can be chucked into any drill press, flexible shaft, lathe head or electric drill.

Order today. Complete set, 1/4", 3/8", 3/4" and 1" diam., in polished wood case, sample strips and instructions. \$12.50 prepaid.

FOR A LIMITED TIME ONLY we will include 48 assorted abrasive strips (a \$2.00 value) at no extra charge.



THE SPINGRIT CO.
16550 Greenfield Road, Detroit 27, Michigan

*PAT. PENDING

STOP

**CHANGING MOTOR OIL--
KEEP IT CLEAN INSTEAD!**

End this needless waste and expense forever with

RECLAIMO Today's Most Advanced Oil RE-REFINING Filter

Continuously cleans and RE-REFINES motor oil as you drive (by utilizing motor heat)—keeps oil in high grade lubricating quality at all times—reduces motor wear to a minimum! Proves conclusively that "Oil Does Not Wear Out Mechanically" as stated by U. S. Bureau of Standards, (Bulletin 86).

"RECLAIMO"

- REMOVES SOLIDS (by filtration)
- REMOVES WATER (by distillation)
- PREVENTS Excess Fuel Dilution
- PREVENTS Acid and Sludge Formation

MAINTAINS Stable Viscosity ELIMINATES All Oil Changes
CAR • TRUCK • TRACTOR OWNERS!

You'll want to know more about Reclamo's Oil, Motor and Money-Saving Features. **FREE 40-PAGE BOOK "OIL FACTS"** gives you the complete "Reclamo" story plus details about our **New 90-Day No Risk-No Cost TRIAL OFFER!** WRITE for YOUR COPY TODAY!

RECLAIMO MFG. CO.
5083 ELSTON AVE., Dept. 90, CHICAGO 30, ILL.

REPUTABLE DEALERS WANTED

NEW ADDED FEATURE!
Gas - Moisture Vapor Injector
Increases Mileage with Smoother Performance



THIS "Stays Put"

Hang it, set it down, carry it—brilliant beam hits the spot you choose. 80-100 hours of light on 6-volt battery. At hdwe., sport or electric stores. Price, less battery. **\$3.25**



Delta REDDYLITE ELECTRIC LANTERN
DELTA ELECTRIC COMPANY, MARION, INDIANA

MYSTERIOUS DEVICE WELDS BRAZES SOLDERS & CUTS

ANYONE CAN OPERATE



This newly invented **FOUR-WAY PORTABLE ELECTRIC WELDER** will do brazing, soldering, welding and cutting on brass, bronze, iron, steel, cast iron and other metals. It's easy to use, **WORKS INSTANTLY** off any properly wired 110 VOLT A.C. OR D.C. LINE. Does a thousand and one professional type repair jobs. **SAVES TIME AND MONEY** on auto, home appliance, farm and shop repairs. It's indispensable for maintenance men, farmers, repair shops, engineers, tin smiths, home and auto owners, bicycle and fix-it shops, etc.

10 DAY TRIAL OFFER The **FOUR-WAY WELDER** COMES COMPLETE WITH ALL SUPPLIES READY TO OPERATE including simplified instructions. IT'S FULLY GUARANTEED. Order one today for 10 DAY TRIAL or write for FREE particulars. **FOUR-WAY WELDER CO., Dept. PMD-39**
3180 North Clark St., Chicago 14, Illinois

FREE PLANS POWER MOWER KITS FREE PLANS

Have one of the finest mowers money can buy. Write for **FREE PLANS and PARTS LIST** showing you how to **SAVE up to 75%** by assembling Triangle's **POWER MOWERS**.



SPECIAL FACTORY PRICES

Kits, Parts, Engines, Wheels, Etc. Also complete **TRIANGLE MOWERS** ready to mow, at Low Factory Prices. 3 and 4 wheel models.

SAVE your back. Assemble or build your own 3 or 4 wheel power mower with our precision made kits and parts. Write today for full facts. Free Plans, Parts List, Low Factory Prices. **DEALERS INVITED.**
TRIANGLE MANUFACTURING CO., Dept. M-1, Box 185, Fort Scott, Kans.

NOW! Everyone can afford a Sprunger



for only **\$54.95**
Ideal... for shop or home. 8" blade tilts to 45°; cuts to 2 1/2" depth. Rip fence fastens front and back of table; operated by micrometer adjustment. 18" x 15" rust-proof, cast table. Lubricated-for-life ball-bearings.
Price subject to change
See your dealer, or write Dept. 130
SPRUNGER BROS. INC. TOPEKA, IND.

With a Crosman... YOU SHOOT ACCURATELY!

These well balanced Crosman pneumatic pistols and rifles shoot with smooth, snappy, correctly engineered compressed air power... controllable for moderate to extreme velocities. Barrels are micro-precision rifled. Sights are accurate, finely adjustable. Trigger action is smooth and crisp. And, you're always in form: with Crosman controllable power and low-cost Crosman Super-PELL ammunition, you do more shooting, anytime... indoors or out. At your dealers. Send for illustrated catalog.



CROSMAN ARMS COMPANY, INC.
3 HENRIETTA STREET • ROCHESTER 7, NEW YORK

Barron DRILL PRESS TOOLS!

15 Essential workshop operations now accomplished on any drill press with famous Barron Tools and Accessories . . .

Planing, mortising, rabbeting, shaping, surface sanding, polishing, tenoning, grooving, routing, drum sanding, beading, paneling, veining, edging, molding, dovetailing, etc.

FREE! Workshop Guide

Including a complete catalog of time-proved, precision built Barron Workshop Tools. Convert ANY drill press into your most versatile, low cost power tool.

FULL 10 DAY MONEY BACK GUARANTEE

BARRON TOOL CO., INC.
669 ARCHITECTS BLDG. DETROIT 1, MICH.



Drill Press Planner \$7.50



Rotary Surface Sander \$5.95



Society Shaper Cutter and Blades \$9.00

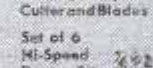

Set of 6 Hi-Speed Router Bits \$9.50

Sensational Value in AC-DC POCKET TESTER



This analyzer, featuring a sensitive repulsion type meter housed in a bakelite case, represents the culmination of 15 years achievement in the instrument field by a large company specializing in electronic test equipment.

Specifications of the AC-DC Model Volt-Ohmmilliammeter:
AC Volts—0-25, 50, 125, 250
DC Volts—0-25, 50, 125, 250
Milliamperes AC—0 to 50
DC Milliamperes—0 to 50
Ohms Full Scale—100,000
Ohms Center Scale—2400
Capacity—.05 to 15 Mfd.

Total Price, prepaid anywhere in the USA—\$7.00
Similar DC Meter, lacking the AC operated ranges of above, \$5.50 prepaid.

BUFFALO RADIO SUPPLY

219-221 Genesee St. Dept. PM Buffalo 3, N. Y.

BURIED TREASURE, MINERALS AMAZING NEW GOLDAK LOCATORS

SENSATIONAL NEW MODEL!
ONLY 11 pounds weight! One hand operation! Money-Back Guarantee of Superiority. Write for full details.

THE GOLDAK CO.
1542 WEST GLENOAKS BLVD.
GLENDALE 1, CALIFORNIA

World's largest maker of fine locators.



FREE to Victims of DANDRUFF Dry Hair, Itchy Scalp

16-page epoch-making booklet. A new approach to age-old problems, it is jam-packed with authentic information, simple suggestions that bring prompt relief, better hair. Write for your free copy today.
REGIME PRODUCTS, 9 S. Clinton St., Dept. C-4, Chicago 6, Ill.



HIGH POWERED TELESCOPE 60 POWER — 5 SECTIONS — only \$4.50

HARDENED ALUMINUM TUBES—LENGTH OPEN 33", CLOSED 11", WT. 8 OZ. VARIABLE POWER EYEPIECE 15X-30X-60X
NEW! 3 different magnifications by simple adjustment of the 30 and 60 power for extra long range. Guaranteed to bring distant objects, people, sports events, ships, moon, stars, etc., 60 times as close. Most powerful for anywhere near the money.



Leather Case Included

All 5 tubes are made of strong but lightweight aluminum. 4 precision ground and polished optical glass lenses. When collapsed it is used as a powerful compound microscope adjustable to 3 different magnifications. Directions included. Money back guarantee. Complete and ready for use, with genuine leather carrying case, at the amazingly low price of only \$4.50. We pay the postage. Immediate delivery.



BROWNSCOPE CO. Dept. 3M, 24 West 45th St. New York 19, N. Y.

Build This Beautiful "CUBSTER" BODY (Low Cost) With Our BODY KIT



• NO METAL FORMING • NO SPECIAL TOOLS • IMMEDIATE DELIVERY •

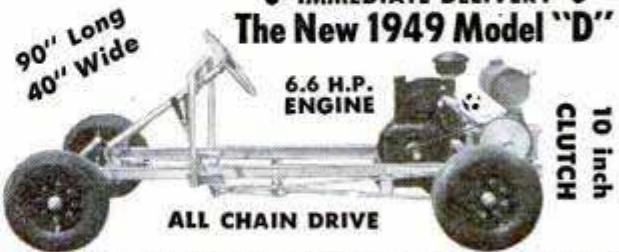

Chassis as Shown ONLY \$299.50 (Plus \$7.50 crating)
F.O.B. Doylestown

Runs as low as 2 miles per hour or UP TO 35 MILES PER HOUR
4.00x8 High Speed Wheels



OTHER MODELS FROM \$59.50 up. Ride Around in Your Own Car

• BALL BEARING STEEL WHEELS •

12"x2 1/2" Ball Bearing Heavy Steel Wheels with Gates 225 lb. Load Semi-Pneumatic Tire, For 1/2" or 5/8" Axles.

Two for Only \$10.50

Four for Only \$21.00

25% DEPOSIT ON C.O.D. ORDERS.

Add 10% for prepaid Shipment in U.S.A. 32 other sizes and type wheels in stock.

Descriptive Circulars and Lists of our products will be mailed promptly if you enclose 10c in your letter.

OSBORN WHEEL CO., 115 So. Main St., Dept. P-3, Doylestown, Penn.

BE YOUR OWN BOSS! We Show You How To Set Up Your Own Profitable Mfg. Business

CASTING NOVELTIES FOR MONEY

with Complete Tested Instructions as to how you can start your own business even in your own home

Even In Spare Time In Your Own Home

Here's Your big opportunity. Exciting chance to start your own business even at home. No experience or special education needed. "Casting Novelties For Money" tells all. Every page chock-full of ideas . . . tested ideas hundreds of men and women have used to make big money. Every chapter just bulging with ideas for your financial freedom. Here's some of them: • Picture directions on how to make your own flexible rubber molds for casting all types of novelties. • Step-by-step photo and word instructions for making professional reinforcement shells for your molds. A big Must when casting castings for piggy banks, etc. Speed production methods explained. • How to preserve a precious baby's handprint in plaster plaque form. • Tells what Liquid Marble is and its uses for novelties and tiles. • Complete chapter on Floc-Rite, the amazing new material of 1001 uses. With colorful Floc-Rite you can create surfaces that take on the appearance of plush, velvet, velour, or suede. Big full page of complete color samples of actual Floc-Rite. • A complete chapter on "Selling Aids" is most valuable if you're now in the Mfg. business or plan to get into it. Space limits us to properly do justice to this booklet. We'd like you to have this marvelous booklet free but high printing cost forces us to send it only to those who mean business and are not mere curiosity seekers. Thus the \$1.00 price. If not more than completely satisfied, return booklet in one week and we will refund your \$1.00 promptly. Or if you feel that it means your financial independence, keep it, and you'll get \$1.00 credit on your first \$5.00 materials order. Can we make it any easier for you to reap big profits in a business of your own? Send your \$1.00 today . . . check, cash or money-order. Tomorrow You Be The Boss.

BING PRODUCTS, Dept. PM3F, 88 Broad St., Boston, Mass.

NEW DIRECT FLAME SOLDERING OUTFIT

RANSOME
NO. "99"



Operates on Bottled Gas
Complete Unit \$32.25, Exp. prepaid

Ransome "99" soldering outfit will permit you to do twice the work with half the effort. Torch operates on butane or propane (bottled gas). Lights with a match and stays lighted. No time lost refuelling, generating, pumping pressure, or reheating work. Torch weight only 12 oz. Is 14" long. 2½ gallon cylinder of fuel lasts 200 hours. Burns without smoke, soot, or odor. Ideal for home craftsmen, electricians, plumbers, sheet metal workers, radio repair men. Ransome "99" Outfit consists of: Torch with choice of A, B, or C Tips; 2½ gallon ICC approved cylinder; gas regulating valve; 10' high pressure hose. \$32.25, express prepaid. Have your oil company fill cylinder and you are ready to go to work. Torch only with A, B, or C tip \$9.00, postpaid. Extra tips A, B, or C \$4.50 each. Tip D is \$8.00. Torch with all 4 tips \$26.00, postpaid. To avoid time lapse for personal checks to clear, remit by bank draft, cashier's check, or money order.

RANSOME COMPANY

4032 HOLLIS STREET EMERYVILLE, CALIFORNIA

SO HANDY FOR
SO MANY USES

AT HOME
OFFICE AND SHOP

THE
JIFFY
METAL
CABINET



32 DRAWER
MODEL PICTURED
ONLY
\$5.95
POST PAID

Now you can keep nuts, bolts, screws, nails, parts, washers, stamps, hobbyist needs, etc., at your fingertips.

Just think, 32 or 64 drawer cabinet to keep those small items that usually get mislaid. Spot welded steel cabinet, enamel finish, metal drawer guides. Looks good anywhere. Send check or money order please—no C.O.D.'s. Prices below. Your money refunded if not satisfied.

SPECIFICATIONS	WITH ALUMINUM DRAWERS	WITH CARDBOARD DRAWERS
32 Drawer Unit 6" Deep 12¾" Wide 15¼" High	One piece rustproof aluminum drawers for heavy service—good for work bench and industry use.	Suitable for most home uses. Heavy board kraft covered. Metal drawer pulls.
64 Drawer Unit 6" Deep 25½" Wide 15¼" High		
Drawer Size 1¼" Deep 2¾" Wide 6" Long	32 drw. \$8.95 64 drw. \$15.95	32 drw. \$5.95 64 drw. \$9.95
	POSTAGE PAID	POSTAGE PAID

KAYTEE PRODUCTS DEPT. M, BOX 588 CANTON, O

LEARN CELESTIAL NAVIGATION



COMPLETE COURSE OF
INSTRUCTIONS AND VALUABLE
ACCESSORIES GIVEN FREE
WITH \$200.00 SEXTANT
ALL FOR **\$14.95**
ONLY

IT'S A ONCE-IN-A-LIFETIME VALUE!

Learn navigation from same course as used by the Gov't to train our birdmen. Take readings from the sun or other heavenly bodies from your porch or back yard to determine your position within a few feet on land; within a mile when on a ship at sea.

GENUINE LINK PRECISION SEXTANT

This famous (war surplus) Sextant originally cost \$200.00. You can buy it now for only \$14.95 and with it we will give you the instruction course on Celestial Navigation; also complete sextant instructions. Sextant is fitted with night lighting attachment, easy reading vernier scale and good indicating bubbles. Slightly used but guaranteed perfect. Carrying case included. Ship. Wgt. 12 lbs. Send check or money order. Only **\$14.95**

AERO PARTS SUPPLY, Dept. PM3
Municipal Airport Houston 17, Texas



Rebuilt GENERATORS

Chevrolet—Ford—Plymouth
exchange price **\$6.95** guaranteed
F.O.B. Chi.

Generators rebuilt by factory-trained experts. Also hard-to-get parts for every car. STARTERS, TRANSMISSIONS and rear ends at tremendous savings.

WORLD AUTO PARTS CO. ORDER from one of the nation's largest replacement dealers
2200 N. Ashland Chicago 14, Ill.

URAC "185" NOW AVAILABLE... IN SMALL CONTAINERS



Best bonding agent for gluing structures: furniture, toys, plastic table tops, phenolic and melamine laminates, masonite, ETC... Easy to mix, easy to use. Water Resistant. Hot proof. Stain proof. Pts. \$1.50; Qts. \$2.25; Gal. \$5.50 and 5-gal. \$23.75 including hardener.

Send Payment and Save postage and C.O.D. **TRADE NAME REGISTERED BY AMERICAN CYANAMID CO., MFR.**

THE NELSON COMPANY
IRON MOUNTAIN - MICHIGAN

WHAM-O
SPORTSMAN
Powerful - New - Accurate
Kills rabbits, squirrels, etc.
Routs pests.

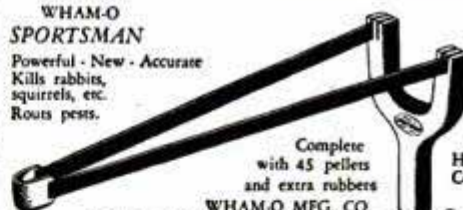

\$1.00
postpaid

Complete with 45 pellets and extra rubbers
WHAM-O MFG. CO.
BOX V 21, SO PASADENA, CALIF. Order Several

Free Booklet on FLEX-O-SHAFT

Illustrating this all-purpose power machine with hand-piece that handles as easily as a pen. Motor with switch, foot-operated rheostat, and 66 accessories at special low price. Write

FLEX-O-SHAFT SALES CO.

Dept. C Prairieview, Illinois.

MAKES PERFECT WORK EASY!

New **GRIP-TITE**
SELF-ADJUSTING
BENCH CLAMP

The tool of a thousand uses!

BETTER than a vise... AUTOMATICALLY LOCKS and holds any thickness board up to 2 in. Work can't slip. Will last a lifetime. \$3.00 POSTPAID. Money-back guarantee. ORDER TODAY.

GRIP-TITE
313 Stanley Ave. Waukegan, Ill.

SPEEDS UP BENCH WORK 25 TO 30%

POPULAR MECHANICS

POWELL AGAIN SETS THE PACE

* Luggage rack extra



ONLY \$247³⁴

F. O. B. COMPTON, CALIF.
Excise Tax Included

Only POWELL brings you all these BIG cycle features . . . at so low a price

- Cruises at 45 MPH—with faster pickup than car
- 39" high, 71" long overall, wt., 190 lbs.
- 8 HP motorcycle engine—Bore 3-1/16"—Stroke 3-1/4"—24 cu. in. displacement
- 50 miles to the gallon
- Automatic clutch
- Internal expanding brakes (42 sq. in. braking surface) handle-grip controls
- Finished in rich black baked enamel with chrome trim

DEALERS:
There are still a few dealer franchises available. Write today for complete information.

RIDE IT! IT'S YOURS IT'S THE POWELL P-81!

The husky, lightweight (190 lbs.) low cost motorcycle you've dreamed about is here! It's the powerful Powell P-81, with a 24 cu. inch engine; rugged, lightweight, tubular, all steel frame; and BIG motorcycle features throughout and at an unbelievably low price! Send in coupon and get full details.



Send for Free Folder and Name of Nearest Dealer

Your Name _____
Address _____
City _____ State _____
Age _____

POWELL

MANUFACTURING COMPANY

Since 1927

Compton

California

PM 349

Complete MODEL FLYING OUTFIT! only \$6.95

Here's your chance to buy, at a ridiculously low price, a complete model plane outfit. The plane is rugged (all balsa), with wings, tail & fuselage finished and colored, ready to assemble with landing gear, wheels and everything you need to fly it!



HERE IS WHAT YOU GET:

- Herkimer CO2 engine, ready-to-run
- * Prefabricated and colored plane, ready to assemble and fly
- * CO2 Capsule holder
- * CO2 Capsules for power
- * Correct propeller
- * Engine instructions
- * Landing gear
- * Flight log
- * Insomnia
- * etc., etc.



Entire Outfit \$6.95

Fly the latest in model airplanes, powered by CO2 capsules—the same capsules that charge home soda bottles! No gasoline, oil or smelly exhaust fumes. There's nothing like the thrill of CO2 flying. You don't need much space for free-flights (100 ft. square on calm days).

Send remittance in full or send \$1.00. We Order Yours TODAY! will ship same day, balance C.O.D. Large illustrated 2-color Hobby Catalog only 10¢ Dept. BF-39 156 West 22 Street, New York 11

Sensational Bargains: LOWEST PRICES! All Items Guaranteed As Represented



BACKGEAR VOLUME BLOWER made by ILG MOTOR

90 RPM 110V, 60 cycle, A.C. slow speed motor. All brass construction. Sturdy gears & bearings. Drives

window displays, toys & useful experimental work, 6"x2 1/2", 5/32" shaft. Pulley FREE. \$3.50 ea. Postpaid. In lots of 6 ONLY \$2.95 each.



6 in. Wheel—1000 CFM Complete with 1/6 H.P. Motor, 110 V, 60 cycle A.C., 1750 RPM. Height 12"—Intake 6" dia. Outlet 6x5—Weight 60 lbs. No. 8-54 . . . \$45.00 Fob. Chgo.



MOTORS: Westinghouse, Leland, G.E. & others, 1/2 H.P. AC-110-220, 60 cycle 1750 RPM. Like new—Totally enclosed 50° C—Fully Guaranteed . . . ONLY \$19.75 Fob. Chgo.
NEW G.E. Capacitor Type, 110 V—60 cyc—3450 RPM, 1/2 H.P., ONLY \$23.50 Fob. Chgo.
NEW G.E. Capacitor Type, 220 V—60 cyc—3450 RPM, 1/2 H.P., ONLY \$21.00 Fob. Chgo.



THERMOSTATICALLY controlled water supply puts more moisture in the air. Gives healthier air. Easily installed in bonnet of air furnace. Complete with Thermostat Water Control Valve, Tubing and parts for complete installation. POSTPAID ONLY \$7.50

THE VAPORITE Automatic HUMIDIFIER for Warm Air Furnaces . . .

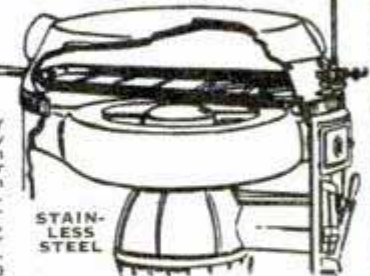

STAIN-LESS STEEL

Write for our Illustrated Price List on Other Bargains and SAVE MONEY—

C. MARSHALL SALES, 3546 W. Fullerton Ave., Dept. P-3, CHICAGO 47, ILL. • RUSH ORDER TODAY

ROYAL 48" "Aluminum Bound" MASON'S LEVEL



ROYAL OAK INDUSTRIES
GRAND HAVEN, MICHIGAN

IMMEDIATE DELIVERY

\$10⁵⁰

POSTPAID

Masons—tilesetters, you'll be proud of this quality level. Best grade Mahogany—all working edges protected with aluminum channel—6 permanently set, easy-to-read vials. Accuracy guaranteed. Satisfaction or your money back. If your dealer cannot supply, order direct.

Outstanding Surplus Value!

BRAND NEW—GUARANTEED

GRINDING WHEEL KITS

HUNDREDS OF ASSORTED ITEMS—A \$50 VALUE



FOR CUTTING,
SHAPING,
GRINDING,
& POLISHING
WOOD, METAL
OR PLASTIC.

\$8.95

While supply
still lasts, only

Per Complete
Kit

F.O.B. Chicago

SET INCLUDES OVER 300 ITEMS

- 25 Grinding and cut-off wheels, sizes 1 to 5 inches, 1/8 to 3/4 hole
- 6 Cut-off Wheels on 1/8" mandrel
- 3 Steel cutters 1/8"
- 5 Steel cutters 3/32"
- 1 Steel circular saw mounted on mandrel
- 1 Drum sander 1/2" mounted on 3/32" mandrel
- 1 One inch buff on 1/8" mandrel
- 2 Leather wheels
- 3 Roughing stone
- 2 Honing stones
- 2 Felt bobs
- 10 Sanding rolls
- 6 Sanding sleeves
- 1 One inch felt wheel on 1/8" mandrel
- 1 7/8" rubber wheel on 1/8" mandrel
- 2 High speed rotary files 1/4" shank
- 100 3/4" cloth butterfly abrasive discs
- 1 Box paper discs—100
- 1 Rag wheel—4 inch
- 10 Mounted stones—3/32", 1/8", 1/4"
- 1 One inch wire wheel 5/8" hole, brass center
- 1 Bristle brush 3", 5/8" hole, brass center

In sturdy compact container 13 1/4 x 9 1/4 x 2 1/2", weight 8 1/2 pounds; with installed rack for all drills.

- 1 4" Wire brush
- 1 Bristle brush 3", 5/8" hole, brass center

I enclose \$8.95 Check M. O. Send C. O. D.

Name _____

Address _____

GROBAN SUPPLY CO. 1522 So. Michigan Ave. Dept. PM-M, Chicago 5, Ill.



For Finest Performance Use
SHOPMASTER TOOLS

SHOPMASTER INC.

1214 THIRD ST. S., MINNEAPOLIS 15, MINN.

Power YOUR BOAT

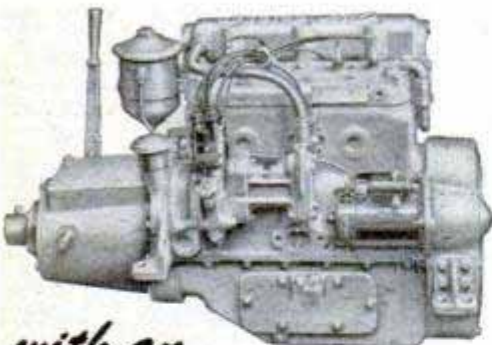

with an ATLAS "SKIPPER"

There is such a definite relationship between hull and horsepower and boat speed, that you ought to determine just what you want in an engine, before you get too far along with hull plans or construction. Here is a compact 55 H.P. heavy duty gasoline engine, made by one of America's foremost builders of Marine Diesel engines. With direct drive, it weighs under 500 pounds. Its heavy flywheel cushions power impulses and provides that smooth operation that delights every yachtsman. We make this one size and type only, because it is ideal for the requirements of so many sportsmen, fishermen, lake and river boatmen. For pleasure craft or small commercial vessels, investigate "The Skipper." Write for complete specifications and prices.

ATLAS IMPERIAL DIESEL ENGINE CO.
1000 - 19th Ave. Oakland, California, U.S.A.
Branches in Principal Ports

LAWN MOWER SHARPENER



lawn mower sharpening at low cost!

\$42.50

less motor.

turn spare time into dollars

Order direct from
QUAD CITY PRODUCTS Company, Inc.
Box 42, Rock Island, Ill.

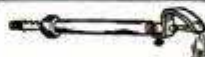

MACK'S GAS TORCH AND SOLDERING IRON
5,000 B.T.U. attaches to any gas hose; furnished with 1 jets for natural and bottled gas; equipped with adjustment set screw. Postpaid \$2.00



Mack's GAS BURNER
Jet Power, Self-Acting, (Pat. pending), 24,000 B.T.U. for natural and bottled gas, industrial and home use. Guaranteed. Postpaid \$2.00

Mack's Automatic Water Heater

Approx. 20 gal. capacity and larger for home and industry. Easily installed. Amazingly low-priced. Guaranteed. Del. \$32.50



Prompt Delivery • Order Now • Factory Service • Send Check or Money Order

McDaniel

MANUFACTURING CO., INC.
1012 14 EDWARDS ST. • DALLAS 2, TEX.

FOR LOWER COST HOME MOVIES BUY DIRECT AND SAVE WITH SOLAR

35mm-16mm MOVIE FILM
FAVORITE OF FANS SINCE 1937
24-HR. FREE PROCESSING
Send for Free Illustrated Book Describes all types of SOLAR FILM. Hundreds of rental subjects. Rates as low as 3 feature length films for only \$1. SEND TODAY. Buy Direct & Save. SOLAR CINE PRODUCTS, Inc. PM3 4247 S. Kedzie Ave. Chicago 32 Ill.

\$5.95 LOOK HOT WATER IN 5 MINUTES

POST-PAID SEND FOR FREE LITERATURE

New portable Electric Heater plugs into any light socket. Thousands used in homes, cottages, trailers and on the farm. Comes complete with 6 ft. waterproof insulated rubber cord and plug. Send check or money order. Money back guarantee



ELDEN PRODUCTS COMPANY, 41 Burroughs, Detroit 2, Michigan

RED GARDEN TRACTOR

NO BELTS • NO CHAINS
POWER TURNING

BUY DIRECT from FACTORY or FACTORY DISCOUNT write for BIG, FREE CATALOG

PLOW, DISC, HARROW, CULTIVATE and PLOW SNOW
3-4.5 H.P.
Easy to Operate • Economical

RED-E IS DIRECT DRIVE-ALL GEARS ENCLOSED.

RED-E TRACTOR CO.
233 Fond du Lac Rd., RICHFIELD, WIS.

U-BUILD-IT TRAILER COMPANY



supplies all parts to size for quick, easy assembly of complete metal trailer body—Roof Caps, Roof Bows, Doors, Complete Chassis, Roof Corners, Roof Ends. Build this modern

streamlined design economically yourself.

Write for complete working plans showing detailed construction, location of parts for 12 ft., 16 ft., 20 ft., 24 ft., 28 ft. and 32 ft. lengths. Only \$100
U-BUILD-IT Trailer Co., Dept. B, P. O. Box 354, Elkhart, Ind.

Here are Real **WAR SURPLUS BARGAINS!**



Gear Head MOTOR

Holtzer Cabot 110 volt AC 60 cycle. Can be used for turn tables, telescope drives, etc. Approx. 1/20 H.P. Output shaft — 50 RPM. **\$14.95**
Stock #406. New, only

HALES FIRE PUMP



For fire depts., factories, forest fire protection, etc. 600 gal. per min. Can be operated with 4 or 6 cylinder gas engine. 4 1/2" intake . . . 2—2" outlets . . . 265 ft. head at 120 lbs. pressure. Passed by National Board of Fire Underwriters. **\$175.00**
NEW, Stock #407 . . .

PLASTIC HOSE

Good for water, oil, air, etc. Will stand 75 lb. pressure. Available in 50, 100 ft. or more lengths.

1/4", 3/16" (your choice)	1/4"	5/16", 3/8" (your choice) per foot.	4c
per foot	2c	3/4", 1" (your choice) per foot.	6c
5/16", 1/2" (your choice) per foot.	3c	1 1/4" per foot	8c

Portable BUZZ SAW



Powered by 6 1/2 HP Briggs & Stratton air cooled gas engine. Adjustable hinge, requires no clutch. 28" blade, will take up to 12" hardwood. 1 3/4" ball bearing mandrel. Has power take-off. Complete unit mounted with 400 x 8 pneumatic tires. Has tow bar for trailing. Wt. approx. 400 lbs. Sold complete or less blade, engine or wheels. Make \$25 to \$50 a day sawing wood with this sturdy unit. **WRITE FOR FREE CIRCULAR. (Stock #350)**

Automatic AIR COMPRESSOR



Complete. Piston type with 10 gal. tank. 1/2 HP capacitor type. AC, 110-220 volt 60 cycle motor. Will develop 75 lb. pressure—approx. 2 cu. ft. Brand new. **\$79.50**
(Stock #340) . . . only

Assemble yourself and save \$10.
ABOVE tank with legs and saddle. **\$11.95**
AS ABOVE—1/2 HP motor, 2 cyl. Westinghouse compressor. **\$109.50**
3 CFM at 75 lbs.

Portable AIR COMPRESSOR



Electric motor driven, portable spray painting unit for jobs requiring a larger quantity of material. Piston type, single cyl. air compressor has 2" bore by 1 3/4" stroke. 2.86 CFM. Max. working pressure 40 lbs. Mounted on base. Equipped with safety valve & drain cock. 1/2 HP capacitor type motor, 110 volt AC, with cord and plug. 20 ft. air hose and fittings. Ship. wt. 45 lbs. Brand **\$42.50**
new. (Stock #348) . . . only

KELLOG AIR COMPRESSOR



Kellog Model 241 air compressor. Piston type with 2" x 1 3/4" bore. Capacity of 2.8 CFM at 100 lbs. V-belt drive. 3/4" shaft. Can be run with 1/2 or 1/3 HP motor. Delivers oil free air. Max. recommended working pressure 150 lbs. **\$14.95**
(Stock #349). NEW . . . only



AC ARMY LIGHT PLANTS

New 750 watt 110 volt 60 cy. light plant with Briggs-Stratton model AP gas engine. (Stock #315) . . . **\$149.50**

New 1000 watt 110 volt 60 cy. light plant with Briggs-Stratton model BP gas engine. (Stock #316) . . . **\$179.50**

New 2500 watt 110 volt 60 cy. light plant Briggs-Stratton model Z 6 HP gas engine. Used, like new . . . **\$225.00**

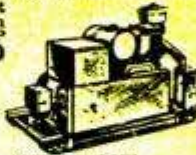

New . . . **\$265.00**
Add \$10 for tools and spare parts.

Rebuilt 5000 watt 110 volt 60 cy. light plant with automatic remote control. Powered by Jeep 4 cyl. gas engine. Rebuilt like new and guaranteed. (Stock #318) . . . **\$625.00**

7,500 watt, 110 volt AC light plant powered by VE-4 Waukesha 4 cyl gas engine. Continental or Hollinsworth generator. Remote control starting with 100 ft. starting cable, and 100 ft. of 3 wire #6 cable. Complete switch board. Used, like new and guaranteed. (Stock #347) . . . **\$675.00**

Add \$65.00 for transformer to make plant 3 phase 220 volt.
10,000 watt 110 and 220 volt 60 cy. light plant with automatic remote control. Powered by Jeep 4 cyl. gas engine. Rebuilt like new and guaranteed. (Stock #319) . . . **\$900.00**

PORTABLE DC LIGHT PLANT

3000 watt 110 volt DC powered by new 6 HP Briggs-Stratton model ZEP gas engine. Rebuilt generator. Generator alone lists at \$243.00. Has volt meter, rheostat, 4 female plugs, and ball bearing 2.75 x 10 rubber wheels. Guaranteed. (Stock #320) . . . only **\$185.00**

SPECIAL!

300 WATT, 110-220 VOLT A.C., 60 CYCLE

LIGHT PLANT

Powered by 1 1/4 HP gas engine. Mounted on base. Stock #409. **\$99.50**
New, only . . .

GENERATORS

AC—750 watt 110 volt 60 cycle with voltmeter, rheostat, 3/4" shaft. Dimensions: 9"H x 12"W x 13"L. Wt. 52 lbs. Shielded to prevent radio interference. Mfg. by Elcor. \$125.00 value. **\$69.50**
OUR PRICE, new (Stock #322)



AC 1000 watt — **\$79.50**
(Stock #403) . . .

DC-300 watt, 12 volt, 2900 RPM. Heavy duty, with current cut-out relay, high and low switch, 30 amp. meter. Can be bought less shaft and base to be used direct mounted to Briggs-Stratton 1 HP engine. **\$7.00**
NEW (Stock #323) . . .

Complete with base, shaft and bearing. (Stock #324) . . . **\$15.95**

HORNS and HOWLERS



Motor driven (not a vibrator). Heavy duty with great power and long life. Adjustable for high, medium or low tone. 110 volt AC current. Weather proof. For alarm or signal horn on boats, school yards, factories, etc. List price \$47.00. **OUR PRICE, \$9.45**
Stock #302 new . . .



Productimeter COUNTER

Manufactured by Durant. Readings up to 5 figures. Rotating drive shaft. NEW, Stock #405 . . . only **\$3.95**

HALF TON WAGON



Heavy duty wagon with plate aluminum body 24" x 42" 5/8" steel axle with ball bearing wheels. Heavy rubber tires. Ideal for newsboys, farms, grocers, parts dept, etc. Approx. wt. 88 lbs. Nothing like it now on the market. **WRITE FOR FREE CIRCULAR. (Stock #332)**

KITCHEN EXHAUST FAN



For kitchens, attics, basements, etc. 8" ball bearing fan Mfg. by Robbins & Meyers. Can be run vertically or horizontally. 110 volt AC 60 cycle motor with plug and cord. New in original box. Stock #401 . . . only **\$11.95**

Electric Rubber Cable (ALL NEW) CORD SETS



Extension cords, 100 ft. heavy duty. Plug, socket and guard. Number 16 wire. Worth at least \$10. **OUR PRICE . . . \$5.95**
(Stock #310)
Same as above—50 ft. length. (Stock #311) . . . **\$4.25**

HEAVY DUTY ELECTRIC CABLE

3 wire #10 Super Cable, Stock #408
100 ft. . . **\$22.00** 250 ft. . . **\$48.00**
4 conductor neoprene covered #18 stranded tinned copper wire (two blacks & two whites). Run in parallel gives you #16 gauge. Lugs furnished for parallel run. Water & oil resistant. (Stock #346).
100 ft. 250 ft. 500 ft. 1320 ft. reel
\$4.25 \$10.00 \$19.00 \$36.00

150 ft. reels, 3 wire #6 with 4, 60 amp Crouse & Hines connectors—2 male & 2 female. Perfect for welders, hay loaders, saws, electric ranges, etc. List price **\$65.00**
\$190. per reel. **OUR PRICE . . . \$65.00**
(Stock #313)

BALL BEARING ARBORS



Grinding and saw arbor, has 1 1/2" double end shaft, 1 1/2" long with 2" center pulley. New Departure double roll ball bearings. Right and left hand thread. Self aligning Dodge pillow block. 10,000 RPM. Bearings alone list at \$10. Complete arbor new. **\$4.95**
(Stock #305) . . . only

HI-SPEED GRINDER (not pictured). Has 2 step pulley driven thru rear or base. **\$10.95**
(Stock #328) . . .

CLUTCH

for motor-scooters, motor-bikes, lawn mowers, etc.
Mercury centrifugal clutch for use with any small gas engine. 3" "A" belt pulley, 5/8" bore. Brand **\$9.95**
new only. (Stock #400) . . .



ALL ITEMS GUARANTEED AS REPRESENTED C & H ELECTRIC Co.
434 W. JUNEAU AVE.
MILWAUKEE 3, WISCONSIN

All prices F.O.B. Milwaukee. 25% deposit required on all C.O.D. orders. No C.O.D.'s under \$10.00. Use stock number when ordering. Many other bargain items not listed—write for our free circulars.

WAR SURPLUS BARGAINS

● **POWER PLANTS.** 110-volt, 60-cycle, 2500-watt & 3000-watt sizes. Some types with remote switch starting. Easy to add automatic starting. Army's best plants with tools, parts, maintenance manuals. Ideal for farmers, sportsmen, contractors. Both new & used plants. Orig. cost over \$700 on 3000-watt. Some units low as \$199. Frt. prepaid. (Write for details.)

● **MARINE ENGINES.** New single cylinder Briggs 3.5 h.p. air cooled, flame arrester, thrust bearing, shaft coupler. Ideal for fishing boats. Complete installation instructions. Standard price \$130. Our prepaid price only\$89.90
Same engine with Arnolt clutch.....\$99.90

● **POWER PRESSURE SPRAYER.** Portable engine driven unit. Briggs 1½ h.p. engine. Westinghouse 2 cyl. compressor. Gauge, regulator, valves—complete. (No gun or hose.) Nearly new and guaranteed. Cost over \$250. Special prepaid\$99.50

● **GAS ENGINES.** Nearly new & excellent. Genuine Briggs ZZ 6.5 h.p. Useful tractors, grain elevators, weed & paint sprayers, pumps, scooters, saws. Cost \$140. Our freight paid price.....\$86.90

● **A-C MOTORS.** New 110-volt, 60-cycle, with marvelous speed reduction gear. Speeds of 8, 32, 320 & 4000 r.p.m. on four separate shafts simultaneously. Useful buffers, grinders, drills, coil winders, photo room, window displays. Cost over \$30.00. Our prepaid price..... \$8.75

● **ROTARY GEAR PUMPS.** Precision unit. New condition. High vacuum and pressure. Dozens of uses. ½ drive shaft. Full instructions. Cost \$36. Our prepaid price.... \$3.95

● DeLuxe Electronic Exp. Kits.....\$6.77
● Tulsa 6-ton Winches & Cable.....\$110.50
● \$40.00 W. E. Intercom. Phones, pair.... \$9.58
● \$30.00 HYDRAULIC CYL. PUMPS.....\$7.90

Order direct from ad or send for bargain catalog. We prepay all freight and P.P. We accept personal checks or send M.O.

Our reference Natl. Bank of Comm. and 17 years in business in Lincoln.

LECO ENGINEERING CO.

BOX 908 PM-16

LINCOLN, NEBR.

HOLD-E-ZEE

AUTOMATIC GRIP SCREW-DRIVERS

UNSURPASSED QUALITY

Plus the **EXCLUSIVE GRIPPER**

UPSON BROS., INC., 86 EXCHANGE ST., ROCHESTER 4, N. Y.

Pat'd
Gripper slides up out of way when not in use. Insulating handles. Complete range of sizes. AT LEADING DEALERS EVERYWHERE



M-6 COMPASS

Precision compass by "Sherrill". Easy to compensate, equipped with nite lite, excellent for planes, cars, boats, trucks, etc. Easily mounted. Instruction manual and calculator included. \$25.00 value.

FREE CATALOG

Over 250 Surplus Bargains

\$5.95 prepaid
WRITE TODAY!

FISLER SALES CO. DEPT. PM-11
723 WALNUT ST. KANSAS CITY 6, MO.

CARBURETOR TOO RICH MAKES MOTORIST TOO POOR



Car owners who are wasting money and not getting proper gas mileage due to over-rich mixtures will be pleased to learn how to save gasoline by VACU-MATING over-rich mixtures. VACU-MATIC fits all cars, trucks and tractors. It is automatic and operates on the supercharge principle. Easily installed in a few minutes.

SALESMEN WANTED! Big Profits! Send name, address on penny postcard for free particulars and how to get yours for introducing.

VACU-MATIC CO., 7617-1480 W. State St., WAUWATOSA, WIS.

SAY YOU SAW IT IN POPULAR MECHANICS

Mows and Trims Lawns



In One Simple Easy Operation
8¼ Lbs.

Save Time and Labor with a

MONTAMOWER

New model. New type metal handle has special device to adjust cutting height. Drive shaft now mounted on free rolling, factory lubricated, sealed ball bearings. No tired backs or aching arms. 8¼ lbs. live precision made mechanism that first gathers, then cuts smoothly a clean 16" swath through grass, dandelions, spike grass, lawn weeds. No noise or clatter. As modern and efficient as your electric razor. Cuts right up to walls, fences, trees or posts; leaves no fringes to be trimmed by hand. Cutters self-sharpening. Built to last many years. Many thousands in use. Sold direct from factory for 26 years. Costs little. Write at once for trial on your own lawn "approval offer," guarantee information and literature.

MONTAMOWER DISTRIBUTING CO.

93 Keeler Bldg.

GRAND RAPIDS 2, MICHIGAN

REMOTE INDICATORS



for use on . . . ● WEATHER VANES
● LIQUID LEVELS ● TV AND HAM ANTENNAS
● FILM FOOTAGE-LENS FOCUS
● HUNDREDS of other uses.

When shaft of one unit is turned other will follow accurately to the same position. Works at any distance, with only simple electrical connections. 2¼" dia. 3½" long. Operate on 115V 60cy. AC. Complete instructions.

Add postage 30c east of Rockies, 50c west.

ELECTRO SALES CO., Dept. PM3
110A Pearl St. Boston 10, Mass.

\$2.95 pair

SPECIAL OFFER!

LOCK-STITCH SEWING AWL

\$1. Postpaid

Famous, patented lock-stitch sewing awl complete with needles, waxed thread and direction folder. Hundred uses — sewing, repairing leather goods, canvas, belting, harness, saddles, gun cases, awnings, golf bags. Extra needles and thread available. Satisfaction guaranteed or money back. Send currency, check or money order. Yates Mfg. Co., 611-H Main St., Lake Geneva, Wisconsin

FREE SCREEN TEST



Special offer! Simple 3 minute test shows amazing "Theater-Quality" brilliance you get in showing slides, movies, film strips on DA-LITE Crystal-Beaded Screen Surface. Black-and-white and color pictures "come to life" in sharp detail.

Da-Lite Screens, first choice of theaters for 40 years. 5 popular models to suit any purse or purpose. Guaranteed. Any photo dealer will demonstrate.

Send for **FREE SAMPLE SWATCH.**
OFFER LIMITED. WRITE TODAY!
Da-Lite Screen Co., 2721 N. Pulaaki Rd., Chicago 39, Ill.

DA-LITE THEATER QUALITY SCREENS



SURPRISE VALUE
 100 Pieces for **\$1.00**
 Electric Grinders
 A Bagful of Bargains at
 Post Paid in U.S.A.
 Grinding Wheels, Cut-off Wheels, Sanding Discs, Mounted Stones, Sharpening and Honing Stones, Rotary Cutting Burs, Abrasive Cartridges, and many other items. Rush check or Money Order.



18 ROTARY CUTTERS
\$5.85
 \$13.50 Value
 Post Paid in U.S.A.

Assorted sizes cutter on 1/8" or 3/32" shank. Will fit all hand grinders. Ideal for cutting wood, metal, or plastic. Brand new.



2 CIRCULAR SAWS
 AT A RECORD BREAKING PRICE—BOTH AT ONLY **\$1.50**
 1" diameter saws on 1/8" Mandrels. For cutting wood, plastic, or soft metals. Order at once! Send Check or Money Order for this big bargain. Post Paid in U.S.A.

Special Bargain! SANDING DISCS
 7 in. Diameter Assorted Grits **\$1.80** Doz.
 9 in. Diameter Assorted Grits **\$2.00** Doz.
 SCHUPACK SUPPLY CO., 7331 Cottage Grove, Dept. M3, Chicago 19, Ill.

POWERFUL!
ECONOMY TRACTOR
 Lightweight, Low-priced, Big capacity for all jobs, Ideal for small acreage, Implementation attachments available.
 Write Dept. M3
 Tractor Features: Adjustable Tread, High Clearance, 7 H.P. Air Cooled Engine, Automatic Clutch, Differential and Transmission.
 ENGINEERING PRODUCTS CO. 915 Niagara Court Waukesha, Wis.

LAWN ORNAMENT-NOVELTY PATTERNS
 28 Lawn Ornament Patterns, 25c. Other patterns; 15-20" high; Dutch Girl, Dutch Boy, Pirate, Bull Terrier, Mexican Girl, Mexican Boy, Dwarf, Penguin, Flower Girl, 10c each. 25 Novelty Patterns, 30c. All 62 Full Size Patterns, \$1.00 Postpaid. Strother Pattern Service, Dept. AX-8, Box 128, Belington, W. Va.

Genuine Snap-on Tools
 Available Only Through Snap-on's Direct-To-User Tool Service
 WRITE FOR INFORMATION
 SNAP-ON TOOLS CORP. • Kenosha, Wisconsin

RISLONE with your oil gives guaranteed smoother driving

You feel the improvement within 10 miles — when you get rid of gum and sludge

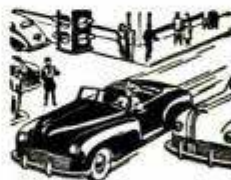

Rislone gives your car smooth power at all speeds... immediate starting and power-surge pickup in any weather. It keeps your car at peak performance as you drive. Gets rid of sticking valves, sluggish power, and slow-speed jerkiness.

It's "motor magic" that works in cars of any age. Actually, Rislone permits normal driving speeds immediately in new and reconditioned cars. There are no harmful ingredients in Rislone. It's a real full-time lubricant, a super oil-alloy that keeps modern motor-oils up to snuff, absorbs gum and sludge, keeps your motor clean and protected. Prove it to yourself. Try Rislone today. Available at car dealers, better garages, and service stations everywhere. If you can't feel a smooth-driving difference in 10-miles — you get a full refund. The Shaler Company, Waupun, Wis.



Whenever you change your oil ..put in a quart of **SHALER**

Rislone

(2 quarts for larger cars). As you add oil, make every fourth quart RISLONE.

SAY YOU SAW IT IN POPULAR MECHANICS

"I'LL TAKE THE WHITE ONE EVERY TIME!"



WYTEFACE
 TRADE MARK
STEEL MEASURING TAPES

K+Σ
KEUFFEL & ESSER CO.

Special!

Riflemen, Gadgeteers get this new N3C sight for use as a collimator.



An interesting article is found in the January issue of Popular Mechanics on the use of reflector sights for alignment of telescopic sights. The N-3-C is ideal for this use. It contains 2 3/16" condensing lense with a 6" focal length, and will produce an excellent target. The N-3-C is offered at the unbelievably low price of only \$2.25 postpaid anywhere in the U.S.A.

Make your own scopes or optical instruments?

If so, we have a real deal for you. Twenty-five assorted mounting rings and retainers ranging from 19/32 to 1 7/16" in I.D. at only \$1.00 postpaid anywhere in the U.S.A.

MICH. RES. Add 3% Sales Tax

N. SILVERSTINE CO.

6532 EAST McNICHOLS ROAD DETROIT 12, MICHIGAN

Seven Acres of Surplus

A TOOLSHOP IN YOUR HAND



There's Only One Genuine Handee

First tool of its kind—today's finest. Smooth, steady power at your fingertips. Easy to handle. Make ship, plane and train models, bookends, costume jewelry. Grinds, drills, polishes, routs, carves, sands, saws, engraves on metal, wood, plastic, glass, leather, etc. 25,000 r.p.m. AC or DC. Wt. 12 oz. With 7 accessories \$20.50. In case with 40 accessories \$27.50. At stores or sent postpaid. A fine gift for a friend or yourself. CHICAGO WHEEL & MFG. CO., 1101 W. Monroe St., Dept. PM, Chicago 7, Ill. Free 52-page manual.

HANDEE

TOOL OF 1001 USES

Build Your Own BICYCLE TRAILER or UTILITY CART



Enjoy camping trips, make extra money running errands. Will carry up to 200 pounds. Handy cart around home. Change bicycle hitch to cart handle in second. Kit of complete parts, including special hitch to bicycle with body and tongue metal parts already shaped.

COMPLETE PARTS for only \$7.95

FOR UTILITY CART HANDLE with easy attachable joint, **\$1.85**

add Full instructions how to build. Easy and enjoyable. If not completely satisfied return in five days for refund. You pay return post charges. Send cash or money order to Dept. T-4 or write for free literature.

WHIPPLE MFG. CO., Inc.
SPIRIT LAKE, IOWA

Takes Less Than 3 Hours to Convert HAND MOWERS to POWER MOWERS

Handy-Dandy Lawn Mower Kit fits any hand mower from the 16 to the 20 inch size. Kits furnished separately or with power units.

Available

Kits available for Power Products, Maytag, Lauson, Briggs Stratton, Clinton, other small gas engines or electric motors. In stock 1/4 or 1 1/2 h.p. Lauson engine and 19" heavy duty Pennsylvania Mowers.

DEALERS WANTED

LE CLAIRE MANUFACTURING CO., LE CLAIRE, IOWA
DEPT. P.M. 150

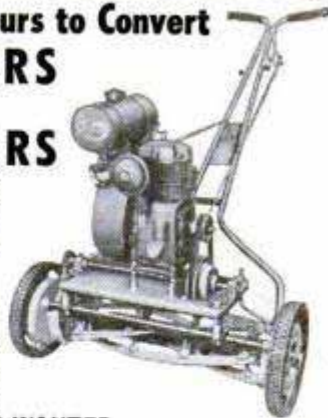

BUILD YOUR POWER TOOLS

WITH OUR GUARANTEED INDUSTRIAL POLY BALL BEARING ARBORS



New Departure Self Lubricating Bearings

10,000 R.P.M.



(No extra charge for left hand threads)

C4-1 1/2" Pictured

B33-\$5.45 PP. C4-1 1/2x12 1/2 spindle, housing 2x8... \$7.95 PP.
5/8 x 4 1/2 Spindle C5-5/8x12 1/2 spindle, housing 2x8... \$8.45 PP.
B15 Plain Spindle C6-3/4x12 1/2 spindle, housing 2 1/4x8... \$9.45 PP.
\$3.95 PP. D8-1x17 1/2 spindle, housing 2 5/8x11... \$18.75 PP.
1 INCH BETWEEN WASHER AND COLLAR
SHAPER ARBORS—Free literature on request.

POLY PRODUCTS, 2032-A E. Walnut, Pasadena 8, Calif.

Prices are DOWN!

Save on war surplus, job lots, close-outs, overstocked merchandise, and leading standard brands. Thousands of useful items for home, farm, factory, shop, industrial plants, laboratories. Write us for anything you need, including hardware, hand and power tools, toys, machinery, motors, engines, aluminum, etc.

THE ORIGINAL MIDWEST BUY ANYTHING CO.
Dept. M, 1520 Locust St., Kansas City, Mo.
Not connected with Firms of Similar Names

Write for **FREE CATALOG** of America's Most Varied Merchandise Store!

DUAL CROSS and ROTARY FEED

PALMGREN ROTARY, INDEX, MILLING TABLE

Has 8" table, 360° movement and 4" cross feed travel. Adjusting wheels and dials graduated in degrees and thousands. Slotted for bolting to table. No. 83 Priced \$49.50. No. 82 without rotary feed \$39.75. Write for Circular No. 10 CHICAGO TOOL AND ENGINEERING CO. 8365 South Chicago Ave., Chicago 17, Ill.



TRAILER BUILDERS' SUPPLIES!

TO BUILD, REPAIR OR MODERNIZE! And save money. You must have our big Catalog. We are the largest and most complete trailer supply house in the States. Our new

large 1949 catalog 10c; blue prints and building instructions, 25c. NATIONAL TRAILER EQUIPMENT CO., 1007 N. Water St., Milwaukee 2, Wis.

SAY YOU SAW IT IN POPULAR MECHANICS

MUFFLERS

STEELS and ALUMINUMS with a motorboat tone



SINGLES, Chev., V-8, Plymouth, Steels \$5.50, Aluminum \$7.00. Chry., Olds., Buicks, etc., Steels \$7.50, Aluminum \$9.00. V-8 and MERCURY DUALS, Steel \$17.50, Aluminum \$21.00. '49 FORD DUALS, \$2.50 extra. Split Manifold Sets, Steels \$35.00, Aluminum \$45.00. Aluminums are guaranteed for life of your car.

DEALERS WANTED

SANDEE MUFFLER CO.
BOX 296 LA TIJ., LOS ANGELES 43, CALIF
2624 W. SLAUSON AVE., LOS ANGELES, CALIF.

HERCULES GASOLINE ENGINES

Model ZXB, 4-Cyl., 2 5/8" x 3", 64.9 Cu. In.

20 Horsepower at 2800 R.P.M.



Power for Midget Cars, Boats, Saws, Grinders, Generators, Etc.

Bare engine, as illustrated, with manifold, governor, water pump, fan pulley, bellhousing and flywheel, \$126.00.

Accessories available at low prices: Fan with bracket and fan belt, \$2.95; Muffler, \$1.90; Carburetor, \$4.50; Magneto with impulse Coupling (Amer. Bosch MJC4) \$18.50; Spark Plugs (Champion C-10-S) \$.30; Air Maze Air Cleaner, \$2.70. All prices f.o.b. Los Angeles, Calif.

All New Material — Immediate Shipment

PIONEER ELECTRIC COMPANY

3700 E. OLYMPIC BLVD., LOS ANGELES 23, CALIF.

SEND FOR THESE AUTOMATIC SHUT-OFFS

Timers for Water Heaters and Incinerators



FULL MONEY BACK GUARANTEE on these automatic shut-offs which eliminate return trips to the basement! Installed in a few minutes with ordinary tools. Come with simple, complete instructions. Order direct from factory.

GET ERIE-TIME-O-GAS for your water heater or incinerator. Described in Popular Mechanics October issue. Replaces regular gas-cock on inlet pipe. Easy to install. To operate, set knob to burn for 2 to 55 minutes. ERIE TIME-O-GAS shuts off gas automatically! Works on manufactured, natural, mixed gas. Use with or without pilot. Pilot lighter included FREE with each unit.

Other Models Available for Many Other Applications. Send only \$8.95 for postpaid ERIE-TIME-O-GAS, or C.O.D. plus postage; or write for FREE information. (Specify if ERIE TIME-O-GAS is for heater or incinerator.)

ERIE MFG. CO., Dept. P-5, 300 N. 8th St., Milwaukee 3, Wis.

Electric HOME-UTILITY Tools

for HOMES • FARMS • WORKSHOPS

Products of the Black & Decker Mfg. Co.

Only \$16.95 DUAL PURPOSE SPRAY GUN

Complete USES ONLY 25 LBS. AIR PRESSURE FLOCKS AND SANDBLASTS



AT HOME: You can refinish Lamps, Radios, Book Ends, Statues and hundreds of things with lovely colorful flocking. **ETCH GLASS:** Many designs and initials can be sandblasted on shower doors, ash trays, glassware. **AUTO INTERIORS:** Transform ugly dirty auto interiors to "new car beauty" with a BLASTO DUAL PURPOSE SPRAY GUN. Merely spray flock similar to Velvet, Plush, Suede and Mohair inside your car. **ANTIQUE WOOD . . . REMOVE PAINT. MAKE EXTRA MONEY** by doing any or all the above for profit. BLASTO is highest quality and carries a 5 day money-back guarantee. Operates on small air compressor. Send \$16.95 cash, check or money order for postpaid delivery. Write for free information. Full line of Flocking Supplies.

BLASTO SPRAY GUN MFG. Dept. PM-3, 7007 Haas Avenue Los Angeles 44, California

WAR SURPLUS BARGAINS

\$500,000.00 INVENTORY for QUICK LIQUIDATION

Surplus items—hundreds of them for home, shop, factory, farm and outdoor use. New items, used items, reconditioned items—all at tremendous savings—all priced for quick sale.

Page After Page of Values

This big catalog shows page after page of amazing money saving values. Write for your copy today. Send 10c to cover postage, mailing, etc. Write today!

SEND TODAY FOR YOUR COPY

10c

STARK'S Dept. PM3A 509 So. STATE STREET CHICAGO 5, ILLINOIS

BUILD YOUR OWN TILTING ARBOR SAW!

Exclusive GIL-BILT Build-It-Yourself Features

SAVE \$50 OR MORE

- No machining—build easily with hand tools only
- No blueprint reading—step-by-step pictorial plans, full size patterns, actual photographs
- Sturdy wood, aluminum, and steel construction
- Capacity and performance of commercial saws selling for \$60 and up

GIL-BILT 10-INCH TILTING ARBOR SAW

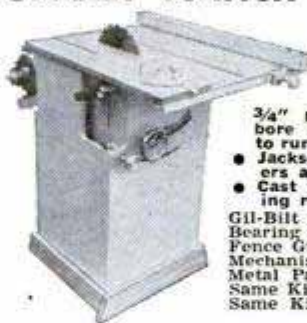

- 27x28 in. table, 13 1/2 in. capacity in front of blade
- 10 in. blade cuts 3 3/4 in. deep, tilts full 45 degrees
- Floor model, 34" high table always stays level
- New Departure ball bearing arbor, 3/4" precision shaft turned down for 5/8" bore blades, alum. housing, shipped ready to run
- Jackscrew and 4 1/2 in. dia. handwheel lowers and raises blade
- Cast aluminum miter gauge and self-aligning rip fence guide

Gil-Bilt Metal Parts Kit includes Plans, Ball Bearing Arbor, Miter Gauge and Bar, Rip Fence Guide, Machined Lock Knobs, Jackscrew Mechanism and Handwheel, and All Other Metal Parts (less blade).....\$20.95
Same Kit with 10" comb. blade..... 25.90
Same Kit with 8" comb. blade..... 24.90

GIL-BILT 8-INCH TILTING TABLE SAW

- 21x27 in. table tilts full 45 degrees, 13 in. capacity in front of blade
- 8 in. blade cuts from 0 to 2 1/2 inches
- New Departure ball bearing arbor, 5/8" precision shaft turned down for 1/2" bore blades, alum. housing, ready to run
- Cast aluminum miter gauge and self-aligning rip fence guide (same as above)



GIL-BILT Metal Parts Kit includes Plans, Ball Bearing Arbor, Miter Gauge and Bar, Rip Fence Guide, Machined Lock Knobs, Tilt Support Segments, and All Other Metal Parts (less blade).....\$15.95
Same Kit with 8" Combination Blade..... 19.90

GIL-BILT 12-INCH BAND SAW

- Cuts to center of 24 in. circle
- Handles stock up to 6 in. thick
- Fully enclosed mechanism for utmost safety
- Wheels turn on heavy 5/8 in. shafts, four Oilite bronze bearings
- 18x18 in. table tilts 45 degrees
- Upper wheel tension and tilt mechanism of cast aluminum; completely assembled
- Two blade guides, each has ball thrust bearing, self-lub bronze jaws
- Rubber tired wheels. Choice of cast alum. or make-your-own wood wheels on metal hubs
- Uses standard 78 in. blades up to 3/8 in. wide

GIL-BILT Metal Parts Kit includes Plans, rubber tires, 3/16" blade, hubs for wood wheels, bearings, shafts, tilt mechanism, guides, tilt support segments, and all other metal parts.....\$16.95
Same kit with two ready-to-install 12" cast aluminum wheels 20.95

NO DEALERS—ONE LOW PRICE! Prices include postage up to 600 miles. Send cash, check or money order for complete kit, or send \$1.00 for Step-by-Step Plans and Order kit later less cost of Plans. Plans sent postpaid anywhere in the world.

COMPLETE PLANS only \$1.00 EACH

GILLIOM POWER TOOLS

P. O. Box 1-PC, Lambert Field, St. Louis 21, Missouri

Do it
Faster
and
Easier
with
the

WRITE FOR FREE CATALOG — shows attachments that save time and money!



PAGE Garden Tractor

New 1949 line with extra features! Riding and walking models, 1 1/2 to 5 HP. Complete gear drive, no cheap belts or chains. Large tires—high clearance—easy to handle—power turn. Low factory prices—\$188 to \$436 with cultivator. Get benefits of 24 years of garden tractor experience!

PAGE DAIRY and FARM EQUIPMENT
1904 S. 81st STREET • MILWAUKEE 14, WIS.

WAR SURPLUS AND OTHER BARGAINS

Self-Priming ELECTRIC PUMP



Good for fuel pumps, fluid meters, coolant pumps, pressure lubricating pumps, oil burners, aquariums, general industrial use, etc. Can remove pump and use motor as high speed grinder, tool post grinder, etc.

WELDON TOOL CO. PUMP with standard 1/4" tubing ports, rated 2 G. P. H. **BLACK & DECKER MOTOR.** 1/75 H.P.; double ball bearing, series wound, continuous duty. Rated 12,000 R.P.M. Can be used on 24-32 VDC current or with transformer on 110 VAC line. SIZE: 7 3/4" long x 3 1/4" high x 3 1/4" wide. Wt. 5 lbs. Value more than \$50.00! **\$7.95** postpaid

SEND CHECK, MONEY ORDER or CASH

TRANSFORMERS

Jefferson Electric step up or step down transformer. Input, primary 110-117 Volts A.C. Output, from 5 Volts to 650 Volts. Suitable for use with war surplus gadgets, heater relays, radio test filaments, electric trains, house chimes, etc. Weight 10 lbs. **New \$7.95** Each

Automatic Winding Company Transformer. 60 cycles A. C. Input 75-125 volts. 4 step output 5-6.3 volts. Single winding. For radio, radar, television, chimes, and all low voltage gadgets. Wgt. 5 lbs. **New! Each \$3.50.**



ALL PRICES F.O.B. CULVER CITY, CALIF.

MICROMETERS:

Chrome plated, precision engineered and carefully tooling to give long life, all new . . . 0-1" capacity, each **\$2.25.** 1-2" capacity, each, **\$3.50.** 2-3" capacity . . . each **\$5.50.**

FANCY BRIAR PIPES

We have been awarded 100,000 fancy briar pipes by Quartermaster Corps. Assorted shapes and sizes. All popular makes. **Set of 7, \$3.50**



POWER DRIVEN ANTENNA REEL: 1/2 H.P., G. E. Motor —12-24 V. Removable 6" Reel. Cam worm gears, bevel gear. Solenoid clutch. In gear only when current on. Operates clockwise or counter clockwise. Ideal for power fish line, opening or closing doors, auxiliary power take-off. Can be used as buffing machine or for dozens of other uses. New! Weight 6 lbs. . . . **\$4.00 ea.**



25% DEPOSIT REQUIRED ON C.O.D. ORDERS

CLAMPS—Adel Aluminum Co., Rubber lined, hundreds of uses in any shop. Assorted sizes, all new. 5 Doz. \$1 — 500 \$5

CAR & TRUCK HEATER: Can also be used in trailers, offices, darkrooms, homes or may be used as dryer. **DUMORE Motor** 1/6 cont. H.P., Amperage 7.5, RPM 6400, 24 V. Radiator type circulation, copper coils. Very efficient for car or truck heater when connected to battery. Simple installation. Wgt. 13 lbs. . . . **New! \$15.00.**

AIRBORNE SALES CO., INC. DEPT. PM 3-9 CULVER CITY, CALIF.

WORLD'S MOST POWERFUL

Completely Different Than Any Other!

HY-SCORE AIR PISTOL

Famed HY-SCORE used by experts. Expensively made. Looks and feels like a Luger. Revolutionary mechanism blasts pellets at close-to-firearm speed. **EXTREMELY ACCURATE.** Cal. .177 or .22. **\$19.85** including 500 HY-SCORE pellets (pellet value \$1.49 for cal. .177; \$1.88 for cal. .22). Also sample dart.



If your dealer cannot supply, write for free booklet, Dept. PM-3 **HY-SCORE ARMS CORP. • BROOKLYN 1, N.Y.**

BIG PROFITS RESTRINGING RACKETS AT HOME! WRITE US!



Earn big profits restringing tennis rackets at home. Easy work. Experience unnecessary. Save on your tennis, badminton, squash! Send for **FREE CATALOG** of Tennis Equipment—**Hurry!** **H. E. Wills Co., 1047 W. 47th St. Dept. PM-39, Chicago, U. S. A.**

Save On GUT! —Buy Direct from Factory **SILK!**

"ROYAL" ROTARY MOWER

IT'S NEW! IT'S PERFECT! IT'S TRULY A BEAUTIFUL ECONOMICAL MOWER—THE MOST PRACTICAL EVER MADE

Have a Beautiful Lawn • Mosquito Free Surroundings Cut with a **SMOOTH FINISH** through any **LAWN, Spike Grass, Dandelions and High Weeds.** Easy to Adjust Cutting Height. Clippings are Scattered Evenly. **NO NEED for RAKING** or after **TRIMMING.** **SOLD Direct to YOU, at FACTORY PRICES.** Light Weight (only 34 lbs.) Royal Mower for Either Gasoline or Electric Motor—20 Inch Cut—Without **\$500** Engine.

"Precision Built" to Last a Life Time



OUR DEPENDABLE GASOLINE ENGINE. 2 H. P. 4 Cycle **AIR COOLED.** Light Weight 30 lb. Quick Easy Starting at any Temperature. No Vibration. Best Engine Ever **\$55.50** Made

SAVE MONEY: ROYAL MOWER and Gasoline Engine, Complete as Shown only \$100.00

ALL PRICES F.O.B. ROYAL OAK, MICH. Prompt Shipment. Order Today. If you Prefer Send Check or Money Order for \$20.00. We Ship C.O.D. for Balance.

Absolute Money Back Guarantee

ROYAL OAK LAWN MOWER SHOP Dept. A—Box 48 ROYAL OAK, MICHIGAN

AMAZING NEW SAFE JIG SAW READY!

At last — a revolutionary, new electric jig saw small children may use, yet powerful enough to be the basic tool in Dad's workshop. Make "Standing Photo Silhouettes" of favorite snap shots . . . fancy what-nots, toys, for fun and profit! Handy as a hammer—just plug in! No motor to buy—no oiling. Thousands sold. Use in livingroom, apartments, etc. Patented. Nothing else like it. Mail postal NOW for illustrated, Free Circular, low price!



FREE Circular!

SYNCR0

Dealers Write!

SYNCR0 CORPORATION, Dept. H-39, Rochester, Mich.

GENERAL ELECTRIC & WESTINGHOUSE MOTORS

(Brand New, Not Gov't Surplus)

HP	VOLTS	TYPE	PRICE
1/6	110	Split Phase	\$11.95
1/6	110	Capacitor	17.50
1/4	110	Split Phase	12.50
1/4	110	Capacitor	19.50
1/3	110	Split Phase	15.50
1/2	115	Capacitor	35.00

CANAL ELECTRIC CO., PM3, 310 Canal St., NYC 13, N. Y.

SAVE ON TOOLS MECHANICS NET PRICES



Send 25c in stamps for "Illustrated Catalog." Hundreds of Nationally Known, **NEW & GUARANTEED** Hand & Specialty Tools at **Mechanics NET** prices. Guaranteed by manufacturers. **NOT War Surplus.** **GIZMO TOOL CO.** BOX 656-A SAN FRANCISCO 2, CALIF.

NEW KNIFE SENSATION!

A MUST for every Model Builder, Hobbyist, Tinkerer!



Only \$1.00 SEND **NO MONEY!**

—Amazing idea! Amazing value! Imagine a knife that looks just like an expensive fountain pen. Handy, convenient to carry in pocket or purse. Ideal for model builders, amateur radio men, home workshops. No tool box should be without one. Pen-like housing contains super-sharp carbon steel blade that slips in and out of safety holder with flick of finger. Adjusts to any length up to 1 1/2". Weighs less than one ounce. Handsomely, sturdily made of durable spun aluminum and red plastic. **ORDER TODAY!** Just send name and address. Pay postman \$1.00 plus postage on delivery. Send \$1.00 with order and we ship postpaid. You must be delighted or your money back. Order several—they make ideal gifts for men, women, boys—everyone!

HALL PENROD, Dept. 110, 222 W. North Bank Dr., Chicago 54, Ill.

**NOW! USE YOUR ELECTRIC DRILL for
POLISHING!
GRINDING!
SANDING!**

**Work on curved
or flat
surfaces**

You can use it to fix bodies, fenders; wax; polish cars, floors, linoleum; re-finish furniture, wood, metal surfaces; smooth, reduce welds, etc.

**FITS ANY 1/4 IN. CHUCK or DRILL,
FLEXIBLE SHAFT, MOTOR, etc.**

Designed and engineered for high speed sanding, polishing, finishing, etc. Full 6 1/2 inch rubber face plate bonds into curved surface. New clamp arrangement mounts sanding discs instantly—no cementing. Draw-string lamb's wool bonnet slips on for high speed polishing, finishing, etc. Outfit includes 6 1/2" flexible rubber disc with 1/4" metal shank, fibre backed sanding disc and heavy lamb's wool polisher. Equals \$75.00 outfits in performance. You'll find hundreds of time saving uses for it. Fully guaranteed. Shp. wgt. 2 lbs. F.O.B. Chicago. Complete, only

\$4.95

At your favorite hardware store or direct.

PREHLER PROVED PRODUCTS

Division Norbert Prehler & Co. Chicago 47, Illinois
Dept. PM-3 - 1623-25 Milwaukee Ave.



On Flat Surface



On Curved Surface



Polishes

Memo to Prospectors...

Be ready. Your next trip in search of radioactive ores may pay out if you have the best equipment. TX-GEIGER COUNTERS were used in locating most of recent strikes. Write for details.

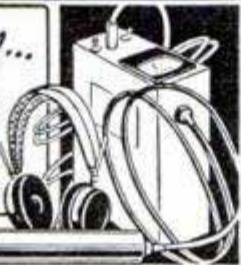

OMAHA SCIENTIFIC SUPPLY CO.
DEPT. M, 3623 LAKE ST., OMAHA 4, NEBR.

BARGAIN!

HIGH SPEED ROTARY FILES

Set of 5 Assorted.....	\$ 2.00
" " 10 "	3.75
" " 20 "	7.25
" " 30 "	10.00

1/4" shank



WE BUY SURPLUS TOOLS

SID TOOL CO., 183 Grand St., N. Y., N. Y.

New! **Pencil-size POCKET MICROSCOPE**

**MAGNIFIES AREA
400 TIMES (20X)**

**PRECISION-BUILT
SHARP IMAGE**

**NOTHING
TO ADJUST**



**ONLY
\$2.98**

Now! A powerful pocket microscope to reveal hidden things. Amazing power. Sand looks like expensive gems, a handkerchief like a net. Has a multitude of uses. Replaces many costly microscopes. An excellent inspection instrument in many industries. Instant focus. No adjustments. Perfect wide field. Aluminum body beautifully finished. Amazingly low price. Marvelous for everyone. Multiplies the pleasures of hobbies. Opens a WONDERLAND FOR CHILDREN. Order today. Send a dollar bill. Will ship return first class mail. Full refund end 5 day trial. No c.o.d.

DU MAURIER CO., Dept. 203 Elmira, New York

**4 LENS
OPTICAL
SYSTEM**

- Used by:
- HOBBYISTS
 - STUDENTS
 - TEACHERS
 - PRINTERS
 - BANKERS
 - ENGRAVERS
 - ENGINEERS

The Nation's Finest
TRAILER COACH VALUE

Better for living or travel because SCHULT offers incomparable quality . . . the result of exclusive, highly developed machine production and advanced engineering, as contrasted to usual hammer and saw methods.



Write
FOR FREE BOOK

See beautiful new interiors offering many advantages . . . details of kitchens, closets, bedrooms . . . Exclusive "Heat-Saver" and construction features . . . floor plans and furnishings of latest, moderately priced, easy-trailing SCHULT models.



SCHULT CORP., Dept. 3203, Elkhart, Ind.
In Canada: John Inglis Co., Ltd., Toronto

SCHULT *Trailer Coaches*

**AMES UNIVERSAL DIAL INDICATOR SETS
NEW SURPLUS**

OUR \$15.00
PRICE

Reg. sold for
\$23.00

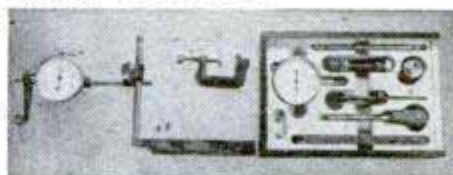

You get a complete set including Dial Gage with hole Attachment, Bar with Upright, Clamp sliding swivel, Dial holding rod and three contact points. Hole attachment also, can be adjusted to almost any position, and used in places inaccessible to ordinary indicators. All this along with a beautiful box for only \$15.00. Write today before limited supply of these AMES KITS are exhausted.

VETERAN TOOL AND SUPPLY CO.
88 Baxter Street New York 13, N. Y.

**Say You Saw It in
POPULAR MECHANICS**

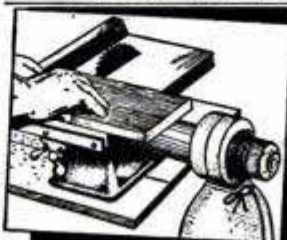

DUST-O-VAC the Dust & Chip Collector

for Home Workshops and Industry
DUST-O-VAC collects and bags wood and plastic chips, wood and metal dust, wood shavings. **Free Bag** . . . Attaches to circular saw, planer, hand saw, grinder, belt or disc sander, shaper, drill press with shaper or sander attachment, spindle shaper, wood lathe or jig saw. 110 A.C., D.C. Free lit.

\$19.95

Free Ship, east of Miss. West of Miss., add \$1. Check, M.O.

UNIVERSAL YONKERS CORP., 137 Alexander St., S-3, Yonkers 2, N. Y.

A NEW KIND OF MOTORCYCLING

WITH



SAFE - COMFORTABLE - POWERFUL

Automatic Clutch. Telefloat Spring Suspension. Foot Gear Shift. 95 miles per gallon. 70 Miles per hour. See and drive it at your nearest JAWA DEALER or write for free folder.

DEALER INQUIRIES INVITED

JAWA MOTORCYCLE CO.

2432 Grand Concourse, Dept. M
Bronx 57, New York

Say You Saw It in Popular Mechanics

Amazing Value!
THERE'S NOTHING YET...LIKE
"The Culti-Vette"!

The New Light Duty,
Economy Model

Garden-All
LAWN and GARDEN TRACTOR

Write for
Folder

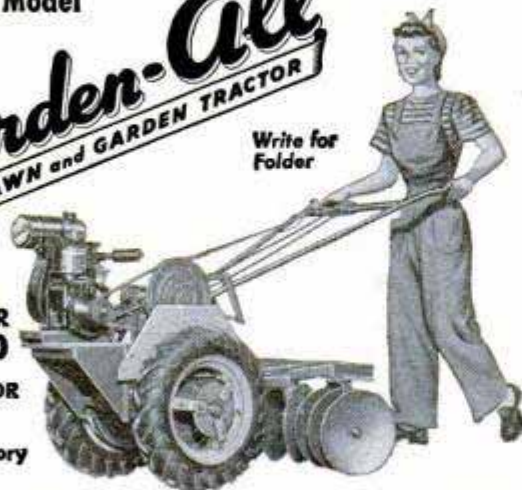

TRACTOR
\$159.50

CULTIVATOR
\$19.50

F. O. B. Factory

Be sure to see "The Culti-Vette." It's a big value! All the famous features, like Front Hitch, Instant Tool Attachment, Exclusive Depth Control . . . previously only on larger Garden-All models . . . plus POWER TURN and many other new features. Sturdy, powerful, simple construction with nothing to get out of order. See "The Culti-Vette" NOW!

GARDEN-ALL TRACTOR, INC.

Dept. P, 110 W. UNION STREET, LIBERTY, INDIANA

An Outstanding METAL HAND PUNCH
with unusual
performance

Needed by every
Mechanic in every
Shop



No. 5 Jr. HAND PUNCH

CAPACITY—1/4" THRU 16

Ga. Mild Steel. 3/32" —

1/8" — 5/32" — 3/16" —

7/32" — 1/4" — 9/32" —

Punches and Dies Furnished.

THROAT

DEPTH

2 inches

Weights
2 3/4 lbs.

only **\$8.75**

ORDER YOURS TODAY!

Write for **FREE** Catalog on other tools.

Postpaid in
U.S.A.

WHITNEY METAL TOOL CO., Dept. P-3, Rockford, Ill.

3-Pc PAINT STRIPE SET Only **\$1.00**



3 SEPARATE TOOLS—Each makes different width

Stripe perfect lines—straight, curved, with any paint, lacquer, enamel, easy as drawing lines with ruler! Beautify furniture, toys, autos; make signs and imitation tile. Simple instructions included.

SEND NO MONEY. Mail order. Pay postman only \$1.00 plus postage. If not delighted return in 5 days for money back. Order Now.

STRADER MFG. CO.

259 Strader Ave. Dept. E-351
Cincinnati 26, Ohio

TRY A Dry Lube!!

NEOLUBE contains colloidal graphite. Apply like paint to wood, metal, glass, rubber, plastics. Dries rapidly. Adheres firmly. Does not brush off. The films formed are lubricating, conductive and opaque. Home craftsmen, sportsmen and hobbyists use NEOLUBE for chain drives, hinge pins, sticking windows, working models, electrical contacts, toys; on delicate mechanisms or engine bearings; on threaded parts for easy disassembly, on reels, guns and autos. Hundreds of uses for the tinkerer or skilled mechanic. Literature on request. Send **\$1.00** for 2 oz. bottle. Postage paid in U.S.A. for cash with order.

HURON INDUSTRIES, P. O. BOX 557, PORT HURON 1, MICHIGAN

WRITE NOW FOR FREE CATALOG NO. MM

THE Foster LINE
POWER TOOLS

FOSTER MFG. CO., 247 DELAWARE AVE., BUFFALO 2, N. Y.



USE YOUR BENCH SAW

With Our six in. tool steel cutters. Make mouldings, casings, drop-leaf tables, grooves heading & jointing 1" wide \$1.75, 1 1/2" \$2.25, Postpaid. State size hole, List & folder free. John A. Sandstrom, Rt. 2-D, Clearwater, Fla.

SCREWMASTER

New, Revolutionary Time Saver

Belongs in every tool chest . . . Saves time and effort. Easily removes bound, rusted or mutilated threaded fastenings. Removes or sets screws with or without heads . . . Powerful cam action magnifies lateral shocking force . . . Begins where conventional screw drivers fail . . . Made of special hardened steel

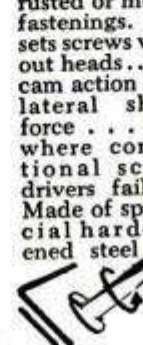

\$4.95

ORDER D & C SALES CO.
NOW! 145 State St. Springfield, Mass.

POPULAR MECHANICS

500 p. Catalog, 7,000 Novelties 10c



10c
Kits Wigs Pipes
Guns Jokes Locks

Roto Picture Section, 3,500 Illustrations, Beautiful 6-Color Cover

Novelties, gadgets, gifts, funmakers from all over world. Carnival, circus, world's fair & science exhibit rolled into one. Covers hobbies, useful gadgets, timesavers & ALL novelties. Money-makers, money-savers. Live monkeys, shrunken skulls.

- | | | | | | | |
|---------|------------|---------------|-----------------|-------------------|---------------------|-------------------------|
| Boats | Jewelry | Telescopes | Field Glasses | Fortune Tellers | Electric Shockers | Smoker's Novelties |
| Rings | Hobbies | Funmakers | Money Savers | Symbol Jewelry | Imported Articles | Home Printing Sets |
| Tools | Gadgets | Slide Rules | Curious Seeds | Office Novelties | Radios & Supplies | Engines — Motors |
| Games | Billfolds | Barometers | Makeup Goods | Lucky Novelties | Sweater Emblems | Musical Instruments |
| Knives | Cameras | Chameleons | Banks & Vaults | Occult Novelties | Projectors & Film | Live Animals & Pets |
| Models | Airplanes | Microscopes | Rubber Stamps | Indian Novelties | Western Novelties | Auto & Bike Accessories |
| Turtles | Disguises | Home Tools | Sporting Goods | Fishing Novelties | Scientific Supplies | 1000 Fascinating Books |
| Stamps | Excisiers | Magic Tricks | Artist Supplies | Hula Hula Skirts | Religious Novelties | Many, Many Other Things |
| Puzzles | Magnifiers | Electric Eyes | Novelty Checks | | | |

Collier's, Tide, Coronet, New Yorker Write About This Amazing "World's Greatest" Catalog

25,000,000 orders in 35 years—our record. A catalog, but most wonderful book you've ever seen! Costs us 75c per copy to get out. Complete paper cover edition, 10c; De Luxe hard bound library edition, 25c. Sent Air Mail for \$1.00. (Stamps accepted.) One per customer. **JOHNSON SMITH & COMPANY** DEPT. C-45 DETROIT 7, MICHIGAN

SURPLUS BRAND NEW AIR COMPRESSORS

for Garage - Shop - Factory - Farm or Home
Height 9" - Weight 7½ lbs. Uses ¼ HP Motor

A sturdy, well built air compressor of steel and die cast metal constructed to give satisfactory and lasting service. 20-30 lbs. continuous pressure. Higher pressure for intermittent service. Formerly sold for \$14.50. (Spray gun and hose also available, write for prices.)

WHILE THEY LAST

\$8.50

Prepaid

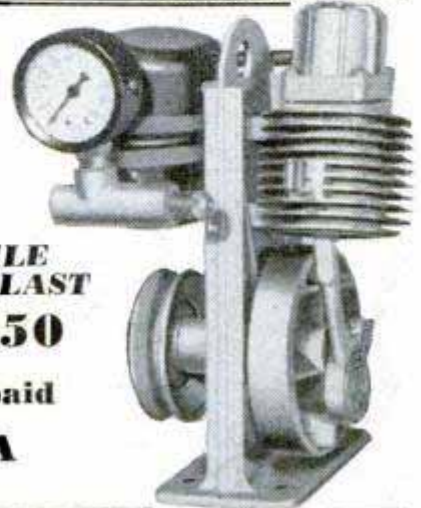

COMPRESSOR CORPORATION OF AMERICA
St. Joseph, Mich.



Increase The LIFE and APPEARANCE of YOUR CONVERTIBLE

"DURA-TOP" is easily installed or removed in 5 MINUTES

ALL PLASTIC COVER — Protects — Insulates — Beautifies
The Perfect Cover For SUMMER or WINTER, Lowers With the Roof. Can Be Washed. Insulates Against Cold For WINTER COMFORT. Strong, Non-Porous, Translucent Material; with Transparent Window for Perfect Rear Vision.

For BUICK, CADILLAC, OLDSMOBILE 98, MERCURY, LINCOLN, CHRYSLER and DE SOTO CARS costs ONLY \$24.95 Postpaid. For FORD, PONTIAC, CHEVROLET and OLDSMOBILE 65 CARS costs ONLY \$22.50 Postpaid. Also inquire about our NEW "JIFFEE-TOP" Cover for your convertible exclusively for Summer use when your top is down. SAVES YOUR UPHOLSTERY FROM RAIN AND HAIL. MAIL ORDER TODAY. Be Sure and Give MAKE & MODEL CAR. **WINTERSEAL COMPANY, 6124 W. Gunnison St., Dept. P-3, CHICAGO 30, ILL.**

REYNOLDS CIRCULAR SAW GRINDER

For jointing, gumming, tooth forming and resharpening.



Cuts saw maintenance costs, increases saw sharpening profits. Any hook or pitch of tooth and depth of cut is quickly adjusted. Both hands are free to control position of saw while grinding. Ball bearing action sealed against grit and dust.

PROVIDENCE SAW & KNIFE COMPANY
REYNOLDS MACHINERY CO. BLDG.
303 EDDY STREET, PROVIDENCE 3, R. I.

AMAZING NEW WOOD-TURNING TOOLS

SHARPEN ONCE IN 12-YEARS! (UNDER NORMAL USE)

These remarkable tools tipped with TUNGSTEN CARBIDE will astound you with their performance. They work FREE HAND equally well in wood, plastic or soft metals—and at the same time hold their razor-like edge almost indefinitely. Tests show that they will turn wood or plastic for days and days CONTINUOUSLY without showing any signs of dulling. They are the finest tools available at any price. Beautifully finished 5" blade—flush ground, polished tip—finest brass tube ferrule—9" hardwood handle—over all length 14"—10 tools to choose from; round and square nose from 1/8" to 1/2"—1/8" cut off; and 1/2"x30" skew. Amazingly Low Prices! Write at once for free literature. **JOHNS CARBIDE MFG. CO., Dept. PM3, Dunellen, N. J.**

The New Improved All-Purpose

DYNAMIC Super Charged ARC WELDER

Industrial Transformer Type

ONLY **\$28.50** COMPLETE



IDEAL FOR AUTO HOME APPLIANCE AND FARM IMPLEMENT REPAIRS
WORKS on IRON, STEEL and other metals. Does work you'd expect from a larger costlier machine. Portable, easily carried. OPERATES from any properly wired 110 Volt Line. Also available for 220 volt current at slight additional cost.

IT WELDS • IT BRAZES • IT SOLDERS
EASY TO OPERATE TRANSFORMER TYPE WELDER. If inexperienced you can learn to do professional work by following the SIMPLIFIED WELDING and OPERATING INSTRUCTIONS FURNISHED—comes complete ready to operate with helmet, rods, cable, instructions. SAVE TIME and MONEY—Do your own welding. Just a few repair jobs will pay for this machine. A practical and profitable machine tool for any workshop. Make money doing repair work for others. Write today for full particulars.

DYNAMIC WELDER CO., Dept. 39-T, 15 E. 23rd St., Chicago 16, Ill.

SPECIAL GIFT OFFER! ARC TORCH WORTH \$6.80 YOURS at NO EXTRA COST!

TWIN CARBON TORCH (illustrated) for use with DYNAMIC is unsurpassed for brazing, soldering, pre-heating and cutting iron, steel, brass, bronze and other metals. With it you greatly increase profitable uses of your welder. Does work of oxy-acetylene torch. Comes complete with instructions, carbons and cables. For LIMITED TIME ONLY we are giving a

Twin Carbon Electric Arc Torch worth \$6.80 with every DYNAMIC WELDER. Act now to get this valuable premium at the single low price of welder alone.



—Mail Coupon FOR FREE FACTS—

10-DAY TRIAL OFFER

DYNAMIC WELDER CO., Dept. 39-Y 15 E. 23rd St., Chicago 16, Ill. Send me FREE details of your ELECTRIC Arc Torch Gift Offer and Dynamic Welder 10-Day TRIAL OFFER.

NAME _____
ADDRESS _____
CITY _____ ZONE _____ STATE _____

FAST WAY TO DO FANCY WORK



Rounded over edge on pie crust table

Beading on edge of plaque or decorative shelf

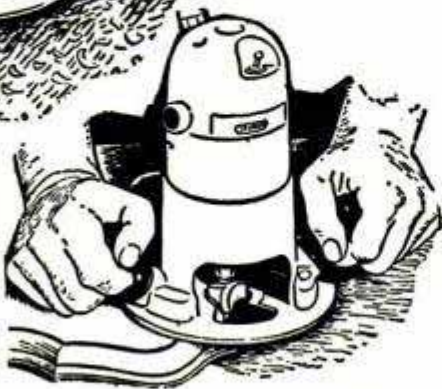

STANLEY HAND ROUTER

Write for instructive Catalog 608. Stanley Electric Tools, 488 Myrtle St., New Britain, Conn.

Model 10A



Reg. U.S. Pat. Off.

HARDWARE • HAND TOOLS • ELECTRIC TOOLS • STEEL STRAPPING

Build a Velvety Lawn, This Easy Way



● The MOW-MASTER makes a fine mulch of clippings. The new MOW-MASTER zips right through short or tall grass and weeds. Powered by the powerful, quiet, smooth-running Power-Pak Motor. Light weight; easy to handle. Ruggedly built for long, dependable service. Many outstanding exclusive features. Reasonably priced. MOW-MASTER "Tops the Field".

PROPULSION ENGINE CORP.

7th and White Eagle Road
Kansas City, Kan.



SEE YOUR DEALER OR MAIL COUPON

PROPULSION ENGINE CORPORATION
Dept. 539 • 7th & White Eagle Rd. • Kansas City 15, Kansas
Without obligation, send me free literature describing MOW-MASTER.

NAME _____

STREET _____

CITY _____

STATE _____

BUY DIRECT FROM THE IMPORTER!

HIGH POWER IMPORTED

BINOCULARS



\$30.00 with Fed. Tax 1.26

8 x 30 mm. Including De Luxe, lined genuine leather case & straps. No extras to buy!

BEST VALUE WIDE ANGLE PRISM BINOCULARS EVER OFFERED - BRAND NEW - INDIVIDUAL EYE FOCUS - LIFETIME CONSTRUCTION & PERFORMANCE - PRECISION GROUND BRILLIANT ACHROMATIC LENSES - MOISTURE & DUSTPROOF - MILITARY APPROVED - FEATHERWEIGHT

6 x 25 Retail @ \$52.00. Importer-to-you ONLY \$28.00

8 x 30 Retail @ \$68.00. Importer-to-you ONLY \$36.00

7 x 50 Retail @ \$88.00. Importer-to-you ONLY \$48.00

Coated Lenses - 7x50 & 6x25, \$10 - 8x30, \$12 additional

Above prices include 20% Fed. Tax • De Luxe Leather Case and 2 straps • Shipping Charges Prepaid

We accept Mail Orders and guarantee absolute satisfaction. Send Check or Money Order. Use binoculars for 10 days. If you are not delighted with your purchase, money cheerfully refunded. At these special prices - No C.O.D.'s please!

D. P. BUSHNELL & CO., Dept. M., 672 S. Lafayette Park Pl., Los Angeles 5, Calif.

Who Ever Heard of POWER TOOLS

Only \$8.00 Each?

Own a power workshop. Have fun. Make money. Get heavy-duty Emrick Lathe, Drill Press, Circular Saw, Grinder, Sander—all in ONE machine. Use ¼ to ½ H.P. motor. Equals in performance equipment costing \$200 or more. Direct factory price \$39.95 complete. Send \$18.00 (balance c.o.d.) for 10-day FREE TRIAL. Money-back guarantee. Our fifty-first year. Write today for FREE Catalog.



EMRICK, INC., 1733 Clinton, Kalamazoo, Mich.

5-in-1 MACHINE

NEW 1949 CATALOG

48 PAGES OF REAL VALUES

for the home workshop—hobbyists—woodworking equipment—sprayers—welding outfits—tools—motors—hundreds of other items.

Make this interesting catalogue your shopping guide. Send 10c to cover handling and mailing—TODAY.

MIDWEST SALES CO. 2533 C INDIANA KANSAS CITY, MO.

SHARP-TUNER

A completely new, really efficient

RADIO RECEIVER



The best signal-powered set ever offered. Single control actually separates stations, even in large cities! New circuit developed by leading electronics company. Costly precision parts—Germanium detector, Letts coil, modern capacitors. Beautiful durable enclosed cabinet 2 1/4" long! Uses no batteries or electricity—lasts indefinitely—reception guaranteed. Set alone with leads and directions, \$3.69. Trimm single headset included \$1.00 more. Foreign orders 10% extra, prepaid only.

CARING PRODUCTS Dept. AC, Box No. 1308 Chicago 90, Ill.



MACHINE SCREW GAUGE

Instantly identifies screw size, threads per inch, tap drill and body drill size of popular machine screws from 3-48 to ¼-28. Quick, Simple, Accurate, made of hardened steel. Send money direct to H. T. & M. Co., 150 Bedford Rd., Battle Creek, Mich.



Hollywood GOOSE HORN

FOR BICYCLES • TRICYCLES
SCOOTERS



\$1 POSTPAID

RIDE SAFELY
Many communities have laws requiring a warning signal for bicycles.

Be safe! Ride a fully equipped bike. Put the new, smart looking Hollywood Goose Horn on your bike today. A precision built, bulb-type bicycle horn. Overall length 9 inches with 2 1/2 inch flared bell. Black live-rubber bulb. Clamp fits securely to front of handle bar near the steering post in PROTECTED position. Only \$1.00 Postage Paid. Send cash, check or M. O. Order direct today, if your dealer can't supply you. No COD's please.

YODER MANUFACTURING COMPANY

2403 21-X E. 103rd Street, Los Angeles 2, California

"Wellworth" Sensational Offer! WESTINGHOUSE AIR COMPRESSOR

plus pressure tank, safety valve,
gauge for tank, air regulator &
gauge, filter, spray gun, 20 ft.
air hose, check valve & air chuck

11 items \$42.75
All For

IDEAL FOR HOME • FARM • FACTORY

Wherever compressed air is needed

A fortunate purchase from the government enables us to offer you this amazing buy at a small fraction of its original cost. All brand new. You get the WESTINGHOUSE COMPRESSOR and all of the accessories shown for only \$42.75. Shipping wt. 40 lbs. Designed for automotive truck or tractor mounting. Can be run off fan belt or power takeoff, or mounted horizontally. Comes with automatic clutch. Can be installed for use on farm trucks, jeeps, tractors, tire or garage service trucks, contractor or road building machinery, pneumatic devices, etc. Can be operated with 1/2 H.P. or more electric motor or equivalent portable gas engine.

Compressor separately, \$22.50

THE COMPRESSOR

Piston Type, 2-cylinder, 2 inch bore, 1 1/2" Stroke Ball Bearing, AUTOMATIC CLUTCH, OIL FREE AIR. 3.27 c.f.m. at 600 R.P.M. 6.54 at 1200. Suggested operating pressure 75 P.S.I. DIMENSIONS: 9" wide, 11 1/8" high, 6 3/4" deep. Wt. 23 lbs.

AIR TANK

Stainless steel. Size 12" x 24". Suitable for 100 lb. pressure. Equipped with gauge and safety valve, air regulator gauge, filter and hose connection.

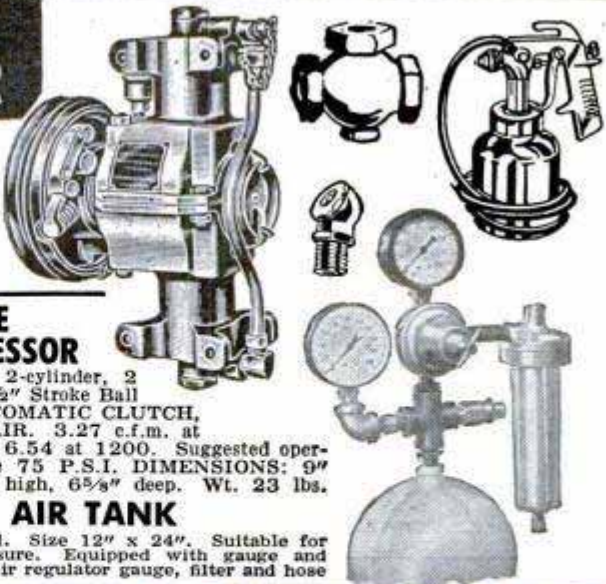

AMAZING "Wellworth" COMPRESSOR DEAL

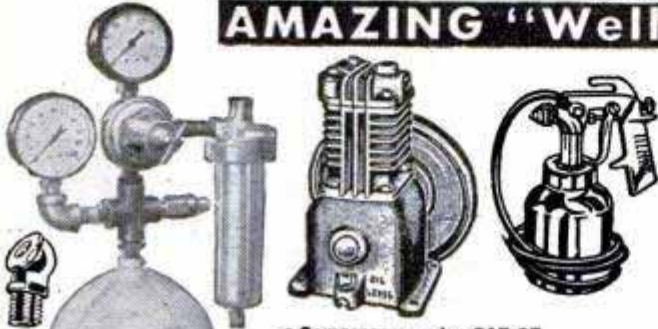

- Compressor only—\$17.95
- 2 1/2" Air Gauge—\$1.75
- Spray Gun and Hose—\$10.45 — Wt. 5 lbs.
- Adjustable 1/4" Pop Valve—\$1.50
- Tank and accessories as shown above—\$14.50. Wt. 7 lbs.

PORTABLE SPRAY OUTFIT

1/3 HP
"Wellworth"
ELECTRIC
MOTOR
DRIVEN
OUTFIT

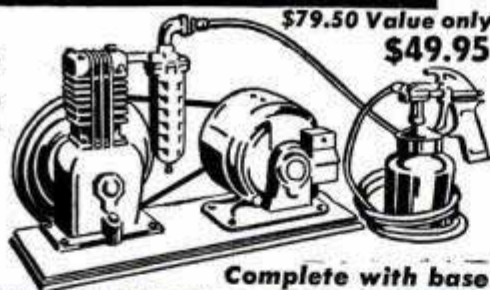

\$79.50 Value only
\$49.95

Complete with base

Well balanced portable outfit for use where paint job requires larger quantity of material. Sprays all types of average viscosity paints, enamels, lacquers, varnishes, etc. Piston type, single cylinder air compressor, 2 in. bore by 1 3/4 in. stroke. Displacement 2.86 c.f.m.; maximum working pressure 40 lbs. Mounted on sturdy wood base with rubber feet. Pulsation chamber equipped with safety valve, drain cock. 1/3 H.P. G-E motor, 110-volt AC, cord and plug; 20 ft. air hose and fittings. Spray gun is pressure feed type, internal atomizing, with one qt. metal cup. Fan and round spray nozzle furnished. Shipping wt. 50 lbs.

PRICE ONLY
\$49.95

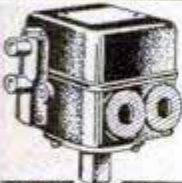

Automatic Pressure Switch with Unloader
Double pole, with 2 way release valve. Set at 125 to 150 lbs. pressure. For use on compressor units 1/4 to 3 H.P. Pressure range 20 to 200 lbs. Weight 4 lbs. **only \$10.25**

WATER PRESSURE SWITCH

Double Pole, double break. Range 5 to 60 lbs. Set 20 to 40 lbs. Wt. 2 lbs. **Special at \$5.50**

"WELLWORTH" CHECK VALVES



1/4" valve \$ 2.75
1/2" valve \$ 4.50
3/4" valve \$ 9.50
1" valve \$12.50

"WELLWORTH" PRESSURE TANK



8" x 42" Welded Steel. 3/4" opening on each end. 1/4" and 3/8" openings at centers. Convex Head and Bottom. 100 lbs. working pressure. Shipping Wt. 35 lbs. **SPECIAL PRICE only \$8.75**

POP TYPE VALVES

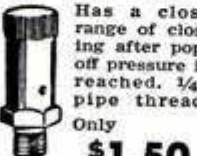

Has a close range of closing after pop-off pressure is reached. 1/4" pipe thread. **Only \$1.50**

Price f.o.b. Chicago. Immediate delivery. All items sold on money back guarantee. Send check or money order today. Write for free folder.

WELLWORTH TRADING CO.

Merged with
C & M Equipment Co.

1831 S. STATE ST., DEPT. D-3
CHICAGO 16, ILL.

Air Compressor: Piston type, size 2 x 1 3/4", both valves in head, bronze bearings, splash lubrication, "V" Belt drive. Intake muffler and cleaner. Capacity 2.8 c.f.m. at 100 lbs. continuous pressure or 150 lbs. intermittent, with 1/2 HP motor. Can be used with 1/4 HP or 1/3 HP at lower speed. Wt. 14 lbs. Operating instructions furnished.

Air Tank: Stainless steel. 6" x 24" with gauge and safety valve, air regulator gauge and filter, drain cock, hose connection. Suitable for 100 lb. pressure.

SENSATIONAL OFFER!

Complete outfit consists of compressor, pressure spray gun with 2 nozzles, pop valve, air chuck, 20 ft. hose, air tank and accessories as described. Complete for only.....

\$37.50

"Wellworth" COMPRESSORS

Build your own compressor unit. Sizes 12, 17.3, 30 and 45.7 c.f.m. at 100 lbs. per sq. inch. Timken bearings, splash lubrication, automatic unloading and idling.

Built-in loadless starting for automatic stop and start operation, or constant speed suction unloader for continuous operation. Single stage duplex cylinder with intake filter. 1 Year Guarantee.

Size	C.F.M.	Price	Ship. Wt.	Motor Required
2 1/2 x 2 1/2	12	\$102.05	140	2 HP
3 x 2 1/2	17.3	113.75	160	3 HP
3 1/2 x 3	30	153.85	210	5 HP
4 x 3 1/2	45.7	246.55	310	7 1/2 HP

State if desired for automatic stop and start or continuous operation with constant speed unloader. Belts, pulleys, motors and gasoline engines available. Prices upon request.



PNEUMATIC AIR TOOLS

Riveting and chipping hammers for many uses: riveting, chipping, hammering, auto body work, concrete breaking, etc.; used, guaranteed like new.

Chicago Pneumatic Riveter & Chipping Hammer



CP4X Pistol Grip handle with air control. Takes up to 3/16" rivet. Weight 6 lbs. List price \$73.00.

Special Price..... **\$1295**
Same as above, by brand new..... **\$1950**
Size CP3—Takes **\$895**
5/32" Rivet.....

CHICAGO PNEUMATIC LEVER TYPE AIR DRILL



With 1/4" Jacob Chuck. Wt. 2 lbs. List price \$55.00. **\$1500** Only.

A.V.C. 11 INGERSOLL RAND



Push button, takes 5/32" rivet. Wt. 3 lbs. List price \$85.00. **\$895** Only.

Ingersoll Rand AIR DRILL



With 1/4" Jacob Chuck. Wt. 2 lbs. List price \$55.00. **\$1500** Only.....

A.V.C. 10 Ingersoll Rand CHIPPING HAMMER



Takes 1/8" rivet. Wt. 3 lbs. List price \$80.00. **\$895** Only.....

6 FT. STOW FLEXIBLE SHAFT



3/8" Core. Ball bearing handle and arbor. Operates on 1/4 H.P. Motor at 1725 or 3450 r.p.m. \$29.00 value, **\$14.50**. Wt. 8 lbs.

**SAVE A LIFE!
IT MAY BE YOUR OWN**

KLEER-VUE

*Night Driving
Glasses*

**PREVENT FATAL ACCIDENTS
CAUSED BY
HEADLIGHT GLARE!**

The average visibility at night is only half the recognized minimum for safety. Most FATAL ACCIDENTS happen at night, even with 75% lighter road traffic. Oncoming HEADLIGHT GLARE is YOUR Worst Night Driving HAZARD!!



Are the greatest Contribution to Night Driving Safety. . . Reduce cause of 50% of highway fatalities. . . Improve night visibility, focus objects sharply and more clearly at night or during stormy, murky, misty, or foggy weather.

KLEER-VUE GLASSES are the WORLD'S FINEST NIGHT DRIVING GLASSES. Designed to give full view, Rest and relax the eyes, sharpen focus, keep colors clear and undistorted.

KLEER-VUE NIGHT DRIVING GLASSES not only eliminate headlight . . . even help YOU to see clearly thru rain . . . snow or sleet.

IDEAL FOR TELEVISION

KLEER-VUE NIGHT DRIVING GLASSES help amazingly in sharpening the focus, eliminating the glare and flicker of TELEVISION. Discover greater enjoyment at HOME as on the HIGHWAYS.

INTRODUCTORY OFFER

THESE ATTRACTIVE KLEER-VUE GLASSES with 57mm yellow amber 6 base optically corrected precision ground and polished lenses in either gold plated adjustable frame with Pearloid sweat band and Pads.

In Case A \$15.00 VALUE ND-1 **\$5.79**

Or in CLIP-ON STYLE For attaching to your glasses

KLEER-VUE CLIP-ON . . . Same lens, without temple bars. Just slip on over regular glasses CND-1
Including convenient carrying case ONLY **\$4.29**



PROTECT YOUR EYES...

FROM SUN AND DAYLIGHT DRIVING

Here's the Real McCoy!
GENUINE

**U.S. ARMY AIR FORCE
SUN GLASSES**



with 6 BASE optically correct precision ground and polished, GLARE-FREE LENS. Adjustable gold plated frame, Pearloid Sweat band and pads. Beautiful leather case that can be attached to belt.

A Super-Dooper Value SG-1 **\$3.95**

Effectively protect your eyes from harsh glare of summer sun & winter snow. Wear these smartly-made, official Army sun glasses for care free, glare-free pleasure . . . the year 'round!

ARMY AIR FORCE TYPE SUNGLASSES SG-2
In appearance like above but with 4 base lens
In leatherette case. Both men and womens sizes **\$1.95**



MADE TO MEET AND SURPASS THE MOST RIGID GOVERNMENT SPECIFICATIONS FOR THE ELIMINATION AND ABSORPTION OF ULTRA VIOLET AND INFRA-RED RAYS.

PALLEY SUPPLY CO.

6321 SAN FERNANDO ROAD
GLENDALE 1, CALIFORNIA

Order from this Ad. All sales final. All Prices F. O. B. Los Angeles. Pay by M. O. or Check, P. O.'s. Acct'd. from D & B firms. 1/3 deposit with C. O. D's.

SAVE 85% in WAR SURPLUS-SENSATIONAL VALUES

When visiting California come in and say "Hello".

IN MANY ITEMS WE HAVE THE WORLD'S LARGEST SUPPLY

B-15 STYLE JACKET

A Garment You'll be PROUD TO WEAR! Water repellent, wind resistant, nile green, satene, genuine Zealand Sanitized Poplin, full zipper front with slash pockets and large genuine Moulton Fur Collar. Heavy Alpaca lined for Warmth. Sleeves also lined with Heavy Nylon Rib-knit cuff and bottom.

LOOK AT THE PRICE!
Junior B-15 in appearance and manufactured like garment above.

Sizes 34 through 46. **\$11.95**
In Sizes 6 to 18 **\$9.95**

Navy Melton Cossack Style Jacket

NEW All Wool, Sturdy, Warm Zipper front 2 slash pockets, Taped Collar. Wonderful Buy For Utility and long lasting Qualities **\$5.69**

Sizes 34 thru 46

HUNTING KNIFE

6" chrome vanadium blade handle, leather grip. In leather sheath.

\$5.98 Value For Only **\$1.79**

Like above but black Parkerized Finish. #307A **\$1.49**

BOLO KNIFE

10" x 2" Parkerized Blade 5" Gripped Handle. Weight 1 1/2 lbs. Ideal for Hunting, Clearing Brush, or Trails. **\$1.19 ea.**

MACKINAW

Made of heavy water repellent poplin cover. Wool blanket lined, thigh length, sleeve flap for adjustment. An ideal coat for the outdoor man, truck driver, hunter, farmer. Sizes 36 to 38 **\$7.95**

MESS TRAY

6 compartments, rustless, stainless steel. Barbecue, outdoor cooking, save dishwashing. Hospital, Restaurant, Home, or roughing. **83c**

#311A Used but in Fine Serviceable Condition **59c ea.**

SLEEPING BAG

NEW! Mummy type, Heavy duty 30 zipper. #303 Gov't. Cost \$22.00 **\$3.95**

\$1.95 extra for water repellent cover. Sold only with Sleeping Bag.

FLYING HELMET

#407 Fleece or Chamois **\$1.59 ea.**

lined winter type. Ideal for cycle drivers, racers, sportsmen. Used.

New, Chamois lined with chin cup intermediate wt. **\$1.95**

U. S. Army ALL WOOL SOCKS Reg. O. D. Bleached white, standard lgh. ribbed tops, sizes 11, 12, 13 now, but can be shrunk to am. sizes. Really priced to sock you in the eye.

39c a Pair .. 6 Pair for Only **\$2.19**

CLAMP ON ANYWHERE LAMP

With adjustable ball and socket swivel head, long rubber covered cord and wall plug.

The All Purpose Lamp. Wonderful for Indoor Photography, Floodlights, Baby Spot or Large Spot, Personal Bed Reading. **99c**

Highly Polished 9" diameter Parabolic Reflector or 5" diameter Spot Reflector at Only **85c ea.**

NEW OXYGEN MASK

A-14 Demand type **\$3.50** ea.

Slightly used but perfect **\$1.95** ea.

Used with milk **\$2.50** ea.

RUBBER GLOVES

Neo-Prone. Protective. Impermeable.

1000 Uses. Home Farm, Factory or Laboratory. **69c**

HERE ARE PLASTIC KITS

UNSURPASSED VALUES FOR ARTISTICALLY INCLINED HOME HOBBYISTS!

Start Planning Now! Kit #1 contains 2 lbs. plasticine & 1000 sheets in various shapes. 1 ea. bottle of clearst cement. 1 ea. bottle color set cement and 4 bottles of color in Orchid, Red, Yellow, Peach, etc. Also a Plastic Handbook of uses and instructions. This set easily worth **\$2.50**. Our Price **\$2.19**

Kit #2 contains 1 1/2 lbs. of plastic sheet, 1 ea. bottle of clearst cement, and the Plastic Handbook. A \$2.50 Value for ONLY **99c**

TEAR SHAPED PLEXI DOME

Overall length 21" width at widest point 11" at base 4" 6" deep. **\$1.39 ea.**

FISH & FLOWER BOWLS, CAR ROOF LIGHTS

Plexiglass Windows

in Alum. Frames for your trailer, boat, or home ornamental use. Priced at the value of the sheet alone.

#703A - 18 1/2" x 15 1/2" x 3/16" thick **\$2.95**

#704A 12" x 9" x 3/16" **\$1.59**

#704A Plexiglass & Nascolite Clear Plastic Shds. at Tremendous Savings to You!

NASCOLITE - Full sheets app 1/2 x 27 1/2" x 24 1/2" app. 10 1/2" Sq. Per Sheet **\$12.50**

PLEXIGLASS - Full Sheet. Approx 1/4" x 28" x 28" Per Sheet **\$15.00**

Fabricator write in for our special quantity prices. All above are saw & mach'd. Also inquire about our other large stocks of Plastics.

NEW 100% ALL WOOL BLANKET

7 x 7 ft. Extra heavy. Also Double warmth. Fits Wood's Robe sleeping bag. **\$4.65**

NEW TARPS - HEAVY CANVAS

Mildew & Flame Resistant. Cheap Outside Storage. They are Really Moving at These Prices.

5' x 7' **\$3.95**

16' x 32' **\$29.95**

8' x 10' **\$8.50**

16' x 22' **\$20.95**

Rubberized Linen 7' x 11' NEW **\$5.95**

Only 3 lb. light weight yet waterproof! Ideal for outside car storage.

LORR RAIN REPELLER KIT

For keeping aircraft & automobile windshield clear and water free.

Includes ten applications of a chemical which creates a film on the windshield. The water cannot accumulate on this film and will roll off . . . with applicators, repellent tray and a complete book of instructions.

Nothing else necessary. Don't fly blind in the air or on the ground. Complete in strong cardboard box. Order this kit today . . . ONLY **\$3.25**

CONTENTS

1. Rain Repeller for 10 applications
2. 3 Bottles Rain Repeller Cleaner
3. Glass Tray
4. Applicator Frame and Glass
5. 15 Applicator Pads
6. 125 two-ply cleaning tissues.

AMO BOX

Made of heavy gauge steel with detachable lid that can be hinged, air tight. 18"x9"x13". Many uses: bait, fishing, refrigeration, on camping trip, tool chest, fire safe, etc. **\$1.59**

NEW SUN VISOR

17 1/2" long x 8" wide. Adjustable arm. Swivel head. Can be swung in any direction. Made of clear green plastic. Mfg. for Air Corp by Falcon Co. A very useful accessory for your Car, Truck, Tractor or Boat. SPECIAL **ONLY \$1.29**

NEW WHIST WATCHES

15 Jewel, waterproof stainless steel case Swiss movement. Radium face with choice of black or white dial. Leather wrist band. Guaranteed.

1 year. FX No. 2085 Our Price **\$16.95**

AIRCRAFT PILOT SEAT

The AAF's most adaptable seat, with 14 positions in 5" height adjustment, 5 position tilt adjustment from 65° to 90°, 12 position in 5" forward & reverse on tracks that can be easily mounted on floor. Swing-Away cushioned arm rest, also equipped with two shoulder and waist Safety Belts.

Made of Aluminum with standard Chrome-Moly tube frame. Ideal for deep sea fishing, Boats, Tractors, Jeeps, Trucks, Planes, etc.

This Executive type Chair is a Steel at **\$7.49**

CUSHIONS

Mid. for Aircraft seat, but can be used in trucks, autos, boats, tractors. Made to Gov't. Spec. of finest imitation leather, yellow pigskin col. filled with kapok. Will float. Same as shown in LIFE magazine saving a man from drowning.

New Back Rest 22"x16" x 1 1/2" thick **\$2.95**

Used Back Rest 22"x16" x 1 1/2" thick **\$1.95**

SEAT, New, 17"x16"x3" thick **\$3.49**

SEAT, Used, 17"x16"x3" thick **\$2.29**

GOGGLES

Aviators (AN-6530) Waterproof & Dusted for deep sea fishing, Boats, Tractors, Jeeps, Trucks, Planes, etc. Ideal for Motorcycling, etc. **\$1.69 ea.**

Same appearance as above, but with plastic lens, in clear color only. GO-2 **79c ea.**

Shrimp Nets

45 ft. x 45 ft. 2000 square feet of heavy, treated O.D. netting, manufactured for the Army. Heavy, durable & strong, used by Army for various purposes Shrimp, fishing, camouflage, acrobatics, etc. Textile worth many times the price **\$27.10**

AIR CORPS FLEECE LINED JACKET

D-1 TYPE

These have been reconditioned, cleaned, and brushed.

If you want a warm, rugged, full sheepskin felt, fleece lined collar, zippered front, leather jacket that has lots of outdoor wear left in it, that you can't beat for value **\$8.95 ea.** at this close-out price . . . You'd better write in fast, before they are all gone.

Ideal for Hunters, Farmers, Garage Mechanics, etc. Large Size Only.

FLYING SUIT or BLUE BUNNY SUIT

Swell for hunting, wnt. sports, skiing or "bundling". As coveralls for cold outdoor, or farm work. Made of 100% woven wool with extra Bannel inner lining giving double warmth & ability. Wiring so fine, flexible it does not interfere with movement. Can be used with or without heating or can be plugged into car. Only **\$3.49**

tractors, or truck battery, sizes 36 thru 44

Ski or Snow Jackets

Converted out of Bunny flying suits. Ribbed knit waistbands & wristbands. Zippered front and pocket. You'll wear 'em. **\$3.49**

& wear 'em. Only **\$3.49**

Trousers to match. Only **\$3.49**

COMPASSES

#151 Marching, lensitic, with luminous dial **\$1.59**

#152 Matchbox, both jewel & liquid floating dial **39c**

#154 Wrist Strap Compass **69c**

NEW 11 Jewel, Watch Pocket Compass **\$1.59**

New Navigators Magnetic Compass

#411 type D-12 size 7" dia x 4 1/2" deep Rubber lined - rotating bezel range rings calibrated in 1 degree from 0-360° with 2 parallel grid wires for alignment with N.S. line, East. **\$14.95**

Pressure Bottle

Steel - Tested to 3000 P.S.I. For spray painting, portable welding, etc. All have std. pipe port.

9 1/2" x 3 1/2" dia. **\$2.50**

14" x 3 1/2" dia. **\$4.50**

19" x 3 1/2" dia. **\$3.95**

19" x 5 1/2" dia. **\$7.95**

RUBBERIZED HAIR CUSHIONS

#8C1 16" dia. x 1 1/2" **69c ea**

#8C2 21" x 13 1/2" x 1 1/2" Canvas Cover **69c ea**

#8C3 22" x 15" x 1 1/2" **\$1.19 ea.**

#8C4 21" x 13 1/2" x 1 1/2" **\$1.19 ea**

The rubberized hair filling worth more than our price for entire cushions.

'Twas Made for the Air Force

THE BEST Loose Leaf BINDER

You ever saw a metal post cylindrical locking heavy duty 3 1/2" fabricated lined cover. End modification window. Ideal for price books, salesman catalogues, photo albums, students publications, Reference books, actual sketch books, etc. Will hold 500 sheets 8 1/2" x 11". A \$3.00 Value for Only **59c**

50 Page Binder Band Fillers for 25c Cont.

PALLEY THE LARGEST FIRM OF ITS TYPE IN THE WORLD

Order from this Ad. All sales final. All Prices F. O. B. Los Angeles. Pay by M. O. or Check, P. O.'s, Acceptd. from D & B firms. 1/2 deposit with C. O. D's.

DEPT. P. M. 3
6321 SAN FERNANDO RD.
GLENDALE 1, CALIF.

Now Available New 1948 Edition 90-Page Freely Illustrated Catalogue with valuable information tables, data. Send 25c to cover binding, mailing chgs. etc.

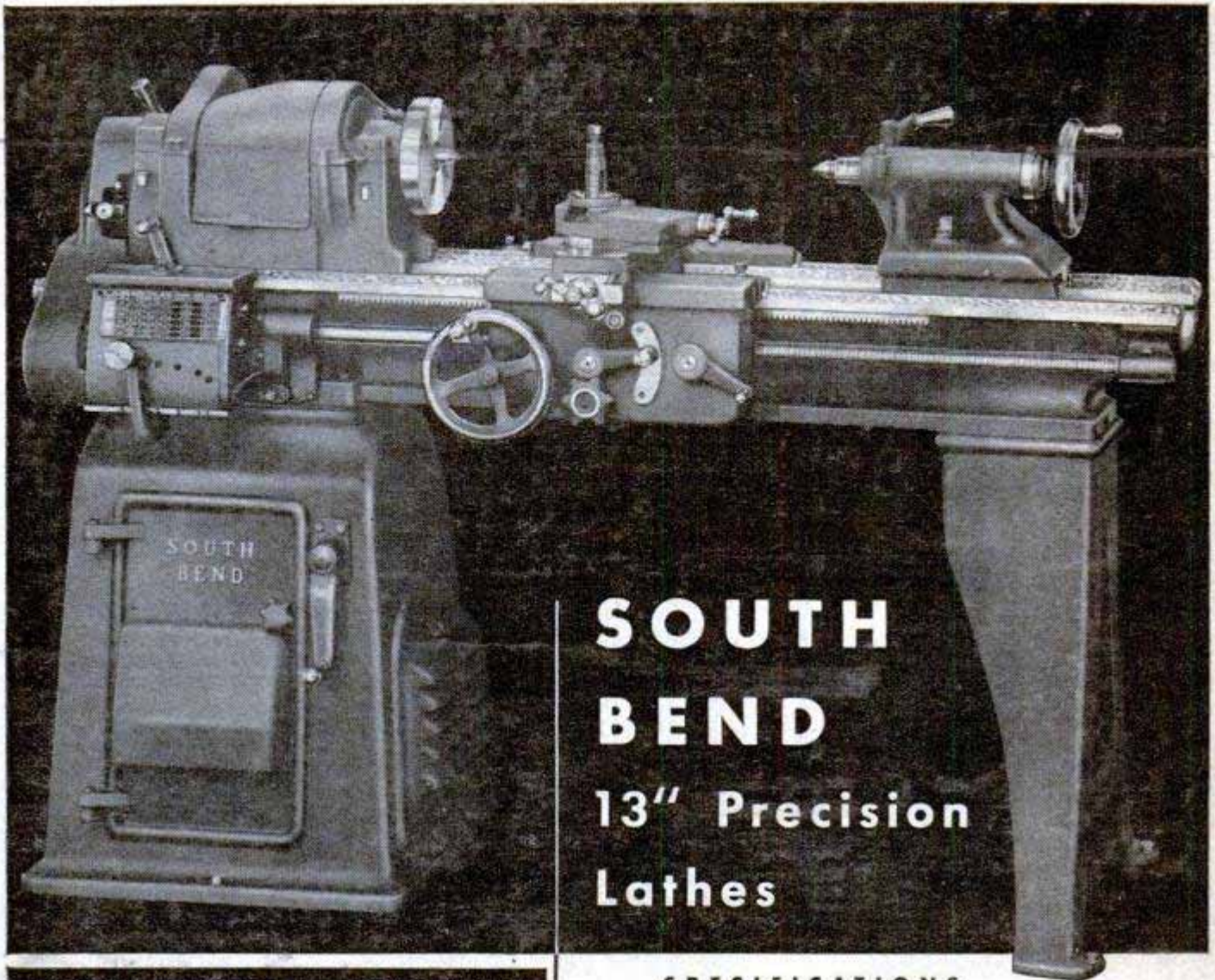

SOUTH BEND

13" Precision Lathes

NOW - 1" Collet Capacity

Catalog No. 145-B 13" x 5' Quick Change Gear Lathe with 3 phase, 60 cycle, 220 volt, A.C. motor and drum switch; f. o. b. factory **\$1332.25**

South Bend 13" Precision Lathes now offer even more advantages where close-tolerance machining is required. They are economical, accurate, fast, and versatile. The new headstock with increased collet capacity permits a greater variety of collet jobs. Substantial savings in capital investment, floor space, and labor cost often result from their installation.

The Quick Change Gear model is popular for production operations, maintenance and service work. The Toolroom model has sufficient capacity for a large variety of toolroom work—its accuracy insures perfect results. Numerous tools and attachments are available for special jobs. Other South Bend Precision Lathes are made with 9", 10", 14½", 16", and 16/24" swings. Also Precision Turret Lathes with ½" and 1" collet capacities, a 14" Drill Press in bench and floor models, and a 7" Bench Shaper. Immediate deliveries can be made. Time Payment Plan is available.

SPECIFICATIONS

SWINGS: 13-1/8" over bed and saddle wings; 8-3/4" over saddle with chip guard removed.
BED LENGTHS 4, 5, 6, and 7 feet
DISTANCE BETWEEN CENTERS 16 to 52 inches
MAXIMUM COLLET CAPACITY: 1" (Collets interchangeable with South Bend 10"-1" collet, Series 1000, 14½", 16", 16/24" Lathes)
SPINDLE BORE 1-3/8 inch
SPINDLE SPEEDS: Eight 34 to 875 r. p. m.
POWER LONGITUDINAL FEEDS: 48 R.H. or L.H., .0015" to .0841"
POWER CROSS FEEDS: 480006" to .0312"
THREAD CUTTING: 48 R.H. or L.H. pitches . . 4 to 224 per inch
CROSS SLIDE TRAVEL 8-1/8 inches
TAILSTOCK TOP SET-OVER 15/16"

Write FOR THIS CATALOG NO. 73

Describes and illustrates new South Bend 13" Precision Lathes with 1" maximum collet capacity. Includes complete specifications and prices.



SOUTH BEND LATHE WORKS

Building Better Tools Since 1906 • 455 E. MADISON ST., SOUTH BEND 22, INDIANA

Printed by Popular Mechanics Company, Chicago, Ill., U. S. A.

Save Time, Work, Money - Make extra Profits
with **SHAW**

"DU-ALL" and "PEPPY-PAL" TRACTORS

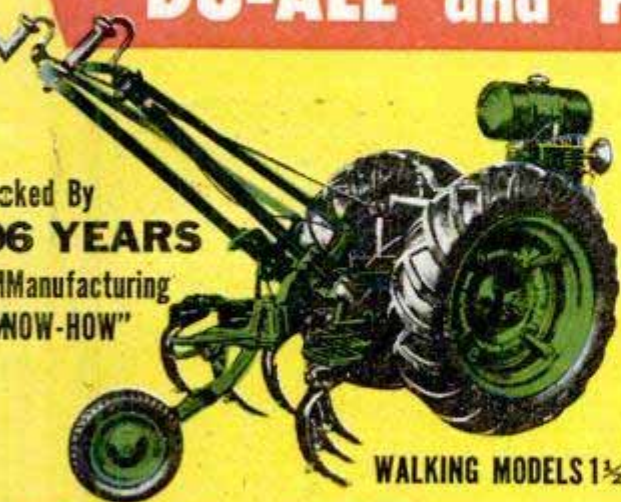

Backed By
36 YEARS
of Manufacturing
"NOW-HOW"

WALKING MODELS 1½ to 5 H. P.



PLOW



CULTIVATE



MOW

and Dozens of Other Jobs

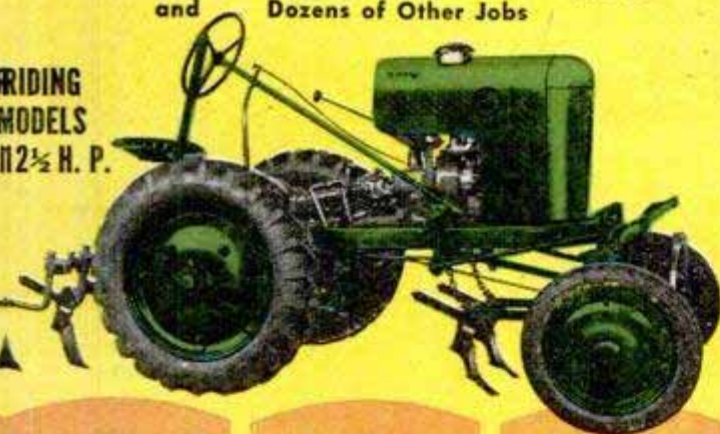

RIDING
MODELS
12½ H. P.

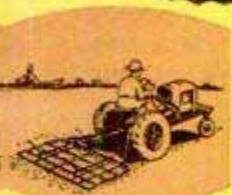

HARROW

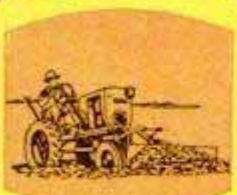

BULLDOZE, SNOWPLOW



RAKE

and Many Other Jobs - Winter and Summer

**DO DOZENS OF JOBS
QUICKLY AND EASILY
WITH JUST ONE TRACTOR!**

Shaw tractors are always ready to plow, cultivate, bulldoze, harrow, mow, haul, rake, seed, spray, disc, saw and do scores of other jobs on a minute's notice. A child can operate these amazing machines and the low-cost Jiffy Hitch attachments are quick and easy to change.

IDEAL TRACTOR FOR GARDENS, SMALL FARMS

If you're gardening, farming, maintaining a golf course, chick hatchery, orchard, estate, cabin camp, truck farm, park, etc., you need a Shaw Du-All or Peppy-Pal. You'll get more jobs done, at lower cost, in a fraction of the time. You'll get top-quality work out of these dependable, efficient Shaw tractors.

SOON PAYS FOR ITSELF - CHEAP TO OPERATE

The remarkably low initial cost of Shaw tractors and attachments plus the low operating costs (only a few cents an hour) makes Shaw the buy of the year. It will soon pay for itself in time and labor-saving plus helping make extra profits for the man who job-contracts or likes to earn spare-time money.

ECONOMICAL TO BUY - TOP QUALITY MATERIALS

From big heavy duty tires to the smallest engine pin you receive only first quality materials—carefully and sturdily constructed, thoroughly inspected and tested for longer service and low maintenance. Precision engineering and efficient power utilization assure top performance on the toughest job.

FULL GUARANTEE - PROMPT SHIPMENT

Every Shaw tractor carries a full year's guarantee against any defect in workmanship or material. Check the many features of Shaw tractors—many different models ranging from 1½ to 12½ horsepower, variable speeds, power turn, forward and reverse, Timken roller bearings, Ross steering device and scores of other important features. Mail the coupon below, select and order your Shaw tractor for early delivery.

SAW WOOD
DO ALL KINDS OF BELT JOBS



LOW FACTORY PRICES

A modern factory and streamlined production methods assure you substantial savings. Compare the price and the value—you'll agree that Shaw gives you more for your money.

FREE! NEW ILLUSTRATED
"ACTION-PICTURE" BULLETIN AND PRICE LIST
MAIL COUPON NOW

ACT NOW - SEND NO MONEY

Mail Coupon for FREE Booklet and Price List

SHAW MANUFACTURING CO.
4503 Front Street, Galesburg, Kansas, or
668G North 4th Street, Columbus, Ohio

Please send me Free Booklet and price list.

Name

Address

Prove **CAMEL MILDNESS** for Yourself!



In a recent 30-day test of hundreds of Camel smokers, noted throat specialists reported **NOT ONE SINGLE CASE OF THROAT IRRITATION** due to smoking **CAMELS!**

According to a Nationwide survey:
MORE DOCTORS SMOKE CAMELS than any other cigarette

Doctors smoke for pleasure, too! And when three leading independent research organizations asked 113,597 doctors what cigarette they smoked, the brand named most was Camel!

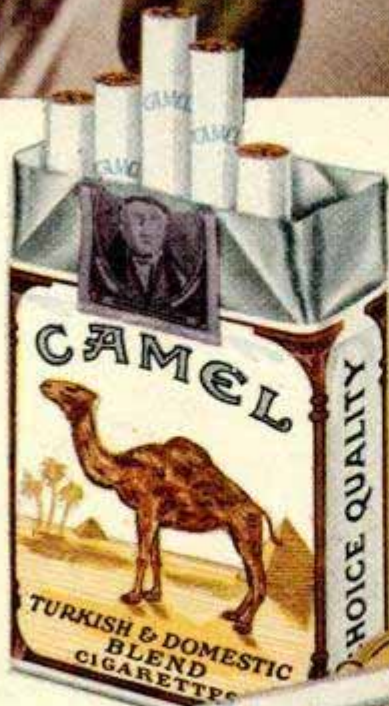

● How mild can a cigarette be? Make the 30-day Camel mildness test—and then you'll know!

A similar test was recently made by hundreds of smokers. These men and women smoked Camels, and only Camels, for 30 days. Each week, noted throat specialists examined the throats of these smokers. And these specialists reported *not one single case of throat irritation due to smoking Camels!*

Put Camels to the test yourself—in your "T-Zone." T for Taste—T for Throat.

Money-Back Guarantee!

Try Camels and test them as you smoke them. If, at any time, you are not convinced that Camels are the mildest cigarette you ever smoked, return the package with the unused Camels and we will refund its full purchase price, plus postage. (Signed) R. J. Reynolds Tob. Co., Winston-Salem, N. C.

